

PENNSYLVANIA 2012-2013

TREE FRUIT PRODUCTION GUIDE



PENNSTATE



COLLEGE OF AGRICULTURAL SCIENCES

Production Guide

Coordinator

J. M. Halbrendt

Horticulture

R. M. Crassweller,
section coordinator
J. R. Schupp

Entomology

G. Krawczyk, section
coordinator
L. A. Hull
D. J. Biddinger

***Pollination and Bee
Management***

M. Frazier
D. J. Biddinger

Plant Pathology

H. K. Ngugi, section
coordinator
N. O. Halbrendt

Nematology

J. M. Halbrendt

Wildlife Resources

G. San Julian

Environmental Monitoring

J. W. Travis

Pesticide Safety

Penn State Pesticide Education
Program

Orchard Sprayer Techniques

J. W. Travis

Harvest and Postharvest Handling

R. M. Crassweller
J. R. Schupp

Cider Production and Food Safety

L. F. LaBorde

Orchard Budgets

J. K. Harper
L. F. Kime

Farm Labor Regulations

R. H. Pifer

Designer

G. Collins

Editor

A. Kirsten

Disease, insect figures

C. Gregory
C. Jung

Cover Photos

iStock

**This guide is also
available on the web at
agsci.psu.edu/tfpg**

Visit Penn State's College of Agricultural Sciences on the web: agsci.psu.edu

This publication is available from the Publications Distribution Center, The Pennsylvania State University, 112 Agricultural Administration Building, University Park, PA 16802. For information telephone 814-865-6713.

Where trade names appear, no discrimination is intended, and no endorsement by Penn State Cooperative Extension or the College of Agricultural Sciences is implied.

This publication is available in alternative media on request.

The Pennsylvania State University is committed to the policy that all persons shall have equal access to programs, facilities, admission, and employment without regard to personal characteristics not related to ability, performance, or qualifications as determined by University policy or by state or federal authorities. It is the policy of the University to maintain an academic and work environment free of discrimination, including harassment. The Pennsylvania State University prohibits discrimination and harassment against any person because of age, ancestry, color, disability or handicap, national origin, race, religious creed, sex, sexual orientation, gender identity, or veteran status. Discrimination or harassment against faculty, staff, or students will not be tolerated at The Pennsylvania State University. Direct all inquiries regarding the nondiscrimination policy to the Affirmative Action Director, The Pennsylvania State University, 328 Boucke Building, University Park, PA 16802-5901; Tel 814-865-4700/V, 814-863-1150/TTY.

© The Pennsylvania State University 2012

Produced by Ag Communications and Marketing

Code# AGRS-045 .75M12/11kb 3841

The 2012–2013 edition of the *Pennsylvania Tree Fruit Production Guide* has been updated and revised to make it as accurate as possible for current recommendations and pesticide registrations. The chapters, or parts, are printed on the back cover with tab markings to make them easy to locate. A comprehensive table of contents is located on the following pages. Chemical management tables are grouped together to make them easily accessible. The index has been updated and a new special section on the biology and control of the brown marmorated stink bug has been added. New parts were also added to Parts 2, 3 and 4. The pesticide registration information included in this guide reflects available labels as of September 2011. Always read the current pesticide label before any pesticide application.

You also can access the *Tree Fruit Production Guide* on the Web at agsci.psu.edu/tfpg. The Web version of the production guide also includes several databases, pictures of fruit cultivars, and slide presentations on aspects of fruit production. Penn State's *Fruit Times* newsletters are available at extension.psu.edu/fruit-times.

OVERVIEW OF THE PENNSYLVANIA TREE FRUIT PRODUCTION GUIDE

More than a “spray guide,” the *Pennsylvania Tree Fruit Production Guide* collates information on the full range of commercial tree fruit production issues. The guide is revised every two years with input by a score of Penn State faculty members and other consultants. It is meant to be a reference that growers and other fruit industry personnel can turn to often.

Part I, Cultural Information, contains guidelines for establishing an orchard, choosing a tree fruit nursery, caring for nonbearing trees, and maintaining bearing orchards. Included is a listing of nurseries, up-to-date information on disease-resistant cultivars and rootstock availability, as well as recommendations for summer pruning. Environmental monitoring and frost protection also are discussed in detail. The bee and pollination issues are also discussed in this chapter.

Part II, Diseases, Pests, and Natural Enemies, stresses the use of all possible control strategies in pest and pesticide management. It contains information on the biology of tree fruit pests and provides control options other than chemicals.

Part III, Chemical Management, describes the appropriate use of chemicals within integrated pest management (IPM) and pesticide resistant management (PRM) strategies. It deals with safety, spraying, and the use of individual pesticides.

Part IV, Chemical Management Tables, includes efficacy and timing tables for pesticide use in the various tree fruit crops. It also covers reentry and preharvest intervals and pesticide storage.

Part V, Integrated Pest Management Spray Programs, offers specific suggestions for pesticide use on apples, pears, peaches, nectarines, apricots, cherries, and plums. Remember that the pesticide label is the document that ultimately prescribes how a chemical can be used, and that labels can change. When applying a chemical, have a copy of the label in hand.

Part VI, Harvest and Postharvest Handling, incorporates new information on controlled-atmosphere fruit storage. Also discussed are fruit testing to determine maturity, storage guidelines, and the control of common postharvest fruit disorders.

Part VII, Cider Production, describes how to make, handle, and market safe, high-quality apple cider. Good manufacturing practices for cider production are described.

Part VIII, Maintaining the Safety of Apples and Apple Products, describes good management practices for growing, packing, and cider production to avoid potential food safety hazards.

Part IX, Farm Management, presents sample budgets for land preparation, orchard planting, and mature orchards, as well as production budgets for fresh-market apples, processing apples, fresh-market peaches, and other tree fruit. Also included in Part IX are updated descriptions of state and federal laws that apply to Pennsylvania fruit producers, including those governing hiring, wages and withholding, worker and community safety, workplace discrimination, and seasonal/migrant labor.

Appendix: Tree Fruit on the Web is a list of websites with information for growers. A bibliography of important reference texts follows the web listings. The index is a comprehensive listing of topics covered in this production guide. Finally, a chart of useful conversions for weights and measures is included.

The IPM Approach

Pesticide use and pest resistance can be decreased—and even eliminated in some cases—by understanding diseases and insects clearly, scouting for pests routinely, and monitoring environmental conditions daily. Effective pesticide programs require careful pesticide applications and correct timing. The combination of thorough orchard monitoring, horticultural controls, and judicious pesticide use is known as integrated pest management (IPM).

IPM is the guiding concept of the 2012–2013 *Pennsylvania Tree Fruit Production Guide*. To make the best use of this guide, study and understand the biology of diseases and insects. Then incorporate horticultural control measures, as well as chemical ones, into your control strategy.

Always read the label before using any chemical on your farm. Application rates in this guide's tables and spray programs are given as amounts of the commercial formulations. Consult the section on pesticide safety (in Part III) or your county extension office concerning the safe disposal of any chemical mentioned in this publication.

All pesticides discussed in this guide are registered for the indicated crops as of September 2011. Application suggestions are based on the continued registration of each pesticide. If any material listed should lose or change its registered usage, a notice to that effect will be announced. A brief update of the information in this guide may be published in early 2013 and distributed at extension educational meetings and local extension offices. Do not use this publication after 2013.

Contents PART I Cultural Information

Orchard Establishment.....	1	Pears.....	66
Site Selection and Soil Preparation.....	1	Site Selection and Soil Preparation.....	66
Orchard Layout.....	2	Asian Pears.....	66
Choosing a Nursery for Fruit Trees.....	3	Recommended Cultivars.....	66
Orchard Floor and Weed Management.....	6	Rootstocks.....	67
Row Middle Management.....	6	Peaches.....	67
Tree Row Management.....	6	Site Selection and Soil Preparation.....	67
Establishing a New Orchard.....	7	Nursery Tree Quality.....	67
Plant Nutrition.....	10	Planting Depth.....	68
Determining Tree Nutritional Status through Foliar Analysis.....	10	Peach and Nectarine Cultivars.....	68
Nutrient Deficiency and Toxicity Symptoms in Tree Fruit ...	12	Pruning and Training Peaches the Year of Planting.....	68
Foliar Application of Nutrients.....	14	Rootstocks.....	68
Fertilizer Application.....	14	Split Pit.....	70
Apples.....	16	Shattered Pit.....	70
Cultivars.....	16	Nectarine Pox.....	70
The Future of Scab-Resistant Cultivars.....	24	Cherries.....	71
The Basics of Pruning.....	25	Site Selection and Soil Preparation.....	71
Pruning and Training in Young Trees.....	26	Growth Regulators.....	71
Summer Pruning of Apples and Peaches.....	27	Cultivars.....	72
Deciding on a Production System.....	27	Rootstocks.....	74
Production Systems for Apples.....	28	Collecting Weather Information in Orchards.....	75
Tree Support Systems.....	33	Comparisons of Weather Monitoring Equipment.....	75
Apple Tree Spacing.....	34	Frost Protection for Tree Fruit.....	77
Using Beds to Attain Higher-Density Orchards.....	36	Selecting the Right Site.....	77
Determining the Number of Trees per Acre (TPA) in Bed		Heating.....	77
Plantings.....	36	Sprinkling.....	77
Apple Rootstocks.....	37	Wind Machines.....	77
Planting Depth.....	40	Critical Temperatures for Various Fruits.....	78
Pollination.....	40		
Fertilizing Newly Planted Apple Trees.....	49		
Cork Spot and Bitter Pit Fruit Disorders.....	50		
Growth Regulators in Apple and Pear Production... ..	54		
Increasing Branching.....	54		
Shoot Growth Suppression.....	55		
Management of Fire Blight Using Apogee.....	55		
Increasing Return Bloom.....	56		
Chemical Thinning of Apples.....	56		
General Comments on Thinning.....	57		
Apple Preharvest-Drop-Control Sprays.....	61		
Record Keeping for the Application of Plant Growth			
Regulators.....	64		

Contents PART II Diseases, Pests, and Natural Enemies

IPM Approach	81	Dogwood Borer	106
Basics of Insect Monitoring with Sex Pheromone		European Apple Sawfly	107
Traps	81	European Red Mite	107
Integrated Pest Management Supply Sources.....	82	Green Aphids (Apple Aphid and Spirea Aphid)	109
Diseases, Insects, and Mites: Biology, Monitoring, and Management	82	Green Fruitworms	110
Diseases in Pennsylvania	82	Green Peach Aphid	111
Anthracnose of Peach	82	Gypsy Moth	111
Apple Crown Rot.....	83	Japanese Beetle.....	111
Apple Scab.....	83	Lesser Appleworm	112
Bacterial Canker	84	Lesser Peachtree Borer	112
Bacterial Spot.....	85	Mullein Plant Bug.....	112
Bitter Rot of Apple.....	86	Obliquebanded Leafroller	113
Black Knot of Plum	86	Oriental Fruit Moth.....	113
Black Rot of Apple	87	Peachtree Borer.....	114
Blister Spot on Crispin (Mutsu).....	88	Pear Psylla	115
Blossom End Rot of Apple	88	Pear Slug	116
Blotch of Apple.....	88	Pear Thrips.....	116
Blue Mold of Apple	89	Pearleaf Blister Mite and Pear Rust Mite	116
Brooks Fruit Spot of Apple.....	89	Periodical Cicada.....	117
Brown Rot of Stone Fruit.....	90	Plum Curculio.....	118
Cherry Leaf Spot.....	90	Potato Leafhopper.....	119
Crown Gall of Peach.....	91	Redbanded Leafroller	119
Cytospora Canker of Stone Fruits.....	91	Rose Leafhopper	119
Fire Blight.....	93	Rosy Apple Aphid.....	120
Nectria Twig Blight of Apple.....	94	San Jose Scale.....	120
Peach Leaf Curl	94	Shothole Borer	121
Pear Leaf Blight and Fruit Spot.....	95	Spotted Tentiform Leafminer.....	122
Pear Leaf Spot.....	95	Tarnished Plant Bugs, Other Plant Bugs, and Native Stink Bugs	123
Pear Scab	95	Tufted Apple Bud Moth (TABM)	124
Plum Leaf Spot	96	Twospotted Spider Mite	127
Plum Pockets	96	Variegated Leafroller	128
Plum Pox Virus	96	Western Flower Thrips.....	128
Powdery Mildew of Apple.....	97	White Apple Leafhopper.....	129
Powdery Mildew of Cherry and Plum	97	Woolly Apple Aphid	129
Powdery Mildew of Peach, Nectarine, and Apricot.....	98	Natural Enemies/Biological Control in Deciduous Fruit Crops	130
Rhizopus Rot of Stone Fruits.....	98	Types of Biological Control Agents.....	130
Rust Disease of Apple.....	98	Biological Control of Mites	131
Sooty Blotch and Flyspeck of Apple	99	Biological Control of Aphids	133
Sooty Mold of Pear.....	99	Weeds in Deciduous Fruit Crops.....	135
White Rot of Apple.....	100	Nematode Problems in Deciduous Fruit Trees	136
Insect and Mite Pests in Pennsylvania	100	Peach Stem Pitting	136
American Plum Borer	100	Apple Union Necrosis and Decline	136
Apple Grain Aphid.....	101	Replant Problems and the Root-Lesion Nematode.....	137
Apple Leafminer.....	102	Sampling for Plant-Parasitic Nematodes	137
Apple Maggot	102	Mammal Control in Orchards.....	138
Apple Rust Mite.....	102	Voles.....	138
Black Cherry Aphid.....	103	White-Tailed Deer.....	140
Brown Marmorated Stink Bug.....	103	Special Section: Brown Marmorated Stink Bug— New Exotic Insect Pest.....	143
Buffalo Treehopper	104		
Cherry Fruit Fly and Black Cherry Fruit Fly.....	104		
Codling Moth.....	104		

Contents PART III Chemical Management

Using Pesticides Safely	149	Fungicides, Herbicides, Insecticides, Nematicides, and Plant Growth Regulators	161
General Guidelines for Pesticide Safety	149	Adjuvants	190
Pesticide Toxicity	149	References and Contacts	191
Acute Toxicity and Acute Effects	149	Fungicide Use Strategies.....	191
Signal Words	150	Types of Fungicides	191
Chronic Toxicity and Chronic Effects.....	150	Modes of Action.....	193
Symptoms of Pesticide Poisoning.....	150	Fungicide Resistance Management Strategies	195
Responding to Pesticide Poisoning Symptoms.....	150	Fungicide Resistance Issues for Specific Diseases	195
First Aid for Pesticide Poisoning	151	The Future of Apple Disease Control	195
Basic First Aid Instructions.....	151	Using Pheromones for Monitoring and Mating Disruption	195
Specific First Aid Instructions.....	151	Management of Codling Moth with a CM Granulovirus.....	197
Safe Storage of Pesticides	152	Recommended Use Options for CpGV Products within Pennsylvania Apple Orchards.....	199
Safe Disposal of Pesticides	152	Resistance Management Approach for New Insecticides in Tree Fruits	199
Current Status of Restricted-use Pesticides in Pennsylvania	152	Use of the New Chemical Tools in a Resistance Management Approach.....	199
Worker Protection Standard for Agricultural Pesticides	153	Final Thoughts	200
Orchard Spraying.....	153	Nematode Management Strategies.....	200
Tree Spraying.....	153	Benefits of Nematicides and Soil Fumigants	200
Selecting a Nozzle.....	154	Dagger Nematode Control with Green Manure.....	200
General Recommendations	155	Biorational Nematode Control.....	202
Ground Spraying.....	158		
After Applying an Herbicide.....	161		
Factors Affecting the Efficacy of Nematicides	161		

Contents PART IV Chemical Management Tables

Herbicide Management	203	Table 4-6. Apples: insecticide and miticide efficacy.....	210
Nematicide Management.....	203	Table 4-7. Apples: fungicide timing.....	212
Insecticide and Fungicide Management	203	Table 4-8. Apples: fungicide efficacy.....	212
Reentry and Preharvest Intervals	203	Table 4-9. Pears: insecticide and miticide timing.....	213
Pesticide Compatibility and Storage Issues.....	203	Table 4-10. Pears: insecticide and miticide efficacy.....	213
Table 4-1. Tree fruit herbicide registration by crop.....	204	Table 4-11. Stone fruit: insecticide and miticide timing.....	214
Table 4-2. Herbicides labeled for use in orchards.....	206	Table 4-12. Stone fruit: insecticide and miticide efficacy.....	214
Table 4-3. Soil fumigants and nematicides.....	208	Table 4-13. Stone fruit: fungicide and antibiotic timing.....	215
Table 4-4. Toxicity of pesticides to mite and aphid predators, at rates recommended in Part V	209	Table 4-14. Stone fruit: fungicide and antibiotic efficacy.....	215
Table 4-5. Apples: insecticide and miticide timing.....	210	Table 4-15. Reentry (REI) and preharvest (PHI or spray-to-harvest) intervals.....	216
		Table 4-16. Storage suggestions for pesticides used on tree fruit.....	219

Contents PART V IPM Spray Programs

Apple Integrated Pest Management (IPM)

Program	221
Apples—Silver Tip	221
Apples—Green Tip	221
Apples—½-Inch Green Delayed Dormant	222
Apples—Tight Cluster to Open Cluster	223
Apples—Pink	225
Apples—Bloom	226
Apples—Petal Fall	226
Apples—First Cover	228
Apples—Second, Third, and Fourth Covers	229
Apples—Fifth Cover	231
Apples—Sixth and Seventh Covers	232

Pear Integrated Pest Management Program

233	
Pears—Dormant to Green Tip	233
Pears—Green Cluster Bud	233
Pears—White Bud, Popcorn Stage	234
Pears—Bloom	234
Pears—Petal Fall, First through Fifth Covers	234
Pears—Sixth Cover, Early August	236
Postharvest Disorders of Pears	236

Peach Integrated Pest Management Program

236	
Peaches—Dormant, Before Bud Swell	236
Peaches—Pink to First Open Bloom	237
Peaches—Bloom	237
Peaches—Petal Fall	238
Peaches—Shuck Split, Shuck Fall	238
Peaches—First, Second, Third Covers	239
Peaches—Fourth and Later Covers	240
Postharvest Disorders of Peaches	241
Peaches—Fall Leaf Drop	241

Nectarine Integrated Pest Management

Program	242
Nectarines—Dormant, Before Bud Swell	242
Nectarines—Pink to First Open Bloom	242
Nectarines—Bloom	243
Nectarines—Petal Fall	243
Nectarines—Shuck Split, Shuck Fall	244
Nectarines—First, Second, Third Covers	244
Nectarines—Fourth Cover to Preharvest	245
Postharvest Disorders of Nectarines	246
Nectarines—Fall Leaf Drop	246

Apricot Integrated Pest Management Program

247	
Apricots—Dormant	247
Apricots—Pink to First Open Bloom	247
Apricots—Bloom	247
Apricots—Petal Fall	248
Apricots—Shuck Split, First, Second Cover to Preharvest ..	248
Postharvest Disorders of Apricots	249

Sweet Cherry Integrated Pest Management

Program	249
Sweet Cherries—Dormant	249
Sweet Cherries—Prebloom	249
Sweet Cherries—Bloom	249
Sweet Cherries—Petal Fall	249
Sweet Cherries—Shuck Fall, First Cover	250
Sweet Cherries—Second Cover	251
Sweet Cherries—Preharvest	252
Postharvest Disorders of Sweet Cherries	252

Tart Cherry Integrated Pest Management

Program	253
Tart Cherries Dormant	253
Tart Cherries Prebloom	253
Tart Cherries Bloom	253
Tart Cherries Petal Fall	253
Tart Cherries Shuck Fall	254
Tart Cherries—First, Second (Maggot Spray), Third Cover	255
Tart Cherries—Preharvest	256

Plum and Prune Integrated Pest Management

Program	256
Plum and Prune—Dormant	256
Plum and Prune—Prebloom	257
Plum and Prune—Bloom	257
Plum and Prune—Petal Fall, Shuck Fall, First and Second Covers	257
Plum and Prune—Third and Fourth Covers	258
Plum and Prune—Fifth Cover, Preharvest	258
Postharvest Disorders of Plums and Prunes	259

Contents 🍏 PART VI 🍏 Harvest and Postharvest Handling

Determining Fruit Maturity	261	Controlled Atmosphere Storage of Apples and Storage Scald	266
Apple Maturity Indices	261	Storage	266
Pear Maturity Indices	263	Storage Scald in Apples and Pears.....	266
Harvesting Fruit	263	Drenching for Scald Control and Storage Requirements by Cultivar	267
Bruising in Fruit	263	Postharvest Fruit Disorders.....	268
Excessive Heat and Worker Safety	264	Picture Guide to Apple Postharvest Defects and Disorders .	268
Guidelines for Placing Fruit in Storage	265	Peach Skin Discoloration.....	268
SmartFresh (1-MCP).....	266	Peach Chilling Injury	269
		Watercore: A Maturity Problem.....	269

Contents 🍏 PART VII 🍏 Cider Production

Identity Standards and Regulations.....	271	Production Operations and Practices Affecting Cost, Yield, and Quality	273
Quality and Composition of Cider	271	Selecting and Blending Apples	273
Preservation and Shelf Life	271	Sorting, Trimming, and Washing Operations.....	274
Microbiology of Cider	271	Chopping or Milling Equipment.....	274
Maximizing Shelf Life	272	Press Aids.....	274
		Pressing Systems	274
		Screening/Filtering.....	275
		Chilling and Cold Storage	275
		Labeling Requirements and Options.....	275
		Required Labeling Information.....	275
		Optional Labeling Information	276

Contents 🍏 **PART VIII** 🍏 **Maintaining the Safety of Pennsylvania Apples and Apple Products**

Foodborne Illness in the U.S.....	279	Recommended Resources	289
Fresh Produce.....	279	Books and Pamphlets	289
Juice and Cider.....	279	Websites	289
Good Management Practices for Safe Apple Growing, Packing, and Cider Production	279	Penn State Workshops and Short Courses	290
1. Orchard Operations.....	280		
2. Packing Operations	282		
3. Cider Processing	284		

Contents 🍏 **PART IX** 🍏 **Farm Management**

Tree Fruit Production Budgets.....	291	State and Federal Laws That Apply to Farm Labor	299
Table 9-1. Land preparation budget, tree fruit, Pennsylvania, 2012. Summary of estimated costs per acre.	292	Preliminary Considerations.....	299
Table 9-2. Apple orchard planting budgets, medium- and high-density orchards, Pennsylvania, 2012. Summary of estimated costs per acre.....	293	Hiring Considerations	300
Table 9-3. Fresh-market apple production budgets, 908 trees per acre, with and without mating disruption, Pennsylvania, 2012. Summary of estimated costs per acre.....	294	Pennsylvania’s New Hire Reporting Program	300
Table 9-4. Processing apple production budget, 272 trees per acre, Pennsylvania, 2012. Summary of estimated costs per acre.....	295	Immigration Reform and Control Act of 1986	302
Table 9-5. Mature fresh-market peach orchard budget, 155 trees per acre, Pennsylvania, 2012. Summary of estimated costs per acre.	296	Child Labor Laws	302
Table 9-6. Mature tart cherry orchard budget, 121 trees per acre, Pennsylvania, 2012. Summary of estimated costs per acre.....	297	Wage and Withholding Considerations.....	304
Table 9-7. Mature sweet cherry orchard budget, 89 trees per acre, Pennsylvania, 2012. Summary of estimated costs per acre.....	298	Employee Health and Safety.....	306
		Special Employment Concerns	309

ORCHARD ESTABLISHMENT

Site Selection and Soil Preparation

The success of an orchard is only as good as the planning and site preparation that go into it. This is a simple maxim, but one that is often overlooked by novice and experienced grower alike. Shortcuts and haphazard approaches can result in less-than-ideal growth and other problems during the orchard's life. It is easier to amend a site before the trees are planted than it is once they are in the ground.

To build a good orchard, you need a good foundation. The ideal site is on rolling or elevated land so that cold air can drain during spring frosts. Figure 1-1 shows typical site arrangements. Site A is a warm location that receives more sun. This site is not affected by late spring frosts because cold air drains to lower-lying areas. Site B also misses late spring frosts, but the top may be too cold in winter because of exposure. Site C is similar to site A but colder, warming up later in the spring. Site D is the most susceptible to spring frosts because cold air drains into it from elevated areas. Site E can still be frosty, but the woods act as a windbreak, sheltering this site from prevailing winds. Site F is not desirable because of the dense woods at the base of the hill. Woods can trap cold air and prevent it from draining to lower-lying areas. Site G is similar to site B.

Slope exposure should be considered for its effect on fruit trees as they come out of dormancy. A southern-facing slope warms up faster in spring, while the opposite is true of a northern slope. Eastern-facing slopes are intermediate. In Mid-Atlantic areas, a western-facing slope tends to be windier. Wind can cause spraying problems during the growing season.

While uphill or rolling land is the most desirable, the degree of slope can also limit its suitability. The ideal site has a 4 to 8 percent slope. It may be difficult to operate machinery on slopes of more than 10 percent.

Selecting a site for an orchard involves belowground considerations as well, primarily soil depth and soil texture. An old recommendation for a desirable orchard soil is that it be deep and well drained.

Soil drainage is probably the most important factor in the longevity of an orchard. This is because of the inherent inability of certain types of fruit trees to survive when planted in imperfectly drained soils. Stone fruits (peaches, cherries, and plums) are the most susceptible to poor drainage. Apples are intermediate, and pears can survive on the more poorly drained soils.

Soils are made up of four basic ingredients: mineral elements, pore space, organic matter, and other items consisting mainly of living organisms, including fungi, bacteria, and nematodes. One classification of soils is based on the mineral part of soil and consists of four sizes of particles. Clay particles are the smallest, followed by silt, sand, and gravel. The USDA has devised another system of classifying soil particles. In this system soil is divided into seven categories: clay, silt, and five sizes of sand.

Soil texture is determined by the percentage of sand, silt, and clay in the soil. Arendtsville gravelly loam, Highfield channery

silt loam, and Steinsberg sandy loam are examples of soil types having different textures. The structure of a soil is influenced by soil texture and also by the aggregation of small soil particles into larger particles. The amount of aggregation in a soil is strongly influenced by the amount of organic matter present.

The pore spaces in a soil are normally filled with air or water. As the amount of water increases, the amount of air must therefore decrease. The pores of a well-drained soil have certain physical characteristics that, after a period of heavy rainfall, enable water to rapidly drain away and allow air to return to its original percentage.

The amount of organic matter in soil is an important factor in soil structure. Organic matter consists of dead and decomposing plant and animal parts. Living organisms break down plant debris into organic matter.

The cation exchange capacity, or the ability of soil to store cations (positively charged particles) is highly dependent on the amount of clay and organic matter in the soil. Clay and organic matter contain predominantly negatively charged sites that attract cations. Applied nutrients such as ammonium nitrogen, potassium, calcium, and magnesium attach themselves to the negatively charged soil particles. This phenomenon is called cation exchange, and it allows the soil to be a reservoir for plant nutrients.

Before selecting a site for an orchard, consult a county soil map. Soil surveys are available at most Natural Resources Conservation Service offices in Pennsylvania. These publications are valuable in determining if your particular site has the detailed requirements for a long-term viable orchard operation. A more detailed site evaluation is probably warranted, and we recommend that a backhoe be used to dig holes 5 to 7 feet deep so that the soil profile can be examined. A test similar to a percolation test used for installing septic systems may also be advisable where internal soil drainage is questionable. Poorly drained soils often have horizontal layers of light-colored material.

Although pH and fertility are often considered important factors for orchard soils, internal soil drainage is actually the most important. Soil fertility can often be corrected by applying fertilizer or by increasing the level of organic matter in the soil. Soil pH can be corrected and is not usually a limiting factor unless a site is highly acid. In this case only the plow layer depth can be corrected with applications of lime.

The best soil is a well-drained loam a minimum of 3 to 4 feet deep. Good drainage, however, should take preference over depth. In Figure 1-1, soils at site B are most likely to be the shallowest

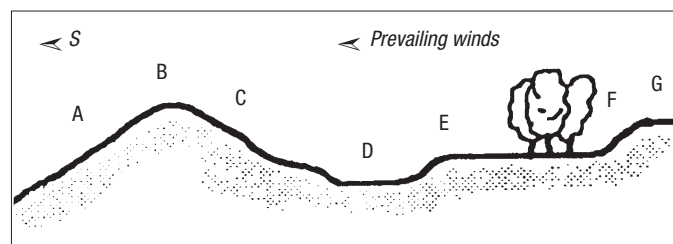

Figure 1-1. Considerations for orchard sites.

because of erosion, while those at site D tend to be the richest. Soil fertility should be medium to low. Overly fertile soils can lead to excessive tree growth at the expense of fruit production. Adding fertilizer to increase tree vigor is easier than trying to reduce vigor. Fruit trees grow well in soil with a pH of 6.0 to 6.5. Higher or lower levels can cause nutrient deficiencies.

Once you have selected a site, you must prepare it. If you are replacing an existing orchard, particularly a stone fruit orchard, it is important to take a nematode test before the old trees are removed to determine the need for fumigation. Next, take a soil test to determine soil fertility. If you are replacing an existing orchard or clearing the land for a new one, take the soil sample after removing the trees and as many of the roots as possible. An initial plowing and leveling should also be done before taking the soil sample. In this way, any subsoil that comes to the surface can be thoroughly mixed.

If the site has been open pasture or field cropland, be sure to take a nematode sample. For more information on nematode management, see *Nematode Problems in Deciduous Fruit Trees* in Part II. Examine the field for the presence of perennial weeds before working the ground. If multiflora rose, thistle, poison ivy, or hackberry are in the field, they should be treated in the summer or fall with glyphosate. If the problem weeds have been established for a number of years, controlling them will require two or three treatments of glyphosate. It is best to subsoil as deeply as possible. Running a deep shank in two directions across the field will break up any existing hardpans.

Plow down any stubble left from the field crop in late summer to increase soil organic matter. After the field crop has been plowed down, take a soil test before doing the final disking and leveling. Incorporate any needed amendments, such as lime, phosphorus, or potassium.

Orchard sod should be planted the fall before trees are planted. The grass cover traditionally used is Kentucky-31 tall fescue. It establishes itself rapidly and is a durable cover crop, although it does require frequent mowing during the growing season. The ideal time to plant seed is mid-August to late September. Seed the grass at a rate of 20 to 40 pounds per acre.

Orchard Layout

Laying out an orchard on level land is a simple matter of establishing a straight baseline, usually next to a fence or roadway. Then, lines at right angles to the baseline are established at both ends of the plot and one or two places in the middle. An easy way to establish these angles is to use three ropes whose lengths are in a 3:4:5 proportion (based on the Pythagorean theorem). For example, use ropes 30, 40, and 50 feet long. Put the 40-foot rope along the baseline, then place the 30-foot rope at approximately a right angle, and, finally, close the triangle with the 50-foot rope (Figure 1-2). Adjust the 30-foot segment in either direction so that it just touches the end of the 50-foot piece. This ensures that the 30-foot section is at a right angle to the baseline.

Next, place stakes along the baseline and the right angle line for sighting to extend these lines. From this point on, any desired row and tree spacing can be established using a tape measure or knotted rope to measure off the proper intervals. If an auger is to be used, place a handful of lime to mark the spot where each tree is to be planted.

An alternative method is to use a tree planter to cross-hatch the

ground. This method requires a skillful tractor operator who can drive a straight line over a large area. A single shank is attached to the tractor. The driver then lays out all the rows and finishes cross-hatching by going from side to side at a distance based on the desired within-row spacing.

A third method is used on sloping land. Trees are planted beginning at the steepest point of the field, and rows follow the contour of the land (Figure 1-3). This method requires the use of a surveyor's level and rod. Plant the first row at the highest elevation and stake it out level (i.e., make all points on the line the same elevation, A to C). Next, find the steepest slope along this row (along the line A to B) and measure the minimum distance between rows. From that point lay out the next row on a level line as before. As one moves from the steepest slope to less steep slopes, the rows become wider apart. Wherever the distance between two adjacent rows becomes twice the minimum distance, lay out a short contour row between them from that point to the end of the plot (squares marked D).

To plant trees, you can use either an auger or a tree planter. If you use an auger, take care to prevent "glazing" the sides of the hole. Glazing can occur if you dig the holes when the soil is too wet. One remedy is to slice the edge of the hole with a shovel or pick. Another is to weld a steel tine onto the auger.

The most common mistake in using a tree planter is going too fast and failing to place the trees at the proper depth. Along with the tractor driver and the person on the planter, a third or fourth person should walk behind the planter to straighten up trees and adjust them to the proper depth. This can be done right after planting simply by pulling up or stepping down on the newly planted tree.

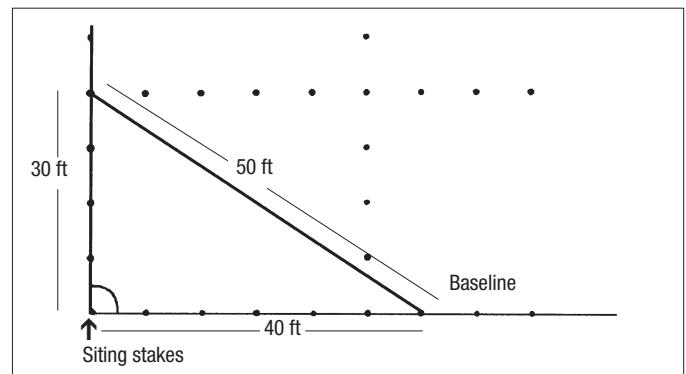

Figure 1-2. Orchard layout based on a triangle.

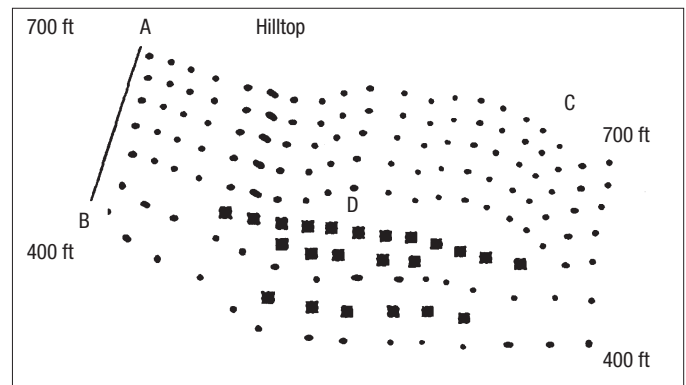

Figure 1-3. Orchard layout on the contour.

Determining the number of trees per acre in single-row plantings

The traditional method of determining the number of trees per acre (TPA) has been to multiply the in-row spacing by the between-row spacing and divide that number by the number of square feet in an acre (43,560 sq ft). Table 1-1 gives the TPA at various spacings for single-row orchards. To determine TPA, locate the desired or planned in-row spacing of trees on either the vertical or horizontal axis. Next, locate the between-row spacing on the other axis. The number of trees per acre can be found at the intersection of the two spacings.

For example, if we want trees to be spaced 10 feet in the row with 18-foot between-row spacings, we would go down the left-hand column to 18 and follow across to where the 10-foot column intersects, and we find the TPA to be 242. (For information on bed systems, see Using Beds to Attain Higher-Density Orchards.)

Choosing a Nursery for Fruit Trees

An orchard can only be as good as the quality of its young trees. A planting begun with poor-quality trees may never recover. Buy the best trees that you can. Bargain or low-priced trees are often more costly in the long run. Fortunately, most nurseries are honest, but accidents can occur. Growers should be aware of a nursery's policies on replacing incorrectly labeled trees.

When ordering trees, choose a nursery carefully. Ask if the nursery has the cultivar and strain, rootstock, tree size, and quality that you want and if there are enough in stock to meet your needs. You could end up with a spacing problem in your orchard because you have planted a mixed block of cultivars, strains, and rootstocks. You're better off in delaying your planting for a year until you are able to get exactly what you want. Don't accept an undesirable cultivar-rootstock combination.

Information that comes from word of mouth and other growers' experiences can be of invaluable help when deciding on a nursery. Most nurseries realize that the best advertisement for their product is a satisfied customer.

Talk to growers who have ordered from a nursery you do not know. Ask about the condition of trees on arrival and about problems in ordering or receiving the trees. It's also a good idea

to visit the nursery, if at all possible. Nurseries usually welcome anyone interested in their operation.

Another factor to consider before ordering trees is the nursery's guarantee concerning survivability, quality, and trueness to name. All Pennsylvania tree fruit nurseries that sell to commercial growers participate in the Pennsylvania Department of Agriculture Certification Program. These nurseries guarantee their trees to be true to name and free from all disease and insect problems. Some nurseries in other states also have their own certification programs. You would be wise to ask the nursery if it participates in a certification program. If not, ask if it has its own guarantee.

Selecting a grade of tree to order

The Pennsylvania Fruit Tree Improvement Program is a cooperative voluntary program administered by the Pennsylvania Department of Agriculture (PDA). A Program Advisory Committee is composed of PDA employees, Penn State research and extension workers, and Pennsylvania fruit tree nurserymen. The purpose of the committee is to direct the programming of the Fruit Tree Improvement Program to ensure that it is addressing the needs of the participating nurseries, that it is practically and scientifically sound, and that it is fulfilling its mission as outlined in the regulations. In addition, the committee is to provide an opportunity for exchange of information among industry, university, and regulatory personnel with fruit tree responsibilities.

Regulations of the program under Section D describe two types of certified nursery blocks. The first is Penn-Premium trees. These have rootstocks that must be approved by PDA and shall originate from registered seed trees or registered stool beds. Registered scion sources are propagated onto these rootstocks.

Penn-Standard trees should use registered scion sources when available. Alternatively, PDA-approved scions also may be used. There are no specifications for rootstocks in this grade.

It is recommended that Pennsylvania stone fruit growers buy Penn-Premium trees whenever possible to ensure that the rootstocks and scions are of the highest quality. Since most apple rootstocks are produced on the West Coast by specialty nurseries, quality control in apple rootstocks normally is better than that seen in stone fruit rootstock sources.

Table 1-1. Number of trees per acre at various tree spacings.

	3	4	5	6	7	8	9	10	11	12	13	14	15	16	17	18	19	20
8	1,815	1,361	1,089	907	777	680												
9	1,613	1,210	968	806	691	605	537											
10	1,452	1,089	871	726	622	544	484	435										
11	1,320	990	792	660	565	495	440	396	360									
12	1,210	907	726	605	518	453	403	363	330	302								
13	1,116	838	670	558	478	418	372	335	304	279	257							
14	1,037	778	622	518	444	388	345	311	282	259	239	222						
15	968	726	580	484	414	363	322	290	264	242	223	207	193					
16	907	680	544	453	388	340	302	272	247	226	209	194	181	170				
17	854	641	512	427	366	320	284	256	232	213	197	183	170	160	150			
18	806	605	484	403	345	302	268	242	220	201	186	172	161	151	142	134		
19	764	573	435	382	327	286	254	229	208	191	176	163	152	143	134	127	120	
20	726	545	414	363	311	272	242	217	198	181	167	155	145	136	128	121	114	108
	3	4	5	6	7	8	9	10	11	12	13	14	15	16	17	18	19	20

To use this table, locate the desired or planned in-row spacing of trees on either the vertical or horizontal axis. Next, locate the between-row spacing on the other axis. The number of trees per acre can be found at the intersection of the two spacings.

Ordering trees

Order trees from a nursery as far in advance as possible. Nurseries become overloaded in late winter with last-minute orders. They may not be able to get your trees to you until it is too late to plant. Ordering early will also give you a better choice of cultivars and rootstocks.

Some nurseries will custom bud or graft a particular cultivar from your orchard if you give them the budwood far enough in advance. If you want a nursery to do this, contact it no later than June or July, two years in advance of the year you wish to plant. Therefore, if you wish to plant in 2012, contact the nursery in 2010.

Fruit trees are sold according to trunk caliper. In addition, the recent emphasis on large tree sizes has created a demand for trees that are well branched. As a result, some nurseries have a special category for this type of tree. Be specific about the type and age of trees you want. At present, there is considerable discussion about whether a feathered tree (one with branches) is better than a nonfeathered tree or a whip. If you are establishing a high-density planting system, it would be beneficial to pay the extra expense for feathered trees because they will be larger and will come into bearing earlier if handled properly. Otherwise, unbranched whip trees may be acceptable.

Some growers prefer trees that already have branches even when they are planted at lower densities. The advantage is that you begin with larger trees that already have some scaffolds in addition these often have wide branch angles. The disadvantages are that the branches may not be in the right location or at the right height. Nurseries have more problems shipping trees with branches than they do shipping nonfeathered trees or whips. Branches can be broken during handling and shipping.

The ideal size for a tree that is purchased as a whip is one with a diameter of $\frac{1}{2}$ to $\frac{5}{8}$ inch. Such a tree is usually 4 to 6 feet tall. If you cannot order a tree of that size, then the next size smaller, which is $\frac{3}{8}$ to $\frac{1}{2}$ inch in diameter, is better than the next size larger, which is $\frac{3}{8}$ to $\frac{3}{4}$ inch in diameter. Unless as previously noted you will be planting a high-density system, it is better to opt for the larger tree as your second choice.

Normally, trees sold from nurseries have been growing in beds for two years. For budded trees, during the first year the rootstocks are grown in the field and then budded in late summer. In the spring of the second year, the rootstock is cut off just above the bud and the scion is forced to grow. The tree is then dug in the fall or late winter for shipment to the grower. The exception to this procedure occurs in southern nurseries where the trees are budded in June and forced the same year for shipment the following spring.

Trees that are bench grafted usually are also grown for an additional year in nursery beds. Interstem trees, if budded, require an extra year in the nursery. Interstem trees that are bench grafted do not require the extra year because both the interstem and the scion are grafted on at the same time and grown out for one additional growing season before shipment. Since interstem trees require additional handling, they cost more to purchase.

A new type of tree recently introduced from the Netherlands is called the "sleeping eye" tree. These trees are produced by growing and budding the rootstock in the traditional manner, but cutting off the rootstock above the bud before shipping the tree to the grower. The advantage to the nursery is that it saves

on growing and shipping costs. At present we do not know how these trees have performed in the Mid-Atlantic region.

Should you propagate your own trees?

Some growers do not like the expense of ordering trees for their orchard plantings and think they can propagate their own. This can be a very costly mistake. Propagating and growing trees is a very specialized business; trees require special equipment and training. Much care is required to ensure that trees are not neglected and that they do not become overgrown with weeds or suffer from water stress.

Another consideration is that many of the latest cultivars are protected by plant patents. This means you are in violation of a patent should you collect budwood from one of these trees for propagation in your orchard. Patented trees cannot be propagated without paying a royalty to the original source.

Fruit growers need to realize that they are in the business of producing either fruit or trees. Rarely can a fruit grower produce trees as good as those sold by a reputable nursery. Any savings realized by propagating your own trees are quickly eliminated by the added cost of production delays from poor-quality trees.

There are, however, certain instances when growers may wish to propagate a few trees for particular reasons. If you want to propagate a few trees, your best choice is to purchase rootstocks from a nursery and either graft or bud onto them. Set aside a small area and grow the trees out one year before planting them into the main orchard blocks. It is much easier to care for young trees if they are grouped together in one location where they can be checked daily. Scattered throughout the orchard, young trees easily can be forgotten and become overgrown with weeds. Do not try to plant the rootstocks in their final space in an orchard and then bud them. If you have poor bud take, tree size in the block will not be uniform since you will have to use replants to replace the missing trees.

Sources of fruit trees

Listed below are some nurseries that sell fruit trees. The list is not all inclusive and does not imply endorsement of these nurseries; nor are nurseries not listed inferior. The list is merely a starting point for anyone purchasing trees. If we have omitted a particular nursery, we would appreciate receiving a catalog so that in the future we may include it in this listing. Please note that many of the nurseries have their own Web sites that can provide additional information.

Adams County Nursery, Inc., 26 Nursery Rd., PO Box 108, Aspers, PA 17304

Agri-Sun Nursery, 6910 E. Clarkson Ave., Selma, CA 93662
Banning Orchards and Nursery, 4000 Grant Rd., East Wenatchee, WA 98802

Boyer's Nursery and Orchards, 405 Boyer Nursery Rd., Biglerville, PA 17307

Brandt's Fruit Trees, Inc., PO Box B, Parker, WA 98939,
www.brandtsfruittrees.com/index.html

Bright's Nursery, 5246 S. Plainsburg Rd., LeGrand, CA 95333
Burchell Nursery, Inc., 12000 State Highway 120, Oakdale, CA 95361

Cameron Nursery, 1261 Ringold Rd., PO Box 300, Eltopia, WA 99330-0300

C&O Nursery Co., PO Box 116, Wenatchee, WA 98807-0116
Columbia Basin Nursery, PO Box 458, Quincy, WA 98848
Cumberland Valley Nurseries, Inc., PO Box 471, McMinnville, TN 37110-5342

Cummins Nursery, 1408 Trumansburg Rd., Ithaca, NY 14850
Freedom Tree Farms, 1147 U.S. Route 41, Pelham, TN 37366
Fowler Nurseries, Inc., 525 Fowler Rd., Newcastle, CA 95658
Green Tree Nursery, 23979 Lake Rd. La Grange, CA 95329
Hilltop Fruit Trees, PO Box 538, 60395 Co. Rd. 681, Hartford, MI 49057

L. E. Cooke, 26333 RD 140, Visalia, CA 93277

Moser Fruit Tree Sales, 5329 Defield Rd., Coloma, MI 49038
Nursery Connection, PO Box 874, Coloma, MI 49038

ProTree Nurseries, 741 Sunset Rd., Brentwood, CA 94513

Sierra Gold Nurseries, 5320 Garden Highway, Yuba City, CA 95991-9499

Stark Bros. Nurseries, PO Box 368, Commercial Dept., Louisiana, MO 63353

Summit Tree Sales, 55826 60th Ave., Lawrence, MI 49064

TRECO Inc., 10906 Monitor-McKee Rd. NE, Woodburn, OR 97071

Tree Connection, PO Box 549, Dundee, OR 97115-0549

Van Well Nursery, Inc., 2821 Grant Rd., Wenatchee, WA 98802

Vaughn Nursery, 8678 Smithville, Highway, McMinnville, TN 37110

Wafler Nurseries, 10662 Slaght Rd., Wolcott, NY 14590

Dave Wilson Nursery, 19701 Lake Rd., Hickman, CA 95323

White Oak Nursery, 2515 White Oak Rd, Strasburg, PA 17579-9422

Willow Drive Nursery, 3539 Road 5 NW, Ephrata, WA 98823

Yakima Valley Nursery, 551 Weiker Rd., Yakima, WA 98908-0410

Foreign nurseries

D&L Nursery, 75 Avenue Jean Joxe, 49100 Angers, France
Janssen Brothers Nurseries Limited, PO Box 2711 6030 aa
Nederweert, Holland

Jos Morren Nurseries, Bosstraat 85-3545, Halen, Belgium
McGrath Nurseries, 192/2 Gorton Rd. RD 2 Cambridge,
Waikato, New Zealand, 07 827-8281

Nakajima Tenkoe Co., No.34, 1-Chome Nakajima dori, Higashine City, Yamagata Perf. Japan 999-37

Schrama Nursery, Prof. Zuurlaan 10, 8256 PE, Biddinghuizen, Holland

Star Fruits, Les Genets D'or, No. 14, 84430 Mondragon, France

Viveros Requinoa, Victoria Subercaseaux No. 323, Santiago, Chile

Wiel Willems, Zuidwesterringweg 5-II, 8308 PC Nagele, Holland

Sources of rootstocks

Brandt's Fruit Trees, Inc., PO Box B, Parker, WA 98

Burchell Nursery, Inc., 4201 McHenry Ave., Modesto, CA 95356

Cameron Nursery, 1261 Ringold Rd., PO Box 300, Eltopia, WA 99330-0300

CopenHaven Farms Nursery, 12990 SW Copenhagen Rd., Gaston, OR 97119

Cummins Nursery, 18 Glass Factory Bay Rd., Geneva, NY 14456

Grootendorst Nurseries, Lakeside, MI 49116

Firdale Nursery, Rt. 2, Box 374D, Cornelius, OR 97113

Four Mile Nursery, 27027 South Hwy. 170, Canby, OR 97013

Janssen Brothers Nurseries Limited, PO Box 2711 6030 aa
Nederweert, Holland

Lawyer Nursery, Inc., 950 Highway 200 West, Plains, MT 59859

TRECO Inc., 10906 Monitor-McKee Rd. NE, Woodburn, OR 97071

Van Well Nursery, Inc., PO Box 1339, Wenatchee, WA 98801

Willamette Nurseries, Inc., 25571 S. Barlow Rd., Canby, OR 97013

Willow Drive Nursery, 3539 Road 5 N.W., Ephrata, WA 98823

Sources that carry antique cultivars

Big Horse Creek Farm, PO Box 70, Lansing, NC 28643

Boyer's Nursery and Orchards, RD 2, Biglerville, PA 17307

Fedco Trees, PO Box 520, Waterville, ME 04903

Lawson's Nursery, 2730 Yellow Creek Rd., Ballground, GA 30107

Moser Fruit Tree Sales, 5329 Defield Rd., Coloma, MI 49038

Southmeadow Fruit Gardens, PO Box 211, Baroda, MI 49101

Trees of Antiquity, 20 Wellsona Rd., Paso Robles, CA 93446

Vintage Virginia Apples, PO Box 210, North Garden, VA 22959

White Oak Nursery, 494 White Oak Rd., Strasburg, PA 17579

ORCHARD FLOOR AND WEED MANAGEMENT

Row Middle Management

The ground cover in an orchard must be managed just as the tree canopy is managed. The orchard floor can be divided into two distinct areas: the area between the tree rows, and the area directly underneath the trees. Row middle management in Pennsylvania orchards traditionally has fallen into three broad categories: (1) clean cultivation, (2) trashy cultivation, and (3) planting a permanent cover crop. The first two are no longer recommended because they tend to destroy soil structure by increasing soil compaction and erosion. They also create an ideal seedbed for the establishment of broadleaved perennial and annual weeds, which serve as a reservoir for viruses. The vast majority of commercial orchards in Pennsylvania are grown under a ground management system of a sod row middle with a vegetation-free zone underneath the trees. Sod between the rows prevents soil erosion, provides traction for equipment, adds organic matter to the soil, improves soil moisture and structure, and can be a site for beneficial predatory insects.

Grass covers used in row middles tend to grow rapidly and require frequent mowing. Perennial ryegrass, K-31 tall fescue, and clover are covers that have been traditionally grown in Pennsylvania orchards; however, a number of newly developed turfgrasses have been found to perform well as slow-growing cover crops. Because they grow more slowly, these new grasses require fewer mowings. They tolerate low-fertility soils, poor growing conditions, and heavy traffic, and they grow densely enough to crowd out weeds.

The addition of clover or other legumes is not recommended for orchard row middles. While they may provide additional nitrogen to the orchard, the release of that nitrogen is unpredictable. Legumes also can serve as reservoirs for tomato ringspot virus, which causes stem pitting in peaches and apple union necrosis in pome fruit.

A relatively recent criterion of grass cultivar quality is the presence of endophytes. Endophyte-enhanced varieties are recommended over those without endophytes. Endophytes are fungi that live within the grass plant and deter certain turf insects from feeding. Some species and varieties have naturally high levels of endophytes. Penn State researchers have been evaluating these grasses primarily for use in ornamental nurseries. This research and other observations made around the state indicate that hard fescue, chewings fescue, creeping red fescue, and slow-growing, turf-type perennial ryegrass can be used with success in orchard row middles. Each type may contain many acceptable cultivars. New cultivars regularly become available; check with your local supplier.

Using these grasses successfully depends on proper establishment practices. Failure to follow the steps below may result in a cover that is too sparse to be effective.

- Eliminate perennial weeds before planting. During their establishment phase, slow-growing grasses do not compete well with perennial weeds.
- Have soil tested and amended according to crop needs. Apply 20 to 40 pounds of actual nitrogen per acre when the cover is being established.

- Thoroughly work the soil before seeding. Any broadcast machine will do. Do not cover the seed with soil.
- A cyclone spreader, drop spreader, or Brillion seeder is recommended for planting seed. If a grain drill is used, disconnect the hoses at the grain box and let the seed fall to the ground. The light, fine seed of the fescues will not fall through the hoses.
- Seed the grass at a rate of 20 to 60 pounds per acre. The higher rates will produce a faster cover.
- The best time to seed is late August to late September. The next best time is mid-March to early May. If planted in spring, slow-growing grasses will not compete well with weeds the first growing season.
- Limit weed competition the year of planting by mowing weeds before they reach 10 inches tall. Timely applications of 2,4-D will prevent broadleaved weeds from becoming established.
- If desired, you may want to add a nurse crop of oats in the seeding mix at a rate of 5 pounds per acre to help establish a covering to prevent erosion.

Other comments

- To remain effective, turf-type perennial ryes need two applications of nitrogen each year at 40 pounds per acre. All others need an application of nitrogen only every other year.
- Chewings fescue and creeping red fescue grow taller than hard fescues and mat down more, but they seem to establish faster.

Tree Row Management

The area underneath the trees is important in the development of an orchard. Numerous studies have shown that excessive vegetation underneath trees competes with the tree for water and nutrients and can reduce the growth and cropping of the trees. Research in New York showed that apple trees grown in a mowed sod were nearly 25 percent smaller than trees grown under a herbicide program 6 years after planting. Research at Penn State with peaches also showed that the width of the vegetation-free strip affected tree growth and yield, with a narrower 2-foot-wide strip producing less fruit and smaller trees. Ideally, the vegetation-free strip should extend out to the edge of the tree's canopy width. The width should be established early in the life of the orchard and should not be reduced on newly planted trees.

The timing of weed control has also been shown to be critical. A study with Gala/M.26 showed that the first crop in the life of the orchard was much larger when weeds were controlled early in the season. The weed competition also affected fruit size. Based on this work, it is believed that the critical period for weed competition in apple runs from bloom to 30 days after petal fall.

At first thought, mulching might seem to offer some attractive potential benefits for orchards. Mulching usually results in greater moisture retention, increased organic matter, and can help to suppress weed growth. However, mulch also provides an ideal habitat for meadow and pine voles, which can feed on tree trunks and roots.

Cultivation under the trees has some potential with the development of improved machinery. However, it can increase erosion and does require frequent cultivation and a skillful tractor driver.

Herbicides are the primary tools used to manage vegetation under the tree row, but they also have risks. Young trees can be very sensitive to herbicides, and drift onto green bark or foliage can stunt or kill the tree. Continual usage of herbicides can also build up residues of the chemical in the soil, resulting in sterilization. Herbicides are, however, the most cost-effective means currently available to control vegetation under the tree.

Establishing a New Orchard

Preplant

Establishing a weed control program for orchards begins with site preparation. Prior to planting, any persistent perennial weeds should be treated and removed. Most of the herbicides labeled for tree fruit work well against annual weeds, but only a few can control perennial weeds. Therefore, you should clean up any problem perennial weeds before planting. Ideally, the site to be planted should be either fallow or row cropped for at least two years before planting. The most common practice is to rent out the land to a local farmer to grow crops such as corn or wheat. Grains such as these cannot serve as reservoirs of tomato ringspot virus.

Care should be taken in selecting herbicides for the rotational crops. Many common corn and wheat herbicides can persist and injure subsequent crops. Persistent herbicides can kill young trees, reduce growth, or injure root systems. Root system injury may not show up until later in the growing season, when the plants are under stress. Typical signs of root injury include the sudden collapse of the tree.

Generally, three major classes of herbicides used in row crops are persistent and can cause damage to new plantings: the sulfonylureas, the imidazolinones, and the triazines. Examples of the sulfonylureas include the brand names Accent, Escort, and Pinnacle; examples of the imidazolinones include Pursuit, Raptor, and Steel. Atrazine is the most common triazine used in field crops, but it is also closely related to simazine, which is a common herbicide used in tree fruit. Injury from these two classes of herbicides is typified by chlorosis of the growing points and new growth, along with root growth inhibition. Atrazine inhibits photosynthesis, which may cause the older leaves of plants to turn yellow.

Herbicide persistence is dependent on soil and environmental factors. Breakdown of herbicides in the soil occurs either by microbial degradation or chemical hydrolysis. Both factors require that the soil be moist and temperatures warm. Thus, cool temperatures and dry conditions slow herbicide degradation. Soil pH and organic matter are also important for herbicide degradation. For example, degradation of some herbicides is slowed considerably when the soil's pH is above 6.5. We also know that if the soil pH is 6.0 or lower, microbial breakdown of herbicides slows down. Because of these soil and environmental influences on herbicide degradation and persistence, rotation restrictions should be used as minimum guidelines.

If you are unsure whether there is a herbicide residue, conduct a bioassay. Collect small samples of soil and place in a small growing flat. Sow either grass seed or oats and watch the germination. If there is still a residue, germination and growth

will be poor. If the germination test shows no residue then the field should be planted to a suitable grass sod. Research by the USDA Appalachian Fruit Station has shown that establishing an orchard-wide ground cover of grass and then killing off the rows where the trees will be planted with glyphosate has resulted in better initial tree growth. The grass residue improved soil moisture and organic matter and usually persisted for about 3 years after planting.

After planting

If you do not use the killed sod method described above, then herbicide applications are recommended to control weeds around young plantings. There is a critical period in crop development where weed competition hurts yields. For new orchards, this is usually the first 2 to 3 months of the planting. If weeds are controlled early in this first season, trees grow better and start cropping earlier and heavier. For bearing trees, this period runs from prebloom until 4 to 6 weeks after bloom. Weeds will rob the most growth and fruit size from your trees during the months of May and June. If weeds are controlled during this critical time, yields will not be reduced. Weed growth later in the season primarily affects the water status of the tree and may not be a problem in most years. Weak weed growth under your trees from August onward can actually be a good thing—as long as it does not hamper harvest—because it may help the tree go dormant faster.

Herbicides labeled for use on newly planted trees are listed in Tables 4-1 and 4-2 in Part IV. The rates and timings are listed in the tables in Part IV. Be careful when applying herbicides to newly planted trees. Read and follow label instructions completely. No herbicides should be applied until after the ground has settled around the tree and there are no cracks in the soil. Avoid using paraquat on newly planted trees unless you shield the tree trunks from the spray. We have purchased rolls of Tyvek sheet insulation that can be stapled in a tube around the trunk of the tree to protect green bark. Rolls of Tyvek are available from Irrigro, 291 Riverview Blvd., St. Catharines, Ontario, Canada L2T 3n3, 905-688-4090. The tubes usually last in the orchard for three years.

As trees age and become established, the range of herbicides that can be used increases. Chateau, Diuron, Kerb, Matrix, Rely, simazine, 2,4-D, and others can be applied to orchards established at least 1 year. Once trees have been in the ground for 2 years, a combination of Sinbar plus diuron can be used, as well as glyphosate. Sinbar can be used alone at higher rates once the trees have been in the orchard for 3 years.

Herbicides should be rotated to prevent the buildup of resistant biotypes and a gradual shift in weed population. Weed scientists have confirmed that certain species of weeds that were once susceptible and easily controlled by herbicides no longer are controlled. Herbicide resistance most likely occurs when a particular population of weeds is continuously exposed to a particular family of herbicides. The most common example is the development of triazine-resistant pigweed and lambsquarters. The only triazine material used in orchards is simazine, which is one of our most commonly used materials. Rotation away from a continual usage of simazine will help reduce the chance of resistance developing.

Some scientists believe that to be effective in preventing herbicide resistance you need to not only rotate specific herbicides, but also rotate between similar modes of action. Mode of action refers to how the herbicide will kill the plant once it is absorbed. Some herbicide modes of actions are very specific and only work on one site in the plant. Others may work on several sites. As with fungicides and insecticides, the more sites a herbicide affects, the less likely resistance is to develop. In the case of simazine, it acts by inhibiting photosynthesis. The same is true of norfluzon, diuron, and terbacil.

Continual use of one particular residual herbicide can also lead to a gradual shift in the weed species present. Knowing which herbicides affect which weed species can tell you if you are causing that population shift. One of the best things you can do during the supervision of your harvest crews is to notice the weed population in your various orchard blocks. You should note where the weed problems are the worst, how dense the weed growth is, and the weed species present. Follow up by making a physical map of the weeds to prepare to control the problem.

Split applications of herbicides

A normal weed control program would include a combination of a residual material, such as simazine or diuron, plus a contact material, such as paraquat or glyphosate. In recent years, better weed control in the tree row has been achieved when split applications of herbicides are used. Applying a half rate of a combination in the late fall after the fruit has been harvested, then applying the second half the following spring during June can provide better weed control. Split applications result in some residue being present for a longer period of time. The herbicide application in the fall helps prevent the development of annual winter weeds such as mustards. The second application helps control some of the later-germinating weeds, such as foxtails.

Controlling perennial weeds

Nearly all the herbicides labeled for weed control in tree fruit are designed to work against annuals. Many times, in established orchards the majority of the weeds in the tree row are perennial weeds. This means that they do not germinate, flower, and die in one year, but rather survive by means of underground roots or rhizomes. We only have a few herbicides that can, with regular use, control perennial weeds, including 2,4-D, glyphosate, and clopyralid.

Once perennial weeds become established it is difficult to eliminate them from the orchard. In most cases, it will take several applications at different timings. The first step in eliminating perennial weeds is to make a spring “chemical mowing” application. This consists of applying some sort of burndown material such as paraquat, glyphosate, 2,4-D, or in the case of stone fruits clopyralid, during the early growth stage of the plant usually sometime in April through June. The second step is to prevent the weed from flowering and producing seeds. This is accomplished by another burn down application or physically cutting the weed before it flowers. The final step is a fall application of glyphosate, which is preferred, or a 2,4-D product. Fall applications have the added advantage of having the material translocated downward in the plant to the roots or other storage organs resulting in death of the plant. When applying herbicides in the fall spray on a day

with a mild afternoon following cool morning temperatures to encourage translocation of the herbicide to the belowground organs. In any event, perennial broad leaf weeds should be sprayed while they are still actively growing, which is usually before a hard frost has occurred. In most instances where perennial weeds are well established it will take 2 to 3 years following the steps outlined above to rid the orchard of perennial weeds. Be sure to treat perennial weeds that are growing in the fence rows or in adjacent fields to prevent them from flowering, producing seeds, and being blown into the orchard by wind.

Weed identification

The importance of knowing the weed species present and the extent of the spread can provide you with valuable insight on possible control strategies. The book *Weeds of the Northeast* by Uva, Neal, and DiTomaso is an excellent reference book to help in identifying weeds. It has color pictures and helpful keys to identify the weeds. Numerous university Web sites have online resources with pictures of weeds (see Appendix: Tree Fruit on the Web at the back of this guide).

Not all weed problems need to be controlled by a blanket application to the tree rows. Some weeds introduce themselves into orchards in discrete patches rather than over the entire orchard floor. Quackgrass, nutsedge, and thistle tend to enter an orchard in one area then jump in patches. Weeds that produce fruit and seeds for animals to disperse may also typically develop in patches. Site-specific herbicide applications to these “patch communities” will be more cost-effective as long as they are timed appropriately. On the other hand, weed species that depend primarily on wind dispersal of their seeds for spread may spread evenly over the orchard; a good example is dandelions and their light, airy seeds. This is also a point of attack for control. Destroy weeds before they flower and shed seeds. Pay particular attention to the edge of your orchard or along the roadsides. In the late summer and early fall scout your orchard for weeds, and map out the weed patches. Try to identify any weeds you are unsure of. Destroy weeds in flower before they shed seeds. This is very important around field edges and along roadsides. Many of our problem weeds are being blown into the orchards.

Plant factors affecting weed control

Several characteristics of specific plants interact with the efficacy of herbicides. Contact herbicides will be ineffective if the growing point of the herbicide is either protected in a sheaf of leaves or below the soil surface. Plants that have narrow or upright leaves can result in herbicide runoff as compared to plants with broad or flat leaves. Plants with thick wax or cuticle layer can prevent herbicide entry to the leaf and the waxy surfaces can cause the spray mix to form droplets, which can run off of leaves. Dense leaf hairs can hold spray droplets away from the leaf. Young, rapidly growing plants are more susceptible to herbicides. Seedlings are very susceptible to most weed control methods. Some perennial plants can be very susceptible to systemic materials just prior to their blooming.

Site factors affecting weed control

The orchard site can influence the response of the weeds to herbicides. The primary influencing factor is soil texture. Soils that are heavier—either having higher amounts of clay or higher amounts of organic matter—may require higher rates of herbicides. Control in these types of soils may also not be as long as on lighter soils. On the other hand, overdosing and causing herbicide injury may be easier on lighter soils.

Herbicide mode of action

Herbicides must (1) adequately contact the target weeds, (2) be absorbed by the weed, (3) move within the weed to the site of action without being neutralized, and (4) be in high enough concentration to be toxic at the site of action. The mode of action refers to the chain of events from absorption to the weed's death. The specific site the herbicide affects is referred to as the site of action. Understanding herbicide mode of action is helpful in knowing what groups of weeds are killed. It can specify the application technique that will be most effective. It can help in diagnosing herbicide injury problems and preventing the development of herbicide-resistant weeds.

A common method of grouping herbicides is by the mode of action. Many herbicides have similar chemical properties and are grouped into chemical families. In some instances there may be two or more chemical families that may have the same mode of action and can, therefore, be grouped into herbicide classes. The table below lists the herbicides used in tree fruit according to those characteristics. The grower should utilize this table to

determine which herbicides are similar or have a similar mode of action. Rotating to an herbicide that has a different mode of action on an annual basis can prevent the buildup of resistant types of weeds and will help maintain a diverse weed population without the increase of any dominant species. For a more complete listing of herbicides by their class, go to hracglobal.com and click on the Publications tab.

Herbicide failure

Many growers who apply herbicides but do not obtain the desired results blame the material. However, in many cases it is not the fault of the herbicide but rather that of the applicator. Unlike insecticides and fungicides, many soil-applied herbicides need rain to work well. They need about ½ inch of rain shortly after application to activate them. Some herbicides, like Devrinol and Casoron, need rainfall to move them into the soil away from sunlight to prevent photodegradation. Also, if rainfall comes some time later, it will stimulate germination of weed seedlings just at the time that the concentration of the herbicide falls below its effective level due to natural breakdown in the soil. With our erratic weather patterns in the last few years, herbicides in orchards have not performed as well as we would like. Most herbicides generally do not give complete season-long control of all weeds, especially in young plantings where the canopies have not filled out completely. In older, more mature plantings, denser and fuller canopies often provide some shade that helps inhibit weed seedling growth under them.

Herbicide Resistance Action Committee (HRAC) Classification of Herbicides According to Mode of Action

Herbicide Class	Chemical	Trade Name	Chemical Family	Mode of Action	WSSA Group*
A	fluzifop-P-butyl	Fusilade	aryloxyphenoxy-propionate	Inhibition of acetyl CoA carboxylase	1
A	clethodim	Prism, Arrow, Select Max	cyclohexanedione		1
A	sethoxydim	Poast	cyclohexanedione		1
B	rimosulfuron	Matrix , Solida, Pruvion	sulfonylurea	Inhibition of acetolactate synthase ALS	2
B	halosulfuron methyl	Sandea	sulfonylurea		2
C1	simazine	Princep plus others	triazine	Inhibition of photosynthesis at photosystem II	5
C1	terbacil	Sinbar	uracil		5
C1	saflufenacil	Treevix	uracil		14
C2	diuron	Karmex plus others	urea	Inhibition of photosynthesis at photosystem II	7
D	paraquat	Gramoxone	bybridylum	Photosystem-1-electron diversion	22
E	oxyfluorfen	Goal, Galigan, GoalTender	diphenylether	Inhibition of protoporphyrinogen oxicase	14
E	pyraflufen-ethyl	Venue	phenylpyrazole		19
E	flumioxazin	Chateau	n-phnenylphthalimide		14
E	carfentrazone-ethyl	Aim	triazolinone		14
F1	norflurazon	Solicam	pyridazinone	Inhibition of carotenoid biosynthesis	13
G	glyphosate	many brands	glycine	Inhibition of EPSP synthase, amino acid synthesis enzyme	9
G	sulfosate	Touchdown	glycine		9
H	glufosinate	Rely	phosphinic acid	Inhibition of glutamine synthase	10
K1	oryzalin	Surflan	dinitoraniline	Microtubule assembly inhibition	3
K1	pendimethalin	Prowl	dinitoraniline		3
K1	pronamide	Kerb	benzamide		21
L	dichlobenil	Casoron	nitrile	Inhibition of cell wall synthesis (cellulose)	20
L	isoxaben	Gallery	benzamide		21
L	indaziflam	Alion	alkylazine	Cellulose inhibitor	29
O	2,4-D	Several brands	phenoxy-carboxylic acid	Action like indole acetic acid	4
O	clopyralid	Stinger	pyridine carboxylic acid		4

*WSSA = Weed Science Society of America

The second most common reason for herbicide failure is applying materials that do not control the weed species present in your orchard. Read the label carefully and be sure the material you are using is labeled to control your problem weed. This means you must also be able to correctly identify the weed. There are many pictorial sites for weed identification on the Web. Look in the Appendix section of this guide for those sites.

The third most common reason for poor weed control is applying the material at the wrong time. Poor timing is more of a problem with materials such as glyphosate, Fusilade, Poast, and 2,4-D. Read the label carefully to determine the appropriate time for the best control of the weed species present. Environmental conditions can also affect timing. Most of the postemergent herbicides mentioned above should be applied when the weeds are not under stress and instead are actively growing.

The last possibility for failure is the development of herbicide-resistant weed species. Similar to the way apple scab can develop resistance, the overuse of a single mode of action herbicide can speed the development of resistance. Rotate the herbicides you use to incorporate different modes of action. To learn more about herbicide mode of action, visit the Herbicide Resistance Action Committee Web site at www.plantprotection.org/HRAC.

PLANT NUTRITION

Nutritional requirements of fruit trees differ from those of agronomic crops, cover crops, and orchard sod. Growers may estimate fruit trees' nutritional needs through leaf and soil analysis, tree growth and cropping, and past experience. Since fruit trees are a perennial crop, leaf or foliar analysis is the most accurate way to determine nutritional status of an orchard. Factors such as rootstock, crop load, soil type, and weather conditions influence whether or not trees are absorbing enough nutrients to produce maximum yields of high-quality fruit.

Foliar analysis can also be of value in diagnosing the cause(s) of abnormalities in plant growth or fruit development. While only a single sample may be needed, paired samples, one from normal foliage and one from abnormal foliage, are frequently helpful. Foliar analysis, particularly if done over a period of years, can warn of an approaching deficiency or toxicity before the plant shows any visible symptoms.

Soil analyses, on the other hand, are not nearly as accurate in determining the nutritional status of an orchard. They do, however, play an important role in fertility programs when used in specific situations. In established orchards the main value of a soil test is to monitor soil pH. A soil test should also always be taken before an orchard is planted, since it is much easier to adjust nutrient levels before the trees are established. Renovating older orchards disturbs the subsoil enough to alter the soil test results. Therefore, when removing an old orchard for replanting, it is best to collect a soil sample after all the roots have been removed and any grading or soil disturbance has been completed.

Occasionally, soil and leaf analyses may offer opposing recommendations for fertilizing with phosphorus, potassium, and magnesium. If this occurs, follow the recommendations listed on the leaf analysis. However, if the soil analysis recommends lime, lime should always be applied.

Determining Tree Nutritional Status through Foliar Analysis

What is foliar analysis?

Foliar analysis is the process whereby leaves from fruit trees are dried, ground, and chemically analyzed for their nutrient content. Nitrogen, phosphorus, potassium, calcium, magnesium, iron, copper, boron, and manganese are among the elements tested for. A foliar analysis can help determine what fertilizer(s) a grower needs to apply. Unlike soil tests, which only show what is in the ground, a leaf analysis shows what the trees actually absorbed. Soil tests do not typically give accurate measurements of nitrogen or the minor elements.

When to collect samples

Specific guidelines must be followed when collecting a leaf sample for analysis. The first is timing. Leaves should be collected starting around mid-July until approximately mid-August. Samples are collected then because the nutrient levels in fruit trees are the most stable at that time. Earlier in the season, trees are actively growing and transporting nutrients up into the leaves; later in the season, senescence is beginning and nutrients are being transported out of leaves. To avoid contamination (see below), samples should be collected as long as possible after a cover spray or just before a cover spray.

Frequency of sampling

To gain the most benefit from a foliar analysis program, we recommend sampling each block of your orchard at least once every three years. A good method is to divide your orchard into thirds and sample one third each year.

Collecting the sample

Healthy leaves should be collected from the midsection of the current season's growth, located about midway on the tree or chest high on large trees, and at a representative height of the majority of foliage on young, small or dwarf trees. Similar to the procedure for taking a soil sample, randomly walk through your orchard and pull leaves from trees until you have approximately 60 to 70 leaves. No more than two leaves should be taken from an individual terminal shoot. Alternatively, you can select 8 to 10 trees in a block that are uniform and typical of the entire block and collect an equal number of leaves from the chosen trees.

We strongly recommend that you collect leaves from one cultivar on one rootstock in a similar soil type. The next best sample comes from one cultivar on one rootstock and, finally, from a single cultivar. We do not recommend collecting leaves from several cultivars to be mixed into a single sample. Do not mix leaves from young and old trees of the same cultivar. Younger trees will have distinctly different nutritional requirements than older mature trees. Make sure you fill out the informational sheet accompanying the leaf sample as completely and accurately as possible. The information is used in making a recommendation.

Contaminated leaf samples

Certain fungicides contain trace amounts of the minor elements. This becomes evident when the leaf analysis reports unusually high levels of elements such as manganese or zinc. The following fungicides contain manganese: Dithane M-45, Manzate 200, Manzate M-22, Maneb 80, and Polyram. Fungicides containing zinc include Ziram, Manzate 200, Maneb Plus, and Penncozeb.

Some growers might think that washing the leaves will help; it does if you do it right. But most growers are not equipped to wash leaves properly. Washing involves using a 0.1 percent soap solution and triple rinsing in distilled water. Most attempts to wash leaves will only produce greater contamination.

Interpreting foliar analyses

Table 1-2 lists the standard nutrient values used to interpret leaf tissue analysis results. The ranges outlined in the table cover the levels within which various kinds of fruit will grow, flower, and fruit sufficiently to produce high-quality commercial crops. The range for nitrogen, however, is purposely broad owing to factors such as tree age, fruit use, and fruit cultivar. Nitrogen should be higher for young nonbearing fruit trees. To further interpret nitrogen status in an orchard, refer to Tables 1-3 and 1-5, and the section on nitrogen that follows.

Table 1-2. Nutritional ranges used to interpret leaf analysis values for apples, peaches, nectarines, pears, and cherries.

APPLES				
	Deficient	Low	Normal	High
Dry matter (%)				
Nitrogen ^a	<1.60	<1.80	1.80–2.80	>2.80
Phosphorus	<0.11	<0.15	0.15–0.30	>0.30
Potassium	<0.70	<1.20	1.20–2.00	>2.00
Calcium	<0.31	<1.30	1.30–3.00	>3.00
Magnesium	<0.03	<0.20	0.20–0.40	>0.40
ppm				
Manganese	<5	<22	22–140	>140
Iron	<25	<40	40–100	>100
Copper	<4	<6	6–25	>25
Boron	<11	<35	35–80	>80
Zinc	<6	<20	20–200	>200
PEACHES AND NECTARINES				
	Deficient	Low	Normal	High
Dry matter (%)				
Nitrogen	<2.00	<2.50	2.50–3.40	>3.40
Phosphorus	<0.10	<0.15	0.15–0.30	>0.30
Potassium	<1.70	<2.10	2.10–3.00	>3.00
Calcium	<0.50	<1.90	1.90–3.50	>3.50
Magnesium	<0.03	<0.20	0.20–0.40	>0.40
ppm				
Manganese	<10	<19	19–150	>150
Iron	<40	<51	51–200	>200
Copper	<4	<6	6–25	>25
Boron	<11	<25	25–50	>50
Zinc	<6	<20	20–200	>200
PEARS				
	Deficient	Low	Normal	High
Dry matter (%)				
Nitrogen	<1.35	<1.60	1.60–2.40	>2.40
Phosphorus	<0.15	<0.18	0.18–0.26	>0.26
Potassium	<0.16	<0.20	0.20–2.00	>2.00
Calcium	<0.10	<1.30	1.30–3.00	>3.00
Magnesium	<0.05	<0.30	0.30–0.60	>0.60
ppm				
Manganese	<5	<20	20–200	>200
Iron	<40	<50	50–400	>400
Copper	<2	<6	6–25	>25
Boron	<5	<35	35–80	>80
Zinc	<5	<20	20–200	>200
CHERRIES				
	Deficient	Low	Normal	High
Dry matter (%)				
Nitrogen	<2.00	<2.30	2.30–3.30	>3.30
Phosphorus	<0.20	<0.23	0.23–0.38	>0.38
Potassium	<0.80	<1.00	1.00–1.90	>1.90
Calcium	<0.30	<1.60	1.60–2.60	>2.60
Magnesium	<0.03	<0.49	0.49–0.65	>0.65
ppm				
Manganese	<5	<18	18–150	>150
Iron	<40	<50	50–250	>250
Copper	<3	<6	6–25	>25
Boron	<5	<39	39–80	>80
Zinc	<5	<20	20–200	>200

a. See also Table 1-3.

Nutrient Deficiency and Toxicity Symptoms in Tree Fruit

Growers often look at their orchards and suspect that something is not quite correct. Listed below are general guidelines for diagnosing symptoms that result from deficiencies or toxicities of certain elements. A tree may be deficient in these elements not only because they are scarce but also because an excess of other elements has prevented a balanced uptake of essential elements.

The guidelines are not precise, and drastic changes in fertilizer practices should not be made based on a visual assessment.

If you suspect a nutrient deficiency or toxicity, a leaf analysis should be conducted to confirm the visual symptoms. Information that follows was adapted from Childers (1966), Shear and

Faust (1980), and Stiles and Reid (1991). See these sources for further reading and color photographs.

Elements required by plants are broken down into two broad categories: macronutrients and micronutrients. Plants need both to grow, flower, and fruit naturally. The distinction between the two groups is the quantities required by the plant. Macronutrients are needed in a larger amount and are usually expressed as percent dry weight. The micronutrients are required in smaller quantities and are usually expressed in parts per million.

Macronutrients

Nitrogen

Deficiency: Symptoms appear as reduced top growth with short spindly shoots that have pale green to yellow leaves. Generally speaking, symptoms first become evident in the older leaves at the base of shoots. In stone fruits deficient leaves appear reddish and may exhibit a “shothole” effect as the condition worsens. Fruits, especially stone fruits, tend to be smaller and to mature earlier.

Toxicity: Symptoms appear as an excessive amount of shoot growth accompanied by dark green foliage and delayed leaf drop in the fall. As nitrogen increases above the optimum, fruit color is reduced and maturity is delayed. Red cultivars are less red, and yellow cultivars tend to remain green. In apples and pears flavor and storage life are reduced. Besides direct

Table 1-3. Recommended leaf nitrogen levels for apple cultivars by bearing habit.

Cultivar ^a	Nonbearing	Early bearing	Mature
Paulared, McIntosh, Empire, Golden Delicious, Gala, Jonagold, Mutsu	2.4–2.6	2.0–2.4	1.8–2.1
Delicious, Fuji, Braeburn	2.4–2.6	2.2–2.4	2.2–2.25
York Imperial, Rome Beauty, Stayman	2.4–2.6	2.2–2.6	2.2–2.4

a. Fruit destined for fresh market will have better color and firmness if N levels are reduced by 0.2 percent, but high N levels are associated with maximum tonnage. Note: N levels may be lower on light-cropping trees.

Table 1-4. Foliar applications for special nutritional problems.

Problem nutrient	Material	Annual rate/acre ^a	Timing ^b	Comments
Nitrogen	Urea (45% N, Low biuret)	10 lbs	P or PF	Not recommended where calcium deficiency disorders are problems.
Calcium	Calcium chloride (77–80% CaCl ₂)	15–50 lbs	1–7	Do not substitute calcium nitrate. Do not premix calcium chloride with Solubor. (See Cork Spot and Bitter Pit Fruit Disorders.)
Potassium	Potassium sulfate (27% K ₂ O)	6–10 lbs	D or PH	Apply in a dilute spray. Do not use potassium materials containing nitrogen.
Magnesium	Magnesium sulfate (11%)	10 lbs	PF	May be applied in first or second cover. Compatible with pesticides.
Manganese	Manganese sulfate (24%)	5 lbs	D or PH	Apply in spring before growth starts.
Copper	Copper sulfate (22% Cu)	4–6 lbs	D or PH	Apply in spring before growth starts.
Boron	Solubor (20.5% B)	4 lbs 8 lbs	PF & 1 PH	Make two applications of equal rates, but do not exceed 8 lb/A per year.
Zinc	Zinc sulfate (89%)	5.5–11 lbs	D or PH	Apply before growth starts.

The materials listed are some of the more concentrated, single nutrient sources of these nutrients. Other materials may be suitable, but always ask for independent test results on products not known to be effective.

a. Commercial formulation.

b. D = dormant, P = pink stage, FB = full bloom, PF = petal fall, 1–7 = first through seventh cover sprays, PH = postharvest.

Table 1-5. General indices for judging nitrogen status of fruit trees.

Index	Low N	Normal N	Excessive N
Shoot growth	Bearing: small diam. <8 inches long Nonbearing: <10 inches	Avg. 12–18 inches Avg. 18–24 inches	Avg. 18–24 inches Avg. 24–40 inches
Leaf size	Small, thin	Medium to average	Large, thick, often puckering at tip
Leaf color	Pale yellow green	Normal green	Very dark green
Fall leaf drop	Early, leaves show red in veins	Normal, leaves green to light green	Late, leaves dark green until frost
Bark color	Light brown to red brown	Gray to dark gray brown	Green gray to gray
Fruit set	Poor, heavy June drop	Normal, 1–3 fruits per cluster	Little or no effect or reduction
Fruit overcolor	Highly colored often earlier than normal	Average color	Poor color
Fruit undercolor	Yellow earlier than normal	Yellow green at maturity	Green to green yellow at harvest
Fruit maturity	Earlier than normal	Normal	5–10 days later than normal

Adapted from G. Cahoon, Fertilizing Fruit Crops (Ohio Cooperative Extension Service).

toxic effects, other physiological problems, such as corking and bitter pit, can occur in apples and pears because of higher nitrogen levels that are not in balance with calcium levels.

Phosphorus

Deficiency: Deficiencies severe enough to produce visual symptoms are rare in fruit trees. When they do occur, symptoms may appear first as limited and slender terminal growth with young expanding leaves that are abnormally dark green. The young leaves' lower sides, especially along the margins and main veins, frequently show purplish discoloration. The leaves may have a leathery texture and form abnormally acute angles with the stem. Leaf symptoms are most often seen early in the growing season and diminish later in the season. When soil moisture is low, lower levels of phosphorus are common in leaf analysis results.

Toxicity: Effects of excess phosphorus are usually expressed as deficiencies of one or more of the essential heavy metals, such as zinc, copper, iron, and manganese. Since deficiency symptoms of these elements may also be induced by excesses of phosphorus, visual foliar symptoms of phosphorus toxicity are not reliable.

Potassium

Deficiency: Symptoms generally develop first on older leaves at the base of the current season's shoot growth. They are characterized by a marginal scorching of the leaves. In stone fruits an upward lateral curling and chlorosis may also become evident with the development of scorching. A heavy fruit crop usually accentuates the appearance of symptoms. Research suggests there is an inverse relationship between leaf potassium and crop load. Therefore, the lighter the crop the higher the demand for potassium. As with phosphorus, under conditions of low soil moisture, lower levels of potassium are common in leaf analysis results.

Toxicity: No known visual symptoms are directly attributable to high levels of potassium. However, magnesium deficiencies tend to appear when there are high levels of potassium.

Calcium

Deficiency: Specific foliar deficiency symptoms of a lack of calcium are rare in orchards. More common are symptoms induced by high levels of other nutrients. If deficiencies are present, they are first noticed in younger leaves as an upward cupping of leaf margins and a uniform veinal and interveinal chlorosis of the expanding leaves. Fruit often shows symptoms associated with a low level of calcium even when there may be sufficient levels in the leaves. (See section on bitter pit and corking.)

Toxicity: No known symptoms are associated with toxic levels of calcium.

Magnesium

Deficiency: In their severest stages, symptoms may look similar to the marginal scorching associated with potassium deficiency, although this is very rarely observed in Pennsylvania. More characteristic is a fading of the green color

at the terminals of older leaves, progressing interveinally (between veins) towards the base and midrib of the leaf and giving the typical "herringbone" appearance. In pears, dark purplish islands of tissue surrounded by chlorotic bands may develop in the interveinal areas. As the growing season progresses, symptoms develop on progressively younger leaves and the older leaves fall off.

Toxicity: Symptoms of excessive magnesium levels are not specific but usually appear as a deficiency of either potassium or calcium.

Micronutrients

The following elements are classified as micronutrients because they are required by plants in smaller quantities. With the exception of manganese, toxicities are very difficult to diagnose visually. Deficiency symptoms tend to be characteristic of the lack of a particular element.

Iron

Deficiency: Iron deficiencies are very common in plants.

Initial symptoms are a loss of green color in the very young leaves. While the interveinal tissue becomes pale green, yellow, or even white, the veins remain dark green. New leaves may unfold completely devoid of color, but the veins usually turn green later.

Toxicity: Although rare in the field, an excess of iron usually produces symptoms similar to those of manganese deficiency.

Manganese

Deficiency: Symptoms begin as chlorosis between the main veins starting near the margin of the leaf and extending toward the midrib. Symptoms can often be confused with those of iron and magnesium deficiencies. But unlike magnesium deficiency, manganese deficiency symptoms seldom develop so far as to produce interveinal chlorosis, the chlorosis normally being confined to leaf margins. The other distinguishing characteristic is that manganese deficiencies appear on the youngest leaves first, and the finest leaf veins do not remain green as they do with iron deficiencies.

Toxicity: "Measles" is a disorder of apples, especially Delicious and Jonathan. It is caused in part by an excess of manganese accompanied by low calcium levels.

Boron

Deficiency: In most fruit crops, boron deficiencies show up in the fruit before appearing in the leaves. Symptoms in apples and pears are similar: gnarled, misshapen fruit caused by depressions usually underlaid by hard corky tissue. This symptom is often confused with bitter pit or corking caused by calcium deficiency. Researchers disagree whether the two symptoms can be told apart visually. Boron deficiency might be distinguished from bitter pit by the presence of pitting from the peel to the core, whereas in bitter pit the pitting usually occurs only at the calyx end and only very close to the skin. In some instances of boron deficiency, the entire surface is covered with cracks that have callused over, producing a russeted appearance.

In plums, the symptoms appear as brown sunken areas in the fruit flesh, ranging in size from small spots to almost the whole fruit. The fruit usually colors earlier than normal, and falls. Gum pockets may also form in the flesh. In peaches, the flesh adjacent to the pit develops brown, dry, corky areas, and some fruits may crack along the suture. The most typical vegetative symptom is the death of the terminal growing points, resulting in a “witch’s broom” appearance.

Toxicity: Symptoms in apples include dieback of twigs, greatly enlarged nodes on 1- and 2-year-old twigs, early fruit maturity, internal breakdown, and dropping of fruit. Foliar symptoms occur first on the older leaves and include a yellowing along the midrib and the large lateral veins. In peaches vegetative symptoms include necrotic lesions on leaves, crinkling of margins and tips of leaves, reduced flower bud formation and set, and pit splitting.

Copper

Deficiency: Younger leaves appear stunted or misshapen, narrow, and slightly elongated with wavy margins. There may be some terminal dieback. Copper and zinc deficiencies often occur together and are aggravated in soils that have a high pH.

Toxicity: Symptoms are almost nonexistent under orchard conditions, but when present they may resemble those of zinc deficiency.

Zinc

Deficiency: Symptoms have often been described as a “rosetting” of leaves or “little leaf.” Newly developing leaves are smaller than normal. Reduced shoot elongation keeps them close together, resulting in the rosette appearance. In severe cases, older leaves may drop, resulting in a more pronounced rosetting. In the early spring, the observer might notice a delayed foliation of lateral leaves on last year’s shoots. This symptom has been confused with that of winter injury, but the distinguishing characteristic is that winter injury will also produce browning of the cambium.

Toxicity: Symptoms are rare and most likely are masked by secondary symptoms resembling those of other micronutrient toxicities.

Foliar Application of Nutrients

The most efficient way to apply nitrogen, phosphorus, potassium, and magnesium is by ground application. Foliar applications of these elements should be viewed as temporary or emergency solutions only. Boron, zinc, copper, and manganese can be added by either foliar or ground application. The foliar method is usually preferred because very small amounts are applied per acre. Table 1-4 gives foliar application suggestions. The materials listed in the table are the most common and the cheapest, but other commercial formulations are available. Since formulations differ by manufacturer, it is essential to check compatibility of the material when mixing. Foliar application of calcium to control cork spot and bitter pit is dealt with in Cork Spot and Bitter Pit Fruit Disorders.

Fertilizer Application

Nitrogen

Nitrogen requirements are best determined by tree growth and performance. Soil tests for nitrogen have not proven useful in determining tree needs. Table 1-5 gives visual indices for judging nitrogen status of fruit trees. As mentioned previously, nitrogen levels in a foliar analyses should be higher for young nonbearing trees. The values should be towards the upper end listed in Table 1-2. Leaf nitrogen levels also tend to be higher in samples from trees carrying heavy crops. Biennial bearing trees in their off year or trees with a light crop generally have lower nitrogen levels. This is probably related to the inverse relationship between shoot growth and fruiting.

Nitrogen cycle and its availability is a complex situation. Nearly 80 percent of our atmosphere is composed of nitrogen. Some can be precipitated out during thunderstorms and rain events. Additionally, much nitrogen is recycled when organic matter decomposes. It has been estimated that for every 1 percent of organic matter in the soil as much as 20 to 45 pounds of nitrogen per acre per year can be made available for plants to absorb. In addition, much of the nitrogen in the leaves can be remobilized back into the tree to be stored in the structural portions of the tree. This stored nitrogen is what supplies the initial tree growth in the spring. The larger the tree, the more potential nitrogen the tree can store. Conversely, this means that the new smaller trees on a per-tree basis will store less nitrogen.

In apples, we have a better understanding of nitrogen levels based on cultivar. Cornell University researchers (Warren Stiles and W. Shaw Reid, *Orchard Nutrition Management, Information Bulletin 219*, Cornell Cooperative Extension) suggest the following nitrogen levels in mature trees based on cultivar (Table 1-3):

1.8 to 2.2 percent nitrogen: Soft cultivars such as Cortland, Gala, Golden Delicious, Jersey Mac, Jonagold, Jonamac, Jonathan, Macoun, McIntosh, Mutsu, Paulared, Spartan, Tydeman’s Red, and other early ripening cultivars.

2.2 to 2.4 percent nitrogen: Delicious, Empire, Idared, Liberty, Melrose, Rhode Island Greening, Rome Beauty, Stayman, York Imperial, and other varieties.

Application rates: As a general rule, young trees may require about 0.01 to 0.04 pound of actual nitrogen per year of age up to 0.3 pound actual nitrogen per tree at maturity. These general levels should be adjusted up or down, depending on pruning, size of crop, cultural practices, indices presented above, and leaf analyses. Young nonbearing trees should grow up to 24 inches annually. Mature and heavily bearing trees should grow less, with apple and pear trees growing 12 to 18 inches; apricot, cherry, plum, and prune trees 15 to 18 inches; and peach and nectarine trees 18 to 24 inches.

Form of nitrogen: Fruit trees respond to any form of nitrogen fertilizer. Avoid using ammonium sulfate, urea, or ammonium nitrate if pH is below 6.0. Urea sprays may help increase fruit set but will not supply trees with all the nitrogen they require. Pear trees do not respond well to urea sprays. Applications of urea sprays to stone fruits are ineffective during the growing season. Calcium nitrate sprays should be avoided to discourage corking. (See Cork Spot and Bitter Pit Fruit Disorders.)

Time of application: Traditionally, we have said that nitrogen should be applied no later than 4 to 6 weeks before bloom. Recent research in the Pacific Northwest, however, indicates that application at this time results in the nitrogen chiefly accumulating in the foliage of the trees with little going into the flowers and developing fruitlets to help fruit set. Studies have shown that the majority of the nitrogen used to set fruit comes from the reserves within the tree and spring-applied nitrogen does not reach the developing fruit in time to be effective. In studies in apples in Oregon, late summer to early fall nitrogen application was found to be preferentially translocated to the roots and the flower buds where it was mobilized from the roots and available in the flower buds next spring to increase flower strength and fruit set capabilities. The theory that nitrogen should not be applied after the middle of July may be incorrect; however, we have no sound research on this different application timing in Pennsylvania. Until we have adequate information, the safest method is to continue your past fertilization practices or to experiment only on a small scale.

Phosphorus

Phosphorus is important to plant growth because it is a catalyzing agent that induces metabolic reactions. It permits the plant to use nitrogen and to develop seeds. Failure of seeds to set often results in abortion of the young fruit and in misshapen fruit. Preplant soil test recommendations are made to attempt to raise soil levels to 100 pounds available phosphorus per acre.

Application rates: Rates should be based on either leaf analysis or soil analysis. Soil levels of less than 100 pounds phosphorus per acre indicate that an application of phosphorus is needed. Leaf analysis levels of less than 0.18 percent in apples and pears; 0.15 percent in peaches and nectarines; 0.23 percent in cherries; and 0.09 percent in plums indicate a need for phosphorus.

Form of phosphorus: The effectiveness of special forms of phosphorus under Pennsylvania conditions has not been documented.

Time of application: Application may be made anytime during the year in established orchards. Preferably, applications should be broadcast before the trees are planted and turned under with the previous crop. This aids in getting phosphorus down into the root zone.

Potassium

Potassium is believed important for maintaining water turgor in leaves and for functioning in the opening and closing of stomates. It is available in the soil as a cation; at excessive levels it competes with calcium and magnesium for uptake by the plant.

Application rates: If the potassium level in the foliage is over 1.5 percent, a response to potassium application is doubtful regardless of the soil test, unless leaf nitrogen or soil magnesium is too high. When soil test values exceed 4.5 percent base saturation of potassium, then no additional potassium is needed. Values lower than this call for an application.

Form of potassium: Any added value of one type of potassium fertilizer over another has not been determined.

Time of application: Same timing as for phosphorus.

Calcium

Calcium plays a vital role in reducing the incidence of corking and bitter pit. Low soil-test values are often found in very sandy or shaley soils, but such values usually do not indicate a need to apply calcium or lime. Calcium in the form of limestone is important for maintaining soil pH. Improper soil pH can lead to deficiencies or toxicities of other nutrients. The need for lime is best determined by a soil test. Calcium, like potassium and magnesium, is available to the plant as a cation, and an excess of potassium or magnesium can reduce calcium uptake.

Application rates: Soil application depends on soil pH, buffer pH, and depth of pH change desired. Calcium chloride applied as a foliar spray is recommended to prevent corking and bitter pit in the fruit. Current recommendations and additional information are listed in Cork Spot and Bitter Pit Fruit Disorders.

Form of calcium: Growers should base their limestone-purchase decisions on the price per ton of calcium carbonate equivalent, including spreading costs. Most limestone contains some impurities, the most common being magnesium. Continual use of dolomitic or high-magnesium lime can cause problems in a tree's uptake of calcium. Dolomitic lime should not be used unless the soil test or the leaf analysis indicates a need for magnesium.

Time of application: In preplanting situations lime is most effective when broadcast and incorporated at least 6 to 12 months prior to planting. In established orchards any time is suitable, although postharvest or early spring applications allow rains to move lime into the soil. Regardless of how much rain accumulates, the process of raising the soil pH is slow, with the effects of lime moving downward at about 1 inch per year.

Magnesium

Leaf analysis values below 0.2 percent in apples and plums, 0.3 percent in peaches and pears, and 0.49 percent in cherries suggest that trees may respond to applications of magnesium. In soil tests, when the ratio of the percentage base saturation of magnesium to potassium is less than 2.0, magnesium applications may be needed.

Application rates: Foliar applications of magnesium sulfate at 10 pounds per acre should be viewed as quick but temporary measures. A more permanent solution is to apply a magnesium containing limestone at rates recommended in the soil analysis.

Form of magnesium: Magnesium is normally found in all but the purest limestone. The Penn State soil test results give a separate recommendation for magnesium. Growers should examine the purity of the limestone to determine whether the percentage of magnesium contained in it will also satisfy the magnesium requirement.

Time of application: Magnesium sprays are effective only when applied during the growing season. Applications may be single or split (i.e., applied at petal fall or in the first two cover sprays). Foliar sprays appear to be most effective when applied separately from pesticide applications. Ground applications can be made when lime is applied.

Boron

Boron is a nutrient often found to be low or deficient in orchards. Deficiency symptoms are observed more often in apple, plum, and pear trees than in peach and cherry trees. In apple trees, a deficiency may be expressed as internal cork in the fruit, as a dieback of shoots, and as bark necrosis. In pear trees, a deficiency may be expressed as internal cork, withering of blossoms, or poor fruit set. In peach trees, toxicity symptoms appear as necrotic lesions on leaves, crinkling of margins and tips of leaves, reduced flower bud formation and set, and pit splitting.

Tissue test values less than 35 ppm in apples indicate a shortage of boron. Values between 35 and 60 ppm indicate sufficiency. In the soil, values less than 0.5 ppm are low, while values between 0.5 and 1.0 ppm indicate a sufficient level. Caution: Excessive boron can be extremely toxic. Leaf values of over 80 ppm or soil values of over 1.0 ppm are excessive.

Application rates: In orchards where boron is low, apply 0.8 to 1.6 pounds per acre of actual boron (4–8 lb/A of Solubor 20.5% B) in two separate sprays at bloom, petal fall, or first cover; or apply a single postharvest foliar spray of 1.6 pounds per acre of actual boron. For trees more than 3 years old, apply boron annually to the soil. Apply 0.12 pound of actual boron per acre for 4-year-old trees. For each additional year of tree age up to 16 years, increase the rate by 0.02 pound per acre of actual boron. Use the lower rate as a maintenance program when no leaf analysis has been made. Eight pounds of Solubor per acre is recommended for proven cases of low boron.

Form of boron: Boron is most effective when applied as a foliar spray. Special formulations such as Boro-spray or Solubor should be used. Agricultural borax is adequate for ground applications.

Time of application: Soil applications can be made anytime. Foliar applications can be made during bloom or postharvest while leaves are still green and active on the tree.

Copper

Copper is a catalyzing element in plant metabolic reactions. Foliar analysis is best for determining copper deficiency. Values below 5 ppm indicate the need to apply copper.

Application rates: When leaf analysis indicates a deficiency, 4 to 6 pounds per acre of copper sulfate is recommended.

Form of copper: Copper sulfate (22% Cu) is the most readily available and cheapest material to use.

Time of application: Foliar applications should be made during the dormant season or after the fruit is off and while the leaves are still active and green. Soil applications can be made anytime.

Zinc

Deficiencies of zinc are becoming more common in Pennsylvania. Small leaves clustered on the end of shoots indicate zinc deficiency but may be confused with winter injury. Zinc applications are recommended when leaf levels are below 20 ppm. Foliar applications of zinc sulfate should only be made during dormancy or postharvest. Do not apply zinc sulfate with oil or apply within 30 days of the application of oil.

APPLES

Cultivars

The apple cultivar situation is changing rapidly across the country and within Pennsylvania. While the 2002 Pennsylvania Tree Fruit Survey indicates that Delicious and Golden Delicious are the state's two leading cultivars, several new cultivars are being widely planted.

Consider thoroughly which cultivars to plant. The first consideration is to determine how you intend to sell the fruit. Roadside markets, pick your own, and, to some extent, wholesale fresh market growers all need a continual supply of products. Therefore, it is important to choose cultivars that will accommodate an extended marketing period.

Information about various cultivars and their ripening sequences can be found in nursery catalogs. However, you should avoid being carried away by claims about a strain or cultivar—remember that nurseries are in the business of selling fruit trees. New to this edition of this guide is the addition of Table 1-6B, which lists the parentage, place of origin, and synonyms for many of the traditional apple cultivars grown throughout the United States as well as some of the newer, experimental cultivars.

The cultivar market has recently changed with the release of cultivars that have restrictions on the sale of the trees and/or the fruit. “Club” or “controlled supply” cultivars have been established to control oversupply in the market and enhance the dollar return to the grower. These restrictions can take multiple forms. Some cultivars are restricted geographically by only allowing certain areas to grow the fruit. Some are restricted by marketing constraints where the fruit must meet a minimum quality standard to be labeled. Finally, some cultivars may be restricted by only allowing a certain number of trees to be propagated, thereby controlling the overall supply of the fruit. Pacific Rose and Jazz are two club cultivars that require the grower to pay an “entrance fee”—purchase the trees then pay a percentage of the gross returns to a marketing firm. Kiku Fuji is another club cultivar that has no entrance fee, but in order to label the fruit Kiku Fuji, they must be graded to specific standards and marketed through a licensed broker. Common current apple cultivars grown in the United States or Canada that are managed in some form include Pink Lady, Tentation (Delblush), Ambrosia, Piñata, Jazz, Sundowner, SweeTango, and Aurora Golden Gala.

Before setting out large plantings of a new strain or cultivar, always plant a few trees on a trial basis. Also try to visit or talk to growers who may already have bearing fruit of a particular cultivar.

Many of the new cultivars are being introduced from Europe, New Zealand, and Japan. The marketplace is shifting, with more emphasis on taste and quality. Produce managers are looking for different color combinations to use in displaying apples. Following are comments from around the country on some of the newer cultivars being planted. Additional information can be found in Table 1-6. The harvest dates suggested in the table should produce apples with the most flavor. These periods will probably not coincide with harvest dates that are optimal for extended storage. For more information on harvesting for storage, refer to Part VI, Harvest and Postharvest Handling. The following are brief synopses of some of the more prominent cultivars.

Table 1-6. Apple cultivars.

Cultivar ^a	Pollen viability	Bloom	Vigor ^b	Harvest	DAFB ^c range est.	S ^e	PM ^e	CAR ^e	FB ^e
Akane	Good	Early to midseason	V	Early Sept.	105–110	M ^f	H ^f	H	M
Arlet*	Good	Early to midseason	MV	Mid-Sept.	125–130	H	H	H	M
Blondee	Good	Mid- to late season	MV	Late Aug.	105–115	H	— ^f	—	—
Braeburn*	Good	Midseason	MV	Late Oct.	160–170	H	H	H	H
Cameo* (Carousel)	Good	Midseason	VV	Mid-Oct.	155–165	H	M	H	M
Cortland	Good	Midseason	V	Early to mid-Oct.	125–135	H	H	H	H
Crimson Crisp ^d	Good	Midseason	V	Mid-Sept.	125–135	O	M	L	M
Crimson Gold ^d	Good	Midseason	V	Mid-Sept.	125–135	O	—	—	—
Crispin (Mutsu)	Not good	Midseason	VV	Late Oct.	160–170	M	M	M	L
Cripps Pink (Pink Lady*)	Good	Mid- to late season	VV	Mid- to late Nov.	180–195	H	O	O	H
Criterion	Good	Midseason	VV	Late Oct.	—	—	—	—	—
Delicious	Good	Midseason	MV–LV	Late Sept.	135–155	L	L	L	L
Earligold*	Good	Midseason	VV	Mid-Aug.	95–105	—	—	—	H
Elstar	Good	Mid- to late season	V	Early Sept.	110–125	H	H	H	—
Empire	Good	Midseason	LV	Early Oct.	125–140	H	H	L	M
Enterprise ^{g*}	Good	Mid- to late season	V	Late Sept.	135–145	O	M	O	O
Freedom ^d	Good	Mid- to late season	V	Late Sept.	140–150	O	O	H	L
Fortune	Good	Mid- to late season	V	Mid-Oct.	150–160	L	—	—	H
Fuji	Good	Mid- to late season	V	Late Oct to mid-Nov.	165–175	H	O	H	H
Gala	Good	Midseason	MV	Late Aug.	110–120	H	M	H	H
Galarina ^d	Good	Midseason	MV	Early–mid-Sept.	145–165	O	M	—	M
Gala Supreme*	Good	Mid- to late season	V	Early Oct.	150–160	M	M	M	—
Ginger Gold*	Good	Midseason	V	Early Aug.	95–105	H	M	H	H
Golden Delicious	Good	Midseason	V–MV	Mid-Sept. to early Oct.	135–150	L	L	L	M
Golden Supreme*	Good	Mid- to late season	MV	Early to mid-Sept.	125–140	M	M	L	—
GoldRush ^d	Good	Late Season	MV	Late Oct.	165–175	O	R	H	M
Granny Smith	Good	Late season	MV	Early Nov.	165–180	H	H	H	M
Gravenstein	Not good	Early season	VV	Early Sept.	110–115	H	H	H	M
Grimes Golden	Good	Early season	MV	Mid-Sept.	130–145	O	L	O	M
Honeycrisp*	Good	Early season	MV	Mid-Sept.	125–140	L	M	M	M
Idared	Good	Early season	MV	Early Oct.	145–160	H	H	H	H
Jerseymac	Good	Early season	VV	Mid-Aug.	90–110	H	H	L	M
Jonafree ^d	Good	Midseason	MV	Late Sept.	135–150	O	L	H	M
Jonagold	Not good	Midseason	V	Late Sept.	135–150	H	L	H	H
Jonamac	Good	Midseason	MV	Mid-Sept.	115–130	H	H	L	M
Jonathan	Good	Midseason	LV	Mid- to late Sept.	135–145	H	H	H	H
Liberty ^d	Good	Early season	V	Late Sept.	140–150	O	L	L	L
Lodi	Good	Early season	V	July	65–75	H	H	H	H
McIntosh	Good	Midseason	MV	Mid-Sept.	120–135	H	H	L	M
Macoun	Good	Midseason	LV	Mid-Oct.	130–140	H	H	H	M
Melrose	Good	Late season	V	Late Oct.	140–165	H	H	H	L
Mutsu (Crispin)	Not good	Midseason	VV	Late Oct.	160–170	H	H	H	M
Northern Spy	Good	Late season	VV	Mid-Oct.	140–160	H	H	H	H
Northwest Greening	Good	Midseason	V	Mid-Oct.	130–145	—	—	—	M
Novamac ^d	Good	Early season	MV	Mid-Sept.	115–125	O	M	L	L
Nova Spy	Good	Midseason	V	Mid-Oct.	—	O	L	M	L
Orin	Not good	Midseason	MV	Early Oct.	145–165	H	H	M	—
Paulared	Good	Early season	MV	Early Sept.	95–100	L	H	L	H
Pristine ^d	Good	Early season	V	Early Aug.	90–100	O	L	L	O
Redfree ^d	Good	Midseason	MV	Late Aug.	90–100	O	L	O	L
Rome Beauty	Good	Late season	V	Late Oct.	165–170	H	H	H	H
Sansa	Good	Midseason	LV	Late Aug.	100–115	—	—	—	—
Scarlet O'Hara ^d	Good	Midseason	M	Late Sept.	135–145	O	L	O	H
Shizuka*	Not good	Midseason	V	Mid-Sept.	130–140	—	—	—	—
Silken	Good	Early season	MV	Mid-Sept.	125–135	M	L	H	—

(continued)

Table 1-6. Apple cultivars (continued).

Cultivar ^a	Pollen viability	Bloom	Vigor ^b	Harvest	DAFB ^c range est.	S ^e	PM ^e	CAR ^e	FB ^e
Snow Sweet	Good	Early season	MV	Late Sept.	125–140	M	—	—	M
Spartan	Good	Midseason	V	Late Sept.	120–130	H	H	H	M
Spigold	Not good	Midseason	VV	Mid-Oct.	140–155	H	H	H	H
Stayman	Not good	Early season	MV	Late Oct.	165–175	H	L	M	M
Summer Rambo	Not good	Early season	VV	Late Aug.	90–100	H	H	H	M
Suncrisp*	Good	Midseason	V	Late Sept.	140–160	M	M	M	H
Sundance ^d	Good	Midseason	V	Mid-Oct.	140–150	O	L	O	O
Sunrise	Good	Midseason	MV	Mid-Aug.	95–105	O	—	—	—
Tydemans Red	Good	Early season	MV	Late Aug.	90–100	H	L	H	H
Williams Pride ^d	Good	Early season	MV	Mid-Aug.	85–90	O	M	O	L
Winesap	Not good	Late season	V	Late Oct.	165–175	H	L	H	L
Winter Banana	Good	Midseason	MV–LV	Late Oct.	160–170	H	H	H	H
Yellow Transparent	Good	Midseason	V	Mid-Aug.	65–75	H	H	H	H
York Imperial	Good	Midseason	MV	Late Oct.	170–180	H	H	H	H
Zestar!	Good	Early season	V	Late Aug.	95–100	M	O	M	M

Appreciation is expressed to Dr. Stephen Miller of the USDA Fruit Research Lab in Kearneysville, West Virginia, for additional information on disease susceptibility.

- a. Asterisk denotes newest cultivars. Some information is estimated based on data from other areas of the country.
- b. V = vigorous; MV = moderately vigorous; VV = very vigorous; LV = low vigor.
- c. DAFB = days after full bloom.
- d. Scab-resistant cultivar.
- e. S = scab; PM = powdery mildew; CAR = cedar apple rust; FB = fire blight; — = insufficient information.
- f. H = high; M = moderate; L = low; O = not susceptible; — = unknown.

Table 1-6B. Parentage of common and new apple cultivars.

Cultivar	Female parent		Male parent	Country/area of origin	Comments/notes	Synonyms
Akane	Jonathan	x	Worcester Permain	Aomori, Japan		Tohoku #3
Ambrosia	chance seedling			British Columbia, Canada	Possibly from Red and Golden Delicious	
Arlot	Golden Delicious	x	Idared	Wadenswil, Switzerland		Swiss Gourmet
Autumn Gold	chance seedling			Tieton, Washington	One parent is Golden Delicious	
Braeburn	chance seedling			Nelson, New Zealand	Possibly Lady Hamilton x ?	
Cameo	chance seedling			Dryden, Washington		Carousel
Cortland	Ben Davis	x	McIntosh	Geneva, New York		
Cripps Pink (Pink Lady)	Golden Delicious	x	Lady Williams	Australia	Correctly it should be called Cripps Pink	
Delicious	chance seedling			Peru, Iowa	Possibly seedling from Yellow Bellflower	
Elstar	Golden Delicious	x	Ingrid Marie	Wageningen, Netherlands		
Empire	McIntosh	x	Delicious	Geneva, New York		
Fiesta	Cox's Orange Pippin	x	Idared	East Malling, United Kingdom		
Fuji	Ralls Janet	x	Delicious	Aomori, Japan		
Gala	Kidd's Orange	x	Golden Delicious	Wairarapa, New Zealand		
GalaSupreme	chance seedling			Wenatchee, Washington		
Ginger Gold	chance seedling			Nelson County, Virginia	One parent may be Winesap	
Golden Delicious	chance seedling			Clay County, West Virginia	Possibly Grimes Golden x Golden Reinette	
Golden Supreme	chance seedling			Fruitland, Idaho		
GoldRush	Golden Delicious	x	Co-op 17	West Lafayette, Indiana		
Granny Smith	chance seedling			Sydney, Australia		
Honeycrisp	Keepsake	x	Unknown	Excelsior, Minnesota		Honey Crunch
Idared	Jonathan	x	Wagener	Moscow, Idaho		
Jonagold	Golden Delicious	x	Jonathan	Geneva, New York		
Jonathan	chance seedling			Kingston, New York		
Lodi	Montgomery	x	Yellow Transparent	Geneva, New York		
Macoun	McIntosh	x	Jersey Black	Geneva, New York		
McIntosh	chance seedling			Ontario, Canada		
Melrose	Jonathan	x	Delicious	Wooster, Ohio		
Mutsu/Crispin	Golden Delicious	x	Indo	Aomori, Japan		
Nittany	chance seedling			Biglerville, Pennsylvania	Possibly a York Imperial x Golden Delicious	
Northern Spy	chance seedling			Ontario County, New York		
Pacific Rose	Gala	x	Splendour	New Zealand		Sciros
Paulared	chance seedling			Sparta, Michigan		
Pink Lady	see Cripps Pink above					
Rome Beauty	chance seedling			Proctorville, Ohio		
Sansa	Gala	x	Akane	Morioka, Japan		
Silken	Honeygold	x	8C-27-96	Summerland, British Columbia		
Spartan	McIntosh	x	Newtown Pippin	British Columbia, Canada		
Spigold	Red Spy	x	Golden Delicious	Geneva, New York		
Stayman	chance seedling			Leavenworth, Kansas	Incorrectly called Stayman Winesap	
Sunrise	10C-10-19	x	PCF 3-120 9	Summerland, British Columbia		
Winesap	chance seedling			New Jersey?		
York Imperial	chance seedling			York, Pennsylvania		
Zestar!	State Fair	x	MN 1691	University of Minnesota		MN #1824

Akane was developed in Japan as a cross between Jonathan and Worcester Permain. The fruit is medium to small in size, round to oblate, and dark red. It matures one week ahead of Jonathan. Storage life is only about 3 weeks.

Arlet, also known as Swiss Gourmet, was developed in Switzerland as a cross between Golden Delicious and Idared. Apples are medium to large, round to conical, and brightly red striped. Harvest is reportedly 10 days sooner than that of Jonathan, but there is discrepancy in the literature. Fruit appearance has been very poor in the NE-183 planting at Rock Springs. Based on this, we are not recommending planting of Arlet.

Blondee was originally tested as MO 1040 by International Plant Management. It is a limb sport of Kidd's D-8 Gala that ripens one week before Gala. It is a completely yellow apple with Gala texture and Golden Delicious flavor. Storage is approximately 2 months in regular atmosphere. The cream-colored flesh of the fruit shows good resistance to browning.

Braeburn is a chance seedling from New Zealand most likely of Granny Smith parentage. Fruit is oval, small to medium, with slightly red shoulders over a green background. Braeburn has a long storage life. Red mutations are being discovered, primarily in New Zealand. Common strains along with their fruit surface coloration pattern are Kumeu Crimson (striped), Joburn (striped), Hillwell (striped), Eve (blush), Redfield (blush), and Lochbuie (blush). There is disagreement over its exact maturity date. One source places maturity around Rome Beauty season. These maturity differences may be related to nitrogen fertilization practices and strains. The cultivar is very precocious and growers should be careful not to fruit the trees too soon. Trees at Rock Springs have not been very productive and may be overly sensitive to either spring frosts or chemical thinners.

Cameo was originally introduced as Carousel and was also tested as Wenatchee 66. It is a chance seedling of unknown parentage. The fruit is an attractive bright red striped over a yellow-green ground color. Fruits are round to slightly elongated and medium to large in size. The flesh is firm and creamy white. Flavor has been reported as sweet-tart and well received by consumers. Storage life is reported to be up to 1 year in CA storage. Fruit matures in mid-October, after Delicious and about the same time as Braeburn.

Carousel. See Cameo.

Chinook is a cross between Splendour and Gala developed at the Summerland Research Centre in British Columbia. In the 1999 NE-183 plantings in Pennsylvania, fruit size has been extremely small. It was released due to its long storage life, but the size will probably keep this from being a viable cultivar in the eastern United States.

Cortland was developed at Cornell from a cross of Ben Davis and McIntosh made in 1898. The fruit are roundish oblate, attractively red colored, with a heavy bloom. Trees tend to be precocious and set heavy crops. Being a tip bearer, growth habit is similar to that of Rome Beauty. Standard Cortland may not color well in southern Pennsylvania. Therefore, two new strains having exceptional coloring capability, Redcort and Royal Court, are recommended for planting.

Creston was developed in British Columbia as a Golden type. Fruit

is medium to large with a green color that occasionally has a red shoulder. Flesh texture is firm and fine-grained. Fruit ripens around the middle of September in central Pennsylvania.

Cripps Pink (Pink Lady) is the correct name of the apple cultivar that is being marketed as Pink Lady. When trees are purchased, the grower receives a royalty-free license from Pink Lady America LLC, allowing the grower to use the Pink Lady name. It was developed in western Australia from a cross between Golden Delicious and Lady Williams. The fruit is medium in size and oblong in shape. The fruit has a pink blush over a yellow background with cream-colored flesh. The fruit has very firm flesh and has a long storage life. Trees are vigorous and upright growing, and are susceptible to fire blight. Most locations in Pennsylvania, however, do not have a long enough growing season to adequately mature the fruit. In central Pennsylvania fruit are harvested still immature around November 5.

Criterion is a chance seedling found in a Delicious and Golden Delicious orchard in Washington. Fruit is medium to large with a shape similar to that of Delicious. It is a clear yellow with an occasional red blush. Fruit matures around Rome Beauty season. The flesh is cream colored with a mildly sweet flavor that is juicy and aromatic.

Delicious is not a new cultivar, but new strains are available. Considering current economic factors, only spur types are recommended for planting. The following new spur types are available:

Ace Spur is as a limb sport of Oregon Spur and was developed by Columbia Basin Nursery. Although a spur type, it is a very vigorous-growing spur type. Fruit color is similar to that of Oregon Spur but is earlier coloring.

Adams Apple is a very early coloring strain that developed as a limb mutation of Oregon Spur in an orchard in Washington state. Fruit develops 100 percent red color shortly after fruit set. Growth habit is similar to that of Oregon Spur.

Early Red One, although not a spur type, is a weaker-growing nonspur. It deserves mention as one of the darkest strains evaluated. In some areas, it may color too intensely.

Midnight Spur is an early solid red coloring strain developed as a mutation of Oregon Spur.

Oregon Spur II is a higher-coloring sport of the original Oregon Spur. It also develops stripes, and vigor is similar to that of its parent. Trials in West Virginia indicate that it is a heavy bearer. It will probably replace its parent in new plantings.

Redchief (Campbell) has been one of the best early coloring strains evaluated, but one drawback is its lack of vigor. It is very precocious and if fruited too early will runt out and not fill the allotted space. If designing plantings with this strain, either use a more vigorous rootstock than other spur types or plant trees 1 to 2 feet closer in the row. This strain is no longer patented and may be listed in some catalogs simply as Campbell Delicious.

Schlect Spur, an early coloring strain that may mature earlier as well, was found in Yakima, Washington.

Superchief is a whole tree mutation of Redchief. Like its parent tree, the fruit fills in as a stripe but earlier than Redchief.

The tree has the same compact growth habit, so care must be taken not to fruit the tree too soon or it may run out.

Older strains continue to be productive, but they take longer to develop color than the strains mentioned above. Starkrimson, Oregon Spur I, Redspur, Sturdeespur, and Wellspur have consistently rated lower in color evaluations at 145 to 150 days after bloom. Growers who desire early, high-coloring strains are advised not to depend on these.

Delblush is a cross between Golden Delicious and Blushing Golden and is known in France as Tentation. Fruit size is medium. The color is golden yellow with an orange blush over the shoulders. The fruit has a slightly sweet to sub-acid flavor as grown in Pennsylvania. Harvest in central Pennsylvania in 2002 was approximately 4 days after Golden Delicious.

Earligold is another chance seedling found in Selah, Washington. Fruit size is medium, having a clear yellow finish with little or no russeting. Fruit from plantings in central Pennsylvania mature approximately 5 days before Ginger Gold. Storage life of this fruit was shorter than that of Ginger Gold. At this point, Earligold should be considered primarily for roadside market sales.

Elstar, sometimes also referred to as Lustre Elstar, was developed in Holland as a cross between Golden Delicious and Ingrid Marie. Fruit is medium to large, round to conical, with red striping over a bright yellow background. Elstar matures in early to mid-September and has a medium storage life. In Europe it is marketed as a red blushed Golden Delicious. Fruit from plantings in central Pennsylvania appear nearly solid red. Fruit is heavily russeted across the shoulders.

Enterprise. See discussion below on scab resistant apple cultivars.

Fortune was developed by Cornell University and was tested as NY429. Fruits from plantings in central Pennsylvania are large to very large with an attractive overall red color. The flesh is creamy white, and the tree may tend toward biennial bearing. At present we do not know how it will perform in the warmer areas of the state. It is popular in New England and is recommended for trial only in areas where McIntosh is grown.

Fuji was developed in Japan as a cross between Ralls Janet and Delicious. Fruit is medium-sized, round to conical. The strong biennial bearing habit of the cultivar makes it imperative that the trees are adequately thinned. This cultivar would be a good candidate for midseason applications of NAA to enhance return bloom. In recent years there have been a number of early maturing strains of Fuji discovered, which would allow the cultivar to be grown in nearly all portions of the state. Following are some comments on the various available strains:

Early maturing strains:

Autumn Rose is a full tree mutation of Nagafu 12 found in Oregon.

Auvil Early Fuji (Fuji 216) was discovered in Washington and ripens 3–4 weeks before standard Fuji. It contains apple mosaic virus and therefore should not be grafted onto G.16 rootstock.

Daybreak Fuji (Rankin strain) was found as a limb sport of Yataka in an orchard in Adams County, Pennsylvania. It ripens about 5 days ahead of Yataka and has better color and a smoother skin.

Jubilee Fuji (formerly known as September Wonder Fuji) is an early maturing strain of standard Fuji. In 2002 it ripened in mid-September in Pennsylvania and had excellent fruit color.

Morning Mist Fuji ripens 3 to 4 weeks ahead of standard Fuji with a thin striping pattern of red color.

Rising Sun matures 4 to 5 weeks before standard Fuji with a bright pinkish-red blush.

Normal maturing strains:

Aztec (DT2 cultivar) was discovered in New Zealand and produces a blush coloration pattern.

Brak (Kiku) is a branch mutation found in Japan by a grower from Italy. This strain, if it meets grading standards, can be sold by a licensed broker under the brand name of Kiku Fuji.

Lynd's Spur Fuji was found at Lynd's orchard in central Ohio, but the color pattern has not been reported.

BC#2 (Moriho-fu #2) is another irradiated selection from Japan that develops a striped color pattern.

Nagafu #2, Nagafu #6, and Nagafu #12 were all developed at the Nagano Research Station in Japan. *Nagafu #6* is a striped red, while the other two are blush colored. Of the three, *Nagafu #2* is reported to develop the most color.

Sun Fuji is a sport discovered in California and is reported to have a better color than any of the other strains.

Myra Red Fuji (Broetje strain) is a red sport found in the Pacific Northwest.

TRECO Red Fuji (Cooper strain) has a red striped color pattern.

Top Export Fuji (Snyder strain) is a sport of BC#2 with better color capabilities.

Gala was developed in New Zealand as a cross between Kidd's Orange Pippin and Golden Delicious. Fruit is small to medium in size and uniformly oval to round. The original Gala is pale to golden yellow, with bright red-orange stripes. The fruit matures at the end of August in the southern portions of Pennsylvania. Storage life is rated at approximately 3 to 6 months. Gala requires multiple pickings for best quality. Available strains include Original (Kidd's D8), Autumn Gala (Harry Black), Brookfield Gala, Buckeye Gala (Peace Valley strain), Crimson Gala (Waliser), Extra Red Gala (Wyles), Galaxy Gala (Kiddle), Gale Gala (Malaga), Imperial Gala (Tenroy), Lydia's Red Gala (Hilltop), Spur Gala (Lynd), Pacific Gala (Olsen), Regal Gala (Fulford), Regal Gala (Applewaites), Royal Gala (Tenroy), Scarlet Gala (Creech), Star Gala (Weaver), TRECO Red Gala No. 42 (Cooper), Twin Bee Gala, Ultima Gala (Banning), and Ultrared Gala (Obrogala).

Gala Supreme is a chance seedling that developed from a root sucker on a seedling rootstock in Washington. It should not be confused with Gala or any Gala strain. Fruits have up to a 90 percent attractive red stripe over a yellow ground with pronounced red lenticels. Flesh is firm, crisp, and very juicy. Fruit matures around the time that Delicious does, but should only be stored for 2 to 4 months in common storage. It is not recommended for commercial trials due to its uneven fruit color and fruit finish.

Ginger Gold is a chance seedling found in a commercial orchard in Virginia. It is sold as an early maturing Golden type, har-

vested in early to mid-August. Fruit finish is very smooth with little russetting. Storage potential is rated as very good. Trees are very precocious. In test plantings in central Pennsylvania, second leaf trees on M.9 size rootstocks have had up to 15 fruits per tree. Trees are susceptible to powdery mildew.

Golden Supreme is a Golden Delicious–like fruit that occasionally has a pink blush. It is a chance seedling and produces fruit that is pleasantly sweet but better and tarter than Golden Delicious. It is also more vigorous than Golden Delicious. In the NE-183 plantings, it is one of the most attractive-looking apples with very little russet. A drawback is that it has not been very precocious in the planting at Rock Springs. May need multiple harvests and tends toward biennial bearing like Golden Delicious.

Hampshire is a chance seedling found in New Hampshire that is being evaluated in the 1999 NE-183 planting. Fruit is medium to large and has a well-colored red surface. It has some McIntosh-looking characteristics. Flowers may have some frost tolerance since this cultivar did not seem to be excessively affected by late frosts in 2002.

Honeycrisp was developed at the University of Minnesota and tested as Minnesota #1711R. Fruits are large with a 50 to 90 percent solid to mottled scarlet red over green. Storage life in common storage has been as long as 6 to 7 months. Noted for outstanding crispness and juiciness. Leaves of Honeycrisp frequently exhibit a green mottling during the summer. At present, we do not know if the discoloration is affecting production. The tree is not very vigorous and should not be planted on M.9 or B.9 unless they are spaced close together. For further information on this and the other cultivars recently released by the University of Minnesota, go to www.apples.umn.edu/nurseries/posters.html.

Jonagold was developed in New York as a cross between Golden Delicious and Jonathan. Although introduced in 1968, Jonagold has become more popular in Europe. Because of this demand, however, it is gaining favor in the United States. Jonagold is rated as one of the best-tasting apples. Fruit is large and conical, similar to Golden Delicious. Jonagold may have only medium storage potential. It is a vigorously growing triploid and therefore cannot be used as a pollen source. It is also intersterile with Golden Delicious. As with Gala, red sports are being released and there is similar concern about marketplace acceptance of noncoloring strains. Some of the more popular strains are: Morren's Jona-go-red, DeCoster (Swillen), Jonica (Schneica), Nicobel, Rubinstar (Herr), Jored (Nicolai's King Jonagold), and Wilamuta. In addition, many strains are being developed and tested in Europe. These include Crimson, Jomured, Jonabel, Crowngold, and others.

Nittany, although not a new cultivar, has recently attracted attention from many areas outside of Pennsylvania. Discovered as an open-pollinated seedling of York Imperial (pollen source may have been Golden Delicious), it has the flesh color, texture, and firmness of York. Fruit have been described as attractive, oblong, and light cherry red, with a good sweet tart flavor. It is a vigorous tree. The major problem seems to be storage and calcium-related disorders.

Orin is a cross of Golden Delicious by Indo developed in Japan. It has the same parentage as Shizuka and Mutsu. Fruit are medium to large, oblong, and yellow-green in color. The flesh is firm, aromatic, juicy, and very sweet. Test plantings at Rock Springs, however, have shown a tendency for prominent markings of the lenticels. This cultivar will probably not be of sufficient quality to be grown in Pennsylvania.

Pristine. See section on scab-resistant cultivars.

RubINETTE is a high-quality introduction from the Swiss breeding program, a cross between Golden Delicious and Cox's Orange Pippin. The fruit is described as having a brilliant red stripe over a golden ground with a faint russet. Fruit is small and has a very sweet flavor with a slight tang and aroma. Tree growth habit is like that of Golden Delicious; moderately susceptible to powdery mildew and moderately resistant to apple scab.

Sansa is attractive, crisp, aromatic, medium-sized, and sweet-flavored. It may be stored for up to 2 months. One report says that Sansa is resistant to apple scab. The fruit matures in central Pennsylvania about 2 weeks before Gala. Good-quality fruit for its season. The trees in the NE-183 planting at Rock Springs have weak vegetative growth, and it is unknown if this is the natural condition of the cultivar.

Shizuka was developed in Japan from a cross between Golden Delicious and Indo. It has the same parentage as Orin and Mutsu. Fruit is very large with a green to yellow skin that occasionally shows a pink blush. Fruit is sweeter than Mutsu, but fruit quality is not as good. Fruit is harvested in late September. Tree growth is very spreading. Shizuka is being promoted as a replacement for Mutsu because it does not appear to be susceptible to Blister spot. It is a triploid, and therefore the pollen is not viable.

Silken is a cross between Honeygold and a numbered selection (8C-27-96) developed at the Summerland Research Centre in British Columbia. It is an early apple, ripening in August. The skin has a soft, yellow, almost translucent quality. Fruit is crisp and juicy. Trees are slow growing, but precocious. Limited commercial availability.

Snow Sweet is the latest release from the University of Minnesota. It was developed from a cross between Sharon and Connell Red. The flesh is sweet with a hint of tartness and bright white that does not oxidize very easily. Tree growth habit is more willowy. Fruit ripen approximately 2 weeks after Honeycrisp. For further information on this and the other cultivars recently released by the University of Minnesota, go to www.apples.umn.edu/nurseries/posters.html.

Suncrisp (NJ 55) is a large late season yellow apple, striped orange cheek over a lemon yellow ground color; conic fruit with crisp yellow flesh; unique spicy flavor; good storage potential. Harvest season is about one week after Delicious. Very precocious; in the NE-183 cultivar trials in central Pennsylvania, it was among trees with the largest yields in their third leaf. Fruit quality improves with a short storage period.

Sunrise is another release from British Columbia and ripens just before Gala. Fruit color is an attractive pinkish-red over a yellow ground color that is medium in size. Fruit flavor is mild to slightly sweet.

Zestar! is the most recent release from the Minnesota breeding program. It is an early season apple that ripens in late August. It was developed from a cross of State Fair x MN 1691. The apples are globose with an average diameter of 3 inches and are typified by a red striping. As a young tree the growth habit is upright. It is susceptible to fire blight. Growers should only make trial plantings of this cultivar. For further information on this and the other cultivars recently released by the University of Minnesota, go to www.apples.umn.edu/nurseries/posters.html.

(Some of the information on specific cultivars was compiled from Pacific Northwest Fruit Testing Association materials as well as the NE-183 website, www.ne183.org.)

Scab-resistant cultivars

Many scab-resistant cultivars have recently been released as a result of breeding programs in the United States and elsewhere. They were developed primarily for resistance to apple scab, but some are also resistant to cedar apple rust, powdery mildew, and fire blight. Disease resistance does not mean total freedom from pesticides, since none of these cultivars are immune to insect damage or summer diseases like sooty blotch or flyspeck. There are some new cultivars coming from Germany that will have multiple resistances to such diseases as powdery mildew and fire blight, among others. These are being marketed as “ReZista Series.”

Earlier releases such as Prima and Priscilla were not well accepted because of poor fruit quality. Since their release, newer cultivars now available may have promise for commercial orchards. Following are comments on selected apple-scab-resistant cultivars (see also Table 1-6):

Crimson Crisp was named by the Purdue Rutgers Illinois cooperative breeding program. It was tested as Co-op 39. The medium to dark red fruit have a cream-colored, mildly acidic, coarse flesh. The fruit will store about 6 months in regular storage. In addition to apple scab they are moderately resistant to rusts and powdery mildew. It is susceptible to fire blight. Fruit matures around the middle to end of September and hangs well on the tree.

Crimson Gold was originally tested as Svatava from the Czech Republic. While resistant to scab it is slightly susceptible to powdery mildew and susceptible to fire blight. Fruit are medium size with fine texture, juicy, and have a good acid balance. Fruit ripen just before Golden. Storage life is 7 to 8 months. May not be suitable for more northern areas of PA as it has been reported to produce better under warmer conditions.

Crimson Topaz was developed in the Czech Republic from a cross between the Czech apple cultivars Vanda and Rubin. Topaz is a medium to medium-large apple. The skin color is yellow overlain with a red and crimson flush. The flesh is crisp and cream colored. The trees are moderately vigorous and very precocious. Trees are resistant to apple scab and moderately resistant to powdery mildew. Fruit matures about 1 week after Golden Delicious.

Dayton was released in 1988. Its fruit ripens about 4 weeks before Delicious. Fruits are large with a glossy red color. Reports indicate that maximum storage may only be one month. The tree is vigorous, with strong, upright-growing branches. It has good resistance to mildew and cedar apple rust and moderate resistance to fire blight. No trees of this cultivar have been planted in Pennsylvania for evaluation.

Enterprise (Co-op 30) was released in 1993 by the PRI program as a later-maturing, scab-resistant apple cultivar. Flesh is yellow, with a 75 percent red skin. Fruit is of good quality. Flavor is very good although on the tart or acid side. Enterprise matures around October 15 in south-central Pennsylvania and about a week later in central Pennsylvania. The tree has a very vigorous growth habit. It is suggested for both homeowner and commercial trials. It is believed prone to corking, but this has been controlled in south-central Pennsylvania plantings with standard calcium chloride programs.

Freedom (NY58553-1) is ready for harvest around the end of September. Fruits are large and their external appearance is not very good, having a rough-looking finish. This cultivar does not store well, having ripened unevenly on the tree. Suggested for home plantings only.

Galarina is a Gala-like apple that is resistant to apple scab and can be stored for longer periods. It was developed in France from a Gala and Florina cross. The medium-size fruit matures 1 to 2 weeks after Gala. The skin color is 65 to 100 percent orange red over greenish yellow with flesh that is yellowish white. The flavor is aromatic and slightly tart. Trees are moderately vigorous.

GoldRush (Co-op 38) was released in 1993 by the PRI program and is resistant to apple scab. The tree is moderately vigorous with an upright growth habit. The fruit ripens very late. Its growing season may be too long to be planted from central Pennsylvania northward. Fruit quality is excellent, and fruit has an approximately 7-month storage period. Fruits are medium to large and have a spicy to slightly acid taste at harvest, becoming better after a period of 2 months in storage. For someone looking for a Golden Delicious type, GoldRush would work very well. Suggested for both homeowner and commercial trials.

Jonafree, released in 1979, ripens with Jonathan and has a 95 percent red overcolor much like Jonathan's, but it is less susceptible to fire blight and powdery mildew than Jonathan. Jonafree is a very hard apple that does not develop a good flavor until after a period of storage. This cultivar has very vigorous growth and tends to be a tip bearer as well as an alternate year bearer. May work for processing and for homeowner use.

Liberty (NY55140-19), released in 1978, is dark red and resistant to rusts, mildew, and fire blight. Its harvest date is the last week in September to the first week in October in State College, although one source indicates ripening is about 10 days after McIntosh. The fruit tends to be small and may require multiple pickings; flavor is better after storage. Japanese beetles favor this cultivar to the extent that extra sprays are needed to control the pest.

Nova Easygro was released in 1975 from Kentville, Nova

Scotia. It is a large apple, red striped over green, somewhat like McIntosh but a deeper red. The calyx is partially open to closed. Flesh is cream-colored and of a medium coarse texture. Flavor is tart (like Jonathan). The tree is very vigorous and ripens somewhat unevenly. The quality of apples grown in State College has been fair to poor. Plantings in 1990 experienced a preharvest fruit drop. No longer recommended in Pennsylvania for either commercial or home use.

Novamac is a McIntosh type released from Kentville, Nova Scotia. In plantings at Rock Springs on M9 rootstocks, the trees have been very precocious and have been consistent croppers. The fruit looks and tastes like McIntosh. This cultivar holds promise for both backyard and commercial use in areas where McIntosh is grown. Severe preharvest fruit drop in 1994.

Nova Spy was developed in Nova Scotia as a scab-resistant “Spy-type” apple. It is a juicy, firm-fleshed red apple. It is moderately susceptible to rusts and only lightly susceptible to powdery mildew. It was developed in Canada from a cross between Nova Easygro and NY-44411-1. The fruit are attractive, moderate high quality, long keeping, and similar to Northern Spy. Fruit are medium in size, globose conical, and slightly ribbed. The flesh is creamy yellow, fine, very firm, crisp, and juicy. The fruit mature between Delicious and Northern Spy. It is an excellent processing cultivar. The tree is upright and moderately vigorous.

NY-75414-1 is an advanced selection from Cornell, developed by crossing Liberty with Macspur. Fruit grown in central Pennsylvania are very dark red to almost purple and slightly resemble Macoun. It is harvested around the middle of September. In the NE-183 planting at Rock Springs, it is one of the weakest-growing trees.

Otava was developed in the Czech Republic from a cross between Sampion and Jolana. The globose and ribbed fruit matures with Golden Delicious and has yellow skin with a slight red-orange blush. The flesh is yellow to cream with fine-grained texture, juicy, and has a sweet subacid flavor. It is resistant to apple scab and tolerant to powdery mildew.

Pixie Crunch was released in 2004 from the Purdue, Rutgers, and Illinois cooperative breeding program. The blushed dark red to purple fruit have a yellow flesh that is extremely crisp, medium to fine grained, and juicy. Storage life is at best 2 months. The flavor is moderately to mildly acid. Fruit size tends to be small (2.5 inches diameter), which may decrease its value as a commercial cultivar. It is immune to apple scab, susceptible to powdery mildew, and moderately susceptible to fire blight.

Pristine was released from the Purdue, Rutgers, Illinois breeding program in 1995. It is also moderately resistant to fire blight, slightly resistant to cedar apple rust, and resistant to powdery mildew. Fruit matures with Lodi and should be used as a replacement for Lodi. Plantings at Rock Springs have been very productive. Fruit color is green to yellow.

Querina is also known as Florina and was developed in France. Fruit size is similar to Empire. Tree is moderately susceptible to powdery mildew and tolerant of fire blight. Matures about 2 weeks after Goldens.

Redfree, released in 1981, is a red-skinned summer apple. Harvest is around the middle of August in State College (6–7 weeks before Delicious). Storage life is only about 2 months; shows moderate tolerance to fire blight and powdery mildew. Tree wood is very brittle and weak. Redfree tends to be a tip bearer like Rome Beauty. Suggested only for homeowner use and possibly roadside markets.

Rubinola is resistant to apple scab and powdery mildew and matures 10 days before Golden Delicious. The trees are vigorous. The cultivar was the result of a cross between Prima and Rubin. The fruit are medium to large, flat, globose, and with a skin that is bright red over most of the surface, although some russetting can occur. The flesh is yellow, firm, fine textured, juicy, and has a sweet aromatic flavor.

Scarlet O’Hara was released in 2004 from the Purdue, Rutgers, and Illinois cooperative breeding program. It was previously tested as Co-op 25. It is a midseason red apple that ripens one week before Delicious. The fruit are round to slightly conic. The overcolor is described as 75 to 90 percent medium red to orange with a green yellow to yellow undercolor. The flesh is yellow to cream colored, firm, and crisp. The flavor is sweet to mildly subacid. The tree and fruit are field immune to scab, moderately resistant to powdery mildew, highly resistant to cedar apple rust, and highly susceptible to fire blight.

Sundance was released in 2004 from the Purdue, Rutgers, and Illinois cooperative breeding program. It was previously tested as Co-op 29. The pale yellow fruit are large and attractive. They have moderate stem-end russet. The flesh is medium to coarse cream colored with a very firm and crisp texture. The fruit have good storage potential and mature about 2.5 weeks after Delicious. Fruit tastes best after about a month in storage. Sundance is moderately resistant to powdery mildew and highly resistant to cedar apple rust and fire blight. Full details on the cultivar can be viewed in *HortScience* volume 39 number 2.

Williams Pride was released in 1988, one of the earliest-ripening cultivars released. Matures approximately 1 week after Lodi; in our plantings has matured around the middle of August. The dark red fruits are large with a semitart flavor that is very good. May have uneven ripening requiring multiple pickings. Growth observations indicate that the tree is very willowy. Suggested for homeowner use and roadside markets. Shows a strong tendency toward bitter pit.

The Future of Scab-Resistant Cultivars

Many more cultivars are being developed and tested in Europe. The Czech Republic, Italy, France, and Latvia all have active breeding and testing programs. The limitations to obtaining these cultivars is the inability to import new plant materials without going through a lengthy screening process. The other limitation to the wide adoption of scab-resistant cultivars is that most of the cultivars only carry the Vf gene for resistance. Establishing solid plantings of Vf-resistant cultivars may cause a breakdown in resistance of scab protection. In Switzerland where they have been growing scab-resistant cultivars, it is recommended that even if the cultivar is scab resistant a minimum number of sulfur sprays be applied each year to prevent the buildup of apple scab populations that can overcome the Vf resistance.

The Basics of Pruning

Fruit growers are constantly manipulating tree canopies to maximize fruit production. This is done in two ways: by pruning to remove limbs or shoots or by bending limbs or shoots in specific orientations. Pruning and training are therefore horticultural manipulations done to modify naturally occurring growth patterns within plants. The primary processes being modified are apical dominance (see below) and the natural flowering and/or fruiting characteristics of the trees.

The first point to remember is that pruning is a dwarfing process. A pruned tree will always be smaller than a same-aged tree that was not pruned. For pruning to be effective, however, it must be practiced with an understanding of how trees respond to branch or shoot removal and of how those removals affect future tree growth.

The second point to remember is that training affects primarily tree form, while pruning affects mainly function. Training determines the general character and even the details of the plant's outline and its branching and framework. Pruning is meant to determine how and when the tree will fruit. Therefore, training and pruning are two different aspects of modifying naturally occurring growth patterns. Training involves tree development and form, whereas pruning involves tree function and size.

Training takes place in the first 4-5 years of the tree's life. Pruning is conducted for the entire life of the tree. In a tree's early productive years, the goal of pruning is to contain excessive vigor. During declining years, pruning's emphasis shifts to promoting vigor and allowing maximum sunlight to penetrate the tree canopy.

Types of pruning cuts

Regardless of the kind of fruit tree (or, for that matter, kind of plant), only two types of pruning cuts are made: heading back cuts and thinning out cuts. Every other cut you may hear discussed is a variation of these two. A heading back cut is the partial removal of a shoot, limb, or branch. In orchards this may range from the tipping of leaders or branches to the use of mechanical hedging machines. A thinning out cut is the removal of an entire shoot, limb, or branch at its point of origin. In orchards this can include the removal of a primary or secondary scaffold limb, removal of a spur system, or desuckering interior water sprouts arising from horizontal limbs.

Impact of flower position

The difference in how a tree or plant responds to these two cuts is the basis for the different training systems. Concurrent with knowing how a tree responds to these two cuts is knowing where the particular species produces flowers and fruits. Every bud on a tree is regarded as a potential flower bud; therefore, flowers can occur in many areas. In general, however, they occur (a) terminally on long or short growths, (b) laterally in the axils of the current or past season's leaves, and (c) adventitiously from any point on the exposed bark of limbs, trunks, or roots (rarely).

As a rule, the position of the flower or inflorescence on the shoot relative to the current season's growth is characteristic of the species or cultivar and does not change much. In apples fruit buds are borne terminally, unfolding to produce leafy shoots that terminate in flower clusters. Most of these terminal flowers are on short shoots called spurs. However, they can occur at the ends

of long shoots, especially in the "terminal bearers" such as Rome Beauty. Flowers are infrequently also found as laterals arising on last year's wood. In most instances, in Pennsylvania and the Mid-Atlantic areas, these flowers do not set fruit. When the lateral flowers do set fruit, the resulting apples are usually small and of poor quality. The proportion of spur growth and flowering sites to terminal long shoot flowers is characteristic of a given cultivar and must be assessed when pruning in the field.

Apical dominance

Regardless of basic growth habit, all trees respond similarly to a given type of pruning cut. Heading cuts remove the growing point and developing leaves if applied during the summer and the terminal bud if applied during the winter. This operation severely changes the shoot's hormonal balance and forces the plant to react accordingly. The tendency for suppression of the lateral bud break is referred to as the apical dominance of the terminal bud.

This young growing point or terminal bud is the site of manufacture of the class of plant hormones known as auxins. Removing either the shoot tip or the young growing leaves stimulates the growth of lateral buds into side shoots because of the removal of that site of auxin manufacture. The lateral buds are inhibited in growth by auxins produced in the young meristematic tissues contained in the shoot tip and transported back downward. This effect must occur when the leaves are very young because removing young, developing leaves can stimulate lateral bud break; but removing fully expanded leaves cannot stimulate growth.

There are two ways to overcome this apical dominance effect from shoot tips. One is to remove the shoot tip as in a heading cut and the other is to bend a shoot tip to a more horizontal position. The latter works because auxins generally move in response to gravity.

Research has suggested that the inhibition of flower bud formation can be explained by the alteration of three plant hormones: cytokinin, auxins, and gibberellins. All three occurred in higher concentrations in the conductive tissues of trees that were pruned. Cytokinin-like substances were doubled in the conductive tissues at the very beginning of growth in the spring. In mid-June, after a month of growth, auxin levels were much higher in pruned trees than in nonpruned trees. This was followed by higher levels of gibberellins from the middle of June to the end of July in the pruned trees, compared to controls.

Trees given no pruning

When growth begins, the terminal and subterminal buds are usually the first to start; in most deciduous trees and vines (less so in shrubs) they produce the longest and strongest shoots, although shoots may grow from many of the lower buds. However, seldom do all the lateral buds start, and as a rule the largest percentage of those remaining dormant are on the basal portion of the shoot.

Response to heading cuts

The result of a heading cut is the loss of apical dominance as mentioned above, with the removal of the inhibiting effect on the lateral buds. The net result is an increase in total shoot growth. Both shoot number and length are affected, but the impact is affected by shoot age, severity of cut, growth habit, and shoot orientation.

Shoot age

The stimulation of shoot growth is most pronounced when heading cuts are made into 1-year-old wood. Such cuts usually result in very vigorous shoots from the three to four buds immediately below the cut. These shoots can develop very narrow angles. Heading cuts made near the top of these shoots induce the top five to seven buds to grow, usually within 6 to 9 inches below the cut (although this will also vary by severity of cut and orientation of the branch).

Severity of cut

Severity can be long, medium, short, or very short (with a very short cut removing the most wood). Regrowth is related to the severity of cut in a bell curve response and time of season that pruning is done. Strong shoots have well-developed buds along the upper three-fourths of the shoot. At the shoot base, however, the buds normally are not as well developed. This difference may explain why the strongest regrowth usually occurs when shoots are headed by one-half to three-fourths their length. At the same time, heading back close to the annual ring (where growth began or very short will likely lead to less regrowth. The results of dormant shoot heading thus are influenced by the condition of the bud that becomes uppermost after heading. Heading cuts made in the dormant season stimulate the most regrowth, while those made late in the summer stimulate less regrowth.

Heading into older wood is not as invigorating as cuts made in 1-year-old wood. Nevertheless, it still increases total shoot growth.

Growth habit

Researchers have classified apple cultivars into four general growth and flowering habits. They use the terms acropetal or acrotonic to describe cultivars that we call tip bearers, such as Rome Beauty or Granny Smith. At the opposite end of the spectrum are basipetal or basitonic cultivars. These produce mostly spur growth and are typified in the extreme by Redchief, the Campbell strain of Delicious. Lightly heading back basitonic cultivars (spur Delicious types) does not generate as much vigorous shoot regrowth as heading back those that do not have a strong spur growth habit. Heading back the acrotonic (weeping) growth habit cultivars increases regrowth to a greater extent and also reduces flower bud formation.

Shoot orientation

Regrowth response is also affected by a shoot's orientation from the horizontal. The more upright the shoot, the greater the regrowth. Generally, heading cuts into upright shoots produces shoots that have a very narrow angle and that are very vigorous. These vigorous shoots create undesirable shade and have very low fruiting potential.

Not all heading cuts are detrimental to a tree, however. In some instances heading cuts are needed to stimulate growth to keep a tree in balance. They should be used to stimulate lateral growth and branching. Heading cuts should also be made to shorten and to stiffen branches. These cuts are necessary when a cultivar tends to produce too much fruit on the end of branches. In peaches, owing to the site of flower production, heading cuts are a necessity.

Response to thinning cuts

Thinning cuts primarily are used for two purposes: (1) to increase light penetration and (2) to remove competing or crowding shoots or limbs. Vigorous shoot growth may develop in the immediate vicinity of the pruning cut, but the effect on adjacent parts of the tree is minimal. Thinning cuts do not change the relationship of various parts of the shoot or branch to each other as heading cuts do, because either the entire shoot or the branch is removed or left intact. The ratio of terminal to lateral buds is largely undisturbed, and as a result, thinning cuts do not increase shoot growth as much as heading cuts. Thinning cuts also reduce flower formation less and can increase flowering when better light penetration is achieved. Yield is reduced only to the extent that the bearing surface is removed and is not reduced because of invigorating buds to form shoots rather than flowers.

Pruning and Training in Young Trees

During the first year or two of a tree's existence in an orchard, most time is spent on training the tree to develop a strong framework. The next period can be considered the "formative years"—when growth is directed and early intervention is performed to ensure that a proper structure develops. Intervention most frequently takes the form of limited pruning and training.

Scaffold selection occurs during the first one to two years. In most training systems the first scaffold should not be any lower than 18 to 20 inches above the ground. Thereafter, shoots should be selected so that they are spaced about 4 to 8 inches apart vertically and well distributed around the trunk.

The major mistake growers often make during the formative years is allowing the top of the tree to develop too soon. The result is that the tree forms a "sail" top and can be blown over, and the lower limbs do not develop sufficiently. Treetops naturally tend to develop sooner and to a greater extent because they are the most vigorous area of the tree and are exposed to the highest light levels. One rule of thumb for this area of the tree is the "one-half to two-thirds" rule. When branches on the central axis are between one-half and two-thirds the diameter of the central axis, they should be removed.

On the other hand, in some cultivars the dominance of the central leader is sometimes lost. This can result either from overcropping or from allowing too many limbs to develop from one area. It may then be necessary to rehead the leader back to invigorate it.

One exception to the rule of reduced pruning occurs with spur-type Delicious. It is not unusual for trees to fail to form sufficient numbers or quality of scaffold limbs the year of planting. In this case it is necessary to cut back the tree severely. This is accomplished by heading the central leader back to an inch or two above where you headed the tree last year. The side limbs that did grow are also cut back using what is commonly called a Dutch or bevel cut. By drastically reducing the top of the tree, you invigorate the tree and encourage greater growth. The Dutch cut is made to force new scaffolds to develop on the underside of the original shoot having a naturally wider angle. The disadvantage of this system is a delay in early bearing by one year.

Once the initial lower framework and tree structure is established, then pruning during the early bearing years is a matter of repeated intervention to ensure good sunlight exposure and to develop a series of tiers of branching structures. As you move progressively up in the tree, each tier should get shorter and weaker.

Summer Pruning of Apples and Peaches

Rising costs have forced fruit growers to turn to more intensive planting systems to increase production per acre and per man-hour. As a consequence, tree crowding with a loss of productivity and fruit quality has occurred in some plantings. Traditional dormant pruning restricts root growth and reduces tree trunk enlargement, while it stimulates growth near the cuts. Such growth can worsen tree crowding and reduce light penetration. Fruit growers are therefore turning to summer pruning as a means of controlling growth. Summer pruning also offers a way to balance the workload by reducing the time spent on dormant pruning.

Pruning fruit trees during the summer has been of interest for well over 100 years. A few researchers in this country evaluated summer pruning between 1900 and 1920, concluding that responses were too variable to recommend its widespread adoption. Little was said or written about summer pruning in the United States between 1930 and 1975, when further research was begun in Virginia and Ohio. Since 1975, research has focused on the effects of summer pruning on apples and peaches. Misunderstandings about summer pruning have arisen and should be cleared up.

First, what is summer pruning? It is removing any vegetative growth when there are leaves or flowers on the tree. This includes desuckering the interior of trees, selecting scaffolds on young trees, tipping terminal growth, summer topping of peaches, and dormant-style pruning conducted during the growing season. With all pruning, be it dormant or summer, the ultimate effect is to control tree size.

Effects on growth

Probably the most mistaken idea is that summer pruning restricts growth more than winter pruning. Work in Virginia and Ohio on apples and in New Jersey on peaches has shown that summer pruning causes more vigorous vegetative growth the following year than traditional dormant pruning. Summer pruning does restrict increases in trunk enlargement, branch diameter, and root growth. However, tree crowding in intensive plantings is the result of shoot growth, and summer pruning does not suppress shoot growth as much as dormant pruning.

In assessing tree response to summer pruning, it is important to compare that response with the effects of comparable dormant pruning. For example, at the growing season's end, a tree pruned in summer will obviously look much different from a dormant-pruned tree. After comparable dormant pruning, however, both trees look very similar.

The later you summer prune the less likely the chance of regrowth during the season of pruning. Pruning in mid- to late August can be beneficial to open the canopy up and to allow better sunlight penetration for enhanced color development of fruit.

Effects on flowering and fruiting

Research conducted on the effect of summer pruning on flowering and fruiting has had mixed results. In studies on apple trees pruned in late July or August, no increase in flowering took place the following year. Summer pruning done earlier, in June or early July, was shown to increase flowering in apples. Pruning Redhaven peaches on July 1 or August 1 reduced the number of flower buds proportional to the length of shoots removed;

however, the August 1 pruning increased the number of flower buds per node.

In peaches, summer topping was shown to reduce the cold hardness of flower buds on two out of four sampling dates. Flowering of summer-topped Sunqueen peach trees also appeared advanced, compared to that of dormant-pruned trees.

Effects on overall yield have been variable. In the Virginia apple studies, total fruit weight and numbers per tree did not consistently increase. In Ohio, fruit yield per tree was reduced, but yield per canopy volume was unaffected. Sunqueen peaches mechanically topped over a two-year period had a yield 9 percent lower than yields of dormant-pruned or normal summer-pruned trees. Overall, in individual cases, responses to flowering and fruiting probably depend on variety, timing, and severity of pruning.

Effects on fruit quality

The influence of summer pruning on fruit quality depends on variety and overall tree vigor. Summer pruning has been shown to increase fruit color, especially in crowded plantings where light levels are low. Severely summer-pruned trees tend to produce smaller fruit and lower soluble solids when pruning is done earlier in the season. On the favorable side, summer pruning tends to reduce bitter pit and enhance color in apples. Flesh firmness of Loring peaches was increased by summer topping. Summer desuckering of peaches has been shown to be beneficial in improving fruit color without the side effects on fruit size. Desuckering consists of removing only the large vigorous upright shoots in the center of the tree.

Economic effects

Dormant-type pruning of apples even done in the summer may not lower overall pruning costs, but it does allow a better distribution of the labor force. Summer pruning offers the grower the option of maintaining a constant number of employees by shifting some of the winter workload to the summer. In mature peach trees, summer topping can save a grower 20 to 25 percent in pruning costs, although there may be a loss in yield after topping.

Summer pruning is a useful tool in fruit production, with certain limitations. It should never be viewed as the sole method of pruning. The best practice is to combine selective summer pruning with yearly dormant pruning. Summer pruning can help improve fruit color, alter fruit quality, train trees, and allow a better distribution of labor.

Before embarking on a program of summer pruning, growers must know what effect they wish to achieve. The earlier in the season summer pruning is completed, the greater the flowering and vegetative regrowth. Conversely, the later in the season summer pruning is done, the less it will affect flowering and the less regrowth there will be. Late season pruning enhances fruit color but can reduce soluble solids and final fruit size.

Deciding on a Production System

Cost

Generally, cost of trees in the long run is a small part of production costs. The big expense is in the labor required for early training and pruning. This expense should decrease over time, but the higher the density, the greater the labor requirements. A good rule of thumb is: "The more intensive, the more expensive."

Spacing

For optimal production, it is necessary to make best use of the surface area of available land. Spacing that is too wide makes for inefficient planting, while spacing that is too narrow means that excessive labor will be needed to contain trees in their allotted spaces. Once a production system is worked out, spacing is determined by cultivar to be planted, rootstock, soil vigor, and slope.

“Plantsmanship”

Any given production system will be only as good as the grower’s ability to manipulate the trees. The more intensive the system, the more growers or their workers must be familiar with how trees grow. There is less room for error in high-density production.

Labor requirements

A high-density orchard requires greater management skills; it also requires that labor be spread over a longer time period. Pruning must be done in both winter and summer. Because tree size is smaller, production becomes more efficient. Brains and nimbleness replace the need for brute strength, allowing greater flexibility in the labor you can hire. High-density orchards also make it easier for fewer people to take care of more trees, but in a smaller area.

Common misconceptions clarified

- There is no perfect production system. You need to develop your own style and a production system that suits your abilities, growing conditions, and chosen cultivars.
- High density does not necessarily mean greater yields. It is very possible to achieve 1,000 bushels per acre on well-managed, standard trees. However, it takes more years to reach full production capacity with standard trees than with dwarf trees.
- Yields and dollar returns do not always occur more quickly in high-density production. Mismanaging a high-density system in the early years can delay fruiting and production. Since the purpose of high-density plantings is to have early production, anything that delays early production will delay returns.

Finally, do not pass judgment on a particular system without adjusting all the factors.

Too often, growers give up on a system because they have tried to handle it the way they handle all their other systems. Make allowances for different row spacings to accommodate smaller equipment.

Production Systems for Apples

As the Pennsylvania industry moves from conventional medium-density, freestanding orchards to high-density, supported orchards, many pruning and training modifications must be made. In the medium-density central leader system, portions of trees are cut back severely for several years to stimulate growth. Emphasis is placed on building a large, strong framework to support future crops.

Conversely, in high-density systems excessive growth is discouraged; and instead of a large, strong framework, a weak-framed tree is desirable. To achieve these ends in a system such as slender spindle, very little pruning is done in early years. The goal is to promote early fruiting, which itself will inhibit future

growth. All high-density systems require a greater knowledge and understanding of plant growth and of how the tree will respond to cuts. In early years, more attention is paid to training and positioning limbs than to pruning them. As trees mature, most high-density systems will be more productive if trees are pruned in both winter and summer.

High-density systems also demand greater precision in spacing trees. Since trees are not meant to be vigorous, too wide a spacing is an uneconomical use of the land. Conversely, too narrow a spacing will necessitate more pruning, increasing vigor and reducing light and fruit quality.

Central leader system

This is the most widely planted system in Pennsylvania. Trees are usually, but not always, freestanding. With the range of rootstocks available (see Apple Tree Spacing), trees can vary from 7 to 20 feet tall. Trees can be kept smaller by periodically heading back the central leader into 2-year-old wood to stiffen the central axis. Size and vigor can also be controlled by selecting less-vigorous branches as the central leaders.

Trees are trained into a Christmas tree shape with the tops always narrower than the lower branches. Annual pruning is required for maximum sunlight penetration into the tree’s interior and for greater production. In some instances, summer pruning is also beneficial.

The cost of establishing this system is relatively low because no tree supports are used and there are fewer trees per acre. In early years, efforts are focused on trying to invigorate trees to fill their allotted spaces. Early production years are then spent in slowing the trees down and getting them into an annual bearing habit. Later, as the planting grows older, it is necessary to maintain fruit spur quality by pruning annually and keeping tree tops from overshadowing lower branches.

The following is a “cookbook” method of how to prune and train trees to a central leader system.

At planting

- Remove all scaffolds below 18 inches flush to the trunk. Trees with fewer than three scaffold branches should be headed at 30 inches and all feathery removed with a bevel or Dutch cut. Trees with three or more branches offer three options depending on the vigor of the scion and rootstock. Always remove any scaffolds that are more than half the diameter of the central trunk. The options in order of low vigor to high vigor are as follows:
- Option 1: Head leader 10 to 12 inches above the uppermost branch and all branches by a third.
- Option 2: Head leader 10 to 12 inches above the uppermost branch and do not head the side branches.
- Option 3: Do not head leader or side branches.

First growing season

- May: Install stakes and tie the leader to the stake. Remove two or three competing buds that broke and began to grow below the chosen leader if you headed the tree back at planting. Spread the scaffolds horizontally if you had left them on at planting.

- June: Clothespin new shoots when they are as long as, or just longer than, the clothespin.

Second leaf

- Dormant: If additional scaffolds are needed, score above desired buds in the late dormant season (4 to 6 weeks before bud break) or apply Promalin mixed with latex paint.

Do not head the central leader. Select three to five first-tier scaffold branches of moderate vigor with wide crotch angles and remove the rest. Care should be taken to attain good spacing of branches around the trunk, both radially and vertically. Scaffold branches that are evenly distributed around the tree will assure even light distribution and scaffolds that are spaced out vertically will assure that leader dominance is maintained.

- June: Position permanent scaffolds at a 50- to 75-degree angle from vertical using spreaders, weights, elastics, or string.

Third leaf

- Head the central leader, removing half to a third of previous year's growth. Thin out overly vigorous limbs that are of no use.
- June: Position permanent scaffolds at a 50- to 75-degree angle from vertical using spreaders, weights, elastics, or string. When 3 to 6 inches of new growth has developed in the top third of last year's central trunk growth, select shoots to be the second-tier scaffolds. Pinch out the most and least vigorous shoots, leaving three to four of moderate vigor. Clothespin these second tier scaffolds to obtain wide crotch angles.

Fourth leaf

- *Do not head the leader:* Prune out only overly vigorous limbs that are of no use.
- June/July: Position first-tier scaffolds at a 50- to 75-degree angle, and position second-tier scaffolds horizontally using spreaders, weights, elastics, or string. Position overly vigorous limbs below horizontal.

Fifth and succeeding years

- Do not head the leader until it has bent over with a crop. Maintain good light distribution by making a minimal number of thinning cuts. Continue to position scaffold limbs with spreaders until this function is replaced by the weight of a crop. Shorten bottom tier of scaffolds by pruning back to side branch. Shorten pendulant branches back to a more horizontal position. Summer prune as needed in August to maintain light penetration.

Final leader height

- The ideal situation is that the leader will bend with a crop to restrict the tree height. This is termed the "crop and flop" method. However, in some cultivars the leader does not bend and the tree continues to grow upward. If this occurs you can cut the leader back to a lower, more horizontal branch, but only do so after the upper portion of the tree has fruited.

Slender spindle

This system is suited for densities of 400 trees or more per acre. It requires a very dwarfing rootstock, some form of support, and

early fruiting to restrict tree size. Since all pruning can delay the onset of fruit production, little or no pruning is done in the first few years. The overall shape of trees resembles that of the Christmas tree central leader. However, secondary and tertiary branches off the scaffolds are not created or maintained unless they are very weak-growing.

The ideal is to start with a well-branched, 1-year-old tree. At planting, remove only those branches lower than 18 inches. Heading should not be performed on any of the scaffolds. If the new tree is an unbranched or poorly branched whip, head the tree at 28 to 30 inches. Side shoots, however, should not be headed. Any vigorous branches that arise from the severe heading are then tied or weighed down during the early growing season to reduce their growth and encourage flowering. Failure to restrict the growth of these vigorous shoots in the first year will delay fruiting.

To control tree height and reduce growth, a strong, upward-growing branch should not be chosen as the central leader, but rather a less vigorous shoot tilted at an angle of 20 to 60 degrees above the horizontal. The effect is to create a zig-zag central axis. This weaker lateral is tied to the support pole so that it becomes the new leader for that growing season. It is always important to keep the top of the tree subservient to the lower part. If the top becomes too vigorous, it will shade out the lower portions. All overly vigorous and vertical-growing shoots should be removed. When a branch becomes too long, a heading cut is made to a weak-growing branch or spur.

The following is a "cookbook" method on how to train and prune trees to a spindle system.

At planting

- Remove all scaffolds below 18 inches, flush to the trunk. Trees with fewer than 3 branches should be headed at 30 inches and all feathers removed with a bevel or Dutch cut. Trees with 3 or more branches should be headed 12 inches above the top-most scaffold limb. Remove any feathers that are one-half or more the diameter of the central trunk. Attach trees to the support post or conduit as soon as possible.

First growing season

- May/June: Select the most vigorous upright growing shoot that develops below the headed leader. Remove the two or three competing buds below the chosen leader. Clothespin new shoots that will become future scaffolds or tie down existing shoots to a more horizontal position using string, elastics or weights.

Second leaf

- Dormant: Head the central leader on a weak growing tree by removing one-half to one-third of previous year's growth. On very vigorous trees remove the leader and tie up a weaker leader from a branch below. Alternatively, vigorous leaders can be bent to a 90-degree angle or greater.
- June/July: Remove two to three competing buds below the leader if the tree was headed in the dormant season. Tie developing leader to the support post. Position overly vigorous limbs and shoots horizontally with weights. Tie up scaffolds that may bend under weight of fruit. Remove any branch

that is more than one-half the diameter of the central leader utilizing a Dutch cut.

Third leaf

- Dormant: Head the central leader on weak growing trees by removing one-half to one-third of the previous year's growth. On vigorous trees remove the shoot and tie up a weaker leader from a branch below, or bend the leader over to 90-degree angle.
- June/July: Remove two to three competing shoots that broke below the leader if the tree was headed in the dormant season. Install clothespins to spread new developing side shoots. Remove any vigorous vertical growing shoots. Position overly vigorous limbs and shoots horizontally with weights. Tie up scaffolds that may bend under weight of fruit.

Fourth leaf

- Dormant: Remove overly vigorous leaders, and replace each with a suitable side scaffold. Reduce the length of scaffold branches that do not appear capable of supporting a fruit crop by cutting back to a side branch.
- August: Summer prune if necessary to maintain pyramidal shape and to encourage light interception. Remove vigorous upright growing shoots.

Fifth and succeeding years

- Minimize winter pruning to renew vigorous scaffold limbs in the top half of the tree. Maintain tree height at 6 to 8 feet by cutting the leader to a weak side scaffold as needed to prevent excessive growth in the top of the tree. Remove pendulant branches and spur complexes by cutting to a more horizontal shoot or spur system. Shorten bottom tier scaffolds as needed to maintain fruit quality by pruning back to a side branch.

Trellis systems

A trellis system relies on the use of three to four wires to serve as support and training aids. Several ultimate tree forms or training patterns may be chosen in developing a trellis. Certain components critical to this system must be understood and avoided regardless of the tree form chosen:

1. Branches to be trained to the wires should always originate on the main trunk below the wire. Bending branches from the main trunk or axis down to the wire will encourage upright water sprouts at the point of the bend. Water sprouts are unproductive and lead to an overabundance of growth.
2. Do not keep every branch on the tree. Branches growing vigorously into the drive row should be removed. Do not try to bend every branch back into the wire.
3. As trees get older do not allow the upper portions of the trellis to become overly vigorous and shade out the lower branches. Maintain a pyramidal shape as is done with the central leader system.
4. It is not necessary to stop branches from extending into adjoining trees. The ideal is to create an interwoven wall of bearing surface.

The following is a "cookbook" method for training trees to a Penn State low hedgerow four-wire trellis system.

- Oblique Palmette is a central-axis tree with four pairs of oblique scaffolds spaced approximately 18 inches apart in a narrow vertical plane. Scaffolds from adjacent trees cross each other, forming a lattice framework on which bearing wood is developed and managed as the fruiting mantle of the trellis hedgerow.

At planting

- Nonfeathered Trees: A one-year whip is planted vertically and headed at 18 inches, the height of the bottom wire. Usually, three shoots appear as a "crow's foot." The center one is selected to be the leader of the tree, and is tied to the bottom wire. At the same time, or a little later, two lateral shoots about 3 to 4 inches below the wire, one on each side of the tree, are selected to become a pair of scaffold limbs. When about a foot in length, these are inclined at a slope of approximately 60 degrees and secured to the bottom wire. When 2 to 3 feet in length, they are reset at a 45-degree slope. The leader is allowed to elongate and secured to the second wire when its wood has matured sufficiently for tying. Other lateral growth usually is removed. In the fall, the tree's central axis, leader, and scaffolds are secured to the trellis wires for overwintering.

Second year

- The tree's leader and scaffolds are allowed to elongate. Lateral growth normally is retained unless too vigorous, showing dominance on a scaffold or on the central axis. Lowest scaffolds are allowed to elongate at a 30- to 45-degree slope. When the two low scaffolds from adjacent trees pass the second wire, they are crossed and tied together at the middle of the second wire. Some repositioning of the tie on the first wire may be necessary to develop an even slope in the scaffold. Any strong lateral growth from these scaffolds showing dominance is headed at approximately 6 inches to either a downward or lateral growing shoot. One-year wood over 12 inches in length is usually pruned in half. If a terminal in a scaffold sets fruit, the fruit is removed and the leader renewed.
- Lateral shoots usually develop naturally on the central leader. At each trellis wire, a pair of suitable laterals is selected to become scaffolds. These should arise approximately 3 to 4 inches below the wire. Laterals are inclined and attached to give about a 45-degree slope. Later in the season, these are repositioned at approximately 30 degrees. If a young scaffold is not sufficiently long to be positioned, it may be marked for later identification, which is easily done with a spring clothespin. Growth may be enhanced by tying to about 60 degrees. Any strong lateral growth below and/or immediately above a pair of selected shoots is removed.
- This procedure for developing scaffolds is followed at each wire or level in the trellis. However, if suitable laterals fail to develop naturally, a heading cut may be made similar to that done at planting. The cut should be at or near a trellis wire for laterals to arise about 3 to 4 inches below the wire.

Third and subsequent years

- Training follows that outlined for the second leaf. If lateral shoots do not arise naturally at or near the desired location for scaffolds, the tree is headed at the wire to stimulate branching.

- When the central leader of the tree extends a foot or more above the top wire, it is bent to one side along the fourth wire to form half of the top tier. It is tied in a horizontal position. A suitable lateral, originating below the arch on the opposite side of the tree, is trained to form the other half of the fourth pair. However, it is usually inclined to the top wire before being trained horizontally. In future years, as scaffolds from the third tier (below) reach the top wire, top scaffolds are headed back periodically to reduce their shading on those immediately below. Eventually, fourth-tier scaffolds may be no longer than 12 inches in length. All vertical shoots and wood are removed from the top of the trellis (fourth-scaffold tier). This is usually done in early August just prior to summer grooming of the bearing mantle.
- Scaffolds are arrested in further elongation when they reach the middle of an adjacent tree. This is usually accomplished by not tying up the terminal. Occasionally, tipping or cutting back to a downward-growing lateral may be needed.
- Annual pruning is both summer and dormant pruning. Summer pruning is in August, about three months after bloom, and is considered mainly a grooming operation. All vertical vigorous growth from the top of the trellis is removed, which reduces shading, aids in suppression of the vigor in the top scaffolds, and maintains a hedgerow height of 6 feet. In addition, all vertical growth within the hedgerow itself is removed, but this may be done at any time during the summer. Further, all lateral shoots 12 inches or longer are stubbed by heading back to three basal shoot leaves, or to about $\frac{1}{2}$ or $\frac{3}{4}$ inches. This August stubbing of shoots is the most important pruning of the year and is what distinguishes the Penn State system. Besides increasing the exposure of bearing wood and maturing fruits to sunlight, stubbing enhances the development of bearing wood by manipulating vigorous growth into short shoots and spurs. Dormant pruning is largely heading back of older bearing wood, making corrective cuts, thinning out spurs, and, where necessary, re-stubbing to continue the control of vigorous wood.
- Feathered trees: A tree is planted vertically and oriented so that two feathers on opposite or nearly opposite sides of the tree occur approximately 14 to 15 inches from the ground (3 to 4 inches below the lowest trellis wire at 18 inches). These are inclined at a 45- to 60-degree slope, depending on length (vigor), and secured to the lowest trellis wire.
- If a suitable pair of feathers is located only above the bottom wire, training is possible for developing them into suitable scaffolds, provided they are located within 4 to 5 inches from the bottom wire. Training is a two-step operation. First, the basal part of a feather is bent horizontally or arched down to the wire. After tying, the remainder of the lateral is brought upward and fixed by dropping either a string or several ties attached together from the second wire. If of sufficient length, it is positioned at 45 to 60 degrees. Otherwise, it is just raised so that the terminal bud becomes the highest point. In a raised position, continued elongation of the young scaffold is assured. After sufficient growth, repositioning may be done. Thus, a high originating lateral may be made into a suitable scaffold. Its appearance would resemble that of a scaffold originating 3 to 4 inches below the bottom wire.

Vertical or French axe

Developed in France, this system has generated interest among Pennsylvania growers. It differs from the trellis or slender spindle mainly in ultimate tree height. Trees in the French axe system are allowed to grow 10 to 14 feet tall, depending on the cultivar. The simplest way to picture this system is to consider a pole with short fruiting spurs.

Trees are planted closer together than in other systems. A critical point in establishing the French axe system is to immediately stake or tie the tree's central axis the first year. Trees can be headed at planting to a height of 28 to 30 inches, but thereafter they are never headed. To achieve the narrowest tree, only a single upright-growing branch is left to grow during the first year. Variations to produce a wider tree permit weak-growing horizontal branches to remain on the tree. Vigorous branches should be removed or tied down early in the season.

The easiest way to control vigorous branches at the top is to allow the leader to bend over with fruit. Later, the drooping portion of the central leader is completely removed. Dormant pruning each year consists of removing vigorous, upright-growing shoots. Vigorous top branches can also be controlled with timely summer pruning. If performed properly, summer pruning can encourage a greater fruiting surface. If a branch has fruited and needs to be replaced, make an angled stub cut. A new branch will emerge from adventitious buds.

The following is a "cookbook" method of how to train and prune trees to a vertical axe system.

At planting

- Remove all scaffolds below 18 inches, flush to the trunk. Trees with fewer than three branches should be headed at 30 inches. Attach trees to the support system as soon as possible. Trees with three or more branches offer two options depending on the vigor of the scion and rootstock. Always remove any scaffolds that are more than one-half the diameter of the central trunk. The alternatives in order of low vigor to high vigor are:
 - Option 1: Head leader 10 to 12 inches above the uppermost branch and do not head the side branches. Bend the side branches to horizontal by using weight string or elastics.
 - Option 2: Do not head leader or side branches. This last option is best used when there are three to five good feathers (branches).

First growing season

- May: Remove the two or three buds that began to grow below the chosen leader if you headed the tree back at planting. Bend the side branches to horizontal by using weight string or elastics.
- June: Clothespin new shoots when they are as long as, or just longer than, the clothespin.

Second leaf

- If additional scaffolds are needed, score above desired buds in the late dormant season (4 to 6 weeks before bud break) or apply Promalin mixed with latex paint.
- *Do not head the leader.* If additional scaffolds are needed,

notch above desired buds in the late dormant season (4 to 6 weeks before bud break) or apply Promalin mixed with latex paint.

- June: When 3 to 6 inches of new growth develops on shoots in the top half of the leader, pinch the new growth back by one-third their length. Position permanent scaffolds horizontally by using weights, elastics, or string. Position vigorous shoots below horizontal by means of weights, elastics, or string.
- July: Re-pinch all laterals as outlined above, as needed. If tree is vigorous, pinching the shoots a third time in August may be necessary.

Third leaf

- *Do not head the leader.* Tie down vigorous upright limbs below horizontal. Remove any side branches above the main scaffolds that are more than one-half the diameter of the central axis with a Dutch cut.
- June: When 3 to 6 inches of new growth has developed on shoots in the top third of last year's central leader, pinch them back by one-third to one-half their length.

Fourth leaf

- *Do not head the leader.* Prune out overly vigorous limbs that are of no use.
- June/July: Position excessively vigorous limbs slightly below horizontal.
~OR~
- August: Summer prune, removing vigorous limbs, to maintain pyramid shape and improve light interception.

Fifth and succeeding years

- *Do not head the leader.* Shorten bottom tier scaffolds by pruning back to a side branch. If desired begin removing/renewing scaffolds by thinning out the one most vigorous limb in the bottom middle and top of the tree. Remove any side branches above the main scaffolds that are more than one-half the diameter of the central axis with a Dutch cut. Leave all weak fruiting wood. Shorten pendant branches back to a more horizontal position. Summer prune as needed in August to maintain light interception.

Final leader height

- The ideal situation is that the leader will bend with a crop to restrict the tree height. This is termed the "crop and flop" method. However, in some cultivars the leader does not bend, and the tree continues to grow upward. If this occurs, you can cut the leader back to a lower more horizontal branch, but only do so after the upper portion of the tree has fruited.

Tall spindle

First leaf

- At planting: Plant highly feathered trees (10–15 feathers) at a spacing of 3–4 feet by 11–12 feet. Adjust graft union to 6 inches above soil level. Remove all feathers below 24 inches using a flush cut. Do not head the leader or the feathers. Remove any feathers that are larger than two-thirds the diameter of the leader.

- Three- to four-inch growth: Rub off the second and third shoots below the new leader shoot to eliminate competitors to the leader shoot.
- May: Install a three- to four-wire tree support system that will allow the tree to be supported to 3 meters. Attach the trees to the support system with a permanent tree tie above the first tier of feathers, leaving a 2-inch diameter loop to allow for trunk growth.
- Early June: Tie down each feather that is longer than 10 inches to a pendant position below horizontal.

Second leaf

- Dormant: Do not head leader or prune trees unless there are scaffolds that are more than half the diameter of the central axis.
- Make sure the leader is securely fastened to the support wires or conduit
- Four- to six-inch growth: Pinch the lateral shoots in the top fourth of last year's leader growth, removing about 2 inches of growth (the terminal bud and four to five young leaves).
- Early June: Hand-thin the crop to single fruit four inches apart (you should target 15 to 20 fruit per tree if tree growth was good, otherwise see chart below).
- Mid June: Repinch all lateral shoots in the top fourth of last year's growth. Tie the developing leader to the support system with a permanent tie.

Third leaf

- Dormant: Do not head the leader. Remove all broken branches by heading back or renewal cut to a spur. Remove overly vigorous limbs that are more than two-thirds the diameter of the leader using a bevel cut.
- Late May: Chemically thin according to crop load, tree strength, and weather conditions, then follow up with hand-thinning to the appropriate levels to ensure regular annual cropping and adequate fruit size (target 50 to 60 fruit per tree). See chart below to adjust crop load based on trunk diameter and cultivar.
- June: Tie the developing leader to the support system with a permanent tie.
- August: Lightly summer prune to encourage good light penetration and fruit color.

Number of fruit to leave on young bearing apple trees

Trunk diameter (in.)	Annual bearing habit	Biennial bearing habit
0.75	17	11
1.00	30	20
1.25	48	32
1.50	68	46
1.75	93	62
2.00	122	81
2.25	154	103
2.50	190	127
2.75	230	153
3.00	274	182

Fourth leaf

- Dormant: Do not head the leader. Remove overly vigorous limbs that are more than two-thirds the diameter of the leader using a bevel cut.
- Late May: Chemically thin and follow up with hand thinning to the appropriate levels to ensure regular annual cropping and adequate fruit size (target 100 fruit per tree).
- June: Tie the developing leader to the support system with a permanent tie at the top of the pole.
- August: Lightly summer prune to encourage good light penetration and fruit color.

Mature tree pruning (fifth to twentieth leaf)

Dormant: Limit the tree height to 90 percent of cross-row spacing by cutting the leader back to a fruitful side branch. For example, if the cross row spacing is 11 feet, then $11 \times 0.9 = 9.9$ or 10 feet. Annually, remove at least two limbs, including the lower tier scaffolds that are more than two-thirds the diameter of the leader using a bevel or Dutch cut. Columnarize the branches by removing any side branches that develop. Remove any limbs larger than 1 inch in diameter in the upper 2 feet of the tree. On varieties like Gala, McIntosh, Delicious, and Golden Delicious if shoots start to taper down to smaller than pencil-size diameter, head them back to where they are pencil size, preferably to a slightly upright growing shoot or spur.

Tree Support Systems

As apple growers move to higher-density production systems using more dwarfing rootstocks, tree support becomes more of a concern. Most of the very dwarfing rootstocks require support, but there are somewhat more vigorous rootstocks that can perform well without support under certain conditions. However, depending on cultivar, soil type, slope, vigor, and cropping conditions, support may be necessary for semidwarf stocks.

Support systems should be installed soon after planting. Tall spindle and vertical axe training systems depend upon installing the system shortly after planting to keep the leader upright and growing vigorously.

The cost of tree support systems varies widely. One system commonly used is a single wire set at 9–10 feet off the ground and a 12-foot piece of conduit driven into the ground and then attached to the wire. In recent years the cost of conduit has risen to the point that growers are now looking at using 4 or 5 wires spaced 1.5–2.0 feet apart as the support system. Penn State has developed and Orchard Support System Component Costs Calculator as an Excel spreadsheet. This spreadsheet can be downloaded from the web at extension.psu.edu/fruit-production under “Tree Fruit Resources” in “Orchard Spreadsheets.” The spreadsheet is updated on a yearly basis but you can also input prices that you obtain locally. The calculator will estimate how many end posts and line posts will be needed.

Examples of the cost per acre of support system components based on different tree densities.

	Wire	End posts	Line posts	Tree stakes	Total cost
<i>2,178 trees per acre = 2 foot x 10 foot spacing</i>					
6 foot 4-wire trellis	\$314	\$257	\$340	0	\$911
Staked with small conduit	78	257	340	2,940	3,616
<i>871 trees per acre = 5 foot x 10 foot spacing</i>					
6 foot 4-wire trellis	314	257	340	0	911
Staked with small conduit	78	257	340	1,176	1,852
<i>622 trees per acre = 5 foot x 14 foot spacing</i>					
6 foot 4-wire trellis	224	184	243	0	650
Staked with small conduit	56	184	243	840	1,323
<i>544 trees per acre = 8 foot x 10 foot spacing</i>					
6 foot 4-wire trellis	314	257	340	0	911
6 foot 5-wire trellis	392	257	340	0	989
6 foot 6-wire trellis	470	257	340	0	1,067
Staked with small conduit	78	257	340	735	1,410
<i>340 trees per acre = 8 foot x 16 foot spacing</i>					
Staked with big conduit	49	161	213	596	1,018
Staked with big conduit w/o wire	0	0	0	596	596
Staked with wooden post	0	0	0	1,004	1,004
<i>272 trees per acre = 10 foot x 16 foot spacing</i>					
6 foot 4-wire trellis	\$196	\$161	\$213	0	\$569
6 foot 5-wire trellis	245	161	213	0	618
Staked with big conduit	49	161	213	476	899
Staked with small conduit	49	161	213	368	790
Staked with wooden post	0	0	0	803	803
<i>227 trees per acre = 12 foot x 16 foot spacing</i>					
Staked with big conduit	49	161	213	397	819
Staked with wooden post	0	0	0	669	669
<i>218 trees per acre = 10 foot x 20 foot spacing</i>					
6 foot 4-wire trellis	157	129	170	0	455
Staked with small conduit	39	129	170	294	632
<i>202 trees per acre = 12 foot x 18 foot spacing</i>					
6 foot 4-wire trellis	174	143	189	0	506
Staked with small conduit	44	143	189	272	647
Staked with wooden post	0	0	0	595	595

Apple Tree Spacing

Apple orchards are a long-term investment, so it is essential to choose a tree spacing and a production system that will make best use of land and capital to produce fruit. Potential acre yields depend on the volume of bearing wood maintained in an orchard. Increasing the number of trees per acre is one way to increase the volume of bearing wood and thus yield. Yield can also be increased through proper pruning, training, and management. Growers must consider their ability or inability to manage a particular production system.

To determine in-row tree spacing, consider the following factors.

1. Variety

Table 1-6 lists common Pennsylvania-grown varieties and their characteristics, including vegetative vigor. (For example, Northern Spy is among the most vigorous and spur Delicious is among the least.)

2. Type of production systems

Low-trellis hedgerow

This system requires that the grower have a thorough understanding of tree growth and a large commitment of time and money. In a trellis hedgerow, trees are trained to a four-wire trellis to develop a solid hedge about 6 feet tall and 3 to 4 feet across. Branches originate from a main trunk below the wire and are trained up and across the wires. Trellising has the potential for high yields and early bearing and is a desirable system for growers limited by land or equipment. Suitable rootstocks and suggested in-row spacings are EMLA 9 (6 to 7 ft) and EMLA 26 (7 to 9 ft). M.27 (5 ft) can be used but is still experimental.

Slender spindle, hoop skirt, spindle bush

These systems also require a thorough understanding of tree growth. They differ from trellising in the way in which the scaffold branches are trained. In slender spindle, the scaffolds are bent and tied down to reduce shoot growth and to enhance cropping. In hoop skirt, scaffolds are trained nearly horizontal, with low limbs retained for a period of time. In spindle bush, scaffolds are developed by a combination of pruning and spreading. If posts or wires are used for support, these systems will be the most expensive to establish. Training and pruning require more effort than trellising. Yields may be slightly lower than in the trellis system, depending on the grower's commitment to pruning and training trees. These systems on EMLA 26 may not need individual tree support. Rootstocks suited for these systems and suggested in-row spacings are EMLA 27 (4 to 5 ft), EMLA 9 (5 to 7 ft), and EMLA 26 (7 to 10 ft).

Freestanding central leader tree on semidwarf rootstocks

This system uses a more vigorous rootstock to provide tree support. The tree is kept small by periodically heading back the central leader into 2-year-old wood to stiffen the tree's central axis. Trees are trained to a central leader system and pruned annually to keep them within their allotted spaces. The cost of establishing this system is relatively low because no tree supports are used and there are fewer trees per acre. Suggested rootstocks and in-row spacings are EMLA 26 (8 to 10 ft), MARK (8 to 10 ft), EMLA 7 (9 to 12 ft), M.9/MM.106 and M.9/MM.111 (10

to 13 ft), EMLA 106 (11 to 14 ft), M2 (12 to 15 ft), and EMLA 111 (15 to 18 ft).

Freestanding central leader tree on semistandard and standard rootstocks

In this system tree height is not as severely controlled. Grower knowledge, time, and expense may be the lowest of any other system. Potential yields and returns are also the lowest, especially in the early years. The age of bearing and early production will be inversely related to the ultimate size of the tree. The system still requires early pruning and spreading of branches. Suggested rootstocks and in-row spacings are EMLA 106 (16 to 20 ft), EMLA 111 (17 to 20 ft), seedling (18 to 24 ft).

3. Rootstock effect

The effect of the rootstock on ultimate size, precocity, cultural practice, and spacing is another factor to consider. Penn State has been a leader in testing and evaluating rootstocks for tree fruit. Test plantings of all the new rootstocks for apples are located at either University Park or Biglerville. The more common rootstocks are classified immediately below. Certain rootstocks in each size category may overlap into the next largest tree size owing to scion variety, production system, or soil type.

In the future there will be numerous rootstocks from which to choose. Growers are advised that many of these rootstocks have had only limited testing in Pennsylvania. We recommend proceeding with caution when trying new rootstocks, but urge you to try small test plantings with the cultivars that you grow (Table 1-7). In the section titled "Apple Rootstocks," we provide brief descriptions of apple rootstocks that you might see in nursery catalogs.

4. Soil vitality

Soil type, fertility, depth, water-holding capacity, and replant conditions all affect tree spacing. Pennsylvania soils have been divided into five classes according to potential productive capacity. A listing of these classes is available at county extension offices. Soils in Classes II and III are best suited for orchards. Soils in Class I are the most fertile and can lead to overly vigorous plantings.

In-row spacings should be adjusted according to soil strength. For Class I soils the widest in-row spacing is recommended, for Class II the middle range, and for Class III the narrowest spacing. Orchard soil should be a minimum of 2 to 3 feet deep. For shallower soils, in-row spacing can be reduced. Soils with a high water-holding capacity usually encourage more vigorous growth, while droughty soils slow growth.

Old orchard sites require special attention. Continually replanting the same sites can lead to poor tree growth and production. Before being replanted, soil should lie fallow or be put into field crops for 2 or more years. Every effort should be made to replenish soil nutrients before replanting. Before removing the old trees, take a soil test and nematode analysis. After removing trees, apply the recommended amounts of lime and fertilizer. Then subsoil the site and work in the fertilizer. Organic matter additions are also suggested.

5. Cultural practices

Mulching, weed control, irrigation, and other cultural practices all affect orchard spacing. Mulching helps conserve moisture in the soil and reduces the number of competing weeds, but it can also attract meadow and pine voles. Eliminating weeds from under the tree helps reduce competition and produces a larger tree. Although Pennsylvania has a humid climate, frequent dry spells can affect tree growth and performance. Irrigation has been shown to be beneficial.

6. Equipment

The size of equipment to be used in the orchard depends largely on the between-row spacing. Maximum width between rows of trees should be the sum of in-row spacing plus 8 feet. For example, if trees are to be planted 7 feet apart in the row, then between-row spacing should be 15 feet (7 ft + 8 ft). Adjustments downward can be made when narrower tractors and sprayers are used. When a new, more efficient planting is being established, between-row spacing should not be based solely on the width of old equipment. Until the trees fill their allotted space, larger equipment can be used. Smaller tractors can be substituted as the planting ages.

7. Between-row spacing

Research has shown that the most critical factor in determining early production and high yields in an orchard is the rapidity with which the canopy of the trees develops and fills its allotted space. In designing an orchard, growers are often more concerned about planting trees too close. Spacing trees too far apart, however, can be just as detrimental.

The overriding factor in determining optimum row spacing is to choose a spacing that will capture the most sunlight while not shading the adjacent rows. Orchards whose rows are spaced too far apart capture less than the optimum amount of sunlight. The old rule of thumb in determining row spacing is to take the in-row spacing and add 8 feet to it to equal the distance between rows. However, growers switching to small trees should avoid the mistake of keeping wide drive rows to accommodate old equipment.

As mentioned previously, in-row spacing depends on rootstock, cultivar, training system, and other factors. Between-row spacing is determined by all of the previously mentioned factors plus the ultimate tree height. Many growers in their quest

Table 1-7. Comparisons of apple rootstock characteristics.

Rootstock	Size class	Support	Suckering	Burrknots	Fire blight	Collar rot	Availability
Budagovsky 146	VD	Yes	No	No	Very susc.	Mod. susc.	Limited
Malling 27	VD	Yes	No	No	Susc.	Resis.	Some
Poland 22	VD	Yes	No	No	Susc.	Resis.	Limited
Geneva 65	D	Yes	Some	No	Resis.	Resis.	Limited
Budagovsky 491	VD	Yes	No	Some	Very susc.	Mod. resis.	Limited
Poland 16	VD	Yes	No	No	Susc.	Mod. resis.	Limited
Poland 2	D	Yes	No	No	Susc.	Resis.	Limited
Budagovsky 9	D	Yes	No	No	Susc.	Resis.	Widely
Geneva 16	D	Yes	No	No	Resis.	Resis.	Some
Geneva 41	D	Yes	Some	No	Resis.	Resis.	Some
Geneva 214	D	Yes	Unknown	Unknown	Resis.	Resis.	Limited
Malling 9*	D	Yes	Some	Some	Very susc.	Resis.	Widely
Geneva 11	D	Yes	No	No	Resis.	Mod. Resis.	Some
Mark	D	Yes	No	Yes	Susc.	Susc.	Some
Ottawa 3	D	Yes	No	No	Susc.	Resis.	Limited
Geneva 935	D	Yes	No	?	Resis.	Resis.	Some
Vineland 1	SD	Sometimes	No	No	Resis.	Unknown	Not yet
Malling 26	SD	Sometimes	No	Yes	Very susc.	Susc.	Widely
Geneva 210	SD	Sometimes	Some	No	Resis.	Resis.	Limited
Geneva 969	SD	Sometimes	Unknown	Unknown	Resis.	Unknown	Limited
Supporter 4 (Pi.80)	SD	Sometimes	No	No	Susc.	Unknown	Some
Geneva 30	SD	Sometimes	No	No	Resis.	Resis.	Widely
Malling 7	SD	Sometimes	Yes	Some	Mod. resis.	Mod. resis.	Widely
Malling Merton 106	SV	No	No	No	Susc.	Very susc.	Widely
Malling Merton 111	SV	No	No	Yes	Resis.	Resis.	Widely
Malling 2	SV	No	No	Some	Resis.	Resis.	Limited
Budagovsky 490	SV	No	No	Some	Unknown	Unknown	Limited
Budagovsky 118	V	No	No	?	Unknown	Resis.	Some
Poland 18	V	No	No	No	Mod. resis.	Resis.	Some
Seedling	V	No	Some	Some	Variable	Variable	Widely

*Refers to NAKB 337 clone of M9.

Size class: VD = very dwarf; D = dwarf; SD = semidwarf; SV = semivigorous; V = vigorous

Some of the material in this table came from information supplied by J. N. Cummins, personal communication; R. L. Perry, Proc. Mich. Hort. Soc.; and B. H. Barritt, Intensive Orchard Management.

for small trees do not realize that to achieve optimal yields they must also move the rows closer together. Failure to do this will result in significantly lower yields than old standard or semidwarf plantings. The following are three methods that can be used to arrive at possible between-row spacings.

- $(\text{desired tree height} / 2) + \text{in-row spacing} = \text{between-row spacing}$
- $(2 \times \text{desired tree height}) - 6 = \text{between-row spacing}$
- $\text{desired tree height} / 0.75 = \text{between-row spacing}$

As an example, assuming you want to maintain your trees at 10 feet within the row and no more than 10 feet tall, the above formulas can be used to help estimate row spacings.

- $10 / 2 = 5$ feet, $5 \text{ feet} + 10 = 15$ feet between rows
- $(2 \times 10) - 6 = 14$ feet between rows
- $10 / 0.75 = 13$ feet between rows

Therefore, the optimum distance between rows is 13 to 15 feet apart.

Finally, one way to evaluate older plantings to see if they are spaced properly is to observe them late in the afternoon on a sunny day. Looking at the base of the trees in a row, if the shadow cast from the adjacent row is covering less than 10-20 percent of the lower canopy then the trees are spaced properly. If the shadow from the adjacent tree is covering more than 20 percent of the canopy of the adjacent row, then the trees are too close together. If no shadow strikes the adjacent row, then the trees are spaced too far apart. (Portions adapted from T. Robinson, Dept. of Horticultural Sciences, NYAES, Cornell University)

Using Beds to Attain Higher-Density Orchards

Most orchards in Pennsylvania have uniform row spacings. The term “bed” in fruit production originated in the Netherlands, where growers have researched and tested three- to eight-row beds. No equipment traveled between the rows in a bed, and the beds were kept weed free. In Pennsylvania, wide weed-free beds are not advisable because of the likelihood of excessive erosion, so Dutch-style bed production probably is not workable.

In a broader sense, however, “beds” for tree fruit production can simply be thought of as plantings with unequal row spacings. Beds in this sense have been around a long time. Some Pennsylvania growers have alternated narrower rows, where no bin handling occurs, with wider spacings where bin handling does occur. Thus, for example, where a row spacing of 25 feet might be standard in an orchard with uniform row spacing, this 25-foot

spacing can be alternated with 20-foot row middles, resulting in an average row spacing of 22.5 feet.

Since most Pennsylvania growers prefer to use relatively wide row middles for spraying and especially for bin handling, row spacing becomes a limiting factor in designing moderately high-density orchards. Thus, growers desiring 6 to 8 feet for operating large equipment cannot obtain significantly higher tree densities. However, growers could design “Pennsylvania bed orchards,” in which single, wide row middles are used for spraying and for hauling bins. Figure 1-4 presents examples of the traditional arrangement, a two-row bed, and a three-row bed. Note that within the bed, trees might be staggered to allow spray to penetrate. With the smaller trees being planted today, spray deposition is likely to be more than adequate.

Table 1-8 gives an expanded example of trees at different spacings. The example shows that the increase in trees per acre could range from a low of 10.6 percent to as much as 28.5 percent. The bed itself can be designed with row spacings so that mowing can be done with a small tractor, but spraying would not normally be done within the bed. Alternatively, small compact sprayers can be used. Six-row beds of this design have been used by some South Carolina peach producers. This arrangement would result in significantly higher tree densities and may be a workable plan that would enable Pennsylvania growers to obtain higher tree densities while keeping wide row middles for large equipment.

Determining the Number of Trees per Acre (TPA) in Bed Plantings

As discussed above, bed systems can be used in many forms in commercial orchards. Beds in the Dutch system have very closely spaced trees with a vegetation-free area. The concept proposed above allows for herbicide strips directly underneath the tree rows within the bed and grassed drive rows between the bed tree rows and the wider drive rows. In either case, it is necessary to alter the traditional method of determining the TPA for bed systems. The following can be used to determine the TPA in a bed planting:

1. Measure the distance from the trunk of the edge tree in one bed to the trunk of the tree in a similar position in the adjacent bed.
2. Divide this distance by the number of rows in the bed to get the average row spacing.
3. Multiply the average row spacing by the distance between trees in a row to get the square feet occupied by one tree.

Table 1-8. Increase in tree density made possible using beds.

Conventional planting			Bed planting specifications					
<i>In-row tree spacing</i>	<i>Row spacing</i>	<i>Trees/A</i>	<i>In-row tree spacing</i>	<i>Wide row spacing</i>	<i>In-bed row spacing</i>	<i>Rows/bed</i>	<i>Trees/A</i>	<i>Percent increase trees/A</i>
10	18	242	10	18	14	2	272	12.4
			10	18	14	3	284	17.4
			10	18	12	2	290	19.8
			10	18	12	3	311	28.5
14	22	141	14	22	18	2	156	10.6
			14	22	18	3	161	14.2
			14	22	16	2	164	16.3
			14	22	16	3	173	22.7

4. Divide 43,560 square feet (1 acre) by the square feet occupied by one tree (from Step 3). This gives the TPA in the bed system you have designed.

Example: From the diagrams in Figure 1-4, the TPA is determined as follows:

Two-row bed	Three-row bed
30 feet (12 + 18)	42 feet (12 + 12 + 18)
$30 \div 2 \text{ rows} = 15 \text{ feet}$	$42 \div 3 \text{ rows} = 14 \text{ feet}$
$15 \text{ feet} \times 10 \text{ feet} = 150 \text{ feet}$	$14 \text{ feet} \times 10 \text{ feet} = 140 \text{ feet}$
$43,560 \div 150 = 290.4$	$43,560 \div 140 = 311.1$
290 trees per acre	311 trees per acre

Apple Rootstocks

History

Rootstocks to control tree size have been used in apple production for over 2,000 years. The clonal apple rootstocks that we use in the United States have traditionally originated in Europe.

In the mid-1800s horticulturists began referring to rootstocks by name. They were called Paradise (or French Paradise) or Doucin (or English Paradise), the former being more dwarfing than the latter. These plants, however, showed much variation in size control. In addition, many new stocks had been introduced inaccurately under these names; undoubtedly viruses and genetic mutations had occurred in the plant material. In the late 1800s one author described 14 different kinds of Paradise rootstocks. This diversity led researchers at England's East Malling Research Station to gather the selections to determine their trueness to name. The researchers concluded that indeed there were numerous misnamed and mixed collections of plant material.

Dr. R. Hatton decided that because of the confusion he would drop the proper names and assign each stock a number. He assigned a Roman numeral to each of 24 selections but did not number them in any order with respect to tree size. Hence, M.9 with a larger number is a smaller tree than M.2. Most of these,

with the exception of M.9, M.7, M.2, M.8, and M.13, were never commercially important in the United States. In succeeding years some rootstocks were developed from controlled crosses, M.26 and M.27 being the most famous.

In 1917 a second research station, the John Innes Institute of Merton, England, joined with the East Malling station to begin a breeding program. Their efforts, oriented mainly toward developing rootstocks resistant to woolly apple aphids, produced the Malling-Merton series of rootstocks, of which MM.106 and MM.111 are still used widely today.

In the late 1960s, researchers began work to remove many of the viruses naturally present in the rootstocks in order to reduce incompatibility problems caused by the viruses. The first rootstock to be partially cleaned up was M.7; it was designated M.7a. Later still, more viruses were removed from all of the Malling and Malling-Merton series of rootstocks. These were then designated EMLA for the East Malling and Long Ashton research stations in England. While the viruses have been removed, some of the rootstocks' size control has been lost. Therefore, the old "dirty" M.9 will produce a smaller tree than the "clean" M.9EMLA. Currently in the industry nearly all apple rootstocks are virus free.

The next few years will bring several new rootstocks, many developed in Europe. Those likely to be available first are the Budagovsky series. Designated as either Bud or B, they were developed in the central plains of the Soviet Union for their coldhardiness. The next rootstocks to be released will probably be from Poland and are called the "P-series." Like the Russian series they are expected to have some coldhardiness. The P-series was developed from crosses between M.9 and common Antonovka. Reportedly, these stocks have good resistance to collar rot.

The newest rootstocks, however, are being developed here in the United States. One group comes from Cornell University's breeding program, which has bred rootstocks for resistance to fire blight. Some of these rootstocks are also resistant to other problems such as apple scab, collar rot, and woolly apple aphids, and exhibit a reduction in burrknot formation.

A large multistate research program known as the NC-140 Research Project is primarily responsible for conducting most evaluations of these new rootstocks. Penn State has been a member of this project since its inception.

Growers should be aware of each rootstock's known capabilities and limitations. Many of the newer rootstocks will probably be available to the commercial industry before they have been thoroughly evaluated with different cultivars.

Specific rootstocks

Following are brief descriptions of and comments on apple rootstocks. Rootstocks are listed in order from smallest to largest. (Much of the information was gleaned from research reports of the NC-140 committee from around the country.)

Poland 22 (P.22): P.22 produces trees that are smaller than those grown on M.9. It is reported to be resistant to collar rot, apple scab, powdery mildew, and crown gall. P.22 is susceptible to fire blight and woolly apple aphids. Its major benefit may be as an interstem piece. In one trial planting with Gala, it has produced a tree slightly smaller than P.16. However, in a younger planting with Ginger Gold, it is slightly larger.

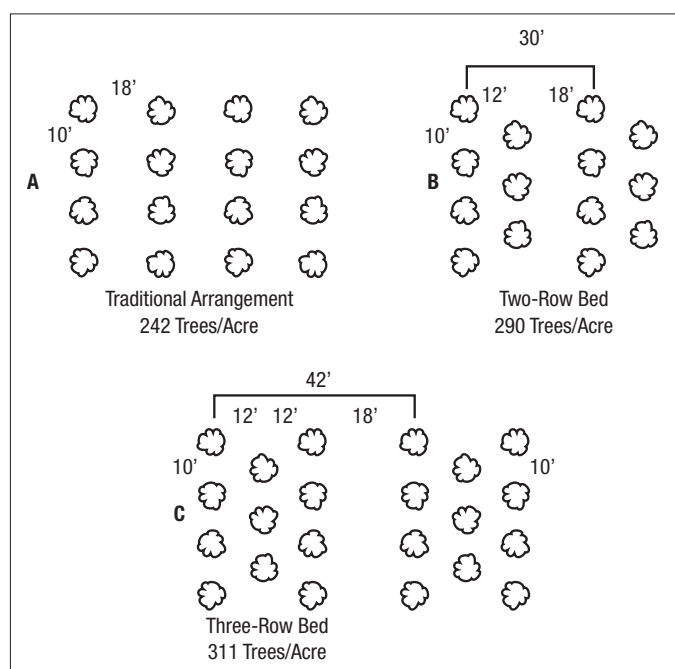

Figure 1-4. Traditional arrangement and possible arrangements of two- and three-row beds.

Malling 27 (M.27): A very dwarfing rootstock. Unless the central leader is supported, the tree will be very small. Little is known about disease or insect susceptibility. To date, most commercial nurseries are using this rootstock only as an intermediate stem piece on MM.106 or MM.111. If handled and spaced properly, it can be a very productive stock for a vertical axe system.

Budagovsky 469 (B.469) induces dwarfing similar to that of M.27 and is very winter hardy. Its only use would be for an interstem. Test plantings of Ginger Gold with this rootstock at University Park have not been viable. In New York State trials B.469 has shown very good compatibility between the scion, without the typical overgrowth.

Poland 16 (P.16) is from the same cross as the other Poland rootstocks and is reported to produce a tree about the size of M.27, although this has not proven to be the case in research trials in Pennsylvania. Test plantings of this rootstock at University Park with ‘Gala’ and ‘Ginger Gold’ show that trees are about 40 percent of the size of the same cultivar on M.9 rootstock. At this time this rootstock is suggested for trial only. P.16 is reported to be resistant to apple scab, powdery mildew, collar rot, and crown gall. It is susceptible to fire blight.

Geneva 65 (G.65) was developed by Dr. Jim Cummins at Cornell University. Due to errors in tissue culture buildup of this rootstock, the U.S. distribution of this rootstock has been hindered. Tree size once thought to be about that of M.9 is now considered to be closer to M.27. The rootstock is difficult to propagate in nursery stool beds. It is susceptible to tomato ring spot virus and apple stem grooving virus.

Budagovsky 9 (B.9 or Bud9) is a new dwarfing rootstock bred in the Soviet Union from the cross of M.8 x Red Standard (Krasnij Standart). Like the other stocks in this series, the leaves are a distinctive red. Trees on this stock are 25 to 35 percent smaller than M.9EMLA depending on the cultivar. In a 10-year trial at University Park, York Imperial, Rome Beauty, and Empire on B.9 were approximately 25 percent smaller than the same cultivar on M.9EMLA; while Jonagold, Golden Delicious, and McIntosh were approximately 35 percent smaller. B.9 appears to be resistant to collar rot and is very cold-hardy. In limited trials, it has performed very well across a wide range of conditions. Trees will need to be supported.

Poland 2 (P.2) was developed from a cross between M.9 and Common Antonovka. Trees grown on P.2 are 15 to 25 percent smaller than M.9. The rootstock is resistant to collar rot and slightly susceptible to apple scab and powdery mildew. Young test plantings in Pennsylvania with Gala and Ginger Gold show that P.2 is nearly as precocious as M.9. Smoothie Golden Delicious on this rootstock produces a very smooth and straight union. However, Delicious grown on P.2 is reportedly as susceptible to apple union necrosis as the same cultivar grown on MM.106.

Malling 9 (M.9): The traditional and best-known dwarfing rootstock. It should be planted on a well-drained site. Trees on this rootstock always require leader support. The rootstock is very susceptible to fire blight and can develop burr knots. Numerous clones of M.9 are now being sold by nurseries,

including M.9 NAKB 337, the current dominant strain used. It is a virus-free clone from Holland and appears to be 5–10 percent less vigorous than M.9EMLA. M.9EMLA is a virus-free clone from the East Malling/Long Ashton research stations. It is approximately 25–30 percent more vigorous than M.9. Pajam 1 (Lancep) and Pajam 2 (Cepiland) are French selections that are relatively new. They are 35 to 40 percent more vigorous than M.9 NAKB 337. One other clone is M.9 RN 29, selected by Rene Nicolai in Belgium. In plantings at University Park with Gala, it is approximately 30 percent larger than M.9 NAKB 337.

Geneva 41 (G.41) was released as a rootstock that produces trees the size of M.9. The rootstock was developed from a cross between M.27 and Robusta 5 made in 1975. It was selected for resistance to Phytophthora and fire blight. Oldest planting with this rootstock is located at FREC in Biglerville and started in 1998 with Jonagold. Three-year-old trees at Rock Springs with Golden Delicious are 12 percent smaller than trees on M.9T337 and about 30 percent smaller than M.26. Finished trees should be readily available.

MARK: Formerly named MAC 9, developed in Michigan. It is an open-pollinated seedling of M.9. Trials in Pennsylvania indicate that this rootstock is not freestanding and is slightly larger than M.9. The central leader tends to lean. In recent years this rootstock has fallen into disfavor due to an abnormal growth proliferation at the soil line. Trees with this growth proliferation cease to grow and become spur bound; therefore, it is not recommended to be planted unless supplemental irrigation is provided. Very drought sensitive.

Geneva 16 (G.16): This is a recent rootstock released from Cornell University’s breeding program. Like others in the series, it is resistant to fire blight. It is tolerant of collar rot and immune to apple scab. It is susceptible to woolly apple aphid and powdery mildew. Size is reported to be between that of M.9 and M.26. In a trial at Rock Springs at the end of the fourth growing season it is approximately 14 percent larger than M.9T337 and 8 percent smaller than M.26. It does appear, however, to induce wider branch angles in the scion cultivar. Geneva 16 is very sensitive to latent viruses in apple and should only be propagated with virus free scion wood on top. At this time, G.16 is recommended for trial only because of this problem.

Ottawa 3 (O.3): This relatively new rootstock was bred in Canada for its coldhardiness, with one parent being M.9. Trees on O.3 are about the size of M.9EMLA but smaller than M.26. Induces early bearing. Resistant to collar rot, but susceptible to fire blight and woolly apple aphids. Ottawa 3, although being available for many years, has not been popular with the nursery industry. Young stool beds of O.3 produce few saleable liners, although with age the stool beds become more productive. Ottawa 3 is very susceptible to apple mosaic virus, so only material known to be virus free should be planted on this rootstock.

Vineland 1 (V.1): This rootstock came from the breeding program at the Vineland station in Ontario, Canada. Tree size is comparable or slightly larger than M.26. Yield efficiency and fruit size are equal to or greater than M.26. However, unlike

M.26, it appears to be highly resistant to fire blight. It should be in limited supply for the 2003 growing season.

Malling 26 (M.26): A more vigorous rootstock than M.9. It can be used to produce either a dwarf or a semidwarf tree, depending on scion variety, production system, and soil type. It is susceptible to collar rot and fire blight and should not be planted in a wet site. Certain varieties, such as Rome, Stayman, Golden Delicious, and many triploids, when grafted onto this rootstock may exhibit signs of graft union incompatibility. When incompatibility occurs, the trees may break off at the union in high winds. Because exposed portions of the rootstock have a strong tendency to produce burr knots, the union between the scion variety and the rootstock should be set no more than 1 to 2 inches above the final soil level.

Geneva 935 (G.935) is a 1976 cross of Ottawa 3 and Robusta 5. Size is reported to be slightly larger than M.26, but the rootstock has resistance to fire blight and crown rot. It is not resistant to wooly apple aphid. Production efficiency is rated equal to M.9. In the Golden Delicious trial at Rock Springs in 2006, tree size was about 9 percent larger than M.9 and 12 percent smaller than M.26. Production efficiency was not significantly different although slightly higher than M.9 in 2005. The rootstock seems to induce wider angled branching in the scion. Finished trees should be readily available in 2008.

Geneva 11 (G.11): The second release of the Cornell breeding program; only limited plantings exist in Pennsylvania. Reported to be similar in size to M.26 but more productive. Has the advantage of being resistant to fire blight and crown rot as well as only rarely producing suckers or burrknots. Availability limited. Tissue-cultured trees are larger than trees propagated by stool beds.

Geneva 202 (G.202) is a semi-dwarfing rootstock that produces a tree slightly larger than M.26. It was developed from a cross of M.27 and Robusta 5. It is fire blight and Phytophthora resistant as well as having resistance to wooly apple aphids. The rootstock has been mainly tested in New York and New Zealand. In New Zealand they are looking at this rootstock as a possible replacement for M.26 since it is more productive than M.26. In a 9-year study with the scion cultivar of Liberty, G.202 was about 50 percent smaller than M.7 but had much greater production efficiency.

Pillnitzer Supporter 4 (Pi.80), a cross between M.9 and M.4, has recently been introduced from Germany. It is reported similar in size and in anchorage to M.26. Yield capacity is reported to be better than that of M.26. A planting with McIntosh as the cultivar was established in 1999 at Rock Springs. To date, Supporter 4 is about 15 percent larger than M.7 EMLA. Yield in 2001 was nearly double that of McIntosh/M.7EMLA and 50 percent greater than McIntosh/M.26EMLA.

Interstems are becoming increasingly popular in Pennsylvania orchards. This stock is composed of an understock such as seedling MM.111 or MM.106, onto which an intermediate stem piece of M.9 or M.27 is grafted. The variety is budded or grafted onto M.9 or M.27. Size control is directly related to the length of the intermediate stem piece. Interstem apple trees offer a strong root system while reducing the size of the overall tree. Interstem trees should be planted so that a por-

tion of the interstem is buried. Test plantings in Pennsylvania indicate that interstems on either MM.106 or MM.111 sucker, and very vigorous varieties and Stayman have not performed well on interstems.

Geneva 30 (G.30) is currently available from commercial nurseries. The advantages of this M.7-size rootstock are early production, fewer burr knots, and less suckering. Tests at Rock Springs do indicate that trees on this rootstock come into bearing earlier and produce more fruit than M.7. Unfortunately, in the last two years questions have arisen about the graft compatibility of this rootstock with Gala. In tests around the country in the NC-140 trials, there have been occasions where Gala/G.30 have snapped off at the bud union during high winds. Therefore, it is recommended that if Gala is propagated on G.30, the trees be supported by two wires, one at approximately 36–40 inches above the ground and a second wire at 8–9 feet. Individual stakes or poles have not been sufficient because they allow excessive twisting of the trees in the wind.

Malling 7 (M.7): This rootstock produces a semidwarf tree that is freestanding in deep well drained soils. In rocky, steep, or shallow soils, it tends to lean. High budding and deeper planting may help remedy this problem. The rootstock may sucker profusely and is susceptible to collar rot. M.7a is a clone of the original M.7. but which has had some of the inherent viruses removed.

Poland 1 (P.1): This rootstock appears to be about the size of M.7. It may, however, require some tree support.

Budagovsky 490 (B.490): This rootstock produces a tree the size of MM.106 and has the same favorable characteristic of inducing early bearing. Burr knots rarely occur. The rootstock has some resistance to collar rot and is reportedly moderately resistant to fire blight. Nurseries find this stock easy to propagate by hardwood cuttings and are grooming it to replace MM.106.

Malling-Merton 106 (MM.106): A rootstock, slightly larger than M.7, that produces freestanding, early bearing trees. Trees on MM.106 are susceptible to collar rot when planted in wet soils and are not recommended for poorly drained sites. Delicious on MM.106 is susceptible to apple union necrosis.

Malling 2 (M.2): An older rootstock that is reappearing in nurseries and orchards. It produces a semidwarf to semistandard freestanding tree, depending on scion variety. Trees are strong, crop well, and do not have collar rot problems.

Poland 18 (P.18): This stock holds the most promise for those wanting a larger tree about the size of MM.111. Its other advantages are tolerance to fire blight and resistance to collar rot. It will probably perform better in wet or heavier soils.

Malling-Merton 111 (MM.111): A well-anchored rootstock, resistant to wooly apple aphids, and tolerant of drier soil conditions. It is the most cold-hardy rootstock readily available. Trees on MM.111 are semistandard to standard in size. Planting depth of this rootstock is critical. The union should be no higher than 1 to 2 inches above the final soil line.

Budagovsky 118 (B.118) is a more vigorous clone out of the Minsk breeding program. It is more vigorous than the other rootstocks in the series but still imparts the high degree of

winter-hardiness. It propagates easily in stool beds and does not sucker. It has moderate resistance to fire blight but is susceptible to *Phytophthora*. Because of the vigor of the rootstock it is only recommended for spur strains of apple or in weak soil or replant situations.

Seedling: A rootstock from apple seeds, with a variable genetic makeup and suckering and disease susceptibility. Varieties on this rootstock produce the largest trees.

Planting Depth

Apple rootstocks are usually propagated clonally in stool beds and have been selected because they root well. The roots are induced on aboveground parts of a stem. When apple trees are budded high on rootstocks and planted with a union at the ground, the belowground portion of the rootstock has the ability to form roots.

When the union is planted 2 or more inches aboveground, the exposed portion is unable to form normal roots and may form root initials or burr knots instead. Burr knots are areas of rootstocks where roots try to form but cannot because they are not in a medium conducive to root growth. Rootstocks with burr knots do not enlarge radially in a normal fashion because phloem and xylem cells do not develop all the way around the tree. Several species of tree borers may enter burr-knot areas. Thus, apple rootstocks should be planted with the union at approximately 2–4 inches above ground level. When mechanical tree planters are used, trees may be set too high. However, trees can be set 1 or 2 inches deeper and manually adjusted to the proper depth. Research suggests that the height of the union also will influence the amount of dwarfing induced by a rootstock. The more of the rootstock shank that is exposed the greater the dwarfing. A general rule of thumb is that for every 4 inches of exposed rootstock shank below the graft union you can expect 10 percent more dwarfing.

Pollination

Pollination is the sexual portion of a tree's life cycle and involves the integration of several biological and physical factors, including cultivar compatibility, synchronous blooming, insects, and proper weather conditions. If any one of these components is missing or limiting, crop yield and quality can be affected.

All apple cultivars require cross-pollination to ensure commercial crops. Varieties differ in their self-fruitfulness. For example, Golden Delicious is considered partially self-fruitful, while Delicious largely is self-unfruitful. Regardless of the degree of self-fruitfulness, provide cross-pollination in every planting.

With respect to cross-pollination, all red sports and spur types are considered the same as the parent variety. For example, Yorking is not a pollinizer for York Imperial. Closely related varieties do not pollinate each other; for example, McIntosh, Early McIntosh, Cortland, and Macoun. Triploid varieties do not pollinate any varieties. Otherwise, all varieties with satisfactory pollen are pollinizers of each other if the bloom periods overlap. It is advisable to have three pollinizer varieties in all Stayman and Winesap blocks.

Cold periods during flowering can reduce pollination and subsequent fruit set. Pollen may fail to germinate when temperatures are below 41°F, and pollen tube growth is extremely

slow below 51°F. Therefore, in some situations, temperatures could be warm enough for bees to fly (65°F), but if the weather turns cold the pollen tubes may not grow fast enough before the embryo sac deteriorates.

Effective Pollination Period (EPP)

The Effective Pollination Period (EPP) is the difference between the period of time for pollen tube growth and that of ovule longevity. The longer the effective pollination period, the greater the likelihood of adequate fertilization and seed development. Pollination must occur within 2–4 days after the flowers open; otherwise, the embryo sac will degenerate before fertilization can occur. Studies have shown that this period can vary depending on cultivar.

The growth of the pollen tube and eventual fertilization of the embryo is largely dependent on temperature and its relationship to the Effective Pollination Period. The EPP was introduced in the mid-1960s as a way of establishing the time frame between when a flower is pollinated and when the embryo becomes un-receptive. After pollination it takes a certain time for the pollen tube to reach the embryo sac. Once a flower opens, the embryo has only a limited time when it is receptive. If the pollen tube does not reach the embryo before it degenerates, then the flower will not set. The length of the EPP will vary by cultivar, flower position within the cluster, and by certain cultural practices. In general, the EPP can be as short as 3 days and as long as 12 days; Delicious has one of the shortest EPP's.

In 1970, Williams and Wilson developed a temperature response index to allow the estimation of the time required for a pollen tube to grow to the embryo (see below). The index is based on the daily mean temperature over a period of days. When the index reaches or exceeds 100 percent, the pollen tube should have reached the embryo and fertilized the egg.

As an example, suppose the average mean temperature over the past five days had been 50, 54, 50, 52, and 59 degrees. Pollen tube growth would be expected to be $14 + 20 + 14 + 17 + 50 = 115$ percent, meaning pollen tube growth would have taken slightly less than 5 days.

Effective Pollination Period Index

Mean daily temp (°F)										
41	43	45	46	48	50	52	54	55	57	59
Pollen tube growth index (%)										
8	9	10	11	12	14	17	20	25	35	50

Table 1-6 gives a partial listing of the pollen nature of several apple varieties. Your extension pomologist can provide information about the pollination requirements of varieties not listed.

Five conditions are necessary for satisfactory cross-pollination:

- Pollinizer and main variety bloom periods must overlap.
- The pollinizer variety must have viable diploid pollen.
- The pollinizer variety must be located near the producing tree.
- Bees and other insects must be present in the orchard and be active at bloom.
- Weed blossoms, such as dandelions, mustard, and wild radish, should not be present in quantity since they attract bees away from fruit tree blossoms.

Certain varieties have a biennial bearing tendency. During the “off” year of the pollinizer, the adjacent variety, although an annual bearer, will tend to become biennial because of the lack of cross-pollination. This is not as serious when one of the two is relatively self-fruitful; however, the problem must be considered along with all the other factors that affect pollination.

A pollinizer is the source of pollen necessary to set fruit. A pollinizer might be another tree with compatible pollen or a bouquet of flowering branches placed in the orchard; whereas a pollinator transfers pollen from tree to tree. The most important pollinators are bees.

Trees that provide sufficient compatible pollen for the main cultivar(s) in the block are necessary for pollination. A desirable arrangement is a pollinizer located not more than 100 feet from the variety to be pollinated. In larger blocks, plant two rows of pollinizer (starting on the windward side of the block), four rows of main variety, two rows of another pollinizer, four rows of the main variety, then two rows of the first pollinizer, etc., and repeat the arrangement across the block. We recommend that no fewer than three pollen-compatible varieties be planted in an orchard. Thus, for example, if you are planting a Delicious block, select two additional suitable pollinizer varieties to plant.

Where additional pollen is needed, graft a pollinizer branch into each tree. Select main variety and pollinizer trees with overlapping annual bloom times. Large bouquets of pollinizer branches placed in drums of water near main variety trees may be used when no other pollinizers are available. The nearer the pollinizer to the producing tree, the better distribution by the bees of pollen to all blossoms.

All fruit species require pollination to set fruit. Some species are self-fruitful and do not require more than one cultivar per block. Peaches, nectarines, tart cherries, most apricots, and some European plums are self-fruitful, and a solid block of one cultivar may be planted. Apples, pears, and sweet cherries require mixed plantings of different cultivars for adequate cross-pollination.

Improving conditions for pollination can lead to increased production owing to larger fruit size and/or a greater number of fruit per tree. Research in Massachusetts has shown that fruit size and calcium content are directly related to the number of seeds per fruit, with the number of seeds being dependent on good pollination. The more pollinizer trees in a planting, the better the potential for cross-pollination. However, using pollinizers means the loss of some efficiency in orchard operations. Having two or more cultivars in an orchard may pose problems in spray-to-harvest limitations and cultural practices, and it may confuse pickers, resulting in bins of mixed cultivars. There also may be an inefficient use of land owing to differences in growth habits. These disadvantages, however, are far outweighed by the greater yields associated with pollinizer use.

Pollinizer placement

The placement of pollinizers is important. Ideally, every tree in an orchard should be located as close to a pollinizer tree as possible. However, efficient orchard production practices do not include scattering pollinizers of commercial cultivars throughout a block. (An exception is listed below in the discussion of ornamental crabapples.) The preferred arrangement of pollinizers is in solid rows. One scheme is to alternate two rows of pollinizers between four rows of the major cultivar. An exception is plant-

ing cultivars, such as Delicious, that have a tendency to be less fruitful. In these instances, and when it is desirable to maximize pollination, a pollinizer row should be set every third row.

Supplemental pollination practices

Even with an adequate allowance for pollinizers, it may sometimes be necessary to provide for additional pollen when weather conditions do not favor cross-pollination. Using hive inserts with commercially obtained pollen is a common practice that can increase pollen sources. Inserts are specially constructed to fit in the entrance of hives and are filled on a frequent basis with pollen. The inserts are constructed so that bees are forced to track across the pollen and carry it to the flowers as they forage.

A second method of increasing pollen is to cut bouquets of flowering branches from trees elsewhere in the orchard and place them in large containers of water within the tree rows. Bouquets should be checked daily and replenished as needed.

A third method is to graft selected limbs with a compatible pollinizer branch. The disadvantage of this method is the necessity to clearly mark the limb to prevent it from being pruned out in the winter and prevent harvest crews from mixing the fruit in bins. All these methods should be viewed as supplemental means of increasing pollination. The best pollination method is to have an adequate number of pollinizer cultivars and strong, healthy honey bee colonies.

Using ornamental crabapples

Planting annual blooming ornamental crabapple trees to provide additional pollen and improve cross-pollination has been suggested and has been tested by a number of Pennsylvania growers. Ornamental crabapples are noted for their abundant annual production of flowers. Frequently, flowering crabapples will bloom on both spurs and 1-year-old wood. The wide variety of available cultivars allows the grower to achieve enough overlap of bloom that even the latest flowers on the main cultivar have an equal opportunity for cross-pollination.

Trees are propagated on dwarfing rootstocks and placed between the trees of the main cultivars to be pollinated. The trees are pruned so that they do not crowd the commercial cultivar.

Using ornamental crabapples has several advantages. First, it allows the grower to plant a single cultivar block and to manage the block as a single unit. Second, it eliminates the need for less profitable cultivars in a planting solely for their use as pollen sources. Third, it prevents pickers from mixing two similar apple cultivars in harvest bins and reduces the need for multiple harvests in blocks of mixed cultivars.

Some of the more commonly used crabapple cultivars are Manchurian, Pioneer Scarlet, Rosedale, Golden Hornet, Snowdrift, and Simpson 10-35. Nearly every tree fruit nursery sells ornamental crabapples. Growers should exercise caution, however, in selecting a particular crabapple for their orchards. Not all crabapples are suitable for use as pollinizers. Research has shown that white single flowering crabs may be better for cross-pollination because these flowers are most like apple flowers. Crabapples with darker colored flowers may alter honeybee visitation patterns.

We recommend a minimum of two to three different cultivars with slightly different bloom seasons. How many pollinizers to plant will vary with how difficult it is for the apple cultivar to set

fruit. Golden Delicious blocks require fewer pollinizers, whereas Delicious blocks require more trees per block. A common scheme is to plant a crabapple between every third tree in every third row. This situates every tree of the main cultivar adjacent to a pollinizer. Crabapples can also be interplanted in existing blocks that have a traditional pollinizer arrangement. The addition of the crabapples will increase the potential for pollination and help in situations where the fruiting pollinizers may have lost their flowers due to cold injury or become biennial.

Bees and pollination

European honey bees are our most important managed pollinators. Their activity assures sufficient cross-pollination, without which small or misshapen fruits and low yields may result. Although many native and introduced species of bees can be found in an orchard during bloom, most of these species vary in their abundance from year to year. In addition, regular pesticide applications may limit the abundance and diversity of these pollinators and some agricultural practices, such as soil tillage, may destroy those that nest in the soil (Table 1-9). Honey bees can be managed, however, to provide consistent pollinator abundance from year to year.

The changing pollination picture

With the introduction of parasitic honey bee mites (mainly *Varroa destructor*), the pollination picture has changed. Abundant feral colonies (wild colonies nesting in trees or other cavities) once provided a measure of pollination security for fruit and vegetable growers; however, this is no longer the case. Feral honey bee colonies are now nearly nonexistent in most areas. Estimates vary, but the Northeast may have lost 80 percent of its feral honey bees. Despite intense efforts to protect their bees, beekeepers are losing large numbers of colonies to mites and the diseases they transmit.

In addition, the recent dramatic dieoff of tens of thousands of honey bee colonies has left many beekeepers devastated and some growers without the quantity and quality of bees needed to pollinate crops. This phenomena, known as Colony Collapse Disorder (CCD), is under investigation and pesticide exposure is one of the possible contributing factors being studied. Pesticides being investigated include those used within the hive for mite and disease control as well as those used on crops that may inadvertently find their way into hives. Honey bees are vulnerable to many of the pesticides used to control insects, pathogens, and weed species. Growers dependent on honey bees must constantly maintain a delicate balance between protecting their crops from pests and pathogens and protecting pollinators. Until we have more documented information, it is advisable to err on the precautionary side when using pesticides.

Recommendations for growers

- Know the pesticides you are using and their toxicity to bees (do not depend on a third party to provide this information).
- *Read the label and follow the label directions.*
- **Never** use a pesticide on a blooming crop or on blooming weeds if honey bees are present.
- The use of a pesticide prebloom, just before bees are brought onto a crop, is *not* recommended. If one of these materials

must be used prebloom (for example, at pink in apples), select a material that has a lower toxicity to bees and apply only when bees are not foraging, preferably in late evening.

- Do not apply these materials postbloom (example: petal fall) until after the bees have been removed from the crop.
- Blooming time varies depending on cultivars. Bees pollinating one variety or crop may be at risk while another postbloom crop or variety is being treated with insecticides. Also, while crops may have completed blooming, bees may be visiting blooming weeds in and around crops. Be aware of these situations and avoid the application of pesticides on a nonblooming crop if there is risk of drift onto blooming crops and weeds if bees are present. If a spray must be applied, use the least toxic material and apply only when bees are not foraging.
- Protect water sources from contamination by pesticides. If necessary, provide a clean source of water close to colony locations prior to their arrival in the orchard or crop.
- The mode of action of many fungicides is unknown; however, some are known to synergize with pesticides and together these can be highly toxic to bees. It is highly desirable to avoid the application of fungicides on blooming crops when bees are present.

As a result of mites, diseases, and CCD, fewer beekeepers are providing fewer honey bee colonies for growers. In addition, the quality of honey bee colonies, at times, may be marginal for the purpose of pollination. Never before has the pollination situation been so critical. To ensure maximum crop yields, growers now must give careful attention and consideration to crop pollination.

To ensure adequate quality and numbers of colonies, growers should consider the following:

- Contact beekeepers early. Since honey bee colonies may be in short supply during some years, it is critical to contact beekeepers as early as possible so they know you are depending on them to supply bees. If you do not have a past relationship with the beekeeper, you should make initial contact with him or her in the fall. Beekeepers assess the survival and strength of their colonies from mid-February to mid-March. Contact your beekeeper during this time to be certain that enough bees are available for spring pollination. In addition, you should make every effort to give beekeepers at least 48 hours' notice to move bees onto the crop.
- Draw up a pollination contract. To prevent misunderstandings, it is a good idea to draw up a pollination agreement between the grower and the beekeeper. This will ensure that enough pollinators are provided and that beekeepers are protected from pest control practices that may injure bees (Figure 1-5).
- Obtain an adequate number of colonies. The number of honey bee colonies you will need will vary depending on the crop, location, attractiveness of the crop, density of the flowers, length of the blooming period, colony strength, and competitive plants in the area. The rule of thumb is to start with one colony per acre and make adjustments from there. Areas well populated with wild solitary bees and wild honey bee colonies will not need as many rented colonies.

(continued on page 47)

Table 1-9. Toxicity of insecticides, miticides, fungicides, and blossom- and fruit-thinning agents to honey bees.

Insecticide/miticide	Honey bee toxicity rating	Do not apply on blooming crops or weeds	Apply only during late evening*	Apply only during late evening, night, or early morning*	Apply at any time
Abamectin/avermectin (Agri-Mek), ≤0.025 lb ai/A [8 hours]	HT		X		
Abamectin/avermectin (Agri-Mek), >0.025 lb ai/A [1–3 days]	HT	X			
acequinocyl (Kanemite)	NT				X
acephate	HT				
acetamiprid (Assail)	ST			X	
azadirachtin (Azatin, Neemix) [<2 hours]				X	
azinphos-methyl WSP (Guthion) [4 days]	HT	X			
<i>Bacillus thuringiensis</i> Bt (Dipel)	NT				X
bifenazate (Acramite)	MT			X	
bifenthrin (Brigade), < 0.04 lb ai/A	HT			X	
bifenthrin (Brigade), 0.04 lb ai/A	HT		X		
bifenthrin (Brigade), ≥0.06 lb ai/A [>1 day]	HT	X			
buprofezin (Centaur)	NT				X
carbaryl 4F (Sevin)*, 1 lb ai/A or less	HT		X		
carbaryl 4F (Sevin), 2 lb ai/A	HT	X			
carbaryl WP (Sevin) [3–7 days]	HT	X			
carbaryl XLR (Sevin), ≤1.5 lb ai/A [8 hours]	HT		X		
carbaryl XLR (Sevin), ≥1.5 lb ai/A [>1 day]	HT	X			
chlorpyrifos EC (Lorsban,) [4–6 days]	HT	X			
clofentezine (Apollo)	NT				X
clothianidin (Clutch)	HT	X			
<i>Cydia pomonella</i> granulosus virus (Carpovirusine, Cyd-X)	NT				X
cyfluthrin (Baythroid) [>1 day]	HT	X			
deltamethrin (Decis) [<4 hours]	HT			X	
diazinon EC or WP [2 days]	HT	X			
dimethoate (Cygon) [3 days]	HT	X			
emamectin benzoate (Proclaim) [<2 hours]	HT			X	
endosulfan (Thiodan, Thionex), ≤0.5 lb ai/A [2–3 hours]	MT			X	
endosulfan (Thiodan, Thionex), >0.5 lbai/acre [8 hours]	MT		X		
esfenvalerate (Asana), ≤0.025 lb ai/A	HT		X		
esfenvalerate (Asana), 0.0375 lb ai/A [1 day]	HT	X			
ethephon (Ethrel)	NT				X
etoxazole WDG (Zeal)	NT				X
fenbutatin-oxide (Vendex)	NT				X
fenpropathrin (Danitol) [1 day]	HT	X			
fenpyroximate (Portal)	NT				X
flonicamid (Beleaf 50SG)	ST				X
flubendiamide (Belt)	NT				X
formetanateHCl (Carzol), ≥1 lb ai/A [<12 hours]	HT		X		
hexythiazox (Onager, Savey)	NT				X
horticultural mineral oils [<3 hours]	MT			X	
imidacloprid (Provado), ≤0.1 lb ai/A [<8 hours]	HT	X			
indoxacarb (Avaunt) [3 hours]	HT			X	
kaolin clay (Surround)	NT (repellent)	X			X
lambda-cyhalothrin (Warrior), ≤0.02 lb ai/A	HT		X		
lambda-cyhalothrin (Warrior), ≥0.03 lb ai/A [>1 day]	HT	X			
lime sulfur (repellent for up to 7 days)	NT	X			X
malathion EC [2–6 hours]	HT		X		

(continued)

Table 1-9. Toxicity of insecticides, miticides, fungicides, and blossom- and fruit-thinning agents to honey bees (continued).

Insecticide/miticide	Honey bee toxicity rating	Do not apply on blooming crops or weeds	Apply only during late evening*	Apply only during late evening, night, or early morning*	Apply at any time
malathion ULV, ≤3 fl oz ai/A [3 hours]	HT			X	
malathion ULV, 8 fl oz ai/A [5.5 days]	HT	X			
malathion WP [2 days]	HT	X			
methidathion (Supracide) [1–3 days]	HT	X			
methomyl (Lannate) [2 hours]	MT			X	
methoxyfenozide (Intrepid)	NT				X
NAA/1-Naphthaleneacetic acid	NT (possibly repellent)				X
novaluron (Rimon) (sublethal reproductive effects on adults w/in 24 hours of application, contaminated pollen lethal to larvae)	HT to larvae w/ contaminated pollen	X	X		
oxamyl (Vydate), ≤ 0.5 lb ai/A [3 hours]	HT			X	
oxamyl (Vydate), ≥1 lb ai/A [8 hours]	HT		X		
permethrin (Ambush, Pounce), 0.1 lb ai/A [0.5–2 days]	HT	X			
phosmet (Imidan), 1 lb ai/acre [>3 days]	HT	X			
potassium salts of fatty acids/soap (M-Pede)	NT				X
pyrethrins (Pyrenonee, Pyrocide) [<2 hours]				X	
pyridaben (Nexter) [<2 hours]				X	
pyriproxyfen (Esteem)	NT				X
renaxypyr (Altacor)					X
spinosad (Entrust, Success) [<2 hours]	HT			X	
spirodiclofen (Envidor)	HT	X			
spinetoram (Delegate) [<2 hours]	HT			X	
spirotetramat (Movento)	NT				X
sulfur	NT				X
tebufenozide (Confirm)	NT				X
thiacloprid (Calypso)	ST			X	
thiamethoxam (Actara) [7–14 days]	HT	X			
oxamyl (Vydate), 1 lb ai/acre or more [8 hours]		X			
oxydemeton-methyl EC (MSR spray concentrate) [<2 hours]			X		
permethrin (Ambush, Pounce), 0.1 ai/acre [0.5–2 days]	X				
phosmet (Imidan), 1 lb ai/acre [>3 days]	X				
potassium salts of fatty acids/soap (M-Pede)				X	
pyrethrins (Pyrenonee, Pyrocide) [<2 hours]			X		
pyridaben (Nexter, Pryamite) [<2 hours]			X		
pyriproxyfen (Esteem)				X	
rotenone [<2 hours]			X		
spinosad (Entrust, Success) [<2 hours]			X		
spirodiclofen (Envidor)	X				
sulfur				X	
tebufenozide (Confirm) [<8 hours]		X			
thiacloprid (Calypso)			X		
thiamethoxam (Actara) [7–14 days]	X				

Adapted from Riedl, H., E. Johansen, L. Brewer, and J. Barbour; How to Reduce Bee Poisoning from Pesticides (Pacific Northwest Extension, 2006).

*These materials are more hazardous to bees in a moist climate, such as East Coast fruit-growing regions.

Time periods in brackets refer to the length of the residual toxic effect. Do not return bees to the field within that time period.

Additional label restrictions may apply; see pesticide label.

Insecticide toxicity is generally measured using acute contact toxicity values LD_{50} —the exposure level that causes 50 percent of the population exposed to die.

Toxicity thresholds are generally as follows to adult bees:

- HT, highly toxic (acute $LD_{50} < 2/\mu\text{g}/\text{bee}$)
- MT, moderately toxic (acute $LD_{50} 2\text{--}10.99\mu\text{g}/\text{bee}$)
- ST, slightly toxic (acute $LD_{50} 11\text{--}100\mu\text{g}/\text{bee}$)
- NT, nontoxic (acute $LD_{50} > 100\mu\text{g}/\text{bee}$)

POLLINATION AGREEMENT

This agreement is made _____, 20____, between _____, and _____.
(date) (grower's name) (beekeeper's name)

I. TERM OF AGREEMENT

The term of this agreement shall be for the 19____ growing season.

2. RESPONSIBILITIES OF THE BEEKEEPER

a. The beekeeper shall supply the grower with _____ hives (colonies) of honeybees to be delivered to the _____ as follows:
(orchard, field, etc.)

(Fill in the appropriate line or lines and cross out those that do not apply)

Approximate date of introduction: _____. Number of days after written notice from the grower: _____.

Time in relation to the following amount of bloom:

Description of location(s): _____

(For additional space attach a separate sheet dated and signed by both parties)

The beekeeper shall locate said bees in accordance with directions of the grower, or, if none are given, according to his/her judgment in providing the maximum pollination coverage.

b. The beekeeper agrees to provide colonies of the following minimum standards:

Disease-free colonies with a laying queen as evidenced by brood.

_____ frames with brood, with adult bees to cover.

_____ pounds of honey stores or other food.

_____ story hives.

The beekeeper agrees to open and demonstrate the strength of colonies randomly as selected by the grower.

c. The beekeeper agrees to maintain the bees in proper pollinating condition by judicious inspection and supering or honey removal as needed.

d. The beekeeper agrees to leave the bees on the crop until:

(Fill in the appropriate line or lines and cross out those that do not apply)

Approximate date of removal: _____. Number of days of written notice from grower: _____.

Time in relation to amount of crop bloom: _____

Other: _____

(Please complete reverse side)

Figure 1-5. Pollination agreement.

3. RESPONSIBILITIES OF THE GROWER

- a. The grower agrees to provide a suitable place to locate the hives. The site must be accessible to a truck and other vehicles used in handling and servicing the colonies. The grower shall allow the beekeeper entry on the premises whenever necessary to service the bees, and the grower assumes full responsibility for all loss and damage to his fields or crops resulting from the use of trucks or other vehicles in handling and servicing such colonies of honeybees.
- b. The grower agrees not to apply pesticides toxic to bees to the crop while the bees are being used as pollinators nor immediately prior to their movement if the residue would endanger the colonies. See Beekeeping Topics No. 4 “Honey Bees and Pesticides” for determining which pesticides are hazardous to bees.
- c. The following pesticides, other agricultural chemicals, and methods of application are mutually agreed to be suitable while the bees are on the crop.

- d. The grower also agrees to properly dispose of all pesticide solutions in such a manner that bees will not be able to contact the material while searching for a water source.
- e. The grower agrees to give the beekeeper a 48-hour notice if hazardous materials not listed need to be applied. The cost of moving the bees away from and back to the crop to prevent damage from highly toxic materials shall be borne by the grower.
- f. The grower agrees to pay for _____ colonies of bees at the rate of \$_____ per colony. Payment shall be made to the beekeeper as follows: \$_____ per colony on delivery and the balance on or before _____ of said year.
(date)
Additional moves or settings shall require \$_____ per hive per move.
- g. The grower agrees to provide adequate watering facilities for the bees if none are available within one-half mile of each colony used in pollinating the crop.

Signed: _____
Grower
Beekeeper

Address: _____

Phone: _____

- Obtain bees at the appropriate time. For apples and other tree fruit, move colonies in at 10 to 25 percent bloom. If primary blossoms produce the choice apple fruit, however, bees should be present at the start of bloom or when king bloom on the south side of trees starts to open. Competing bloom from other flowers in the orchard, such as dandelions, should be eliminated by mowing, cultivation, or the use of herbicides. For melons, cucumbers, squash, strawberries, blueberries, and cranberries, honey bees should be moved onto the crop when the crop is attractive to the bees. This means that there should be many blooming flowers (10 to 20 percent) to attract bees to the crop.
- Place colonies for maximum effect. Place colonies in groups of four to eight in favorable locations throughout the orchard or field to provide even distribution of the bees. In large orchards or fields, pollination is just as effective if groups of 10 to 20 hives are strategically distributed in sunny, wind-protected spots. Colonies should be protected from the wind and exposed to the sun from early morning until evening. Bales of straw or packing boxes stacked behind colonies offer wind protection. Colony entrances that face east or southeast encourage bee flight. Hives should be placed off the ground, and front entrances should be kept free of grass and weeds. Do not place colonies under trees or in the shade.

Bee activity is determined by weather and by conditions within the hive. Honey bees rarely fly when the exterior temperature is below 55°F. Wind speeds above 15 mph seriously slow activity, and activity stops when winds are between 21 and 25 mph. The stronger the colony, the lower the temperature at which bees initiate flight. Cold, rainy weather inhibits foraging. Under marginal weather conditions, foraging is limited to trees close to the hives. An extended period of inclement weather may require greater hive distribution to obtain adequate coverage.

- Assess colony strength; be sure you are getting strong colonies. It is important that the colonies you rent are healthy and contain a large enough population to do the job. For pollination, package bees (bees purchased through the mail and recently installed) and small hives are inferior to strong, overwintered colonies. The field bee population generally is correlated with the amount of brood in the hive. In packages and weak colonies, most of the hive population must remain in the hive to maintain temperatures of 93 to 95°F and rear brood. Two weak colonies are not equal to one strong colony! Colony strength can be assessed in several ways:

1. Inspect hives. This method is the most time consuming but also the most accurate for assessing the quality of your investment in rented honey bee colonies. Colonies used for springtime pollination should have the following at minimum:

- a laying queen
- one and one-half or two stories (hive bodies or boxes)
- four to six frames of brood
- enough adult bees to cover six to eight frames

These are minimum requirements; stronger colonies with larger populations make superior pollination units and may command a higher price. As these stronger colonies are opened, bees will “boil out,” or cover the tops of the frames. When smoked, however, the bees move down onto the frames

and may not cover the frame tops. In this case, the frames themselves should be covered with bees. Note that there will be some variability in the quality of the colonies you rent. As a general rule, a group of colonies with 10 percent falling below the minimum standard is acceptable if 10 percent are above the minimum standard. Also, for a variety of reasons, some colonies may become queenless for a time; however, if these colonies meet all the other minimum requirements they still will be effective pollination units.

The Pennsylvania Department of Agriculture Apiary Inspection Service runs a hive evaluation program for colonies used in pollination situations. Inspections are performed by request only. Requests may be made by either the grower or the beekeeper and should be arranged through the state apiarist at the PDA Bureau of Plant Industry, 2301 North Cameron Street, Harrisburg, PA 17110; telephone 717-772-5225. Requests for inspections should be made as early as possible to facilitate scheduling. If an evaluation is requested by the grower, the beekeeper will be informed that a request has been made.

Inspections are performed by the local or state apiarist. Colonies are inspected objectively to determine the colony size (number of supers), the presence of a laying queen, the number of frames of brood and adult bees, and the presence of disease and parasites. At least 10 percent of the colonies in an apiary, or a minimum of five colonies, are selected at random for inspection. Inspected colonies are identified by sticker. If selected colonies are banded or stapled, these are not refastened by the inspector. A copy of the evaluation report is given to both the grower and the beekeeper.

2. Assess traffic at hive entrance. This method is less time consuming but also less accurate. On a warm (70 to 80°F), calm day between 11 AM and 3 PM, bee traffic at hive entrances should be heavy. During a one-minute observation period, strong colonies should have 50 to 100 or more bees arriving and leaving the hive. Bees also should be seen arriving with pollen pellets on their back legs. In weak colonies, perhaps only 10 to 20 bees will be seen arriving and leaving. Colonies that are being used for summer pollination should have even heavier traffic at the hive entrance.

Another crude way to assess colony strength is to observe entrances when temperatures are cool (between 55 and 60°F). The stronger the colony, the lower the temperature at which bees will fly. In general, weaker colonies rarely fly when temperatures are below 60°F. Strong colonies will fly when temperatures are between 55 and 60°F. In general, honey bees rarely fly when temperatures are below 55°F.

3. Assess bee density on the crop. This method allows you to assess the contribution of feral or other honey bee colonies in the area, if present, in addition to rented bees. If you are using rented colonies, however, this method tells you little about the quality of the bees you have rented. We suggest that if you use this technique and find that the number of bees on the crop is low, you then use options (1) or (2) to assess the strength of the rented bees before renting additional bees.

For apple trees, make observations in late morning during king bloom; at a glance you should see one to two bees foraging on blooms. Make several assessments at different locations around the orchard. Note: This guideline is appropriate only for honey bees and is not accurate for bumble bees or solitary bees. It is only a rough guideline and may change depending on variety and planting conditions.

- Carefully consider the use of bee attractants. Research on sugar-based attractant sprays for improving pollination indicates that such materials are generally ineffective. The entire tree is sprayed with the attractant and bees collect the sugar off the leaves, usually without visiting the flowers. Although this brings more bees into the field or orchard, more pollination does not necessarily occur. In addition, the sugar may be detrimental if it serves as a medium for the growth of sooty molds. Other attractants containing bee-derived communication pheromones, such as geraniol, have proved more successful, but further testing is needed before a full recommendation can be made.

One of the newest and most promising attractants, Fruit Boost, contains honey bee queen mandibular pheromone. Canadian research has shown that when it is sprayed on flowering crops, queen mandibular pheromone can result in dramatic increases in yields for some crops. This product is sold in both Canada and the United States, and is being marketed mainly for use on pears, highbush blueberries, Gala apples, and in vegetable seed production. U.S. distributors are located in the Pacific Northwest. For more information, contact Contech Enterprises Inc., Unite 115-19 Dallas Rd., Victoria, BC V8V 5A6, Canada; phone: 800-767-8658; fax: 604-940-9433; their Grand Rapids Office, phone: 616-459-4139; fax 616-459-4140; or online at www.contech-inc.com.

- Other precautions and requirements: Beekeepers should be given at least 48 hours' notice to move bees onto or off the crop. Insecticides applied on or near the crop before or during bloom are a serious threat to bees. Give the beekeeper 48 hours' advance notice of any applications so that the bees can be removed from the field or orchard.

Honey bees need water for temperature regulation and brood production. Provide a clean water supply near the hives. Keep orchard wheel ruts and areas around the pesticide sprayer fillpoint drained to eliminate a possible insecticide-laden water source.

Additional information

The publications listed below are available at your local extension office or by contacting the Penn State Department of Entomology at 814-865-1895, on the MAAREC website at <https://agdev.anr.udel.edu/maarec/>, or from the Center for Pollinator Research (ento.psu.edu/pollinators).

- *Beekeeping Basics*
- *Beekeeping Topics: Sources of Bees for Pollination in Pennsylvania, Bees and Insecticides, Pollination Contracts, Basic Biology and Management of the Japanese Hornfaced Bee*

Sources of pollination rentals

Growers who need bees should make contracts with the beekeepers as early as possible (mid-February) so that proper preparations can be made. Specialized management is necessary in order to

develop strong, efficient colonies, especially for early spring pollination. Therefore, beekeepers need to know how many colonies are needed and the approximate time of delivery as early as possible.

For an up-to-date list of beekeepers with colonies of bees for rent (*Sources of Bees for Pollination in Pennsylvania*), please visit the MAAREC website at <https://agdev.anr.udel.edu/maarec/> or contact your county extension office or the Penn State Department of Entomology at 814-865-1896.

Alternative pollinators

Growers of bee-pollinated crops, particularly apples, are becoming increasingly interested in the possible use of solitary bees as managed pollinators. Two species in the genus *Osmia* (mason bees) are currently being used, on a limited basis, for tree fruit pollination: the Blue Orchard Bee (BOB) (*Osmia lignaria*) and the Japanese Orchard Bee (JOB) (*Osmia cornifrons*), which was introduced by the USDA into Pennsylvania fruit orchards from Japan in the 1990s. The native blue orchard bee (BOB) is also being investigated as a commercial pollinator of almonds along the West Coast, and JOB has been used to pollinate the majority of apple production in Japan for more than 50 years. In 2007–08, extensive surveys of native pollinators by Penn State and the Pennsylvania Department of Agriculture determined that JOB is now established in the wild throughout most of Pennsylvania and co-exists with BOB in areas adjacent to fruit orchards. Another Japanese bee, *Osmia taurus*, was also found in many areas of the state for the first time, but it was not introduced by USDA and therefore was not quarantined for parasites and pathogens. *O. taurus* is very similar in appearance to JOB and was probably accidentally introduced by a hobbyist, despite strict regulations against the introduction of foreign bees. Adults of all three species emerge early in the spring and begin to fly at approximately the same time as apricot bloom. At least 120 species of native bees have now been found in fruit orchards during the growing season.

Unlike honey bees, mason bees are solitary, meaning all females mate, reproduce, and provision their own nests. Although these bees are solitary, they are gregarious and prefer to nest in groups. Under natural conditions, these bees nest in hollow reeds or stems of plants, but they can be easily encouraged to nest in cardboard tubes or wooden nesting blocks drilled with holes of the correct diameter. They have also been found nesting naturally in large numbers in old apple wood stored in apple bins for firewood. Beetle larvae boring into the apple wood for several seasons apparently made holes of the right diameter for JOB nests.

In the Mid-Atlantic region, *Osmia* are active only for about 6 to 8 weeks from about mid-April through mid-June. Males emerge about 1 week before pear trees bloom in the spring. Females emerge 2–3 days after males, or longer, depending on weather conditions. Mating occurs immediately after females emerge with the males being attracted by a pheromone.

Both male and female bees make floral visits. Females collect primarily pollen and carry it on the lower surface of their abdomens (unlike honey bees, which carry pollen on their legs). After their ovaries have developed fully, females begin provisioning cells and laying eggs within the nest "tube." They collect a large mass of pollen first and then nectar, which they regurgitate on the pollen ball. This sticky nectar acts as glue to hold the egg

on the pollen ball. After the egg is laid, a mud wall is built and the next cell is provisioned and the next egg is laid. Females can make 1–2 cells a day under favorable conditions.

Newly laid eggs take approximately a week to hatch and the larvae will consume the pollen ball over a month period. Last instar larvae then spend about a week spinning a thick multilayered cocoon in the early summer after which the pre-pupa enters diapause. Pupation takes place in the late summer and adults eclose and expand their wings in the early fall without leaving the cocoon. The fully formed adults enter diapause for the winter and normally emerge in the early spring at apricot bloom or about 1 week before pear bloom.

Management of *Osmia*

Once they are initially obtained, *Osmia* species are relatively easy to manage. They will nest in cardboard tubes or wood blocks that have $\frac{5}{16}$ -inch diameter openings and are between 4 and 10 inches deep. They will also nest in reeds (*Phragmites*) and sections of bamboo of approximately the same diameter. Under favorable conditions, and with availability of abundant nest sites, populations tend to double or triple from year to year. Females tend to nest in the same area (instead of flying off to seek a new nesting site) when there are 3 to 5 times as many empty as full tubes. Both species of *Osmia* are susceptible to parasitic wasps if they are left in the field during June and July. It is best to remove the nesting tubes from the field once the adult bees are no longer active and store them in an unheated, parasite-proof shelter.

Sanitation of nesting materials is important in long-term management of *Osmia* due to parasitic mites (*Chaetodactylus*), which kill developing bees and feed on stored pollen (see crawford.tardigrade.net/bugs/BugofMonth35.html). *Osmia* will use the same nesting blocks, tubes, reeds, or bamboo section year after year if allowed, but mite populations will quickly build to infest over 50 percent of the cells and cause the decline and eventual destruction of colonies if not controlled. The mites move to new colonies on the bodies of bees as they move through infested cells as they emerge in the spring and then on to new nesting sites. More than 1,500 mites have been found on a single JOB adult in the spring, which prevented it from flying. The mites themselves are very small and hard to see without magnification, but infested cells are recognizable from the fluffy remains of shed mite exuvia and eaten pollen rather than a compact ball of yellow pollen. The most effective way to control these mites is by moving *Osmia* colonies to new or sanitized nesting materials each year. The best way to do this is to remove the overwintering adults in their cocoons from the nesting materials during the early winter months. This is easily done in bamboo or reed sections by splitting them or by unraveling cardboard tubes, but is impossible with wooden blocks. Specially built wooden blocks sectioned and laminated together like the pages of a book, however, are available for *Osmia* management and can be cleaned of parasites and re-used for many years. These are sold commercially as Binder Boards (see www.binderboard.com/Binderboards/Osmiabb.htm). The cocooned adults can be washed in cold water and are easily stored in small containers after removal from nesting materials, but they must be placed next to nesting sites before emergence in the spring. Upon emergence in the spring adult *Osmia*, conduct an orientation flight to fix the location of the nest from which they emerged. If this orientation flight is prevented or if the nest

is moved more than a few inches after they emerge, the bees will abandon the site for new nests.

JOB and BOB require a cold period before they can emerge from their cells. JOB is apparently less cold tolerant than the native BOB, and it is recommended that they be sheltered when temperatures get below 10°F, although colonies have survived temperatures below 0°F in Michigan, Ohio, and Pennsylvania. They do best in a humid, temperate climate, in USDA Plant Hardiness Zones 5–8. You may place JOB and BOB cocoons in a refrigerator for winter storage, but make sure humidity levels stay around 75 percent. Spring emergence can be delayed up to 1 month in this way, but mortality increases quickly thereafter. It should be noted that experience has shown that both species of *Osmia* obtained from the western United States may not adjust well to conditions in the Mid-Atlantic region.

Both species of orchard bee and more than 500 species of other solitary bees are common throughout the Mid-Atlantic region and it may be possible to encourage these bees to form aggregations in your orchard simply by providing nesting sites and restricting the use of pesticides during the short period that these bees are active. To learn more about the management of solitary bees and where to obtain these bees and/or cardboard nesting tubes, visit the MAAREC website at <https://agdev.anr.udel.edu/maarec/> or contact your county extension office or the Penn State Department of Entomology at 814-865-1896. A very good source of information on *Osmia* management with links to other sources of information on solitary bees is Pollinator Paradise, www.binderboard.com/default.htm.

Fertilizing Newly Planted Apple Trees

Newly planted apple trees require special attention where nitrogenous fertilizers are concerned. Lack of application, improper placement, or high rates can seriously damage young trees. Incorporating fertilizer into the hole at planting is not recommended because this practice can kill trees by burning young roots. Failure to apply nitrogen after planting can result in less-than-ideal growth. The rule of thumb when fertilizing new trees is to apply 0.02 pound of actual nitrogen per year in the orchard for the first 3 years. After this period, nitrogen application should be based on leaf analysis results and shoot growth. Any phosphorus or potassium as recommended by a soil test should have been applied to the field before planting and incorporated.

Follow the suggestions below for newly planted apple trees:

- Apply all fertilizer on undisturbed soil and keep the material 12 inches away from any disturbed soil (for trees planted by either auger or tree planter).
- If the nitrogen source is not critical, use whatever material is cheapest per unit of nitrogen. Table 1-10 lists the amounts of various nitrogen sources to be applied per tree to achieve the required 0.04 pound of actual nitrogen per year. If you use a source other than those listed, calculate the amount of material needed in the following fashion. First, multiply 0.02 by 1 (for a result in pounds per tree); or by 16 (for ounces per tree); or by 454 (for grams per tree). Divide the result by the decimal equivalent of the percentage of nitrogen in the material.

Example: You have a material with a nitrogen content of 46 percent. You wish to find out how many ounces to apply

per tree before the beginning of the second growing season.

$$0.02 \times 16 \text{ oz} = 0.32 \text{ oz}$$

$$0.32 \text{ oz} / 0.46 = 0.7 \text{ oz}$$

0.7 oz x 2 years = 1.4 oz per tree at the beginning of the second year

Cork Spot and Bitter Pit Fruit Disorders

Cork spot and bitter pit in York Imperial, Delicious, and Golden Delicious apples, along with other calcium-deficiency physiological disorders, continue to cause apple producers economic losses. These disorders appear to be specifically related to low levels of calcium and sometimes high levels of nitrogen in the fruit flesh. Fruit flesh calcium content is influenced by many factors. Good horticultural management techniques that improve soil conditions, encourage uniform annual cropping, and encourage moderate tree vigor will decrease calcium-related fruit disorders.

Corking, characterized by spherical dead areas in the flesh, is an orchard disorder, while bitter pit is primarily a storage disorder and usually attacks the skin and adjacent cells. However, symptoms vary according to area, variety, and environmental conditions, making this distinction less than clearcut.

While corking is worse under conditions of low calcium, lack of calcium does not appear to be the sole cause. Corking is worse under conditions of excessive tree vigor or moisture stress and has been most severe on Delicious and York Imperial. Bitter pit is worse on Golden Delicious and is aggravated by early harvest.

During the past 20 years much research has been conducted on calcium nutrition of apples in South Africa, Australia, New Zealand, England, and the United States. From this research, as well as research conducted in Pennsylvania, a comprehensive program is recommended to reduce corking and bitter pit.

A program to control bitter pit and corking should involve almost all cultural practices conducted in apple production, since no one practice guarantees control of the disorder below the economic injury level. An effective program should be based on the consideration of all five factors explained below, since in any specific orchard block one factor could be primarily responsible for the problem. Growers are urged to use these recommendations when the cost of control practices is less than losses from the disorders.

The five points in the program are listed as a person should think of them in the life of an orchard and not in order of effectiveness. Calcium chloride sprays, though listed last, offer many advantages over other parts of the program mainly because they can be started in June the year of harvest, while some of the other practices take years to accomplish.

Table 1-10. Sources of nitrogen, nitrogen content, and application rates.

Nitrogen source	Nitrogen content	Actual amount of material to apply per tree
Urea	46%	0.04 lb or 0.7 oz or 20 g
Ammonium nitrate	33%	0.06 lb or 0.97 oz or 28 g
Monammonium phosphate	11%	0.18 lb or 2.9 oz or 83 g
Diammonium phosphate	18%	0.11 lb or 1.8 oz or 50 g
Calcium nitrate	15.5%	0.13 lb or 2.1 oz or 59 g
Sodium nitrate	16%	0.125 lb or 2.0 oz or 57 g
19-19-19	19%	0.10 lb or 1.7 oz or 48 g
10-10-10	10%	0.20 lb or 3.2 oz or 91 g
5-5-5	5%	0.40 lb or 6.4 oz or 182 g

Soil conditions

Poor soil conditions can contribute to low-calcium fruit; factors to consider are explained in Table 1-11. Water stress caused by either excessive or deficient soil moisture can contribute to increases in corking and bitter pit. Tiling to remove excessive moisture and irrigation to supply supplemental water should be practiced as appropriate.

Correcting low soil pH with agricultural limestone is recommended to reduce the availability of soil aluminum and manganese, thereby maximizing the size of the root system. The magnesium content of the lime should be regulated by the tree's requirement for magnesium and the total amount of lime needed. High-magnesium (dolomitic) lime should not be used for routine soil pH correction. High-magnesium lime should be used when a soil test indicates the need for lime and a leaf analysis indicates the need for a large amount of magnesium.

Balanced nutrition

Soil testing to check soil pH and leaf analysis to determine the plant's uptake of essential nutrients are necessary in managing an orchard fertilization program. Listed in Table 1-12 are the nutritional elements that need to be managed to produce high-calcium fruit, their modes of action, and grower actions. Avoid excessive levels of nitrogen, potassium, and magnesium and deficient levels of calcium, boron, and zinc, since these conditions may contribute to deficient fruit-calcium levels.

Although soil testing and leaf analysis are not practiced by all growers, they are universally recognized as the best methods on which to base a sensible nutritional program. These two tools will minimize wasted money on unnecessary fertilizer, prevent the application of nutrient elements already present in adequate or excessive amounts, and recommend application of only those fertilizer elements necessary to ensure a profit for the grower.

Calcium sulfate

The use of gypsum (calcium sulfate), also called landplaster, to correct poor soil structure is a reasonably old practice. Gypsum can improve soil structure by increasing the aggregation of several small soil particles into larger particles. This can result in faster rates of water infiltration. Gypsum also is used as a source of calcium for soil applications on some crops. Peanuts in the southeastern U.S. are routinely sidedressed with about 1,000 pounds of gypsum annually. The use of gypsum to improve the calcium status of apple trees and fruits has been investigated in only two North American sites.

In Massachusetts, a series of studies has been conducted on Delicious and Cortland apple trees. In general, it appears that it takes 2–3 years for results to appear in the fruit. The treatments raised leaf and fruit calcium levels (20 percent and 10 percent, respectively), depressed leaf and fruit magnesium levels (20 percent and 5 percent, respectively), but had no effect on leaf and fruit potassium levels. Little or no effect was seen on fruit firmness at harvest or after storage, but bitter pit (50 percent reduction) and senescent breakdown after storage were reduced. Although high rates were used in early studies, in later studies it appeared that annual rates of as low as 3 to 4 tons per treated acre per year were effective. In a Nova Scotia study, annual applications of 5 tons per treated acre, for 5 years, raised leaf and fruit calcium levels in years 2 through 7 of the study but lowered magnesium levels.

For growers who have persistent calcium problems and who feel adventurous, the following treatment regime is suggested on an experimental basis. Apply 3 tons per treated acre, banded under the trees. This likely will be between 1.5 and 2.0 tons per acre of orchard. Follow a strict soil and leaf analysis program on an every-other-year basis to avoid nutritional problems. Special attention should be paid to magnesium, as gypsum may depress magnesium uptake.

Gypsum comes in various grades based largely on its color, with white grades being more expensive. For this use, the only relevant characteristic is the percentage of calcium in the product. The use of gypsum will not reduce the grower's need for lime.

Moderate tree vigor

Since the vegetative portions of a tree have relatively high concentrations of calcium and are seldom deficient in it, excessive tree vigor can use calcium that otherwise might be available

for the fruit. Table 1-13 contains a list of factors that need to be considered to promote moderate vegetative vigor in apple trees. Excessive pruning and nitrogen fertilization, coupled with overcrowding of trees, are often interrelated and can result in overly vigorous trees. Excessive tree vigor can also result from an inadequate fruit load. Growth regulators should be used to obtain a uniform fruit load in order to promote uniform, moderate tree vigor.

Moderate fruit density

High levels of corking and bitter pit may be found on trees with a light crop. When trees bear a light crop of apples, the fruits are normally very large and low in calcium. They are prone to low-calcium physiological disorders. Apples on trees with an excessively large crop usually have little corking and bitter pit but seldom reach optimum size to maximize profitability. Table 1-14 contains a list of factors that need to be managed to pro-

Table 1-11. Poor soil conditions that may result in low-calcium fruit disorders, their modes of action, and corrective measures.

MODES OF ACTION	CORRECTIVE MEASURES
Excessive soil moisture	
1. Water stress in trees owing to lack of air for roots.	1. Plant orchards on deep, well-drained soils with good water-holding capacity.
2. Restricted root system caused by poor root growth.	2. Install drainage tile.
Deficient soil moisture	
1. Water stress in trees caused by deficient soil moisture.	1. Plant orchards on deep, well-drained soils with good water-holding capacity.
2. Restricted root system owing to poor root growth.	2. Irrigate as needed to reduce water stress.
Low soil pH	
1. Restricted root growth caused by aluminum and manganese toxicity.	Maintain soil pH between 6.0 and 6.5 with high lime. Regulate the quantity of magnesium applied potent magnesium fertilizer and also as a liming agent.
2. Deficient soil calcium.	
3. Deficient soil magnesium.	

Table 1-12. Nutritional imbalances that may interfere with production of high-calcium apples, their modes of action, and corrective measures.

MODES OF ACTION	CORRECTIVE MEASURES
Excessive nitrogen (N)	
1. The flesh of fruit from high N trees is more likely to have corking (direct effect)	Regulate the N status of trees with the aid of leaf analysis and field observations.
2. High N trees normally are overly vigorous (indirect effect).	Keep other nutrients in balance so the desired vigor level can be attained with minimal N levels.
Excessive potassium (K)	
1. Some calcium deficiency disorders appear to be related to high levels of K as well as low calcium	1. Regulate the K status of trees with the aid of leaf analysis. 2. Do not apply K unless it's definitely needed.
2. Direct cation competition between K and calcium in soil and at the root surface.	
Excessive magnesium (Mg)	
1. Some calcium deficiency disorders appear to be related to high levels of Mg as well as low calcium	1. Regulate the Mg status of trees with the aid of leaf analysis. 2. Do not apply Mg unless it's definitely needed. 3. Do not correct low soil pH with high magnesium (dolomitic) lime.
2. Direct cation competition between Mg and calcium in soil and at the root surface.	
Deficient calcium (Ca)	
Many physiological disorders of apples are directly related to low fruit flesh Ca levels although low Ca may not be the direct cause.	1. Maintain a soil pH of 6.0 to 6.5 with high-calcium lime. 2. Use high-magnesium (dolomitic) lime only in cases with a proven need for large quantities of magnesium. 3. Apply Ca sprays. 4. Use all other parts of the program to increase fruit Ca levels
Deficient boron (B)	
1. B deficiency can directly cause fruit flesh deformities.	1. Regulate the B status of trees with the aid of leaf analysis. Maintain 35 to 60 ppm of leaf B. 2. Make ground applications of borax or tree sprays of boron when needed.
2. Some B deficiencies appear to increase corking.	
3. Some B deficiencies appear to interfere with normal translocation of calcium.	

Table 1-13. Causes of excessive vegetative growth that may compete for available calcium, their modes of action, and corrective measures.

MODE OF ACTION	CORRECTIVE MEASURES
Excessive pruning Severe pruning can overinvigorate an apple tree.	<ol style="list-style-type: none"> 1. Reduce tree vigor so that moderate pruning can be used to maintain tree size. 2. Maintain an annual, moderate pruning program.
Excessive nitrogen (N) Excessive N fertilization often results in overly vigorous trees.	Maintain a nutritionally healthy tree so that a minimum level of N can be used to maintain moderate tree vigor.
Inadequate spacing Planting trees too close together can result in a vicious cycle of excessive	Integrate variety, rootstock, soil type, and your management intentions into pruning followed by excessive vigor.
Low fruit load Trees bearing a light crop normally divert growth into excessive vegetation.	Maintain a system of annual cropping to avoid excessive tree vigor.

Table 1-14. Factors that may result in a small crop of large fruit, their modes of action, and corrective measures.

MODE OF ACTION	CORRECTIVE MEASURES
Poor fruit bud formation Production of annual crops must integrate the production of a fruit crop and good numbers of fruit buds each year	<ol style="list-style-type: none"> 1. Maintain moderate tree vigor and tree health to encourage production of a bud crop each and every year. 2. Use growth regulators to encourage fruit bud formation 3. Thin excessive fruits to encourage annual production
Insufficient desirable pollen Without adequate pollen for cross-pollination, a crop cannot be produced.	<ol style="list-style-type: none"> 1. Plant two desirable pollen-source varieties for the main varieties in all blocks. Can be crabapples. 2. Add bouquets at full bloom 3. Plant additional pollinizers in mature orchards. 4. Graft additional pollinizers onto trees of the main variety. 5. Use pollen inserts in beehives.
Poor weather conditions Cross-pollination by insects is most easily accomplished in warm sunny weather.	
Not enough bees Cross-pollination by insects is considered essential for fruit set. Additional bees should normally be placed in an orchard if other factors are not optimal.	Under normal conditions, use one hive for each acre.
Frost damage <ol style="list-style-type: none"> 1. Eliminating or reducing the crop severely upsets any management system for annual production 2. Crop reduction results in stimulation of vegetative growth and excessive fruit size. 	<ol style="list-style-type: none"> 1. Select frost-free sites for orchards. 2. Use techniques such as wind machines or overhead irrigation to reduce frost damage

duce annual crops of moderately sized fruit. Some factors to be managed for uniformity of cropping are frost protection, pollen source, bee population, and pollinating weather.

A prerequisite for achieving moderate annual fruit density is the annual production of high-vigor fruit buds. An essential ingredient in this program is the effective use of growth regulators to thin excessive crops and to encourage the production of high-vigor flower buds for the following year's crop. Many registered growth regulators are available for this purpose, including NAA, NAD, ethephon, benzyladenine, carbaryl, and oxamyl. See other sections of this guide for current recommendations in the proper use of these products.

Calcium sprays

Sprays of calcium chloride have been successful in reducing or commercially controlling corking and bitter pit, but seldom have these sprays completely eliminated the problem. Extensive research has been conducted around the world to define the products, rates, and timings that will minimize the incidence of low-calcium physiological disorders in apples. The major portion of the research has been conducted on Golden Delicious and York Imperials. However, recommendations developed from research in Pennsylvania have effectively controlled corking and bitter pitting in nearly all varieties.

The effective use of calcium chloride tree sprays may be the most cost-effective, quickest cultural practice for reducing low-calcium physiological disorders in apples. We recommend applying 15 to 50 pounds of calcium chloride per acre per season in six to eight cover sprays. Calcium in the form of calcium chloride is recommended because of its proven effectiveness and lower cost.

Other products that supply calcium are available. Many are recommended at rates that supply lower amounts. These products may be beneficial when only small amounts of calcium are needed to correct the deficiency. To evaluate other materials effectively, growers should compare the cost per pound of actual calcium and the amount of formulation needed to achieve an equivalent rate to the 15 to 50 pounds of calcium chloride per acre per season needed to control problems. See "Determining the amount of elemental calcium in a commercially formulated product." Growers experiencing severe bitter pit on summer cultivars, especially Summer Rambo, may need to apply special calcium sprays in addition to cover sprays.

15–20 pounds per acre per year: This is the lowest rate that should be used. It will give some control of bitter pitting and corking, will cause no leaf burning, and will probably not enhance storage life of the fruit.

20–30 pounds per acre per year: This rate should give good control of preharvest physiological disorders and probably

should be the standard rate where these disorders are chronic problems. It will not cause any significant leaf injury and will probably not enhance the storage life of the fruit.

30–40 pounds per acre per year: This rate should give excellent control of corking and bitter pitting and should be the intermediate rate for Pennsylvania. It may somewhat enhance the storage potential of apples and should result in almost no leaf injury.

40–50 pounds per acre per year: This is probably the highest rate that should be used in Pennsylvania and should give outstanding control of corking and bitter pit. This rate may result in some slight burning on the edges of the leaves, but it usually does not appear until mid-September or October. This rate may enhance the storage life of the fruit.

Applying calcium chloride sprays

Time of application: Include in all cover sprays. Do not premix calcium chloride with Solubor in a small volume of water before adding to the tank, when both materials are to be applied together.

Gallons per acre: No restrictions; sprays with as little as 20 gallons per acre have been effective.

Compatibility: At the rates recommended, calcium chloride and/or Solubor may be mixed with spray oil (Superior 70 Sec.), with WP formulations, or with EC formulations of the more common fruit pesticides. Compatibility of materials other than calcium chloride is uncertain, and growers should either check the label for information or conduct a compatibility test in a small jar.

Leaf injury: Some leaf injury may occur from calcium chloride sprays following wet, cool springs or hot, dry summers. When injury is noticed, reduce calcium chloride to one-half the rate in the next spray or delete calcium chloride from the cover sprays until one-half inch of rain has fallen.

Equipment: Calcium chloride can corrode some types of spray equipment. Few problems have occurred if sprayers and tractors are rinsed after use. The newer sprayers made of stainless steel, fiberglass, or various plastics that are rust resistant are desirable.

Special considerations: If early maturing cultivars continue to exhibit bitter pitting and storage breakdown after the standard rate of calcium chloride has been used, a higher rate should be used. Only calcium that hits the skin of the fruit can increase fruit quality. Therefore, in the standard program, 8 pounds of calcium per acre per year may be applied to Delicious, Rome Beauty, and Golden Delicious, but early maturing cultivars such as Summer Rambo may be receiving only 4 pounds of calcium per acre per year prior to harvest.

In summary, many factors influence fruit calcium concentration, and since it is difficult to raise fruit calcium level, growers should use all methods possible to gain the upper hand against corking, bitter pitting, and other low-calcium-related disorders. Cultural practices involve soil and nutritional factors as well as tree vigor and fruit density.

Determining the amount of elemental calcium in a commercially formulated product

1. Look for, or determine, the percentage of elemental calcium in the product. This should be listed somewhere on the label.
2. For a liquid formulation multiply the percentage by the weight of the material per gallon. For a solid multiply the percentage by the weight of material you will add to the tank. Result equals the pounds of calcium per gallon or pound of formulated product.
3. Determine the rate of formulated material you intend to apply per acre per application. For a specific calcium product this is usually listed on the label.
4. Multiply the amount of material per acre by the number of applications to be made during the season. Result equals the amount of total product per acre per season.
5. Multiply the amount of total product per acre per season (from Step 4) by the pounds of calcium per gallon or pound of formulated product (from Step 2). Result equals the total amount of elemental calcium per acre per season.
6. Compare the result from Step 5 with our recommendation of 4 to 14 pounds of elemental calcium per acre per season.
7. Compare the season-long cost of materials. Multiply the amount of material used per season times the cost of the material.

Example 1. Product A sells for \$6.50 per gallon and is a liquid listed as containing 15% elemental calcium. The weight per gallon is 12 pounds. The label recommends 2 to 4 quarts per acre per application with eight applications suggested per season. You decide to apply 2 quarts per acre per application.

Step 1: Product contains 15% elemental calcium.

Step 2: $12 \text{ lb} \times 0.15 = 1.8 \text{ lb}$ of elemental calcium per gal.

Step 3: You choose to apply 2 quarts (or 0.5 gal) per acre per application.

Step 4: $0.5 \text{ gal per acre per application} \times 8 \text{ applications per season} = 4 \text{ gal of material per acre per season}$.

Step 5: $4 \text{ gal} \times 1.8 = 7.2 \text{ lb}$ of elemental calcium per acre per season.

Step 6: Our recommendation is 4.0 to 14.0 lb of elemental calcium per acre per season.

Step 7: $4.0 \text{ gal} \times \$6.50 \text{ per gal} = \26.00 .

Example 2. Product B sells for \$1.50 per pound and is a solid powder containing 30 percent elemental calcium. The label recommends 3 to 4 pounds per acre per application with eight applications suggested per season.

Step 1: Product contains 30% elemental calcium.

Step 2: $1 \text{ lb} \times 0.30 = 0.30 \text{ lb}$ of elemental calcium per lb of material.

Step 3: You choose to apply 3.0 lb of material per acre per application.

Step 4: $3 \text{ lb per acre per application} \times 8 \text{ applications per season} = 24 \text{ lb of material per acre per season}$.

Step 5: $24 \text{ lb} \times 0.30 = 7.2 \text{ lb}$ of elemental calcium per acre per season.

Step 6: Our recommendation is 4.0 to 14.0 lb of elemental calcium per acre per season.

Step 7: $24 \text{ lb} \times \$1.50 \text{ per lb} = \36.00 .

Comparing costs

You wish to compare the cost per pound of elemental calcium in two products. From Products A and B above, we can determine which is cheaper.

1. Determine the pounds of elemental calcium per gallon or pound of formulated product for each product you are considering. (Same as in Step 2 above).
2. Determine the cost per pound of elemental calcium in each product.
3. Compare the two materials' cost.

Example: From Products A and B above, determine which is cheaper per pound of elemental calcium.

Step 1: Product A = $12 \text{ lb} \times 0.15 = 1.8 \text{ lb}$ of elemental calcium
Product B = $1 \text{ lb} \times 0.30 = 0.30 \text{ lb}$ of elemental calcium

Step 2: Product A = $\$6.50 \text{ per gallon} \div 1.8 \text{ lb calcium per gal of material} = \3.61 per lb
Product B = $\$1.50 \text{ per lb} \div 0.30 \text{ lb calcium per lb of material} = \5.00 per lb

Step 3: Product A costs $\$3.61 \text{ per lb}$ of elemental calcium-
Product B costs $\$5.00 \text{ per lb}$ of elemental calcium

Determining the amount of product needed to apply 14 pounds of elemental calcium

You are comparing two products to determine what rate you need to apply to achieve 14 pounds of elemental calcium per acre per season. Again use the same two materials outlined above and assume that you will be making eight applications during the season.

1. Divide the number of pounds of elemental calcium desired per season by the number of applications. Result is the pounds of elemental calcium needed per acre per application.
2. Divide the amount of elemental calcium per gallon or pound of material by the pounds of elemental calcium needed per acre per application. Result is the gallons or pounds of formulated material needed per acre per spray.

Example:

Step 1: $14.0 \text{ lb of elemental calcium per acre per season} \div 8 \text{ applications per season} = 1.75 \text{ lb}$

Step 2: Product A = $1.75 \div 1.8 \text{ lb elemental calcium per gal} = 0.97 \text{ gal per application}$

Product B = $1.75 \div 0.3 \text{ lb elemental calcium per lb} = 5.83 \text{ lb per application}$

Warning: The maximum labeled rate per application for Product B is 4 pounds per acre per application. Therefore, you are exceeding recommended labeled rates by using Product B to achieve a 14-pound recommended rate.

In summary, to effectively evaluate materials other than calcium chloride, you need to compare the cost per pound of actual calcium with the amount of the formulation needed to achieve the 4 to 14 pounds of actual calcium per acre per season needed to control problems.

GROWTH REGULATORS IN APPLE AND PEAR PRODUCTION

Plant growth regulators (PGRs) are chemicals used to modify tree growth and structure, remove excess fruit, or alter fruit maturity. In order to be effective, PGRs must be applied with adequate coverage, and then be absorbed by the plant and translocated to the site of activity in sufficient concentration to give the desired response. Consequently, numerous factors affect PGR performance. Weather conditions before, during, and after application will impact their effectiveness. The environmental conditions before the application can alter leaf characteristics and affect the amount of chemical that will enter the plant. The environmental conditions (temperature and humidity) during the application and the details of the application itself (gallons of water applied, coverage, and surfactants) also can affect the amount of chemical that will enter the plant. The environmental conditions after the application can influence the responsiveness of the tree to the chemical that has entered the plant. Thus, the process of actually modifying plant growth processes is very complicated, and much research must be conducted to develop effective programs.

The amount of water in which PGRs are applied can also alter performance. In general, the more water in which PGRs are applied, the more uniform will be the response. We recommend that you determine the dilute spray gallonage requirement for your orchard blocks based on tree row volume (see the section on calculating tree row volume in Part III of this guide under "Orchard Spraying"). Although many pest control sprays are applied at 50 gallons per acre, we recommend a minimum of 100 gallons per acre for PGR application in most instances.

Increasing Branching

A growth regulator composed of cytokinins and gibberellic acid (BA+GA) such as Promalin, Perlan, or Typy can be used to stimulate additional branches to grow on young trees. Foliar applications should be made when new shoot growth is approximately 1 to 3 inches long, approximately 2 to 4 weeks after bloom. Apply 125 to 500 ppm (0.25 to 1.0 pt/5 gal) of spray mixture. Thoroughly soak the area of the tree where branching is desired. A buffering agent (e.g., buffer X) or nonionic wetting agent (e.g., Tween 20 or Triton X-100) should be added to the tank at a rate of 0.2 to 0.3 percent (1 to 2 oz/5 gal) before adding BA+GA. The final spray solution should have a pH no greater than 8.

Thoroughly wet the foliage and bark of trees to be treated. Five to 10 gallons of spray mixture applied with a pressurized hand sprayer will treat 200 to 300 nonbearing trees 1 to 4 years old.

BA+GA may also be mixed with latex paint and applied directly to buds. Apply in the spring when terminal buds begin to swell, but before shoots emerge. DO NOT apply after buds break. Applications made after buds have broken may cause injury to tender shoot tips and fail to promote shoot growth from that point. The application rate is 5,000 to 7,500 ppm (0.2 to 0.33 pt/pt of latex paint). Add a buffering agent or a nonionic wetting agent to the latex paint at a rate of 0.5 to 1.0 percent (0.1 to 0.15 oz/pt of paint) before adding BA+GA. The wetting agent improves the dispersion of BA+GA in the latex paint; it also improves wetting and absorption through the waxy layer of the bark.

Uniformly apply the BA+GA-latex paint mixture with a brush or sponge and thoroughly cover the bark surface. NOTE: Apply only to 1-year-old wood (Table 1-17).

Shoot Growth Suppression

Apogee, a PGR for vigor control in apples, will reduce the length of shoot growth. Apogee is also labeled for the control or reduction of fire blight in apples. Shoot growth suppression by Apogee is very consistent when the first application is properly timed and where a sufficient dosage is applied during the active growth season. Apogee acts to retard shoot growth by blocking the production of gibberellic acid (GA). By decreasing the level of GA in the plant, Apogee will inhibit the shoots' ability to elongate, thereby resulting in shorter shoots. Since there is some residual GA in the plant, it usually takes about 10 days for shoot extension growth to slow. One application of Apogee will last for about 2 to 4 weeks, depending on tree vigor and dosage used. Repeated applications of Apogee are required to maintain growth control when conditions are favorable for further growth.

It is critical that the first application be applied when the longest shoots on the trees are between 1 and 3 inches long. In most situations, this will be between late bloom and petal fall. Careful monitoring is essential to time this application.

The interval between sprays can range from 1 to 4 weeks, depending on tree vigor and the dosage of Apogee that had been previously applied. Subsequent applications should be made when the first few shoots show signs of regrowth. Failure to reapply Apogee when conditions are still favorable for growth can result in loss of growth control.

The rate of Apogee recommended for shoot growth control varies from 3 to 12 ounces per 100 gallons of dilute spray. The rate of Apogee to be applied per acre should be calculated by determining the tree row volume of a block and multiplying the dilute rate by this figure.

$$\frac{\text{ounces of Apogee}}{100 \text{ gal of water}} \times \frac{\text{Tree Row Volume (in 100's of gallons)}}{\text{acre}} = \frac{\text{ounces}}{\text{acre}}$$

The total dosage and timing of sprays will depend on the inherent vigor in an orchard. The vigor in an orchard is dependent on many factors, including fruit load, rainfall, variety, rootstock, soil type, nutritional status, and pruning severity. Pruning is a major factor in increasing the vigor and shoot growth of trees. These factors should all be considered when selecting an application regime for a specific orchard block.

Apply Apogee with sufficient water to obtain thorough coverage and use a nonionic surfactant. The sprayer must be able to deliver the spray to the parts of the tree that have excessive vigor. Conversely, if shoot growth suppression is desired in only a portion of the tree, it is possible to spray only that portion of the tree.

If calcium is present in the spray water, the water is said to be "hard" and it deactivates Apogee. Therefore, when the source of spray water is hard, a proprietary water conditioner or high-grade, sprayable, ammonium sulfate should be used. The amount of conditioner to use depends on the degree of hardness. Test strips for water hardness can be obtained through swimming pool and spa suppliers.

Likewise, calcium fertilizer materials applied in the tank with Apogee deactivates it. Therefore, it is recommended that

an Apogee application be delayed until ½ inch of rain has fallen after a spray of calcium has been applied. It is permissible to apply calcium sprays a few days after an Apogee spray without a reduction in effectiveness.

Apogee is labeled to decrease June drop in apples when applied at between 10 and 12 ounces per 100 gallons. This would be 30 to 36 ounces per acre for an orchard with a tree row volume of 300 gallons. However, at lower rates typically used for shoot growth control, Apogee also may increase the set of apples. Avoid the use of excessive rates of Apogee during the thinning window to minimize this effect. When Apogee is used for shoot growth control, the aggressiveness of the thinning program may need to be increased. This may include increasing the strength of the thinner or making an additional application of thinner, depending on the circumstances.

The quantity of Apogee needed per application and the number of applications needed to reduce shoot growth in a specific apple block is dependent on the inherent vigor in a block. Listed below are some suggested rates and timings that may prove to be useful.

Suggested rate and timing scenarios to control excessive shoot growth in apples with Apogee (rate in ounces per 100 gallons).

Tree Vigor	1-3					Total mat./ year/100 gals of dilute spray
	inches of shoot growth	+10-14 days	+10-14 days	+10-14 days	+10-14 days	
Medium 1	3	2	2			7
Medium 2	4	3	2			9
High 1	4	3	3			10
High 2	5	4	3	3		15
V. High 1	5	4	4	3		16
V. High 2	6	4	4	3		17
Crop Loss 1	6	4	4	3	3	20
Crop Loss 2	6	6	4	4	3	23

In an orchard with a tree row volume of about 300 gallons, the following treatment regimes seemed to work well: 16, 12, and 8 ounces per acre in a pruned orchard, and 12, 10, and 6 ounces per acre in an unpruned orchard.

Management of Fire Blight Using Apogee

Apple trees are less susceptible to fire blight when sprayed with Apogee for shoot growth reduction. Results obtained in Pennsylvania tests indicate that the rate of 12 ounces per 100 gallons applied in a single application when new shoot growth is 3 inches long is more than 95 percent effective in preventing shoot infection in mature York Imperial trees following wound inoculation with the fire blight pathogen. Making 2 applications at the rate of 6 ounces per 100 gallons at 7-day intervals was 99 percent effective in preventing infection, while making 3 applications of 4 ounces per 100 gallons was 88 percent effective in preventing fire blight shoot infection. Apogee is not directly active against the fire blight bacterium (*Erwinia amylovora*) but induces resistance in the treated trees. The time required for resistance to become active in the tree following treatment is 7-10 days. The resistance remains active in newly developing shoots for about 21 days. On high-vigor trees that are highly susceptible to fire blight shoot infection, repeated applications are necessary until 3 weeks before the end of the terminal shoot growth period. Follow the growth reduction timings and rates to control fire blight using Apogee.

Increasing Return Bloom

An effective chemical thinning program is essential to obtaining adequate return bloom; however, in some years it is desirable to enhance return bloom on apple cultivars that tend to be biennial. This is especially important on trees that have a full crop load. Treatments of summer NAA applied starting 6 to 8 weeks after bloom will increase return bloom even on cultivars that tend to be biennial bearers. This timing is after any potential thinning from NAA has passed. Fruits that are 1 inch in diameter won't respond to NAA thinning action. Flower bud initiation has already begun but can be enhanced by NAA treatments during the next 30 days after the thinning period ends. The rate of NAA applied per acre should be adjusted to tree row volume levels. The applications can be concentrated. These sprays can be added right to the cover sprays during that time period. Some years these treatments do not perform well, especially during drought years. Cultivars that have a moderate to high biennial bearing tendency should be considered for bloom-enhancement sprays. Both Fruitone N and Fruitone L should be applied at 2 ounces (fluid or dry) per 100 gallons, which results in a 5-ppm concentration of NAA. Multiple applications (up to 3) of this lower rate work better than a stronger concentration single application. Multiple applications should be spaced at 7–14 days apart.

Summer ethephon can also enhance return bloom by the application of 0.5–3.0 pints of material per acre at 2–4 weeks after bloom on young nonbearing apple trees or at 6 weeks after bloom on bearing trees. However, summer ethephon can in some years thin 1-inch-diameter fruit and also advance maturity of early maturing varieties.

Treatments during extremely hot temperatures (maximum temperatures above 95°F) should be avoided. If surfactant or oil is included with the application, consider reducing the NAA amount by one-third.

Chemical Thinning of Apples

Chemical thinning applications are probably the most important single spray in a season. Small fruit do not have a strong market and the effects of less return bloom following a heavy crop can affect overall profitability.

Current thinking suggests that the susceptibility of fruit to chemical thinners is affected by the carbohydrate status of the tree. When carbohydrates are in abundance it is more difficult to thin. Conditions such as cloudy weather and high nighttime temperatures, adversely affect the carbohydrate reserves, and make trees easier to thin.

Weather conditions 24 hours before and 72 hours after the application of the growth regulator thinners (NAA, NAD, 6BA) are thought to be more important than actual fruit size at time of application. The significance for applicators is that if they are faced with applying a thinner when weather conditions are cold because the fruit is at the ideal size, we recommend delaying the application until more favorable weather is expected. This suggestion applies to the range of fruit size between 5 mm and 17 mm.

Along with the effects of weather, certain materials can be more effective at different fruit sizes. NAA materials, Sevin, and Vydate can be effective from petal fall to fruit sizes of 20 mm. NAA materials, however, should never be applied to Spur Delicious fruit when the size is above 9 mm in diameter. Applications above 9 mm in diameter result in excessive production of pygmy fruit.

Certain materials should not be mixed together on certain varieties. Do not make applications of 6BA and NAA materials to the same trees of Delicious or Fuji. The combination of these two can result in excessive formation of pygmy fruit.

6BA

6BA is a cytokinin—an active fruit thinner that can also enhance cell division. Therefore, a purported advantage of 6BA is an increase in fruit size above that achieved by thinning alone. There are several formulations of 6BA labeled for thinning apple (e.g., MaxCel, Rite Size, Exilis Plus), each with slightly different concentrations and different label restrictions, requiring the applicator to carefully read the label before use. 6BA is an effective thinner at a concentration of 75 to 150 ppm, and many varieties are thinned satisfactorily at about 100 ppm. (See Table 1-16.) Varieties, such as Fuji and spur-type Delicious, that are considered difficult to thin with NAA may thin more easily with 6BA. Regardless of the formulation used, 6BA thins best when daytime high temperatures reach 70°F for several days during and following the application. 6BA is best used in combination with Sevin or Vydate. Never mix 6BA and NAA products in the same season on Delicious or Fuji, as severe pygmy fruit may result.

Amid-Thin W

Napthalene acetamide (NAD or NAAM) is the amide salt of NAA and is considered a relatively weak thinner. It has less hormonal activity than NAA but remains active over a longer period. Because NAD has fewer side effects on vegetative growth, it is recommended for use on early cultivars, but it is not recommended for cultivars that mature after McIntosh. NAD is a mild thinner and is often tank-mixed with Sevin or Vydate to increase the thinning response. Application in less than 100 to 150 gallons per acre of NAD has not given satisfactory thinning. Amid-Thin should not be applied to Delicious, as pygmy fruit may result. Also see Amid-Thin in Part III.

Ethephon

Ethephon (Ethrel, Ethephon II) is especially valuable when other thinners have been used and insufficient thinning has occurred. Ethephon offers the opportunity for “rescue thinning” as it has been shown to effectively remove apples up to 22 mm in size. As with other PGR-based thinners, ethephon thins more when temperatures are in the 70s. Ethephon may be mixed with carbaryl and with horticultural spray oil to increase the thinning response, if needed. Golden Delicious and Rome are easily overthinned with ethephon, and the thinning response to ethephon is especially great when daytime highs reach the 80s. Lower rates and caution are called for in these circumstances.

Addition of a nonionic surfactant can enhance treatment effectiveness. Buffering spray solution to a pH of 3 to 5 can improve performance where water is alkaline. Use a spray volume sufficient to cover trees thoroughly and uniformly. Also see ethephon in Part III.

NAA

Napthalene acetic acid (NAA) has been used as a thinner for many years. The material was once available in several similar formulations, but only the Fruitone N dry formulation and Fruitone L liquid formulation are currently registered for use in

the east. NAA stimulates ethylene production by fruit tissues, which in turn slows the development of the youngest and weakest fruits more than the older fruit. The result is that the weaker fruit cannot compete for resources and they abscise. NAA may be applied between bloom and 17 mm fruit diameter, although the traditional target window for optimal response to NAA is 10 to 12 mm fruit diameter. Timing of application depends in part on cultivar being treated. Delicious, Fuji, and Gala should be treated earlier than other cultivars. Late applications to these varieties can cause small fruit called pygmies to remain on the tree until harvest. Also see NAA in Part III.

Carbaryl

There are several formulations of carbaryl (carbaryl, Sevin) that are labeled for fruit thinning. The Sevin XLR Plus label indicates that it can be used for thinning fruit between 80 percent petal fall and a fruit size of 16 mm. Sevin is a mild thinner and is used in combination with other thinners. Some problems have been encountered with poor fruit finish under extremely humid, warm conditions, especially when oil is used as an adjuvant.

In light of the toxicity of carbaryl to honey bees, we strongly urge you to follow the cautions listed on the label.

Also see Sevin in Part III.

Vydate

Vydate L may be used as a thinner in Pennsylvania, New Jersey, Virginia, and West Virginia. Vydate is a carbamate like Sevin and has similar thinning properties. Work in Virginia suggests that the thinning response may be dose dependent. Since Vydate is a little less toxic to certain predators than Sevin, it may be a better choice than Sevin.

The label recommends applying one to two dilute sprays between 5 and 30 days after full bloom. This period coincides with petal fall, when fruit is approximately 5 mm in diameter, to when it is approximately 20 mm in diameter. The application rate should be 2 to 4 pints per acre, and not more than 8 pints in any one year. Vydate can be tank-mixed with Ethrel, 6BA, or NAA. There is a warning about the possibility for increased russetting on russet-prone cultivars such as Golden Delicious or Stayman. A surfactant such as Regulaid, LI 700 or Tween 20 can be used to increase the effectiveness of Vydate. Do not apply oil with Vydate, as russetting can be increased. Also see Vydate in Part III

General Comments on Thinning

Chemical thinning increases fruit size and enhances return bloom. Many factors influence fruit thinning (examples are given in Table 1-15), and the farm manager will need to consider all these factors when deciding how to chemical thin. Table 1-16 provides general apple thinning guidelines to provide a starting point for these deliberations.

- Use chemical thinners only in blocks where bloom density and pollination were adequate to set an excessive crop.
- First key to making the right call on thinning: accurate assessment of initial set.
- Second key: understanding the role of light and temperature and getting an accurate weather forecast.
- Sunny weather: harder to thin. Heavy clouds for 2 to 3 days: easy to thin.

- Cool weather (below 65°F): less thinning. Hot weather (above 80°F): more thinning.
- “2X4”—The temperatures and sunlight on the 2 days before, and the 4 days following thinner spray are the most crucial.
- Use fruit diameter as a centering date, but the best timing is a blend of temperature, light, and fruit diameter.
- 6BA (MaxCel, Excelis Plus) is not very effective when the temp is below 68°F.
- Carbamates (Sevin and Vydate) still somewhat effective in suboptimal temperatures.
- NAA also has some thinning activity when temperatures are suboptimal, but this increases the chances of mummies and pygmies.

Table 1-15. Tree and weather conditions affecting fruit thinning with chemicals.

Trees are easy to thin under the following conditions:

1. Bloom is heavy, especially after a heavy crop.
2. Nitrogen is low or moisture inadequate.
3. Fruit spurs are low in vigor on the shaded inside branches.
4. Root systems are weak due to injury or disease.
5. Trees are young, with many vigorous upright branches.
6. Trees are self-pollinated or poorly pollinated.
7. Fruit-set appears heavy on easily thinned cultivars such as Delicious.
8. Fruit sets in clusters rather than singles.
9. The cultivars tend to have a heavy June drop.
10. Bloom period is short with many varieties and species in bloom simultaneously.
11. High temperature is accompanied by high humidity before or after spraying.
12. Blossoms and young leaves are injured by frost before the spray application.
13. Foliage is conditioned for increased chemical absorption by prolonged cloudy periods before spraying.
14. Prolonged cloudy periods reduce photosynthesis before or after application of chemicals.
15. Rain occurs before or after spray application.

Trees are difficult to thin under the following conditions:

1. Insects are active in orchards of cross-pollination varieties.
2. Trees are in good vigor with 12 to 18 inches terminal growth and no mineral deficiencies.
3. Precocious trees come into fruiting with good vigor and mature bearing habit.
4. Fruits are developing on spurs in well-lighted areas of tree (tops and outer canopy).
5. Trees bear biennially.
6. Trees have horizontal or spreading fruiting branches.
7. Fruit sets in singles rather than clusters.
8. Cultivars such as Golden Delicious and the heavy-setting spur-types are to be thinned.
9. Ideal fruit growth is occurring before and after thinning.
10. Low humidity causes rapid drying of the spray, and decreased absorption occurs before and after spraying.
11. Mild, cloudy to partly cloudy periods after bloom without tree stress.
12. Bloom was light, and high leaf-to-fruit ratio occurs (with the exception of young trees).
13. Limbs and/or spurs slightly girdled from winter injury.
14. Endogenous ethylene production is low.
15. When Apogee has been used for growth control or for fire blight control.

Adapted from Edgerton, L. J., and M. W. Williams, “Chemical Thinning of Apples,” chapter 8 in Tree Fruit Growth Regulators and Chemical Thinning: Shortcourse Proceedings 1981, edited by R. B. Tukey and M. W. Williams (Pullman: Washington State University Coop. Ext. Service, 1981).

Table 1-16. Suggested apple thinning recommendations.

Type of variety	Level of thinning needed	Application Timing		Notes
		<i>Rates are per 100 gallons dilute tree row volume</i>		
		Petal fall	7- to 12-mm diameter	
Easy to thin	Light	—	Sevin, 0.5 lb	
Examples: Braeburn, GingerGold, Granny Smith, IdaRed, Pink Lady, and others	Moderate	—	Sevin, 0.5 lb, plus Fruitone, 1 oz	
	Heavy	Sevin, 0.5 lb	plus Sevin, 0.5 lb, plus Fruitone, 2.0 oz OR Sevin, 0.5 lb, plus 6BA, 53.0 oz	
Moderately difficult to thin Examples: Cameo, Empire, Gala, JonaGold, Std. Rome, and others	Light	—	Sevin, 0.5–1.0 lb, plus Fruitone, 2.0–3.0 oz OR Sevin, 0.5–1.0 lb, plus 6BA, 64.0 oz OR Sevin, 1.0 lb, plus spray oil, 1.0 qt	High NAA rates and later timing increase risk of pigmy fruit for Delicious, Fuji, or Gala. Check 6BA label; maximum rate varies by formulation. Spray oil rate is per 100 gal finished spray mix; do not concentrate oil.
	Moderate	Sevin, 0.5–1.0 lb	plus Sevin, 0.5–1.0 lb, plus Fruitone, 2.0–3.0 oz OR Sevin, 0.5–1.0 lb, plus 6BA, 64.0 oz OR Sevin, 1.0 lb, plus spray oil, 1.0 qt	High NAA rates and later timing increase risk of pigmy fruit for Delicious, Fuji, or Gala. Check 6BA label; maximum rate varies by formulation. Spray oil rate is per 100 gal finished spray mix; do not concentrate oil.
	Heavy	Sevin, 1.0 lb	plus Sevin, 1.0 lb, plus Fruitone, 3.0 oz, plus spray oil, 1 qt OR Sevin, 1.0 lb, plus 6BA, 64.0 oz, plus spray oil, 1 qt	High NAA rates and later timing increase risk of pigmy fruit for Delicious, Fuji, or Gala. Check 6BA label; maximum rate varies by formulation.
	Light	—	Sevin, 1.0 lb, plus Fruitone, 4.0–6.0 oz OR Sevin, 1.0 lb, plus 6BA, 64.0–96.0 oz	High NAA rates and later timing increase risk of pigmy fruit for Delicious, Fuji, or Gala. Check 6BA label; maximum rate varies by formulation.
Difficult to thin Examples: Fuji, Golden Delicious, Spur Delicious, Spur Rome, York Imperial, and others	Moderate	Sevin, 1.0 lb, spray oil, 1 qt	plus Sevin, 1.0 lb, plus Fruitone, 4.0–6.0 oz OR Sevin, 1.0 lb, plus 6BA, 64.0–96.0 oz OR Sevin, 1.0 lb, plus Ethephon, 1.0–1.5 pt	Do not concentrate oil. Check 6BA label; maximum rate varies by formulation.
	Heavy	Sevin, 1.0 lb spray oil, 1 qt	plus Sevin, 1.0 lb, plus 6BA, 64.0–96.0 oz, plus spray oil, 1 qt OR Sevin, 1.0 lb, plus Ethephon, 1.0–1.5 pt, plus spray oil, 1 qt	Do not concentrate oil. Check 6BA label; maximum rate varies by formulation. Do not concentrate oil.

Table 1-17. Growth regulators for apples and pears. (See also Table 1-16 for combinations for apple thinning.)

Purpose	Trade name	Rate of commercial product/gal, product/A	Comments
Growth regulators affecting fruiting capacity			
Fruit thinning—apples	MaxCel, Exilis Plus, Rite Size	3 pt–3 qt/A	One to two applications can be made per season for thinning and to increase fruit size. Apply when king fruits are 5 to 17 mm in diameter and when warm temperatures are likely to occur over a period of several days following application. Use of 6BA in combination with either Sevin or Vydate results in more effective thinning. Rates vary by product; refer to the label.
	Amid-Thin W	2.4–8.0 oz/100 gal (15–50 ppm)	Rates vary by cultivar. Apply at petal fall or within 5 to 7 days after petal fall.
	Ethrel, Ethephon II (21.7% ai)	0.5–1 pt/100 gal (2–4 pt/A)	Apply 10–20 days after full bloom. If used for thinning may not be used for fruit loosening in fall. Especially useful for thinning larger-sized fruit. Do not treat low-vigor trees.
	Fruitone N, Fruitone L	0.8–8.0 oz/100 gal (2–20 ppm)	Applications should be made between petal fall and 21 days past full bloom. See notes in discussion on thinning. Do not use on cultivars that ripen before McIntosh.
	Sevin 80S or Sevin 80WSP	1.25–3.75 lb/A	Use lower rates on easy-to-thin cultivars and higher rates on more difficult-to-thin cultivars such as Golden Delicious. Note: Commercial formulation already incorporates a surfactant. Can increase mite problems. Apply between 10 and 25 days after full bloom.
	Sevin XLR Plus or Sevin 4F	1–3 qt/A	Apply between 80% petal fall and 16 mm. Use lower rates on easy-to-thin cultivars and apply between 10- and 16-mm fruit size. Use higher rates on more difficult-to-thin cultivars and apply between 80% petal fall and 16 mm fruit size. Remove all bee hives from the orchard to be treated prior to spraying. Can increase mite problems. Do not exceed 6 pints per acre per application. Note: Commercial formulation already incorporates a surfactant.
	Vydate L	1–2 pt/100 gal or 2–4 pt/A	Apply 5 to 30 days after full bloom or at 5–20 mm fruit diameter. Do not add oil when applying Vydate, but a surfactant may be added. Vydate can also be tank-mixed with other thinning materials such as carbaryl, ethephon, or Accel. Vydate L may increase russetting on varieties prone to russet.
Fruit thinning—pears	Amid-Thin W	1.6–8.0 oz/100 gal (10–50 ppm)	Rates vary by cultivar. Apply at petal fall or within 5–7 days after petal fall. Labeled for use only on Bartlett and Bosc pears.
	Fruitone N, Fruitone L	2–4 oz/100 gal	Response varies by variety and climatic conditions. Use lower rates when thinning easily thinned varieties such as D'Anjou. Recommended temperature range is daytime high in the 70s.
	MaxCel	96–112 fl oz/100 gal	Apply when average fruit diameter is 5–7 mm. Use sufficient volume to ensure complete coverage.
Growth regulators affecting fruit quality—apples			
Improve “type-ness” and/or weight of apples under conditions of an extended bloom	Promalin, Typy, Perlan	1–2 pt/A in 50–200 gal/A or 0.5–1.0 pt/A	Apply when king bloom is just opening and secondary flowers are at full balloon stage. Wetting agents may improve response. Or, n two sprays as a split application, the first at the first bloom and the second applied 3–21 days later at full bloom.
Increase fruit size	MaxCel	10–50 ppm	Make 2 to 4 applications starting at petal fall and continuing at 3 to 10 day intervals
Reduce russetting in apples	ProVide, TypRus	10–13 oz/100 gal (use 50–100 gal/A)	Apply at beginning of petal fall, then at 7- to 10-day intervals for 3 more sprays. Do not exceed 40 oz/A/yr. Do not use a spreader sticker. If used to reduce russetting, then may not be used for cracking.
Reduce cracking of Stayman apples	ProVide, TypRus	16–32 oz/A application	Apply 3–6 times at 2- to 3-week intervals at least 2–3 weeks before fruit cracking is likely (begin in mid-June). Use wetting agent. If used to reduce russetting, then may not be used for cracking.
Promote early skin coloration	Ethrel, Ethephon II	For McIntosh and earlier varieties: 1–4 pt/A For later maturing varieties: 2–4 pt/A	Begin spraying 2–3 weeks before normal harvest date and about 1–2 weeks before desired harvest date. Apply as a normal dilute spray using sufficient water for thorough uniform coverage. Do not apply Ethrel to more acreage than can be harvested in 1–2 days. Note: Always apply NAA 4–5 days before Ethrel is applied.
Loosen fruit	Ethrel, Ethephon I	Early varieties: 2.5 pt/A Later varieties (after McIntosh): 5 pt/A	Apply 7–14 days before normal harvest. Air temperature 60–70°F.
Reduce preharvest fruit drop	Fruitone N, Fruitone L	4–8 oz/100 gal (10–20 ppm)	Apply when first sound fruits begin to drop. Do not apply within 2 days of harvest. No more than 2 applications can be made. Same restrictions and cautions as above.
Reduce preharvest fruit drop, delay harvest, manage reduce watercore	ReTain	0.73 lb/A (50 g ai/A)	Apply 4 weeks before anticipated normal harvest for the current year in enough water to thoroughly fruit drop, delay and uniformly wet the fruit and fruit foliage. ReTain must be used with an organosilicone surfactant such as Silwet L-77 or Sylgard 309 at 0.05 to 0.1% v/v (6.5 to 13 fl oz/100 gallons) to obtain optimum response. ReTain should be applied under slow-drying conditions and the spray solution should be adjusted to a pH of between 6 and 8.

(continued)

Table 1-17. Growth regulators for apples and pears (continued).

Purpose	Trade name	Rate of commercial product/gal, product/A	Comments
Increase storage life, delay loss of fruit firmness and watercore development, reduce fruit scald, maintain sugar:acid ratio in fruit	SmartFresh	Rate depends on size of room	Fruit is fumigated in airtight rooms or containers no later than 2 weeks after harvest. The product comes premeasured in a proprietary generator system. The generator is turned on and 2 gallons of water are added to the container. The fruit must remain sealed in the room for 24 hours. At the end of the treatment time, allow 30 minutes to vent the room of the gas.
Growth regulators affecting fruit quality—pears			
Reduce preharvest fruit drop	Fruitone N, Fruitone L	4–8 oz/100 gal	Treatments become effective 3–4 days after application. Do not apply more than 2 sprays for this use.
Reduce preharvest fruit drop, delay harvest, manage fruit maturity	ReTain	0.73 lb/A (50 g ai/A)	Apply 4 weeks before anticipated normal harvest in this season in enough water to thoroughly and uniformly wet the fruit and fruit foliage. Addition of an organosilicone surfactant such as Silwet L-77 at 0.05 to 0.1% v/v (6.5 to 13 fl oz /100 gal) is highly recommended.
Growth regulators affecting vegetative characteristics—apples			
Shoot growth suppression	Apogee	2–6 oz/100 gal	From 3 to 5 applications will be necessary to get season-long shoot growth suppression. The first application should be applied when the longest shoots are 1–3 inches long. Apogee can also reduce the severity of fire blight on shoots. See Part III for a complete discussion of Apogee.
Reduce water sprouts on limbs	Tre-Hold Sprout Inhibitor A112 (15.1% ai)	8 gal/92 gal or 10 fl oz/118 fl oz	Dormant season after pruning. Do not treat more than one-third of the limb surface. Substitute 1 qt interior water base white latex paint for an equal amount of water to reflect sun.
Reduce root suckers	Tre-Hold Inhibitor A112	8 gal/92 gal	Dormant season or 4 weeks after petal fall when regrowth is 6–12 inches tall.
Improve branching on 1-year-old shoots, apples (bearing and nonbearing)	Promalin TypyPerlan	4–16 fl oz/5 gal of solution (125–500 ppm) or 3–5 oz/pt of latex (5,000–7,000 ppm)	When new growth is 1–3 inches, with a pressurized hand sprayer. Add 1–2 oz of nonionic wetting agent. Apply as a brush-on application paint in spring when terminal buds begin to swell before shoots emerge.
Improve branching on 1-year-old shoots, pears (nonbearing only)	Promalin TypyPerlan	0.5–2.0 pt/5 gal of solution (250–1,000 ppm)	When new growth is 1–3 inches, with a pressurized hand sprayer. Add 1–2 oz of nonionic wetting agent.
Increase flower bud development	Ethrel/Ethephon II		Treat only vigorous healthy trees. On trees with fruit present some size reduction can occur.
Nonbearing trees	Ethrel, Ethephon	2–8 pt/A	Apply 2–4 weeks after full bloom on nonbearing trees.
Bearing trees	Ethrel, Ethephon II Fruitone N, Fruitone L	0.5–3.0 pt/A 2 oz/100 gal	Apply 6 weeks after full bloom on bearing trees or those just coming onto bearing. Treatments begin 6 weeks after petal fall and repeat at weekly or biweekly intervals. Apply in sufficient water to ensure good coverage.

- Mummies and pygmy fruits can result from postbloom sprays of certain thinners (NAA and 6BA), and this risk rises with increasing chemical rate and with later thinning timing.
- All thinners work best when temps in the 70s, and all chemistries have the potential to overthin when temperatures are in the mid- to high 80s. There is no “safe” thinner at high temperatures.
- Adding carbaryl in a tank mix with NAA or 6BA increases thinning response. Adding oil at 1 quart per 100 gallons of finished spray mix boosts efficacy of all thinners.
- Varieties once considered chemically hard to thin (Golden Delicious, Gala, Fuji) may not be hard to thin with 6BA/carbaryl tank mix.
- For most effective thinning, no less than 100 gallons of water per acre should be used for adequate coverage, and sufficient wetting time must be allowed to permit foliage to absorb the thinner.
- Use extra caution if freezing temperatures occurred during bloom. Delay thinning until you are certain that fruits are growing. Consider reduced rates of chemical thinner in this circumstance.
- Trees less than 5 years old are more apt to be overthinned.
- Be sure to leave several nonsprayed trees so that you can check the results of using thinner.
- In some instances, it may be desirable to remove all fruit from the trees. In such cases, a mixture of 15 ppm NAA, 2 pints of Sevin XLR, and 1 pint of spray oil per 100 gallons of water applied at petal fall is effective.

While chemical fruit thinning is not an exact science because of differences between orchard blocks, cultivars, sites, and years, nevertheless the materials are standard. For a discussion of specific materials used in thinning, please turn to Part III, Chemical Management. Materials are listed alphabetically in this section.

Late thinning

When fruit diameter reaches 18 mm, apples become difficult to thin with NAA and 6BA. Once the fruit reach about 22 mm, they become unresponsive to chemical thinners. Apple fruits grow about 1 mm per day in warm weather, so when fruit are 18 mm in diameter, you have only about four days to apply chemical thinners.

The two chemistries that still have thinning activity at this advanced stage of fruit growth are carbaryl and ethephon. Where mild thinning is all that is required, carbaryl at 0.5 to 1 pound per 100 gallons may suffice. To create a moderately strong late thinning spray, add 1 quart of spray oil per 100 gallons of finished spray mix to the carbaryl. Oil and captan cause phytotoxicity, so if you are using oil in this spray, keep captan out of the orchard for the next two cover sprays.

If a strong thinning combination is called for, then combine ethephon, at 1.5 pints per 100 gallons, with carbaryl and oil. Golden Delicious and Rome are very sensitive to ethephon. Reduce the ethephon rate to 12 fluid ounces per 100 gallons for Rome and to 1 pint per 100 gallons for Golden Delicious.

Apple Preharvest-Drop-Control Sprays

As apples mature they begin to produce large amounts of the ripening hormone, ethylene. One of the ripening processes stimulated by ethylene is stem loosening. Ethylene stimulates the production of enzymes that break down the cell walls in the abscission zone of the stem, leaving the fruit connected to the tree by only the vascular strands, which are easily broken. Once this natural process is complete, susceptible varieties begin to drop. It should also be noted that enzymatic cell wall breakdown is an irreversible process. Once the fruit stems loosen, there is no way to strengthen them up!

Stop drops are plant growth regulators that interfere with the enzymatic breakdown of the cell walls in the abscission zone. Two plant growth regulators are currently registered for control of preharvest drop in apples. Naphthaleneacetic acid (NAA) and aminoethoxyvinylglycine (AVG) are both effective, but they are very different compounds with respect to the modes of action, optimal timing, and effect on the fruit. This section offers a brush up on stop drops—how the two work and how to optimize control of preharvest drop with each of them (Table 1-18).

ReTain

The active ingredient in ReTain is aminoethoxyvinylglycine (AVG), a “look-alike” for one of the chemical precursors to ethylene. When absorbed into plant tissues, AVG binds irreversibly with a key enzyme. This prevents the ethylene precursor from binding, thus blocking the production of ethylene. Natural ripening processes are slowed, including stem loosening, fruit flesh softening, starch disappearance, and red color formation. ReTain is labeled for apples, pears, nectarines, peaches, plums, prunes, and apricots.

There are several potential harvest management benefits to slowing the fruit maturation process. Growers can spread the effective harvest window for a given variety, retaining fruit firmness and without excessive drop. Apples on unstressed healthy trees will continue to grow at the normal rate following ReTain treatment (about 1 mm per day). An additional week on the tree can add a quarter inch to fruit diameter. Fruit red color can be increased in cases where a delay in harvesting exposes the fruit to improved weather for coloring (warm sunny days and cool

Table 1-18. A quick comparison of the two compounds registered as stop drops.

Parameter	ReTain	Fruitone N/Fruitone L
Active ingredient	AVG	NAA
What is blocked	Ethylene production	Stem loosening
Drop delay (approximate)	14 days	5–7 days
Fruit ripening	Slowed	Advanced
Fruit color	Delayed	No effect
Fruit softening	Delayed	Advanced
Applied (relative to drop)	4 weeks before	Just prior to
Rescue option?	No	Yes
Days to “take effect”	>7	~2
Split sprays helpful?	No	Yes
REI	12 hours	48 hours
PHI	7 days	2 days

nights). The incidences of fruit disorders associated with ripening, such as water core and stem end cracking, can be reduced.

In order for AVG to be effective it must be applied well in advance of the climacteric rise in ethylene production that signals the onset of fruit maturity. The label recommends applying ReTain 4 weeks before anticipated harvest for cultivars that are normally harvested in a single picking. This has sometimes caused confusion, as the grower is timing the spray relative to some future, unknown date. A more scientific basis for timing would be to state that ReTain should be applied 4 weeks before the natural climacteric rise in fruit ethylene, but this is still a future event with an element of uncertainty. The good news is that there is a fairly wide window when ReTain can be applied with optimal results, and a fairly easy way to determine when to apply it (Figure 1-6).

For early season varieties, such as McIntosh, start by estimating when you would normally expect to begin harvesting the variety if no ReTain or ethephon were used. Now take into consideration the season. For instance, if the bloom date and the ripening pattern of cherries, peaches, and summer apple varieties suggest that the season is about 10 days earlier than normal, the anticipated harvest date can be adjusted accordingly. Then count back 4 weeks on the calendar. Now mark the calendar from that date through the next 7 days. This is your application window for that early season variety. Watch for good spray conditions and a 6-hour drying time within that week and apply the material at the first opportunity. Now mark your calendar for 7 days after the spray was applied. This is the preharvest interval, as required by the label. Repeat the same thought process for later varieties, but keep in mind that later varieties are usually less affected by seasonal variation in maturity than stone fruit or early apple varieties. It is usually unnecessary to account for seasonal variation in fruit maturity for Empire and later varieties.

There is an alternative application timing for cultivars that have multiple harvest days, such as Gala or Honeycrisp. Apply ReTain 7 to 14 days before the anticipated beginning of harvest (first pick). Application at this time usually does not delay the first harvest but will help control maturity for later harvests.

ReTain is an expensive chemical to produce, and the maximum rate of AVG allowed by the label is at the low end of the effective range. For most applications, every molecule we apply

needs to be absorbed and do its duty. One exception to this rule is application to low ethylene varieties.

Varieties differ in the production of ethylene and consequently differ in their response to ReTain. Low ethylene producers such as Gala are strongly influenced, while ethylene production is much harder to control for high ethylene varieties such as McIntosh. Fruit maturity of Gala on dwarfing rootstocks can be slowed with 7.5 oz (two-thirds of the full label rate) of ReTain if timing and application recommendations are followed closely. Most varieties, however, require the full labeled rate of ReTain (1 pouch or 333 grams per acre) in order to obtain satisfactory results.

Growers who are planning to use ethephon (Ethrel, Ethephon II) to color Macs should apply the full rate of ReTain at the usual time. There is some limited research that suggests ReTain can offset the deleterious effects of ethephon on fruit maturity and fruit softening.

Use a 100 percent organosilicone surfactant, such as Silwet L-77 or Sylgard 309 at 12 oz per 100 gallons. For optimum results, apply ReTain with 100 gallons of water per acre and spray each row from both sides. Split applications do not enhance the performance of ReTain. A single well-timed spray will give the best delay in maturity and best control of preharvest drop.

ReTain requires a considerable time to act, and its effects persist for a considerable period of time, so the effect of weather is little understood. It is known that trees under stress (mites, drought, etc.) are less responsive to ReTain and are poor candidates for its use. Much of what is known centers on the need to maximize coverage and absorption.

Ideally, no rain should fall for at least 6 hours after ReTain is applied; however if the coverage was good, the ReTain spray was applied with a full rate of Silwet, and the residue dried before it rained, you probably got most of the benefit of the spray. Just keep a close eye on drop and fruit maturity.

Application of ReTain under slow drying conditions is thought to be beneficial. Conversely, spraying ReTain on wet foliage can result in a loss of performance due to the material dripping off before it can be absorbed. Wait until the foliage dries. If you must apply ReTain to damp foliage, reduce the rate of Silwet to 6 fluid oz instead of 12 to reduce the sheeting action and possible runoff. Another tactic that can work on a limited scale if time is running out is to drive slowly through the block to be sprayed with just the fan on before applying the spray.

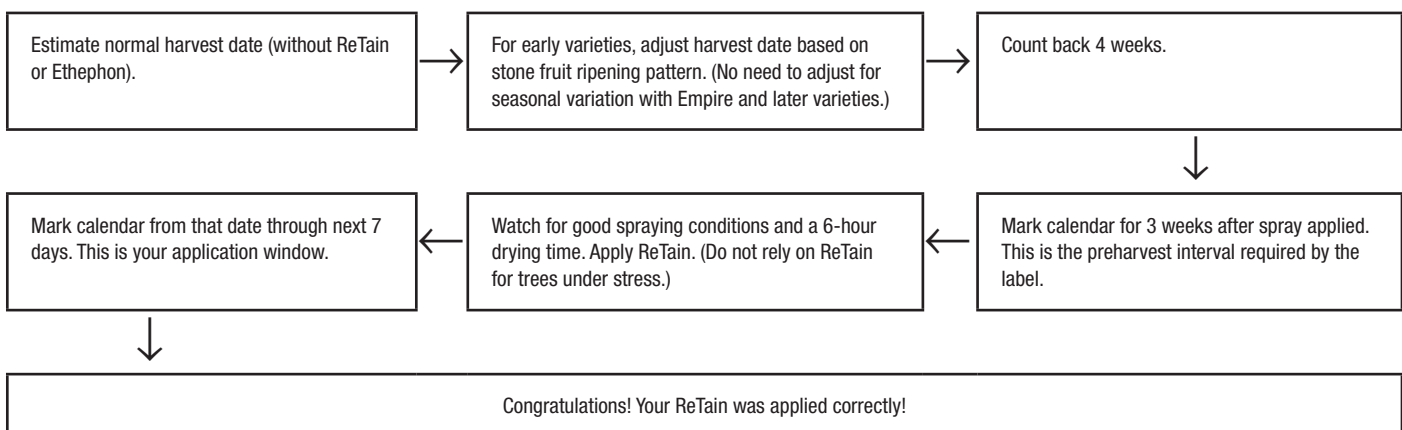

Figure 1-6. Determining application timing for ReTain to increase effective harvest window, increase fruit firmness, and reduce preharvest drop.

NAA

Shortly after synthetic auxins (NAA, 2,4-D, 2,4,5-TP) were discovered, it was learned that these materials had activity as stop drops. Auxins interfere directly with the enzymes that create the abscission zone. Today, the one remaining auxin that is registered for this use is NAA (Fruitone N, Fruitone L).

Unlike ReTain, fruit maturity of apples treated with NAA is not delayed; in some cases, it may be accelerated. Since the optimal application time for NAA is just before the onset of drop, NAA offers a “rescue” treatment, should the threat of preharvest drop be increased due to unforeseen circumstances. Examples of such situations include unavoidable delays in harvest due to bad weather or labor issues, slow red color development, and overlapping harvest schedules of varieties with similar maturity windows, such as that of Empire and Delicious.

A single spray of NAA can provide about 7 days of drop control. Since it is less expensive than ReTain, it may be more cost effective to use NAA when only a few days of drop control are needed to conduct an orderly harvest. For example, when using ethephon (Ethrel, Ethephon II) to promote fruit coloring, growers should also use NAA to prevent excessive fruit drop resulting from accelerated fruit maturation. When NAA is used to control drop on ethephon-treated trees, the two may be tank-mixed if the fruit are to be harvested within 7 days. If the fruit are to be left on the tree longer than 7 days after the ethephon, then NAA should be applied 2 to 3 days after the ethephon.

Other than when applying NAA with ethephon, timing an NAA stop-drop spray is a little like a game of chicken, requiring both steely nerves and a good understanding of your opponent (Figure 1-7). The label says to apply NAA when the first sound fruit begin to drop. Based on research with McIntosh, a variety that is very prone to drop, a single spray of 10 to 20 ppm NAA can control drop for about 7 days from the date of application, but it takes 2 or 4 days to “kick in.” If NAA is applied too early, then effective drop control may wear off when it is needed most. On the other hand, if NAA is applied just a few days too late, a significant portion of the crop may be on the ground before it takes effect. Predictive degree-day models and the pattern of starch disappearance, as gauged by the starch index test, can provide a general indication of whether the potential for drop is earlier or later than normal, but more direct monitoring is required for the actual timing of the sprays.

Varieties that are susceptible to preharvest drop should be monitored to determine when fruit drop is beginning. Limb tapping is one method that can be used to determine the onset of drop as fruit near maturity. Bump several scaffold limbs of 3 or

4 inches in diameter throughout the block on a daily basis. Use the palm of your hand with a short firm stroke, striking the limb at its mid-point (just like golf, this skill improves with practice and experience). If zero to one apple per limb drops on average, it is too soon to apply NAA. If the average is about two, check again later the same day or the next morning. When several apples drop in response to limb bumping, it is time to harvest within 2 days or apply NAA.

Rates of 10 to 20 ppm NAA are usually needed to be an effective stop-drop. To obtain the maximum drop control, use a split application of 10 ppm in the first spray, followed by a second spray of 10 ppm five days after the first. Split applications can provide some drop control for about 12 days from the date of the first application.

NAA must be taken up by the spur leaves in order to be effective and does not translocate very far within the tree, so it must be applied with good coverage and plenty of water. Concentrating beyond 4X (less than 75 gallons of water per acre for 300 gallon TRV trees) may diminish the effectiveness. The use of alternate row spraying is discouraged. Use of a nonionic or organosilicone surfactant is recommended to enhance uptake.

Calcium in the spray water is detrimental to NAA efficacy. This includes both tank-mixed calcium for bitter pit control as well as calcium present because of hard water. If your water source provides hard water, use of a water conditioner is advisable.

Weather conditions following the application also impact efficacy. Rewetting within 2 or 3 days of the spray application and spraying under slow drying conditions (high humidity) will both increase the uptake of NAA. Temperatures in the mid-70s produce a better response than cooler temperatures, while excessively hot weather immediately following an NAA spray may result in accelerated ripening.

When used as a stop-drop, NAA may advance ripening, especially at the maximum label rate of 20 ppm. The primary impact of this advance in maturity is reduced storage potential of the fruit, particularly in the loss of firmness. This effect is not consistent from year to year and may be attributed to high temperatures, as mentioned previously.

Some research showed that the deleterious effects of NAA sprays on fruit maturity and fruit softening were minimized in Delicious by making repeated applications of 5 ppm NAA at four weekly intervals prior to harvest. This “preloading” technique has recently been included as an application option on the Fruitone labels. This research was repeated on Delicious in 2004, and NAA preloading accelerated ethylene and fruit softening. Also, using NAA preloading on McIntosh resulted in more advanced

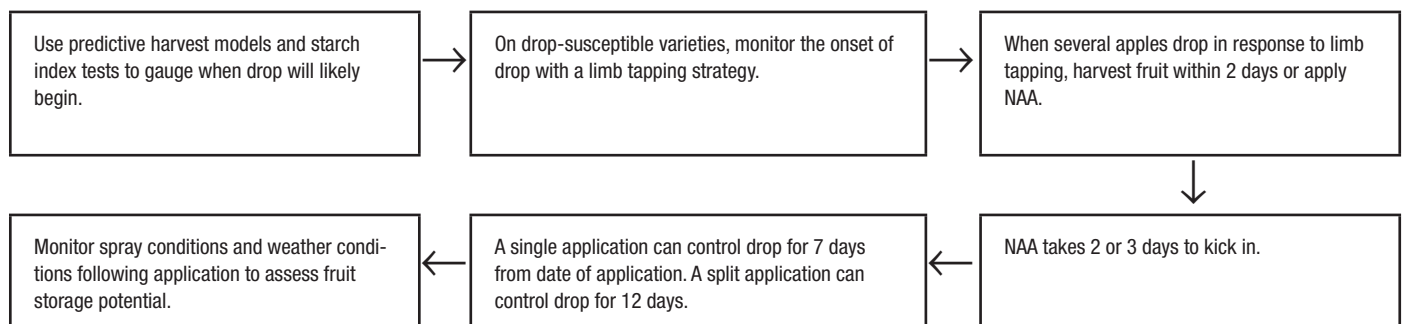

Figure 1-7. Determining application timing for NAA to extend harvest window and reduce preharvest drop.

ripening, accelerated drop, and fruit softening, not less! NAA preloading for McIntosh and other early season, high-ethylene varieties is not recommended. Growers should use caution when trying preloading on high ethylene-producing varieties until more is known about how different varieties will respond.

The question then arises whether NAA-treated fruit have potential for CA storage or treatment with SmartFresh (1-MCP). Perhaps the simplest way to answer the question with regard to CA is to remember the adage “garbage in, garbage out.” If the fruit were left on the tree to the bitter end of the drop control, are measurably softer than previously harvested fruit, and have elevated starch index values, then they should be marketed in the short term. On the other hand, if the fruit were harvested within a week after treatment and have appropriate firmness and starch values for CA storage for the variety, there is little reason to expect performance different than similar fruit that received no NAA.

Finally, a comment about use of NAA on trees previously treated with ReTain. The use of both stop drops at the respective correct times results in drop control that is superior to that obtained by using either one alone. Fruit treated in this manner, then left for an extended time on the tree, often have limited storage potential (see above). This combination, however, can be an effective way of getting the ultimate in drop control. This drop control comes at a high price and should therefore only be used on high value fruit with little or no storage period, such as for a few rows of trees held for late picking in pick-your-own blocks.

Table 1-18 summarizes the attributes of ReTain and NAA. Both stop drops are useful compounds, although quite different with respect to activity and timing.

Record Keeping for the Application of Plant Growth Regulators

Evaluating your application of plant growth regulators to your orchards is an important but often overlooked aspect of record keeping. The response of most PGRs is highly influenced by the weather conditions before, during, and after they are applied to the trees. Therefore, it is important that you have good weather records so you can learn how weather influences your use of PGRs in your orchard. On the previous page is a sheet that can be duplicated and used to track conditions under which you applied your thinners, growth-controlling compounds, or preharvest drop materials.

Table 1-19. Ounces of Fruitone N or Fruitone L to apply per acre in enough water to thoroughly wet the foliage at a given ppm.

ppm	gal/A						
	25	50	100	200	300	400	500
2	0.2	0.4	0.8	1.6	2.4	3.2	4.0
4	0.4	0.8	1.6	3.2	4.8	6.4	8.0
6	0.6	1.2	2.4	4.8	7.2	9.6	12.0
8	0.8	1.6	3.2	6.4	9.6	12.8	16.0
10	1.0	2.0	4.0	8.0	12.0	16.0	20.0
12	1.2	2.4	4.8	9.6	14.4	19.2	24.0
14	1.4	2.8	5.6	11.2	16.8	22.4	28.0
16	1.6	3.2	6.4	12.8	19.2	25.6	32.0
18	1.8	3.6	7.2	14.4	21.6	28.8	36.0
20	2.0	4.0	8.0	16.0	24.0	32.0	40.0

Table 1-20. Concentration of NAA (ppm) applied based on amount of Fruitone N or Fruitone L desired per acre (from Table 19) and gallons of water to be applied per acre.

oz	gal/A					
	25	50	100	200	300	400
2	20	10	5	2.5	1.7	1.3
4	40	20	10	5.0	3.3	2.5
6	60	30	15	7.5	5.0	3.8
8	80	40	20	10.0	6.7	5.0
10	100	50	25	12.5	8.3	6.3
12	120	60	30	15.0	10.0	7.5
14	140	70	35	17.5	11.7	8.8
16	160	80	40	20.0	13.3	10.0
18	180	90	45	22.5	15.0	11.3
20	200	100	50	25.0	16.7	12.5
22	220	110	55	27.5	18.3	13.8
24	240	120	60	30.0	20.0	15.0
26	260	130	65	32.5	21.7	16.3
28	280	140	70	35.0	23.3	17.5
30	300	150	75	37.5	25.0	18.8
32	320	160	80	40.0	26.7	20.0

Table 1-21. Concentration of NAA (ppm) applied based on amount of Fruitone N or Fruitone L desired per acre (from Table 19) and gallons of water to be applied per acre.

Parts per million (ppm) of NAA in tank based on amount of Amid-Thin W added to tank of (x) size

Amount/Amid-Thin W	ppm of NAA in tank size				
	lb	oz	50 gal	100 gal	200 gal
0.125	2	25	13	6	3
0.188	3	37	19	9	4
0.250	4	50	25	12	5
0.313	5	62	31	16	6
0.375	6	75	37	19	7
0.438	7	87	44	22	9
0.500	8	100	50	25	10
0.563	9	112	56	28	11
0.625	10	125	62	31	12
0.688	11	137	69	34	14
0.750	12	150	75	37	15
0.813	13	162	81	41	16
0.875	14	175	87	44	17
0.938	15	187	94	47	19
1.000	16	200	100	50	20
1.063	17	212	106	53	21
1.125	18	225	112	56	22
1.188	19	237	119	59	24
1.250	20	250	125	62	25
1.313	21	262	131	66	26
1.375	22	275	137	69	27
1.438	23	287	144	72	29
1.500	24	300	150	75	30
1.563	25	312	156	78	31

Ounces (oz) of Amid-Thin W to add to a tank of (x) size to achieve a given ppm solution

Amount/Amid-Thin W	oz of Amid-Thin W added to tank size			
	ppm	50 gal	100 gal	200 gal
1	0.08	0.16	0.32	0.80
10	0.80	1.60	3.20	8.00
15	1.20	2.40	4.80	12.01
20	1.60	3.20	6.40	16.01
25	2.00	4.00	8.00	20.01
30	2.40	4.80	9.61	24.01
35	2.80	5.60	11.21	28.02
40	3.20	6.40	12.81	32.02
45	3.60	7.20	14.41	36.02
50	4.00	8.00	16.01	40.02

Note: To convert to pounds divide by 16. To convert to grams (g) multiply by 28.375.

Plant Growth Regulator Evaluation Checklist**Keep annual records for each treatment block**

Treatment block: _____

Date: _____

Environmental conditions

Time applied: starting: _____ ending: _____

Air temperature at application or range _____

Relative humidity _____ Wind speed and direction: _____

High temperature the day of application: _____

Did it rain within 8 to 12 hours after application? yes noWeather conditions for two days *prior* to applicationDay 1: sunny cloudy daily temperatures: high _____ low _____Day 2: sunny cloudy daily temperatures: high _____ low _____Weather conditions for the two days *following* applicationDay 1: sunny cloudy daily temperatures: high _____ low _____Day 2: sunny cloudy daily temperatures: high _____ low _____**Tree Vigor**

Fruitlet size (mm) _____ Age of trees: _____

Cultivar(s): _____

General vigor of the block: high medium lowPrevious season production: high medium low**Dosage details**

What chemical or mix of chemicals was applied? _____

How much formulated material was added to the spray tank? _____

How large was the spray tank? _____

How many gallons of water were applied per acre? _____

When was the sprayer last calibrated? _____

Tree Response

What was the tree response? How well did the treatment work? _____

PEARS

Site Selection and Soil Preparation

Our remarks on site and soil selection for apples (see Orchard Establishment) apply equally to pears. Maintain pear blocks in permanent sod cover. Use herbicides to keep grass and weeds away from tree trunks.

Pears are considered self-unfruitful under eastern United States conditions. Cross-pollination should be provided to ensure commercial crops. There is one case of incompatibility in pear varieties—the Bartlett-Seckel combination. If these two are planted, a third variety is needed to ensure commercial crops. Both Magness and Waite are pollen sterile. D'Anjou, Bosc, Highland, Flemish Beauty, and Clapps Favorite are excellent pollinators.

For chemical thinning, apply Amid-Thin W (NAAm) at 25 ppm during the period from petal fall to 7 days after full bloom. This schedule is particularly satisfactory for Bartlett and Bosc. Do not use later than 7 days after full bloom, or small, misshapen fruit will result.

Fire blight susceptibility may be increased by excessive nitrogen. Shoot growth over 18 inches annually indicates excessive nitrogen. It is recommended that no more than 0.01 pound of actual nitrogen per tree per year of age be applied annually up to 15 years old. After that, do not apply more than 0.225 pound of actual nitrogen per tree regardless of its age.

Asian Pears

Asian pears, also called Apple Pears, Oriental, Korean, Chinese, Sand, and Nashi pears, depending on where they are grown in the country, are unique and different from our traditional European pears. Although a large commercial market for this fruit has never developed in the United States, Asian pears are very popular in Japan, China, and Korea. In Pennsylvania the market tends to be located in larger cities where ethnic populations are in greater numbers. Asian pears can be just as susceptible to fire blight as traditional pears. Our traditional pears can serve as pollinizers for Asian pears, but the two groups rarely have an overlap in bloom to provide sufficient pollination opportunities.

There are three types of Asian pears: (1) round or flat fruit with yellow to green skin, (2) round or flat fruit having bronze-colored skin with russeting, and (3) pear-shaped fruit with either smooth or russeted skin. While many cultivars are available, only five are worth commercial plantings.

Recommended Cultivars (listed in order of ripening)

Shinseiki is a round, firm, yellow-skinned fruit that can be stored up to three months in common storage. This cultivar under California conditions is self-fruitful and does not require cross-pollination. Fruit hangs well on the tree and requires multiple harvests. Shinseiki is one of the top cultivars in California.

Hosui is a very large, juicy, sweet, low-acid, bronze, russet-skinned fruit that ripens in August. Trees are extremely vigorous and develop an open and spreading tree; they are very susceptible to fire blight. The fruit does not store longer than two to three months and may become soft in storage sooner than other cultivars.

20th Century, also known as Nijisseiki in Japan, originated in Japan about 100 years ago and is responsible for the popularity of Asian pears in that country. The fruits are round and yellow skinned, but bruise easily. They can be stored up to six months in common storage. Trees must be thinned aggressively to ensure adequate fruit size. Optimum flavor develops when fruit is slightly overripe, imparting a distinctive flavor.

Shinko is a large, round to slightly flattened fruit with a bronze russet skin. Trees are well shaped and very productive with no tendency toward biennial bearing. Shinko is reported to be nearly resistant to fire blight. Fruit will only store approximately two months.

Olympic is variously known as A-Ri-Rang, Olympic Giant, or Korean Giant and is a new cultivar developed in Korea. Fruits are large, late, and round and have an attractive golden russeted skin. Reportedly this pear's bloom period overlaps with Bartlett, and the two make compatible pollinizers. Olympic has the longest storage life of the Asian pears.

Other cultivars

Ichiban Nashi and **Shinsui** are an early maturing brown fruit. Their major asset is that they are early enough to fit into a niche market.

Kikusui is a flat yellow green, medium-sized fruit. It has an excellent flavor, but the skin is too tender to withstand shipping. The fruit is suitable for roadside markets if handled carefully. Preharvest drop can be a problem in some years. This cultivar is very susceptible to fire blight.

Yoinashi is a brown-skinned fruit with good flavor. It ripens along with 20th Century. The Pacific Northwest Testing Association suggests that this may be a replacement for 20th Century.

Chojuro is an old cultivar whose fruit is brown to orange and flat. The trees are very productive. This pear is not nearly as juicy as other cultivars and hence is losing favor. Fruit should be harvested when the first yellow-brown color appears and can be kept in storage for five months.

Niitaka is a large, firm, brown russet fruit. Its major attraction is its large size. Trees are very productive. The pollen is not viable, so this cultivar cannot be used as a pollinizer for other cultivars.

Ya Li is one of the most important pears grown in China. Fruits are green with a pear shape and large. The flavor is sweet but mild. Fruit ripens over an extended period, therefore requiring multiple harvests. Storage life is up until February.

Tse Li is a large, football-shaped green fruit. Its quality is best after a period of storage. In California it is reported that only Ya Li can pollinate this cultivar.

Okusankichi is originally from Korea. The fruit is medium sized with a brown russet finish. Fruit quality improves with storage, and it is reported that fruit can be stored up to 10 months.

(Adapted in part from *Asian Pear Summary* by Pacific Northwest Fruit Testers Association)

Rootstocks

Most pears are propagated on seedlings collected from open-pollinated seeds of Bartlett fruit. Of all tree fruit rootstocks, these are generally the most tolerant of wet, poorly drained soils. Since they are open-pollinated seedlings, there can be some variability in their growth patterns. These seedlings are fire blight susceptible, so every effort must be made to reduce suckering of the rootstocks.

Some nurseries now offer a group of fire blight resistant stocks selected from Old Home x Farmingdale crosses. These rootstocks are clonally propagated and cost more than seedlings. Besides being resistant to fire blight, they have dwarfing ability, and are earlier bearing. Those showing the most promise are OHxF333 and OHxF51; the former is semidwarf and the latter dwarf. However, OHxF51 reportedly has been hard to establish in orchards and has shown winter injury in Canada. These rootstocks would merit small-scale grower trials.

Quince has been the most common dwarfing rootstock for pears. The three clones available are Quince A, Provence, and Quince C. Pears on Quince A and Quince C are dwarfs, while those on Provence are slightly larger. Orchard performance of most quince rootstocks has been variable. Quince is very susceptible to fire blight and low winter temperatures; it should be planted at only the most favorable sites and in areas with good soil drainage. Certain cultivars, such as Bartlett, Bosc, Seckel, D'Anjou, and Clapp's Favorite, are incompatible with quince and require an Old Home interstem.

Two new quince clones, Provence Quince (Le Page Series C) and Provence Quince (BA 29-C), may also be available in limited supplies. Reports from France indicate that BA 29-C is a virus-free selection of Provence Quince, Le Page Series C. Both are reported to be precocious and high yielding and produce a tree one-half to two-thirds the size of standards. They are also susceptible to fire blight. Quince rootstocks are not recommended unless they have proven successful in trial plantings in your orchard.

A new series of pear rootstocks are slowly being released to the industry. This line of rootstocks was developed using crosses of Old Home and Bonne Luise at the Geisenheim Research Institute Department of Pomology in Germany. The first to be released was named Pyrodwarf (Rhenus #1). Trees on Pyrodwarf are reported to be about 50 percent smaller than similar cultivars on OHxF 97 and begin producing in their fifth leaf. Fruit size is maintained with a high-yield efficiency and good anchorage and winter hardiness. It also does not produce root suckers.

A second release, Pyro 2-33 (Rhenus #3), is also a *Pyrus communis* seedling from the same cross as Pyrodwarf. Trees on this rootstock is very precocious with cropping starting in the second leaf and heavy production two years earlier than OHxF clones. Vigor is similar to seedling.

At the present time, we only recommend limited plantings of these two rootstocks since they have not been evaluated in the Mid-Atlantic region.

PEACHES

Site Selection and Soil Preparation

Site selection for peaches and all stone fruits is similar to that for apples (see Orchard Establishment), with the following additional considerations:

First, more attention must be paid to minimum winter temperatures. Areas of Pennsylvania having winter temperatures of -10°F or below should not be considered for growing peaches or other stone fruits.

We strongly recommend that, if stone fruit is to be followed with stone fruit, a nematode sample be taken before removing the old orchard and that the ground be row-cropped for 1 to 2 years with a suitable grain. Do not use broadleaved crops such as soybeans or alfalfa since they may harbor the stem pitting virus. Corn or small grains are suitable. For more information on nematode problems and site preparation, see Part II, Diseases, Pests, and Natural Enemies—Peach Stem Pitting. The season before planting it is important to take care in choosing the herbicide program for the agronomic crop. Avoid high rates of atrazine during that year.

All commercial peach varieties, except J. H. Hale, are considered to be self-fertile. Even so, it is advisable to place bees in large blocks of one variety to ensure adequate pollination.

Using a water-soluble, exterior grade, white latex paint on stone fruit tree trunks may reduce winter injury. A good grade of dairy whitewash paint will also work. Apply to the southern and southwestern sides of stone fruit tree trunks, including the bases of main branches. The paint reflects much of the sunshine striking the trunk during bright winter days and reduces the amount of heat entering the bark. This lowers the possibility of bark splitting and subsequent tree damage.

It is particularly important to paint stone fruit tree trunks and the bases of main limbs up to 8 to 10 years of age. Smaller trunks and main limbs of younger trees respond more to the extreme fluctuations of winter temperatures and may be injured more severely than older trees.

Nursery Tree Quality

A problem in Pennsylvania orchards is the presence of a virus called stem pitting, which causes early death in peach trees. In response to the problem, the Pennsylvania Department of Agriculture (PDA), Bureau of Plant Industry, has established a virus-free certification program in cooperation with Pennsylvania nurseries. The program seeks to provide and maintain virus-free sources of budwood for state nurseries and growers. Pennsylvania nurseries can therefore offer two grades of trees: Penn Standard and Penn Premium. Penn Standard trees are certified for virus-free budwood, but not for virus-free rootstocks. Penn Premium trees are certified for both virus-free budwood and rootstocks.

Surrounding states may also have certified virus-free trees. Growers are encouraged to take advantage of these programs. When ordering trees ask the nursery if it belongs to such a program.

Tree caliper is another measure of nursery tree quality. Trees of a larger caliper—greater than $\frac{5}{8}$ inch in diameter—often are not suited for today's orchards. The larger a tree's diameter, the less choice you will have in selecting scaffolds. Thicker trees tend to be taller, and it may be difficult to force branches low to the ground. In addition, after a larger-caliper tree is headed back,

Cytospora canker may infect the large wound area, eventually resulting in the tree's death. Small-caliper trees, less than ½ inch, are easier to train for certain production systems, such as the central leader, but they need extra care the year of planting to prevent competition from weeds.

Planting Depth

Problems with stone fruits in Pennsylvania have been attributed to setting the bud union 6 to 10 inches below ground. Because many sites have limited topsoil, trees may be planted too deep for optimal growth. At the lower depths oxygen is inadequate for root growth. Rootstocks used for stone fruits are normally propagated by seeds and thus are anatomically true root tissues. The aboveground portions of stone fruit rootstocks cannot form roots. Therefore, trees should be planted at the same level they were in the nursery.

Peach and Nectarine Cultivars

Peaches are the second most important tree fruit crop grown in Pennsylvania. Unlike apples, however, there has been and continues to be extensive breeding of new and improved cultivars. Breeding programs at the USDA in Kearneysville, West Virginia, and at Byron, Georgia, along with private programs in California and Michigan have produced a number of new cultivars in recent years. Extensive evaluations of these cultivars are being performed by Jerry Frecon of the Rutgers Cooperative Extension system.

In recent years interest has grown in white-fleshed peaches and nectarines. In Table 1-22 the white-fleshed cultivars are indicated with an asterisk next to their name. The table is set up according to average ripening dates for south-central Pennsylvania. The cultivars listed under the Peaches column are those that begin to ripen during the particular period. The next column reflects our opinion as to the best cultivars in that particular time frame. The third column contains suggestions for peach cultivars to try on an experimental basis. We do not know how well they will perform, but based on limited observation they seem worth trying on a small scale. The final column indicates all nectarines that ripen during that period.

Pruning and Training Peaches the Year of Planting

The open center training system is still the most popular in Pennsylvania. It is uniquely suited to peaches and many other stone fruits because of the location of flower and fruit buds on the tree. Peaches produce fruit on wood that grew the previous season. Therefore, the open center system, which relies heavily on heading cuts to encourage new growth, promotes the greatest fruit production under normal conditions.

To achieve maximum production when trees are mature, start training trees the year they are planted. Head trees back immediately after planting. The major scaffolds will then develop 6 to 12 inches below this cut. Scaffolds should be started as close to the ground as feasible. The lower the scaffolds originate, the easier it will be to limit ultimate tree height without sacrificing production. Scaffold branches present at planting can be retained if they are healthy and have a good crotch angle (45–60°). Leave three to four equally spaced branches around the tree. On large-diameter trees these branches should be headed back approximately one-half their length.

An alternative training procedure can be used on poorly branched or small-diameter trees (those having a caliper less than ⅝ inch). At planting head the trees as before, but do not remove competing branches. Heading at planting will encourage three to four strong branches to grow directly below the cut. Traditionally these branches are trained into the main scaffolds. However, they are also the most vigorous and upward-growing. The result is that later in the life of the tree they must be severely "benched out" and often have narrow crotch angles.

In May to June, cut these vigorous upright branches in half to create a small bush in the center of the tree. Pruning temporarily stops their growth and dominance and directs energy into shoots lower down. These lower shoots quickly assume dominance and grow out and around the small bush in the center. Because of this small bush, the lower branches are forced to grow out at a wider angle.

If you wish to use this method, it is critical that trees not be stripped up to the top four shoots at planting or shortly thereafter. Instead, develop trees with seven to eight shoots early in the season, then cut the upper ones in half to force the lower branches. Remove the small bush the first winter.

Training in subsequent years is similar to that of the standard open center system. The main advantage is the creation of wide angle branches closer to the ground and able to support a greater fruit crop.

Rootstocks

At present no known adaptable peach rootstocks induce dwarfing in peaches. Peach seedlings are still the principal rootstock source for commercial peach trees. Seedlings can be divided into three classes: wild types (e.g., Tennessee Natural), commercial cultivars (Halford and Lovell), and seedlings developed for use as rootstocks (Siberian C, Bailey, Rutgers Red Leaf). Interspecific hybrids are also being evaluated in Pennsylvania. They have been developed from crosses between peaches and almonds (Nemaguard, GF 677). Finally, nurseries are exploring the possibility of rooting peach cuttings without propagating them on a rootstock. Following are comments about specific rootstocks that are currently available or that might have potential:

Halford: Grown in California as a canning clingstone type.

Some nurseries obtain seed from this open-pollinated fruit, while others have seed blocks and collect fruit only from self-pollinated trees. Seedlings from self-pollinated fruit usually produce the most uniform trees. Halford is compatible with all commercial cultivars.

Lovell: Also grown in California as a clingstone for dried fruit.

Seeds are obtained from self-pollinated blocks and perform like Halford.

Bailey: Developed in Iowa for its cold hardiness. Preliminary trials indicate it to be as productive as Halford and Lovell; however, only a few nurseries offer trees on this rootstock for sale. Only small trial plantings are recommended.

Citation: A peach-apricot-plum hybrid developed in California by Floyd Zaiger. Reportedly tolerant to wet soils, it is compatible with plum and apricot and provides 50 percent dwarfing. However, it cannot be recommended yet because not enough is known about its performance in Pennsylvania. Preliminary studies indicate that it may not be compatible with Redhaven.

Table 1-22. Commercially grown and promising peach and nectarine cultivars for Pennsylvania.

Ripening date in southern PA	Best peach cultivars	Best nectarine cultivars	Promising peach cultivars for trial	Promising nectarine cultivars for trial
June 30–July 5	Desiree NJ 350 Spring Snow (W) Sunbrite Flamin Fury 5B Manon (W) Spring Prince	Mayfire	RichMay Carored Queencrest Spring Flame	
July 6–July 12	Harrow Diamond Sugar May (W) Ruby Prince Sentry	Arctic Star (W) Jade (W)	Harrow Dawn Scarlet Pearl (W)	Silvergem NJ N100
July 13–July 19	Glenglo Garnet Beauty Summer Serenade Flamin Fury PF7	Arctic Glo (W) Easternglo	Vulcan BuenOs NJF18	Honeyblaze
July 20–July 26	Flavorcrest GaLa	Arctic Sweet (W) Harblaze	BuenOs NJF15 Flamin Fury PF10 Saturn (W) Snowbride (W) Vinegold	Flamin Fury PF 11
July 27–August 3	Early Loring Flamin Fury PF 15A John Boy Late Sunhaven Redhaven White Lady (W) Flamin Fury PF Lucky 13 Starfire	Harflame Summer Beauty	Blazing Star Blaze Prince Flamin Fury PF9A-007 Flamin Fury PF 11 Flamin Fury Jersey 14 Snow Beauty (W) Galaxy (W) TangOs NJF 16	Emeraude (W)
August 4–August 10	Salem Coralstar Klondike (W) Bounty	Arctic Jay (W) Flavortop Sunglo	Harrow Fair Flamin Fury PF 19A-007 Flamin Fury PF 20-007 TangOs NJF 17 (W)	Arctic Belle (W)
August 11–August 18	Flamin Fury PF17 Loring Flamin Fury PF 22-007 Flamin Fury F 23 Flamin Fury PF 24-007 July Prince	Redgold	Allstar Carolina Belle (W) Contender Glowingstar Scarlet Prince Suncrest Opale(W)	
August 19–August 26	Gloria NJ 351 Cresthaven Flamin Fury PF Lucky 24B Messina NJ 352 Flamin Fury PF 25	Fantasia	Sugar Giant (W) Blushingstar (W) Benedicte (W)	Stark Ovation Zephyr
August 27–September 3	Flamin Fury PF 28-007 Flamin Fury PF 27A Jerseyqueen Redskin		Lady Nancy (W) Autumn Prince	
September 3–September 10	Autumnglo Encore Flameprince LauroI		Autumn Star Snow Giant (W) Yukon King (W) Flamin Fury PF 35-007 Fat Lady	Artic Pride (W)
September 11 and Later	Parade Victoria NJ 353		Big Red (CVN #3) September Snow (W)	

“W” indicates the cultivar is white fleshed.

Table developed by Jerry Frecon, Rutgers NJAES Cooperative Extension.

Other newer rootstocks are being tested across the country as well as in Pennsylvania. Most originated in Europe and are interspecific hybrids. The main criteria for their development were a tolerance to wetter soils and tree longevity. St. Julian is compatible with peaches and plums and supposedly reduces scion vigor by 10 to 15 percent. Damas (GF 1869) is a plum hybrid compatible with peaches and plums but not nectarines. A serious drawback observed in Pennsylvania is the large output of root suckers from this stock. Amandier (GF 677) is a vigorous rootstock fully compatible with peaches, plums, and nectarines.

Many California nurseries have recently been selling several new rootstocks. Krymsk 1 (VVA-1) and Krymsk 2 (VSA-1) were developed in Russia along the Black Sea for their dwarfing ability and cold-hardiness. Both are compatible with peach and plum. Hiawatha is another rootstock that is available commercially. It provides about 10 percent dwarfing capabilities. They have not been tested in replicated trials in the Mid-Atlantic region.

The University of California at Davis is also in the process of releasing two size-controlling rootstocks for peaches and nectarines. Controller 5, tested as K-146-43, reportedly produces a tree about 50 to 60 percent of the size of trees on Lovell. Controller 9, tested as P-30-135, reportedly produces a tree about 90 percent of the size of trees on Lovell. A study comparing these two rootstocks and others can be viewed online in the *California Agriculture Journal* at calag.ucop.edu/0502AMJ/pdfs/Rootstocks.pdf.

A final option becoming more common is to grow peach trees on their own roots. These trees do not have a true rootstock, but only the scion cultivar. They are expected to be more uniform than those grafted onto a rootstock. Their ultimate size varies according to the genetic makeup of the scion cultivar. Very limited information is available about how these trees perform in Pennsylvania. Indications are, however, that self-rooted trees may be more drought tolerant and able to absorb nutrients more efficiently.

The following peach rootstocks, which may be available from certain nurseries, are not recommended for use in Pennsylvania for the reasons listed. Siberian C does not survive well in areas with fluctuating winter temperatures. NemaGuard has been found not to be cold hardy in this region. *P. tomentosa* and *P. besseyi* lack vigor and have compatibility problems.

Split Pit

Split pit of peaches is a problem for Pennsylvania growers, particularly with early maturing cultivars. Cultivars such as Candor or Garnet Beauty may have 25 to 50 percent split pits, especially if overthinned. The term normally refers to the opening of the pit at the stem and splitting of fruit. This split becomes evident during the third stage of fruit growth, the final swell. However, the weakening of the pit that leads to opening at the stem end probably occurs in the latter stages of pit hardening.

Fruit with split pit generally develops rot much faster than sound fruit. Also, by federal grade standards, split pit is considered a defect. Some level of split pit in most cultivars is normal, especially in early maturing cultivars. Early cultivars such as Candor may have 25 to 50 percent split pits, especially if overthinned.

Shattered Pit

Shattered pit differs from split pit in that it is an internal problem federal inspectors have only recently begun to examine. Fruit with pits broken into more than three pieces plus gum deposits near the flesh are considered out of grade. While the split pits develop at the stem end and are visible, the opposite is true of shattered pits. Fruit with visible split pits at the stem end may also have fractured pit halves and considerable gumming in the pit cavity. In shattered-pit peaches, the damage is centered at the blossom end of the fruit, and growers cannot see and thus remove all peaches with fractured pits during the grading process.

The exact causes of pit breakage are not known. Some researchers suspect that low temperatures and/or freezing damage during flowering and early fruit development are factors. Studies conducted in the south showed that shattered-pit is much less severe in fruits possessing viable seeds. However, it is not known if the pit shatters because of seed death or if breakage of the pit actually causes seed death. The studies suggested that the problem is much worse in early peach varieties. Generally, cultural practices that enhance fruit size—such as thinning, applying nitrogen, or irrigating—usually increase the incidence of split and shattered pits in susceptible cultivars. When freezes excessively reduce fruit yields, pit breakage problems usually increase.

Growers are limited in what they can do culturally to minimize pit breakage. The first line of defense is to select and/or eliminate cultivars with a consistent history of these problems. Avoiding low or frosty sites can help reduce the possibility of light crops caused by cold damage. Finally, on early maturing cultivars it may be necessary to leave heavier crop loads, although in doing so you must settle for smaller size.

Nectarine Pox

Nectarine pox is a disorder that reduces packout of commercially grown nectarines. It was first identified and studied in West Virginia and has since been found in nearly all areas of the Cumberland-Shenandoah fruit-growing regions.

The disorder is characterized by superficial warty or raised outgrowths that in some years may occur on 20 to 80 percent of the fruit in an orchard block. Symptoms are usually observed within 40 days after full bloom as pale white or light-colored circular spots or raised areas. In some instances spots may cluster together, forming a large irregular rough raised area. As fruit develops and enlarges, the spots expand and raise higher than surrounding tissue. Raised areas are usually redder than the surrounding tissue. Slicing through the raised areas shows normal fruit tissue below.

Research results suggest that the disorder is accentuated in overly vigorous trees and in trees with high levels of fruit nitrogen and potassium and low levels of fruit calcium. Suggested control measures include the use of cultural practices that reduce excessive shoot growth. Such practices are proper fertilization, good pruning, and regular leaf analysis to monitor nutrient levels. Root pruning has also been shown to help reduce the incidence of nectarine pox, probably owing to the effects of reducing shoot growth. Avoid excessive nitrogen applications and excessive dormant pruning. Since this disorder appears to have the same causes, growers may want to try, on an experimental basis, the control strategies used for corking in apples. See page 50.

CHERRIES

Site Selection and Soil Preparation

Site preparation and nursery tree selection are similar to that for apples (see Orchard Establishment). All commercial sweet cherries (except Stella and Duke) are considered self-unfruitful. Tart cherry pollen will pollinate sweet cherries, but the bloom periods do not overlap. Tart cherries are self-fruitful and will produce commercial crops when set in solid blocks of trees.

Growth Regulators

Young trees

Early flowering in a newly planted cherry orchard can delay vegetative development and lower long-term productivity. The use of gibberellic acid (Pro-Gibb 4%) beginning the year after planting can prevent overflowering in young trees (Table 1-23).

Applications should be made as dilute sprays with a handgun, or airblast sprayer, in 25 to 50 gallons of spray per acre. Apply the spray 2 to 4 weeks after bloom, with 3 weeks the optimal timing. Apply 50 to 100 ppm (20 to 40 oz Pro-Gibb/100 gal) as a fine mist. Use higher rates for trees growing in poorer soils and lower rates for trees in high-vigor soils.

Promalin may also be used to increase branching in young sweet cherry trees. Use it as you would for apples (see “Growth Regulators to Aid in Apple Tree Training”). Application can only be made, however, in a mixture with latex paint. Apply

the mixture to nodes where branches are desired. Do not apply after buds have broken, or young shoots may be damaged (see Table 1-23).

Bearing or mature trees

Foliar applications of Pro-Gibb 4% can help reduce blind wood and increase fruiting of tart cherries. The material works by affecting lateral bud differentiation, which is apparent the year after application. Therefore, changes in shoot, spur, and flower production will not be evident until 2 or 3 years after the program is begun. Once this period is satisfied, response will be yearly provided annual applications have been made.

Apply Pro-Gibb 4% as a foliar spray containing 4 to 8 fluid ounces in 100 gallons finished spray from 14 to 28 days after bloom (or up to 14 days after shuck split). Use full coverage sprays of 50 to 150 gallons per acre on medium to large bearing trees. Be sure entire trees receive good coverage. A good horticultural wetting agent will aid in foliar wetting.

Ethephon (Ethrel) may be used to loosen red tart cherries for mechanical harvest. Caution: Ethephon has caused severe gummosis in some Pennsylvania tart cherry orchards, affecting low-vigor trees most severely. Apply ethephon only to trees making optimum growth. Do not use more than 2.5 pints ethephon or less than 50 gallons of water per acre. Apply 14 to 7 days before anticipated harvest. Do not apply when the temperature is below 60°F or above 85°F. Be sure to leave some trees unsprayed for comparative purposes.

Table 1-23. Growth regulators for stone fruit.

Purpose	Trade name	Rate of commercial product/A or ai/A	Comments
Reduce preharvest fruit drop; delay harvest	ReTain	0.73 lbs/A (1 pouch)	Apply 7 to 10 days prior to anticipated harvest. Apply in 100 gal/A or enough volume for adequate coverage without excessive runoff. PHI = 7 days.
Loosen fruit; hasten fruit maturity TART CHERRIES	Ethrel, Ethephon II (21.7% ai)	3–4 pt/A dilute or 0.6–1 pt/A concentrated spray	Apply when fruit ground color changes from bright green to yellow. Do not treat when air temperatures exceed 85°F. PHI = 7 days and REI = 48 hrs.
SWEET CHERRIES		3–4 pt/A dilute or 2–3 pt/A concentrated spray	Same as above.
Produce larger, brighter colored, firmer fruit (sweet cherries)	ProGibb 40% WSG or ProGibb 4%	16–48 g ai/A (40–120 g/A) 16–48 oz/A	Apply a single spray when fruit is translucent green to straw colored. For cultivars with uneven maturity, make two applications. Apply 1/3 to 1/2 of the total desired amount when the majority of the fruit is translucent green. Apply remaining material 3–7 days later.
Increase fruiting capacity and reduce blind wood of bearing tart cherries	ProGibb 4% or Falgro 20SP	4–18 oz/A 20–90 g/A (4–18 g ai/A)	Apply when at least 1–3 inches of terminal growth has occurred. This is usually 14–28 days after full bloom. Use higher rates on vigorous trees and lower rates on low-vigor trees.
Reduce flowering and fruiting in young nonbearing stone fruit trees	Falgro 20SP	100–400 g/A	Make one application during flower bud initiation period in the second leaf and in third leaf if later fruiting is desired in the fourth season. Discontinue use one year before commercial harvest is desired.
Stone fruits to increase fruit firmness and improve fruit quality in the season of application	ProGibb 40% WSG	16–32 gal/A (40–80 g/A) or 1.4 to 2.8 oz/A	Apply as a single spray 1 to 4 weeks prior to the beginning of harvest. Use sufficient water to achieve complete coverage of fruits and foliage. This application has been known to cause a reduction in flower counts the year following the application, especially if it is made during the months of May through July.
Increase lateral branching of nonbearing sweet cherries (<i>nursery only</i>)	Promalin or Typy	250–1,000 ppm or 0.5–2.0 pt/5 gallons of spray solution	Treat trees after they have reached a terminal height at which lateral branching is desired.
Increase lateral branching of nonbearing sweet cherries (<i>orchard only</i>)	Promalin or Typy	5,000 to 7,500 ppm or 3.2–5.3 fluid oz per pint of latex paint	Apply in the spring when terminal buds begin to swell but before buds begin to break shoots. Apply only to one-year-old wood. 365 PHI.
Stone fruits (EXCEPT CHERRY) to improve harvest management, allow for increased fruit size, maintain fruit firmness, reduce preharvest fruit drop, improve fruit quality, and enhance storage life	ReTain	11.7 oz or 1 water soluble bag/A	Apply 1 to 2 weeks prior to anticipated beginning of normal harvest in no more than 100 gallons of spray. Use of an organosilicone adjuvant is recommended at 0.1% v/v.

Cultivars

Two important species of cherries are grown for commercial production: *Prunus avium*, sweet cherry, and *Prunus cerasus*, tart cherry. They can be grafted onto each other and, when cross-pollinated, produce seeds that become Duke hybrid cultivars.

Sweet cherries are more difficult to produce than tart. They are scarcely more hardy than peaches, bloom early, and thus are frequently caught by spring frosts. Many sweet cherry cultivars experience severe cracking if water is allowed to remain on the skin for a few hours before harvest. Rains at harvest time will often ruin a crop. Recent testing of antitransparents has shown them to have promise in reducing cracking. Also, breeders are trying to develop more crack-resistant cultivars; many have been and will continue to be released.

Many common cultivars were originally developed in Europe and brought to this country. European cultivars still grown in the United States are Black Tartarian, Napoleon, Hedelfingen, and Schmidt. Windsor, Vista, Van, Vega, Summit, and Stella are cultivars developed in Canada. Ulster and Hudson were recently introduced in New York, while Angella and Utah Giant were recently introduced in Utah.

There are four kinds of sweet cherries: light-colored hearts, dark-colored hearts, and light- and dark-colored Bigarreaus. Hearts are mostly soft-fleshed fruit best suited for home use or eating fresh. Light-colored hearts produce nearly colorless juice and have a predominantly yellow skin with or without a red blush. Dark-colored hearts have red to deep red juice, and soft fruit. Black Tartarian is the best known example.

Bigarreaus produce firmer fruit and are widely planted by the commercial industry. They also are divided into light- and dark-colored groups. The lights have yellowish skin and nearly colorless juice, and are used mainly for brining and maraschino production.

Sweet cherries are further classified based on their ability to cross-pollinate with one another (Table 1-24). Nearly all sweet cherry cultivars appear to be self-unfruitful. They produce viable pollen, but not all cultivar combinations are fruitful. There are many cross-incompatible groups of sweet cherries. Cultivars within a group should not be planted together without a suitable pollinizer. Following are some of the more common cross-incompatible groupings:

Table 1-24. Sweet cherry pollination guide.

Bloom Time	Early			Early Midseason				Midseason						Late Midseason					Late								
	Somerset	Viscount	Kristin	Viva	Chelan	Burlat	Republican	Royalton	Summit	Rainier	Napolean/Royal Ann	Valera	Ulster	Bing	Emperor Francis	Hartland	Schmidt	Van	Hedelfingen	Regina	Lambert	Windsor	Vogue	Sam	Gold	Hudson	
Somerset	I		I																								
Viscount		I					I			I																	I
Kristin	I		I								I		I	I							I						
Viva				I																			I				
Chelan					I	I																					
Burlat					I	I																					
Republican		I					I	I		I																	I
Royalton								I									I								I		
Summit									I							I											
Rainier		I					I			I																	I
Napolean/Royal Ann	I		I								I		I	I							I						
Valera											I																
Ulster	I		I										I	I	I							I					
Bing	I		I								I		I	I	I							I					
Emperor Francis	I		I								I		I	I	I							I					
Hartland									I							I											
Schmidt								I									I								I		
Van																		I		I		I					
Hedelfingen																			I								
Regina																			I		I		I				
Lambert	I		I								I		I	I								I					
Windsor																		I		I		I					
Vogue				I																			I				
Sam								I									I							I			
Gold																										I	
Hudson		I					I			I																	I

Adapted from Dr. R. L. Andersen et al. 2001. Sweet cherry pollination considerations for 2001. NY Fruit Quarterly 9(1):25–28.
I = Incompatible. Gray-shaded area = compatible, but different bloom time, so do not use as pollinizers.

- I. Bing, Lambert, Napoleon, Emperor Francis, Somerset, and Vernon
- II. Windsor and Abundance
- III. Black Tartarian, Somerset, Black Eagle, Knight's Early Black, Bedford Prolific, and Early Rivers
- IV. Centennial and Napoleon
- V. Advance and Rockport
- VI. Elton, Governor Wood, Stark's Gold, and Hartland
- VII. Early Purple, Royalton, and Rockport
- VIII. Black Tartarian, Early Rivers, and V29023
- IX. Sodus, Van, Venus, and Windsor
- X. Velvet, Victor, Gold, Merton Heart, Viva, and Vogue
- XI. Hedelfingen, Vic, and Ulster
- XII. Hudson, Giant, Schmidt, Ursala, Chinook, Ranier, and Viscount
- XIII. Seneca, Vega, and Vista
- XIV. Royal Purple, Lambert, Ironside, Woodring, and Bing
- XV. Schmidt and Oreland

Tart or sour cherries are a different species from sweet cherries. As a group tart cherries are probably as hardy as any other fruit. Their ability to adapt to various soils and climates is much greater than that of sweet cherries. Tart cherries are self-fruitful and will produce heavy commercial crops when planted in solid blocks. They do not have severe cracking problems or as much brown rot as sweet cherries.

Self-fertile sweet cherry cultivars

Due to the problems associated with cross-pollination of sweet cherries, plant breeders have been developing self-fertile sweet cherry cultivars. These cultivars do not require pollen from a different cultivar to set fruit. The self-fertile cultivars can therefore be planted in solid blocks. At present there are 11 self-fertile cultivars (Table 1-25). Very little is known about their performance in Pennsylvania, and some are reported to be susceptible to rain-induced fruit cracking in other states. Growers should be

Table 1-25. Self-fertile sweet cherry cultivars and approximate bloom season.

Cultivar	Bloom time
Lapins	Early
Sweetheart	Early to midseason
Vandalay	Early to midseason
Whitegold	Early to midseason
Selah	Early to midseason
Skeena	Midseason
Sandra Rose	Midseason
Santina	Midseason
Sonata	Midseason
Stella	Midseason
Symphony	Midseason
Tehranivee	Midseason
Sunburst	Midseason to late
Blackgold	Late season
Benton	Late season

Adapted from Dr. R. L. Andersen, NYAES.

cautious when ordering these cultivars because of the unknown crack susceptibility.

Newer sweet cherry cultivars

White or yellow-fleshed cherries (used mainly for brining)

Corum: July 8 ripening. Semifirm, but productive and hardy.

Emperor Francis: July 10 ripening. Major cultivar used in the East. Can be eaten fresh or used for brining.

Gold: July 15 ripening. Trees are hardy and productive. Flower buds more hardy than most other cultivars. Fruit is small. As part of a unique pollination group, Gold can serve as a pollenizer for many other brining cultivars.

Whitegold: (NY 13688) Early to midseason self-fertile cultivar released by Cornell University in 1998. Fruit can be used for fresh or processing purposes. Whitegold can serve as a universal pollinator for other sweet cherry cultivars. Fruits are yellow with a red blush. Reported to bloom later than other white-fleshed cherries and to have good field tolerance to bacterial canker and leaf spot.

Dark sweet cherries

Blackgold: (NY 13791) A mid- to late season self-fertile cultivar released by Cornell University in 1998. It is the latest blooming cultivar in the Cornell collection, giving it a good tolerance to spring frost. The fruit, which has dark skin and flesh, can be used for both fresh and processing purposes.

Hartland: Developed in New York, it ripens in early to mid-season productive black sweet cherry. The tree is winter hardy and disease-tolerant. Fruit are medium to large and medium firm better than Hedelfingen.

Hedelfingen: July 17 ripening. Early bearing and very productive. Reported not to crack in the Geneva area, but severe cracking occurs on the West Coast.

Hudson: July 25 ripening, making it the latest-ripening cherry commercially available. Very firm fruit of very good quality, low susceptibility of fruit to cracking in the field. Tree of medium hardness and productivity.

Kristin: Originated in New York and widely tested in Norway, where it has performed well. Average ripening date of July 15. Fruit size averages 1 inch. Precocious and moderately productive. Moderate resistance to rain cracking.

Royalton: (NY 11390) The exceptionally large fruit ripens mid-season with Hedelfingen. Trees are vigorous with an upright growth habit. Fruit are firmer than Hedelfingen and may be a good replacement for that cultivar

Sam: July 6 ripening. Good rain-cracking resistance, but this may be related to soft fruit texture. Hardy, but only moderately productive. Late blooming. Fruit of some trees has a bitter aftertaste. Black fruit, $\frac{3}{4}$ to $\frac{7}{8}$ inch in size.

Somerset: (NY6476) July 17 ripening. Developed by the Geneva Experiment Station and released in 1994. Fruit looks similar to Bing in shape but are much darker and ripen later than Bing. Fruit has a high tolerance to cracking. The tree is very precocious and produces many lateral branches.

Stella: The first named self-fruitful sweet cherry cultivar developed in British Columbia. Cracking can be a problem.

Ulster: July 14 ripening. Nearly black fruit, $\frac{3}{4}$ – $\frac{7}{8}$ inch. Medium hardness but productive. Resembles Schmidt but more productive. Moderate resistance to rain cracking most years.

Valera: Introduced from Vineland, ripening a few days before Bing. Medium-sized, semifirm, good-quality fruit. More consistent cropping record than Venus. Cracking susceptibility unknown.

Vandalay: (V690618) Developed at the Vineland Research station in Canada from a Van x Stella cross. Trees are self-fertile. Cracking may be a problem.

Viscount: Another introduction from Vineland. Medium to large, firm, good-quality, dark glossy red cherries that ripen with Bing. Productive, with good resistance to cracking.

Viva: July 4 ripening. Dark red, $\frac{3}{4}$ inch, semifirm fruit. Good cracking resistance, but this may be due to its soft texture.

Sweet cherries not recommended

Several cultivars that are not recommended or that have problems with rain cracking: Napoleon (known as Royal Ann on the West Coast), Ranier, Bing, Chinook, Compact Lambert, Lambert, Schmidt, and Summit.

Processing sweet cherry cultivars

Two new cultivars that are especially suited for processing were released by Cornell University in the fall of 2006.

Andersen: Tested as NY 9295, this cultivar is named after Dr. Bob Andersen. It is a large-size cherry that may have good use as a cocktail cherry. The tree blooms mid to late with BlackGold and Gold and is self-incompatible. Fruit are moderately susceptible to cracking and tend to carry the fruit as large singles. The skin color is a red blush with a yellow ground color

Nugent: Tested as NY 518, this cultivar is named after Dr. Jim Nugent. The fruit are all yellow and are similar in appearance to Gold. Bloom is early to midseason, but fruit ripen the same time as Gold. The tree is spreading and quite willowy with heavy yields.

Tart cherry cultivars

Tart or sour cherries are a different species from sweet cherries. As a group, tart cherries are probably as hardy as any other fruit. Their ability to adapt to various soils and climates is much greater than that of sweet cherries. Tart cherries are self-fruitful and will produce heavy commercial crops when planted in solid blocks. They do not have severe cracking problems or as much brown rot as sweet cherries.

Montmorency: This is the most widely grown tart cherry cultivar. Some nurseries offer spur-bearing Montmorency types.

Balaton: A new tart cherry from Hungary that was released through Michigan State University. Fruit are red-fleshed and the juice is red. It has a higher sugar content than Montmorency, but is still classified as a tart cherry.

Danube: Another release Released from Michigan State, this new tart cherry is dark red and sweeter than Montmorency. Fruit juice is very dark red, indicating high levels of anthocyanins. Fruit ripen a few days before Montmorency. This cultivar produces the largest of the three new tart cherries.

Jubileum: A second dark red skin, flesh, and juice released from Michigan State. Has very high sugar levels (18 to 19 Brix). Fruit average 5.5 to 6 grams each. Fruit ripen early midseason. Suitable for fresh market sales.

Rootstocks

Rootstocks now available for cherries are Mazzard, Mahaleb, Colt, and the MxM series. Mazzard is a sweet cherry seedling adaptable to both sweet and tart cherries. It is tolerant of heavier soils. Trees on Mazzard are larger than the same cultivar on Mahaleb. Mahaleb is the standard rootstock for tart cherries because it is slightly dwarfing, more tolerant of drought and cold, and more precocious than Mazzard. It is not, however, compatible with all sweet cherry cultivars.

Colt, a recently introduced rootstock from England, is reported to be precocious and semidwarfing. A size reduction of 25 percent was reported over standard rootstocks for cherries. However, trees on Colt have been found to be drought sensitive and not cold hardy. Therefore, Colt is recommended only for warmer areas with irrigation.

The MxM series was developed in Oregon by Lyle Brooks from crosses made between Mahaleb and Mazzard. Currently MxM 2, MxM 60, and MxM 39 are available commercially. None provide any dwarfing capabilities. As a group all are reported to have good resistance to most common root rot problems.

MxM 2: More vigorous than Mazzard but more precocious. May perform better in weaker or sandier soils. Tolerant to both *Prunus* necrotic ringspot and prune dwarf viruses. Also reported to have good field tolerance to bacterial canker of cherry (*Pseudomonas syringae*).

MxM 39: Supposed to be the most dwarfing, producing a tree about 80 percent the size of Mazzard. However, Pennsylvania trials have shown that it does not appear to be that much smaller in its early years.

MxM 60: Reportedly produces a tree about 90 percent the size of standard rootstocks. In Pennsylvania, Montmorency on this rootstock produces very bushy trees. MxM 60 is compatible with both sweet and tart cherries. Tolerant to both *Prunus* necrotic ringspot and prune dwarf viruses. Also reported to have good field tolerance to bacterial canker of cherry (*Pseudomonas syringae*).

New cherry rootstocks

The next few years may bring an increase in the number of rootstocks for both tart and sweet cherries. Right now, however, we are not recommending that cherry growers plant large blocks of these rootstocks until they have been thoroughly evaluated. Growers should try small plantings under their own conditions as rootstocks become available.

In 1998, an NC-140 rootstock trial was established at a commercial orchard in Franklin County and the grape research station in Erie County. The cultivars were Hedelfingen in Erie County and Montmorency in Franklin County. Rootstocks in the trial include Edabriz, Gi 195-20, Gi 209-1, Gi 473-10, Gisela 5, Gisela 6, Gisela 7, Weiroot 10, Weiroot 13, Weiroot 158, Weiroot 53, Weiroot 72, and *P. avium* and *P. mahaleb* as controls.

The Gisela series of rootstocks was developed in Germany in the 1960s at Justus Leibig University in Giessen by Drs. Werner

Gruppe and Hanna Schmidt. Several of the more promising selections were imported into the United States in the 1980s and included in the 1987 NC-140 planting at various locations throughout the country. From these trials four rootstocks have become commercially available: Gisela 5, Gisela 6, Gisela 7, and Gisela 12. Size control ranges from 45 to 80 percent of the size of similar cultivars on Mazzard. Initial reaction was very favorable, but in recent years there has been concern about virus susceptibility. Nevertheless, they do offer some size control. Growers should take care that the trees do not overcrop in the early years and fail to develop proper canopy size. In general, tree support is recommended for all the Gisela stocks that have been released. An article from the *New York Fruit Quarterly* on managing the Gisela cherry rootstocks is available at www.nysaes.cornell.edu/hort/fq/winter99/NYFQ_Winter.Anderson.PM.pdf. Below are descriptions of the four.

Gisela 5: Tested as Gi148/2, this is very precocious, producing a tree about 50 percent the size of Mazzard. The rootstock seems to induce an open canopy with wide branch angles. Trees produce few suckers. Trees must be pruned hard and the crop load intensely managed or the tree may run out. Do not plant on dry, sandy soils.

Gisela 6: Tested as Gi148/1, this is a precocious rootstock that produces trees about 65 to 95 percent of the size of trees on Mazzard. It induces early bloom and is tolerant of viruses. Extra care must be taken to ensure that desired shoot extension growth is maintained.

Gisela 12: Tested as Gi195/2, this is a semidwarf type producing a tree about 70 percent the size of Mazzard. It is reported to have good virus resistance and does not sucker.

COLLECTING WEATHER INFORMATION IN ORCHARDS

Collecting weather data is becoming more important to successful implementation of integrated pest management (IPM) and making orchard cultural management decisions. Weather information is useful for monitoring disease infection periods, operating insect degree-day models, monitoring irrigation systems, applying fruit thinning chemicals, and operating computer-based orchard management software.

This section describes ways to record weather data to obtain information for making fruit-production decisions. The emphasis is on setting up a weather station, choosing instruments, taking observations, and modifying TV and radio forecasts for local conditions. However, customized weather prediction services that are specific for your farms can also be purchased from private companies. While many weather variables can be observed routinely to describe local weather, only a few of the most critical are discussed here. For more information, consult the reference list at the end of this guide.

Weather can vary over small distances, owing to variations in terrain, vegetative cover, proximity to water bodies, and other factors. Therefore, weather observations taken at one location may not be representative of another location, even within the same county, farm, or orchard. Similarly, weather forecasts for a nearby city or area may not be adjusted for local weather influences (i.e., terrain) within a county or on a farm. It is therefore necessary for growers to take weather observations on their own farms to make informed decisions. If there are significant differences in the locations of your orchards, you may need to take weather observations at several sites on the farm. You can use these as a basis for adjusting more general TV and radio weather forecasts to your local conditions.

Both manual and automated weather instruments are available for recording weather data. Automated instruments provide continuous observations of weather and their data can be automatically downloaded into a personal computer. Automated instruments will cost between \$500 and \$6,000 depending on the number and type of sensors and the accompanying software. Manual instruments are less expensive and need less maintenance, but observations must be taken at least on a daily basis. Data collection, summary, and input into the computer is performed manually by the observer.

Comparisons of Weather Monitoring Equipment

Many environmental monitoring systems exist for collecting weather data in orchards. These systems must be compared for information reliability and ease of use. Most of the systems that are commercially available will collect accurate weather information in orchards. The factor that often determines whether a grower utilizes farm-based weather information to make decisions is the ease-of-use of the system they are operating.

Weather collection systems

Weather collection systems have been tested for use in orchards by Penn State personnel since the early 1990s. Many weather collection systems have been tested for ease of use and accuracy. This summary will review a manual system, consisting of ther-

mometers and a hygrothermograph; several automated systems, including the Sensor Field Monitor and Metos; and a weather data delivery service, SkyBit E-Weather, which delivers daily summaries and forecasts. Each system presents different features, but all provide temperature, relative humidity, precipitation, and leaf wetness information. There are several other weather collection systems that are commercially available but are not included in this summary.

Quality of the weather data

As a generalization, all of the systems measured temperature and relative humidity well. There were some discrepancies in precipitation and a general disagreement on leaf wetness. However, the accuracy of the weather information provided by all of the systems was adequate for day-to-day orchard IPM decision making.

Rating ease of use: how each system compared

Setup often requires a pole or shelter for mounting the equipment, and some smaller poles or stakes to mount the gauges and sensors. Most of the automated systems could benefit from better manuals. Additionally, all of the systems are susceptible to failure. Each system we used experienced some data loss from a variety of causes, such as low batteries, insects in the equipment, problems with software, and difficulty operating the unit. To get the most out of the electronic units, a computer is necessary. If you don't have a phone line to connect to the electronic units, you will need a portable computer to take into the field to collect the data.

Manual systems: hand-operated sensors and hygrothermograph

A hand-operated (thermometer, rain gauge) weather collection system is the least expensive system. An on-farm hand-operated collection system can be purchased for as little as \$100. The shortcoming of a hand-operated system is the lack of hourly information that is necessary for most disease and insect predictive models. Hand-operated systems require daily readings of thermometers and rain gauges at the same time each day. The hand-operated instrument observer routinely visits the weather station each morning at the same time to record the weather records from the previous 24-hour period. Commitment and time is required to operate manual weather systems. Hygrothermographs eliminate the need for daily readings. They are reliable and accurate when regularly calibrated. The charts must be changed once a week, and information must be retrieved manually from the charts. Weather information must be manually summarized and entered into the computer. These instruments are becoming more expensive, costing in the range of \$1,800 to \$2,000. The hygrothermograph is also prone to human error, since people perform all readings and manually summarize the information.

SkyBit E-Weather

SkyBit E-Weather is quite different from the other systems. There is no equipment in the field. Site-specific weather information is provided daily by e-mail or fax. The grower must provide the latitude, longitude, and elevation of the orchard site to the company. If you are comfortable with e-mail or have a fax machine, E-Weather is easy to get and use. Additionally, E-Weather provides a forecast, which can provide the grower with the information to

plan for pesticide applications or labor management. E-Weather also provides weather trends, degree-day accumulations, and disease and insect predictive model outputs.

Daily leaf wetness and precipitation information provided by E-Weather is less accurate than the orchard units described earlier. The quality of forecast data is very good for temperature and relative humidity, but not as reliable for precipitation and leaf wetness.

Which system is the right choice?

No single system is the right choice for everyone. The prices range from as little as \$100 to several thousand dollars for a field monitoring unit. Weather monitoring units placed in the orchard have the advantage of very accurately recording the weather at the orchard site, but they must be maintained and routinely accessed for weather information retrieval. SkyBit E-Weather calculates the weather information for the site without the need to place and maintain an orchard unit. In addition, SkyBit E-Weather provides forecast information for a specific orchard. The system a grower chooses depends on the needs of the individual grower.

All of these systems are being tested by Penn State personnel. Please contact your local extension agent if you have questions about the selection of a weather monitoring system.

Distributors

E-Weather
Skybit, Inc.
369 Rolling Ridge Drive
Bellefonte, PA 16823
1-800-454-2266
www.skybit.com

Hygrothermograph
Belfort Instrument Company
727 S. Wolfe Street
Baltimore, MD 21231
1-800-937-2353
belfortinstrument.com

Thermometers, rain gauges, etc.

Ben Meadows Company
PO Box 5277
Janesville, WI 53547-5277
1-800-241-6401
www.benmeadows.com

Forestry Suppliers, Inc.,
205 West Rankin Street
PO Box 8397
Jackson, MS 39284-8397
1-800-647-5368
www.forestry-suppliers.com

FROST PROTECTION FOR TREE FRUIT

Frost causes the loss of a certain percentage of tree fruit crops almost every year. Susceptibility to frost damage depends on a tree's stage of development, variety, and location, but certain preventative measures can be taken. The goal of all frost protection methods is to maintain the blossom temperature above the critical temperature.

Only a few frost protection methods have been consistently effective over the years. These vary considerably in cost, management time, and effectiveness. It is very important to get a good estimate of actual economic losses caused by frost before deciding whether to implement a frost protection system. A small average annual loss of crop to frost may not be worth the time and money invested in a protection system.

Selecting the Right Site

When air near the ground cools, it becomes denser. If the ground is sloped, the colder air will flow downhill into a pocket or onto level ground. Therefore, planting the orchard on a hill is the first step in frost protection, because there is nothing to trap the cold air as it drains. In some cases, cold air drainage may protect the crop from frost enough that no other method is necessary. However, if a good sloped site is not available or a site already established is experiencing frost damage, other protection measures may be required.

Heating

Burning combustible materials to protect crops from frost originated thousands of years ago. This is the most effective way to maintain the temperature above the critical level, but it is also the most expensive and environmentally damaging. Stack heaters, still available from selected distributors, burn fuel oil stored in the heater's base or injected through nozzles from a fuel line. The heaters often have a diffuser on the top to spread out the flume. Trees are heated through radiative transfer directly from the heaters or from air warmed by them.

Sprinkling

Using water to protect blossoms from cold has gained popularity over the last couple decades. Compared to heating, irrigation for frost protection lowers expenses and reduces environmental damage. Irrigation lines can also be used for soil moisture maintenance, chemical injection, and heat suppression. Although water use can protect against frost, it involves greater risks than heating. Overuse of water can saturate soils, increasing the likelihood of diseases, and build up ice, which may damage trees. Water application rates depend on the desired bud temperature (buds in earlier stages of development are hardier and therefore have lower critical temperatures), air temperature, humidity, and wind speed.

Overtree

Applying water directly to flower buds allows the heat released from freezing water to maintain a bud temperature near freezing, which is a few degrees above the critical damaging level. As long as the rate of water being applied and the rate of freezing are balanced, bud temperature will remain close to the freezing mark. Insufficient application can do more damage than no protection at all, because evaporation may cause flower bud temperature to drop below air temperature.

One problem with overtree sprinkling is not knowing how much water to apply. Application rate models have been developed by modeling the energy balance between heat lost from the buds as a result of environmental conditions, and heat gained from freezing of the water. Rates for different conditions have been determined using the sprinkler application rate model FROSTPRO (Perry, 1986) and are shown in the table below. Note that lower humidities will increase the application rate.

Sprinkler application rates from FROSTPRO, inches per hour.

Temperature (°F)	Wind speed (mph)			
	1	2	5	10
30	0.05	0.05	0.09	0.12
28	0.07	0.10	0.15	0.16
26	0.10	0.13	0.20	0.24
24	0.12	0.17	0.26	0.32
22	0.14	0.20	0.31	0.40
20	0.17	0.24	0.37	0.47

Note: Results are based on the assumptions that the critical temperature of the bud is 28°F and the relative humidity is 75 percent.

Pulsing

The principle behind pulsing (or cycling) of the irrigation system is that the rate by which water is delivered to the orchard can be varied by turning the water on and off in short cycles, e.g., 2 minutes on and 2 minutes off. First, determine the fixed rate of the sprinklers. If it is not known, you can determine the application rate by placing buckets in a grid pattern in the orchard and sprinkling for one hour. Measure the depth of water in the buckets, and use the average application rate in inches per hour. For example, if the fixed rate is 0.20 inch per hour, and the recommended rate is 0.10 inch per hour, the cycle would be something like 2 minutes on and 2 minutes off. The on time should not be less than the time for a sprinkler head to make a complete rotation, and it is not recommended that the off time exceed 3 minutes.

Undertree

A sprinkling technique that is gaining acceptance is the use of undertree sprinklers to protect trees from frost. How this method works is not completely understood, but it is believed that the heat released as water vapor condenses on leaves and blossoms keeps buds above the critical temperature. This approach uses less water, and there is little or no damage to the tree as a result of ice buildup; but certain blossoms, especially those at the top and exposed to the sky, may receive inadequate protection.

Wind Machines

The lowest several hundred feet of the atmosphere become stratified under calm, clear, frost conditions. An inversion condition thus exists, meaning that temperature increases as it rises to the top of the inversion layer. A wind machine mixes the warmer air from the upper portions of the inversion layer with the colder air near the ground, raising air temperatures around the trees by a few degrees.

Wind machines are motor driven and therefore consume fuel, although not nearly as much as stack heaters. They work under calm, clear conditions as long as the frost is not too "deep"; that

is, temperatures are not more than three or four degrees below the critical temperature. Wind machines do not work under cold, windy conditions, because the wind usually mixes the atmosphere enough to prevent an inversion layer from developing.

When using wind machines, it is important that the machines are turned on when the air temperature in the orchard is still above critical temperatures. If air temperature is being monitored in a protected shelter within or outside of the orchard, the machines should be initiated when the air temperature is still above 32°F. It is very possible that bud temperatures may be several degrees below the air temperature due to radiative cooling, and they can experience damage even if the air is still above freezing.

More information about choosing and implementing frost protection systems can be obtained from your county extension specialist or from commercial dealers that offer frost protection systems and components.

Critical Temperatures for Various Fruits

The temperature at which fruit buds are injured depends primarily on their stage of development. As flowers begin to swell and expand into blossoms, they become less resistant to freeze injury.

Not all blossoms on a tree are equally tender. Resistance to freeze injury varies within trees as it does between orchards, cultivars, and crops. Buds that develop slowly tend to be more resistant. As a result, some buds are usually killed at higher temperatures, while others are resistant at much lower temperatures. Table 1-26 shows the average temperatures required to kill 10 percent and 90 percent of buds. Consideration should also be given to weather conditions preceding cold nights. Prolonged cool weather tends to increase bud hardiness during the early stages of bud development.

Table 1-26. Critical temperatures for various fruits.

Stage of development	10% kill (°F)	90% kill (°F)	Stage of development	10% kill (°F)	90% kill (°F)	Stage of development	10% kill (°F)	90% kill (°F)
<i>Apples^a</i>			<i>Pears^b</i>			<i>Apricots</i>		
Silver tip	15	2	Scales separating	15	0	First swelling	15	-
Green tip	18	10	Blossom buds exposed	20	6	Tip separates	20	0
½-inch green	23	15	Tight cluster	24	15	Red calyx	22	9
Tight cluster	27	21	First white	25	19	First white	24	14
First pink	28	24	Full white	26	22	First bloom	25	19
Full pink	28	25	First bloom	27	23	Full bloom	27	22
First bloom	28	25	Full bloom	28	24	In the shuck	27	24
Full bloom	28	25	Post bloom	28	24	Green fruit	28	25
Post bloom	28	25						
<i>Peaches</i>			<i>Sweet cherries</i>					
First swelling	18	1	First swelling	17	5			
Calyx green	21	5	Side green	22	9			
Calyx red	23	9	Green tip	25	14			
First pink	25	15	Tight cluster	26	17			
First bloom	26	21	Open cluster	27	21			
Full bloom	27	24	First white	27	24			
Post bloom	28	25	First bloom	28	25			
			Full bloom	28	25			
			Post bloom	28	25			

Adapted from 1989 Spray Guide for Tree Fruits in Eastern Washington. *Bulletin EBO419*. E. H. Beers, coordinator.

- a. For Red Delicious, Golden Delicious and Winesap are approximately 1 degree hardier. Rome Beauty is 2 degrees hardier, except after petal fall when all cultivars are equally tender.
- b. For Bartlett, D'Anjou is similar but may bloom earlier and therefore may be more tender than Bartlett at the same date.

Table 1-27. Management practices for apples and stone fruits.

Month	Apples	Stone fruits
January, February	Mouse control. Prune. Repair bulk bins. Check for rabbit damage. Cut out fire blight.	
March, April	Pesticide sprays. Bees for pollination. Grafting. Chemical weed control. Calibrate sprayer.	Begin pruning older peach and tart cherry when buds swell. Calibrate sprayer. Pesticide sprays. Apply leaf curl spray before buds swell.
May	Pesticide sprays. Chemical thinning. Solubor sprays. Chemical weed control. Take soil sample for nematode analysis.	Pesticide sprays. Chemical weed control. Cut out Cytospora canker. Take soil sample for nematode analysis.
June	Pesticide sprays. Check minimum intervals between last application and harvest. Calcium sprays. Summer pinch new shoots. Pull suckers.	Pesticide sprays. Complete hand thinning. Check minimum interval between last application and harvest. Take soil sample for nematode analysis. Cut out Cytospora canker.
July	Calibrate sprayer. Calcium sprays. Summer prune. Pesticide sprays. Take soil sample for mineral analysis. Pull suckers. Budding. Order trees needed in two years. After July 15 take leaf samples for nutrition analysis.	Calibrate sprayer. Pesticide sprays. Summer prune. Order trees needed in two years. After July 15 take leaf samples for nutrition analysis. Prune sweet cherry trees after harvest.
August	Pesticide sprays. Ethephon sprays. Calcium sprays. Budding. Before August 15 take leaf samples for nutritional analysis.	Complete summer pruning. Pesticide sprays. Control peach tree borers. Before August 15 take leaf samples for nutritional analysis.
September	Nematode test for new plantings. Pesticide sprays. Calcium sprays. Ethephon sprays. Take soil sample for mineral analysis.	Nematode test for new plantings. Soil fumigation where needed. Control peach tree borer. Take soil sample for nematode analysis.
October	Mouse control. 2,4-D for dandelions. Take soil sample for mineral analysis. Clean and store sprayer. Mow close for mouse control. Place mouse bait stations in orchards.	Fumigate soil for nematodes. Control peach tree borers (late September). Clean and store sprayer. Take soil samples for nematode analysis and mineral analysis.
November	Prune. Mow orchard. Winterize equipment. Take soil sample for mineral analysis. Apply rodenticides. Apply fall herbicides.	Paint tree trunks white. Take soil sample for mineral analysis. Apply fall herbicides. Apply leaf curl spray.
December	Prune. Apply rodenticides.	Paint tree trunks white.

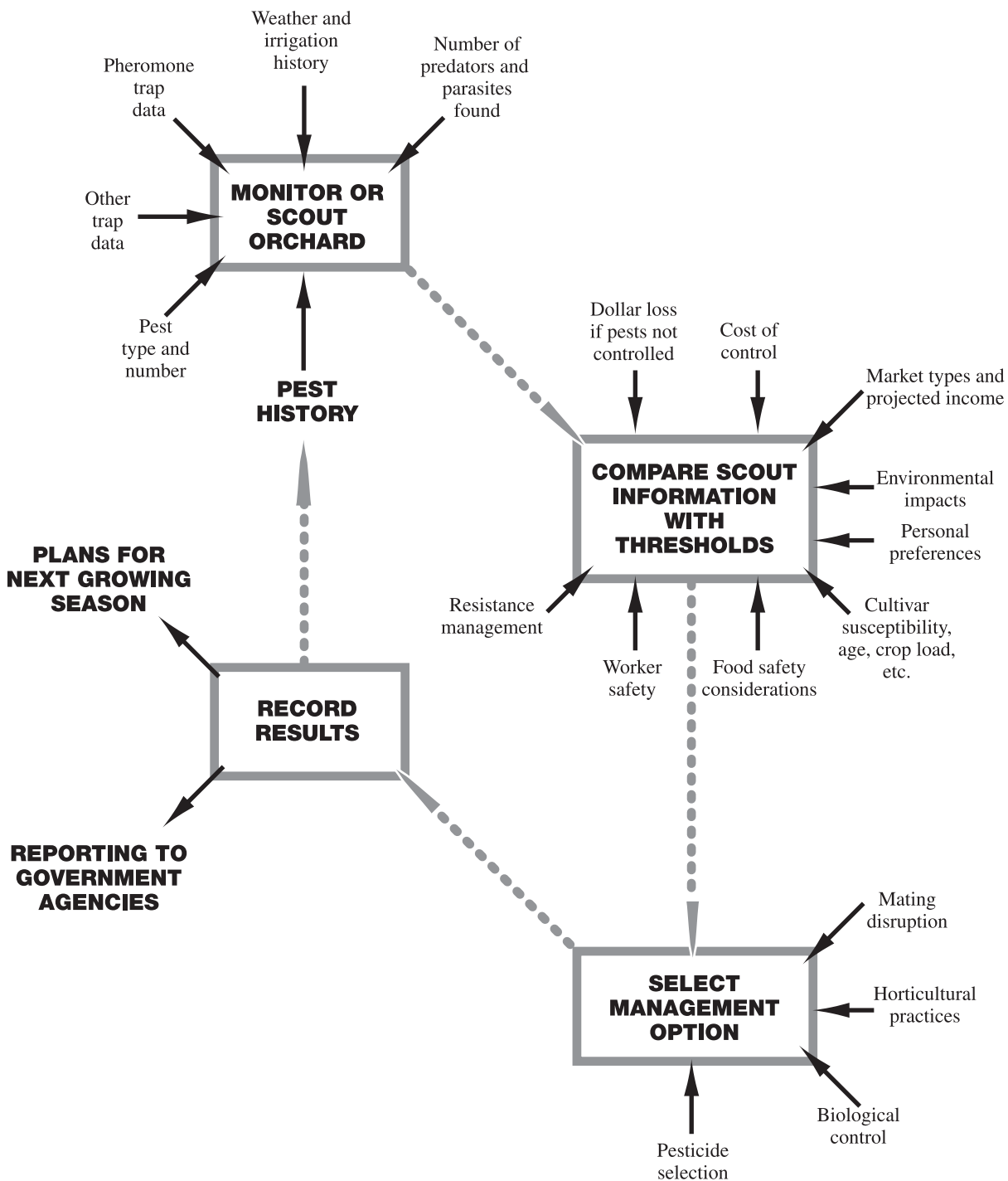

Figure 2-1. How to make an integrated pest management decision.

IPM APPROACH

The modern approach to managing pests is referred to as integrated pest management (IPM). IPM involves compiling detailed, timely information about a crop and its pests to ensure that pest management decisions are economically, environmentally, and socially sound. In addition, IPM advocates integrating as many suitable pest management tactics as possible.

At the farm level, IPM is approached as a series of activities that culminate in a decision made by the grower (Figure 2-1). The first activity is gathering information about the environment, pest, and crop. This activity is termed scouting, or monitoring, and is performed frequently during the growing season. In scouting the grower assesses the growth status and general health of the crop and determines the presence and intensity of pest infestations or the potential for future pest problems. The resulting data are entered into a record-keeping system such as a notebook or computer data base.

The next activity is comparing pest levels noted during scouting with threshold values. Thresholds may be economically determined with the damage to the crop caused by a given pest population is compared with the cost of implementing a control procedure against that pest. If pest damage is higher, control is warranted. Other thresholds may be used depending on the desires of the fruit grower.

Once an over-the-threshold determination has been made, a control tactic or set of tactics can be selected and used. Tactics include biological control: using one organism to control another by predation, parasitism, or competition; cultural control: using horticultural practices such as planting disease-resistant cultivars, specialized pruning, and orchard sanitation; and behavior modification, such as mating disruption. The success of the control tactic should be assessed at a later date, usually the next monitoring period, and corrective action taken if necessary. All IPM activities should be permanently recorded so they can be used for making decisions in subsequent years.

Some IPM tactics should be performed in anticipation of future pest problems. These include pruning and shaping the tree to improve air circulation and prevent disease, selecting cultivars resistant to various pests, and managing the orchard to be hospitable to beneficial organisms, such as the predator *Stethorus punctum*. Other IPM practices occur after the growing season. Fruit from the orchard at harvest time represents a cumulative record of insect and disease activity for the season. This record can provide valuable insight into how well an IPM program is working and what changes in the program need to be made the following year. A sample of fruit from each orchard block should be inspected, insect and disease damage identified, and a written record made. The grower can refer to this record in subsequent years to make decisions about insect and disease control.

BASICS OF INSECT MONITORING WITH SEX PHEROMONE TRAPS

The presence (or absence) of insects pest species in the orchard can be detected and monitored by a wide variety of traps and methods, but the utilization of traps with an insect sex pheromone is probably the simplest and, at the same time, the most accurate way to monitor insect pests. Although multiple designs of traps work best for various pests, the general principle of how the average trap works is almost always the same: each trap needs to have a source of pheromone or attractant (usually rubber- or plastic-based lure/septa with incorporated sex pheromone), means to capture visiting moths (usually floor or liner coated with nondrying glue) and some kind of plastic or paper dome to protect the lure and floor.

The pheromone traps can be used to monitor insect species that are able to release pheromones. Most lepidopteran insects (moths and butterflies) produce pheromone to improve the ability of one gender individuals to find the individuals of the opposite gender. As long as the sex pheromone for the species is identified and can be manufactured, there is a possibility that pheromone traps can be used for monitoring of this species. And although the pheromone traps are a great tool for insect monitoring, they will not control insect pests. In our specific orchard ecosystem, traps are competing with the female moths in attracting male moths, but since normally there are a lot of more wild moths than traps, there is a strong possibility that mating occurs anyway and female moths will still be able to deposit viable eggs. Therefore, traps are excellent tool for moths monitoring but by themselves will not control the pest(s).

In Pennsylvania orchards, numerous pests can be responsible for injuries in fruit orchards. The importance of various pest species fluctuates from year to year, but almost always the most important pests will be part of leafroller complex with tufted apple bud moth (TABM), obliquebanded leafroller (OBLR), internal fruit feeders complex with Oriental fruit moth (OFM) and codling moth (CM), or borers such as dogwood borer or peach tree borer. Fortunately, with the current emphasis on practical implementation of IPM methods, the sex pheromone traps for all of those species are available for a purchase.

A single trap should be used to monitor only a single insect species. In properly monitored orchard, at least two traps per species should be used per block. In larger blocks—more than 20 acres—at least one trap per every 10 acres should be employed. It is important that traps within each block be placed in such locations that they would be able to provide accurate readings of moth pressure. Placing traps too far away from, or close to, possible moth sources such as large bin piles and abandoned or neglected orchards may provide inaccurate image of possible pest pressure. In orchards where only the absolute minimum trapping program is to be implemented, and traps will be used only to provide information about the best timing for insecticide applications, at least two traps per species have to be used per farm.

Pheromone traps should not be placed closer to the border of the blocks than on second to third row/tree from outside of the orchard. All traps placed in the orchard should be easily accessible by the person who will monitor them. The optional height for trap placement on the tree is at about 5 to 7 feet from above the ground, although traps for some pest species, especially codling moth, should be placed in the upper fourth of the tree height. For this higher placement, traps can be attached to bamboo posts and elevated into the upper part of the canopy. All traps should be placed within a tree canopy, not outside the tree. To make it easier for the person who will monitor traps during the season, traps for different pest species can be located on adjacent trees. It also may be helpful if the trees and tree rows with the traps will be marked with contrasting flagging tape.

The pheromone-loaded septa attracts moths only for a set period of time, usually from 4 to 8 weeks depending on the lure specification. In order to maintain reliable pest monitoring, the lure needs to be replaced before its attractiveness starts to deteriorate. Usually, the manufacturer provides the information for how long a lure will be active in the orchard. The glue-coated floors or liners also need to be replaced regularly, especially if high numbers of moths are being collected regularly and the glue layer is no longer sufficient to capture moths. In contrast to lures, which cannot be reused, the liners after cleaning and coating with new layer of glue can be reused in traps. It is very important that the reusable liners be used only in the traps for the same species as they were used previously.

Insect pheromones are species specific, and each species use a different set of chemicals to attract individuals from the opposite sex. Therefore, unless the trap (or the lure) is contaminated with some other pheromone specific chemicals, only the addressed species should be encountered in the trap. Of course, various colors of the traps can also attract other insects by visual attraction, but the presence of other insect species in the trap most likely will be incidental and/or sporadic.

With the yearly estimated price of monitoring system for one species (2 traps, 10 lures, 10 liners) circulating around \$40 to \$70 (without labor), the traps will pay for themselves in no time. A vigilant monitoring system should help growers avoid problems with unexpected occurrence of pests in the orchard. Even, as a result of pest monitoring, additional insecticide application will be necessary to manage detected problem, dealing with the infestation before actual fruit damage occurred seems to be a much better approach than dealing with injured fruit at harvest.

Unfortunately, in our Mid-Atlantic fruit region, a number of other common pest species such as stink bugs, apple maggot, plum curculio, European apple sawfly, or various plant feeding bugs also can create a serious threat to fruit. This group of pests does not have a good pheromone-based monitoring system; however, other trapping/monitoring methods using other means such as visual or food-odor-related clues are also being used for pest detection. It is very important that growers monitor these pests as well.

Even though the best designed and most complete monitoring program will not eliminate the insect problems from the orchards, such activity will certainly help to better manage fruit pests.

Integrated Pest Management Supply Sources

Supplies such as pheromones, traps, and environmental monitors may be purchased at some local orchard supply dealers or ordered by mail. Some mail order outlets are:

AgBio Inc.
Westminster, CO 80031
Ph.: 303-469-9221
Fax: 303-469-9598

E-mail: agbio@agbio-inc.com
Web: www.agbio-inc.com

Alfascents
7676 Tuttle Rd.
Bridgeport, NY 13030
315-699-1991

E-mail: sales@alphascents.com
Web: www.alphascents.com

Gempler's
211 Blue Mounds Rd.
Mt. Horeb, WI 53572
800-382-8473

E-mail: custservice@gemplersmail.com
Web: www.gemplers.com

Great Lakes IPM
10220 Church Rd.
Vestaburg, MI 48891
800-235-0285

E-mail: gliplm@nethawk.com
Web: www.greatlakesipm.com

Suterra LLC
213 SW Columbia St.
Bend, OR 97702
866-326-6737

E-mail: agsales@suterra.com
Web: suterra.com

Trece Inc.
PO Box 129
Adair, OK 74330
866-785-1313

E-mail: trece@trece.com
Web: www.trece.com

DISEASES, INSECTS, AND MITES: BIOLOGY, MONITORING, AND MANAGEMENT

This section gives descriptions of common disease, insect, mite pests, and natural enemies. Included in each description is a brief discussion of life cycle, habits, and damage symptoms; instructions for monitoring for IPM decision-making; and suggestions for nonchemical or cultural management techniques.

Diseases in Pennsylvania

ANTHRACNOSE OF PEACH

The first report of anthracnose occurring in the United States came from California in 1916, where it was found on almond. Significant losses from peach anthracnose were prominent during the late 1940s, especially in the southeastern states. Most years, anthracnose is considered a minor disease of peach. In past years the disease has occurred sporadically on fruit. If left unchecked, peach anthracnose can cause serious fruit rot infection.

Peach anthracnose is caused by two species of fungus *Colletotrichum* (*C. acutatum* and *C. gloeosporioides*). It is also known as *Glomerella cingulata*, the fungus that causes bitter rot of apple. These fungi have a very broad host range, including apples, pears, nectarines, plums, tart cherries, grapes, nuts, vegetables, various legumes, herbaceous annuals, and perennials. Because of this wide host range, the disease can become established in peach orchards in a short time.

Symptoms

The disease begins as lesions characterized by small, brown spots that become darker, circular, and slightly sunken as they age. Young lesions may be confused with those of brown rot caused by *Monilinia* species, and *Botryosphaeria* species (black rot and white rot). At this stage, identification depends on laboratory isolations. In time the lesions become brown and sunken. Large, sunken anthracnose lesions are firm to the touch and are often

covered with concentric rings of salmon-colored spore masses. The salmon-pink sticky spore mass is a characteristic symptom of anthracnose on peach and other fruits.

Disease cycle

The fungus overwinters on mummified fruit and in cracks and crevices in the bark. The fungus can also overwinter on other host species near the orchard. Anthracnose is spread by the dispersal of fungal spores that occurs by splashing rain. Warm, moist weather favors disease development (75–86°F). Once young peach fruit are infected, the fungus grows through the fruit and into the phloem of the twig. The infected twig remains alive throughout the winter and dies in the spring. Once the twig dies, the fungus sporulates on the surface of the twig.

Disease management

Orchard floor and orchard perimeter management that eliminates leguminous hosts and wild *Prunus* species should be practiced to prevent the spread of disease. Captan and Pristine are the only registered fungicide known to be effective for control of anthracnose on peach.

APPLE CROWN ROT

Crown rot continues to be a major cause of tree death in Pennsylvania orchards. It is often observed on 3- to 8-year-old trees grown on Malling Merton (MM) 104, MM.106, M.7, and to a lesser degree MM.111 rootstocks. The disease is often observed in low-lying areas of orchards with heavy, poorly drained soils.

Symptoms

The first symptoms to appear in the spring are delayed bud break, leaf discoloration, and twig dieback. These symptoms indicate that crown infection is advanced. While infected trees may survive the growing season, they show symptoms of leaf and bark discoloration and premature leaf drop in the fall.

The most obvious symptom found on affected trees is a partial or complete girdling of the trunk. Close examination of the roots often reveals reddish brown, water-soaked areas of necrotic tissue located at the base of the root where it attaches to the rootstock. The entire underground portion of the stem is usually water-soaked and brown, and the necrotic area usually extends upward to the graft union.

Disease cycle

The disease is caused by the fungus *Phytophthora cactorum*, which belongs to a group of fungi known as the water molds. The fungus requires high levels of moisture and cool temperatures for growth and reproduction, and grows best at temperatures around 56°F. Trees are therefore attacked at about blossom time (April) and during the onset of dormancy (September). The fungus can infect apple trees in the following ways: (1) collar rot—infection above the tree union, (2) crown rot—infection of the lower trunk and root bases, and (3) root rot—infection of the lateral and fibrous root system.

Disease management, cultural

- **Rootstock susceptibility**—Of the rootstocks preferred by growers none are completely resistant to crown rot. The rootstocks M.7, MM.104, and MM.106 have appeared to be the most susceptible. Although less susceptible, M.2 and MM.111

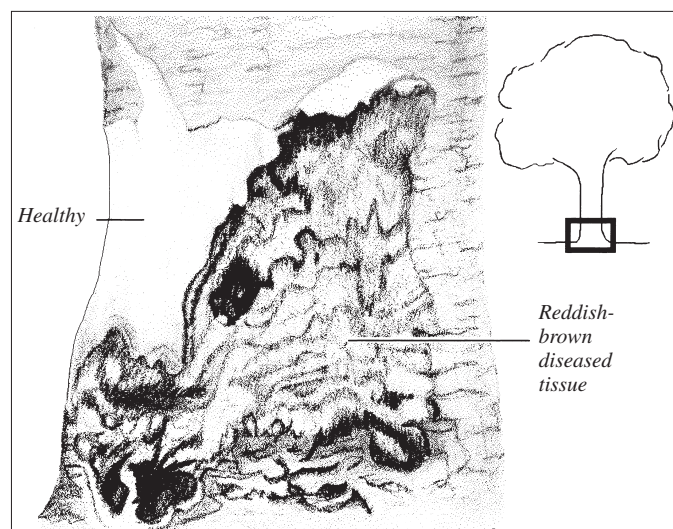

Apple Crown Rot

can be infected by crown rot under favorable conditions. The most resistant rootstocks are M.4 and M.9.

- **Orchard site selection**—Avoid planting orchards in heavy, poorly drained soils. These sites favor fungal growth and development. Crown rot prevention is difficult and eradication almost impossible in low-lying, poorly drained sites.
- **Horticultural**—If the tree has not been completely girdled, remove the soil from the base of the tree; then scrape the surface of the discolored area and leave exposed to dry. Drying often stops crown rot from progressing further. In-arch grafting may also be used to bridge the damaged area.

Disease management, chemical

Alliette and Ridomil Gold EC are presently registered for control of crown rot on apple and stone fruits. Refer to the label for specific use recommendations.

APPLE SCAB

Apple scab is Pennsylvania's most important apple disease, attacking wild and cultivated apple and crabapple. Early season disease management is directed primarily at controlling apple scab.

Symptoms

The first infections often occur on the leaves surrounding flower buds. Dull, olive green areas visible on the undersides of leaves are the first evidence of the disease. As the lesions (infected areas) become older, they assume a definite outline as olive-green or brown circular spots. Leaves are susceptible to infection for about 5 days after they unfold. Severe early leaf infection can result in dwarfed, twisted leaves, which may drop later in the season.

Early infection may occur on the calyx (blossom end of the fruit) or on the pedicel (fruit stem). Severe pedicel infection results in fruit drop. Fruit may become infected at any time in its development. Typical fruit lesions are distinct, almost circular, rough-surfaced, olive-green spots up to ¾ inch in diameter. Heavily infected fruits are usually misshapen and may crack and drop prematurely. When leaf infection is active just before harvest, the fruit may become infected. These spots do not show at harvest

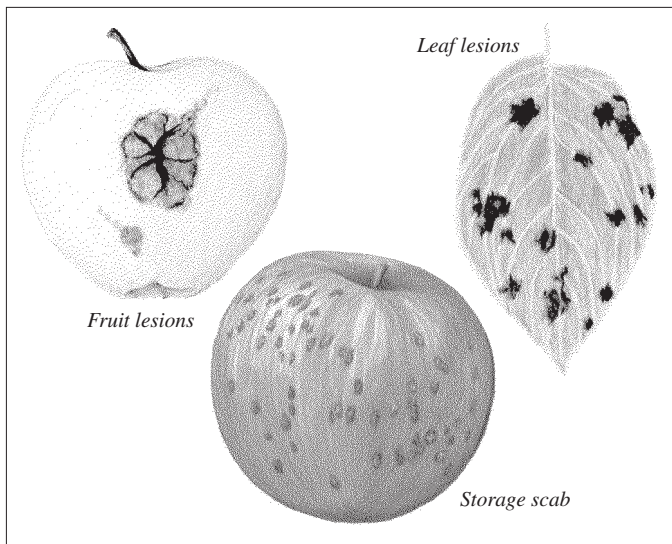

Apple Scab

Table 2-1. Calculating apple scab infection periods.

Hours of wetting ^a	Average air temperature (°F) ^b	Number of days for secondary spores to develop
48	32–40	17+
30	40–42	17+
22	42–45	17+
15	45–50	17
13	50–53	16
12	53–58	14
10	58–62	9
9	64–75	8

a. Calculate hours of wetting by either (1) beginning the count at the time leaves first become wet and ending the count when the relative humidity drops below 90 percent, or (2) adding consecutive wet periods (hours) if the leaves are again wetted within 8 hours from the time relative humidity dropped below 90 percent.

b. Add lowest and highest temperatures during wet period and divide sum by 2 to get average.

time but develop slowly, while the apples are in storage. This phase of apple scab disease is termed storage scab.

Disease cycle

The apple scab fungus (*Venturia inaequalis*) overwinters in infected leaves that have fallen to the ground. Fruiting bodies are produced within the dead leaf tissue. As spring approaches these begin to mature and produce spores (ascospores) that are discharged into air currents and carried to developing apple buds. The fruiting bodies in the fallen leaves must be wet for the spores to discharge. The ascospores are not all discharged with the first spring rains, for they mature over a 4- to 6-week period. This period usually coincides with the time that elapses from ¼ inch green until 2 to 3 weeks after petal fall.

When the spores land on wet apple buds, leaves, or fruit, and if they remain wet for a few hours, they germinate and grow into the apple tissue. The time required for germination and penetration depends on temperature and the presence of a wet surface. At 40°F almost 48 hours of continuous wetting is required for infection, while at 65 to 75°F, only 10 hours are required (Table 2-1). After the fungus has penetrated, it continues to grow and

enlarge beneath the cuticle. After 8 to 18 days (development occurs most rapidly at high temperatures) a visible scab lesion is produced. On its surface appear more spores (conidia), which are easily dislodged when the lesions are wet. The spores are splashed around by rain and blown by wind to new leaf and fruit surfaces within the tree. They germinate on wet surfaces, infect the tissue, and produce a new lesion. In this manner, several secondary infection cycles may occur in the course of a growing season.

Disease management

Scab infections may be prevented by applying fungicides at regular intervals throughout the growing season. The object is to provide a protective coating that will inactivate any spores landing on the fruit and foliage. It is critical to control scab early in the season from bud emergence through the second spray after blossom petals fall (second cover period). If scab infection can be prevented during the time all the ascospores are discharged from the fruiting bodies in the fallen leaves, the disease cycle is broken and no further source of infection remains for the rest of the season. However, if the cycle is not controlled, and leaf and fruit infection does occur, then conidia are produced on these lesions and scab will remain a constant threat all season whenever wet weather occurs.

Scab-control fungicides may be protectants or dual-action materials that combine both protectant and eradicant properties. Protectant fungicides, to be effective, must be present on the leaf or fruit surface before the spores land. Materials of this type are captan, ferbam, thiram, and wettable sulfur. If the germ tube has already penetrated the leaf or fruit, these materials will not stop infection. In contrast, an eradicant fungicide can be applied to infected surfaces after the infection has occurred and will stop the infection process. This property of certain fungicides is quite useful, as the grower may apply the fungicide a short time after the beginning of a rain period and still prevent infection. Procure, Rubigan, and Rally will control scab up to 96 hours after infection has occurred, but they have few protectant properties.

BACTERIAL CANCKER

While bacterial canker can occur on all stone fruit trees, and on apple and pear blossoms, it is important only on sweet cherry and ornamental flowering cherry trees in the northeastern United States. It is caused by the bacterium *Pseudomonas syringae*. Several other names (most commonly, gummosis and sour sap) have been used for the same disease.

Symptoms on sweet cherry trees

Bacterial canker affects branches, twigs, buds, leaves, and fruit. The most conspicuous symptoms are the cankers and the dying branches they girdle. On twigs cankers are darkened areas often located at the base of buds. On limbs or trunks cankers are frequently darker than normal bark, sunken in their centers, and may extend for a considerable distance. Gumming is frequent in the spring and fall, when the disease is most active. Leaves and shoot growth beyond the canker may wilt and die during the growing season when cankers girdle a branch or the trunk. Leaf and flower buds are killed during the dormant season, probably as a result of infection during the fall. Small cankers often develop at the base of these dead buds. At times, infected fruiting spurs

blossom normally, only to wilt and die shortly afterward.

During periods of cool, wet weather after bloom, leaf and fruit infections may be common. The leaf spots are mostly angular in shape and dark purple, brown, or black. The infected areas of the leaf may drop out, producing a tattered appearance, or the entire leaf may yellow and fall. Fruit infection shows as deep, black depressions, as does infection of fruit stems.

Disease cycle

Causal bacteria overwinter in the margins of cankers in wood and in infected buds. In spring, during wet periods, the bacteria multiply and ooze from the cankers. Spread by rains, they enter the plant through natural openings or wounds. Periods of frequent rain, cool temperatures, and high winds are most favorable for infection. Frost-injured leaves and blossom spurs and cold-injured trees seem especially susceptible. With the higher temperatures of late spring and summer, disease development stops. At this time the newly formed buds become infected through either leaf scars or bud scales, or both.

Disease management

While bacterial canker can be a severe disease in itself, it is often much more severe on cold-injured trees and trees growing in sites with poor internal soil drainage.

The causal bacteria can be transmitted by pruning tools, so these should be disinfected between prunings if bacterial canker is present. Limbs with cankers on lightly to moderately infected trees should be cut off several inches during the winter when temperatures are below freezing.

Sprays during the growing season have not been effective in controlling the disease. Some benefit has been achieved from applications made when most of the leaves have dropped in the fall and just before bud swell in the spring. For maximum benefit, these sprays should be continued for several years on susceptible trees.

BACTERIAL SPOT

Bacterial spot occurs in most countries where stone fruits are grown. The disease is caused by a bacterium *Xanthomonas arboricola* pv. *pruni* (formerly *Xanthomonas campestris* pv. *pruni*). Other names for the disease are bacteriosis, bacterial leaf spot, or bacterial shot hole. Common hosts include peach, nectarine, prune, plum, and apricot. Other hosts are sweet and tart cherry, almond and wild peach. Cultivars within *Prunus* species vary widely in their susceptibility to this disease. The disease affects fruit, leaves, and twigs. Fruit loss on some cultivars can be very high. Early and severe defoliation can affect fruit size and the winter hardiness of buds and wood.

Symptoms

The symptoms of bacterial spot are quite different from other diseases of stone fruits. They may be confused with nitrogen deficiency and spray injury. The disease first appears as small, water-soaked, grayish areas on the undersides of leaves. Later the spots become angular and purple, black, or brown in color. The mature spots remain angular and are most numerous at the tip ends and along the midribs of leaves. The infected areas may drop out, giving the infected leaves a shot hole, tattered appearance. On plum, the shot-hole effect is more pronounced

than on other stone fruits. Infected leaves eventually turn yellow and drop. Severe defoliation often results in reduced fruit size and increased sunburn and fruit cracking. As a result, tree vigor and winter hardiness are also reduced. Other leafspot diseases and spots due to spray injury tend to be much more circular in outline. Often, these are not confined by veins in the leaf as is bacterial spot.

Fruit infected early in the season develop unsightly deep-pitted blemishes and may exhibit gumming. Since the infected areas cannot expand with increased fruit size, the spots crack as the fruit matures. Pits or cracks on the fruit surface extend into the flesh and create large, brown to black depressed areas on the fruit surface. Lesions that develop during the preharvest period are usually superficial and give the fruit a mottled appearance. On plum, the fruit symptoms are likely to be quite different in that large, black, sunken areas are most common. On a few cultivars small, pit-like spots occur. Cracks on fruit serve as points of infection by the brown rot fungus as the fruit ripens.

On peaches and nectarines, twig symptoms usually consist of cankers on the previous year's growth associated with and initially extending to about an inch on either side of leaf and flower buds; these affected buds usually fail to open. These overwintering cankers, often termed spring cankers, are first visible during bloom. A canker extending downward from the terminal bud that fails to open is referred to as a "black tip." When conditions are moist, the canker surface has a black, water-soaked appearance. As the season progresses, the canker can lengthen and the bark surface cracks. Summer cankers are formed on current-season growth and are visible early to midsummer (June through early August).

Disease Cycle

The bacterial spot pathogen overwinters in association with buds, in protected areas on the woody surface of the tree (e.g., cracks in the bark), and in leaf scars that become infected during leaf drop the previous season. In late winter as temperatures are above 65°F, leaf and flower buds swell, new tissue emerges, and the bacteria begin to multiply. The bacteria are spread from cankers by dripping dew and in splashing and/or wind-blown rain to the newly emerging leaves. Bacteria can also infect through natural openings or wounds. High-moisture conditions are very favorable for both leaf and fruit infections. Leaf infections can occur for at least as long as terminal growth and leaf emergence continue. Severe fruit infections are more common when frequent periods of rainfall or even extended heavy dews and very high humidity occur from late bloom to near pit-hardening. Bacterial spot is more severe in areas where peaches are grown in light, sandy soils and disease is more severe on stressed trees. Wind and wind-blown sand can increase the severity of bacterial spot by creating wounds for the bacteria to infect.

Disease Management

Bacterial spot is very difficult to control on highly susceptible cultivars. Under optimal environmental conditions for disease development, control can be difficult even on moderately susceptible cultivars. Control and management measures must be applied preventatively to successfully reduce losses from this disease. Once bacterial spot symptoms are observed, it is almost impossible to bring the disease under control if environmental

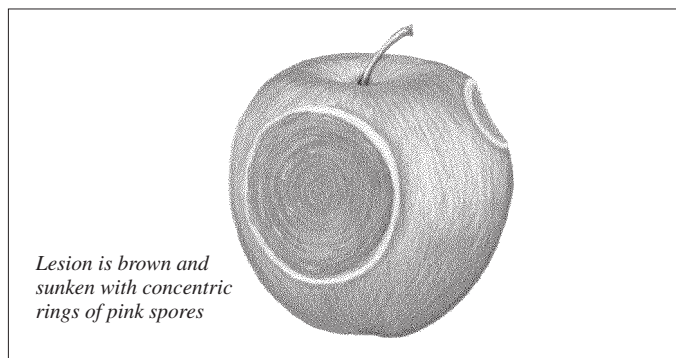

Lesion is brown and sunken with concentric rings of pink spores

Bitter Rot

conditions remain favorable. Environmental conditions that favor bacterial spot development include heavy rain events when temperatures are above 75°F.

Planting resistant cultivars is the most effective control measure. An increasing number of good peach cultivars are highly resistant to bacterial spot. Resistance in plums, nectarines, and apricots is not as common. Most, if not all, cultivars developed west of the Rocky Mountains are highly susceptible because they are bred in an environment unsuitable for disease development. Many of the new low-acid white and yellow stone fruit cultivars are highly susceptible to bacterial spot infection. Check with the nursery on the bacterial spot susceptibility before purchasing and planting new stone fruit cultivars.

Major outbreaks of bacterial spot in young orchards are often attributed to poor cultural practices. Trees in poor vigor are more susceptible, so orchard management programs should be designed to maintain good vigor. High populations of ring nematode have also been associated with increased bacterial spot, which may be related to stress caused by the nematodes. Minimize blowing sand and/or soil particles within and surrounding the orchard by employing appropriate ground covers and/or by use of appropriately placed windbreaks to blunt the damaging effects of strong winds while still allowing for air movement through the orchard.

There are no completely successful spray programs for control of bacterial spot. Chemical sprays with copper-based bactericide and the antibiotic oxytetracycline have moderate efficacy but must be used preventatively. Copper-based sprays are applied from dormant to shuck-split phenology stages to reduce initial inoculum. Because of high sensitivity of peach foliage to copper, rates are reduced progressively in successive sprays during this period. For the cover sprays that start at shuck-off, copper is replaced by the antibiotic oxytetracycline (Mycoshield or Flame-Out). Because chemical control is uncertain, planting resistant cultivars appears to be the best long-term control strategy.

BITTER ROT OF APPLE

Bitter rot is an important disease in the southern states but occurs in Pennsylvania only infrequently. It is caused by the fungus *Glomerella cingulata*. Its hosts are apple and pear trees. On peaches and nectarines the same fungus causes a disease known as anthracnose; on grapes it causes ripe rot; and on chestnuts it causes blossom-end rot of green burrs. The discussion below is limited to the disease as it affects apple and pear trees.

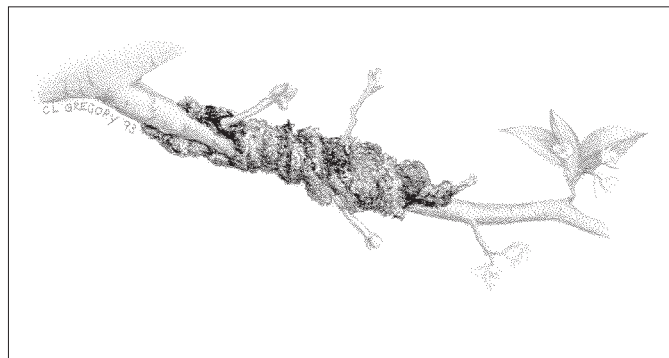

Black Knot of Plum

Symptoms

Bitter rot occurs only on fruit. Cankers can form on twigs, but they are rare. The fungus is one of the few fruit rot organisms that can penetrate the unbroken skin of the fruit. The disease is noticed first, during midsummer or later, as a small, light brown, circular spot. One or many spots may appear; if temperatures are high they enlarge quite rapidly and soon change to a dark brown. By the time the spots are 1/8 to 1/4 inch in diameter, they are distinctly sunken or saucer-shaped. When they reach 1/2 inch in diameter, small black dots, the fruiting bodies of the fungus, appear in the sunken lesion. These may be arranged in concentric rings. Later, they ooze a gelatinous, salmon-pink mass of spores, washed by rains to other fruit. Beneath the surface of the spot, the flesh is light brown and watery in a cone-shaped area, with the small end of the cone toward the fruit center. As the fruit ripens, it decays rapidly and finally shrivels into a mummy.

Disease cycle

The fungus overwinters in mummied fruit and in cracks and crevices in the bark. Jagged ends of broken limbs are ideal sites. With the advent of warm weather the fungus produces spores washed by rains to developing fruit. Often the first infections appear as a cone-shaped area on the tree and can be traced to a source of spores at the tip of the cone. The optimal conditions for the disease to develop are rains, relative humidity of 80 to 100 percent, and a temperature of 85°F.

Disease management

Routine fungicide sprays normally control bitter rot in Pennsylvania. Summer fungicide applications should not be extended beyond 14-day intervals.

BLACK KNOT OF PLUM

Black knot of plum, caused by the fungus *Dibotryon morbosum*, is well-named because of the characteristic black, warty knots it forms on branches of infected trees. Such trees grow poorly and gradually become stunted; occasionally, their limbs may be girdled. The disease is most important on plum trees and, secondarily, on cherry trees.

Symptoms

The disease is present only in the woody parts of trees, occurring most frequently on twigs and branches and sometimes on trunks and scaffold limbs. The warty swellings first become visible in late summer or the following spring on new shoots. At first the knots are somewhat greenish and corky, but with age they become

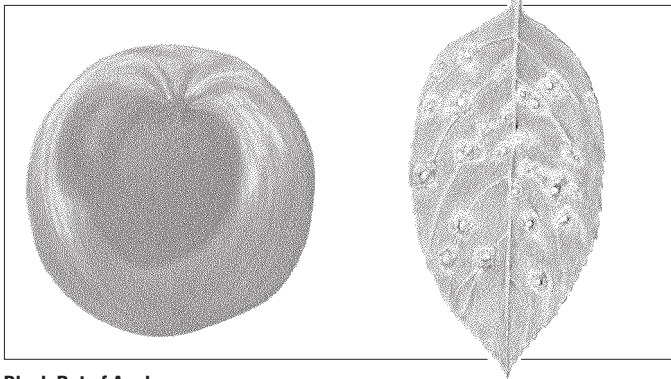

Black Rot of Apple

black and hard. They vary in length from an inch to nearly a foot. Many times they do not completely circle the branch. Those a year old or older may become covered with the pinkish white mold of another fungus and may become riddled with insects, especially lesser peach borers.

Disease cycle

About the time new seasonal growth is ½ inch long, spores of the fungus are discharged from tiny sacs in the surface of the knots. These are spread by rain and wind to the new growth, where infection takes place. Spore discharge and infection are greatest during wet periods, at temperatures ranging from 55 to 75°F. Infections continue to occur until terminal growth stops. A few greenish, corky swellings may become visible the fall after infection occurs, but most will not be noticed until the following spring. Generally, the knots produce no spores until the second spring after they become visible. The fungus in woody tissues continues to grow in the spring and fall, increasing the knots' length. Their eventual size depends greatly on the host species and cultivar.

Disease management

New plantings of plums should not be made next to old ones with black knot. Remove any wild plum and cherry trees from nearby woods and fencerows for at least 500 feet from the new orchard. Once the disease appears in the trees, remove the knots. When they occur on twigs and small branches, prune out the infected branches about 4 inches below the knot. On large branches and trunks the knots can be cut out. This is done most successfully during August when the fungus does not extend far beyond the visible swelling. Remove the diseased wood and about 1 inch of clean wood around the knot. It is best to remove knots before growth begins in the spring and to take them away from the orchard, as they will continue to produce spores for several weeks after removal. Once the knots have been removed, fungicide sprays can be applied to control the disease.

BLACK ROT OF APPLE

The black rot fungus, *Botryosphaeria obtusa*, covers a wide geographical range, attacking the fruit, leaves, and bark of apple trees and other pomaceous plants. The fungus is a vigorous saprophyte and may colonize the dead tissue of many other hosts. However, its parasitic activities are confined mainly to pome fruits.

The disease may occur in three forms: a fruit rot, leaf spot, and limb canker on apple trees, and a fruit rot on pear and quince.

In northern regions, losses from black rot result principally from the cankering of large limbs and dieback of twigs and branches. Losses from fruit rot and defoliation resulting from leaf spot can be considerable, especially in warm, humid areas of southern and central fruit-growing regions of the eastern United States.

Symptoms

The first signs of black rot are small, purple spots appearing on the upper surfaces of leaves and enlarging into circles ⅛ to ¼ inch in diameter. Leaf margins remain purple, while the centers turn brown, tan, or yellowish brown. After a few weeks, secondary enlargement of leaf spots occurs. Because this is not a uniform expansion, the spots become irregular or lobed in shape, at which time they assume a characteristic "frog eye" appearance: a purple margin with a zone of dark brown surrounding the tan-to-gray center. Small, black pycnidia (pimplelike fruiting bodies of the fungus) may appear in the centers.

Infected areas of branches and limbs are reddish brown and are sunken slightly below the level of surrounding healthy bark. These cankers may expand each year, a few eventually reaching several feet in length. The margins of older cankers are slightly raised and lobed, and the bark within their centers usually turns light-colored, loosens, and scales off raggedly. This characteristic is not confined to black rot cankers, so it is not a good diagnostic symptom. Pycnidia form on dead wood of the cankered areas.

Fruit rot usually appears at the calyx end of the fruit. It can originate at any wound that penetrates the epidermis, including insect injuries. There is usually one spot per fruit, a characteristic that distinguishes black rot from bitter rot. Initially, the infected area becomes brown and may not change in color as it increases in size, or it may turn black. As the rotted area increases, often a series of concentric bands form, darker bands of mahogany brown to black alternating with brown bands. The flesh of the decayed area remains firm and leathery. Eventually, the apple completely decays, dries, and shrivels into a mummy. Pycnidia-containing spores of the black rot fungus appear on the surface of rotted tissue.

Disease cycle

The fungus overwinters in fruiting bodies (pycnidia and perithecia) on dead bark, dead twigs, and mummified fruit. It can invade almost any dead, woody tissue and is frequently found in tissue killed by fire blight. Early leaf infections often are visible as a cone-shaped area on the tree, with a dead twig or mummified fruit at the apex.

In the spring, black pycnidia and perithecia release conidia and ascospores, respectively. Conidia may continue to be produced during wet periods throughout the summer and may remain viable for long periods. When wet, the pycnidium produces a gelatinous coil containing thousands of spores. Disseminated by splashing rains, wind, and insects these spores can infect leaves, the calyxes of blossoms, tiny fruit, and wounds in twigs and limbs. Leaf infection develops during petal fall, at which time conidia attach, germinate in a film of moisture within 5 to 6 hours, and penetrate through stomata or wounds. Infections of fruit and wood may not become visible for several weeks.

Initial fruit infections occur during the bloom period but are not usually apparent until midsummer as the apple approaches maturity. Throughout the growing season, infections occur

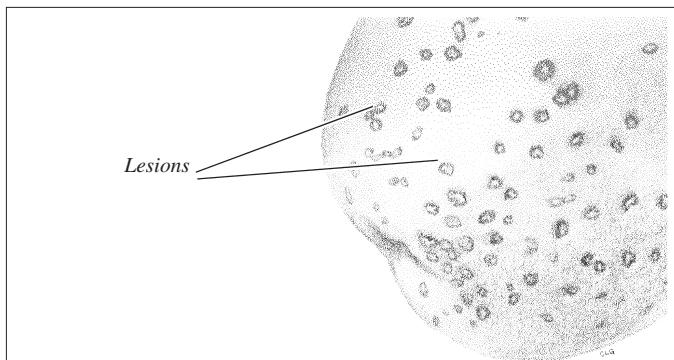

Blister on Crispin

through wounds. Harvest injuries may become infected and the fruit may decay during or after storage, especially if the fruit was harvested during a wet period. Dead fruit spurs or twigs, particularly those killed by fire blight, pruning wounds, winter injuries, and sun scald, are commonly invaded by the black rot fungus.

Disease management

Timing of chemical treatments and cultural control strategies can affect the level of control achieved for black rot. Management programs based on sanitation to reduce inoculum levels in the orchard are the primary means of control.

1. Carefully prune and dispose of dead wood. This should be an important component of both current-season and long-range management.
2. Prune and remove cankers at least 15 inches below the basal end; properly dispose of prunings by burial or burning.
3. Remove all mummified fruit.
4. Control fire blight by pruning out infected wood or controlling insect vectors.

Refer to fungicide and application rate recommendations in Part V.

BLISTER SPOT ON CRISPIN (MUTSU)

Crispin apples are highly susceptible to the blister spot bacterial infections about 2 weeks after petal fall for a period of 2 to 4 weeks. The causal bacteria, *Pseudomonas syringae*, overwinter in the infected buds and multiply on the leaf surface in spring. Rain washes the bacteria onto the fruit where they infect through the lenticels to cause the reddish spot. A brief shower is all that is required to distribute the bacteria to new infection sites. The standard recommendation for control of this disease is to apply streptomycin at ½ pound per 100 gallon dilute rate 10 to 14 days after petal fall. If the weather pattern of rain continues, two additional sprays should be applied at weekly intervals. Resistance of this bacteria to streptomycin has been documented in commercial orchards in the northeastern United States. Refer to the streptomycin label for specific use recommendations and limitations.

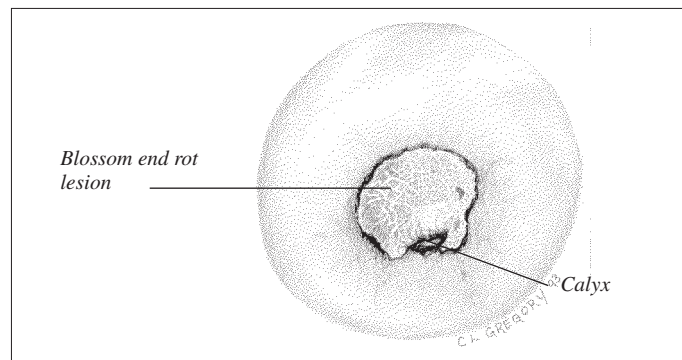

Blossom End Rot

BLOSSOM END ROT OF APPLE

Blossom end rot of apple is not a major problem in Pennsylvania orchards. Because it occurs only infrequently, very little is known about its cycle and control.

The disease, caused primarily by the fungus *Botrytis cinerea*, attacks the blossom end of apple fruit (a severe bunch rot of grape is caused by the same organism). The infection is likely to occur during bloom, although it is not visible until several weeks later. The infected area is seen as a small, ¼- to ½-inch-diameter lesion next to or including part of the calyx. Usually brown, the spot is slightly sunken and often has a red border. A shallow, dry or corky rot develops in the flesh beneath the spot.

Blossom end rot appears to be more common in seasons of prolonged cool, wet weather during and shortly after bloom. It has appeared most frequently on Delicious, Rome Beauty, and McIntosh. On stored fruit, especially Delicious, blossom end rot often leads to moldy core.

BLOTCH OF APPLE

Blotch is caused by the fungus *Phyllosticta solitaria*, which can infect the fruit, leaves, and twigs of apple and crabapple trees. Only occasionally seen in Pennsylvania fruit orchards, this disease does not pose a very large problem for apple producers here.

Symptoms

Two types of leaf spots appear as a result of blotch. The less frequent occurs on the leaf between the veins as a small, light gray spot with a dark dot in its center. The more common leaf spots occur on the veins, midribs, and petioles (leaf stems) as long, narrow, slightly sunken, light-colored lesions. These contain several dark dots, the fruiting structures (pycnidia) of the fungus. When petiole infections are numerous, leaves may drop off.

New shoot infections at first look similar to petiole infections, except they are longer and are seen more easily. They occur at the juncture of the petiole with the shoot (node) or between the nodes. Once the lesion is established, it may continue to enlarge for 3 or 4 years, becoming noticeably larger than the diameter of the normal limb. In this manner the organism causing apple blotch establishes itself in the tree.

Fruit infections vary in size from small, dark spots to large blotches that may cover much of the fruit surface. Edges of the larger lesions are irregularly lobed with many radiating projections. Large lesions often cause the fruit to crack.

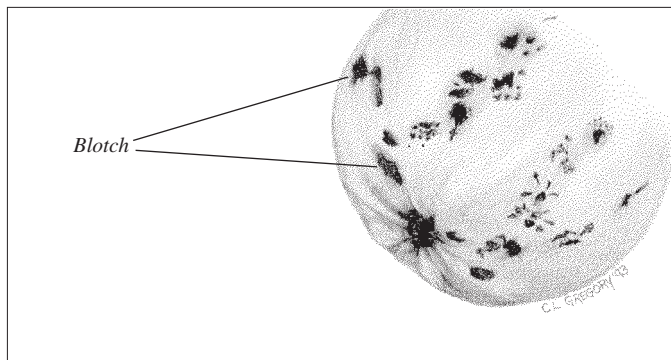
**Blotch****Disease cycle**

The causal fungus remains alive throughout the year in the twig and limb cankers. The first infections in spring occur about petal fall on leaves, young fruit, and new shoot growth from spores oozing from the cankers. Secondary infections from spores produced in the pycnidia can occur until late summer. Frequent rains and temperatures above 75°F favor the disease.

Disease management

Routine fungicide applications will normally control this disease in Pennsylvania. Summer fungicide applications should not be extended beyond 14-day intervals.

BLUE MOLD OF APPLE

Blue mold, a common rot of stored apples and pears, is caused by the fungus *Penicillium expansum*. Other names for the disease are soft rot, bin rot, and *Penicillium* rot. Aside from losses in fruit caused by rot, sound fruit in the same container as decaying fruit may absorb a moldy odor and flavor.

Symptoms

Soft rot appears as soft, light brown, watery spots that begin around injuries or lenticels on the outer surface of fruit. Rotted fruits have a characteristically moldy odor and flavor. When the relative humidity is high, grayish blue masses of spores may appear on the fruit surface.

Disease cycle

Spores of the soft rot fungus are present almost everywhere and can survive long periods of unfavorable conditions. Bulk bins, field crates, packhouse lines, and storage rooms are usually contaminated. Injuries to fruit, especially during picking and handling operations, are the primary points of entry. At ordinary temperatures, infected fruit can rot in 2 weeks or less.

Disease management, cultural

To control blue mold, it is important to prevent fruit from becoming injured during picking and handling. It is also essential to move harvested fruit into cold storage as rapidly as possible. Packing line equipment and storage rooms should be cleaned and clean water maintained in water dumps and antiscald solutions.

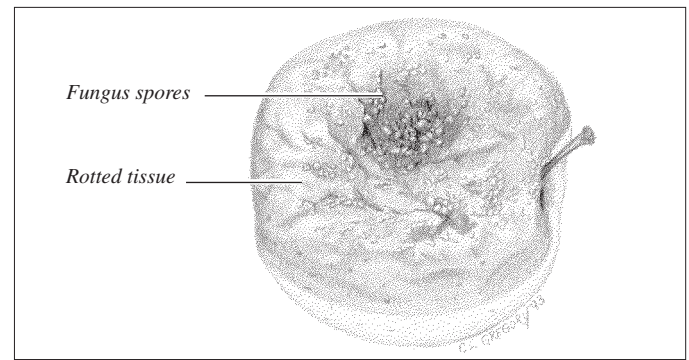
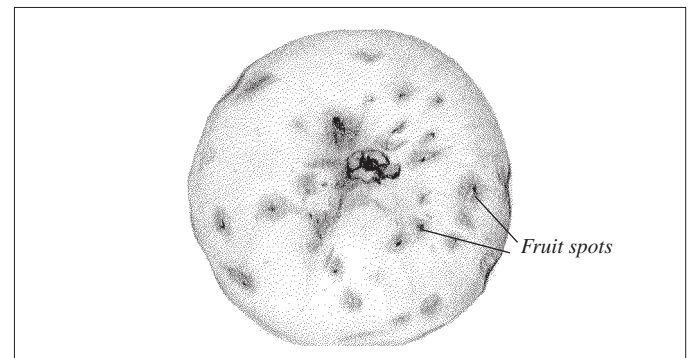
**Blue Mold****Brooks Fruit Spot****Disease management, chemical**

Picking bins and boxes can be disinfected with fungicides or steam. Disinfectants or fungicides can be used in fruit dips and combined with wax applications.

BROOKS FRUIT SPOT OF APPLE

Caused by the fungus *Mycosphaerella pomi*, Brooks fruit spot is also known as Phoma fruit spot. The disease attacks apple and crabapple trees and is rarely found in well-sprayed orchards. When cover sprays are stopped too soon, or when trees are not well-pruned and sprayed, severe losses can occur. Varieties such as Rome Beauty, Stayman, Jonathan, and Grimes Golden are quite susceptible.

Symptoms

Spots on fruit are about ¼ inch in diameter. They are somewhat irregular in shape, slightly sunken, and usually most numerous on the calyx end. On red fruit surfaces spots are red to black; on green and yellow fruit surfaces they are dark green. Spots may be quite inconspicuous at harvest. Unless infected fruit is placed in cold storage immediately after harvest, the spots increase in size and become more sunken, thus more visible.

Disease cycle

The disease cycle is much like that of apple scab, except it begins later in the spring. About the time of petal fall, ascospores are discharged from fallen leaves. Just how the fungus gets on the leaves is not known, as there is no evidence of the disease on leaves

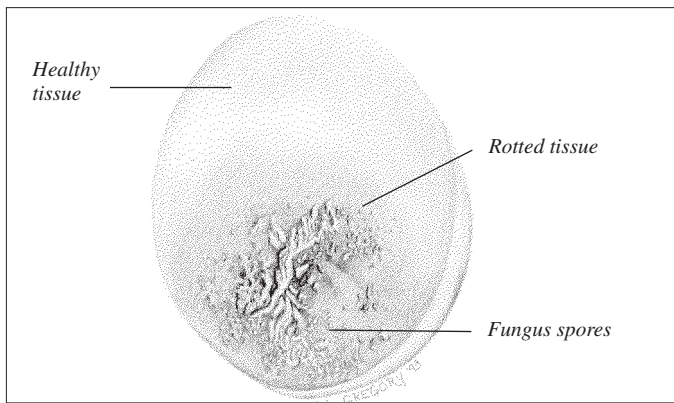

Brown Rot (on nectarine)

while they remain on the trees. Rain and high humidity favor spore discharge and infection of fruit. Infections continue until midsummer, although they decrease as the season progresses.

Disease management

Routine fungicide applications normally control this disease in Pennsylvania. Summer fungicide applications should not be extended beyond 14-day intervals.

BROWN ROT OF STONE FRUIT

Brown rot is caused by the fungus *Monilinia fructicola*. It affects peaches, apricots, nectarines, plums, and cherries. It is one of the major stone fruit diseases in Pennsylvania.

Symptoms

Brown rot first affects blossoms, which wilt and turn brown. Blossom infections may also extend into twigs, causing necrosis and eventual girdling. The infected blossom parts serve as a source of fungus spores for future fruit infections. Fruit decay occurs as the fruit ripens. The infections begin as small brown spots, and the entire fruit can rot within a few hours under favorable conditions. Under wet and humid conditions, ash-gray to brown tufts of fungus develop over the surface of the infected area. If favorable weather conditions persist, the infection can spread from the fruit into small twigs and cause a canker. The canker may girdle the twig, causing it to die. Rotted fruits dry out and become mummified.

Disease cycle

The fungus overwinters in mummies formed the previous season. The mummies persist in the trees or on the ground over winter. The first fungus spores are formed about the time the blossoms begin to open. Upon wetting, the spores are forcibly ejected into the air to be blown by the wind to blossoms. Infected blossoms serve as a source of the fungus for future fruit infections. Environmental conditions are important for the development of the disease. Warm, wet, or humid weather is very favorable for the development of the disease. The severity of brown rot increases as the fruit ripens. Wounded fruit is more susceptible to infection. Mature fruit can completely decay in two days from the time of infection under favorable weather conditions.

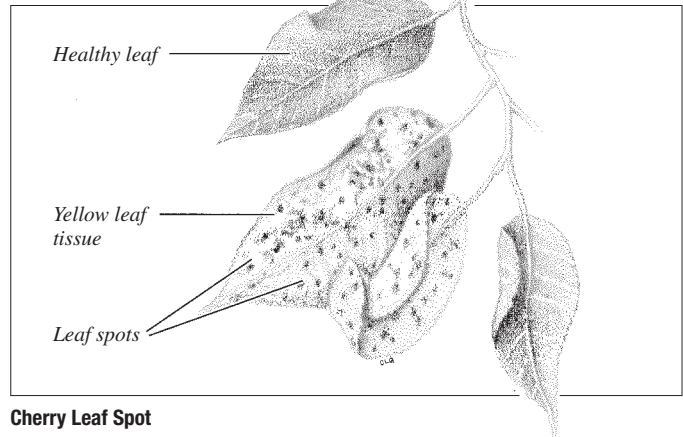

Cherry Leaf Spot

Control

Removing all rotted fruit after harvest helps to reduce the amount of fungus overwintering in orchards. Adequate pruning will increase air circulation, allowing faster drying and fewer fruit infections. Apply fungicide sprays during bloom and as fruit ripens.

CHERRY LEAF SPOT

Cherry leaf spot, caused by the fungus *Blumeriella jaapii* (formerly *Coccomyces hiemali*), attacks the leaves, leaf stems, fruit, and fruit stems of tart, sweet, and English Morello cherries. The disease is most severe on leaves and may cause them to drop prematurely. When defoliation occurs before harvest, the fruit fails to mature normally, remaining light-colored and low in soluble solids. Buds and wood become susceptible to winter injury, which may show the next season as poor growth, dead spurs, and dead limbs.

Symptoms

The disease first emerges on upper sides of leaves as tiny, red to purple, circular spots. These enlarge to 1/8 to 1/4 inch in diameter and become red-brown to brown. By then, spots show brown on the undersides of leaves, and during wet periods tiny, whitish, feltlike patches appear in their centers. These contain the spores (conidia) of the causal fungus. On sweet cherry leaves the spots tend to be somewhat larger. Some spots may drop out, leaving a shotholed appearance. After the leaves become infected, they turn yellow and fall.

Disease cycle

The fungus overwinters in diseased leaves on the ground. Around bloom or shortly afterward, sexual spores (ascospores) mature and are discharged. They are blown to young, expanded leaves where infection takes place through the stomates on the undersides. These first infections are often so few in number that they may be overlooked. However, conidia from the feltlike centers of spots on leaf undersides mature 10 to 15 days after the first infections. They are spread by rains. Each succeeding wave of infection becomes heavier, and severe defoliation begins.

Disease management

Rotary mowing the orchard after leaves drop in fall will hasten leaf decay and reduce the numbers in which the fungus can overwinter. Otherwise, fungicide applications are the primary means of control.

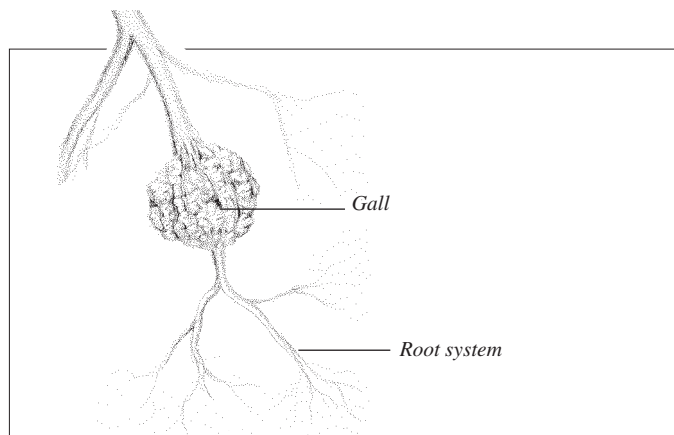

Crown Gall of Peach

CROWN GALL OF PEACH

Crown gall is caused by a bacterium, *Agrobacterium tumefaciens*, and affects peaches, nectarines, apricots, plums, cherries, apples, pears, and quince. Peach and Mazzard cherry rootstocks are especially susceptible. The disease is common in tree fruit nurseries and can occur in orchards.

Symptoms

Crown gall is readily recognized by wartlike swellings, or galls, on tree roots and crown. Occasionally, the galls may be seen aboveground on trunks or branches. Young galls are light in color and with age become dark and hard, ½ inch to 3 or 4 inches in diameter. When galls are numerous, or if located on major roots or the crown, they may disrupt the flow of water and nutrients. Trees show reduced growth, an unhealthy appearance, and possibly nutritional deficiency symptoms.

Disease cycle

The bacteria causing crown gall are distributed widely in numerous soils and can attack many different kinds of plants. Soil may become contaminated if planted with infected nursery stock.

Bacteria entering the plant must do so through a wound. Wounds are commonly made during digging and tree-planting operations, by tillage equipment, and by injury from root-feeding insects and nematodes. Secondary galls may develop a considerable distance from the initial infection. These may be formed in the absence of the crown gall bacteria, apparently due to a tumor-inducing substance produced at the site of the original infection.

Disease management

Avoid planting infected stock or wounding trees at planting.

CYTOSPORA CANKER OF STONE FRUITS

Cytospora canker is one of the most destructive diseases of peaches, nectarines, apricots, sweet cherries, and plums in Pennsylvania. Also known as perennial canker, peach canker, Leucostoma canker, and Valsa canker, the disease may cause trees in young orchards to die. Infected trees in older orchards gradually lose productivity and slowly decline.

Symptoms

The fungus attacks the woody parts of stone fruit trees through bark injuries and pruning cuts, and through dead shoots and buds.

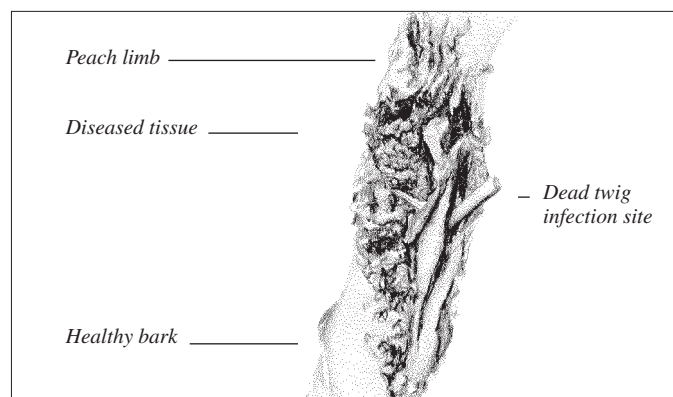

Cytospora Canker

Visible first is the exudation of gum at the point of infection. The canker forms from a small necrotic center that slowly enlarges with the collapse of the inner bark tissue. Cankers enlarge more along the length than the width of the branch. Older cankers are therefore oval to elongated in outline.

Outer bark of new cankers usually remains intact, except at points of gumming. In older cankers the bark in the center becomes torn. The gum turns black from alternate wetting and drying and from the presence of saprophytic fungi. Older cankers are surrounded by a roll of callus tissue. Each year the canker enlarges by repeated invasion of healthy tissue. With renewed growth in the spring, the tree forms a callus ring around the canker as a defense mechanism. This can be a very effective defense except when the lesser peach tree borer breaks the callus ring by burrowing through it into healthy tissue.

Disease cycle

The fungi causing the disease overwinter in cankers and dead twigs. Small black fruiting bodies appear on the smooth bark covering diseased areas of dead wood and begin to produce spores once temperatures are above freezing. Wet weather washes the spores from the fruiting structures. Because infections do not usually occur when trees are growing vigorously, most occur during fall, early spring, and winter.

Healthy bark or buds are not attacked by the fungus. Cold-injured buds or wood and pruning cuts are the most important sites of infection. The fungus can also penetrate brown rot cankers, Oriental fruit moth damage, sunscale wounds, hail injury, leaf scars, and mechanical wounds. Once established in the wood, the fungus forms a canker by invading the surrounding healthy tissue.

Disease management

Managing Cytospora canker involves total orchard management. Since no stone fruit tree is immune, and fungicide treatments alone are not effective, control efforts must be aimed at reducing tree injuries where infection could begin.

Planning a new orchard

- Select a site well away from old Cytospora-infected trees. This has proven to be the best method of keeping canker out of newly planted orchards.
- Select a site with deep, well-drained soil and good air drainage to reduce the possibility of winter injury.

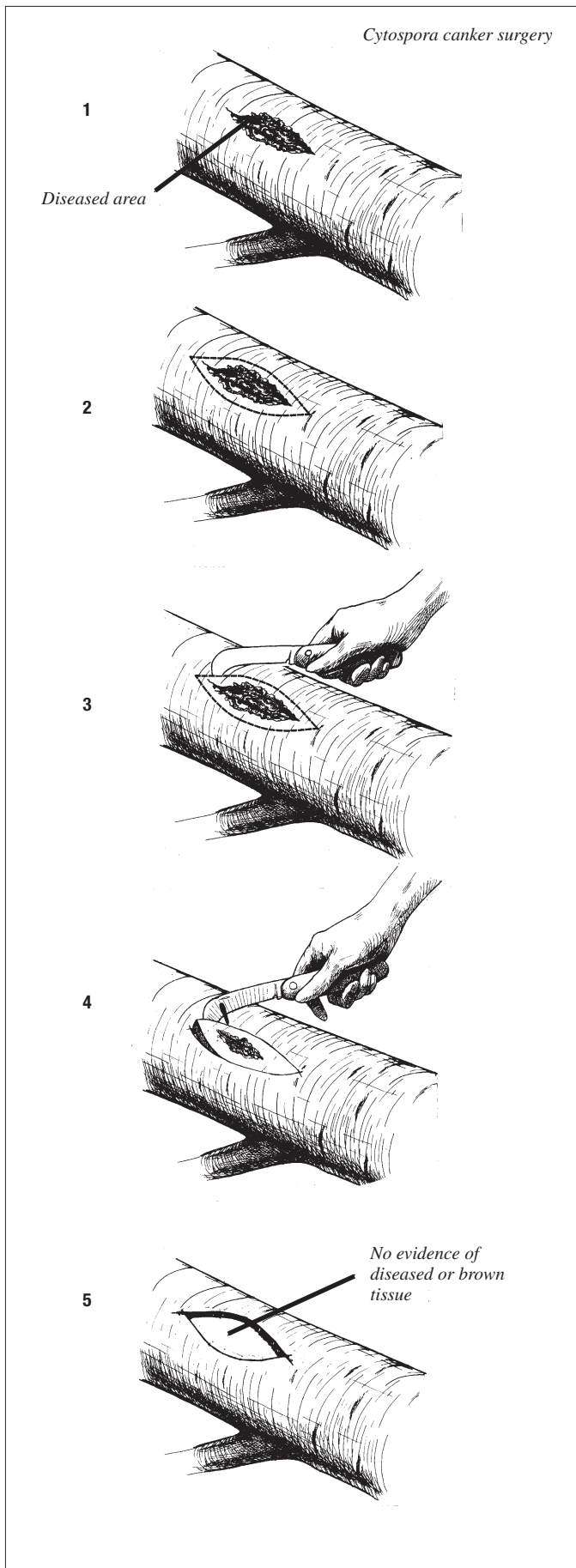

Figure 2-2. Eradicating *Cytospora canker*.

- Plant only the hardier varieties, especially if *Cytospora canker* has been a major problem in your orchard. Also, painting the trunks and lower scaffold limbs of cold-susceptible cultivars with white latex paint will somewhat moderate temperatures under the bark and reduce cold injury and canker in critical areas of the tree.
- Plant only disease-free nursery stock. Trees planted when infected with *Cytospora* will probably not live to produce fruit.
- Plant whips no larger than $\frac{1}{16}$ inch in diameter. Large-diameter whips do not heal properly when headed back and may become rapidly infected with *Cytospora*. The infection becomes obvious in the crotch of the tree when it is 3 to 4 years old. Completely remove all branches, leaving no stubs and taking care not to injure the buds at the base of each branch.

Fertilizing

- To avoid late, cold-tender growth in the fall, fertilize in late winter or early spring.
- Avoid excessive nitrogen fertilization. Excessively vigorous trees are slow to harden off in the fall and may be injured by cold if early frosts occur. Cold-injured tissue is very susceptible to *Cytospora* infection.

Training and pruning

- Start training young trees early to prevent broken limbs as a result of poor tree structure. Broken branches are sites of *Cytospora* infection.
- Prune regularly so that large cuts will not be necessary. Prune during or after bloom; actively growing trees can protect pruning cuts from infection. Do not leave pruning stubs; stubs die and can harbor the disease, which may then infect healthy branches. Remove or spread narrow-angled crotches since they tend to split and serve as infection sites. Remove all weak and dead wood and fruit mummies. Spray newly pruned trees the same day if possible or before the next rain with a fungicide used to control brown rot.

Controlling insects and other diseases

- Control the lesser peach tree borer—it aids in canker expansion and death of the tree.
- Control brown rot and remove any brown-rotted fruit from trees before cankers form on the twigs. Annual brown rot cankers may serve as infection sites for *Cytospora*.
- Control the Oriental fruit moth and peach tree borer. Injuries inflicted by these insects serve as infection sites.

Eradicating *Cytospora canker*

- During bloom or later, remove all cankers on small branches, cutting at least 4 inches below the margin of the canker.
- Surgically removing cankers on younger trees may prevent the slow decline and ultimate death of the tree. Recent research trials have shown that although this procedure is time-consuming (the average treatment time ranges from 1 to 5 minutes per canker), it is nearly 100 percent effective. If the surgery is done improperly, however, the canker is almost never eradicated. When surgery is conducted before too many cankers are evident per tree, cankers can be eliminated from young orchards before extensive infection and tree death occur.

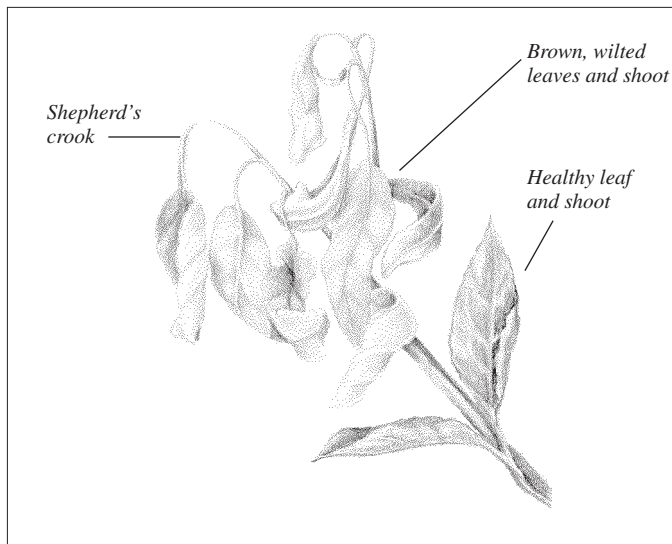
**Fire Blight**

The best time of the year for canker surgery is May and June. Do not attempt surgery on cankers encompassing more than half the branch diameter. The diseased tissue often extends beyond the canker margin that is visible at the surface of the bark. To remove diseased tissue and promote maximum healing, take the following steps (Figure 2-2):

1. Place your knife at the top of the canker $\frac{1}{2}$ to 1 inch above visible diseased tissue.
2. Outline the area to be removed, maintaining a $\frac{1}{2}$ - to 1-inch margin beyond the canker. Outline a point at the top and at the bottom of the area to be removed. When outlining, press the knife blade straight through the bark into the wood.
3. Push the knife blade beneath the bark of the outlined area and remove the diseased tissue. It is not necessary to dig into the hardwood. Clean out all diseased tissue. Note: If the diseased brown tissue extends into the margin of the cut, expand the margin until only healthy (green) tissue is evident at the margin.
4. Keep the margin of the cut clean; torn tissue will not heal properly.
5. Do not paint cut surfaces with standard wound dressings (water asphalt emulsions, oil-based paints, or latex paints). They have not proven beneficial in the wound-healing process.

FIRE BLIGHT

Fire blight is destructive to apples and quince and is the most serious pear disease in the eastern United States. Caused by the bacterium *Erwinia amylovora*, the disease can attack some 75 species of plants of the rose family. Fire blight also occurs frequently on pyracantha, spirea, hawthorn, and mountain ash. In fruit trees, the disease can kill blossoms, fruit, shoots, limbs, and tree trunks. Certain varieties of apples are more susceptible than others. Susceptible varieties include Braeburn, Fuji, Gala, Granny Smith, Jonathan, Rome, Yellow Transparent, and Idared.

Symptoms

The disease gains entry to the tree through two main points, blossoms and new shoots, and often appears first in spring as

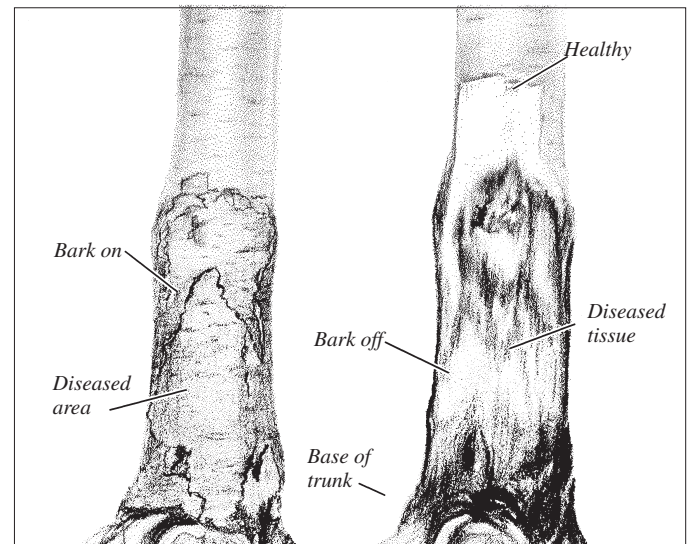
**Fire Blight Root**

blossom, fruit spur, and new shoot blight. Infected blossoms wilt rapidly and turn light to dark brown. Bacteria may move through the pedicel to the fruit spur and out into the leaves. Here they follow the midrib and main veins, which soon darken. The leaves wilt, turning brown on apples and quince and dark brown to black on pear. The blighted flowers and leaves remain attached for much, if not all, of the growing season. Some remain even after normal leaf fall.

Fire blight's two main symptoms are shoot blight and cankers on limbs. Shoot blight begins with the infection of the young, succulent growing tip. It may occur any time during the season while the shoots are still growing and when environmental conditions are most favorable for the disease. The leaves wilt rapidly, turn dark, and remain attached as in the case of spur blight. A characteristic symptom of shoot blight is the bending of terminal growth into the shape of a shepherd's crook. Pearly or amber-colored droplets of bacterial ooze are often present on diseased blossoms, fruit, and leaf stems, on succulent shoot stems, and on the exterior of infected fruits. Inside these droplets are millions of bacteria, which may cause new infections.

Fire blight bacteria can move from blighted spurs and shoots through the vascular system into larger limbs and tree trunks. Infected branches may be girdled, resulting in loss of the entire branch. Suckers at the base of trees are often invaded and may blight back to the trunk or rootstock, causing the loss of the entire tree in one season. This is true of susceptible pears, especially Bartlett, Bosc, and Clapp's Favorite, and certain clonal apple rootstocks, especially M.26 and M.9.

Cankers, slightly sunken areas of various sizes surrounded by irregular cracks, occur on small to large limbs, trunks, and even roots. They often begin at the bases of blighted spurs, shoots, and suckers. Active blight cankers are characterized by an amber or brown exudate on their surfaces or on the bark below.

The bacteria may also invade fruit, which becomes water-soaked. Droplets of bacterial ooze appear on the surface. Later the fruit becomes leathery, turns brown (apples) and black (pears and quince), shrivels, and usually remains attached to the fruit spur.

Disease cycle

Bacteria overwinter in the margins of cankers on branches and trunks. Once the temperature reaches about 65°F, bacteria begin to multiply and appear on the outsides of the cankers in drops of clear to amber-colored ooze. The bacteria are spread to blossoms primarily by rain with some transmission by flies and ants. Blossom-to-blossom transmission is carried out mainly by bees and other insects that visit the flowers. Insects also transmit bacteria to growing shoots. If the temperature is 65°F or above and relative humidity is 60 percent or more, or there is rain, new infections can occur. At 75°F, blossom blight and shoot blight will be evident in 4 to 5 days. Bacterial ooze appears on the new infections soon after the symptoms, providing additional sources of bacteria for new infections. In early to midsummer, during prolonged periods of muggy weather, blighted shoots and spurs, infected fruit, and new branch cankers all may have droplets of ooze on them.

The bacteria usually enter the flowers through natural openings such as stomates. Wounds are also important entry points to leaves, shoots, and fruit. Aphids, leafhoppers, lygus bugs, and other insects with piercing mouthparts may transfer fire blight bacteria directly into susceptible tissues. Wounds from hail often lead to a severe outbreak of fire blight. Any fresh wound can serve as an entry point.

Disease management

Temperatures just before and during bloom will determine if fire blight becomes serious in early spring. Daily temperatures must average 65°F or above during pink through petal fall for bacterial populations to grow enough to cause severe disease. The disease also occurs later in the season when bacteria enter late opening blossoms or growing tips of new shoots.

Where this disease was present the previous year, we suggest the following management program:

- Prune out all cankers in limbs 1 inch or more in diameter. Cut apple limbs at least 8 inches below external evidence of the canker and cut pear limbs at least 12 inches below. Pruning tools do not need to be disinfected when temperatures are below 45°F.
- Where the disease was severe the previous year, apply a dilute Bordeaux spray plus miscible superior oil at silver tip. This spray is not warranted if there were only occasional infections.
- When daily temperatures average 65°F or higher during pink through petal fall, make at least two applications of a streptomycin formulation. Apply the first streptomycin spray anytime after first blossoms open when daily temperatures are above 65°F or are expected within 24 hours. Repeat sprays at 5- to 7-day intervals through late bloom. A minimum of two applications is necessary to provide control. (Streptomycin formulations are much more effective when applied during slow drying conditions, such as at night.)
- When average daily temperatures fail to reach 65°F during pink through petal fall, delay the streptomycin application until the disease first appears. To detect the first appearance of fire blight, inspect trees at 5- to 7-day intervals beginning at petal fall. When disease is seen, it is important to determine whether infections result from blossoms or from overwintered cankers. Blossom infections indicate the streptomycin program was

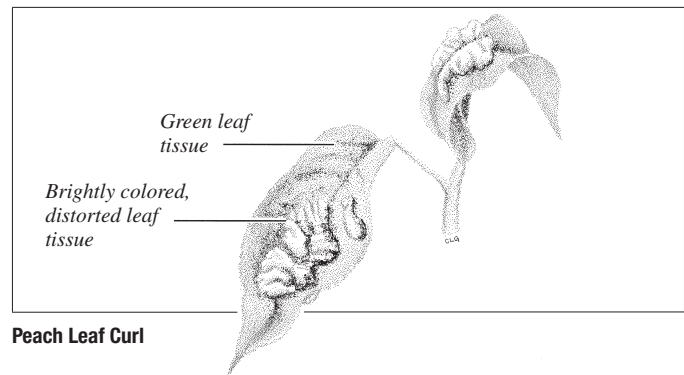

Peach Leaf Curl

not effective and needs to be evaluated for timing; infections originating from cankers imply that a better pruning job is required. When the disease is seen, prune or break out all new infections. Again, remove shoots 8 to 12 inches below the last signs of browning. Research suggests that disinfecting pruning tools is not as important as previously thought, provided that the cuts are made at least 12 inches below the symptom.

- We do not recommend cutting out blighted shoots after terminal growth has stopped. When growth stops, the spread of fire blight should also stop. The most important thing to do to control fire blight during the summer is to control sucking insects like aphids and leafhoppers. Applying streptomycin sprays within 24 hours after hail to prevent new infections is also a good practice.

NECTRIA TWIG BLIGHT OF APPLE

Nectria twig blight, caused by the fungus *Nectria cinnabarina*, is a minor disease that breaks out occasionally. Because its symptoms are similar to those of fire blight, growers need to be able to recognize it. The chemical controls used for fire blight would be wasted on necrotic twig blight.

Symptoms

In early summer leaves and shoots of infected twigs wilt and turn brown. Close examination will show that a canker has girdled the twig at the point where shoots begin to grow. Most often this spot is located at the base of the previous season's cluster bud. Rome Beauty, characterized by enlarged cluster-bud bases, is very susceptible. In midsummer a few pink or coral fruiting structures of the fungus may appear in the cankered area.

Disease management

No control is necessary.

PEACH LEAF CURL

The peach leaf curl fungus, *Taphrina deformans*, destroys early peach leaves. Although new leaves develop, their growth reduces established food reserves, weakens the tree, and may reduce yield. Defoliation by peach leaf curl in successive seasons may kill the tree.

Symptoms

Infected leaves, which begin appearing in mid-May, are easily distinguished from healthy leaves in that they are puckered and thicker than normal. Deformed areas are red to yellow at first and then turn brown. Eventually the infected leaves fall from the tree.

Disease cycle

Spores of the leaf curl fungus overwinter on the surface of peach twigs. In spring, the spores multiply during periods of moist weather until the leaf buds swell and open. Rain is necessary for infection. The spores are carried on a film of water into the buds, where leaves are infected. Cool, wet weather slows leaf development and allows more time for leaf curl infection. Infection occurs readily at 50° to 70°F. Dry weather during bud swell and bud break limits leaf curl infection.

After the deformed and discolored leaves turn brown and fall, they produce powdery gray spores. These are blown by winds to peach twig surfaces and remain there for the winter.

Disease management, chemical

Peach leaf curl is not difficult to control. A single fungicide application made in the fall after leaves have dropped or in spring before bud swell will control the disease. The spring application must be made before bud swell. Once the fungus enters the leaf, the disease cannot be controlled.

The fungicide kills the spores on twig surfaces. For either the spring or the fall spray to be effective, application must be thorough. Complete coverage of the twigs, branches, and trunks is essential. Applications made from one side of the tree or with highly concentrated sprays may not be effective.

Disease management, cultural

Where leaf curl is severe, it is very important to maintain tree vigor by: (1) thinning fruit to reduce demand on the tree, (2) irrigating to reduce drought stress, and (3) fertilizing trees with nitrogen by June 15. Be careful not to overstimulate trees.

PEAR LEAF BLIGHT AND FRUIT SPOT

This disease should not be confused with the fire blight or leaf spot diseases of pears. Leaf blight and fruit spot is caused by the fungus *Fabraea maculata*, which infects the leaves, fruit, and shoots of pear and quince trees and the leaves of apple trees. The disease can build up rapidly, even in orchards where it has not been a problem. If conditions favor the disease and it is not controlled, pear trees may become defoliated in a few weeks.

Symptoms

Leaf spots first appear as small purple dots on the leaves nearest the ground. They grow to circular spots about ¼ inch in diameter, becoming purplish black or brown. A small black pimple appears in the center of the spot. When the leaf is wet, a gelatinous mass of spores oozes from the pimple and gives the spot a creamy, glistening appearance. Each lesion may have dozens of spots, resulting in extensive defoliation. Fruit lesions are much like those on leaves, but they are black and slightly sunken. They may be so numerous as to run together and make the fruit crack.

Lesions on twigs occur on current-season growth. They are purple to black, with indefinite margins. The lesions may run together and form a superficial canker.

Early defoliation leads to small fruit, weak bud formation, and fall blossoming. Infected fruit has no sale value and often is cracked and misshapen.

Disease cycle

The sexual spore stage develops on fallen, overwintered leaves. Conidia, asexual spores, may also develop in the spots on

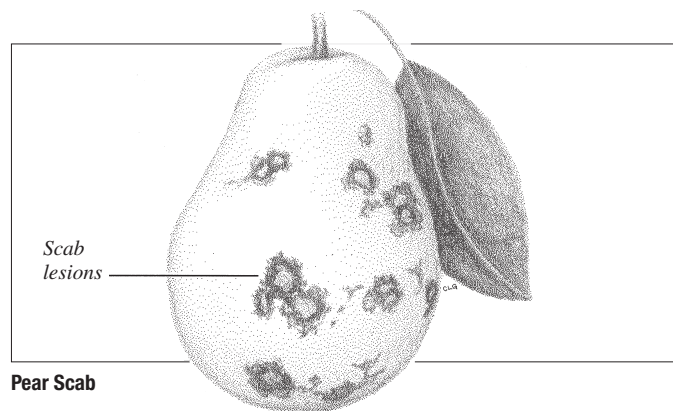
**Pear Scab**

overwintered leaves, or they may be produced in the previous season's shoot infections. Often the first infections do not occur until mid-June to the first of July. Secondary infections begin about 1 month later and reoccur throughout the season during periods of rain.

Disease management

Routine fungicide sprays normally control this disease in Pennsylvania.

PEAR LEAF SPOT

The pear leaf spot fungus, *Mycosphaerella pyri*, infects the leaves of pear, quince, and occasionally apple trees. Numerous leaf spots can produce defoliation. Fortunately, this does not often occur before fall, except in nurseries.

Symptoms

Mature leaf spots are easily recognized by their grayish white centers with sharply defined margins. Appearing first on upper leaf surfaces as small, brown lesions, they enlarge to ⅛ to ¼ inch in diameter. The borders become dark brown, and small black pimples appear in the centers.

Disease cycle

Sexual spores are produced on overwintered, fallen leaves and are carried by air currents to newly formed leaves. About a month after infection, new spores are generated in the centers of the grayish white leaf spots, from which they are washed by rain to other leaves. These secondary infections usually peak in late summer or early fall.

Disease management

Routine fungicide sprays normally control this disease in Pennsylvania.

PEAR SCAB

Pear scab resembles apple scab in nearly all respects and is caused by the closely related fungus *Venturia pirina*. Although it is not particularly common, pear scab is very destructive when it does occur. Its symptoms and disease cycle are so similar to those of apple scab that they need not be repeated here. A major difference is the frequent appearance of pear scab on twigs, where it can overwinter and start new infections in spring. Leaf infection of pear is not as common as apple scab on apple leaves.

Disease management

Routine fungicide sprays normally control this disease in Pennsylvania.

PLUM LEAF SPOT

Leaf spot of plums and prune-type plums is caused by the fungus *Coccomyces prunophorae*. The fungus, its life cycle, and the disease it causes are very similar to those of cherry leaf spot. On plum leaves the spots tend to be smaller, and severely infected leaves often have a tattered appearance. Unlike cherry infection, severe plum leaf infection is often followed by a heavy fruit drop.

Disease management

Most cultivars are susceptible to the disease, so fungicide sprays along with the sanitation practices suggested for cherry leaf spot are necessary for control. A light discing should be done just before overwintered spores on leaves are ready to be discharged, about the time of shuck fall.

PLUM POCKETS

A number of diseases of stone fruit are caused by fungi similar to the leaf curl fungus. In the northeastern United States, the most important disease affecting American-type plums is known as plum pockets, or bladder plum. It is caused by *Taphrina communis*.

Symptoms

First evidence of the disease on fruit are small, white blisters. These enlarge rapidly and soon involve the entire fruit. The fruit becomes spongy and tissues of the seed cavity wither and die. Enlarging rapidly, fruits grow 10 times their normal size, turn reddish, and become so misshapen that they are hardly recognizable. As their spongy interiors dry up, the plums turn velvety gray as spores grow on their surfaces.

New shoots and leaves are usually infected as well as fruit. Shoots thicken and are often curled or twisted. Diseased leaves are thickened and curled as in leaf curl.

Disease cycle

Spores overwinter on twigs and during cool, wet periods in early bloom may be splashed to the opening buds, where infection takes place. Developing ascospores give the infected fruit a velvety gray appearance, thus completing the disease cycle.

Disease management

Routine fungicide sprays normally control this disease in Pennsylvania.

PLUM POX VIRUS

Plum pox virus (PPV), or Sharka, is a viral disease that infects not only plum but other economically important *Prunus* species, including peach, nectarine, apricot, almond, and cherry, and ornamentals, such as flowering almond and purple leaf plum. PPV is known to infect wild *Prunus* and a large number of native and introduced weeds under laboratory conditions. Some common plants that can become infected with PPV include lamb's quarter (*Chenopodium* spp.), shepherd's purse (*Capsella bursa-pastoris*), ground cherry (*Physalis* spp.), buttercup (*Ranunculus* spp.), red and white clover (*Trifolium* spp.), and sweet clover (*Melilotus* spp.). Common garden hosts include tomato, pea, petunia, and zinnia.

Symptoms

Symptoms on leaves may consist of mild light green discoloration bordering the leaf veins (vein yellowing) or yellow to light green rings. These symptoms may be barely visible to the eye, depending on factors described above. Flower symptoms can occur on varieties with showy blossoms, but do not always occur.

Peach and apricot fruit may develop lightly pigmented yellow rings or line patterns resulting from several rings running together on the surface of the fruit. Fruit may become deformed or irregular in shape and develop necrotic or brown dead areas. Apricot fruit may show no external evidence of disease, but may have a white ring or line patterns on the seed.

Plums generally are more severely affected and show more severe symptoms than other stone fruits. Therefore, plums are a good indicator host to observe for symptoms of infection, allowing growers to monitor for PPV infection in orchards. For some plum cultivars, infected fruit drops prematurely from the tree. Infected plum fruits often are severely deformed and develop darker rings or spots on the skin and a reddish discoloration of the flesh.

Infected trees may or may not produce visual symptoms on leaves and fruits, but crop yield may be reduced even on symptomless trees. PPV also reduces fruit quality, resulting in reductions in grade, and eventually debilitates the tree, shortening its productive life. PPV symptoms may vary considerably with the cultivar, age, nutrient status of the host plant, and the temperature. In addition, different strains of PPV vary in the severity of the disease they cause and the resulting symptoms. Not every leaf or fruit on an infected tree will show symptoms. The virus can often be detected at the bottom of a branch but not the tip; however, once a branch shows symptoms, it will continue to display them in subsequent years.

Mechanisms of PPV transmission and spread**Short-distance spread in and between orchards**

In commercial settings such as orchards, PPV is spread over short distances by aphids. At least six North American aphid species are able to vector PPV, and four of these are common in Pennsylvania orchards. One of the most efficient vectors is the green peach aphid (*Myzus persicae*), which colonizes peaches and other stone fruits in Pennsylvania.

Long-distance spread between orchards or geographical regions

Long-distance spread of PPV and the introduction of the virus to new regions where it previously has not been known to exist occurs primarily by movement of infected plants or plant parts by human activity. Buds taken from infected trees will carry the virus and transfer it when grafted to healthy trees.

Identification and eradication of PPV in Pennsylvania

The plum pox virus is an introduced pathogen and given quarantine status by USDA/APHIS. After its discovery in Pennsylvania in 1999 an aggressive eradication program was developed to prevent it from spreading and eliminate it if possible. The eradication program included surveys to identify infected trees, destruction of infected orchards, creation of buffer zones and a moratorium on replanting *Prunus* in quarantined areas, among other efforts. After ten years and the destruction of over 1,500 acres of fruit trees, Pennsylvania was declared free of PPV in

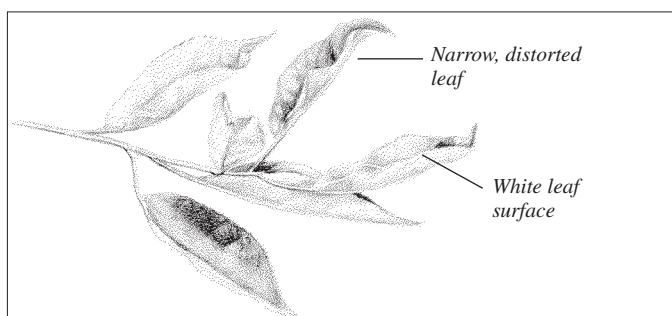

Powdery Mildew of Apple (leaf)

October 2009 and the moratorium on replanting *Prunus* was rescinded across the state.

Although the eradication program was successful, the occurrence of PPV in Pennsylvania serves to remind everyone of the importance and the need for strict plant quarantine and testing procedures associated with imported nursery materials. In almost all cases, intercontinental spread of plant disease causal agents is associated with human transfer of infected host materials. Therefore, once the diseases have been eliminated, careful regulation and inspection, combined with education of importers and travelers, could prevent the reintroduction of exotic plant diseases such as PPV from threatening U.S. crops. The Pennsylvania Department of Agriculture (PDA) will continue to monitor for PPV on a reduced scale for an additional 10 years to ensure that reservoirs of the virus did not escape detection. In addition, growers that spot suspect fruit are urged to bring it to the attention of PDA for testing.

Disease management

Once PPV becomes established in a geographical region, it is very difficult to control or eradicate. Therefore, the primary focus is placed on preventing the introduction of PPV to new fruit-growing areas. Commercial growers and nursery propagators are reminded to purchase only certified virus-free planting stock that has been tested and verified to be free of PPV and other fruit viruses. In the future, it will be important for growers to verify that certified stone fruit nursery stock from any source also has been tested for PPV.

More information, including photos of PPV symptoms, can be found at sharka.cas.psu.edu.

POWDERY MILDEW OF APPLE

Powdery mildew, caused by the fungus *Podosphaera leucotricha*, attacks buds, blossoms, leaves, new shoots, and fruit of wild and cultivated apples and crabapples. It interferes with the proper functioning of leaves, reduces shoot growth, reduces fruit set, and produces a netlike russet on the fruit of some cultivars. It is often a serious problem in apple nurseries.

Symptoms

The first sign of powdery mildew in spring is a 3- to 4-day delay in the opening of infected buds. Leaves and blossoms of these buds soon become covered with a white to light gray powder, the spores of the powdery mildew fungus. Flowers do not develop normally, are likely to be greenish white, and produce no fruit. On leaves of new shoot growth symptoms of powdery mildew

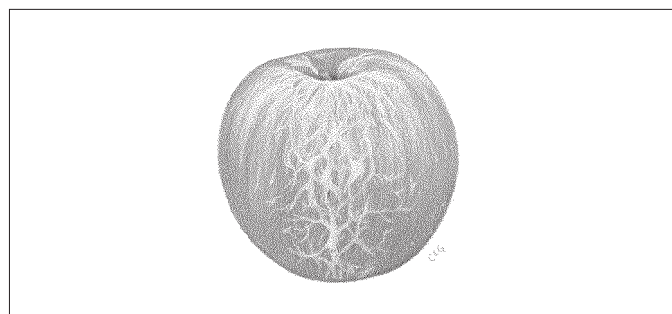

Powdery Mildew of Apple (fruit)

are feltlike, white patches on the margins and lower surfaces. Infected leaves curl upward and soon become covered with a powdery coating of spores. New infections of succulent leaves and growing shoots reduce the size of the entire shoot. By mid-summer, leaves and shoots may turn brown.

Disease cycle

The fungus overwinters as mycelium (fungus threads) inside infected buds. As these buds open in spring, all of their parts become covered with a powdery coating of spores. The spores, easily windblown, infect new leaves, fruit, and shoots. Fruit infection takes place during and shortly after the blossom period. Leaf and shoot infection may continue as long as shoot growth continues. Buds can become infected as they begin to form until they are matured for overwintering. Infections occur at temperatures of 65 to 80°F when relative humidity is high. Mildew-susceptible varieties include Jonathan, Rome Beauty, Cortland, Monroe, and Idared.

Disease management

Mildew sprays should begin at the tight cluster bud stage, where the disease is severe. Fungicides need to be continued until new shoots stop growing or about the fourth cover spray. Sterol inhibitor fungicides (Rally, Rubigan) applied to control apple scab are very effective in controlling powdery mildew.

POWDERY MILDEW OF CHERRY AND PLUM

The disease is caused by *Podosphaera oxyacanthae*, one of the common species of the powdery mildew group of fungi. The same fungus reportedly causes powdery mildew in peach, apricot, apple, pear, quince, and persimmon trees, and a few ornamental plants. This discussion will be limited to the disease as it affects plums and tart and sweet cherries.

The fungus attacks leaves and twigs, producing symptoms much like powdery mildew on apples. Infected leaves curl upward. Newly developed leaves on new shoot growth become progressively smaller, are generally pale, and are somewhat distorted. New shoots are shorter in length than normal. By mid-season the whitish fungus can be seen growing over the leaves and shoots, sometimes in patches and other times covering most of the new growth. Such symptoms are especially common in nursery trees.

Disease cycle

The fungus may overwinter on diseased, fallen leaves, but usually it does so in infected buds, as in apple powdery mildew. As

infected buds expand in spring, new growth is overrun by the fungus. Much of the visible white growth consists of conidia, which are spread by wind to other new leaves and shoots. Warm temperatures without rain, but with sufficiently high humidities for morning fog or dews, are ideal for rapid increase of the disease.

Disease management

Fungicides may be applied as the disease develops.

POWDERY MILDEW OF PEACH, NECTARINE, AND APRICOT

Powdery mildew, sometimes called rose mildew (it affects some woody ornamentals), is not often serious. The causal fungus, *Sphaerotheca pannosa*, attacks leaves, twigs, and fruit.

Symptoms

On fruit the disease first appears as round, whitish spots 2 to 4 weeks after shuck fall. The spots get bigger until they cover much of the fruit. The white spots are produced by the fungus mycelium and its spores. About the time of pit-hardening, the skin of the fruit under the spot turns pinkish, and the fungus and its spores disappear. Eventually the skin becomes leathery or hard, turns brown, and may crack.

Diseased leaves often fail to unfold normally, while those of new shoots become narrow, straplike, and distorted. New shoots are shorter than normal and distorted. The white mycelium and spores of the fungus may cover infected leaves and shoots or may appear as whitish patches.

Disease cycle

The fungus overwinters on shoots infected the previous season. Quite likely it survives behind leaf bud scales. Flower buds of infected shoots often do not survive the winter. As leaf buds expand in spring, young leaves become infected and the spores produced on the leaves serve to infect young fruit, new shoot growth, and newly expanding leaves.

Disease management

Routine fungicides adequately control this disease.

RHIZOPUS ROT OF STONE FRUITS

Rhizopus rot, caused by *Rhizopus nigricans*, can be very destructive to harvested fruit. While it can develop in hail-injured or cracked fruit on the tree, it most commonly affects fruit in storage, during transit, and at the marketplace. Peaches, nectarines, sweet cherries, and plums are most susceptible.

Rhizopus rot begins much like brown rot—as a small, brown, circular spot—but with a detectable difference. The skin of Rhizopus rot-infected fruit slips readily from the underlying flesh, while the skin of brown rotted areas is tough and leathery. At normal temperatures, the small spots of Rhizopus rot enlarge rapidly and can involve the entire fruit in 24 to 48 hours. A white, whiskery mold appears on the surface of infected fruits, spreading to nearby fruit and the walls of the container. By this time the fruit tends to leak and to smell like vinegar. Finally, tiny, black, spherical structures are produced on stalks above the white mold. Each of these contains thousands of spores (sporangiospores) that are released to float in the air. At this stage the mold looks mostly black.

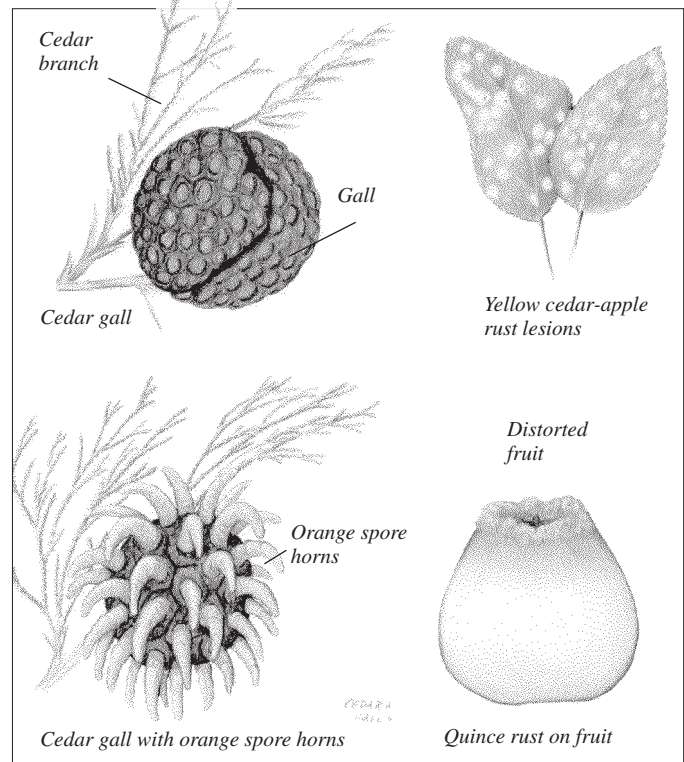

Cedar-Apple and Quince Rust

Disease cycle

Rhizopus rot occurs on all decaying vegetation, including ripe fruits and vegetables. When environmental conditions are not favorable, it produces thick-walled zygospores that can withstand long periods of cold and drying. These are present on dead vegetation, in used fruit containers, and in packhouses and storages. Thus, some type of spore of the Rhizopus rot fungus is always present where fruit is handled.

An injury through the skin of fruit must be present for the first infections to occur, and injuries as tiny as the prick of a pin are sufficient. In packed fruit or clustered ripe fruit on trees, the fungus can spread over the uninjured skin from an infected fruit nearby and eventually cause a rot. High temperatures and humidities favor the rapid growth of the fungus and decay of fruit.

Disease management

Preventing skin cuts and punctures during harvest and packing is prime in controlling Rhizopus rot. Clean containers and good housekeeping in the packing shed and storage will aid greatly in reducing the spore population. Quickly removing field heat drastically slows decay, as does refrigerating fruit until it is sold to the consumer or is processed.

RUST DISEASE OF APPLE

There are three rust diseases: cedar-apple rust, hawthorn rust, and quince rust. The most common is cedar-apple rust. All three must spend part of their life cycles on red cedar. These diseases can cause economic losses in several ways. Severe leaf infection and defoliation may make trees susceptible to winter injury. Severe defoliation reduces fruit size and quality, and infected fruit is deformed, sometimes very seriously. The hosts of cedar-apple rust are leaves and fruit of apple and crabapple trees. Of hawthorn

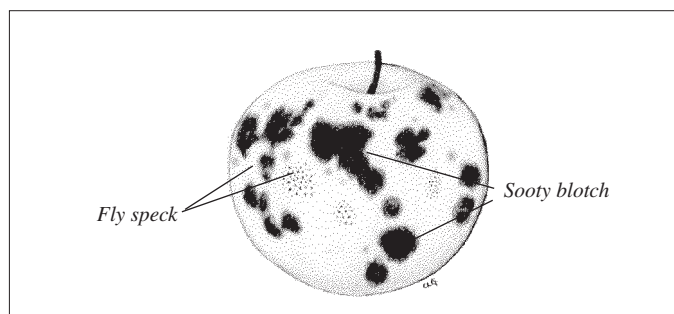

Sooty Blotch and Flyspeck of Apple

rust, hosts are leaves of pear, hawthorn, apple, and crabapple; and of quince rust, hosts are the leaves and fruit of quince and the fruit of pear, apple, and crabapple.

Symptoms

On leaves, cedar-apple rust, caused by the fungus *Gymnosporangium juniperi-virginianae*, first appears as small, pale yellow spots on the upper surfaces. The spots enlarge to about 1/8 inch in diameter. Eventually, tiny, black, fruiting bodies (pycnia) become visible. Often a number of orange-yellow protuberances, called aecia, are produced in each spot on the underside of the leaf. Infected leaves may remain on the tree or may become yellowed and drop.

Fruit lesions appear on the blossom (calyx) end. They are somewhat like leaf lesions but much larger and often cause fruit to become disfigured or to develop unevenly.

Light brown to reddish brown galls form on the branches of red cedar. When they are dry and hard they may be 1/2 to 2 inches in diameter and are known as “cedar apples.” The galls’ surfaces are covered with depressions much like those on a golf ball. In the spring, when the “cedar apples” become wet, a yellow, gelatinous horn (telial horn) up to 2 inches long protrudes from each depression.

Disease cycle

Spores discharged from these gelatinous telial horns on red cedar are easily windborne, infecting apple leaves and fruit. Spore discharge begins about the pink stage of apple bloom and is usually completed in a few weeks. Following a few wet periods, the cedar galls die. Spots on apple leaves can be seen about 10 days after infection. Visible fruit infections require a somewhat longer time.

Aecia on the undersides of apple leaves or on fruit lesions themselves produce spores. Borne by winds, the spores may be carried back to the red cedar. After lodging in leaf axils or in crevices on cedar twigs, they germinate, infect the twig, and produce tiny galls the following spring. One year later, these galls become able to produce gelatinous horns bearing spores that can infect apple trees.

Disease management

Fungicide applications should be made at the pink bud stage of apples.

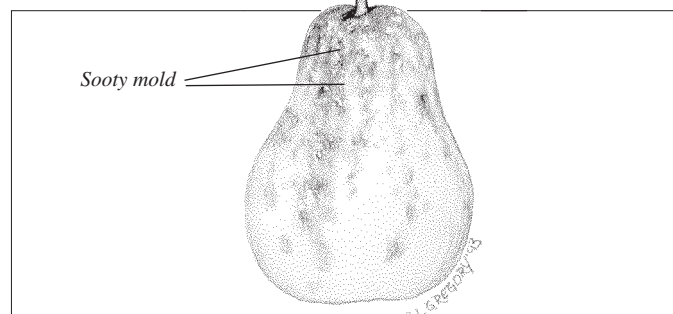

Sooty Mold of Pear

SOOTY BLOTCH AND FLYSPECK OF APPLE

Affecting apple, crabapple, and pear trees, sooty blotch and flyspeck of apple are separate diseases, but both are normally present on the same fruit. They cause surface blemishes that detract from fruit appearance, lowering fruit quality and market value. Sooty blotch also shortens fruit storage life because of increased water loss. Sooty blotch is a disease complex caused by several unrelated fungi. Flyspeck is caused by the fungus *Zygothiala jamaicensis*.

Symptoms

Sooty blotch appears on fruit surfaces as sooty or cloudy blotches with indefinite borders. These blotches, which are olive green to black, can be removed by rubbing vigorously. Flyspeck looks like true “flyspecks” characterized by sharply defined, small, black, shiny dots in groups of a few to nearly 100 or more.

Disease cycle

Both fungi overwinter on the twigs of many woody plants as well as apple and pear. The diseases are spread by these overwintering hosts. Spores of the fungi are windblown into and throughout the orchard; fruit infection can occur anytime after petal fall but is most prevalent in mid- to late summer. Disease outbreaks are favored by extended periods of above-normal summer temperatures combined with frequent rainfall and high humidity. These diseases usually appear on fruit late in the season.

Disease management

Routine fungicide sprays normally control this disease in Pennsylvania. Summer fungicide applications should not be extended beyond 14-day intervals. Cultural controls include removing alternate hosts such as brambles from the orchard and surrounding hedgerows. Dormant and summer pruning that opens up the tree canopy and facilitates air movement and the drying of fruit after rainfall helps control these diseases. Thinning to separate the fruit clusters also helps prevent disease.

No cultivar resistance to these diseases is known. Prune trees annually to improve air circulation and reduce the potential for disease. Cool fruit after picking to retard disease development.

SOOTY MOLD OF PEAR

Sooty mold fungi of the genus *Capnodium* cause an unsightly blackening over the surface of fruit and leaves. Sooty mold attacks many plants and is most common on pear, although it can affect all tree fruits and tree nuts. The fungi live on honeydew excreted by insects such as aphids, psylla, and white flies. When only a few insects are present on host plants, thus excreting a

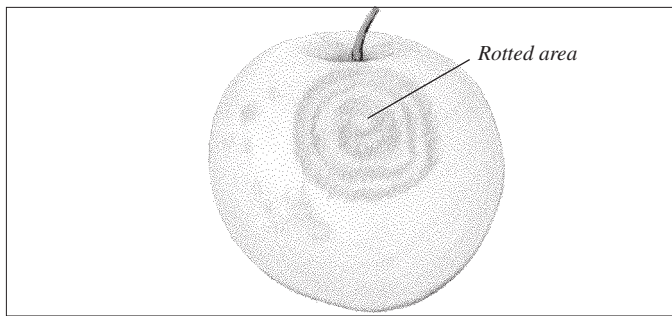

White Rot of Apple

small amount of honeydew, sooty mold appears in spots. When insect secretions are abundant, the surfaces of leaves and fruit may have a near-continuous coating of the black, tissuepaper-thin sooty mold.

Disease management

Control is directed against the insects producing the honeydew. These insects need to be identified before appropriate controls can be undertaken.

WHITE ROT OF APPLE

The white rot fungus, *Botryosphaeria dothidea*, often referred to as “Bot rot” or *Botryosphaeria* rot, is most important on apple trees, but it also attacks crabapple, pear, grape, and chestnut. On apple trees it can be observed as a distinct canker on twigs, limbs, and trunks. The fungus produces two types of fruit rot, but leaf infections do not occur. Losses from fruit rot can be considerable, especially in southeastern regions of the United States. Drought stress and winter injury have been associated with an increase in infection and canker expansion.

Symptoms

New infections on twigs and limbs start to become evident by early summer, appearing as small circular spots or blisters. As the lesions expand, the area becomes slightly depressed. Cankers stop enlarging in late fall and can be indistinguishable from black rot canker (caused by *Botryosphaeria obtusa*), making isolation of the pathogen necessary for correct identification of the causal organism. By spring small, black pycnidia, the spore-containing structures of the fungus, appear on the smooth surface of new cankers. On older cankers, these may be present throughout the year. Cankers exhibit a scaly, papery outer bark that is often orange. Tissues beneath the canker surfaces are watery or slimy and brown. Most cankers are not deep, extending at most to the wood.

The fungus causes two fruit rots. Fruit rot infection results in two types of symptoms, depending on the developmental stage of the fruit. One type originates from external infections and the other appears to start internally. External rot is first visible as small, slightly sunken, brown spots that may be surrounded by a red halo. As the decayed area expands, the core becomes rotten and eventually the entire fruit. Red-skinned apple varieties may bleach during the decay process and become a light brown. Because of this characteristic, the disease may be referred to as “white rot.”

This external rot of fruit can be confused with both black rot and bitter rot. The decayed apple flesh of black rot is firm

and somewhat leathery, the surface of the spot is not sunken, and pycnidia eventually form. Decayed flesh of *Botryosphaeria* rot is at first cup- or egg-shaped. The rot is soft, the surface of the spot slightly sunken. Bitter rot causes cone-shaped areas of decay, the surface is sunken, and concentric rings of spores form on the surface.

Apples with no external sign of decay may break down rapidly after harvest or after removal from cold storage. The rot is soft and droplets of a clear sticky liquid may form on the skin. Fruiting bodies of the fungus can be seen under the skin if the apples are left at room temperature. The origin of this internal decay is not known.

Disease cycle

Similar to that of black rot. The fungus grows best under warm conditions, with the optimum temperature for infection about 86°F. Conversely, for black rot infection the optimum temperature is about 68°F.

White rot overwinters in fruiting bodies on dead, woody tissue. During spring and summer rains, spores ooze from these structures and are splashed to other parts of the tree. Dead wood and fire-blighted twigs and branches are especially susceptible to invasion, but living twigs, branches, and trunks may also be attacked. Fruit infections can occur at any time from the bloom period to harvest. Infections in young apples usually are not evident until the apples are nearly mature. External rot lesions are found most commonly on the sides of fruit exposed to high temperatures. Drought, heat stress, mechanical wounding, and winter injury favor disease development.

Disease management

Same as for black rot of apple.

Insect and Mite Pests in Pennsylvania

This section was designed to collate information from selected, high-quality publications and from our own knowledge. It contains information compiled from several sources listed at the end of this guide including research and extension publications from universities in most apple-growing states. The reader who desires further information on these pests is referred to this literature list.

Pests are organized alphabetically rather than by crop as in previous versions of this guide. “Description and life cycle” and “Monitoring and management” sections are included for each pest. Life cycles are based on a “normal” year in south-central Pennsylvania. When dates are given, growers should make appropriate adjustments based on the difference in growing season for their region of the state. When the pest life cycle is based on the stage of the trees, generally no adjustments need to be made. The “Monitoring and management” section is subdivided for some pests. These divisions include “Monitoring,” “Cultural management,” and “Chemical management.”

AMERICAN PLUM BORER

American plum borer, *Euzophera semifuneralis*, has become a major indirect pest of tart cherries after widespread use of mechanical cherry harvesters causing shaker wounds that allow this pest to penetrate bark to feed on the underlying cambium. This moth, in the same family as European corn borer, *Ostrinia nubilalis* (Lepidoptera: Pyralidae), at the same time has increased in

apples with the use of clonal rootstocks, which allow an entrance through the burr knots.

Description and life cycle

Adults are night-flying moths with front wings that vary from a reddish brown to a grayish brown with a broad black or dark purple band transversing the outer third of the wing. The hind wings are a light dusky tan color with slightly darker veins. They are about 1 inch long when at rest with the wings folded and have a wingspan of $\frac{3}{4}$ to 1 inch. Larvae range in color from a dirty white with a greenish tinge along the underside to a deep reddish purple, have a dark brown head capsule, and reach about 1 inch at maturity. Pupae are about $\frac{1}{2}$ inch long and are found in a white silken cocoon under the bark with reddish frass scattered around, but not part of, the cocoon. Larvae of lesser peachtree borer occupy a similar habitat but are white with a yellowish brown head capsule. The pupae of the lesser peachtree borer are similar in size, but the cocoons are dark brown, with frass forming an integral part of their construction. Emerged pupal skins of the plum borer do not extrude from the cocoon or from the bark as do those of the lesser peachtree borer.

American plum borer has two generations per year. Nearly full-grown larvae overwinter within silken hibernaculae near the cambium feeding sites or on the underside of overlying dead bark. Most larvae pupate within the hibernacula as soon as the cherry buds begin to open, and first adult emergence occurs by the white bud stage about 2 weeks later. Peak adult emergence of the first generation occurs just after full bloom. The majority of eggs of the first generation are laid by petal fall, although adult emergence often continues for another 3 weeks. Adult emergence of the second generation begins in June, peaks in mid July, and continues into August or September. Peak emergence and egg laying coincides with the mechanical harvesting of cherries when there is an abundance of fresh cracks and wounds suitable for oviposition and chemical control is impossible because of residue problems on the harvested fruit.

Females are attracted to fresh wounds and lay very small pink eggs singly around the wound. The eggs quickly turn white and upon hatching the larvae immediately enter the wound to feed. In all tree fruits except plum, the larvae feed exclusively on the cambium. Sweet cherries and plums appear to be more tolerant of damage than tart cherries. About 90 percent of larvae are found girdling the trunk and lower scaffold limbs within 4 feet of the ground where the clamps from trunk shakers have caused damage. The use of limb shakers, however, may cause infestations above this height as may heavy top pruning. Populations of over 10 larvae per tree are common in some cherry-growing regions of Michigan and can girdle an 18-inch trunk in 10 years. The decrease in the life of a tart cherry orchard with populations this high has been estimated at 25 percent owing to the entry of disease into these wounds and the eventual complete girdling of the trunk or limb. A gradual decrease in yield would also be expected but has not been investigated. Although larvae may feed on plum in the trunk and on limbs in black knot growths, this host appears more tolerant of damage than tart cherries. This borer may be found feeding in burr knots in apples alongside the dogwood borer, especially where NAA (naphthalene acetic acid) has been used to kill the burr knots.

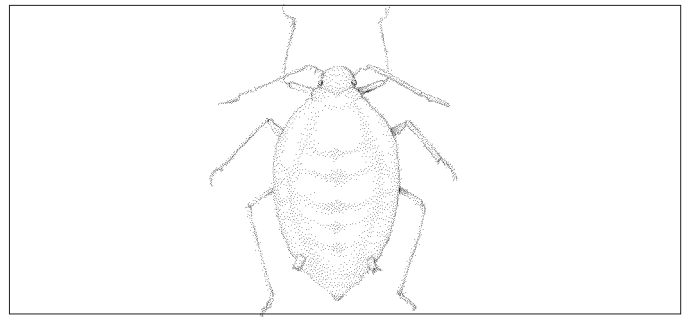

Apple Grain Aphid

Monitoring

The need for control and timing of sprays for American plum borer management can be predicted by trapping adults using a commercially available sex pheromone to monitor male flight. Three monitoring traps per ten acres should be placed as close to the orchard center as possible to minimize drawing adults from alternate hosts in adjacent woodlots. If the average catch exceeds six moths per trap per week during the adult flight of either generation, this species is likely causing economic damage.

A more accurate way to measure infestation levels is to check for the white hibernacula and reddish frass around shaker wounds by peeling away any overlying dead bark near the wound. This should be done in the early spring before white bud or in midsummer just before harvest so that new hibernacula can be distinguished from those of previous generations by the presence of live larvae or pupae. The sample trees should be scattered throughout the block, and examination of wounds often requires the use of a long-handled screwdriver or wood chisel to pry away dead bark. A threshold is more than two to three larvae in fresh hibernacula in each of several visibly wounded trees from previous years.

Cultural management

Minimize shaker injury.

Chemical management

A dilute handgun application of a long residual insecticide is recommended at petal fall if treatment thresholds are exceeded. Chlorpyrifos 4E (at 3 quarts per 100 gallons) or Lorsban Advanced at the same rate applied to the trunk and lower scaffold limbs at petal fall controls hatching larvae of both generations. Endosulfan (Thionex) at varying rates gives good control for a single generation, but under heavy pest pressure its shorter residual activity does not control the second generation. Chlorpyrifos-containing materials are highly phytotoxic to the foliage of sweet cherries.

APPLE GRAIN APHID

Apple grain aphid, *Rhopalosiphum fitchii*, rarely causes damage to apples, but it is the first aphid to appear on apples in spring and may appear in large, but innocuous, numbers.

Description and life cycle

This aphid overwinters as an egg on apple and related trees and moves to grass and grain hosts for the spring and summer. Overwintering eggs are shiny black and hard to distinguish from the eggs of green aphids and rosy apple aphids, but usually hatch

around silver tip or about 7 to 10 days earlier than the others. Nymphs are dark green with a light-colored stripe running down the back. This stripe darkens as the aphid gets older. Apple grain aphids are distinguished from other species by antennae much less than half the body length and very short cornicles. In the fall, aphids return to apple trees, produce sexual forms, mate, and lay eggs.

Monitoring and management

Monitoring and management of this species in most orchards is unnecessary since it rarely causes a problem.

APPLE LEAFMINER

Apple leafminer, *Lyonetia prunifoliella*, has become fairly common in young, nonbearing trees since in the 1980s, but has not resulted in economic injury.

Description and life cycle

Adults are similar to the spotted tentiform leafminer, but larvae make a winding linear mine that widens into a blotch mine on the upper surface of the leaf. Frass ejected from the mine through holes chewed in the lower epidermis is commonly seen hanging from the mine in threads. Portions of the leaf beyond the mine frequently become chlorotic. Pupation occurs outside the mine, often on another leaf, where the pupa is suspended beneath in a silken “hammock.” Most infestation is in leaves on succulent shoots and sprouts.

Monitoring and management

This leafminer does not appear to be economically damaging.

APPLE MAGGOT

Apple maggot, *Rhagoletis pomonella*, also known as the “railroad worm,” is abundant in untreated orchards and backyard trees. Although adults are found above treatment thresholds in many commercial orchards in Pennsylvania, use of broad-spectrum insecticides in July and August prevents injury.

Description and life cycle

The adult fly is black, about the size of a house fly, with three or four white stripes across the body in the males and females, respectively, and has a prominent white spot in the middle of the back. The wings are clear, with four black bands shaped somewhat like the letter “F.” Maggots are white and legless and reach about ¼ inch at maturity. Pupae resemble a grain of wheat.

Host range includes apples, cherries, and hawthorns. Early maturing and thin-skinned apples are often most severely infested. In many apple cultivars more than 90 percent of the maggots in the fruit fail to survive if the apple remains on the tree.

Apple maggots have only one generation per year. Pupae overwinter in the soil. Adults emerge during the summer (mid-June), with peak emergence in July and August. After a 7- to 10-day mating and preoviposition period females begin depositing eggs singly just under the skin of the fruit. Eggs hatch in a few days and the young maggots start to feed, working their way through the fruit. Injury is characterized by pitting and dimpling on the apple surface, and brown, winding trails caused by maggot tunneling and excrement along with an associated bacteria. Infested apples drop prematurely and the mature maggots leave to pupate in the soil.

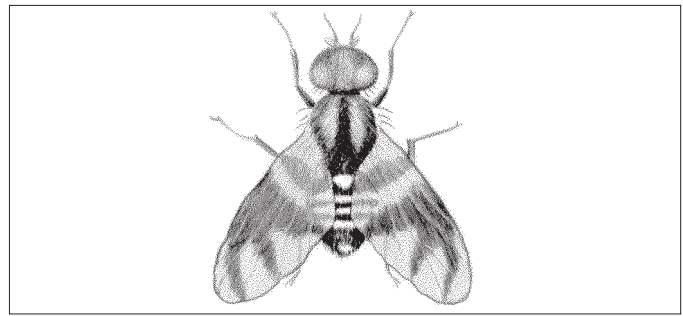

Adult Apple Maggot Fly

Monitoring

Adult apple maggot flies are monitored most effectively by sticky red spheres baited with apple volatile lures or less effectively with yellow sticky traps. Three traps are recommended per block, near the border, one to two rows in from the edge. Traps should be placed in the orchard around mid-June, about head height, positioned so they are surrounded by fruit and foliage but not touched by them or obstructed from view. Traps should be inspected and cleaned weekly. If no insecticide residue remains, a contact insecticide application is recommended immediately when an average of five flies per trap are captured. Capture of flies for 1–14 days following an insecticide application can be discounted.

Cultural management

Remove abandoned apple trees and alternate hosts from 100 yards around the orchard. Infestation may be reduced in small orchards by trapping out adults using unbaited sticky red traps at the rate of one trap per 100 to 150 apples. Insecticide-treated spheres are being developed to provide control and reduce pesticide use. Frequently picking up and destroying dropped apples may reduce the problem the following year, but it will not be effective if infested, abandoned apple trees are nearby.

Chemical management

Effective control of apple maggots requires spray coverage when trap thresholds are exceeded. Insecticides are directed against adult flies before eggs are laid. In areas with a history of apple maggot problems, regular-contact, broad-spectrum insecticide applications in July, August, and possibly early September, with thorough coverage of all foliage, should give adequate control of this important pest. Please refer to Table 4-6 for recommended assortment of effective insecticides.

APPLE RUST MITE

Apple rust mite, *Aculus schlechtendali*, is commonly found, but is rarely an important pest of apple in Pennsylvania. It is usually controlled by natural predators or acaricide sprays such as Envidor or Portal applied against other pests. However, rust mite populations can build to injurious levels in some situations.

Description and life cycle

The motile stages of this mite are cone- or sausage-shaped, and are very difficult to see with the unaided eye. Examination of the leaf midrib with a strong hand lens is usually needed to verify mite presence.

Apple rust mites overwinter as adult females under the bud

scales of apple trees. At budbreak they become active and feed and reproduce until July or early August when overwintering females are produced. In low numbers, apple rust mites are considered beneficial in that they provide an alternate food source for the predators of European red mites and twospotted spider mites.

These mites feed on the underside of the leaf, usually causing little if any damage. Under some conditions mite populations may expand, and their feeding can cause the leaf to take on a silvery appearance as leaf cells are destroyed and chlorophyll is lost. Silvering symptoms do not appear until mite populations build beyond 200 mites per leaf. Under increasing damage from larger populations or more prolonged feeding, apple leaves may longitudinally roll, giving the appearance that the tree is under drought stress. Sometimes these mites will move to the fruit and may be found at either the calyx or the stem end. In extremely rare cases they will russet the fruit.

Monitoring and management

Monitoring should begin before petal fall and continue through the first week of August. A good hand lens or microscope is required. Inspect 10 leaves from 10 different trees. Concentrate the inspections on the basal third of the leaf midrib on the underside of the leaf. It is too tedious to count the exact number of mites, so a quick estimate should be made on each leaf. When more than an average of about 200 mites per leaf is found, then a pesticide treatment is recommended. A treatment is also recommended upon the appearance of plant symptoms such as silvering or leaf rolling. See Table 4-6 for the list of compounds effective against apple rust mite.

BLACK CHERRY APHID

The black cherry aphid, *Myzus cerasi*, is the most common aphid attacking cherries, primarily sweet cherries, in most parts of North America.

Description and life cycle

Adults and nymphs are readily identified by their shiny black coloration. The adults are $\frac{1}{8}$ inch long and have both winged and wingless forms. Nymphs are similar in appearance, but smaller.

Although the aphid can survive on most cherries, it prefers commercial cherry varieties, greatly preferring sweet cherries. Napoleon, Black Tartarian, Schmidt, and Windsor are most susceptible to injury, while Dykeman and Yellow Spanish are not very susceptible. Alternate summer hosts include water cress, peppergrass, and members of the mustard family.

The black cherry aphid overwinters as an egg on the bark of small branches. The eggs begin to hatch as soon as cherry buds break, with young aphids moving to new green tissue. After 3 to 4 weeks wingless, stem mother females have established large colonies on growing shoots. Two to three generations occur on cherry trees by early July when most of the aphids move to alternate hosts for the summer. In September or October winged males and females return to cherry trees, mate, and lay eggs.

Feeding causes curling and stunting of leaves and stems. Heavy infestations may kill young trees and reduce crop quality and quantity and return bloom on mature trees. Honeydew from these aphids also causes the growth of black sooty fungus.

Monitoring and management

Trees should be scouted in early spring to detect the presence of stem mothers on actively growing shoots. It is important to determine aphid severity before the leaves curl. While no thresholds have been established for mature trees, young trees cannot tolerate even low numbers of aphids. Delayed dormant applications of oil and insecticides applied to control other cherry pests usually control the black cherry aphid. Aphid natural enemies including syrphid flies, lacewings, and lady beetles are often abundant enough to control this species.

BROWN MARMORATED STINK BUG

The brown marmorated stink bug (BMSB), *Halyomorpha halys*, is an exotic insect species naturally occurring in Japan, southern China, and Korea. Since the late 1990s BMSB populations have become established in North America, with the first official identification record from Lehigh County, Pa., dated September 2001. At the time of this initial finding, the species was already well established in the Allentown, Pa., area and was reported to cause damage to various home garden products and ornamental plants. During this initial detection period, brown marmorated stink bug adults were frequently reported as a nuisance to homeowners as they tended to overwinter inside houses and other dwellings. Currently, BMSB is reported from most counties in Pennsylvania and more than 30 states across United States.

Description and life cycle

The brown marmorated stink bug has two generations in southern Pennsylvania. Under normal conditions, overwintering adults emerge from their winter hideouts in early spring to mid-June and immediately move to feed on available hosts. The feeding of BMSB adults and nymphs are reported from more than 300 possible host plants. Their ability to survive and reproduce on various plants and move unrestricted among various hosts is one of the main factors contributing to the continuous and quite unpredictable presence of this pest in orchards.

Feeding damage on fruit caused by BMSB can occur throughout most of the season. Although the mechanism of BMSB feeding is similar during various parts of the season, the injury caused by stink bugs can have various appearances based on the time of the season the feeding takes place. Early feeding injury can result in misshapen fruit, while late season feeding on maturing fruit can cause the formation of necrotic tissue (corking) close to the skin surface. Sometime stink bug injuries on fruit can be confused with the physiological disorder called "corking" caused by calcium deficiency.

Monitoring and management

Visual observations remain the most accurate method to monitor the occurrence of brown marmorated stink bug adults and nymphs. Since no specific BMSB pheromones or other attractants are currently available, conventional traps are not reliable tools for the monitoring of this pest. Insecticides with various modes of action can effectively control the brown marmorated stink bug. While a number of commonly used products are effective against this pest (e.g., neonicotinoids, carbamates, or pyrethroids), the continuous challenge revolves around the unrestricted influx of new stink bug adults from surrounding vegetation and therefore causes the necessity for multiple, repeated applications of in-

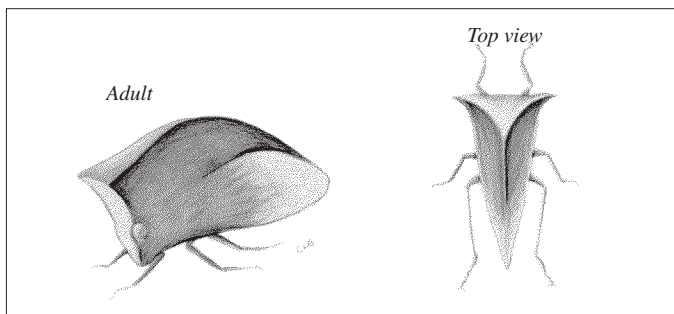
**Buffalo Treehopper**

secticides. Detailed management options and possible ways to reduce their impact on integrity of the Pennsylvania IPM system are discussed in “Special Section: Brown Marmorated Stink Bug—New Exotic Insect Pest” on page 145.

BUFFALO TREEHOPPER

Buffalo treehopper, *Stictocephala bisonia*, is an occasional pest of fruit trees in Pennsylvania. It gets its name from its hump-backed resemblance to the shape of a buffalo.

Description and life cycle

The buffalo treehopper adult is green, $\frac{3}{8}$ inch long, triangle-shaped when viewed from above and hump-backed when viewed from the side. The nymphs are spiny. Females lay eggs from July until October in the bark of the upper sides of small branches of apple, pear, cherry, prune, and quince trees. A row of slits is cut along the branch, and six to twelve eggs are laid in each slit. The slits heal and gradually enlarge, giving the branch a rough and scabby appearance. Young trees may be significantly damaged by heavy infestations because severe scarring can stunt and weaken limbs. In May or June the overwintered eggs hatch and the nymphs move to nearby grasses and weeds. Weedy orchards or those near weedy fields are most often affected.

Monitoring and management

Young trees should be checked for the presence of scarring in autumn or winter. Severely scarred branches should be pruned out. Controlling weeds should reduce alternate feeding sites. Since the egg-laying period lasts several months, insecticide spray timing is difficult. Insecticides should be used only if economic damage is occurring to young trees beyond the control ability of winter pruning.

CHERRY FRUIT FLY AND BLACK CHERRY FRUIT FLY

Cherry fruit fly, *Rhagoletis cingulata*, and black cherry fruit fly, *R. fausta*, are found on cherry, pear, plum, and wild cherry trees. These insects are common in alternate hosts, but can be effectively managed in commercial orchards.

Description and life cycle

These flies are slightly smaller than the common house fly and have wings marked with distinctive black bands. The cherry fruit fly female has four white bands crossing the abdomen lacking in the black cherry fruit fly. Maggots are creamy white, legless, tapered at the head end, blunt in the rear, and reach $\frac{5}{16}$ inch at maturity.

Both species have one generation per year. Adults emerge from

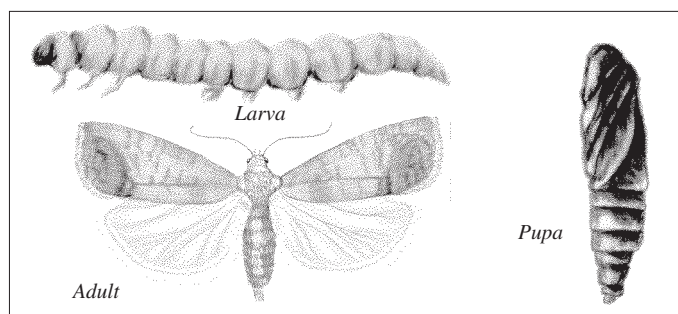
**Codling Moth Life Stages**

the soil in June and July. The black cherry fruit fly emerges about a week before the cherry fruit fly. Females lay eggs in cherries over a 3- to 4-week period. Newly hatched maggots burrow into the fruit as they feed on the flesh. There are three larval instars lasting a total of 10 to 21 days. The last instar emerges from the fruit, falls to the ground, and burrows down 3 inches where it pupates.

Maggot-infested fruit is often shrunken and misshapen, ripens earlier than surrounding fruit, and is unmarketable.

Monitoring and management

Adults can be monitored using adhesive-covered yellow panel traps baited with an ammonium-carbonate lure. Traps should be placed in the fruiting canopy of the tree, with fruit and foliage removed from around it for 12 to 18 inches. Traps are used to detect the beginning of fly emergence, but they are not good indicators of the level of infestation.

Management is directed against the adults because once the maggot burrows into the fruit it is protected from insecticides. Insecticide treatments should begin about one week after the first fly emerges. A long-residual insecticide should be applied every 10 to 21 days until after harvest to kill adults before they can lay eggs.

CODLING MOTH

Codling moth, *Cydia pomonella*, was introduced from Europe in colonial times and now occurs throughout North America as well as most of the world, wherever apples are grown. In the past in Pennsylvania, the codling moth was maintained at low population levels by insecticides sprayed to control other pests and usually did not seriously affect apple production in commercial orchards. However, during last few years the significance of this pest drastically changed and numerous orchards have experienced increased pressure from this pest. Codling moth has been known to infest 95 percent of the apples in an orchard when control measures were not taken against it. Given this insect's ability to adapt to various fruits (e.g., the ability to coincide with different fruiting times) and to develop resistance to insecticides, fruit growers must continually be on guard against a resurgence of codling moth.

Description and life cycle

The adult female moth is approximately $\frac{3}{8}$ inch long and grayish in color. The male is slightly smaller and has a grouping of hair-like scales near the wing base. The wing is generally a darker shade of gray near the base, with a dark patch containing coppery

scales near the inside wing tip. The larvae have a cream to pinkish body and a brown head with dark speckles on the prothoracic shield behind the head. Larvae reach 1/2 to 5/8 inch long at maturity. Oriental fruit moth larvae, which are often confused with the codling moth larvae, are smaller, lack spots on the prothoracic shield, and have a comblike structure (anal comb) on the posterior end visible under magnification. Codling moth eggs, laid singly, appear as flat, slightly oval discs. At first translucent, they later become reddish, and finally enter the black head stage just before hatching, when the dark head capsule can be seen.

Codling moth overwinter as full-grown larvae within a cocoon under leaf litter, loose bark scales, or any other sheltered place they may encounter. Pupation occurs at about first pink, with first flight occurring about full bloom, and light occurring approximately 2 to 8 or 10 weeks after full bloom. First-generation eggs are laid on leaves near fruit or on the fruit and hatch in about 6 to 10 days. Newly hatched larvae bore through the fruit surface, generally at the side of the fruit, and feed near the surface for a time before boring to the core. Larvae feed on the seeds and surrounding flesh until they are fully grown in 3 to 4 weeks. They then exit the fruit, seek shelter, spin a cocoon, and may or may not pupate. Some first-generation larvae do pupate, emerge as adults in 2 to 3 weeks at about the fourth or fifth cover spray, and produce a second generation. The majority of the second generation overwinter as mature larvae.

First-generation larvae that do not pupate enter a quiet diapausing phase, overwinter as last instar larvae, and become first-generation adults the following year. Some larvae of the second generation may also pupate and attempt to produce a third generation at the seventh or eighth cover spray. This generation, which most of the time does not survive the winter, is termed a

suicide generation. Individual larvae can, however, inflict additional late season fruit injury.

Damage to apples may be shown either by a tunnel emanating from the apple side or calyx and extending to the core, or by "stings," small shallow holes the size of pin pricks, with a little dead tissue on the cavity walls. Stings are caused by early instar larvae that have been poisoned and die shortly after puncturing the apple skin. Larvae that feed on the core characteristically leave frass exuding from the point of entry. Stings lower the value of the fruit from fresh market to processing grade apples. Tunneling causes the fruit to be rejected.

Monitoring and management

Pheromone traps for monitoring populations of adult male codling moths should be used to determine if and when controls are necessary. Traps should be placed at a density of at least one trap per 5 acres (but no less than two traps per block) by the pink stage and situated on the outside of the tree, preferably in the upper fourth of the canopy. The higher the trap placement, the better codling moth is monitored. Check traps daily until the first adult is caught and then weekly thereafter. In orchards without mating disruption, if the action threshold of five moths per trap per week is exceeded an insecticide application should be made within 5 to 8 days. Repeat applications should be made if the number of captured moths exceeds this threshold 14 days after the insecticide application. In orchards implementing mating disruption for codling moth control, monitoring should be done using high-dose lures (10x) or special CM DA Combo lures.

Optimum timing of insecticide applications based on egg hatch can be determined with the aid of a degree-day model (Table 2-2). First adult capture in a pheromone trap is used as

Table 2-2. Degree-day look-up table for codling moth (lower threshold 50°F, upper threshold 88°F, horizontal cut off, using sine-wave curve).

To find the total degree-days for a day, locate the minimum and maximum temperatures and follow the rows to where they intersect. For temperatures between those listed, use the nearest shown. Temperatures and degree-days must be determined on a daily basis.

		Minimum temperature																											
		30	32	34	36	38	40	42	44	46	48	50	52	54	56	58	60	62	64	66	68	70	72	74	76	78	80		
Maximum temperature	50	0	0	0	0	0	0	0	0	0	0	0																	
	52	0	0	0	0	0	0	0	0	1	1	1	2																
	54	1	1	1	1	1	1	1	1	1	2	2	3	4															
	56	1	1	1	1	2	2	2	2	2	3	4	5	6															
	58	2	2	2	2	2	3	3	3	3	4	5	6	7	8														
	60	3	3	3	3	3	3	4	4	4	5	6	7	8	9	10													
	62	3	3	4	4	4	4	5	5	5	6	7	8	9	10	11	12												
	64	4	4	4	4	5	5	5	5	6	6	7	8	9	10	11	12	13	14										
	66	5	5	5	5	6	6	6	6	7	7	8	9	10	11	12	13	14	15	16									
	68	6	6	6	6	7	7	7	7	8	8	9	10	11	12	13	14	15	16	17	18								
	70	6	7	7	7	7	8	8	8	9	9	10	11	12	13	14	15	16	17	18	19	20							
	72	7	7	8	8	8	8	9	9	10	10	11	12	13	14	15	16	17	18	19	20	21	22						
	74	8	8	8	9	9	9	10	10	11	11	12	13	14	15	16	17	18	19	20	21	22	23	24					
	76	9	9	9	10	10	10	11	11	12	12	13	14	15	16	17	18	19	20	21	22	23	24	25	26				
	78	10	10	10	11	11	11	12	12	13	13	14	15	16	17	18	19	20	21	22	23	24	25	26	27	28			
	80	11	11	11	11	12	12	13	13	14	14	15	16	17	18	19	20	21	22	23	24	25	26	27	28	29	30		
	82	11	12	12	12	13	13	14	14	15	15	16	17	18	19	20	21	22	23	24	25	26	27	28	29	30	31		
	84	12	13	13	13	14	14	15	15	16	16	17	18	19	20	21	22	23	24	25	26	27	28	29	30	31	32		
	86	13	14	14	14	15	15	16	16	17	17	18	19	20	21	22	23	24	25	26	27	28	29	30	31	32	33		
	88	14	14	15	15	16	16	17	17	18	18	19	20	21	22	23	24	25	26	27	28	29	30	31	32	33	34		
90	15	15	16	16	16	17	17	18	18	19	20	21	22	23	24	25	26	27	28	29	30	31	32	33	34	35			
92	16	16	16	17	17	17	18	18	19	20	20	21	22	23	24	25	26	27	28	29	30	31	32	33	34	35			
94	16	16	17	17	18	18	18	19	20	20	21	22	23	24	25	26	27	28	29	30	31	32	33	34	35				
96	17	17	17	18	18	19	19	20	20	21	22	23	24	25	26	27	28	29	30	31	32	33	34	35	35				
98	17	17	18	18	19	19	19	20	21	21	22	23	24	25	26	27	28	29	30	30	31	32	33	34	35	36			
100	18	18	18	19	19	19	20	20	21	22	22	23	24	25	26	27	28	29	30	31	32	32	33	34	35	36			

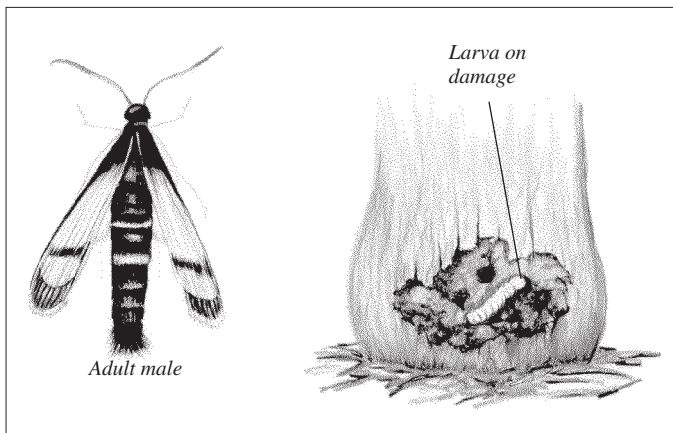

Dogwood Borer

a biofix, and degree-days are accumulated thereafter. Growers wishing to time sprays based on egg development and hatch should make an application of broad-spectrum insecticide at 250–350 degree-days (base 50°F) after the first capture of males in the sex pheromone traps. A second application can be applied 14 to 21 days following the initial application if needed. If insecticides with ovicidal activity are planned for codling moth control, the first application should be performed no later than at about 150 DD after the biofix. Due to frequently extended codling moth flight observed in many orchards, additional insecticide treatments may be necessary after the second application. The delayed timing for initial insecticide application is recommended in orchards where observations from pheromone traps during previous seasons detected extended CM flight, often lasting until end of June.

Mating disruption represents a valuable alternative to insecticide treatment for isolated orchards with a low codling moth population. The hand-applied pheromone dispensers (ties) and various forms of sprayable pheromones are commercially available and can be used for codling moth control. If Oriental fruit moth is also a problem in the same block, then Isomate CM/OFM CTT or CheckMate Duel should be used for the control of both species. In orchards with codling moth populations resistant to organophosphate insecticides, a combination of mating disruption and codling moth granulosis virus is recommended to effectively control this pest. Also, the recently registered insecticides with new modes of action are very effective against this pest. Refer to Table 4-6 for a recommended assortment of effective insecticides.

DOGWOOD BORER

Dogwood borer, *Synanthedon scitula*, was found for the first time in the 1980s as a common pest in the burr knots of apple trees on clonal rootstocks in northern Virginia, Pennsylvania, and the rest of the Northeast. Untreated infestations may reduce yields and in rare cases girdle young trees.

Description

Adults are typical black and yellow clear-winged moth similar to but smaller than adult lesser peachtree borer and peachtree borer, with a wingspan of only $\frac{3}{4}$ inch. Females have a wide yellow band on the fourth abdominal segment, compared to a much narrower band on the same segment of the males. Larvae are nearly white to light pink with a deep brown head capsule,

and reach $\frac{1}{2}$ inch at maturity. They may take 13 to 22 months to complete larval development. Larvae pupate in galleries in a cocoon made up of silken thread and covered by a layer of its reddish frass. Pupal cases often protrude slightly from the tree and remain visible for up to a year after the adults have emerged.

Dogwood borers feed on a wide variety of forest trees. On apple, larvae feed inside burr knots, which usually develop on the exposed aboveground portion of clonal rootstocks. Malling and Malling-Merton rootstocks have a tendency to develop burr knots, enhanced by low light conditions around the trunk due to shading by weeds, low limbs, suckers, opaque tree guards, and shallow planting. These aggregations of partially developed root initials occur in clusters at or below the graft union. Reddish frass on the surface of a burr knot is a visible sign of an active infestation by dogwood borer.

Larvae overwinter in a hibernaculum in one of their galleries and emerge early in the spring to continue feeding. Pupation lasts about 25 days and begins in early June. Adults emerge over a period of about three months, beginning in June. Mating and egg laying occur within a few days of emergence. Females lay eggs on or near burr knots and are particularly attracted to trees with infested burr knots. Eggs hatch after 8 to 9 days and larvae bore into the tissue between the root initials and begin feeding. Dogwood borer almost never enter healthy bark or pruning wounds in apple trees.

Feeding is initially confined to the burr knot, but it sometimes spreads to healthy bark outside it. Feeding in the burr knot itself does little or no damage to the tree, while feeding below the bark is much more destructive and may eventually girdle the tree. Although these borer injuries can kill trees, several consecutive years of infestation are often needed before the tree shows decline. Persistent infestations over several years can contribute to a slow decline of the tree and reduced yields.

Monitoring

Dogwood borer is monitored by checking under tree guards in the spring to locate active infestations. Pheromone traps can be used to estimate the timing of peak flight. These traps should be placed at about 4 feet above the ground for optimal catch. Placement much higher or lower in the tree may mean as much as a fivefold decrease in catch.

Cultural management

Although NAA can be used to control burr knots, this is not desirable because it forces the larvae to feed into healthy cambium at the edges of burr knots. Also, other borers, such as the American plum borer, may establish in the dead burr knots. Rootstocks M.9, M.9/MM.106, M.26, MM.106, and MM.111 show some difference in susceptibility, but only MM.111 has a considerably lower infestation level. Undiluted white latex paint applied by brush to the lower trunk before egg laying will significantly reduce infestations. Tree guards should not be left on longer than necessary.

Chemical management

Dogwood borer can be controlled with trunk applications of a long-residual insecticide. Lorsban 75WG at 2.0 pounds per 100 gallons or Lorsban 4E and Lorsban Advanced at 2.0 quarts are effective when applied as direct spray. Thorough coverage of burr knots and surrounding areas of the lower trunk in single sprays

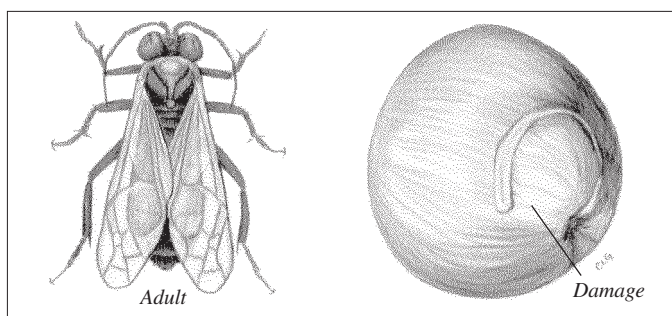

European Apple Sawfly

timed from pink stage through late June should provide excellent control. Do not exceed 100 gallons per acre. The postbloom applications of any product containing chlorpyrifos can be applied only to the tree trunk, without contacting foliage. Only a single application of chlorpyrifos is allowed per growing season.

EUROPEAN APPLE SAWFLY

Since 1985, European apple sawfly (*Hoplocampa testudinea*) has extended its range from the northeastern portion of Pennsylvania to the Maryland border. Now this pest is common throughout Pennsylvania. Injured fruit were first reported in Adams County during 1998.

Description and life cycle

European apple sawfly adults are about $\frac{5}{16}$ inch long and wasp-like, but with a broad attachment of the thorax and abdomen. Sawfly larvae resemble caterpillars, but have prolegs on each abdominal segment. Sawfly overwinter as larvae in the soil and have only one generation per year. Adults emerge during late pink and early bloom. Eggs are laid on the calyx end of developing fruit. The first instar larvae tunnels just under the epidermis of the fruit, resulting in the typical ribbonlike scar (primary injury). These apples usually remain on the tree, and the presence of the scars at harvest can reduce fruit value. The second and older instar larvae bore deeply into the seed chamber of the fruit and can penetrate additional fruit, usually causing fruit abortion. Later instar injuries on fruit with a brownish frass at the entry are called "secondary damage."

Monitoring and management

Sticky, rectangular, nonultraviolet-reflecting, white traps should be placed at a density of one per 3 to 5 acres along the orchard periphery at the pink stage of apples on the south sides of trees at 5 to 6 feet above the ground. Insecticide treatment thresholds are 5 flies per trap by petal fall if no prebloom insecticide has been applied or average of 7 flies per trap with a prebloom insecticide. An application of an effective insecticide as soon as pollination is complete is the best control tactic for orchards with a history of this sawfly.

Numerous predators and parasitoids of sawfly are reported from Europe, but no native biocontrol agents are reported to be effective in North America. A partially successful classical biological control program was initiated in Canada to introduce a solitary larval endoparasitoid *Lathrolestes ensator* Brauns (Hymenoptera: Ichneumonidae) for the control of this pest. Other options for biological control of European apple sawfly

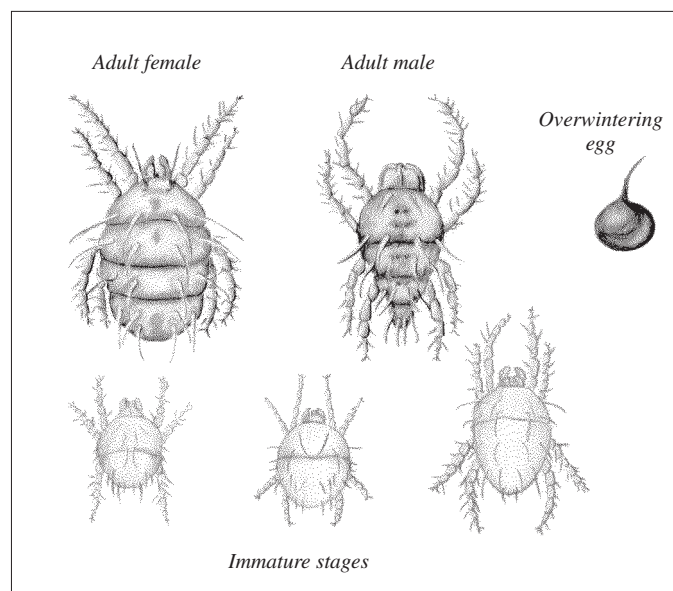

European Red Mite Life Stages

are the Heterohabditid and Steinernematid entomopathogenic nematodes, which are still being investigated in laboratory and semifield conditions.

EUROPEAN RED MITE

European red mite, *Panonychus ulmi*, a major tree fruit pest attacking apples, stone fruits, and pears, is considered by many growers throughout Pennsylvania to be one of the most important apple pests. The mite was introduced into North America from Europe in the early 1900s and is now established in most fruit-growing areas.

Description and life cycle

Eight-legged females are $\frac{1}{64}$ inch long, bright red, and have four rows of white hairs on their backs. Males are smaller, lighter in color, and have pointed abdomens. Overwintering eggs are round, bright red, and have a small stalk, approximately the length of the diameter of the egg, arising from the top. Summer eggs are pale and translucent. Six-legged nymphs hatch from the eggs, molt to eight-legged protonymphs, then deutonymphs, and finally adults.

Overwintering eggs are laid in groups on roughened bark, in crevices and cracks, and around bud scales on twigs and branches. Eggs begin to hatch at prepink bud stages and continue throughout bloom. Young mites move to newly opened leaves where they feed, mature, and reproduce. The first generation requires approximately three weeks to develop; summer generations are completed in 10 to 18 days. The rate at which mites develop is primarily temperature dependent. Hot, dry weather favors development, while cool, wet weather delays mite activities. Each female is capable of laying 35 eggs during her average life span of 18 days. Eight to 10 generations occur during the year.

Mites feeding on leaves cause injury to the tree by removing leaf tissue. The most serious injury occurs in early summer when trees are producing fruit buds for the following season. Moderate to heavily infested trees produce fewer and less vigorous fruit buds. Mites feeding on leaves also reduce the ability of leaves to manufacture enough food for desirable sizing of fruit. A char-

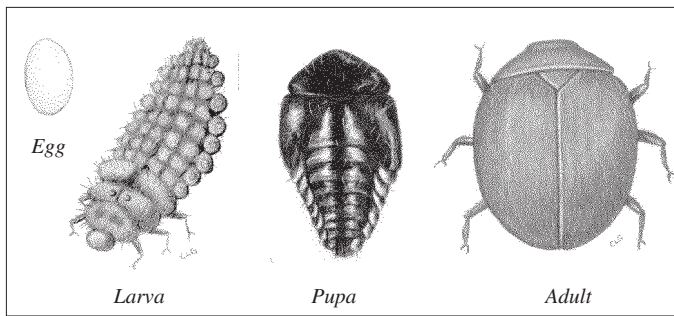

Stethorus punctum, Black Ladybird Beetle Life Stages

acteristic brown foliage that, in severe cases, becomes bronze, results from heavy mite feeding. Left unchecked, mite populations can affect fruit color and result in premature fruit drop.

Monitoring

Our integrated mite management program for apples depends largely on the phytoseiid predatory mites *Typhlodromus pyri* (Scheuten) and *Neoseiulus fallacis* (Garman) to regulate pest mites to low levels during the cooler spring and late summer/fall months. Once established, *T. pyri* is capable of maintaining pest mite populations at very low levels if not disrupted due to the use of toxic pesticides (see Table 4-5 for toxicity ratings). It is estimated that about a third of the apple acreage in Adams and adjacent counties have established *T. pyri* populations, but it has not been found in apple orchards outside of this area. *T. pyri* is able to regulate pest mites at much lower levels than the black ladybug, *Stethorus punctum*, and which it has largely replaced in many grower orchards. For more information on establishing and conserving this predatory mite or *Stethorus*, refer to the “Natural Enemies” section.

Overwintering eggs: European red mite eggs may be evaluated in the dormant period up to prepink. Inspect with a hand lens the bases of twigs and spurs on the 5 to 10 selected trees. Look for clusters of tiny (less than 1/50 inch), red spheres. If overwintering eggs are easily visible, especially to the unaided eye, then a prebloom application of oil or a miticide-ovicide is recommended to prevent mite injury through June.

Pink and beyond, before a miticide that kills motile mites is applied in the current season: If no adulticide has been applied in the current season, scan 5 to 10 leaves on each of the selected trees for mites. A leaf is mite infested if it contains one or more motile mite. Record each leaf as either “mite infested” or “mite free.” Divide the number of mite-infested leaves by the total number of leaves examined. Multiply the number by 100 to compute the percentage of mite-infested leaves. As mite populations increase, so will the percentage of infested leaves. Refer to Table 2-3 to estimate the expected number of mites per leaf for the given percentage of mite-infested leaves.

After a miticide has been sprayed to control motile mites in the current season: Follow the above procedures except that the number of motiles mites (all stages except eggs) per leaf should be counted. Determine the average number of mites per leaf by dividing the total number of mites found on all leaves by the number of leaves examined.

Stethorus: When the percentage of mite-infested leaves reaches 65 to 75, begin estimating the *Stethorus* population by

counting the number of adults and larvae seen in 3 minutes while walking slowly around the tree periphery. *Stethorus* is described in this part under “Natural Enemies.”

Predatory mites: The impact of beneficial predatory mites *Neoseiulus fallacis*, *Typhlodromus pyri*, and *Zetzellia mali* on phytophagous mite population is described under the “Natural Enemies” section

Mite action thresholds and predator/prey ratio calculations

This section offers guidelines for incorporating the economic impact of mite management into the decision-making process. Variables such as time of season, crop load, and miticide costs and efficiency are considered, along with predatory mite and *Stethorus* counts. Action thresholds have been developed to aid in making mite management decisions. An action threshold is a mite population level at which control measures should be taken to prevent economic damage. Factors that tend to lower action thresholds are damage by other pests (e.g., white apple leafhopper) and severe weather conditions (e.g., extremely dry conditions intensify the losses from mite damage).

Figure 2-3 includes mite action thresholds for various crop loads at different times of the growing season. To use this figure, determine the number of mites per leaf based on either percent mite-infested leaves or actual counts after an acaricide has been applied. Next, estimate the projected production per acre (har-

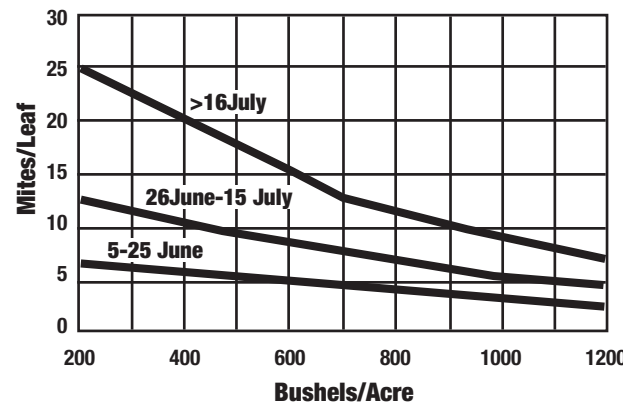

Figure 2-3. Action thresholds for mites in Pennsylvania.

Table 2-3. European red mite densities predicted from the percentage of mite-infested leaves.

Percentage of mite-infested leaves ^a	Expected density in mites/leaf	Limits of mite populations in mites/leaf ^b
40	0.7	0.25–1.20
45	0.9	0.35–1.45
50	1.1	0.45–1.75
55	1.3	0.60–2.15
60	1.6	0.80–2.65
65	2.0	1.05–3.25
70	2.6	1.35–4.10
75	3.4	1.85–5.35
80	4.7	2.55–7.25
85	6.8	3.85–10.55
90	11.4	6.50–17.55
95	26.4	15.30–40.30

a. Leaves with at least 1 motile stage.
 b. 95% confidence interval.

vested bushels) for the affected block. Select the threshold line on the figure for the appropriate time of the growing season. For a given time of the growing season and a given estimated crop load, if the mites per leaf exceed the threshold, then control either by using predatory mites, *Stethorus punctum*, or by applying miticides. If you are using the alternate row middle system of spraying to make your miticide applications, reduce the action threshold to one-half the figure value since you are only spraying one-half of the tree. These levels apply to healthy, vigorous trees with mite damage occurring only after June 5 (Table 2-4).

If the mites per leaf do not exceed the action threshold, no control action need be taken. Typically, orchards with stable populations of *T. pyri* never reach these thresholds as they never leave the tree and exert their control over pest mites in the spring and fall. Mite control with *N. fallacis* is much more variable. They do not overwinter on the tree but instead move up from the weeds in the ground cover midseason and sometimes arrive too late to exert their control over pest mites. Alternate row middle spray with a selective miticide is sometimes required to establish the proper predator-to-pest ratio for biological control. For both *T. pyri* and *N. fallacis*, a predator-to-prey ratio of 1 predator to 10 pest mites will almost always ensure biological mite control if not disrupted with toxic pesticides. *Z. mali* is strictly an egg predator and mostly supplements early and late season control with the other predator mites. For biological control with *Stethorus*, populations should be assessed by determining a predator-to-mite ratio. To calculate predator-to-mite ratios, divide the number of *Stethorus* adults and larvae counted in 3 minutes by the number of motile mites per leaf. Example: 25 *Stethorus* adults and larvae divided by 10 motile mites per leaf equals a predator-to-mite ratio of 2.5. If the predator-to-mite ratio is less than 2.5 and the action threshold has been reached, then a miticide application is justified. The orchard should be checked again in 5 to 7 days.

Biological control with *Stethorus* and predatory mites

- Avoid pesticides that are toxic to the natural enemies (see Table 4-5).
- Do not attempt to eliminate the entire mite population and in the process also risk eliminating predatory mites.
- The alternate row middle pesticide application method is sometimes recommended, although certain conditions will dictate the use of complete sprays. These conditions include extremely high mite pressure, use of a pesticide of questionable

Table 2-4. Relationship between number of European red mites per leaf at their peak and accumulated number of mite days per leaf.

Peak number of mites/leaf	Expected accumulated number of mite days	Expected limits of number of mite days ^a
5	88	0–332
10	176	0–420
15	263	10–507
20	351	107–595
25	439	195–683
30	527	283–771
35	615	371–859
40	702	458–946
45	790	546–1,034
50	878	634–1,122

a. 95 percent confidence interval—there is only a 1 in 20 chance of the accumulated mite-day value falling outside of this range.

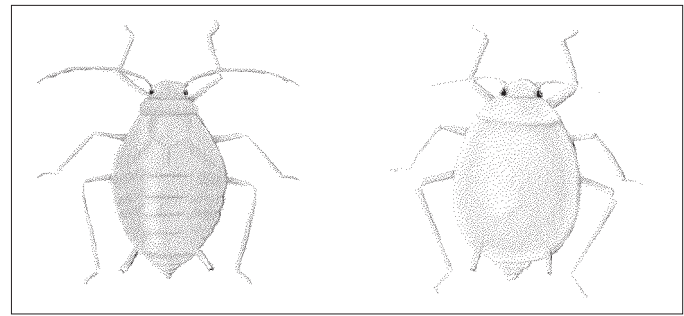

Rosy Apple Aphid

Green Apple Aphid

efficacy, inadequate spray coverage, and weather conditions conducive to a rapid increase in the mite population.

- The population densities of the mites and the beetles must be known in order to determine if the predator populations are sufficient to overcome the mite population or if the aid of a miticide is needed.

Chemical management

- Closely monitor mite populations.
- Encourage natural enemies into the orchard by using insecticides and miticides more selectively.
- Use action thresholds to determine the necessity of spraying.
- Rotate miticides within the same season (i.e., do not use the same chemical more than once in the same growing season).
- Spray late in the evening or at night for better coverage and contact.
- If using the alternate row middle method to apply miticides, do not allow the number of mites to get too high before applying a miticide (i.e., use one-half the thresholds listed above). If properly timed, only one alternate row middle application may be needed.
- Increase the volume of water to 100 gallons per acre if coverage is a problem.

The efficacy of various acaricides is detailed in Table 4-7 (apple), Table 4-11 (pears), and Table 4-13 (stone fruit).

GREEN APHIDS (APPLE APHID AND SPIREA APHID)

Spirea aphid, *Aphis spiraecola*, has largely displaced the apple aphid, *A. pomi*, in apple since the mid-1980s. The spirea aphid has a broader host range and is more likely to immigrate into apple than apple aphid, which may stay on apple year round or immigrate later in the season. The spirea aphid also tends to be less susceptible to insecticides than the apple aphid. However, these two species are difficult to distinguish and are managed together as green aphids.

Description and life cycle

Overwintering eggs are small, shiny, and black and cannot be distinguished from those of other aphid species. Stem mothers are wingless females that are pear-shaped and bright green. Immature green aphids can readily be distinguished from immature rosy apple aphids by shorter antennae and less well-developed cornicles. In the summer aphids vary from a yellow-green to a light green and have black cornicles.

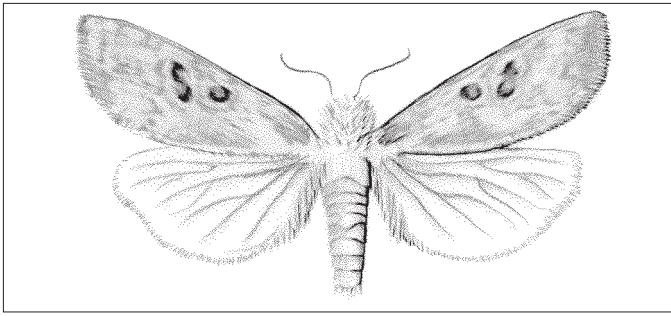

Adult Green Fruitworm

Eggs are laid on bark and/or on buds in the fall by the wingless female. They hatch at about silver tip into stem mothers which give birth to a generation of green viviparous aphids, about three-quarters of which develop into winged females. The rest remain wingless. The winged forms spread the species to other parts of the tree or other trees. About half of the second generation and some of the later generations may develop wings and migrate.

Unlike the rosy apple aphid, green aphids may live on the apple tree all year, breeding continuously during the summer. In August and during the autumn months, these aphids are found almost exclusively on watersprouts or terminal branches of young trees that are still growing, and where male and female sexual forms are produced.

Monitoring

Since the overwintering eggs are indistinguishable from rosy apple aphid eggs, early season scouting and management for both species are identical. However, because this aphid complex does not migrate to alternate hosts as rosy apple aphids do, it must be scouted for and managed until the terminals harden off. Beginning in early June, select 10 growing shoots, not watersprouts, on each of five trees of the major variety within the block. On each shoot, determine the number of leaves that have wingless aphids. If an average of more than 4.2 leaves per shoot are aphid infested, and less than 20 percent of the aphid colonies have predators, an insecticide application is recommended.

Cultural management

A number of natural enemies of aphids have proven effective for biological control of aphids in Mid-Atlantic apple orchards. They include syrphid fly larvae, aphid midge, lacewing larvae, and ladybird beetle adults and larvae. These predators appear as soft-bodied and sometimes very colorful larvae feeding right in the aphid colonies. A single syrphid larva can clean a leaf of aphids in days. A pesticide application may be delayed or eliminated if 20 percent of the colonies have predators. Use of pesticides with low toxicity to the predators (see Table 4-4) will increase the chance for biological control.

Chemical management

Insecticides with aphicidal activity are listed in Table 4-6.

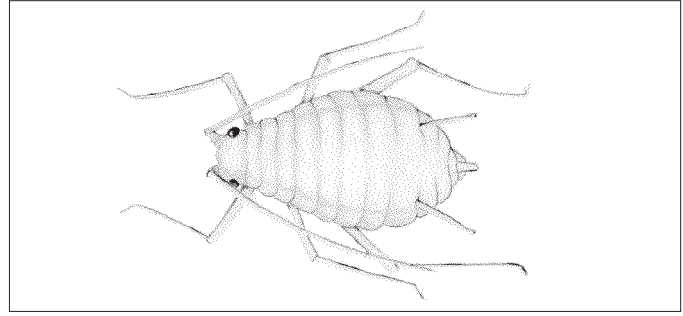

Green Peach Aphid

GREEN FRUITWORMS

The speckled green fruitworm, *Orthosia hibisci*, is the most common of several green fruitworm pests occurring in commercial orchards. The larvae feed on a variety of deciduous shade, forest, and fruit trees including apple, pear, and cherry. These pests have only one generation annually.

Description and life cycle

Adults are night-fliers whose flight period closely parallels apple bud development. Flight begins at about green tip, peaks at tight cluster, and ends by the pink stage. Adults are about $\frac{2}{3}$ inch in length. Their forewings are grayish pink, each marked near the middle by two purplish gray spots outlined by a narrow, pale border. The hind wings, not visible when the moth is at rest, are slightly lighter in color than the forewings. Freshly laid eggs are white with a grayish tinge and have numerous ridges radiating from the center. Shortly before hatching the egg takes on a mottled appearance. Newly hatched larvae are $\frac{1}{4}$ inch long and have a grayish green body with a brown head and thoracic shield. Mature larvae are $1\frac{3}{16}$ to $1\frac{5}{8}$ inches long and have a light green body and head. Several narrow white stripes run longitudinally along the top of the body, while a slightly wider, more distinct white line runs along each side. The green areas between the stripes are covered with numerous white speckles. Pupae are dark brown and about $\frac{5}{8}$ inch long.

Females begin egg laying on twigs and developing leaves when apples are in the $\frac{1}{2}$ -inch green stage. A female is capable of laying several hundred eggs but normally deposits only one or two at any given site. Young larvae feed on new leaves and flower buds and can often be found inside a rolled leaf or bud cluster. Older larvae damage flower clusters during bloom and continue to feed on developing fruit and leaves for 2 to 3 weeks after petal fall. They then drop to the ground, burrow 2 to 4 inches beneath the soil surface, and pupate over the winter.

Most flower buds and blossoms damaged by larvae abort. Most fruit damaged just before and shortly after petal fall also drop prematurely. Some, however, remain at harvest and exhibit deep corky scars and indentations. This injury is indistinguishable at harvest from that caused by the overwintering larvae of the obliquebanded leafroller.

Monitoring and management

Orchards with a history of green fruitworm injury should benefit from effective insecticide applications at both prepink and petal fall.

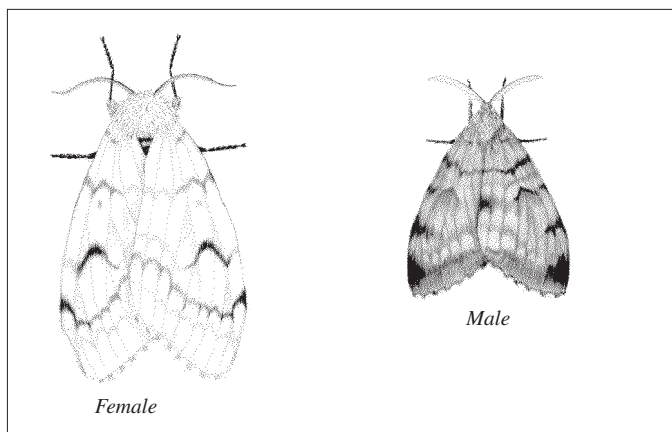

Gypsy Moth

GREEN PEACH APHID

The green peach aphid, *Myzus persicae*, is a common pest of peach and nectarine in Pennsylvania. Resurgence of this aphid on peaches following sprays of broad-spectrum foliar insecticides is attributed to the destruction of natural predators and to insecticide resistance.

Description and life cycle

The green peach aphid is recognized by three longitudinal dark green stripes on the pale green body. This species has a complex life cycle, with five distinct morphological forms and two different behavioral forms. Its primary host and overwintering source is peach trees. Green peach aphids overwinter as wingless females and/or eggs underneath peach buds. Eggs hatch and young nymphs develop into stem mothers, which produce living young. After several generations of wingless adults, winged aphids appear during June, and all aphids leave peach trees during June and July. These migrant aphids do not affect peaches because they infest other crops and weeds. Large numbers of green peach aphids may develop on weeds in the ground cover of peach orchards. Aphids return in the fall to peach trees to overwinter.

Monitoring and management

Trees should be inspected weekly from petal fall until the terminals harden off. For nectarines the treatment threshold is one colony per tree, and for peaches the threshold is five or more colonies per tree. Large trees can tolerate higher levels of infestation. Currently available insecticides provide excellent control of green peach aphid. Neonicotinoid compounds (e.g., Actara, Assail, Belay, Calypso, Provado) or Movento are the most effective insecticides; thorough coverage of lower leaf surfaces is necessary. Predators such as syrphid fly larvae and ladybird beetles often contribute to biological control of this aphid.

The green peach aphid is a known vector of the quarantine stone fruit disease plum pox (Sharka), which was identified in late 1990s in some south-central Pennsylvania peach and nectarine orchards. Plum pox disease is one of the most devastating diseases of stone fruit in Europe.

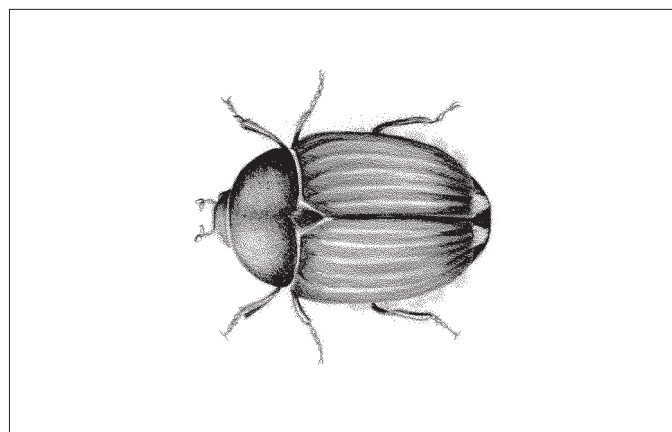

Japanese Beetle

GYPSY MOTH

Gypsy moth, *Lymantria dispar*, may attack fruit trees, especially apple, causing defoliation that can stunt or kill young trees.

Description and life cycle

Egg masses deposited in July on trees, rocks, and other surfaces hatch the following year in April and May. Orchards may be invaded by young larvae ballooning long distances on silk threads. Larvae pupate in mid- to late June and adults emerge in July. Females cannot fly.

Monitoring and management

Trees should be inspected in early June. If gypsy moth larvae are found, they may be removed by hand and destroyed, or killed with an insecticide. *Bacillus thuringiensis*-based compounds are effective insecticides with low toxicity to other animals.

JAPANESE BEETLE

Japanese beetle, *Popillia japonica*, is one of the best-known pests to be encountered by Pennsylvania fruit growers, nursery operators, and gardeners. It is often the most important pest of tree-ripened peaches and can cause severe damage to other important crops.

Description and life cycle

Japanese beetle adults have metallic green bodies with coppery brown wing covers surrounded with 12 white tufts of hair. Eggs are pearly white, elliptical, and $\frac{1}{16}$ inch in diameter. The soft-bodied grubs are whitish with a brown head, "C" shaped, and are 1 inch long at maturity.

Japanese beetles overwinter in the soil as grubs and complete their growth in early spring. Adults emerge in greatest numbers during July and are active for a month. The gregarious beetles are most active on warm, sunny days on favorite hosts. Adults enter the ground in early evening. Females lay 40 to 60 eggs that hatch in 2 weeks. Grubs feed on organic matter and fine grass roots until late fall. They reach maturity in early spring and, after spending 3 to 4 weeks in the pupal stage, emerge as adults. There is only one generation per year.

Adults feed on leaves and fruit. They chew leaf tissue between veins and leave a lacelike skeleton. Severely injured leaves soon turn brown and often drop. Fruit of early ripening peach trees may be gouged in irregular, shallow patches.

Monitoring and management

Fruit and foliage may be protected from damage by spraying at regular intervals when beetles first cause unacceptable injury. Because sprayed trees can be reinvaded, they should be inspected weekly when adults are present.

LESSER APPLEWORM

Lesser appleworm, *Grapholita prunivora*, is a common species, although infrequent as a pest in Pennsylvania orchards. Larvae are general fruit feeders attacking apples, pears, peaches, apricots, plums, and cherries.

Description and life cycle

Adults are only $\frac{1}{4}$ inch long and are brownish and yellowish colored. When the moth is at rest, a gold band becomes evident across its back. Eggs are white to yellowish and are laid singly on leaves and fruit. Larvae are pinkish, have an anal comb, and reach $\frac{3}{8}$ inch when mature.

Lesser appleworm has two and possibly a partial third generations in Pennsylvania. This insect overwinters as full-grown larvae in a cocoon on the tree, under loose bark scales, or in litter on the ground. The life cycle overlaps closely with codling moth.

Larvae form extensive shallow mines under the fruit skin and may burrow deeper as they mature, although not into the core. Feeding injury in the fall is often limited to the calyx region.

Monitoring and management

Management procedures (except species-specific mating disruption) for codling moth also control this pest.

LESSER PEACHTREE BORER

Lesser peachtree borer, *Synanthedon pictipes*, is an important pest in peach and cherry orchards throughout Pennsylvania and surrounding states. Problems are almost always associated with widespread incidence of Cytospora canker and, to a much lesser extent, pruning wounds, winter injury, and mechanical damage.

Description and life cycle

Adults are day-flying moths that resemble wasps. Veins and margins of transparent wings are fringed with steel-blue scales; the body is blue and narrowly fringed with yellow. Males of lesser peachtree borer have yellow scales on the top of the head between the eyes and black scales between the antennae. This combination differentiates them from peachtree borer males, which have black scales between the eyes and yellow scales between the antennae. Lesser peachtree borer larvae are white with a yellowish brown head and reach 1 inch at maturity.

There are two and possibly a partial third generations each year; the first flight occurs during May and June, and the second during August and September. The lesser peachtree borer overwinters as larvae and reaches full growth during April and May. Larvae eat an exit hole nearly through the bark, spin a cocoon, and pupate in a small cavity. In 3 to 4 weeks, a clear-winged moth emerges, leaving an empty pupal skin projecting from the burrow. Adults are active for several weeks. The female moth is capable of laying several hundred eggs in cracks, under bark scales, and in cankered areas. Moths are attracted to trees that have been injured or previously infested. Eggs hatch in a

week to 10 days, and young worms move to the inner bark and continue to feed.

Monitoring

Growers first notice evidence of borer infestation by checking for pupal skins in cankered areas. An early sign of lesser peachtree borer injury is the presence of wood chips, sawdust, and frass produced by feeding borers in the gum in cankered areas. If the gum does not contain this particulate material, the injury is probably not caused by borers. As an aid in timing sprays, growers should obtain pheromone trap records on flight activity. Treat at peak flight, usually toward the end of June, if there is an average of more than two borers per tree, and again in late summer. If fewer than two pupal skins are located in each tree, target only the second generation in late summer.

Cultural management

Any horticultural practice that prevents canker and maintains good tree development will help prevent borer damage.

Mating disruption

The Isomate PTB Dual pheromone was registered in 2009 for the control of lesser peachtree borer on peach, nectarine, cherry, prune, plum, and apricot. It replaces the Isomate L mating-disruption product. Dispensers release pheromones for 100 to 120 days and should be placed in the orchard before moth emergence in the spring. For effective control of lesser peachtree borer, use at least 150 pheromone dispensers per acre. To improve the efficacy of mating disruption, distribute the dispensers uniformly throughout the entire block.

Chemical management

High-volume handgun sprays thoroughly wetting trunk and scaffold limbs are necessary, with at least 1 gallon of spray mixture applied per tree. The late summer spray can be applied after harvest. If peachtree borer is also a problem this spray should be made within the first 2 weeks of September. If only lesser peachtree borer is present, sprays may be applied to late maturing varieties in early August. Do not allow spray residue to contaminate fruit.

MULLEIN PLANT BUG

Mullein plant bug, *Campylomma verbasci*, is a “two-edged sword” of the insect world. During one part of its life it is a beneficial insect feeding on pests such as aphids, thrips, and pear psylla, but in the early season when fruits are forming it feeds on flowers and developing fruitlets potentially causing serious direct damage to the crop. An increase in activity of this pest was noted in Pennsylvania in the early 1990s.

Description and life cycle

Mullein plant bug adults are gray-brown, elongate-oval, and $\frac{1}{10}$ inch long. Nymphs are pale green, and when older, develop black spines on the legs. Nymphs may be confused with white apple leafhopper, but have a stouter-looking body and thicker, distinctly segmented antennae with a dark stripe near the base.

This plant bug overwinters as eggs in the woody tissues of several host plants, including apple and pear. Only a small part of the egg ($\frac{1}{28}$ inch long) is visible without slicing into the host tissue. In the spring, eggs hatch beginning about tight cluster and

finishing about petal fall. There are two to four generations per year, with each lasting about 3 to 4 weeks.

Mullein plant bug stays primarily on woody host plants such as apple and pear in the spring, but later generations move to weedy hosts, most notably mullein, for most of the summer. In the fall they move back to woody hosts, mate, and lay eggs. Around bloom and early fruit development mullein plant bug feeding on fruit produces a dark, raised, corky wart, often surrounded by a shallow depression. Multiple feeding punctures or “stings” on a fruit may cause the fruit to be misshapen. Stings are more notable on Golden Delicious than on red cultivars, and the scars may be light tan in color. Early blooming cultivars are more seriously affected. Many of the injured fruits will drop during June.

Monitoring and management

At this point, the mullein plant bug is an infrequent pest in Pennsylvania. If orchard records indicate feeding damage in past years, especially on yellow-skin varieties, then attention should be paid to this pest around the flowering period. If fruit damage was present but not heavy the previous year, then populations should be assessed just prior to and during bloom. A beating tray or close visual examination of flowering and fruiting structures may be used to determine the presence of small nymphs. If fruit damage was heavy in the previous year, a diazinon spray may be applied prepink. Mullein plant bugs seen later in the season are not harmful to the crop.

OBLIQUEBANDED LEAFROLLER

Obliquebanded leafroller, *Choristoneura rosaceana*, is native to and widely distributed throughout temperate North America. Larvae feed on a wide range of plants. Their preferred hosts are plants from the family Rosaceae, including apple, peach, and pear. Although historically this leafroller is considered a minor pest in Pennsylvania, multiple outbreaks in various areas are cause for concern.

Description and life cycle

This species is one of the larger leafrollers feeding on tree fruit in Pennsylvania. Adults are ½ inch long with a wingspan of 1 inch. The forewings are light reddish-brown and are crossed by three oblique chocolate brown bands. The hind wings, not visible when the moth is at rest, are pale yellow. Egg masses are laid on the upper surfaces of leaves, are greenish yellow, are about ⅓ by ⅜ inches in area, and may contain 200 or more eggs. The black head capsules of embryonic larvae become visible just before they hatch. Newly hatched larvae have a yellowish green body and a black head and thoracic shield. Mature larvae are 1 inch long and distinct from other leafrollers by the combination of either a black or variably brown head and thoracic shield with a green body. Pupae are dark brown, about ½ inch long, and are usually found in rolled leaves on the tree.

Obliquebanded leafroller has two generations per year, overwintering as small larvae in the trees. The overwintering larvae become active when trees break dormancy, and they complete their development about 3 weeks after the apple blossom period. Adults begin to emerge in late May or early June. Females can lay up to 900 eggs during a 7- to 8-day oviposition period. Eggs hatch in about 10 to 12 days. This generation takes almost two months to complete development. Adult flight of the second

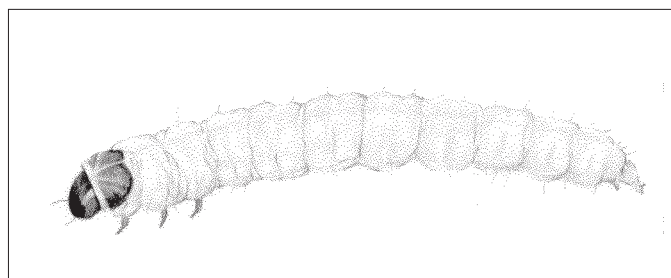

Oriental Fruit Moth (larva)

generation occurs in August, and the larvae hatch in August and September. Young larvae construct hibernation sites on twigs or bark to spend the winter.

This species has three feeding periods during the year. Overwintered larvae feed on developing flower buds and floral parts throughout the blossom period. After petal fall, these larvae continue to feed on developing fruit. Newly hatched first generation (summer) larvae move to and feed on tender growing terminals, watersprouts, or developing fruit. As these larvae reach the third instar, they display an increasing propensity to damage fruit. The second-generation larvae, which develop in late summer and fall, feed primarily on leaves until they enter diapause, although they may occasionally damage fruit.

Monitoring and management

Scout for larval shelters at petal fall. A petal fall treatment with an insecticide effective on mid-sized to large larvae should control overwintered larvae. The flight of adults can be monitored with pheromone traps. The trap data can establish biofix and estimate the population density. The second window of control is in June/July, when most summer-brood eggs have hatched.

The efficacy of various insecticides for control of obliquebanded leafroller larvae is listed in Table 4-6. Since the larvae preferably feed on or inside young growing terminals, it is recommended to repeat insecticide applications if intensive new terminal growth occurs.

ORIENTAL FRUIT MOTH

Oriental fruit moth, *Grapholita molesta*, is a pest of most stone and pome fruits. In pome fruits, its appearance and injury is similar to that of the codling moth and lesser appleworm.

Description and life cycle

Adults are gray, with a wing spread of ¼ inch; the wings are gray with dark markings. Eggs are single, flat, whitish ovals on twigs or the undersides of leaves. Larvae are pinkish white with a black head and reach ½ inch at maturity. Larvae are distinguished from codling moth by the presence of a black anal comb on the bottom of the last body segment.

Oriental fruit moths have four to five generations per year in Pennsylvania, with the first and last two generations most numerous. They overwinter as larvae in silken cocoons on the tree or on the ground, and they pupate and begin to emerge as adults during April, shortly before peach trees bloom. These females lay up to 200 eggs, primarily during May. The succeeding overlapping generations extend into September and October.

The earliest indication of injury is a dying back of the new growth of twigs in spring. A first-generation larva enters at a

leaf axil near the tip of a shoot and bores down the central core for several inches, causing the terminal to wilt, or “flag.” Later-generation larvae may enter the fruit near the stem end and make feeding burrows that can extend to the pit or to the core. In peaches, the mature larva exits the fruit from the side, leaving a large gumming hole with much frass. In apples, Oriental fruit moth larvae may feed around, but not in, the core.

Monitoring and management

Spray timing can be aided by using pheromone traps to establish a biofix (i.e., first sustained capture of two or more moths per trap) and then calculating and recording degree days to determine the percent egg hatch for each generation. Place sex pheromone traps in stone fruit and/or apple orchards in early April and check daily until biofix is established. Then, monitor traps weekly thereafter throughout the season. Table 2-11 gives degree-day calculations for OFM. To use this table, you must record the local temperature each day, beginning with the establishment of biofix. Timing of broad-spectrum insecticide sprays for the first and second generations on peaches are as follows: first generation—150 to 200 and 350 to 375 degree-days following biofix; second generation—1,150 to 1,200 and 1,450 to 1,500 degree-days; and for the third generation, 2,100 to 2,200 and 2,450 to 2,500 degree-days for peaches and 2,450 to 2,500 and 2,900 to 3,000 degree-days

Table 2-5. Timing of insecticide applications on apples and peaches to control the Oriental fruit moth based on crop stage or degree days from biofix.

Crop	Application timing ^a			Comments ^b
	OFM brood	Crop stage or DD (°F)	Approximate egg hatch (%)	
Peach	1	170–195	10–15	Most important spray on peach for first brood. Pest density determines if second application is needed.
	1	350–375	55–60	
Apple	1	Pink	0	To kill adult moths. Most important spray on apple for first brood.
	1	350–375	55–60	
Peach	2	1,150–1,200	15–20	Most important spray for second brood. Pest density determines if second application is needed.
	2	1,450–1,500	65–72	
Apple	2	1,450–1,500	?	Very important if trap threshold exceeded (>10 moths/trap/week) and/or fruit injury is found. Use only a single application for second brood on apple.
Peach	3	2,100–2,200	10–20	Very important if trap threshold exceeded (>10 moths/trap/week) and/or fruit injury is found.
	3	2,450–2,500	50–60	
Apple	3	2,450–2,500	?	Important if trap threshold exceeded (>10 moths/trap/week) and/or fruit injury is found.
	3	2,900–3,000	?	
Both	4	September	?	Important if trap threshold exceeded (>15 moths/trap/week) and/or fruit injury is found.

a. Application timings for products with ovicidal activity (e.g., Rimon, Intrepid, Assail, Calypso) may be earlier (e.g., 100–150 DD) than those specified due to their mode of action.

b. Pheromone trap catches and monitoring for pest injury (e.g., flagging and fruit injury) should be used to determine the need to spray.

for apples. See Table 2-5 for more information about insecticide timing for OFM control. The differences in larval development due to feeding on various food sources (e.g., terminals, fruits, apple, peach) and possible adult movement between adjacent apple and peach orchards contribute to significant overlapping between generations late in the season. Using pheromone traps to monitor the OFM population in each block is necessary to assess the potential problems caused by this pest.

Mating disruption materials such as sprayable pheromones and hand-applied dispensers (e.g., Isomate M-100, Isomate Rosso, Cidetrak OFM or Disrupt OFM) can be used to manage this pest. If codling moth is also a problem in the same block, then Isomate CM/OFM TT or Checkmate CM-OFM Duals should be used for the control of both species. Hand-applied dispensers should be placed in the upper level of the tree canopy at the label rate at the pink stage. Various kinds of hand-applied dispensers are available on the market, but even the dispensers with the shortest pheromone release time remain effective for at least 90 days. The sprayable pheromones can be applied together with routine pesticide applications. Their effective time depends on pheromone formulation, rate, and weather conditions. Ideally, orchards should be at least 5 to 10 acres in size for mating disruption to be effective. Moreover, monitoring should proceed as usual to check the effectiveness of disruption.

In addition, some new mating disruption technologies such as low-number point release (Disrupt OFM mats or CheckMate Puffer OFM), micro dispensers (Disrupt OFM Micro Flakes), or attract-and-kill products (Last Call OFM) are being developed and are available for Oriental fruit moth control.

PEACHTREE BORER

The peachtree borer, *Synanthedon exitiosa*, is primarily a pest of peach and nectarine trees, but it also attacks apricot, cherry, and plum. This native American borer has been known since colonial times and is a pest wherever peaches are grown.

Description and life cycle

Adults resemble wasps when flying and are often mistaken for them. Female moths are dark blue with a broad orange band around the body and forewings darker than the clear hind wings. The male is smaller and has three to four narrow yellowish bands across the body; both pairs of wings are clear. Males of peachtree borer have black scales on the top of the head between the eyes and yellow scales between the antennae. This combination differentiates them from males of lesser peachtree borer, which have yellow scales between the eyes and black scales between the antennae. Larvae are white with a brown head and 1.5 inches long at maturity.

Peachtree borer has a single generation per year, but it can result in severe losses if not managed correctly. This borer overwinters in a wide range of larval stages. Larvae become active and resume feeding in April, with larger larvae completing their feeding during June and July. Most adults emerge and lay up to 500 eggs during July and August on tree trunks, in cracks or under bark scales, and in soil near the tree trunk. Eggs hatch in 10 days and young larvae feed on tree bark, working their way into the trunk as they become larger. One of the first signs of peachtree borer attack is a mass of gum exuding from the trunk base approximately 3 inches above to 1 foot below soil surface.

This gum mass contains bits of wood chips, sawdust, and frass produced by the feeding larvae. Burrowing larvae weaken the tree, resulting in lower fruit production or, if borers are numerous, death of the tree. Neglected trees or those suffering from drought or winter injury are most likely to be infested.

Monitoring

Pheromone trap capture peaking at less than ten moths per week generally indicates that this species is not causing losses. If any evidence of feeding is observed on trees up to three years old, a treatment is warranted. Older trees with more than one larva per tree should be treated.

Cultural management

Maintain healthy trees.

Mating disruption

The Isomate PTB Dual mating disruption pheromone dispensers are registered for the control of peachtree borer on peach, nectarine, cherry, prune, plum, and apricot. Dispensers release pheromones for 100 to 120 days and should be placed in the orchard before moth emergence in early June. For effective control of peachtree borer, use at least 150 Isomate PTB Dual pheromone dispensers per acre. To improve the efficacy of mating disruption, distribute the dispensers uniformly throughout the entire block. The Isomate PTB Dual will also control lesser peachtree borer, but has to be placed in the orchard earlier in the spring before adult LPTB emergence.

Chemical management

Roots should be dipped in an insecticide solution before planting. Protective trunk sprays should be applied in the summer from the lower scaffold branches to the soil line (see Part V, IPM Spray Programs). Soak the bark to runoff, so that a puddle of solution can be seen at the base of the tree.

PEAR PSYLLA

Pear psylla, *Cacopsylla pyricola*, can be a limiting factor in pear production. It is a native species that produces abundant honeydew, which allows a sooty fungus to grow on the fruit surface. The result can be severe tree injury.

Description and life cycle

Pear psylla adults look like small, dark reddish brown, 1/10-inch-long cicadas. Eggs, just visible to the naked eye, are pear-shaped, yellowish, and are laid in cracks in the bark and around the buds. They become dark yellow before hatching. Nymphs have sucking mouthparts and feed on plant sap. The young nymphs are soft-bodied and creamy yellow. As they mature they become dark brown and more oval in shape, with distinct wing pads present on the late instars. These late instar nymphs are commonly referred to as “hard shells.”

There are generally four generations per year. The adults, which overwinter on trees or other sheltered places, become active anytime the temperature is above 40°F. Females begin laying eggs in late March and continue through the white bud stage. One female can produce as many as 650 eggs. The peak of egg laying is green tip to green cluster bud. Eggs hatch begins at the green cluster bud to white bud stage, with peak hatch occurring about petal fall. Nymphs move to succulent stems and developing

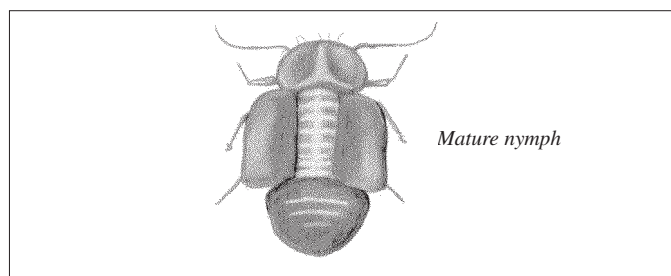

Pear Psylla

leaves to feed, with the heaviest concentration along the mid-veins of leaves and at the calyx end of fruit. They pass through five instars, each subsequent stage becoming more difficult to control. The early nymphal stages produce more honeydew than the later, larger stages. The first summer adults mature about 20 to 25 days past full bloom. They begin laying eggs on growing shoots as the population shifts from spur leaves to the more succulent shoot leaves. Late season infestations are typically found on water sprouts.

The pear psylla secretes large amounts of honeydew, which runs down over foliage and fruit and in which a sooty fungus grows. This causes the skin of the fruit to become blackened and scarred and the foliage to develop brown spots. Heavy infestations may cause partial to complete defoliation of trees, reducing vitality and preventing the formation of fruit buds. Return bloom and fruit set are often reduced the following season. Overall tree growth can be stopped or stunted with heavy psylla injury. These combined effects are often termed “psylla shock.” There is also limited evidence that psylla inject some type of toxin into the tree, causing a disease known as pear decline. In addition, pear psylla have been implicated in the transmission of fire blight.

Monitoring

Growers should monitor for the presence of pear psylla using their most sensitive pear variety (e.g., Bartlett). To sample for pear psylla nymphs in the early season, examine at least 10 leaves (five spur and five recently expanded shoot leaves) per tree on a minimum of five trees per block. The action threshold at this time is 0.5 nymphs per leaf. For the summer generations again examine at least 10 leaves (recently expanded shoot leaves) per tree on a minimum of five trees per block. The action threshold now is 1.5 nymphs per leaf. When the psylla population is primarily in the adult stage, examine the leaves for the presence of adult activity and egg laying.

Cultural management

Several cultural control practices will reduce psylla populations and dependence on insecticidal control. First minimize heavy pruning, which encourages the proliferation of terminal shoot growth. An overabundance of terminals provides more feeding sites for the psylla. Second, pear trees should receive the minimum amount of nitrogen fertilization necessary for proper tree and fruit growth. Overfertilization can cause extended terminal growth and delay hardening off, allowing optimal feeding conditions for the psylla. Third, and most important, is to remove water sprouts during late June and early July. Because water sprouts provide one of the only sources of succulent leaves at this time of the year, this technique can eliminate a large portion of the psylla population.

Chemical management

In orchards with a history of psylla infestations, insecticidal control begins with a strong prebloom spray program designed to eliminate as many overwintering adults as possible before they have the opportunity to lay many eggs. As with all psylla sprays, good coverage is critical for control of this pest. All sprays should be applied to both sides of the trees and in a volume of water high enough to thoroughly wet and cover the entire tree. In most situations, this requires at least 100 gallons per acre. Surfactants may be added to achieve better coverage. Alternate row middle applications are not recommended unless tree size is quite small.

The first application should include oil, which has been shown to delay egg laying by over 95 percent for a 5-week period, plus an adulticide to eliminate adult psylla overwintering on the tree. This application also serves to concentrate in time a higher proportion of pesticide-vulnerable individuals later in the season. Typically, egg deposition and hatch occurs over a long period of time, making pesticide timing difficult. Early season oil sprays “bunch up” the population so sprays can be more easily targeted. The early season oil application must be applied prior to egg maturation in the female psylla. For growers in south-central Pennsylvania, this application should be made in most years by March 15–20.

With the oviposition period delayed, the delayed dormant spray (bud burst) becomes extremely important because additional adult control can be achieved by waiting until adult psylla that are living away from the pear tree return from their overwintering sites. This spray should again contain oil as well as an adulticide such as one of the synthetic pyrethroids.

The next prebloom spray should be applied between the green cluster bud stage and the white bud stage. This is the period when first-generation eggs begin to hatch. A number of very effective insecticides are available for this spray: Centaur, endosulfan, Esteem, and synthetic pyrethroids.

The next vulnerable period occurs at petal fall, when the first generation nymphal population is usually at its peak. The best materials currently available are Agri-Mek and Actara. Since petal fall is a key period for the activity of other pests that attack pears, it is usually necessary to add a broad-spectrum organophosphate insecticide at this time. If the four applications recommended thus far are carefully applied, psylla populations should be very low.

The next major period to control psylla is not until the second generation of nymphs begins hatching about mid-June. The new insecticide Delegate and/or neonicotinoid insecticides such as Provado, Actara, Assail, Calypso, or Belay are probably the insecticides of choice owing to their activity against early instar nymphs. A second application should be repeated within 10 to 12 days of the first to control additional nymphs hatching from eggs. If the population warrants additional applications, these can be made against the third generation of nymphs, which usually begin hatching around mid- to late July. Since the second and third generations tend to overlap during the season, close attention should be given to determining which nymphal stages are present, since insecticides are most effective when directed against the early instars. Growers should rotate to different insecticidal chemistries for each spray. The efficacy of various insecticides for control of pear psylla is listed in Table 4-10.

PEAR SLUG

The pear slug, *Caliroa cerasi*, resembles a slug in appearance, but it is actually a sawfly. It is rarely a pest in commercial pear orchards but may appear as sprays for other insects are reduced.

Description and life cycle

Adults are small ($\frac{1}{5}$ inch), black sawflies with transparent wings. Larvae are shiny black and sluglike with seven pairs of prolegs in addition to three pairs of true legs, and reach $\frac{1}{3}$ inch long at maturity.

Pupae overwinter in the soil. Adults emerge in the spring and begin oviposition by inserting eggs into small slits in the leaf, laying two to five eggs per leaf. Females produce eggs without mating. Larval feeding results in skeletonization of the upper leaf surface, leaving only leaf veins uneaten. Mature larvae drop to the ground and burrow into the soil about 4 inches to pupate. A second generation emerges midsummer and continues skeletonizing leaves. Second-generation damage is usually more severe, sometimes retarding tree growth the following year.

Monitoring and management

The extent of skeletonization should be observed weekly beginning in midsummer. No thresholds are available. Minor feeding is acceptable.

PEAR THRIPS

Pear thrips, *Taeniothrips inconsequens*, was introduced early this century, probably from Europe. It can be a severe pest of sugar maple. Thrips feeding in nectarine blossoms and fruitlets in areas of the state where sugar maples are common has caused scarring injury on the fruit.

Description and life cycle

Pear thrips produce just one generation per year. Adults are dark brown and occur only as females in North America. Adult emergence occurs around the time of leaf flush of sugar maple. In outbreak years pear thrips may infest many deciduous hosts that are in bloom at this time, including most tree fruits. Adult and larvae feeding on developing nectarine fruit can cause scarring injury that expands as the fruit matures. Pear thrips injury to apple blossoms has occurred in New England but is not known in Pennsylvania.

Monitoring and management

Monitoring should begin at bloom in areas at risk for pear thrips. Sample blooms from 10 to 12 trees at each of three to four sites per orchard. Blooms should be slapped against a light yellow surface to determine abundance of adults. The presence of larvae is determined by dissecting at least 50 blooms per orchard. The threshold is adult infestation of more than 5 per 50 blooms or presence of larvae. Carzol provides excellent control of thrips at petal fall.

PEARLEAF BLISTER MITE AND PEAR RUST MITE

Pearleaf blister mite, *Phytoptus pyri*, and pear rust mite, *Epitrimerus pyri*, are similar species, virtually invisible to the naked eye, that often are common on unsprayed trees.

Description and life cycle

Pearleaf blister mite adults are white to light red and extremely

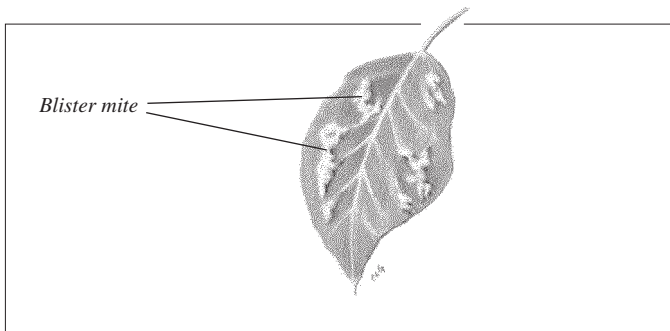

Pearleaf Blister Mite

small ($\frac{1}{100}$ inch). The body is sausage-shaped. Nymphs resemble adults, but are smaller. This species causes brownish blisters that appear on the undersides of leaves and fruit. On pear trees, blisters first appear as small greenish pimples that become reddish, then brown. They may cover the lower leaf surface. On developing fruit, early feeding causes depressed russeted spots surrounded by clear halos that look like blisters. Since these mites do not move very quickly or very far, their infestations are often confined to single trees or even single branches. Pear rust mite is similar in appearance to blister mite, but the injury is characterized by a smooth russetting of the fruit.

Adult blister mites enter bud scales in August to September to overwinter. They become active at bud break, migrate to the tender, new leaves, and burrow beneath the epidermis of the undersides of leaves to feed. This results in a gall, or blister, in which the eggs are laid. The nymphs remain in the blister, emerging as adults to migrate a short distance to form new galls.

Monitoring and management

Examine terminal and fruit buds for mites during dormant and again just before bloom. During the summer, examine shoot foliage and the calyx end of developing fruit. Applications of Vydate or Diazinon at delayed dormant or prepink should provide a good control of blister mite.

PERIODICAL CICADA

The periodical cicada, *Magicicada septemdecim*, is a large flying insect with a unique life history. It lives most of its 17-year life underground (Table 2-6).

Description and life cycle

Beginning about the third week in May, in areas where cicada are due to emerge and continuing into June, mature nymphs (young) dig themselves out of the ground in great numbers, crawl to the nearest tree trunk, shrub, or other vertical surface, and climb several inches up. The nymph's skin then splits down the back, and the winged, sexually mature adult emerges. The adult is about 1.5 inches long, mostly black, with red eyes and other reddish markings. The wings are large and clear except for orange-red veins. Males are capable of producing an ear-splitting, high-pitched whine. Females, which produce no sound, are attracted to the males to mate.

A week to 10 days after the males begin "singing," the females begin to lay eggs. Each female lays up to 400 eggs in 40 to 50 pockets in the wood of several small branches of many types of trees. More than 75 species of trees are known to be attacked. The type of branch preferred by the females is about the width

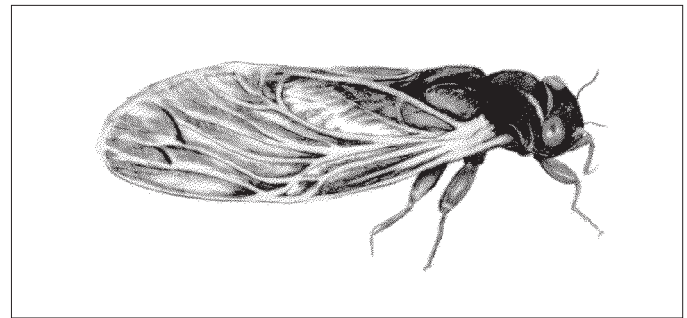

Cicada

of a pencil up to $\frac{1}{2}$ inch in diameter or a little larger. To lay eggs a female slices into the wood of the branch with her egg-laying apparatus and places the egg into the wood. She usually lays one to several dozen eggs in a single branch before moving to another branch or tree. This egg-laying activity lasts approximately 30 days, and about 6 to 7 weeks later the eggs hatch into tiny white nymphs. The nymphs fall to the ground and burrow into the soil to feed on grass roots and, eventually, tree roots for the next 17 years. A numbering system established in 1893 to keep track of these broods is still used today.

Cicadas damage fruit trees in two ways. The most obvious damage is done during the egg-laying process. The slits made by the female in small branches severely weaken them; often the weakened branches snap off in the wind. Under a heavy attack a majority of the branch tips may be killed. In larger trees, where most of the branches are larger than the preferred thickness for egg laying, the loss of even most of the branch tips may not severely damage the tree. However, in small trees 4 years old or less, most of the branches are of the preferred size. Under a heavy attack such a tree can be severely damaged and sometimes killed. Therefore, control measures should be concentrated on these small trees. Moreover, with the emphasis placed on early training and pruning of fruit trees, the loss of incipient scaffold limbs can affect the productivity of a tree for the rest of its life.

The second type of damage is less obvious. After entering the ground the nymphs eventually attach themselves to the roots of

Table 2-6. Emergence of different broods of periodical cicada in Pennsylvania counties by year.

Year	Brood	County
2012	I	Adams, Cumberland, Franklin
2013	II	Berks, Bucks, Carbon, Chester, Dauphin, Delaware, Lancaster, Lebanon, Lehigh, Luzerne, Monroe, Montgomery, Northampton, Philadelphia, Pike, Schuylkill, Wyoming
2016	V	Fayette, Greene, Somerset, Washington, Westmoreland
2017	VI	Bucks, Dauphin, Lancaster, Lehigh, Montgomery, Northampton, Philadelphia, Westmoreland
2018	VII	Allegheny, Butler, Washington, Westmoreland
2019	VIII	Allegheny, Armstrong, Beaver, Butler, Cambria, Clarion, Crawford, Fayette, Forest, Huntingdon, Indiana, Lawrence, Mercer, Venango, Washington, Westmoreland
2021	X	Adams, Bedford, Berks, Blair, Bucks, Carbon, Chester, Clinton, Columbia, Cumberland, Dauphin, Delaware, Franklin, Fulton, Huntingdon, Juniata, Lackawanna, Lancaster, Lebanon, Lehigh, Luzerne, Lycoming, Mercer, Mifflin, Monroe, Montgomery, Montour, Northampton, Perry, Philadelphia, Schuylkill, Snyder, Somerset, Union, York

the fruit tree, insert their needlelike mouthparts into the roots, and feed on nutrients that would otherwise help the tree grow and produce fruit. Feeding by hundreds or even thousands of these insects on a tree root system for 17 years probably affects the tree productivity, although this has never been fully documented.

Monitoring

It is difficult to predict whether or not a particular orchard will be severely affected. The best strategy is to be alert for the first signs of male “singing” and to scout the orchards intensively a week later to look for egg-laying females. Considering the potential damage this insect can cause, a fruit grower can take several actions to minimize any detrimental effects.

Cultural management

Such actions include delaying planting to avoid cicada emergence and postponing until summer the winter pruning of trees less than 4 years old. Delayed pruning would decrease the probability of damage to incipient scaffold limbs and give the grower a chance to remove damaged wood after cicadas have finished laying eggs. Summer pruning and the removal of trimmings from the orchard, if done within the 4- to 6-week period after eggs are laid but before nymphs fall to the ground, would allow the grower to prevent many cicadas from feeding on tree roots for the next 17 years.

During the emergence period the most immediate problem is to protect trees (especially young trees) from damage caused by egg laying. There are two strategies to accomplish this objective, depending primarily on the size of the orchard. Trees in small orchards or backyards can be protected mechanically by enclosing them in netting or some other kind of cloth for the duration of the egg-laying period. This cloth should have a mesh size no larger than about ¼ inch. The netting should be placed on trees when the first male singing is heard and removed after adult activity has stopped. All branches less than ½ inch in diameter should be protected.

Chemical management

If netting is too expensive or too time-consuming, pesticide sprays may be used. There are several pesticide options. Pyrethroid insecticides, with quick knockdown, a fairly long residual action, and repellent properties, are recommended for young fruit trees. The frequency of applications will depend on egg-laying pressure. We recommend scouting the orchard every 2 or 3 days during the egg-laying period to check on the effectiveness of any insecticide applications that have been applied. If much egg-laying activity is apparent, another repeat application should be considered. Neonicotinoid insecticides (e.g., Assail, Calypso) should also provide adequate control of adult cicadas.

Remember that a constant vigil must be kept during an outbreak because cicadas can reinvade an orchard from adjacent woodlots. Be aware that pyrethroids can be disruptive to the *Stethorus*-mite balance in the orchard and will probably cause mite outbreaks later in the season. With small trees, however, this is usually manageable. In orchards with older trees pyrethroid use is not recommended because subsequent mite problems may be more costly than the cicada injury. For larger trees we recommend a mix of Lannate or neonicotinoid insecticides and organophosphate insecticides. These compounds kill cicadas

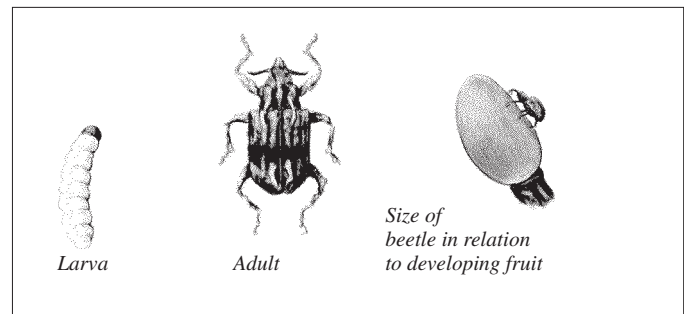

Plum Curculio

although they lack the quick knockdown of the pyrethroids. We do not recommend using carbaryl because of its possible impact on thinning and mites.

PLUM CURCULIO

Plum curculio, *Conotrachelus nenuphar*, is an injurious pest of apples, cherries, nectarines, peaches, and plums throughout the state. The characteristic crescent-shaped oviposition scars are being observed more frequently in Pennsylvania as narrow-spectrum insecticides are used without an organophosphate insecticide after bloom.

Description and life cycle

Adult beetles are ¼ inch long, dark brown with whitish patches, with four humps on their wing covers, and a protruding snout one-third its body length. Eggs are pearly white. Larvae are yellowish white with a brown head, lack legs, and are ¼ inch long when fully grown.

Adult plum curculio beetles first appear in orchards during the time of apple bloom. Most beetle activity occurs during the first warm period after petal fall, when the maximum temperature is 70°F or higher. Periods of cool, rainy weather with maximum temperatures below 70°F are not suitable for curculio activity. The plum curculio is usually more abundant on fruit trees adjacent to woods, fencerows, and trashy fields. Adults can be found in orchards for 5 to 7 weeks. Slight feeding occurs on petals, buds, and blossoms, but there is little injury until the fruit is available. Eggs are laid singly in a small cavity underneath the fruit skin during the first warm periods after petal fall; eggs hatch in 7 days. When fruit is approximately ½ inch in diameter, it provides abundant food and a suitable place for egg laying. Early blooming varieties are the first to provide suitable locations for feeding and depositing eggs.

Adults average over 100 feeding and/or egg punctures during their normal life. Feeding punctures are small, round holes extending ⅛ inch into the fruit; egg punctures are distinguished by a characteristic crescent-shaped cut that partly surrounds the sunken egg. Larvae are most likely to develop in fruit that drops. They make large irregular cavities and feed for about 16 days before maturing. Larvae then leave the fruit and enter the soil where they pupate and emerge as adults during August. These adults feed for a short time before seeking winter quarters. In some years a partial second generation may occur in southern portions of the state. When the eggs fail to hatch, a half-moon scar forms. When the eggs hatch and the larvae begin to feed, the scar is indented and does not expand. These larvae may deform the fruit but rarely complete development in fruit that remains on the tree.

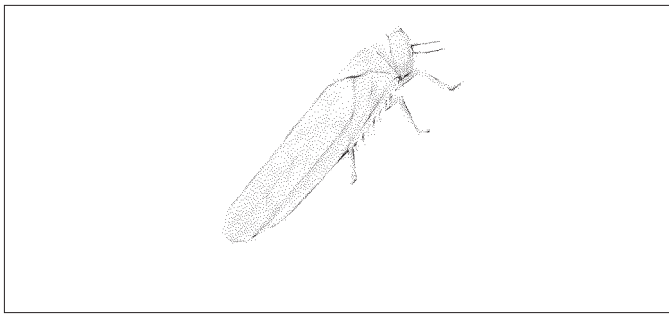

Potato Leafhopper

Monitoring and management

The critical period for controlling plum curculio is during the first few days of warm and humid weather following petal fall, when maximum temperatures remain approximately 70°F. Control is more difficult when feeding is greatly reduced by low temperatures and moderate rains because spray deposits are washed from fruit and foliage. Low temperatures also extend the period during which curculio is active in orchards. Temperature monitoring is important in timing sprays. A spray residue should be maintained for 308 DD base 50 following petal fall (McIntosh). On stone fruits, sprays should be timed for the shuck split stage and repeated if needed.

In blocks with a history of plum curculio injury, the following are important considerations: (1) shorten interval between sprays during peak curculio activity (this may be necessary on outside rows only), (2) increase insecticide rate during peak activity, and (3) select the most effective insecticides without sacrificing control of other pests or interfering with the integrated pest management program. See Table 4-6 for the list of effective insecticides.

POTATO LEAFHOPPER

Potato leafhopper, *Empoasca fabae*, is a migratory pest of many crops. It feeds on leaves of rapidly growing apple terminals and may aid in spread of fire blight.

Description and life cycle

Nymphs and adults of the potato leafhopper are yellowish green to pale green and otherwise resemble white apple leafhoppers. Nymphs tend to move sideways and quickly retreat to the opposite side of the leaf when disturbed.

Potato leafhoppers overwinter as adults in southern states and move northward mainly through the action of storm fronts. They arrive in southern Pennsylvania in late May or early June. Their movement and severity depend on many weather-related phenomena as well as the availability and proximity of alternate food sources. Therefore, the seriousness of this pest is sporadic. It is most damaging from mid-June to mid-August.

Unlike the white apple leafhopper, the potato leafhopper feeds near the edges of leaves. A triangular chlorotic area extends from the feeding site to the leaf edge. If several feeding sites are present on a leaf, the leaf will cup downward. If several leaves on a shoot are affected, shoot growth may be greatly stunted. Feeding by the potato leafhopper in the vascular tissue is such that it may spread fire blight.

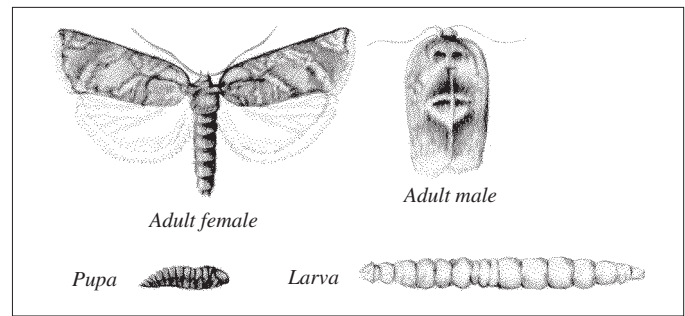

Redbanded Leafroller

Monitoring and management

Scout often after mid-May following frontal systems. No threshold is currently available. Fire blight susceptible varieties and young trees where this species has been a problem in the past should be protected when the first adults appear. Neonicotinoid insecticides (e.g., Actara, Assail, Belay, Calypso, or Provado) have excellent activity against potato leafhopper.

REDBANDED LEAFROLLER

Redbanded leafroller, *Argyrotaenia velutinana*, is considered a minor pest of apples and many other deciduous fruit crops throughout most of Pennsylvania.

Description and life cycle

Adults have a wingspread of ½ inch. The forewing is marked with a band that widens towards the edge. Egg masses of the first brood are deposited on the undersides of larger limbs, while the eggs of the later broods are laid mostly on the upper leaf surface. Larvae are pale green with yellowish heads, and reach ⅝ inch at maturity.

This leafroller has three generations in Pennsylvania. Pupae overwinter in the ground cover. Moths emerge during April and May. First generation larvae hatch at late petal fall. Subsequent flights occur in July and late August. Larvae may be found from May to late September.

Larvae skeletonize leaves from the underside, folding and webbing them together. They feed on the fruit, especially when leaves touch it, making shallow, irregular channels.

Monitoring and management

In orchards with a history of redbanded leafroller problems, the pheromone traps should be used for monitoring moth activity. The redbanded leafroller injury can be controlled by insecticide sprays directed against the early larval instars. See Table 4-6 for the list of effective insecticides.

ROSE LEAFHOPPER

Rose leafhopper, *Edwardsiana rosae*, is becoming more common on apple. Orchards in the vicinity of multiflora rose or brambles are especially at risk.

Description and life cycle

Rose leafhopper resembles the white apple leafhopper in appearance, habits, and tree injury. However, this species is distinguished as a nymph by the presence of small black spots on the thorax and wing pads. Adults are indistinguishable unless dissected. Rose leafhopper overwinters on multiflora rose and

brambles. The first of the three generations per year stays on the overwintering host, with the adults dispersing to apple trees in early June. Nymphs appear on apple trees in early July and adults again in early August, preceding the appearance of white apple leafhopper adults. Watersprouts often have heavier populations of second-brood leafhoppers than other areas of the tree. Moderate drought conditions favor outbreaks.

Besides injuring leaves, leafhoppers deposit numerous small spots of excrement on fruit, potentially reducing its quality. Honeydew secreted by leafhoppers may cause black specks on fruit and foliage.

Monitoring and management

Examine five trees per block, 20 leaves per tree, and check the undersides of leaves for nymphs. One leafhopper per leaf during second-generation activity (third cover) is justification for applying an insecticide. Populations of two or more leafhoppers per leaf during third-brood activity in August and September should be treated. Sprays should be timed for young nymphs. Insecticides recommended for aphid control should adequately control leafhoppers also. Neonicotinoid insecticides such as Provado, Actara, Calypso, Belay, or Assail provide excellent control, although *Stethorus* beetle populations may be adversely affected.

ROSY APPLE APHID

The rosy apple aphid, *Dysaphis plantaginea*, has been a major pest of apple trees since the end of the nineteenth century. While apple trees are its preferred host, this species also feeds on pear and hawthorn trees.

Description and life cycle

The body of this aphid has a waxy coating and usually a slight purplish or rosy tinge; hence the name. Eggs are laid on the bark of apple trees, are oval, and about $\frac{3}{100}$ inch long. When first laid they are a bright yellow that gradually changes to greenish yellow and finally within two weeks to shiny jet black.

Egg hatch occurs between silver tip and $\frac{1}{2}$ -inch green. The young, as soon as they hatch, seek out the opening buds of the apple, seeming to prefer the fruit buds. They feed on the outside of the leaf bud and fruit bud clusters until the leaves begin to unfold. Then they work their way down inside the clusters and begin sucking the sap from the stems and newly formed fruits. Their feeding causes the leaves to curl, affording the aphids protection from insecticide applications and some natural enemies.

The first young develop into stem mothers when apple trees are coming into pink. The production of young usually begins 2 or 3 days after the last molt and continues without interruption for over a month. A single female produces an average of about 185 young. Normally, the period of reproduction extends from about May 10 to June 20 or later. The maximum period of productive activity often coincides with the period when young fruits are beginning to set and grow actively.

Young aphids congregate closely around the stem mother. In some cases, the congregations are made up of more than one layer of aphids. This habit soon causes the death of the infested leaves and the consequent migration of the aphids. When several stem mothers congregate on a single leaf, forced migration soon follows. The young move actively to locate a suitable feeding ground. It is at this period that they are frequently found con-

gregated on the forming fruits or attacking the new succulent unfolding foliage.

Nymphs of the second generation, all of which are females, reach maturity in 2 to 3 weeks; the great majority begin to reproduce on the apple, although a few may develop wings and migrate to the weed plantain. The third generation is produced in June and early July. The majority of this generation develop wings and migrate to plantain. In some seasons wingless females of the third generation produce a fourth generation on the apples. In the fall, the winged females fly back to the apple trees. They are darker than the migrants that left the tree in spring. These returning females lay eggs, from which males also develop. The males mate with the females, which then deposit eggs on the bark.

These aphids cause a decrease in tree vigor because of foliage loss and damage to the fruit through dwarfing, misshaping, and staining. The severe curling of foliage caused by this species is probably the most characteristic feature of its work. A single stem mother located on the underside of a leaf near the midrib will cause the leaf to fold almost as tightly as the outer wrappings of a cigar. The presence of only a few stem mothers can cause a severe curling of all leaves surrounding an opening flower bud; within such curls ideal protection is afforded to the rapidly developing aphids. A cool, wet spring favors aphid development because it provides conditions unfavorable for parasites and predators of aphids.

Monitoring

Starting at early pink, 5 to 10 trees should be selected from each block. Sensitive varieties such as Rome, York Imperial, Golden, and Stayman should be selected if present. For 3 minutes, on each tree, count the number of fruit spurs showing curled leaves. If more than one aphid-infested cluster is observed per tree justifies an insecticide treatment to prevent fruit injury.

Cultural management

Maintain properly trimmed trees to make conditions less favorable to aphids and to achieve better spray coverage.

Chemical management

Optimum timing for control of rosy apple aphid is at green tip to half-inch green. Pyrethroid insecticides are often used at this time for control of this aphid. Esteem is also very effective at this time, as well as Lorsban and Supracide. However, some areas have experienced some control failures with Lorsban in recent years. If the green tip to half-inch green application was not made and the threshold is exceeded, an insecticide applied at pink or Actara, Assail, Belay, Calypso, or Provado applied at petal fall is recommended.

SAN JOSE SCALE

The San Jose scale, *Quadraspidiotus perniciosus*, is a pest of fruit trees, but it attacks many other trees as well as shrubs. Once established, most scale insects are difficult and expensive to control.

Description and life cycle

Female scales are very prolific and over a 6-week period can produce approximately 400 young. San Jose scale produce living young called crawlers; most other scales produce eggs. Crawlers move around for a short period in search of a suitable

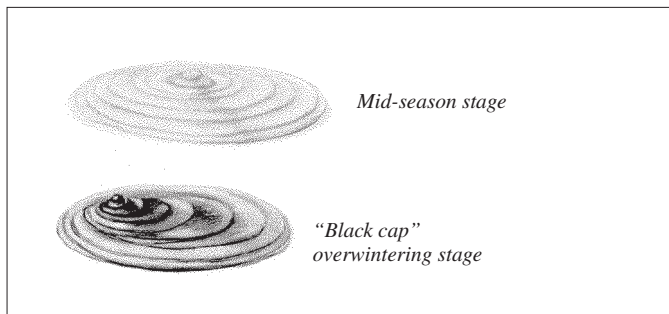

San Jose Scale

place to settle. It takes 25 days for males to mature and 31 days for females.

There are two to three generations of the San Jose scale each year. The scale overwinters as immature blackcaps; adults mature during the bloom period. Males emerge and mate at petal fall. First-generation crawlers begin appearing in early June in southern areas and continue for a month. These crawlers develop into mature adults by late July. Second-generation adults appear from late July to early September; and, if a third generation occurs, it appears in late October to early November. The life cycle is completed in about 37 days. Crawlers can usually be found from early June until a hard frost in the fall.

Crawlers are lemon-colored and very small, $\frac{1}{25}$ inch long. When they settle, they secrete a waxy substance that produces a grayish-yellow scale covering which becomes darker with age. The male scale is oblong, with a small black spot near one end, and is much smaller than the female. Color varies with age; very young females are round and nearly white but turn dark gray as they mature. There is a characteristic black spot in the center of the scale.

Scales on new growth and fruit produce deep purplish-red coloration in the tissue. When scales are removed from the fruit, a light-colored bull's eye is evident. Additional injury to the tree is caused by loss of plant sap, which depletes vigor and decreases yield. Prolonged attack causes cracking and splitting of the wood; if the scale is not controlled, the tree may die.

Monitoring

Sex pheromone traps are available for monitoring male adult emergence. These traps should be hung in trees with known or suspected overwintering scale populations. Traps should be placed at the pink stage and monitored weekly. Later in the season, usually from early to mid-June, the crawlers can be monitored. Locate infested branches and wrap black electrician's tape around the branch at each end of the infestation. Coat the middle section of the tape with a very thin film of petroleum jelly. Check the tape often for the presence of crawlers trapped in the jelly. Apply an insecticide when the first crawler is observed. If fruit is to be exported, levels greater than 0.1 percent of harvested fruit should be treated the following spring. If branches or limbs infested with scales are found during pruning, treatments should be applied at the appropriate time.

Cultural management

Prune out infested branches to reduce the population and improve spray penetration.

Chemical management

Scales are especially difficult to control on large trees with rough bark. The secret to successful control is coverage. If scales are present, then trees would benefit from an oil plus insecticide spray at the dormant or delayed dormant period. An insecticide can also be applied at early petal fall to control the males before they mate with the females if populations are high. Later in the season, usually from early to mid-June, the crawlers can be targeted with applications of Esteem, Centaur, or Movento if the oil sprays were less than effective.

SHOTHOLE BORER

The shothole borer, *Scolytus rugulosus*, sometimes called the fruit tree bark beetle, is a native of Europe but now occurs throughout the United States. It attacks a wide variety of deciduous fruit trees and other trees, but it usually attacks only trees that have been weakened by some other condition.

Description and life cycle

The adult is a dark brown to black beetle, blunt on both ends, about $\frac{1}{10}$ inch long. The tips of the antennae, legs, and wing covers are reddish brown. The wing covers are striated with rows of shallow punctures. Larvae are white with a reddish head, legless, and about $\frac{1}{8}$ inch long when fully grown.

Adult shothole borers drill holes, such as might be made by small shot, in the bark and wood of twigs, branches, and trunks of infested trees. The holes usually occur in clusters and may be either entrance or exit holes. Entrance holes are often near a lenticel and thus can be identified. Adults feed and reproduce beneath the bark, creating 2-inch-long tunnels that usually run parallel with the grain. Larval galleries leave the main tunnel and radiate out across the grain. Galleries are easily visible when the bark of infested trees is removed.

Shothole borer damage usually is limited to weak, declining trees, and borer infestations frequently hasten tree or limb death. Beetles are rarely the primary cause of death. When borers are abundant, they will occasionally attack apparently healthy trees nearby. Attacks on healthy trees may be evident on small twigs where adults bore in or around buds. This injury usually is indicated by small droplets of gum exuding from the tiny, round feeding sites. Buds are often destroyed and twig dieback can result.

Shothole borers overwinter as larvae beneath the bark. They pupate in early spring and adults usually emerge in April to May. Adults can fly considerable distances. Females mate, then locate unhealthy trees and bore through their bark. They excavate tunnels beneath the bark and lay eggs along the sides. Larvae hatch, burrow across the grain, away from the parent gallery, and feed on sapwood for about a month. Larval galleries are generally packed with frass and sawdust, while parent galleries are usually clean. Pupation occurs at the end of the larval gallery, and adults exit directly through the bark. Soon after emerging, the beetles reinfest trees to deposit eggs for the next generation. Two generations or more may develop in a tree after it dies.

Monitoring and management

Good horticultural practices are important in preventing shothole borer infestations. Keep trees healthy and vigorous. Eliminate breeding sites by removing and destroying infested trees or limbs as soon as they are found. Prunings should be removed

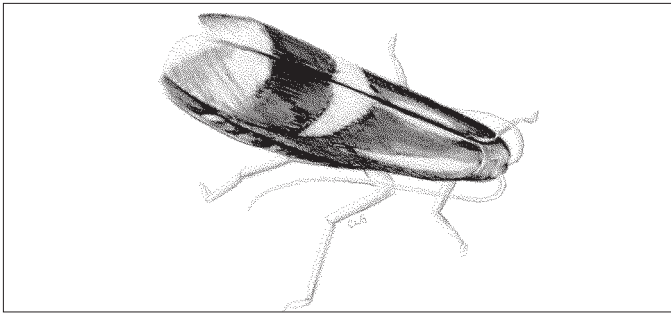

Spotted Tentiform Leafminer

and destroyed before adults emerge each April. Wild fruit trees and other potential breeding sites near the orchard should also be removed. Painting tree trunks with whitewash or white water-based latex paint is sometimes helpful in repelling adult beetles, especially on young trees. Infested trees can also be sprayed with a residual insecticide to prevent reinfestation. There are no effective controls for insects already in the trees.

SPOTTED TENTIFORM LEAFMINER

The spotted tentiform leafminer, *Phyllonorycter blancardella*, affects the leaves of apple trees throughout the growing season. Problems caused by this species are presently associated with development of resistance to commonly used organophosphate insecticides.

Description and life cycle

The adult moth is $\frac{1}{8}$ inch long and brown with white transverse stripes margined with black. Eggs are $\frac{1}{10}$ inch in diameter, oval, and creamy to transparent in color. They are laid on the undersides of the leaves and are more difficult to see on cultivars with hairy foliage. Full-grown larvae are yellowish and $\frac{1}{8}$ inch long at maturity.

This leafminer overwinters as pupae in apple leaves on the orchard floor. Adults begin to emerge at the $\frac{1}{2}$ -inch green stage and continue activity through bloom. Females lay approximately 25 eggs singly on leaves. As they hatch in 6 to 10 days, young larvae chew a hole through the egg and into the leaf. They go through two developmental stages: sap-feeding and tissue-feeding. The sap-feeding stage is composed of very small larvae that pierce plant cells and feed on sap. The tissue-feeding stage has well-developed mouthparts and feeds on leaf tissue. A complete generation requires 35 to 55 days; there are three to four generations each year.

Damage caused by this insect consists entirely of leafmining. Each completed mine reduces the leaf's green tissue by about 5 percent. Sap-feeding mines are visible as light areas on the bottom of the leaf. The completed tissue-feeding mine buckles the leaf like a small tent and has white spots on the upper surface, hence the name spotted tentiform leafminer. Excessive mining combined with drought is particularly destructive. Because mines remain visible after the leafminer has emerged or been killed they must be opened to determine if they are active.

Monitoring and management

Studies in Massachusetts were conducted to correlate the number of leafminers per trap with the average number of mines per leaf. An effective trap for monitoring leafminer adults is a sticky-

coated, 8-by-12-inch red trap, slightly (about 135°) tent-shaped to allow for water runoff and hung at chest height in the interior of the apple tree canopy. We recommend using one such trap for every 3 to 5 acres and, if cumulative prebloom captures from silver tip onward reach or exceed 12 adults per trap, applying an insecticide treatment against the adults. The trap should reduce the need to wait until first-generation mines appear before a leafminer spray decision can be made accurately.

Control decisions for first generation can be based on sap-feeding mine counts. A procedure developed at Cornell University for determining threshold levels is as follows:

1. During petal fall, select three fruit clusters from around the canopy of each tree sampled.
2. Using a magnifier, count the sap-feeding mines on the undersides of the second, third, and fourth leaves in each cluster, counting leaves in the order they unfolded.
3. After two trees have been sampled, begin comparing the accumulated total number of mines found with the limits for that number of trees.
4. If the number of mines falls between the two values given, sample another tree. If the total is less than the lower limit, sampling is stopped and no treatment is required. If the total is greater than the upper limit, sampling is stopped and a treatment is recommended. If seven trees are sampled and the total number of mines is less than or equal to 63, no treatment is necessary.

For second brood, which begins to appear in early to mid-June, proceed as follows:

1. Sampling should be done once, about 5 days after peak male moth catch (early July).
2. Start at the orchard edge and, moving toward its center, sample every other tree until enough trees have been sampled. Select five mature terminal leaves from each tree, and count the sap-feeding mines on the undersides of those leaves using a magnifier.
3. After 15 leaves have been examined, begin comparing the accumulated total number of mines found with the limits

Table 2-7. Counts of sap-feeding spotted tentiform leafminer mines to determine infestation status and the necessity for treatment.

First generation (petal fall) No. of trees	Lower limit	Upper limit
2	7	30
3	13	41
4	20	52
5	27	63
6	35	73
7	63	63
Second generation No. of trees	Lower limit	Upper limit
15	12	46
20	22	55
25	31	65
30	41	75
35	51	85
40	61	95
45	70	105
50	98	98

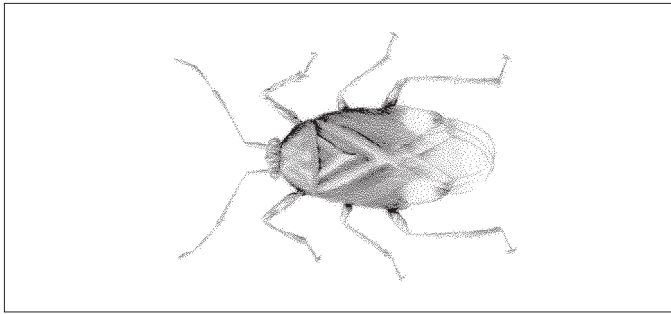

Tarnished Plant Bug

given in Table 2-7 for that number of leaves. If the number of mines falls between the two values given, take more leaf samples (five per tree), continuing to add the number of mines found to the running total while checking the chart again. If the total is less than the lower limit, sampling is stopped and no treatment is required. If the total is greater than the upper limit, sampling is stopped and a treatment is required.

Chemical management

Please refer to Table 4-6 for the list of insecticides effective against spotted tentiform leafminer. Actara, Agri-Mek, Assail, Belay, Calypso, and Provado are very effective in controlling sap-feeding larvae in the mines.

TARNISHED PLANT BUGS, OTHER PLANT BUGS, AND NATIVE STINK BUGS

Tarnished plant bugs, *Lygus lineolaris*, other plant bugs, and various species of stink bugs feed on various tree fruits and on many wild and cultivated plants and make up a unique pest complex.

Description and life cycle

Tarnished plant bug adults are about ¼ inch long, oval, fragile-looking insects, green to dark brown, flecked with white, yellow, reddish brown, and black markings. Nymphs are pale yellow to green. Stink bugs are broadly shield-shaped, flattened, with a narrow head and rather short legs, and are green to brown. All have the front half of the forewing leathery and the back half membranous. Mouthparts are the piercing-sucking type; the beak is three- or four-segmented, arises on the front of the head, and is held below the body, between the legs, when not in use. Antennae are usually long and four- or five-segmented. Compound eyes are normally large. Nymphs (immature stage) are generally similar to adults but do not have wings.

These bugs feed by sucking sap from plants. They are believed to inject a toxic substance into the plant when feeding to break down plant tissues. Their feeding is very destructive to fruit and other tender plant parts. On apples tarnished plant bugs feed on developing fruitlets and cause dimpling. Earliest injury to peaches is caused by tarnished plant bugs, other *Lygus* spp., and possibly stink bugs, which are active in the early spring. Tarnished plant bugs often cause the most damage, because they are normally present in high numbers when peaches start to grow. They feed on swelling fruit and leaf buds, causing the buds to dry up. When fruit buds are damaged, blossoms may never open or may be deformed. Later, feeding on open blossoms or small fruit usually causes the damaged blossoms or fruit to fall. If damaged peaches do not fall, they become scarred and malformed (catfacing injury) as they grow. Cold weather or hail may cause similar injury.

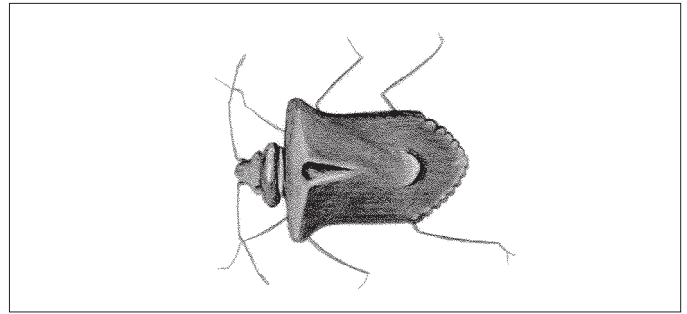

Dusky Stink Bug

Tarnished plant bug feeding on young, tender, terminal or lateral shoots can also cause wilting and dying back, sometimes giving young trees a brushy appearance.

Most severe catfacing damage is done immediately following bloom, from petal fall until peaches are ½ to ¾ inch in diameter. Cells are destroyed and fruit development inhibited at the feeding site, while surrounding tissues continue to grow and expand. As peaches increase in size, feeding by plant bugs or stink bugs causes less scarring and distortion of the fruit. When mature or nearly mature, peaches are attacked, primarily by stink bugs. Beads or strings of gum may exude from the feeding site and shallow, dry, corky, sunken areas may develop. Peaches on the edges of orchards bordering woodlands, fence rows, or fields are usually the first and most severely damaged.

These bugs overwinter as adults in protected places, such as in ground debris or between the leaves of various plants. A newly introduced species of stink bug—brown marmorated stink bug, *Halyomorpha halys* (Stål)—will attempt to overwinter inside houses or other buildings. Many may become active periodically on warm days during the winter. Time of emergence from hibernation in the spring varies with species, but most bugs emerge in early spring (see also “Brown Marmorated Stink Bug” and “Special Section: Brown Marmorated Stink Bug—A New Exotic Species”).

Tarnished plant bugs are often present in peach orchards by the time buds begin to swell. They feed on the flower buds of peach trees and numerous other plants. They are strongly attracted to orchards with winter annual weeds in bloom. Egg laying begins shortly after adults emerge, most eggs being laid in the tender shoots or flower heads of herbaceous weeds, vegetables, and legumes. Few eggs are laid in peaches. Eggs hatch in about 10 days and emerging nymphs begin to feed. The nymphal stage lasts about a month. There are several generations of tarnished plant bugs each year, but the bugs normally begin to leave peaches shortly after petal fall and move to other hosts. Populations in peach trees usually decline significantly by shuck fall.

Stink bugs feed throughout the growing season. They have one or two generations per year, depending on species. The complex of native stink bugs includes more than 20 different species present in the Mid-Atlantic region.

Monitoring

Plant bug and stink bug populations may be monitored by trapping, sampling, and fruit survey. Trapping is most successful in apple where visual sticky white cards are hung out about two feet from the ground from an outer branch at silver tip and checked weekly. Traps should be placed at the edge of the block at one

per three to five acres. The economic injury level is 2.4 tarnished plant bug adults per trap by tight cluster and 4.1 per trap by late pink. Monitoring in peaches and nectarines is critical at petal fall to shuck fall. Sweep net sampling of blooming ground cover in sections of orchards bordering woodlands, fencerows, or other favorable hibernation sites is used to indicate populations that can move into the trees. Two hundred fruit should be checked periodically per block to pick up fresh feeding.

Cultural management

Preventing broadleaved winter annual weeds and legumes in and around orchards can reduce the populations of these bugs. Legumes such as clover and vetch should be avoided as cover crops. Good control of early blooming broadleaved weeds may improve the performance of catfacing sprays.

Chemical management

Preventing serious catfacing injury depends largely on well-timed, early season insecticide applications. On pome fruits critical timings for the control of tarnished plant bug and most native stink bugs are pink and petal fall. On stone fruits applications at petal fall, shuck fall, and 10 days after shuck fall typically provide good control. Applications during pink are often unnecessary because most fruit injured at this time aborts. Please refer to Table 4-6 for the list of insecticides effective against tarnished plant bug.

TUFTED APPLE BUD MOTH (TABM)

The tufted apple bud moth, *Platynota idaeusalis*, is a serious direct pest of apples in the five-state Cumberland-Shenandoah region of the eastern United States. Although the pest is found in most commercial orchards in Pennsylvania, orchards in the south-central and southeastern portions of the state are more seriously affected.

Description and life cycle

The adult female moth is approximately ½ inch long, the male slightly smaller. Wing color is generally one-third grayish at the base, gradually darkening to brown at the tips, with a lighter-colored margin along the leading edge of the wings. The moth is named for the tufted scales that can be seen as two or three groups on the tops of the wings. Moths are extremely well camouflaged on tree trunks.

Larvae are a light brown to grayish tan with a chestnut-brown head capsule, a darker prothoracic shield (hardened area between the head and body), and a dark stripe down the back of the body. This coloration distinguishes TABM larvae from various other leafrollers. The redbanded leafroller has a pale green body with a yellowish green head; the obliquebanded leafroller has a yellowish green body with a brown to black head and a pale-yellowish-green to black prothoracic shield; and the fruit-tree leafroller has a translucent apple-green body with a reddish to dark brown head and an amber prothoracic shield. Bud moths deposit their eggs in an ovoid apple-green mass consisting of as many as 150 eggs or more. The mass is usually deposited on the upper leaf surface, and along a leaf vein.

TABM produce two generations per year. Larvae overwinter as second through fourth instars in shelters such as leaves and decaying fruit beneath trees in apple, cherry, peach, and pear

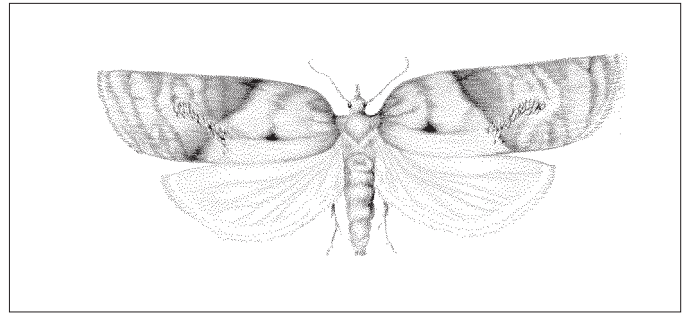

Adult Tufted Apple Bud Moth

orchards. The larvae become active in early spring and complete their development on root suckers or various broadleaf weeds such as dandelion, dock, and wild strawberry in the ground cover. The larvae pupate and emerge as adults around the beginning of May. They start laying eggs about the beginning of June. First-instar larvae disperse by crawling or ballooning (floating on the wind). First and second instars then feed along a leaf midrib, and, beginning with the third instar, create shelters by rolling leaves, tying leaves to other leaves or fruit, and building shelters within fruit clusters. Larvae generally pupate within these shelters, emerge as adults, and begin second-brood egg-laying about the beginning of August. Late season, second-brood larvae (second through fourth instars) drop to the ground to overwinter as leaves fall in autumn.

Although TABM belongs to a family of moths known as leafrollers, the leafrolling activity has little economic impact on the fruit grower and little physiological impact on the tree. It is when this insect webs a leaf onto the apple and feeds directly on the fruit that it becomes a pest. Damage appears as tiny holes (early instar feeding), as irregular scarring or gallerying of the apple surface, or as an area of rot, generally found around the stem. Rot or corking around the stem occurs usually after the larvae have finished feeding and have pupated. Larvae occasionally enter the apple calyx and feed unnoticed within the seed cavity. Most damage to apples is caused by second-brood feeding, although in some years first-brood damage can exceed that caused by the following generation. Damage to fruits destined for fresh markets has a greater economic impact, since their cash value is much higher than that of processing grade apples. Generally, TABM injury does not reduce the grade of processing apples, but it can affect the storageability of those apples by promoting decay.

Monitoring and management

Insecticide resistance has made TABM increasingly difficult to control. Timing and coverage are of major importance in controlling this pest. Spray intervals should be shortened during early instar development. At least 100 gallons of water per acre should be used to attain good insecticide coverage. Some reduction in TABM populations may be realized by removing spring apple root suckers and suppressing ground cover under tree canopies. Techniques for estimating the potential injury at an orchard level and to time insecticide applications are presented below. This is followed by a ground cover treatment option and an insecticide resistance management plan.

Predicting TABM damage at harvest

Estimated fruit injury at harvest may be predicted based on the number of TABM males captured in pheromone traps in the first three weeks of the spring flight. Thus, pheromone trap captures can not only be used to determine when an intensive insecticide program should be applied, but if an intensive insecticide program should be applied against this pest. In many cases, where TABMs are not predicted to be as severe, one or more alternate row middle sprays may be eliminated from the program. Obviously, this can save pesticides, time, and money.

Type of trap. A commercially available wing-style or plastic delta-shaped sex pheromone trap containing a rubber septum dispenser loaded with synthetic TABM sex pheromone should be used. Be sure to follow directions for trap assembly and pheromone dispenser placement. Before attaching the trap bottom, spread the clear adhesive with a spatula so that it is evenly distributed.

Trap density and placement. At least two or three traps are needed for every block of Red Delicious or York Imperial block of 5 acres or less. Place one trap close to the orchard border and locate the others toward the center of the block. For blocks greater than 5 acres, use three or more traps. Each should be attached to a limb at a height of 5 to 6 feet in the outer third of the tree canopy.

Trap monitoring and maintenance. Place traps in the orchard by May 1. Check traps every day until the first TABM adult is caught, and record this date. Thereafter, check the traps on the same day once a week (traps should be checked and cleaned more frequently during high TABM pressure so the trap bottom does not become clogged with moths and unable to trap anymore). During each visit to the trap, record the number of TABM moths caught and remove them from the trap (or replace with clean trap bottom). Also remove any other debris. Spread the adhesive with the spatula and reset the trap. Those growers choosing to trap beyond 3 or 4 weeks after biofix should change the lures once a month or as suggested. Trap data later in the season are difficult to interpret at this time, although growers may wish to maintain a few traps to observe flight timing and relative pest abundance.

Predicting TABM damage in harvested apples

After the first TABM is caught, monitor traps for 3 weeks. At the end of the 3 weeks, total the number of TABM caught for each trap (“three-week cumulative catch”). Determine the average number of TABM per trap for each block if there are multiple traps in a block. To determine if a block needs to be treated with an insecticide for TABM, use the graph in Figure 2-4. On the

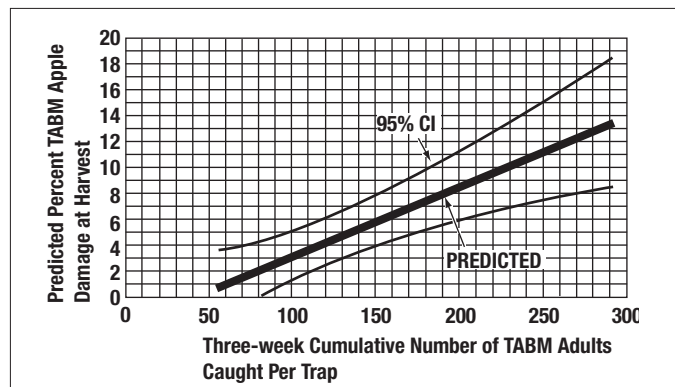

Figure 2-4. Predicted fruit damage as a function of TABM pheromone trap.

horizontal axis locate the appropriate cumulative catch. Find the closest vertical grid line and follow it to the predicted line in the body of the graph. Then follow the closest horizontal grid line to the vertical axis to obtain a prediction of apple damage for that block.

If the predicted damage is too high for your apple marketing plans, an organophosphate, carbamate, insect growth regulator (IGR) insecticides (Intrepid or Rimon), ryanodine receptor agonist insecticide (e.g., Altacor, Belt, and Voliam Flexi or Voliam Express), or Delegate should be used:

- Use 5-day spray intervals for alternate row middles and 10-day intervals for every row middle. These sprays should begin (in an average year) on June 5 and end June 30 for first brood, and begin August 5 and end September 5 for second brood. Use the degree-day accumulation model described below for estimating the best time to begin applying insecticides for TABM control.
- Use the maximum recommended rates of insecticides for TABM found in Part V of this guide.
- Use at least 100 gallons of water per acre in the spray mixture.

If predicted damage is not too high, then:

- Stretch spray intervals to 10 days for alternate row middles and 15 days for every row middle (use same beginning and ending dates as mentioned above).
- Use minimum recommended rates of insecticides for TABM as found in Part V of this guide.
- Use at least 50 to 100 gallons of water per acre in the spray mixture.

If Altacor, Delegate, Intrepid, or Rimon is used for the control of tufted apple bud moth larvae, no more than 2 complete precisely timed applications of insecticide per brood are recommended. To control first-brood TABM, make the first application of Intrepid or Rimon at 10 to 30 percent egg hatch (500 to 650 DD, base 45°F). If the second application is necessary, apply the insecticide at 60 to 70 percent egg hatch (800 to 850 DD). For second-brood control, apply Intrepid or Rimon at 20 to 30 percent egg hatch (2,355 to 2,435 DD) and repeat at 60 to 70 percent (2,665 to 2,740 DD). Do not use insecticides with the same mode of action for the control of both broods of TABM. Often, it is safer to reduce first brood sprays than second brood sprays.

Predicting TABM egg hatch based on degree days

A close relationship exists between the number of accumulated degree days beginning with first pheromone trap capture of an adult tufted apple bud moth and egg hatch for both first and second brood. This means that by monitoring orchard temperatures on a daily basis, a fruit grower can confidently predict the best time to apply an insecticide. The egg hatch prediction can be used in conjunction with, or independent of, the fruit damage prediction method. The egg hatch period is a time when the larvae of this pest are most susceptible to insecticides. Table 2-8 lists the percentage of eggs that are hatched for various degree-day totals for both broods of TABM. Tables 2-9 and 2-10 list the optimum spray periods for applying insecticides.

Table 2-11 gives degree days for TABM. To use these tables you must record the local temperature daily beginning at first TABM pheromone trap catch (see Environmental Monitoring in

Table 2-8. Relation between percentage of egg hatch and degree-day (DD) accumulations from first pheromone trap capture of adult tufted apple bud moth (TABM).

First brood		Second brood	
% egg hatch	DD	% egg hatch	DD
1	480	1	2,210
10	530	10	2,280
20	585	20	2,355
30	640	30	2,435
40	695	40	2,510
50	750	50	2,585
60	805	60	2,665
70	855	70	2,740
80	910	80	2,815
90	965	90	2,890
100	1,020	100	2,960

DD = degree days accumulated from capture of first adult TABM in a sex pheromone trap using a lower base of 45 and upper base of 91°F (min/max). DD are rounded to the nearest 0 or 5.

Table 2-9. Recommended spray timing for conventional pesticides based on degree-day (DD) accumulations for TABM depending on application method.

Alternate row-middle applications					
First brood			Second brood		
Spray no.	DD from First trap catch	Hatch (%)	Spray no.	DD from First trap catch	Hatch (%)
1	475–505	0–5	1	2,210–2,245	0–5
2	610–640	25–30	2	2,395–2,435	25–30
3	750–775	50–55	3	2,585–2,625	50–55
4	885–910	75–80	4	2,775–2,815	75–80

Complete applications					
First brood			Second brood		
Spray no.	DD from First trap catch	Hatch (%)	Spray no.	DD from First trap catch	Hatch (%)
1	530–585	10–20	1	2,280–2,355	10–20
2	805–855	60–70	2	2,665–2,740	60–70

DD = degree days accumulated from capture of the first adult TABM in a sex pheromone trap using a lower base of 45 and upper base of 91°F (min/max). DD are rounded to the nearest 0 or 5.

Table 2-10. Recommended spray timing for *Bacillus thuringiensis* (Bt) based on degree-day (DD) accumulations for TABM depending on application method. Use only complete sprays.

First brood			Second brood		
Spray no.	DD from First trap catch	Hatch (%)	Spray no.	DD from First trap catch	Hatch (%)
1	585–640	20–30	1	2,355–2,435	20–30
2	805–855	60–70	2	2,585–2,665	50–60
			3	2,815–2,890	80–90

DD = degree days accumulated from capture of the first adult TABM in a sex pheromone trap using a lower base of 45 and upper base of 91°F (min/max). DD are rounded to the nearest 0 or 5.

Table 2-11. Degree-day look-up table for TABM (lower threshold 45°F, upper threshold 91°F) and OFM (45–90°F) (horizontal cut off, using sine-wave curve).

To find the total degree-days for a day, locate the minimum and maximum temperatures and follow the rows to where they intersect. For temperatures between those listed, use the nearest shown. Temperatures and degree-days must be determined on a daily basis.

		Minimum temperature																													
		30	32	34	36	38	40	42	44	46	48	50	52	54	56	58	60	62	64	66	68	70	72	74	76	78	80				
Maximum temperature	44	0	0	0	0	0	0	0	0																						
	46	0	0	0	0	0	0	0	0	1																					
	48	1	1	1	1	1	1	1	1	2	3																				
	50	1	1	1	1	1	2	2	2	3	4	5																			
	52	2	2	2	2	2	2	3	3	4	5	6	7																		
	54	2	3	3	3	3	3	4	4	5	6	7	8	9																	
	56	3	3	4	4	4	4	5	5	6	7	8	9	10	11																
	58	4	4	4	5	5	5	6	6	7	8	9	10	11	12	13															
	60	5	5	5	5	6	6	7	7	8	9	10	11	12	13	14	15														
	62	6	6	6	6	7	7	8	8	9	10	11	12	13	14	15	16	17													
	64	6	7	7	7	8	8	8	9	10	11	12	13	14	15	16	17	18	19												
	66	7	8	8	8	9	9	9	10	11	12	13	14	15	16	17	18	19	20	21											
	68	8	8	9	9	9	10	10	11	12	13	14	15	16	17	18	19	20	21	22	23										
	70	9	9	10	10	10	11	11	12	13	14	15	16	17	18	19	20	21	22	23	24	25									
	72	10	10	11	11	11	12	12	13	14	15	16	17	18	19	20	21	22	23	24	25	26	27								
	74	11	11	12	12	12	13	13	14	15	16	17	18	19	20	21	22	23	24	25	26	27	28	29							
	76	12	12	12	13	13	14	14	15	16	17	18	19	20	21	22	23	24	25	26	27	28	29	30	31						
	78	13	13	13	14	14	15	15	16	17	18	19	20	21	22	23	24	25	26	27	28	29	30	31	32	33					
	80	14	14	14	15	15	16	16	17	18	19	20	21	22	23	24	25	26	27	28	29	30	31	32	33	34	35				
	82	15	15	15	16	16	17	17	18	19	20	21	22	23	24	25	26	27	28	29	30	31	32	33	34	35	36	37			
84	15	16	16	17	17	18	18	19	20	21	22	23	24	25	26	27	28	29	30	31	32	33	34	35	36	37	38				
86	16	17	17	18	18	19	19	20	21	22	23	24	25	26	27	28	29	30	31	32	33	34	35	36	37	38	39				
88	17	18	18	19	19	20	20	21	22	23	24	25	26	27	28	29	30	31	32	33	34	35	36	37	38	39	40				
90	18	19	19	20	20	21	21	22	23	24	25	26	27	28	29	30	31	32	33	34	35	36	37	38	39	40	41				
92	19	20	20	21	21	22	22	23	24	25	26	27	28	29	30	31	32	33	34	35	36	37	38	39	40	41	42				
94	20	20	21	21	22	22	23	24	25	26	27	28	29	30	31	32	33	34	35	36	37	38	39	40	41	42	43				
96	21	21	21	22	22	23	24	24	25	26	27	28	29	30	31	32	33	34	35	36	37	38	39	40	41	42	43	44			
98	21	22	22	22	23	24	24	25	26	27	28	29	30	31	32	33	34	35	36	37	37	38	39	40	41	42	43	44	45		
100	22	22	23	23	24	24	25	25	26	27	28	29	30	31	32	33	34	35	36	37	37	38	39	40	41	42	43	44	45	46	

Orchards, Part I). If alternate row middle sprays are used, consult the first section of Table 2-9 to determine the best degree-day accumulation targets for each spray. If complete sprays are to be used, consult the lower section of Table 2-9. An insecticide application should be applied when a degree-day target is reached according to the measured orchard temperature conditions.

Asana XL ground cover treatment

Asana XL is registered for control of overwintering TABM larvae in apple and peach trees in Maryland, North Carolina, New Jersey, Pennsylvania, Virginia, and West Virginia. The label specifies a rate of 8.0 to 14.5 fluid ounces of product per acre in a minimum of 30 gallons of water per treated acre with the rate dependent on the size of the larvae and population pressure. The lower rate is advised at pink while the larvae are smaller and the higher rate at petal fall after the larvae have grown larger.

The application at the pink stage on apples is usually the most effective. However, growers desiring to use Asana XL at the pink stage should understand that it might affect *Stethorus punctum* adults that are emerging from the ground cover at this time. This predator overwinters in the same areas of the orchard ground cover as TABM and moves into apple trees from mid-April through mid-May when maximum daily temperatures exceed 65°F. Emergence from the ground cover is 20–70 percent complete by pink and 90–100 percent complete by petal fall of the cultivar Yorking.

Make applications in broad band from trunk to drip line since TABM larvae move out of the herbicide strip to find weeds to feed on. This insecticide treatment should only be used in problem orchards and then only in conjunction with proper management of TABM during the season. This material can be combined with a herbicide application or applied alone.

For peaches, application timings are similar to those for apples. Make an application at either the popcorn or shuck split stages at the same rates as for apples. *Stethorus* also overwinters in peach orchards, so the same cautions for apples apply to peaches.

Resistance management

Numerous TABM populations in south-central Pennsylvania have become resistant to many organophosphate and carbamate pesticides within the last 10 to 15 years. A strategy for counteracting this resistance is outlined on the next page.

1. Plant smaller block units of apple trees intermixed with other deciduous fruit trees to preserve refugia for susceptible individuals.
2. Practice good ground cover management within the orchard (e.g., eliminate broadleaved weeds and dropped fruit within the tree drip line) and apply Asana XL to orchard ground cover within the drip line at pink or petal fall.
3. Keep trees well pruned, remove water sprouts, and thin fruit properly.
4. Use correct application procedures (e.g., alternate row middle or complete sprays), calibrate sprayer to match tree size, and use the proper volume of water per tree to ensure coverage.
5. Spray only when economically necessary (i.e., use action thresholds based on sex pheromone traps or fruit injury) and use the lowest most effective rates compatible with IPM.

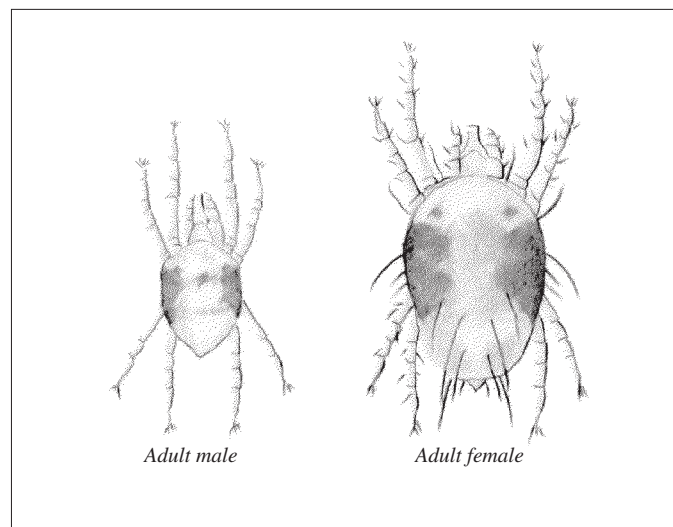

Twospotted Spider Mite

6. Use an egg degree-day model to properly time sprays to kill most susceptible stages (i.e., eggs and newly hatched larvae)—DO NOT TREAT FOR LARGE LARVAE.
7. Alternate among insecticide classes between generations where possible, or use combinations of insecticide classes within generations to promote integrated mite management. Chemical options are as follows:
 - Use *Bacillus thuringiensis* products or Intrepid, Altacor, Delegate, or Rimon for one generation only, preceded or followed by another of these products (or another insecticide class) for the other generation.
 - Use one of the above products for both generations within one season, and do not use for the first generation the following season.
 - Use combinations of organophosphates and methomyl within a generation, preceded or followed by another insecticide class for the other generation.
 - Alternate between organophosphates and methomyl between generations.

TWOSPOTTED SPIDER MITE

The twospotted spider mite, *Tetranychus urticae*, while a pest of apple, peach, and other fruit trees, also feeds on a wide range of both wild and cultivated plants.

Description and life cycle

Twospotted spider mite adult males are pale yellow, pale to dark green, brownish, or at times faintly orange. An inconspicuous dark area is generally present on each side, and other dark areas are frequently seen along the middle. Females are oval, about $\frac{3}{100}$ inch long and about $\frac{2}{100}$ inch wide and vary in color, with gradations ranging from light yellow, straw color, green, brown, and black to various shades of orange. Newly emerged females have two large black spots, one on each side just back of the eyespot. After feeding, black splotches show up in irregular patterns in other parts of the body. Males are readily distinguished from females in this stage by the smaller size of the body, the pointed abdomen, and the small size of the spots.

Eggs are spherical in shape. When first deposited they are clear and watery, becoming opaque and glassy as incubation progresses. Eggs turn a pale straw color just before hatching. The embryo's red eyespots are plainly visible at this time. Newly hatched larvae are round, about the size of the egg, have six legs, and are colorless except for red eyes. Feeding begins at once and the color changes to pale green, brownish-green, or very dark green; two black spots appear, one on each side of the eyespot. Protonymphs, larger and more oval in outline than the larva, have four pairs of legs. They are pale green to dark green, sometimes brownish green. The two spots are larger and more pronounced than in the larvae. Deutonymphs are generally a shade of green, which apparently is influenced by food. The spots are larger and more distinct.

Full-grown females and some immature mites overwinter under bark scales on tree trunks or among fallen leaves and in other protected places on the ground. With the arrival of warm weather in the spring, these mites leave their places of hibernation and start wandering about looking for food plants. Almost all of those on tree trunks crawl down to the ground, where they feed on weeds and grasses.

The first eggs can usually be found about the first week in May. In warm weather, they hatch in 5 to 8 days. A complete generation from egg to adult may require no more than 3 weeks. There are from five to nine generations in the orchard each season, depending on the weather. In mid- or late summer, when drought and other factors, such as herbicide applications, cause poor food conditions among weeds and grasses, mites move from the old host up tree trunks or to low-hanging apple branches in contact with ground vegetation. Low-hanging branches that touch grass or weeds are usually attacked first; then the mites spread upward and into the tree interior.

Once established, the population may become a serious infestation and may cause injury. Injury to leaves resembles that caused by the European red mite, except that a grayish cast is more prevalent. As indicated previously, these mites also spin a fine silken web over many infested leaves. In the fall the adults either leave the trees and hibernate among weeds, leaves, or in the soil, or remain in the tree.

Monitoring and management

Twospotted spider mites should be monitored and managed in much the same way as European red mites. Counts of the two species should be combined in determining whether thresholds are exceeded. Refer to Table 4-6 for a list of insecticides effective against twospotted spider mite.

VARIEGATED LEAFROLLER

Although variegated leafroller, *Platynota flavedana*, is an important pest in Virginia and West Virginia, it only occasionally causes damage in southern Pennsylvania. Its biology, habits, and insecticide resistance levels are similar to those of the tufted apple bud moth.

Description and life cycle

Variegated leafroller is a general feeder whose hosts include strawberry, apple, azalea, blackberry, clover, sunflowers, maple, peach, and rose. Adult males have a ½-inch wingspan and are brown with a cream-colored band towards the end of the wings.

Females are larger (½- to ¾-inch wingspan) and have varying shades of brown and reddish-brown on the wings. There is a dark spot on the leading edge of the front wings. Small larvae (first and second instar) are yellowish with a black head. Older larvae are green with a light brown head and thoracic shield.

The life cycle and overwintering hosts and sites are almost identical to tufted apple bud moth, although adults emerge 7 to 10 days later in the spring.

Monitoring and management

Injury to both the foliage and the fruit cannot be distinguished from that of tufted apple bud moth. Monitoring is accomplished using pheromone traps. Traps should be hung at the beginning of May, 6 feet high in the apple tree. At peak flight, around the end of May, start searching for and marking the location of several egg masses. Monitor the marked egg masses. When eggs turn black then insecticides should be applied. Although thresholds have not been well worked out, 1 percent fruit damage in the previous generation should alert the grower to a problem.

WESTERN FLOWER THRIPS

Widespread fruit loss from western flower thrips, *Frankliniella occidentalis*, feeding on both nectarine and peach fruit during harvest in some areas of southern Pennsylvania and adjoining Mid-Atlantic states was first observed in early 1990. Although this species is well established, damage has been lower in subsequent years.

Description and life cycle

Western flower thrips, formally limited to western North America, has become virtually cosmopolitan since the 1970s. This species is a key pest in the greenhouse production of flowers and vegetables. Out-of-doors it is a pest of several field and vegetable crops and also tree fruits. Although oviposition by this species causes a condition called pansy spot on some apple varieties in the west, it has not been shown to injure apples in the east. In addition to direct feeding injury, it transmits tomato spotted wilt virus.

Adult females are slender, about ¼ inch long, yellow or brown, and hold their fringed wings over their backs. Males are about two-thirds the size of females and generally lighter in color. Larvae resemble adults but lack wings and are smaller. This species is difficult to distinguish from less injurious species of flower thrips.

Dark brown adult females overwinter in leaf litter and other organic matter and emerge in late April and May. Populations build up on crop and weed hosts throughout the season, peaking in the summer. Generation time in summer conditions is about two weeks. Apparently drought conditions and above-average temperatures, such as occurred in Adams County in 1991, can result in damaging populations of this thrips.

Western flower thrips causes two types of direct injury to nectarine and peach trees. The first occurs during the bloom period when adult and larval thrips feed in flower parts and on the developing fruitlet under the shuck. Early season feeding causes scars on the fruit surface that expand as the fruit grows. Scarring injury has not been commonly observed in Pennsylvania.

The second type of injury occurs primarily just prior to and during harvest when adults move from alternate weed or crop

hosts to the fruit. Adults and larvae feed on the fruit surface in protected sites, such as in the stem end, the suture, under leaves and branches, and between fruit. Feeding on the surface of ripe fruit removes cell contents and results in silver stipling or patches. Silvering injury is particularly obvious on highly colored varieties. Silvering that covers more than a 1/8-inch-square area can result in downgrading of the fruit. Injured fruit also may contain thrips eggs.

Monitoring and management

Monitoring should begin at bloom in areas where this species is common. Extension guidelines in California recommend sampling blooms from 10 to 12 trees at each of three to four sites per orchard. Blooms should be slapped against a light yellow surface to determine abundance of adults. The presence of larvae is determined by dissecting at least 50 blooms per orchard. The extension guidelines recommend treatment if adults infest more than 5 per 50 blooms or if larvae are present.

The second critical monitoring period is when the first fruit ripens. Count the number of adult thrips on 10 fruits at each of five sites per orchard. Sample fruit from the ends of branches in the lower third of the canopy. Five adult thrips per 50 fruits and the presence of silvering may indicate a damaging population.

Cultural management

Several cultural practices may reduce injury by western flower thrips. These include proper thinning to reduce the amount of protected feeding sites between fruit, reducing the amount of clover in rod middles, not mowing adjacent fields or weedy row middles during bloom or harvest, and avoiding the use of insecticides, such as Sevin, that are not effective against these thrips and may actually increase the amount of injury occurring during harvest by killing natural enemies.

Chemical management

Carzol provides excellent control of thrips at petal fall. Lannate has a short preharvest interval, therefore it can be used to control thrips during harvest. Also, Delegate can be used on nectarines and peaches, within 1 day of harvest. An application after the first harvest may prevent subsequent losses; however, an additional application may be needed if thrips pressure is severe.

WHITE APPLE LEAFHOPPER

White apple leafhopper, *Typhlocyba pomaria*, has become abundant in many apple orchards throughout the state. As opposed to rose and potato leafhoppers, this species' primary host is apple. Its pest status relates to its injury to the leaves, excrement on the fruit, and nuisance to workers.

Description and life cycle

Adults are white and 1/8 inch long. Leafhopper nymphs are whitish green, smaller, and wingless, and are usually found on the undersides of older leaves. They move quickly sideways as well as forward.

White apple leafhoppers overwinter as eggs in the bark of 1- to 5-year-old wood. Hatch begins at pink and may continue for 3 to 4 weeks during May and June when weather is variable. The nymphs develop over several weeks. Adults then lay eggs in the petiole and veins of leaves. Second-generation eggs begin to hatch during late July and August. The nymphs feed during August and

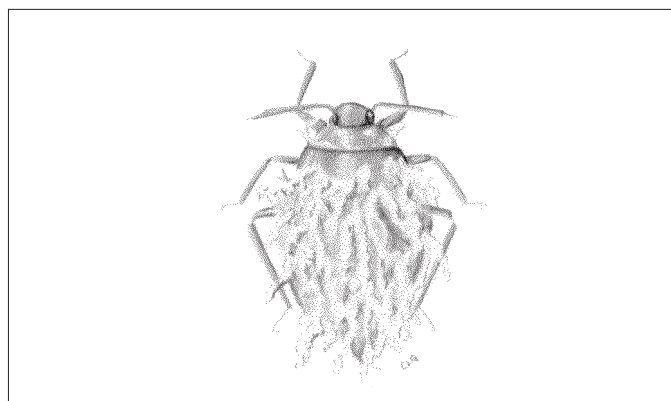

Woolly Apple Aphid

are fully grown by late August or September. Overwintering eggs are laid during September and early October.

White apple leafhopper adults and nymphs feed on leaves and do not directly attack the fruit, although excrement on the fruit can reduce its quality. Leaves become speckled or mottled with white spots as green tissue is destroyed where leafhoppers suck sap from the leaves. Abundant adults during harvest can be a severe nuisance factor.

Monitoring

One leafhopper per leaf during first-brood activity (petal fall to second cover) is justification for applying an insecticide. Populations of two or more leafhoppers per leaf during second-brood activity in August and September should be treated. Examine five trees per block, 20 leaves per tree, and check the undersides of leaves for nymphs.

Chemical management

Young leafhoppers are much easier to control than adults. Effective control of the first generation may directly reduce high populations of the second. The first generation is a better target since the hatch is fairly synchronous, and leafhoppers of the age vulnerable to insecticides are present at one time. Also, insecticides may be used at lower rates since less foliage is present during the first generation. Thorough coverage of upper and lower leaf surfaces is necessary and considered essential for effective control. Neonicotinoid insecticides (e.g., Actara, Assail, Belay, Calypso, Provado) are very effective against this pest.

WOOLLY APPLE APHID

The woolly apple aphid, *Eriosoma lanigerum*, is a widely distributed pest of apple trees, especially where its parasites have been killed by insecticides. It can also be found on pear, hawthorn, mountain ash, and elm trees.

Description and life cycle

Some apple varieties, such as Northern Spy, are resistant to this pest. Elm trees in the vicinity of orchards increase the migration of the aphid to apple trees. Infested nursery stock is also a source for spreading aphids.

Injury caused by the woolly apple aphid consists of gall-like formations and swollen enlargements on roots. Once started, these galls increase in size from year to year as a result of aphid feeding. Galls form favorable places for fungi to attack.

Aboveground colonies of aphids may develop around leaf

axils on sprouts or on new growth, particularly at abrasions or cuts, and they prevent injured bark from healing. They are often found on the crowns of trees just above the roots. They may also develop in large knots on roots and underground parts of the trunk. Infested trees often have many short fibrous roots. The underground forms are more damaging, while the aboveground forms cause little damage, especially on larger trees. The foliage of infested trees takes on a yellowish appearance. Young trees are easily uprooted when infested.

The aphids' bodies are nearly covered by a woolly mass of long waxy fibers that gives them a whitish, mealy appearance and that are much shorter on the root-inhabiting aphids.

The aphid spends winter in two stages: the egg stage and the immature nymphal stage. Nymphs hibernate underground on the roots of the tree. When elms were prevalent, eggs were usually laid in fall in the cracks or crevices of bark. Eggs hatched in the spring into wingless, parthenogenetic, viviparous stem mothers. These fed on elm buds and leaves for two generations during May and June, causing the elm leaves to curl into a rosette. They then produced a winged third generation that migrated to apple, hawthorn, or mountain ash. After establishing new colonies the migrants produced repeated generations during the summer. They fed in wounds on the trunk and branches of the tree. In fall, winged aphids developed in both the aerial and the root colonies. They flew back to the elm, where they gave birth to males and females. Both males and females were wingless. A few days after mating, the female laid a single, long, oval, cinnamon-colored egg almost as large as her body. The egg was laid in the crevices of bark.

With the disappearance of elm trees, the woolly apple aphid lives primarily on apple trees throughout the year. Each group of aphids, small or large, is termed a colony. Aphids are present year-round on the roots. Females in the aerial colonies may give birth to crawlers at any time in spring, summer, or fall.

Newborn nymphs are very important in the distribution of woolly apple aphid. They spread either through some mechanical agent or directly by crawling. Birds and insects can also transport aphids. Crawlers are generally more abundant in spring and fall. They are not able to work into and through the soil. In orchards the swaying back and forth of trees by wind and the presence of organic matter, clods, stones, and other factors may provide pathways to the roots. Crawlers begin to infest the roots early in the season. Their downward motion begins any time the crawlers are numerous, especially in early summer and fall. Infestations by aerial colonies are not a true indication of root infestations, since trees can have aerial infestations over a season without their roots becoming infested.

Monitoring and management

Some pesticides, such as certain carbamates and pyrethroids, encourage outbreaks by killing parasites. These should be used sparingly when woolly apple aphids are present. An application of a summer aphid treatment (e.g., Movento) or diazinon will control woolly apple aphids. There are presently no control methods for underground aphids.

Cultural Control

The best control of woolly apple aphid is genetic. Plant resistant rootstocks like M.106. The Malling Merton series of rootstocks was bred specifically for woolly apple aphid resistance.

NATURAL ENEMIES/BIOLOGICAL CONTROL IN DECIDUOUS FRUIT CROPS

Natural enemies and environmental factors limit populations of insect and mite pests in natural ecosystems. When natural enemies are killed by human's actions in any habitat or when pests are introduced to new habitats without their natural enemies, natural control often fails and results in pest outbreaks. Biological control of pest species by predators, parasitoids, and pathogens has been a cornerstone of IPM since its inception. It has been difficult to utilize the full potential of biological control in tree fruit and other crops that receive periodic sprays of broad-spectrum pesticides and/or have high quality standards. The best pest targets for biological control in tree fruits are generally the secondary foliage-feeding pests that do not cause direct fruit injury (e.g., mites, aphids, and leafminers). Populations of pests that feed directly on the fruit (e.g., codling moth, Oriental fruit moth, and plum curculio) generally cannot be tolerated at levels high enough for special biological control agents to reproduce.

While biological control is often thought of as a biopesticide where a single species of beneficial arthropod is released or conserved, the best results are most often achieved where a complex of many species of natural enemies, including predators and parasitoids, each contribute to reducing pest populations at different times of the season and on different developmental stages. While the development of pesticide resistance (mainly to organophosphates) has occurred in *Stethorus punctum*, the black ladybeetle predator, and several species of predatory mites, such resistance is generally much slower to develop in beneficial arthropods. Resistance to pesticides in tree fruit pests is generally through enzymatic degradation of the pesticide within the pest's body. Plant-feeding pests developed these enzymes before the use of pesticides to degrade the toxic chemical defenses of their host plants. Many predators/parasitoids do not possess these multi-purpose enzymes and hence are less able to deal with pesticides. Thus, the biological control potential of the vast majority beneficial arthropods is not realized unless they develop resistance to pesticides, no pesticides are used, or only pesticides that are selective and nontoxic to these arthropods are used.

Types of Biological Control Agents

Predators

- Consume many prey during development.
- Generally larger than prey.
- All stages may be predators.
- Are often generalists rather than specialists on any one prey type and eat both adults and immatures.

Parasitoids

- Immatures feed only on a single host and almost always kill it.
- Are smaller than the host.
- Are often specialized in their choice of host species and life stages thereof.
- Only the female attacks the host and lays eggs or larvae on or in the host.
- Immatures remain on or in the host, adults are free living and mobile and may be predaceous, feed on nectar, or not feed at all.

Parasites

- Smaller than host and don't generally kill it (e.g., mites)

Pathogens

- Diseases caused by fungi, bacteria, and viruses that kill the host.
- Some are naturally occurring and some have been commercially developed.
- *Bacillus thuringiensis* (Bt) toxins and spores—Dipel, etc.
- Fermentation products from fungi are precursors to making abamectin (Agri-Mek) and spinosad (SpinTor).
- Codling moth polyhedrosis virus available commercially for control as Cyd-X.
- Naturally occurring *Beauveria* and *Hirsutella* fungal pathogens.

Biological Control of Mites

The most successful biological control programs in eastern tree fruits have centered on the conservation of native species of mite predators to control the European red mite and twospotted spider mite. After 40 years of use, some of these predators have developed resistance to organophosphate insecticides (e.g., *Stethorus*), but are suppressed or eliminated when broad-spectrum carbamate and pyrethroid insecticides are used. The use of pheromone mating disruption, horticultural oils, and some of the more selective reduced-risk insecticides and miticides will allow a natural increase of predators capable of regulating pest mite populations to tolerable levels without the use of miticides. Mite control through biological control has the additional advantage of stopping the development of miticide resistance and, once established, is sustainable long-term if the use of certain harmful pesticides is avoided. The routine use of carbamates and pyrethroids in stone fruits, pears, grapes, and small fruits currently prevents reliable biological mite control agents even though many of the same predators found in apples can be present.

Listed below are descriptions of the main biological mite predators found in Pennsylvania apple orchards:

TYPHLODROMUS PYRI (PHYTOSEIIDAE)

Discovered in Pennsylvania for the first time in 2003, this predatory mite is currently the most reliable and effective mite predator in eastern U.S. apple orchards. Pear shaped and slightly larger than a European red mite adult, they are white/translucent until they feed. When feeding on adult red mites or apple rust mites, its abdomen may appear reddish. It is very similar in appearance to *Neoseiulus fallacis*, also commonly found in apple orchards, but the predatory mite is an omnivore and much more closely associated with its apple host. *T. pyri* is very active and moves rapidly to consume up to 350 mite prey in a lifespan of about 75 days. Females may lay up to 70 eggs each and have several generations per season. Populations, therefore, can build rapidly in response to pest mite populations. Most effective in the cooler weather of the spring and fall, *T. pyri* is somewhat less effective in the summer months. It overwinters on the apple tree under the bark where it is less susceptible to dormant oil applications and is very tolerant of Pennsylvania's winters.

Preferring spider mites, *T. pyri* is able to regulate pest mite

populations well below injury thresholds of less than five pest mites per leaf. It is able to reproduce well on relatively harmless apple rust mite populations when spider mites are absent and can subsist for long periods on other predatory or scavenger mite species, and on pollen and fungal spores when pest mite populations are low. It is also known to feed on immature thrips and scale crawlers. Well adapted to living in apple, *T. pyri* does not leave the tree during the season and once populations are established, sustainable mite control is virtually assured when the predator-to-prey ratio is at least 1:5 and is highly probable at a ratio of 1:10. For apple varieties less susceptible to spider mites than Delicious, predator-to-prey ratios as low as 1:20 may still result in successful biological control if they occur during the cooler spring and fall months. This seasonal association with its apple host, however, makes them very susceptible to toxic pesticides. Because they do not disperse quickly, they may take several growing seasons to reestablish after elimination by harmful pesticides unless artificially reintroduced. Once populations are identified or artificially established, conservation is therefore very important and applications of certain pesticides have to be avoided (see Table 4-5). Natural populations are most likely to be found in grower orchards that rely primarily on organophosphate and reduced-risk insecticides and where pheromone mating disruption is being used. *T. pyri* can sometimes be found in orchards with large, standard-sized trees despite harmful pesticide applications because inadequate spray coverage may leave refuge areas for populations to persist. Establishment of *T. pyri* into orchards where it is absent is relatively simple and can be accomplished in one to two seasons once "donor" orchards with abundant *T. pyri* populations have been identified as a source. Transfers of *T. pyri* from these orchards can be successful by physically moving blossom clusters or shoots in May and June. (See orchard transfer methodology sections below.)

Conservation and augmentation of *Typhlodromus pyri*

While a number of mite predators such as *Stethorus punctum*, *Neoseiulus fallacis*, and *Zetzellia mali* may contribute to the biological control of European red mites and twospotted spider mites in apples, only the conservation of native populations of *Typhlodromus pyri* have proven to give consistent, long-term control. Once established, *T. pyri* can almost completely regulate pest mite populations without the need for miticides, if the use of certain toxic pesticides is avoided.

1. The first step for apple growers in establishing mite control with *T. pyri* is to determine if it exists in significant numbers in their orchards. The most likely sites are:
 - Those that have not received pyrethroid or methomyl applications for several seasons.
 - Older orchards with large trees where spray coverage is not complete.
 - Abandoned orchards.
 - Reduced-risk pesticide orchards or those relying mostly on pheromone mating disruption to control codling moth and Oriental fruit moth.

Sample several trees in each block by examining with a hand lens (10 to 15X) the underside, mid-veins of 25 leaves per tree for fast-moving, teardrop-shaped mites. They will ap-

pear to be clear or slightly reddish, but not red or bright yellow in color or have spots. The best time to sample orchards would be midseason (June or July) or when pest mites are beginning to build. Samples taken early in the spring and in the fall may have relatively low populations that are difficult to detect.

- If *T. pyri* is present, do not use pyrethroids or carbamate insecticides after bloom (with the exception of carbaryl for fruit thinning).

T. pyri begins to emerge from overwintering sites deep in bark crevices at the beginning of bloom, so prebloom pesticides have little effect on them. In addition, dormant and summer oil applications have little effect on *T. pyri*, but help suppress pest mite populations. Applications of pyrethroids and methomyl after bloom cause near complete elimination of populations, and may require two to three seasons to return naturally. If a ratio of at least one predator to every ten pest mites is not reached, it may be necessary to suppress the pest populations with a selective miticide (see Table 4-5).

- If *T. pyri* is not present in particular orchards, they can be introduced from shoots or blossom clusters cut from identified “donor” sites.

In order to have the best chance of establishing *T. pyri* populations in a single season, transfers of shoots and leaf spurs are best made early season after petal fall (and June), but before the hot weather of summer (July and August). Transfers after July appear to be less likely to establish populations. Also effective are transfers of flower clusters during bloom when *T. pyri* are concentrated in order to feed on pollen. Transfers should be made at two shoots or clusters to every sixth tree in high-density plantings and every third tree in normal plantings. Cutting with hand pruners from a *T. pyri* donor orchard and placing the shoots or flower clusters in the tree canopy of a new orchard takes approximately 1.5 hours per person/acre.

NEOSEIULUS FALLACIS (PHYTOSEIIDAE)

Almost indistinguishable from *T. pyri* except under a microscope, this predator is currently more widespread in distribution in Pennsylvania apple orchards than *T. pyri*, due to a higher tolerance for some pesticides and the use of alternative plant hosts. Like *T. pyri*, *N. fallacis* is also very active, but is able to build populations three times faster during the hotter summer months. This predator lives only about 20 days with each female laying 40 to 60 eggs and may have 6 to 7 generations/year. Like *T. pyri*, *N. fallacis* is resistant to organophosphate insecticides, but it is very susceptible to pyrethroids and carbamates.

This predator is not as tolerant of cool weather in the spring and fall and is susceptible to winter kill in Pennsylvania. Purely a predator, *N. fallacis* is not able to coexist on apple trees without pest spider mite populations to consume and will often leave the tree to feed on mites in the orchard ground cover. Apple rust mites are not an attractive alternative prey for this predator. Because its association with the apple host is not nearly as close as that of *T. pyri*, *N. fallacis* populations often do not build until mid- to late summer, leaving trees susceptible to early season mite injury. Because it can also survive in the orchard ground cover, however, *N. fallacis* is not as susceptible to elimination in the orchard due to applications of toxic pesticides applied to the tree. If conserved

using selective pesticides, *T. pyri* gradually replaces *N. fallacis* after several seasons. The predator-to-prey ratio of *T. pyri* also applies to *N. fallacis* and distinguishing between the two species is not important as long as this ratio is reached.

ZETZELLIA MALI (STIGMAEIDAE)

An omnivore like *T. pyri* that is able to exist on pollen, fungi, and rust mites when spider mite populations are absent, *Z. mali* is very slow moving and feeds only on the eggs of pest and predatory mites. Its diamond shape and bright yellow coloration (turning more reddish after feeding) make it easy to distinguish this predator from other predatory mites. It is smaller in size than the European red mite. Because it is less active, it is able to exist on pest mite populations even lower than *T. pyri*. Like *T. pyri*, it is also more active in the cooler spring and fall months. However, with only a couple of generations each season and a consumption rate of only two to three eggs per day, it cannot usually be relied on to control mite pests alone. It is a valuable supplement to control by other mite predators and is much more tolerant of most pesticides, including carbamates and pyrethroids. Generally, populations of more than one per leaf are necessary to exert significant control of spider mite populations.

STETHORUS PUNCTUM (COCCINELLIDAE)

Once the cornerstone of biological mite control in Pennsylvania apple orchards, this small, black ladybeetle predator has greatly declined in importance over the last five years. Although one of the smallest of all ladybird beetles, *S. punctum* was the most important beneficial insect in Pennsylvania apple orchards starting in the mid-1970s and conservation of this predator reduced miticide use by 50 percent for over 30 years. While tolerant of many organophosphate insecticides, the decline of this predator was mainly due to the greater use of pyrethroids and the introduction of several new neonicotinoid and IGR insecticides that are toxic to various life stages of this predator. Reproducing only when populations of pest mites exceed eight to ten mites per leaf, relying on *S. punctum* alone requires grower tolerance of some foliar mite injury. With the registration of newer, more effective miticides in recent years, most growers are not willing to tolerate this injury, despite the high cost of miticides. *S. punctum* is now much less common in orchards and generally in small localized “hot spots” of mites. The main advantage of this predator is its ability to fly and quickly colonize areas of high mite populations.

Description and life cycle

Stethorus adults are tiny ($1/20$ inch long), oval, convex, uniformly shiny black, and covered with sparse, fine, yellowish to white hairs. Eggs are very small ($1/50$ inch long), pale white, and oval. They become blackish just before the larva emerges. Larvae are gray to blackish and have many long-branched hairs and black patches. As the larva matures it becomes reddish, at first on the edges; just prior to pupation the entire larva turns reddish. Pupae are uniformly black, small, and flattened. The wing pads are prominent and the entire body is covered with yellow hairs. For a short period after it is formed, the pupa is orange.

Stethorus produces three generations per year in south-central Pennsylvania. The average period from the time the egg is laid to the appearance of the adult is 23 days. The adults feed for an average of 25 days before beginning to lay eggs. This time

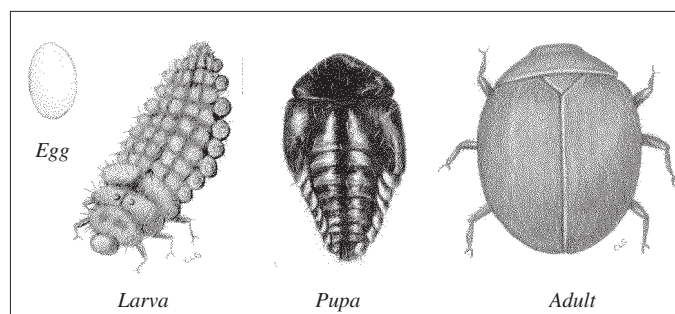

***Stethorus punctum*, Black Ladybird Beetle Life Stages**

lag between emergence and egg-laying is of little consequence because there is such an overlapping of active adults in the trees at all times. Adults overwinter beneath the trash cover under fruit trees and in other protected habitats near the orchard. The distribution of *Stethorus* in the orchard ground cover is closely associated with the leaf litter, especially around root suckers. About 70 percent of the adults are located immediately around the trunks, 20 percent are located in the border of the herbicide strip and the row middles, and the remaining 10 percent reside in the rest of the herbicide strip. The overwintering adults emerge from these sites and move into the trees between tight cluster and petal fall.

Stethorus adults are very active when in fruit trees and if disturbed will often fall to the ground. They are good fliers and thus tend to concentrate where prey is plentiful and to disappear when the mite population becomes low. Indications are that areas in the orchard having at least five mites per leaf are necessary to keep *Stethorus* active, and that from eight to ten mites per leaf are needed in these “pockets” to encourage the beetle to reproduce. The beetles feed on all stages of mites, and the adult can consume approximately nine mites per hour, or about 75 to 100 mites per day.

During early May *Stethorus* females begin to lay eggs on the leaves of fruit trees. The eggs are laid singly on their sides, with one to ten per leaf depending on mite density. Most of the eggs are laid close to the primary veins of the leaf and adhere tightly, with 95 percent on the under surface of the leaf and 5 percent on the upper surface. Egg-laying continues through mid-August.

After a 5-day development period, larvae hatch and begin feeding on all stages of mites. Larvae go through four stages in an average of 12 days. The peak periods of larval activity in south-central Pennsylvania are mid-May, mid-June, and mid-August, but this is highly dependent on mite populations. The larva eats an average of approximately 10 mites per hour. After feeding for the 12-day period the fourth-stage larva fastens itself to the leaf and remains there in a motionless state for 24 to 48 hours before pupation. The pupal stage lasts an average of 5 days. Although pupae are constantly in the trees, the peak pupal periods are late May, late June, and late August, again dependent on the availability of mites to consume.

Monitoring and management

It is advisable not to disturb the area in the herbicide strip near the trunk of the tree from November 1 to mid-April. Adults are active in the orchard from mid-April to late October. See “European red mite” for determining the predator-to-prey ratio for making decisions about mite management.

Biological Control of Aphids

APHID MIDGE—*APHIDOLETES APHIDIMYZA* (CECIDOMYIIDAE)

The aphid midge, *Aphidoletes aphidimyza*, often contributes to biological control of spirea and green aphids in pome fruits. They feed on many species of aphids on many type of crops, but are not generally found in stone fruits because of their susceptibility to pyrethroids. Generally tolerant to organophosphate insecticides as immatures and slightly less so as adults, all stages are susceptible to carbamates, pyrethroids, neonicotinoid, and certain miticides. This species can be reared and is sold from biological control companies for mass releases in many crops, but especially for aphid control in greenhouses.

Description and life cycle

Adults are tiny, delicate flies ($\frac{1}{16}$ inch) similar to mosquitoes and feed on honeydew. Each female may lay up to 70 reddish-orange eggs that are laid singly or in groups, in numbers that are proportional to aphid density. The tiny larvae are bright orange to red maggots that are about $\frac{1}{10}$ inch long with the head at the pointed end. A single larva may eat from 7 to 80 aphids to complete development, with early instars also feeding on mites. The life cycle lasts from 3 to 6 weeks with 3 to 6 generations/year, depending on the temperature and host species. Larval development lasts from 12 to 17 days with 15 to 32 days spent as pupae in the soil beneath the trees.

Monitoring and management

A ratio of one midge egg or larvae per five aphids may result in complete aphid control within a few days, but ratios of one egg per larvae to 15 aphids may still be adequate for control over a longer period of time. Insecticides used during the period that aphid colonies are building should be chosen with regard to the level of toxicity to predators (see Table 4-4).

LADYBIRD BEETLES (COCCINELLIDAE)

Adults from these easily recognized beetles are oval, often brightly colored and spotted, and vary in size from 1.5 mm to 6 mm. Approximately a dozen of the 450 species found in North America are found in fruit with most feeding primarily on aphids, but some like *Stethorus* specialize on mites while others specialize on scales and mealybugs. A number of species require pollen as adults to reproduce and some can be important predators of moth eggs.

MULTICOLORED ASIAN LADYBIRD BEETLE—*HARMONIA AXYRIDIS*

The multicolored Asian ladybird beetle has recently become the most common and most effective aphid predator in Pennsylvania orchards, replacing *Coccinella septempunctata* and several native species. *H. axyridis* is native to Asia, but was released in Pennsylvania in 1978 and 1981. However, overwintering individuals were not recorded until 1993, and the populations that have become established may have resulted from an accidental introduction by an Asian freighter in New Orleans.

Description and life cycle

Adults are about $\frac{3}{32}$ inch long and $\frac{7}{32}$ inch wide. They are oval or convex in shape and range from yellow to orange above. The segment behind the head hides the head from view and is

cream to yellow in color, with a black “M” design in the center. Underneath, the adults are black with an orange border around the abdomen. The wing covers have from zero to 19 black spots. Eggs are laid in upright clusters of 15 to 20 and are oval and yellow. Larvae are elongate, covered with spines, and are black and orange.

Overwintering occurs as adults, often in houses and other buildings. Eggs are laid on the undersides of leaves of various plants. The life cycle from egg to adult takes about 30 to 36 days with larvae eating 600 to 1,200 aphids during development and adults eating 90 to 270 aphids per day. Adults may live for over a year.

Monitoring and management

Highly mobile fliers and voracious as both adults and larvae, ladybird beetles are often the most important aphid predators in apple orchards and can quickly control extremely high pest populations. These beetles have a slight tolerance to organophosphate insecticides, but should be conserved by selective pesticide use (see Table 4-5).

GREEN AND BROWN LACEWINGS (CHRYSOPIDAE AND HAEMORBIIDAE)

Green lacewing adults are $\frac{1}{10}$ to $\frac{1}{10}$ inch in length, green with transparent wings with an interconnecting network of fine veins. The many different species are difficult to distinguish, but the adult of the most common green lacewing species has golden eyes. The adults feed on nectar, honeydew, and pollen with females producing 400 to 500 eggs each over a relatively long life of up to 3 months. Green lacewing eggs are laid on the tips of long, white, hair-like stalks to prevent cannibalism. The larvae (called aphid lions) are generalist predators of mites, thrips, soft scales, and almost any other soft-bodied prey. They are voracious aphid predators, eating 100 to 600 aphids during a 1 to 2 week development period and can be important predators of moth eggs and larvae as well. Prey are seized in hollow, sickle-like jaws protruding from the head and sucked dry. The larvae make a small, round, and white pupal case, often on the stem or calyx end of the fruit where they overwinter or, in the case of one species, overwinter as adults in bark crevices and other protected places.

Brown lacewings are smaller ($\frac{1}{5}$ to $\frac{1}{10}$ inch long) and are predatory, both as adults and larvae. They are much more tolerant of colder weather than the green lacewings and are more useful predators early in the season. Females lay 100 to 460 eggs, but not on stalks like the green lacewings. Larvae may consume more than 20 aphids per day or 30 to 40 mites per day. Developmental times are slower with most species only having two generations per season. Both types of lacewings have some tolerance to organophosphate insecticides, but should be conserved by selective pesticide use (see Table 4-5).

MINUTE PIRATE BUG—ORIOUS INSIDIOSUS

Generalist predators of aphids and mites, these are very small $\frac{1}{10}$ inch, black, somewhat oval-shaped bugs that look like miniature, dark, tarnished plant bugs. They are most easily recognized by white, shiny wing patches on the adults. Able to feed on a wide variety of small prey, including thrips, leafhoppers, moth eggs, and young larvae, they are able to subsist on pollen or plant juices when prey are not available. This habit of feeding on

plant juices may make them more susceptible to plant systemic products like some neonicotinoid insecticides. They are efficient at searching out high-prey densities and will aggregate where there is an abundance of prey. When handled, Pirate Bugs are capable of causing a mild sting with their beak. *Orius* has several generations/year and take about 20 days to develop from egg to adult. The adults live about 35 days with each female inserting about 130 eggs into plant tissues. Immature stages and adults can eat about 30 mites/aphids per day. Adults appear in late April, continue to feed all season until early fall, and then overwinter in the leaf litter both inside and outside orchards. They have some tolerance to organophosphate insecticides, but should be conserved by selective pesticide use (see Table 4-4).

SYRPHID FLIES

Several species of syrphid flies are among the most voracious of aphid predators in Pennsylvania orchards.

Description and life cycle

Adults are known as hover flies and resemble bees except that they have only one pair of wings. They are generally brown to black with yellowish areas. Their food source is pollen, nectar, and aphid honeydew, which is necessary for proper development of the eggs. Eggs are white, elliptical, and less than $\frac{1}{100}$ inch long. The larvae, or maggots, are elongate, tapering gradually toward the head end and may be cream, yellow, gray, or a combination of these colors.

Adults lay eggs in the midst of aphid colonies. Larvae cast their head side to side to locate aphids, which they pierce and consume. A single larva may destroy hundreds of aphids as it completes its three development stages in about 3 weeks. There may be five to seven generations per year with most species overwintering as adults or last instar larvae.

Monitoring and management

Check for the presence of eggs and larvae in aphid colonies. Control of green aphids may result if 20 percent of the aphid colonies have syrphid larvae present.

LEPIDOPTERAN PREDATORS—GROUND BEETLES (CARABIDAE) AND ROVE BEETLES (STAPHYLINIDAE)

These are two of the largest families of beetles with 1,500 ground beetle and 3,000 rove beetle species in North America. Many are generalist predators that are effective in controlling pests that pupate or overwinter in the ground cover or on the trunks (e.g., codling moth, Oriental fruit moth, apple maggot, plum curculio, European apple sawfly, leafrollers). Many live in the ground cover away from pesticide applications made to tree foliage, but some may climb trunks. All are very pesticide susceptible and are often used as indicators of environmental quality.

WOOLY APPLE APHID PARASITOID—APHELINUS MALI

These adult wasps are very small and they insert their eggs singly into the body of aphids, where they will develop internally to kill the host. There are six to seven generations each year with each generation taking about 20 to 25 days to develop. Larvae or pupae overwinter within the mummified body of the aphid. *A. mali* are most effective in reducing small wooly apple aphid

colonies in the spring when colonies are small. If biological control is disrupted with toxic pesticides, *A. mali* are less effective in controlling larger colonies later in the season. These very small wasps are able to attack only the aphids on the periphery of the colony and cannot successfully penetrate the wax and mass of aphid bodies to attack the center of the aphid colony, thus the percentage of parasitism actually decreases as the aphid colonies get larger in size. From midsummer to late season woolly apple aphid colonies are usually brought under control by a complex of syrphid fly species and generalist predators, such as brown and green lacewings. Ladybug larvae and adults are occasional predators of woolly apple aphids but do not appear able to deal with the waxy covering and give little control.

Rootstocks with resistance (e.g., M.106 and M111) to woolly apple aphid and *A. mali* provide adequate control of both root and aerial colonies of this pest during most seasons, unless biological control is disrupted with toxic pesticides. This parasitoid has some tolerance to organophosphate insecticides but should be conserved by selective pesticide use (see Table 4-4). Multiple applications of some chitin-inhibiting IGRs and spinosyn-type products appear to be toxic to *A. mali* and can cause woolly apple aphid flare-ups.

LEPIDOPTERAN PARASITOIDS

Tachinid Flies—important parasitoids of leafrollers in the spring. One species, *Actia interrupta*, is currently the most important parasitoid of the obliquebanded leafroller. Eggs are laid on the skin of larvae to hatch and develop externally on the larvae to eventually leave just an empty husk of skin. Pupae are generally found near the host remains and resemble a grain of wheat in size and shape. All species appear to be very susceptible to pesticides and are important only in pheromone disruption or orchards with minimal pesticide sprays.

Braconid and Ichneumon Wasps—with approximately 120,000 known species and many as yet undescribed, this is a virtually untapped source of biological control in modern agriculture. With various complex life histories, often alternating between several hosts and attacking specific life stages, these wasps have not been important sources of biological control in tree fruit since the introduction of disruptive broad-spectrum insecticides. Previous to this, however, they provided almost complete control of many of the leafroller species. Currently, there are more than 40 different wasp parasitoids capable of attacking tufted apple bud moth in Pennsylvania apple orchards. All species appear to be very susceptible to pesticides and are important only in pheromone disruption or orchards with minimal pesticide sprays. Braconid species appear to be most important late in the growing season.

Trichogramma Egg Parasitoid—most commonly employed as a biopesticides obtained from biological supply houses for mass releases into many crops. These tiny wasps complete their development inside a single egg of their moth or butterfly host. Native populations of mostly *T. minutum* attack many different orchard pests in Pennsylvania (most important are the several species of leafrollers, codling moth, and oriental fruit moth). The life of the adults and the number of eggs laid are greatly increased with the provision of nectar sources and females may then live

up to 2 weeks and lay over 80 eggs. Although present during most of the growing season, populations generally do not build to be significantly important in controlling these orchard pests until late summer. *Trichogramma* is very susceptible to pesticides and is important only in pheromone disruption or orchards with minimal pesticide sprays.

WEEDS IN DECIDUOUS FRUIT CROPS

Weeds compete with fruit plants for water and nutrients, and an overabundant weed population can severely stunt the growth of desired plants. Many common orchard weeds may also serve as reservoirs of important plant viruses. Weeds can be classified into three broad categories: annuals, perennials, and biennials. An annual plant is one that completes its life cycle in one year. It grows from seed, produces seed, and then dies. Summer annuals germinate in the spring or summer, while winter annuals germinate in the fall. A perennial plant grows and produces seed year after year. Herbaceous perennials, such as quackgrass and Canada thistle, die back to the ground each year. Woody perennials may drop their leaves, but they do not die back to the ground. The longer that perennial weeds are allowed to grow uncontrolled, the larger their root system becomes, the more they spread, and the harder they are to control.

A biennial plant, such as mare's tail, wild carrot, and dandelion, requires two growing seasons to complete its life cycle. During the first season after the seed germinates, the plant develops an extensive root system and a dense cluster of leaves, and generally dies back to ground level at the growing season's end. The next year the plant regrows from the root system, produces seed, and dies. Ways of managing these various types of weeds are discussed in Part III.

NEMATODE PROBLEMS IN DECIDUOUS FRUIT TREES

Nematodes are economically important pathogens on fruit crops. They reduce tree vigor and crop yields by parasitizing tree roots; they predispose trees to disease, reduce winter hardiness, and transmit viruses. Two of the most serious nematode problems in Pennsylvania are peach stem pitting and apple union necrosis and decline. Both diseases are caused by the tomato ringspot virus (ToRSV), transmitted by the dagger nematode (*Xiphinema* spp.).

The only natural means of infection with ToRSV is by dagger nematode transmission (Figure 2-5). The nematode acquires ToRSV when it feeds on an infected plant and transmits the virus when it feeds on a healthy plant. In the absence of dagger nematodes the virus does not naturally spread to fruit trees.

ToRSV can be transported over great distances in the seed of some weeds, such as dandelion. See Table 2-12 for a list of common orchard weeds that have been identified as hosts for ToRSV. Dagger nematodes and ToRSV are both common in orchards of the Mid-Atlantic states.

Peach Stem Pitting

Trees with ToRSV have the general appearance of being girdled, and the leaves appear drought stressed. Superficially, the symptoms may be confused with those of a number of disorders and injuries, including root rot, nutrient deficiencies, herbicide damage, mouse girdling, and implement injury. Characteristic symptoms include reduced terminal growth and drooping leaves that may curl upward lengthwise. Leaves of infected trees may turn yellow and drop earlier than those on comparable healthy trees. Generally, infected trees produce a large number of fruits, which tend to ripen early and be highly colored and small.

Bark from belowground portions of the trunk is unusually thick and corky. When bark is removed from an infected rootstock, pits or grooves may be seen in the wood. The severity of pitting varies with tree variety and stage of disease development.

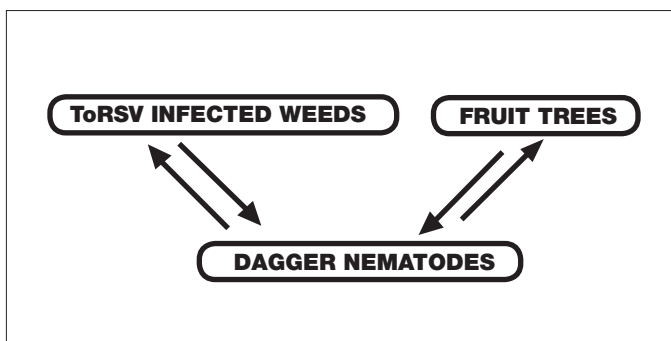

Figure 2-5. Tomato ringspot virus transmission.

Table 2-12. Orchard weeds identified as reservoirs of ToRSV.

Common chickweed	Lambsquarters	White-head aster
Oxeye daisy	Common thistle	Dandelion
Wild carrot	Swine cress	Pennycress
Leafy spurge	Prostrate spurge	Red clover
White clover	Common polkweed	Buckhorn plantain
Common mullein	Common plantain	Sheep sorrel (red)
Curly dock	Wild strawberry	Broadleaf plantain

The pitting may or may not extend across the graft union. Some affected trees may break off easily at ground level or below. The tendency to break is apparently correlated with the tree's age at the time of infection. Breakage may be confused with incompatibility of the graft union.

Trees infected with ToRSV lose vigor and eventually die. Once infected they do not recover and cannot be cured. Although feeding by the dagger nematode is the only natural means of virus infection, peach stem pitting may also be spread by grafting and budding. No sources of genetic resistance to ToRSV have been identified for peaches or nectarines. Virtually all other stone fruits, including apricots, cherries, and plums, are likewise susceptible to ToRSV. Therefore, it is important to only purchase trees that have been certified virus free.

Apple Union Necrosis and Decline

Apple union necrosis is an economic problem only in commercial apple orchards. Ornamental crabapples and other *Malus* species appear unaffected, as do most apple cultivars on seedling rootstocks. ToRSV has been isolated from clonally propagated, size-controlling rootstocks and Malling Merton 106 (MM.106) is the most frequently, naturally infected clone.

Apple trees infected with ToRSV normally begin to exhibit symptoms when they reach bearing age. Foliation is delayed on infected trees, the leaves are small and sparse, and their color is a dull, pale green. Terminal shoot growth is reduced, the stem internodes are short, and infected trees flower heavily and set large crops of small, highly colored fruit. Partial or complete separation of the graft union is common on severely affected trees. Removal of the bark above and below the graft union reveals abnormally thick, spongy, orange-colored bark and a distinct necrotic line at the scion-rootstock union.

The severity of apple union necrosis is influenced by the cultivar-rootstock combination. Red Delicious on MM.106 rootstocks is the most severely affected combination and may exhibit severe graft union necrosis followed by decline and death. The symptoms are generally less severe on other cultivars. See Table 2-13 for a summary of rootstocks and scions that have been reported as resistant or susceptible to apple union necrosis and decline disease. Rootstocks and scions not on the list have not been reported.

Table 2-13. Susceptibility of apple rootstocks and scions to apple union necrosis and decline disease.

Susceptible rootstocks					
M.26	MM.106	MAC-30	MAC-39	P-2	
Partially susceptible rootstocks					
M.27	MM.111	Bud9	MAC-1	MAC-9	Ottawa 3
P-18					
Resistant rootstocks					
C6	Robusta 5	M2	Bud-146	M4	Bud-490
M7	Bud-491	M9	Kansas-14	M13	NAC-24
P-1	MM.102	P-13	OAR-1	P-16	Ottawa 7
P-22	Ottawa 11	CG10	CG24		
Susceptible scions					
Stayman	Paulared	Tydemans Early	Ginger Gold		
Spartan	Winesap	Red Delicious			
Resistant scions					
Rome Beauty Empire		Golden Delicious			

Note: Rootstocks and scions that are not listed have not been tested under controlled conditions.

Although dagger nematodes are the primary vectors of ToRSV, other factors are important in the spread of the virus in woody fruit crops. Because apples are propagated by grafting, it is important to purchase certified virus-free trees. Infected weeds can also play a major role in spreading ToRSV.

Replant Problems and the Root-Lesion Nematode

Replanted fruit trees frequently have difficulty becoming reestablished, often because of interactions between nematodes and other soil microorganisms. The root-lesion nematode, *Pratylenchus penetrans*, is often the cause of the problem. It is perhaps the most widespread and best-known nematode pest of fruit trees. It damages roots through feeding and intracellular migration, which destroys tissue in the root cortex. Root damage caused by this nematode promotes infection by root-rotting microorganisms. The resulting damage is greater than that caused by the nematode alone.

Root-lesion nematodes migrate and seek new feeding sites when roots become crowded or decayed. Although root impairment results in a loss in vigor and yield of mature trees, the role of root-lesion nematodes in the development of replant problems is of greater economic importance.

Orchards affected by replant disease never reach their full production potential, and there are no remedial measures that can fully correct problems after the orchard is established. Depending on the extent of the problem, infested orchards force the grower to make tough economic decisions, such as whether to keep trees that are not highly profitable or to reestablish a new orchard at major expense and loss of several years' productivity. However, replant disease can be prevented by assessing the risk of problems with preplant nematode assays and by proper site preparation.

The symptoms of orchard replant disease include stunting, yellowing of leaves, discolored and necrotic feeder roots, and in severe cases tree death within the first few years after planting. Necrotic roots may or may not show obvious lesions. Typically, affected trees show a patchy distribution, and the severity of disease may be quite variable within the orchard.

Nematode management is based on rotating crops, using synthetic soil fumigants or nematicides, or incorporating green manure of rapeseed, which releases nematicidal chemicals. These methods are outlined in Nematode Management in Part III.

Sampling for Plant-Parasitic Nematodes

The nematode diagnostic service at the Fruit Research and Extension Center in Biglerville has been discontinued. Two university labs that still offer a nematode testing program are listed below. Visit their websites for sample submission instructions and forms. Other laboratories providing this service can be found on Google by searching "Nematode Testing Services" or "Nematode Diagnostic Service."

University of Delaware Plant Diagnostic Clinic
151 Townsend Hall
Newark, DE 19716-2170
Phone: 302-831-1390
Fax: 302-831-0605
E-mail: bobmul@udel.edu
Website: ag.udel.edu/Extension/pdc/index.htm

Virginia Tech Nematode Assay Laboratory
Phone: 540-231-4650
115 Price Hall
Blacksburg, VA 24061-0331
Fax: 540-231-7477
E-mail: jon@vt.edu
Website: www.ppws.vt.edu/~clinic/nematode.php

Suggestions for collecting nematode soil samples on orchard sites

1. If the soil in the area to be sampled is fairly uniform and is 2 acres or less in size, one composite sample will suffice. If the field is larger than 2 but less than 4 acres, divide the field into two blocks of approximately equal size and take composite samples from each block. Fields larger than 4 acres should be divided into blocks accordingly, each of which is not larger than 2 acres and has a uniform history and soil type. This is only a guideline. The smaller the area sampled, the more accurately the sample will represent the site.
2. In each site to be assayed, take a sample from each area that has a common cropping history and that will be planted with a single crop. For example, if a 2-acre field is to be planted with peaches next year and if half the field was in apples last season and the rest in woods, collect a sample from each area.
3. If the soil in the area to be sampled is variable, such as having a heavy clay soil in one portion and a sandy soil in another, take one composite sample from each soil type.
4. Preferably using a 1-by-12-inch sampling tube (or a trowel, small shovel, or similar tool if a sampling tube is unavailable), *take at least 20 cores of soil* from each sampling area. Samples should be taken to a depth of 8 to 12 inches in the root zone.
5. Feeder roots, found at varying depths, are usually most abundant at the dripline, directly below the outer leaf canopy. *Soil samples should be taken from the same area where the roots are growing.*
6. Do not sample from dead or nearly dead trees. Nematodes feed on live roots and may migrate away from dying plants. Therefore, when sampling problem areas, the samples should be taken from adjacent trees that either appear healthy or show early symptoms of stress.

Since nematodes are not uniformly distributed in a field, a carefully prescribed sampling procedure must be followed to obtain root and soil samples representative of the area surveyed. In addition, the samples must be properly handled and shipped to ensure that the nematodes remain alive until they are processed in the laboratory. If there has been a prolonged dry spell, or if the soil has been saturated with water for an extended period, wait until normal soil-moisture conditions return before sampling.

Handling samples

1. Make certain that all information requested is included on the nematode assay form that you receive with the assay packet. This information is needed to identify the sample and to aid in interpreting assay data. If you collect more than one sample, you must assign a field number to each area sampled and place that number in the appropriate area of the form. Each plastic

bag of soil should be sealed tightly. A separate assay packet must be used for *each* composite sample.

- Keep samples out of direct sunlight to avoid overheating. Samples may also be damaged by heat if they are stored in the trunk of a car or other hot location. Use a Styrofoam cooler to keep samples cool. *Heat kills nematodes, and dead nematodes are unsuitable for identification.*

MAMMAL CONTROL IN ORCHARDS

Voles

Identification

Voles are small rodents with short legs, stocky bodies, small eyes and ears, and short tails. Two species, the meadow vole (*Microtus pennsylvanicus*) and the woodland or pine vole (*Microtus pinetorum*), may damage fruit trees and become serious pests in orchards.

The meadow vole is approximately 5.5 to 7.5 inches long. It has brown fur mixed with black, and its tail is approximately twice the length of its hind foot. The pine vole is Pennsylvania's smallest vole. It is 4 to 5 inches long and has chestnut or auburn fur and a short tail approximately as long as or shorter than the hind foot.

Distribution

The meadow vole is one of the most widespread mammals in Pennsylvania. It abounds in grassy fields, moist meadows, orchards, or any area with a dense ground cover of grasses. Pine voles are most abundant in southeastern Pennsylvania, where they are common in old fields, thickets, gardens, orchards, and the edges of agricultural land, particularly where the soil is loose and sandy.

General biology and behavior

Voles are primarily vegetarians, feeding on grasses, tubers, and seeds. They also consume the bark of young trees. Unlike many other small mammals, voles do not hibernate. Instead, they are active throughout the year, both day and night, with peak activity at dawn and dusk.

Meadow voles create surface runways in the grass, and in winter, both are active in runways beneath the snow. Woodland voles build underground tunnels in loose, crumbly soil. As they build the tunnels they push out dirt, producing small conical piles of soil on the ground surface. Both voles build large globular nests of dry grasses and leaves. The nests are located close to tree trunks, in tussocks of grass, and at the end of burrows.

Voles are extremely prolific. Their peak breeding activity occurs between March and October, but when winters are mild, voles may breed all year long. A female meadow vole could potentially produce over 70 young in a year. Voles become sexually mature at between 4 and 6 weeks of age. As a result, under ideal conditions vole populations can reach densities as high as 270 voles per acre. Scientists have found that voles exhibit regular population fluctuations at approximately 4-year intervals. Populations apparently crash to levels as low as 10 voles per acre after peak years and then begin to build up again. Extensive damage may occur in orchards, particularly during peak population years.

Damage

Voles may cause extensive damage to fruit trees and orchards as a result of girdling seedlings and trees and damaging roots. Damage occurs primarily during winter when other types of food are scarce. The most common form of tree injury caused by meadow voles is trunk girdling at or near the ground surface. Since voles burrow in the snow, they may damage tree trunks as high as snow accumulates. Young trees are especially susceptible to attack. Occasionally, meadow voles will burrow in the soil and damage roots, resulting in weak, unhealthy trees.

Damage from pine voles is harder to detect because it occurs underground as they consume small roots, girdle large roots, and eat bark from the base of trees. By the time orchardists note weak, unhealthy trees, the damage is already extensive.

Monitoring

The most easily identified sign of meadow vole presence is a system of surface runways in the grass. Meadow voles create these runways by their feeding activities and keep them free of vegetation. The runways are generally about 1.5 inches wide. After a close mowing, the pattern of runways is often visible. Bits of freshly cut vegetation and accumulations of vole droppings (brown or green in color and shaped like rice grains) in the runway are positive evidence they are being used. Vegetation, small roots, or mold in the runways indicate that the voles are no longer using them. Pine voles do not use surface runways, so their presence is much harder to detect. In apple orchards, tiny, elongated tooth marks on apples on the ground are signs of both meadow voles and pine voles. Probing the area under the tree with your fingers may help determine if there are woodland vole runs close to the surface.

The apple indexing method is a way to determine the distribution of voles in an orchard and their relative abundance. Place a slice from the cheek of an apple into a meadow vole runway or in a pine vole tunnel. Check the apple after 24 hours for vole tooth marks. The presence of tooth marks will indicate where vole activity is highest and which trees are at risk. To obtain an estimate of the abundance of voles, weigh the apple before putting it out and after 24 hours. One pine vole consumes approximately 0.5 ounce of apple in a 24-hour period and one meadow vole consumes about 0.7 ounce.

Most orchardists do not need to know the exact number of voles present, but they may want to know whether the population is increasing or decreasing, or whether a particular treatment had an impact on population size. Monitoring vole numbers with the apple indexing method is a means of achieving these goals.

Trapping can also be used to assess the effectiveness of a vole-control program. Before initiating the control program, select approximately 10 trees and place four wooden-base (mouse-size) snap traps in runways near these trees (for trap placement see section on trapping below). Record the number of voles trapped in a 3- to 5-day period. After the control program is finished, set the traps in the same place and, for the same length of time, compare the number of voles caught after treatment with the number caught before treatment. If the program has been successful, you should trap no more than two or three voles.

The number of voles that can be tolerated is a trade-off between cost of control and cost of damage, and it depends on the orchardist. A single vole may cause damage, but most damage

occurs at high population levels. Monitoring vole populations enables growers to assess when populations are starting to increase and to begin control programs at that time.

Management

Biological control

Hawks, owls, snakes, weasels, raccoons, foxes, and coyotes all feed on voles. More than 50 percent of an owl's or hawk's diet is made of voles. These predators are beneficial in orchards because they help keep vole populations under control. Whenever possible, orchardists should encourage these predators, or at least not harass them.

When natural controls are inadequate, artificial methods must be used to control vole populations. The fall is the best time for initiating control programs. A number of different control methods are listed below. The greatest success is usually achieved by using a variety of techniques at once.

Habitat modification

In orchards, the major food sources for voles are normally not the fruit trees, but roots and stems of grasses and other ground cover. As a result, habitat modification, that is, reducing or eliminating grasses and cover, is one of the best long-term methods for controlling voles. Repeated mowings that maintain ground cover at a low level serve to limit both food and cover and expose voles to predators. Where possible, mow or till both between trees in a row as well as along tree rows. Too much delay between mowings results in excessive vegetation, which, when cut (especially with a sickle-bar mower), forms a thatch layer that protects voles. A flail or rotary mower cuts closer and is preferred for reducing thatch.

Establishing vegetation-free zones under tree canopies that extend at least 2 feet from tree trunks will discourage voles from living near the bases of trees, where they cause the most damage. Vegetation-free zones may be established by mowing, applying herbicides, cultivating, or placing a layer of crushed stone or gravel 3 to 4 inches deep that extends 15 to 18 inches from the trunk. Do not allow mulch, prunings, or decaying vegetation to accumulate around the bases of trees or in tree rows. Drops should be cleaned up quickly.

Exclusion

Hardware cloth barriers can be used to keep voles from girdling small trees. Wrap a strip of 1/4 mesh hardware cloth around the base of small trees. The hardware cloth should be set 4 to 6 inches into the ground and be approximately 18 to 24 inches high. The guards should be at least 4 inches higher than anticipated snow depth. Tree guards should be large enough to allow for 5 years of growth. This method is very effective but extremely labor intensive and expensive when a larger number of trees need protection.

Trapping

Trapping is not an efficient way of controlling voles in large orchards, but it is an effective and safe control method for small orchards or around selected trees. Use standard wooden-base snap traps (mouse size) and bait them with a peanut butter and oatmeal mixture or apple slices. For meadow voles, place the traps in runways, flush with the ground and perpendicular to the runway. Place the trigger end in the runway. For pine voles, locate

a tunnel and place the trap within the tunnel and perpendicular to it. Put a cover such as a bent roofing shingle or box over the traps. This helps protect most nontarget animals and makes the voles more likely to take the bait. In some situations it may be necessary to drill a hole in the corner of the trap, attach a string or wire, and use a large nail to stake it in the ground. Occasionally, cats will remove the vole and the trap.

Repellents

Repellents containing thiram (a fungicide), ammonium salts, or capsaicin (the ingredient that makes chili peppers hot) are registered for vole control. Little data is available on the effectiveness of repellents to deter vole damage; therefore, repellents should not be used as the sole method of vole control. A food-grade product certified as organic is being marketed as a repellent and is not labeled as a pesticide.

Thiram-based repellents are labeled for use on tree seedlings, shrubs, ornamental plantings, nursery stock, and fruit trees. Most labels allow thiram to be used on fruit trees only during the dormant season. Capsaicin-based products are labeled for use on ornamental trees, fruit and nut trees, fruit bushes and vines, nursery stock, shrubs, and lawns. Capsaicin should be applied only before the fruit sets or after the harvest. Capsaicin is registered for use on vegetable plants and agricultural crops only before edible portions and/or heads begin to form. The organic products used for voles are the same as mole repellent.

To prevent a feeding pattern from developing, apply repellents before damage becomes significant or, in the case of monitored populations, before damage occurs. They must be reapplied after a rain, heavy dew, or new plant growth. Always follow label directions for the repellent being used. Never apply repellents to any portion of a plant likely to be eaten by humans or livestock unless the label permits it.

Toxicants

Used in conjunction with habitat modification, rodenticides are an important component of most control programs because they provide the quickest and most practical means of bringing large populations of voles under control. Several rodenticides (ZP Rodent Bait AG, Rozol Paraffinized Pellets, Ramik Brown, Hopkins Zinc Phosphide Mouse Bait, Vole Whacker, and Hopkins Zinc Phosphide Pellets) are currently registered for use in Pennsylvania orchards. To determine if a specific rodenticide can still be used, read the label very carefully. The label will provide information on rates and applications, and list legal uses for the product. Note any restrictions placed on the product. Most rodenticides may be used only during the dormant season when trees are not bearing fruit. If the label does not specifically state that it is legal for use in orchards, you can call the Department of Agriculture, Division of Agronomic Services, 717-772-5211, check state.ceris.purdue.edu/htbin/stweb.com, or send an e-mail to jlake@state.pa.us, and ask them to check if the product is registered for use in Pennsylvania orchards.

Bait type is an important consideration in vole control programs. Acute rodenticides, such as those containing zinc phosphide, are fast-acting poisons that usually require only a single feeding to achieve a lethal dose. In contrast, chronic rodenticides, which include anticoagulants such as those found in Rozol pellets, require multiple feedings over a period of several

days before a lethal dose is achieved.

Both acute and chronic rodenticides are available in pelleted bait formulations, which are superior to grain baits because they are more effective against voles and are not as hazardous to ground-feeding birds and other nontarget wildlife.

Bait shyness occurs when animals consume sublethal doses of acute toxicants, then develop an aversion to the bait. Therefore, growers are advised not to apply zinc phosphide baits more often than once every 6 months. Ideally, growers can reduce the pest population with an initial application of a zinc phosphide bait and then after 2 days conduct an apple-slice index to assess the need for a follow-up application with an anticoagulant bait.

Recommended application rates for acute rodenticides are 2 pounds per acre when hand-placing zinc phosphide pellets in runways and 10 pounds per acre for broadcast application. Do not apply to bare ground. Recommended application rates for chronic rodenticides are 10 pounds per acre when hand-placing pellets or 15 to 20 pounds per acre for broadcast applications. Chronic rodenticides may be reapplied 30 to 60 days later if the vole problem persists.

Bait placement is critical to the success of a control program. Broadcast distribution of pellets and hand placing of pellets at recommended rates will work, but the best results are achieved by using bait stations. In addition, bait in stations is less available to nontarget wildlife.

Bait stations can be made from discarded beverage cans. Enlarge the opening in the end of the can so that it is about 1.5 inches in diameter. Dent the side of the can. Put bait in the can and place it dented side down in the area to be protected. Mark the bait containers with flags or stakes so they can be relocated.

Another type of bait station that has been successful is made from an automobile tire split longitudinally. Tires are placed with the hollow side down, and the bait is placed in a small cup under the tire. The tire halves are then distributed one per tree or one every 10 yards throughout the area. Discontinue use if nontarget animals are coming into contact with bait.

Pine voles are not as active above ground, so bait should be placed directly in runways and burrow openings at two to four locations under infested trees. If runways and burrows cannot be found, roofing shingles, boards, or other objects placed on the ground at each placement site provide voles with shelters where they may build tunnels or nests. Place bait under these shelters after they have been in place for several weeks.

Timing also influences the success of control programs. Wet weather reduces the effectiveness of rodenticides, so apply baits when weather is likely to be fair and dry for at least 3 days. Baits are most effective when naturally occurring foods, such as green vegetation and fruit drops, are limited. Late fall is an important time to bait voles because it serves to reduce populations before the onset of winter, when vole damage is most severe and snow cover precludes rodenticide use. When winter survival is high, baits should be applied in the spring before the breeding season and before renewed growth of ground cover diminishes bait acceptance. Most rodenticide labels stipulate that bait can only be applied during the dormant season, after harvest, and before bud burst in the spring.

For additional information on controlling voles, see the *Wild-life Damage Control 9: Voles* fact sheet, available from your local cooperative extension office.

Sources of supply

Bell Laboratories, Inc.
3699 Kinsman Blvd.
Madison, WI 53704
608-241-0202
www.belllabs.com
(ZP Rodent Bait AG)

Hacco, Inc.
hacco.com/#contact
(Ramik Brown)

Liphatech
3600 W. Elm St.
Milwaukee, WI 53209
888-331-7900
www.liphatech.com
(Rozol Paraffinized Pellets)

Messina Wildlife Management
55 Willow Street, Suite 1
Washington, NJ 07882
www.MessinaWildlife.com
(Mole Repellent)

Miller Chemical and Fertilizer Corp.
Box 333, 120 Radio Road
Hanover, PA 17331
717-632-8921
www.millerchemical.com
(Hot Sauce Animal Repellent)

White-Tailed Deer

Distribution

The white-tailed deer is one of the most widely distributed and well-known mammals of North America, and it is a common species throughout Pennsylvania. Deer prefer early successional forests that are in the shrub-tree sapling stage. They are also abundant in agricultural areas where field crops and orchards are interspersed with forest habitat.

General biology and behavior

Deer are most active during early morning and evening hours. They have a home range of several hundred acres, but this varies with season, habitat, sex, and even individual characteristics. Whitetails are creatures of habit; most use the same home range year after year. They also tend to establish one part of their home range as a feeding area, and another part for resting. For instance, if deer establish an orchard as a source of food, they will habitually move into the area a little before sunset to feed, and move back to the woods before dawn to rest.

The natural food habits of deer depend on the time of year and the plant species available. During the winter months, deer consume evergreen and dry leaves, as well as dormant buds. In the spring and summer, they eat new growth on woody and herbaceous plants. From late summer to early winter, fruits and nuts compose a large part of a deer's diet.

White-tailed deer can mate from September to late January. Adult bucks are polygamous, mating with as many does as possible. A doe's reproductive ability is influenced by her age and nutritional condition. Adult does will usually bear twins, while younger does more often bear single fawns.

Damage

Deer cause damage to orchards year-round, but the most serious damage occurs in the winter months when the availability of natural foods is limited. Dwarf, semidwarf, and young standard fruit trees are the most susceptible because most of the tree is within reach of the deer. In winter, browsing on dormant terminal buds may lead to stunted or misshapen growth in standard fruit trees under 3 years old. Browsing on fruit buds of dwarf and semidwarf trees may lower fruit production. In either case, severe winter browsing can reduce tree vitality and even cause death.

During the spring and summer, natural sources of forage are readily available to whitetails. However, they may browse new growth on orchard trees and eat ripening fruit. In autumn, deer may continue to browse and eat fruit within the orchard. Additionally, they can cause severe damage by rubbing their antlers on trees. This can result in broken limbs, girdling of the trunk, and subsequent death of the tree if the deer removes enough bark.

Monitoring

The extent of damage caused by deer can be monitored through direct and indirect observation. They may be caught “in the act” during active periods of evening and early morning. Indirect observation means recognizing signs that deer leave behind. Whitetails selectively browse leaves and twigs from various plants, but prefer some species over others. In spite of this preference, they may heavily browse one plant while ignoring another of the same species that is close by.

Lacking upper incisor teeth, deer characteristically tear off vegetation, leaving jagged edges that you can use to identify browsed trees. In comparison, browsing by rodents and rabbits leaves a clean-cut surface. However, the height of the damage may be all you need to eliminate any mammal other than deer. Another method for determining deer as the source of damage is to search for tracks. They leave a distinctive split-hoofed track that can easily be seen in damp soil or snow. Monitoring your orchard for damage is an important, ongoing process and the first step in a successful management plan.

Management

Effective management begins by anticipating the extent of damage and responding with the appropriate control. The easiest way to predict damage is to combine the past year’s damage with the Pennsylvania Game Commission’s estimate of deer density in your area. For example, if deer density is on the increase, you can expect that damage to your orchard will also increase.

Before deciding on a control method, if any, you should consider the cost benefits of the control program. If the damage you incur is economically greater than the cost of a control measure, you should apply the control measure. In most instances, an integrated pest management (IPM) plan is the best approach. This strategy combines ongoing population management of the local deer herd with either repellents or fencing, depending on the extent of damage.

Hunting

In Pennsylvania, the game commission is authorized to manage the size of the deer herd through regulated hunting of antlered and antlerless deer. As a landowner, you should encourage hunting in your area, especially if your orchard is subject to heavy deer

damage. Posted areas that are closed to hunting serve as refuges for deer during the hunting season and may compound the damage to an orchard by concentrating the deer population.

If a commercial orchard is your primary means of gaining a livelihood, those members of your immediate family living on the premises, as owner, lessee, or tenant, as well as any hired help regularly and continuously assisting in the cultivation of the land, may hunt without a license during regular hunting season on the property, and on detached lands that are operated under written lease as part of the same operation. This applies only to persons who are otherwise eligible to be issued a hunting license. Consult your local wildlife conservation officer for information on opening your land to hunters, or on eligibility requirements for hunting.

To assist hunters in locating land that is open to public hunting, the Pennsylvania Game Commission maintains a detailed map that shows the location of all private landowners that are enrolled in any of the agency’s public access programs. If you are not currently enrolled in the Safety Zone, Forest Game, or Farm Game Cooperative Program, please contact your local wildlife conservation officer to find out details about each of these public access programs. For more information on the public access programs or to view the statewide map detailing these properties, visit www.portal.state.pa.us/portal/server.pt?open=514&objID=617662&mode=2.

The Deer Management Assistance Program (DMAP) is designed to help landowners manage deer numbers on their properties. Qualified landowners participating in DMAP receive a limited number of coupons (determined by acreage) that they may make available to hunters. The coupons are then redeemed for a DMAP antlerless deer permit to hunt on the property for which they were issued. For more information on this program, visit www.portal.state.pa.us/portal/server.pt?open=514&objID=622401&mode=2.

Shooting

Even though your land is open for hunting, you may still experience problems with deer when they are no longer in season. Because of this, you may be eligible to kill any deer witnessed to be causing or about to cause damage to your orchard, outside of the regular hunting season. You must contact your local wildlife conservation officer when you plan to shoot deer. There are procedures and regulations that you must follow if you are planning to protect your orchard in this manner. If the property is open to hunting, the orchard owner may keep one deer for personal use; all other deer must be field-dressed and turned over to the game commission. If the land is not open to hunting, all deer must be field-dressed and turned over to the game commission. Be sure to contact the local wildlife conservation officer before you act to ensure complete understanding of all the regulations.

Repellents

Repellents are most effective when integrated into an IPM plan that includes repellents, fencing, and hunting. If you have had damage in the past, apply repellents before the first sign of damage to prevent deer from establishing a feeding pattern at the site. There are two types of repellents: area and contact. Area repellents repel deer by odor and are applied close to plants in need of protection. By applying the repellents along the orchard borders,

you can protect many trees at a relatively low cost. Area repellents include tankage (putrefied meat scraps), ammonium soaps, bone tar oil, blood meal, and human hair. Contact repellents work by taste and must be applied directly on the plant. These repellents work best if you apply them in the dormant season on dry days when temperatures are above freezing. Examples of contact repellents are putrescent egg solids, thiram, kaolin clay, and hot pepper sauce. Remember, whenever you apply a commercial repellent, the law requires strict compliance to the label. Hinder (ammonium soap) and Deer Stopper (certified organic food product) are currently the only products registered for use on edible plant materials.

Repellents have variable results; what works for one grower may not work for another, and success differs from year to year. Some repellents do not weather well and require repeated applications during the season. Also, if deer are very hungry and the area lacks other, more palatable food resources, they may ignore the repellents. Success must be measured by how much the damage has been reduced, since it is rarely eliminated. In areas where deer density is low and damage is light, repellents may be a cost-effective part of your IPM strategy.

Fencing

Fencing deer out of the orchard is the most efficient way to reduce damage when deer density is high and damage extensive. The conventional 8-foot woven-wire fence effectively excludes deer by forming a barrier around the orchard. The fence consists of two widths of 4-foot woven wire and 12-foot posts. To prevent deer from crawling under, keep the wire close to ground level. Unfortunately, deer-proof fencing is expensive, but it is effective, long lasting, and requires little maintenance.

An alternative to barrier fencing is the use of an electric fence. This type of fence is designed to change the deer's behavior. Although deer can easily jump an electric fence, they will instead try to go through or under. An electric fence takes advantage of this behavior and successfully trains the deer to stay 3 to 4 feet away from the wires. Adding an attractant such as peanut butter on aluminum strips will entice deer to touch the fence with their mouth and nose. Touching the fence with sensitive tongue and lips will aid in training them to avoid the fence.

Researchers at Penn State have developed a low-cost, five-wire electric fence. Through tests conducted statewide, the design has shown to be an adequate means of deer control. The fence incorporates high-tensile steel wire; in-line wire strainers; and high-voltage, low-impedance energizers. High-tensile fence can absorb the impact of deer and tree limbs, thereby eliminating some of the problems associated with softwire fences. In addition to Penn State's five-wire fence, other high-tensile electric fence designs are available.

The disadvantages of electric fences are that they require high maintenance and regular inspections. You must maintain a 6- to 8-foot mowed strip along the fence perimeter to discourage deer from jumping and to decrease the weed load on the fence. You must also check the electric current regularly to ensure that the shocking power is sufficient for turning the deer. The advantages include a relatively low cost and, when properly maintained, a long-lasting fence.

Other

Some growers have successfully protected their orchards by keeping dogs within the orchard. Deer tend to avoid these orchards because of the dogs, and any that do enter are chased out. The dogs are kept in the orchard by an invisible electric fence.

Sources of supplies

Most nurseries and home centers sell commercial repellents and fencing materials. Some companies that manufacture repellents and the product they supply are listed below.

Ehrlich Distribution—Reading, PA
500 Spring Ridge Drive
Reading, PA 19612-3848
Phone: 888-225-6080 ext 29208 or 29209
Fax: 610-378-9744
www.ehrlichdistribution.com
(Magic Circle)

Nott Products Co., Inc.
PO Box 975
Coram, NY 11727
Phone: 631-563-4455
E-mail: Nottproducts@aol.com
www.Nottproducts.com/contact.htm
(Chew-Not)

Ben Meadows
PO Box 5277
Janesville, WI 53547-5277
Phone: 800-241-6401
www.benmeadows.com
(Deer-Away)

Messina Wildlife Management
55 Willow Street, Suite 1
Washington, NJ 07882
www.MessinaWildlife.com
(Deer Stopper)

Miller Chemical and Fertilizer Corp.
Box 333, 120 Radio Road
Hanover, PA 17331
Phone: 717-632-8921
www.millerchemical.com
(Hot Sauce Animal Repellent)

Bonide Products, Inc.
6301 Sutliff Rd
Oriskany, NY 13424
Phone: 315-736-8231
www.bonideproducts.com
(Repellent and Bulb Saver)

Bayer CropScience LP
PO Box 12014
2 T.W. Alexander Drive
Research Triangle Park, NC 27709
Phone: 866-99BAYER (866-992-2937)
(Thiram 42-S)

SPECIAL SECTION: BROWN MARMORATED STINK BUG—NEW EXOTIC INSECT PEST

The brown marmorated stink bug (BMSB), *Halyomorpha halys* (Stål) (Heteroptera-Pentatomidae), has established itself in our surroundings and most likely will continue to pose an extremely serious threat to our agricultural systems for years to come. During the last two years researchers and extension specialists throughout the Mid-Atlantic States have documented the enormous potential of this insect to destroy the quality of various fruits, vegetables, and some agronomic crops, such as soybean and corn. According to information recently gathered by the U.S. Apple Association, the estimated losses during the 2010 season for this region's fruit growers exceeded \$37million.

Damage on fruit caused by BMSB feeding can occur throughout the entire growing season. Although the mechanism by which BMSB feeds on fruit is similar throughout the season, the time of the season the feeding occurs can have a profound influence on the type and appearance of the injury. For example, early season feeding usually causes misshapen fruit, whereas, late season feeding usually causes depressions on the fruit surface and the appearance of necrotic tissue (corking) just below the fruit surface. Late season feeding injury is often confused with the physiological disorder called "corking," which is caused by a calcium deficiency. Although the amount of damage varied significantly among various locations throughout the state in 2010, some stone or pome fruit orchards suffered more than 60 percent injured fruit by harvest.

The management options for BMSB populations are quite complicated and, as observed last season by some growers dealing with this challenging pest, also quite frustrating (Figure 2-6). Despite using the best available practices to conserve our IPM program and utilizing the best recommended products and tactics that we knew last year to control BMSB, fruit injury levels in affected orchards ranged from low to extremely high, with most being well above acceptable levels to growers and costumers.

Following are some of the possible reasons for the observed problems in the management of BMSB.

Unique elements of BMSB biology

Although more and more observations suggest that this insect can survive the winter without the protection under human-made

Brown marmorated stink bug (aka Asian stink bug) is not your usual insect pest.

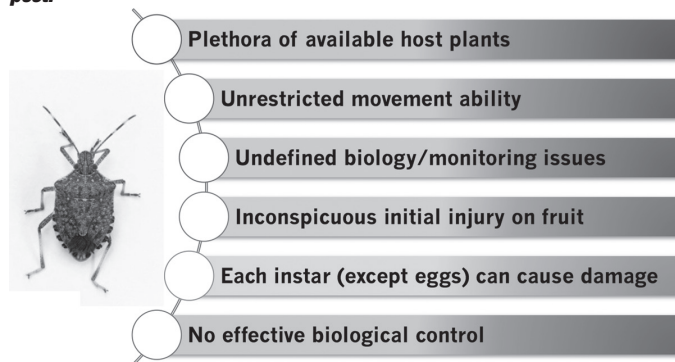

Figure 2-6. Examples of specific (and unique) challenges presented by BMSB to Pennsylvania fruit growers.

structures, at this time we still believe most BMSB adults overwinter inside some kind of dwellings located most of the time outside of orchards or other agricultural settings. In the spring, adult BMSB move from their overwintering shelters, but not necessarily directly to the orchard. It appears that almost all green plants can support their feeding habits. The spring emergence of adult bugs from overwintering sites is very extended, lasting from late April until early June. These differences in the starting point for overwintering adults likely create a situation that allows all possible BMSB nymphal and adult stages to be present in the orchard at the same time. Throughout the season, for reasons not yet well understood, BMSB adults at any point can start moving into orchards or between orchards. Feeding on stone fruits seems to be the preferred early season behavior, but these hosts are not exclusive and any green, growing plants (including pome fruits) are also possible hosts. Reports in the scientific literature estimate that BMSB can feed on 250–300 different host plants. Later in the season (i.e., late June, July, August, and September) various instars of BMSB are frequently observed feeding on apple, pears, and small fruits, including various berries and strawberries.

BMSB behavior

Host plant choice is still not well understood. We still do not know exactly when and, more important, why BMSB moves from one host to another. Due to the extensive host range of this pest in our region, it is important to understand that BMSB can move to orchards at any time from May until October, including multiple, consecutive influxes from surrounding vegetation. Effective control of one wave of stink bugs in the orchard does not prevent another wave of BMSB from entering the orchard a short time later. And since BMSB is not a resident pest in the orchard, even the best management activities against the pest in the spring will not prevent new stink bugs from invading again later in the season, even in October. Therefore, it is quite obvious that in addition to using effective insecticides, the most crucial, practical element for successful BMSB management is the development of a reliable pest detection and monitoring strategy.

Efficacy of insecticides

Our laboratory bioassays conducted during the fall, winter, and spring of this past year evaluating the effectiveness of various insecticides against adult stink bugs demonstrated the availability of multiple active ingredients that are effective. These bioassays also identified a large group of currently registered products, which provided very minimal direct mortality of BMSB adults. Although various evaluations of available insecticide choices we conducted using different methods, the results when evaluated together provide a good complementary picture of what to expect from various products. The "lethality index" developed by USDA researchers provides information on efficacy of products against adult BMSB after exposing them for 6 hours to a dry residue of insecticides, while the Penn State "percent mortality" readings provide information on the toxicity of adult stink bugs after direct contact with a 2 µl of an insecticide solution applied directly to the dorsal part of the insect abdomen. Both methods utilized long-term observations (up to 120 hours after treatment) to develop the final results (Tables 2.14 and 2.15).

Table 2.14. Efficacy of various insecticides against BMSB adults during direct contact laboratory bioassay.

Active ingredient (IRAC group)	Product (rate tested)	Percent direct mortality at 24/72 hours after ^a	Number of applications per season ^b	Comments ^c
acetamiprid (IRAC 4A)	Assail (6 oz)	87/87	SF: 4 PF: 4	7-day PHI on SF and PF
clothianidin (IRAC 4A)	Belay (6 oz)	100/100	Peach: 2 PF: 2 app	Not registered on nectarines
imidacloprid (IRAC 4A)	Admire Pro (7 oz)	82/87	SF: 1 PF: 1 app	21-day PHI on SF and PF
	Leverage 360 (2.8 oz, mix)	95/93	SF: 1 PF: 1	7-day PHI on SF and PF, includes beta-cyfluthrin
thiacloprid (IRAC 4A)	Calypso (8 fl oz)	58/52	PF: 2	Not registered on stone fruit
thiamethoxam (IRAC 4A)	Actara (4.0 oz)	92/97	SF: 2 PF: 3	No more than 0.25 lb AI per season on pome fruit/0.17 lb AI on stone fruit
	Endigo (5 oz, mix)	98/100	SF: 3 PF: 4	See comments for Actara and Warrior
	Voliam Flexi (6 oz, mix)	100/100	SF: 2 PF:	See comments for Actara
methomyl (IRAC 1A)	Lannate SP (16 oz)	92/98	Apple: 5 Nectarine: 3 Peach: 6	Strong rate response
	Lannate LV (3 pt)	87/92	Apple: 5 Peach: 6	Not registered on nectarines
oxamyl (IRAC 1A)	Vydate (6 pt)	68/73	Apple: 1	Thinning caution
fenpropathrin (IRAC 3)	Danitol (16 oz)	95/82	SF: 2 PF: 2	3-day PHI on SF, 14-day PHI on PF
lambda-cyhalothrin (IRAC 3)	Warrior II (2.5 oz)	73/72	SF: 4 PF: 4	No more than 0.16 lb AI per season
	Lambda-Cy (4.4 oz)	52/40	SF: 5 PF: 5	No more than 0.16 lb AI per season
	Voliam Xpress (10 fl oz, mix)	40/40	SF: 4 PF: 4	See comments on Warrior
	Endigo (5 oz, mix)	98/100	SF: 3 PF: 4	See comments on Actara and Warrior
endosulfan (IRAC 2A)	Thionex (2 lb)	52/98	SF: 2 PF: 3	Very long REI (20 days)
dinotefuran (IRAC 4A)	Scorpion 35 SL (5 oz)	97/98	Section 18 emergency registration	
	Venom (3 oz)	93/98		

Source: Penn State Fruit Research and Extension Center 2011

- a. Dead and moribund BMSB adults grouped as dead.
 b. SF = stone fruit, PF = pome fruit. Always read and follow the most current pesticide label.
 c. Other tested products (rate) with adult BMSB direct mortality lower than 50 percent: Altacor (3 oz); Asana (14 oz); Avaunt (6 oz); Baythroid XL (2.8 oz); Beleaf (2.8 oz); Delegate (7 oz); Diazinon 50 W (3 lb); Esteem (5 oz); Guthion (2 lb); Imidan (4 lb); M-Pede (2%); Neemix 4.5 (16 oz); Pounce 25 WP (16 oz); Rimon (30 oz); Sevin XLR Plus (3 pt); Stylet oil (2%).

Table 2.15. Suggested timings and product options for the control of BMSB in fruit orchards.

Timing ^a	Other pests to remember ^b	BMSB product options ^c	Comments
Before bloom (PF)	Scale, RAA, mites, EAS, PB	Lorsban, Carzol (PF only)	To suppress early populations
After bloom (May–mid-June)	CM, OFM, TABM, OBLR, PC, aphids, leafhoppers	Admire, Assail, Actara, Voliam Flexi, Voliam Xpress	To suppress early populations
Midsummer	Aphids, JB, AM, mites, scales, leafhoppers	Vydate, Actara, Leverage, Assail, Danitol, Belay, Admire	Control on SF; suppression on PF
Late summer	CM, OFM, TABM, leafhoppers	Lannate, Danitol, Belay, Endigo, Warrior	Control on PF
After harvest (SF; early PF)		Thionex	Control, suppression

- a. PF = pome fruit; SF = stone fruit.
 b. AM = apple maggot; CM = codling moth; EAS = European apple sawfly; JB = Japanese beetle; OBLR = obliquebanded leafroller; OFM = oriental fruit moth; PB = peachtree borer; PC = periodical cicada; RAA = rosy apple aphid; TABM = tufted apple bud moth.
 c. Suggested assortment of products is based on “direct mortality” assessed during laboratory bioassays conducted at the Penn State Fruit Research and Extension Center during 2011.

Suggestions for BMSB management in Pennsylvania fruit orchards

The laboratory bioassays conducted this past winter demonstrated various efficacies of currently registered insecticides against BMSB adults (Table 2.14). With 10 various active ingredients (from four different Insecticide Resistance Action Committee [IRAC Groups]) causing above 50 percent mortality during the direct contact bioassays, it appears we have enough products to control BMSB populations that enter orchards throughout the entire growing season (Table 2.15). The challenge with this seasonal approach is to manage the usage of these various products so they provide not only the best control for all injury causing stages of stink bug but also all other pests present in orchard throughout the season. These available products are not equal in their efficacy against stink bugs and they are also not equal in their activity against other pests at the time when insecticide applications might be needed. A grower can choose to ignore these other pests and concentrate only on the management of BMSB, but based on our experience from the era “before the stink bug,” it might not be the best option especially with known pressures in our orchards from such pests as codling moth, oriental fruit moth, and leafrollers.

When developing a seasonal strategy to manage BMSB at any particular location, the following factors need to be considered during the planning process:

Insecticides

The efficacy ratings for either direct contact or residual toxicity against BMSB are two of the most important factors in choosing the best product(s), but growers should also consider the time of the season and what other pests are likely active in the orchard. Also, factors such as an insecticide’s preharvest interval (PHI),

the number of available applications per season, and the amount of an insecticide active ingredient that can be used for the entire season (be aware of multiple products with the same active ingredients) need to be critically assessed. While it may be wise on stone fruit to use the more effective products earlier in the season, the same products on apples may be much more valuable for BMSB control in August, September, or October. Since all products have a limited number of applications and active ingredients that can be used during a season, utilizing the most effective insecticides before they are essentially needed will likely leave us with only less effective alternatives later in the season.

Expected sources of BMSB influx

Population pressure from BMSB is not uniform from outside or within any particular orchard, but it also fluctuates during various times of the season. Some orchard blocks located next to woods may not have to deal with stink bugs until later in the summer; blocks next to various kinds of dwellings most likely will be affected earlier in the season; while blocks located inside other large groups of orchards may experience only low pest pressure throughout the season. However, in every orchard, due to the ability of adult BMSB to rapid move quickly among various hosts, a constant and vigilant monitoring program is the very basis for successful management.

Crop/block-specific characteristics

Factors such as different harvest dates for fruit, the mixture of cultivars, surrounding vegetation as a possible source or barrier for BMSB populations during the season, and the attractiveness of the crop to BMSB mandate individual treatment strategies for each separate orchard or block within the orchard. While some fruit blocks might require seasonal, intensive management options against BMSB, other blocks might require a less intensive program. Unfortunately, there is no “one size fits all” recipe for successful management in dealing with this pest.

Necessity of controlling other pests

In orchards that experience continuous, seasonal pressure from BMSB, seasonal control options must be carefully selected. In selecting these control options, growers should also consider what other fruit pests and the beneficial natural enemies may be affected by their selection of products used against BMSB. Detailed monitoring of all pests will be crucial in order to prevent additional crop losses caused by the “normal pests.”

Planning for a seasonal insect control program

Since we currently cannot predict when BMSB will move into orchards and how intensive their populations and feeding will be this season, we should prepare ourselves for a season-long monitoring and management program. Also, the results of our early season management activities will likely not minimize the pest pressure that fruits experience in late summer and early fall. While BMSB can cause fruit damage at any point during the season, maturing fruit likely represent the most attractive and most likely available source of nutrients for this insect and, therefore, pest pressure may be the strongest as we move into the late summer and early fall period.

Maintaining the Integrity of IPM in Pennsylvania While Battling the Brown Marmorated Stink Bug

Pennsylvania tree fruit growers have embraced the principles of integrated pest management (IPM) since the late 1960s and early 1970s. By one definition, IPM is the “utilization of all suitable techniques and methods in as compatible manner as possible and maintains the pest populations at levels below those causing economic injury.” The goal of IPM is to minimize the number and severity of perturbations in the agroecosystem while reducing the economic, environmental, and human health costs associated with the particular management options(s). Fruit growers in Pennsylvania were one of the first states throughout the country to adopt the principles and practices of IPM by integrating the use of the black lady beetle (*Stethorus punctum*), commonly referred to by most growers as the “black beetle,” for the biological control of spider mites (e.g., European red mite and twospotted spider mite). This program over the last 40 years was responsible for significantly reducing the number and amount of miticides used by fruit growers and reducing the severity of miticide resistance. More recently (2004–present), the predatory mite *Typhlodromus pyri* has replaced *Stethorus* in many grower orchards as the principal biological control agent for spider mites in Pennsylvania.

When the IPM program in Pennsylvania was developed and used by growers during the late 1960s through the mid-1990s, the majority of insecticides registered at that time were primarily organophosphate (e.g., azinphosmethyl, phosmet) and carbamate (e.g., carbaryl, methomyl) chemistries—all of which were considered broad-spectrum insecticides in that they killed many different species of pests as well as the natural enemies (i.e., beneficial predators and parasites) of the pests. Faced with these broad-spectrum insecticides, researchers at Penn State had to learn how to develop an IPM program for tree fruit crops using these types of materials. The selectivity of insecticide chemistries is divided into two categories based on physiological and ecological selectivity. Physiological selectivity is the property of a compound that discriminates in terms of mortality between two taxa (i.e., pest groups for example codling moth versus aphids) when applied at comparable rates of active ingredient. Over the past 15 years, growers have started to use many products (e.g., Confirm, Intrepid, Altacor, Delegate, Cyd-X) for insect control in tree fruits that are defined as physiological selective insecticides. The majority of these products are relatively safe to many natural enemies inhabiting orchards. Ecological selectivity is the judicious use of pesticides, based on critical selection, timing, dosage, placement, and formulation of broad-spectrum pesticides (e.g., organophosphates, carbamates, pyrethroids). Its goal is to maximize pest mortality while minimizing beneficial mortality and to alter the predator to prey ratio in favor of the former.

The IPM program in Pennsylvania has had to change and survive the challenges from many pest perturbations down through the years. For example, the tufted apple bud moth, once considered the number-one direct-feeding pest of apples from the 1970s through the late 1990s, quickly developed resistance to most of the organophosphate insecticides in the 1970s and 1980s and later developed resistance to methomyl in the 1990s. Brood X of the periodical cicada, which occurs every 17 years, had outbreaks in 1970, 1987, and 2004. Many of the insecticides used to control this pest were very harmful to the many natural enemies

that inhabit orchards. The codling moth and oriental fruit moth developed resistance to a number of organophosphate, carbamate, and pyrethroid insecticides in the 1990s, which eventually led to the rejection and loss of thousands of loads of apples and peaches throughout Pennsylvania. Despite all of these perturbations over the past 40 years, the IPM program has withstood fairly well the majority of these challenges.

Fruit growers in Pennsylvania are now faced with the next major perturbation and challenge to their crops and their IPM program—the invasion of the brown marmorated stink bug. As all of you are so keenly aware, BMSB was found in the Allentown area in the late 1990s and was occasionally found in other areas of the state over the past 10 years, but rarely caused any economic damage. However, in 2010 BMSB populations exploded on many fruit farms and other crops, especially in counties across the southern part of the state, causing damage to many peaches and apples with some growers losing over 50–60 percent of their peach crops to the ravages of BMSB, while some apple growers experienced damage to over 20 percent of their crops.

How are we going to control this pest in 2011? Many of you have heard us speak at the winter educational meetings about the prospects of controlling this pest, what products to use, and certainly what future research needs to be done. As you have heard, the near-term solutions for BMSB will involve many different types of insecticides. Unfortunately, based on recent laboratory data generated by Dr. Tracy Leskey and her research team at the USDA lab in Kearneysville, West Virginia, using a dry-film residual assay and the laboratory data that we generated at FREC this past winter and spring using a direct contact topical assay, the most effective insecticides for BMSB control belong primarily to the chemistries of the synthetic pyrethroids, the carbamate group methomyl, the chlorinated hydrocarbon endosulfan (Thionex), and a couple of the neonicotinoids. As previously stated, the pyrethroids and methomyl are considered broad-spectrum insecticides that are highly toxic to many, if not all of the natural enemies found in tree fruits. Because of this toxicity to natural enemies, Penn State entomologists have only recommended the pyrethroids before bloom on apple to minimize their toxicity. Growers who have used these products postbloom on apples in the past have seen many flare-ups from European red mites, woolly apple aphids, San Jose Scale, etc.

Given the seriousness of the BMSB situation, the very high overwintering populations, its potential to possibly cause even higher levels of fruit damage in 2011, and that the most effective products for BMSB control are methomyl, pyrethroids, and some of the neonicotinoid products (i.e., Actara), how can growers successfully control BMSB and not completely destroy all natural enemies and the integrity of the IPM program in Pennsylvania? Growers need to only look back to what they did in the late 1900 era, when the only products available to them were primarily broad-spectrum insecticides. They will need to understand and employ all of the tactics used in applying the principles of ecological selectivity to this group of broad-spectrum insecticides. Listed below are some tactics growers can use to minimize the toxicity these products to natural enemies while still controlling BMSB.

Selection of an insecticide

All insecticides are not equal in their toxicity to natural enemies. When selecting an effective product for BMSB control, always refer to Table 4-4 in this guide and determine its toxicity for the various natural enemies that may also be present. Choose the product that is the least harmful to the natural enemies.

Timing of an insecticide

Proper timing is often the most effective and economical method of achieving differential insecticide selectivity for the pest/natural enemy complex. Only apply a highly effective insecticide for BMSB when they are in your orchards; therefore, growers must be very, very vigilant to monitor their blocks and surroundings and only apply these highly toxic insecticides when BMSB is present and a threat to their crops.

Dosage

The toxicity of any chemical compound is directly related to its dose. When using one of these broad-spectrum insecticides for BMSB control, always apply the lowest effective dose possible. Not only will the lowest dose likely conserve some of the natural enemies, but it will also save you some money.

Application techniques and methods

The only purpose in applying an insecticide is to kill the intended pest(s). Many growers in Pennsylvania have used the alternate row middle (ARM) technique of spraying to apply pesticides to their crops for over 40 years. We know from many years of research that this technique will provide effective pest control if done properly, but at the same time will allow for the survival of many natural enemies. Given the likelihood that the most effective control of BMSB will occur through the direct contact of the insecticide to this pest, the ARM method of spraying may be the best method to apply these broad-spectrum insecticides. By integrating low rates and frequent applications of insecticides (i.e., the original idea behind using the ARM method), better control of BMSB will likely be achieved while causing less harm to natural enemies.

Selective placement

Restricting an insecticide to a specific part of the tree or location within an orchard is another method to minimize the impact of toxic insecticides to natural enemies. Since BMSB is highly likely to move into orchards from the outside (e.g., woods, neighboring crops [soybeans, corn, vegetables, etc.], buildings), restricting the application of these broad-spectrum insecticides to border rows, etc., will likely conserve many natural enemies.

The brown marmorated stink bug is here and most likely will be an important and serious threat to our fruit system for a long time. Over time, we will learn how to manage this pest more effectively. New tools such as insect behavior modifying materials (e.g., a sex pheromone, an attractant, repellent, or deterrent) will likely be required to successfully control and minimize the threat from this pest. In the meantime, with the knowledge we have and the tools that are available, we need to try to “outsmart” this pest in order to continue to produce the best quality fruits. This new, exotic pest will require new management approaches, but until we can field test some of our BMSB management hypotheses,

these ideas will remain just “concepts” that may prove attractive in theory but difficult or even impractical to implement. As the growing season progresses, we will continue to “learn as we go” and provide the newest information to growers as fast as possible.

Overcoming the challenges of effective and sustainable BMSB control will not be an easy task in the near term. Much research needs to be done in order for us to develop the most effective management program for the long-term control of this pest. In the meantime, however, I also encourage growers to not lose sight of our current IPM program in Pennsylvania. We have achieved so much over the years and we have learned how to deal with those pest perturbations that seem to always occur. If we are not careful in how we manage BMSB, we may be causing many future pest problems for our industry by destroying the natural enemies that help us keep many of the other pests of tree fruits in balance.

Current and new updates and recommendations are being posted weekly during the season at the Penn State Fruit Research and Extension website (agsci.psu.edu/frec).

Resources

Hull, L. A., G. Krawczyk, and D. Biddinger. “Maintaining the integrity of IPM in Pennsylvania while battling the brown marmorated stink bug.” *Pennsylvania Fruit News* 91, no. 4 (2011): 9–10.

Krawczyk, G., and L. A. Hull. “Management option for the control of brown marmorated stink bug—a Pennsylvania perspective.” *Pennsylvania Fruit News* 91, no. 5 (2011): 15–21.

If Pennsylvania growers are to produce a commercially acceptable and profitable product, they often need to rely on the use of pesticides. For years, many growers in the state have practiced and continue to practice integrated pest management (IPM) where pesticides play a vital role. Applicators must clearly understand their legal obligations when using pesticides. Furthermore, applicators who implement pesticide safety practices and take proper precautions will greatly reduce the possibility of accidents.

USING PESTICIDES SAFELY

General Guidelines for Pesticide Safety *Always read the label!*

When pesticides are necessary it is important to make sure many factors are considered when selecting the specific chemical to use. Before using any pesticide product, always read the label, as it is a legal document. The label provides information on which pests can be controlled, on which crops the pesticide product can be used, and the recommended rates and times of application. Using a pesticide in a way that is not allowed by the label is a violation of both federal and state laws. Correct use of pesticides is essential to protect human, animal, and plant health as well as to protect the environment. It is also critical to help ensure pest control without damaging crops. For example, in some cases when rates that are higher than recommended by the label are used, crop injury occurs. Proper use will ensure that chemical residues on crops and livestock do not exceed legal limits (tolerances).

- Before using any pesticide, **READ THE LABEL**.
- Become familiar with current federal and state pesticide laws and regulations.
- Follow all safety precautions on the label.
- Wear protective clothing and use protective equipment (both are referred to as personal protective equipment, PPE) according to instructions on the pesticide label.
- Minimum clothing requirements are long pants, long-sleeved shirt, socks, and shoes. In addition, the applicator should wear chemically resistant gloves (nitrile, butyl, or neoprene) and unlined rubber boots.
- Be careful when handling pesticide materials to avoid spilling on skin or clothing.
- Never eat, drink, smoke, or use tobacco products while applying pesticides.
- When selecting pesticides, consider type of formulation and the application equipment required.
- Avoid drift to nontarget areas, which may endanger other plants or animals. Dusts drift more than sprays and airblast sprayers create more drift than boom sprayers.
- For record-keeping requirements, record the date, time, location, amount of each pesticide used, and any other required information within 24 hours of the application. In addition, if workers/handlers are employed that are covered under the Worker Protection Standard (WPS), this information must be documented at the completion of the application. It must also be available at a central location where employees have unrestricted access to the information.
- Bathe or shower in hot, soapy water after applying pesticides.
- Wash clothing worn while applying pesticides separately from other laundry, in hot, soapy water. Contaminated clothing must be handled with the same precautions as the pesticide itself.

PESTICIDE TOXICITY

For all pesticides to be effective against the pests they are intended to control, they must be biologically active, or toxic. Because pesticides are toxic, they are also potentially hazardous to humans and animals. Any pesticide can be poisonous or toxic if absorbed in excessive amounts. Pesticides can cause skin or eye damage (topical effects) and can also induce allergic responses. However, if used according to label directions and with the proper personal protective equipment (PPE), pesticides can be used safely. For this reason, people who use pesticides or regularly come in contact with them must understand the relative toxicity and the potential health effects of the products they use. The risk of exposure to pesticides can be illustrated with the following simple equation:

$$\text{Hazard of Pesticide Use} = \text{Toxicity} \times \text{Actual Exposure}$$

Toxicity is a measure of a pesticide's ability to cause injury, which is a property of the chemical itself. Pesticide toxicity is determined by exposing test animals to different dosages of the concentrated active ingredient. Tests are also done with each different formulation of the product (for example, liquids, dusts, and granulars). By understanding the difference in toxicity levels of pesticides, a user can minimize the potential hazard by selecting the pesticide with the lowest toxicity that will control the pest.

Applicators may have little or no control over the availability of low-toxicity products or the toxicity of specific formulated products. However, exposure can be significantly reduced or nearly eliminated by using the correct PPE. For example, over 90 percent of all pesticide exposure comes from dermal exposure, primarily to the hands and forearms. By wearing chemically resistant gloves, this exposure can be reduced by at least 90 percent. Therefore, by wearing the correct PPE, the hazard of pesticide use can be reduced significantly for the applicator.

Acute Toxicity and Acute Effects

Acute toxicity of a pesticide refers to the chemical's ability to cause injury to a person or animal from a single exposure, generally of short duration. The four routes of exposure are dermal (skin), inhalation (lungs), oral (mouth), and ocular (eyes). Acute toxicity is determined by examining the dermal toxicity, inhalation toxicity, and oral toxicity of test animals. In addition, the potential for eye and skin irritation are also examined.

Acute toxicity is usually expressed as LD₅₀ (lethal dose 50) or LC₅₀ (lethal concentration 50) values. This is the amount or concentration of a toxicant required to kill 50 percent of a test population of animals under a standard set of conditions. The most common practice is for the toxicity of pesticides to be referred to by their LD₅₀ values. The LD₅₀ of a pesticide is recorded in milligrams of pesticide per kilogram of body weight of the test animal (mg/kg), or in parts per million (ppm). LC₅₀ values of pesticides are recorded in milligrams of pesticide per volume of air or water (ppm). To put these units into perspective, 1 ppm is analogous to 1 inch in 16 miles or 1 minute in 2 years.

The LD₅₀ and LC₅₀ values are useful in comparing the toxicity

of different active ingredients as well as different formulations of the same active ingredient. The lower the LD₅₀ value of a pesticide, the less it takes to kill 50 percent of the test population, and therefore the greater the acute toxicity of the chemical. Pesticides with higher LD₅₀ values are considered the least acutely toxic to humans when used according to the directions on the product label.

The LD₅₀ and LC₅₀ values are found in the products' Material Safety Data Sheets (MSDS), which are available from the supplier or product manufacturer when pesticide products are purchased. Most are also available from various online sources, including the manufacturer's website or through various search engines as listed on the Pesticide Education Program's website at www.pested.psu.edu/resources/web/labels.shtml. For many reasons, especially in an emergency situation, maintaining a file with copies of the label and MSDS for each pesticide product used is highly recommended.

Signal Words

The LD₅₀ of the chemical is the basis for assigning pesticides to a toxicity category and determining the appropriate signal word for the product label. Pesticides that are classified as "highly toxic," on the basis of either oral, dermal, or inhalation toxicity, must have the signal words **DANGER** and **POISON** (in red letters) and a graphic of a skull and crossbones prominently displayed on the package label. **PELIGRO**, the Spanish word for danger, must also appear on the label of highly toxic chemicals. Acute oral LD₅₀ values for pesticide products in this group range from a trace amount to 50 mg/kg. An exposure of a few drops of a highly toxic material taken orally could be fatal to a 150-pound person.

Some pesticide products are labeled with the signal word **DANGER** without the skull and crossbones symbol. A **DANGER** signal word in this instance does not provide information about the LD₅₀ value of the chemical. Instead, this signal word means that potentially damaging skin or eye effects (due to the product's irritant or corrosive properties) are more severe than the acute toxicity (LD₅₀) of the product would indicate.

Pesticide products considered "moderately toxic" must have the signal words **WARNING** and **AVISO** (Spanish) displayed on the label. Acute oral LD₅₀ values range from 50 to 500 mg/kg. An exposure of 1 teaspoon to 1 ounce could be fatal to a 150-pound person.

Pesticide products classified as either "slightly toxic" or "relatively nontoxic" are required to have the signal word **CAUTION** on the pesticide label. Acute oral LD₅₀ values are greater than 500 mg/kg.

Chronic Toxicity and Chronic Effects

Any harmful effects that occur from repeated small doses over a period of time are called chronic effects. The chronic toxicity of a pesticide is determined by observing symptoms in test animals that result from long-term exposure to the concentrated active ingredient.

Some of the potential chronic effects from exposure to certain pesticides include birth defects (teratogenesis); fetal toxicity (fetotoxic effects); production of tumors (oncogenesis), either benign (noncancerous) or malignant (cancerous/carcinogenesis); genetic changes (mutagenesis); blood disorders (hemotoxic ef-

fects); nerve disorders (neurotoxic effects); and reproductive effects. The chronic toxicity of a pesticide is more difficult to determine through laboratory analysis than is acute toxicity. However, the product's MSDS also contains information regarding chronic symptoms of pesticide exposure based on laboratory animal test results.

SYMPTOMS OF PESTICIDE POISONING

The symptoms of pesticide poisoning can range from a mild skin irritation to coma or even death. Different classes or families of chemicals cause different types of symptoms. Individuals also vary in their sensitivity to different levels of these chemicals. Some people may show no reaction to an exposure that may cause severe illness in others. Because of potential health concerns, pesticide users and handlers must recognize the common signs and symptoms of pesticide poisoning.

The effects, or symptoms, of pesticide poisoning can be broadly defined as either topical or systemic. Topical effects generally develop at the site of pesticide contact and are a result of either the pesticide's irritant properties (from either the active and/or inert ingredient) or an allergic response by the person exposed. Dermatitis, or inflammation of the skin, is accepted as the most commonly reported topical effect associated with pesticide exposure. Symptoms of dermatitis range from reddening of the skin to rashes and/or blisters. Some individuals exhibit allergic reactions when using pesticides or when these materials are applied in or around their homes or places of work. Symptoms of allergic reactions range from reddening and itching of the skin and eyes to respiratory discomfort that often resembles an asthmatic condition.

Systemic effects are quite different from topical effects. They often occur away from the original point of contact, as a result of the pesticide being absorbed into and distributed throughout the body. Systemic effects often include nausea, vomiting, fatigue, headache, and intestinal disorders.

Seeking prompt medical attention and providing information about the potential of a pesticide exposure causing the symptoms is important. However, the development of certain symptoms is not always the result of exposure to a pesticide. For example, common illnesses such as the flu, heat exhaustion or heat stroke, pneumonia, asthma, respiratory and intestinal infections, and even a hangover can cause symptoms similar to pesticide exposure. Carefully consider all possible causes of your symptoms and provide medical personnel with all of the information they need to make an informed diagnosis.

Responding to Pesticide Poisoning Symptoms

Be alert for the early symptoms of pesticide poisoning. Responding immediately and appropriately when pesticide exposure is suspected will help minimize the effects of exposure and, in extreme cases, may save a life. If you are having symptoms but are unsure whether they are pesticide related, at least notify someone in case your symptoms become worse. If you are not feeling well and suspect it may be due to a pesticide exposure, call the National Poison Center at 1-800-222-1222 for guidance on the proper response to your symptoms. This number will direct your call to the nearest poison center, which is staffed on a 24-hour basis.

If safe to do so, take the pesticide container to the telephone. However, if the pesticide container is contaminated, write down the EPA registration number, product name and percentage of active ingredients, and take that information to the phone. The product label provides medical personnel information such as active ingredients, an antidote, and an emergency contact number for the manufacturer of the product. If you must go to the hospital or doctor's office, take the entire container, including the label, with you. In order to avoid inhaling fumes or spilling the contents, make sure the container is tightly sealed and never put it in the enclosed passenger section of a vehicle. If the Material Safety Data Sheet (MSDS) is available, also take this with you because it frequently contains additional information for medical personnel to determine treatment options.

In addition to posting emergency numbers or having them readily available by a telephone, keep these numbers in all service vehicles involved in transporting pesticides. Additional pesticide information can also be obtained by contacting the National Pesticide Information Center (NPIC) located at Oregon State University at 1-800-858-7378. The NPIC provides a variety of unbiased information about pesticides to anyone in the United States.

FIRST AID FOR PESTICIDE POISONING

Reviewed by J. Ward Donavon, medical director of Pinnacle Health Toxicology Center, Harrisburg Hospital

Immediate and appropriate action, such as providing basic first aid, may be necessary to prevent serious injury to a victim of pesticide poisoning. The situation can be a life-or-death matter. Providing immediate care is important; however, it is more important to provide the correct assistance and protect yourself in the process. The product label should be one of the first sources of information in a pesticide exposure emergency, in addition to calling 911 and the National Poison Center (1-800-222-1222). *First aid is only the "first response" and is not a substitute for professional medical help.*

Basic First Aid Instructions

- Most important, be sure to protect yourself by wearing appropriate protective clothing and equipment if there is a likelihood of being directly exposed to a pesticide while administering first aid or removing the victim from an enclosed area.
- Have current labels and MSDSs available.
- Have emergency response telephone numbers readily available.
- Assemble a first aid kit with necessary supplies.
- Always have a source of clean water available. In an extreme emergency, even water from a farm pond, irrigation system, or watering trough could be used to dilute the pesticide.
- If oral or dermal exposure has occurred, the first objective is usually to dilute the pesticide and prevent absorption.
- If inhalation exposure occurs, first protect yourself, and then get the victim to fresh air immediately.
- Never give anything orally to an unconscious person.
- Become familiar with the proper techniques of artificial respiration; it may be necessary if a person's breathing has stopped or become impaired.

Specific First Aid Instructions

If the victim **IS NOT** breathing:

FIRST—Evaluate the surroundings of the victim. Protect yourself from pesticide exposure prior to and while giving assistance.

SECOND—Administer artificial respiration and call 911.

THIRD—Call the National Poison Center (1-800-222-1222).

FOURTH—Decontaminate the victim immediately; wash thoroughly and quickly. Speed is essential.

If the victim **IS** breathing:

FIRST—Evaluate the surroundings of the victim. Protect yourself from pesticide exposure prior to and while giving assistance.

SECOND—Decontaminate the victim immediately; wash thoroughly and quickly. Speed is essential.

THIRD—Call 911 if the victim has ill effects from the exposure.

FOURTH—Call the National Poison Center (1-800-222-1222).

If the pesticide has been spilled on the skin or clothing, remove any contaminated clothing immediately and thoroughly wash the skin with soap and water. Avoid harsh scrubbing, as this enhances pesticide absorption. Rinse the affected area with water, wash again, and rinse. Gently dry the affected area and wrap it in a loose cloth or blanket, if necessary. If chemical burns of the skin have occurred, cover the area loosely with a clean, soft cloth. Avoid the use of ointments, greases, powders, and other medications unless instructed by medical personnel.

Heavily contaminated clothing should be disposed of properly. If clothing is not heavily soiled, wash all contaminated clothing separately from any other laundry, in hot water, at a high water level, and with a heavy duty liquid detergent. Run the washer through a complete cycle with detergent and no clothes to remove pesticide residue from the washer drum before the next load of laundry. Store washed protective clothing separately from other clothes. Also, do not store protective clothing and equipment in pesticide storage areas.

If the pesticide has entered into the eyes, hold the eyelid open and immediately begin gently washing the eye with clean running water, so that the water flows away from the nose. If contact lenses are worn, remove and discard the contacts before beginning this process. Do not use chemicals or drugs in the eye wash water. Continue washing for 15 minutes. If only one eye is involved, avoid contaminating the other one. Flush under the eyelids with water to remove debris. Cover the eye with a clean piece of cloth and seek medical attention immediately.

If the pesticide has been inhaled, get the victim to fresh air immediately. However, do not attempt to rescue someone who is in an enclosed area unless you are wearing appropriate protective equipment. Have the victim lie down and loosen their clothing. Call 911. Keep the victim warm and quiet. If the victim is convulsing, watch their breathing and protect their head. Keep the chin up to keep air passages free for breathing. If breathing stops, administer artificial respiration. Call the National Poison Center (1-800-222-1222) after the victim is stabilized for further advice.

If the pesticide has been swallowed, contact the National Poison Center (1-800-222-1222) and provide them with the EPA registration number, product name, and approximate amount of material that was ingested. Call 911 immediately if the victim has symptoms from the exposure. If the pesticide has entered the mouth but has not been swallowed, rinse the mouth with large amounts of water. **Inducing vomiting is rarely advised for any poisoning, including pesticide poisonings.** Check the product label to determine the appropriate immediate action.

If a petroleum product (kerosene, gasoline, oil, lighter fluid, EC pesticides) **has been swallowed**, call the National Poison Center (1-800-222-1222) and 911 immediately for further instruction.

If a corrosive poison (a strong acid or alkali) **has been swallowed**, dilute with water or milk immediately. Consult the National Poison Center (1-800-222-1222) and 911 immediately. The victim may experience severe pain and have extensive mouth and throat burns. Fortunately, most commonly used pesticides are not corrosive, but some cleaners, disinfectants, and germicides fall into this category.

SAFE STORAGE OF PESTICIDES

- Read the label for specific storage instructions and precautions.
- Store pesticides in a clean, cool, dry, and well-ventilated building. Always lock the area to prevent entry by children and untrained persons. Mark the storage facility with an appropriate warning sign.
- Maintain proper temperature control. For example, if emulsion-type materials freeze, the emulsion may be destroyed, resulting in loss of effectiveness and possible serious plant injury.
- To avoid the danger of cross-contamination, do not store herbicides with other pesticides.
- Keep dry materials above liquid materials.
- Do not store pesticides where food, water, feed, seeds, fertilizers, or personal protective clothing and equipment (such as respirators) can become contaminated.
- Store pesticides in their original containers. Never store pesticides in any food or drink containers.
- Do not remove the labels. Keep lids tightly closed.
- Check containers frequently for leaks.
- Clean up spilled chemicals promptly and properly. Dispose of broken or damaged containers and any pesticide waste in an approved and safe manner as directed on the product label.
- Keep an inventory of all chemicals. Mark each container with the year of purchase.
- Inform your local fire department of any chemicals (including fertilizers) stored in large quantity.

SAFE DISPOSAL OF PESTICIDES

- Read the pesticide label for specific disposal instructions.
- Avoid disposal problems by purchasing only the amount of material needed for one growing season. Do not stockpile.
- Use proper personal protective clothing and equipment when you dispose of pesticide wastes and containers.
- Mix only the amount of pesticide required for a particular application. If you mix too much, use the surplus by applying the material at the recommended rate to one of the crops listed on the label.
- Do not dump pesticides or pesticide rinsates on the ground or pour them down sinks, toilets, or other drains, including storm sewers.
- Pressure rinse or triple rinse empty pesticide containers with water. Pour the rinse water into the spray tank, making sure to drain the container for 30 seconds each time.
- After rinsing metal, plastic, or glass containers, puncture, break, crush, or in some way to render unusable. Where possible, recycle plastic containers through a Plastic Pesticide Container Recycling Program; in some states these are sponsored by the state's Department of Agriculture. Contact your state pesticide regulatory agency or extension office for further information. Otherwise disposal in a sanitary landfill is desirable if conducted in accordance with local regulations.
- If stated on the label and permitted by local ordinances, combustible containers can be burned. However, do not burn pesticide containers near residential areas or where the smoke can contact humans. Avoid exposure to the smoke; it may contain toxic vapors. Bury the ashes since they also may be toxic.
- Send large metal drums to a reconditioning company.
- Before disposing of pesticide concentrates, check with your state pesticide regulatory agency, which may provide disposal options for unwanted and outdated pesticide concentrates free of charge. For example, in Pennsylvania this can be accomplished by participating in the CHEMSWEEP program sponsored by the Department of Agriculture.
- Do not reuse empty pesticide containers for any purpose.
- Clean up thoroughly after handling and disposing of pesticides.

CURRENT STATUS OF RESTRICTED-USE PESTICIDES IN PENNSYLVANIA

Under the authority of the amended Federal Insecticide, Fungicide, and Rodenticide Act (FIFRA), applicators who apply restricted-use pesticides (RUPs) in the production of an agricultural crop must be certified as a private applicator or must work under the direct supervision of a certified applicator. Furthermore, only certified applicators can purchase restricted-use pesticides. The pesticide dealer is required by law to record the name, address, and certification number of the purchaser of RUPs, as well as the identity of the product, amount sold, and date of purchase. Either photo identification or two other acceptable forms of identifica-

tion are required to be presented to the dealer when RUPs are delivered. Commercial and public pesticide applicators must be certified to use both general and restricted-use pesticide products.

RUPs include all pesticide products designated as restricted-use by the U.S. Environmental Protection Agency; however, for use to be legal, products must also be registered by the state. In addition, states may choose to assign restricted-use status to other products if it is deemed in the interest of the public health and welfare. States may also refuse to register a pesticide for use if they choose. If a pesticide is restricted-use, this status will be clearly marked on the label.

WORKER PROTECTION STANDARD FOR AGRICULTURAL PESTICIDES

In 1992, the U.S. Environmental Protection Agency (EPA) revised its Worker Protection Standard (WPS), which addresses the protection of agricultural workers from pesticide exposure (40 CFR Part 170). The WPS includes requirements designed to reduce the risks of illness or injury to agricultural workers and pesticide handlers from occupational or accidental exposure to pesticides in the production of agricultural plants on farms and in nurseries, greenhouses, and forests.

The WPS expands the scope of prior worker protection regulations to identify two types of agricultural employees:

- **pesticide handlers**—those who handle agricultural pesticides (mix, load, apply, clean or repair contaminated equipment, act as flaggers, etc.), and
- **agricultural workers**—those who perform tasks related to the cultivation and harvesting of plants on farms or in greenhouses, nurseries, or forests where pesticides are used.

The WPS holds growers/employers responsible for compliance. The regulations expand requirements for the employer to make sure that employees are provided with the following:

- Warnings about pesticide applications
- Clean and properly maintained personal protective equipment (PPE), which employers must ensure is worn
- Restrictions on reentry by personnel to treated areas (all pesticides used on farms and in forests, nurseries, and greenhouses have specific restricted-entry intervals (REIs) that are listed on the label under the “Agricultural Use Requirements” section)
- Decontamination facilities
- Pesticide safety training and information
- Notification of pesticide applications and information about the pesticide(s) used
- Maintained contact with handlers when applying highly toxic pesticides
- Emergency assistance when required
- A pesticide safety poster placed in an area where it can be seen easily by all workers and handlers
- Information about pesticide label safety for pesticide handlers and early entry workers
- A centrally located listing of recent pesticide applications made on the premises within the past 30 days

Under WPS, labels now include statements specifying personal protective equipment, restricted-entry intervals (REIs),

and (on some pesticide labels) a requirement to provide both oral warnings and posting of treated areas.

EPA developed these regulations with the non-English-speaking worker specifically in mind. Safety warnings, information, and training must be given in “a manner the worker can understand.”

The Pesticide Safety Fact Sheet *EPA Worker Protection Standard for Agricultural Pesticides* from the Penn State Pesticide Education Program describes these requirements in some detail. It is available from the Publications Distribution Center, The Pennsylvania State University, 112 Agricultural Administration Building, University Park, PA 16802; phone 814-865-6713, or online at www.pested.psu.edu/resources/facts.

ORCHARD SPRAYING

Orchard spraying falls into two classes: (1) tree spraying for disease and pest control, nutrition, growth regulation, and chemical thinning, and (2) ground spraying for weed control. Each class requires different equipment. Air-blast sprayers are generally used for tree application, and hydraulic sprayers and granular applicators are used for ground application. Air-blast sprayers use water and air as diluents and carriers for the chemical, while hydraulic sprayers use water and pressure. Growers with very small orchards may want to consider using a handgun (for dilute spraying only).

Tree Spraying

The air-blast sprayer plays an important role in achieving the level of pest control obtained with a specific amount of pesticide. Best results are obtained when the sprayer has enough fan capacity to blow the spray through the trees and at least 10 feet beyond, even when operating against a 5-mph wind. Maximum spray deposit requires that the droplets be forced against the object to be covered. Spray that drifts at slow speeds past tree tops is not sufficient.

Many sprayers are unable to achieve adequate deposit on trees over 20 feet high. Most sprayers should be operated at 2.5 mph or less on mature trees. When low air volume sprayers are being used, the ground speed usually must be limited to 2 mph or less, even on trees of small to moderate size. Sprays should be applied only when there is little or no wind. Large trees require sprayers with large air volume capacities. Match the sprayer capability to the tree size. Air capacity and air speed are not the same. Use water-sensitive paper targets in the trees to evaluate coverage.

Low-volume (concentrate) spraying involves reduced amounts of water per acre, generally a reduction from 350 to 400 gallons per acre for dilute sprays to 20 to 100 gallons. The term “low volume” is derived from the fact that a smaller volume of water, not air, is used to carry the chemical. Runoff is eliminated with low-volume spraying. Individual sprayers are designed to operate most efficiently at certain gallonages per acre, and best spray coverage and deposit are obtained within the manufacturer’s recommended range. Tree size and number of trees per acre as well as spray droplet size influence the gallonage needed for adequate coverage.

Choose the gallonage per acre best suited to your equipment, tree size, and orchard problems. Then add the amount of chemical needed per acre to that amount of water. Spraying less than 40 gallons of water per acre onto trees over 18 feet high usually

results in unsatisfactory coverage. See “Tree Row Volume” in this section.

The amount of pesticide per acre in low-volume spray is reduced in comparison with the amount needed in a standard 400 gallons of dilute spray per acre. For example, a fungicide might be suggested at 8 pounds in 400 gallons of water per acre. With low-volume sprays on apples and sweet cherries, the 8 pounds can be reduced about 20 percent. In low-volume sprays for peaches, pears, nectarines, plums, and tart cherries, the rate can be reduced by about 25 percent or to 5.25 pounds per acre. For lower rates to be effective, the entire tree must be covered without runoff.

The advantages of low-volume spraying are: less pesticide, water, labor, and time, with fewer refills. The disadvantages are in the increased care required to calibrate the sprayer, maintain a constant ground speed, select good spraying conditions, and train a skilled operator. As gallonage is reduced, errors become more critical. In addition, some materials such as dormant oil and growth regulators need to be applied at higher water gallonage per acre to be effective. Rates of water of 100 to 300 gallons per acre may be required. Fire blight sprays should be applied at full dilute rate. Dual “flop over” nozzles, multiple-orifice nozzles, or adjustable flow to air-shear nozzles are convenient time savers.

Application costs decrease most rapidly when changing from 400 gallons to 50 gallons of spray solution per acre. Below 50 gallons per acre the savings are smaller, and complete coverage will be difficult even on moderate-size trees. The additional savings with less than 50 gallons per acre may not be worth the additional risks.

Alternate middle row spraying often is used by fruit growers. The basic plan calls for one complete coverage of apple trees before the first scab infection period in the spring. Then alternate rows are sprayed at a fixed interval, such as every 7 days. This method permits frequent application of low amounts of pesticides, many of which are short-lived on the tree. With minor modifications, it is the preferred method in pest management programs and in other programs where minimum use of pesticides is a major goal. If the advantages of the alternate-row spraying method are to be realized, it is essential that the sprayer have adequate air volume and velocity to provide at least light spray coverage on at least 90 percent of the tree each half spray. With full-size apple trees planted in rows 30 to 40 feet apart, large sprayers delivering 90,000 to 100,000 cubic feet of air per minute at 80 mph or more are satisfactory for alternate-row spraying. Smaller trees and closer rows permit sprayers with smaller air capacities to be used. For good results, the sprayer should push some spray 10 to 15 feet beyond the tree.

Selecting a Nozzle

- Select ground speed (rate of travel) to be used.
- Determine the distance between tree rows.
- Decide gallons of spray wanted per acre based on tree size, material to be applied, and efficient operation of your sprayer.
- From Table 3-1 determine spray output per minute needed for the entire sprayer (two sides). For example, to apply 50 gallons of spray per acre at 2 mph, 4.0 gallons per minute will be needed for rows 20 feet apart and 6.1 for 30-foot rows. If

one-side delivery is used, the amount needed is one-half the amount in the table.

- Consult the dealer or the operator’s manual for capacity of discs and whirlers, after determining the pressure at the nozzle outlet. Then select those needed to give the desired output per minute, with conventional air-blast sprayers, nozzles should be selected and installed to allow delivery of 85 percent of the spray volume to the top two-thirds of the tree; 50 percent of the spray volume should be delivered to the top third of the tree. Sprayers with air-shear nozzles should be adjusted for similar distribution. Tower air-blast sprayers should have even or nearly uniform nozzles with slightly bigger ones on the top. On full dwarf and trellised trees, the nozzles can be nearly uniform since all parts of the trees are about the same distance from the nozzles. Table 3-2 illustrates how various combinations of discs and whirl plates can be used to achieve a wide range of flow rates. See your sprayer dealer or company representative for a complete range of choices.

Calibrating the sprayer—first method

Sprayers often do not deliver the calculated amount of spray per minute. There are several ways to check this. The following method is suggested.

1. Fill the sprayer tank completely with water only.
2. Pressurize the system to desired level and spray for 3 minutes. With PTO units, be sure that the pump speed and pressure are identical to that used when spraying.
3. Determine the amount of water required to refill tank.
4. Calculate gallons per minute and compare that amount with what should have been used (see Table 3-1).
5. Adjust pressure, nozzle sizes, or flow control and repeat the procedure until the delivery is correct.
6. Further check application rate by observing the acreage covered by a tankful (1 acre equals 43,560 sq ft).

Example: We pressurize a sprayer to 200 psi and spray (in place) for 3 minutes. Carefully measuring, we determine that it requires 14.5 gallons to refill the sprayer tank to previous level. To determine the rate, divide the amount delivered (14.5 gal) by the time (3 min) to calculate the delivery rate (4.8 gal/min). If we are to spray an orchard having a distance between rows of 26 ft at a rate of 50 gal of spray/A with the sprayer traveling at 2 mph, we find that the rate should be 5.3 gallons per minute (by checking Table 3-1). To increase application, we can increase pressure, increase nozzle size or flow rate, decrease travel speed, or any combination of these. Make changes and rerun calibration test.

Calibrating the sprayer—second method

1. Fill sprayer completely or to known level with water only.
2. Spray a known area such as $\frac{1}{4}$ or $\frac{1}{2}$ acre. Area sprayed can be determined by counting trees sprayed (two half trees equals one tree) and multiplying by area occupied by each tree (row spacing x in-row spacing). One acre equals 43,560 square feet.
3. Return to filling site and try to position sprayer and tractor in same position as in (1) above.

4. Carefully measure amount of water needed to refill to previous level.
5. Convert to an acreage rate. For example, if enough trees are sprayed to cover ¼ acre (10,890 sq ft) and 12 gallons are required to refill the tank, the application rate is 48 gallons per acre.

Example: We want to spray a block of apples planted 14 feet apart in 22-foot-row spacing (14 ft x 22 ft). Each tree (or two half trees) occupies 308 (14 x 22) square feet of area. Therefore, there are 140 (43,560 sq ft/A ÷ 308 sq ft) trees per acre, or 35 trees in ¼ acre. We spray 35 trees at desired speed and pressure and return to filling spot.

Carefully measuring the amount of water required to refill to previous level, we find that we sprayed 12 gallons. The application rate per acre is 48 (12 x 4) gallons per acre. Adjust pressure, driving speed, nozzle flow, or any combination to change rate.

General Recommendations

Economic considerations favor low-volume over dilute sprayers. A low-volume sprayer will cover more acreage in a given time period than a sprayer calibrated for dilute application. However, some tree fruit production chemicals, such as growth regulators and oil sprays, are more effective when applied in larger amounts of water per acre than can be applied with some low-volume sprayers. Check maximum application rate when purchasing a sprayer.

Select nozzle sizes to distribute the spray droplets throughout the air stream. Distribution depends on tree shape, size, and distance from the sprayer (also row spacing with two-side delivery). Adjustments should be made throughout the growing season and when moving to a block of different size trees.

A wear-resistant nozzle, such as those with ceramic or hardened stainless-steel orifices, should be used. A worn orifice will result in poor droplet formation and distribution. To check orifice wear, mark a section of your orchard covered properly by one tankful of spray mixture when the nozzles are new and the sprayer is calibrated properly. Each time this marked section of the orchard is sprayed, it serves as a check on the flow regulation of the nozzle set in your sprayer. Anytime the variation is more than 5 percent, the nozzles should be replaced. Where whirlplates are used, replace them when nozzles are replaced.

When using a mist sprayer equipped with air-shear nozzles, make sure the fan (engine or PTO shaft) is operating at correct speed. Correct air velocity is very important for proper size of droplet formation as well as tree canopy penetration.

When using PTO-powered units, be sure to match tractor size to sprayer requirements. The tractor must have enough total horsepower to operate the sprayer at rated PTO speed and to maintain a constant ground speed on all terrain conditions. Check sprayer manufacturer's specifications to determine the horsepower requirement of the unit. Be certain the tractor can be operated at the desired ground speed when the engine is operating the PTO at the standard speed. For example, assume a PTO-powered sprayer is operating at 2 mph; the tractor must have sufficient horsepower to provide a ground speed of 2 mph and operate the PTO shaft at the 540 rpm required for proper sprayer operation. Allow 15 to 30 horsepower for transporting the sprayer, depending on its loaded weight and the terrain. Check tractor ground speeds at standard PTO speed to make sure there is a gear that will provide an acceptable rate of travel.

Table 3-1. Total gallons per minute sprayed (both sides) for various row spacings and gallons-per-acre rates, when sprayer moves at 1.5, 2.0, and 2.5 mph.

WHEN SPRAYER MOVES AT 1.5 MPH											
(Use twice these gallons per minute when traveling 3 mph, which is too fast for tall and thick trees.)											
Distance between rows (ft)	gal of spray/A										
	20	30	40	50	60	70	80	90	100	300	400
40	2.4	3.6	4.8	6.1	7.3	8.5	9.7	10.9	12.1	36.4	48.5
38	2.3	3.4	4.6	5.8	6.9	8.1	9.2	10.4	11.5	34.5	46.1
36	2.2	3.3	4.4	5.5	6.5	7.6	8.7	9.8	10.9	32.7	43.6
34	2.1	3.1	4.1	5.2	6.2	7.2	8.2	9.3	10.3	30.9	41.2
32	1.9	2.9	3.9	4.8	5.8	6.8	7.8	8.7	9.7	29.1	38.8
30	1.8	2.7	3.6	4.5	5.5	6.4	7.3	8.2	9.1	27.3	36.4
28	1.7	2.5	3.4	4.2	5.1	5.9	6.8	7.6	8.5	25.5	33.9
26	1.6	2.4	3.2	3.9	4.7	5.5	6.3	7.1	7.9	23.6	31.5
24	1.5	2.2	2.9	3.6	4.4	5.1	5.8	6.5	7.3	21.8	29.1
22	1.3	2.0	2.7	3.3	4.0	4.7	5.3	6.0	6.7	20.0	26.7
20	1.2	1.8	2.4	3.0	3.6	4.2	4.8	5.5	6.1	18.2	24.2
18	1.1	1.6	2.2	2.7	3.3	3.8	4.4	4.9	5.5	16.4	21.8
16	1.0	1.5	1.9	2.4	2.9	3.4	3.9	4.4	4.8	14.5	19.4
14	0.8	1.3	1.7	2.1	2.5	3.0	3.4	3.8	4.2	12.7	17.0

WHEN SPRAYER MOVES AT 2 MPH											
Distance between rows (ft)	gal of spray/A										
	20	30	40	50	60	70	80	90	100	300	400
40	3.2	4.8	6.5	8.1	9.7	11.3	12.9	14.5	16.2	48.5	64.6
38	3.1	4.6	6.1	7.7	9.2	10.7	12.3	13.8	15.4	46.1	61.4
36	2.9	4.4	5.8	7.3	8.7	10.2	11.6	13.1	14.5	43.6	58.2
34	2.8	4.1	5.5	6.9	8.2	9.6	11.0	12.4	13.7	41.2	55.0
32	2.6	3.9	5.2	6.5	7.8	9.1	10.3	11.6	12.9	38.8	51.7
30	2.4	3.6	4.8	6.1	7.3	8.5	9.7	10.9	12.1	36.4	48.5
28	2.3	3.4	4.5	5.7	6.8	7.9	9.0	10.2	11.3	33.9	45.2
26	2.1	3.2	4.2	5.3	6.3	7.4	8.4	9.5	10.5	31.5	42.0
24	1.9	2.9	3.9	4.9	5.8	6.8	7.8	8.7	9.7	29.1	38.8
22	1.8	2.7	3.6	4.4	5.3	6.2	7.1	8.0	8.9	26.6	35.5
20	1.8	2.7	3.2	4.0	4.8	5.7	6.5	7.3	8.1	24.2	32.3
18	1.5	2.2	2.9	3.6	4.4	5.1	5.8	6.5	7.3	21.8	29.1
16	1.3	1.9	2.6	3.2	3.9	4.5	5.2	5.8	6.5	19.4	25.8
14	1.1	1.7	2.3	2.8	3.4	4.0	4.5	5.1	5.7	17.0	22.6

WHEN SPRAYER MOVES AT 2.5 MPH											
Distance between rows (ft)	gal of spray/A										
	20	30	40	50	60	70	80	90	100	300	400
40	4.0	6.1	8.1	10.1	12.1	14.1	16.2	18.2	20.2	60.6	80.8
38	3.8	5.8	7.7	9.6	11.5	13.4	15.4	17.3	19.2	57.6	76.8
36	3.6	5.5	7.3	9.1	10.9	12.7	14.5	16.4	18.2	54.5	72.7
34	3.4	5.2	6.9	8.6	10.3	12.0	13.8	15.5	17.2	51.6	68.7
32	3.2	4.8	6.5	8.1	9.7	11.3	12.9	14.5	16.2	48.5	64.6
30	3.0	4.5	6.1	7.6	9.1	10.6	12.1	13.6	15.2	45.5	60.0
28	2.8	4.2	5.7	7.1	8.5	9.9	11.3	12.7	14.1	42.4	56.6
26	2.6	3.9	5.3	6.6	7.9	9.2	10.5	11.8	13.1	39.4	52.5
24	2.4	3.6	4.8	6.1	7.3	8.5	9.7	10.9	12.1	36.4	48.5
22	2.2	3.3	4.4	5.6	6.7	7.8	8.9	10.0	11.1	33.3	44.4
20	2.0	3.0	4.0	5.1	6.1	7.1	8.1	9.1	10.1	30.3	40.4
18	1.8	2.7	3.6	4.5	5.5	6.4	7.3	8.2	9.1	27.3	36.4
16	1.6	2.4	3.2	4.0	4.8	5.7	6.5	7.3	8.1	24.2	32.2
14	1.4	2.1	2.8	3.5	4.2	4.9	5.7	6.4	7.1	21.2	28.3

NOTE: The output in gallons per minute should be 25 percent less at 1.5 mph than at 2 mph and 25 percent more at 2.5 mph than at 2 mph. It should be 50 percent more at 3 mph than 2 mph. Increasing ground speed from 2 to 3 mph without recalibration results in 33 percent less spray per acre.

Table 3-2. Nozzle flow (gal/min) of various cone tips at various pressures

Nozzle ^a	Pressure (psi)				
	60	80	100	150	250
D4-25	0.35	0.40	0.45	0.54	0.68
D4-45	0.43	0.50	0.56	0.68	0.86
D6-45	0.72	0.83	0.93	1.15	1.48

a. Typical air-blast sprayer nozzles. For each nozzle, the first number describes the disc and the second identifies the whirl plate.

Always check the spray coverage obtained. One rule of thumb is that some spray mist should be 10 feet beyond the tree to obtain complete coverage. Some spray mist should pass through the tree. This is most important when alternate-row spraying is practiced. The effective coverage is less than the extent of visible mist. The mist that carries farthest from the sprayer contains very small droplets and therefore very low amounts of chemical. These very small droplets probably will not deposit on the trees. Techniques using a fluorescent tracer and a black light or water-sensitive paper will provide a more accurate evaluation. The ultimate check is the degree of pest control obtained.

How much pesticide in my spray tank?

An accurate and easy way to suggest the amount of pesticide in low-volume sprays is the amount of pesticide per acre. We especially encourage all who use low-volume sprays (usually 20–100 gal spray/A) to calibrate and recalibrate sprayers accurately. When the sprayer is calibrated according to the methods suggested, you must determine the number of gallons of spray needed per acre. Choose this figure based on your sprayer's limitations, in order to adequately cover the most difficult plantings. Wide rows, dense or tall trees, and low-to-moderate air volumes require more water for best coverage. Then add the amount of pesticide wanted per acre to the amount of water to be used per acre. For example, if 6.5 pounds is wanted in 50 gallons of water per acre, then 13 pounds is added to 100 gallons of water for 2 acres, or 65 pounds to 500 gallons of water for 10 acres.

For those who want to make their own calculations, use the amount of pesticides in low-volume sprays on mature apples and sweet cherry trees based on the amount of pesticides suggested

for 400 gallons of dilute spray per acre minus 20 percent. For example, Captan 50WP usually is suggested for early season apple scab control at 2 pounds per 100 gallons of dilute spray. At 400 gallons per acre, this would be 8 pounds Captan 50WP per acre. This is reduced by 20 percent for low-volume sprays to 6.4 or 6.5 pounds per acre. Variations from this formula can be made as needed or desired.

Further pesticide reductions per acre can be made where trees are open and less than 18 feet in height. Reductions in pesticides needed per acre due to minor variations in tree size or thickness can be accomplished by closing nozzles or increasing the rate of travel. It is not necessary to recalibrate the sprayer with every change from one tree size to another. For example, going from mature apple trees to peach trees, if you increase the rate of travel from 2 to 3 mph, you will reduce gallons per acre by 33 percent. One or more nozzles at the top or at the bottom of the manifold may not be needed and may be turned off. Determine the number of gallons of spray needed per acre for each orchard on the farm and mix the amount of pesticide needed in that amount of water. For example, it may be found by trial that the sprayer can be adjusted quickly to apply 65 gallons of spray per acre on peaches. Mix the amount of pesticide needed per acre in 65 gallons of water and apply that amount per acre.

In Part V of this guide, alternate row middle applications and half-spray recommendations are given as pesticide treatment options. Alternate row middle applications can result in more efficient pesticide use and lower application costs. This practice also helps protect beneficial insects and mites in the orchard. In the alternate row middle system, the sprayer is driven down every other row instead of every row. Most of the spray material is thus deposited on only one side of the tree, providing both adequate pest control until the next spray period and a refuge for beneficial insects. At the next spray period, the sprayer is driven down the rows that were not treated previously. This system not only uses half the amount of pesticide normally required per acre, but it also provides superior pest control when the spray intervals are kept relatively short, the sprayer is correctly calibrated, the orchard is properly monitored, and the correct chemical rates are used at the proper times.

Table 3-3. Converting dilute spray rate to concentrate rate of pesticide materials.

When dilute spray rate/100 gal is:	Amount of chemical/100 gal							
	100 gal/A		50 gal/A		30 gal/A		20 gal/A	
	Large trees ^a	Small trees	Large trees	Small trees	Large trees	Small trees	Large trees	Small trees
0.25 lb	0.8	0.7	1.6	1.4	2.7	2.2	4.0	3.3
0.25 pt (see 4 fl oz)								
0.40 lb	1.2	1.1	2.4	2.1	4.0	3.5	6.0	5.3
0.50 lb	1.6	1.3	3.2	2.5	5.3	4.2	8.0	6.4
0.75 pt or lb	2.4	2.0	4.8	3.9	8.0	6.5	12.0	9.8
1.00 lb, pt, or qt	3.2	2.6	6.4	5.2	10.7	8.7	16.0	13.1
1.25 lb	4.0	3.3	8.0	6.5	13.3	10.9	20.0	16.4
2.50 lb	4.8	3.9	9.6	10.5	21.3	17.5	32.0	26.3
2.00 lb	6.4	5.3	12.8	10.5	21.3	17.5	32.0	26.3
3.00 lb	9.6	7.9	19.2	15.7	32.0	26.2	48.0	39.4
4.00 fl oz or lb	12.8	10.5	25.6	21.0	42.6	35.0	64.0	52.5
5.00 lb	16.0	13.1	32.0	26.2	53.5	43.7	80.0	65.5
6.00 lb	19.2	15.8	38.4	31.5	63.9	52.4	96.0	78.8
For miscible superior oil								
2.00 gal	4.5	3.5	9.0	7.0	15.0	11.7	22.5	17.5

a. Large trees are generally taller than 15 feet. However, trees vary considerably in foliage density and other factors that may affect spray coverage.

Converting dilute to concentrate rates

The accurate way to use pesticides is on a sprayed-area basis. We encourage all who use low-volume sprays to practice this method and to accurately calibrate sprayers. Some may choose to convert dilute rates per 100 gallons directly to low-volume rates per 100 gallons. Table 3-3 provides a general conversion. It will be fairly accurate for most, but not all, pesticides.

Tree row volume

Fruit growers face the challenge of accurately applying pesticides to fruit trees of various sizes and shapes. For environmental and economic reasons, it is essential to apply enough pesticide for good control without being wasteful. To aid in this effort, the tree row volume (TRV) concept was developed. As an example:

Imagine two 1-acre blocks of fruit trees. Block A has very large trees, while block B has much smaller ones. Obviously, these two blocks should be sprayed differently, since there are more trees to spray in block A than in block B. But how do we decide how

Table 3-4. Calculating tree row volume.

1. Determine the number of linear feet of tree row per acre (L).
43,560 square feet per acre \div distance between rows (ft) = L (ft)
2. Measure the average tree height (H) and the tree canopy diameter (W). For orchards with large and small trees interplanted, use measurements for larger trees.
3. Calculate the amount of tree row volume (TRV) per orchard acre.
 $L \times W \times H =$ cubic feet TRV per acre

ADJUSTING GALLONS PER ACRE WITH TRV

$$\frac{\text{TRV (cu ft /A)} \times 0.7 \text{ gallon}}{1,000 \text{ cu ft}} = \text{gallons per acre (dilute basis)}$$

ADJUSTING CHEMICAL RATES PER ACRE WITH TRV

$$\text{TRV (cu ft /A)} \times \text{product rate} = \text{ounces of product}$$

Example: Rally 40 WP, 0.1 ounce per 10,000 cubic feet;

TRV = 500,000 cubic feet per acre;

$$\frac{500,000 \text{ cubic feet per acre} \times 0.1 \text{ ounce}}{10,000 \text{ cubic feet}} = 5 \text{ ounces per acre}$$

much liquid it will take to spray these different blocks, or how much pesticide should be applied to the trees?

One way is to try different amounts of water in the orchard until optimum coverage is obtained. This method is time-consuming and usually requires years of experience. The other method is to calculate the actual volume of the tree canopy—the tree row volume. In such calculations a row of trees is considered as a continuous hedge of foliage, and the volume is calculated as shown in Table 3-4. These calculations take into consideration tree height, width, and distance between rows in a particular orchard. The methods for determining the proportion of the acre sprayed are shown in Figure 3-1.

Adjusting gallons per acre with TRV

Once you have calculated the volume of foliage to be sprayed, you must determine the volume of water applied per acre based on the dilute (400 gal/acre) spraying of “standard-sized” trees. In other words, if an orchard with standard-sized trees (height = 20 ft, width = 23 ft, space between rows = 35 ft) is sprayed at 400 gallons per acre, then another orchard with half the TRV of the standard would be sprayed at 200 gallons per acre. This means that every 1,000 cubic feet of foliage is sprayed with 0.7 gallon of spray solution. This technique of adjusting gallons per acre for differences in TRV has been used in North Carolina for applying chemical thinners. Recommendations in North Carolina also include a range of rates from 0.7 to 1.0 gallon per 1,000 cubic feet to account for differences in canopy density. Recent studies conducted in Pennsylvania indicate that canopy density is not an important factor to be considered in TRV calculations in well pruned orchards.

Adjusting chemical rates per acre with TRV

Another way to use TRV is to adjust the amount of chemical mixed in the spray tank. For example, the label for Rally 40 WP carries the recommendation of 0.1 to 0.2 ounce of product per 10,000 cubic feet of canopy volume. If you want to spray an orchard that has 500,000 cubic feet per acre and you choose the lower rate of 0.1 ounce per 10,000 cubic feet, then you should apply 5 ounces per acre. Keep in mind that when using TRV this

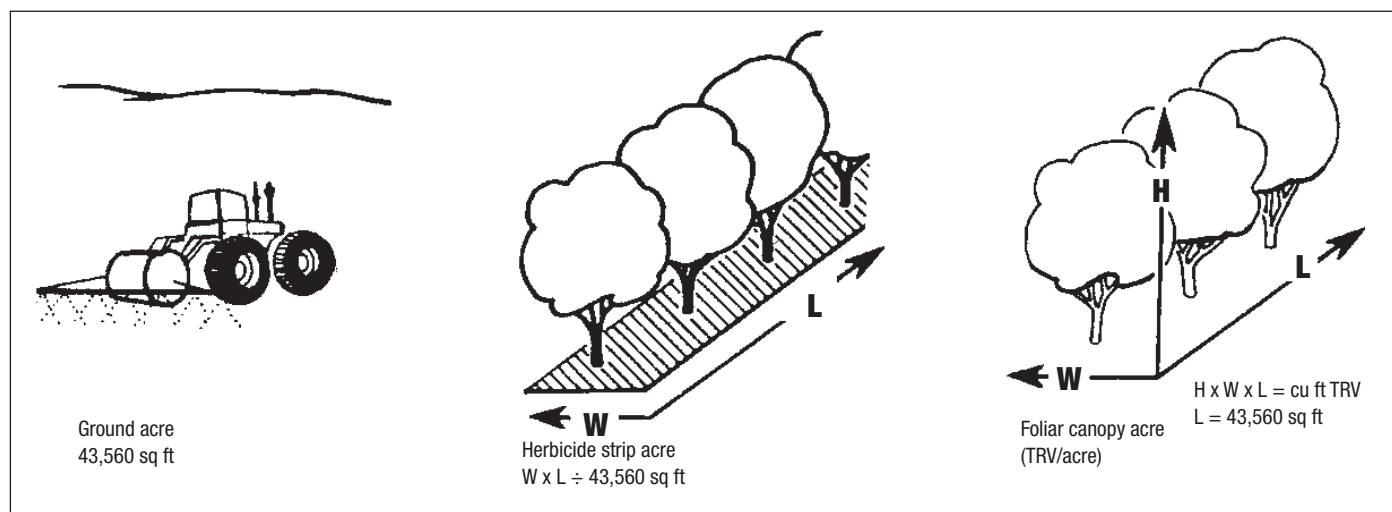

Figure 3-1. Representation of ground acre, herbicide strip acre, and foliar canopy acre.

way you must be sure that the spray rate in gallons per acre used is sufficient to ensure adequate coverage of all areas of the tree canopy and may vary from 20 to 100 gallons per acre.

For pesticides that do not offer TRV rates the rate per acre may be calculated by first determining the proportion of your orchard size to a standard orchard. Then multiply this figure by the pesticide rate per acre recommended. The TRV for a standard mature orchard is approximately 570,250 cubic foot per acre, requiring 400 GPA of dilute spray. A pesticide labeled for use at 1.5 pounds per 100 gallons dilute would be used at 6.0 pounds per acre. If the TRV for your orchard is 427,688 cu ft, its proportion to the standard would be:

$$\frac{427,688}{570,250}$$

which is equal to 0.75.

The amount of pesticide to apply per acre at the 6.0 pounds-per-acre rate would then be:

$$6.0 \text{ lb} \times 0.75 = 4.5 \text{ lb/A}$$

This amount would be mixed and applied in the desired amount of spray volume per acre for your sprayer type. The distribution and canopy coverage with conventional airblast sprayers are better at rates above 50 GPA. Low-volume sprayers are designed to apply rates from 20–40 GPA. Recent research results show that pest control is poor to inadequate when pesticide rates are adjusted below a proportional rate of less than 0.50. Until additional results are obtained, caution should be used in using pesticide less than 50 percent below label amounts unless TRV rates are given on the label.

The pesticide rates given in the *Pennsylvania Tree Fruit Production Guide* have been adjusted for Pennsylvania orchards and may be listed at below labeled rates. In TRV calculations full rates on the label should be used.

Chemical Thinning Tree Row Volume

Old standard-sized trees (height = 20 ft, width = 23 ft, tree rows = 35 ft) would be sprayed at 400 gallons per acre in a full dilute spray. This orchard has a tree row volume of 572,502 cubic feet. Therefore, it was felt that a full dilute spray would take 0.7 gallons of spray per 1,000 cubic feet of tree canopy. The table below is based on this assumption.

To use Table 3-5, compute the area of the trees (height times width) at the end of a tree row. For example, a tree 15 feet tall and wide would have a tree row end view area of 225 square feet. Then follow across from the 225 square feet, in the left-hand column, until you are under the row width for your block. If these trees were planted in rows 22 feet apart, then the tree row volume for that block would be 312 gallons. This figure is the volume of spray water needed to spray your block on a dilute basis. This dilute gallonage can be used to determine the quantity of thinners to apply to an acre of that orchard. For example, Ethrel is recommended at a dilute rate of 0.5 to 1.0 pint per 100 gallons, so for this example Ethrel should be used at from 1.6 (0.5 times 3.12) to 3.1 (1.0 times 3.12) pints per acre.

In a similar way, Vydate L is labeled at 1-2 pints per 100 gallons but not over 2-4 pints per acre. In this example, Vydate L should be applied at between 3.1 (1 times 3.12) to 4.0 pints per acre. Note that the higher rate is determined by the maximum rate of Vydate L allowed per acre and not by a tree row volume calculation.

Advantages and disadvantages

The TRV concept has several advantages. One is that TRV makes it possible to apply pesticides and growth regulators with greater accuracy. Therefore, you may attain better pest control while saving money and reducing pesticides in the environment.

One disadvantage is that it takes time to make the volume calculations for each block. It also puts extra demand on spraying techniques. As pesticides are reduced, weak links in the system become noticeable. Improperly calibrated sprayers, worn nozzles, and varying travel speeds can seriously affect the distribution of chemicals within the tree and, ultimately, the degree of pest control.

Mixing oil and pesticide

Tank mixing oil and pesticides necessitates some special precautions. To prevent oil-pesticide combinations from separating, or “buttering out” a surfactant may be added. Check the label for rates, mixing instructions, and when to add to the sprayer tank. Add the pesticide when the tank is one-half to two-thirds full, and add the oil last. The spray tank must be clean, because residues from the previous tank of spray may cause the emulsion in the oil to separate. Rinsing the tank with water after each load may help minimize the problem. Buildups of the “butter” can be removed by using a heavy duty cleaner or low-flammable solvent and by vigorous agitation. Dissolving the buildup may require up to 20 minutes.

Ground Spraying

In fruit production, chemical weed control is usually the least expensive option. Controlling weeds underneath fruit tree plantings benefits the plantings, as well as production, in several ways: (1) Herbicides reduce injury from mice by keeping vegetation away from the tree trunk; (2) herbicides prevent root and bark injury caused by disking; (3) herbicides allow the soil to remain undisturbed, helping to prevent weed seed germination and soil

Table 3-5. Simplified tree row volume table.

Tree row end view area (ft ²)	Figures in the body of the table are the gallons/acre dilute based on spraying 1,000 cubic feet of canopy with 0.7 gallon of spray.												
	Row width (ft)												
	10	12	14	16	18	20	22	24	26	28	30	32	34
25	76	64	54	48	42	38	35	32	29	27	25	24	22
50	152	127	109	95	85	76	69	64	59	54	51	48	45
75	229	191	163	143	127	114	104	95	88	82	76	71	67
100	305	254	218	191	169	152	139	127	117	109	102	95	90
125	381	318	272	238	212	191	173	159	147	136	127	119	112
150		381	327	286	254	229	208	191	176	163	152	143	135
175			381	334	296	267	243	222	205	191	178	167	157
200				381	339	305	277	254	235	218	203	191	179
225					381	343	312	286	264	245	229	214	202
250						381	347	318	293	272	254	238	224
275							381	349	322	300	280	262	247
300								381	352	327	305	286	269
325									381	354	330	310	291
350										381	356	333	314
375											381	357	336
400												381	359

CAUTION: This table can be used for other spray applications, but caution is advised when making pest control applications on very small trees. Poor control has been noted when spraying very small trees with the amount of chemical determined with the tree row volume method.

erosion; (4) reducing vegetation around fruit plants can help prevent virus, disease, and insect problems.

Before establishing any fruit crop, it is important to eliminate persistent perennial weeds from the field. For tree fruits it is best to establish the grass cover crop the year before planting. The cover crop will help prevent erosion and allow you to get into the field earlier in springtime to plant. The fall before planting, treat the field with a 2,4-D herbicide to eliminate any perennials that were established with the grass cover. Immediately before planting, treat rows where trees will be planted with glyphosate to kill grass and aid in planting.

Getting the most from herbicides requires good management. Sprayer calibration, dosage, soil type and organic matter content, and rainfall all affect the success of a weed control program. Below are cautions and reminders to be aware of before applying herbicides:

Sprayer calibration

Always calibrate sprayers before each season of use. During the season periodically check calibration. Replace worn nozzles and check pressure gauges at least once a year. (See Calibrating Sprayers for Orchard Applications below.)

Correct dosage

Newly established plantings are more susceptible to overdoses than established plantings. On young plantings use the lower suggested rates. Rates listed in this publication are given as pounds of material per treated acre. The actual area of land treated in a fruit planting may be one-third of the land surface covered by trees. Avoid overlapping or doubling dosages. If a tank runs out in the middle of a block, carefully mark the last treated area.

Soil type and organic matter

Sandy soils or soils low in organic matter allow easy penetration and quick uptake, which can damage plants. Clay soils or soils high in organic matter require higher rates of materials for adequate control to be achieved. Read the herbicide label and adjust rates, if needed, based on soil type. Applying certain herbicides to soils having less than 0.5 percent organic matter is apt to damage plants. Most chemicals will not damage plants in soils with 2 percent or more organic matter. Some herbicides give poor results when used on soils with organic matter over 4 percent. Under these conditions, select herbicides that are systemic or that are absorbed through foliage.

Rainfall (irrigation)

Most residual herbicides work best when incorporated into the soil by rainfall or irrigation. They will have maximum effect if the water is applied within 4 to 10 days after application. Failure to water adequately can diminish the herbicide's effectiveness. Generally, 0.5 inch of water is sufficient.

Tank-mixing of herbicides

Concentrated herbicides should never be added directly to an empty tank. Add one-half of the necessary water to the tank, then the herbicide concentrate, and finally the rest of the water. Never allow a sprayer with mixed chemicals to stand without agitation.

When applying combinations, add them to the tank in this order: (1) wettable powders, (2) flowables, (3) water solubles, (4) adjuvants, (5) emulsifiable concentrates. Constant agitation is especially important when combinations of pesticides are in a tank.

Combining two different preemergent materials at lower rates or a preemergent and a postemergent will usually give broader-spectrum control. A labeled herbicide may be tank-mixed with any other labeled herbicide to be applied at the same time, provided both materials are being applied according to their respective labels. All precautions and limitations respective of both materials must be followed when they are applied together. If there is a days-to-harvest limitation on either or both materials, you must follow the more stringent one—that is, the longest limitation.

Before tank mixing, be sure to check the compatibility of the materials. If you are unsure of the compatibility, use the following test: (1) At rates proportional to field use, add herbicides to 1 pint of water in a quart jar. (2) Close the jar and mix contents by inverting jar 10 times. (3) Inspect immediately. (4) Allow jar to stand quietly for 30 minutes and inspect again.

If the mixture remains uniform for 30 minutes, the combination can be used. If it does not, add a surfactant or compatibility agent to the jar and test again. If the mixture separates after 30 minutes but remixes readily with 10 jar inversions, the mixture can be used if good agitation is maintained in the tank.

Herbicide sprayers

Herbicides may be applied with a hydraulic sprayer operating at pressures ranging from 10 to 40 psi. Flat-fan, flooding, or off-center nozzles should be used for spraying herbicides. Flooding nozzles permit complete coverage with the boom located nearer the ground to avoid low-hanging limbs. For more information on operating herbicide sprayers, see Penn State Agricultural Engineering Fact Sheet B-56, *Herbicide Application Equipment for the Orchard*, available from your county extension office.

What size of area should be treated with herbicides? What is a sprayed acre? The area to be treated may be a continuous strip along either side of the tree row or an area around the trunk of each tree. In general, the treated area should be wide enough so that all grass is kept away from the trunk (to reduce the possibility of mouse damage or mower damage to the trunk).

To avoid confusion about the meaning of "treated acre," use the following to calculate the area to be treated in your orchard. One acre equals 43,560 square feet. The area in each example equals a treated acre:

- A 2-ft-wide strip on either side of the row (4 ft overall) and 10,900 ft long (43,560 sq ft/4 ft)
- A 3-ft-wide strip on either side of the row (6 ft overall) and 7,260 ft long
- A 4-ft-wide strip on either side of the row (8 ft overall) and 5,500 ft long
- A 5-ft-wide strip on either side of the row (10 ft overall) and 4,360 ft long
- An area 2 ft x 2 ft under 10,900 trees
- An area 3 ft x 3 ft under 4,840 trees
- An area 4 ft x 4 ft under 2,720 trees
- An area 5 ft x 5 ft under 1,740 trees

- A 2-ft-diameter circle under 13,870 trees
- A 3-ft-diameter circle under 6,170 trees
- A 4-ft-diameter circle under 3,470 trees
- A 5-ft-diameter circle under 2,220 trees
(Area = 0.79 x diameter)

For selective-area spraying, such as in tree rows, a special boom with nozzle(s) mounted on the end or a hand-held gun is satisfactory. A swivel nozzle with an off-center nozzle tip can be used. The band width can be increased by adding flat-fan tips along the boom. The application rate per treated acre should be the same from all nozzles. Use low pump pressures, in the range of 20 to 40 psi.

When wettable powders are applied, agitation in the tank is required to maintain the suspension. Jet or mechanical agitation is recommended. Agitation is easily accomplished by placing a jet in the bottom of the tank to provide a stirring action. On a sprayer equipped with either a roller or a piston pump, run a separate line from a point between the pump and the pressure regulator to the jet agitator in the tank. If a centrifugal pump is used, there is adequate volume from the bypass line, and the jet agitator may be attached directly to the end of the line. For uniform mixing, the agitator should be operating with some water in the tank when the chemical is added.

Calibrating sprayers for herbicide applications

1. Measure band width covered by all nozzles and express the width in feet; for example, 34 inches = 2.8 feet. If mixing nozzle types (e.g., OC and flat nozzles) make sure that the gallons per acre (GPA) of all nozzles is the same. Record tractor rpm's and pressure at the pump or boom.
2. Divide 340 square feet by the band width (in feet) determined in step 1. This gives you the distance to drive to cover 340 square feet.
3. Measure a course of that distance.
4. Drive the course (without the sprayer running) and determine the time to cover the course. If you are calibrating a PTO weed sprayer, you must drive with the tractor operating at the same rpm's as it did in step 1.
5. With the tractor stopped (brakes locked, please) and the sprayer operating as in step 1, catch the nozzle output for the time determined in step 4 (the same nozzles used for determining band width in step 1).
6. The number of fluid ounces caught equals the GPA applied by making an application with the nozzle setup and pressure used in step 1 and the driving speed used in step 4.
7. To increase GPA, either increase pressure or drive slower.
8. To decrease GPA, either decrease pressure or drive faster.

Minimizing spray drift. It is important to minimize drift for economical, effective control and to protect the environment. Small droplets tend to drift, so it is better to use nozzles that produce a large droplet. Use low pressure, large orifices, and drift reduction adjuvants, and avoid spraying on windy days. For more details see Agricultural and Biological Engineering Fact Sheets B-110, *Spray Drift Control*, and B-78, *Sprayer Nozzles*, available from your county extension office.

Cleaning the sprayer

Cleaning the sprayer is very important. At the end of each day's spraying, completely rinse the inside and outside of the sprayer with clean water. When changing from one chemical to another, or at the end of the spraying season, give the sprayer a thorough cleaning according to manufacturer's recommendations. If these are not available, use the following procedure:

Remove the nozzle tips and screens and clean them with a toothbrush, using a detergent and activated charcoal solution, ammonia solution, or trisodium phosphate. Flush the system with clean water. Rinse it thoroughly with a detergent solution. Rinse again with clean water.

It is difficult to remove 2,4-D compounds from sprayers; therefore, sprayers used for applying these compounds should not be used for any purpose other than applying herbicides. The 2,4-D-type materials can be removed if the following steps are taken immediately after use:

- Flush the entire system with a detergent solution.
- Fill the tank and prime the spray system with a 10 percent ammonia solution and let stand for 12 to 24 hours.
- Disassemble nozzles and soak caps, screens, etc., in the ammonia solution.
- Rinse thoroughly with water and circulate it through sprayer. A weed sprayer should not be used for any other purpose.

For more details about cleaning, obtain a copy of Penn State Agricultural and Biological Engineering Fact Sheet B-72, *Sprayer Cleaning*, from your county extension office.

Granular applicators and their calibration

Instead of sprayers, granular applicators may be used to apply certain herbicides in orchards. Special spinner spreaders can be attached to a telescopic boom, or commercial units are available that can be mounted directly on the tractor. For small orchards, a hand-carried spinner spreader, which gives satisfactory results, can be used. Uniform distribution of the granules is necessary and application should be made only when there is very little or no wind.

Granular applicators may be calibrated by operating equipment over a known area, such as 0.1 acre. There are 43,560 square feet in an acre. Disconnect the spinner and catch the granules in a plastic bag. Make adjustments and repeat until desired rate is obtained. Remember to maintain the same travel speed at all times.

Granular applicators must be calibrated with the same material that is to be applied. Therefore, a check test must provide some means to collect and weigh the granules. When herbicides are applied in a band along the tree row, it is important to understand that only a portion of the orchard floor is being treated. This portion, called the treated acreage, receives the same rate of application as if broadcast application were being used. The importance difference is that only part of the orchard acreage is treated and therefore band application requires less chemical than broadcast application.

Disconnect the spreading mechanism (if one is used) and attach a catchpan, plastic or paper bag, pail, or other appropriate container to catch the granules. Select a test plot of known area. Select an area large enough so the amount of granules collected

can be accurately weighed on an available scales. Remember that an acre is equal to 43,560 square feet. Operate the equipment at the recommended settings and ground speed for the desired rate. Be sure to operate only over the measured course and to catch all the material that flows through the applicator.

For example, if you want to apply 150 pounds per treated acre in a 4-foot band, you will travel 10,890 feet per acre ($43,560 \div 4$). For the test, however, you can select a smaller area. The ideal choice is a plot large enough to minimize errors and small enough to be practical. Assuming scales are available to accurately weigh samples in the 5- to 15-pound range ($\frac{1}{30}$ th to $\frac{1}{10}$ th acre), let's select a $\frac{1}{20}$ -acre test plot. One-twentieth of an acre is a band 545 feet long ($10,890 \div 20$). When the check is run, 7.5 pounds ($150 \div 20$) of granules should be collected. If the actual amount is different, adjust and rerun until the desired rate is obtained.

Repeat calibration for any change in conditions (temperature, humidity, lot number of granules), when you use a different chemical, drive at a different speed, or change the agitator speed.

CAUTION: Strict control of herbicide application is necessary, as weed killers can injure trees. Proper design and calibration of the equipment are necessary. Always read the label on the herbicide container and follow the directions. Assistance is available from your county extension office.

After Applying an Herbicide

Any time you apply a pesticide, make a complete record of it. Record the date of application, material, formulation, rate, area treated, volume of water, growth stage of crop and weeds, and comments on anything unusual. To be able to assess the treatment's effectiveness, also record the following weather factors: temperature, cloud cover, and time to next 0.5 inch rainfall.

If the material did not work, check your records to see why. You may need to alter the time or rate of application, application technique, or chemical used. If trees are injured, accurate records will help you determine what changes must be made to prevent injury from reoccurring.

Factors Affecting the Efficacy of Nematicides

As with any pesticide, the two factors that determine efficacy are concentration and exposure time. If toxic concentrations of a nematicide do not come in contact with the nematode for a sufficient period of time, then acceptable levels of control will not occur. Many factors can dilute the concentration of nematicide available in the soil and/or effectively shorten the time that nematodes are exposed.

Good site preparation is extremely important. The soil should be thoroughly tilled several weeks before application to break up clods and encourage the decomposition of plant debris. Large root pieces should be removed. Nematicides can adsorb to organic debris and thus reduce the amount of compound free in the soil. Large soil clods can interfere with the uniform distribution of nematicides and serve as protected areas for nematodes.

Fumigant nematicides such as Telone or Vapam volatilize *quickly* and move through the soil as a gas. These gases penetrate the nematode cuticle and interfere with vital processes, causing death. The mode of action is relatively quick. The movement of a fumigant through the soil is strongly affected by factors such as temperature, moisture, and soil texture. Fumigants tend to move

upwards through the soil and will dissipate quickly unless the surface is sealed after treatment. Follow the label to ensure that you are applying the correct dose for your conditions.

Most nonfumigant nematicides are organophosphate or carbamate compounds, which are potent cholinesterase inhibitors. These products are extremely water soluble, and their redistribution in the soil depends on water movement. Excessive rain or irrigation creates a risk of diluting the nematicide below the level needed to be effective. On the other hand, too little water may prevent the nematicide from being distributed effectively in the root zone. Unlike fumigant nematicides, contact nematicides act relatively slowly. Although high concentrations are lethal, the lower concentrations in soil generally kill by behavior modification. The affected nematodes typically are unable to move, find a host, feed, or find a mate. Eventually, they die. If exposure to the nematicide is too short or at a low concentration, however, these behavioral modifications can be reversed and the treatment is not effective.

FUNGICIDES, HERBICIDES, INSECTICIDES, NEMATICIDES, SOIL FUMIGANTS, AND PLANT GROWTH REGULATORS

Pesticide suggestions are based on the need for pest control under average conditions. Applying reduced amounts of pesticide is practical under relatively ideal conditions, which include using highly effective chemicals and efficient sprayers, as well as having an orchard with no special pest problems. Conditions can change rapidly, especially during periods of unusually moist weather. Be prepared to adjust the amount and frequency of pesticide applications to handle such situations in accordance with label limitations.

The pesticides listed below appear in alphabetical order. They are described under the trade name if that trade name is unique or under the common name if more than one trade name exists for the same material. Common names begin with a lowercase letter, and trade names begin with a capital letter. **Restricted-use pesticides are indicated by an asterisk (*).** Each chemical is followed by notes describing its activity and some special use characteristics. Where available, each insecticide is also assigned to a specific IRAC (Insecticide Resistance Action Committee) group based on active ingredient mode of action. Additional information on the IRAC can be found at www.ircac-online.org. Also, see Table 3-7.

Labels of soil fumigant pesticide products have been updated to include new safety provisions that went into effect in late 2010. The labels will be updated again in late 2011 to include new safety requirements for buffer zones and related measures, and it is imperative that applicators comply with current regulations and requirements. The EPA has developed a Soil Fumigant Toolbox website at www.epa.gov/pesticides/reregistration/soil_fumigants to provide easy access to this information.

This information does not substitute for label information. Before applying any pesticide, read and follow label directions. The full text of most pesticide labels and Material Safety Data Sheets can be found at the Crop Data Management Systems Inc. website at www.cdms.net/manuf/manuf.asp or at the Greenbook Free Web Search (C&P Press, Inc.) at www.greenbook.net/free.asp.

1-MCP—see SmartFresh.

1,3-dichloropropene (*Telone II, *Telone C-17, *Telone C-35). Products including the active ingredient 1,3-dichloropropene are effective soil fumigants for the control of plant-parasitic nematodes and other soilborne pests. Telone products are very effective against nematodes; the primary difference is the addition of chloropicrin to Telone C-17 and Telone C-35, which increases its efficacy against soilborne fungi. These products can only be used as preplant soil fumigants, and tree death will result if the soil is not allowed to aerate sufficiently before planting. Rates vary with soil texture and efficacy is strongly affected by soil moisture and temperature. Therefore, careful attention must be given to label recommendations and site preparation.

2,4-D (Weedar 64, Orchard Master, Amine 4, Saber, 2,4-D Amine 4). 2,4-D is a postemergent herbicide used to control broadleaved weeds. 2,4-D products are not effective on grasses. They are particularly useful for controlling annual and perennial broadleaved weeds that escape preemergence treatments. Do not apply 2,4-D compounds to bare ground or under hot, dry conditions. Exercise extreme caution if using these materials in fields adjacent to growing grapes. Applications made early in the spring or postharvest will give the best results. Use only low-volatile formulations and do not use ester formulations of 2,4-D, as plant injury can occur due to vaporization. Symptoms of 2,4-D damage to both target weeds and nontarget plants include a downward cupping of the leaves and a twisting of the growing stem. Observe restrictions on days-to-harvest limitations as stone fruits and pome fruits have different limits. Growers are also cautioned that some 2,4-D materials are not registered on all tree fruit crops. Be sure to check the label to see if the material you have is labeled for the crop to which you intend to apply it. Some labels allow two applications per growing season if applications are separated by at least 75 days.

6-benzyladenine (MaxCel, Exilis plus, RiteWay) is a cytokinin, a class of growth regulator that promotes cell division. 6BA acts as a thinner when applied shortly after bloom. Compared to other chemical thinners, it reportedly will increase fruit size beyond what would occur during the normal crop-thinning process. Response to 6BA is very temperature dependant. Do not apply if temperatures are below 65°F. The product should be applied in the morning or evening when conditions are best for slow drying. Do not exceed a total of 308 ounces per acre per season. The products are labeled for both apples and pears. Note that Exilis plus has a slightly higher percent active ingredient, so rates need to be adjusted accordingly.

6-benzyladenine + gibberellins A4A7 (Promalin, Typy, Perlan, RiteSize) is a mixture of two plant growth regulators—a cytokinin and a gibberellin—and has two uses in tree fruit production. On bearing apple trees, foliar applications increase the length-to-diameter ratio of fruit, producing more elongated fruit at harvest. The spray is more effective when daytime high temperatures reach or exceed 70°F. Mild thinning may occur with later applications

The material also can be used to increase branch angles and the number of lateral branches on apple, pear, and cherry trees. On apples, it may be applied as a directed foliar spray or in a

latex paint mix on young bearing or nonbearing trees, either in the nursery or the orchard. On pears, it may be applied only as a foliar spray on young nonbearing trees, either in the nursery or the orchard. On sweet cherries, it may be applied as a foliar spray only to nonbearing trees in the nursery, or in a latex paint mix to nonbearing trees in the orchard.

***Abacus—see abamectin.**

***Abba—see abamectin.**

abamectin (Abacus, Abba, Agri-Flex, Agri-Mek, Zoro) (IRAC Group 6 Insecticide) is an avermectin miticide-insecticide with both contact and stomach action labeled for use on pears, apples, peaches, nectarines, cherries, plums, and prunes. Abamectin must be applied with a summer oil or other penetrant before the leaves harden off. This allows translaminar movement into the leaves and thus residual control. For apples, abamectin is recommended at petal fall to about 10 days after petal fall to control European red mite and spotted tentiform leafminer and to suppress white apple leafhopper. For pears, abamectin is applied at petal fall to about 10 days after petal fall to control pear psylla. Abamectin is toxic to bees when sprayed but poses no additional danger once it has moved into the leaves. It is nonphytotoxic when used as directed. See the oil section for incompatibilities and potential phytotoxicity problems if oil is used as the penetrant. Do not exceed 20 fluid ounces per application or 40 fluid ounces per growing season. Do not make more than two applications per growing season. If a second application is necessary, do not retreat within 21 days. On apples and pears, do not apply within 28 days of harvest. On plums and prunes, the PHI is 21 days. Agri-Flex is a mixture product of abamectin and thiametoxam registered only for use on apples, pears, and grapes.

Abamectin is a restricted-use pesticide because of its toxicity to fish, mammals, and aquatic organisms. The following precautions are to be observed when spraying in the vicinity of aquatic areas such as lakes, reservoirs, permanent streams, marshes or natural ponds, estuaries, and commercial fish farm ponds: Spray last three rows windward of aquatic areas using nozzles on one side only, with spray directed away from aquatic areas. Avoid spray going over tops of trees by adjusting or turning off top nozzles. Shut off nozzles when turning at end of rows and passing tree gaps in rows. Do not apply when weather conditions favor drift to aquatic areas. Do not apply within 110 feet upwind of aquatic areas or when wind speed is above 8 mph. Do not apply during a temperature inversion.

acequinocyl—see Kanemite.

acetamiprid—see Assail.

Acramite (bifenazate) (IRAC Group 25 Insecticide). Acramite's active ingredient, bifenazate, belongs to the carbazate class of chemistry, providing a new mode of action for this acaricide. This summer acaricide is registered for the control of mobile forms of mites on apples, pears, peaches, nectarines, plums, prunes, grapes, hops, and strawberries. Acramite is very active against all stages of two-spotted mites and motile stages of European red mite, but it will not control rust mites. Acramite can be used up to 7 days before harvest (PHI) on apples and pears; 14 days on grapes and hops; 3 days on peaches, nectarines, plums

and prunes; and 1 day on strawberries. On all registered crops the restricted entry interval (REI) is 12 hours, except for some activities on grapes where the REI is extended to 5 days. The compound provides quick mite knockdown through contact activity and long residual control. Acramite is not systemic in action; therefore complete coverage is essential for product activity. The recommended rate is 0.75 to 1.0 lb per acre in minimum of 50 gallons per acre. Only one application per season is permitted.

Actara—see thiamethoxam.

Adament 50 WG (tebuconazole plus trifloxystrobin) is a broad-spectrum fungicide for the control of certain diseases of pome and stone fruit. Adament is labeled to control diseases of pome fruit (apple, pear, crabapples, loquat, mayhaw, and quince), including scab, cedar-apple rust, powdery mildew, sooty blotch, fly speck, bitter rot, and white rot (tank-mixed with captan). It is also labeled on stone fruit (apricot, cherry, nectarine, peach plum, plumcot, fresh prune) to control brown rot blossom blight, green fruit rot (*Botrytis*), shot hole, alternaria, anthracnose, powdery mildew, rusty spot, scab, cherry leafspot, *Monilinia* fruit rot, and rust. Adament works by interfering with both energy and cell membrane production in plant pathogenic fungi. The active ingredients in Adament belong to two different chemistry classes. Tebuconazole belongs to the QoI (Group 3) class of chemistry, which may exhibit cross-resistance to other Group 3 fungicides, such as propiconazole and myclobutanil. Trifloxystrobin belongs to the QoI (Group 11) class of chemistry, such as azoxystrobin, pyraclostrobin, and kresoxim-methyl. Fungal pathogens are known to develop resistance to products with the same mode of action when used repeatedly. Use of this product should conform to resistance management strategies established for the crop and use area. Resistance management strategies include rotating and/or tank-mixing with products having different modes of action or limiting the total number of applications per season.

***Adjourn—see esfenvalerate.**

Admire Pro—see imidacloprid.

Advise—see imidacloprid.

Agree—see Bt. This product is OMRI registered.

agricultural streptomycin—see streptomycin sulfate.

***Agri-Flex—see abamectin and thiametoxam.**

***Agri-Mek—see abamectin.**

Agri-mycin 17—see streptomycin sulfate.

Aim (carfentrazone-ethyl) is a burndown material that is labeled for all tree fruits. It can also be used to suppress root suckers. Application rates of 0.5 to 2.0 fl oz per acre should be applied when the undesired vegetation is still succulent and green. The addition of a nonionic surfactant at 0.25% v/v (2 pints/100 gallons) or crop oil concentrate at 1% v/v (one gallon/100 gallons) will enhance control. Do not apply more than 2.0 fl oz per acre per application or more than 7.9 fl oz per acre per season. Allow a minimum of 3 days PHI. Do not allow spray to come in contact with any green tissue. Aim may also be used to suppress grass row middles during the growing season to reduce the necessity to mow the middles.

Aliette (fosetyl). Aliette 80WDG is a systemic fungicide with protective and curative action against collar rot caused by the *Phytophthora* fungus. It is registered for use on nonbearing apple trees only (trees that will not produce marketable fruit for 12 months after the last application). Apply Aliette at a rate of 5 pounds per 100 gallons of water beginning at the start of the growing season. Up to four foliar applications may be made during the season at 60-day intervals. Do not apply more than 100 gallons per acre.

Allias—see imidacloprid.

Alion (indaziflam) is a new herbicide registered in late 2011. It is a preemergent material for use in pome and stone fruits for control of grass and broadleaf weeds. Alion will only control weeds before they emerge; if weeds are present, then a postemergent contact material should be included in the application. It is most effective when activated by rain or applied when the soil is moist. In trials in Pennsylvania it was most effective when applied in the fall but also provided good weed control when applied in the early spring to bare ground. Alion works by inhibiting cellulose biosynthesis. The REI is 12 hours and the preharvest interval is 14 days. Do not apply more than 10.3 oz per year.

Altacor (chlorantraniliprole/rynaxypyr) (IRAC Group 28 Insecticide) was registered for use in Pennsylvania's pome and stone fruit orchards during the 2008 season. Altacor has a unique new mode of action: activation of the insect's ryanodine receptors within the cells of their muscles. A treated insect exhibits a rapid cessation of feeding, lethargy muscle paralysis, and eventual death. The primary route of exposure to pests is through ingestion, but there is some reported ovicidal (i.e., egg) and ovilarvicidal activity for codling moth. It also is highly effective against a number of serious pests—CM, OFM, TABM, OBLR, other leafrollers, and leafminers. Altacor also has reported activity against the European apple sawfly. The rate per acre (oz/acre) for Altacor on pome fruits ranges from 2.5 to 4.0 oz with a seasonal maximum of 9.0 oz per acre. In our research trials, Altacor has provided excellent residual control of CM, OFM, and the leafrollers at rates of 2.5–3.0 oz per acre. Altacor is registered as reduced-risk insecticides (i.e., low impact to humans, the environment, nontarget organisms, and natural resources). The product is highly selective for pests with minimal or no impact on our existing natural enemies present—*Typhlodromus pyri*, *A. fallacies*, *Stethorus punctum*, and a group of aphid predators (e.g., lady beetles, syrphid fly larvae). Altacor has a 4-hour REI and should not be applied less than 5 days before harvest on pome fruit and 10 days before harvest on stone fruit.

***Ambush—see permethrin.**

Amid-Thin W (NAAm). Amid-Thin is an auxin used to thin fruit on pears and early maturing apple cultivars and to prevent preharvest fruit drop because it is safer to the foliage than NAA; it is usually applied at or near petal fall at 25–50 ppm, often tank-mixed with cararyl. It is usually applied at petal fall and is slightly less toxic and active than NAA. Best results are obtained using Amid-Thin in dilute sprays. See also Amid-Thin W in Part I.

Amine 4—see 2,4-D.

amino ethoxyvinylglycine—see ReTain.

Apogee (prohexadione calcium). Apogee is a plant growth regulator that has the ability to eliminate the production of gibberellins (GAs) in apple trees. This reduction in the level of GAs reduces the rate of shoot growth. This effect may reduce pruning costs, increase the red color of apples when light in the tree is limiting, make the tree canopy easier to spray, and aid in the control of some disease and insect pests. Apogee is also labeled for the control or reduction of fire blight in apples. Apogee is recommended to be applied when shoot growth is about 1–3 inches in length. This period usually occurs around petal fall. Rates are 3 to 12 ounces/100 gallons on a dilute basis or 9 to 36 ounces per acre, depending on the vigor and current crop load of the trees. In south-central Pennsylvania, most growth occurs in May and June, so two to four applications may be needed to get season-long shoot growth suppression. It takes about 10 to 14 days for Apogee to have an effect on growth, and the growth suppression lasts for about 2 to 4 weeks. Significant regrowth may occur in the tops of trees when sprays are terminated too soon or where spray coverage is poor.

Apollo (clofentezine) (IRAC Group 10A Insecticide). Apollo is registered for mite control on apples, pears, peaches, nectarines, apricots, and cherries. Apollo possesses ovicidal activity against eggs and nymphs of the European red mite and twospotted spider mite. The Apollo SC label for apple allows applications up to 45 days before harvest. The Apollo SC label for apple allows applications up to 45 days before harvest, while on pears, apricots, cherries, peaches, and nectarines the PHI is 21 days. The Apollo 42 percent formulation is not registered for use on apples. The appropriate timing for Apollo SC would be petal fall or first cover. An application at this time should perform better in most years than an application at formerly recommended tightcluster. Applications on other crops should be made when mites are first found because Apollo acts primarily against the eggs, and control of the mite population may take 10 to 14 days. Thorough coverage of foliage is necessary for long residual control. Apollo has low toxicity to mammals and is nonphytotoxic. Apollo SC is not disruptive to beneficial insects and mites. Only one application is recommended per season. If additional miticide applications are needed, apply a miticide with a different mode of action. To prevent the buildup of resistance, do not alternate Apollo SC with other miticides with a similar mode of action (e.g., Savey).

***Arctic—see permethrin.**

Arrow—see clethodim.

***Asana XL—see esfenvalerate.**

Assail (acetamiprid) (IRAC Group 3 Insecticide). The active ingredient acetamiprid belongs to the family of chemistries known as neonicotinoids. Acetamiprid interrupts the function of the insect nervous system by acting as an agonist (or promoter) of the nicotinic receptor on the postsynaptic membrane of the nerve cells. The compound has low mammalian toxicity (toxicity category III). Assail is active on sucking insects such as aphids, leafhoppers, leafminers, stink bugs, and pear psylla. In contrast to other insecticides from the neonicotinoid group, acetamiprid also possesses good activity against codling moth and Oriental fruit moth. The compound provides systemic, translaminar activity and is active as an ovicide through direct kill of insect eggs.

Assail should be applied in a minimum finished spray volume of at least 80 gallons per acre using 2.5 to 8.0 ounces of Assail 30SG per acre. Assail has a 12-hour restricted entry interval (REI) and should not be applied less than 7 days before harvest (PHI = 7 days). The product is toxic to bees exposed to direct treatment.

Avaunt (indoxacarb) (IRAC Group 22 Insecticide). Avaunt has a unique mode of action: it inhibits the sodium ion entry into nerve cells, resulting in pest paralysis and death. This class of chemistry, with no evidence of cross-resistance to other chemistries, should allow for the introduction of this compound into current management practices. Avaunt is registered for the control of codling moth, Oriental fruit moth, lesser appleworm, redbanded leafroller, tufted apple bud moth, white apple leafhopper, potato leafhopper, plum curculio, tarnished plant bug, and apple maggot. The compound should be applied at 5.0 to 6.0 ounces per acre with no more than 4 applications per season. For best results, Avaunt should be applied with 50 to 150 gallons of water per acre. Avaunt is highly toxic to bees exposed to direct treatment on blooming crops or weeds, so the product should not be applied or allowed to drift to blooming plants while bees are actively visiting the treatment area. Avaunt is registered for use on pome and stone fruits.

azadirachtin (Aza-Direct, Azatin XL, Neemix) (IRAC Group 18B Insecticide). This azadirachtin-based biological insecticide, repellent, antifeedant, and insect growth regulator is used mostly in soft, organic insect control programs. It controls pests on contact and ingestion. Aza-Direct can be applied using standard spraying equipment up to the day of harvest. Do not exceed 57 ounces of formulated product per acre, per application. This pesticide is toxic to fish and aquatic invertebrates. AzaDirect is OMRI listed.

Aza-Direct—see azadirachtin.

Azatin XL—see azadirachtin.

azinphos-methyl (Guthion Solupak) (IRAC Group 1B Insecticide). Azinphos-methyl is a nonsystemic organophosphate insecticide with contact and stomach action labeled for use on all tree fruit crops. Products containing azinphos-methyl provide a broad-spectrum control of fruit pests. However, mites, aphids, leafminers, leafhoppers, pear psylla, and tufted apple bud moth have developed resistance. Azinphos-methyl is highly suited for use in integrated pest management programs because all stages of *Stethorus*, *Amblyseius fallacis*, and *Zetzellia mali* tolerate applications at the suggested rates. However, these products are highly toxic to bees exposed to direct treatment or residues on crops or blooming weeds. During the 2012 season, the limits for the amount of active ingredient are 1.5 lb ai on apples and pears, and 0.75 lb ai on sweet and tart cherries. It will be illegal to use azinphos-methyl on fruit crops after the 2012 season. Do not enter or allow worker entry into treated areas during restricted entry interval, which is set for 14 days (15 days for cherries) for all kinds of activity. Due to label changes for azinphos-methyl, the product is not allowed for use on peaches and nectarines as of September 30, 2006. Special restricted-entry guidelines are enforced for the use of azinphos-methyl on all registered crops. See product label.

Bacillus thuringiensis—see Bt.

Bac-Master—see streptomycin sulfate.

Badge—see copper compounds.

Basamid G—see dazomet.

***Battalion**—see deltamethrin.

Bayleton (triadimefon). Bayleton is a systemic fungicide with protective, curative, and eradicant action, which is very effective for controlling apple powdery mildew and cedar apple rust. Bayleton should be first applied at the green-tip stage and continue applications at 7- to 14-day intervals or as needed until terminal growth stops. Bayleton is also recommended for the control of powdery mildew on pear. The first application should be made at the budburst stage and continue applications at 7- to 14-day intervals or as needed. Bayleton is recommended at 2 to 8 ounces per acre, depending on disease severity. If mildew is severe, other fungicides that are effective against mildew should be applied at the tight cluster bud stage and at first cover.

***Baythroid**—see cyfluthrin.

Belay (clothianidin) (IRAC Group 4A Insecticide). Belay is a neonicotinoid insecticide that inhibits binding to the acetylcholine receptor and shows rapid and residual activity by contact and ingestion. The compound is registered for use on apples, pears and peach for the control of aphids, leafhoppers, codling moth, plum curculio, apple maggot, leafminers, leafrollers, Oriental fruit moth, and pear psylla. Clothianidin is also very effective against brown marmorated stink bug. Belay is registered only for postbloom applications and should not be applied within 7 days of harvest. No more than 12.0 oz of Belay (0.2 lb of active ingredient) can be applied per season. Multiple applications of Belay are reported to cause mite flare-ups. Previously Belay used to be marketed under the trade name Clutch.

Beleaf (flonicamid) (IRAC Group 9C Insecticide). Beleaf is a member of the pyridinecarboxamide class of chemistry. It provides control of a wide spectrum of aphids and plant bugs by provoking rapid and irreversible feeding cessation. It controls pests by contact and ingestion. The product is registered for use on pome fruit (21-day PHI) and stone fruits (14-day PHI). No more than three applications at 2.8 oz/acre are allowed per season.

Belt (flubendiamide) (IRAC Group 28 Insecticide). The active ingredient of Belt SC flubendiamide belongs to chemical class known as phthalic acid diamides, which bind to ryanodine receptors located in insect muscles and interfere with regulation of calcium balance. Flubendiamide is an oral toxicant, affecting feeding larvae at a very low dose. On fruit, Belt is registered for the control of codling moth, Oriental fruit moth, leafroller complex, leafminers, green fruitworm, and lesser appleworm. The recommended rate on pome fruit is 5 oz/acre and 4 oz/acre on stone fruit. Belt has 12-hour REI and a 14-day PHI on pome fruit and 7-day PHI = 7 days on stone fruit. Belt is very safe to beneficial insects. See also *Tourismo*.

bifenazate—see *Acramite*.

bifenthrin—(**Brigade, Discipline, Fanfare, Tundra**) (IRAC Group 3 Insecticide). Bifenthrin-based insecticides are broad-spectrum pyrethroid insecticides with contact and stomach action. Among other pests listed on the label, bifenthrin is very effec-

tive against brown marmorated stink bug. Bifenthrin-containing products in fruit system are registered only for use on pears. All formulations are restricted-use product due to toxicity to fish and other aquatic organisms. Bifenthrin is highly toxic to bees exposed to direct treatment and residues on plants. Use recommendations are generally limited to before bloom in Pennsylvania to conserve *Stethorus* and other predators of European red mite.

Biobit—see *Bt*. This product is OMRI listed.

BioCover (petroleum oils). A group of highly refined, 98 percent petroleum oils (BioCover UL, BioCover LS, BioCover MLT, and BioCover SS) registered for dormant, delayed dormant and foliar applications on apples, pears, apricots, cherries, peaches, plums, and prunes. Due to possible severe phytotoxic effects, this oil cannot be applied within 30 days of sulfur or lime sulfur application and 14 days before or after Captan application. For summer application do not exceed 1.5 gallons per acre per application. Apply in a minimum of 50 gallons water per acre. Excellent coverage is essential for efficacious control of soft-bodied insects. Also please see dormant oils and summer oils.

Bravo 720—see chlorothalonil.

***Brigade**—see bifenthrin.

Broadstar (flumioxazin) is a granular herbicide that is only labeled for nonbearing orchards. It is applied at a rate of 150 lb/A to control broadleaf weeds and some grasses. One-half to ¾ of an inch of water must be applied immediately after application of the herbicide. Do not apply to trees that are less than 1 year in the field.

Bt (*Bacillus thuringiensis*) (**Agree, Biobit, Condor, Crymax, Deliver, Dipel, Javelin, MVP, Thuricide, XenTari**) (IRAC Group 11 Insecticide). *Bacillus thuringiensis* are aerobic, spore-forming, rod-shaped bacteria that form crystals of protein called delta-exotoxins. Several different types of exotoxins are produced by two *B. thuringiensis* subspecies and their various strains which, when ingested, damage the stomach wall of Lepidoptera larvae. These types of exotoxins are produced in varying proportions by the different strains and are formulated for use in tree fruits. *B. thuringiensis* subsp. *aizawai* products include Agree and XenTari. *B. thuringiensis* subsp. *kurstaki* products include Biobit, Condor, Crymax, Dipel, Javelin, MVP, and Thuricide. MVP is unique in that it consists of delta-exotoxins encapsulated in killed *Pseudomonas fluorescens* to extend field efficacy.

Bts in general provide control of larvae of tufted apple bud moth (TABM), other leafrollers, green fruitworm, and most forest-orchard species (gypsy moth, tent caterpillars, webworms) that feed on foliage. Control of Oriental fruit moth and codling moth larvae is less successful because these larvae feed internally and may not ingest enough toxin. MVP has been shown to be less effective on TABM than other Bt products. Although Bts are generally safe for applicators and to most nontarget species, XenTari is highly toxic to honey bees and other natural enemies exposed to direct spray.

Since Bts are effective only against larvae and not eggs, they should be applied beginning about one week later, when 20 percent of the eggs have hatched. Extenders that block ultraviolet degradation may improve the efficacy of Bts. If mixing Bts with

other products, always add the Bt first and use good mechanical agitation. Bts are incompatible with mixtures having a high pH. Thorough spray coverage is needed to provide a uniform deposit of Bts insecticide at the site of larval feeding. Most products containing Bt are OMRI listed.

buprofezin—see Centaur.

Cabrio—see pyraclostrobin.

Calypso (thiacloprid) (IRAC Group 4A Insecticide). The active ingredient, thiacloprid, is a neonicotinoid insecticide registered for use on apples and pears. Calypso possesses both excellent systemic activity and crop safety. Its mode of action is through interference with the nicotinic acetylcholine receptor, and it controls pests by both contact and stomach activities. Calypso has a low acute toxicity to warm-blooded animals; however, it is highly toxic to marine/estuarine invertebrates. Calypso possesses activity on apples against aphids, leafminers, leafhoppers, mirid bugs, codling moth, and plum curculio. It will also suppress scale insects and the apple maggot. On pears, it is active against pear psylla, aphids, mealybugs, leafminers, and the pear midge. It will also suppress scale insects on pears. Calypso has a 12-hour restricted entry interval and should not be applied less than 30 days before harvest (PHI = 30 days) on both apples and pears. Do not apply more than 8 fluid ounces per acre in a single application and no more than 16 fluid ounces per acre per year on either apples or pears.

captan (Captan, Captec). Captan is a fungicide with protective and curative action formulated as 50 and 80 percent wettable powders and various dust mixtures for use on fruit. Captec is a liquid formulation of captan. Captan is effective against scab, black rot, white rot, bitter rot, Brooks spot, and blossom end rot on apples. It is effective against sooty blotch and flyspeck if the last spray application is not more than 30 to 40 days before harvest. It is not effective against the rusts, fire blight, or powdery mildew. In some cases, captan may cause an increase in the amount of powdery mildew compared to unsprayed trees.

Where the early season apple scab control program fails and scab becomes established in the trees, captan at low rates cannot be expected to provide control. However, this fungicide is highly effective in reducing spore germination. Use at least 5 to 6 pounds per acre in low-volume sprays applied at intervals of no more than 10 to 14 days.

On stone fruits, captan is a good fungicide for the control of brown rot and scab when adequate spray schedules are followed. Captan plus wettable sulfur can be used on peaches where brown rot, scab, and mildew are present. Captan is effective against cherry leaf spot and brown rot on tart cherries if the diseases are at a low level and the spray intervals do not exceed 2 weeks.

Captan has caused a necrotic spotting, yellowing, and dropping of leaves when used under poor drying conditions or in combination with sulfur, especially on Delicious, Stayman, Baldwin, and King apple varieties. Foliage of d'Anjou pears has been stunted and cupped. Necrotic spots on fruit and foliage have occurred on both plums and prunes where captan was used from petal fall until the fruit begins to ripen. Its use usually results in acceptable fruit finish on apples, peaches, and nectarines. Captan residues on peaches at harvest may cause increased skin discoloration from abrasions that occur during picking and packing.

The leaves of some sweet cherry varieties may be injured by repeated captan applications. A full-season program of captan may require the use of miticides or close adherence to a pest management program.

Captan has few spray incompatibilities, but it should not be used with oil, lime, or other alkaline materials. The use of captan within a week either before or after an oil application may result in leaf injury on apple trees. Combinations with sulfur may result in increased injury under high temperatures and high relative humidity. Equivalent captan products include Captan 50% WP, Captan 80% WP, Captan 80WDG, and Captec 4L. Check the label for rates. REI restrictions vary from 24 hours to 4 days, so check the label of the product you are using.

carbaryl (Carbaryl, Sevin) (IRAC Group 1A Insecticide). Carbaryl is a carbamate insecticide with contact and stomach action, and slight systemic activity. Carbaryl is highly toxic to bees and should not be used near bloom. Sevin XLR Plus is formulated to be less hazardous to bees and other beneficial insects and to provide a longer period of residual activity. When applied between petal fall and 20 mm fruit diameter, carbaryl acts as a fruit thinner on many varieties. Carbaryl is not recommended for season-long programs because of high toxicity to mite predators that may lead to rapid increase in mite populations. See also Sevin in Part I.

Carpovirusine—see codling moth granulosus virus. This product is OMRI listed.

Carzol (formetanate hydrochloride) (IRAC Group 1A Insecticide). Carzol SP is a nonsystemic carbamate miticide-insecticide with contact and stomach action. It is registered for control of mites on peaches, nectarines, apples, and pears. It also suppresses spotted tentiform leafminer and white apple leafhopper when used in the integrated spray program in alternate row middle sprays at 6 to 10 ounces per acre. The lower rate is suggested for leafhoppers as a preventive treatment at petal fall. It is effective on western flower thrips, plant bugs, and stink bugs on peaches and nectarines. Carzol is highly toxic to predatory mites and toxic to bees. Do not apply more than 4 pounds on apples, pears, and nectarines; 3 pounds on plums and prunes; and more than 1.25 pounds on peaches during one growing season. The product is not stable in alkaline mixtures and should not be used if the pH is 8 or higher. Carzol can be used only for 1 application per season and cannot be used after petal fall.

Casoron. Casoron's active ingredient, dichlobenil, acts by inhibiting germination and actively dividing meristems of growing points and root tips. It is absorbed primarily from the soil by the root system. Because dichlobenil volatilizes under warm conditions, applications should be made only under cool or cold weather conditions in late fall or very early spring. A fall application may be necessary to control many perennials, such as fescues, orchardgrass, quackgrass, docks, and dandelion. Dichlobenil is labeled for use on apples, pears, and cherries. A liquid formulation of Casoron CS makes it easier to use in orchard production. Casoron CS should be applied preemergent to early postemergent. It should not be applied until after the trees have been established for at least 1 year, while the granular formulation can be applied anytime after 4 weeks from planting.

Centaur (buprofezin) (IRAC Group 16 Insecticide). The active ingredient in Centaur belongs to a group of insect growth regulators and is effective against the nymph stages of scales and immature stages of other molting insects by inhibiting chitin biosynthesis. Buprofezin also suppresses oviposition of adults and reduces viability of eggs. For effective pest control excellent coverage is essential. Centaur is registered for the control of scales and leafhoppers on apples (one application per season), scales and pear psylla on pears (up to two applications), and scales on peaches (two applications per season). For the best control of scales the application should be made at the peak crawler emergence. Centaur should not be applied within 14 days of harvest. See also *Tourismo*.

Chateau (flumioxazin) is a contact and residual herbicide that controls primarily broadleaf weeds in bearing and nonbearing orchards. It can be used in the year of planting if the trees are shielded from contact with the spray. It is labeled for apples and all stone fruits. As a contact material it is most effective when applied while the emerged weeds are very small. Application rate is 6 to 12 ounces per treated acre. The REI is 12 hours and the PHI is 60 days. Do not apply more than 12 oz in a single application and do not exceed more than 24 oz in any 12-month period. A supplemental label has additional restrictions and warnings. These include restrictions on soil types, danger of damage from dust from soils drifting onto trees, and proximity of nondormant pears to the application site. Chateau should only be applied prior to pink bud and bud break in stone fruit and pears. The preferred timing of application is in the fall to take advantage of the potential for rain to activate the material.

CheckMate CM—see CheckMate MD products.

CheckMate CM-F—see sprayable pheromones.

CheckMate CM-OFM Duel—see CheckMate MD products.

CheckMate MD products—a group of mating disruption products for the control of codling moth (CheckMate CM, CheckMate CM-F, Oriental fruit moth; CheckMate OFM Dispenser and CheckMate OFM-F or both species at the same time; CheckMate CM-OFM Duel). The hand-applied dispensers should be placed in the orchards before the spring emergence of the pests (biofix) or when the moths are first detected in pheromone traps. CheckMate Puffer products provide mating disruption of targeted species with a low density dispenser system. Similarly to other mating disruption materials, the CheckMate products will not have an effect on female moths, eggs, or larvae. The CheckMate pheromone dispensers (pouches) are placed on trees by hand and therefore require high labor input. The time of application, length of activity, number of dispensers per acre, and placement within the tree vary from species to species, and detailed instructions from the product label should be followed to achieve success. Mating disruption usually works better under lower pest pressure and may require supplemental insecticide treatments. It is recommended that mating disruption be used on the whole orchard or block. Most of CheckMate hand-applied MD products are OMRI listed (for more information, see “Using pheromones for mating disruption”).

CheckMate OFM Dispenser—see CheckMate MD products.

CheckMate OFM-F—see CheckMate MD products.

CheckMate OFM-SL—see CheckMate MD products.

CheckMate Puffer CM—see CheckMate MD products.

CheckMate Puffer OFM—see CheckMate MD products.

chlorothalonil (Bravo 720, Terranil). Bravo 720 and the other chlorothalonil formulations are nonsystemic foliar fungicides with protective action registered for the control of brown rot blossom blight; leaf curl of stone fruits; coryneum blight (shothole) and scab on peaches, nectarines, and apricots; and is excellent for cherry leaf spot. These products are recommended at 3.1 to 4.1 pints per acre depending on the disease and the time of application. Bravo is not registered for use after shuck split and before harvest, but it can be used after harvest for cherry leaf spot control. Bravo is also recommended for control of black knot on cherries and plums.

chlorothalonil (Bravo 720, Terranil). Bravo 720 and the other chlorothalonil formulations are nonsystemic foliar fungicides with protective action registered for the control of brown rot blossom blight; leaf curl of stone fruits; coryneum blight (shothole) and scab on peaches, nectarines, and apricots; and is excellent for cherry leaf spot. These products are recommended at 3.1 to 4.1 pints per acre depending on the disease and the time of application. Bravo is not registered for use after shuck split and before harvest, but it can be used after harvest for cherry leaf spot control. Bravo is also recommended for control of black knot on cherries and plums.

***chlorpyrifos (*Chlorpyrifos, *Lorsban, *Warhawk, *Yuma)** (IRAC Group 1B Insecticide). Chlorpyrifos is an organophosphate insecticide with nonsystemic contact, stomach, and vapor action highly effective on a wide range of insects on apples, peaches, and nectarines. This material is formulated as an emulsifiable concentrate and as a wettable powder. Chlorpyrifos 4E, Lorsban 4E, and Lorsban Advanced are products labeled for dormant to delayed dormant applications on apples, peaches, nectarines, and plums to control scale and other pests. Trunk sprays of these products thoroughly wetting all bark areas from ground level to scaffold limbs will control peachtree borer. Apply only one borer application per season, and do not apply within 14 days of harvest. As a postharvest spray, these products at 1 to 2 quarts per 100 gallons are effective on second-generation lesser peachtree borer. Lorsban 4E or Lorsban Advanced can be used to directly treat burr knots for control of dogwood borer and other borers on apples. Apply 1.5–3.0 quarts of Lorsban Advanced per 100 gallons. On young trees, as little as 6 fluid ounces per tree can provide successful control. Optimum timing is during the summer at peak flight. Do not apply the last treatment within 28 days before harvest. On apples, peaches, and nectarines only one application of product containing chlorpyrifos is allowed per year.

Lorsban 75 WG is labeled for use on apples at the rate of 0.33 lb to 0.67 lb per 100 gallons of water in dilute sprays and no less than 1 lb per acre in concentrate sprays. Lorsban cannot be applied for foliar applications after petal fall.

Cidetrak CM (8E,10E)-8,10-dodecadien-1-ol). Mating disruption formulation for codling moth. For more information, see “Using pheromones for monitoring and mating disruption.”

Cidetrak OFM-L (Z-8-Dodecen-1-yl Acetate, E-8-Dodecen-1-yl Acetate, Z-8-dedecen-1-ol). Mating disruption formulation for Oriental fruit moth. For more information, see “Using pheromones for monitoring and mating disruption.”

clethodim (Arrow, Clethodim, Select Max, Shadow). Clethodim is a postemergent herbicide for the control of annual and perennial grasses. It does not control sedges or broadleaved weeds. Rate varies depending on the weed species and stage of growth. Apply higher rates to control perennial grasses. Do not apply to grasses that are under stress. EPA requires the signal word “WARNING” to appear on the label. A reentry restriction period of 12 hours is required after application. It is sold under four brand names: Arrow, Clethodim, Shadow, and Select Max.

clofentezine—see Apollo.

clothianidin—see Belay.

Clutch—see Belay.

codling moth granulosis virus (CpGV) (Carpovirusine, Cyd-X). CpGV is a biological insecticide registered for the control of codling moth in apples, pears, and walnuts. A codling moth larva must ingest the virus in order to become infected. Larval mortality is not immediate, but infected larvae will stop feeding within a few days and eventually die. Multiple applications per generation are recommended for the best efficacy of this product. The first application should be made at the beginning of egg hatch and repeated every 7 days. Mating disruption in combination with codling moth granulosis virus should provide very good control of pesticide-resistant codling moth populations. In laboratory tests conducted at the Penn State Fruit Research and Extension Center, codling moth granulosis virus was also effective in controlling neonate Oriental fruit moth. Both products Cyd-X and carpovirusine are OMRI listed.

Condor—see Bt.

copper compounds. Copper is a foliar fungicide and bactericide with protective action. Copper compounds can be highly toxic to many fruit crops and must be used with extreme care. Read the label of the product you intend to apply to determine the type of copper, the percent active ingredient, and any cautions that accompany its use. Copper was first used in the mid-1800s in grape vineyards in France to discourage theft of the grapes. Copper sulfate and lime were mixed in a slurry and spread over the grape vines. The blue copper material made the grapes very unappetizing. In 1882 a French scientist observed that this anti-theft treatment was effective in reducing a disease called downy mildew on grapes. This observation was made near the town of Bordeaux; so the mixture of copper sulfate and lime became known as Bordeaux mixture.

Copper sulfate is soluble in water. This high degree of solubility is the fundamental cause of toxicity problems, which copper sulfate can cause to all fruit crops. Fixed coppers have been developed that are relatively insoluble and therefore less toxic to plants. However, fixed coppers can also result in phytotoxicity under certain conditions. Fixed coppers include basic copper sulfate (Basicop, Cuprofix), basic copper chloride, copper oxide, copper oxychloride, and copper hydroxide (Champ, Kocide, Nu-Cop, Badge).

The fungicidal activity of copper is based on its ability to destroy proteins in plants. This is true for all plants, fungi, and fruit plants. When lime is combined with copper compounds, it reacts with the copper making it more stable. Thus, copper compounds in the presence of lime would generally produce lower, more uniform concentrations of free copper, which in turn would be less apt to injure plant tissues than if no lime were used. Because copper has the ability to kill all types of plant tissue, the use of copper fungicides carries with it the risk of causing injury to fruit plants. Ideally, copper on the leaf or fruit surface should be high enough to kill the fungus or bacteria but low enough not to cause injury to the plant. Factors that can promote injury include: failure to use enough lime; cold, wet weather conditions that apparently increase copper’s solubility, allowing more into the plant and resulting in toxicity; and application of excessive rates of copper. Even when no injury is evident on the plant, subtle effects of the copper on the plant may be occurring. In addition to reducing growth and yields, it has been shown that the use of copper fungicides can reduce the maturity of the fruit as well as that of the shoots. Copper fungicides can have subtle, chronic negative impacts on fruit plants.

Copper provides low to moderate control of many fungal and bacterial diseases. Fixed coppers, plus lime, are safer than Bordeaux. They may be used for fire blight of apples and pears, leaf curl control on stone fruits and pre- and postharvest leaf spot control on tart cherries. Copper compounds should not be applied in a postharvest spray without adding lime. If copper is applied without lime, orchards will show toxicity symptoms such as chlorosis (yellowing), leaf drop on tart cherries, and necrosis (browning) on sweet cherries. If a copper material is applied without lime and yellowing and leaf drop occur, an application of lime within 2 to 3 weeks after the copper application may prevent further yellowing and leaf drop. Do not use immediately before or after using ferbam. These compounds are useful in plant nutrition as they supply copper to the plant.

Couraze—see imidacloprid.

Crymax—see Bt.

Cyd-X—see codling moth granulosis virus. This product is OMRI listed.

***cyfluthrin (Baythroid 2E, Tombstone)** (IRAC Group 3 Insecticide) is a broad-spectrum pyrethroid insecticide with contact and stomach action. It is registered for use on apples, crabapples, pears, quince, peaches, apricots, nectarines, plums, prune plums, and cherries. Similar to other pyrethroids, Baythroid is a restricted-use product due to its toxicity to fish and other aquatic organisms. Baythroid is highly toxic to bees exposed to direct treatment and residues on plants. Use recommendations are generally limited to only before bloom in Pennsylvania to conserve *Stethorus* and other predators of spider mites.

Cythion—see malathion.

Damoil—see dormant and summer oils.

***Danitol (fenpropathrin)** (IRAC Group 3 Insecticide). Danitol is a broad-spectrum pyrethroid insecticide/miticide with contact and stomach action. It is registered for use on both pome and stone fruit groups. On apples, the product is registered for a very wide range of insect pests, including brown marmorated stink

bug, potato leafhopper, white apple leafhopper, rosy apple aphid, spirea aphid, spotted tentiform leafminer, tarnished plant bug, plum curculio, European apple sawfly, Japanese beetle, apple maggot, obliquebanded leafroller, tufted apple bud moth, Oriental fruit moth, and many more. On pears, Danitol is registered for the control of codling moth and pear psylla. The rate for Danitol varies from 10.67 to 21.33 fluid ounces per application, with no more than 42.67 fluid ounces per season. The product is highly toxic to fish and aquatic organisms. Due to fenpropathrin toxicity to beneficial organisms, the compound is recommended mainly for prebloom insecticide applications in Pennsylvania.

dazomet (Basamid G). Basamid is a broad-spectrum soil fumigant used for the preplant control of nematodes, weeds, and soilborne diseases. Unlike other fumigants, Basamid is a granular product that must be mechanically incorporated into the soil. A soil fumigation rig is not required. Toxic gases are not released until after the product begins to absorb moisture from the soil. These gases do not produce a high vapor pressure, and therefore Basamid is not considered a true soil fumigant by the Pennsylvania Department of Agriculture. A category 21 (soil fumigation) certification is not required for the application of Basamid. Basamid's efficacy is affected by the same soil conditions and features that affect other fumigants, including moisture, temperature, texture, organic matter content, site preparation, and effective surface sealing after application. The product is phytotoxic and will harm trees if the gases have not completely dissipated from the soil before planting.

Deadline Bullets (metaldehyde)—registered product to control slugs and snails. The product should be applied to the ground at the rate of 20 to 40 lb per acre. Cannot be applied directly to or contaminate edible portions of the plant.

***Decis—see deltamethrin.**

Delegate (spinetoram) (IRAC Group 5 Insecticide). Delegate is a member of the spinosyn class of insecticides derived from fermentation of *Saccharopolyspora spinosa* but with chemical modifications. Spinetoram causes excitation of the insect nervous system by altering the function of nicotinic and GABA-related ion channels. Delegate exhibits good translaminar activity but not systemic activity. Delegate is registered for use on pome fruit, stone fruit, bushberries, caneberries, and grapes. For pome and stone fruit the in-season recommended rate is from 4.5 oz to 7.0 oz per acre. Delegate provides excellent control of leafrollers, leafminers, codling moth, Oriental fruit moth, thrips, pear psylla, and suppression of apple maggot and plum curculio. As a larvicide, the compound needs to be ingested by the insect for optimal pest control. Due to the same mode of action as Spintor, no more than three consecutive applications of those two compounds are recommended. No more than four applications are allowed per season. Delegate has a 7-day PHI on apples, cherries, plums, and prunes; 14 days on peaches and apricots; and a 1-day PHI on nectarines.

Deliver—see Bt products. This product is OMRI listed.

***Delta Gold—see deltamethrin.**

***deltamethrin (Battalion, Decis, Delta Gold)** (IRAC Group 3 Insecticide). This group of compounds is a broad-spectrum pyrethroid insecticide with contact and stomach action. It is registered for use on pome fruits such as apples, loquat, mayhaw,

quince, and pears but is not registered for the use on stone fruits. Decis is extremely toxic to fish and other aquatic organisms. The product is also highly toxic to bees exposed to direct treatment and residues on plants. In Pennsylvania use recommendations are generally limited to only before-bloom applications to conserve *Stethorus* and other predators of spider mites.

Des-X (potassium salts of fatty acids)—insecticidal soap that kills pests by disrupting membrane and cellular function of soft-bodied insects. Direct contact of the solution with insect body is necessary for the product to provide pest mortality. Product is OMRI registered.

diazinon (*Diazinon, *D•z•n diazinon) (IRAC Group 1B Insecticide). Diazinon is a nonsystemic, organophosphate insecticide with contact, stomach, and respiratory action. Diazinon has a broad spectrum of insect control. It is recommended in the apple programs in the ½-inch green and prebloom sprays for scale control and as a foliar application after bloom to control woolly apple aphid. No more than two applications per season are allowed on both stone and pome fruit. Diazinon AG500 is not registered on pome fruit. Diazinon 50W carries a 21-day preharvest interval.

dichlobenil—see Casoron.

dicofol—see Kelthane.

difenoconazole—see Inspire Super MP.

Dimate (dimethoate) (IRAC Group 1B Insecticide)—OP insecticide registered only for application on pears against aphids, leafhoppers, pear psylla, and mites (PHI = 28 days, REI = 10 days).

Dipel—see Bt.

Direx—see diuron.

***Discipline—see bifenthrin.**

Disrupt Micro-Flakes CM ((E,E)-8, 10-Dodecadien-1-ol). Mating disruption material for the control of codling moth. For more information, see “Using pheromones for monitoring and mating disruption.”

Disrupt OFM Hand Applied ((Z)-8-Dodecen-1-yl acetate, (E)-8-Dodecen-1-yl acetate, (Z)-8-Dodecen-1-ol). Mating disruption material for the control of Oriental fruit moth (for more information, see “Using pheromones for monitoring and mating disruption”).

Disrupt OFM Mats ((Z)-8-Dodecen-1-yl acetate, (E)-8-Dodecen-1-yl acetate, (Z)-8-Dodecen-1-ol). Mating disruption material for the control of Oriental fruit moth (for more information, see “Using pheromones for monitoring and mating disruption”).

DiTera DF (dried fermentation solids and solubles of *Myrothecium verrucaria*). DiTera DF may be applied to the soil as a preplant, at planting or postplant treatment for the control of plant-parasitic nematodes. Preplant treatments should be applied as close to actual planting times as possible. DiTera DF must be incorporated into the soil either mechanically or by irrigation for best results. In perennial crops, the optimal application time is just prior to a flush of root growth. Do not apply DiTera directly to foliage.

diuron (Direx 4L, Diuron 4L, Diuron DF, Karmex DF). Diuron is a substituted urea herbicide that is applied as a preemergent and is effective primarily on broadleaved weeds with some post-emergent activity. After being taken up by the roots and spread

throughout the plant, it acts to inhibit photosynthesis. At high rates the material is relatively nonselective and can injure trees. It should not be applied to soils that have less than 1 percent organic matter or to sand, loamy sand, gravelly soil, or exposed subsoils. The label also recommends not to replant the site for at least 2 years after the last treatment. Trees on M.9 rootstock and its clones may show sensitivity to its use. Diuron has a low acute toxicity to mammals even though it carries the signal word “WARNING” on the label. The signal word is applied because the compound can cause eye and throat irritation. It is much less of an irritant to intact skin. Do not apply to apple or pear trees that have been established less than 1 year or to peach trees established less than 3 years in the orchard. Diuron will not control emerged weeds such as dandelion, plantains, or yellow rocket. The use of diuron plus terbacil (Sinbar) on apples and peaches established at least 2 years in the orchard gives a broader spectrum of control. Note that some of the liquid formulations of diuron have different maximum rates; be sure to read the label carefully.

dodine—see **Syllit**.

Dormant Oil 435—see **dormant oils**.

dormant oils (BioCover, Damoil, Dormant Oil 435, Mite-E-Oil, Omni Supreme Spray, Par F70 Soluble Oil, PureSpray Oil, Spray Oil 415, Sunspray 6E, Super 94 Spray Oil, Superior Spray Oil, Supreme 470 Spray Oil). Oils are physical pesticides, which are effective as a smothering film on European red mite eggs and young nymphs, and several other pests. Oils in the 60- or 70-second viscosity range are recommended as a control measure for preventing San Jose scale and European red mite. These oils are safer than earlier dormant oils because they are more volatile, resulting in less persistence on the tree. They remain on the tree long enough to kill the pest, but not so long as to interfere with vital plant processes or oil-incompatible pesticides that may be applied later. Because of this safety factor these oils can be applied up to the prepink stage of tree development. Oil applied during silver tip to ¼-inch green is not nearly as effective on mites as it is when applied between ½-inch green and full pink. Use 2 gallons of oil per 100 gallons dilute between half-inch green and tightcluster. To lower the possibility of tree injury after oil applications, reduce the oil rate to 1 gallon/100 gallons dilute if application is made after tightcluster. Oils should never be mixed with fungicides containing sulfur.

***D•z•n diazinon**—see **diazinon**.

Elite (tebuconazole). Elite 45DF is effective in controlling brown rot (blossom blight and fruit rot) in peaches, nectarines, and cherries and in the control of leaf spot and powdery mildew in cherries. Elite is not registered for use on apricots. Elite is applied at 2 ounces per 100 gallons dilute and 4 to 8 ounces per acre low volume. To control brown rot blossom blight, begin applications at white bud in cherries or pink bud in peaches and nectarines. Apply again at 50 percent bloom and at petal fall if conditions continue to be favorable for disease development. For fruit rot begin applications at 2 to 3 weeks before harvest and continue at 7-day intervals through the day of harvest. On cherry trees begin leaf spot applications at petal fall or when first leaves unfold and continue applications at 7- to 14-day intervals. Applications should be made at 7-day intervals early in the growing

season when terminal growth is rapid and/or under severe disease conditions. A postharvest application to control leafspot may be made to maintain control and reduce overwintering inoculum. For powdery mildew follow the leaf spot schedule until terminal growth ceases. Elite 45DF may be applied up to and including the day of harvest (0-day PHI). Do not apply more than 3 pounds of product per acre per crop season.

***Endigo (thiametoxam and lambda-cyhalothrin mixture)** (IRAC Group 3 and Group 4A insecticide mixture). Endigo is mixture product containing neonicotinoid and pyrethroid active ingredients. Endigo is registered for use on pome and stone fruit for the control of wide array of pests including stink bug species. This product is extremely toxic to fish and aquatic organisms, highly toxic to bees, and toxic to wildlife. See also thiametoxam and lambda-cyhalothrin.

endosulfan (Thionex) (IRAC Group 2A Insecticide). Endosulfan is a nonsystemic organochlorine insecticide with contact and stomach action. Endosulfan is used for stink bugs, borers, catfacing insects, and aphid control on stone fruits and aphid, apple rust mite, tarnished plant bug, tentiform leafminer, and white apple leafhopper control on apples. Endosulfan is also registered for use on pears and plums. It may be used within 21 days of harvest on apricots, nectarines, and peaches if only the bark from the ground to scaffold branches is sprayed; within 30 days if the entire tree is sprayed. Do not apply more than twice per season on stone fruits and pears, or three times per season on apples. Restricted-entry interval (REI) for Thionex is 20 days. Due to current label change it will be illegal to use Thionex after July 31, 2012, on peaches, nectarines, tart and sweet cherries, plume and prune; after July 31, 2013, on pears; and after July 31, 2015, on apples.

Entrust. OMRI-listed product with spinosad as active ingredient. See SpinTor for more information.

Envidor (spirodiclofen) (IRAC Group 23 Insecticide). Envidor is a nonsystemic foliar miticide belonging to the chemical class of tetrone acids. Envidor mode of action is classified as lipid biosynthesis inhibitor and is active by contact against all developmental stages of mites including eggs and female adults. Adult males are not affected. The product is registered for use on pome and stone fruits. Envidor is registered for the control of European red mites, twospotted spider mites, peach silver mites, and rust mites. Only one application is allowed per growing season.

***esfenvalerate (Adjourn, Asana)** (IRAC Group 3 Insecticide). Products containing esfenvalerate are broad-spectrum pyrethroid insecticides with contact and stomach action. Esfenvalerate is registered for use on apples, peaches, apricots, nectarines, plums, prune plums, cherries, and pears. Esfenvalerate is a restricted-use product because of toxicity to fish and other aquatic organisms. Esfenvalerate is highly toxic to bees exposed to direct treatment and residues on plants. Use recommendations are generally limited to before bloom in Pennsylvania to conserve Stethorus and other predators of European red mite. Do not feed pomace to livestock.

Esteem (pyriproxyfen) (IRAC Group 7D Insecticide). Esteem is an insect growth regulator that acts by suppressing embryogenesis within the insect eggs and by inhibiting metamorphosis (the

change from one stage to another, for example from pupa to adult) and adult emergence of target pests. Esteem has no activity on adult insects, but hatching of eggs laid by treated adults will be suppressed (sterile activity). Pyriproxyfen exhibits translaminar movement in leaves. On apples, it is registered for the control of codling moth, San Jose scale, leafminers, and aphids. On pears, Esteem is additionally registered for the control of pear psylla. On stone fruit, in addition to the scale insects Esteem is also registered for suppression of peach twig borer. The addition of oil has been shown to improve the control of codling moth and San Jose scale. Esteem should not be applied more than twice during the growing season. This pesticide is toxic to fish and aquatic invertebrates.

ethephon (Ethrel, Ethepon 2E). Ethepon is an ethylene-releasing material that can advance fruit maturity, increase red color, increase flowering, and thin fruit in apples. In cherries, it can be used to increase color and help loosen fruit. Ethrel must be applied in spray mixtures that have a pH less than 8.5. At a pH above 8.5, Ethrel does not break down to form ethylene. Do not apply Ethrel on cherries when temperatures exceed 85°F, or on apples when temperatures exceed 90°F. Ethepon may be used as a fruit thinner for apples, but the amount of thinning can be excessive, especially when hot (> 80°F) weather follows the application. Ethepon will thin apples up to 20 mm in diameter, making it valuable as a rescue thinner. To improve fruit loosening and red color in apples, apply 7 days before normal harvest and include a suitable stop-drop material such as NAA. Where Ethrel is applied to bearing trees to increase flowering for the next year, some reduction in fruit size can occur. To avoid a thinning response on apples when trying to increase flowering, delay application until 6 weeks after bloom or June drop, whichever is later. Ethrel is not very mobile within the tree; therefore, to obtain the desired response good spray coverage is essential so that the material reaches the fruit.

etoxazole—see Zeal.

Exillis Plus—see 6BA.

Falgro—a 20 percent formulation of gibberellic acid (A3) with multiple uses on cherries and other stone fruit. In tart cherries, an application of 4 to 21 grams of active ingredient per acre at 2 to 4 weeks after bloom or when there are 1–3 inches of terminal growth will increase fruit-bearing wood and reduce blind nodes. The rate will vary based on tree age and vigor. It may also be used on sweet cherries to increase fruit size. Applications to increase fruit size should be made on large, mature trees when the fruit is light green to straw colored at a rate of 16–48 grams of active ingredient per acre. To reduce flowering and fruiting on young sweet and tart cherry trees, make an application of 10–20 grams of active ingredient per acre at 2–4 weeks after bloom. Falgro can also be used on other stone fruit trees to increase fruit firmness and fruit quality with a single application of 16–32 grams of active ingredient per acre at 1–4 weeks prior to the beginning of harvest. Applying Falgro at a rate of 20–80 grams of active ingredient per acre during flower bud initiation for the following season will reduce flowering and fruiting of young stone fruit trees.

***Fanfare—see bifenthrin.**

fenarimol—see Rubigan.

fenbuconazole—see Indar.

fenbutatin oxide—see Vendex.

fenpropathrin—see Danitol.

fenpyroximate—see Portal.

ferbam (Carbamate, Ferbam). Ferbam is a foliar fungicide with protective action and secondary action against leaf yellowing (chlorosis). It is effective on apples for rust and scab control, on stone fruits for leaf curl, on cherries and plums for clear spots and black knot, and on pears for leaf and fruit spot control. Do not use with lime. Ferbam may produce unsightly residues on leaves and fruit. On Golden Delicious, Jonathan, and other varieties that russet easily, injury may result from using ferbam, especially if it is applied in the pink through first cover periods. The best time to use it is in the prepink period or in the second or later cover sprays.

Firewall—see streptomycin sulfate.

Flint (trifloxystrobin). Flint is a strobilurin fungicide that is highly effective on apples against apple scab and powdery mildew. It also provides moderate control of cedar-apple rust, fruit rots, sooty blotch, and fly speck. Flint provides outstanding protection and post-infection control of apple scab. It prevents spore germination and is highly suppressive of sporulation of scab and powdery mildew lesions. The control of diseases is brought about by the strong association of the strobilurin molecule with the waxy layer on leaves and fruits. The active ingredient is slowly absorbed from the cuticle. It redistributes at the plant surface by superficial vapor movement and to newly formed leaves during rain periods. Residual activity of spray residue may be as long as 3 weeks, allowing for extended spray intervals during sporadic rain periods.

Flint and other strobilurin fungicides (Sovran and Pristine) are subject to the development of insensitive pathogen strains, particularly those of apple scab. Thus, strong measures must be taken to prevent or delay this development. In spray programs, alternate strobilurin fungicides (Flint, Sovran, and Pristine) with other nonstrobilurin fungicides (captan, Dithane, Manzate, Penncozeb, ziram, thiram, Rally, Rubigan, Procure, Inspire Super, Indar, Topguard), and limit the number of seasonal applications. The Flint label requires that it not be used in more than 4 applications per season or 3 sequential applications.

Do not apply Flint where spray drift may reach Concord grapes or crop injury may occur. Spray equipment should be rinsed after applying Flint before application of other products to Concord grapes or crop injury may occur.

flonicamid—see Beleaf.

fluazifop—see Fusilade.

flubendiamide—see Belt.

formetanate hydrochloride—see Carzol.

fosetyl—see Aliette.

Fruitone L—see NAA.

Fruitone N—see NAA.

FujiMite—see Portal.

Fusilade is a selective phenoxy herbicide used for postemergence control of annual and perennial grass weeds. It is registered for use in nonbearing apple and pear orchards that will not be harvested within a year after application. It may be applied to bearing stone fruit orchards. It will control most emerged annual and perennial grasses, but not broadleaved weeds. Either a crop oil concentrate (2 pints per 25 gallons) or nonionic surfactant (0.5 pints per 25 gallons) must be added to the tank mix. Applications should be made to young (2- to 8-inch) actively growing grasses before seedhead development. Do not apply more than 72 fluid ounces of product in any one year. For best response, weed species should be actively growing and not under any stress. Where a mixture of weeds exists, treat the area when the first weed to be controlled reaches the recommended growth stage. This material has no residual activity. Fusilade is a slightly toxic compound which carries the signal word “CAUTION” on its label. A single dose of the formulated compound (Fusilade DX) can cause severe stomach and intestinal disturbance. Ingestion of large quantities may cause problems in the central nervous system such as drowsiness, dizziness, loss of coordination, and fatigue. Breathing small amounts of the product may cause vomiting and severe lung congestion.

GA 3—see Pro-Gibb.

GA 4+7 (ProVide, TypRus) is a blend of two gibberellins—plant growth regulators that suppress fruit russetting of apples and reduce preharvest cracking of Stayman fruit. To reduce russetting on apples, apply in two to four applications beginning at petal fall and continuing at 7- to 10-day intervals. Rates are 10 to 13 ounces in 100 gallons of water per acre. No additional surfactants should be added to the tank when applying ProVide for suppressing russet. Application of ProVide to suppress cracking on Stayman apples is done at least 2 to 3 weeks before fruit cracking is likely to be observed. Depending on the orchard’s location in Pennsylvania, applications can begin as early as July 1. Application rates are 16 to 32 ounces per acre per spray at 14- to 21-day intervals between sprays. For control of fruit cracking, add a nonionic wetting agent approved for use on food to improve spray coverage and enhance absorption. If ProVide is used for russet suppression on a variety, it may not be used for cracking suppression in the same year.

Galigan—see oxyfluorfen.

Galigan Slapshot (oxyfluorfen + glyphosate) is a proprietary combination of oxyfluorfen at 2.0 lb/gal and glyphosate at 1.0 lb/gal. It is labeled for apples, sweet and tart cherries, nectarines, peaches, plums, prunes, pears, and quince. It should only be applied prior to bloom or postharvest and never applied when fruit is present on the tree. Application rates are 4 to 6 pints per treated acre. Since this material contains glyphosate you should follow all the precautions and application directions that are associated with any form of glyphosate including the use of shielded sprayers as necessary.

Gallery (isoxaben). Gallery 75DF is labeled for all nonbearing tree fruit crops for preemergent control of certain broadleaved weeds. “Nonbearing” is defined as plants that will not bear fruit for at least one year after treatment. Application rates are

0.66 to 1.33 pounds of material per treated acre depending on the weeds present. A repeat application (at 1 pound per acre or more) should not be made sooner than 60 days after the previous application. Do not apply more than 4 pounds per acre in any 12-month period. The EPA requires that the signal word “CAUTION” appear on all Gallery labels. The restricted reentry period for Gallery is 12 hours.

gamma-cyhalothrin—see Proaxis.**Gem 500—see Flint.****gibberellic acid—see ProGibb and Promalin.****glufosinate—see Rely.**

glyphosate (Roundup Ultra, Rattler, Glyphomax, Touchdown, and many other brand names). Glyphosate is usually formulated as an isopropylamine salt. While it can be described as an organophosphorus compound, glyphosate is not an organophosphate ester but a phosphanoglycine, and it does not inhibit cholinesterase activity. Glyphosate is registered for use on apples and pears and in stone fruit orchards. It is effective in controlling many emerged annual and perennial grasses and broadleaved weeds. Best results occur when applied in 20 to 40 gallons of water per acre. It is labeled as a directed spray on apples, pears, and cherries. In other stone fruits it must be applied through a wick applicator. Glyphosate has no preemergence activity; therefore, for residual activity it should be combined with a preemergent material.

Glyphosate is a moderately toxic herbicide and carries the signal word “WARNING” on the label. Even though the LD50 values show the compound to be relatively nontoxic, it can cause significant eye irritation. The toxicity of the technical product (glyphosate) and the formulated product (Roundup) is nearly the same. The acute oral LD₅₀ in the rat is 5,600 mg/kg.

In recent years, glyphosate has been sold under a variety of brand names. Manufacturers and distributors continue to develop new formulations and/or marketing strategies to differentiate themselves from competing glyphosate products. Growers should thoroughly read the label on the product they purchase to use. Different formulations may or may not require the addition of a surfactant. The reentry interval also varies by the formulation. Selecting the proper rate for the situation and using appropriate additives are important considerations in obtaining consistent control with glyphosate products. Since several different concentrations of glyphosate are now being marketed, it is important to adjust rates according to the product used.

In comparing different glyphosate products it is important that you compare the acid equivalent of the products. This is the actual amount of glyphosate acid that is in the product. It is different from the active ingredient, which includes both the acid equivalent plus the associated salt. Glyphosate products are always formulated with some form of a salt to keep the compound stable; however, the salt portion of the compound does not produce any herbicidal effects. Typical salts are an isopropylamine salt or a potassium salt or a diammonium salt. To compare glyphosate products divide the price per gallon by the acid equivalent. The result will be the price per pound of glyphosate acid.

All glyphosate brands recommend the addition of ammonium sulfate (AMS) if using hard water as the carrier. Always add 8.5

to 17 pounds AMS per 100 gallons to the tank before adding the glyphosate product.

CAUTION: Avoid all contact with tree foliage. The chemical is not readily metabolized by plants, and accidental coverage could cause injury the following year. Glyphosate should not be stored or applied in galvanized steel or unlined steel (except stainless) containers or tanks. It can react with these containers to produce highly combustible hydrogen gas mixtures. Glyphosate has a high affinity for soil particles. Dirty water from streams or ponds can reduce glyphosate effectiveness.

Goal—see oxyflourfen.

***Gramoxone—see paraquat.**

GreenMatch (d-limonene). This herbicide is listed with OMRI for use as a burndown material with no residual action in organic production. It is basically a citrus extract. It will work against most broadleaf and grass weeds. It is nonselective and will only kill the portions of the weeds that are directly sprayed. It is labeled for bearing and nonbearing trees. Thorough coverage of the weeds with the spray mixture is essential. The REI is 4 hours. PHI for spot applications is 1 week. On bearing trees, GreenMatch can only be used up to initial fruit set as a broadcast treatment;

thereafter, it is only labeled as a spot treatment. Avoid contact of the spray mixture with all green tissue, including green bark. It should be applied as a 14 percent solution or 8.5 gallons of product per 51.5 gallons of water (1:6 ratio v/v).

***Guthion—see azinphos-methyl.**

GF-120 NF Naturalyte Fruit Fly Bait (IRAC Group 5 Insecticide). For selective attractance and control of tephritid flies. The GF-120 NF is a bait concentrate of spinosad, sugars, and attractants that need to be diluted with water to attract various flies. The GF-120 NF is registered for use on pome and stone fruit in conventional and organic orchards. The product should be diluted up to 1:5 (GF-120 NF:water) and applied to the lower leaf surface of protected plants with the droplets size of 4,000 to 6,000 μ . Applications need to be repeated every 7 to 14 days. This product is OMRI listed.

hexythiazox—see Savey.

***idomethane (*Midas 98:2, *Midas 50:50, *Midas 33:67, *Midas 25:75).** Products including the active ingredient idomethane are effective soil fumigants for the control of plant-parasitic nematodes and other soilborne pests. Midas products are very effective

Formulations of Glyphosate

Trade name	Salt	Company	Glyphosate acid ¹	% ai	Surfactant ^{2,3}	REI	PHI Pome Fruit	PHI Stone Fruit
Buccaneer	isopropylamine salt	Tenkoz	3 lbs/gal	41	Yes	12	1	17
Buccaneer Plus	isopropylamine salt	Tenkoz	3 lbs/gal	41	No	12	1	17
Cornerstone	isopropylamine salt	AgriSolutions	3 lbs/gal	41	Yes	4	1	17
Cornerstone Plus	isopropylamine salt	AgriSolutions	3 lbs/gal	41	No	4	1	17
Credit	isopropylamine salt	NuFarm	3 lbs/gal	41	Yes	12	1	17
Credit Duo	isopropylamine salt + monoammonium	NuFarm	2.7 + 0.3 lbs/gal	37.5 + 3.4	Yes	12	1	17
Credit Duo Extra	isopropylamine salt + monoammonium	NuFarm	2.7 + 0.3 lbs/gal	37.5 + 3.4	No	12	1	17
Credit Extra	isopropylamine salt	NuFarm	3 lbs/gal	41	No	12	1	17
Duramax	dimethylamine salt	Dow AgroSciences	4 lbs/gal	50.2	Yes	4	1	17
Durango DMA	dimethylamine salt	Dow AgroSciences	4 lbs/gal	50.2	Yes	4	1	17
Galigan Slapshot ⁴	isopropylamine salt	Makhteshsham	1 lb/gal	14.2	Yes	24	bud swell	bud swell
Gly 4	isopropylamine salt	UCPA	3 lbs/ gal	41	Yes	4	1	17
Gly 4 Plus	isopropylamine salt	UCPA	3 lbs/gal	41	No	4	1	17
Glyfos	isopropylamine salt	Cheminova	3 lbs/ gal	41	Yes	12	1	17
Glyfos X-TRA	isopropylamine salt	Cheminova	3 lbs/gal	41	No	12	1	17
Glyphogan	isopropylamine salt	Makhteshsham	3 lbs/gal	41	Yes	12	1	17
Glyphomax	isopropylamine salt	Dow AgroSciences	3 lbs/gal	41	Yes	12	1	17
Glyphomax Plus	isopropylamine salt	Dow AgroSciences	3 lbs/gal	41	No	4	1	17
Glyphomax XRT	isopropylamine salt	Dow AgroSciences	4 lbs/gal	53.6	Yes	4	1	17
Glyphos	isopropylamine salt	Cheminova	3 lbs/gal	41	Yes	12	1	17
Glyphosate 4	isopropylamine salt	Makhteshsham	3 lbs/gal	41	Yes	12	1	17
Glyphosate 41	isopropylamine salt	Helm Agro	3 lbs/gal	41	Yes	12	1	17
Glyphosate 41 Plus	isopropylamine salt	CropSmart	3 lbs/gal	41	No	4	1	17
Gly Star 5	isopropylamine salt	Agristar	4 lbs/gal	53.8	Yes	4	1	17
Gly Star 5 Extra	isopropylamine salt	Agristar	4 lbs/gal	53.8	No	4	1	17

continued

Formulations of Glyphosate (continued)

Trade name	Salt	Company	Glyphosate acid ¹	% ai	Surfactant? ^{2,3}	REI	PHI Pome Fruit	PHI Stone Fruit
Gly Star Original	isopropylamine salt	Agristar	3 lbs/gal	41	Yes	4	1	17
Gly Star Plus	isopropylamine salt	Agristar	3 lbs/gal	41	No	4	1	17
Helosate Plus	isopropylamine salt	Helena	3 lbs/gal	41	Yes	12	1	17
HM-2028	NL ⁸	Helena	1.55 lbs/gal	11.4	Yes	12	1	17
Honcho	isopropylamine salt	Monsanto	3 lbs/gal	41	Yes	12	1	17
Honcho Plus	isopropylamine salt	Monsanto	3 lbs/gal	41	Yes	12	1	17
Imitator Plus	isopropylamine salt	Drexel	3 lbs/gal	41	Yes	12	14	17
Imitator Xtra	potassium salt	Drexel	3 lbs/gal	35.6	Yes	4	14	17
Makaze	isopropylamine salt	Loveland Products	3 lbs/gal	41	No	4	1	17
Mirage	isopropylamine salt	UAP Loveland Prod.	3 lbs/gal	41	Yes	4	1	17
Mirage Plus	isopropylamine salt	UAP Loveland Prod.	3 lbs/gal	41	Yes	12	1	17
Rattler	isopropylamine salt	Helena	3 lbs/gal	41	Yes	12	1	17
Rattler Plus	isopropylamine salt	Helena	3 lbs/gal	41	Yes	12	1	17
Recoil ⁷	isopropylamine salt	Nufarm	1.58 lbs/gal	23.03	Yes	12	14	40
Roundup Original	isopropylamine salt	Monsanto	3 lbs/gal	41	Yes	12	1	17
Roundup Original MAX	potassium salt	Monsanto	4.5 lbs/gal	48.7	Not required ⁶	4	1	17
Roundup PowerMAX	potassium salt	Monsanto	4.5 lbs/gal	48.7	Not required ⁶	4	1	17
Roundup UltraDry	ammonium salt	Monsanto	0.75 lb/gal	71.4	No	4	1	17
Roundup UltraMAX	isopropylamine salt	Monsanto	4.5 lbs/gal	48.8	No	4	1	17
Roundup WeatherMAX	potassium salt	Monsanto	4.5 lbs/gal	48.8	No	4	1	17
Showdown	isopropylamine salt and monoammonium salt	Helena	3.0 lbs/gal	41	Yes	12	1	14–17
monoammonium salt	Helena	3.0 lbs/gal	41	Yes	12	1	14–17	17
Touchdown HiTech	monopotassium salt	Syngenta	5 lbs/gal	52.3	Yes	12	1	17
Touchdown Total	potassium salt	Syngenta	4.17 lbs/gal	36.5	No	12	1	17

1. Pounds of glyphosate acid per gallon of material.

2. "Yes" indicates that a surfactant can be added; "No" indicates no surfactant should be added.

3. Note all products allow the addition of ammonium sulfate even if they do not allow nonionic surfactant.

4. Proprietary mix of glyphosate and 2 lb/gal oxyfluorfen.

5. Yes, except for use in a wiper applicator.

6. Not required; however, add surfactant if >30 gpa or rates < 16 oz/A.

7. Proprietary mix of glyphosate and 1.07 lb/gal 2,4-D.

8. Not listed on label.

against nematodes; the primary difference between formulations is the concentration of chloropicrin, which increases its efficacy against soilborne fungi. These products can only be used as pre-plant soil fumigants, and tree death will result if the soil is not allowed to aerate sufficiently before planting. Rates vary with soil texture and efficacy is strongly affected by soil moisture and temperature. Therefore, careful attention must be given to label recommendations and site preparation. A buffer zone is required.

Imida—see **imidacloprid**.

imidacloprid (Admire Pro, Advise, Alias, Couraze, Imida, ImidaStar, Impulse, Montana, Lada, *Leverage, Macho, Mallet, Montana, Nuprid, Pasada, Prey, Sherpa, Widow) (IRAC Group 4A Insecticide)—a systemic insecticide with contact and stomach action labeled for use on apricots, cherries, nectarines, peaches, plums, apples, and pears. Its mode of action is similar to that of nicotine. Imidacloprid is used postbloom in apples for control of leafhoppers, leafminers, and aphids. For first-generation spotted tentiform leafminer, apply imidacloprid-containing products while the larvae are still in the sap-feeding stage, or within about 5 days after pollination is complete. For second and succeeding generations, apply 2 weeks after peak of pheromone trap catch for each generation. A second application may be required if severe pressure continues or if generations are overlapping. For white apple leafhopper, target nymphs of the first and, if necessary, the second generation. Imidacloprid is toxic to bees. Do not apply products containing imidacloprid or allow them to drift to blooming crops or weeds if bees are visiting the treatment area.

Imidan (phosmet) (IRAC Group 1B Insecticide). Imidan is a nonsystemic organophosphate insecticide with predominantly contact action. Imidan is an excellent material for the control of major pests except mites, aphids, and leafhoppers. It is particularly effective against plum curculio. It fits well with the integrated pest management program because the major mite predators tolerate applications at the suggested rates. It has a lower order of toxicity to humans and animals than most of the other insecticides. Imidan is highly toxic to bees. White apple leafhopper may become numerous with Imidan schedules. Do not use with water that has a high pH. Due to a recent change on the Imidan label, the REI was increased to 3 days.

ImidaStar—see **imidacloprid**.

Impulse—see **imidacloprid**.

Indar (fenbuconazole). Indar is a systemic fungicide with protective, curative, and eradicant action registered to control brown rot, blossom blight, and fruit rot on apricots, cherries, nectarines, and peaches, and apple diseases, scab, powdery mildew, rusts, flyspeck, and sooty blotch. It is also registered to control scab on peaches. Indar is very effective for the control of cherry leaf spot. The best disease control is achieved when a protectant fungicide application schedule is followed in addition to Indar. Resistance and cross-resistance of the apple scab, brown rot, and cherry leaf spot fungi to the DMI fungicides including Indar requires growers to evaluate the use of these fungicides frequently for disease management in their orchards. Use of this product should conform to resistance management strategies outlined elsewhere in this guide.

Blossom blight control on apricots, cherries, nectarines, and peaches: Begin applications at early red bud stage before infections occur. If conditions are favorable for disease development, apply again at full bloom and at petal fall.

Fruit rot control on apricots, cherries, nectarines, and peaches: Begin applications 2 to 3 weeks before harvest using a 7- to 10-day spray interval.

Scab control on peaches: Begin applications at shuck split. Make two to three subsequent thorough coverage applications at 10- to 14-day intervals.

For stone fruits, use one 2-ounce pouch of Indar 75WSP per acre in a minimum of 50 gallons of spray. Indar may be applied up to the day of harvest. A wetting agent or other spray adjuvant approved for use in registered pesticide products should be added to spray solutions according to manufacturers' use instructions to achieve optimum disease control. This product is compatible with most commonly used agricultural fungicides, insecticides, growth regulators, micronutrients, or spray adjuvants. NOTE: Indar 75WSP is compatible with boron and spray oils; however, the water-soluble pouches must be completely dissolved before spray oils or products containing boron are added to spray mixtures. Indar has a 12 hour restricted-entry interval after application and may be applied up to the day of harvest. Do not apply more than 1 pound of Indar 75WSP fungicide per acre per season.

For apple disease control, begin applications as early as green tip on a 7- to 10-day schedule through the first cover spray for apple scab, powdery mildew, and rust diseases; thereafter, apply on a 10- to 14-day schedule to control sooty blotch and flyspeck when disease risk is moderate to low. Do not make more than 4 applications or apply more than 10.67 oz of Indar 75WSP per acre per season. Do not apply within 14 days of harvest.

indoxacarb—see **Avaunt**.

insecticidal soap—see **M-Pede**.

Inspire Super (difenoconazole) (Group 3 class fungicide). The mode of action of Inspire Super is a demethylation inhibitor of sterol biosynthesis (DMI), which disrupts membrane synthesis by blocking demethylation. Resistance and cross-resistance of the apple scab fungus to the DMI fungicides including Inspire Super requires growers to evaluate the use of these fungicides frequently for apple scab management in their orchards. Use of this product should conform to resistance management strategies outlined elsewhere in this guide. Inspire Super is labeled for use on pome fruit (apple, crabapple, loquat, mayhaw, pear, oriental pear, and quince) to manage apple and pear scab, cedar apple and quince rust, powdery mildew, sooty blotch and flyspeck, brooks fruit spot, and *Alternaria* blotch. Do not make more than two consecutive applications or more than 20 fl oz of Inspire Super per acre per season. Do not apply Inspire Super within 14 days of harvest (PHI). Inspire Super is labeled for use with Vanguard. Do not apply more than 30 oz of Vanguard per acre per season.

Intrepid (methoxyfenozide) (IRAC Group 18 Insecticide). Intrepid is modeled on the natural insect molting hormone, 20-hydroxyecdysone, and belongs to the MAC (Molting Accelerating Compound) family of insecticides (similar to Confirm). When ingested by the larvae, within hours it induces a premature lethal molt of the larvae and cessation of feeding. Subsequently, larvae die of dehydration and starvation within a few days. The

compound is registered for use on pome and stone fruit. On pome fruit Intrepid is registered for the control of leafrollers (oblique-banded leafroller, redbanded leafroller, fruittree leafroller, variegated leafroller, eyespotted budmoth, tufted apple bud moth), internal fruit worms (codling moth, Oriental fruit moth, lesser appleworm), and spotted tentiform leafminer. Intrepid is active on all larval feeding stages of target Lepidoptera species. The compound also possesses the ability to move translamarily through the plant tissue. Intrepid has no effect on any other order of insects or Arthropods except Lepidoptera. Good coverage is critical for efficacy of this compound. For trees less than 10 feet tall, Intrepid should be applied with a minimum of 50 gallons of water per acre, while for trees taller than 10 feet Intrepid should be applied with a minimum of 100 gallons of water. The rate of application varies from 6 to 16 fluid ounces per acre. The lower rate can be used for tufted apple bud moth control. Do not apply more than 64 fluid ounces of Intrepid per acre per season. To prevent or delay the development of resistance, Intrepid should be rotated with insecticides of alternate modes of action.

iprodione—see Rovral.

Isomate CM/OFM TT—see Isomate MD products.

Isomate MD products. The commercial formulations of various insect sex pheromones used for mating disruption of insect pest species. Isomate CM/OFM TT is registered for the control of codling moth; Isomate M-100, M-Rosso, and CM/OFM TT for control of Oriental fruit moth, Isomate PTB Dual for control of peach tree borer and lesser peach tree borer. Additional Isomate pheromone products are commercially available for control of other insect species, mainly lepidopteran pests. The Isomate pheromone dispensers (ties or twin tubes) are placed on trees by hand and therefore require high labor input. The time of application, length of activity, number of dispensers per acre, and placement within the tree vary from species to species, and detailed instructions from the product label should be followed to achieve success. In general, for the best results of mating disruption materials, place dispensers as high in the tree canopy as possible. Mating disruption usually works better under lower pest pressure and may require supplemental insecticide treatments. It is recommended that mating disruption be used on the whole orchard or block, preferably including all blocks within an orchard. Most of the Isomate MD products are OMRI listed. (For more information, see “Using pheromones for monitoring and mating disruption.”)

Isomate M-100—see Isomate MD products.

Isomate M-Rosso—see Isomate MD products.

Isomate PTB Dual—see Isomate MD products.

isoxaben—see Gallery.

Javelin—see Bt.

JMS Stylet Oil (white paraffinic oil). A highly refined, mineral oil registered for dormant, delayed dormant and foliar applications on apples, pears, apricots, cherries, peaches, plums, and prunes. Due to possible severe phytotoxic effects, this oil cannot be applied within 30 days of sulfur or lime sulfur application and 14 days before or after Captan application. For summer applica-

tion do not exceed 1.5 gallons per acre per application. Apply in a minimum of 50 gallons water per acre. Excellent coverage is essential for efficacious control of soft-bodied insects. JMS Stylet Oil is also registered for the control of powdery mildew. Also see dormant oils and summer oils. Organic JMS Stylet Oil is OMRI listed.

Kanemite (acequinocyl) (IRAC Group 20B Insecticide). Kanemite belongs to the phenoxypyrazole class of insecticides. Its mode of action is a mitochondrial electron transport inhibitor (METI) blocking cellular respiration. This mode of action is similar to the mode of action of two other acaricides: Nexter and FujiMite. Therefore, no more than one application of compounds from the METI group is recommended per season. Kanemite is effective against European red mites and twospotted spider mites but is not effective against rust mites. Kanemite provides quick knockdown activity and up to 21 days residual activity. Only one application per season is recommended. The compound has a 14 day preharvest interval.

kaolin—see Surround.

Karmex—see diuron.

Kelthane (dicofol) (IRAC Group UN Insecticide). Kelthane is a nonsystemic organochlorine miticide with contact activity. It is registered for use on apples, pears, and quince and can be used at any time during the season. Widespread resistance of European red mite to Kelthane has reduced its efficacy. In areas where resistance has not developed, limiting use to only once per year may delay resistance. Kelthane is compatible in tank mixes with other chemicals except those that cause high alkalinity (pH>8). *Stethorus* and predatory mites tolerate Kelthane applications.

Kerb (pronamide). Kerb is an herbicide used either before weeds emerge (preemergence) and/or after weeds come up (postemergence). It controls a wide range of annual and perennial grasses, as well as certain annual broadleaved weeds. Pronamide is usually incorporated into the soil by cultivation, irrigation, or rain immediately following application. The toxic action of this herbicide is selective, meaning that it kills specific target plants while sparing other desirable plants. Kerb should be applied in the fall, before the ground freezes, to control annual and perennial grasses, winter annuals, and existing quackgrass. It acts by inhibiting root and shoot growth. It will not provide full-season control of many summer annual weeds; therefore, it should be used in conjunction with other materials to obtain full-season control of most annual weeds. Use lower rates on coarse soils and higher rates on clay soils.

For optimum weed control, clear the area to be treated of all surface litter (dead or decaying weeds and leaves, grass clippings, etc.). Do not treat blocks less than 1 year old or spring-planted trees less than 6 months old. Kerb is classified by EPA as a slightly poisonous herbicide. Products containing pronamide must bear the signal word “CAUTION.” Mixers and applicators are expected to receive the most exposure to this material through skin contact.

Lada—see imidacloprid

***Lambda-Cy—see lambda-cyhalothrin**

***Lambda-T—see lambda-cyhalothrin**

lambda-cyhalothrin (*Endigo, *Lambda-Cy, *Lambda-T, *Taiga Z, *Warrior II with Zeon Technology) (IRAC Group 3 Insecticides). Lambda-cyhalothrin belongs to a well-known group of pyrethroid ester insecticides. Among other crops, the new product is registered for use on pome fruits (apple, pear, crabapple, loquat, mayhaw, Oriental pear, and quince), stone fruit (apricot, sweet cherry, sour cherry, nectarine, peach, plum, Chickasaw plum, damson plum, Japanese plum, plumcot, and prune), and tree nuts. The compound can be used for control of a wide spectrum of pests, including leafrollers, internal fruit feeders, leafminers, leafhoppers, apple maggot, plum curculio, plant bug, stink bug, periodical cicada, rosy apple aphid and apple aphid, pear psylla, fruit infestation of San Jose scale, wood borer complex of stone fruit, rose chafer, and black cherry aphid. The REI for each crop is 24 hours. On pome fruit the PHI is 21 days, while on stone fruit and tree nuts the PHI is 14 days. On pome and stone fruits no more than 1.6 pints/acre (0.2 lb ai) can be applied during an entire year but no more than 1.28 pints/acre (0.16 lb ai) per year can be applied post bloom. Lambda-cyhalothrin is highly toxic to bees and extremely toxic to fish and aquatic organisms. Endigo is a mixture product of thiametoxam and lambda-cyhalothrin.

***Lannate (methomyl)** (IRAC Group 1A Insecticide). Lannate is a limited systemic carbamate insecticide with contact and stomach action. Lannate is effective on tufted apple bud moths (TABM) and other leafrollers, fruitworms, aphids, leafminers, leafrollers, and white apple leafhoppers. It may be used in the IPM spray program at 6–8 ounces of the 90SP or the equivalent rate of 18–24 fluid ounces of the LV per acre sprayed, with only slight to moderate harm to *Stethorus*. To permit *Stethorus* populations to become established, do not use methomyl before June 10 or when *Stethorus* populations are starting to develop in orchards. At these rates, methomyl is not effective alone and should be added to an organophosphate. Lannate rates may need to be increased to 8 to 12 ounces of 90SP or 24 to 36 fluid ounces of LV to control TABM.

Do not apply Lannate on Early McIntosh and Wealthy apple varieties. Do not stretch spray intervals when using methomyl alone because of its short residual activity. Methomyl is registered for use on peaches for control of the Oriental fruit moth and green peach aphid. Outbreaks of woolly apple aphid may result from continuous use. Do not use Lannate during July unless TABM larvae are a problem. Lannate is highly toxic to predatory mites.

Lannate 90SP has been issued a Special Local Needs 24(c) Label for use on nectarines and peaches in Pennsylvania to control thrips. The label specifies ½ to 1 pound per acre. No more than three applications can be made within a season; a 1-day preharvest interval exists for nectarines, and a 4-day preharvest interval exists for peaches. Reentry into treated areas is prohibited for 3 days on apples and nectarines and 4 days on peaches unless personal protective clothing and equipment specified on the Lannate product label for early reentry are worn. Growers wishing to use this product should carefully check early ripening fruit for the presence of silvering, the damage caused by the feeding of the thrips on the skin of the fruit. It is extremely important that fruits are thoroughly covered since the thrips hide underneath leaves covering the fruit or around the stem end. Do not use Lannate in highly alkaline solutions. Lannate LV can be used on apples

(5 applications/season), peaches (6 applications/season), and pears (2 applications/season), but it is not registered for use on nectarines in Pennsylvania. Lannate SP can be used on nectarines (3 applications/season), peaches (6 applications/season), apples (5 applications/season), and pears (2 applications/season).

***Leverage (imidacloprid and cyfluthrin mixture)** (IRAC Groups 3 and 4A Insecticides). Leverage SC insecticide contains a mixture of two insecticides from different IRAC groups: pyrethroids (cyfluthrin) and neonicotinoids (imidacloprid). The product is registered on pome fruit (PHI = 7 days) and stone fruit (PHI = 7 days) against wide range of pests: codling moth, Oriental fruit moth, leafroller complex, leafminers, apple maggot, European apple sawfly, plum curculio, crawlers of San Jose scale, stink bugs, and aphids (except woolly apple aphid). Due to bee toxicity, Leverage should not be applied prebloom or during the bloom of pome or stone fruit. See also imidacloprid and cyfluthrin.

Lime sulfur is effective for leaf curl control on peaches and nectarines during the dormant season. As part of the PROFIT organic apple production project, recent evaluations of new liquid lime sulfur formulations has shown this material to be highly effective in controlling the major fruit diseases of apple. High rates will also control scales on stone fruit trees. Several formulations are available. Lime sulfur is incompatible with most pesticide formulations and should be used alone. Several formulations of lime sulfur may control insect pests as well. These include aphids, pear psylla, San Jose scale, and mites.

***Lorsban—see chlorpyrifos.**

M-Pede (insecticidal soap). M-Pede is a “natural” pesticide for insect and mite control on fruit trees. This soaplike material, consisting of long-chain biodegradable fatty acids, is thought to disrupt the cellular metabolism of insects and mites. It has been used to control a variety of insects on various crop and noncrop plants. Insecticidal soap is only effective in the liquid state as it contacts the insect or mite. Once dried, it is not toxic to the pest. Testing at the Penn State Fruit Research and Extension Center and elsewhere indicates that, in certain situations, this pesticide can be an effective alternative to traditionally used insecticides. In addition, it is extremely safe for humans and other animals. There are no worker reentry restrictions, and sprays can be applied up to the day of harvest. There is, however, a lingering concern about fruit russetting associated with the product, especially in dilute applications. Moreover, it may be toxic to *Stethorus*, the black ladybird beetle mite predator. Therefore, at present we recommend insecticidal soap only for nonbearing apple and pear trees.

On apples, M-Pede has proven effective for motile stages of mites, aphids, and white apple leafhoppers. Apply 1 part M-Pede and 50 parts soft water (i.e., 2 gal soap/100 gal water) to foliage. Be aware that agitation in the spray tank may cause excessive foaming and require the use of defoamer (see label on soap container). On pears, M-Pede is effective against pear psylla and mites in postbloom applications at the same rate recommended for apples. However, it is not effective against many other pear pests during postbloom. It can be mixed with a one-half rate of an organophosphate insecticide, and this mixture can be used in sprays alternated with Mitac sprays. M-Pede is OMRI listed.

malathion (Malathion) (IRAC Group 1B Insecticide). Malathion is a nonsystemic organophosphate insecticide recommended for the control of black cherry aphids. Alkaline solution will reduce its residual toxicity.

Macho—see imidacloprid.

Mallet—see imidacloprid.

mancozeb (Dithane, Manzate, Penncozeb). Mancozeb products are ethylenebisdithiocarbamate (EBDC) fungicides with protective action effective for controlling apple scab and apple rusts, but not effective for controlling powdery mildew. Mancozeb usage is restricted to the early season on apples. Two application programs may be used (do not integrate the two programs):

1. Prebloom through bloom. Applications begin at the ¼- to ½-inch green tip stage and continue at 7- to 10-day application intervals through bloom. Do not apply more than 6 pounds per acre per application. There is a limit to the amount of EBDC fungicide that can be applied per acre each year. Refer to the label of the product you are using for specific yearly application limits. As an example, the limit per acre per year for Penncozeb DF and Dithane Rainshield NT75DF is 25.6 pounds, for Dithane M-45 it is 24 pounds, and for Manzate 200DF it is 24 pounds.
2. Extended application. Begin applications at the ¼- to ½-inch green tip stage and continue at 7- to 10-day application intervals through the second cover spray. Do not apply within 77 days of harvest. Do not apply more than 3 pounds per acre per application. There is a limit to the amount of EBDC fungicide that can be applied per acre each year. Refer to the label of the product you are using for specific yearly application limits. As an example, the limit per acre per year for Penncozeb DF and Dithane Rainshield NT75DF is 22.4 pounds, for Dithane M-45 it is 21 pounds, and for Manzate 200DF it is 21 pounds.

Generally, all formulations are compatible with oil. Under high scab conditions or during periods of peak spore release, other more effective fungicides (Rally, Procure, Flint, and Sovran) should be added to improve control.

Matrix FVN—see rimsulfuron.

MaxCel—see 6BA.

metalaxyl—see Ridomil.

metam-sodium—see Vapam.

methidathion—see Supracide.

methomyl—see Lannate.

methoxyfenozide—see Intrepid.

metiram—see Polyram.

***Midas**—see idomethane.

Mite-E-Oil (petroleum oil). Mite-E-Oil is a highly refined 90 percent petroleum oil registered for dormant, delayed dormant, and foliar applications on apples, pears, apricots, cherries, peaches, plums, and prunes. Due to possible severe phytotoxic effects, this oil cannot be applied within 30 days of sulfur application and 14 days before or after Captan application. For summer applica-

tion do not exceed 1.5 gallons per acre per application. Apply in a minimum of 50 gallons of water per acre. For summer mite control excellent coverage is essential.

Montana—see imidacloprid.

Movento (spirotetramat) (IRAC Group 23 Insecticide). Systemic foliar insecticide belonging to the tetramic acid chemical class. The active ingredient acts as a lipid biosynthesis inhibitor. The product is active via ingestion against immature stages and has high efficacy against female insects by reducing fecundity and survival of offspring. Following the application to plant foliage, spirotetramat is absorbed into the leaf and readily hydrolyzed into a form that is highly mobile within the plant vascular system (phloem and xylem), able to be transported to new shoots and to the roots of the plant. Movento is nontoxic to most beneficial insect groups but is moderately harmful to predatory mites. On pome fruit (PHI = 7days) and stone fruit (PHI = 7 days) the product is registered to control aphids, including woolly apple aphid, pear psylla, San Jose scale, white peach scale, mealybugs, and whiteflies. For the best pest control, Movento must be mixed with a spray adjuvant/additive having spreading and penetrating properties. The use of Induce is prohibited in a mixture with Movento on stone and pome fruit.

***Mustang**—see zeta-cypermethrin.

***Mustang Max**—see zeta-cypermethrin.

MVP—see Bt.

myclobutanil—see Rally.

Mycoshield (oxytetracycline). Mycoshield is registered for the control of fire blight on apple and pear and bacterial spot on peach and nectarine. For fire blight, use 1 pound of Mycoshield per 100 gallons of water and begin spraying at 10 percent bloom but do not exceed 5 applications per entire season. Repeat spray applications at 4- or 6-day intervals depending on disease severity. Caution is advised because Mycoshield can cause phytotoxicity to the fruit and/or foliage of sensitive varieties of pears, especially Asian varieties. For bacterial spot, apply 6 ounces of Mycoshield per 50 gallons of water or 12 ounces of Mycoshield per 100 gallons on a weekly schedule starting at shuck split. Applications the first 5 weeks are likely to be the most critical for disease control. Do not apply within 60 days of harvest. The PHI is 60 days for pears and 21 days for peaches and nectarines. Tank-mixing Mycoshield with streptomycin has been suggested as a good strategy for mitigating resistance to these antibiotics in the bacterium that cause fire blight.

Myrothecium verrucaria (dried fermentation solids and solubles)—see DiTerra ES.

NAA (naphthalene acetic acid) (Fruitone N, Fruitone L, Threshold Sprout Inhibitor A-112, Tree-Hold Sprout Inhibitor RTU, Sucker Stopper RTU). NAA is an auxin-type plant growth regulator used to chemically thin apples and pears. The effective range for thinning is 2.5 to 20 ppm depending on the variety and crop load. NAA has thinning activity from full bloom through 17 mm fruit diameter. Early timings provide milder thinning activity, and the optimal range is 10 to 12 mm fruit diameter. Later applications may still be effective, but may result in unacceptable

levels of pygmy fruit, especially when high rates of NAA are used. Delicious and Fuji are especially prone to development of NAA-induced pygmies. NAA also may be used to stimulate return bloom. When no additional thinning is desired, sprays for return bloom should begin 5 to 6 weeks after petal fall. When applied close to harvest it helps prevent preharvest fruit drop. One spray of 20 ppm or 2 sprays of 10 ppm will delay preharvest drop for 7 to 11 days, respectively.

Tre-Hold Sprout Inhibitor A-112 and Sucker Stopper RTU are other formulations of NAA. Tree-Hold Sprout Inhibitor and Sucker Stopper RTU formulations of NAA are not labeled for chemical thinning. It is an ethyl ester formulation that has 15.1 percent active ingredient. Their labeled use is to reduce excessive water sprouts or root suckers. On scaffold limbs to control regrowth of suckers where existing ones were removed, DO NOT treat limbs after bud activity starts. Limit area treated to no more than 10 percent of the total bark area. Do not treat weak trees. Some reduction in fruit size has been noted on older weak Golden Delicious trees. When treating basal sprouts or root suckers, be sure to prune them off before treating. These sprouts can be treated before the green tip stage of flowering or during the summer pruning season when they are 6 to 12 inches tall. On bearing trees do not treat suckers during bud swell to at least 4 weeks after petal fall. Both are labeled for apples and pears.

NAAM—see Amid-Thin W.

NAD (naphthalene acetamide)—see Amid-Thin W. See Part I for more information on apple thinning with Amid-Thin W.

naphthalene acetamide—see Amid-Thin W. See Part I for more information on apple thinning with Amid-Thin W.

Neemazad—see azadirachtin. This product is OMRI listed.

Neemix—see azadirachtin. This product is OMRI listed.

Nexter (pyridaben) (IRAC Group 21 Insecticide). Nexter is a new formulation of Pyramite, which was registered in 1997 for use on apples to control motile stages of European red mites and twospotted spider mites, and on pears to control mites and pear psylla. Recently, additional registrations were also granted for use on apricots, cherries, nectarines, peaches, plums, and prunes. Nexter has a unique mode of action as a mitochondrial electron transport inhibitor, blocking cellular respiration. Nexter is very active against immature mites at 4.4 ounces per acre, but has low activity against adult female twospotted spider mites. Nexter should be applied when mites exceed action thresholds. Although the label allows 2 applications per season on apricots, cherries, nectarines, peaches, plums, and prunes, we recommend only 1 application per season for resistance management. This product can give up to 45 days of mite control, but also is toxic to Stethorus. For pear psylla, Nexter is most effective against the small nymphs. On apples and pears do not apply more than 10.67 ounces per acre; make no more than 1 application per season. Use at least 100 gallons per acre. Nexter also controls pear rust mites. Note that the Nexter label specifies 30 days between applications and a 25-day preharvest interval on apples and 7 days on other crops. On apricots and cherries, Nexter can be only used after harvest (300-day preharvest interval). Applications are prohibited within 110 feet of surface water.

NoMate CM ((E,E)-8,10-Dodecadien-1-ol). Mating disruption product for the control of codling moth (for more information, see “Using pheromones for monitoring and mating disruption”).

NoMate OFM (Z-8Dodecen-1-yl acetate, E-8 dodecen-1-yl acetate, Z-8 Dodecenol). Mating disruption product for the control of Oriental fruit moth (for more information, see “Using pheromones for monitoring and mating disruption”).

norflurazon—see Solicam.

Novagib—see GA4+7.

novaluron—see Rimon.

Nuprid—see imidacloprid.

Omni Supreme Spray—see dormant and summer oils.

Onager (hexythiazox) (IRAC Group 10A Insecticide). Onager (hexythiazox was formerly sold under the name Savey) is an ovicide-miticide used commonly on apples since 1995. It is effective against eggs and larvae of mites. Onager is recommended at 12–24 ounces per acre and can be applied up to 28 days before harvest. The product is also registered for use on pears, apricots, cherries, nectarines and peaches. Because Onager and Apollo have similar modes of action, these two products should be rotated between years to forestall resistance development. The use of alternate-row-middle spraying for a Onager application is not recommended. It is recommended that Onager be applied prior to adult mite buildup (less than one mite per leaf). Onager is toxic to fish and aquatic invertebrates.

Orbit (propiconazole). Orbit is a systemic foliar fungicide with protective and curative action registered for control of brown rot, cherry leaf spot, and powdery mildew on cherries (sweet and tart), apricots, nectarines, peaches, and plums. Resistance and cross-resistance of the brown rot fungus to the DMI fungicides including Orbit requires growers to evaluate the use of these fungicides frequently for brown rot management in their orchards. Use of this product should conform to resistance management strategies outlined elsewhere in this guide.

Brown rot blossom blight—Apply 4 fluid ounces per acre of Orbit at early bloom. If disease pressure is high, a second application of 4 fluid ounces per acre may be needed through petal fall. If blossoming is prolonged or if conditions favorable for disease persist, make a third application from 75 to 100 percent bloom through petal fall.

Fruit brown rot—Apply a maximum of two preharvest sprays of Orbit at 4 fluid ounces per acre during the period beginning 3 weeks before harvest through the day of harvest. Orbit has a 0-day preharvest limitation.

Follow the brown rot blossom blight schedule and read the label if additional applications are warranted.

Orbit may also be used for the control of powdery mildew. Orbit provides only moderate control of cherry leaf spot.

Orchard Master—see 2, 4-D.

oryzalin (Surflan, Oryzalin) is a selective, preemergence, surface-applied herbicide used to control annual grasses and broadleaved weeds in fruit trees, nut trees, and vineyards. It inhibits the growth of germinating weed seeds. It is available in aqueous suspension, dry flowable, and wettable powder formulations. It can be used

safely on all newly planted trees after the soil has settled. Treated areas must be free of established weeds and other vegetation. A half inch of rain is necessary to activate the herbicide. Surflan has low acute toxicity to mammals. Surflan can cause mild irritation to the skin or eye. It may cause allergic skin reactions in some individuals. The oral LD50 for technical oryzalin in rats and mice is more than 5,000 mg/kg.

***oxamyl—see Vydate.**

oxyfluorfen (Goal, Galigan, GoalTender). Oxyfluorfen is a selective pre- and postemergent herbicide used to control certain annual broadleaved and grassy weeds. It is a contact herbicide and requires light to affect target plants. It is available as an emulsifiable concentrate. It is unique because it has preemergent and some postemergent effects in controlling broadleaved annuals. Apply only to dormant trees; dormancy determines the suitability and safety of using the material. Application rates for postemergent weed control are 2 to 8 pints per treated acre. Since oxyfluorfen has contact activity, thorough coverage of emerged weeds is essential; therefore, apply it in at least 20 gallons of solution per acre. The addition of 0.25% v/v of a registered nonionic surfactant will enhance control of emerged weeds. For preemergent weed control, the rates recommended are 5 to 8 pints per treated acre. The most effective postemergence weed control is achieved when Goal is applied to seedling weeds (less than four-leaf stage). For postemergence control of certain grassy and broadleaved weeds, a tank mixture of Goal and either paraquat or glyphosate is recommended. Irrigation or rainfall within 3 to 4 weeks after application is necessary for maximum effectiveness. Products containing oxyfluorfen must bear the signal word “WARNING” on the label. Oxyfluorfen is moderately toxic by ingestion and slightly toxic by dermal absorption. Vapors may cause irritation of the nose, throat, skin, and eyes, and other forms may cause irritation to skin and eyes.

Par F70 Soluble Oil—see dormant and summer oils.

***paraquat (Firestorm, Gramoxone Inteon, Parazone 3SL)** is a quaternary nitrogen herbicide widely used for postemergent weed control. It is a quick-acting, nonselective compound that destroys green plant tissue on contact and by translocation within the plant. It is effective in killing most annual weeds and in suppressing some perennial weeds. It is most effective when applied to growing weeds less than 4 to 6 inches tall. It may be combined with other herbicides, but not with oil. We recommend adding a nonionic surfactant to paraquat. Paraquat is a restricted-use pesticide and is banned for use in several Scandinavian countries. Paraquat is highly toxic to animals by all routes of exposure and is labeled with the signal word, “DANGER—POISON.” The REI for Gramoxone Inteon is 12 hours and 24 hours for the other formulations, and the preharvest interval varies by crop. The maximum number of applications for stone fruits is 3 per year and 5 per year for pome fruits.

CAUTION: Gramoxone is very toxic to humans, particularly if inhaled during mixing or if swallowed. Use a full-face shield, gloves, and apron when filling and mixing. Avoid contact with skin and clothing. Wash after mixing and spraying.

Parazone 3SL—see paraquat.

Pasada—see imidacloprid.

pendimethalin (Prowl, Prowl H₂O, Pendimethalin). Pendimethalin is a selective herbicide used to control most annual grasses and certain broadleaved weeds. Only Prowl H₂O is labeled for both bearing and nonbearing orchards; all other products are only labeled for nonbearing orchards. The preharvest limitation for Prowl H₂O is 60 days for both stone fruits and pome fruits. It may be applied to newly planted trees after the soil has settled. It controls weeds as they germinate but does not control established weeds. Best results are obtained when rainfall or irrigation occurs within 21 days of application. Products containing pendimethalin must bear the signal word “CAUTION” or “WARNING” depending on the formulation. Pendimethalin is slightly toxic if ingested, inhaled, or absorbed through the skin.

Perlan—see 6-benzyladenine + gibberellins A4A7.

***permethrin (*Ambush, *PermaStar, *Perm-Up, *Pounce, Arctic)** (IRAC Group 3 Insecticide). Permethrin is a nonsystemic pyrethroid insecticide with contact and stomach action, having a slight repellent effect. The compound is registered for use on apples, cherries, peaches, nectarines, and pears (prebloom only). Ambush or Pounce are generally not recommended after bloom to prevent outbreaks of European red mite.

***PermaStar—see permethrin.**

***Perm-Up—see permethrin.**

pheromone—see Sprayable Pheromone, Isomate MD Products, CheckMate MD Products.

phosmet—see Imidan.

Poast (sethoxydim). Poast is a selective postemergent herbicide used for control of annual and perennial grass weeds in bearing and nonbearing apple, apricot, cherry, nectarine, peach, pear, and quince orchards. It is not labeled for bearing plum or prune orchards, but can be applied to nonbearing plum and prune orchards. (Nonbearing trees are those that will not have any fruit for 1 year from application.) Poast is specific to grasses and will not control sedges and broadleaf weeds. Apply 0.5 to 2.5 pints per treated acre to actively growing grasses at the proper stage of development, depending on the grass to be controlled. Do not apply to grasses that are dormant, under water stress, or under cold-temperature growing conditions. A nonphytotoxic oil concentrate must be added to the spray tank. The label recommends the use of the product Dash HC as the oil concentrate of choice. Do not apply Poast within 25 days of harvest on bearing stone fruits and within 14 days of harvest on apples and pears. Do not apply more than 5 pints of Poast per treated acre in any 12-month period for stone fruits and 7.5 pts in pome fruit orchards. Poast in combination with 2,4-D may be used to control grass growth of orchard floor middles. An application after the sod has greened up in early spring and before bloom will provide growth suppression of cool season grasses for 5 to 8 weeks. The addition of 2,4-D will help control broadleaf weeds such as dandelion before they hamper pollination.

Polyram (metiram). Polyram is a nonsystemic foliar EBDC fungicide with protective action effective in controlling apple scab and apple rusts, but not effective in controlling powdery mildew. The use of Polyram is restricted to the early season on apples. Two application programs may be used:

1. Prebloom through bloom. Applications begin at the ¼- to ½-inch green tip stage and continue at 7- to 10-day application intervals through bloom. Do not apply more than 6 pounds per acre per application. There is a limit to the amount of Polyram fungicide that can be applied per acre each year. Refer to the label of the product you are using for specific yearly application limits.
2. Extended application. Begin applications at the ¼- to ½-inch green tip stage and continue at 7- to 10-day application intervals through the second cover spray.

Do not apply within 77 days of harvest. Do not apply more than 3 pounds per acre per application. There is a limit to the amount of Polyram that can be applied per acre each year. Refer to the label of the product you are using for specific yearly application limits. Note: Do not combine or integrate the two programs. Polyram is compatible with oil. Under severe scab conditions, other, more effective fungicides (Rubigan, Rally, Procure, Sorvan, Flint) should be added for better control.

Portal (fenpyroximate) (IRAC Group 21 Insecticide). Portal belongs to the phenoxypropylazole class of acaricides. Its mode of action is a mitochondrial electron transport inhibitor (METI) blocking cellular respiration. This mode of action is similar to the mode of action of two other acaricides: Nexter and Kanemite. Therefore, no more than one application of compounds from the METI group is recommended per season. Portal is active on larvae, nymphs, and adult mites as well as on pear psylla, leafhoppers, and mealybugs. It halts feeding damage and oviposition within hours after application, and the mortality of mites within 4 to 7 days. Portal is registered for use on the pome fruit group but not on stone fruit. Portal can be applied up to 14 days before harvest but no more than one application per season is recommended. Similarly, as with all other acaricides, excellent coverage is necessary to achieve good mite control. Portal was previously sold for use on fruit market under the trade name Fujimite.

***Pounce—see permethrin.**

Prey—see imidacloprid.

Princep—see simazine.

Pristine is a mixture of pyraclostrobin (Cabrio, 12.8 percent) and boscalid (25.2 percent). It is effective against brown rot of stone fruits (apricot, sweet and tart cherry, nectarine, peach, plum, and prune). Pristine is also labeled for many diseases of apple and pear. These include apple scab, *Alternaria* blotch, bitter rot, black rot, white rot, Brooks spot, sooty blotch, flyspeck, powdery mildew and pear scab. On stone fruit, begin applications at pinkbud or prior to the onset of disease development and continue on a 7-to-14 day interval. Use shorter intervals and/or higher rates when disease pressure is high. On apple and pear, begin applications prior to disease development and continue on a 7- to 10-day interval. Do not make more than two sequential applications of Pristine before alternating to a labeled fungicide with a different mode of action. Do not make more than five applications (stone fruit) or 4 applications (pome fruit) of Pristine or related fungicide (Cabrio) per season. Pristine has a 12-hour REI and a 0-day PHI.

***Proaxis (gamma-cyhalothrin)** (IRAC Group 3 Insecticide). Proaxis is a microencapsulated synthetic pyrethroid insecticide

that controls insects by contact and ingestion. The compound is registered for the control of multiple pests on pome and stone fruit. On pome fruit Proaxis cannot be applied within 21 days of harvest, while on stone fruit within 14 days of harvest. Proaxis is extremely toxic to fish and aquatic organisms and toxic to wildlife. This product is also highly toxic to bees exposed to direct treatment and/or residues on blooming crops or weeds.

***Proclaim (emamectin benzoate)** (IRAC Group 6 Insecticide). Proclaim is a contact insecticide but is most efficacious when ingested. The product should be applied to target small larvae; addition of summer oil should increase the compound efficacy. Proclaim is effective against leafrollers and leafminers and provides suppression of internal fruit feeders. On pome fruit Proclaim has 48-hour REI and 14-day PHI. This compound should not be used at the rate below the lowest label rate and no more than 14.4 oz per acre is allowed per season.

Procure (triflumizole). Procure 50WS is a systemic fungicide with protective and curative action for the control of scab, powdery mildew, and cedar apple rust on apples and scab on pears. Procure is also used for the control of powdery mildew, leaf spot, blossom blight, and fruit rot on sweet and tart cherries. See caution on resistance and cross-resistance to DMI fungicides.

Apples (powdery mildew)—Apply 2 to 4 ounces per 100 gallons dilute or apply 8 to 16 ounces per acre. Initiate spraying at first sign of mildew, usually at the ½-inch green tip stage. Continue application at 7- to 14-day intervals as needed through the terminal growth period. Procure 50WS may be applied up to 14 days prior to harvest.

Apples (scab and cedar apple rust)—Apply 2 to 4 ounces per 100 gallons dilute or apply 8 to 16 ounces per acre. Procure may be applied according to a standard spray schedule or an eradicant spray schedule (postinfection schedule).

Standard spray schedule—Apply at the rate of 2 to 4 ounces per 100 gallons or 8 to 16 ounces per acre at 7- to 10-day intervals from the ½-inch green tip stage through second cover or until sporulation is complete.

Eradicant spray schedule (postinfection schedule)—Apply at the rate of 2 to 4 ounces per 100 gallons or 8 to 16 ounces per acre within 96 hours after the beginning of an infection period. Do not apply more than 64 ounces of Procure 50WS per acre of apples per season.

Pears (scab)—Resistance same as Rubigan. Apply 2 to 4 ounces per 100 gallons dilute or apply 8 to 16 ounces per acre. Procure may be applied according to a standard spray schedule or an eradicant spray schedule (postinfection schedule).

Standard spray schedule—Apply at the rate of 2 to 4 ounces per 100 gallons or apply 8 to 16 ounces per acre at 7- to 10-day intervals from green tip through second cover.

Eradicant spray schedule (postinfection schedule)—Apply Procure 50WS at the rate of 2 to 4 ounces per 100 gallons or 8 to 16 ounces per acre within 96 hours after the beginning of an infection period. Do not apply more than 64 ounces of Procure 50WS per acre of pears per season.

Cherries: For powdery mildew control, apply 8 to 16 ounces per acre. Begin treatments at early popcorn stage and continue at 7- to 14 day intervals until terminal growth ceases. For blossom blight and fruit rot control, apply 10 to 16 ounces per acre. Treatments should be applied at early popcorn, full bloom, and

petal fall. Complete coverage must be obtained throughout the bloom period. For leaf spot control, Procure 50WS applications used for powdery mildew and blossom blight will suppress the development of leaf spot. Procure 50WS should be tank-mixed with other products registered for leaf spot control.

NOTES:

- Procure 50WS may be applied up to 14 days prior to harvest.
- Do not enter or allow worker entry into treated areas during the restricted-entry interval (REI) of 12 hours.
- Do not tank-mix Procure 50WS water-soluble pouches with products that contain boron or release-free chlorine. A chemical reaction may occur that changes the film into an insoluble plastic.

ProGibb (gibberellic acid—GA3). ProGibb is a plant growth regulator labeled for use on young sweet and tart cherries to reduce flowering and fruiting and to minimize the competitive effect of early fruiting on tree development. Treatment should not be made the year of planting, but should be delayed until the second year. Pro-Gibb can also be used on bearing sweet cherries to delay harvest and increase color, firmness, and size. It should be applied when fruit is light green to straw-colored in enough spray to thoroughly wet the foliage. Do not apply within 1 week of harvest. On tart cherries Pro-Gibb can be applied to maintain and extend high fruiting capacity of bearing trees and reduce the occurrence of blind nodes by stimulating lateral vegetative buds to develop a more productive balance of shoots and spurs. Desired response is not observed, however, until the year after treatment and is best after 2 to 3 years of treatment. Higher rates should be used on larger, more vigorous trees. Excessive rates on any tree will increase vegetative growth at the expense of fruit production the following year. Do not apply within 1 month of harvest.

Promalin—see 6-benzyladenine + gibberellins A4A7.

pronamide—see Kerb.

propiconazole—see Orbit.

Provado—see imidacloprid.

ProVide—see GA4+7.

Prowl—see pendimethalin.

Pruvin—see rimsulfuron.

Puffer CM (8,10 dodecadien-1 ol, E,E). Puffer CM is used as a MD product with Puffer aerosol cabinet—an automated metered dispenser—delivering a single puff of pheromone every 15 minutes through the night to disrupt the nocturnal mating behavior of codling moth. (For more information, see “Using pheromones for mating disruption.”)

Puffer OFM [(Z)-8-Dodecenyl acetate, (E)-8-Dodecenyl acetate, and (Z)-8-Dodecenol]. Puffer OFM is a MD product with Puffer aerosol cabinet—an automated metered dispenser—delivering a single puff of pheromone every 15 minutes to disrupt the mating behavior of Oriental fruit moth. (For more information, see “Using pheromones for mating disruption.”)

PureSpray Oil—see dormant and summer oils.

PyGanic (natural pyrethrins) is a botanical insecticide derived from chrysanthemums with very short period of activity. Registered for a wide range of pests with no preharvest interval. This product is OMRI listed.

Pyramite (pyridaben). During fall 2003, Pyramite was replaced by new formulation of pyridaben called Nexter. Pyramite is no longer available for commercial sale. See Nexter.

Pyraclostrobin (Cabrio). Pyraclostrobin is effective against brown rot of cherries (sweet and tart cherry). Do not make more than 2 sequential applications of Cabrio before alternating to a labeled fungicide with a different mode of action. Do not make more than 5 applications of Cabrio or related fungicide (Pristine) per season. The maximum rate per acre per season is 47.5 ounces. Cabrio has a 12-hour REI and a 0-day PHI.

pyridaben—see Nexter.

pyrimethanil (Scala). Scala is an anilinopyrimidine fungicide that inhibits or interferes with the secretion of enzymes necessary for infection in several plant-pathogenic fungal species. Because resistance can develop, the use of this product should conform to resistance management strategies established for the crop. When applying Scala alone, do not make more than two consecutive applications without alternating with a fungicide from a different resistance management group. Scala cannot be used on cherries.

Stone fruit: On apricots, nectarines, peaches, and plums, Scala can be used for brown rot blossom blight, shothole, and gray mold. Apply when bud tissue is susceptible to infection. If conditions continue to be favorable for disease development, apply at full bloom or at petal fall. Preharvest applications should be made on 7-day intervals or longer. Apply 9 to 18 fluid ounces per acre, however, do not make more than three applications of Scala alone or more than 54 fluid ounces per acre and within 2 days of fruit harvest.

Pome fruit: On apple and pear, Scala can be used for inhibiting scab. Begin applications at green tip or as soon as conditions become favorable for disease development. Apply 7 to 10 fluid ounces of Scala alone or 5 fluid ounces when using in tank-mixes. Do not apply more than 40 fluid ounces of Scala per crop and do not apply within 72 days of harvest.

pyriproxifen—see Esteem.

Quash (metconazole) is a broad-spectrum systemic DMI fungicide with protective and curative activity registered for use on stone fruits (apricot, cherry, nectarine, peach, and plum) for control of brown rot, cherry leaf spot, powdery mildew, and scab. Quash can be applied pre- or postinfection, but the best results are obtained when applications are made prior to infection. To prevent wash-off, Quash should not be applied if rain is expected within 2 hours after application. Label recommendations: 4 oz (0.125 lb ai/A) per acre per application with a maximum of two sequential applications and no more than three applications per season. Since orchard tree sizes vary, refer to the label for specific rate recommendations. See caution on resistance and cross-resistance to DMI fungicides.

Rage (Aim 2EC + glyphosate) is a proprietary mix of carfentrazone-ethyl and glyphosate that gives a faster and longer burndown of weeds. It contains 0.04 lbs per gallon of Aim and 3.71 lbs per

gallon of glyphosate acid. It should be applied at a rate of 22–99 fluid ounces per acre; with the rate varying by weeds that are present. The maximum amount that can be applied in any one year is 272 fluid ounces. It is labeled for all tree fruit planted in Pennsylvania; however, in stone fruits it cannot be applied during the fruiting cycle and can only be applied prior to bud burst or postharvest unless it is applied with a hooded sprayer. Those restrictions do not apply to pome fruits. Further restrictions include the requirement to use a hooded sprayer if the branches of the trees are touching the ground in all tree fruits. The addition of a nonionic or crop oil concentrate is also required. Rage can also be used for chemical mowing of the row middles at a rate of 3–4 fluid ounces per acre. Do not apply within 3 days of harvest for pome fruit orchards. Do not apply Rage spray to rootsuckers. The REI is 12 hours. The preharvest interval is 3 days for pome fruit, 17 days for stone fruit if using a hooded sprayer and budburst if not using a hooded sprayer.

Rally (myclobutanil). Rally is a systemic DMI fungicide with protective and curative action registered for use on apples to control apple scab, powdery mildew, and cedar apple rust. Resistance and cross-resistance of the apple scab fungus to the DMI fungicides including Rally requires growers to evaluate the use of these fungicides frequently for apple scab management in their orchards. Directions from the label are as follows: Best control of labeled diseases is achieved when the fungicide is applied on a 7- to 10-day application schedule. Label use recommendations (oz of product/100 gal of spray) are based on dilute sprays with a 400-gallon-per-acre base. Orchard tree heights, tree spacing, and pruning practices vary. Refer to the label for specific rate recommendations. The table below provides general guidance in calculating proper use rates for well-pruned orchards.

	Pome fruits	Stone fruits
Tree height (ft)	(Ounces of Rally 40W per acre)	
10 (or less)	2.5 to 5.0	2.5 to 4.0
15	3.75 to 6.0	4.0 to 6.0
20 (or more)	5.0 to 10	6.0

Scab (prebloom)—Begin application at green tip. During periods favorable for primary scab development, use high rates and a 7-day application schedule. Apply Rally alone or tank-mix with a protective fungicide.

Scab (postbloom)—Use Rally 40W in a tank mixture with the recommended use rate of a protectant fungicide.

Scab (postinfection)—Rally 40W fungicide provides 96-hour postinfection control or curative activity and suppresses sporulation of established lesions when used in two or more applications. Apply as soon as possible after an infection period. Follow with standard protectant spray schedule.

Powdery mildew—Begin application at tight cluster and continue through the second cover spray. Additional sprays beyond second cover may be needed on susceptible varieties or under heavy disease pressure. Use high label rate if powdery mildew was present in previous years.

Rusts—Begin applications at pink stage and continue through the second cover spray.

Restrictions—Do not apply within 14 days of harvest. Do not apply more than 5 pounds of Rally per acre per season. Do not graze livestock in treated areas or feed cover crops grown

in treated acres to livestock. Application by ground equipment only. Resistance same as Rubigan.

Recoil (2,4-D + glyphosate) is a proprietary mixture of 2,4-D and glyphosate. Contains 1.58 lbs per gallon of glyphosate acid plus 1.07 lbs per gallon of 2,4-D. Minimum days to harvest is 14 days for apples and pears and 60 days for stone fruits. There are no restrictions on the label for stone fruits for the use of a wick applicator or shielded boom, but extreme caution should be exercised to avoid any contact with foliage of stone fruits with the spray mixture.

Rely (glufosinate). Rely is a nonselective foliar active contact herbicide with no residual activity, labeled only for apples. It is used to control emerged annual and perennial weeds. The mode of action is similar to that of glyphosate. Rely should be applied only to nonstressed weeds. Weeds under stress or in dense populations will require usage at the highest labeled rate. Response is best when the material is applied under warm conditions with bright sunshine and high relative humidity.

Caution: Trunk damage has been observed in Pennsylvania when interstem trees with root suckers have received two applications in a single year with handgun applications.

ReTain (amino ethoxyvinylglycine AVG). ReTain works as an ethylene biosynthesis inhibitor to delay the ripening of apples and associated preharvest fruit drop. It can also retard the loss of firmness, loss of starch, increase in soluble solids, and development of watercore and red color. It may indirectly increase the red color on fruit by allowing the fruit to remain on the tree longer for additional color development to a period when cooler. See Part I for more information on ReTain.

Ridomil (mefenoxam). Ridomil Gold EC is a systemic fungicide with protective and curative action absorbed through the leaves, stems, and roots and registered for use on both bearing and non-bearing apple and stone fruits—apricots, cherries (sweet and tart), nectarines, peaches, plums, and prunes. Ridomil applications should be made before symptoms appear, especially in areas of the orchard favorable for disease development. Ridomil will not revitalize trees showing moderate to severe disease symptoms.

In stone fruit, make the first application two weeks after planting. Additional applications should be made at 2- to 3-month intervals or to coincide with periods most favorable for root, crown, or collar rot development. For established plantings, the application should be made in spring before the plants start growth. Additional applications should be made at 2- to 3-month intervals or to coincide with periods most favorable for root, crown, or collar rot development. Apply 2 quarts per treated acre (6 fl oz/1,000 sq ft) in sufficient water to obtain thorough coverage of the soil under the canopy of the trees. Up to three applications can be made per year.

In apples two application methods can be used. For broadcast spray or banded applications apply 2 quarts per treated acre (6–12 fl oz/1,000 sq ft) in sufficient water to obtain thorough coverage. The treated area is the area under the tree canopy or the area of the sprayed row (similar to the herbicide strip). Soil surface applications of Ridomil Gold EC will not be effective until the fungicide is moved into the root zone by rainfall or irrigation. Applications should be made in early spring before growth starts and in the fall after harvest but before the ground freezes.

For drench mix ½ pint of Ridomil Gold EC with 100 gallons of water. Apply the amount of diluted mixture indicated in the table below around the trunk of each tree. Applications should be made in early spring before growth starts and in the fall after harvest but before the ground freezes. For new plantings, delay the first application until 2 weeks after planting. To determine trunk diameter, measure the trunk 12 inches above the soil line.

Restrictions: Do not dip roots of trees in or spray bare roots with solutions containing Ridomil Gold EC. Do not graze or feed cover crops in treated orchards, or illegal residues may occur.

Trunk diameter	Quarts of diluted mixture/tree
< 1 inch	1
1–3 inches	2
3–5 inches	3
> 5 inches	4

Note: Do not dip roots of trees in, or spray bare roots with, solutions containing Ridomil. Do not graze or feed cover crops in treated orchards, or illegal residues may occur.

Rimon (novaluron) (IRAC Group 15 Insecticide). Novaluron belongs to a class of insecticides called the benzoylphenyl ureas (insect growth regulators) and it affects chitin synthesis of immature insects disrupting their normal growth and development. The compound is registered for the control of codling moth, Oriental fruit moth, obliquebanded leafroller, and tufted apple budmoth. Rimon is effective on CM/OFM eggs if eggs are deposited on active residue of the compound. Rimon does not affect the adult stages of insects. Rimon must be ingested and/or contacted by insects to be fully effective. Excellent tree coverage is necessary to obtain optimum pest control. To benefit from Rimon's ovicidal activity the compound should be applied earlier than older insecticides (e.g., at 75 to 150 DD base 50 for the first spray to control codling moth). The compound has a 12-hour REI and 14-day PHI. Rimon is registered on pome fruit, except pears, and stone fruit, except cherries. No more than four applications of Rimon are allowed per season. During field trials conducted over the past few years at the Penn State's Fruit Research and Extension Center in Biglerville, it was always observed that multiple applications of Rimon resulted in the increased number of European red mite on treated trees. In order to prevent the development of resistance, it is recommended that Rimon be used only for a single generation of CM and OFM during the growing season.

rimsulfuron (Matrix, Pruvion, Solida) is labeled for use in stone fruit, nut crops, pome fruit, and grapes that have been established at least one year in the field. It provides selective control of certain broadleaf weeds and grasses. Optimum control occurs when the material is applied preemergence or early postemergent. Degree of control will depend on weed density, plant size, and environmental conditions at and following treatment. Rimsulfuron is absorbed through the roots and foliage of the weeds and acts to inhibit weed growth. Best results are obtained when the soil is moist at the time of application and a 0.5 inch of rain occurs within 3 weeks. The restricted-entry interval is 4 hours and the preharvest interval is 7 days for pome fruit and 14 days for stone fruit, nut trees, and grapes. A partial list of weeds controlled includes crabgrass, foxtails, quackgrass, henbit, common mallow, pigweeds, and spurge. Rimsulfuron can also be used

to suppress yellow nutsedge. Treatment regimes for nutsedge control are either a preemergence plus early postemergence or early postemergence followed by an application 14 days after the first. When applied as a banded treatment (50 percent band or less), Rimsulfuron may be applied two times per year but only apply 4 oz for any one treatment.

RiteSize—see 6BA+GA4+7.

RiteWay—see 6-benzyladenine.

Roundup Ultra—see glyphosate.

Rovral (iprodione). Resistance of the apple scab fungus to the DMI fungicides including Rubigan requires growers to evaluate the use of DMI fungicides frequently for apple scab management in their orchards. Rovral 4 Flowable is a contact fungicide with protective and curative action. It is highly effective for controlling brown rot of stone fruits during bloom. Rovral is recommended at 1 to 2 pints per acre. The higher rate is recommended under severe disease conditions. Apply when bud tissue is susceptible to disease development. If conditions favorable for disease development persist, apply at full bloom or at petal fall. Do not apply more than two applications per season. This product may not be applied after petal fall.

Rubigan (fenarimol). Resistance and cross-resistance of the apple scab fungus to the DMI fungicides including Rubigan requires growers to evaluate the use of DMI fungicides frequently for apple scab management in their orchards. Rubigan E.C. is a locally systemic fungicide with protective, curative, and eradicant action. It is registered for the control of scab, powdery mildew, and rusts of apples; scab and powdery mildew of pears; and leaf spot and powdery mildew of cherries. When applying Rubigan alone, it is suggested to use a surfactant. In apples, Rubigan may be used from ½-inch green to 30 days before harvest. Rubigan may be applied at 8 to 12 fluid ounces per acre alone. or at 4 or more fluid ounces per acre in combination. When tank-mixing with a protectant fungicide, use recommended rates of the protectant fungicide. Do not apply more than 12 fluid ounces of Rubigan E.C. per acre per application and more than 84 fluid ounces per season. It may be used in dilute sprays at 3 fluid ounces alone or in tank-mix combination at 3 to 4 fluid ounces per 100 gallons of water and applied to the point of runoff. Rubigan should be applied in complete sprays until more information is available on its use in alternate side applications.

For control of apple scab, Rubigan used in combination with a protectant fungicide improves its protective properties. Use Rubigan at 4 to 6 fluid ounces per acre in combination with mancozeb, captan 50WP, Ziram 76WP, or Thiram at 4 pounds per acre. At application, 4 days' eradication of infection plus 6 days' protection can be expected. Spray intervals should not exceed 10 days. Use the higher combination rates and shorter spray intervals when disease conditions are severe. Applied alone, Rubigan at 8 to 12 fluid ounces per acre provides 4 days of eradication and 3 days of protection. The interval should not exceed 10 days between petal fall and second cover if scab infection periods occur.

Rubigan may be applied on a postinfection schedule. The first application should be made within 96 hours (4 days) from the beginning of the first scab infection period. A minimum of two

consecutive sprays should be applied at rates used in the protective schedules, and the second application should be made 7 days later. The protective fungicide program should be resumed 7 days after the second Rubigan application, or during the next scab infection period if the postinfection schedule is continued.

For control of powdery mildew, applications of Rubigan at 9 fluid ounces per acre made from tight cluster to second cover may control light to moderate infections. Where mildew is severe, use Rubigan at 9 to 12 fluid ounces per acre or other fungicides highly effective against powdery mildew. Do not apply Rubigan to pears until after petal fall. Also, do not apply more than 12 fluid ounces of Rubigan E.C. per acre per application and more than 84 fluid ounces per season. The preharvest interval on apples and pears is 30 days.

On cherries: To control powdery mildew and leaf spot, applications of Rubigan should begin at petal fall and continue until harvest. One or two postharvest applications may be made within 45 days after harvest. Do not apply more than 12 fluid ounces of Rubigan per acre per application and more than 36 fluid ounces per acre prior to harvest. Rubigan may be applied up to and after harvest.

Saber—see 2,4-D.

Sandea (halosulfuron-methyl) is primarily a postemergent herbicide with some preemergent activity for broadleaf weeds and nutsedge. It is labeled for apples under a supplemental label. You will need a copy of the supplemental label as well as the original in your possession. The greatest use of this herbicide will be for controlling nutsedge. For nutsedge control, apply Sandea postemergent as a single spray at a minimum of 0.75 oz/A when nutsedge plants are in the 3- to 5-leaf stage. If needed, a second treatment may be applied later in the season to any secondary nutsedge emergence. Do not treat orchards where the trees are established less than one year. The preharvest interval is 14 days and the reentry interval is 12 hours. For preemergent treatment, application to bare ground works best. If small weeds are present, include a broad-spectrum postemergent material as well. Include a nonionic surfactant in the mixture.

Savey—see Onager.

Scythe is a contact nonselective broad-spectrum foliar herbicide. It will only control actively growing, emerged, green vegetation. The active ingredient is pelagornic acid. It may also act as an enhancer when used with glyphosate at a rate of 1–3 percent solution. Recommended rates are 3–10 percent on a volume/volume basis. It may also be used to control root suckers as long as they are treated when they are still green. Do not allow spray to contact any desirable green foliage. Do not apply to trees until they have been established in the orchard for at least one year unless a nonpervious trunk protection is in place.

Select—see clethodim

sethoxydim—see Poast.

Sevin—see carbaryl. See Part I for more information on apple thinning with Sevin.

Shadow—see clethodim.

Sherpa—see imidacloprid.

simazine (Princep 4L, Princep Caliber 90, Simazine 4L, Sim-Trol). Simazine is a selective triazine herbicide and is used to control broadleaved weeds and annual grasses. It is available in several formulations and can be used around apple, peach, pear, and cherry trees established at least 1 year in the orchard. Simazine should be applied before weeds emerge or after removal of weed growth. It does not kill emerged weeds but may be used in combination with paraquat or glyphosate. Use lower rates on light soils and soils low in organic matter, higher rates on heavy soils and soils high in organic matter. Products containing simazine must bear the signal word “Caution.” Note that some products have a 12-hour REI and some have a 48-hour REI. Likewise, a few products have a 150-day PHI for apples. Be sure to read the label thoroughly.

Sinbar (terbacil). Terbacil is a selective herbicide used to control annual weeds and perennial grasses. It is sprayed on soil surfaces preferably just before, or otherwise during, the period of active weed growth. Terbacil works in plants by interfering with photosynthesis. It is part of a family of chemicals called substituted uracils. Terbacil at full rates is recommended for use on apple and peach trees established at least 3 years. Apply it either before weeds emerge in the spring or after harvest in the fall.

Terbacil controls barnyard grass, annual bluegrass, chickweed, crabgrass, seedling dandelion, foxtail, henbit, knotweed, lambsquarters, pigweed, purslane, ragweed, and smartweed. Use lower rates on light soils and soils with low organic matter; higher rates on soils with higher organic matter content. Do not use on soils with less than 1 percent organic matter or on areas with exposed tree roots. Sinbar should not be used on sandy or gravelly soils. Do not replant treated areas to any crop within 2 years after application. Terbacil may be applied with diuron at reduced rates for broader-spectrum control. The EPA requires the signal word “CAUTION” on containers of formulated terbacil.

A supplemental label for the use of Sinbar was approved to allow application on newly transplanted trees at rates of 0.5 to 1.0 pound per acre. Up to two applications at the 0.5-pound rate can be made in a year. You must have a copy of the supplemental label in your possession to apply Sinbar in this fashion.

SmartFresh (1-MCP). A new tool for postharvest management of apples gained EPA approval and registration in 2002. SmartFresh, 1-Methylcyclopropene (1-MCP), is registered and marketed by AgroFresh, a Rohm and Haas company. The benefits that 1-MCP brings to the fruit industry are dramatic. The mode of action of 1-MCP involves inhibiting the ripening process by attaching to ethylene binding sites and rendering the fruit insensitive to ethylene exposure. This binding results in fruit that maintains firmness and acidity levels higher than untreated fruit. For treatment purposes, 1-MCP is a gas and needs to be applied in an airtight room or chamber. The product comes packaged in a proprietary generator system that must be returned after use. The amount of 1-MCP needed to treat apples depends on the size of the room in which the fruit will be treated. 1-MCP has been shown to be very active at low concentrations. Its label rate for application is 1 ppm for a period of 24 hours. At the end of the 24-hour period, the room must be vented for at least 30 minutes before entering. Other benefits include inhibition of superficial scald in varieties like Delicious and Granny Smith that are prone to scald occurrence. Applications of 1-MCP should be made on fruit that is

designated for intermediate to long-term storage. Do not treat apples that have had a preharvest application of ethephon. 1-MCP will not solve all postharvest problems, but it is an important tool in providing a quality product to the consumer.

Snapshot is a proprietary granular mixture of 2 percent trifluralin plus 0.5 percent isoxaben that is labeled for nonbearing fruit trees. The material will control a variety of broadleaf and grass weeds depending on the application rates. Application rates are 100 to 200 lbs per treated acre, or 2.3 to 4.6 lbs per 100 sq ft. REI is 12 hours.

Solicam (norflurazon). Solicam is recommended for preemergent control of annual grasses and certain broadleaved weeds in apples, apricots, cherries, nectarines, peaches, and plums. In apples, norflurazon may be applied the year of planting. In cherries, norflurazon should not be applied on sandy or loamy-sand soils, nor may it be applied sooner than 18 months after trees have been established in the orchard. In apricots, pears, plums, and prunes, it may not be applied to trees established in the orchard for less than 12 months. Application to peaches may be made no sooner than 6 months after planting. In apples, Solicam may be applied the year of planting once the ground has firmed and settled with no cracks in the soil. Irrigation or rainfall is recommended within 4 weeks after soil application. Apply norflurazon in the fall postharvest or early in the spring before weeds germinate.

Solida—see rimsulfuron.

Sovran (kresoxim-methyl). Sovran is a fungicide registered for use on apple, crabapple, pear, and Oriental pears. It is highly effective against apple scab and apple powdery mildew and is also effective for controlling fruit rots, sooty blotch, and flyspeck. The active ingredient belongs to a class of fungicides known as strobilurins and was derived from strobilurin A, produced by the mushroom *Strobiluris tenacellus*. It provides both protective and curative/eradication action against the fungi causing apple scab and powdery mildew. It protects by inhibiting spore germination and suppresses growth and sporulation of the pathogen. Part of the Sovran spray residue is absorbed by leaves and fruit relatively quickly and moves within the leaf, but is not translocated to other leaves. The diffusion in the gaseous phase and the effective concentration in the leaf is retained by reabsorption from the primary deposit and that impregnated in the waxy cuticle layer. Penetration into the leaves and fruit is by diffusion through the cuticle and by normal gaseous exchanges through the stomata.

For control of early season diseases (scab, powdery mildew, apple rust, frog-eye leaf spot) Sovran should be used in protective sprays at 7- to 10-day intervals, but has curative action against scab when used up to 92 hours postinfection. The label recommends the use of Sovran for control of flyspeck, sooty blotch, white rot, and Brooks fruit spot beginning at second cover and continuing at 7- to 14-day intervals. Sovran or other strobilurin fungicide (Flint) should not be applied in more than four applications per season, using not more than two consecutive applications. See caution on resistance and cross-resistance to QoI fungicides on Flint. Sovran may not be used within 30 days of harvest, and sprayed areas should not be entered within 12 hours after treatment. Apply Sovran in alternation with labeled non-strobilurin fungicides with a different mode of action.

The active ingredient of Sovran has a low acute toxicity to mammals and favorable profiles to human safety, safety to the environment, and safety to terrestrial and aquatic ecosystems. It is classified by EPA as a reduced-risk compound.

spinetoram—see Delegate.

spinosad—see SpinTor.

SpinTor (spinosad) (IRAC Group 5 Insecticide) is a member of the Naturalyte class of insecticides labeled for apples in 1998. SpinTor is also labeled for control of leafrollers and thrips on peaches, plums, cherries, nectarines, prunes and apricots. It is formulated as a suspension concentrate. This product, with both contact and ingestion activity, provides about 7 to 8 days residual activity on the tree. SpinTor can be used to manage various lepidopterous pests and also has activity against apple maggot. Control of spotted tentiform leafminer is very good with 1 application per brood. The addition of a penetrating adjuvant is necessary for optimum activity. Excellent control can be achieved for tufted apple bud moth and obliquebanded leafroller with 2 applications per generation. Only one generation of these pests should be targeted with SpinTor in a given year. Targeting the first generation of tufted apple bud moth or the summer generation of obliquebanded leafroller may offer the advantage of a shorter period of egg hatch and a higher level of leafminer control.

SpinTor can be used on nectarines to control thrips. The label specifies the rate of 4 to 8 fluid ounces per acre. No more than 29 ounces can be applied per season; a 1-day preharvest interval exists for nectarines. Growers wishing to use this product should carefully check early ripening fruit for the presence of silvering, the damage caused by the feeding of the thrips on the skin of the fruit. It is extremely important that fruits are thoroughly covered since the thrips hide underneath leaves covering the fruit or around the stem end.

spiroadiclofen—see Envirod.

spirotetramat—see Movento.

Splat Cydia ((E,E)-8,10-Dodecadien-1-ol). Mating disruption product for the control of codling moth (for more information, see “Using pheromones for monitoring and mating disruption”).

Splat OFM 30M-1 ((Z)-8-Dodecenyl acetate, (E)-8-Dodecenyl acetate, (Z)-8-Dodecenol). Mating disruption product for the control of Oriental fruit moth (for more information, see “Using pheromones for monitoring and mating disruption”).

spray oil—see dormant and summer oils.

sprayable pheromone OFM (Z-8-Dodecenyl acetate, E-8-Dodecenyl acetate, Z-8-Dodecenol) (CheckMate OFM-F). Sprayable pheromones are time-release microencapsulated pheromone concentrates used for mating disruption of the Oriental fruit moth. The product is registered to help manage Oriental fruit moth populations in apples, peaches, and any other crop where OFM is a problem. It can reduce or prevent mating by interfering with chemical communication system between OFM males and females. Supplemental insecticides may be required if initial populations in the treated area are too high or if a major source of mated OFM females is present adjacent to the treated area. The pheromone can be applied with conventional ground application equipment. It is recommended that the first applica-

tion will be made before the start of flight of controlled moth generation. Pheromone trap monitoring is necessary for initial assessment of the treatment efficacy. Recommended rate is 2 fl oz of formulated product per acre per application. No more than 22 fl oz of product can be applied per acre per season.

Stinger (clopyralid) is a postemergent herbicide labeled for all stone fruits to help control some of the problem perennial weeds that invade orchards. Stinger gives excellent control of dandelion, horseweed, nightshades, and thistles. Application rate is $\frac{1}{3}$ to $\frac{2}{3}$ pint per treated acre in one to four applications per crop per year not to exceed $\frac{2}{3}$ pint per treated acre per year. The PHI is 30 days. REI is 12 hours.

Streptomycin sulfate (Agri-mycin 17, Firewall 17) is a fungicide used for the control of fire blight on apples and pears. Bloom sprays are most effective when applied at night and combined with Regulaid. See discussion of bloom sprays in apple and pear spray programs for amounts and timing.

Stylet oil (white mineral oil)—see **JMS Stylet Oil**.

sulfur. There are numerous formulations of sulfur on the market and the percentage of sulfur in each formulation has a very broad range (5 to 98 percent). There are many types of spray sulfurs, and dusting sulfurs, including That Flowable Sulfur, Liquid Sulfur Six, Microspray Wettable Sulfur (MicroSulf, Microthiol Disperss, Microfine Sulfur), and Sulfur DF to name a few. Because there are so many types of sulfurs offered, it is important to read the label carefully since some sulfur formulations can be phytotoxic to plants. Sulfur is very effective against powdery mildew of apples and cherries and against scab on peaches and nectarines. Confine traditional wettable powder formulations to the prebloom period on sulfur-sensitive apple varieties. Jonathan and Cortland are more tolerant than Stayman and Delicious. Rome Beauty is intermediate. Allow at least 7 days between oil and sulfur. Some of the newer sulfur formulations can be used in seasonal programs on apples without injury. In organic treatment trials, sulfur was found to provide excellent control of apple scab on some cultivars.

summer oils (BioCover, Damoil, JMS Stylet oil, Mite-E-Oil, Omni Supreme Spray, Par F70 Soluble Oil, PureSpray Oil, Spray Oil, Sunspray Ultrafine Oil, Super 94 Spray Oil, Superior Spay Oil, Supreme Oil). These are horticultural “superior oils” with a narrow 10–90 percent distillation range that permits relatively safe use on apple foliage during the summer months. In orchards under an effective prebloom mite control program, a summer oil can effectively suppress mite populations when applied at petal fall and in two subsequent cover sprays at rates of 1 to 2 gallons per 100 gallons finish spray solution, using a minimum of 100 gallons of spray per acre. Some leaf spotting may occur at the 2-gallon-per-100 rate. The rate of 1 gallon per 100 in these three applications may not be adequate for season-long control under conditions of severe population pressure; however, effective control has been achieved in such conditions using $\frac{1}{2}$ to 1 gallon per 100 in a seasonal program starting at petal fall and continuing on a 2-week schedule until mid-August. Using oil at concentrate rates increases the likelihood of phytotoxicity and is therefore not recommended. Apple variety and spray drying conditions should be taken into account to minimize any

possible effects on fruit finish. The slow drying conditions and extremes of cool or hot conditions should be avoided when applying horticultural mineral oils. Treatment with other materials is generally not recommended at this time unless all previous sprays were either omitted or completely ineffective.

Sunspray 6E—see **dormant oil**.

Sunspray Ultrafine Oil—see **summer oils**.

***Supracide (methidathion)** (IRAC Group 1B Insecticide). Supracide is a nonsystemic organophosphate insecticide labeled for use on all tree fruits during the dormant to delayed dormant stages for control of San Jose scale and rosy apple aphids. Do not apply after any blossoms open, otherwise injury may occur. Both an emulsifiable concentrate and a wettable powder are available. These products should be applied with dormant oil.

Super 94 Spray Oil—see **dormant and summer oils**.

Superior Spray Oil—see **dormant and summer oils**.

Supreme Oil—see **dormant and summer oils**.

Surflan—see **oryzalin**.

Surround (kaolin clay). Surround is a novel, nontoxic material that forms a mechanical barrier film to protect fruit against insect and solar damage. Surround is registered for use on pears, apples, and stone fruit. Surround suppresses insects by creating a protective white particle barrier on plant surfaces, which repels and irritates insects. For best results, the material should be first used before expected insect appearance and reapplied every 7 to 14 days throughout the season. At least 25 to 50 pounds of Surround have to be applied during a single application. Uniform and consistent coverage is essential for effective insect suppression and control. Special washing may be required at harvest to remove residue from fruit. Surround is OMRI listed.

Syllit (dodine). This product is effective for cherry leaf spot control at 1 pound per acre low volume (6 oz/100 gal dilute). For orchards with a history of cherry leaf spot, begin applications at petal fall or when first leaves unfold. Repeat applications at 7- to 10-day intervals. Due to the risk of fungicide resistance, no more than one application of Syllit is recommended per year for cherry leaf spot control. Syllit is recommended with caution for use on apples due to the potential for fungicide resistance. Under light to moderate disease conditions, Syllit plus captan can be used to inhibit bacterial spot on peaches. Read the label for exact rates depending on the Syllit formulation used.

It is not effective in controlling brown rot or powdery mildew. Wettable sulfur for the control of powdery mildew can be used in combination with Syllit for leaf spot control on cherries. Do not mix Syllit with lime.

***Taiga Z**—see **lambda-cyhalothrin**.

tebuconazole—see **Elite**.

tebufenozide—see **Confirm**.

***Telone**—see **1,3-dichloropropene**.

terbacil—see **Sinbar**.

terramycin—see **Myco-Shield**.

thiamethoxam (Actara, Agri-Flex, Endigo, Voliam Flexi) (IRAC Group 4A Insecticide). Thiamethoxam is a second-generation neonicotinoid insecticide belonging to the thianicotinyl subclass of chemistry. Thiamethoxam interferes with a unique receptor site in the insect nervous system, the nicotinic acetylcholine receptor. The compound is very effective against brown marmorated stink bug and many chewing and sucking insects: aphids, leafminers, leafhoppers, mullein bug, plum curculio, European apple sawfly, and pear psylla. Thiamethoxam exhibits rapid translaminar penetration into plant surfaces and is rainfast as soon as the spray dries. Actara is registered for use on pome fruits (apples, crabapples, loquat, mayhaw, quince, and pear fruit) and stone fruits (apricots, cherries, nectarines, peaches, plums, and prunes). Actara should be used from 2.0 to 5.5 ounces per acre per application depending on target pest. No more than 8.0 ounces per acre can be applied during a single growing season. Actara should be applied with a minimum of 50 gallons of water per acre. Thiamethoxam is very toxic to bees exposed to direct treatment. Agri-Flex is a mixture product of thiamethoxam and abamectin; Endigo is a mixture product of thiamethoxam and lambda-cyhalothrin; Voliam Flexi is a mixture product of thiamethoxam and chlorantraniliprole.

Thionex—see endosulfan.

thiophanate-methyl—see Topsin-M.

Thiram Granuflo (thiram). Thiram is a broad-spectrum protective fungicide first introduced for use on fruit crops in the early 1950s. It is registered for use on stone fruits for control of brown rot and peach leaf curl and for peach scab on peach/nectarine. It is effective against and registered for control of Botrytis gray mold on strawberries and would provide protection against blossom-end rot of apple during cool wet periods when blossoms are present. Thiram can be effectively used as a companion fungicide for mixtures with strobilurin, sterol inhibitors, and other unrelated fungicides. The new dispersible granular formulation is compatible with most pesticides. Precautions on the label for applicators and handlers should be noted, and personal protective equipment should be used by persons sensitive to Thiram. Treated areas should not be entered within 24 hours. The preharvest interval (PHI) is 7 days for peaches. Thiram can be applied at prebloom, calyx, early cover sprays, and late cover sprays

Thuricide—see Bt.

***Tombstone—see cyfluthrin.**

Topguard (flutriafol) is in the group of fungicides referred to as sterol demethylation inhibitors, or DMIs. It is a locally systemic fungicide with protective, curative, and eradicator action. It is registered for the control of scab, powdery mildew, and rusts of apples and has shown excellent activity against powdery mildew in our field tests. In apples, Topguard may be used from ½-inch green to 14 days before harvest, but we recommend it be used for primary scab and powdery mildew control (i.e., between ½-inch green and first cover sprays). Although this fungicide is newly registered, cross-resistance of the apple scab fungus to the DMI fungicides including Elite, Indar, Inspire Super, Procure, Rally, and Rubigan requires growers to evaluate the use of DMI fungicides frequently for apple scab management in their orchards. Topguard may be applied at 10 to 13 fluid ounces per acre alone depending on the depending on the disease targeted

and it should be tank-mixed with a protectant fungicide. When tank-mixing with a protectant fungicide, use recommended rates of the protectant fungicide. Do not apply more than 52 fl oz per acre per season.

Topsin-M (thiophanate-methyl). Topsin-M is a systemic fungicide with protective and curative action labeled for use on apples and all stone fruits. It was at one time one of the most effective fungicides available for control of apple scab and brown rot on stone fruits. However, due to widespread fungal resistance to this fungicide, it is no longer recommended for use in controlling apple scab or brown rot. Topsin-M is still highly effective in controlling sooty blotch and fly speck and is widely used late in the season to control these diseases. Topsin-M is also labeled on pear for the control of scab, sooty blotch and flyspeck, powdery mildew, and *Fabraea* leaf spot. Apply at intervals of 5-10 days from green tip through petal fall. Apply again at 7-14 day intervals in cover sprays. Do not exceed 3.2 lbs of product per acre per season. Do not apply within 1 day of harvest.

Tourismo (flubendiamide and buprofezin mixture) (IRAC Groups 28 and 16 Insecticide). Tourismo shares its active ingredients with Belt and Centaur and is registered for use on pome fruit (PHI=14 days) and stone fruit (PHI=14 days). The product is registered for the control of codling moth, Oriental fruit moth, leafroller complex, leafminers and suppression of San Jose scale. Tourismo cannot be applied using alternate-row-middle-spray application method. See also Belt and Centaur.

Treevix is an herbicide labeled for apples and pears as a burn-down material for broadleaf weeds with a limited amount of preemergence action. It will not burn down grasses or sedges. Test trials showed a good broad spectrum of control including control of mare's tail. The active ingredient in Treevix is saflufenacil. It is formulated as a water dispersible granule (WG). It may be applied no more than 3 times per year at rates of 1 oz per acre with a suitable adjuvant. Multiple applications in a year must be 21 days apart. Do not apply to apples or pears less than 1 year old. Tree guards should be used until adequate bark has formed to protect trees from potential injury (typically by 2 to 3 years after establishment). Reentry limit is 12 hours and it may be applied up to 1 day before harvest of pome fruit.

triadimefon—see Bayleton.

triflumizole—see Procure.

trifluralin is sold under various brand names as a herbicide labeled for use in apricot, nectarine, peach, plums and prunes. It is especially effective against pigweeds, barnyardgrass, bindweed, chickweed and foxtails. The rate of application will vary depending on soil type. The material must be incorporated into the soil, which will probably limit its use in orchards. It can be applied prior to planting and then incorporated. The preharvest interval is 60 days.

triforine—see Funginex.

Trilogy (neem oil) is a clarified hydrophobic extract of neem oil. Trilogy is registered a broad spectrum fungicide with activity also against mites. This product is OMRI listed.

***Tundra—see befenthrin.**

TypRus—see **GA4+7**.

Typy—see **6-benzyladenine + gibberellins A4A7**.

Vanguard (cyprodinil). Vanguard WG belongs to the chemical class of anilinopyrimidines. It is a systemic fungicide that is easily taken up into the cuticle and wax layers of leaves and fruit and moves within the leaf. Penetration occurs within 2 hours. It provides both protective action up to 6 days and curative activity (post-infection) for up to 48 hours. It is highly effective against apple and pear scab; however, it should not be used alone on pears. It is also recommended for brown rot blossom blight on all stone fruits except sweet cherry. The disease control spectrum on apple is broadened to include cedar apple rust if combined with the effective EBDCs Manzate, Dithane, Polyram, or the fungicides Thiram or Ziram. The control of powdery mildew is also enhanced if combined with sulfur or the sterol-inhibitor fungicides (Rally, Procure, Rubigan). Vanguard has shown no cross-resistance to other classes of fungicides, but it has a high risk for resistance development, so the number of applications per season should be limited. The REI is 12 hours and the PHI is 72 days. When using Vanguard WG to control brown rot blossom blight on stone fruit (not sweet cherries), do not apply more than 10 ounces per acre per year. Vanguard WG can be applied alone or used in tank mixtures with the recommended rate of another fungicide registered for stone fruit.

***Vapam HL (metam-sodium)**. Vapam is a broad-spectrum biocide that can be used to control plant-parasitic nematodes and a number of other soilborne diseases, fungi, and weeds. The product is a water-soluble liquid that quickly decomposes in soil to a gaseous fumigant consisting mainly of toxic methylisothiocyanate. Vapam can only be used as a preplant treatment and phytotoxicity will result if the soil has not been given sufficient time to aerate after treatment. The efficacy of Vapam is affected by soil moisture, temperature, texture and organic matter content. Careful site preparation is essential for good nematode control. In preparation of replant sites, it is recommended that as much root debris as possible be removed from the old orchard in preparation for Vapam treatment.

Vendex (fenbutatin oxide) (IRAC Group 12B Insecticide). Vendex is a nonsystemic organotin miticide with contact and stomach action. Vendex 50WP miticide is recommended for mite control on apples and pears. Thorough coverage of foliage and fruit is necessary for optimum mite control. Do not apply more than three times between petal fall and harvest.

Venue (pyraflufen ethyl) is a nonselective postemergent herbicide. It should be applied as a dormant or prebloom spray for control of winter annual and summer annual broadleaf weeds. Weeds should be less than 4 inches in height. The material is best used in combination with a residual preemergent herbicide. Rates are 0.7 to 4.0 fluid ounces per treated acre. REI is 12 hours. In bearing orchards, it can only be applied postharvest until prebloom. Venue may be applied to bearing tree fruit and grapes at rates of 1–4 oz/acre, not to exceed two applications per year. There is a 0-day preharvest interval. Exercise caution and do not allow spray material to drift up into the canopy of the trees.

Voliam Flexi (thiamethoxam and chlorantraniliprole mixture) (IRAC Groups 4A and 28 Insecticide). Voliam Flexi shares its active ingredients with Altacor and Actara. Voliam Flexi exhibits translaminar and locally systemic movement into plant tissue. The product is registered for use on pome fruit (PHI = 35 days) and stone fruit (PHI = 14 days) for the control of codling moth, Oriental fruit moth, leafroller complex, leafminers, European apple sawfly, plum curculio, and aphids. Voliam Flexi is highly toxic to bees exposed to direct treatment. See also Altacor and Actara.

***Voliam Xpress (lambda cyhalothrin and chlorantraniliprole mixture)** (IRAC Group 3 and 28 Insecticide). Voliam Xpress shares its active ingredients with Altacor and Warrior II. The product is registered for use on pome fruit (PHI = 21 days) and stone fruit (PHI = 14 days) for the control of codling moth, Oriental fruit moth, apple maggot, Japanese beetle, leafroller complex, leafminers, plum curculio, thrips, plant bugs, leafhoppers, periodical cicada, aphids, and suppression of pear psylla and spirea aphid. Voliam Xpress is highly toxic to bees exposed to direct treatment. See also Altacor and Warrior II.

***Vydate (oxamyl)** (IRAC Group 1A Insecticide). Vydate is a carbamate insecticide-miticide-nematicide-plant growth regulator with contact and systemic activity. It is a contact, moderate-residual insecticide when applied as a foliar spray. It is labeled for use on apples to control spotted tentiform leafminer, European red mite, white apple leafhopper, rosy apple aphid, and twospotted spider mite.

Vydate, like Sevin, acts to promote chemical thinning, but it is not as harmful to predatory insects. Because of this quality we think Vydate will provide a slightly better IPM approach for thinning. When used at petal fall Vydate may provide some insecticidal benefits in addition to the thinning benefits. Vydate should be applied as a dilute spray between 5 and 30 days after full bloom (5 to 20 mm fruit diameter). Vydate may increase russet on cultivars prone to russet. When using Vydate as a thinner, do not combine with oil. Vydate is incompatible with alkaline materials.

When applied to the soil (preplant or postplant, nonbearing only), Vydate 10G acts as a nonfumigant nematicide. Vydate can be used as a preplant or postplant treatment for control of plant-parasitic nematodes on nonbearing trees only (i.e., trees that will not bear for at least 12 months). When used as a preplant treatment, Vydate is most effective if incorporated into the top 4 to 8 inches of soil and trees are planted within 24 hours. In postplant situations, the efficacy of surface-applied Vydate will improve if followed by rain or irrigation water. Foliar-applied oxamyl will be translocated within plants; however, foliar applications for nematode control are not recommended. See Part I for more information on apple thinning with Vydate.

***Warrior II**—see **lambda-cyhalothrin**.

***Warhawk**—see **chlorpyrifos**.

Weedar 64—see **2,4-D**.

Widow—see **imidacloprid**.

XenTari—see **Bt**.

***Yuma**—see **chlorpyrifos**.

Zeal (etoxazole) (IRAC Group 10B Insecticide). Zeal is a miticide primarily effective against eggs and larval stages of tetranychidae mites (European red mites and twospotted spider mites), but it also sterilizes adult mites. The compound works by inhibiting the molting process through disruption of the cell membrane. Etoxazole exhibits translaminar movement in plant leaves. Since the compound has no acute toxicity to adults, mite control may not be observable for several days after application. The compound will not control rust mites. Zeal can be applied only once per season on pome fruits at the rate of 2 to 3 ounces per acre. This product is not registered for use on stone fruit. Etoxazole has little to moderate toxic effect on most beneficial insect and mites. Zeal should not be applied within 14 days of harvest.

***zeta-cypermethrin (*Mustang, *Mustang Max)** (IRAC Group 3 Insecticide). Pyrethroid insecticides with a broad spectrum of controlled insect pests. Very toxic to beneficial insects and bees. Registered for use on pome (PHI = 14 days) and stone fruit (PHI = 14 days).

Ziram (ziram). Ziram is a contact foliar fungicide with protective action. It is registered for control of apple scab, cedar apple rust, quince rust, sooty blotch, flyspeck, bitter rot, and necrotic leaf blotch on apples; Fabrea leaf spot and pear scab on pears; peach scab and brown rot on peaches and nectarines; and shothole and brown rot on apricots. Ziram is less effective against apple scab than captan and about equal to Thiram. It may be used in combination with oil or near-oil applications for scab control during the early sprays. Ziram is registered for control of apple scab when used at 1 to 2 pounds per 100 gallons or 6 to 8 pounds per acre from green tip through early cover sprays. It has shown good control of sooty blotch and flyspeck during the late cover sprays. Do not apply Ziram within 14 days of harvest on apple. Apply Ziram after leaf drop and/or prior to budswell to control leaf curl on peaches and nectarines at the rate of 3 ¾ to 8 pounds per acre. It is also registered for control of brown rot when used at pink, 25 to 75 percent bloom, and petal fall and early cover sprays. Do not apply Ziram within 14 days of harvest on peaches, nectarines, and cherries. Do not apply Ziram on apricots within 30 days of harvest. Do not apply Ziram on pears within 5 days of harvest. Read the label carefully since recommendations vary between crops.

***Zoro—see abamectin.**

Z-8-Dodecenyl acetate—see Sprayable Pheromone OFM.

ADJUVANTS

Adjuvants are added to spray mixtures to increase the effectiveness of the main active ingredient. There are many classes of adjuvants, each with its own spectrum of activity. An adjuvant may have more than one mode of action. When the cost of the adjuvant is less than that of the chemical, there may be clear economic advantages in using an adjuvant rather than a high rate of a chemical. For example, the rate of NAA may be reduced 50 percent when a suitable surfactant is added to the spray mixture.

The use of adjuvants with pesticides may significantly enhance their activity. Plant growth regulators are applied to modify plant growth; to be effective they must enter the plant as with other systemic pesticides. This is in contrast to most other pesticide

applications, in which a uniform deposit is desired on the outside of the plant. Because leaf exteriors have waxes, cutin, pectin, and cellulose between the chemical and the cell contents, anything we can do to bring about a uniform deposit and penetrate these barriers to uptake must be seriously considered.

The wholesale use of adjuvants with orchard sprays may not be warranted. Many pesticides contain adjuvants to stabilize the product and to make it effective in the spray tank. Thus, growers should be cautious in using adjuvants and should rely on reputable sources of information for data regarding the selection of a suitable adjuvant. See Table 3-6 for a list of adjuvants available from major ag chemical suppliers. Check labels of specific products before using in any application.

Below are different classifications of adjuvants.

Acidifier. Acidifiers are adjuvants that have the ability to reduce the pH of solutions. They are useful when the pH of the spray water is too high. However, because acidifiers can only lower the pH, their indiscriminate use is not recommended. In some cases if the spray water pH is correct or lower than the recommended pH for the chemical in question, then the use of an acidifier can reduce the pesticide's effectiveness.

Antifoaming agent. See defoamer.

Antitranspirant. Antitranspirants are chemicals that can reduce transpiration in plants. They can be applied as main chemicals or may be used to enhance the activity of other chemicals. Antitranspirants can be effective in transplanting nursery stock, especially when leaves are present and low humidity and/or high winds are expected.

Buffering agent. Buffering agents raise or lower the pH of the spray mixture to the designed pH of that buffering agent. Thus, buffering agents can be useful when the spray water pH is either too high or too low.

The quantity of buffering agent needed in a spray tank may be difficult to determine. Various buffering agents have different powers to buffer. In addition, merely measuring the pH of a spray solution may not give an indication of the quantity of buffering agent needed. For example, sulfuric acid and acetic acid (the acid in vinegar) may both have low pH values. However, sulfuric acid is a much stronger acid than acetic acid, and much more buffering agent would be needed to change the pH of a sulfuric acid solution than an acetic acid solution.

Compatibility agent. Compatibility agents are adjuvants that allow easier mixing of two or more components in a solution. Using compatibility agents may allow the use of two or more chemicals in a tank that would otherwise be incompatible.

Crop oil. Crop oils normally contain 95 to 98 percent petroleum oil with 1 to 2 percent added surfactant. Crop oils can be effective as penetrants and as surfactants.

Crop oil concentrate. Crop oil concentrates normally contain between 80 and 85 percent petroleum oil with 15 to 20 percent surfactant. These products can be effective as penetrants and as surfactants.

Defoamer. Defoamers are adjuvants that reduce foaming when there is excessive foam in a spray tank. Excessive foaming can be a significant problem with some agitation systems in sprayers,

especially when the water level in a tank gets low enough that a mechanical agitation system would cause excessive foam.

Drift retardant. Drift retardants are used to reduce off-target drift of pesticides and are often used with aerial applications. Since aerial applications normally are made with highly concentrated spray mixtures, spray nozzles that create small droplets are often used. Since small droplets can travel farther than larger droplets, some drift retardants work by increasing mean droplet size.

Extender. Extenders are adjuvants that can extend the useful life of a spray chemical. They work by increasing the chemical's adhesion to the leaf, by reducing any factor that can diminish chemical effectiveness, or by enhancing chemical weatherability. Since many pesticides are broken down by ultraviolet light, some extenders have the ability to intercept ultraviolet light.

Organosilicon surfactants are a new class of surfactants. Generally they are more effective per unit of active ingredient than the more traditional surfactants.

Penetrant. Penetrants are adjuvants that help chemicals penetrate plants.

Spreader. Spreaders are surfactants. See surfactants.

Sticker. Stickers are adjuvants that aid in the attachment of a chemical to a surface. They can lengthen the time that a chemical is attached to a plant surface. Stickers generally make pesticide deposits less easily removed from leaves by forces such as rain or wind.

Sticker-spreader (spreader-sticker). Sticker-spreaders are compounds that perform two functions at the same time. They stick and spread chemicals to plant surfaces. See stickers and surfactants for descriptions of individual types of adjuvants.

Surface active agent. Surface active agents are surfactants. See surfactants.

Surfactant. Surfactants are adjuvants that reduce the surface tensions of solutions, helping them spread and cover surfaces more effectively. Surfactants are probably the best-known class of adjuvants. Most adjuvants are a double-ended molecule, one end being water soluble and one end being oil soluble. Therefore, these molecules can line up between waterlike compounds and oillike compounds and make them more compatible. Surfactants can be uncharged (nonionic), positively charged (cationic), or negatively charged (anionic).

Suspension agent. Suspension agents aid the suspension of one material in another. These types of adjuvants are often used in liquid fertilizer mixes as well as in liquid pesticide formulations to help maintain a uniform product mix.

Thickener. Thickeners are adjuvants that increase the viscosity of solutions. Calcium dips were proven more effective in increasing fruit calcium levels when a thickener was added to the calcium dipping solution, compared to a water solution.

Vegetable oil concentrate. These adjuvants are similar to crop oil and crop oil concentrates except that vegetable oils are used instead of petroleum oils.

Wetting agent. This is another name for surfactants. See Surfactants.

References and Contacts

Agrilience Agrisolutions. 2004. *Adjuvant Technical Handbook. Agrilience Know How.*

Helena Chemical Company. 2000. *Adjuvant Guide.*

A Guide to Agricultural Spray Surfactants used in the United States, 1992. Lori T. Harvey. 244 pages. \$17.50. Thomson Publications, PO Box 9335, Fresno, CA 93791.

Kalo Technical Product Materials. Kalo Laboratories, Inc., 4550 W. 109th Street, Suite 250, Overlook Park, KS 66211-1311 (800-255-5196).

Miller specimen labels, Miller Chemical & Fertilizer Corp., PO Box 333, Hanover, PA 17331 (717-633-1434).

Riverside Adjuvant Tech. Handbook. 1997. Terra International, Inc., 600 Fourth Street, PO Box 6000, Sioux City, IA 51102-6000 (800-762-3837).

Setre Chemical Company Product Label Book, 1995. Setre Chemical Company, 6075 Poplar Ave., Suite 500, Memphis, TN 38119. Contact local Helena Chemical Co. representative.

FUNGICIDE USE STRATEGIES

Tree fruit growers are well aware of the complex of pathogens that produce disease on leaves, branches, and fruit spanning the season from bud break to postharvest. There are 10 or more major diseases of apple trees alone. Managing these pathogens at levels below economic injury requires the integration of cultural and sanitation measures with prudent use of agricultural chemicals.

In this section we focus on different fungicide-use options for efficient and effective disease management. It is assumed that acceptable pruning, fertilization, and sanitation measures known to reduce disease inoculum levels are being used and that minimal fungicide rates to maintain low disease levels are desirable.

Types of Fungicides

Pesticides used for managing fungi-caused fruit diseases are either fungicidal (they kill fungi) or fungistatic (they inhibit fungal growth). Fungicides can be separated into two categories: protectants and systemics.

Protectant fungicides protect the plant against infection at the site of application. Their characteristics are as follows:

- They provide protection against infection.
- They do not penetrate into the plant.
- They require uniform distribution over the plant surface.
- They require repeated application to renew deposit.
- They have a multisite mode of action against fungi.
- Fungi are not likely to become resistant to protectant fungicides.

Some common protectant fungicides are Bravo, captan, copper, Dithane, Manzate, Polyram, sulfur, and Ziram.

Systemic fungicides prevent disease from developing on parts of the plant away from the site of application. Their characteristics are as follows:

- They penetrate into the plant.
- They move within the plant.

Table 3-6. Adjuvants available for use on tree fruit.

Class	Trade name	Manufacturer	Class	Trade name	Manufacturer		
Acidifier	Aero Dyne-Amic	Setre	Sticker (continued)	Latron B-1956	Rohm and Haas		
	Choice	Loveland		Latron CS-7	Rohm and Haas		
	Combine	Riverside		Mo-Bait	Loveland		
	Invade Plus	Riverside		NU-FILM 17	Miller		
	Latron AG-44M	Rohm and Haas		NU-FILM-P	Miller		
	LI 700	Loveland		Plex	Riverside		
	LI Combo	Loveland		Plyac	Loveland		
Spray-Aide	Miller	Surfix		Setre			
Antitranspirant	Vapor Gard	Miller		Surfactant	Aero Dyne-Amic	Setre	
Buffering agent	Combine	Riverside			Bio-Film	Kalo	
	Invade Plus	Riverside	Bond		Loveland		
	Latron AG-44M	Rohm and Haas	Buffer-X		Kalo		
	NXS DC	Setre	Latron CS-7		Rohm and Haas		
	Optima	Setre	LI Combo		Loveland		
	Penetrator Plus	Setre	Meth Oil		Riverside		
Quest	Setre	Optima	Setre				
Compatibility agent	Blendex VHC	Setre	Rivet		Riverside		
	Combine	Riverside	Windcheck		Riverside		
	Compex	Kalo	Surfactant nonionic	80 Non-Ionic Spreader			
	E-Z Mix	Loveland		Activator Surfactant	Kalo		
	Latron AG-44M	Rohm and Haas		90 Non-Ionic Spreader			
	LI Combo	Loveland		Activator Surfactant	Kalo		
	Setre FA-1	Setre		Activate Plus	Riverside		
	Spray-Aide	Miller		Activator 90	Loveland		
Unite	Loveland	Activator NF		Loveland			
Crop oil	4N 1 Oil	Loveland		AD 100	Riverside		
	Agri-Dex	Setre		Agri Wet	Loveland		
	Dyne-Amic	Setre		Agri-Dex	Setre		
	Crop oil concentrate	Agicide Activator	Loveland	Bio-88	Kalo		
Crop Oil Concentrate		Kalo	Biosurf	Loveland			
Herbimax		Loveland	Chaser 25-0-0	Riverside			
Maximizer		Loveland	Cohort DC	Setre			
MSO		Loveland	Complex	Riverside			
Prime Oil		Riverside	Dispatch	Loveland			
Prime Oil II		Riverside	Dispatch 2N	Loveland			
Defoamer	Anti-Foam	Kalo	dri	Kalo			
	Defoamer	Kalo	Dyne-Amic	Setre			
	Defoamer	Riverside	Exit	Miller			
	Defoamer ST30	Riverside	Freeway	Loveland			
	Fighter F	Loveland	Induce	Setre			
	Foam Fighter	Miller	Invade Plus	Riverside			
	Spreader 80	Loveland	Kinetic	Setre			
	The Unfoamer	Loveland	Kinetic DC*	Setre			
Drift retardant	Brace	Riverside	Kinetic HV*	Setre			
	Chem-Trol	Loveland	Latron AG-98	Rohm and Haas			
	Deposit	Loveland	Latron AG-98 (N)	Rohm and Haas			
	Drop Zone DC	Setre	Latron B-1956	Rohm and Haas			
	Intac	Loveland	LI 700	Loveland			
	Strike Zone DC	Setre	Methylated Seed Oil	Kalo			
	Windbrake	Riverside	NU-FILM 17	Miller			
	Windcheck	Riverside	NU-FILM-P	Miller			
	Windri	Riverside	Patrol	Setre			
	Extender	Exit	Miller	Plyac	Loveland		
NU-FILM 17		Miller	Regulaid	Kalo			
Plex		Riverside	Silkin*	Riverside			
Penetrant	Activator 90	Loveland	Silwet L-77*	Loveland			
	Activator NF	Loveland	Silwet L-77 Surfactant*	Setre			
	Androc Diluent	Riverside	Soy Wet	Loveland			
	Biosurf	Loveland	Spreader 80	Loveland			
	Freeway	Loveland	Surf-Aid	Riverside			
	Kinetic	Setre	Surfix	Setre			
	Kinetic HV	Setre	X-77	Loveland			
	LI 700	Loveland	Suspension agent	Assist	Riverside		
	Oil Concentrate	Loveland		Flozine	Loveland		
Sticker	Bond	Loveland		Support	Loveland		
	Complex	Riverside		Synergist	Incite	Loveland	
	Intac	Loveland			Vegetable oil concentrate	Veg-Oil	Loveland
	Lastick	Setre					

*Organosilicon surfactant

- They control disease by protectant and/or curative action.
- They often have a very specific mode of action against fungi.

Some systemic fungicides are Elite, Flint, Indar, Rally, Orbit, Pristine, Procure, Rubigan, and Sovran.

Modes of Action

Fungicides can act on fungi by (1) inhibiting energy production (e.g., sulfur, copper, Manzate, Dithane, captan, Flint, Pristine, and Sovran), (2) interfering with cell structure (e.g., Syllit), and (3) interfering with growth (e.g., Elite, Procure, Rally, and Rubigan).

Fungicide Options for Apple Trees

Growers used to have few fungicide options for apple scab control other than protective fungicides that had to be applied before infection occurred. With the introduction of dodine, benzimidazole (Benlate, Topsin-M), and sterol-inhibitor fungicides (Funginex, Rubigan, Rally) came greater versatility in timing of application and often more complex scenarios of usage patterns. These fungicides were either more effective when used in combination with chemically unrelated compounds (captan, Manzate, Dithane, Polyram, thiram) or were perceived as effective in the selection of less sensitive pathogen strains in the orchard.

It is now recognized that strains of the apple scab pathogen tolerant of the benzimidazole fungicides can be found rather commonly in Mid-Atlantic orchards. This factor, along with the reduced usage of the EBDC fungicides (Dithane, Manzate, Penncozeb, Polyram), have made decisions about fungicide selection and application timing more difficult. Dodine (Syllit) usage in the past has been limited essentially to early season because of its narrow spectrum of disease activity and is currently not recommended due to the high risk of existing fungicide resistance. There is also concern that resistance is developing in Pennsylvania orchards to the sterol-inhibitor fungicides (e.g., Elite, Procure, Rally, and Rubigan) and strobiluron fungicides (Flint, Pristine, and Sovran). Another complicating situation has been the desirability of spray oil usage for European red mite management and the incompatibility of captan or sulfur with oil.

Moreover, captan is apt to cause leaf spotting on Delicious, and sulfur is more injurious to most apple cultivars when the temperature is above 90°F. In sorting out the various options, dividing the various diseases and control options during the growing season into early, mid-, and late season periods will help to optimize disease-management decision making.

Early season (green tip through second cover)

Fungal diseases of primary concern during this period are scab, powdery mildew, and rust, all of which occur on both leaves and fruit. Although scab may infect leaves as early as green tip under favorable environmental conditions, the number of infections increases with ascospore maturation rate from ½-inch green through second cover with peak periods between pink and first cover. Mildew infections blanket the period between the open cluster and second cover growth stages and become significant in orchards having overwintering infections when the temperature is above 50°F.

Cedar-apple and quince rust must be controlled in areas where susceptible red cedars are common. Infections occur from pink through second cover but are more likely to cause economic injury between bloom and first cover. The frog-eye leafspot phase of the black rot disease may be of concern in some orchards during petal fall through second cover.

The choice of which fungicides to use during the early season may vary, depending on which diseases are present in the orchard and whether oil is used for mite control at the ½-inch green stage. A wide range of fungicides with different modes of action may be used during this time. Protective fungicides effective at this time (listed in descending order of effectiveness) include Vanguard, Manzate, Dithane, Polyram, captan, thiram, ferbam, and Ziram.

The sterol-inhibitor (SI) fungicides (Rubigan 1E, Rally 40W, Procure) are highly effective for control of scab, rust, and mildew. They are recommended during open cluster through the second cover. They are more effective against scab when used in combination with a protectant fungicide. To avoid or delay the development of tolerant strains of pathogens, we strongly recommend that the use of sterol inhibitor fungicides be limited and that they be used preventively, not curatively, and that they be tank mixed, alternated, or used in alternate groups of sprays with a chemically unrelated fungicide.

The SI fungicides are very effective for scab control when used in postinfection applications timed 72–96 hours from the beginning of the infection period. A single postinfection application generally is not as effective as two or more used in sequence. A good method is to follow the postinfection spray with another application 5–7 days later during times when infection periods occur at intervals of 10 or more days. However, the threat of SI fungicide resistance limits the potential for the use of these materials in Pennsylvania orchards.

The strobilurin or “stroby” fungicides, Flint, Sovran and Pristine, represent a different class of fungicides registered for use on apple and pear. These fungicides have both protective and curative activity against a number of early season diseases of apple and pear including scab, powdery mildew, frog-eye leaf spot, apple rusts, and fruit rots. As with other curative fungicides, the stroby fungicides are likely to select out resistant strains of one or more pathogens if used excessively. There is concern that fungal tolerance to the mode of action of this group of fungicides has already begun in Pennsylvania. To avoid this selection and increase the effective life of these fungicides, limit their use to the restrictions on the label. Unlike the sterol inhibitors, it is not necessary to mix these fungicides with protectants; however, using them in alternating applications with unrelated fungicide chemistry is strongly encouraged. Spray programs using the stroby fungicides in a limited number of applications alternating with other fungicides should provide control of the fungal disease complex common in many orchards.

Midseason (third, fourth, and fifth cover sprays)

The major fungal pathogens of apple are generally less active during this period, so fungicide usage may be safely limited by reducing fungicide rates, lengthening application intervals, or eliminating one or more sprays. Where scab has been controlled there is little risk of fruit infection during this period because the primary inoculum has been dispensed. Powdery mildew and rust are no longer a threat, and fruit is less susceptible to the decay-

producing pathogens. Sooty blotch and flyspeck may cause infections as early as third cover when rainfall is frequent, but they are generally not a problem until later in the season.

Fungicides of choice include captan, thiram, and Ziram. The rates of each can be reduced to 50–60 percent of full rates without appreciable risk unless rainfall is frequent.

Late season (sixth, seventh, and eighth cover sprays)

Rainfall is frequently heavier during late July, August, and September. This heavier rainfall is favorable for the pathogens causing fruit decay (black rot, bitter rot, bot rot, and Alternaria rot) and blotches (sooty blotch and flyspeck). Bitter rot, particularly, is more prevalent when rainfall is frequent and temperatures are above 85° F. Sooty blotch and flyspeck may not be readily apparent until early September, although infections may occur as early as mid-June. Under conditions of frequent rainfall, control of these diseases requires using protective fungicides at a minimum of three applications and at rates near or at full labeled rates.

Fungicides such as Pristine, Topsin-M, Ziram, captan, and thiram are effective for late season control when used in complete sprays at 14-day intervals or in alternate-side sprays at 7–10 day intervals. Because captan, thiram, and Ziram are not as persistent on the fruit during frequent rains, using them along with Topsin-M reduced label rates will provide better disease control than if either is used alone. Topsin-M is ineffective against bitter rot and provides only fair control of black rot. In orchards with a history of these diseases, captan used in combination at 70–80 percent of full rate in the fifth through eighth cover sprays is more likely to provide satisfactory control. The interval between the last spray and harvest should not exceed 45 days. A recently registered fungicide, Pristine is highly effective against the late season diseases, fruit rots, sooty blotch, and flyspeck.

Sooty blotch and flyspeck often become visible within 40 days after the last application on fruit sprayed with captan, thiram, or Ziram. Since the incubation period for these pathogens is about 30 days in the field, the effective residual protection is about 10–14 days for these protectants. The residual protection from a combination with a Topsin-M is approximately 20 days. Thus symptoms should not be evident for 50 days after the last application. Combinations are preferred for late maturing cultivars grown for fresh markets.

The “stroby” fungicides, Pristine, Flint and Sovran, are registered for control of several apple diseases that occur during the late summer months. Research data from the Mid-Atlantic region on application timing and efficacy against bitter rot, Brooks fruit spot, black rot, bot rot, sooty blotch, and flyspeck indicate that the stroby fungicides are very effective. The choice of using these fungicides during the summer should be balanced against the need for control of early season diseases and the limited number of applications recommended on the label.

Fungicide options for peach and nectarine trees

Diseases infecting peach and nectarine trees span the entire growing season, from dormancy in the spring through harvest and postharvest. As on apple, sanitation measures that eliminate or reduce inoculum levels in the orchard or packing house used in combination with effective fungicides are necessary for acceptable control. A minimum of five fungal and bacterial diseases must be managed in most commercial orchards. Their intensity

varies with cultivar susceptibility, inoculum levels, and favorable environmental conditions.

Peach leaf curl is a threat unless inoculum is maintained at very low levels. A single application of ferbam, Bravo, copper fungicides, or Ziram is effective when applied in spring before bud swell or in the autumn when most leaves have fallen. In orchards where leaf curl has not been present for two or more years, this application can be safely omitted until the first symptoms become evident. Careful monitoring for low disease incidence is important if spray omission is planned.

Brown rot is the most destructive fungal disease of stone fruit. Infections occur first in blossoms, then grow into shoots, causing them to blight and later produce heavy inoculum (spores) that cause fruit decay. Nectarines are particularly susceptible and require closer attention to sanitation measures and thorough applications of fungicides. Effective fungicides include Adament, Pristine, Elite, Gem, Indar, Orbit, Funginex, Quash, Rovral, Bravo, Vanguard, Scala, captan, thiram, and sulfur.

In orchards where blossom blight has been a problem, two applications from pink through bloom are required for control when rain periods occur with temperatures 55°F or above. The removal of mummified fruit from trees, light cultivation to disturbed mummies on the ground beneath trees, and careful timing of applications during bloom before infection periods can eliminate the need for one or possibly both of these applications. The necessity of applications on green peach fruit for brown rot control is in question, even though growers routinely spray during this period.

Losses from brown rot are more apparent during and after harvest. Fruit becomes more susceptible as it matures, and fungicide protection from one or two weeks before harvest and during harvest is required for control.

Peach scab causes minor losses in Mid-Atlantic orchards but can build up if no fungicides are used. It is common in orchards where complete crop losses from freezing occurred the previous year and fungicides were not used. Three fungicide applications at 2-week intervals starting at late shucksplit are effective for controlling scab. Captan and sulfur is are highly effective and a either are good choices during this period. Rovral is not effective and should not be depended on for control.

Bacterial leaf and fruit spot is a very destructive disease along the eastern seaboard on susceptible cultivars (e.g., Sunhigh, Loring, Sweet Dream, Snow King). The disease generally is not difficult to control in most Mid-Atlantic orchards unless it builds up during rain periods with temperatures of 70 to 85°F. Cultivars show varying levels of resistance from highly susceptible to moderate to highly tolerant (Redhaven, Encore). Infection begins on leaves, twigs, and fruit at shucksplit and continues through the growing season.

Maintaining good tree vigor is helpful in control. Myco-Shield 17SP and FlameOut are effective if applied weekly as a dilute spray but can be expensive because as many as eight applications may be required. Dormant copper applications have been shown to reduce disease pressure. Susceptibility of the cultivar and frequency of favorable environmental conditions are important factors in choosing the cultivar to grow.

Rhizopus rot is a fungal disease that infects ripe fruit at harvest and may cause extensive losses in harvested fruit in transit or on grocery shelves. The fungus is widespread in nature and

gains entry through wounds or may spread from rotting fruit to adjacent fruit in storage containers. Sanitation and cultural practices that maintain low inoculum levels are essential for control. Fungicides applied for brown rot at harvest generally provide good protection.

FUNGICIDE RESISTANCE MANAGEMENT STRATEGIES

Resistance of diseases, insects, and mites to pesticides is a major concern for Pennsylvania fruit growers. Intensive and nearly exclusive use of the same pesticide kills more susceptible than resistant individuals. Thus more resistant individuals reproduce and their offspring will inherit the capacity for resistance and take over the niches previously occupied by susceptible individuals. Over time the whole population may become resistant.

Resistance has sometimes resulted in pest-management-program failures. As we lose more pesticides to resistance, our pest management options decrease as the risk increases of having no effective pesticide treatment for a serious pest. In many cases resistance is inevitable, and our main strategy is to manage pests and pesticide use to delay the onset of resistance as long as possible. Below are presented tactics to help delay resistance to fungicides.

Fungicide Resistance Issues for Specific Diseases

Apple scab

Vanguard, Scala, Flint, Sovran, Pristine, Rubigan, Procure, and Rally are highly effective against scab infection. However, apple scab can become resistant to these fungicides, especially if any of them is continually applied alone. Growers using one of these fungicides to control apple scab must be certain to alternate it with an unrelated fungicide or to use it in combination with another fungicide, like captan, metiram (Polyram), mancozeb, Ziram, thiram, sulfur, or ferbam. These highly effective materials should not be used once the major threat of scab infection is over. Another strategy to prevent resistance is to alternate the use of these materials throughout the season. The less any one of them is used in an orchard during a given season, the lower the chances that resistance will develop.

Powdery mildew

Frequent applications of fungicide may be required for mildew control. Flint, Sovran, Bayleton, Rubigan, and Rally are effective in controlling powdery mildew. There are presently no documented cases of apple powdery mildew resistance to these materials.

Cedar apple rust

Only a brief part of the life cycle of the cedar apple rust fungus is spent on apple trees. Infection of apple leaves or fruit occurs between the pink and first cover spray periods. The cedar apple rust fungus survives 19 months or longer on red cedar. The contact between the fungus and the fungicide applied to apples is relatively short, reducing the potential for resistance to develop. If a resistant cedar apple rust fungus does develop, it must also survive on red cedar. Therefore, resistance of the cedar apple rust fungus to any fungicide is not likely.

The type of fungicide used affects the potential for a fungus to develop fungicide resistance.

Broad-spectrum fungicides like copper, captan, and sulfur act by interfering with several of the fungus's vital life functions. The multiple action of these fungicides allows little chance for resistance, since the fungus must undergo multiple changes to counteract the fungicide.

Systemic fungicides like Vanguard, Scala, Flint, Sovran, Pristine, Rubigan, and Rally are highly effective against many apple diseases. They interfere with one vital life function, so one change is needed for the fungus to become resistant. Thus the potential for resistance to these fungicides is much greater than to broad-spectrum fungicides.

How do fungi develop resistance to a fungicide in an orchard?

As previously discussed, resistance is more likely to develop against fungicides that have a single mode of action, especially if they are used alone for a long time. In the orchard, resistant fungi may occur naturally, in very small numbers, even before the fungicide is first used. When a fungicide is applied, it reduces the number of susceptible apple scab fungi. The few scab fungi that are resistant to the fungicide are able to increase in number. As the fungicide is repeatedly used, the number of resistant fungi increases. The fungicide becomes less effective as the apple scab fungus becomes more resistant to it.

Resistant apple scab fungi are not "super" fungi.

Apple scab fungi that are resistant to certain fungicides are still susceptible to others that have a different toxic action against the fungi. Using fungicide mixtures will delay the buildup of resistant scab fungi. Mixtures are most effective when used before resistance becomes a problem. Alternating chemicals that have different modes of action is another strategy to prevent resistance from developing.

The Future of Apple Disease Control

Growers can prevent resistance by using fungicide mixtures or alternating chemicals. All possible control tactics, including cultural controls, must be used against diseases like apple scab.

USING PHEROMONES FOR MONITORING AND MATING DISRUPTION

A pheromone is a chemical messenger produced naturally by an organism and released into the environment. When detected by a second individual of the same species, the pheromone changes the behavior of that second individual. A sex pheromone is used to help one sex (typically the male in insects) orient toward and find the other sex for mating. Sex pheromones can be detected over hundreds of yards on wind currents, and by flying upwind in the pheromone plume, the male can almost always find the female.

Chemists have extracted and analyzed natural pheromones and have created processes to produce these complex chemicals in large quantities. This has given entomologists several new tools to use in pest management. To date, the most successful and widespread use of pheromones has been in monitoring traps. Moni-

toring traps consist of cardboard or plastic devices that contain a pheromone emitter and a sticky surface. A male moth, fooled into thinking that the emitter is a female releasing a pheromone, flies into the trap and is caught on the sticky surface.

Monitoring traps are placed in the orchard before the beginning of moth emergence. They are checked daily to record the first capture, or biofix, and then at weekly intervals. Each week the trapped insects and debris are removed. Traps and pheromones are replaced as necessary. The biofix can be used to begin accumulating degree days to predict future insect stage distribution. By recording the number of males found each week, a grower may monitor the development of a pest population over time.

Each season the information on moth capture in pheromone traps for codling moth, Oriental fruit moth, leafrollers, and various other insect species in Biglerville is available at the Penn State Fruit Research and Extension Center (FREC) website (agsci.psu.edu/frec) and published by Penn State Extension in the monthly newsletter *Fruit Times* (extension.psu.edu/fruit-times). Degree days based insect development models (eggs hatch models) are also used to track insect development and provide the information to growers so they will know the optimum timing to control the various pests. This information can be combined with scouting information from individual orchards and used in making pest management decisions.

Recently mating disruption, another pheromone-based tool, has emerged as a useful method in insect management. Mating disruption by pheromones takes place when enough artificial sources of pheromone are placed in an area that the probability of a female being found by a male, mating, and laying viable eggs is reduced below the point where economically significant damage occurs. Mating disruption pheromone systems are available for the codling moth, Oriental fruit moth, peachtree borer and lesser peachtree borer as well as for some leafroller species. These are used extensively in the western states and a number of growers are using them in the eastern seaboard.

Large-scale mating disruption implementation trials have yielded significant reductions in pesticide use while keeping crop damage levels acceptably low. Because of difficulties in managing high populations of pests, mating disruption programs should not be viewed as stand-alone strategies, but rather as one tactic within the toolbox of pest management options.

The advantages of pheromone-based pest management systems include the following:

- Negligible health risks to applicator and consumer.
- Virtually no detectable residues for some types of dispensing systems.
- No accumulation in groundwater or wildlife.
- Reduced worker reentry in orchards after application and shorter preharvest intervals.
- Strong tool for managing insecticide resistance to other pesticides and no documented cases of resistance to the pheromone itself.
- Highly selective to the pest species being targeted for disruption without causing secondary pest outbreaks due to the elimination of biological control agents. This selectivity creates opportunities for the biological control of other pest species. Nontarget effects are generally not seen within or outside of the treated orchard.

- Improved control of the targeted pest if overlaid onto the standard insecticide program.

The disadvantages of pheromone-based pest management include the following:

- The high degree of selectivity can also be a disadvantage when other pests are able to move into orchards because insecticide targeted for the primary pest is eliminated and often unrealized collateral control of these other pests is released. For example, in apple, disruption of codling moth often releases leafrollers from pesticide control and in peaches; disruption of the Oriental fruit moth has led to an increase of stink bug injury for the same reasons.
- High development and production costs that often make these products significantly more expensive than the synthetic pesticides they may be replacing.
- Requirements for specialized application techniques or equipment with some types of pheromone products and possible increases in labor costs.
- The need to supplement expensive pheromone programs in high pest pressure situations with other pesticides for the same target pest.
- Effectiveness is often directly related to the size of the orchards being disrupted, and may be ineffective in orchards fewer than 5 to 10 acres in size. Effectiveness may be reduced along borders with other orchards/crops that are not being disrupted as well.
- Monitoring the target pest in a disrupted orchard can be a problem because the pheromones used to disrupt mating will prevent moths from locating pheromone traps. The use of high dose lures that still attract some moths even under mating disruption is useful for tracking the flights of pests like codling moth and to assess effectiveness of the MD program. Other moths like Oriental fruit moth do not exhibit this response to high dose lures and other means for assessing effectiveness are needed.
- Treatment thresholds have been developed using these high dose lures, but in most cases are dependent on levels of injury from previous seasons or on the trap catches of pest generations previous to disruption.

Special considerations are necessary for type of mating disruption product, rate, and application method being used. Borders of disrupted blocks are often at higher risk because of pest mating occurring outside the disrupted area and therefore efficacy increased with the size of the block treated. Peach and apple orchards adjacent to each other benefit from disruption in both crops for pests like the Oriental fruit moth. The residual activities of many of these products vary greatly. Below are some of the type of pheromones and special considerations in use.

Sprayable pheromones. Microencapsulated pheromones are enclosed in a polymer capsule that controls the pheromone release rate. These capsules are small enough and durable enough to be applied in water through normal airblast sprays in the same manner as conventional pesticides. This makes them very attractive to use by many fruit growers. Residual activity is generally up to 4 to 6 weeks which gives them some flexibility in pest management programs but also means they may need to be reapplied several times in a season for a target pest. Residual

activity may be reduced by rainfall soon after application and a sticker type spray adjuvant is often recommended. Currently, the only available effective material is for the control of Oriental fruit moth (Check-Mate OFM-F). Several formulations for codling moth and several species of leafrollers and wood-boring insects have been tested and even sold commercially, but have not given reliable control.

Hand-applied dispensers. Include systems with an impermeable reservoir fitted with an impermeable membrane for regulating pheromone release. Pheromone impregnated polymer spirals, ropes, dispensers, or tubes are most commonly used products currently. Wires, clips, or circular twin tubes allow these dispensers to be twist-tied, clipped, or draped directly onto the plant. The larger reservoirs of these products allows for longer residual activity ranging from 60 to 140 days. This may allow early season applications to suppress mating for most or all of the growing season depending on the type of dispenser and pest species. Application rates vary from one to several dispensers per tree (5 to 400 dispensers per acre) and can be labor intensive. Costs for these products tend to be significantly higher than the chemical control programs they are replacing, especially in high pest pressure situations where supplemental insecticides would be needed for acceptable control.

Hand-applied dispensers can be used to either control a single or multiple species of pests. The examples of single-species hand-applied dispensers for the control of Oriental fruit moth include Isomate M-100, Isomate Rosso, CheckMate OFM, Cidetrak OFM, NoMate OFM, Disrupt OFM Mats, and Disrupt OFM. Codling moth only control can be achieved by the use of Checkmate CM, Cidetrak CM or NoMate CM. Available hand-applied mating disruption products with a dual action against codling moth and Oriental fruit moth include Isomate CM/OFM TT and Checkmate CM-OFM Duel.

Other methods. Many other methods of mating disruption are being developed or tested in the eastern fruit regions, but most of them have not been proved commercially yet. These include pheromone impregnated flakes (Disrupt Micro Flakes OFM and Disrupt Micro Flakes CM) applied aerially or with specialized ground equipment; Specialized Pheromone & Lure Application Technology “SPLAT”; “attract and kill” methods of applying droplets of pheromone to foliage by hand (Last Call OFM, Last Call CM) that also contain pyrethroids to kill attracted males; and high emission dispensers such aerosol “puffers” (e.g., CheckMate Puffer CM and CheckMate Puffer OFM) or polymer bags loaded with large doses of pheromone. Some of these products are already available commercially, but more practical experience is needed to recommend some of those products to fruit producers.

MANAGEMENT OF CODLING MOTH WITH A CM GRANULOVIRUS

Many apple growers in Pennsylvania continue to do battle with the internal fruit feeding pest complex, the codling moth (CM) *Cydia pomonella*, and the Oriental fruit moth (OFM) *Grapholita molesta*. Last year (2006) was the first time since 1998 that CM, rather than OFM, was responsible for the majority of rejected loads of fruit destined for Pennsylvania processors from eastern U.S. growers. Most growers continue to rely on insecticides as their principal control tool for this pest complex, but more and more growers are also adding sex pheromone mating disruption to their management toolbox. Despite the loss of some valuable insecticides due to the Food Quality Protection Act (FQPA) and the development of insecticide resistance to a number of other remaining products, the toolbox for the control of the internal fruit-feeding complex continues to expand each year. Among the many new tools available to control CM is a naturally occurring virus that was identified back in 1964 in Mexico on infected CM larvae. Because of its high selectivity toward this pest, it is called the codling moth granulovirus (CpGV). It does show some activity to a couple of closely related species (e.g., OFM), but it is noninfectious toward beneficial insects, fish, wildlife, livestock, and humans.

Mode of action. Each CpGV particle is naturally microencapsulated within a protein occlusion body (OB) that protects it to some degree from degradation. These viral OBs are extremely small, 400 by 200 nanometers (i.e., 4,000 OBs placed end to end are approximately 1/16 inch). Depending on the product, a single ounce of the aqueous suspension concentrate can contain more than one to three trillion OBs. In order for the virus to be effective, the tiny particles must be ingested by the larva—there is no contact activity with CpGV. It only takes a couple of these OBs to cause death in a young larva. Once the larva ingests the virus, the OBs are dissolved in the alkaline gut of the larva, rapidly releasing the viral particles. The virus rapidly penetrates the gut lining, causing the virus to replicate numerous copies of itself, which then rapidly spread to other organs within the larva. This multiplication causes the larva to stop feeding within a few days, becoming sluggish and discolored as the virus moves throughout the body of the insect. Upon death, the larvae “melts,” spreading billions of the viral OBs that can be ingested by other CM larvae. Each OB is capable of causing a new infection within other newly hatched larvae.

Products. In Pennsylvania, there are two products that are currently available for use by fruit growers, Cyd-X (Advan LLC, formerly Certis USA) and Carpovirusine (Arysta LifeSciences, Inc.). The label use rate for Cyd-X is 1 to 6 fluid ounces per acre, and the label rate for Carpovirusine is 6.8 to 13.5 fluid ounces per acre. Both products can be used right up to the day of harvest and they both have a 4-hour reentry window. The products should be refrigerated until use because warm temperatures cause the degradation of the OBs. Also, these products are certified for use in organic orchards.

We have been researching both products at the Fruit Research and Extension Center during the last few years and have achieved much success in substantially reducing CM populations,

especially where CpGV was integrated with some form of sex pheromone mating disruption for CM. There are a number of opportunities for using CpGV in a CM management program. Before using a CpGV product there are a number of important points to understand: (1) the virus must be ingested by the larva, thus timing and coverage are extremely critical; (2) the virus breaks down rapidly in an orchard environment due to both UV rays from the sun and rainfall, thus spray intervals should not be stretched for more than 7 to 9 days; and (3) the feeding larva causes some injury to the fruit, commonly referred to as a “sting”—injury less than 1 to 2 mm in depth—before the virus eventually kills the larva.

Timing. Since CpGV is most active against young larvae and these larvae usually penetrate the fruit within 24 hours of hatching from the egg, it is very important to have the virus present when egg hatch begins (approximately 230 to 250 degree days [DD] following biofix—first sustained adult capture in a sex pheromone trap). If CpGV is intended as the primary control tactic for CM, then the first application should be timed to coincide with the beginning of egg hatch (Figure 3-2A). Depending on the length of the egg hatch period, normally a total of three to five applications each spaced about 7 to 9 days apart will be necessary to cover this time frame. Recently, in some apple orchards

in Pennsylvania, we have observed the egg hatch period for CM to extend over a longer period of time than what is normally predicted by the CM developmental model. Under these conditions, it may be prudent to apply an insecticide with ovicidal activity (e.g., against the eggs, Esteem, Intrepid, or Rimon) at approximately 75 to 150 DD, then start the CpGV applications at about 300 to 350 DD, and repeat the applications every 7 to 9 days or approximately every 125 to 150 DD following this initial application (Figure 3-2B). Since the virus rapidly breaks down in the orchard environment, it is our experience that frequent applications of a lower rate are better than high rates applied at longer spray intervals.

As stated above, the CpGV must replicate itself within the larva in order to be effective, thus allowing the larva to continue to feed for a few days and causing some shallow feeding damage (“stings”) to a fruit. If growers are trying to decide when to use a CpGV product, they may want to restrict their use of a CpGV product to the first generation. If stings or even some deep entries do occur in the small fruits during June from the first-generation larvae, these fruit often fall from the tree or can be thinned off. In addition, at this time of the season, the fruit on the tree are still small and canopy volume is still not complete, thus allowing more thorough coverage of the fruit.

CpGV products are compatible with most fungicides and in-

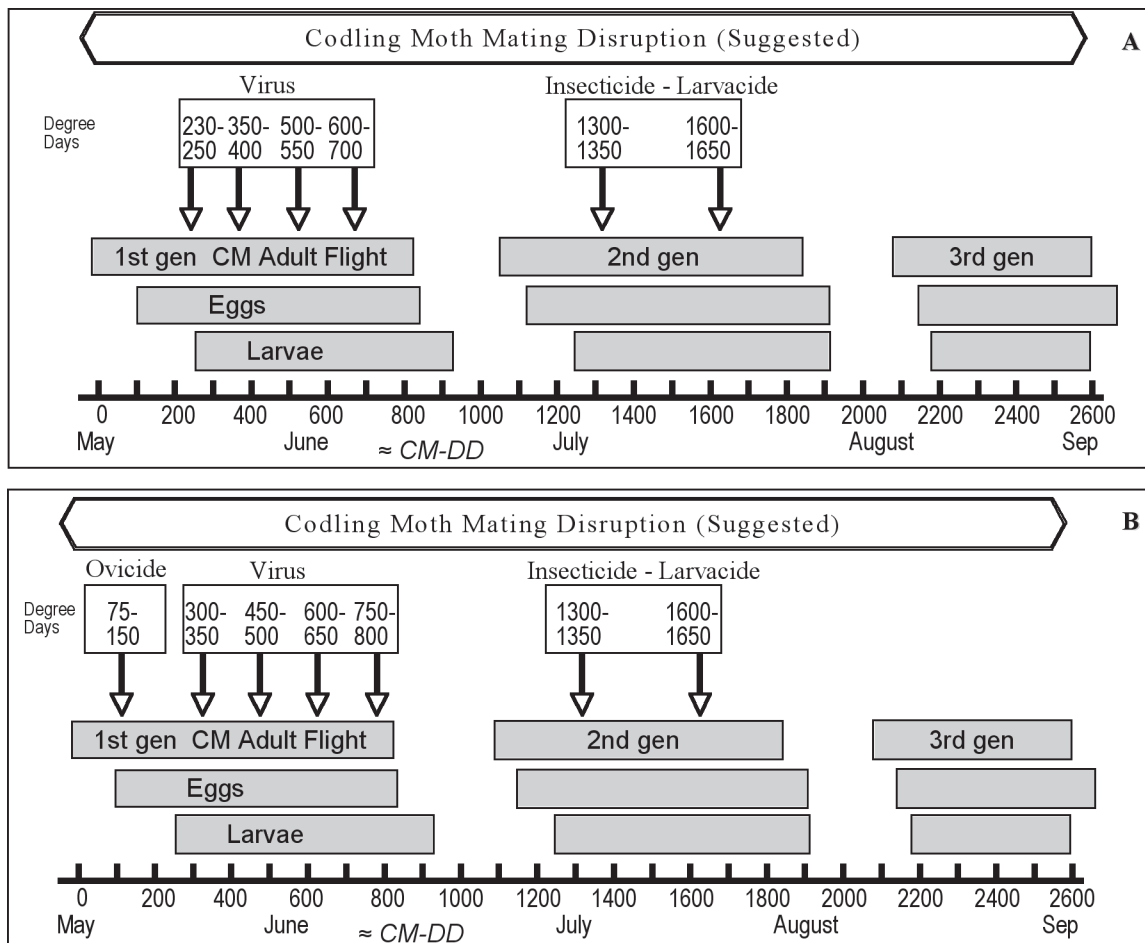

Figure 3-2. Various scenarios for applying a CpGV product for codling moth control. (A) timing when using a CpGV product and CM mating disruption. (B) timing of CpGV applications when using an ovicidal insecticide to begin control of first-brood CM, followed by a CpGV product.

secticides sprayed on apples. However, since CpGV is sensitive to high alkaline conditions, it should not be mixed with copper fungicides or lime sulfur. In addition, it is recommended to use a buffer to neutralize the spray mix if the pH is above 9 or below 5. Also, Dr. Larry Gut, entomologist at Michigan State University, has cautioned Michigan growers to avoid tank mixing CpGV with the neo-nicotinoid insecticides, Assail and Calypso, since these compounds have some anti-feeding activity which may interfere with the larva ingesting the virus.

Since UV light can rapidly break down the virus particles, it is also recommended that growers avoid applying the virus during periods of intense sunlight conditions. Also, if rain is forecast in the immediate future, try to wait until after the rain period to make the application.

Many growers in Pennsylvania commonly make their pesticide applications using the alternate row middle (ARM) method of spraying. We have used CpGV successfully with ARM sprays, but the studies have always been conducted with sex pheromone mating disruption for CM as a basic component of the program. Thus, here are recommendations for applying CpGV using the ARM approach:

- Since the virus must be consumed, thorough coverage is critical. Thus, ARM sprays must provide some coverage on the unsprayed side of the trees.
- Depending on the size of the tree, water volumes of at least 50 (trees 6 to 10 feet in height) to 100 GPA (trees larger than 10 feet in height) should be used.
- Dependent on pest pressure and weather conditions, ARM intervals should not stretch beyond 5 to 7 days between sprays.
- This method of applying CpGV should only be used in conjunction with some form of CM mating disruption.

Recommended Use Options for CpGV Products within Pennsylvania Apple Orchards

- Make the first application at the beginning of egg hatch (i.e., approximately 230 to 250 DD after biofix) (Figure 3-2A).

~OR~

- Use an ovicidal insecticide at approximately 75 to 150 DD, then begin virus applications at roughly 300 to 350 DD (Figure 3-2B).

~AND~

- Repeat applications every 7 or 9 days or roughly every 125 to 150 DD.
- Use a higher rate of CpGV for the first application.
- Repeat applications at lower rates for subsequent applications.
- Apply three to five applications for the first brood depending on the length of the adult flight and egg hatch period.
- Use primarily for first-brood CM control.
- For more effective control, combine with CM mating disruption, especially where CM populations are high and/or fruit injury from CM was present last season.

RESISTANCE MANAGEMENT APPROACH FOR NEW INSECTICIDES IN TREE FRUITS

Fruit growers throughout Pennsylvania now have at their disposal some highly effective and selective chemical tools to assist them in their battle against a number of the major arthropod pests of tree fruits, especially the codling moth (CM), oriental fruit moth (OFM), and the leafroller complex, which includes the tufted apple bud moth (TABM) and obliquebanded leafroller (OBLR). Both CM and OFM have caused serious problems for many growers over the past 10–12 years, resulting in the rejections of many loads of fruit destined for both the fresh and processing markets. The leafrollers have been serious pests since the early 1970s. All four of these pests have developed varying levels of resistance to a number of insecticidal chemistries over the years, including the organophosphates, carbamates, and pyrethroids. With the introduction of these new chemical tools for pest management, fruit growers need to adopt an approach to prevent this group of pests from developing resistance quickly to these new products. The following list contains the trade names and registrant for each of these new chemical tools:

- Altacor (DuPont)
- Belt (Bayer CropSciences)
- Delegate (Dow AgroSciences)
- Turismo (Nichino America)
- Voliam Flexi (Syngenta Crop Protection)
- Voliam Xpress (Syngenta Crop Protection)

Refer to the “Fungicides, Herbicides, Insecticides, Nematicides, and Plant Growth Regulators” section in Part III: Chemical Management and Table 3-7 for a further description of their mode of action, a list of registered uses and activity against various pests.

Use of the New Chemical Tools in a Resistance Management Approach

How should growers use these new products within the same season? First, it is important to understand which chemicals of this group have similar modes of action. According to the IRAC (Insecticide Resistance Action Committee) mode of action classification (see table in Part I), Altacor, Belt, Turismo, Voliam Flexi, and Voliam Xpress have a similar mode of action (i.e., ryanodine receptor modulators), thus they belong to Group 28. Delegate has a totally different mode of action (i.e., nicotinic acetylcholine receptor allosteric activators), thus it belongs to Group 5 (see Table 3-7).

Second, all of these products are highly active against CM, OFM, and the two major leafrollers, TABM and OBLR. Since five of the products have a similar mode of activity (i.e., they are chemically related) and we want to delay the onset of resistance to either group for many years, we highly suggest that they be used only against a specific generation of a pest(s) and that the grower should rotate to other compound(s) or to other chemical classes (e.g., Group 1—organophosphates and carbamates, Group 4—Nicotinic acetylcholine receptor agonists [Assail, Calypso, etc.]) of compounds to control the next generation of the targeted pest(s). For example, if a grower decides to use Delegate (Group 5) during the first generation of CM flight and egg hatch, then the grower should rotate to products in Group 28

or some other nonrelated group for the second-generation flight of CM. The same approach applies to OFM and the leafrollers.

Final Thoughts

Below are our final thoughts on how to best use these new products as part of your pest management program for 2010 and beyond. All of the products listed above are excellent and highly effective insecticides against CM, OFM, and leafrollers. Some of these products have activity against other pests as well. In order for these chemicals to be used most effectively against this group of pests, it is extremely important that growers achieve thorough coverage to get the most activity from these products since the pests must ingest the products to be effective. If thorough coverage is not achieved, the desired level of control will not be attained. Many of these products are fairly residual in their activity, but growers should not stretch the period between sprays too long. And, finally, if your pest management plans call for using both of these chemical groups during 2010 and beyond, use one chemical group for a single generation of a pest and then rotate to the other chemical group or some other unrelated group for the next generation. Do **not** use any of these products for consecutive generations of a targeted pest within the same growing season.

We highly encourage growers to use these products carefully and sparingly so we do not lose them to pest resistance in the future.

NEMATODE MANAGEMENT STRATEGIES

Nematode problems in orchards are difficult to control and therefore good nematode management should focus on preventive measures. In general, nematode control is accomplished with nematicides and/or cultural practices. The benefits of each strategy are outlined below.

Benefits of Nematicides and Soil Fumigants

Treating orchard soil before planting trees will reduce replant problems, control parasitic nematodes, and reduce the incidence of soilborne virus diseases, such as stem pitting in stone fruit and union necrosis in apple. Broad-spectrum fumigants may be used for all three purposes and are effective against most replant disorders. Fumigant and contact-type nematicides effectively control nematodes, including species that transmit soilborne viruses. See Table 4-3.

Decisions regarding chemical control options should be based on the history of the site and the results of a nematode diagnostic test. Options include treating the entire site (broadcast treatment), treating strips along the proposed tree rows, or treating only individual trees. Broadcast treatments effectively limit contamination and reinvasion by nematodes from untreated areas. If parasitic-nematodes are the only problem, a strip fumigation may be sufficient. Postplant treatment with nonfumigant-type materials may be desirable in areas that have received a preplant treatment with a fumigant-type material.

Soil fumigants should be applied during the late summer or fall and trees planted the following spring. Spring application is an option but poses a risk of phytotoxicity if not timed well. Poor decomposition of root debris and previous cover crops will

reduce the effectiveness of the fumigant. Adequate soil aeration is essential. Nonfumigant nematicides work well if applied in the spring when soil moisture and rainfall are plentiful. Fall application is an option if conditions are good.

Management of soilborne virus diseases in tree fruits requires control of the nematode vectors and the weeds that serve as virus reservoirs (see Table 2-12). Careful attention should be given to eliminating such weeds from tree rows as well as the groundcover in row middles. Consult Table 4-2 for recommended herbicides

Dagger Nematode Control with Green Manure

In recent years some fumigants have been identified as a threat to public health by groundwater contamination or ozone depletion. As a result, many of the most effective soil fumigants are no longer available because they have either been banned for environmental protection reasons or withdrawn from the market due to the high cost of meeting new safety regulations and requirements. Products that remain on the market have become increasingly expensive; thus, there is a need to develop safe and environmentally sound alternatives.

Over the past decade or more, many labs have evaluated a variety of novel rotation and green manure crops for the treatment of replant sites. This work showed that some plants naturally reduce populations of plant-parasitic nematodes and improve soil structure. Based on these results we recommend the use of selected rapeseed varieties to help control dagger nematodes.

The use of a crop rotation for nematode control can provide several benefits. Rotation crops can reduce weed problems, increase soil organic matter, improve nutrient availability, and help control erosion. In addition, decomposition of rotation crop roots can improve soil drainage and aeration by creating soil channels. This improves tree growth and promotes nutrient recycling.

Rapeseed provides all these benefits to some extent. Best results are obtained when rapeseed is incorporated into the soil while still green (aka green manure), and experiments showed that decomposing rapeseed released nematicidal compounds. The release of naturally occurring nematicidal compounds by plants is referred to as “biofumigation.” Experimental results have shown that two years of crop rotation is most desirable, but even one year is beneficial especially if two rotations including at least one crop of rapeseed can be incorporated.

The following timetable is suggested for producing two rotations of rapeseed within one year:

- Prepare seedbed and plant rapeseed by late April or early May. (Plant only recommended winter rapeseed varieties.)
- Incorporate (i.e., turn under) green rapeseed by early September. Prepare seedbed and plant second crop by mid-September.
- The second crop should be turned under in late spring after soil temperatures reach 45°F or higher.
- Ideal conditions for incorporating the cover crop are similar to those required for obtaining the maximum benefit from fumigation (e.g., the soil temperature should be above 45°F and moist).
- Alternatively, planting dates may be reversed so that the first planting is in the fall followed by a second crop planted in the spring. This would end the rotation sequence in fall of the following year.

Table 3-7. Comparison of insecticide modes of action based on Insecticide Resistance Action Committee (IRAC) classification (issued August 2008).

Mode of action	Chemical subgroup	Active ingredients	Examples of trade name(s)
1. Acetylcholinesterase inhibitors	1A. Carbamates	carbaryl formetanate methomyl oxamyl	Carbaryl, Sevin Carzol Lannate Vydate
	1B. Organophosphates	azinphos-methyl chlorpyrifos diazinon dimethoate methidathion phosmet	Azinphos-methyl, Guthion Chlorpyrifos, Lorsban, Nufos, Warhawk, Yuma Diazinon Dimate, Dimethoate Supracide Imidan
2. GABA-gated chloride channel antagonists	2A. Cycloidiene organochlorines	endosulfan	Endosulfan, Thionex
3. Sodium channel modulators	3A. Pyrethroids, Pyrethrins	bifenthrin cyfluthrin cyhalothrin deltamethrin esfenvalerate fenpropathrin permethrin zeta-cypermethrin	Brigade, Discipline, Fanfare, Tundra Baythroid, Leverage, Tombstone Proaxis, Taiga Z, Warrior, Voliam Xpress Battalion, Decis, Delta Gold Asana XL, Adjourn Danitol Ambush, Arctic, Permethrin, Pounce Mustang Max
4. Nicotinic acetylcholine receptor agonists	4A. Neonicotinoids	acetamiprid clothianidin dinotefuran imidacloprid thiacloprid hhiamethoxam	Assail Belay Venom, Scorpion Admire Pro, Couraze, Imida, Leverage, Pasada, Prey, Provado, Sherpa Calypso Actara, Voliam Flexi
5. Nicotinic acetylcholine receptor allosteric activators	5. Spinosyns	spinetoram spinosad	Delegate Entrust, Spintor
6. Chloride channel activators	6. Avermectins, Milbemycins	abamectin emamectin benzoate	Agri-Mek, Abacus, Abba Proclaim
7. Juvenile hormone mimics	7C. Pyriproxyfen	pyriproxyfen	Esteem
9. Selective homopteran feeding blockers	9C. Flonicamid	flonicamid	Beleaf
10. Mite growth inhibitors	10A. Clofentezine, Hexythiazox	clofentezine hexythiazox	Apollo Savey, Onager
	10B. Etoxazole	etoxazole	Zeal
11. Microbial disruptors of insect midgut membranes	11. <i>Bacillus thuringiensis</i> and the insecticidal proteins it produce	<i>Bacillus thuringiensis</i> subsp. aizawai <i>Bacillus thuringiensis</i> subsp. kurstaki	Agree Biobit, Deliver, Dipel
15. Inhibitors of chitin biosynthesis, type 0, Lep.	15. Benzoylureas	diflubenzuron novaluron	Dimilin Rimon
16. Inhibitors of chitin biosynthesis, type 1, Hom.	16. Buprofezin	buprofezin	Centaur, Turismo
18. Ecdysone receptor agonists	18. Diacylhydrazines	methoxyfenozide tebufenozide	Intrepid Confirm
20. Mitochondrial complex III electron transport inhibitors (Coupling site II)	20B. Acequinocyl	acequinocyl	Kanemite
21. Mitochondrial complex I electron transport inhibitors	21A. METI acaricides	fenpyroximate yyridaben	FujiMite, Portal Nexter
22. Voltage-dependent sodium channel blockers	22A. Indoxacarb	indoxacarb	Avaunt
23. Inhibitors of acetyl CoA carboxylase	23. Tetrone and tetramic acid derivatives	spirodiclofen spirotetramat	Envidor Movento
28. Ryanodine receptor modulators	24. Diamides	chlordantraniliprole flubendiamide	Altacor, Voliam Flexi, Voliam Xpress Belt, Turismo
UN. Compounds of unknown or uncertain mode of action	UN. Azadirachtin	azadirachtin	Aza-Direct, Azatin, Neemix
	Bifenazate	bifenazate	Acramite
	Dicofol	dicofol	Dicofol, Kelthane

Source: www.irac-online.org.

Table completed in August 2011. Modified to include insecticides commonly used by fruit growers.

Which rapeseed varieties to plant?

Some rapeseed varieties are more effective at suppressing nematode populations than others, and some varieties will not overwinter or bloom too early in summer to be useful. The winter varieties Dwarf Essex and Humus work well for both spring and fall planting dates. When planted in the spring, these varieties do not bloom but instead grow vigorously and help crowd out weeds.

Some seed companies have started to develop their own line of biofumigant rotation crop (usually a rapeseed or mustard variety) selected for use in different regions and sold under different trade names. A search on the web using keywords such as biofumigation, nematicidal rapeseed, or nematicidal mustard may help in finding a local source of seed.

Tips:

- Rapeseed (and mustard) requires a firm, smooth seedbed that is free of weeds, heavy residue, and large clods.
- Seed may be drilled or broadcast. Avoid planting too deep! A seeding depth of $\frac{3}{8}$ -inch is good or if broadcast, a cultipacker may be used.
- A preplant herbicide treatment such as Treflan at 1.5 pt/A can help prevent noxious weeds from becoming established.
- A seeding rate of 7–8 pounds per acre works well.
- Rapeseed is sensitive to broadleaf herbicide carryover.
- Fall-planted rapeseed should have 8–10 true leaves and a 5- to 6-inch tap root with a $\frac{3}{8}$ -inch diameter root neck before the ground freezes.
- Sulfur is necessary for rapeseed to produce nematicidal compounds. Although most orchard soil is not deficient in sulfur, a soil test to test the availability of this element may be beneficial.

Biorational Nematode Control

The efficacy of cultural practices such as crop rotation and green manure to control nematodes varies with the nematode species being controlled because of differences in biology, host range, and life cycle. What works for one nematode may not work for others. In some cases, a rotation crop that suppresses one plant-parasitic nematode may actually stimulate an increase in another. Therefore, it is important to know which nematodes are present when developing a nematode management plan. While rapeseed green manure has been shown to effectively suppress dagger nematodes, this practice is not very effective against the lesion nematode and rapeseed green manure is not recommended if there is a potential lesion nematode problem.

The lesion nematode has a broad host range and is notoriously difficult to control with rotation crops. Several plants capable of suppressing lesion nematode populations have been identified but have not proven practical on a commercial scale because of cost or because they are very difficult to establish. Marigold and black-eyed-Susan are two examples. Forage Pearl Millet looks promising as an effective lesion nematode suppressive rotation crop; however, more research is needed before commercial recommendations can be made.

This part groups many of the large, frequently used chemical management tables into an easily located position in the guide. Chemicals covered include herbicides, nematicides, insecticides/miticides, and fungicides.

HERBICIDE MANAGEMENT

Tables 4-1 through 4-2 deal with herbicides recommended for use in Pennsylvania orchards, along with their restrictions, application times and rates, and efficacy.

NEMATICIDE MANAGEMENT

Table 4-3 outlines the use of soil fumigants and nematicides.

INSECTICIDE AND FUNGICIDE MANAGEMENT

Table 4-4 presents rankings of toxicity for common pesticides to natural enemies of mites and aphids. This information is used to allow pesticide-use decisions that facilitate biological control by existing natural enemies.

Tables 4-5 through 4-14 are presented with the ideal timing for applying pesticides and the efficacy of available products for various pest species. The timing and efficacy tables for the crop and type of pest (either insects and mites or diseases) are paired to show the ideal timing together with the efficacious products. Tables are presented for apples (insects/mites and disease), pears (insects/mites), and stone fruits (insects/mites and disease).

REENTRY AND PREHARVEST INTERVALS

During the last month before harvest, it is possible to deposit excessive pesticide residues on fruit if time limitations before last spray and harvest are not followed closely. Short residual or high-tolerance materials should be used in preharvest sprays. A spray residue may be within legal limitations and still be highly undesirable for fresh consumption or export because of visible residue. In general, avoid highly colored chemicals or mixtures that leave a heavy, spotted residue in the late cover sprays. The time limitations for pesticides between final spray and harvest are summarized in Table 4-15. *Be certain about the control of late season insects and diseases before ending spray programs. Sprays on apples may be needed until mid-September for tufted apple bud moth in many areas and for sooty blotch, flyspeck, and scab control on varieties ripening after McIntosh.*

PESTICIDE COMPATIBILITY AND STORAGE ISSUES

Table 4-16 presents information on storage.

Table 4-1. Tree fruit herbicide registration by crop (continued).

Crop	Aim	Alton	Casoron	Chateau	clethodim	duron	duron + Sinbar	Fusilade	Galigan Stapsot	Gallery	GreenMatch	glyphosate ^b	Kerb	oryzalin	oxyfluorfen	parquat	Poast	Pendimethalin, Prowl	Prowl H ₂ O	Rage	Rely	rimsulfuron	Sanda	Scythe	Simazine	Sinbar	Snapshot	Solicam	Stinger	Treevix	trifluralin	Venue	
																																	Days-to-harvest limitation and safe worker reentry interval (RE)
Apples	14	3	14	30	60	30	365	365	dormant or post-harvest only	365	fruit set or 7	14	1-Jan	NL	dormant or post-harvest only	NL	14	365	60	3	14	7	14	14	NL	14 or 150	60	365	60	30	1	60	0
Apricot	40	3	14	60	60	365	14	365	dormant or post-harvest only	365	fruit set or 7	17	1-Jan	NL	dormant or post-harvest only	28	25	365	60	dormant or 17	14	14	NL	NL	NL	365	60	30	60	0			
Cherry, tart	40	3	14	30	60	365	14	365	dormant or post-harvest only	365	fruit set or 7	17	1-Jan	NL	dormant or post-harvest only	28	25	365	60	dormant or 17	14	14	NL	14	NL	365	60	30	60	0			
Cherry, swt	40	3	14	30	60	365	14	365	dormant or post-harvest only	365	fruit set or 7	17	1-Jan	NL	dormant or post-harvest only	28	25	365	60	dormant or 17	14	14	NL	14	NL	365	60	30	60	0			
Nectarine	40	3	14	60	60	365	14	365	dormant or post-harvest only	365	fruit set or 7	17	1-Jan	NL	dormant or post-harvest only	28	25	365	60	dormant or 17	14	14	NL	14	NL	365	60	30	60	0			
Peach	40	3	14	60	365	20-90	20-90	14	dormant or post-harvest only	365	fruit set or 7	17	1-Jan	NL	dormant or post-harvest only	14	25	365	60	dormant or 17	14	14	NL	14	NL	365	60	30	60	0			
Pear	14	3	14	30	60	365	NL	365	dormant or post-harvest only	365	fruit set or 7	14	1-Jan	NL	dormant or post-harvest only	NL	14	365	60	3	7	7	NL	14	NL	365	60	1	60	0			
Plum	40	3	14	60	60	365	14	365	dormant or post-harvest only	365	fruit set or 7	17	1-Jan	NL	dormant or post-harvest only	28	365	365	60	dormant or 17	14	14	NL	14	NL	365	60	30	60	0			
Prune	40	3	14	60	60	365	14	365	dormant or post-harvest only	365	fruit set or 7	17	1-Jan	NL	dormant or post-harvest only	28	365	365	60	dormant or 17	14	14	NL	14	NL	365	60	30	60	0			
Quince		3							dormant or post-harvest only		14				dormant or post-harvest only		14	365			7		NL							0			
REI (hrs)	48	12	12	12	24	12	12	12	24	12	4	4-24	24	24	24	12	12	24	24	12	12	4	12	12	12	12	12	12	12	12	12		

NL = none listed on the label; however, herbicides should not be applied when fruit is on the ground.
 a. Planting = can be used in year of planting. Other values indicate earliest time after planting that material can be used. This material must be applied to these stone fruits in PA only under the tree row using a wick applicator.
 b. This material must be applied to these stone fruits in Pennsylvania only under the tree row using a wick applicator.
 c. Days-to-harvest limitation varies by manufacturer. Be sure to read the label of the product you are using.

Table 4-2. Herbicides labeled for use in orchards.

Common name	Trade name(s)	Crops	Amount/A
For orchards the year of planting (do not apply until after the ground has settled and there are no visible cracks in the soil):			
carfentrazone-ethyl	Aim EC, EW	AP, AT, CH, NE, PE, PL, PR	0.5–2.0 fl oz
carfentrazone-ethyl + glyphosate	Rage	AP, AT, CH, NE, PE, PL, PR	22–99 fl oz
clethodim	Prism	AP, AT, CH, NE, PE, PL	13–17 fl oz
	Select Max	AP, AT, CH, NE, PE, PL	9–32 fl oz
	Arrow 2EC	AP, AT, CH, NE, PE, PL	6–8 fl oz
	Clethodim		
dichlobenil	Casoron 4G	AP, CH, PR	100–150 lbs
d-limonene	GreenMatch	AP, AT, CH, NE, PE, PL, PR	1:6 ratio v/v
diquate dibromide	Reglone	AP, CH, NE, PE, PL, PR	1.5–2.0 pt
fluzifop-butyl	Fusilade DX	AP, AT, CH, NE, PE, PL, PR	16–24 fl oz
norflurazon	Solicam DF	AP, NE ^a , PE ^a	2.5–5.0 lbs
oryzalin	Surflan AS	AP, AT, CH, NE, PE, PL, PR, QU	2–6 qt
oxyfluorfen	Goal 2XL, Galigan 2E	AP, AT, CH, NE, PE, PL, PR, QU	2–8 pt
	GoalTender	AP, AT, CH, NE, PE, PL, PR, QU	1–4 pt
paraquat	Gramoxone Inteon	AP, AT, CH, NE, PE, PL, PR	2.5–4.0 pt
	Parazone 3SL, Firestorm	AP, AT, CH, NE, PE, PL, PR	1.7–2.7 pt
pendimethalin	Prowl 3.3EC, Pendimethalin	AP, AT, CH, NE, PE, PL, PR	2.4–4.8 qt
	Prowl H ₂ O	AP, AT, CH, NE, PE, PL, PR	2.0–4.2 qt
sethoxydim	Poast	AP, AT, CH, NE, PE, PL, PR, QU	0.5–2.5 pt
terbacil	Sinbar	AP, AT, CH, PE, PL, PR	0.5–1.0 lbs
trifluralin	Trifluralin 4EC, Treflan 4EC	AT, NE, PE, PL	1–2 pt
For orchards established at least one year (any of the previously listed materials may also be used):			
2,4-D	2,4-D Amine 4, Saber, Weedar 64	AP, AT, CH, NE, PE, PL, PR	1–3 pt
	Orchard Master		
	Unison	AP, CH, NE, PE, PL, PR	3–9 pt
	Weedestroy AM-40	AT, CH, NE, PE, PL,	3 pt
2,4-D + glyphosate	Recoil	AP, AT, CH, NE, PE, PL, PR	1–4 qt
dichlobenil	Casoron CS	AP, CH, PR	1.4–2.8 gal
diuron	Diuron 4L, Direx 4L	AP, PR	3 qt, 3.2 qt
	Diuron DF, Karmex DF, Diuron 80WDG, Diuron 80 DF, Karmex XP	AP, PR	4.0 lb or 2 + 2 lb
flumioxazin	Chateau	AP, AT, CH, NE, PE, PL, PR	6–12 oz/A
halosulfuron-methyl	Sandea	AP	0.5–1.0 oz
isoxaben	Gallery 75DF	AP, CH, NE, PE, PL, PR	0.66–1.33 lb
isoxaben + trifluralin	Snapshot 2.5TG	AP, AT, CH, NE, PE, PL, PR, QU	100–200 lbs
norflurazon	Solicam DF	AT, PR, PL	2.5–5.0 lbs
pelagornic acid	Scythe	AP, AT, CH, NE, PE, PL, PR, QU	3–10% solution
pronamide	Kerb 50W	AP, AT, CH, NE, PE, PL, PR	2.0–8.0 lbs
glufosinate	Rely 280	AP	48–82 oz
pyraflufen ethyl	Venue	AP, AT, CH, NE, PE, PL, PR, QU	0.7–4.0 fl oz
rimsulfuron	Matrix FNV, Pruvix, Solida	AP, AT, CH, NE, PE, PI, PR, QU	4.0 oz
saflufenacil	Treevix	AP, PR	1.0 oz
simazine	Princep 4L, Simazine 4L, Sim-Trol 4L	AP, sour CH, PR	2–4 qt
	Caliber 90, Simazine 90DF	AP, sour CH, PR	2.2–4.4 lbs
	Princep 4L, Simazine 4L	PE, PL, sweet CH	1.6–4 qt
	Caliber 90, Simazine 90DF	PE, PL, sweet CH	1.75–4.4 lbs
terbacil + diuron	Sinbar + Karmex	AP, PE	1–2 lbs + 1–2 lbs

(continued)

Table 4-2. Herbicides labeled for use in orchards (continued).

Common name	Trade name(s)	Crops	Amount/A
For orchards established at least two years (any of the previously listed materials may also be used):			
clopyralid	Stinger	AT, CH, NE, PE, PL	0.33–0.67 pt
diuron + terbacil	(Diuron 4L, Direx 4L) + Sinbar	AP, PE	(0.75–1.5 qt, 1.2–1.6 qt) + 1–2 lbs
diuron + terbacil	(Diuron DF, Karmex DF, Diuron 80DF, Diuron 80DF, Karmex XP) + Sinbar	AP, PE	1.0–2.0 + 1.0–2.0 lbs
glyphosate	Roundup, Touchdown	AP, PR, CH	Rate varies by formulation
	Rattler, Glyphomax + many other brands	AT, NE, PE, PL	33% solution in a wick applicator
norflurazon	Solicam DF	CH ^b	2.5–5.0 lbs
oxyfluorfen plus glyphosate	Galigan Slapshot	AP, AT, CH, PE, PL, PR, QU	4–6 pt
sulfosate	Touchdown 5	AP, AT, CH, NE, PE, PL, PR	0.6–2.4 pt
For orchards established at least three years (any of the previously listed materials may also be used):			
diuron	Direx 4L, Diuron 4L	PE	1.6–3.2 qt
	Diuron 80, Diuron DF, Diuron 80 DF, Karmex DF, Karmex XP	PE	2.0–2.75 lbs
	Diuron 80WDG	PE	2.0–5.0 lbs
terbacil	Sinbar	AP, PE	2.0–4.0 lbs
diuron plus	Diuron 4L	AP	1.5–2.0 pt
diuron + oryzalin	Diuron 4L + Surflan	AP	0.75–1.5 pt + 2–6 qt
indaziflam	Alion	AP, AT, CH, NE, PE, PL, PR	5.0–6.5 oz

Crop codes: AP = apples; AT = apricots; CH = cherries; NE = nectarines; PE = peaches; PR = pears; PL = plums; QU = quince

a. Do not apply until trees have been established at least 6 months in the orchard.

b. Do not apply sooner than 18 months after trees have been planted, and do not apply on sandy or loamy-sandy soils at any age.

Table 4-3. Soil fumigants and nematicides.

Product name	Active ingredient	Application method	Rate	Notes
Soil fumigants (preplant only)				
Vapam HL	Sodium methylthiocarbamate (anhydrous) (42%)	Till, irrigate or inject, and seal	37.5–75 gal/A	Soil temperature at the depth of application should be 40–90°F. Soil moisture should be 60–80% field capacity
Telone II	1-3 dichloropropene (97.5%)	Inject and seal	27–35 gal/A	Soil temperature at the depth of application should be 40–80°F. See label for determination of required soil moisture level.
Telone C-17	1-3 dichloropropene (81.2%), chloropicrin (16.5%)	Inject and seal	32–42 gal/A	Soil temperature at the depth of application should be 40–80°F. See label for determination of required soil moisture level.
Telone C-35	1-3 dichloropropene(63.4%), chloropicrin (34.7%)	Inject and seal	39–50 gal/A	Soil temperature at the depth of application should be 40–90°F. See label for determination of required soil moisture level.
Basamid G	dazomet (99%)	Incorporate (rotovate) and seal	220–450 lbs/A depending on soil and target nematode	Soil temperature at the depth of application between 43-90°F (54-69°F considered optimal). Soil must be moist.
Midas 98:2	idomethane (97.8%), chloropicrin (1.99%)	Inject and seal	6.3–9.3 gal/A	Stone fruit and grapes. Soil temperature above 55°F. Buffer zone required.
Midas 50:50	idomethane (49.9%), chloropicrin (49.75%)	Inject and seal	15.1–22 gal/A	Stone fruit and grapes. Soil temperature above 55°F. Buffer zone required.
Midas 33:67	idomethane (32.93%), chloropicrin (66.67%)	Inject and seal	23.8–34.4 gal/A	Stone fruit and grapes. Soil temperature above 55°F. Buffer zone required.
Nematicides (preplant or postplant)				
DiTera DF	fermentation products of <i>Myrothecium verrucaria</i> (90%)	Incorporate or irrigate	13–100 lb/A	Do not apply to foliage.
Vydate L	oxamyl (24%)	Incorporate or irrigate	2 gal/A	Nonbearing only (trees that will not bear for 12 months).

Note: It is a violation of federal law to use pesticides in a manner inconsistent with their labeling. Read and follow all label precautions and directions. Pesticides should be used only by individuals trained in their proper use.

The EPA Soil Fumigant Toolbox website at www.epa.gov/pesticides/reregistration/soil_fumigants is a good source of information on current fumigation regulations.

Table 4-4. Toxicity of pesticides to mite and aphid predators, at rates recommended in Part V.

Material	<i>Stethorus</i> adults	<i>Stethorus</i> larvae	<i>Typhlodromus</i> <i>pyri</i>	<i>Neoseiulus</i> <i>fallacis</i>	<i>Zetzellia</i> <i>mali</i>	<i>Aphidoletes</i>	Ladybugs	Minute pirate bugs	Lacewings	Fly and wasp parasitoids
Insecticides										
Actara	+++	+++	+	+	0	++	++	++	++	+++
Agri-Flex	+++	+++	++	+	0	++	++	++	++	+++
Aitacor	0	0	0	0	0	0	0	0	0	0
Asana XL	+++	+++	+++	+++	++	++	+++	++	+++	+++
Assail	++	++	+	0	0	++	++	++	++	+++
Avaunt	++	++	0	0	0	+	++	+	+	+++
azadirachtin	+	+	—	—	—	—	+	—	—	+
Azinphosmethyl	+	+	0	0	0	+	++	+	++	+++
Belay	+++	+++	+	+	0	++	++	++	++	+++
Beleaf	—	—	—	—	—	—	—	—	—	—
Belt	0	0	0	0	0	0	0	0	0	0
Bt	0	0	0	0	0	0	0	0	0	0
Calypso	++	++	0	0	0	+	++	++	++	+++
carbaryl	+++	+++	++	++	+	++	+++	++	++	+++
Centaur	++	++	+	+	+	—	—	—	—	—
codling moth granulosis virus	0	0	0	0	0	0	0	0	0	0
cyfluthrin	+++	+++	+++	+++	++	+++	+++	+++	+++	+++
Danitol	+++	+++	+++	+++	++	++	+++	++	+++	+++
Delegate	+	+	++	++	+	+	+	+	+	++
deltamethrin	+++	+++	+++	+++	++	++	+++	++	+++	+++
diazinon	+	+	+	+	+	+++	++	+	++	+++
Endigo	+++	+++	+++	+++	++	+++	+++	+++	+++	+++
endosulfan	++	++	+	+	+	++	++	+	++	+++
Esteem	++	+++	0	0	0	0	+++	+++	+++	+++
imidacloprid	++	++	+	+	0	+	++	++	++	++
Imidan	+	+	0	0	0	+	++	++	++	+++
Intrepid	0	0	0	0	0	0	0	0	0	0
Lannate	++	++	+++	+++	++	+++	+++	++	+++	+++
Leverage	+++	+++	+++	+++	—	—	+++	—	—	+++
Lorsban prebloom	+	+	+	0	0	0	+	0	0	++
malathion	+	+	0	0	0	+	++	+	+	++
Movento	+	+	0	0	0	+	+	+	+	—
Mustang Max	+++	+++	+++	+++	++	+++	+++	+++	+++	+++
Permethrin	+++	+++	+++	+++	++	+	++	++	++	+++
Proaxis	+++	+++	+++	+++	++	+++	+++	+++	+++	+++
Rimon	++	+++	0	0	0	—	+++	++	+++	+++
Sevin XLR	+++	+++	++	++	++	+++	++	++	++	+++
Surround	++	++	++	++	++	++	++	—	+	++
Tourismo	++	++	+	+	+	—	++	++	—	—
Voliam Flexi	++	++	+	0	0	++	++	++	++	+++
Voliam Xpress	+++	+++	+++	+++	++	+++	+++	+++	+++	+++
Warrior II	+++	+++	+++	+++	++	+++	+++	+++	+++	+++
Miticides										
Acramite	0	0	++	++	++	+	0	0	0	—
Agri-Mek	++	++	++	++	+	+	+	+	+	—
Apollo SC	0	0	+	+	+	0	0	0	0	—
Envidor	++	++	0	0	0	—	—	—	—	—
Kanemite	+	+	+	+	+	—	—	—	—	—
Nexter	++	++	+++	+++	++	++	++	++	++	—
Portal	++	++	+++	++	+	—	—	—	—	—
Savey	0	0	+	+	+	0	0	0	0	—
summer oil	+	+	++	++	+	+	+	+	+	—
Vendax	+	+	++	++	++	+	+	+	+	—
Vydate	++	++	+++	+++	+++	++	++	+++	+++	+++
Zeal	0	0	++	++	++	+	—	—	—	—
Fungicides										
Bayleton	+	+	+	+	—	—	—	—	—	—
captan	+	+	+	+	+	—	—	—	—	—
Flint	+	+	0	0	0	—	—	—	—	—
Inspire Super	+	+	0	0	0	—	—	—	—	—
lime sulfur	++	++	+++	+++	+++	—	—	—	—	—
mancozeb	+	+	++	++	+	—	—	—	—	—
Polyram	+	+	++	++	+	—	—	—	—	—
Pristine	+	+	0	0	0	—	—	—	—	—
Procure	+	+	0	0	0	—	—	—	—	—
Rally	+	+	0	0	0	—	—	—	—	—
Rubigan	0	0	0	0	0	—	—	—	—	—
Sovran	0	0	0	0	0	—	—	—	—	—
sulfur	++	++	++	++	+	—	—	—	—	—
Thiram	+	+	+	+	—	—	—	—	—	—
Topgard	+	+	0	0	0	—	—	—	—	—
Topsin M	+	+	+	+	++	—	—	—	—	—
Vanguard	0	0	0	0	0	—	—	—	—	—
Ziram	+	+	+	+	+	—	—	—	—	—

+ = slightly toxic, ++ = moderately toxic, +++ = highly toxic, — = no data available, 0 = nontoxic

For toxicity to honey bees, see Table 1-9.

Some information adapted from New York Agricultural Experiment Station data, Midwest Biological Control News, and Washington State University Tree Fruit and Extension Center.

Table 4-5. Apples: insecticide and miticide timing.

Time of spray	Pest																								
	AM	ARM	BMSB	CM	EAS	ERM	GA	GFW	LAW	OBL	OFM	PC	PLH	RAA	RBL	RLH	SB	SJS	STLM	TABM	TPB	TSM	WAA	WALH	
Dormant	—	—	—	—	—	—	+	—	—	—	—	—	—	++	—	—	—	—	—	—	—	+	—	—	—
1/2-inch green	—	—	—	—	—	+	+	++	—	—	+	—	—	++	+	—	—	—	—	—	—	+	—	—	—
Prepink	—	+	—	—	+	+	+	++	—	+	++	—	—	+	+	—	—	—	—	++	—	++	—	—	—
Bloom	—	—	+	—	+	—	—	—	—	—	—	—	—	—	—	—	—	—	—	—	—	—	—	—	—
Petal fall	—	+	+	+	++	++	+	++	+	++	++	++	—	+	++	—	—	—	—	++	—	++	—	—	++
First cover spray	—	++	+	++	—	+	++	—	++	+	+	+	+	+	++	—	—	—	—	+	+	+	—	—	+
Second cover spray	+	++	+	++	—	+	++	—	++	+	+	+	+	—	++	—	—	—	—	++	+	+	—	—	+
Third cover spray	++	++	++	++	—	+	++	—	++	+	+	+	+	—	++	—	—	—	—	++	+	+	—	—	+
Fourth cover spray	++	+	++	++	—	+	+	—	++	+	+	—	++	—	++	—	—	—	—	++	+	+	—	—	+
Fifth cover spray	++	+	++	++	—	+	+	—	++	+	+	—	+	—	++	—	—	—	—	++	+	+	—	—	++
Sixth cover spray	++	—	++	++	—	+	+	—	++	+	+	+	—	—	++	—	—	—	—	++	+	+	—	—	++
Seventh cover and late season sprays	++	—	++	++	—	+	+	—	++	+	+	—	—	—	+	—	—	—	—	++	+	+	—	—	+

++ = ideal timing of spray for insect control; + = presence of pest and possible control; — = control generally not needed

AM = apple maggot; ARM = apple rust mite; BMSB = brown marmorated stink bug; CM = codling moth; EAS = European apple sawfly; ERM = European red mite; GA = green apple aphid, spirea aphid; GFW = green fruitworm; LAW = lesser appleworm; OFM = Oriental fruit moth; OBL = obliquebanded leafroller; PC = plum curculio; PLH = potato leafhopper; RAA = rosy apple aphid; RBL = redbanded leafroller; RLH = rose leafhopper; SB = native stink bug; SJS = San Jose scale; STLM = spotted tentiform leafminer; TABM = tufted apple bud moth; TPB = tarnished spider mite; TSM = two-spotted spider mite; WAA = woolly apple aphid; WALH = white apple leafhopper

Table 4-6. Apples: insecticide and miticide efficacy.

Pesticide ^a	Pest																							
	AM	ARM	BMSB	CM	EAS	ERM	GA	GFW	LAW	OBL	OFM	PC	PLH	RAA	RBL	RLH	SJS	STLM	TABM	TPB/SB	TSM	WAA	WALH	
Acramite	—	—	—	—	—	2	—	—	—	—	—	—	—	—	—	—	—	—	—	—	—	—	—	—
Actara	—	1	—	3	—	1	—	—	—	—	—	2	1	1	—	1	—	2	—	2	—	—	—	1
Agri-Flex	—	2	4	—	3	1	—	—	—	—	—	2	1	1	—	1	—	—	—	—	—	—	—	1
Agri-Mek	—	2	4	—	—	1	—	—	—	—	—	—	—	—	—	—	—	—	—	—	—	—	—	3
Altacor	4	—	4	1	—	—	—	1	1	1	1	4	—	—	1	—	—	—	1	—	—	—	—	—
Apollo	—	4	—	—	—	1	—	—	—	—	—	—	—	—	—	—	—	—	—	—	—	—	—	—
Asana XL	2	—	3	2	2	—	3	2	1	2	1	3	2	2	1	2	4	1	2	2	2	—	4	2
Aessal	1	—	2	2	2	—	1	—	1	4	1	1	1	1	4	1	2	1	4	2	2	—	3	1
Avaunt	3	—	4	2	2	—	4	2	2	4	2	1	4	3	2	4	4	4	4	2	2	—	—	2
azinphos-methyl ^b	1	—	4	1	1	—	4	2	1	3	1	1	4	4	2	3	3	4	3	3	3	—	4	4
Belay	—	1	2	—	—	—	1	—	2	—	2	—	1	1	—	1	—	—	—	—	—	—	—	1
Beleaf	—	4	—	—	—	—	2	—	—	—	—	—	—	—	—	—	—	—	—	2	—	—	—	—
Belt SC	4	—	4	1-2	—	—	—	1	1	1	1-2	4	—	—	1	—	—	—	1	1	—	—	—	—
B. thuringiensis	—	—	—	4	—	—	—	2	4	2	4	—	—	—	1	—	—	—	2	—	—	—	—	—
Calypso	2	—	3	2	1	—	1	—	1	4	1	1	1	1	4	1	3	1	4	2	—	—	3	1
carbaryl	3	—	3	3	—	—	4	3	2	4	2	2	1	4	3	1	4	3	4	3	—	—	—	4
Centaur	—	4	—	—	—	—	—	—	—	—	—	—	—	—	—	—	—	—	—	—	—	—	—	—
chlorpyrifos	—	—	2	—	—	—	1	2	—	—	—	—	—	2	2	—	1	—	—	3	—	—	—	—
Cp GV	—	—	1	—	—	—	—	—	—	—	3	—	—	—	—	—	—	—	—	—	—	—	—	—
cyfluthrin	2	—	2	—	—	—	3	2	1	2	1	3	2	2	1	2	4	1	1	1	1	—	—	4
Danitol	2	—	1	2	1	3 ^c	3	2	1	2	1	2	2	3	1	2	4	1	2	2	2	—	—	4
deltamethrin	2	—	2	2	—	—	4	2	1	3	1	3	1	2	1	1	4	1	2	2	2	—	—	4
Delegate	3	—	4	1	—	—	—	—	1	1	1	3	—	—	1	—	—	—	1	1	—	—	—	—
diazinon	—	4	—	—	—	—	2	—	—	—	—	—	—	—	—	—	2	4	—	2	—	—	—	1
dormant oil	—	—	—	—	—	—	—	—	—	—	—	—	—	—	—	—	—	—	—	—	—	—	—	—
Endigo	2	—	1	2	2	—	2	—	—	—	1	1	1	1	1	—	—	—	—	—	—	—	—	1
Envidor	—	1	—	—	—	—	—	—	—	—	—	—	—	—	—	—	—	—	—	—	—	—	—	—
Esteem	—	—	4	3	—	—	—	—	—	3	2	—	—	3	—	—	1	1	3	—	—	—	—	—

(continued)

Table 4-6. Apples: insecticide and miticide efficacy (continued).

Pesticide ^a	Pest																							
	AM	ARM	BMSB	CM	EAS	ERM	GA	GFW	LAW	OBL	OFM	PC	PLH	RAA	RBL	RLH	SJS	STLM	TABM	TPB/SB	TSM	WAA	WALH	
fenpyroximate	—	—	—	—	—	1	—	—	—	—	—	—	—	—	—	—	—	—	—	—	—	—	—	—
imidacloprid	4	—	2	—	—	—	1	—	—	—	—	—	1	1	—	1	3	1	—	—	—	—	—	—
Imidan	2	—	4	2	2	—	3	3	1	3	2	1	4	4	3	4	4	4	3	3	3	—	—	—
Intrepid	—	—	4	2	—	—	—	—	2	1	2	—	—	—	—	—	—	2	1	—	—	—	—	—
Kanemite	—	—	4	—	—	1	—	—	—	—	—	—	—	—	—	—	—	—	—	—	—	—	—	—
lambda-cyhalothrin 2	—	—	2	2	2	—	2	2	1	2	1	3	1	2	1	1	4	1	1	1	1	—	—	—
Lannate	4	—	1	2	3	—	3	2	2	2	3	2	2	3	1	2	3	2	1	1	1	—	—	—
Leverage	2	—	1	3	2	—	1	2	3	2	2	2	1	2	2	1	4	1	2	2	2	—	—	—
Lorsban 75WG	—	—	2	—	—	—	2	2	—	2	2	—	—	2	1	—	2	—	—	—	—	—	—	—
Movento	—	—	—	—	—	—	1	—	—	—	—	—	—	1	—	—	1	—	—	—	—	—	—	—
Mustang Max	—	—	3	2	2	—	2	—	1	2	1	—	—	—	1	—	—	1	1	1	1	—	—	—
Neemix	—	4	4	—	4	4	3	4	—	4	—	4	4	4	4	4	4	4	4	4	4	4	4	4
Nexter	—	1	—	—	—	2	—	—	—	—	—	—	—	—	—	—	—	—	—	—	—	—	—	—
Onager	—	4	—	—	—	1	—	—	—	—	—	—	—	—	—	—	—	—	—	—	—	—	—	—
permethrin	—	—	3	—	2	—	3	2	—	3	1	3	—	1	1	2	4	2	—	1	—	—	—	—
Proclaim	—	4	3	—	—	—	—	2	3	1	3	—	—	—	1	—	—	1	1	—	—	—	—	—
Rimon	—	—	4	1	—	—	—	—	1	1	1	—	—	—	1	—	—	1	1	—	—	—	—	—
Savey	—	4	—	—	—	1	—	—	—	—	—	—	—	—	—	—	—	—	—	—	—	—	—	—
summer oil	—	—	—	4	—	—	—	—	4	—	4	—	—	—	—	—	3	4	—	—	—	—	—	—
Supracide	—	—	—	—	—	—	1	1	—	—	—	—	—	2	1	—	—	—	—	—	—	—	—	—
Surround	3	—	3	3	—	3	—	—	3	4	3	3	3	—	4	3	3	4	4	4	4	—	—	—
Thionex	4	2	1	4	—	—	3	4	4	4	4	3	2	3	4	2	3	3	4	1	—	—	—	—
Tourismo	4	—	4	1-2	—	—	—	1	1	1	1-2	4	—	—	1	—	2	1	1	1	—	—	—	—
Vendex	—	2	—	—	—	3	—	—	—	—	—	—	—	—	—	—	—	—	—	—	—	—	—	—
Voliam Flexi	4	—	1	1	3	—	1	1	1	1	1	2	1	1	1	1	—	1	1	2	—	—	—	—
Voliam Xpress	—	—	2	1	2	—	—	1	1	1	1	3	1	—	1	—	—	1	1	2	—	—	—	—
Wydate	—	2	2	—	—	3	3	—	—	—	—	—	2	2	—	2	4	2	—	2	2	4	2	—
Warrior II	2	—	2	2	2	—	2	2	1	2	1	3	1	2	1	1	4	1	1	1	1	—	—	—
Zeal	—	—	—	—	—	—	—	—	—	—	—	—	—	—	—	—	—	—	—	—	—	—	—	—

See Table 4-5 for pest name abbreviations.

Pest control rating system when used at recommended rates: 1 = excellent, 2 = good, 3 = fair, 4 = poor; — = not rated for this insect or mite. Ratings are based on moderate insect or mite pressure. Heavy infestation may require either higher dosage or shorter intervals, or both.

Fruit finish on yellow varieties when used as directed excellent for all products except the following: good for diazinon.

a. Uppercase names are trade names; lowercase names are common names for products with more than one trade name.

b. Azinphos-methyl is no longer legal to use on apples after the 2012 season.

c. Danitol is less effective for late season ERM control.

Table 4-7. Apples: fungicide timing.

	Disease									
	Apple scab	Bitter rot	Black rot	Blossom end rot (<i>Botrytis</i>)	Core rot (<i>Alternaria</i>)	Flyspeck	Powdery mildew	Rusts	Sooty blotch	White rot
½-inch green	++	—	—	—	—	—	—	—	—	—
Prepink	++	—	—	—	—	—	++	—	—	—
Pink	++	—	+	—	—	—	++	+	—	—
Bloom period	++	—	++	+	+	—	++	++	—	—
Petal fall	++	—	++	+	+	—	++	++	—	—
First cover spray	++	—	++	+	+	—	+	+	—	—
Second cover spray	++	—	+	—	—	—	+	—	+	—
Third cover spray	+	+	+	—	—	+	—	—	+	+
Fourth cover spray	+	+	—	—	—	+	—	—	+	+
Fifth cover spray	+	++	—	—	—	++	—	—	++	++
Sixth cover spray	+	++	++	—	—	++	—	—	++	++
Seventh cover spray	+	++	++	—	—	++	—	—	++	++

++ = ideal timing of material for disease control; + = presence of disease and possible control; — = control generally is not needed at that time

Table 4-8. Apples: fungicide efficacy.

	Disease									
	Apple scab	Bitter rot	Black rot	Blossom end rot (<i>Botrytis</i>)	Core rot (<i>Alternaria</i>)	Flyspeck	Powdery mildew	Rusts	Sooty blotch	White rot
Bayleton	6	6	6	6	6	6	1	1	6	6
captan	2	2	1	3	2	3	5	5	2	1
ferbam	3	4	2	4	3	3	5	2	3	2
Flint ^a	1	2	2	6	6	2	1	3	1	6
Indar ^a	1	1	5	5	5	5	1	1	5	5
Inspire Super ^a	1	5	5	6	5	5	2	1	5	5
mancozeb	2	2	2	2	2	4	5	2	4	2
Pristine ^a	1	1	1	1	6	1	1	3	1	1
Procure ^a	2	5	5	5	5	5	1	1	5	5
Rally ^a	2	5	5	5	5	5	1	1	5	5
Rubigan ^a	3	5	5	5	5	5	2	2	5	5
Scala ^a	1	6	6	6	6	6	6	6	6	6
Sovran ^a	1	2	2	6	6	2	1	3	1	2
sulfur	4	3	4	4	4	4	3	4	4	4
Syllit	1	—	—	—	—	—	3	2	—	—
Topguard ^b	1 ^b	—	—	—	—	—	1	1	—	—
Topsin-M ^c	5	5	3	2	5	2	2	5	1	3
Vanguard ^a	1	6	6	6	6	6	6	6	6	6
Ziram	3	4	2	4	3	3	5	2	2	2

Degree of control: 1 = best, 2 = good, 3 = fair, 4 = slight, 5 = none, 6 = no registration

Uppercase names are trade names; lowercase names are common names for products with more than one trade name.

- Rankings assume no resistance in the pathogen population in an orchard except for Procure, Rally, and Rubigan, for which rankings have been adjusted to reflect performance under moderate levels of resistance. Reduced effectiveness of the sterol inhibitor fungicides in Pennsylvania documented for some of the newer products and reports of resistance to QoI fungicides in nearby surrounding states may result in the lowering of effectiveness ratings from 1 or 2 to ≥3.
- Effectiveness on apple scab assumes Topguard is tank-mixed with captan.
- Mite suppression fair for Topsin-M and slight for sulfur. Fruit finish on yellow varieties when used as recommended: very good for Bayleton, Captan, Funginex, Procure, Rally, Rubigan, Flint, Sovran, Pristine, good for Thiram and Ziram, fair for Topsin-M, and poor for ferbam and sulfur.

Table 4-9. Pears: insecticide and miticide timing.

Time of spray	Pest													
	BMSB	CM	ERM	GA	GFW	LR	OFM	PC	PLBM	PP	PRM	SJS	TPB/SB	TSM
Dormant	—	—	+	+	+	—	—	—	+	++	+	++	—	—
Cluster bud	—	—	++	+	++	+	—	—	+	++	++	++	++	—
White bud	—	—	—	+	++	+	+	—	+	++	+	+	++	—
Petal fall	—	+	+	+	++	+	++	+	+	++	+	++	++	+
First cover spray	—	++	+	+	+	+	++	++	+	+	++	+	+	+
Second cover spray	+	++	++	+	—	+	+	++	+	++	+	++	+	++
Third cover spray	++	+	++	+	—	+	+	—	+	++	+	++	+	++
Fourth cover spray	++	+	++	+	—	+	+	—	—	+	+	+	+	++
Fifth cover spray	++	++	+	—	—	+	++	—	—	++	+	+	+	+

++ = ideal timing of material for control; + = presence of pest and possible control; — = control generally not needed

BMSB = brown marmorated stink bug; CM = codling moth; ERM = European red mite; GA = green aphids; GFW = green fruitworm; LR = leafrollers; OFM = Oriental fruit moth; PC = plum curculio; PLBM = pearleaf blister mite; PP = pear psylla; PRM = pear rust mite; SJS = San Jose scale; TPB = tarnished plant bug/native stink bugs; TSM = twospotted spider mite

Table 4-10. Pears: insecticide and miticide efficacy.

Pesticide ^a	Pest													
	BMSB	CM	ERM	GA	GFW	LR	OFM	PC	PLBM	PP	PRM	SJS	TPB	TSM
Acramite	—	—	1	—	—	—	—	—	—	—	—	—	—	1
Actara	1	—	—	1	—	—	—	2	—	1	—	—	—	—
Agri-Flex	4	—	1	1	—	—	—	1	1	1	1	—	1	1
Agri-Mek	4	—	1	—	—	—	—	—	1	1	1	—	—	1
Altacor	4	1	—	—	1	1	1	4	—	—	—	—	—	—
Apollo	—	—	1	—	—	—	—	—	—	—	—	—	—	1
Asana XL	3	2	—	2	2	1	2	3	—	2	—	4	1	—
Assail	1	1	—	1	2	4	1	2	—	2	—	2	2	—
Avaunt	4	2	—	—	—	4	2	2	—	—	—	—	—	—
azinphos-methyl ^b	4	1	—	4	1	2	1	1	—	4	—	3	2	—
Belay	1	1	—	1	—	—	1	2	—	1	—	2	2	—
Beleaf	4	—	—	2	—	—	—	—	—	—	—	—	—	—
Belt	4	1	—	—	1	1	1	—	—	—	—	—	—	—
bifenthrin	1	2	—	2	2	1	2	3	—	2	—	4	1	—
Brigade	1	2	—	—	—	1	3	3	—	2	—	3	1	—
Bt	—	3	—	—	2	2	2	—	—	—	—	—	—	—
Calypso	3	2	—	1	—	4	2	1	—	2	—	—	1	—
Carzol	3	—	1	—	—	—	—	—	1	—	1	—	2	1
Centaur	4	—	—	—	—	—	—	—	—	2	—	1	—	—
chlorpyrifos	2	—	—	1	1	—	—	—	—	3	—	1	—	—
Cp GV	—	1	—	—	—	—	3	—	—	—	—	—	—	—
cyfluthrin	2	2	—	2	2	1	1	—	—	1	—	—	1	—
Danitol	1	2	2 ^c	—	—	2	1	3	—	1	—	—	—	—
Delegate	4	1	—	—	—	1	1	3	—	1	—	—	—	—
deltamethrin	—	2	—	2	1	1	1	3	—	1	—	—	1	—
diazinon	4	—	—	—	—	—	—	—	—	3	—	1	—	—
dormant oil	—	—	1	3	—	—	—	—	—	2	3	1	—	—
Endigo	1	2	—	1	—	1	1	—	—	1	—	—	1	—
Envidor	—	—	1	—	—	—	—	—	—	—	1	—	—	1
Esteem	4	1	4	4	—	2	—	—	—	2	—	1	—	—
fenpyroximate	—	—	1	—	—	—	—	—	—	1	2	—	—	1
Imidan	4	1	—	4	2	4	1	1	—	4	—	4	3	—
Intrepid	4	2	—	—	1	1	2	—	—	—	—	—	—	—
imidacloprid	—	—	—	1	—	—	—	—	—	2	—	3	4	—
Kanemite	—	—	1	—	—	—	—	—	—	—	—	—	—	1
Lannate	1	2	—	1	1	1	2	3	—	3	—	4	2	—
Leverage	1	3	—	1	2	2	3	2	—	1	—	4	2	—
Mitac	—	—	1	—	—	—	—	—	1	2	1	—	—	3
Movento	—	—	—	1	—	—	—	—	—	1	—	1	—	—
Mustang Max	3	2	—	2	2	1	1	—	—	2	—	—	1	—
Nexter	—	—	1	—	—	—	—	—	—	3	1	—	—	3
Onager	—	—	1	—	—	—	—	—	—	—	1	—	—	1
permethrin	3	2	—	2	2	2	2	3	—	2	—	4	—	—
Proclaim	4	3	—	—	2	1	3	—	—	—	—	—	—	—
Savey	—	—	1	—	—	—	—	—	—	—	1	—	—	1
Supracide	—	—	—	—	2	—	—	—	—	3	—	1	—	—
Surround	3	3	—	—	—	4	3	3	—	2	—	3	—	—
Thionex ^d	1	—	—	1	—	—	—	3	3	2	3	4	3	—
Tourismo	4	1	—	—	1	1	1	—	—	3	—	3	—	—
Voliam Xpress	2	1	—	2	—	1	1	—	—	1	—	—	—	—
Voliam Flexi	1	1	—	1	1	1	1	2	—	1	—	—	—	—
Vydate	2	—	1	3	—	—	—	—	2	3	2	—	1	1
Warrior II	2	2	—	2	2	1	1	1	—	1	—	—	1	—
Zeal	—	—	1	—	—	—	—	—	—	—	—	—	—	1

Pest control rating system when used at recommended rates: 1 = excellent, 2 = good, 3 = fair, 4 = poor, — = not registered or efficacy unknown

Fruit finish, when used as recommended, is excellent for all products except good for diazinon and fair for M-Pede.

See Table 4-9 for pest name abbreviations.

a. Uppercase names are trade names; lowercase names are common names for products with more than one trade name.

b. Azinphos-methyl is no longer legal on pears after the 2012 season.

c. Danitol is less effective for late season ERM control.

d. It is unlawful to use Thionex on pears after July 31, 2013.

Table 4-11. Stone fruit: insecticide and miticide timing.

Time of spray	Pest															
	BMSB	ERM	GPA	JB	LPTB	LS	LR	OFM	PC	PT	PTB	SB	SJS	TPB	TSM	WFT
Dormant	—	+	+	—	—	++	—	—	—	—	+	—	++	—	—	—
Pink	—	—	+	—	—	—	—	+	—	++	+	+	+	++	—	+
Petal fall	++	+	++	—	—	+	—	++	+	++	—	+	—	++	—	+
Shuck fall	++	+	+	—	—	+	+	+	++	—	+	+	—	++	—	—
First cover	++	+	+	+	+	+	+	+	++	—	+	+	—	+	+	—
Second cover	++	++	+	+	++	++	+	++	+	—	+	+	+	+	+	—
Third cover	++	++	—	++	++	+	+	++	—	—	++	+	++	+	+	—
Fourth cover	++	++	—	++	+	+	+	++	—	—	++	++	++	+	+	+
Fifth cover	++	++	—	++	+	+	++	++	—	—	++	++	++	+	+	++

++ = ideal timing of material for control; + = presence of pest and possible control; — = control generally not needed

BMSB = brown marmorated stink bug; ERM = European red mite; GPA = green peach aphid; JB = Japanese beetle; LPTB = lesser peachtree borer; LS = lecanium scale; LR = leafrollers; OFM = Oriental fruit moth; PC = plum curculio; PT = pear thrips; PTB = peachtree borer; SB = native stink bugs; SJS = San Jose scale; TPB = tarnished plant bug; TSM = twospotted spider mite; WFT = western flower thrips

Table 4-12. Stone fruit: insecticide and miticide efficacy.

Pesticide ^a	Pest															
	BMSB	ERM	GPA	JB	LPTB	LS	LR	OFM	PC	PT	PTB	SB	SJS	TPB	TSM	WFT
Acramite	—	1	—	—	—	—	—	—	—	—	—	—	—	—	1	—
Actara	1	—	1	3	—	—	—	—	2	—	—	1	—	1	—	—
Altacor	4	—	—	—	—	—	1	1	4	—	—	—	—	—	—	—
Apollo	—	1	—	—	—	—	—	—	—	—	—	—	—	—	1	—
Asana XL	3	—	3	2	1	4	1	1	3	—	1	2	—	2	—	2
Assail	1	—	1	2	4	2	4	1	2	—	4	2	2	2	—	—
Avaunt	4	—	—	2	3	—	2 ^b	2	1	—	3	2	—	3	—	—
Belay	1	—	1	—	—	—	—	—	2	—	—	1	2	1	—	—
Beleaf	4	—	2	—	—	—	—	—	—	—	—	3	—	3	—	—
Belt	4	—	—	—	—	—	1	1–2	—	—	—	—	—	—	—	—
Bt	—	—	—	—	—	—	2	4	—	—	—	—	—	—	—	—
carbaryl	3	—	4	1	4	4	4	2	3	—	4	3	4	3	—	4
Carzol	2	1	—	—	—	—	—	—	—	2	—	2	—	2	1	1
Centaur	4	—	—	—	—	1	—	—	—	—	—	—	1	—	—	—
chlorpyrifos	2	—	—	—	1	1	—	—	—	—	1	—	1	—	—	—
cyfluthrin	2	—	3	2	—	—	1	1	—	—	—	2	—	2	—	—
Delegate	4	—	—	—	—	—	1	1	3	—	—	—	—	—	—	1
diazinon	4	—	—	—	—	1	—	—	—	—	—	3	1	3	—	—
dormant oil	—	1	3	—	—	1	—	—	—	—	—	—	1	—	—	—
Endigo	1	—	1	2	—	—	1	1	1	—	—	1	—	1	—	—
Envidor	—	1	—	—	—	—	—	—	—	—	—	—	—	—	1	—
Esteem	4	4	4	—	—	1	—	2	—	—	—	—	1	—	4	—
imidacloprid	2	—	1	3	—	—	—	—	3	—	—	2	2	3	—	—
Imidan	4	—	4	2	4	4	3	2	1	—	4	3	3	3	—	—
Intrepid	4	—	—	—	—	—	1	2	—	—	—	—	—	—	—	—
Lannate	1	—	2	2	—	—	1	2	2	—	—	1	—	1	—	2
Leverage	1	—	1	2	—	—	1	1	—	—	—	1	—	1	—	—
Movento	—	—	1	—	—	1	—	—	—	—	—	—	1	—	—	—
Mustang Max	3	—	—	—	—	—	1	1	—	—	—	2	—	1	—	—
Nexter	—	1	—	—	—	—	—	—	—	—	—	—	—	—	2	—
permethrin	3	—	3	2	2	—	1	1	3	—	2	3	—	3	—	2
Savey	—	1	—	—	—	—	—	—	—	—	—	—	—	—	1	—
Supracide	—	—	3	—	—	1	—	—	—	—	—	—	1	—	—	—
Thionex ^c	1	—	3	2	2	2	—	—	3	—	2	2	3	3	—	—
Tourismo	4	—	—	—	—	3	1	1–2	—	—	—	—	3	—	—	—
Voliam Xpress	2	—	—	—	—	—	1	1	3	—	—	2	—	1	—	—
Voliam Flexi	1	—	2	3	—	—	1	1	2	—	—	2	—	2	—	—
Warrior II	2	—	3	2	—	—	1	1	3	—	—	2	—	2	—	—

Pest control rating system when used at recommended rates: 1 = excellent, 2 = good, 3 = fair, 4 = poor; — = not rated for this insect or mite
See Table 4-11 for pest name abbreviations.

a. Uppercase names are trade names; lowercase names are common names for products with more than one trade name.

b. Avaunt will not provide adequate control of obliquebanded leafroller.

c. It is unlawful to use Thionex on peaches/nectarines after July 31, 2012.

Table 4-13. Stone fruit: fungicide and antibiotic timing.

Time of spray	Disease						
	Bacterial spot	Brown rot	Cherry leaf spot	Cytospora canker	Leaf curl	Powdery mildew	Scab
Dormant	++ ^a	—	—	—	++	—	—
Pink	—	++	—	++	—	—	—
Bloom	—	++	—	++	—	—	—
Petal fall	—	+	++ ^b	++	—	—	—
Shuck split	++	+	++	++	—	++	++
Shuck fall	++	+	++	++	—	++	++
First cover spray	++	—	++	++	—	++	++
Second cover spray	++	—	++	++	—	++	++
Third cover spray	++	—	++	—	—	+	—
Fourth cover spray	++	—	NA	—	—	+	—
Fifth cover spray	++	—	NA	—	—	+	—
Preharvest	++	++	++	—	—	—	—
Postharvest	—	NA	++	—	++	—	—

++ = ideal timing of material for control; + = presence of pest and possible control; — = control generally not needed; NA = not applicable

a. Dormant copper applications.

b. For cherry leaf spot control begin applications at petal fall or when first leaves unfold and continue applications at 7- to 14-day intervals. A postharvest application may be made to maintain control and reduce overwintering inoculum.

Table 4-14. Stone fruit: fungicide and antibiotic efficacy.

Pesticide ^a	Disease						
	Bacterial spot	Brown rot	Cherry leaf spot	Cytospora canker	Leaf curl	Powdery mildew	Scab
Adament ^{b,c,d}	6	1	1	6	6	1	2
Bravo	6	2	1	6	1	4	6
Cabrio	6	1	6	6	6	1	6
captan	6	2	4	6	4	4	2
copper	2	5	2	4	1	3	5
Elite ^d	6	1	1	6	5	1	6
ferbam	6	3	2	4	1	4	4
FlameOut	1	6	6	6	6	6	6
Gem 500 ^{b,d}	6	1	1	6	6	1	2
Indar ^d	6	1	1	6	6	6	2
Myco-Shield	1	6	6	6	6	6	6
Orbit ^d	6	1	3	6	5	1	6
Pristine ^d	6	1	1	6	6	1	1
Quash ^{b,d}	6	1	1	6	6	1	1
Rally ^d	6	3	6	6	6	1	6
Rovral ^d	6	2	6	6	6	6	2
sulfur	6	4	6	6	4	3	3
Syllit ^d	6	6	1	6	6	6	6
Ziram	4	2	4	6	1	4	6

Degree of control: 1 = best, 2 = good, 3 = fair, 4 = slight, 5 = none, 6 = no registration

a. Uppercase names are trade names; lowercase names are common names for products with more than one trade name.

b. No efficacy data from Pennsylvania; expected performance based on the ai chemistry and preliminary observations in neighboring states.

c. Adament is a mixture of tebuconazole (SI) and trifloxystrobin (i.e., strobilurin) fungicides.

d. Rankings assume no resistance to the active ingredient of the fungicide in the pathogen population in your orchard.

Table 4-15. Reentry (REI) and preharvest (PHI or spray-to-harvest) intervals.

Listed below are pesticides used on tree fruits. Not all materials listed here are suggested in the spray schedules. Pesticides used at the rates and times suggested should be within the legal residue tolerance at harvest. Pomace made from apples or pears sprayed according to these suggestions may contain illegal residues if used for animal feeds. Always check the label for the actual REI and PHI.

B	Remove residue by brushing	FB	Full bloom	PH	Postharvest	SD	Soil drench or spray
BH	Before harvest	0–60	PHI	SC	Second cover or ½-inch fruit diameter		
BPH	Before pit hardening (stone fruit)	HG	½-inch green	SS	To shuck split		
D	Dormant only	PB	Prebloom	NE	Not established		
EC	Early cover sprays	LB	To late bloom	—	No registration		
LC	To late cover sprays	PF	To petal fall	SF	To shuck fall		

Antibiotics	REI (hrs)	PHI (days)						
		Apple	Pear	Peach	Nectarine	Apricot	Cherry	Plum
agricultural streptomycin	12	50	30	—	—	—	—	—
Agri-mycin 17	12	50	30	—	—	—	—	—
Bac-Master	12	50	30	—	—	—	—	—
Firewall	12	50	30	—	—	—	—	—
FlameOut (oxytetracycline)	12	—	60	21	21	—	—	—
Mycoshield (oxytetracycline)	12	60	60	21	21	—	—	—
Fungicides								
Adament	12	75	75	1	1	1	1	1
Bayleton	12	45	45	—	—	—	—	—
Bravo Weather Stik	12	—	—	0	0	0	SS	0
Cabrio	12	—	—	—	—	—	0	—
Captan	24–96	0	—	0	0	0	0	0
Chlorothalonil 720	12	—	—	0	0	0	0	0
copper hydroxide	24	HG–PH	LB	21	21	FB	FB	FB
copper sulfate (Basic)	48	D–LB	FB	PB	PB	FB	PF–PH	EC
Elite	12	—	—	0	0	—	0–PH	—
ferbam	24	7	7	21	21	—	0–PH	—
Flint	12	14	14	—	—	—	—	—
Gem 500	12	—	—	1	1	1	1	1
Indar	12	14	—	0	0	0	0	0
Inspire Super	12	72	72	—	—	—	—	—
lime sulfur	48	D–PF	0	0	0	—	0	0
mancozeb ^a	24	77	77	—	—	—	—	—
Orbit	12	—	—	0	0	0	0	0 ^b
Polyram	24	77	—	—	—	—	—	—
Pristine	12	0	0	0	0	0	0	0
Procure	12	14	14	—	—	—	1	—
Quash	12	—	—	14	14	14	14	14
Quintec	12	—	—	7	7	7	—	7
Rally	24	14	—	0	0	0	0	0
Ridomil	48	0	—	SD	SD	SD	SD	SD
Rovral	24	—	—	PF	PF	PF	PF	PF
Scala	12	72	72	2	2	2	—	2
Rubigan	12	30	30	—	—	—	0–PH	—
Sovran	12	30	30	—	—	—	—	—
sulfur	24	LC ^c	LC ^d	LC	LC	LC	LC	LC
Syllit	48	7	7	15	—	—	7	—
Thiram	24	—	—	7	—	—	—	—
Topguard	12	14	—	—	—	—	—	—
Topsin-M	12	1	1 (72 REI)	1	1	1	1	1
Vanguard	12	72	72	2	2	2	1 ^e	2
Vintage	24	30	30	—	—	—	0–PH	—
Ziram	48	14	5	14	14	30	14	—
Plant growth regulators								
Accel	12	28	—	—	—	—	—	—
Amid-Thin W	48	NE	NE	—	—	—	—	—
Apogee	12	45	—	—	—	—	—	—
Ethrel	48	7	—	—	—	—	7	—
Exilis plus	12	86	—	—	—	—	—	—
Falgro	4	—	—	0	0	0	0	0
Fruitone L	48	2	2	—	—	—	—	—
Fruitone N	48	2	2	—	—	—	—	—
MaxCel	12	86	86	—	—	—	—	—
Perlan	4	NE	—	—	—	—	—	—
ProGibb 4%	12	0	—	—	—	—	7	—
ProGibb 40%	4	0	—	—	—	—	7	—
Promalin for fruit shape	4	NE	—	—	—	—	—	—
Promalin for branching	4	NE	365	365	—	—	365	—
ProVide	4	NE	—	—	—	—	—	—

(continued)

Table 4-15. Reentry (REI) and preharvest (PHI or spray-to-harvest) intervals (continued).

	REI (hrs)	PHI (days)						
		Apple	Pear	Peach	Nectarine	Apricot	Cherry	Plum
ReTain	12	7	7	7	7	7	—	7
RiteSize	12	NE	—	—	—	—	—	—
SmartFresh	24.5	NE	—	—	—	—	—	—
Tre-Hold A-112	12	D	D	—	—	—	—	—
Typy for fruit shape	12	NE	—	—	—	—	—	—
Typy for branching	12	NE	365	365	—	—	365	—
Insecticides/miticides								
Abacus	12	28	28	21	21	21	21	21
Abba 0.15EC	12	28	28	—	—	—	—	21
Acramite 50WS	12	7	7	3	3	3	3	3
Actara	12	14–35 ^f	14–35 ^f	14	14	14	14	14
Adjourn	12	21	28	14	14	14	14	14
Admire PRO	12	7	7	0	0	0	7	7
Agree	4	0	0	0	0	0	0	0
Agri-Flex	96	35	35	—	—	—	—	—
Agri-Mek 0.15EC	12	28	28	21	21	21	21	21
Altacor	4	5	5	10	10	10	10 ^g	10
Ambush 25W	12	PF	PB	14	—	—	3	—
Apollo SC	12	45	21	21	21	21	21	—
Arctic 3.2 EC	12	PF	PB	14	14	—	3	—
Asana XL	12	21	28	14	14	14	14	14
Assail 30SG	12	7	7	7	7	7	7	7
Avaunt	12	14	28	14	14	14	14	14
Aza-Direct	4	0	0	0	0	0	0	0
Azatin XL	4	0	0	0	0	0	0	0
Battalion 0.2 EC	12	21	21	—	—	—	—	—
Baythroid XL	12	7	7	7	7	7	7	7
Belay ^h	12	7	7	21	—	—	—	—
Beleaf 50 SG	12	21	21	14	14	14	14	14
Belt SC	12	14	14	7	7	7	7	7
Biobit HP	4	0	0	0	0	0	0	0
BioCover MLT	4	0	0	0	0	0	0	0
Brigade 2 EC	12	—	14	—	—	—	—	—
Calypso 4F	12	30	30	—	—	—	—	—
Carbaryl 4L	12	3	3	3	3	3	3	3
Carpovirusine	4	0	0	—	—	—	—	—
Carzol SP	120	PF	PF	PF	PF	—	—	—
Centaur WDG	12	14	14	14	14	14	14	14
chlorpyrifos 4E	96	PB/28	PB	PB/14 ⁱ	PB/14 ⁱ	PB/14	21	PB/21 ⁱ
Cyd-X	4	0	0	—	—	—	—	—
Danitol 2.4EC	24	14	14	3	3	3	3	3
Delegate	4	7	7	14	1	14	7	7
Deliver	4	0	0	0	0	0	0	0
Delta Gold	12	21	21	—	—	—	—	—
Diazinon 50W	96	21 ^j	21 ^j	21 ^j	21 ^j	21	21 ^j	21 ^j
Dimate 4E	240	—	28	—	—	—	—	—
Dimethoate 4EC	48	—	28	—	—	—	—	—
Dimilin25W	12	—	14	—	—	—	—	—
Dipel	4	0	0	0	0	0	0	0
Discipline	12	—	14	—	—	—	—	—
Dormant plus oil	12	D	D	D	D	D	D	D
Endosulfan 3EC	168	21–30	7	21–30	21–30	21–30	21	—
Envidor 2SC	12	7	7	7	7	7	7	7
Esteem 0.86EC	12	45	45	14	14	14	14	14
Entrust	4	7	7	1	1	14	7	7
Guthion Solupak	336–360 ^{k,l}	14–21 ^b	14–21 ^b	—	—	—	15	—
Imidan 70WP	72	7	7	14	14	14	—, 7 ^m	7
Intrepid 2F	4	14	14	7	7	7	7	7
JMS Stylet oil	4	0	0	0	0	0	0	0
Kanemite 15SC	12	14	14	—	—	—	—	—
Kelthane 50 WSP	48	7	7	—	—	—	—	—
Lambda-Cy	24	21	21	14	14	14	14	14
Lannate SP, LV	72–96	14	7	4	1 ⁿ	—	—	—
Leverage 2.7 SE	12	7	7	7	7	7	7	7
Lorsban Advanced	96	PB ^o	—	PB/14	PB/14	—	PB/21	—
Lorsban 75WG	96	PF	—	—, 14 ^p	—, 14 ^p	—	—, 21 ^{p,q}	—
Malathion 5EC	12	—	—	7	7	7	3	—
Mite-E-Oil	4	0	0	0	0	0	0	0

(continued)

Table 4-15. Reentry (REI) and preharvest (PHI or spray-to-harvest) intervals (continued).

	REI (hrs)	PHI (days)						
		Apple	Pear	Peach	Nectarine	Apricot	Cherry	Plum
Movento	24	7	7	7	7	7	7	7
Mustang Max	12	14	14	14	14	14	14	14
Neemix 4.5	12	0	0	0	0	0	0	0
Neemazad 1% EC	4	0	0	0	0	0	0	0
Nexter	12	25	7	7	7	300	300	7
Onager	12	28	28	7	7	7	7	7
Permethrin 3.2EC	12	PF	PB	14	14	—	7	—
Perm-Up 3.2 EC, 25DF	12	PF	PB	14	14	—	3	—
Portal	12	14	14	—	—	—	—	—
Pounce 25WP	12	PF	PB	14	14	—	3	—
Prey 1.6	12	7	7	0	0	0	7	7
Proaxis	24	21	21	14	14	14	14	14
Proclaim	12–48	14	14	—	—	—	—	—
Provado 1.6F	12	7	7	0	0	0	7	7
Rimon 0.83EC	12	14	8	8	8	8	—	8
Savey 50DF	12	28	28	28	28	28	28	28
Sevin XLR	12	3	3	3	3	3	3	3
SpinTor 2SC	4	7	7	14	1	14	7	7
Superior Spray Oil	12	0	0	0	0	0	0	0
Supracide 25W/2E	72	PB	PB	PB	PB	PB	PB	PB
Surround WP	4	0 ^r	0 ^r	0 ^r	0 ^r	0 ^r	0 ^r	0 ^r
Taiga Z	24	21	21	14	14	14	14	14
Thionex 50W/3EC	480	21	20	21	21	21	21	—
Tombstone	12	7	7	7	7	7	7	7
Tourismo	12	14	14	14	14	14	14	14
Trilogy	4	0	0	BPH	BPH	BPH	BPH	BPH
Tundra EC	12	—	14	—	—	—	—	—
Voliam Flexi	12	35 ^s	35 ^s	14	14	14	14	14
Voliam Xpress	24	21	21	14	14	14	14	14
Vendex 50WP	48	14	14	14	14	—	14	14
Vydate L	48	14	14	—	—	—	—	—
Warhawk	96	PB	PB	D/14	D/14	—	D/21	D
Warrior II	24	21	21	14	14	14	14	14
Yuma 4E	96	D	D	D/14	D/14	—	D/21	D
Zeal 72WDG	12	14	14	7	7	7	7	7
Zoro	12	28	28	—	—	—	—	21
Nematicides and fumigants								
Basamid G	120	—	—	—	—	—	—	—
Vapam HL	120	—	—	—	—	—	—	—
Telone (All formulations)	120	—	—	—	—	—	—	—
Midas (All formulations)	120	—	—	—	—	—	—	—
DiTera DF	4	—	—	—	—	—	—	—
Vydate L	48	—	—	—	—	—	—	—

- a. Some equivalent products include Dithane, Manzate, and Penncozeb.
b. If last application before harvest exceeds 1.0 lb active ingredient/acre, the PHI is 21 days.
c. Do not apply to sensitive apple varieties.
d. Do not apply to D'anjou pear.
e. Do not apply to sweet cherry.
f. 14-day PHI for Actara used at rate equal or less than 2.75 oz/acre; 35-day PHI for use of more than 2.75 oz/acre.
g. Do not use adjuvant for application on sweet and tart cherries.
h. Belay supplemental label for use on pome fruit and peach will expire on October 2, 2012.
i. Exceptions are PTB and LPTB trunk-only sprays.
j. Only one dormant and one application per growing season are allowed.
k. On apples and pears the REI is 14 days (336 hours).
l. On cherries the REI is 15 days (360 hours).
m. Imidan is not registered for use on sweet cherries; up to 7 days preharvest on tart cherries.
n. Lannate LV is not registered for use on nectarines.
o. Lorsban Advanced and 50W can be used on apples as a direct trunk spray for the control of borers with a 28-day PHI.
p. Lorsban 75 WG can be applied directly to tree trunk for borer control on cherries (PHI is 21 days) and peach and nectarine (PHI is 14 days).
q. Lorsban is recommended for sour cherries only.
r. To avoid Surround residue on fruit, it is recommended that applications be stopped in adequate time before harvest (see the label).
s. Do not use an adjuvant with application of Voliam Flexi within 60 days of harvest.

Table 4-16. Storage suggestions for pesticides used on tree fruit.

Common name	Product name	Do not store above 100°F	Do not store below indicated temperature			No freezing problem
			40°F	32°F	0°F	
	Adament	✓				
amitraz	Mitac W				✓	
azadirachtin	Aza-Direct	✓			✓	
azinphos-methyl	Guthion SoluPak	✓		✓		
Bt	Biobit FC, HP	✓		✓		
	Dipel 2X	✓				✓
	Javelin WG	✓		✓		
	XenTari	✓				✓
captan	Captan 50, 80WP	✓				✓
	Captec 4L	✓			✓	
carbaryl	Sevin XLR Plus	✓				✓
carfentazone-ethyl + glyphosate	Rage			✓		
chlpyralid	Stinger	✓				
chlorothalonil	Bravo 720	✓				✓
chlorpyrifos	Lorsban 4E	✓				
	Lorsban 75WG	✓		✓		
clethodim	Arrow 2EC			✓		
clofentezine	Apollo SC					✓
CpGV	Cyd-X	✓				✓
	Carpovirusine	✓				✓
2,4-D amine				✓		
d-limonene	GreenMatch	✓				
dazomet	Basamid G	✓				✓
deltamethrin	Decis 1.5EC	✓	✓			
diazinon	D.z.n. diazinon	✓				
dicofol	Kelthane WP	✓				✓
dormant oil	Par F 70 Soluble Oil	✓				✓
endosulfan	Thiodan 3EC	✓		✓		
	Thiodan 50WP	✓				✓
esfenvalerate	Asana XL					✓
fenarimol	Rubigan EC			✓		
fenbutatin oxide	Vendex 50WP					✓
fenpropathrin	Danitol 2.4EC	✓				
fluzifop-butyl	Fusilade DX					✓
flutriafol	Topguard	✓		✓		
formentante	Carzol SP	✓				✓
gamma-cyhalothrin	Proaxis		✓			
glyphosate					✓	
indaziflam	Alion Herbicide			✓		
insecticidal soap	M-Pede					✓
malathion	Malathion 57EC				✓	
mancozeb	Dithane M-45			✓		
metham sodium	Vapam HL			✓		
maneb	Maneb					✓
metalaxyl	Ridomil 2E		✓			
methidathion	Supracide 25WP	✓	✓			✓
	Supracide 2E	✓	✓			
methomyl	Lannate LV			✓		
	Lannate SP					✓
methoxyfenozide	Intrepid 2F			✓		
<i>Myrothecium verrucaria</i>	DiTera DF	✓		✓		
oxamyl	Vydate L				✓	
oxyfluorfen	Goal, Galigan, GoalTender			✓		
parafinic oil	JMS Stylet Oil			✓		
paraquat				✓		
pendimethalin	Prowl	✓	✓			
permethrin	Pounce 3.2EC	✓				
	Pounce WSB			✓		
phosmet	Imidan 70WSB	✓				✓
pyraflufen-ethyl	Venue	✓		✓		
pyriproxyfen	Esteem 0.86EC	✓				
sethoxydim	Poast	✓				
sprayable pheromone	3M Sprayable Pheromone			✓		
ziram	Ziram 76DF					✓

Adapted from *Crop Protection Reference*, 13th ed. (Chemical and Pharmaceutical Press, 1997). Updated August 2009.

The pesticide recommendation tables in this section display 2 rates for each pesticide, based on 2 application methods. The first column (dilute rate/100 gal) shows the amount of formulated pesticide to be added to the spray tank for every 100 gallons of water. This rate assumes a total spray-mixture volume of 300 to 400 gallons per acre for apples, pears, and cherries and 300 gallons per acre for other stone fruits. The second column displays the recommended rate of formulated pesticide to be applied on a sprayed-acre basis regardless of the total amount of spray mixture. We recommend that at least 50 gallons per acre be applied in most situations and that at least 100 gallons per acre be applied for particularly serious situations, such as heavy mite populations, potentials for severe scab infection, and high probability of fruit damage from the leafrollers and internal fruit feeders (e.g., Oriental fruit moth, codling moth). *Note that the amount per sprayed acre is equivalent to spraying 1 acre of orchard if both sides of the tree are sprayed and 2 acres of orchard if alternate sides of the tree are sprayed.*

APPLE INTEGRATED PEST MANAGEMENT (IPM) PROGRAM

An important part of an IPM program can be implemented by applying pesticides using either complete or alternate row middle (ARM) sprays. If using ARM sprays, do not stretch intervals between half-sprays unless pest pressure is low. Also, for ARM sprays to be effective for insect and disease control: (1) Use a sprayer capable of partial coverage of the nonsprayed side of each tree row. Sprayers with less than 90,000 cfm and 180 psi are not likely to be successful in this program unless trees are not more than 12 feet high or the rows 25 feet apart. Intermediate airflow sprayers can be used when they are properly matched with the tree size to be sprayed. (2) Be aware of the small black ladybird beetle, *Stethorus punctum*, and the predatory mites *Typhlodromus pyri*, *Neoseiulus fallacis*, and *Zetzellia mali*, for biological control of the European red mite; regular mite and *Stethorus* counts are needed. (3) Adjust the interval between half-sprays as pest pressures increase or decrease.

The advantages of reduced pesticide and integrated pest management programs include (1) less pesticide is used, (2) time and orchard equipment are managed more efficiently, (3) predators are used in mite control, (4) populations of other parasites and predators may increase, and (5) chances decrease that pests will develop resistance to pesticides. If scab, powdery mildew, and other diseases were present the previous year, or if weather conditions become favorable for disease outbreaks, shorten spray intervals and increase rates.

A NOTE ABOUT IPM PROGRAMS AND FUNGICIDE RESISTANCE IN THE APPLE SCAB FUNGUS

Populations of the *Venturia inaequalis*, the apple scab fungus, in many Pennsylvania orchards have become resistant to the DMI fungicides. There is also preliminary data indicating that some orchards may have resistance to strobilurin and possibly AP fungicides (Vanguard and Scala). However, the status of resistance is highly variable across orchards and even within orchard blocks. This situation greatly complicates the implementation of IPM programs for disease management as such programs must now be tailored to fit the resistance status of specific orchards and/or blocks. Important things to note: (1) Not all orchards have resistant *V. inaequalis* populations for any or all of the fungicide classes. For orchards with sensitive populations, the IPM programs incorporating site-specific fungicides (DMIs, strobilurins, APs, etc.) provide the best means of apple scab control and may continue to do so for many years to come. (2) Some orchards have resistance to only one of the major fungicide classes but not the other—in such a case, it may still be possible to use a modified version of the IPM programs with site-specific fungicides. (3) Some orchards (or blocks) may have resistance to the two main classes, the DMI and strobilurin fungicides. Such orchards should abandon the use the IPM programs that rely on site-specific fungicides for disease management because they will fail. If an orchard has resistance to both DMI and strobilurin fungicides, we recommend programs that utilize the protectant fungicides listed in the tables to be used alone at high rates, and that such products be applied in complete spray programs in dilute sprays to ensure maximum coverage of the foliage. Based on this, it is imperative that growers regularly assess the resistance status of the apple scab fungus in their orchards.

Apples—Silver Tip

Special fire blight spray. Where fire blight was severe last year, applying a copper spray at silver tip will aid in reducing the amount of bacteria available for infection later in the spring and summer. Do not apply copper to apples after ¼-inch green leaf stage or when drying conditions are slow, as severe injury can occur. Copper and its residue have many compatibility problems with other pesticides. Refer to Part II, Diseases, Pests, and Natural Enemies.

Apples—Green Tip

Apple scab. In most years apple scab spores are mature and available for infection by green tip. The first fungicide application for apple scab should be applied at green tip. The application of copper at this time will contribute to the control of many of the early season apple diseases including apple scab and fire blight. Read the label of the copper material you are using for rates and restrictions.

Apples—½-Inch Green Delayed Dormant

Apple scab. For effective scab control, apply at least 2 half-sprays or 1 complete spray before the first infection period.

Insects. Oil is effective in San Jose scale and mite control. Adding an insecticide will strengthen the program against aphids, mites, leafrollers, and scales. In all orchards where oil is not used, check for mites on a regular schedule.

For mite control, make oil applications between green tip and tight cluster to open cluster and use a minimum of 100 gallons of water per acre. If mites were a problem the previous year, especially from mid- to late season, use at least 4 gallons per acre (or 2 gal oil/100 gal water—dilute) of dormant oil anytime between the green tip and ½-inch green periods. If the application is made later (up to tight cluster to open cluster), reduce the oil rate to 2 gallons per acre (or 1 gal/100 gal water). Again, use a minimum of 100 gallons of water per acre. *Oil can cause plant injury if used improperly.* (Also see Part III, Chemical Management.) Remember to use as high a volume of water as possible to achieve thorough coverage.

Rosy apple aphid. Oil alone will not prevent rosy aphid injury. Two close-interval alternate row middle sprays or 1 complete spray should be applied by ½-inch green leaf. When using chlorpyrifos, Esteem, Supracide, or any of the synthetic pyrethroid insecticides in alternate row middle sprays, apply the first spray at green tip and the second alternate row middle spray no later than ½-inch green tissue. Only a gallon or less of oil per acre is needed when using these products for aphid control. However, this low rate of oil will not satisfactorily control European red mite.

Pesticide recommendations for apples, ½-inch green.^a

Pesticide	Dilute rate/100 gal ^b	Rate sprayed/A
CHOOSE 1 of the following:		
Indar 2F ^{c,d}	refer to footnote c	6.0–8.0 fl oz
Inspire Super ^{d,e}		8.5–16.0 fl oz
Lime sulfur ^f	—	2.5–3.0% solution
Procure 50WS ^d	2.0–4.0 oz	8.0–16.0 oz
Rally 40WP ^{d,g,h}		5.0–10.0 oz
Scala SC ^{d,i}		8.0–16.0 fl oz
Syllit FL ^{d,j}	—	1.5–3.0 pints
Vanguard WG ^{d,i}	1.25 oz	5.0 oz
Vintage SC ^d		8.0–12.0 fl oz
Topguard ^{d,k}	3.2 fl oz	13 fl oz
In combination with 1 of the following:		
captan 80WDG ^g	refer to footnote g	2.5–5.0 lb
Penncozeb 75DF ^{l,m}	0.80 lb	3.2 lb
Polyram 80WP ^{l,m}	0.75 lb	3.0 lb
Ziram 76WDG	1.0 lb	4.0 lb
OR select 1 of the following to be applied aloneⁿ:		
captan 80WDG ^d	1.25 lb	5.0 lb
Penncozeb 75DF ^{l,m}	1.6 lb	6.2 lb
Polyram 80WP ^{l,m}	1.5 lb	6.0 lb
Ziram 76WDG	1.5–2.0 lb	6.0–8.0 lb
PLUS:		
Insecticides should be selected and combined according to their efficacy against individual pests (see Table 4-6).		
dormant oil ¹	2.0 gal	4.0 gal
PLUS 1 of the following:		
Asana XL 0.66EC ²	3.0–4.0 fl oz	6.0–12.0 fl oz
Battalion 0.2EC ²	—	7.0–14.0 fl oz
Baythroid 2E ²	—	2.0–2.8 fl oz
chlorpyrifos 4EC ²	1.0 pt	3.0 pt
Danitol 2.4 EC ²	3.5–7.0 fl oz	10.7–21.3 fl oz
diazinon 50W	1.0 lb	2.0–3.0 lb
Esteem 35WP	1.0–1.5 oz	4.0–5.0 oz
Lorsban Advanced	1.0 pt	3.0 pt
Mustang Max ²	—	1.3–4.0 fl oz
permethrin 2EC ²	4.0 fl oz	8.0–12.0 fl oz
permethrin 3.2EC ²	2.5 fl oz	5.0–7.5 fl oz
permethrin 25WP ²	0.25 lb	0.50–0.75 lb
Proaxis 0.5EC ²	—	2.5–5.1 fl oz
Supracide 2EC ²	1.5–2.0 pt	1.5–2.0 qt
Supracide 25WP ²	1.5–2.0 lb	3.0–4.0 lb
Warrior II ²	—	1.3–2.5 fl oz

Fungicide and Antibiotic Notes

- See note on fungicide resistance. If you have resistance to both DMI and strobilurin fungicides refer to note o below.
- Based on dilute sprays with a 400-gallon-per-acre base. Maintain per-acre use-rate regardless of spray volume per acre.
- Do not make more than 4 applications per year. Do not apply Indar within 14 days of harvest.
- These fungicides should be used in combination with another fungicide to improve their efficacy and to prevent or delay buildup of resistant strains of the fungus causing apple scab.
- Do not make more than 2 consecutive applications and more than 60 fl oz of Inspire Super per acre per season. Do not apply Inspire Super within 72 days of harvest (PHI).
- Use on sensitive cultivars (e.g., Delicious) may cause injury. Used at this rate with 2% oil it is effective against powdery mildew.
- Equivalent products include Captan 50% W and WP and Captec 4L. Check the label for rates/100 GPA. REI restrictions vary from 24 hours to 4 days; check the label of the product you are using.
- Maintain per-acre use rate regardless of spray volume per acre.
- Do not use Scala SC or Vanguard WG for more than 5 sprays when applied in combination with a fungicide from a different fungicide group and mode of action. When applying Scala SC or VanguardWG alone do not make more than 2 consecutive applications without alternating to an equal number of sprays from a different fungicide resistance management group. Do not alternate or mix with any fungicide to which resistance has already developed.
- Do not make more than 3 applications or exceed 9 pints per year; do not apply less than 7 days after last application or before harvest.
- Do not apply more than 52 fl oz/acre per season or exceed 13 fl oz/acre in a single application. Do not apply within 14 days to harvest.

- l. Some equivalent products include Dithane, and Manzate. Check the label for rates.
 - m. The EBDC fungicides (mancozeb, Polyram) are labeled for use on apples. Two application programs may be used:
 1. Prebloom through bloom. Applications begin at the ¼- to ½-inch green tip stage and continue at 7- to 10-day application intervals through bloom. Do not apply more than 6 pounds per acre per application. There is a limit to the amount of EBDC fungicide that can be applied per acre each year. Refer to the label of the product you are using for specific yearly application limits.
 2. Extended application. Begin applications at the ¼- to ½-inch green tip stage and continue at 7- to 10-day application intervals through the second cover spray. Do not apply within 77 days of harvest. Do not apply more than 3 pounds per acre per application. There is a limit to the amount of EBDC fungicide that can be applied per acre each year. Refer to the label of the product you are using for specific yearly application limits.
- Note: Do not combine or integrate the 2 programs.
- n. Use the per-acre use rates in this section for protectant fungicides (captan, mancozeb, Polyram, or Ziram) in orchards with resistance to both DMI and strobilurin fungicides. Apply the protectant fungicides in complete sprays with a minimum volume of 100 gallons per acre.

Insecticide and Acaricide Notes

1. To prevent bud, leaf, and twig injury from oil, be certain that the oil emulsion is stable and use at least 50 gallons of spray per acre with these rates of oil. To a pint of water in a quart jar, add any wettable powder or flowable material first, and emulsifiable concentrates or oils last. Close jar, shake gently, and then observe after 5 to 10 minutes. If materials separate (precipitate, form a gel, foam excessively, or oil droplets appear), they are not physically compatible or the oil emulsion is not stable. Adding a spray adjuvant when testing compatibility of mixes may eliminate separation problems.
2. Some failures with chlorpyrifos, Supracide, and the various pyrethroids for rosy apple aphid control have been observed in recent years. Observe RAA populations during the bloom period where these products were applied prebloom to determine the level of control achieved.

Apples—Tight Cluster to Open Cluster

Apple scab. For effective scab control, apply at least 2 half-sprays or 1 complete spray before the first infection period.

Caution, oil-fungicide injury. The tight cluster to open cluster spray should not follow oil for at least 5 to 7 days and until 2 new leaves unfold when captan or sulfur is used. Both conditions should be met.

Rosy apple aphid. In orchards where rosy apple aphids have caused problems, an aphicide such as Assail, Belay, Calypso, or Vydate may be needed.

Spotted tentiform leafminer. Synthetic pyrethroids (Asana XL, Battalion, Baythroid, Danitol, Decis, Mustang Max, Proaxis, Warrior, and permethrin) or Vydate provide excellent early season control. Endosulfan is effective in controlling adults during the prebloom period. Exercise caution when using the synthetic pyrethroid insecticides. These products are known to exacerbate mite problems even several weeks and months after their application. Even the tight cluster to open cluster application can affect postbloom mite populations.

Powdery mildew. The period of most rapid spread is during the active terminal growth period. Where needed, add an effective fungicide to all sprays until terminal shoots stop growing. Standard types of wettable sulfur are not suggested after first cover spray. Bayleton, Rally, Rubigan, Sorvan, and Flint are effective in controlling apple powdery mildew. They should be applied at pink, bloom, and petal fall. If mildew is very severe, additional fungicides should be applied at the tight cluster bud stage and at first cover.

Refer to Table 5-1 and Part II, Diseases, Pests, and Natural Enemies, for management recommendations.

Pesticide recommendations for apples, tight cluster to open cluster.^a

Table 5-1. Powdery mildew recommendations.

Pesticide	Dilute rate/100 gal	Rate sprayed/A
CHOOSE one of the following:		
Bayleton 50DF	1.0–2.0 oz ^a	3.0–6.0 oz
Flint 50W ^b	0.5–0.6 oz ^a	2.0–2.5 oz
Indar 2F ^c	Refer to footnote c	6.0–8.0 fl oz
Inspire Super ^d		8.5–12.0 fl oz
Pristine		18.5 oz
Procure 50WS ^e	2.0–4.0 oz ^a	8.0–16.0 oz
Rally 40WP ^e	1.25–2.25 oz ^a	5.0–10.0 oz
Vintage SC ^e	2.25–3.0 fl oz ^a	9.0–12.0 fl oz
Sovran 50W ^b	1.0–1.5 oz ^a	4.0–6.4 oz
Sulfur ^f		10.0–20.0 lb
Topguard ^g	2.0–3.0 fl oz	8.0–12.0 fl oz

Fungicide and Antibiotic Notes

- a. Based on dilute sprays with a 400-gallon-per-acre base.
- b. Do not make more than four total applications per season or two consecutive applications of Flint or Sovran. Do not apply Sovran within 30 days of harvest and Flint within 14 days of harvest.
- c. Maintain per-acre use rate regardless of spray volume per acre. Do not make more than four applications per year. Do not apply Indar within 14 days of harvest.
- d. Do not make more than two consecutive applications and more than 60 fl oz of Inspire Super per acre per season. Do not apply Inspire Super within 14 days of harvest.
- e. These fungicides should be used in combination with another fungicide to improve their efficacy and to prevent buildup of resistant strains of the fungus causing apple scab.
- f. There are different formulations of micronized sulfur. See product label for details. Oil-fungicide injury: Sulfur causes injury when used with or too close to oil applications. When used in the tight cluster to open cluster spray, sulfur should not be applied for at least 5 to 7 days after oil or before two new leaves unfold. Both conditions should be met. Also, see warning under each compound listed in Part III, Chemical Management. Sulfur is preferred for mildew control in the tight cluster to open cluster and pink sprays, but it may reduce bud set on Delicious and Stayman varieties if applied in late sprays. For other formulations of sulfur, see Part III.
- g. Do not make two applications within less than 14 days. Do not exceed 52 fl oz/A per season or apply less than 14 days prior to harvest.

Pesticide	Dilute rate/100 gal ^b	Rate sprayed/A
CHOOSE 1 of the following:		
Flint 50W ^{c,d}	0.5–0.6 oz	2.0–2.5 oz
Indar 2F ^{c,e}	refer to footnote c	6.0–8.0 fl oz
Inspire Super ^{c,f}		8.5–16.0 fl oz
Lime sulfur ^g	—	2.5–3.0% solution
Procure 50WS ^c	2.0–4.0 oz	8.0–16.0 oz
Rally 40WP ^{c,h,i}		5.0–10.0 oz
Scala SC ^{c,j}		8.0–16.0 fl oz
Sovran 50W ^{c,d}	1–1.5 oz	4.0–6.4 oz
Syllit FL ^{c,k}		1.5–3.0 pints
Topguard ^{c,l}	3.2 fl oz	13.0 fl oz
Vanguard WG ^{c,j}	1.25 oz	5.0 oz
Vintage SC ^c		8.0–12.0 fl oz
In combination with 1 of the following:		
captan 80WDG ^h	refer to footnote h	2.5–5.0 lb
Penncozeb 75DF ^{m,n}	0.80 lb	3.2 lb
Polyram 80 WP ⁿ	0.75 lb	3.0 lb
Ziram 76WDG	1.0 lb	4.0 lb
OR select 1 of the following to be applied alone ^o :		
captan 80WDG ^h	refer to footnote h	5.0 lb
Penncozeb 75DF ^{m,n}	1.6 lb	6.2 lb
Polyram 80WP ⁿ	1.5 lb	6.0 lb
Ziram 76WDG	1.5–2.0 lb	6.0–8.0 lb
PLUS 1 of the following:		
Use 1 or more of the following insecticides or miticides if green fruitworm, spotted tentiform leafminer, rosy apple aphid, redbanded leafroller, tarnished plant bug, or mites are a problem. Insecticides and miticides should be selected and combined according to their efficacy against individual pests (see Table 4-6).		
Apollo 4SC	1.0–2.0 fl oz	4.0 fl oz
Asana XL 0.66 EC	3.0–4.0 fl oz	6.0–10.0 fl oz
azinphos-methyl 50WP	0.35 lb	1.0–1.5 lb
Battalion 0.2EC	—	7.0–14.0 fl oz
Baythroid 2E	—	2.0–2.8 fl oz
Danitol 2.4 EC	3.5–7.0 fl oz	10.7–21.3 fl oz
Esteem 35WP	1.0–1.5 oz	4.0–5.0 oz
Lorsban 75WG	0.33–0.67 lb	1.0–2.0 lb
Mustang Max	—	1.3–4.0 fl oz
Onager		12.0–24.0 fl oz
permethrin 2EC	4.0 fl oz	8.0–12.0 fl oz
permethrin 3.2EC	2.5 fl oz	4.0–8.0 fl oz
permethrin 25WP	0.25 lb	0.50–0.75 lb
Proaxis 0.5EC	—	2.5–5.1 fl oz
Savey 50WP	—	3.0–4.0 oz
Thionex 50W	1.0 lb	3.0–3.5 lb
Thionex 3EC	21.0 fl oz	4.0–5.0 pt
Vydate 2L	1.5 pt	3.0–4.0 pt
Warrior II	—	1.3–2.5 fl oz

Fungicide and Antibiotic Notes

- See note on fungicide resistance. If you have resistance to both DMI and strobilurin fungicides refer to note p below.
- Based on dilute sprays with a 400-gallon-per-acre base. Maintain per-acre use-rate regardless of spray volume per acre.
- These fungicides should be used in combination with another fungicide to improve their efficacy and to prevent or delay buildup of resistant strains of the fungus causing apple scab.
- Do not apply more than 4 total applications per season or 2 consecutive applications of Flint, Sovran, and Pristine. Do not apply Sovran within 30 days of harvest, Flint within 14 days of harvest, and Pristine within 0 days of harvest.
- Do not make more than 4 applications per year. Do not apply Indar within 14 days of harvest.
- Do not make more than 2 consecutive applications and more than 60 fl oz of Inspire Super per acre per season. Do not apply Inspire Super within 14 days of harvest (PHI).
- Use on sensitive cultivars (e.g., Delicious apples) may cause injury. Used at this rate with 2% oil it is effective against powdery mildew.
- Equivalent products include Captan 50% W and WP and Captec 4L. Check the label for rates/100 GPA. REI restrictions vary from 24 hours to 4 days; check the label of the product you are using.
- Maintain per-acre use rate regardless of spray volume per acre.
- Do not use Scala SC or Vanguard WG for more than 5 sprays when applied

in combination with a fungicide from a different fungicide group and mode of action. When applying Scala SC or Vanguard WG alone do not make more than 2 consecutive applications without alternating to an equal number of sprays from a different fungicide resistance management group. Do not alternate or mix with any fungicide to which resistance has already developed.

- Do not make more than 3 applications or exceed 9 pints per year; do not apply less than 7 days after last application or before harvest.
- Do not apply more than 52 fl oz/acre per season or exceed 13 fl oz/acre in a single application. Do not apply within 14 days to harvest.
- Some equivalent products include Dithane, and Manzate. Check the label for rates.
- The EBDC fungicides (mancozeb, Polyram) are labeled for use on apples. Two application programs may be used:
 - Prebloom through bloom. Applications begin at the ¼- to ½-inch green tip stage and continue at 7- to 10-day application intervals through bloom. Do not apply more than 6 pounds per acre per application. There is a limit to the amount of EBDC fungicide that can be applied per acre each year. Refer to the label of the product you are using for specific yearly application limits.
 - Extended application. Begin applications at the ¼- to ½-inch green tip stage and continue at 7- to 10-day application intervals through the second cover spray. Do not apply within 77 days of harvest. Do not apply more than 3 pounds per acre per application. There is a limit to the amount of EBDC fungicide that can be applied per acre each year. Refer to the label of the product you are using for specific yearly application limits.

Note: Do not combine or integrate the 2 programs.
- Use the per-acre use rates in this section for protectant fungicides (captan, mancozeb, Polyram, or Ziram) in orchards with resistance to both DMI and strobilurin fungicides. Apply the protectant fungicides in complete sprays with a minimum volume of 100 gallons per acre.

Apples—Pink

Apple scab. Peak spore release of primary apple scab spores (ascospores) usually begins about pink stage in Pennsylvania.

Oriental fruit moth. An insecticide application at this time will provide some protective control during the bloom period, when egg hatch of the first generation starts.

Mites. Apollo, Onager, or Savey can be applied at pink, especially if no oil treatment has been applied. If a low rate of oil was applied (1–2 gal/A) and overwintering eggs were clearly visible to the unaided eye on the tree bark, then apply Apollo, Onager, or Savey at pink. If a high rate of oil was used (4 gal/A), an ovicidal acaricide application is usually not necessary at this time.

Powdery mildew. If powdery mildew is a problem, refer to Table 5-1 and Part II, Diseases, Pests, and Natural Enemies, for management recommendations.

Cedar apple rust. If cedar apple rust is historically a problem in an orchard, refer to Table 5-2 and Part II for management recommendations.

Table 5-2. Cedar apple rust recommendations.

Effective fungicides should be applied in the pink, bloom, petal fall, and first cover sprays. Where cedar apple rust is not a major problem, Flint, Sovran, or Pristine will be effective. Bayleton, Rubigan, Nova, Procure, mancozeb, or Ziram will control rust, but when captan is used, add one of the following:

Pesticide	Dilute rate/100 gal	Rates sprayed/A
CHOOSE one of the following:		
Bayleton 50DF	0.5–2.0 oz	2–8.0 oz
Penncozeb 75DF ^{a,b}	0.8 lb	3.2 lb
Polyram 80WP ^b	0.75 lb	3.0 lb
Procure 50WS ^c	2.0–4.0 oz	8.0–16.0 oz
Rally 40WP ^c	1.25–2.0 oz	5.0–8.0 oz ^d
Rubigan EC ^c	2.0–3.0 oz	8.0–12.0 oz
Indar 2F ^e	Refer to footnote c	6.0–8.0 fl oz
Inspire Super ^f		8.5–12.0 fl oz
Ziram 76WDG	2.0 lb	6.0–8.0 lb

Fungicide and Antibiotic Notes

- Some equivalent products include Dithane, Manzate. Check label for rates.
- The EBDC fungicides (e.g., Penncozeb, Polyram) for cedar apple rust control:

- Prebloom through bloom. Applications begin at the ¼- to ½-inch green tip stage and continue at 7- to 10-day application intervals through bloom. Do not apply more than 6 pounds per acre per application. There is a limit to the amount of EBDC fungicide that can be applied per acre each year. Refer to the label of the product you are using for specific yearly application limits.
- Extended application. Begin applications at the ¼- to ½-inch green tip stage and continue at 7- to 10-day application intervals through the second cover spray. Do not apply within 77 days of harvest. Do not apply more than 3 pounds per acre per application. There is a limit to the amount of EBDC fungicide that can be applied per acre each year. Refer to the label of the product you are using for specific yearly application limits.

Note: Do not combine or integrate the two programs.

- Should be used in combination with another fungicide to prevent buildup of resistant strains of the fungus causing apple scab.
- Based on dilute sprays with a 400-gallon-per-acre base.
- Maintain per-acre use rate regardless of spray volume per acre. Do not make more than four applications per year. Do not apply Indar within 14 days of harvest.
- Do not make more than two consecutive applications and more than 60 fl oz of Inspire Super per acre per season. Do not apply Inspire Super within 14 days of harvest.

Pesticide recommendations for apples, pink.^a

Pesticide	Dilute rate/100 gal ^b	Rate sprayed/A
CHOOSE 1 of the following:		
Flint 50W ^{c,d}	0.5–0.6 oz	2.0–2.5 oz
Indar 2F ^{c,e}	refer to footnote e	6.0–8.0 fl oz
Inspire Super ^{c,f}		8.5–16.0 fl oz
Lime sulfur ^g	—	2.5–3.0% solution
Procure 50WS ^c	2.0–4.0 oz	8.0–16.0 oz
Rally 40WP ^{c,h,i}		5.0–10.0 oz
Scala SC ^{c,j}		8.0–16.0 fl oz
Sovran 50W ^{c,d}	1–1.5 oz	4.0–6.4 oz
Syllit FL ^{c,k}		1.5–3.0 pints
Topguard ^{c,l}	3.2 fl oz	13.0 fl oz
Vanguard WG ^{c,j}	1.25 oz	5.0 oz
Vintage SC ^c		8.0–12.0 fl oz
In combination with 1 of the following:		
captan 80WDG ^h	refer to footnote h	2.5–5.0 lb
Penncozeb 75DF ^{m,n}	0.80 lb	3.2 lb
Polyram 80 WP ⁿ	0.75 lb	3.0 lb
Ziram 76WDG	1.0 lb	4.0 lb
OR select 1 of the following to be applied alone^o:		
captan 80WDG ^h	refer to footnote h	5.0 lb
Penncozeb 75DF ^{m,n}	1.6 lb	6.2 lb
Polyram 80WP ⁿ	1.5 lb	6.0 lb
Ziram 76WDG	1.5–2.0 lb	6.0–8.0 lb
PLUS 1 of the following:		
Use 1 or more of the following insecticides or miticides if Oriental fruit moth, redbanded leafroller, rosy apple aphid, obliquebanded leafroller, tarnished plant bug, or mites are a problem. Insecticides and miticides should be selected and combined according to their efficacy against individual pests (see Table 4-6).		
Apollo 4SC	1.0–2.0 fl oz	4.0 fl oz
Assail 30SG ¹	—	2.5–4.0 oz
Avaunt 30WDG ¹	—	5.0–6.0 oz
Belay ¹	—	3.0–6.0 fl oz
Calypso 4F ¹	0.5–1.0 fl oz	2.0–4.0 fl oz
Esteem 35WP ¹	1.0–1.5 oz	4.0–5.0 oz
Onager		12.0–24.0 fl oz
Savey 50WP	—	3.0–4.0 oz
Vydate 2L ¹	1.5 pt	2.0–8.0 pt

Fungicide and Antibiotic Notes

- See note on fungicide resistance. If you have resistance to both DMI and strobilurin fungicides refer to note p below.
- Based on dilute sprays with a 400-gallon-per-acre base. Maintain per-acre use-rate regardless of spray volume per acre.
- These fungicides should be used in combination with another fungicide to improve their efficacy and to prevent or delay buildup of resistant strains of the fungus causing apple scab.
- Do not apply more than 4 total applications per season or 2 consecutive applications of Flint, Sovran, and Pristine. Do not apply Sovran within 30 days of harvest, Flint within 14 days of harvest, and Pristine within 0 days of harvest.
- Do not make more than 4 applications per year. Do not apply Indar within 14 days of harvest.
- Do not make more than 2 consecutive applications and more than 60 fl oz of Inspire Super per acre per season. Do not apply Inspire Super within 14 days of harvest (PHI).
- Use on sensitive cultivars (e.g., Delicious apples) may cause injury. Used at this rate with 2% oil it is effective against powdery mildew.
- Equivalent products include Captan 50% W and WP and Captec 4L. Check the label for rates/100 GPA. REI restrictions vary from 24 hours to 4 days; check the label of the product you are using.
- Maintain per-acre use rate regardless of spray volume per acre.
- Do not use Scala SC or Vanguard WG for more than 5 sprays when applied in combination with a fungicide from a different fungicide group and mode of action. When applying Scala SC or VanguardWG alone do not make more than 2 consecutive applications without alternating to an equal number of sprays from a different fungicide resistance management group. Do not alternate or mix with any fungicide to which resistance has already developed.
- Do not make more than 3 applications or exceed 9 pints per year; do not apply less than 7 days after last application or before harvest.
- Do not apply more than 52 fl oz/acre per season or exceed 13 fl oz/acre in a single application. Do not apply within 14 days to harvest.

- m. Some equivalent products include Dithane, and Manzate. Check the label for rates.
- n. The EBDC fungicides (mancozeb, Polyram) are labeled for use on apples. Two application programs may be used:
1. *Prebloom through bloom.* Applications begin at the 1/4- to 1/2-inch green tip stage and continue at 7- to 10-day application intervals through bloom. Do not apply more than 6 pounds per acre per application. There is a limit to the amount of EBDC fungicide that can be applied per acre each year. Refer to the label of the product you are using for specific yearly application limits.
 2. *Extended application.* Begin applications at the 1/4- to 1/2-inch green tip stage and continue at 7- to 10-day application intervals through the second cover spray. Do not apply within 77 days of harvest. Do not apply more than 3 pounds per acre per application. There is a limit to the amount of EBDC fungicide that can be applied per acre each year. Refer to the label of the product you are using for specific yearly application limits.
- Note: Do not combine or integrate the 2 programs.
- o. Use the per-acre use rates in this section for protectant fungicides (captan, mancozeb, Polyram, or Ziram) in orchards with resistance to both DMI and strobilurin fungicides. Apply the protectant fungicides in complete sprays with a minimum volume of 100 gallons per acre.

Insecticide and Acaricide Note

1. Do not make applications of any insecticides listed above when any flowers are open.

Apples—Bloom

Use the same materials as in the pink spray. Do not go over 5 days between half-sprays, and shorten this period in wet weather. Apply the bloom spray at a tractor speed 0.5 mph faster.

Apple scab. Peak release of primary apple scab spores (ascospores) usually occurs around bloom stage in Pennsylvania.

Powdery mildew. If powdery mildew is a problem, refer to Table 5-1 and Part II, Diseases, Pests, and Natural Enemies, for management recommendations.

Cedar apple rust. If cedar apple rust is historically a problem in an orchard, refer to Table 5-2 and Part II, Diseases, Pests, and Natural Enemies, for management recommendations.

Fire blight. Conditions favorable for infection include (1) open blossoms or succulent new growth, (2) an average daily temperature of 65°F or higher, plus (3) rainfall or a relative humidity of 60 percent or higher. Apply first streptomycin spray any time after first blossoms open when above conditions exist or are expected within 24 hours. Repeat sprays at 5- to 7-day intervals through late bloom. A minimum of 2 applications is necessary to provide control.

Use streptomycin formulations at 4 to 8 ounces per 100 gallons dilute (60 to 100 ppm) or 1.5 pounds per acre concentrate (use at least 50 gal mixture/A), plus 1 pint Regulaid in each 100 gallons of spray. Streptomycin formulations are much more effective when applied during slow drying conditions such as at night. Refer to Part II, Diseases, Pests, and Natural Enemies, for more information on fire blight.

Gypsy moth. For gypsy moth control during bloom, refer to *Bacillus thuringiensis* (Bt) in Part III, Chemical Management.

Obliquebanded leafroller. If obliquebanded leafroller larvae are problematic, use a *Bacillus thuringiensis* (Bt) product listed in Part III, Chemical Management.

Boron nutrition. Boron should be applied in an annual maintenance program. Each year apply a single spray of 1.0 pound of Solubor per 100 gallons (4 lb/acre) sometime during the period of full bloom through the first cover spray. In cases of documented deficiency, refer to Foliar Application of Nutrients in Part I.

Apples—Petal Fall

Boron nutrition. See note at full bloom spray.

Cedar apple rust. If cedar apple rust is historically a problem in an orchard, refer to Table 5-2 and Part III, Chemical Management, for management recommendations.

Fire blight. Prevent late blossom infections at petal fall, when environmental conditions are often favorable for fire blight.

Powdery mildew. The period of most rapid spread is from bloom until terminal growth stops. Where needed, add an effective fungicide to all sprays until terminal shoots stop growing. Standard types of wettable sulfur are not suggested after the first cover spray. See also Table 5-1 and Part III, Chemical Management, for management recommendations.

Rosy apple aphid. If rosy apple aphid is a problem, use Admire Pro at 2–3 fluid ounces per acre, imidacloprid 1.6F at 6–8 fluid ounces per acre, Actara at 4.5–5.5 ounces per acre, Assail at 5–6 ounces per acre, or Calypso at 3–4 fluid ounces per acre.

Spotted tentiform leafminer. Actara, Admire-Pro, Agri-Mek, Assail, Belay, Calypso, Delegate, imidacloprid and Movento are all very effective when applied at petal fall. The addition of a penetrating surfactant to Agri-Mek and Agri-Flex will increase activity toward leafminers.

White apple leafhopper and mites. First-brood leafhoppers could be quite injurious at this time. Check for leafhopper activity during the next few weeks. Admire Pro at 2–3 fluid ounces per acre; imidacloprid 1.6F at 4–6 fluid ounces per acre; Actara at 2.0–2.75 ounces per acre; Assail at 4.0–5.0 ounces; or Calypso at 2.0–4.0 fluid ounces will also control leafhoppers.

Plum curculio. Cool, wet weather may be responsible for extended activity and less pesticide residue. To improve control, use an effective insecticide listed below and shorten the spray interval during the next 3 to 4 weeks. Many orchards may need this application only for the 3 to 4 rows that border woods and fence rows. Plum curculio has recently increased in severity in many regions of the state.

Obliquebanded leafroller. If obliquebanded leafroller larvae are present, use either Intrepid at 12–16 fluid ounces per acre, Proclaim at 3.2–4.8 oz plus a penetrating surfactant, Rimon at 20 fluid ounces, or Voliam Flexi at 4–7 oz per acre.

Other insects. In orchards with a history of Oriental fruit moth problems, use Assail, azinphos-methyl, Avaunt, Calypso, Delegate, or Imidan.

Pesticide recommendations for apples, petal fall.^a

Pesticide	Dilute rate/100 gal ^b	Rate sprayed/A
CHOOSE 1 of the following:		
Flint 50W ^{c,d}	0.5–0.6 oz	2.0–2.5 oz
Indar 2F ^{c,e}	refer to footnote c	6.0–8.0 fl oz
Inspire Super ^{c,f}		8.5–16.0 fl oz
Procure 50WS ^c	2.0–4.0 oz	8.0–16.0 oz
Rally 40WP ^{c,g,h}		5.0–10.0 oz
Scala SC ^{c,i}		8.0–16.0 fl oz
Sovran 50W ^{c,d}	1–1.5 oz	4.0–6.4 oz
Syllit FL ^{c,j}		1.5–3.0 pints
Topguard ^{c,k}	3.2 fl oz	13.0 fl oz
Vanguard WG ^{c,i}	1.25 oz	5.0 oz
Vintage SC ^c		8.0–12.0 fl oz
In combination with 1 of the following:		
captan 80WDG ^g	refer to footnote g	2.5–5.0 lb
Penncozeb 75DF ^{l,m}	0.80 lb	3.2 lb
Polyram 80 WP ^m	0.75 lb	3.0 lb
Ziram 76WDG	1.0 lb	4.0 lb
OR select 1 of the following to be applied alone^l:		
captan 80WDG ^g	refer to footnote g	5.0 lb
Penncozeb 75DF ^{l,m}	1.6 lb	6.2 lb
Polyram 80WP ^m	1.5 lb	6.0 lb
Ziram 76WDG	1.5–2.0 lb	6.0–8.0 lb
PLUS 1 of the following:		
Insecticides and/or acaricides should be selected and combined according to their efficacy against individual pests (see Table 4-6).		
Actara	—	4.5–5.5 oz
Admire Pro	—	2.0–3.0 fl oz
Agri-Flex ¹	—	5.5–8.5 fl oz
Agri-Mek 0.15EC ¹	2.5–5.0 fl oz	10.0–20.0 fl oz
Apollo 4SC	1.0–2.0 fl oz	4.0 fl oz
Assail 30SG ²	—	5.0–8.0 oz
Avaunt 30WDG	—	5.0–6.0 oz
Belay	—	3.0–6.0 fl oz
Bt	(use label rate)	
Calypso 4F	1.0–2.0 fl oz	4.0–6.0 fl oz
Guthion 50W ³	0.5–0.75 lb	1.5–2.0 lb
imidacloprid 1.6F	1.0–2.0 fl oz	4.0–6.0 fl oz
Imidan 70WP	0.75–1.0 lb	2.5–4.0 lb
Intrepid 2F	3.0–4.0 fl oz	8.0–16.0 fl oz
Movento	—	6.0–9.0 fl oz
Onager	—	12.0–24.0 fl oz
Proclaim 5SC ²	0.8–1.2 fl oz	3.2–4.8 fl oz
Rimon 0.83EC ⁴	—	20.0–30.0 fl oz
Savey 50WP	—	3.0 oz
Voliam Flexi 40WDG ⁵	—	4.0–7.0 oz
PLUS:		
Solubor 20.5% B	1.0 lb	3.0 lb

Fungicide and Antibiotic Notes

- See note on fungicide resistance. If you have resistance to both DMI and strobilurin fungicides refer to note o below.
- Based on dilute sprays with a 400-gallon-per-acre base. Maintain per-acre use-rate regardless of spray volume per acre.
- These fungicides should be used in combination with another fungicide to improve their efficacy and to prevent or delay buildup of resistant strains of the fungus causing apple scab.
- Do not apply more than 4 total applications per season or 2 consecutive applications of Flint, Sovran, and Pristine. Do not apply Sovran within 30 days of harvest, Flint within 14 days of harvest, and Pristine within 0 days of harvest.
- Do not make more than 4 applications per year. Do not apply Indar within 14 days of harvest.
- Do not make more than 2 consecutive applications and more than 60 fl oz of Inspire Super per acre per season. Do not apply Inspire Super within 14 days of harvest (PHI).
- Equivalent products include Captan 50% W and WP and Captec 4L. Check the label for rates/100 GPA. REI restrictions vary from 24 hours to 4 days; check the label of the product you are using.
- Maintain per-acre use rate regardless of spray volume per acre.

- Do not use Scala SC or Vanguard WG for more than 5 sprays when applied in combination with a fungicide from a different fungicide group and mode of action. When applying Scala SC or VanguardWG alone do not make more than 2 consecutive applications without alternating to an equal number of sprays from a different fungicide resistance management group. Do not alternate or mix with any fungicide to which resistance has already developed.
 - Do not make more than 3 applications or exceed 9 pints per year; do not apply less than 7 days after last application or before harvest.
 - Do not apply more than 52 fl oz/acre per season or exceed 13 fl oz/acre in a single application. Do not apply within 14 days to harvest.
 - Some equivalent products include Dithane, and Manzate. Check the label for rates.
 - The EBDC fungicides (mancozeb, Polyram) are labeled for use on apples. Two application programs may be used:
 - Prebloom through bloom. Applications begin at the ¼- to ½-inch green tip stage and continue at 7- to 10-day application intervals through bloom. Do not apply more than 6 pounds per acre per application. There is a limit to the amount of EBDC fungicide that can be applied per acre each year. Refer to the label of the product you are using for specific yearly application limits.
 - Extended application. Begin applications at the ¼- to ½-inch green tip stage and continue at 7- to 10-day application intervals through the second cover spray. Do not apply within 77 days of harvest. Do not apply more than 3 pounds per acre per application. There is a limit to the amount of EBDC fungicide that can be applied per acre each year. Refer to the label of the product you are using for specific yearly application limits.
- Note: Do not combine or integrate the 2 programs.
- Use the per-acre use rates in this section for protectant fungicides (captan, mancozeb, Polyram, or Ziram) in orchards with resistance to both DMI and strobilurin fungicides. Apply the protectant fungicides in complete sprays with a minimum volume of 100 gallons per acre.

Insecticide and Acaricide Notes

- Agri-Mek and Agri-Flex should be combined with a summer oil for best results; however, other penetrating adjuvants can be used with somewhat less efficacy. The rate for the summer spray oil should be a 0.5–1.0 percent concentration (2 qt/100 gal or a minimum of 1 gal/A). For best results, apply Agri-Mek and Agri-Flex at petal fall or within 10 days of petal fall, and use a minimum of 50 gallons of water per acre (100 gal/A is recommended). If foliage is hardening off, apply at petal fall. Agri-Mek and Agri-Flex are not broad-spectrum insecticides and should not be the only insecticide applied at this time.
- Adding 1.0–2.0 quarts of summer oil per 100 gal will increase Assail and Proclaim efficacy. Proclaim is highly effective against leafrollers and leafminers, but it only provides suppression for codling moth and Oriental fruit moth.
- Guthion is only legal on apples during the 2012 season (until Sept. 30, 2012) and the maximum seasonal rate is 3.0 lbs per acre.
- If Rimon is used at petal fall for leafroller control, it will also provide some aid in the control of codling moth eggs because of its residual activity. However, the ideal timing of Rimon for CM control is 75–100 degree days following biofix, usually late petal fall.
- Voliam Flexi is very effective against the lepidopterous pests present at petal fall, including the obliquebanded leafroller and Oriental fruit moth as well as the plum curculio. Because Voliam Flexi belongs to Group 28 (IRAC ryanodine receptor modulators), which also contains the compounds Altacor, Belt and Turismo, growers should not use any of these products against consecutive generations of any particular pest complex. They should switch to other chemical classes to control the next generation of the targeted pest.

Green aphids and white apple leafhopper. If these insects occur concurrently, 1 of the following insecticides should control both.

Pesticide	Dilute rate/100 gal	Rate sprayed/A
CHOOSE 1 of the following:		
Actara ¹	—	2.0–5.5 oz
Admire Pro	—	2.0–4.0 fl oz
Assail 30SG	—	2.5–4.0 oz
Belay	—	3.0–6.0 fl oz
Beleaf 50SG ²	—	2.0–2.8 oz
Calypso 4F	0.5–1.0 fl oz	2.0–4.0 fl oz
imidacloprid 1.6F	1.0–2.0 fl oz	4.0–6.0 fl oz
Lannate 90SP ³	4.0 oz	6.0–8.0 oz
Lannate LV ³	12.0 fl oz	18.0–24.0 fl oz
Movento ⁴	—	6.0–9.0 fl oz
Sevin XLR Plus ⁵	0.5–1.0 pt	1.0 qt
Thionex 50W	1.0 lb	3.0–3.5 lb
Thionex 3EC	21.0 fl oz	4.0–5.0 pt

Insecticide and Acaricide Notes

1. Use the lower rate for leafhoppers, the higher rate for aphids.
2. Beleaf is only recommended for aphid and plant bug control.
3. Lannate, while providing good control, will probably adversely affect *Stethorus* and *T. pyri* populations.
4. Movento is only active against aphids (including the woolly apple aphids), not leafhoppers. It is very active against San Jose Scale as well. Use a penetrating adjuvant with this product.
5. Sevin XLR Plus can be used for leafhopper control only; however, *Stethorus* populations will probably be adversely affected. Sevin XLR Plus is also a fruit thinning agent.

Apples—First Cover

Blister spot on Crispin (Mutsu). Crispin apples are highly susceptible to the blister spot bacterial infections about 2 weeks after petal fall for a period of 2–4 weeks. The causal bacteria overwinter in the infected buds and multiply on the leaf surface in spring. Rain washes the bacteria onto the fruit where they infect through the lenticels to cause the reddish spot. A brief shower is all that is required to distribute the bacteria to new infection sites. The standard recommendation for control of this disease is to apply streptomycin at ½ pound per 100 gallon dilute rate 10 to 14 days after petal fall. If the weather pattern of rain continues, 2 additional sprays should be applied at weekly intervals. Resistance of this bacteria to streptomycin has been documented in commercial orchards in the northeastern United States. Do not use more than necessary or up to 3 applications.

Fire blight. Do not use streptomycin on apple trees within 50 days of harvest.

Codling moth. If present, codling moth can be controlled with various products, including either the broad-spectrum insecticides (e.g., Avaunt, Guthion, Imidan) applied at 250 and 550–600 degree days after biofix, or the more selective insecticides and virus products, including Altacor, Assail, Belt, Calypso, Carpvirusine, Cyd-X, Delegate, Intrepid, Rimon, Turismo, and Voliam Flexi. There are a number of orchards in Pennsylvania where the codling moth has developed resistance to azinphos-methyl and Imidan. If resistance is suspected, use one of the selective insecticides mentioned above. Rimon should be applied at 75–100 degree days following biofix and again 14–17 days later. Intrepid should be applied at 150 and 450 degree days after biofix. Applications of Carpvirusine (6.5–13.5 fluid ounces) or Cyd-X (2.0–6.0 ounces per acre) or Virosoft^{CP4} (1.3 ounces per acre) should commence at 230–240 degree days and repeated every 7–9 days during the first brood egg hatch period. The virus products are much more effective when used in combination with codling moth pheromone mating disruption (see Management of Codling

Moth with CM Granulovirus on page 199).

Cork and bitter pit in fruit. See Part I.

Powdery mildew. If powdery mildew is a problem, refer to Table 5-1 and Part II, Diseases, Pests, and Natural Enemies, for management recommendations.

Cedar apple rust. If cedar apple rust is historically a problem, refer to Table 5-2 and Part II, Diseases, Pests, and Natural Enemies, for management recommendations.

Pesticide recommendations for apples, first cover^a

Pesticide	Dilute rate/100 gal ^b	Rate sprayed/A
CHOOSE 1 of the following:		
Flint 50W ^{c,d}	0.5–0.6 oz	2.0–2.5 oz
Indar 2F ^{c,e}	refer to footnote e	6.0–8.0 fl oz
Inspire Super ^{c,f}	—	8.5–16.0 fl oz
Procure 50WS ^c	2.0–4.0 oz	8.0–16.0 oz
Rally 40WP ^{c,g,h}	—	5.0–10.0 oz
Scala SC ^{c,i}	—	8.0–16.0 fl oz
Sovran 50W ^{c,d}	1–1.5 oz	4.0–6.4 oz
sulfur ⁱ	—	6.0–10.0 lb
Syllit FL ^{c,k}	—	1.5–3.0 pints
Topguard ^{c,l}	3.2 fl oz	13.0 fl oz
Vanguard WG ^{c,i}	1.25 oz	5.0 oz
Vintage SC ^c	—	8.0–12.0 fl oz
In combination with 1 of the following:		
captan 80WDG ^g	refer to footnote g	2.5–5.0 lb
Penncozeb 75DF ^{m,n}	0.80 lb	3.2 lb
Polyram 80 WP ⁿ	0.75 lb	3.0 lb
Ziram 76WDG	1.0 lb	4.0 lb
OR select 1 of the following to be applied alone^o:		
captan 80WDG ^g	refer to footnote g	5.0 lb
Penncozeb 75DF ^{m,n}	1.6 lb	6.2 lb
Polyram 80WP ⁿ	1.5 lb	6.0 lb
sulfur ⁱ	—	10.0–15.0 lb
Ziram 76WDG	1.5–2.0 lb	6.0–8.0 lb
PLUS 1 of the following:		
Insecticides should be selected and combined according to their efficacy against individual pests (see Table 4-6).		
Altacor 35WDG ¹	—	2.5–3.0 oz
Assail 30SG ²	—	4.0–8.0 oz
Avaunt 30WDG	—	5.0–6.0 oz
Belay	—	3.0–6.0 fl oz
Belt SC ¹	—	4.0–5.0 fl oz
Bt	use label rate	—
Calypso 4F	1.0–2.0 fl oz	4.0–6.0 fl oz
Carpovirusine	—	6.5–13.5 fl oz
Cyd-X (CM virus)	—	2.0–6.0 oz
Delegate 25WG ¹	—	4.5–6.0 oz
Guthion 50W ³	0.35–0.5 lb	1.5–2.0 lb
Imidan 70WP	0.50–1.0 lb	3.0–4.0 lb
Intrepid 2F	3.0–4.0 fl oz	12.0–16.0 fl oz
Rimon 0.83EC	—	20.0–30.0 fl oz
Tourismo ¹	—	12.0–17.0 fl oz
Virosoft ^{CP4} (CM virus)	—	1.3 oz
Voliam Flexi 40WDG ¹	—	4.0–7.0 oz
PLUS:		
Calcium chloride (77–80% flake)	0.7–2.3 lb	2.0–7.1 lb
Solubor 20.5%B	1.0 lb	3.0 lb

Fungicide and Antibiotic Notes

1. See note on fungicide resistance. If you have resistance to both DMI and strobilurin fungicides refer to note p below.
2. Based on dilute sprays with a 400-gallon-per-acre base. Maintain per-acre use-rate regardless of spray volume per acre.
3. These fungicides should be used in combination with another fungicide to improve their efficacy and to prevent or delay buildup of resistant strains of the fungus causing apple scab.
4. Do not apply more than 4 total applications per season or 2 consecutive applications of Flint, Sovran, and Pristine. Do not apply Sovran within 30

days of harvest, Flint within 14 days of harvest, and Pristine within 0 days of harvest.

- e. Do not make more than 4 applications per year. Do not apply Indar within 14 days of harvest.
- f. Do not make more than 2 consecutive applications and more than 60 fl oz of Inspire Super per acre per season. Do not apply Inspire Super within 14 days of harvest (PHI).
- g. Equivalent products include Captan 50% W and WP and Captec 4L. Check the label for rates/100 GPA. REI restrictions vary from 24 hours to 4 days; check the label of the product you are using.
- h. Maintain per-acre use rate regardless of spray volume per acre.
- i. Do not use Scala SC or Vanguard WG for more than 5 sprays when applied in combination with a fungicide from a different fungicide group and mode of action. When applying Scala SC or Vanguard WG alone do not make more than 2 consecutive applications without alternating to an equal number of sprays from a different fungicide resistance management group. Do not alternate or mix with any fungicide to which resistance has already developed.
- j. Use on sensitive cultivars (e.g., Delicious) may cause injury. Do not use oil within 14 days of sulfur application.
- k. Do not make more than 3 applications or exceed 9 pints per year; do not apply less than 7 days after last application or before harvest.
- l. Do not apply more than 52 fl oz/acre per season or exceed 13 fl oz/acre in a single application. Do not apply within 14 days to harvest.
- m. Some equivalent products include Dithane, and Manzate. Check the label for rates.
- n. The EBDC fungicides (mancozeb, Polyram) are labeled for use on apples. Two application programs may be used:
 1. Prebloom through bloom. Applications begin at the ¼- to ½-inch green tip stage and continue at 7- to 10-day application intervals through bloom. Do not apply more than 6 pounds per acre per application. There is a limit to the amount of EBDC fungicide that can be applied per acre each year. Refer to the label of the product you are using for specific yearly application limits.
 2. Extended application. Begin applications at the ¼- to ½-inch green tip stage and continue at 7- to 10-day application intervals through the second cover spray. Do not apply within 77 days of harvest. Do not apply more than 3 pounds per acre per application. There is a limit to the amount of EBDC fungicide that can be applied per acre each year. Refer to the label of the product you are using for specific yearly application limits.

Note: Do not combine or integrate the 2 programs.

- o. Use the per-acre use rates in this section for protectant fungicides (captan, mancozeb, Polyram, or Ziram) in orchards with resistance to both DMI and strobilurin fungicides. Apply the protectant fungicides in complete sprays with a minimum volume of 100 gallons per acre.

Insecticide and Acaricide Notes

1. In order to prevent the development of pest resistance to these new chemistries and to practice the most effective resistance management approach, we highly encourage growers to use only 1 chemical class of products (i.e., mode of action) for a particular generation of a targeted pest and to rotate to another chemical class to control the succeeding generation of the targeted pest. For example, if using Delegate to control the first generation of codling moth, use Altacor, Belt, Tourismo, or Voliam Flexi to control the second generation, or if using either Altacor, Belt, Tourismo, or Voliam Flexi to control the first generation of codling moth, then switch to Delegate or another chemical class (Assail, Calypso, etc.) to control the second generation. Altacor, Belt, Tourismo, and Voliam Flexi belong to the same chemical class (Insecticide Resistance Action Committee Group 28) and should not be used for consecutive generations of a targeted pest.
2. Adding 1–2 qt of summer oil per 100 gal will increase Assail efficacy.
3. Guthion is only legal on apples during the 2012 season (until Sept. 30, 2012) and the maximum seasonal rate is 3.0 lbs per acre.

Apples—Second, Third, and Fourth Covers

Apple scab. If infections from primary scab are a problem, use the fungicides listed for first cover being careful to observe label restrictions.

Powdery mildew. If powdery mildew is a problem, refer to Table 5-1 and Part II, Diseases, Pests, and Natural Enemies, for management recommendations.

Fire blight. Apply streptomycin within 24 hours of hail injury, especially in orchards where fire blight is a problem. Do not use streptomycin on apple trees within 60 days of harvest.

San Jose scale. Add Esteem 35WP at 4.0–5.0 oz/acre or Centaur at 35 oz/acre.

Aphids. See petal fall spray.

Dogwood borer. Handgun or backpack sprayer applications of Lorsban 4E (1.5 qt/100 gal) or Lorsban Advanced (1.5 qt/100 gal) from the pink stage until mid- to late June or after harvest and directed at burrknot-affected areas are most effective. Do not allow spray to contact foliage or fruit. Do not use a spray volume of more than 100 gallons per acre. Pheromone traps can be used to determine periods of male moth activity. These traps should be hung about 4 feet off the ground near the tree trunk.

Tufted apple bud moth. Growers having trouble with tufted apple bud moth can use Altacor, Belt, Delegate, Intrepid, Rimon, Tourismo, or Voliam Flexi. Observe the proper spray intervals and close these intervals at the appropriate times during the egg-hatching period of both broods (approximately second to third and sixth to seventh covers). Use Table 2-8 or 2-9 to properly time sprays. Maximum spray coverage is extremely important. Low-volume sprays (20–50 gal/A) often are not adequate. Growers should increase water volumes to adequately wet the trees during the critical egg-hatching periods of both broods.

Cork and bitter pit in fruit. See Part I.

Increasing intervals between sprays. Beginning with the second or third cover, growers often increase the interval between half-sprays. When scab or mildew is present on trees, when shoot growth is rapid, and when rains are frequent, the intervals between half-sprays should not exceed 7 days.

Pesticide recommendations for apples, second, third, and fourth covers.^a

Pesticide	Dilute rate/100 gal^b	Rate sprayed/A
CHOOSE 1 of the following:		
Flint 50W ^{c,d}	0.5–0.6 oz	2.0–2.5 oz
Indar 2F ^{c,e}	refer to footnote e	6.0–8.0 fl oz
Inspire Super ^{c,f}		8.5–16.0 fl oz
Pristine ^{c,d}	4.8–6.0 oz	14.5–18.5 oz
Sovran 50W ^{c,d}	1–1.5 oz	4.0–6.4 oz
sulfur ^g		6.0–10.0 lb
In combination with 1 of the following:		
captan 80WDG ^h	refer to footnote h	2.5–5.0 lb
Ziram 76WDG	1.0 lb	4.0 lb
OR select 1 of the following to be applied aloneⁱ:		
captan 80WDG ^h	refer to footnote h	5.0 lb
sulfur ^g		10.0–15.0 lb
Ziram 76WDG	1.5–2.0 lb	6.0–8.0 lb
PLUS 1 of the following: Insecticides should be selected and combined according to their efficacy against individual pests (see Table 4-6).		
Altacor 35WDG ¹	—	2.5–3.0 oz
Assail 30SG ^{2,3}	—	4.0–8.0 oz
Avaunt 30WDG	—	5.0–6.0 oz
Belay	—	6.0–12.0 fl oz
Belt SC ¹	—	3.0–5.0 fl oz
Bt	use label rate	
Calypso 4F ²	1.0–2.0 fl oz	4.0–6.0 fl oz
Carposvirusine (CM virus)	—	6.5–13.5 fl oz
Centaur	—	35.0 oz
Cyd-X (CM virus)	—	2.0–6.0 oz
Delegate 25WG ¹	—	4.5–6.0 oz
Guthion 50W ⁴	0.35–0.5 lb	1.5–2.0 lb
Imidan 70WP	0.75–1.0 lb	3.0–4.0 lb
Intrepid 2F ⁵	3.0–4.0 fl oz	8.0–16.0 fl oz
Lannate 90SP ⁶	4.0 oz	8.0–12.0 oz
Lannate LV ⁶	12.0 fl oz	24.0–36.0 fl oz
OFM sprayable pheromones	—	use label rate
Proclaim 5SC ³	0.8–1.2 fl oz	3.2–4.8 fl oz
Rimon 0.83EC	—	20.0–30.0 fl oz
Tourismo ¹	—	12.0–17.0 fl oz
Virossoft ^{CP4} (CM virus)	—	1.3 oz
Voliam Flexi 40WDG ¹	—	4.0–7.0 oz
PLUS:		
Calcium chloride (77–80% flake)	0.7–2.3 lb	2.0–7.1 lb

Fungicide and Antibiotic Notes

- See note on fungicide resistance. If you have resistance to both DMI and strobilurin fungicides refer to note q below.
- Based on dilute sprays with a 400-gallon-per-acre base. Maintain per-acre use-rate regardless of spray volume per acre.
- These fungicides should be used in combination with another fungicide to improve their efficacy and to prevent or delay buildup of resistant strains of the fungus causing apple scab.
- Do not apply more than 4 total applications per season or 2 consecutive applications of Flint, Sovran, and Pristine. Do not apply Sovran within 30 days of harvest, Flint within 14 days of harvest, and Pristine within 0 days of harvest.
- Do not make more than 4 applications per year. Do not apply Indar within 14 days of harvest.
- Do not make more than 2 consecutive applications and more than 60 ft oz of Inspire Super per acre per season. Do not apply Inspire Super within 14 days of harvest (PHI).
- Use on sensitive cultivars (e.g., Delicious) may cause injury. Do not use oil within 14 days of sulfur application.
- Equivalent products include Captan 50% W and WP and Captec 4L. Check the label for rates/100 GPA. REI restrictions vary from 24 hours to 4 days; check the label of the product you are using.
- Use the per-acre use rates in this section for protectant fungicides (captan, sulfur or Ziram) in orchards with resistance to both DMI and strobilurin fungicides. Apply the protectant fungicides in complete sprays with a minimum volume of 100 gallons per acre.

Insecticide and Acaricide Notes

- In order to prevent the development of pest resistance to these new chemistries and to practice the most effective resistance management approach, we highly encourage growers to use only 1 chemical class of products (i.e., mode of action) for a particular generation of a targeted pest and to rotate to another chemical class to control the succeeding generation of the targeted pest. For example, if using Delegate to control the first generation of codling moth, use Altacor, Belt, Turismo, or Voliam Flexi to control the second generation, or if using either Altacor, Belt, Turismo, or Voliam Flexi to control the first generation of codling moth, then switch to Delegate or another chemical class (Assail, Calypso, etc.) to control the second generation. Altacor, Belt, Turismo, and Voliam Flexi belong to the same chemical class (IRAC Group 28) and should not be used for consecutive generations of a targeted pest.
- Use higher rates of Assail or Calypso when populations of CM and OFM are high.
- Adding 1–2 qt of summer oil per 100 gal will increase Assail and Proclaim efficacy. Proclaim is highly effective against leafrollers and leafminers, but it only provides suppression for codling moth and Oriental fruit moth.
- Guthion is only legal on apples during the 2012 season (until Sept. 30, 2012) and the maximum seasonal rate is 3.0 lbs per acre.
- Use lower rate for TABM control, the higher end of the range for CM, OFM, and obliquebanded leafroller control.
- Growers using Lannate should closely watch the interaction between mites and their natural enemies (e.g., Stethorus, predatory mites), since Lannate is moderately to highly toxic to these natural enemies. Outbreaks of mites may occur where Lannate is used. To increase the likelihood of successful biological control by the natural enemies, refrain from using Lannate unless using it for control of the brown maromated stink bug. Because of widespread resistance to the organophosphate insecticides by tufted apple bud moth, alternative control measures to use are Altacor, Belt, Delegate, Intrepid, Rimon, Turismo, or Voliam Flexi for first brood control.

Mites. This is the period when decisions to use a miticide should not be made hastily. Table 2-3 and Figure 2-3 are invaluable for making pest management choices, as they help take the guesswork out of mite control when using *Stethorus* and/or predatory mites. Miticide rates should not be increased above those suggested in the following chart if a biological control program is being followed. See Table 4-4 for toxicity ratings of various miticides against the mite predators. If using a miticide in a half-spray application, do not add a miticide to the second half-spray unless it is needed. As a good practice, rotate miticide types to reduce the probability of resistance. Never use the same miticide or a miticide in the same chemical class more than once per year.

When mite populations are high or increasing rapidly, apply miticides using more water, switch to every row middle sprays, use full rates of miticides, rotate the use of miticide products, use combinations of several miticides, and spray in the evening rather than the morning.

Miticide recommendations for apples.

Several miticide options are given. The miticide chosen and its rate should be based on the size of the mite population, the number of predators present, and the degree of resistance in particular orchard blocks (see Table 4-6).

Pesticide	Dilute rate/100 gal	Rate sprayed/A
CHOOSE 1 of the following:		
Acramite 50WS ¹	—	1.0 lb
Apollo 4SC	1.0–2.0 fl oz	4.0 fl oz
Envirdor 2SC	—	14.0–18.0 fl oz
Kanemite 15SC	—	21.0–31.0 fl oz
Nexter 75WP ^{2,3}	—	4.4–5.2 oz
Onager	—	12.0–24.0 fl oz
Portal	—	1.0–2.0 pt
Savey 50WP	—	3.0–4.0 oz
Vendex 50WP	4.0–6.0 oz	12.0–16.0 oz
Vydate 2L	1.0–1.5 pt	2.0–3.0 pt
Zeal 72WDG	—	2.0–3.0 oz

Insecticide and Acaricide Notes

1. Add a surfactant for improving coverage. It is strongly recommended that water hardness be reduced with ammonium-sulfate containing water treatment prior to adding the surfactant and Acramite.
2. *Nexter* is a fairly effective miticide for most growers in Pennsylvania. There have been cases of resistance to *Nexter* reported in Pennsylvania. If resistance or lack of control is suspected, switch to another product. If using as ARM application, be sure to initiate spraying while the mite populations are low. The amount of water recommended is 100 gallons per acre as every middle spray. For resistance management purposes, only 1 application of *Nexter* per season is recommended. If boron-containing products are to be used, the water soluble bags containing *Nexter* must be dissolved completely before the boron-containing products are added to the tank.
3. For twospotted spider mite, use *Nexter* at 8.8–10.67 oz rate.

Apples—Fifth Cover

Cork and bitter pit in fruit. See Part I.

Sooty blotch and flyspeck. These diseases are likely to be a problem from this time of the growing season through harvest, especially if rainfall is above normal. Refer to Part II, Diseases, Pests, and Natural Enemies.

Codling moth. If present, the second brood of codling moth can be controlled with broad-spectrum or selective insecticides applied at 1,250–1,300 and 1,600–1,650 degree days after biofix. In orchards with suspected organophosphate resistance, other choices include Altacor, Assail, Belt, Calypso, Delegate, Rimon, Turismo, and Voliam Flexi. If Rimon is used, start applications at 1,150–1,200 degree days and repeat again in 14–17 days. Thorough coverage is required to successfully control this brood of codling moth. It is recommended that at least 100 gallons per acre be used for the remainder of the season.

Fruit rots. White rot, black rot, and bitter rot all occur in Pennsylvania, but white rot is most common and causes the most loss. Warm, wet conditions favor the fruit rots during the summer months and at harvest. Refer to Part II, Diseases, Pests, and Natural Enemies.

Pesticide recommendations for apples, fifth cover.^a

Pesticide	Dilute rate/100 gal ^b	Rate sprayed/A
CHOOSE 1 of the following:		
Flint 50W ^{c,d}	0.5–0.6 oz	2.0–2.5 oz
Indar 2F ^{c,e}	refer to footnote e	6.0–8.0 fl oz
Inspire Super ^{c,f}		8.5–16.0 fl oz
Pristine ^{c,d}	4.8–6.0 oz	14.5–18.5 oz
Sovran 50W ^{c,d}	1–1.5 oz	4.0–6.4 oz
sulfur ^g		6.0–10.0 lb
In combination with 1 of the following:		
captan 80WDG ^h	refer to footnote h	2.5–5.0 lb
Ziram 76WDG	1.0 lb	4.0 lb
OR select 1 of the following to be applied aloneⁱ:		
captan 80WDG ^h	refer to footnote h	5.0 lb
sulfur ^g		10.0–15.0 lb
Ziram 76WDG	1.5–2.0 lb	6.0–8.0 lb
PLUS 1 of the following: Insecticides should be selected and combined according to their efficacy against individual pests (see Table 4-6).		
Altacor 35WDG ¹	—	2.5–3.0 oz
Assail 30SG ^{2,3}	—	4.0–8.0 oz
Avaunt 30WDG	—	5.0–6.0 oz
Belay	—	6.0–12.0 fl oz
Belt SC ¹	—	3.0–5.0 fl oz
Bt		use label rate
Carpovirusine	—	6.5–13.5 fl oz
Cyd-X (CM virus)	—	2.0–6.0 oz
Calypso 4F ³	1.0–2.0 fl oz	4.0–6.0 fl oz
Delegate 25WG ¹	—	4.5–6.0 oz
Guthion 50W ⁴	0.5–0.75 lb	1.5–2.0 lb
Imidan 70WP	0.75–1.5 lb	3.0–4.0 lb
Intrepid 2F	3.0–4.0 fl oz	8.0–16.0 fl oz
OFM sprayable pheromones	—	use label rate
Rimon 0.83EC	—	20.0–30.0 fl oz
Tourismo ¹	—	12.0–17.0 fl oz
Virosoft ^{CP4} (CM virus)	—	1.3 oz
Voliam Flexi ¹	—	4.0–7.0 oz
PLUS:		
Calcium chloride (77–80% flake)	0.7–2.3 lb	2.0–7.1 lb

Fungicide and Antibiotic Notes

1. See note on fungicide resistance. If you have resistance to both DMI and strobilurin fungicides refer to note j below.
2. Based on dilute sprays with a 400-gallon-per-acre base. Maintain per-acre use-rate regardless of spray volume per acre.
3. These fungicides should be used in combination with another fungicide to improve their efficacy and to prevent or delay buildup of resistant strains of the fungus causing apple scab.
4. Do not apply more than 4 total applications per season or 2 consecutive applications of Flint, Sovran, and Pristine. Do not apply Sovran within 30 days of harvest, Flint within 14 days of harvest, and Pristine within 0 days of harvest.
5. Do not make more than 4 applications per year. Do not apply Indar within 14 days of harvest.
6. Do not make more than 2 consecutive applications and more than 60 fl oz of Inspire Super per acre per season. Do not apply Inspire Super within 14 days of harvest (PHI).
7. Use on sensitive cultivars (e.g., Delicious) may cause injury. Do not use oil within 14 days of sulfur application.
8. Equivalent products include Captan 50% W and WP and Captac 4L. Check the label for rates/100 GPA. REI restrictions vary from 24 hours to 4 days; check the label of the product you are using.
9. Use the per-acre use rates in this section for protectant fungicides (captan, sulfur or Ziram) in orchards with resistance to both DMI and strobilurin fungicides. Apply the protectant fungicides in complete sprays with a minimum volume of 100 gallons per acre.

Insecticide and Acaricide Notes

1. In order to prevent the development of pest resistance to these new chemistries and to practice the most effective resistance management approach, we highly encourage growers to use only 1 chemical class of products (i.e., mode of action) for a particular generation of a targeted pest and to rotate to another chemical class to control the succeeding generation of the targeted pest. For example, if using Delegate to control the first generation of codling moth, use Altacor, Belt, Turismo, or Voliam

Flexi to control the second generation, or if using either *Altacor*, *Belt*, *Tourismo*, or *Voliam Flexi* to control the first generation of codling moth, then switch to *Delegate* or another chemical class (*Assail*, *Calypso*, etc.) to control the second generation. *Altacor*, *Belt*, *Tourismo*, and *Voliam Flexi* belong to the same chemical class (IRAC Group 28) and should not be used for consecutive generations of a targeted pest.

- Adding 1–2 qt of summer oil per 100 gal will increase *Assail* efficacy.
- Use higher rates of *Assail* and *Calypso* when populations of CM and OFM are high.
- Guthion* is only legal on apples during the 2012 season (until Sept. 30, 2012) and the maximum seasonal rate is 3.0 lbs per acre.

Apples—Sixth and Seventh Covers

Sooty blotch and flyspeck. These diseases are likely to be a problem from this time of the growing season through harvest, especially if rainfall is above normal. Refer to Part II, Diseases, Pests, and Natural Enemies.

Fruit rots. Historically, white rot, black rot, and bitter rot all occur in Pennsylvania. In most years, white rot is the most common and causes the most fruit rot. Bitter rot has been increasing in some orchards the last few years. Warm, wet conditions favor the fruit rots during the summer months and at harvest. Refer to Part II, Diseases, Pests, and Natural Enemies.

Cork spot and bitter pit in fruit. See Part I.

Oriental fruit moth. If Oriental fruit moth is a problem, thorough coverage (at least 100 gallons per acre) needs to be maintained until at least mid-September. This is the period when adult flight and egg-laying can be continuous, the majority of the fruit injury will occur, and live worms can be present at harvest. Refer to the Oriental fruit moth write-up in Part II for additional information on proper timing of chemical sprays. *Altacor*, *Assail*, *Belt*, *Calypso*, *Delegate*, *Rimon*, *Tourismo*, *Voliam Flexi* and organophosphate insecticides (unless OP resistance is suspected) will provide the best protection, but growers should be aware of required preharvest intervals.

Pesticide recommendations for apples, sixth and seventh covers.^a

Pesticide	Dilute rate/100 gal ^b	Rate sprayed/A
CHOOSE 1 of the following:		
Flint 50W ^{c,d}	0.5–0.6 oz	2.0–2.5 oz
Pristine ^{c,d}	4.8–6.0 oz	14.5–18.5 oz
Sovran 50W ^{c,d}	1–1.5 oz	4.0–6.4 oz
Topsin-M 70 WDG ^e	4.0–6.0 oz	1.0–1.5 lb
In combination with 1 of the following:		
captan 80WDG ^e	refer to footnote e	2.5–5.0 lb
Ziram 76WDG	1.0 lb	4.0 lb
OR select 1 of the following to be applied alone^f:		
captan 80WDG ^e	refer to footnote e	5.0 lb
Ziram 76WDG	1.5–2.0 lb	6.0–8.0 lb
PLUS 1 of the following: Insecticides should be selected according to their efficacy against individual pests (see Table 4-6).		
Altacor 35WDG ¹	—	2.5–3.0 oz
Assail 30SG ^{2,3}	—	4.0–8.0 oz
Avaunt 30WDG	—	5.0–6.0 oz
Belay	0.35–0.5 lb	6.0–12.0 fl oz
Belt SC ¹	—	3.0–5.0 fl oz
Bt	—	use label rate
Calypso 4F ²	1.0–2.0 fl oz	4.0–6.0 fl oz
Delegate 25WG ¹	—	4.5–6.0 oz
Guthion 50W ⁴	0.35–0.5 lb	1.5–1.75 lb
Imidan 70WP	0.75–1.0 lb	3.0–4.0 lb
Intrepid 2F	3.0–4.0 fl oz	8.0–16.0 fl oz
Lannate 90SP ⁵	4.0 oz	6.0–10.0 oz
Lannate LV ⁵	12.0 fl oz	24.0–36.0 fl oz
OFM sprayable pheromones	—	use label rate
Proclaim 5SC ³	0.8–1.2 fl oz	3.2–4.8 fl oz
Rimon 0.83EC	—	20.0–30.0 fl oz
Tourismo ¹	—	2.0–17.0 fl oz
Voliam Flexi ¹	—	4.0–7.0 oz
PLUS:		
Calcium chloride (77–80% flake)	0.7–2.3 lb	2.0–7.1 lb

Fungicide and Antibiotic Notes

- See note on fungicide resistance. If you have resistance to both DMI and strobilurin fungicides refer to note f below.
- Based on dilute sprays with a 400-gallon-per-acre base. Maintain per-acre use-rate regardless of spray volume per acre.
- These fungicides should be used in combination with another fungicide to improve their efficacy and to prevent or delay buildup of resistant strains of the fungus causing apple scab.
- Do not apply more than 4 total applications per season or 2 consecutive applications of *Flint*, *Sovran*, and *Pristine*. Do not apply *Sovran* within 30 days of harvest, *Flint* within 14 days of harvest, and *Pristine* within 0 days of harvest.
- Equivalent products include *Captan 50% W* and *WP* and *Captex 4L*. Check the label for rates/100 GPA. REI restrictions vary from 24 hours to 4 days; check the label of the product you are using.
- Use the per-acre use rates in this section for protectant fungicides (*captan*, or *Ziram*) in orchards with resistance to both DMI and strobilurin fungicides. Apply the protectant fungicides in complete sprays with a minimum volume of 100 gallons per acre.

Insecticide and Acaricide Notes

- In order to prevent the development of pest resistance to these new chemistries and to practice the most effective resistance management approach, we highly encourage growers to use only 1 chemical class of products (i.e., mode of action) for a particular generation of a targeted pest and to rotate to another chemical class to control the succeeding generation of the targeted pest. For example, if using *Delegate* to control the first generation of codling moth, use *Altacor*, *Belt*, *Tourismo*, or *Voliam Flexi* to control the second generation, or if using either *Altacor*, *Belt*, *Tourismo*, or *Voliam Flexi* to control the first generation of codling moth, then switch to *Delegate* or another chemical class (*Assail*, *Calypso*, etc.) to control the second generation. *Altacor*, *Belt*, *Tourismo*, and *Voliam Flexi* belong to the same chemical class (IRAC Group 28) and should not be used for consecutive generations of a targeted pest.
- Use higher rates of *Assail* or *Calypso* when populations of CM and OFM are high.
- Adding 1–2 qt of summer oil per 100 gal will increase *Assail* and *Proclaim* efficacy. *Proclaim* is highly effective against leafrollers and leafminers, but it only provides suppression for codling moth and Oriental fruit moth.

- Guthion is only legal on apples during the 2012 season (until Sept. 30, 2012) and the maximum seasonal rate is 3.0 lbs per acre.
- Growers using Lannate should closely watch the interaction between mites and their natural enemies (e.g., *Stethorus predatory mites*) since Lannate is moderately toxic to these natural enemies. Outbreaks of mites may occur where Lannate is used. To increase the likelihood of successful biological control by the natural enemies, refrain from using Lannate unless using it for control of the brown maromated stink bug. Because of widespread resistance to the organophosphate insecticides, alternative control measures to use are Altacor, Belt, Delegate, Intrepid, Rimon, Tourismo, or Voliam Felxi for second brood control.

PEAR INTEGRATED PEST MANAGEMENT PROGRAM

Pears—Dormant to Green Tip

Insects. Pear psylla, blister mite, scale.

Fire blight. Refer to Part II, Diseases, Pests, and Natural Enemies, for information on fire blight. Apply copper under good drying conditions and before the ½-inch green stage.

Pesticide recommendations for pears, dormant to green tip.

Pesticide	Dilute rate/100 gal	Rate sprayed/A
dormant oil	2.0 gal	4.0–6.0 gal
PLUS 1 of the following: Insecticides should be selected and combined according to their efficacy against individual pests (see Table 4-10).		
Asana XL 0.66EC	4.0–5.0 fl oz	10.0–16.0 fl oz
Battalion 0.2EC	—	7.0–14.0 fl oz
Baythroid 2E	—	1.4–2.8 fl oz
chlorpyrifos	0.75 pt	1.0–1.5 qt
Danitol 2.4EC	4.0–5.0 fl oz	16.0–21.3 fl oz
Esteem 35WP ¹	1.0–1.5 oz	4.0–5.0 oz
Lorsban 75WG	0.33–0.67 lb	1.0–2.0 lb
Mustang Max	—	2.0–4.0 fl oz
permethrin 3.2EC	4.0 fl oz	12.0 fl oz
permethrin 25WP	0.4 lb	1.2 lb
Proaxis	—	2.5–5.1 fl oz
Supracide 25WP	1.0–2.0 lb	3.0–6.0 lb
Surround WP	25.0–50.0 lb	25.0–50.0 lb
Thionex 3EC	1.0 qt	2.6 qt
Thionex 50W	1.5 lb	4.0 lb
Warrior II	—	1.3–2.5 fl oz

Insecticide and Acaricide Note

- Only 2 applications permitted between swollen bud and petal fall. Thorough coverage is required.

Pears—Green Cluster Bud

(separation of flower buds, but before petal show)

Insects. Pear psylla, plant bug, stink bug, pear midge, pear rust mite.

Pear psylla. Excellent psylla control has been achieved in the green cluster bud spray when an insecticide was used with oil. If pear psylla is not a problem, reduce the insecticide rate by 25 percent.

Pesticide recommendations for pears, green cluster bud.

Pesticide	Dilute rate/100 gal	Rate sprayed/A
dormant oil	1.0 gal	2.0–3.0 gal
PLUS 1 of the following: Insecticides should be selected and combined according to their efficacy against individual pests (see Table 4-10).		
Actara 25WP ¹	—	4.5–5.5 oz
Asana XL 0.66EC ²	3.0–4.0 fl oz	9.0–12.0 fl oz
Battalion 0.2EC	—	7.0–14.0 fl oz
Baythroid 2E ²	—	1.4–2.8 fl oz
Danitol 2.4EC ²	4.0–5.0 fl oz	16.0–21.3 fl oz
Endigo ZC ²	—	5.0–6.0 fl oz
Esteem 35WP ³	1.0–1.5 oz	4.0–5.0 oz
Mustang Max ²	—	2.0–4.0 fl oz
permethrin 2EC ²	6.0 fl oz	18.0 fl oz
permethrin 3.2EC ²	4.0 fl oz	12.0 fl oz
permethrin 25WP ²	0.4 lb	1.2 lb
Proaxis ²	—	2.5–5.1 fl oz
Surround WP	25.0–50.0 lb	25.0–50.0 lb
Thionex 50W	1.5 lb	4.0 lb
Thionex 3EC	1.0 qt	2.6 qt
Warrior II	—	1.3–2.5 fl oz

Insecticide and Acaricide Notes

- Do not make more than 1 application prebloom; do not apply after green cluster stage and before complete petal fall. After an Actara application wait at least 5 days before placing bee hives in the treated area.
- Pyrethroid resistance is definitely present in some areas of Pennsylvania. Limit prebloom applications of pyrethroids to 2 applications.
- Only 2 applications permitted between swollen bud and petal fall. Thorough coverage is required.

Pears—White Bud, Popcorn Stage

Diseases. Leaf and fruit spot, scab.

Insects. Pear psylla, plant bug, stink bug, pear midge. Avoid killing bees on opening blossoms and cover crops; watch insecticides that are toxic to bees (refer to pesticide label).

Pesticide recommendations for pears, white bud, popcorn stage.

Pesticide	Dilute rate/100 gal ^a	Rate sprayed/A
CHOOSE 1 of the following:		
Inspire Super ^b		8.5–16.0 fl oz
Procure 50WS ^c	2.0–4.0 oz	8.0–16.0 oz
Scala SC ^{c,d}		8.0–16.0 fl oz
Topsin-M 70WP ^{c,e}	4.0 oz	1.0 lb
VanguardWG ^{c,d}	1.0 oz	5.0 oz
PLUS 1 of the following:		
ferbam 76WP ^f	1.0 lb	4.0 lb
Penncozeb 75DF ^{g,h}	0.80 lb	3.2 lb
Ziram 76WDG ⁱ	1.0 lb	4.0 lb
OR 1 of the following applied alone:		
ferbam 76WP ^f	1.5 lb	6.0 lb
Flint 50W ^j	0.5–0.6 oz	2.0–2.5 oz
mancozeb 75DF ^{g,h}	1.6 lb	6.2 lb
Pristine ^{l,k}	4.8–6.0 oz	14.5–18.5 oz
Sovran 50W ^j	1.0–1.5 oz	4.0–6.4 oz
Ziram 76WDG	1.5–2.0 lb	6.0–8.0 lb

PLUS 1 of the following: Use 1 or more of the following insecticides if green fruitworm, green apple aphids, tarnished plant bug, plum curculio, San Jose scale, or mites are a problem. Insecticides should be selected according to their efficacy against individual pests (see Table 4-10).

Asana XL 0.66EC ¹	3.0–4.0 fl oz	9.0–12.0 fl oz
Assail 30SG	—	4.0–8.0 oz
Battalion 0.2EC	—	7.0–14.0 fl oz
Baythroid 2E ¹	—	1.4–2.8 fl oz
Calypso 4F	1.0–2.0 fl oz	4.0–8.0 fl oz
Carzol SP	6.0 oz	16.0 oz
Danitol 2.4EC ¹	4.0–5.0 fl oz	16.0–21.3 fl oz
Esteem 35WP	1.0–1.5 oz	4.0–5.0 oz
Imidan 70WP	0.75–1.0 lb	2.0–4.0 lb
Mustang Max ¹	—	2.0–4.0 fl oz
permethrin 3.2EC ¹	4.0 fl oz	12.0 fl oz
permethrin 25WP ¹	0.4 lb	1.2 lb
Proaxis ¹	—	2.5–5.1 fl oz
Thionex 3EC	1.0 qt	2.6 qt
Thionex 50W	1.5 lb	4.0 lb
Vydate 2L	1.0 pt	2.0–8.0 pt
Warrior II	—	1.3–2.5 fl oz

Fungicide and Antibiotic Notes

- Based on dilute sprays with a 400-gallon-per-acre-base, except for Pristine.
- Do not make more than 2 consecutive applications and more than 60 fl oz of Inspire Super per acre per season. Do not apply Inspire Super within 14 days of harvest (PHI).
- These fungicides should be used in combination with another fungicide to improve their efficacy and to prevent or delay buildup of resistant strains of the fungus causing pear scab.
- Do not use Scala SC or VanguardWG for more than 5 sprays applied in combination with a fungicide from a different fungicide group and mode of action. Do not mix with any fungicide to which resistance has already developed. Do not apply Scala or Vanguard within 72 days of harvest.
- Topsin-M should be used in combination with another fungicide to improve their efficacy and to prevent or delay buildup of resistant strains of the fungus causing pear scab. REI is 3 days. PHI is 1 day.
- Late season applications may result in unsightly residues. Do not apply within 7 days of harvest.
- Some equivalent products are Dithane, Manzate, and Penncozeb. Check label for rates.
- Two application programs may be used:
 - Prebloom through bloom. Applications begin at the ¼- to ½-inch green tip stage and continue at 7- to 10-day application intervals through bloom. Do not apply more than 6 pounds per acre per application. There is a limit to the amount of EBDC fungicide that can be applied per acre each year. Refer to the label of the product you are using for specific yearly application limits.

- Extended application. Begin applications at the ¼- to ½-inch green tip stage and continue at 7- to 10-day application intervals through the second cover spray. Do not apply within 77 days of harvest. Do not apply more than 3 pounds per acre per application. There is a limit to the amount of EBDC fungicide that can be applied per acre each year. Refer to the label of the product you are using for specific yearly application limits.

Note: Do not combine or integrate the 2 programs.

- Days to harvest varies from 5 to 14 days. Read the label of the product you are using.
- Do not apply more than 4 total applications per season or 2 consecutive applications of Flint, Sovran, or Pristine. Do not apply Sovran within 30 days of harvest and Flint within 14 days of harvest.
- Based on dilute sprays with a 300-gallon-per-acre base.

Insecticide and Acaricide Note

- Pyrethroid resistance is definitely present in some areas of Pennsylvania. Limit prebloom applications of pyrethroids to 2 applications.

Pears—Bloom

Use the same materials as recommended in white bud, popcorn stage.

Fire blight. Conditions favorable for fire blight include (1) open blossoms or succulent new growth, (2) average daily temperature above 65°F, plus (3) rainfall or relative humidity above 60 percent. The disease is likely to be severe in orchards where fire blight was present the preceding year. Most effective control is provided by Streptomycin at 8 ounces per 100 gallons dilute (100 ppm) or 1.5 pounds per acre concentrate or at 4 ounces per 100 gallons dilute (50 ppm) or 0.75 pounds per acre concentrate or Regalaid at 1 pint per 100 gallons. Apply at least 50 gallons of spray per acre.

Apply the first spray as soon as there are open blossoms and during conditions as described in the previous paragraph. Repeat at 4- to 7-day intervals as long as there are open blossoms and weather conditions remain favorable for fire blight, or if these conditions recur. A minimum of 2 applications is needed for control. Refer to Part II, Diseases, Pests, and Natural Enemies, for information on fire blight.

Leafspot, fruit spot, and scab. Do not go over 10 days between fungicide sprays during the bloom period. In wet weather, shorten the period to 7 days. Use the same fungicides as in the white bud spray.

Pears—Petal Fall, First through Fifth Covers

Diseases. Leaf and fruit spot, scab, sooty blotch, fruit rots, sooty mold.

Insects. Pear psylla, plum curculio, plant bugs, codling moth, Oriental fruit moth, leafrollers, and mites.

Pear psylla. Where psylla persist or increase, shorten the interval between 2 successive cover sprays to 5 to 7 days. Azinphos-methyl, Imidan, and Lannate are not effective in controlling psylla.

NOTE: The insecticide rates suggested below are rates needed for pear psylla control. If psylla is not a problem, reduce rates by 25 percent.

Sooty mold. Control is based on control of aphids and pear psylla.

NOTE: Apply the first cover spray 10 days after petal fall and the remaining cover sprays at 14-day intervals.

Pesticide recommendations for pears, petal fall, first through fifth covers.

Pesticide	Dilute rate/100 gal ^a	Rate sprayed/A
CHOOSE 1 of the following:		
Inspire Super ^b		8.5–16.0 fl oz
Procure 50WS ^c	2.0–4.0 oz	8.0–16.0 oz
Rubigan EC ^d	3.0–4.0 fl oz	8.0–12.0 fl oz
Scala SC ^{c,e}		7.0–10.0 fl oz
Topsin-M70WP ^{c,f}	4.0 oz	1.0 lb
VanguardWG ^{c,e}	1.0 oz	5.0 oz
PLUS 1 of the following:		
ferbam 76WP ^{a,g}	1.5 lb	6.0 lb
Ziram 76WDG ^a	1.5–2.0 lb	6.0–8.0 lb
OR 1 of the following applied alone:		
ferbam 76WP ^{a,g}	1.5 lb	6.0 lb
Flint 50W ^h	0.5–0.6 oz	2.0–2.5 oz
Pristine ^{i,j}	4.8–6.0 oz	14.5–18.5 oz
Sovran 50W ^h	1.0–1.5 oz	4.0–6.4 oz
Ziram 76WDG ^a	1.5–2.0 lb	6.0–8.0 lb
PLUS 1 of the following: Use 1 or more of the following insecticides if green fruitworm, green apple aphid, leafrollers, tarnished plant bug, pear psylla, plum curculio, San Jose scale, or mites are a problem. A number of the products below do not affect pear psylla, the most serious pest in Pennsylvania pear orchards. Insecticides should be selected and combined according to their efficacy against individual pests (see Table 4-10).		
Actara 25WP ¹	—	4.5–5.5 oz
Admire Pro ²	—	6.0–8.0 fl oz
Agri-Flex ³	1.5–2.0 fl oz	5.5–8.5 fl oz
Agri-Mek 0.15EC ³	5.0 fl oz	20.0 fl oz
Altacor 35WDG ⁴	—	2.5–3.0 oz
Assail 30SG ²	—	5.0–8.0 oz
Belay	—	6.0–12.0 fl oz
Belt SC ⁴	—	3.0–5.0 fl oz
Brigade 50WSB	—	6.4–32.0 oz
Calypso 4F	1.0–2.0 fl oz	6.0–8.0 fl oz
Carzol 92SP ⁵	6.0 oz	18 oz
Centaur ⁶	—	34.5 oz
Delegate 25 WG ^{4,7}	—	6.0–7.0 oz
diazinon 50W ⁸	0.75–1.0 lb	2.0–3.0 lb
Esteem 35WP ⁹	1.0–1.5 oz	4.0–5.0 oz
imidacloprid 1.6F ²	4.0–5.0 fl oz	16.0–20.0 fl oz
Imidan 70WP	0.75–1.0 lb	2.0–4.0 lb
Intrepid 2F	—	12.0–16.0 fl oz
Lannate 90SP	4.0–8.0 oz	12.0–16.0 oz
Lannate LV	12.0 fl oz	36.0 fl oz
Movento ¹⁰	—	6.0–9.0 fl oz
Nexter 75WP ¹¹	—	8.8–10.6 oz
Portal	—	2.0 pt
Thionex 50W ¹²	1.5 lb	4.0 lb
Thionex 3EC ¹²	1.0 qt	2.6 qt
Tourismo ⁴	—	12.0–17.0 fl oz
Voliam Flexi 40W ⁴	—	4.0–7.0 fl oz

Fungicide and Antibiotic Notes

- Days to harvest varies. Read the label of the product you are using.
- Do not make more than 2 consecutive applications and more than 60 fl oz of Inspire Super per acre per season. Do not apply Inspire Super within 14 days of harvest (PHI).
- These fungicides should be used in combination with another fungicide to improve their efficacy and to prevent or delay buildup of resistant strains of the fungus causing pear scab.
- Do not apply Rubigan until after petal fall and not closer than 30 days to harvest.
- Do not use Scala or Vanguard for more than 5 sprays applied in combination with a fungicide from a different fungicide group and mode of action. Do not mix with any fungicide to which resistance has already developed.
- Topsin-M has an REI of 3 days.
- Late season applications of ferbam may result in unsightly residues on the fruit.
- Do not apply more than 4 total applications per season or 2 consecutive applications of Flint Sovran, or Pristine. Do not apply Sovran within 30 days of harvest and Flint within 14 days of harvest.

- Based on dilute sprays with a 400-gallon-per-acre base, except for Pristine.
- Based on dilute sprays with a 300-gallon-per-acre base.

Insecticide and Acaricide Notes

- Do not apply more than 16.5 oz per season of Actara or 0.258 lb of active ingredients of thiamethoxam containing products per season.
- Adding a quart of summer oil per 100 gals will increase Assail, Admire Pro, and imidacloprid efficacy.
- Agri-Flex and Agri-Mek should be combined with a horticultural spray oil (not a dormant oil) for best results; however, other penetrating adjuvants can be used with somewhat less efficacy. The rate for the horticultural spray oil should be a 0.25 percent concentration (1 qt/100 gal or a minimum of 1 gal/A). For best results, apply Agri-Flex and Agri-Mek at petal fall or within 10–15 days of petal fall and use a minimum of 100 gallons of water per acre. Make a maximum of 2 applications per season. If foliage is hardening off, do not apply. Agri-Flex and Agri-Mek are not broad-spectrum insecticides and should not be the only insecticide applied at this time.
- In order to prevent the development of pest resistance to these new chemistries and to practice the most effective resistance management approach, we highly encourage growers to use only 1 chemical class of products (i.e., mode of action) for a particular generation of a targeted pest and to rotate to another chemical class to control the succeeding generation of the targeted pest. For example, if using Delegate to control the first generation of codling moth, use Altacor, Belt, Turismo, or Voliam Flexi to control the second generation; or, if using either Altacor, Belt, Turismo, or Voliam Flexi to control the first generation of codling moth, then switch to Delegate or another chemical class (Assail, Calypso, etc.) to control the second generation. Altacor, Belt, Turismo, and Voliam Flexi belong to the same chemical class (IRAC Group 28) and should not be used for consecutive generations of a targeted pest.
- Do not apply Carzol after petal fall.
- Centaur is highly active against San Jose scale crawlers and effective against pear psylla. Thorough coverage is required. Apply only 1 application per season.
- Control of pear psylla with Delegate can be improved with the addition of an adjuvant (e.g., 2 qts/100 gals of a summer oil).
- Only 1 application of diazinon is allowed during the season.
- Allowed only 2 applications between swollen bud and petal fall. Thorough coverage is required.
- For increased effectiveness add a penetrating adjuvant.
- Nexter is most effective against the small nymphs of pear psylla. Do not apply more than 13.2 ounces per acre; make no more than 2 applications per season. Allow a minimum of 30 days between applications. Use at least 100 gallons per acre. Nexter also controls European red mite, pear rust mite, and, to some extent, twospotted spider mite.
- Make no more than 2 endosulfan (Thionex) applications during the fruiting period if pears are to be harvested 7 days after the last application.

Mites. Use 1 of the following for mite control. Mite injury on pears mimics fire blight injury.

Several miticide options are given. The miticide chosen and its rate should be based on the size of the mite population, the number of predators present, and the degree of resistance in particular orchard blocks. Miticides should be selected according to their efficacy against individual pests (see Table 4-10).

Miticide	Dilute rate/100 gal	Rate sprayed/A
CHOOSE 1 of the following:		
Acramite 50WS ¹	—	1.0 lb
Agri-Flex ²	1.5–2.0 fl oz	5.5–8.5 fl oz
Agri-Mek 0.15EC ²	2.5–5.0 fl oz	10.0–20.0 fl oz
Apollo 4SC ³	1.0–1.5 oz	4.0–6.0 oz
Envidor 2SC	—	14–18 fl oz
Kanemite 15SC	—	21.0–31.0 fl oz
Nexter 75WP ⁴	—	4.4–6.6 oz
Portal ⁵	—	1.0–2.0 pt
Savey 50WP ³	1.0–1.5 oz	4.0–6.0 oz
Vendex 50WP	0.25 lb	0.75 lb
Vydate 2 L	1.0 pt	3.0 pt
Zeal 72WDG	—	2.0–3.0 oz

Insecticide and Acaricide Notes

1. Add a surfactant for improving coverage. It is strongly recommended that water hardness be reduced with water treatment containing ammonium sulfate prior to adding the surfactant and Acramite.
2. Agri-Flex and Agri-Mek should be combined with a horticultural spray oil (not a dormant oil) for best results; however, other penetrating adjuvants can be used with somewhat less efficacy. The rate for the horticultural spray oil should be a 0.25 percent concentration (1 qt/100 gal or a minimum of 1 gal/A). For best results, apply Agri-Flex and Agri-Mek at petal fall or within 10–15 days of petal fall and use a minimum of 100 gallons of water per acre. Make 2 applications maximum per season. If foliage is hardening off, do not apply.
3. Do not apply Apollo and Savey in the same year.
4. If two-spotted spider mites are the intended target of Nexter, use 8.8–10.6 oz per acre.
5. Portal also has activity against pear psylla nymphs.

Pears—Sixth Cover, Early August

Diseases. Sooty blotch, fly speck, fruit rots.

Insects. Codling moth, Oriental fruit moth, leafrollers, pear psylla.

Sprays before harvest. Refer to Table 4-15 when selecting sprays during the last month before harvest.

Pesticide recommendations for pears, sixth cover, early August.

Pesticide	Dilute rate/100 gal ^a	Rate sprayed/A
CHOOSE 1 of the following:		
Procure 50WS ^{b,c}	2.0–4.0 oz	8.0–16.0 oz
Topsin-M 70WP ^{b,c}	4.0 oz	1.0 lb
PLUS 1 of the following:		
ferbam 76WP ^d	1.0 lb	4.0 lb
Ziram 76WDG ^d	1.0 lb	4.0 lb
OR 1 of the following applied alone:		
ferbam 76WP ^d	1.0 lb	4.0 lb
Flint 50W ^e	0.5–0.6 oz	2.0–2.5 oz
Pristine ^{e,f}	4.8–6.0 oz	14.5–18.5 oz
Ziram 76WDG ^d	1.5–2.0 lb	6.0–8.0 lb
PLUS 1 of the following: Insecticides should be selected and combined according to their efficacy against individual pests (see Table 4-10).		
Admire Pro ¹	—	6.0–8.0 fl oz
Assail 30SG ¹	—	4.0–8.0 oz
Belay	—	6.0–12 fl oz
Delegate 25 WG ²	—	6.0–7.0 oz
imidacloprid 1.6F ¹	4.0–5.0 fl oz	16.0–20.0 fl oz
Imidan 70WP	0.75–1.0 lb	2.0–4.0 lb
Movento ³	—	6.0–9.0 fl oz
OFM sprayable pheromones	—	use label rate
Thionex 3EC ⁴	1.0 qt	2.6 qt
Thionex 50W ⁴	1.5 lb	4.0 lb

Fungicide and Antibiotic Notes

1. Based on dilute sprays with a 400-gallon-per-acre base except Pristine.
2. These fungicides should be used in combination with another fungicide to improve their efficacy and to prevent or delay buildup of resistant strains of the fungus causing pear scab.
3. Topsin-M should be used in combination with another fungicide to

improve their efficacy and to prevent or delay buildup of resistant strains of the fungus causing pear scab. Topsin-M re-entry interval is 3 days and preharvest interval is 1 day. Do not apply Procure within 14 days of harvest.

4. Do not apply Ziram within 14 days of harvest and ferbam within 7 days of harvest; read the label for specific late cover spray.
5. Do not apply more than 4 total applications per season or 2 consecutive applications of Flint, Sovran, or Pristine. Do not apply Flint within 14 days of harvest. Pristine has a 0 day to harvest limitation.
6. Based on dilute sprays with a 300 gallon per acre base.

Insecticide and Acaricide Notes

1. Adding a quart of summer oil per 100 gals will increase Admire Pro, Assail, and imidacloprid efficacy.
2. Control of pear psylla with Delegate can be improved with the addition of an adjuvant (e.g., 2 qts/100 gals of a summer oil).
3. For increased effectiveness, add a penetrating adjuvant.
4. Make no more than 2 Thionex applications during the fruiting period if pears are to be harvested 7 days after the last application.

Postharvest Disorders of Pears

See Part VI, Harvest and Postharvest Handling.

PEACH INTEGRATED PEST MANAGEMENT PROGRAM

Peaches—Dormant, Before Bud Swell Disease. Leaf curl, bacterial spot.

Insects. Mites, scales. Lecanium scale and San Jose scale: apply Esteem at 4.0–5.0 oz with oil. Use the higher rates of Esteem, chlorpyrifos, Lorsban, and Surpricide under heavy scale pressure.

Pesticide recommendations for peaches, dormant, before bud swell.

Pesticide	Dilute rate/100 gal ^a	Rate sprayed/A
CHOOSE 1 of the following:		
Bravo Weather Stik	1.0 pt	3.1–4.0 pt
Chlorothalonil 720	1.0 pt	3.1–4.0 pt
copper compounds		see label for rates
ferbam 76WP	1.5 lb	4.5 lb
Thiram 75WDG	1.2 lb	3.5 lb
Ziram 76WDG	2.0 lb	6.0–8.0 lb
PLUS 1 of the following: Insecticides should be selected and combined according to their efficacy against individual pests (see Table 4-12).		
chlorpyrifos	0.5–1.0 pt	2.0–3.0 pt
dormant oil	2.0 gal	4.0 gal
Esteem 35WP	—	4.0–5.0 oz
Lorsban 75WG	0.33–0.67 lb	1.0–2.0 lb
Supracide 2EC	1.0–2.0 pt	3.0–4.0 pt
Supracide 25WP	1.0–2.0 lb	3.0–4.0 lb

Fungicide and Antibiotic Note

1. Based on dilute spray of 300 gallons per acre. Maintain per-acre use rate regardless of spray volume per acre.

Brown rot. Remove all fruit from trees after last picking to prevent brown rot fungus from overwintering in mummies and twig cankers. Disking lightly under the trees no later than first bloom will aid in preventing fruiting of the brown rot fungus on old mummies in contact with the soil. Clean cultivation is not necessary—just disturb the mummy's contact with the soil. If this is not done, bloom sprays may become more critical. Refer to Part II, Diseases, Pests, and Natural Enemies, for more information on brown rot.

Cytospora canker. Refer to Part II, Diseases, Pests, and Natural Enemies.

Peaches—Pink to First Open Bloom

Disease. Brown rot (blossom blight). Blossom blight typically is not a problem unless temperatures are above 55°F, it is warm and wet, or brown rot has been a problem in the past.

Insects. Plant bugs, green peach aphid.

Plant bugs. Applying alternate row-middle sprays at reduced intervals should improve control. Plant bug feeding injury results in sunken areas on developing fruit that is not pubescent. Bugs are most persistent in orchards with alfalfa or clover sods. Since peaches are most vulnerable to catfacing injury at pink and petal fall, do not cultivate soil in orchards at those times. Cultivation only serves to destroy many alternate host plants, thus driving the insects up into the peach trees.

Oriental fruit moth mating disruption. If hand-applied mating disruption is used, dispensers should be placed at the pink stage at the recommended label rate. All dispensers should be in place before bloom. See Part III for a discussion on mating disruption. If a sprayable pheromone formulation for OFM is used, make first applications before the start of second brood flight. Repeat applications every 2–3 weeks or as needed. If chemical control is necessary, use degree-day egg hatch model for the best timing of available insecticides.

Pesticide recommendations for peaches, pink to first open bloom.

Pesticide	Dilute rate/100 gal ^a	Rate sprayed/A
Apply 1 of the following alone:		
Bravo Weather Stik	1.0 pt	3.1–4.0 pt
Chlorothalonil 720	1.0 pt	3.1–4.0 pt
captan 80WDG ^b	refer to footnote b	2.5–5.0 lb
Elite 45 DF ^{c,d,e}	2.0 oz	4.0–8.0 oz
Gem 500 SC ^{d,f}	—	2.9–3.8 fl oz
Indar 2F ^{c,d,g}	—	6.0–12.0 fl oz
Orbit ^{c,d}	—	4.0 fl oz
Pristine ^{c,h}	—	14.5 oz
Quash ^{c,i}	—	4.0 oz
Rovral 4F ^j	—	1.0–2.0 pt
Scala SC ^k	—	18.0 oz
Vanguard ^l	—	10.0 oz
Thiram 75WDG	1.2 lb	3.5 lb
Ziram 76WDG	2.0 lb	6.0–8.0 lb

PLUS 1 of the following: Insecticides should be selected and combined according to their efficacy against individual pests (see Table 4-12).

Asana XL 0.66EC	2.0–4.0 fl oz	4.8–8.0 fl oz
Baythroid 2E	—	1.4–2.8 fl oz
Carzol 92SP	4.0 oz	10.0 oz
Danitol 2.4 EC	3.5–7.0 fl oz	10.7–21.3 fl oz
Imidan 70WP	0.75–1.0 lb	2.0–3.0 lb
Lannate 90SP	4.0 oz	12.0 oz
Lannate LV	12.0 fl oz	36.0 fl oz
Mustang Max	—	1.3–4.0 fl oz
permethrin 3.2EC	2.5 fl oz	6.0–7.5 fl oz
permethrin 25W	0.25 lb	0.60–0.75 lb
Proaxis	—	2.5–5.1 fl oz
Thionex 50W	1.0 lb	3.0–3.5 lb
Thionex 3EC	21.0 fl oz	4.0–5.0 pt
Warrior II	—	1.3–2.5 fl oz

Fungicide and Antibiotic Notes

- Based on dilute spray with a 300-gallon-per-acre base. Maintain per-acre use rate regardless of spray volume per acre.
- Equivalent products include Captan 50% W & WP and Captec 4L. Check the label for rates/100 GPA. REI restrictions vary from 24 hours to 4 days; check the label of the product you are using. Some Captan products may be applied up to the day of harvest.
- Apply at early bloom stage (pink bud). Make a second application at 50 to 75 percent bloom. If blossoming is prolonged or conditions favorable for

disease persist, make a third application at petal fall.

- These fungicides are most effective when applied in combination with Ziram, Thiram or captan. Refer to the label for specific recommendations.
- Refer to the Elite label for specific dilute application rates and recommendations.
- Gem is a strobilurin fungicide, but unlike Pristine, it does not have a protectant compound and is therefore best used in combination with one. Do not use more than 15.2 fl oz per acre per season. Do not apply within 1 day of harvest. Do not make more than 2 sequential application of Gem or exceed 4 applications per season.
- Apply in a minimum of 50 gallons of water per acre. Maximum disease control is obtained when used in combination with a wetting agent (see label instructions). Indar may be applied up to the day of harvest.
- Do not make more than 2 sequential applications of Pristine before alternating to a labeled fungicide with a different mode of action. Do not make more than 5 applications of Pristine or related fungicide per season. Pristine has a 24-hour REI and a 0-day PHI.
- Do not make more than 2 applications of Quash after petal fall. Do not apply within 14 days of harvest. Do not make more than 3 applications per season or exceed 12 oz/A per season.
- Do not make more than 2 applications per season. Do not apply after petal fall.
- Do not apply more than 3 applications of Scala alone. Do not apply within 2 days of harvest or make more than 2 applications of a Group 9 fungicide within 30 days of harvest. Do not use on cherries.
- Vanguard may be applied alone or in combination with an unrelated fungicide; Vanguard is applied at a rate of 5 oz per acre (tank-mixes) and 10 oz per acre (alone). Do not apply Vanguard to sweet cherries. Do not apply Vanguard more than 2 times during bloom.

Peaches—Bloom

Disease. Brown rot (blossom blight).

Pesticide recommendations for peaches, bloom.

Pesticide	Dilute rate/100 gal ^a	Rate sprayed/A
Bravo Weather Stik	1.0 pt	3.1–4.0 pt
Chlorothalonil 720	1.0 pt	3.1–4.0 pt
captan 80WDG ^b	refer to footnote b	2.5–5.0 lb
Elite 45 DF ^{c,d,e,m}	2.0 oz	4.0–8.0 oz
Gem 500 SC ^{d,f,m}	—	2.9–3.8 fl oz
Indar 2F ^{c,d,g,m}	—	6.0–12.0 fl oz
Orbit ^{c,d,m}	—	4.0 fl oz
Pristine ^{c,h,m}	—	14.5 oz
Quash ^{c,i,m}	—	4.0 oz
Rovral 4F ^{c,j,m}	—	1.0–2.0 pt
Scala SC ^{k,m}	—	18.0 oz
Thiram 75WDG	1.2 lb	3.5 lb
Vanguard ^{l,m}	—	10.0 oz
Ziram 76WDG	2.0 lb	6.0–8.0 lb

Fungicide and Acaricide Notes

- Based on a dilute spray with a 300-gallon-per-acre base. Maintain per-acre use rate regardless of spray volume per acre.
- Equivalent products include Captan 50% W & WP and Captec 4L. Check the label for rates/100 GPA. REI restrictions vary from 24 hours to 4 days; check the label of the product you are using. Some Captan products may be applied up to the day of harvest.
- Apply at early bloom stage (pink bud). Make a second application at 50 to 75 percent bloom. If blossoming is prolonged or conditions favorable for disease persist, make a third application at petal fall.
- These fungicides are most effective when applied in combination with Ziram, Thiram, or captan. Refer to the label for specific recommendations.
- Refer to the Elite label for specific dilute application rates and recommendations.
- Gem is a strobilurin fungicide, but unlike Pristine, it does not have a protectant compound and is therefore best used in combination with one. Do not use more than 15.2 fl oz per acre per season. Do not apply within 1 day of harvest. Do not make more than 2 sequential application of Gem or exceed 4 applications per season.
- Apply in a minimum of 50 gallons of water per acre. Maximum disease control is obtained with a wetting agent (see label instructions). Indar may be applied up to the day of harvest.
- Do not make more than 2 sequential applications of Pristine before alternating to a labeled fungicide with a different mode of action. Do not make more than 5 applications of Pristine or related fungicide per season. Pristine has a 24-hour REI and a 0-day PHI.
- Do not make more than 2 applications of Quash after petal fall. Do not

apply within 14 days of harvest. Do not make more than 3 applications per season or exceed 12 oz/A per season.

- j. Do not make more than 2 applications per season. Do not apply after petal fall.
- k. Do not apply more than 3 applications of Scala alone. Do not apply within 2 days of harvest or make more than 2 applications of a Group 9 fungicide within 30 days of harvest. Do not use on cherries.
- l. Vanguard may be applied alone or in combination with an unrelated fungicide; Vanguard is applied at a rate of 5 oz per acre (tank-mixes) and 10 oz per acre (alone). Do not apply Vanguard to sweet cherries. Do not apply Vanguard more than 2 times during bloom.
- m. It is highly recommended that these products be tank-mixed with a protectant fungicide (e.g., captan, chlorothalonil, Ziram) to reduce the risk of resistance.

Peaches—Petal Fall

Disease. Brown rot (blossom blight), scab.

Insects. Oriental fruit moth, plant bugs, plum curculio, aphids.

Plum curculio. If plum curculio is a problem, shorten spray intervals through the first cover spray.

Green peach aphid. If this aphid is present, add Actara, Admire Pro, Assail, Beleaf, imidacloprid, or Movento.

Pesticide recommendations for peaches, petal fall.

Pesticide	Dilute rate/100 gal ^a	Rate sprayed/A
Bravo Weather Stik	1.0 pt	3.1–4.0 pt
captan 80WDG ^b	refer to footnote b	2.5–5.0 lb
Chlorothalonil 720	1.0 pt	3.1–4.0 pt
Elite 45 DF ^{c,m}	2.0 oz	4.0–8.0 oz
Gem 500 SC ^{d,e,m}	—	2.9–3.8 fl oz
Indar 2F ^{c,d,m}	—	6.0–12.0 fl oz
Orbit ^{c,d,m}	—	4.0 fl oz
Pristine ^{e,f,m}	—	10.5–14.5 oz
Quash ^{c,g,m}	—	4.0 oz
Rovral 4 F ^{c,h,m}	—	1.0–2.0 pt
Scala SC ^{i,m}	—	18.0 oz
Thiram 75WDG	1.2 lb	3.5 lb
Ziram 76WDG	2.0 lb	6.0–8.0 lb

PLUS 1 of the following: Insecticides should be selected and combined according to their efficacy against individual pests (see Table 4-12).

Actara 25W	—	3.0–5.5 oz
Admire Pro	—	2.0–3.0 fl oz
Asana XL 0.66EC	2.0–4.0 fl oz	4.8–8.0 fl oz
Assail 30SG	—	2.5–6.0 oz
Avaunt 30WDG	—	5.0–6.0 oz
Baythroid 2E	—	1.4–2.8 fl oz
Belay	—	3.0–6.0 fl oz
Beleaf 50SG	—	2.0–2.8 oz
Carzol 92SP	4.0 oz	12.0 oz
Danitol 2.4 EC	3.5–7.0 fl oz	10.7–21.3 fl oz
Delegate 25WG ¹	—	4.5–6.0 oz
Endigo ZC	—	5.0–5.5 fl oz
imidacloprid 1.6F	2.0 fl oz	4.0–6.0 fl oz
Imidan 70WP	0.75–1.0 lb	2.5–4.0 lb
Lannate 90SP	4.0 oz	12.0 oz
Lannate LV	12.0 fl oz	36.0 fl oz
Leverage 2.7SE	—	3.6–5.0 fl oz
Leverage 360	—	2.4–2.8 fl oz
Movento ²	—	6.0–9.0 fl oz
Mustang Max	—	1.3–4.0 fl oz
permethrin 3.2EC	2.5 fl oz	7.5 fl oz
permethrin 25WP	0.25 lb	0.75 lb
Proaxis	—	2.5–5.1 fl oz
Thionex 50W	1.0 lb	3.0–3.5 lb
Thionex 3EC	21.0 fl oz	4.0–5.0 pt
Voliam Flexi 40 WDG ¹	—	4.0–7.0 oz
Voliam Xpress ¹	—	6.0–10.0 fl oz
Warrior II	—	1.3–2.5 fl oz

Fungicide and Antibiotic Notes

- a. Based on dilute spray with a 300-gallon-per-acre base. Maintain per-acre use rate regardless of spray volume per acre.
- b. Equivalent products include Captan 50% W & WP and Captec 4L. Check the label for rates/100 GPA. REI restrictions vary from 24 hours to 4 days; check the label of the product you are using. Some Captan products may be applied up to the day of harvest.
- c. Apply in a minimum of 50 gallons of water per acre. Maximum disease control is obtained with a wetting agent (see label instructions). Indar may be applied up to the day of harvest. Refer to the Elite label for specific dilute application rates and recommendations.
- d. These fungicides are most effective when applied in combination with Ziram, Thiram, or captan. Refer to the label for specific recommendations.
- e. Gem is a strobilurin fungicide, but unlike Pristine, it does not have a protectant compound and is therefore best used in combination with one. Do not use more than 15.2 fl oz per acre per season. Do not apply within 1 day of harvest. Do not make more than 2 sequential application of Gem or exceed 4 applications per season.
- f. Do not make more than 2 sequential applications of Pristine before alternating to a labeled fungicide with a different mode of action. Do not make more than 5 applications of Pristine or related fungicide per season. Pristine has a 24-hour REI and a 0-day PHI.
- g. Do not make more than 2 applications of Quash after petal fall. Do not apply within 14 days of harvest. Do not make more than 3 applications per season or exceed 12 oz/A per season.
- h. Do not make more than 2 applications per season. Do not apply after petal fall.
- i. Do not apply more than 3 applications of Scala alone. Do not apply within 2 days of harvest or make more than 2 applications of a Group 9 fungicide within 30 days of harvest. Do not use on cherries.
- m. It is highly recommended that these products be tank-mixed with a protectant fungicide (e.g., captan, chlorothalonil, Ziram) to reduce the risk of resistance.

Insecticide and Acaricide Notes

1. In order to prevent the development of pest resistance to these new chemistries and to practice the most effective resistance management approach, we highly encourage growers to use only 1 chemical class of products (i.e., mode of action) for a particular generation of a targeted pest and to rotate to another chemical class to control the succeeding generation of the targeted pest. For example, if using Delegate to control the first generation of Oriental fruit moth, use Altacor, Belt, Turismo, Voliam Flexi, or Voliam Xpress to control the second generation; or, if using either Altacor, Belt, Turismo, Voliam Flexi, or Voliam Xpress to control the first generation of Oriental fruit moth, then switch to Delegate or another chemical class (Assail, Calypso, etc.) to control the second generation. Altacor, Belt, Turismo, Voliam Flexi, and Voliam Xpress belong to the same chemical class (IRAC Group 28) and should not be used for consecutive generations of a targeted pest. The same rotation approach applies to Delegate and all other chemistries.
2. For increased effectiveness, add a penetrating adjuvant.

Peaches—Shuck Split, Shuck Fall

Diseases. Scab, brown rot, bacterial spot, rusty spot.

Insects. Plum curculio, Oriental fruit moth, leafrollers, plant bugs, aphids.

Rusty spot. Spotting on the fruit of some varieties appears to be due to the apple powdery mildew fungus. Rio-Oso-Gem, Jerseyqueen, Jefferson, Washington, Redskin, and Loring often are affected. Many of the new peach and nectarine cultivars are also highly susceptible. Sulfur, Pristine, Elite, or Nova may reduce rusty spot incidence. Follow label recommendations.

Bacterial spot. Begin weekly applications of Mycoshield or FlameOut at shuck split on susceptible varieties. Mycoshield and FlameOut are applied at a rate of 12 oz/100 gal of water. Sprayer air velocity should not exceed 100 mph. The first 3 applications are most critical for control. Do not apply within 3 weeks of harvest. Dilute sprays with Mycoshield or FlameOut have provided the best control as complete coverage is essential. Spraying at night under slow drying conditions is most effective.

Green peach aphid. If this aphid is present, add Actara, Admire Pro, Belay, Beleaf, imidacloprid, or Movento.

Plum curculio. For control, see petal fall spray.

Pesticide recommendations for peaches, shuck split, shuck fall.

Pesticide	Dilute rate/100 gal	Rate sprayed/A
CHOOSE either of the following:		
captan 80WDG ^a	refer to footnote a	2.5–5.0 lb
Thiram 75WDG ^b	1.2 lb	3.5 lb
Ziram 76WDG ^b	2.0 lb	6.0–8.0 lb
PLUS the following:		
sulfur ^c	refer to label recommendations	
OR the following applied alone:		
sulfur ^c	refer to label recommendations	
PLUS 1 of the following: Insecticides should be selected and combined according to their efficacy against individual pests (see Table 4-12).		
Actara 25W	—	3.0–5.5 oz
Admire Pro	—	2.0–3.0 fl oz
Asana XL 0.66EC ¹	2.0–4.0 fl oz	4.8–8.0 fl oz
Assail 30SG	—	2.5–6.0 oz
Avaunt 30WDG	—	5.0–6.0 oz
Baythroid 2E ¹	—	1.4–2.8 fl oz
Belay	—	3.0–6.0 fl oz
Beleaf 50SG	—	2.0–2.8 oz
Danitol 2.4 EC ¹	3.5–7.0 fl oz	10.7–21.3 fl oz
Delegate 25WG ²	—	4.5–6.0 oz
Endigo ZC ¹	—	5.0–5.5 fl oz
imidacloprid 1.6F	2.0 fl oz	4.0–6.0 fl oz
Imidan 70WP	0.75–1.0 lb	2.5–4.0 lb
Isomate-PTB Dual ³	—	150–250 dispensers per acre
Lannate 90SP	4.0 oz	8.0–12.0 oz
Lannate LV	12.0 fl oz	24.0–36.0 fl oz
Leverage 2.7SE ¹	—	3.6–5.0 fl oz
Leverage 360 ¹	—	2.4–2.8 fl oz
Movento ⁴	—	6.0–9.0 fl oz
Mustang Max	—	1.3–4.0 fl oz
OFM sprayable pheromones	—	see label rate
Proaxis ¹	—	2.5–5.1 fl oz
Thionex 50W	1.0 lb	3.0–3.5 lb
Thionex 3EC	21.0 fl oz	4.0–5.0 pt
Voliam Flexi 40 WDG ²	—	4.0–7.0 oz
Voliam Xpress ^{1,2}	—	6.0–10.0 fl oz
Warrior II ¹	—	1.3–2.5 fl oz

Fungicide and Antibiotic Notes

- Equivalent products include Captan 50% W & WP and Captec 4L. Check the label for rates/100 GPA. REI restrictions vary from 24 hours to 4 days; check the label of the product you are using. Some Captan products may be applied up to the day of harvest.
- Do not apply Thiram within 7 days of harvest and Ziram within 14 days of harvest.
- Various formulations of sulfur are available commercially; these vary in sulfur content. Use labeled amounts of material that are dependent on the formulation.

Insecticide and Acaricide Notes

- Use of synthetic pyrethroids after petal fall can cause increases in spider mite populations and are quite toxic to all natural enemies.
- In order to prevent the development of pest resistance to these new chemistries and to practice the most effective resistance management approach, we highly encourage growers to use only 1 chemical class of products (i.e., mode of action) for a particular generation of a targeted pest and to rotate to another chemical class to control the succeeding generation of the targeted pest. For example, if using Delegate to control the first generation of Oriental fruit moth, use Altacor, Belt, Tourismo, Voliam Flexi, or Voliam Xpress to control the second generation; or, if using either Altacor, Belt, Tourismo, Voliam Flexi, or Voliam Xpress to control the first generation of Oriental fruit moth, then switch to Delegate or another chemical class (Assail, Calypso, etc.) to control the second generation. Altacor, Belt, Tourismo, Voliam Flexi, and Voliam Xpress belong to the same chemical class (IRAC Group 28) and should not be used for consecutive generations of a targeted pest. The same rotation approach applies to Delegate and all other chemistries.

- Isomate PTB Dual will control both LPTB and PTB and should be placed before first flight of LPTB.
- For increased effectiveness, add a penetrating adjuvant.

Peaches—First, Second, Third Covers

Diseases. Scab, brown rot, bacterial spot.

Insects. Oriental fruit moth, leafrollers, lesser peachtree borer, mites, plant bugs, scales.

Bacterial spot. See shuck split schedule for control. Apply at 10- to 14-day intervals. Reduce interval to 7 days in wet weather.

Pesticide recommendations for peaches, first, second, third covers.

Pesticide	Dilute rate/100 gal	Rate sprayed/A
CHOOSE either of the following:		
captan 80WDG ^a	refer to footnote a	2.5–5.0 lb
Thiram 75WDG ^b	1.2 lb	3.5 lb
Ziram 76WDG ^b	2.0 lb	6.0–8.0 lb
PLUS the following:		
sulfur ^c	refer to label recommendations	
OR the following applied alone:		
sulfur ^c	refer to label recommendations	
PLUS 1 of the following: Insecticides should be selected and combined according to their efficacy against individual pests (see Table 4-12).		
Actara 25W	—	3.0–5.5 oz
Altacor 35WDG ¹	—	2.5–3.0 oz
Asana XL 0.66EC ^{2,3}	2.0–4.0 oz	4.8–8.0 oz
Assail 30SG	—	2.5–6.0 oz
Avaunt 30WDG	—	5.0–6.0 oz
Baythroid 2E ^{2,3}	—	1.4–2.8 fl oz
Belay	—	3.0–6.0 fl oz
Belt SC ¹	—	3.0–4.0 fl oz
carbaryl 4L	—	1.5–2.0 qt
Centaur	—	34.5 oz
Danitol 2.4 EC ³	3.5–7.0 fl oz	10.7–21.3 fl oz
Delegate 25WG ¹	—	4.5–6.0 oz
diazinon 50W ⁴	0.75–1.0 lb	2.0–3.0 lb
Imidan 70WP	0.75–1.0 lb	2.5–4.0 lb
Lannate 90SP	4.0 oz	8.0–12.0 oz
Lannate LV	12.0 fl oz	24.0–36.0 fl oz
Movento ⁵	—	6.0–9.0 fl oz
Mustang Max	—	1.3–4.0 fl oz
OFM sprayable pheromones	—	see label rate
permethrin 3.2EC ^{2,3}	2.0–4.0 fl oz	4.0–8.0 fl oz
permethrin 25WP ^{2,3}	0.25 lb	0.75 lb
Proaxis ^{2,3}	—	2.5–5.1 fl oz
Sevin XLR	—	1.5–2.0 qt
Tourismo ¹	—	10.0–14.0 fl oz
Voliam Flexi 40 WDG ¹	—	4.0–7.0 oz
Voliam Xpress ^{1,2,3}	—	6.0–10.0 fl oz
Warrior II ³	—	1.3–2.5 fl oz

Fungicide and Antibiotic Notes

- Equivalent products include Captan 50% W & WP and Captec 4L. Check the label for rates/100 GPA. REI restrictions vary from 24 hours to 4 days; check the label of the product you are using. Some Captan products may be applied up to the day of harvest.
- Do not apply Thiram within 7 days of harvest and Ziram within 14 days of harvest.
- Various formulations of sulfur are available commercially; these vary in sulfur content. Use labeled amounts of material that are dependent on the formulation.

Insecticide and Acaricide Notes

- In order to prevent the development of pest resistance to these new chemistries and to practice the most effective resistance management approach, we highly encourage growers to use only 1 chemical class of products (i.e., mode of action) for a particular generation of a targeted pest and to rotate to another chemical class to control the succeeding generation of the targeted pest. For example, if using Delegate to control the first generation of Oriental fruit moth, use Altacor, Belt, Tourismo, Voliam Flexi, or Voliam Xpress to control the second generation; or, if

using either Altacor, Belt, Tourismo, Voliam Flexi, or Voliam Xpress to control the first generation of Oriental fruit moth, then switch to Delegate or another chemical class (Assail, Calypso, etc.) to control the second generation. Altacor, Belt, Tourismo, Voliam Flexi, and Voliam Xpress belong to the same chemical class (IRAC Group 28) and should not be used for consecutive generations of a targeted pest. The same rotation approach applies to Delegate and all other chemistries.

- Pyrethroids are very effective against Oriental fruit moth, plant bugs and stink bugs. They are also effective on lesser peachtree borer when applied by handgun or dilute.
- Use of synthetic pyrethroids after petal fall can cause increases in spider mite populations and are quite toxic to all natural enemies.
- Only 1 application of diazinon is allowed during the season.
- For increased effectiveness, add a penetrating adjuvant.

Mites. For mite control, use one of the following.

Miticide recommendations for peaches.

The miticide selected and its rate should be based on the size of the mite population, the number of predators present, and the degree of resistance in particular orchard blocks (see Table 4-12).

Miticide	Dilute rate/100 gal	Rate sprayed/A
CHOOSE 1 of the following:		
Acramite ¹	—	0.75–1.0 lb
Apollo 4SC	1.0–2.0 fl oz	3.0–6.0 fl oz
Envirdor 2SC	—	14.0–18.0 fl oz
Nexter ²	—	4.4–10.6 oz
Onager	—	12.0–24.0 fl oz
Savey 50WP	1.0–2.0 oz	3.0–6.0 oz
Vendex 50WP	4.0–6.0 oz	12.0–16.0 oz

Insecticide and Acaricide Notes

- Add a surfactant for improving coverage. It is strongly recommended that water hardness be reduced with a water treatment that contains ammonium sulfate prior to adding the surfactant and Acramite.
- Higher rate of Nexter is necessary for twospotted spider mite control.

Early season lesser peachtree borer. If there is only a moderate problem (less than 2 borers/tree), wait until late summer to apply controls (see Postharvest Disorders of Peaches, this section). If there are more than 2 borers per tree, make an application now and again in late summer. This borer attacks weak or injured trees in winter-damaged orchards and diseased trees, especially those with canker. Adult borers deposit eggs in wounds from May through August. The peak egg-laying period for the first generation is in June. Low-volume sprays are not effective on lesser peachtree borer. Use only high-volume, handgun applications. Be sure to cover trunk and scaffold limbs.

Lesser peachtree borer recommendations for peaches.

Pesticide	Dilute rate/100 gal
CHOOSE 1 of the following:	
Insecticides should be selected according to their efficacy against individual pests (see Table 4-12).	
Asana XL 0.66EC	2.0–4.0 oz
chlorpyrifos 4EC	1.5–2.0 qt
Lorsban Advanced	1.5–2.0 qt
permethrin 3.2EC	1.6 oz
Thionex 50W	1.5 lb
Thionex 3EC	1.5 qt

Peaches—Fourth and Later Covers

Diseases. Brown rot, scab, sooty mold, bacterial spot.

Insects. Oriental fruit moth, Japanese beetle, mites, leafrollers.

Bacterial spot. See shuck split schedule for control. Apply at 14-day intervals. Reduce spray intervals to 7 to 10 days in wet weather.

Western flower thrips. Lannate SP has been registered for use on nectarines and peaches in Pennsylvania (24c) to control thrips. The label specifies ½ to 1 pound per acre. No more than 3 applications of Lannate can be made within a season. Preharvest intervals are 1 day for nectarines and 4 days for peaches. Reentry into treated areas is prohibited for 3 days unless you wear personal protective clothing and equipment as specified on the Lannate L product label for early reentry.

Delegate is also registered for western flower thrips control. The preharvest interval is 1 day on nectarines and 14 days on peaches.

Growers wishing to use Delegate and Lannate for thrips control should carefully check early ripening fruit for the presence of silvering, the damage caused by feeding thrips on the skin of the fruit. It is extremely important that you cover fruit thoroughly with spray, since the thrips hide underneath leaves covering the fruit or around the stem end.

Pesticide recommendations for peaches, fourth and later covers.

Pesticide	Dilute rate/100 gal ^a	Rate sprayed/A
Apply 1 of the following:		
Elite 45 DF ^{b,c}	2.0 oz	4.0–8.0 oz
Gem 500 SC ^{a,d}	—	2.9–3.8 fl oz
Indar 2F ^{b,e}	—	6.0–12.0 fl oz
Orbit ^{b,f}	—	4.0 fl oz
Quash ^{e,g}	—	4.0 oz
In combination with 1 of the following:		
captan 50WP ^h	2.0 lb	4.0–8.0 lb
Thiram 75WDG ⁱ	1.2 lb	3.5 lb
Ziram 76WDG ⁱ	2.0 lb	6.0–8.0 lb
OR 1 of the following applied alone:		
captan 80WDG ^h	refer to footnote h	2.5–5.0 lb
Pristine ^j	—	10.5–14.5 oz
Scala SC ^k	—	10.0–18.0 oz
PLUS 1 of the following: Insecticides should be selected and combined according to their efficacy against individual pests (see Table 4-12).		
Actara 25W	—	3.0–5.5 oz
Altacor 35WDG ¹	—	2.5–3.0 oz
Asana XL 0.66EC ²	2.0–4.0 fl oz	4.8–8.0 fl oz
Assail 30SG	—	2.5–6.0 oz
Avaunt 30WDG	—	5.0–6.0 oz
Baythroid 2E ²	—	1.4–2.8 fl oz
Belay	—	3.0–6.0 fl oz
Belt SC ¹	—	4.0–5.0 fl oz
carbaryl 50WP	1.5 lb	4.0 lb
carbaryl 80S	1.0 lb	2.5 lb
carbaryl 4L	—	2.0 qt
Centaur	—	34.5 oz
Danitol 2.4 EC ²	3.5–7.0 fl oz	10.7–21.3 fl oz
Delegate 25W ¹	—	4.5–6.0 oz
Imidan 70WP	0.75–1.0 lb	2.5–4.0 lb
Intrepid 2F	2.0–4.0 fl oz	8.0–16.0 fl oz
Lannate 90SP	4.0 oz	8.0–12.0 oz
Lannate LV	12.0 fl oz	24.0–36.0 fl oz
Mustang Max	—	1.3–4.0 fl oz
OFM sprayable pheromones	—	see label rate
Proaxis ²	—	2.5–5.1 fl oz
Sevin XLR	0.75 qt	2.0 qt
Tourismo ¹	—	10.0–14.0 fl oz
Voliam Flexi 40 WDG ¹	—	4.0–7.0 oz
Voliam Xpress ^{1,2}	—	6.0–10.0 fl oz
Warrior II ²	—	1.3–2.5 fl oz

Fungicide and Antibiotic Notes

- Based on spray with a 300-gallon-per-acre dilute. Maintain per-acre use rate regardless of spray volume per acre.
- These fungicides are most effective when applied in combination with Ziram, Thiram, or captan. Refer to the label for specific recommendations.

- c. Refer to the Elite label for specific dilute application rates and recommendations.
- d. Gem is a strobilurin fungicide, but unlike Pristine, it does not have a protectant compound and is therefore best used in combination with one. Do not use more than 15.2 fl oz per acre per season. Do not apply within 1 day of harvest. Do not make more than 2 sequential application of Gem or exceed 4 applications per season.
- e. Begin applications 2 to 3 weeks before harvest using 7-to 10-day spray intervals. Apply in a minimum of 50 gallons of water per acre. Elite and Indar may be applied up to the day of harvest.
- f. Apply as needed a maximum of 2 applications of Orbit up to the day of harvest.
- g. Do not make more than 2 applications of Quash after petal fall. Do not apply within 14 days of harvest. Do not make more than 3 applications per season or exceed 12 oz/A per season.
- h. Equivalent products include Captan 50% W & WP and Captec 4L. Check the label for rates/100 GPA. REI restrictions vary from 24 hours to 4 days; check the label of the product you are using. Some Captan products may be applied up to the day of harvest.
- i. Do not apply Thiram within 7 days of harvest and Ziram within 14 days of harvest.
- j. Do not make more than 2 sequential applications of Pristine before alternating to a labeled fungicide with a different mode of action. Do not make more than 5 applications of Pristine or related fungicide per season. Pristine has a 24-hour REI and a 0-day PHI.
- k. Do not apply more than 3 applications of Scala applied alone. Do not apply within 2 days of harvest or make more than 2 applications of a Group 9 fungicide within 30 days of harvest. Do not use on cherries.

Insecticide and Acaricide Notes

1. In order to prevent the development of pest resistance to these new chemistries and to practice the most effective resistance management approach, we highly encourage growers to use only 1 chemical class of products (i.e., mode of action) for a particular generation of a targeted pest and to rotate to another chemical class to control the succeeding generation of the targeted pest. For example, if using Delegate to control the first generation of Oriental fruit moth, use Altacor, Belt, Tourismo, Voliam Flexi, or Voliam Xpress to control the second generation; or, if using either Altacor, Belt, Tourismo, Voliam Flexi, or Voliam Xpress to control the first generation of Oriental fruit moth, then switch to Delegate or another chemical class (Assail, Calypso, etc.) to control the second generation. Altacor, Belt, Tourismo, Voliam Flexi, and Voliam Xpress belong to the same chemical class (IRAC Group 28) and should not be used for consecutive generations of a targeted pest. The same rotation approach applies to Delegate and all other chemistries.
2. Use of synthetic pyrethroids after petal fall can cause increases in spider mite populations and are quite toxic to all natural enemies.

Sprays before harvest. Refer to Table 4-15 when selecting sprays during the last month before harvest.

VaporGard. VaporGard is an antitranspirant that may improve color and size; apply at a rate of 1 gallon of product in a minimum of 200 gallons of water per acre 2 weeks before anticipated harvest. Application may hasten maturity by approximately 3 days. Caution: Do not apply in a spray-tank mixture of any insecticide or fungicide.

Postharvest Disorders of Peaches

Postharvest fruit rot. See Part VI, Harvest and Postharvest Handling.

Peachtree borer and lesser peachtree borer on bearing and nonbearing trees. Two borer species may be present at this time of the season: peachtree borer (PTB) and lesser peachtree borer (LPTB). If only PTB is present and it is on a late maturing variety, apply a trunk spray during the first week of August. Use 1 of the insecticides under Peaches—First, Second, Third Cover, “Early season lesser peachtree borer.” If it is an early maturing variety, make a postharvest application of either chlorpyrifos 4E at 1.5–3.0 quarts per 100 gallons, Lorsban Advanced at 1.5–3.0

quarts per 100 gallons, or Lorsban 75WG at 2–4 lbs per 100 gallons, as a coarse, low-pressure, handgun application. Apply at least 1 gallon per tree.

If only LPTB is present, either a preharvest spray on late maturing varieties or a postharvest spray may be made as described above.

If both PTB and LPTB are present, use chlorpyrifos 4E, Lorsban Advanced, or Lorsban 75WG within the first 2 weeks of September (postharvest). Thoroughly wet all bark areas from ground level to scaffold limbs. Do allow the spray to contact fruit and watch preharvest intervals on late maturing peach varieties (chlorpyrifos 4E: 14 days; Lorsban 75WG: 14 days).

Nonbearing trees. If peachtree borer damage is present, make 2 applications, the first around July 15 and the second around August 10. Use Thionex 50WP (1.5 lb) per 100 gallons of water. If making only 1 application, apply between July 20 and August 1.

Preplant treatment to control peachtree borer. Chlorpyrifos 4EC, Thionex, Lorsban 75WG, and Lorsban Advanced are effective as a root dip treatment for peach, nectarine, and cherry trees before they are planted. This treatment has given excellent control through the first season only. Use either chlorpyrifos 4EC (3.0 qt/100 gal), Lorsban Advanced (3.0 qt/100 gal), Thionex 3EC (2.0 qt), Thionex 50WP (3.0 lb), or Lorsban 75WG (1.5 lb) per 40 gallons of water. Mix thoroughly. Dip the trees individually or in bundles so that roots and crowns are wetted well above the graft union.

Nematode control. Vydate L insecticide may be added to the endosulfan solution to aid in controlling nematodes on peach and cherry trees. Add 1.5 pints to 40 gallons of water. Roots should be soaked for up to 30 minutes before trees are planted. Vydate L is not registered for this use on plums.

Oxamyl 10G will also control nematodes at this time at 60 to 80 pounds per acre or 1.5 to 2 pounds per 1000 square feet.

PRECAUTIONS: Avoid exposing your skin to the mixture; wear rubber gloves during dipping operation.

Peaches—Fall Leaf Drop

Leaf curl and bacterial spot. The following spray, when applied in the fall just after the last leaves drop, will control leaf curl. Copper may aid in controlling bacterial spot.

Pesticide recommendations for peaches, fall leaf drop.

Pesticide	Dilute rate/100 gal	Rate sprayed/A
CHOOSE either of the following:		
copper compounds	read label for rates (several formulations)	
Bravo Weather Stik	1.0 pt	3.1–4.0 pt
Chlorothalonil 720	1.0 pt	3.1–4.0 pt
ferbam 76WP	1.5 lb	4.5 lb
Ziram 76WDG	2.0 lb	6.0–8.0 lb

Cytospora canker. Studies in Pennsylvania have shown that the fall leaf drop fungicide application is not effective in reducing Cytospora canker. No fungicide spray is recommended after leaf drop for canker control.

NECTARINE INTEGRATED PEST MANAGEMENT PROGRAM

Nectarines—Dormant, Before Bud Swell

Diseases. Leaf curl, bacterial spot.

Scales. Lecanium scale and San Jose scale—apply Esteem at 4.0 to 5.0 ounces with oil. Use higher rate of Esteem under heavy scale pressure.

Insects. Mites, scales.

Canker. For *Cytospora* canker control, see Part II, Diseases, Pests, and Natural Enemies. Late pruning in the spring up to petal fall, followed by a thorough spray before the next rain, will reduce new infections.

Pesticide recommendations for nectarines, dormant, before bud swell.

Pesticide	Dilute rate/100 gal ^a	Rate sprayed/A
ferbam 76WP	1.5 lb	4.5 lb
Bravo Weather Stik	1.0 pt	3.1–4.0 pt
Ziram 76WDG	2.0 lb	6.0–8.0 lb
Chlorothalonil 720	1.0 pt	3.1–4.0 pt
copper compounds		see label for rates
PLUS 1 of the following: Insecticides should be selected and combined according to their efficacy against individual pests (see Table 4-12).		
chlorpyrifos	0.5–1.0 pt	2.0–3.0 pt
dormant oil	2.0 gal	4.0 gal
Esteem 35WP	—	4.0–5.0 oz
Lorsban 75WG	—	1.0–2.0 lb
Supracide 2EC	1.0–2.0 pt	3.0–4.0 pt
Supracide 25WP	1.0–2.0 lb	3.0–4.0 lb

Fungicide and Antibiotic Note

a. Based on dilute spray of 300 gallons per acre. Maintain per-acre use rate regardless of spray volume per acre.

Nectarines—Pink to First Open Bloom

Disease. Brown rot (blossom blight).

Insects. Plant bug, green peach aphid.

Plant bugs. Applying alternate row-middle sprays at reduced intervals should improve control. Plant bug feeding injury results in sunken areas on developing fruit. Bugs are most persistent in orchards with alfalfa or clover sods. Since nectarines are most vulnerable to catfacing injury at pink and petal fall, do not cultivate soil in orchards at those times. Cultivation only serves to destroy many alternate host plants, thus driving the insects up into the peach trees.

Oriental fruit moth mating disruption. If hand-applied mating disruption is used, dispensers should be placed at the pink stage at the recommended label rate. All dispensers should be in place before bloom. See Part III for a discussion of mating disruption. If sprayable pheromone formulation for OFM is used, make first applications before the start of second brood flight. Repeat applications every 2–3 weeks or as needed. If chemical control is necessary, use degree-day egg hatch model for the best timing of available insecticides.

Pesticide recommendations for nectarines, pink to first open bloom.

Pesticide	Dilute rate/100 gal ^a	Rate sprayed/A
Apply 1 of the following:		
Bravo Weather Stik	1.0 pt	3.1–4.0 pt
captan 80WDG ^b	refer to footnote b	2.5–5.0 lb
Chlorothalonil 720	1.0 pt	3.1–4.0 pt
Elite 45DF ^{c,d,e}	2.0 oz	4.0–8.0 oz
Gem 500 SC ^{d,f}	—	2.9–3.8 fl oz
Indar 2F ^{c,d,g}	—	6.0–12.0 fl oz
Orbit ^{c,d}	—	4.0 fl oz
Pristine ^{c,h}	—	10.5–14.5 oz
Quash ^{c,i}	—	4.0 oz
Rovral 4 F ^j	—	1.0–2.0 pt
Scala SC ^k	—	10.0–18.0 oz
Vanguard ^l	—	10.0 oz
Ziram 76WDG	2.0 lb	6.0–8.0 lb
PLUS 1 of the following: Insecticides should be selected and combined according to their efficacy against individual pests (see Table 4-12).		
Asana XL 0.66EC	2.0–4.0 oz	4.8–8.0 oz
Assail 30SG	—	2.5–6.0 oz
Baythroid 2E	—	1.4–2.8 fl oz
Carzol 92SP	4.0 oz	10.0–12.0 oz
Danitol 2.4 EC	3.5–7.0 fl oz	10.7–21.3 fl oz
Imidan 70WP	0.75–1.0 lb	2.0–3.0 lb
Mustang Max	—	1.3–4.0 fl oz
permethrin 3.2EC	2.5 fl oz	6.0–7.5 fl oz
permethrin 25W	0.25 lb	0.6–0.75 lb
Proaxis	—	2.5–5.1 fl oz
Thionex 50W	1.0 lb	3.0–3.5 lb
Thionex 3EC	21.0 fl oz	4.0–5.0 pt
Warrior II	—	3.3–2.5 fl oz

Fungicide and Antibiotic Notes

- Based on a dilute spray of 300 gallons per acre. Maintain per-acre use rate regardless of spray volume per acre.
- Equivalent products include Captan 50% W & WP and Captec 4L. Check the label for rates/100 GPA. REI restrictions vary from 24 hours to 4 days; check the label of the product you are using. Some Captan products may be applied up to the day of harvest.
- Apply at early bloom stage (pink bud). Make a second application at 50 to 75 percent bloom. If blossoming is prolonged or conditions favorable for disease persist, make a third application at petal fall.
- These fungicides are most effective when applied in combination with Ziram or captan. Refer to the label for specific recommendations.
- refer to the Elite label for specific dilute application rates and recommendations.
- Gem is a strobilurin fungicide, but unlike Pristine, it does not have a protectant compound and is therefore best used in combination with one. Do not use more than 15.2 fl oz per acre per season. Do not apply within 1 day of harvest. Do not make more than 2 sequential application of Gem or exceed 4 applications per season.
- Apply in a minimum of 50 gallons of water per acre.
- Do not make more than 2 sequential applications of Pristine before alternating to a labeled fungicide with a different mode of action. Do not make more than 5 applications of Pristine or related fungicide per season. Pristine has a 24-hour REI and a 0-day PHI.
- Do not make more than 2 applications of Quash after petal fall. Do not apply within 14 days of harvest. Do not make more than 3 applications per season or exceed 12 oz/A per season.
- Do not make more than 2 applications per season. Do not apply after petal fall.
- Do not apply more than 3 applications of Scala alone. Do not apply within 2 days of harvest or make more than 2 applications of a Group 9 fungicide within 30 days of harvest. Do not use on cherries.
- Vanguard may be applied alone or in combination with an unrelated fungicide; Vanguard is applied at a rate of 5 oz per acre (tank-mixes) and 10 oz per acre (alone). Do not apply Vanguard to sweet cherries. Do not apply Vanguard more than 2 times during bloom.

Nectarines—Bloom

Disease. Brown rot (blossom blight).

Pesticide recommendations for nectarines, bloom.

Pesticide	Dilute rate/100 gal ^a	Rate sprayed/A
Apply 1 of the following:		
Bravo Weather Stik	1.0 pt	3.1–4.0 pt
captan 80WDG ^b	refer to footnote b	2.5–5.0 lb
Chlorothalonil 720	1.0 pt	3.1–4.0 pt
Elite 45 DF ^{c,d,e,m}	2.0 oz	4.0–8.0 oz
Gem 500 SC ^{d,f,m}	—	2.9–3.8 fl oz
Indar 2F ^{c,d,m}	—	6.0–12.0 fl oz
Orbit ^{c,d,m}	—	4.0 fl oz
Pristine ^{g,m}	—	10.5–14.5 oz
Quash ^{h,i,m}	—	4.0 oz
Rovral 4 F ^{h,i,m}	—	1.0–2.0 pt
Scala SC ^k	—	10.0–18.0 oz
Vanguard ^l	—	10.0 oz
Ziram 76WDG	2.0 lb	6.0–8.0 lb

Fungicide and Antibiotic Notes

- Based on dilute spray of 300 gallons per acre.
- Equivalent products include Captan 50% W & WP and Captec 4L. Check the label for rates/100 GPA. REI restrictions vary from 24 hours to 4 days; check the label of the product you are using. Some Captan products may be applied up to the day of harvest.
- Apply at early bloom stage (pink bud). Make a second application at 50 to 75 percent bloom. If blossoming is prolonged or conditions favorable for disease persist, make a third application at petal fall.
- These fungicides are most effective when applied in combination with Ziram or captan. Refer to the label for specific recommendations.
- Refer to the Elite label for specific dilute application rates and recommendations.
- Gem is a strobilurin fungicide, but unlike Pristine, it does not have a protectant compound and is therefore best used in combination with one. Do not use more than 15.2 fl oz per acre per season. Do not apply within 1 day of harvest. Do not make more than 2 sequential application of Gem or exceed 4 applications per season.
- Do not make more than 2 sequential applications of Pristine before alternating to a labeled fungicide with a different mode of action. Do not make more than 5 applications of Pristine or related fungicide per season. Pristine has a 24-hour REI and a 0-day PHI.
- Do not make more than 2 applications per season. Do not apply after petal fall.
- Do not make more than 2 applications of Quash after petal fall. Do not apply within 14 days of harvest. Do not make more than 3 applications per season or exceed 12 oz/A per season.
- Apply in a minimum of 50 gallons of water per acre.
- Do not apply more than 3 applications of Scala alone. Do not apply within 2 days of harvest or make more than 2 applications of a Group 9 fungicide within 30 days of harvest. Do not use on cherries.
- Vanguard may be applied alone or in combination with an unrelated fungicide; Vanguard is applied at a rate of 5 oz per acre (tank-mixes) and 10 oz per acre (alone). Do not apply Vanguard to sweet cherries. Do not apply Vanguard more than 2 times during bloom.
- It is highly recommended that these fungicides be tank-mixed with a protectant fungicide (e.g., captan) to reduce the risk of resistance.

Nectarines—Petal Fall

Disease. Brown rot.

Insects. Plum curculio, plant bugs, Oriental fruit moth, leafrollers.

Plum curculio. Where control measures are necessary, use insecticides at shorter intervals through the shuck fall spray.

Green peach aphid. If the aphid is present, add Actara, Beleaf, Lannate, or Provado.

Pesticide recommendations for nectarines, petal fall.

Pesticide	Dilute rate/100 gal ^a	Rate sprayed/A
Apply 1 of the following:		
Bravo Weather Stik	1.0 pt	3.1–4.0 pt
captan 80WDG ^b	refer to footnote b	2.5–5.0 lb
Chlorothalonil 720	1.0 pt	3.1–4.0 pt
Elite 45 DF ^{c,d,e,f,k}	2.0 oz	4.0–8.0 oz
Gem 500 SC ^{e,g,k}	—	2.9–3.8 fl oz
Indar 2F ^{c,d,e,k}	—	6.0–12.0 fl oz
Orbit ^{c,d,e,k}	—	4.0 fl oz
Pristine ^{c,h,k}	—	10.5–14.5 oz
Quash ^{c,i,k}	—	4.0 oz
Rovral 4 F ^{c,j,k}	—	1.0–2.0 pt
Ziram 76WDG	2.0 lb	6.0–8.0 lb
PLUS 1 of the following: Insecticides should be selected and combined according to their efficacy against individual pests (see Table 4-12).		
Actara 25W	—	3.0–5.5 oz
Admire Pro	—	2.0–3.0 fl oz
Asana XL 0.66EC	2.0–4.0 fl oz	4.8–8.0 fl oz
Assail 30SG	—	2.5–6.0 oz
Avaunt 30WDG	—	5.0–6.0 oz
Baythroid 2E	—	1.4–2.8 fl oz
Beleaf 50SG	—	2.0–2.8 oz
Carzol 92SP	4.0 oz	12.0 oz
Danitol 2.4 EC	3.5–7.0 fl oz	10.7–21.3 fl oz
Delegate 25WG ¹	—	4.5–6.0 oz
Endigo ZC	—	5.0–5.5 fl oz
imidacloprid 1.6F	2.0 fl oz	4.0–6.0 fl oz
Imidan 70WP	0.75–1.0 lb	2.5–4.0 lb
Lannate 90SP	4.0 oz	12.0 oz
Lannate LV	12.0 fl oz	36.0 fl oz
Leverage 2.7SE	—	3.6–5.0 fl oz
Leverage 360	—	2.4–2.8 fl oz
Mustang Max	—	1.3–4.0 fl oz
Movento ²	—	6.0–9.0 fl oz
permethrin 3.2EC	2.5 fl oz	7.5 fl oz
permethrin 25WP	0.25 lb	0.75 lb
Proaxis	—	2.5–5.1 fl oz
Thionex 50W	1.0 lb	3.0–3.5 lb
Thionex 3EC	21.0 fl oz	4.0–5.0 pt
Voliam Flexi 40 WDG ¹	—	4.0–7.0 oz
Voliam Xpress ¹	—	6.0–10.0 fl oz
Warrior II	—	1.3–2.5 fl oz

Fungicide and Antibiotic Notes

- Based on 300 gallons per acre dilute.
- Equivalent products include Captan 50% W & WP and Captec 4L. Check the label for rates/100 GPA. REI restrictions vary from 24 hours to 4 days; check the label of the product you are using. Some Captan products may be applied up to the day of harvest.
- Apply in 50 gallons of water per acre.
- Apply at early bloom stage (pink bud). Make a second application at 50 to 75 percent bloom. If blossoming is prolonged or conditions favorable for disease persist, make a third application at petal fall.
- These fungicides are most effective when applied in combination with Ziram or captan. Refer to the label for specific recommendations.
- Refer to the Elite label for specific dilute application rates and recommendations.
- Gem is a strobilurin fungicide, but unlike Pristine, it does not have a protectant compound and is therefore best used in combination with one. Do not use more than 15.2 fl oz per acre per season. Do not apply within 1 day of harvest. Do not make more than 2 sequential application of Gem or exceed 4 applications per season.
- Do not make more than 2 sequential applications of Pristine before alternating to a labeled fungicide with a different mode of action. Do not make more than 5 applications of Pristine or related fungicide per season. Pristine has a 24-hour REI and a 0-day PHI.
- Do not make more than 2 applications of Quash after petal fall. Do not apply within 14 days of harvest. Do not make more than 3 applications per season or exceed 12 oz/A per season.
- Do not make more than 2 applications per season. Do not apply after petal fall.
- It is highly recommended that these fungicides be tank-mixed with a protectant fungicide (e.g., captan) to reduce the risk of resistance.

Insecticide and Acaricide Notes

1. In order to prevent the development of pest resistance to these new chemistries and to practice the most effective resistance management approach, we highly encourage growers to use only 1 chemical class of products (i.e., mode of action) for a particular generation of a targeted pest and to rotate to another chemical class to control the succeeding generation of the targeted pest. For example, if using Delegate to control the first generation of Oriental fruit moth, use Altacor, Belt, Turismo, Voliam Flexi, or Voliam Xpress to control the second generation; or, if using either Altacor, Belt, Turismo, Voliam Flexi, or Voliam Xpress to control the first generation of Oriental fruit moth, then switch to Delegate or another chemical class (Assail, Calypso, etc.) to control the second generation. Altacor, Belt, Turismo, Voliam Flexi, and Voliam Xpress belong to the same chemical class (IRAC Group 28) and should not be used for consecutive generations of a targeted pest. The same rotation approach applies to Delegate and all other chemistries.
2. For increased effectiveness, add a penetrating adjuvant.

Nectarines—Shuck Split, Shuck Fall Diseases. Brown rot, scab, bacterial spot.

Bacterial spot. Begin weekly applications of 12 oz/100 gal of water of Mycoshield or FlameOut at shuck split on susceptible cultivars. Sprayer air velocity should not exceed 100 mph. The first 3 applications are most critical for control. Complete coverage of foliage is essential for good control. Do not apply within 3 weeks of harvest.

Insects. Plant bugs, Oriental fruit moth, leafrollers.

Tufted apple bud moth. See petal fall spray.

Plum curculio. See petal fall spray.

Green peach aphid. If this aphid is present, add Actara, Admire Pro, Assail, Beleaf, or imidacloprid.

Pesticide recommendations for nectarines, shuck split, shuck fall.

Pesticide	Dilute rate/100 gal	Rate sprayed/A
CHOOSE either of the following:		
captan 80WDG ^a	refer to footnote a	2.5–5.0 lb
Ziram 76WDG ^b	2.0 lb	6.0–8.0 lb
PLUS the following:		
sulfur ^c	refer to the label recommendations	
OR the following applied alone:		
sulfur ^c	refer to the label recommendations	
PLUS 1 of the following: Insecticides should be selected and combined according to their efficacy against individual pests (see Table 4-12).		
Actara 25W	—	3.0–5.5 oz
Admire Pro	—	2.0–3.0 fl oz
Asana XL 0.66EC ¹	2.0–4.0 fl oz	4.8–8.0 fl oz
Assail 30SG	—	2.5–6.0 oz
Avaunt 30WDG	—	5.0–6.0 oz
Baythroid 2E ¹	—	1.4–2.8 fl oz
Beleaf 50SG	—	2.0–2.8 oz
Danitol 2.4 EC ¹	3.5–7.0 fl oz	10.7–21.3 fl oz
Delegate 25WG ²	—	4.5–6.0 oz
Endigo ZC ¹	—	5.0–5.5 fl oz
imidacloprid 1.6F	2.0 fl oz	4.0–6.0 fl oz
Isomate-PTB Dual ³	—	150–250 dispensers per acre
Lannate 90SP	4.0 oz	8.0–12.0 oz
Lannate LV	12.0 fl oz	24.0–36.0 fl oz
Leverage 2.7SE ¹	—	3.6–5.0 fl oz
Leverage 360 ¹	—	2.4–2.8 fl oz
Movento ⁴	—	6.0–9.0 fl oz
Mustang Max ¹	—	1.3–4.0 fl oz
OFM sprayable pheromones	—	see label rate
Proaxis ¹	—	2.5–5.1 fl oz
Thionex 50W	1.0 lb	3.0–3.5 lb
Thionex 3EC	21.0 fl oz	4.0–5.0 pt
Voliam Flexi 40W ²	—	4.0–7.0 oz
Voliam Xpress ^{1,2}	—	6.0–10.0 fl oz
Warrior II ¹	—	1.3–2.5 fl oz

Fungicide and Antibiotic Notes

- a. Equivalent products include Captan 50% W & WP and Captec 4L. Check the label for rates/100 GPA. REI restrictions vary from 24 hours to 4 days; check the label of the product you are using. Some Captan products may be applied up to the day of harvest.
- b. Do not apply Ziram within 14 days of harvest
- c. Formulations of sulfur available commercially vary in sulfur content. Use labeled amounts of material dependent on the formulation.

Insecticide and Acaricide Notes

1. Use of synthetic pyrethroids after petal fall can cause increases in spider mite populations and are quite toxic to all natural enemies.
2. In order to prevent the development of pest resistance to these new chemistries and to practice the most effective resistance management approach, we highly encourage growers to use only 1 chemical class of products (i.e., mode of action) for a particular generation of a targeted pest and to rotate to another chemical class to control the succeeding generation of the targeted pest. For example, if using Delegate to control the first generation of Oriental fruit moth, use Altacor, Belt, Turismo, Voliam Flexi, or Voliam Xpress to control the second generation; or, if using either Altacor, Belt, Turismo, Voliam Flexi, or Voliam Xpress to control the first generation of Oriental fruit moth, then switch to Delegate or another chemical class (Assail, Calypso, etc.) to control the second generation. Altacor, Belt, Turismo, Voliam Flexi, and Voliam Xpress belong to the same chemical class (IRAC Group 28) and should not be used for consecutive generations of a targeted pest. The same rotation approach applies to Delegate and all other chemistries.
3. Isomate PTB Dual will control both LPTB and PTB and should be placed before first flight of LPTB.
4. For increased effectiveness, add a penetrating adjuvant.

Nectarines—First, Second, Third Covers Diseases. Brown rot, scab, bacterial spot.

Bacterial spot. See shuck split recommendations.

Insects. Oriental fruit moth, leafrollers, mites, borer, scales.

Pesticide recommendations for nectarines, first, second, third covers.

Pesticide	Dilute rate/100 gal	Rate sprayed/A
CHOOSE either of the following:		
captan 80WDG ^a	refer to footnote a	2.5–5.0 lb
Ziram 76WDG ^b	2.0 lb	6.0–8.0 lb
PLUS the following:		
sulfur ^c	refer to the label recommendations	
OR the following applied alone:		
sulfur ^c	refer to the label recommendations	
PLUS 1 of the following: Insecticides should be selected and combined according to their efficacy against individual pests (see Table 4-13).		
Actara 25W	—	3.0–5.5 oz
Altacor 35WDG ¹	—	2.5–3.0 oz
Asana XL 0.66EC ²	2.0–4.0 oz	4.8–8.0 oz
Assail 30SG	—	2.5–6.0 oz
Avaunt 30WDG	—	5.0–6.0 oz
Baythroid 2E ²	—	1.4–2.8 fl oz
Belt SC ¹	—	4.0–5.0 fl oz
carbaryl 4L	—	1.5–2.0 qt
Centaur	—	34.5 oz
Danitol 2.4 EC ²	3.5–7.0 fl oz	10.7–21.3 fl oz
Delegate 25WG ¹	—	4.5–6.0 oz
diazinon 50W ³	0.75–1.0 lb	2.0–3.0 lb
Imidan 70WP	0.75–1.0 lb	2.5–4.0 lb
Lannate 90SP	4.0 oz	8.0–12.0 oz
Lannate LV	12.0 fl oz	24.0–36.0 fl oz
Mustang Max	—	1.3–4.0 fl oz
Movento ⁴	—	6.0–9.0 fl oz
OFM sprayable pheromones	—	see label rate
permethrin 3.2EC ²	2.0–4.0 fl oz	4.0–8.0 fl oz
permethrin 25WP ²	0.25 lb	0.75 lb
Proaxis ²	—	2.5–5.1 fl oz
Sevin XLR	—	1.5–2.0 qt
Tourismo ¹	—	10.1–4.0 fl oz
Voliam Flexi 40 WDG ¹	—	4.0–7.0 oz
Voliam Xpress ^{1,2}	—	6.0–10.0 fl oz
Warrior II ²	—	1.3–2.5 fl oz

Fungicide and Antibiotic Notes

- Equivalent products include Captan 50% W & WP and Captec 4L. Check the label for rates/100 GPA. REI restrictions vary from 24 hours to 4 days; check the label of the product you are using. Some Captan products may be applied up to the day of harvest.
- Do not apply Ziram within 14 days of harvest.
- Various commercial formulations of sulfur vary in sulfur content. Use labeled amounts of material depending on the formulation.

Insecticide and Acaricide Notes

- In order to prevent the development of pest resistance to these new chemistries and to practice the most effective resistance management approach, we highly encourage growers to use only 1 chemical class of products (i.e., mode of action) for a particular generation of a targeted pest and to rotate to another chemical class to control the succeeding generation of the targeted pest. For example, if using Delegate to control the first generation of Oriental fruit moth, use Altacor, Belt, Turismo, Voliam Flexi, or Voliam Xpress to control the second generation; or, if using either Altacor, Belt, Turismo, Voliam Flexim, or Voliam Xpress to control the first generation of Oriental fruit moth, then switch to Delegate or another chemical class (Assail, Calypso, etc.) to control the second generation. Altacor, Belt, Turismo, Voliam Flexi, and Voliam Xpress belong to the same chemical class (IRAC Group 28) and should not be used for consecutive generations of a targeted pest. The same rotation approach applies to Delegate and all other chemistries.
- Use of synthetic pyrethroids after petal fall can cause increases in spider mite populations and are quite toxic to all natural enemies.
- Only 2 applications of diazinon are allowed during the season, one at dormant/delayed dormant and once postbloom.
- For increased effectiveness, add a penetrating adjuvant.

Mites. When mites become troublesome, add 1 of the following materials.

Miticide recommendations for nectarines, first, second, third covers.

Several miticide options are given. The miticide selected and its rate should be based on the size of the mite population, the number of predators present, and the degree of resistance in particular orchard blocks (see Table 4-12).

Miticide	Dilute rate/100 gal	Rate sprayed/A
CHOOSE 1 of the following:		
Acramite ¹	—	0.75–1.0 lb
Apollo 50SC	1.0–2.0 fl oz	3.0–6.0 fl oz
Envirdor 2SC	—	14.0–18.0 fl oz
Nexter ²	—	4.4–10.6 oz
Onager	—	12.0–24.0 fl oz
Savey 50WP	1.0–2.0 oz	3.0–6.0 oz
Vendex 50 WP	4.0 oz	16.0 oz

Insecticide and Acaricide Notes

- Add a surfactant for improving coverage. It is strongly recommended that water hardness be reduced with a water treatment containing ammonium sulfate prior to adding the surfactant and Acramite.
- Higher rate of Nexter is necessary for twospotted spider mite control.

Lesser peachtree borer. Refer to Peach Integrated Pest Management Program. For control, use the following:

Pesticide	Dilute rate/100 gal	Rate sprayed/A
Thionex 50W	1.5 lb	3.5 lb

Nectarines—Fourth Cover to Preharvest

Diseases. Brown rot, scab, bacterial spot.

Bacterial spot. See shuck split schedule for control. Apply oxytetracycline products (Mycoshield or FlameOut) at 14-day intervals. Reduce interval to 7–10 days during wet weather.

Insects. Oriental fruit moth, mites, borer, scales. Apply pesticide at 14-day intervals.

Western flower thrips. Lannate SP has been registered (24c) for use on nectarines and peaches in Pennsylvania to control thrips. The label specifies ½ to 1 pound per acre. No more than 3 applications can be made within a season. The preharvest interval for nectarines is 1 day. Reentry into treated areas is prohibited for 3 days unless you wear personal protective clothing and equipment as specified on the Lannate L product label for early reentry. Delegate 25WG is also labeled for thrips control on nectarines with a 1-day preharvest interval.

Growers wishing to use Delegate and Lannate for thrips control should carefully check early ripening fruit for the presence of silvering, the damage caused by feeding thrips on the skin of the fruit. It is extremely important that you cover fruit thoroughly with spray, since thrips hide underneath leaves covering the fruit or around the stem end.

Pesticide recommendations for nectarines, fourth cover to preharvest.

Pesticide	Dilute rate/100 gal ^a	Rate sprayed/A
Apply 1 of the following:		
Elite 45 DF ^{b,c,d}	2.0 oz	4.0–8.0 oz
Gem 500 SC ^e	—	2.9–3.8 fl oz
Indar 2F ^{b,c}	—	6.0–12.0 fl oz
Orbit ^{c,f}	—	4.0 fl oz
Quash ^{b,g}	—	4.0 oz
In combination with 1 of the following:		
captan 80WDG ^h	refer to footnote h	2.5–5.0 lb
Ziram 76WDG ⁱ	2.0 lb	6.0–8.0 lb
OR 1 of the following applied alone:		
captan 80WDG ^h	refer to footnote h	2.5–5.0 lb
Pristine ^l	—	10.5–14.5 oz
Scala SC ^k	—	10.0–18.0 oz
PLUS 1 of the following: Insecticides should be selected and combined according to their efficacy against individual pests (see Table 4-13).		
Actara 25W	—	3.0–5.5 oz
Altacor 35WDG ¹	—	2.5–3.0
Asana XL 0.66EC ²	2.0–4.0 fl oz	4.8–8.0 fl oz
Avaunt 30WDG	—	5.0–6.0 oz
Baythroid 2E ²	—	1.4–2.8 fl oz
Belt SC ¹	—	3.0–4.0 fl oz
carbaryl 50WP	1.5 lb	4.0 lb
carbaryl 80S	1.0 lb	2.5 lb
carbaryl 4L	—	2.0 qt
Centaur	—	34.5 oz
Danitol 2.4 EC ²	3.5–7.0 fl oz	10.7–21.3 fl oz
Delegate 25WG ¹	—	4.5–6.0 oz
Intrepid 2F	2.0–4.0 fl oz	8.0–16.0 fl oz
Lannate 90SP	4.0 oz	8.0–12.0 oz
Lannate LV	12.0 fl oz	24.0–36.0 fl oz
Mustang Max ²	—	1.3–4.0 fl oz
OFM sprayable pheromones	—	see label rate
Proaxis ²	—	2.5–5.1 fl oz
Sevin XLR	0.75 qt	2.0 qt
Tourismo ¹	—	10.0–14.0 fl oz
Voliam Flexi 40W ¹	—	4.0–7.0 oz
Voliam Xpress ^{1,2}	—	6.0–10.0 fl oz
Warrior II	—	1.3–2.5 fl oz

Fungicide and Antibiotic Notes

- a. Based on a dilute spray of 300 gallons per acre. Maintain per-acre use rate regardless of spray volume per acre.
- b. Begin applications 2 to 3 weeks before harvest using 7- to 10-day spray intervals. Apply a minimum of 50 gallons of water per acre. Elite and Indar may be applied up to the day of harvest.
- c. These fungicides are most effective when applied in combination with Ziram, Thiram, or captan. Refer to the label for specific recommendations.
- d. Refer to the Elite label for specific dilute application rates and recommendations.
- e. Gem is a strobilurin fungicide, but unlike Pristine, it does not have a protectant compound and is therefore best used in combination with one. Do not use more than 15.2 fl oz per acre per season. Do not apply within 1 day of harvest. Do not make more than 2 sequential application of Gem or exceed 4 applications per season
- f. Orbit may be applied up to the day of harvest.
- g. Do not make more than 2 applications of Quash after petal fall. Do not apply within 14 days of harvest. Do not make more than 3 applications per season or exceed 12 oz/A per season.
- h. Equivalent products include Captan 50% W & WP and Captec 4L. Check the label for rates/100 GPA. REI restrictions vary from 24 hours to 4 days; check the label of the product you are using. Some Captan products may be applied up to the day of harvest.
- i. Do not apply Ziram within 14 days of harvest.
- j. Do not make more than 2 sequential applications of Pristine before alternating to a labeled fungicide with a different mode of action. Do not make more than 5 applications of Pristine or related fungicide per season. Pristine has a 24-hour REI and a 0-day PHI. We recommend tank-mixing Pristine with a protectant fungicide as well.
- k. Do not apply more than 3 applications of Scala applied alone. Do not apply within 2 days of harvest or make more than 2 applications.

Insecticide and Acaricide Notes

1. In order to prevent the development of pest resistance to these new chemistries and to practice the most effective resistance management approach, we highly encourage growers to use only 1 chemical class of products (i.e., mode of action) for a particular generation of a targeted pest and to rotate to another chemical class to control the succeeding generation of the targeted pest. For example, if using Delegate to control the first generation of Oriental fruit moth, use Altacor, Belt, Turismo, Voliam Flexi, or Voliam Xpress to control the second generation; or, if using either Altacor, Belt, Turismo, Voliam Flexi, or Voliam Xpress to control the first generation of Oriental fruit moth, then switch to Delegate or another chemical class (Assail, Calypso, etc.) to control the second generation. Altacor, Belt, Turismo, Voliam Flexi, and Voliam Xpress belong to the same chemical class (IRAC Group 28) and should not be used for consecutive generations of a targeted pest. The same rotation approach applies to Delegate and all other chemistries.
2. Use of synthetic pyrethroids after petal fall can cause increases in spider mite populations and are quite toxic to all natural enemies.

Postharvest Disorders of Nectarines

Postharvest fruit rot. See Part VI, Harvest and Postharvest Handling.

Nectarines—Fall Leaf Drop

Diseases. Leaf curl, bacterial spot.

Leaf curl and bacterial spot. The following spray, when applied in the fall just after the last leaves drop, will control leaf curl. Copper may aid in controlling bacterial spot.

Pesticide recommendations for nectarines, fall leaf drop.

Pesticide	Dilute rate/100 gal	Rate sprayed/A
CHOOSE 1 of the following:		
Bravo Weather Stik	1.0 pt	3.1–4.0 pt
Chlorothalonil 720	1.0 pt	3.1–4.0 pt
copper compounds	refer to the label for specific recommendations	
ferbam 76WP	1.5 lb	4.5 lb
Ziram 76WDG	2.0 lb	6.0–8.0 lb

Cytospora canker. Studies in Pennsylvania have shown that the fall leaf drop fungicide application is not effective in reducing Cytospora canker. No fungicide spray is recommended after leaf drop for canker control.

Peachtree borer and lesser peachtree borer. See Postharvest Disorders of Peaches.

APRICOT INTEGRATED PEST MANAGEMENT PROGRAM

Apricots – Dormant

Disease. Bacterial spot.

Scales. Lecanium scale and San Jose scale: apply Esteem at 4.0–5.0 ounces with oil. Use higher rate of Esteem under heavy scale pressure.

Pesticide recommendations where scales are a problem for apricots, dormant.

Pesticide	Dilute rate/100 gal	Rate sprayed/A
copper compounds	see label for rates	
dormant oil	2.0 gal	3.5 gal
Esteem 35WP	—	4.0–5.0 oz
Supracide 2EC	1.0–2.0 pt	3.0–4.0 pt
Supracide 25WP	1.0–2.0 lb	3.0–4.0 lb

Canker. Pruning late in the spring, up to petal fall, followed by a thorough spray before the next rain will reduce new infections.

Apricots – Pink to First Open Bloom

Disease. Brown rot (blossom blight).

Insects. Plant bugs, aphids.

Pesticide recommendations for apricots, pink to first open bloom.

Pesticide	Dilute rate/100 gal	Rate sprayed/A
Apply 1 of the following:		
captan 80WDG ^a	refer to footnote a	1.0–3.5 lb
Gem 500 SC ^{b,c}	—	2.9–3.8 fl oz
Indar 2FP ^{a,c}	—	6.0–12.0 fl oz
Orbit ^{b,d}	—	4.0 fl oz
Pristine ^{d,e}	—	14.5 oz
Quash ^{b,d,f}	—	4.0 oz
Rovral 4 F ^{g,h}	—	1.0–2.0 pt
Scala SC ⁱ	—	10.0–18.0 oz
Vanguard ^j	—	10.0 oz
Ziram 76WDG	2.0–2.5 lb	6.0–8.0 lb
PLUS 1 of the following:		
Asana XL 0.66EC	2.0–4.0 fl oz	4.8–8.0 fl oz
Baythroid 2E	—	2.0–2.8 fl oz
carbaryl 80S	1.0 lb	2.5 lb
carbaryl 50WP	1.5 lb	4.0 lb
Danitol 2.4 EC	3.5–7.0 fl oz	10.7–21.3 fl oz
Imidan 70WP	0.75–1.0 lb	2.0–3.0 lb
Mustang Max	—	1.3–4.0 fl oz
Proaxis	—	2.5–5.1 fl oz
Sevin XLR	0.75 qt	2.0 qt
Thionex 50W	1.0 lb	3.0–3.5 lb
Thionex 3EC	21.0 fl oz	4.0–5.0 pt
Warrior II	—	1.3–2.5 fl oz

Fungicide and Antibiotic Notes

- Equivalent products include Captan 50% W & WP and Captec 4L. Check the label for rates/100 GPA. REI restrictions vary from 24 hours to 4 days; check the label of the product you are using. Some Captan products may be applied up to the day of harvest.
- These fungicides are most effective when applied in combination with Ziram or captan. Refer to the label for specific recommendations.
- Gem is a strobilurin fungicide, but unlike Pristine, it does not have a protectant compound and is therefore best used in combination with one. Do not use more than 15.2 fl oz per acre per season. Do not apply within 1 day of harvest. Do not make more than 2 sequential application of Gem or exceed 4 applications per season.
- Begin applications at red bud stage (5 percent bloom). If conditions are favorable for disease development, apply again at full bloom and at petal fall.

- Do not make more than 2 sequential applications of Pristine before alternating to a labeled fungicide with a different mode of action. Do not make more than 5 applications of Pristine or related fungicide per season. Pristine has a 24-hour REI and a 0-day PHI.
- Do not make more than 2 applications of Quash after petal fall. Do not apply within 14 days of harvest. Do not make more than 3 applications per season or exceed 12 oz/A per season.
- Apply at early bloom stage (red bud). Make a second application as needed up through petal fall.
- Do not make more than 2 applications per season. Do not apply after petal fall.
- Do not apply more than 3 applications of Scala applied alone. Do not apply within 2 days of harvest or make more than 2 applications of a Group 9 fungicide within 30 days of harvest. Do not use on cherries.
- Vanguard may be applied alone or in combination with an unrelated fungicide; Vanguard is applied at a rate of 5 oz per acre (tank-mixes) and 10 (alone) oz per acre. Do not apply Vanguard to sweet cherries. Do not apply Vanguard more than 2 times during bloom.

Apricots – Bloom

Disease. Brown rot (blossom blight).

Pesticide recommendations for apricots, bloom.

Pesticide	Dilute rate/100 gal	Rate sprayed/A
captan 80WDG ^a	refer to footnote a	1.9–3.5 lb
Gem 500 SC ^{b,c,d}	—	2.9–3.8 fl oz
Indar 2FP ^{a,c}	—	6.0–12.0 fl oz
Orbit ^{a,c}	—	4.0 fl oz
Pristine ^{b,e}	—	14.5 oz
Quash ^{b,c,f}	—	2.5–3.5 oz
Rovral 4 F ^g	—	1.0–2.0 pt
Scala SC ^h	—	10.0–18.0 oz
Vanguard ⁱ	—	10.0 oz
Ziram 76WDG ^a	2.0–2.5 lb	6.0–8.0 lb

Fungicide and Antibiotic Notes

- Begin applications at red bud stage (5 percent bloom). If conditions are favorable for disease development, apply again at full bloom and at petal fall. Equivalent products include Captan 50% W & WP and Captec 4L. Check the label for rates/100 GPA. REI restrictions vary from 24 hours to 4 days; check the label of the product you are using. Some Captan products may be applied up to the day of harvest.
- Apply at early bloom stage (red bud). Make a second application. Make a second application as needed up through petal fall.
- These fungicides are most effective when applied in combination with Ziram, or captan. Refer to the label for specific recommendations.
- Gem is a strobilurin fungicide, but unlike Pristine, it does not have a protectant compound and is therefore best used in combination with one. Do not use more than 15.2 fl oz per acre per season. Do not apply within 1 day of harvest. Do not make more than 2 sequential application of Gem or exceed 4 applications per season.
- Do not make more than 2 sequential applications of Pristine before alternating to a labeled fungicide with a different mode of action. Do not make more than 5 applications of Pristine or related fungicide per season. Pristine has a 24-hour REI and a 0-day PHI.
- Do not make more than 2 applications of Quash after petal fall. Do not apply within 14 days of harvest. Do not make more than 3 applications per season or exceed 12 oz/A per season.
- Do not make more than 2 applications per season. Do not apply after petal fall.
- Do not apply more than 3 applications of Scala applied alone. Do not apply within 2 days of harvest or make more than 2 applications of a Group 9 fungicide within 30 days of harvest. Do not use on cherries.
- Vanguard may be applied alone or in combination with an unrelated fungicide; Vanguard is applied at a rate of 5 oz per acre (tank-mixes) and 10 (alone) oz per acre. Do not apply Vanguard to sweet cherries. Do not apply Vanguard more than 2 times during bloom.

Apricots—Petal Fall

Use same fungicides as in pink.

Disease. Brown rot.

Apricots—Shuck Split, First, Second Cover to Preharvest

Diseases. Brown rot, scab.

Insects. Plum curculio, fruitworms. Apply first cover 8 to 10 days after shuck split, second cover 8 to 10 days after first cover, other covers at 10- to 14-day intervals, and preharvest spray about 1 month before harvest.

Pesticide recommendations for apricots, shuck split, first, second cover to preharvest.

Pesticide	Dilute rate/100 gal	Rate sprayed/A
CHOOSE either of the following:		
captan 80WDG ^a	refer to footnote a	1.9–3.5 lb
sulfur ^b	refer to the label recommendations	
Ziram 76WDG ^c	2.0–2.5 lb	6.0–8.0 lb
PLUS 1 of the following:		
Actara 25W	—	3.0–4.5 oz
Admire Pro	—	2.0–3.0 fl oz
Altacor 35WDG ¹	—	2.5–3.0 oz
Asana XL 0.66EC	2.0–4.0 fl oz	4.8–8.0 fl oz
Assail 30SG	—	2.5–6.0 oz
Avaunt 30WDG	—	5.0–6.0 oz
Baythroid 2E	—	2.0–2.8 fl oz
Beleaf 50SG	—	2.0–2.8 oz
Belt SC ¹	—	3.0–4.0 fl oz
carbaryl 50WP	1.5 lb	4.0 lb
carbaryl 80S	1.0 lb	2.5 lb
Danitol 2.4 EC	3.5–7.0 fl oz	10.7–21.3 fl oz
Delegate 25WG ¹	—	4.5–6.0 oz
diazinon 50W ²	1.0 lb	2.0 lb
Endigo ZC	—	5.0–5.5 fl oz
imidacloprid 1.6F	2.0 fl oz	4.0–6.0 fl oz
Imidan 70WP	0.75 lb	2.0–3.0 lb
Leverage 2.7 SE	—	3.0–5.0 fl oz
Leverage 360	—	2.4–2.8 fl oz
Movento ³	—	6.0–9.0 fl oz
Mustang Max	—	1.3–4.0 fl oz
OFM sprayable pheromones	—	see label rate
Proaxis	—	2.5–5.1 fl oz
Sevin XLR	0.75 qt	2.0 qt
Thionex 50W	1.0 lb	3.0–3.5 lb
Thionex 3EC	21.0 fl oz	4.0–5.0 pt
Tourismo ¹	—	10.0–14.0 fl oz
Voliam Flexi 40W ¹	—	4.0–7.0 oz
Voliam Xpress ¹	—	6.0–10.0 fl oz
Warrior II	—	1.3–2.5 fl oz

Fungicide and Antibiotic Notes

- Equivalent products include Captan 50% W & WP and Captec 4L. Check the label for rates/100 GPA. REI restrictions vary from 24 hours to 4 days; check the label of the product you are using. Some Captan products may be applied up to the day of harvest.
- Various formulations of sulfur are available commercially; these vary in sulfur content. Use labeled amounts of material that are dependent on the formulation.
- Do not apply Ziram within 14 days of harvest.

Insecticide and Acaricide Notes

- In order to prevent the development of pest resistance to these new chemistries and to practice the most effective resistance management approach, we highly encourage growers to use only 1 chemical class of products (i.e., mode of action) for a particular generation of a targeted pest and to rotate to another chemical class to control the succeeding generation of the targeted pest. For example, if using Delegate to control the first generation of Oriental fruit moth, use Altacor, Belt, Turismo, Voliam Flexi, or Voliam Xpress to control the second generation; or, if using either Altacor, Belt, Turismo, Voliam Flexi, or Voliam Xpress to control the first generation of Oriental fruit moth, then switch to Delegate or another chemical class (Assail, Calypso, etc.) to control the second generation. Altacor, Belt, Turismo, Voliam Flexi, and Voliam Xpress belong to the same chemical class (IRAC Group 28) and should not be used for consecutive generations of a targeted pest. The same rotation approach applies to Delegate and all other chemistries.

Voliam Flexi, or Voliam Xpress to control the second generation; or, if using either Altacor, Belt, Turismo, Voliam Flexi, or Voliam Xpress to control the first generation of Oriental fruit moth, then switch to Delegate or another chemical class (Assail, Calypso, etc.) to control the second generation. Altacor, Belt, Turismo, Voliam Flexi, and Voliam Xpress belong to the same chemical class (IRAC Group 28) and should not be used for consecutive generations of a targeted pest. The same rotation approach applies to Delegate and all other chemistries.

- Only 2 applications of diazinon are allowed during the season: one at dormant/delayed dormant and once postbloom.
- For increased effectiveness, add a penetrating adjuvant.

Mites. For control, use the following.

Miticide recommendations for apricots.

Miticide	Dilute rate/100 gal	Rate sprayed/A
Apollo 50SC	1.0–2.0 fl oz	3.0–6.0 fl oz
Envirdor 2SC	—	14.0–18.0 fl oz
Nexter ^a	—	4.4–10.6 oz
Onager	—	12.0–24.0 fl oz
Savey 50WP	1.0–2.0 oz	3.0–6.0 oz

Note

- Higher rate of Nexter is necessary for twospotted spider mite control.

Lesser peachtree borer. To control, use trunk spray or cover sprays of the following material.

Lesser peachtree borer recommendation for apricots, shuck split, first, second cover to preharvest.

Pesticide	Dilute rate/100 gal
Asana XL 0.66EC	2.0–4.0 fl oz
Thionex 50W	1.5 lb
Thionex 3EC	1.5 qt

Peachtree borer. Refer to Peach Integrated Pest Management Program in this section. Do not use chlorpyrifos, Thionex, or Vydate L for preplant treatments on apricots since these materials are not registered for this purpose.

Sprays before harvest. Refer to Table 4-15 when selecting sprays during the last month before harvest.

Additional applications before apricot harvest.

Pesticide	Dilute rate/100 gal	Rate sprayed/A
Apply 1 of the following alone:		
Gem 500 SC ^a	—	2.9–3.8 fl oz
Indar 2F ^b	—	6.0–12.0 fl oz
Orbit ^c	—	4.0 fl oz
Quash ^d	—	4.0 oz

In combination with 1 of the following:

captan 80WDG ^e	refer to footnote e	1.0–3.5 lb
Ziram 76WDG	2.0–2.5 lb	6.0–8.0 lb

OR 1 of the following applied alone:

captan 80WDG ^e	refer to footnote e	1.0–3.5 lb
Pristine ^f	—	10.5–14.5 oz
Scala SC ^g	—	10.0–18.0 oz

Fungicide and Antibiotic Notes

- Gem is a strobilurin fungicide, but unlike Pristine, it does not have a protectant compound and is therefore best used in combination with one. Do not use more than 15.2 fl oz per acre per season. Do not apply within 1 day of harvest. Do not make more than 2 sequential application of Gem or exceed 4 applications per season.
- Begin applications 2 to 3 weeks before harvest using 7- to 10-day spray intervals. Apply in a minimum of 50 gallons of water per acre. Indar may be applied up to the day of harvest.
- Apply maximum of 2 preharvest sprays during the period beginning 3 weeks before harvest through the day of harvest. Orbit has a 0-day preharvest limitation.
- Do not make more than 2 applications of Quash after petal fall. Do not apply within 14 days of harvest. Do not make more than 3 applications per season or exceed 12 oz/A per season.

- e. Equivalent products include Captan 50% W & WP and Captec 4L. Check the label for rates/100 GPA. REI restrictions vary from 24 hours to 4 days; check the label of the product you are using. Some Captan products may be applied up to the day of harvest.
- f. Do not make more than 2 sequential applications of Pristine before alternating to a labeled fungicide with a different mode of action. Do not make more than 5 applications of Pristine or related fungicide per season. Pristine has a 24-hour REI and a 0-day PHI.
- g. Do not apply more than 3 applications of Scala alone. Do not apply within 2 days of harvest or make more than 2 applications of a Group 9 fungicide within 30 days of harvest. Do not use on cherries.

Postharvest Disorders of Apricots

Postharvest fruit rot. See Part VI, Harvest and Postharvest Handling, for control suggestions.

Postharvest orchard disease control. For brown rot and Cytospora canker control, see discussion following the peach dormant spray.

SWEET CHERRY INTEGRATED PEST MANAGEMENT PROGRAM

Sweet Cherries—Dormant

Scales. Lecanium scale and San Jose scale: apply Esteem at 4.0 to 5.0 ounces with oil. Use higher rate of Esteem under heavy scale pressure.

Pesticide recommendations for sweet cherries, dormant.

Pesticide	Dilute rate/100 gal	Rate sprayed/A
Use 1 of the following:		
dormant oil	2.0 gal	4.5 gal
Esteem 35WP	—	4.0–5.0 oz
Supracide 2EC	1.0–2.0 pt	3.0–4.0 pt
Supracide 25WP	1.0–2.0 lb	3.0–4.0 lb

Sweet Cherries—Prebloom

Apply the following when first blossoms are open.

Black cherry aphid. If present, add endosulfan (see table for Cherries, Petal Fall).

Pesticide recommendations for sweet cherries, prebloom.

Pesticide	Dilute rate/100 gal ^a	Rate sprayed/A
Apply 1 of the following:		
Bravo Weather Stik	1.0 pt	3.1–4.0 pt
Cabrio EG ^b	—	9.5 oz
captan 80WDG ^c	refer to footnote c	2.5 lb
Chlorothalonil 720	1.0 pt	3.1–4.0 pt
Elite 45 DF ^d	2.0 oz	4.0–8.0 oz
Gem 500 SC ^{e,f}	—	2.9–3.8 fl oz
Indar 2F ^{d,e}	—	6.0–12.0 fl oz
Orbit ^g	—	4.0 fl oz
Pristine ^b	—	14.5 oz
Quash ^{e,h}	—	4.0 oz
Rally 40WSP ⁱ	1.25–2.0 oz	2.5–6.0 oz
Rovral 4 F ^j	—	1.0–2.0 pt
Ziram 76WDG	2.0–2.5 lb	5.0–8.0 lb

Fungicide and Antibiotic Notes

- a. Refer to the label for specific dilute application rates and recommendations.
- b. Pristine and Cabrio are related fungicides. Do not make more than 2 sequential applications of Pristine and/or Cabrio before alternating to a labeled fungicide with a different mode of action. Do not make more than 5 applications of Pristine and/or Cabrio per season. Pristine and Cabrio have a 24-hour REI and a 0-day PHI.
- c. Equivalent products include Captan 50% W & WP and Captec 4L. Check the label for rates/100 GPA. REI restrictions vary from 24 hours to 4 days; check the label of the product you are using. Some Captan products may

be applied up to the day of harvest.

- d. Begin applications at for blossom blight at early bloom. If conditions are favorable for disease development, apply again at full bloom and at petal fall.
- e. These products work best when used in combination with a protectant such as Captan or Chlorothalonil to reduce resistance pressure.
- f. Gem is a strobilurin fungicide, but unlike Pristine, it does not have a protectant compound and is therefore best used in combination with one. Do not use more than 15.2 fl oz per acre per season. Do not apply within 1 day of harvest. Do not make more than 2 sequential application of Gem or exceed 4 applications per season.
- g. For brown rot blossom blight make the first application at popcorn stage of bloom, make a second application as needed through petal fall. For powdery mildew and leafspot make up to 2 additional applications on a 10- to 14-day interval from the end of petal fall to harvest.
- h. Do not make more than 2 applications of Quash after petal fall. Do not apply within 14 days of harvest. Do not make more than 3 applications per season or exceed 12 oz/A per season.
- i. Controls leaf spot and powdery mildew but not blossom blight. Do not apply Rally within 7 days of harvest. Rubigan may be applied from petal fall to harvest.
- j. Do not make more than 2 applications per season. Do not apply after petal fall.

Sweet Cherries—Bloom

For brown rot control apply when the first blossoms open and again at 70 to 90 percent open blossoms. Follow recommendation in the prebloom schedule. Do not use an insecticide during bloom.

Sweet Cherries—Petal Fall

Diseases. Brown rot, leafspot.

Insects. Leafrollers, aphids.

Black cherry aphid. If the aphid is present, use Actara or Provado (see following table for rates).

American plum borer. American plum borer is increasing in high populations infesting a number of tart cherry orchards in Pennsylvania. Control of this pest can be achieved at petal fall by applying a dilute application of endosulfan 50WP at 1 pound per 100 gallons. Direct spray to the entire trunk area up to the lower scaffold limbs and to all areas cracked and damaged by shaker clamps or other means. Do not apply chlorpyrifos 4E, Lorsban Advanced, or Lorsban 75WG to sweet cherries, as they are highly phytotoxic to the foliage.

Pesticide recommendations for sweet cherries, petal fall.

Pesticide	Dilute rate/100 gal ^a	Rate sprayed/A
Apply 1 of the following:		
Bravo Weather Stik	1.0 pt	3.1–4.0 pt
Cabrio EG ^b	—	9.5 oz
captan 80WDG ^c	refer to footnote c	2.5 lb
Chlorothalonil 720	1.0 pt	3.1–4.0 pt
Elite 45 DF ^d	2.0 oz	4.0–8.0 oz
Gem 500 SC ^{e,f}	—	2.9–3.8 fl oz
Indar 2F ^{d,e}	—	6.0–12.0 fl oz
Orbit ^g	—	4.0 fl oz
Pristine ^b	—	14.5 oz
Quash ^{e,h}	—	4.0 oz
Rally 40WSP ⁱ	1.25–2.0 oz	2.5–6.0 oz
Rovral 4 F ^j	—	1.0–2.0 pt
Rubigan EC ⁱ	3.0–4.0 oz	6.0–12.0 fl oz
Ziram 76WDG	2.0–2.5 lb	5.0–8.0 lb
PLUS 1 of the following:		
Actara ¹	—	3.0–4.5 oz
Admire Pro	—	2.0–3.0 fl oz
Asana XL 0.66EC	2.0–4.0 fl oz	6.0–12.0 fl oz
Assail 30SG	—	2.5–6.0 oz
Avaunt 30WDG	—	5.0–6.0 oz
Baythroid 2E	—	2.0–2.8 fl oz
Beleaf 50SG	—	2.0–2.8 oz
carbaryl 50WP	1.5 lb	4.0 lb
Danitol 2.4 EC	3.5–7.0 fl oz	10.7–21.3 fl oz
Delegate 25WG ²	—	4.5–6.0 oz
Endigo ZC	—	5.0–5.5 fl oz
imidacloprid 1.6F ³	2.0 fl oz	4.0–6.0 fl oz
Leverage 2.7SE	—	3.0–5.0 fl oz
Leverage 360	—	2.4–2.8 fl oz
Movento ³	—	6.0–9.0 fl oz
Mustang Max	—	1.3–4.0 fl oz
permethrin 3.2EC	2.0 oz	7.0 oz
Proaxis	—	2.5–5.1 fl oz
Thionex 50W	1.0 lb	3.0–3.5 lb
Thionex 3EC	21.0 fl oz	4.0–5.0 pt
Voliam Flexi 40W ^{1,2}	—	4.0–7.0 oz
Voliam Xpress ²	—	6.0–10.0 fl oz
Warrior II	—	1.3–2.5 fl oz

Fungicide and Antibiotic Notes

- Refer to the label for specific dilute application rates and recommendations.
- Pristine and Cabrio are related fungicides. Do not make more than 2 sequential applications of Pristine and/or Cabrio before alternating to a labeled fungicide with a different mode of action. Do not make more than 5 applications of Pristine and/or Cabrio per season. Pristine and Cabrio have a 24-hour REI and a 0-day PHI.
- Equivalent products include Captan 50% W & WP and Captec 4L. Check the label for rates/100 GPA. REI restrictions vary from 24 hours to 4 days; check the label of the product you are using. Some Captan products may be applied up to the day of harvest.
- Begin applications at early bloom. If conditions are favorable for disease development, apply again at full bloom and at petal fall. For leafspot control, begin applications at petal fall and continue on 10- to 14-day intervals.
- These products work best when used in combination with a protectant such as Captan or Chlorothalonil to reduce resistance pressure.
- Gem is a strobilurin fungicide, but unlike Pristine, it does not have a protectant compound and is therefore best used in combination with one. Do not use more than 15.2 fl oz per acre per season. Do not apply within 1 day of harvest. Do not make more than 2 sequential application of Gem or exceed 4 applications per season.
- For brown rot blossom blight make the first application at popcorn stage of bloom, make a second application as needed through petal fall. For powdery mildew and leafspot make up to 2 additional applications on a 10- to 14-day interval from the end of petal fall to harvest.
- Do not make more than 2 applications of Quash after petal fall. Do not apply within 14 days of harvest. Do not make more than 3 applications per season or exceed 12 oz/A per season.
- Controls leaf spot and powdery mildew but not blossom blight. Do not apply Rally within 7 days of harvest. Rubigan may be applied from petal fall to harvest.

- Do not make more than 2 applications per season. Do not apply after petal fall.

Insecticide and Acaricide Notes

- Do not apply Actara or Voliam Flexi if bees are active in the orchard or on flowering cover crops.
- In order to prevent the development of pest resistance to these new chemistries and to practice the most effective resistance management approach, we highly encourage growers to use only 1 chemical class of products (i.e., mode of action) for a particular generation of a targeted pest and to rotate to another chemical class to control the succeeding generation of the targeted pest. For example, if using Delegate to control the first generation of Oriental fruit moth, use Altacor, Belt, Tourismo, Voliam Flexi, or Voliam Xpress to control the second generation; or, if using either Altacor, Belt, Tourismo, Voliam Flexi, or Voliam Xpress to control the first generation of Oriental fruit moth, then switch to Delegate or another chemical class (Assail, Calypso, etc.) to control the second generation. Altacor, Belt, Tourismo, Voliam Flexi, and Voliam Xpress belong to the same chemical class (IRAC Group 28) and should not be used for consecutive generations of a targeted pest. The same rotation approach applies to Delegate and all other chemistries.
- For increased effectiveness add a penetrating adjuvant.

Sweet Cherries—Shuck Fall, First Cover

Diseases. Brown rot, leafspot.

Insects. Plum curculio, leafrollers.

Pesticide recommendations for sweet cherries, shuck fall, first cover.

Pesticide	Dilute rate/100 gal ^a	Rate sprayed/A
Cabrio EG ^b	—	9.5 oz
captan 80WDG ^c	refer to footnote c	2.5 lb
Elite 45 DF ^d	2.0 oz	4.0–8.0 oz
Gem 500 SC ^{e,f}	—	2.9–3.8 fl oz
Indar 2F ^{d,e}	—	6.0–12.0 fl oz
Orbit ^g	—	4.0 fl oz
Pristine ^{b,d}	—	14.5 oz
Quash ^{e,h}	—	4.0 oz
Rally 40WSP ⁱ	1.25–2.0 oz	2.5–6.0 oz
Rubigan EC ⁱ	3.0–4.0 oz	6.0–12.0 fl oz
sulfur ^j	refer to the label for rates and recommendations	
Ziram 76WDG	2.0–2.5 lb	4.0–8.0 lb
PLUS 1 of the following:		
Actara 25W	—	3.0–4.5 oz
Admire Pro	—	2.0–3.0 fl oz
Altacor 35WDG ¹	—	2.5–3.0 oz
Asana XL 0.66EC	2.0–4.0 fl oz	7.0–14.0 fl oz
Assail 30SG	—	2.5–6.0 oz
Avaunt 30WDG	—	5.0–6.0 oz
Baythroid 2E	—	2.0–2.8 fl oz
Belt SC ¹	—	3.0–4.0 fl oz
Beleaf 50SG	—	2.0–2.8 oz
carbaryl 50WP	1.5 lb	4.0 lb
Danitol 2.4 EC	3.5–7.0 fl oz	10.7–21.3 fl oz
Delegate 25WG ¹	—	4.5–6.0 oz
diazinon 50W ²	1.0 lb	2.0 lb
Endigo ZC	—	5.0–5.5 fl oz
Leverage 2.7SE	—	3.0–5.0 fl oz
Leverage 360	—	2.4–2.8 fl oz
Movento ³	—	6.0–9.0 fl oz
Mustang Max	—	1.3–4.0 fl oz
permethrin 3.2EC	2.0 oz	7.0 oz
Proaxis	—	2.5–5.1 fl oz
Thionex 50W	1.0 lb	3.0–3.5 lb
Thionex 3EC	21.0 fl oz	4.0–5.0 pt
Tourismo ¹	—	10.0–14.0 fl oz
Voliam Flexi 40W ¹	—	4.0–7.0 oz
Voliam Xpress ¹	—	6.0–10.0 fl oz
Warrior II	—	1.3–2.5 fl oz

PLUS 1 of the following:

Actara 25W	—	3.0–4.5 oz
Admire Pro	—	2.0–3.0 fl oz
Altacor 35WDG ¹	—	2.5–3.0 oz
Asana XL 0.66EC	2.0–4.0 fl oz	7.0–14.0 fl oz
Assail 30SG	—	2.5–6.0 oz
Avaunt 30WDG	—	5.0–6.0 oz
Baythroid 2E	—	2.0–2.8 fl oz
Belt SC ¹	—	3.0–4.0 fl oz
Beleaf 50SG	—	2.0–2.8 oz
carbaryl 50WP	1.5 lb	4.0 lb
Danitol 2.4 EC	3.5–7.0 fl oz	10.7–21.3 fl oz
Delegate 25WG ¹	—	4.5–6.0 oz
diazinon 50W ²	1.0 lb	2.0 lb
Endigo ZC	—	5.0–5.5 fl oz
Leverage 2.7SE	—	3.0–5.0 fl oz
Leverage 360	—	2.4–2.8 fl oz
Movento ³	—	6.0–9.0 fl oz
Mustang Max	—	1.3–4.0 fl oz
permethrin 3.2EC	2.0 oz	7.0 oz
Proaxis	—	2.5–5.1 fl oz
Thionex 50W	1.0 lb	3.0–3.5 lb
Thionex 3EC	21.0 fl oz	4.0–5.0 pt
Tourismo ¹	—	10.0–14.0 fl oz
Voliam Flexi 40W ¹	—	4.0–7.0 oz
Voliam Xpress ¹	—	6.0–10.0 fl oz
Warrior II	—	1.3–2.5 fl oz

Fungicide and Antibiotic Notes

- Refer to the label for specific dilute application rates and recommendations.
- Pristine and Cabrio are related fungicides. Do not make more than 2 sequential applications of Pristine and/or Cabrio before alternating to a

labeled fungicide with a different mode of action. Do not make more than 5 applications of Pristine and/or Cabrio per season. Pristine and Cabrio have a 24-hour REI and a 0-day PHI.

- c. Equivalent products include Captan 50% W & WP and Captec 4L. Check the label for rates/100 GPA. REI restrictions vary from 24 hours to 4 days; check the label of the product you are using. Some Captan products may be applied up to the day of harvest.
- d. For leaf spot control begin applications at petal fall or when first leaves unfold and continue applications at 7- to 14-day intervals. A postharvest application may be made to maintain control and reduce overwintering inoculum.
- e. These products work best when used in combination with a protectant such as Captan or Chlorothalonil to reduce resistance pressure.
- f. Gem is a strobilurin fungicide, but unlike Pristine, it does not have a protectant compound and is therefore best used in combination with one. Do not use more than 15.2 fl oz per acre per season. Do not apply within 1 day of harvest. Do not make more than 2 sequential application of Gem or exceed 4 applications per season.
- g. For powdery mildew and leafspot, make up to 2 additional applications on a 10- to 14-day interval from the end of petal fall to harvest.
- h. Do not make more than 2 applications of Quash after petal fall. Do not apply within 14 days of harvest. Do not make more than 3 applications per season or exceed 12 oz/A per season.
- i. Controls leaf spot and powdery mildew but not blossom blight. Do not apply Rally within 7 days of harvest. Rubigan may be applied from petal fall to harvest.
- j. Various formulations of sulfur are available commercially; these vary in sulfur content. Use labeled amounts of material that are dependent on the formulation.

Insecticide and Acaricide Notes

1. In order to prevent the development of pest resistance to these new chemistries and to practice the most effective resistance management approach, we highly encourage growers to use only 1 chemical class of products (i.e., mode of action) for a particular generation of a targeted pest and to rotate to another chemical class to control the succeeding generation of the targeted pest. For example, if using Delegate to control the first generation of Oriental fruit moth, use Altacor, Belt, Tourismo, Voliam Flexi, or Voliam Xpress to control the second generation; or, if using either Altacor, Belt, Tourismo, Voliam Flexi, or Voliam Xpress to control the first generation of Oriental fruit moth, then switch to Delegate or another chemical class (Assail, Calypso, etc.) to control the second generation. Altacor, Belt, Tourismo, Voliam Flexi, and Voliam Xpress belong to the same chemical class (IRAC Group 28) and should not be used for consecutive generations of a targeted pest. The same rotation approach applies to Delegate and all other chemistries.
2. Only 2 applications of diazinon are allowed during the season: one at dormant/delayed dormant and once postbloom.
3. For increased effectiveness, add a penetrating adjuvant.

Sweet Cherries—Second Cover Diseases. Brown rot, leafspot.

Insects. Maggots, fruit flies, plum curculio.

Sprays before harvest. Refer to Table 4-15 when selecting sprays during the last month before harvest.

NOTE: In southern Pennsylvania, spray about June 1–10; in northern areas of the state, spray about June 6–16.

Pesticide recommendations for sweet cherries, second cover.

Pesticide	Dilute rate/100 gal ^a	Rate sprayed/A
CHOOSE 1 of the following:		
Cabrio EG ^b	—	9.5 oz
captan 80WDG ^c	refer to footnote c	2.5 lb
Eiite 45 DF ^d	2.0 oz	4.0–8.0 oz
Gem 500 SC ^{e,f}	—	2.9–3.8 fl oz
Indar 2F ^d	—	6.0–12.0 fl oz
Orbit ^g	—	4.0 fl oz
Pristine ^{b,d}	—	14.5 oz
Quash ^{e,h}	—	4.0 oz
Rally 40WSP ⁱ	1.25–2.0 oz	2.5–6.0 oz
Rubigan EC ⁱ	3.0–4.0 oz	6.0–12.0 fl oz
sulfur ^j	refer to the label for rates and recommendations	
Ziram 76WDG	2.0–2.5 lb	4.0–8.0 lb
PLUS 1 of the following:		
Actara 25W	—	3.0–4.5 oz
Assail 30SG	—	2.5–6.0 oz
Avaunt 30WDG	—	5.0–6.0 oz
Baythroid 2E	—	2.0–2.8 fl oz
Beleaf 50SG	—	2.0–2.8 oz
carbaryl 50WP	1.5 lb	4.0 lb
carbaryl 80S	1.0 lb	2.5 lb
Danitol 2.4 EC	3.5–7.0 fl oz	10.7–21.3 fl oz
Delegate 25WG	—	4.5–6.0 oz
diazinon 50W	0.75 lb	2.0 lb
Endigo ZC	—	5.0–5.5 fl oz
Leverage 2.7SE	—	3.0–5.0 fl oz
Leverage 360	—	2.4–2.8 fl oz
Mustang Max	—	1.3–4.0 fl oz
permethrin 3.2EC	2.0 oz	7.0 oz
Proaxis	—	2.5–5.1 fl oz
Sevin XLR	0.75 qt	2.0 qt
Warrior II	—	1.3–2.5 fl oz

Fungicide and Antibiotic Notes

- a. Refer to the label for specific dilute application rates and recommendations.
- b. Pristine and Cabrio are related fungicides. Do not make more than 2 sequential applications of Pristine and/or Cabrio before alternating to a labeled fungicide with a different mode of action. Do not make more than 5 applications of Pristine and/or Cabrio per season. Pristine and Cabrio have a 24-hour REI and a 0-day PHI.
- c. Equivalent products include Captan 50% W & WP and Captec 4L. Check the label for rates/100 GPA. REI restrictions vary from 24 hours to 4 days; check the label of the product you are using. Some Captan products may be applied up to the day of harvest. Do not exceed 3 applications of captan after shuck fall on captan-sensitive varieties such as Schmidt, Emperor Francis, and Giant.
- d. For leaf spot control begin applications at petal fall or when first leaves unfold and continue applications at 7- to 14-day intervals.
- e. These products work best when used in combination with a protectant such as Captan to reduce resistance pressure.
- f. Gem is a strobilurin fungicide, but unlike Pristine, it does not have a protectant compound and is therefore best used in combination with one. Do not use more than 15.2 fl oz per acre per season. Do not apply within 1 day of harvest. Do not make more than 2 sequential application of Gem or exceed 4 applications per season.
- g. For powdery mildew and leafspot make up to 2 additional applications on a 10- to 14-day interval from the end of petal fall to harvest.
- h. Do not make more than 2 applications of Quash after petal fall. Do not apply within 14 days of harvest. Do not make more than 3 applications per season or exceed 12 oz/A per season.
- i. Controls leaf spot and powdery mildew but not blossom blight. Do not apply Rally within 7 days of harvest. Rubigan may be applied from petal fall to harvest.
- j. Various formulations of sulfur are available commercially; these vary in sulfur content. Use labeled amounts of material that are dependent on the formulation.

Miticide recommendations for sweet cherries, second cover.

Several miticide options are given. The miticide chosen and its rate should be based on the size of the mite population, the number of predators present, and the degree of resistance in particular orchard blocks.

Miticide	Dilute rate/100 gal	Rate sprayed/A
CHOOSE 1 of the following:		
Apollo 4SC	1.0–2.0 fl oz	3.0–6.0 fl oz
Envidor 2SC	—	14.0–18.0 fl oz
Nextera ^a	—	4.4–10.6 oz
Onager	—	12.0–24.0 fl oz
Savey 50WP	1.0–2.0 oz	3.0–6.0 oz
Vendex 50WP	4.0 oz	16.0 oz
Zeal	—	2.0–3.0 oz

Note

a. Higher rate of Nextera is necessary for twospotted spider mite control.

Sweet Cherries—Preharvest

Diseases. Brown rot, leafspot.

Insects. Maggots, fruit flies.

Vapor Gard. Apply 2 to 4 weeks before anticipated harvest date at a rate of 1 gallon of product in a minimum of 200 gallons of water per acre. This material helps improve fruit size and color and reduces splitting. Caution: Do not apply in spray-tank mixtures of any insecticide or fungicide.

Brown rot. Do not exceed more than 3 applications of captan on sensitive varieties such as Schmidt, Emperor Francis, and Giant anytime after shuck fall because of possible leaf injury.

Sprays before harvest. Refer to Table 4-15 when selecting sprays during the last month before harvest.

Pesticide recommendations for sweet cherries, preharvest.

Pesticide	Dilute rate/100 gal ^a	Rate sprayed/A
Apply 1 of the following:		
Cabrio EG ^b	—	9.5 oz
captan 80WDG ^c	refer to footnote c	2.5 lb
Elite 45 DF ^d	2.0 oz	4.0–8.0 oz
ferbam 76WP	1.5 lb	4.5 lb
Gem 500 SC ^e	—	2.9–3.8 fl oz
Indar 2F ^d	—	6.0–12.0 fl oz
Orbit ^d	—	4.0 fl oz
Pristine ^{b,f}	—	14.5 oz
Quash ^g	—	4.0 oz
Rally 40WSP ^h	1.25–2.0 oz	2.5–6.0 oz
Rubigan EC ^h	3.0–4.0 oz	6.0–12.0 fl oz
Ziram 76WDG	2.0–2.5 lb	4.0–8.0 lb

PLUS 1 of the following:

Actara 25W	—	3.0–4.5 oz
Baythroid 2E	—	2.0–2.8 fl oz
carbaryl 80S	1.0 lb	2.5–3.5 lb
Proaxis	—	2.5–5.1 fl oz
Sevin XLR	0.75 qt	2.0 qt
Warrior II	—	1.3–2.5 fl oz

Fungicide and Antibiotic Notes

- Refer to the label for specific dilute application rates and recommendations.
- Pristine and Cabrio are related fungicides. Do not make more than 2 sequential applications of Pristine and/or Cabrio before alternating to a labeled fungicide with a different mode of action. Do not make more than 5 applications of Pristine and/or Cabrio per season. Pristine and Cabrio have a 24-hour REI and a 0-day PHI.
- Equivalent products include Captan 50% W & WP and Captec 4L. Check the label for rates/100 GPA. REI restrictions vary from 24 hours to 4 days; check the label of the product you are using. Some Captan products may be applied up to the day of harvest. Do not exceed 3 applications of captan after shuck fall on captan-sensitive varieties such as Schmidt, Emperor Francis, and Giant.

- Begin applications 2 to 3 weeks before harvest using 7- to 10-day spray intervals. Apply a minimum of 50 gallons of water per acre. Indar, Elite, and Orbit may be applied up to the day of harvest.
- Gem is a strobilurin fungicide, but unlike Pristine, it does not have a protectant compound and is therefore best used in combination with one. Do not use more than 15.2 fl oz per acre per season. Do not apply within 1 day of harvest. Do not make more than 2 sequential application of Gem or exceed 4 applications per season.
- For leaf spot control begin applications at petal fall or when first leaves unfold and continue applications at 7- to 14-day intervals.
- Do not make more than 2 applications of Quash after petal fall. Do not apply within 14 days of harvest. Do not make more than 3 applications per season or exceed 12 oz/A per season.
- Controls leaf spot and powdery mildew but not blossom blight. Do not apply Rally within 7 days of harvest. Rubigan may be applied from petal fall to harvest.

Postharvest Disorders of Sweet Cherries

Cherry leaf spot. This spray program is necessary where leaf spot is active beginning at petal fall and continuing after harvest.

Leaf spot recommendations for sweet cherries.

Pesticide ^a	Dilute rate/100 gal	Rate sprayed/A
CHOOSE 1 of the following:		
Petal Fall		
Bravo Weather Stik	1.0 pt	3.1–4.0 pt
Chlorothalonil 720	1.0 pt	3.1–4.0 pt
Shuck Split through Harvest		
Elite 45 DF	2.0 oz	4.0–8.0 oz
Quash ^b	—	4.0 oz
Pristine	—	14.5 oz
Syllit FL ^c	—	1.5–3.0 fl oz
Postharvest		
Bravo Weather Stik	1.0 pt	3.1–4.0 pt
Chlorothalonil 720	1.0 pt	3.1–4.0 pt
Fixed copper (actual) ^d	0.5 lb	2.5 pt
plus Fresh Spray Lime	1.5 lb	3.0 lb

Fungicide and Antibiotic Notes

- For leaf spot control begin applications at petal fall or when first leaves unfold and continue applications at 7- to 14-day intervals. A postharvest application may be made to maintain control and reduce overwintering inoculum. Refer to the label for specific cherry leaf spot recommendations.
- Do not make more than 2 applications of Quash after petal fall. Do not apply within 14 days of harvest. Do not make more than 3 applications per season or exceed 12 oz/A per season. Mixing Quash with a protectant is recommended for resistance management.
- Make 1 application of Syllit after petal fall until harvest.
- Actual metallic copper; 1 pound of a 50 percent material equals 0.5 pound actual copper.

Lesser peachtree borer (LPTB)/peachtree borer. See Peach Integrated Pest Management Program in this section. For LPTB, apply as a coarse spray to trunk and lower limbs in up to 2 sprays: June 10–20 and August 10–25. Do not spray fruit; there is a 14-day preharvest interval for Asana XL, a 14-day preharvest interval for permethrin, and a 21-day preharvest interval for Thionex. Young trees: If peachtree borer damage is present, make 2 applications, the first around July 15 and the second around August 10. Use Thionex 50W (1 lb) or Asana XL (4.0 fl oz) or permethrin 3.2EC (1.6 fl oz) per 100 gallons of water. If using only 1 application, apply between July 20 and August 1.

TART CHERRY INTEGRATED PEST MANAGEMENT PROGRAM

Tart Cherries—Dormant

Scales. Lecanium scale and San Jose scale: apply Esteem at 4.0 to 5.0 ounces with oil. Use higher rate of Esteem under heavy scale pressure.

Pesticide recommendations for tart cherries, dormant.

Pesticide	Dilute rate/100 gal	Rate sprayed/A
chlorpyrifos 4E	—	1.5–3.0 pt
dormant oil	2.0 gal	3.5 gal
Esteem 35WP	—	4.0–5.0 oz
Lorsban Advanced	—	1.5–3.0 pt
Lorsban 75WG	0.33–0.67 lb	1.5–2.5 lb
Supracide 2EC	1.0–2.0 pt	3.0–4.0 pt
Supracide 25WP	1.0–2.0 lb	3.0–4.0 lb

Tart Cherries—Prebloom

Apply when first blooms open.

Diseases. Brown rot blossom blight. Brown rot blossom blight is only rarely a problem on tart cherries in Pennsylvania. If it is warm (above 55°F) and wet, or if brown rot has been a problem in the past, follow the recommendations.

Pesticide recommendations for tart cherries, prebloom.

Pesticide	Dilute rate/100 gal ^a	Rate sprayed/A
CHOOSE 1 of the following:		
Bravo Weather Stik	1.0 pt	3.1–4.0 pt
Cabrio EG ^b	—	9.5 oz
captan 80WDG ^c	refer to footnote c	2.5 lb
Chlorothalonil 720	1.0 pt	3.1–4.0 pt
Elite 45 DF ^d	2.0 oz	4.0–8.0 oz
Gem 500 SC ^e	—	2.9–3.8 fl oz
Indar 2F ^d	—	6.0–12.0 fl oz
Orbit ^f	—	4.0 fl oz
Pristine ^b	—	14.5 oz
Quash ^g	—	4.0 oz
Rally 40WSP ^h	1.25–2.0 oz	2.5–6.0 oz
Rovral 4 F ⁱ	—	1.0–2.0 pt
Vanguard ^j	—	10.0 oz
Ziram 76WDG	2.0–2.5 lb	5.0–8.0 lb

Fungicide and Antibiotic Notes

- Refer to the label for specific dilute application rates and recommendations.
- Pristine and Cabrio are related fungicides. Do not make more than 2 sequential applications of Pristine and/or Cabrio before alternating to a labeled fungicide with a different mode of action. Do not make more than 5 applications of Pristine and/or Cabrio per season. Pristine and Cabrio have a 24-hour REI and a 0-day PHI.
- Equivalent products include Captan 50% W & WP and Captec 4L. Check the label for rates/100 GPA. REI restrictions vary from 24 hours to 4 days; check the label of the product you are using. Some Captan products may be applied up to the day of harvest.
- Begin applications at for blossom blight at early bloom. If conditions are favorable for disease development, apply again at full bloom and at petal fall.
- Gem is a strobilurin fungicide, but unlike Pristine, it does not have a protectant compound and is therefore best used in combination with one. Do not use more than 15.2 fl oz per acre per season. Do not apply within 1 day of harvest. Do not make more than 2 sequential application of Gem or exceed 4 applications per season.
- For brown rot blossom blight make the first application at popcorn stage of bloom; make a second application as needed through petal fall. For powdery mildew and leafspot make up to 2 additional applications on a 10- to 14-day interval from the end of petal fall to harvest.
- Do not make more than 2 applications of Quash after petal fall. Do not apply within 14 days of harvest. Do not make more than 3 applications per season or exceed 12 oz/A per season.

- Controls leaf spot and powdery mildew but not blossom blight. Do not apply Rally within 7 days of harvest.
- Do not make more than 2 applications per season. Do not apply after petal fall.
- Vanguard may be applied alone or in combination with an unrelated fungicide; Vanguard is applied at a rate of 5 oz per acre (tank-mixes) and 10 oz per acre (alone). Do not apply Vanguard to sweet cherries. Do not apply Vanguard more than 2 times during bloom.

Tart Cherries—Bloom

Use the same materials listed at Prebloom.

Make 2 applications: when first blossoms open, and again when 70 to 90 percent of blossoms are open.

Tart Cherries—Petal Fall

Diseases. Brown rot, leaf spot. If a fungicide was not used during bloom, it is important to make the first application at petalfall.

Insects. Plum curculio, leafrollers, aphids.

Black cherry aphid. If the aphid is present, add Actara or Provado.

American plum borer. American plum borer has been increasing in tart cherry orchards in Pennsylvania. Control of this pest can be achieved at petal fall by applying a dilute application of Thionex 50W at 1 pound per 100 gallons or chlorpyrifos 4EC at 1.5–3.0 quarts per 100 gallons or Lorsban 75WG at 2 to 3 pounds per 100 gallons. Direct spray to the entire trunk area up to the lower scaffold limbs and to all areas cracked and damaged by shaker clamps or other means. Do not apply chlorpyrifos 4E or Lorsban 75WG to sweet cherries, as it is highly phytotoxic to the foliage.

Pesticide recommendations for tart cherries, petal fall.

Pesticide	Dilute rate/100 gal ^a	Rate sprayed/A
CHOOSE 1 of the following:		
Bravo Weather Stik	1.0 pt	3.1–4.0 pt
Cabrio EG ^b	—	9.5 oz
captan 80WDG ^c	refer to footnote c	2.5 lb
Chlorothalonil 720	1.0 pt	3.1–4.0 pt
Elite 45 DF ^d	2.0 oz	4.0–8.0 oz
Gem 500 SC ^e	—	2.9–3.8 fl oz
Indar 2F ^d	—	6.0–12.0 oz
Orbit ^f	—	4.0 fl oz
Pristine ^b	—	14.5 oz
Quash ^g	—	4.0 oz
Rovral 4 F ^h	—	1.0–2.0 pt
Rubigan EC ⁱ	3.0–4.0 oz	6.0–12.0 oz
Ziram 76WDG	2.0–2.5 lb	5.0–8.0 lb
PLUS 1 of the following:		
Actara ¹	—	3.0–4.5 oz
Admire Pro	—	2.0–3.0 fl oz
Asana XL 0.66EC	2.0–4.0 fl oz	7.0–14.0 fl oz
Assail 30 SG	—	2.5–6.0 oz
Avaunt 30WDG	—	5.0–6.0 oz
Baythroid 2E	—	2.0–2.8 fl oz
Beleaf 50SG	—	2.0–2.8 oz
Danitol 2.4 EC	3.5–7.0 fl oz	10.7–21.3 fl oz
Delegate 25WG ²	—	4.5–6.0 oz
Endigo ZC	—	5.0–5.5 fl oz
imidacloprid 1.6F	2.0 fl oz	5.0–6.0 fl oz
Imidan 70WP	0.75 lb	2.0–3.0 lb
Leverage 2.7SE	—	3.0–5.0 fl oz
Leverage 360	—	2.4–2.8 fl oz
Lorsban 75WG	0.33–0.67 lb	1.33–2.0 lb
Movento ³	—	6.0–9.0 fl oz
Mustang Max	—	1.3–4.0 fl oz
permethrin 3.2EC	2.0 oz	7.0 oz
Proaxis	—	2.5–5.1 fl oz
Thionex 50W	1.0 lb	3.0–3.5 lb
Thionex 3EC	21.0 fl oz	4.0–5.0 pt
Voliam Flexi 40W ^{1,2}	—	4.0–7.0 oz
Voliam Xpress ²	—	6.0–10.0 fl oz
Warrior II	—	1.3–2.5 fl oz

Fungicide and Antibiotic Notes

- Refer to the label for specific dilute application rates and recommendations.
- Pristine and Cabrio are related fungicides. Do not make more than 2 sequential applications of Pristine and/or Cabrio before alternating to a labeled fungicide with a different mode of action. Do not make more than 5 applications of Pristine and/or Cabrio per season. Pristine and Cabrio have a 24-hour REI and a 0-day PHI.
- Equivalent products include Captan 50% W & WP and Captec 4L. Check the label for rates/100 GPA. REI restrictions vary from 24 hours to 4 days; check the label of the product you are using. Some Captan products may be applied up to the day of harvest.
- Begin applications at for blossom blight at early bloom. If conditions are favorable for disease development, apply again at full bloom and at petal fall. For leaf spot begin applications at petal fall and continue on 10- to 14-day intervals.
- Gem is a strobilurin fungicide, but unlike Pristine, it does not have a protectant compound and is therefore best used in combination with one. Do not use more than 15.2 fl oz per acre per season. Do not apply within 1 day of harvest. Do not make more than 2 sequential application of Gem or exceed 4 applications per season
- For brown rot blossom blight make the first application at popcorn stage of bloom; make a second application as needed through petal fall. For powdery mildew and leafspot make up to 2 additional applications on a 10- to 14-day interval from the end of petal fall to harvest.
- Do not make more than 2 applications of Quash after petal fall. Do not apply within 14 days of harvest. Do not make more than 3 applications per season or exceed 12 oz/A per season.
- Do not make more than 2 applications per season. Do not apply after petal fall.
- Controls leaf spot and powdery mildew but not blossom blight. Do not apply Rally within 7 days of harvest. Rubigan may be applied from petal fall to harvest.

Insecticide and Acaricide Notes

- Do not apply Actara or Voliam Flexi if bees are active in the orchard or on flowering cover crops.
- In order to prevent the development of pest resistance to these new chemistries and to practice the most effective resistance management approach, we highly encourage growers to use only 1 chemical class of products (i.e., mode of action) for a particular generation of a targeted pest and to rotate to another chemical class to control the succeeding generation of the targeted pest. For example, if using Delegate to control the first generation of Oriental fruit moth, use Altacor; Belt, Turismo, Voliam Flexi, or Voliam Xpress to control the second generation; or, if using either Altacor, Belt, Turismo, Voliam Flexi, or Voliam Xpress to control the first generation of Oriental fruit moth, then switch to Delegate or another chemical class (Assail, Calypso, etc.) to control the second generation. Altacor, Belt, Turismo, Voliam Flexi, and Voliam Xpress belong to the same chemical class (IRAC Group 28) and should not be used for consecutive generations of a targeted pest. The same rotation approach applies to Delegate and all other chemistries.
- For increased effectiveness, add a penetrating adjuvant.

Tart Cherries—Shuck Fall

Diseases. Leafspot, fruit rot, powdery mildew.

Insects. Plum curculio, leafrollers, aphids.

Pesticide recommendations for tart cherries, shuck fall.

Pesticide	Dilute rate/100 gal	Rate sprayed/A
CHOOSE 1 of the following:		
Cabrio EG ^a	—	9.5 oz
captan 80WDG ^b	refer to footnote b	2.5 lb
Elite 45 DF ^c	2.0 oz	4.0–8.0 oz
Gem 500 SC ^d	—	2.9–3.8 fl oz
Indar 2F ^c	—	6.0–12.0 oz
Orbit ^e	—	4.0 fl oz
Pristine ^a	—	14.5 oz
Quash ^f	—	4.0 oz
Rally 40WSP ^g	1.25–2.0 oz	2.5–6.0 oz
Rubigan EC ^g	3.0–4.0 oz	6.0–12.0 oz
Ziram 76WDG	2.0–2.5 lb	5.0–8.0 lb
PLUS 1 of the following:		
Actara 25W	—	3.0–4.5 oz
Admire Pro	—	2.0–3.0 fl oz
Altacor 35WDG ¹	—	2.5–3.0 oz
Asana XL 0.66EC	2.0–4.0 fl oz	7.0–14.0 fl oz
Assail 30 SG	—	2.5–6.0 oz
Avaunt 30WDG	—	5.0–6.0 oz
Baythroid 2E	—	2.0–2.8 fl oz
Beleaf 50SG	—	2.0–2.8 oz
Belt SC ¹	—	3.0–4.0 fl oz
Danitol 2.4 EC	3.5–7.0 fl oz	10.7–21.3 fl oz
Delegate 25WG ¹	—	4.5–6.0 oz
Endigo ZC	—	5.0–5.5 fl oz
Imidan 70WP	0.75 lb	2.0–3.0 lb
imidacloprid 1.6F	2.0 fl oz	4.0–6.0 fl oz
Leverage 2.7SE	—	3.0–5.0 fl oz
Leverage 360	—	2.4–2.8 fl oz
Lorsban 75WG	0.33–0.67 lb	1.33–2.0 lb
Movento ²	—	6.0–9.0 fl oz
Mustang Max	—	1.3–4.0 fl oz
permethrin 3.2EC	2.0 oz	7.0 oz
Proaxis	—	2.5–5.1 fl oz
Thionex 50W	1.0 lb	3.0–3.5 lb
Thionex 3EC	21.0 fl oz	4.0–5.0 pt
Tourismo ¹	—	10.0–14.0 fl oz
Voliam Flexi 40W ¹	—	4.0–7.0 oz
Voliam Xpress ¹	—	6.0–10.0 fl oz
Warrior II	—	1.3–2.5 fl oz

Fungicide and Antibiotic Notes

- Pristine and Cabrio are related fungicides. Do not make more than 2 sequential applications of Pristine and/or Cabrio before alternating to a labeled fungicide with a different mode of action. Do not make more than

5 applications of Pristine and/or Cabrio per season. Pristine and Cabrio have a 24-hour REI and a 0-day PHI.

- b. Equivalent products include Captan 50% W & WP and Captec 4L. Check the label for rates/100 GPA. REI restrictions vary from 24 hours to 4 days; check the label of the product you are using. Some Captan products may be applied up to the day of harvest.
- c. For leaf spot control apply on 10- to 14-day intervals.
- d. Gem is a strobilurin fungicide, but unlike Pristine, it does not have a protectant compound and is therefore best used in combination with one. Do not use more than 15.2 fl oz per acre per season. Do not apply within 1 day of harvest. Do not make more than 2 sequential application of Gem or exceed 4 applications per season.
- e. For powdery mildew and leaf spot make up to 2 additional applications on a 10- to 14-day interval from the end of petal fall to harvest.
- f. Do not make more than 2 applications of Quash after petal fall. Do not apply within 14 days of harvest. Do not make more than 3 applications per season or exceed 12 oz/A per season.
- g. Controls leaf spot and powdery mildew. Do not apply Rally within 7 days of harvest. Rubigan may be applied from petal fall to harvest.

Insecticide and Acaricide Notes

1. In order to prevent the development of pest resistance to these new chemistries and to practice the most effective resistance management approach, we highly encourage growers to use only 1 chemical class of products (i.e., mode of action) for a particular generation of a targeted pest and to rotate to another chemical class to control the succeeding generation of the targeted pest. For example, if using Delegate to control the first generation of Oriental fruit moth, use Altacor, Belt, Tourismo, Voliam Flexi, or Voliam Xpress to control the second generation; or, if using either Altacor, Belt, Tourismo, Voliam Flexi, or Voliam Xpress to control the first generation of Oriental fruit moth, then switch to Delegate or another chemical class (Assail, Calypso, etc.) to control the second generation. Altacor, Belt, Tourismo, Voliam Flexi, and Voliam Xpress belong to the same chemical class (IRAC Group 28) and should not be used for consecutive generations of a targeted pest. The same rotation approach applies to Delegate and all other chemistries.
2. For increased effectiveness, add a penetrating adjuvant.

Tart Cherries—First, Second (Maggot Spray), Third Cover

Diseases. Leaf spot, fruit rot, powdery mildew.

Insects. Plum curculio, leafrollers, aphids, cherry maggot, fruit flies.

Cherry fruit flies. Where cherry fruit flies or black cherry fruit flies are a problem or weather conditions are favorable for fruit fly infestation, shorten the interval between sprays.

Sprays before harvest. Refer to Table 4-15 when selecting sprays during the last month before harvest.

Powdery mildew. For powdery mildew control after the first cover, Rally, Rubigan, Topsin-M, Elite, Indar, Orbit, or fixed copper plus lime will provide the best control. Copper may cause severe injury if aphids are present.

Ethephon. See discussion in Part III, Chemical Management.

Apply first cover 10 to 12 days after shuck fall spray; apply the second cover 10 to 12 days after first cover spray; apply the third cover 10 to 14 days after second cover.

Pesticide recommendations for tart cherries, first, second, third cover.

Pesticide	Dilute rate/100 gal	Rate sprayed/A
CHOOSE 1 of the following:		
Cabrio EG ^a	—	9.5 oz
captan 80WDG ^b	refer to footnote b	2.5 lb
Elite 45 DF ^c	2.0 oz	4.0–8.0 oz
Gem 500 SC ^d	—	2.9–3.8 fl oz
Indar 2F ^c	—	6.0–12.0 oz
Orbit ^e	—	4.0 fl oz
Pristine ^a	—	14.5 oz
Quash ^f	—	4.0 oz
Rally 40WSP ^g	1.25–2.0 oz	2.5–6.0 oz
Rubigan EC ^g	3.0–4.0 oz	6.0–12.0 oz
Ziram 76WDG	2.0–2.5 lb	5.0–8.0 lb
PLUS 1 of the following:		
Actara 25W	—	3.0–4.5 oz
Admire Pro	—	2.0–3.0 fl oz
Altacor 35WDG ¹	—	2.5–3.0 oz
Asana XL 0.66EC	2.0–4.0 fl oz	7.0–14.0 fl oz
Assail 30 SG	—	2.5–6.0 oz
Avaunt 30WDG	—	5.0–6.0 oz
Baythroid 2E	—	2.0–2.8 fl oz
Beleaf 50SG	—	2.0–2.8 oz
Belt SC ¹	—	3.0–4.0 fl oz
Danitol 2.4 EC	3.5–7.0 fl oz	10.7–21.3 fl oz
Delegate 25WG ¹	—	4.5–6.0 oz
diazinon 50W ²	1.0 lb	2.0 lb
Endigo ZC	—	5.0–5.5 fl oz
Imidan 70WP	0.75 lb	2.0–3.0 lb
imidacloprid 1.6F	2.0 fl oz	4.0–6.0 fl oz
Leverage 2.7SE	—	3.0–5.0 fl oz
Leverage 360	—	2.4–2.8 fl oz
Lorsban 75WG	0.33–0.67 lb	1.33–2.0 lb
Movento ³	—	6.0–9.0 fl oz
Mustang Max	—	1.3–4.0 fl oz
permethrin 3.2EC	2.0 oz	7.0 oz
Proaxis	—	2.5–5.1 fl oz
Sevin XLR	0.75 qt	2.0 qt
Thionex 50W	1.0 lb	3.0–3.5 lb
Thionex 3EC	21.0 fl oz	4.0–5.0 pt
Tourismo ¹	—	10.0–14.0 fl oz
Voliam Flexi 40W ¹	—	4.0–7.0 oz
Voliam Xpress ¹	—	6.0–10.0 fl oz
Warrior II	—	1.3–2.5 fl oz

Fungicide and Antibiotic Notes

- a. Pristine and Cabrio are related fungicides. Do not make more than 2 sequential applications of Pristine and/or Cabrio before alternating to a labeled fungicide with a different mode of action. Do not make more than 5 applications of Pristine and/or Cabrio per season. Pristine and Cabrio have a 24-hour REI and a 0-day PHI.
- b. Equivalent products include Captan 50% W & WP and Captec 4L. Check the label for rates/100 GPA. REI restrictions vary from 24 hours to 4 days; check the label of the product you are using. Some Captan products may be applied up to the day of harvest.
- c. For leaf spot control apply on 10- to 14-day intervals.
- d. Gem is a strobilurin fungicide, but unlike Pristine, it does not have a protectant compound and is therefore best used in combination with one. Do not use more than 15.2 fl oz per acre per season. Do not apply within 1 day of harvest. Do not make more than 2 sequential application of Gem or exceed 4 applications per season.
- e. For powdery mildew and leafspot make up to 2 additional applications on a 10- to 14-day interval from the end of petal fall to harvest.
- f. Do not make more than 2 applications of Quash after petal fall. Do not apply within 14 days of harvest. Do not make more than 3 applications per season or exceed 12 oz/A per season.
- g. Controls leaf spot and powdery mildew. Do not apply Rally within 7 days of harvest. Rubigan may be applied from petal fall to harvest.

Insecticide and Acaricide Notes

1. In order to prevent the development of pest resistance to these new chemistries and to practice the most effective resistance management approach, we highly encourage growers to use only 1 chemical class of products (i.e., mode of action) for a particular generation of a targeted pest and to rotate to another chemical class to control the succeeding

generation of the targeted pest. For example, if using Delegate to control the first generation of Oriental fruit moth, use Altacor, Belt, Tourismo, Voliam Flexi, or Voliam Xpress to control the second generation; or, if using either Altacor, Belt, Tourismo, Voliam Flexi, or Voliam Xpress to control the first generation of Oriental fruit moth, then switch to Delegate or another chemical class (Assail, Calypso, etc.) to control the second generation. Altacor, Belt, Tourismo, Voliam Flexi, and Voliam Xpress belong to the same chemical class (IRAC Group 28) and should not be used for consecutive generations of a targeted pest. The same rotation approach applies to Delegate and all other chemistries.

- Only 2 applications of diazinon are allowed during the season: one at dormant/delayed dormant and once postbloom.
- For increased effectiveness, add a penetrating adjuvant.

Mites. When mites are a problem, use one of the following:

Miticide recommendations for tart cherries.

Several miticide options are given. The miticide chosen and its rate should be based on the size of the mite population, the number of predators present, and the degree of resistance in particular orchard blocks.

Miticide	Dilute rate/100 gal	Rate sprayed/A
Apollo 4SC	1.0–2.0 fl oz	3.0–6.0 fl oz
Envidor 2SC	—	14.0–18.0 fl oz
Nextera ^a	—	4.4–10.5 oz
Onager	—	12.0–24.0 fl oz
Savey 50WP	1.0–2.0 oz	3.0–6.0 oz
Vendex 50WP	4.0 oz	16.0 oz
Zeal	—	2.0–3.0 oz

Note

- Higher rate of Nextera is necessary for twospotted spider mite control.

Tart Cherries—Preharvest

Diseases. Fruit rots, powdery mildew, leaf spot.

Insects. Cherry fruit flies.

Powdery mildew. For powdery mildew control after the first cover, Topsin-M or fixed copper plus lime may be substituted for captan. Use the rates given in the postharvest spray. Copper may cause severe injury if aphids are present.

Pesticide recommendations for tart cherries, preharvest.

(Apply 1 week before harvest.)

Pesticide	Dilute rate/100 gal	Rate sprayed/A
Apply 1 of the following:		
captan 80WDG ^a	refer to footnote a	2.5 lb
Elite 45 DF ^b	2.0 oz	4.0–8.0 oz
Gem 500 SC ^c	—	2.9–3.8 fl oz
Indar 2F ^b	—	6.0–12.0 oz
Orbit ^b	—	4.0 fl oz
Pristine ^d	—	14.5 oz
Quash ^e	—	4.0 oz
Ziram 76WDG	2.0–2.5 lb	5.0–8.0 lb
PLUS 1 of the following:		
carbaryl 80S	1.0 lb	2.5–3.5 lb
Imidan 70WP	0.75–1.0 lb	2.0–3.0 lb
permethrin 3.2EC	2.0 oz	7.0 oz
Sevin XLR	0.75 qt	2.0 qt

Fungicide and Antibiotic Notes

- Equivalent products include Captan 50% W & WP and Captec 4L. Check the label for rates/100 GPA. REI restrictions vary from 24 hours to 4 days; check the label of the product you are using. Some Captan products may be applied up to the day of harvest.
- Begin applications 2 to 3 weeks before harvest using 7- to 10-day spray intervals. Apply a minimum of 50 gallons of water per acre. Elite, Indar, and Orbit may be applied up to the day of harvest.
- Gem is a strobilurin fungicide, but unlike Pristine, it does not have a protectant compound and is therefore best used in combination with one. Do not use more than 15.2 fl oz per acre per season. Do not apply within 1 day of harvest. Do not make more than 2 sequential applications of Gem or exceed 4 applications per season.

- Pristine and Cabrio are related fungicides. Do not make more than 2 sequential applications of Pristine and/or Cabrio before alternating to a labeled fungicide with a different mode of action. Do not make more than 5 applications of Pristine and/or Cabrio per season. Pristine and Cabrio have a 24-hour REI and a 0-day PHI.
- Do not make more than 2 applications of Quash after petal fall. Do not apply within 14 days of harvest. Do not make more than 3 applications per season or exceed 12 oz/A per season.

Sprays before harvest. Refer to Table 4-15 when selecting sprays during the last month before harvest.

Cherry leaf spot. See cherry leaf spot under postharvest disorders of sweet cherry.

Peachtree borer and lesser peachtree borer (LPTB). For LPTB, apply as a coarse spray to trunk and lower limbs in up to 2 sprays: June 10–20 and August 10–25. Do not spray fruit; there is a 14-day preharvest interval for Asana XL, a 3-day preharvest interval for permethrin, and a 21-day preharvest interval for endosulfan, Lorsban 4E, Lorsban Advanced, and Lorsban 75WG. For peachtree borer, apply as a coarse spray to the trunk only and make 2 applications, the first around July 15 and the second around August 10. Use Asana XL (4.0 fl oz) or Lorsban 4E (1.5–3.0 qts) or Lorsban Advanced (1.5–3.0 qts) or Lorsban 75WG (2–3 lbs) or permethrin 3.2EC (1.6 fl oz) or Thionex 50W (1 lb) per 100 gallons of water. If using only 1 application, apply between July 20 and August 1.

PLUM AND PRUNE INTEGRATED PEST MANAGEMENT PROGRAM

Plum and Prune—Dormant

Black knot. Early season fungicide sprays during rapid growth are most important in controlling black knot. Bravo is 1 of the more effective fungicides. Cut the branch 6 to 8 inches below the visible swollen portion before bud swell begins. Knots on the trunk and main limbs usually can be removed successfully by cutting off the knot growth beginning in August and throughout the dormant season. All infected material should be removed from the orchard. Remove infected wild cherries from fence rows and nearby wooded areas.

Brown rot. In a mixture of varieties, with some blooming early, add a fungicide to the oil at the prebloom rate.

Scales. Lecanium scale and San Jose scale: apply Esteem at 4.0 to 5.0 ounces with oil. Use higher rate of Esteem under heavy scale pressure.

Pesticide recommendations for plum and prune, dormant.

(Apply if scales are present.)

Pesticide	Dilute rate/100 gal	Rate sprayed/A
CHOOSE 1 of the following:		
chlorpyrifos 4EC	1.0 pt	2.5–3.0 pt
dormant oil	2.0 gal	3.5 gal
Esteem 35WP	—	4.0–5.0 oz
Lorsban Advanced	—	2.5–3.0 pt
Supracide 2EC	1.0–2.0 pt	3.0–4.0 pt
Supracide 25WP	1.0–2.0 lb	3.0–4.0 lb

Plum and Prune—Prebloom

Diseases. Brown rot (blossom blight), black knot. Apply when first blossoms open.

Brown rot recommendations for plum and prune, prebloom to first blossom opening.

Pesticide	Dilute rate/100 gal	Rate sprayed/A
CHOOSE 1 of the following:		
Bravo Weather Stik ^a	1.0 pt	3.1–4.0 pt
captan 80WDG ^b	refer to footnote b	3.75 lb
Chlorothalonil 720 ^a	1.0 pt	3.1–4.0 pt
Gem 500 SC ^c	—	2.9–3.8 fl oz
Orbit ^d	—	4.0 fl oz
Pristine ^e	—	14.5 oz
Quash ^f	—	4.0 oz
Rovral 4 F ^g	—	1.0–2.0 pt
Scala SC ^h	—	10.0–18.0 oz
sulfur ⁱ	refer to the label for rates and recommendations	
Vanguard ^j	—	10.0 oz

Fungicide and Antibiotic Notes

- Very effective in the control of black knot.
- Do not use captan on Japanese or Stanley plums before July. Check the label for other cultivar restrictions. Equivalent products include Captan 50% W & WP and Captec 4L. Check the label for rates/100 GPA. REI restrictions vary from 24 hours to 4 days; check the label of the product you are using. Some Captan products may be applied up to the day of harvest.
- Gem is a strobilurin fungicide, but unlike Pristine, it does not have a protectant compound and is therefore best used in combination with one. Do not use more than 15.2 fl oz per acre per season. Do not apply within 1 day of harvest. Do not make more than 2 sequential applications of Gem or exceed 4 applications per season.
- Apply at early bloom stage (plums at green tip). Make a second application (75 to 100 percent bloom) and a third application as needed at petal fall. Do not apply Orbit to Stanley plums earlier than 21 days before harvest; read the label for specific recommendations. Apply up to 2 sprays of Orbit in the preharvest period up to the day of harvest (0-day PHI).
- Do not make more than 2 sequential applications of Pristine before alternating to a labeled fungicide with a different mode of action. Do not make more than 5 applications of Pristine or related fungicide per season. Pristine has a 24-hour REI and a 0-day PHI.
- Do not make more than 2 applications of Quash after petal fall. Do not apply within 14 days of harvest. Do not make more than 3 applications per season or exceed 12 oz/A per season.
- Do not make more than 2 applications per season or apply after petal fall.
- Do not apply more than 3 applications of Scala alone. Do not apply within 2 days of harvest or make more than 2 applications of a Group 9 fungicide within 30 days of harvest. Do not use on cherries.
- Various formulations of sulfur are available commercially; these vary in sulfur content. Use labeled amounts of material that are dependent on the formulation.
- Vanguard may be applied alone or in combination with an unrelated fungicide; Vanguard is applied at a rate of 5 oz per acre (tank-mixes) and 10 oz per acre (alone). Do not apply Vanguard to sweet cherries. Do not apply Vanguard more than 2 times during bloom.

Plum and Prune—Bloom

Brown rot. Follow the prebloom spray fungicide suggestions. Do not use an insecticide during bloom.

Plum and Prune—Petal Fall, Shuck Fall, First and Second Covers

Diseases. Black knot, brown rot, leaf spot.

Insects. Plum curculio, mites, leafrollers.

Black knot. Make a special effort to spray before warm rain periods to control black knot.

Mites. See third cover for miticide suggestions. Apply these sprays at about 10-day intervals.

Aphids. Apply Actara at 3.0 to 4.5 oz/acre, Admire Pro at 2.0 to 3.0 fl oz, Movento at 6.0 fl oz/acre, imidacloprid at 4.0 to 6.0 fl oz/acre, or Thionex 50W at 3.0 lbs/acre.

Pesticide recommendations for plum and prune, petal fall, shuck fall, first and second covers.

Pesticide	Dilute rate/100 gal	Rate sprayed/A
CHOOSE the following:		
Bravo Weather Stik ^a	1.0 pt	3.1–4.0 pt
captan 80WDG ^b	refer to footnote b	3.75 lb
Chlorothalonil 720 ^a	1.0 pt	3.1–4.0 pt
Gem 500 SC ^c	—	2.9–3.8 fl oz
Orbit ^d	—	4.0 fl oz
Pristine ^e	—	14.5 oz
Quash ^f	—	4.0 oz
Rovral 4 F ^g	—	1.0–2.0 pt
Scala SC ^h	—	10.0–18.0 oz
sulfur ⁱ	refer to the label for rates and recommendations	

PLUS 1 of the following:

Actara 25W	—	3.0–4.5 oz
Admire Pro	—	2.0–3.0 fl oz
Altacor 35WDG ¹	—	2.5–3.0 oz
Asana XL 0.66EC	2.0–4.0 fl oz	6.0–12.0 fl oz
Assail 30SG	—	2.5–6.0 oz
Avaunt 30WDG	—	5.0–6.0 oz
Baythroid 2E	—	2.0–2.8 fl oz
Beleaf 50SG	—	2.0–2.8 fl oz
Belt SC ¹	—	3.0–4.0 fl oz
Danitol 2.4 EC	3.5–7.0 fl oz	10.7–21.3 fl oz
Delegate 25WG ¹	—	4.5–6.0 oz
diazinon 50W ²	0.75 lb	2.0 lb
Endigo ZC	—	5.0–5.5 fl oz
Imidan 70WP	0.75–1.0 lb	2.0–3.0 lb
imidacloprid 1.6F	2.0 fl oz	4.0–6.0 fl oz
Intrepid 2F	2.0–4.0 fl oz	8.0–16.0 fl oz
Leverage 2.7SE	—	3.0–5.0 fl oz
Leverage 360	—	2.4–2.8 fl oz
Movento ³	—	6.0 fl oz
Mustang Max	—	1.3–4.0 fl oz
Proaxis	—	2.5–5.1 fl oz
Thionex 50W	1.0 lb	3.0–3.5 lb
Thionex 3EC	21.0 fl oz	4.0–5.0 pt
Tourismo ¹	—	10.0–14.0 fl oz
Voliam Flexi 40W ¹	—	4.0–7.0 oz
Voliam Xpress ¹	—	6.0–10.0 fl oz
Warrior II	—	1.3–2.5 fl oz

Fungicide and Antibiotic Notes

- Do not apply after shuck split.
- Do not use captan on Japanese or Stanley plums before July. Check the label for other cultivar restrictions. Equivalent products include Captan 50% W & WP and Captec 4L. Check the label for rates/100 GPA. REI restrictions vary from 24 hrs to 4 days, check the label of the product you are using. Some Captan products may be applied up to the day of harvest
- Gem is a strobilurin fungicide, but unlike Pristine, it does not have a protectant compound and is therefore best used in combination with one. Do not use more than 15.2 fl oz per acre per season. Do not apply within 1 day of harvest. Do not make more than 2 sequential applications of Gem or exceed 4 applications per season.
- Apply at early bloom stage (plums at green tip). Make a second application (75 to 100 percent bloom) and a third application as needed at petal fall. Do not apply Orbit to Stanley plums earlier than 21 days before harvest; read the label for specific recommendations. Apply up to 2 sprays of Orbit in the preharvest period up to the day of harvest (0-day PHI).
- Do not make more than 2 sequential applications of Pristine before alternating to a labeled fungicide with a different mode of action. Do not make more than 5 applications of Pristine or related fungicide per season. Pristine has a 24-hour REI and a 0-day PHI.
- Do not make more than 2 applications of Quash after petal fall. Do not apply within 14 days of harvest. Do not make more than 3 applications per season or exceed 12 oz/A per season.
- Do not make more than 2 applications per season or apply after petal fall.
- Do not apply more than 3 applications of Scala alone. Do not apply within

2 days of harvest or make more than 2 applications of a Group 9 fungicide within 30 days of harvest. Do not use on cherries.

- i. Various formulations of sulfur are available commercially; these vary in sulfur content. Use labeled amounts of material that are dependent on the formulation.

Insecticide and Acaricide Notes

1. In order to prevent the development of pest resistance to these new chemistries and to practice the most effective resistance management approach, we highly encourage growers to use only 1 chemical class of products (i.e., mode of action) for a particular generation of a targeted pest and to rotate to another chemical class to control the succeeding generation of the targeted pest. For example, if using Delegate to control the first generation of Oriental fruit moth, use Altacor, Belt, Tourismo, Voliam Flexi, or Voliam Xpress to control the second generation; or, if using either Altacor, Belt, Tourismo, Voliam Flexi, or Voliam Xpress to control the first generation of Oriental fruit moth, then switch to Delegate or another chemical class (Assail, Calypso, etc.) to control the second generation. Altacor, Belt, Tourismo, Voliam Flexi, and Voliam Xpress belong to the same chemical class (IRAC Group 28) and should not be used for consecutive generations of a targeted pest. The same rotation approach applies to Delegate and all other chemistries.
2. Only 2 applications of diazinon are allowed during the season: one at dormant/delayed dormant and once postbloom.
3. For increased effectiveness, add a penetrating adjuvant.

Plum and Prune—Third and Fourth Covers Diseases. Leaf spot, brown rot.

Insects. Mites, leafrollers, Oriental fruit moth. Apply about mid-June and early July.

Pesticide recommendations for plum and prune, third and fourth covers.

Pesticide	Dilute rate/100 gal	Rate sprayed/A
CHOOSE 1 of the following:		
captan 80WDG ^a	refer to footnote a	3.75 lb
Gem 500 SC ^b	—	2.9–3.8 fl oz
Orbit ^c	—	4.0 fl oz
Pristine ^d	—	14.5 oz
Quash ^e	—	4.0 oz
Scala SC ^f	—	10.0–18.0 oz
sulfur ^g	refer to the label for rates and recommendations	
PLUS 1 of the following:		
Actara 25W	—	3.0–4.5 oz
Altacor 35WDG ¹	—	2.5–3.0 oz
Assail 30SG	—	2.5–6.0 oz
Avaunt 30WG	—	5.0–6.0 oz
Baythroid 2E	—	2.0–2.8 fl oz
Beleaf 50SG	—	2.0–2.8 oz
Belt SC ¹	—	3.0–4.0 fl oz
carbaryl 80S	1.0 lb	2.5 lb
Danitol 2.4 EC	3.5–7.0 fl oz	10.7–21.3 fl oz
Delegate 25WG ¹	—	4.5–6.0 oz
Imidan 70WP	0.75–1.0 lb	2.0–3.0 lb
Intrepid 2F	2.0–4.0 fl oz	8.0–16.0 fl oz
Leverage 2.7SE	—	3.0–5.0 fl oz
Leverage 360	—	2.4–2.8 fl oz
Mustang Max	—	1.3–4.0 fl oz
Proaxis	—	2.5–5.1 fl oz
Sevin XLR	0.75 qt	2.0 qt
Tourismo ¹	—	10.0–14.0 fl oz
Voliam Flexi 40W ¹	—	4.0–7.0 oz
Voliam Xpress ¹	—	6.0–10.0 fl oz
Warrior II	—	1.3–2.5 fl oz

Fungicide and Antibiotic Notes

- a. Do not use captan on Japanese or Stanley plums before July. Check the label for other cultivar restrictions. Equivalent products include Captan 50% W & WP and Captec 4L. Check the label for rates/100 GPA. REI restrictions vary from 24 hours to 4 days; check the label of the product you are using. Some Captan products may be applied up to the day of harvest.
- b. Gem is a strobilurin fungicide, but unlike Pristine, it does not have a protectant compound and is therefore best used in combination with one.

Do not use more than 15.2 fl oz per acre per season. Do not apply within 1 day of harvest. Do not make more than 2 sequential applications of Gem or exceed 4 applications per season.

- c. Apply at early bloom stage (plums at green tip). Make a second application (75 to 100 percent bloom) and a third application as needed at petal fall. Do not apply Orbit to Stanley plums earlier than 21 days before harvest; read the label for specific recommendations. Apply up to 2 sprays of Orbit in the preharvest period up to the day of harvest (0-day PHI)
- d. Do not make more than 2 sequential applications of Pristine before alternating to a labeled fungicide with a different mode of action. Do not make more than 5 applications of Pristine or related fungicide per season. Pristine has a 24-hour REI and a 0-day PHI.
- e. Do not make more than 2 applications of Quash after petal fall. Do not apply within 14 days of harvest. Do not make more than 3 applications per season or exceed 12 oz/A per season.
- f. Do not apply more than 3 applications of Scala alone. Do not apply within 2 days of harvest or make more than 2 applications of a Group 9 fungicide within 30 days of harvest. Do not use on cherries.
- g. Various formulations of sulfur are available commercially; these vary in sulfur content. Use labeled amounts of material that are dependent on the formulation.

Insecticide and Acaricide Note

1. In order to prevent the development of pest resistance to these new chemistries and to practice the most effective resistance management approach, we highly encourage growers to use only 1 chemical class of products (i.e., mode of action) for a particular generation of a targeted pest and to rotate to another chemical class to control the succeeding generation of the targeted pest. For example, if using Delegate to control the first generation of Oriental fruit moth, use Altacor, Belt, Tourismo, Voliam Flexi, or Voliam Xpress to control the second generation; or, if using either Altacor, Belt, Tourismo, Voliam Flexi, or Voliam Xpress to control the first generation of Oriental fruit moth, then switch to Delegate or another chemical class (Assail, Calypso, etc.) to control the second generation. Altacor, Belt, Tourismo, Voliam Flexi, and Voliam Xpress belong to the same chemical class (IRAC Group 28) and should not be used for consecutive generations of a targeted pest. The same rotation approach applies to Delegate and all other chemistries.

Mites. For control, use 1 of the following.

Miticide recommendations for plum and prune.

Several miticide options are given. The miticide chosen and its rate should be based on the size of the mite population, the number of predators present, and the degree of resistance in particular orchard blocks.

Miticide	Dilute rate/100 gal	Rate sprayed/A
CHOOSE 1 of the following:		
Acramite 50W ^a	—	1.0 lb
Agri-Mek 0.15EC	1.5–5.0 fl oz	10.0–20.0 fl oz
Envidor 2SC	—	14.0–18.0 fl oz
Nexter ^b	—	4.4–10.6 oz
Onager	—	12.0–24.0 fl oz
Savey 50WP	1.0–2.0 oz	3.0–6.0 oz
Vendex 50WP	4.0 oz	16.0 oz

Notes

- a. Add a surfactant for improving coverage. It is strongly recommended that water hardness be reduced with a water treatment that contains ammonium sulfate prior to adding the surfactant and Acramite.
- b. Higher rate of Nexter is necessary for twospotted spider mite control.

Plum and Prune—Fifth Cover, Preharvest Diseases. Brown rot, leaf spot.

Insects. Leafrollers.

Brown rot. Where brown rot is a problem, apply additional fungicide sprays every 5 to 7 days up to harvest. Apply fifth cover in late July; apply preharvest spray about 3 weeks before harvest.

Sprays before harvest. Refer to Table 4-15 when selecting sprays during the last month before harvest.

Pesticide recommendations for plum and prune, fifth cover, preharvest.

Pesticide	Dilute rate/100 gal	Rate sprayed/A
Apply 1 of the following:		
captan 80WDG ^a	refer to footnote a	3.75 lb
Gem 500 SC ^b	—	2.9–3.8 fl oz
Orbit ^c	—	4.0 fl oz
Pristine ^d	—	14.5 oz
Scala SC ^e	—	10.0–18.0 oz
sulfur ^f	refer to the label for rates and recommendations	
PLUS 1 of the following:		
Actara 25W	—	3.0–4.5 oz
Avaunt 30WDG	—	5.0–6.0 oz
Baythroid 2E	—	2.0–2.8 fl oz
carbaryl 80S	1.0 lb	2.5 lb
Danitol 2.4 EC	3.5–7.0 fl oz	10.7–21.3 fl oz
Delegate 25WG	—	4.5–6.0 oz
Imidan 70WP	0.5–0.75 lb	1.5–2.0 lb
Intrepid 2F	2.0–4.0 fl oz	8.0–16.0 fl oz
Proaxis	—	2.5–5.1 fl oz
Sevin XLR	0.75 qt	2.0 qt
Warrior II	—	1.25–2.5 fl oz

Fungicide and Antibiotic Notes

- a. Do not use captan on Japanese or Stanley plums before July. Check the label for other cultivar restrictions. Equivalent products include Captan 50% W & WP and Captec 4L. Check the label for rates/100 GPA. REI restrictions vary from 24 hours to 4 days; check the label of the product you are using. Some Captan products may be applied up to the day of harvest.
- b. Gem is a strobilurin fungicide, but unlike Pristine, it does not have a protectant compound and is therefore best used in combination with one. Do not use more than 15.2 fl oz per acre per season. Do not apply within 1 day of harvest. Do not make more than 2 sequential applications of Gem or exceed 4 applications per season.
- c. Apply at early bloom stage (plums at green tip). Make a second application (75 to 100 percent bloom) and a third application as needed at petal fall. Do not apply Orbit to Stanley plums earlier than 21 days before harvest; read the label for specific recommendations. Apply up to 2 sprays of Orbit in the preharvest period up to the day of harvest (0-day PHI)
- d. Do not make more than 2 sequential applications of Pristine before alternating to a labeled fungicide with a different mode of action. Do not make more than 5 applications of Pristine or related fungicide per season. Pristine has a 24-hour REI and a 0-day PHI.
- e. Do not apply more than 3 applications of Scala alone. Do not apply within 2 days of harvest or make more than 2 applications of a Group 9 fungicide within 30 days of harvest. Do not use on cherries.
- f. Various formulations of sulfur are available commercially; these vary in sulfur content. Use labeled amounts of material that are dependent on the formulation.

Postharvest Disorders of Plums and Prunes

Lesser peachtree borer (LPTB)/peachtree borer (PTB). For LPTB, apply as a coarse spray to trunk and lower limbs in up to 2 sprays: June 10–20 and August 10–25. Do not spray fruit; there is a 14-day preharvest interval for Asana XL and a 21-day preharvest interval for Thionex. For PTB, make 2 applications to the trunk, the first around July 15 and the second at the same time as for LPTB (August 10–15).

Postharvest fruit rot. See Part VI, Harvest and Postharvest Handling.

Postharvest orchard disease control. For brown rot and Cytospora canker control, see discussion in Part II, Diseases, Pests, and Natural Enemies.

DETERMINING FRUIT MATURITY

Apple Maturity Indices

To allow time to schedule labor, growers must estimate optimum harvest dates well before picking fruit. In addition, there are different optimum maturity levels for the same cultivars, depending on intended use and storage life desired. Harvesting too early results in fruit that is off-flavor or lacking flavor, poorly colored, small, and subject to bitter pit and storage scald. Leaving fruit on the tree too long results in softer fruit, the potential development of watercore, and a shorter storage life.

The obvious first step in marketing a high-quality product is to grow a high-quality product. Early tree training, annual pruning, proper fertilization, and sound pest management can greatly affect tree vigor and, thus, fruit condition. Light crops, crops from extended bloom periods, or crops with high nitrogen levels may differ markedly in maturity date and subsequent storage potential. Each block and cultivar or strain should be evaluated separately for its maturity and storage potential.

Within the list of maturity indices (starch, firmness, juice sugar and acid content, seed color, flesh color, presence of watercore, background color, and internal ethylene concentration [IEC]), there is a priority order for making decisions. Identifying the targeted consumer is the first decision to make. Will the harvested fruit be made available for immediate fresh market consumption, future fresh market consumption following regular or controlled atmosphere storage, or is the fruit destined for the processor? Once the targeted consumer is identified, the relative importance of the specific maturity indicators will be known. With the exception of IEC, which involves the use of a gas chromatograph, all these indicators are relatively easily measured.

Of all the indicators, background color, starch content, and firmness are the most important factors in guiding harvest timing. They are correlated to some extent with sugar content, acidity, flavor, aroma, texture, IEC, and potential storage life. If a fruit lacks the characteristic background color of a specific variety, obviously it will be difficult to sell as a fresh market item. A fruit harvested without desirable color will not change significantly during storage. Fruit lacking characteristic background color is most likely going to be firm, starchy, and immature. The only viable outlet for such fruit is most likely the processing market. However, fruit destined for processing also has minimum maturity standards. Fruit with low starch readings of 1–2 on an index of 1–8 are still immature and will lack flavor and sugar content. They will have a desirable firmness, but the flavor aspect will overshadow this. In general, a combination of the presence of background color, starch conversion of 25–35 percent, and firmness above 15 pounds will qualify for a good storage or processing candidate. For immediate consumer consumption, the presence of background color, starches in the range of 4.5–6.0, sugar content above 13 percent, and firmness readings greater than 13 pounds should meet consumer expectations.

Before doing any measurements, collect a representative sample of fruit. Choose five to eight trees per block per cultivar

and rootstock that are typical of the trees in the block, and carefully mark them so that you can collect weekly samples. Trees should have a uniform crop load and be of uniform vigor. Begin sampling approximately 4 to 5 weeks before normal harvest is anticipated. Sample four fruits from the periphery of each tree (recognizing that this represents the most mature fruit on the tree), selecting fruit that is free of any visible insect injury or disease damage. Fruit temperature can affect certain test results; therefore, measurements of the samples' maturity should be performed within 2 hours of harvest.

Days after full bloom (DAFB)

DAFB should be used as a general reference to indicate when fruit might mature. There may be a 5- to 20-day spread between the average harvest date and the optimum harvest date for a particular cultivar. Record full bloom by block and cultivar each spring, since full bloom may vary from one site on your farm to another. Estimated days from full bloom to harvest for some cultivars are listed in Table 1-6. These dates should be used as general guides and can vary from year to year.

Fruit firmness

Fruit firmness can be measured with either an Effigi fruit tester or a Magness-Taylor pressure tester. Both work on the principle that fruit flesh becomes softer as it matures. Many factors, including watercore and fruit size, can affect firmness readings. The presence of watercore will give higher readings that are inaccurate. Therefore, discard firmness measurements of apples that have watercore. Large apples are usually softer than smaller ones, so for firmness measurements try to choose apples of a relatively uniform diameter and that are representative of the fruit in the block.

The most critical feature of firmness testing is the speed with which you apply force to the plunger. The proper speed is about 2 seconds, and to regulate your speed you might say to yourself, "one, one thousand, two, one thousand" as you insert the plunger into the fruit. Applying pressure too fast is probably the most common way of getting a false reading.

For apples, use the 11 mm tip supplied with the pressure tester and penetrate to a depth of 7.9 mm as marked on the plunger. Test each apple on both the blush side and the nonblush side, then average both readings.

Percent soluble solids (or sugar levels)

As fruit matures, starch is converted to sugars. To measure the percentage of Brix, or sugar, in a solution, a refractometer can be used. As fruit matures, refractometer readings increase, indicating fruit maturity is progressing.

Fruit from trees with a heavy crop will have lower readings than fruit from trees with a light crop under similar growing conditions. Sugar content will be higher in years of reduced moisture availability, high temperatures, and high sunlight. As with firmness, refractometer readings will also vary by fruit position within the tree and nutritional status. Fruits located in exposed areas, where considerable photosynthesis is taking place, have higher soluble solids. Fruits heavily shaded and located inside the tree or on weak spurs have the lowest soluble level of fruit on that tree.

A refractometer can be purchased for around \$200 from a number of sources. (Refer to the buyer's guide in each July issue of *American Fruit Grower*). Measurements are made by squeezing a small amount of juice from the fruit onto the prism of the refractometer. A small garlic press works well to produce the juice. Hold the instrument up to the light and read the percentage of soluble solids by looking through the lens. After each sample of juice, rinse the prism face off and wipe with a soft tissue to avoid contamination among samples. One can calibrate refractometers by zeroing with distilled water and at 10 percent with a solution of 10 grams of sucrose dissolved in 90 grams of water. More expensive (~\$600) digital refractometers can be purchased from scientific supply companies such as Fisher, VWR Scientific, or Thomas. Digital refractometers indicate the percent dissolved solids to the nearest 0.1 percent.

Acidity

As fruit mature, their acid content decreases. Malic acid is the major acid in apple juice, and it plays a major role in the flavor attribute. Table 7-3 categorizes several varieties of apples based on their sugar and acid content. Granny Smith apples have developed a well-known image based on their tart or acidic flavor. Some apple varieties, such as Pink Lady, attain acid values as high as 1.4–1.5 percent in juice. There are no guidelines for maturity based on acid level. The amount of acid present is related to the variety and maturity stage. A drop in acid level is an indicator of advancing maturity. Measuring acidity is somewhat cumbersome and involves the use of common laboratory instruments such as a titrator or a buret. For best use as a maturity indicator, acid level should be recorded over a number of harvests to develop patterns and guidelines.

Starch levels

Stage of maturity can also be assessed by performing the starch-iodine test to document starch disappearance. Applying an iodine solution to the cut surface of fruit stains the starch a blue black. The iodine solution can be made by dissolving 10 grams of iodine crystals and 25 grams of potassium iodide in 1 liter of water. The pattern of starch disappearance is specific for each variety. Delicious loses its starch in a fairly even ring, while Golden Delicious shows an uneven pattern.

Preparing a starch-iodine solution

Always use freshly prepared solution at the beginning of every season. The solution is sensitive to light and should be stored in a dark container. A darker colored bottle or glass jar wrapped in aluminum foil will suffice. Chemicals needed for this test are potassium iodide and iodine crystals. Check with your local pharmacist for the iodine. (Note: As part of Homeland Security, iodine can only be purchased in small quantities.) The iodine solution can be made by dissolving 10 grams of iodine crystals and 25 grams of potassium iodide in 1 liter of water. The pattern of starch disappearance is specific for each variety. Delicious loses its starch in a fairly even ring, while Golden Delicious shows an uneven pattern.

Warning: Iodine is a very poisonous chemical. The iodine solution should be properly labeled and kept away from children and pets. Apples used in the test should not be fed to any animals or used in composting. In case of ingestion of iodine or iodine-

treated apples, induce vomiting and consult the Poison Center Hotline immediately.

Wilson Irrigation Supply in Washington sells starch-iodine solution already made. Visit them online at www.wilsonirr.com or call them at 1-800-232-1174.

Fruit used for firmness testing and soluble solids readings can also be used for the starch-iodine test. Cut the fruit at right angles to the core, approximately halfway from the stem to the calyx end. Apply the iodine solution to the cut surface, drain away any excess, and rate the fruit after 2 minutes. The reaction of iodine and starch is temperature-dependent. Under cold conditions, the reaction will take longer. An external heating source will speed up the reaction in cold environments. Avoid contact and be cautious when mixing and applying iodine solution. Test a minimum of 10 fruits per block, preferably 20. A commonly used rating system is a scale of 1 to 6, as follows:

- 1 = full starch (all blue-black)
- 2 = clear of stain in seed cavity and halfway to vascular area
- 3 = clear through the area including vascular bundles
- 4 = half of flesh clear
- 5 = starch just under skin
- 6 = free of starch (no stain)

In Washington State, general guidelines have been established for using this scale to rate the long-term storage potential of Delicious and Golden Delicious: a 1.5-2.0 rating and a 2.0-3.0 rating, respectively. Growers should develop scales of their own for their varieties and growing conditions.

Another good reference for starch testing is "Predicting Harvest Date Windows for Apples" by G. D. Blanpied and K. J. Silsby, Information Bulletin 221, Cornell Cooperative Extension (order from Resource Center, Cornell University, 7 Business and Technology Park, Ithaca, NY 14850). This publication contains a Generic Starch-Iodine Index chart that is an excellent picture guide for making starch index determinations. It is also available online at ecommons.library.cornell.edu/bitstream/1813/3299/2/Predicting%20Harvest%20Date%20Window%20for%20Apples.pdf.

Seed color and fruit color

Seed color can also be used in a general way to determine maturity. Cut the fruit in half and rate the seed color on the following scale:

- 1 = clear (no color)
- 2 = trace (tips brown)
- 3 = ¼ color
- 4 = ½ color
- 5 = ¾ color
- 6 = full color

The test probably works best for early maturing varieties.

Flesh color can help determine the amount of chlorophyll still present in the apple. Take a ¼- to ½-inch-thick slice from the middle of the fruit. Hold the slice up to a bright light and observe the extent of green (chlorophyll) in the flesh. Again, a rating of 1 to 6 can be used:

- 1 = flesh all green
- 2 = some loss of green from center of fruit
- 3 = heavy green band ½ inch thick under skin
- 4 = heavy green band ¼ inch thick

- 5 = heavy green band 1/8 inch thick
- 6 = green essentially gone from under skin

Fruit texture

Texture can be evaluated by a simple taste test. If, as you chew the fruit, the flesh tends to wad up or seem cottony, the apple has not reached an ideal stage for harvest. This is a subjective test and probably no two people will always agree.

New technology is being developed for nondestructive assessment of firmness or texture by companies in Israel (Eshet Eilon), The Netherlands (Aweta), and the United Kingdom (Sinclair). The technologies work on the principle of acoustical vibration, or the amount of elasticity of the fruit following impact by nondestructive tapping of the fruit surface. With acoustics, it has been shown that consumers are able to differentiate fruit based on the acoustical properties as measured by an electronic instrument that taps the fruit and calculates an index based on the fruit's weight and vibration frequency. Bench-top models have been developed. The goal of these companies is to automate the systems for use on packing lines to assess fruit texture at a rate of up to 10 fruit per second.

Remember, harvesting fruit at its optimum maturity requires skill and experience. Do not rely on just one maturity test, but try to use several different tests each year.

Pear Maturity Indices

Pear maturity indices are not as reliable or consistent as those used for apples. Indices similar to those used for apples historically have not been as consistent for different years or orchards. The exception is firmness and possibly days after full bloom.

A combination of two or more of the following indices will give a better indication of fruit maturity. As with any measurement used to predict fruit maturity, expect variations from year to year, block to block, and by tree and growing conditions. The best method is to select several tests and repeat them every year to develop a track record for your orchard.

Days after full bloom (DAFB)

DAFB can give an approximate harvest date or a "ballpark guess." The major problem with this type of measurement is that there is little consistency from year to year and a wide range in suggested DAFB values. For example, for D'Anjou the range can be 120–150 days, for Bartlett 110–133, for Bosc 130–145, and for some of the new Asian pears 112–150. Firmness in pears can be measured with the same device as apples, but with an 8 mm tip to a depth of 7.9 mm

Firmness

In pears, fruit firmness is probably the most reliable indicator of maturity. Fruit to be sold immediately or held only for a short time can be harvested at a much softer stage than fruit to be stored for a longer time. Firmness is not a good indicator of maturity for Asian pears. These types are best when ripened on the tree where fruit pressures will run 8 to 12 pounds. Color and taste are better indices for the Asian types. The recommended ranges for firmness measured by a pressure tester are as follows: D'Anjou 13–15 pounds, Bartlett 15–17 pounds, and Bosc 14–16 pounds.

Fruit appearance

Although it is a subjective evaluation, fruit color and finish can be a valuable maturity indicator. In Bartlett, look for a change from green to a white green, blotchy appearance at the fruit neck and finally a light yellow. Any pink coloration at the calyx end probably indicates a premature ripening problem in Bartlett. For D'Anjou, look for a change in ground color. Russeted Asian pears change from green to brown to orange or gold. Yellow-fruited varieties change from grass green to light green to yellow green.

Fruit finish is another means of judging maturity. For D'Anjou and Bartlett, look for smooth, waxy skin. As the fruit matures, corking of the lenticels is related to fruit maturity. An immature fruit has white lenticels that become brown and shallow. The brown color in lenticels is a good indicator that the fruit will ripen without shriveling.

Other methods

Amount of soluble solids is often not a good indicator of maturity in traditional varieties because of the need to harvest the fruit before it is ripe. A minimum of 11 percent for Bartlett and of 10 percent for all other varieties is recommended, except in Asian pears, where 12 percent is recommended.

Measuring the amount of starch in fruit is a "new" technique that has worked very well for apples but only with limited success for pears. As the fruit matures, starch is converted to sugars. Reports from the Pacific Northwest indicate that the starch iodine test may be a reliable indicator and that fruit should be harvested when 60 percent of the cut fruit surface still contains starch.

HARVESTING FRUIT

Bruising in Fruit

Fresh-market fruit growers have long been concerned about bruising. Processing-fruit growers also have grown concerned, because unbruised fruit commands the best prices. The vast majority of bruising in the harvest process falls into two categories: (1) picking bruises associated with rough handling and detrimental impacts, and (2) compression bruises associated with significant vibrations during transport.

Bruising is an ever-present problem. One study showed that bruising of fruit after harvest ranged from 0.6 to 13 percent, with an average of 7.1 percent. A study conducted of packing sheds indicated that bruising caused 8.1 percent of the culls, while another study found bruising to cause only 2.7 percent of the culls. At the retail level in supermarkets, bruising was found to range from 29 to 78 percent, averaging 61 percent.

While bruising is a concern, it must be regarded as a defect that can be controlled through basic management principles. We encourage growers to determine the quality of the product being produced and to determine the dollar value of defects in the product. Good management practices then dictate that production steps be modified if the cost of correcting the problem is less than the cost incurred by defects in the product.

Damage inflicted on fruit is related to the energy available for bruising and the characteristics of the product. The energy available for bruising is in turn related to

1. the suspension characteristics of the vehicle transporting the fruit,

- the energy input to the system (a function of roughness of the road and vehicle speed), and
- a third engineering factor involving both the properties and the packaging of fruit.

The damage suffered by fruit is dependent on the number of individual shocks and their severity, and is directly related to the energy absorbed by the fruit.

We may think we cannot change the characteristics of the products we deal with, but this is not entirely so. Packers of Golden Delicious have learned that packing apples directly on removal from storage may produce more bruised fruit than if fruit is packed after being held at a relatively low humidity for a few days to create an outer layer of bruise-resistant cells. Reducing the amount of bruising in fruit appears to be attainable by reducing the amount of energy that fruit receives in handling.

In practical terms, bruising can occur during any of six operations in which fruit is removed from the tree and moved into storage. In several Pennsylvania harvest operations, some of these steps may be combined, but they are discussed here individually to show the complexity of an efficient, high-volume harvest operation. Listed below are seven locations of fruit and the six steps involved in moving the fruit from tree to storage:

Fruit location	Fruit-handling operation	
Fruit on the tree	Step 1	Harvesting
Fruit in the bins	Step 2	Moving bins out of the orchard
Bins at the edge of the orchard	Step 3	Moving bins to loading area
Bins in loading area	Step 4	Loading bins on truck
Bins on truck in loading area	Step 5	Trucking bins to storage
Bins on truck at storage	Step 6	Forklift hauling bins to storage
Bins in storage		

The harvest season is a hectic time of year, but we strongly recommend that growers educate employees in the proper method of performing assigned tasks.

Proper harvesting involves the following:

- Wearing proper clothing and a hat.
- Adjusting the bucket. Picking buckets with rigid sides and of a reasonable size is recommended.
- Checking all ladders before using.
- Carefully setting ladders and setting them at the proper angle.
- Keeping your body centered on the ladder.
- Handling fruit like eggs.
- For apples, using stem-on picking methods.
- Getting your hands in the bucket to prevent bruising.
- Picking a tree from the bottom up.
- Releasing fruit carefully and slowly into the bulk bin.
- Reporting all accidents to the grower.

In Step 1, we suggest that growers offer incentives to pickers who pick properly and that growers give disincentives or penalties to those who cause more bruising than the set limit. Offering both rewards and penalties does more to encourage pickers to harvest fruit properly than if either penalties or rewards are used alone. In addition, we recommend the use of an active supervision system for picking crews.

Major bruise-reducing practices in Washington State include the use of three-legged aluminum stepladders. Growers do not allow pickers to set straight ladders into trees because they find the resulting damage (bruising and dropped fruits) unacceptable. Another practice is to use bubble liners in bins to absorb energy and vibrations for cultivars such as Golden Delicious and other high-value crops, such as bagged Fuji.

Step 2 involves moving the fruit within the orchard to the end of the rows. This operation is performed by tractors. In Washington State growers prefer the use of low-profile orchard tractors with wide tires. These tires act like springs and can intercept energy to prevent it from transferring to fruit in a bin.

Most Pennsylvania orchard tractors, in contrast, have 12- or 16-inch-wide tires on 24- or 28-inch-diameter rims. These tires are normally inflated to be fairly hard and can therefore transmit more energy to the fruit in a bin as the tractor moves over rough terrain. We recommend using tractors equipped with 18.4 by 16.1 orchard tires.

Step 3 involves moving fruit from the edge of the orchard to a loading area. If the haul distance is short it may be desirable to combine this step with Step 2. Special straddle vehicles or four-bin trailers may be useful. In some areas the trailers are operated in reverse and are attached to the front of the tractors. Using a multibin conveyance system may be more efficient than hauling bins singly on tractors. To lessen bruising, all orchard roads should be as smooth as possible to reduce the energy transferred to fruit during transport. Most loading areas should be smooth and paved, if possible, or at the very least covered with gravel. Muddy loading areas add a significant risk of spreading spores and soil-borne decay organisms. Organic material and dirt caught in bin runners can defeat sanitation procedures used at the warehouse in storing and packing fruit.

Step 4 is loading straight trucks or tractor-trailers for further bin movement. When this operation is performed on paved surfaces, using conventional rubber-tired forklifts may maximize efficiency and may be necessary for handling large volumes of fruit.

Step 5 is trucking the fruit from orchard to storage. Drivers should be instructed to follow the smoothest roads and to travel at reasonable speeds, especially over rough roads. Special trailers with “air-cushioned rides” will absorb more road shock than conventional trailers.

The final step, Step 6, is moving the fruit from the trailer to the storage itself. In this phase, loading areas should be as smooth as possible and shock-absorbing forklifts should be used, especially on rough loading areas.

Bruising may be viewed as a profit-reducing phenomenon and a manageable problem. Bruise-producing operations can be corrected for less money than the reduction in profit caused by the bruising. Remember, bruising is usually caused by only a few procedures. Growers may want to evaluate their present practices in view of the ideas presented here.

Excessive Heat and Worker Safety

A combination of very high temperatures (significantly above normal) and a higher-than-normal humidity can severely reduce the body's ability to maintain a proper internal temperature.

Prolonged exposure to these conditions can lead to heat cramps, heat exhaustion, and heat stroke. For some, especially the old and infirm, it can lead to death.

The heat index (HI), also referred to as the “apparent temperature,” is a measure of how humidity acts along with high temperatures to reduce the body’s ability to cool itself. The HI is the temperature (in degrees) the body senses, based on normal humidity levels. For example, if the actual temperature is 100°F with 40 percent relative humidity, the effect of these conditions on the body is the same as 110°F with normal humidity (about 20 percent). The basic assumption in computing HI is that the person is in the shade, at sea level, with a wind speed of 6 mph. Exposure to full sunshine can increase the HI about 5 to 15°F. Various wind speeds can also alter the HI but usually have small effect.

The following table shows heat index, or apparent temperature, based on current air temperature and relative humidity.

Air temp. (°F)	Relative humidity (percent)						
	10	20	30	40	50	60	70
105	100	105	113	123	135	149	—
100	95	99	104	110	120	132	144
95	90	93	96	101	107	114	124
90	85	87	90	93	96	100	106
85	80	82	84	86	88	90	93
80	75	77	78	79	81	82	85
75	70	72	73	74	75	76	77
70	65	66	67	68	69	70	70

To use this table find the current air temperature in the lefthand column; follow that row across until you reach the appropriate humidity column. The number you find there is the heat index (HI) or the apparent temperature.

The degree of heat stress may vary with age, health, and body characteristics. Listed below are some heat stress symptoms associated with several apparent temperatures. Symptoms of heat stress include a feeling of weakness, fatigue, giddiness, and nausea. Headaches and cramps are also signs of heat stress. Symptoms of heat stroke include mental confusion, loss of consciousness, convulsions, body temperatures of 106 degrees or higher, loss of coordination, and hot, dry skin that may be red, mottled, or bluish.

Preventing heat stroke among farm workers

Employers should take the following steps:

- Learn to spot the signs of heat stroke, which can be fatal.
- Provide frequent rest breaks for the workers.
- Consider a workers’ physical condition when assigning work in extreme heat.
- Make available plenty of drinking water (about a quart per hour per worker).
- During extreme heat and humidity, schedule work during the morning and late afternoon hours where possible.
- Provide shade, such as awnings and canopies, if natural shade is not available.

Workers should do the following:

- Get used to the heat for short periods and then follow with longer periods of work.
- Alternate work and rest breaks, with longer rest breaks in cooler areas.
- Wear hats to protect them from the sun.
- Dress in lightweight, loose-fitting, light-colored clothing, such as cotton.
- Drink plenty of water, even if they are not thirsty.
- Do not drink beer and alcohol or take cold medications.
- Take frequent breaks and get out of the sun, if possible.
- Know signs of heat stroke and fatigue and get immediate medical attention.

Apparent temperature (°F)	Danger category	Heat syndrome
80–90	Caution	Fatigue possible with prolonged exposure and physical activity
90–105	Extreme caution	Sunstroke, heat cramps, and heat exhaustion possible with prolonged exposure and physical activity.
105–30	Danger	Sunstroke, heat cramps, or heat exhaustion likely. Heatstroke possible with prolonged exposure and physical activity.
130+	Extreme danger	Heatstroke or sunstroke imminent.

Adjust work schedules to avoid the most stressful parts of the day.

GUIDELINES FOR PLACING FRUIT IN STORAGE

First, segregate fruit into lots by storage potential. The following types of fruit should not be stored for more than 5 months because of their potential to break down or develop bitter pit:

- Large fruit from lightly cropped trees
- Fruit from excessively vigorous trees
- Fruit from young trees just coming into bearing
- Fruit from interior portions of trees that are heavily shaded
- Early picked fruit high in starch
- Fruit with a low number of seeds (less than five per fruit)

Second, cool the fruit as rapidly as possible after harvest. Just as workers are at risk from high heat, so too are fruit. Removing bins from direct sunlight under high-temperature conditions is a priority. Exposure to elevated temperature reduces the storage and shelf life of the fruit. The sooner you are able to get fruit into the warehouse and under refrigerated conditions, the better. Balancing the capacity of your refrigeration system to the heat load and volume of your freshly harvested fruit is important. Do not overtax the cooling capacity of your system to the detriment of fruit already in storage. If you plan to use controlled atmosphere (CA) storage, in general the more quickly you cool the fruit and achieve the desired atmosphere, the longer the fruit will store. For best results in CA storage, cool the fruit for 2 to

3 days, then achieve the desired atmosphere within 7 days or fewer after harvest. Since most CA rooms are not filled in 1 or 2 days, CA pulldown can commence shortly after the room is filled during the cooling process. Achieving the target temperature for storage should precede achieving final CA conditions. Some newer varieties, such as Braeburn and Fuji, need to be cooled thoroughly (40°F for 14 days) prior to applying CA conditions. Typically these varieties are quite dense and do not respond well to elevated levels of carbon dioxide (internal or external).

Third, when placing fruit in storage, leave representative samples of each cultivar and orchard block close to the door, and check the samples periodically to determine fruit quality. Do not “bury” fruit deep in the storage room with no way to check its condition.

Fourth, maintain a high relative humidity in the storage room. Apples are approximately 85 percent water and can quickly lose enough moisture to show signs of skin shrivel if kept at too low a humidity. Shriveling can appear after an apple loses as little as 3 percent of its fresh weight. Abrasions, bruises, and other injuries increase the rate of water loss. A single bruise can increase water loss nearly fourfold. Warm fruit is cooled by giving up moisture. As moisture is removed from the air by the cold refrigeration coils, a deficit gradient is produced that pulls more moisture out of the fruit, which can result in shrivel. Once the fruit has been cooled, the refrigeration coil temperature can be raised to reduce the amount of moisture being removed from the air.

In general, a relative humidity of 90 to 93 percent gives the best results for storing most apple cultivars and is recommended when mixed cultivars are placed in a common storage. Relative humidity is the amount of water that is present in vapor form. The amount of water needed to raise the humidity is actually very little because of the inability of cold air to hold moisture. Free water on the floor of a refrigerated or CA room does little to increase the relative humidity of the room. Fogging systems have been employed to increase the relative humidity in cold rooms. Fogging systems work better than water on the floor because fog is composed of very small droplets whose combined surface area can be a thousand times greater than that available from the area of the floor alone.

SmartFresh (1-MCP)

SmartFresh, 1-methylcyclopropene (1-MCP), is being registered and marketed by AgroFresh, a Rohm and Haas company. 1-MCP will bring dramatic benefits to the fruit industry. The mode of action of 1-MCP involves inhibiting the ripening process by attaching the ethylene-binding sites and rendering the fruit insensitive to ethylene exposure. This binding results in fruit that maintain firmness and acidity levels higher than those of untreated fruit. For treatment purposes, 1-MCP is a gas and must be applied in an airtight room or chamber. 1-MCP has been shown to be very active at low concentrations. Its label rate for application will be 1 ppm for a period of 24 hours. Other benefits include inhibition of superficial scald in varieties that are prone to scald occurrence, such as Red Delicious and Granny Smith. Applications of 1-MCP should be made on fruit that is designated for intermediate to long-term storage. Recent work at Cornell indicates that the use of SmartFresh on cultivars that have high levels of volatiles, such as McIntosh and Gala, may have some undesirable effects. 1-MCP

will suppress the natural evolution of volatiles that consumers have come to expect. Cultivars that have low levels of natural ethylene during harvest respond best to SmartFresh. However, cultivars that have high levels of ethylene production during harvest do not respond as well. Natural ethylene levels can be stimulated by warmer temperatures or by delaying harvest in an attempt to obtain better color. Blocks treated with ethephon to hasten maturity also do not respond well to SmartFresh treatment. Delaying treatment of fruit for more than 7 days may result in less-than-optimal performance. Fruit should be treated within 3 to 4 days after being placed in cold storage.

CONTROLLED ATMOSPHERE STORAGE OF APPLES AND STORAGE SCALD

Storage

Controlled atmosphere (CA) storage does not improve fruit quality, but it can slow down the loss of quality after harvest. Successful CA storage begins by harvesting fruit at its proper maturity. Apples should be cooled rapidly and recommended atmospheric conditions achieved shortly after field heat is removed. The longer it takes to adjust carbon dioxide and oxygen levels, the less effective the duration of storage. Guidelines for CA storage regimes are shown in Table 6-1.

Apple cultivars harvested at the same time within 7 and 10 days of each other can be stored together if they have similar oxygen and carbon dioxide requirements. When storing more than one variety in a room, choose a carbon dioxide level that is not toxic to any of the varieties. For example, Stayman can tolerate 5 percent carbon dioxide, but if it is stored with Delicious, only 2 to 3 percent carbon dioxide should be used.

Storage Scald in Apples and Pears

Storage scald, also called common scald and superficial scald, affects mainly the skin of fruit and can result in fruit losses. The disorder is believed to be caused by oxidation of a naturally oc-

Table 6-1. Atmospheric and temperature requirements for controlled-atmosphere storage.

Variety	O ₂ (%)	CO ₂ (%)	Temperature (°F)
Braeburn	2–3	0.5	34
Cortland	2–3	5 or 2–3	36 or 32
Delicious	1.2	2	31–32
Empire	2–2.5	1.5–2	34–36
Fuji	4	0.5	34
Gala	1.2	2	33
Gold. Delicious	1.1	2	31–32
Granny Smith	1	1	34
Idared	2–3	2–3	31–32
Jonathan	2–3	2–5	36 for 1 mo., 32 thereafter
Macoun	2–3	5	36
McIntosh	2–3 for 1 mo., 5 thereafter	3	36
Northern Spy	2–3	8 or 2–3	38 or 31–32
Rome Beauty	2–3	2–3	31–32
Spartan	2–3	2–3	31–32
Stayman	2–3	2–5	31–32
York	1.8	0.5	32

curing compound in the skin of fruit. Under certain conditions the compound becomes toxic to the cells of the skin.

Scald, evident only after several months of storage, first appears on skin on the green side of fruit as an irregular burned or scalded area. Fruit removed from storage after December may not show symptoms at first, but when allowed to stand at room temperature for 12 to 24 hours may begin to exhibit scald. The flesh immediately below the affected area may become soft and discolored if scald is severe. If this happens, the fruit cannot be peeled easily when processed.

Scald severity is influenced by variety, season, cultural practices, and postharvest treatments. Susceptible varieties include Ben Davis, Cortland, Delicious, Granny Smith, Rhode Island Greening, Rome Beauty, Stayman, Winesap, and York Imperial. Less susceptible are Braeburn, Fuji, Gala, Golden Delicious, Jonathan, McIntosh, Northern Spy, Pink Lady, and Spartan. Warm temperatures during the last 6 weeks before harvest may increase the likelihood of scald. Hot, dry weather increases susceptibility, while cool, damp weather decreases it. Studies in New Jersey with Stayman showed that when fruit experienced 190 hours or more of temperatures below 50°F on the tree during the weeks just prior to harvest, scald did not develop.

Immature fruit is more likely to scald, and there is some indication that fruit high in nitrogen or low in calcium may have a greater tendency to scald. Delays in storage sometimes can reduce scald severity, but they adversely affect the length of storage life. The problem also appears to be worse on fruit stored at high relative humidity.

The best means of controlling scald is to avoid storing immature or overmature fruit. The fruit should be cooled as rapidly as possible, and if placed in CA storage, the desired oxygen level should be achieved quickly.

Treating the fruit with DPA (diphenylamine) or ethoxyquin (labeled for pears only) reduces scald incidence when proper concentrations have been used (see Table 6-2). DPA may retard the loss of green color in the fruit skin. DPA may also cause injury

Table 6-2 Concentrations of DPA needed to reduce scald.

Variety	DPA (ppm)
Cortland	2,000
Delicious	2,000
Golden Delicious	NR ^a
Granny Smith	2,200
Fuji	1,000
Idared	1,500
McIntosh	1,500
Mutsu	2,000 ^b
Rome Beauty	2,000
Stayman	2,000
Pears	NR

Adapted in part from Blanpied, G. D., and R. M. Smock. Storage of Fresh Market Apples. *Information Bulletin 191*. Cornell University.

a. NR = not recommended.

b. For early picked Mutsu.

to the fruit if drench solutions accumulate too much dirt. It is recommended that DPA solutions be used at the rate of 30 bins per 100 gallons. Injury from ethoxyquin has occurred when tanks are not properly drained and the material becomes concentrated as the water in the dump tanks evaporates. Ethoxyquin is also very sensitive to sunlight and breaks down rapidly, losing effectiveness. The recommendation is not to exceed 100 bins per 100 gallons of diluted material before changing the solution. Water remaining in the dump tank must not be emptied into residential sewer systems or natural watersheds.

Fruit is normally drenched for 30 seconds in the solution. Longer treatments may result in unacceptably high residue levels. Fruit treated with ethoxyquin may be washed and waxed as soon as it is dry.

While it is being prepared, agitate the solution to obtain a uniform mixture. Since the active ingredients of DPA and ethoxyquin vary with the manufacturer, it is important to read the label when preparing the solution.

Ethoxyquin coverage can be detected under ultraviolet light, enabling you to assess your effectiveness in covering the fruit. Allow fruits to dry, then view them in a dark room. Do not look directly into the ultraviolet light, because it can damage your eyes.

Drenching for Scald Control and Storage Requirements by Cultivar (See Tables 6-1 and 6-2)

Braeburn. This variety has a low risk of scald development. Diphenylamine (DPA) at 2,000 ppm should alleviate this risk. DPA has also been reported to reduce internal problem in Braeburn. Precondition fruit for 14–17 days at 40°F prior to applying CA regimes. Oxygen concentration should be kept at 2–3 percent and carbon dioxide below 0.5 percent to help avoid Braeburn browning disorder.

Cortland. Treat with DPA at 2,000 ppm and store at 2–3 percent oxygen and 5 percent or 2–3 percent carbon dioxide at 36°F or 32°F, respectively.

Delicious. Scald can be a problem if fruit is picked too early; therefore, treat fruit with DPA at 2,000 ppm. Store at 1.2 percent oxygen and 2.0 percent carbon dioxide. If carbon dioxide exceeds 3 percent, premature mealiness and cavities can occur.

Empire. Treat with DPA at 1,000 ppm. The storage regime for Empire is 2–2.5 percent oxygen and 1.5–2.0 percent carbon dioxide.

Fuji. Treat with DPA at 1,000 ppm and store at 4 percent oxygen and 0.5 percent carbon dioxide. Maintain this relatively high level of oxygen as long as significant watercore is present.

Gala. No scald treatment is required. The storage regime recommendation is 1.2 percent oxygen and 2 percent carbon dioxide.

Golden Delicious. Skin shriveling can be a problem with CA storage. Polyethylene bin liners, sometimes used to raise humidity around apples, may slow the rate of cooling. Polyethylene hoods, if used, should be placed over the bins after field heat has been removed from apples. To help reduce skin shrivel, do not store bins of Golden Delicious on the top tiers. Golden Delicious does not require anti-scald treatment. Storage conditions are 1.1 percent oxygen and 2 percent carbon dioxide.

Granny Smith. Granny Smith is very prone to scald and requires 2,220 ppm DPA. Storage conditions are 1 percent oxygen and 1 percent carbon dioxide.

Idared. Normally this variety keeps well in regular storage, but because Jonathan is one of Idared's parents, Idared can develop Jonathan spot in regular storage. In CA storage, Jonathan spot usually does not occur. DPA is recommended at 1,500 ppm and storage at 2–3 percent oxygen and 2–3 percent carbon dioxide.

McIntosh. More is probably known about this cultivar, based on work done in New York State, than any other. DPA is recommended at 1,500 ppm and storage at 2–3 percent oxygen and 2–3 percent carbon dioxide. Continuous use of 5 percent carbon dioxide may cause injury on skins of less mature fruit. Thus, the carbon dioxide level should be varied, beginning at 2–3 percent the first month and being raised to 5 percent thereafter. Fruit will be firmer if stored at temperatures below 36°F, but various disorders may appear at lower temperatures.

Northern Spy. No scald control is recommended. Storage regimes include oxygen at 2–3 percent and carbon dioxide at 8 percent and 2–3 percent when stored at 38°F or 31°F, respectively. Although two possible CA combinations are listed (Table 6-2), a temperature of 32°F maintains fruit firmness better.

Rome Beauty. This cultivar has moderate risk of scald and should be treated with 2,000 ppm DPA. A storage regime of 2–3 percent oxygen and 2–3 percent carbon dioxide should be employed.

Stayman. Scald control for this variety is 2,000 ppm DPA. This variety is stored at 2–3 percent oxygen and can withstand up to 5 percent carbon dioxide, but because it is frequently stored with other varieties, 2–3 percent is generally used.

York Imperial. Scald control for this variety is of less concern, given its emphasis in the processing market. A storage regime of 1–2 percent oxygen and 0.5 percent carbon dioxide at 32°F is recommended.

Other varieties. Experiments in New York State with Jonamac, Mutsu, Jonagold, and Spigold indicate that 31 to 32°F with 2 to 3 percent carbon dioxide and oxygen is satisfactory.

POSTHARVEST FRUIT DISORDERS

Picture Guide to Apple Postharvest Defects and Disorders

Washington State Tree Fruit Research and Extension Center has developed a picture card set to aid in identifying common defects found on the packing line. The series of laminated four-by-six-inch cards can be carried in a pocket. They can be ordered from the Good Fruit Grower at 105 South 18th Street, Suite 217, Yakima, WA 98902 or by calling 1800-487-9946. Indicate you want a set of the "Quick Identification Guide to Apple Postharvest Defects and Disorders Card Set." The cost is \$25.00 plus shipping and tax. You can also view the cards on the Web at entomology.tfrec.wsu.edu/Cullage_Site/Cards/Cards.html#contents.

Peach Skin Discoloration

Skin discoloration, also known as inking, is a disorder of peaches that has been a problem for 20 years. A symptom of inking is the development of burgundy-colored areas within the red flesh of the peach, that eventually turn purplish black or ink color. Research at Clemson University, University of California, and Rutgers University has demonstrated that any operation causing peaches to rub, roll, or physically abrade against one another can result in discoloration. Discoloration can also be triggered by iron levels in excess of 10 ppm in the hydrocooler and dump tank, leachate from latex-rubber drying rollers, ammonia, and fungicide sprays.

Four major factors influence the development of inking: the cultivar, dump tank water, contaminants, and abrasions to the skin of the fruit.

Cultivar. Early maturing cultivars seem to be more susceptible. Cultivars that have dark red or purplish over color can show the disorder more regularly. Fruit left on the tree too long in an attempt to achieve greater skin color may be more prone to inking. White-fleshed, low-acid cultivars seem to be more prone to discoloration. There are no recommendations as to susceptibility by cultivar, and the susceptibility may vary by the year.

Dump tank water. The water used in hydrocoolers and the dump tank should be monitored to keep it at or near a pH of 7.0. Water that is high in iron, copper, or aluminum also tends to increase inking problems. Inspect your hydrocoolers and dump tanks to make sure they are not rusty and allowing additional metals to enter into the water. Change the water regularly to prevent the buildup of metal residues. If your water source is naturally high in iron, consider switching your source or install a filtration system. Inking has also been observed to be more prevalent when fruit are harvested in the rain.

Contaminants. Research in California has shown that contaminants can increase the likelihood of inking. Make sure your harvest crew uses good sanitation when picking. Harvest bags, crates, and bins should be clean. Minimize exposure of the fruit to dust. Ensure that hydrocoolers and grading machines are clean. Avoid the use of foliar applications of materials that have heavy metals during the final swell period of fruit development.

Skin abrasions. Minimize rough handling of the fruit during harvest. Consider smoothing orchard roads to avoid excessive jostling of the fruit in transit to the packing house. Brushing to remove the "fuzz" can lead to a greater occurrence of inking.

Inspect your packing line for places where excessive abrasion can occur.

To help control the problem:

- Avoid any operation that causes excessive vibration, rubbing, or rolling.
- Check water used for spraying for heavy metal contamination.
- Avoid spraying foliar nutrients that contain heavy metals while fruit is on trees.
- Cool fruit as soon as possible after picking. Hydrocooling is preferred to storing in a cold room. Before hydrocooling, keep field bins in a shaded area out of direct sunlight.
- Keep hydrocoolers and dump tanks as clean as possible by draining and refilling with fresh water on a regular basis.
- Monitor iron levels and water pH in the hydrocoolers and dump tanks. Excessive iron in tanks can cause discoloration. Water pH should be maintained between 6.5 and 7.0. Water at a pH of 4.0 to 6.0 has caused problems with discoloration and iron levels.
- Wash drying rollers, especially new ones, in detergent and rinse well before installing. Polyurethane drying rollers have proven superior to latex rollers for maintaining fruit quality.
- If using ammonia refrigerant, make sure there are no leaks. Peaches can be adversely affected by ammonia levels under 1 ppm although humans cannot detect concentrations that low.

Peach Chilling Injury

Peaches should be cooled upon harvesting, but cold storage should avoid temperatures in the range of 36–46°F. Peaches can develop a disorder called wooliness if stored within this temperature range.

Watercore: A Maturity Problem

Watercore is a physiological disorder associated with advancing maturity in apples. It varies greatly from year to year and has been shown to be somewhat related to fruit calcium levels. However, calcium sprays do not control watercore. Unusually high amounts of sunshine and a lack of cloudy, rainy days can aggravate the disorder. It is more prevalent in highly colored or larger fruit.

Watercore develops when the spaces between the cells in apples become filled with a sugar solution. This changes the look of the flesh, giving it a water-soaked, glassy appearance. In unaffected fruit the spaces between the cells are filled with air, giving the flesh a normal appearance. The sugar solution builds up in the fruit because as the apples mature, their carbohydrate metabolism changes and the interconversions between sugars and starch change.

Slight watercore does little harm to apples and, in fact, some consumers like the added sweetness. Slight to moderate watercore usually disappears in storage and no harm is done to the fruit. More serious watercore may retard the gas-exchange properties of fruit to the extent that internal breakdown develops in the cells of the affected parts.

Controlling economic losses from watercore rests with the grower's management skills. The extent of watercore is only one factor to be included in harvest management decisions. Orchard blocks with a history of watercore should be harvested before other blocks. Special marketing arrangements for watercored apples may be required.

There is no easy solution to sorting watercore. Agricultural engineers from Washington State University have developed a system of sparging air into water flumes that transport fruit. Sparging changes the specific gravity of the water. Since watercored fruit have a higher specific gravity and do not float like normal apples, a shunt or horizontal partition in the flume can be used to separate watercored fruit as they flow through the flume system.

This section describes the process for making high-quality apple cider. Cider makers who do not pasteurize their product should be aware of the risks associated with consuming fresh juices, especially if they serve it to children, the elderly, or individuals with impaired immune systems. Procedures for minimizing food safety risks associated with unpasteurized cider are provided in Part VIII, Maintaining the Safety of Pennsylvania Apples and Apple Products.

IDENTITY STANDARDS AND REGULATIONS

In Pennsylvania, apple cider is defined as an amber golden, opaque, unfermented, entirely nonalcoholic juice squeezed from apples. Apples used for cider must be inspected, and decayed or rotten fruit, twigs, and any debris collected with mechanical harvesters removed. Freshly squeezed cider may be filtered, partially clarified, and pasteurized. Ascorbic acid (vitamin C), flavors, and preservatives may be added, but the juice must not be diluted with water or another beverage. Natural or artificial flavors or colors generally recognized as safe may be added if their presence is declared on the label by the use of the word “Imitation” in type at least one-half the size of the type used to declare the flavor.

Cider containing more than 0.15 percent alcohol by volume is classified as hard cider. Apple jack is a liquor distilled from hard apple cider. Neither product may be sold in Pennsylvania without a license from the Liquor Control Board. Anyone making or interested in making cider should contact the Bureau of Food Safety and Laboratory Services, Pennsylvania Department of Agriculture, 2301 North Cameron Street, Harrisburg, PA 17110-9408, telephone 717-787-4315, or their local Penn State Extension office.

QUALITY AND COMPOSITION OF CIDER

The traditional aroma, flavor, texture, and color of fresh unpasteurized cider are the result of (1) the type and concentration of aromatic and flavor compounds, the amount and proportion of soluble sugars and acids, and the type and concentration of pectic compounds in the fresh apples, combined with (2) the amount of insoluble carbohydrate, gum, protein, and cell fragments left in the cider and the subsequent development of oxidized flavor and tannin compounds. Some components of apple cider are shown in Table 7-1.

The total amount of sediment formed in unclarified cider would offend many consumers, yet they expect a reasonable amount of sediment. Therefore, insoluble components responsible for the sediment in freshly squeezed juice are partially removed in making cider. If all of the insoluble components are removed quickly from freshly pressed juice, it will resemble canned apple juice in aroma, color, texture, and flavor.

The amount of sugars and acids in fresh apples can vary as much as threefold. Significant variations exist among cultivars,

production regions, seasons, and maturity of apples. When the same apple cultivar is grown in the Northeast and the Southeast regions of Pennsylvania, acidity is lower in those apples grown in the Southeast. Apples from orchards located at a higher elevation or in a cooler or cloudier region generally are higher in acidity, which decreases as apples ripen before or during storage. For example, 33 to 50 percent of acidity is lost by the time a hard mature apple reaches soft-ripe maturity.

The native aroma and flavor compounds in apples are numerous (more than 80), complex, and volatile. Many of these compounds are lost in making a clarified, preserved juice (canned or frozen) from freshly squeezed apples. Tannins (more than 0.05 percent) are responsible for the astringency, while pectins (0.25 to 0.75 percent) are mostly responsible for the body or viscosity of cider.

Apples contain two primary enzymes: polyphenol oxidase and peroxidase. If these enzymes are not quickly heat-inactivated in freshly extracted apple juice, they become very active and accelerate the oxidation of tannins and natural flavors. The discoloration and stronger oxidized flavors in unpasteurized cider are partly due to these oxidized compounds. Some consumers may prefer unpasteurized cider because of these flavors.

PRESERVATION AND SHELF LIFE

Microbiology of Cider

The types and numbers of microorganisms (bacteria, yeast, and mold) that contaminate freshly packaged cider come from (1) the surface of apples, especially if they are rotten, slightly decayed, or damaged, and (2) the facility, equipment, air, water, or people involved in making cider.

High-quality unpasteurized cider will keep 12 to 14 days if the cider is cooled quickly and stored at 32 to 36°F. Shelf life is the range of time (expressed in days, months, or years) that any food product can be stored at a specific temperature before any of the following quality characteristics degrade: aroma, flavor, texture, color, safety, and nutritional quality.

Table 7-1. General composition of cider.

Chemical composition ^a
water (86–88%)
carbohydrates (11–12%)
fat (0.25%)
protein (0.25%)
fiber (0.5%)
ascorbic acid or vitamin C (3–30 mg/100 gm)
Natural sugars
fructose (4.5–8.5%)
sucrose (1.5–4.5%)
glucose (1.2–2%)
Acid composition
malic acid (0.15–1.1%)
citric acid (trace amounts)

a. Expressed as a range or an average.

Uncontrolled microbial growth is the main cause of shortened shelf life in cider. Native acids in apples limit the growth of many bacterial species, but their presence favors the rapid growth of the aciduric bacteria, yeast, and mold species. Usually harmless yeast and bacteria cells grow and multiply many times, producing alcohol and eventually some acetic acid, as in vinegar. Normal populations of these microorganisms range from 1,000 to 100,000 cells per gram, or about 30,000 to 3 million cells per ounce of unpasteurized cider. The shelf life of unpasteurized, refrigerated cider is shortened by higher counts of these microorganisms. Aciduric cells grow most rapidly at temperatures ranging from 70 to 80°F. Growth is reduced as the temperature of cider is lowered, but some species continue to grow slowly even at 32 to 36°F. As the cells grow, they use mainly sugars in the cider and produce many by-products. Most consumers perceive that cider loses its shelf life or “spoils” about the same time as its aciduric cell population increases to 1 to 10 million per gram or 30 to 300 million per ounce of cider.

Aciduric cells also grow in juice residue and on apple pieces that accumulate on and in the equipment used in processing. These cells also grow in pools of juice on the floor and in pomace. In addition to practices recommended for controlling those species that pose a public health concern, the following manufacturing recommendations will help to maximize shelf life by minimizing the initial population of aciduric cells and by preventing or reducing their growth rate in freshly pressed cider.

Unpasteurized cider is unsafe to drink if it becomes contaminated with pathogens. The most effective way to ensure the safety of cider is to pasteurize it. The potential for contamination to occur is reduced by following the Good Management Practices and HACCP plan development procedures provided in Part VIII, Maintaining the Safety of Pennsylvania Apples and Apple Products. Cider can additionally become unsafe to drink if mold growth occurs. Discard any cider that, by flavor or visual observation, contains mold.

MAXIMIZING SHELF LIFE

The shelf life of unpasteurized cider can be greatly increased by quickly chilling freshly pressed cider to a temperature of 35°F and adding either potassium sorbate or sodium benzoate. Maximum concentrations of chemical preservatives allowed in Pennsylvania cider are 0.1 percent of sodium benzoate or benzoic acid (1 ounce per 8 gallons) and 0.05 percent sorbic acid (½ ounce per 8 gallons). If the initial microbial cell count in cider is low and the cider is stored consistently at 32 to 36°F, a preservative concentration as low as 0.05 percent may be adequate.

Potassium sorbate is relatively tasteless, but it is more costly than sodium benzoate. Some consumers prefer potassium sorbate because they dislike the slightly bitter taste and presence of sodium in sodium benzoate. If a preservative is used, it should be added immediately after pressing the cider. For a 0.1 percent concentration of potassium sorbate, add 1 gallon of a 25 percent stock solution to each tank of 250 gallons, or ½ ounce per gallon of cider. Because it is only slightly soluble, the sorbate solution should be added slowly and stirred vigorously in cider. For a 0.1 percent concentration of sodium benzoate, add 1 ounce of a concentrated solution to 8 gallons (or 1 quart to 250 gallons) of cider.

The shelf life of cider may be increased by heat-pasteurization. However, unless the cider is heated rapidly and held for 10 to 15 seconds at 160°F, then cooled rapidly to 35°F, the cider will have a slightly cooked flavor. Among the various systems for pasteurizing cider, a continuous plate, temperature, and flow-controlled pasteurizer (similar to those used for pasteurizing milk) is the most efficient, easily controlled system and results in the best-quality cider. Canning is accomplished by heating cider to 195°F in the same type of pasteurizing system, then filling and sealing containers immediately and waiting five minutes before cooling the metal or glass containers. Fresh-pressed cider preserved by freezing and stored at 0°F retains the most natural aroma and flavor. In fact, frozen cider retains its high quality for several years if packaged and stored properly. The relative quality and shelf life of unpasteurized versus preserved cider stored at several temperatures are compared in Table 7-2.

Table 7-2. Relative initial quality and shelf life of cider.

Initial flavor quality when not preserved and when preserved by various methods

Unpasteurized/no preservatives	0.1% potassium sorbate added	0.1% sodium benzoate added	Heated until pasteurized	Heated until sterile/canned	Frozen/stored at 0°F
Very high	High	Good ^a	Good ^b	Fair ^c	Very high
Relative shelf life as influenced by preservation method and storage temperature					
Stored 2–3 days at 46–50°F	Stored 1–2 wks at 46–50°F	Stored 1–2 wks at 46–50°F	Stored 1–2 mos at 46–50°F	Stored 1–3 yrs at room temp.	Stored 2–3 yrs at 0°F
Stored 12–14 days at 32–36°F	Stored 2–3 mos at 32–36°F	Stored 2–3 mos at 32–36°F	Stored 3–6 mos at 32–36°F		

a. Cider may have a slightly bitter flavor.

b. Cider may have a slightly cooked flavor.

c. Cider will have a detectable cooked flavor.

Shorter shelf life should be expected when:

- lower-quality fresh apples are used
- fresh apples are not properly sorted or washed
- cider is in contact with wood or metals other than stainless steel
- freshly pressed cider is not cooled rapidly
- equipment and facilities are not properly cleaned and sanitized daily when in use
- the temperature of refrigerated cider is allowed to fluctuate by more than 5°F

PRODUCTION OPERATIONS AND PRACTICES AFFECTING COST, YIELD, AND QUALITY

Total costs for fruit and production operations are a major concern. They vary with the source of apples and with certain characteristics of the operations. Use of fresh, unstored, and ungraded smaller apples generally reduces the cost of making cider. Depending on yearly supply and demand, it may be more economical to purchase cider-grade apples from other orchards.

Systems capable of making 150 gallons or more of cider per hour, or at least 1,000 gallons per day and at least 60,000 to 80,000 gallons per year, are most cost-effective. The cost per gallon for making less cider may increase by 10 to 40 percent. This cost difference is attributed to (1) savings per gallon in costs associated with depreciation of equipment and facility; (2) savings in production and cleanup operations; (3) sales; and (4) taxes, insurance, and interest on investment.

The flow diagram (Figure 7-1) shows an ideal system of operations for efficiently producing safe, high-quality cider. The yield of cider made from 100 pounds of fresh apples may vary from 70 to 83 percent by weight, or from 7.2 to 8.5 gallons. Yields per bushel of apples range from 3.2 to 3.6 gallons.

Cider yield may be lower when:

- apples are allowed to reach, or ripen beyond, a soft-ripe maturity before pressing

- pressing firm-ripe apples ground larger than a 3/8-inch particle size
- press aids are not added before pressing ground pulp
- the depth of chopped apples filled into each “cheese” of a rack and frame press exceeds 2 inches
- using a press that is defective or managed improperly

Besides those factors affecting the microbial safety and quality of cider, sensory quality (aroma, color, texture, and flavor of cider) is affected by:

- apple cultivar or blend of cultivars being pressed
- maturity and condition of apples being pressed
- type of press used
- other practices in making cider

Selecting and Blending Apples

An apple that is ready to fall from a tree generally is at or close to firm-ripe maturity. Apples are best for making cider when they are near their peak of juiciness, acidity, and sweetness. Cider made with immature apples will be lower in aroma and sugars and higher in starch, acids, and a bitter or astringent (green apple) flavor. Cider made with overly mature apples will have lower yields and a sweeter, but flatter flavor.

After harvest and during storage, apples gradually ripen, soften, and lose some acidity and juiciness. Apples from a single cultivar or apples stored three or more months may yield cider with a flatter aroma and flavor as well as an imbalance in acidity, sweetness, and astringency. While some consumers prefer cider made with a specific apple variety, such as McIntosh, better cider is made with a blend of apples from three or more cultivars. Table 7-3 shows the primary aroma and flavor characteristics of important apple cultivars.

The blending guidelines provided in Table 7-4 will help you to make a preferred blend of cider by selecting cultivars and controlling their proportions.

- | | | | |
|---|--|----------------------|---------------------------------|
| 1. Apple dump bin and conveyer | 6. Conveyer/elevator | 11. Press | 16. Pump |
| 2. Trash eliminator | 7. Accumulator bin | 12. Pomace discharge | 17. Heat pasteurizer (optional) |
| 3. Inspection, sorting, and trimming conveyer table | 8. Press aid bin and feeder (optional) | 13. Juice collector | 18. Cold storage tank(s) |
| 4. Washer/scrubber | 9. Chopper/mixer | 14. Pump | 19. Pump |
| 5. Fresh water rinsing system | 10. Accumulator bin | 15. Screen | 20. Filter |
| | | | 21. Bottler |

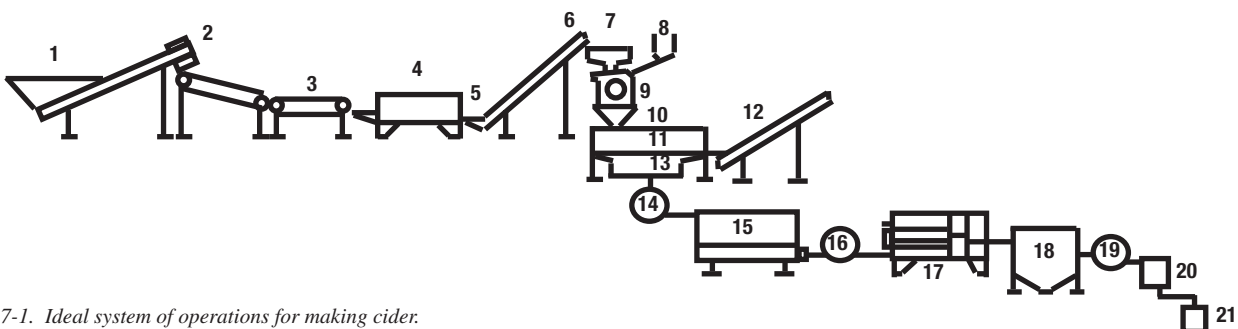

Figure 7-1. Ideal system of operations for making cider.

Table 7-3. Primary flavor characteristics of Pennsylvania apple cultivars.

Group I Relatively acid or tart (S/A <20) ^a	Group II Balanced flavor, sweet and tart (S/A 20 to 40)	Group III Relatively sweet (S/A >40)	Group IV Very aromatic	Group V Very astringent; high in tannins
Granny Smith	Baldwin	Red Delicious	Cortland	Crabapples
Idared	Cortland	Grimes Golden	Golden Delicious	Immature apples
Jonathan	Golden Delicious	Fuji	Empire	
Northern Spy	Empire	Gala	Gravenstein	
R.I. Greening	Gravenstein		Jonagold	
Stayman Wealthy	Mutsu		Macoun	
Winesap	McIntosh		McIntosh	
	Rome Beauty		Wealthy	
	Spartan		Winter Banana	
	York Imperial			
	Braeburn			

a. Ratio of sugar to acid (S/A) is less than 20 (<20).

Table 7-4. Possible cider blends and their flavor characteristics.

	Possible blends	Apples (%) from groups in Table 7-3 needed for blends					Dominant flavor characteristics
		Group I	Group II	Group III	Group IV	Group V	
Using freshly harvested firm to ripe apples	A	15	45–50	15	20	0–5	Balanced
	B	10	40	10	40	0	Very aromatic
	C	30–35	45–50	0	20	0	Very acid or tart
	D	0	45–50	30–35	20	0	Very sweet
Using firm to ripe apples stored 2 to 4 months	A	15	45–50	15	20	0–5	Flat but sweet
	E	25–30	35–45	0	30	0–5	Balanced
	F	45–50	15–25	0	30	0–5	Tart

Sorting, Trimming, and Washing Operations

Storage crates, bins, or bulk loads of apples used in making a preferred blend of cider should be emptied into a dump bin. Apples are fed onto a link bar conveyor moving at a speed of 15 to 25 feet per minute. The links of the conveyor belt should have a 1-to-1½-inch square opening, and the belt should be wide enough for the apples to flow in a single layer, allowing debris (leaves, twigs, etc.) to drop through the openings. As an alternative, a smaller mesh belt can be used to move a single layer of apples under a vacuuming cleaner system. This system removes light debris through a narrow vacuum chute mounted over the full width of the belt. Regardless of the system used, apples should then flow onto a 6-to-8-foot roller conveyor table operated at the same speed. If necessary, an inspector can remove and trim partially decayed apples and discard rotten apples. Acceptable apples then flow into a tank or rotating drum washer where they are washed and brushed with cold, recirculated water, then rinsed with fresh cold water as they leave the washer. Excess water should drip from the apples as they move to the chopping equipment.

Chopping or Milling Equipment

The equipment used to chop the apples to the size needed for pressing is a grater, chopper, or mill. It should be made of stainless steel and be designed with interchangeable screens needed to reduce whole apples to a particle size of ¼ to ¾ inch. The chopper also should have at least 10 percent more capacity than the pressing equipment. If a batch press is used, the chopper should be equipped with a stainless steel bin large enough to store the volume of chopped apples needed for a single filling cycle of a batch pressing system.

Press Aids

Using a press aid may increase the yield of cider from some presses by 10 percent or more. Usually, the value of the additional cider more than offsets the added cost of using a press aid. Approved press aids include sterilized wood pulp and rice hulls, normally used at a rate of 2 to 6 percent by weight, or bleached kraft fiber used at a rate of 1 to 3 percent. The press aid should be added at a uniform rate with a vibrating feeder into the chopper, where the aid is mixed as apples are chopped.

Pressing Systems

The juice in apples is contained in fleshy cells. In making traditional cider, a system with hydraulic, roller, or pneumatic pressure is used to rupture and compress the cells until the recoverable juice is separated from cellular solids called pomace. Available pressing systems for making cider include a vertical hydraulic rack, frame, and cloth press; a horizontal hydraulic rack and cloth-bag press; a continuous belt press; and a pneumatic press.

The least expensive pressing system is a hydraulic rack, frame, and cloth press. Available models have pressing capacities ranging from 30 to 300 gallons per hour. The press is designed with a hydraulic ram for pressing a vertical stack of folded mesh cloths separated with racks. Each cloth is first placed over a standard-size frame and uniformly filled with ground apples to a depth of 2 to 3 inches. The cloth is folded to enclose the pulp. The frame is removed, and a slotted plastic rack is placed over the folded cloth. Each filled cloth is sometimes called a cheese. This process is repeated until a full vertical stack of cheeses is ready for pressing. The stack is then positioned over the ram and pressed hydraulically in two stages for 20 to 30 minutes. The first lower

pressure stage of the pressing cycle ruptures the cells and produce free-run juice. By gradually increasing the pressure, most of the remaining juice is obtained. During the first pressing stage, the extracted juice flows through a continuous web of tiny channels to the surface of the pomace. However, unless a press aid is used with mature apples, these natural channels may collapse during the second stage and reduce the potential cider yield by the portion of juice trapped within the pomace

Press aids are fibrous materials designed to maintain the flow of juice to the surface of pomace throughout the pressing cycle. Compared to other presses, the batch-operated rack, frame, and cloth press is inefficient and has the highest labor cost for operating, cleaning, and maintaining the press. Yields may be similar to those from other presses if the particle size, use of a press aid, and fill of the cheeses are managed optimally. In terms of quality, the difficulty of cleaning and sanitizing an older press with wood surfaces increases the risk that the cider will have a higher initial microbial population and a shorter shelf life. Usually, the flavor is best from pressing systems that produce a low yield of juice. However, only the last 3 to 5 percent of the juice squeezed with a high-yielding press system is lower in flavor quality when tasted separately.

A popular semiautomatic rack and bag horizontal press offers improved operational efficiency. Available models have pressing capacities of 150 to 1,000 gallons per hour. This horizontal hydraulic press has two accordion-like sets of easy-to-use racks and filter bags held in a vertical position. A slurry of fresh apple pulp, without a press aid, is pumped from a grater hopper to fill the opened bags. One set of filled bags is compressed to remove juice while a second set of bags is alternately unloaded and refilled with fresh pulp. The press may be operated by a single person. Because the juice produced is low in suspended solids, the need for filtering is minimized. This press is very efficient to operate, and both juice quality and yield are high.

All current belt presses used to extract juice from fruits are continuous, labor efficient, and known to produce a very good yield of juice. Belt systems have pressing capacities of 40 to more than 1,000 gallons of cider per hour. With or without a press aid, pulp is fed continuously onto a mesh belt, which is then sealed by a converging belt moving at the same speed. The sandwiched pair of belts move through a wedge zone and then revolve around one or more solid or perforated drums, where a series of stainless steel rollers apply progressively higher pressures. Expressed juice flows through the mesh belt and is channeled into a collection tank. After the pressing is completed, the twin belts are continuously separated to discharge the pomace and then are refilled with prepared pulp. Both pressure and speed are adjustable. The system is simple to operate, offers good yields, and requires minimal labor.

The batch-operated pneumatic press is designed as a horizontal cylinder with a strong inflatable rubber bag in the center. The strong stainless steel exterior surface of the cylinder is perforated to serve as a screen. A slurry of freshly chopped pulp with press aid is pumped through a door in the screen until the internal space between the bag and screen is filled. The door is closed and the cylinder is rotated while the bag is inflated with compressed air. Juice squeezed from the pulp passes through the screen and is collected in a tray under the cylinder. After a few minutes, the rotation is stopped while the bag is deflated to allow reposition-

ing of the pomace and more efficient extraction of the remaining juice. The process of rotating, inflating for a time, then releasing the pressure to reposition the pulp is repeated three or four times, or until the volume of juice obtained is insignificant. The entire pressing cycle may be programmed to operate automatically, making this a very labor-efficient press. Both juice quality and yield are very good.

Screening/Filtering

Depending on the press used, freshly extracted juice may contain some undesirable large particles of pulp. To remove these, the collected juice is passed through a screening system. A screen may be a simple drum covered with a stainless mesh cloth and mounted in a horizontal, but slightly inclined, position. The drum is revolved slowly (2 to 5 rpm) as freshly pressed cider continuously and gently flows onto the inside surface of the upper end of the drum. The juice passes through the 80-to-150-mesh cloth, while the undesirable particulates are continuously discharged at the lower end of the drum. Screened cider is collected in a tray under the drum. As an alternative, freshly pressed juice may be bag filtered, bottled, and marketed. An electromagnetically vibrated screen separator may not be as effective in removing undesirable particulates. The juice is then chilled 12 to 24 hours before being bag filtered, bottled, and marketed.

Chilling and Cold Storage

To maximize the quality and shelf life of unpasteurized cider, chill screened juice as quickly as possible to a 32 to 36°F temperature and hold in a refrigerated storage tank at that temperature for 12 or more hours. During this period, additional large particles of insolubles will develop and settle to the bottom of the tank. Clear cider may then be drawn by gravity or pumped from the tank at a location above the sediment, bag filtered, bottled, and marketed.

LABELING REQUIREMENTS AND OPTIONS

Product labels used for cider must provide information in a standardized format.

Required Labeling Information

1. Food name

Cider may be used as the product name on the label only if the product is made solely from apples. If the cider is made from two or more fruits, its food name must identify which fruits were used in order of their dominance by weight. For example, if the product is made of 60 percent fresh apple juice and 40 percent pear juice, the name would be Apple Pear Cider. If the juice is made solely of pears, the name would be Pear Cider. If the cider does not contain a preservative or is not pasteurized, the product would be labeled Fresh Cider, but if it was heat pasteurized, it must be labeled Pasteurized Cider.

2. Net quantity or content

Quantity or content may be stated in English or metric units, but must be listed within the lower third of the panel. The value(s) listed must exclude the container weight. Cider may be listed in fluid ounces, pints, quarts, or gallons along with the equivalent

metric units. Rounded conversions may include:

1 fl oz = 29.6 ml

1 qt = 32 fl oz = 946 ml

1 gallon = 128 fl oz = 3.8 l

3. Ingredients

Ingredients must be listed in descending order of their dominance. If a preservative is added to cider, the specific name of the preservative must be listed. Any added flavor or vitamin C also must be listed.

4. Company name

The identity of the firm (manufacturer/packer or distributor) responsible for marketing the cider and the firm's city, state, and zip code must be listed. Telephone and street numbers are not required.

5. Product dates

Pack, open, pull, freshness, or expiration dates may be used singly or in combination. Pack and freshness dates are the most meaningful. A pack date identifies when the cider was made, while the freshness date shows how long the cider should be of optimal quality. The label might have a freshness date that reads, "Best if used by Oct. 14, 2005."

6. Warning notice

The Food and Drug Administration (FDA) issued a final ruling on labeling of fresh fruit juices that have not received an effective pasteurization treatment. See the section on food safety regulations in Part VIII for details.

Nutrition Facts	
Serving Size: 8 ounces (240 g)	
Servings Per Gallon: 16	
Amount Per Serving	
Calories 110	
	% Daily Value*
Total Fat 0 g	0
Sodium 15 mg	1
Total Carbohydrates 28 g	9
Dietary Fiber 1 g	4
Sugars 26 g	
Protein 0 g	
Vitamin C	4
Iron	2
*Percent daily values are based on a 2,000 calorie diet. Your daily values may be higher or lower depending on your calorie needs.	

Figure 7.2. A sample of a simple nutritional label for gallon containers of cider.

Optional Labeling Information

1. Nutritional labeling

The U.S. Apple Association (USAA) recently developed the first nutritional database and generic labels for cider. The database is the result of analyzing numerous samples collected from sources in the United States. Members may access the database. Pennsylvania cider makers may get assistance from the Pennsylvania Apple Marketing Program, 2301 North Cameron St., Harrisburg, PA 17110, telephone 717-783-5418. Anyone wishing to declare any variation of the USAA labeling information should obtain assistance from a qualified person with a reputable agency or analytical laboratory. Sodium values will be significantly higher if either sodium benzoate (a preservative) or sodium ascorbate is added to increase vitamin C content.

2. Exemptions and options

Small cider producers are exempt from nutritional labeling requirements for any 12-month period, provided no nutritional claim is made and the producer claiming the exemption employs fewer than an average of 100 full-time employees and has annual food sales of less than \$50,000. This exemption does not apply to the warning statement required for unpasteurized cider.

Nutritional facts such as those listed in Table 7-5 and Figure 7-2 may be displayed at the point of purchase or provided in leaflet form to interested consumers. In either case, a simple format may be used but must minimally include the following facts per serving:

- total calories
- total fats, carbohydrates, and protein in grams (g)
- total sodium in milligrams (mg)

Table 7-5. Composition and nutritional data for apple juice.

Compositional factor	Per 8 fl oz serving ^a	Percentage of RDA ^b
Weight	240 g	—
Calories	120 cal	—
Water	215 g	—
Carbohydrates	—	—
Sugars (before inversion)	27.2 g	9
Fructose	14.2 g	—
Glucose	5.1 g	—
Sucrose	6.6 g	—
Sorbitol	1.2 g	—
Acids as malic	0.5%	—
Fiber	1.2 g	5
Pectin	1.2 g	—
Total protein	0.6 g	0.1
Total fats (lipids)	0.6 g	0.9
Saturated fats	0.05 g	0.05
Cholesterol	0 mg	0.0
Ascorbic acid (Vit C)	2.5 mg	4
Iron	0.4 mg	2.0
Sodium	0.25 mg	0.0001
Potassium	282 mg	8.1

Note: These values are for apple juice since values for cider are not available.

a. From Composition of Foods: Fruits and Fruit Juices, Raw • Processed • Prepared. USDA Agricultural Handbook No. 8–9 (1982).

b. These recommended daily allowances (RDAs) are based on the 1994 daily values used in developing a food label for a daily 2,000-calorie intake. Some daily values are maximums, as with 65 grams or less of fat; others are minimums, as with 300 grams or more of carbohydrates.

The values listed in Table 7-5 are averages of the compositional and nutritional data published by researchers and USDA's Human Nutrition Information Service. The values listed for an 8-ounce serving and the percent daily values in Figure 7-2 were computed from these average values for the 1994 labeling requirements. For more information on labeling regulations, contact the Food and Drug Administration at 1-888-463-6332 or visit their website at www.fda.gov.

3. Product codes

Lot coding is a commonly used system of coding (by serial number or other method) each lot of cider that you make. Each lot may differ in one or more quality characteristics because different sources of apples or different blends of cultivars are used. Cider quality also may vary when made by different operators or at different times during the season. Records kept for each lot should show the source and blend of apples and where, when, and by whom the lot was made and sold. This lot coding system and accompanying records make it easier to address a possible consumer concern or regulatory question.

Universal Product Code (UPC) is a 10-digit set of numbers and bars used with computerized scanners and checkout systems and with inventory programs. If cider is to be sold through food stores, an assigned UPC may be obtained for a fee from the Uniform Code Council, Inc., 7887 Washington Village Drive, Suite 300, Dayton, OH 45459; phone 937-435-3870; e-mail info@uc-council.org.

4. Handling instructions

Handling instructions encourage handlers and consumers to store the cider at less than 40°F for maximum shelf life and quality and to consume the cider before the freshness date expires.

5. Health claims

Certain health claims regarding the relationship between fat and cancer (21 CFR 101.73(e)), saturated fat and cholesterol and coronary heart disease (21 CFR 101.75(e)), and sodium and hypertension (21 CFR 101.74(e)) are allowed on an apple juice or cider label. If a nutrient or health claim is made, nutrition information must appear on the package regardless of eligibility for small-business exemptions. For details, contact the Pennsylvania Apple Marketing Program.

FOODBORNE ILLNESS IN THE U.S.

Fresh Produce

Pennsylvania apple growers are justifiably proud of their record for producing wholesome and nutritious apples, and there have been no reported cases of foodborne illness associated with their consumption. However, several highly publicized outbreaks of foodborne illness involving red meats, poultry, seafood, juice, and some fresh fruits and vegetables have caused consumers and government regulators to question the safety of the food we eat.

The U.S. Centers for Disease Control and Prevention estimates that, in the United States, there are 76 million illnesses, 325,000 hospitalizations, and 5,000 deaths per year due to consumption of food contaminated with pathogenic microorganisms. Particularly susceptible to foodborne illness are the very young, the elderly, and individuals with existing diseases or who are receiving medical treatments that suppress their immune systems. In addition to the human toll, outbreaks of foodborne illness have caused severe economic losses to food companies in the form of lost reputation, declining sales, and government sanctions.

The proportion of total foodborne illnesses traced to vegetables and fruits, in particular those that are eaten raw, has increased steadily in the last few decades. In the 1990s produce-related cases increased twelvefold. Between 1997 and 2005 the frequency with which produce has been identified as causing illness outbreaks has more than doubled. Outbreaks or recalls have been attributed to contamination of tomatoes, cantaloupes, and alfalfa sprouts with *Salmonella* spp., cabbage and fresh-cut apples with *Listeria monocytogenes*, imported raspberries with *Cyclospora*, and Mexican strawberries with Hepatitis A virus and *E. coli* O157:H7. To date, there have no reported cases of foodborne illness traced to fresh, whole tree fruits.

Despite the absence of food safety problems associated with tree fruits, growers need to be constantly vigilant for potential sources of contamination. Human pathogens such as *Listeria monocytogenes*, *Clostridium botulinum*, and *Bacillus cereus* are naturally present in soils and, thus, can be transmitted to fresh produce, especially those types that grow close to or contact the ground. *Listeria* grows well in cool, damp environments commonly found in packing houses and thrives on improperly cleaned and sanitized floors, walls, and equipment surfaces. *Salmonella* spp., *E. coli* O157:H7, *Campylobacter jejuni*, and many parasites and viruses have their origin in the intestines of animals and humans. These microorganisms can contaminate fresh produce through the use of raw or inadequately composted manure, contaminated irrigation water, untreated wash water, or harvesters and handlers who do not follow good personal hygiene practices. *E. coli* O157:H7, a relatively new variant of the usually harmless bacteria in the human gut, is of particular concern because only a few cells are required to make a person seriously ill.

Juice and Cider

Several highly publicized outbreaks involving fruit juice and cider have been attributed to the presence of *Salmonella* spp., *E. coli* O157:H7, and *Cryptosporidium* in unpasteurized juice. In a 1996 outbreak, unpasteurized apple juice produced by Odwalla, Inc., became contaminated with *E. coli* O157:H7. Sixty-six cases of illness were confirmed and one child died. The cause of the outbreak was thought to be the use of low-quality, partially decayed apples in the product. Because of this and several other outbreaks that followed, consumers and wholesale buyers of apples are now demanding new assurances that fresh fruits and fruit juices are grown, packed, and processed in a safe manner.

The number of reported outbreaks and product recalls of fresh fruits and vegetables and unpasteurized juices may increase in the coming years as produce consumption increases, the proportion of susceptible individuals in the general population increases, and microbial detection methods become more sensitive. Growers, packers, and processors, therefore, are well advised to follow the guidelines and regulations described in this chapter to prevent contamination before it occurs.

GOOD MANAGEMENT PRACTICES FOR SAFE APPLE GROWING, PACKING, AND CIDER PRODUCTION

This section offers guidelines for recognizing potential food safety hazards in apple growing, packing, and juice production operations. Apples and apple products can become contaminated at any point in the growing, packing, and processing continuum. By taking steps to identify and prevent potential hazards, the Pennsylvania apple industry will continue to maintain consumer confidence in apples and apple products.

“Good Management Practices for Safe Apple Growing, Packing, and Cider Production” is intended to identify a broad range of potential microbial, chemical, and physical hazards that may occur during growing, packing, and distribution of fresh apple products. The scientific basis for identification and prevention of these hazards is not complete. However, the guidelines in this publication are based on established sanitation and hygiene principles for use in food processing and agricultural packing environments. Food safety control measures presented here were drawn from the following documents:

- “Current Good Manufacturing Practice in Manufacturing, Packing, or Holding Human Food (CFR 21 Part 110),” U.S. Code of Federal Regulations
- “Guidance for Industry—Guide to Minimize Microbial Food Safety Hazards for Fresh Fruits and Vegetables,” U.S. Food and Drug Administration
- “Codex Alimentarius Food Hygiene—Basic Texts,” World Health Organization/U.N. Food and Agricultural Organization

Potential hazards and control measures are divided into three sections:

- Orchard operations
- Packing operations
- Cider processing

In each section, the purpose for the guidelines that follow, potential hazards, and preventative or corrective measures are provided. Potential hazards and control methods identified here may not apply to all situations. Individual growers, packers, and distributors, therefore, should seek to identify additional potential hazards and control measures in their own operations as a complement to the broad principles presented in this guide.

1. Orchard Operations

Purpose

To ensure that apples are grown and harvested under conditions that minimize the risk of contamination with human pathogens.

Potential hazards

Apples can become contaminated with human pathogens during preharvest and harvest activities as a result of contact with water, soils, wild or domestic animals, manure, workers, and harvesting equipment.

Preventive or corrective measures

I. Water quality

WATER USED FOR IRRIGATION OR FOR APPLICATION OF FERTILIZERS, PESTICIDES, AND GROWTH REGULATORS SHOULD BE OF ACCEPTABLE MICROBIOLOGICAL QUALITY.

Because apples intended for the fresh market and for use in cider are not treated to kill all microorganisms, growers should be aware of the microbial quality of the water that may contact apples. Practices that might expose apples to direct contact with contaminated water, such as irrigation and fertilization or application of pesticides or growth regulators, may increase microbial food safety risks, especially when applied close to harvest. The microbial quality of water can be confirmed by laboratory testing of samples; however, the quality of surface water such as rivers, ponds, reservoirs, and lakes is often unpredictable and can vary over a short time period. Growers should, therefore, be aware of water sources and distribution and check for wastewater discharge or runoff from upstream livestock operations. Groundwater is less likely to be a source of contamination. However, wells should be properly constructed and protected from surface runoff.

Where water quality is unknown or cannot be controlled, growers may want to consider irrigation practices that minimize contact between water and apples. Low-volume sprays or drip, furrow, or underground irrigation are options that should be considered. If fertilizer, pesticide, and growth regulators are applied close to harvest, only potable water should be used to prepare solutions. If water is not safe for human consumption, it should be treated with an approved disinfectant.

II. Cultivation

DOMESTIC ANIMALS SHOULD BE EXCLUDED FROM ORCHARDS DURING THE GROWING SEASON.

Animal manure may be contaminated with human pathogens such as *Salmonella* or *E. coli* O157:H7. Livestock, therefore, should be prevented from entering orchards by physical barriers such as fences.

ANIMAL WASTE FROM ADJACENT LIVESTOCK OPERATIONS OR WASTE STORAGE FACILITIES SHOULD NOT BE ALLOWED TO CONTAMINATE THE ORCHARD.

If surrounding fields and farms are used for animal production, growers should ensure that animal waste does not enter the orchard or areas where wells are located during heavy rains. This can be accomplished by the use of physical barriers such as ditches, mounds, grass/sod waterways, diversion berms, and vegetative buffer areas.

WILDLIFE SUCH AS DEER OR WATERFOWL SHOULD BE DISCOURAGED FROM ENTERING THE ORCHARD.

Control of wild animal populations such as deer or waterfowl in nearby wooded areas, meadows, and waterways is difficult. However, to the extent possible, where high concentrations of wildlife are a concern, growers should discourage these animals from entering the orchard. Visual, auditory, or physical means may be used. Buffer crops that will not be used for fresh market products may be planted between orchards and wild areas to discourage entry of animals.

APPLES INTENDED FOR FRESH MARKET OR CIDER PRODUCTION MUST NOT BE PRODUCED IN ORCHARDS FERTILIZED WITH RAW HUMAN OR ANIMAL WASTES.

Because there is a high probability that raw manure contains human pathogens, it may contaminate apples when it is applied. Once the manure is on the ground, pathogens may survive through the season and contaminate apples during heavy rains, by dust carried on the wind, or by workers during harvesting.

COMPOSTED MANURE SHOULD NOT BE APPLIED DURING THE GROWING SEASON.

Maximum temperatures achieved during proper composting are sufficient to kill most human pathogens; however, in practice, the effectiveness of composting in eliminating the risk of microbial contamination in orchards is not well understood. Therefore, if growers use composted manure, it should be applied well before the growing season to allow additional time for pathogen levels to decrease.

To ensure that composting operations are not a source of contamination, keep manure storage and composting sites as far as possible from orchards. Piles should be kept covered to prevent the spread of microorganisms by birds or winds, and runoff during heavy rains should be prevented from reaching the orchard.

III. Harvesting

DO NOT HARVEST DROPPED APPLES.

Apples that have dropped onto the ground may have become contaminated with animal manure and should not be used for the fresh market or cider production. Apples attached to lower branches that have contacted the ground under their own weight also should not be used. Training and supervision of harvesters is necessary to ensure that only tree-picked apples are used.

USE ONLY CLEAN, WHOLESOME APPLES.

Only apples that meet the minimum quality standards for “U.S. Cider Grade,” that is, “free from decay, wormholes, and internal breakdown,” should be used. Heavily bruised, punctured, or decaying apples, or fruit that is obviously contaminated with bird feces, should not be used for fresh market or cider apple production.

KEEP HARVEST CONTAINERS CLEAN TO PREVENT CROSS-CONTAMINATION OF APPLES

Harvest containers used repeatedly during a harvest should be routinely cleaned after each load is delivered and before reuse. Removing mud from containers when fields are muddy may not be practical. At such times, adhering mud should be removed at the packing facility prior to sorting, grading, and packing.

Whenever possible, use containers made from cleanable materials. Wooden containers are more difficult to clean and sanitize and, therefore, should be avoided. Discard damaged containers that are no longer cleanable.

Containers should be stored in a clean area free from pests such as rodents, birds, and insects. If the containers are stored outside, they should be cleaned and, as necessary, sanitized before being used to haul apples.

MOVE THE APPLES RAPIDLY FROM THE FIELD TO STORAGE.

Do not let the fruit sit out in the orchard where it is exposed to pests and high temperatures. If apples are to be stored for an extended period of time, quickly cool them to 45°F or lower.

CLEAN HARVEST STORAGE FACILITIES BEFORE USE.

Facilities used to store apples should be cleaned and, as necessary, sanitized before harvest. These facilities also should be inspected for evidence of pests such as rodents, birds, and insects.

USE HARVESTING AND PACKING EQUIPMENT APPROPRIATELY AND KEEP IT AS CLEAN AS PRACTICAL.

Any equipment used to haul garbage, manure, or other debris should not be used to haul apples or be allowed to contact containers or pallets that are used to haul apples without first being carefully cleaned and sanitized.

IV. Sanitary Facilities and Worker Hygiene**WORKERS SHOULD BE PROVIDED READY ACCESS TO CLEAN TOILET AND HANDWASHING FACILITIES.**

Sufficient toilet facilities must be provided as regulated by federal occupational safety and health standards for agricultural workers. Each toilet facility should have a handwashing station adequately supplied with soap and disposable towels. Supervisors must insist that workers use toilet facilities.

WORKERS SHOULD USE GOOD HYGIENIC PRACTICES.

To prevent contamination during harvesting, workers should maintain a high degree of cleanliness while on duty by thoroughly washing their hands before starting work and each time after using the toilet. Clean, warm water with soap should be used. Common or shared towels should be not be used.

CLEAN DRINKING WATER THAT IS FREE OF HARMFUL MICROORGANISMS SHOULD BE MADE AVAILABLE TO WORKERS.

Contaminated drinking water may infect workers, who may then contaminate apples during harvesting and handling.

ANY WORKER WHO HAS DIARRHEA, OR WHO IS A CARRIER OF A COMMUNICABLE DISEASE THAT CAN BE TRANSMITTED BY FOOD, SHOULD NOT BE ALLOWED TO HARVEST OR HANDLE APPLES.

Supervisors and workers should be aware of the presence of symptoms of infectious diseases or of skin boils, sores, or infected wounds so that if symptoms are evident, the supervisor can remove or reassign the worker.

V. Transportation**INSPECT TRUCKS AND TRANSPORT CONTAINERS FOR CLEANLINESS, ODORS, AND OBVIOUS DIRT OR DEBRIS BEFORE BEGINNING THE LOADING PROCESS.**

Growers should be aware of previous loads carried in transport vehicles and take this information into consideration when determining vehicle use. Trucks that were recently used to transport animals or animal products, for example, would increase the risk of contaminating apples if the trucks were not thoroughly cleaned and sanitized before loading.

LOAD APPLES INTO TRUCKS OR TRANSPORT CARTONS IN A MANNER THAT WILL MINIMIZE DAMAGE.

Heavily bruised, punctured, or decaying apples may provide a better growth environment for microorganisms and may be more difficult to wash.

MAINTAIN PROPER TEMPERATURES TO HELP ENSURE BOTH THE QUALITY AND SAFETY OF APPLES.

Do not let apples sit in unrefrigerated trucks for excessively long periods of time. Refrigerated trucks should be precooled before apples are loaded. Containers of apples should be loaded in a way that ensures proper refrigerated air circulation.

VI. Product Traceback**MAINTAIN ADEQUATE PRODUCTION RECORDS.**

When good management practices are used to produce apples for fresh market and cider apples, the probability of a foodborne disease incident is reduced. However, if a foodborne disease outbreak occurs, identification of the source of contamination can help to prevent the further occurrence of food safety problems and also may be useful in identifying and eliminating a hazardous pathway.

Documentation should include the name and location of the orchard and cultivar, the date of harvest, and the name and address of the buyer. Any records that document corrective actions taken to minimize food safety hazards, including water quality testing results, should be included. The records should be legible, permanent, accurate, and signed and dated by the responsible individual.

2. Packing Operations

Purpose

To ensure that apples received from the orchard are packed, stored, and transported under conditions that minimize the risk of microbial contamination.

Potential hazards

Because fresh market and cider apples do not receive a heat treatment that would eliminate harmful bacteria, Good Management Practices are necessary to minimize microbial contamination. Poor sanitation procedures can significantly increase the risk that apples will become contaminated with microorganisms. Pathogens may be found on the floors and in the drains in the packing facility and on the surfaces of sorting, grading, and packing equipment. Without good sanitary practices, any of these surfaces that come in contact with apples could be a potential source of microbial contamination. Workers who do not follow good hygiene practices may infect other workers and contaminate apples. Packers should develop good sanitation and hygiene standards and maintain them throughout the packing operation.

Preventive or corrective measures

I. Water Quality

ALL AREAS IN THE PACKING FACILITY MUST HAVE A SOURCE OF HOT AND COLD POTABLE RUNNING WATER WITH SUFFICIENT PRESSURE FOR ALL REQUIRED WASHING OF FRUIT AND EQUIPMENT AND DAILY FLOOR WASHING.

If nonmunicipal water is used, it must meet minimum federal standards for drinking water. In Pennsylvania, a private water source must be tested by a certified laboratory each year between August 15 and September 15.

All modifications to the plumbing system should be completed by a licensed plumbing contractor and inspected for conformance with local building codes. All hoses inside and outside the plant should have anti-siphoning devices installed.

Surface water or other water of uncertain microbiological quality should not be used for cooling, drenching, or washing operations or in dump tanks, unless it has been treated with an approved disinfectant.

Water used to sanitize food contact surfaces may be treated with sodium hypochlorite or other approved chemicals to prevent accumulation of harmful microorganisms. The concentration of residual chlorine should be maintained at 50–100 ppm by monitoring regularly with a chlorine test kit.

The temperature of dump tank water should be kept at least 10°F warmer than the apples. This is important because when the water temperature is colder than the apples, a slight vacuum forms within the fruit. Water and any contaminants it might contain can then be drawn inside the apple through calyx and stem areas, lenticels, punctures, and cracks. This is generally not a problem if the dump tank water contains a disinfectant and if apples are cooled before packing.

CLEAN DRINKING WATER SHOULD BE MADE AVAILABLE TO WORKERS.

Contaminated drinking water may infect workers, who may then contaminate apples during harvesting and handling.

II. Grounds and Buildings

GROUND AND BUILDINGS SHOULD BE FREE OF CONDITIONS THAT MAY RESULT IN PRODUCT CONTAMINATION.

Grounds in the immediate vicinity of all packing areas should be kept clear of waste, litter, and improperly stored garbage. Remove weeds and keep all grasses cut to discourage the breeding, harboring, and feeding of pests.

Walls and ceilings should be impervious, and the floors must be continuous concrete and have sufficient drains. Walls and ceilings should be light in color for easier cleaning and to provide better lighting on work surfaces. Condensate from fixtures, ducts, and pipes should not contaminate food or food contact surfaces. Drainage areas may contribute to contamination of food by seepage, cross-contamination from shoes and boots, or by providing a breeding place for pests.

Remove any unnecessary articles, including old and inoperative equipment that is no longer used, to eliminate areas that harbor rodents and insects. Minimize the availability of food and water to pests, and eliminate potential nesting or hiding places for pests. Bins should not be stored immediately adjacent to the packing house.

BLOCK ACCESS OF PESTS INTO ENCLOSED FACILITIES.

Prevent entry of pests into packing areas by screening or blocking vents and holes in walls, doors, flooring, etc. All windows, doors, and openings around the packing operation should be screened to prevent insect and rodent entry. Entrances to storage areas by forklifts should be covered with plastic curtains.

ADEQUATE LIGHTING MUST BE PROVIDED IN THE WORK AREAS.

Well-lit areas are more easily monitored for cleanliness. Interior lights must be shielded to prevent pieces of glass from getting onto the product in the event of bulb or tube breakage.

REFRIGERATION FACILITIES SUFFICIENT TO KEEP APPLES STORED AT 32 to 38°F (AS CLOSE TO 32°F AS POSSIBLE) SHOULD BE AVAILABLE.

This will prevent growth of human pathogens as well as extend the product's shelf life.

III. Product Receiving and Storage

ACCEPT ONLY CLEAN, WHOLESOME APPLES THAT MEET THE MINIMUM QUALITY STANDARDS FOR "U.S. CIDER GRADE"; THAT IS, "FREE FROM DECAY, WORMHOLES, AND INTERNAL BREAKDOWN."

Heavily bruised, punctured, or decaying apples or fruits that are obviously contaminated with soil or bird feces should be discarded. Packers should insist that apples are grown in accordance with the Good Management Practices for orchard operations detailed in the previous section.

Additional care should be taken to protect fresh field-packed apples from possible contamination from exposure to manure and animal fecal material in the soil. Operators of open packing facilities also should be aware of potential contamination from airborne contaminants from any nearby livestock or poultry areas or manure storage or treatment facilities.

**INSPECT CONTAINERS UPON RECEIPT FOR CLEANLI-
NESS OR DAMAGE.**

Bins or crates may become a source of contamination if they are soiled when they enter a dump tank. As much adhering dirt as practical should be removed with clean running water.

Damaged container surfaces may cause damage to the surface of apples and make them more difficult to wash. Moreover, smooth container surfaces are desirable because they have fewer protective places for bacteria to survive and accumulate.

STORE APPLES IN A COOL AREA, FREE FROM PESTS.

Clean apples cannot remain clean in dirty surroundings. If apples have been contaminated in the orchard, pathogens will grow quickly at warm temperatures. If apples are to be stored for an extended period of time, quickly cool and store them at 45°F or lower.

IV. Facility and Equipment Sanitation**FACILITIES IN AND AROUND PACKING OPERATIONS
SHOULD ALWAYS BE MAINTAINED IN A CLEAN CON-
DITION.**

Discarded apples attract pests, which may spread harmful microorganisms. Clean and sanitize the dump tank and the washing, grading, and sorting areas daily to reduce the potential for microbial contamination.

Clean product storage areas regularly. Remove, as much as practical, all visible debris, soil, dirt, and unnecessary items from product storage areas on a regularly scheduled and “as needed” basis. Sanitize facilities as necessary.

Floors, walls, and ceilings should be kept clean and be free of peeling paint, rust, dirt, or any evidence of microbial growth. Do not allow standing water to accumulate in packing and storage areas; it provides an ideal environment for growth of harmful microorganisms such as *Listeria*.

**CLEAN EQUIPMENT OR MACHINERY THAT CONTACTS
APPLES ON A DAILY BASIS.**

Because contact with apples may serve as a vehicle for spreading microbial contamination, equipment used in transporting, washing, sorting, and grading apples should be of such material and workmanship as to be adequately cleanable. Proper design, construction, use, and cleaning of equipment can help reduce the risk of cross-contamination.

Remove mud and debris from equipment daily. Equipment such as knives, saws, blades, boots, gloves, smocks, and aprons should be cleaned on a regular basis and replaced as needed. Sanitize cleaned equipment and other food contact surfaces daily with an appropriate sanitizing solution.

**FOOD CONTACT SURFACES THAT HAVE BEEN CLEANED
SHOULD BE SANITIZED ON A DAILY BASIS DURING THE
PEAK SEASON AND AS NEEDED AT OTHER TIMES.**

Sanitizing surfaces not only prevents pathogens from accumulating, but also minimizes the presence of spoilage organisms that can decrease product shelf life. *After food contact surfaces are thoroughly cleaned*, they should be sanitized with an FDA-approved sanitizer. A sanitizing solution can be prepared by mixing $\frac{3}{4}$ to 2½ ounces of 5.25 percent available chlorine bleach (commercial liquid chlorine bleach) to 5 gallons of clean water. The sanitizing solution must be 50–200 ppm—do not exceed

the recommended strength. Chlorine test papers must be used on each batch of sanitizing solution to ensure a proper concentration of chlorine. Good ventilation is required when working with chlorine.

Toxic cleaning compounds and sanitizing agents should be properly labeled and stored in a manner that protects against contamination of food, food contact surfaces, or food packaging materials.

**USE REGULAR INSPECTION TO MAINTAIN THE QUAL-
ITY OF BRUSHES USED TO WASH APPLES.**

Washing efficiency is reduced when brushes are worn or not working correctly. Inspect, clean, and sanitize the brushes daily with an approved disinfectant to prevent accumulation of harmful microorganisms.

**MAINTAIN THE COOLING SYSTEM TO ENSURE PROPER
FUNCTIONING OF THE EQUIPMENT.**

Condensate dripping from cooling systems has been identified as a possible source of *Listeria* in a number of food processing operations. Therefore, it is essential that drainage from air-handlers and condensers is piped directly into the drains and not on the floor. Inspect all cooling equipment daily, remove all debris, and clean as necessary when in use.

V. Pest Control**ESTABLISH A PEST CONTROL SYSTEM.**

Animals, including mammals, birds, and insects, are potential sources of contamination in packing environments because they harbor or could spread pathogens. Apple packers should, therefore, have a pest control program in place that requires regular inspections and treatment of the packing facility by a trained pesticide applicator. The program should include regular and frequent monitoring of affected and treated areas to accurately assess the program’s effectiveness.

Maintain a pest control log that includes dates of inspection, inspection report, and steps taken to eliminate any problems. Establish frequent monitoring of affected and treated areas to determine the effectiveness of the treatment applied.

**USE OF PESTICIDES IS PERMITTED ONLY UNDER PRE-
CAUTIONS AND RESTRICTIONS THAT WILL PREVENT
THE CONTAMINATION OF FOOD OR PACKAGING MA-
TERIALS WITH ILLEGAL RESIDUES.**

All applicators must be trained and licensed. If a pesticide is applied within packing areas, precautions must be taken to protect raw ingredients and packaging materials. All food contact surfaces must be thoroughly cleaned and sanitized between pesticide spraying and the beginning of packing operations.

Pesticide chemicals should be labeled and stored in a manner that protects against contamination of food, food contact surfaces, or food packaging materials.

Pesticide regulations are constantly changing, and you must know the current status of regulations pertaining to the pesticides you use in and around your operation. For further information on insecticides and rodenticides, contact the Pennsylvania Department of Agriculture or your county Penn State Cooperative Extension office.

VI. Sanitation Facilities and Worker Hygiene

WORKERS SHOULD USE GOOD HYGIENIC PRACTICES.

To prevent contamination during packing operations, workers should maintain a high degree of cleanliness while on duty by thoroughly washing their hands before starting work, after breaks, and each time after using the toilet. Clean, warm water with soap should be used. Hands should be dried with hot air or disposable towels. Common or shared towels should not be used.

Establish a training program to teach workers good hygiene practices. All new workers should understand the importance of proper hand washing practices and general sanitation concerns.

ANY WORKER WHO HAS DIARRHEA, OR IS A CARRIER OF A COMMUNICABLE DISEASE THAT CAN BE TRANSMITTED BY FOOD, SHOULD NOT BE ALLOWED TO HANDLE APPLES.

Supervisors and workers should be aware of the presence of symptoms of infectious diseases or of skin boils, sores, or infected wounds so that if symptoms are evident, the supervisor can remove or reassign the worker.

ALL WASTEWATER MUST BE DRAINED PROPERLY INTO THE SEWER OR A SEPTIC SYSTEM SEPARATE FROM THE TOILET SYSTEM.

Consult your local or state health department about the proper disposal facility to be used.

VII. Transportation

INSPECT TRUCKS AND TRANSPORT CONTAINERS FOR CLEANLINESS, ODORS, AND OBVIOUS DIRT OR DEBRIS BEFORE BEGINNING THE LOADING PROCESS.

When receiving apples from an orchard, packers should be aware of previous loads carried in a transport vehicle. Trucks that were recently used to transport animals or animal products, for example, would increase the risk of contaminating apples if the trucks were not cleaned and sanitized before loading.

MAINTAIN PROPER TEMPERATURES TO HELP ENSURE BOTH THE QUALITY AND SAFETY OF APPLES.

Do not let apples sit in unrefrigerated trucks for excessively long periods of time. Refrigerated trucks should be precooled before apples are loaded. Containers of apples should be loaded in a manner that permits refrigerated air to circulate properly.

VIII. Product Traceback

DEVELOP A RECALL SYSTEM THAT ALLOWS TRACEBACK OF APPLES TO THE GROWER.

When apples are grown and packed in accordance with Good Manufacturing Practices for orchard and packing operations, the probability of a foodborne disease incident is low. In the event of an outbreak, however, it is in the packer's best interest to be able to trace apples back to a specific grower. The ability to identify the source of a product can help to prevent the occurrence of food safety problems and also may be useful in identifying and eliminating a hazardous pathway.

A recall system should include methods to identify, locate, and control the recalled product. Records should be kept that will identify a product by name, size, and lot number, which then should indicate the name and location of the grower and the amount and location of product produced, in inventory, and

distributed. Records also should be kept concerning control measures taken to ensure product safety, including standard operating procedures, washing and sanitizing methods, and monitoring records of refrigerated storage rooms. Records should be legible, permanent, accurate, and signed and dated by the responsible individual.

3. Cider Processing

Purpose

Because unpasteurized apple cider is not treated to eliminate harmful bacteria, Good Management Practices are necessary to minimize contamination during processing. Microbial contamination of apples during preharvest and harvest activities may result from contact with water, soils, fertilizers, manure, harvesting equipment, and workers who handle apples. Packing operations with poor sanitation procedures can significantly increase the risk of contaminating apples used for cider.

Important: Cider makers should determine if they are subject to a Food and Drug Administration (FDA) ruling that mandates specific procedures for application of Current Good Manufacturing Practices and development of Hazard Analysis Critical Control Point plans. Details are provided in this chapter under "Food Safety Regulations." In any case, cider makers are considered by the FDA to be food processors, and as such they should carefully read and follow Current Good Manufacturing Practice in Manufacturing, Packing, or Holding Human Food (21CFR 110). The guidelines in "Good Management Practices for Cider Processing" are offered to complement and emphasize the FDA requirements.

Potential hazards

Pathogenic microorganisms may be found on the floors and in the drains in the processing facility and on the surfaces of processing equipment. Without good sanitary practices, any of these surfaces that come in contact with apples or cider could be a potential source of microbial contamination. Workers who do not follow good hygiene practices may infect other workers and contaminate apples.

Apples intended for cider production may come from a variety of sources. Cider processors may have grown and packed the apples themselves or purchased them from outside growers or packers. Despite all sanitation measures during processing, cider may contain harmful levels of pathogens if contaminated apples are used. Cider processors must, therefore, be certain that apples were grown in accordance with Good Management Practices for Orchard Operations and handled in accordance with Good Management Practices for Packing Operations. By doing so, they maintain control throughout the growing, distribution, and processing system and minimize the risk of producing a contaminated product.

Since cider processors often use the same procedures used by apple packers (receiving, storing, dumping, washing, etc.) cider processors should follow Good Management Practices for Packing Operations as appropriate.

Preventive or corrective measures**I. Water Quality**

ALL PROCESSING AREAS MUST HAVE A SOURCE OF HOT AND COLD POTABLE RUNNING WATER WITH SUFFICIENT PRESSURE FOR ALL REQUIRED WASHING OF FRUIT AND EQUIPMENT AND DAILY FLOOR WASHING.

Municipal water is recommended. If nonmunicipal water is used, it must meet federal health standards for drinking water. In Pennsylvania, a private water source must be tested each year between August 15 and September 15 by a certified laboratory. Commercial, state, or local government laboratories should test water of unknown quality.

All modifications to the plumbing system should be completed by a licensed plumbing contractor and inspected for conformance with local building codes. All hoses inside and outside the plant should have anti-siphoning devices installed.

II. Building and Grounds

CIDER PROCESSING OPERATIONS MUST BE LOCATED IN A SEPARATE, ENCLOSED ROOM OR BUILDING.

The walls and ceiling of the processing room must be impervious, and the floors must be continuous concrete and have sufficient drains. Walls and ceilings should be light in color for easier cleaning and to provide better lighting on work surfaces. Drip or condensate from fixtures, ducts, and pipes should not be allowed to contaminate food or food contact surfaces.

GROUND AND BUILDINGS SURROUNDING THE CIDER OPERATION SHOULD BE FREE OF CONDITIONS THAT MAY RESULT IN PRODUCT CONTAMINATION.

Properly store unused equipment and hazardous chemicals and remove litter and waste. Tall grass and weeds may harbor rodents and other pests and should be cut regularly.

THE PROCESSING FACILITY SHOULD BE PROTECTED FROM INSECT AND RODENT ENTRY BY SCREENING OR OTHER PHYSICAL BARRIERS.

All windows, doors, and openings around the cider operation should be screened. Plastic curtains may be installed where forklifts enter storage areas. Temporary screened panels with a walkthrough can be used to frame in garage doors during cider season and can be removed in the off-season. Construct these temporary walls so that the garage door can be closed and opened as desired.

ADEQUATE LIGHTING MUST BE PROVIDED IN WORK AREAS.

Lighting should be sufficient for the work environment and to detect pests. Any interior lights must be shielded to prevent pieces of glass from getting into the product in the event of bulb or tube breakage.

REFRIGERATION FACILITIES SUFFICIENT TO KEEP CIDER STORED AT 32–38°F (AS CLOSE TO 32°F AS POSSIBLE) SHOULD BE AVAILABLE.

This will prevent growth of human pathogens as well as extend the product's shelf life.

III. Facilities and Equipment Sanitation

FACILITIES IN AND AROUND CIDER PROCESSING OPERATIONS ALWAYS SHOULD BE MAINTAINED IN A CLEAN CONDITION.

Discarded apples attract pests, which may spread harmful microorganisms. Clean floors and walls around processing operations daily to reduce the potential for microbial contamination. Clean product storage areas regularly and sanitize facilities as necessary. Do not allow standing water to accumulate in processing and storage areas.

ALL FOOD CONTACT EQUIPMENT MUST BE MADE OF FOOD-GRADE MATERIALS.

Use only stainless steel, food-grade plastic, or wood that is safe, durable, corrosion-resistant, nonabsorbent, and can be cleaned and sanitized easily. As soon as possible, phase out all non-hardwood porous woods and wood in poor condition that contacts the product. The design, construction, use, and general cleanliness of equipment can help reduce the risk of cross-contamination. Copper and copper alloys should not be used in contact with apple cider.

USE ONLY CLEAN AND SANITIZED EQUIPMENT AND CONTAINERS FOR PROCESSING AND STORAGE OF CIDER.

Clean and sanitize food contact surfaces daily with appropriate cleaning and sanitizing solutions. Thoroughly inspect containers before using and sanitize them thoroughly as necessary. After food contact surfaces are thoroughly cleaned, they should be sanitized with an FDA-approved sanitizer. A sanitizing solution can be prepared by mixing $\frac{3}{4}$ to $2\frac{1}{2}$ ounces of 5.25 percent available chlorine bleach (commercial liquid chlorine bleach) to 5 gallons of clean water. The sanitizing solution must be 50–200 ppm—do not exceed the recommended strength. Chlorine test papers must be used on each batch of sanitizing solution to ensure a proper concentration of chlorine. Good ventilation is required when working with chlorine.

STORE HAZARDOUS CHEMICALS IN A SAFE AND SECURE LOCATION.

Cleaners, sanitizers, and other hazardous chemicals should be properly labeled and stored in a manner that protects against contamination of food, food contact surfaces, or food packaging materials.

USE PRESS RACKS MADE ONLY OF FOOD-GRADE PLASTIC OR HARDWOOD PROPERLY COATED WITH PARAFFIN OR FOOD-APPROVED COATING.

Poorly maintained equipment is difficult to clean. Press racks must be kept off the floor at all times. As with the press cloths, the racks must be washed, sanitized, and dried in a well-ventilated, screened-off area at the end of each day's operation.

USE ONLY FILTER CLOTHS SPECIFICALLY DESIGNED FOR CIDER PRESSING, MADE OF DURABLE MATERIAL, AND REPLACED FREQUENTLY.

Sanitary handling of the cloths includes hanging them over a clean line or placing in a clean container between runs. Press cloths must be washed, rinsed, dipped in a sanitizing solution, and dried by hanging on a clean line in a well-ventilated, screened area free from flies and vermin. This should be done at the end

of each day's operation. Use only detergents that have been approved for use with food processing equipment.

TUBING USED IN THE CIDER OPERATION MUST BE APPROVED FOR FOOD USE, AND ANY PLASTIC TUBING MUST BE TRANSPARENT.

Tubing should never be placed on the floor. Tubing must be easily replaced and be protected from abrasion and breakage. Any tubing that passes through spaces that are not readily accessible must be of one piece and easily cleaned. As much as possible, keep the tubing continuous with as few couplings as possible. All tubing, clamps, couplings, and connections periodically must be disassembled, cleaned, and sanitized (tubing must be sanitized after each day's run). Position the tubing so that no pockets of liquid remain after rinsing.

EQUIPMENT AND SUPPLIES MUST BE STORED OFF THE FLOOR IN A CLEAN, DRY, INSECT- AND VERMIN-FREE AREA.

Cider containers must be stored in the original closed plastic bags and inverted with the open tops down to avoid environmental contamination. Thoroughly inspect equipment and containers before using and sanitize them thoroughly as necessary.

AFTER EACH DAY'S OPERATION, THOROUGHLY CLEAN ALL EQUIPMENT WITH CLEAN POTABLE WATER WITH ADEQUATE PRESSURE AND VOLUME TO REMOVE PARTICLES OF FRUIT AND FILM FROM ALL SURFACES.

Use of a suitable high-pressure washer is recommended for this purpose. Following this wash, dismantle all equipment as far as possible and clean and sanitize. Do not rinse after sanitizing. Air-dry the equipment on racks or in a well ventilated, screened area.

PROPERLY DISPOSE OF PRESSED POMACE IMMEDIATELY.

Prompt removal of pomace will help control insects and rodents that may spread human pathogens. Check with local authorities on the proper disposal of these materials. Do not leave pomace residue in processing areas overnight.

DURING THE OFF-SEASON, PRESS RACKS AND CLOTHS MUST BE STORED SO THAT BIRDS, ANIMALS, INSECTS, AND OTHER PESTS ARE UNABLE TO COME IN CONTACT WITH THEM.

Before storage, thoroughly clean, sanitize, dry, and wrap all racks and cloths. At no time should equipment, utensils, or chemicals (supplies) not used in cider processing be stored in the cider-processing or storage areas.

IV. Pest Control

ESTABLISH A PEST CONTROL SYSTEM.

Pests are potential sources of contamination in processing environments because they harbor or could spread a variety of pathogens. Cider processors should, therefore, have a pest control program in place that requires regular inspections and treatment of the processing facility by a trained pesticide applicator. The program should include regular and frequent monitoring of affected and treated areas to accurately assess the program's effectiveness.

Maintain a pest control log that includes dates of inspection,

inspection report, and steps taken to eliminate any problems. Establish frequent monitoring of affected and treated areas to determine the effectiveness of the treatment applied.

USE OF PESTICIDES IS PERMITTED ONLY UNDER PRECAUTIONS AND RESTRICTIONS THAT WILL PREVENT THE CONTAMINATION OF FOOD OR PACKAGING MATERIALS WITH ILLEGAL RESIDUES.

All applicators must be trained and licensed. If pesticide application takes place within the processing area, precautions must be taken to protect all raw ingredients and packaging materials. All food contact surfaces must be thoroughly cleaned and sanitized between pesticide spraying and commencement of food processing operations.

PESTICIDES SHOULD BE PROPERLY LABELED AND STORED IN A MANNER THAT PROTECTS AGAINST CONTAMINATION OF FOOD, FOOD CONTACT SURFACES, OR FOOD PACKAGING MATERIALS.

Pesticide regulations are constantly changing, and you must know the current status of regulations pertaining to the pesticides you use in and around your operation. For further information on insecticides and rodenticides, contact the Pennsylvania Department of Agriculture or your county Penn State Cooperative Extension office.

V. Sanitary Facilities and Worker Hygiene

WORKERS SHOULD USE GOOD HYGIENIC PRACTICES.

To prevent contamination during cider processing, workers should maintain a high degree of cleanliness appropriate for a food processing operation.

Establish a training program to teach workers good hygiene practices. All new workers should understand the importance of proper handwashing practices and general sanitation concerns.

All persons working in the processing area must wear clean outer garments while on duty. Hands must be thoroughly washed with clean, warm water and soap before starting work, after each absence from the working area, between operations, and at any other times the hands have become soiled. Common or shared towels should be not be used.

All jewelry, except wedding bands, should be removed. Hair restraints (hairnets, headbands, caps, etc.) must be worn. If gloves are used, they must be designed for food handling operations. The use of gloves does not exempt workers from using good hygiene practices. Whenever an individual changes from a food-contact or cleaning operation to a nonfood-contact operation, the person must replace gloves or thoroughly wash hands before resuming food-contact operations.

Tobacco use of any kind is prohibited in rooms where food or food ingredients are processed, handled, or stored.

SUPERVISORS AND WORKERS SHOULD BE AWARE OF THE PRESENCE OF SYMPTOMS OF INFECTIOUS DISEASES OR OF SKIN BOILS, SORES, INFECTED WOUNDS, OR OTHER ABNORMAL SOURCES OF MICROBIAL CONTAMINATION SO THAT IF SYMPTOMS ARE EVIDENT, THE SUPERVISOR CAN TAKE APPROPRIATE STEPS.

Any worker who has diarrhea or is a carrier of a communicable disease that can be transmitted by food should not be allowed to work in cider processing areas.

EACH CIDER PROCESSOR SHOULD PROVIDE ITS EMPLOYEES WITH ADEQUATE, READILY ACCESSIBLE TOILET FACILITIES.

Toilet facilities should be completely enclosed and conveniently located near the work area. Hot and cold running water and soap must be provided in the lavatory for hand washing. Disposable towels and covered trash containers also must be provided. A sign reminding employees to wash their hands before returning to work should be posted in the lavatory.

ALL WASTEWATER MUST BE DRAINED PROPERLY INTO THE SEWER OR A SEPTIC SYSTEM SEPARATE FROM THE TOILET SYSTEM.

Consult your local or state health department about the proper disposal facility to be used.

VI. Transportation

INSPECT TRUCKS AND TRANSPORT CONTAINERS FOR CLEANLINESS, ODORS, AND OBVIOUS DIRT OR DEBRIS BEFORE BEGINNING THE LOADING PROCESS.

Processors should be aware of previous loads carried in a transport vehicle and take this information into consideration when determining the use of a vehicle. Trucks that were recently used to transport animals or animal products, for example, would increase the risk of contaminating containers of cider if the trucks were not cleaned before loading.

MAINTAIN PROPER TEMPERATURES TO HELP ENSURE BOTH THE QUALITY AND SAFETY OF CIDER.

Do not let cider sit in unrefrigerated trucks for excessively long periods of time. Refrigerated trucks should be precooled before containers of cider are loaded. Containers should be loaded on the truck in a manner that permits adequate circulation of refrigerated air.

VII. Product Traceback

DEVELOP A RECALL SYSTEM THAT ALLOWS TRACEBACK OF CIDER FROM CONSUMPTION TO GROWER.

Following Good Management Practices will only minimize the probability of a foodborne disease outbreak. In the event of an outbreak, it is in the cider processor's best interests to have a system in place that will allow traceback of cider from the point of consumption to the processor, packer, and grower. The ability to identify the source of a product can help to prevent the occurrence of food safety problems and also may be useful in identifying and eliminating a hazardous pathway.

A recall system should include methods to identify, locate, and control recalled product. Records should be kept that will identify a product by name, size, and lot number, which then should indicate the amount and location of product produced, in inventory, and distributed. Records should include the control measures that were taken to ensure product safety, including sanitation, standard operating procedures, and monitoring records of refrigerated storage rooms.

The records should be legible, permanent, accurate, and signed and dated by the responsible individual.

Laboratory Testing

Laboratory testing of cider samples will not guarantee a safe product. Cider makers who follow Good Management Practices and apply HACCP principles in their operations (see next section) will have the best chance of producing a safe product. However, if you are going to test for microbes before making and marketing fresh, unpasteurized cider, *Escherichia coli* bacteria is a good indicator for the presence of pathogens. Take two or more of the worst samples from each orchard supplying freshly harvested apples. The samples must include individual apples normally discarded or trimmed free of disease or damage lesions. If these apples harbor *E. coli*, they probably have contaminated some sound apples that they may have touched after harvest. Whether you market unpasteurized or pasteurized cider, additional *E. coli* tests should be made to ensure that operators use hygienic practices and that the operational controls and daily cleanup practices maintain product safety.

Other microbial testing can be used to monitor populations of aerobic acidic bacteria, yeasts, and molds in the facility's environment (air, equipment, surfaces, etc.) and in the cider. Test results should first be used to develop proper operational and cleanup practices and later to confirm that the cider being made is safe and will have a good shelf life.

To develop proper operational practices, samples to be tested should be taken at startup, right after pressing the juice, just after cooling but before bottling, at two or more intervals of time from a single lot of cider stored at your site, and whenever uncertainty exists. Normal aerobic populations in freshly pressed, unpasteurized cider may have from 10,000 to 100,000 bacterial colonies per gram of cider. Normal yeast and mold populations range from 1,000 to 10,000 per gram. Potato dextrose agar acidified to a pH of 3.5 should be used in testing for aerobic populations of aciduric bacteria. Recently, test kits have become available to test *E. coli* in finished cider. For information, contact your county Penn State Cooperative Extension office.

A list of commercial laboratories in Pennsylvania that provide microbiological services is provided at the end of this chapter.

Food Safety Regulations

Federal regulations require cider processors to develop a HACCP plan and pasteurize their product if they:

- press and sell cider to other business entities (retail stores or wholesale distributors).
- press and sell cider to other individuals who then resell it (custom press).

Cider makers are exempt from the federal regulation if they:

- sell all the cider they press directly to consumers at their own farm stand or food-service operation.
- sell at an off-site farmer's market *and* sell the same product at the same location it was pressed.

In Pennsylvania, cider makers must register their operation with the Pennsylvania Department of Agriculture.

The following sections describe federal and state regulations that are designed to insure the safety of apples and apple products.

a. Current Good Manufacturing Practice in Manufacturing, Packing, or Holding Human Food (21 CFR Part 110)

Apple growers and packers are by legal definition considered to be engaged solely in the harvesting, storage, or distribution of raw agricultural commodities and therefore are not required to follow Good Manufacturing Practices (GMPs). However, peeling, coring, cutting, or extracting juice from apples are considered to be processing operations and are subject to GMPs. Implementation of GMPs in juice or cider facilities is covered under the new HACCP regulation and is described in more detail below.

Growers and packers should be aware that government agencies throughout the world are increasingly recommending that Good Agricultural Practices (GAPs) be followed to prevent food safety hazards from occurring on the farm or orchard and in packing houses. Food safety standards for safe growing and packing of fresh produce include FDA's "Guide to Minimizing Microbial Food Safety Hazards on Fresh Fruits and Vegetables" and the World Health Organization farm-to-fork standards in the "Codex Alimentarius—Recommended International Code of Practice General Principles Of Food Hygiene." Although these documents carry no regulatory authority, they are increasingly being used by buyers of fresh produce as sanitation and food safety standards that must be met as a condition of sale.

b. Food Labeling: Warning and Notice Statement; Labeling of Juice Products (21 CFR Part 101)

In 1998, the Food and Drug Administration (FDA) required that all fresh fruit juices that have not received a pasteurization treatment equivalent to a 5-log (1/100,000) reduction in harmful bacteria have a separate label that warns of the potential for product contamination. Since the ruling took effect in September 1999, all juice and cider processors have had to place the following statement on their product:

WARNING: This product has not been pasteurized and, therefore, may contain harmful bacteria that can cause serious illness in children, the elderly, and persons with weakened immune systems.

The label must have the word WARNING set in bold capitalized letters and a type size no less than 1/16 inch in height. The warning label must be set off in a "hairline" box from the rest of the label information.

If untreated juice products are sold in package form, they are required to bear the warning statement. However, untreated juice products sold in retail establishments (restaurants, delis, some grocery stores, and roadside stands) that are intended for immediate consumption and are not pre-packaged do not require warning statements. Although the FDA's jurisdiction is technically limited to interstate commerce, the regulation is being broadly enforced by local authorities to include intrastate distribution as well.

c. Hazard Analysis and Critical Control Point (HACCP); Procedures for the Safe and Sanitary Processing and Importing of Juice (21 CFR Part 120).

The Ruling

On January 19, 2001, the Food and Drug Administration issued a final ruling that requires juice processors, including some cider makers, to develop and implement a Hazard Analysis and Critical

Control Point (HACCP) plan that includes control measures sufficient to achieve a 5-log (99.999 percent) reduction in harmful pathogens. As of January 2004, all processors of fruit or vegetable juices (including apple cider), purees, or their concentrated products must comply, regardless of size. The regulation applies to juice products in both interstate and intrastate commerce.

It is important to understand that persons who produce cider and sell it to individual customers within their own retail operation (e.g., roadside stands or farmers markets) are exempt from the regulation. However, retail operations producing unpasteurized juice or cider must still adhere to Good Manufacturing Practices and bear the warning statement described above that informs at-risk consumers of the hazards associated with untreated juices. Exempt cider makers are also urged to voluntarily apply HACCP principles in their operations, especially when children or the elderly are potential customers.

HACCP Principles

A Hazard Analysis Critical Control Point (HACCP) plan is a systematic evaluation of the potential hazards that may occur in a food operation and identification of control methods to prevent those hazards from occurring. The concept was introduced in the 1960s by NASA as a means to prevent astronauts from contracting a foodborne illness while in outer space. Today, HACCP is widely recognized as the most effective way to prevent food contamination from occurring in a product. Meat, poultry, and seafood processors, and now juice processors, are required to develop HACCP plans.

In any HACCP plan, the following seven procedures must be applied:

1. A hazard analysis is conducted that describes all potential hazards that may occur and methods for their control. Potential hazards in juice products may include microbiological contamination, unlawful pesticide residues, natural toxins, unapproved use of food or color additives, presence of metal or glass fragments, and undeclared ingredients that may be allergens. The FDA has ruled that control measures for juice processing must include a treatment that ensures a 5-log reduction in harmful bacteria.
2. Critical control points (CCPs) are established for each of the identified food hazards that are reasonably likely to occur before, during, and after harvest and during processing. Typical CCPs in a cider making operation might include receipt of raw materials, pasteurization, and foreign matter detection.
3. Critical limits are then established that must be met at each of the critical control points; i.e., target levels and allowable tolerances that ensure the CCP is under control.
4. Procedures and the frequency with which they are to be performed are developed that will be used to monitor each of the critical control points to ensure compliance within the critical limits.
5. Corrective action plans are set in place that are to be followed when monitoring indicates that a particular CCP is not under control.
6. Procedures for verification that the HACCP system is working effectively are developed; and
7. A record-keeping system that documents the monitoring and verification of the critical control points is established.

Precise times and temperatures depend on the type of juice you make and the process you use. The Food and Drug Administration recommends that processors consult the scientific literature for information on effective pasteurization treatments. FDA specifically recommends that processors refer to the study “Thermal Inactivation of Stationary-Phase and Acid-Adapted *Escherichia coli* O157:H7, *Salmonella*, and *Listeria monocytogenes* in Fruit Juices,” by Alejandro S. Mazzotta (*Journal of Food Protection*, 1998, Vol. 64, No. 3, 2001, pages 315–320). Consult with an extension specialist in food science for assistance in determining an effective process for your product.

On November 29, 2000, FDA announced that it has approved the use of ultraviolet (UV) radiation to pasteurize juice and cider products (21 CFR 179.39). The ruling has specific requirements for the light source and the characteristics of the juice flowing through it.

For any type of pasteurization or equivalent nonthermal treatment used, juice processors must show evidence, as part of their HACCP plan, that it is effective in achieving a 5-log reduction and that they are operating their equipment correctly.

HACCP Prerequisites

For a HACCP plan to be effective, a strong foundation of safety-related prerequisite programs must be developed. Such programs are not specific to a single product, as is the case with CCPs. Instead, they serve to control the environment in which processing occurs. Prerequisite programs include implementation of Good Manufacturing Practices (21 CFR Part 110) as Sanitation Standard Operating Procedures (SSOP), recall programs, employee hygiene and training, product labeling and coding, facilities design, equipment maintenance, and equipment calibration. As part of a total food safety plan, they are documented and regularly verified for appropriateness and accuracy. The recommendations provided in this chapter as Good Management Practices for Cider Operations include the key features of the federally enforced GMP document. Nevertheless, cider processors are advised to obtain a copy of this regulation and make sure they comply with each point.

In their HACCP ruling, FDA has sought to emphasize the importance of Good Manufacturing practices by specifically requiring Sanitation Standard Operating Procedures (SSOPs) in several key sanitation areas, namely:

1. Safety of the water that comes into contact with food or food contact surfaces
2. Condition and cleanliness of food contact surfaces, including utensils, gloves, and outer garments
3. Prevention of cross-contamination from unsanitary objects to food, food packaging material, and other food contact surfaces, including utensils, gloves, and outer garments, and from raw product to processed product
4. Maintenance of hand washing, hand sanitizing, and toilet facilities
5. Protection of food, food packaging material, and food contact surfaces from adulteration with lubricants, fuel, pesticides, cleaning compounds, sanitizing agents, condensate, and other chemical, physical, and biological contaminants
6. Proper labeling, storage, and use of toxic compounds

7. Control of employee health conditions that could result in the microbiological contamination of food, food packaging materials, and food contact surfaces
8. Exclusion of pests from the food plant.

Developing a HACCP plan can be a challenging without assistance from experienced individuals. For this reason, the FDA requires that plans be developed by individuals who have successfully completed training in the application of HACCP principles to juice processing. Juice and cider makers, therefore, should contact an extension specialist in food science for information on upcoming training opportunities.

RECOMMENDED RESOURCES

Books and Pamphlets

Food Safety Begins on the Farm—A Grower’s Guide. Cornell University GAPs Team. 2000. 28 pp. Available online at www.gaps.cornell.edu

Guide to Minimize Microbial Food Safety Hazards for Fresh Fruits and Vegetables. U.S. Food and Drug Administration. 1999. 40 pp. Available online at www.fda.gov/Food/Guidance-ComplianceRegulatoryInformation/GuidanceDocuments/ProduceandPlanProducts/ucm064574.htm

Guidelines for Producing Unpasteurized Cider in Pennsylvania. L. LaBorde and R. Crassweller. Penn State University. 2003. 20 pp. Food safety and sanitation recommendations for cider makers. Available online at pubs.cas.psu.edu/Publications.asp.

HACCP: A Systematic Approach to Food Safety. 4th ed. Food Processors Institute. 2006. 220 pp.

Principles of Food Sanitation. N. G. Marriott. Aspen Publications. 1999. 364 pp.

Websites

Good Agricultural Practices—Farm Food Safety from Penn State

foodsafety.psu.edu/gaps

Information on farm food safety standards, the USDA GAP audit program, and upcoming training opportunities.

Food Safety for the Pennsylvania Apple Products Industries

extension.psu.edu/food-safety/courses/information/juice-haccp-resources

Links to food safety information for apple growers, packers, and juice and cider processors.

FDA Juice HACCP website

www.fda.gov/Food/FoodSafety/HazardAnalysisCriticalControl-PointsHACCP/JuiceHACCP/default.htm

HACCP and labeling regulations, activities, and training opportunities.

Penn State Workshops and Short Courses

The Penn State Sanitation Short Course—Prerequisites for Food Safety and Security

This three-day workshop on the science and technology of sanitation for food processors is offered every year in State College, Pennsylvania. Contact Dr. Luke LaBorde at 814-863-2298 or visit foodsafety.psu.edu for more information.

Food Safety and Sanitation for Food Manufacturers

A general food safety course for commercial food manufacturers offered on the Internet. For information, visit foodscience.psu.edu/e-learning.

Keeping Fresh Produce Safe Using Good Agricultural Practices

Visit foodsafety.psu.edu/gaps for upcoming trainings.

TREE FRUIT PRODUCTION BUDGETS

This section presents sample tree fruit budgets based on projected costs, technology, and management for the 2012 crop year.* Enterprise budgets represent estimates of the costs and returns associated with the production of specified agricultural products. The information contained in enterprise budgets can be used by agricultural producers, extension specialists, researchers, financial institutions, governmental agencies, and others for making decisions in the food and fiber industry. Budgets are used:

- for farm planning and enterprise evaluation
- as a basis for extending credit
- to complete cash flow projections
- to provide basic data for economic research
- to inform nonfarmers of the costs incurred in producing food and fiber crops†

To be most effective, a budget should be prepared with a specific objective in mind. The budgets in this section were prepared to provide general information for several different users and do not apply to individual orchards. They should be used, with appropriate modifications, as guides for preparing budgets in individual situations.

Seven types of tree fruit production budgets are included in this section. The first is a budget for land preparation (Table 9-1) and the second is for apple planting (Table 9-2, for both medium and high density). The remainder are mature orchard production budgets for fresh-market apples (Tables 9-3, with and without mating disruption), processing apples (Tables 9-4), fresh-market peaches (Tables 9-5), tart cherries (Tables 9-6), and sweet cherries (Tables 9-7). Nonbearing and intermediate production years are examples of other budgets that you could develop.

The budgets were developed based on a tree spacing of 6 feet by 8 feet (907 trees/A; trellised trees with drip irrigation) for fresh-market apples, 10 feet by 16 feet (272 trees/A; staked trees) for processing apples, 14 feet by 20 feet (155 trees/A) for peaches, 18 feet by 20 feet (121 trees/A) for tart cherries, and 20 feet by 24 feet (89 trees/A) for sweet cherries. In calculating returns above specified costs, harvest costs of \$1.50 per bushel for fresh market apples, \$2.80 per cwt. for processing apples, \$2.25 per bushel for peaches, \$0.10 per pound for tart cherries, and \$0.40 per pound for sweet cherries were used. The pesticides listed in the budgets are for example only; see Part III, Chemical Management, for a complete listing of recommended materials.

These sample budgets should help you ensure that all costs and receipts are included in your budget. Costs are often difficult to estimate in budget preparation because they are numerous and variable. Therefore, you should think of these budgets as a first approximation and then make appropriate adjustments using the “your estimate” column to add, delete, and adjust items to reflect your specific resource situation.

The sample budgets were developed using a computerized budget generator. Input data reflect current production practices and prices. Major subheadings in the budgets are receipts, variable costs, fixed costs, and total specified costs. They are defined as follows:

- Receipts are the gross returns (price times quantity) from production. For tree fruit, receipts may be zero for several years. Because yields, grades, and prices are so variable, you should use representative values for your operation.
- Variable costs are costs that vary depending on the level of production for such inputs as fertilizer, herbicides, insecticides, fungicides, and labor.
- Fixed costs are costs that do not vary by level of production and are incurred by virtue of owning assets such as machinery and land. Depreciation, insurance, and taxes are examples of fixed costs.
- Total specified costs are the sum of variable and fixed costs. A land charge of \$200/acre has been included in the budgets, but this charge can vary greatly from location to location. If you own the land you could include your principal, interest payments, and property taxes as a fixed cost. If you lease the land, then the annual rental cost could be included as a variable cost.

When you subtract receipts from total specified costs you get an estimate of your return to risk and management. This is the estimated profit attributable to your acceptance of risk and your contribution of management expertise. Cash flows over the life of the investment should be accounted for when assessing the overall profitability of the enterprise. Tree fruit production involves large initial investments and can be very risky; weather related crop losses are common and crop prices can be highly variable. Use of individual crop insurance policies for apples, peaches, and pears or whole-farm risk management tools such as AGR-Lite can help you reduce these risks.

*Thanks to Rob Crassweller, Noemi Halbrendt, Greg Krawczyk, Henry Ngugi, Jim Schupp, and Larry Hull for their assistance in updating and improving these budgets.

†For a more detailed discussion on the use of crop budgets, see G. L. Greaser and J. K. Harper, *Agricultural Alternatives: Enterprise Budget Analysis* (University Park: The Pennsylvania State University, 1995).

Table 9-1. Land preparation budget, tree fruit, Pennsylvania, 2012. Summary of estimated costs per acre.

Item	Unit	Price (\$)	Quantity	Amount (\$)	Your estimate*
VARIABLE COSTS					
Lime spreading	ton	12.20	1.00	12.20	_____
Grass seeding	acre	11.20	1.00	11.20	_____
Fertilizers/Soil Amendments					
N	pound	0.25	40.00	10.00	_____
P	pound	0.38	180.00	68.40	_____
K	pound	0.64	75.00	48.00	_____
Lime	ton	14.50	3.00	43.50	_____
Labor, seasonal	hour	12.00	25.00	300.00	_____
Labor, operator	hour	15.00	2.23	33.51	_____
Hard fescue seed	pound	2.85	30.00	85.50	_____
Diesel fuel	gallon	3.50	6.86	24.00	_____
Other _____	_____	_____	_____	_____	_____
_____	_____	_____	_____	_____	_____
_____	_____	_____	_____	_____	_____
_____	_____	_____	_____	_____	_____
Repairs and maintenance					
Tractors	acre		1.00	6.75	_____
Equipment	acre		1.00	9.60	_____
Interest on operating capital	acre		1.00	31.47	_____
Total variable costs				660.13	_____
FIXED COSTS					
Tractors	acre		1.00	13.95	_____
Equipment	acre		1.00	16.78	_____
Land charge	acre		1.00	200.00	_____
Total fixed costs				230.73	_____
Total specified costs				890.86	_____

* These budgets are examples only; use the "your estimate" column to adjust figures for your operation. Budget estimates are based on data available in August 2011.

Other potential costs:

	Per acre
Tree removal	\$750–\$1,500
Root and stump removal	\$500–\$1,000
Bulldozing, grading	\$500–\$1,000
Fumigation	\$1,000–\$2,000

Table 9-2. Apple orchard planting budgets, medium- and high-density orchards, Pennsylvania, 2012. Summary of estimated costs per acre.

Item	Unit	Price (\$)	Medium density (272 TPA)		High density (908 TPA)		Your estimate*
			Quantity	Amount (\$)	Quantity	Amount (\$)	
VARIABLE COSTS							
Apple trees	each	7.60	272.00	2,067.20	908.00	6,900.80	_____
Fertilizer							
N	pound	0.25	50.00	12.50	50.00	12.50	_____
Herbicides							
Gramoxone Inteon	gallon	32.83	0.31	10.26	0.31	10.26	_____
Solicam DF	pound	27.01	0.75	20.26	0.75	20.26	_____
Fungicides							
Captan 80W	pound	6.99	21.00	146.79	21.00	146.79	_____
Sulfur 90W	pound	0.68	24.00	16.32	24.00	16.32	_____
Streptomycin	pound	11.76			3.00	35.28	_____
Insecticides							
Admire Pro	ounce	3.19	4.20	13.40	4.20	13.40	_____
Warrior II	ounce	3.01	2.50	7.53	2.50	7.53	_____
Labor							
Regular	hour	13.50	9.00	121.50	45.00	607.50	_____
Seasonal	hour	12.00	10.00	120.00	7.38	88.50	_____
Operator	hour	15.00	4.49	67.42	17.90	268.50	_____
Other							
Deer repellent	each	0.75	272.00	204.00	908.00	681.00	_____
Tree guards	each	0.75	272.00	204.00	908.00	681.00	_____
Rodenticide	pound	1.00	10.00	10.00	10.00	10.00	_____
Drip tape	foot	0.03			3,111.00	93.33	_____
Diesel fuel	gallon	3.50	15.14	53.00	75.00	262.53	_____
Trellis/support system							
Crimping tool	each	58.00			1.00	58.00	_____
Anchors/tensioners	each	20.00			51.00	1,020.00	_____
End posts	each	17.48			34.00	594.32	_____
Posts	each	13.40			85.00	1,139.00	_____
Wire	1,000 ft	24.00			14.52	348.48	_____
Wire connectors	each	0.16			69.00	11.04	_____
Staples	each	0.11			100.00	11.00	_____
Tree stakes	each	6.50	272.00	1,768.00			_____
Tree ties	each	0.12	544.00	65.28	1,816.00	217.92	_____
Repairs and maintenance							
Tractors	acre		1.00	11.15	1.00	53.72	_____
Equipment	acre		1.00	18.20	1.00	156.52	_____
Interest on operating capital	acre		1.00	244.35	1.00	645.00	_____
Total variable costs				5,181.16		14,110.50	_____
FIXED COSTS							
Tractors	acre		1.00	23.65	1.00	111.85	_____
Equipment	acre		1.00	46.80	1.00	369.53	_____
Land charge	acre		1.00	200.00	1.00	200.00	_____
Total fixed costs				270.45		681.38	_____
Total specified costs				5,451.61		14,791.88	_____

* These budgets are examples only; use the "your estimate" column to adjust figures for your operation. Budget estimates are based on data available in August 2011.

Table 9-3. Fresh-market apple production budgets, 908 trees per acre, with and without mating disruption, Pennsylvania, 2012. Summary of estimated costs per acre.

Item	Unit	Price (\$)	Without mating disruption		With mating disruption		Your estimate*
			Quantity	Amount (\$)	Quantity	Amount (\$)	
RECEIPTS	bushel						
VARIABLE COSTS							
Lime	ton	26.70	0.50	13.35	0.50	13.35	
Fertilizer							
N	pound	0.25	20.00	5.00	20.00	5.00	
P	pound	0.38	30.00	11.40	30.00	11.40	
K	pound	0.32	30.00	9.60	30.00	9.60	
Urea (spray additive)	pound	0.25	2.50	0.63	2.50	0.63	
Solubor	pound	1.88	6.00	11.28	6.00	11.28	
Calcium chloride	pound	0.44	50.00	22.00	50.00	22.00	
Herbicides							
2,4-D amine	gallon	14.82	0.23	3.47	0.23	3.47	
Gramoxone Inteon	gallon	32.83	0.08	2.56	0.08	2.56	
Princep 90DF	pound	5.70	0.75	4.28	0.75	4.28	
Solicam 80DF	pound	27.01	0.75	20.26	0.75	20.26	
Fungicides							
Captan 80W	pound	6.99	23.00	160.77	23.00	160.77	
Flint 50WG	ounce	10.79	2.50	26.98	2.50	26.98	
Inspire Super	ounce	1.70	20.00	34.00	20.00	34.00	
Kocide 3000	pound	10.00	7.00	70.00	7.00	70.00	
Penncozeb DF	pound	3.62	15.00	54.30	15.00	54.30	
Streptomycin	pound	11.76	9.00	105.84	9.00	105.84	
Sulfur 90W	pound	0.68	12.00	8.16	12.00	8.16	
Topguard	pound	6.88	26.00	178.88	26.00	178.88	
Pristine 38WG	ounce	3.11	37.00	115.07	37.00	115.07	
Insecticides/Mating Disruption**							
Actara	ounce	3.15			5.00	15.75	
Agri-Mek	ounce	1.59	10.00	15.90	10.00	15.90	
Altacor	ounce	11.79	2.50	29.48	3.00	35.37	
Assail 30SG	ounce	5.76	5.00	28.80	5.00	28.80	
Avaunt 30WDG	ounce	6.00	6.00	36.00	6.00	36.00	
Calypso	ounce	2.66	6.00	15.96	6.00	15.96	
Delegate WG	ounce	7.44	10.20	75.89	5.10	37.94	
Isomate CM-OFM TT	each	0.61			200.00	122.00	
Lannate 90SP	pound	29.01	2.25	65.27	1.50	43.52	
Lorsban Advanced	gallon	41.30	0.38	15.49	0.38	15.49	
Voliam Flexi	ounce	7.92	6.00	47.52	6.00	47.52	
dormant oil	gallon	16.20	4.00	64.80	4.00	64.80	
Labor							
Trellis maintenance	acre	82.00	1.00	82.00	1.00	82.00	
Pest scouting	acre	35.00	1.00	35.00	1.00	35.00	
Thinning***	hour	12.00	20.00	240.00	20.00	240.00	
Operator	hour	15.00	5.68	85.28	5.68	85.28	
Misc. seasonal	hour	12.00	3.94	47.25	5.06	60.75	
Pruning	tree	0.25	908.00	227.00	908.00	227.00	
Harvesting	bushel	1.50	800.00	1,200.00	800.00	1,200.00	
Other							
Bee rental	acre	75.00	1.00	75.00	1.00	75.00	
Insect traps	acre	16.00	1.00	16.00	1.00	16.00	
Plant growth regulators****	acre	375.00	1.00	375.00	1.00	375.00	
Rodenticide	pound	1.00	10.00	10.00	10.00	10.00	
Diesel fuel	gallon	3.50	61.15	214.07	60.32	211.18	
Repairs and maintenance							
Tractors	acre		1.00	38.56	1.00	38.56	
Equipment	acre		1.00	111.88	1.00	110.62	
Interest on operating capital	acre		1.00	126.36	1.00	128.94	
Total variable costs				4,136.39		4,232.26	
FIXED COSTS							
Tractors	acre		1.00	80.52	1.00	80.52	
Equipment	acre		1.00	275.44	1.00	272.45	
Land charge	acre		1.00	200.00	1.00	200.00	
Total fixed costs				555.96		552.97	
Total specified costs				4,692.35		4,785.23	

* These budgets are examples only; use the "your estimate" column to adjust figures for your operation. Budget estimates are based on data available in August 2011.

** Additional insecticide sprays may be required for control of brown marmorated stink bug. Insecticides such as Belay, Danitol, Actara, and Lannate 90SP provide control for a cost of approximately \$15–22/A for each additional spray (plus application cost).

*** Assuming chemical thinning in addition to hand thinning.

**** See Tables 1-17 and 1-18 for alternative growth regulators used in apples. Depending on the thinning, growth control, and harvest management program used, plant growth regulator costs could vary from \$0 to more than \$500 per acre.

Table 9-4. Processing apple production budget, 272 trees per acre, Pennsylvania, 2012. Summary of estimated costs per acre.

Item	Unit	Price (\$)	Quantity	Amount (\$)	Your estimate*
RECEIPTS	cwt				
VARIABLE COSTS					
Lime	ton	26.70	0.50	13.35	
Fertilizer					
N	pound	0.25	20.00	5.00	
P	pound	0.38	30.00	11.40	
K	pound	0.32	30.00	9.60	
Urea (spray additive)	pound	0.25	2.50	0.63	
Solubor	pound	1.88	6.00	11.28	
Calcium chloride	pound	0.44	50.00	22.00	
Herbicides					
2,4-D amine	gallon	14.82	0.23	3.47	
Gramoxone Inteon	gallon	32.83	0.08	2.56	
Princep 90DF	pound	5.70	0.75	4.28	
Solicam 80DF	pound	27.01	0.75	20.26	
Fungicides					
Captan 80W	pound	6.99	27.00	188.73	
Fiint 50WG	ounce	10.79	5.00	53.95	
Kocide 3000	pound	10.00	7.00	70.00	
Manzate Pro Stik	pound	5.01	3.00	15.03	
Penncozeb DF	pound	3.62	12.00	43.44	
Rally 40W	ounce	3.60	10.00	36.00	
Streptomycin	pound	11.76	6.00	70.56	
Sulfur 90W	pound	0.68	18.00	12.24	
Topsin-M 70WSB	pound	11.84	2.00	23.68	
Insecticides**					
Actara	ounce	3.15	5.00	15.75	
Agri-Mek	ounce	1.59	10.00	15.90	
Altacor	ounce	11.79	3.00	35.37	
Assail 30SG	ounce	5.76	5.00	28.80	
Avaunt 30WDG	ounce	6.00	6.00	36.00	
Calypso	ounce	2.66	6.00	15.96	
Delegate WG	ounce	7.44	10.20	75.89	
Lannate 90SP	pound	29.01	1.50	43.52	
Lorsban Advanced	gallon	41.30	0.38	15.49	
Voliam Flexi	ounce	7.92	6.00	47.52	
dormant oil	gallon	16.20	4.00	64.80	
Labor					
Pest scouting	acre	35.00	1.00	35.00	
Thinning***	hour	12.00	20.00	240.00	
Operator	hour	15.00	6.25	93.68	
Pruning	tree	1.50	272.00	408.00	
Harvesting	cwt	2.80	300.00	840.00	
Other					
Bee rental	acre	75.00	1.00	75.00	
Insect traps	acre	16.00	1.00	16.00	
Plant growth regulators****	acre	375.00	1.00	375.00	
Rodenticide	pound	1.00	10.00	10.00	
Diesel fuel	gallon	3.50	29.11	101.94	
Repairs and maintenance					
Tractors	acre		1.00	17.32	
Equipment	acre		1.00	30.84	
Interest on operating capital	acre		1.00	105.27	
Total variable costs				3,120.91	
FIXED COSTS					
Tractors	acre		1.00	35.77	
Equipment	acre		1.00	68.71	
Land charge	acre		1.00	200.00	
Total fixed costs				304.48	
Total specified costs				3,425.02	

* These budgets are examples only; use the "your estimate" column to adjust figures for your operation. Budget estimates are based on data available in August 2011.

** Additional insecticide sprays may be required for control of brown marmorated stink bug. Insecticides such as Belay, Danitol, Actara, and Lannate 90SP provide control for a cost of approximately \$15–22/A for each additional spray (plus application cost).

*** Assuming chemical thinning in addition to hand thinning.

**** See Tables 1-17 and 1-18 for alternative growth regulators used in apples. It is assumed in this budget that all fruit thinning will be done with plant growth regulators. Depending on the thinning, growth control, and harvest management program used, plant growth regulator costs could vary from \$0 to more than \$500 per acre.

Table 9-5. Mature fresh-market peach orchard budget, 155 trees per acre, Pennsylvania, 2012. Summary of estimated costs per acre.

Item	Unit	Price (\$)	Quantity	Amount (\$)	Your estimate*
RECEIPTS	bushel				
VARIABLE COSTS					
Lime	ton	26.70	0.50	13.35	
Fertilizer					
N	pound	0.25	30.00	7.50	
P	pound	0.38	30.00	11.40	
K	pound	0.32	30.00	9.60	
Herbicides					
2,4-D amine	gallon	14.87	0.23	3.47	
Gramoxone Inteon	gallon	32.83	0.08	2.56	
Karmex DF	pound	8.26	0.50	4.13	
Sinbar WDG	pound	48.66	0.50	24.33	
Fungicides					
Bravo Weather Stik	gallon	30.53	2.44	74.42	
Captan 80W	pound	6.99	10.00	69.90	
Kocide 3000	pound	10.00	5.00	50.00	
Lime sulfur	gallon	17.86	2.50	44.65	
Indar 2F	ounce	1.98	30.00	59.40	
Mycoshield	pound	13.44	7.50	100.80	
Pristine 38WG	ounce	3.11	12.00	37.32	
Sulfur 90W	pound	0.68	30.00	20.40	
Insecticides/mating disruption**					
Admire Pro	ounce	3.19	2.10	6.70	
Assail	ounce	5.76	12.00	69.12	
Isomate OFM M-100	each	0.30	100.00	30.00	
Isomate PTB Dual	each	0.41	150.00	61.50	
Lannate 90 SP	pound	29.01	1.69	49.00	
Voliam Express	ounce	3.85	9.00	34.65	
Voliam Flexi	ounce	7.92	6.00	47.52	
Warrior II	ounce	3.01	2.50	7.53	
Labor					
Pest scouting	acre	35.00	1.00	35.00	
Hand thinning***	hour	12.00	15.00	180.00	
Operator	hour	15.00	7.65	114.68	
Pruning	tree	2.25	155.00	348.75	
Harvesting	bushel	2.25	275.00	618.75	
Other					
Bee rental	hive	75.00	1.00	75.00	
Insect traps	acre	16.00	1.00	16.00	
Rodenticide	pound	1.00	10.00	10.00	
Diesel fuel	gallon	3.50	26.74	93.65	
Repairs and maintenance					
Tractors	acre		1.00	17.72	
Equipment	acre		1.00	37.15	
Interest on operating capital	acre		1.00	85.78	
Total variable costs				2,471.77	
FIXED COSTS					
Tractors	acre		1.00	36.60	
Equipment	acre		1.00	79.18	
Land charge	acre		1.00	200.00	
Total fixed costs				315.78	
Total specified costs				2,787.55	

* These budgets are examples only; use the "your estimate" column to adjust figures for your operation. Budget estimates are based on data available in August 2011.

** Additional insecticide sprays may be required for control of brown marmorated stink bug. Insecticides such as Belay, Danitol, Actara, and Lannate 90SP provide control for a cost of approximately \$15–22/A for each additional spray (plus application cost).

*** Fruit thinning is assumed to be done with a combination of string thinning and hand thinning.

Table 9-6. Mature tart cherry orchard budget, 121 trees per acre, Pennsylvania, 2012. Summary of estimated costs per acre.

Item	Unit	Price (\$)	Quantity	Amount (\$)	Your estimate*
RECEIPTS	pound				
VARIABLE COSTS					
Lime	ton	26.70	0.50	13.35	
Fertilizer					
N	pound	0.25	60.00	15.00	
P	pound	0.38	30.00	11.40	
K	pound	0.32	30.00	9.60	
Herbicides					
2,4-D amine	gallon	14.82	0.23	3.47	
Gramoxone Inteon	gallon	32.83	0.08	2.56	
Princep 90DF	pound	5.70	0.75	4.28	
Solicam 80DF	pound	27.01	0.75	20.26	
Fungicides					
Bravo Weather Stik	gallon	30.53	1.50	45.80	
Captan 80W	pound	6.99	5.00	34.95	
Elite 45DF	pound	58.75	0.75	44.06	
Indar 2F	ounce	1.98	18.00	35.64	
Insecticides					
Assail	ounce	5.76	12.00	69.12	
Avaunt	ounce	6.00	6.00	36.00	
Imidan 70WSP	pound	9.75	4.00	39.00	
Lorsban Advanced	gallon	41.30	0.50	20.65	
Sevin XLR Plus	gallon	47.82	0.50	23.91	
Warrior II	ounce	3.01	2.50	7.53	
Labor					
Pest scouting	acre	35.00	1.00	35.00	
Operator	hours	15.00	7.16	107.39	
Other					
Ethephon 2E	gallon	40.38	0.13	5.05	
Shaking	pound	0.15	8,000.00	1,200.00	
Rodenticide	pound	1.00	10.00	10.00	
Diesel fuel	gallon	3.50	24.89	87.15	
Repairs and maintenance					
Tractors	acre		1.00	15.86	
Equipment	acre		1.00	26.92	
Interest on operating capital	acre		1.00	38.17	
Total variable costs				1,962.15	
FIXED COSTS					
Tractors	acre		1.00	32.77	
Implements	acre		1.00	59.35	
Land charge	acre		1.00	200.00	
Total fixed costs				292.12	
Total specified costs				2,254.27	

* These budgets are examples only; use the "your estimate" column to adjust figures for your operation. Budget estimates are based on data available in August 2011.

Table 9-7. Mature sweet cherry orchard budget, 89 trees per acre, Pennsylvania, 2012. Summary of estimated costs per acre.

Item	Unit	Price (\$)	Quantity	Amount (\$)	Your estimate*
RECEIPTS	pound				
VARIABLE COSTS					
Lime	ton	26.70	0.50	13.35	
Fertilizer					
N	pound	0.25	60.00	15.00	
P	pound	0.38	30.00	11.40	
K	pound	0.32	30.00	9.60	
Herbicides					
2,4-D amine	gallon	14.82	0.23	3.47	
Gramoxone Inteon	gallon	32.83	0.08	2.56	
Princep 90DF	pound	5.70	0.75	4.28	
Solicam 80DF	pound	27.01	0.75	20.26	
Fungicides					
Bravo Weather Stik	gallon	30.53	2.00	61.06	
Elite 45DF	pound	58.75	0.75	44.06	
Indar 2F	ounce	1.98	18.00	35.64	
Pristine 38WG	ounce	3.11	24.00	74.64	
Insecticides					
Assail	ounce	5.76	6.00	34.56	
Avaunt	ounce	6.00	6.00	36.00	
Lorsban Advanced	gallon	41.30	0.50	20.65	
Sevin XLR Plus	gallon	47.82	0.50	23.91	
Warrior II	ounce	3.01	5.00	15.05	
Labor					
Operator	Hours	15.00	6.66	99.89	
Pruning	tree	1.50	89.00	133.50	
Hand harvest	pound	0.40	4,000.00	1,600.00	
Other					
Diesel fuel	gallon	3.50	21.59	75.59	
Rodenticide	pound	1.00	10.00	10.00	
Repairs and maintenance					
Tractors	acre		1.00	14.26	
Equipment	acre		1.00	23.50	
Interest on operating capital	acre		1.00	80.88	
Total variable costs				2,498.15	
FIXED COSTS					
Tractors	acre		1.00	29.47	
Equipment	acre		1.00	51.59	
Land charge	acre		1.00	200.00	
Total fixed costs				281.06	
Total specified costs				2,779.21	

* These budgets are examples only; use the "your estimate" column to adjust figures for your operation. Budget estimates are based on data available in August 2011.

STATE AND FEDERAL LAWS THAT APPLY TO FARM LABOR

This section is intended to provide accurate and timely information on some, but not all, of the issues regarding farm labor. As time passes, some of this information may no longer be accurate, and the reader is cautioned to be aware of that. The material is not intended to provide legal, accounting, or other professional advice and should not be relied upon as such or as a substitute for such advice. Growers who desire such advice should seek independent professional counsel before acting on any information contained in this section.

Preliminary Considerations

Is a Worker an Employee or an Independent Contractor?

As will be seen in the following pages, when a worker is considered an employee, the worker's employer assumes certain obligations to both the employer and the government. What if a person who provides services to another is not an employee, but rather is in some type of classification other than an employee? Not all working relationships meet the requirements of an employer-employee relationship, and other relationships are recognized. Some employers try to classify their relationships under one category or the other to gain what they believe to be an advantage over the other relationship. The following discussion examines three of the main rules that distinguish the relationship of an employer-employee from that of an employer-independent contractor. These rules relate to important concepts about the nature of the workplace relationship and the importance of clarifying the relationship before a worker begins work.

A. Common Law

In common law, the prevailing distinction between an employer and those workers who provide a service to the employer was couched in terms of master-servant and principal and agent relationships. In defining the terms "master" and "servant," the central distinction focused on the right of the master to control the worker's physical performance of a desired service. If the master retained the right to control the physical conduct of the worker while performing assigned duties, the worker was classified as a *servant*. The absence of the master's right to control resulted in classifying the worker as an *independent contractor*.

In determining whether a worker is a servant or an independent contractor, several factors are considered, such as the following:

1. The extent of control the master may exercise over the details of the work
2. Whether the one employed is engaged in a distinct occupation or business
3. The kind of occupation with reference to whether, in the locality, the work is usually done under the direction of the employer or by a specialist without supervision
4. The skill required in the particular occupation
5. Whether the employer or the worker supplies the tools and the place where work is performed
6. The length of time for which the person is employed
7. The method of payment, whether by the time or by the job

8. Whether the work is part of the regular business of the employer
9. Whether the parties believe they are creating the relation of master and servant
10. Whether the master operates a business

B. The Internal Revenue Code

As will be seen in later pages, the Internal Revenue Code imposes obligations on employers to withhold a portion of an employee's pay as income tax withheld. In addition, the employer pays an additional amount that is based on the employee's earnings toward the employee's withheld income taxes. In this situation the burden of the income tax is shared between the employer and employee. If the relationship is that of an employer-independent contractor, the contractor is responsible for paying all income taxes without sharing with anyone else. Therefore, the relationship of employer-employee triggers important tax-paying obligations. Under current tax law, the relationship of employer and employee exists when the person for whom services are performed has the right to control and direct the individual who performs the services, not only as to the result to be accomplished by the work, but also as to the details and means by which that result is accomplished. Employees are those who are subject to the will and control of an employer, not only as to what is done, but also how it is done. It is not necessary that the employer actually direct or control the manner in which the services are performed; it is sufficient if the employer has the right to do so. If the employer-employee relationship exists, the description that the parties give to it will be of no consequence.

In agricultural relationships, there have been a variety of relationships that have not been considered employer-employee relationships, such as crop-share rental arrangements, which are not considered to be employer-employee relationships. In such cases, two or more parties produce agricultural commodities on a parcel of land owned by one of them. One party plants and manages the production and all parties agree to share the production between the landowner and the production manager. In many cases, the amount of the share is dependent on the volume produced. In those cases the worker is considered to be self-employed and not an employee.

As an aid to deciding whether an individual is an employee, the Internal Revenue Service has listed twenty factors or elements that can be used as a guide to determine whether sufficient control is present to be an employer-employee relationship. Among all of the factors, the importance to be given to any one of them will vary according to the occupation performed and the factual context in which the service is performed. These 20 factors are:

1. Instructions. Control is present if the person for whom the services are performed has the right to require compliance with instructions.
2. Training. Training a worker through various means indicates that the person for whom the services are provided wants the services to be provided in a particular method or manner.
3. Integration. Integration of the worker's services into the business operations of the person for whom the services are provided generally shows that the worker is subject to direction and control. If the success or continuation of a business depends upon the performance of certain services,

the workers who perform those services must necessarily be subject to a certain amount of control by the owner of the business.

4. Rendering services personally. If services must be performed personally, it is presumed that the person for whom the services are performed is interested in the methods used to accomplish the results.
5. Hiring, supervising, and paying assistants. If the person for whom the work is performed hires, supervises, and pays assistants to work with the person who provides the service, this factor generally indicates control over the workers on the job. If the person performing the work performs these tasks, that factor is indicative of an independent contractor.
6. Continuing relationship. A continuing relationship, even one that occurs at frequent yet regular intervals, is indicative of an employer-employee relationship.
7. Set hours of work. The establishment of set hours of work by the person for whom services are performed is a factor indicating control.
8. Full time required. A worker who must devote substantially full time to providing service to another is impliedly under the control of the person for whom the services are provided.
9. Doing work on the employer's premises. Work performed on the premises of the person for whom the services are performed is generally under the control of that person. This fact alone is not indicative, however.
10. Order of sequence set. The person who establishes the order or sequence in which work is to be done generally has the authority to control the person who provides the service.
11. Oral or written reports. Requiring regular or written reports to the person for whom the work is provided is indicative of a degree of control over the worker.
12. Pay by the hour, week, or month. These facts point to an employer-employee relationship, provided that the method of payment is not just a convenient way to pay a lump sum agreed upon as the cost of the job.
13. Payment of business and/or travel expenses. Payment of these expenses is generally indicative of an employer-employee relationship.
14. Furnishing tools and materials. Supplying significant tools, materials, and other equipment tends to show the existence of an employer-employee relationship.
15. Significant investment. A worker's significant investment in the facilities used to perform the services indicates an independent contractor relationship.
16. Realizing profit or loss. A worker who can realize a profit or suffer a loss as a result of the worker's actions is generally an independent contractor. However, the risk that a worker will not receive payment for services provided is a risk that is common to employees and independent contractors.
17. Working for more than one firm. Performing more than de minimis services for a multitude of unrelated persons at the same time is generally indicative of an independent contractor.

18. Making services available to the public. Making services available to the general public on a regular and consistent basis is indicative of an independent contractor.
19. Right to discharge. Having the right to discharge a worker is indicative of the right of an employer.
20. Right to terminate. If a worker has the right to end his or her relationship with the person to whom the work is provided, at any time and without incurring liability, that is indicative of an employer-employee relationship.

C. The Fair Labor Standards Act of 1938

As later discussions will show, the Fair Labor Standards Act governs minimum wages, overtime pay, employer record keeping, and child labor issues. In determining whether a worker is an employee or an independent contractor for the many issues in which the answer to the question is important, the U.S. Department of Labor applies an "Economic Reality" test to the facts of the relationship between the person providing service and the person to whom it is provided. Under this test the following factors are considered:

1. The degree to which the worker has the right to control the results to be accomplished (What shall be done?) and the manner in which the work is to be performed (How shall it be done?)
2. The degree to which the employer determines the worker's opportunity for profit and loss
3. The degree of skill, training, and independent initiative required to perform the work
4. The permanency, exclusivity, or duration of the working relationship
5. The extent to which the work is an integral part of the employer's business
6. The extent of the worker's investment in equipment or materials required for his or her task

Among these factors, no single factor is considered to be controlling. Additional factors, such as the intent of the parties and the terms of any contract or agreement, are also considered. In analyzing the factors, the central question to be answered is whether, under the facts and circumstances of the total situation, including the risk undertaken, control exercised and the opportunity for profit from sound management, the economic reality is that the worker can be characterized as an independent contractor rather than an employee.

Hiring Considerations

Pennsylvania's New Hire Reporting Program

All Pennsylvania employers, including agricultural employers, are required to comply with the state's New Hire Reporting Program. This program was created through an amendment to the Domestic Relations Act and is similar to those of other states. It is designed to provide a registry of all employed persons within the state in order to facilitate child support enforcement.

Information regarding the program was sent by the Commonwealth to over 250,000 Pennsylvania employers. However, because farmers are exempt from many of the taxes and reports from which databases are assembled, most agricultural employers

probably did not make the address list. The following information is only a partial description of the program. The official guide to the reporting requirements can be obtained from the New Hire Reporting Program at the address below. Any questions about the program should be directed to the New Hire Reporting Program at the phone number listed below, or to a qualified attorney familiar with the program.

Who is an “employer” that must comply?

All employers, regardless of size or type of business, must comply with the New Hire Reporting Program. This includes agricultural employers who may be exempt from other labor requirements.

Who is an “employee” for purposes of the program?

Under the New Hire Reporting program, an “employee” is any person working for an employer, regardless of the person’s age, hours worked, or wages earned. This includes officers of a corporation. An independent contractor is not considered an “employee” under the program. For new hire reporting purposes, a person is an employee and not an independent contractor if the employer:

- Must require a W-4 form under applicable law
- Must provide a W-2 form under applicable law
- Must pay Pennsylvania Unemployment Compensation Tax under applicable law
- Must pay Pennsylvania Workers’ Compensation under applicable law

Required information

In order to comply with the program, an employer is required to report within 20 days of hire the following information regarding each employee hired on or after January 1, 1998:

- Name
- Home address
- Social Security Number
- Date of birth
- Date of hire

Information must be filed not only for new employees, but also for rehired employees who have been terminated, laid off, furloughed, separated, or granted leave without pay for more than 30 days. For these rehired employees, the date of hire is the date of the latest rehire.

The report must also include the following information regarding the employer:

- Name
- Address
- Federal Employer Identification Number (FEIN, the identifying number assigned to the employer for federal tax purposes)
- Name of employer contact person
- Telephone number of employer contact person

If the employer so chooses, a report can be filed by simply attaching the date of hire and name and telephone number of an employer contact to the W-4 form submitted for the newly hired employee.

Methods of reporting

Information can be recorded on paper, diskette, cartridge, or magnetic tape and sent to the New Hire Reporting Program via first-class mail. Paper records can also be sent via fax. An additional method of reporting is via the Internet. Detailed instructions regarding all of these methods are available from the New Hire Reporting Program, and an employer should consult these instructions before making a report using any method. Regardless of the reporting method chosen by the employer, an employee’s information must be submitted no later than 20 days from the date of hire of the employee, as stated above. If an employer chooses any nonpaper method, that employer should submit two monthly reports no less than 12 days nor more than 16 days apart.

Multistate employers

If an employer has employees in more than one state, that employer only has to send reports to the new hire program of one of those states. For example, if an employer has some employees that work in Pennsylvania and some that work in Maryland, that employer only has to report the required information to the new hire program in Maryland or the new hire program in Pennsylvania, not both. However, the employer must report the information of all employees, regardless of the state in which they work, and multistate reports can only be made by diskette, cartridge, magnetic tape, or over the Internet, not by paper.

A multistate employer who chooses to file a multistate report must notify the U.S. Secretary of Health and Human Services in writing as to which state the new hire information is being sent, and must send a copy of the notification letter to the Pennsylvania New Hire Reporting Program, regardless of which state will receive the reports. The notification letter must include all of the following:

- Employer’s name
- Employer’s FEIN
- Employer’s phone number
- State selected for receipt of reports
- All states where the employer has employees
- Employer contact name
- Employer contact phone number

This notification requirement is for the purpose of maintaining the National Directory of New Hires in accordance with the Federal Welfare Reform Act of 1997.

Authorized uses of the information

The primary use of the new hire information will be to facilitate the enforcement of child support obligations under the Federal Welfare Reform Act of 1997, but the information will also be used to administer the workers’ compensation and unemployment compensation programs of the Pennsylvania Department of Labor and Industry. Any further use of the information by government employees or agencies is prohibited.

Penalties

If an employer fails to report or falsely reports the required information, the employer will be subject to the following penalties:

- For the first violation, a written warning.

- For the second and each subsequent violation, a civil penalty up to \$25.
- If the failure to report or the submission of a false report is the result of a conspiracy between the employer and employee, a civil penalty up to \$500.

Important addresses, phone numbers

An information packet, including detailed instructions for each method of reporting, can be obtained by contacting the Pennsylvania New Hire Reporting Program by phone at 1-888-PAHIRE (1-888-724-4737).

Immigration Reform and Control Act of 1986

Who must comply?

Employers of one or more employees are subject to this act. It prohibits employers from hiring illegal aliens for employment in the United States. An employer who hires, recruits, or refers for a fee someone known to be an illegal alien violates the act. In addition, an employer who fails to comply with the employment-verification provisions violates this act.

This law makes employers responsible for verifying an employee's identity and eligibility to work in the United States. An employer's failure to do this is a violation of the act, even if the employee hired is not an illegal alien. An employer who can establish that he or she complied in good faith with the requirement to verify an employee's identity and eligibility to work in the United States has an affirmative defense to claims that the employer knowingly hired an illegal alien to work in the United States.

What are employers required to do?

An employer subject to the act must do six things:

1. Obtain a copy of the individual's Social Security number, if the individual has been issued a Social Security number, or an authorization number established by the Immigration and Naturalization Service.
2. Have employees complete part 1 of the employment eligibility verification form, known as form I-9.
3. Check documents, submitted by the employee, that establish the employee's identity and eligibility to work in the United States. Employees state their citizenship status in these documents. Identification accepted: United States passport, Resident Alien Card, or other documentation authorized by the Attorney General.
4. Complete the employer's portion of form I-9.
5. Retain the completed form for at least 3 years after the employee has been hired or 1 year after the employment relationship has been terminated, whichever is longer.
6. Present the filed form I-9 to an officer of the Department of Labor or the Immigration and Naturalization Service (INS) who is making an inspection.

Employers must complete form I-9 within 3 business days of the date of hire. Date of hire should be considered as the date an employee actually starts to work. If an employee is hired for less than 3 days, the I-9 is to be completed at the time of hire.

If an employer rehires an employee for whom an I-9 was completed within 3 years of the date of rehire, the employer

can reverify the information on the first I-9 to determine if the employee is still eligible to work in the United States. After the information is verified, the employer must update the I-9 to reflect the date of rehire. If the employer's inspection of the I-9 determines that the individual's employment authorization has expired, the employer must reverify the employee's eligibility to work in the United States. If the employee cannot establish eligibility, the employee cannot be hired.

Antidiscrimination

The act has very specific antidiscrimination provisions. These prohibit employers from discriminating against any employee when hiring, firing, recruiting, or referring because of the employee's national origin, citizenship, or intended citizenship status. In this context, discrimination means that an employer treats some potential employees differently than others are treated for reasons that are prohibited by law. For example, it would be discriminatory for an employer to refuse to consider a job applicant because the applicant is a foreign citizen. It would not be discrimination, however, to refuse employment to an applicant who is not authorized to work in the United States. This is what the act requires employers to do. These prohibitions are in addition to all other federal laws that deal with discrimination on the basis of sex, race, religion, and age. Note: This section does not apply to persons who employ three or fewer employees.

Child Labor Laws

Who is an "agricultural employer"?

For purposes of this section, an agricultural employer means any person who owns or operates a farm, ranch, processing establishment, cannery, gin, packing shed, or nursery, or who produces or conditions seed and who either recruits, solicits, hires, employs, furnishes, or transports any migrant or seasonal agricultural worker.

Who must comply?

The Fair Labor Standards Act (FLSA) sets wage, hour, and employment standards that affect most workers in the United States, including young people. The standards affecting young workers vary for different age groups and for farm employment. In addition, the Pennsylvania Child Labor Law and Seasonal Farm Labor Act have various provisions that affect employment of children in agricultural situations.

Restrictions for farm work

If you are 16 years old or older, you may work at any time in any farm job. If you are 14 or 15 years old, you may work outside of school hours in any farm job except those designated as hazardous agricultural occupations. Such occupations include:

1. Operating or having any contact with a tractor of over 20 PTO horsepower or any of its implements.
2. Operating or having any contact with other farm machinery, including a corn picker, combine, earthmoving equipment, potato combine, hay mower, forage harvester, hay baler, feed grinder, forage blower, or auger conveyor.
3. Operating a power post-hole digger, post driver, or nonwalking tiller.

4. Operating or having any contact with trenching equipment, a fork lift, or power-driven saws.
5. Working in a pen with male breeding stock or animals with newborn young.
6. Working with timber having a butt diameter greater than 6 inches.
7. Working from a ladder or scaffold above 20 feet in height.
8. Driving a bus, truck, or car to transport passengers.
9. Working inside buildings used for storage of fruit, forage, or grain designed to retain an oxygen deficient or toxic atmosphere.
10. Working inside an upright silo after silage is added or while a top-loading device is running; a horizontal silo while operating a tractor to pack the silage.
11. Working in a manure pit.
12. Having any contact with agricultural chemicals of Class I toxicity (those which use the word "poison" and have "skull and crossbones" warnings) or Class II toxicity (those which use the word "warning" on the label).
13. Handling or using a blasting agent.
14. Having any contact with anhydrous ammonia, including transportation.

Fourteen- or 15-year-olds who have specialized training may be able to obtain approval to engage in some of the preceding farm occupations. See your vocational agriculture instructor or 4-H leader for more details.

If the employee is 12 or 13 years old, he or she may work outside school hours in nonhazardous farm jobs with his or her parents' written consent, or may work on a farm where the parents are employed.

If the employee is younger than 12 years old, he or she may work with parents' written consent and outside school hours in nonhazardous tasks on farms whose employees do not have to be paid minimum wage.

On farms subject to minimum wage, local minors 10 and 11 years old may work for no more than 8 weeks between June 1 and October 15, with approval from the Secretary of Labor. This work must be confined to hand harvesting short-season crops outside school hours, under very limited and specified circumstances as prescribed by the Secretary of Labor.

Pennsylvania Child Labor Laws and Seasonal Farm Labor Act
Pennsylvania's child labor law and Seasonal Farm Labor Act also have provisions that are applicable to employment of youth. The following list describes some of these additional restrictions and limitations:

No child under **18 years of age** shall be employed to work in any establishment or in any occupation for more than 6 consecutive days in any 1 week, or more than **44 hours** in any 1 week, or more than **8 hours** in any one day.

No child under **18 years of age** shall be employed for more than **5 hours** continuously in any establishment without at least 30 minutes for a lunch period and no period of less than 30 minutes to interrupt a continuous period of work.

No child under **18 years of age**, who is enrolled in regular day school and working outside school **hours**, shall be employed to

work for more than **28 hours** during a school week.

No child under **18 years of age** shall be employed or permitted to work in any establishment between the **hours** of 12:00 A.M. and 6:00 A.M. if such minor is enrolled in regular day school. Children who are 16 and 17 years of age may be employed until, but not after, 1:00 A.M. on Fridays and Saturdays, and on days preceding a school vacation occurring during the school year, excepting the last day of such vacation period.

No child under **16 years of age** shall be employed to work in any occupation before 7:00 A.M. or after 7:00 P.M. of any day except during school vacation period from June to Labor Day, when such minor may work between the **hours** of 7:00 A.M. and 10:00 P.M. No child who is enrolled in school and working outside school **hours** can be employed or permitted to work in any occupation more than **4 hours** on a school day, or more than **8 hours** on any other day, or more than **18 hours** during a school week.

A child under **16 years of age** employed on a farm by a person other than the farmer in the hatching, raising, or harvesting of poultry may be employed or permitted to work until 10:00 P.M. as long as the minor is not working in an agricultural occupation declared hazardous by the United States Secretary of Labor.

Students **14 years of age and over** whose employment is part of a recognized school-work program, supervised by a recognized school authority, may be employed for **hours** which, combined with the **hours** spent in school, do not exceed 8 a day.

It is unlawful for any **child** under **16 years of age** who is not a resident of this Commonwealth to be employed to work in this Commonwealth in any factory or cannery, or in berry, **fruit**, and vegetable raising and harvesting, during the time in which the laws of the state of his residence require his attendance at school.

No **child** from **14 to 17 years of age** inclusive who is employed or permitted to work as a seasonal farm worker can be employed between the hours of 7:00 A.M. and one hour following the end of the school day or any regular school day of the school district wherein the child is then a resident, whether or not such **minor** is registered as a pupil in such school district.

No **child** under **14 years of age** can be required to work, or be penalized for failing to work, as a seasonal farm worker.

At any age, a child may work in any farm job on a farm that his or her parents own or operate.

Minimum wage for youth

If the employee works in a job covered by the Fair Labor Standards Act, whether farm or nonfarm, he or she must be paid the same minimum wage and overtime pay as older workers, unless a specific exemption applies.

Employment certificate

Employment of persons under the age of 18 is unlawful without an employment certificate or farm service permit. For persons under the age of 18 to be employed in Pennsylvania, an employment certificate must be obtained by the minor person and retained on file by the employer. These certificates are available at local public school district offices or school principals' offices.

In regard to employment of children on a farm, two provisions of Pennsylvania law seem to contradict each other. Under the Public School Code of 1949, as amended, no person shall,

during the hours public schools are in session, accept the services from or employ any child under 18 years of age, unless the employer has on file an employment certificate or a farm or domestic service permit issued according to law. Pennsylvania's child labor law also establishes the need for an employer to obtain an employment certificate when a minor under the age of 18 is employed in an establishment. However, in its definition of the term "establishment," the child labor law states that it does not apply to children employed on the farm or in domestic service in private homes.

In light of these two provisions, a farm employer can require minor employees to produce a certificate. This provides proof of the minor employee's age and allows the employer to determine which tasks the minor is eligible to perform. The duty rests with the employer to see that all requirements concerning employment certificates and minor work attendance are met and followed.

For more information

Any questions about hazardous occupations or child labor regulations should be referred to the nearest office of the U.S. Department of Labor.

Wage and Withholding Considerations

Wage and Hour Laws: Minimum Wage and Hours Worked

Who must comply?

Labor on a farm is exempt from Pennsylvania's minimum-wage laws. Seasonal farm workers, however, are to be paid at least the statutory minimum wage or a piece rate equivalent to it.

Agriculture is exempt from federal and Pennsylvania overtime requirements. Federal minimum-wage laws do apply to those farmers who hired over 500 work-days of labor in a calendar quarter of the preceding year. A work-day is as little as one person putting in one hour of work on any given day.

For example, an employer who employs seven people to work at least 1 hour per day for 5 days in a given week has generated 35 work days for that week. If these seven workers work 5 days a week for the full 13-week calendar quarter, then the employer has generated 455 work days during the calendar quarter. Employers who hire many workers to work only short periods should note there are many ways to generate more than 500 work days in a calendar quarter. For example, 50 workers employed to work at least 1 hour a day for 12 days will generate 600 work days in the calendar quarter when the work is performed.

If a farm retail outlet sells only the farm's own produce, the above minimum-wage test and the overtime exemption apply. Such a retail store is part of agriculture.

An employee is employed in agriculture if the employee's duties involve activities that fall within either the primary or secondary meaning of agriculture. Under the primary meaning agriculture includes farming, and all of its branches, whether that involves cultivating and tilling the soil; dairying; the production, cultivation, growing, and harvesting of any agricultural or horticultural commodities; and the raising of livestock, bees, fur-bearing animals, or poultry.

The secondary meaning of agriculture is broader than the primary meaning. It includes any practices, whether or not they are themselves farming practices, which are performed either by a farmer or on a farm as an incident to or in conjunction with a

farming operation, which includes forestry or lumbering. Persons who are not employed in farming, or by a farmer, or on a farm are not considered to be employed in farming.

To come within the secondary meaning of agriculture, a practice must be performed either by a farmer or on a farm. It must be performed either in connection with the farmer's own operations or in connection with farming operations conducted on the farm where the practice is performed. In addition, the practice must be performed as an incident to or in conjunction with farming operations. Performance on a farm of any practice that may be incidental to farming operations will not constitute agriculture if the practice is performed upon any commodities that have been produced elsewhere than on such farm. With respect to all practices that are performed on products, such as packing, storing, or selling at retail, and for which an agricultural exemption is sought, the practices must be performed only on the products produced or raised by the particular farmer or on the particular farm.

Donning, Doffing, and Sanitization

Recently, the Pennsylvania Superior Court interpreted regulations defining "hours worked" to include time that employees are required to spend donning, doffing, and sanitizing their protective gear under the Pennsylvania Minimum Wage Act of 1968.

The definition provides the following: "Hours worked—The term includes time during which an employee is required by the employer to be on the premises of the employer, to be on duty or to be at the prescribed work place, time spent in traveling as part of the duties of the employee during normal working hours and time during which an employee is employed or permitted to work; provided, however, that time allowed for meals shall be excluded unless the employee is required or permitted to work during that time, and provided further, that time spent on the premises of the employer for the convenience of the employee shall be excluded."

Federal and State Minimum Wage Provisions

Federal Minimum Wage Rates in General

The federal minimum wage for covered nonexempt employees is \$7.25 per hour, effective July 24, 2009. Where an employee is subject to both the state and federal minimum wage laws, the employee is entitled to the higher minimum wage rate.

Limited Federal Wage Rates for Employees under Age 20

A federal minimum wage of not less than \$4.25 may be paid to employees under the age of 20 for their first 90 consecutive calendar days of employment with any employer as long as their work does not displace other workers. After 90 consecutive days of employment, or when the worker reaches age 20 (whichever comes first), the worker must receive at least the federal minimum wage.

Pennsylvania Minimum Wage Rates in General

The Pennsylvania minimum wage is \$7.25 per hour, equal to the federal minimum wage, effective July 24, 2009.

For more information

Write or call the nearest office of the U.S. Department of Labor.

Pennsylvania Wage Payment and Collection Law

Caution: Employers should note that several provisions of the Wage Payment and Collection Law are superseded by other laws, particularly the Pennsylvania Seasonal Farm Labor Act. Before making important decisions or taking other action, employers should carefully review both acts.

Who is covered?

Every person, firm, partnership, association, corporation, or receiver and any agent of any of the previously mentioned classes who employs any person in the Commonwealth.

What is meant by “wages”?

“Wages” includes all earnings of an employee, regardless of whether determined on time, task, piece, commission, or other method of calculation. The term also includes fringe benefits or wage supplements, whether payable by the employer from his or her funds or from amounts withheld from the employee’s pay by the employer.

What does the act require?

- Every employer is required to pay all wages on regular paydays designated in advance by the employer. If this period is not designated in a written contract of employment, the pay period should reflect the standard period that is customary in the trade, or be every 15 days. Every employer is required to notify his or her employees at the time of hiring of the time and place of payment, the rate of pay, and the amount of any fringe benefits or wage supplements to be paid to the employee. If changes in these payments occur, the employer is to notify the employee of these changes before they are effective. This requirement can be met by posting the required information in a conspicuous place at the employer’s place of business.
- Wages are to be paid in cash or check.
- When an employee separates, quits, or resigns, wages or compensation earned are due and payable at the next regular payday. If requested by the employee, this payment must be made by certified mail.

All employers must make their payroll records and other employment records available for inspection by the Department of Labor and Industry.

Who enforces the act?

The Secretary of Labor and Industry has the duty to enforce this act and investigate complaints of violations. The Secretary’s right is not exclusive, however, and employees, labor organizations, or parties to whom the wages are payable may initiate legal actions to enforce the terms of this law.

Penalties or sanctions an employer faces for violating the act

An employer who violates this law may be liable for a penalty of 10 percent of the unpaid wages or compensation found to be due an employee. In addition, a court involved in deciding a question of violation of the act may award the parties who bring the action costs of their reasonable attorney’s fees.

Withholding Income, Social Security, and Medicare Taxes

Who must comply?

Farmers whose total payment for agricultural labor provided

by all employees is more than \$2500, or who pay an individual employee more than \$150 in cash wages during the year, must withhold income, social security, and Medicare taxes. Only cash wages paid to farm workers are subject to social security and Medicare taxes. Cash wages include checks, money orders, and any kind of money or cash. Only cash wages subject to social security and Medicare taxes are credited to your employees for social security benefit purposes. Noncash wages include food, lodging, clothing, transportation passes, and other goods and services. Noncash wages paid to farm workers, including commodity wages, are not subject to social security and Medicare taxes. However, they are subject to these taxes if the substance of the transaction is a cash payment.

Wages paid to a child aged 18 to 21 years by a parent-employer, and wages paid to a spouse by his or her spouse-employer, are considered wages for Social Security purposes.

Wages paid to employees are exempt from income and Social Security withholding if the employee meets all of the following requirements:

- Earns less than \$150 from an agricultural employer
- Is employed as a hand-harvest laborer
- Is paid on a piece-rate basis
- Commutes daily from his or her permanent residence
- Is employed in agriculture less than 13 weeks during the preceding calendar year

Wages paid to employees meeting these requirements, although exempt from Social Security, are still counted toward the \$2500 amount by which coverage is determined for other employees who do not qualify for this exemption.

Employers should give each new employee a Form W-4 as soon as they hire the employee. For Spanish-speaking employees, employers may use Formulario W-4(SP), which is the Spanish translation of Form W-4. Have the employee complete and return the form to the employer before the first payday. If the employee does not return the completed form, the employer must withhold federal income tax as if the employee is single and claims no withholding allowances.

Form W-4 for 2011. The IRS is suggesting that employers should make the 2011 Form W-4 available to their employees and encourage them to check their income tax withholding for 2011. Those employees who owed a large amount of tax or received a large refund for 2010 may want to file a new Form W-4.

Cost to the employer

Employers who are required to withhold income taxes from their employees should refer to the tax withholding tables found in *Circular E, the Employer’s Tax Guide*, published by the Internal Revenue Service (IRS). These tables will enable the employer to calculate the correct amount of tax to be withheld.

For Social Security purposes, an employer in 2011 withheld 4.2 percent of an employee’s gross wages, paid an additional amount of 6.2 percent, and deposited the total amount of 10.4 percent with an authorized bank. The maximum amount of wages to which the Social Security withholding and employer tax rates applied was \$106,800 in 2011. This amount, known as the wage base, is subject to change as average wage levels change. In addition, a Medicare tax of 1.45 percent of an employee’s gross

wages was imposed on an employee and employer in 2011 for a total tax of 2.9 percent. This tax applied to the full amount of an employee's wages.

For more information

Contact your local IRS or Social Security office.

Unemployment Compensation: Federal

Who must comply?

Agricultural employers are subject to the Federal Unemployment Tax Act (FUTA), if they meet either of two tests:

1. Total cash wages paid were \$20,000 or more in any calendar quarter during the current or preceding year.
2. Ten or more farm workers were employed at least part of one day during 20 different calendar weeks of the current or preceding year.

For example, if an employer had 10 people employed for 1 hour on any single day, that week would be counted as one of the 20 weeks. Family members and children under the age of 21 are not included in the wage determination or in counting the number of farm workers. Also, wages paid to alien workers are not subject to FUTA tax but are included in the wage test.

Cost to the employer

The FUTA tax rate is 6.0 percent of the first \$7,000 of wages paid. Employers also subject to Pennsylvania Unemployment Compensation are eligible for a reduction of up to 5.4 percent, resulting in a net liability of 0.8 percent.

Tax deposits and forms

Taxes must be deposited in a Federal Reserve Bank or authorized financial institution within one month following the close of a quarter when liability exceeds \$100. Amounts less than \$100 are carried to the next quarter. Deposits are made on Federal Tax Deposit Coupons.

An annual return, Form 940, or Form 940-EC Employer's Annual Federal Unemployment Tax Return must be filed by January 31, following the close of a calendar year. Any tax due is payable with the form. If no tax is due, forms must be filed by February 10. Form 940 must be filed on a calendar-year basis even if your farm operates on a fiscal-year basis.

Unemployment Compensation: State

Who must comply?

Employer eligibility rules for Pennsylvania Unemployment Compensation are the same as for FUTA, except for two areas. FUTA taxes exempt the wages of children under the age of 21. Pennsylvania rules exempt the wages only of children under the age of 18. It is possible for an employer to be subject to Pennsylvania Unemployment Compensation, but exempt from FUTA. The wage base for Pennsylvania Unemployment Compensation is \$8,000, compared to \$7,000 for FUTA.

Cost to the employer

Contribution rates for employers vary. Beginning rates are 3.5 percent. Rates change after the employer establishes a payment record. At that time, rates are determined by several components.

Currently, contribution rates vary from 2 to 9.7 percent on the first \$8,000 of taxable wages. These rates are subject to periodic adjustments.

Tax deposits and forms

Form UC-2 and 2a is filed quarterly on or before the last day of the month following the close of the calendar quarter.

For more information

Contact your local office of the Pennsylvania State Job Service.

Employee Health and Safety

Workers' Compensation Insurance

Who must comply?

Any agricultural employer is required to provide workmen's compensation coverage for all employees, if during the calendar year such employer either:

- pays wages to one employee for agricultural labor totaling \$1,200 or more, or
- furnishes employment to one employee of agricultural labor on 30 or more days

The term "employee" includes all natural persons who perform services for another for pay or some valuable consideration. The term does not include persons whose employment is casual in character and not in the regular course of the employer's business. Casual employment is described as employment for a temporary or limited purpose that is performed on an occasional basis with long intervals between periods of such employment.

An employed spouse or child who is under 18 years of age is not considered an employee unless the services of the spouse or child are engaged by the employee under an express written contract of employment that is filed with the Department of Labor and Industry.

"Employee" also does not include persons to whom articles or materials are given out to be made up, cleaned, washed, altered, ornamented, finished, repaired, or adapted for sale in the worker's own home or in other premises not under the control or management of the employer.

Cost to the employer

The cost of coverage varies, depending on the general type of farm activity and the cost that the insurance industry has experienced in settling claims in that type of farm activity.

Farmers who hire very limited quantities of labor should be aware that their insurance company will make a minimum charge for coverage.

Compensation coverage

This coverage is available from private insurance agencies or from the State Workmen's Insurance Fund.

For more information

Bureau of Workers' Compensation

Department of Labor and Industry

1171 S. Cameron Street

Room 103

Harrisburg, PA 17104

Phone: 717-783-5421 or 717-772-3702

Environmental Protection Agency Worker Protection Standard for Agricultural Pesticides

See “Worker Protection Standard for Agricultural Pesticides” in Part III of this guide.

Occupational Safety and Health Act

Who must comply?

All employers have a general duty to provide a place of employment free from recognized hazards that are causing or are likely to cause death or serious physical harm to employees.

Other duties of employers

- To remove, guard against, or warn employees of potential hazards
- To report to the nearest Occupational Safety and Health Administration (OSHA) area office within 8 hours a major accident on their farm that results in a fatality or in the hospitalization of three or more employees
- To post in the workplace the OSHA poster informing employees of their rights and responsibilities
- To comply with standards for:
 1. slow-moving vehicle signs
 2. logging and pulpwood operations
 3. storing and handling anhydrous ammonia
 4. rollover protection devices on certain tractors (see complete description below)
 5. temporary labor camps
 6. safety guards on agricultural equipment
 7. hazard communication

Rollover Protection Structure (ROPS) regulations

Every employee who operates an agricultural tractor over 20 horsepower is to be informed of the following practices or any other practices dictated by the work environment:

- Securely fasten your seatbelt if the tractor has a ROPS.
- Where possible, avoid operating the tractor near ditches, embankments, and holes.
- Reduce speed when turning, crossing slopes, and on rough, slick, or muddy surfaces.
- Stay off slopes too steep for safe operation.
- Watch where you are going, especially at row ends, on roads, and around trees.
- Do not permit others to ride.
- Operate the tractor smoothly—no jerky turns, starts, or stops.
- Hitch only to the drawbar and hitch points recommended by tractor manufacturers.
- When tractor is stopped, set brakes securely and use park lock if available.

This information is to be provided to employees at the time of initial assignment and at least annually thereafter.

Where ROPS are required an employer must also: (1) provide each tractor with a seatbelt, (2) ensure that each employee uses such seatbelt while the tractor is moving, and (3) ensure that each employee tightens the seatbelt sufficiently to confine the

employee to the protected area provided by the ROPS.

Exempt uses for the ROPS and seatbelt requirements include:

- Low-profile tractors while they are used in orchards, vineyards, hop yards inside farm buildings or greenhouses and while their use is incidental to the work performed therein
- Tractors with mounting equipment which is incompatible with ROPS such as corn pickers, cotton strippers, vegetable pickers, and fruit harvesters

Field sanitation

Employers with 11 or more employees must provide toilets, hand-washing facilities, and drinking water for employees engaged in hand-labor operations. Employees who perform field work for 3 hours or less during the day, including transportation time to and from the field, are exempt from toilet and hand-washing regulations. Also exempt are employees engaged in logging operations, caring for livestock, or working in a permanent structure.

Employers must:

1. Provide readily accessible potable water, suitably cool, and in sufficient amounts for the needs of all employees, considering temperature, humidity, and nature of work performed. Water is to be dispensed in single-use cups or by a fountain.
2. Provide one toilet facility and one hand-washing facility for every 20 employees. These facilities must be adequately ventilated, latched from the inside, and constructed to ensure privacy. They must be located within one-quarter mile's walk of each employee's place of work in the field. When there is no feasible location because of terrain, facilities must be located as close as possible. All facilities must be kept clean and sanitary.
3. Inform employees of the importance of good hygiene practices to minimize exposure in the field to heat, communicable disease, retention of urine, and agrichemical residues. Employers must instruct employees to:
 - Use water and sanitary facilities for dining, washing, and elimination
 - Drink water frequently, especially on hot days
 - Urinate as frequently as necessary
 - Wash hands before and after using toilet and before eating or smoking

Exemptions

In December 1996, the Secretary of Labor delegated and assigned responsibility to the Employment Standards Administration of the Department of Labor to enforce compliance by agricultural employers and to issue compliance interpretations regarding Occupational Safety and Health act standards for field sanitation and temporary labor camps (i.e., conduct inspections and investigations, issue administrative subpoenas and citations, assess and collect penalties). This transfer of authority within the Department of Labor recognizes that these agencies would make more effective and efficient use of their resources by fulfilling the assigned responsibilities.

With respect to employers who operate temporary labor camps and hire migrant and seasonal employees (as defined by MSPA) in agricultural employment, the Employment Standards Admin-

istration will be the agency principally involved in compliance matters, regardless of the number of employees who are hired.

OSHA's provisions do not apply to family members employed on a farm by a member of the immediate family. Also, in past years, Congress has been unwilling to appropriate money to the Department of Labor to enforce OSHA rules, regulations, and orders against any person engaged in a farming operation that does not maintain a temporary labor camp and that employs 10 or fewer employees (members of an employer's immediate family are not counted in the total number of employees in such cases). Whether Congress will continue to hold this viewpoint is uncertain.

OSHA Hazard Communication Standard

This standard is concerned only with the question of an employer's obligation to employees. The standard does not address the rights of the public to request information about hazardous material from employers.

To comply with obligations owed by an employer to an employee, as defined by the standard, the employer has to do four things:

1. Determine which materials in the workplace are hazardous.
2. Obtain and file material safety data sheets (MSDS) for each identified hazardous material.
3. Develop and implement a written hazard communication program for the employer's workplace.
4. Ensure that labels and other forms of warning used on containers of hazardous materials meet the standard's requirements.

MSDS prepared by chemical manufacturers and importers contain information about chemicals present, health hazards, physical hazards, control measures, emergency first aid, and safe handling procedures associated with the chemicals. Employees are to have access to MSDS information. An employer is required to train employees when initially assigned to a job and whenever a new risk develops in the workplace.

Since 1988, the OSHA Hazard Communication Standard applies to manufacturing and nonmanufacturing employers, including those in production agriculture. Under federal law, if the OSHA standard applies to an employer, the OSHA standard will preempt any inconsistent state law, such as Pennsylvania's Right-to-Know Act provisions that affect an employer's obligation to employees. Since OSHA does not apply to the general public, Pennsylvania law will continue to apply to those issues affecting an employer's obligation to the general public.

For more information

For more information about the Hazard Communication Standard, materials considered hazardous, how the standard may affect you, or any other OSHA question, contact any OSHA office.

Pennsylvania Worker and Community Right-to-Know Act

This act is intended to be a comprehensive program for dealing with the risks and hazards faced by workers in their jobs and by public citizens who live or work in Pennsylvania. Effective in 1986, the act requires employers to survey their workplace to determine if they have any of the materials the act identifies as hazards, special hazards, or environmental hazards. Once the

surveys are completed, the employer is required to make that information available upon request to any employee who could come in contact with these materials.

Who must comply?

As originally passed, the act applied to all employers in Pennsylvania. The term employers was defined to include individuals, partnerships, corporations, or associations doing business in the Commonwealth. The Commonwealth and its political subdivisions, such as cities, boroughs, townships, school districts, and authorities, are also considered employers under this act. As explained above, the Occupational Safety and Health Administration (OSHA) also issued its Hazard Communication Standard. If an employer is subject to the OSHA standard, the standard will prevent the application of the Pennsylvania Right-to-Know Act provisions that relate to an employer's obligations to an employee. Since the OSHA standard does not apply to an employer's obligation to disclose information to the general public, the Pennsylvania Right-to-Know rules dealing with that obligation will continue to apply to all employers.

In light of the OSHA Hazard Communication Standard's application to production agriculture and agribusiness, provisions of the Pennsylvania Right-to-Know Act regarding the public's right to this information require the following steps to be taken to comply with the act.

1. Survey the workplace to identify hazards and complete the hazardous substance survey form annually by April 1.
2. File the survey form for future reference.
3. Update the form during the year, as needed.
4. Make the form available if requested by the Department of Labor and Industry.

Requests for this information are made directly to the Department of Labor and Industry, which contacts the employer. Requests by local police, fire, or emergency response agencies may be made directly to the employer concerned.

For more information

If you need information about this act and how it may affect you, or information about materials considered hazardous, contact the Pennsylvania Department of Labor and Industry.

Superfund Amendments and Reauthorization Act (SARA)

This act continues the superfund program that is targeted at cleaning up the environment. In 1986, new amendments were added, entitled "Emergency Planning and Community Right to Know." The agency involved with this program is the federal Environmental Protection Agency (EPA).

What does the act require?

The act created four major responsibilities:

1. The first is to report the presence of hazardous materials at a facility to the state emergency response commission and the local emergency planning committee. The obligation to file this report is tied to the presence of the hazardous material in a quantity that exceeds the threshold amount set by EPA in its regulations. Once this report is filed, the person having the material appoints someone to be involved in local planning committee activities. State and county offices of the Farm Ser-

vice Agency can assist you in identifying hazardous materials and threshold amounts;

2. The second major responsibility under this act is to report the release of any of these hazardous materials. In this case the duty to file the report is triggered by the release of hazardous material in an amount exceeding that set by EPA in its regulations. Under this section, pesticides registered under federal law that are used in accordance with their intended purpose and the normal application of fertilizers are exempt from the release-reporting requirement.
3. The third major responsibility applies to employers subject to the OSHA Hazard Communication Standard. It requires those employers to make information available to the general public and emergency response agencies. This provision becomes particularly important in light of the decision to expand coverage of the OSHA standard. Under this section as well, chemicals used in routine agricultural operations and household products are not subject to this reporting requirement.
4. The fourth major responsibility applies to manufacturing employers with 10 or more full-time employees who use specified toxic chemicals. If these toxic chemicals are released into the environment, the employer must report the release in the manner required by the act.

Since this act involves the federal government and its agencies with the rights of the public regarding hazardous materials, the question of the relationship between state and federal law arises. The SARA amendments are not intended to preempt any state or local law, as in the case of the OSHA Hazard Communication Standard. Therefore, state and federal laws could both apply to these situations.

Special Employment Concerns

The Americans with Disabilities Act

Purpose

This act prohibits discrimination against “qualified individuals with disabilities” in employment, public services, transportation, public accommodation, and telecommunication services.

Key terms and what they mean

A “qualified individual with a disability” is a person who, with or without reasonable accommodation, can perform the essential functions of a job, as taken from the job description of a particular position.

A “disability” is a physical or mental impairment that substantially limits a “major life activity.” A person who has a record of an impairment or someone whom others regard as impaired can also be considered disabled.

A “substantial” impairment is an inability to perform a “major life activity” or a significant restriction as to the condition, manner, or duration under which that activity can be performed.

“Major life activities” include such things as caring for oneself, performing manual tasks, walking, seeing, hearing, speaking, breathing, learning, and working. They are activities that the average person in the general population can perform with little or no difficulty.

Who must comply?

Employer provisions of the act are extended to employers of 15 or more employees. For purposes of the act, an employee is a person that works each day in each of 20 or more calendar weeks in the current or preceding calendar year.

What does the act require?

Employers must post and keep posted in a conspicuous place where notices to employees are customarily posted a description of the applicable provisions of this act.

What is prohibited?

1. Discrimination is prohibited in regard to application procedure, hiring, advancement, discharge, compensation, training, and other terms, conditions, and privileges of employment. Forms of discrimination include, among other things:

- Acts that adversely affect opportunities for disabled persons.
- Failure to make a reasonable accommodation to known physical or mental limitations.

Reasonable accommodation includes making existing facilities accessible and usable by the handicapped. Structures, schedules, assignments, equipment, materials, and policies must accommodate people with disabilities.

An exception to this requirement exists if making such an accommodation would result in an undue hardship. In determining if undue hardship exists, the nature of the accommodation, the financial resources of the facility, the number of employees, the impact on expenses and resources, the characteristics of the employer, the location of the facility, and the composition and function of the work force are considered.

- Using tests, standards, and criteria that are not job related and that screen out disabled persons.
- Inquiries concerning disability or the severity of a disability. An exception exists if the inquiry relates to job duties.

Preemployment physicals may be required if the physicals are job related, are consistent with business necessity, and are performed after an offer of employment is made to the applicant. Offers of employment can be conditioned on the results of the physicals only if all employees in the same job category are subject to examination and the information obtained from them is kept confidential in separate medical files.

- Discrimination against recovering alcoholics and drug addicts who have been in a rehabilitation program and are not using drugs or alcohol.

Employers may prohibit the use of illegal drugs and alcohol in the workplace and may require employees to come to work sober and drug free.

2. An employer may not enter into a contractual or other arrangement or relationship with an entity, such as an employment or referral agency, that would have the effect of discriminating against a qualified applicant or employee with a disability.

Although it doesn't specifically mention farm labor contractors, it is possible that this provision would prohibit a farmer or grower from entering a relationship with a farm labor contractor that discriminates on the basis of disability.

Defenses

If a claim of discrimination is made, defenses include:

- An inability to accommodate based on job-related conditions that are consistent with business necessity
- A direct threat to the health or safety of others in the workplace posed by the employee
- The employer is a religious organization that gives preference to members of its own faith
- The potential for the spread of specific infectious diseases cannot be reduced or controlled

For more information

Contact the Equal Employment Opportunity Commission.

Pennsylvania Seasonal Farm Labor Act

Purpose

The Seasonal Farm Labor Act was passed by the Pennsylvania legislature to improve the conditions of seasonal farm workers. The act establishes standards for wages, hours, conditions of work, housing, food facilities, fire protection, and safety. For example, the act provides that no seasonal farm worker will be required to work or be penalized for failing to work on any premises for more than six days in any one week, more than 10 hours in any one day, or more than 48 hours in any one week. If a worker is employed by more than one employer, the daily and weekly limits described above will apply to work performed on all premises. In addition, it establishes a permit requirement to operate and occupy seasonal farm labor camps, and lists prohibited practices by farm labor contractors and their agents.

Who must comply?

Farm labor contractors must comply with this act.

A “farm labor contractor” is any person who, for payment, wages, salary, fee, or other consideration, either for himself or on behalf of another person, recruits, solicits, hires, furnishes, or transports five or more seasonal farm workers (excluding members of his immediate family) in any calendar year for employment in agriculture. A seasonal farm worker is defined in the following list.

In the case of a partnership, firm, association, corporation, or organization that supplies seasonal farm workers solely for its own operation, the term “farm labor contractor” means the officer, official, supervisor, or employee most directly responsible for the activities mentioned above.

The term “farm labor contractor” does *not* include:

- An individual farmer who hires seasonal workers only for his or her own operation. However, if an employee of an individual farmer engages in these activities, that employee is considered a “farm labor contractor.”
- A person who arranges for the employment of seasonal farm workers from another nation and the employment is subject to an agreement between the United States and the foreign nation, or an agreement provided by an instrumentality of the foreign nation.
- Those licensed under the employment agency law.
- Nonprofit charitable organizations or educational institutions.

- Farm labor employers. “Farm labor employer” includes every individual, firm, partnership, association, trust, corporation, receiver, or any person or group of persons acting directly or indirectly in the interest of an employer in relation to an employee, employing or permitting to work any seasonal farm worker in the Commonwealth, and including every farmer, grower, nursery operator, or landowner who employs, or on whose premises or in whose interest is employed, any seasonal farm worker.
- A “seasonal farm worker” is any individual employed on a seasonal or temporary basis to perform agricultural labor in the planting, processing, storing, or transporting of agricultural commodities or farm products. In addition, the statute covers any person who lives in quarters owned, leased, or operated by an employer or a farm labor contractor and occupied by four or more unrelated persons, regardless of whether they work on a seasonal or temporary basis. The statute specifically excludes from its coverage persons who commute from their permanent residence to the work site in their own transportation or that is provided by someone other than the employer or a farm labor contractor.

For more information

Contact the Pennsylvania Department of Labor and Industry, Bureau of Labor Standards Seasonal Farm Labor Section.

Federal Migrant and Seasonal Agricultural Workers Protection Act (MSPA)

The MSPA is intended to supplement state law. Compliance with it does not excuse any person from complying with appropriate state law and regulation.

Who must comply?

- Agricultural employers. An “agricultural employer” is any person who owns or operates a farm, ranch, processing establishment, cannery, gin, packing shed, or nursery, or who produces or conditions seed, and who either recruits, hires, employs, furnishes, or transports any migrant or seasonal agricultural worker (defined below).
- Farm labor contractors. A “farm labor contractor” is any person, other than an agricultural employer, an agricultural association, or an employee of an agricultural employer or agricultural association, who, for money or other valuable consideration, performs any farm labor contracting activity, such as recruiting, soliciting, hiring, employing, furnishing, or transporting any migrant or seasonal agricultural worker.

NOTE: Agricultural employers and farm labor contractors may be jointly responsible for the requirements of this act. In other words, if the farm labor contractor does not comply, the agricultural employer is responsible, regardless of whether the farm labor contractor qualifies as an independent contractor.

Consider the following factors in determining whether an employer is jointly responsible with the farm labor contractor are:

1. Whether the agricultural employer has the power, either alone or through control of the farm labor contractor, to direct, control, or supervise the worker(s) or the work performed

2. Whether the agricultural employer has the power, either alone or in addition to another employer, directly or indirectly, to hire or fire, modify the employment conditions, or determine the pay rates or the methods of wage payment for the worker(s)
3. The degree of permanency and duration of the relationship of the parties, in the context of the agricultural activity at issue
4. The extent to which the services rendered by the worker(s) are repetitive, rote tasks requiring skills acquired with relatively little training
5. Whether the activities performed by the worker(s) are an integral part of the overall business operation of the agricultural employer
6. Whether the work is performed on the agricultural employer's premises, rather than on the premises owned or controlled by another business entity
7. Whether the agricultural employer undertakes responsibilities in relation to the worker(s) which are commonly performed by employers, such as preparing and/or making payroll records, preparing and/or issuing pay checks, paying FICA taxes, providing workers' compensation insurance, providing field sanitation facilities, housing or transportation, or providing tools and equipment or materials required for the job (taking into account the amount of investment)

Key terms and what they mean

A "migrant agricultural worker" is an individual employed in agriculture on a seasonal or other temporary basis, and who is required to be absent overnight from his or her permanent place of residence. NOTE: This term does not include members of the immediate family of a farm labor contractor or an agricultural employer, or temporary nonimmigrant H-2a alien workers.

A "seasonal agricultural worker" is an individual who is employed in agriculture on a seasonal or temporary basis and who is not required to be absent overnight from his or her permanent place of residence when employed on a farm or ranch in performing field work related to planting, cultivating, or harvesting operations or when employed in canning, packing, ginning, seed conditioning, or related research, or processing operations, and who is transported or caused to be transported to or from the place of employment by means of a day-haul operation (pick-up and return on the same day). NOTE: This term does not include any migrant agricultural worker; any immediate family member of an agricultural employer or farm labor contractor; or temporary nonimmigrant agricultural H-2a alien workers.

Who is exempt?

- Family businesses. The act is not applicable to an individual who engages in farm labor contracting activities on behalf of a farm owned or operated by that person or an immediate family member, if the activities are performed only for such operation and exclusively by such individual or an immediate family member.
- Small businesses. The act is not applicable to an employer who employs agricultural labor less than 500 worker-days in each calendar quarter of the preceding calendar year. This is

the same standard as the Fair Labor Standards Act exemption from federal minimum wage requirements.

- A person whose labor-contracting activities are conducted within a 25-mile radius of the person's permanent residence and for not more than 13 weeks per year.
- Common carriers whose only connection with agriculture is the transport of migrant or seasonal agricultural workers.
- Nonprofit charitable organizations and public and private educational institutions.
- Custom combining, hay-harvesting, or sheep-shearing operations.
- Custom poultry-harvesting, breeding, debeaking, desexing, or health-service operations.
- Some students serving apprenticeships and some employees of seed and tobacco producers.

What does the act require?

- Farm labor contractors must have a certificate of registration.
- Agricultural employers must confirm that the farm labor contractor is registered.
- Farm labor contractors, agricultural employers, and agricultural associations that recruit migrant and/or seasonal agricultural workers must disclose the following information to such workers:
 1. Place of employment
 2. Wage rates to be paid
 3. Crops and kinds of work activity on which worker may be employed
 4. Period of employment
 5. Transportation, housing, and other employee benefits to be provided, and cost, if any
 6. Existence of any strike or other work stoppage, slowdown, or other work interruption at the place of employment
 7. Any arrangement with the owner or agent of an establishment under which the contractor, employer, or association is to receive a commission or any other benefit resulting from sales to the workers
 8. Whether state workers' compensation insurance is provided, and, if so: (a) the name of the state workers' compensation insurance carrier; (b) the name of the policyholder of such insurance; (c) the name and telephone number of each person who must be notified of an injury or death; and (d) the time period within which such notice must be given

Compliance with this item may be met if the worker is given a photocopy of any notice regarding workers' compensation insurance required by law of the state in which the worker is employed. The worker must be given the disclosure at the time of recruitment or, if sufficient information is unavailable at that time, at the earliest practicable time, but no later than the commencement of work.

- Farm labor contractors, agricultural employers, and agricultural associations that recruit migrant agricultural workers must post the above information in English, Spanish, or another language common to the workers.

- Those who own or control facilities used to house migrant workers are responsible for having these facilities meet federal and state safety and health standards.

For further details, see “Migrant Labor Housing” (below).

- Each farm labor contractor, agricultural employer, or agricultural association that recruits migrant agricultural workers must maintain for 3 years those records dealing with:

1. The basis for wages paid
2. Piece work units earned
3. Sums withheld and purpose of withholding
4. Number of hours worked
5. Total pay period earnings
6. Net pay

- When using any vehicle to provide transportation, each farm labor contractor, agricultural employer, and agricultural association that recruits migrant workers must ensure:

1. The vehicle conforms to federal and state safety standards
2. Drivers are validly licensed
3. An insurance policy or liability bond in the minimum amount of \$100,000 per seat in the vehicle (the total amount required is not more than \$5,000,000) is in force to cover property damage and personal injury

Use of machinery and equipment while actually engaged in planting, harvesting, etc. is exempt from this requirement.

NOTE: The required level of insurance is that required of a common carrier under federal law, but if a contractor, employer, or association maintains workers’ compensation coverage for its workers and this coverage includes transporting workers, then no additional insurance is necessary and the workers’ compensation policy may meet the insurance requirement. This decision requires a thorough review of the existing policy with an insurance adviser.

For more information

Contact any regional office of the U.S. Department of Labor.

Migrant Labor Housing—Federal Regulations

Who must comply?

Anyone who supplies housing to migrant workers is subject to housing standards. There are certain exemptions for small employers and camp operators who provide the same housing to the general public on a commercial basis.

What do the regulations require?

1. Before migrant labor housing can be occupied, a state or local health authority or other appropriate agency must certify that the facility meets all applicable safety and health standards, including federal and state regulations. A copy of the certification must be posted at the site. Certification prior to occupancy will not prevent the housing provider from being assessed penalties for violations that occur after occupancy has begun.
2. Migrant labor housing owned by growers and crew leaders subject to the Migrant and Seasonal Agricultural Workers

Protection Act (see previous section) must be registered, inspected, and approved by the Wage and Hour Division of the U.S. Department of Labor. Specific requirements exist for:

- housing sites
- shelter and housing
- water supply
- toilet facilities
- sewage disposal
- laundry, hand washing, and bathing facilities
- electrical lighting
- refuse and garbage disposal
- cooling and eating facilities
- screening, insect, and rodent control
- fire safety and first-aid facilities
- reporting of communicable diseases

These regulations can be found in the Code of Federal Regulations, Volume 20 section 654.400 et seq.

3. The Employment Training Administration of the U.S. Department of Labor must approve migrant labor housing before it will supply workers to the operation.
4. The Occupational Safety and Health Administration has the authority to inspect any farm labor housing facility in response to a complaint, a report of an injury or accident, or on a random basis. No registration is required under OSHA regulations.

Penalties

Employers and migrant farm labor camp owners are subject to fines if found in violation of housing standards. In certain cases, violations may cause the inspecting agency to close the camp and revoke the employer’s certification, which could result in an employer losing the employees who are needed to pick a crop.

For more information

Contact any regional office of the U.S. Department of Labor.

Migrant Labor Housing—Pennsylvania Regulations

Purpose

Regulations set standards for permits, plans, sites, and camp housing. Under housing requirements, regulations cover:

- occupancy
- sleeping room contents
- cleanliness
- water supply
- plumbing
- toilet facilities
- sewage disposal
- laundry, hand-washing, and bathing facilities
- lighting and electrical
- refuse
- food service
- insect and rodent control
- first-aid and fire prevention
- exits and entrances

Other sections deal with occupants’ concurrent responsibilities and obligations of owners and operators. These regulations can be found in Pennsylvania Code, Volume 7, Section 82.

Who must comply?

All employers of migrant and seasonal farm labor in Pennsylvania that provide living quarters for four or more unrelated farm workers are subject to the regulations. If an employee has been employed for less than one year, the employee is presumed to be a seasonal one, unless the employer can prove otherwise.

What do the regulations require?

1. Plans for the construction, remodeling, or alteration of farm labor camps must be approved by the governing agency before such construction, etc. may begin.
2. All seasonal farm labor camps must have a permit from the governing agency. A permit is valid for one year. Initial applications for new camps must be submitted 60 days prior to occupancy. Currently operating farm labor camps will receive a renewal application 60 days prior to the expiration of their current permit.
3. All camps must be ready for inspection by the governing agency at least 45 days prior to occupancy. Violations may cause the camp to be reinspected before a permit is issued. Continued noncompliance with regulations may cause the agency to levy fines or revoke the operating permit.
4. Upon receipt of a permit, the camp owner or operator must post the permit at a prominent location that is readily accessible.

For more information

Contact the Pennsylvania Department of Agriculture Bureau of Food Safety and Laboratory Services.

Family and Medical Leave Act of 1993 (FMLA)**Who is covered?**

The Family and Medical Leave Act (FMLA) provides a means for employees to balance their work and family responsibilities by taking unpaid leave for certain reasons. The act is intended to promote the stability and economic security of families as well as the nation's interest in preserving the integrity of families.

The FMLA applies to any employer in the private sector who engages in commerce, or in any industry or activity affecting commerce, and who has 50 or more employees each working day during at least 20 calendar weeks in the current or preceding calendar year.

The law covers all public agencies (state and local governments) and local education agencies (schools, whether public or private). These employers do not need to meet the "50 employee" test. Title II of FMLA covers most federal employees, who are subject to regulations issued by the Office of Personnel Management.

To be eligible for FMLA leave, an individual must (1) be employed by a covered employer and work at a worksite within 75 miles of which that employer employs at least 50 people; (2) have worked at least 12 months (which do not have to be consecutive) for the employer; and (3) have worked at least 1,250 hours during the 12 months immediately before the date FMLA leave begins.

Basic provisions/requirements

The FMLA provides an entitlement of up to 12 weeks of job-protected, unpaid leave during any 12-month period for the following reasons:

- Birth and care of the employee's child, or placement for adoption or foster care of a child with the employee
- Care of an immediate family member (spouse, child, parent) who has a serious health condition
- Care of the employee's own serious health condition

If an employee was receiving group health benefits when leave began, an employer must maintain them at the same level and in the same manner during periods of FMLA leave as if the employee had continued to work. Usually, an employee may elect (or the employer may require) the use of any accrued paid leave (vacation, sick, personal, etc.) for periods of unpaid FMLA leave.

Employees may take FMLA leave in blocks of time less than the full 12 weeks on an intermittent or reduced leave basis when medically necessary. Taking intermittent leave for the placement, adoption, or foster care of a child is subject to the employer's approval. Intermittent leave taken for the birth and care of a child is also subject to the employer's approval except for pregnancy-related leave that would be leave for a serious health condition.

When the need for leave is foreseeable, an employee must give the employer at least 30 days' notice, or as much notice as is practicable. When the leave is not foreseeable, the employee must provide such notice as soon as possible.

An employer may require medical certification of a serious health condition from the employee's health care provider. An employer may also require periodic reports during the period of leave of the employee's status and intent to return to work, as well as "fitness for duty" certification upon return to work in appropriate situations.

An employee who returns from FMLA leave is entitled to be restored to the same or an equivalent job (defined as one with equivalent pay, benefits, responsibilities, etc.). The employee is not entitled to accrue benefits during periods of unpaid FMLA leave, but the employer must return him or her to employment with the same benefits at the same levels as existed when leave began.

Employers are required to post a notice for employees outlining the basic provisions of FMLA and are subject to a \$100 civil money penalty per offense for willfully failing to post such notice. Employers are prohibited from discriminating against or interfering with employees who take FMLA leave.

Employee rights

The FMLA provides that eligible employees of covered employers have a right to take up to 12 weeks of job-protected leave in any 12-month period for qualifying events without interference or restraint from their employers. The FMLA also gives employees the right to file a complaint with the Wage and Hour Division of the Department of Labor's Employment Standards Administration, file a private lawsuit under the act (or cause a complaint or lawsuit to be filed), and testify or cooperate in other ways with an investigation or lawsuit without being fired or discriminated against in any other manner.

Compliance assistance available

The Wage and Hour Division of the Employment Standards Administration administers FMLA. More detailed information, including copies of explanatory brochures, may be obtained by contacting your local Wage and Hour Division office. In addition, the Wage and Hour Division has developed the “elaws” Family and Medical Leave Act Advisor, which is an online resource that answers a variety of commonly asked questions about FMLA, including employee eligibility, valid reasons for leave, notification responsibilities of employers and employees, and rights and benefits of employees. Compliance assistance information is also available from the Wage and Hour Division’s Web site at www.wagehour.dol.gov. For additional assistance, contact the Wage and Hour Division at 1-866-4USWAGE.

Penalties/sanctions

Employees and other persons may file complaints with the Employment Standards Administration (usually through the nearest office of the Wage and Hour Division: www.dol.gov/esa/whd). The Department of Labor may file suit to ensure compliance and recover damages if a complaint cannot be resolved administratively. Employees also have private rights of action, without involvement of the Department of Labor, to correct violations and recover damages through the courts.

Relation to state, local, and other federal laws

A number of states have family leave statutes. Nothing in the FMLA supersedes a provision of state law that is more beneficial to the employee, and employers must comply with the more beneficial provision. Under some circumstances, an employee with a disability may have rights under the Americans with Disabilities Act.

The Employment Law Guide is offered as a public resource. It does not create new legal obligations and it is not a substitute for the U.S. Code, Federal Register, and Code of Federal Regulations as the official sources of applicable law. Every effort has been made to ensure that the information provided is complete and accurate as of the time of publication, and this will continue. Later versions of this guide will be offered at www.dol.gov/compliance or by calling the Toll-Free Help Line at 1-866-4-USA-DOL (1-866-487-2365).

APPENDIX: TREE FRUIT ON THE WEB

Bees and Pollination

Eastern Apicultural Society.....	www.easternapiculture.org
Mid-Atlantic Apiculture.....	maarec.psu.edu
Pennsylvania Beekeepers Association	www.pastatebeekeepers.org
Pollen and Pollination (Firm Yield Pollen and Orchard Supply).....	www.firmyield.com
Virtual Beekeeping Gallery.....	www.beekeeping.com/index.html

Fruit General

Apple Crop Electronic Discussion Group.....	www.virtualorchard.net/applecrop.html
British Columbia Tree Fruit Information.....	www.agf.gov.bc.ca/treefrt/index.htm
Cornell Fruit Resources	www.hort.cornell.edu/extension/commercial/fruit/index.html
Fruitipedia.....	www.fruitipedia.com
Horticulture New Zealand.....	www.hortnz.co.nz
Mid-Atlantic Apiculture.....	maarec.cas.psu.edu
Mid-Atlantic Regional Fruit Loop	www.caf.wvu.edu/kearneysville/fruitloop.html
Northwest Pear Bureau	www.usapears.com
New Zealand Hort Net	www.hortnet.co.nz
National Agricultural Statistics Service	www.nass.usda.gov/index.asp
Market Diseases of Apples, Pears, and Quinces	postharvest.tfrec.wsu.edu/marketdiseases/cork.html
NE-183 National Apple Trials Information	www.ne183.org
Orange Pippin	www.orangepippin.com
Organic Apple Production.....	attra.ncat.org/attra-pub/PDF/omapple.pdf
Pacific Agri-Food Research Canada	res2.agr.ca/parc-crapac/summerland/progs/horticulture/horticul_e.htm
Pennsylvania Department of Agriculture.....	www.agriculture.state.pa.us
Tree Spacing Template.....	www.hrt.msu.edu/department/Perry/Spacing_Fruit/mispacingLapTop.htm
USDA Economics & Statistics Service	usda.mannlib.cornell.edu
USDA-ARS Appalachian Fruit Res. Station.....	afrsweb.usda.gov
USDA-ARS Wenatchee Tree Fruit Lab	www.tfrl.ars.usda.gov
Virtual Orchard	www.virtualorchard.net/default.html

Guides/Magazines/ Newsletters

Cornell Scaffolds Newsletter	www.nysaes.cornell.edu/ent/scaffolds
Good Fruit Grower.....	www.goodfruit.com/index.php
Massachusetts Fruit Advisor.....	www.umass.edu/fruitadvisor
Ontario Fruit Growing Information	www.omafra.gov.on.ca/english/crops/index.htm
New York Fruit Quarterly.....	www.nyshs.org/fq.php
PA and NY Grape Pest Management.....	ipmguidelines.org/grapes/default.asp

Nurseries

Adams County Nursery, Aspers, PA.....	www.acnursery.com
Big Horse Creek Farm, Lansing, NC.....	www.bighorsecreekfarm.com
Boyer's Nursery, Biglerville, PA.....	www.boyernurseries.com
Brandt's Fruit Trees, Parker, WA	www.ewbrandt.com/bft
Burchell Nursery Inc, Oakdale, CA.....	www.burchellnursery.com
C & O Nursery, Wenatchee, WA.....	www.c-onursery.com
Columbia Basin Nursery, L.L.C, Quincy, WA.....	www.cbnllc.com
CopenHaven Farms Nursery	www.copenhavenfarms.com
Cummins Nursery, Geneva, New York	www.dabney.com/cumminsnursery
Dave Wilson's Nurseries, CA	www.davewilson.com
Four Mile Nursery, Canby, OR	www.fourmile.com
Green Tree Nursery, La Grange, CA	greentreenursery.com
Janssen Brothers Nurseries LTD, Netherlands	www.janssen-rootstocks.nl/main.htm
Johnson Nurseries, Ellijay, GA.....	www.johnsonnursery.com
Lawson's Nursery, Ball Ground, GA.....	www.lawsonsnursery.com
Meadow Lake Nursery, McMinnville, OR	www.meadow-lake.com
Moser Fruit Tree Sales	www.forfruittrees.com

Sierra Gold Nurseries, Yuba City, CA.....	www.sierragoldtrees.com
Southmeadow Fruit Gardens.....	www.southmeadowfruitgardens.com
Stark Bros. Nurseries, Louisiana, MO.....	www.starkbros.com
Summit Tree Sales.....	www.summittreesales.com
Tree Connection, Dundee, OR.....	www.treeconnect.com
Trees of Antiquity, Paso Robles, CA.....	www.treesofantiquity.com
TRECO, Woodburn, OR.....	www.treco.nu
V. Kraus Nurseries Ltd, Carisle Ontario.....	www.krausnurseries.com
Van Well Nurseries, Wenatchee, WA.....	www.vanwell.net
Vintage Virginia Apples.....	www.vintagevirginiaapples.com
Viveros Requinoa, Santiago, Chile.....	www.viverosrequinoa.cl
Wafler Nurseries, Wolcott, NY.....	www.waflernursery.com
Willamette Nurseries Inc, Canby, OR.....	www.willamettenurseries.com
Willow Drive Nursery, Ephrata, WA.....	www.willowdrive.com

Orchard Supply Sources

Alfa Scents Monitoring Supplies.....	www.alphascents.com
Amberg's Nursery, Inc., Stanley, NY.....	www.ambergs.com
Gemplers.....	www.gemplers.com
Great Lakes IPM.....	www.greatlakesipm.com
OESCO, Conway, MA.....	www.oescoinc.com
Orchard Valley Supply.....	orchardvalleysupply.com
Peach Ridge Orchard Supply, Sparta, MI.....	www.peachridge.com/storeinfo/index.htm
Wilson Irrigation & Orchard Supply Yakima, WA.....	www.wilsonirr.com

Penn State Fruit Resources

College of Agricultural Sciences.....	agsci.psu.edu
Department of Entomology.....	ento.psu.edu
Department of Horticulture.....	horticulture.psu.edu
Department of Plant Pathology.....	plantpath.psu.edu
Fruit Times Newsletter.....	extension.psu.edu/fruit-times
FREC Biglerville.....	agsci.psu.edu/frec
Fruit Pathology Web site.....	extension.psu.edu/fruit-diseases
Lake Erie Regional Grape Research and Extension Center.....	agsci.psu.edu/research/centers/erie
Plum Pox.....	sharka.cas.psu.edu
Tree Fruit Production Guide.....	agsci.psu.edu/tfpg
Weather Links at Penn State.....	www.psu.edu/ur/weather

Pesticide Information/Labels

AGRIAN.....	www.agrian.com/home
C & P Green Book of Pesticide Labels.....	www.greenbook.net
CDMS Pesticide and MSDS Labels.....	www.cdms.net/manuf/default.asp
DowAgro Sciences.....	www.dowagro.com
DuPont.....	www.dupont.com
Insecticide Resistance Action Committee.....	irac-online.org
National Pesticide Information Center.....	www.npic.orst.edu
National Pesticide Information Retrieval System.....	state.ceris.purdue.edu
PaPlants.....	https://www.paplants.state.pa.us/
Penn State Pesticide Education Program.....	extension.psu.edu/pested
Pennsylvania Department of Agriculture.....	www.agriculture.state.pa.us
U.S. Environmental Protection Agency.....	www.epa.gov/pesticides

Professional Societies

American Pomological Society.....	americanpomological.org
International Fruit Tree Association.....	ifruittree.org
Michigan Apple Committee.....	www.MichiganApples.com

Midwest Apple Improvement Association www.hort.purdue.edu/newcrop/maia/default.html
 State Horticultural Association of Pennsylvania (SHAP) shaponline.org
 U.S. Apple Association www.usapple.org

Rootstock Information

Cornell University Fact Sheets www.nysaes.cornell.edu/hort/breeders/appleroots/Factsheets/FSAccess.htm
 NC-140 www.nc140.org
 Ontario Ministry of Agriculture & Food Fact Sheets www.OMAFRA.gov.on.ca/english/crops/facts/00-007.htm

Stone Fruit

Cherry Marketing Institute www.cherrymkt.org
 Cherry Production extension.oregonstate.edu/wasco/horticulture/a_mainpagehort.html
 Cherry Pollination www.nysaes.cornell.edu/hort/faculty/andersen/Pollination_Information/Pollination%20information.html
 Peach Production Information, University of Georgia www.griffin.peachnet.edu/caes/gapeach

USDA-NRCS Conservation Programs

Pennsylvania USDA-NRCS www.pa.nrcs.usda.gov
 PA IPM NRCS paipm.cas.psu.edu/65.htm
 Michigan State University EQIP IPM Program for Specialty Crops www.ipm.msu.edu/farmbill.htm
 Center for Agricultural Partnerships www.agcenter.org
 West Virginia NRCS IPM Program in Tree Fruit www.caf.wvu.edu/Kearneysville/FruitSchool2009/Panel-NRCS-IPM.pdf

Weed Information/Identification

Purdue bluestem.hort.purdue.edu/plant/weeds.html
 Oregon oregonstate.edu/dept/nursery-weeds
 Rutgers www.rce.rutgers.edu/weeds/default.asp
 Michigan State web1.msue.msu.edu/msue/iac/e1363/e1363.htm
 University of California www.ipm.ucdavis.edu/PMG/weeds_intro.html

Wildlife Information

Northeast Wildlife Damage Management Coop wildlifecontrol.info/NEWDMC/Publications.html
 Internet Center for Wildlife Damage icwdm.org
 University of Nebraska Institute of Agriculture and Natural Resources ianrpubs.unl.edu/wildlife/index.htm
 Jack H. Berryman Institute www.berrymaninstitute.org

Universities' Resources

Cornell University www.nysaes.cornell.edu
 WVU TFREC www.caf.wvu.edu/kearneysville/wvufarm1.html
 Michigan State Fruit Information www.msue.msu.edu/fruit/index.htm
 U.C. Davis Fruit and Nut Information Center fruitsandnuts.ucdavis.edu
 Washington State University
 Postharvest Information Network postharvest.tfrec.wsu.edu/index.html
 Soils and Nutrition soils.tfrec.wsu.edu
 Tree Fruit Research & Extension Center www.tfrec.wsu.edu/TFREC.html

BIBLIOGRAPHY

Cultural Information, Harvest and Postharvest Handling

- American Society of Heating, Refrigeration and Air-Conditioning Engineers, Inc. (ASHRAE), Refrigeration Application for Foods and Beverages, Technical Committee 10.9. (1998). "Thermal properties of foods." In *Refrigeration* (pp. 8.1-8.30). Atlanta, GA: ASHRAE.
- ASHS Press. 1997. *Brooks and Olmo register of fruit and nut varieties*. 600 Cameron St, Alexandria, VA 22314-2562 Phone: 703-836-4606, Fax: 703-836-2024, e-mail: ashspres@ashs.org
- Barritt, B. H. 1992. Intensive orchard management. *Good Fruit Grower*. 1005 Tieton Drive, Yakima, WA 98902.
- Baucher, T. A., and S. S. Singha. (eds.) 2003. *Concise Encyclopedia of Temperate Tree Fruit*. The Haworth Press Inc., 10 Alice Street, Binghamton, NY 13904-1580.
- Brown, S. K., R. D. Way, and D. E. Terry. 1989. Sweet and tart cherry varieties. *New York Food and Life Science Bulletin* 127.
- Childers, N. F. 1966. *Fruit nutrition*. Gainesville, FL: Horticultural Publications.
- Childers, N. F., J. R. Morris, and G. S. Sibbett (eds.). 1995. *The peach, world cultivars to marketing*. Gainesville, FL: Horticultural Publications.
- Combrink, J. C. (1996). *Integrated management of post harvest quality*. Stellenbosch, South Africa: Infruitec.
- Eskin, N. A. Michael, ed. (1991). *Quality and preservation of fruits*. Boca Raton, FL: CRC Press.
- Faust, Miklos. 1989. *Physiology of temperate zone fruit trees*. New York: John Wiley.
- Ferree, D. C. and I. J. Warrington. 2003. *Apples Botany, production and uses*. CAB International, 44 Brattle Street, Cambridge, MA 02138.
- Fidler, J., B. Wilkinson, K. Edney, and R. Sharples. 1973. *The biology of apple and pear storage*. Slough, England: Commonwealth Agricultural Bureaux (Central Sales, Farnham Royal, Slough SL2 3BN, England).
- Forshey, C. G., D. C. Elfving, and R. L. Stebbins. 1992. *Training and pruning apple and pear trees*. American Society for Horticultural Science. 600 Cameron St, Alexandria, VA 22314-2562 Phone: 703-836-4606, Fax: 703-836-2024, e-mail: ashspres@ashs.org
- Hardenburg, R. E., A. E. Watada, and C. Y. Wang. (1986). *The commercial storage of fruits, vegetables, and florist and nursery stocks*, Handbook No. 66. Washington, D.C.: USDA.
- Jackson, D. I., and N. E. Looney. 1999. *Temperate and subtropical fruit production*. 2nd Edition. CABI Publishing, 10 E. 40th Street, Suite 3202, New York, New York 10016. Phone: 212-481-7018, Fax: 212-686-7993, e-mail: cabi-nao@cabi.org
- Kader, A., R. Kasmire, G. Mitchell, M. Reid, N. Sommer, and J. Thompson. (1985). *Postharvest technology of horticultural crops*, Publication 3311. Davis, CA: Univ. of California Cooperative Extension Service, Division of Agriculture and Natural Resources.
- Kays, S. J. (1997). *Postharvest physiology of perishable plant products*. Athens, GA: Exon Press.
- Kitinoja, L. and A. A. Kader. (1995). *Small-Scale Postharvest Handling Practices: A Manual for Horticultural Crops* 3rd Edition. Postharvest Horticultural Series No. 8. Department of Pomology, University of California, Davis, California 95616.
- LaRue, J. H., and R. S. Johnson. (eds.). 1989. *Peaches, plums and nectarines*. Publications, Division of Agriculture and Natural Resources, University of California, 6701 San Pablo Ave., Oakland, CA 94608-1239.
- Layne, D., and D. Bassi. (eds.). 2008. *The Peach: Botany production and uses*. CAB International, 44 Brattle Street, Cambridge, MA 02138.
- Little, C. R. and R. J. Holmes. (2000). *Storage technology for apples and pears*. Knoxfield, Victoria, Australia: Department of Natural Resources and Environment.
- Maib, K. M., P. K. Andrews, G. A. Lang and K. Mullinix. (eds.) 1996. *Tree fruit physiology: Growth and development*. Available from *Good Fruit Grower*, Dept. I-O, P.O. Box 9219, Yakima, WA 98909.
- Peterson, A. B and R. G. Stevens (eds.). 1994. *Tree fruit nutrition shortcourse proceedings*. Available from *Good Fruit Grower*, Dept. I-O, P.O.Box 9219, Yakima, WA 98909.
- Rieger, M. 2006. *Introduction to fruit crops*. Haworth Press, 10 Alice Street, Binghamton, NY 13904
- Rom, Roy C., and R. F. Carlson (eds.). 1987. *Rootstocks for fruit crops*. New York: John Wiley.
- Ryugo, K. 1988. *Fruit culture, its science and art*. New York: John Wiley.
- Shear, C. B., and M. Faust. 1980. Nutritional ranges in deciduous tree fruits and nuts. *Hort. Reviews*. 2:142-163.
- Stiles, W. C., and W. S. Reid. 1991. *Orchard nutrition management*. Information Bull. 219. Cornell Cooperative Extension.
- Van der Zwet, T., and N. F. Childers (eds.). 1982. *The pear, cultivars to marketing*. Gainesville, FL: Horticultural Publications.
- Webster, A. D., and N. E. Looney. 1996. *Cherries: Crop physiology, production and uses*. CAB International University Press, Cambridge, United Kingdom
- Westwood, M. N. 1993. *Temperate zone pomology*. Portland, OR: Timber Press.
- Wills, R., W. Glasson, D. Graham, T. Lee, and E. Hall. 1989. *Postharvest, an introduction to the physiology and handling of fruit and vegetables*. New York: Van Nostrand Reinhold.
- Wills, R., B. McGlasson, D. Graham, and D. Joyce. (1998). *Postharvest: An introduction to the physiology and handling of fruit, vegetables and ornamentals*, Fourth edition. Adelaide, South Australia: Hyde Park Press.

Environmental Monitoring

- Fischer, W. C., and C. E. Hardy. 1976. *Fire-weather observers' handbook*. Agriculture handbook no. 494. Washington, DC: Forest Service, U.S. Dept. of Agriculture.
- National Weather Service. 1972. *National weather service observing handbook no. 2, substation observations*. Washington, DC: National Oceanic and Atmospheric Administration, U.S. Dept. of Commerce.
- Truxall, D. L., and J. W. Travis. 1994. Analysis of the accuracy of predicted weather data on the impact of apple disease management. *Phytopathology* 84: 1125.
- World Meteorological Organization. 1971. *Guide to meteorological instruments and observing practices*. WMO no. 8. Geneva, Switzerland: World Meteorological Organization.
- Mammal Control
- Anonymous. 1982. *Deer*. Pennsylvania wildlife nuisance and damage. Pennsylvania wildlife nuisance and damage control, no. 12. Penn State School of Forest Resources and Pennsylvania Game Commission.
- Byers, R. E. 1985. Management and control. In R. H. Tamarin (ed.), *Biology of new world microtus*. American Society of Mammalogists 8: 621-646.
- Byers, R. E., and D. H. Carbaugh. 1987. Efficacy of rodenticides for control of orchard voles. *Journal of the American Society for Horticultural Science* 112: 267-272.
- Halls, L. K. (ed.). 1984. *White-tailed deer ecology and management*. Wildlife Management Institute. Harrisburg, PA: Stackpole Books.

- Hynstrom, S. E., R. M. Timm, and G. E. Larson (eds). 1994. *Prevention and control of wildlife damage*. Univ. Nebraska Cooperative Extension Service.
- Palmer, W. L., R. G. Wingard, and J. L. George. 1983. Evaluation of white-tailed deer repellents. *Wildlife Society Bulletin* 11: 164-166.
- Selders, A. W., and J. B. McAninch. 1987. *High-tensile wire fencing*. NRAES 11. Ithaca, NY: Northeast Regional Agricultural Engineering Service.
- Thurston, S. N., and M. C. Brittingham. 1997. *Voles*. Wildlife Damage Control 9. Penn State College of Agricultural Sciences.

Orchard Spraying, Tree Row Volume

- Steiner, P. W. 1987. Tree row volume: a concept for improving pesticide dosage control. *Proceedings 128th annual meeting, Pennsylvania State Horticultural Society*.
- Sutton, T. B., and C. R. Unrath. 1984. Evaluation of the tree-row-volume concept with density adjustments in relation to spray deposits in apple orchards. *Plant Disease* 68: 480-484.
- Tobin, M. E., and M. E. Richmond. 1993. *Vole management in fruit orchards*. U.S. Department of Interior, FWS Biol. Report 5.
- Travis, J. W., Skroch, W. A., and Sutton, T. B. 1987. Effects of travel speed, application volume, and nozzle arrangement on deposition and distribution of pesticides in apple trees. *Plant Disease* 71: 606-612.
- Unrath, C. R., T. B. Sutton, J. D. Obermiller, and K. M. Williams. 1986. *A tree row volume model for determining proper spray rates in apple orchards*. Publication no. 001. Edneyville, NC: North Carolina Apple Growers Association.

Tree Fruit Diseases

- Brunt, A. A., Crabtree, K., Dallwitz, M. J., Gibbs, A. J., Watson, L. and Zurcher, E. J. (eds.) 1999. "Plum Pox Potyvirus." In: *Plant Viruses Online: Descriptions and Lists from the VIDE Database*. Version: 16th January, 1997. (biology.anu.edu.au/Groups/MES/vide/)
- Jones, Alan L., and T. B. Sutton. 1984. *Diseases of tree fruits*. North central regional extension publication no. 34. Michigan State University.
- Jones, Alan L., and T. B. Sutton. 1990. *Compendium of apple and pear diseases*. Amer. Phytopath. Soc., St. Paul, Minnesota.
- Ogawa, J. M., E. Zehr, G. W. Bird, D. F. Ritchie, Y. Urrio, J. K. Uyemoto. 1995. *Compendium of stone fruit diseases*. Amer. Phytopath. Soc., St. Paul, Minnesota.
- Travis, J. W. 1988. *Cytospora canker of stone fruits*. Extension fact sheet no. 1988. The Pennsylvania State University, Department of Plant Pathology.
- Zehr, E. I. 1983. Importance and control of blossom blight in the southeastern United States. Pp. 2-4 in T. J. Burr (ed.), *Proceedings, Brown rot of stone fruit workshop*, Ames, Iowa.

Tree Fruit Pests

- Agnello, A. M., and D. P. Kain. 1996. *Codling moth*. Tree fruit IPM Agnello, A. M., and D. P. Kain. 1996. *Codling moth*. Tree fruit IPM insect identification sheet no. 12. New York State Agricultural Experiment Station.
- Agnello, A., J. Kovach, J. Nysop, and H. Reissig. 1990. *Simplified insect management program*. Cornell Cooperative Extension. IPM Number 201A.
- Beers, E. H. 1997. *Crop production guide for tree fruits in Washington*. Washington State Cooperative Extension Service.
- Beers, E. H. (ed.) 1993. *Orchard pest management: A resource book for the Pacific Northwest*. Washington State University.
- Belding, R. D. (coord.). 1997. *Commercial tree fruit production guide*. Cooperative extension bulletin E002J. Rutgers University.
- Brunner, J. F., and S. C. Hoyt. 1987. *Codling moth control—a new tool for timing sprays*. Extension bulletin 1072. Washington State Cooperative Extension.

- Frost, S. W. 1951. *Insects that attack the apple in Pennsylvania*. Bulletin no. 535. Agricultural Experiment Station. The Pennsylvania State College.
- Hogmire, H. W. (ed.). 1995. *Mid-Atlantic orchard monitoring guide*. Ithaca, NY: Northeast Regional Agricultural Engineering Service, Cooperative Extension.
- Howitt, A. J. 1993. *Common tree fruit pests*. Michigan State University Extension, NCR 63.
- Koehler, G. W. (ed.). 1996-97 *New England apple pest management guide*. Universities of Connecticut, Maine, Massachusetts, New Hampshire, Rhode Island, and Vermont. Cooperative Extension Service.
- Leeper, J. R. 1980. Extension-based tree-fruit insect pest management strategies for apple and pear. *Plant Sciences* No. 85. New York State Agric Exp. Stat. Bull.
- Leeper, J., and J. Tette. 1978. *Pear psylla*. Tree fruit IPM insect identification sheet no. 1. New York State Agricultural Experiment Station.
- Lienk, S. 1980. *Peachtree borer*. Tree fruit IPM insect identification sheet no. 6. New York State Agricultural Experiment Station.
- Lienk, S. 1980. *Plum curculio*. Tree fruit IPM insect identification sheet no. 3. New York State Agricultural Experiment Station.
- Rajotte, E. G., and L. A. Hull. 1987. Managing periodical cicada in Pennsylvania fruit orchards. *Pennsylvania Fruit News* 66 (5).
- Reissig, W. H. 1991. *Apple maggot*. Tree fruit IPM insect identification sheet no. 8. New York State Agricultural Experiment Station.
- Reissig, W. H. 1980. *Green fruitworm*. Tree fruit IPM insect identification sheet no. 4. New York State Agricultural Experiment Station.
- Reissig, W. H. 1980. *Obliquebanded leafroller*. Tree fruit IPM insect identification sheet no. 5. New York State Agricultural Experiment Station.
- Weires, R. 1980. *Predatory phytoseiid mite*. Tree fruit IPM insect identification sheet no. 7. New York State Agricultural Experiment Station.
- Weires, R., and J. Leeper. 1980. *Rosy apple aphid*. Tree fruit IPM insect identification sheet no. 11. New York State Agricultural Experiment Station.

Cider Production

- Anonymous. 1998. "Hazard Analysis and Critical Control Point (HACCP); Procedures for the Safe and Sanitary Processing and Importing of Juice." *Federal Register*, April 24, 1998, Volume 63, Number 79, pp. 20449-20486. Docket No. 97N-0511. Comment deadline: July 8, 1998
- Anonymous. 1998. "Food Labeling: Warning and Notice Statements; Labeling of Juice Products; Final Rule" *Federal Register*, July 8, 1998, Volume 63, Number 130, pp. 37029-37056. Docket No. 97N-0524.
- Anonymous. Current Good Manufacturing Practice in Manufacturing, Packing, or Holding Human Food, *Code of Federal Regulations* 21 Part 110. (www-seafood.ucdavis.edu/GUIDELINES/gmps.htm)
- Anonymous. 1998. *Guidance for Industry—Guide to Minimize Microbial Food Safety Hazards for Fresh Fruits and Vegetables*, U.S. Department of Health and Human Services, Food and Drug Administration, Center for Food Safety and Applied Nutrition. (www.foodsafety.gov/~dms/prodguid.html)
- Besser, R. E., M. S. Lett, J. T. Weber, M. P. Doyle, T. J. Barrell, J. G. Wells, and P. M. Griffin. An outbreak of diarrhea and hemolytic uremic syndrome from escherichia coli d157:h7 in fresh pressed apple juice. 1993. *Journal of the American Medical Association* 269: 2217-2220.
- Beuchat, L. R. 1982. Thermal inactivation of yeasts in fruit juices supplemented with food preservatives and sucrose. *Journal of Food Science* 47: 1679-1682.
- Cider Stuff*. 1999. Current public issues related to cider manufacturing. (www.virtualorchard.net/rce/ciderstuff.html)

- Downing, D. L. 1989. Apple cider. pp. 169–187 in *Processed apple products*, D.L. Downing, ed. New York: Van Nostrand Reinhold.
- Emerson, F. H. 1983. Apple cider production. *Pennsylvania Fruit News*: 26–35.
- Ferguson, W. E., and W. D. Powrie. 1957. Studies on the preservation of fresh apple juice with sorbic acid. *Applied Microbiology* 5: 41–43.
- Filtration and blending is key to sparkling apple juice at Carolina Products. January 1985. *Food Products Management*: 64–65.
- Focus On Food Labeling. 1993. *FDA Consumer*. May 1993.(www.fda.gov/fdac/special/foodlabel/food_toc.html)
- The food label. 1999. *FDA Backgrounder*. BG: 99-5
- Funt, R. C. Sept. 1987. Put the squeeze on cider costs. *Fruit Grower*: 25–27.
- Goverd, K. A., Beech, F. W., Hobbs, H. P., and Shannon, R. 1979. The occurrence and survival of coliforms and salmonellas in apple juice and cider. *Journal of Applied Bacteriology* 46: 521–530.
- HACCP: State-of-the-Art Approach to Food Safety. *FDA Backgrounder* BG: 99-6
- Hager, D. Sept. 1985. The cider appeal. *The Grower*: 25–26.
- Hope, G. W. 1965. Temporary preservation of apple juices by preservation and pH adjustment. *Food Technology* 19: 155–158.
- International Apple Institute. *Apple juice and cider—America's favorite natural fruit beverage*.
- Johnson, K. M. 1984. Microbiology of apple juice. In *Special report no. 54*, 24–26. Ithaca, N.Y.: Cornell Cooperative Extension.
- Katsuyama, A.M., ed. 1993. *Principles of Food Processing and Sanitation*. Food Processors Institute, National Food Processors Association.
- Kozempel, M. 1998. The cost of pasteurizing apple cider. *Food Technology* 52 (1): 50-52.
- Marriott, N.G. 1999. *Principles of Food Sanitation*. Aspen Publications.
- Mattick, L. R. 1984. Chemical composition of apple juice. In *Special report no. 54*, 2–4. Ithaca, NY: Cornell Cooperative Extension.
- Moyer, J. C. 1984. Apple juice extraction. In *Special report no. 54*, 13–17. Ithaca, NY: Cornell Cooperative Extension.
- Norris, J. G. 1982. Sanitation in the processing and packaging of raw cider. *Dairy and Food Science* 2: 143–144.
- Pennsylvania Department of Agriculture. 1983. Quality cider comes from Pennsylvania. *News Bulletin* 68 (17).
- Pooley, M. and J. Lomax. *Real Cidermaking on a Small Scale*. 1999. Nexus Inc., U.K.
- Proulx, A. and L. Nichols. *Cider Making, Using, and Enjoying—Sweet and Hard Cider*. 1980. Story Communications. Pownal, Vermont.
- Sapers, G. M., J. Abbot , D. Massie, A. Watoda, and E. E. Finney, Jr. 1977. Volatile compositions of McIntosh apple juice as a function of maturity and ripen indices. *Journal of Food Science* 42: 44–47.
- Steele, B.T., N. Murphy, and C. P. Rence. 1982. An outbreak of hemolytic uremic syndrome associated with the ingestion of fresh apple juice. *Journal of Pediatrics*. 101: 963–965.
- Succeeding with cider. August 1984. *Fruit Grower*: 13–14.
- Swanson, K. M. J., S. B. Leasor, and D. L. Downing. 1985. Aciduric and heat resistant microorganisms in apple juice and cider processing operations. *Journal of Food Science* 50: 336–339.
- Swientek, R. J. April 1985. Expression–type belt press delivers high juice yields. *Food Processing*: 110–111.
- Watson, B. *Cider Hard and Sweet—History, Traditions, and Making Your Own*. 1999. The Countryman Press. Woodstock, Vermont.
- Wheeler, J. L., M. A. Harrison, and P. E. Koehler. 1987. Presence and stability of patulin in pasteurized apple cider. *Journal of Food Science* 52: 479–480.
- Zhao, T., M. P. Doyle, and R. E. Besser. 1993. Fate of enterohemorrhagic escherichia coli. D157:h7 in apple cider with and without preservatives. *Applied Environmental Microbiology* 59: 2526–2530.

INDEX

Symbols

- 1,3-dichloropropene 162 173
- 2,4-D 162
- 6BA 56
- 6-benzyladenine 162
- 6-Benzyladenine + Gibberellins A4A7 162

A

- acequinocyl 162
- acetamiprid 162
- acidifier 190
- Actara 163
- Acute toxicity and acute effects 150
- Adjuvants 190
- Adjuvants, type
 - buffering agent 190
 - compatibility agents 190
 - crop oil 190
 - defoamer 190
 - drift retardant 191
 - extender 191
 - sticker-spreader 191
 - surfactant 191
 - wetting agent 191
- aecia 99
- Agree
 - Agreesee Bt 165
- Agrobacterium 91
- Aliette 163
- alternate row middle 154
- Alternative pollinators 48
- Ambush 163
 - Ambushsee permethrin 180
- American plum borer 100
- Americans with Disabilities Act 309
- Amid-Thin W 56
- Amine 4 162 163
- amino ethoxyvinylglycine or AVG
 - amino ethoxyvinylglycine or AVGsee ReTain 183
- anthracnose 82 86
- anthracnose of peach 82
- antifoaming agent 190
- antitranspirant 190
- Apical dominance 25
- Apollo 164
- Apple
 - cultivars 16
 - apple black rot 87
 - apple crown rot 83
 - apple grain aphid 101
 - apple leafminer 102
 - apple maggot 102
 - apple rust mite 102
 - apples 16
 - balanced nutrition 50
 - between-row spacing 35
 - calcium chloride 53
 - cork spot and bitter pit 50
 - cultivars 23
 - Days after full bloom 261
 - diseases 82
 - fertilizing 49
 - fruit firmness 261
 - fruit maturity 261
 - fruit thinning 57

- growth regulators 54
- low-calcium fruit 50
- percent soluble solids 261
- pollination 40 41
- production systems 27 30 31 32
- rootstocks 34 40
- site selection 1
- starch levels 262
- storage 265
- storage scald 266
- sugar levels 261
- thinning 56
- tree spacing 34
- trees per acre 3

Apples

- Applesinsecticide efficacy 210
- Applesinsecticide timing 210
- calcium sprays 52
- fruit density 51
- insecticide efficacy 211
- Training Systems 28
- tree vigor 51
- apple scab 83
- Apple thinning 57
- apple union necrosis 136
- Arrow 168
- ascospores 84
- Asian Pears 66
- Assail 162

B

- B9 38
- B.469 38
- B.490 39
- Bacillus thuringiensis 164
 - Bacillus thuringiensissee Bt 165
- Bac-Master 165
- bacterial canker 84
- bacterial spot 194
- Basamid
 - BasamidSee dazomet 169
- Basicop
 - Basicopsee copper compounds 168
- Bayleton 165
- Beds 36
- bee
 - hornfaced 48
 - mason 48
- bee colonies 42
- bin rot 89
- Biobit
 - Biobitsee Bt 165
- Bitter Pit 13 50
- bitter rot 86
- bitter rot of apple 82
- black cherry aphid 103
- black knot 86
- black rot 87
- blister spot 88
- blossom end rot 88
- blotch 88
- blue mold 89
- Bordeaux mixture
 - Bordeaux mixturesee copper compounds 168
- boron 13 16

- Botryosphaeria 82
- Botryosphaeria dothidea 100
- Botryosphaeria obtusa 87
- Botrytis cinerea 88
- Bravo 720
 - Bravo 720see chlorothalonil 167
 - see chlorothalonil 167
- Brooks fruit spot 89
- brown rot 90 194
- bruising 263
- Bt 165
- Budagovsky 9 38
- Budagovsky 469 38
- Budagovsky 490 39
- buffalo treehopper 104
- buffering agent 190
- Buprofezin 166

C

- Cabrio 166 182
- calcium 13 15 50
 - determination 53
 - sprays 52 53
- calcium chloride 52 53
- calcium rates 53
- Calcium sulfate 50
- calibration 154
- callus tissue 91
- Calypso 166
- Capnodium 99
- captan 166
- Captec
 - Captecsee captan 166
- Carbamate
 - Carbamatesee ferbam 171
- carbaryl 166
- Carzol 166
- Casoron 166
- cation exchange capacity 1
- cedar apple rust 181
- cedar-apple rust 98 99
- Centaur 167
- Central leader system 28
- Champ
 - Champsee copper compounds 168
- Chateau 167
- chemical thinning 56
- cherries 71 72
 - cultivars 72
 - diseases 82
 - growth regulators 71
 - rootstocks 74
 - site selection 71
 - soil preparation 71
- cherry fruit fly 104
- cherry leaf spot 90
- Child Labor Laws 302
- chlorosis 13
- chlorypyrifos 167
- chronic rodenticides 139
- Chronic toxicity and chronic effects 150
- cicada 117
- cider
 - blending apples 273
 - pressing systems 274
- shelf life 272
- Cider
 - Preservation and Shelf Life 271
 - Production Operations and Practices 273
 - Quality and Composition 271
 - Safety 284
- cider composition 271
- cider, labeling
 - optional 275
 - required 275
- cider, pressing systems 274
- clethodim 168
- clofentezine 168
 - clofentezinesee Apollo 164
- clothianidin 168
- Coccomyces hiemalis 90
- Coccomyces prunophorae 96
- codling moth 104
 - degree day accumulation table 105
- collar rot 39 83
- collect leaf samples 10
- Colletotrichum (C. acutatum and C. gloeosporioides) 82
- compatibility agent 190
- Condor 168
 - Condorsee Bt 165
- conidia 84
- copper 14 16
- copper compounds 168
- Cork Spot 50
- critical temperatures 78
- crop oil 190
- crown gall 91
- crown rot 83
- Crymax 168
- Cryomix
 - Cryomixsee Bt 165
- Cyd-X 168
- cyprodinil
 - cyprodinilSee Vanguard 189
- Cythion 168
 - Cythionsee malathion 178
- Cytospora canker 91

D

- Damofil 168
- Danitol 168
- dazomet 169
- deer
 - biology 140
 - damage 141
 - fencing 142
 - management 141
 - repellents 141 142
- Deficiency\
 - defoamer 190
- Dibotryon morbosum 86
- dichlobenil 169
- Dichlobenil 166
- dicofof
 - dicofofsee Kelthane 176
- Dipel 169
 - Dipelsee Bt 165
- Diphenylamine 267
- Direx 169

- Direxsee diuron 169
disease 75
disposal of pesticides 152
Dithane
 Dithanese mancozeb 178
diuron 169
dodine 170
 dodinese Syllit 187
dogwood borer 106
Dormant Oil 435 170
DPA 267
drift retardant 191
dropped apples 280
Dzn diazinon 170
- E**
E. coli O157
 H7 279
Elite 170
endosulfan 170
Envidor 170
environmental monitoring 75
Erwinia amylovora 93
esfenvalerate 170
Esteem 170
Ethephon 171
ethoxyquin 267
etoxazole 171 190
European apple sawfly 107
European red mite 107
E-Weather 76
Exilis plus 162
Exillis Plus 171
extender 191
- F**
Fabraea maculata 95
Falgro 171
Farm labor contractors 310
Federal Migrant and Seasonal Agricultural Workers P 310
Federal Unemployment Tax Act (FUTA) 306
fenarimol 171
 fenarimolsee Rubigan 184
fenbuconazole 171
 fenbuconazolesee Indar 175
fenbutatin oxide 171
 fenbutatin oxidesees Vendex 189
fenpropathrin 168
fenpyroximate 171
ferbam 171
Fertilizer Application 14
Fertilizing 49
Field Sanitation 307
fire blight 39 66 93
Firestorm 180
Firewall 171
First aid for pesticide poisoning 151
First aid general instructions 151
Fiint 171
fluazifop 171
fluazifop-p-butyl
 fluazifop-p-butylsee Fusilade 172
flyspeck of apple 99
foliar analysis 10
foliar nutrient sprays 12
Food Safety
 Cider Processing 284
 Orchard Operations 280
 Packing Operations 282
 Food Safety Regulations 287
 formetanate hydrochloride 171
 formetanate hydrochloridesees Carzol 166
 fosetyl 163 171
 French axe 31
 Frost 77
 FROSTPRO 77
 frost protection 77
 critical temperatures 78
 heaters 77
 sprinkling 77
 water application 77
 water pulsing 77
 Fruitone N 171
 fruit thinning 54
 FujiMite 172
 fumigation
 fumigationbenefits 200
 fungicides 161
 broad-spectrum 195
 modes of action 193
 systemic 195
 types 191
 Fungicides
 options 194
 Funginex 84 172
- G**
G.11 39
G.16 38
G.65 38
GA 3 172
GA 4+7 172
Galigan 172 180
Gallery 172
galls 91 99
gamma-cyhalothrin 172
Geneva 11 39
Geneva 16 38
Geneva 65 38
GF-120 NF Naturalyte Fruit Fly Bait 173
gibberellic acid 172
Gibberellic acid
 Gibberellic acidsee ProGibb 182
Gibberellin A4A7 172
Gisela 74
Gisela 5 75
Gisela 6 75
Gisela 12 75
Glomerella cingulata 82 86
glufosinate 172
 glufosinatesee Rely 183
glyphosate 2 172
Goal 173 180
Good Management Practices for Safe Apple Growing, Packing, and Cider Production 279
Gramoxone 173
Gramoxone Extra 180
green aphids 109
green fruitworms 110
green manure 200
GreenMatch 173
green peach aphid 111
ground cover 6
growth regulators 54
Guthion 173
gypsum 50
gypsy moth 111
- H**
HACCP 288
hawthorn rust 98 99
Hazard Analysis and Critical Control Point (HAACP) 288
heading cut 25
heat 264
heat index 265
Herbicide failure 9
Herbicide mode of action 9
herbicides
 tank mixing 159
Herbicides
 HerbicidesCasaron 166
 HerbicidesDiuron 169
 HerbicidesFusilade 172
 HerbicidesGaligan 180
 HerbicidesGallery 172
 Herbicidesglufosinate 183
 HerbicidesGoal 180
 HerbicidesGramoxone 180
 HerbicidesKarmex 169
 HerbicidesKerb 176
 Herbicidesnorflurazon 186
 Herbicidesoxyfluorfen 180
 Herbicidesparaquat 180
 Herbicidespendimethalin 182
 HerbicidesPoast 180
 HerbicidesProwl 182
 HerbicidesRage 182
 HerbicidesRely 183
 HerbicidesSelect Max 168
 Herbicidessethoxymdim 180
 HerbicidesShadow 168
 Herbicidesdimazine 185
 HerbicidesSinbar 185
 HerbicidesSolicam 186
 Herbicidessterbacil 185
hexythiazox 173
Hiring
 child labor laws 300
 Immigration Reform and Control Act 300
honeybees
 pollination agreement 42
hornfaced bee 48
hygrothermograph 76
- I**
Imidan 175
Immigration Reform and Control Act of 1986 302
Increasing Branching 54
Increasing Return Bloom 56
Indar 175
indoxacarb 164
Indoxacarb 175
inking 268
insecticidal soap 175
 insecticidal soapsee M-Pede 177
insecticide efficacy
 insecticide efficacypears 213
 insecticide efficacystone fruit 214
Insecticide efficacy
 apples 211
 Insecticide efficacyapples 210
insecticide timing
 insecticide timingapples 210
 pears 213
 stone fruit 214
 insect, mite pests 100
 integrated pest management 75 81
 Integrated pest management supply sources 82
 interstems 39
 Intrepid 175
IPM
 supplies 82
iprodione 176
 iprodionesee Rovral 184
iron 13
Isomate 176
isoxaben 176
 isoxabensees Gallery 172
- J**
Japanese beetle 111
Javelin 176
 Javelinsee Bt 165
- K**
Kanemite 162
kaolin 176
kaolin clay 187
Karmex 176
 Karmexsee diuron 169
Kelthane 176
Kerb 176
Kocide
 Kocidesees copper compounds 168
kresoxim-methyl
 kresoxim-methylSee Sovran 186
- L**
Labor 299
lambda-cyhalothrin 177
landplaster 50
Lannate 177
Late thinning 61
leaf analysis 10
leaf spot 90 96
leaf wetness 76
lesser appleworm 112
lesser peachtree borer 112
Leucostoma canker 91
lime 168 171
lime sulfur 177
Listeria 279 283
Lorsban 177
 Lorsbansee chlorpyrifos 167
- M**
M.2 39
M.7 39
M.9 38
M.26 39
M.27 38
magnesium 13 15
malathion 178
Malling 2 39
Malling 7 39
Malling 9 38
Malling 26 39
Malling 27 38
Malling-Merton 106 39
Malling-Merton 111 39
mammal control 138
 voles 138
 white-tailed deer 140

- mancozeb 178
manganese 13
Manzate
 Manzatesee mancozeb 178
MARK 38
mason bee 48
mating disruption
 mating disruptionsprayable pheromones 186
Matrix 178
MaxCel 162 178
Measles 13
Medicare Taxes 305
metalaxyl 178
 metalaxylsee Ridomil 183
metam-sodium 178
 metam-sodiumsee Vapam 189
methidathion 178
 methidathionsee Supracide 187
methomyl 178
 methomylsee Lannate 177
methoxyfenozide 178
metiram 178
 metiramsee Polyram 180
Metos Model D 76
Micronutrients 13
Migrant Labor Housing 312
 federal 312
 Pennsylvania 312
Mite-E-Oil 178
MM.106 39
MM.111 39
Mode of Action, herbicide 9
 moldy core 88
Monilinia 82
M-Pede 177
mullein plant bug 112
MVP 178
 MVPsee Bt 165
mycelium 97
myclobutanil
 myclobutanilsee Nova 183
Mycoshield 178
Mycosphaerella pomi 89
Mycosphaerella sentina 95
- N**
NAA 178
NAAM 179
NAD 179
naphthalene acetamide 179
National Poison Center Toll-Free Number 151
Naturalyte
 Naturalytesee SpinTor 186
Nectria cinnabarina 94
nectria twig blight 94
nematicide
 nematicidebenefits 200
nematodes 136
 apple union necrosis 136
 peach stem pitting 136
 root lesion 137
 sampling for 137
 tomato ringspot virus 136
Nexter 179
nitrogen 12 14
nitrogen levels
 leaf 14
nonionic surfactant 191
norflurazon 179
- norflurazonsee Solicam 186
Nova 179
Novagib 179
novaluron 179
nozzle 154
Nu-Cop
 Nu-Copsee copper compounds 168
nurseries 3
 European 5
 rootstocks 5
nutrition
 balanced 50
 deficiency, toxicity 12 13 14
 foliar analysis 10
 foliar application 14 15 16
 nitrogen 12
Nutritional ranges 11
- O**
O.3 38
obliquebanded leafroller 113
Occupational Safety and Health Act 307
oil 158
 Mixing 158
Omni Supreme Spray 179
Orbit 179
orchard 157
 beds 36
 environmental monitoring 75
 fumigation 2
 nematode test 2
 orchardspraying 157
 resistance management 195
 row middle management 6
 site selection 1 66 67
 spraying 153
 trees per acre 3
Orchard Establishment 1
Orchard Master 162 179
orchard sod 2
organic matter 1
organosilicon surfactant 191
Organosilicon surfactants 191
Oriental fruit moth 113
ornamental crabapples 41
Ottawa 3 38
overtree sprinkling 77
oxamyl 180
 oxamylsee Vydate 189
oxyfluorfen 180
oxytetracycline 178
- P**
P.1 39
P.2 38
P.16 38
P.18 39
P.22 37
paraquat 180
Parazone 3SL 180
Par F70 Soluble Oil 180
peach anthracnose 82
peaches
 diseases 82
 growth regulators 71
 planting depth 68
 pruning 68
 rootstocks 68
 shattered pit 70
 site selection 67
 skin discoloration 268
 split pit 70
 thinning 70
 training 68
peach leaf curl 94
peach stem pitting 136
peachtree borer 114
pear leaf blight and fruit spot 95
pearleaf blister mite 116
pear leaf spot 95
pear psylla 115
pears 54
 diseases 82
 fruit thinning 57
 growth regulators 54
 maturity 263
 Nashi 66
 rootstocks 67
 site selection 66
Pears
 insecticide timing 213
 Pearsinsecticide efficacy 213
pear scab 95
pear thrips 116
pear varieties 66
Pendimax 180
pendimethalin 180
 pendimethalinsee Prowl 182
penetrant 191
Penicillium expansum 89
Penncozeb
 Penncozebsee mancozeb 178
Penn-Premium 3
Penn-Standard 3
Pennsylvania Seasonal Farm Labor Act 310
Pennsylvania Wage Payment and Collection Law 305
Pennsylvania Worker and Community Right-to-Know Act 308
Perlan 162
permethrin 180
pest
 threshold 81
Pesticide poisoning symptoms 150
pesticides
 descriptions of 161
 resistance 195
 spray-to-harvest limitations 203
pesticide storage 219
Pesticide toxicity 149
PGR table
 apples and pears 59 60
pheromone 180 195
Phoma fruit spot 89
phosmet 180
 phosmetsee Imidan 175
phosphorus 13 15
Phyllosticta solitaria 88
Planting Depth 40
Plant nutrition 10
plum black knot 86
plum curculio 118 175
plum leaf spot 96
plum pockets 96
Poast 180
Podosphaera leucotricha 97
Podosphaeria oxycanthae 97
Poland 1 39
Poland 2 38
Poland 16 38
Poland 18 39
- Poland 22 37
pollination
 supplemental 41
Pollination 40
pollination rentals 48
pollinator 41
pollinizer 41
Pollinizer placement 41
Polyram 180
postharvest fruit disorders
 scald 266
potassium 13 15
potato leafhopper 119
Pounce 181
 Pouncesee permethrin 180
powdery mildew 181
 of apple 97
 of cherry, plum 97
 of peach, nectarine, apricot 98
powdery mildew 187
Pratylenchus penetrans 137
precipitation 76
Preharvest Drop 61
preharvest (PHI) 216 217 218
Princep 181
 Princepsee simazine 185
Pristine 181
Proaxis 181
Product Traceback 281
Promalin 162 182
pronamide 182
 pronamidese Kerb 176
propiconazole 182
 propiconazolesee Orbit 179
ProVide 172 182
Prowl 180 182
Pruning 25
 peaches 68
 Summer 27
Pyraclostrobin 182
Pyramite 182
pyridaben 182
Pyrimethanil 182
pyriproxyfen 182
- Q**
quince rust 98 99
- R**
Rage 182
rapeseed 200
Rattler,
 Rattler,see glyphosate 172
Recoil 183
redbanded leafroller 119
Reentry (REI) 216 217 218
relative humidity 76
Rely 182
replant problems 137
resistance 195
 apple scab 195
 Bayleton, Rubigan, Nova 195
 captan, ferbam, mancozeb, sulfur, thiram, Ziram 195
 cedar apple rust 195
 collar rot 39
 development 195
 fire blight 39
 powdery mildew 195
Responding to pesticide poisoning symptoms 150

Restricted use pesticides 153
 ReTain 61 183
 Rhizopus rot 98 194
 of nectarines 98
 of peaches 98
 of plums 98
 of sweet cherries 98
 Ridomil 183
 Rimon 184
 RiteSize 162 184
 RiteWay 162
 rodenticides
 acute 139
 Acute 139
 application rates 140
 chronic 139
 sources for 140
 root-lesion nematode 137
 root rot 83
 rootstocks
 apple 37
 cherry 74
 Gisela 75
 nurseries 5
 peach 70
 pear 67
 planting depth 40
 rose leafhopper 119
 rosy apple aphid 120
 Roundup Ultra,
 Roundup Ultra, see glyphosate
 172
 Rovral 184
 Rubigan 184
 russetting 171 177
 rust diseases 98

S

Saber 185
 Salmonella 279 280
 Sanitation Standard Operating Procedures (SSOP) 289
 San Jose scale 120
 saprophytic fungi 91
 Savey 185
 scab 181
 Scab-resistant cultivars 23
 scald control 267
 Scythe 185
 Seasonal Agricultural Workers Protection Act 312
 Seedling 39
 Select 185
 Sensor Field Monitor 76
 sethoxydim 185
 sethoxydimsee Poast 180
 Sevin 185
 Sevinsee carbaryl 166
 Shoot Growth Suppression 55
 shothole borer 121
 Signal words 150
 simazine 185
 Sinbar 185
 SkyBit 76
 SkyBit E-Weather 76
 Slender spindle 28
 SmartFresh 185
 Snapshot 186
 Social Security 305
 soft rot 89

soil 50
 ingredients 1
 low-calcium fruit 50
 texture 1
 soil fumigants 162 175
 Sok
 Soksee Bt 165
 Solicam 186
 sooty blotch 99
 sooty mold 99
 Sovran 186
 Sphaerotheca pannosa 98
 spinosad 186
 Spinosad 186
 SpinTor 186
 Spirodiclofen 186
 sporangiospores 98
 spotted tentiform leafminer 122
 Sprayable Pheromone 186
 sprayers 153 159
 calibrating 160
 calibration 154
 cleaning 160
 granular 160
 Herbicide 159
 spray-to-harvest limitations 203
 spreader, spreader-sticker 191
 Sprinklers
 overtree 77
 stem pitting virus 67
 sticker, sticker-spreader 191
 Stinger 187
 Stone fruit
 insecticide timing 214
 Stone fruitinsecticide efficacy
 214
 storage 265
 storage of pesticides 152
 Storage suggestions for pesticides used
 on tree fruit
 Storage suggestions for pesticides
 used on tree fruit 219
 streptomycin sulfate 163
 Streptomycin sulfate 187
 Stylet oil 187
 sulfur 187
 summer oils 187
 sunscale wounds 91
 Sunspray 6E 187
 Sunspray Ultrafine Oil 187
 Superfund Amendments and Reauthori-
 zation Act (SARA) 308
 Support Systems 33
 Supracide 187
 surface active agent 191
 surfactant 158 191
 Surflan 187
 Surround 187
 suspension agent 191
 Sweet cherry pollination 72
 Syllit 187

T

TABM
 degree day accumulation table
 126
 Tall Spindle 32
 Taphrina communis 96
 Taphrina deformans 94
 Tart cherry cultivars 74
 tebuconazole 187
 tebuconazolesee Elite 170
 tebufenozide 187
 telial horn 99
 Telone 178 187
 Telonesee 1,3-dichloropropene
 162 173
 temperature 76
 terbacil 187
 terbacilsee Sinbar 185
 terramycin 187
 Terranil
 see chlorothalonil 167
 Terranilsee chlorothalonil 167
 thiacloprid 166
 thiamethoxam 163 188
 thickener 191
 thinning
 Ethephon 56
 NAA 56
 peaches 70
 Thinning cut 26
 Thinning Tree Row Volume 158
 Thionex 188
 thiophanate-methyl 188
 thiophanate-methylsee Topsin-
 M 188
 Thiram 188
 Thuricide 188
 Thuricidesee Bt 165
 tomato ringspot virus 136
 Topsin-M 188
 Touchdown 188
 Training aids 31
 training systems 28
 central leader 28
 French axe 31
 slender spindle 29
 trellis 30
 tree
 nurseries 4
 sources 4
 Tree Row Volume Table 158
 Tree Spacing 34
 Trees Per Acre 36
 Tree Support Systems 33
 Trellis 30
 triadimefon 188
 trifloxystrobin
 trifloxystrobinsee Flint 171
 triflumizol
 triflumizolsee Procure 181
 triflumizole 188
 triforine 188
 TRV 157
 tufted apple bud moth 124
 egg hatch predictions 125
 ground cover treatment 127
 two-spotted spider mite 127
 TypRus 189
 Typy 162 189

U

Unemployment Compensation 306
 federal 306
 state 306

V

V.1 38
 Valsa canker 91
 Vanguard 189
 Vapam 189
 variegated leafroller 128
 Varieties
 pear 66
 vascular system 93
 vegetable oil concentrate 191
 Vendex 189
 Venturia inaequalis 84
 Venturia pirina 95
 Vineland 1 38
 virus 67
 stem pitting 67
 voles 138
 biology 138
 damage 138
 distribution 138
 identification 138
 management 139
 meadow vole 138
 monitoring 138
 pine vole 138
 repellents 139
 Vydax 189

W

Wage 304
 hour laws 304
 minimum wage 304
 withholding 304
 Warrior 189
 watercore 183 269
 water molds 83
 weather 75
 weather stations 75
 Weedar 64 189
 western flower thrips 128
 wetting agent 191
 When to collect samples 10
 white apple leafhopper 129
 white mineral oil 187
 white rot 100
 white-tailed deer 140
 woolly apple aphid 129 177
 worker hygiene 281 284
 Worker Protection Standard 153
 Workers Compensation Insurance
 306

X

Xentari
 Xentarisee Bt 165
 XenTari 189

Z

Z-8-Dodecenyl acetate 190
 Zeal 190
 zinc 14 16
 Ziram 190
 Zygophiala jamaicensis 99
 zygospores 98

CONVERSION OF WEIGHTS AND MEASURES

Dry measure

16 ounces = 1 pound
 one ton = 2,000 pounds
 1 metric ton = 1.102 ton

Square measure

one acre = 43,560 square feet = 4,840 yards
 one square foot = 144 square inches
 one square yard = 9 square feet

Weights of liquids

1 gallon water = 8.34 pounds
 1 cubic foot water = 62.4 pounds
 231 cubic inches = 1 gallon

Linear measure

one foot = 12 inches
 one yard = 3 feet = 36 inches
 one rod = 16.5 feet = 5.5 yards
 one mile = 5,280 feet = 8 furlongs
 one rod x 1 mile = 2 acres

Cubic measure

1 cubic foot = 1,728 cubic inches
 1 cubic yard = 27 cubic feet
 231 cubic inches = 1 gallon

Parts per million (ppm)

ppm = % x 10,000
 1% = 10,000 ppm
 1 ppm = 1 milligram per liter
 = 1 milligram per kilogram
 1 ppm = one part per million by weight
 = 1 pound in 100,000 gals. of water
 100 ppm = 1 pound in 1,000 gals. of water
 = 1.6 ounces in 100 gals. of water

Liquid measure

1 tablespoon = 3 teaspoons
 1 fluid ounce = 2 tablespoons
 1 cup = 8 fluid ounces = ½ pint
 1 pint = 2 cups = 16 fluid ounces
 1 quart = 2 pints = 4 cups = 32 fluid ounces
 1 gallon = 4 quarts = 8 pints = 16 cups = 128 fluid ounces

Miscellaneous facts

diameter = circumference x 0.318
 area of a circle = diameter² x 0.785
 volume of a cylinder = 3.14 x radius² x height
 volume of a sphere = diameter³ x 0.524
 volume of a cone = area of base x height ÷ 3
 1 ppm is approximately:
 1 inch in 16 miles or
 1 minute in 2 years or
 1 ounce in 31 tons or
 1 cent in \$10,000

METRIC WEIGHTS AND MEASURES

Centimeters	Inches	Feet	Meters	Yards	Inches	Kilometers	Miles
1.00	0.394	0.0328	1.000	1.093	39.37	1.000	0.621
2.54	1.000	0.083	0.914	1.000	36.000	1.609	1.000
30.48	12.000	1.000					

Acres	Hectares	Grams	Ounces	Pounds	Kilograms	Ounces	Pounds
1.000	0.405	1.00	0.035	0.002	1.000	35.274	2.205
2.471	1.000	28.35	1.000	0.063	0.028	1.000	0.063
		453.59	16.000	1.000	0.454	16.000	1.000
		1000.00	35.274	2.205			

Liters	Pints	Quarts	Gallons	Milliliter	Teaspoon	Tablespoon	Fluid ounce	Cup
1.000	2.113	1.057	0.264	1.000	0.200	0.064	0.032	0.004
0.473	1.000	0.500	0.125	15.000	3.000	1.000	0.500	0.063
0.946	2.000	1.000	0.250	240.000	48.000	16.000	8.000	1.000
3.785	8.000	4.000	1.000	30.000	6.000	2.000	1.000	0.125

COMMON METRIC EQUIVALENTS

Metric	U.S.	U.S.	Metric
Millimeter	0.039 inches	Inch	2.54 centimeters
Centimeter	0.39 inches	Foot (12 in.)	30.5 centimeters
Meter (100 cm)	39.4 inches = 3.28 feet	Mile (5,280 ft.)	1.6 kilometers
Kilometer (1,000 m)	0.62 miles	Square inch	6.5 square centimeters
Square centimeter	0.155 square inches	Square foot (144 sq. in.)	930 square centimeters
Square meter	1.2 square yards	Square yard (9 sq. ft.)	0.84 square meters
Hectare (10,000 sq m)	2.471 acres	Acre (43,560 sq. ft.)	0.405 hectares
Square kilometer (100 ha)	247 acres	Ounce	28.3 grams
Gram	0.035 ounces	Pound (16 oz.)	453.5 grams = 0.454 kilograms
Kilogram (1,000 g)	2.2 pounds	Tablespoon (3 teaspoons)	14.79 milliliters
Ton (metric) (1,000 kg)	1.1 tons (U.S.)	Fluid ounce (2 tablespoons)	29.6 milliliters
Milliliter	0.032 fluid ounce	Pint (2 cups)	0.473 liters
Liter (1,000 ml)	1.056 quarts = 2.1 pints	Quart (4 cups)	0.946 liters
Cubic meter (1,000 l)	264.17 gallons (U.S.)	Gallon (U.S.) (4 quarts)	3.8 liters

I.	Cultural Information.....	1
II.	Diseases, Pests, and Natural Enemies	81
III.	Chemical Management	149
IV.	Chemical Management Tables	203
V.	IPM Spray Programs	221
VI.	Harvest and Postharvest Handling	261
VII.	Cider Production.....	271
VIII.	Maintaining the Safety of Pennsylvania Apples and Apple Products	279
IX	Farm Management.....	291
X	Appendix, Bibliography, Index.....	315