

APPENDIX O

Automated Parking Garages

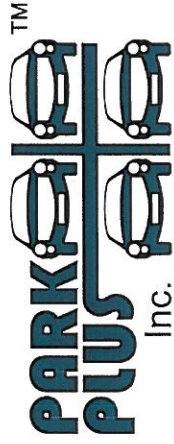

Leaders in high density vehicle storage systems

CORPORATE HEADQUARTERS

31 Iron Horse Rd
Oakland, NJ 07436
Office: +1 (973) 574-8020
Fax: +1 (973) 574-8030
Toll Free: 1-800-966-5509

SERVICE & OPERATIONS DEPARTMENT

480 Main Ave, Unit 1
Wallington, NJ 07057
Office: +1 (973) 574-8020
Fax: +1 (973) 574-8030
Toll Free: 1-800-966-5509

PARK PLUS FLORIDA, INC.

1835 East Hallandale Beach Blvd
Suite 439
Hallandale, FL 33009
Office: +1 (954) 374-8434
Fax: +1 (953) 374-8660

PARK PLUS CHICAGO

P.O. Box 59505
Schaumburg, IL 60159
Office: +1 (847) 612-4038
Fax: +1 (847) 592-6789

www.parkplusinc.com

email: info@parkplusinc.com

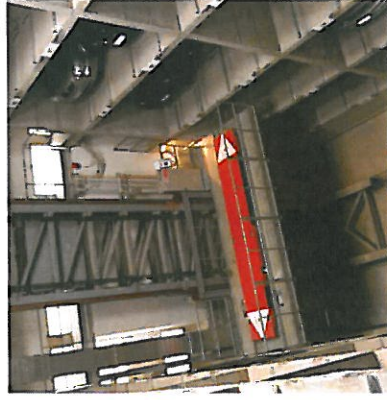
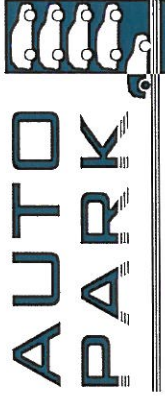

AUTOMATED SYSTEMS



AUTOMATED VEHICLE STORAGE SYSTEMS



Lift Sliding System
Semi-Automatic vehicle storage system

The Lift Sliding parking system maneuvers stacked vehicles on platforms in horizontal and vertical motions in order to lower vehicles to grade position through a Programmable Logic Control system.

EQUIPMENT DIMENSIONS (Lift Sliding system)

Length	L1	19'-8"
Width	W1	7'-11" to 8'-3" (Per platform)
Height	H1	Variable
PL Requirement	H2	Variable
CERTIFIED LIFTING CAPACITY		5200 lbs/ Platform
LIFTING SPEED		1.3 - 26 ft/ min
SLIDING SPEED		26 ft/ min
MAXIMUM STACKING		5 Above Grade/ 3 Below Grade
OPERATION CONTROL		Automatic Key pad/ remote devices
ELECTRICAL POWER		3-phase/ 60 Hz

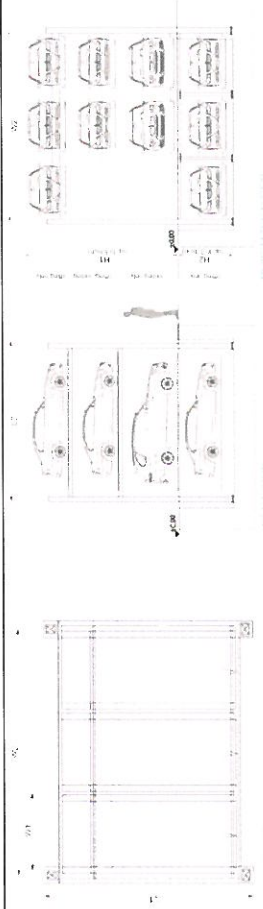

Parking Tower System
Automatic vehicle storage system

The Parking Tower System consists of 2 vertical vehicle stacks separated by a vertical transfer shaft. This vehicle storage and retrieval system utilizes parking pallets or platforms that are placed into position on a storage racking system.

EQUIPMENT DIMENSIONS (Parking Tower system)

Length	L1	18'
Width	W1	25'-12"
Height	H1	10'-6"
	H2/H3	Variable
	H4	6'-7"
	H5	6'-8" to 7'-8" (minimum clearance)
		4'-11" (per car)
CERTIFIED LIFTING CAPACITY		6000 lbs/ Platform
MAXIMUM STACKING		25 Above Grade
OPERATION CONTROL		Automatic Key pad/ remote devices
ELECTRICAL POWER		3-phase/ 50 Hz

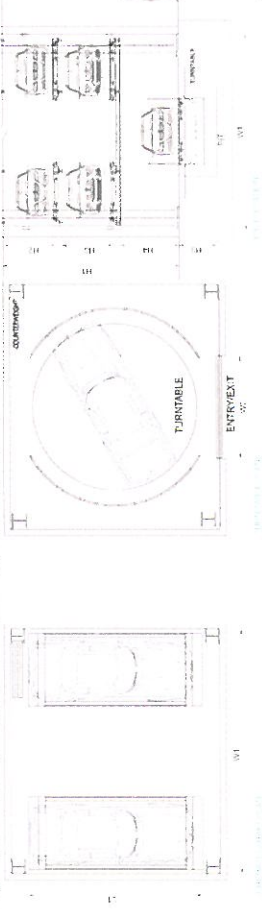

Auto Park
Fully Automatic vehicle storage system

The Auto Park system is designed for maximum efficiency and space utilization for high density parking. It features a virtually unlimited stacking capability and a fully integrated storage and retrieval functionality. Each design layout is custom suited for each project.

EQUIPMENT DIMENSIONS (Auto Park)

Length	L1	18'-6"
	L2	18'-6"
Width	W1	19'-1" (Transfer Aisle)
	W2	8'-1" (First center line)
		7'-4" (Typical center line)
Height	H1	5'-0"
	H2	7'-4"
	H3	5'-10"
		(Min. Side Clearance requirement)
		(Min. Seismic clearance requirement)
CERTIFIED LIFTING CAPACITY		6000 lbs/ Platform
MAXIMUM STACKING		Variable
OPERATION CONTROL		Automatic Key pad/ Remote device
ELECTRICAL POWER		3-phase/ 60 Hz

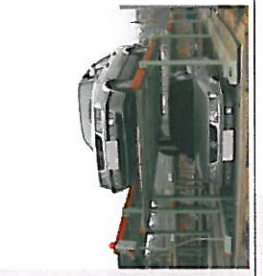
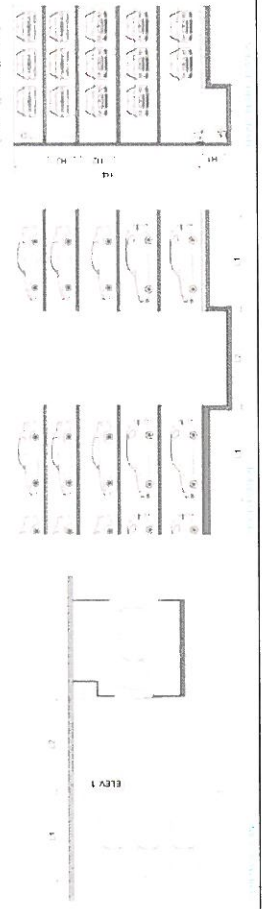

Mini System
Mechanical vehicle storage system with pit

This system includes the use of an in-ground pit in order to retrieve stacked vehicles without the need for removing any other vehicles within the system, therefore this type of system can be considered as "self-parking". This product is available as a 2 vehicle stacking unit or as a 3 vehicle stacking unit.

EQUIPMENT DIMENSIONS (Mini System)

Length	L1	17'-3"
Width	W1	8'-2-1/2" (Center to center)
Height	H1	5'-9" to 7'-6" (platform height)
Clearance requirement	H2	11'-6" to 17'-3"
	H3	7'-3"
		(per car)
CERTIFIED LIFTING CAPACITY		6000 lbs/ Platform
LIFTING SPEED		8 ft/ min
MAXIMUM STACKING		3 Vehicles
OPERATION CONTROL		Electrical Push button
ELECTRICAL POWER		3-phase/ 60 Hz

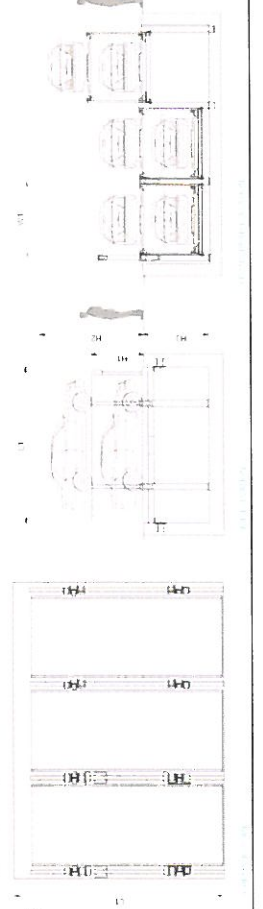



Leaders in high density parking systems

1. Product Name

Valet Parking Systems

- Double Parking System
- Triple Parking System
- Quadruple Parking System

Self-Parking Systems

- Lift-Sliding Semi-Automatic Parking System
- Auto Park Fully Automatic Parking System

2. Manufacturer

Park Plus, Inc.
 480 Main Avenue, Unit 1
 Wallington, NJ 07057
 (800) 966-5509
 (973) 574-8020
 Fax: (973) 574-8030
 E-mail: info@parkplusinc.com
 www.parkplusinc.com

3. Product Description

BASIC USE

Park Plus, Inc., manufactures parking systems to meet high-density parking requirements. Park Plus systems provide efficient space utilization in multiple applications and offer a variety of vehicle storage and retrieval options, from attended systems (valet) to fully automatic systems that require no human intervention. These systems are freestanding and can be installed indoors or outdoors, retrofitted into existing buildings, or designed specifically for new building projects and enclosed to client specifications.

BENEFITS

- Designed or retrofitted in accordance with client specifications
- Cost-effective and can be installed with little to no site preparation; standard garage doors, facade siding and roofs can be used to enclose all systems
- Construction periods and costs are minimized with Park Plus systems and require no ramps or drive aisles
- Beneficial floor area ratio (FAR) - Systems regarded as one level in many cities
- Systems are MEA approved for New York City

TYPES & SIZES

Valet Parking Systems

This system is designed for attended parking applications and consists of simple devices that stack 2, 3 or 4 vehicles atop a single parking space. A trained operator raises a vehicle on a platform from a control device, which creates an additional space for another vehicle to be stored below. This process is repeated until the system reaches capacity. To retrieve a vehicle, the operator removes the vehicle below (at grade position) in order to lower the platform and return the stacked vehicle requested.

Double Parking System - Designed to double parking capacities, this system is available as a hydraulic or electric 2-post cantilevered unit that requires no foundation anchorage. It is also offered in a suspended electric postless design. Low profile equipment is available for minimal height clearances.

Triple Parking System - This system is designed to vertically stack vehicles up to 3 high. It is available as a 4-post hydraulic or electric machine or a 2-post electric machine. Both types require a reinforced concrete base.

Quadruple Parking System - This system is designed to vertically stack vehicles up to 4 high. It is available as a 4-post electric machine and requires a reinforced concrete base.

Self-Parking Systems

The Lift Sliding Parking System maneuvers stacked vehicles on platforms in horizontal and vertical motions in order to lower vehicles to grade position through a Programmable Logic Control (PLC) system. This process allows efficient direct access to vehicles.

The system can be designed with a pit depth for up to 3 vehicles below grade and up to 5 vehicles above grade, giving a total vertical stacking capacity of 8 vehicles in the space usually occupied by a single vehicle. There are no horizontal limitations to the system. This system can be customized for indoor and outdoor applications, complete with external cladding/siding, garage doors and roof, per client specifications.

The Auto Park System is designed for maximum efficiency and space utilization for high-density parking. It features an unlimited stacking capability and a fully integrated storage and retrieval functionality.

Vehicles are placed in a Park and Drive (P & D) station. Once secure of all persons, the Mole transfers the vehicle onto the VTC (Vehicle Transfer Carrier), which moves the vehicle to a

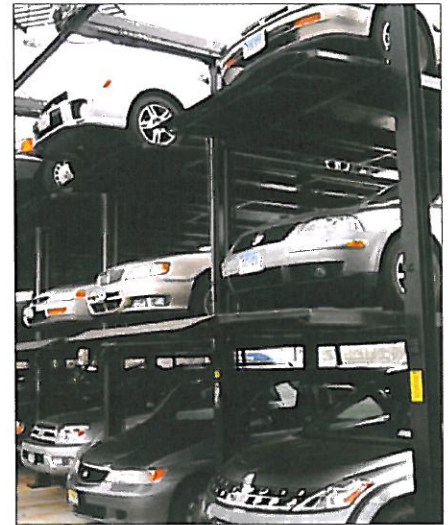

Car Stackers® for high density parking requirements

designated parking stall. The Mole then stores the vehicle and awaits the next instruction.

The system may also include a turntable for entry and exit purposes, and a vehicle lifting device may be necessary for multi-level applications.

Note - See Tables 1 and 2 for more information.

ELECTRICAL SUPPLY REQUIREMENTS

- 3-phase - 208 to 480 Volts
 - Single Phase - 110 to 220 Volts
- Power Packs supplied with hydraulic-operated systems (specifications available)

COMPOSITION & MATERIALS

Valet Parking Systems

- Structure - Prefabricated steel frame
- Platforms - Galvanized/diamond-plate steel beds
- Operation - Hydraulic (cylinders driven by a Power Pack) or electric motor—see supply requirements
- Manual override for emergency lowering
- Full safety features

Self-Parking Systems

Lift Sliding Semi-Automatic Parking System

- Structure - Standard steel members
- Platforms - Galvanized steel beds
- Operation - Electric motors with cable
- Control - Programmable Logic Control (PLC) system
- Manual override for emergency retrieval
- Full safety features



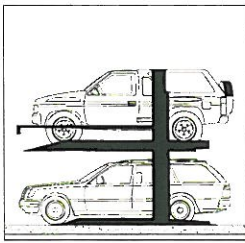

Double Parking System - DP

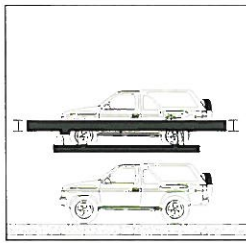

Double Parking System - NP

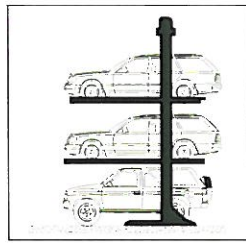

Triple Parking System - TP

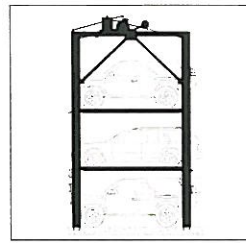

Triple Parking System - GT

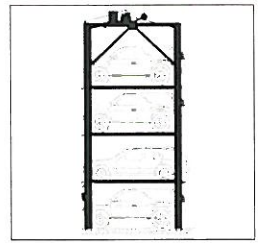

Quadruple Parking System

TABLE 1 VALET PARKING SYSTEMS - MECHANICAL VEHICLE STACKING EQUIPMENT

Type	Double Parking System		Triple Parking System		Quadruple Parking System
	DP Standard	NP No-Post suspended platforms	TP Electric	GT Hydraulic	QP Electric
Maximum levels	2	2	3	3	4
Length, ft-in (m)	14, 3 (4.3)	14 - 20 (4.3 - 6.1)	13 - 17 (4 - 5.2)	20, 6 (6.2)	13 - 17 (4 - 5.2)
Width, ft-in (m)	7, 11 - 8, 3 (2.4 - 2.5)	7, 10 (2.4)	8, 3 - 8, 6 (2.5 - 2.6)	8, 1 (2.5)	8, 3 - 8, 6 (2.5 - 2.6)
Clearance requirement (height), ft-in (m)	10, 6 (3.2)	10, 6 (3.2)	24, 6 (7.5)	20 (6.1)	31, 5 (9.6)
Lifting capacity per platform, lb (kg)	6000 (2722)	6000 (2722)	6000 (2722)	6000 (2722)	6000 (2722)
Operation	Electric motor or hydraulic cylinders	Electric motor	Electric motor	Hydraulic cylinders	Electric motor

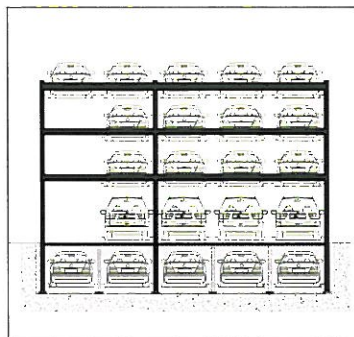

Lift Sliding (LS)

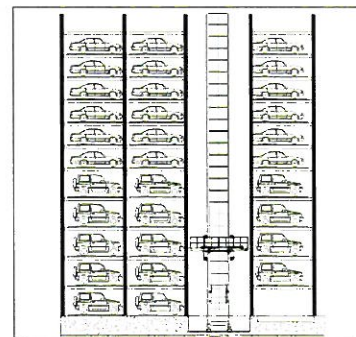

Auto Park (AP)

TABLE 2 SELF-PARKING SYSTEMS - AUTOMATIC VEHICLE STORAGE

Type	Lift Sliding (LS)	Auto Park (AP)
	Semi-automatic parking system	Fully automatic parking system
Maximum levels	8	25
Stall length, ft-in (m)	19, 8 (6)	19, 8 (6)
Stall width, ft-in (m)	8, 3 (2.5)	7, 3 - 8, 3 (2.2 - 2.5)
Clearance requirement/stall (height), ft-in (m)	6, 4 - 8, 1 (1.9 - 2.5)	4, 6 - 6, 9 (1.4 - 2.1)
Certified lifting capacity, lb (kg)	5200 (2359)	6000 (2722)
Operation	Automatic with manual override	Automatic with manual override

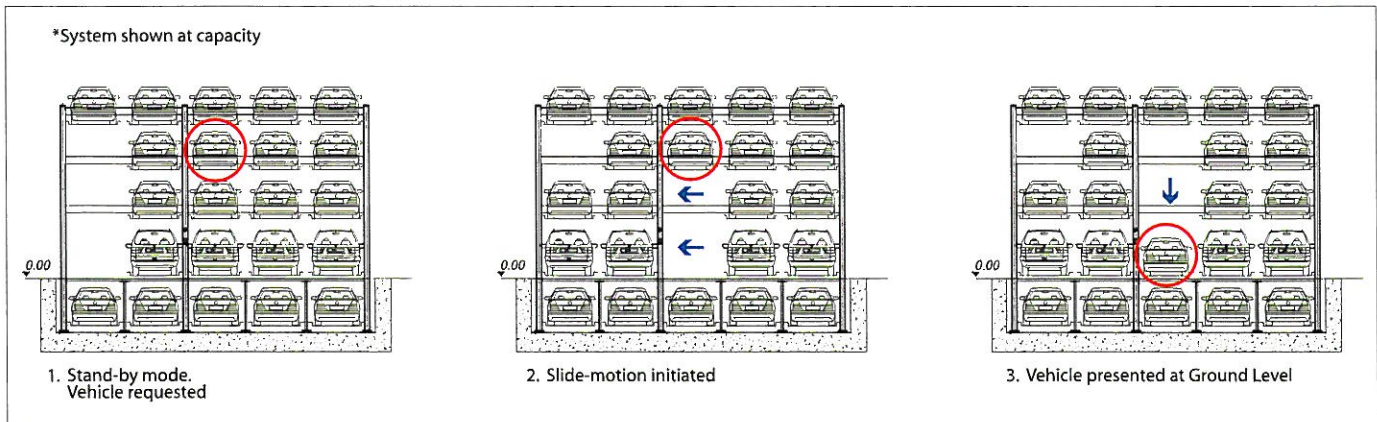

This self-park Lift Sliding System gives patrons the opportunity to lock vehicles and retain the keys.

- Auto Park Fully Automatic Parking System
- Structure - Standard steel members or reinforced concrete construction
 - Park and Drive station (P&D) - Loading and unloading bay
 - Turntable - All vehicles are stored in same direction and presented to client face-out
 - Vehicle Transfer Carrier (VTC) - Automated storage and retrieval system
 - Mole - Robotic trolley for vehicle transfer to VTC (patented design)
 - Vehicle Lifting Device (VLD)
 - Parking Stalls - Various structural components for storage of vehicle
 - Operation - Electric motors
 - Control - Integrated software program
 - Manual override for emergency retrieval
 - Full safety features

4. Technical Data

APPLICABLE STANDARDS

- American National Standards Institute (ANSI)
- ANSI/ALI ALCTV American National Standard for Construction, Testing and Validation
 - ANSI/ASME B30.13 Storage/Retrieval (S/R) Machines and Associated Equipment

Deutsches Institut für Normung (DIN) - DIN EN 14010 Safety of Machinery - Equipment for Power Driven Parking of Motor Vehicles - Safety and EMC Requirements for Design, Manufacturing, Erection and Commissioning Stages

GB 17907 Mechanical Parking Systems - General Safety Requirement

National Fire Protection Association (NFPA) - NFPA 88A Standard for Parking Structures

APPROVALS

MEA certified for City of New York.

ENVIRONMENTAL CONSIDERATIONS

Valet Parking Systems

Hydraulic-operated systems require routine maintenance and service inspections to prevent leaking of hydraulic fluid to immediate environment. Biodegradable hydraulic fluid is also available.

Electric-operated systems have the benefit of being environmentally sustainable, using standard brake motors instead of hydraulic cylinders for operation.

Self-Parking Systems

Automated and semi-automated parking systems are environmentally sustainable. These systems are electrically operated, require considerably less construction materials than conventional parking garages, require significantly less useable space and have little or no need for additional lighting, heating, ventilation and cooling.

5. Installation

PREPARATORY WORK

Handle and store product according to manufacturer's recommendations.

Verify that site conditions are acceptable for installation. Do not proceed with installation until unacceptable conditions are corrected.

All components are prefabricated offsite and assembled onsite to minimize installation time. Surface conditions for the installation of the mechanical parking systems must be of suitable structural quality and finished in either blacktop or reinforced concrete slabs, depending on the weight of system.

Double Parking Systems can be erected on unprepared surfaces with a grade of up to 5%, whereas all other systems must be on grade of no more than 2%.

Surface conditions for the installation of the Automated Parking Systems and Semi-Automated Parking Systems must be of suitable structural quality, finished in either blacktop or reinforced concrete slabs and designed specifically for the weight of system. These systems require even grades.

Installation instructions and guidelines are available. Park Plus, Inc., must provide experienced and qualified technicians to carry out all necessary installation work. Uninterrupted access to the work area is necessary at all times for equipment, labor, transport and services as required. Installation periods vary according to project specific conditions and will be determined accordingly.

6. Availability & Cost

AVAILABILITY

Park Plus, Inc., provides detailed customized quotations, complete with layout drawings to maximize the number of parking/storage spaces and efficient separation. Standard stock items are available as new or refurbished equipment, and deliveries on customized systems can be expected within 8 - 24 weeks depending on the size and sophistication of the system.

COST

Cost per space is calculated according to the number of stalls required, speed of operation and design functionality.



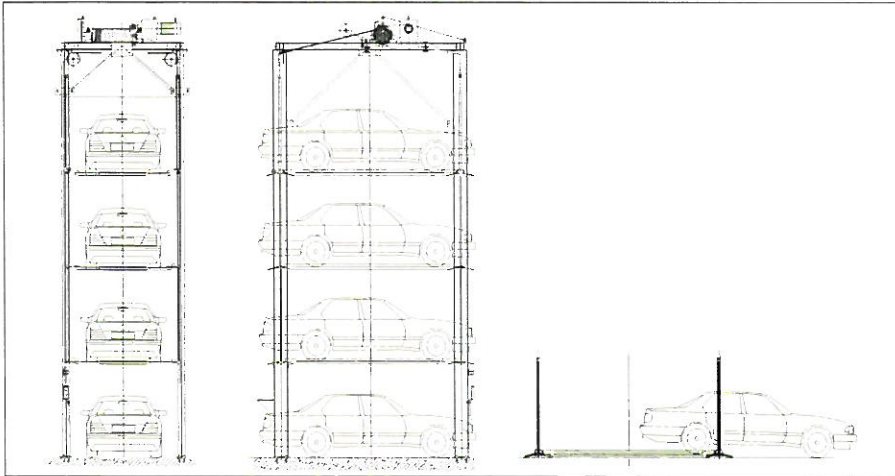

Valet systems allow 2, 3, or 4 vehicles to be stacked atop a single parking space.

10. Filing Systems

- Reed First Source
- MANU-SPEC®
- Additional product information is available from the manufacturer.

Car Stackers® and SpaceMaker® are registered trademarks of Park Plus, Inc.

7. Warranty

Equipment is warranted for a specified period following date of delivery to Owner, according to individual contracts. Warranties cover all equipment and components, including labor. The warranty is invalidated by any defects resulting from faulty or negligent operation, lack of maintenance, overloading, abuse or force majeure (acts of God).

8. Maintenance

Park Plus, Inc. equipment is certified, and the Service and Maintenance Department operates on a 24/7 basis. All service and repair work must be carried out by authorized Park Plus, Inc., technicians. Work performed by unauthorized technicians may invalidate the warranty.

Park Plus, Inc. will provide a technician to visit installation sites to fully inspect and service each unit under the service agreement at regular intervals. At the end of the warranty period, a service and maintenance contract is available upon request. Contracts can include labor and/or parts.

9. Technical Services

Park Plus, Inc. provides design, manufacturing, installation and support services for all their products. Other services include in-house engineering and architectural support, as well as financial services and lease options on all products.



Leaders in high density parking systems



Valet parking systems



Double parking system

Mechanical vehicle storage system

Designed to double parking capacities, this system is available as a hydraulic or electric two-post cantilevered unit that requires no foundation anchorage. Low profile equipment is available for minimal height clearances.

- Valet parking system
- Immediate cost effective solution
- Free standing (no ground bolts)
- Interior/exterior use
- Full safety features
- MEA approved for NYC
- ISO Compliant



Triple parking system

Mechanical vehicle storage system

This system is designed to vertically stack vehicles up to 3 high. It is available as a four-post hydraulic or electric machine or a two-post electric machine. All types require a reinforced concrete base.

- Valet parking system
- Cost effective multi-layered parking solution
- Interior/exterior use
- Increased vehicle capacity
- Full safety features
- MEA approved for NYC
- ISO Compliant



Quad parking system

Mechanical vehicle storage system

This system is designed to vertically stack vehicles up to 4 high. It is available as a four-post hydraulic or electric machine and requires a reinforced concrete base.

- Valet parking system
- Cost effective multi-layered parking solution
- Interior/exterior use
- Increased vehicle capacity
- Full safety features
- MEA approved for NYC
- ISO Compliant

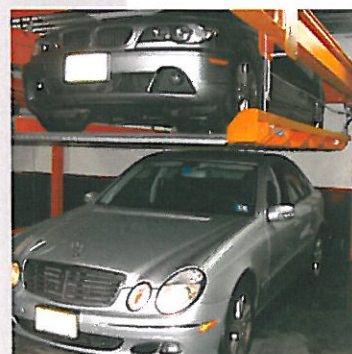

Suspended platform system

Mechanical vehicle storage system

The Suspended Platform system includes a structural framework from which a vehicle platform is suspended. The structural frame can be integrated with a building's structure to eliminate the use of additional supporting members or it can be designed as a separate supporting system. These supporting members can be designed to provide a virtually column-free/ obstruction free area.

- Valet parking system
- Suspended design
- Custom designs to suit application
- Obstruction-free area
- Interior/exterior use
- Full safety features
- MEA approved for NYC
- ISO Compliant

Automated parking systems



Lift Sliding parking system

Semi-Automatic vehicle storage system

The Lift Sliding parking system maneuvers stacked vehicles on platforms in horizontal and vertical motions in order to lower vehicles to grade position through a Programmable Logic Control system.

- Self-parking (no attendant required)
- Cost effective multi-layered parking solution
- No hydraulics
- Retrofitted into existing buildings
- Floor Area Ratio (FAR) beneficial
- Full safety features
- MEA approved for NYC
- ISO Compliant



Parking Tower system

Automatic vehicle storage system

The Parking Tower System consists of 2 vertical vehicle stacks separated by a vertical transfer shaft. This vehicle storage and retrieval system utilizes parking pallets or platforms that are placed into position on a storage racking system.

- Self-parking (no attendant required)
- Modular design
- Transfer devise for storage and retrieval solution
- Cost effective multilayered parking
- Floor Area Ratio (FAR) beneficial
- Full safety features
- MEA approved for NYC
- ISO Compliant



Auto Park

Fully Automatic vehicle storage system

The Auto Park system is designed for maximum efficiency and space utilization for high density parking. It features a virtually unlimited stacking capability and a fully integrated storage and retrieval functionality. Each design layout is custom suited for each project.

- Patented pallet-less system
- Innovative design and technology
- Transfer Device for storage and retrieval solution
- Floor Area Ratio (FAR) beneficial
- High Efficiency
- Full safety features
- MEA approved for NYC
- ISO Compliant



Mini parking system

Mechanical vehicle storage system with pit

This system includes the use of an in-ground pit in order to retrieve stacked vehicles without the need for removing any other vehicles within the system, therefore this type of system can be considered as "self-parking". This product is available as a 2 vehicle stacking unit or as a 3 vehicle stacking unit.

- Valet/Self-parking system
- Pit-design for direct vehicle access
- Interior/exterior use
- Full safety features
- MEA approved for NYC
- ISO Compliant

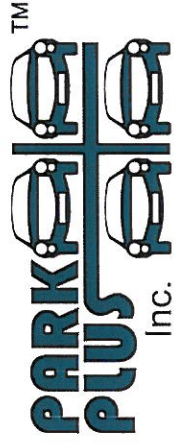

Leaders in high density vehicle storage systems

CORPORATE HEADQUARTERS

31 Iron Horse Rd
Oakland, NJ 07436
Office: +1 (973) 574-8020
Fax: +1 (973) 574-8030
Toll Free: 1-800-966-5509

SERVICE & OPERATIONS DEPARTMENT

480 Main Ave, Unit 1
Wallington, NJ 07057
Office: +1 (973) 574-8020
Fax: +1 (973) 574-8030
Toll Free: 1-800-966-5509

PARK PLUS FLORIDA, INC.

1835 East Hallandale Beach Blvd
Suite 439
Hallandale, FL 33009
Office: +1 (954) 374-8434
Fax: +1 (953) 374-8860

PARK PLUS CHICAGO

P.O. Box 59505
Schaumburg, IL 60159
Office: +1 (847) 612-4038
Fax: +1 (847) 582-6789

www.parkplusinc.com

email: info@parkplusinc.com

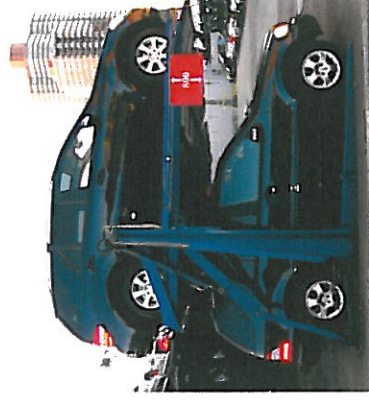

VALET SYSTEMS

Double Parking System

Mechanical vehicle storage system

Designed to double parking capacities, this system is available as a hydraulic or electric system. It is available as a four-post, hydraulic or electric machine or a two-post, electric machine. All types require a reinforced concrete base.

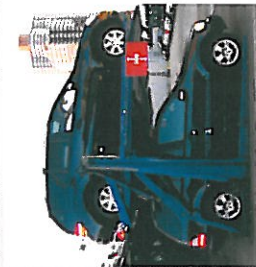

EQUIPMENT DIMENSIONS (Double Parking system)

Length	L1	14'-3"
Width	W1	7'-11" to 8'-3"
Height	H1	5'-0" to 6'-7"
	H2	9'-5"
	H3	10'-0" to 14'-0"
Clearance requirement		2860 lbs
WEIGHT		6000 lbs
CERTIFIED LIFTING CAPACITY		Hydraulic with manual emergency lowering
OPERATION		3 Phase 60Hz
ELECTRICAL POWER		

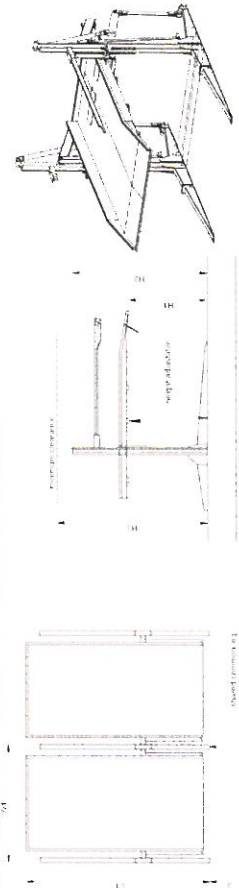

Triple Parking System

Mechanical vehicle storage system

This system is designed to vertically stack vehicles up to 3 high. It is available as a four-post, hydraulic or electric machine or a two-post, electric machine. All types require a reinforced concrete base.



EQUIPMENT DIMENSIONS (Triple Parking system)

Length	L1	13'
	L2	15'-2"
Width	W1	8'-3" to 8'-5"
Height	H1/H2	5'-2" to 6'-8"
	H3	18'-0" to 24'-6"
Clearance requirement		6000 lbs platform
CERTIFIED LIFTING CAPACITY		13 ft/min
LIFTING SPEED		3 Above Grade
MAX STACKING		Fully Electrical/Hydraulic
OPERATION		3-phase/60 Hz
ELECTRICAL POWER		

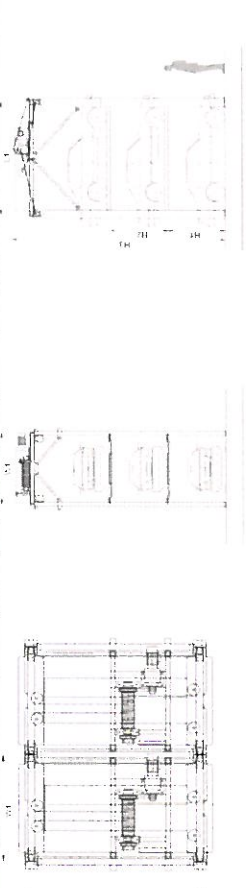

Quad Parking System

Mechanical vehicle storage system

This system is designed to vertically stack vehicles up to 4 high. It is available as a four-post, hydraulic or electric machine and requires a reinforced concrete base.

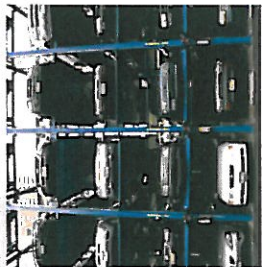

EQUIPMENT DIMENSIONS (Quad Parking system)

Length	L1	13'
	L2	15'-2"
Width	W1	8'-3" to 8'-6"
Height	H1/H2	5'-2" to 6'-8"
	H3	24'-0" to 31'-5"
Clearance requirement		6000 lbs Platform
CERTIFIED LIFTING CAPACITY		13 ft/min
LIFTING SPEED		4 Above Grade
MAX STACKING		Fully Electrical/Hydraulic
OPERATION		Push Button
CONTROL		3-phase/60 Hz
ELECTRICAL POWER		

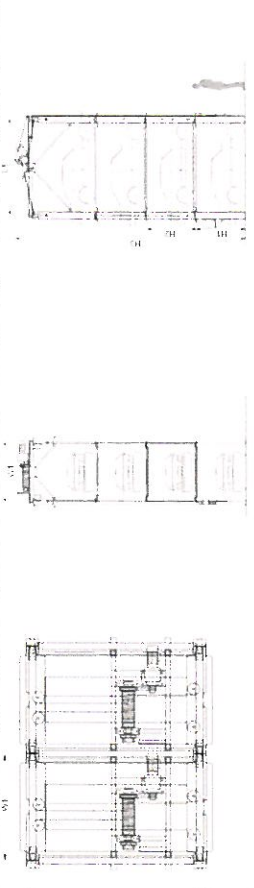

Suspended Parking System

Mechanical vehicle storage system

The Suspended Platform system includes a structural framework from which a vehicle platform is suspended. The structural frame can be integrated with a building's structure to eliminate the use of additional supporting members to provide a virtually column-free area.



EQUIPMENT DIMENSIONS (Suspended Parking system)

Length	L1	19'-8"
Width	W1	7'-11" to 8'-4"
Height	H1	Variable
Clearance requirement		10'-6"
CERTIFIED LIFTING CAPACITY		6000 lbs Platform
LIFTING SPEED		13 ft/min
OPERATION		Fully Electrical
ELECTRICAL POWER		3-phase/60 Hz
MOTOR		2.2 kW (3.0 Hp)

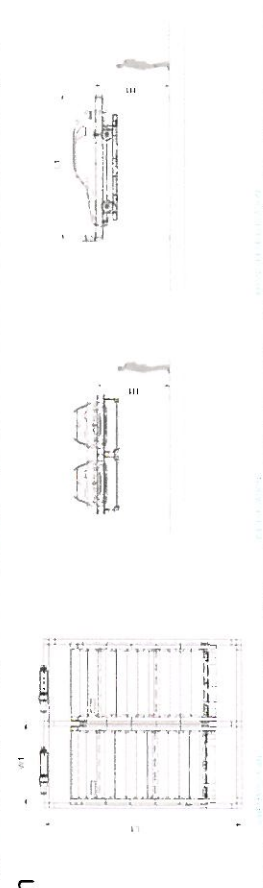



ROBOTIC PARKING SYSTEMS, INC.

Simply a smarter & safer way to park

More Cars. Less Space. Cleaner Environment. Less Cost.

Idea



Parking does not need more space - just a more intelligent solution.

Traffic congestion today and tomorrow represents an exceptional challenge. According to an MIT study, more than 50% of drivers in the centers of major cities are searching for a place to park. More and more cars are sharing a limited volume of available space - both in the search for parking and in parking itself. And this, in spite of the attractiveness of the city center, places of work, leisure centers and public facilities, is dependent to a decisive extent on the parking space available. Parking facilities must be of adequate size, easily accessible, comfortable and safe to use.

The future of parking is Robotic Parking. It is not more space, but rather, a more intelligent use of space that will solve the parking problems of today and those of tomorrow. By means of this patented, automated and modular parking system, Robotic Parking offers the most convincing - and also the most cost effective alternative to conventional multi-story parking facilities. Automated parking offers the best solution for planners, investors, operators, and, last but not least, for the drivers themselves.



CONCLUSION

“Traffic congestion is a problem of space. Space can be better utilized using Robotic Parking, the automated, hi-tech parking solution.”

12812 60th Street N., Clearwater, FL, US
Phone: 727-539-7275 / Fax: 727-538-1900
Toll-Free: 888-ROBOPARK / 888-762-6727
info@roboticparking.com / www.roboticparking.com



ROBOTIC PARKING SYSTEMS, INC.

Simply a smarter & safer way to park

More Cars. Less Space. Cleaner Environment. Less Cost.

Technology

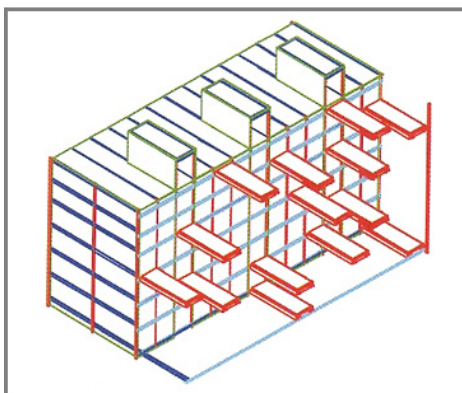
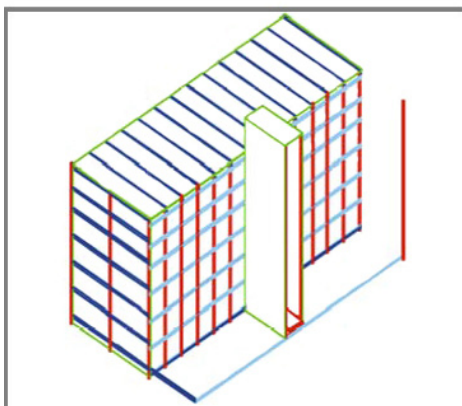
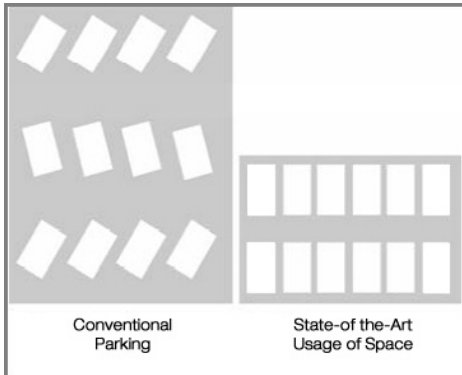

From the conventional multi-story car park to state-of-the-art usage of space.

Conventional multi-story car parks have many disadvantages. They require reinforced foundations, ramps, stairways, and passenger elevators. Vehicles are parked at an angle and offset, taking up space that is no longer available for parking. These factors increase costs and the price of real estate.

Robotic Parking offers a trend-setting solution. The old multi-story car park now becomes a state-of-the-art, computer-controlled and fully automated storage facility. As opposed to conventional multi-story car parks, and mechanical stackers, Robotic Parking provides:

- management with cumulative experience of more than 60 years in the construction of robotic parking facilities
- new and optimized storage logistics processes
- most modern technologies in the movement and “storage” of vehicles
- Human Graphical User Interface (HGUI), all-encompassing computer technology
- state-of-the-art electronic and mechanical controls: no hydraulics
- an impressive number of simultaneous, rapid pallet movements
- efficient peak traffic control of vehicles based on number of cars/hour
- modular system capacity from 100 to more than 10,000 automobiles
- extremely high redundancy as a result of several integrated back-up systems
- key strategic partnerships worldwide including GE Fanuc; development project with NASA/SATOP.

Both the method as well as the Human Graphical User Interface procedures are protected by US patents. HGI, GUI or HMI (Human Machine Interface) was the first patent of its kind ever awarded in the US and the first of this kind issued for industrial use throughout the world. The system is now patented (or patent pending) throughout the world.

This “industrial” technology solution for the problem of parking enables a previously unknown degree of efficiency to be achieved in the use of both space and resources. It is superior to conventional multi-story car parks in a number of aspects including safety. All of this, at lower total costs.

CONCLUSION

“While conventional multi-story car parks are limited, Robotic Parking is the convincing state-of-the-art alternative.”

12812 60th Street N., Clearwater, FL, US
Phone: 727-539-7275 / Fax: 727-538-1900
Toll-Free: 888-ROBOPARK / 888-762-6727
info@roboticparking.com / www.roboticparking.com



ROBOTIC PARKING SYSTEMS, INC.

Simply a smarter & safer way to park

More Cars. Less Space. Cleaner Environment. Less Cost.

Advantages

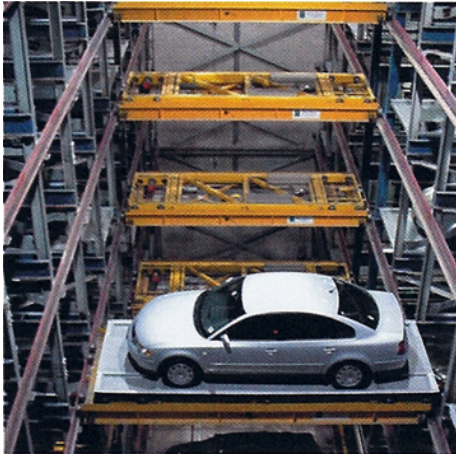

The innovative parking facility that benefits everyone — even the car.

Whether planner, developer, investor, operator, local authority or driver — Robotic Parking offers decisive advantages for everyone:

- can be constructed in every form: above ground, underground, on roofs or inside a building complex
- modular and flexible capacity for 100 to thousands of vehicles: negotiations are currently in process for a parking facility for 9,000 vehicles at a major airport
- the number of entry/exit stations, elevators and machines can be designed for every level of traffic density
- average waiting time for storing or retrieving the car: approximately 140 seconds in the case of highest throughput capacity
- more than double the parking capacity in the same space
- far more favorable total building costs than conventional multi-story car parks
- considerable reduction in running costs: personnel, ventilation, lighting, etc.
- considerable reduction in the load placed on the environment: no exhaust fumes, no noise
- greatest possible degree of safety — no one must enter the area where cars are stored
- maximum user friendliness, the customers are enthusiastic

A Robotic Parking Economic Model

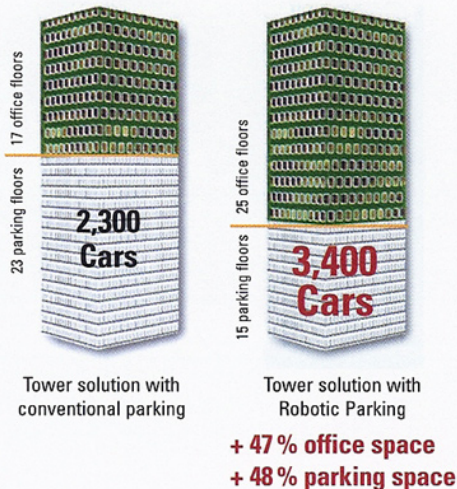

Even the vehicles themselves benefit from Robotic Parking. Cars are transported free of touch on separate pallets. The typical car park damage, such as dents, dings on paint and bodywork damages become a thing of the past. And, as an additional factor, this helps keep insurance costs down.



CONCLUSION

“The advantages of Robotic Parking are every bit as versatile as they are unique.”

12812 60th Street N., Clearwater, FL, US
Phone: 727-539-7275 / Fax: 727-538-1900
Toll-Free: 888-ROBOPARK / 888-762-6727
info@roboticparking.com / www.roboticparking.com



ROBOTIC PARKING SYSTEMS, INC.

Simply a smarter & safer way to park

More Cars. Less Space. Cleaner Environment. Less Cost.

Going Green



Earn LEED points with Robotic Parking — an environmentally clean parking facility.

The US Green Building Council is getting more and more support for its LEED (Leadership in Energy and Environmental Design) Green Building Rating System. The US federal government has mandated that all of its new buildings be constructed to meet a minimum LEED certification of Silver. To achieve this level a new project must receive a minimum of 33 LEED points out of a possible 69. Many states, counties and cities are following this lead.

Robotic Parking garages are “green” products that conserve gas and diesel since vehicles are not wasting time and energy driving up and down ramps in search of a parking space. This significantly reduces the emissions of harmful gases and ensures an environmentally clean parking facility.

A review of LEED codes indicates that a Robotic Parking System could receive at least 10 points and as many as 17 points. Innovation in Design could earn an additional four points.

Here is an estimate for emissions reduction and energy saved in a 1,442 space robotic garage:

- An annual savings of 19,828 gallons of gasoline in the parking process
- Quantity of toxic emissions eliminated are:
 - 2,885 lbs of Hydrocarbons (HC) per year
 - 1,486 lbs of Nitrogen Oxides (NOx) per year
 - 11.149 tons of Carbon Monoxide (CO) per year
 - 198 tons of Carbon Dioxide (CO2) per year

Robotic Parking Systems, in addition to reducing US energy consumption, have the potential to improve quality of life by positively affecting the way buildings and communities are designed, built and operated.

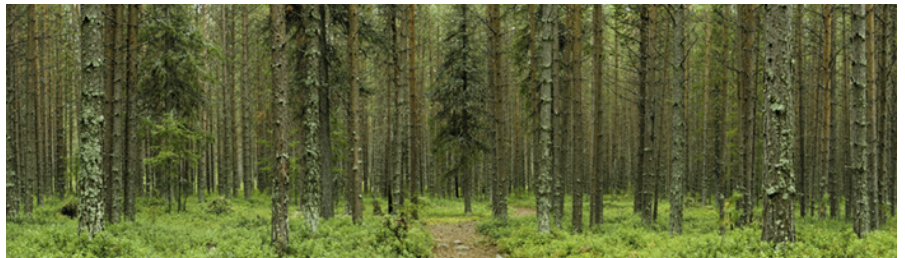

CONCLUSION

“Robotic Parking garages are ‘green’ products that conserve gas and diesel.”

12812 60th Street N., Clearwater, FL, US
Phone: 727-539-7275 / Fax: 727-538-1900
Toll-Free: 888-ROBOPARK / 888-762-6727
info@roboticparking.com / www.roboticparking.com



ROBOTIC PARKING SYSTEMS, INC.

Simply a smarter & safer way to park

More Cars. Less Space. Cleaner Environment. Less Cost.

Design



From brick to mirrored glass — the garage façade can fit seamlessly into your project.

Interior construction and design of the facade for the robotic, automated parking garage are naturally undertaken by local companies under the supervision of architects and building construction specialists. Robotic Parking installs elevators, machines, pallets and computer control systems that have been pre-tested in the factory for the specific project involved.

The steel construction of the Robotic Parking System will support a variety of façades. This allows planners and architects a free hand in designing the external appearance of the facility. Whether you choose a half-timbered, brick, aluminum or glass facade, the choice is yours. The garage can be designed to fit harmoniously into its environment. Entry / exit stations can also be integrated into the façade environment, while observing both visual as well as functional criteria.



CONCLUSION

“Planners and architects have a free hand in designing the external appearance of the garage.”

12812 60th Street N., Clearwater, FL, US
Phone: 727-539-7275 / Fax: 727-538-1900
Toll-Free: 888-ROBOPARK / 888-762-6727
info@roboticparking.com / www.roboticparking.com

© 2008 Robotic Parking Systems, Inc.



ROBOTIC PARKING SYSTEMS, INC.

Simply a smarter & safer way to park

More Cars. Less Space. Cleaner Environment. Less Cost.

References

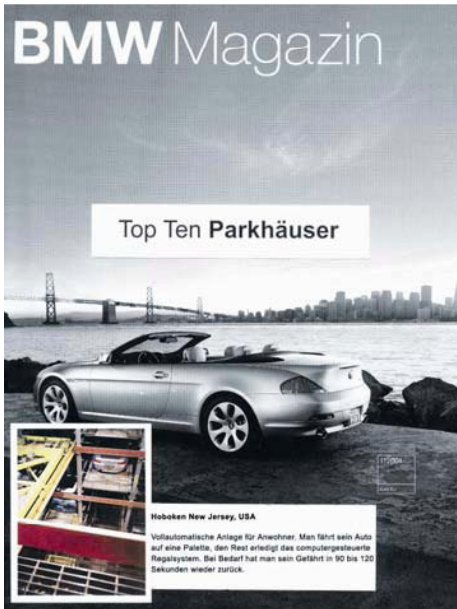

BWM Magazine describes Robotic Parking as being one of the top ten garages in the world:

“Fully automatic system for residents. Just drive your car onto a pallet and the computer-controlled bay system does the rest. You can get your trusty steed back in just 90 to 120 seconds.”

Comments from industry specialists and press.

City planners, architects, developers and other car park specialists, have stated convincingly what they think of the Robotic technology.

Here are some of the statements made:

- “For 25 years I have looked for a solution for the parking problem. I have visited the garage, have investigated the Robotic Parking System and I say: ‘That’s it! I’m part of it!’”
J. K., Owner of the oldest construction company in the USA — has built hundreds of parking garages.
- “I have seen other systems around the world and there’s nothing comparable. And that’s impressive!”
T. K., Planner, Developer
- “.. that’s fantastic. In fact, it’s a breakthrough in parking.”
R. B., Architect.
- “As a city planner I can say that this technology is a dream come true! The implementation of these Robotic Parking Systems garages will have a major positive impact for any city planning.”
D. C., Head of City Planning.
- “I want to express our extreme pleasure and thanks.... we were thoroughly impressed and satisfied that it was one of the few things we’ve seen that shows off the 20th century technology.”
A. S., Chairman of the Board of Crossgates Development
- “.. for drivers leaving or retrieving their cars at a parking garage, it’s a dream; no exhaust fumes, no strange nicks or scratches appearing.”
“Wall Street Journal”
- “.. the garage displays a stunning agility - it lifts and carries cars about on computer-controlled steel pallets as if they were delicate ballerinas, moving with precision and speed inside a structure that is remarkably compact.”
“New York Times”

More evaluations and comments can be found on our web site at www.roboticparking.com.

CONCLUSION

“Specialists recognize Robotic Parking as a solution for parking problems.”

12812 60th Street N., Clearwater, FL, US
Phone: 727-539-7275 / Fax: 727-538-1900
Toll-Free: 888-ROBOPARK / 888-762-6727
info@roboticparking.com / www.roboticparking.com



ROBOTIC PARKING SYSTEMS, INC.

Simply a smarter & safer way to park

More Cars. Less Space. Cleaner Environment. Less Cost.

Company

Over 60 years in logistics, automation and high tech computer solutions.

The management team of Robotic Parking Systems, its service company and sales organization, incorporates more than 60 years of cumulative competence in the development, the construction and the operation of automated transport systems. In the past, famous companies such as Mercedes, Volkswagen, Hitachi, ABB and Krupp have known how to make use of the team's experience - including the launching pad of the Ariane 4 carrier rocket.

Strategic partnerships with General Electric Fanuc, Honeywell and NASA SATOP ensure the permanent know-how transfer in the field of state-of-the-art electronic management and control systems.

The unique patents represent one side of the coin. The satisfaction provided by this hi-tech solution is the other proven side.

A comprehensive overview of the company, innovations, products, patents and much more can be found via the website at: www.roboticparking.com.

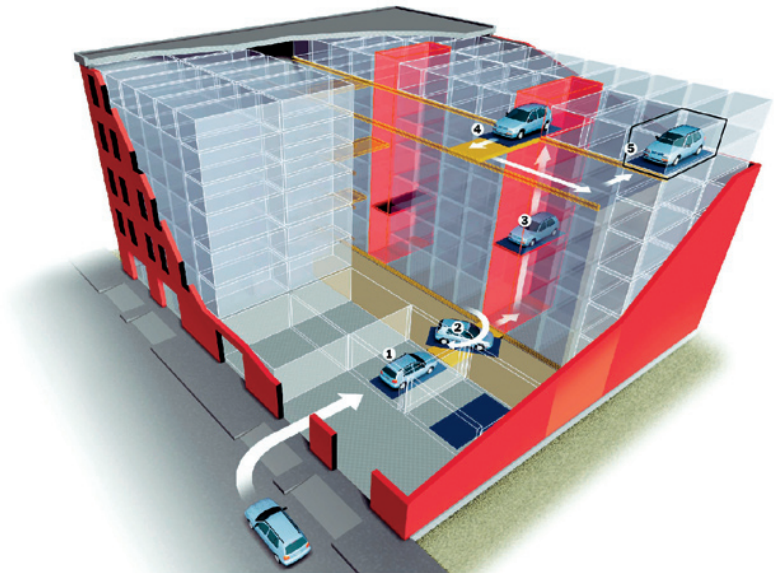
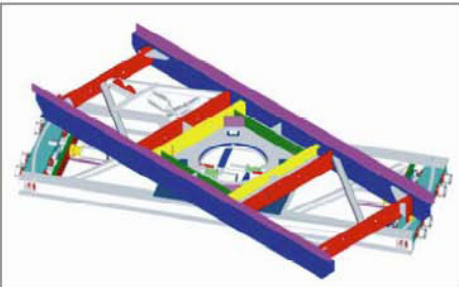
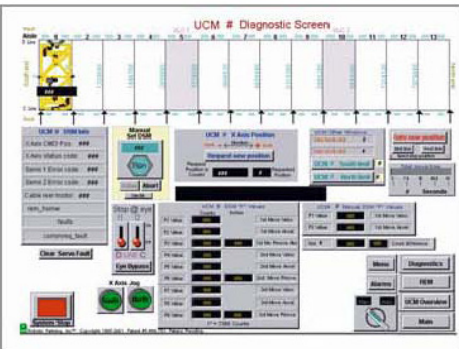
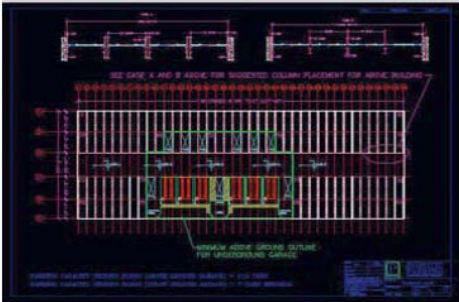
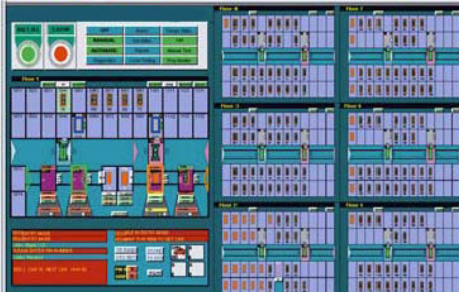

CONCLUSION

“Specialists recognize Robotic Parking as a solution for parking problems.”

12812 60th Street N., Clearwater, FL, US
Phone: 727-539-7275 / Fax: 727-538-1900
Toll-Free: 888-ROBOPARK / 888-762-6727
info@roboticparking.com / www.roboticparking.com



ROBOTIC PARKING SYSTEMS, INC.

Simply a smarter & safer way to park

More Cars. Less Space. Cleaner Environment. Less Cost.

Manufacturing



All Robotic Parking Systems' machinery is manufactured in Clearwater, Florida.

Robotic Parking Systems, Inc. has the only full scale manufacturing facility in North America that is completely dedicated to designing and building custom automated parking garages. We are not an OEM or distributor. We manufacture our machinery from raw steel to finished product using off the shelf components from local US distributors.

Quality control is maintained using our 150 car research and testing garage located within our production plant. This facility allows us to test and certify every machine before it's shipped to the customer's job site.

We are currently expanding by adding another 42,000 square feet and two additional overhead cranes to our production facility. This will give us the capacity to set up the first US based assembly line for automated parking systems.

Come and see it for yourself. Contact us to schedule your tour.

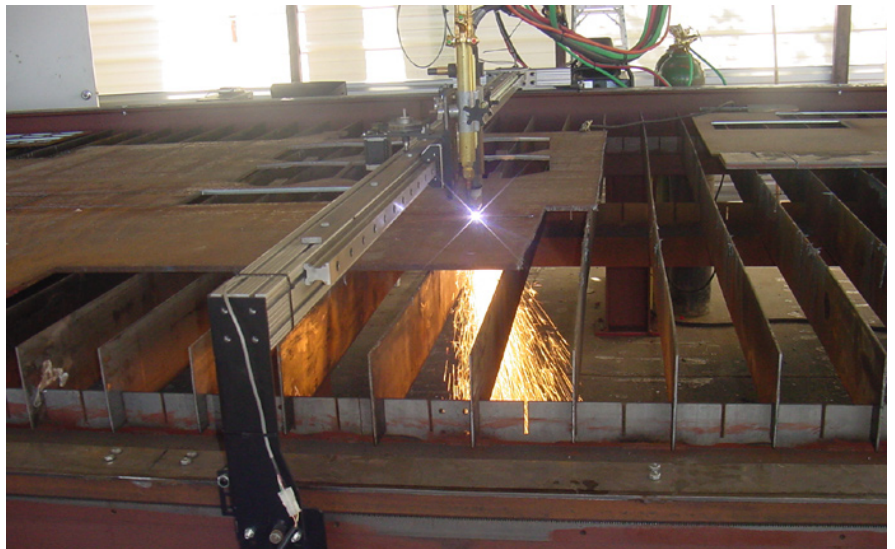

CONCLUSION

"Robotic Parking maintains complete control over the entire manufacturing process from raw steel to completed and certified machines.

12812 60th Street N., Clearwater, FL, US
Phone: 727-539-7275 / Fax: 727-538-1900
Toll-Free: 888-ROBOPARK / 888-762-6727
info@roboticparking.com / www.roboticparking.com

© 2008 Robotic Parking Systems, Inc.



ROBOTIC PARKING SYSTEMS, INC.

Simply a smarter & safer way to park

More Cars. Less Space. Cleaner Environment. Less Cost.

Contact



Call us to find out how you can park more cars in less space!

Call us today for more information. We will be happy to prepare a cost estimate for you for a robotic garage that meets the specifications of your project.

Further information is available at our web site at www.roboticparking.com.

Telephone: 727-539-7275 / 888-ROBOPARK (888-762-6727)

Fax: 727-538-1900

Email: info@roboticparking.com



Solution Provider



CONCLUSION

“Robotic Parking Systems offers more cars, less space, cleaner environment and less cost.”

12812 60th Street N., Clearwater, FL, US
Phone: 727-539-7275 / Fax: 727-538-1900
Toll-Free: 888-ROBOPARK / 888-762-6727
info@roboticparking.com / www.roboticparking.com

© 2008 Robotic Parking Systems, Inc.



- Green Space & Common Areas.
- More Space For Design Development & Community.

... Changing The Dynamics Of Land Use.

www.roboticparking.com



ROBOTIC PARKING SYSTEMS, INC.

The
BIGGEST IDEAS
in Automated Parking

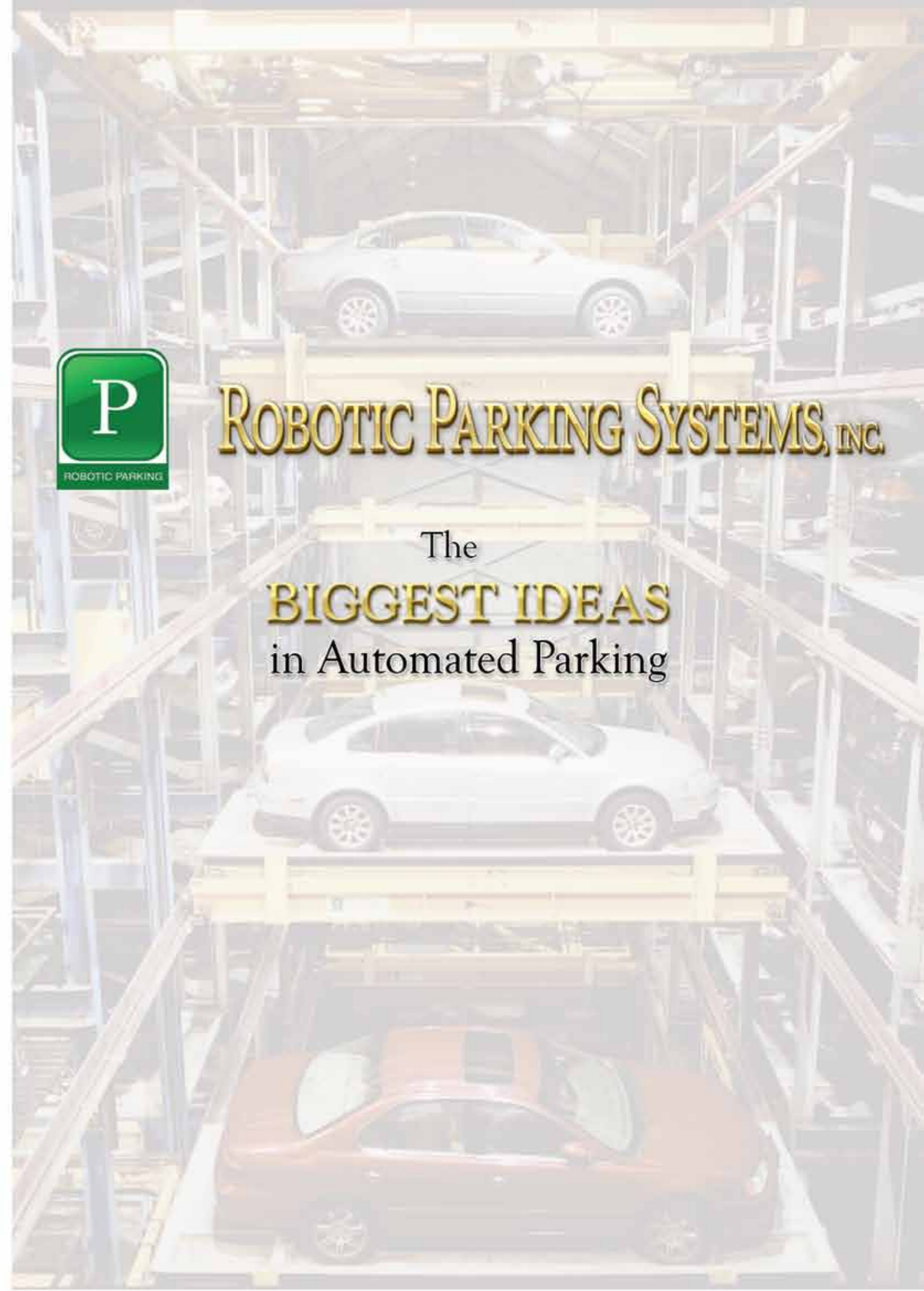



- Company
- Idea
- Technology
- Advantage
- How It Works
- Going Green
- Design
- Manufacture
- Projects
- References
- Contact



ROBOTIC PARKING SYSTEMS, INC.

The BIGGEST IDEAS in Automated Parking

Affiliations

Robotic Parking Systems is affiliated with key companies and organization in high-tech automation, parking, fire safety and more.











Patents

The Robotic Parking Systems technology is patented in the United States and in countries throughout the world.



E - Garage



E - Park

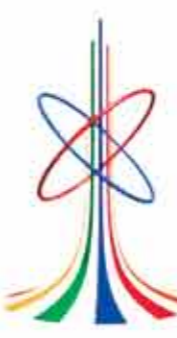

CONCLUSION

"Highly redundant, clever designed system with good traceability."

www.roboticparking.com

Robotic parking: it's not more space, or more money, but rather, more intelligence, which does solve the parking problems, today and tomorrow.

MORE SPACE FOR DESIGN, Development and Community

Robotic Parking Systems manufactures high-speed automated parking systems from hundreds to thousands of cars in half the space of a conventional parking garage.

By means of the patented, modular hi-tech parking system, Robotic Parking offers the most convincing - and also the most price-worthy alternative to conventional type multi-storey parking facilities.

Robotic Parking Systems, the U.S. based designer, manufacturer and operator of fully automated, modular parking systems accommodates for 100 to 5000+ parking spaces - ideally where space is limited and at a premium. We park twice the number of cars in the same space as a conventional garage or use half the space to park the same number of cars. We certainly achieve overall lower development costs.

Robotic Parking's Technology is a flexible, modular, fully automated parking system, utilizing the latest technology in electronics and automation, having all mechanical components electro-mechanically driven and Best Practices applied. The unique, patented design is capable of performing multiple simultaneous motions that are considered unique by industry experts when compared to other automated parking system designs in the world.

Besides the usual averaging 80 to 160 seconds retrieval time for a single car handling as a given industry standard today, the most impressive factor is the PT (Peak Traffic) capacity where Robotic Parking shines with over 250 cars / hour so far actually demonstrated in real world - real time performance.

And, of course it's easier as driving in and out of your garage at home - because you don't need to back out: forward in - forward out.

Architects and develops use less space for parking and create space for design, development and community enhancements.

- Create more saleable space by using Robotic Parking Systems
- Space gained can be used for green space and open areas to meet LEED standards
- Delivers faster retrieval times than other automated garages or ramp-style parking.
- Automated parking offers security for both individual and car
- Robotic Parking System provides premium valet service without the valet
- Automatic parking reduces CO2 emissions and other pollutants and green house gases.
- Flexible design allows the automated parking garage to fit into any neigh hood or project.
- Robotic Parking Systems relieve traffic congestion.

FOR YOUR NOTES:

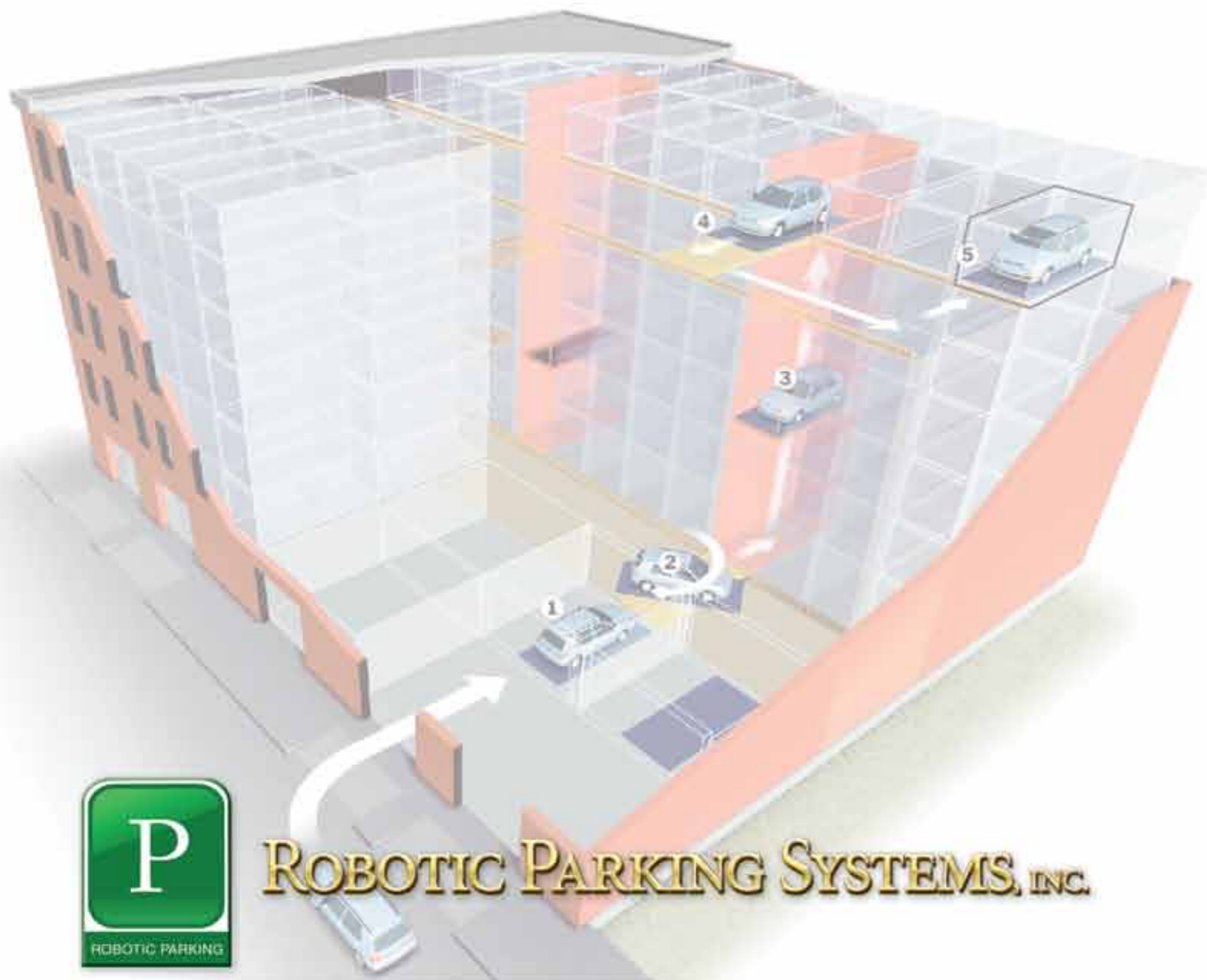

- Company
- Idea
- Technology
- Advantage
- How It Works
- Going Green
- Design
- Manufacture
- Projects
- References
- Contact



ROBOTIC PARKING SYSTEMS, INC.

The BIGGEST IDEAS in Automated Parking

Parking does not need more space just more intelligence.



Colored areas indicate parking facilities in downtown Columbus.



Green areas show potential savings with Robotic Parking Systems.

Traffic congestion today and tomorrow represents an exceptional challenge. According to an MIT study, more than 50% of traffic on the roads in the centers of major cities are searching for a place to park. More and more cars are sharing a limited volume of available space - both in the search for parking and in parking itself. And this, in spite of the attractiveness of the city center, places of work, leisure centers and public facilities, is dependent to a decisive extent on the parking space available. Parking facilities must be of adequate size, easily accessible, comfortable and safe to use.

The future of parking is Robotic Parking. It is not more space, but rather, a more intelligent use of space that will solve the parking problems of today and those of tomorrow. By means of this patented, automated and modular parking system, Robotic Parking offers the most convincing - and also the most cost effective alternative to conventional multi-story parking facilities. Automated parking offers the best solution for planners, investors, operators, and, last but not least, for the drivers themselves.



CONCLUSION
 "Traffic congestion is a problem of space. Space can be better utilized and increased using Robotic Parking, the automated, hi-tech parking solution."
www.roboticparking.com

FOR YOUR NOTES:



ROBOTIC PARKING SYSTEMS, INC.

- Company
- Idea
- Technology
- Advantage
- How It Works
- Going Green
- Design
- Manufacture
- Projects
- References
- Contact

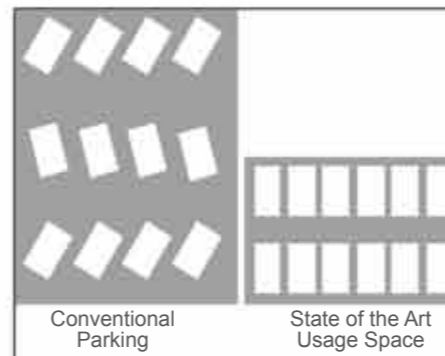

From the conventional multi-story car park to state-of-the-art usage of space.

Conventional multi-story car parks have many disadvantages. They require reinforced decks, ramps, stairways, and passenger elevators. Vehicles are parked at an angle and offset, taking up space that is no longer available for parking. These factors increase costs and the price of real estate. Robotic Parking offers a trend-setting solution. The old multi-story car park now becomes a state-of-the-art, computer-controlled and fully automated storage facility. As opposed to conventional multi-story car parks, and mechanical stackers, Robotic Parking provides:

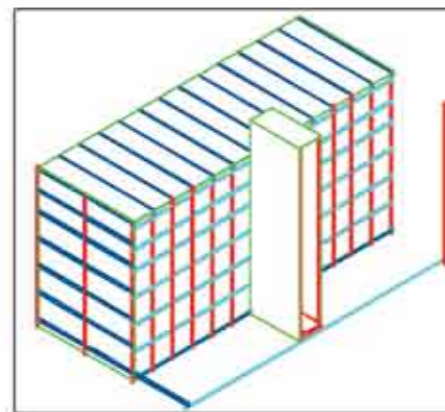

Typical Stacker System

- new and optimized storage logistics processes.
- most modern technologies in the movement and “storage” of vehicles.
- Human Machines Interface (HMI), all-encompassing diagnostics.
- state-of-the-art electronic and mechanical controls: no hydraulics.
- an impressive number of simultaneous, rapid pallet movements.
- efficient peak traffic control of vehicles based on number of cars/hour.
- modular system capacity from 100 to more than 10,000 auto mobiles.
- extremely high redundancy as a result of several integrated back-up systems.
- key strategic partnerships worldwide including GE Fanuc; development project with NASA/SATOP.

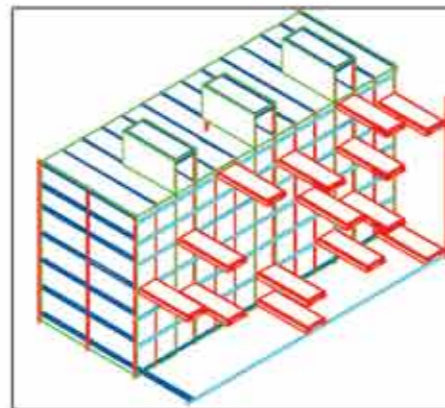

Patented Robotic System

Both the method as well as the Human Graphical User Interface procedures are protected by US patents. HMI (Human Machine Interface) was the first patent of its kind ever awarded in the US and the first of this kind issued for industrial use throughout the world. The system is now patented (or patent pending) throughout the world. This “industrial” technology solution applied for parking enables a previously unknown degree of efficiency to be achieved in the use of both space and resources. It is superior to conventional multi-story car parks in a number of aspects including safety. All of this, at lower total costs.

CONCLUSION
 “The Robotic Parking Systems technology sets highest industrial standard on peak traffic.”
www.roboticparking.com

FOR YOUR NOTES:

Parking does not need more space – but more intelligence.



ROBOTIC PARKING SYSTEMS, INC.

Safety & Security comes first in our priorities.

German & American Technology

- Company
- Idea
- Technology
- Advantages
- How It Works
- Going Green
- Design
- Manufacture
- Projects
- References
- Contact



ROBOTIC PARKING SYSTEMS, INC.

The BIGGEST IDEAS in Automated Parking

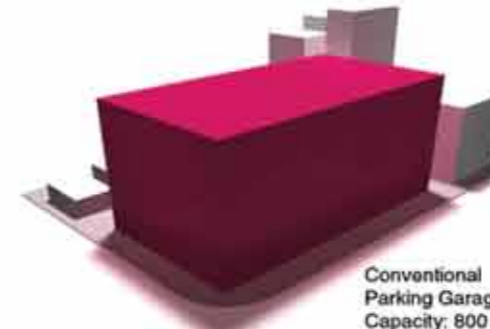

Conventional Parking Garage
Capacity: 800 Cars

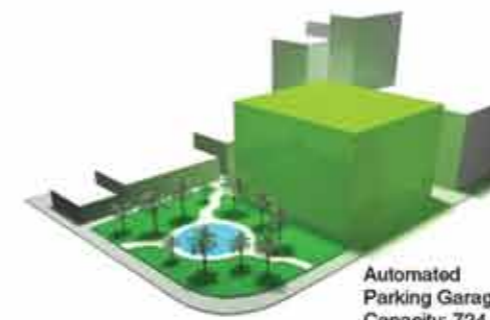

Automated Parking Garage
Capacity: 724 Cars

The innovative parking facility that benefits everyone — even the car.

Whether planner, developer, investor, operator, local authority or driver — Robotic Parking offers decisive advantages for everyone: can be constructed in every form: above ground, underground, on roofs or inside a building complex.

- Create space.
- Increased Roi.
- Total security.
- Premium valet.
- Flexible facade + design.
- Absolute redundancy.
- Reduced liability.
- Modular and flexible capacity for 100 to thousands of vehicles: Additionally refer to our Building Information Modeling (BIM Tools) on http://www.roboticparking.com/robotic_parking_tools.htm
- The number of entry/exit stations, elevators and machines can be designed for every level of traffic density.
- Average waiting time for storing or retrieving the car: approximately 140 seconds in the case of highest throughput capacity.
- More than double the parking capacity in the same space. far more favorable total building costs than conventional multi-story car parks.
- Considerable reduction in running costs: personnel, ventilation, lighting, etc.
- Considerable reduction in the load placed on the environment: no exhaust fumes, no noise.
- Greatest possible degree of safety — no one must enter the area where cars are stored.
- Maximum user friendliness, the customers are enthusiastic.

A Robotic Parking Economic Model

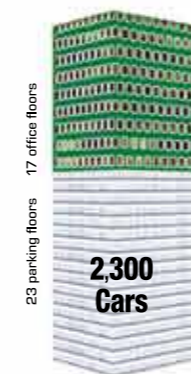

Tower solution with conventional Parking



Tower solution with Robotic Parking

+ 47% office space
+ 48% parking space

Even the vehicles themselves benefit from Robotic Parking. Cars are transported free of touch on separate pallets. The typical car park damage, such as dents, dings on paint and bodywork damages become a thing of the past. And, as an additional factor, this helps keep insurance costs down.

CONCLUSION

"The advantages of Robotic Parking are: every bit as versatile as they are unique."

www.roboticparking.com

FOR YOUR NOTES:

ADVANTAGE



ROBOTIC PARKING SYSTEMS, INC.

- Company
- Idea
- Technology
- Advantage
- How It Works
- Going Green
- Design
- Manufacture
- Projects
- References
- Contact



ROBOTIC PARKING SYSTEMS, INC.

The BIGGEST IDEAS in Automated Parking

PARK YOUR CAR



1. Drive up to the automated parking garage. The Robotic Parking System offers complete design flexibility and can blend with any neighborhood or project.



2. Drive into the convenient parking terminal. Multiple automatic sensors ensure that the car is properly positioned for parking. Robotic Parking Systems offer better care and safety for vehicles.



3. Get out and lock the car. There is no need to drive through the garage to find a parking space. Robotic Parking Systems offer a greater level of convenience.



4. Take the parking card from the kiosk and walk away. You get premium valet parking without the valet.



5. Robotic Parking Systems does the rest. The car is picked up by the computerized machinery and lifts that will safely place it inside the building on a shelving system. The automated parking garage at Ibn Battuta Gate handles 250 cars per hour with up to 32 cars in motion at any one time.

RETRIEVE YOUR CAR



6. Enter the well lit and secure ground floor lobby and put the parking card into the kiosk. The Robotic Parking System provides the highest possible level of security for individuals.



7. Screens display the exit terminal where the car can be retrieved. The Robotic Parking System swiftly delivers the car in 3 minutes or less.



8. The Robotic Parking Systems' machinery delivers the car facing forward so that it is safe and easy to exit the garage.



9. Get into the car in the exit terminal. It is not necessary to wander around inside the garage to retrieve the car.



10. Drive away. The Robotic Parking System makes parking safe and hassle free.

CONCLUSION

"Robotic Parking garages are 'easy to use as simple as valet parking'."

www.roboticparking.com

FOR YOUR NOTES:

HOW IT WORKS



- Company
- Idea
- Technology
- Advantage
- How It Works
- Going Green
- Design
- Manufacture
- Projects
- References
- Contact



Earn LEED points with Robotic Parking — an environmentally clean parking facility.

The US Green Building Council as well as Middle East Center for Sustainable Development (MECSD), ESTIDAMA and others are getting more and more support for its LEED (Leadership in Energy and Environmental Design) Green Building Rating System. The US federal government has mandated that all of its new buildings be constructed to meet a minimum LEED certification of Silver. To achieve this level a new project must receive a minimum of 33 LEED points out of a possible 69. Many states, counties and cities are following this lead.

Robotic Parking garages are “green” products that conserve gas and diesel since vehicles are not wasting time and energy driving up and down ramps in search of a parking space. This significantly reduces the emissions of harmful gases and ensures an environmentally clean parking facility.

A review of LEED codes indicates that a Robotic Parking System could receive at least 10 points and as many as 17 points. Innovation in Design could earn an additional four points.

Here is an estimate for emissions reduction and energy saved in a 1,442 space robotic garage:

- An annual savings of 19,828 gallons of gasoline in the parking process.
- Quantity of toxic emissions eliminated are:
 - 2,885 lbs of Hydrocarbons (HC) per year.
 - 1,486 lbs of Nitrogen Oxides (NOx) per year.
 - 11.149 tons of Carbon Monoxide (CO) per year.
 - 198 tons of Carbon Dioxide (CO2) per year.

Robotic Parking Systems, in addition to reducing energy consumption, have the potential to improve quality of life by positively affecting the way buildings and communities are designed, built and operated.



CONCLUSION
 Robotic Parking Systems are earning additional LEED points + reduce carbon footprint.
www.roboticparking.com

FOR YOUR NOTES:

GOING GREEN



ROBOTIC PARKING SYSTEMS, INC.

- Company
- Idea
- Technology
- Advantage
- How it Works
- Going Green
- Design
- Manufacture
- Projects
- References
- Contact



ROBOTIC PARKING SYSTEMS, INC.

The BIGGEST IDEAS in Automated Parking



From Brick to Mirrored Glass

The Façade of a Robotic Parking Garage Can Blend Seamlessly into Any Project or Neighborhood.

Creative freedom for architects and developers has arrived! Planners can hang any type of façade onto the clean outside structural support system of a Robotic Parking garage.

Robotic Parking Systems installs its industrial lifts, machines, pallets and the computer control systems inside the supporting structure and never interferes with the façade.

The steel or concrete supporting construction of the Robotic Parking System will accept any variety of façades. This allows planners and architects a free hand in designing the external appearance of the facility. Whether you choose a half-timbered, brick, aluminum, concrete or glass facade, the choice is yours. The garage can be designed to fit harmoniously into its environment. Entry / exit terminals can also be integrated into the façade environment, while observing both visual as well as functional criteria.

Here are just a few examples of project designs that include the Robotic Parking Systems.



CONCLUSION

"Planners and architects have a free hand in designing the external appearance of the garage."

www.roboticparking.com

FOR YOUR NOTES:

DESIGN



ROBOTIC PARKING SYSTEMS, INC.

- Company
- Idea
- Technology
- Advantage
- How It Works
- Going Green
- Design
- Manufacture
- Projects
- References
- Contact



ROBOTIC PARKING SYSTEMS, INC.

The BIGGEST IDEAS in Automated Parking



All Robotic Parking Systems' machinery is manufactured in Clearwater, Florida.

Robotic Parking Systems, Inc. has the only full scale manufacturing facility in North America that is completely dedicated to designing and building custom automated parking garages. We are not an OEM or distributor. We manufacture our machinery from raw steel to finished product using off the shelf components from local US distributors.



Quality control is maintained using our 150 car research and testing garage located within our production plant. This facility allows us to test and certify every machine before it's shipped to the customer's job site.

With its 100,000+ SF manufacturing floor Robotic Parking Systems is capable of building projects of any size, and deliver quality product on time, to meet the demands of even unusual requirements.

The factory personnel are highly trained, motivated and in possession of all certificates for the needs of highly specialized processes.



Come and see it for yourself. Contact us to schedule your tour.



CONCLUSION
 "Robotic Parking maintains complete control over the entire manufacturing process from raw steel to completed and certified machines.
www.roboticparking.com

FOR YOUR NOTES:



- Company
- Idea
- Technology
- Advantage
- How It Works
- Going Green
- Design
- Manufacture
- Projects
- References
- Contact



ROBOTIC PARKING SYSTEMS, INC.
The BIGGEST IDEAS in Automated Parking



Designed, implemented and operated the 314 space automated parking facility. The Robotic Parking System was operated 24 / 7 for four years with 99.9% uptime over 750,000 vehicle transactions and approximately 34,000 hours.



Turnkey system design, start up of operations and maintenance for a 765 space automatic parking garage for the Ibn Battuta Gate project in Dubai, UAE. Operations started in August 2009.



Designed, built and has been operating a 150 space Robotic Parking System in Pinellas Park, Florida for three years.



Turnkey design contract and delivery of machinery for a 1200 space Robotic Parking System for the Emirates Financial Tower in Dubai, UAE.



Turnkey design and machinery built for a 220 space automatic parking garage for the Hollywood Grande project.



Design and delivery of machinery and automation for 320 spaces for Traders Hotel in Abu Dhabi, UAE.

CONCLUSION
"Robotic Parking Systems built systems for close to 3000 spaces."
www.roboticparking.com

FOR YOUR NOTES:



- Company
- Idea
- Technology
- Advantage
- How It Works
- Going Green
- Design
- Manufacture
- Projects
- References
- Contact



ROBOTIC PARKING SYSTEMS, INC.
The BIGGEST IDEAS in Automated Parking



Just in time for the fall, an innovative parking that's all about your convenience

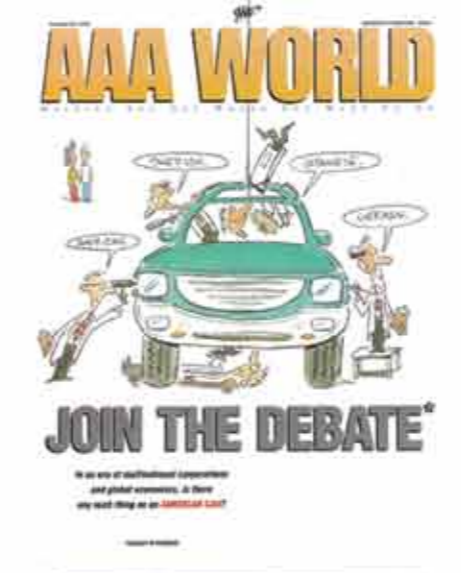

CONCLUSION
"Robotic Parking Systems was recognized by TEXAS A & M as: The pioneer in Automated Parking"
www.roboticparking.com

Comments from industry specialists and press.

City planners, architects, developers and other car park specialists, have stated convincingly what they think of the Robotic technology. Here are some of the statements made:

- "One of the most intelligent inventions of the 20th century" AAA World Magazine
- "... One of the Top Ten Garages in the world" BMW Magazine.
- "...the Robotic garage displays a stunning agility-it lifts and carries cars about on computer-controlled steel pallets as if they were delicate ballerinas, moving with precision and speed inside a structure that is remarkable compact...we appreciate the articulateness of the eloquent parking architect" NY Times.
- "The pioneer and US expert in automated parking" Parking symposium at the Texas A & M March 2002.
- "It could put to rest a car owner's worst parking nightmare" CNN (Jeanne Moos).
- "...when you return...no guesswork about where you parked it, no strange nicks, dents or scratches ...and no parking attendant to tip" Peter Jennings -ABC World News Tonight.
- "...For drivers leaving or retrieving their cars at a parking garage, it's a dream; no exhaust fumes, no strange nicks or scratches appearing..." Wall street Journal.
- "For 25 years I have looked for a solution for the parking problem. I have visited the garage, have investigated the Robotic Parking System and I say: 'That's it! I'm part of it!'" J. K., Owner of the oldest construction company in the USA has built hundreds of parking garages.
- "I have seen other systems around the world and there's nothing comparable. And that's impressive!" T. K., Planner, Developer.
- "... that's fantastic. In fact, it's a breakthrough in parking." R. B., Architect.
- "As a city planner I can say that this technology is a dream come true! The implementation of these Robotic Parking Systems garages will have a major positive impact for any city planning." D. C., Head of City Planning.
- "I want to express our extreme pleasure and thanks.... we were thoroughly impressed and satisfied that it was one of the few things we've seen that shows off the 20th century technology." A. S., Chairman of the Board of Crossgates Development.

More evaluations and comments can be found on our web site at www.roboticparking.com.



FOR YOUR NOTES:



ROBOTIC PARKING SYSTEMS, INC.

- Company
- Idea
- Technology
- Advantage
- How It Works
- Going Green
- Design
- Manufacture
- Projects
- References
- Contact



ROBOTIC PARKING SYSTEMS, INC.
The BIGGEST IDEAS in Automated Parking

Call us to find out how you can park more cars in less space!



USA

12812 60th Street N., Clearwater, FL 33760 USA
 Tel: +1 (727)-539-7275, Fax: +1 (727)-538-1900
www.roboticparking.com, info@roboticparking.com

UAE

P.O.Box 124875, Dubai U.A.E
 Tel: +(971) 800 ROBOTIC, Fax: +(971) 4 3953749
www.mrs.ae, dubai@roboticparking.com

CONCLUSION
 "Robotic Parking Systems offers more cars, less space, cleaner environment and less development cost."
www.roboticparking.com

FOR YOUR NOTES:



Robotic Parking

Solutions for Urban Environments

Results

- Storage capacity doubled
- Vehicles are moved at speeds up to 2 m/s and positioned with 1 mm accuracy
- Development costs reduced by up to 40%
- Operating costs reduced by up to 40%
- Extensive in-built redundancy
- Flexible above/below ground location
- Up to 16 points towards LEED certification
- System access via the web

“With the control and monitoring software, the PLCs and servo systems all coming from one source, GE Fanuc Intelligent Platforms, this one-stop-shop offers many advantages.”

Constantin Haag

COO

Robotic Parking Systems, Inc.

HMI/SCADA Solution From GE Fanuc Intelligent Platforms Facilitates Eco-friendly Parking

Matching the theme of GE's ecomagination initiative and a commitment to invest in innovative solutions to solve environmental challenges, Robotic Parking Systems Inc. has developed automated car parking facilities that double the storage capacity of a conventional multi-story car park. GE Fanuc Intelligent Platform's Proficy® HMI/SCADA-CIMPLICITY® is used to provide overall control and monitoring of the automated parking process.

Per car park space, the automated parking and retrieval systems typically offer savings of between 30% and 40% in terms of development costs and savings of between 30% and 40% in running costs thanks to the savings in volume of over 50%.



Solutions for Urban Environments

A recent example of Robotic Parking Systems design is a 765-car free-standing system in Dubai, United Arab Emirates, next to the Ibn Battuta shopping mall. The garage serves the adjacent shops, as well as an office complex and a hotel. With a footprint of 76m x 30m, the car park has seven levels which take up just 18m in height. A second planned installation in Dubai comprises a 1,200 capacity underground car park, below two tower blocks in the financial center. The 1,200 spaces are located within a 92m x 36m footprint on nine levels within a depth of 22m.

Quick and easy

For the driver, the parking of the vehicle is simple. He or she simply drives onto a pallet at the ground floor entrance of the facility and leaves the vehicle just as if it were being parked by a valet. The driver swipes a card and the automated system does the rest. The door closes, the pallet is transported under computer control via various horizontal and vertical conveyors and lifts until the car is parked in a permanent position.



When the owner of the car returns to the ground floor exit at the Ibn Battuta car park, he or she goes to a kiosk and follows the simple instructions before swiping his card again. The system informs the car owner on flatbed screens which gate to go to for the car. Retrieval by the system takes approximately 1 to 2.5 minutes on average, with the car then ready to drive away.

The automated parking systems designed by Robotic Parking offer complete flexibility in design. They may be incorporated above ground or underground, inside a building, under a building, or even at the top of a building. The façade can match that of the surrounding

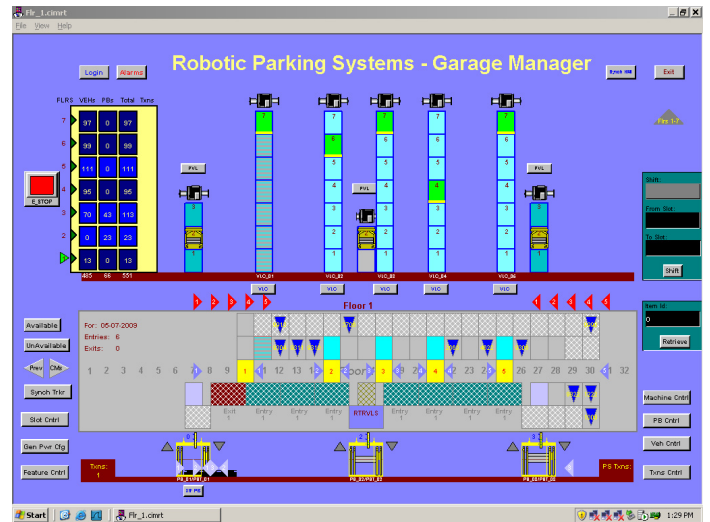

buildings. There are no ramps, no high ceilings, and no space either side of the car for occupants to exit, therefore the large savings in space.

The best applications of the technology are in areas with limited space and where land is expensive or where there is a high demand for parking. This would include urban sites, office and commercial buildings, retail and entertainment sites, hotels and residential development projects, hospitals, airports, etc. Irregular shaped ground sites can be developed as well.

Eco-friendly

The Robotic Parking Systems offer eco-friendly advantages during operation on a number of fronts. For example, the production of pollutants to manipulate a car into a space in a conventional multi-story car park is completely avoided.

As well as maximizing parking capacity, the park operator achieves considerable savings in terms of operating costs. A parking unit is typically operated by one operator. Lighting and ventilation requirements are minimized, maintenance and cleaning of a typical concrete infrastructure is eliminated and insurance claims are drastically reduced. In all, operating savings of between 30% and 40% are typical.

For certification that a building is environmentally responsible and profitable under the Leadership in Energy and Environmental Design (LEED) Green Building Rating System, the Robotic Parking Systems design already qualifies the new parking facility for up to 16 points out of the 35 needed to achieve certification.

System operation

The Robotic Automated Parking Software (RAPS) system developed by Robotic Parking is an intelligent process control system that optimizes the operation of the garage by constantly monitoring and intelligently controlling every aspect of the operation.

The operator in the main control room can access the system by means of an HMI screen, which is connected by an Ethernet link to the main server running GE Fanuc's Proficy HMI/SCADA CIMPLICITY software. This server monitors and controls the whole system using GE Fanuc 90-30 PLCs to interface with GE Fanuc servo systems which maneuver the parking pallets that convey each car to and from its automatically allocated parking position. The Ibn Battuta installation comprises 60 PLCs with approximately 35,000 points of control.

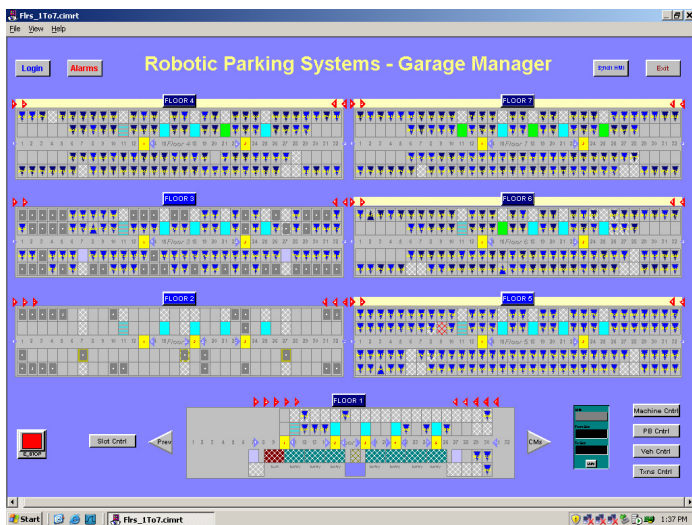

GE Fanuc servo motors move the vehicles at speeds up to 2 m/s, positioning them with 1 to 3 mm accuracy. Since most of the driving servo motors actually move considerable distances with the pallets, conveyors and lifts, RF communications are used between the PLCs and their motors rather than cables. In real-time, RAPS tracks the status of all the equipment and can notify personnel of alarm conditions via the main control monitor or via a pager. The control room operator can drill down through HMI screens to resolve the issue.

Gerhard Haag, founder and President of Robotic Parking, commented, "We have had excellent support from GE Fanuc right from our start up in 1994. In the RAPS system, there are around 50 different HMI screens which proved easy to develop in CIMPLICITY."

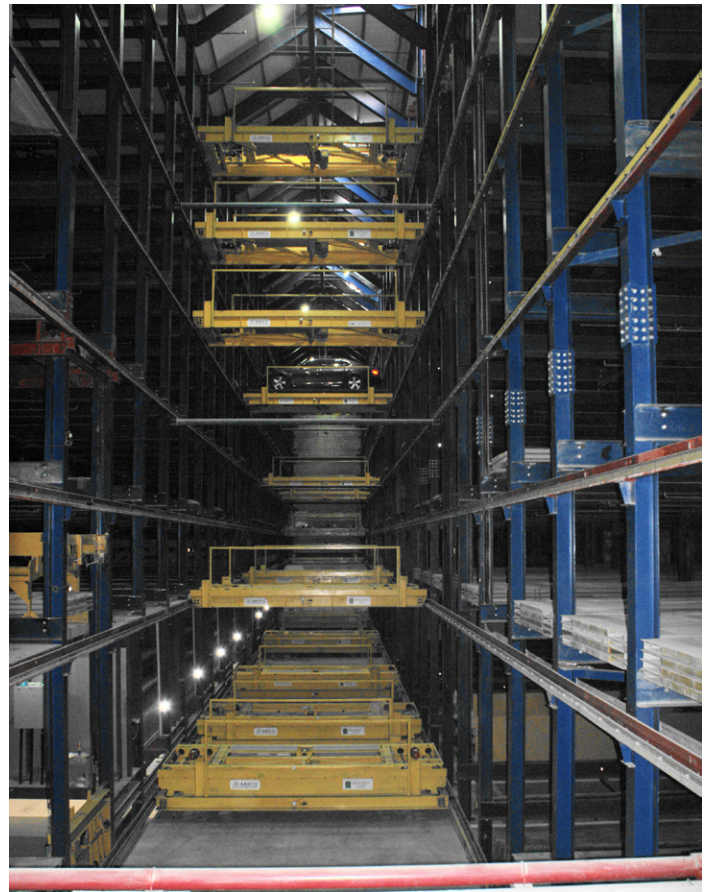

Preventative maintenance

Every component in the automated infrastructure is monitored and recorded by CIMPLICITY for maintenance purposes. When certain thresholds of usage are approached, the need for maintenance or replacement is flagged on a separate preventative maintenance HMI screen so that the work can be planned and carried out before problems arise.

Data is continuously archived, including CCTV images of all cars entering and exiting the facility. CIMPLICITY-captured data can be accessed via a LAN or Internet link using a browser. Built-in security ensures that only authorized personnel can query the system. Data is also exported to the Building Management System to provide information such as the number of vehicles in the building and the processing of credit cards. A historical data analyzer can access historical data and provide trending and graphical reports.

To ensure maximum system availability, extensive control and monitoring equipment redundancy is built-in, including duplication of servers, HMIs and PLCs on separate networks. The computers

will switch over automatically in the event of a fault and an emergency stand-by power generator will take over in the event of a power outage. Should there be a catastrophic failure of the computer system, there is a manual override facility. The servo systems that move the pallets also work in pairs, with one system capable of driving the whole load in the event of a failure of one of them.

Safety and flexibility

The system also offers high levels of security and safety. Personal safety issues inside a conventional multi-story park including traffic accidents and threats such as robbery are avoided since the driver and passengers never enter the building. Automated parking also avoids theft of belongings from within the vehicle as well as chips and scratches that might be caused by other car users in the confined space of a conventional garage.

Robotic Parking operates a full turnkey operation. Each new installation is manufactured and installed by Robotic Parking Systems. The internal infrastructure of pallets, lifts and carriers is produced by the parent company, Robotic Parking Systems Inc., in Florida, and shipped to the site. For the Dubai car park, the local establishment, Robotic Systems FZE - Dubai, designed the local components and subcontracted the 'skin' and installed and commissioned the infrastructure.

Constantin Haag added, "With the control and monitoring software, the PLCs and servo systems all coming from one source, GE Fanuc Intelligent Platforms, this one-stop-shop offers many advantages. Also GE Fanuc's GlobalCare Service reassures customers of spare parts and service availability anywhere in the world."

GE Fanuc Intelligent Platforms Information Centers

Headquarters:
1 800 GE FANUC
1 800 322 3616
1 434 978 5100

Global Regional phone numbers are available on our website at www.gefanuc.com

© 2009 GE Fanuc Intelligent Platforms, Inc. All Rights Reserved.
*Trademark of GE Fanuc Intelligent Platforms, Inc.
All other brands or names are property of their respective holders.

Additional Resources

For more information, please visit the GE Fanuc Intelligent Platforms web site at:

www.gefanuc.com





CAR PARKING

UP system

AUTOMOTION
PARKING SYSTEMS

CONSUMER BENEFITS

- ◆ **Safe, Secure and Convenient**
 - No one enters the car, personal belongings are secure
 - No scratches, dents, or dings
 - Retrieval in less than 2 minutes for all system applications

GROUNDBREAKING ADVANCES

- ◆ **Maximizes land use and parking revenues**
 - 2 to 3 times more spots than the conventional parking equivalent
 - Parking spaces can be created where previously impossible
 - Significantly increases project's financial performance
- ◆ **Improves customer parking experience**
- ◆ **System designed to eliminate the possibility of damage to vehicles**
- ◆ **Environmentally friendly**
 - Consistent with "Green" building requirements – LEEDS
 - Eliminates harmful emissions – no running engines
- ◆ **Reduced infrastructure costs**
 - Limits underpinning, excavation costs, as well as site preparation
- ◆ **Reduced labor costs**
- ◆ **Reduced operations costs**
- ◆ **Optional features**
 - Fully integrated user interface and cash management system
 - Car wash
 - Remote management
 - Redundant power supply
- ◆ **Research & Development**
 - Bomb detection
 - High security facility

UP Car Parking System

The UP system is our most common solution and accommodates heights up to 65' (780"). Based on a modular concept that can be built above or below grade, the UP easily adapts to meet the specific requirements of a prospective parking location. The UP's transfer room can be placed on any level of the parking system. The transfer room can also be located on a level above the parking area and connected to it via elevator. The UP allows for various car heights, and its integrated quick change system allows drivers to retrieve cars rapidly, minimizing wait time. The rotating turntable in the transfer room or on the storage and retrieval unit (SRU) allows the vehicle to be positioned toward the exit, ready for driving.

Side view: Parking spots within a steel structure

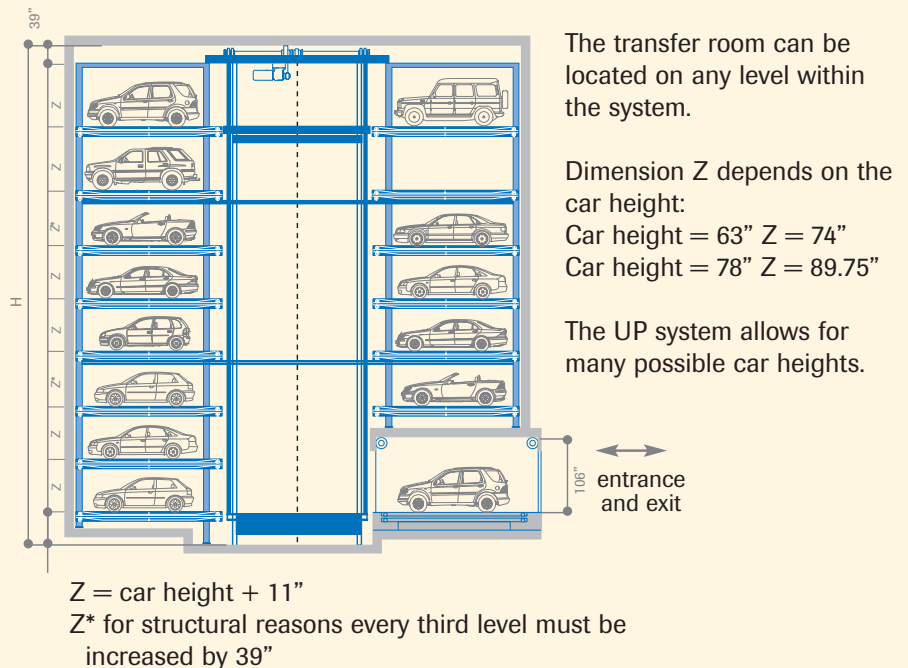

Side view: Parking spots within a concrete structure

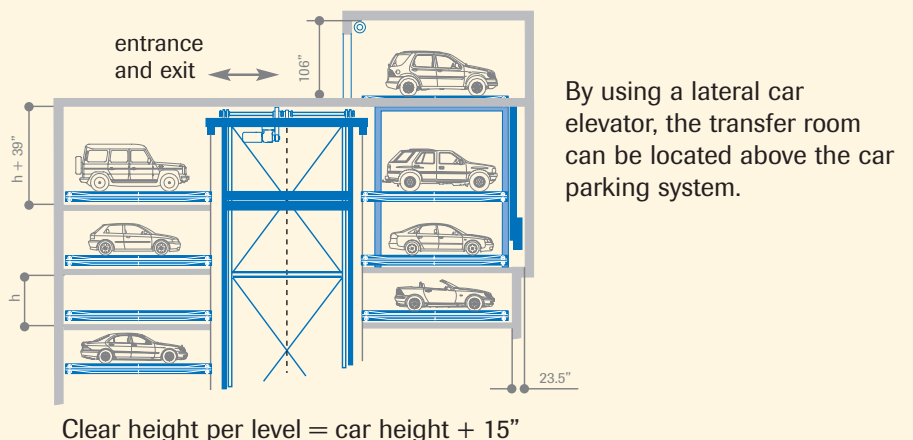

Entrance and Exit Alternatives

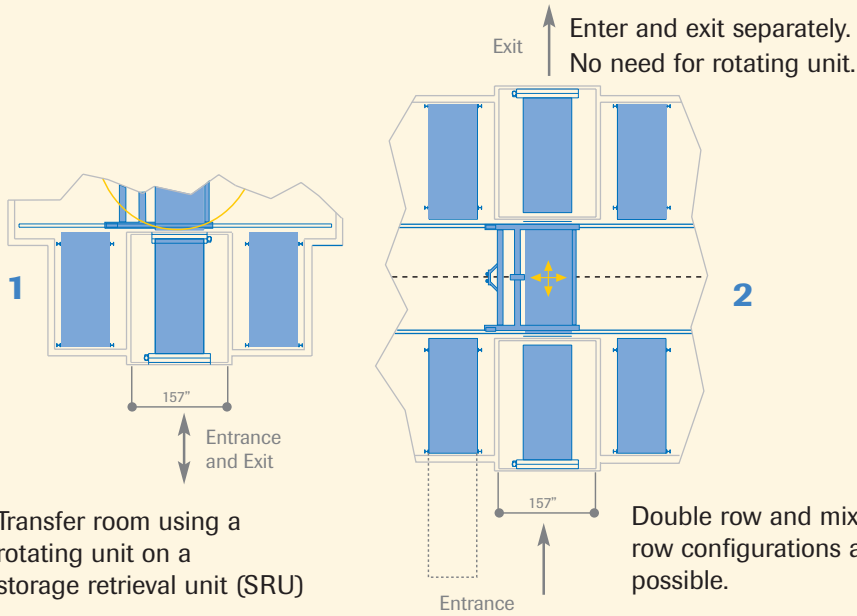

Transfer room using a rotating unit on a storage retrieval unit (SRU)

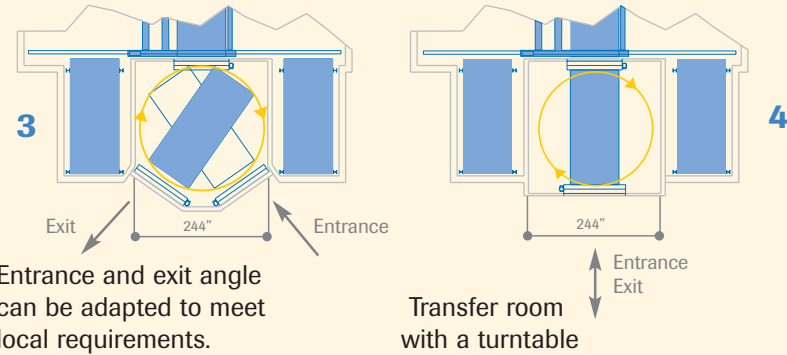

Entrance and exit angle can be adapted to meet local requirements.

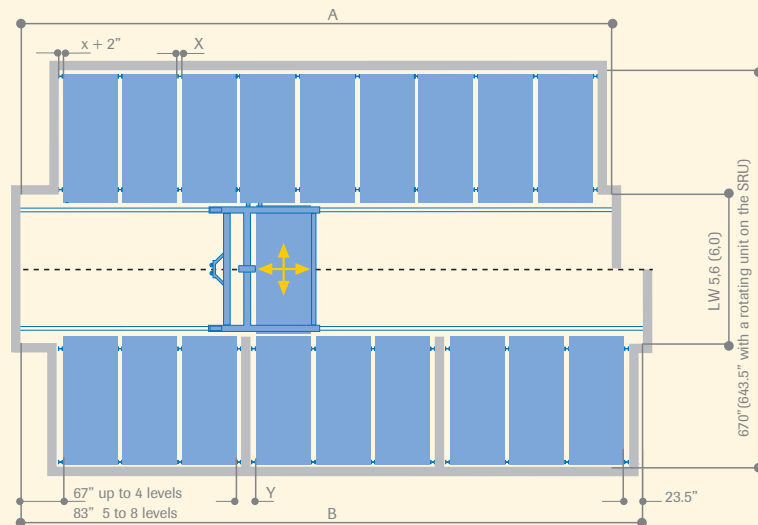

Parking spots in a steel structure require the pallet distance X and Y depend on the height of the entire system: X without wall plates / Y with wall plates $s = 12"$.

- 2 to 4 levels: $X = 7"$ / $Y = 29"$
- 5 and 6 levels: $X = 8"$ / $Y = 31"$
- 7 and 8 levels: $X = 8.5"$ / $Y = 32"$

Dimensions for free-standing systems available upon request.

Dimensions of parking platform 17.1' (205") x 87"

*Assumes vehicle dimensions of 16.8' (201") L x 87" W.

All dimensions refer to these platform dimensions.

Platform dimensions can be customized

Parking spots within a concrete structure require the pallet distance $X = 4.75"$ without wall plates and $Y = \text{thickness of the wall plate} + 11"$. Control cabinets must be installed in a room with a minimum surface area of 11.4' (137") x 71". The room height must be a minimum of 87". Please note that this room should be located close to the transfer room.

Automotion is an innovative parking system that combines a traditional elevator parking system with computerized guidance software. This allows Automotion to maximize the number of cars a location can handle while automating the entire vehicle storage and retrieval process. Automotion Parking Systems employs a comprehensive staff of architects, engineers and automated site planning solution specialists to aid in the development of your project. Automotion Parking Systems is the leader in transient parking systems in The United States.

STOPA is the leader in world wide automated storage systems and automated parking systems with over 1500 installations

SP System	LP System	TP System	UP System
<p>Parking solution for a large number of parking spots and high-volume traffic</p> <ul style="list-style-type: none"> ■ Customized configurations ■ Retrieves cars quickly, minimizing driver wait times ■ Turntable allows drivers to enter and exit in driving direction ■ Accommodates a variety of vehicle heights ■ Suitable for public use ■ Works best in concrete buildings 	<p>Parking solution for narrow buildings</p> <ul style="list-style-type: none"> ■ Customized configurations ■ Installation above or below grade ■ Retrieves cars quickly, minimizing driver wait times ■ Turntable allows drivers to enter and exit in driving direction ■ Accommodates a variety of vehicle heights 	<p>Parking solution for spaces with minimum surface area and high headroom</p> <ul style="list-style-type: none"> ■ Customized configurations ■ Installation above or below grade ■ Retrieves cars quickly, minimizing driver wait times ■ Turntable allows drivers to enter and exit in driving direction ■ Accommodates a variety of vehicle heights ■ Suitable for public use 	<p>Universal parking solution</p> <ul style="list-style-type: none"> ■ Customized configurations ■ Installation above or below grade ■ Retrieves cars quickly, minimizing driver wait times ■ Turntable allows drivers to enter and exit in driving direction ■ Accommodates a variety of vehicle heights ■ Suitable for public use

Carbox System	Parking solution for a maximum of 20 parking spots		
<ul style="list-style-type: none"> ■ Suitable for long-term parkers only 	<ul style="list-style-type: none"> ■ Single or double row configurations 	<ul style="list-style-type: none"> ■ Installation above or below grade 	<ul style="list-style-type: none"> ■ Turntable optional



411 Hempstead Turnpike
 Suite 200
 West Hempstead NY 11552
 Tel 516 565 5600
www.automotionparking.com



CAR PARKING

TP system



CONSUMER BENEFITS

- ◆ **Safe, Secure and Convenient**
 - No one enters the car, personal belongings are secure
 - No scratches, dents, or dings
 - Retrieval in less than 2 minutes for all system applications

GROUNDBREAKING ADVANCES

- ◆ **Maximizes land use and parking revenues**
 - 2 to 3 times more spots than the conventional parking equivalent
 - Parking spaces can be created where previously impossible
 - Significantly increases project's financial performance
- ◆ **Improves customer parking experience**
- ◆ **System designed to eliminate the possibility of damage to vehicles**
- ◆ **Environmentally friendly**
 - Consistent with "Green" building requirements – LEEDS
 - Eliminates harmful emissions – no running engines
- ◆ **Reduced infrastructure costs**
 - Limits underpinning, excavation costs, as well as site preparation
- ◆ **Reduced labor costs**
- ◆ **Reduced operations costs**
- ◆ **Optional features**
 - Fully integrated user interface and cash management system
 - Car wash
 - Remote management
 - Redundant power supply
- ◆ **Research & Development**
 - Bomb detection
 - High security facility

Car Parking TP System

The TP system is a parking solution for small surface areas with high headroom. Based on a modular concept that can be built above or below ground, the TP easily adapts to meet the specific requirements of a prospective parking lot and can accommodate up to 100 parking spots per system. Multiple systems can be placed on the site allowing for maximum space efficiency. The TP's transfer room can be placed on any level of the parking system. The transfer room can also be located on a level above the parking area and connected to it via elevator. The TP accommodates a variety of car heights, adding to its flexibility. Like all Automotion parking systems, the TP retrieves cars quickly, minimizing the driver's wait time. The TP's rotating turntable platform, whether positioned in the transfer room or on the storage and retrieval unit (SRU) positions the vehicle toward the exit, allowing the driver to proceed immediately forward.

Side view: Parking spots within a steel structure

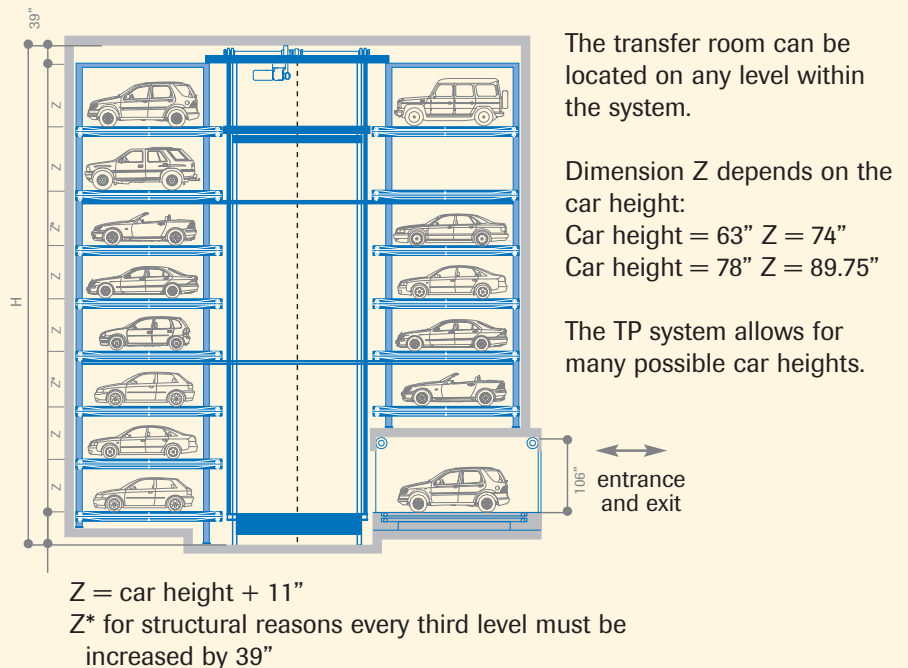

Side view: Parking spots within a concrete structure

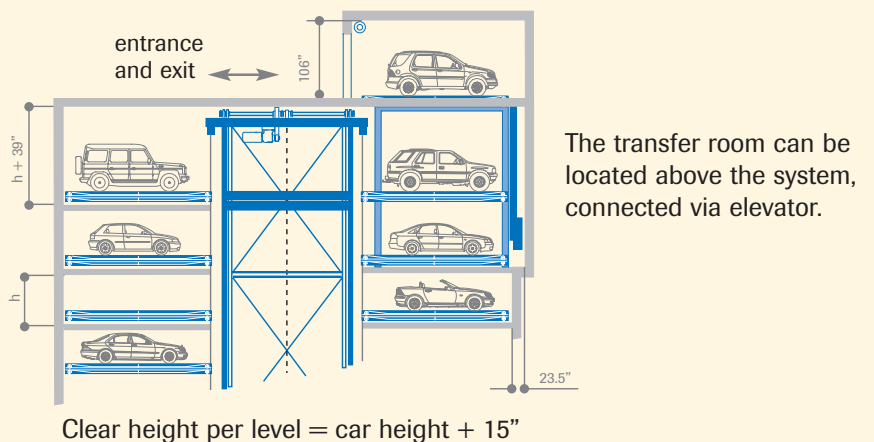

Entrance and Exit Alternatives

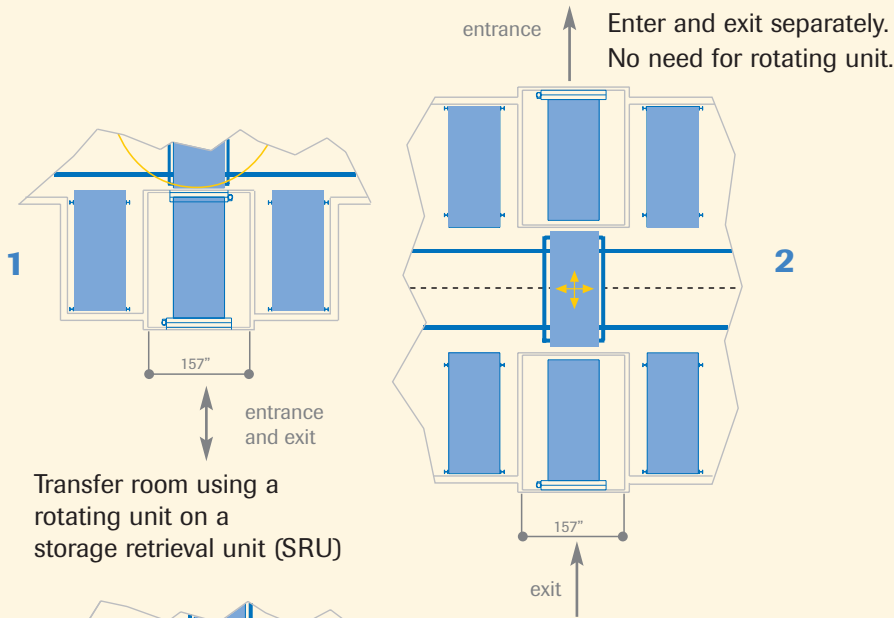

Transfer room using a rotating unit on a storage retrieval unit (SRU)

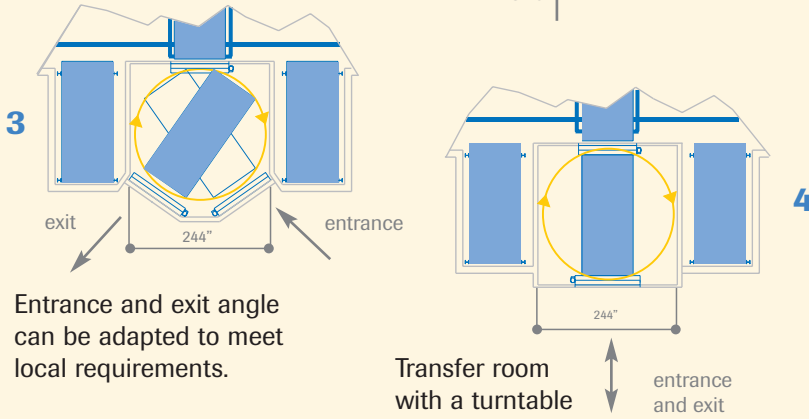

Entrance and exit angle can be adapted to meet local requirements.

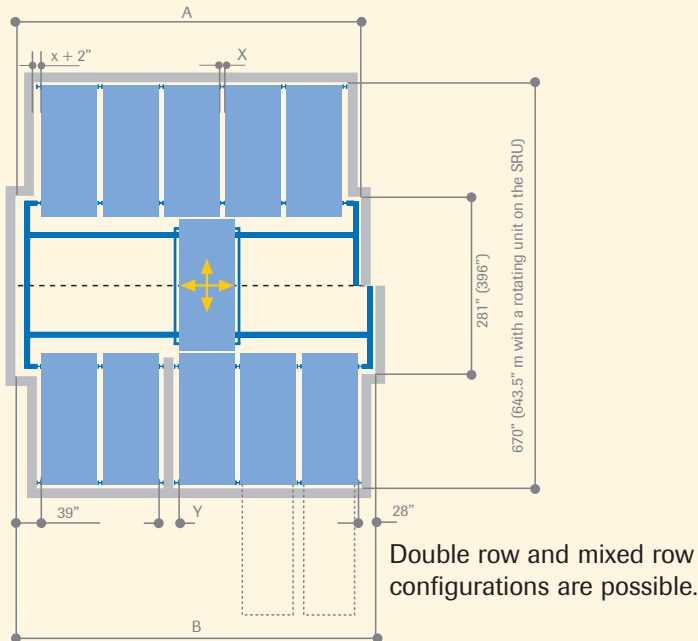

Parking spots on concrete ceilings require the pallet distance $X = 4.75"$ without wall plates and $Y = \text{thickness of the wall plate} + 11"$.

Control cabinets must be installed in a room with a minimum surface area of $11.4'$ ($137"$) \times $71"$. The room height must be a minimum of $87"$. Please note this room should be located close to the transfer room.

Control cabinets must be installed in a room with a minimum surface area of $11.4'$ ($137"$) \times $71"$. The room height must be a minimum of $87"$. Please note this room should be located close to the transfer room.

Parking spots on a steel structure require that the pallet distance X and Y depend on the height of the parking system: X without wall plates / Y with wall plates $s = 12"$.

- 4 to 6 levels: $X = 7"$ / $Y = 29"$
- 7 and 8 levels: $X = 8"$ / $Y = 31"$
- 9 and 10 levels: $X = 8.5"$ / $Y = 32"$
- 11 and 12 levels: $X = 9"$ / $Y = 34"$

Dimensions for additional parking levels and free-standing systems available upon request.

Dimensions of parking platform $17.1'$ ($205"$) \times $87"$
*Assumes vehicle dimensions of $16.8'$ ($201"$) $L \times 87"$ W .

All dimensions refer to these platform dimensions.

Platform dimensions can be customized.

Automotion is an innovative parking system that combines a traditional elevator parking system with computerized guidance software. This allows Automotion to maximize the number of cars a location can handle while automating the entire vehicle storage and retrieval process. Automotion Parking Systems employs a comprehensive staff of architects, engineers and automated site planning solution specialists to aid in the development of your project. Automotion Parking Systems is the leader in transient parking systems in The United States.

STOPA is the leader in world wide automated storage systems and automated parking systems with over 1500 installations

SP System	LP System	TP System	UP System
<p>Parking solution for a large number of parking spots and high-volume traffic</p> <ul style="list-style-type: none"> ■ Customized configurations ■ Retrieves cars quickly, minimizing driver wait times ■ Turntable allows drivers to enter and exit in driving direction ■ Accommodates a variety of vehicle heights ■ Suitable for public use ■ Works best in concrete buildings 	<p>Parking solution for narrow buildings</p> <ul style="list-style-type: none"> ■ Customized configurations ■ Installation above or below grade ■ Retrieves cars quickly, minimizing driver wait times ■ Turntable allows drivers to enter and exit in driving direction ■ Accommodates a variety of vehicle heights 	<p>Parking solution for spaces with minimum surface area and high headroom</p> <ul style="list-style-type: none"> ■ Customized configurations ■ Installation above or below grade ■ Retrieves cars quickly, minimizing driver wait times ■ Turntable allows drivers to enter and exit in driving direction ■ Accommodates a variety of vehicle heights ■ Suitable for public use 	<p>Universal parking solution</p> <ul style="list-style-type: none"> ■ Customized configurations ■ Installation above or below grade ■ Retrieves cars quickly, minimizing driver wait times ■ Turntable allows drivers to enter and exit in driving direction ■ Accommodates a variety of vehicle heights ■ Suitable for public use

Carbox System	Parking solution for a maximum of 20 parking spots		
<ul style="list-style-type: none"> ■ Suitable for long-term parkers only 	<ul style="list-style-type: none"> ■ Single or double row configurations 	<ul style="list-style-type: none"> ■ Installation above or below grade 	<ul style="list-style-type: none"> ■ Turntable optional



411 Hempstead Turnpike
 Suite 200
 West Hempstead NY 11552
 Tel 516 565 5600
www.automotionparking.com



CAR PARKING

SP system

AUTOMOTION
PARKING SYSTEMS



CONSUMER BENEFITS

- ◆ **Safe, Secure and Convenient**
 - No one enters the car, personal belongings are secure
 - No scratches, dents, or dings
 - Retrieval in less than 2 minutes for all system applications

GROUNDBREAKING ADVANCES

- ◆ **Maximizes land use and parking revenues**
 - 2 to 3 times more spots than the conventional parking equivalent
 - Parking spaces can be created where previously impossible
 - Significantly increases project's financial performance
- ◆ **Improves customer parking experience**
- ◆ **System designed to eliminate the possibility of damage to vehicles**
- ◆ **Environmentally friendly**
 - Consistent with "Green" building requirements – LEEDS
 - Eliminates harmful emissions – no running engines
- ◆ **Reduced infrastructure costs**
 - Limits underpinning, excavation costs, as well as site preparation
- ◆ **Reduced labor costs**
- ◆ **Reduced operations costs**
- ◆ **Optional features**
 - Fully integrated user interface and cash management system
 - Car wash
 - Remote management
 - Redundant power supply
- ◆ **Research & Development**
 - Bomb detection
 - High security facility

SP Car Parking System

The SP system is designed for locations that require a large number of parking spots and receive a high volume of traffic. Based on a modular concept, the SP can be adapted to meet the specific requirements of any given location. Through the combination of vertical car elevators passing through the entire system and shuttles that work on each individual parking level, the SP boasts a limitless array of possible configurations. The SP provides several hundred parking spots that can be built above or below grade. Transfer rooms can be placed on every level within or above the system. The SP allows for various car heights and its integrated quick change system allows drivers to retrieve cars rapidly, minimizing wait time. The transfer rooms and rotating turntable are arranged to position the vehicle toward the exit, allowing the driver to proceed immediately forward.

Side view: Parking spots within a concrete structure

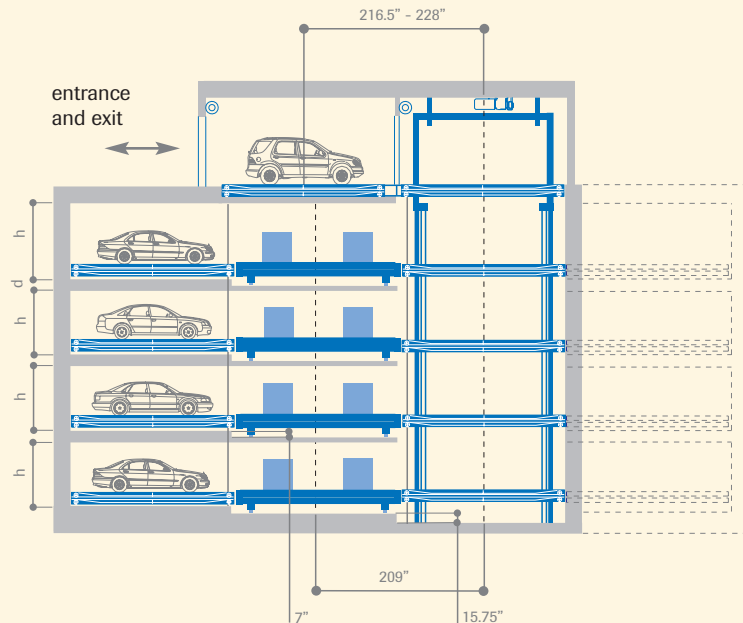

Clear height per level = car height + 15"

The size of the control cabinet room depends on the number of car elevators and the number of transfer rooms. If the system contains one car elevator and one transfer room, the control cabinet room must be 11.5' (138") L x 79" W x 86.5" H. To accommodate an additional car elevator, the length must be increased to 14.75' (177").

Entrance and Exit Alternatives

IMAGE 1

Directly driving onto the elevator. In this case, the transfer room is a drive-through solution without a rotating unit. This solution requires the elevator pit's dimensions to be increased by 39".

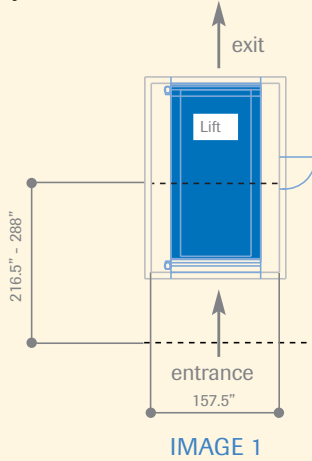

IMAGE 2

Lateral transfer room with turntable. The elevator can process a new request while the transfer room is occupied.

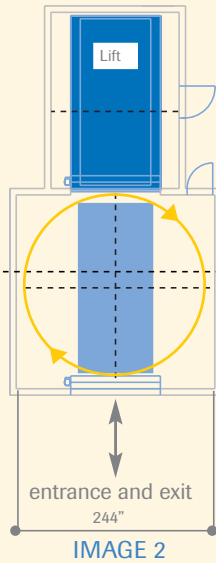

IMAGE 3

Double-sided transfer rooms, each with turntable. This allows both transfer rooms to be used for entering and exiting the parking system, based on demand.

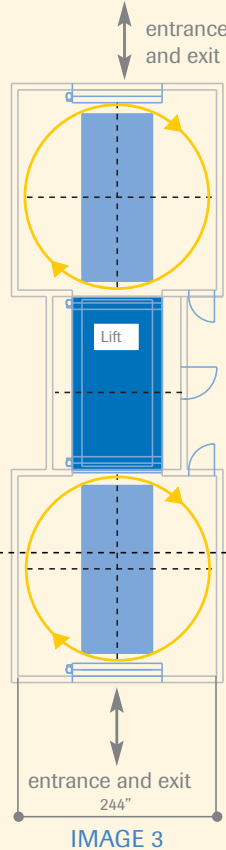
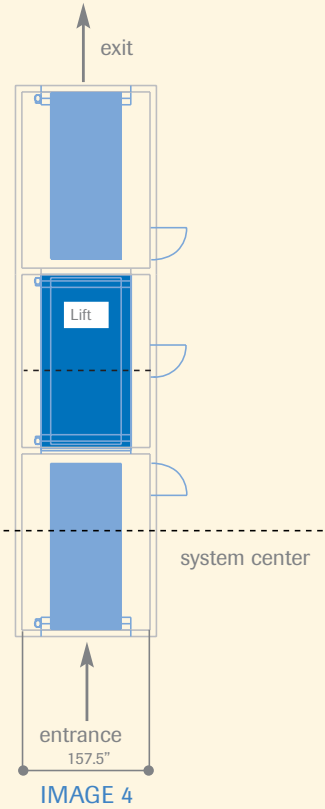

IMAGE 4

Double-sided transfer rooms with dedicated entrance room and exit room. The car elevator can process a new request while the transfer room is occupied.



Pallet distance $X = 4.75"$, pallet distance $Y = 23.5"$ in case of a wall plate with $s = 12"$.

Double and mixed row configurations are possible.

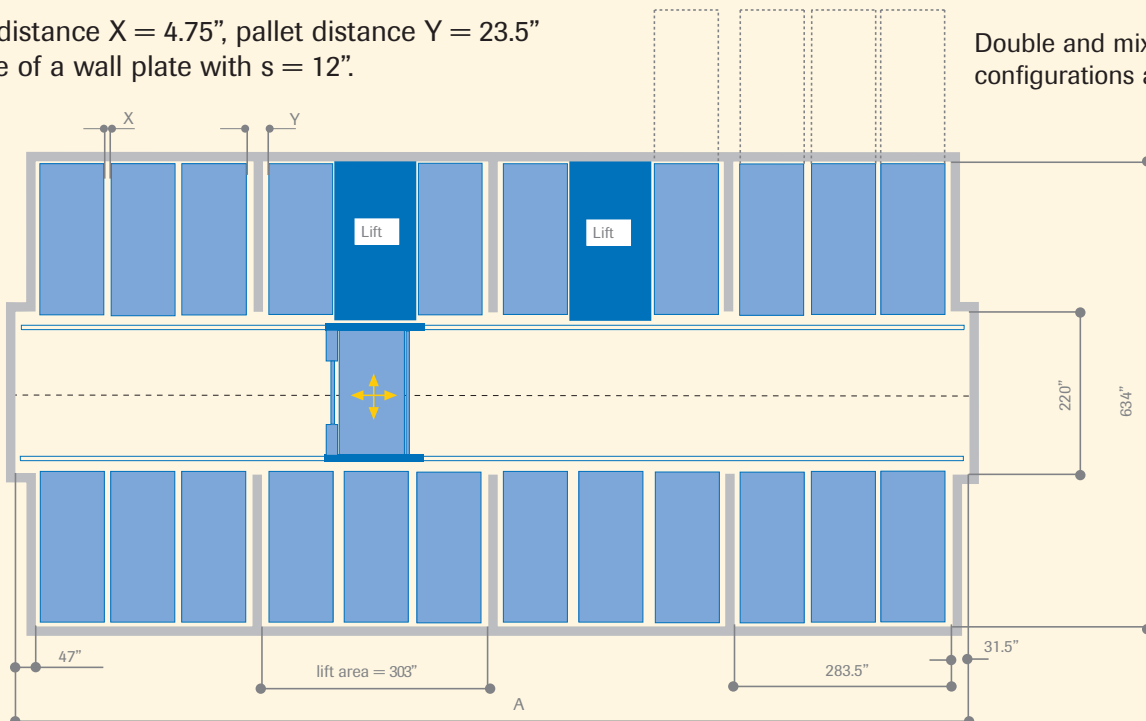

Automotion is an innovative parking system that combines a traditional elevator parking system with computerized guidance software. This allows Automotion to maximize the number of cars a location can handle while automating the entire vehicle storage and retrieval process. Automotion Parking Systems employs a comprehensive staff of architects, engineers and automated site planning solution specialists to aid in the development of your project. Automotion Parking Systems is the leader in transient parking systems in The United States.

STOPA is the leader in world wide automated storage systems and automated parking systems with over 1500 installations

SP System	LP System	TP System	UP System
<p>Parking solution for a large number of parking spots and high-volume traffic</p> <ul style="list-style-type: none"> ■ Customized configurations ■ Retrieves cars quickly, minimizing driver wait times ■ Turntable allows drivers to enter and exit in driving direction ■ Accommodates a variety of vehicle heights ■ Suitable for public use ■ Works best in concrete buildings 	<p>Parking solution for narrow buildings</p> <ul style="list-style-type: none"> ■ Customized configurations ■ Installation above or below grade ■ Retrieves cars quickly, minimizing driver wait times ■ Turntable allows drivers to enter and exit in driving direction ■ Accommodates a variety of vehicle heights 	<p>Parking solution for spaces with minimum surface area and high headroom</p> <ul style="list-style-type: none"> ■ Customized configurations ■ Installation above or below grade ■ Retrieves cars quickly, minimizing driver wait times ■ Turntable allows drivers to enter and exit in driving direction ■ Accommodates a variety of vehicle heights ■ Suitable for public use 	<p>Universal parking solution</p> <ul style="list-style-type: none"> ■ Customized configurations ■ Installation above or below grade ■ Retrieves cars quickly, minimizing driver wait times ■ Turntable allows drivers to enter and exit in driving direction ■ Accommodates a variety of vehicle heights ■ Suitable for public use

Carbox System	Parking solution for a maximum of 20 parking spots		
<ul style="list-style-type: none"> ■ Suitable for long-term parkers only 	<ul style="list-style-type: none"> ■ Single or double row configurations 	<ul style="list-style-type: none"> ■ Installation above or below grade 	<ul style="list-style-type: none"> ■ Turntable optional



411 Hempstead Turnpike
 Suite 200
 West Hempstead NY 11552
 Tel 516 565 5600
www.automotionparking.com



CAR PARKING

LP system



CONSUMER BENEFITS

- ◆ **Safe, Secure and Convenient**
 - No one enters the car, personal belongings are secure
 - No scratches, dents, or dings
 - Retrieval in less than 2 minutes for all system applications

GROUNDBREAKING ADVANCES

- ◆ **Maximizes land use and parking revenues**
 - 2 to 3 times more spots than the conventional parking equivalent
 - Parking spaces can be created where previously impossible
 - Significantly increases project's financial performance
- ◆ **Improves customer parking experience**
- ◆ **System designed to eliminate the possibility of damage to vehicles**
- ◆ **Environmentally friendly**
 - Consistent with "Green" building requirements – LEEDS
 - Eliminates harmful emissions – no running engines
- ◆ **Reduced infrastructure costs**
 - Limits underpinning, excavation costs, as well as site preparation
- ◆ **Reduced labor costs**
- ◆ **Reduced operations costs**
- ◆ **Optional features**
 - Fully integrated user interface and cash management system
 - Car wash
 - Remote management
 - Redundant power supply
- ◆ **Research & Development**
 - Bomb detection
 - High security facility

Car Parking LP System

The LP system is our solution for long and narrow sites. Based on a modular concept that can be built above or below grade, the LP easily adapts to meet the space requirements of any prospective parking location. The LP accommodates a variety of car heights, adding to its flexibility. Like all Automotion parking systems, the LP retrieves cars quickly, minimizing the driver's wait time. In addition, the LP's rotating turntable platform positions the vehicle toward the exit, allowing the driver to proceed immediately forward.

Features: LPM System

- **Double and mixed row configurations**
- **Transfer room is centrally located above the vehicle storage and retrieval unit**
- **Turntable can be installed with or without wall plates***

**Wall plates may be needed to maintain the structural integrity of the building.*

Without Turntable

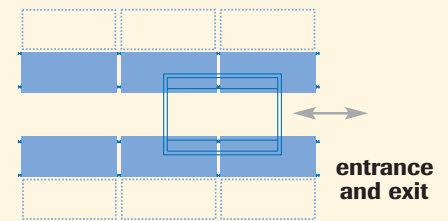

With Turntable

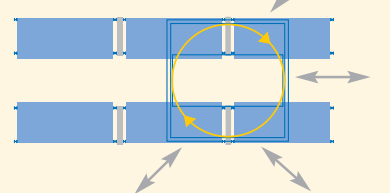

entrance and exit (various directions)

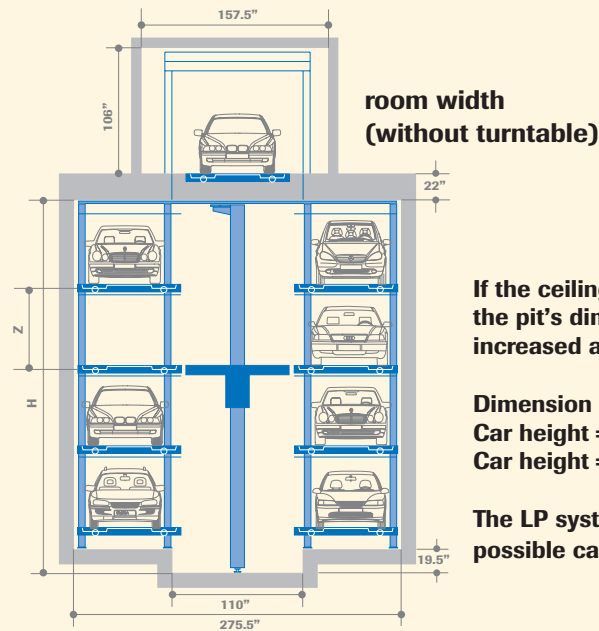

If the ceiling is higher than 19.5", the pit's dimensions must be increased accordingly.

**Dimension Z depends on the car height:
Car height = 63" Z= 68"
Car height = 79" Z= 83.5"**

The LP system allows for many possible car heights.

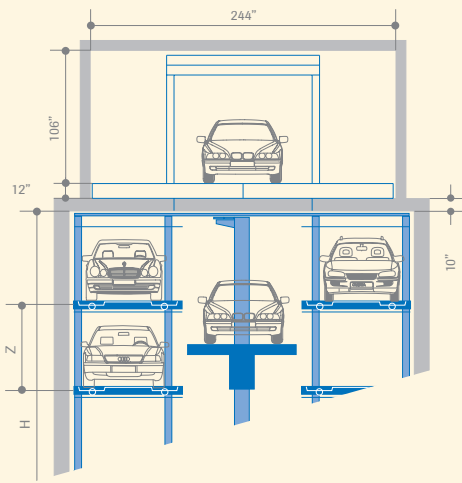

Room width with turntable

If the ceiling is higher than 10", the pit's dimensions must be increased accordingly.

Features: LPS System

- Double and mixed row configurations
- Transfer room is located laterally above the shelves
- Turntable can be installed with or without wall plates*
- Elevator quick change system minimizes access times
- Elevator can be adapted based on ceiling height

without turntable

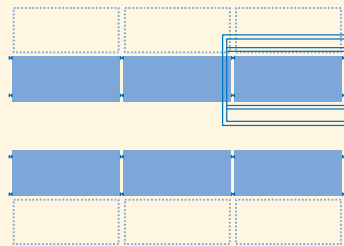

entrance and exit

with turntable

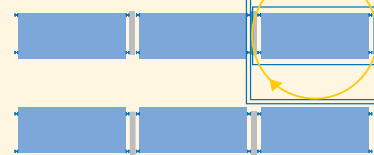

entrance and exit

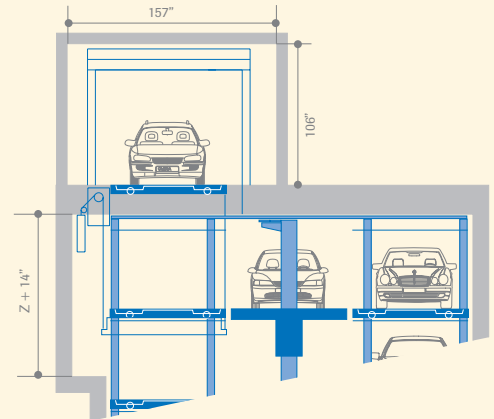

Dimension Z depends on the car height:
Car height = 63" Z = 68"
Car height = 79" Z = 53"

The LPS system allows for many possible car heights.

Shared Features: LPM and LPS

Dimensions of parking platform 17.1' (205") x 7.2' (86.5")*

*Assumes vehicle dimensions of 200" (16.7') L x 83" W.

All dimensions refer to these platform dimensions.

Pallet dimensions customized

X without wall plates / Y with wall plates 30 cm

2 and 3 levels: X = 7" / Y = 24"

4 and 5 levels: X = 8.5" / Y = 27.5"

6 and 7 levels: X = 9" / Y = 29"

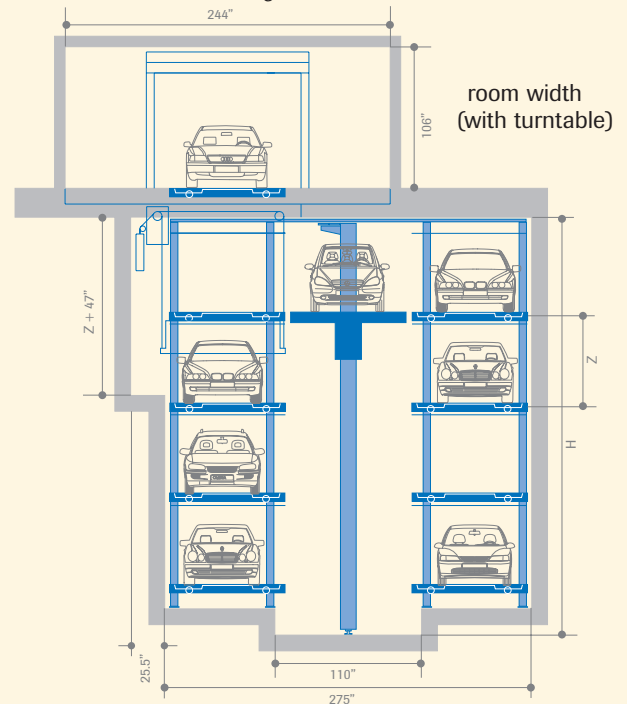
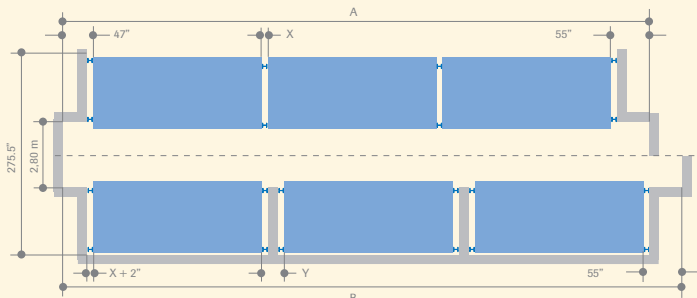

Dimensions for free-standing systems are available upon request.

Control cabinets must be installed in a room with a minimum surface area of 8.5' (102") x 70" and a height of 86". Please note that the control cabinets should be located close to the transfer room.

Automotion is an innovative parking system that combines a traditional elevator parking system with computerized guidance software. This allows Automotion to maximize the number of cars a location can handle while automating the entire vehicle storage and retrieval process. Automotion Parking Systems employs a comprehensive staff of architects, engineers and automated site planning solution specialists to aid in the development of your project. Automotion Parking Systems is the leader in transient parking systems in The United States.

STOPA is the leader in world wide automated storage systems and automated parking systems with over 1500 installations

SP System	LP System	TP System	UP System
<p>Parking solution for a large number of parking spots and high-volume traffic</p>	<p>Parking solution for narrow buildings</p>	<p>Parking solution for spaces with minimum surface area and high headroom</p>	<p>Universal parking solution</p>
<ul style="list-style-type: none"> ■ Customized configurations ■ Retrieves cars quickly, minimizing driver wait times ■ Turntable allows drivers to enter and exit in driving direction ■ Accommodates a variety of vehicle heights ■ Suitable for public use ■ Works best in concrete buildings 	<ul style="list-style-type: none"> ■ Customized configurations ■ Installation above or below grade ■ Retrieves cars quickly, minimizing driver wait times ■ Turntable allows drivers to enter and exit in driving direction ■ Accommodates a variety of vehicle heights 	<ul style="list-style-type: none"> ■ Customized configurations ■ Installation above or below grade ■ Retrieves cars quickly, minimizing driver wait times ■ Turntable allows drivers to enter and exit in driving direction ■ Accommodates a variety of vehicle heights ■ Suitable for public use 	<ul style="list-style-type: none"> ■ Customized configurations ■ Installation above or below grade ■ Retrieves cars quickly, minimizing driver wait times ■ Turntable allows drivers to enter and exit in driving direction ■ Accommodates a variety of vehicle heights ■ Suitable for public use

Carbox System	Parking solution for a maximum of 20 parking spots		
<ul style="list-style-type: none"> ■ Suitable for long-term parkers only 	<ul style="list-style-type: none"> ■ Single or double row configurations 	<ul style="list-style-type: none"> ■ Installation above or below grade 	<ul style="list-style-type: none"> ■ Turntable optional



411 Hempstead Turnpike
 Suite 200
 West Hempstead NY 11552
 Tel 516 565 5600
www.automotionparking.com



Space-Age Garages That Save Space

THE NEW YORK TIMES

Real Estate

Sunday, September 21, 2003

Robotic Chauffeurs

Cars parked at a robotic garage in Hoboken ride to their computer-assigned parking spaces atop a pallet. The pallet is moved by motorized carrier on and off an elevator and then on and off a platform that moves laterally to align the car with the designated space.

- 1) The customer drives into the garage and parks on a steel pallet.
- 2) The computer-controlled carrier pulls the pallet in and rotates it by 180 degrees, so the car is facing forward when it is retrieved.
- 3) One of two elevators takes the pallet and car to an upper level.
- 4) The pallet is transferred to another carrier that moves it laterally to an open space.
- 5) The car and its pallet are moved into the designated parking spot.

By ANTOINETTE MARTIN

IT lumbered and thudded into existence -- three years late, some still-debated but hefty amount over budget -- but the Hoboken municipal parking garage that opened its robotically controlled doors last year displays a stunning agility. It lifts and carries cars about on computer-controlled steel pallets as if they were delicate ballerinas, moving with precision and speed inside a structure that is remarkably compact.

While performance tests are still going on, the garage is limited to operating at two-thirds of its full capacity. When all systems are go, however, it will park 324 cars on just a 100-by-100-foot lot. The seven-level garage is 56 feet high, not much higher than the four-story row houses that are its neighbors.

"This is amazingly proficient use of space," commented Darius Sollohub, a New Jersey Institute of Technology professor who studies parking and urban land use. "It may provide one of the solutions to the most important conflict in urban design: where do you put all the cars in environments where car volume is high and space is at a premium?"

Although an automated garage is more expensive to build it typically takes only about half as much precious real estate as a conventional ramped garage to handle the same number of cars, or even more. That is why in European and Asian cities, the automatic garage was long ago anointed as the best solution, Mr. Sollohub said.

The Hoboken structure, designed by Gerhard Haag, an engineer and architect born in Germany, where ramped garages are rare and automatic garages common, is a first-of-its-kind in the United States. There are other automated garages in the country, some dating from the

1950's. But the Hoboken garage -- and another smaller one designed by a different company in a Washington apartment building -- belong to a new generation of fully automated garages that parking industry specialists say is generating new interest. Indeed, Mr. Haag said, there are 67 American cities, including Manhattan, where his company is currently discussing proposals.

Hoboken's Garden Street Garage is completely computerized, with two identical elevator systems that are able to move simultaneously in both vertical and horizontal directions and communicate with each other by wireless transmitters. The garage's computer figures out which of the hundreds of spaces in the building a vehicle should occupy, and then delivers it there untouched by human hands.

A monthly parker pulls into one of four driveways at the red-brick building on Garden Street, which on the outside looks pretty much like a group of Hoboken row houses. The driver powers the car forward a few yards onto a steel pallet, maneuvering the wheels between guardrails as instructions appear on an L.E.D. signboard about correct alignment, then turns off the engine and gets out.

After locking the car, the parker swipes a card in front of a magnetic reader, and while the sign on the wall is flashing a reminder to step back, automatic elevator doors close around the car and it is whisked to a computer-assigned slot.

The computer factors in the vehicle's size when making an assignment, putting larger S.U.V.'s on lower levels. It also takes into account the driver's schedule on previous visits, putting vehicles whose owners enter and exit frequently in the slots that the system can most easily access.

When the owner returns for the car and swipes the card again, the process begins in reverse. Within seconds, another electronic sign announces at which bay the car will appear, still on the pallet where the parker placed it. In its first year of operation, according to the computer records, the average wait to retrieve a car was 2.5 minutes.

THE key breakthrough with his type of design, according to Mr. Haag, is that the mechanized system is "truly redundant." With older automated designs, said Mr. Haag, all three movements a car elevator can make -- in and out, up and down, side to side -- are powered by one central unit. If any single part fails, the garage becomes inoperable.

Mr. Haag's patented design has dual systems, so that its two elevators can move separately and independently, and the three types of movements they make are each powered by separate motors. Furthermore, each individual motor has a backup. There are twin motors powering the rollers under the pallets, for example, each working at less than half capacity and programmed to take over if the other should fail.

Besides increasing reliability, notes Dale F. Denda of PMRC, a national parking market research company, the fully automatic garage means "throughput" is enhanced -- parking lingo for shortening the time it takes to store cars and retrieve them.

The one other fully automatic garage in the United States is set beneath the Summit Grand Parc, an apartment building two blocks from the White House in Washington that incorporates both a new apartment tower and historic structure that was once home to the United Mineworkers. Designed by the Spacesaver Parking Company, a division of the Mid-American Elevator Company, and using equipment manufactured by a German concern, Wohr, the garage parks just 74 cars, and has only one automated elevator system.

"But without the automated system," said Michael A. Underwood, a senior vice president of the project's developer, Summit Properties, "we wouldn't have had parking at all. For the kind of luxury apartments we provide, we had to have parking -- but this was a narrow lot between existing buildings, and with a conventional garage, we found ourselves hamstrung by site constraints. Automation provided an option."

Urban land use specialists say that this sort of situation will continue to occur in congested American cities, and that automated parking could become a widely used option. Tomorrow, in fact, a seminar on automated parking is scheduled at the Urban Land Institute, a Washington research institute, using the Summit Grand Parc as a case study.

The Spacesaver company has another 99-car automatic garage that has been approved in Aspen. The company reports additional interest in various Northeastern metropolitan areas, and a spokeswoman said it also had a project under discussion in New York City, although she would not provide details about the site.

The Manhattan site that Mr. Haag is eyeing would involve tearing down an old building and constructing a privately operated 300-car fully automatic garage.

Monthly rates for parkers would be competitive with those at a conventional garage, said Mr. Haag, "or else the market wouldn't exist." In Hoboken, a standard municipal fee of \$200 per month applies, at the automated garage and all others. In Washington, Summit Grand Parc residents pay \$225 monthly, and for S.U.V. size spots, \$250.

Until very recently, the American way has been to indulge a cultural passion for driving, even in a parking structure, observed Shannon Sanders McDonald, an architect and scholar who is writing two books on the history of parking garages and land use -- one of them with Mr. Haag.

"People love their cars in this country," Ms. McDonald said. "and the car-loving culture is the main reason for the garage typology."

In Europe and Asia, the development history, traffic patterns, and parking "culture" are different, she said, and cities simply are not built to accommodate the hulking presence of a typical ramped structure. There are roughly 5,000 automated garages on those two continents - including dozens that are fully computerized and robotically operated like the ones in Hoboken and Washington.

Ramped garages are actually very unpopular with many Americans -- "ignored at best," Ms. McDonald said, "hated by many." Why would people loathe a parking garage? Let her count the ways: "They are perceived to be ugly, grimy, scary places where muggers are waiting to snatch purses and wallets, you will probably get your car paint scratched or your fender bent, and you are more than likely to get trapped in a long line of cars spewing exhaust when you're trying to get to the exit."

Ms. McDonald, an architect who currently serves as an adjunct professor of architecture at North Dakota State University in Fargo, says garages have been made a "scapegoat for urban ills." Yet she and others in the emergent field of scholarly research on parking -- along with entrepreneurs like Mr. Haag -- make a case that automatic garages actually help alleviate some of what ails modern cities, by eliminating the dirty-and-scary factor, and by maximizing land use.

"The main advantage of automated garages," said Mr. Denda, who is the research director for PMRC, which is based in McLean, Va., "is that they can be built on sites that are too small or irregular for the construction of conventional garages."

Of course, the cost of construction and operation also figure in heavily to a developer's decision to build an automated garage.

IN Baltimore, Ashbourne Properties is considering Mr. Haag's Robotic Parking system for a proposed three-building apartment complex that has street access only 60 feet wide. "It is the only way we could provide on-site parking -- and we are happy to have the option," said Ashbourne's president, Crispin Etherington.

"The price we have been quoted is \$22,000 per space, when conventional parking costs about \$15,000 per space. We are studying the economics of our project, and the Baltimore market before deciding which way to go."

Another developer, David Barry of the Applied Companies in Jersey City, said his company recently decided against automated parking for a 12-story apartment structure going up in that city based on cost, and also the general reluctance of lenders to underwrite "something so new, and untested."

Mr. Haag also noted that being on the cutting edge can cause problems for conservative lenders. In his view, the ongoing tests of the structural strength and reliability of the Hoboken garage being done to satisfy the construction bonding company are "really overdoing it."

But as developers in many metropolitan areas find themselves scrapping over sites they would have considered unbuildable even a year or two ago, Mr. Denda said, automatic parking garage proposals are increasingly coming into play -- and familiarity with the issues they raise will rise.

The four-level automatic garage in Washington, beneath the Summit Grand Parc, occupies a space measuring 60 by 106 feet -- smaller than many suburban yards. It is 32 feet floor-to-ceiling -- shorter than many power poles.

The Hoboken garage is situated in the middle of a block on a narrow street with metered spaces on both sides and is built on land that required considerable environmental cleanup. Mr. Haag said that if a ramped garage could even have been built on the Hoboken site -- which is questionable in his view -- it would have provided only 95 spaces, compared with 324, and construction costs would have run close to \$30,000 per space, compared with \$20,000.

Precisely what the Hoboken garage cost, and how long it took to build, remain touchy issues in the city -- with the mayor having recently abolished the parking authority after an investigation into how it handled the project, and Mr. Haag's Florida-based company, Robotic Parking Inc., and Belcor -- the company that acted as general contractor -- still locked in legal battle over which one was responsible for construction issues that caused delays.

But Mr. Denda from the parking research company said none of that was particularly surprising. "That's the construction industry," he shrugged, "and in Hoboken, the municipality was involved, which only adds to the complications."

Seymour Gage, a veteran parking garage engineer from Manhattan, said he finds it difficult to

believe one of the new fully automated garages will ever be built in New York.

Mr. Gage, 83, designed two automated garages in the 1950's that are still working today -- as is he. The Showbiz Parking structure in the Manhattan theater district, off Eighth Avenue, between 45th and 46th Streets, was built in 1957, Mr. Gage said, using an elevator-on-wheels system devised by an Iowa inventor, Virgil Bowser, and Mr. Gage's engineering know-how. Like other mechanized garages of the era, it requires a staff -- 8 to 10 people during peak hours -- with valets stationed on each floor.

The new robotic computerized garages are "a totally different animal" from that one, Mr. Gage said. He is currently working as a consultant on construction of a fully automatic garage in Moscow, "which is becoming a hotbed of parking," he said, with hundreds of buildings going up, all with automatic parking structures beneath.

"Other companies are building in Beijing," Mr. Gage said, "and in Europe, right now a company called Klaus is putting up about 30 -- very similar to the one in Hoboken."

"We Americans," he added, "are way behind on this, absolutely."

The additional cost of constructing an automated garage is one of the reasons for that, Mr. Gage said. "There is no question that the fully automatic garage is more expensive to build -- maybe 50 to 75 percent more for a small one, 60 spaces or less," he said.

On the other hand, Mr. Gage said he was recently asked to consult on a proposal for building a large underground automated garage being contemplated in Brooklyn. In that case, he said, a robotic garage would be cheaper -- by 20 percent.

"The main reason is it would be underground," he said. "That is more costly in general. But below ground, automated parking beats self-parking, because of savings on construction. You don't have to go as deep, or as horizontally."

AN industry group formed two years ago in Los Angeles -- the Automated and Mechanical Parking Association -- said the \$20,000-per-space cost of an automated garage is a "disadvantage" planners have to consider. On the other hand, Mr. Haag insists that if the cost of land is figured in, an automated garage for 60 cars or more is always less expensive to build than one with the same capacity with ramps.

"Also, when comparing costs, many times it is forgotten," he said, "that our price includes a closed facade, a sprinkler system and a valet parking service." Automatic garages do not require a ventilation system, he pointed out, since the car engine is never running while the car is inside, and no exhaust fumes are generated. No pedestrian elevators, fire doors or emergency staircases are needed either.

An automated system uses more electrical power, he pointed out -- but is much less labor-intensive. In Hoboken, there are just two young men running the show -- Mr. Haag's son, Constantin, and Filipe Sousa, who oversees the computer system, watching blinking lights on his screen track the movement of cars through the garage, and receiving messages when any motor reaches one million revolutions and needs a maintenance check.

"It's really the garage doing all the work," Mr. Sousa said with a laugh. "We're just along for the ride."

[top of page](#)

[home](#) · [product line](#) · [corporate](#) · [press room](#) · [employment](#) · [contact us](#)

©1994-2009 Robotic Parking Systems, Inc. All rights reserved.
Robotic Parking is a trademark and is not to be used without expressed permission. Patents Pending.



[Automated Parking](#) [Automatic Parking](#) [Parking Garages](#) [Parking Today](#) [Robitic Parking Network](#) [Airport Parking](#) [Robotic Parking Services](#) [Parking Lot](#) [Automated Parking Garage](#) [Automatic Parking Garages](#) [Robotic Parking Professionals](#) [Pollution Parking Crisis Solutions](#) [Secure Parking](#) [Robotic Parking Solutions](#) [Gerhard Haag](#) [Automated Parking Automatic Parking Systems](#) [The Industry Leader in Robotic Parking - Automated Parking - Automatic Parking](#) [Automated Parking Automatic Parking Parking Garages](#) [Parking Today](#) [Robitic Parking Network](#) [Airport Parking](#) [Robotic Parking Services](#) [Parking Lot](#) [Automated Parking Garage](#) [Automatic Parking Garages](#) [Robotic Parking Professionals](#) [Pollution Parking Crisis Solutions](#) [Secure Parking](#) [Robotic Parking Solutions](#) [Automated Parking Solutions](#) [The Industry Leader in Robotic Parking - Automated Parking - Automatic Parking](#) [Automated Parking Automatic Parking Parking Garages](#) [Parking Today](#) [Robitic Parking Network](#) [Airport Parking](#) [Robotic Parking Services](#) [Parking Lot](#) [Automated Parking Garage](#) [Automatic Parking Garages](#) [Robotic Parking Professionals](#) [Pollution Parking Crisis Solutions](#) [Secure Parking](#) [Robotic Parking Solutions](#) [Automated Parking Solutions](#) [Automated Parking Automatic](#) [Gerhard Haag](#) [Parking Systems](#)