

C O N T E N T S

Servo systems p.2

Index p.2

FA total solutions p.6

Overview and domain diagram of a typical servo system p.8

How to read markings p.9

AC servo systems p.10

Index

AC servo systems “ P ” series

Domain diagram

Motors

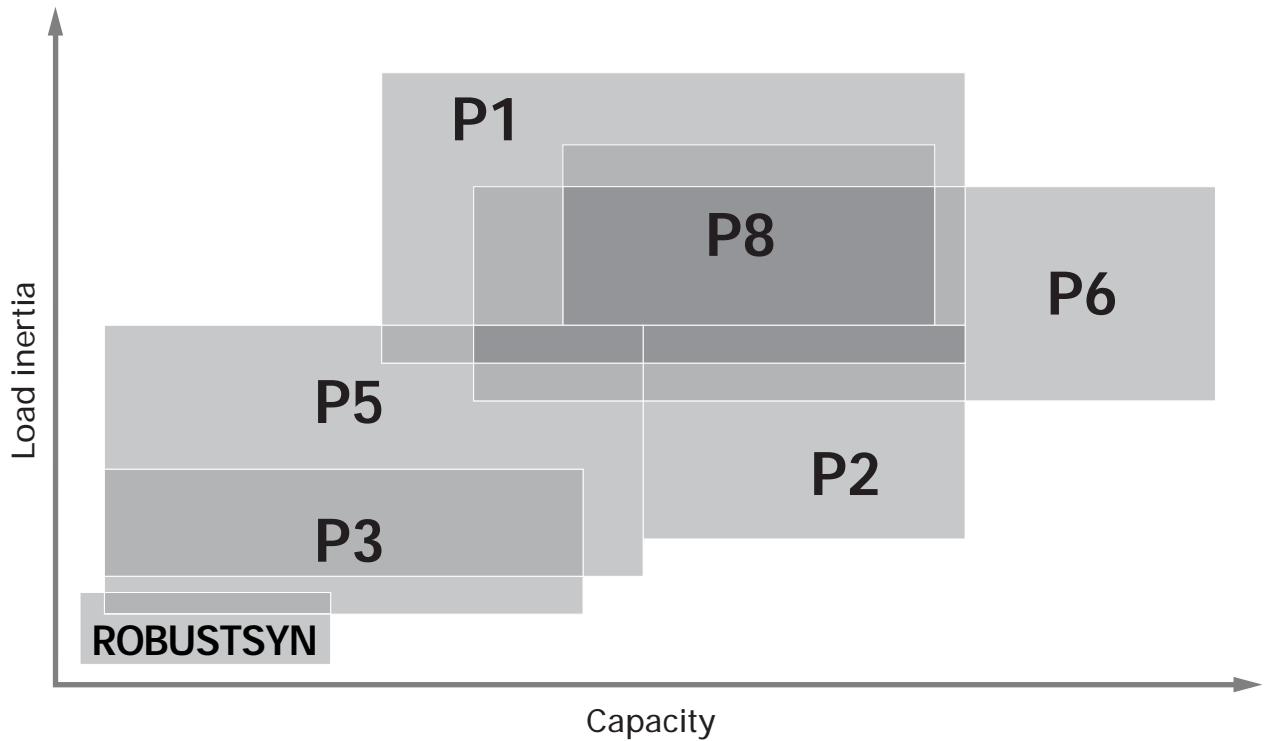

P1 Motor 



Rated rotating speed
2,000min⁻¹

Maximum rotating speed
3,000min⁻¹

Uses

Motor capacity
0.3 to 5.5kW

Applicable amplifier
PZ/PE/C

- Machines for precision machining
- Lathes
- Milling machines
- Transfer machines
- General industrial machines

P2 Motor 



Rated rotating speed
3,000min⁻¹



Maximum rotating speed
4,500min⁻¹

Uses

Motor capacity
1 to 5.0kW

Applicable amplifier
PZ/PE/C

- Machines for superfast response
- Semiconductor-making machines
- Mounters and inserters
- Mounters and inserters printed circuit boards

P3 Motor  



Rated rotating speed
3,000min⁻¹





Maximum rotating speed
4,500min⁻¹

Uses

Motor capacity
30 to 750W

Applicable amplifier
PU/PV/PZ/PE/C

- Small simple robots
- Mounters
- Inserters
- Wafer transfer machines
- Semiconductor-making machines

P5 Motor    



Rated rotating speed
3,000min⁻¹



Maximum rotating speed
4,500min⁻¹

Uses

Motor capacity
30 to 1,000W

Applicable amplifier
PU/PV/PZ/PE/C

- Robots
- Winding machines
- General industrial machines

P6 Motor  



Rated rotating speed
2,000min⁻¹



Maximum rotating speed
3,000min⁻¹

Uses

Motor capacity
0.5 to 30kW

Applicable amplifier
PU/PV/PZ/PE/C

- Robots
- General-purpose machine tools
- General industrial machines
- Transfer machines
- Food processors
- Medical equipment

P8 Motor  



Rated rotating speed
2,000min⁻¹

Maximum rotating speed
3,000min⁻¹

Uses

Motor capacity
0.75 to 4.5kW

Applicable amplifier
PZ/PE/C

- Robots
- General industrial machines
- Take-up machines
- Transfer machines

* For the hollow servomotors “P5”, “P6”, and “P8”, see pages 60 and 61.

Amplifiers

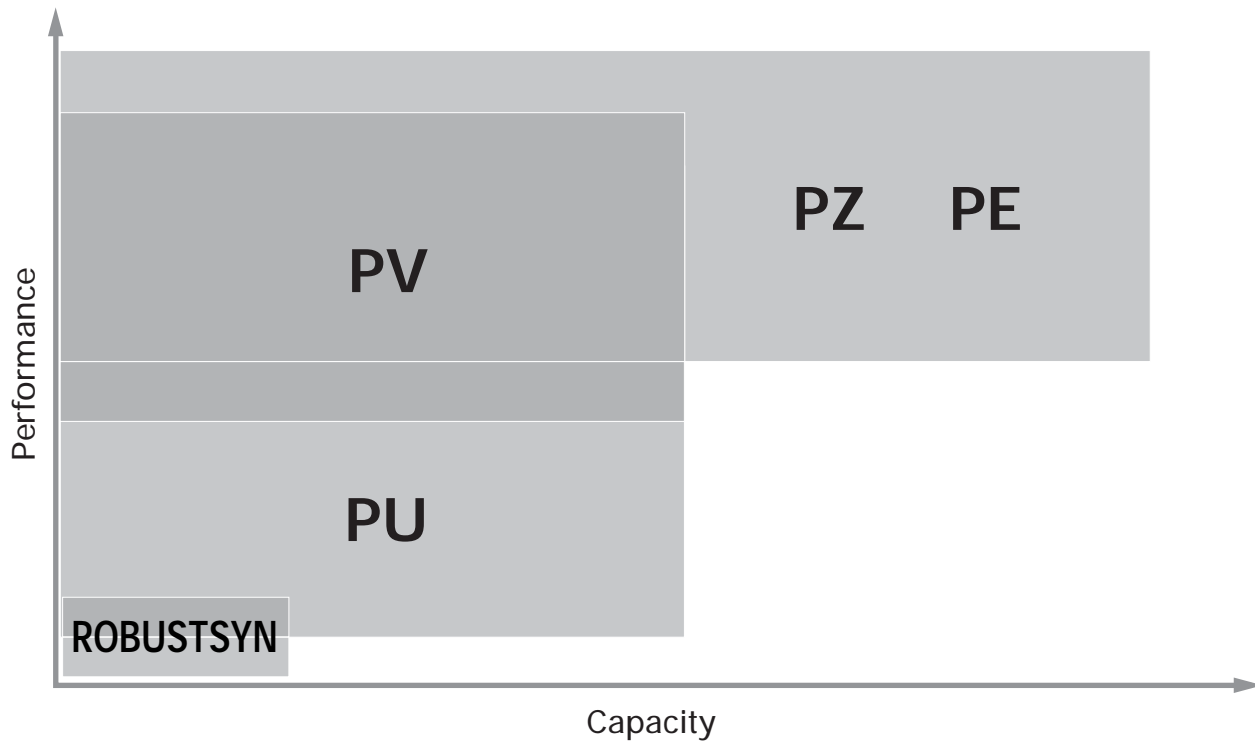

PU
Amplifier



Amplifier capacity
15A/30A/50A

Uses

- Various robots
- Roll feeders
- Food processors
- General industrial machines

Motor capacity
30 to 1,000W

Applicable motors
P3/P5/P6

PZ
Amplifier



Amplifier capacity
15A/30A/50A/100A
150A/300A/600A

Uses

- Machine tools
- Various robots
- Transfer machines
- Take-up machines
- Printers
- Roll feeders
- Food processors
- General industrial machines

Motor capacity
30W to 30kW

Applicable motors
P1/P2/P3/P5/P6/P8

PE
Amplifier



Amplifier capacity
15A/30A/50A

Uses

- Machine tools
- Various robots
- Transfer machines
- Take-up machines
- Printers
- Roll feeders
- Food processors
- General industrial machines

Motor capacity
30W to 7kW

Applicable motors
P1/P2/P3/P5/P6/P8

PV
Amplifier



Amplifier capacity
15A/30A

Uses

- Machine tools
- Various robots
- Transfer machines
- Take-up machines
- Printers
- Roll feeders
- Food processors
- General industrial machines

Motor capacity
30 to 1,000W

Applicable motors
P3/P5/P6

C-TYPE
Controller-equipped amplifiers



Amplifier capacity
15A/30A/50A
100A/150A

Uses

- Transfer machines
- Index tables
- Various robots
- Food processors
- General industrial machines

Motor capacity
30W to 15kW

Applicable motors
P1/P2/P3/P5/P6/P8

ROBUSTSYN



Rotating speed
4,500min⁻¹

Uses

- Mounters
- Laboratory equipment
- Bonders

Motor capacity
20 to 750W

Amplifier Power Input
DC24/38V
AC100/200V

AC servo systems “ S ” series

Domain diagram

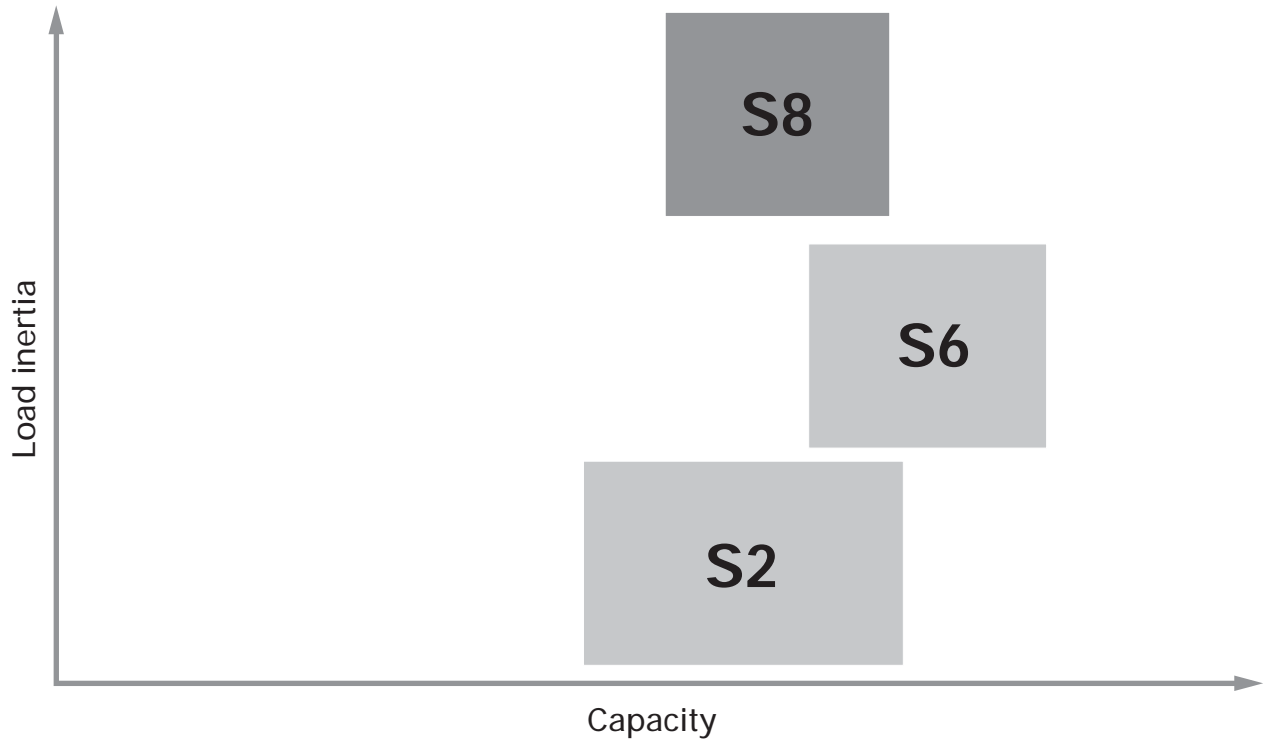

S2 Motor 



Rated rotating speed
1,500min⁻¹

Maximum rotating speed
2,000min⁻¹

Uses

- Press machines
- Paper raisers
- Injection molders
- Transfer machines
- Shearing machines

Motor capacity
5.5 to 30kW

Applicable amplifier
SZ

S6 Motor 



Rated rotating speed
1,500min⁻¹

Maximum rotating speed
2,000min⁻¹

Uses

- Tower automatic warehouses
- Tower parking systems
- Transfer machines
- Conveyors
- Pipe benders

Motor capacity
22 to 45kW

Applicable amplifier
SZ

S8 Motor 



Rated rotating speed
1,500min⁻¹

Maximum rotating speed
2,000min⁻¹

Uses

- Tower automatic warehouses
- Can-making machines
- Printers

Motor capacity
11 to 30kW

Applicable amplifier
SZ

SZ Amplifiers



Amplifier capacity
300A/600A
900A

Uses

- Press machines
- Turret machines
- Tower automatic warehouses
- Main spindles of machine tools
- Injection molders

Motor capacity
2.2 to 45kW

Applicable amplifier
S2/S6/S8

System controllers

Networking controllers and digital controllers

S-MAC



3Types

- Networking NC
... TypeA
- PC based NC
... TypeB
- Motion
Cardless NC
... TypeC

PDC-1300



Applicable amplifiers and drivers

- PU
- PZ
- PE
- PV

3 shafts simultaneously
Communications by RS-232C and RS-485
PTP operation
Compatible with G codes

PDC-1600



Applicable amplifiers and drivers

- PU
- PZ
- PE
- PV

6 shafts simultaneously
Communications by RS-232C and RS-485
Bus and PTP operation
Compatible with G codes

DC servo systems

SUPER V



Rated rotating speed

3,000min⁻¹

Maximum rotating speed

5,000min⁻¹

Uses

- Semiconductor-making machines
- Liquid product-making machines
- Sheet metal machines
- Robots
- Ticket vendors

Motor capacity

23 to 500W

Applicable amplifier

DA2

DA2



Amplifier capacity

15A/30A

Uses

- Semiconductor-making machines
- Liquid product-making machines
- Sheet metal machines
- Robots
- Ticket vendors

Motor capacity

23 to 500W

Applicable amplifier

Super V

Cautions

Failure to observe any of the precautions indicated on the right-hand side may cause a light to medium-degree injury or property damage. It may even lead to a serious disaster. Be sure to observe all of the precautions.

Cautions

- Do not use any of these products for medical or other equipment that may affect human lives.
- Do not use any of these products for equipment that may have a serious impact on society or the public.
- Do not use any of these products in a vehicle, ship, or other environment exposed to vibration.
- Do not remodel or machine any of these products.
- Before using any of these products, be sure to read its operation manual.

* For any question or inquiry regarding the above, contact our Sales Department.

The PDC-1300 and PDC-1600 are strategic commodities as defined in the Foreign Exchange and Foreign Trade Control Law with Concomitant Orders and Ordinances. Exporters of any of these products, therefore, must apply to the Ministry of International Trade and Industry for a permit to export. All other products are non-strategic. Therefore, exporters of these other products do not need a permit to export from the MITI. However, exporters may be asked by the customs officers that the products being exported are non-strategic. Exporters are therefore encouraged to contact us for a document explaining the non-strategic nature of a specific product.

If any product is incorporated in another product, be sure to follow the strategic or non-strategic requirements of that other product.

FA total solutions

“Technology to protect the earth's environment”

“Technology to protect the health and safety of humans”

“Technology to use new energies and to conserve energy”

Based on these technological principles, we, the members of Sanyo Denki, will aggressively pursue research and development independently of established ideas.

With technologies in sensors, motors, amplifiers, networks, controllers, and other equipment, we will keep making proposals that will bring about true advantages to our customers.



SANYO DENKI *TECHNOLOGY CENTER*

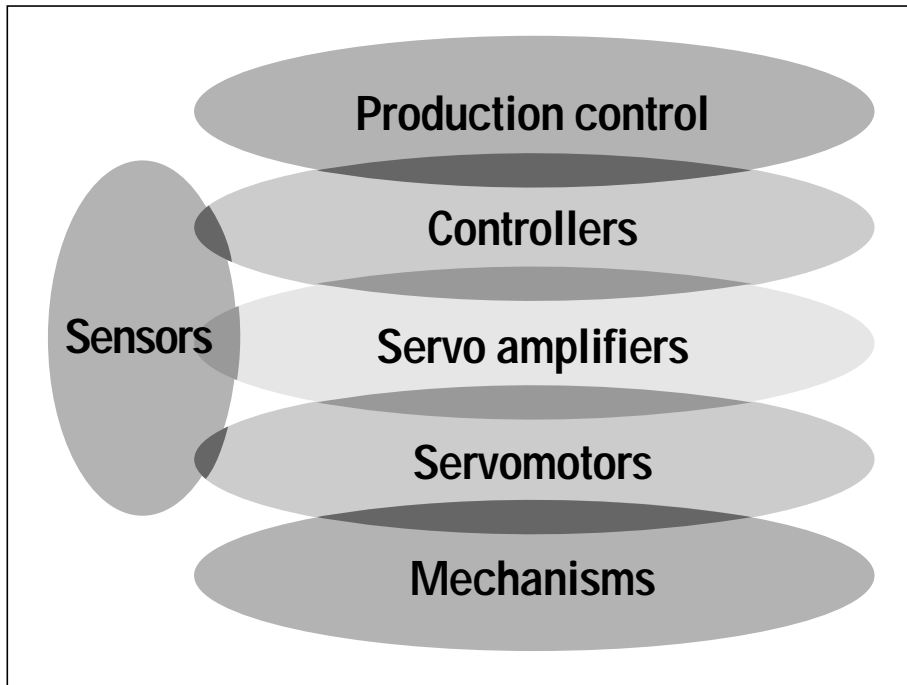

A diagram of a typical decentralized FA system

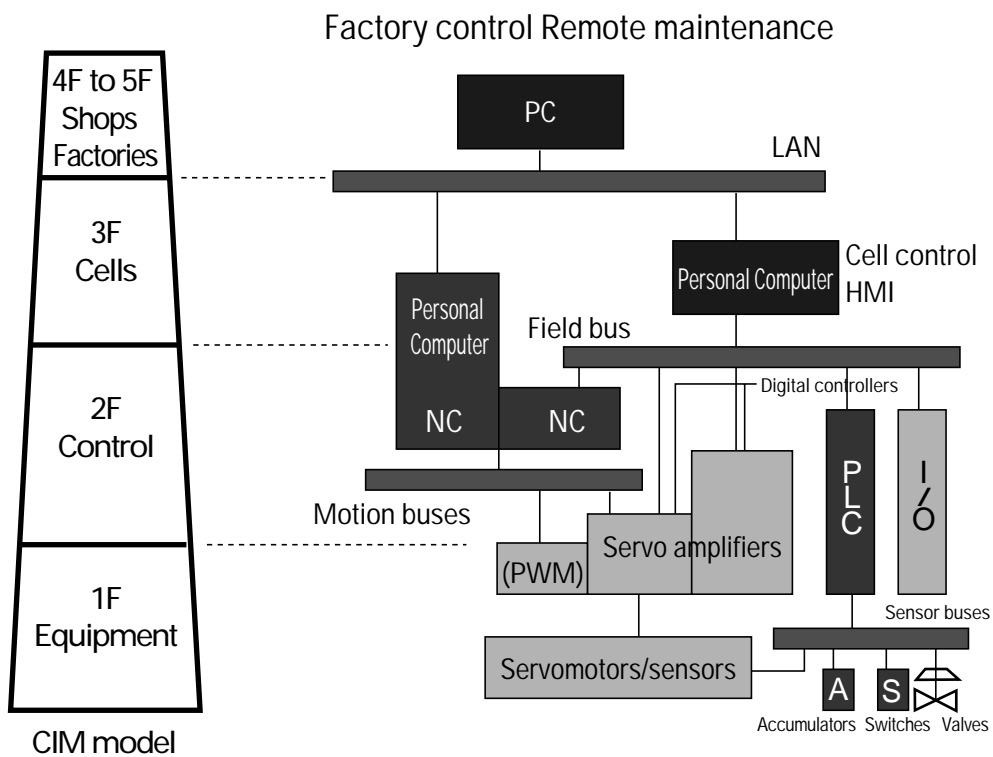

Diagram of a servo system and a field area network (FAN)

Overview and domain diagram of a typical servo system

Overview

In response to demand for flexible, intelligent products, production systems in various industrial sectors these days are increasingly require smaller, faster, higher-performance, and higher-precision servo systems.

To meet the requirements of these different industrial sectors, Sanyo Denki provides a complete family of servo systems that meet a wide range of applications.

Characteristics

DC servomotors

DC servomotors incorporate a stator made of a permanent magnet and a rotor made of a coil structure, achieving quick starts and stops and stable, smooth rotation. Our DC servomotors have the following features:

- 1) small rotor inertia
- 2) high maximum torque
- 3) small torque ripples
- 4) small electrical and mechanical time constants.

In addition to the above, control is relatively easy to build up.

Sanyo Denki's "SUPER V" DC servomotor and "DA2" super-small DC servo amplifier have less brush wear, known to be a major problem with DC motors, and higher reliability.

Uses: press brakes and mat cutters

AC servo amplifiers

In recent years, servo amplifiers have shifted from analog to digital software to increase controllability and maintenance and servicing efficiency, to reduce adjustment time and adjustment variances, to speed up communications, and to bring about other advantages in performance and functions. Attempts to make compact and lightmass servo amplifiers are also under way by using gate arrays and ASICs, compact components, and advanced surface-mount technology.

Families available are "PU" general-purpose compact servo amplifiers,

"PZ" and "PV" high-performance and high-functionality servo amplifiers, and "PE" and "PV" servo amplifiers conforming to overseas standards.

AC servomotors

AC servomotors generally come in two types: synchronous and induction types. Devoid of sliding and contact portions, these motors are maintenance-free and contribute to the buildup of clean environments. Synchronous servos are compact and high in response and precision and consist of a stator made of a coil and a rotor made of a permanent magnet. Rectification is performed electronically, but needs a position sensor.

These servomotors are widely used in robots, machine tools, and semiconductor-making machines, along with various production systems. Sanyo Denki offers a wide variety of products: "P1" through "P8" series.

Induction servos are compact and fast and achieve high torque. The stator incorporates a coil, while the rotor incorporates a secondary coil. A speed sensor is needed for vector control.

Sanyo Denki offers a variety of families designed for particular uses: "S2" through "S8" series.

Uses: Press machines, turret machines, tower automatic warehouses, main spindles of machine tools, injection molders, etc.

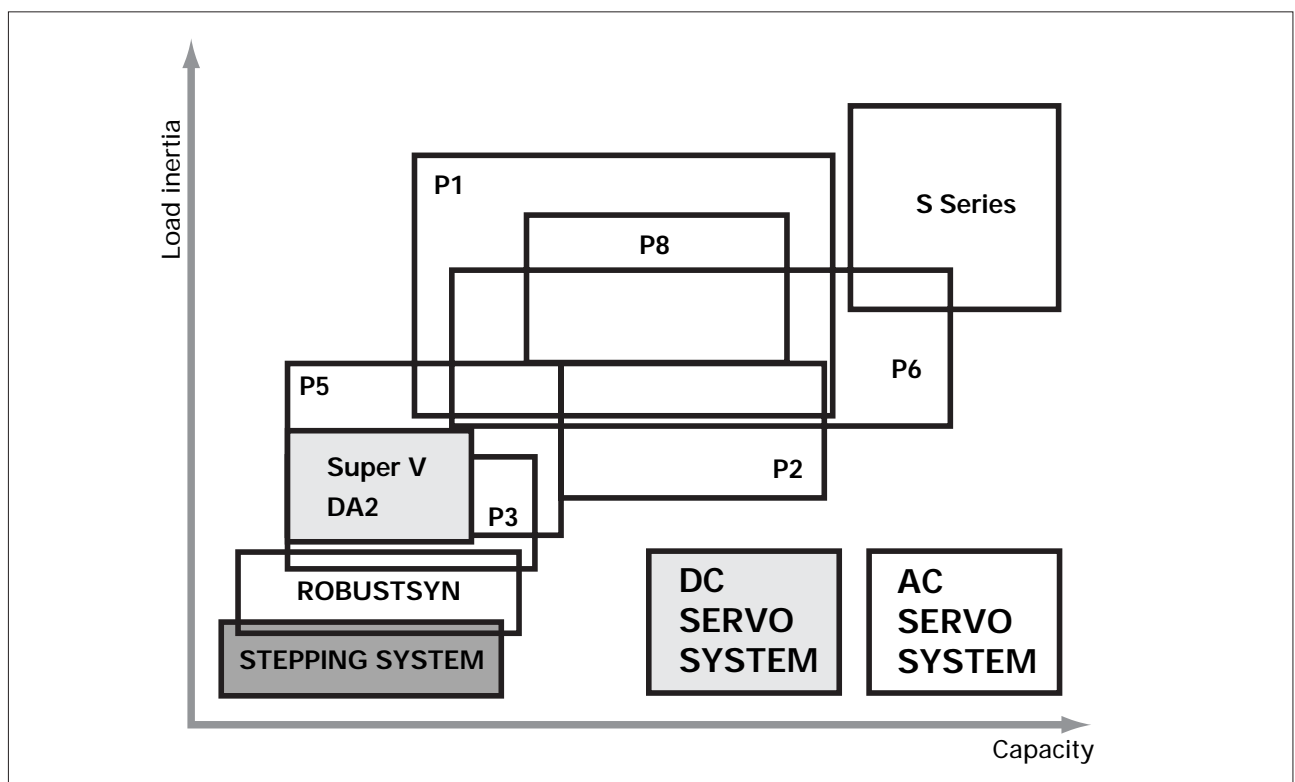

How to read markings

How to read markings

Safety markings

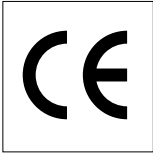

A safety marking representing a European Union Board of Ministers Directive (EC Directive) (EC). Only those products conforming to the safety regulations of a specific EU directive can bear this marking and can be sold in the EC territory. These markings are combined with certification markings affixed by TÜV or other private inspection agency.

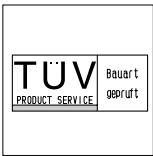

A certification marking representing TÜV Product Service.

SERCOS



SERCOS stands for SERIAL Real-time COMMUNICATION SYSTEM.

This specification is for an interface between an open controller and an intelligent digital drive. SERCOS systems are made noise-resistant by optical fiber cable, and they are designed for serial communications of closed-loop data in a standardized, real-time manner.

Applicable motor series marking

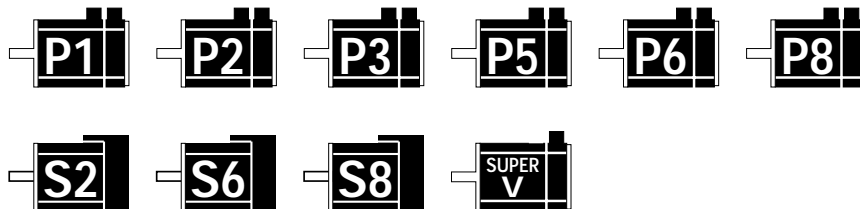

Hollow servomotor marking



IPCODE marking



Applicable amplifier series marking



AC servo system

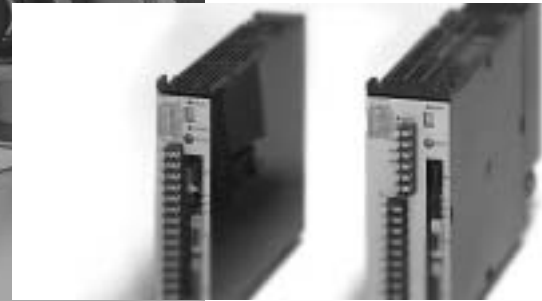

tems

AC servo systems

Selected software of servomotors

p.12

“P” series

p.15

P series

Selected software for servomotors

Selecting a mechanical structure

Horizontal structure

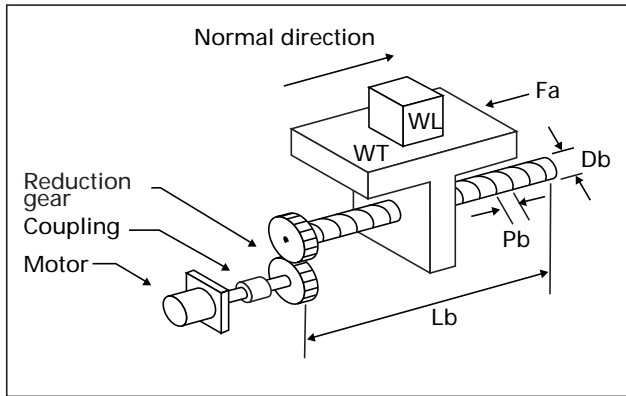

Rotary ball screw and normal screw type

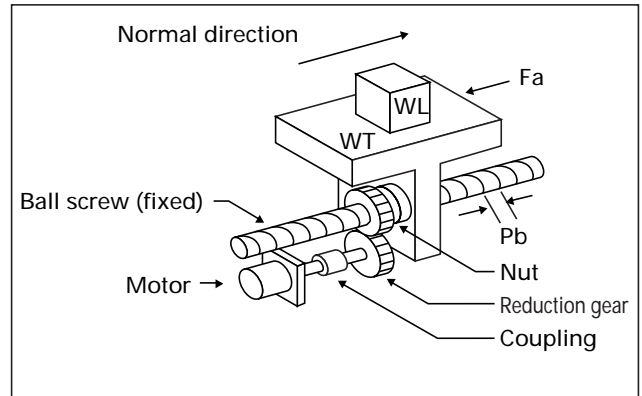

Rotary ball screw and nut type

Vertical structure

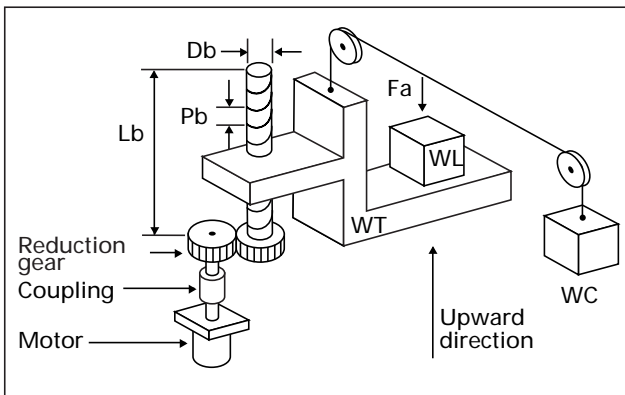

Rotary ball screw and normal screw type

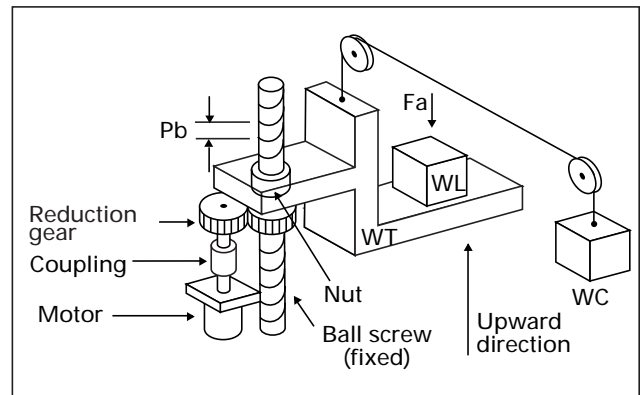

Rotary ball screw and nut type

Other

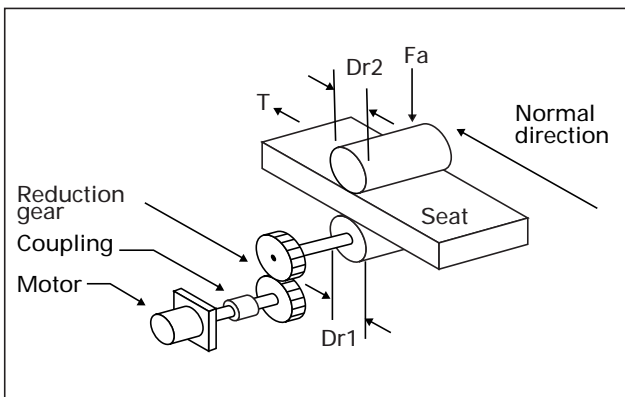

Roll feed

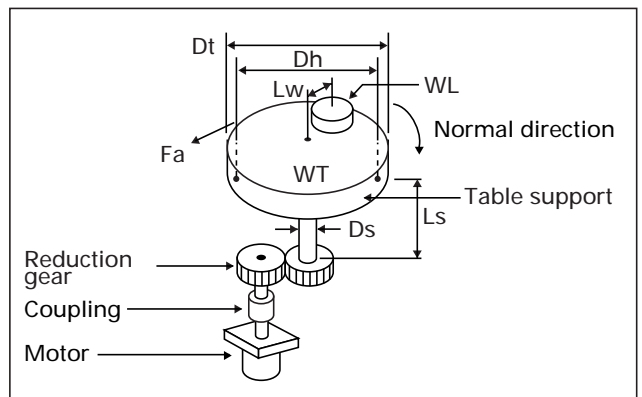

Rotary table

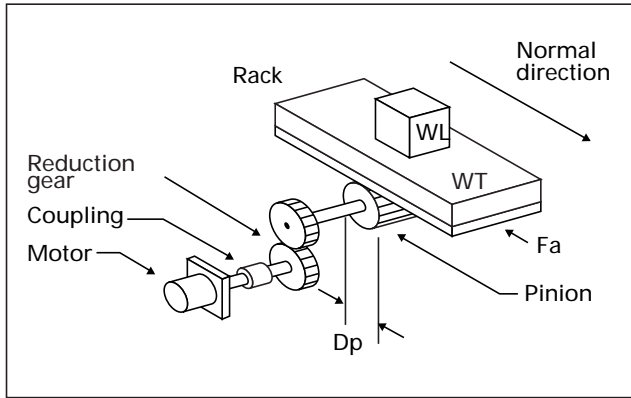

Rack and pinion

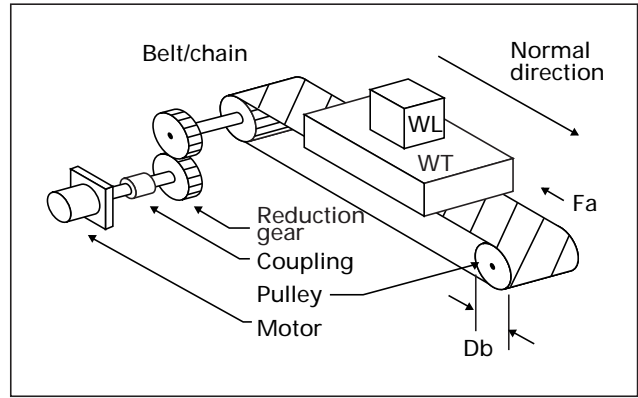

Belt/chain

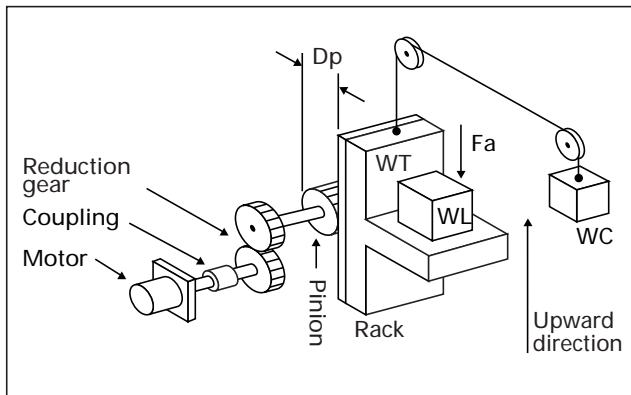

Rack & pinion

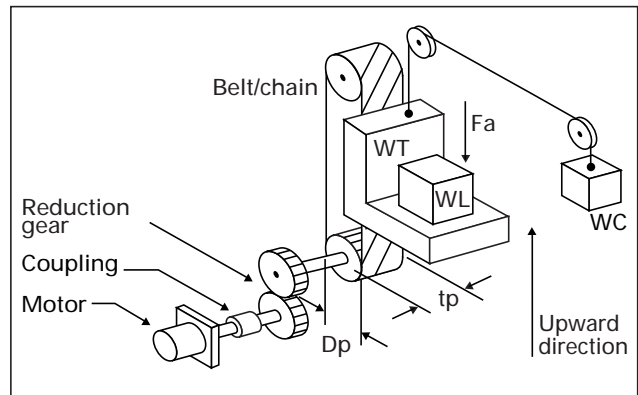

Belt/chain

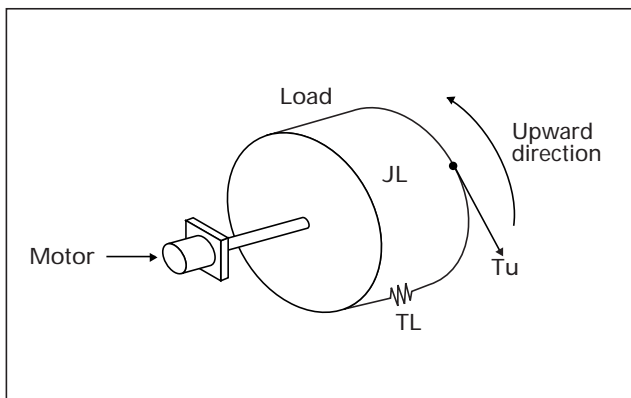

Irregularly shaped

For selected software for servomotors, please contact our sales representative.



P series

Domain diagram	p.16
How to read servomotor model numbers	p.18
Functions	p.22
Motors	
P1	p.26
P2	p.30
P3	p.34
P5	p.40
P6	p.50
P8	p.56
Hollow servomotors	p.60

“P” Series

P series

Domain diagram

Motors

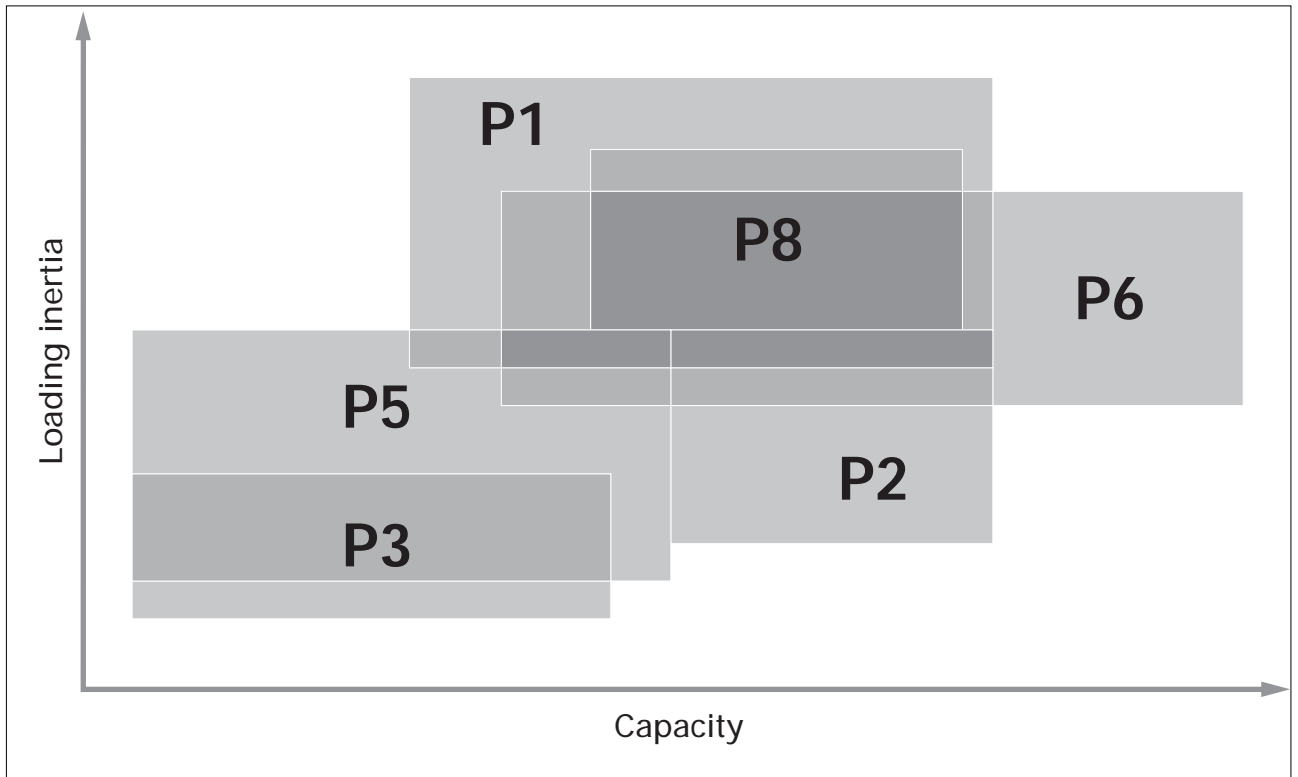

Amplifiers

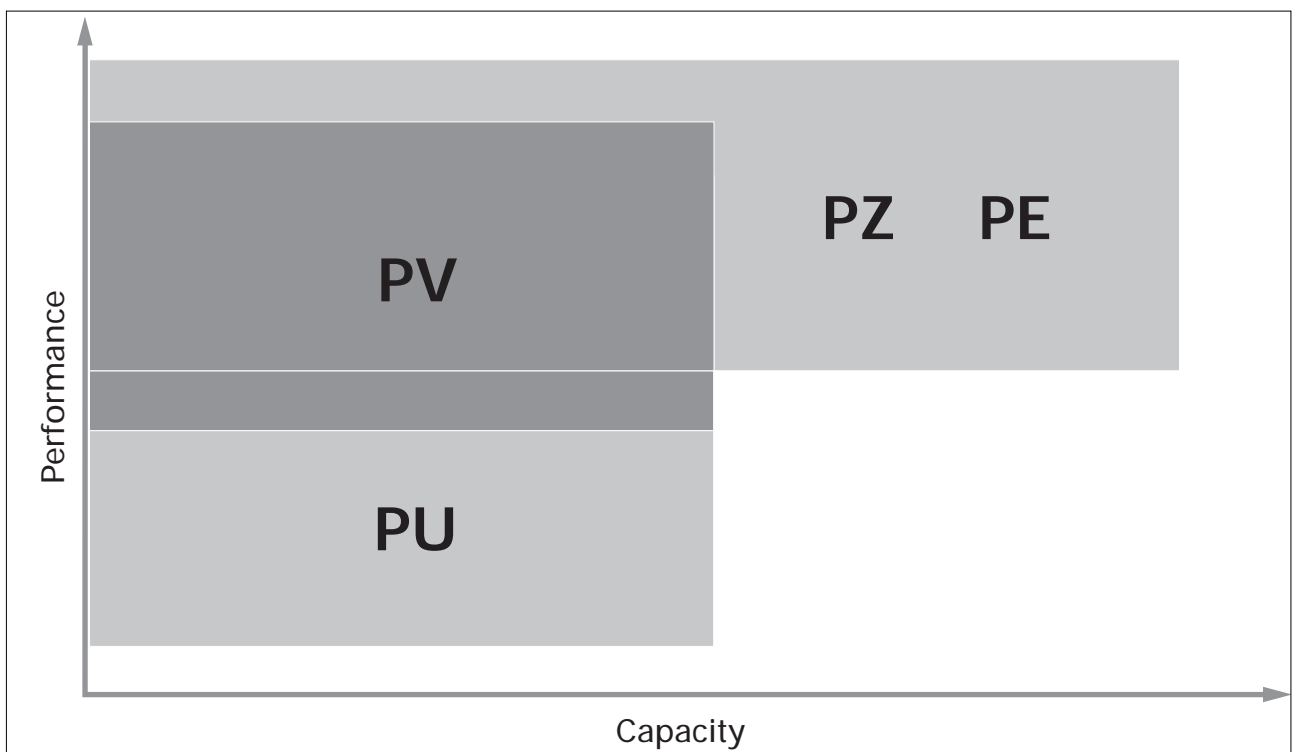

How to read servomotor model numbers

“P1”

Example: If you need a servomotor of the “P1” type (medium-capacity, square-cylinder) having a rated output of 2 kW, a rotational speed of 3,000 min⁻¹, a flange angle 180 × 180 mm, a wiring-saving incremental (6,000P/R), and a 90 VDC brake, use the following model number:

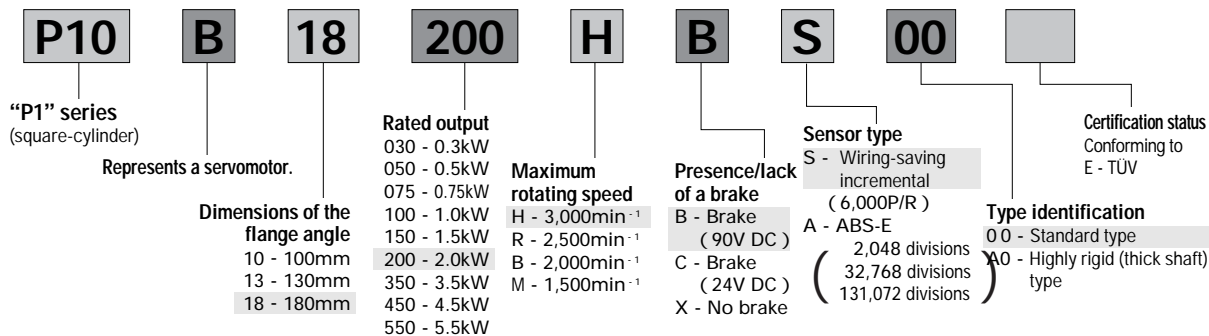

“P2”

Example: If you need a servomotor of the “P2” type (medium-capacity, high-response, square-cylinder) having a rated output of 2 kW, a rotational speed of 4,500 min⁻¹, a flange angle 100 × 100 mm, a wiring-saving incremental (2,000P/R), and a 90 VDC brake, use the following model number:

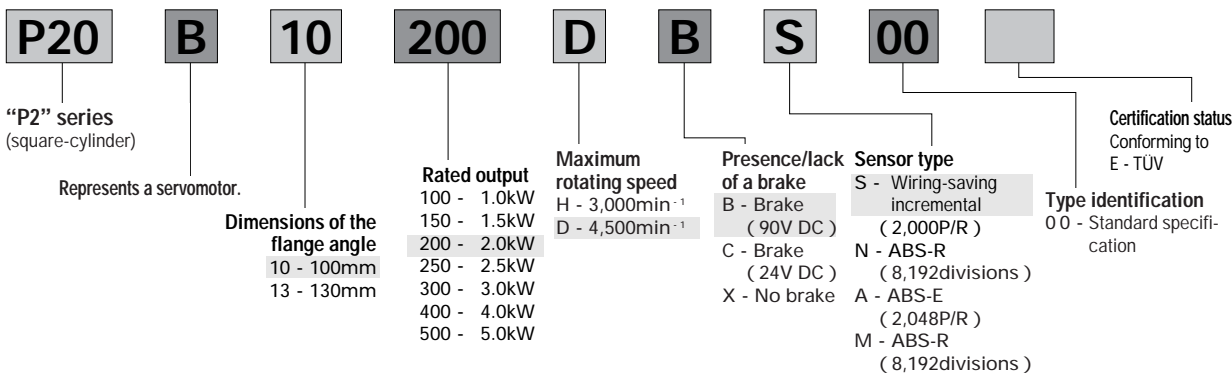

Outputs and dimensions of motors and amplifiers (The dimensions include those of an incremental encoder but without a brake.)

Dimensions of the flange angle (mm)		100					130					180						
Rated output (kW)		0.3	0.75	1.0	1.5	2.0	2.5	0.5	1.0	1.5	3.0	4.0	5.0	2.0	3.5	4.5	5.5	
“P1”	Overall length (mm)	182	272					176	221	272				230	280	350	501	
	Installed dimensions (mm)	115	115					145	145	145				200	200	200	200	
	Shaft diameter (mm)	16	16					19	19	22				35	35	35	42	
“P2”	Overall length (mm)		147	172	197	222					194	228	267					
	Installed dimensions (mm)		115	115	115	115					145	145	145					
	Shaft diameter (mm)		22	22	22	22					28	28	28					
“PZ”	Amplifier capacity (A)	Maximum rotating speed symbol	D		50	50	100	100			100	150	150					
			H	15	30	30	50	50	100	30	50	50	100	100	150	100	150	
			R															150
			B							30	30	50				50	100	100
			M															

“P” Series

P series

How to read servomotor model numbers

“P3”

Example: If you need a servomotor of the “P3” type (super-small, square-cylinder) having a rated output of 400W, a rotating speed of 4,500min⁻¹, a motor 60 × 60mm, an absolute sensor (ABS-R), and a 90 VDC brake, use the following model number:

P30 B 06 040 D B N 00

- P30**: “P3” series (square-cylinder) Represents a servomotor.
- B**: Dimensions of the flange angle: 04 - 40, 06 - 60, 08 - 80
- 06**: Rated output: 003 - 30W, 005 - 50W, 010 - 100W, 020 - 200W, 040 - 400W, 075 - 750W
- 040**: Maximum rotating speed: D - 4,500min⁻¹ (200V AC), H - 3,000min⁻¹ (200V AC), P - 4,500min⁻¹ (100V AC)
- D**: Presence/lack of a brake: B - Brake (90V DC), C - Brake (24V DC), X - No brake
- B**: Sensor type: S - Wiring-saving incremental (2,000 P/R), N - ABS-R (8,192 divisions), M - ABS-R (8,192 divisions)
- N**: Type identification: 00 - Standard type (w/o oil seal, w/o connector), 01 - w/ oil seal, w/o connector, 50 - w/o oil seal, w/ connector, 51 - w/ oil seal, w/ connector
- 00**: Certification status: Conforming to E - TÜV

Identification	Gear type	Gear ratio
A	A type Planetary gear	1/3
B		1/5
C		1/9
D		1/15
E		1/25
J	B type Spur gear	1/5
K		1/10
L		1/15
S	C type Backlash-less planetary gear	1/5
T		1/11
U		1/21
V		1/33

“P5”

Example: If you need a servomotor of the “P5” type (compact, square-cylinder) having a rated output of 750W, a rotating speed of 4,500min⁻¹, a motor 86 × 86mm, an absolute sensor (ABS-R), and a 90 VDC brake, use the following model number:

P50 B 08 075 D B N 00

- P50**: “P5” series (square-cylinder) Represents a servomotor.
- B**: Dimensions of the flange angle: 03 - 35, 04 - 42, 05 - 54, 07 - 76, 08 - 86
- 08**: Rated output: 003 - 30W, 005 - 50W, 006 - 60W, 010 - 100W, 020 - 200W, 030 - 300W, 040 - 400W, 050 - 500W, 075 - 750W, 100 - 1,000W
- 075**: Maximum rotating speed: D - 4,500min⁻¹, H - 3,000min⁻¹
- D**: Presence/lack of a brake: B - Brake (90V DC), C - Brake (24V DC), X - No brake
- B**: Sensor type: S - Wiring-saving incremental (2,000 P/R), N - ABS-R (8,192 divisions), A - ABS-E (2,048 divisions), M - ABS-R (8,192 divisions)
- N**: Type identification: 00 - Standard type
- 00**: Certification status: Conforming to E - TÜV

* A flange angle 35 × 35mm is unavailable. The flange angles 42 × 42mm and 54 × 54mm are J.

Outputs and dimensions of motors and amplifiers

(The dimensions include those of an incremental encoder but without a brake.)

	35	40	42	54	54	60	76	76	80	86	86							
Dimensions of the flange angle (mm)	35	40	42	54	54	60	76	76	80	86	86							
Rated output (kW)	30	30	50	100	60	100	50	100	200	200	400	200	300	400	750	500	750	1000
“P3”	Overall length (mm)	64	70	88			95.5	123.5		140								
	Installed dimensions (mm)	30	30	30			50	50		70								
	Shaft diameter (mm)	6	8	8			14	14		16								
“P5”	Overall length (mm)	67.5		82	95	76	86	105		97	103	113		126	149	172		
	Installed dimensions (mm)	30		34	34	50	50	50		70	70	70		80	80	80		
	Shaft diameter (mm)	5		7	7	8	8	11		14	14	14		16	16	1		
“PU”	Amplifier capacity (A)	15	15	15	15	15	15	15	15	30	15		30	30	30	50	50	
“PZ”	Amplifier capacity (A)	15	15	15	15	15	15	15	15	30	15		30	30	30	50	50	
“PV”	Amplifier capacity (A)	15	15	15	15	15	15	15	15	30	15		30					

“P6”

Example: If you need a servomotor of the “P6” type (medium-capacity, square-cylinder, super-small) having a rated output of 2kW, a rotating speed of 3,000min⁻¹, a flange angle 180 × 180mm, a wiring-saving incremental (2,000P/R), and a 90 VDC brake, use the following model number:

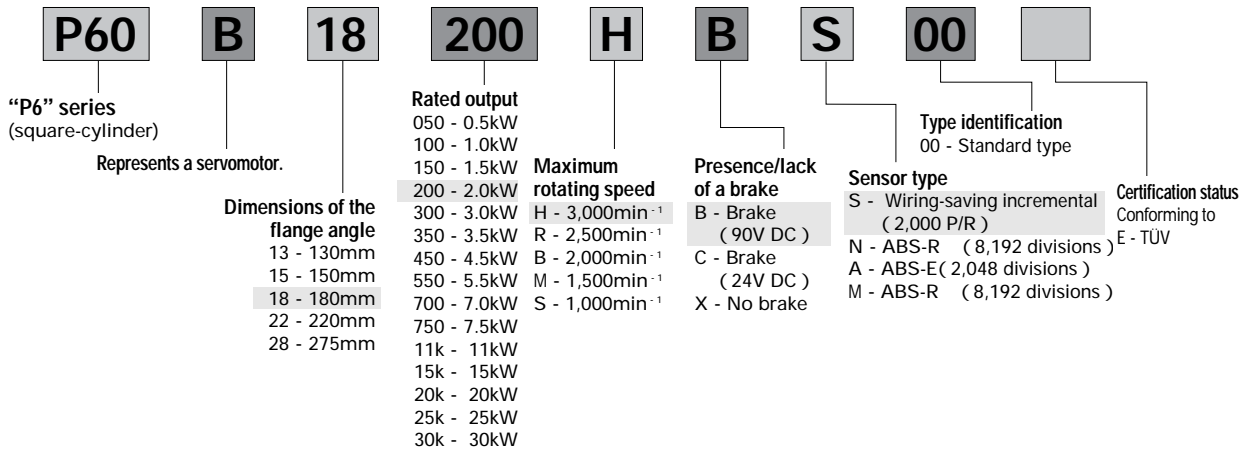

“P8”

Example: If you need a servomotor of the “P8” type (medium-capacity, super-flat) having a rated output of 3.5kW, a rotating speed of 3,000min⁻¹, a flange 220 × 220mm, an absolute unit (ABS-R), with 8,192 divisions), and a 90 VDC brake, use the following model number:

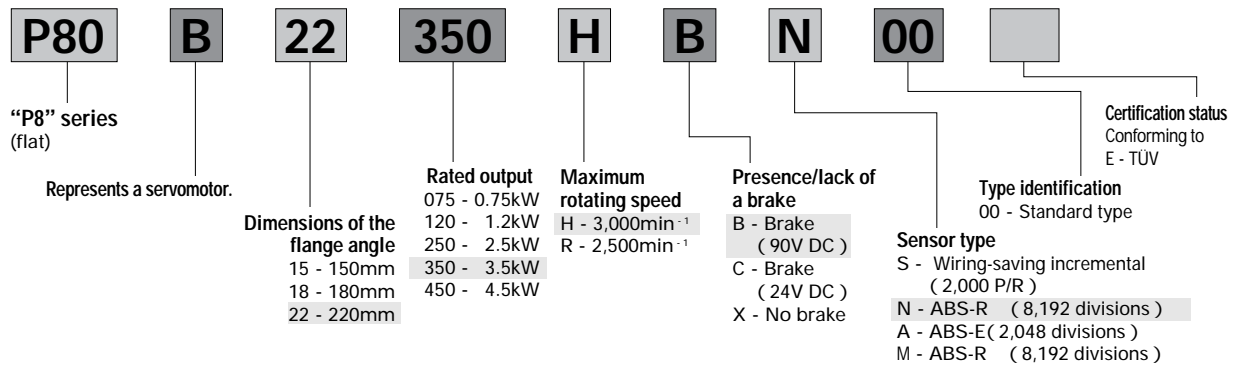

Outputs and dimensions of motors and amplifiers (The dimensions include those of an incremental encoder but without a brake.)

Dimensions of the flange angle (mm)		130	150	180	220	275
Rated output (kW)		0.5 1.0	1.5 2.0	0.75 3.0	1.2 2.0 3.5 4.5 5.5 7.5	2.5 3.5 4.5 5.5 7.0 11 15 20 20 25 30
“P6”	Overall length (mm)	113 133	152 171	182	144 169 192 267 332	209 285 362 405 490 429 454 479
	Installed dimensions (mm)	145 145	145 145	165	200 200 200 200 200	235 235 235 235 235 300 300 300
	Shaft diameter (mm)	22 22	22 28	28	35 35 35 42 42	55 55 55 55 55 55 55 55
“P8”	Overall length (mm)		116	119	122 136 151	
	Installed dimensions (mm)		165	200	235 235 235	
	Shaft diameter (mm)		22	28	35 35 35	
“PU”	Amplifier capacity (A)	50	50			
“PZ”	Amplifier capacity (A)	30 50	50 100	30 150	50 100 150 150 150 300	100 150 150 150 150 300 300 600 600 600 600
“PE”	Amplifier capacity (A)	30 50	50 100	30 150	50 100 150 150 150	100 150 150 150 150

* For the 20kW, 25kW, and 30kW models, contact our sales representative.

How to read servo amplifier model numbers

How to read servomotor model numbers

“PU” servo amplifiers

Example: If you need a servo amplifier of the “PU” type (super-small amplifier) having a “P3” motor, an output of 400W, a position control mechanism, a 200 VAC input, and an absolute sensor (ABS-R), use the following model number:

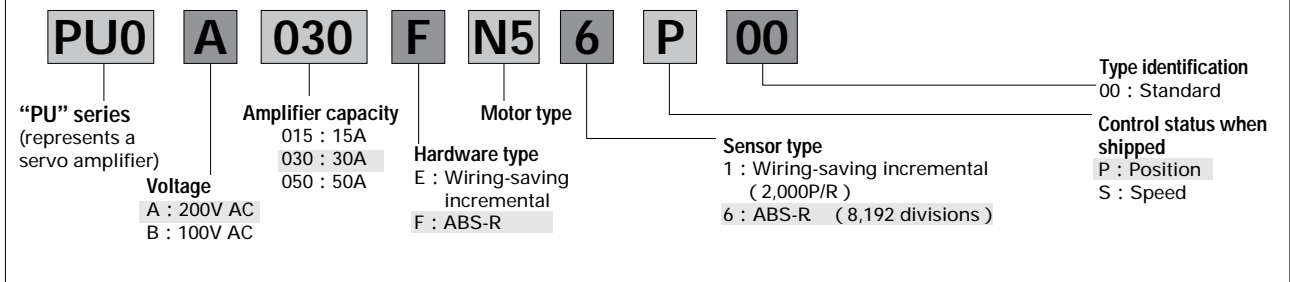

“PZ” servo amplifiers

Example: If you need a servo amplifier of the “PZ” type (small amplifier) having a “P5” motor, an output of 200W, dimensions 54 × 54mm, a position control mechanism, a 200 VAC input, and an absolute sensor (ABS-E), use the following model number:

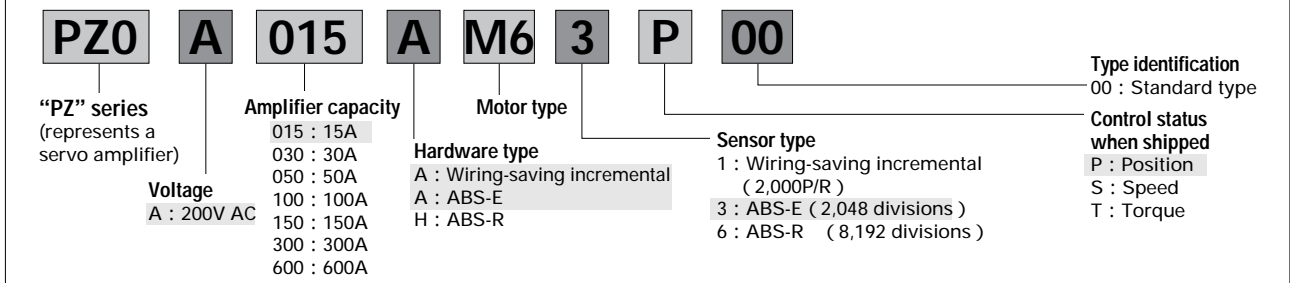

“PV” servo amplifiers

Example: If you need a servo amplifier of the “PV” type (super-small amplifier) having a “P5” motor, an output of 400W, a position control mechanism, a 200 VAC input, and a wiring-saving incremental, use the following model number:

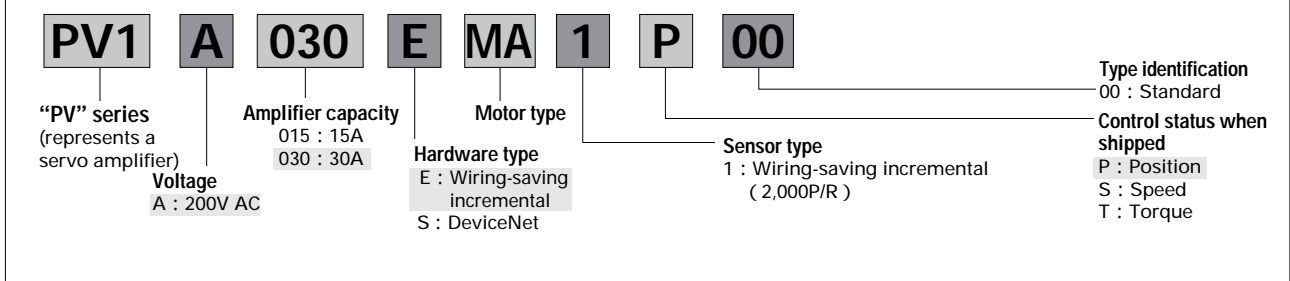

“PE” servo amplifiers

Example: If you need a servo amplifier of the “PE” type (small amplifier) having a “P5” motor, an output of 200W, dimensions 54 × 54mm, a position control mechanism, a 200 VAC input, and an absolute sensor (ABS-E), use the following model number:

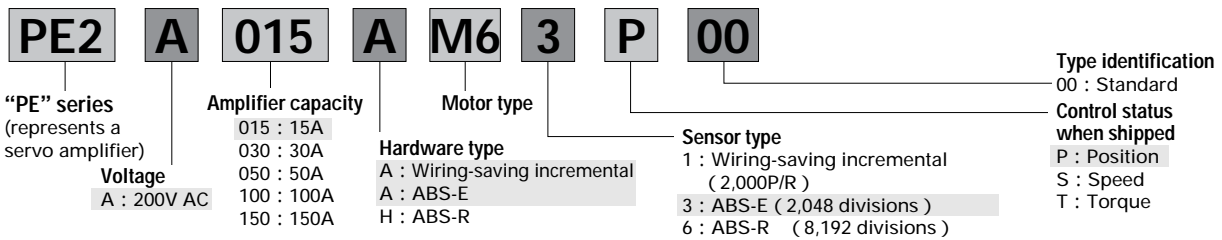

Motor types

200 VAC family

11 : P10B10030H	1A : P10B13050B	21 : P20B10100D	2A : P20B10200H	N1 : P30B04003D
12 : P10B10075H	1B : P10B13100B	22 : P20B10150D	2B : P20B10250H	N2 : P30B04005D
13 : P10B13050H	1C : P10B13150B	23 : P20B10200D	2C : P20B13300H	N3 : P30B04010D
14 : P10B13100H	1D : P10B18200B	24 : P20B10250D	2D : P20B13400H	N4 : P30B06020D
15 : P10B13150H	1E : P10B18350B	25 : P20B13300D	2E : P20B13500H	N5 : P30B06040D
16 : P10B18200H	1F : P10B18450B	26 : P20B13400D		N6 : P30B08075D
17 : P10B18350H		27 : P20B13500D		
18 : P10B18450R		28 : P20B10100H		
19 : P10B18550M		29 : P20B10150H		

M1 : P50B03003D	MA : P50B07040D	PA : P60B13050H	PR : P60B18550R	R2 : P80B15075H
M2 : P50B04006D	MC : P50B08050D	P1 : P60B13100H	PW : P60B18750R	R3 : P80B18120H
M3 : P50B04010D	MF : P50B08075H	P2 : P60B13150H	PG : P60B2211KB	R4 : P80B22250H
M4 : P50B05005D	MG : P50B08100H	P3 : P60B13200H	PX : P60B2215KB	R5 : P80B22350H
M5 : P50B05010D	MB : P50B08040D	P4 : P60B15300H	T4 : P60B2220KB	R6 : P80B22450R
M6 : P50B05020D	MD : P50B08075D	P5 : P60B18200H	T5 : P60B2820KM	
M8 : P50B07020D	ME : P50B08100D	P6 : P60B18350H	T6 : P60B2825KM	
M9 : P50B07030D		P7 : P60B18450R	P8 : P60B22550M	
		P8 : P60B22550M	T7 : P60B2830KM	
		P9 : P60B22700S		

100 VAC family

MH : P50B03003P	NA : P30B04003P
MJ : P50B04006P	NB : P30B04005P
MK : P50B04010P	NC : P30B04010P
ML : P50B05005P	ND : P30B06020P
MM : P50B05010P	
MN : P50B05020P	
MR : P50B07020P	

AC servo systems "P" series

P series

Functions

List of functions of "P" series servo amplifiers

Function	Position control	Speed control	Torque control	Position, speed, and torque One pack	Serial communications (CAN,RS-485)
"PU" amplifiers					
"PZ" amplifiers					
"PE" amplifiers					
"PV" amplifiers					

Selection of various controls and various styles of communications

These flexible servos allow users to select various styles of control, including position control, speed control, torque control, and serial communications (CAN RS-485).

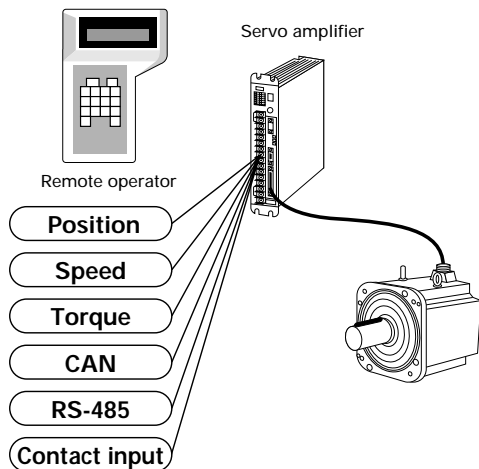

Built-in regenerative processing function **PZ PE CZ**

These servos incorporate a regenerative processing circuit and a regenerative resistor.

Allowable effective power of a regenerative resistor contained in "PU" amplifiers

Amplifier capacity	15A	30A
Resistance (Ω)	100	100
Allowable effective value(W)	5	7

Allowable effective power of a regenerative resistor contained in "PZ", "PE", and "PV" amplifiers

Amplifier capacity	15A	30A	50A	100A	150A
Resistance (Ω)	100	50*	20	10	6.7
Allowable effective value(W)	5	5	30	60	90

Note: 100 Ω only for "PV".

* For 300A and above, use an external regenerative resistor.

Compatible with open networks **PV**

These servos incorporate an interface for CAN (patents applied for) DeviceNet.

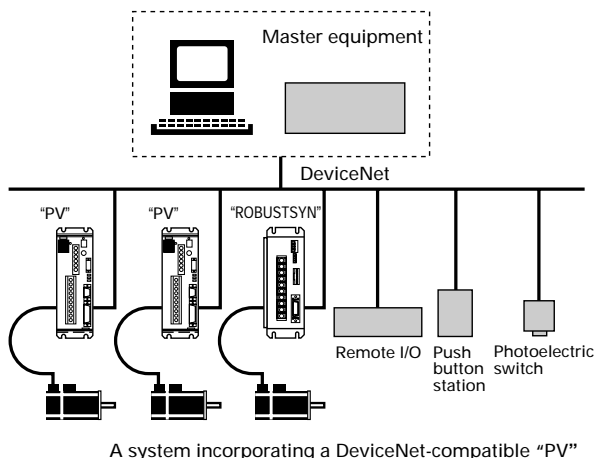

Contact input (speed selection type) **Optional PV**

Four speeds preset inside can be selected according to the external contact.

Speed selection type

Turning on normal or reverse rotation turns on the unit at an acceleration detected with TA0 (TA1) up to a speed selected with VC0 and VC1 (VC2).

Turning it off turns the unit off at a selected acceleration.

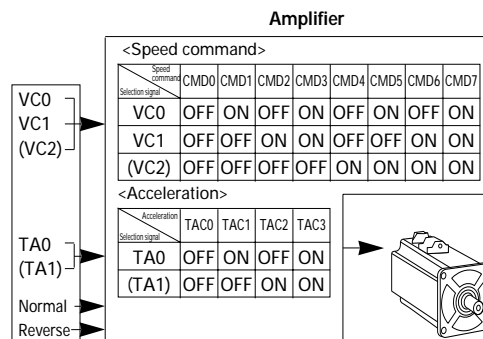

Note: The speed selection signal (VC2) and acceleration selection signal (TA1) are optional. They can be selected on the remote operator.

Contact input	Regenerative processing	Built-in dynamic brake	Brake timing output	Vibration control	Power supply separation of control and main circuit
(Optional)					

Timing output for the operation of the holding brake **PZ PE C Z**

Timing signals for operating the holding brake are output by the amplifier. Operating the holding brake according to these signals prevents the gravity shaft from falling by its own mass in an event such as an emergency stop.

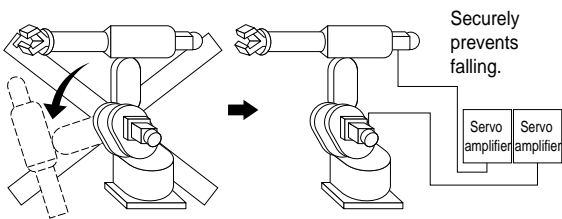

Vibration control **PU PZ PE PV C Z**

This unit incorporates a programmable filter. Adjusting the filter controls the vibration level of the machine on the load side and achieves smooth, silent operation.

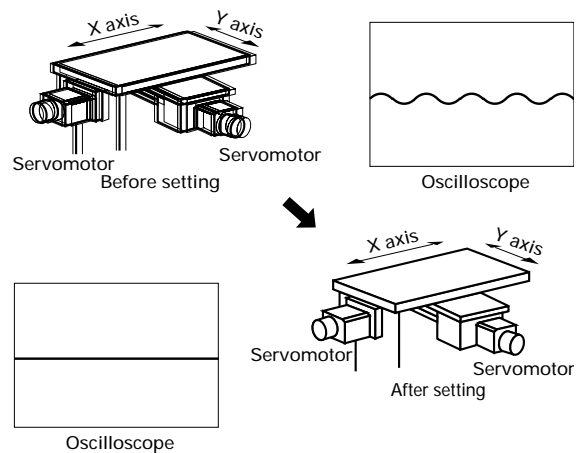

Built-in dynamic brake **PZ PE PV C Z**

These amplifiers incorporate a dynamic brake circuit. It is activated in the event of a blackout or a shutdown of the main circuit power supply. It is activated when an alarm occurs, regardless of the status of the main circuit power supply. "PU" amplifiers provide an external dynamic brake. Contact our sales representative when you need one.

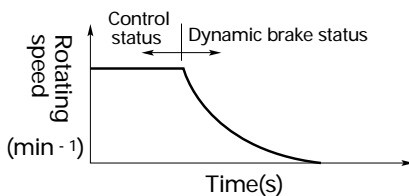

Separation of control power supply from main circuit power supply **PU PZ PE PV C Z**

The control power supply is separated from the main circuit power supply. In the case of an alarm or emergency stop, only the main circuit power supply can be shut down for safety. The control power supply can be separated and held to maintain the transmission status of alarms, thus facilitating analysis and maintenance.

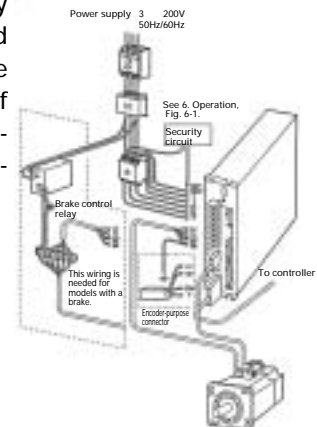

AC servo systems "P" series

Functions

List of functions of "P" series servo amplifiers

Function	Supporting function for servo tuning	Electronics gear	Pulse resolution switchover	Alarm tracing	Normal/reverse switchover
"PU" Amplifier					
"PZ" Amplifier					
"PE" Amplifier					
"PV" Amplifier					

Supporting function for servo tuning **PU PZ PE PV C Z**

This function automatically estimates load inertia levels, allows users to set appropriate parameters, and facilitates adjustment in test runs.

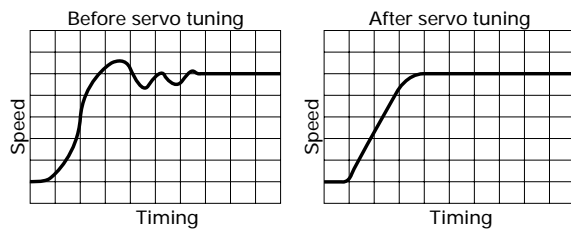

Pulse resolution switchover **PU PZ PE PV**

Changing the parameters with the remote operator divides encoder signal pulses in a desired manner.

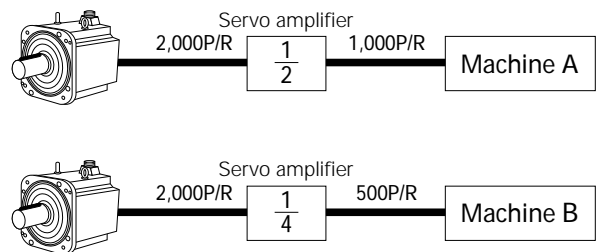

Note : Effective only in the case of a wiring-saving incremental encoder and an absolute encoder (ABS-E).

Electronics gear **PU PZ PE PV C Z**

These servos incorporate an electronics gear that sets the amount of movement per pulse of position command to a desired value. The amount of movement can be changed without changing the mechanical gear.

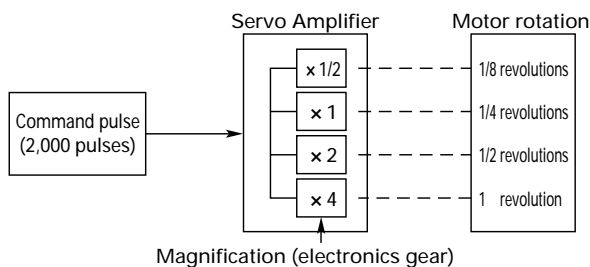

Alarm tracing **PU PZ PE PV C Z**

These servos store the history of the last seven alarms. They can be monitored on the remote operator to help in troubleshooting.

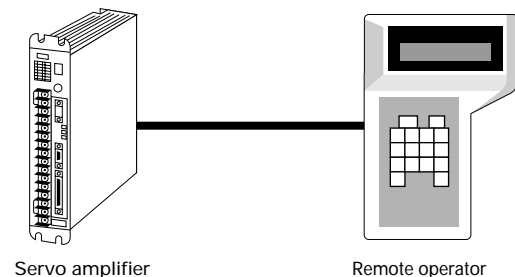

Overtravel stop	Built-in circuit for preventing rush currents in main circuit	Incremental encoder	ABS-R	ABS-R	ABS-E

Normal/reverse switchover

PU PZ PE PV C Z

Parameter values can be changed to switch over normal and reverse commands. This obviates the need for command polarity and wire replacement, thus facilitating operation.

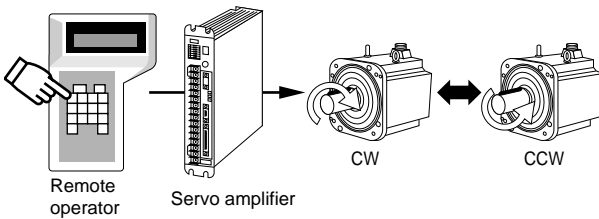

PC interface

PZ PE PV C Z

This interface allows users to edit and set servo parameters, display various monitor panels, and indicate other operation statuses on the remote operator. In addition, users can store data onto floppy disks and perform other operations on a PC.

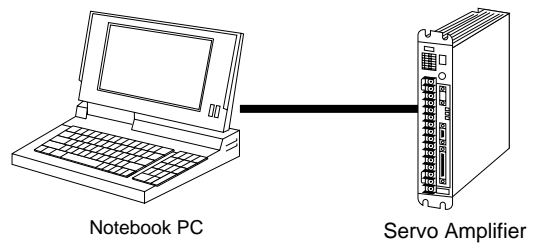

Overtravel stop

PZ PE PV C Z

Overtravel signals can be entered with the limit switch to stop the motor instantaneously. This protects machines from damage due to runaway or other operation exceeding their operational limits.

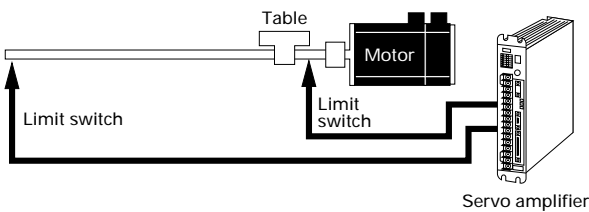

IP CODE

The protective model of a motor itself satisfies the IEC standards. For use in an environment constantly exposed to liquid, contact Sanyo Denki.

	P1	P2	P3	P5	P6	P8
Protective model	IP67	IP40		P50B03、04:IP40 P50B05、07、08:IP55	IP67	

The cannon connector types "P1", "P2", "P6", and "P8" can be adapted to by using a waterproof connector or conduit for the destination cannon connector.

For "P6" and "P8"

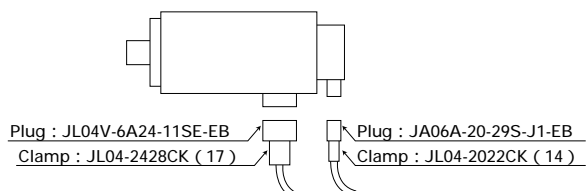

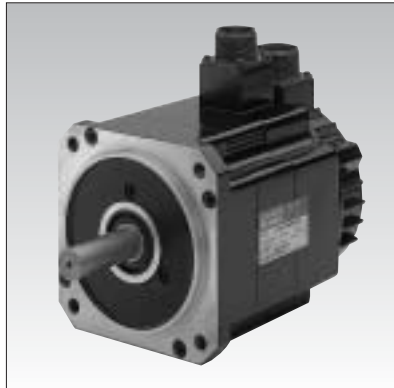

Capacity
0.3 to 5.5kW(9 types)

Features

High rigidity and performance

High in rigidity and performance, these motors run smoothly even at super-low speeds. They are best suited for precision positioning and feeding.

Uses

- Machines for precision machining
- Lathes
- Milling machines
- Transfer machines
- Machines for industrial industries

Common specifications

Time rating	Continuous
Insulation grade	F type
Dielectric strength	1,500 VAC, 1 minute
Insulation grade	500 VDC, 10 M or more
Protection system	Fully closed, self-cooling
Presence/lack of seal	Yes
Ambient temperature	0 to +40
Storage temperature	- 20 to 65
Ambient humidity	20 to 90% (non-condensing)
Vibration grade	V10
Paint color	Munsell N1.5 or equivalent (circumference)
Excitation system	Permanent magnet
Installation method	Flange type

Standard specifications

Motor model (wiring-saving INC, w/o brake): < > dimensions of flange angle			P10B10030HXS	P10B10075HXS
Sq. flange size in 《 》	Condition	Symbol	Unit	《 100》
Rated output		PR	kW	0.3
Rated rotating speed		NR	min ⁻¹	2,000
Maximum rotating speed		Nmax	min ⁻¹	3,000
Rated torque		TR	N · m	1.5
Continuous stall torque		TS	N · m	1.5
Instantaneous maximum stall torque		TP	N · m	4.4
Rated armature current		IR	Arms	2.7
Continuous stall armature current		IS	Arms	2.5
Instantaneous maximum stall armature current		IP	Arms	7.9
Torque constant		KT	N · m/Arms	0.67
Induced voltage constant		KE	mV/min ⁻¹	23.4
Phase armature resistance		R		3.63
Rated power rate		QR	kW/S	5.5
Electric time constant		te	ms	1.9
Mechanical time constant (w/o sensor)		tm	ms	9.6
Rotor inertia (INC)		JM	kg · m ² (GD ² /4)	3.98 × 10 ⁻⁴
Rotor inertia (ABS-E)		JM	kg · m ² (GD ² /4)	4.0 × 10 ⁻⁴
Detector wiring-saving INC			P/R	6,000
Detector ABS-E			Division	32,768
Mass including wiring-saving INC		WE	kg	5.1
Brake holding torque		TB	N · m	3.9
Brake excitation voltage		VB	V	90 (24)
Brake excitation current		IB	A	0.23 (0.76)
Brake inertia		JB	kg · m ² (GD ² /4)	0.34 × 10 ⁻⁴
Brake mass		W	kg	0.8
Motor operating temperature and humidity				Temperature: 0 to 40 , humidity: 90% or less (non-condensing)

Applicable amplifier model	PZ0A015	PZ0A030
Amplifier power supply	200 to 230V AC +10% - 15% 50/60Hz ±3Hz 3-phase	
Amplifier operating temperature and humidity	Temperature: 0 to 55 , humidity: 90% or less (non-condensing)	
Power capacity (at rating)	kVA	1.0
Amplifier mass	kg	2.2

Motor model (wiring-saving INC, w/o brake): < > dimensions of flange angle			P10B13050BXS	P10B13100BXS
Sq. flange size in 《 》	Condition	Symbol	Unit	《 130》
Rated output		PR	kW	0.5
Rated rotating speed		NR	min ⁻¹	2,000
Maximum rotating speed		Nmax	min ⁻¹	2,000
Rated torque		TR	N · m	2.4
Continuous stall torque		TS	N · m	2.9
Instantaneous maximum stall torque		TP	N · m	8.8
Rated armature current		IR	Arms	2.9
Continuous stall armature current		IS	Arms	3.4
Instantaneous maximum stall armature current		IP	Arms	11.0
Torque constant		KT	N · m/Arms	0.98
Induced voltage constant		KE	mV/min ⁻¹	34.3
Phase armature resistance		R		2.43
Rated power rate		QR	kW/S	4.7
Electric time constant		te	ms	3.2
Mechanical time constant (w/o sensor)		tm	ms	9.0
Rotor inertia (INC)		JM	kg · m ² (GD ² /4)	12.08 × 10 ⁻⁴
Rotor inertia (ABS-E)		JM	kg · m ² (GD ² /4)	12.1 × 10 ⁻⁴
Detector wiring-saving INC			P/R	6,000
Detector ABS-E			Division	32,768
Mass including wiring-saving INC		WE	kg	7.6
Brake holding torque		TB	N · m	8.8
Brake excitation voltage		VB	V	90 (24)
Brake excitation current		IB	A	0.25 (0.86)
Brake inertia		JB	kg · m ² (GD ² /4)	0.5 × 10 ⁻⁴
Brake mass		W	kg	1.5
Motor operating temperature and humidity				Temperature: 0 to 40 , humidity: 90% or less (non-condensing)

Applicable amplifier model	PZ0A030	
Amplifier power supply	200 to 230V AC +10% - 15% 50/60Hz ±3Hz 3-phase	
Amplifier operating temperature and humidity	Temperature: 0 to 55 , humidity: 90% or less (non-condensing)	
Power capacity (at rating)	kVA	1.3
Amplifier weight	kg	2.2

- Note 1. means a combination with a standard amplifier after the temperature rises and gets saturated. The values are typical.
2. means values when the windings are at 20 . The values are typical.

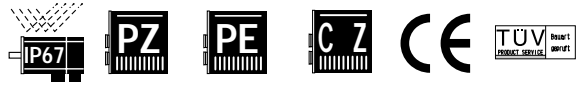

	P10B13050HXS 《130》	P10B13100HXS 《130》	P10B13150HXS 《130》	P10B18200HXS 《180》	P10B18350HXS 《180》	P10B18450RXS 《180》	Symbol	
	0.5	1.0	1.5	2.0	3.5	4.5	PR	
	2,000							NR
	3,000						2,500	Nmax
	2.4	4.7	7.4	9.3	16.7	21.6	TR	
	2.9	5.9	8.8	11.8	21.6	32.4	TS	
	8.8	15.2	18.6	29.4	55.9	78.5	TP	
	4.0	8.3	11.2	16.9	23.3	26.0	IR	
	4.6	9.0	12.0	19.7	29.5	34.0	IS	
	15.1	25.0	26.5	48.3	74.2	83.0	IP	
	0.72	0.75	0.83	0.74	0.92	1.16	KT	
	25.1	25.8	28.9	25.9	32.2	40.2	KE	
	1.31	0.44	0.32	0.16	0.096	0.080	R	
	4.7	9.0	15	12	19	23	QR	
	3.2	4.5	5.3	7.5	8.8	11	te	
	9.0	5.9	4.9	6.3	4.9	3.7	tm	
	12.08×10^{-4}	25.08×10^{-4}	35.08×10^{-4}	73.08×10^{-4}	144.08×10^{-4}	206.08×10^{-4}	JM	
	12.1×10^{-4}	25.1×10^{-4}	35.1×10^{-4}	73.1×10^{-4}	144.1×10^{-4}	206.1×10^{-4}	JM	
	6,000							
	32,768							
	7.6	11.7	16.1	23.1	32.6	44.7	WE	
		8.8			32.4		TB	
	90 (24)						VB	
		0.25 (0.86)			0.37 (1.4)		IB	
		0.5×10^{-4}			3.4×10^{-4}		JB	
		1.5			5.0		W	
Temperature: 0 to 40 , humidity: 90% or less (non-condensing)								

PZ0A030	PZ0A050	PZ0A100	PZ0A150
200 to 230V AC +10% -15% 50/60Hz ±3Hz 3-phase			
Temperature: 0 to 55 , humidity: 90% or less (non-condensing)			
1.3	3.5	3	4
2.2	4.4	6.0	8.5

	P10B13150BXS 《130》	P10B18200BXS 《180》	P10B18350BXS 《180》	P10B18450BXS 《180》	P10B18550MXS 《180》	Symbol
	1.5	2.0	3.5	4.5	5.5	PR
	2,000				1,500	NR
	2,000				1,500	Nmax
	7.4	9.3	16.7	21.6	35.3	TR
	8.8	11.8	21.6	32.4	46.1	TS
	19.6	29.4	45.6	69.6	118	TP
	6.9	9.5	17.5	18.4	24.4	IR
	7.9	11.1	22.1	23.2	30.2	IS
	17.9	26.5	45.5	52.7	79.0	IP
	1.34	1.32	1.23	1.62	1.81	KT
	47.0	46.0	42.9	56.3	63.3	KE
	0.84	0.50	0.17	0.157	0.113	R
	15.0	12.0	19.0	23.0	38	QR
	5.3	7.5	8.8	11	12	te
	4.9	6.3	4.9	3.7	3.4	tm
	35.08×10^{-4}	73.08×10^{-4}	144.08×10^{-4}	206.08×10^{-4}	330.08×10^{-4}	JM
	35.1×10^{-4}	73.1×10^{-4}	144.1×10^{-4}	206.1×10^{-4}	330.1×10^{-4}	JM
	6,000					
	32,768					
	16.1	23.1	32.6	44.7	66.1	WE
	8.8		32.4		49.0	TB
	90 (24)					VB
	0.25 (0.86)	0.37 (1.4)			0.28 (1.1)	IB
	0.5×10^{-4}	3.4×10^{-4}			7.8×10^{-4}	JB
	1.5	5.0			7.0	W
Temperature: 0 to 40 , humidity: 90% or less (non-condensing)						

PZ0A050	PZ0A100	PZ0A150
200 to 230V AC +10% -15% 50/60Hz ±3Hz 3-phase		
Temperature: 0 to 55 , humidity: 90% or less (non-condensing)		
3	4	9.2
4.4	6.0	8.5

“P1” + “PZ” system: characteristics of torque versus rotating speed

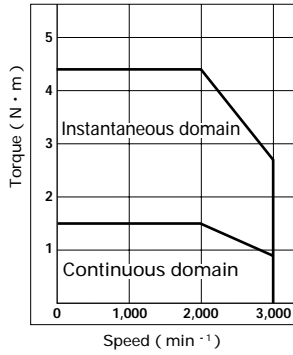

P10B10030H (0.3kW)

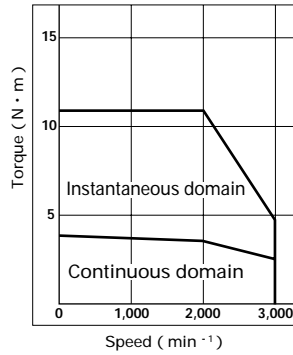

P10B10075H (0.75kW)

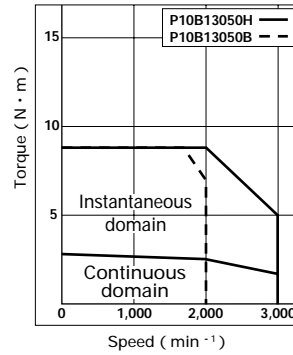

P10B13050H (0.5kW)
P10B13050B (0.5kW)

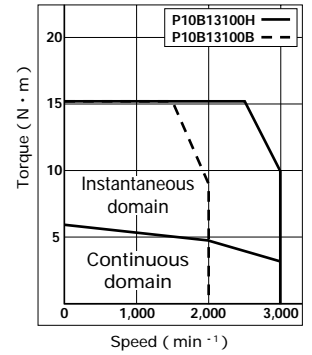

P10B13100H (1.0kW)
P10B13100B (1.0kW)

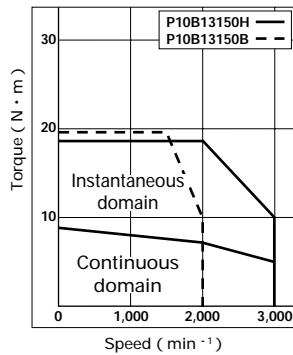

P10B13150H (1.5kW)
P10B13150B (1.5kW)

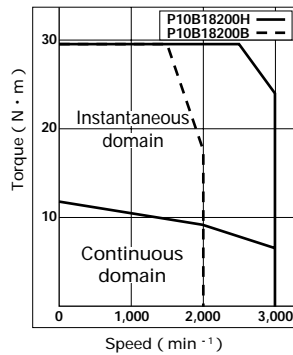

P10B18200H (2.0kW)
P10B18200B (2.0kW)

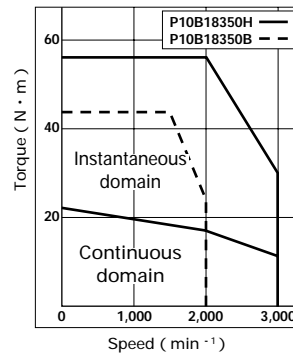

P10B18350H (3.5kW)
P10B18350B (3.5kW)

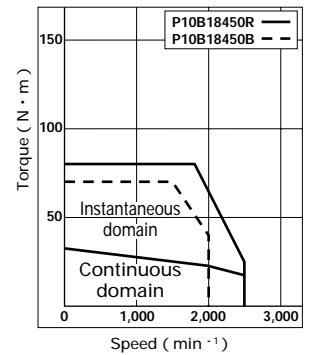

P10B18450R (4.5kW)
P10B18450B (4.5kW)

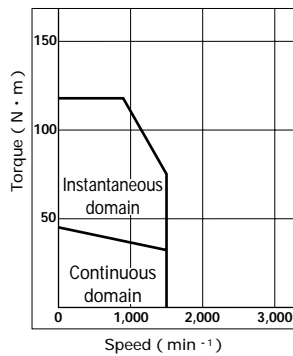

P10B18550M (5.5kW)

Dimensions [unit:mm]

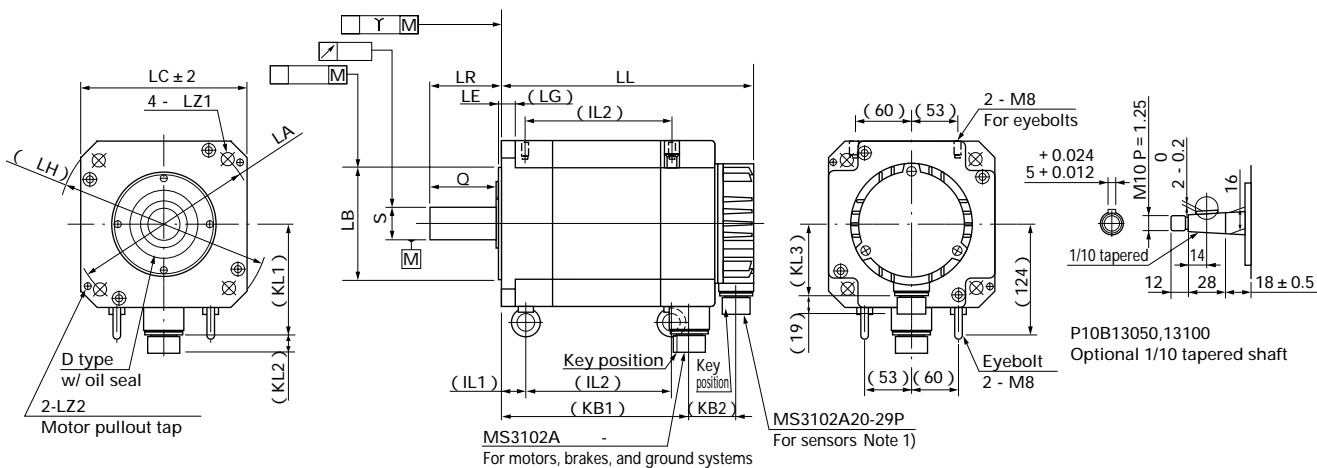

MODEL	Incremental		ABS - E		Connector (motor), Note 1)				Shaft										ABS - E		Y	IL1	IL2								
	w/o brake	w/ brake	w/o brake	w/ brake	w/o brake	w/ brake	MS3102A	KL1	KL2	MS3102A	KL1	KL2	LG	LA	LB	LE	LH	LC	LZ1	LZ2				Standard (618M compatible)	Highly rigid	Q	KB1	KL3	KL3		
P10B10030	182	225	234	277	18 - 10P	76	19	20 - 15P	76	19	10	115	95 - 0.035	3	130	100	9	35	16 - 0.011	30	45	22 - 0.013 0 25 - 0.013	40	108 198	64	96	0.02	0.04	0.04	-	-
P10B10075	272	315	324	367																											
P10B13050	176	216	214	253																			100								
P10B13100	221	261	259	298	18 - 10P	91	19	20 - 15P	91	19	12	145	110 - 0.035	6	165	130	9	M6	58	19 - 0.013 0 22 - 0.013	58	25 - 0.013 0 35 - 0.016	40	145 196	80	96	0.02	0.04	0.04	-	-
P10B13150	272	312	310	349																											
P10B18200	230	278	269	317	22 - 22P		19																158								113
P10B18350	280	328	319	367	24 - 11P	118	21	24 - 11P	118	21	16	200	114.3 - 0.035	3	230	180	13.5	M8	79	35 0 +0.01	76	79 0 48 - 0.016	76	208 278	80	96	0.02	0.04	0.04	27	163
P10B18450	350	398	389	437																											233
P10B18550	501	565	544	604	24 - 10P		21																110								381

Note 1): Connectors are waterproof when engaged. To meet the needs of IP76, therefore, use waterproof connectors for receiving plugs.
 * For the dimensions of the high-resolution ABS-E (131,072 divisions), consult us.

External connection diagram for "P1"

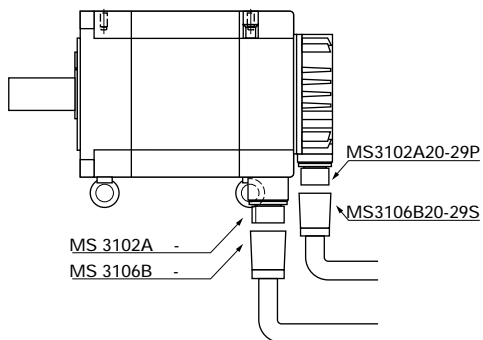

MODEL	Brake	Plug and clamp	Terminal number				
			U	V	W	E	Brake
P10B10030	Yes	MS3106B20-15S,MS3057-12A	A	B	C	D	E,F
P10B13150	No	MS3106B18-10S,MS3057-10A	A	B	C	D	-
P10B18200	Yes	MS3106B24-11S,MS3057-16A	D	E	F	G,H	A,B
P10B18350	No	MS3106B22-22S,MS3057-12A	A	B	C	D	-
P10B18450	Yes	MS3106B24-11S,MS3057-16A	D	E	F	G,H	A,B
P10B18550	No	MS3106B24-10S,MS3057-16A	A,B	C,D	E,F	G	-



Capacity
1 to 5.0kW (7 types)

Features
Low inertia
High response
Faster servos

Maximum rotating speed of 4,500min⁻¹
for quicker positioning.

Uses
Super-fast response machines
Semiconductor-making machines
Mounters and inserters
PCB drilling units

Common specifications

Time rating	Continuous
Insulation grade	F type
Dielectric strength	1,500 VAC, 1 minute
Insulation grade	500 VDC, 10 M or more
Protection system	Fully closed, self-cooling
Presence/lack of seal	Yes
Ambient temperature	0 to +40
Storage temperature	-20 to 65
Ambient humidity	20 to 90% (non-condensing)
Vibration grade	V10
Paint color	Munsell N1.5 or equivalent (circumference)
Excitation system	Permanent magnet
Installation method	Flange type

Standard specifications

Motor model (wiring-saving INC, w/o brake): < > dimensions of flange angle			P20B10100DXS 《100》	P20B10150DXS 《100》	
Sq. flange size in 《 》	Condition	Symbol	Unit		
Rated output		PR	kW	1.0	1.5
Rated rotating speed		NR	min ⁻¹	3,000	
Maximum rotating speed		Nmax	min ⁻¹	4,500	
Rated torque		TR	N · m	3.19	4.79
Continuous stall torque		TS	N · m	3.92	4.90
Instantaneous maximum stall torque		TP	N · m	10.3	14.7
Rated armature current		IR	Arms	6.9	8.4
Continuous stall armature current		IS	Arms	8.0	8.1
Instantaneous maximum stall armature current		IP	Arms	23.2	26.5
Torque constant		KT	N · m/Arms	0.53	0.65
Induced voltage constant		KE	mV/min ⁻¹	18.6	22.6
Phase armature resistance		R		0.51	0.42
Rated power rate		QR	kW/S	69	117
Electric time constant		te	ms	11	13
Mechanical time constant (w/o sensor)		tm	ms	0.80	0.59
Rotor inertia (INC)		JM	kg · m ² (GD ² /4)	1.55 × 10 ⁻⁴	2.04 × 10 ⁻⁴
Rotor inertia (ABS-E)		JM	kg · m ² (GD ² /4)	1.54 × 10 ⁻⁴	2.03 × 10 ⁻⁴
Detector wiring-saving INC			P/R	2,000	
Detector ABS-E			Division	8,192	
Mass including wiring-saving INC		WE	kg	5.4	6.5
Brake holding torque		TB	N · m	3.92	7.84
Brake excitation voltage		VB	V	90 (24)	
Brake excitation current		IB	A	0.20 (0.75)	
Brake inertia		JB	kg · m ² (GD ² /4)	0.15 × 10 ⁻⁴	0.40 × 10 ⁻⁴
Brake mass		W	kg	1.3	1.5
Motor operating temperature and humidity				Temperature: 0 to 40 , humidity: 90% or less (non-condensing)	

Applicable amplifier model	PZ0A050		
Amplifier power supply	200 to 230V AC +10% -15% 50/60Hz ±3Hz 3-phase		
Amplifier operating temperature and humidity	Temperature: 0 to 55 , humidity: 90% or less (non-condensing)		
Power capacity (at rating)	kVA	2.5	3
Amplifier mass	kg	4.4	

Motor model (wiring-saving INC, w/o brake): < > dimensions of flange angle			P20B10100HXS 《100》	P20B10150HXS 《100》	
Sq. flange size in 《 》	Condition	Symbol	Unit		
Rated output		PR	kW	1.0	1.5
Rated rotating speed		NR	min ⁻¹	3,000	
Maximum rotating speed		Nmax	min ⁻¹	3,000	
Rated torque		TR	N · m	3.19	4.79
Continuous stall torque		TS	N · m	3.92	4.90
Instantaneous maximum stall torque		TP	N · m	10.3	17.7
Rated armature current		IR	Arms	4.1	6.5
Continuous stall armature current		IS	Arms	4.7	6.3
Instantaneous maximum stall armature current		IP	Arms	14	26.5
Torque constant		KT	N · m/Arms	0.89	0.83
Induced voltage constant		KE	mV/min ⁻¹	31.2	29.0
Phase armature resistance		R		1.6	0.67
Rated power rate		QR	kW/S	69	117
Electric time constant		te	ms	10	13
Mechanical time constant (w/o sensor)		tm	ms	0.89	0.57
Rotor inertia (INC)		JM	kg · m ² (GD ² /4)	1.55 × 10 ⁻⁴	2.04 × 10 ⁻⁴
Rotor inertia (ABS-E)		JM	kg · m ² (GD ² /4)	1.54 × 10 ⁻⁴	2.03 × 10 ⁻⁴
Detector wiring-saving INC			P/R	2,000	
Detector ABS-E			Division	8,192	
Mass including wiring-saving INC		WE	kg	5.4	6.5
Brake holding torque		TB	N · m	3.92	7.84
Brake excitation voltage		VB	V	90 (24)	
Brake excitation current		IB	A	0.20 (0.75)	
Brake inertia		JB	kg · m ² (GD ² /4)	0.15 × 10 ⁻⁴	0.40 × 10 ⁻⁴
Brake mass		W	kg	1.3	1.5
Motor operating temperature and humidity				Temperature: 0 to 40 , humidity: 90% or less (non-condensing)	

Applicable amplifier model	PZ0A030		PZ0A050	
Amplifier power supply	200 to 230V AC +10% -15% 50/60Hz ±3Hz 3-phase			
Amplifier operating temperature and humidity	Temperature: 0 to 55 , humidity: 90% or less (non-condensing)			
Power capacity (at rating)	kVA	2.5	3	
Amplifier mass	kg	2.2	4.4	

Notes: 1. means a combination with a standard amplifier after the temperature rises and gets saturated. The values are typical.
2. means values when the windings are at 20 . The values are typical.



P20B10200DXS 《100》	P20B10250DXS 《100》	P20B13300DXS 《130》	P20B13400DXS 《130》	P20B13500DXS 《130》	Symbol
2.0	2.5	3.0	4.0	5.0	PR
		3,000			NR
		4,500			Nmax
6.37	7.97	9.51	12.7	15.7	TR
7.36	8.82	10.8	14.7	18.1	TS
19.6	23.8	28.4	39.2	47.6	TP
16.5	16.5	16.4	23.4	24.5	IR
17.9	17.6	18.2	25.6	26.9	IS
53.0	52.0	55.0	76.0	77.0	IP
0.44	0.54	0.64	0.62	0.73	KT
15.5	18.8	22.3	21.6	25.3	KE
0.14	0.15	0.13	0.076	0.071	R
148	175	128	167	198	QR
13	14	18		20	te
0.59	0.56	0.68	0.58	0.50	tm
2.83×10^{-4}	3.71×10^{-4}	7.14×10^{-4}	9.79×10^{-4}	12.58×10^{-4}	JM
2.82×10^{-4}	3.43×10^{-4}	7.13×10^{-4}	9.78×10^{-4}	12.57×10^{-4}	JM
		2,000			
		8,192			
8.7	9.4	11.4	14.4	18.1	WE
7.84	9.8	11.8		19.6	TB
		90 (24)			VB
	0.20 (0.75)		0.25 (0.95)		IB
	0.40×10^{-4}	0.5×10^{-4}	0.58×10^{-4}		JB
	1.5	1.7	2.2		W
Temperature: 0 to 40 , humidity: 90% or less (non-condensing)					

PZ0A100			PZ0A150		
200 to 230V AC +10% -15% 50/60Hz ±3Hz 3-phase					
Temperature: 0 to 55 , humidity: 90% or less (non-condensing)					
4	4.2	5	6.7	8.3	
	6.0		8.5		

P20B10200HXS 《100》	P20B10250HXS 《100》	P20B13300HXS 《130》	P20B13400HXS 《130》	P20B13500HXS 《130》	Symbol
2.0	2.5	3.0	4.0	5.0	PR
		3,000			NR
		3,000			Nmax
6.37	7.97	9.51	12.7	15.7	TR
7.36	8.82	10.8	14.7	18.1	TS
19.6		34.3	39.2	53.9	TP
8.5	11.0	14.7	17.0	22.3	IR
9.3	11.9	14.4	18.1	22.9	IS
26.5	55	52	54	76	IP
0.85	0.79	0.80	0.87	0.85	KT
30.0	27.6	28.0	30.4	29.7	KE
0.50	0.31	0.19	0.16	0.11	R
148	175	128	167	198	QR
13	14		19		te
0.56	0.54	0.62	0.61	0.57	tm
2.83×10^{-4}	3.71×10^{-4}	7.14×10^{-4}	9.79×10^{-4}	12.58×10^{-4}	JM
2.82×10^{-4}	3.43×10^{-4}	7.13×10^{-4}	9.78×10^{-4}	12.57×10^{-4}	JM
		2,000			
		8,192			
8.7	9.4	11.4	14.4	18.1	WE
7.84	9.8	11.8		19.6	TB
		90 (24)			VB
	0.20 (0.75)		0.25 (0.95)		IB
	0.40×10^{-4}	0.50×10^{-4}	0.58×10^{-4}		JB
	1.5	1.7	2.2		W
Temperature: 0 to 40 , humidity: 90% or less (non-condensing)					

PZ0A050	PZ0A100			PZ0A150
200 to 230V AC +10% -15% 50/60Hz ±3Hz 3-phase				
Temperature: 0 to 55 , humidity: 90% or less (non-condensing)				
4	4.2	5	6.7	8.3
4.4		6.0		8.5

“P2” + “PZ” system: characteristics of torque versus rotating speed

P series

P2

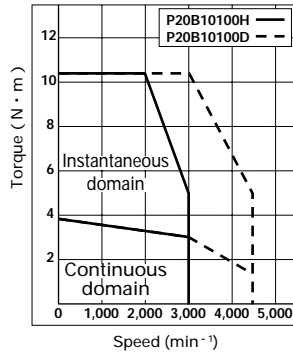

P20B10100H (1.0kW)
P20B10100D (1.0kW)

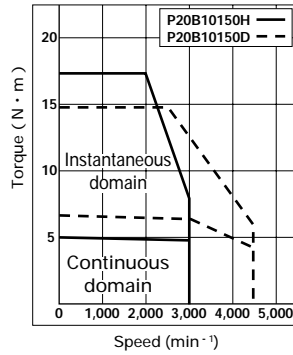

P20B10150H (1.5kW)
P20B10150D (1.5kW)

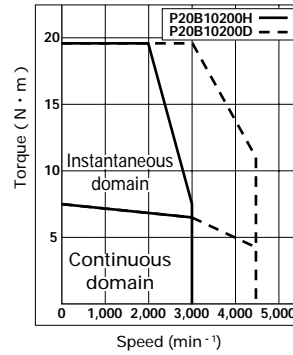

P20B10200H (2.0kW)
P20B10200D (2.0kW)

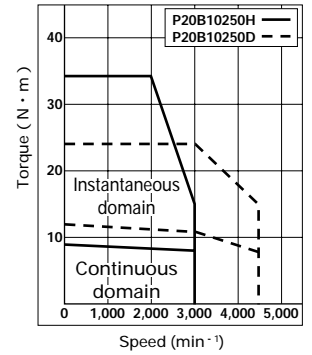

P20B10250H (2.5kW)
P20B10250D (2.5kW)

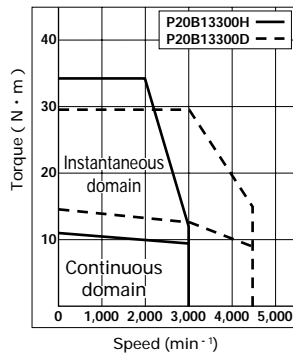

P20B13300H (3.0kW)
P20B13300D (3.0kW)

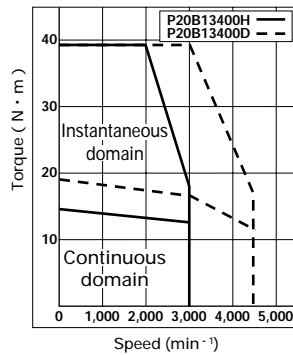

P20B13400H (4.0kW)
P20B13400D (4.0kW)

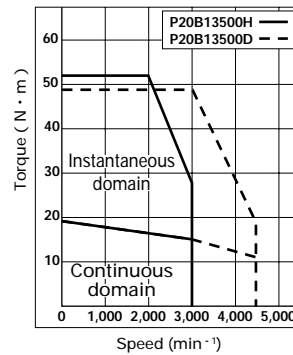

P20B13500H (5.0kW)
P20B13500D (5.0kW)

Dimensions [unit:mm]

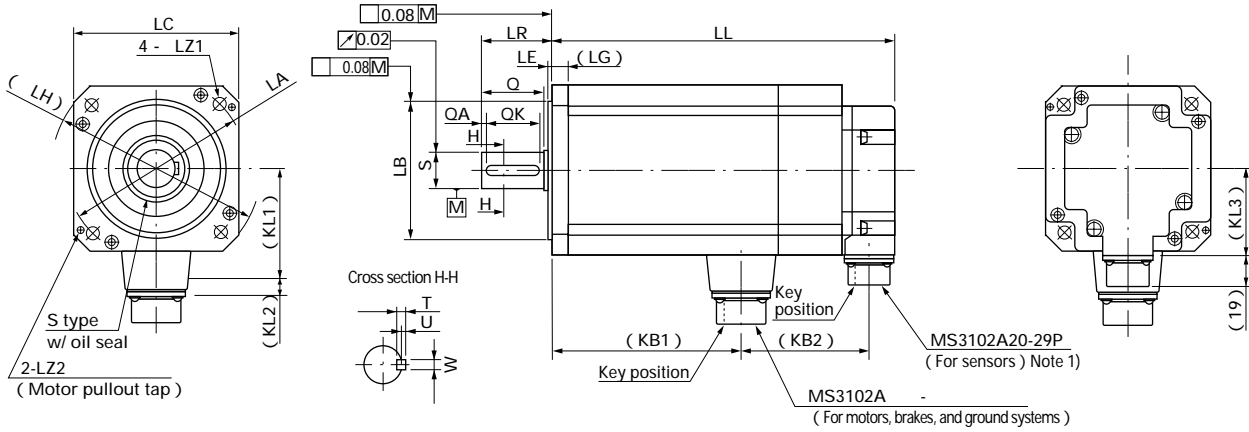

MODEL	Incremental		ABS - R		ABS - E		Note 1) Connector													Incremental											
	w/o brake	w/ brake	w/o brake	w/ brake	w/o brake	w/ brake		MS3102A	KL1	KL2	LG	LA	LB	LE	LH	LC	LZ1	LZ2	LR	S	Q	QA	QK	W	T	U	KB1	KL3	KL3	KL3	
P20B10100	147	191	177	221	187	231																									80
P20B10150	172	216	202	246	212	256																								105	
P20B10200	197	241	227	271	227	281	132	20-15P	76	19	10	115	⁰ _{95-0.035}	3	130	100	9		45	⁰ _{22-0.013}	40	3	32	⁰ _{6-0.030}	6	2.5			130		
P20B10250	222	266	252	296	262	306																								155	
P20B13300	194	236	224	266	234	276																								117	
P20B13400	228	270	258	300	268	310	140	24-11P	98	21	12	145	⁰ _{110-0.035}	4	165	130	9	M6	55	⁰ _{28-0.013}	50	3	42	⁰ _{8-0.036}	7	3			151		
P20B13500	267	309	297	339	307	349																								190	
																														70	
																														80	
																														80	

Note 1): Connectors are waterproof when engaged. To meet the needs of IP76, therefore, use waterproof connectors for receiving plugs.

External connection diagram for "P2"

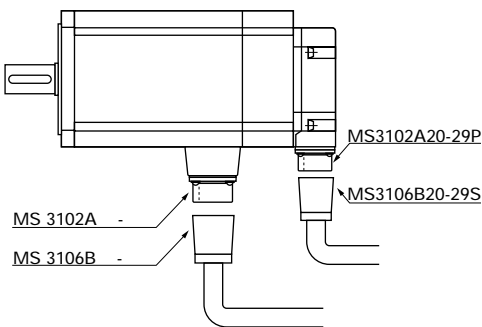

MODEL	Brake	Plug and clamp	Terminal number				
			U	V	W	E	Brake
P20B10100	Yes	MS3106B20-15S, MS3057-12A	A	B	C	D	E, F
P20B10250	No		A	B	C	D	-
P20B13300	Yes	MS3106B24-11S, MS3057-16A	D	E	F	G, H	A, B
P20B13400	Yes		D	E	F	G, H	-
P20B13500	No		D	E	F	G, H	-

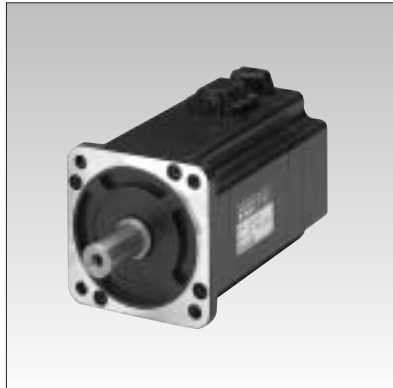

Capacity
30 to 750W (6 types)

Features
Low inertia /high power rate

Best suited for high-response applications with light-load low machine inertia levels

Faster servos
Maximum rotating speed of 4,500min⁻¹ for quick

Uses
Small simple robots
Semiconductor-making machines
Mounters and inserters
Wafer transfer

Common specifications

Time rating	Continuous
Insulation grade	F type
Dielectric strength	1,500 VAC, 1 minute
Insulation grade	500 VDC, 10 M or more
Protection system	Fully closed, self-cooling IP40
Presence/lack of seal	No
Ambient temperature	0 to +40
Storage temperature	- 20 to 65
Ambient humidity	20 to 90% (non-condensing)
Vibration grade	V15
Paint color	Munsell N1.5 or equivalent (circumference)
Excitation system	Permanent magnet type
Installation method	Flange type

Standard specifications 200 VAC type

Motor model (wiring-saving INC, w/o brake) < > dimensions of flange angle Sq. flange size in 《 》	Condition	Symbol	Unit	P30B04003DXS	P30B04005DXS
				《40》	《40》
Rated output		Pr	W	30	50
Rated rotating speed		Nr	min ⁻¹	3,000	
Maximum rotating speed		Nmax	min ⁻¹	4,500	
Rated torque		Tr	N · m	0.098	0.157
Continuous stall torque		Ts	N · m	0.108	0.167
Instantaneous maximum stall torque		Tp	N · m	0.322	0.49
Rated armature current		Ir	Arms	0.54	0.74
Continuous stall armature current		Is	Arms	0.56	0.75
Instantaneous maximum stall armature current		Ip	Arms	1.79	2.4
Torque constant		Kt	N · m/Arms	0.20	0.235
Induced voltage constant		Ke	mV/min ⁻¹	7.1 ± 10%	8.2 ± 10%
Phase armature resistance		R		12.5	9.1
Rated power rate		Qr	kW/S	4.9	9.3
Electric time constant		te	ms	1.2	1.2
Mechanical time constant (w/o sensor)		tm	ms	1.8	1.3
Rotor inertia (INC)		Jm	kg · m ² (GD ² /4)	0.024 × 10 ⁻⁴	0.031 × 10 ⁻⁴
Rotor inertia (ABS-RII / RIII)		Jm	kg · m ² (GD ² /4)	0.021 × 10 ⁻⁴	0.028 × 10 ⁻⁴
Detector wiring-saving INC			P/R	2,000	
Detector ABS-RII / RIII			P/R	8,192	
Mass including wiring-saving INC		We	kg	0.3	0.35
Brake holding torque		Tb	N · m	0.098	0.157
Brake excitation voltage		Vb	V	90 (24)	
Brake excitation current		Ib	A	0.07 (0.26)	
Brake inertia		Jb	kg · m ² (GD ² /4)	0.0078 × 10 ⁻⁴	
Brake mass		W	kg	0.24	
Motor operating temperature and humidity				Temperature: 0 to 40 , humidity: 90% or less (non-condensing)	

Applicable amplifier model	PU0A015- / PZ0A015-
Amplifier power supply	200 to 230V AC + 10% - 15% 50/60Hz 1
Amplifier operating temperature and humidity	Temperature: 0 to 55 , humidity: 90% or less (non-condensing)
Power capacity (at rating)	kVA 0.2
Amplifier mass	kg 0.85

100VAC type

Motor model (wiring-saving INC, w/o brake) < > dimensions of flange angle Sq. flange size in 《 》	Condition	Symbol	Unit	P30B04003PXS	P30B04005PXS
				《40》	《40》
Rated output		Pr	W	30	50
Rated rotating speed		Nr	min ⁻¹	3,000	
Maximum rotating speed		Nmax	min ⁻¹	4,500	
Rated torque		Tr	N · m	0.098	0.157
Continuous stall torque		Tp	N · m	0.322	0.49
Instantaneous maximum stall torque		Ir	Arms	1.0	1.5
Rated armature current		Ip	Arms	3.6	5.1
Continuous stall armature current		Kt	N · m/Arms	0.1	0.113
Instantaneous maximum stall armature current		Ke	mV/min ⁻¹	3.65 ± 10%	3.93 ± 10%
Torque constant		R		3.04	2.25
Induced voltage constant		Qr	kW/S	4.9	9.3
Phase armature resistance		te	ms	1.2	1.3
Rated power rate		tm	ms	1.6	1.4
Electric time constant		Jl	kg · m ² (GD ² /4)	0.24 × 10 ⁻⁴	0.31 × 10 ⁻⁴
Mechanical time constant (w/o sensor)			P/R	2,000	
Rotor inertia (INC)		Jm	kg · m ² (GD ² /4)	0.024 × 10 ⁻⁴	0.031 × 10 ⁻⁴
Rotor inertia (ABS-RII / RIII)		We	kg	0.3	0.35
Detector wiring-saving INC			P/R	8,192	
Detector ABS-RII / RIII		Jm	kg · m ² (GD ² /4)	0.021 × 10 ⁻⁴	0.028 × 10 ⁻⁴
Mass including wiring-saving INC		We	kg	0.39	0.44
Brake holding torque		Tb	N · m	0.098	0.157
Brake excitation voltage		Vb	V	90 (24)	
Brake excitation current		Ib	A	0.07 (0.26)	
Brake inertia		Jb	kg · m ² (GD ² /4)	0.0078 × 10 ⁻⁴	
Brake mass		W	kg	0.24	
Motor operating temperature and humidity				Temperature: 0 to 40 , humidity: 90% or less (non-condensing)	

Applicable amplifier model	PU0B015-
Amplifier power supply	200 to 230V AC + 10% - 15% 50/60Hz ± 3Hz single-phase
Amplifier operating temperature and humidity	Temperature: 0 to 55 , humidity: 90% or less (non-condensing)
Power capacity (at rating)	kVA 0.2
Amplifier mass	kg 0.85

- Notes: 1. means a combination with a standard amplifier after the temperature rises and gets saturated. The values are typical.
2. means values when the windings are at 20 . The values are typical.



P30B04010DXS 《40》	P30B06020DXS 《60》	P30B06040DXS 《60》	P30B08075DXS 《80》	Symbol
100	200	400	750	Pr
3,000				Nr
4,500				Nmax
0.32	0.637	1.274	2.38	TR
0.353	0.686	1.372	2.55	TS
0.98	1.96	3.82	7.15	TP
1.1	2.2	2.7	4.6	IR
1.3	2.3	2.8	4.8	IS
4.1	7.5	8.6	15.0	IP
0.292	0.316	0.533	0.565	KT
10.2 ± 10%	11.0 ± 10%	18.6 ± 10%	19.74 ± 10%	KE
4.3	1.5	1.4	0.52	R
22.0	29.0	64.0	92.0	QR
1.4	3.8	4.6	8.3	te
0.7	0.63	0.38	0.3	tm
0.051×10^{-4}	0.144×10^{-4}	0.255×10^{-4}	0.635×10^{-4}	JM
0.048×10^{-4}	0.141×10^{-4}	0.252×10^{-4}	0.647×10^{-4}	JM
2,000				
8,192				
0.5	1.15	1.7	3.3	WE
0.32	0.637	1.274	2.38	TB
90 (24)				VB
0.07 (0.26)	0.07 (0.31)		0.08 (0.37)	IB
0.0078×10^{-4}	0.06×10^{-4}		0.343×10^{-4}	JB
0.24	0.44		0.8	W
Temperature: 0 to 40 , humidity: 90% or less (non-condensing)				

PU0A015- / PZ0A015-	PU0A030- / PZ0A030-
200 to 230V AC +10% -15% 50/60Hz 1	
Temperature: 0 to 55 , humidity: 90% or less (non-condensing)	
0.3	1.7
0.85	1.1

P30B04010PXS 《40》	P30B06020PXS 《60》	Symbol
100	200	Pr
3,000		Nr
4,500		Nmax
0.32	0.637	TR
0.98	1.96	TP
2.2	4.6	IR
7.4	15.8	IP
0.162	0.151	KT
5.63 ± 10%	5.28 ± 10%	KE
1.58	0.39	R
22.0	29.0	QR
1.3	3.6	te
0.8	0.71	tm
0.51×10^{-4}	1.44×10^{-4}	JL
2,000		
0.051×10^{-4}	0.144×10^{-4}	JM
0.5	1.15	WE
8,192		
0.048×10^{-4}	0.141×10^{-4}	JM
0.59	1.35	WE
0.32	0.637	TB
90 (24)		VB
0.07 (0.26)	0.07 (0.31)	IB
0.0078×10^{-4}	0.06×10^{-4}	JB
0.24	0.44	W
Temperature: 0 to 40 , humidity: 90% or less (non-condensing)		

PU0B015-	PU0B030-
200 to 230V AC +10% -15% 50/60Hz ±3Hz single-phase	
Temperature: 0 to 55 , humidity: 90% or less (non-condensing)	
0.3	0.5
0.85	1.1

Planetary gears

Model	Motor output	Reduction ratio	Backlash	Efficiency	Rated torque	Instantaneous maximum torque	Rotating speed	Dimensions
	W							
P30B04010DXS *A	100	1/3	30	75	0.7	2.2	1,000	54 × 54mm
P30B04010DXS *B		1/5			1.3	3.9	600	
P30B04010DXS *C		1/9	80	2.3	7.1	333		
P30B04010DXS *D		1/15		3.8	11.8	200		
P30B04005DXS *E	50	1/25	42	70	2.9	8.9	120	
P30B06040DXS *A	400	1/3	24	75	2.9	8.6	1,000	78 × 78mm
P30B06040DXS *B		1/5			4.8	14.3	600	
P30B06040DXS *C		1/9	8.5	25.8	333			
P30B06040DXS *D		1/15	30	14.3	43.0	200		
P30B06020DXS *E	200	1/25	30	70	11.9	36.8	120	
P30B08075DXS *A	750	1/3	24	75	5.4	16.1	1,000	96 × 96mm
P30B08075DXS *B		1/5			8.9	26.8	600	
P30B08075DXS *C		1/9	30	70	15.0	45.0	333	
P30B08075DXS *D		1/15			25.0	75.1	200	

Flat gears

Model	Motor output	Reduction ratio	Backlash	Efficiency	Rated torque	Instantaneous maximum torque	Rotating speed	Dimensions		
	W								Minute	%
P30B04005DXS *J	50	1/5	60	95	0.75	1.8	600	60 × 60mm		
P30B04005DXS *K		1/10		90	1.4	3.4	300			
P30B04005DXS *L		1/15		2.1	5.2	200				
P30B06020DXS *J	200	1/5		60	95	3.0	6.0	600	82 × 82mm	
P30B06020DXS *K		1/10			90	5.7	11.4	300		
P30B04010DXS *L	100	1/15			4.3	8.6	200			
P30B04010DXS *J	400	1/5			60	95	6.0	12.0	600	102 × 102mm
P30B04010DXS *K		1/10				90	11.5	23.0	300	
P30B06020DXS *L	200	1/15				8.6	25.2	200		
P30B08075DXS *J	750	1/5	60			80	9.5	19.0	600	120 × 120mm
P30B08075DXS *K		1/10				19.0	38.0	300		

Note: To protect the gears, limit the torques to double their ratings.

Amplifiers can be delivered with different internal settings if you specify them when placing an order.

Backlash-less planetary gears

Model	Motor output	Reduction ratio	Backlash	Efficiency	Rated torque	Instantaneous maximum torque	Rotating speed	Dimensions
	W							
P30B04010DXS *S	100	1/5	2	75	1.2	3.7	600	70 × 70mm
P30B04010DXS *T		1/11	2.8		8.6	273		
P30B04005DXS *U	50	1/21	3	80	2.7	8.2	143	
P30B04005DXS *V		1/33			4.2	12.9	91	
P30B06040DXS *S	400	1/5	2	75	4.8	14.3	600	
P30B06040DXS *T		1/11	10.5		31.5	273		
P30B06020DXS *U	200	1/21	3	75	10.0	30.9	143	
P30B06020DXS *V		1/33			15.8	48.5	91	
P30B08075DXS *S	750	1/5	2	70	8.3	25.0	600	120 × 120mm
P30B08075DXS *T		1/11	3		18.3	55.1	273	



“P3” + “PZ” system: characteristics of torque versus rotating speed

200 VAC type

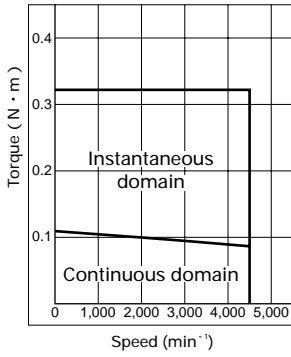

P30B04003D (30W)

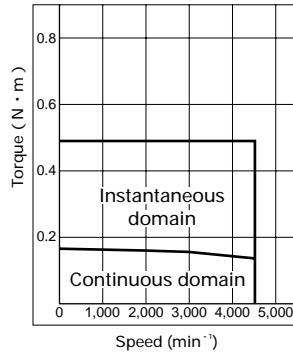

P30B04005D (50W)

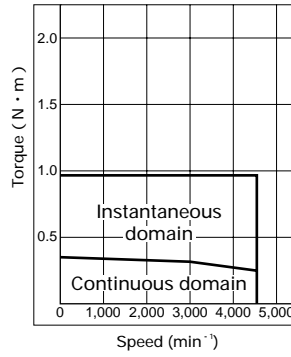

P30B04010D (100W)

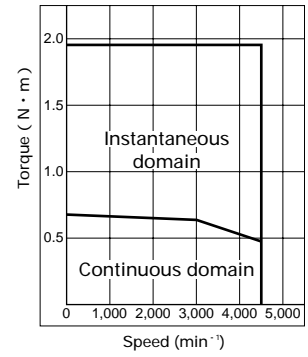

P30B06020D (200W)

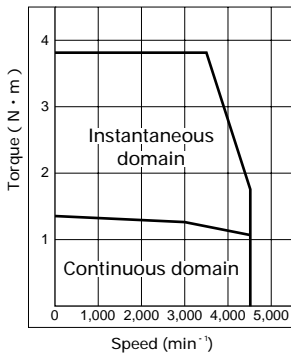

P30B06040D (400W)

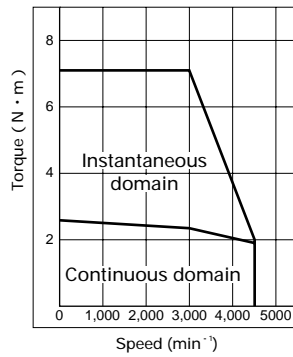

P30B08075D (750W)

“P3” + “PU” system: characteristics of torque versus rotating speed

100 VAC type

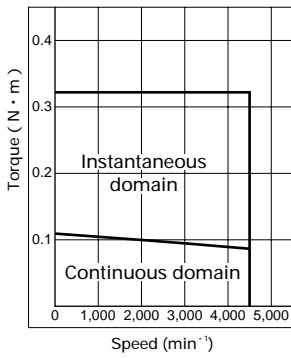

P30B04003P (30W)

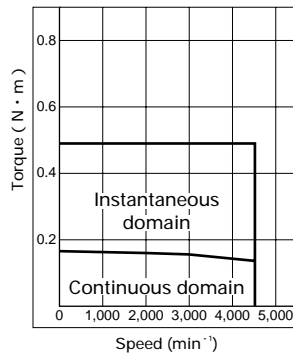

P30B04005P (50W)

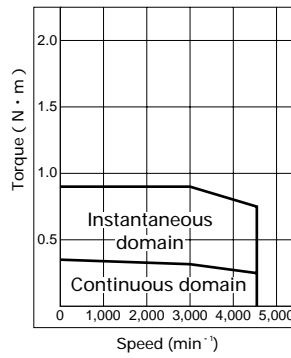

P30B04010P (100W)

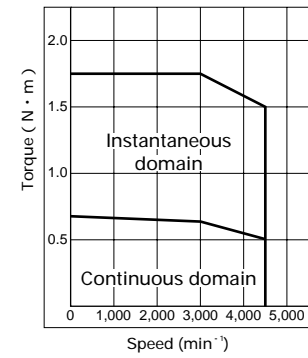

P30B06020P (200W)

Dimensions [unit:mm]

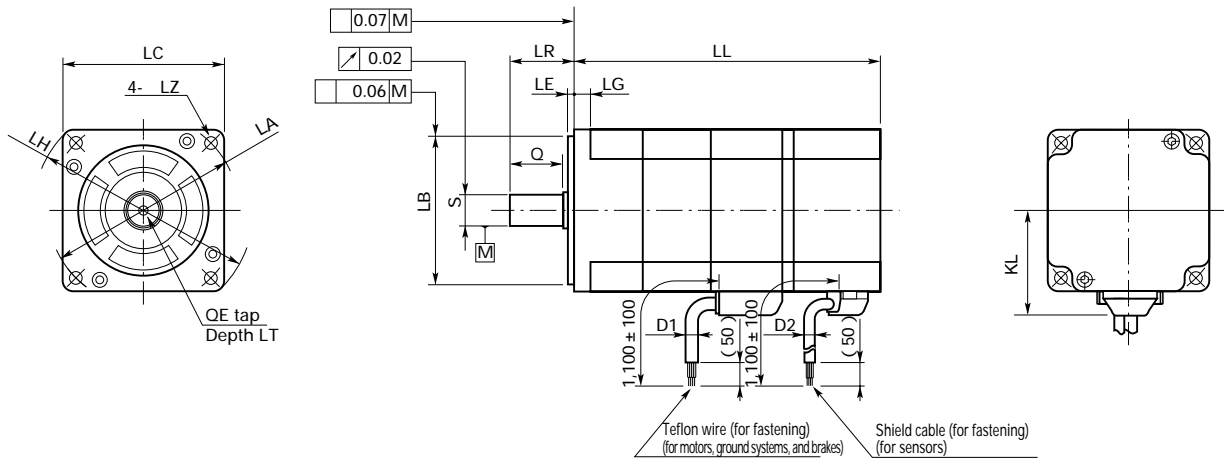

MODEL	Incremental		ABS-R		LG	KL	LA	LB	LE	LH	LC	LZ	LR	S	Q	OE	LT	D1	D2	Incremental-R	ABS-R
	w/o brake	w/ brake	w/o brake	w/ brake																	
P30B04003	64	102.5	70	108.5	5	30	46	30 - 0.021	2.5	54	40	4.5	25	0 6 - 0.008				6			5.1
P30B04005	70	108.5	76	114.5										0 8 - 0.009							
P30B04010	88	126.5	94	132.5										0 14 - 0.011							
P30B06020	95.5	133.5	101	139	6	41	70	50 - 0.025	3	81	60	5.5	30	0 16 - 0.011	M5	12	6.7			4.7	
P30B06040	123.5	161.5	129	167										0 70 - 0.030							
P30B08075	140	180.5	145	185.5	8	52	90	70 - 0.030	3	107	80	6.6	40	0 16 - 0.011	35						7.9

Note: ABS-E and ABS-RIII come with sensors having different dimensions.

Planetary gears

Flat gears

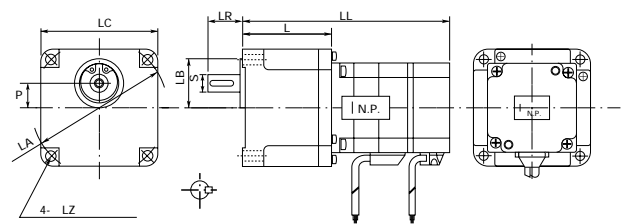
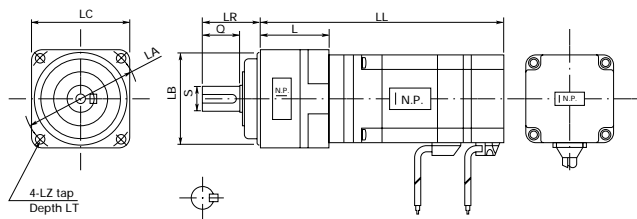

Planetary gears		LL	L	LA	LB	LC	S	LR	Q	LZ	LT	Mass
		mm	mm	mm	mm	mm	mm	mm	mm	mm	mm	kg
P30B04010DXS	*A	138	50									0.5
P30B04010DXS	*B											
P30B04010DXS	*C		60	50	54	12	32	20	M5	10		0.65
P30B04010DXS	*D	153	65									
P30B04005DXS	*E	135										
P30B06040DXS	*A	191	67									1.85
P30B06040DXS	*B											
P30B06040DXS	*C											
P30B06040DXS	*D	211	87	90	70	78	19	50	30	M6	12	2.3
P30B06020DXS	*E	183										
P30B08075DXS	*A	208	68									1.85
P30B08075DXS	*B											
P30B08075DXS	*C											
P30B08075DXS	*D	242	102	115	90	96	24	61	40	M8	16	3.5

Flat gears		LL	L	LA	LB	LC	S	LR	Q	LZ	LT	Mass
		mm	mm	mm	mm	mm	mm	mm	mm	mm	mm	kg
P30B04005DXS	*J											
P30B04005DXS	*K	117	47	70	18	60	8	32	5	10	4.5	0.4
P30B04005DXS	*L											
P30B06020DXS	*J	147										
P30B06020DXS	*K		51	94	44	82	12	26.5	5	15	6.5	0.7
P30B06040DXS	*L	139										
P30B06040DXS	*J	202										
P30B06040DXS	*K		78	120	40	102	15	32	3	20	6.5	1.3
P30B06020DXS	*L	174										
P30B08075DXS	*J	220										
P30B08075DXS	*K		80	146	50	120	19	35	5	25	9	1.5



Backlash-less planetary gears

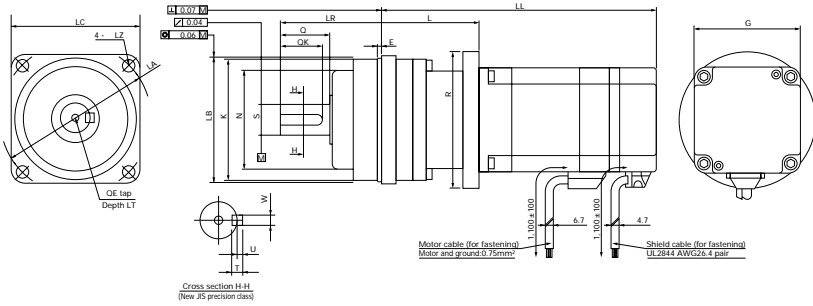

Backlash-less planetary gear	LL	L	LA	LB	E	LC	LR	G	S	QK	Q	K	N	R	LZ	OE	LT	KL	W	T	U	Mass	
	mm	mm	mm	mm	mm	mm	mm	mm	mm	mm	mm	mm	mm	mm	mm	mm	mm	mm	mm	mm	mm	mm	Kg
P30B04010DXS *S	127	57																					
P30B04010DXS *T	154		80	65	8	70	60	40	16	25	28	64.5	50	72	6.6	M4	8	38	5	5	2	0.8	
P30B04005DXS *U		66																					
P30B04005DXS *V	136																						
P30B06040DXS *S	192	68	105	85	10	90	74		20	32	36	83	60			M5	10		6	6	2.5	1.6	
P30B06040DXS *T	211							60										50					
P30B06020DXS *U		87	120	100	12	105	84		25	36	42	96	70	104	9		M6	12		8	7	3	2.4
P30B06020DXS *V	183																						
P30B08075DXS *S	216	76	120	100	12	105	84		25	36	42	96	70	116	9		M6	12		8	7	3	2.4
P30B08075DXS *T	236	96	135	115	14	120	105	80	32	50	58	112	90	120	11		M8	16		10	8	3	3.9

External connection diagram for "P3"

Incremental encoder

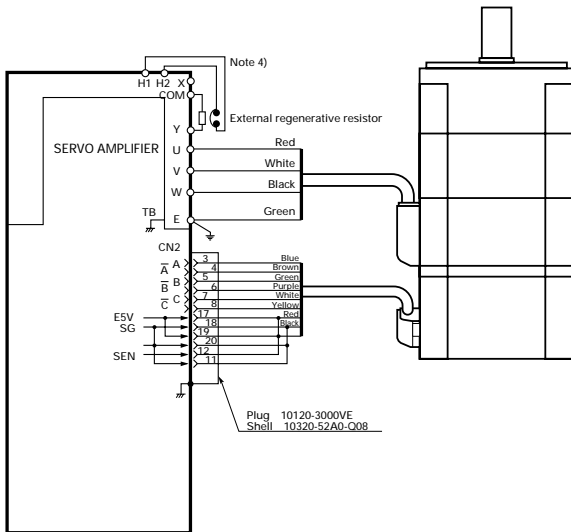

Absolute sensor (ABS-R)

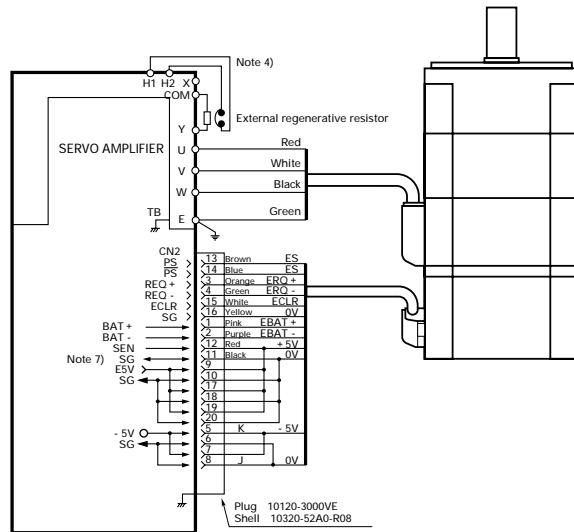



Capacity
30 to 1,000W (13 types)

Features
High rigidity
Faster servos

Maximum rotating speed of 4,500min⁻¹
for quicker positioning.

Uses
Robots
Machines with windings
Machines for industrial industries

Common specifications

Time rating	Continuous
Insulation grade	F type
Dielectric strength	1,500 VAC, 1 minute
Insulation grade	500 VDC, 10 M or more
Protection system	Fully closed, self-cooling
	P50B03,04 : IP40 P50B05,07,08 : IP55
Presence/lack of seal	P50B03,04 : No P50B05,07,08 : Yes
Ambient temperature	0 to +40
Storage temperature	- 20 to 65
Ambient humidity	20 to 90% (non-condensing)
Vibration grade	V15
Paint color	Munsell N1.5 or equivalent (circumference)
Excitation system	Permanent magnet
Installation method	Flange type

Standard specifications 200 VAC type

Motor model (wiring-saving INC, w/o brake) < > dimensions of flange angle Sq. flange size in ()	Condition	Symbol	Unit	P50B03003DXS	P50B04006DXS
				(35)	(42)
Rated output		PR	W	30	60
Rated rotating speed		NR	min ⁻¹	3,000	
Maximum rotating speed		Nmax	min ⁻¹	4,500	
Rated torque		TR	N · m	0.098	0.191
Continuous stall torque		TS	N · m	0.108	0.216
Instantaneous maximum stall torque		TP	N · m	0.323	0.647
Rated armature current		IR	Arms	0.5	0.7
Continuous stall armature current		IS	Arms	0.53	0.76
Instantaneous maximum stall armature current		IP	Arms	1.8	2.7
Torque constant		KT	N · m/Arms	0.206	0.304
Induced voltage constant		KE	mV/min ⁻¹	7.2 ± 10%	10.6 ± 10%
Phase armature resistance		R		20.5	10.4
Rated power rate		QR	kW/S	6.5	7.5
Electric time constant		te	ms	0.7	1.4
Mechanical time constant (w/o sensor)		tm	ms	2.1	1.6
Rotor inertia (INC)		JM	kg · m ² (GD ² /4)	0.0197 × 10 ⁻⁴	0.054 × 10 ⁻⁴
Rotor inertia (ABS-RII / RIII)		JM	kg · m ² (GD ² /4)	0.0167 × 10 ⁻⁴	0.051 × 10 ⁻⁴
Detector wiring-saving INC			P/R	2,000	
Detector ABS-RII / RIII			P/R	8,192	
Mass including wiring-saving INC		WE	kg	0.24	0.46
Brake holding torque		TB	N · m	0.098	0.191
Brake excitation voltage		VB	V	90 (24)	
Brake excitation current		IB	A	0.07 (0.25)	0.07 (0.26)
Brake inertia		JB	kg · m ² (GD ² /4)	0.0021 × 10 ⁻⁴	0.0078 × 10 ⁻⁴
Brake mass		W	kg	0.15	0.24
Motor operating temperature and humidity				Temperature: 0 to 40 , humidity: 90% or less (non-condensing)	

Applicable amplifier model	PU0A015- / PZ0A015-
Amplifier power supply	200 to 230V AC +10% -15% 50/60Hz ± 3Hz 3-phase
Amplifier operating temperature and humidity	Temperature: 0 to 55 , humidity: 90% or less (non-condensing)
Power capacity (at rating)	kVA 0.2 0.3
Amplifier mass	kg 2.2

Motor model (wiring-saving INC, w/o brake) < > dimensions of flange angle Sq. flange size in ()	Condition	Symbol	Unit	P50B07040DXS	P50B08050DXS
				(76)	(86)
Rated output		PR	W	400	500
Rated rotating speed		NR	min ⁻¹	3,000	
Maximum rotating speed		Nmax	min ⁻¹	4,500	
Rated torque		TR	N · m	1.274	1.589
Continuous stall torque		TS	N · m	1.372	1.96
Instantaneous maximum stall torque		TP	N · m	3.92	5.88
Rated armature current		IR	Arms	3.0	3.9
Continuous stall armature current		IS	Arms	3.1	4.5
Instantaneous maximum stall armature current		IP	Arms	10.0	15.0
Torque constant		KT	N · m/Arms	0.481	0.473
Induced voltage constant		KE	mV/min ⁻¹	16.8 ± 10%	16.5 ± 10%
Phase armature resistance		R		1.65	0.94
Rated power rate		QR	kW/S	22.1	21.8
Electric time constant		te	ms	4.0	5.2
Mechanical time constant (w/o sensor)		tm	ms	1.6	1.5
Rotor inertia (INC)		JM	kg · m ² (GD ² /4)	0.74 × 10 ⁻⁴	1.161 × 10 ⁻⁴
Rotor inertia (ABS-RII / RIII)		JM	kg · m ² (GD ² /4)	0.752 × 10 ⁻⁴	1.173 × 10 ⁻⁴
Detector wiring-saving INC			P/R	2,000	
Detector ABS-RII / RIII			P/R	8,192	
Mass including wiring-saving INC		WE	kg	2.1	3.0
Brake holding torque		TB	N · m	0.98	1.96
Brake excitation voltage		VB	V	90 (24)	
Brake excitation current		IB	A	0.08 (0.3)	0.08 (0.33)
Brake inertia		JB	kg · m ² (GD ² /4)	0.245 × 10 ⁻⁴	0.343 × 10 ⁻⁴
Brake mass		W	kg	0.57	0.8
Motor operating temperature and humidity				Temperature: 0 to 40 , humidity: 90% or less (non-condensing)	

Applicable amplifier model	PU0A030- / PZ0A030-
Amplifier power supply	200 to 230V AC +10% -15% 50/60Hz ± 3Hz 3-phase
Amplifier operating temperature and humidity	Temperature: 0 to 55 , humidity: 90% or less (non-condensing)
Power capacity (at rating)	kVA 1.3 1.5
Amplifier mass	kg 2.2

Notes: 1. means a combination with a standard amplifier after the temperature rises and gets saturated. The values are typical.
2. means values when the windings are at 20 . The values are typical.

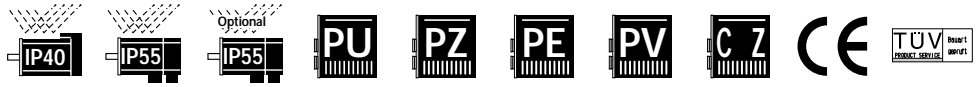

P50B04010DXS 《42》	P50B05005DXS 《54》	P50B05010DXS 《54》	P50B05020DXS 《54》	P50B07020DXS 《76》	P50B07030DXS 《76》	Symbol
100	50	100	200	200	300	PR
3,000						NR
4,500						Nmax
0.319	0.159	0.319	0.637	0.637	0.931	TR
0.353	0.167	0.353	0.686	0.686	0.98	TS
0.98	0.49	0.98	1.96	1.96	2.94	TP
1.0	0.85	1.1	1.6	2.2		IR
1.2	0.85	1.2	1.7	2.3	2.2	IS
3.6	2.9	3.7	5.5	7.4	7.5	IP
0.333	0.249	0.319	0.436	0.348	0.483	KT
11.6 ± 10%	8.7 ± 10%	11.1 ± 10%	15.2 ± 10%	12.15 ± 10%	16.86 ± 10%	KE
7.0	9.2	4.9	3.4	2.5	2.9	R
13.8	4.4	10.6	24.2	10.6	17.7	QR
1.5	2.1	2.5	2.9	3.6	3.8	te
1.4	2.6	1.4	0.9	2.4	1.8	tm
0.079×10^{-4}	0.063×10^{-4}	0.101×10^{-4}	0.173×10^{-4}	0.386×10^{-4}	0.495×10^{-4}	JM
0.076×10^{-4}	0.06×10^{-4}	0.098×10^{-4}	0.17×10^{-4}	0.398×10^{-4}	0.507×10^{-4}	JM
2,000						
8,192						
0.59	0.53	0.74	1.07	1.57	1.71	WE
0.319	0.167	0.353	0.353	0.69	0.98	TB
90 (24)						VB
0.07 (0.26)	0.11 (0.4)			0.08 (0.3)		IB
0.0078×10^{-4}	0.029×10^{-4}			0.245×10^{-4}		JB
0.24	0.3			0.57		W
Temperature: 0 to 40 , humidity: 90% or less (non-condensing)						
PU0A015- / PZ0A015-						
200 to 230V AC +10% -15% 50/60Hz ±3Hz 3-phase						
Temperature: 0 to 55 , humidity: 90% or less (non-condensing)						
0.4	0.3	0.4	0.8	1.0		
2.2						

P50B08075DXS 《86》	P50B08100DXS 《86》	Symbol
750	1,000	PR
3,000		NR
4,500		Nmax
2.381	3.185	TR
2.94	3.92	TS
8.82	11.76	TP
6.0	6.7	IR
7.1	7.5	IS
23.7	25.7	IP
0.447	0.553	KT
15.6 ± 10%	19.3 ± 10%	KE
0.43	0.41	R
29.5	38.3	QR
5.8	5.9	te
1.2	1.1	tm
1.926×10^{-4}	2.651×10^{-4}	JM
1.938×10^{-4}	2.663×10^{-4}	JM
2,000		
8,192		
3.9	5.05	WE
2.94		TB
90 (24)		VB
0.08 (0.33)		IB
0.343×10^{-4}		JB
0.8		W
Temperature: 0 to 40 , humidity: 90% or less (non-condensing)		
PZ0A050-		
200 to 230V AC +10% -15% 50/60Hz ±3Hz 3-phase		
Temperature: 0 to 55 , humidity: 90% or less (non-condensing)		
2.0	2.5	
5.2		

Standard specifications 200 VAC type

Motor model (wiring-saving INC, w/o brake) < > dimensions of flange angle	P50B03003PXS		P50B04006PXS		P50B04010PXS		P50B05005PXS		
Sq. flange size in 《 》	Condition	Symbol	Unit	《35》	《42》	《42》	《54》		
Rated output		PR	W	30	60	100	50		
Rated rotating speed		NR	min ⁻¹	3,000					
Maximum rotating speed		Nmax	min ⁻¹	4,500					
Rated torque		TR	N · m	0.098	0.191	0.319	0.159		
Instantaneous maximum stall torque		TP	N · m	0.322	0.647	0.98	0.49		
Rated armature current		IR	Arms	1.0	1.3	1.8	1.6		
Instantaneous maximum stall armature current		IP	Arms	3.6	5.0	6.0	5.0		
Torque constant		K _T	N · m/Arms	0.108	0.164	0.195	0.136		
Induced voltage constant		KE	mV/min ⁻¹	3.79 ± 10%	5.74 ± 10%	6.8 ± 10%	4.76 ± 10%		
Phase armature resistance		R		5.4	2.95	2.35	2.6		
Rated power rate		QR	kW/S	6.5	7.5	13.8	4.4		
Electric time constant		te	ms	0.7	1.5	1.6	2.2		
Mechanical time constant (w/o sensor)		tm	ms	2.0	1.5	1.3	2.4		
Applicable load inertia		JL	kg · m ² (GD ² /4)	0.197 × 10 ⁻⁴	0.54 × 10 ⁻⁴	0.79 × 10 ⁻⁴	0.63 × 10 ⁻⁴		
Detector wiring-saving INC			P/R	2,000					
Inertia (including wiring-saving INC)		JM	kg · m ² (GD ² /4)	0.02 × 10 ⁻⁴	0.054 × 10 ⁻⁴	0.079 × 10 ⁻⁴	0.063 × 10 ⁻⁴		
Mass including wiring-saving INC		WE	kg	0.24	0.46	0.59	0.53		
Detector ABS-RII			P/R	8,192					
Inertia (including ABS-RII)		JM	kg · m ² (GD ² /4)	0.167 × 10 ⁻⁴	0.051 × 10 ⁻⁴	0.076 × 10 ⁻⁴	0.06 × 10 ⁻⁴		
Mass including ABS-RII		WE	kg	0.31	0.52	0.65	0.61		
Brake holding torque		TB	N · m	0.098	0.191	0.319	0.167		
Brake excitation voltage		VB	V	90/24					
Brake excitation current		IB	A	0.07/0.25	0.07/0.26			0.11/0.4	
Brake inertia		JB	kg · m ² (GD ² /4)	0.0021 × 10 ⁻⁴	0.0078 × 10 ⁻⁴			0.029 × 10 ⁻⁴	
Brake mass		W	kg	0.15	0.24			0.3	
Motor operating temperature and humidity	Temperature: 0 to 40 , humidity: 90% or less (non-condensing)								

Applicable amplifier model	PU0B015-								
Amplifier power supply	200 to 230V AC +10% -15% 50/60Hz ±3Hz 3-phase								
Amplifier operating temperature and humidity	Temperature: 0 to 40 , humidity: 90% or less (non-condensing)								
Power capacity (at rating)	kVA	0.2	0.3	0.2	0.2				
Amplifier mass	kg	0.85							

- Notes: 1. means a combination with a standard amplifier after the temperature rises and gets saturated. The values are typical.
 2. means values when the windings are at 20 . The values are typical.
 3. The constants are those measured when the motor is mounted on an aluminum plate 305 x 305 x 12mm thick.

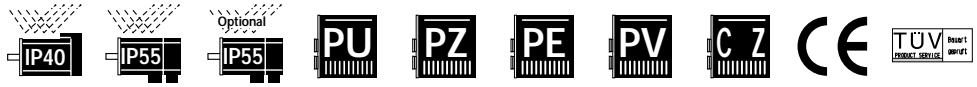

	P50B05010PXS 《54》	P50B05020PXS 《54》	P50B07020PXS 《76》	Symbol
	100	200		PR
		3,000		NR
		4,500		Nmax
	0.319	0.637		TR
	0.98	1.96	1.96	TS
	2.1	3.4	4.3	IR
	6.7	11	14.4	IP
	0.176	0.218	0.18	KT
	6.25 ± 10%	7.6 ± 10%	6.3 ± 10%	KE
	1.5	0.85	0.66	R
	10.6	24.2	10.6	QR
	2.6	2.8	3.6	te
	1.4	0.9	2.3	tm
	1.01 × 10 ⁻⁴	1.73 × 10 ⁻⁴	3.86 × 10 ⁻⁴	JL
		2,000		
	0.101 × 10 ⁻⁴	0.173 × 10 ⁻⁴	0.386 × 10 ⁻⁴	JM
	0.74	1.07	1.57	WE
		8,192		
	0.098 × 10 ⁻⁴	0.17 × 10 ⁻⁴	0.398 × 10 ⁻⁴	JM
	0.82	1.15	1.61	WE
	0.353		0.69	TB
	90/24			VB
	0.11/0.4		0.08/0.3	IB
	0.029 × 10 ⁻⁴		0.245 × 10 ⁻⁴	JB
	0.3		0.57	W
	Temperature: 0 to 40 , humidity: 90% or less (non-condensing)			
	PU0B015-	PU0B030-		
	200 to 230V AC +10% -15% 50/60Hz ±3Hz 3-phase			
	Temperature: 0 to 40 , humidity: 90% or less (non-condensing)			
	0.3	0.5	0.6	
	0.85	1.1		

Planetary gears

Model	Motor output	Reduction ratio	Backlash	Efficiency	Rated torque	Instantaneous maximum torque	Rated rotating speed	Dimensions
	W							
P50B05010DXS *A	100	1/3	30	75	0.72	2.2	1,000	54 × 54mm
P50B05010DXS *B		1/5			1.3	3.9	600	
P50B05010DXS *C		1/9	42	80	2.3	7.1	333	
P50B05010DXS *D		1/15			3.8	11.8	200	
P50B05005DXS *E	50	1/25		70	2.9	8.9	120	
P50B07040DXS *A	400	1/3	24	75	2.9	8.9	1,000	78 × 78mm
P50B07040DXS *B		1/5			4.8	14.8	600	
P50B07040DXS *C		1/9	30	75	8.5	26.3	333	
P50B07040DXS *D		1/15			14.3	44.1	200	
P50B07030DXS *E	300	1/25		70	17.4	55.1	120	
P50B08075DXS *A	750	1/3	24	70	5.4	19.8	1,000	98 × 98mm
P50B08075DXS *B		1/5			8.9	33.1	600	
P50B08075DXS *C		1/9	30	70	15.0	55.5	333	
P50B08075DXS *D		1/15			25.0	92.2	200	

Flat gears

Model	Motor output	Reduction ratio	Backlash	Efficiency	Rated torque	Instantaneous maximum torque	Rated rotating speed	Dimensions	
	W								Minute
P50B04006DXS *J	60	1/5	60	95	0.9	1.8	600	60 × 60mm	
P50B04006DXS *K		1/10		90	1.7	3.4	300		
P50B04006DXS *L		1/15		2.6	5.2	200			
P50B05020DXS *J	200	1/5		60	95	3.0	6.0	600	82 × 82mm
P50B05020DXS *K		1/10			90	5.7	11.4	300	
P50B05010DXS *L	100	1/15			60	90	4.3	8.6	200
P50B07040DXS *J	400	1/5	95				6.0	12.0	600
P50B07040DXS *K		1/10	90			11.5	23.0	300	102 × 102mm
P50B07030DXS *L	300	1/15				12.6	25.2	200	
P50B08075DXS *J	750	1/5	60	80		9.5	19.0	600	120 × 120mm
P50B08075DXS *K		1/10				19.0	38.0	300	
P50B08050DXS *L	500	1/15		60	90	21.5	43.0	200	

Note: To protect the gears, limit the torques to double their ratings.

Amplifiers can be delivered with different internal settings if you specify them when placing an order.

Backlash-less planetary gears

Model	Motor output	Reduction ratio	Backlash	Efficiency	Rated torque	Instantaneous maximum torque	Rated rotating speed	Dimensions
	W							
P50B05010DXS *S	100	1/5	2	75	1.2	3.7	600	70 × 70mm
P50B05010DXS *T		1/11			2.8	8.6	273	
P50B05005DXS *U	50	1/21	3	80	2.7	8.2	143	70 × 70mm
P50B05005DXS *V		1/33			4.2	12.9	91	
P50B07040DXS *S	400	1/5	2	75	4.8	14.7	600	90 × 90mm
P50B07040DXS *T		1/11			10.5	32.3	273	
P50B07030DXS *U	300	1/21	3	75	14.7	46.3	143	105 × 105mm
P50B07020DXS *V	200	1/33			15.8	48.5	91	
P50B08075DXS *S	750	1/5	2	70	8.3	30.9	600	120 × 120mm
P50B08075DXS *T		1/11			18.3	72.8	273	
P50B08050DXS *U	500	1/21	3	70	25.0	92.6	143	

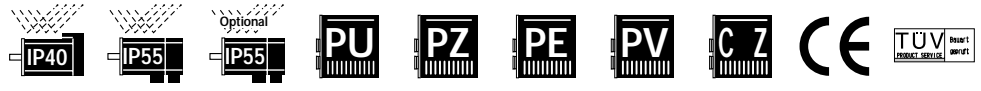

"P5" + "PZ" system: characteristics of torque versus rotating speed

200 VAC type

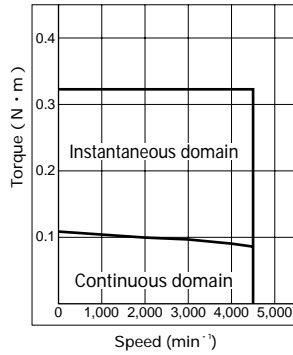

P50B03003D (30W)

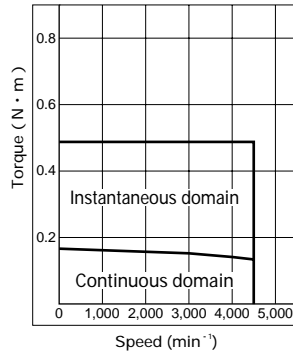

P50B05005D (50W)

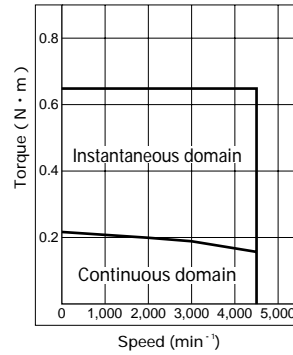

P50B04006D (60W)

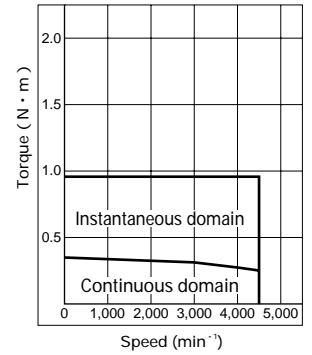

P50B04010D (100W)
P50B05010D (100W)

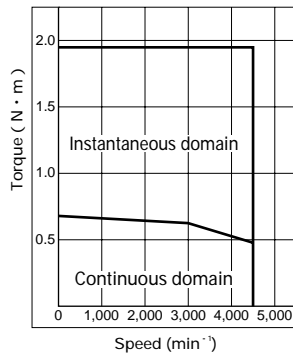

P50B05020D (200W)
P50B07020D (200W)

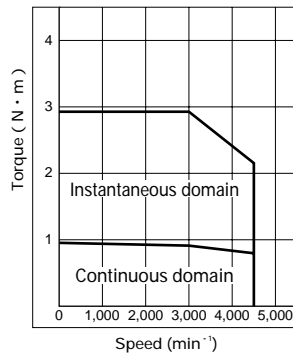

P50B07030D (300W)

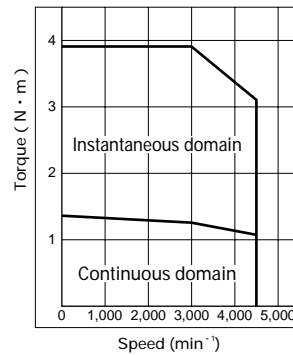

P50B07040D (400W)

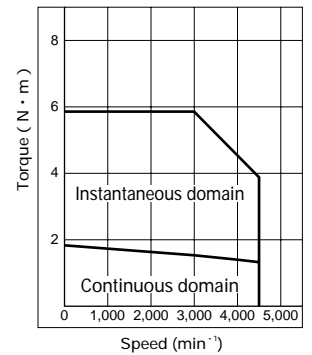

P50B08050D (500W)

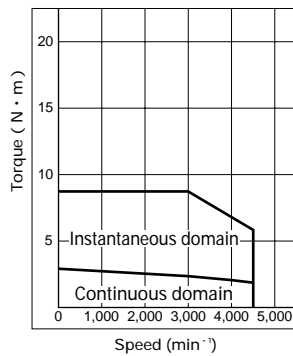

P50B08075D (750W)

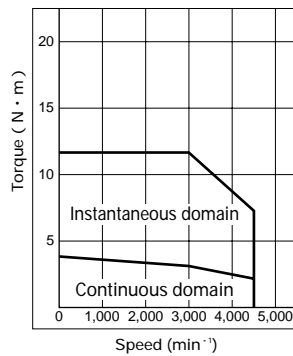

P50B08100D (1000W)

“P5” + “PU” system: characteristics of torque versus rotating speed

100 VAC type

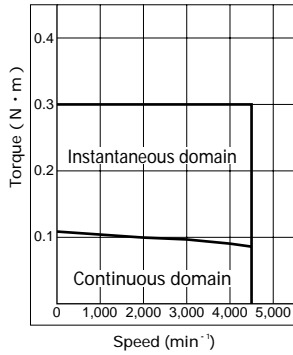

P50B03003P (30W)

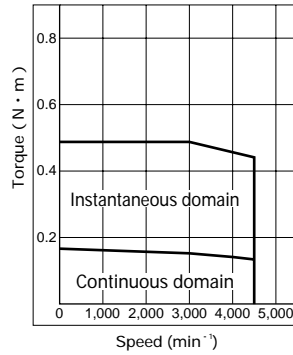

P50B05005P (50W)

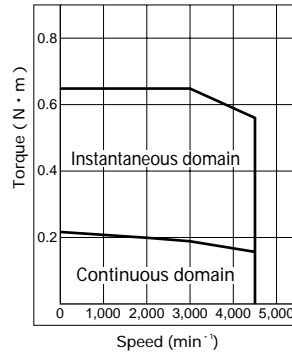

P50B04006P (60W)

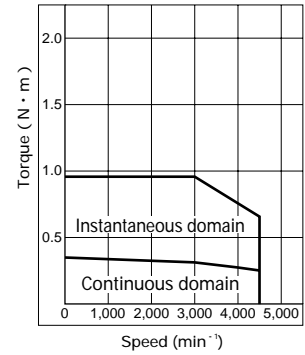

P50B04010P (100W)

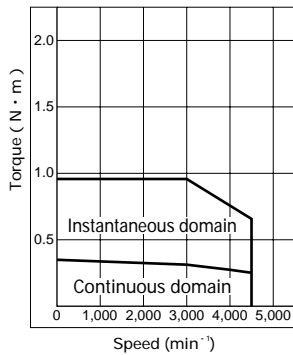

P50B05010P (100W)

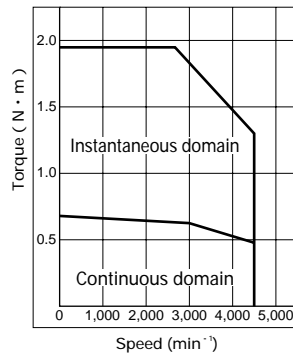

P50B05020P (200W)

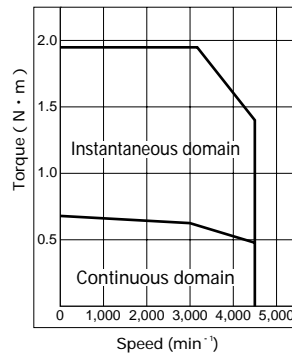

P50B07020P (200W)

Dimensions [unit:mm]

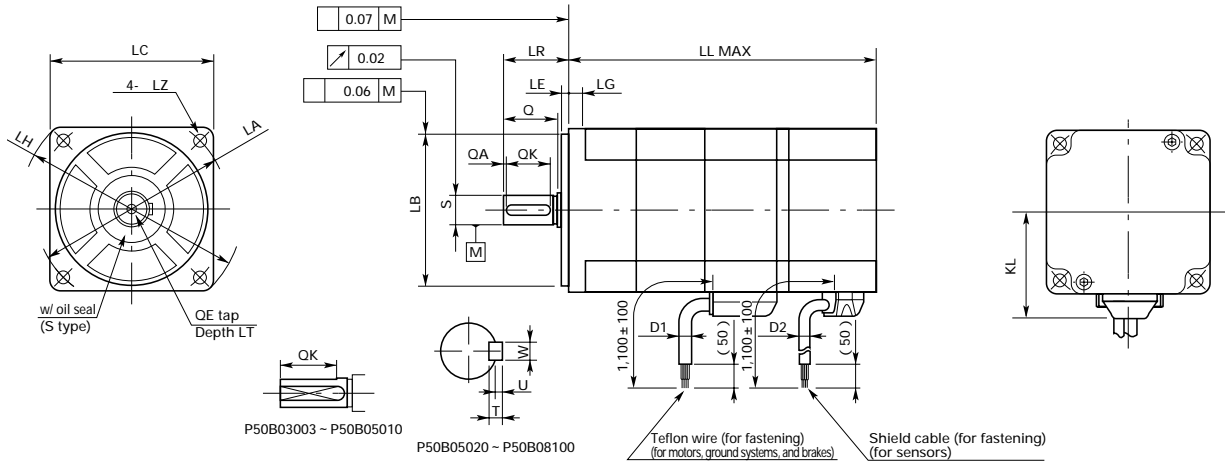

MODEL	Incremental		ABS-R		LG	KL	LA	LB	LE	LH	LC	LZ	LR	S	Q	QA	QK	W	T	U	OE	LT	D1	Incremental	ABS-R	Oil seal		
	w/o brake	w/ brake	w/o brake	w/ brake																							LL	LL
P50B03003	67.5	98	87	117	4.5	27.5	40	30 - 0.021	2	47	35	3.5	15	5 - 0.008			11	With 2 slots 4.5 ± 0.2					6			No		
P50B04006	82	114	100	132	5	31	48	34 - 0.025	2	57	42	3.5	24	7 - 0.009	20	15	15	With 2 slots 6.5 ± 0.2					6	5.1				
P50B04010	95	127	113	145																								
P50B05005	76	105	95.5	124.5	5	38	60	50 - 0.025	2.5	71.5	54	4.5	24	8 - 0.009	20	15	With 2 slots 7.5 ± 0.2		M3	8	6.7	4.7	7.9	Yes				
P50B05010	86	115	105.5	134.5																								
P50B05020	105	134	124.5	153.5	8	50	90	70 - 0.030	3	102.5	76	5.5	30	14 - 0.011	25	2	20	4	4	1.5	M4	10	6.7	7.9	Yes			
P50B07020	97	124	102	129																								
P50B07030	103	130	108	135	8	55	100	80 - 0.030	3	115	86	6.6	35	16 - 0.011	30	2	25	5	5	2	M5	12	6.7	7.9	Yes			
P50B07040	113	140	118	145																								
P50B08050	126	166	131	171	8	55	100	80 - 0.030	3	115	86	6.6	35	16 - 0.011	30	2	25	5	5	2	M5	12	6.7	7.9	Yes			
P50B08075	149	189	154	194																								
P50B08100	172	212	177	217																								

Note: ABS-E and ABS-R111 come with sensors having different dimensions.

Planetary gears

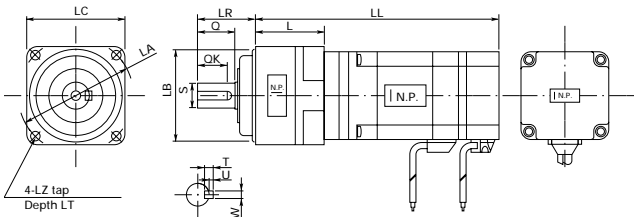

Flat gears

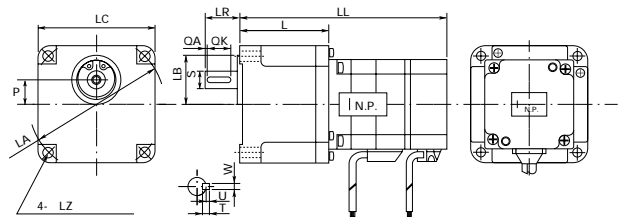

Flat gears	LL	L	LA	LB	LC	S	LR	Q	LZ	LT	QK	W	T	U	Mass of gear only Kg
	mm	mm	mm	mm	mm	mm	mm	mm	mm	mm	mm	mm	mm	mm	
P50B05010DXS *A	129	43													0.5
P50B05010DXS *B															
P50B05010DXS *C															
P50B05010DXS *D	144	58	60	50	54	12	32	20	M5	10	16	4	4	1.5	0.65
P50B05005DXS *E	134														
P50B07040DXS *A	173	60													1.85
P50B07040DXS *B															
P50B07040DXS *C															
P50B07040DXS *D	193	80	90	70	78	19	50	30	M6	12	22	6	6	2.5	2.3
P50B07030DXS *E	183														
P50B08075DXS *A	209	60													1.85
P50B08075DXS *B															
P50B08075DXS *C															
P50B08075DXS *D	243	94	115	90	96	24	61	40	M8	16	30	8	7	3	3.5

Flat gears	LL	L	LA	LB	LC	S	LR	LZ	LT	QK	QA	W	T	U	Mass of gear only Kg
	mm	mm	mm	mm	mm	mm	mm	mm	mm	mm	mm	mm	mm	mm	
P50B04006DXS *J															
P50B04006DXS *K	129	47	70	18	60	8	32	4.5	6	12	2	3	3	0.4	
P50B04006DXS *L															1.5
P50B05020DXS *J	156														
P50B05020DXS *K	156	51	94	44	82	12	26.5	6.6	8	16	2	4	4	0.7	
P50B05010DXS *L	137														
P50B07040DXS *J	191														
P50B07040DXS *K	191	78	120	40	102	15	32	6.5	10	20	2	5	5	2	1.3
P50B07030DXS *L	181														
P50B08075DXS *J	229														
P50B08075DXS *K	229	80	146	50	120	19	35	9	12	25	2	6	6	2.5	1.5
P50B08050DXS *L	206														

Backlash-less planetary gears

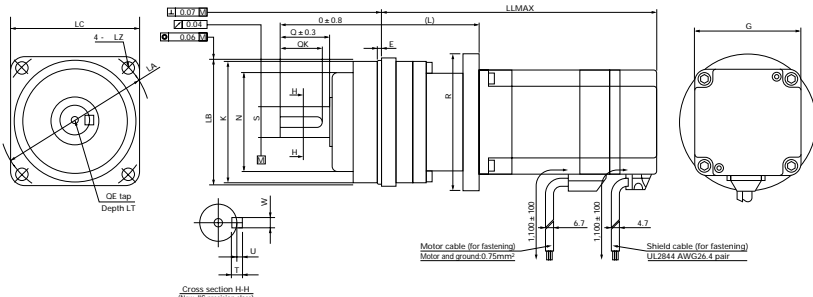

Backlash-less planetary gear	LL	L	LA	LB	E	LC	LR	G	S	QK	Q	K	N	R	LZ	QE	LT	KL	W	T	U	Mass	
	mm	mm	mm	mm	mm	mm	mm	mm	mm	mm	mm	mm	mm	mm	mm	mm	mm	mm	mm	mm	mm	mm	Kg
P50B05010DXS *S	136	50																					
P50B05010DXS *T	145																						
P50B05005DXS *U	135	59	80	65	8	70	60	54	16	25	28	64.5	50	72	6.6	M4	8	38	5	5	2	0.8	
P50B05005DXS *V	135																						
P50B07040DXS *S	174	61	105	85	10	90	74		20	32	36	83	60			M5	10		6	6	2.5	1.6	
P50B07040DXS *T	193																						
P50B07030DXS *U	183	80	120	100	12	105	84	76	25	36	42	96	70	104	9	M6	12	50	8	7	3	2.4	
P50B07020DXS *V	177																						
P50B08075DXS *S	217	68	120	100	12	105	84		25	36	42	96	70	116	9	M6	12		8	7		2.4	
P50B08075DXS *T	237																						
P50B08050DXS *U	214	88	135	115	14	120	105	86	32	50	58	112	90	120	11	M8	16	55	10	8	3	3.9	

External connection diagram for "P5"

Incremental encoder

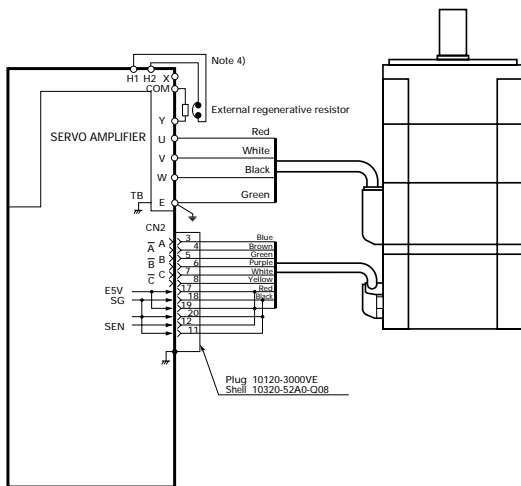

Absolute sensor (ABS-R)

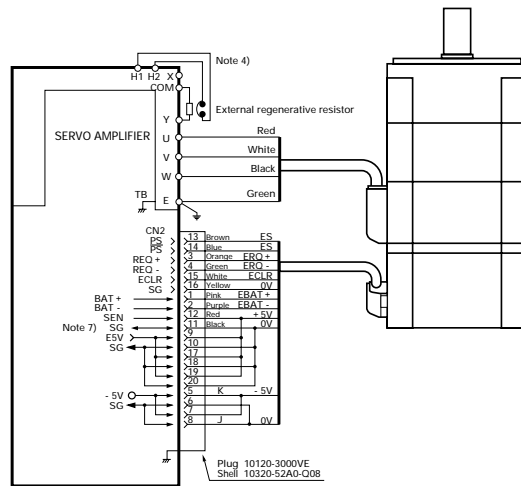



Capacity
0.5 to 30kW (18 types)

Features

Small and highly rigid

Faster servos

Maximum rotating speed of 4,500min⁻¹ for quicker positioning.

Uses

Robots

General-purpose machine tools

Transfer machines

Food processors

Medical equipment

Machines for industrial industries

Common specifications

Time rating	Continuous
Insulation grade	F type
Dielectric strength	1,500 VAC, 1 minute
Insulation grade	500 VDC, 10 M or more
Protection method	Fully closed, self-cooled, IP67 Models with 20kW through 30kW fans are forcefully cooled, IP45.
Presence/lack of seal	Yes
Ambient temperature	0 to +40
Storage temperature	- 20 to 65
Ambient humidity	20 to 90% (non-condensing)
Vibration grade	V15
Paint color	Munsell N1.5 or equivalent (circumference)
Excitation system	Permanent magnet
Installation method	Flange type

Standard specifications

Motor model (wiring-saving INC, w/o brake): < > dimensions of flange angle			P60B13050HXS 《130》	P60B13100HXS 《130》
Sq. flange size in 《 》	Condition	Symbol	Unit	
Rated output		PR	kW	0.5
Rated rotating speed		NR	min ⁻¹	2,000
Maximum rotating speed		Nmax	min ⁻¹	3,000
Rated torque		TR	N · m	2.5
Continuous stall torque		TS	N · m	3.0
Instantaneous maximum stall torque		TP	N · m	7.0
Rated armature current		IR	Arms	4.5
Continuous stall armature current		IS	Arms	5.2
Instantaneous maximum stall armature current		IP	Arms	15.0
Torque constant		KT	N · m/Arms	0.65
Induced voltage constant		KE	mV/min ⁻¹	22.5
Phase armature resistance		R		0.64
Rated power rate		QR	kW/S	22
Electric time constant		te	ms	9.1
Mechanical time constant (w/o sensor)		tm	ms	1.3
Rotor inertia (INC)		JM	kg · m ² (GD ² /4)	2.8 × 10 ⁻⁴
Rotor inertia (ABS-RII / RIII)		JM	kg · m ² (GD ² /4)	2.8 × 10 ⁻⁴
Detector wiring-saving INC			P/R	2,000
Detector ABS-RII / RIII			P/R	8,192
Mass including wiring-saving INC		WE	kg	4.7
Brake holding torque		TB	N · m	3.5
Brake excitation voltage		VB	V	90 (24)
Brake excitation current		IB	A	0.25 (0.91)
Brake inertia		JB	kg · m ² (GD ² /4)	0.5 × 10 ⁻⁴
Brake mass		W	kg	1.5
Motor operating temperature and humidity				Temperature: 0 to 40 , humidity: 90% or less (non-condensing)

Applicable amplifier model		PZ0A030	PZ0A050
Amplifier power supply	---	200 to 230V AC +10% -15% 50/60Hz ±3Hz 3-phase	
Amplifier operating temperature and humidity		Temperature: 0 to 55 , humidity: 90% or less (non-condensing)	
Power capacity (at rating)	kVA	1.4	2.5
Amplifier mass	kg	2.2	4.4

Motor model (wiring-saving INC, w/o brake): < > dimensions of flange angle			P60B18750RXS 《180》	P60B22550MXS 《220》
Sq. flange size in 《 》	Condition	Symbol	Unit	
Rated output		PR	kW	7.5
Rated rotating speed		NR	min ⁻¹	1,500
Maximum rotating speed		Nmax	min ⁻¹	2500
Rated torque		TR	N · m	48.0
Continuous stall torque		TS	N · m	54.9
Instantaneous maximum stall torque		TP	N · m	118
Rated armature current		IR	Arms	58
Continuous stall armature current		IS	Arms	65
Instantaneous maximum stall armature current		IP	Arms	155
Torque constant		KT	N · m/Arms	0.90
Induced voltage constant		KE	mV/min ⁻¹	31.6
Phase armature resistance		R		0.014
Rated power rate		QR	kW/S	243
Electric time constant		te	ms	26
Mechanical time constant (w/o sensor)		tm	ms	0.49
Rotor inertia (INC)		JM	kg · m ² (GD ² /4)	95.1 × 10 ⁻⁴
Rotor inertia (ABS-RII / RIII)		JM	kg · m ² (GD ² /4)	95.1 × 10 ⁻⁴
Detector wiring-saving INC			P/R	2,000
Detector ABS-RII / RIII			P/R	8,192
Mass including wiring-saving INC		WE	kg	44.7
Brake holding torque		TB	N · m	54.9
Brake excitation voltage		VB	V	90 (24)
Brake excitation current		IB	A	0.37 (1.4)
Brake inertia		JB	kg · m ² (GD ² /4)	4.5 × 10 ⁻⁴
Brake mass		W	kg	6.0
Cooling fan		Pf	W	10.4
Motor operating temperature and humidity				Temperature: 0 to 40 , humidity: 90% or less (non-condensing)

Applicable amplifier model		PZ0A300	PZ0A150
Amplifier power supply	---	200 to 230V AC +10% -15% 50/60Hz ±3Hz 3-phase	
Amplifier operating temperature and humidity		Temperature: 0 to 55 , humidity: 90% or less (non-condensing)	
Power capacity (at rating)	kVA	12.6	10.1
Amplifier mass	kg	22	8.5

Notes: 1. means a combination with a standard amplifier after the temperature rises and gets saturated. The values are typical.
2. means values when the windings are at 20 . The values are typical.



P60B13150HXS 《130》	P60B13200HXS 《130》	P60B15300HXS 《150》	P60B18200HXS 《180》	P60B18350HXS 《180》	P60B18450RXS 《180》	P60B18550RXS 《180》	Symbol
1.5	2.0	3.0	2.0	3.5	4.5	5.5	PR
2,000						1,500	NR
3,000			2,500				Nmax
7.5	9.5	14.5	9.5	17.0	21.5	35.0	TR
9.0	12.0	18.0	12.0	22.0	32.0	37.3	TS
20.0	30.0	44.0	30.0	50.0	70.0	88.3	TP
9.4	15.5	25.0	14.6	26.4	24.9	32	IR
10.7	18.3	28.1	17.0	32.3	34.0	33	IS
26.5	52.4	77.7	48.7	80.2	81.2	83	IP
0.90	0.69	0.68	0.74	0.75	1.03	1.18	KT
31.4	24.1	23.5	25.7	26.0	36.0	41.2	KE
0.27	0.10	0.048	0.079	0.048	0.052	0.040	R
67	77	102	42	83	98	198	QR
10	12	17	20	19	23	23	te
0.82	0.75	0.65	0.94	0.89	0.69	0.52	tm
8.3×10^{-4}	12.1×10^{-4}	20.1×10^{-4}	22.1×10^{-4}	34.1×10^{-4}	47.1×10^{-4}	61.9×10^{-4}	JM
8.3×10^{-4}	12.1×10^{-4}	20.1×10^{-4}	22.1×10^{-4}	34.1×10^{-4}	47.1×10^{-4}	61.9×10^{-4}	JM
2,000							
8,192							
7.8	9.8	13.4	13.6	17.7	21.7	31.7	WE
9.0	12.0	20.0	12.0	32.0		54.9	TB
90 (24)							VB
0.25 (0.86)	0.28 (1.0)	0.27 (1.0)	0.28 (1.0)	0.37 (1.4)			IB
0.5×10^{-4}		0.68×10^{-4}	0.5×10^{-4}	3.4×10^{-4}		4.5×10^{-4}	JB
1.5	1.7	2.6	1.9	5.0		6.0	W
Temperature: 0 to 40 , humidity: 90% or less (non-condensing)							
PZ0A050	PZ0A100	PZ0A150	PZ0A100	PZ0A150			
200 to 230V AC +10% - 15% 50/60Hz ±3Hz 3-phase							
Temperature: 0 to 55 , humidity: 90% or less (non-condensing)							
3.9	5.0	6.9	5.0	7.4	8.4	10.1	
4.4	6.0	8.5	6.0	8.5			
P60B22700SXS 《220》	P60B2211KBXS 《220》	P60B2215KBXS 《220》	P60B2220KBXS 《220》	P60B2820KMXS 《275》	P60B2825KMXS 《275》	P60B2830KMXS 《275》	Symbol
7.0	11	15	20		25	30	PR
1,000			1,500				NR
1,000		2,000			1,500		Nmax
67.0	70.0	95.5	127.4		156.8	191.1	TR
70.0	88.3	95.5	127.4		156.8	191.1	TS
150.0	181	240	280.3	313.6	362.6	411.6	TP
31.3	51	58	104.7	97.5	108.2	117.7	IR
32.4	64	58	98.3	87.1	94.7	109.5	IS
77.1	142	155	180.6	179	177.3	185.3	IP
2.32	1.48	1.78	1.38	1.49	1.74	1.88	KT
80.9	51.5	62.3	48.1	52.1	60.7	65.7	KE
0.063	0.0155	0.020	0.012	0.014	0.015	0.014	R
254	217	367	655	428	581	821	QR
32	39	37	33	34	36	38	te
0.62	0.53	0.47	0.47	0.71	0.63	0.53	tm
177×10^{-4}	225×10^{-4}	248×10^{-4}		380×10^{-4}	424×10^{-4}	445×10^{-4}	JM
177×10^{-4}	225×10^{-4}	248×10^{-4}		380×10^{-4}	424×10^{-4}	445×10^{-4}	JM
2,000							
8,192							
52.8	67.5	77.5	83	95	100	109	WE
90.0				191.1			TB
90 (24)							VB
0.44 (1.7)				0.75 (2.46)			IB
24×10^{-4}				11.8×10^{-4}			JB
10.4				19.1			W
				65			PF
200 to 230V AC +10% - 15% 3-phase 50/60Hz							
Temperature: 0 to 40 , humidity: 90% or less (non-condensing)							
PZ0A150	PZ0A300		PZ0A600				
200 to 230V AC +10% - 15% 50/60Hz ±3Hz 3-phase							
Temperature: 0 to 55 , humidity: 90% or less (non-condensing)							
12.2	15.7	21.4					
8.5	22						

“P6” + “PZ” system: characteristics of torque versus rotating speed

P series

P6

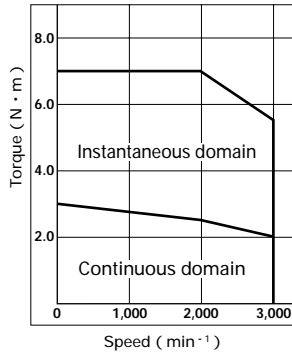

P60B13050H (0.5kW)

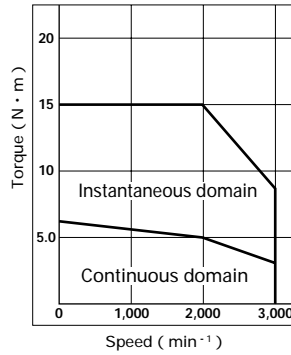

P60B13100H (1.0kW)

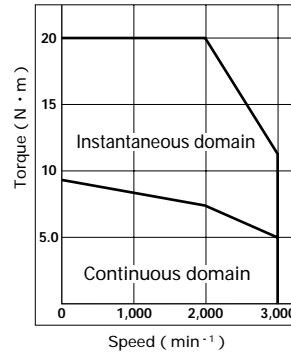

P60B13150H (1.5kW)

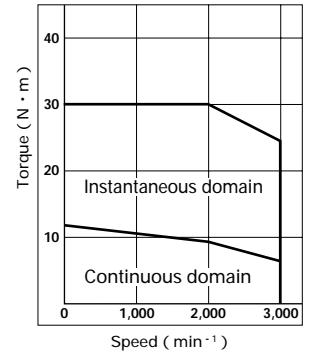

P60B13200H (2.0kW)

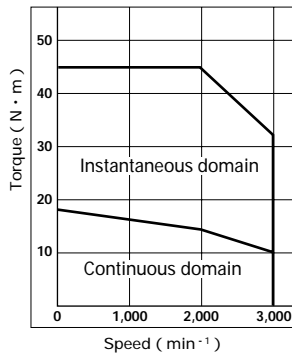

P60B15300H (3.0kW)

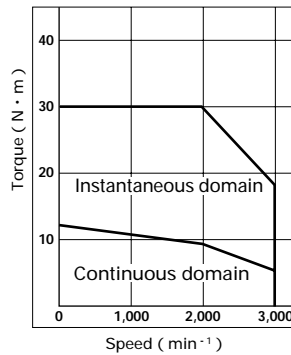

P60B18200H (2.0kW)

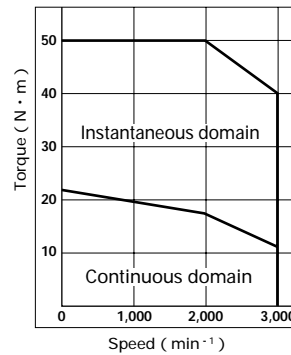

P60B18350H (3.5kW)

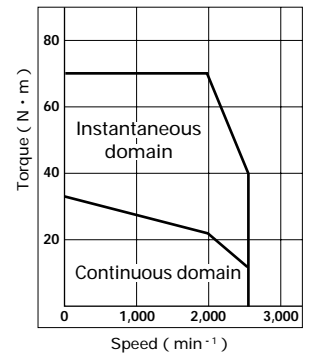

P60B18450R (4.5kW)

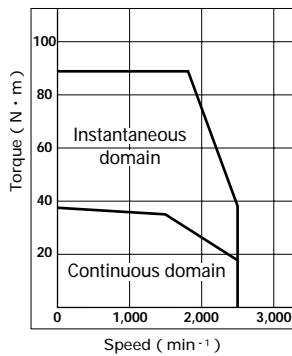

P60B18550R (5.5kW)

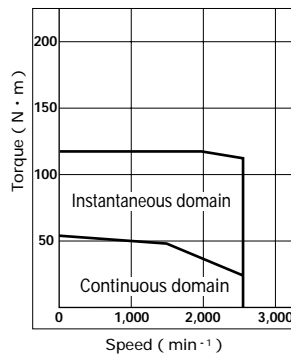

P60B18750R (7.5kW)

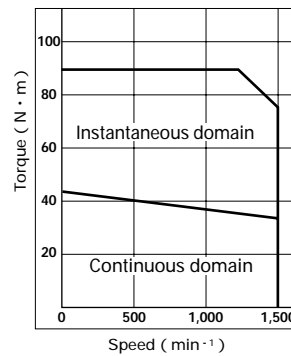

P60B22550M (5.5kW)

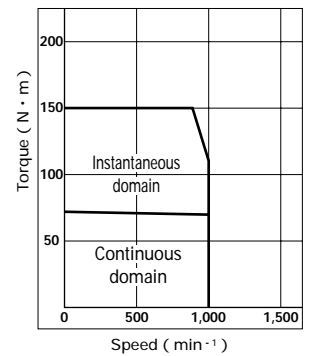

P60B22700S (7.0kW)

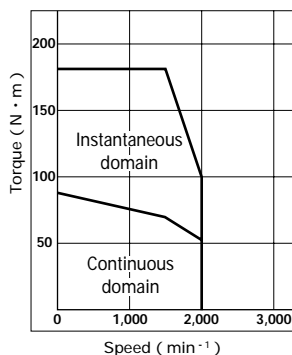

P60B2211KB (11kW)

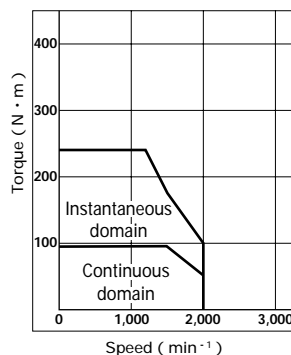

P60B2215KB (15kW)

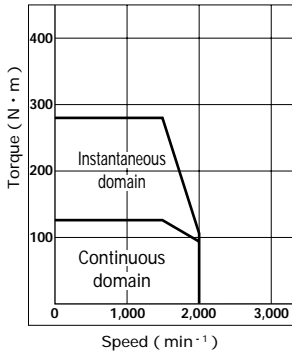

P60B2220KB (20kW)

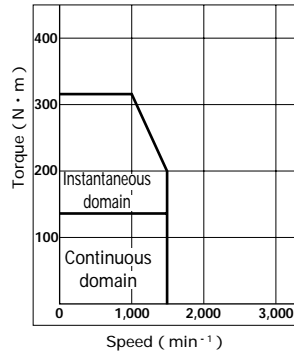

P60B2820KM (20kW)

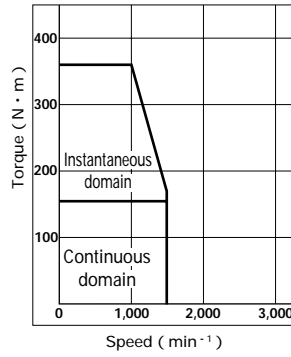

P60B2825KM (25kW)

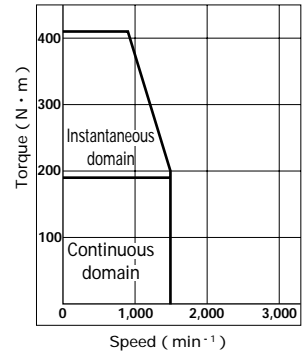

P60B2830KM (30kW)

Dimensions [unit:mm]

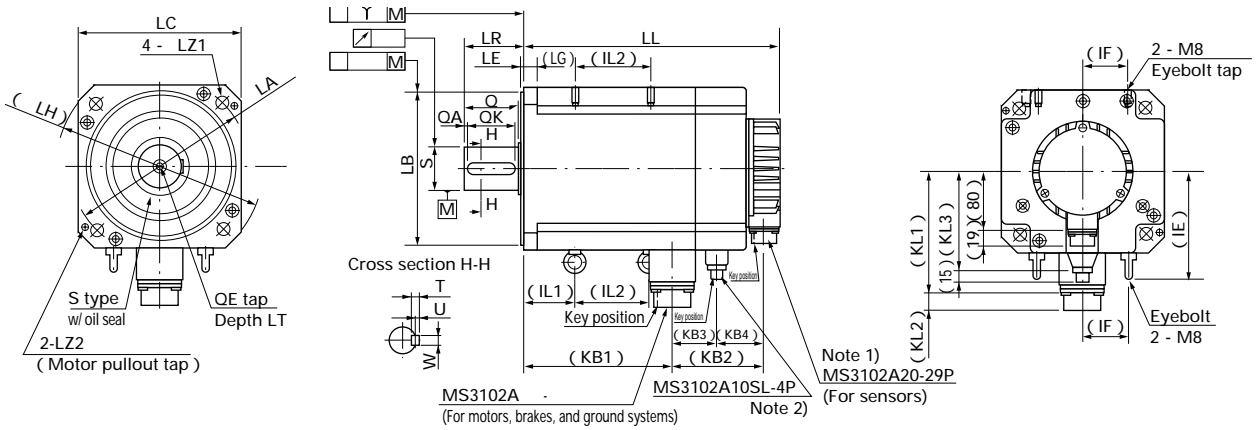

MODEL	Incremental ABS - R				ABS - E				Connector, note 1)																																				
	w/o brake	w/ brake	w/o brake	w/ brake	w/o brake	w/ brake	w/o brake	w/ brake	Motor and ground system	Brake (if any)	KL1	KL2	KL3	LG	LA	LB	LE	LH	LC	LZ1	LZ2	LR	S	QA	QK	W	T	U	KB1	Y	QE	LT	IE	IF	IL1	IL2									
P60B13050	113	56	143	86		123	66	153	96																																				
P60B13100	133	166	90		143	176	100			24 - 11P	98	21	12	145	110-0.035	4	165	130	9	M6	55		22-0.013	50	3	42		6-0.030	6	2.5	56														
P60B13150	152	57	185		162	67	195																																						
P60B13200	171	208	94		181	218	104																																						
P60B15300	182	56	225	99	192	66	235	109		24 - 11P	106	21	12	165	130-0.040	4	190	150	11	M6	50		28-0.013	50	3	42		8-0.036	7	3	94														
P60B18200	144	179			154	189																																							
P60B18350	169	56	204	91	179	66	214	101		24 - 11P	123	21	16	200	114.3-0.035	3	230	180	13.5	M8	65		35-0.016	60	3	50		10-0.036	8	3	93	0.02	0.08	0.08	M8	25				64	20				
P60B18450	192	227			202	237																																							
P60B18550	267	314			277	324																																							
P60B18750	332	72	379	119	59	60	342	102	324	129	59	70	32 - 17P	10SL - 4P	144	22	115	19	200	114.3-0.035	3	230	180	13.5	M8	79	42	0-0.016	75	3	67	12-0.043	8	3	175	0.02	0.08	0.08	M10	25	124	50		60	70
P60B22550M	209	256	107		219	70	266	117																																					
P60B22700S	285	60	332		295	342			24 - 11P	141	21	19	235	200-0.046	4	270	220	13.5	M10	79		55-0.019	75	3	67		16-0.043	10	4	209	0.03	0.08	0.10	M10	25	142	60		53	40					
P60B2211K	362	409			382	429				32 - 17P	162	22	132	19	235	200-0.046	4	270	220	13.5	M10	79		55-0.019	75	3	67		16-0.043	10	4	256	0.03	0.08	0.10	M10	25	142	60		69	100			
P60B2215K	405	87	452	134	59	75	472	107	429	154	59	95	32 - 17P	10SL - 4P	162	22	132	19	235	200-0.046	4	270	220	13.5	M10	79		16-0.043	10	4	299	0.03	0.08	0.10	M10	25	142	60		69	130				

Note 1): Connectors are waterproof when engaged. To meet the needs of IP76, therefore, use waterproof connectors for receiving plugs.

Note 2): Available only in P60B18550, 18750, 2211K, and 2215K equipped with a brake.

Note 3): Some models of P60B22700 have different dimensions when the maximum rotating speed changes. Contact our sales representative.

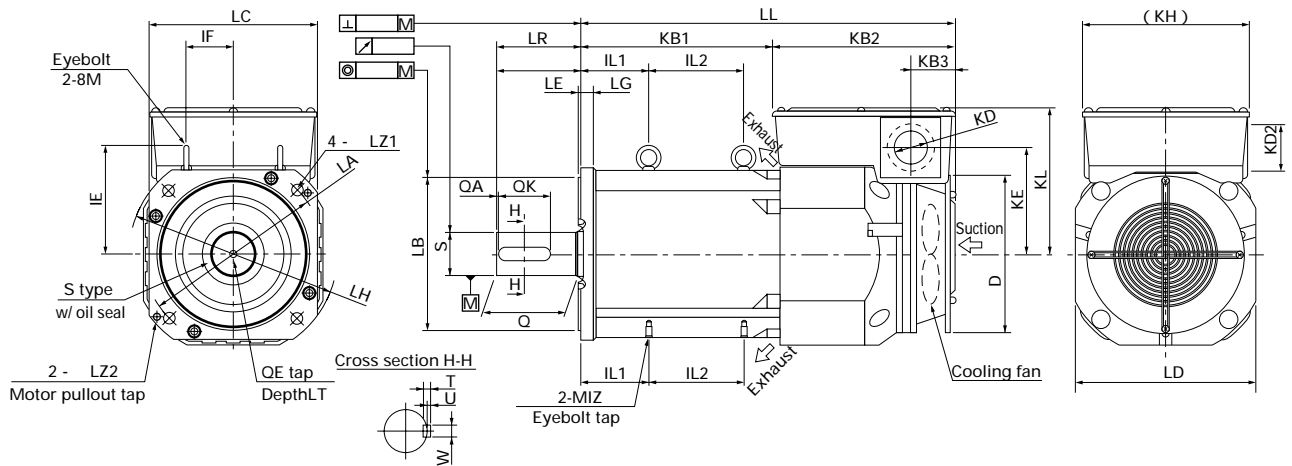

MODEL	Incremental ABS - R		KL	KH	LG	LA	LB	LE	LH	LC	LZ1	LZ2	LR	S	Q	QA	QK	W	T	U	KB1	KB3	KD1	KD2	KE	QE	LT	IE	IF	IL1	IL2	IZ	LD	D				
	w/o brake	w/ brake																																				
P60B2220K	490	605	191		19	235	200-0.046	4	270	220	13.5	M10		106							251				139	0.03	0.08											
P60B2820K	429	529	238	218		300	250-0.052	5	345	275	18.5	M12	110	55-0.019		3	67	16-0.043	10	4	190	58	42.5	61														
P60B2825K	454	554	215																		215				163	0.04	0.1	0.1	M10	25								
P60B2830K	479	579																			240																	

External connection diagram for "P6"

1. P60B13050 to 2215K (models with a cannon plug)

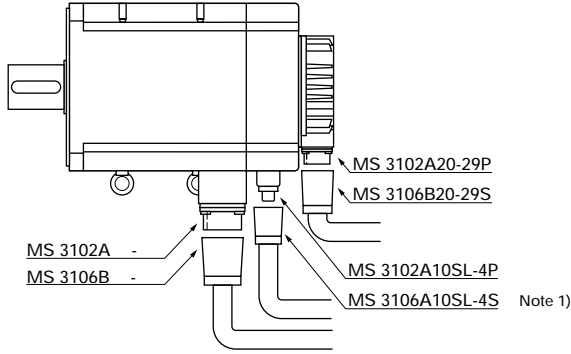

Note 1) Available in P60B18550, 18750, 2211K, and 2215K with a brake.

MODEL	Brake	Plug and clamp	Terminal number				
			U	V	W	E	Brake
Other than those below	Yes	MS3106B24-11S,MS3057-16A	D	E	F	G,H	A,B
	No	(non-waterproof)	D	E	F	G,H	-
P60B18550	Yes	MS3106B32-17S,MS3057-40A	A	B	C	D	
P60B18750							A,B
P60B2211K	No	MS3106B10SL-4S,MS3057-4A	A	B	C	D	
P60B2215K							-

2. P60B2220K to 2830K(Terminal block type)

MODEL	Brake	Terminal block	
		Motor	Fan motor and brake
P60B2220K	Yes	UF1005-150A-3P (M8, hexagon bolt)	F1005-20S-5P (M4, round head sems screw)
P60B2820K			
P60B2825K	No		
P60B2830K			

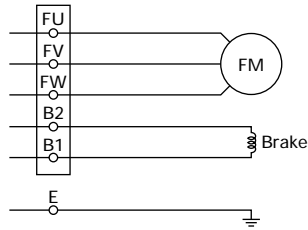
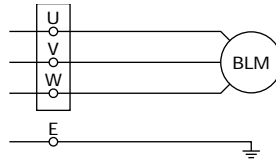

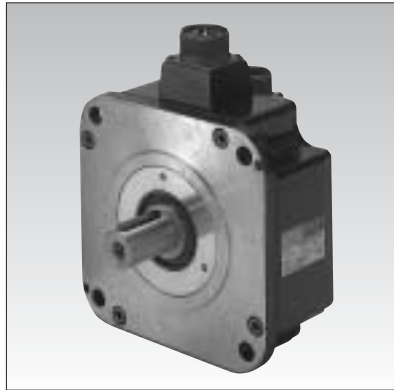

Capacity
0.75 to 4.5kW (5 types)

Features

Flat

Faster servos

Maximum rotating speed of
4,500min⁻¹ for quicker positioning.

Uses

Robots

General-purpose machine tools

Transfer machines

Machines for industrial industries

Common specifications

Time rating	Continuous
Insulation grade	F type
Dielectric strength	1,500 VAC, 1 minute
Insulation grade	500 VDC, 10 M or more
Protection system	Fully closed, self-cooling, IP67
Presence/lack of seal	Yes
Ambient temperature	0 to +40
Storage temperature	-20 to 65
Ambient humidity	20 to 90% (non-condensing)
Vibration grade	V15
Paint color	Munsell N1.5 or equivalent (circumference)
Excitation system	Permanent magnet
Installation method	Flange type

Standard specifications

Motor model (wiring-saving INC, w/o brake) < > dimensions of flange angle	Condition	Symbol	Unit	P80B15075HXS 《150》	P80B18120HXS 《180》
Sq. flange size in 《 》					
Rated output		PR	W	0.75	1.2
Rated rotating speed		NR	min ⁻¹	2,000	
Maximum rotating speed		Nmax	min ⁻¹	3,000	
Rated torque		TR	N · m	3.6	5.6
Continuous stall torque		TS	N · m	3.7	6.5
Instantaneous maximum stall torque		TP	N · m	9.0	14.0
Rated armature current		IR	Arms	5.2	10.4
Continuous stall armature current		IS	Arms	5.2	10.8
Instantaneous maximum stall armature current		IP	Arms	13.9	26.5
Torque constant		KT	N · m/Arms	0.78	0.73
Induced voltage constant		KE	mV/min ⁻¹	27.0	25.3
Phase armature resistance		R		0.44	0.22
Rated power rate		QR	kW/S	25	27
Electric time constant		te	ms	13	18
Mechanical time constant (w/o sensor)		tm	ms	1.1	1.5
Rotor inertia (INC)		JM	kg · m ² (GD ² /4)	5.3 × 10 ⁻⁴	12.1 × 10 ⁻⁴
Rotor inertia (ABS-RII / RIII)		JM	kg · m ² (GD ² /4)	5.3 × 10 ⁻⁴	12.1 × 10 ⁻⁴
Detector wiring-saving INC			P/R	2,000	
Detector ABS-RII / RIII			P/R	8,192	
Mass including wiring-saving INC		WE	kg	6.2	10.0
Brake holding torque		TB	N · m	9.0	
Brake excitation voltage		VB	V	90 (24)	
Brake excitation current		IB	A	0.25 (0.86)	
Brake inertia		JB	kg · m ² (GD ² /4)	0.5 × 10 ⁻⁴	
Brake mass		W	kg	1.5	
Motor operating temperature and humidity				Temperature: 0 to 40 , humidity: 90% or less (non-condensing)	

Applicable amplifier model	PZ0A030	PZ0A050	
Amplifier power supply	200 to 230V AC +10% -15% 50/60Hz ±3Hz 3-phase		
Amplifier operating temperature and humidity	Temperature: 0 to 55 , humidity: 90% or less (non-condensing)		
Power capacity (at rating)	kVA	1.8	3.1
Amplifier mass	kg	2.2	4.4

- Notes: 1. means a combination with a standard amplifier after the temperature rises and gets saturated. The values are typical.
2. means values when the windings are at 20 . The values are typical.



	P80B22250HXS 《220》	P80B22350HXS 《220》	P80B22450RXS 《220》	Symbol
	2.5	3.5	4.5	PR
	2,000			NR
	3,000		2,500	Nmax
	12.0	17.0	21.5	TR
	13.5	22.0	32.0	TS
	30.0	50.0	70.0	TP
	21.4	24.3	24.1	LR
	22.4	29.3	31.6	LS
	55.0	76.1	79.7	LP
	0.66	0.78	1.05	KT
	23.0	27.4	36.7	KE
	0.056	0.036	0.043	R
	52	67	80	QR
	27	31	33	te
	1.1	0.76	0.68	tm
	27.1×10^{-4}	43.1×10^{-4}	58.1×10^{-4}	JM
	27.1×10^{-4}	43.1×10^{-4}	58.1×10^{-4}	JM
	2,000			
	8,192			
	15.5	18.5	22.0	WE
	32.0			TB
	90 (24)			VB
	0.42 (1.6)			LB
	9.9×10^{-4}			JB
	5.9			W
	Temperature: 0 to 40 , humidity: 90% or less (non-condensing)			
	PZ0A100	PZ0A150		
	200 to 230V AC +10% -15% 50/60Hz ±3Hz 3-phase			
	Temperature: 0 to 55 , humidity: 90% or less (non-condensing)			
	5.9	7.4	8.4	
	6.0	8.5		

“P8” + “PZ” system: characteristics of torque versus rotating speed

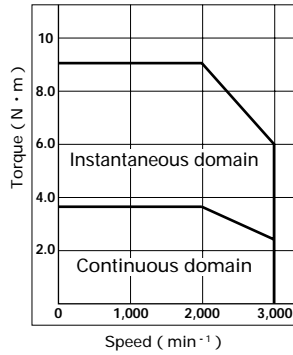

P80B15075H (0.75kW)

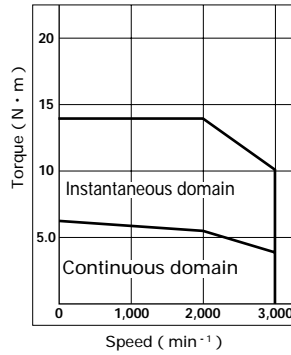

P80B18120H (1.2kW)

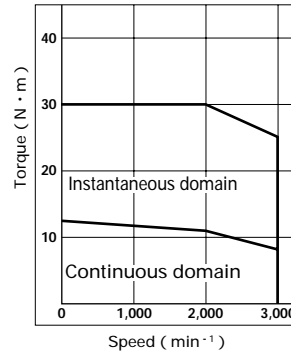

P80B22250H (2.5kW)

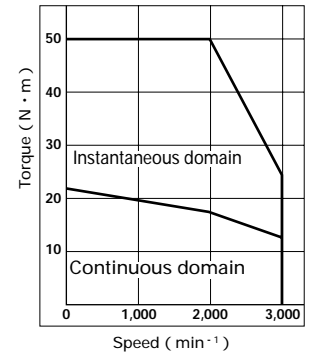

P80B22350H (3.5kW)

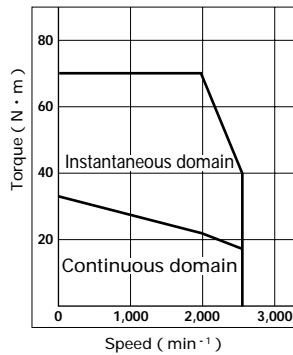

P80B22450R (4.5kW)

Dimensions [unit:mm]

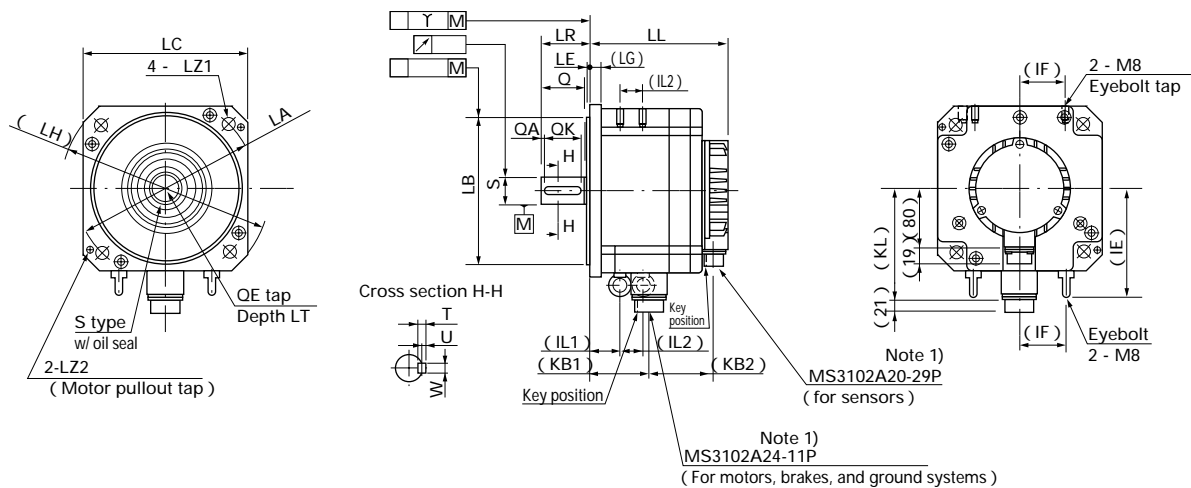

MODEL	Incremental/ABS - R				ABS - E				KL	LG	LA	LB	LE	LH	LC	LZ1	LZ2	LR	S	Q	QA	QK	W	T	U	KB1	QE	LT	IE	IF	IL1	IL2	
	w/o brake	w/ brake	w/o brake	w/ brake	LL	KB2	LL	KB2																									
P80B15075	116	56	150	90	126	66	160	100	106	12	165	$130^{0-0.040}$	4	190	150	11	M6	55	$22^{0-0.013}$	50	3	42	$6^{0-0.030}$	6	2.5	40	M6	20					
P80B18120	119	55	152	88	129	65	162	98	123	12	200	$114.3^{0-0.035}$	3	230	180	13.5	M8	55	$28^{0-0.013}$	50	3	42	$8^{0-0.036}$	7	3	44	M8	25					
P80B22250	122	154	132	164																					50					41			
P80B22350	136	52	168	84	146	62	178	94	141	16	235	$200^{0-0.046}$	4	270	220	13.5	M10	65	$35^{0-0.016}$	60	3	50	$10^{0-0.036}$	8	3	64	M8	25	142	60	40	15	
P80B22450	151	183	161	193																				79					40	30			

Note 1): Connectors are waterproof when engaged. To meet the needs of IP67, therefore, use waterproof connectors for receiving plugs.

External connection diagram for "P8"

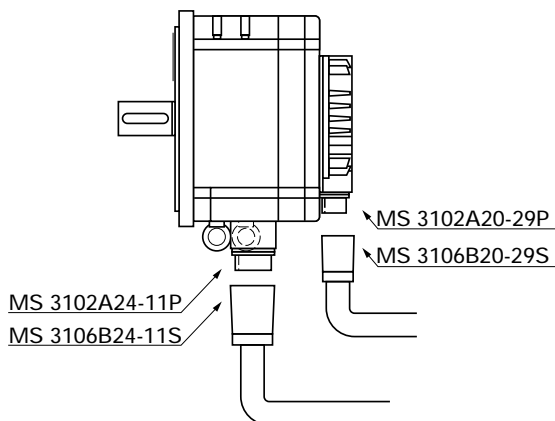

MODEL	Brake	Plug and clamp	Terminal number				
			U	V	W	E	Brake
P80B15075 P80B18120	Yes	MS3106B24-11S,MS3057-16A	D	E	F	G,H	A,B
P80B22250 P80B22350 P80B22450	No	MS3106B24-11S,MS3057-16A	D	E	F	G,H	-

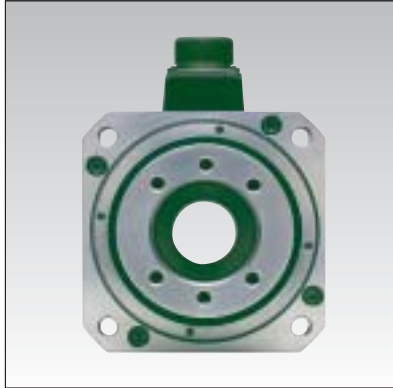

Uses

- Robots
- Machines with windings
- Machines for industrial industries
- General-purpose machine tools
- Transfer machines
- Food processors
- Medical equipment

Dimensions [unit:mm]

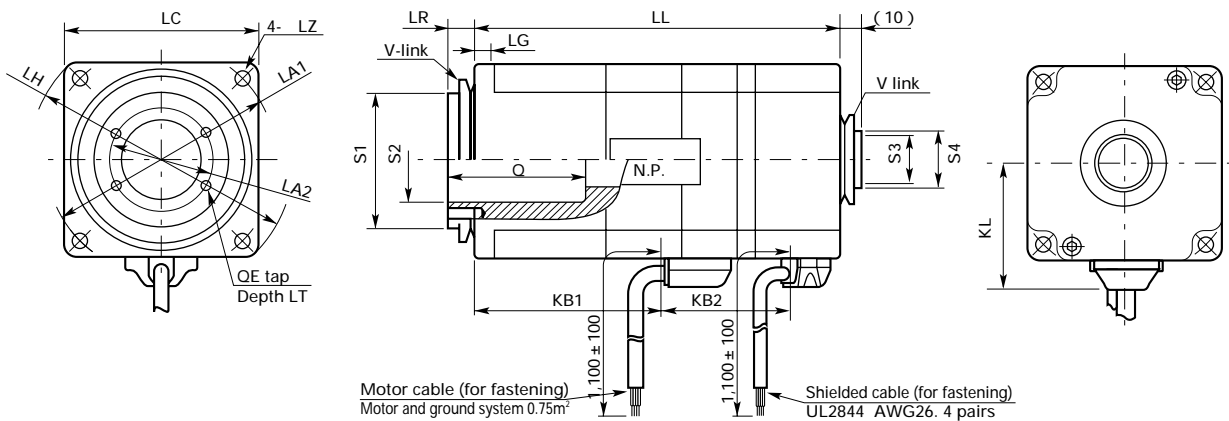

MODEL	Motor characteristics						Outside dimensions (note 1)													(Unit: mm)						
	Output W	Rated torque N·m	Instantaneous maximum torque N·m	Rated rotating speed min ⁻¹	Maximum rotating speed min ⁻¹	Applicable ball screw dia	LC	LH	LL	LA1	LZ1	LG	KB1	KB2	KL	LA2	Q	QE	LT	LR	S1	S2	S3	S4		
P50C07020DXS	200	0.637	1.96	3,000	4,500	20mm dia or smaller	76	102.5	124	90	5.5	8	62	47	50	(Note 2)								22 ± 0.2 (Ball screw, 20mm dia or smaller)	25	
P50C07030DXS	300	0.931	2.94						140				68													78
P50C07040DXS	400	1.276	3.92						150				83													83
P50C08050DXS	500	1.589	5.88						165				106													57
P50C08075DXS	750	2.381	8.82						188				106													55
P50C08100DXS	1,000	3.185	11.76						211				129													

How to read model numbers

Example: **P50C07020DXS**

Models equipped with a hollow shaft are marked C here. For other symbols, see the Standard Catalog for the "P5" series.

Sensor: Incremental encoder (wiring-saving); number of basic divisions, 2,000P/R

Waterproof: IP55 (except for the shaft end)

Dimensions [unit:mm]

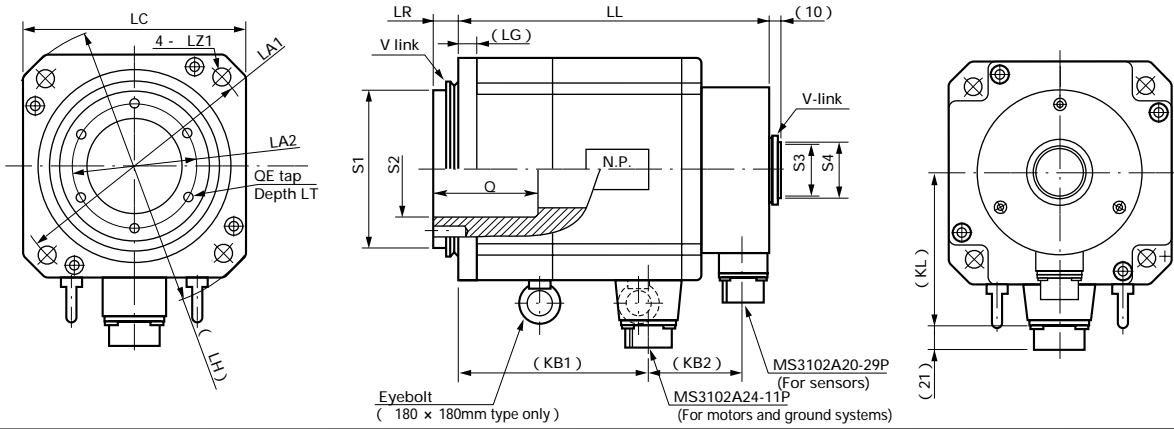

MODEL	Motor characteristics					Outside dimensions (note 1)																(Unit: mm)			
	Output kW	Rated torque N·m	Instantaneous maximum torque N·m	Rated rotating speed min ⁻¹	Maximum rotating speed min ⁻¹	Applicable ball screw dia	LC	LH	LL	LA1	LZ1	KB1	KB2	KL	LG	LA2	Q	QE	LT	LR	S1	S2	S3	S4	
P60C13050HXS	0.5	2.5	7.0	2,000	3,000	45mm dia or smaller	130	165	182	145	9	89	72	98	12	(Note 2)	Q	QE	LT	LR	S1	S2	S3	S4	
P60C13100HXS	1.0	5.0	15.0				202	109	128																
P60C13150HXS	1.5	7.5	20.0				221	128	147																
P60C13200HXS	2.0	9.5	30.0			240	147	128																	
P60C18200HXS	2.0	9.5	30.0			225	128	76	123	16															
P60C18350HXS	3.5	17.0	50.0			250	153	76	123	16															
P60C18450RXS	4.5	21.5	70.0	2,500	3,000	45mm dia or smaller	180	230	273	200	13.5	153	176	76	123	16									55

How to read model numbers

Example: **P60C13050DXS**

Models equipped with a hollow shaft are marked C here. For other symbols, see the Standard Catalog for the "P6" and "P8" Series.

Sensor: Incremental encoder (wiring-saving); number of basic divisions, 2,000P/R

Waterproof: IP55 (except for the shaft end)

Dimensions [unit:mm]

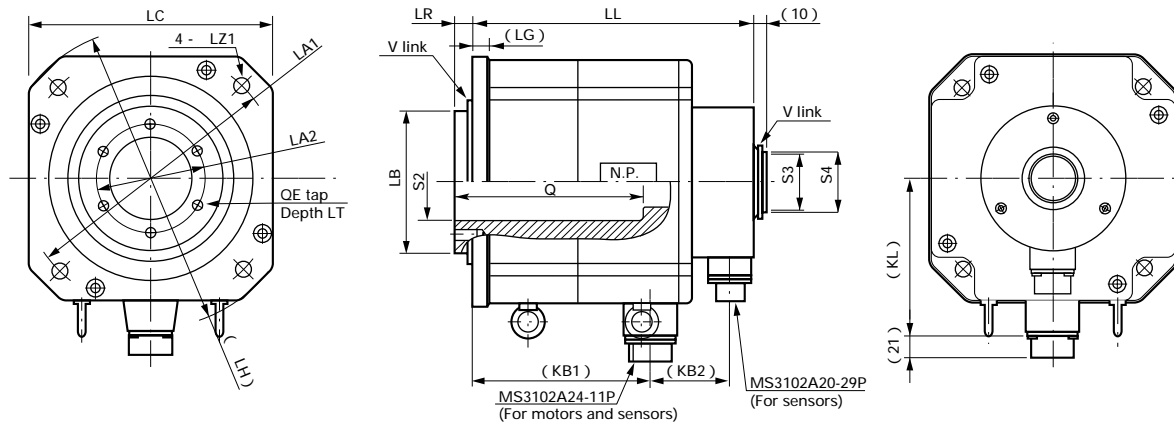

MODEL	Motor characteristics					Outside dimensions (note 1)																(Unit: mm)		
	Output kW	Rated torque N·m	Instantaneous maximum torque N·m	Rated rotating speed min ⁻¹	Maximum rotating speed min ⁻¹	Applicable ball screw dia	LC	LH	LL	LA1	LZ1	KB1	KB2	KL	LG	LA2	Q	QE	LT	LR	S1	S2	S3	S4
P80C22250HXS	2.5	12	30	2,000	3,000	45mm dia or smaller	220	270	223	235	13.5	129	72.5	141	16	(Note 2)	Q	QE	LT	LR	S1	S2	S3	S4
P80C22350HXS	3.5	17	50				237	143	158															
P80C22450RXS	4.5	21.5	70				252	158	158															

How to read model numbers

Example: **P80C22250DXS**

Models equipped with a hollow shaft are marked C here. For other symbols, see the Standard Catalog for the "P6" and "P8" Series.

Sensor: Incremental encoder (wiring-saving); number of basic divisions, 2,000P/R

Waterproof: IP55 (except for the shaft end)

Note 1: The outside dimensions are subject to change. When you consider purchasing any of these models, check their latest specifications with us.

Note 2: The dimensions of the nut bases for ball screws vary with ball screw types. For detailed dimensions, contact us.

Sales network

Network

AMERICA SANYO DENKI AMERICA, INC.

468 Amapola Avenue Torrance, CA 90501 U.S.A.

TEL: +1 310 783 5400 FAX: +1 310 212 6545

AMERICA SANYO DENKI AMERICA, INC.

Silicon Valley Office 1500 Wyatt Dr. Ste 10 Santa Clara, CA 95054 U.S.A.

TEL: +1 408 988 1700 FAX: +1 408 982 1700

AMERICA SANYO DENKI AMERICA, INC.

NEW ENGLAND OFFICE 35 Merchant Drive, Walpole, MA 02081 U.S.A.

TEL: +1 508 660 2470 FAX: +1 508 660 7912

AMERICA SANYO DENKI AMERICA, INC.

Midwest Office 100 Fairway Drive, Suite 126 Vernon Hills, IL 60061 U.S.A.

TEL: +1 847 362 3723 FAX: +1 847 362 4903

AMERICA AUTOMATION INTELLIGENCE INC.

2855 Premiere Parkway, Suite A Duluth, GA 30097-4902 U.S.A.

TEL: +1 770 497 8086 FAX: +1 770 497 8666

AMERICA ENPROTECH CORPORATION

15180 Keel Street Plymouth Township MI 48170-6006 U.S.A.

TEL: +1 734 414 8600 +1 800 228 2215 FAX: +1 734 414 8601

FRANCE SANYO DENKI EUROPE SA.

BP.50286 95958 Roissy Charles-De-Gaulle Cedex France

TEL: +33 1 48 63 26 61 FAX: +33 1 48 63 24 16

ITALIA R.T.A. s.r.l.

Via Einaudi, 5 27020 Travaso Siccomario (PV) Italy

TEL: +39 0382 559 001 FAX: +39 0382 559 810

GERMANY SANYO DENKI EUROPE SA.

German Liaison Office Niederlassung Deutschland,

Posthof 4 D86609 - Donauwoerth Germany

TEL: +49 906 24 57 00 FAX: +49 906 24 57 01

GERMANY Telemeter Electronic GmbH

Joseph-Gaensler-strasse 10D86609 - Donauwoerth Germany

TEL: +49 906 706 93 47 FAX: +49 906 706 93 50

GERMANY R.T.A Deutschland GmbH

Bublitzer Strasse 34 40599 Dusseldorf Germany

TEL: +49 211 7490581 FAX: +49 211 7490675

BELGIUM SERVOTRONIC BVBA

Wasseri jstraat 3, B-2900 SCHOTEN, Belgium

TEL: +31 172 490 505 FAX: +31 172 473 977

DENMARK IMCASE A/S

Svaneve j4, DK 2400 Kobenhavn NV, Denmark

TEL: +45 35 83 38 00 FAX: +45 35 83 34 00

U.K. EAO LTD.

Albert Drive, Burgess Hill, West Sussex RH15 9TN U.K.

TEL: +44 01444 23 6000 FAX: +44 01444 23 6641

U.K. WYKO INDUSTRIAL SERVICES

Slough Trading Estate 527 Ipswich Road Slough GB-SL1 4EP Berkshire

TEL: +44 1753 822 481 FAX: +44 1753 537 487

SWEDEN Moeller Electric AB

Skalholtsgatan 6 P.O.Box 1171 S-164 22Kista/Stockholm Sweden

TEL: +46 8 6323000 FAX: +46 8 7507978

FINLAND WEXON OY

Juhanilantie 4 FIN-01740 Vantaa, Finland

TEL: +358 9 290 440 FAX: +358 9 290 44100

SPAIN DIODE Espana, SA

Orense 94, 28020 Madrid, Spain

TEL: +91 456 81 00 FAX: +91 555 49 17

SWISS Telemeter Electronic GmbH

Im Gree 79, 8566 Ellighausen, Switzerland

TEL: +41 71 699 20 20 FAX: +41 71 699 20 24

ISRAEL CONLOG LTD.

7 Leshem St., Petach Tikva, P.O.B 3571 Petach Tikva 49134, Israel

TEL: +972 3 9269565 FAX: +972 3 9233367

AUSTRALIA TRONICS PTY LTD.

85 Northgate Drive, Thomastown, Victoria, Australia, 3074

TEL: +61 3 9464 2400 FAX: +61 3 9464 2538

AUSTRALIA AVNET PACIFIC PTY LTD.

No.2 Giffnock Avenue, North Ryde, NSW 2113, Australia

TEL: +61 2 9878 1299 FAX: +61 2 9878 1266

INDIA SYSTEM CONTROLS

73-B, Keonics Industrial Estate, Electronics City,

Bangalore-561 229.

TEL: +91 80 8522297 FAX: +91 80 8523507

TAIWAN SANYO DENKI CO.,LTD.TAIWAN BRANCH

ROOM 401, 4FL, NO.96, SEC.2, CHUNG SHAN NORTH RD,

TAIPEI, TAIWAN

TEL: +886 2 2511 3938 FAX: +886 2 2511 3975

TAIWAN YUNG HO CO.,LTD.

5th Fl., 36, Kuan Chien RD., Taipei 100 Taiwan, R.O.C.

TEL: +886 22311 6561 FAX: +886 22311 6469

SINGAPORE SAN-ACE ELECTRONICS (S) PTE LTD.

No.10 JALAN BESAR NO.12-12 SIM LIM TOWER SINGAPORE

208787

TEL: +65 292 6565 FAX: +65 291 4563

SINGAPORE PUMAS AUTOMATION & ROBOTICS PTE LTD.

1001 Jalan Bukit Merah #06-01 to #06-10

Singapore 159455

TEL: +65 278 3289 FAX: +65 278 8372 +65 278 7904

HONG KONG ORIENTAL MACHINERY LTD.

269-271 Un Chau St., 1st Floor Shamshuipo, Kowloon, Hong Kong

TEL: +852 2361 0102 FAX: +852 2387 4057

KOREA HAN YANG CORP.

CCMM Bldg., 7F RM 710B, 12 Yoiedo-Dong Youngdungpo-Ku,

Seoul, Korea

TEL: +82 2 761 3131 FAX: +82 2 782 4780

THAI COSMOS POLYTECH LTD.

19/300 Moobanchaikul Moo 10, Rama 2Rd, Kwang Bangmod,

Jomthong, Bangkok 10150

TEL: +66 2 898 5313 FAX: +66 2 898 5314

CHINA BEIJING YANGHAI AUTOMATION TECHNOLOGY CO., LTD.

No.708 Room Pacific Building No.52, Haidian Road

Haidian District Beijing City P.R.O.C

TEL: +86 10 82627773 FAX: +86 10 82627772

PHILIPPINES SANYO DENKI PHILIPPINES, INC.

(Overseas subsidiary factory) Subic Special Economic and

Freeport Zone(SSEFZ), Subic, Zambales, PHILIPPINES

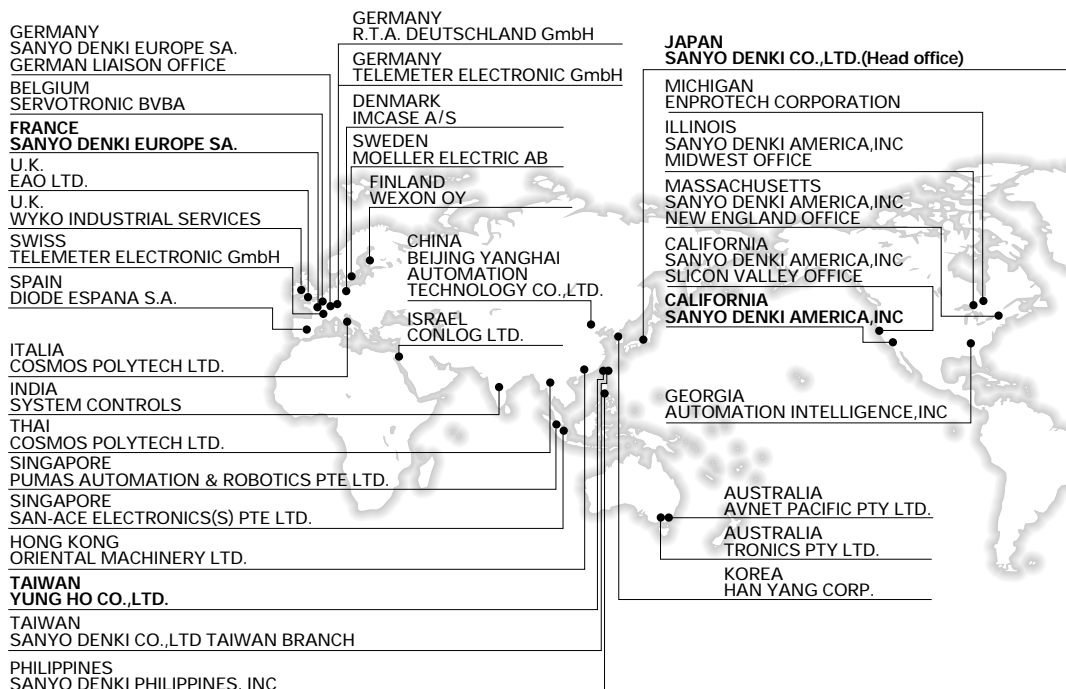

Specification List of System Configuration

When making an inquiry or placing an order, please fill out the following list.
If you have any question or desire, write them on a separate sheet.

Company name _____

Section _____ Person in charge _____

Date. _____ . _____ . _____

Phone No _____

Fax No _____

Phone No. +81-3-3917-5151 (Main)

FAX No. +81-3-3917-0643

1. Application :

2. Machine name :

3. Quantity:

4. Enter your desired model to the following item:

· AC Servo System	P1 Series	P2 Series	P3 Series	P5 Series	P6 Series	P8 Series	Robustsyn
	S2+SZ Series	S6+SZ Series	S8+SZ Series				
· DC Servo System	Super V	DA2					
· Stepping Motor	Two-phase Series	Five-phase Series					

5. Enter the control method to the following item: Speed control Position control Torque control

6. Enter your desired sensor to the following item:

Incremental encoder ABS-R ABS-E Tacho-generator
Incremental encoder + Tacho-generator (DC servo only for and .)

7. Enter the drive direction to the following item: Horizontal Vertical Aslant

8. Fill out the following list referring to the driving method

	Symbol	Unit	1st axis	2nd axis	3rd axis	4th axis	5th axis
(4) Desired Model No.							
(5) Control Method No.							
(6) Desired Sensor No.							
(7) Drive Direction No.							
(8) Driving Method No.							
Desired revolving speed		min ⁻¹					
Mover mass	W	kg					
Driver specific gravity		kg/m ³					
Load inertia	GD ²	kg·m ²					
Loading torque	T _L	N·m					
Tension	F	N					
Pressing force	W	N					
Roll diameter	D	cm					
Friction factor	μ						
Transmission efficiency							
Gear reduction ratio	1/G						
Ball screw pitch	P	cm					
Ball screw diameter	D	cm					
Ball screw length	L	cm					
Pulley diameter (Motor side)	D ₁	cm					
Pulley length (Motor side)	t ₁	cm					
Pulley diameter (Load side)	D ₂	cm					
Pulley length (Load side)	t ₂	cm					
Pinion pitch	P	cm					
Pinion diameter	D	cm					
Pinion thickness	t	cm					

9. Duty Cycle

	Symbol	Unit	1st axis	2nd axis	3rd axis	4th axis	5th axis
Positioning distance	L _p	mm					
Moving part speed	V _p	m/min					
Positioning time	t _r	s					
Accelerating/Decelerating time	t _{a,tb}	s					

10. Working Environment · Operating temperature _____ ~ _____
 · Others _____

Contact our sales personnel for Servomotor selecting software.

