



Technical catalog

Tmax. T Generation

Low voltage molded case
circuit breakers up to 1200 A
UL 489 and CSA C22.2 Standard



Main characteristics

1



The ranges

2



Accessories

3



Characteristic curves
and technical information

4



Wiring diagrams

5



Overall dimensions

6

T GENERATION

TMAX. ADAPTABILITY AND VERSATILITY.



Tmax is freedom. Freedom now reaching up to 1200 A with the new Tmax T7 circuit breaker. There's a boundless and highly diversified world of differing types of installations, requirements, needs and problems from 15 to 1200 A. With the T Generation everything becomes simple and rational – eight sizes to find the solutions you're looking for.

BE FREE TO SIZE ANY TYPE OF INSTALLATION IN AN IDEAL WAY AT ALL TIMES.

Thanks to the eight sizes and a complete series of magnetic

only, thermal magnetic and electronic trip units. Also a wide range of accessories are available together with the possibility of selecting dedicated families for all market applications, even the most specific and advanced.

BE FREE TO INSTALL ALL SIZES WITHOUT DIFFICULTY.

T Generation is undeniably the family of molded case circuit breakers with the best performance/size ratio available on the market.

ATION



This means there is more space there is for cabling and simpler installation. There is also a reduction in the dimensions of the switchboard.

BE FREE TO RIDE THE MOST ADVANCED TECHNOLOGY.

It is thanks to this technology that T Generation now offers performance levels that were previously out of the question in circuit breakers with these dimensions. There are also some exclusive technical solutions which only ABB

can offer you, such as the brand new UL 489 supplement SE electronic trip units designed for the new Tmax T7 or the new rapid accessory fitting system.

FREEDOM FOR TOTALLY SAFE SELECTION.

The safety of knowing that behind Tmax there is ABB's strong and constant commitment to the search for excellence at the base of each product and service. ABB quality.

TMAX T1, T2, Ts3 AND T3. ALL SOLUTIONS PERFECTLY COORDINATED, UP TO 225 A.



Tmax T1, T2, Ts3 and T3 – the four “little ones” of the Tmax family – were thought up from the beginning to work together. You can select functions and performances which until now could not be found in circuit breakers with these dimensions. Perfect up to 225 A.

There are many characteristics common to the T1, T2 and T3 frames. The single depth 2.76" (70 mm) of the three frames makes installation truly simpler. The new arcing chambers are produced with a gasifying material and an innovative construction system allows the arc extinction time to be reduced. All three sizes are fitted with standard adjustment of the thermal threshold and have new three-pole and four-poles designed and constructed to optimize space in the switchboard and simplify coupling with the circuit breaker.

Tmax T1, T2 and T3 have a completely standardized range of accessories.



TMAX T1. THE LITTLE ONE THAT'S REALLY BIG.
Thanks to its extremely compact dimensions, Tmax T1 is a unique circuit breaker in its category. Compared to any other



circuit breaker with the same performance (100 A – up to 50 kA at 240 VAC), the overall dimensions of the apparatus are notably smaller.

TMAX T2. INTELLIGENCE AND HIGH PERFORMANCE IN THE PALM OF YOUR HAND.

Tmax T2 is the only 100 A circuit breaker available with such high performances in such compact overall dimensions. A breaking capacity of 150 kA at 240 VAC can be achieved. Tmax T2 can also be fitted with a latest generation electronic trip unit.



TMAX T3. 225 A IN A DEPTH OF 2.76" (70 MM) FOR THE FIRST TIME.

Tmax T3 is the first circuit breaker which carries 225 A in considerably smaller overall dimensions compared to any other similar device – a large step forward for this type of breaker.

TMAX Ts3

ABB Tmax Ts3 circuit breaker, in the 150 A frame, can be used at 600 VAC providing excellent interrupting rating performance. The possibility of having circuit breakers certified for use at this voltage allows perfect standardization of the apparatus both on the US and the Canadian market, where 600 V is most widely used.

TMAX T4, T5 AND T6. BE FREE TO CHOOSE UP TO 800 A.



Tmax T4, T5 and T6 are the molded case circuit breakers with the best performance/size ratio on the market. The possibilities are practically unlimited, thanks to their dedicated and specific ranges, advanced electronics, as well as a complete and standardized range of accessories.

The top quality materials and innovative construction techniques used by ABB mean Tmax circuit breakers can guarantee truly exceptional performance. For example, T4 and T5 have an interrupting capacity up to 150 kA at 480 VAC.

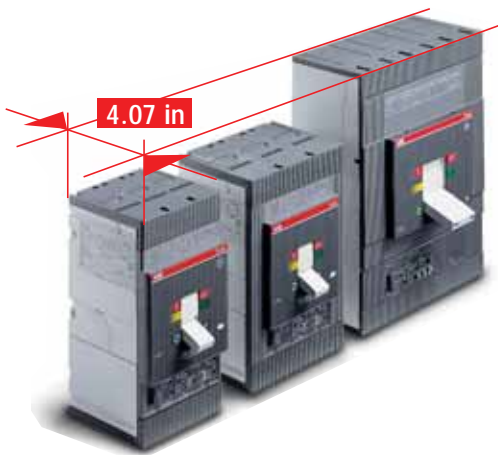

The series of electronic trip units, equipped with latest generation technology, offers solutions exclusive to ABB. T4, T5 and T6 have the same depth, simplifying their use in switchboards, and also have a complete, standardized and unified range of accessories, simplifying selection, making them more flexible and reducing stock item count.

TMAX T7. FREEDOM TO THE NTH DEGREE.



The new Tmax T7, available up to 1200 A either with a manual operating mechanism or motor operator, was conceived with a revolutionary design for circuit breakers of this type: advanced electronics, exceptional performance and new installation and accessory solutions.

Tmax T7's flexibility is absolutely exceptional: it can be installed both vertically and horizontally (in both fixed and draw out versions) with all types of terminals and a new, faster and safer racking-out system for moving parts.

Additionally, cabling is facilitated by the reduced height.

The new rapid accessory wiring system is great news. There are no loose wires inside the circuit breaker. Connection to the external circuit is rapid, simple and safe and no screws for terminating the external power supply cables are needed.

The new cable interlock provides notable benefits in terms of flexible applications. By using this accessory it is possible to interlock two circuit breakers in any position and to interlock a T7 with an Emax power circuit breaker as well.



Special attention has been paid to the electronics and the results are the PR231, PR232, PR331 and PR332 new interchangeable electronic trip units, with modules and rating-plugs which can be replaced by the customer.



The PR231 and PR232 trip units, with dip-switches for setting the protection thresholds, offer LEDs to signal tripping for each protection function: so the reason for circuit breaker tripping can always be easily found. The PR332 is decidedly ahead of its time fitted with a large graphic display, it allows all the information needed to be displayed simply and clearly. It also offers advanced protection functions. For example, the exclusive data logger function allows all the events and values before the fault to be recorded for later analysis.





Index

Overview of the Tmax family	1/2
General	1/4
Construction characteristics	
Distinguishing features of the series	1/6

Overview of the Tmax family

MCCB

Type		Tmax T1 1p	Tmax T1	Tmax T2		Tmax T3		Tmax Ts3		
Frame size	[A]	100	100	100		225		150		
Number of poles	[No.]	1	3-4	3 ⁽⁶⁾ -4		3-4		2-3-4		
Rated voltage	AC (50-60 Hz)	347	600Y/347	480		600Y/347		600		
	DC		500			500		600		
Interrupting ratings		B	N	S	H	N	S	N	H	L
240 V AC	[kA rms]		50 ⁽²⁾	65	150	50	65	65	100	150
277 V AC	[kA rms]	18 ⁽¹⁾								
347 V AC	[kA rms]	14 ⁽¹⁾								
480 V AC	[kA rms]		22 ⁽²⁾	35	65	25	35	25	50	85 ⁽⁵⁾
600Y/347 V AC	[kA rms]		10			10	10			
600 V AC	[kA rms]							14	14	25
250 V DC (2 poles in series)	[kA rms]		25			25	35			
500 V DC (3 poles in series)	[kA rms]		25			25	35			
500 V DC (2 poles in series)	[kA rms]							35	50	65
600 V DC (3 poles in series)	[kA rms]							20	35	50
Trip units	TMF	■	■	■		■			■	
	TMD/TMA									
	MA			■		■			■	
	Electronic									
	PR221DS			■						
	PR222DS/P									
	PR222DS/PD-A									
	PR231/P									
	PR232/P									
	PR331/P									
PR332/P										
Dimensions	H [in/mm]	5.12/130	5.12/130	5.12/130		5.9/150		6.7/170		
	W 3p [in/mm]	1/25.4	3/76	3.54/90		4.13/105		4.13/105		
	D [in/mm]	2.76/70	2.76/70	2.76/70		2.76/70		4.07/103.5		
Mechanical life	[No. operations]	25000	25000	25000		25000		25000		

⁽¹⁾ In 15 A = 10 kA @ 277 V AC - 10 kA @ 347 V AC

⁽²⁾ In 15 A = 35 kA @ 240 V AC - 14 kA @ 480Y/277 V AC

⁽³⁾ T5 600 with electronic trip units only and in three pole version

⁽⁴⁾ 2p T4250 and T5400 available only in N interrupting rating

⁽⁵⁾ In from 15 A up to 30 A = 65 kA @ 480 V AC

⁽⁶⁾ T2H 100 3p, T4H 250 3p, T4V 250 3p, T5H 400 3p, T5V 400 3p are defined "current limiting". See the current limiting chapter

MCP

Type		Tmax T2	Tmax T3	Tmax Ts3				
Frame size		100	225	150-225				
Poles		3	3	3				
Ratings		20...100	100...200	3...25	50...150	175...200		
Icu		S	H	S	L	L		
	240 V AC	[kA rms]	65	150	65	50	150	150
	480 V AC	[kA rms]	35	65	35	25	85	65
	600Y/347 V AC	[kA rms]			10			
	600 V AC	[kA rms]				10	25	
500 V DC	[kA rms]			35	65 ⁽¹⁾	65	50	
600 V DC	[kA rms]				50	50		
Trip unit	Adjustable magnetic only (6...12xIn)	■	■	■				
	Adjustable magnetic only (4...12xIn)				■	■	■	
	PR221DS-I							
	PR231/P-I							
PR211/P-I								

⁽¹⁾ Only for 25A rating

MCS

Type		Tmax T1N-D	Tmax T3S-D	Tmax T3S-D
Rating	[A]	100	150	225
Poles	[No.]	3-4	3-4	3-4
Magnetic override	[A]	1000	1500	2250
Rated Voltage	AC (50-60 Hz)	600Y/347	600Y/347	600Y/347
	DC	500	500	500

Construction characteristics

Modularity of the series

1

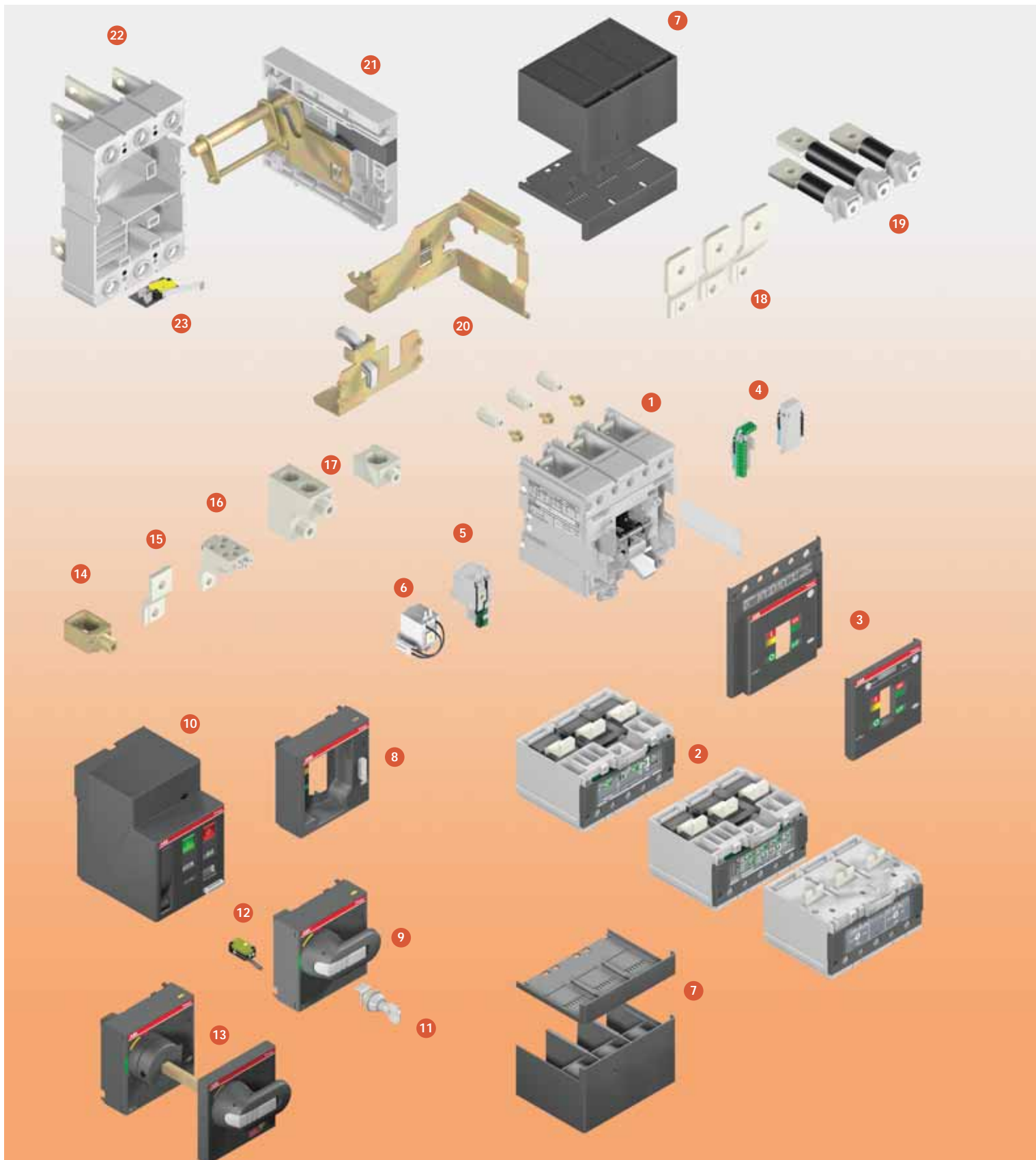



Starting from the fixed version circuit breaker, all the other versions used for various requirements are obtained by means of mounting conversion kits.

The following are available:

- kit for converting a fixed circuit breaker into the moving part of a plug-in and draw out one
- circuit breaker cradles for plug-in and draw out circuit breakers
- conversion kit for the connection terminals.

Various accessories are also available:

1. Frame
2. Trip units
3. Front plate
4. Auxiliary contacts - AUX and AUX-E
5. Undervoltage release - UVR
6. Shunt trip - SOR and P-SOR
7. Terminal covers
8. Front for lever operating mechanism - FLD
9. Direct rotary handle - RHD
10. Stored energy motor operator - MOE
11. Key lock - KLF
12. Early auxiliary contact - AUE
13. Transmitted rotary handle - RHE
14. Front terminal for copper cable - FC Cu
15. Front extended terminal - EF
16. Multi-cable terminal - MC
17. Front terminal for copper-aluminium - FC CuAl
18. Front extended spread terminal - ES
19. Rear orientated terminal - R
20. Conversion kit for plug-in/draw out versions
21. Cradle guide in the draw out version
22. Cradle - FP
23. Auxiliary position contact - AUP
24. Phase separators
25. PR010T
26. TT1
27. Racking out crank handle
28. Residual current release.

Construction characteristics

Distinguishing features of the series

1

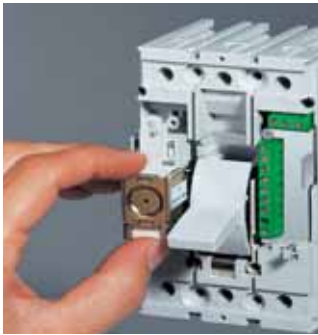

1SDC210A17F0001

Double insulation

Tmax has double insulation between the live power parts (excluding the terminals) and the front of the apparatus where the operator works during normal operation of the device. The placement of each electrical accessory is completely segregated from the power circuit, preventing any risk of contact with live parts and the operating mechanism is completely insulated from the powered circuits. Furthermore, the circuit breaker has oversized insulation, both between the live internal parts and in the area of the connection terminals. In fact, the distances exceed those required by the IEC Standards and comply with the UL 489 Standard.



1SDC210A18F0001

Positive operation

The operating lever always indicates the precise position of the moving contacts of the circuit breaker, thereby providing safe and reliable signals, in compliance with IEC 60073 and IEC 60417-2 Standard (I = Closed; O = Open; yellow-green line = Open due to protection trip). The circuit breaker operating mechanism is trip free regardless of the pressure on the lever. Protection tripping automatically opens the moving contacts: to close them again the operating mechanism must be reset by pushing the operating lever from the tripped position into the reset position.

Isolation behaviour

In the open position, the circuit breaker complies with the IEC 60947-2 Standard. The oversized insulation distances guarantee there are no leakage currents and dielectric resistance to any overvoltages between input and output.



1SDC210A19F0001

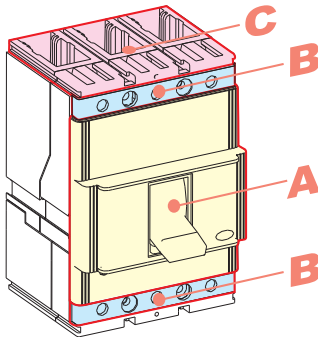

1SDC210A20F0001

Degrees of protection

The table indicates the degrees of protection guaranteed by the Tmax circuit breakers according to the IEC 60529 Standard:

	With front	Without front ⁽²⁾	Without terminal covers	With high terminal covers	With low terminal covers	With IP40 protection kit on the front
A	IP 40 ⁽³⁾	IP 20	-	-	-	-
B ⁽⁴⁾	IP 20	IP 20	IP 20	IP 40	IP 40	IP 40
C	-	-	-	IP 40 ⁽¹⁾	IP 30 ⁽¹⁾	-

⁽¹⁾ After correct installation

⁽²⁾ During installation of the electrical accessories

⁽³⁾ Also for front for lever operating mechanism and direct rotary handle

⁽⁴⁾ Only for T1...T6

The cradles are always preset with IP20 degree of protection. IP54 degree of protection can be obtained with the circuit breaker installed in a switchboard fitted with a rotary handle operating mechanism transmitted on the compartment door and special kit (RHE – IP54).

Operating temperature

The Tmax circuit breakers can be used in ambient conditions where air temperature varies between -13 °F and +158 °F (-25 °C and +70 °C), and stored in environments with temperatures between -40 °F and +158 °F (-40 °C and +70 °C).

The circuit breakers fitted with thermal magnetic trip units have their thermal element set for a reference temperature of 104 °F (+40 °C). For temperatures other than 104 °F (+40 °C), with the same setting, there is a deviation table as shown beginning on page 4/50.

The electronic trip units do not undergo any variations in performance as the temperature varies except in cases of temperatures exceeding 104 °F (+40 °C). Then maximum setting for protection against overloads L must be reduced, as indicated in the derating graph beginning on page 4/37, to take into account the heating phenomena which occur in the current carrying copper parts of the circuit breaker.

For temperatures above 158 °F (+70 °C) the circuit breaker performances are not guaranteed. To ensure service continuity of the installations, the temperature must be kept within acceptable levels for operation of the various devices and the circuit breakers by using forced ventilation in the switchboards or in their installation room.



Altitude

Up to an altitude of 6600 ft the Tmax circuit breakers do not undergo any changes in their rated performance. Above this altitude, the atmospheric properties are altered in terms of composition, dielectric resistance, cooling capacity and pressure, requiring the circuit breaker performance to be derated per the table below.

Altitude	[ft]	6600	9900	13200	16500
Rated service voltage, Ue	[V~]	600	522	435	348
Rated uninterrupted current, Iu	%Iu	100	98	93	90

Construction characteristics

Distinguishing features of the series

1



Electromagnetic compatibility

Protection operation is guaranteed by using the electronic trip units and the electronic residual current releases in the presence of interference caused by electronic devices, atmospheric disturbances or electrical discharges. No interference with other electronic devices near the place of installation is generated either. This is in compliance with the IEC 60947-2 Appendix B + Appendix F Standards and European Directive No. 89/336 regarding EMC - electromagnetic compatibility.



Tropicalization

Circuit breakers and accessories in the Tmax series are tested in compliance with the IEC 60068-2-30 Standard, carrying out 2 cycles at 131 °F (55 °C) with the "variant 1" method (clause 6.3.3). The suitability of the Tmax series for use under the most severe environmental conditions is therefore ensured with the hot-humid climate defined in the climatograph 8 of the IEC 60721-2-1 Standards thanks to:

- moulded insulating cases made of synthetic resins reinforced with glass fibres;
- anti-corrosion treatment of the main metallic parts;
- Fe/Zn 12 zinc-plating (ISO 2081) protected by a conversion layer, free from hexavalent-chromium (ROHS-compliant), with the same corrosion resistance guaranteed by ISO 4520 class 2c;
- application of anti-condensation protection for electronic overcurrent releases and relative accessories.



Resistance to shock and vibration

The circuit breakers are unaffected by vibrations generated mechanically or due to electromagnetic effects, in compliance with the IEC 60068-2-6 Standards and the regulations of the major classification organizations⁽¹⁾:

- RINA
- Det Norske Veritas
- Bureau Veritas
- Lloyd's register of shipping
- Germanischer Lloyd
- ABS
- Russian Maritime Register of Shipping.

The T1-T5 Tmax circuit breakers are also tested according to the IEC 60068-2-27 Standard to resist shock up to 12g for 11 ms. Please ask ABB for details about higher performance in terms of resistance to shock.

⁽¹⁾ Ask to ABB for Tmax certificates of approval.



Versions and types

All the Tmax circuit breakers are available in fixed versions, T2, T3, Ts3, T4 and T5 in the plug-in version and Ts3, T4, T5, T6 and T7 also in the draw out one.

All the circuit breakers can be manually operated by the operating lever or the rotary handle (direct or variable depth), and electrically operated. For electric operation different solutions are available:

- The solenoid operator for T1, T2 and T3
- The direct action motor operator for Ts3
- The stored energy motor operator for T4, T5 and T6
- T7 with the stored energy operating mechanism, gear motor for the charging of the closing springs and shunt opening and closing releases.



Installation

Tmax circuit breakers can be installed in switchboards mounted in any horizontal, vertical or lying down position on the back plate or on rails, without undergoing any derating. Tmax circuit breakers can be easily installed in all types of switchboards, thanks to the possibility of being reversefed.

Apart from fixing on the base plate, T1, T2 and T3 can also be installed on DIN 50022 rails and Ts3 can also be installed on DIN 50023 rails thanks to the special fixing brackets.

Furthermore, the depth of 2.76 inches (70 mm) takes Tmax T3 to the same depth as the two smaller sizes, making assembly of circuit breakers up to 225 A in standard switchboards even simpler. In fact, it is possible to prepare standardized support structures, facilitating the design stage and construction of the switchboard interior.

Construction characteristics

Distinguishing features of the series

Racking-out with the door closed

With Tmax Ts3, T4, T5, T6 and T7 circuit breakers in the draw out version the circuit breaker can be racked-in and out with the compartment door closed, increasing operator safety and allowing realization of low voltage arc proof switchboards.

Racking out can only be carried out with the circuit breaker open (for safety reasons), using a special racking-out crank handle supplied with the conversion kit from fixed circuit breaker to moving part of draw out circuit breaker.



Range of accessories

The completeness and installation rationality of the Tmax series is also achieved thanks to innovative solutions in development of the accessories:

- single range of accessories for T1, T2 and T3; one for T4, T5 and T6, and one for T7, characterised by completeness and simplicity for installation. The Ts3 due to its unique characteristics has its own group of accessories. Harmonization of the accessories allows reduction in stocks and greater service flexibility, offering increasing advantages for users of the Tmax series;
- new system of rapid assembly for internal electrical accessories of Tmax T7 without cables for the connections to the terminal box;
- same possibility of equipping with terminals, in terms of connection devices (terminals, terminal covers and phase separators), between fixed circuit breakers and cradles of plug-in circuit breakers for Tmax T2 and T3.
- moreover, Tmax offers a wide choice of IEC rated residual current releases (IEC only):
 - three-pole and four-pole RC221 and RC222 up to 225 A with T1, T2 and T3;
 - RC211 and RC212 for Ts3;
 - RC222, four-pole up to 500 A for T4 and T5;
 - RC223 (type B) also sensitive to currents with continuous slowly variable components (IEC 60947-2 Annex M), four-pole for T3 and T4, up to 250 A.



Compliance with Standards and company Quality System

The Tmax circuit breakers and their electrical accessories conform to the UL 489 (Underwriters Laboratories Incorporated) and CSA C22.2 No. 5.1 (Canadian Standard Association) North American Standards, and to the international IEC 60947-2 Standards and comply with the EC directive:

- "Low Voltage Directives" (LVD) no. 2006/95/CE (replaces 72/23/EEC and subsequent amendments)
- "Electromagnetic Compatibility Directive" (EMC) no. 89/336 EEC.

Certification of compliance with the above-mentioned product Standards is carried out, in respect of the European EN 45011 Standard, by the Italian certification body ACAE (Association for Certification of Electrical Apparatus), a member of the European LOVAG organization (Low Voltage Agreement Group). The ABB test laboratory is accredited by SINAL (certificate no. 062/2002).

The ABB Quality System complies with the international ISO 9001 - 2000 Standard (model for quality assurance in design, development, construction, installation and service) and with the equivalent European EN ISO 9001 and Italian UNI EN ISO 9001 Standards.

The independent certifying Body is RINA S.p.A. ABB obtained its first certification with three-year validity in 1990, and has now reached its fourth reconfirmation.

The new Tmax series has a hologram on the front, obtained using special anti-imitation techniques, which guarantees the quality and that the circuit breaker is an original ABB product.

Attention to protection of the environment and to health and safety in the work place is another priority commitment for ABB and, as confirmation of this, the company environmental management system has been certified by RINA in 1997, in conformity with the international ISO 14001 Standard. This certification has been integrated in 1999 with the Management System for Health and Safety in the workplace, according to OHSAS 18001 (British Standards), obtaining one of the first certification of integrated management System, QES (Quality, Environment, Safety) issued by RINA. ABB – the first industry in the electromechanical section in Italy to obtain this recognition – thanks to a revision of the production process with an eye to ecology, has been able to reduce the consumption of raw materials and processing waste by 20%.

ABB's commitment to safeguarding the environment is also shown by the Life Cycle Assessments of its products carried out directly by ABB Research and Development in collaboration with the ABB Research Center. Selection of materials, processes and packing materials is made optimizing the true environmental impact of the product, also foreseeing the possibility of its being recycled.



Index

Power distribution circuit breakers

Electrical characteristics	2/4
General characteristics.....	2/6
Thermal magnetic trip units.....	2/8
Electronic trip units.....	2/9

Motor Control Protection circuit breakers: MCP

Electrical characteristics	2/34
General characteristics.....	2/36

Molded Case Switches: MCS

Electrical characteristics	2/40
----------------------------------	------

Current Limiting

Electrical characteristics	2/44
----------------------------------	------

Power distribution





Power distribution circuit breakers



Index

Power distribution circuit breakers

Electrical characteristics	2/4
General characteristics.....	2/6
Thermal magnetic trip units.....	2/8
Electronic trip units.....	2/9

Power distribution circuit breakers

Electrical characteristics

MCCB

Type		Tmax T1 1p	Tmax T1	Tmax T2		Tmax T3		Tmax Ts3		
Frame size	[A]	100	100	100		225		150		
Number of poles	[No.]	1	3-4	3 ⁽⁶⁾ -4		3-4		2-3-4		
Rated voltage	AC (50-60 Hz)	347	600Y/347	480		600Y/347		600		
	DC		500			500		600		
Interrupting ratings		B	N	S	H	N	S	N	H	L
	240 V AC [kA rms]		50 ⁽²⁾	65	150	50	65	65	100	150
	277 V AC [kA rms]	18 ⁽¹⁾								
	347 V AC [kA rms]	14 ⁽¹⁾								
	480 V AC [kA rms]		22 ⁽²⁾	35	65	25	35	25	50	85 ⁽⁵⁾
	600Y/347 V AC [kA rms]		10			10	10			
	600 V AC [kA rms]							14	14	25
	250 V DC (2 poles in series) [kA rms]		25			25	35			
	500 V DC (3 poles in series) [kA rms]		25			25	35			
	500 V DC (2 poles in series) [kA rms]							35	50	65
	600 V DC (3 poles in series) [kA rms]							20	35	50
Versions		F	F	F-P		F-P		F-P-W		
Trip units	TMF	■	■	■		■		■		
	TMD/TMA									
	MA			■		■		■		
	Electronic									
	PR221DS			■						
	PR222DS/P									
	PR222DS/PD-A									
	PR231/P									
	PR232/P									
	PR331/P									
PR332/P										
Dimensions	H [in/mm]	5.12/130	5.12/130	5.12/130		5.9/150		6.7/170		
	W 3p [in/mm]	1/25.4	3/76	3.54/90		4.13/105		4.13/105		
	D [in/mm]	2.76/70	2.76/70	2.76/70		2.76/70		4.07/103.5		
Mechanical life	[No. operations]	25000	25000	25000		25000		25000		

⁽¹⁾ In 15 A = 10 kA @ 277 V AC - 10 kA @ 347 V AC

⁽²⁾ In 15 A = 35 kA @ 240 V AC - 14 kA @ 480Y/277 V AC

⁽³⁾ T5 600 with electronic trip units only and in three pole version

⁽⁴⁾ 2p T4250 and T5400 available only in N interrupting rating

⁽⁵⁾ In from 15 A up to 30 A = 65 kA @ 480 V AC

⁽⁶⁾ T2H 100 3p, T4H 250 3p, T4V 250 3p, T5H 400 3p,

T5V 400 3p are defined current limiting. See the

current limiting chapter

F = Fixed

P = Plug-in

W = Draw-out

Tmax Ts3			Tmax T4					Tmax T5					Tmax T6				Tmax T7		
225			250					400-600 ⁽³⁾					800				1000-1200		
2-3-4			2 ⁽⁴⁾ -3 ⁽⁶⁾ -4					2 ⁽⁴⁾ -3 ⁽⁶⁾ -4					3-4				3-4		
480			600					600					600				600		
500			600					600					600						
N	H	L	N	S	H	L	V	N	S	H	L	V	N	S	H	L	S	H	L
65	100	150	65	100	150	200	200	65	100	150	200	200	65	100	200	200	65	100	150
25 50 65			25 35 65 100 150					25 35 65 100 150					35 50 65 100				50 65 100		
			18 25 35 65 100					18 25 35 65 100					20 25 35 42				25 50 65		
20 35 50			25 35 50 65 100					25 35 50 65 100					35 35 50 65						
			16 25 35 50 65					16 25 35 50 65					20 20 35 50						
F-P-W			F-P-W					F-P-W					F-W				F-W		
■			■					■					■						
■																			
			■					■					■						
			■					■					■						
			■					■					■				■		
																	■		
																	■		
																	■		
																	■		
6.7/170			8.07/205					8.07/205					10.55/268				10.55/268		
4.13/105			4.13/105					5.51/140					8.26/210				8.26/210		
4.07/103.5			4.07/103.5					4.07/103.5					4.07/103.5				6.06/154(toggle)-7/178(motor)		
25000			20000					20000					20000				10000		

Power distribution circuit breakers

General characteristics

The series of Tmax molded case circuit breakers – complying with the UL 489 and CSA C22.2 No. 5 Standards – is divided into different basic sizes, with an application range from 15 A to 1200 A and breaking capacities up to 150 kA at 480 VAC.

For protection of alternating current networks, the following are available:

- T1B 1p, T1, T2, T3, Ts3 and T4 circuit breakers equipped with TMF thermal magnetic trip units with fixed thermal and magnetic threshold ($I_3 = 10 \times I_n$);
- T4 (up to 50 A) circuit breaker equipped with TMD thermal magnetic trip units with adjustable thermal threshold ($I_1 = 0.7 \dots 1 \times I_n$) and fixed magnetic threshold ($I_3 = 10 \times I_n$);
- T4, T5 and T6 circuit breakers with TMA thermal magnetic trip units with adjustable thermal threshold ($I_1 = 0.7 \dots 1 \times I_n$) and adjustable magnetic threshold ($I_3 = 5 \dots 10 \times I_n$);
- T2 with PR221DS electronic trip unit;
- T4, T5 and T6 with PR221DS, PR222DS/P and PR222DS/PD-A electronic trip units;
- the T7 circuit breaker, which completes the Tmax family up to 1200 A, fitted with PR231/P, PR232/P, PR331/P and PR332/P electronic trip units. The T7 circuit breaker is available in the two versions: with a manual operating mechanism or a motorized stored energy operating mechanism⁽¹⁾.

The field of application in alternating current of the Tmax series varies from 1 A to 1200 A with voltages up to 600 V. The Tmax T1, T2, T3, Ts3, T4, T5 and T6 circuit breakers equipped with TMF, TMD and TMA thermal magnetic trip units can also be used in direct current plants, with a range of applications from 15 A to 800 A and a minimum operating voltage of 24 V DC, according to the appropriate connection diagrams.

The three-pole T2, T3 and Ts3 circuit breakers can also be fitted with MA adjustable magnetic only trip units, both for applications in alternating current and in direct current, in particular for motor protection (see page 2/33 and following).

For all the circuit breakers in the series, fitted with thermal magnetic and electronic trip units, the single-phase trip current is defined (see page 4/26).

⁽¹⁾ For motorization, the T7 circuit breaker with stored energy operating mechanism must be ordered, complete with geared motor for automatic spring charging, opening coil and closing coil.

Interchangeability

The Tmax T4, T5 and T6 circuit breakers can be equipped either with TMF, TMD or TMA thermal magnetic trip units, MA magnetic only trip units or PR221DS, PR222DS/P, PR222DS/PD-A electronic trip units.

Similarly, Tmax T7 can also mount the latest generation PR231/P, PR232/P, PR331/P⁽¹⁾ and PR332/P⁽¹⁾ electronic trip units.

Trip units

Circuit breakers	TMF		TMD			TMA									
	15	20	30	40	50	80	100	125	150	200	250	300	400	600	800
T4 250	■	■	■	■	■	■	■	■	■	■	■				
T5 400												■	■		
T5 600															
T6 800														■	■
T7 1000															
T7 1200															

■ = Complete circuit breaker already coded
 ▲ = Circuit breaker to be assembled

⁽¹⁾ If ordered loose PR331/P and PR332/P must be completed with the "trip unit adapters" (see page 3/45)

Range of application of the circuit breakers in alternating current and in direct current

AC	Trip unit	Range [A]
T1 1p 100	TMF	15...100
T1 100	TMF	15...100
T2 100	TMF	15...100
	MA	20...100
	PR221DS	25...100
T3 225	TMF	60...225
	MA	100...200
Ts3 150	TMF	15...150
	MA	3...150
Ts3 225	TMF	175...225
	MA	175...200
T4 250	TMF	15...250
	TMD	20
	TMA	30...50
	PR221DS	80...250
	PR222DS/P-PR222DS/PD-A	100...250
T5 400/600	TMA	300...400
	PR221DS	300-400-600
	PR222DS/P-PR222DS/PD-A	300-400-600
T6 800	TMA	600...800
	PR221DS	600...800
	PR222DS/P-PR222DS/PD-A	600...800
T7 1000/1200	PR231/P-PR232/P	400...1200
	PR331/P-PR332/P	400...1200
DC		
T1 100	TMF	15...100
T2	MA	20...100
T3 225	TMF	60...225
Ts3 150	TMF	15...150
	MA	3...150
Ts3 225	TMF	175...225
	MA	175...200
T4 250	TMD	15...250
	TMA	15...250
	TMF	15...250
T5 400/600	TMA	300-400
T6 800	TMA	600...800

- MA = magnetic only trip unit with adjustable magnetic thresholds
- TMF = thermal magnetic trip unit with fixed thermal and magnetic thresholds
- TMD = thermal magnetic trip unit with adjustable thermal and fixed magnetic thresholds
- TMA = thermal magnetic trip unit with adjustable thermal and magnetic thresholds
- PR22_, PR23_, PR33_ = electronic trip units

Thanks to their simple assembly, the end customer can change the type of trip unit extremely rapidly according to their own requirements and needs. In this case, correct assembly is the customer's responsibility. Above all, this means into increased flexibility of use of the circuit breakers with considerable savings in terms of costs thanks to better rationalization of stock management.

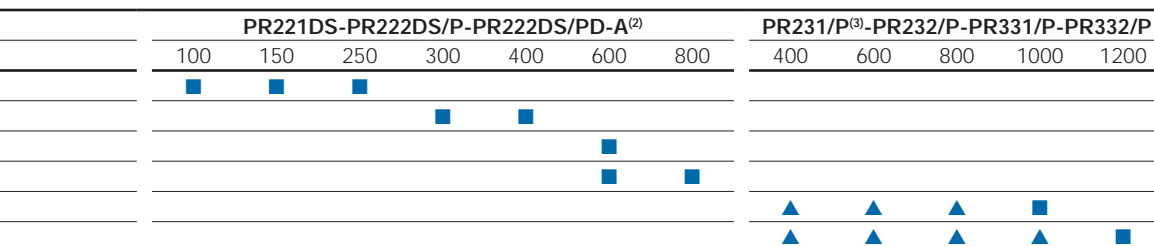

⁽²⁾ PR223DS, minimum In = 160 A

⁽³⁾ Interchangeability of PR231/P can be requested by means of the dedicated ordering code 1SDA063140R1

Power distribution circuit breakers

Thermal magnetic trip units

The Tmax T1 1p, T1, T2, T3, Ts3, T4, T5 and T6 circuit breakers can be fitted with thermal magnetic trip units and are used in protection of alternating and direct current networks with a range of use from 15 A to 800 A. They allow the protection against overload with a thermal device (with fixed threshold for T1 1p, T1, T2, T3, Ts3, T4 and adjustable threshold for T4, T5 and T6) realized using the bimetal technique, and protection against short-circuit with a magnetic device (with fixed threshold for T1, T2, T3, Ts3 and T4 up to 50 A and adjustable threshold for T4, T5 and T6).

The four-pole circuit breakers are always supplied with the neutral protected by the trip unit and with protection of the neutral at 100% of the phase settings up to 100 A. For higher settings, the protection of the neutral is at 50% of the phase setting unless the protection of the neutral at 100% of the phase setting is required.

Thermal magnetic trip units

In [A]	15	20	25	30	35	40	50	60	70	80	90	100	125	150	175	200	225	250	300	400	600	800	
Neutral [A]	15	20	25	30	35	40	50	60	70	80	90	100	125	150	175	200	225	250	300	400	600	800	
T1 (I _n =In)	■	■	■	■		■	■	■	■	■	■	■											
T2 (I _n =In)	■	■	■	■	■	■	■	■	■	■	■	■											
T3 (I _n =In)									■	■	■	■	■	■	■	■	■	■					
Ts3 (I _n =In)	■	■	■	■	■	■	■	■	■	■	■	■	■	■	■	■	■	■					
T4 (I _n =In)	■	■																					
T4 (I _n =0.7...1xIn)				■		■	■			■		■	■	■		■		■					
T5 400 (I _n =0.7...1xIn)																				■	■		
T6 (I _n =0.7...1xIn)																						■	■
T1																							
I ₃ [A]	1000	1000	1000	1000		1000	1500	1500	1500	1500	1500	1500											
Neutral [A]	1000	1000	1000	1000		1000	1500	1500	1500	1500	1500	1500											
T2, T3																							
I ₃ [A]	500	500	500	500	500	500	500	600	700	800	900	1000	1250	1500	1750	2000	2250						
Neutral [A]	500	500	500	500	500	500	500	600	700	800	900	1000	1250	1500	1750	2000	2250						
Ts3																							
I ₃ [A]	500	500	500	500	500	500	500	600	700	800	900	1000	1250	1500	1750	2000	2250						
Neutral [A]	500	500	500	500	500	500	500	600	700	800	900	1000	1250	1500	1750	2000	2250						
T4, T5																							
I ₃ [A]	500	500		500		500	500			400		500	625	750		1000		1250	1500	2000	2500	3000	4000
Neutral [A]	500	500		500		500	500			400		500	625	750		1000		1250	1500	2000	2500	3000	4000
										800		1000	1250	1500		2000		2500	3000	4000	6000	8000	8000
T6																							
I ₃ = 5...10xIn [A]																						3000	4000
Neutral [A] - 100%																						6000	8000
Neutral [A] - 50%																						3000	4000
																						6000	8000
																						1500	2000
																						3000	4000

Power distribution circuit breakers

Electronic trip units

For use in alternating current the Tmax T2, T4, T5, T6 and T7 circuit breakers can be equipped with trip units constructed using electronic technology. This allows protection functions to be obtained which provide high reliability, tripping precision and insensitivity to temperature and to the electromagnetic components.

The power supply needed for correct operation is supplied directly by the current sensors of the trip unit, and tripping is always guaranteed, even under single-phase load conditions.

Characteristics of the Tmax electronic trip units

Operating temperature	-13 °F...+158 °F (-25 °C...+70 °C)
Relative humidity	98%
Self-supply	0.2 x In (single phase)
Auxiliary power supply (where applicable)	24 V DC
Operating frequency	45...66 Hz
Electromagnetic compatibility (LF and HF)	IEC 60947-2 Annex F

For Tmax T2, T4, T5 and T6 the protection trip unit consists of:

- 3 or 4 current sensors (current transformers)
- external current sensors (e.g. for the external neutral), when available
- a trip unit
- a trip coil (for T2 housed in the right slot, for T4, T5 and T6 integrated in the electronic trip unit).

For Tmax T7 the protection trip unit consists of:

- 3 or 4 current sensors (Rogowski coils and current transformers)
- external current sensors (e.g. for the external neutral)
- interchangeable rating plug
- a trip unit
- a trip coil housed in the body of the circuit breaker.

Rating plugs

Circuit breaker	CS Rated current I _n	In [A]				
		400	600	800	1000	1200
T7	1000	■	■	■	■	
	1200	■	■	■	■	■

The current sensors supply the electronic trip unit with the energy needed for correct operation of the trip unit and the signal needed to detect the current.

The current sensors are available with rated primary current as shown in the table.

Current sensors

	In [A]	25	60	100	150	250	300	400	600	800	1000	1200
PR221DS	T2	■	■	■	■							
	T4			■	■	■	■					
	T5						■	■	■			
	T6								■	■		
PR222DS/P, PR222DS/PD-A	T4			■	■	■	■					
	T5						■	■	■			
	T6								■	■		
PR231/P, PR232/P, PR331/P, PR332/P	T7							■	■	■	■	■

When a protection function trips, the circuit breaker opens by means of the trip coil, which changes the contact AUX-SA (supplied on request, see chapter "Accessories" at page 3/21 and following) to tripping. Mechanical signalling reset takes place with resetting of the circuit breaker.

Power distribution circuit breakers

Electronic trip units

Basic protection functions



(L) Protection against overload

This protection function trips when there is an overload with inverse long-time delay trip according to an inverse time curve ($I^2t=k$). The protection cannot be excluded.



(S) Protection against short-circuit with time delay

This protection function trips when there is a short-circuit, with long inverse time-delay trip ($I^2t=k$ ON) or a constant trip time ($I^2t=k$ OFF). The protection can be excluded.



(I) Instantaneous protection against short-circuit

This protection function trips instantaneously in case of a short-circuit. The protection can be excluded.



(G) Protection against ground fault

The protection against ground fault trips when the vectorial sum of the currents passing through the current sensors exceeds the set threshold value, with long inverse time-delay trip ($I^2t=k$ ON) or a constant trip time ($I^2t=k$ OFF). The protection can be excluded.

Advanced protection functions

The PR332/P trip unit makes it possible to carry out highly developed protection against the most varied types of fault. It adds the following advanced protection functions to the basic protection functions.



(U) Protection against unbalanced phase

The protection function against unbalanced phase U can be used in those cases where a particularly precise control is needed regarding missing and/or unbalance of the phase currents. The trip time is instantaneous. The protection can be excluded.



(OT) Protection against overtemperature

The protection against overtemperature trips instantaneously when the temperature inside the trip unit exceeds 85 °C, in order to prevent any temporary or continual malfunction of the microprocessor. The protection cannot be excluded.



(ZS) Zone selectivity

ZS zone selectivity is an advanced method for carrying out coordination of the protections in order to reduce the trip times of the protection closest to the fault in relation to the time foreseen by time selectivity. Zone selectivity can be applied to the protection functions S and G, with constant time-delay trip. The protection can be excluded.



(UV, OV, RV) Protections against voltage

The three protections trip with a constant time-delay in the case of undervoltage, overvoltage and residual voltage respectively. The latter allows to detect interruptions of the neutral (or of the ground conductor in systems with grounded neutral). The protections can be excluded.



(RP) Protection against reversal of power

The protection against reversal power causes tripping of the breaker, with constant time-delay trip, when the flow of power reverses sign and exceeds, as an absolute value, the set threshold. It is particularly suitable for protection of large machines such as generators. The protection can be excluded.





(UF, OF) Protections of frequency

The two protections detect the variation in network frequency above or below the adjustable thresholds, opening the circuit breaker, with constant time-delay trip. The protection can be excluded.

Electronic trip units for power distribution

SACE PR221DS		
Protection functions	PR221DS	PR221DS
	L S I	I

SACE PR222DS/P		
Protection functions	PR222DS/P	PR222DS/P
	L S I	L S I G

SACE PR222DS/PD-A		
Protection functions	PR222DS/PD-A	PR222DS/PD-A
	L S I	L S I G

Power distribution circuit breakers

Electronic trip units

SACE PR231/P



PR231/P

L S / I

PR231/P

I

Protection functions

SACE PR232/P



PR232/P

L S I

Protection functions

SACE PR331/P



PR331/P

L S I G

Protection functions

SACE PR332/P



PR332/P

L I

PR332/P

L S I

PR332/P

L S I G⁽¹⁾

Protection functions

Advanced protection function⁽²⁾

L U⁽³⁾

L U⁽³⁾

L U⁽³⁾

Opt.^(*)

UV OV RV RB UB OB

UV OV RV RB UB OB

UV OV RV RB UB OB

⁽¹⁾ In alternative to Rc (with external toroid).
⁽²⁾ For all versions.

^(*) Available with PR330/V. Measurement module.
⁽³⁾ According to IEC 60255-3.

PR221DS – Tmax T2, T4, T5 and T6

The PR221DS trip unit, available for T2, T4, T5 and T6, provides protection functions against overload L and short-circuit S/I (version PR221DS-LS/I): with this version you can choose whether to have inverse time-delay S or instantaneous I protection against short-circuit by moving the dedicated dip-switch. Alternatively, the version with only the protection function against instantaneous short-circuit I is available (version PR221DS-I, also see page 2/33 and following).

There is a single adjustment for the phases and the neutral. The neutral is adjustable from 50 - 100% of the phases for Tmax T2 $I_n = 160$ A ($T2 I_n < 160$ A, $N = 100\%$), whereas for T4, T5 and T6 it is possible to select the protection threshold OFF, 50% or 100% directly from the front of the trip unit by means of the specific dip switch.

The trip coil is always supplied with the PR221DS trip unit for Tmax T2 and is housed in the right-hand slot of the circuit breaker. Dedicated auxiliary contacts are available for T2 with electronic trip units (see page 3/21).

For Tmax T4, T5 and T6, the opening solenoid is housed internally and therefore, by not using the right-hand slot of the circuit breaker, all the auxiliary contacts available can be used.

PR221DS-LS/I

Protection S
Against short-circuit with delayed trip

Protection L
Against overload

Dip-switch for neutral setting (only for T4, T5 and T6)

Socket for TT1 test unit

Protection I
Against short-circuit with instantaneous trip

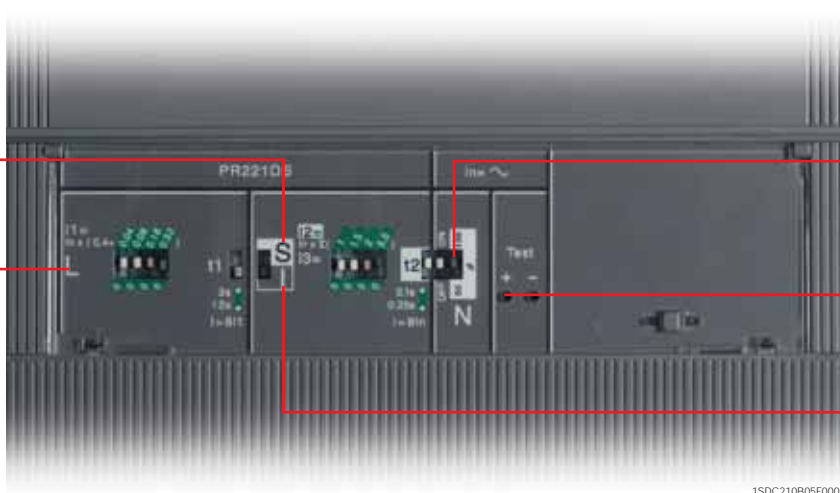

1SDC210B05F0001

PR221DS - Protection functions and settings

Protection functions

L	Against overload with long inverse time delay trip and trip characteristic according to an inverse time curve ($I^2t = \text{constant}$)
CANNOT BE EXCLUDED	
S	Against short-circuit with inverse short time delay trip and trip characteristic with inverse time ($I^2t = \text{constant}$) (selectable as an alternative to protection function I)
CAN BE EXCLUDED	
I	Against short-circuit with instantaneous trip (selectable as an alternative to protection function S)
CAN BE EXCLUDED	

Trip threshold

	$I_1 = 0.40 - 0.44 - 0.48 - 0.52 - 0.56 - 0.60 - 0.64 - 0.68 - 0.72 - 0.76 - 0.80 - 0.84 - 0.88 - 0.92 - 0.96 - 1 \times I_n$ Release between $1.1 \dots 1.3 \times I_1$ (IEC 60947-2 and UL 489)
	$I_2 = 1 - 1.5 - 2 - 2.5 - 3 - 3.5 - 4.5 - 5.5 - 6.5 - 7 - 7.5 - 8 - 8.5 - 9 - 10 \times I_n^{(2)}$ Tolerance: $\pm 10\%$ (T4-T5) $\pm 10\%$ up to $2 \times I_n$ (T2) $\pm 20\%$ above $2 \times I_n$ (T2)
	$I_3 = 1 - 1.5 - 2 - 2.5 - 3 - 3.5 - 4.5 - 5.5 - 6.5 - 7 - 7.5 - 8 - 8.5 - 9 - 10 \times I_n^{(3)}$ Tolerance: $\pm 10\%$ (T4-T5) $\pm 20\%$ (T2)

Trip curves⁽¹⁾

at $6 \times I_1$ $t_1 = 3s$	at $6 \times I_1$ $t_1 = 6s$ only for T2	at $6 \times I_1$ $t_1 = 12s$ only for T4, T5
Tolerance: $\pm 10\%$ up to $6 \times I_n$ $\pm 20\%$ above $6 \times I_n$		
$a \ 8 \times I_n$ $t_2 = 0,1s$	$a \ 8 \times I_n$ $t_2 = 0,25s$	
Tolerance: $\pm 10\%$ up to $6 \times I_n$ (T4-T5) $\pm 20\%$ above $6 \times I_n$ (T4-T5) $\pm 20\%$ (T2)		
instantaneous		

⁽¹⁾ These tolerances hold in the following conditions:
- self-powered relay at full power and/or auxiliary supply;
- two or three-phase power supply.

In conditions other than those considered, the following tolerances hold:

	Trip time
S	$\pm 20\%$
I	$\leq 40ms$

⁽²⁾ For T5 $I_n = 600$ A $\Rightarrow I_2 \text{ max} = 9.5 \times I_n$
⁽³⁾ For T5 $I_n = 600$ A $\Rightarrow I_3 \text{ max} = 9.5 \times I_n$

Power distribution circuit breakers

Electronic trip units

PR222DS/P – Tmax T4, T5 and T6

The PR222DS/P trip unit, available for T4, T5 and T6, has protection functions against overload L, delayed S and instantaneous I short-circuit (version PR222DS/P-LSI). Alternatively, in addition to the functions L, S, I, it also has protection against ground fault G (version PR222DS/P-LSIG).

Setting of the PR222DS trip unit can be carried out either by means of dip switches on the front of the circuit breaker or electronically, using the PR010/T programming and control unit (see page 3/48) or the BT030 wireless communication unit (see page 3/45).

There is a single setting for the phases and neutral for which one can decide whether to set the threshold of the protection functions to OFF, to 50% or to 100% of the phases by means of two dedicated dip switches.

Furthermore, on the front of the PR222DS/P (or PR222DS/PD-A) trip units, signalling of pre-alarm and alarm of protection L is available. The pre-alarm threshold value, signalled by the red LED fixed, is equal to $0.9 \times I_n$. It is also possible to remotely transmit the alarm of protection L by simply connecting connector X3 to the dedicated contact.

PR222DS/PD-A – Tmax T4, T5 and T6

Apart from the protection functions available for the PR222DS/P trip unit (for the settings see page 2/18), the PR222DS/PD-A trip unit, available for T4, T5 and T6 also has the communication unit integrated with Modbus® RTU protocol.

The Modbus® RTU protocol has been known and used worldwide for many years and is now a market standard thanks to its simplicity of installation, configuration and to its integration in the various different supervision, control and automation systems, as well as good level performances.

The PR222DS/PD-A trip units allow the Tmax T4, T5 and T6 circuit breakers to be integrated in a communication network based on the Modbus® RTU protocol. Modbus® RTU provides a Master-Slave system architecture where a Master (PLC, PC...) cyclically interrogates several Slaves (field devices). The devices use the EIA RS485 standard as the physical means for data transmission at a maximum transmission speed of 19.2 kbps.

Again for this trip unit, the power supply needed for correct operation of the protection functions is supplied directly by the current transformers of the trip unit and tripping is always guaranteed, even under conditions of single-phase load down. Nevertheless, communication is only possible with an auxiliary power supply of 24 V DC.

PR222DS/PD-A – Electrical characteristics

Auxiliary power supply (galvanically insulated)	24 V DC \pm 20%
Maximum ripple	\pm 5%
Inrush current @ 24 V	1 A for 30 ms
Rated current @ 24 V	100 mA
Rated power @ 24 V	2.5 W

The PR222DS/PD-A trip unit, with integrated communication and control functions, allows a wide range of information to be acquired and transmitted remotely, opening and closing commands to be carried out by means of the electronic version motor operator, the configuration and programming parameters of the unit to be stored, such as the current thresholds of the protection functions and the protection curves.

All the information can be consulted both locally, directly on the front of the circuit breaker with the front display unit FDU, or on the HMI030 switchgear multi-meter and remotely by means of supervision and control systems.

Moreover, by connecting of the BT030 external module to the test connector of the PR222DS/PD-A trip unit, wireless communication to a PDA or Notebook is possible through a Bluetooth port.

The PR222DS/PD-A trip units can be associated with the AUX-E auxiliary contacts to know the state of the circuit breaker (open/closed), and with MOE-E motor operator (the AUX-E are obligatory when MOE-E is to be used) to remotely control circuit- breaker opening and closing as well.

If the circuit breaker fitted with the PR222DS/PD-A trip unit is inserted in a supervision system, during the test phases with the PR010/T unit, communication is automatically abandoned and starts again on completion of this operation.

	PR222DS/P	PR222DS/PD-A
Communication functions		
Protocol		Modbus RTU standard
Physical medium		EIA RS485
Speed (maximum)		19.2 kbps
Measurement functions		
Phase currents	■ ⁽¹⁾	■
Neutral current	■ ⁽¹⁾	■
Ground current	■ ⁽¹⁾	■
Voltages (phase to phase, phase to ground)		
Powers (active, reactive, apparent)		
Power factors		
Energies		
Peak factor		
Frequency		
Signalling functions		
L pre-alarm and alarm LED	■ ⁽⁵⁾	■ ⁽⁵⁾
L alarm output contact ⁽²⁾	■	■
Available data		
Circuit breaker status (open, closed) ⁽³⁾		■
Mode (local, remote)		■
Protection parameters set	■ ⁽¹⁾	■
Alarms		
Protections: L, S, I, G	■ ⁽¹⁾	■
Failed tripping under fault conditions	■ ⁽¹⁾	■
Maintenance		
Total number of operations		■
Total number of trips		■
Number of trip tests		■
Number of manual operations		■
Number of trips for each individual protection function		■
Record of last trip data	■ ⁽¹⁾	■
Commands		
Circuit breaker opening/closing (with motor operator)		■
Alarm reset	■ ⁽¹⁾	■
Circuit breaker reset (with motor operator)		■
Setting the curves and protection thresholds	■ ⁽¹⁾	■
Safety function		
Automatic opening in the case of failed Trip command fail (with motor operator) ⁽⁴⁾		■
Events		
Changes in circuit breaker state, in the protections and all the alarms		■

⁽¹⁾ With PR010/T unit or BT030 unit

⁽²⁾ Typical contact: MOS photo Vmax: 48 V DC/30 V AC
I_{max}: 50 mA DC/35 mA AC

⁽³⁾ Available with AUX-E electronic auxiliary contacts

⁽⁴⁾ The motor operator must be in electronic version (MOE-E) and electronic auxiliary contacts (AUX-E) have to be used

⁽⁵⁾ Signals: - Pre-alarm L - permanently lit

- Alarm L - flashing (0.5 s ON / 0.5 s OFF)

- Incongruent manual setting (L > S / S > I) - flashing (1 s ON / 2 s OFF)

- WINK (remote control to identify the relay) - flashing (0.125 s ON / 0.125 s OFF)

Power distribution circuit breakers

Electronic trip units

PR222DS/P

Protection S

Against short-circuit
with delayed trip

Protection L

Against overload

Socket for TT1
test unit

Socket for connection
of PR010/T test unit
and BT030 wireless
communication unit



Protection I

Against short-circuit
with instantaneous trip

Dip-switch for
neutral setting

Selection for electronic
or manual setting

1SDC210B06F0001

2

PR222DS/PD-A

Protection S

Against short-circuit
with delayed trip

Protection L

Against overload

Socket for TT1
test unit

Socket for connection
of PR010/T test unit
and BT030 wireless
communication unit

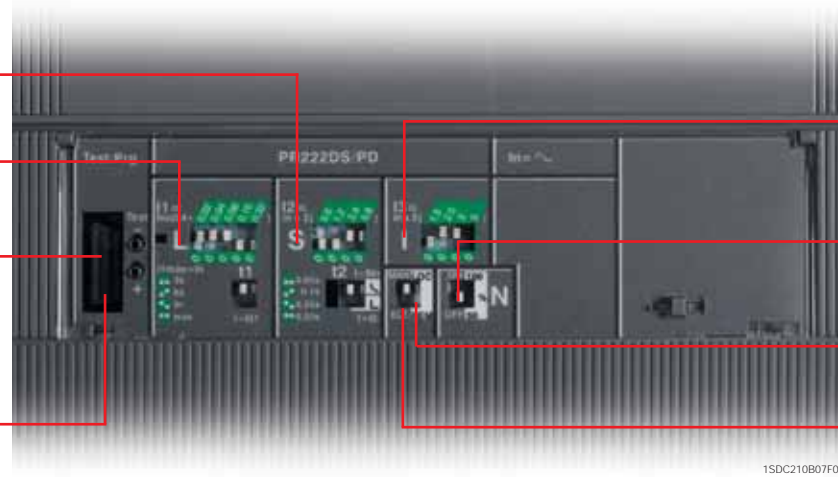

Protection I

Against short-circuit
with instantaneous trip

Dip-switch for
neutral setting









Selection for electronic
or manual setting

Selection for local
or remote setting

1SDC210B07F0001

PR222DS/P, PR222DS/PD-A – Protection functions and settings

Protection functions

Protection function	Trip threshold	Trip curves ⁽¹⁾
 <p>CANNOT BE EXCLUDED</p> <p>Against overload with long inverse time delay trip and trip characteristic according to an inverse time curve ($I^2t=constant$)</p>	 <p>Manual setting $I_1 = 0.40 - 0.42 - 0.44 - 0.46 - 0.48 - 0.50 - 0.52 - 0.54 - 0.56 - 0.58 - 0.60 - 0.62 - 0.64 - 0.66 - 0.68 - 0.70 - 0.72 - 0.74 - 0.76 - 0.78 - 0.80 - 0.82 - 0.84 - 0.86 - 0.88 - 0.90 - 0.92 - 0.94 - 0.96 - 0.98 - 1 \times I_n$</p> <p>Electronic setting $I_1 = 0.40 \dots 1 \times I_n$ (step 0.01 $\times I_n$) Release between 1.1...1.3 $\times I_1$ (IEC 60947-2 and UL 489)</p>	<p>Manual setting at 6 $\times I_1$ $t_1 = 3s$ at 6 $\times I_1$ $t_1 = 6s$ at 6 $\times I_1$ $t_1 = 9s$ at 6 $\times I_1$ $t_1 = 18s^{(2)}$</p> <p>Electronic setting at 6 $\times I_1$ $t_1 = 3 \dots 18s$ (step 0.5s)⁽²⁾ Tolerance: $\pm 10\%$</p>
 <p>CAN BE EXCLUDED</p> <p>Against short-circuit with inverse short time delay trip and trip characteristic with inverse time ($I^2t=constant$) or definite time</p>	<p>$I^2t=const$ ON</p>  <p>Manual setting $I_2 = 0.6 - 1.2 - 1.8 - 2.4 - 3.0 - 3.6 - 4.2 - 5.8 - 6.4 - 7.0 - 7.6 - 8.2 - 8.8 - 9.4 - 10 \times I_n^{(3)}$</p> <p>Electronic setting $I_2 = 0.60 \dots 10 \times I_n$ (step 0.1 $\times I_n$)⁽³⁾ Tolerance: $\pm 10\%$</p>	<p>Manual setting at 8 $\times I_n$ $t_2 = 0.05s$ at 8 $\times I_n$ $t_2 = 0.1s$ at 8 $\times I_n$ $t_2 = 0.25s$ at 8 $\times I_n$ $t_2 = 0.5s$</p> <p>Electronic setting at 8 $\times I_n$ $t_2 = 0.05 \dots 0.5s$ (step 0.01s) Tolerance: $\pm 10\%$⁽⁴⁾</p>
	<p>$I^2t=const$ OFF</p>  <p>Manual setting $I_2 = 0.6 - 1.2 - 1.8 - 2.4 - 3.0 - 3.6 - 4.2 - 5.8 - 6.4 - 7.0 - 7.6 - 8.2 - 8.8 - 9.4 - 10 \times I_n^{(3)}$</p> <p>Electronic setting $I_2 = 0.60 \dots 10 \times I_n$ (step 0.1 $\times I_n$)⁽³⁾ Tolerance: $\pm 10\%$</p>	<p>Manual setting $t_2 = 0.05s$ $t_2 = 0.1s$ $t_2 = 0.25s$ $t_2 = 0.5s$</p> <p>Electronic setting $t_2 = 0.05 \dots 0.5s$ (step 0.01s) Tolerance: $\pm 10\%$⁽⁴⁾</p>
 <p>CAN BE EXCLUDED</p> <p>Against short-circuit with instantaneous trip</p>	 <p>Manual setting $I_3 = 1.5 - 2.5 - 3 - 4 - 4.5 - 5 - 5.5 - 6.5 - 7 - 7.5 - 8 - 9 - 9.5 - 10.5 - 12 \times I_n^{(3)}$</p> <p>Electronic setting $I_3 = 1.5 \dots 12 \times I_n$ (step 0.1 $\times I_n$)⁽³⁾ Tolerance: $\pm 10\%$</p>	<p>instantaneous</p>
 <p>CAN BE EXCLUDED</p> <p>Against ground fault with inverse short time delay trip and trip characteristic according to an inverse time curve ($I^2t=constant$)</p>	 <p>Manual setting $I_4 = 0.2 - 0.25 - 0.45 - 0.55 - 0.75 - 0.8 - 1 \times I_n$</p> <p>Electronic setting $I_4 = 0.2 \dots 1 \times I_n$ (step 0.01 $\times I_n$) Tolerance: $\pm 10\%$</p>	<p>Manual setting up to 3.15 $\times I_4$ $t_4 = 0.1s$ up to 2.25 $\times I_4$ $t_4 = 0.2s$ up to 1.6 $\times I_4$ $t_4 = 0.4s$ up to 1.10 $\times I_4$ $t_4 = 0.8s$</p> <p>Electronic setting $t_4 = 0.1 \dots 0.8 \times I_n$ (step 0.01s) Tolerance: $\pm 20\%$</p>

⁽¹⁾ These tolerances hold in the following conditions:
 – self-powered relay at full power and/or auxiliary supply;
 – two or three-phase power supply.
 In conditions other than those considered, the following tolerances hold:

⁽²⁾ For T5 In = 600 A $\Rightarrow t_1 = 10.5s$
⁽³⁾ For T5 In = 600 A $\Rightarrow I_3 \max = 9.5 \times I_n$
 $I_2 \max = 9.5 \times I_n$
⁽⁴⁾ Tolerance: ± 10 ms up to $t_2 = 0.1s$

	Trip time
S	$\pm 20\%$
G	$\pm 20\%$

Power distribution circuit breakers

Electronic trip units

PR231/P – Tmax T7

The PR231/P trip unit is the basic trip unit for Tmax T7. It provides protection functions against overload L and short-circuit S/I (version PR231/P-LS/I). With this version you can choose whether to have protection S or protection I by moving the dedicated dip-switch. Alternatively the version with only the protection function against instantaneous short-circuit I is available (version PR231/P-I see also page 2/33 and following).

Setting the trip parameters of the PR231/P trip unit is done directly on the front of the circuit breaker by means of dip switches. There is only one for the phases and the neutral, so it is possible to set the protection threshold at 50% or at 100% of the phase protection.

To provide protection of the installation by means of the PR231/P protection trip unit, it is necessary to select the rated network frequency (50/60 Hz), using the special dip-switch.

Interchangeability of PR231/P can be requested by means of the dedicated ordering code 1SDA063140R1.

2

PR231/P

Protection L
Against overload

Socket for TT1 test unit

Rating Plug

Dip-switch for network frequency







Protection S
Against short-circuit with delayed trip

Dip-switch for neutral setting

Protection I
Against short-circuit with instantaneous trip

PR231/P - Protection functions and settings

Protection functions	Trip threshold	Trip curves ⁽¹⁾	Excludability	Relation $t = f(I)$
 L Against overload with long inverse time delay trip and trip characteristic according to an inverse time curve ($I^2t = \text{constant}$) CANNOT BE EXCLUDED	$I_1 = 0.40 \dots 1 \times I_n$ step = $0.04 \times I_n$ Trip between $1.1 \dots 1.3 \times I_1$ IEC 60947-2 UL 489	at $6 \times I_1$ at $6 \times I_1$ $t_1 = 3 - 12s$ Tolerance: $\pm 10\%$	-	$t = k/I^2$
 S Against short-circuit with long inverse time delay trip and trip characteristic with inverse time ($I^2t = \text{constant}$) (selectable as an alternative to protection function I) CAN BE EXCLUDED	$I_2 = 1-1.5-2-2.5-3-3.5-4.5-5.5-6.5-7-7.5-8-8.5-9-10 \times I_n$ Tolerance: $\pm 10\%$	at $10 \times I_n$ at $10 \times I_n$ $t_2 = 0.1 - 0.25s$ Tolerance: $\pm 10\%$		$t = k/I^2$
 I Against short-circuit with instantaneous trip (selectable as an alternative to protection function S) CAN BE EXCLUDED	$I_3 = 1-1.5-2-2.5-3-3.5-4.5-5.5-6.5-7-7.5-8-8.5-9-10 \times I_n$ Tolerance: $\pm 10\%$	instantaneous	-	$t = k$

⁽¹⁾ These tolerances hold in the following conditions:
 - self-powered trip unit at full power
 - two or three-phase power supply
 In conditions other than those considered, the following tolerances hold:

	Trip threshold	Trip time
S	$\pm 10\%$	$\pm 20\%$
I	$\pm 15\%$	$\leq 60ms$

PR232/P – Tmax T7

The PR232/P trip unit, available for T7, provides protection functions against overload L, delayed short-circuit S and instantaneous short-circuit I (version PR232/P-LSI).

Setting the trip parameters (see table) of the PR232/P trip unit can be carried out by means of the dip-switches it is unique for the phases and the neutral, for which it is possible to set the protection threshold to OFF, to 50%, 100% or 200% of the threshold of the phases directly from the front of the trip unit with a special dip-switch. In particular, adjustment of the neutral to 200% of the phase current requires setting protection L to respect the current-carrying capacity of the circuit breaker.

To provide protection of the installation by means of the PR232/P protection trip unit, it is necessary to select the rated network frequency (50/60 Hz) with the special dip-switch.

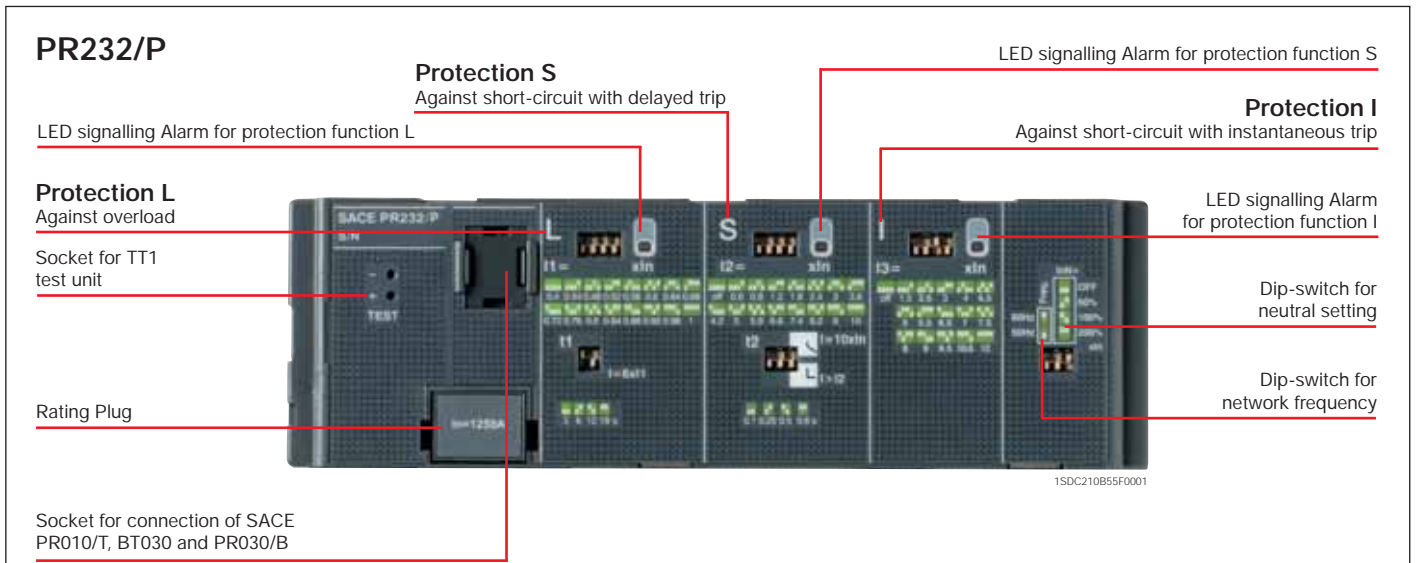

PR232/P - Protection functions and settings

Protection functions	Trip threshold	Trip curves ⁽¹⁾	Thermal memory ⁽²⁾	Excludability	Relation t = f(I)
<p>L CANNOT BE EXCLUDED</p> <p>Against overload with long inverse time delay trip and trip characteristic according to an inverse time curve ($I^2t=constant$)</p>	$I_1 = 0.40...1 \times I_n$ step = $0.04 \times I_n$ Trip between $1.1...1.3 \times I_1$ IEC 60947-2 UL 489	at $6 \times I_1$ $t_1 = 3s$ $t_1 = 6s$ $t_1 = 12s$ $t_1 = 18s$ Tolerance: $\pm 10\%$	■	-	$t = k/I^2$
<p>S CAN BE EXCLUDED</p> <p>Against short-circuit with inverse short time delay trip and trip characteristic with inverse time ($I^2t=constant$) or definite time</p>	$I_2 = 0.6 - 0.8 - 1.2 - 1.8 - 2.4 - 3 - 3.6 - 4.2 - 5 - 5.8 - 6.6 - 7.4 - 8.2 - 9 - 10 \times I_n$ Tolerance: $\pm 10\%$	at $10 \times I_n$ $t_2=0.1s$ $t_2=0.25s$ $t_2=0.5s$ $t_2=0.8s$ Tolerance: $\pm 10\%$	■	■	$t = k/I^2$
<p>I CAN BE EXCLUDED</p> <p>Against short-circuit with instantaneous trip</p>	$I_3 = 1.5 - 2.5 - 3 - 4 - 4.5 - 5 - 5.5 - 6.5 - 7 - 7.5 - 8 - 9 - 9.5 - 10.5 - 12 \times I_n$ Tolerance: $\pm 10\%$	at $I > I_3$ $t_3=0.1s$ $t_3=0.25s$ $t_3=0.5s$ $t_3=0.8s$ Tolerance: $\pm 10\%$	-	■	$t = k$

⁽¹⁾ These tolerances hold in the following conditions:
 - self-powered trip unit at full power (without start-up)
 - two or three-phase power supply

In conditions other than those considered, the following tolerances hold:

	Trip threshold	Trip time
S	$\pm 10\%$	$\pm 20\%$
I	$\pm 15\%$	$\leq 60ms$



⁽²⁾ Active up to 7 min. after tripping of the breaker (ON/OFF setting by means of PR010/T test unit).

Power distribution circuit breakers

Electronic trip units

There are three red LEDs available on the front of the PR232/P trip unit dedicated to the signalling alarm of protections L, S, and I. Furthermore, a yellow flashing LED allows the state of pre-alarm of function L to be signalled, which is activated when 90% of the set trip threshold is reached. The yellow flashing LED every 3s indicates the normal operation.

PR232/P - Alarm and Pre-alarm LED

Protection	Colour	Pre-alarm	Alarm	Last trip
	Yellow	■	-	-
	Red	-	■	■
	Red	-	■	■
	Red	-	■	■

Following circuit breaker opening, it is possible to know which protection function made the trip unit trip by connecting the PR030/B battery unit onto the front of the trip unit. This is also possible thanks to the PR010/T test and configuration unit.

By means of the BT030 wireless communication unit the PR232/P can be connected to a PDA or to a personal computer, extending the range of information available for the user. In fact, by means of the ABB SACE's SD-Pocket communication software, it is possible to read the values of the currents flowing through the circuit breaker, the value of the last 20 interrupted currents, and the protection settings.

PR331/P – Tmax T7

The PR331/P, available for Tmax T7 in the PR331/P-LSIG version, is suitable for protecting a wide range of alternating current installations with its complete range of protection functions together with the wide combination of thresholds and trip times offered. In addition the unit is provided with multifunction LED indicators. Furthermore, PR331/P allows connection to external devices enhancing its advanced characteristics like remote signalling and monitoring, or interface from front of HMI030 panel.

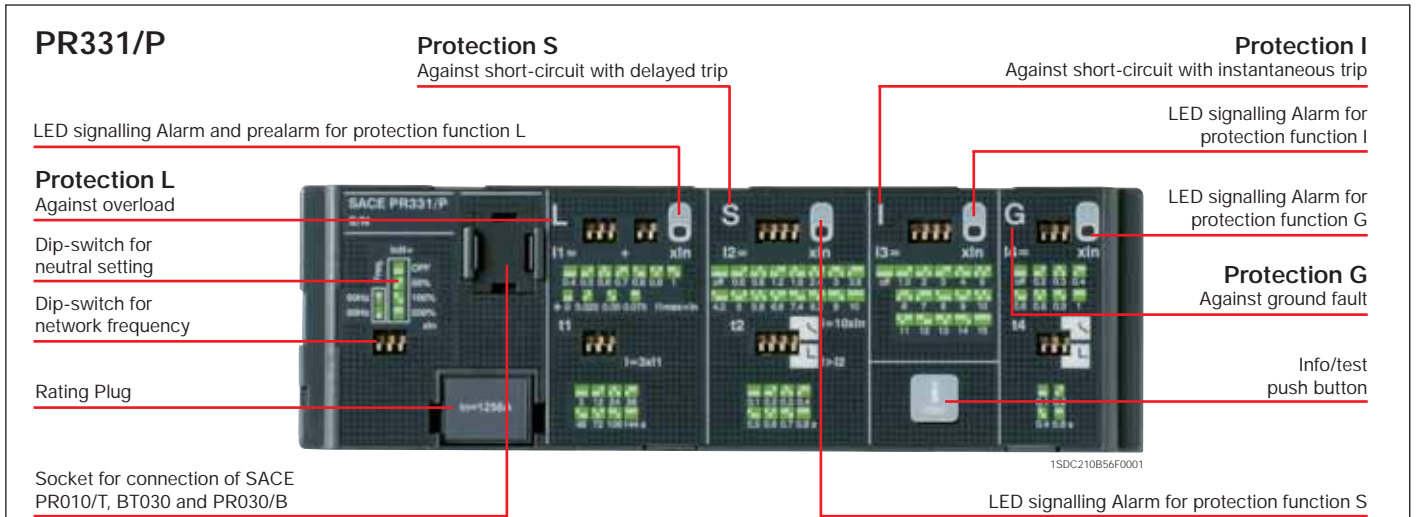

PR331/P - Protection functions and settings

Protection functions	Trip threshold	Trip curves ⁽¹⁾	Excludability	Relation t = f(I)
L CANNOT BE EXCLUDED Against overload with long inverse time-delay trip and trip characteristic according to an inverse time curve ($I^2t=k$)	$I_1 = 0.40 \dots 1 \times I_n$ step = $0.025 \times I_n$ Trip between $1.05 \dots 1.2 \times I_1$	at $3 \times I_1$ $t_1 = 3 - 12 - 24 - 36 - 48 - 72 - 108 - 144s$ Tolerance: $\pm 10\%$ up to $6 \times I_n$ $\pm 20\%$ above $6 \times I_n$	-	$t = k/I^2$
S CAN BE EXCLUDED Against short-circuit with short inverse time-delay trip and trip characteristic with inverse time ($I^2t=k$) or with definite time	$I_2 = 0.6 - 0.8 - 1.2 - 1.8 - 2.4 - 3 - 3.6 - 4.2 - 5 - 5.8 - 6.6 - 7.4 - 8.2 - 9 - 10 \times I_n$ Tolerance: $\pm 7\%$ up to $6 \times I_n$ $\pm 10\%$ above $6 \times I_n$	at $10 \times I_n$ $t_2 = 0.1 \dots 0.8s$ step = $0.1s$ Tolerance: min ($\pm 10\%$, $\pm 40ms$)	■	$t = k/I^2$
I CAN BE EXCLUDED Against short-circuit with adjustable instantaneous trip	$I_3 = 0.6 - 0.8 - 1.2 - 1.8 - 2.4 - 3 - 3.6 - 4.2 - 5 - 5.8 - 6.6 - 7.4 - 8.2 - 9 - 10 \times I_n$ Tolerance: $\pm 7\%$ up to $6 \times I_n$ $\pm 10\%$ above $6 \times I_n$	$I > I_3$ $t_2 = 0.1 \dots 0.8s$ step = $0.1s$ Tolerance: $\pm 15\%$ up to $6 \times I_n$ $\pm 20\%$ above $6 \times I_n$	■	$t = k$
G CAN BE EXCLUDED Against ground fault with short inverse time-delay trip and trip characteristic according to an inverse time curve ($I^2t=k$) or with definite time	$I_4 = 1.5 - 2 - 3 - 4 - 5 - 6 - 7 - 8 - 9 - 10 - 11 - 12 - 13 - 14 - 15 \times I_n^{(2)}$ Tolerance: $\pm 10\%$	$\leq 30 ms$	■	$t = k$
	$I_4 = 0.2 - 0.3 - 0.4 - 0.6 - 0.8 - 0.9 - 1 \times I_n$ Tolerance: $\pm 7\%$	$4.47 \times I_4$ $3.16 \times I_4$ $2.24 \times I_4$ $1.58 \times I_4$ $t_4=0.1s$ $t_4=0.2s$ $t_4=0.4s$ $t_4=0.80s$ Tolerance: $\pm 15\%$	■	$t = k/I^{(2)}$ ⁽³⁾
	$I_4 = 0.2 - 0.3 - 0.4 - 0.6 - 0.8 - 0.9 - 1 \times I_n$ Tolerance: $\pm 7\%$	$t_4=0.1s$ $t_4=0.2s$ $t_4=0.4s$ $t_4=0.80s$ Tolerance: min ($\pm 10\%$, $\pm 40ms$)	■	$t = k$

⁽¹⁾ These tolerances hold in the following conditions:
 - self-powered trip unit at full power and/or auxiliary supply
 - two or three-phase power supply
 In conditions other than those considered, the following tolerances hold:

	Trip threshold	Trip time
L	Release between 1.05 and 1.25 $\times I_1$	$\pm 20\%$
S	$\pm 10\%$	$\pm 20\%$
I	$\pm 15\%$	$\leq 60ms$
G	$\pm 15\%$	$\pm 20\%$

⁽²⁾ For T7 $I_n = 1200 A \Rightarrow I_{3,max} = 12 \times I_n$
⁽³⁾ $t = k/I^2$ up to the current value indicated, $t = k$ equating to the chosen setting) beyond the current value indicated

Power distribution circuit breakers

Electronic trip units

User interface

The user communicates directly with the trip unit by means of the dip switches. Up to four LEDs (according to the version) are also available for signalling. These LEDs (one for each protection) are active when:

- a protection is timing. For protection L the pre-alarm status is also shown;
- a protection has tripped (the corresponding LED is activated by pressing the "Info/Test" pushbutton);
- a failure in connection of a current sensor or in the trip coil is detected. The indication is active when the unit is powered (through current sensors or an auxiliary power supply)
- wrong rating plug for the circuit breaker.

The protection tripped indication works even with the circuit breaker open, without the need for any internal or external auxiliary power supply. This information is available for 48 hours of inactivity after the trip and is still available after reclosing. If the query is made more than 48 hours later it is sufficient to connect a PR030/B battery unit, PR010/T, or a BT030 wireless communication unit.

Setting the neutral

Protection of the neutral can be set at 50%, 100% or 200% of the phase currents. In particular, adjustment of the neutral at 200% of the phase current is possible if the following inequality is respected: $I_n \times I_n \times \%N < I_u$. The user can also switch the neutral protection OFF.

Test function

The Test function is carried out by means of the Info/Test pushbutton and the PR030/B battery unit (or BT030) fitted with a polarized connector housed on the bottom of the box, which allows the device to be connected to the test connector on the front of PR331/P trip units. The PR331/P electronic trip unit can be tested by using the SACE PR010/T test and configuration unit by connecting it to the TEST connector.

Power supply

The unit does not require an external power supply for protection functions or for alarm signalling functions. It is self-supplied by means of the current sensors installed on the circuit breaker.

For operation, it is required for the three phases to be passed through by a current of 70 A. An external power supply can be connected in order to activate additional features, and in particular for connection to external devices: HMI030 and PR021/K.

PR331/P - Electrical characteristics

Auxiliary power supply (galvanically insulated)	24 V DC \pm 20%
Maximum ripple	\pm 5%
Inrush current @ 24 V	~1 A for 5 ms
Rated power @ 24 V	~2 W

Communication

By means of the BT030 wireless communication unit, PR331/P can be connected to a PDA or to a personal computer, extending the range of information available for the user. In fact, using ABB's SD-Pocket communication software, it is possible to read the values of the currents flowing through the circuit breaker, the value of the last 20 interrupted currents, and the protection settings.

PR331/P can also be connected to the optional external PR021/K signalling unit, for the remote signalling of protections alarms and trips, and to HMI030, for the remote user interfacing.

PR332/P – Tmax T7

The SACE PR332/P trip unit for Tmax T7 (available in four versions: PR332/P-LI, PR332/P-LSI, PR332/P-LSIG) is a sophisticated and flexible protection system based on a state-of-the-art microprocessor and DSP technology. Fitted with the optional internal PR330/D-M dialogue unit, PR332/P turns into an intelligent protection, measurement and communication device based on the Modbus® RTU protocol. By means of the PR330/D-M, PR332/P can also be connected to the ABB EP010 Fieldbus plug adapter, which makes it possible to choose among several different networks, such as Profibus and DeviceNet. The new PR332/P is the result of ABB SACE's experience in designing trip units. The exhaustive range of settings makes this protection unit ideal for general use in power distribution. Access to information and programming using a keyboard and graphic liquid crystal display is extremely simple and intuitive. An integrated ammeter and many other additional features are provided over and above the protection functions. These additional functions can be further increased with addition on board of the dialogue, signalling, measurement, and wireless communication units. All the thresholds and trip curve delays of the protection functions are stored in special memories which retain the information even when no power is supplied.

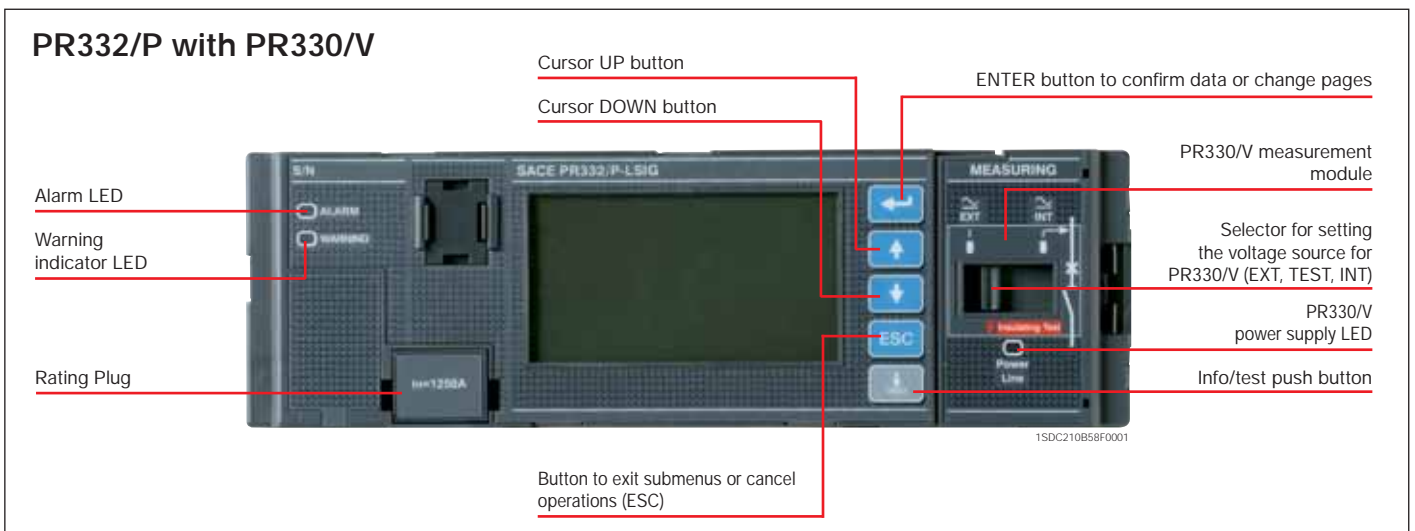

Power distribution circuit breakers

Electronic trip units

PR332/P - Protection functions and settings

Protection functions	Trip threshold	Trip curves ⁽¹⁾	Excludability	Relation $t = f(I)$	Thermal memory ⁽²⁾	Zone selectivity ⁽²⁾
L Against overload with inverse long-time delay trip	$I_1 = 0.4 \dots 1 \times I_n$ step = $0.01 \times I_n$ Trip between $1.05 \dots 1.2 \times I_1$	at $I = 3 \times I_1$ $t_2 = 3 \dots 144s$ step = 3s Tolerance: $\pm 10\%$ up to $6 \times I_n$ $\pm 20\%$ above $6 \times I_n$	–	$t = k/I^2$	■	–
	$I_1 = 0.4 \dots 1 \times I_n$ step = $0.01 \times I_n$ Trip between $1.05 \dots 1.2 \times I_1$	$t_2 = 3 \dots 144s$ step = 3s Tolerance: $\pm 10\%$ up to $6 \times I_n$ $\pm 20\%$ above $6 \times I_n$	■	$t = f(\alpha)^{(3)}$ $\alpha = 0.02-1-2$	■	–
S Against short-circuit with short inverse time-delay trip and trip characteristic with inverse time ($I^2t=k$) or with definite time	$I_2 = 0.6 \dots 10 \times I_n$ step = $0.1 \times I_n$ Tolerance: $\pm 7\%$ up to $6 \times I_n$ $\pm 10\%$ above $6 \times I_n$	at $10 \times I_n$ $t_2 = 0.05 \dots 0.8s$ step = 0.01s Tolerance: $\pm 15\%$ up to $6 \times I_n$ $\pm 20\%$ over $6 \times I_n$	■	$t = k/I^2$	■	–
	$I_2 = 0.6 \dots 10 \times I_n$ step = $0.1 \times I_n$ Tolerance: $\pm 7\%$ up to $6 \times I_n$ $\pm 10\%$ above $6 \times I_n$	$t_2 = 0.05 \dots 0.8s$ step = 0.01s $t_{2\text{ sel}} = 0.04 \dots 0.2s$ step = 0.01s Tolerance: min ($\pm 10\%$; $\pm 40ms$)	■	$t = k$	–	■
I Against short-circuit with adjustable instantaneous trip	$I_3 = 1.5 \dots 15 \times I_n$ step = $0.1 \times I_n$ Tolerance: $\pm 10\%$	$\leq 30 \text{ ms}$	■	$t = k$	–	–
G Against ground fault with short inverse time-delay trip and trip characteristic according to an inverse time curve ($I^2t=k$) or with definite time	$I_4 = 0.2 \dots 1 \times I_n$ step = $0.02 \times I_n$ Tolerance: $\pm 7\%$	$t_4 = 0.1 \dots 1s$ step = 0.05s Tolerance: $\pm 15\%$	■	$t = k/I^2$ ⁽⁵⁾	–	–
	$I_4 = 0.2 \dots 1 \times I_n$ step = $0.02 \times I_n$ Tolerance: $\pm 7\%$	$t_4 = 0.1 \dots 1s$ step = 0.05s $t_{4\text{ sel}} = 0.04 \dots 0.2s$ step = 0.05s Tolerance: min ($\pm 10\%$; $\pm 40ms$)	■	$t = k$	–	■
OT Against overtemperature of the trip unit with instantaneous trip	Trip unit temperature over 85°C	instantaneous	–	temp = k	–	–
U Against unbalanced phase with definite time-delay trip	$I_6 = 2\% \dots 90\% \times I_1$ step = $1\% \times I_1$ Tolerance: $\pm 10\%$	$t_6 = 0.5 \dots 60s$ step = 0.5s Tolerance: min ($\pm 20\%$; $\pm 100ms$)	■	$t = k$	–	–

PR332/P with PR330/V - Advanced protection functions and settings

Advanced protection functions	Trip threshold	Trip curves ⁽¹⁾	Excludability	Relation $t = f(I)$	Thermal memory ⁽²⁾	Zone selectivity
UV Against undervoltage with adjustable constant time	$U_9 = 0.5 \dots 0.95 \times U_n$ step = $0.01 \times U_n$ Tolerance: $\pm 5\%$	$t_9 = 0.1 \dots 5s$ step = 0.1s Tolerance: min ($\pm 20\%$ $\pm 100ms$)	■	$t = k$	–	–
OV Against overvoltage with adjustable constant time	$U_9 = 1.05 \dots 1.2 \times U_n$ step = $0.01 \times U_n$ Tolerance: $\pm 5\%$	$t_9 = 0.1 \dots 5s$ step = 0.1s Tolerance: min ($\pm 20\%$ $\pm 100ms$)	■	$t = k$	–	–
RV Against residual voltage with adjustable constant time	$U_{10} = 0.1 \dots 0.4 \times U_n$ step = $0.01 \times U_n$ Tolerance: $\pm 5\%$	$t_{10} = 0.5 \dots 30s$ step = 0.5s Tolerance: min ($\pm 10\%$ $\pm 100ms$)	■	$t = k$	–	–
RP Against reversal of power with adjustable constant time	$P_{11} = -0.3 \dots -0.1 \times P_n$ step = $0.02 \times P_n$ Tolerance: $\pm 10\%$	$t_{11} = 0.5 \dots 25s$ step = 0.1s Tolerance: min ($\pm 10\%$ $\pm 100ms$)	■	$t = k$	–	–
UF Against underfrequency with adjustable constant time	$f_{12} = 0.90 \dots 0.99 \times f_n$ step = $0.01 \times f_n$ Tolerance: $\pm 5\%$	$t_{12} = 0.5 \dots 3s$ step = 0.1s Tolerance: min ($\pm 10\%$ $\pm 100ms$)	■	$t = k$	–	–
OF Against overfrequency with adjustable constant time	$f_{13} = 1.01 \dots 1.10 \times f_n$ step = $0.01 \times f_n$ Tolerance: $\pm 5\%$	$t_{13} = 0.5 \dots 3s$ step = 0.1s Tolerance: min ($\pm 10\%$ $\pm 100ms$)	■	$t = k$	–	–

⁽¹⁾ These tolerances are valid under the following conditions:
– trip unit self-supplied at full power and/or auxiliary supply
– two or three-phase power supply
In conditions other than those considered, the following tolerances hold:

	Trip threshold	Trip time
L	Release between 1.05 and $1.25 \times I_1$	$\pm 20\%$
S	$\pm 10\%$	$\pm 20\%$
I	$\pm 15\%$	$\leq 60ms$
G	$\pm 15\%$	$\pm 20\%$
Other	$\pm 10\%$	$\pm 20\%$

⁽²⁾ Active with 24V auxiliary power supply

⁽³⁾ $t = \frac{(3^\alpha - 1)}{\left(\frac{1}{I_1}\right)^\alpha - 1} t_1 (3 \times I_1)$

⁽⁴⁾ For $T7 I_n = 1000 \text{ A} \Rightarrow I_{3\text{ max}} = 12 \times I_n$

⁽⁵⁾ $k = (2s) \cdot (I_d)^2$

Setting the neutral

In PR332/P, the neutral protection is 50% of the value set for phase protection in the standard version. The neutral protection can be excluded or set to 100%.

In installations where very high harmonics occur, the resulting current at the neutral can be higher than that of the phases. Therefore it is possible to set the neutral protection at 150% or 200% of the value set for the phases. In this case it is necessary to reduce the setting of L protection accordingly. The table below lists the neutral settings for the various possible combinations between type of circuit breaker and the threshold I_1 setting.

Adjustable neutral protection settings

Threshold I_1 settings (overload protection)

Circuit breaker model	$0.4 < I_1 < 0.5$	$0.5 < I_1 < 0.66$	$0.66 < I_1 < 1^{(*)}$
T7	0-50-100-150-200%	0-50-100-150%	0-50-100%

^(*) The setting $I_1 = 1$ indicates the maximum overload protection setting. The actual maximum setting allowable must take into account any derating based on temperature, the terminals used and the altitude (see the "Installations" chapter)

Start-up function

The start-up function allows protections S, I and G to operate with higher trip thresholds during the start-up phase. This avoids untimely tripping caused by the high inrush currents of certain loads (motors, transformers, lamps).

The start-up phase lasts from 100 ms to 30 s, in steps of 0.01 s. It is automatically recognized by the PR332/P trip unit when the peak value of the maximum current exceeds the threshold that can be set by the user. A new start-up becomes possible after the current has fallen down to $0.1 \times I_n$, if the trip unit is supplied from an external source.

Protection against overtemperature

The user has the following signals or commands available for protection against overtemperature:

- lighting up of the "Warning" LED when the temperature is higher than 70 °C or lower than -20 °C (temperature at which the microprocessor is still able to operate correctly);
- lighting up of the "Alarm" LED when the temperature is higher than 85 °C or lower than -25 °C (temperature above which the microprocessor can no longer guarantee correct operation) and, when decided during the unit configuration stage, simultaneous opening of the circuit breaker with indication of the trip directly on the display, as for the other protections.

Self-diagnosis

The PR332/P range of trip units contains an electronic circuit which periodically checks the continuity of internal connections (trip coil and each current sensor, including the Source Ground Return when present).

In the case of a malfunction an alarm message appears directly on the display. The Alarm is highlighted by the Alarm LED as well.

Test Functions

Once enabled from the menu, the "Info/Test" pushbutton on the front of the trip unit allows correct operation of the chain consisting of the microprocessor, trip coil and circuit breaker tripping mechanism to be checked.

The control menu also includes the option of testing correct operation of the display, signalling LEDs. By means of the front multi-pin connector it is possible to apply a SACE PR010/T Test unit which allows the functions of the PR222DS/P, PR222DS/PD-A, PR232/P, PR331/P and PR332/P ranges of trip units to be tested and checked.

Power distribution circuit breakers

Electronic trip units

User interface

The human-machine interface (HMI) of the device is made up of a wide graphic display, LEDs, and browsing pushbuttons. The interface is designed to provide maximum simplicity.

The language can be selected from among five available options: Italian, English, German, French and Spanish.

As in the previous generation of trip units, a password system is used to manage the "Read" or "Edit" modes. The default password, 0001, can be modified by the user.

The protection parameters (curves and trip thresholds) can be set directly via the HMI of the device. The parameters can only be changed when the trip unit is operating in "Edit" mode, but the information available and the parameter settings can be checked at any time in "Read" mode.

When a communication device (internal PR330/D-M module or external BT030 device) is connected, it is possible to set parameters simply by downloading them into the unit (over the network for PR330/D-M, by using the SD-Pocket software and a PDA or a notebook for BT030). Settings can then be carried out quickly and automatically in an error-free way by transferring data directly from DocWin.

Indicator LEDs

LEDs on the front panel of the trip unit are used to indicate all the warnings and alarms. A message on the display always explicitly indicates the type of event that has concerned.

Example of events indicated by the "WARNING" LED:

- unbalance between phases;
- pre-alarm for overload ($L1 > 90\% \times I_n$);
- first temperature threshold exceeded (70 °C);
- contact wear beyond 80%;
- phase rotation reversed (with optional PR330/V).

Example of events indicated by the "ALARM" LED:

- timing of function L;
- timing of function S;
- timing of function G;
- second temperature threshold exceeded (85 °C);
- contact wear 100%;
- timing of Reverse Power flow protection (with optional PR330/V).

Data logger

PR332/P is provided with the Data Logger function that automatically records the instantaneous values of all the currents and voltages in a wide memory buffer. Data can be easily downloaded from the unit by means of SD-Pocket or SD-TestBus2 applications and can be transferred to any personal computer for elaboration. The function freezes the recording whenever a trip occurs or in case of other events, so that a detailed analysis of faults can be easily performed. SD-Pocket and SD-TestBus2 also allow reading and downloading of all the other trip information.

- Number of analog channels: 8
- Maximum sampling rate: 4800 Hz
- Maximum sampling time: 27 s (@ sampling rate 600 Hz)
- 64 events tracking.

Trip information and opening data

In case a trip occurs PR332/P store all the needed information:

- Protection tripped
- Opening data (current)
- Time stamp (guaranteed with auxiliary supply or self-supply with power failure no longer than 48h).

By pushing the "Info/Test" pushbutton the trip unit shows all these data directly on display.

No auxiliary power supply is needed. The information is available to user for 48 hours with the circuit breaker open or without current flowing.

The information of the latest 20 trips are stored in memory.

If the information can be furthermore retrieved more than 48 hours later, it is sufficient to connect a PR030/B battery unit or a BT030 wireless communication unit.

Load control

Load control makes it possible to engage/disengage individual loads on the load side before the overload protection L is tripped, thereby avoiding unnecessary trips of the circuit breaker on the supply side. This is done by means of contactors or disconnect switches (externally wired to the trip unit), controlled by the PR332/P through PR021/K unit.

Two different Load Control schemes can be implemented:

- disconnection of two separate loads, with different current thresholds
- connection and disconnection of a load, with hysteresis.

Current thresholds and trip times are smaller than those available for selection with protection L, so that load control can be used to prevent overload tripping. External PR021/K accessory unit is required for Load Control. The function is only active when an auxiliary power supply is available.

PR330/V Measurement Module

This optional internal module, installed in PR332/P, allows the trip unit to measure the phase and neutral voltages and to process them in order to achieve a series of features, in terms of protection and measurement.

The PR330/V module when ordered mounted on the circuit breaker, does not require any external connection or voltage transformers since it is connected internally to the upper terminals of Tmax T7 (selector in "INT" position) through the internal voltage sockets. When necessary, the connection of voltage pickups can be moved to any other point (i.e. lower terminals), by using the alternative connection located in the terminal box and by switching the selector to the "EXT" position. For the dielectric test of the circuit breaker the selector must be switched to the "Insulating TEST" position. PR330/V is able to energize the PR332/P while line voltage input is above 85 V. The use of Voltage Transformers is mandatory for rated voltages higher than 690 V.

Voltage transformers shall have burdens between 5 VA and 10 VA and accuracy class 0.5 or better.

Additional Protections with PR330/V:

- Undervoltage (UV) protection
- Overvoltage (OV) protection
- Residual voltage (RV) protection
- Reversal of power (RP) protection
- Underfrequency (UF) protection
- Overfrequency (OF) protection.

All the above indicated protections can be excluded, although it is possible to leave only the alarm active when required: in this case the trip unit will indicate the "ALARM" status. With the circuit breaker closed, these protections also operate when the trip unit is self-supplied. With the circuit breaker open, they operate when the auxiliary power supply (24 V DC or PR330/V) is present.

Power distribution circuit breakers

Electronic trip units

Measurement function

The current measurement function (ammeter) is present on all versions of the PR332/P trip unit. The display shows histograms showing the currents of the three phases and neutral on the main page. Furthermore, the most loaded phase current is indicated in numerical format. Ground fault current, where applicable, is shown on a dedicated page.

The latter current value takes on two different meanings depending on whether the external toroidal transformer for the "Source Ground Return" function or the internal transformer (residual type) is connected. The ammeter can operate either with self-supply or with an auxiliary power supply voltage. The display is rear-lit and the ammeter is active even at current levels lower than 160 A.

Accuracy of the ammeter measurement chain (current sensor plus ammeter) is no more than 1.5% in the 0.3-6 x I_n current interval of I_n.

- Currents: three phases (L1, L2, L3), neutral (Ne) and ground fault;
- Instantaneous values of currents during a period of time (data logger);
- Maintenance: number of operations, percentage of contact wear, opening data storage (last 20 trips and 20 events).

When the optional PR330/V is connected the following additional measurement functions are present:

- Voltage: phase-phase, phase-neutral and residual voltage
- Instantaneous values of voltages during a period of time (data logger)
- Power: active, reactive and apparent
- Power factor
- Frequency and peak factor
- Energy: active, reactive, apparent, counter.

Communication

PR332/P electronic trip unit can be fitted with communication modules, which make possible to exchange data and information with other industrial electronic devices by means of a network.

The basic communication protocol implemented is Modbus RTU, a well-known standard of widespread use in industrial automation and power distribution equipment. A Modbus RTU communication interface can be connected immediately and exchange data with the wide range of industrial devices using the same protocol. ABB has developed a complete series of accessories for electronic trip unit PR332/P:

- PR330/D-M is the communication module for PR332/P protection trip units. It is designed to allow easy integration of the Tmax circuit breakers in a Modbus network. The Modbus RTU protocol is used widely in the power and the automation industries. It is based on a master/slave architecture, with a bandrate of up to 19.2 kbps. A standard Modbus network is easily wired up and configured by means of an RS485 physical layer. ABB SACE trip units work as slaves in the field bus network. All information required for simple integration of PR330/D-M in an industrial communication system is available on the ABB Web page.
- BT030 is a device to be connected to the Test connector of PR222DS/P, PR222DS/PD-A, PR232/P, PR331/P and PR332/P trip units. It allows Bluetooth communication between the trip unit and a PDA or a Notebook with a Bluetooth port. This device is dedicated to use with the SD-Pocket or SD-TestBus2 application. It can provide the auxiliary supply needed to energize the protection trip unit by means of rechargeable batteries.
- EP010-FBP-PDP22 is the Fieldbus Plug interface allows connection of ABB SACE trip units with Modbus communication to a Profibus, DeviceNet, or AS-I field bus network.

Furthermore, a new generation of software dedicated to installation, configuration, supervision and control of protection trip units and circuit- breakers is now available:

- SD-View 2000
- SD-Pocket
- SD-TestBus2.

All information required for simple integration of PR330/D-M in an industrial communication system are available on the ABB Web page (<http://www.abb.com>).

Measurement, signalling and available data functions

Details about functions available on PR332/P, trip units with PR330/D-M and EP010 – FBP – PDP22 are listed in the table below:

	PR332/P + PR330/D-M	PR332/P + PR330/D-M and EP010
Communication functions		
Protocol	Modbus RTU standard	FBP-PDP22
Physical means	RS485	Profibus-DP or DeviceNet cable
Speed (maximum)	19.2 kbps	115 kbps
Measurement functions		
Phase currents	■	■
Neutral current	■	■
Ground current	■	■
Voltage (phase-phase, phase-neutral, residual)	opt. ⁽¹⁾	opt. ⁽¹⁾⁽²⁾
Power (active, reactive, apparent)	opt. ⁽¹⁾	opt. ⁽¹⁾⁽³⁾
Power factor	opt. ⁽¹⁾	⁽⁴⁾
Frequency and peak factor	opt. ⁽¹⁾	⁽⁴⁾
Energy (active, reactive, apparent)	opt. ⁽¹⁾	⁽⁴⁾
Harmonic analysis	–	–
Signalling functions		
LED: auxiliary power supply, pre-alarm, alarm, transmission, reception	■	■
Temperature	■	■
Indication for L, S, I, G and other protection	■	■
Available data		
Circuit breaker status (open, closed)	■	■
Circuit breaker position (racked-in, racked-out)	■	■
Mode (local, remote)	■	■
Protection parameters set	■	■
Load control parameters	■	■
Alarms		
Protections: L, S, I, G	■	■
Undervoltage, overvoltage and residual voltage protection (timing and trip)	opt. ⁽¹⁾	opt. ⁽¹⁾
Reverse power protection (timing and trip)	opt. ⁽¹⁾	opt. ⁽¹⁾
Directional protection (timing and trip)	–	–
Underfrequency/overfrequency protection (timing and trip)	opt. ⁽¹⁾	opt. ⁽¹⁾
Phases rotation	–	–
Failed tripping under fault conditions	■	■
Maintenance		
Total number of operations	■	■
Total number of trips	■	■
Number of trip tests	■	■
Number of manual operations	■	■
Number of separate trips for each protection function	■	■
Contact wear (%)	■	■
Record data of last trip	■	■
Commands		
Circuit breaker open/close	■	■
Alarms reset	■	■
Setting of curves and protection thresholds	■	■
Synchronize system time	■	■
Events		
Status changes in circuit breaker, protections and all alarms	■	■

⁽¹⁾ With PR330/V

⁽²⁾ No residual voltage

⁽³⁾ No apparent power available

⁽⁴⁾ Please ask ABB for further details

Power distribution circuit breakers

Electronic trip units

Power supply

The PR332/P trip unit does not normally require any external power supplies, being self-supplied from the current sensors (CS): to activate the protection and ammeter functions, it is sufficient for at least one phase to have a current load higher than 80 A.

The unit ensures fully self-supplied operation. When an auxiliary power supply is present, it is also possible to use the unit with the circuit breaker either open or closed with very low current flowing through (<80 A).

It is also possible to use an auxiliary power supply provided by the PR030/B portable battery unit, which allows the protection functions to be set when the trip unit is not self supplied.

PR332/P stores and shows all the information needed after a trip (protection tripped, trip current, time, date). No auxiliary supply is required.

	PR332/P	PR330/D-M
Auxiliary power supply (galvanically insulated)	24 V DC \pm 20%	from PR332/P
Maximum ripple	\pm 5%	\pm 5%
Inrush current @ 24 V	-1 A for 5 ms	-0.5 A for 5 ms
Rated power @ 24 V	-3 W	+1 W

PR330/V can give power supply to the trip unit when at least one line voltage is equal or higher to 85V RMS.

Motor Protection

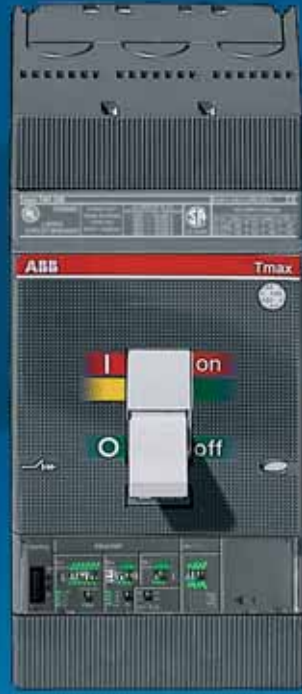



Motor Control Protection circuit breakers: MCP



Index

Motor Control Protection circuit breakers: MCP

Electrical characteristics	2/34
General characteristics.....	2/36

Motor Control Protection circuit breakers: MCP

Electrical characteristics



MCP

Type		Tmax T2		Tmax T3	Tmax Ts3		
Frame size		100		225	150-225		
Poles		3		3	3		
Ratings		20...100		100...200	3...25	50...150	175...200
Icu		S	H	S	L	L	L
	240 V AC	65	150	65	50	150	150
	480 V AC	35	65	35	25	85	65
	600Y/347 V AC			10			
	600 V AC				10	25	
	500VDC			35	65 ⁽¹⁾	65	50
	600VDC				50	50	
Trip unit	Adjustable magnetic only (6...12xIn)	■	■	■			
	Adjustable magnetic only (4...12xIn)				■	■	■
	PR221DS-I	■	■				
	PR231/P-I						

⁽¹⁾ Only for 25A rating



Tmax T4					Tmax T5					Tmax T6					Tmax T7				
250					400-600					800					1000-1200				
3					3					3					3				
100-150-250					300-400-600					600-800					1000-1200				
N	S	H	L		N	S	H	L		N	S	H	L		S	H	L		
65	100	150	200		65	100	150	200		65	100	200	200		65	100	150		
25	35	65	100		25	35	65	100		35	50	65	100		50	65	100		
18	25	35	65		18	25	35	65		20	25	35	42		25	50	65		
■	■	■	■		■	■	■	■		■	■	■	■		■	■	■		

Motor Control Protection circuit breakers: MCP

General characteristics

MCP circuit breakers are used to protect three phase asynchronous motors. The traditional system used for this purpose is based on three different devices: a circuit breaker for protection against short-circuit, a thermal relay for protection against overload and phase loss or unbalance of phase, and a contactor for motor switching. All this has to take into account the problems that arise at the moment of the motor starting. In particular, when selecting these devices, different factors must be taken into consideration, such as:

- the motor power;
- the diagram and type of starting;
- the type of motor: with cage rotor or with wound rotor;
- the fault current at the point of the network where the motor is installed.

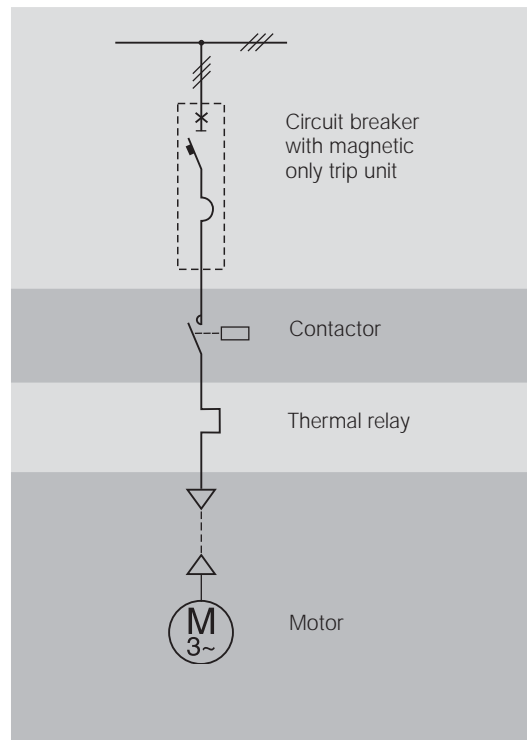

Protection against short-circuit

ABB offers two different protection types:

- a magnetic only trip unit (MA) for Tmax T2 and T3 with adjustable threshold between $6 \dots 12 \times I_n$, for Ts3 with adjustable threshold between $4 \dots 12 \times I_n$;
- an electronic trip unit with only an instantaneous short circuit protection I, PR221DS-I for Tmax T4, T5 and T6, and PR231/P-I for Tmax T7.

MA – Magnetic only trip unit (for T2 and T3)

 $I_3 = 6...12 \times I_n$	In [A]	20	50	100	125	150	200
	T2	■	■	■			
	T3			■	■	■	■
	I₃ [A]	120...240	300...600	600...1200	750...1500	900...1800	1200...2400

MA – Magnetic only trip unit (for Ts3)

 $I_3 = 4...12 \times I_n$	In [A]	3	5	10	25	50	100	125	150	175	200
	Ts3	■	■	■	■	■	■	■	■	■	■
	I₃ [A]	12...36	20...60	40...120	100...300	200...600	400...1200	500...1500	600...1800	700...2100	800...2400

Electronic trip units

In [A]	100	150	250	300	400	600	800	1000	1200
T4	■	■	■						
T5				■	■	■			
T6						■	■		
T7								■	■
Trip current function I									
I₃ [A]	100...1000	150...1500	250...2500	300...3000	400...4000	600...6000	800...8000	1000...12000	1200...14400

PR221DS-I

Protection function	Trip threshold	Excludability	Relation t=f(I)
 Against short-circuit with adjustable instantaneous trip	$I_3 = 1 - 1.5 - 2 - 2.5 - 3 - 3.5 - 4.5 - 5.5 - 6.5 - 7 - 7.5 - 8 - 8.5 - 9 - 10 \times I_n$ Tolerance: ± 20% (T2) ± 10% (T4-T5, T6)	■	t = k

Note: The tolerances are valid under the following hypotheses:
 – relay self-supplied on running and/or auxiliary power supply (without start up)
 – two-phase or three-phase power supply.

In all the cases not foreseen by the above-mentioned hypotheses, the following tolerance values are valid:

	Trip threshold	Trip time
I	± 20%	≤ 40ms

PR231P-I

Protection function	Trip threshold	Excludability	Relation t=f(I)
 Against short-circuit with adjustable instantaneous trip	$I_3 = 1 - 1.5 - 2 - 2.5 - 3 - 3.5 - 4.5 - 5.5 - 6.5 - 7 - 7.5 - 8 - 8.5 - 9 - 10 \times I_n$ Tolerance: ± 10%	–	t = k

Note: The tolerances are valid under the following hypotheses:
 – relay self-supplied on running and/or auxiliary power supply (without start up)
 – two-phase or three-phase power supply.

In all the cases not foreseen by the above-mentioned hypotheses, the following tolerance values are valid:

	Trip threshold	Trip time
I	± 15%	≤ 60ms

Molded Case Switches





Molded Case Switches: MCS



Index

Molded Case Switches: MCS

Electrical characteristics2/40

Molded Case Switches: MCS

Electrical characteristics

The MCS can be used as a general circuit breakers in sub-switch-boards, switching and isolation parts for lines, busbars or groups of apparatus, or as bus-ties. They can be part of a general isolation device of groups of machines or of complexes for motor operation and protection.

The MCS are derived from the corresponding circuit breakers of which they keep the overall dimensions, versions, fixing systems and the possibility of mounting accessories. All the molded case switches in accordance with UL 489 and CSA C22.2 Standards are self protected.



2 MCS

Type	
Rating	[A]
Poles	[Nr]
Magnetic override	[A]
Rated Voltage	AC (50-60 Hz) [V]
	DC [V]

Tmax T1N-D	Tmax T3S-D	Tmax T3S-D	Tmax Ts3H-D 150	Tmax Ts3H-D 225
100	150	225	150	225
3-4	3-4	3-4	3-4	3-4
1000	1500	2250	1500	2250
600Y/347	600Y/347	600Y/347	600	480
500	500	500	600	500

Isolation

MCS's main function is to isolate the circuit they are inserted in. Once the contacts are open they are at a distance which prevents an arc from striking, in accordance with the standards regarding isolation behaviour. The position of the operating lever corresponds with the position of the contacts (positive operation).

Protection

Each molded case switch must be protected on the supply side by a device which safeguards it against short-circuits.



2

Tmax T4N-S-H-L-V-D		Tmax T5N-S-H-L-V-D		Tmax T6H-D		Tmax T7H-D	
	250		400-600		800		1200
	3-4		3-4		3-4		3-4
	3000		5000		10000		20000
	600		600		600		600
	600		600		600		-

Current limiting





Index

Current Limiting

Electrical characteristics	2/44
----------------------------------	------

Current Limiting

Electrical characteristics

Present 3 poles UL circuit breakers Tmax T2 H, Tmax T4 H and T4 V and Tmax T5 H 400 A and T5 V 400 A have been undergone to specific tests according to UL 489 in order to be classified as UL Current Limiting circuit breakers.

These breakers have peculiar characteristics in terms of limitation of peak current and limitation of specific let-through energy.

According to UL 489 standard, Current Limiting circuit breakers will be signed "Current Limiting" on the front and will have a label on the right side specifying peak current and specific let-through energy values.

Accessories and trip units are the same ones as those available for standard UL Tmax MCCBs.

Tmax Current Limiting

Type		Tmax T2	Tmax T4		Tmax T5	
Frame size	[A]	100	250		400	
Number of poles	[Nr]	3	3		3	
Rated voltage	AC (50-60 Hz)	480	600		600	
	DC		600		600	
Interrupting ratings		H	H	V	H	V
	240 V AC [kA rms]	150	150	200	150	200
	277 V AC [kA rms]					
	347 V AC [kA rms]					
	480 V AC [kA rms]	65	65	150	65	150
	600Y/347 V AC [kA rms]					
	600 V AC [kA rms]		35	100	35	100
	250 V DC (2 poles in series) [kA rms]					
	500 V DC (3 poles in series) [kA rms]					
	500 V DC (2 poles in series) [kA rms]		50	100	50	100
	600 V DC (3 poles in series) [kA rms]		35	65	35	65
Trip units	TMF	■		■		
	TMD/TMA			■		■
	Electronic	■		■		■
Dimensions	H [in/mm]	5.12/130	8.07/205		8.07/205	
	W 3p [in/mm]	3.54/90	4.13/105		5.51/140	
	D [in/mm]	2.76/70	4.07/103.5		4.07/103.5	
Mechanical life	[No.operations]	25000	20000		20000	

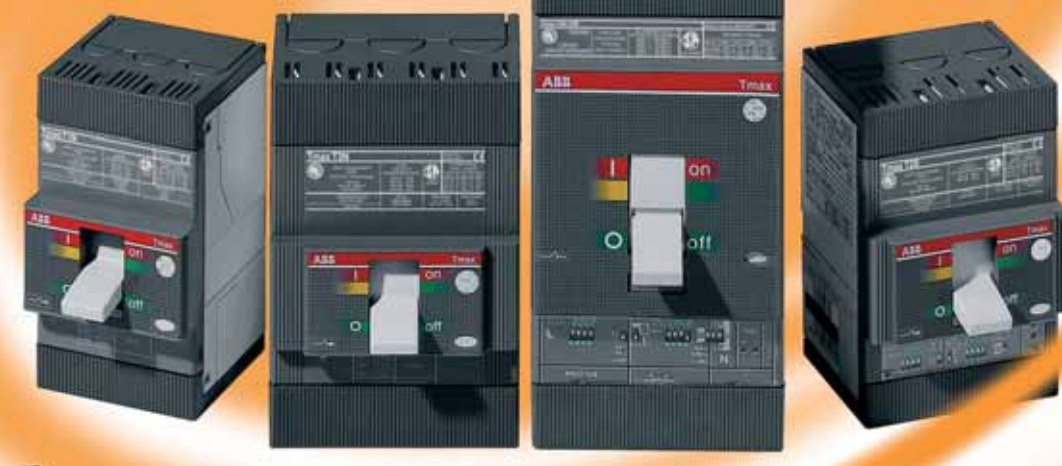



Index

Versions and types	3/2
Connection terminals	3/6
Service releases	3/15
Electrical signals.....	3/21
Remote control.....	3/27
Operating mechanisms and locks.....	3/34
Residual current releases - IEC only	3/40
Accessories for electronic trip units	3/45
Test and configuration accessories.....	3/50
Automatic transfer switch - ATS010 (IEC only)	3/51
Installation accessories and spare parts	3/54
Compatibility of internal accessories	3/55

Accessories

Versions and types

Starting from the fixed version with front terminals, the Tmax circuit breakers can be converted into the various versions (plug-in for T2, T3, Ts3, T4 and T5; draw out for Ts3, T4, T5, T6 and T7), using the conversion kits. This makes management of the product, its versions and stock very flexible. In any case, it is always possible to request the circuit breaker in the desired version completely preset in the factory, by ordering, on the same line, the fixed circuit breaker and the conversion kit, to which must be added the cradle.

T7 is available in two different versions: the toggle version similar to the other sizes in the Tmax family, and the new motorizable version.



Fixed

The Tmax FIXED three-pole or four-pole version circuit breakers offer:

- circuit breakers characterized by just two depths up to 1000 A: 70 mm for Tmax T1, T2 and T3 and 103.5 mm for Tmax Ts3, T4, T5 and T6. For T7 the depth varies according to the type of operating mechanism (with toggle or spring charging motor)
- standard circuit breaker fronts: 45 mm for Tmax T1, T2 and T3 and 105 mm for Ts3, T4 and T5, 140 mm for T6 and 280 mm for T7
- flange for compartment door
- possibility of assembly on back plate (or on DIN rail with T1, T2, T3 and Ts3, with the help of a special accessory, see page 3/52)
- thermomagnetic (on Tmax T1, T2, T3, Ts3, T4, T5 and T6) or electronic (on Tmax T2, T4, T5, T6 and T7) trip units
- standard FC Cu type terminals (front for copper cables) for T1 and F type (front) on all the Tmax family sizes.



Plug-in

The PLUG-IN version of the circuit breaker (Tmax T2, T3, Ts3, T4 and T5) consists of:

- cradle to be installed directly on the back plate of the unit
- moving part obtained from the fixed circuit breaker with addition of the isolating contacts (near the connection terminals), of the rear frame (for fixing to the cradle) and of the terminal covers.

The circuit breaker is racked out by unscrewing the top and bottom fixing screws. A special lock prevents circuit breaker racking in and racking out with the contacts in the closed position.

In case the circuit breaker has electrical accessories mounted (SOR, UVR, MOS, MOE, MOE-E, AUX, AUX-E, AUE, RC222), the socket-plug connectors or the adapters for isolation of the relative auxiliary circuits must also be ordered (see page 3/32).



Draw out

The circuit breakers in the DRAW OUT version (Tmax Ts3, T4, T5, T6 and T7) are made up of:

- cradle to be installed directly on the back plate of the unit fitted with lateral guides to allow the moving part racking-in and racking-out operation to be carried out easily, and a dedicated flange for the compartment door to replace the one provided with the circuit breaker in the fixed version;
- moving part obtained from the fixed circuit breaker with addition of the relative conversion kit from fixed to draw out moving part;
- mandatory accessory to be applied onto the front of the circuit breaker selected between front for lever operating mechanism (standard supply for circuit breakers fitted with accessories in the factory, excluding T7) motor operator and rotary handle operating mechanism. Application of one of these accessories allows the racking-in and racking-out of the moving part with the compartment door closed (on T7 no accessory is required to have racking-out with the door closed).



1SD0210015F0001 UL

Racking-in and racking-out of the moving part is carried out the special operating lever supplied with the cradle. This particular device allows the circuit breaker to be placed in the isolated position (with power and auxiliary circuits disconnected) with the compartment door closed, to the great advantage of operator safety. The handle can only be inserted with the circuit breaker open. Once removed or racked-out, the circuit breaker can be operated in open/closed and, by means of special connection extensions, blank tests can be carried out of the auxiliary control circuit functions.

The T4, T5 and T6 circuit breakers in the draw out version can only be fitted with pre-wired electrical accessories, provided with the appropriate ADP adapters for isolation of the relative auxiliary circuits (see page 3/31).

Stored Energy

The stored energy T7 circuit breaker can be equipped with the spring charging motor. To allow a complete remote control with T7 motorizable, the circuit breaker must be fitted with:

- shunt trip;
- closing coil;
- spring charging motor.

Versions available

	F Fixed	P Plug-in	W Draw out
T1	■		
T2	■	■	
T3	■	■	
Ts3	■	■	■
T4	■	■	■
T5	■	■	■
T6	■		■
T7	■		■
T7M	■		■



1SD0210023D0001

Cradle – FP (UL FILE: E116596)

The cradle, available for all the sizes of the Tmax family starting from T2, allows the circuit breaker to be made in the plug-in or draw out version. Different positions of the circuit breaker are possible:

- plug-in: connected, removed;
- draw out: connected, removed, racked-out for test (only for T7), racked-out.

In the standard version, the cradles of T2 and T3 are available with front terminals (F). A distinctive characteristic is the possibility of fitting these cradles with the same terminal, terminal cover and phase separator kits used for the fixed circuit breakers. With Tmax Ts3, T4, T5, T6 and T7, cradles with dedicated front and rear terminals are available. Moreover, the cradles of Ts3, T4 and T5 with front terminals can also be fitted with the special ES, FC Cu and FC CuAl terminals.

The rear flat terminals of the cradles of Tmax T7 are orientated (horizontally or vertically). Factory assembly is horizontal as standard. By means of the extra code 1SDA063571R1, it is possible to ask for the cradle with vertical terminals. This extra code can be associated either with the top or bottom terminals (if asking for assembly of both the terminals vertically, the extra code must be repeated twice). The anti-racking-in locks, to be mounted on the left side of the cradle, and which prevent racking-in of incorrect moving parts are supplied as standard fitting of the cradles of Tmax T7. In detail, it is possible to define the different ways of combination between the cradle and the moving part according to: T7 with lever or which can be motorized, breaking capacity and rated uninterrupted current.

Accessories

Versions and types

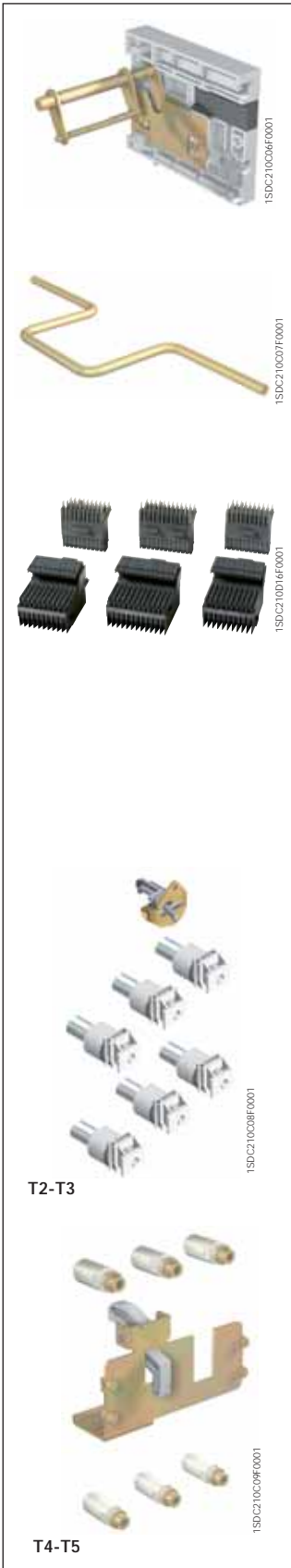

Kit for conversion of plug-in cradle to draw out cradle (UL FILE: E116596)

For Tmax Ts3, T4 and T5 a conversion kit is available which is made up of a guide to prepare the plug-in cradle of the circuit breaker to the draw out cradle of the circuit breaker, a racking-out crank handle and by the flange for the compartment door to replace the one supplied with the fixed or plug-in circuit breaker version.

Racking-out crank handle

This allows racking-out and racking-in of the draw out circuit breaker into the cradle, with the door closed. The crank handle is the same for the whole range of circuit breakers and is automatically supplied with the cradle of draw out circuit breakers or with the conversion kit for plug-in cradles to draw out cradles.

Sliding contacts blocks

The sliding contact blocks are required for Tmax T7 in the draw out version equipped with electrical accessories or with an electronic trip unit. Their function is to realize the electrical connections of the secondary circuits between the mobile part and the cradle and these blocks work in pairs: one block is to be mounted on the mobile part and the other one on the cradle. The following table combines the types of sliding contact blocks and the electrical accessories.

Left block	Central block	Right block
Spring charging motor	PR331	Auxiliary contacts (Q or SY)
Spring charged contact (AUX-SC)	PR332	Shunt trip
Ready to close contact (AUX-RTC)		Closing coil
Early auxiliary contacts (AUE)		Under voltage release
Contact for signalling trip coil release trip (AUX-SA)		
Trip reset		

If at least one of the electrical accessories listed in the previous table is fitted on the circuit breaker the respective pair of blocks must be mounted on the mobile part and on the cradle.

Kit for conversion into moving part of plug-in for T2 - T3 - Ts3 - T4 - T5 (UL FILE: E116596)

Allows the fixed circuit breaker with front terminals to be converted into the moving part of a plug-in circuit breaker. The kit consists of:

- isolating contacts
- anti-racking out safety device
- assembly screws and nuts
- low terminal covers for the moving part.

The cradle for plug-in version is necessary to complete the circuit breaker.



T4-T5-T6

150C210C10F0001



T7

150C210D17F0001

Kit for conversion into moving part of draw out for Ts3 - T4 - T5 - T6 - T7 (UL FILE: E116596)

Allows the fixed circuit breaker with front terminals to be converted into the moving part of a draw out circuit breaker. The kit consists of:

- isolating contacts
- frame
- assembly screws and nuts
- low terminal covers for the moving part.

The circuit breakers in the draw out version must always be completed either with the front for lever operating mechanism (standard supply for circuit breakers fitted with accessories in the factory, excluding T7), rotary handle operating mechanism or motor operator.

The cradle for draw out version is necessary to complete the circuit breaker.

Kit for conversion of cradle into draw out for RC222 and RC223 residual current releases (IEC only)

With the dedicated conversion kit, the RC222 and RC223 residual current releases for T4 and T5 also can be converted from the fixed to the plug-in version. The kit consists of four copper busbars which make the connection between the terminals of the residual current relay and the isolating contacts mounted on the circuit breaker terminals.

Therefore, to obtain a circuit breaker fitted with the residual current release accessory in the plug-in version, the two kits for conversion of circuit breakers and for residual current release must be ordered.

The power circuit is connected to the connection terminals of the cradle.

Kit for conversion of plug-in into draw out for RC222 and RC223 residual current releases (IEC only)

The RC222 and RC223 residual current releases for T4 and T5 can be converted from the plug-in to the draw out version by adding a special kit consisting of a bellows to be applied on the front of the residual current release to allow racking-out of the circuit breaker and of the residual current release with the switchgear door closed.

This kit can also be mounted on the fixed version circuit breaker when there is the front for locks or the direct rotary handle operating mechanism, therefore widening the range of use of the residual current releases.

Accessories

Connection terminals

The basic version circuit breaker is supplied with:

- front terminals for copper cables (FC Cu), for the Tmax T1 circuit breaker
- front terminals (F), for all the other Tmax family sizes.

Different types of terminals, which can be combined in different ways, are also available (top of one type, bottom of a different type), thereby allowing the circuit breaker to be connected to the plant in the most suitable way in relation to installation requirements.

The following can be distinguished:

- **front terminals** which allow connection of cables or busbars working directly from the front of the circuit breaker
- **oriented rear terminals** which allow installation of the circuit breakers in switchboards with rear access to both the cable and busbar connections.

Terminals are available for direct connection of bare copper or aluminium cables and terminals for connection of busbars or cables with cable lugs.

On page 3/8 and following, the information needed to make the connections for each type of terminal is summarised. For connection with bare cables, the minimum and maximum cross-sections of the cables, which can be clamped in the terminals, the type of cables (rigid or flexible) and the diameter of the terminal are indicated. For connections with busbars, flat terminals of different sizes and composition are recommended.

The torque values to be applied to the terminal tightening screws for cables and to the screws used to connect the busbars to the flat terminals are indicated.

The circuit breakers can be ordered complete with the terminals required (mounted directly in the factory), by associating the terminal kit codes with the code of the standard version circuit breaker, or the terminals can be ordered individually in packs of 3 - 4 - 6 or 8 pieces.

To receive the circuit breaker with mixed terminals, the two terminal half-kits must be specified, loading the one to be mounted on top as the first half-kit and then the one to be mounted below.

If the top terminals are the same as the bottom ones, it is compulsory to order the complete kit (6 or 8 pieces) and not the two half-kits: the configuration would not be accepted by the system.



15DC270C11F0001



15DC270C12F0001

Insulating terminal covers

The terminal covers are applied to the circuit breaker to prevent accidental contact with live parts and thereby guarantee protection against direct contacts. The following are available:

- low terminal covers (LTC): these guarantee IP40 degree of protection for fixed circuit breakers with rear terminals and for moving parts of plug-in and draw out circuit breakers
- high terminal covers (HTC): these guarantee IP40 degree of protection, for fixed circuit breakers with front, front extended, front for cables terminals.

With Tmax T2 and T3, the cradles of plug-in circuit breakers can use the same terminal covers as the corresponding fixed circuit breakers. For cradles of T4 and T5, the proper terminal covers (TC-FP) are available.

The degrees of protection indicated at page 1/8 are valid for the circuit breaker installed in a switchboard.



1SDC210C13F0001



1SDC210C14F0001



1SDC210C15F0001

Phase separators

These allow increased insulation characteristics between the phases at the connections. They are mounted from the front, even with the circuit breaker already installed, inserting them into the corresponding slots and they are available in two versions:

- 3.94" (100 mm) high
- 7.87" (200 mm) high.

The H = 3.94" (100 mm) phase separators are supplied as obligatory with front extended type terminals (EF), whereas the ones with height 7.87" (200 mm) are obligatory with front extended spread type terminals (ES).

The phase separating partitions are incompatible with both the high and low insulating terminal covers; while with Ts3 circuit breakers, phase separating partitions are always supplied with low terminal covers.

The cradles can use the same phase separating partitions as the corresponding fixed circuit breakers. With the phase separating partitions mounted, on request, with Tmax T1, T2 and T3 a special kit is available to reach IP40 degree of protection from the front of the circuit breaker.

It is possible to mount the phase separating partitions between two circuit breakers or cradles side by side.

Screws for sealing the terminal covers

These are applied to the terminal covers of fixed circuit breakers or to the moving parts of plug-in or draw out circuit breakers. They prevent removal of both the high and low terminal covers and can be locked with a wire and lead seal.

Kit for taking up the auxiliary power supply







Special kits are available with the fixed version of Tmax T2, T3, T4 and T5 circuit breakers for taking up the auxiliary power supply directly from the connection terminals. They can only be combined with the front terminals for copper cables (FC Cu) for T2, T3 and T4 or with the front terminals (F) for T4-T5.

Accessories

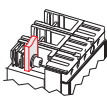
Connection terminals

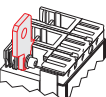
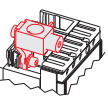
Connection terminals

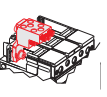
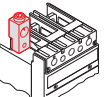
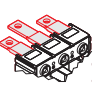
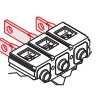
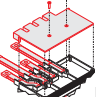
Circuit breaker

	F	EF	ES	FC Cu	FC CuAl ⁽¹⁾	MC	RC CuAl	HR	VR	HR for RC221/222	R
											
	Front terminals	Front extended terminals	Front extended spread terminals	Front terminals for copper cables	Front terminals for CuAl cables	Multi-cable terminals	Rear terminals for CuAl cables	Rear flat horizontal terminals	Rear flat vertical terminals	Rear flat horizontal terminals	Rear terminals
T1		F		F ⁽²⁾	F			F		F	
T2	F ⁽²⁾	F	F	F	F						F
T3	F ⁽²⁾	F	F	F	F						F
Ts3	F ⁽²⁾	F	F	F	F		F				F
T4	F ⁽²⁾	F	F	F	F	F					F
T5	F ⁽²⁾	F	F	F	F						F
T6	F ⁽²⁾	F	F		F		F				F
T7	F ⁽²⁾	F	F		F			F	F		F

⁽¹⁾ UL listed
⁽²⁾ Standard supply
 F = Fixed

Cradle

	F	EF	ES	FC Cu	FC CuAl ⁽¹⁾	R	RS	HR	VR	HR/VR	RC
	Front terminals	Front extended terminals	Front extended spread terminals	Front terminals for copper cables	Front terminals for CuAl cables	Rear terminals	Rear spreaded terminals	Rear flat horizontal terminals	Rear flat vertical terminals	Rear flat terminals	Rear terminals for CuAl cables
T2	P ⁽²⁾	P	P	P	P	P					
T3	P ⁽²⁾	P	P	P	P	P					
Ts3		P-W		P-W ⁽¹⁾						P-W	
T4		P-W		P-W	P-W			P-W	P-W		
T5		P-W	P ⁽³⁾ -W ⁽³⁾	P-W	P-W			P-W	P-W		
T6		W						W	W ⁽¹⁾		
T7		W					W			W	W ⁽¹⁾

⁽¹⁾ UL listed
⁽²⁾ Standard supply
⁽³⁾ For T5 600 only
 P = Plug-in
 W = Draw out

Front terminals - F

Allow connection of busbars or cables with ring terminals



Type	Version	Pieces	Busbars/cable terminal [in-mm]				Tightening [lbin-Nm]	Terminal covers			Phase separators
			W	H	D	Ø		high	low	cradle	
T2	F-P	1	0.79-20	0.30-7.5	0.20-5	0.26-6.5	54-6	R	R	-	R
T3	F-P	1	0.94-24	0.37-9.5	0.31-8	0.33-8.5	71-8	R	R	-	R
Ts3 150	F	1	0.79-20	0.39-10	0.16-4	0.35-9	80-9	R	R	-	R*
Ts3 225	F	1	0.79-20	0.39-10	0.24-6	0.35-9	80-9	R	R	-	R*
T4	F	1	0.98-25	0.37-9.5	0.31-8	0.33-8.5	161-18	R	R	-	R
T5	F	1	1.38-35	0.43-11	0.39-10 ⁽¹⁾	0.41-10.5	252-28	R	R	-	R
T6	F	2	1.97-50	0.47-12	0.20-5	2x0.28-2x7	80-9	R	R	-	R
T7	F	2	1.97-50	0.79-20	0.31-8	2x0.43-2x11	161-18	-	R	-	R

⁽¹⁾ minimum 0.19"-5 mm



Front extended terminals - EF

Allow connection of busbars or cables with ring terminals



Type	Version	Pieces	Busbars [in-mm]			Cable terminal [in-mm]		Tightening [lbin-Nm]		Terminal covers			Phase separators
			W	D	Ø	W	Ø	A	B ⁽¹⁾	high	low	cradle	
T1	F	1	0.59-15	0.20-5	0.33-8.5	0.59-15	0.33-8.5	63-7	80-9	R	-	-	S
T2	F-P	1	0.79-20	0.16-4	0.33-8.5	0.79-20	0.33-8.5	54-6	80-9	R	-	-	S
T3	F-P	1	0.79-20	0.24-6	0.39-10	0.79-20	0.39-10	71-8	161-18	R	-	-	S
Ts3 150	F	1	0.79-20	0.16-4	0.33-8.5	0.79-20	0.31-8	80-9	80-9	R	R	R	R*
Ts3 225	F-P-W	1	0.79-20	0.24-6	0.33-8.5	0.79-20	0.33-8.5	80-9	80-9	R	R	R	R*
T4	F	1	0.79-20	0.39-10	0.39-10	0.79-20	0.39-10	161-18	161-18	R	-	-	S
	P-W	1	0.79-20	0.39-10	0.31-8	0.79-20	0.31-8	-	80-9	-	-	R	R
T5	F	2	1.18-30	0.28-7	0.43-11	1.18-30	0.43-11	252-28	161-18	R	-	-	S
	P-W	2	1.18-30	0.59-15	0.39-10	1.18-30	0.39-10	-	161-18	-	-	R	R
T6	F-W	2	1.97-50	0.20-5	0.55-14	1.97-50	0.55-14	80-9	268-30	-	R	R	R
T7	F-W	2	1.97-50	0.39-10	4x0.43-4x11 ⁽²⁾	-	-	161-18 ⁽³⁾	355-40 ⁽⁴⁾	-	R	-	S

⁽¹⁾ class 4.8 screws (not supplied)

⁽²⁾ only use two holes diagonally

⁽³⁾ 12 Nm onto cradle of draw out circuit breaker

⁽⁴⁾ class 8.8 screws (not supplied)

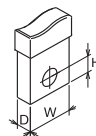

A = Tightening the terminal onto the circuit breaker

B = Tightening the cable/busbar onto the terminal

R = On request

R* = Are supplied with low terminal covers (which are, in turn, on request)

S = Standard

Pieces = Number of busbars, cables or cable terminals

Accessories

Connection terminals

Front extended spread terminals - ES

Allow connection of busbars or cables terminated with cable terminal



Type	Version	Pieces	Busbars [in-mm]			Cable terminal [in-mm]		Tightening [lbin-Nm]		Terminal covers			Phase separators
			W	D	Ø	W	Ø	A	B ⁽¹⁾	high	low	cradle	
T2	F-P	1	1.18-30	0.16-4	0.41-10.5	1.18-30	0.41-10.5	54-6	161-18	-	-	-	S
T3	F-P	1	1.18-30	0.16-4	0.41-10.5	1.18-30	0.41-10.5	71-8	161-18	-	-	-	S
Ts3	F	1	1.18-30	0.16-4	0.33-8.5	1.18-30	0.33-8.5	80-9	80-9	-	S	-	S*
T4	F	1	1.18-30	0.24-6	0.41-10.5	1.18-30	0.41-10.5	161-18	161-18	-	-	-	S
T5	F-P ⁽²⁾ -W ⁽²⁾	1	1.58-40	0.39-10	0.43-11	0.43-11	0.43-11	252-28	161-18	-	-	-	S
T6	F	1	3.15-80	0.20-5	3x-0.51-3x13	3x1.77-3x45	0.51-13	80-9	268-30	-	-	-	-
T7	F	2	1.97-50	0.39-10	3x-0.51-3x13	4x1.77-4x45	0.51-13	161-18	355-40	-	-	-	S

⁽¹⁾ class 4.8 screws (not supplied)

⁽²⁾ for T5 600 only



Front terminals for copper cables - FC Cu

Allow connection of bare copper cables directly to the circuit breaker



Type	Assembly	Version	Pieces	Cable [AWG or Kcmil-mm²]		Flexible busbars W x S x N ⁽²⁾	Tightening [lbin - Nm]		Ø [in-mm]	Terminal covers			Phase separators
				rigid	flexible		A	B		high	low	cradle	
T1/T1 1p	standard	F	1	2.5...70	2.5...50	9 x 0.8 x 6	-	63-7	0.47-12	R	R	-	R
	standard	F	2	-	2.5...35	-	-	63-7	0.47-12	R	R	-	R
T2	standard	F-P	1	1...95	1...70	13 x 0.5 x 10	-	63-7	0.55-14	R	R	R	R
	standard	F-P	2	-	1...50	-	-	63-7	0.55-14	R	R	R	R
T3	standard	F-P	1	6...185	6...150	15.5 x 0.8 x 10	-	89-10	0.71-18	R	R	R	R
	standard	F-P	2	-	6...70	-	-	89-10	0.71-18	R	R	R	R
Ts3	standard	F-P-W	1	10...350-6...185	-	-	-	142-16	0.71-18	R	R	S	R*
T4	standard	F-P-W	1	2.5...185	2.5...120	15.5 x 0.8 x 10	-	89-10	0.71-18	R	R	S	R
	standard	F-P-W	2	-	2.5...95	-	-	89-10	0.71-18	R	R	S	R
T5	standard	F-P-W	1	16...300	16...240	24 x 1 x 10	-	222-25	1.10-28	R	R	S	R
	standard	F-P-W	2	-	16...150	-	-	222-25	1.10-28	R	R	R	-
	external	F	2	120...240	-	-	18	222-25	-	S	-	-	-

⁽¹⁾ UL Listed

⁽²⁾ W = width; S = thickness; N = n. of bars

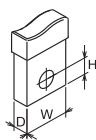

A = Tightening the terminal onto the circuit breaker
 B = Tightening the cable/busbar onto the terminal
 R = On request
 S = Standard
 R* = Are supplied with low terminal covers (which are, in turn, on request)
 S* = Are supplied as standard with the low terminal covers
 Pieces = Number of busbars, cables or cable terminals

Front terminals for copper/aluminium cables - FC CuAl (UL listed)

Allow connection of bare copper or aluminium cables directly to the circuit breaker (solid aluminium cables cannot be used)



T2-T5
Standard



T4-T5
External

Type	Assembly	Version	Pieces	Cable [AWG or Kcmil-mm ²]		Tightening [lbin-Nm]		Ø [in-mm]	Terminal covers			Phase separators
				rigid		A	B		high	low	cradle	
T1 1P/T1	standard	F	1	14...10-2.5...6	20-2.5	-	0.37-9.5	R	R	-	R	
				8.0-10	40-4.5	-	-	-	-	-	-	
				6...1/0-16...50	45-5	-	-	-	-	-	-	
T2 100	standard	F-P	1	14...1/0-2.5...50	80-9	50-5.6	-	R	R	R	R	
T3 100	standard	F-P	1	14...1/0-2.5...50	80-9	50-5.6	0.39-10	R	R	R	R	
T3 225	standard	F-P	1	4...300-25...150	80-9	200-22.6	0.67-17	R	R	R	R	
Ts3-D 150 (In=100)	standard	F	1	14...1/0-2.5...50	80-9	50-5.6	-	R	-	-	-	
Ts3 150	standard	F	1	2...4/0-35...95	80-9	120-13.5	0.56-14.2	R	-	-	-	
Ts3 225	standard	F	1	4...300-25...150	80-9	276-31	-	R	-	-	-	
T4 250	standard	F-P-W	1	6...350-6...185	274-31	80-9	0.7-18	R	R	S	R	
T4 250	standard	F	1	14...1/0-2.5...50	50-5.6	80-9	0.39-9.9	R	R	-	R	
T5 400	external	F	2	3/0...250-95...120	274-31	159-18	0.61-15.5	S	-	-	R	
T5 400	standard	F-P-W	1	250...500-120...240	380-43	159-18	0.84-21.5	R	R	S	R	
T5 600	external	F	2	3/0...500-95...240	274-31	159-18	0.84-21.5	S	-	-	R	
T6 600	standard	F	2	250...500-120...240	44-5	276-31	0.87-22	S	-	-	-	
T6 800	standard	F	2	250...500-120...240	44-5	276-31	0.87-22	S	-	-	-	
T7 1200	external	F	4	2/0...500-70...240	160-18	380-43	0.84-21.5	S	-	-	-	



Multi-cable terminals - MC

Allow connection of cables directly to the circuit breaker



1SDC210C4F0001

Type	Version	Pieces	Cable [AWG or Kcmil-mm ²]		Tightening [lbin-Nm]		Terminal covers			Phase separators
			max	flexible	rigid	A	B	high	low	
T4	F	6	2.5...25	2.5...35	161-18	63-7	S	-	-	-
T5	F	6	-	16...50	161-18	45-5	S	-	-	-



1SDC210C4F0001 UL

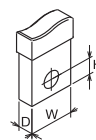

A = Tightening the terminal onto the circuit breaker
 B = Tightening the cable/busbar onto the terminal
 R = On request
 S = Standard
 Pieces = Number of busbars, cables or cable terminals

Accessories

Connection terminals

Rear terminals for copper/aluminium cables - RC CuAl

Allow connection of bare copper or aluminium cables directly to the circuit breaker

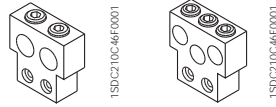

Type	Version	Pieces	Cable [AWG or Kcmil-mm ²]		Tightening [lbin-Nm]		Ø [in-mm]	Terminal covers	
			rigid		A	B		high	low
Ts3	F	1	4...250	25...120	80-9	276-31	0.63-16	S	-
T6 600	F	2	250...500	120...240	80-9	383-43	0.69-17.5	S	-
T6 800	F	3	2/0...350	70...185	80-9	276-31	0.69-17.5	S	-

Rear flat horizontal terminals - HR

Allow connection of busbars or cable terminal at the rear. They can only be installed horizontally.

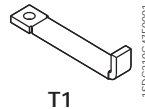

T1

Type	Version	Pieces	Busbars [in-mm]			Cable terminal [in-mm]		Tightening [lbin-Nm]		Terminal covers		Phase separators
			W	D	Ø	W	Ø	A	B ⁽¹⁾	high	low	
T1	F	1	0.55-14	0.20-5	0.24-6.2	0.55-14	0.24-6.2	63-7	44-5	-	S	-
T7	F	2	1.97-50	0.39-10	2x0.43-2x11	-	-	179-20	355-40	-	S	-

⁽¹⁾ class 8.8 screws (not supplied)

Rear flat vertical terminals - VR

Allow connection of busbars or cable terminal at the rear. They can only be installed vertically.

Type	Version	Pieces	Busbars [in-mm]			Cable terminal [in-mm]		Tightening [lbin-Nm]		Terminal covers		Phase separators
			W	D	Ø	W	Ø	A	B ⁽¹⁾	high	low	
T7	F	2	1.97-50	0.31-8	2x0.43-2x11	-	-	179-20	355-40	-	S	-

⁽¹⁾ class 8.8 screws (not supplied)

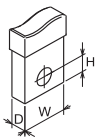

A = Tightening the terminal onto the circuit breaker
 B = Tightening the cable/busbar onto the terminal
 R = On request
 S = Standard
 Pieces = Number of busbars, cables or cable terminals

Rear flat horizontal terminals for RC221/RC222 - HR

Allow connection of busbars or cable terminal at the rear with RC221/RC222.

They can be installed horizontally

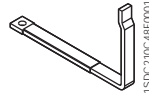

Type	Version	Pieces	Busbars [in-mm]			Tightening [lbin-Nm]		Terminal covers		Phase separators
			W	D	Ø	A	B ⁽¹⁾	high	low	
T1	F	1	0.55-14	0.20-5	0.24-6.2	63-7	44-5 ⁽¹⁾	-	-	-

⁽¹⁾ class 8.8 screws (not supplied)

Rear terminals - R

Allow connection of busbars or cable terminal at the rear. They can be installed in 4 different positions to facilitate connection to cable/busbars

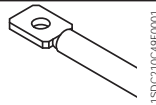

Type	Version	Pieces	Busbars [in-mm]			Tightening [lbin-Nm]		Terminal covers		Phase separators
			W	D	Ø	A	B ⁽¹⁾	high	low	
T2	F-P	1	0.79-20	0.16-4	0.33-8.5	54-6	80-9	-	S	-
T3	F-P	1	0.79-20	0.24-6	0.33-8.5	54-6	80-9	-	S	-
Ts3 150	F	1	0.79-20	0.16-4	0.49-12.5	89-10	179-20	-	S	S*
	P-W	1	0.79-20	0.16-4	0.49-12.5	89-10	179-20	-	-	-
Ts3 225	F	1	0.79-20	0.24-6	0.49-12.5	89-10	179-20	-	S	S*
	P-W	1	0.79-20	0.24-6	0.49-12.5	89-10	179-20	-	-	-
T4	F	1	0.79-20	0.39-10	0.33-8.5	54-6	80-9	-	S	-
T5	F	2	1.18-30	0.28-7	0.43-11	161-18	161-18	-	S	-
T6	F	2	1.97-50	0.20-5	0.55-14	161-18	268-30	-	S	-
T7	F	2	1.97-50	0.31-8	2x0.43-2x11	179-20	355-40	-	S	-

⁽¹⁾ class 8.8 screws (not supplied)

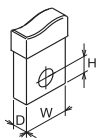

A = Tightening the terminal onto the circuit breaker
 B = Tightening the cable/busbar onto the terminal
 R = On request
 S = Standard
 S* = Are supplied as standard with the low terminal covers
 Pieces = Number of busbars, cables or cable terminals

Accessories

Connection terminals

Rear spreaded terminals - RS

Allow connection of busbars and cable terminal at the rear.

Type	Version	Pieces	Busbars [in-mm]			Tightening [lbin-Nm]		Terminal covers			Phase separators
			W	D	Ø	A	B	high	low	cradle	
T7	W	2	2.36-60	0.39-10	2 x 11	161-18	355-40	-	-	-	-

Rear flat horizontal and vertical terminals for cradles - HR/VR

These allow connection of busbars or cable terminals at the rear.

There are rear horizontal or vertical terminals.

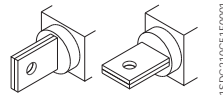

Type	Version	Pieces	Busbars [in-mm]			Cable terminal [in-mm]		Tightening [lbin-Nm]		Terminal covers			Phase separators
			W	D	Ø	W	Ø	A	B ⁽¹⁾	high	low	cradle	
T4	P - W	1	0.79-20	0.39-10	0.39-10	0.79-20	0.39-10	-	159-18	-	-	-	-
T5 400	P - W	1	0.98-25	0.39-10	0.47-12	0.98-25	0.47-12	-	159-18	-	-	-	-
T5 600	P - W	2	1.57-40	0.59-15	0.43-11	1.57-40	0.43-11	-	159-18	-	-	-	-
T6	W	2	1.97-50	0.20-5	0.55-14	1.97-50	0.55-14	-	268-30	-	-	-	-
T7	W	2	1.97-50	0.39-10	2x0.43-2x11	-	-	106-12	355-40	-	-	-	-

⁽¹⁾ class 4.8 screws (not supplied)

⁽²⁾ for vertical assembly directly in the factory, use extra code 1SDA063571R1

Rear terminals for CuAl cables - RC (UL LISTED)

Type	Version	Pieces	Cable terminal [in-mm]		Tightening [lbin-Nm]		Terminal covers			Phase separators
			W	Ø	A	B	high	low	cradle	
T7	W	1	1.38-35	0.55-14	425-48	355-40	-	-	-	-

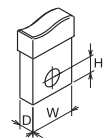
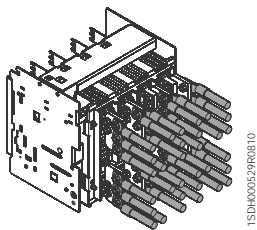

A = Tightening the terminal onto the circuit breaker
 B = Tightening the cable/busbar onto the terminal
 R = On request
 S = Standard
 Pieces = Number of busbars, cables or cable terminals

Accessories

Service releases

The Tmax family of circuit breakers can be fitted with service releases (shunt trip, closing coil and undervoltage release). These are available in the pre-cabled version, depending on the size of the circuit breaker fitted with 39.4" (1 m) long free cables, with a connector with 39.4" (1 m) cables or with a simple pin connector and two terminals to be mounted in the terminal board.

Assembly is carried out for all the releases by pressing into the special seat in the left part of the circuit breaker (right for T7) and fixing with the screw provided.

The releases are interchangeable for T1, T2, T3, Ts3 (both for the three-pole and four-pole version), whereas for T4, T5 and T6 in the four-pole version the shunt trip (not possible with PS-SOR) and the undervoltage release can be housed at the same time, as long as they are in the wired version and the shunt trip is necessarily mounted in the slot of the third pole. T4, T5, T6 circuit breakers in the draw out version can only be equipped with pre-cabled accessories; the T4-T5-T6 circuit breakers complete with motorized controls can only be fitted with prewired undervoltage and shunt trips.

The T7 circuit breaker allows simultaneous mounting of all three service releases. These two possibilities are available on the three-pole version as well. Moreover Tmax T7 can be equipped with two shunt trips instead of the undervoltage release to facilitate some specific applications where a very high safety level of the remote circuit breaker opening command is required.

Shunt trip – SOR (UL FILE: E116596)

Allows circuit breaker opening by means of an electric command. Operation of the trip is provided for a voltage between 70% and 110% of the rated power supply voltage value U_n , both in alternating current and in direct current. For Tmax T1, T2, T3, T4, T5 and T6, the SOR shunt trip is fitted with a limit contact for cutting off the power supply in the open position and with the release tripped.



1SDC210C52F0001

T1-T2-T3



1SDC210C53F0001

T4-T5-T6



1SDC210D18F0001

T7

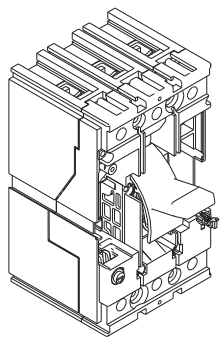

T1-T2-T3

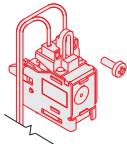

1SDC210C54F0001

Ts3

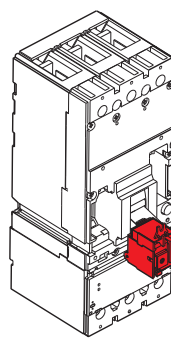

1SDC210C09F0001

T4-T5-T6

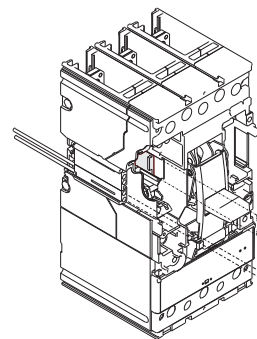

1SDC210C55F0001

Accessories

Service releases

Shunt trip - SOR - Electrical characteristics

Version	Inrush power consumption							
	Tmax T1, T2, T3		Tmax Ts3		Tmax T4, T5, T6		Tmax T7	
	AC [VA]	DC [W]	AC [VA]	DC [W]	AC [VA]	DC [W]	AC [VA]	DC [W]
12 V DC		50		120		150		
24 V AC/DC			100	100 or 4 ⁽¹⁾			300	300
24...30 V AC/DC	50	50			150	150		
30 V AC/DC							300	300
48 V AC/DC				120			300	300
48...60 V AC/DC	60	60			150	150		
60 V AC/DC							300	300
110...120 V AC/DC			100 or 4 ⁽¹⁾				300	300
120...127 V AC/DC							300	300
110...127 V AC-110...125 V DC	50	50		120	150	150		
220...240 V AC/DC							300	300
220...240 V AC-220...250 V DC	50	50	100	120	150	150		
240...250 V AC/DC							300	300
380...400 V AC							300	
380...440 V AC	55				150			
415...440 V AC							300	
480 V AC			100					
480...525 V AC	55				150			
Opening times [ms]	15	15	≤ 15	≤ 15	15	15	20	20

⁽¹⁾ Shunt trip of permanent supply

Shunt trip with permanent service – PS-SOR

Furthermore, for T4, T5 and T6, opening coils with permanent service (PS-SOR) are available, with much lower power consumption and which can be supplied continuously: in this case, in fact, they are not fitted with auxiliary limit contact. The pre-cabled or uncabled version can be chosen for these coils as well.

Shunt trip - PS-SOR - Electrical characteristics

Version	Tmax T4, T5, T6	
	AC [VA]	DC [W]
24 V AC/DC	4	4
110...120 V AC	4	-



1SDC210C56F0001

Shunt trip Test Unit – SOR Test Unit

The SOR Test Unit - control/monitoring unit - allows correct operation of the shunt trips which can be mounted on the Tmax T7 circuit breaker to be verified, to guarantee a high level of reliability for the circuit breaker opening command.

The SOR Test Unit - control/monitoring unit - allows continuity of the shunt trips with a rated service voltage between 24 V and 250 V (AC and DC) to be verified, as well as operation of the electronic circuit of the opening coil. The continuity check is carried out cyclically at an interval of 20 seconds between one test and the next.

The unit has LED optic signals on the front which provide the following information:

- POWER ON: presence of power supply
- YO TESTING: test being carried out
- TEST FAILED: indication following a failed test or lack of auxiliary power supply
- ALARM: signalling after three failed tests.

There are also two relays and a changeover switch available on board the unit which allow the following two events to be signalled remotely:

- failure of a test (resetting takes place automatically when the alarm goes off)
- failure of three tests (resetting only takes place by means of the manual RESET from the front of the unit).

Characteristics

Auxiliary power supply	24 V...250 V AC / DC
Maximum interrupted current	6 A
Maximum interrupted voltage	250 V AC



1SDC210D118F0001

T7

Closing coil – SCR

The closing coil - only available on the motorizable versions of Tmax T7 - allows remote closure of the circuit breaker when the circuit breaker closing springs are charged. The technical characteristics and the service voltages of the closing coil are identical to those of the shunt trip available on T7. The closing time of the circuit breaker by means of SCR is 80 ms.

Accessories

Service releases



1SDC210C57F0001

T1-T2-T3



1SDC210C58F0001

T4-T5-T6



1SDC210D18F0001

T7

Undervoltage release – UVR (UL FILE: E116596)

The undervoltage release opens the circuit breaker due to lack of release power supply voltage or due to values under $0.7 \times U_n$ with a trip range from 0.7 to $0.35 \times U_n$. After tripping, the circuit breaker can be closed again with a voltage higher than $0.85 \times U_n$. With the undervoltage release de-energised, it is not possible to close the circuit breaker or the main contacts.

UVR - Electrical characteristics

Version	Power consumption during permanent operation							
	Tmax T1, T2, T3		Tmax Ts3		Tmax T4, T5, T6		Tmax T7	
	AC [VA]	DC [W]	AC [VA]	DC [W]	AC [VA]	DC [W]	AC [VA]	DC [W]
24 V AC/DC			6	3			3.5	3.5
24...30 V AC/DC	1.5	1.5			6	3		
30 V AC/DC							3.5	3.5
48 V AC/DC	1	1	6	3	6	3		
60 V AC/DC	1	1			6	3		
110...120 V AC/DC			6				3.5	3.5
120...127 V AC/DC							3.5	3.5
110...127 V AC-110...125 V DC	2	2			6	3		
220...240 V AC/DC							3.5	3.5
220...240 V AC-220...250 V DC	2.5	2.5		3	6	3		
220...250 V AC			6					
240...250 V AC/DC							3.5	3.5
380...400 V AC							3.5	
380...440 V AC	3				6			
415...440 V AC							3.5	
480 V AC			6					
480...525 V AC	4				6			
Opening times [ms]	15	15	- 18	≤ 18	≤ 25	≤ 25	≤ 25	≤ 25

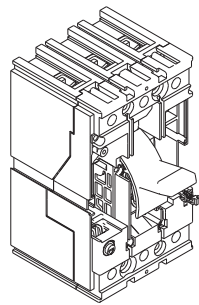

T1-T2-T3

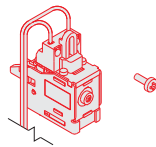

1SDC210C58F0001

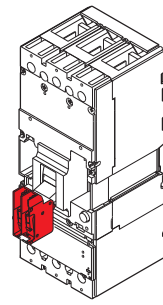

Ts3

1SDC210A88F0001

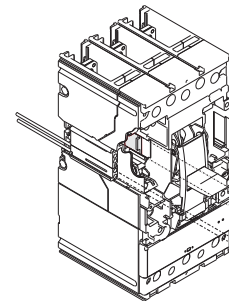

T4-T5-T6

1SDC210C58F0001



1SDC210G59F0001

Time delay device for undervoltage release – UVD

The undervoltage release (UVR) can be combined with an external electronic power supply time delay device, which allows circuit breaker opening to be delayed in case of a drop or failure in the power supply voltage of the release itself, according to preset and adjustable delays, in order to prevent unwarranted trips caused by temporary malfunctions. The delay device must be combined with an undervoltage release with the same corresponding voltage.

Two time delay devices with the same characteristics are available. For T1-T6 a time delay device which can be combined also on the Isomax circuit breakers is available. The time delay device for Tmax T7 is the same as the one already available on the Emax range.

UVD

Circuit breaker	Power supply voltage [V AC/DC]
T1 - T2 - T3 - T4 - T5 - T6	24...30
T1 - T2 - T3 - T4 - T5 - T6	48...60
T1 - T2 - T3 - T4 - T5 - T6	110...125
T1 - T2 - T3 - T4 - T5 - T6	220...250
Delay which can be set [s]	0.25 - 0.5 - 0.75 - 1 - 1.25 - 2 - 2.5 - 3
Trip time tolerance	± 15%

Circuit breaker	Power supply voltage [V AC/DC]
Ts3	110
Ts3	220
Delay which can be set [s]	0.25 - 0.5 - 1 - 2 - 3

Circuit breaker	Power supply voltage [V AC/DC]
T7	24...30
T7	48
T7	60
T7	110...125
T7	220...250
Delay which can be set [s]	0.5 - 1 - 1.5 - 2 - 3

Accessories

Service releases



Connectors for service releases (only for Ts3)

These allow the shunt trip or undervoltage release to be connected to the power supply circuit. They are available in the following versions:

- for fixed circuit breakers
- for plug-in/draw out circuit breakers.

Assembly is by means of pressure into special slots in the left side of the circuit breaker.

Cables of different lengths (UL/CSA) are available.

Socket-plugs with 3, 6 or 12 poles and cable kit (UL/CSA) with a length of 78.8" (2 m) are available for Tmax: the socket-plugs are necessary only for plug-in version.

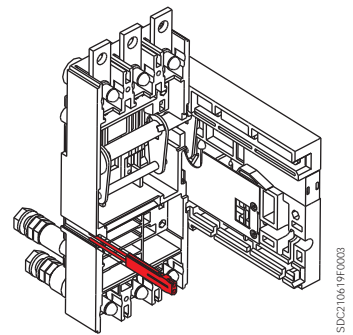
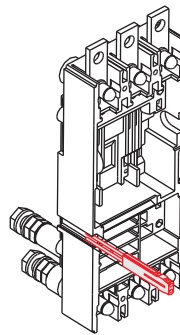
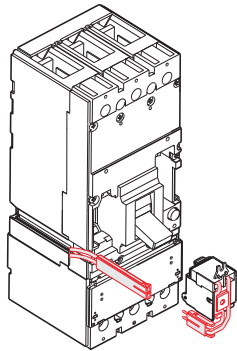

Testing extension for service releases

Available for Tmax Ts3, T4, T5 and T6, this allows the service releases to be supplied with the circuit breaker in the removed position. With the circuit breaker in safe conditions, i.e. isolated from the power circuits, this makes it possible to carry out blank tests of the circuit breaker functionality.

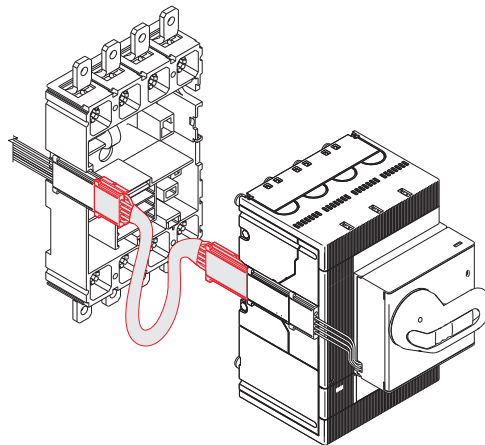

Accessories

Electrical signals

These allow information on the operating state of the circuit breaker to be real outside.

Installation of these accessories is carried out directly from the front of the circuit breaker in special slots placed on the right-hand side of the circuit breaker, completely segregated from the live parts - all to the benefit of user safety. The auxiliary contacts can be supplied (depending on the type) either with cabling directly on the circuit breaker terminal board or in the pre-cabled version, depending on the size of the circuit breaker fitted with free cables 39.4" (1 m) long, with a connector with 39.4" (1 m) long cables. The pre-cabled version is mandatory on the T4, T5 and T6 circuit breakers in the draw out version. The auxiliary contacts for T7 are always fitted with three terminals to be mounted in the terminal board to carry out the cabling. The auxiliary contacts are available for use both in direct and alternating current at various voltages. The signals are reset when the circuit breaker is reset.



15DC210C2AF0001

AUX - 250 V AC/DC



15DC210C2AF0001

AUX-C - 250 V AC/DC

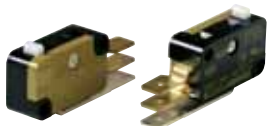

15DC210D19F0001

T7

T1-T7 (AUX)

Available both in the pre-cabled and uncabled version, auxiliary contacts supply the following electrical signalling:

- Form C (open/closed): indicates the position of the circuit breaker contacts (Q)
- Bell alarm: signals circuit breaker opening due to overcurrent release trip (for overload or short circuit), trip of the residual current release, of the opening coil or of the undervoltage release, of the emergency opening pushbutton of the motor operator or two to operation of the test pushbutton (SY)
- Contact for signalling electronic trip unit tripped: signals intervention of one of the protection functions of the electronic trip unit (S51) (except for Ts3).

The auxiliary contacts for T7 are always fitted with terminals to be mounted in the terminal box to carry out wiring.

T4, T5, T6 and T7 with electronic trip units (AUX-SA)

There is a contact for signalling electronic trip units tripped, only available in the pre-cabled version for use at 250 V AC.

T4, T5 and T6 (AUX-MO)

This auxiliary contact, only in the uncabled version, must be combined with the motor operator and indicates the motor operation mode (manual or remote).

T7 (AUX-RTC)

The "circuit breaker ready to close" auxiliary contact is available with wiring directly on the terminal box of the stored energy T7 circuit breaker and signals that the circuit breaker is ready to accept a closing command if there are the following five conditions:

- circuit breaker open
- closing springs charged
- any opening coil de-energised
- any undervoltage coil energised
- opening solenoid armed.

T7 (AUX-SC)

Remotely indicates the state of the circuit breaker operating mechanism is closing springs (supplied only with the spring charging motor).

Accessories

Electrical signals

T4, T5 and T6 with PR222DS/PD-A and electronic trip unit (AUX-E)

Only available in the pre-cabled version, the auxiliary contacts AUX-E (also called electronic version contacts) communicate the state of the circuit breaker to the electronic trip unit and make an open/closed signal available to the outside and another one for electronic trip unit tripped.

They can only be combined with the PR222DS/PD-A electronic trip unit and only function when there is a 24 V DC auxiliary power supply to the trip unit for the communication functions.

The AUX-E contacts can, moreover, be directly connected to the MOE-E motor operator (see page 3/29).

The "traditional" version of the auxiliary contacts can also be combined with the protection trip units with dialogue; in this case, only electrical signalling of the state of the circuit breaker will be provided and it will not be possible to communicate remotely or control the motor.

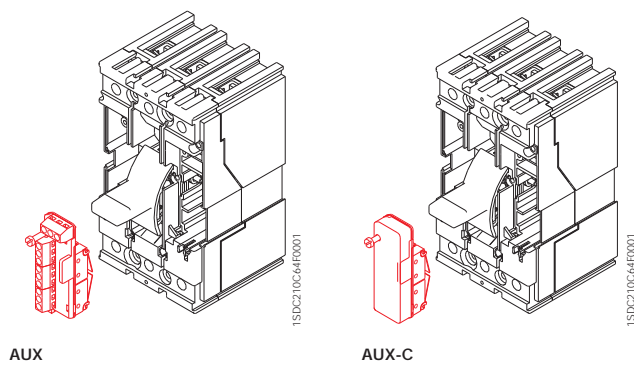

AUX - Electrical characteristics

AUX 250 V - T1...T6

Power supply voltage	Service current	
	Category of utilisation (IEC 60947-5-1)	
	AC 14	DC 13
125 V	6 A	0.3 A
250 V	5 A	0.15 A

Protection with gG 10x38 type fuse (I_{max} 6 A)

AUX 400 V - Ts3

Power supply voltage	Breaking capacity	
	AC (50-60) [V]	Ohmic Load [A]
	125	0.3
	250	0.15
250		6
400		3

AUX 400 V - T4...T7

Power supply voltage	Service current I _n [A]	
	AC	DC
125 V	-	0.5
250 V	12 ⁽¹⁾	0.3
400 V	3	-

⁽¹⁾ 5 A for T_{max} T7

AUX 24 V - T1...T7

Power supply voltage	Service current I _n [A]	
	AC	DC
24 V	-	≥ 0.75 mA
5 V	-	≥ 1 mA

AUX-E - T4...T6

Typical contact	Mosfet
V _{max}	350 V DC/230 V AC
I _{max}	50 mA AC/DC
P _{max} (resistive load)	17 W, 11 VA
System contact/ground insulation	2000 V AC (1 min. @ 50 Hz)
Contact/contact insulation	400 V DC

Table of the possible combinations of the T7-T7M auxiliary contacts

T7	SY	Q1			1Q + 1SY	T7M			Q2	Q3	2Q
			Q2	Q3	2Q		Q4	Q1			2Q
	SY	Q1	Q2	Q3	3Q + 1SY		Q4	Q1	Q2	Q3	4Q

Accessories

Electrical signals

Types of auxiliary contacts

		T1	T2 TMD	T2 PR221	T3	Ts3	T4	T5	T6	T7
AUX 250 V AC/DC	1 open/closed changeover contact + 1 bell alarm changeover contact	■	■		■		■	■	■	
AUX 250 V AC/DC	3 open/closed changeover contacts + 1 bell alarm changeover contact	■	■		■		■	■	■	
AUX 250 V AC/DC	1 SA electronic release trip contact + 1 open/closed changeover contact + 1 bell alarm changeover contact			■						
AUX 250 V AC/DC	2 open/closed changeover contacts + 1 bell alarm changeover contact			■						
AUX 400 V AC	1 open/closed changeover contact + 1 bell alarm changeover contact						■	■	■	■
AUX 400 V AC	2 open/closed changeover contacts					■	■	■	■	■
AUX 400 V AC	1 open/closed changeover contact + 1 bell alarm					■				
AUX 24 V DC	1 open/closed changeover contact + 1 bell alarm changeover contact									■
AUX 24 V DC	2 open/closed changeover contacts									■
AUX 24 V DC	3 open/closed changeover contacts + 1 bell alarm changeover contact	■	■		■		■	■	■	
AUX-SA 250 V AC	1 SA electronic release trip contact						■	■	■	■
AUX-MO	1 contact signalling manual/remote						■	■	■	
AUX-RTC 24 V DC	1 contact signalling ready to close									■
AUX-RTC 250 V AC/DC	1 contact signalling ready to close									■
AUX-SC 24 V DC	1 contact signalling closing springs charged									■
AUX-SC 250 V AC/DC	1 contact signalling closing springs charged									■
AUX-E	1 open/closed contact + 1 bell alarm contact (only with PR222DS/PD-A)						■	■	■	

3



Connectors for auxiliary contacts (only for Ts3)

These allow the auxiliary contacts to be connected to the relative power supply circuit. For Ts3 circuit breakers, the auxiliary contacts (fitted with plug connector) can only be supplied by means of the specific connectors to be ordered specifying the size and version of the circuit breaker (fixed or plug-in/draw out). Assembly is carried out by mounting into special slots on the right side of the circuit breaker. Socket-plugs with 3, 6 or 12 poles and cable kit (UL/CSA) with a length of 78.8" (2 m) are available.

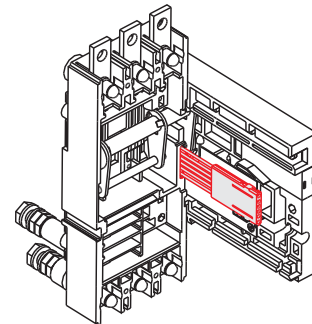
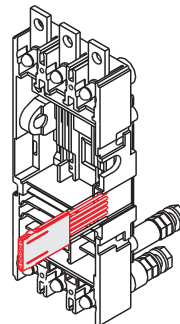
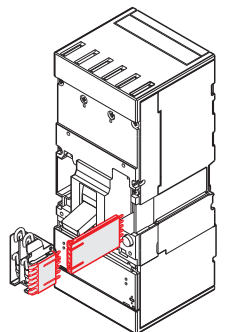



15DC210C66F0001

Testing extension for auxiliary contacts

Available for Tmax T4, T5 and T6 circuit breakers, this allows the auxiliary contacts to be connected to the relative power supply circuit with the circuit breaker in the removed position. With the circuit breaker in a safe position, i.e. isolated from to the power circuits, it is possible to carry out blank function tests of the circuit breaker.

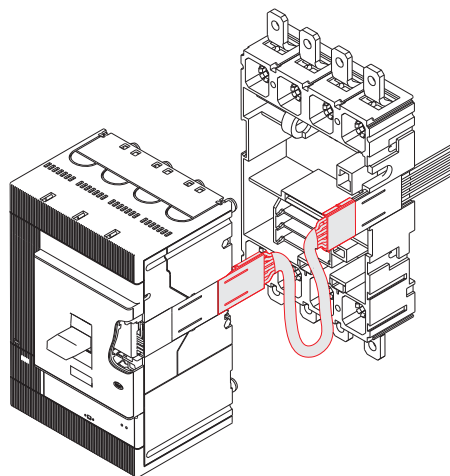

15DC210C65F0001



15DC210C66F0001

Early auxiliary contacts – AUE

Early auxiliary contacts are normally open contacts, advanced in relation to closing (2 contacts for all the sizes, except for T7 where there are 3). They allow the undervoltage release to be supplied in advance, in relation to closing of the main contacts, in compliance with the IEC 60204-1 and VDE 0113 Standards. They are mounted inside the direct and transmitted rotary handle operating mechanism, whereas on T7 with the electric operating mechanism they are mounted directly on the circuit breaker. The early contacts are only supplied in the cabled version with 39.4" (1 m) long cables, complete with socket-plugs with 6 poles for T1, T2 and T3 or with socket-plug connectors with 39.4" (1 m) cables for T4, T5 and T6. It is necessary to bear in mind that once the connectors for T4, T5 and T6, are inserted in the special slot on the right-hand side of the circuit breaker they extend further out than the outline of the circuit breaker itself. For Ts3 the contact is supplied complete with double slide socket connectors for simultaneous connection of the undervoltage release and of the consent contact itself. The early auxiliary contacts for T7 are always fitted with 3 terminals to be mounted in the terminal board to carry out the cabling.

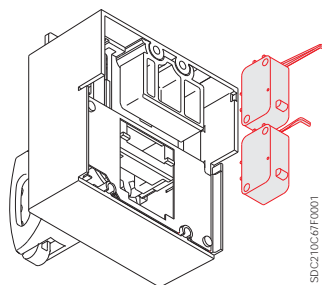

15DC210C66F0001

Accessories

Electrical signals

Auxiliary position contacts – AUP

Auxiliary position contacts which provide electrical signalling of the circuit breaker position in relation to the cradle are available. The following auxiliary position contacts are available:

T2 - T3

- contacts signalling circuit breaker is racked-in.

Ts3

- contacts signaling circuit breakers is racked-in
- contacts signaling circuit breakers is drawn-out.

T4 - T5 - T6

- circuit breaker racked-in signalling contacts for plug-in and draw out versions
- circuit breaker racked-out signalling contacts only for draw out version
- circuit breaker racked-in signalling contacts for plug-in and draw out versions 24 V DC
- circuit breaker racked-out signalling contacts only for draw out version 24 V DC.

T7

- contacts for signalling circuit breaker is racked-in
- contacts for signalling circuit breaker is isolated-test
- contacts for signalling circuit breaker is racked-out.

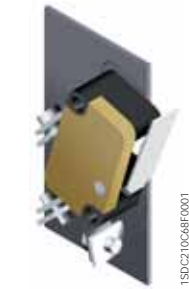

1SDC210C26RF0001



1SDC210D20RF0001

T7

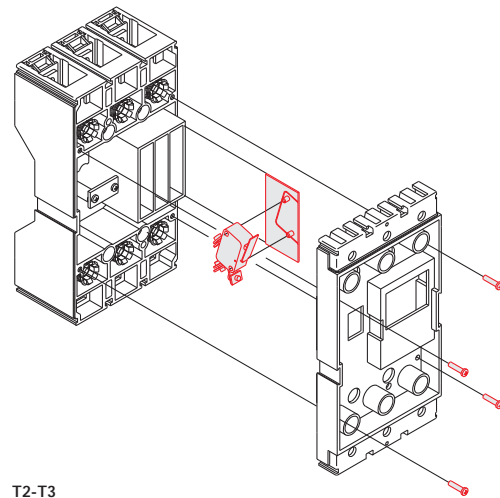

T2-T3

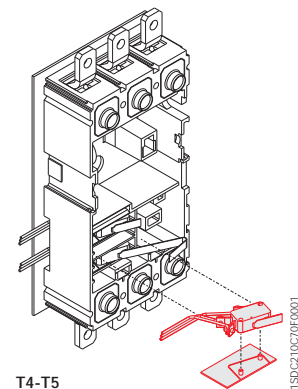

T4-T5

A maximum of three contacts can be installed on the cradle of T2, T3, T4 and T5, a maximum of two contacts for Ts3, whereas up to five auxiliary contacts can be mounted on the cradle of T6 in all the combinations (for T4 and T5, in the draw out version, only one contact for signalling circuit breaker racked-out can be housed in the compartment closest to the bottom terminals).

The auxiliary contacts for T7 are inserted in a single block consisting of two contacts for signalling racked-in, two for isolated-test and two for racked-out.

Trip reset

Available on the motorized T7 the trip reset is a coil which allows remote circuit breaker resetting following a trip of the overcurrent releases. It is available with two power supply voltages: 24...30 V AC/DC, 110...130 V AC/DC and 200...240 V AC/DC.

Mechanical operation counter

Available on the motorized T7, it is connected to the operating mechanism by means of a simple lever mechanism. It indicates the number of circuit breaker mechanical operations. The indication is visible from the outside on the front of the circuit breaker.



1SDC210N78F0001



1SDC210D20RF0001

Accessories

Remote control

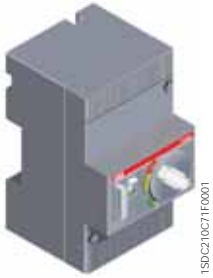

15DC210C71F0001



15DC210C72F0001

Solenoid operator for T1, T2 and T3 – MOS (UL FILE: E116596)

The solenoid operator allows remote circuit breaker opening and closing control and is particularly recommended for use in electric network supervision and control systems. A selector allows switching from automatic to manual operation and a block is also available (supplied as standard) for the operating mode of the motor. It is always provided with a padlock in the open position which prevents any additional commands, either locally or remotely. It operates both circuit breaker opening and closing, working directly on the circuit breaker lever.

It is offered in two versions, the first is "side-by-side" with the circuit breaker for T1 and T2, for installation on a panel or DIN EN 50022 rail. The other on the "front" for T1, T2 and T3, suitable for installation directly on the front of the circuit breaker.

The latter is complete with an operating handle. The front version can also be used with plug-in circuit breakers.

Coupling with the residual current release is only allowed for a circuit breaker with a side-by-side solenoid operator, to allow access to the user interface of the residual current release from the front of the switchgear. In fact, using the solenoid operator superimposed would imply the circuit breaker position on the rear of the door and its residual current release and the interface would no longer be accessible.

This combination can only be installed directly on the back plate of the switchgear. Both versions can be used either in the three-pole or four-pole version. The solenoid operator is supplied complete with 1m long cables and, just for the superimposed version, with a socket-plug connector with 5 poles.

Both the opening and closing commands are operated by the solenoid which acts directly on the circuit breaker lever.

The main parameters relative to the solenoid operator are indicated in the table.

Rated voltage, Un

AC	[V]	110...250
DC	[V]	48...60 / 110...250
Operating voltage		85...110% Un
Inrush power consumption during operation		1800 [VA] / 1000 [W]
Power on stand-by		< 100 [mW]
Time	opening [s]	< 0.1
	closing [s]	< 0.1
Mechanical life	[no. Operations]	25000
	[no. Operations/h]	240 (T1 and T2); 120 (T3)
Degree of protection, on the front		IP30
Minimum control impulse time on opening and closing	[ms]	>100

The unit is permanently supplied on stand-by, a control is applied by means of an external contact (relay, opto-insulator) in a low power circuit.

Contact characteristics: V AC/DC = 24 V
I AC/DC = 50 mA

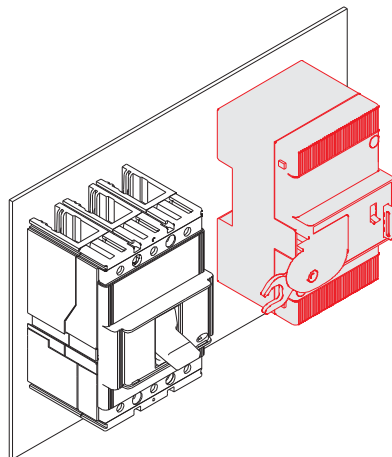

15DC210C73F0001

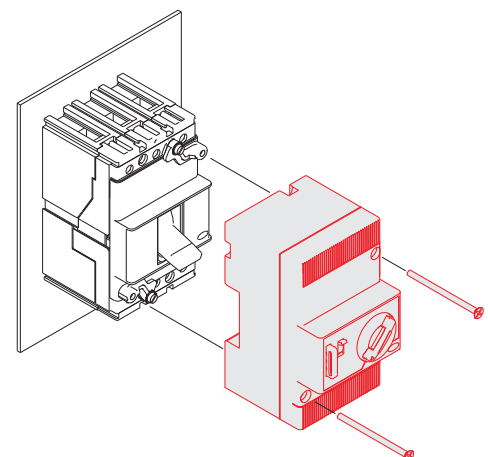

15DC210C74F0001

Accessories

Remote control



15DC210627F0003

Direct action motor operator for Ts3 (UL file: E116596)

Both the opening and closing command is controlled by the motor, which acts directly on the circuit breaker lever. The table shows the power supply voltage values U_n [V].

Motor operator Ts3

		AC	DC
Rated voltage, U_n	[V]		24
	[V]		48...60
	[V]	120	125
	[V]	240	250
	[V]	440	
Operating voltage		85...110% U_n	
Inrush power absorption P_s		500 [VA]	500 [W]
Service power absorption P_c		350 [VA]	350 [W]
Operating frequency	[Hz]	50-60	
Time constant	[ms]	18	
Duration	opening [s]	0.1	
	closing [s]	0.1	
Mechanical life	[no. operations]	15000 (S3-S4) - 10000 (S5)	
Degree of protection, on the front		IP30	
Minimum duration of the opening and closing command impulse	[ms]	≥ 150	

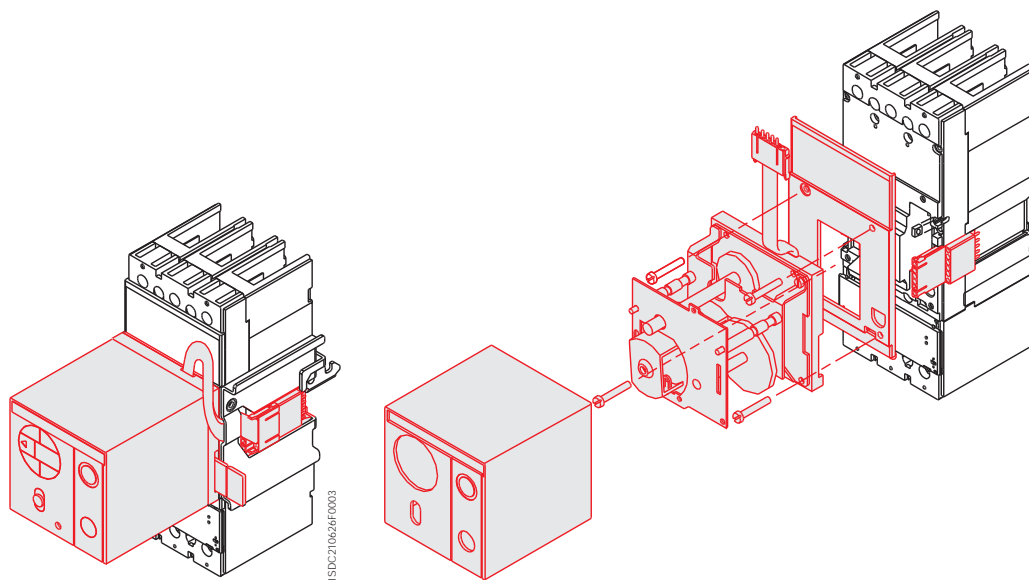

15DC210627F0003

15DC210627F0003



1SD02106530F0003

Connectors for motor operators (only for Ts3)

The motor operators for Ts3 can only be supplied by means of the specific connectors. They are of the slide type and allow simultaneous connection of both the motor operator and the auxiliary contacts to the relative power supply circuit. They are an alternative to the corresponding connectors for the auxiliary contacts because they are housed in the same seat. They must be ordered specifying the size and version of the circuit breaker (fixed or plug-in/draw out).

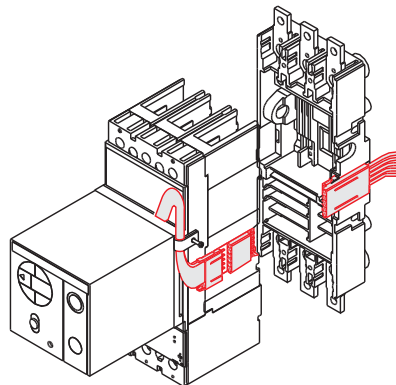

1SD02106530F0003

Accessories

Remote control



1SD/C210C/76/F0001

Stored energy motor operator for T4, T5 and T6 – MOE and MOE-E (UL FILE: E116596)

With the stored energy motor operator, it is possible to control both opening and closing of the circuit breaker on which it is installed. During opening of the circuit breaker, the spring system is recharged automatically: the stored energy is exploited in this way to close the circuit breaker.

The motor operator is always supplied with socket-plug connectors with 39.4" (1 m) long cables and is always fitted with a padlock in the open position, which prevents any command, either locally or remotely. The connectors, once inserted in the special slot on the left-hand side of the circuit breaker, extend out of the outline of the circuit breaker itself and are only compatible with pre-wired electrical accessories. A selector allows passage from automatic to manual operation and a block is also available (supplied as standard) for the operating mode of the motor.

The motor operator can be fitted both with a key lock in the open position (with the same MOL-S keys for groups of circuit breakers or different MOL-D keys) and with an MOL-M key lock against manual operation: in the former case, the lock in the open position is both of electrical and mechanical type, in the latter case, only of mechanical type, i.e. only closing from the front of the circuit breaker (remote closing is allowed). In the case of interlocked circuit breakers, for safety reasons the key lock against manual operation is required.

The motor operator is always fitted with a contact to signal "auto" or "manual" (not on changeover).

On request, it can also be fitted with an AUX-MO auxiliary contact (on changeover), which provides a signal of its state of service: "auto" (remote control of the circuit breaker) or "manual".

If the circuit breaker is fitted with the PR222DS/PD-A electronic trip unit, instead of the MOE motor operator, it is possible to use the MOE-E motor operator: for its use, the circuit breaker must also be fitted with the AUX-E auxiliary contacts (standard supply with MOE-E). The MOE-E allows use of the digital signals coming from the supervision and control system, by means of the PR222DS/PD-A and the AUX-E contacts, and to convert these into power signals to operate the motor operator. All the characteristics indicated above for the MOE motor operator are also valid for the MOE-E.

The main parameters relative to the stored energy motor operator are indicated in the table.

MOE and MOE-E

	Tmax T4-T5		Tmax T6	
	AC [V]	DC [V]	AC [V]	DC [V]
Rated voltage, Un	-	24	-	24
	-	48...60	-	48...60
	110...125	110...125	110...125	110...125
	220...250	220...250	220...250	220...250
	380	-	380	-
Operating voltage [% Un]	85...110	85...110	85...110	85...110
Power consumption on inrush Ps	≤ 300 VA	≤ 300 W	≤ 400 VA	≤ 400 W
Power consumption in service Pc	≤ 150 VA	≤ 150 W	≤ 150 VA	≤ 150 W
Duration	opening [s]	1.5	3	
	closing [s]	< 0.1	< 0.1	
	resetting [s]	3	5	
Mechanical life [no. Operations]	20000		10000	
Degree of protection, on the front	IP30		IP30	
Minimum control impulse time on opening and closing [ms]	≥ 100		≥ 100	

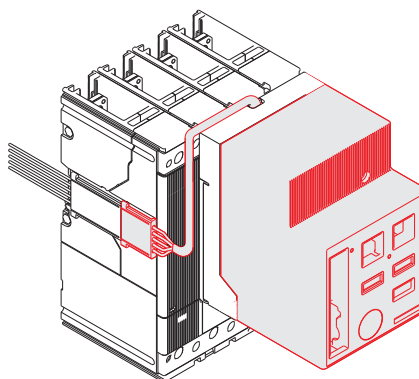

1SD/C210C/76/F0001



Testing extension for motor operators

Available for circuit breakers Tmax T4, T5 and T6, the testing extension for motor operators allows the motor operator to be connected to the relative power supply circuit with the circuit breaker in the removed position. With the circuit breaker in a safe position, i.e. isolated from the power circuits, it is possible to carry out blank tests of the circuit breaker functions.

Spring charging motor for the stored energy T7

Only available on Tmax T7 in the stored energy version, the spring charging motor automatically charges the circuit breaker operating mechanism springs. This operation is carried out automatically immediately after closure of the circuit breaker.

When there is no power supply or during maintenance work, the closing springs can, in any case, be charged manually by means of the special operating mechanism lever. It is always fitted with limit contact. The spring charging motor is always fitted with a terminal to be mounted in the terminal board to carry out the cabling.

Spring charging motor

	Tmax T7M	
	AC [V]	DC [V]
Rated voltage, Un	24...30	24...30
	48...60	48...60
	100...130	100...130
	220...250	220...250
	380...415	
Opening voltage [% Un]	85...110	85...110
Power consumption	≤ 100 VA	≤ 100 W
Charging time [s]	8 - 10	8 - 10

Note: To allow a complete remote control with T7 motorizable, the circuit breaker must be fitted with:
 - shunt trip;
 - closing coil;
 - spring charging motor.

Accessories

Remote control

Adapters – ADP

For the SOR, PS-SOR, UVR, AUX, MOE or MOE-E and AUE pre-wired electrical accessories used with Tmax T4, T5 and T6 in the plug-in or draw out versions, it is necessary to use the adapters to be coupled with the plug, which will then be connected to the socket on the cradle.

According to the electrical accessories required, one or two adapters must be mounted on the left and/or right side of the moving part.

There are four adapter types available:

- 5-way adapters
- 6-way adapters
- 10-way adapters
- 12-way adapters.

The table below indicates the adapters which have to be used for the various possible combinations of electrical accessories:

Adapters ADP for T4, T5 and T6 wired accessories

	5- way	6- way	10- way	12- way
Left side				
SOR	■			
UVR	■			
SA for residual current release RC222	■			
SOR or UVR + SA for residual current release RC222	■			
MOE (MOE-E)			■	
MOE (MOE-E) + SOR or UVR			■	
MOE (MOE-E) + SOR or UVR + SA for residual current release RC222			■	
AUE			■	
AUE + SOR or UVR			■	
AUE + SOR or UVR + SA for residual current release RC222			■	
Right side				
AUX 1Q + 1SY 1 open/closed changeover contact + 1 trip unit tripped changeover contact		■		
AUX 2Q 2 open/closed changeover contacts		■		
AUX 3Q + 1SY 3 open/closed changeover contacts + 1 trip unit tripped changeover contact				■

On the other hand, for Tmax T2 and T3 in the plug-in version it is necessary, to order the socket-plug connectors: with 12 poles for the AUX auxiliary contacts - 3 open/closed changeover + 1 release tripped changeover, with 6 poles for the AUX auxiliary contacts - 1 open/closed changeover + 1 release tripped changeover and with 3 poles for the service releases (SOR or UVR).

For T2 in the plug-in version with PR221 electronic trip unit and suitable auxiliary contact, it is necessary to order a 6 and a 3 pole socket-plug connector.

Socket plug connectors

In order to allow the racking-in and racking-out operations of the moving part of the plug-in circuit breaker, the wired and unwired electrical accessories of Tmax T2 and T3 and the unwired electrical accessories of Tmax T4, T5 and T6 must be fitted with one or more socket plug connectors, as per the table below.

Socket plug connectors

	3 poles	6 poles	12 poles
T2-T3-T4-T5-T6			
SOR	■		
UVR	■		
AUX 1Q + 1SY 1 open/closed changeover contact + 1 trip unit tripped changeover contact		■	
AUX 2Q 2 open/closed changeover contacts		■	
AUX 3Q + 1SY 3 open/closed changeover contacts + 1 trip unit tripped changeover contact			■
T2-T3			
MOS overload ⁽¹⁾		■	
AUE	■		
AUX 2Q + 1SY for PR221 2 open/closed contacts + 1 trip unit tripped changeover contact	■	■	
AUX 1S51 + 1Q + 1SY for PR221 1 changeover contact + 1 SA electronic release trip contact + 1 trip unit tripped changeover contact	■	■	

⁽¹⁾ Always provided with the overlaid solenoid operator

Accessories

Operating mechanisms and locks



T4-T6

Rotary handle operating mechanism – RHD/RHE (UL FILE: E116596)

Thanks to its ergonomic grip, the rotary handle facilitates the circuit breaker closing and opening operations.

It is always fitted with a padlock-lock in the open position which prevents circuit breaker closing. The opening in the padlock-lock can take up to 3 padlocks - Ø 0.27" (7 mm) stem (not supplied), 0.24" (6 mm) only for Ts3 (not supplied). It is always (except for Ts3) fitted with a compartment door lock and on request it can be supplied with a key lock in the open position. On request, the Ts3 can be supplied with a compartment door lock or key lock in the open position. Application of the rotary handle operating mechanism is an alternative to the motor operator and to the front interlocking plate (MIF) for T1, T2 and T3, or to the motor operator and to the front for lever operating mechanism for Ts3, T4, T5 and T6. The rotary handle operating mechanism is available in either the direct mount or variable depth version on the compartment door. The rotary handle operating mechanism in the emergency version, complete with a red on yellow background handle, suitable for controlling machine tools, is available in both the versions.

The rotary handle operating mechanism is available on T7 with lever operating mechanism and, only for the direct mount version, is characterised by an articulated grip which allows the switchgear door to be opened in case of an emergency with the circuit breaker closed. The release settings and nameplate data remain accessible to the user.

The variable depth rotary handle operating mechanisms can be ordered by building up the following three devices:

- rotary handle on the compartment door
- shaft (19.68"/500 mm)
- base for circuit breaker or, alternatively, by using the code of the ready-configured version.

3

Type of RH_ operating mechanism

		T1			T2, T3			Ts3			T4, T5			T6		T7 ⁽¹⁾	
		F	F	P	F	P	W	F	P	W	F	W	F	W			
RHD	Direct	■	■	■	■	■	■	■	■	■	■	■	■	■	■	■	
RHD_EM	Emergency direct	■	■	■	■	■	■	■	■	■	■	■	■	■	■	■	
RHE	Transmitted with adjustable distance	■	■	■	■	■	■	■	■	■	■	■	■	■	■	■	
RHE_EM	Emergency transmitted with adjustable distance	■	■	■	■	■	■	■	■	■	■	■	■	■	■	■	
RHE_B	Base for circuit breaker	■	■	■				■	■	■	■	■	■	■	■	■	
RHE_S	Shaft for variable depth handle	■	■	■	■	■		■	■	■	■	■	■	■	■	■	
RHE_H	Handle for transmitted RH with variable depth	■	■	■				■	■	■	■	■	■	■	■	■	
RHE_H_EM	Emergency handle for transmitted RH with variable depth	■	■	■				■	■	■	■	■	■	■	■	■	

⁽¹⁾ The rotary handle operating mechanism is only available for T7 with lever operating mechanism and it is as an alternative to the key lock mounted on the circuit breaker.

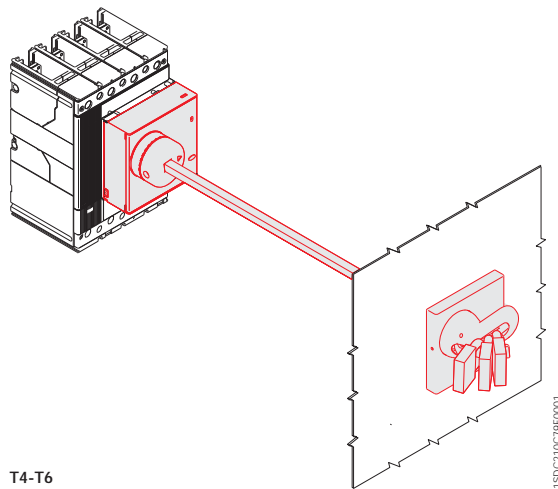

T4-T6



The IP54 protection for rotary handle (UL FILE: E116596)

Allows IP54 degree of protection to be obtained.
It is available for the transmitted rotary handle operating mechanism on the compartment door (RHE) for all the Tmax circuit breakers.

Front for lever operating mechanism – FLD (UL FILE: E116596)

This can be installed on fixed, plug-in or draw out Tmax Ts3, T4, T5 and T6 circuit breakers. In the case of draw out circuit breakers, installed in a switchboard, it allows the IP40 degree of protection to be maintained for the whole isolation run of the circuit breaker.

It is always fitted with a padlock in the open position Ø 0.24" (6 mm) stem up to three padlocks (not supplied) which prevents closing of the circuit breaker and of the compartment door, and with compartment door lock. On request, it can be fitted with a key lock in the open position.

It is available in the following versions:

- for fixed or plug-in circuit breaker
- for draw out circuit breaker.

The front for lever operating mechanism is always an alternative to the motor operator and to the rotary handle and to the display FDU.

The same flange for the compartment door already supplied with the circuit breaker or the one supplied with the conversion kit for draw out (except for Ts3) version can be used.

Padlock for operating lever – PLL

This is applied to the T1 - T2 - T3 circuit breaker cover to prevent the lever closing or opening operation. It allows installation up to a maximum of three padlocks Ø 0.24" (7 mm) stem (not supplied). It is available in the following versions:

- plug-in locking device only of the closing operation
- locking plate on the closing and opening operation according to the assembly position. The lock on the opening operation does not prevent release of the mechanism following a fault or remote control command
- locking plate just for the closing operation.

It is incompatible with the front accessories: solenoid operator, rotary handle operating mechanism and mechanic interlock.

The padlock is also available for T7 and it is directly mounted on the circuit breaker cover.

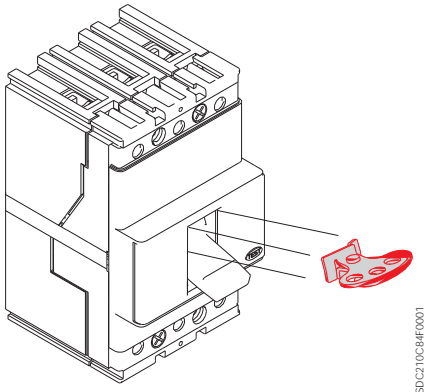

T1-T3

15DC210C84F0001

Accessories

Operating mechanisms and locks



1SDC210C85F0001

Key lock on the circuit breaker for T1, T2, T3 and T7 – KLC

This allows the mechanical closing operation of the circuit breaker to be locked and is installed directly on the front in the slot in correspondence with the left pole. This cannot be installed when the front operating mechanism, rotary handle operating mechanism, motor operator, or RC221/RC222 residual current releases are present, or on the three-pole circuit breakers equipped with service releases (UVR, SOR). The key lock is the Ronis 622 type and is available in two versions:

- standard type, with key only removable with the circuit breaker locked
- special type, with key removable in both positions.

On T7 the key lock in the open position is mounted directly on the circuit breaker cover both in the version with different keys and with the same keys. Presettings for Ronis and Profalux key locks are also available.



1SDC210C86F0001

Key lock for rotary handle operating mechanism for T1, T2 and T3 – RHL

This allows the mechanical closing operation of the circuit breaker to be locked.

The following versions are available:

- lock with a different key for each circuit breaker
- lock with the same key for groups of circuit breakers.

The circuit breaker in the open position ensures isolation of the circuit in accordance to the IEC 60947-2 Standard. It is also available in the version which allows the lock both in the open and closed position. The lock in the closed position does not prevent release of the mechanism following a fault or remote control.



1SDC210D24F0001

Key lock for Ts3, T4, T5, T6 and T7 – KLF-D and KLF-S

This allows mechanical operation of the circuit breaker to be locked. This lock can be used with the direct or transmitted rotary handle operating mechanism mounted on the base for circuit breaker or with the front for lever operating mechanism.

The lock of the circuit breaker in the open position ensures isolation of the circuit in accordance with the IEC 60947-2 Standard. For Ts3 different locks are supplied for the direct action motor operator, for stored energy motor operator, for rotary handle or front for lever operating mechanism. For T4, T5, T6 and T7 in the lever operating mechanism version key locks in the open position are available either with different keys (KLF-D) or with the same keys (KLF-S): in this case, up to four different key numbering codes are available (n. 2005-2006-2007-2008).

Lock in the racked-out position for cradle (Ts3, T4, T5 and T6)

For Ts3, T4, T5 and T6 draw out circuit breakers, key or padlocks locks are available to be applied onto the rail of the cradle, to prevent racking-in of the plug-in part.

Selection can be made among the following:

- key lock with different keys (KLF-D FP)
- key lock with the same keys for groups of circuit breakers (KLF-S FP)
- Ronis type key lock (KLF-D Ronis FP)
- padlock, which can take up to three padlocks with $\varnothing 0.24"$ (6 mm) stem, not supplied (PLL FP).



Lock in racked-in – isolated – racked-out position for cradle of T7

This device allows the moving part of a draw out T7 circuit breaker to be locked in the racked-in, isolated-test or racked-out position in the relative cradle. Thanks to mounting an additional accessory, the lock can be limited just to the racked-out position. The cradle can be equipped with 1 or 2 of these key locks.



Mechanical lock of compartment door

A mechanical lock of compartment door available on Ts3 and T7 for both the lever operating mechanism and for the motorizable version. It does not allow the compartment door to be opened with the circuit breaker closed (and circuit breaker racked-in for circuit breakers in the draw out version) and locks the circuit breaker closing with the compartment door open.

For Ts3 circuit breakers, it consists of two elements: one applied to the rotary handle operating mechanism or to the front for the lever operating mechanism, the other consisting of a metal striker to be applied onto the compartment door.

For T7 two versions are available: a door lock made by means of cables and a second type fixed directly on the side of the circuit breaker or of the relative cradle. The cable door lock must also be fitted with the interlock cable kit and the interlocking plate corresponding to the combined circuit breaker.



Sealable thermal adjustment lock

This is applied to the circuit breaker cover near the thermal element regulator of the TMD thermomagnetic trip unit for T1, T2, T3 and Ts3 and prevents it being tampered with.

Overview of the available locks

	T1	T2	T3	Ts3	T4	T5	T6	T7
FDL Front for lever operating mechanism				■	■	■	■	
PLL_ Padlock for operating lever	■	■	■					■
KLC_ Key lock on the circuit breaker	■	■	■					■
RHL Keylock for rotary handle operating mechanism	■	■	■					
KLF-D and KLF-S Key lock for front for lever and rotary handle				■	■	■	■	
MOL-D and MOL-S_ Key lock in open position for MOE and MOE_E					■	■	■	
MOL-M_ Key lock against manual operation for MOE and MOE_E					■	■	■	
KLF-FP and PLL FP_ Locks in open position for cradle					■	■	■	■
Mechanical lock on compartment door				■				■
Sealable lock of thermal adjustment	■	■	■	■				

Accessories

Operating mechanisms and locks

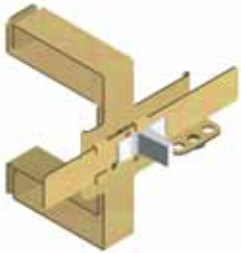

1SD0210C8BF0001

T1-T2-T3



1SD0210C8BF0001

T3-T4-T5-T6

Mechanical interlock (UL FILE: E116596)

T1-T2-T3

The mechanical MIF interlock can be applied on the front of two T1, T2 or T3 circuit breakers mounted side by side, in either the three-pole or four-pole fixed version and prevents simultaneous closing of the two circuit breakers. Fixing is carried out directly on the back plate of the switchboard. The front interlocking plate allows installation of a padlock in order to fix the position (possibility of locking in the O-O position as well). It is also possible to interlock three circuit breakers side by side, using the proper plate, thereby making the following interlock combinations: IOO-OIOOOI-OOO. It is incompatible with the front accessories (solenoid operator, rotary handle operating mechanism) and with the residual current releases.

T3

For T3, in the three-pole or four-pole fixed or plug-in version, the MIR mechanical interlock is available. This rear interlock, available in the horizontal (MIR-H) and vertical (MIR-V) version, is compatible with all the front accessories and with the residual current release (only MIR-H).

The following interlocking combinations can be made: IO-OI-OO.

Ts3

For Ts3 circuit breakers the (rear) mechanical interlock allows installation of two circuit breakers in a single support and, by means of a walking beam mechanism, makes them mechanically interdependent. It prevents operation in parallel of two power supply sources (eg. normal-emergency). It consists of a kit with levers and assembly accessories and a metallic support. The mechanical interlock is available in the version for side-by-side circuit breakers and for superimposed circuit breakers. Only circuit breakers of the same size and in the same version can be interlocked.

T4-T5-T6

The mechanical interlock for T4, T5 and T6 allows installation of two circuit breakers on a single support and, by means of special lever mechanisms, makes them mechanically interdependent.

For Tmax T4 and T5 this is a rear interlock consisting of a vertical or horizontal frame group (MIR-HR or MIR-VR) and of a pair of metal plates for fixing the circuit breakers (MIR-P). The frame group is made up of metal frame and of the lever mechanism interlock. The metal plates are of different type according to the sizes of the circuit breakers to be interlocked.

For Tmax T6 this is a rear interlock consisting of a vertical or horizontal support.

Interlock

Type			
A	T4 (F-P-W)	+	T4 (F-P-W)
B	T4 (F-P-W)	+	T5 400 (F-P-W) o T5 630 (F)
C	T4 (F-P-W)	+	T5 630 (P-W)
D	T5 400 (F-P-W) o T5 630 (F)	+	T5 400 (F-P-W) o T5 630 (F)
E	T5 400 (F-P-W) o T5 630 (F)	+	T5 630 (P-W)
F	T5 630 (P-W)	+	T5 630 (P-W)

There are no limitations on the versions to be interlocked, therefore, for example, a fixed circuit breaker can be interlocked with a draw out version switch-disconnector.

Since this is a rear interlock, all the front accessories which are compatible with the circuit breakers can be used.

In the vertical interlock the bottom terminals of the upper circuit breaker and the top terminals of the lower circuit breaker must be of rear type.

To be able to receive the circuit breakers mounted directly on the interlocking plate, code "1SDA050093R1" must be specified as the accessory of the second circuit breaker (or cradle) you want to interlock.



1SD0210D24F0001



T7

This mechanism makes the mechanical interlock between two T7 circuit breakers by means of flexible cables, which are connected on a plate mounted on the side of the circuit breaker preventing simultaneous closing of the two circuit breakers. The plates to be mounted on the circuit breaker differ according to whether the circuit breaker is in the fixed or draw out version.

The interlock is available both for the manual operating mechanism version and for the motor operator one.

Transparent pushbutton protection – TCP

A transparent protection for the circuit breaker opening and closing pushbuttons is available in two different versions on T7 with stored energy operating mechanism: one which protects both the pushbuttons and the other which alternatively protects either the opening or the closing pushbutton.

There is the possibility of putting a padlock, which adds the lock function to the protection. In the closed position this lock does not prevent release of the mechanism following a fault or a remote command.

IP54 door protection

Available with T7 motorizable, it is made by means of a transparent plastic cover which completely protects the front of the circuit breaker and allows IP54 degree of protection to be reached. Mounted on hinges, it is provided with a key lock.

Accessories

Residual current releases - IEC only

All the Tmax series of circuit breakers, both automatic circuit breakers and switch-disconnectors, are preset for assembly with residual current releases.

In particular, the Tmax T1, T2 and T3 circuit breakers can be combined with the new version of the SACE RC221 or RC222 series of residual current releases.

Tmax Ts3 can be combined with SACE RC211 or RC212 residual current releases and four-pole T4 and T5 with RC222 or RC223 to be installed below the circuit breaker.

The T6 and T7 circuit breakers can be combined with the RCQ residual current switchgear release.

Apart from the protection against overloads and short-circuits typical of automatic circuit breakers, the residual current circuit breakers derived from them also guarantee protection of people and protection against ground fault currents, thereby ensuring protection against direct contacts, indirect contacts and fire hazards. The residual current releases can also be mounted on the Tmax T1D, T3D, T4D and T5D switch-disconnectors. In that case, the derived apparatus is a "pure" residual current circuit breaker, i.e. one which only guarantees residual current protection and not the protections typical of circuit breakers. "Pure" residual current circuit breakers are only sensitive to the ground fault current and are generally applied as main switch-disconnectors in small distribution switchboards towards end users.

The use of "pure" and "impure" residual current circuit breakers allows continual monitoring of the state of plant insulation, ensuring efficient protection against fire and explosion hazards and, when the devices have $I_{\Delta n} \leq 30$ mA, ensure protection of people against indirect and direct ground contacts to fulfil the compulsory measures foreseen by the accident prevention regulations and prescriptions.

The residual current releases are constructed in compliance with the following Standards:

- IEC 60947-2 appendix B
- IEC 61000: for protection against unwarranted release.

They are constructed using electronic technology and act directly on the circuit breaker by means of a trip coil, supplied with the residual current release, to be housed in the special slot made in the left-hand pole area.

They do not require an auxiliary power supply as they are supplied directly by the network and their operation is guaranteed even with only a single phase plus neutral or only two phases supplied with voltage and in the presence of unidirectional pulsating currents with direct components. All the possible connection combinations are allowed, except for guaranteeing, in the four-pole version, connection of the neutral to the first pole on the left.

The RC221 and RC222 residual current releases can either be supplied from above or from below.

The operating conditions of the apparatus can be continually controlled by the electronic circuit test pushbutton and the magnetic indicator of residual current trip.

A disconnection device of the power supply during the insulation test is available.

The four-pole circuit breaker complete with residual current release can be fitted with the electrical accessories normally available for the circuit breaker. The shunt opening and undervoltage releases are housed in the special slot made in the neutral pole for the four-pole circuit breakers, whereas they are incompatible with the three-pole circuit breakers.

The residual current releases are supplied complete with:

- a trip coil to be housed in the area of the third pole, complete with an auxiliary contact signalling residual current release trip
- dedicated flange.

A changeover contact for signalling residual current protection trip is always supplied for Tmax circuit breakers, combined with the RC221 and RC222 residual current releases. Two changeover contacts for signalling pre-alarm and alarm are also available with the RC222 release.

The opening solenoid for the RC221, RC222 and RC223 residual current releases is available as a spare part.

A circuit breaker cannot have the residual current release and the rotary handle or the motor operator mounted at the same time (except for MOS in the side-by-side version for T1 and T2).



1SDC210C9R0001 UL



1SDC210C9R0001

T1-T2-T3

RC221 and RC222 residual current releases for T1, T2 and T3

The RC221 and RC222 residual current releases for T1, T2 and T3 circuit breakers are available both with three-pole and four-pole circuit breakers, in the fixed version.

The configuration foresees insertion of the circuit breaker on the structure of the corresponding residual current release, making access to the adjustments on the left-hand side of the circuit breaker available, whilst the toroid is in the underneath position.

A distinguishing characteristic is provided by the type of cable connection which is made directly on the circuit breaker, once the residual current release has been mounted, thereby ensuring simplification and rationalisation of the installation procedure.

With Tmax T2 and T3, only front terminals for copper cables (FC Cu) at the bottom are mounted on the residual current releases.

For this reason, when the residual current release is ordered, the FC Cu terminal semi-kit is always supplied.

On the other hand, for four-pole Tmax T1, it is also possible to mount the rear horizontal flat terminal kit below (HR for RC221/RC222).

Furthermore for four-pole T1 a version of the RC222 residual current release is available in 7.87" (200 mm) modules. This release keeps the same technical characteristics as the normal RC222 for T1, T2 and T3 but thanks to its reduced height, allows installation in 7.87" (200 mm) modules. Its special shape also allows a reduction in the overall dimensions when two or more units are placed side by side.

The bracket for fixing onto DIN 50022 rail is available on request.

A circuit breaker cannot have the residual current release and the overlaid solenoid operator or the rotary handle operating mechanism mounted at the same time.

SACE RC211 and RC212 electronic residual current releases for Ts3

The SACE RC211 or RC212 residual current releases can be installed on the Tmax Ts3 circuit breaker, in the fixed, four-pole version and can be supplied in two versions as follows:

- for assembly beside the circuit breaker
- for assembly under the circuit breaker.

They are constructed using analogue technology and act directly on the circuit breaker by means of an opening solenoid, supplied with the release, to be housed in the special slot made in the area of the third pole.

They do not require an auxiliary power supply since they are supplied directly from the network and their operation is guaranteed even with only a single phase supplied with voltage and in the presence of one-direction pulsating currents with continuous components.

The operating conditions of the apparatus can be controlled constantly by means of the test pushbutton of the electronic circuit and the residual current trip magnetic indicator.

The circuit breaker complete with residual current release can be fitted with the electrical accessories normally available for the circuit breaker. The opening and undervoltage releases are housed in the special slot made in the fourth pole.

Residual current release beside the four-pole version circuit breaker

This is supplied complete with:

- power cables for connection to the lower terminals of the circuit breaker (respect correspondence with the neutral and phases)
- an opening solenoid to be housed in the area of the third pole, complete with plug-socket connector for connection to the residual current release
- 2 brackets for fixing on DIN rail (one for the circuit breaker and one for the residual current release)
- plug connector to make the connection of the remote opening pushbutton (to be provided by the customer).

For the Tmax Ts3 circuit breaker, the residual current release is fitted with front terminals and is also supplied with a front flange H = 1.77" (45 mm) for the circuit breaker. On request, the front terminals for cables can be mounted, using the standard circuit breaker kit.

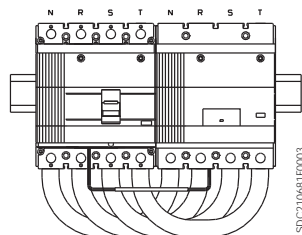

beside

1SDC210481F0003

Accessories

Residual current releases - IEC only



1SDC210C92F0001, UL



1SDC210C93F0001

T4-T5

RC222 residual current release for T4 and T5

The RC222 release for T4 and T5 is available in the four-pole version and is mounted below the circuit breaker.

The release is supplied with standard front terminals, but it can also be combined with all the terminals available for the corresponding circuit breaker.

The RC222 residual current release, in the fixed version, can easily be converted into plug-in and into draw out by adding the special conversion kit and applying a derating of the performances as indicated in the table on the next page.

A circuit breaker cannot have the residual current release and the motor operator mounted at the same time.

RC223 (B type) residual current release for T3 and T4 250 A

The RC223 (B type) residual current release can only be combined with the Tmax T3 and T4 250 A four-pole circuit breakers in the fixed, plug-in and draw out version (plug-in and draw out version only for T4). The range of operation of the primary line-to-line voltage of this residual current release varies between 110 V and 500 V, with operation starting from 55 V phase-neutral. It is characterised by the same types of reference as the RC222 (S and AE type) release, but can also boast conformity with type B operation, which guarantees sensitivity to residual fault currents with alternating, alternating pulsating and direct current components.

The reference Standards are: IEC 60947-1, IEC 60947-2 Appendix B, and IEC 60755.

Apart from the signals and settings typical of the RC222 residual current release, the RC223 also allows selection of the maximum threshold of sensitivity to the residual fault frequency (3 steps: 400 - 700 - 1000 Hz). It is therefore possible to adapt the residual current device to the different requirements of the industrial plant according to the prospective fault frequencies generated on the load side of the release. Typical installations which may require frequency thresholds different from the standard ones (50 - 60 Hz) are the welding plants for the automobile industry (1000 Hz), the textile industry (700 Hz), airports and three phase drives (400 Hz).

A circuit breaker cannot have the residual current release and the motor operator mounted at the same time.

The residual current RC223 for T3 has front terminals as default. For connection to the T3+RC223 unit, use the terminal kits available for size T3 on the top terminals and terminal kits for T4 on the bottom terminals.

Circuit breakers size	RC211	RC212	RC221	RC222		RC223
	Ts3 (4p only)	Ts3 (4p only)	T1-T2-T3	T1-T2-T3	T4 and T5 (4p only)	T3 and T4 (4p only)
Type	beside/below	beside/below	"L" shaped	"L" shaped	placed below	placed below
Technology	microprocessor-based	microprocessor-based	microprocessor-based	microprocessor-based	microprocessor-based	microprocessor-based
Action	with solenoid	with solenoid	with trip coil	with trip coil	with trip coil	with trip coil
Primary service voltage ⁽¹⁾ [V]	220...500	50...500	85...500	85...500	85...500	110...500
Operating frequency [Hz]	45...66	45...66	45...66	45...66	45...66	45...66
Self-supply	■	■	■	■	■	■
Test operation range ⁽¹⁾ [V]	220...500	50...500	85...500	85...500	85...500	110...500
Rated service current [A]	up to 250 A	up to 250 A	up to 250 A	up to 250 A	up to 500 A	up to 250 A (225 A for T3)
Rated residual current trip [A]	0.03-0.1-0.3	0.03-0.1-0.3-0.5-3	0.03-0.1-0.3-0.5-1-3	0.03-0.05-0.1-0.3-0.5-1-3-5-10	0.03-0.05-0.1-0.3-0.5-1-3-5-10	0.03-0.05-0.1-0.3-0.5-1
Time limit for non-trip [s]	instantaneous	0.1-0.25-0.5-1-1.5	instantaneous	instantaneous 0.1-0.2-0.3-0.5-1-2-3	instantaneous 0.1-0.2-0.3-0.5-1-2-3	instantaneous 0.1-0.2-0.3-0.5-1-2-3
Tolerance over trip times		± 20%		± 20%	± 20%	± 20%
Power consumption ⁽²⁾			< 8 W at 400 V AC	< 10 W at 400 V AC	< 10 W at 400 V AC	< 10 W at 400 V AC
Local trip signalling	■	■	■	■	■	■
Trip coil with changeover contact for trip signalling	■	■	■	■	■	■
Input for remote opening		■		■	■	■
NO contact for pre-alarm signalling				■	■	■
NO contact for alarm signalling				■	■	■
Indication of pre-alarm from 25% I _{Δn} (tolerance ±3%)			■	■	■	
Indication of alarm timing at 75% I _{Δn} (tolerance ±3%)			■	■	■	
"A" type for pulsating alternating current, AC for alternating current	■	■	■	■	■	■
"AE" type for remote release device				■	■	■
Type B for pulsed current and direct current						■
Selective "S" type				■	■	■
Switch for insulation test			■	■	■	■
Power supply from above and below			■	■	■	■
Assembly with three-pole circuit breakers			■	■		
Assembly with four-pole circuit breakers	■	■	■	■	■	■
Kit for conversion of circuit breaker with residual current release from fixed to plug-in					■	■

⁽¹⁾ Operation up to 50 V Phase-Neutral (55 V for RC223)

⁽²⁾ The values of power consumption can be inferior at lower supply voltage

RC222-RC223 T4-T5 Performances

T3
T4 250
T5 400⁽²⁾
T5 600⁽²⁾

⁽¹⁾ 225 A with RC223

⁽²⁾ Available only with RC222

Maximum withstand current

Fixed	Plug-in/Draw out
250 A ⁽¹⁾	-
250 A	250 A
400 A	400 A
500 A	-

Accessories

Residual current releases - IEC only



SACE RCQ switchboard residual current relay (IEC only)

The Tmax circuit breakers can also be combined with the SACE RCQ switchboard relay with separate toroid (to be installed externally on the line conductors) and these fulfil requirements with thresholds up to 30 A trips and times up to 5 s or when the installation conditions are particularly restrictive, such as with circuit breakers already installed, or limited space in the circuit breaker compartment.

Thanks to the wide range of settings, the SACE RCQ switchboard relay is suitable for applications where a system of residual current protection coordinated with the various distribution levels, from the main switchboard to the end user, is required. It is particularly recommended when low sensitivity residual current protection is required, such as in partial (current) or total (chronometric) selective chains, and for high sensitivity applications (physiological sensitivity) to provide protection of people against direct contacts. On a drop in the auxiliary power supply voltage, the opening command can intervene after a minimum time of 100 ms and after the time set plus 100 ms.

The SACE RCQ relay is a type A residual current relay and detects residual currents both of the alternating and pulsating type with continuous components.

The SACE RCQ relay is of the type with indirect action and acts on the circuit breaker release mechanism by means of the shunt trip (or of the undervoltage release) of the circuit breaker itself (to be ordered by the user). It is housed in the special slot made on the left-hand pole of the circuit breaker.

Residual current relay		SACE RCQ	
Power supply voltage	AC [V] DC [V]	80 ... 500	48 ... 125
Operating frequency	[Hz]	45 ÷ 66 Hz	
Power consumption on in rush		100 [VA] / 100 [W]	
Power consumption in service		6 [VA] / 6 [W]	
Trip threshold adjustment I Δ n		0.03-0.05-0.1-0.3-0.5	1-3-5-10-30
1st range of adjustments	[A]		
2nd range of adjustments	[A]		
Trip time adjustment	[s]	instantaneous 0.1-0.2-0.3-0.5-0.7-1-2-3-5	
Pre-alarm threshold adjustment	[%] x I Δ n	25 ... 75% x I Δ n	
Range of use of closed transformers			
Toroidal transformer Ø 2.36"/60 mm	[A]	0.03 ... 30	
Toroidal transformer Ø 4.33"/110 mm	[A]	0.03 ... 30	
Toroidal transformer Ø 7.28"/185 mm	[A]	0.1 ... 30	
Range of use of transformers which can be opened			
Toroidal transformer Ø 4.33"/110 mm	[A]	0.3 ... 30	
Toroidal transformer Ø 7.08"/180 mm	[A]	0.3 ... 30	
Toroidal transformer Ø 9.05"/230 mm	[A]	1 ... 30	
Signalling for alarm pre-threshold		Yellow flashing LED 1 N.O., change-over contact 6 A - 250 V AC 50/60 Hz	
Residual current relay trip signalling		Yellow magnetic flag change-over contacts (N.O. N.C.; N.O.) 6 A - 250 V AC 50/60 Hz	
Remote opening control		N.O. contact - Trip time 15 ms	
Connection to the toroidal transformer		By means of 4 twisted conductors. Maximum length: 5 m	
Dimensions W x H x D	[In/mm]	3.77" x 3.77" x 5.17" / 96 x 96 x 131.5 mm	
Drilling for assembly on door	[In/mm]	3.62" x 3.62" / 92 x 92 mm	
Degree of protection on the front		IP41	
Degree of protection on the rear		IP30	

Accessories

Accessories for electronic trip units



1SDC210095F0001

Front display unit – FDU

The front display is a display unit of the setting currents, alarms and parameters of the PR222DS/P and PR222DS/PD-A electronic trip units of T4, T5 and T6. The display unit can operate correctly with self-supply with $I \geq 0.35 \times I_n$ on at least one phase.

If the display is used in combination with the PR222DS/PD-A trip unit, and therefore with an auxiliary power supply, it is also possible to detect the protection which has caused the release trip and the fault current.

It is not compatible with the front accessories: rotary handle operating mechanism, motor operator and front for lever operating mechanism.

HMI030 interface on the front of switchgear

This accessory, which can be used with all the protection trip units fitted with dialogue, is designed for installation on the front of the switchgear. It consists of a graphic display where all the trip unit measurements and alarms/events are displayed. The user can navigate in a simple and intuitive way among the measurements by using the navigation pushbuttons. The device can replace the traditional multimeters without the need for current/voltage transformers. The HMI030 is connected directly to the protection trip unit by means of a serial line and requires a 24 V DC power supply.

Optional modules

The PR332/P trip unit for T7 can be enriched with additional internal modules, thereby increasing the capacity of the trip units and making these units highly versatile.



1SDC210039F0001

PR330/V voltage measuring module

This optional internal module can be added to PR332/P. It measures and processes the phase and neutral voltages, transferring this data to the protection trip unit so that a series of protection and measurement functions can be implemented.

It can be connected to the PR332/P at any time and the latter recognises it automatically without having to be configured.

PR330/V module, when ordered mounted on the circuit breaker, does not require any external connection or voltage transformers since it is connected internally to the upper terminals of Tmax T7 (selector in "INT" position) though the internal voltage sockets.

At the ordering stage, the code of the internal voltage socket can be specified in addition to the code of the T7 circuit breaker so as to guarantee the possibility to install even afterwards the PR332/P trip unit equipped with the PR330/V module connected internally to the upper terminals. If necessary, the connection of the voltage sockets can be moved externally with connection to the terminal board using voltage transformers connected to the top or bottom terminals.

On the PR330/V module there is a selector which defines the method of wiring implemented to detect the voltage measurements (INT = connection of the internal module towards the top terminals – EXT = connection to the terminal box). The "Insulating Test" position guarantees carrying out the dielectric test. A "Power Line" LED indicates presence of the line voltage.



1SDC210031T0001

PR330/D-M communication module (Modbus RTU)

The PR330/D-M communication module is the solution for connecting Tmax to a Modbus network for remote supervision and control of the circuit breaker.

It is suitable for the PR332/P trip unit for T7. As for the PR330/V, this module can be added to the protection trip unit and its presence is recognised automatically.

The electronic trip unit is supplied with three LEDs on the front:

- "Power" power supply LED, which indicates the presence of auxiliary power supply to the PR333/ D-M module
- "Tx" data transmission LED
- "Rx" data reception LED.

Accessories

Accessories for electronic trip units

3



PR330/R – Actuator module

The PR330/R actuator module is fitted in the right slot of T7 and it is used for opening (for T7 with lever operating mechanism it is allowed only the opening operation), and closing the circuit breaker by means of the shunt opening and closing releases by remote control. It is suitable for the PR332/P and must be compulsory ordered with the PR330/D-M communication module.

BT030 wireless communication unit

BT030 is a device to be connected to the Test connector of PR222DS, PR232/P, PR331/P and PR332/P. It allows Bluetooth communication between the protection trip unit and a hand-held or laptop PC with a Bluetooth port. BT030 can also be used with Emax circuit breakers fitted with PR121/P, PR122/P and PR123/P.

This device is dedicated for use with the SD-Pocket und SD-TestBus2 application. BT030 can provide the power supply needed for self-supply and for the protection release by means of a rechargeable Li-ion battery.

PR030/B power supply unit

With this accessory, which is always supplied with the PR332/P range of trip units, it is possible to read and configure the parameters of the unit whatever the state of the circuit breaker is (open-closed, in the isolated for test position or racked-in, with/without auxiliary power supply).

PR030/B is needed for the readout of the data relative to trips if the trip occurred more than 48 hours previously and the trip unit was no longer supplied.

An electronic circuit inside allows power supply to the unit for about 3 hours continuously to carry out just the data reading and configuration operations.

The life of the battery decreases if the SACE PR030/B is also used to carry out the Trip test and the Auto test.

Trip unit adapter

In order to allow all the connections between the electronic trip unit type PR33x and the terminal board on the circuit breaker, the circuit breaker itself must be fitted with a trip unit adapter.

Two different trip unit adapters are available: one is suitable with T7 level operating mechanism, the other with T7 motorizable.

Rating plug

Available on the electronic trip units which can be mounted on T7, the rating plug must be applied on the front of the trip unit itself and provides information about the current sensor settings. It is therefore no longer necessary to change the circuit breaker current sensors, but is sufficient just to replace the rating plug to obtain modification of the rated current of the circuit breaker.

Type of circuit breaker	Rated current I _n	I _n (A)				
		400	600	800	1000	1200
T7	1000	■	■	■	■	
	1200	■	■	■	■	■



1SDC210039F0001



1SDC210037F0001

EP010 - FBP

It is the “E-plug” interface which can connect T4, T5 and T6, equipped with the PR222DS/PD-A electronic trip unit, to the field bus plug system, allowing user to choose among several field bus system (ASI, Device Net, Profibus). This must be connected to the PR222DS/PD-A trip unit by means of the specific X3 connector. It can be used with T7 with PR332/P electronic trip unit equipped with PR330/D-M communication module.

When using EP010 for profibus, the PDP22 Fieldbus Plug must be used. The PDP21 Fieldbus Plug cannot be used with EP010.

SACE PR021/K signalling unit

The SACE PR021/K signalling unit can convert the digital signals supplied by the PR222DS/PD-A (LSI or LSIG), PR331 and PR332 trip unit into electrical signals with normally open electrical contacts.

The unit is connected to the protection trip unit by means of the Modbus RTU standard serial change-over line, on which all the information about the activation status of the protection functions flows. The corresponding electrical contacts are closed based on these information.

In particular, the following signals are available:

- the alarm signal remains active throughout the overload, until the trip unit is tripped
- the trip signals of the protections remain active during the timing phase, and even after the trip unit is tripped.

A reset pushbutton allows the state of all the signals to be reset.

The unit also has ten LEDs to visually signal the following information:

- “PW/WD”: auxiliary power supply present and W.D.
- “TX/RX”: flashing synchronised with dialogue with the serial Bus and several warning indications
- eight LEDs associated with the internal contacts.

The table indicates the characteristics of the signalling relays available in the SACE PR021/K unit.

Power contacts electrical characteristics

Maximum changeover power (resistive load)	100W / 1250 VA (resistive load)
Maximum changeover voltage	130 V DC / 250 V AC
Maximum changeover current	5 A
Breaking capacity (resistive load) @ 30 V DC	3.3 A
Breaking capacity (resistive load) @ 250 V AC	5 A
Contact/coil insulation	2000 V rms (1 min @ 50 Hz)

Note: the PR021/K unit is an alternative to any supervision and control systems.

K51

1
2
3
4
5
6-7
8

PR222DS

Protection L alarm
Protection S alarm
Protection I alarm
Protection G alarm
Bus K.O.
Release trip
Protection L pre-alarm

Accessories

Accessories for electronic trip units

Current sensor for external neutral

This is applied to the external neutral conductor and allows protection G against earth faults to be carried out with external neutral three-pole circuit breakers.

The current sensor must be connected to the trip unit by means of the specific connectors X4 for T4, T5 and T6 or with a direct connection in the terminal board for T7. The combination is not possible with electronic trip unit PR221, PR231 and PR232.

T4 [A]	T5 [A]	T6 [A]	T7 [A]
100	300	600	400
150	400	800	600
250	600		800
			1000
			1200

Connectors

Connectors X3 and X4 allow connection of the electronic trip units with external plant units or components. In fact, they are used to make the L alarm signal available outside, connection of the external neutral, connection to the PR021/K signalling unit, to the PR212/CI contactor control unit or to the temperature sensor of the PTC motor and allows two-way communication from the circuit breaker fitted with dialogue towards the outside and vice versa.

Both the connectors are available both for fixed version circuit breakers and for plug-in or draw out version circuit breakers.

Connector	Function	Trip unit
X3	PR021/K	PR222DS/PD-A
	L alarm signal	PR222DS/P, PR222DS/PD-A
	Auxiliary supply	PR222DS/PD-A
	EP 010	PR222DS/PD-A
X4	External neutral	PR222DS/P, PR222DS/PD-A

Accessories for trip units

Circuit breakers	T2-T4-T5-T6			T7			
	PR221	PR222DS/P	PR222DS/PD-A	PR231/P	PR232/P	PR331/P	PR332/P
Trip units							
Accessories							
TT1 - Test unit	■	■	■	■	■		
PR010/T - Test unit		■	■		■	■	■
PR021/K ⁽¹⁾ - Signalling unit			■			■	■
FDU ⁽²⁾ - Front display unit		■	■				
HMI030 ⁽¹⁾ - Interface on the front of switchgear			■			■	■
X3 - Connectors		■	■ ⁽³⁾				
X4 - Connectors		■	■				
X13 - Connectors SHORT/LONG		■	■			■	■
BT030 - Wireless communication unit		■	■		■	■	■
MOE-E (AUX-E included) ⁽²⁾ - Motor operator			■				
AUX-E - Auxiliary contacts			■				
EP010 ⁽¹⁾ - Field Bus plug			■				■
CT - Current transformers		■	■				
Extracode for interchangeability				■			
Rating plugs				■	■	■	■
PR030/B - Power supply unit					■	■	■
PR330/D-M - Communication module							■
PR330/V - Voltage measuring module							■
PR330/R - Actuator module							■
CT Sensor - Current sensors						■	■

⁽¹⁾ Accessories not compatible

⁽²⁾ Accessories not compatible

⁽³⁾ Compulsory

Accessories

Test and configuration accessories



1SDXC210003F0001

SACE PR010/T test and configuration unit

The SACE PR010/T unit is an instrument capable of performing the test, programming and parameter reading functions for the protection units equipping SACE Isomax S and Tmax molded case circuit breakers and SACE Emax power circuit breakers.

In particular, for Tmax T4, T5, T6 and T7 circuit breakers fitted with the different versions of trip units, the test programming and parameter reading functions are available.

All the functions mentioned can be carried out ON BOARD by connecting the SACE PR010/T unit to the front multi-pin connector on the protection units. Special interfacing cables supplied as standard with the unit guarantee the connection.

The human-machine interface is ensured by using a membrane keypad and a multi-line alphanumerical display.

There are also two LEDs on the unit which indicate, respectively:

- POWER-ON and STAND BY state
- state of the battery charge.

Two different types of test are provided: manual and automatic.

By means of connection to a computer (with the software supplied by ABB SACE), it is possible to upgrade the software of the SACE PR010/T unit to allow upgrading of the test unit as new products are developed.

Moreover the results of greatest interest regarding the test can be stored in the unit itself and sent to the PC on specific request for "issue of report".

In automatic and manual mode the SACE PR010/T unit can test:

- protection functions L, S, I, G
- monitoring correct operation of the microprocessor.

The SACE PR010/T unit is portable, operating with rechargeable batteries and/or with an external power supply.

In the standard supply, the unit includes the following:

- SACE PR010/T test unit complete with rechargeable batteries
- SACE TT1 test unit
- 100...240 V AC/12 V DC external power supply
- connection cables between the unit and the multi-pin connector on the range of trip units which equip the Tmax, SACE Isomax S and SACE Emax series
- connection cable between the unit and the PC (RS232 serial)
- power supply cable
- instruction manual and diskette with application SW
- plastic container.



1SDXC210004F0001

SACE TT1 test unit

This allows tripping of all the electronic trip units which equip the Tmax family of circuit breakers in the various versions (except for PR33x) to be checked and the trip test of the trip coil (CTC). The device, supplied with power by means of a replaceable 12 V battery, is provided with a two-pole polarised connector housed at the back of the box which allows connection of the device to the test input bushings located on the front of the electronic trip unit.

The compact dimensions of the accessory make it practically pocket size.

Accessories

Automatic transfer switch - ATS010 (IEC only)



1SXU210023D0201

Automatic transfer switch – ATS010

The switching unit ATS010 (Automatic Transfer Switch) is the new network-group switching device offered by ABB. It is based on microprocessor technology in compliance with the leading electromagnetic compatibility and environmental standards (EN 50178, EN 50081-2, EN 50082-2, IEC 60068-2-1, IEC 60068-2-2, and IEC 60068-2-3).

The device is able to manage the entire switching procedure between the normal line and emergency line circuit breakers automatically. This provides great flexibility of settings. In case of an error in the normal line voltage, in accordance with the delays set, the normal line circuit breaker is opened, the generator started and the emergency line circuit breaker closed. Similarly, when the normal line returns to range, the reverse switching procedure is automatically controlled.

It is especially suited for use in all emergency power supply systems requiring a solution that is ready to install, easy to use and reliable.

Some of the main applications include: power supply for UPS (Uninterrupted Power Supply) units, operating rooms and primary hospital services, emergency power supply for civilian buildings, airports, hotels, data banks and telecommunications systems, power supply of industrial lines for continuous processes.

The switching system consists of the ATS010 unit connected to two motor-driven and mechanically interlocked circuit breakers.

The Tmax Ts3, T4, T5, T6 and T7 circuit breakers and the switch-disconnectors of the respective sizes can be used (for T3, please ask ABB).

The built-in mains sensor of the ATS010 device makes it possible to detect errors in the mains voltage. The three inputs may be directly connected to the three phases of the normal power supply line for networks with rated voltage up to 500 V AC. Networks with a higher voltage require the insertion of voltage transformers (TV), setting a rated voltage for the device that matches their secondary voltage (typically 100 V).

Two change-over contacts for each circuit breaker connect directly to the motor operator. The circuit breaker connection is completed by wiring the status contacts: Open/Closed, Relay tripped, Racked-in (for draw out/plug-in circuit breakers).

That is why on every circuit breaker connected to the ATS010 unit the following accessories are included in addition to the mechanical interlock:

- motor operator from 24 V to 110 V DC or up to 250 V AC
- key lock only against manual operation for motor operator
- open/closed contact and contact for tripped
- racked-in contact (in the case of draw out).

The ATS010 device is designed to ensure extremely high reliability for the system it controls. It contains various safety systems intrinsically related to software and hardware operation.

For software safety, a special logic prevents unwarranted operations, while a constantly operative watchdog system points out any microprocessor malfunctions via a LED on the front of the device.

Hardware safety allows integration of an electrical interlock via power relay, so that there is no need to use an external electrical interlock system. The manual selector on the front of the device can also control the entire switching procedure, even in the event of a microprocessor fault, by working electromechanically on the control relays.

General specifications	
Rated supply voltage (galvanically insulated from ground)	24 V DC ± 20% - 48 V DC ±10% (maximum ripple ±5%)
Maximum absorbed power	5 W @ 24 V DC - 10 W @ 48 V DC
Rated power (mains present and circuit breakers not controlled)	1.8 W @ 24 V DC - 4.5 W @ 48 V DC
Operating temperature	-25 °C...+70 °C
Maximum humidity	90% without condensation
Storage temperature	-25 °C...+80 °C
Protection rating	IP54 (front panel)
Dimensions	[In/mm] 5.66" x 5.66" x 3.34" / 144 x 144 x 85
Weight	[lb/kg] 1.76 / 0.8

Accessories

Automatic transfer switch - ATS010 (IEC only)

Setting range for thresholds and times

Minimum voltage	Un Min	-5%...-30% Un
Maximum voltage	Un Max	+5%...+30% Un
Fixed frequency thresholds		10%...+10% fn
t_1 : opening delay of the normal line circuit breaker due to network error	(CB-N)	0...32s
t_2 : generator start-up delay due to network error		0...32s
t_3 : stopping delay of the generator		0...254s
t_4 : switching delay due to network stop		0...254s
t_5 : closing delay of the emergency line circuit breaker after detecting the generator voltage	(CB-E)	0...32s

Operating sequence

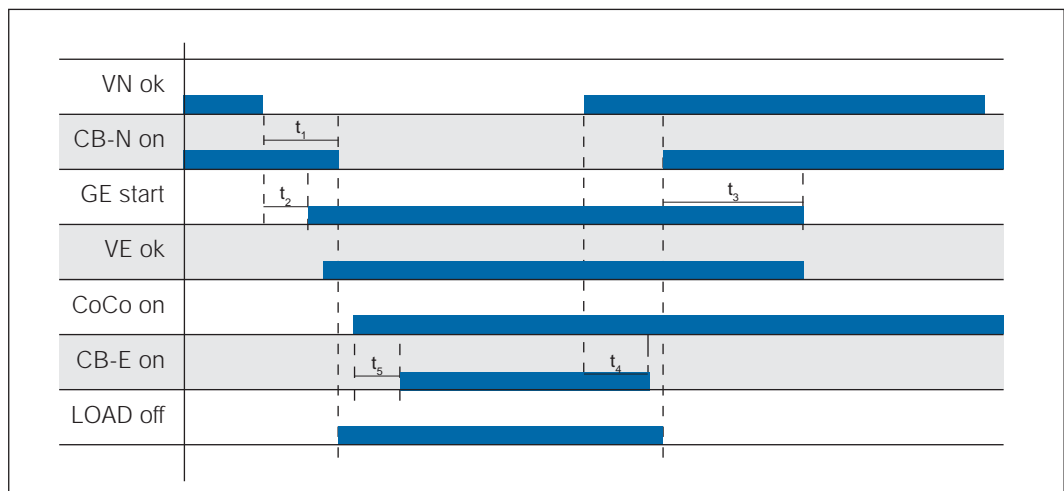

Caption

VN	Mains voltage
CB-N	Normal line circuit breaker closed
GE	Generator
VE	Emergency line voltage
CoCo	Enable switching to emergency line
CB-E	Emergency line circuit breaker closed
LOAD	Disconnection of lower priority connected loads

Side panel settings

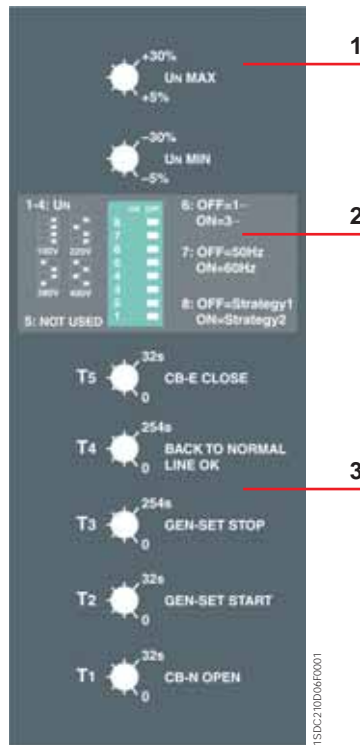

Caption

- 1 Selectors to set the under- and over-voltage thresholds
- 2 Dip-switches to set:
 - rated voltage
 - normal single-phase or three-phase line
 - mains frequency
 - switching strategy
- 3 Switching delay time settings for T1...T5

3

Front panel



Caption

- 1 Status of the ATS010 unit and logic
- 2 Operating mode selector
- 3 Normal line check
- 4 Normal line circuit breaker status
- 5 Voltage on the emergency line
- 6 Emergency line circuit breaker status
- 7 Generator status

Accessories

Installation accessories and spare parts

Bracket for fixing on DIN rail

This is applied to the fixed circuit breaker and allows installation:

- on standardized DIN EN 50022 rails (for T1, T2, T3);
- on standardized DIN EN 50023 rails (for Ts3).

The bracket for fixing on DIN rail is also available for Tmax circuit breakers combined with RC221 and RC222 residual current releases or with the solenoid operator of the side-by-side type.

The fixing bracket kit for Ts3 circuit breakers also includes the front H = 1.77" (45 mm).



1SDC21008BF001



1SDC21009FF001



1SDC21003BF001

Flange for compartment door

For Ts3 circuit breakers it is possible to use the same flange (to be ordered), which can be used with the circuit breaker (to be ordered separately), with the rotary handle operating mechanism, front for lever operating mechanism and motor operator.

All the flanges for T1, T2, T3, T4, T5, T6, T7 are of new design and do not require the use of screws for installation: fixing is greatly simplified by just a simple coupling operation. The flange for compartment door for T1, T2, T3, T4, T5, T6, T7 is always supplied with the circuit breakers. When a rotary handle operating mechanism or residual current releases is used, a dedicated flange is supplied to be used instead of the one supplied with the circuit breaker.

For T4, T5, T6 and T7 draw out circuit breakers, the flange supplied with fixed part must be used instead of the one supplied with the fixed circuit breaker.

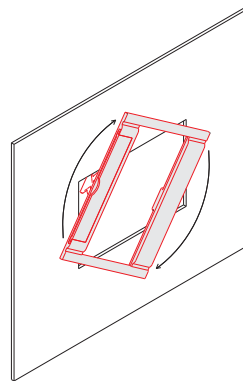

1SDC21001GF001

Spare parts

A wide range of spare parts is available for the Tmax family of circuit breakers. For further details about the complete range of spare parts available, please ask for the "Spare Parts Catalogue".

Accessories

Compatibility of internal accessories

Compatibility

An overview of the assembly compatibility of (internal) accessories with the Tmax Series circuit breakers can be found in this section.

Possible combination of internal accessories

The drawing represents the internal slot of the circuit breakers. A, C and F are housed in the slots on the left of the operating lever, while B, D, E and G in the right one.

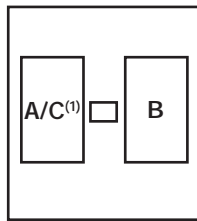

T1, T2 TMD, T3, Ts3, T4, T5, T6
3 poles

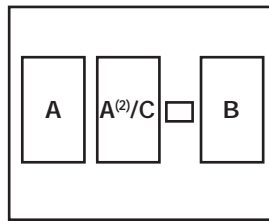

T1, T2 TMD, T3, Ts3, T4, T5, T6
4 poles

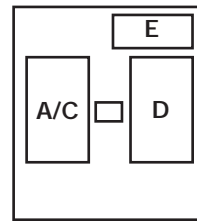

T2 PR221DS,
3 poles

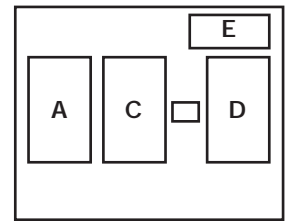

T2 PR221DS,
4 poles

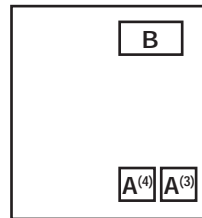

T7 3/4 poles

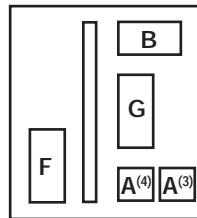

T7M 3/4 poles

⁽¹⁾ only for T1-T2-T3

⁽²⁾ only SOR for T4-T5-T6. If use SOR-C order also the 3 way connector for second SOR-C 1SDA055273R1

⁽³⁾ position for assembly of the SOR

⁽⁴⁾ position for assembly of the UVR

A = Shunt trip (SOR) or Undervoltage release (UVR)

B = Auxiliary contacts

C = Trip coil of the residual current

D = Trip coil of the electronic trip unit PR221DS

E = Auxiliary contacts for T2 with electronic trip unit PR221DS

F = Spring charging motor

G = Closing coil (SCR)



Index

Characteristic curves

Examples of curve readout.....4/2

Trip curves for power distribution

Circuit breakers with thermal magnetic trip units.....4/3

Circuit breakers with electronic trip units4/7

Trip curves for motor protection (MCP)

Circuit breakers with magnetic only trip units4/15

Circuit breakers with electronic trip units4/16

Specific let-through energy curves⁽¹⁾ (current limiting circuit breakers)

T2 H4/17

T4 H/V4/18

T5 400 H/V4/18

Limitation curves⁽¹⁾ (current limiting circuit breakers)

T2 H4/20

T4 H/V4/21

T5 400 H/V4/21

Technical information

Temperature performances

Circuit breakers with electronic trip unit.....4/23

Circuit breakers with thermal magnetic trip units.....4/24

Power losses4/26

⁽¹⁾ For T1 1p and T2 with PR221DS, please ask ABB SACE directly.

Examples of curve readout

Example 1 - T4N 250 A

Trip curves for power distribution (thermal magnetic trip unit)

Considering a T4N 250 $I_n = 250$ A circuit breaker. By means of the thermal adjustment trimmer, the current threshold I_1 is selected, for example at $0.9 \times I_n$ (225 A); the magnetic trip threshold I_3 , adjustable from 5 to $10 \times I_n$, we select at $10 \times I_n$, equal to 2500 A.

It can be noted that, on the basis of the conditions in which the overload is presented, i.e. with the circuit breaker at thermal running or not, the thermal relay trip varies considerably. For example, for an overload current of $2 \times I_1$, the trip time is between 21.4 and 105.3 s for hot trip, and between 105.3 and 357.8 s for cold trip.

For fault current values higher than 2500 A, the circuit breaker trips instantaneously with the magnetic protection.

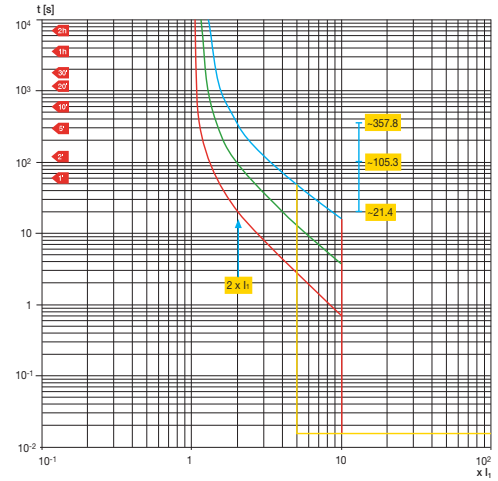

15DC21001F0001

Example 2 - T2H 100 A

Current-limiting curves

The following figure shows the trend of Tmax T2 100 PR221 current-limiting curve at 480 V. The rms of the prospective symmetrical short circuit current is indicated on the abscissa of the diagram, whereas the peak value is on the ordinates.

For example, T2 at a voltage of 480 V limits the peak to 20 kA for a rms fault current of 40 kA.

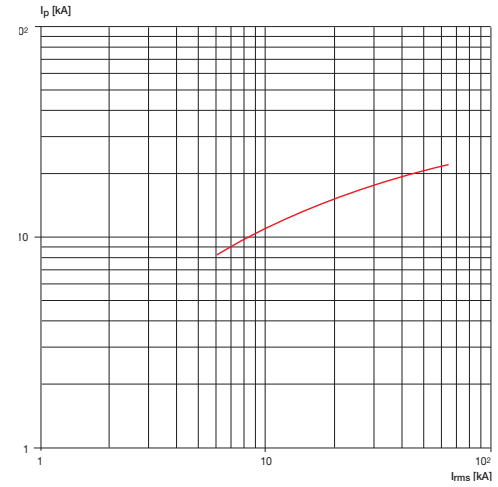

15DC210009F0001

Example 3 - T2H 30 A

Specific let-through energy curve

The following figure shows the trend of Tmax T2 TM 30 A let-through energy at 480 V. The rms of the prospective symmetrical short circuit current is indicated on the abscissa of the diagram, whereas the ordinates show the specific let-through energy.

For example, T2 at a voltage of 480 V limits the I^2t to 0.4×10^6 A²s for a rms sc current of 40 kA.

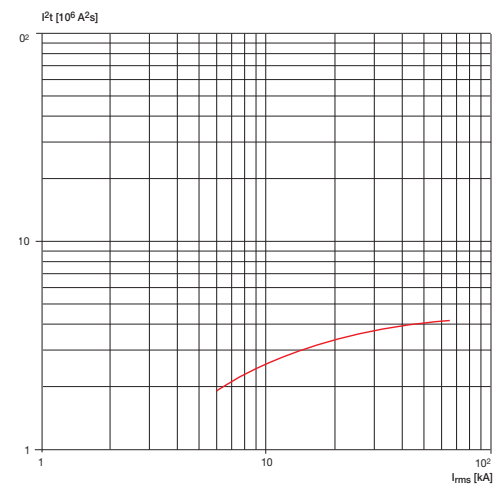

15DC210001F0001

Abbreviations used

- I_n = Ampère rating of the thermal magnetic or electronic trip unit
- I_1 = Long-time pick-up setting
- I_3 = instantaneous pick up setting
- I_{rms} = prospective symmetrical short-circuit current

4

Trip curves for power distribution

Circuit breakers with thermal magnetic trip units

T1 100 / T1 100 1P - TMF

$I_n = 15 \div 70 \text{ A}$

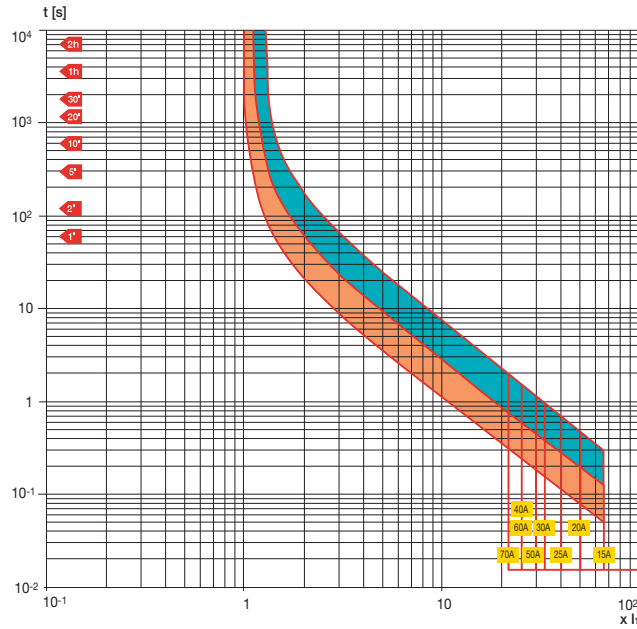

T1 100 / T1 100 1P - TMF

$I_n = 80 \div 100 \text{ A}$

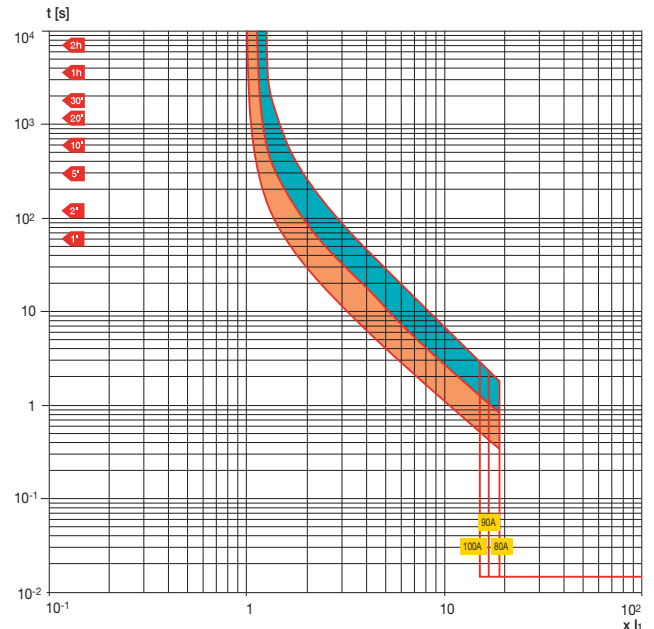

T2 100 - TMF

$I_n = 15 \div 50 \text{ A}$

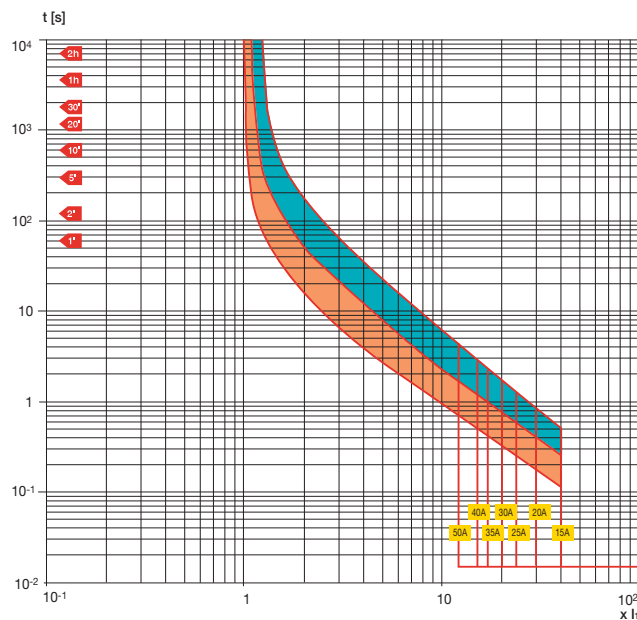

T2 100 - TMF

$I_n = 60 \div 100 \text{ A}$

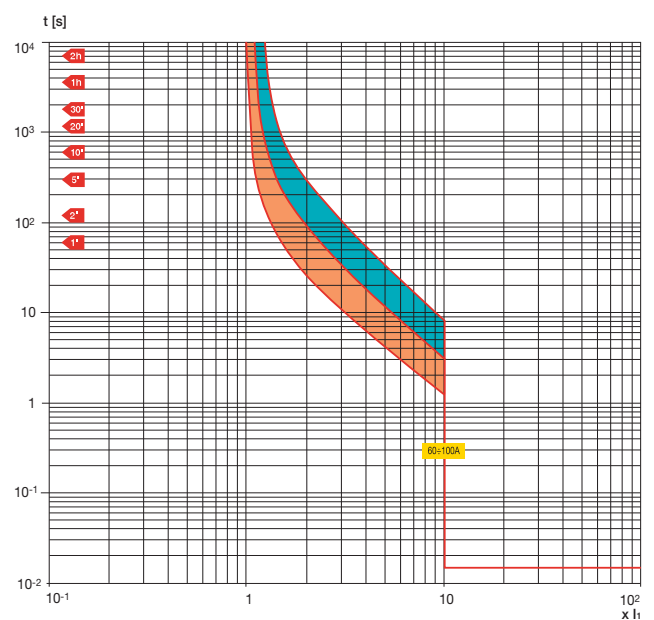

Trip curves for power distribution

Circuit breakers with thermal magnetic trip units

T3 225 – TMF

$I_n = 60 \div 100 \text{ A}$

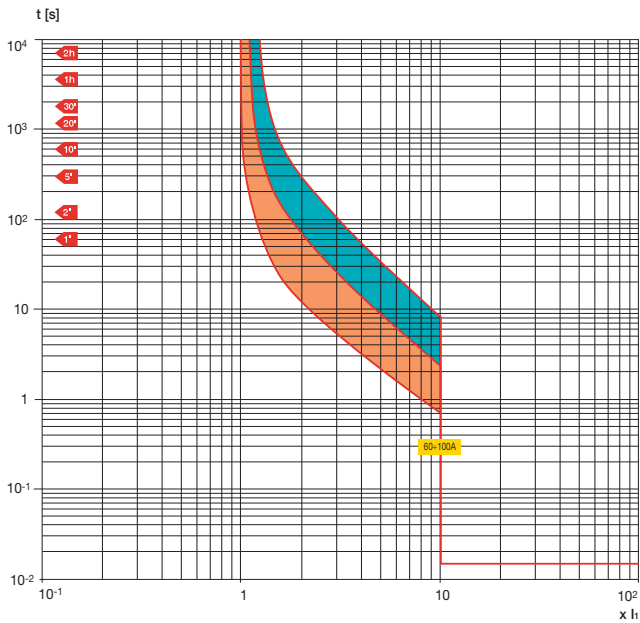

T3 225 – TMF

$I_n = 125 \div 225 \text{ A}$

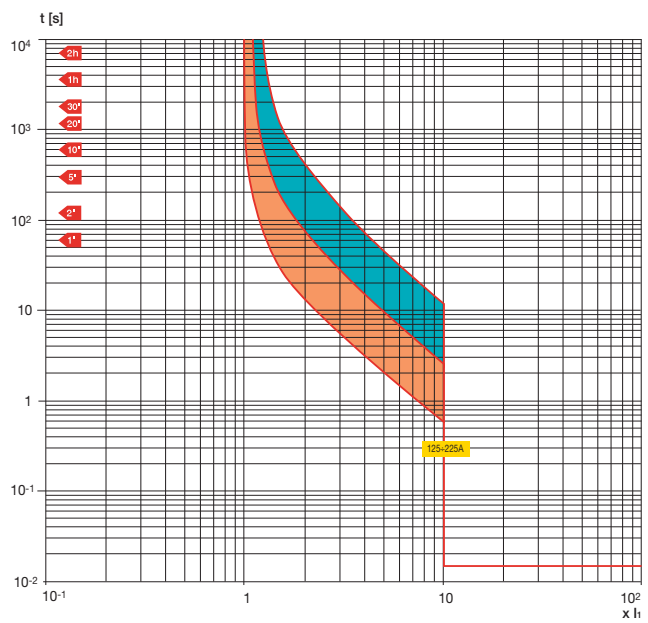

Ts3 150 – TMF

$I_n = 15 \text{ A}$

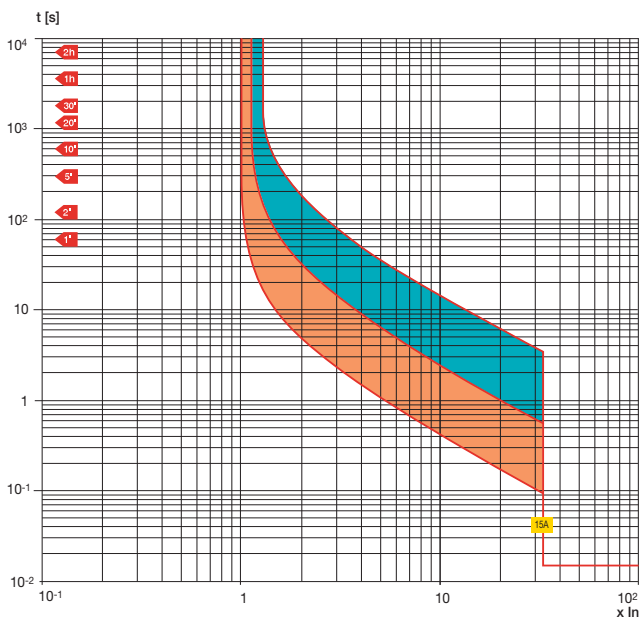

Ts3 150 – TMF

$I_n = 20 \div 30 \text{ A}$

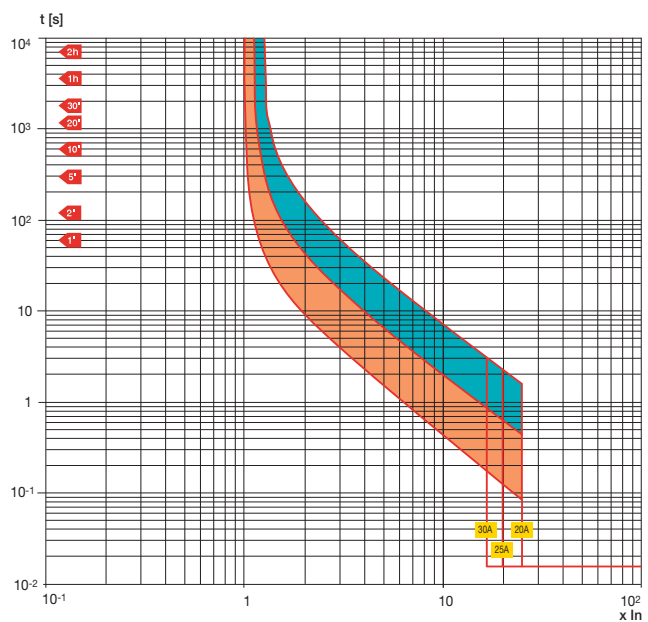

4

Ts3 150 – TMF

In = 35 ÷ 50 A

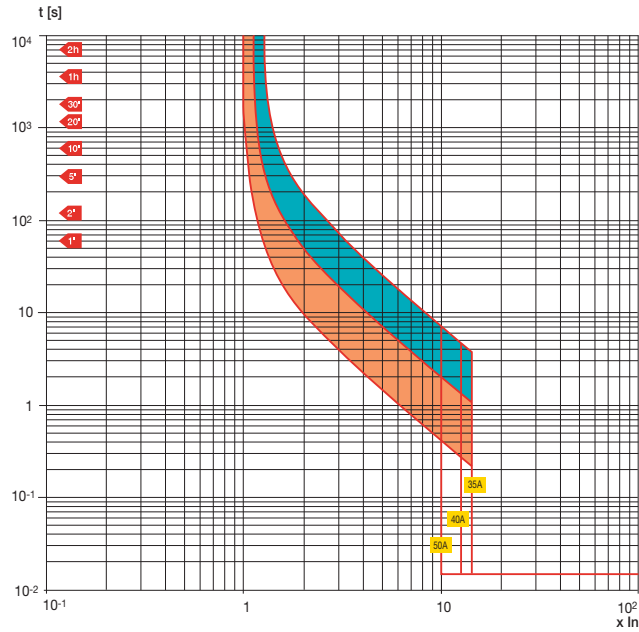

Ts3 150 – TMF

In = 60 ÷ 100 A

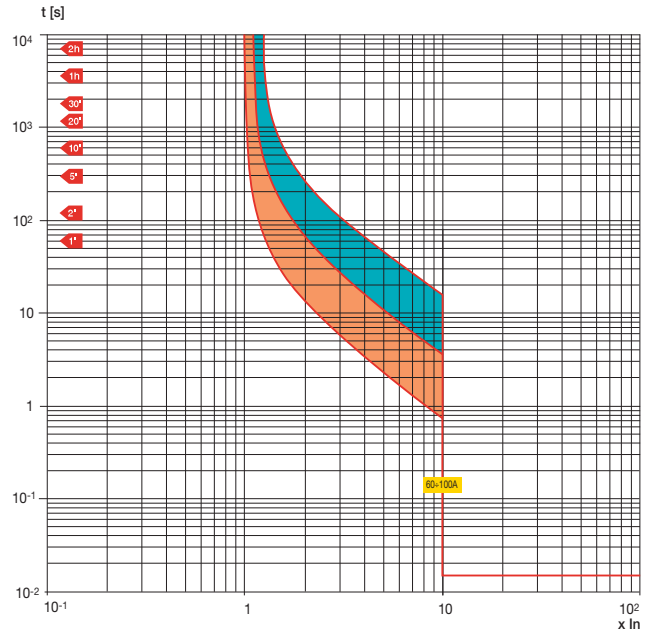

Ts3 150 / Ts3 225 – TMF

In = 125 ÷ 225 A

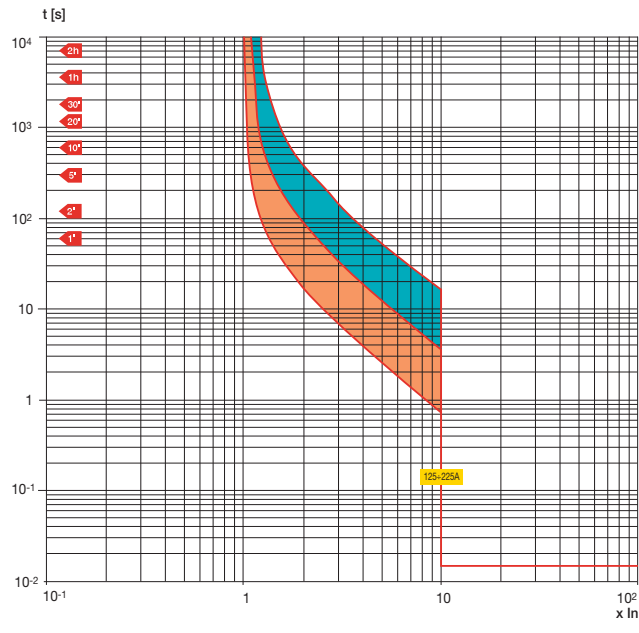

T4 250 – TMF/TMD

In = 20 ÷ 50 A

In = 15, 20 TMF

In = 30, 40, 50 TMD

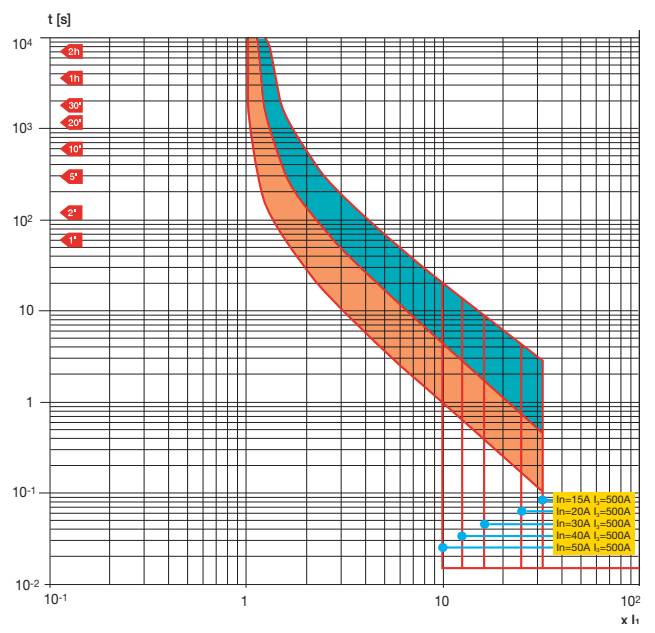

Trip curves for power distribution

Circuit breakers with thermal magnetic trip units

T4 250 – TMA

$I_n = 80 \div 250 \text{ A}$

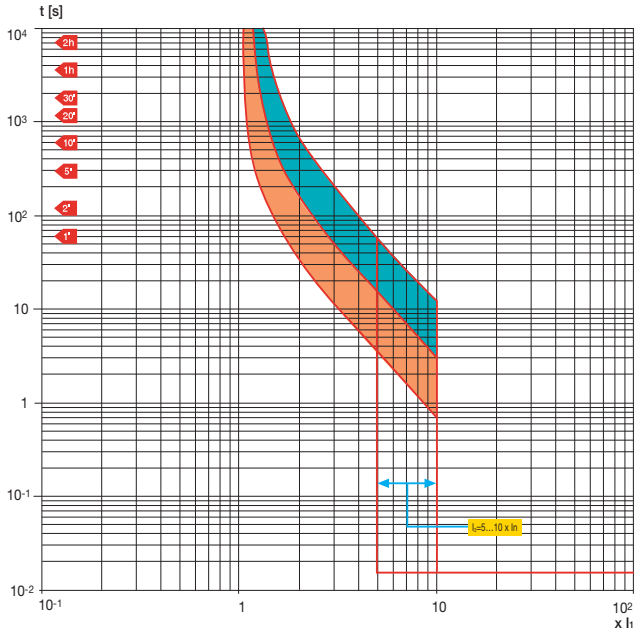

1SBC210016F0001

T5 400 – TMA

$I_n = 300, 400 \text{ A}$

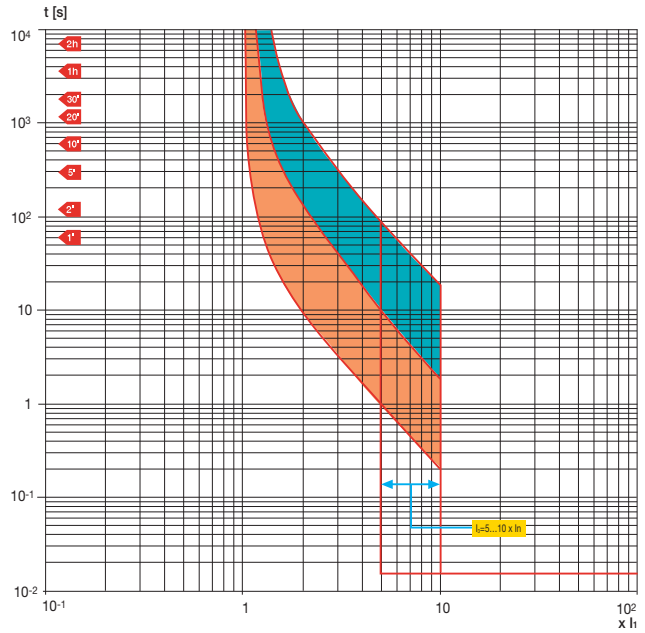

1SBC210017F0001

T6 800 – TMA

$I_n = 800 \text{ A}$

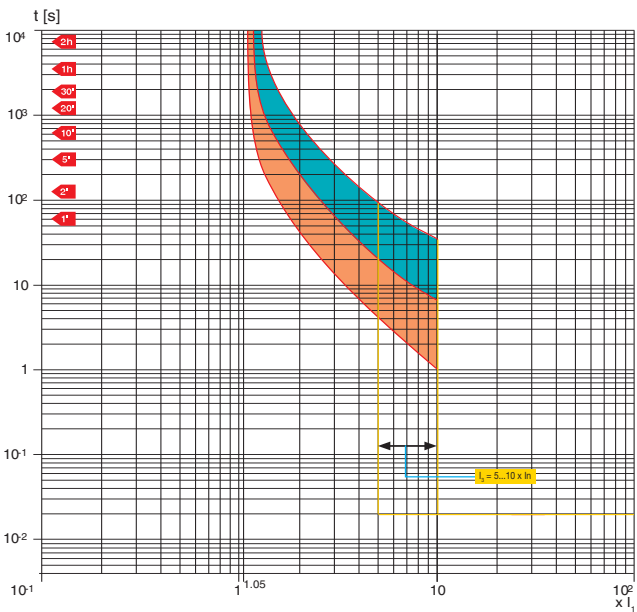

1SBC210018F0001

4

Trip curves for power distribution

Circuit breakers with electronic trip units

T2 100 – PR221DS-LS

L-I Functions

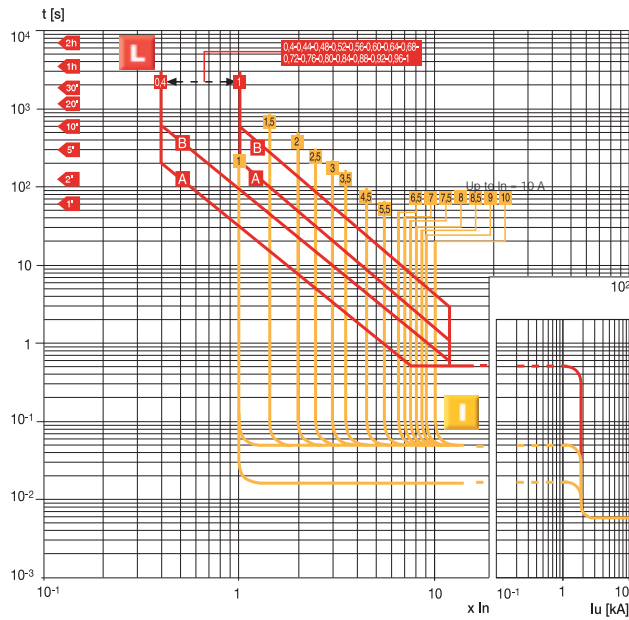

T2 100 – PR221DS-LS

L-S Functions

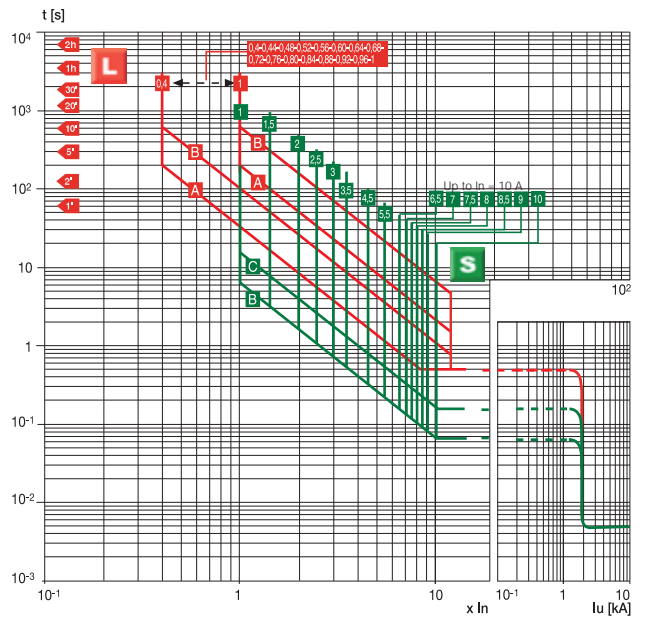

T2 100 – PR221DS-I

I Function

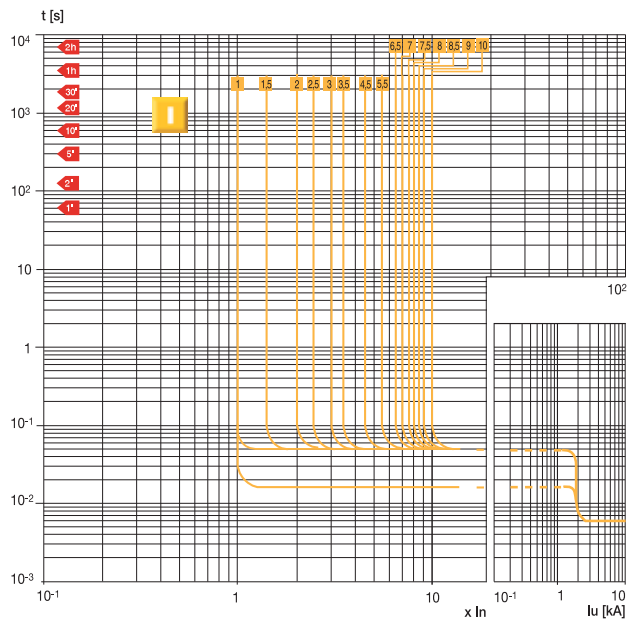

T4 250 / T5 400/600 – PR221DS

L-I Functions

Note: For T5 In = 600 A ⇒ I₃max = 9.5 x In

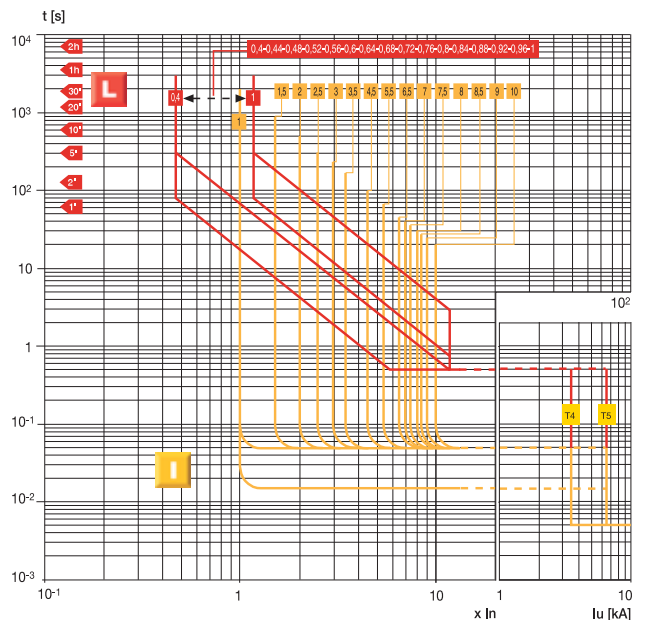

Trip curves for power distribution

Circuit breakers with electronic trip units

T4 250 / T5 400/600 – PR221DS

L-S Functions

Note: For T5 In = 600 A $\Rightarrow I_{p,max} = 9.5 \times I_n$

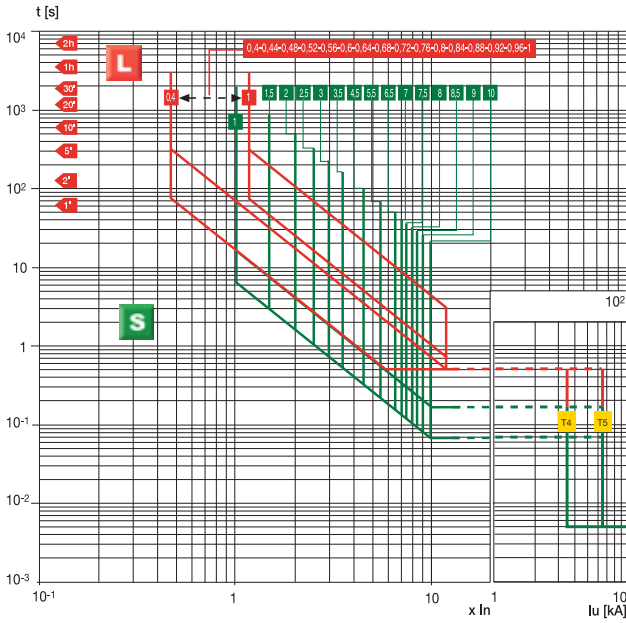

1SDC210023F0001

T4 250 / T5 400/600

PR222DS/P and PR222DS/PD-A

L-S-I Functions (I²t const = ON)

Note: For T5 In = 600 A $\Rightarrow I_{p,max} = 9.5 \times I_n$

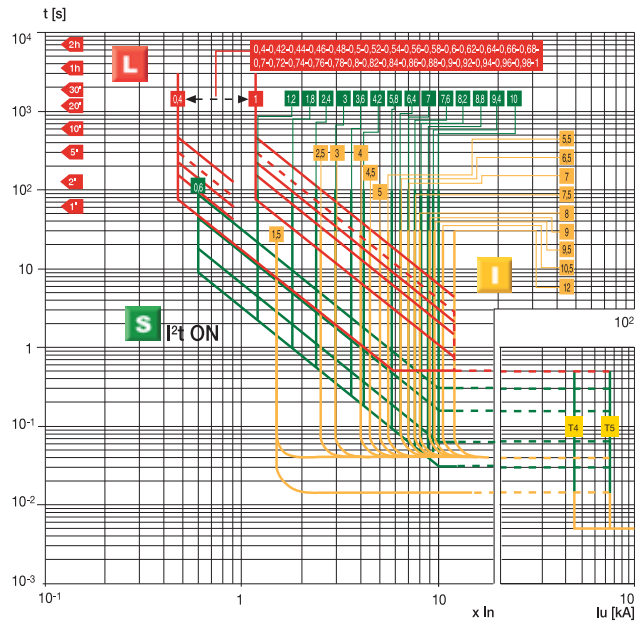

1SDC210024F0001

T4 250 / T5 400/600

PR222DS/P and PR222DS/PD-A

L-S-I Functions (I²t const = OFF)

Note: For T5 In = 600 A $\Rightarrow I_{p,max} = 9.5 \times I_n$

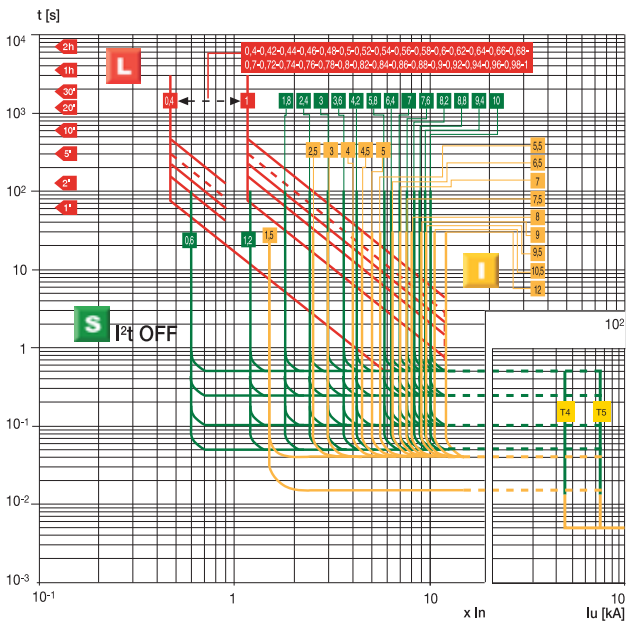

1SDC210025F0001

T4 250 / T5 400/600

PR222DS/P and PR222DS/PD-A

G Function

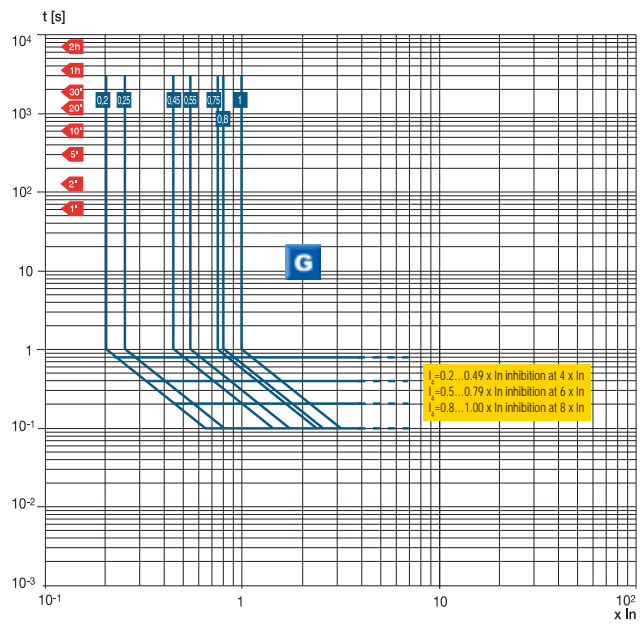

1SDC210026F0001

T6 800 – PR221DS

L-I Functions

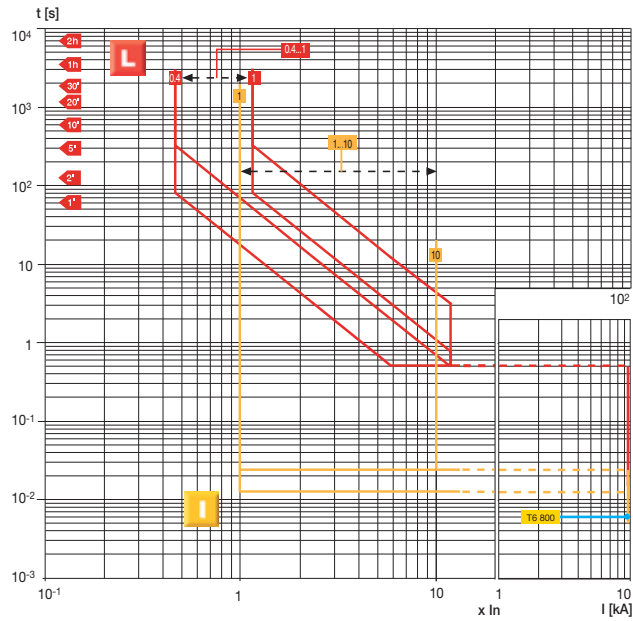

T6 800 – PR221DS

L-S Functions

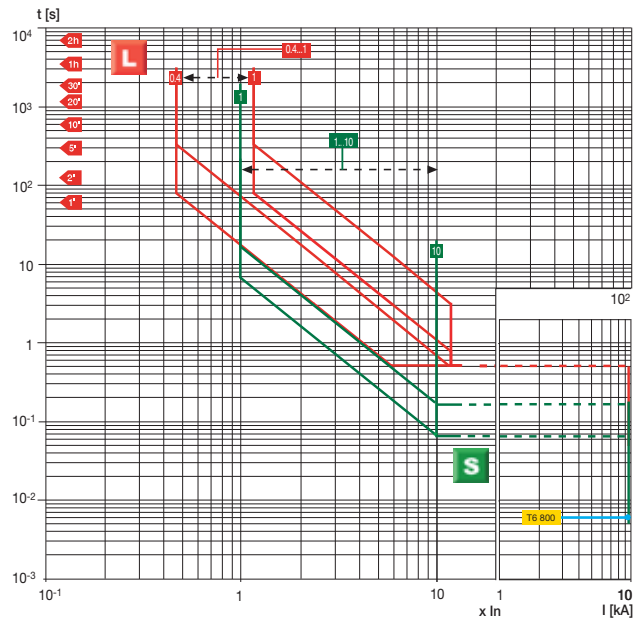

T6 800 – PR222DS and PR222DS/PD-A

L-S-I Functions

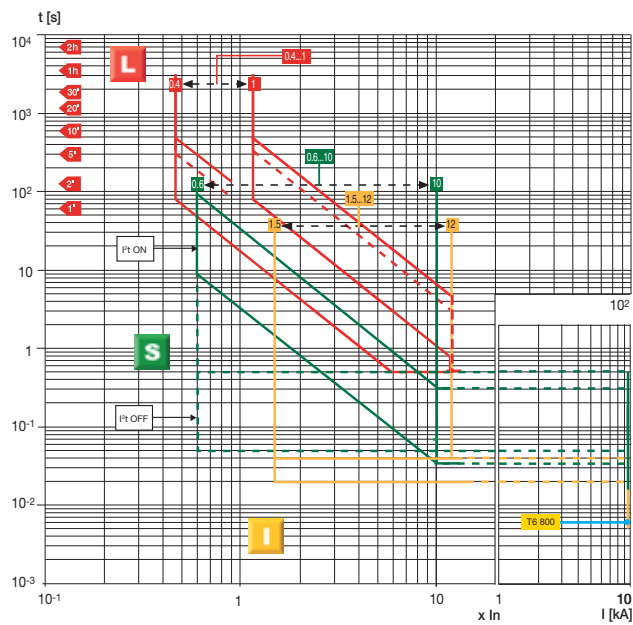

T6 800 – PR222DS and PR222DS/PD-A

G Function

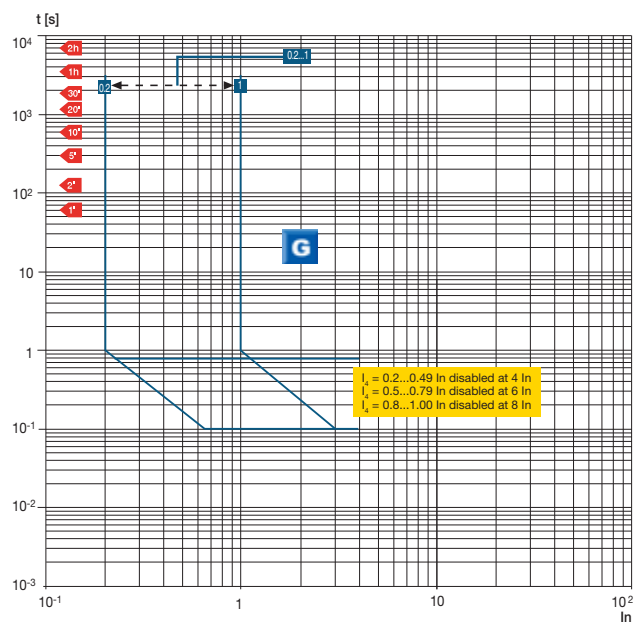

Trip curves for power distribution

Circuit breakers with electronic trip units

T7 1000/1200 – PR231/P

L-I Functions

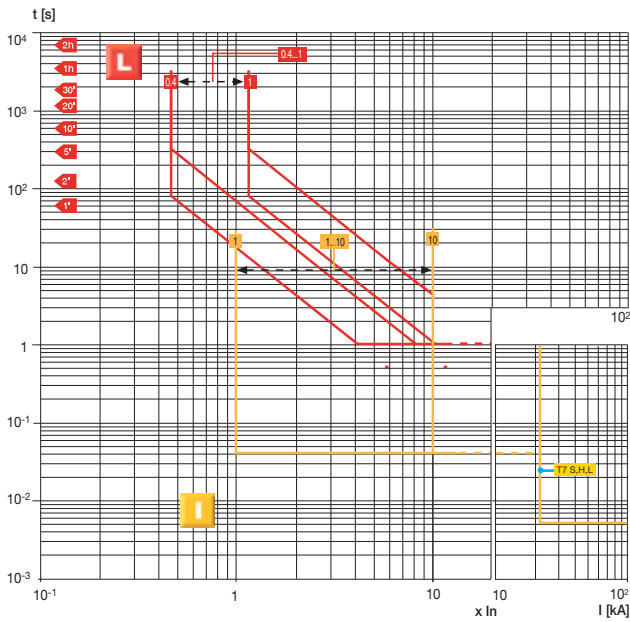

1SDC210031F0001

T7 1000/1200 – PR231/P

L-S Functions

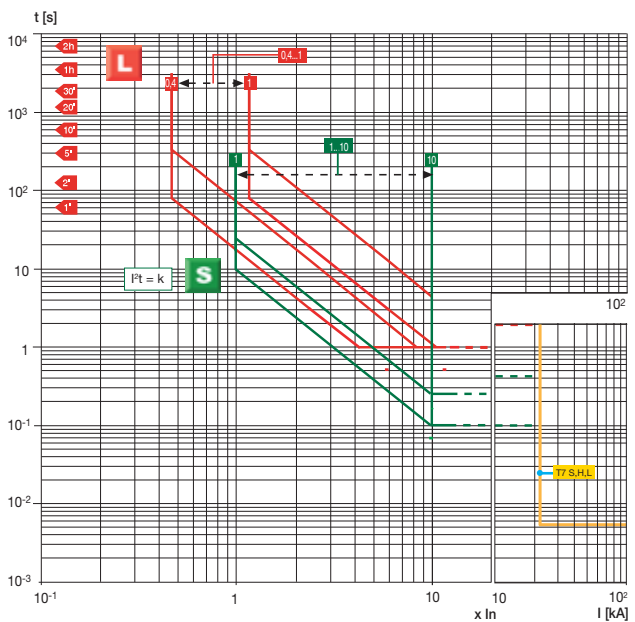

1SDC210032F0001

T7 1000/1200 – PR232/P

L-S-I Functions

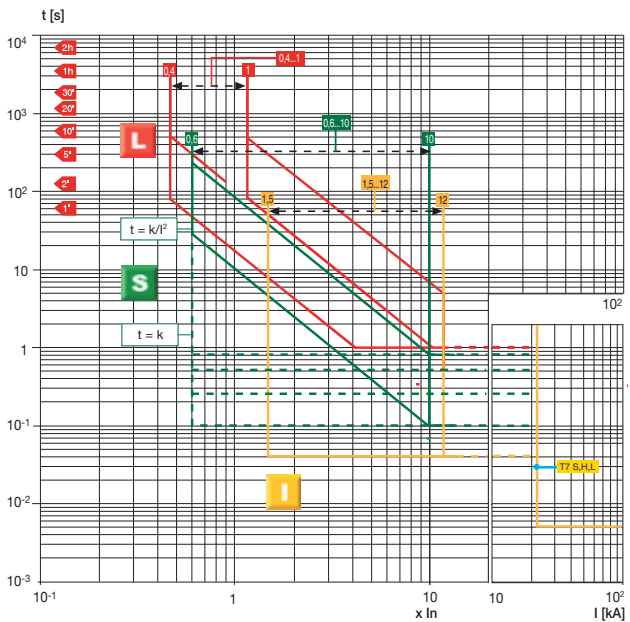

1SDC210033F0001

T7 1000/1200 – PR331/P

L-S-I Functions

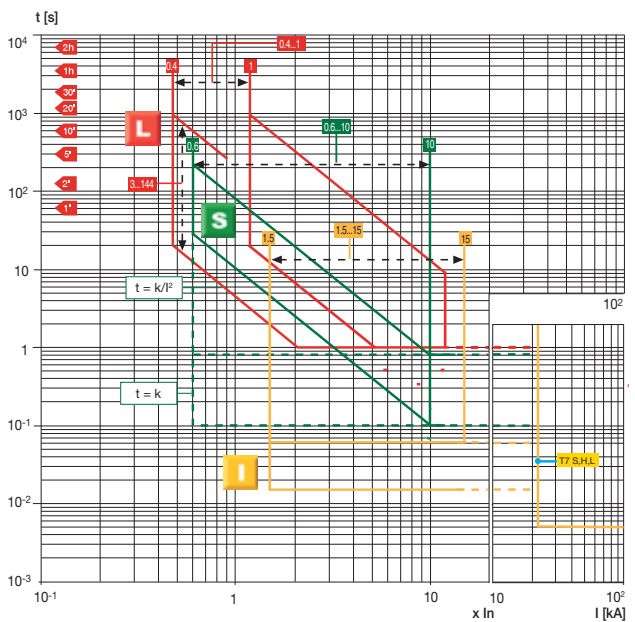

1SDC210034F0001

T7 1000/1200 – PR331/P

G Function

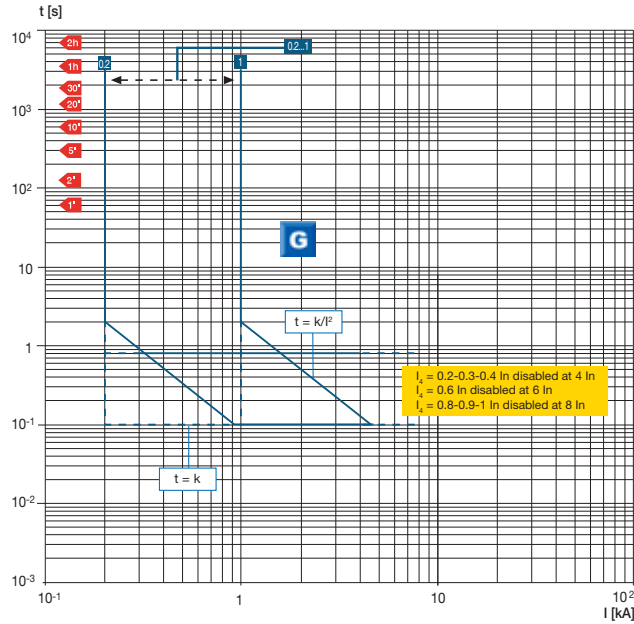

T7 1000/1200 – PR332/P

L-I Functions

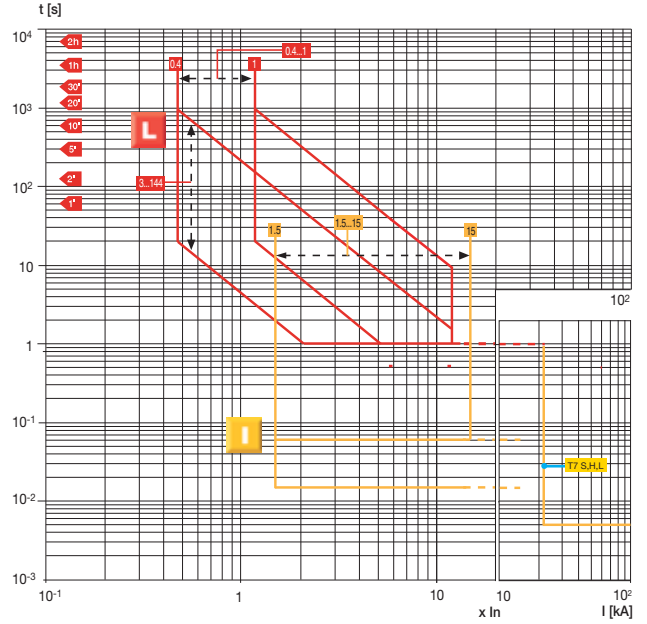

T7 1000/1200 – PR332/P

L-S-I Functions

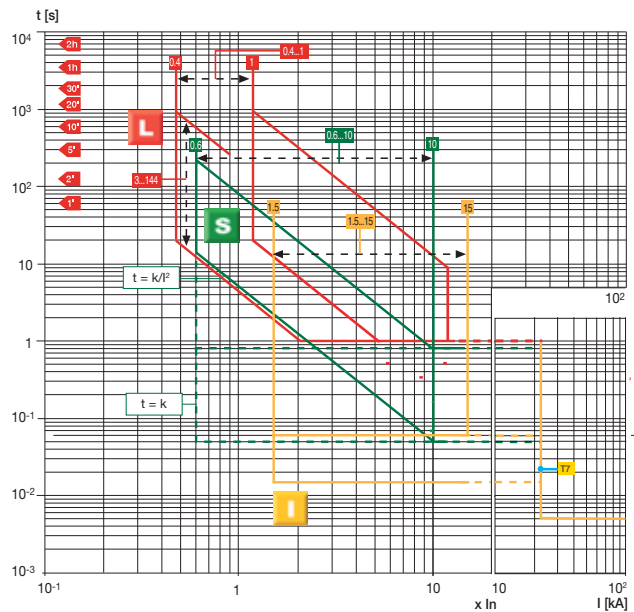

T7 1000/1200 – PR332/P

G Function

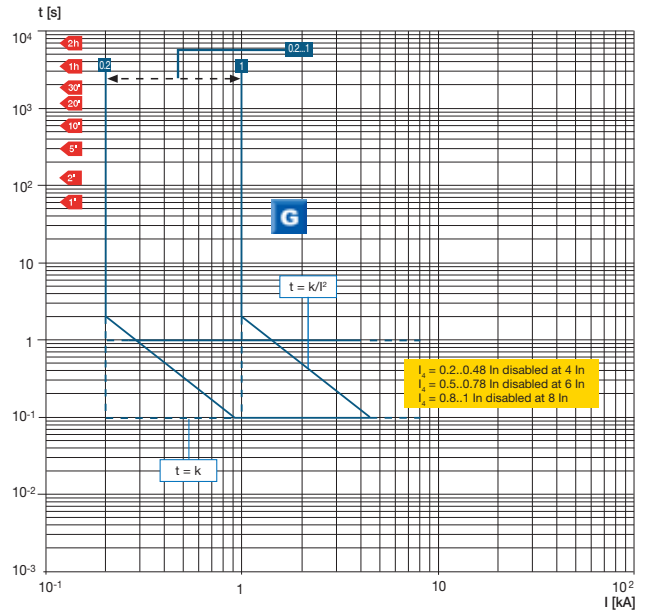

Trip curves for power distribution

Circuit breakers with electronic trip units

T7 1000/1200 – PR332/P

Rc Function

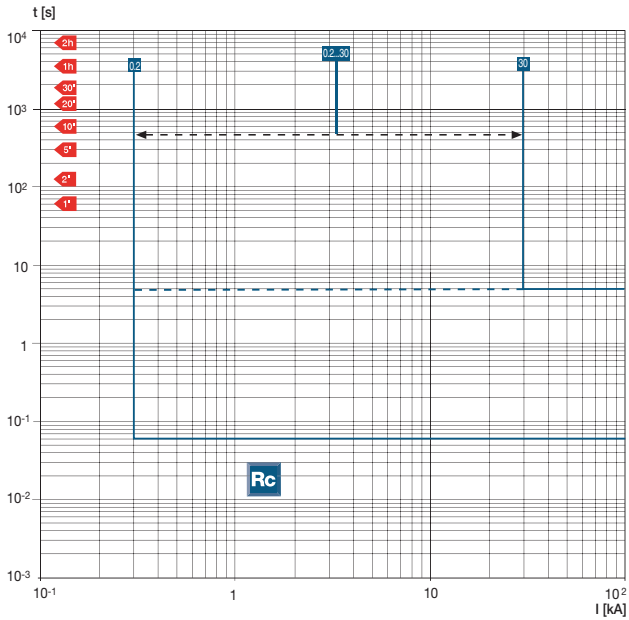

1SDC210U4F0001

T7 1000/1200 – PR332/P

L Function

$k = 0.14$ $\alpha = 0.02$

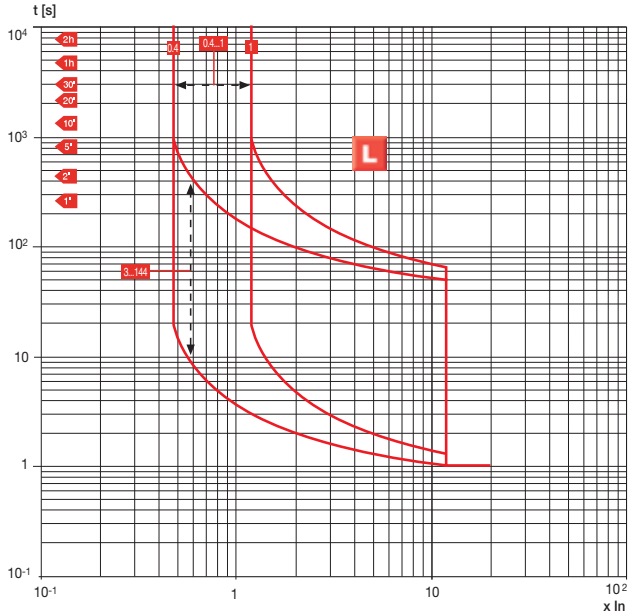

1SDC210U4F0001

T7 1000/1200 – PR332/P

L Function

$k = 13.5$ $\alpha = 1$

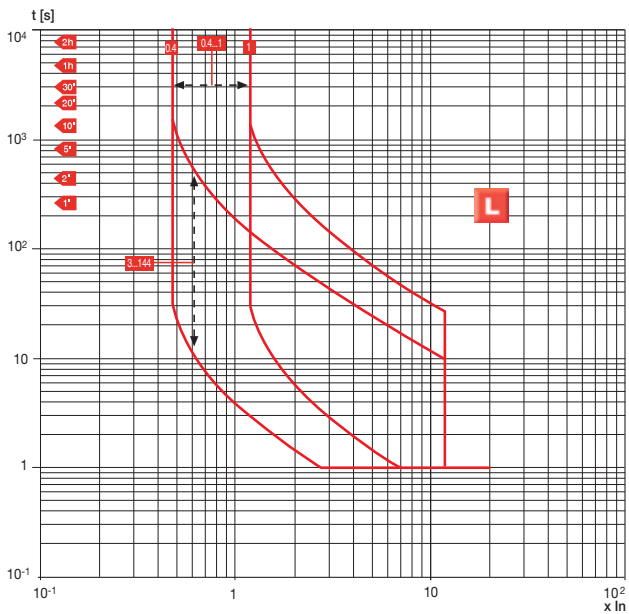

1SDC210U4F0001

T7 1000/1200 – PR332/P

L Function

$k = 80$ $\alpha = 2$

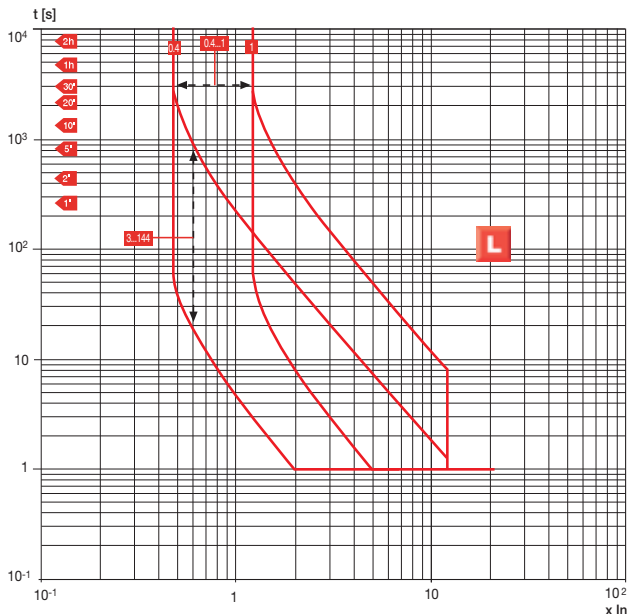

1SDC210U4F0001

4

T7 1000/1200 – PR332/P

U Function

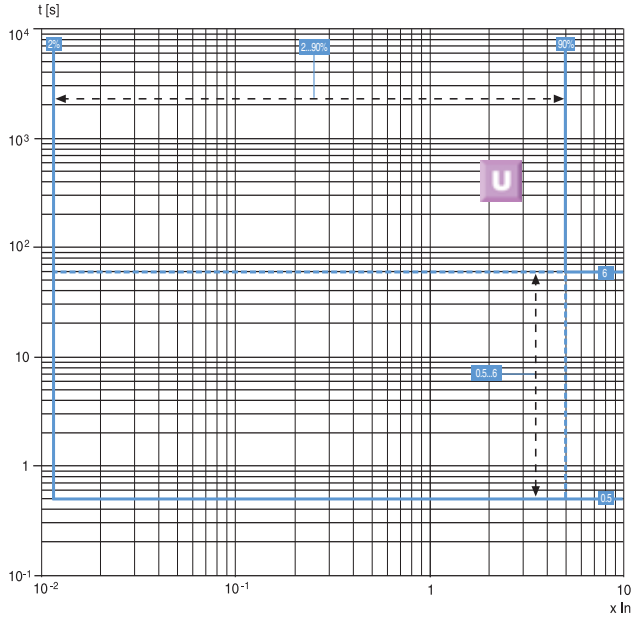

T7 1000/1200 – PR332/P with PR330/V

UV Function

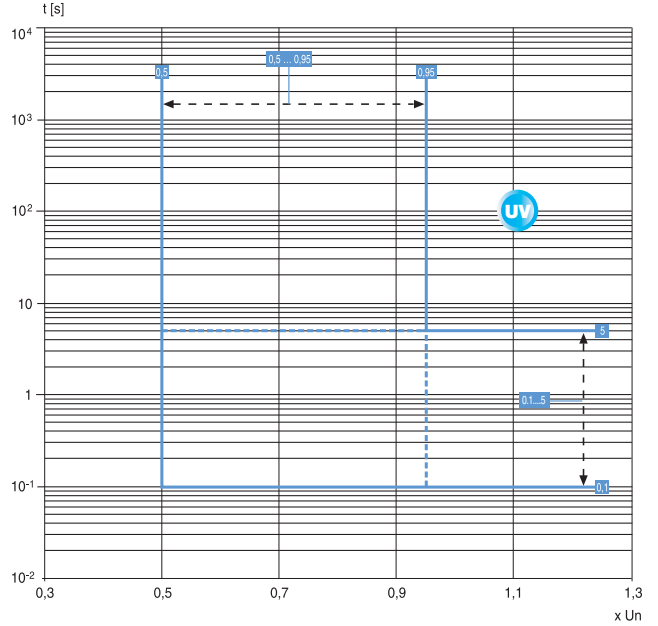

T7 1000/1200 – PR332/P with PR330/V

OV Function

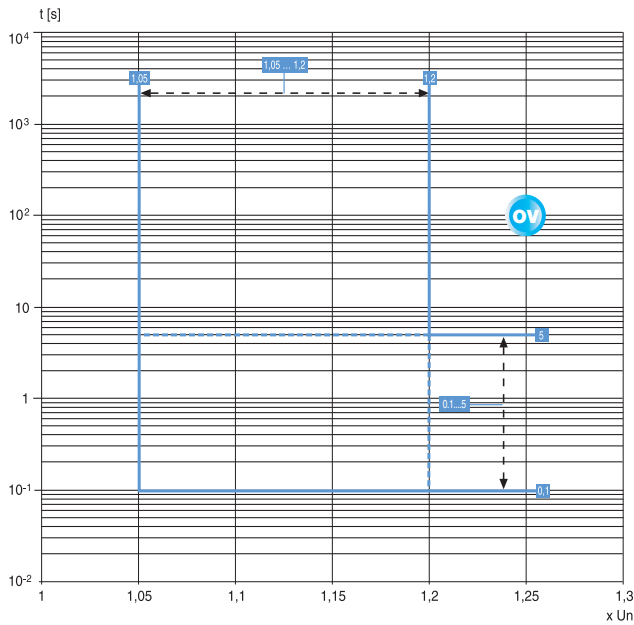

T7 1000/1200 – PR332/P with PR330/V

RV Function

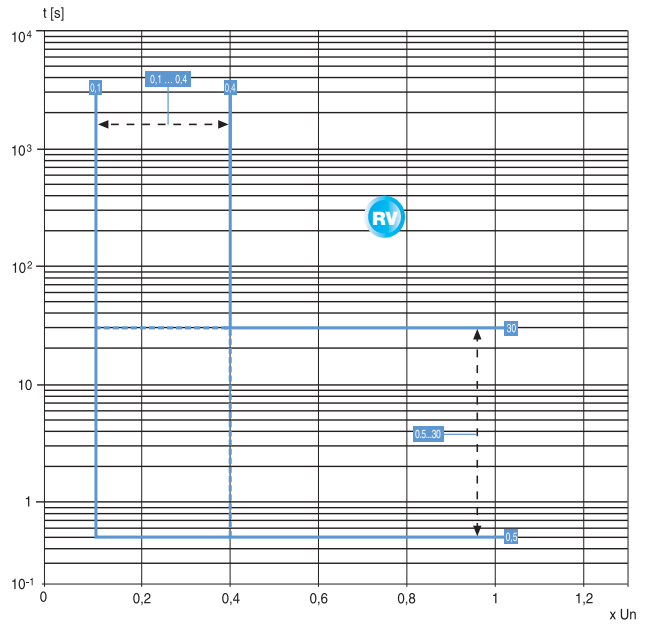

Trip curves for power distribution

Circuit breakers with electronic trip units

T7 1000/1200 – PR332/P with PR330/V

RP Function

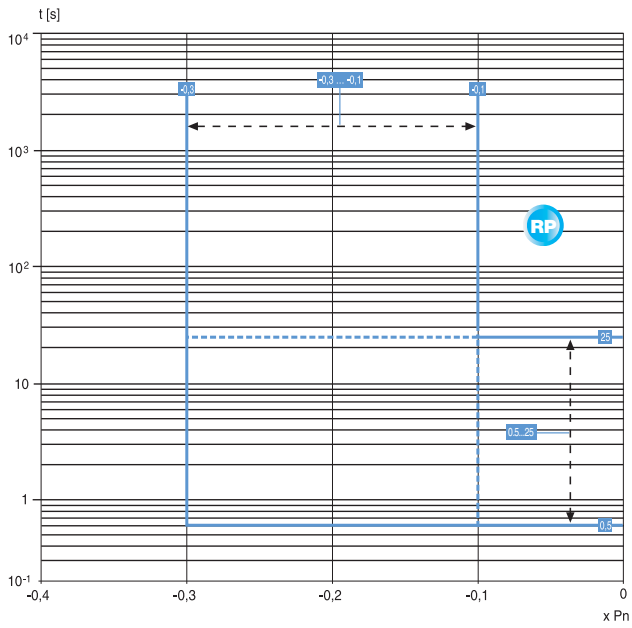

1SDC210L47R0001

Trip curves for motor protection (MCP)

Circuit breakers with magnetic only trip units

T2-T3 100 MCP

Adjustable magnetic only trip unit $I_3 = 6 \dots 12 \times I_n$

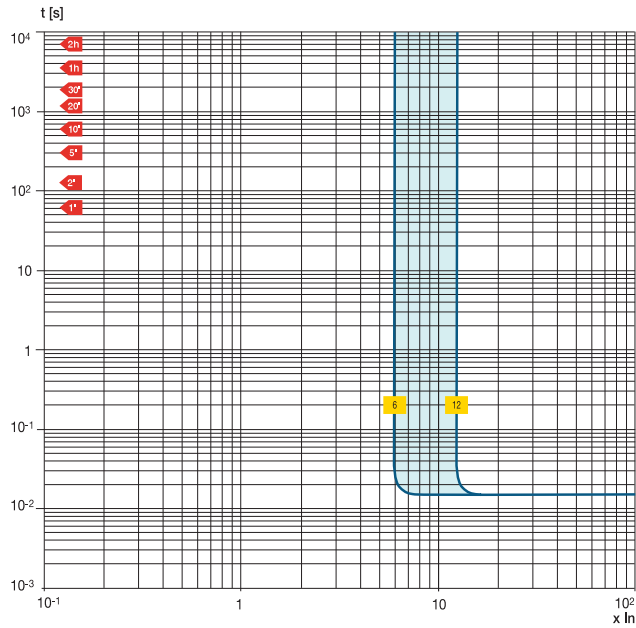

1SDC210U48P0001

Ts3 150

Adjustable magnetic only trip unit $I_3 = 4 \dots 12 \times I_n$

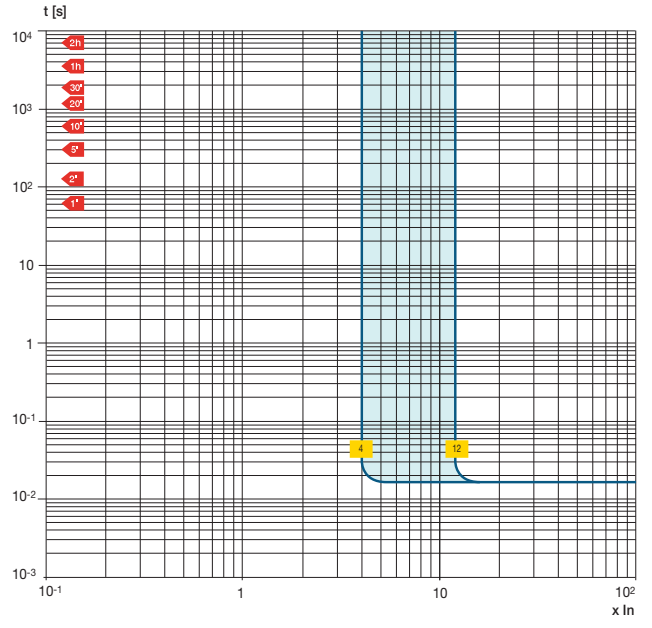

1SDC210U49P0001

Trip curves for motor protection (MCP)

Circuit breakers with electronic trip units

T2 100 – PR221DS-I

I Function

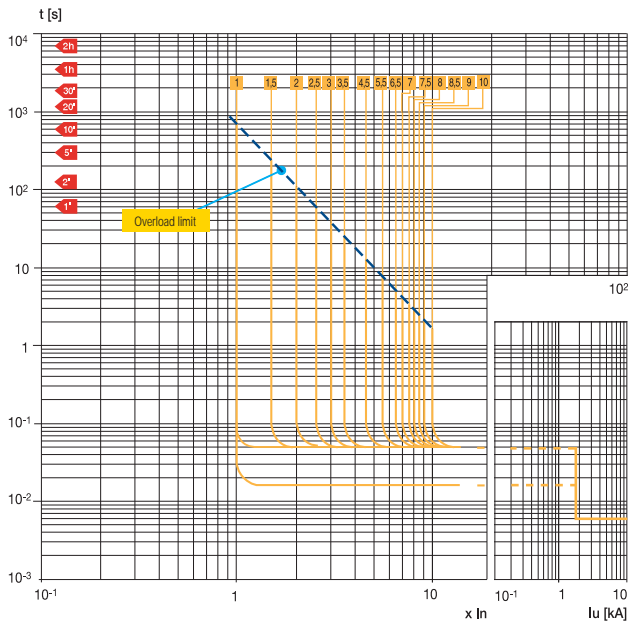

1SDC210U51F0001

T4 250 / T5 400/600 – PR221DS-I

I Function

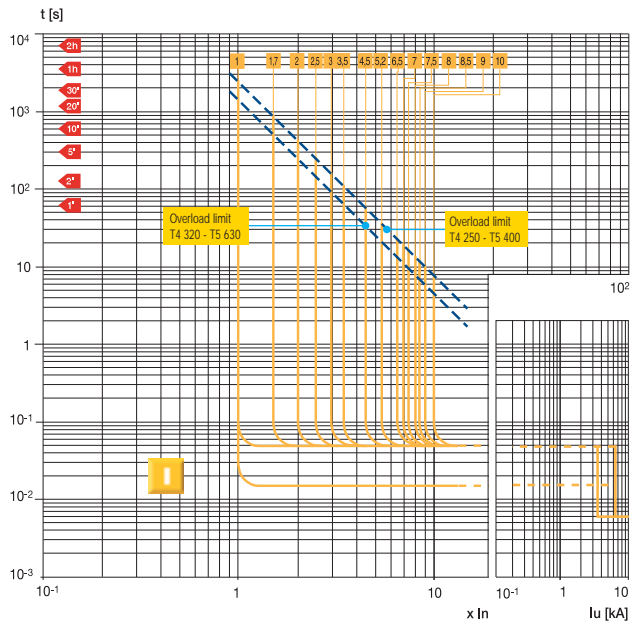

1SDC210U51F0001

T6 800 – PR221DS-I

I Function

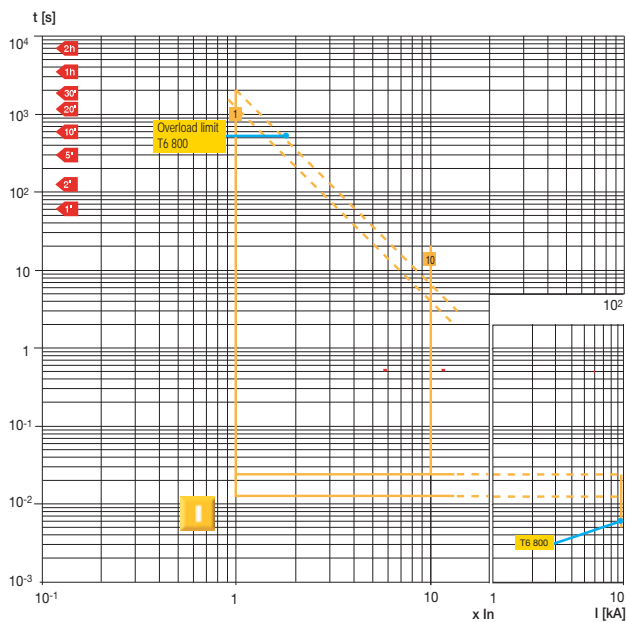

1SDC210U52F0001

T7 1000/1200 – PR231/P-I

I Function

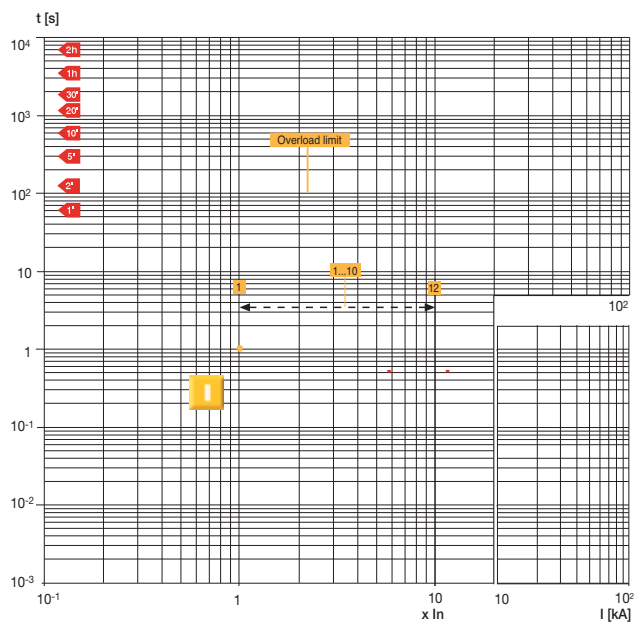

1SDC210G0F0001

4

Specific let-through energy curves (current limiting circuit breakers)

T2 H PR221 100A
480 V

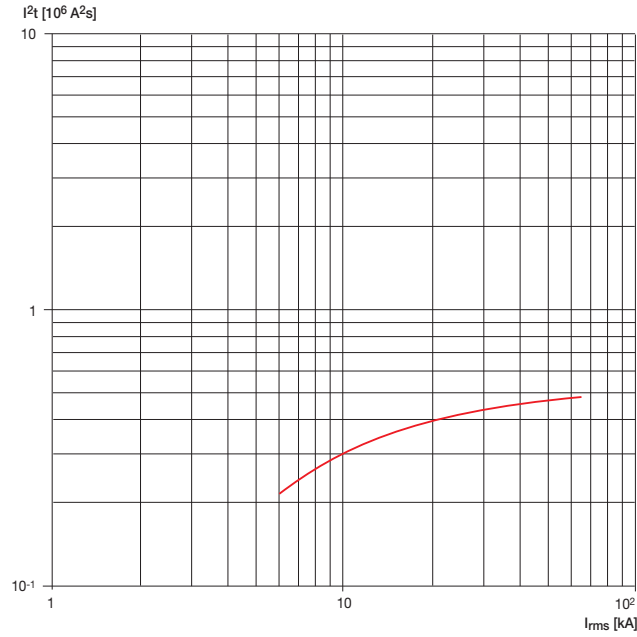

T2 H TM 100A
480 V

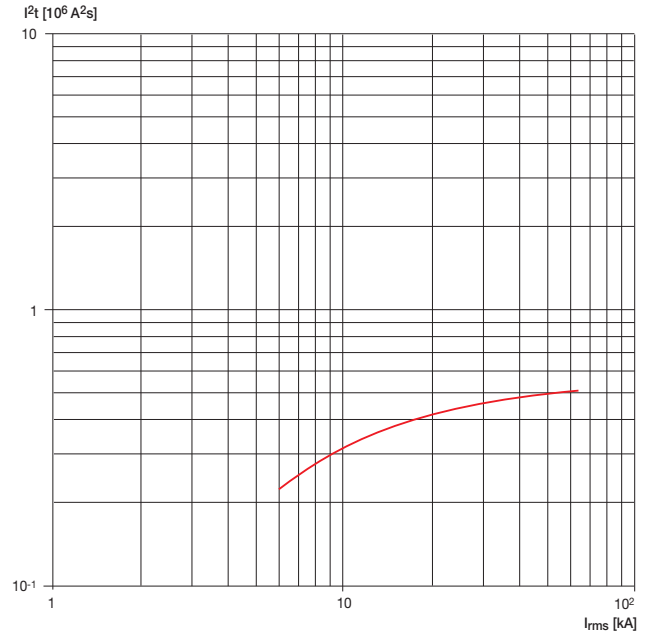

T2 H TM 50A
480 V

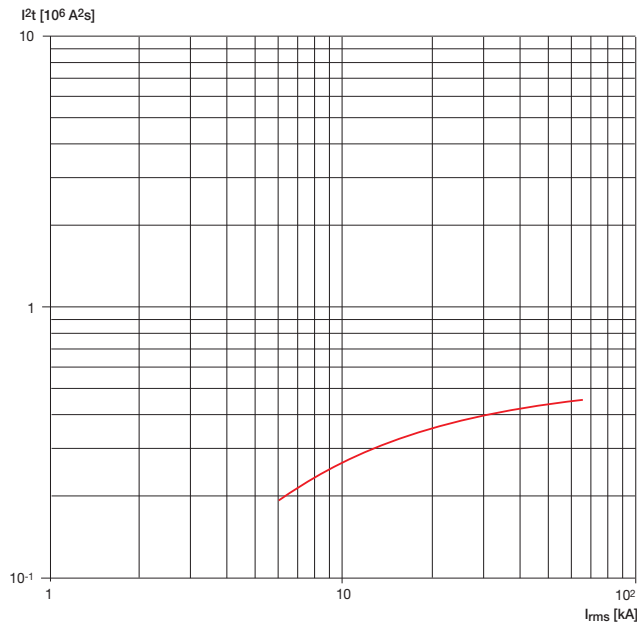

T2 H TM 30A
480 V

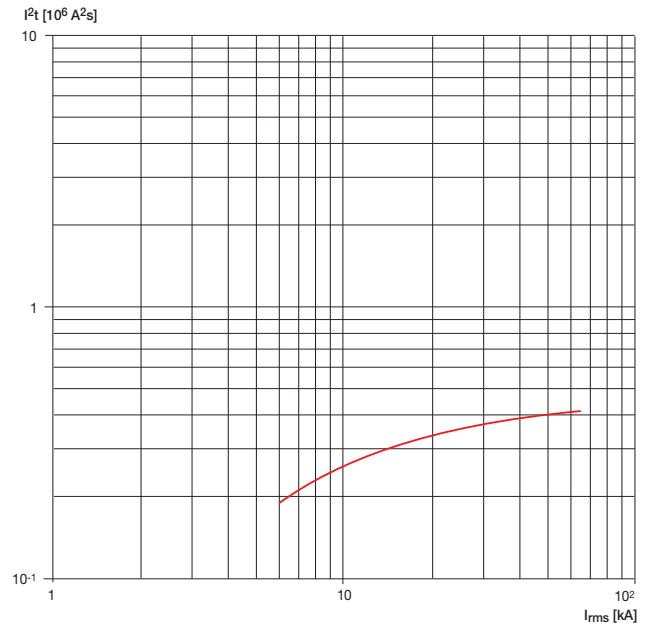

Specific let-through energy curves (current limiting circuit breakers)

T2 H TM 15A

480 V

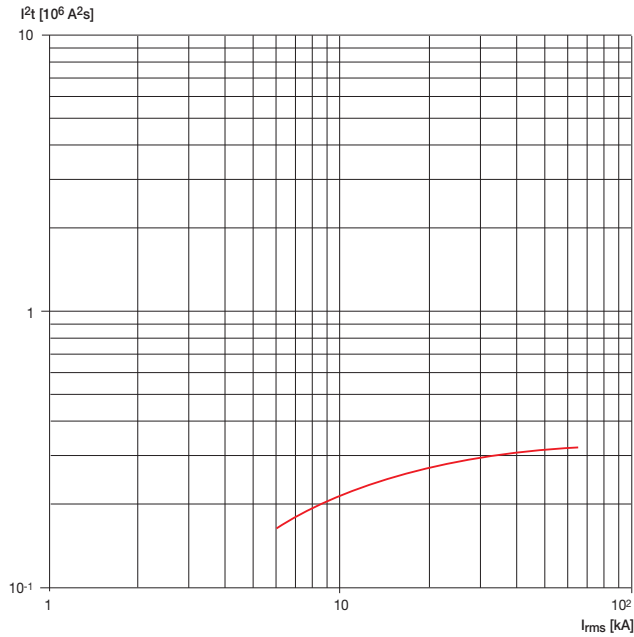

1SDC21002070001

T4 H/V

480 V

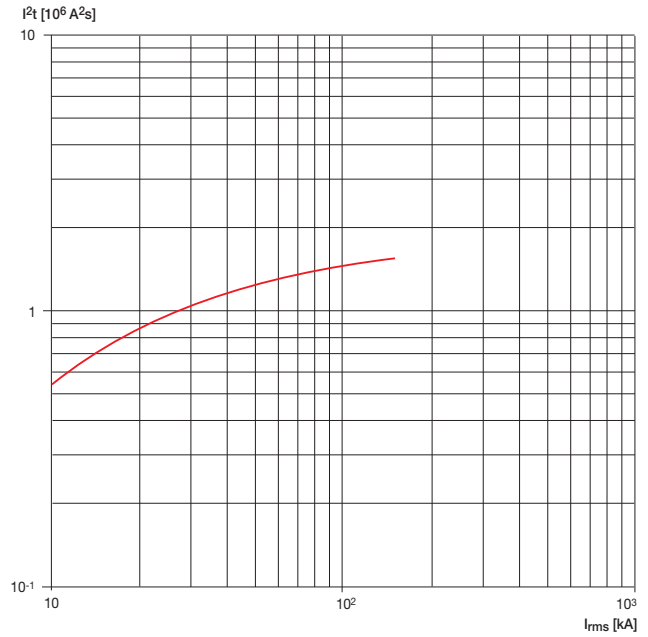

1SDC21003810001

T4 H/V

600 V

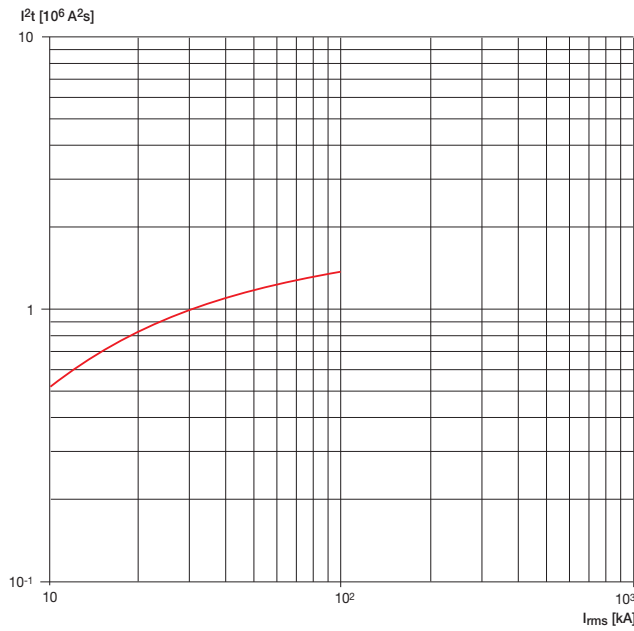

1SDC2100390001

T5 400 H/V

480 V

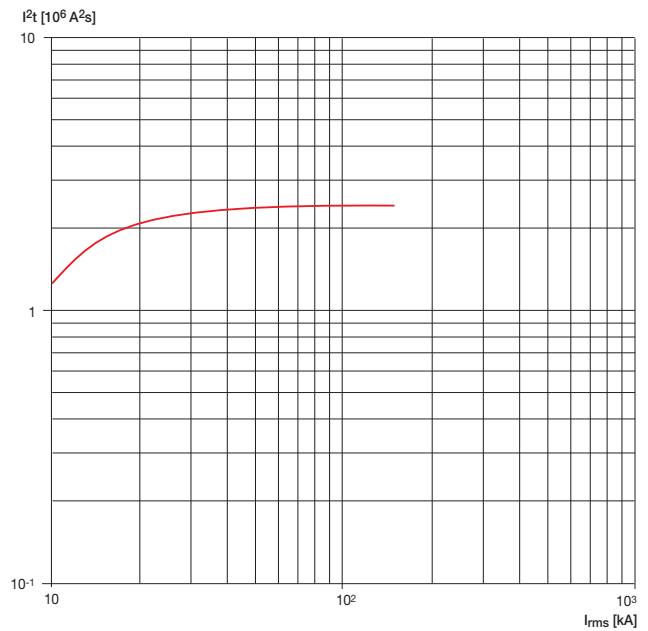

1SDC2100100001

T5 400 H/V

600 V

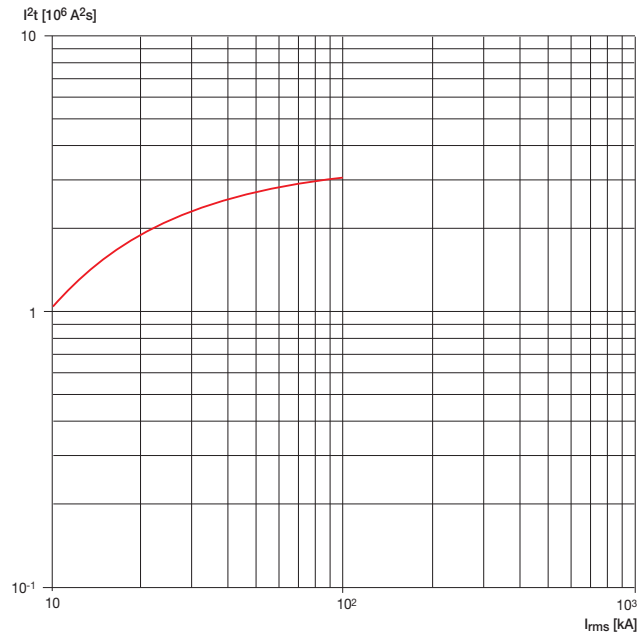

1SXC210031T0001

Limitation curves (current limiting circuit breakers)

T2 H PR221 100A

480 V

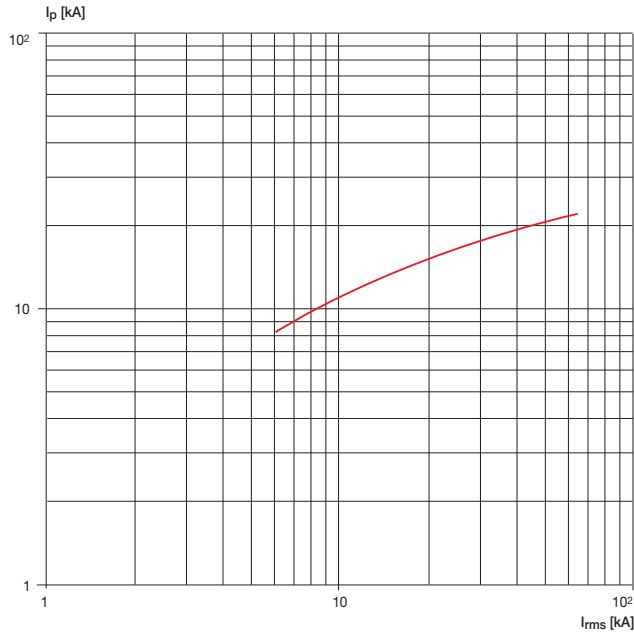

15DC21000100001

T2 H TM 100A

480 V

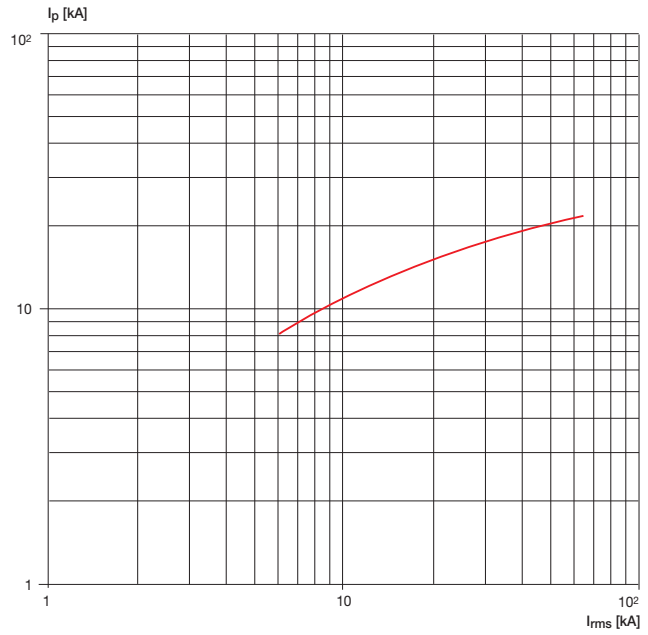

15DC2100012100001

T2 H TM 50A

480 V

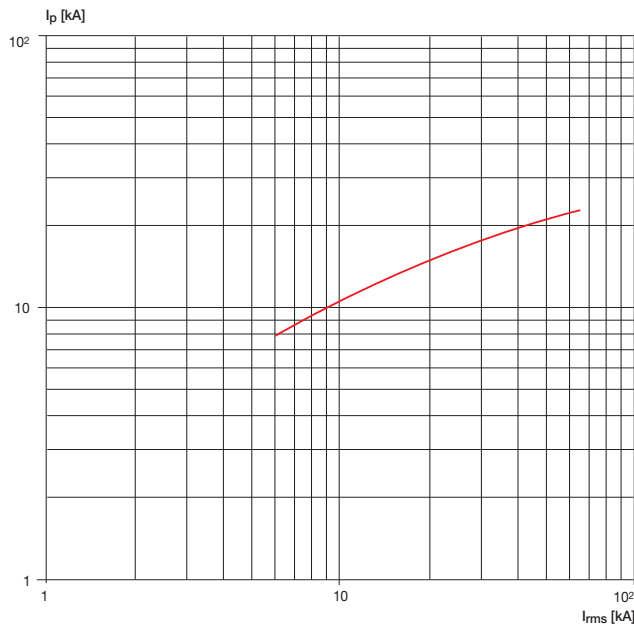

15DC210013100001

T2 H TM 30A

480 V

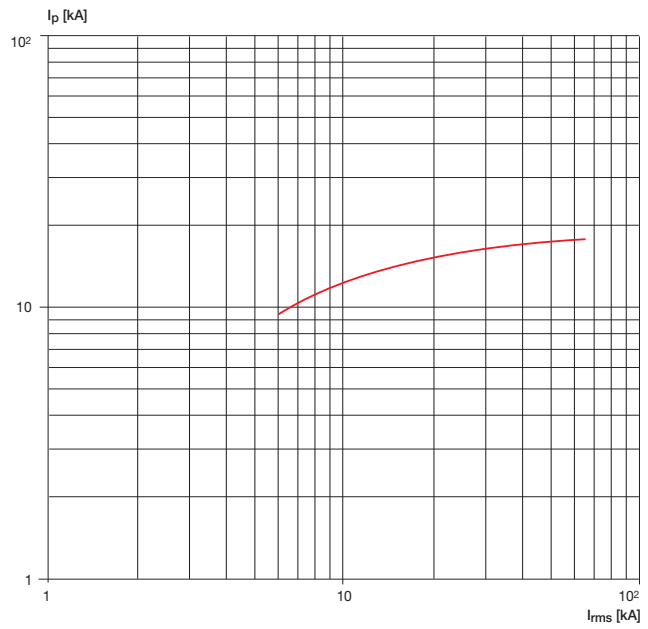

15DC210011100001

4

T2 H TM 15A
480 V

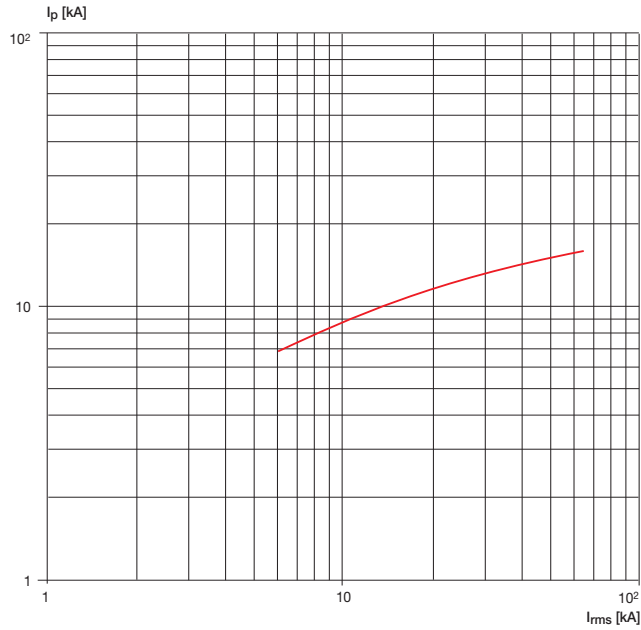

1SDC210021F0001

T4 H/V
480 V

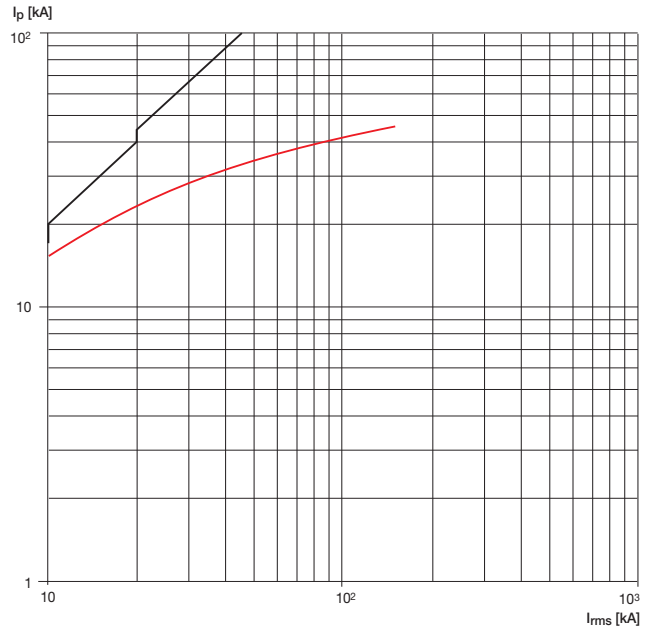

1SDC210021F0001

T4 H/V
600 V

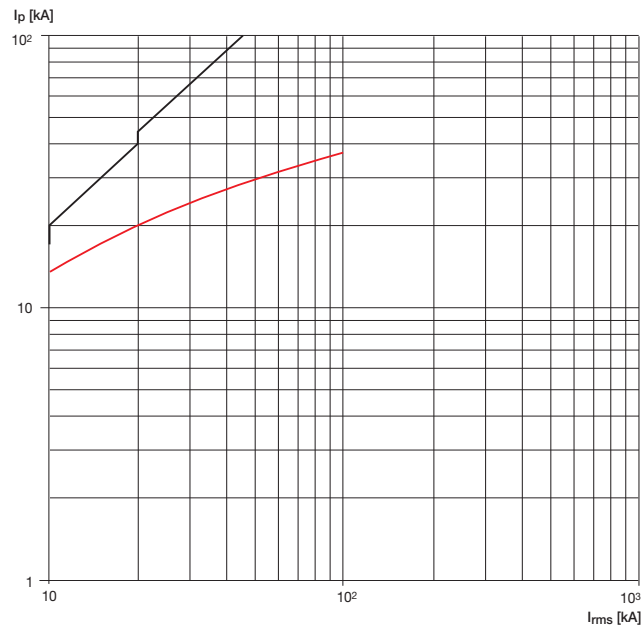

1SDC210021F0001

T5 400 H/V
480 V

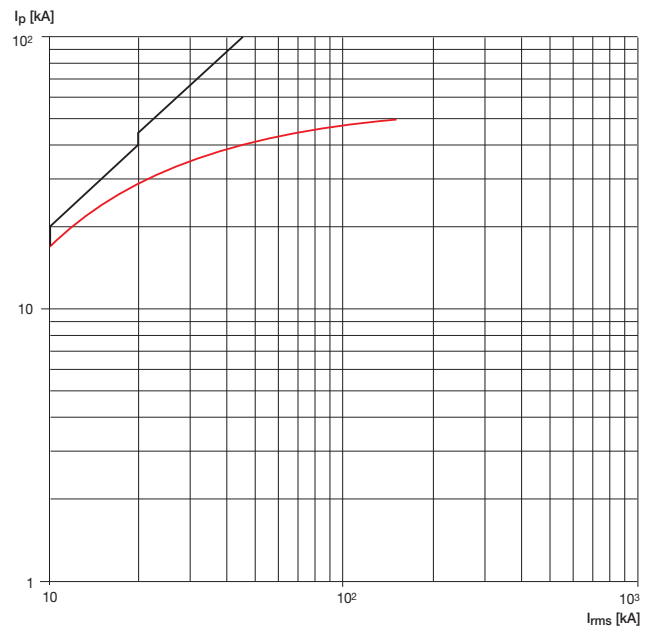

1SDC210021F0001

Limitation curves (current limiting circuit breakers)

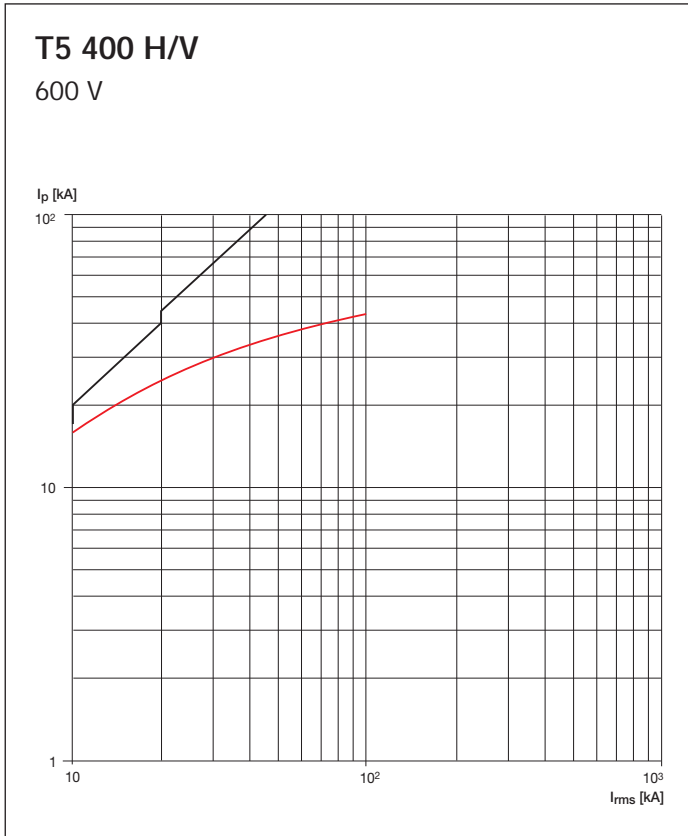

4

Temperature performances

Circuit breakers with electronic trip unit

PR221DS
PR222DS/P
PR231/P
PR232/P
PR331/P
PR332/P

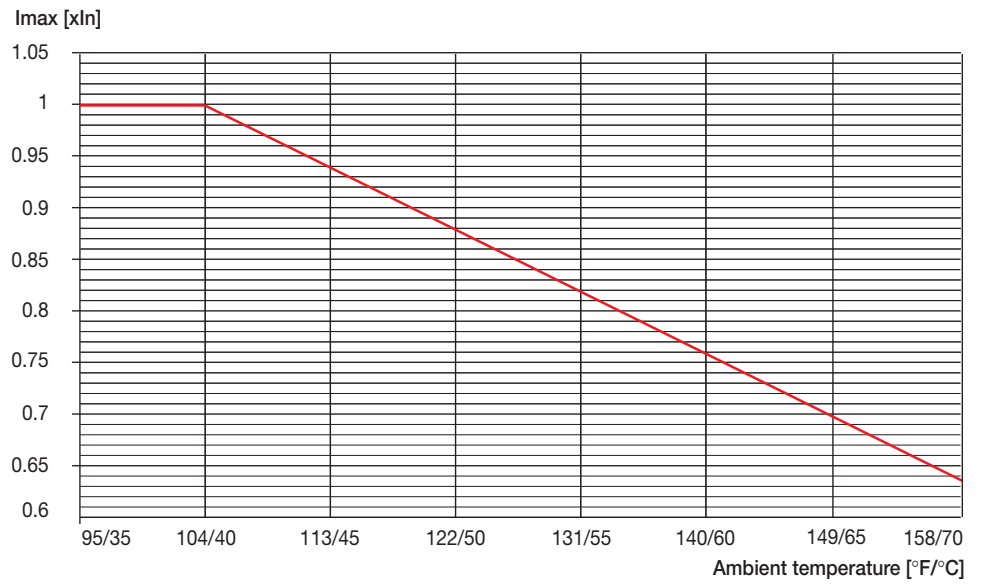

1SXU210023D0201

Temperature performances

Circuit breakers with thermal magnetic trip units

Tmax T1 and T1 1P

In [A]	50 °F / 10 °C	68 °F / 20 °C	86 °F / 30 °C	104 °F / 40 °C	122 °F / 50 °C	140 °F / 60 °C
15	18	17	16	15	14	13
20	24	22	21	20	19	17
25	29	28	27	25	23	22
30	35	34	32	30	28	26
40	47	45	43	40	37	34
50	60	57	53	50	46	42
60	71	68	64	60	56	51
70	83	79	75	70	65	60
80	94	90	85	80	75	69
90	106	101	96	90	84	78
100	121	114	107	100	92	84

Tmax T2

In [A]	50 °F / 10 °C	68 °F / 20 °C	86 °F / 30 °C	104 °F / 40 °C	122 °F / 50 °C	140 °F / 60 °C
15	18	17	16	15	14	12
20	24	23	21	20	18	17
25	30	28	27	25	23	21
30	35	33	32	30	28	26
35	40	39	37	35	33	31
40	46	44	42	40	38	35
50	56	54	52	50	48	45
60	71	68	64	60	56	51
70	83	79	75	70	65	60
80	96	91	86	80	74	67
90	109	103	97	90	83	75
100	115	110	105	100	95	89

Tmax T3

In [A]	50 °F / 10 °C	68 °F / 20 °C	86 °F / 30 °C	104 °F / 40 °C	122 °F / 50 °C	140 °F / 60 °C
60	70	67	64	60	56	52
70	82	78	74	70	66	61
80	92	88	84	80	75	71
90	104	100	95	90	85	79
100	117	112	106	100	94	87
125	145	139	132	125	118	110
150	175	167	159	150	141	131
175	205	195	185	175	164	152
200	236	224	213	200	187	172
225	264	251	239	225	211	195

Tmax Ts3 150

In [A]	50 °F / 10 °C	68 °F / 20 °C	86 °F / 30 °C	104 °F / 40 °C	122 °F / 50 °C	140 °F / 60 °C
15	18	17	16	15	14	13
20	24	22	21	20	19	17
25	30	28	27	25	23	21
30	35	33	32	30	28	26
35	41	39	37	35	33	30
40	47	44	42	40	37	34
50	59	56	53	50	47	43
60	71	67	64	60	56	51
70	83	78	74	70	66	60
80	94	90	85	80	75	68
90	106	101	95	90	85	77
100	118	112	106	100	95	85
125	148	140	133	125	119	106
150	177	168	159	150	143	127

Tmax Ts3 225

In [A]	50 °F / 10 °C	68 °F / 20 °C	86 °F / 30 °C	104 °F / 40 °C	122 °F / 50 °C	140 °F / 60 °C
175	207	196	186	175	166	149
200	236	224	212	200	190	170
225	266	252	239	225	214	191

Tmax T4

In [A]	50 °F / 10 °C	68 °F / 20 °C	86 °F / 30 °C	104 °F / 40 °C	122 °F / 50 °C	140 °F / 60 °C
20	24	22	21	20	19	17
25	30	28	27	25	23	21
40	47	44	42	40	37	34
50	59	56	53	50	47	43
80	94	90	85	80	75	68
100	118	112	106	100	95	85
125	148	140	133	125	119	106
150	177	168	159	150	143	127
200	236	224	212	200	190	170
250	266	252	239	225	214	191

Tmax T5 400/600

In [A]	50 °F / 10 °C	68 °F / 20 °C	86 °F / 30 °C	104 °F / 40 °C	122 °F / 50 °C	140 °F / 60 °C
300	241...345	230...328	220...314	210...300	200...286	187...267
400	325...465	310...442	295...420	280...400	265...380	250...355
600	483...690	459...656	440...628	420...600	400...572	374...534

Tmax T6 800

In [A]	50 °F / 10 °C	68 °F / 20 °C	86 °F / 30 °C	104 °F / 40 °C	122 °F / 50 °C	140 °F / 60 °C
600	520...740	493...705	462...660	441...630	405...580	380...540
800	685...965	640...905	605...855	560...800	520...740	470...670

Power losses

Type	Trip unit	In [A]	P [W/pole]
T1 - T1B 1p	TMF	15	1.3
		20	1.3
		25	2.0
		30	1.8
		40	2.6
		50	3.7
		60	3.9
		70	5.3
		80	4.8
		90	6.1
T2	TMF	100	6.8
		15	1.0
		20	1.7
		25	1.6
		30	2.4
		35	3.0
		40	2.8
		50	3.2
		60	4.6
		70	4.7
T3	TMF	80	5.4
		90	6.9
		100	7.7
		10	0.5
		25	1.0
		63	3.5
Ts3	TMF	100	8.0
		60	3.9
		70	4.2
		80	4.8
		90	5.0
		100	5.3
		125	6.6
		150	7.4
		175	11.6
		200	13.2
Ts3	TMF	225	15.0
		15	3.2
		20	3.2
		25	3.3
		30	3.5
		35	4.8
		40	6.3
		50	5.3
		60	7.7
		70	4.6
		80	6.0
		90	7.6
		100	7.0
		125	6.7
150	8.8		
175	9.2		
200	12.0		
		225	13.5

4

Type	Trip unit	In [A]	P [W/pole]
T4	TMF	15	3.6
		20	3.6
		30	3.6
	TMD	40	3.8
		50	3.9
		80	4.6
		100	5.2
		125	5.7
	TMA	150	6.9
		200	9.9
		250	13.7
		100	1.7
ELT		150	3.9
		200	10.7
		300	12.3
T5	TMA	400	19.5
		600	40.1
		300	9.3
	ELT	400	16.5
		600	37.1
T6	TMA	600	30.6
		800	31
	ELT	600	30
		800	32
T7	ELT	400	5
		600	12
		800	19.3
		1000	30
		1200	47