



**Corbin  
Russwin**

**ASSA ABLOY**



# 2022 Price List

Number 36  
USA & Canada Prices Effective February 1, 2022

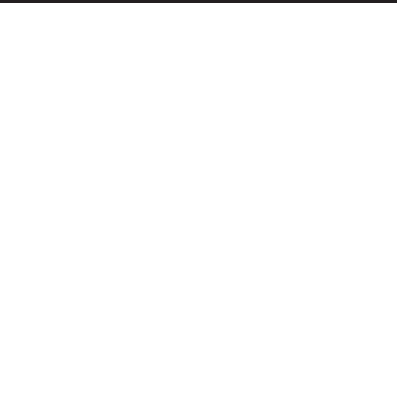

Experience a safer  
and more open world

SECTION	PAGE
Service Center Business Hours, Holiday Schedule	5
Partner Services in Canada, Business Hours, Holiday Schedule	5
Order Forms	6
Key System Information Request Form	10
Keyed Order Lead Sheet	11
Tools and Rules	14
Terms and Conditions	18
Warranty	22
Finishes, Samples, Templates	24
<b>KEY SYSTEMS</b>	
General Information	26
Policy	29
Construction Core	30
Keying, Stamping, Cut Keys	31
Bitting List	32
Key Wizard	33
Key Blanks	34
Access 3 AP Security Cylinders	36
Pyramid Cylinders	42
Conventional Cylinders	48
Interchangeable Core Cylinders	56
Security Cylinders	62
Master Ring Cylinders	68
Service Equipment	71
<b>MORTISE LOCKSETS AND TRIM</b>	
MicroShield® How to Order	74
ML2000 Series / Museo Levers & Inspire Trim, Roses & Thumbturns, Escutcheons	75
Vineyard™ Collection	90
Vandal Resistant Trim	92
ML20900 Series & ML20600 NAC Series / Museo Levers	93
Cylinder and Keying Options	112
Miscellaneous Options	115
<b>HEALTHCARE HARDWARE</b>	
MicroShield® How to Order	118
BHSS Trim	119
BLSS Trim	120
HSS Trim	121
HPSK Trim	122
HP3000 Series Tubular Lock with Push/Pull Trim	123
<b>CYLINDRICAL LOCKS</b>	
MicroShield® How to Order	126
TL3700 Series: Museo Levers & Inspire Trim, Levers & Roses, Options	127
CL3100 Series Grade 1 Vandal Resistant Cylindrical Lever Locksets	132
CLX3300 Series Grade 1 Extra Heavy-Duty Cylindrical Lever Locksets	138
CL3300 Series Grade 1 Heavy-Duty Cylindrical Lever Locksets	144
CL3500 Series Grade 1 Cylindrical Lever Locksets	150
CL3800 Series Grade 2 Standard-Duty Lever Locksets	156
CK4300 Series Grade 1 Cylindrical Knob Locksets	159
CK4400 Series Grade 2 Cylindrical Knob Locksets	160

PRE-ASSEMBLED UNIT LOCKSETS	PAGE
UT5200 Series	168
AUXILIARY HARDWARE	
PL5000 Series Padlocks	173
DL2200 Series Cylindrical Deadlocks	175
DL3000 Series Cylindrical Deadlocks	178
DL3200 Series Cylindrical Deadlocks	181
DL4100 Series Mortise Deadlocks	184
MULTIPOINT LOCKS	
FE5400S	189
MP6600	203
FE6600	216
BL6600	229
FE6700	242
MP9800	246
EXIT DEVICES	
MicroShield® Technology	261
ED3000 Crossbar Series	262
ED4000 Narrow Stile Pushpad Series / Museo Levers with 800 Series Escutcheon	275
ED5000 Pushpad Series / Museo Levers with 900 Series Escutcheon	289
ED7000 Narrow Stile Crossbar Series	314
ED8000 Pushpad Series	325
DOOR CLOSERS	
DC3000 Series	336
DC5000 Series (Cam Action Door Closer)	339
DC6000 Series	342
DC8000 Series	344
DC46900 Series (Safeguard™)	349
DC62900 Series	350
PARTS	
Key Systems	
Plugs and Shells	352
Cylinder Parts	353-354
Standard Diameter Cylinder Collars	355
Master Ring Cylinder Collars	356
Tools	356
Mortise Locksets and Trim	
ML2000 Series – Mortise Locks	357-359
ML2000 Series – Mortise Trim	360-368
Vandal Resistant Cylindrical Lever Locksets	
CL3100 Series	369-371
Extra Heavy-Duty Cylindrical Lever Locksets	
CLX3300 Series	372-375
Extra Heavy-Duty Cylindrical Lever Locksets	
CL3300 Series	376-378
Heavy-Duty Cylindrical Lever Locksets	
CL3500 Series	379-380
Grade 2 Key-In-Lever	
CL3800 Series	381-382
Heavy-Duty Cylindrical Knob Locksets	
CK4300 Series	383

*Continued on next page.*

PARTS <i>(continued)</i>	PAGE
<b>Standard-Duty Cylindrical Knob Locksets</b>	
CK4400 Series	384
<b>Pre-Assembled Unit Locksets</b>	
UT5200 Series	385-386
<b>Padlocks, Deadlocks and Push-Pull Latches</b>	
Padlocks	386
DL3000 Series Deadlocks	386
<b>ED4000 and ED5000 Series</b>	
Device Parts	387-389
Trim Parts	389-391
<b>Crossbar Exit Devices and Trims</b>	
ED7000 Series	392-396
<b>Pushpad Exit Devices and Trims</b>	
ED8000 Series	397-399
<b>Door Closers</b>	
DC3000 Series	399
DC5000 Series	399
DC6000 Series	400
DC8000 Series	401
<b>Electronic Hardware Parts</b>	
DC46900 Series	402
DC62900 Series	402
Access 800® AC2 Series	402
<b>Parts Index</b>	<b>403</b>

**Service Center Business Hours**

**ASSA ABLOY Door Security Solutions®**

**Customer Service – Monroe** ..... 8:00 a.m. – 4:30 p.m. (Eastern)

1902 Airport Road

Monroe, NC 28110

Telephone Number: ..... (800) 438-1951

Fax Number: ..... (800) 338-0965

**Technical Product Support** ..... 8:00 a.m. - 4:30 p.m. (Eastern)

225 Episcopal Road

Berlin, CT 06037

Telephone Number: ..... (888) 607-5703

**Electrified Technical Product Support** ..... 8:00 a.m. - 4:30 p.m. (Eastern)

Telephone Number: ..... (800) 810-WIRE (9473)

Fax Number: ..... (203) 603-5981

**Holiday Schedule\* These following entities will be CLOSED on these dates:**

**ASSA ABLOY Door Security Solutions® Customer Service – Monroe**

**Technical Product Support**

**Electrified Technical Product Support- New Haven CT**

January 3, 2022

April 15, 2022

May 30, 2022

July 4, 2022

September 5, 2022

October 28-29, 2022

November 24-25, 2022

December 23-26, 2022

January 3 (New Years)

January 17 (Martin Luther King, Jr. Day)

February 21 (President’s Day)

April 15 (Good Friday)

May 30 (Memorial Day)

July 4 (4th of July)

September 5 (Labor Day)

November 24 and 25 (Thanksgiving)

December 23, 26 and 30 (Christmas)

January 3 (New Years)

January 17 (Martin Luther King, Jr. Day)

February 21 (President’s Day)

April 15 (Good Friday)

May 30 (Memorial Day)

July 4 (4th of July)

September 5 (Labor Day)

November 24 and 25 (Thanksgiving)

December 23, 26 and 30 (Christmas)

\* Dates subject to change.

**Partner Services In Canada**

**Business Hours: Customer Service Hours:** 8:00 AM to 4:30 PM Eastern Standard Time.

**Toll Free Telephone Number:** 1-800-461-3007

**Order Fax Number:** 1-800.461.8989.

**Order email:** orders.dss.ca@assaabloy.ca

**RGA email:** rga.dss.ca@assaabloy.com

**Technical Support email:** techsupport.dss.ca@assaabloy.com

**Customer Support:** Ontario email: customerservice.dss.caontario@assaabloy.com

**Customer Support:** East email: customerservice.dss.caeast@assaabloy.com

**Customer Support:** West email: customerservicedss.cawest@assaabloy.com

**2022 Canadian Calendar:**

January 1, 2022

February 21, 2022

April 15, 2022

May 23, 2022

July 1, 2022

August 1, 2022

September 5, 2022

October 10, 2022

December 25-26, 2022

**For Terms & Conditions and Warranty information pertaining to product sales in Canada, please visit [www.assaabloy.ca/terms](http://www.assaabloy.ca/terms).**

**Note that some products may not be available in Canada as well as some of the programs offered in this price book may differ between the USA and Canada. Please contact your sales representative for more information.**













**ASSA ABLOY**

Date: \_\_\_\_\_

**KEY SYSTEMS INFORMATION**

\*Registry Number: \_\_\_\_\_

\*Job Name and Location: \_\_\_\_\_

\*Keyway: \_\_\_\_\_ Top Master Key Bitting: \_\_\_\_\_

Any Other Known System Information:

Information Requested:

Requested By: \_\_\_\_\_

Phone: \_\_\_\_\_ Fax: \_\_\_\_\_ Email: \_\_\_\_\_

Agency/Distributor Name: \_\_\_\_\_

Key System Administration Response:

**Please attach a Letter of Authorization from the end user if requesting bitting information.**

**\*Required Information**

Sheet 1 of _____
Date: _____
Purchase Order No.: _____
Date Required: _____

**SOLD TO:**

\_\_\_\_\_

\_\_\_\_\_

\_\_\_\_\_

**SHIP TO:**

\_\_\_\_\_

\_\_\_\_\_

\_\_\_\_\_

**1. JOB NAME AND ADDRESS**

\_\_\_\_\_

\_\_\_\_\_

\_\_\_\_\_

**2. SYSTEM STATUS**

New  Existing ..... Registry No. \_\_\_\_\_

Customer Bittings (Please attach and indicate How to Read)  Bow to Tip  Tip to Bow

Corbin Russwin Factory Order No. \_\_\_\_\_ Authorized Security Code\* \_\_\_\_\_

\* Not required if opt-out has been recorded on SID

**3. HIGHEST LEVEL OF SYSTEM**

1 - SKD  2 - MK  3 - GM  4 - GGM  5 - GGGM

**4. SYSTEM TYPE**

Security  IC  Master Ring  Conventional  Pyramid\*\*  Access 3 - AP\*\*  Access 3 - AS\*\*  Access 3 - AHS\*\*

Other \_\_\_\_\_

\*\*Required documentation must accompany each initial Pyramid or Access 3 order to avoid delay.

**5. KEYS**

**Keyway Selection:**  Stock-L4  Standard  Restricted\*  Patented\* Protected

Specific Keyway \_\_\_\_\_

**Number of Pins:**  5  6 (Default)  7

\* Requires PRIOR Key Systems Approval

**Depth System:**  System 70 (Default)  Pre-System 70  Access 3-AP  Access 3-AS/AHS

**Key Bow Style:** \_\_\_\_\_

**Pyramid & Access 3 have dedicated Bows:** \_\_\_\_\_

**Key Stamping:**

<input type="checkbox"/> VKC0 - No Bitting or Key Set Stamping on Keys	<input type="checkbox"/> Bittings (Standard for Conventional Change Keys)
<input type="checkbox"/> VKC1 - Visual Key Control Keys Only	<input type="checkbox"/> DO NOT DUPLICATE
<input type="checkbox"/> VKC2 - Visual Key Control Keys and Cylinders	<input type="checkbox"/> US PROPERTY DO NOT DUPLICATE
<input type="checkbox"/> VKC3 - Visual Key Control Cylinders Only	<input type="checkbox"/> Special Stamping: _____
<input type="checkbox"/> CKC2 - Concealed Key Control Cylinders and VKC Keys	_____
<input type="checkbox"/> CKC3 - Concealed Key Control Cylinders Only	_____



**SOLD TO:**

\_\_\_\_\_  
\_\_\_\_\_  
\_\_\_\_\_

Sheet 2 of _____
Date: _____
Purchase Order No.: _____
Date Required: _____

**8. CONSTRUCTION MASTER KEYING\***

\*This section Does NOT Refer To Temporary Construction Cores  
This Order: Yes  No  Establish for future use only

Ship Construction Keys To: \_\_\_\_\_

Attention: \_\_\_\_\_

**9. PRICING**

Order subject to follow pricing:

- Price List Dated \_\_\_\_\_
- Special Job Quote \_\_\_\_\_
- Date Quoted \_\_\_\_\_
- Quote No. \_\_\_\_\_

- Discounts Quoted**
- Cylindrical Locks \_\_\_\_\_
  - Mortise Locks \_\_\_\_\_
  - Deadlocks \_\_\_\_\_
  - Cylinders Only \_\_\_\_\_

- Exit Devices \_\_\_\_\_
- Door Closers \_\_\_\_\_
- Electrical Options \_\_\_\_\_
- Other \_\_\_\_\_
- Other \_\_\_\_\_

**10. PACKAGING AND MARKING**

- Pack change keys with locks (Standard)
  - Pack change keys separately (Security, Pyramid and CMK jobs always)
- Label Boxes:  Key symbol  Door No.  Heading

Ship Change Keys To: \_\_\_\_\_

Attention: \_\_\_\_\_

**11. SHIPPING INSTRUCTIONS FOR MASTER KEYS**

Ship Master Keys To: \_\_\_\_\_

Attention: \_\_\_\_\_

**12. BITTING LIST**

Provide Bitting List for This Order:  Yes  No  
Letter of Authorization:  Attached

Mail Bitting List To: \_\_\_\_\_

Attention: \_\_\_\_\_

**13. CONTACT**

Name of individual in your organization who is knowledgeable about this project, should any clarification be necessary. (Please print or type.)

Name \_\_\_\_\_

Phone \_\_\_\_\_

Fax \_\_\_\_\_

This form has been completed by: (please print)

Name: \_\_\_\_\_

**ADDITIONAL INFORMATION (attach)**

System Expansion Requirements, Special Remarks, etc.

## Ordering Tips

- Please submit **Quick Ship Program Orders** and **Plant Product Orders** on separate order forms.
- Please use **Quick Ship Program Forms** for all **Quick Ship Product Orders** and include **Quick Ship Part Numbers**.
- **Order Forms** are included in the Price Book and at [www.corbinrusswin.com](http://www.corbinrusswin.com).
- We recommend using the **Order Form** included with this Price Book when placing purchase orders for Corbin Russwin products. The **Order Form** is available for copying prior to placing your order.
- Please include **Job Name and Registry Number** for all contract orders.
- Be sure to include **Voltage** on all Electrified Hardware orders.
- A **Letter of Authorization** is required for all Protected and Pyramid Keyways.
- **Keyed Lead Sheets A and B** are *recommended* for contract orders that are keyed to existing Master Key systems.
- Remember to include **Keysets** on all contract orders.
- Be sure to include **Handing** for all unit locks, mortise locks and exit devices.
- If you have a **Quote**, please include it with the purchase order. Orders without this information may be delayed.

## Ordering Tip — Administrative Documentation

When submitting purchase orders to ASSA ABLOY Door Security Solutions® Consultants for processing, please remember that certain cylinder types and/or keyways require additional administrative documentation before the order can be entered.

Purchase orders will be held and questioned if the following keyway/cylinder types do not have the proper administrative documentation submitted with each purchase order:

- Protected and Pyramid keyway products
- Security cylinders and keys
- High security cylinders and keys

All of the above product types must be accompanied by additional administrative documents unless they are shipping direct to the end user facility. These administrative documents include, but may not be limited to, the following:

- Letter of Authorization – must be submitted on the end user facility letterhead, dated and signed by an authorized individual from the facility. Letter must be quantity specific for certain product types. ASSA ABLOY Door Security Solutions Consultants does not keep letters of authorization on file.
- Registration Certificate – only required for Pyramid systems.

## Ordering Checklist

Before placing your order, check for the following:

- ✓ Purchase Order on company letterhead
- ✓ Purchase Order is legible
- ✓ Purchase Order Number
- ✓ Account Number
- ✓ Ship To Address
- ✓ Contact Person for additional information requirements
- ✓ Pricing Requirements – Buying Program or CPQ (please attach)
- ✓ Quick Ship Order (Quick Ship Order Form or Quick Ship part numbers included)
- ✓ Contract Order (Keyed Lead Sheets attached)
- ✓ Handing (if applicable)
- ✓ Design (if applicable)
- ✓ Backset & Strike (if applicable)
- ✓ Finish (if applicable)

**Website**

Corbin Russwin’s website at [www.corbinrusswin.com](http://www.corbinrusswin.com) is the place to go for all your Corbin Russwin product information needs. Easy-to-navigate menus and intuitive icons allow simple and fast access to the latest on new products, as well as the most up-to-date catalogs, templates and installation instructions.

Another great benefit of the Corbin Russwin website is the ability to become an eBusiness member. Access gives additional information for Corbin Russwin account customers only.

**eBusiness**

Visit [www.corbinrusswin.com](http://www.corbinrusswin.com) to sign up for ASSA ABLOY Door Security Solutions eBusiness access.

ASSA ABLOY Door Security Solutions Consultants provides sales, marketing and support for Corbin Russwin.

To sign up for eBusiness, follow the simple instructions listed below. Register today and start enjoying the many benefits!

eBusiness offers anytime access to:

- Order Status
- Stock Status Check
- Key Systems
- Newsletters
- Contact Webmaster
- Fax Order Acknowledgment
- Extended Literature (Price Books, Order Forms, Keyed Lead Sheets)
- Order Check by P.O.
- Cross Reference Guide
- Key Wizard® Order Forms
- ASSA ABLOY Door Security Solutions Online Store
- Fax Program Sign Up
- Fax Invoice

**How to sign up for eBusiness access:**

- Step 1: Visit our website at [www.corbinrusswin.com](http://www.corbinrusswin.com)
- Step 2: Double-click eBusiness icon (top right corner)
- Step 3: Complete ASSA ABLOY Door Security Solutions eBusiness sign up form





**ONLINE ORDER ENTRY**

Would you like to reduce the time to get your orders entered to the factory and eliminate errors associated with manual order entry?

Then try our on-line order entry system. Our convenient web-based order forms can help you submit your orders directly to the factory in minutes.

Contact your customer service representative who will be able to issue your user name and password as well as set up appropriate training sessions for you and your staff.

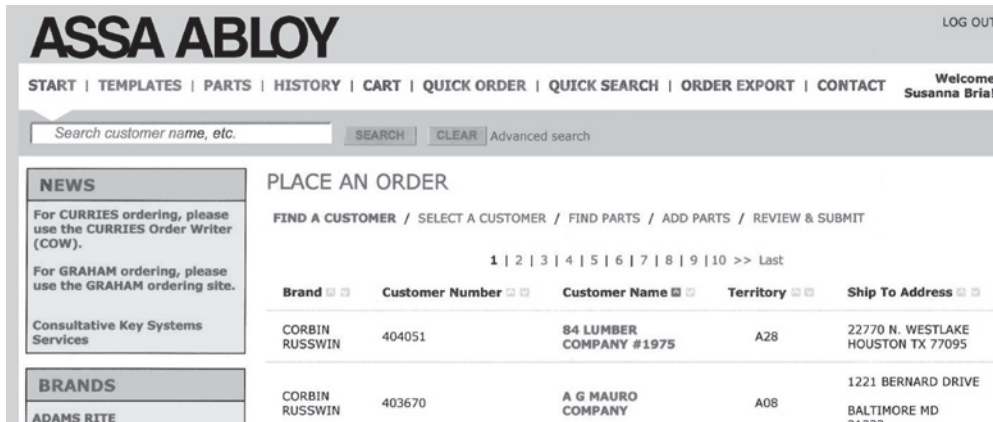

**FAX PROGRAM**

Would you like to receive your acknowledgments and invoices, invoices and Return good Authorizations quickly and efficiently?

If so, ASSA ABLOY Door Security Solutions offers the Order Acknowledgment and Invoice, invoices and Return good Authorizations Fax Program. Please see the simple steps below to get signed up today!

Requirement: Valid eBusiness User ID and Password. (If you do not have an eBusiness User ID and Password, please refer to eBusiness Sign Up Section included in this Price Book.)

Step 1: Log into eBusiness.

Step 2: Double-click on "Sign Up for ASSA ABLOY Door Security Solutions' Fax Program Now!"

Step 3: Fill in appropriate information and send.

**Fax Program Signup**

If your distributor would like to receive their CORBIN RUSSWIN, NORTON, RIXSON and YALE order acknowledgements, invoices, and return goods authorizations by fax, please complete the form below to sign them up today!

Yes - Fax Invoices to Fax #:

Yes - Fax Order Acknowledgements to Fax #:

Yes - Fax Return Goods Authorizations to Fax #:

Enter the distributor's Account Number in the input box below and click [Add] to add it to your Account Number list. Repeat for each distributor Account Number that you have.

Enter Account Number:

Account Number List:

**Terms and Conditions****ACCEPTANCE**

Corbin Russwin reserves the right to decline an order, in whole or in part, when the type or quantity of goods or credit worthiness of the Purchaser is not satisfactory to us in our sole and absolute discretion.

Purchase Orders, Quote Requests, Acknowledgments or the like issued by the Purchaser that have contrary standard terms and conditions are not binding on Corbin Russwin, unless such terms and conditions are approved in a separate written agreement by Corbin Russwin's authorized representatives. In the event of an acceptance of Purchaser's Purchase Order by Corbin Russwin, the Purchaser agrees that such acceptance is solely conditioned on Purchaser's acceptance of the terms and conditions set forth in this instrument, regardless of the terms and conditions specified in Purchaser's Purchase Order. The terms and conditions in Purchaser's Purchase Order which conflict with the terms and conditions of this instrument shall be disregarded and are hereby rejected, and this instrument shall constitute the entire agreement between Corbin Russwin and the Purchaser.

In the event that Corbin Russwin does not enforce or require strict performance of any term or condition hereof, or of any other document, instrument or other agreement relating to goods sold, such lack of enforcement or requirement of strict performance will not waive, affect or diminish any right of Corbin Russwin to enforce or require strict performance of such term or condition in the future.

**PRICES**

All prices are subject to change without notice and are not guaranteed. All shipments will be made at prices in effect at the time of shipment.

Possession of this price list does not constitute an agreement to sell.

We reserve the right to correct clerical, stenographic and other obvious errors at any time.

**TERMS**

Invoices dated the 1st through the 15th will be due for 2% discount on the \*10th of the following month. Invoices dated the 16th through the 31st will be due for 2% discount on the \*25th of the following month. \*Net immediately thereafter. (Corbin Russwin retains the right to sell or to decline to sell to any Customer for any reason whatsoever when in its judgment is deemed sufficient.)

It is understood that Corbin Russwin may impose and charge a finance charge which is the lesser of one and one-half percent (1-1/2%) per month or the highest rate allowed by law on any amount which becomes past due and delinquent. Additionally the Customer shall be responsible for all collection costs, court costs and reasonable attorney's fees (where allowed by law) in connection with the recovery of any delinquent amount.

**FREIGHT**

All orders are shipped FOB factory/warehouse, except as expressly provided below. When delivered to the Transportation Company, the Purchaser assumes the risk of loss or damage in transit.

Customer orders with net product value in excess of \$12,000.00 will be shipped prepaid by Corbin Russwin's carrier of choice to a single destination point in the United States.

Customer orders with net product value less than \$12,000.00 will be shipped prepaid by Corbin Russwin's carrier of choice and freight and handling charges will be added to the customer's invoice.

A minimum freight and handling charge of \$15.00 will be charged on orders with net product value of \$400.00 or less. The minimum freight and handling charge will not apply to orders for only Cut (bitted) keys of any type, Master Keys, Master keyed cylinders or padlocks and factory generated bitting lists that do not have any other product types included on the order. Freight on these orders will be charged as the percentage of invoice value.

For orders with net product value greater than \$400.00 and less than \$12,000.00, freight charges will be calculated as a percentage of the net invoice value and will be added to Customer's invoice. The percentage is based on the National U.S. Average On Highway Diesel Fuel Prices as reported by the US Department of Energy in effect at the beginning of each quarter. On the first Monday of each quarter, the new rate will be published on the Corbin Russwin and Door Security Solutions extranet and will go into effect on the 2nd Monday of the quarter. Please refer to the extranet for the rate chart and information on the current freight charge percentage. The percentage in effect at the time of shipment of the order will be charged.

Great Grand Master keys, Grand Master keys, Master keys, Construction Master keys, Control Keys, Lot Day Keys which are shipped separate from customer order for security reasons, on orders with total net product value in excess of \$12,000.00 will be shipped prepaid by Corbin Russwin's carrier of choice. If the total order value is less than \$12,000.00, the shipping charges will be added to Customer's invoice.

If a customer provides their own freight account # for the freight charges, Corbin Russwin will apply a handling fee of \$25.00 to the invoice.

Quick Ship Orders – All 1-Week Quick Ship orders are guaranteed to ship from Corbin Russwin 5 working days after receipt of all information necessary to process order or Corbin Russwin will pay freight costs. If Quick Ship is held for credit reasons Corbin Russwin will not be responsible for freight costs.

Expedited shipping options – If the customer requests an expedited method of shipment such as "Next Day Air" the charges will be prepaid by Corbin Russwin and the full rate for the service, as published by the carrier, will be added to the customer's invoice.

**Terms and Conditions continued**

Packing – Corbin Russwin will pack, mark and ship the products according to its standard procedures for shipment, unless the parties agree, in writing, that Corbin Russwin will comply with any special instructions provided by the customer. Special instructions must be submitted, in writing, at time of order placement. Compliance with special instructions may result in an increased price.

**MINIMUM ORDER**

Minimum order value for complete product is \$250.00 net product value. The minimum order value for parts orders is \$100.00 net product value. In the event that the net product value does not meet the required net minimum, Corbin Russwin may, at its sole discretion (a) apply a minimum order charge, (b) reject the order or (c) waive the minimum requirement provided that the waiver of the requirement for one order shall not constitute a waiver of the requirement for any future orders.

The following products are exempt from this policy: Cut (bitted) Keys of any type, Master Keyed Cylinders, Master Keyed Padlocks and Factory Generated Bitting Lists.

**QUOTATIONS**

If Corbin Russwin elects to offer a quote, such quote will be valid until the expiration date on that quote. Complete shipment of the order must be accepted by Purchaser within standard manufacturing lead times. The quote number must be referenced on the order. Any invoiced order that has the incorrect discount applied to it and did not have the quote number written on the order will have a service fee of \$100.00 net DEDUCTED from any sales credit issued for the difference in discount. The quote is null and void if the Purchase Order does not include ALL product lines listed on the quote or if the quantities for any item covered by the quote deviate by 10% or more. With the issuance and acceptance of a quote for the purchase of products, the Purchaser agrees that products so purchased will not be resold or transferred to any Distributor not authorized by Corbin Russwin to sell its products. This would be inclusive of branches of the quoted Distributor. Failure to abide by this restriction may result in the Distributor's ineligibility for Quotations, or other actions in Corbin Russwin's discretion. Corbin Russwin and its sales representatives reserve the right, in their sole discretion and for any reason, to refuse a Distributor's request to quote a price other than Corbin Russwin's standard list price and regardless of whether Corbin Russwin or its sales representatives have previously quoted discounted prices to the Distributor on some or all of its orders.

**NON-CATALOGED PRODUCTS**

Products not cataloged or listed in this price book will be considered as special products, and will not be manufactured without prior written approval from Corbin Russwin. A minimum special handling charge of \$50.00 will be added for non-cataloged product. Any additional labor or material required will be charged accordingly. Special products require special handling, and therefore standard lead times may not apply. Please consult with your Sales Representative for further details.

**CHANGES/CANCELLATION OF ORDERS**

Changes or cancellations to an order will result in a charge of costs for material and labor expenses that have been incurred prior to notification from Customer. If products have already been made and/or are located in the shipping room, the 45% change/cancellation fee will apply. Handling charges are billed on Customer's original order. All Non-Cataloged Goods and Corbin Russwin Quick Ship Orders may not be changed or canceled.

**ADD-ON ORDERS TO QUOTE**

Any new order requesting special pricing to match an existing quote number, which has already been ordered, will be accepted up to sixty (60) days after the acknowledgment of the original order. All add-on orders must reference the original factory order number, and the corresponding quote number to receive the quoted pricing discount. Add-on orders for stock will not be accepted.

**PACKAGING**

Many items are defined as to Case Lot Packaging or Minimum Order. The Case Lot policy does not apply to hardware to be used on a specific hardware project.

**DELIVERY**

Orders will be acknowledged and given a scheduled delivery date based on estimated manufacturing lead times. Complete information is required to process all orders. Orders with insufficient information for processing (i.e. keying information, door sizes, handing, etc.) may be subject to extended lead times which are relative to the time required in obtaining the necessary information for order processing. Manufacturing lead time will begin once all information is received to process an order. Corbin Russwin will use reasonable efforts to deliver products as estimated, but makes no guarantees as to delivery dates. Corbin Russwin will not be liable for back charges incurred based on availability of product or as a result of delays in delivery caused by insufficient information required to process an order. Corbin Russwin will not be held responsible for delays in delivery caused by strikes, fires, floods or any other causes beyond our control, including the delivery of material to us. Under no circumstances shall Corbin Russwin be liable or accountable for consequential damages due to failure of delivery.

**CLAIMS**

In the event of Company or Customer error, claims for shortages, pricing errors and/or incorrectly filled orders must be submitted in writing to Customer Service within thirty (30) days from receipt of material. Any claims for shortages or damage by the Carrier must be made by the Customer directly to the Carrier.

**Terms and Conditions continued****INVOICE DEDUCTION**

A Corbin Russwin Sales Representative or Customer Service Representative must be notified of any disputed invoices within sixty (60) days from the date of invoice. Deductions should only be taken for the disputed amount and the balance of the invoice is due and payable within standard payment terms.

**RETURNED GOODS**

It is the policy of Corbin Russwin to not accept returns of any materials that are correctly furnished as per the Distributor's Purchase Order. Return of product due to customer order error or accommodation must be pre-arranged with Corbin Russwin and approved in writing by Sales Management.

All products returned as "Goodwill" must meet the following criteria to be considered a return:

- Be in original, unmarked and undamaged cartons.
- Be valued in excess of \$250.00 net.
- Shipped and invoiced within the previous one hundred twenty (120) days.
- Custom, non-cataloged goods, master-keyed or Corbin Russwin Quick Ship product is not returnable.

A MINIMUM reprocessing fee of 45% will be charged. Upon receipt and verification by Corbin Russwin that the returned merchandise meets the foregoing conditions, a credit will be issued for the original invoice amount less the MINIMUM 45% reprocessing fee.

Defective goods and "Goodwill" products that meet the foregoing criteria may be returned by fulfilling the following conditions:

- Send an RGA request in writing to the Corbin Russwin Sales Representative serving the Purchaser's area.
- Ensure the RGA labels that are sent to Purchaser by Corbin Russwin are visible on return goods shipment.
- Ensure that the RGA number appears on the return shipment label and is legible.
- Return the authorized merchandise within sixty (60) days from the date of RGA issuance date.
- Return shipments must be freight prepaid to the location specified on the RGA.
- Corbin Russwin is not liable for damages to product during shipping.

No credit may be taken or issued prior to RGA approval and receipt of product.

All defective goods within the terms of our limited warranty may be returned for credit or replacement.

**RETURNED GOODS – ELECTROMECHANICAL**

All defective replacement requests for electromechanical products/components must be authorized by contacting the Electromechanical Applications Team at 1-800-810-WIRE to obtain a case number. In order to receive credit for the replacement of an electromechanical product the following criteria needs to be met:

- Defective product return must be under warranty
- Defective product/component return must arrive at factory within 60 days of the Returned Goods Authorization issuance
- Returned product must be found defective or nonfunctional upon test at factory
- Returned product must not have been damaged during installation process

**TAXES**

Prices do not include any present or future Federal, State, or Local property, license, privilege, sales, use, excise, gross receipts or other like taxes or assessments, which may result from transactions or any services performed in connection herewith.

**GOVERNING LAW**

The rights and obligations of the parties shall be governed by the laws of the State of North Carolina, excluding any conflicts of law provisions. The United Nations Convention on Contracts for the International Sale of Goods shall not apply to this Agreement.

**LIMITED WARRANTY**

The Terms and Conditions outlined above are subject to Corbin Russwin's Limited Warranty, which is included in this Price List and incorporated herein by reference.

**PRODUCT MODIFICATIONS**

Corbin Russwin products are not designed or intended for aftermarket modification. The warranty on Corbin Russwin products becomes void if the product is modified in any way, regardless of whether the modification causes or contributes to any alleged defect. Warranty voiding modifications include, but are not limited to, third-party electrification of non-electric products and/or the installation of non-approved or non-Corbin Russwin components.

If a Corbin Russwin product is modified it no longer meets industry certification and quality control standards applicable to the original product and is no longer a genuine Corbin Russwin product. A modified product may not be sold as a Corbin Russwin product and the Corbin Russwin and Design® trademark or certification marks based on the original Corbin Russwin product, such as U.L. or ANSI/BHMA marks, may not appear anywhere on the modified product or on any packaging, literature, or instructions sold with the modified product.

All original Corbin Russwin packaging and literature carries the Corbin Russwin and Design® trademark and must be destroyed if the original Corbin Russwin product is modified. Portions of the product that carry the Corbin Russwin and Design® trademark or certification mark must be discarded and/or replaced by the party making the modification. U.L. and other certification testing and marking are also the responsibility of the party making modification. The use of the Corbin Russwin and Design® trademark on modified products constitutes trademark infringement.

**Terms and Conditions continued****FIRE RATED OPENINGS**

Any retrofit or other field modification to a fire rated opening can potentially impact the fire rating of the opening, and Corbin Russwin, Inc. makes no representations or warranties concerning what such impact may be in any specific situation. When retrofitting any portion of an existing fire-rated opening, or specifying and installing a new fire-rated opening, please consult with a code specialist or local code official (Authority Having Jurisdiction) to ensure compliance with all applicable codes and ratings.

The following policy ("Policy") of ASSA ABLOY Americas ("ASSA ABLOY"), and all of its affiliated group companies (collectively, the "Group Companies"), applies to the use of certain intellectual property of all such Group Companies, including all trademarks, names, logos, product images, and related information (the "ASSA ABLOY Marks"). ASSA ABLOY Marks are proprietary and critical to the success of ASSA ABLOY and the Group Companies, and may only be used in strict compliance with this Policy.

This Policy covers any person or entity reselling any product of any Group Company with the consent of such Group Company (each, an "Approved Reseller"). Each Approved Reseller has a non-exclusive right to use certain of the ASSA ABLOY Marks relating to any of the Group Companies for which it is an Approved Reseller, subject to the following conditions:

- (1) Approved Reseller's use of ASSA ABLOY Marks must be truthful, fair, and not misleading;
- (2) Approved Reseller's advertising must clearly indicate that it is advertising of the Approved Reseller, and is not advertising of ASSA ABLOY;
- (3) Approved Reseller may not use any ASSA ABLOY Marks as part of or in connection with a domain name;
- (4) Approved Reseller's advertising must not imply or suggest an association between the Approved Reseller and ASSA ABLOY other than that of buyer and seller;
- (5) Approved Reseller's use of ASSA ABLOY Marks must be a positive representation of ASSA ABLOY, the Group Companies, and their products;
- (6) Approved Reseller's trade name must be more predominant on Approved Reseller's advertising than the ASSA ABLOY Marks;
- (7) Approved Reseller's use of ASSA ABLOY Marks must include the trademark symbol ® or ™, as appropriate, along with the following trademark legend printed in legible text on the Web page or document containing ASSA ABLOY Marks: "[describe ASSA ABLOY Marks] are trademarks or registered trademarks of ASSA ABLOY, Inc. or one of its affiliates in the United States and other countries.";
- (8) Approved Reseller must not make modifications of any ASSA ABLOY Marks; and
- (9) Approved Reseller may use only ASSA ABLOY Marks associated with the Group Companies for which it is an Approved Reseller (e.g., an Approved Reseller that sells Group Company X products but not Group Company Y products may use Group Company X trademarks in connection with its sale of Group Company X products, but may not use Group Company Y trademarks).

ASSA ABLOY reserves the right to review Approved Reseller's usage of ASSA ABLOY Marks at any time and may:

- (a) require changes to the use of ASSA ABLOY Marks at any time in its sole discretion, which changes must be implemented within 30 days of written notice to Approved Reseller;
- (b) condition the use of ASSA ABLOY Marks on ASSA ABLOY's prior approval of such use, which approval may be withheld in its sole discretion;
- (c) revoke permission to use ASSA ABLOY Marks at any time for any or no reason upon 30 days prior written notice to Approved Reseller; and
- (d) revoke permission to use ASSA ABLOY Marks immediately upon notice to Approved Reseller in the event Approved Reseller is in violation of this Policy, or of any other agreement with ASSA ABLOY or any Group Company.

Approved Reseller's right to use ASSA ABLOY Marks in no way conveys to Approved Reseller any proprietary or economic interest in any ASSA ABLOY Marks.

Use of ASSA ABLOY Marks in violation of this Policy may result in severe civil and criminal liabilities. ASSA ABLOY will vigorously enforce this Policy by seeking all appropriate legal remedies, including, but not limited to, pecuniary damages and injunctive relief.

If there are any questions on this policy, please contact Linda Dean at [ldean@assaabloyusa.com](mailto:ldean@assaabloyusa.com) or 203-498-5596.

**TECHNICAL INFORMATION AND ADVICE**

(a) All designs, data, and specifications provided by Company are proprietary and will not be disclosed or reused by Customer without the prior written consent of Company; (b) Company assumes no obligation or liability for any advice given by Company, the results obtained, or damages incurred, and all such advice is given and accepted at Customer's risk.

**Limited Warranty**

Corbin Russwin, Inc. (Company) warrants that its products sold under the Corbin Russwin and Design® trade name in the United States of America are free from defects in workmanship and materials under normal use and service. This warranty does not cover defects or damage arising from improper installation, lack of or improper maintenance, improper storage, shipping and handling, corrosion, erosion, ordinary wear and tear, misuse, abuse, accident, unauthorized service, or use with unauthorized non-Corbin Russwin products or parts. This warranty is void if any modification is made to the warranty product, regardless of whether the modification causes or contributes to the alleged defect. All modifications are made at the risk of the party making the modification.

The only liability of the Company in tort or contract whether under this warranty or otherwise shall be limited to the repair or replacement of any product or component part which shall prove defective as covered by this warranty, within the stated time frame listed below, after delivery to the original purchaser.

DC6200 & DC6400 Series Door Closers .....	30 years
DC8000 Series Door Closers.....	30 years
DC3200 Series Door Closers.....	15 years
DC5000 Series Door Closers.....	10 years
ML2000 Series Mortise Locksets.....	10 years
CL3100 Series Cylindrical Locksets .....	10 years
CLX3300 Series Cylindrical Locksets .....	10 years
CL3300/CL3500/CL3800 Series Cylindrical Locksets .....	7 years
FE5400S/FE6700/FE6800/MP6600/BL6600 Series Multi-point Locksets.....	7 years
ED4000, ED5000 Series Exit Devices, MELR Option & 900 Series Trim .....	5 years
MP9800 Series .....	5 years
Pyramid Cylinders.....	5 years
CK4300 Series Cylindrical Knob Locksets.....	3 years
All Electro-mechanical and electronic products.....	2 years
Electrified Exit Devices.....	2 years
Access 3 Cylinders.....	1 year
All Other Locksets .....	1 year
All Other Exit Device Trim.....	1 year
All Other Corbin Russwin Products.....	1 year
ED3000, ED7000, ED8000 Series Exit Devices & Trim.....	1 year
MicroShield® Finish .....	1 year

**Finishes:**

Corbin Russwin finishes are covered by a limited warranty period of one year after invoice date.

**Warranty Requirements for Cylinders Factory or Field Combined:**

Cylinders are lubricated at the factory with a petroleum based lubricant (Moist-Out / MO-10). Cylinders should be lubricated periodically depending upon environmental conditions. FLUID FILM lubricant is recommended. Never mix petroleum based lubricants with dry lubricants. Corbin Russwin cylinder and/or core warranty will be voided if used in non-Corbin Russwin locking devices.

**Warranty Requirements for Cylinders Field Combined:**

1. Keys shall be cut to the Corbin Russwin key biting specifications required for the particular keyway and depth system.
2. All pin lengths shall be selected according to prevailing factory standards.
3. Original Corbin Russwin cylinders and cylinder components, including pin tumblers and key blanks, shall be used. We reserve the right to void the warranty if we deem that a malfunction is a result of non-original components which do not conform to Corbin Russwin standards.

*Continued on next page*

**Limited Warranty continued****Keying Systems:**

All bittings shall be originated or authorized by the Corbin Russwin Key Systems Department to be compatible with one another in a specific type of cylinder (Access 3, Pyramid, conventional, security, master ring, interchangeable core) and within a particular keying system. Product repair or replacement, or associated charges, will not be accepted under this warranty unless prior authorization from Corbin Russwin has been given. Upon receipt of products returned for repair or replacement, we will determine whether products qualify for repair or replacement under this warranty. If they do not, we will obtain authorization prior to proceeding. We have no liability to pay any costs of repair performed by anyone other than qualified personnel authorized by Corbin Russwin prior to the work being done.

The Company will not pay for the cost of repair performed other than in accordance with this warranty. Written notice of a product or component part believed to be defective as covered by this warranty should be sent to Corbin Russwin, Inc. 225 Episcopal Road, Berlin, CT 06037, and should include your name and address, an identification of the product or component part and a brief description of the defect. Upon receipt of such notice, the Company will inform you where to ship such product or component part, shipping charges prepaid, for examination and, in the event such examination reveals defect covered by this warranty, the product will be repaired or replaced. The Company reserves the right to replace discontinued product with an equivalent product as deemed by the Company.

THIS WARRANTY IS IN LIEU OF ALL OTHER EXPRESS WARRANTIES. TO THE EXTENT PERMITTED BY LAW, ALL IMPLIED WARRANTIES ARE LIMITED TO THE DURATION OF THIS WARRANTY. CORBIN RUSSWIN, INC. SHALL NOT BE LIABLE FOR ANY INCIDENTAL OR CONSEQUENTIAL DAMAGES. NO AGENT, SALES REPRESENTATIVE OR DEALER HAS THE AUTHORITY TO INCREASE OR ALTER THE OBLIGATIONS OF THIS WARRANTY. SOME STATES DO NOT ALLOW LIMITATIONS ON HOW LONG AN IMPLIED WARRANTY LASTS OR THE EXCLUSION OR LIMITATION OF INCIDENTAL OR CONSEQUENTIAL DAMAGES, SO THE ABOVE LIMITATION OR EXCLUSIONS MAY NOT APPLY TO YOU. THIS WARRANTY GIVES YOU SPECIFIC LEGAL RIGHTS, AND YOU MAY ALSO HAVE OTHER RIGHTS WHICH VARY FROM STATE TO STATE.

## Finishes

ANSI/BHMA Designation	Finish/Description
600	Primed for Painting (USP)
605	Bright Brass (US3)
606	Satin Brass (US4)
611	Bright Bronze (US9)
612	Satin Bronze (US10)
613	Dark Oxidized Satin Bronze, Oil Rubbed (US10B)
613E	Dark Oxidized Satin Bronze - Equivalent
613L	Dark Oxidized Satin Bronze, Clear Coated
618	Bright Nickel Plated (US14)
619	Satin Nickel Plated (US15)
622	Flat Black Coated (US19)
625	Bright Chromium Plated (US26)
626	Satin Chromium Plated (US26D)
628	Satin Aluminum, Clear Anodized (808 Mullion)
629*	Bright Stainless Steel (US32)
630*	Satin Stainless Steel (US32D)
689	Silver Aluminum Painted (SBL)
690	Dark Bronze Painted (DBL)
691	Light Bronze Painted (LBL)
693	Black Painted (FBL)
695	Dark Bronze Painted or Anodized (808 Mullion)
696	Satin Brass Painted (GBL)
722	Black oxidized bronze, oil rubbed
BSP	Black Suede Powder Coat
WSP	White Suede Powder Coat

\*629 and 630 finish options are Not available for the following Muséo levers: 101, 104, 105,111, 112, 113, 114, 115, 116, 117, 119, 121, 122, 126, 127,130, 131, 132

## Samples

Display Mounts (Base Hardware not included). Price covers mount only.

For Product Series	Specify	Price
CL3100, CK4400	SM-CL-NTB	\$195.00
CL3300, CL3500, CL3800	SM-CL-TB	\$195.00
ML2000 x Sectional Trim (Lever, Knob, BLSS, HSS, HPSK)	SM-ML-L	\$182.00
ML2000 x BHSS trim	SM-ML-WAVE-CYL x TP	\$286.00
ML2000 x Roseless	SM-ML-RL	\$195.00
UT5200	SM-UT	\$195.00
HP3000	SM-CL-HP3000	\$238.00
Access 800® CL33800	SM-CL-A800	\$225.00
Access 800® ML20800	SM-ML-A800	\$314.00
Access 800® ED5000 x 9800	SM-ED-A800	\$340.00

Pyramid Sample Display Case

Specify	Price
PS-20-DC	\$340.00

Finish folder with cylinder scalps.

Specify	Price
FP	\$176.00

## Corbin Russwin Templates

Templates of Corbin Russwin products that are most commonly used are available through our website <http://www.corbinrusswin.com/en/site/corbin-russwin/Library/Product-Templates/>



**General Information:**

Standard Features: Keying, Keys, Pins	26
Keyway Availability	27
General Information	28
Policy	29
Construction Core Program	30
Keying, Stamping, Cut Keys	31
Bitting List	32
Key Wizard	33

**Key Blanks:**

Stamping, Standard, Pyramid, Access 3	34
Security Bow, Large Bow, Emergency Blanks, Emergency Master Key	35

**Access 3 AP Security Cylinders**

AP Fixed Core (Mortise/Rim), AP LFIC (Mortise/Rim)	36
AP LFIC, Fixed Core Component Cylinder, Deadlock Cylinder	37
AS Fixed Core (Mortise/Rim), AS LFIC (Mortise/Rim)	38
AS LFIC Core, AS Fixed Core Component Cylinder, AS Fixed Core Deadlock Cylinder	39
AHS Fixed Core (Mortise/Rim), AHS LFIC (Mortise/Rim)	40
AHS LFIC Core, AHS Fixed Core, Deadlock Cylinder, UL LFIC 6-Pin Housing (Mortise/Rim)	41

**Pyramid Cylinders:**

Fixed Core (Mortise/Rim)	42
Key-In-Lever/Knob High Security UL437 Listed	43
Interchangeable Core (Mortise/Rim)	44
Fixed Core (Mortise/Rim)	45
Key-In-Lever/Knob	46
Interchangeable Core (Mortise/Rim)	47

**Conventional Cylinders:**

Standard Mortise	48
Flexible Head Mortise, Concealed Shell Mortise	49
Special Function Mortise, Hotel Function Mortise	50
Non-Keyed Mortise, Thumbturn, Dummy, Rim Thumbturn Cylinders	51
Rim (.552 diameter Plug)	52
Key-In-Lever/Knob (.509 Plug), DL2200, DL3200 Series Cylindrical Deadlock	53
Key-In-Lever/Knob UT5200, CK4200, CK4400, G10, PL5000	54
Key-In-Lever/Knob (.552 dia Plug), Adams Rite 4025 Pull	55

**Interchangeable Core Cylinders:**

IC Mortise, Hotel Function IC Mortise	56
IC Rim, Core Only	57
SFIC Mortise, SFIC Rim	58
SFIC Rim, SFIC Core Only	59
LFIC Mortise Housing Only, LFIC Rim Housing Only	60
SFIC Mortise Housing Only, SFIC Rim Housing Only	61

**Security Cylinders:**

Standard Security Mortise	62
Special Function Security Mortise, Hotel Security Rim	63
Security Rim	64
Security Key-In-Lever/Knob (.552 Plug)	65
Security Interchangeable Cylinders: IC Mortise, Hotel Function	66
Security Interchangeable Cylinders: IC Rim, Security Core	67

**Master Ring Cylinders:**

Standard Master Ring Cylinder	68
Flexible Head Master Ring Mortise	69
Master Ring Rim, CK4200 & UT5200 Series, Special Applications	70
Service Equipment	71
Blank Page	72

**Standard Features  
Keying**

0-bitted except high security; random keying option offered at no charge

**Keys**

Two nickel silver keys

**Pins**

5-pin for 252, 752, 852 and A Class; all others furnished 6-pin

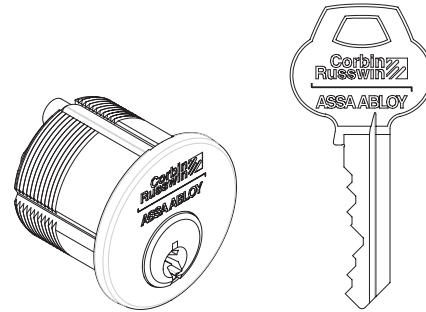

**Ordering Examples**

**Stock Order - Conventional Cylinder**

Quantity	Cylinder	Finish
25	CR1000	626

**Contract/Detailed Order - Conventional Cylinder**

Quantity	Keyset	Cylinder	Finish	Option
25	AA1	CR1000-138-A02-7	626	CKC2

**Stock Order - IC Cylinder**

Quantity	Cylinder	Finish
20	CR1080	626

**Contract/Detailed Order - IC Cylinder**

Quantity	Keyset	Cylinder	Finish	Misc.Option
4	AF3	CR1080-112-A04-7	606	CKC2

## Keyway Availability

Corbin Russwin keyways are separated into categories known as **Key Classes**, based on blade width and bitting dimensions. **Certain key blanks and cylinders are not available for certain key classes**, and notes to that effect appear in the catalog and price book. If you find a keyway exclusion notice and do not know the class of the keyway you need, refer to the list below.

Some keyways listed here are *inactive*. They remain available to support existing systems, but no *new systems* are generated on them.

Keyway	Remarks
26	Discontinued
27 Series	X Class (28 and 29 are inactive)
57 Series	X Class
59 Series	Z Class
60	Z Class
67 Series	X Class (68 and 69 are inactive)
70	Z Class
77 Series	X Class (77 and 78 are inactive)
97 and 99	X Class
252	852 Class (inactive)
752	752 Class (inactive)
852	852 Class (inactive)
981, 982, 983	981 Class (inactive)
A1 thru A24	A Class (inactive)
Access 3	Access 3
AR, BR, BL	X Class
D1 thru D4	DH Class
G	852 Class (inactive)
H1 thru H8	DH Class
L1 thru L4	Z Class (L2 formerly CCL)
N1 thru N28	N Class (inactive)
Pyramid	Pyramid
Protected	DH or Z Class
Restricted	DH or Z Class
Best	Best keyways for SFIC

## Keyway Name Changes

All Multiplex Keyways using letters with numbers are now standardized to have the letter first and number last. Also, keyway designation will no longer include the number of pins. K and Z designations are being replaced by the more common N and A Series, respectively. 960 and 970 Series are replaced by the more common 980 Series. Only the following Russwin® older keyways are affected:

Old Designation	Pins	New Designation
1N thru 28N	6	N1 thru N28
1K thru 28K	5 or 7	N1 thru N28
1A thru 24A	5	A1 thru A24
1Z thru 24Z	6	A1 thru A24
961, 962, 963	6	981, 982, 983
971, 972, 973	7	981, 982, 983

Category	Description	Price
Stock L4	Keyway used for stock orders and limited keying systems.	No Charge
Standard (see list at left)	Keyways in general use for keying systems.	No Charge
Restricted (not published)	Selective keyways for use in new and existing keying systems.	No Charge
Protected	Notice of Acceptance showing facilities name, address and contact information must be submitted to key records before orders can be processed. Key system administration approval required prior to processing of order.	No Charge
Pyramid	One of Corbin Russwin's line of high security cylinders	See Pyramid pages 42-47
Security	Old Emhart®/Security cylinders.	For existing systems only
Access 3	Corbin Russwin's highest level of key control.	See Access 3 pages 36-41

**Key Systems Security Policy**

The purpose of this security policy is to enforce our policies Access 3, Pyramid, Security, Protected & Restricted keyway product, including key system information.

No master key system information or security related product is to be given or sold to anyone other than the facility owner through written correspondence. Verification must be submitted (fax copy will be acceptable) to Key Systems Administration. The verification must be on the facility's letterhead and signed by a facility authorized systems administrator. Key Systems Administration does not maintain "Letters of Authorization" on file. Each order must be accompanied by proper authorization. Only after the authorization has been verified will the order be processed for production.

Also includes:

- Bitting information (even one bitting, absolutely no top-level master keys)
- Bitting lists (all formats; i.e., hard copy, disc)
- Key blanks and systems components for Access 3, Pyramid, protected and security cylinder systems.

Please note:

- No orders are to be processed through Key Systems Administration without proper authorization.
- Only orders with appropriate authorization attached will be given priority.
- Requests for systems information without proper authorization from the owner will be denied.
- Requests for information regarding the purchase of any systems support products as listed above will be referred to the local authorized sales agency.
- Refer to the current price lists for additional policies and procedures as they relate to this security policy.

Remember:

The purpose for the establishment of any security system is to provide an increased level of protection for the Facility owner.

## Construction Core Program

### How To Order

Use Quick Code CT6 for 6-PIN LFIC, CT7 for 7-PIN LFIC, CT6SB for 6-PIN SFIC, CT7SB for 7-PIN SFIC, and CTP for Access 3, Pyramid IC products. Use a separate purchase order or line item to order the permanent systems' core.

### Cut Keys

Specify the required number of change keys and control keys on the order. Two control keys are provided at no charge. Two change keys are provided at no charge for the first 20 units ordered. One additional change key is provided for every 10 additional units at no charge.

Examples: 25 units provide 2 operating keys; 30 units provide 3; 100 units provide 10. Additional keys will be invoiced at the prevailing cut key price.

### How To Return Cores

Contact your Customer Service Representative for a Returned Goods Authorization.

Provide the factory order number and year of the original order. Credit is issued for all cores returned in good operating condition, based on the price of a standard 6- or 7-pin core at the time of the original order. Applicable discounts to the original unit are applied to the returned core.

Current pricing is as follows:	Price
6-PIN CONSTRUCTION CORE: (e.g. CR8000-CT6) returned for credit	\$91.00
7-PIN CONSTRUCTION CORE: (e.g. CR8000-CT7) returned for credit	\$93.00

## How To Price

Use Quick Code charts in lockset and exit device price sections.

1 ea. Lockset	ML2051 NSA 626	\$1,169.00	List Price
x Construction Core	CTP	\$91.00	List Price
		\$1,260.00	Subtotal
	Less 50/25% discount	\$472.50	Subtotal Net Price
1 ea. Pyramid Permanent Core	CR8027 x 626	\$159.00	List Price
	Less 50% discount	\$79.50	Net Price
		\$552.00	Subtotal Net Price
Return Construction Core	CR8000 Construction Core	\$91.00	List Price
	Less 50/25% discount	\$34.13	(Credit - RGA from factory)
		\$517.88	Your Total Cost

**Cylinders for Competitor Products:**

CORBIN RUSSWIN cylinders or cores for use in non-CORBIN RUSSWIN manufactured locking devices for which CORBIN RUSSWIN has an equivalent, will be assessed an additional Cylinder Service Fee. This fee applies to masterkeyed cylinder only orders, 1 bitted high security cylinders and zero or 1 bitted restricted cylinder orders.

### Keying

Description	Specify Quick Code	Add or Deduct
Keyed random <sup>3</sup>	KR	No Charge
Masterkey Service Fee. Applies to cylinders not being installed in Assa Abloy products		Consult Factory
Master keyed (all cylinders except CR8000, CR8020, CR8200, CR8027, CR8500, CR8600, CR8700 IC Cores)	specify keyset	Add \$16.00 per cylinder
Master keyed Pyramid (except CR8020, CR8027 IC Core)	specify keyset	Add \$16.00 per cylinder
Master keyed Access 3 (except CR8500, CR8600, CR8700 IC Core)	specify keyset	Add \$16.00 per cylinder
Master keyed Security (including IC cylinder and core)	specify keyset	Add \$16.00 per cylinder
Master keyed (CR8000, CR8020, CR8027, CR8200, CR8500, CR8600, CR8700 IC Cores)	specify keyset	No Charge
Master keyed to customer bittings or sample key	specify keyset	Add \$16.00 per cylinder
Construction master keyed <sup>1,2</sup>	CMK	Add \$16.00 per cylinder
Temporary Construction core, 6-pin LFIC (Red, Blue or Green) including Access 3 AP & AS	CT6R, CT6B, CT6G	No Charge
Temporary Construction core, 7-pin LFIC (Red, Blue or Green)	CT7R, CT7B, CT7G	No Charge
Temporary Construction core, 6-pin SFIC (Blue)	CT6SB	No Charge
Temporary Construction core, 7-pin SFIC (Blue)	CT7SB	No Charge
Temporary Construction core, 6-pin (Red, Blue or Green) Access 3 AHS	CT6AHR, CT6AHB, CT6AHG	No Charge
Temporary Construction core, Access 3 Pyramid	CTP	No Charge
Temporary Disposable core <sup>6</sup>	CT6D, CT7D, CTPD	No Charge
Small Format Temporary Disposable Cores <sup>6</sup>	CTSD	No Charge
Uncombined (Access 3, Pyramid, Security fixed and IC core) <sup>7</sup>	UC	Deduct \$8.00
Uncombined (conventional CR8000 IC core) <sup>7</sup>	UC	Deduct \$2.00
Bump-Resistant Cylinder	BRP	Add \$25.00 per cylinder
More than 2 keys per lock	KY# (e.g., KY6)	See Cut Keys Section Below
For keys packed separately (Indicate appropriate "ship to" address on keying cover sheet)		Add \$4.00 per cylinder

### Stamping

Visual key control (VKC)		
- No stamping	VKC0	\$4.50
- Keys only	VKC1	No Charge
- Cylinders and Keys <sup>4</sup>	VKC2	\$8.00
- Cylinders only <sup>4</sup>	VKC3	\$8.00
Concealed key control (CKC)		
- CKC cylinders with VKC keys	CKC2	\$8.00
- CKC cylinders only <sup>4</sup>	CKC3	\$8.00
DO NOT DUPLICATE	Order by number	See pages 34-35
End user custom die stamps* for key bows		\$4.00
Other stamping on keys or cylinders (Up to 7 characters on cylinders)		\$3.00 per character

\* For development of custom key stamp add one-time charge of \$840.00. Die is property of Corbin Russwin.

### Cut Keys

	Conventional Keyway <sup>5</sup> Restricted Keyway		Protected Keyway		SFIC Keys	Security Keys	Pyramid Keys	Access 3		
	10 Series Bow	50 Series Bow	10 Series Bow	50 Series Bow	KB42 or KB43	KB90 or KB92	KB28	AP	AS	AHS
Extra cut change keys with lockset/cylinder	\$6.00	\$6.50	\$7.00	\$7.40	\$9.90	\$22.20	\$11.70	\$5.90	\$11.70	\$11.70
Cut change keys without lockset/cylinder	\$12.50	\$13.00	\$13.50	\$13.90	\$9.90	\$22.20	\$17.00	\$12.50	\$18.30	\$18.30
Cut master keys (all levels) and control keys with or without lockset/cylinder	\$12.50	\$13.00	\$13.50	\$13.90	\$9.90	\$22.20	\$17.00	\$12.50	\$18.30	\$18.30
Cut construction master keys with or without lockset/cylinder	\$12.50	\$13.00	\$13.50	\$13.90	N/A	N/A	N/A	\$12.50	\$18.30	N/A

Cut Change/Control keys for temporary cores with or without lockset/cylinder (Conventional Keyway 10 series only & SFIC KB42 only carry pricing. All other N/A)

Note: Two (2) cut change keys are provided per lockset or cylinder at no charge. Keyblanks cannot be substituted for cut keys.

For keys with bows other than 10 and 90, specify "KB" + number as Quick Code, e.g. KB12. KB92 cannot be furnished with VKC or other markings. Cylinders pinned directly to GMK or MK level keys do not include cut keys. Please order GMK and MK keys separately.

Notes:

1. CMK Construction master keying charge is in addition to master keying charge.
2. CMK Construction master keying is not available in interchangeable core, Access 3, Pyramid, or Security series.
3. Access 3 and Pyramid series is not available keyed random or 0-bitting. All LFIC and SFIC cylinders unavailable keyed random.
4. VKC2, VKC3 is not available in Access 3, Pyramid or Security series.
5. Conventional cut change keys are furnished standard with key section, system type and bitting number.
6. Disposable cores ordered separately - \$49.00 per set. Sold in multiples of 10 sets.
7. Keys, springs, and spring covers not included.

Presentation Keys		Price
Specify:	Key Symbol; Plating (nickel is standard); Stamping; Bow, if available for key class	
Standard Bow:	51 for all except below	
	90 for Security series	Nickel Plated \$123.00
	10 for 6PIN 852 & A Class keys	Gold Plated \$236.00

## Bitting Lists

A letter of authorization from the end user is required to release a copy of the bitting lists for a factory established system. To protect the security of keying systems, bitting lists will only be sent to the end user or his designated agent, via Certified Mail Return Receipt Requested or UPS AOD. Copies will not be transmitted via fax. The complete name and address where the bitting list is to be sent must be indicated on the letter of authorization and on the purchase order.

Master key system bitting lists will not be created by Corbin Russwin Key Systems Administration unless the request is accompanied by an order for factory keyed product. Corbin Russwin releases all liabilities for cylinders not pinned to factory master key systems.

Number of Bittings	Price
1-50	\$223.00
51-200	\$341.00
201-1000	\$456.00
1001-3000	\$574.00
3001-6000*	\$672.00
6001-9000*	\$997.00
Over 9000*	Consult Key Systems Administration

\*Lead times may vary; consult Key Systems Administration

**NOTE:** Bitting Lists requested for keysets ordered with factory keyed product for either a new or existing system will be provided at no charge, except when KeyWizard® software requested. For existing system pricing above will apply. For new system see page 33

- Additional Bittings or P.O.'s for Bitting Lists Only – **EXISTING MASTER KEY GROUPS**  
Up to 10 **total** for keysets tied to **existing** master key groups will be provided at no charge  
11 or more bittings will be charged per above chart
- Additional Bittings or P.O.'s for Bitting Lists Only – **NEW MASTER KEY GROUPS**  
Regardless of the quantity being requested, will be charged per above chart

These prices are for a hierarchical Master Key system with no cross-keying of selected keys.  
For special requirements or for systems prior to 1999, consult Key Systems Administration for a quote.

Corbin Russwin releases all liabilities for cylinders not pinned to factory master key systems.

### Cylinders for Competitor Products:

CORBIN RUSSWIN cylinders or cores for use in non-CORBIN RUSSWIN manufactured locking devices for which CORBIN RUSSWIN has an equivalent, will be assessed an additional Cylinder Service Fee. This fee applies to masterkeyed cylinder only orders, 1 bitted high security cylinders and zero or 1 bitted restricted cylinder orders.



<b>Key Management Software</b>		<b>Price</b>
Key Wizard® – Special online ordering procedures accessible via the ASSA ABLOY Door Security Solutions Extranet ( <a href="http://www.assaabloydss.com">www.assaabloydss.com</a> ) - contact customer service for more information.		
Single Version – Order part number 68092		\$1,474.00
Network Version – Order part number 68093		\$1,732.00
Upgrade from Single Version to Network Version - Order part number 68095		\$889.00
Corbin Russwin factory key system formatted for importing to KeyWizard®. For existing systems, see Bitting Lists pricing on page 32. Note: Not available for key systems established prior to 1999. May not be available for systems since 1999. Consult Key Systems Administration for eligibility of system.		\$682.00
<b>Key Systems Administration</b>		<b>Price</b>
Customer bittings and sample keys 1,2,3,4,5		Add \$16.00 per cylinder
<p>Notes:</p> <ol style="list-style-type: none"> <li>1. This charge is for keying to customer supplied bittings only.</li> <li>2. All cylinders requested to be keyed to combinations not supplied by Corbin Russwin will be subject to this charge.</li> <li>3. Corbin Russwin releases all liabilities, including key interchange, to systems generated by customer-supplied bittings and/or sample keys that are supplied by others.</li> <li>4. Purchase orders with customer-supplied bittings or sample keys not meeting Corbin Russwin's specifications will be processed 0-bitted in the specified keyway and exempt from upcharge.</li> <li>5. Master keying or CMK charges not included.</li> </ol> <p><b>Disclaimer</b> Corbin Russwin reserves the right to release total liability of any factory generated master key system which incorporates cross keying, both controlled and uncontrolled. A master key system incorporating cross keying yields less security and jeopardizes system expansion.</p> <p><b>Controlled Cross Keying:</b> A condition in which two or more different keys of the same level of keying and under the same higher level</p>		
Cross Keying		No Charge
<p>key(s) operate one cylinder by design; e.g., XAA1 operated by AA2.</p> <p><b>Uncontrolled Cross Keying:</b> A condition in which two or more different keys under different higher-level keys operate one cylinder by design; e.g., XAA1 operated by AB, AB1.</p>		

**Stamping Key Section on Key Blanks**

Key blanks are furnished standard with no key section ID. When so specified, key blanks can be stamped with the key section at no charge.  
The minimum quantity for this service is a box of 50 key blanks

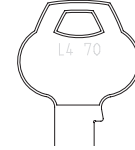
**Standard Bow, Nickel Silver (Order in multiples of 50)**

Coined Logo	Plain Both Sides	DO NOT DUPLICATE	US PROPERTY DO NOT DUPLICATE	RESTRICTED DO NOT DUPLICATE	Price Each		
					Standard Single Section	Restricted Single Section	Standard and Restricted Multi-Section**
(X1, Z1, R)*	(X4, Z4, P)*	(X5, Z5, P5)*	(X6, Z6, P6)*				
xx-5PIN-10	xx-5PIN-11	xx-5PIN-12	xx-5PIN-13	xx-5PIN-19	\$2.50	\$2.65	\$2.80
xx-6PIN-10	xx-6PIN-11	xx-6PIN-12	xx-6PIN-13	xx-6PIN-19			
xx-7PIN-10	xx-7PIN-11	xx-7PIN-12	xx-7PIN-13	xx-7PIN-19	\$2.57	\$2.72	\$2.82

\*(Old Reference)

\*\*Multi-section keys enter more than one keyway; eg. D12, H41, 2852, 9812, 59A, 57AD, 067, etc.

<sup>1</sup> Protected keyway keys will be stamped "Restricted"

**Pyramid (Available in quantities of 10, 25, 50 and multiples of 50)**

Standard bow furnished for all Pyramid Keys.



Key Blank Number	Description	Price Each
XX-7PIN-28	Single section	\$8.50
	Multi-section	\$15.90

**Access 3**

Key Blank Number	Description	Price Each
6PIN-38-AP	Standard key blanks for AP cylinders	\$4.40
6PIN-38-AS	Standard key blanks for AS & AHS cylinders	\$8.50

**Security Bow No other shape for security keys. (Order in multiples of 50)**

Not Available for 252, 752, 852, A, N, or X Class keys.

Inactive, for existing systems only.



Coined Logo	Plain Both Sides	DO NOT DUPLICATE	US PROPERTY DO NOT DUPLICATE	RESTRICTED DO NOT DUPLICATE	Price Each
xx-6PIN-90	xx-6PIN-91	xx-6PIN-92	xx-6PIN-93	xx-6PIN-99	\$8.50
xx-7PIN-90 for hotel EMK					\$10.70

**Large Bows (Order in multiples of 50)**

Large Not Available for 252, 752, 852 or A Class keys.

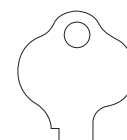

Plain Both Sides	DO NOT DUPLICATE	US PROPERTY DO NOT DUPLICATE	RESTRICTED DO NOT DUPLICATE	Price Each	PROTECTED DO NOT DUPLICATE	Price Each
(Y4 and S)	(Y5 and S5)	(Y6 and S6)				
xx-5PIN-51	xx-5PIN-52	xx-5PIN-53	xx-5PIN-59	\$4.00	xx-5PIN-59	\$6.00
xx-6PIN-51	xx-6PIN-52	xx-6PIN-53	xx-6PIN-59		xx-6PIN-59	
xx-7PIN-51	xx-7PIN-52	xx-7PIN-53	xx-7PIN-59		xx-7PIN-59	

**SFIC Key Blanks**

Description	Key Number	Price Each
Duplication Prohibited 6-Pin Key	6PIN-42-KB	\$3.20
Duplication Prohibited 7-Pin Key	7PIN-42-KB	\$3.20
US Property Do Not Duplicate 6-Pin Key	6PIN-43-KB	\$3.20
US Property Do Not Duplicate 7-Pin Key	7PIN-43-KB	\$3.20

**Emergency Key Blanks for Hotel Function Access 3 Cylinder**

Description	Key Number	Price Each
Emergency key for mortise AP cylinders	6PIN-38-E2-AP	\$6.10
Emergency key for mortise AS & AHS cylinders	6PIN-38-E2-AS	\$8.70
Emergency key for key-in lever AP cylinders	6PIN-38-E6-AP	\$6.10
Emergency key for key-in lever AS & AHS cylinders	6PIN-38-E2-AS	\$8.70

**Emergency Master Key Blanks for Hotel Function Cylinder (Order in multiples of 10)**

Non-IC mortise cylinder use 7PIN blanks, as already listed: xx-7PIN-51 & xx-7PIN-90. (Order in multiples of 50)

Not Available for 252, 752, 852 or A Class keys.



Lockset	EMK Blank	Price Each
IC Mortise	xx-6PIN-51-E1	\$6.10
IC Mortise, Security	xx-6PIN-90-E1	\$8.30
CK4229, including IC; CK4429	xx-6PIN-51-E4	\$6.10
CK4229 Security, Including IC	xx-6PIN-90-E4	\$8.30
CL3329, CL3429, CL3629 6PIN, Including IC	xx-6PIN-51-E8	\$6.10
CL3329, CL3429, CL3629 7PIN, Including IC	xx-7PIN-51-E8	\$6.10
1400/4300 and 5600/3300 Series	xx-6PIN-51-E5	\$7.10

### Mortise Cylinder

Cylinder Number	Description	605, 606, 611, 612, 613, 613E, 618, 619, 622, 625, 626, 629, 630, 722, BSP, WSP
CR1500-114	ML2000 Series mortise locks (including electrified and EAC devices) DL3000 and DL4100 deadlocks ED5600, ED6600 and ED7600 exit devices All ED5000 cylinder dogging, alarm units, delayed egress cylinders	\$105.00
CR1500-138		
CR1500-112		
CR1500-134		
CR1501-114-A01	AP Hotel Mortise Cylinder	\$141.00

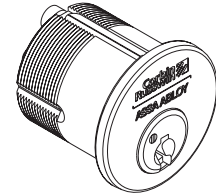

### Rim Cylinder

Cylinder Number	Description	605, 606, 611, 612, 613, 613E, 618, 619, 622, 625, 626, 629, 630, 722, BSP, WSP
CR3500-058	5/8" tailpiece	\$105.00
CR3500-138	1-3/8" M61 & M62 option for ED8200 and obsolete ED9200 exit device alarms; ED5202(A) inside cylinder	
CR3500-200	2" tailpiece	
CR3500-200N	2" ED4000/ED5000 night latch function	
CR3500-200V	2" vertical tailpiece	\$107.00
CR3500-312	3-1/2" tailpiece	
CR3500-312V	3-1/2" vertical tailpiece	

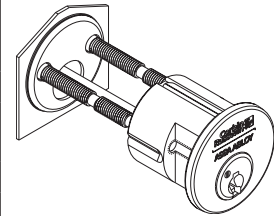

### AP LFIC - Mortise Cylinder

Cylinder Number	Description	605, 606, 611, 612, 613, 613E, 618, 619, 622, 625, 626, 629, 630, 722, BSP, WSP
CR1580-114	ML2000 Series mortise locks (including electrified and EAC devices) DL3000 and DL4100 deadlocks ED5600, ED6600 and ED7600 exit devices All ED5000 cylinder dogging, alarm units, delayed egress cylinders	\$196.00
CR1580-138		\$199.00
CR1580-112		\$207.00
CR1580-134		\$207.00

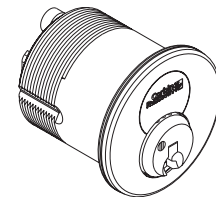

### AP LFIC - Rim Cylinder

Cylinder Number	Description	605, 606, 611, 612, 613, 613E, 618, 619, 622, 625, 626, 629, 630, 722, BSP, WSP
CR3580-058	5/8" tailpiece	\$196.00
CR3580-114	1-1/4" M61 & M62 option for ED8200 and ED9200 exit device alarms	
CR3580-178	1-7/8" tailpiece	
CR3580-178V	1-7/8" vertical tailpiece	
CR3580-318	3-1/8" tailpiece	\$198.00

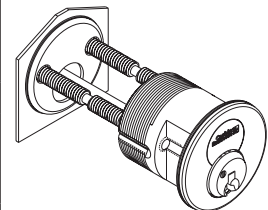

\*LFIC Cores are provided in 606, 626 or BSP finish only.

### AP LFIC Core

Cylinder Number	Description	Finish: 606, 626
CR8500	All Corbin Russwin LFIC cylinders	\$91.00

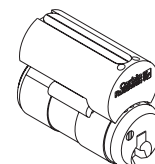

### AP Fixed Core Component Cylinder

Cylinder Number	Description	Finish: 606, 626
CR2500-031	CL3100 Series Vandal Resistant, CK4300 Knob	\$98.00
CR2500-033	CL3300, CL3500, CL3600 (June 2000 and after), CL3800, Lever Trim - A6/N6/PR6	
CR2500-033H	G10 Exit Device Knob Trim	
CR2500-037	CL3700 Lever, CK4700 Knob	
CR2500-039	CL3900	
CR2500-039L	CL3900 Lever (2" and 2-1/4" Thick Door)	
CR2500-044	CK4400	
CR2500-052	CK4200/UT5200	

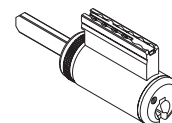

### AP Fixed Core Deadlock Cylinder

Cylinder Number	Description	Finish: 606, 626
CR4500-134-A51	DL2200/DL3200 Series	\$98.00
CR4500-134-A52		
CR4500-214-A52		

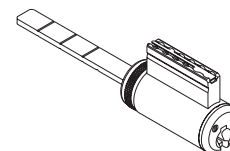

### AP Fixed Core Hotel Cylinder

Cylinder Number	Description	Finish: 606, 626
CR2501-031	CL3100 Series Vandal Resistant	\$112.00
CR2501-034	CL3300	

### AS Fixed Core - Mortise Cylinder

Cylinder Number	Description	605, 606, 611, 612, 613, 613E, 618, 619, 622, 625, 626, 629, 630, 722, BSP, WSP
CR1600-114	ML2000 Series mortise locks (including electrified and EAC devices)	\$161.00
CR1600-138	DL3000 and DL4100 deadlocks	
CR1600-112	ED5600, ED6600 and ED7600 exit devices	\$171.00
CR1600-134	All ED5000 cylinder dogging, alarm units, delayed egress cylinders	

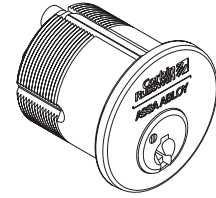

### AS Fixed Core - Rim Cylinder

Cylinder Number	Description	605, 606, 611, 612, 613, 613E, 618, 619, 622, 625, 626, 629, 630, 722, BSP, WSP
CR3600-058	5/8" tailpiece	\$161.00
CR3600-138	1-3/8" M61 & M62 option for ED8200 and obsolete ED9200 exit device alarms; ED5202(A) inside cylinder	
CR3600-200	2" tailpiece	
CR3600-200N	2" night latch function	
CR3600-200V	2" vertical tailpiece	
CR3600-312	3-1/2" tailpiece	\$163.00
CR3600-312V	3-1/2" vertical tailpiece	

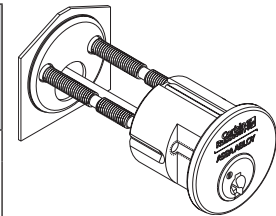

### AS LFIC - Mortise Cylinder

Cylinder Number	Description	605, 606, 611, 612, 613, 613E, 618, 619, 622, 625, 626, 629, 630, 722, BSP, WSP
CR1680-114	ML2000 Series mortise locks (including electrified and EAC devices)	\$252.00
CR1680-138	DL3000 and DL4100 deadlocks	\$255.00
CR1680-112	ED5600, ED6600 and ED7600 exit devices	
CR1680-134	All ED5000 cylinder dogging, alarm units, delayed egress cylinders	\$263.00

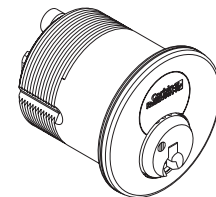

### AS LFIC - Rim Cylinder

Cylinder Number	Description	605, 606, 611, 612, 613, 613E, 618, 619, 622, 625, 626, 629, 630, 722, BSP, WSP
CR3680-058	5/8" tailpiece	\$252.00
CR3680-114	1-1/4" M61 & M62 option for ED8200 and ED9200 exit device alarms	
CR3680-178	1-7/8" tailpiece	
CR3680-178V	1-7/8" vertical tailpiece	
CR3680-318	3-1/8" tailpiece	
		\$254.00

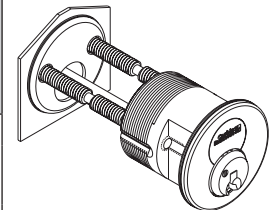

\*LFIC Cores are provided in 606, 626 or BSP finish only.

### AS LFIC Core

Cylinder Number	Description	Finish: 606, 626
CR8600	All Corbin Russwin LFIC Cylinders	\$147.00

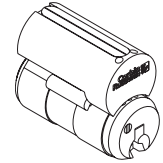

### AS Fixed Core Component Cylinder

Cylinder Number	Description	Finish: 606, 626
CR2600-031	CL3100 Series Vandal Resistant, CK4300 Knob	\$154.00
CR2600-033	CL3300, CL3500, CL3600 (June 2000 and after), CL3800, Lever Trim - A6/N6/PR6	
CR2600-033H	G10 Exit Device Knob Trim	
CR2600-037	CL3700 Lever, CK4700 Knob	
CR2600-039	CL3900	
CR2600-039L	CL3900 Lever (2" and 2-1/4" Thick Door)	
CR2600-044	CK4400	
CR2600-052	CK4200/UT5200	

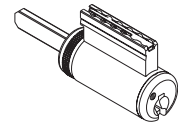

### AS Fixed Core Deadlock Cylinder

Cylinder Number	Description	Finish: 606, 626
CR4600-134-A51	DL2200/DL3200 Series	\$154.00
CR4600-134-A52		
CR4600-214-A52		

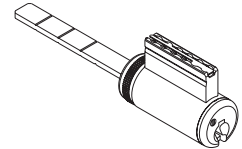

### AS Fixed Core Hotel Cylinder

Cylinder Number	Description	Finish: 606, 626
CR2601-031	CL3100 Series Vandal Resistant	\$168.00
CR2601-034	CL3300	

**AHS Fixed Core - Mortise Cylinder**

Cylinder Number	Description	605, 606, 611, 612, 613, 613E, 618, 619, 622, 625, 626, 629, 630, 722, BSP, WSP
CR1700-114	ML2000 Series mortise locks (including electrified and EAC devices)	\$184.00
CR1700-138	DL3000 and DL4100 deadlocks	
CR1700-112	ED5600, ED6600 and ED7600 exit devices	\$194.00
CR1700-134	All ED5000 cylinder dogging, alarm units, delayed egress cylinders	

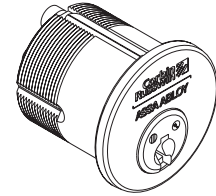

**AHS Fixed Core - Rim Cylinder**

Cylinder Number	Description	605, 606, 611, 612, 613, 613E, 618, 619, 622, 625, 626, 629, 630, 722, BSP, WSP
CR3700-058	5/8" tailpiece	\$184.00
CR3700-138	1-3/8" M61 & M62 option for ED8200 and obsolete ED9200 exit device alarms; ED5202(A) inside cylinder	
CR3700-200	2" tailpiece	
CR3700-200N	2" night latch function	
CR3700-200V	2" vertical tailpiece	\$186.00
CR3700-312	3-1/2" tailpiece	
CR3700-312V	3-1/2" vertical tailpiece	

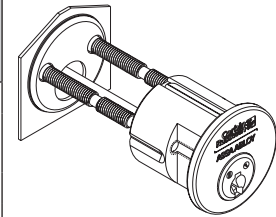

**AHS LFIC - Mortise Cylinder**

Cylinder Number	Description	605, 606, 611, 612, 613, 613E, 618, 619, 622, 625, 626, 629, 630, 722, BSP, WSP
CR1788-114	ML2000 Series mortise locks (including electrified and EAC devices)	\$274.00
CR1788-138	DL3000 and DL4100 deadlocks	\$277.00
CR1788-112	ED5600, ED6600 and ED7600 exit devices	
CR1788-134	All ED5000 cylinder dogging, alarm units, delayed egress cylinders	\$285.00

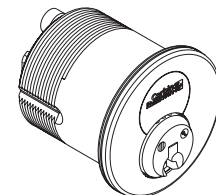

**AHS LFIC - Rim Cylinder**

Cylinder Number	Description	605, 606, 611, 612, 613, 613E, 618, 619, 622, 625, 626, 629, 630, 722, BSP, WSP
CR3788-058	5/8" tailpiece	\$274.00
CR3788-114	1-1/4" M61 & M62 option for ED8200 and ED9200 exit device alarms	
CR3788-178	1-7/8" tailpiece	
CR3788-178V	1-7/8" vertical tailpiece	
CR3788-318	3-1/8" tailpiece	\$276.00

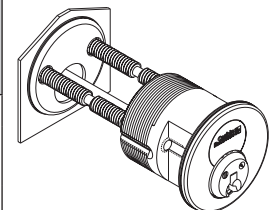

\*LFIC Cores are provided in 606, 626 or BSP finish only.



### AHS LFIC Core

Cylinder Number	Description	Finish: 606, 626
CR8700	All Corbin Russwin LFIC cylinders	\$169.00

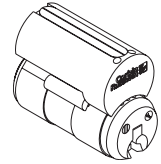

### AHS Fixed Core Component Cylinder

Cylinder Number	Description	Finish: 606, 626
CR2700-031	CL3100 Series Vandal Resistant, CK4300 Knob	\$177.00
CR2700-033	CL3300, CL3500, CL3600 (June 2000 and after), CL3800, Lever Trim - A6/N6/PR6	
CR2700-033H	G10 Exit Device Knob Trim	
CR2700-037	CL3700 Lever, CK4700 Knob	
CR2700-039	CL3900	
CR2700-039L	CL3900 Lever (2" and 2-1/4" Thick Door)	
CR2700-044	CK4400	
CR2700-052	CK4200/UT5200	

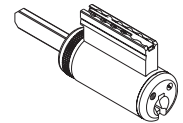

### AHS Fixed Core Hotel Cylinder

Cylinder Number	Description	Finish: 606, 626
CR2701-031	CL3100 Series Vandal Resistant	\$191.00
CR2701-034	CL3300	

### AHS Fixed Core Deadlock Cylinder

Cylinder Number	Description	Finish: 606, 626
CR4700-134-A51	DL2200/3200 Series	\$177.00
CR4700-134-A52		
CR4700-214-A52		

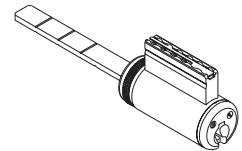

### UL LFIC 6-Pin Mortise Housing

Cylinder Number	Description	605, 606, 611, 612, 613, 613E, 618, 619, 622, 625, 626, 629, 630, 722, BSP, WSP
CR1078-114	ML2000 Series mortise locks (including electrified and EAC devices)	\$105.00
CR1078-138	DL3000 and DL4100 deadlocks	\$108.00
CR1078-112	ED5600, ED6600 and ED7600 exit devices	
CR1078-134	All ED5000 cylinder dogging, alarm units, delayed egress cylinders	\$116.00

### UL LFIC 6-Pin Rim Housing

Cylinder Number	Description	605, 606, 611, 612, 613, 613E, 618, 619, 622, 625, 626, 629, 630, 722, BSP, WSP
CR3078-058	5/8" tailpiece	\$105.00
CR3078-114	1-1/4" M61 & M62 option for ED8200 and ED9200 exit device alarms	
CR3078-178	1-7/8" tailpiece	
CR3078-178V	1-7/8" vertical tailpiece	
CR3078-318	3-1/8" tailpiece	

**Fixed Core Mortise**

7-Pin - No Cross Keying - Furnished standard with 610502 solid recessed collar unless otherwise indicated.  
High Security UL437 Listed.

**Cylinder Number Example**

To simplify ordering, options designated "standard" may be omitted from the ordering sequence.

**CR1020 - 114 - A01 - 626**

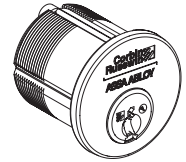

Length		Cam	Finish	
114	(1-1/4")	A01	605	622
		A02	606	625
112	(1-1/2")	A03	611	626
		A04	612	629
		A05	613	630
		A06 <sup>2</sup>	613E	722
		A07	618	BSP
		A62	619	WSP
		A92		
		A93 <sup>1</sup>		
Cylinder No.			Price	
CR1020-114			\$215.00	

- Notes: 1. Add \$2.00 per cylinder for A93 cam
- 2. Add \$5.00 per cylinder for A06 cam

**Fixed Core Rim**

7-Pin - No Cross Keying - Furnished standard with 422F88 surface mount collar unless otherwise indicated.  
High Security UL437 Listed.

**Cylinder Number Example**

**CR3020 - 200 - 626**

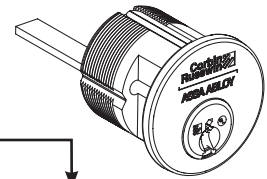

Tailpiece Length	Finish	
058 - 5/8"	605	622
138 - 1-3/8" M61 & M62 option for ED8200 and obsolete ED9200 exit device alarms	606	625
200 - 2"	611	626
200N - 2" ED4000/ED5000 Night Latch Function	612	629
200V - 2" vertical	613	630
312 - 3-1/2"	613E	722
312V - 3-1/2" vertical	618	BSP
	619	WSP
Cylinder Number	Price	
CR3020 - _____	\$215.00	

**Key-In-Lever/Knob**

7-Pin - No Cross Keying

**High Security UL437 Listed**

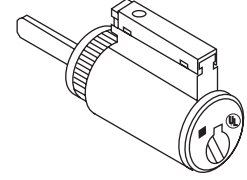

Cylinder Number	Used for	Finish: 606, 626
CR2020-031	CL3100 Lever, CK4300 Knob	\$204.00
CR2020-033	CL3300, CL3500, CL3800 [CL3600 (June 2000 and after)], A6, N6, PR6 Exit device trim	
CR2020-033H	G10 Exit device trim	
CR2020-034	CL3400, [CL3600 (prior to June 2000)], A5, N5 obsolete ED8000 trims	
CR2020-037	CL3700 Lever, CK4700 Knob	
CR2020-038	CL3800 Lever	
CR2020-039	CL3900 Lever	
CR2020-039L	CL3900 Lever (2" - 2-1/4" door)	
CR2020-051	G3 Exit Device Knob Trim	
CR2020-052	CK4200 Knob, UT5200 Knob and Lever	
CR4420-134-A51	DL2200, DL3200 Cylindrical Deadlock	
CR4420-134-A52	DL2200, DL3200 Cylindrical Deadlock	
CR4420-214-A52	DL2200, DL3200 Cylindrical Deadlock	

**Key-In-Lever/Knob**

For Other Manufacturers' Products

**High Security UL437 Listed**

Cylinder Number	Used for	Finish: 606, 626
CR2220-001-P21	Alarm Lock DL2500 Series	\$206.00
	Arrow® H Series Knobs and Levers	
	Arrow Q Series Levers	
	Sargent® 10 line*	
	Schlage® D Series Levers	
CR2220-002-P21	Schlage D Series Knobs	
CR2220-001-P22	Schlage AL and ND Series Levers	
CR2220-002-P22	Schlage A Series Knobs (PLY, etc.)	
CR2220-002-P23	Schlage A Series Knob (ORB only)	

\* When ordered with a 30- prefix, this cylinder is accepted without modification to the lever.

\*LFIC Cores are provided in 606 or 626 finish only.

**IC Mortise**

7-Pin - No Cross Keying - Furnished standard with 610F02 solid recessed collar unless otherwise indicated.

**Cylinder Number Example**

To simplify ordering, options designated "standard" may be omitted from the ordering sequence.

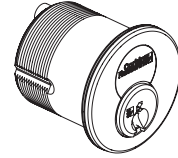

Length		Cam		Finish	
114	1-1/4"	A01	Cloverleaf (standard)	605	622
138	1-3/8"	A02	Straight	606	625
112	1-1/2"	A03	Adams Rite® MS & DL3000	611	626
134	1-3/4"	A04	DL4000 Deadlock	612	629
		A05	Adams Rite® 4070	613	630
		A06 <sup>2</sup>	Schlage® L9000	613E	722
		A07	DL4100 Series Deadlock	618	BSP
		A62	Straight	619	WSP
		A92	Exit Grip 01, 02		
		A93 <sup>1</sup>	For Obsolete Corbin® 610 Series and Russwin® 1403 Series Deadlock		
Cylinder Number				Price	
CR1030-114				\$301.00	

Notes: 1. Add \$2.00 per cylinder for A93 cam.  
2. Add \$5.00 per cylinder for A06 cam.

**IC Rim**

7-Pin - No Cross Keying - Furnished standard with 422F88 surface mount collar unless indicated.

**Cylinder Number Example**

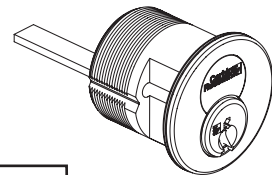

Tailpiece Length	Finish
058 - 5/8"	605 622
	606 625
114 - 1-1/4" M61 & M62 option for ED8200 and ED9200 exit device alarms	611 626
	612 629
178 - 1-7/8"	613 630
	613E 722
178V - 1-7/8" vertical	618 BSP
	619 WSP
Cylinder Number	Price
CR3030-_____	\$301.00

**Pyramid Core Only** – Finish: 606, 626

Cylinder Number	Price
CR8020	\$194.00

Note: For mortise and rim housing only, see page 93.

\*LFIC Cores are provided in 606 or 626 finish only.

**Fixed Core Mortise**

7-Pin - No Cross Keying - Furnished standard with 605F43 spring collar unless otherwise indicated.

**Cylinder Number Example**

To simplify ordering, options designated "standard" may be omitted from the ordering sequence.

**CR1027 - 114 - A01 - 626**



Length	Cam	Finish	
114 (1-1/4")	A01 Cloverleaf (standard)	605	622
112 (1-1/2")	A02 Straight	606	625
	A03 Adams Rite® MS	611	626
	A04 DL4000 Deadlock	612	629
	A05 Adams Rite 4070	613	630
	A06 <sup>2</sup> Schlage® L9000	613E	722
	A07 DL4100 Series Deadlock	618	BSP
	A62 Straight	619	
	A92 Exit Grip O1, O2		
	A93 <sup>1</sup> For Obsolete Corbin® 610 Series and Russwin® 1403 Series Deadlock		

Cylinder Number	Price
CR1027-114	\$179.00

- Notes: 1. Add \$2.00 per cylinder for A93 cam.  
2. Add \$5.00 per cylinder for A06 cam.

**Fixed Core Rim**

7-Pin - No Cross Keying - Furnished standard with 422F88 surface mount collar unless otherwise indicated.

**Cylinder Number Example**

**CR3027 - 200 - 626**

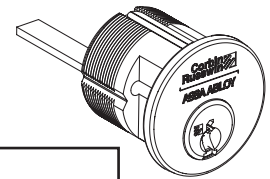

Tailpiece Length	Finish	
058 - 5/8"	605	622
138 - 1-3/8" M61 & M62 option for ED8200 and obsolete ED9200 exit device alarms	606	625
200 - 2"	611	626
200N - 2" ED4000/ED5000 Night Latch Function	612	629
200V - 2" (vertical)	613	630
312 - 3-1/2"	613E	722
312V - 3-1/2" (vertical)	618	BSP
	619	

Cylinder Number	Price
CR3027-_____	\$179.00

**Key-In-Lever/Knob**

7-Pin - No Cross Keying.

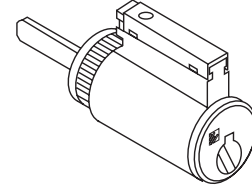

Cylinder Number	Used for	Finish: 606, 626
CR2027-031	CL3100 Lever, CK4300 Knob	\$172.00
CR2027-033	CL3300, CL3500, CL3800 [CL3600 (June 2000 and after)], A6, N6, PR6 Exit Device Trim	
CR2027-033H	G10 Exit device trim	
CR2027-034	CL3400, [CL3600 (before June 2000)], A5, N5 obsolete ED8000 trims	
CR2027-037	CL3700 Lever, CK4700 Knob	
CR2027-038	CL3800 Lever	
CR2027-039	CL3900 Lever	
CR2027-039L	CL3900 Lever (2" - 2-1/4" door)	
CR2027-051	G3 Exit Device Knob Trim	
CR2027-052	CK4200 knob, UT5200 Knob and Lever	
CR4427-134-A51	DL2200, DL3200 Cylindrical Deadlock	
CR4427-134-A52	DL2200, DL3200 Cylindrical Deadlock	
CR4427-214-A52	DL2200, DL3200 Cylindrical Deadlock	

**Key-In-Lever/Knob**

**For Other Manufacturer's Products**

Cylinder Number	Used for	Finish: 606, 626
CR2227-001-P21	Alarm Lock DL2500 Series	\$174.00
	Arrow® H Series Knobs and Levers	
	Arrow Q Series Levers	
	Sargent® 10 line (Enlarge Lever Hole)	
	Schlage® D Series Levers	
CR2227-002-P21	Schlage D Series Knobs	
CR2227-001-P22	Schlage AL and ND Series Levers	
CR2227-002-P22	Schlage A Series Knobs (PLY, etc.)	
CR2227-002-P23	Schlage A Series Knob (ORB only)	

**IC Mortise**

7-Pin - No Cross Keying - Furnished standard with 605F43 spring collar unless otherwise indicated.

**Cylinder Number Example**

To simplify ordering, options designated "standard" may be omitted from the ordering sequence.

**CR1037 - 114 - A01 - 626**

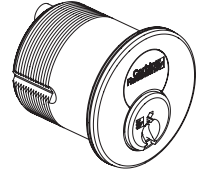

Length	Cam		Finish	
114 1-1/4"	A01	Cloverleaf (standard)	605	622
138 1-3/8"	A02	Straight	606	625
112 1-1/2"	A03	Adams Rite® MS & DL3000	611	626
134 1-3/4"	A04	DL4000 Deadlock	612	629
	A05	Adams Rite® 4070	613	630
	A06 <sup>2</sup>	Schlage® L9000	613E	722
	A07	DL4100 Series Deadlock	618	BSP
	A62	Straight	619	
	A92	Exit Grip 01, 02		
	A93 <sup>1</sup>	For Obsolete Corbin® 610 Series and Russwin® 1403 Series Deadlock		
Cylinder Number			Price	
CR1037-114			\$264.00	

- Notes: 1. Add \$2.00 per cylinder for A93 cam.  
2. Add \$5.00 per cylinder for A06 cam.

**IC Rim**

7-Pin - No Cross Keying - Furnished standard with 422F88 surface mount collar unless otherwise indicated.

**Cylinder Number Example**

**CR3037 - 178 - 626**

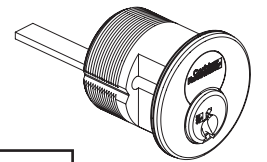

Tailpiece Length	Finish	
058 - 5/8"	605	622
114 - 1-1/4" M61 & M62 option for ED8200 and ED9200 exit device alarms	606	625
178 - 1-7/8"	611	626
	612	629
	613	630
178V - 1-7/8" vertical	613E	722
318 - 3-1/8"	618	BSP
	619	

Cylinder Number	Price
CR3037-_____	\$264.00

**Pyramid Core Only**

Cylinder Number	Price
CR8027	\$159.00

Note: For mortise and rim housing only, see page 93.

**Standard Mortise**

**Cylinder Number Example**

To simplify ordering, options designated "standard" may be omitted from the ordering sequence.

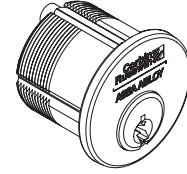

**CR1000 - 118 - A01 - 6 - L4**



Length		Cam		Pins	Keyway
100	1" (5-pin only)	A01	Cloverleaf (standard)	5	L4
118	1-1/8" (standard)	A02	Straight	6 (standard)	(standard)
114	1-1/4"	A03	Adams Rite® MS	7	
138	1-3/8"	A04	DL4000 Deadlock		
112	1-1/2"	A05	Adams Rite 4070		
134	1-3/4"	A06 <sup>2</sup>	Schlage® L9000		
200	2"	A07	DL4100 Series Deadlock		
		A62	Straight		
214	2-1/4"	A92	Exit Grip O1, O2		
212	2-1/2"	A93 <sup>1</sup>	For Obsolete		
234	2-3/4"		Corbin® 610 Series and Russwin®		
300	3"		1403 Series Deadlock		
314	3-1/4"				
312	3-1/2"				
334	3-3/4"				

Cylinder Number	Finish: 605, 606, 611, 612, 613, 613E, 618, 619, 622, 625, 626, 629, 630, 722, BSP, WSP	
	5- OR 6-PIN	7-PIN
CR1000-100-__-5- Keyway	\$105.00	Not Available
CR1000-118-__- Keyway		
CR1000-114-__- Keyway	\$105.00	\$107.00
CR1000-138-__- Keyway		
CR1000-112-__- Keyway	\$115.00	\$117.00
CR1000-134-__- Keyway		
CR1000-200-__- Keyway	\$125.00	\$127.00
CR1000-214-__- Keyway		
CR1000-212-__- Keyway	\$135.00	Not Available
CR1000-234-__- Keyway		
CR1000-300-__- Keyway		
CR1000-314-__- Keyway		
CR1000-312-__- Keyway		
CR1000-334-__- Keyway		

- Notes:  
 1. Add \$2.00 per cylinder for A93 cam.  
 2. Add \$5.00 per cylinder for A06 cam.



**Flexible Head Mortise**

**Cylinder Number Example**

To simplify ordering, options designated "standard" may be omitted from the ordering sequence.

**CR1100 - 118 - A01 - 6 - L4**



Length	Cam	Pins	Keyway
100 1" (6-pin standard)	A01 Cloverleaf (standard)	5	L4
118 1-1/8"	A02 Straight	6 (standard)	(standard)
114 1-1/4"		7	

Cylinder Number	Finish: 605, 606, 611, 612, 613, 613E, 618, 619, 622, 625, 626, 722, BSP, WSP	
	5- OR 6-PIN	7-PIN
CR1100-100-__ - __ - Keyway	\$200.00	Not Available
CR1100-118-__ - __ - Keyway		\$202.00
CR1100-114-__ - __ - Keyway		\$204.00

**Concealed Shell Mortise**

**Cylinder Number Example**

To simplify ordering, options designated "standard" may be omitted from the ordering sequence.

**CR1200 - 118 - A01 - 6 - L4**



Length	Cam	Pins	Keyways
100 1" (5-pin standard)	A01 Cloverleaf (standard)	5	L4
118 1-1/8" (6-pin standard)	A02 Straight	6 (standard)	(standard)
114 1-1/4"		7	
138 1-3/8"			
112 1-1/2"			

Cylinder Number	Finish: 606, 626	
	5- OR 6-PIN	7-PIN
CR1200-100-__ - 5 - Keyway	\$159.00	N/A
CR1200-118-__ - __ - Keyway		
CR1200-114-__ - __ - Keyway		
CR1200-138-__ - __ - Keyway		
CR1200-112-__ - __ - Keyway		\$161.00

## Special Function Mortise

## Hotel Function\* Cylinders

To simplify ordering, you may specify only the first 4 digits (1001, 1101, 1201).

Cylinder Number	Description	605, 606, 611, 612, 613, 613E, 618, 619, 622, 625, 626, 629, 630, 722, BSP, WSP
CR1001-114-A01	Standard	\$155.00
CR1101-118-A01	Flex Head	\$179.00
CR1201-118-A01	Concealed Shell	\$165.00

\* Not available with D1, D2, L1, L2, 752, 852 or A class keyways.

## Cylinder for Discontinued Exit Device

Inside of Corbin® 3726-1/2, 3727-1/2 and Russwin® 736-1/2, 737-1/2

Cylinder Number	605, 606, 611, 612, 613, 613E, 618, 619, 622, 625, 626, 629, 630, 722, BSP, WSP
CR1006-118-A02	\$130.00

## Non-Keyed Mortise

## Thumbturn Cylinders

Cylinder Number	Description	605, 606, 611, 612, 613, 613E, 618, 619, 622, 625, 626, 629, 630, 722, BSP, WSP
CR1300-100-A02	Standard*	\$105.00
CR1300-118-A02		
CR1300-114-A02	Standard*	\$109.00
CR1300-138-A02		
CR1300-100-A03	Standard*	\$105.00
CR1300-118-A03		
CR1300-114-A03	Standard*	\$109.00
CR1300-138-A03		
CR1300-118-A93	Standard*	\$107.00
CR1303-100-A03	Classroom*	
CR1303-118-A03		
CR1303-114-A03	Classroom*	\$111.00
CR1303-138-A03		

## Dummy Cylinders

Cylinder Number	605, 606, 611, 612, 613, 613E, 618, 619, 625, 626, 629, 630, 722, BSP, WSP
CR1400-118	\$90.00
CR1400-114	\$94.00
CR1400-138	\$98.00

## Rim Thumbturn Cylinders

Cylinder Number	605, 606, 611, 612, 613, 613E, 618, 619, 625, 626, 629, 630, 722, BSP, WSP
CR3300 -138	\$98.00
CR3300-138-M34	\$116.00
CR3300-200	\$98.00
CR3300-200-M34	\$116.00

\* All CR1300 and CR1303 are available with M34 Ergonomic Thumbturn.

**Rim (.552 dia. Plug)**

**Cylinder Number Example**

To simplify ordering, options designated "standard" may be omitted from the ordering sequence.

**CR3000 - 200 - 6 - L4**

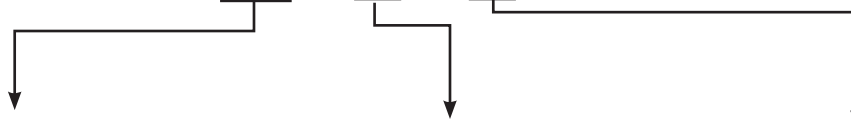
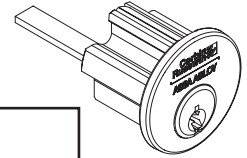

Tailpiece Length	Pins	Keyway
058 5/8"	5	L4 (Standard)
138 1-3/8" M61 & M62 option for ED8200 and obsolete ED9200 Exit Device Alarms	6 (Standard)	
200 2" (Standard)	7	
200N 2" ED4000/ED5000 Night Latch Function		
200V 2" Vertical		
312 3-1/2" (Thick door)		
312 3-1/2" (Thick door) Vertical		

Cylinder No.	605, 606, 611, 612, 613, 613E, 618, 619, 622, 625, 626, 629, 630, 722, BSP, WSP	
	5- OR 6-PIN	7-PIN
CR3000-058 ___ - Keyway	\$105.00	\$107.00
CR3000-138 ___ - Keyway		
CR3000-200- ___ - Keyway		
CR3000-200N- ___ - Keyway		
CR3000-200V- ___ - Keyway		
CR3000-312- ___ - Keyway	\$107.00	\$109.00
CR3000-312V- ___ - Keyway		

## Key-In-Lever/Knob (.509" plug)

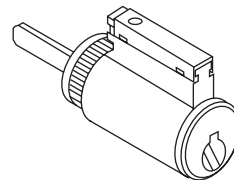

Cylinder Number		Finish: 606, 626, BSP		
		Series	6-PIN	7-PIN <sup>4</sup>
CR2000-031	Standard	CL3100, CK4300	\$98.00	\$100.00
CR2001-031 <sup>1</sup>	Hotel	CL3100	\$112.00	\$114.00
CR2400-031-C <sup>2</sup>	Schlage® C Keyway	CL3100	\$98.00	Not Available
CR2400-031-LA <sup>3</sup>	Sargent® LA Keyway	CL3100		
CR2000-033	Standard	CL3300, CL3500, CL3600, CL3800 <sup>B</sup>		\$100.00
CR2000-038	Standard	CL3800 <sup>A</sup>		
CR2001-034 <sup>1</sup>	Hotel	CL3300		\$112.00
CR2400-033-C <sup>2,5</sup>	Schlage® C keyway	CL3300, CL3500, CL3600, CL3800 <sup>B</sup>	\$98.00	Not Available
CR2400-033-LA <sup>3,5</sup>	Sargent® LA keyway			
CR2000-037	Standard			
CR2400-037-C <sup>2,5</sup>	Schlage® C keyway	CL3700, CK4700		
CR2400-037-LA <sup>5</sup>	Sargent® LA keyway			
CR2000-039	Standard	CL3900	\$98.00	Not Available
CR2000-039L	2" to 2-1/4" Door			
CR2400-039-C <sup>2,5</sup>	Schlage® C keyway			
CR2400-039-LA <sup>3,5</sup>	Sargent® LA keyway			
CR2000-034	Standard	CL3400, CL3600 (Prior to June 2000)		
CR2001-034 <sup>1</sup>	Hotel		\$112.00	\$114.00
CR2400-034-C <sup>2,5</sup>	Schlage® C keyway		\$98.00	Not Available
CR2400-034-LA <sup>3,5</sup>	Sargent® LA keyway			

**Notes:**

1. Not available in 752, 852 or A Class keyways.
  2. Available 0-bitted & keyed random only.
  3. Available 0-bitted only.
  4. For 7-pin version suffix "-7" to number. Not available in 752, 852 or A Class keyways.
  5. Available in 606 or 626 finish only.
- A. CL3800 manf. 1993-1997  
 B. CL3800 manf. 2006 -

## Cylindrical Deadlocks DL2200, DL3200 Series

Cylinder Number	Door Thickness	Function	Finish: 606, 626, BSP Price
CR4400-134-A51	6-Pin Conventional	All	\$98.00
CR4400-134-A52	6-Pin Conventional	1-3/8" to 1-3/4"	
CR4400-214-A52	6-Pin Conventional	2" to 2-1/4"	
CR4400-134-A51-7	7-Pin Conventional	All	\$100.00
CR4400-134-A52-7	7-Pin Conventional	1-3/8" to 1-3/4"	
CR4400-214-A52-7	7-Pin Conventional	2" to 2-1/4"	

## Key-In-Lever/Knob

### For UT5200 & CK4200 Series Locksets (.552" dia plug)

Cylinder Number	Description	Finish: 606, 626, BSP
CR2000-052	Standard	\$98.00
CR2001-052*	Hotel with Indicator	\$112.00
CR2100-052**	Discontinued Ronde & Continental Knob	\$112.00

### For CK4400 Series Locksets (.509" dia plug)

Cylinder Number	Description	Finish: 606, 626, BSP
CR2000-044	All except below	\$98.00
CR2003-044	CK4455 & CK4482 before 8/93	
CR2001-044*	CK4429 with Indicator Pin New Style Straight Tailpiece	\$112.00
CR2001-066*	CK4429 with Indicator Pin Old Style Twisted Tailpiece	

### For G10 Exit Device Knob Trim

Cylinder Number	Description	Finish: 606, 626, BSP
CR2000-033H	Standard	\$98.00

\* Not available with 752, 852 or A Class keyways.

\*\* Also available in 605, 611, 612, 613, 625 finishes. Not available with X Class keyways.

### For PL5000 Series Rekeyable Fixed Core Padlocks

Cylinder Number	Description	Finish: 606, 626, BSP
CR2300PL	Standard 6-pin	\$98.00

### For B2, G2, G3 Exit Device Trim

Cylinder Number	Description	Finish: 606, 626, BSP
CR2000-051	Standard 6-pin	\$98.00

## Key-In-Lever/Knob (.552 dia Plug)

For Other Manufacturers' Products

Cylinder Number	Description	Finish: 606, 626, BSP
CR2200-001-A21	Alarm Lock DL2500 Series	\$102.00
	Arrow® H Series Knobs and Levers	
	Arrow Q Series Levers	
	Sargent® 10 line*	
	Schlage® D Series Levers	
CR2200-001-A22	Schlage AL and ND Series Levers	
CR2200-002-A21	Schlage D Series Knobs	
CR2200-002-A23	Schlage A Series Knobs (ORB only)	
CR2200-002-A22	Schlage A Series Knobs (PLY, etc.)	
CR2200-003-A24	Lockwood® H Series Knobs (Enlarge Knob Hole)	
CR2200-008	Sargent 7, 8, 9 Line (Enlarge Knob Hole)	
CR2200-054	Yale® 5400, 6200 Knobs Only (Enlarge Knob Hole)	
CR2200-076	Sargent 7600 Integrallock	\$108.00

\* When ordered with a 30- prefix, this cylinder is accepted without modification to the lever.

## For Adams Rite® 4025 Pull (.552" dia. Plug)

Cylinder Number	Description	Finish: 606, 626, BSP
CR4200-003-A47	Cylinder & Housing	\$166.00
CR4200-002-A47	Cylinder Only	\$98.00

LFIC Cores are provided in 606, 626, or BSP finish only.

**IC Mortise**

For Construction Core Program, see page 30.  
For housing only, see page 60-61.

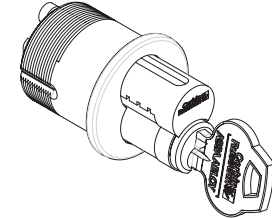

**Cylinder Number Example**

To simplify ordering, options designated "standard" may be omitted from the ordering sequence.

**CR1080 - 114 - A01 - 6 - L4**

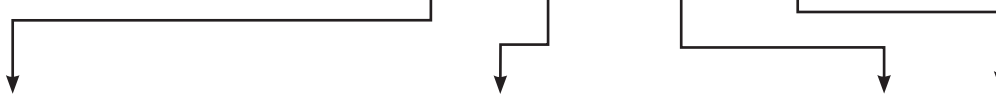

Length	Cam	Pins	Keyway
114 1-1/4" (6-pin standard)	A01 Cloverleaf (standard)	6 (standard)	L4 (standard)
138 1-3/8"	A02 Straight	7**	
112 1-1/2"	A03 Adams Rite® MS & DL300		
134 1-3/4"	A04 DL4000 Deadlock		
200 2"	A05 Adams Rite 4070		
214 2-1/4"	A06 <sup>2</sup> Schlage® L9000		
212 2-1/2"	A07 DL4100 Series Deadlock		
234 2-3/4"	A62 Straight		
	A92 Exit Group 01, 02		
	A93 <sup>1</sup> For obsolete Corbin® 610 Series and Russwin® 1403 Series Deadlocks		

Cylinder Number	605, 606, 611, 612, 613, 613E, 618, 619, 622, 625, 626, 629, 630, 722, BSP, WSP	
	6- PIN	7-PIN
CR1080-114-	\$196.00	Not Available
CR1080-138-	\$199.00	Not Available
CR1080-112-__-	\$199.00	\$203.00
CR1080-134-__-	\$207.00	\$211.00
CR1080-200-	\$207.00	\$211.00
CR1080-214-	\$213.00	\$217.00
CR1080-212-	\$219.00	\$223.00
CR1080-234-	\$223.00	\$227.00

- Notes:  
1. Add \$2.00 per cylinder for A93 Cam.  
2. Add \$5.00 per cylinder for A06 Cam.

**Hotel Function IC Mortise**

To simplify ordering, options designated "standard" may be omitted from the ordering sequence.

Cylinder Number	605, 606, 611, 612, 613, 613E, 618, 619, 622, 625, 626, 629, 630, 722, BSP, WSP	
	6-PIN	7-PIN
CR1081-138-A01-6** (Hotel function uses E1-suffix EMK blank)	\$210.00	Not Available

- \*\* Not available with 752, 852 or A Class keyways.  
\*\* Only available in 1-1/2" and 1-3/4" length.



\*LFIC Cores are provided in 606 or 626 finish only.

**IC Rim**

For Construction Core Program, see page 30.  
For housing only, see page 60-61.

**Cylinder Number Example**

To simplify ordering, options designated "standard" may be omitted from the ordering sequence.

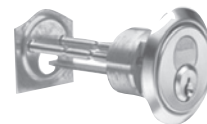

**CR3080 - 178 - 6 - L4**

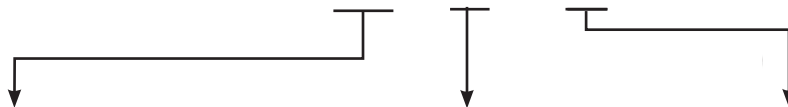

Tailpiece Length		Pins	Keyway
058	5/8" Tailpiece	6 Pin (standard) 7 Pin	L4 (standard)
178	1-7/8" (standard)		
178V	1-7/8" Vertical		
318	3-1/8" (Thick door)		
114	1-1/4" M61 & M62 option for ED8200 and obsolete ED9200 exit device alarms		

Cylinder Number	605, 606, 611, 612, 613, 613E, 618, 619, 622, 625, 626, 629, 630, 722, BSP, WSP	
	6 PIN	7 PIN
CR3080-058-	\$196.00	\$200.00
CR3080-178-__		
CR3080-178V-__		
CR3080-318-__	\$198.00	\$202.00
CR3080-114-__ (no back plate or screw)	\$198.00	\$202.00

**Core Only**



Cylinder Number (specify keyway)		Finish: 626, 606, BSP
CR8000	6-Pin Standard	\$91.00
CR8000EMK*	6-Pin Standard set to hotel mortise EMK	
CR8000-7	7-Pin	\$93.00
CR8001-034*	6-Pin for CL3329, hotel indicator pin	\$107.00
CR8001-034-7*	7-Pin for CL3329, hotel indicator pin	\$109.00
CR8001-042*	6-Pin for CK4229, hotel indicator pin	\$107.00

\* Not available with 752, 852 or A Class keyways.

Note: For uncombined cores suffix "UC". See page 48 for deduct.

\*SFIC Cores are provided in 606 or 626 finish only.

**SFIC Mortise**

For Construction Core Program, see page 30.  
For housing only, see page 60-61.

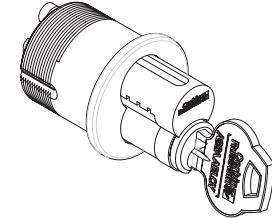

**Cylinder Number Example**

To simplify ordering, options designated "standard" may be omitted from the ordering sequence.

**CR1050 - 114 - A01 - 6 - A**



Length	Cam	Pins	Keyway
114 1-1/4" (6-pin standard)	A01 Cloverleaf (standard)	6 (standard)	A, B, C, D, E, F, G, H, J, K, L, M
138 1-3/8"	A02 Straight	7**	
112 1-1/2"	A03 Adams Rite® MS & DL300		
134 1-3/4"	A04 DL4000 Deadlock		
	A05 Adams Rite 4070		
	A06 <sup>2</sup> Schlage® L9000		
	A07 DL4100 Series Deadlock		
	A62 Straight		
	A92 Exit Group 01, 02		
	A93 <sup>1</sup> For obsolete Corbin® 610 Series and Russwin® 1403 Series Deadlocks		
Cylinder Number		605, 606, 611, 612, 613, 613E, 618, 619, 622, 625, 626, 629, 630, 722, BSP, WSP	
		6- PIN	7-PIN
CR1050-114-		\$187.00	Not Available
CR1050-138-		\$190.00	\$192.00
CR1050-112-		\$190.00	\$192.00
CR1050-134-		\$198.00	\$200.00

Notes:

1. Add \$2.00 per cylinder for A93 Cam.
2. Add \$5.00 per cylinder for A06 Cam.

\*SFIC Cores are provided in 606 or 626 finish only.

**SFIC Rim**

For Construction Core Program, see page 30.  
For housing only, see page 60-61.

**Cylinder Number Example**

To simplify ordering, options designated "standard" may be omitted from the ordering sequence.

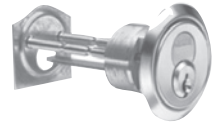

**CR3050 - 178 - 6 - A**

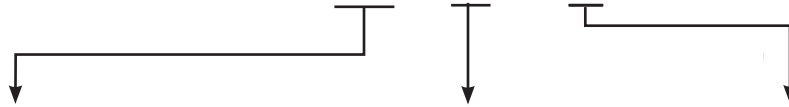

Tailpiece Length		Pins	Keyway
058	5/8" Tailpiece	6 Pin (standard) 7 Pin	A, B, C, D, E, F, G, H, J, K, L, M
178	1-7/8" (standard)		
318	3-1/8" (Thick door)		

Cylinder Number	605, 606, 611, 612, 613, 613E, 618, 619, 622, 625, 626, 629, 630, 722, BSP, WSP	
	6 PIN	7 PIN
CR3050-058-	\$187.00	\$189.00
CR3050-178-	\$187.00	\$189.00
CR3050-318-	\$189.00	\$191.00

**SFIC Core Only**



Cylinder Number (specify keyway)		Finish: 626, 606
CR8200	6-Pin Standard	\$82.00
CR8200-7	7-Pin	

Note: For uncombined cores suffix "UC". See page 48 for deduct.

**LFIC Mortise Housing Only**

**Housing Number Example**

To simplify ordering, options designated "standard" may be omitted from the ordering sequence.

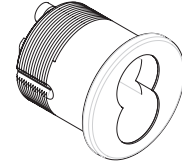

**CR1070 - 114 - A01 - 6**

Length	Cam		Pins
114 1-1/4" (6-pin standard)	A01	Cloverleaf (standard)	6 (standard)
138 1-3/8"	A02	Straight	7
112 1-1/2"	A03	Adams Rite® MS	
134 1-3/4"	A04	DL4000 Deadlock	
214 2-1/4"	A05	Adams Rite® 4070	
	A06 <sup>2</sup>	Schlage® L9000	
	A07	DL4100 Series Deadlock	
	A62	Straight	
	A92	Exit Group 01, 02	
	A93 <sup>1</sup>	For obsolete Corbin® 610 Series and Russwin® 1403 Series Deadlocks	

Cylinder Number	605, 606, 611, 612, 613, 613E, 618, 619, 622, 625, 626, 629, 630, 722, BSP, WSP	
	6 PIN	7 PIN
CR1070-114-	\$105.00	Not Available
CR1070-138-	\$108.00	
CR1070-112-__-	\$108.00	\$110.00
CR1070-134-__-	\$116.00	\$118.00
CR1070-214-	\$122.00	Not Available
CR1071-138-A01 (Hotel function uses -E1 suffix EMK blank)	\$119.00	

**Notes:**

To simplify ordering, you may specify only "1071" since no length or cam variations exists.

1. Add \$2.00 per cylinder for A93 Cam.
2. Add \$5.00 per cylinder for A06 Cam.

**LFIC Rim Housing Only**

**CR3070 - 058 - 626**

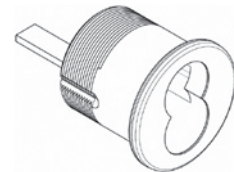

Cylinder Number	605, 606, 611, 612, 613, 613E, 618, 619, 622, 625, 626, 629, 630, 722, BSP, WSP	
	6 PIN	7 PIN
CR3070-058- 5/8" tailpiece	\$105.00	\$107.00
CR3070-178-__ 1-7/8" tailpiece (standard)		
CR3070-178V-__ 1-7/8" vertical		
CR3070-318-__ 3-1/8" tailpiece (thick door)	\$107.00	\$109.00
CR3070-114-__ 1-1/4" tailpiece for M61, M62 exit alarm options. No back plate or screws.		

**SFIC Mortise Housing Only**

**Cylinder Number Example**

**CR1040 - 114 - A01 - 6**

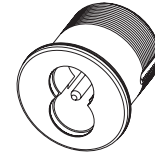

Length	Cam	Pins
114 1-1/4" (6-pin standard)	A01 Cloverleaf (standard)	6 (standard)
	A02 Straight	
	A03 Adams Rite® MS	
	A04 DL4000 Series Deadlock	
	A05 Adams Rite 4070	
	A06 Schlage® L9000	
	A07 DL4100 Series	
	A62 MR Straight	
	A93 Obsolete Deadlocks Corbin® 610 Series and Russwin® 1403 Series	
138 1-3/8" (7-pin standard) 112 1-1/2" (7-pin standard) 134 1-3/4" (7-pin standard)	A01 Cloverleaf (standard)	7
	A02 Straight	
	A03 Adams Rite® MS	
	A04 DL4000 Series Deadlock	
	A05 Adams Rite 4070	
	A06 Schlage® L9000	
	A07 DL4100 Series	
	A62 MR Straight	
	A93 Obsolete Deadlocks Corbin® 610 Series and Russwin® 1403 Series	

Cylinder Number	605, 606, 611, 612, 613, 613E, 618, 619, 622, 625, 626, 629, 630, 722, BSP, WSP	
	6 PIN	7 PIN
CR1040-114-__	\$105.00	Not Available
CR1040-138-__	\$108.00	\$110.00
CR1040-112-__	\$108.00	\$110.00
CR1040-134-__	\$116.00	\$118.00

**SFIC Rim Housing Only**

**CR3040 - 058 - 626**

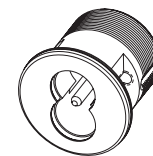

Cylinder Number		605, 606, 611, 612, 613, 613E, 618, 619, 622, 625, 626, 629, 630, 722, BSP, WSP	
		6 PIN	7 PIN
CR3040-058-	5/8" tailpiece	\$105.00	\$107.00
CR3040-178-__	1-7/8" tailpiece	\$105.00	\$107.00
CR3040-318-__	3-1/8" tailpiece	\$107.00	\$109.00

**Standard Security Mortise**

For Existing Systems Only.\*  
For uncombined cylinders, suffix "UC".  
See page 48 for deduct.

6-Pin Only - No Cross Keying - Available in Z and DH Class Keyways only.  
Available UC or master keyed only.  
Not available KR or 0-bitted.

\* L4, D1 and 60 keyway sections may be ordered Keyed Random only, without prior Key Systems Administration approval

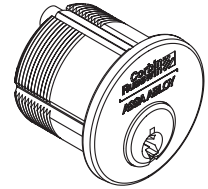

**Cylinder Number Example**

To simplify ordering, options designated "standard" may be omitted from the ordering sequence.

**CR1010 - 118 - A01 - L4**

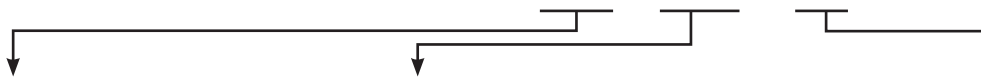

Length		Cam		Keyway
118	1-1/8" (standard)	A01	Cloverleaf (standard)	L4 (standard) Available only with Z and DH Class keyways.
114	1-1/4"	A02	Straight	
138	1-3/8"	A03	Adams Rite® MS & DL3000	
112	1-1/2"	A04	DL4000 Deadlock	
134	1-3/4"	A05	Adams Rite 4070	
200	2"	A06 <sup>2</sup>	Schlage® L9000	
214	2-1/4"	A07	DL4100 Series Deadlock	
		A62	Straight	
		A92	Exit Grip 01, 02	
212	2-1/2"	A93 <sup>1</sup>	For obsolete Corbin® 610 Series and Russwin® 1403 Series Deadlocks	
234	2-3/4"			

Cylinder Number	605, 606, 611, 612, 613, 613E, 618, 619, 622, 625, 626, 629, 630, 722, BSP, WSP
CR1010-118-__	\$244.00
CR1010-114-__	
CR1010-138-__	\$252.00
CR1010-112-__	\$274.00
CR1010-134-__	\$284.00
CR1010-200-__	\$290.00
CR1010-214-__	\$296.00
CR1010-212-__	\$304.00
CR1010-234-__	\$308.00

- Notes:
1. Add \$2.00 per cylinder for A93 Cam.
  2. Add \$5.00 per cylinder for A06 Cam.

**Special Function Security Mortise**

For Existing Systems Only.\*  
 6-Pin Only - No Cross Keying - Available in Z and DH Class Keyways only.  
 Available UC or master keyed only.  
 Not available KR or O-bitted.  
 \* L4, D1 and 60 keyway sections may be ordered Keyed Random only, without prior Key Systems Administration approval

**Hotel Function Cylinders**

Cylinder Number	Description	605, 606, 611, 612, 613, 613E, 618, 619, 622, 625, 626, 629, 630, 722, BSP, WSP
CR1011-114-A01	1-1/4" Cloverleaf cam only	\$262.00

To simplify ordering, you may specify only "1011" since no length or cam variations exist.  
 For uncombined cylinders, suffix "UC". See page 31 for deduct.  
 Not available in D1, D2, L1 or L2 keyways.

**Security Rim**

For Existing Systems Only.\*

6-Pin Only - No Cross Keying - Available in Z and DH Class Keyways Only.  
Available UC or master keyed only. Not available KR or 0-bitted.

\* L4, D1 and 60 keyway sections may be ordered Keyed Random only, without prior Key Systems Administration approval

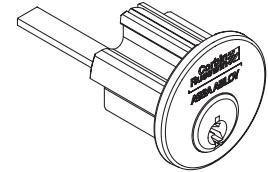

**Cylinder Number Example**

To simplify ordering, options designated "standard" may be omitted from the ordering sequence.

**CR3010 - 200 - L4**

Function	Tailpiece Length	Keyway
<b>For 3010 Only:</b>	<b>For 3010 Only:</b>	L4 (standard) Available only with Z and DH Class keyways.
0 (standard)	200 2" (standard)	
	200V 2" vertical	
	312 3-1/2" (thick door)	
	312V 3-1/2" (thick door) vertical	
	058 5/8" Tailpiece	
	138 1-3/8" M61 and M62 option for ED8200 . . . . . and obsolete ED9200 exit device alarms	
	<b>For 3012 Only:</b>	
	178 1-7/8" (standard)	
	178V 1-7/8" vertical	
	318 3-1/8" (thick door)	
	318V 3-1/8" (thick door) vertical	

Cylinder Number	605, 606, 611, 612, 613, 613E, 618, 619, 622, 625, 626, 629, 630, 722, BSP, WSP
CR3010-058-__	\$244.00
CR3010-200-__	
CR3010-200V-__	
CR3010-312-__	\$246.00
CR3010-312V-__	
CR3010-138-__ No back plate or screws	\$244.00
CR3012-178-__	\$252.00
CR3012-178V-__	
CR3012-318-__	\$254.00
CR3012-318V-__	



**Security Key-In-Lever/Knob**

For Existing Systems Only.\*  
6-Pin Only - No Cross Keying - Available in Z and DH Class Keyways Only.  
Available UC or master keyed only. Not available KR or 0-bitted.

\* L4, D1 and 60 keyway sections may be ordered Keyed Random only, without prior Key Systems Administration approval

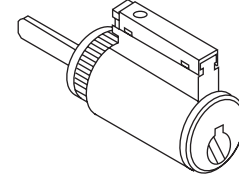

**For Key-In-Lever/Knob Trim (.552" plug)**

Cylinder Number	Series	Finish: 606, 626, BSP
CR2010-031	CL3100, CK4300	\$233.00
CR2010-033	CL3300, CL3500, CL3800 <sup>a</sup> , [CL3600 (June 2000 and after)]	
CR2010-034	CL3400, [CL3600 (prior to June 2000)]	
CR2010-038	CL3800 <sup>a</sup>	
CR2010-039	CL3900	
CR2010-039L	CL3900 ( 2 - 2-1/4" door)	
CR2010-052	CK4200, UT5200	
CR2011-042	CK4229 Hotel Function*	\$247.00
CR2010-051	B2, G2 Exit Device Knob Trim	\$233.00
CR4410-134-A51	DL2200, DL3200 Cylindrical Deadlock	\$233.00
CR4410-134-A52	DL2200, DL3200 Cylindrical Deadlock	\$233.00
CR4410-214-A52	DL2200, DL3200 Cylindrical Deadlock	\$233.00

For uncombined cylinders suffix "UC" - See page 48 for deduct.  
\*Not available with 752, 852, or A Class Keyways.

Notes: A CL3800 manf. 1993-1997  
B CL3800 manf. 2006 -

**For Other Manufacturers' Products (.552" plug)**

Cylinder Number	Series	Finish: 606, 626, BSP
2210-001-A21	Alarm Lock DL2500 Series	\$237.00
	Arrow <sup>®</sup> H Series Knobs and Levers	
	Arrow Q Series Levers	
	Sargent <sup>®</sup> 10 line*	
	Schlage <sup>®</sup> D Series Levers	
2210-001-A22	Schlage AL and ND Series Levers	
2210-002-A21	Schlage D Series Knobs	
2210-002-A23	Schlage A Series Knobs (ORB, only)	
2210-002-A22	Schlage A Series Knobs (PLY, ect)	
2210-003-A24	Lockwood <sup>®</sup> H Series Knobs (enlarge knob hole)	
2210-008	Sargent 7, 8, 9 Line (enlarge knob hole)	
2210-054	Yale <sup>®</sup> 5400, 6200 Knobs only (enlarge knob hole)	

\* When ordered with a 30- prefix, this cylinder is accepted without modification to the lever.

\*LFIC Cores are provided in 606 or 626 finish only.

**IC Mortise**

For Existing Systems Only.\*  
For Construction Core Program, see page 30. For housing only, see page 60-61.

6-Pin Only - No Cross Keying - Available in Z and DH Class Keyways Only.  
Available UC or master keyed only. Not available KR or 0-bitted.

\* L4, D1 and 60 keyway sections may be ordered Keyed Random only, without prior Key Systems Administration approval

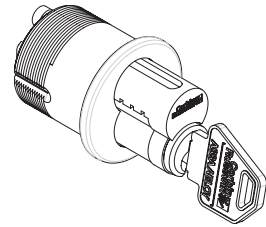

**Cylinder Number Example**

To simplify ordering, options designated "standard" may be omitted from the ordering sequence.

**CR1090 - 114 - A01- L4**

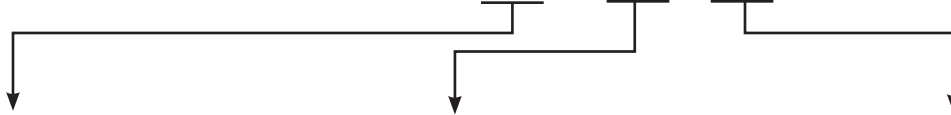

Length	Cam	Keyway
114 1-1/4" (standard)	A01 Cloverleaf (standard)	L4 (standard) Available only with Z and DH Class keyways.
138 1-3/8"	A02 Straight	
112 1-3/8"	A03 Adams Rite® MS & DL3000	
134 1-3/4"	A04 DL4000 Deadlock	
	A05 Adams Rite 4070	
	A06 <sup>2</sup> Schlage® L9000	
	A07 DL4100 Series Deadlock	
	A62 Straight	
	A92 Exit Grip 01, 02	
	A93 <sup>1</sup> For obsolete Corbin® 610 Series and Russwin® 1403 Series Deadlocks	

Cylinder Number	605, 606, 611, 612, 613, 613E, 618, 619, 622, 625, 626, 629, 630, 722, BSP, WSP
CR1090-114-	\$331.00
CR1090-138-	\$334.00
CR1090-112-	\$342.00
CR1090-134-	

- Notes:  
1. Add \$2.00 per cylinder for A93 Cam.  
2. Add \$5.00 per cylinder for A06 Cam.

**Hotel Function IC Mortise**

Cylinder Number	605, 606, 611, 612, 613, 613E, 618, 619, 622, 625, 626, 629, 630, 722, BSP, WSP
CR1091-138-A01 Hotel function uses - E1 suffix EMK blank	\$345.00

To simplify ordering, you may specify only "1091" since no length or cam variations exist.

\*LFIC Cores are provided in 606 or 626 finish only.

**IC Rim**

For Existing Systems Only.\*  
 For Construction Core Program, see page 30.  
 For housing only, see page 60-61.  
 6-Pin Only - No Cross Keying - Available in Z and DH Class Keyways Only. Available UC or master keyed only. Not available 0-bitted.  
 \* L4, D1 and 60 keyway sections may be ordered Keyed Random only, without prior Key Systems Administration approval

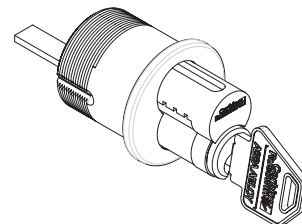

**Cylinder Number Example**

To simplify ordering, options designated "standard" may be omitted from the ordering sequence.

**CR3090 - 178 - L4**

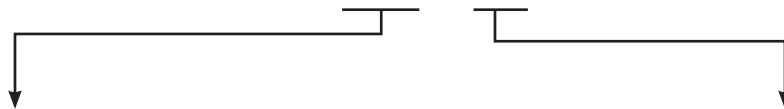

Tailpiece Length		Keyway
058	5/8" Tailpiece	L4 (standard). Available only with Z and DH Class keyways.
178	1-7/8" (standard)	
178V	1-7/8"(standard) vertical	
318	3-1/8" (thick door)	
114	1-1/4" for M61 and M62 option alarmed exit devices	

Cylinder Number	605, 606, 611, 612, 613, 613E, 618, 619, 622, 625, 626, 629, 630, 722, BSP, WSP
CR3090-058	\$331.00
CR3090-178	
CR3090-178V	
CR3090-318	
CR3090-114 No back plate or screws	

**Security Core Only**

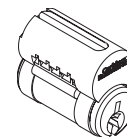

Cylinder Number	606, 626, BSP
CR8010 6-pin standard	\$226.00
CR8010EMK 6-pin standard set to hotel mortise EMK	
CR8011-042 6-pin for CK4229, hotel indicator pin	

For uncombined cores, suffix "UC," see page 48 for deduct.

**Standard Master Ring Mortise**

**Cylinder Number Example**

To simplify ordering, options designated "standard" may be omitted from the ordering sequence.

**CR1060 - 118 - A61 - 6 - L4**

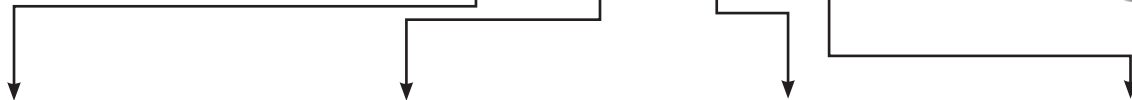

Length	Cam	Pins	Keyway
100 1" (5-pin only)	A61 New Cloverleaf (standard) (for locks made after 5/93; requires thumbturn hub 562F41-2)	5	L4 (standard)
118 1-1/8" (std)	A62 Straight	6 (standard)	
114 1-1/4"	A63* Large Short	7 (optional for 1-3/8" only)	
138 1-3/8"	A64* Large Long		
134 1-3/4"	A65* Old Cloverleaf (formerly 11A)		
112 1-1/2"			
200 2"			
214 2-1/4"			
212 2-1/2"			
234 2-3/4"			
300 3"			

Cylinder Number	605, 606, 611, 612, 613, 613E, 618, 619, 622, 625, 626, 722, BSP, WSP
CR1060-100-__-5	
CR1060-118-__-__	\$164.00
CR1060-114-__-__	
CR1060-138-__-__	
CR1060-112-__-__	\$174.00
CR1060-134-__-__	
CR1060-200-__-__	
CR1060-214-__-__	\$184.00
CR1060-212-__-__	
CR1060-234-__-__	
CR1060-300-__-__	\$184.00

\*Add \$2.00 per cylinder for A63, A64 and A65 Cam.

**Flexible Head Master Ring Mortise**

**Cylinder Number Example**

To simplify ordering, options designated "standard" may be omitted from the ordering sequence.

**CR1160 - 118 - A61 - 6 - L4**

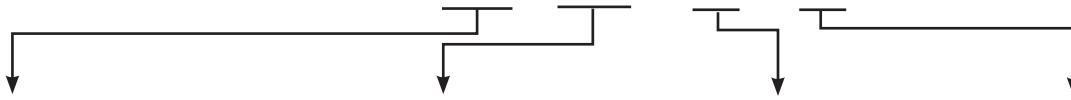

Length	Cam	Pins	Keyway
100 1" (6-pin std)	A61 New Cloverleaf (standard) (for locks made after 5/93; requires thumbturn hub 562F41-2)	5	L4 (standard)
118 1-1/8"		6 (standard)	
114 1-1/4"			
	A62 Straight		
	A63* Large Short		
	A64* Large Long		
	A65* Old Cloverleaf (formerly 11A)		

Cylinder Number	605, 606, 611, 612, 613, 613E, 618, 619, 622, 625, 626, 722, BSP, WSP
CR1160-100-__-__	\$202.00
CR1160-118-__-__	
CR1160-114-__-__	

\* Add \$2.00 per cylinder for A63, A64 or A65 Cam.

**Dummy Master Ring Mortise Cylinders**

Cylinder Number	605, 606, 611, 612, 613, 613E, 618, 619, 622, 625, 626, 722, BSP, WSP
CR1460-118	\$156.00
CR1460-114	
CR1460-138	
CR1460-112	

## Master Ring Rim

Cylinder Number (Specify Keyway)	F605, 606, 611, 612, 613, 613E, 618, 619, 622, 625, 626, 722, BSP, WSP
CR3060-200      Standard horizontal tailpiece	\$164.00
CR3060-312      Thick door, horizontal tailpiece	
CR3060-200V      Vertical tailpiece	
CR3060-312V      Thick door, vertical tailpiece	

## For CK4200 & UT5200 Series Locksets (.552" dia. plug)

Cylinder Number	Finish: 606, 626, BSP
CR2060-052      Standard	\$137.00
CR2061-042*      CK4229 Hotel with indicator pin	\$163.00
CR2160-052**      Discontinued Ronde and Continental Knob	\$147.00

\* Not Available with 752, 852 or A Class keyways.  
 \*\* Also Available in 605, 611, 612, 613, 625 finishes.  
 Not Available with X Class and certain restricted keyways.

## Master Ring Special Applications For Exit Device Operators (.552" plug)

Cylinder Number	Finish: 606, 626, BSP
CR4266-001-A02      ED6800 x B5 or B6 trim	\$151.00
ED7400 x 03 or 04 trim	
CR4266-001-A92      ED6800 x 01 or 02 trim	

## Pin Kits

Description	Catalog Number	Part Number	Price
Corbin Russwin System 70 and Pre-System 70, 752, 852 and A Class keyways <i>Not for System 70 Security</i>	PK-1070	610F538	\$1,114.00
Corbin® Z Class and Russwin® DH Class keyways System 70, all cylinders except Security	PK-70-ZDH	602F129	\$743.00
Russwin N Class System, all cylinders	PK-70-N	602F119	\$580.00
Corbin X Class, all cylinders	PK-70-X	602F109	\$567.00
Pyramid High Security cylinders	PK-20-HS	694F968	\$1,528.00
Pyramid Security cylinders	PK-20-PS	715F968	\$1,130.00
Security cylinders, including interchangeable core, blackout and Brink	PK-70-HS	610F529	\$2,107.00
Access 3 Key System AP only	PK-30-AP	763F088	\$1,086.00
Access 3 Key System - AP, AS, AHS	PK-30-MASTER	763F098	\$1,582.00

## Tools

Description	Catalog Number	Part Number	Price
Tool kit - contains 1 each: CT-4, CT-11, CT-19, CT-21, CT-22, CT-23, CT-54	CT-93	612F588	\$353.00
Plug follower, .509" brass	CT-4	073F992	\$35.00
Pin chamber reamer	CT-5	239F758	\$100.00
Pin chamber burring tool	CT-7	382F188	\$265.00
Loading tool for .509" shell	CT-10	577F499	\$100.00
Key gauge, all Corbin® key classes	CT-11	239F377	\$35.00
Tweezers (was CT-6)	CT-19	239F368	\$42.00
Plug follower, .496	CT-20	694F972	\$14 (order in mult.of 10)
Key gauge, Pyramid	CT-20K	698F367	\$35.00
Key gauge, Access 3	CT-30K		
Key gauge, Russwin® N	CT-21	603F277	
Key gauge, Russwin® D & H	CT-22	604F197	
Key gauge, Russwin® 981/852	CT-23	604F187	
Plug follower, .552" brass	CT-54	073F982	\$43.00
IC mortise cylinder installation wrench	CT-80	363F612	\$61.00
Follower, disposable, .509" plug		484F729	\$1.00 (order in mult. Of 50)
Follower, disposable, .552" plug		484F739	\$0.50 (order in mult. Of 100)

Blank Page



**ML2000 Series:**

MicroShield®	74
ML2000 Series	75

**ML2000 Museo Series:**

ML2000 Series: Museo Georgia, Pablo, Jackson, Salvador, Marc Levers, Inspire Trim	76
ML2000 Series: Museo Georgia, Pablo, Jackson, Salvador, Marc, Josef Levers, Roses & Thumbturns	77
ML2000 Series: Museo Josef, Georges Levers, Roses & Thumbturns	78
ML2000 Series: Museo Piet Levers, Roses & Thumbturns	79
ML2000 Series: Museo Piet Levers, Roses & Thumbturns	80
ML2000 Series: Museo Georgia, Pablo, Jackson, Salvador, Marc, Josef Levers & Escutcheons	81
ML2000 Series: Museo Josef, Georges Levers & Escutcheons	82
ML2000 Series: Museo Piet Levers & Escutcheons	83
ML2000 Series: Museo Piet Levers & Escutcheons	84

**ML2000 Series:**

ML2000 Series: LWA, RWA, LWN, LWM, LWP, LWR, LWVN	85
ML2000 Series: LSA, LSN, LSM, LSP, LSR, LSVN	86
ML2000 Series: ASA, CSA, NSA, PSA, RSA, NSM, NSN, NSP, NSR, NSVN	87
ML2000 Series: DSA, ESA, DSM, DSN, DSP, DSR, DSVN	88
ML2000 Series: GZA, GZB, GZF, GZH, YZA, YZB, YZF, YZH, GZM, GZP, GZR, GZVN	89
ML2000 Series Vineyard Collection: FSG, MSG, ZSG, FSL, MSL, ZSL, FSVN, MSVN, ZSVN	90
ML2000 Series: Deadbolts: M, N, P, L, R, VN	91
Vandal Resistant Trim: CSV, NSV	92

**ML20900 Museo Series:**

ML20900 Series: Museo Georgia, Pablo, Jackson, Salvador, Marc Levers & Roses	93
ML20900 Series: Museo Georgia, Pablo, Jackson, Salvador, Marc, Josef Levers, Escutcheons, Roses and Thumbturns	94
ML20900 Series: Museo Piet Levers, Escutcheons, Roses and Thumbturns	95
ML20900 Series: Museo Piet Levers, Escutcheons, Roses and Thumbturns	96
ML20900 Series: Museo Josef, Georges Levers, Escutcheons, Roses and Thumbturns	97

**ML20900 Series:**

ML20900 Series: LWA, RWA, LWM, LWN, LWR, ASA, CSA, LSA, NSA, PSA, RSA, NSM, NSN, NSR	98
ML20900 Series: DSA, ESA, DSM, DSN, DSR, CSV, NSV	99
ML20900 Series Vineyard Collection: FSG, MSG, ZSG, FSL, MSL, ZSL	100
ML20900 Series: GZA, GZB, GZF, GZH, YZA, YZB, YZF, YZH, GZM, GZP, GZR	101

**ML20600 NAC Museo Series:**

ML20600 NAC Series: Museo Georgia, Pablo, Jackson, Salvador, Marc Levers with High Security Monitoring	102
ML20600 NAC Series: Museo Georgia, Pablo, Jackson, Salvador, Marc, Josef Levers & Roses with High Security Monitoring	103
ML20600 NAC Series: Museo Piet Levers & Roses with High Security Monitoring	104
ML20600 NAC Series: Museo Piet Levers & Roses with High Security Monitoring	105
ML20600 NAC Series: Museo Josef, Georges Levers & Roses	106

**ML20600 NAC Series:**

ML20600 Series NAC: LWA, RWA, LWM, LWN, LWR, LWVN, ASA, CSA, LSA, NSA, PSA, RSA, NSM, NSN, NSR, NSVN	107
ML20600 Series NAC: DSA, ESA, DSM, DSN, DSR, DSVN, CSV, NSV	108
ML20600 Series NAC: Electrified Mortise with High Security Options: FSG, MSG, ZSG, FSL, MSL, ZSL, FSVN, MSVN, ZSVN	109

**ML2000/20900 Series:**

ML20600 NAC Series Lever Designs	110
ML2000 & ML20900 Series Ordering Options	111
ML2000 & ML20900 Series Cylinder & Keying Options	112
ML2000 & ML20900 Series Cylinder & Keying Options (Continued), ML2000/20900 Strike Options	113
ML2000 & ML20900 Series Door Thickness with Locksets Mortised on Center, Panel Applications	114
ML2000 & ML20900 Series Miscellaneous Options, Thumbturn Options	115
ML2000 & ML20900 Series Indicator Options, Sectional Trim Retrofit Kits for V Series Indicators, Ordering Examples	116

# MicroShield®

Look for the *MicroShield* icon.

## **MicroShield®**

As part of their promise to provide innovative solutions to their customers, certain ASSA ABLOY Group brands offer the MicroShield® technology, a silver-based antimicrobial coating designed to inhibit the growth of bacteria.

MicroShield® is a registered trademark of ASSA ABLOY Access and Egress Hardware Group, Inc.

Product	Series	MicroShield® Coated Components
Mortise Locks	ML2000 Series	Knobs/Levers, roses and/or escutcheons

## **AVAILABLE FINISHES**

- MicroShield® is available on 626 and 630. Other finishes available by Special Product Application Request Form only.
- Specify 626C (satin chrome plated) or 630C (satin stainless steel) when ordering.
- MicroShield® coating will be applied over 626 and 630 finishes. All components will match 626.

*Note: MicroShield® coating will only be applied to "high touch" components.*

## **HOW TO ORDER**

Product	How to Order
Mortise Locks	ML2055 x LWA x 626C x RHR

Description	Add
Mortise Locks	Add \$79.00

**Standard Features  
Handing**

Field reversible

**Door Thickness**

1-3/4"

**Backset**

2-3/4"

**Warranty**

10 Years

**Strike**

ANSI straight lip  
4-7/8" x 1-1/4" x 1-1/8" lip to center

**Cylinder**

Brass, 6-pin, L4 keyway, 0-bitted

**Keys**

Two nickel silver keys

**Case Quantity**

6

**Case Weight**

Variable

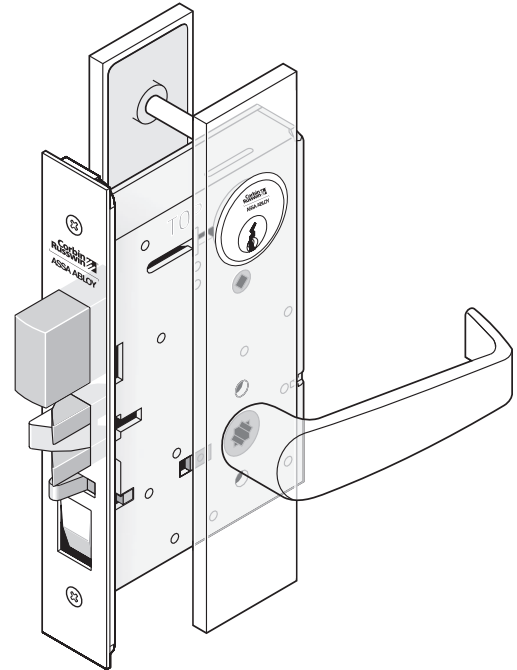

Please refer to the ML2000 Series catalog for more information.

**Ordering Example:**

**Stock Order**

Quantity	Series/Function	Trim	Finish	Hand
100	ML2055	LSB	626	RHR

**Split Trim/Split Finish**

Quantity	Series/Function	Trim		Finish		Hand
		Outside	Inside	Outside	Inside	
12	ML2055	LSB	NSB	626	625	RHR

Split trim is not available mixing escutcheon with sectional trim or with a different escutcheon

**Contract/Detailed Order**

Quantity	Keyset	Series/Function	Trim	Finish	Hand	Strike	Misc. Options	Cylinder and Keying
24	AA1	ML2055	LSB	626	RHR	SA200	M17-M26	C7-VKC3

**Working Trim Only**

Quantity	Function only	Trim	Finish	Hand	Door Thickness	Misc. Options
6	ML2055	LWA	626	RHR	D214	M31

(includes grip and spindle, rose or escutcheon, thumbturn, adapters and screws)

**High Security Monitoring Option Order**

Quantity	Series/Function	Technology Code	Trim	Finish	Hand	Fail Safe/ Fail Secure	High Security Monitoring Options
24	ML20608	NAC	ASA	626	RHR	SEC	PHRR01

# Mortise Locksets

ML2000 Series: Muséo Levers and Inspire™ Roseless Trim

USA & Canada Prices Effective February 1, 2022

contemporary trim to complement the interior design of your next project

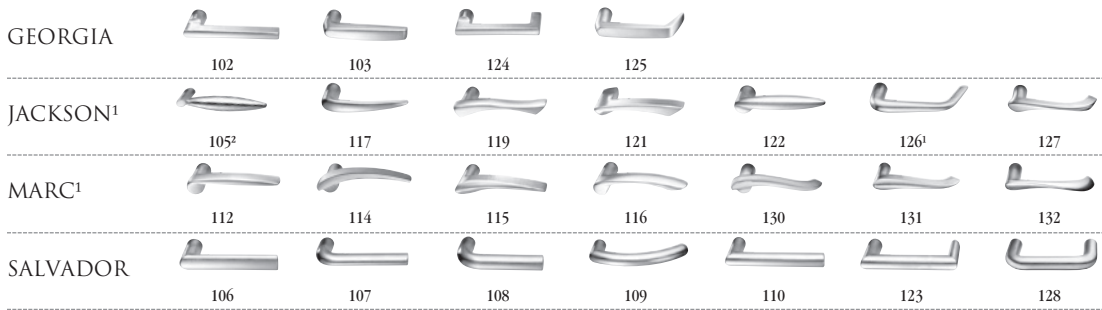

J Collar

¹Handed: specify hand when ordering.  
²Contact factory for current lead time.

\*629 and \*630 finish options are Not available for all Muséo levers. Please refer to page 24 for availability.

613E	Dark Oxidized Satin Bronze - Equivalent	605	Bright Brass, Clear Coated	618	Bright Nickel Plated
606	Satin Brass, Clear Coated	606	Satin Brass, Clear Coated	619	Satin Nickel Plated
611	Bright Chromium Plated	611	Bright Bronze, Clear Coated	625	Bright Chromium Plated
626	Satin Chromium Plated	612	Satin Bronze, Clear Coated	629*	Bright Stainless Steel
BSP	Black Suede Powder Coat	613	Dark Oxidized Satin Bronze, Oil Rubbed	630*	Satin Stainless Steel
WSP	White Suede Powder Coat	613L	Dark Oxidized Satin Bronze, Clear Coated	722	Black Oxidized Bronze, Oil Rubbed

### Function

Function	Model	Description	Price	Price
Non-Keyed	ML2010	Passage	\$1,087.00	\$1,111.00
	ML2020	Privacy	\$1,186.00	\$1,210.00
	ML2030			
	ML2060	Privacy	\$1,157.00	\$1,181.00
	ML2050	Half Dummy	\$409.00	\$421.00
	ML2070	Full Dummy	\$818.00	\$842.00
	ML2080	Half Active Dummy Trim	\$711.00	\$723.00
	ML2090	Full Active Dummy Trim	\$1,120.00	\$1,144.00
Single Cylinder	ML2003	Classroom	\$1,243.00	\$1,267.00
	ML2051	Office		
	ML2055	Classroom		
	ML2056	Classroom Holdback		
	ML2057	Storeroom		
	ML2069	Institution Privacy		
	ML2053	Entrance	\$1,261.00	\$1,285.00
	ML2054	Entrance		
ML2058	Entrance Holdback			
ML2068	Privacy or Classroom			
Single Cylinder with Deadbolt	ML2024	Entrance	\$1,291.00	\$1,315.00
	ML2048	Entrance		
	ML2049	Storeroom Deadbolt		
	ML2059	Security Storeroom		
	ML2065	Dormitory		
	ML2067	Apartment		
	ML2073	Classroom Security		
	ML2075	Entrance/Office		
ML2029	Hotel	\$1,334.00	\$1,358.00	
Double Cylinder	ML2002	Classroom Intruder	\$1,348.00	\$1,372.00
	ML2032	Institution		
	ML2042	Entrance		
	ML2052	Classroom Intruder		
	ML2087	Security Vestibule		
Double Cylinder with Deadbolt	ML2022	Store Door	\$1,396.00	\$1,420.00
	ML2062	Intruder Deadbolt		
	ML2072	Classroom Security Intruder		
	ML2082	Dormitory		
	ML2092	Security Institution		
Full Working Trim (Quick Code M31) No cylinder; includes thumbturn lever			\$861.00	\$885.00

### Ordering Example Details

<b>ML2000</b>	ML2051	Office Function
Sectional Trim	102	Georgia Family Lever
(rose)	J	Collar
	625	Finish
	RHR	Handing



### Stock Order

Quantity	Series/Function	Trim	Finish	Hand
24	ML2051	102J	625	RHR



Experience a safer and more open world

# Mortise Locksets

ML2000 Series: Muséo Levers, Roses and Thumbturns

USA & Canada Prices Effective February 1, 2022

contemporary levers to complement the interior design of your next project

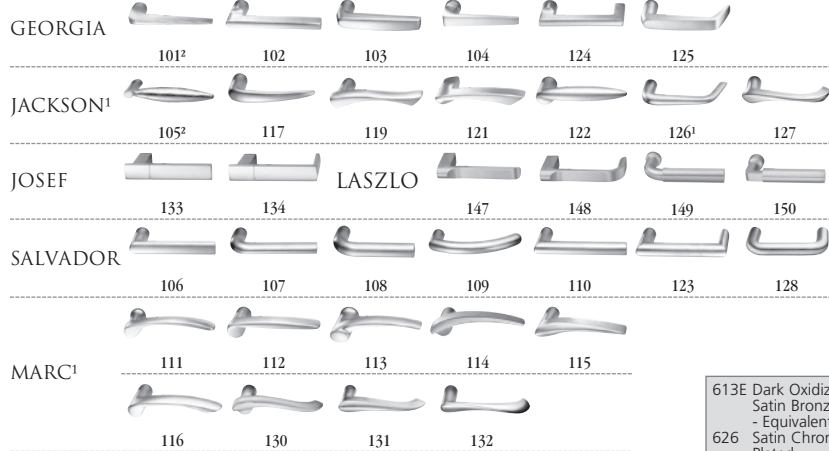

## ROSES

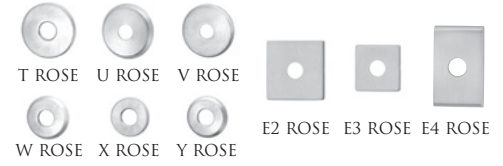

## THUMBTURN<sup>3</sup>



1. Handed: specify hand when ordering
2. Contact factory for current lead time
3. Specify thumbturn as quick code. Thumbturn backplate will match shape of rose chosen (i.e. round or square)

\*629 and \*630 finish options are Not available for all Muséo levers. Please refer to page 24 for availability.

### Function

613E	Dark Oxidized Satin Bronze - Equivalent	605	Bright Brass, Clear Coated	618	Bright Nickel Plated
626	Satin Chromium Plated	606	Satin Brass, Clear Coated	619	Satin Nickel Plated
BSP	Black Suede Powder Coat	611	Bright Bronze, Clear Coated	625	Bright Chromium Plated
WSP	White Suede Powder Coat	612	Satin Bronze, Clear Coated	629*	Bright Stainless Steel
		613	Dark Oxidized Satin Bronze, Oil Rubbed	630*	Satin Stainless Steel
		613L	Dark Oxidized Satin Bronze, Clear Coated	722	Black Oxidized Bronze, Oil Rubbed

Function	Model	Description	Price	Price
Non-Keyed	ML2010	Passage	\$1,045.00	\$1,069.00
	ML2020	Privacy	\$1,144.00	\$1,168.00
	ML2030			
	ML2040	Passage w/Indicator – VXX Option on Page 116 Applies	\$1,120.00	\$1,144.00
	ML2060	Privacy		
	ML2050	Half Dummy	\$488.00	\$500.00
	ML2070	Full Dummy	\$976.00	\$1,000.00
	ML2080	Half Active Dummy Trim	\$596.00	\$608.00
ML2090	Full Active Dummy Trim	\$1,084.00	\$1,108.00	
Single Cylinder	ML2003	Classroom	\$1,201.00	\$1,225.00
	ML2051	Office		
	ML2055	Classroom		
	ML2056	Classroom Holdback		
	ML2057	Storeroom	\$1,219.00	\$1,243.00
	ML2069	Institution Privacy		
	ML2053	Entrance		
	ML2054	Entrance		
ML2058	Entrance Holdback	\$1,292.00	\$1,316.00	
ML2068	Privacy or Classroom			
Single Cylinder with Deadbolt	ML2024	Entrance	\$1,249.00	\$1,273.00
	ML2048	Entrance		
	ML2049	Storeroom Deadbolt		
	ML2059	Security Storeroom		
	ML2065	Dormitory		
	ML2067	Apartment		
	ML2073	Classroom Security		
	ML2075	Entrance/Office		
ML2029	Hotel	\$1,292.00	\$1,316.00	
Double Cylinder	ML2002	Classroom Intruder	\$1,306.00	\$1,330.00
	ML2032	Institution		
	ML2042	Entrance		
	ML2052	Classroom Intruder		
	ML2087	Security Vestibule		
Double Cylinder with Deadbolt	ML2022	Store Door	\$1,354.00	\$1,378.00
	ML2062	Intruder Deadbolt		
	ML2072	Classroom Security Intruder		
	ML2082	Dormitory		
	ML2092	Security Institution		
Full Working Trim (Quick Code M31) No cylinder; includes thumbturn lever			\$879.00	\$903.00

### Ordering Example Details

<b>ML2000</b>	ML2051	Office Function
Sectional Trim	111	Marc Family Lever
(rose)	W	Rose
	625	Finish
	RHR	Handing

### Stock Order

Quantity	Series/Function	Trim	Finish	Hand
24	ML2051	111W	625	RHR



Experience a safer and more open world

# Mortise Locksets

ML2000 Series: Muséo Levers, Roses and Thumbturns

USA & Canada Prices Effective February 1, 2022

contemporary levers to complement the interior design of your next project

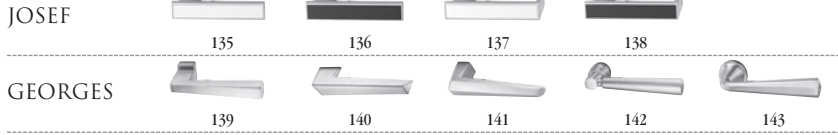

## ROSES

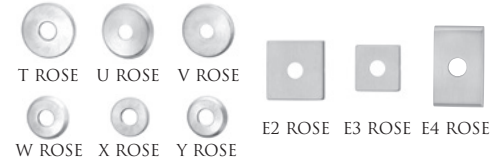

## THUMBTURNS<sup>3</sup>



1. Handed: specify hand when ordering
2. Contact factory for current lead time
3. Specify thumbturn as quick code. Thumbturn backplate will match shape of rose chosen (i.e. round or square)

## Function

613E	Dark Oxidized Satin Bronze - Equivalent	605	Bright Brass, Clear Coated	618	Bright Nickel Plated
626	Satin Chromium Plated	606	Satin Brass, Clear Coated	619	Satin Nickel Plated
BSP	Black Suede Powder Coat	611	Bright Bronze, Clear Coated	625	Bright Chromium Plated
WSP	White Suede Powder Coat	612	Satin Bronze, Clear Coated	629	Bright Stainless Steel
		613	Dark Oxidized Satin Bronze, Oil Rubbed	630	Satin Stainless Steel
		613L	Dark Oxidized Satin Bronze, Clear Coated	722	Black Oxidized Bronze, Oil Rubbed

Function	Model	Description	Price	Price
Non-Keyed	ML2010	Passage	\$1,310.00	\$1,334.00
	ML2020	Privacy	\$1,365.00	\$1,389.00
	ML2030			
	ML2040	Passage w/Indicator – VXX Option on Page 116 Applies	\$1,341.00	\$1,365.00
	ML2060	Privacy		
	ML2050	Half Dummy	\$510.00	\$522.00
	ML2070	Full Dummy	\$1,020.00	\$1,044.00
	ML2080	Half Active Dummy Trim	\$795.00	\$807.00
ML2090	Full Active Dummy Trim	\$1,305.00	\$1,329.00	
Single Cylinder	ML2003	Classroom	\$1,422.00	\$1,446.00
	ML2051	Office		
	ML2055	Classroom		
	ML2056	Classroom Holdback		
	ML2057	Storeroom	\$1,440.00	\$1,464.00
	ML2069	Institution Privacy		
	ML2053	Entrance		
	ML2054	Entrance		
ML2058	Entrance Holdback	\$1,513.00	\$1,537.00	
ML2068	Privacy or Classroom			
Single Cylinder with Deadbolt	ML2024	Entrance	\$1,470.00	\$1,494.00
	ML2048	Entrance		
	ML2049	Storeroom Deadbolt		
	ML2059	Security Storeroom		
	ML2065	Dormitory		
	ML2067	Apartment		
	ML2073	Classroom Security		
	ML2075	Entrance/Office		
ML2029	Hotel	\$1,513.00	\$1,537.00	
Double Cylinder	ML2002	Classroom Intruder	\$1,527.00	\$1,551.00
	ML2032	Institution		
	ML2042	Entrance		
	ML2052	Classroom Intruder		
	ML2087	Security Vestibule		
Double Cylinder with Deadbolt	ML2022	Store Door	\$1,575.00	\$1,599.00
	ML2062	Intruder Deadbolt		
	ML2072	Classroom Security Intruder		
	ML2082	Dormitory		
	ML2092	Security Institution		
Full Working Trim (Quick Code M31) No cylinder; includes thumbturn lever			\$1,022.00	\$1,046.00

### Ordering Example Details

ML2000 Sectional Trim (rose) ML2051 Office Function Josep Family Lever  
 E4 Rose  
 625 Finish  
 RHR Handing



### Stock Order

Quantity	Series/Function	Trim	Finish	Hand
24	ML2051	135E4	625	RHR



Experience a safer and more open world

# Mortise Locksets

ML2000 Series: Muséo Levers, Roses and Thumbturns

USA & Canada Prices Effective February 1, 2022

contemporary trim to complement the interior design of your next project



\*613E, BSP, WSP finishes are not available with 21M levers

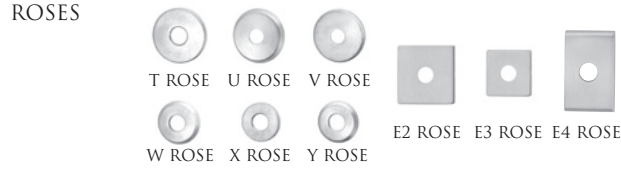

613E	Dark Oxidized Satin Bronze – Equivalent
629	Bright Stainless Steel
630	Satin Stainless Steel
BSP	Black Suede Powder Coat
WSP	White Suede Powder Coat

**Function**

<b>Non-Keypad</b>	ML2010	Passage	\$1,236.00
	ML2020	Privacy	\$1,291.00
	ML2030	Passage w/Indicator – VXX Option on Page 116 Applies	\$1,267.00
	ML2040	Privacy	
	ML2050	Half Dummy	\$481.00
	ML2070	Full Dummy	\$962.00
	ML2080	Half Active Dummy Trim	\$750.00
	ML2090	Full Active Dummy Trim	\$1,231.00
<b>Single Cylinder</b>	ML2003	Classroom	\$1,348.00
	ML2051	Office	
	ML2055	Classroom	
	ML2056	Classroom Holdback	
	ML2057	Storeroom	\$1,366.00
	ML2069	Institution Privacy	
	ML2053	Entrance	
	ML2054	Entrance	
<b>Single Cylinder with Deadbolt</b>	ML2024	Entrance	\$1,396.00
	ML2048	Entrance	
	ML2049	Storeroom Deadbolt	
	ML2059	Security Storeroom	
	ML2065	Dormitory	
	ML2067	Apartment	
	ML2073	Classroom Security	
	ML2075	Entrance/Office	
ML2029	Hotel	\$1,439.00	
<b>Double Cylinder</b>	ML2002	Classroom Intruder	\$1,453.00
	ML2032	Institution	
	ML2042	Entrance	
	ML2052	Classroom Intruder	
	ML2087	Security Vestibule	
<b>Double Cylinder with Deadbolt</b>	ML2022	Store Door	\$1,501.00
	ML2062	Intruder Deadbolt	
	ML2072	Classroom Security Intruder	
	ML2082	Dormitory	
	ML2092	Security Institution	
Full Working Trim (Quick Code M31) No cylinder; includes thumbturn lever			\$951.00

Ordering Example Details

<b>ML2000</b>	ML2051	Office Function
Sectional Trim	21M	Piet Family Lever - Polished with Satin Insert
(rose)	V	Rose
	293029	Lever Finish
		Polished with satin stainless steel insert (630), polished stainless steel (629) shank and polished stainless steel (629) grip
	629	Lock Finish
	RHR	Handing

Stock Order					
Quantity	Series/Function	Trim	Lever Finish	Lock Finish	Hand
2	ML2051	21MV	293029	629	RHR



Experience a safer and more open world

# Mortise Locksets

ML2000 Series: Muséo Levers, Roses and Thumbturns

USA & Canada Prices Effective February 1, 2022

contemporary levers to complement the interior design of your next project



## PIET



## ROSES

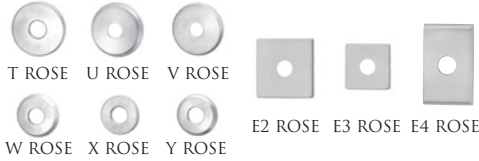

## THUMBTURNS



Specify thumbturn as quick code. Thumbturn backplate will match shape of rose chosen (i.e. round or square)

613E	Dark Oxidized Satin Bronze – Equivalent
629	Bright Stainless Steel
630	Satin Stainless Steel
BSP	Black Suede Powder Coat
WSP	White Suede Powder Coat

## Function

Function	Model	Description	Price
Non-Keyed	ML2010	Passage	\$1,334.00
	ML2020	Privacy	\$1,389.00
	ML2030		
	ML2040	Passage w/Indicator – VXX Option on Page 116 Applies	\$1,365.00
	ML2060	Privacy	
	ML2050	Half Dummy	\$522.00
	ML2070	Full Dummy	\$1,044.00
	ML2080	Half Active Dummy Trim	\$807.00
ML2090	Full Active Dummy Trim	\$1,329.00	
Single Cylinder	ML2003	Classroom	\$1,446.00
	ML2051	Office	
	ML2055	Classroom	
	ML2056	Classroom Holdback	
	ML2057	Storeroom	\$1,464.00
	ML2069	Institution Privacy	
	ML2053	Entrance	
	ML2054	Entrance	
ML2058	Entrance Holdback	\$1,464.00	
ML2068	Privacy or Classroom		
Single Cylinder with Deadbolt	ML2024	Entrance	\$1,494.00
	ML2048	Entrance	
	ML2049	Storeroom Deadbolt	
	ML2059	Security Storeroom	
	ML2065	Dormitory	
	ML2067	Apartment	
	ML2073	Classroom Security	
	ML2075	Entrance/Office	
ML2029	Hotel	\$1,537.00	
Double Cylinder	ML2002	Classroom Intruder	\$1,551.00
	ML2032	Institution	
	ML2042	Entrance	
	ML2052	Classroom Intruder	
	ML2087	Security Vestibule	
Double Cylinder with Deadbolt	ML2022	Store Door	\$1,599.00
	ML2062	Intruder Deadbolt	
	ML2072	Classroom Security Intruder	
	ML2082	Dormitory	
	ML2092	Security Institution	
Full Working Trim (Quick Code M31) No cylinder; includes thumbturn lever			\$1,046.00

## Ordering Example Details

<b>ML2000</b>	ML2051	Office Function
Sectional Trim (rose)	23M	Piet Family Lever - Wood Insert
	U	Rose
	29BH29	Lever Finish, Wood insert with polished stainless steel (629) shank and polished stainless steel (629) grip
	629	Lock Finish
	RHR	Handing

## Stock Order

Quantity	Series/Function	Trim	Lever Finish	Lock Finish	Hand
2	ML2051	23MU	29BH29	629	RHR



Experience a safer and more open world

Copyright © 2002-2022 Corbin Russwin, Inc., an ASSA ABLOY Group company. All rights reserved. Reproduction in whole or in part without the express written permission of Corbin Russwin, Inc., is prohibited. Contact us at: 800-543-3658 or visit [www.corbinrusswin.com](http://www.corbinrusswin.com). In Canada contact us at: 800-461-3007 or visit [www.assaabloydss.ca](http://www.assaabloydss.ca)



# Mortise Locksets

ML2000 Series: Muséo Levers and Escutcheons

USA & Canada Prices Effective February 1, 2022



contemporary levers to complement the interior design of your next project

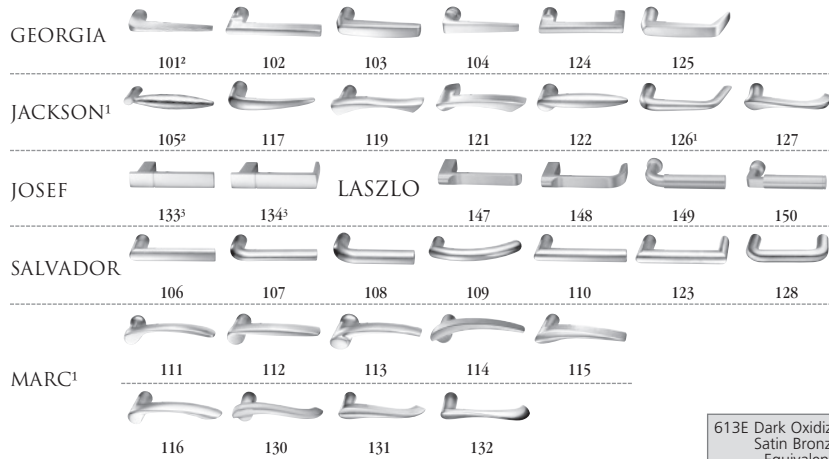

1. Handed: specify hand when ordering.
2. Contact factory for current lead time.
3. Not available with VN escutcheon.
4. VN escutcheon available only with indicators. Must be ordered with "V" indicator options. See page 116 for available functions. Option add also applies. Not available with 629 or 630 finish.

\*629 and 630 finish options are Not available for all Muséo levers. Please refer to page 24 for availability.

613E	Dark Oxidized Satin Bronze - Equivalent	618	Bright Nickel Plated
626	Satin Chromium Plated	619	Satin Nickel Plated
BSP	Black Suede Powder Coat	625	Bright Chromium Plated
WSP	White Suede Powder Coat	629*	Bright Stainless Steel
605	Bright Brass, Clear Coated	630*	Satin Stainless Steel
606	Satin Brass, Clear Coated	722	Black Oxidized Bronze, Oil Rubbed
611	Bright Bronze, Clear Coated	613L	Dark Oxidized Satin Bronze, Clear Coated
612	Satin Bronze, Clear Coated		

### Function

Function	Model	Description	Price (USA)	Price (Canada)
Non-Keyed	ML2010	Passage	\$1,099.00	\$1,123.00
	ML2020	Privacy	\$1,198.00	\$1,222.00
	ML2030			
	ML2040	Passage w/Indicator – VXX Option on Page 116 Applies	\$1,174.00	\$1,198.00
	ML2060	Privacy		
	ML2050	Half Dummy	\$515.00	\$527.00
	ML2070	Full Dummy	\$1,030.00	\$1,054.00
	ML2080	Half Active Dummy Trim	\$623.00	\$635.00
ML2090	Full Active Dummy Trim	\$1,138.00	\$1,162.00	
Single Cylinder	ML2003	Classroom	\$1,255.00	\$1,279.00
	ML2051	Office		
	ML2055	Classroom		
	ML2056	Classroom Holdback		
	ML2057	Storeroom	\$1,273.00	\$1,297.00
	ML2069	Institution Privacy		
	ML2053	Entrance		
	ML2054	Entrance		
ML2058	Entrance Holdback	\$1,346.00	\$1,370.00	
ML2068	Privacy or Classroom			
Single Cylinder with Deadbolt	ML2024	Entrance	\$1,303.00	\$1,327.00
	ML2048	Entrance		
	ML2049	Storeroom Deadbolt		
	ML2059	Security Storeroom		
	ML2065	Dormitory		
	ML2067	Apartment		
	ML2073	Classroom Security		
	ML2075	Entrance/Office		
ML2029	Hotel	\$1,408.00	\$1,432.00	
ML2002	Classroom Intruder			
ML2032	Institution			
ML2042	Entrance			
Double Cylinder	ML2042	Entrance	\$1,360.00	\$1,384.00
	ML2052	Classroom Intruder		
Double Cylinder with Deadbolt	ML2022	Store Door	\$1,408.00	\$1,432.00
	ML2062	Intruder Deadbolt		
	ML2072	Classroom Security Intruder		
	ML2082	Dormitory		
	ML2092	Security Institution		
Full Working Trim (Quick Code M31) No cylinder; includes thumbturn lever			\$933.00	\$957.00

### Ordering Example Details

<b>ML2000</b>	ML2051	Office Function
Escutcheon Trim	111	Marc Family Lever
	L	Escutcheon
	619	Finish
	RHR	Handing

### Stock Order

Quantity	Series/Function	Trim	Finish	Hand
24	ML2051	111L	619	RHR



Experience a safer and more open world

# Mortise Locksets

ML2000 Series: Muséo Levers and Escutcheons

USA & Canada Prices Effective February 1, 2022

contemporary levers to complement the interior design of your next project



## JOSEF



## GEORGES



L ESCUTCHEON



R ESCUTCHEON

1. Handed: specify hand when ordering.
2. Contact factory for current lead time.
3. Not available with escutcheon indicators.

613E Dark Oxidized Satin Bronze - Equivalent	605 Bright Brass, Clear Coated	618 Bright Nickel Plated
626 Satin Chromium Plated	606 Satin Brass, Clear Coated	619 Satin Nickel Plated
BSP Black Suede Powder Coat	611 Bright Bronze, Clear Coated	625 Bright Chromium Plated
WSP White Suede Powder Coat	612 Satin Bronze, Clear Coated	629 Bright Stainless Steel
	613 Dark Oxidized Satin Bronze, Oil Rubbed	630 Satin Stainless Steel
	613L Dark Oxidized Satin Bronze, Clear Coated	722 Black Oxidized Bronze, Oil Rubbed

## Function

Function	Model	Description	Price	Price
Non-Keyed	ML2010	Passage	\$1,383.00	\$1,407.00
	ML2020	Privacy	\$1,438.00	\$1,462.00
	ML2030	Privacy		
	ML2040	Passage w/Indicator – VXX Option on Page 116 Applies	\$1,414.00	\$1,438.00
	ML2060	Privacy		
	ML2050	Half Dummy	\$547.00	\$559.00
	ML2070	Full Dummy	\$1,093.00	\$1,117.00
	ML2080	Half Active Dummy Trim	\$832.00	\$844.00
	ML2090	Full Active Dummy Trim	\$1,378.00	\$1,402.00
Single Cylinder	ML2003	Classroom		
	ML2051	Office		
	ML2055	Classroom	\$1,495.00	\$1,519.00
	ML2056	Classroom Holdback		
	ML2057	Storeroom		
	ML2069	Institution Privacy		
	ML2053	Entrance		
	ML2054	Entrance	\$1,513.00	\$1,537.00
Single Cylinder with Deadbolt	ML2058	Entrance Holdback		
	ML2068	Privacy or Classroom		
	ML2024	Entrance		
	ML2048	Entrance		
	ML2049	Storeroom Deadbolt		
	ML2059	Security Storeroom	\$1,543.00	\$1,567.00
	ML2065	Dormitory		
	ML2067	Apartment		
Double Cylinder	ML2073	Classroom Security		
	ML2075	Entrance/Office		
	ML2029	Hotel	\$1,586.00	\$1,610.00
	ML2002	Classroom Intruder		
	ML2032	Institution	\$1,600.00	\$1,624.00
Double Cylinder with Deadbolt	ML2042	Entrance		
	ML2052	Classroom Intruder		
	ML2022	Store Door		
	ML2062	Intruder Deadbolt	\$1,648.00	\$1,672.00
	ML2072	Classroom Security Intruder		
	ML2082	Dormitory		
	ML2092	Security Institution		
Full Working Trim (Quick Code M31) No cylinder; includes thumbturn lever			\$1,095.00	\$1,119.00



### Ordering Example Details

ML2000 Escutcheon Trim

ML2051 Office Function  
 135 Josef Family Lever  
 L Escutcheon  
 619 Finish  
 RHR Handing

### Stock Order

Quantity	Series/Function	Trim	Finish	Hand
24	ML2051	135L	619	RHR



ASSA ABLOY

Experience a safer and more open world

Copyright © 2002-2022 Corbin Russwin, Inc., an ASSA ABLOY Group company. All rights reserved. Reproduction in whole or in part without the express written permission of Corbin Russwin, Inc., is prohibited.

Contact us at: 800-543-3658 or visit [www.corbinrusswin.com](http://www.corbinrusswin.com). In Canada contact us at: 800-461-3007 or visit [www.assaabloydss.ca](http://www.assaabloydss.ca)

# Mortise Locksets

ML2000 Series: Muséo Levers and Escutcheons

USA & Canada Prices Effective February 1, 2022



contemporary levers to complement the interior design of your next project



\*613E, BSP, WSP finishes are not available with 21M levers.

- 1. VN escutcheon available only with indicators. Must be ordered with "V" indicator options. See page 116 for available functions. Option add also applies. Not available with 629 or 630 finish.



613E	Dark Oxidized Satin Bronze – Equivalent
629	Bright Stainless Steel
630	Satin Stainless Steel
BSP	Black Suede Powder Coat
WSP	White Suede Powder Coat

## Function

Function	Model	Description	Price
Non-Keyed	ML2010	Passage	\$1,309.00
	ML2020	Privacy	\$1,364.00
	ML2030		
	ML2040	Passage w/Indicator – VXX Option on Page 116 Applies	\$1,340.00
	ML2060	Privacy	
	ML2050	Half Dummy	\$518.00
	ML2070	Full Dummy	\$1,035.00
	ML2080	Half Active Dummy Trim	\$787.00
	ML2090	Full Active Dummy Trim	\$1,304.00
Single Cylinder	ML2003	Classroom	\$1,421.00
	ML2051	Office	
	ML2055	Classroom	
	ML2056	Classroom Holdback	
	ML2057	Storeroom	\$1,439.00
	ML2069	Institution Privacy	
	ML2053	Entrance	
	ML2054	Entrance	
ML2058	Entrance Holdback	\$1,439.00	
ML2068	Privacy or Classroom		
Single Cylinder with Deadbolt	ML2024	Entrance	\$1,469.00
	ML2048	Entrance	
	ML2049	Storeroom Deadbolt	
	ML2059	Security Storeroom	
	ML2065	Dormitory	
	ML2067	Apartment	
	ML2073	Classroom Security	
	ML2075	Entrance/Office	
ML2029	Hotel	\$1,512.00	
Double Cylinder	ML2002	Classroom Intruder	\$1,526.00
	ML2032	Institution	
	ML2042	Entrance	
	ML2052	Classroom Intruder	
Double Cylinder with Deadbolt	ML2022	Store Door	\$1,574.00
	ML2062	Intruder Deadbolt	
	ML2072	Classroom Security Intruder	
	ML2082	Dormitory	
	ML2092	Security Institution	
Full Working Trim (Quick Code M31) No cylinder; includes thumbturn lever			\$1,024.00



### Ordering Example Details

<b>ML2000</b>	Office Function
Escutcheon	21M Piet Family Lever - Polished with Satin Insert
Trim	L Escutcheon
	293029 Lever Finish
	Polished with satin stainless steel insert (630), polished stainless steel (629) shank and polished stainless steel (629) grip
629	Lock Finish
RHR	Handing

### Stock Order

Quantity	Series/Function	Trim	Lever Finish	Lock Finish	Hand
2	ML2051	21ML	293029	629	RHR



ASSA ABLOY

Experience a safer and more open world

# Mortise Locksets

ML2000 Series: Muséo Levers and Escutcheons

USA & Canada Prices Effective February 1, 2022

contemporary levers to complement the interior design of your next project



PIET



L ESCUTCHEON R ESCUTCHEON VN ESCUTCHEON (See Note 4)

- 1. VN escutcheon available only with indicators. Must be ordered with "V" indicator options. See page 116 for available functions. Option add also applies. Not available with 629 or 630 finish.

613E	Dark Oxidized Satin Bronze – Equivalent
629	Bright Stainless Steel
630	Satin Stainless Steel
BSP	Black Suede Powder Coat
WSP	White Suede Powder Coat

## Function

Function	Model	Description	Price
Non-Keyed	ML2010	Passage	\$1,407.00
	ML2020	Privacy	\$1,462.00
	ML2030		
	ML2040	Passage w/Indicator – VXX Option on Page 116 Applies	\$1,438.00
	ML2060	Privacy	
	ML2050	Half Dummy	\$559.00
	ML2070	Full Dummy	\$1,117.00
	ML2080	Half Active Dummy Trim	\$844.00
ML2090	Full Active Dummy Trim	\$1,402.00	
Single Cylinder	ML2003	Classroom	\$1,519.00
	ML2051	Office	
	ML2055	Classroom	
	ML2056	Classroom Holdback	
	ML2057	Storeroom	\$1,537.00
	ML2069	Institution Privacy	
	ML2053	Entrance	
	ML2054	Entrance	
ML2058	Entrance Holdback	\$1,537.00	
ML2068	Privacy or Classroom		
Single Cylinder with Deadbolt	ML2024	Entrance	\$1,567.00
	ML2048	Entrance	
	ML2049	Storeroom Deadbolt	
	ML2059	Security Storeroom	
	ML2065	Dormitory	\$1,610.00
	ML2067	Apartment	
	ML2073	Classroom Security	
	ML2075	Entrance/Office	
ML2029	Hotel	\$1,610.00	
Double Cylinder	ML2002	Classroom Intruder	\$1,624.00
	ML2032	Institution	
	ML2042	Entrance	
	ML2052	Classroom Intruder	
Double Cylinder with Deadbolt	ML2022	Store Door	\$1,672.00
	ML2062	Intruder Deadbolt	
	ML2072	Classroom Security Intruder	
	ML2082	Dormitory	
	ML2092	Security Institution	
Full Working Trim (Quick Code M31) No cylinder; includes thumbturn lever			\$1,119.00

**BHMA CERTIFIED** ML2000 Escutcheon Trim

Ordering Example Details →

ML2051 Office Function  
 23M Piet Family Lever - Wood Insert  
 L Escutcheon  
 29BH29 Lever Finish  
 Wood insert with polished stainless steel (629) shank and polished stainless steel (629) grip  
 629 Lock Finish  
 RHR Handing

Stock Order					
Quantity	Series/Function	Trim	Lever Finish	Lock Finish	Hand
2	ML2051	23M	29BH29	629	RHR



Experience a safer and more open world



LWA RWA  
Lever: Wrought  
Rose: Wrought

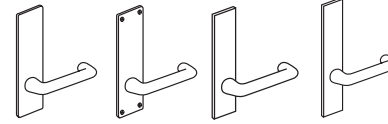

LWM LWN LWP LWR  
Lever: Wrought  
Escutcheon: Wrought

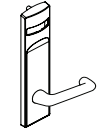

LWVN  
Lever: Wrought  
Esc: Solid Stainless  
Steel or Forged Brass  
Escutcheon:  
Forged Brass

Levers: LW, RW Roses: A Roses: B, F (see note 1)	
613E, 626, BSP, WSP	605, 606, 611, 612, 613, 618, 619, 625, 629, 630, 722

Levers: LW, RW Escutcheons: M, N, P	
613E, 626, BSP, WSP	605, 606, 611, 612, 613, 618, 619, 625, 629, 630, 722

Levers: LW, RW Escutcheons: R (see note 2) VN (see note 3)	
613E, 626, BSP, WSP	605, 606, 611, 612, 613, 618, 619, 625, 629, 630, 722

Function	Model	Description	613E, 626, BSP, WSP	605, 606, 611, 612, 613, 618, 619, 625, 629, 630, 722	613E, 626, BSP, WSP	605, 606, 611, 612, 613, 618, 619, 625, 629, 630, 722	613E, 626, BSP, WSP	605, 606, 611, 612, 613, 618, 619, 625, 629, 630, 722
Non-Keyed	ML2010	Passage	\$826.00	\$850.00	\$846.00	\$870.00	\$900.00	\$924.00
	ML2020	Privacy	\$957.00	\$981.00	\$977.00	\$1,001.00	\$1,031.00	\$1,055.00
	ML2030							
	ML2040	Passage w/Indicator – VXX Option on Page 116 Applies	\$882.00	\$906.00	\$902.00	\$926.00	\$956.00	\$980.00
	ML2060	Privacy						
	ML2050	Half Dummy	\$451.00	\$463.00	\$461.00	\$473.00	\$488.00	\$500.00
	ML2070	Full Dummy	\$902.00	\$926.00	\$922.00	\$946.00	\$976.00	\$1,000.00
	ML2080	Half Active Dummy Trim	\$388.00	\$400.00	\$398.00	\$410.00	\$425.00	\$437.00
ML2090	Full Active Dummy Trim	\$839.00	\$863.00	\$859.00	\$883.00	\$913.00	\$937.00	
Single Cylinder	ML2003	Classroom	\$956.00	\$980.00	\$976.00	\$1,000.00	\$1,030.00	\$1,054.00
	ML2051	Office						
	ML2055	Classroom						
	ML2056	Classroom						
	ML2057	Storeroom						
	ML2069	Institution Privacy						
	ML2053	Entrance	\$974.00	\$998.00	\$994.00	\$1,018.00	\$1,048.00	\$1,072.00
	ML2054	Entrance						
ML2058	Entrance Holdback							
ML2068	Privacy or Apartment							
Single Cylinder with Deadbolt	ML2024	Entrance	\$1,004.00	\$1,028.00	\$1,024.00	\$1,048.00	\$1,078.00	\$1,102.00
	ML2048	Entrance						
	ML2049	Storeroom Deadbolt						
	ML2065	Dormitory						
	ML2059	Security Storeroom						
	ML2067	Apartment						
	ML2073	Classroom Security						
ML2075	Entrance/Office							
ML2029	Hotel	\$1,047.00	\$1,071.00	\$1,067.00	\$1,091.00	\$1,121.00	\$1,145.00	
Double Cylinder	ML2002	Classroom Intruder	\$1,061.00	\$1,085.00	\$1,081.00	\$1,105.00	\$1,135.00	\$1,159.00
	ML2032	Institution						
	ML2042	Entrance						
	ML2052	Classroom Intruder						
	ML2087	Security Vestibule					N/A	N/A
Double Cylinder with Deadbolt	ML2022	Store Door	\$1,109.00	\$1,133.00	\$1,129.00	\$1,153.00	\$1,183.00	\$1,207.00
	ML2062	Intruder Deadbolt						
	ML2072	Classroom Security Intruder						
	ML2082	Dormitory						
	ML2092	Security Institution						
Full Working Trim (Quick Code M31) No cylinder; includes thumbturn lever			\$675.00	\$699.00	\$695.00	\$719.00	\$749.00	\$773.00

NOTES: 1. Rose substitutions for LWA, RWA: 2-1/4" cast rose in place of 2-1/4" wrought rose, substitute letter "B" in place of "A" (e.g. LWB). **Add \$46.00 per lockset**  
2-7/8" cast rose in place of 2-1/4" wrought rose, substitute letter "F" in place of "A" (e.g. RWF). **Add \$61.00 per lockset**

2. "R" Escutcheon trims are available for 1 3/8", 1 3/4", 2", or 2 1/4" door thickness only.

3. VN escutcheon available only with indicators. Must be ordered with "V" indicator options. See page 116 for available functions. Option add also applies. Not available with 629 or 630 finish.

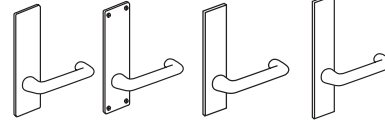
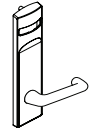
**LSA**  
Lever: Cast  
Rose: Wrought

**LSM LSN LSP LSR**  
Lever: Cast  
Escutcheon: Wrought

**LSVN**  
Lever: Cast  
Escutcheon: Steel or Forged Brass  
Forged Brass

<b>Levers: LS</b>	
<b>Roses: A</b>	
<b>Roses: B, F (see note 1)</b>	
613E, 626, BSP, WSP	605, 606, 611, 612, 613, 618, 619, 625, 629, 630, 722

<b>Levers: LS</b>	
<b>Escutcheons: M, N, P</b>	
613E, 626, BSP, WSP	605, 606, 611, 612, 613, 618, 619, 625, 629, 630, 722

<b>Levers: LS</b>	
<b>Escutcheons: R (see note 2)</b>	
<b>VN (see note 3)</b>	
613E, 626, BSP, WSP	605, 606, 611, 612, 613, 618, 619, 625, 629, 630, 722

Function			613E, 626, BSP, WSP		605, 606, 611, 612, 613, 618, 619, 625, 629, 630, 722		613E, 626, BSP, WSP		605, 606, 611, 612, 613, 618, 619, 625, 629, 630, 722	
	Non-Keyed	ML2010	Passage	\$860.00	\$950.00	\$1,033.00	\$1,057.00	\$1,067.00	\$1,091.00	
	ML2020	Privacy	\$959.00	\$1,049.00	\$1,132.00	\$1,156.00	\$1,166.00	\$1,190.00		
	ML2030									
	ML2040	Passage w/Indicator - VXX Option on Page 116 Applies	\$935.00	\$1,025.00	\$1,108.00	\$1,132.00	\$1,142.00	\$1,166.00		
	ML2060	Privacy								
	ML2050	Half Dummy	\$323.00	\$368.00	\$528.00	\$552.00	\$545.00	\$569.00		
	ML2070	Full Dummy	\$646.00	\$736.00	\$1,056.00	\$1,080.00	\$1,090.00	\$1,114.00		
	ML2080	Half Active Dummy Trim	\$576.00	\$621.00	\$606.00	\$618.00	\$623.00	\$635.00		
	ML2090	Full Active Dummy Trim	\$899.00	\$989.00	\$1,072.00	\$1,096.00	\$1,106.00	\$1,130.00		
Single Cylinder	ML2003	Classroom								
	ML2051	Office								
	ML2055	Classroom	\$1,016.00	\$1,106.00	\$1,189.00	\$1,213.00	\$1,223.00	\$1,247.00		
	ML2056	Classroom								
	ML2057	Storeroom								
	ML2069	Institution Privacy								
	ML2053	Entrance								
	ML2054	Entrance	\$1,034.00	\$1,124.00	\$1,207.00	\$1,231.00	\$1,241.00	\$1,265.00		
ML2058	Entrance Holdback									
ML2068	Privacy or Apartment									
Single Cylinder with Deadbolt	ML2024	Entrance								
	ML2048	Entrance								
	ML2049	Storeroom Deadbolt	\$1,064.00	\$1,154.00	\$1,237.00	\$1,261.00	\$1,271.00	\$1,295.00		
	ML2065	Dormitory								
	ML2059	Security Storeroom								
	ML2067	Apartment								
	ML2073	Classroom Security								
	ML2075	Entrance/Office								
ML2029	Hotel	\$1,107.00	\$1,197.00	\$1,280.00	\$1,304.00	\$1,314.00	\$1,338.00			
Double Cylinder	ML2002	Classroom Intruder								
	ML2032	Institution								
	ML2042	Entrance	\$1,121.00	\$1,211.00	\$1,294.00	\$1,318.00	\$1,328.00	\$1,352.00		
	ML2052	Classroom Intruder								
	ML2087	Security Vestibule								
						N/A	N/A			
Double Cylinder with Deadbolt	ML2022	Store Door								
	ML2062	Intruder Deadbolt								
	ML2072	Classroom Security Intruder	\$1,169.00	\$1,259.00	\$1,342.00	\$1,366.00	\$1,376.00	\$1,400.00		
	ML2082	Dormitory								
	ML2092	Security Institution								
Full Working Trim (Quick Code M31) No cylinder; includes thumbturn lever			\$669.00	\$759.00	\$959.00	\$983.00	\$993.00	\$1,017.00		

NOTES: 1. Rose substitutions for LSA: 2-1/4" cast rose in place of 2-1/4" wrought rose, substitute letter "B" in place of "A" (e.g. LSB). **Add \$46.00 per lockset**  
 2-7/8" cast rose in place of 2-1/4" wrought rose, substitute letter "F" in place of "A" (e.g. LSF). **Add \$61.00 per lockset**  
 2. "R" Escutcheon trims are available for 1 3/8", 1 3/4", or 2 1/4" door thickness only  
 3. VN escutcheon available only with indicators. Must be ordered with "V" indicator options. See page 116 for available functions. Option add also applies.  
 Not available with 629 or 630 finish.



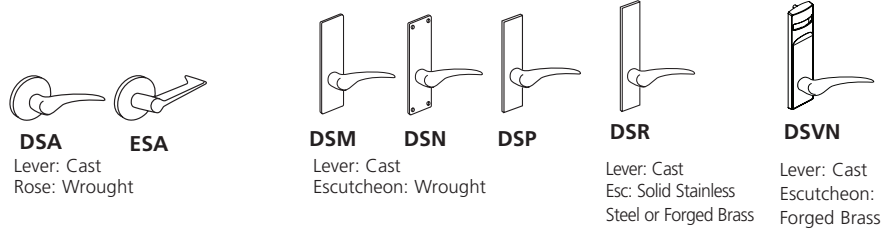

Levers: DS, ES Roses: A Roses: B, F (see note 1)		Levers: DS, ES Escutcheons: M, N, P		Levers: DS, ES Escutcheons: R (see note 2) VN (see note 3)	
613E, 626, BSP, WSP	605, 606, 611, 612, 613, 618, 619, 625, 629, 630, 722	613E, 626, BSP, WSP	605, 606, 611, 612, 613, 618, 619, 625, 629, 630, 722	613E, 626, BSP, WSP	605, 606, 611, 612, 613, 618, 619, 625, 629, 630, 722

Function	Model	Description	613E, 626, BSP, WSP	605, 606, 611, 612, 613, 618, 619, 625, 629, 630, 722	613E, 626, BSP, WSP	605, 606, 611, 612, 613, 618, 619, 625, 629, 630, 722	613E, 626, BSP, WSP	605, 606, 611, 612, 613, 618, 619, 625, 629, 630, 722
Non-Keyed	ML2010	Passage	\$1,045.00	\$1,069.00	\$1,065.00	\$1,089.00	\$1,099.00	\$1,123.00
	ML2020	Privacy	\$1,144.00	\$1,168.00	\$1,164.00	\$1,188.00	\$1,198.00	\$1,222.00
	ML2030							
	ML2040	Passage w/Indicator – VXX Option on Page 116 Applies	\$1,120.00	\$1,144.00	\$1,140.00	\$1,164.00	\$1,174.00	\$1,198.00
	ML2060	Privacy						
	ML2050	Half Dummy	\$488.00	\$500.00	\$498.00	\$510.00	\$515.00	\$527.00
	ML2070	Full Dummy	\$976.00	\$1,000.00	\$996.00	\$1,020.00	\$1,030.00	\$1,054.00
	ML2080	Half Active Dummy Trim	\$596.00	\$608.00	\$606.00	\$618.00	\$623.00	\$635.00
ML2090	Full Active Dummy Trim	\$1,084.00	\$1,108.00	\$1,104.00	\$1,128.00	\$1,138.00	\$1,162.00	
Single Cylinder	ML2003	Classroom	\$1,201.00	\$1,225.00	\$1,221.00	\$1,245.00	\$1,255.00	\$1,279.00
	ML2051	Office						
	ML2055	Classroom						
	ML2056	Classroom						
	ML2057	Storeroom						
	ML2069	Institution Privacy						
	ML2053	Entrance	\$1,219.00	\$1,243.00	\$1,239.00	\$1,263.00	\$1,273.00	\$1,297.00
	ML2054	Entrance						
ML2058	Entrance Holdback							
ML2068	Privacy or Apartment							
Single Cylinder with Deadbolt	ML2024	Entrance	\$1,249.00	\$1,273.00	\$1,269.00	\$1,293.00	\$1,303.00	\$1,327.00
	ML2048	Entrance						
	ML2049	Storeroom Deadbolt						
	ML2065	Dormitory						
	ML2059	Security Storeroom						
	ML2067	Apartment						
	ML2073	Classroom Security						
ML2075	Entrance/Office							
ML2029	Hotel	\$1,292.00	\$1,316.00	\$1,312.00	\$1,336.00	\$1,346.00	\$1,370.00	
Double Cylinder	ML2002	Classroom Intruder	\$1,306.00	\$1,330.00	\$1,326.00	\$1,350.00	\$1,360.00	\$1,384.00
	ML2032	Institution						
	ML2042	Entrance						
	ML2052	Classroom Intruder						
	ML2087	Security Vestibule						
Double Cylinder with Deadbolt	ML2022	Store Door	\$1,354.00	\$1,378.00	\$1,374.00	\$1,398.00	\$1,408.00	\$1,432.00
	ML2062	Intruder Deadbolt						
	ML2072	Classroom Security Intruder						
	ML2082	Dormitory						
	ML2092	Security Institution						
Full Working Trim (Quick Code M31) No cylinder; includes thumbturn lever			\$879.00	\$903.00	\$899.00	\$923.00	\$933.00	\$957.00

NOTES: 1. Rose substitutions for DSA, ESA: 2-1/4" cast rose in place of 2-1/4" wrought rose, substitute letter "B" in place of "A" (e.g. DSB). **Add \$46.00 per lockset**  
 2-7/8" cast rose in place of 2-1/4" wrought rose, substitute letter "F" in place of "A" (e.g. ESF). **Add \$61.00 per lockset**  
 2. "R" Escutcheon trims are available for 1 3/8", 1 3/4", or 2 1/4" door thickness only.  
 3. VN escutcheon available only with indicators. Must be ordered with "V" indicator options. See page 116 for available functions. Option add also applies.  
 Not available with 629 or 630 finish.



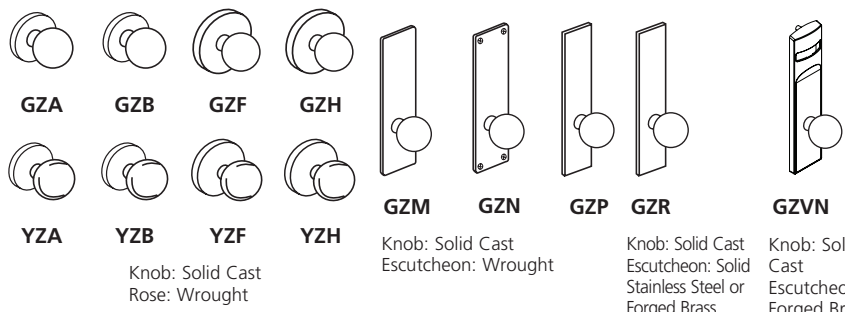

Function	Knobs: GZ, YZ Roses: A, H Roses: B, F (see note 2)		Knobs: GZ, YZ Escutcheons: M, N, P		Knobs: GZ, YZ Escutcheons: R (see note 2) VN (see note 3)			
	613E, 626, BSP, WSP	605, 606, 611, 612, 613, 618, 619, 625, 722	613E, 626, BSP, WSP	605, 606, 611, 612, 613, 618, 619, 625, 722	613E, 626, BSP, WSP	605, 606, 611, 612, 613, 618, 619, 625, 722		
Non-Keyed	ML2010	Passage	\$1,035.00	\$1,059.00	\$1,055.00	\$1,079.00	\$1,089.00	\$1,113.00
	ML2020	Privacy	\$1,098.00	\$1,122.00	\$1,118.00	\$1,142.00	\$1,152.00	\$1,176.00
	ML2030							
	ML2040	Passage w/Indicator – VXX Option on Page 116 Applies	\$1,091.00	\$1,115.00	\$1,111.00	\$1,135.00	\$1,145.00	\$1,169.00
	ML2060	Privacy						
	ML2050	Half Dummy	\$601.00	\$613.00	\$611.00	\$623.00	\$628.00	\$640.00
	ML2070	Full Dummy	\$1,202.00	\$1,226.00	\$1,222.00	\$1,246.00	\$1,256.00	\$1,280.00
	ML2080	Half Active Dummy Trim	\$437.00	\$449.00	\$447.00	\$459.00	\$464.00	\$476.00
ML2090	Full Active Dummy Trim	\$1,038.00	\$1,062.00	\$1,058.00	\$1,082.00	\$1,092.00	\$1,116.00	
Single Cylinder	ML2003	Classroom	\$1,155.00	\$1,179.00	\$1,175.00	\$1,199.00	\$1,209.00	\$1,233.00
	ML2051	Office						
	ML2055	Classroom						
	ML2056	Classroom						
	ML2057	Storeroom						
	ML2069	Institution Privacy						
	ML2053	Entrance	\$1,173.00	\$1,197.00	\$1,193.00	\$1,217.00	\$1,227.00	\$1,251.00
	ML2054	Entrance						
ML2058	Entrance Holdback							
ML2068	Privacy or Apartment							
Single Cylinder with Deadbolt	ML2024	Entrance	\$1,203.00	\$1,227.00	\$1,223.00	\$1,247.00	\$1,257.00	\$1,281.00
	ML2048	Entrance						
	ML2049	Storeroom Deadbolt						
	ML2065	Dormitory						
	ML2059	Security Storeroom						
	ML2067	Apartment						
	ML2073	Classroom Security						
	ML2075	Entrance/Office						
ML2029	Hotel	\$1,246.00	\$1,270.00	\$1,266.00	\$1,290.00	\$1,300.00	\$1,324.00	
Double Cylinder	ML2002	Classroom Intruder	\$1,260.00	\$1,284.00	\$1,280.00	\$1,304.00	\$1,314.00	\$1,338.00
	ML2032	Institution						
	ML2042	Entrance						
	ML2052	Classroom Intruder						
	ML2087	Security Vestibule					N/A	N/A
Double Cylinder with Deadbolt	ML2022	Store Door	\$1,308.00	\$1,332.00	\$1,328.00	\$1,352.00	\$1,362.00	\$1,386.00
	ML2062	Intruder Deadbolt						
	ML2072	Classroom Security Intruder						
	ML2082	Dormitory						
	ML2092	Security Institution						
Full Working Trim (Quick Code M31) No cylinder; includes thumbturn lever.			\$879.00	\$903.00	\$899.00	\$923.00	\$933.00	\$957.00

- NOTES: 1. "R" Escutcheon trims are available for 1 3/8", 1 3/4", or 2 1/4" door thickness only.  
 2. Rose substitutions: 2-1/4" cast rose in place of 2-1/4" wrought rose, substitute letter "B" in place of "A" (e.g. GZB). **Add \$46.00 per lockset**  
 2-7/8" cast rose in place of 2-1/4" wrought rose, substitute letter "F" in place of "A" (e.g. GZF). **Add \$61.00 per lockset**  
 3. VN escutcheon available only with indicators. Must be ordered with "V" indicator options. See page 116 for available functions. Option add also applies.

**Lever Designs: FSG, MSG, ZSG**

**Lever: Rose:**  
Cast Cast



**Frascati**



**Lever Designs: FSL, MSL<sup>1</sup>, ZSL, FSVN, MSVN, ZSVN**

**Lever: Escutcheon:**  
Cast Cast

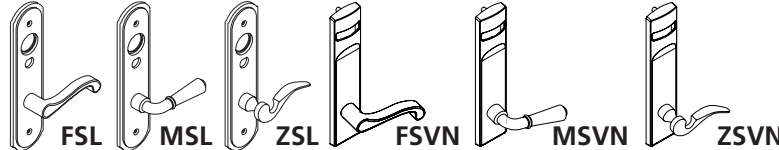

**Merlot**

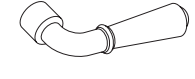

**Zinfandel**



Function	Description	FSG, MSG, ZSG		FSL, MSL, ZSL FSVN, MSVN, ZSVN (see note 3)		
		613E, 626, BSP, WSP	605, 606, 611, 612, 613 <sup>2</sup> , 613L <sup>2</sup> , 618, 619, 625, 722	613E, 626, BSP, WSP	605, 606, 611, 612, 613 <sup>2</sup> , 613L <sup>2</sup> , 618, 619, 625, 722	
Non-Keyed	ML2010	Passage	\$1,045.00	\$1,069.00	\$1,099.00	\$1,123.00
	ML2020	Privacy	\$1,144.00	\$1,168.00	\$1,198.00	\$1,222.00
	ML2030					
	ML2040	Passage w/Indicator – VXX Option on Page 116 Applies	\$1,120.00	\$1,144.00	\$1,174.00	\$1,198.00
	ML2060	Privacy				
	ML2050	Half Dummy	\$488.00	\$500.00	\$515.00	\$527.00
	ML2070	Full Dummy	\$976.00	\$1,000.00	\$1,030.00	\$1,054.00
	ML2080	Half Active Dummy Trim	\$596.00	\$608.00	\$623.00	\$635.00
ML2090	Full Active Dummy Trim	\$1,084.00	\$1,108.00	\$1,138.00	\$1,162.00	
Single Cylinder	ML2003	Classroom	\$1,201.00	\$1,225.00	\$1,255.00	\$1,279.00
	ML2051	Office				
	ML2055	Classroom				
	ML2056	Classroom Holdback				
	ML2057	Storeroom				
	ML2069	Institution Privacy				
	ML2053	Entrance	\$1,219.00	\$1,243.00	\$1,273.00	\$1,297.00
	ML2054	Entrance				
ML2058	Entrance Holdback					
ML2068	Privacy or Apartment					
Single Cylinder with Deadbolt	ML2024	Entrance	\$1,249.00	\$1,273.00	\$1,303.00	\$1,327.00
	ML2048	Entrance				
	ML2049	Storeroom Deadbolt				
	ML2059	Dormitory				
	ML2065	Security Storeroom				
	ML2067	Apartment				
	ML2073	Classroom Security				
	ML2075	Entrance/Office				
ML2029	Hotel	\$1,292.00	\$1,316.00	\$1,346.00	\$1,370.00	
Double Cylinder	ML2002	Classroom Intruder	\$1,306.00	\$1,330.00	\$1,360.00	\$1,384.00
	ML2032	Institution				
	ML2042	Entrance				
	ML2052	Classroom Intruder				
ML2087	Security Vestibule			N/A	N/A	
Double Cylinder with Deadbolt	ML2022	Store Door	\$1,354.00	\$1,378.00	\$1,408.00	\$1,432.00
	ML2062	Intruder Deadbolt				
	ML2072	Classroom Security Intrude				
	ML2082	Dormitory				
ML2092	Security Institution					
Full Working Trim (Quick Code M31) No cylinder; includes thumbturn lever			\$879.00	\$903.00	\$933.00	\$957.00

NOTES: 1. Escutcheon trims are available for 1-3/8", 1-3/4" or 2-1/4" door thicknesses only.  
2. 613 finish is brass base lever & rose/escutcheon.  
3. VN escutcheon available only with indicators. Must be ordered with "V" indicator options. See page 116 for available functions. Option add also applies.

**Deadbolt Only**

Include lockcase, armored front, strike, screw pack, cylinder(s) and thumbturn lever.

**Ordering Example**

Quantity	Series/Function	Trim Design (Escutcheon Type Only)	Finish	Door Thickness
12	ML2013	N	626	D138

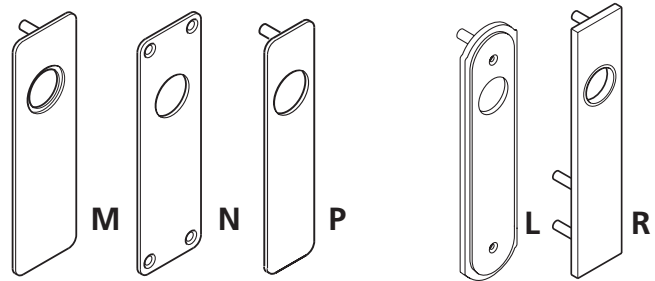

Deadlock No Trim

Function	
613E, 626, BSP, WSP	605, 606, 611, 612, 613, 618, 619, 625, 629, 630, 722

Wrought

M, N, P	
613E, 626, BSP, WSP	605, 606, 611, 612, 613, 618, 619, 625, 629, 630, 722

L, R: Solid Stainless Steel or Forged Brass

L, R	
613E, 626, BSP, WSP	605, 606, 611, 612, 613, 618, 619, 625, 629, 630, 722

**Function**

Function	Series	Price 1	Price 2	Price 3	Price 4	Price 5	Price 6
Single Cylinder	ML2011	\$482.00	\$488.00	\$538.00	\$544.00	\$610.00	\$616.00
Double Cylinder	ML2012	\$587.00	\$593.00	\$671.00	\$677.00	\$760.00	\$766.00
Cylinder x Thumbturn	ML2013	\$500.00	\$506.00	\$584.00	\$590.00	\$673.00	\$679.00
Classroom Function Cylinder x Thumbturn	ML2017	\$500.00	\$506.00	\$584.00	\$590.00	\$673.00	\$679.00

- NOTES: 1. Escutcheon trims are available for 1 3/8", 1 3/4", or 2 1/4" door thickness only.  
 2. VN escutcheon available only with sectional V series indicators. See page 116 for option codes  
 Not available with 629 or 630 finish.

**Vandal Resistant Trim**

**Lever Designs: CSV, NSV**

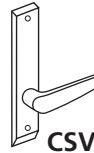

**CSV**

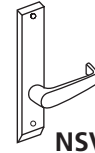

**NSV**

Lever: Cast  
Escutcheon: Cast

**Citation**



**Newport**

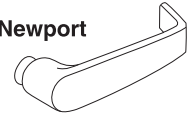

**CSV, NSV**

**630**

Function			
Non-Keyed	ML2010VR	Passage	\$1,702.00
	ML2020VR	Privacy	\$1,801.00
	ML2030VR		
	ML2060VR		
	ML2090VR		
Single Cylinder	ML2003VR	Office	\$1,858.00
	ML2051VR	Classroom	
	ML2055VR	Classroom Holdback	
	ML2056VR	Storeroom	
	ML2057VR	Institution Privacy	
	ML2069VR	Entrance	\$1,876.00
	ML2053VR		
	ML2054VR		
	ML2058VR		
	ML2068VR		
Single Cylinder with Deadbolt	ML2024VR	Entrance	\$1,906.00
	ML2048VR	Entrance	
	ML2049VR	Security Storeroom	
	ML2059VR	Dormitory	
	ML2065VR	Apartment	
	ML2067VR	Classroom Security	
	ML2073VR	Entrance/Office	
	ML2075VR	Hotel	
ML2029VR			
Double Cylinder	ML2002VR	Institution	\$1,963.00
	ML2032VR	Entrance	
	ML2042VR	Classroom Intruder	
	ML2052VR	Store Door	\$2,011.00
	ML2022VR		
	ML2062VR		
	ML2072VR		
	ML2082VR		
ML2092VR	Security Institution		
Deadlock	ML2011VR	Single Cylinder	\$1,511.00
	ML2013VR	Cylinder x Thumbturn	
	ML2017VR	Double Cylinder	
	ML2012VR	Double Cylinder	
Full Working Trim (Quick Code M31) No cylinder; includes thumbturn lever			\$1,421.00

NOTE:  
Escutcheon trims are available for 1 3/4", 2", or 2 1/4" door thickness only

# Mortise Locksets

ML20900 Series Museo Levers and Inspire Roseless Trim

USA & Canada Prices Effective February 1, 2022



contemporary levers to complement the interior design of your next project

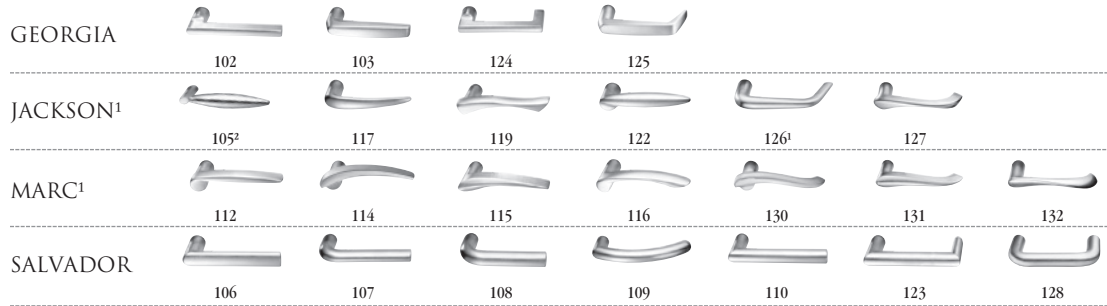

J Collar

- 1. Handed: specify hand when ordering
- 2. Contact factory for current lead time

613E	Dark Oxidized Satin Bronze - Equivalent	605	Bright Brass, Clear Coated	618	Bright Nickel Plated
626	Satin Chromium Plated	606	Satin Brass, Clear Coated	619	Satin Nickel Plated
BSP	Black Suede Powder Coat	611	Bright Bronze, Clear Coated	625	Bright Chromium Plated
WSP	White Suede Powder Coat	612	Satin Bronze, Clear Coated	629*	Bright Stainless Steel
		613	Dark Oxidized Satin Bronze, Oil Rubbed	630*	Satin Stainless Steel
		613L	Dark Oxidized Satin Bronze, Clear Coated	722	Black Oxidized Bronze, Oil Rubbed

### Function

Lever with Roses				
Single Cylinder	ML20914	Fail Safe/Fail Secure	\$1,482.00	\$1,506.00
	ML20906			
No Cylinder Override	ML20907	Fail Safe/Fail Secure	\$1,377.00	\$1,401.00
	ML20915			
Double Cylinder	ML20932	Fail Safe/Fail Secure	\$1,587.00	\$1,611.00
	ML20987			



### Ordering Example Details

<b>ML2000</b>	ML2051	Office Function
Sectional Trim (rose)	102	Georgia Family Lever
	J	Collar
	625	Finish
	RHR	Handing

### Stock Order

Quantity	Series/Function	Trim	Finish	Hand
24	ML2051	102J	625	RHR

\*629 and \*630 finish options are Not available for all Muséo levers. Please refer to page 24 for availability.



Experience a safer and more open world

# Electrically Controlled Mortise Locksets

## ML20900 Series: Muséo Levers, Escutcheons, Roses and Thumbturns

USA & Canada Prices Effective February 1, 2022

contemporary levers to complement the interior design of your next project

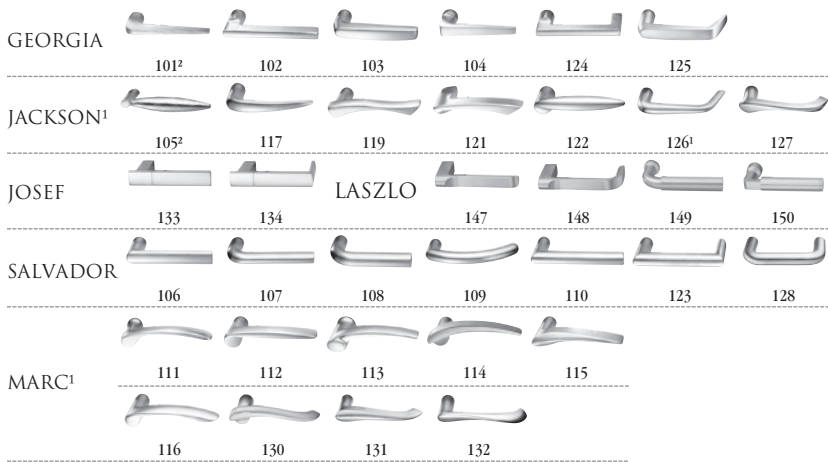

### ROSES

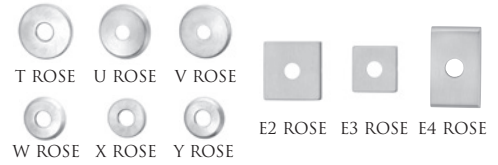

### ESCUTCHEONS



### THUMBTURNS<sup>3</sup>



1. Handed: specify hand when ordering
2. Contact factory for current lead time
3. Specify thumbturn as quick code. Thumbturn backplate will match shape of rose chosen (i.e. round or square). Not available with escutcheons.
4. ML20987 not available for L or R escutcheons.

\*629 and \*630 finish options are Not available for all Muséo levers. Please refer to page 24 for availability.

613E	Dark Oxidized Satin Bronze - Equivalent	605	Bright Brass, Clear Coated	618	Bright Nickel Plated
626	Satin Chromium Plated	606	Satin Brass, Clear Coated	619	Satin Nickel Plated
BSP	Black Suede Powder Coat	611	Bright Bronze, Clear Coated	625	Bright Chromium Plated
WSP	White Suede Powder Coat	612	Satin Bronze, Clear Coated	629*	Bright Stainless Steel
		613	Dark Oxidized Satin Bronze, Oil Rubbed	630*	Satin Stainless Steel
		613L	Dark Oxidized Satin Bronze, Clear Coated	722	Black Oxidized Bronze, Oil Rubbed

### Function

Lever with Escutcheons: L,R						
Single Cylinder	ML20914	Fail Safe/Fail Secure*	\$1,494.00			\$1,518.00
	ML20906					
No Cylinder Override	ML20907	Fail Safe/Fail Secure*	\$1,389.00			\$1,413.00
	ML20915					
Double Cylinder	ML20932	Fail Safe/Fail Secure*	\$1,599.00			\$1,623.00
	ML20987		N/A			N/A
Lever with Roses: V,U,T,Y,X,W,E2,E3,E4						
Single Cylinder	ML20914	Fail Safe/Fail Secure*	\$1,440.00			\$1,464.00
	ML20906					
No Cylinder Override	ML20907	Fail Safe/Fail Secure*	\$1,335.00			\$1,359.00
	ML20915					
Double Cylinder	ML20932	Fail Safe/Fail Secure*	\$1,545.00			\$1,569.00
	ML20987					

\*Must specify: SAF for Fail Safe or SEC for Fail Secure.



#### Ordering Example Details

<b>ML20900 ECL</b>	ML20914	Single Cylinder
Escutcheon Trim	SEC	Fail Secure
	104	Salvador Family Lever
	L	Escutcheon
	613	Finish
	RHR	Handing
	24 AD	24 Volt AC/DC

#### Stock Order

Quantity	Series/Function	Fail Safe/Fail Secure	Trim	Finish	Hand	Voltage
24	ML20914	SEC	104L	613	RHR	24 AD



Experience a safer and more open world

# Electrically Controlled Mortise Locksets

ML20900 Series: Muséo Levers, Escutcheons, Roses and Thumbturns

USA & Canada Prices Effective February 1, 2022



contemporary levers to complement the interior design of your next project



Specify thumbturn as quick code. Thumbturn backplate will match shape of rose chosen (i.e. round or square)

NOTE: ML20987 not available with L or R escutcheons.

613E	Dark Oxidized Satin Bronze – Equivalent
629	Bright Stainless Steel
630	Satin Stainless Steel
BSP	Black Suede Powder Coat
WSP	White Suede Powder Coat

### Function

Lever with Escutcheons: L,R			
Single Cylinder	ML20914	Fail Safe/Fail Secure*	\$1,660.00
	ML20906		
No Cylinder Override	ML20907	Fail Safe/Fail Secure*	\$1,555.00
	ML20915		
Double Cylinder	ML20932	Fail Safe/Fail Secure*	\$1,765.00
	ML20987		N/A
Lever with Roses: V,U,T,Y,X,W,E2,E3,E4			
Single Cylinder	ML20914	Fail Safe/Fail Secure*	\$1,587.00
	ML20906		
No Cylinder Override	ML20907	Fail Safe/Fail Secure*	\$1,482.00
	ML20915		
Double Cylinder	ML20932	Fail Safe/Fail Secure*	\$1,692.00
	ML20987		

\*Must specify: SAF for Fail Safe or SEC for Fail Secure.

**BHMA CERTIFIED** **ML20900 ECL** Ordering Example Details

Escutcheon Trim	ML20914 Single Cylinder Fail Safe
	SAF 21M Piet Family Lever - Polished with Satin Insert
	L Escutcheon Lever Finish
293029	Polished with satin stainless steel insert (630), polished stainless steel (629) shank and polished stainless steel (629) grip
	629 Lock Finish
RHR	Handing
24 AD	24 Volt AC/DC

Stock Order							
Quantity	Series/Function	Fail Safe/Fail Secure	Trim	Lever Finish	Lock Finish	Hand	Voltage
2	ML20914	SAF	21ML	293029	629	RHR	24 AD



Experience a safer and more open world

# Electrically Controlled Mortise Locksets

ML20900 Series: Muséo Levers, Escutcheons, Roses and Thumbturns

USA & Canada Prices Effective February 1, 2022

contemporary levers to complement the interior design of your next project

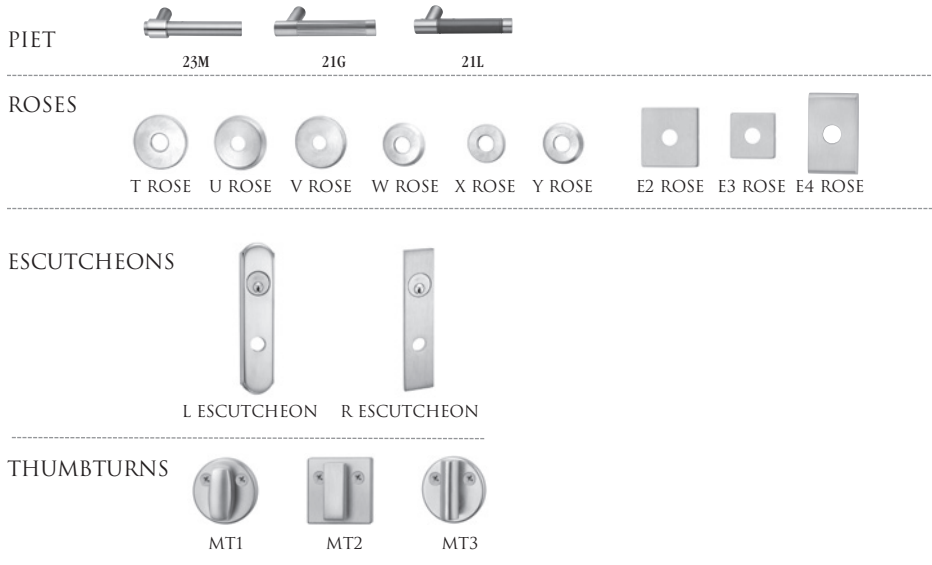

Specify thumbturn as quick code. Thumbturn backplate will match shape of rose chosen (i.e. round or square)  
NOTE: ML20987 not available with L or R escutcheons.

613E	Dark Oxidized Satin Bronze – Equivalent
629	Bright Stainless Steel
630	Satin Stainless Steel
BSP	Black Suede Powder Coat
WSP	White Suede Powder Coat

## Function

Lever with Escutcheons: L,R			
Single Cylinder	ML20914	Fail Safe/Fail Secure*	\$1,758.00
	ML20906		
No Cylinder Override	ML20907	Fail Safe/Fail Secure*	\$1,653.00
	ML20915		
Double Cylinder	ML20932	Fail Safe/Fail Secure*	\$1,863.00
	ML20987		N/A
Lever with Roses: V,U,T,Y,X,W,E2,E3,E4			
Single Cylinder	ML20914	Fail Safe/Fail Secure*	\$1,685.00
	ML20906		
No Cylinder Override	ML20907	Fail Safe/Fail Secure*	\$1,580.00
	ML20915		
Double Cylinder	ML20932 ML20987	Fail Safe/Fail Secure*	\$1,790.00

\*Must specify: SAF for Fail Safe or SEC for Fail Secure.

**BHMA CERTIFIED** Ordering Example Details →

<b>ML20900 ECL</b>	ML20914 Single Cylinder
Escutcheon	SEC Fail Secure
Trim	23M Piet Family Lever - Wood Insert
	L Escutcheon
	29BH29 Lever Finish
	Wood insert with polished stainless steel (629) shank and polished stainless steel (629) grip
	629 Lock Finish
	RHR Handing
	24 AD 24 Volt AC/DC

Stock Order							
Quantity	Series/Function	Fail Safe/Fail Secure	Trim	Lever Finish	Lock Finish	Hand	Voltage
2	ML20914	SEC	21ML	29BH29	629	RHR	24 AD



Experience a safer and more open world



# Electrically Controlled Mortise Locksets

ML20900 Series: Muséo Levers, Escutcheons, Roses and Thumbturns

USA & Canada Prices Effective February 1, 2022



contemporary levers to complement the interior design of your next project

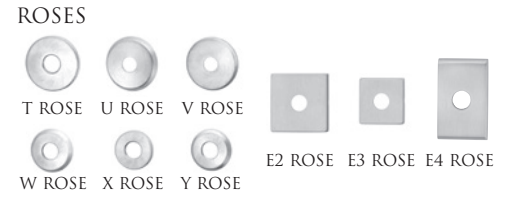
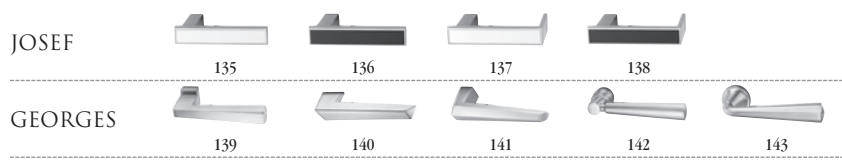

1. Handed: specify hand when ordering
2. Contact factory for current lead time
3. Specify thumbturn as quick code. Thumbturn backplate will match shape of rose chosen (i.e. round or square). Not available with escutcheons.
4. ML20987 not available with L or R escutcheons.

613E	Dark Oxidized Satin Bronze - Equivalent	605	Bright Brass, Clear Coated	618	Bright Nickel Plated
626	Satin Chromium Plated	606	Satin Brass, Clear Coated	619	Satin Nickel Plated
BSP	Black Suede Powder Coat	611	Bright Bronze, Clear Coated	625	Bright Chromium Plated
WSP	White Suede Powder Coat	612	Satin Bronze, Clear Coated	629	Bright Stainless Steel
		613	Dark Oxidized Satin Bronze, Oil Rubbed	630	Satin Stainless Steel
		613L	Dark Oxidized Satin Bronze, Clear Coated	722	Black Oxidized Bronze, Oil Rubbed

## Function

Lever with Escutcheons: L,R					
Single Cylinder	ML20914	Fail Safe/Fail Secure*	\$1,734.00		\$1,758.00
	ML20906				
No Cylinder Override	ML20907	Fail Safe/Fail Secure*	\$1,629.00		\$1,653.00
	ML20915				
Double Cylinder	ML20932	Fail Safe/Fail Secure*	\$1,839.00		\$1,863.00
	ML20987		N/A		N/A
Lever with Roses: V,U,T,Y,X,W,E2,E3,E4					
Single Cylinder	ML20914	Fail Safe/Fail Secure*	\$1,661.00		\$1,685.00
	ML20906				
No Cylinder Override	ML20907	Fail Safe/Fail Secure*	\$1,556.00		\$1,580.00
	ML20915				
Double Cylinder	ML20932	Fail Safe/Fail Secure*	\$1,766.00		\$1,790.00
	ML20987				

\*Must specify: SAF for Fail Safe or SEC for Fail Secure.

## Ordering Example Details

**ML20900 ECL**  
 Escutcheon Trim  
**BHMA CERTIFIED**  
 ML20914 Single Cylinder  
 SEC Fail Secure  
 135 Josef Family Lever  
 L Escutcheon  
 613 Finish  
 RHR Handing  
 24 AD 24 Volt AC/DC

## Stock Order

Quantity	Series/Function	Technology Code	Trim	Finish	Hand	Voltage	Fail Safe/Fail Secure	High Security Monitoring Options
24	ML20914	NAC	135L	613	RHR	24 AD	SEC	PHRR01



Experience a safer and more open world

# Electrically Controlled Mortise Locksets

## ML20900 Series

USA & Canada Prices Effective February 1, 2022

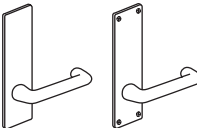
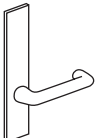
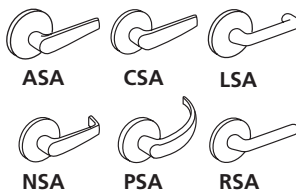
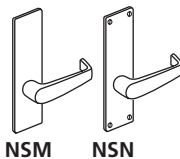
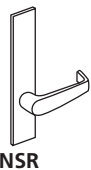
			 LWA      RWA Lever: Wrought Rose: Wrought		 LWM      LWN Lever: Wrought Escutcheon: Wrought		 LWR Lever: Wrought Escutcheon: Solid Stainless Steel or Forged Brass		
			<b>Levers: LW, RW</b> <b>Roses: A</b> Roses: B, F (see note 1)		<b>Levers: LW, RW</b> <b>Escutcheons: M, N</b>		<b>Levers: LW, RW</b> <b>Escutcheons: R</b> (see note 2)		
Description	Function	Option (See Note 3)	613E, 626, BSP, WSP	605, 606, 611, 612, 613, 618, 619, 625, 629, 630, 722	613E, 626, BSP, WSP	605, 606, 611, 612, 613, 618, 619, 625, 629, 630, 722	613E, 626, BSP, WSP	605, 606, 611, 612, 613, 618, 619, 625, 629, 630, 722	
Single Cylinder	ML20914	Fail Safe/Fail Secure	\$1,195.00	\$1,219.00	\$1,215.00	\$1,239.00	\$1,269.00	\$1,293.00	
	ML20906								
No Cylinder Override	ML20907	Fail Safe/Fail Secure	\$1,090.00	\$1,114.00	\$1,110.00	\$1,134.00	\$1,164.00	\$1,188.00	
	ML20915								
Double Cylinder	ML20932	Fail Safe/Fail Secure	\$1,300.00	\$1,324.00	\$1,320.00	\$1,344.00	\$1,374.00	\$1,398.00	
	ML20987						N/A	N/A	
			 ASA      CSA      LSA NSA      PSA      RSA Lever: Cast Rose: Wrought			 NSM      NSN Lever: Cast Escutcheon: Wrought		 NSR Lever: Cast Escutcheon: Solid Stainless Steel or Forged Brass	
			<b>Levers: AS, CS, LS, NS, PS, RS</b> <b>Roses: A</b> Roses: B, F (see note 1)			<b>Levers: AS, CS, LS, NS, PS, RS</b> <b>Escutcheons: M, N</b>		<b>Levers: AS, CS, LS, NS, PS, RS</b> <b>Escutcheons: R</b> (see note 2)	
Description	Function	Option (See Note 3)	613E, 626, BSP, WSP	605, 606, 611, 612, 613, 618, 619, 625, 629, 630, 722	613E, 626, BSP, WSP	605, 606, 611, 612, 613, 618, 619, 625, 629, 630, 722	613E, 626, BSP, WSP	605, 606, 611, 612, 613, 618, 619, 625, 629, 630, 722	
Single Cylinder	ML20914	Fail Safe/Fail Secure	\$1,408.00	\$1,432.00	\$1,428.00	\$1,452.00	\$1,462.00	\$1,486.00	
	ML20906								
No Cylinder Override	ML20907	Fail Safe/Fail Secure	\$1,303.00	\$1,327.00	\$1,323.00	\$1,347.00	\$1,357.00	\$1,381.00	
	ML20915								
Double Cylinder	ML20932	Fail Safe/Fail Secure	\$1,513.00	\$1,537.00	\$1,533.00	\$1,557.00	\$1,567.00	\$1,591.00	
	ML20987						N/A	N/A	

**NOTES:**

- 1 - Rose substitutions for LWA, LSA, etc.: 2-1/4" cast rose in place of 2-1/4" wrought rose, substitute letter "B" in place of "A" (e.g. LSB). **Add \$46.00 per lockset**
- 2-7/8" cast rose in place of 2-1/4" wrought rose, substitute letter "F" in place of "A" (e.g. LWF). **Add \$61.00 per lockset**
- 2 - "R" Escutcheon trims are available for 1 3/8", 1 3/4" or 2 1/4" door thickness only.
- 3. Must Specify: SAF for Fail Safe or SEC for Fail Secure.

**ElectroLynx®**

As part of their promise to provide innovative, fast and effective high security solutions to their customers, certain ASSA ABLOY Group brands offer *ElectroLynx®*, a universal quick-connect system that simplifies the electrification of the door opening.

# Electrically Controlled Mortise Locksets ML20900 Series

USA & Canada Prices Effective February 1, 2022



Lever: Cast  
Rose: Wrought

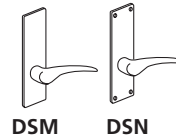

Lever: Cast  
Escutcheon: Wrought

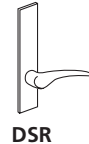

Lever: Cast  
Escutcheon: Solid Stainless Steel  
or Forged Brass

Description	Function	Option (See Note 3)	Lever: DS, ES Roses: A Roses: B, F (see note 1)		Lever: DS, ES Escutcheons: M, N		Lever: DS, ES Escutcheons: R (see note 2)	
			613E, 626, BSP, WSP	605, 606, 611, 612, 613, 618, 619, 625, 629, 630, 722	613E, 626, BSP, WSP	605, 606, 611, 612, 613, 618, 619, 625, 629, 630, 722	613E, 626, BSP, WSP	605, 606, 611, 612, 613, 618, 619, 625, 629, 630, 722
Single Cylinder	ML20914	Fail Safe/Fail Secure	\$1,440.00	\$1,464.00	\$1,460.00	\$1,484.00	\$1,494.00	\$1,518.00
	ML20906							
No Cylinder Override	ML20907	Fail Safe/Fail Secure	\$1,335.00	\$1,359.00	\$1,355.00	\$1,379.00	\$1,389.00	\$1,413.00
	ML20915							
Double Cylinder	ML20932	Fail Safe/Fail Secure	\$1,545.00	\$1,569.00	\$1,565.00	\$1,589.00	\$1,599.00	\$1,623.00
	ML20987						N/A	N/A

**NOTES:**

- 1 - Rose substitutions for DSA, ESA: 2-1/4" cast rose in place of 2-1/4" wrought rose, substitute letter "B" in place of "A" (e.g.DSB). **Add \$46.00 per lockset.** 2-7/8" cast rose in place of 2-1/4" wrought rose, substitute letter "F" in place of "A" (e.g. ESF). **Add \$61.00 per lockset.**
- 2 - "R" Escutcheon trims are available for 1 3/8", 1 3/4", or 2 1/4" door thickness only.
- 3. Must Specify: SAF for Fail Safe or SEC for Fail Secure.

## Lever Designs: CSV, NSV

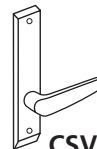

CSV

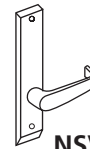

NSV

Lever: Cast  
Escutcheon: Cast

Description	Function	Option (See Note 3)	CSV, NSV	
			Finish: 630	
Single Cylinder	ML20914VR	Fail Safe/Fail Secure	\$2,097.00	
	ML20906VR			
No Cylinder Override	ML20907VR	Fail Safe/Fail Secure	\$1,992.00	
	ML20915VR			
Double Cylinder	ML20932VR	Fail Safe/Fail Secure	\$2,202.00	

**Note:**

- Escutcheon trims are available for 1 3/8", 1 3/4", or 2 1/4" door thickness only.
- 3. Must Specify: SAF for Fail Safe or SEC for Fail Secure.

**ElectroLynx®**

As part of their promise to provide innovative, fast and effective high security solutions to their customers, certain ASSA ABLOY Group brands offer ElectroLynx®, a universal quick-connect system that simplifies the electrification of the door opening.

**Lever Designs: FSG, MSG, ZSG** 

**Lever: Rose:**  
Cast Cast



Vineyard™  
collection

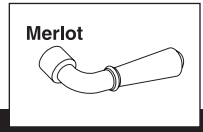
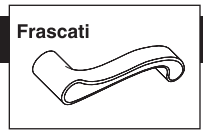

**Lever Designs: FSL, MSL, ZSL** 

**Lever: Escutcheon:**  
Cast Cast

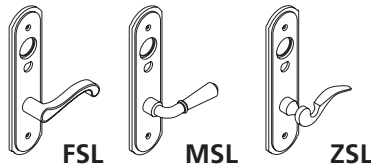

Vineyard™  
collection



Description	Function	Option (See Note 3)	FSG, MSG, ZSG		FSL, MSL, ZSL	
			613E, 626, BSP, WSP	605, 606, 611, 612, 613 <sup>2</sup> , 613L <sup>2</sup> , 618, 619, 625, 722	613E, 626, BSP, WSP	605, 606, 611, 612, 613 <sup>2</sup> , 613L <sup>2</sup> , 618, 619, 625, 722
Single Cylinder	ML20914	Fail Safe/Fail Secure	\$1,440.00	\$1,464.00	\$1,494.00	\$1,518.00
	ML20906					
No Cylinder Override	ML20907	Fail Safe/Fail Secure	\$1,335.00	\$1,359.00	\$1,389.00	\$1,413.00
	ML20915					
Double Cylinder	ML20932	Fail Safe/Fail Secure	\$1,545.00	\$1,569.00	\$1,599.00	\$1,623.00
	ML20987				N/A	N/A

Notes:

1. Escutcheon trims are available for 1-3/8", 1-3/4" or 2-1/4" door thicknesses only.
2. 613 finish is brass base lever & rose/escutcheon.
3. Must Specify: SAF for Fail Safe or SEC for Fail Secure

**ElectroLynx®**

As part of their promise to provide innovative, fast and effective high security solutions to their customers, certain ASSA ABLOY Group brands offer *ElectroLynx®*, a universal quick-connect system that simplifies the electrification of the door opening.

# Electrically Controlled Mortise Locksets ML20900 Series

USA & Canada Prices Effective February 1, 2022

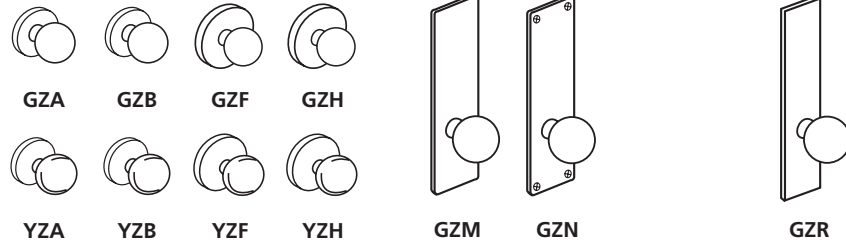

Knob: Solid Cast  
Rose: Wrought

Knob: Solid Cast  
Escutcheon: Wrought

Knob: Solid Cast  
Escutcheon: Solid Stainless  
Steel or Forged Brass

**Knobs: GZ, YZ  
Roses: A, H  
Roses: B, F (see note 2)**

**Knobs: GZ, YZ  
Escutcheons: M, N**

**Knobs: GZ, YZ  
Escutcheons: R (see note 1)**

Description	Function	Option (See Note 3)	Knobs: GZ, YZ Roses: A, H Roses: B, F (see note 2)		Knobs: GZ, YZ Escutcheons: M, N		Knobs: GZ, YZ Escutcheons: R (see note 1)	
			613E, 626, BSP, WSP	605, 606, 611, 612, 613, 618, 619, 625, 722	613E, 626, BSP, WSP	605, 606, 611, 612, 613, 618, 619, 625, 722	613E, 626, BSP, WSP	605, 606, 611, 612, 613, 618, 619, 625, 722
Single Cylinder	ML20914	Fail Safe/ Fail Secure	\$1,394.00	\$1,418.00	\$1,414.00	\$1,438.00	\$1,448.00	\$1,472.00
	ML20906							
No Cylinder Override	ML20907	Fail Safe/ Fail Secure	\$1,289.00	\$1,313.00	\$1,309.00	\$1,333.00	\$1,343.00	\$1,367.00
	ML20915							
Double Cylinder	ML20932	Fail Safe/ Fail Secure	\$1,499.00	\$1,523.00	\$1,519.00	\$1,543.00	\$1,553.00	\$1,577.00
	ML20987						N/A	N/A

**NOTE 1:** "R" Escutcheon trims are available for 1 3/8", 1 3/4", or 2 1/4" door thickness only.

**NOTE 2:** Rose substitutions: 2-1/4" cast rose in place of 2-1/4" wrought rose, substitute letter "B" in place of "A" (e.g. GZB). **Add \$46.00 per lockset**  
2-7/8" cast rose in place of 2-1/4" wrought rose, substitute letter "F" in place of "A" (e.g. GZF). **Add \$61.00 per lockset**

**NOTE 3:** Must Specify: SAF for Fail Safe or SEC for Fail Secure.

**ElectroLynx®**

As part of their promise to provide innovative, fast and effective high security solutions to their customers, certain ASSA ABLOY Group brands offer *ElectroLynx®*, a universal quick-connect system that simplifies the electrification of the door opening.

*Electrically Controlled Mortise Locksets*  
 ML20600 NAC Series Electrified Mortise Lock with High Security Monitoring

USA & Canada Prices Effective February 1, 2022



contemporary levers to complement the interior design of your next project

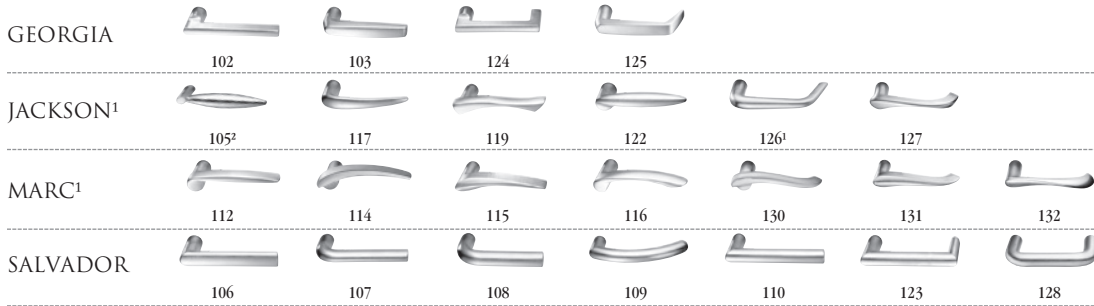

1. Handed: specify hand when ordering
2. Contact factory for current lead time

613E	Dark Oxidized Satin Bronze - Equivalent	605	Bright Brass, Clear Coated	618	Bright Nickel Plated
626	Satin Chromium Plated	606	Satin Brass, Clear Coated	619	Satin Nickel Plated
BSP	Black Suede Powder Coat	611	Bright Bronze, Clear Coated	625	Bright Chromium Plated
WSP	White Suede Powder Coat	612	Satin Bronze, Clear Coated	629*	Bright Stainless Steel
		613	Dark Oxidized Satin Bronze, Oil Rubbed	630*	Satin Stainless Steel
		613L	Dark Oxidized Satin Bronze, Clear Coated	722	Black Oxidized Bronze, Oil Rubbed

**Function**

Lever with Roses					
Single Cylinder	ML20606 x NAC	Fail Safe/Fail Secure	\$1,657.00		\$1,681.00
	ML20608 x NAC	Fail Safe/Fail Secure	\$1,732.00		\$1,756.00
No Cylinder Override	ML20607 x NAC	Fail Safe/Fail Secure	\$1,552.00		\$1,576.00
	ML20609 x NAC	Fail Safe/Fail Secure	\$1,627.00		\$1,651.00

*ML20600 High Security Monitoring Options*

Description	Specify	Add or Deduct
Mercury and Lenel compatible 1KΩ/2KΩ resistance supervision	R01	Add \$100.00 per lockset
Software House compatible 1KΩ/2KΩ resistance supervision	R03	Add \$100.00 per lockset
AMAG compatible 4-state supervision	R04	Add \$100.00 per lockset
Deadbolt Privacy Function	PHR	Add \$100.00 per lockset
Deadbolt Privacy and Mercury / Lenel 1KΩ/2KΩ	PHRR01	Add \$200.00 per lockset
Deadbolt Privacy and Software House 1KΩ/2KΩ	PHRR03	Add \$200.00 per lockset
Deadbolt Privacy and AMAG 4-State	PHRR04	Add \$200.00 per lockset



Ordering Example Details →

ML2000 Mortise Lock x NAC x No Cylinder x Deadbolt x Fail-Secure

- Muséo® lever 102 with J Collar
- Polished chrome finish
- Right hand reverse
- Deadbolt privacy function, Mercury and Lenel compatible 1KΩ/2KΩ resistance supervision

Stock Order								
Quantity	Series/Function	Technology Code	Trim	Finish	Hand	Fail Safe/Fail Secure	High Security Monitoring Options	
24	ML20608	NAC	102J	625	RHR	SEC	PHRR01	

\*629 and \*630 finish options are Not available for all Muséo levers. Please refer to page 20 for availability.



Experience a safer and more open world

# Electrically Controlled Mortise Locksets

## ML20600 NAC Series Electrified Mortise Lock with High Security Monitoring

USA & Canada Prices Effective February 1, 2022



contemporary levers to complement the interior design of your next project

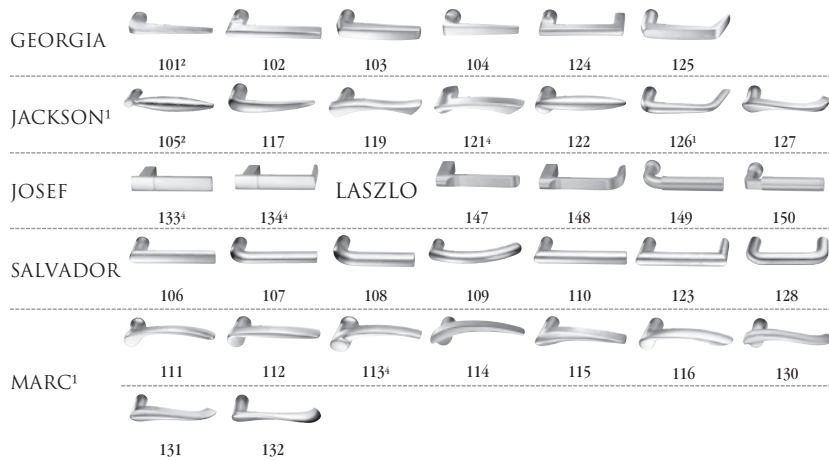

### ROSES

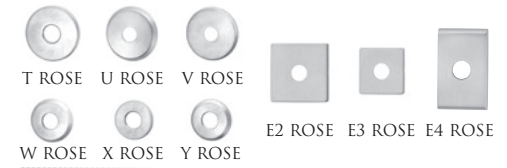

### ESCUTCHEONS



### THUMBTURNS<sup>3</sup>



1. Handed: specify hand when ordering
2. Contact factory for current lead time
3. Specify thumbturn as quick code. Thumbturn backplate will match shape of rose chosen (i.e. round or square). Not available with escutcheons.
4. Not available with VN escutcheon.
5. VN escutcheon available only with indicators. Must be ordered with "V" indicator options. See page 116 for available functions. Option add also applies. Not available with 629 or 630 finish.

\*629 and \*630 finish options are Not available for all Muséo levers. Please refer to page 24 for availability.

613E	Dark Oxidized Satin Bronze - Equivalent
626	Satin Chromium Plated
BSP	Black Suede Powder Coat
WSP	White Suede Powder Coat

605	Bright Brass, Clear Coated	618	Bright Nickel Plated
606	Satin Brass, Clear Coated	619	Satin Nickel Plated
611	Bright Bronze, Clear Coated	625	Bright Chromium Plated
612	Satin Bronze, Clear Coated	629*	Bright Stainless Steel
613	Dark Oxidized Satin Bronze, Oil Rubbed	630*	Satin Stainless Steel
613L	Dark Oxidized Satin Bronze, Clear Coated	722	Black Oxidized Bronze, Oil Rubbed

### Function

Lever with Escutcheons: L,R				
Single Cylinder	ML20606 x NAC	Fail Safe/Fail Secure	\$1,669.00	\$1,693.00
	ML20608 x NAC	Fail Safe/Fail Secure	\$1,744.00	\$1,768.00
No Cylinder Override	ML20607 x NAC	Fail Safe/Fail Secure	\$1,564.00	\$1,588.00
	ML20609 x NAC	Fail Safe/Fail Secure	\$1,639.00	\$1,663.00

Lever with Roses: V,U,T,Y,X,W,E2,E3,E4				
Single Cylinder	ML20606 x NAC	Fail Safe/Fail Secure	\$1,615.00	\$1,639.00
	ML20608 x NAC	Fail Safe/Fail Secure	\$1,690.00	\$1,714.00
No Cylinder Override	ML20607 x NAC	Fail Safe/Fail Secure	\$1,510.00	\$1,534.00
	ML20609 x NAC	Fail Safe/Fail Secure	\$1,585.00	\$1,609.00

\*Must specify: SAF for Fail Safe or SEC for Fail Secure.

### ML20600 High Security Monitoring Options

Description	Specify	Add or Deduct
Mercury and Lenel compatible 1KΩ/2KΩ resistance supervision	R01	Add \$100.00 per lockset
Software House compatible 1KΩ/2KΩ resistance supervision	R03	Add \$100.00 per lockset
AMAG compatible 4-state supervision	R04	Add \$100.00 per lockset
Deadbolt Privacy Function	PHR	Add \$100.00 per lockset
Deadbolt Privacy and Mercury / Lenel 1KΩ/2KΩ	PHRR01	Add \$200.00 per lockset
Deadbolt Privacy and Software House 1KΩ/2KΩ	PHRR03	Add \$200.00 per lockset
Deadbolt Privacy and AMAG 4-State	PHRR04	Add \$200.00 per lockset



Ordering Example Details

<b>ML20600 NAC</b> Escutcheon Trim	ML20608	Single Cylinder
	SEC	Fail Secure
	104	Salvador Family Lever
	L	Escutcheon
	613	Finish
	RHR	Handing
	24 AD	24 Volt AC/DC

### Stock Order

Quantity	Series/Function	Technology Code	Trim	Finish	Hand	Fail Safe/Fail Secure	High Security Monitoring Options
24	ML20608	NAC	104L	613	RHR	SEC	PHRR01



Experience a safer and more open world

# Electrically Controlled Mortise Locksets

ML20600 NAC Series Electrified Mortise Lock with High Security Monitoring

USA & Canada Prices Effective February 1, 2022

contemporary levers to complement the interior design of your next project

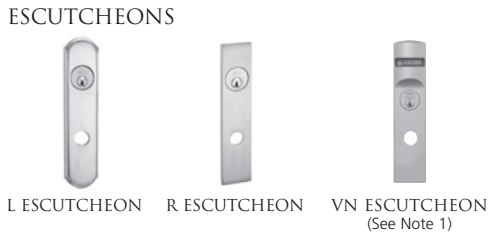

Specify thumbturn as quick code. Thumbturn backplate will match shape of rose chosen (i.e. round or square)

NOTES:  
1. VN escutcheon available only with indicators. Must be ordered with "V" indicator options. See page 116 for available functions. Option add also applies. Not available with 629 or 630 finish.

613E	Dark Oxidized Satin Bronze – Equivalent
629	Bright Stainless Steel
630	Satin Stainless Steel
BSP	Black Suede Powder Coat
WSP	White Suede Powder Coat

**Function**

Lever with Escutcheons: L,R			
Single Cylinder	ML20606 x NAC	Fail Safe/Fail Secure*	\$1,835.00
	ML20608 x NAC		\$1,910.00
No Cylinder Override	ML20607 x NAC	Fail Safe/Fail Secure*	\$1,730.00
	ML20609 x NAC		\$1,805.00
Lever with Roses: V,U,T,Y,X,W,E2,E3,E4			
Single Cylinder	ML20606 x NAC	Fail Safe/Fail Secure*	\$1,762.00
	ML20608 x NAC		\$1,837.00
No Cylinder Override	ML20607 x NAC	Fail Safe/Fail Secure*	\$1,657.00
	ML20609 x NAC		\$1,732.00

**ML20600 High Security Monitoring Options**

Description	Specify	Add or Deduct
Mercury and Lenel compatible 1KΩ/2KΩ resistance supervision	R01	Add \$100.00 per lockset
Software House compatible 1KΩ/2KΩ resistance supervision	R03	Add \$100.00 per lockset
AMAG compatible 4-state supervision	R04	Add \$100.00 per lockset
Deadbolt Privacy Function	PHR	Add \$100.00 per lockset
Deadbolt Privacy and Mercury / Lenel 1KΩ/2KΩ	PHRR01	Add \$200.00 per lockset
Deadbolt Privacy and Software House 1KΩ/2KΩ	PHRR03	Add \$200.00 per lockset
Deadbolt Privacy and AMAG 4-State	PHRR04	Add \$200.00 per lockset

\*Must specify: SAF for Fail Safe or SEC for Fail Secure.

Ordering Example Details

**ML20600 NAC** ML20914 Single Cylinder  
Escutcheon SEC Fail Secure  
Trim 23M Piet Family Lever - Wood Insert  
L Escutcheon  
29BH29 Lever Finish Wood insert with polished stainless steel (629) shank and polished stainless steel (629) grip  
629 Lock Finish  
RHR Handing  
24 AD 24 Volt AC/DC

Stock Order									
Qty	Series/Function	Tech. Code	Trim	Lever Finish	Finish	Hand	Voltage	Fail Safe/Fail Secure	High Security Monitoring Options
2	ML20608	NAC	21ML	29BH29	629	RHR	24 AD	SEC	PHRR01



Experience a safer and more open world



# Electrically Controlled Mortise Locksets

## ML20600 NAC Series Electrified Mortise Lock with High Security Monitoring

USA & Canada Prices Effective February 1, 2022



contemporary levers to complement the interior design of your next project

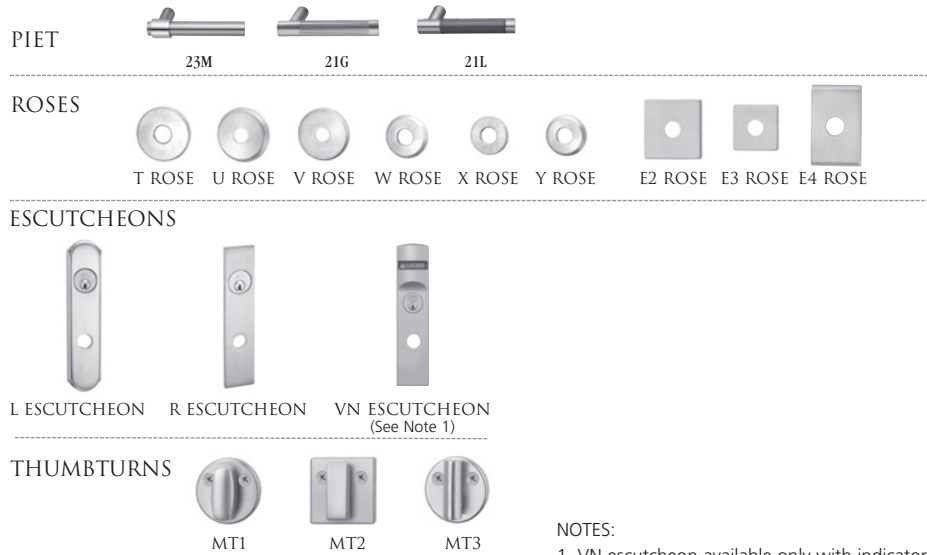

Specify thumbturn as quick code. Thumbturn backplate will match shape of rose chosen (i.e. round or square)

### NOTES:

1. VN escutcheon available only with indicators. Must be ordered with "V" indicator options. See page 116 for available functions. Option add also applies. Not available with 629 or 630 finish.

613E	Dark Oxidized Satin Bronze – Equivalent
629	Bright Stainless Steel
630	Satin Stainless Steel
BSP	Black Suede Powder Coat
WSP	White Suede Powder Coat

### Function

Lever with Escutcheons: L,R			
Single Cylinder	ML20606 x NAC	Fail Safe/Fail Secure*	\$1,933.00
	ML20608 x NAC		\$2,008.00
No Cylinder Override	ML20607 x NAC	Fail Safe/Fail Secure*	\$1,828.00
	ML20609 x NAC		\$1,903.00
Lever with Roses: V,U,T,Y,X,W,E2,E3,E4			
Single Cylinder	ML20606 x NAC	Fail Safe/Fail Secure*	\$1,860.00
	ML20608 x NAC		\$1,935.00
No Cylinder Override	ML20607 x NAC	Fail Safe/Fail Secure*	\$1,755.00
	ML20609 x NAC		\$1,830.00

### ML20600 High Security Monitoring Options

Description	Specify	Add or Deduct
Mercury and Lenel compatible 1KΩ/2KΩ resistance supervision	R01	Add \$100.00 per lockset
Software House compatible 1KΩ/2KΩ resistance supervision	R03	Add \$100.00 per lockset
AMAG compatible 4-state supervision	R04	Add \$100.00 per lockset
Deadbolt Privacy Function	PHR	Add \$100.00 per lockset
Deadbolt Privacy and Mercury / Lenel 1KΩ/2KΩ	PHRR01	Add \$200.00 per lockset
Deadbolt Privacy and Software House 1KΩ/2KΩ	PHRR03	Add \$200.00 per lockset
Deadbolt Privacy and AMAG 4-State	PHRR04	Add \$200.00 per lockset

\*Must specify: SAF for Fail Safe or SEC for Fail Secure.

**BHMA CERTIFIED** Ordering Example Details

**ML20600 NAC** Escutcheon Trim

ML20608 Single Cylinder  
SEC Fail Secure  
23M Piet Family Lever - Wood  
Insert  
L Escutcheon  
29BH29 Lever Finish  
Wood insert with polished stainless steel (629)  
shank and polished stainless steel (629) grip  
629 Lock Finish  
RHR Handing  
24 AD 24 Volt AC/DC

Stock Order									
Qty	Series/Function	Tech. Code	Trim	Lever Finish	Finish	Hand	Voltage	Fail Safe/Fail Secure	High Security Monitoring Options
2	ML20608	NAC	21ML	29BH29	629	RHR	24 AD	SEC	PHRR01



Experience a safer and more open world

# Electrically Controlled Mortise Locksets

ML20600 NAC Series Electrified Mortise Lock with High Security Monitoring

USA & Canada Prices Effective February 1, 2022

contemporary levers to complement the interior design of your next project



## JOSEF



## GEORGES



## ROSES

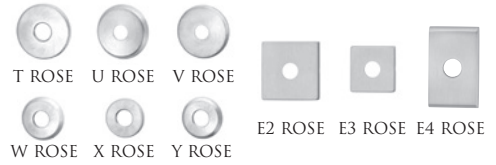

## ESCUTCHEONS



## THUMBTURNS<sup>3</sup>



1. Handed: specify hand when ordering.
2. Contact factory for current lead time.
3. Specify thumbturn as quick code. Thumbturn backplate will match shape of rose chosen (i.e. round or square).  
Not available with escutcheons.
4. Not available with escutcheon indicators.

613E	Dark Oxidized Satin Bronze - Equivalent	605	Bright Brass, Clear Coated	618	Bright Nickel Plated
626	Satin Chromium Plated	606	Satin Brass, Clear Coated	619	Satin Nickel Plated
BSP	Black Suede Powder Coat	611	Bright Bronze, Clear Coated	625	Bright Chromium Plated
WSP	White Suede Powder Coat	612	Satin Bronze, Clear Coated	629	Bright Stainless Steel
		613	Dark Oxidized Satin Bronze, Oil Rubbed	630	Satin Stainless Steel
		613L	Dark Oxidized Satin Bronze, Clear Coated	722	Black Oxidized Bronze, Oil Rubbed

## Function

Lever with Escutcheons: L,R					
Single Cylinder	ML20606 x NAC	Fail Safe/Fail Secure	\$1,909.00		\$1,933.00
	ML20608 x NAC	Fail Safe/Fail Secure	\$1,984.00		\$2,008.00
No Cylinder Override	ML20607 x NAC	Fail Safe/Fail Secure	\$1,804.00		\$1,828.00
	ML20609 x NAC	Fail Safe/Fail Secure	\$1,879.00		\$1,903.00

Lever with Roses: V,U,T,Y,X,W,E2,E3,E4					
Single Cylinder	ML20606 x NAC	Fail Safe/Fail Secure	\$1,836.00		\$1,860.00
	ML20608 x NAC	Fail Safe/Fail Secure	\$1,911.00		\$1,935.00
No Cylinder Override	ML20607 x NAC	Fail Safe/Fail Secure	\$1,731.00		\$1,755.00
	ML20609 x NAC	Fail Safe/Fail Secure	\$1,806.00		\$1,830.00

\*Must specify: SAF for Fail Safe or SEC for Fail Secure.

## ML20600 High Security Monitoring Options

Description	Specify	Add or Deduct
Mercury and Lenel compatible 1KΩ/2KΩ resistance supervision	R01	Add \$100.00 per lockset
Software House compatible 1KΩ/2KΩ resistance supervision	R03	Add \$100.00 per lockset
AMAG compatible 4-state supervision	R04	Add \$100.00 per lockset
Deadbolt Privacy Function	PHR	Add \$100.00 per lockset
Deadbolt Privacy and Mercury / Lenel 1KΩ/2KΩ	PHRR01	Add \$200.00 per lockset
Deadbolt Privacy and Software House 1KΩ/2KΩ	PHRR03	Add \$200.00 per lockset
Deadbolt Privacy and AMAG 4-State	PHRR04	Add \$200.00 per lockset

BHMA CERTIFIED	Ordering Example Details
ML20600 NAC Escutcheon Trim	ML20608 Single Cylinder SEC Fail Secure 104 Salvador Family Lever L Escutcheon 613 Finish RHR Handing 24 AD 24 Volt AC/DC

Stock Order							
Quantity	Series/Function	Technology Code	Trim	Finish	Hand	Fail Safe/Fail Secure	High Security Monitoring Options
24	ML20608	NAC	135L	613	RHR	SEC	PHRR01



Experience a safer and more open world

# Electrified Mortise Lock with High Security Monitoring ML20600 Series NAC

USA & Canada Prices Effective February 1, 2022

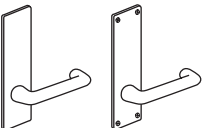
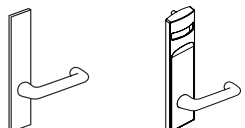
			 <p><b>LWA RWA</b> Lever: Wrought Rose: Wrought</p>		 <p><b>LWM LWN</b> Lever: Wrought Escutcheon: Wrought</p>		 <p><b>LWR LWVN</b> Lever: Wrought Esc: Solid Stainless Steel or Forged Brass    Lever: Wrought Escutcheon: Forged Brass</p>	
			<p><b>Levers: LW, RW Roses: A Roses: B, F (see note 1)</b></p>		<p><b>Levers: LW, RW Escutcheons: M, N</b></p>		<p><b>Levers: LW, RW Escutcheons: R (see note 2) VN (see note 4)</b></p>	
Description	Function	Option (See Note 3)	613E, 626, BSP, WSP	605, 606, 611, 612, 613, 618, 619, 625, 629, 630, 722	613E, 626, BSP, WSP	605, 606, 611, 612, 613, 618, 619, 625, 629, 630, 722	613E, 626, BSP, WSP	605, 606, 611, 612, 613, 618, 619, 625, 629, 630, 722
Single Cylinder	ML20606 x NAC	Fail Safe/Fail Secure	\$1,370.00	\$1,394.00	\$1,390.00	\$1,414.00	\$1,444.00	\$1,468.00
	ML20608 x NAC		\$1,445.00	\$1,469.00	\$1,465.00	\$1,489.00	\$1,519.00	\$1,543.00
No Cylinder Override	ML20607 x NAC	Fail Safe/Fail Secure	\$1,265.00	\$1,289.00	\$1,285.00	\$1,309.00	\$1,339.00	\$1,363.00
	ML20609 x NAC		\$1,340.00	\$1,364.00	\$1,360.00	\$1,384.00	\$1,414.00	\$1,438.00

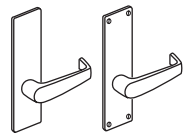
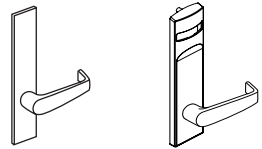
			 <p><b>ASA CSA LSA</b></p>			 <p><b>NSM NSN</b> Lever: Cast Escutcheon: Wrought</p>		 <p><b>NSR NSVN</b> Lever: Cast Esc: Solid Stainless Steel or Forged Brass    Lever: Cast Escutcheon: Forged Brass</p>	
			<p><b>Levers: AS, CS, LS, NS, PS, RS Roses: A Roses: B, F (see note 1)</b></p>			<p><b>Levers: AS, CS, LS, NS, PS, RS Escutcheons: M, N</b></p>		<p><b>Levers: AS, CS, LS, NS, PS, RS Escutcheons: R (see note 2) VN (see note 4)</b></p>	
Description	Function	Option (See Note 3)	613E, 626, BSP, WSP	605, 606, 611, 612, 613, 618, 619, 625, 629, 630, 722	613E, 626, BSP, WSP	605, 606, 611, 612, 613, 618, 619, 625, 629, 630, 722	613E, 626, BSP, WSP	605, 606, 611, 612, 613, 618, 619, 625, 629, 630, 722	
Single Cylinder	ML20606 x NAC	Fail Safe/Fail Secure	\$1,583.00	\$1,607.00	\$1,603.00	\$1,627.00	\$1,637.00	\$1,661.00	
	ML20608 x NAC		\$1,658.00	\$1,682.00	\$1,678.00	\$1,702.00	\$1,712.00	\$1,736.00	
No Cylinder Override	ML20607 x NAC	Fail Safe/Fail Secure	\$1,478.00	\$1,502.00	\$1,498.00	\$1,522.00	\$1,532.00	\$1,556.00	
	ML20609 x NAC		\$1,553.00	\$1,577.00	\$1,573.00	\$1,597.00	\$1,607.00	\$1,631.00	

- NOTES: 1. Rose substitutions for LWA, LSA, etc.: 2-1/4" cast rose in place of 2-1/4" wrought rose, substitute letter "B" in place of "A" (e.g. LSB).  
**Add \$46.00 per lockset.** 2-7/8" cast rose in place of 2-1/4" wrought rose, substitute letter "F" in place of "A" (e.g. LWF). **Add \$61.00 per lockset.**  
 2. "R" Escutcheon trims are available for 1 3/8", 1 3/4" or 2 1/4" door thickness only.  
 3. Must Specify: SAF for Fail Safe or SEC for Fail Secure.  
 4. VN escutcheon available only with indicators. Must be ordered with "V" indicator options. See page 116 for available functions.  
 Option add also applies. Not available with 629 or 630 finish.

**ElectroLynx®**

As part of their promise to provide innovative, fast and effective high security solutions to their customers, certain ASSA ABLOY Group brands offer *ElectroLynx®*, a universal quick-connect system that simplifies the electrification of the door opening.

# Electrified Mortise Lock with High Security Monitoring ML20600 Series NAC

USA & Canada Prices Effective February 1, 2022



**DSA ESA**  
Lever: Cast  
Rose: Wrought

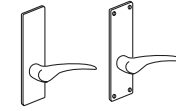

**DSM DSN**  
Lever: Cast  
Escutcheon: Wrought

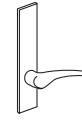

**DSR**  
Lever: Cast  
Esc: Solid Stainless  
Steel or Forged Brass

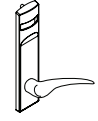

**DSVN**  
Lever: Cast  
Escutcheon:  
Forged Brass

Description	Function	Option (See Note 3)	Lever: DS, ES Roses: A Roses: B, F (see note 1)		Lever: DS, ES Escutcheons: M, N		Lever: DS, ES Escutcheons: R (see note 2) VN (see note 4)	
			613E, 626, BSP, WSP	605, 606, 611, 612, 613, 618, 619, 625, 629, 630, 722	613E, 626, BSP, WSP	605, 606, 611, 612, 613, 618, 619, 625, 629, 630, 722	613E, 626, BSP, WSP	605, 606, 611, 612, 613, 618, 619, 625, 629, 630, 722
Single Cylinder	ML20606 x NAC	Fail Safe/Fail Secure	\$1,615.00	\$1,639.00	\$1,635.00	\$1,659.00	\$1,669.00	\$1,693.00
	ML20608 x NAC		\$1,690.00	\$1,714.00	\$1,710.00	\$1,734.00	\$1,744.00	\$1,768.00
No Cylinder Override	ML20607 x NAC	Fail Safe/Fail Secure	\$1,510.00	\$1,534.00	\$1,530.00	\$1,554.00	\$1,564.00	\$1,588.00
	ML20609 x NAC		\$1,585.00	\$1,609.00	\$1,605.00	\$1,629.00	\$1,639.00	\$1,663.00

NOTES: 1. Rose substitutions for DSA, ESA: 2-1/4" cast rose in place of 2-1/4" wrought rose, substitute letter "B" in place of "A" (e.g.DSB). **Add \$46.00 per lockset.**  
2-7/8" cast rose in place of 2-1/4" wrought rose, substitute letter "F" in place of "A" (e.g. ESF). **Add \$61.00 per lockset.**  
2. "R" Escutcheon trims are available for 1 3/8", 1 3/4", or 2 1/4" door thickness only.  
3. Must Specify: SAF for Fail Safe or SEC for Fail Secure.  
4. VN escutcheon available only with indicators. Must be ordered with "V" indicator options. See page 116 for available functions.  
Option add also applies. Not available with 629 or 630 finish.

## Lever Designs: CSV, NSV

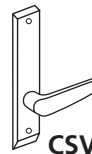

**CSV**

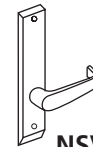

**NSV**

Lever: Cast  
Escutcheon: Cast

Description	Function	Option (See Note 3)	CSV, NSV	
			Finish: 630	
Single Cylinder	ML20606VR x NAC	Fail Safe/Fail Secure	\$2,272.00	
	ML20608VR x NAC		\$2,347.00	
No Cylinder Override	ML20607VR x NAC	Fail Safe/Fail Secure	\$2,167.00	
	ML20609VR x NAC		\$2,242.00	

Note:  
Escutcheon trims are available for 1 3/8", 1 3/4", or 2 1/4" door thickness only.  
3. Must Specify: SAF for Fail Safe or SEC for Fail Secure.

### ElectroLynx®

As part of their promise to provide innovative, fast and effective high security solutions to their customers, certain ASSA ABLOY Group brands offer *ElectroLynx®*, a universal quick-connect system that simplifies the electrification of the door opening.

# Electrified Mortise Lock with High Security Monitoring ML20600 Series NAC

USA & Canada Prices Effective February 1, 2022

## Lever Designs: FSG, MSG, ZSG



**Frascati**



**Lever: Rose:**  
Cast Cast



**Merlot**

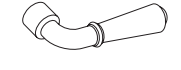

## Lever Designs: FSL, MSL, ZSL, FSVN, MSVN, ZSVN



**Zinfandel**



**Lever: Escutcheon:**  
Cast Cast

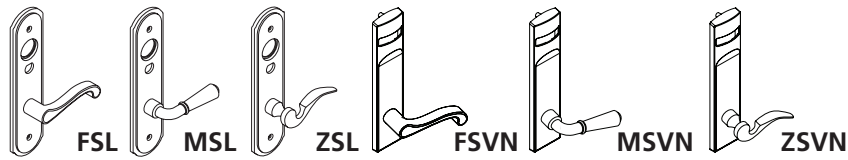

Description	Function	Option (See Note 3)	FSG, MSG, ZSG		FSL, MSL, ZSL FSVN, MSVN, ZSVN (see note 4)	
			Finish: 613E, 626, BSP, WSP	Finish: 605, 606, 611, 612, 613 <sup>2</sup> , 613L <sup>2</sup> , 618, 619, 625, 722	613E, 626, BSP, WSP	Finish: 605, 606, 611, 612, 613 <sup>2</sup> , 613L <sup>2</sup> , 618, 619, 625, 722
Single Cylinder	ML20606 x NAC	Fail Safe/Fail Secure	\$1,615.00	\$1,639.00	\$1,669.00	\$1,693.00
	ML20608 x NAC		\$1,690.00	\$1,714.00	\$1,744.00	\$1,768.00
No Cylinder Override	ML20607 x NAC	Fail Safe/Fail Secure	\$1,510.00	\$1,534.00	\$1,564.00	\$1,588.00
	ML20609 x NAC		\$1,585.00	\$1,609.00	\$1,639.00	\$1,663.00

- NOTES: 1. Escutcheon trims are available for 1-3/8", 1-3/4" or 2-1/4" door thicknesses only.  
 2. 613 finish is brass base lever & rose/escutcheon.  
 3. Must Specify: SAF for Fail Safe or SEC for Fail Secure.  
 4. VN escutcheon available only with indicators. Must be ordered with "V" indicator options. See page 116 for available functions. Option add also applies.

### ElectroLynx®

As part of their promise to provide innovative, fast and effective high security solutions to their customers, certain ASSA ABLOY Group brands offer *ElectroLynx®*, a universal quick-connect system that simplifies the electrification of the door opening.

## Fail Safe/Fail Secure

Description	Specify Quick Code
Fail Safe	SAF
Fail Secure	SEC

## Electrified Options for ML20900

Description	Specify Quick Code	Add or Deduct
Latchbolt Monitor	M91	\$234.00
Request to Exit (REX)	M92	\$231.00
Security monitor	M105	\$406.00
Latchbolt monitor x request to exit	M91 x M92	\$465.00
Request to Exit x security monitor	M92 x M105	\$637.00

## Accessories

Part No.	Description	Add or Deduct
BPS-24-1	Power Supply 24V 1 AMP	\$406.00
BPS-12-1	Power Supply 12V 1 AMP	
BPS-24-2	Power Supply 24V 2 AMP	\$826.00
BPS-12-3	Power Supply 12V 3 AMP	

## ML20600 High Security Monitoring Options

## EcoFlex® Mortise Lock End-of-Line Resistors and Deadbolt Privacy Options

Description	Specify Quick Code	Add or Deduct
Mercury and Lenel compatible 1KΩ/2KΩ resistance supervision	R01	Add \$100.00 per lockset
Software House compatible 1KΩ/2KΩ resistance supervision	R03	Add \$100.00 per lockset
AMAG compatible 4-state supervision	R04	Add \$100.00 per lockset
Deadbolt Privacy Function	PHR	Add \$100.00 per lockset
Deadbolt Privacy and Mercury / Lenel 1KΩ/2KΩ	PHRR01	Add \$200.00 per lockset
Deadbolt Privacy and Software House 1KΩ/2KΩ	PHRR03	Add \$200.00 per lockset
Deadbolt Privacy and AMAG 4-State	PHRR04	Add \$200.00 per lockset

### ElectroLynx®

As part of their promise to provide innovative, fast and effective high security solutions to their customers, certain ASSA ABLOY Group brands offer *ElectroLynx®*, a universal quick-connect system that simplifies the electrification of the door opening.

### Lock Only

Includes lockcase, armored front, strike and screw pack. Cylinder(s) and thumbturn lever are not included.

### Ordering Example

Quantity	Series/Function	Trim See Key Below	Finish	Door Thickness	Optional Strike
12	ML2055	LL	626	D138	SS078

Trim Key							
KK	Knob x Knob	LK	Lever x Knob	HL	Lever Inside only	LLBHSS	BHSS
LL	Lever x Lever	KL	Knob x Lever	HK	Knob inside Only		

Function	Description	LL, LK, KL, HL, HK <sup>2</sup> , KK <sup>2</sup> , LLBHSS		
		Available in all listed mortise trim finishes		
Non-Keyed	ML2010	Passage	\$466.00	
	ML2020	Privacy		
	ML2030		\$540.00	
	ML2040	Passage w/Indicator – VXX Option on Page 116 Applies		
	ML2060	Privacy		
Single Cylinder	ML2051	Office	\$504.00	
	ML2003	Classroom		
	ML2053	Entrance	\$517.00	
	ML2054			
	ML2055	Classroom	\$504.00	
	ML2056	Classroom Holdback		
	ML2057	Storeroom		
	ML2058	Entrance Holdback	\$517.00	
	ML2068	Privacy and Apartment	\$504.00	
	ML2069	Institution Privacy		
Single Cylinder with Deadbolt	ML2024	Entrance	\$540.00	
	ML2048	Entrance		
	ML2049	Storeroom Deadbolt		
	ML2059	Security Storeroom		
	ML2065	Dormitory		
	ML2067	Apartment		
	ML2073	Security		
	ML2075	Classroom		
ML2029	Hotel	\$549.00		
Double Cylinder	ML2002	Classroom Intruder	\$504.00	
	ML2032	Institution		
	ML2042	Entrance		
	ML2052	Classroom		
	ML2087	Security Vestibule		
	ML2022	Store Door		
	ML2062	Intruder		
	ML2072	Classroom		
	ML2082	Dormitory		
ML2092	Security Institution			
Single Cylinder	ML20914	Fail Safe/Fail Secure	\$743.00	
	ML20906			
No Cylinder Override	ML20907	Fail Safe/Fail Secure		
	ML20915			
Double Cylinder	ML20932	Fail Safe/Fail Secure		
	ML20987	Security Vestibule		
No Cylinder Override	ML20833	Without key override		\$893.00
Single Cylinder	ML20834	With key override		
Deadbolt without key override	ML20835	Deadbolt without key override		
Single Cylinder with deadbolt	ML20836	Deadbolt with key override		

Notes: 1. Kits contain internal lock parts only. Order knobs, spindles, escutcheons, cylinders and collars separately.  
 2. For master ring, specify quick code MR-LC. Add \$20.00. Not available for ML20900 series.

Cylinder & Keying Options		
Description	Specify Quick Code	Add or Deduct
Conventional 6-pin	(standard)	No Charge
Conventional 7-pin	7P	Add \$2.00 per cylinder
Less Standard Cylinder	LC	Deduct \$105.00 per cylinder
Less Hotel Cylinder	LC	Deduct \$155.00 per cylinder
Less Master Ring Cylinder <sup>3</sup>	MR-LC	Deduct \$40.00 per cylinder
Less Concealed Shell Cylinder	PO-LC	Add \$5.00 per lockset
<b>LFIC</b>		
LFIC 6-pin	C6	Add \$91.00 per cylinder
LFIC 6-pin Less Core	CL6	No Charge
LFIC 6-pin with Temporary Construction Core (Red)	CT6R	Add \$91.00 per cylinder
LFIC 6-pin with Temporary Construction Core (Blue)	CT6B	Add \$91.00 per cylinder
LFIC 6-pin with Temporary Construction Core (Green)	CT6G	Add \$91.00 per cylinder
LFIC 6-pin with Temporary Disposable Core	CT6D	No Charge
LFIC 7-pin	C7	Add \$93.00 per cylinder
LFIC 7-pin Less Core	CL7	Add \$2.00 per cylinder
LFIC 7-pin with Temporary Construction Core (Red)	CT7R	Add \$93.00 per cylinder
LFIC 7-pin with Temporary Construction Core (Blue)	CT7B	Add \$93.00 per cylinder
LFIC 7-pin with Temporary Construction Core (Green)	CT7G	Add \$93.00 per cylinder
LFIC 7-pin with Temporary Disposable Core	CT7D	Add \$2.00 per cylinder
<b>SFIC</b>		
SFIC 6-pin	C6S	Add \$82.00 per cylinder
SFIC 6-pin with Less Core	CLS6	No Charge
SFIC 6-pin with Temporary Construction Core (Blue)	CT6SB	Add \$82.00 per cylinder
SFIC 6-pin with SFIC disposable temporary core	CT6SD	No Charge
SFIC 7-pin	C7S	Add \$82.00 per cylinder
SFIC 7-pin with Less Core	CLS7	Add \$2.00 per cylinder
SFIC 7-pin with Temporary Construction Core (Blue)	CT7SB	Add \$82.00 per cylinder
SFIC 7-pin with SFIC disposable temporary core	CT7SD	Add \$2.00 per cylinder
<b>Security</b>		
Security <sup>5</sup>	HS	Add \$139.00 per cylinder
Security LFIC <sup>1,5</sup>	CHS	Add \$226.00 per cylinder
<b>Access 3</b>		
Access 3 Patented	AP	No Charge
Access 3 Security	AS	Add \$61.00 per cylinder
Access 3 High Security, UL 437	AHS	Add \$86.00 per cylinder
Access 3 LFIC Patented	ACP	Add \$91.00 per cylinder
Access 3 LFIC Security	ACS	Add \$147.00 per cylinder
Access 3 LFIC High Security, UL 437	ACHS	Add \$169.00 per cylinder
<b>Pyramid</b>		
Pyramid Security Fixed Core <sup>2</sup>	PS	Add \$74.00 per cylinder
Pyramid Security LFIC	PCS	Add \$159.00 per cylinder
Pyramid High Security Fixed Core	PHS	Add \$110.00 per cylinder
Pyramid High Security LFIC	PCHS	Add \$196.00 per cylinder
Pyramid LFIC with Temporary Construction Core <sup>4</sup>	CTP	Add \$91.00 per cylinder
Pyramid LFIC with Temporary Disposable Core <sup>4</sup>	CTPD	No Charge
Pyramid LFIC Less Core <sup>2</sup>	CLP	No Charge
<b>Other</b>		
Master Ring <sup>3</sup>	MR	Add \$79.00 per cylinder
Flex Head Cylinder, 6-pin (sectional trim)	FX6	Add \$95.00 per cylinder
Flex Head Cylinder, 7-pin (sectional trim)	FX7	Add \$97.00 per cylinder
Flex Head Master Ring (sectional trim)	FXM	Add \$154.00 per cylinder
Plug only to show, 6-pin (concealed shell) (avail: for M & R escutcheons and single cyl. functions only)	P06	Add \$105.00 per lockset
Plug only to show, 7-pin (concealed shell) (avail: for M & R escutcheons and single cyl. functions only)	P07	Add \$107.00 per lockset

**Notes:**

1. CHS ordered with CT6 option no charge.
2. Pyramid series and LFIC-7 pin are not available in ML2029 function.
3. Available for "M" escutcheon and sectional trim only. Not available for 17, 29 or 32 functions, and ECL functions. Not available for ML20900 series.
4. Refer to Key construction core program, pg. 63 for example of CTP option pricing.
5. For existing systems only.



### Cylinder & Keying Options\* (continued)

Description	Specify Quick Code	Add or Deduct
0-Bitted with two blank keys <sup>5</sup>	STDKEY	No Charge
Keyed Random <sup>4</sup>	KR	No Charge
Master keyed (all cylinders except 8000, 8020, 8027, 8200)	MK	Add \$16.00 per cylinder
Master keyed Pyramid	MK	Add \$16.00 per cylinder
Master keyed Security (including LFIC cylinder and core)	MK	Add \$16.00 per cylinder
Master keyed (8000, 8020, 8027, 8200)	MK-IC	No Charge
Master keyed to customer bittings or sample key	MK-CB	Add \$16.00 per cylinder
Construction master keyed <sup>1,2</sup>	CMK	Add \$16.00 per cylinder
<b>Visual key control (VKC)</b>		
- No Stamping	VKC0	\$4.50
- Keys only	VKC1	No Charge
- Cylinders and Keys <sup>3</sup>	VKC2	\$8.00
- Cylinders only <sup>3</sup>	VKC3	\$8.00
<b>Concealed key control (CKC)</b>		
- CKC cylinders with VKC keys	CKC2	\$8.00
- CKC cylinders only <sup>3</sup>	CKC3	\$8.00
More than 2 keys per lock	KY# (e.g., KY6)	See page 31 - Cut Keys Section

\*Double Cylinder Keying: Unless otherwise specified, both cylinders of ML2012, 2022, 2032, 2052, 2062, 2072, 2082, 2092 function locks will be keyed alike. The inside cylinder of 42 function locks will be keyed to the master key(s) only, while the outside cylinder will include the change key. If different is required, specify outside cylinder first, then inside cylinder. For key bows other than 10 and 90, specify "KB" + bow number as Quick Code, e.g. KB12. No extra charge.

Notes:

1. CMK Construction master keying charge is in addition to master keying charge.
2. CMK Construction master keying is not available in interchangeable core, Access 3, Pyramid, or Security series.
3. VKC2, VKC3, CKC3 are not available in Pyramid or Security series.
4. Pyramid series is not available keyed random.
5. Security series is not available 0-bitted.

### Strike Options\*

(To purchase strike separately, see catalog or parts manual for part no.)

Lip Length	ANSI Straight Lip – Specify Quick Code	ANSI Curved Lip – Specify Quick Code	Add or Deduct
7/8"	SS078	N/A	No Charge
1-1/8"	(standard)	N/A	
1-1/4"	SS114	SA114	
1-3/8"	SS138	SA138	
1-1/2"	SS112	SA112	
1-3/4"	SS134	SA134	Add \$17.00 per cylinder
2"	SS200	SA200	
2-1/4"	SS214	SA214	
2-1/2"	SS212	SA212	
2-3/4"	SS234	SA234	
3"	SS300	SA300	

Description	Door Thickness	Specify Quick Code	Add or Deduct
Open Back Strike	1-3/4"	SB134	Add \$100.00 per lockset
Open Back Strike	2"	SB200	Add \$160.00 per lockset
Open Back Strike	2-1/4"	SB214	
Rabbeted front and strike		SR118	Add \$103.00 per lockset

\* If door thickness is standard or has been specified and no special door or frame condition exist, then only the first two characters of the optional strike Quick Code must be specified (e.g. "SA"). The correct lip length will be determined by our order entry system based on the standard or specified door thickness.

### Door Thickness with Locksets Mortised on Center

(Note: Door thickness with panel not to exceed 2" from centerline of lock.)

Door Thickness	Sectional Rose Trim Specify Quick Code	Escutcheon <sup>1,2</sup> Trim Specify Quick Code	Add or Deduct
1-3/4" (standard)	—	—	No Charge
1-3/8"	D138	D138	Add \$56.00
1-7/8"	D178	N/A	No Charge
2"	D200	D200	
2-1/8"	D218	N/A	
2-1/4"	D214	D214	
2-3/8"	D238	D238	Add \$92.00 per lockset
2-1/2"	D212	D212	
2-5/8"	D258	D258	
2-3/4"	D234	D234	
2-7/8"	D278	D278	
3"	D300	D300	
3-1/8"	D318	D318	
3-1/4"	D314	D314	
3-3/8"	D338	D338	
3-1/2"	D312	D312	
3-5/8"	D358	D358	
3-3/4"	D334	D334	
3-7/8"	D378	D378	
4"	D400	D400	

**Notes:**

- For 2-3/8" to 4" door thickness: throughbolts and thumbturn lever spindle for 4" door will be provided. Throughbolts and spindles may be field cut.
- "R" and "L" escutcheons are only available for 1-3/8", 1-3/4" and 2-1/4" door thicknesses.

### Panel Applications

Specify Quick Code	Description	Add or Deduct
PNL <sup>1</sup>	Centerline of lockcase to edge of panel not to exceed 2"	Add \$92.00 per lockset

**Note:**

- When ordering, specify door thickness (less panel), panel thickness, and side of door panel will be applied (outside or inside).

### Custom Laser Engraving- LASER

**Laser engraving processing charge (all engraving types)**

- \$250.00 net per order. Charge will be applied to production order when placed.

**Single Vanity, Logo or Other (same engraving on all parts)**

- Lever - \$10.00 net add each
- Mortise Escutcheon - \$10.00 net add each
- HPSK Paddle - \$10.00 net add each

**Unique laser engraving (i.e. Room Number, Apartment Number, etc)**

- \$12.00 net add each (per piece)

### Miscellaneous Options

Description	Specify Quick Code	Add or Deduct
Split designs and split finishes	Outside Trim x Inside Trim	Higher set price prevails
Spanner head screws	M02	Add \$24.00 per lockset
Torx® head screws (n/a with N escutcheon)	M04	Add \$30.00 per lockset
ANSI wrought strike box	M17	No Charge
Knurling outside and inside	M20 <sup>1</sup>	Add \$172.00 per lockset
Knurling outside only	M21 <sup>1</sup>	Add \$86.00 per lockset
Knurling inside only	M22 <sup>1</sup>	Add \$86.00 per lockset
Abrasive coat outside and inside	M23 <sup>1</sup>	Add \$108.00 per lockset
Abrasive coat inside only	M24 <sup>1</sup>	Add \$54.00 per lockset
Abrasive coat outside only	M25 <sup>1</sup>	Add \$54.00 per lockset
Non-ferrous lockcase	M26	Add \$311.00 per lockset
Lead wrapped case	M29	Add \$328.00 per lockset
Half trim (for ML2010, ML2020, ML2022, ML2024, ML2029, ML2030, ML2032, ML2052, ML2053, ML2055, ML2056, ML2057, ML2058, ML2059, ML2062, ML2065 only) supplied with inside trim only	M30*	Deduct \$40.00 per lockset
Working trim only	M31	See pages 74 thru 90
Latch Hold Back 42, 51, 52, 55, 57 functions	LHB	Add \$51.00 per lockset
HPSK Positive Pull Stop Kit (813F068)		Add \$21.00
HPSK "PUSH" & "PULL" Identification (non-handed)	M38	\$31.00
HPSK Security Lever (not available on non-keyed functions)	M111	No Charge

\*Not available with BHSS trim. Requires special application for BLSS, HSS, and HPSK trim.

### Thumbturn Options

Specify door thickness	Specify Quick Code	Add or Deduct
Ergonomic	M34 <sup>2</sup>	Add \$18.00 per TT
Decorative	MT1	No Charge
Decorative square	MT2	No Charge
Decorative cylinder	MT3	No Charge



**MT1**



**MT2**



**MT3**

**Notes:**

1. Not available with Vineyard™ or Muséo® levers.
2. M34 is not available with M19N, M19VN or M19SN.

Note: Thumbturn backplate will match shape of rose chosen (i.e. round or square)

**Indicator Options**

Description	Specify Quick Code	Add or Deduct
Single Indicator Outside - Unlocked/Locked - Green/Red	V10	Add \$140.00 per lockset
Single Indicator Outside - Vacant/Occupied - Green/Red	V20	Add \$140.00 per lockset
Single Indicator Outside - Icons Only - Green/Red	V30	Add \$140.00 per lockset
Single Indicator Outside - Unlocked/Locked - White/Red	V40	Add \$140.00 per lockset
Single Indicator Outside - Vacant/Occupied - White/Red	V50	Add \$140.00 per lockset
Single Indicator Outside - Icons Only - White/Red	V60	Add \$140.00 per lockset
Single Indicator Inside - Unlocked/Locked - Green/Red	V01	Add \$140.00 per lockset
Single Indicator Inside - Icons Only - Green/Red	V03	Add \$140.00 per lockset
Single Indicator Inside - Unlocked/Locked - White/Red	V04	Add \$140.00 per lockset
Single Indicator Inside - Icons Only - White/Red	V06	Add \$140.00 per lockset
Double Indicator - Unlocked/Locked - Green/Red (Outside) Unlocked/Locked - Green/Red (Inside)	V11	Add \$280.00 per lockset
Double Indicator - Vacant/Occupied - Green/Red (Outside) Unlocked/Locked - Green/Red (Inside)	V21	Add \$280.00 per lockset
Double Indicator - Icons Only - Green/Red (Outside) Icons Only - Green/Red (Inside)	V33	Add \$280.00 per lockset
Double Indicator - Unlocked/Locked - White/Red (Outside) Unlocked/Locked - White/Red (Inside)	V44	Add \$280.00 per lockset
Double Indicator - Vacant/Occupied - White/Red (Outside) Unlocked/Locked - White/Red (Inside)	V54	Add \$280.00 per lockset
Double Indicator - Icons Only - White/Red (Outside) Icons Only - White/Red (Inside)	V66	Add \$280.00 per lockset
Single Indicator Outside - Secure/Unsecure - Green/Red (Sectional trim only)	M19S	Add \$155.00 per lockset
Single Indicator Outside - Vacant/Occupied - Green/Red (Sectional trim only)	M19V	Add \$155.00 per lockset
Single Indicator Inside - Secure/Unsecure - Green/Red (Sectional trim only)	M19N	Add \$155.00 per lockset
Double Indicator - Secure/Unsecure - Green/Red (Outside) Secure/Unsecure - Green/Red (Inside), (Sectional trim only)	M19SN	Add \$310.00 per lockset
Double Indicator - Vacant/Occupied - Green/Red (Outside) Secure/Unsecure - Green/Red (Inside) (Sectional trim only)	M19VN	Add \$310.00 per lockset
Outside Engraving with "Lock" and Directional Arrow	EMA	Add \$50.00 per lockset
Inside Engraving with "Lock" and Directional Arrow	EMB	Add \$50.00 per lockset
Engraving Both Sides with "Lock" and Directional Arrow	EMC	Add \$100.00 per lockset

**French Options for V Series Indicators:**

Description	Specify Quick Code	Add or Deduct
Single Indicator Outside - Ouvert/Fermé - Green/Red	V10F	Add \$140.00 per lockset
Single Indicator Outside - Libre/Occupée - Green/Red	V20F	
Single Indicator Inside - Ouvert/Fermé - Green/Red	V01F	Add \$280.00 per lockset
Double Indicator - Ouvert/Fermé - Green/Red (outside) Ouvert/Fermé - Green/Red (inside)	V11F	
Double Indicator - Ouvert/Fermé - Green/Red (outside) Libre/Occupée - Green/Red (inside)	V21F	

**Sectional Trim Retrofit Kits for V Series Indicators (for M19 indicator refer to parts pages)**

Description	Model #	List Price
Keyed Functions	ML190	\$230.00
Cointurn for Emergency Override	ML193	\$230.00
Thumbturn	ML194	\$230.00
No Input - Blank	ML197	\$230.00

**NOTES:**

When ordering sectional trim retrofit kits, specify finish, hand and V code required. i.e. ML190 x RH x 626 x V01.

Kits accommodate indicators on one side of the door only. If indicators are required for both sides, 2 kits must be ordered as required by function. Add for indicator does not apply.

For escutcheon retrofit kits, specify function, trim, hand, finish and V code required X M31 option. See pages 76-109 for pricing, add for indicator also applies.

**Ordering Examples:**

Function	Lever	Rose	Hand	Finish	Options
ML2002	NS	A	RH	626	V01

Double cylinder classroom intruder function x sectional trim x single indicator inside – Unlocked/Locked – Green/Red.

Function	Lever	Escutcheon	Hand	Finish	Options
ML2060	NS	VN	RH	626	V21 x EMB

Privacy function x escutcheon trim x double indicator – Vacant/Occupied – Green/Red (Outside) Unlocked/Locked – Green/Red (Inside) x inside engraving with "lock" and directional arrow.

**NOTES:**

- M19 series indicators are not available with BHSS or BLSS trims.
- V series indicators are not available with BHSS, BLSS, HSS or HPSK trims.
- EMA, EMB and EMC are only for use with V series indicators, for all other engraving, please refer to custom engraving options.
- Contact customer service for other available or custom indicator wording and/or colors.

**Indicators and directional arrow engraving are available with the following functions:**

ML2002, ML2003, ML2011, ML2012, ML2013, ML2017, ML2020, ML2022, ML2024, ML2029, ML2030, ML2048, ML2049, ML2059, ML2060, ML2062, ML2065, ML2067, ML2068, ML2069, ML2072, ML2073, ML2075, ML2082, ML2092, ML20608 x NAC x SEC x PHR, ML20609 x NAC x SEC x PHR.

Please refer to the ML2000 Series catalog for more information.

MicroShield® Healthcare Hardware Finishes, How to Order, Pricing	118
Behavioral Health Series™ Lever Design: BHSS	119
Behavioral Health Series™ Lever Design: BLSS	120
Anti-Harm Knob Trim Knob Design: HSS	121
Healthcare Hardware HPSK Trim	122
<b>HP3000 Series Tubular Lock with Push/Pull Trim:</b>	
HP3000 Series Features & Ordering Example	123
HP3000 Series Strike, Door Thickness, Backset, Miscellaneous Options	124

# MicroShield®

Look for the *MicroShield* icon.

## **MicroShield®**

As part of their promise to provide innovative solutions to their customers, certain ASSA ABLOY Group brands offer the MicroShield® technology, a silver-based antimicrobial coating designed to inhibit the growth of bacteria.

MicroShield® is a registered trademark of ASSA ABLOY Access and Egress Hardware Group, Inc.

Product	Trim	MicroShield® Coated Components
Healthcare Hardware	BHSS, BLSS, HSS, HPSK	Knobs/Levers, roses and/or escutcheons

## **AVAILABLE FINISHES**

- MicroShield® is available on 626 and 630. Other finishes available by Special Product Application Request Form only.
- Specify 626C (satin chrome plated) or 630C (satin stainless steel) when ordering.
- MicroShield® coating will be applied over 626 and 630 finishes. All components will match 626.

*Note: MicroShield® coating will only be applied to "high touch" components.*

## **HOW TO ORDER**

Product	How to Order
Mortise Locks	ML2055 x BHSS x 630C x RHR

Description	Add
Cylindrical Locks & Mortise Locks	Add \$79.00

**Behavioral Health Series™**

**Lever Design: BHSS**

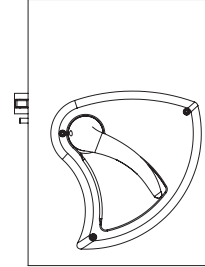

**BHSS**

Lever: Cast  
Escutcheon: Cast

			630
Non-Keyed	ML2010	Passage	\$2,057.00
	ML2020	Privacy	\$2,188.00
	ML2030	Privacy	
	ML2060	Privacy	\$2,114.00
Single Cylinder	ML2003	Classroom	\$2,192.00
	ML2051	Office	
	ML2055	Classroom	
	ML2056	Classroom HB	
	ML2057	Storeroom	\$2,210.00
	ML2069	Institution Privacy	
	ML2053	Entrance	
	ML2054	Entrance	
ML2058	Entrance Holdback	\$2,210.00	
ML2068	Privacy or Apartment		
Single Cylinder with Deadbolt	ML2024	Entrance	\$2,240.00
	ML2048	Entrance	
	ML2049	Storeroom Deadbolt	
	ML2065	Dormitory	
	ML2059	Security Storeroom	
	ML2067	Apartment	
	ML2073	Classroom Security	
	ML2075	Entrance/Office	
ML2029	Hotel	\$2,283.00	
Double Cylinder	ML2002	Classroom Intruder	\$2,297.00
	ML2032	Institution	
	ML2042	Entrance	
	ML2052	Classroom Intruder	
Double Cylinder with Deadbolt	ML2022	Store Door	\$2,345.00
	ML2062	Intruder Deadbolt	
	ML2072	Classroom Security Intruder	
	ML2082	Dormitory	
	ML2092	Security Institution	
Single Cylinder	ML20906	Fail Safe/Fail Secure	\$2,431.00
	ML20914		
No Cylinder Override	ML20907	Fail Safe/Fail Secure	\$2,193.00
	ML20915		
Double Cylinder	ML20932	Fail Safe/Fail Secure	\$2,536.00
	ML20987		
	ML20606	NAC Fail Safe/Fail Secure	\$2,606.00
	ML20608		\$2,681.00
	ML20607	NAC Fail Safe/Fail Secure	\$2,368.00
	ML20609		\$2,443.00
Full Working Trim	M31	No cylinder; includes thumbturn lever	\$1,654.00

**Behavioral Health Series™**

**Lever Design: BLSS**

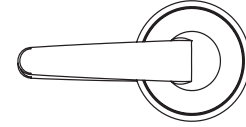

**BLSS**

Lever: Cast  
Rose: Wrought

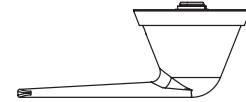

**630**

Non-Keyed	ML2010	Passage	\$1,995.00
	ML2020	Privacy	\$2,126.00
	ML2030	Privacy	
	ML2060	Privacy	\$2,052.00
Single Cylinder	ML2003	Classroom	\$2,130.00
	ML2051	Office	
	ML2055	Classroom	
	ML2056	Classroom HB	
	ML2057	Storeroom	
	ML2069	Institution Privacy	\$2,148.00
	ML2053	Entrance	
	ML2054	Entrance	
Single Cylinder with Deadbolt	ML2058	Entrance	\$2,178.00
	ML2068	Privacy	
	ML2024	Entrance	\$2,221.00
	ML2048	Entrance	
	ML2049	Storeroom Deadbolt	
	ML2059	Security Storeroom	
	ML2065	Dormitory	
	ML2067	Apartment	
ML2073	Classroom Security		
ML2075	Classroom		
Double Cylinder	ML2029	Hotel	\$2,235.00
	ML2002	Classroom Intruder	
	ML2032	Institution	
	ML2042	Entrance	
Double Cylinder with Deadbolt	ML2052	Classroom	\$2,283.00
	ML2022	Store Door	
	ML2062	Intruder	
	ML2072	Classroom	
	ML2082	Dormitory	
Single Cylinder	ML2092	Security Institution	\$2,369.00
	ML20906	Fail Safe/Fail Secure	
No Cylinder Override	ML20914		Fail Safe/Fail Secure
	ML20907		
Double Cylinder	ML20915	Fail Safe/Fail Secure	\$2,474.00
	ML20932		
	ML20987	NAC Fail Safe/Fail Secure	\$2,544.00
	ML20606		
	ML20608	NAC Fail Safe/Fail Secure	\$2,619.00
	ML20607		
	ML20609	NAC Fail Safe/Fail Secure	\$2,473.00
	ML20609		
Full Working Trim	M31	No cylinder; includes thumbturn lever	\$1,592.00



**Anti-Harm Knob Trim**

**Knob Design: HSS**



**HSS** Knob: Brass

<b>HSS<sup>1</sup></b>
<b>630<sup>2</sup></b>

Function			
Non-Keyed	ML2010	Passage	\$1,810.00
	ML2020	Privacy	\$2,226.00
	ML2060	Privacy	\$2,190.00
	ML2090	Full Active Dummy Trim	\$1,839.00
Single Cylinder	ML2003	Classroom	\$2,271.00
	ML2051	Office	
	ML2055	Classroom	
	ML2056	Classroom HB	
	ML2057	Storeroom	\$2,289.00
	ML2069	Inst. Privacy	
	ML2053	Entrance	
	ML2054	Entrance	
	ML2058	Entrance	
ML2068	Privacy		
Single Cylinder with Deadbolt	ML2024	Entrance	\$2,319.00
	ML2048		
Double Cylinder	ML2002	Classroom Intruder	\$2,376.00
	ML2032	Institution	
	ML2042	Entrance	
	ML2052	Classroom	
Double Cylinder with Deadbolt	ML2022	Store Door	\$2,424.00
	ML2092	Security Inst	
Deadlock	ML2011	Single Cylinder	\$706.00
	ML2012	Double Cylinder	\$811.00
	ML2013	Cylinder x Thumbturn	\$736.00
	ML2017	Classroom Function Cylinder x Thumbturn	
Single Cylinder	ML20906	Fail Safe/Fail Secure	\$2,510.00
	ML20914		
No Cylinder Override	ML20907	Fail Safe/Fail Secure	\$2,405.00
	ML20915		
Double Cylinder	ML20932	Fail Safe/Fail Secure	\$2,615.00
	ML20987		

Notes:

1. Sectional lever trim x HSS available.
2. 619 finish provided to match 630 finish.

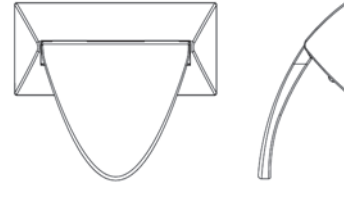

**HPSK**  
Lever: Cast  
Rose: Wrought

Function			630
Non-Keyed	ML2010	Passage	\$1,280.00
	ML2020	Privacy	\$1,324.00
	ML2030	Privacy	
	ML2060	Privacy	\$1,308.00
	ML2090	Full Active Dummy Trim	\$1,309.00
Single Cylinder	ML2003	Classroom	\$1,391.00
	ML2051	Office	
	ML2055	Classroom	
	ML2056	Classroom	
	ML2057	Storeroom	
	ML2069	Institution Privacy	
	ML2053	Entrance	\$1,409.00
	ML2054	Entrance	
	ML2058	Entrance Holdback	
ML2068	Privacy or Apartment		
Single Cylinder with Deadbolt	ML2024	Entrance	\$1,439.00
	ML2048	Entrance	
	ML2065	Dormitory	
	ML2059	Security Storeroom	
	ML2067	Apartment	
	ML2073	Classroom Security	
	ML2075	Entrance/Office	
ML2029	Hotel	\$1,482.00	
Double Cylinder	ML2002	Classroom Intruder	\$1,496.00
	ML2032	Institution	
	ML2042	Entrance	
	ML2052	Classroom Intruder	
	ML2087	Security Vestibule	
Double Cylinder with Deadbolt	ML2022	Store Door	\$1,544.00
	ML2062	Intruder Deadbolt	
	ML2072	Classroom Security Intruder	
	ML2082	Dormitory	
	ML2092	Security Institution	
Single Cylinder	ML20906	Fail Safe/Fail Secure	\$1,630.00
	ML20914		
No Cylinder Override	ML20907	Fail Safe/Fail Secure	\$1,525.00
	ML20915		
Double Cylinder	ML20932	Fail Safe/Fail Secure	\$1,735.00
	ML20987		
Full Working Trim	M31	No cylinder, includes thumbturn lever	\$733.00

**Standard Features**

**Handing**

Passage (HP3010) function is non-handed  
Privacy (HP3020) function is handed

**Door Thickness**

1-3/4" (44mm) standard.  
Optional door thicknesses available

**Backset (5" - Standard)**

5" (127mm) standard.  
Optional: 2-3/4" (70mm) and 7" (177mm)

**Strike**

ANSI curved lip strike standard, 4-7/8" x 1-1/4" x 1-1/4" lip to center.

Optional strikes, lip lengths and ANSI wrought strike box available

**Latchbolt**

Brass, 1/2" (13mm) throw

**Covers**

Cast stainless steel

**Paddles**

Cast stainless steel



**Ordering Example**

**Stock Order**

Series/Function	Trim	Finish	Hand*
HP3010	HPSK	630	RH

\*Passage (HP3010) function is non-handed and privacy (HP3020) function is handed.

Function	Description	Finish
		630
HP3010	Passage	\$536.00
HP3020	Privacy	\$696.00

**Strike Options**

Lip to Center	ANSI Curved Lip. Specify	Curved Lip Box. Specify	Full Lip. Specify	Add or Deduct
1" (25mm)	SA100	SC100		No Charge
1-1/8" (29mm)	SA118	SC118		
1-1/4" (32mm)	(standard)	SC114	SF114*	
1-3/8" (35mm)	SA138	SC138		
1-1/2" (38mm)	SA112	SC112		
1-3/4" (44mm)	SA134	SC134		Add \$17.00 per cylinder
2" (51mm)	SA200	SC200		
2-1/4" (57mm)	SA214	SC214		
2-1/2" (28mm)	SA212	SC212		
2-3/4" (70mm)	SA234	SC234		
3" (76mm)	SA300	SC300		

\* Specify SFR114 for rounded corner.

**Door Thickness Options**

Description	Specify Quick Code	Add or Deduct
1-3/4" (44mm)	(standard)	No Charge
2" (51mm)	D200	
2-1/4" (57mm)	D214	

**Backset Options**

Description	Specify Quick Code	Add or Deduct
2-3/4" (70mm)	B234	No Charge
5" (127mm)	(standard)	
7" (177mm)	B700	Add \$6.00 per lockset

**Miscellaneous Options**

Description	Specify Quick Code	Add or Deduct
Spanner head screws	M02	Add \$24.00 per lockset
Torx® head screws	M04	Add \$30.00 per lockset
Latch front, rounded corners	M13	Add \$2.50 per latch
ANSI wrought strike box	M17	No Charge
Lead lining. Specify Push or Pull side.	M28	Add \$338.00 per lockset
"PUSH & PULL" Identification*	M38	Add \$31.00
Retrofit Kit (part no. 791F39)		Add \$67.00
HP3000 Positive Pull Stop Kit (813F068)		Add \$21.00

MicroShield® Cylindrical Locksets Finishes, How to Order, Pricing	126
<b>TL3700 Museo Series Tubular Locksets:</b>	
TL3700 Series: Museo Georgia, Pablo, Jackson, Salvador, Marc Levers & Inspire Trim:	127
TL3700 Series: Museo Georgia, Pablo, Jackson, Salvador, Marc Levers & Roses	128
TL3700 Series: Museo Josef, Georges Levers & Roses	129
TL3700 Series: Museo Piet Levers & Roses	130
TL3700 Series: Options	131
<b>Grade 1 Vandal Resistant Cylindrical Lever Locksets CL3100 Series:</b>	
CL3100 Series Standard Features, Ordering Examples	132
CL3100 Series Lever Designs	133
CL3100 Series Cylinder Options	134
CL3100 Series Keying Options	135
CL3100 Series Door Thickness, Backset, Strike Options	136
CL3100 Series Miscellaneous Options	137
<b>Grade 1 Heavy-Duty Cylindrical Lever Locksets CLX3300 Series:</b>	
CLX3300 Series Standard Features & Ordering Examples	138
CLX3300 Series Lever Designs	139
CLX3300 Series Cylinder Options	140
CLX3300 Series Keying Options	141
CLX3300 Series Door Thickness, Backset, Strike Options	142
CLX3300 Series Miscellaneous Options	143
<b>Grade 1 Heavy-Duty Cylindrical Lever Locksets CL3300 Series:</b>	
CL3300 Series Standard Features & Ordering Examples	144
CL3300 Series Lever Designs	145
CL3300 Series Cylinder Options	146
CL3300 Series Keying Options	147
CL3300 Series Door Thickness, Backset, Strike Options	148
CL3300 Series Miscellaneous Options	149
<b>Grade 1 Cylindrical Lever Locksets CL3500 Series:</b>	
CL3500 Series Standard Features & Ordering Examples	150
CL3500 Series Lever Designs	151
CL3500 Series Cylinder Options	152
CL3500 Series Keying Options	153
CL3500 Series Door Thickness, Backset, Strike Options	154
CL3500 Series Miscellaneous Options	155
<b>Grade 2 Standard-Duty Lever Locksets CL3800 Series:</b>	
CL3800 Series Standard Features & Ordering Options	156
CL3800 Series Lever Designs	157
CL3800 Series Cylinder & Keying Options	158
CL3800 Series Door Thickness, Backset, Strike, Miscellaneous Options	159
<b>Grade 1 Cylindrical Knob Locksets CK4300 Series:</b>	
CK4300 Series Standard Features & Ordering Example	160
CK4300 Series Knob Designs, Cylinder Keying Options	161
CK4300 Series Strike, Backset, Door Thickness, Miscellaneous Options	162
<b>Grade 2 Cylindrical Knob Locksets CK4400 Series:</b>	
CK4400 Series Standard Features & Ordering Example	163
CK4400 Series Knob Designs, Cylinder & Keying Options, Backset Options	164
CK4400 Series Strike, Miscellaneous Options	165
Blank Page	166

# MicroShield®

Look for the *MicroShield* icon.

## MicroShield®

As part of their promise to provide innovative solutions to their customers, certain ASSA ABLOY Group brands offer the MicroShield® technology, a silver-based antimicrobial coating designed to inhibit the growth of bacteria.

MicroShield® is a registered trademark of Yale Security Inc., an ASSA ABLOY Access and Egress Hardware Group, Inc.

TL3700  
CL3100  
CLX3300  
CL3300  
CL3500  
CL3800

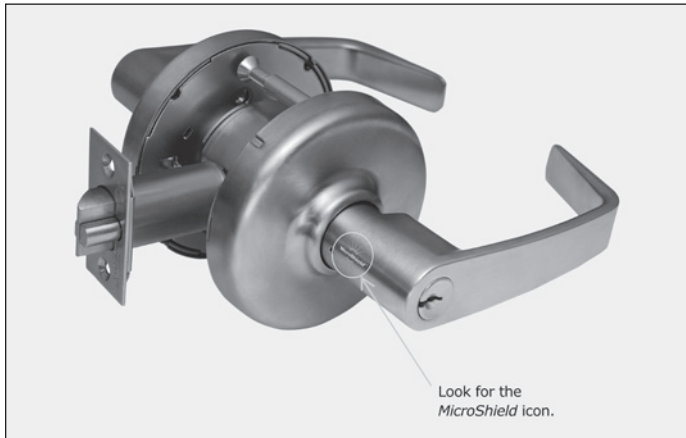

Product	Series	MicroShield® Coated Components
Cylindrical Locks	CL3100, CLX3300, CL3300, CL3500, and CL3800 Series	Levers*, roses

## AVAILABLE FINISHES

- MicroShield® is available on 626. Other finishes available by Special Product Application Request Form only.
- Specify 626C (satin chrome plated) when ordering.
- MicroShield® coating will be applied over 626 finish. All components will match 626.

\* MicroShield® coating will only be applied to "high touch" components.

## HOW TO ORDER

Product	How to Order
Cylindrical Locks	CL3355 x NZD x 626C

Description	Add
Cylindrical Locks	Add \$79.00

# Tubular Locksets

TL3700 Series: Muséo Levers and Inspire™ Roseless Trim

USA & Canada Prices Effective February 1, 2022



contemporary trim to complement the interior design of your next project

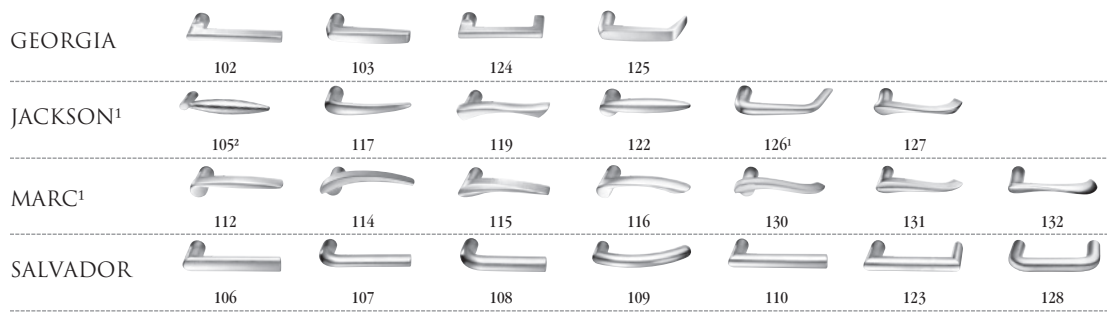

<sup>1</sup>Handed: specify hand when ordering  
<sup>2</sup>Contact factory for current lead time

613E	Dark Oxidized Satin Bronze - Equivalent	605	Bright Brass, Clear Coated
626	Satin Chromium Plated	606	Satin Brass, Clear Coated
BSP	Black Suede Powder Coat	611	Bright Bronze, Clear Coated
WSP	White Suede Powder Coat	612	Satin Bronze, Clear Coated
		613	Dark Oxidized Satin Bronze, Oil Rubbed
		613L	Dark Oxidized Satin Bronze, Clear Coated
		618	Bright Nickel Plated
		619	Satin Nickel Plated
		625	Bright Chromium Plated
		629*	Bright Stainless Steel
		630*	Satin Stainless Steel
		722	Black Oxidized Bronze, Oil Rubbed

### Function

TL3710	Passage Set	\$276.00	\$286.00
TL3710A	Passage Set-3 Hour	\$282.00	\$292.00
TL3720	Privacy Set	\$288.00	\$298.00
TL3720A	Privacy Set-3 Hour	\$294.00	\$304.00
TL3750	Single Lever Pull-Through Bolted	\$122.00	\$127.00
TL3770	Double Lever Pull	\$228.00	\$238.00
TL3780	Communicating Set	\$276.00	\$286.00
TL3780A	Communicating Set-3 Hour	\$282.00	\$292.00

### Ordering Example Details

TL3710 Passage: Non-Keyed tubular lock  
 102J Georgia Family Lever, J Collar  
 626 Satin Chrome Finish  
 LH Left Handed

Trim Only				
Quantity	Series/Function	Trim	Finish	Hand
24	TL3710	102J	626	LH

\*629 and \*630 finish options are Not available for all Muséo levers. Please refer to page 20 for availability.



Experience a safer  
and more open world

# Tubular Locksets

TL3700 Series: Muséo Levers and Roses

USA & Canada Prices Effective February 1, 2022

contemporary trim to complement the interior design of your next project

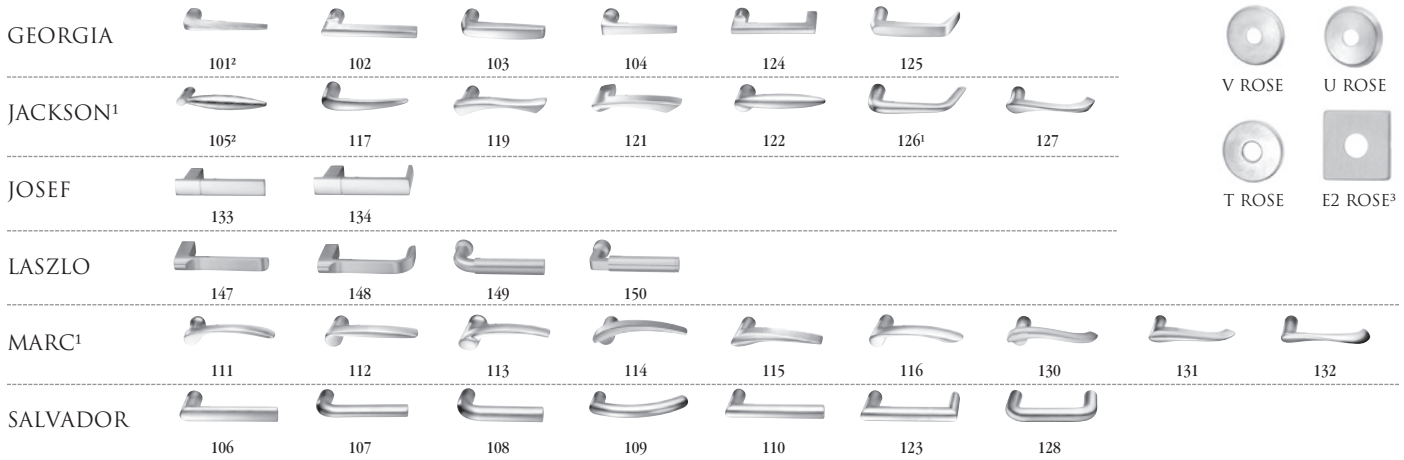

<sup>1</sup>Handed: specify hand when ordering

<sup>2</sup>Contact factory for current lead time

<sup>3</sup>**CAUTION:** Cannot retrofit on existing cylindrical lock door preps with through-bolt holes outside the 2-1/8" bored hole (Ex. CL3300 & CL3500).

613E	Dark Oxidized Satin Bronze - Equivalent	605	Bright Brass, Clear Coated
626	Satin Chromium Plated	606	Satin Brass, Clear Coated
BSP	Black Suede Powder Coat	611	Bright Bronze, Clear Coated
WSP	White Suede Powder Coat	612	Satin Bronze, Clear Coated
		613	Dark Oxidized Satin Bronze, Oil Rubbed
		613L	Dark Oxidized Satin Bronze, Clear Coated
		618	Bright Nickel Plated
		619	Satin Nickel Plated
		625	Bright Chromium Plated
		629*	Bright Stainless Steel
		630*	Satin Stainless Steel
		722	Black Oxidized Bronze, Oil Rubbed

### Function

TL3710	Passage Set	\$267.00	\$277.00
TL3710A	Passage Set-3 Hour	\$273.00	\$283.00
TL3720	Privacy Set	\$279.00	\$289.00
TL3720A	Privacy Set-3 Hour	\$285.00	\$295.00
TL3750	Single Lever Pull-Through Bolted	\$147.00	\$152.00
TL3750S	Single Lever Pull-Surface Mounted	\$117.00	\$127.00
TL3770	Double Lever Pull	\$223.00	\$233.00
TL3780	Communicating Set	\$267.00	\$277.00
TL3780A	Communicating Set-3 Hour	\$273.00	\$283.00

Ordering Example Details →

TL3710 Passage: Non-Keyed tubular lock  
 111T Marc Lever, T-Rose  
 626 Satin Chrome Finish  
 LH Left Handed

Trim Only				
Quantity	Series/Function	Trim	Finish	Hand
24	TL3710	111T	626	LH

\*629 and \*630 finish options are Not available for all Muséo levers. Please refer to page 20 for availability.



Experience a safer and more open world



# Tubular Locksets

TL3700 Series: Muséo Levers and Roses

USA & Canada Prices Effective February 1, 2022

contemporary levers to complement the interior design of your next project



JOSEF



135 136 137 138

GEORGES



139 140\* 141\* 142 143\*

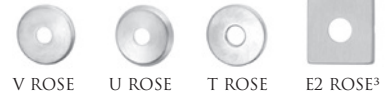

\*Georges Levers 140, 141 and 143 are not available for the following functions: TL3720 and TL3720A

<sup>1</sup>Handed: specify hand when ordering

<sup>2</sup>Contact factory for current lead time

<sup>3</sup>**CAUTION:** Cannot retrofit on existing cylindrical lock door preps with through-bolt holes outside the 2-1/8" bored hole (Ex. CL3300 & CL3500).

613E Dark Oxidized Satin Bronze - Equivalent  
626 Satin Chromium Plated  
BSP Black Suede Powder Coat  
WSP White Suede Powder Coat

605 Bright Brass, Clear Coated  
606 Satin Brass, Clear Coated  
611 Bright Bronze, Clear Coated  
612 Satin Bronze, Clear Coated  
613 Dark Oxidized Satin Bronze, Oil Rubbed  
613L Dark Oxidized Satin Bronze, Clear Coated  
618 Bright Nickel Plated  
619 Satin Nickel Plated  
625 Bright Chromium Plated  
629 Bright Stainless Steel  
630 Satin Stainless Steel  
722 Black Oxidized Bronze, Oil Rubbed

### Function

Function	Price	Price
TL3710 Passage Set	\$371.00	\$381.00
TL3710A Passage Set-3 Hour	\$377.00	\$387.00
TL3720* Privacy Set	\$385.00	\$395.00
TL3720A* Privacy Set-3 Hour	\$391.00	\$401.00
TL3750 Single Lever Pull-Through Bolted	\$249.00	\$254.00
TL3750S Single Lever Pull-Surface Mounted	\$214.00	\$224.00
TL3770 Double Lever Pull	\$327.00	\$337.00
TL3780 Communicating Set	\$371.00	\$381.00
TL3780A Communicating Set-3 Hour	\$377.00	\$387.00

Ordering Example Details →

TL3710 Passage: Non-Keyed tubular lock  
135E2 Josef Lever, E2 Rose  
626 Satin Chrome Finish  
LH Left Handed

Trim Only				
Quantity	Series/Function	Trim	Finish	Hand
24	TL3710	135E2	626	LH



Experience a safer and more open world

# Tubular Locksets

TL3700 Series: Muséo Levers and Roses

USA & Canada Prices Effective February 1, 2022

contemporary trim to complement the interior design of your next project



PIET

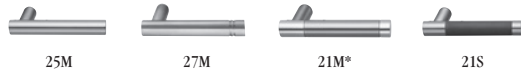

\*613E, BSP, WSP finishes are not available with 21M levers.



613E Dark Oxidized Satin Bronze – Equivalent  
 629 Bright Stainless Steel  
 630 Satin Stainless Steel  
 BSP Black Suede Powder Coat  
 WSP White Suede Powder Coat

### Function

TL3710	Passage Set	\$290.00
TL3710A	Passage Set - 3 Hour	\$296.00
TL3720	Privacy Set	\$307.00
TL3720A	Privacy Set - 3 Hour	\$313.00
TL3750	Single Lever Pull - Through Bolted	\$163.00
TL3750S	Single Lever Pull - Surface Mounted	\$133.00
TL3770	Double Lever Pull	\$246.00
TL3780	Communicating Set	\$290.00
TL3780A	Communicating Set - 3 Hour	\$296.00

PIET

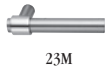

613E Dark Oxidized Satin Bronze – Equivalent  
 629 Bright Stainless Steel  
 630 Satin Stainless Steel  
 BSP Black Suede Powder Coat  
 WSP White Suede Powder Coat

### Function

TL3710	Passage Set	\$359.00
TL3710A	Passage Set - 3 Hour	\$365.00
TL3720	Privacy Set	\$373.00
TL3720A	Privacy Set - 3 Hour	\$379.00
TL3750	Single Lever Pull - Through Bolted	\$225.00
TL3750S	Single Lever Pull - Surface Mounted	\$195.00
TL3770	Double Lever Pull	\$306.00
TL3780	Communicating Set	\$359.00
TL3780A	Communicating Set - 3 Hour	\$365.00

PIET



613E Dark Oxidized Satin Bronze – Equivalent  
 629 Bright Stainless Steel  
 630 Satin Stainless Steel  
 BSP Black Suede Powder Coat  
 WSP White Suede Powder Coat

### Function

TL3710	Passage Set	\$381.00
TL3710A	Passage Set - 3 Hour	\$387.00
TL3720	Privacy Set	\$395.00
TL3720A	Privacy Set - 3 Hour	\$401.00
TL3750	Single Lever Pull - Through Bolted	\$254.00
TL3750S	Single Lever Pull - Surface Mounted	\$224.00
TL3770	Double Lever Pull	\$337.00
TL3780	Communicating Set	\$381.00
TL3780A	Communicating Set - 3 Hour	\$387.00

### Ordering Example Details

TL3710 Passage: Non-Keyed tubular lock  
 23MU Piet Family Lever - Wood Insert, U-Rose  
 29BH29 Lever Finish  
 Wood insert with polished stainless steel (629) shank and polished stainless steel (629) grip  
 629 Lock Finish  
 LH Left Handed

### Stock Order

Quantity	Series/Function	Trim	Lever Finish	Lock Finish	Hand
2	TL3710	23MU	29BH29	629	LH

**¹CAUTION:** Cannot retrofit on existing cylindrical lock door preps with through-bolt holes outside the 2-1/8" bored hole (Ex. CL3300 & CL3500).



Experience a safer and more open world

**Door Thickness Options**

Description	Specify Quick Code	Add or Deduct
1-3/8" (35mm) up to 1-3/4" (44mm)	D138	No Charge
1-3/4" (44mm) up to 2-1/4" (57mm)	(standard)	
2-1/4" (57mm) up to 2-1/2" (64mm)	D214	
(Consult factory if over 2-1/2" (64mm))		

**Backset Options**

Description	Specify Quick Code	Add or Deduct
2-3/4"	B234 (standard)	No Charge
2-3/8" <sup>1</sup>	B238	

**Strike Options**

Lip Length	ANSI Curved Lip - Specify Quick Code	Curved Lip Box - Specify Quick Code	Full Lip Specify Quick Code	Full Lip Radius Corner Specify Quick Code	Add or Deduct
1"	SA100	SC100			No Charge
1-1/8"	SA118	SC118			
1-1/4"	SA114	SC114 (standard)	SF114	SFR114	
1-3/8"	SA138	SC138			
1-1/2"	SA112	SC112 <sup>2</sup>			Add \$17.00 per cylinder
1-3/4"	SA134	SC134			
2"	SA200	SC200			
2-1/4"	SA214	SC214			
2-1/2"	SA212	SC212			
2-3/4"	SA234	SC234			
3"	SA300	SC300			

**Miscellaneous Options**

Description	Specify Quick Code	Add or Deduct
Latch front, rounded corners	M13	Add \$2.50 per latch
1" (25mm) latch front, square corners <sup>3</sup>	M14	Add \$6.00 per lockset
1" (25mm) latch front, rounded corners	M15	Add \$2.50 per latch
ANSI wrought strike box	M17	Add \$6.00 per lockset

Notes:

1. 1" front supplied standard
2. Standard for D214
3. Standard for 2-3/8" backset



**Standard Features**

**Handing**

Non-handed

**Door Thickness**

1-3/4" - 2 standard

**Backset**

2-3/4" standard

**Strike**

ANSI curved lip  
4-7/8" x 1-1/4" x 1-1/4" lip to center

**Cylinder**

Brass, 6-pin, L4 keyway, 0-bitted

**Keys**

Two nickel silver keys

**Case Quantity**

6

**Case Weight**

32 lbs

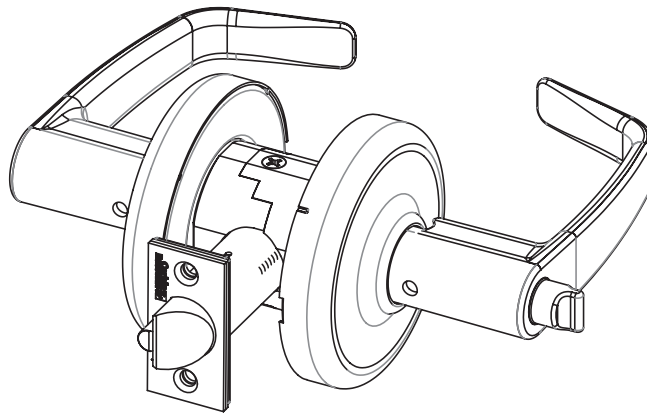

**Ordering Examples**

**Stock Order**

Quantity	Series/Function	Trim	Finish	Hand
100	CL3155	NZD	626	RHR

**Split Finish Order**

Quantity	Series/Function	Finish		Hand
		Outside	Inside	
12	CL3155	626	625	RHR

**Note:** Higher set price prevails

**Contract/Detailed Order**

Quantity	Keypad	Series/Function	Trim	Finish	Hand	Strike	Misc. Options	Cylinder and Keying
24	AA1	CL3155	NZD	626	RHR	SA112	M17	C6-VKC3

**Lever Designs:**



**Levers**

**Roses**

**Lever:**  
Solid Cast Zinc

**Rose:**  
Brass

**Newport**



**Armstrong**

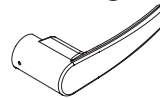

**Princeton**



C ROSE



D ROSE

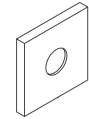

E ROSE



K ROSE

Function	Description		AZC, AZD, AZE, AZK, NZC, NZD, NZE, NZK, PZC, PZD, PZE, PZK	
			Finish: 613E, 626, BSP, WSP	Finish: 605, 606, 611, 612, 613, 613L, 618, 619, 625, 722
CL3110	Non-Keyed	Passage	\$613.00	\$629.00
CL3120		Privacy	\$698.00	\$714.00
CL3120H		Hospital Privacy		
CL3140NT		Exit Latch	\$276.00	\$284.00
CL3150		Half Dummy	\$548.00	\$564.00
CL3170		Full Dummy	\$698.00	\$714.00
CL3180		Passage x blank plate		
CL3151	Single Cylinder	Entrance	\$824.00	\$840.00
CL3155		Classroom		
CL3157		Storeroom	\$841.00	\$857.00
CL3161		Entrance		
CL3175		Corridor/dormitory		
CL3193		Service Station	\$925.00	\$941.00
CL3129	Hotel			
CL3132	Double Cylinder	Institution	\$966.00	\$982.00
CL3152		Classroom Intruder		
CL3162		Communicating		
CL3172		Public Toilet		

### Cylinder & Keying Options

Description	Specify Quick Code	Add or Deduct
Conventional 6-pin	(standard)	No Charge
Conventional 7-pin	7P	Add \$2.00 per cylinder
Less Cylinder <sup>4</sup>	LC	Deduct \$98.00 per cylinder
Less Hotel Cylinder	LC	Deduct \$112.00 per cylinder
<b>LFIC</b>		
LFIC 6-pin	C6	Add \$91.00 per cylinder
LFIC 6-pin Less Core <sup>3</sup>	CL6	No Charge
LFIC 6-pin with Temporary Construction Core (Red) <sup>3</sup>	CT6R	Add \$91.00 per cylinder
LFIC 6-pin with Temporary Construction Core (Blue) <sup>3</sup>	CT6B	Add \$91.00 per cylinder
LFIC 6-pin with Temporary Construction Core (Green) <sup>3</sup>	CT6G	Add \$91.00 per cylinder
LFIC 6-pin with Temporary Disposable Core	CT6D	No Charge
LFIC 7-pin	C7	Add \$93.00 per cylinder
LFIC 7-pin Less Core <sup>3</sup>	CL7	No Charge
LFIC 7-pin with Temporary Construction Core (Red) <sup>3</sup>	CT7R	Add \$93.00 per cylinder
LFIC 7-pin with Temporary Construction Core (Blue) <sup>3</sup>	CT7B	Add \$93.00 per cylinder
LFIC 7-pin with Temporary Construction Core (Green) <sup>3</sup>	CT7G	Add \$93.00 per cylinder
LFIC 7-pin with Temporary Disposable Core	CT7D	No Charge
<b>SFIC<sup>3</sup></b>		
SFIC 6-pin	C6S	Add \$82.00 per cylinder
SFIC 6-pin with Temporary Construction Core (Blue)	CT6SB	Add \$82.00 per cylinder
SFIC 6-pin or 7-pin Temporary Disposable core	CTSD	No Charge
SFIC 7-pin	C7S	Add \$82.00 per cylinder
SFIC 7-pin with Temporary Construction Core (Blue)	CT7SB	Add \$82.00 per cylinder
<b>Security</b>		
Security <sup>3</sup>	HS	Add \$135.00 per cylinder
Security LFIC <sup>3</sup>	CHS	Add \$226.00 per cylinder
<b>Access 3</b>		
Access 3 Patented	AP	No Charge
Access 3 Security	AS	Add \$61.00 per cylinder
Access 3 High Security, UL 437	AHS	Add \$86.00 per cylinder
Access 3 LFIC Patented	ACP	Add \$91.00 per cylinder
Access 3 LFIC Security	ACS	Add \$147.00 per cylinder
Access 3 LFIC High Security, UL 437	ACHS	Add \$169.00 per cylinder
<b>Pyramid</b>		
Pyramid Security Fixed Core <sup>3</sup>	PS	Add \$72.00 per cylinder
Pyramid Security LFIC <sup>3</sup>	PCS	Add \$159.00 per cylinder
Pyramid High Security Fixed Core <sup>3</sup>	PHS	Add \$106.00 per cylinder
Pyramid High Security LFIC <sup>3</sup>	PCHS	Add \$196.00 per cylinder
Pyramid LFIC with Temporary Construction Core	CTP	Add \$91.00 per cylinder
Pyramid LFIC with Temporary Disposable Core	CTPD	No Charge
Pyramid LFIC Less Core	CLP	No Charge
<b>Other</b>		
Lockset furnished in Schlage® C Keyway <sup>1,3</sup>	C	No Charge
Lockset furnished in Sargent® LA Keyway <sup>2,3</sup>	LA	No Charge

**Notes:**

1. Available 0-bitted & key random (KR) only.
2. Available 0-bitted only.
3. Not available in CL3129 function.
4. CL3129 function is not available less cylinder.

*Continued on next page*

<b>Cylinder &amp; Keying Options* (continued)</b>		
<b>Description</b>	<b>Specify Quick Code</b>	<b>Add or Deduct</b>
0-Bitted with 2 blank keys	STDKEY	No Charge
Keyed random	KR	
Construction master keyed <sup>1, 2</sup>	CMK	Add \$16.00 per cylinder
More than 2 keys per lock	KY# (e.g., KY6)	See page 31 - Cut Keys Section
<b>Master Keying</b>		
Master keyed (all cylinders except CR8000, CR8020, CR8027, CR8200, CR8500, CR8600, CR8700)	MK	Add \$16.00 per cylinder
Master keyed Pyramid (except CR8020, CR8027 LFIC cores)	MK	
Master keyed Security (including LFIC cylinder and core)	MK	
Master keyed Access 3 (except CR8500, CR8600, CR8700 LFIC cores)	MK	
Master keyed (CR8000, CR8020, CR8027, CR8200, CR8500, CR8600, CR8700)	MK-IC	No Charge
Master keyed to customer bittings or sample key	MK-CB	Add \$16.00 per cylinder
<b>Visual key control (VKC)</b>		
-No stamping	VKC0	\$4.50
-Keys only	VKC1	No Charge
-Cylinder and Keys <sup>3</sup>	VKC2	\$8.00
-Cylinders only <sup>3</sup>	VKC3	
<b>Concealed key control (CKC)</b>		
-CKC cylinders with VKC keys	CKC2	\$8.00
-CKC cylinders only <sup>3</sup>	CKC3	

**Notes:**

1. CMK Construction master keying charge is in addition to master keying charge.
2. CMK Construction master keying is not available in interchangeable core, Access 3, Pyramid, or Security series..
3. VKC2, VKC3, CKC3 are not available in Access 3, Pyramid or Security series.

\*Double cylinder keying: unless otherwise specified, both cylinders of 32, 52 and 62 functions will be keyed alike. The inside cylinder of 72 function will be keyed to the master key(s) only, while the outside cylinder will include the change key.

If different keying is required, specify outside cylinder first, then inside cylinder.

For key bows other than 10 and 90, specify 'KB' + bow number as Quick Code, e.g. KB12.

### Door Thickness Options

Description	Specify Quick Code	Add or Deduct
1-3/4" - 2"	(standard)	No Charge
Over 2" up to 2-1/4"	D214	

### Backset Options

Description	Specify Quick Code	Add or Deduct
2-3/4"	B234 (standard)	No Charge
3-3/4"	B334	Add \$15.00 per lockset
5"	B500	Add \$24.00 per lockset

### Strike Options<sup>2</sup> (to purchase strike separately, see catalog or parts manual for part no.)

Lip Length	ANSI Curved Lip - Specify Quick Code	Curved Lip Box - Specify Quick Code	Add or Deduct
1"	SA100	SC100	No Charge
1-1/8"	SA118	SC118	
1-1/4"	SA114 (standard)	SC114	
1-3/8"	SA138	SC138	
1-1/2"	SA112	SC112	
1-3/4"	SA134	SC134	Add \$17.00 per cylinder
2"	SA200	SC200	
2-1/4"	SA214	SC214	
2-1/2"	SA212	SC212	
2-3/4"	SA234	SC234	
3"	SA300	SC300	

<sup>1,2</sup>If door thickness is standard or has been specified and no special door or frame condition exist, then only the first two characters of the optional strike Quick Code must be specified (e.g. "SC").  
The correct lip length will be determined by our order entry system based on the standard or specified door thickness.



<b>Miscellaneous Options</b>		
<b>Description</b>	<b>Specify Quick Code</b>	<b>Add or Deduct</b>
Spanner head screws	M02	Add \$24.00 per lockset
Torx® head screws	M04	Add \$30.00 per lockset
Less cylinder and with tailpiece for Schlage® fixed core cylinder (AZ, NZ & PZ designs) <sup>2</sup>	M06	No Charge
Lever to accept 6 or 7-pin SFIC (AZ, NZ & PZ designs) <sup>2</sup>	M08	No Charge
Lever to accept Sargent® fixed core cylinder (AZ, NZ & PZ designs) <sup>2</sup>	M09	No Charge
Security Lever (not available on non-keyed functions)	M111	No Charge
3/4" throw fire latch x 2-3/4" backset (not available for CL3120, 29, 40, and 93 functions)	M16	Add \$100.00 per lockset
Finishes                      Matching		
Available                    Lock Finish		
605                            605, 611,		
606                            606, 612, 613, 613L, 722		
626                            613E, 618, 619, 625, 625, BSP, WSP		
ANSI wrought strike box	M17	No Charge
Knurling outside and inside	M20	Add \$172.00 per lockset
Knurling outside only	M21	Add \$86.00 per lockset
Knurling inside only	M22	Add \$86.00 per lockset
Abrasive coat outside and inside	M23	Add \$108.00 per lockset
Abrasive coat inside only	M24	Add \$54.00 per lockset
Abrasive coat outside only	M25	Add \$54.00 per lockset
Lead lining (roses)	M28	Add \$195.00 per lockset
Lever to accept Schlage® LFIC (AZ, NZ & PZ designs) <sup>2</sup>	M69	No Charge
Lever to accept Yale® 6-pin fixed core cylinder (NZ & PZ designs only) <sup>2</sup>	YC	
Lever to accept Yale® 7-pin fixed core cylinder (NZ & PZ designs only) <sup>2</sup>	YC7	
Lever to accept Yale® 6-pin LFIC (NZ & PZ designs only) <sup>2</sup>	YRC	
Lever to accept Yale® 7-pin LFIC (NZ & PZ designs only) <sup>2</sup>	YRC7	
STC 55 Acoustical Door Kit	M112	

Notes:

2. Not available in CL3129 function.

**Standard Features**

**Handing**

Non-handed

**Door Thickness**

1-3/4" - 2"

**Backset**

2-3/4"

**Strike**

ANSI curved lip  
4-7/8" x 1-1/4" x 1-1/4" lip to center

**Cylinder**

Brass, 6-pin, L4 keyway, 0-bitted

**Keys**

Two nickel silver keys

**Case Quantity**

6

**Case Weight**

32 lbs

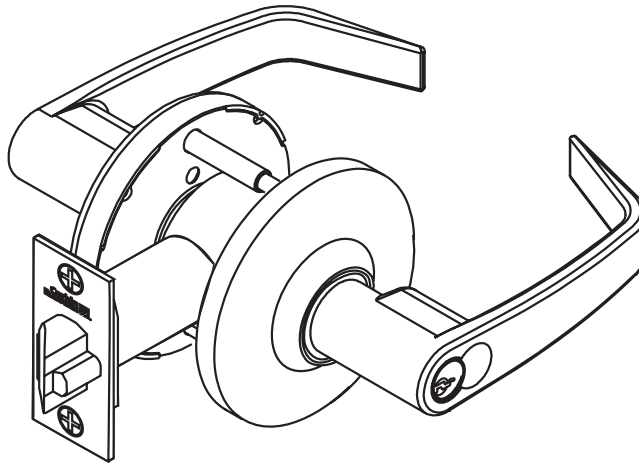

**Ordering Examples**

**Stock Order**

Quantity	Series/Function	Trim	Finish	Hand
100	CLX3355	NZD	626	RHR

**Split Trim/Split Finish Order**

Quantity	Series/Function	Trim		Finish		Hand
		Outside	Inside	Outside	Inside	
12	CLX3355	NZD	AZD	626	625	RHR

**Contract/Detailed Order**

Quantity	Keypad	Series/Function	Trim	Finish	Hand	Strike	Misc. Options	Cylinder and Keying
24	AA1	CLX3355	NZD	626	RHR	SA112	M17	C6-VKC3

**Lever Designs: AZD, NZD, PZD, 102D, 106D, 123D, 124D**



**Lever:** Solid Cast Zinc  
**Rose:** Wrought Brass



**AZD**



**NZD**



**PZD**



**102D**



**106D**



**123D**



**124D**

Function	Description	AZD, NZD, PZD, 102D, 106D, 123D, 124D	
		Finish: 613E, 626, BSP, WSP	Finish: 605, 606, 611, 612, 613, 613L, 618, 619, 625, 722
CLX3310	Passage	\$554.00	\$570.00
CLX3380	Passage x Blank Plate		
CLX3390	Passage x Turnpiece	\$660.00	\$676.00
CLX3320	Privacy		
CLX3320H	Hospital Privacy	\$660.00	\$676.00
CLX3320TO	Time Out Lock		
CLX3340	Patio	\$660.00	\$676.00
CLX3340NT	Exit Latch		
CLX3350	Half Dummy	\$239.00	\$247.00
CLX3370	Full Dummy	\$481.00	\$497.00
CLX3351	Entrance		
CLX3355	Classroom	\$773.00	\$789.00
CLX3357	Storeroom		
CLX3359	Storeroom or Public Restroom		
CLX3361	Entrance	\$789.00	\$805.00
CLX3375	Corridor/Dormitory		
CLX3376	Corridor/Dormitory (modified)	\$858.00	\$874.00
CLX3393	Service Station		
CLX3329	Hotel		
CLX3381	Classroom x Blank Plate		
CLX3383	Storeroom x Blank Plate	\$773.00	\$789.00
CLX3332	Institution		
CLX3352	Classroom Intruder		
CLX3362	Communicating	\$888.00	\$904.00
CLX3372	Public Toilet		
CLX3382	Store Door		

### Cylinder Options

Description	Specify Quick Code	Add or Deduct
Conventional 6-pin	(standard)	No Charge
Conventional 7-pin	7P	Add \$2.00 per cylinder
Less Cylinder(s)	LC	Deduct \$98.00 per cylinder
Less Hotel Cylinder	LC	Deduct \$112.00 per cylinder
<b>LFIC</b>		
LFIC 6-pin	C6	Add \$91.00 per cylinder
LFIC 6-pin Less Core <sup>1</sup>	CL6	No Charge
LFIC 6-pin with Temporary Construction Core (Red) <sup>1</sup>	CT6R	Add \$91.00 per cylinder
LFIC 6-pin with Temporary Construction Core (Blue) <sup>1</sup>	CT6B	Add \$91.00 per cylinder
LFIC 6-pin with Temporary Construction Core (Green) <sup>1</sup>	CT6G	Add \$91.00 per cylinder
LFIC 6-Pin Disposable Core <sup>1</sup>	CT6D	No Charge
LFIC 7-pin	C7	Add \$93.00 per cylinder
LFIC 7-pin Less Core <sup>1</sup>	CL7	No Charge
LFIC 7-pin with Temporary Construction Core (Red) <sup>1</sup>	CT7R	Add \$93.00 per cylinder
LFIC 7-pin with Temporary Construction Core (Blue) <sup>1</sup>	CT7B	Add \$93.00 per cylinder
LFIC 7-pin with Temporary Construction Core (Green) <sup>1</sup>	CT7G	Add \$93.00 per cylinder
LFIC 7-Pin Disposable Core <sup>1</sup>	CT7D	No Charge
<b>SFIC (all lever designs) <sup>1</sup></b>		
SFIC 6-pin	C6S	Add \$82.00 per cylinder
SFIC 6-pin with Temporary Construction Core (Blue)	CT6SB	Add \$82.00 per cylinder
SFIC 6-pin or 7-pin Temporary Disposable core	CTSD	No Charge
SFIC 7-pin <sup>1</sup>	C7S	Add \$82.00 per cylinder
SFIC 7-pin with Temporary Construction Core (Blue)	CT7SB	Add \$82.00 per cylinder
<b>Security</b>		
Security <sup>1</sup>	HS	Add \$135.00 per cylinder
Security LFIC <sup>1</sup>	CHS	Add \$226.00 per cylinder
<b>Access 3</b>		
Access 3 <sup>®</sup> Patented Fixed Core	AP	No Charge
Access 3 <sup>®</sup> Security Fixed Core	AS	Add \$61.00 per cylinder
Access 3 <sup>®</sup> High Security Fixed Core	AHS	Add \$86.00 per cylinder
Access 3 <sup>®</sup> Patented LFIC <sup>1</sup>	ACP	Add \$91.00 per cylinder
Access 3 <sup>®</sup> Security LFIC <sup>1</sup>	ACS	Add \$147.00 per cylinder
Access 3 <sup>®</sup> High Security LFIC <sup>1</sup>	ACHS	Add \$169.00 per cylinder
<b>Pyramid</b>		
Pyramid Security Fixed Core <sup>1</sup>	PS	Add \$72.00 per cylinder
Pyramid Security LFIC <sup>1</sup>	PCS	Add \$159.00 per cylinder
Pyramid High Security Fixed Core <sup>1</sup>	PHS	Add \$106.00 per cylinder
Pyramid High Security LFIC <sup>1</sup>	PCHS	Add \$196.00 per cylinder
Pyramid with Temporary Construction Core <sup>1</sup>	CTP	Add \$91.00 per cylinder
Pyramid Disposable Core <sup>1</sup>	CTPD	No Charge
Pyramid LFIC Less Core <sup>1</sup>	CLP	No Charge
<b>Other</b>		
Lockset furnished in Schlage <sup>®</sup> C Keyway	C	No Charge
Lockset furnished in Sargent <sup>®</sup> LA Keyway	LA	No Charge

Notes:  
1. Not available in CLX3329 function

*Continued on next page*

**Cylinder Options (continued) & Keying Options\***

Description	Specify Quick Code	Add or Deduct
<b>Keying and Keys</b>		
0-bitted with 2 Blank Keys	(standard)	No Charge
Keyed Random	KR	
Construction Master Keyed <sup>2</sup>	CMK	Add \$16.00 per cylinder
More than 2 Keys	KY# (e.g., KY6)	See page 31 - Cut Keys Section
<b>Master Keying</b>		
Master keyed (all cylinders except CR8000, CR8020, CR8027, CR8200, CR8500, CR8600, CR8700)	MK	Add \$16.00 per cylinder
Master keyed Pyramid (except CR8020, CR8027 LFIC cores)	MK	
Master keyed Security (including LFIC cylinder and core)	MK	
Master keyed Access 3 (except CR8500, CR8600, CR8700 LFIC cores)	MK	
Master keyed (CR8000, CR8020, CR8027, CR8200, CR8500, CR8600, CR8700)	MK-IC	No Charge
Master keyed to customer bittings or sample key	MK-CB	Add \$16.00 per cylinder
<b>Visual Key Control (VKC)</b>		
No bitting or keyset stamping on keys	VKC0	\$4.50
Keys only	VKC1	No Charge
Cylinders and keys (not for AS, AHS, ACS, ACHS, HS, CHS, PHS or PCHS)	VKC2	\$8.00
Cylinders only (not for AS, AHS, HS, ACS, ACHS, CHS, PHS or PCHS)	VKC3	
<b>Concealed Key Control (CKC)</b>		
CKC cylinders with VKC keys	CKC2	\$8.00
CKC cylinders only (not for AS, AHS, ACS, ACHS, PHS, PCHS)	CKC3	

**Notes:**

- Not available in CLX3329 function.
- CMK Construction master keying charge is in addition to master keying charge and is not available in interchangeable core, Access 3, Pyramid, or Security series.

\*Double cylinder keying: unless otherwise specified, both cylinders of 32, 62, 72 and 82 functions will be keyed alike. The inside cylinder of 52 function will be keyed to the master key(s) only, while the outside cylinder will include the change key. If different keying is required, specify outside cylinder first, then inside cylinder. For key bows other than 10 and 90, specify 'KB' + bow number as Quick Code, e.g. KB12.

### Door Thickness Options

Description	Specify Quick Code	Add or Deduct
1-3/8" (adapter plates)	D138*	\$27.00
1-3/4" - 2"	(standard)	No Charge
Over 2" up to 2-1/4"	D214	

\*Lock provided with adapter (spacer) plates. Supplied with 2-3/8" backset latch x square corner x 1" front.

### Backset Options

Description	Specify Quick Code	Add or Deduct
2-3/8"	B238**	No Charge
2-3/4"	B234 (standard)	
3-3/4"	B334	Add \$15.00 per lockset
5"	B500	Add \$24.00 per lockset

\*\* Supplied with square corners x 1" front.

### Strike Options\* (to purchase strike separately, see catalog or parts manual for part no.)

Lip Length	ANSI Curved Lip Specify Quick Code	Curved Lip Box Specify Quick Code	Full Lip Specify Quick Code	Add or Deduct
1"	SA100	SC100	SF118	No Charge
1-1/8"	SA118	SC118		
1-1/4"	SA114 (standard)	SC114		
1-3/8"	SA138	SC138		
1-1/2"	SA112	SC112		
1-3/4"	SA134	SC134		Add \$17.00 per cylinder
2"	SA200	SC200		
2-1/4"	SA214	SC214		
2-1/2"	SA212	SC212		
2-3/4"	SA234	SC234		
3"	SA300	SC300		

\*If door thickness is standard or has been specified and no special door or frame condition exist, then only the first two characters of the optional strike Quick Code must be specified (e.g. "SC").  
The correct lip length will be determined by our order entry system based on the standard or specified door thickness.

<b>Miscellaneous Options</b>		
<b>Description</b>	<b>Specify Quick Code</b>	<b>Add or Deduct</b>
Split designs and split finishes	Outside Trim x Inside Trim	Higher set price prevails
Spanner head screws	M02	Add \$24.00 per lockset
Torx® head screws	M04	Add \$30.00 per lockset
Less cylinder, with tailpiece for Schlage® 6-pin fixed core cylinder (all designs)	M06	No Charge
Lever to accept 6 or 7-pin SFIC <sup>2</sup> (all designs)	M08	No Charge
Lever to accept SARGENT® 6-pin fixed core cylinder (all designs)	M09	No Charge
1-1/8" latch front, rounded corners	M13	Add \$2.50 per latch
3/4" throw fire latch x 2-3/4" backset Finishes                      Matching Available                    Lock Finish 605                            605, 611 606                            606, 612, 613, 613L, 722 626                            613E, 618, 619, 625, 626, BSP, WSP	M16	Add \$100.00 per lockset
ANSI wrought strike box	M17	No Charge
Knurling outside and inside (AZ, NZ, PZ only)	M20	Add \$172.00 per lockset
Knurling outside only (AZ, NZ, PZ only)	M21	Add \$86.00 per lockset
Knurling inside only (AZ, NZ, PZ only)	M22	Add \$86.00 per lockset
Abrasive coat outside and inside (AZ, NZ, PZ only)	M23	Add \$108.00 per lockset
Abrasive coat inside only (AZ, NZ, PZ only)	M24	Add \$54.00 per lockset
Abrasive coat outside only (AZ, NZ, PZ only)	M25	Add \$54.00 per lockset
Lead lining	M28	Add \$195.00 per lockset
Lever to accept Schlage® LFIC <sup>2</sup> (AZ, NZ, PZ only)	M69	No Charge
Request to Exit (REX) Switch (CL33900 only)	M92	\$231.00
Rigid outside lever when locked	M200	No Charge
Less cylinder, with tailpiece for Yale® 6-pin fixed core cylinder (all designs)	YC	
Less cylinder, with tailpiece for Yale® 7-pin fixed core cylinder (all designs)	YC7	
Lever to accept Yale® 6-pin LFIC, AZ, NZ, PZ only	YRC	
CL33900 Series electrified options	12AD 24AD	
12VAC/DC <sup>1</sup>		
24VAC/DC		

**Notes:**

1. Voltage is universal for AC or DC current.

**Standard Features**

**Handing**

Non-handed except FZD

**Door Thickness**

1-3/4" - 2"

**Backset**

2-3/4"

**Strike**

ANSI curved lip  
4-7/8" x 1-1/4" x 1-1/4" lip to center

**Cylinder**

Brass, 6-pin, L4 keyway, 0-bitted

**Keys**

Two nickel silver keys

**Case Quantity**

6

**Case Weight**

32 lbs

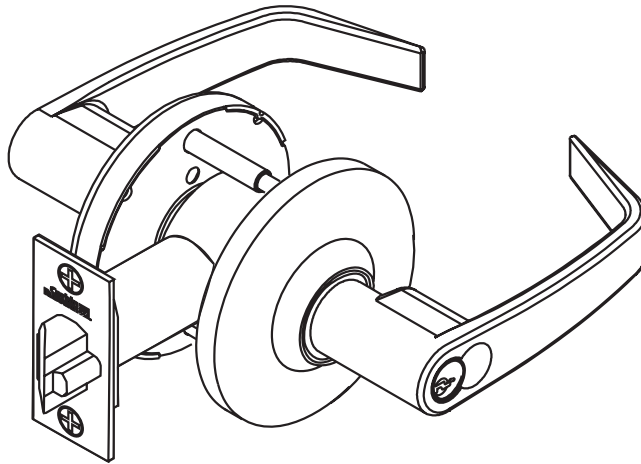

**Ordering Examples**

**Stock Order**

Quantity	Series/Function	Trim	Finish	Hand
100	CL3355	NZD	626	RHR

**Split Trim/Split Finish Order**

Quantity	Series/Function	Trim		Finish		Hand
		Outside	Inside	Outside	Inside	
12	CL3355	NZD	AZD	626	625	RHR

**Contract/Detailed Order**

Quantity	Keyset	Series/Function	Trim	Finish	Hand	Strike	Misc. Options	Cylinder and Keying
24	AA1	CL3355	NZD	626	RHR	SA112	M17	C6-VKC3



**Lever Designs: AZD, NZD, PZD, FZD**



**Lever:**

Die cast zinc

**Rose:**

Wrought Brass

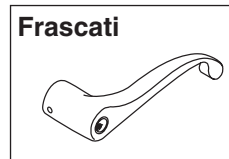
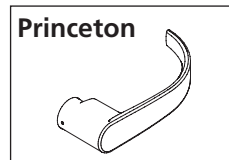
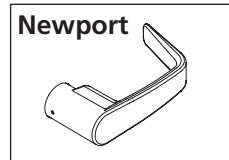

Function	Description		AZD, NZD, PZD, FZD	
			Finish: 613E, 626, BSP, WSP	Finish: 605, 606, 611, 612, 613, 613L, 618, 619, 625, 722
CL3310	Non-Keyed	Passage	\$554.00	\$570.00
CL3380		Passage x Blank Plate	\$660.00	\$676.00
CL3390		Passage x Turnpiece		
CL3320		Privacy	\$660.00	\$676.00
CL3320H		Hospital Privacy		
CL3320TO		Time Out Lock	\$660.00	\$676.00
CL3340		Patio		
CL3340NT		Exit Latch		
CL3350		Half Dummy	\$239.00	\$247.00
CL3370		Full Dummy	\$481.00	\$497.00
CL3351	Single Cylinder	Entrance	\$773.00	\$789.00
CL3355		Classroom		
CL3357		Storeroom		
CL3359		Storeroom or Public Restroom	\$789.00	\$805.00
CL3361		Entrance		
CL3375		Corridor/Dormitory	\$858.00	\$874.00
CL3393		Service Station		
CL3329		Hotel		
CL3381		Keyed x Blank Plate	\$773.00	\$789.00
CL3391		Keyed x Blank Plate		
CL3332	Double Cylinder	Institution	\$888.00	\$904.00
CL3352		Classroom Intruder		
CL3362		Communicating		
CL3372		Public Toilet		
CL33903*	Electrified	Fail Safe	\$1,020.00	\$1,036.00
CL33905*		Fail Secure		

**\*ElectroLynx®**

As part of their promise to provide innovative, fast and effective, and higher security solutions to their customers, ASSA ABLOY Group companies offer ElectroLynx, a universal quick-connect system that simplifies the electrification of the door opening. ElectroLynx® is a registered trademark of ASSA ABLOY, Inc.

### Cylinder Options

Description	Specify Quick Code	Add or Deduct
Conventional 6-pin	(standard)	No Charge
Conventional 7-pin	7P	Add \$2.00 per cylinder
Less Cylinder(s) <sup>4</sup>	LC	Deduct \$98.00 per cylinder
Less Hotel Cylinder	LC	Deduct \$112.00 per cylinder
<b>LFIC</b>		
LFIC 6-pin	C6	Add \$91.00 per cylinder
LFIC 6-pin Less Core <sup>3</sup>	CL6	No Charge
LFIC 6-pin with Temporary Construction Core (Red) <sup>3</sup>	CT6R	Add \$91.00 per cylinder
LFIC 6-pin with Temporary Construction Core (Blue) <sup>3</sup>	CT6B	Add \$91.00 per cylinder
LFIC 6-pin with Temporary Construction Core (Green) <sup>3</sup>	CT6G	Add \$91.00 per cylinder
LFIC 6-pin with Temporary Disposable Core <sup>3</sup>	CT6D	No Charge
LFIC 7-pin	C7	Add \$93.00 per cylinder
LFIC 7-pin Less Core <sup>3</sup>	CL7	No Charge
LFIC 7-pin with Temporary Construction Core (Red) <sup>3</sup>	CT7R	Add \$93.00 per cylinder
LFIC 7-pin with Temporary Construction Core (Blue) <sup>3</sup>	CT7B	Add \$93.00 per cylinder
LFIC 7-pin with Temporary Construction Core (Green) <sup>3</sup>	CT7G	Add \$93.00 per cylinder
LFIC 7-pin with Temporary Disposable Core	CT7D	No Charge
<b>SFIC (all lever designs)<sup>3</sup></b>		
SFIC 6-pin	C6S	Add \$82.00 per cylinder
SFIC 6-pin with Temporary Construction Core (Blue)	CT6SB	Add \$82.00 per cylinder
SFIC 6-pin or 7-pin Temporary Disposable core	CTSD	No Charge
SFIC 7-pin	C7S	Add \$82.00 per cylinder
SFIC 7-pin with Temporary Construction Core (Blue)	CT7SB	Add \$82.00 per cylinder
<b>Security</b>		
Security <sup>3</sup>	HS	Add \$135.00 per cylinder
Security LFIC <sup>3</sup>	CHS	Add \$226.00 per cylinder
<b>Access 3</b>		
Access 3 Patented	AP	No Charge
Access 3 Security	AS	Add \$61.00 per cylinder
Access 3 High Security, UL 437	AHS	Add \$86.00 per cylinder
Access 3 LFIC Patented	ACP	Add \$91.00 per cylinder
Access 3 LFIC Security	ACS	Add \$147.00 per cylinder
Access 3 LFIC High Security, UL 437	ACHS	Add \$169.00 per cylinder
<b>Pyramid</b>		
Pyramid Security Fixed Core <sup>3</sup>	PS	Add \$72.00 per cylinder
Pyramid Security LFIC <sup>3</sup>	PCS	Add \$159.00 per cylinder
Pyramid High Security Fixed Core <sup>3</sup>	PHS	Add \$106.00 per cylinder
Pyramid High Security LFIC <sup>3</sup>	PCHS	Add \$196.00 per cylinder
Pyramid LFIC with Temporary Construction Core	CTP	Add \$91.00 per cylinder
Pyramid LFIC with Temporary Disposable Core	CTPD	No Charge
Pyramid LFIC Less Core	CLP	No Charge
<b>Other</b>		
Lockset furnished in Schlage® C Keyway <sup>1,3</sup>	C	No Charge
Lockset furnished in Sargent® LA Keyway <sup>2,3</sup>	LA	No Charge

**Notes:**

1. Available 0-bitted & key random (KR) only.
2. Available 0-bitted only.
3. Not available in CL3329 function.
4. CL3329 function is not available less cylinder.

*Continued on next page*

**Cylinder Options (continued) & Keying Options\***

Description	Specify Quick Code	Add or Deduct
<b>Keying and Keys</b>		
0-bitted with 2 Blank Keys	(standard)	No Charge
Keyed Random	KR	
Construction master keyed <sup>1,2</sup>	CMK	Add \$16.00 per cylinder
More than 2 Keys	KY# (e.g., KY6)	See page 31 - Cut Keys Section
<b>Master Keying</b>		
Master keyed (all cylinders except CR8000, CR8020, CR8027, CR8200, CR8500, CR8600, CR8700)	MK	Add \$16.00 per cylinder
Master keyed Pyramid (except CR8020, CR8027 LFIC cores)	MK	
Master keyed Security (including LFIC cylinder and core)	MK	
Master keyed Access 3 (except CR8500, CR8600, CR8700 LFIC cores)	MK	
Master keyed (CR8000, CR8020, CR8027, CR8200, CR8500, CR8600, CR8700)	MK-IC	No Charge
Master keyed to customer bittings or sample key	MK-CB	Add \$16.00 per cylinder
<b>Visual Key Control (VKC)</b>		
No bitting or keyset stamping on keys	VKC0	\$4.50
Keys only	VKC1	No Charge
Cylinder and Keys <sup>3</sup> (not for AS, AHS, ACS, ACHS, HS, CHS, PHS or PCHS)	VKC2	\$8.00
Cylinders only <sup>3</sup> (not for AS, AHS, HS, ACS, ACHS, CHS, PHS or PCHS)	VKC3	
<b>Concealed Key Control (CKC)</b>		
CKC cylinders with VKC keys	CKC2	\$8.00
CKC cylinders only (not for AS, AHS, ACS, ACHS, PHS, PCHS)	CKC3	

**Notes:**

1. CMK Construction master keying charge is in addition to master keying charge.
2. CMK Construction master keying is not available in interchangeable core, Access 3, Pyramid, or Security series.
3. VKC2, VKC3, CKC3 are not available in Access 3, Pyramid or Security series.

\*Double cylinder keying: unless otherwise specified, both cylinders of 32 and 82 functions will be keyed alike. The inside cylinder of 72 function will be keyed to the master key(s) only, while the outside cylinder will include the change key.

If different keying is required, specify outside cylinder first, then inside cylinder.

For key bows other than 10 and 90, specify 'KB' + bow number as Quick Code, e.g. KB12.

### Door Thickness Options

Description	Specify Quick Code	Add or Deduct
1-3/4" - 2"	(standard)	No Charge
Over 2" up to 2-1/4"	D214	

### Backset Options

Description	Specify Quick Code	Add or Deduct
2-3/4"	B324 (standard)	No Charge
3-3/4"	B334	Add \$15.00 per lockset
5"	B500	Add \$24.00 per lockset

### Strike Options\* (to purchase strike separately, see catalog or parts manual for part no.)

Lip Length	ANSI Curved Lip - Specify Quick Code	Curved Lip Box - Specify Quick Code	Add or Deduct
1"	SA100	SC100	No Charge
1-1/8"	SA118	SC118	
1-1/4"	SA114 (standard)	SC114	
1-3/8"	SA138	SC138	
1-1/2"	SA112	SC112	
1-3/4"	SA134	SC134	Add \$17.00 per cylinder
2"	SA200	SC200	
2-1/4"	SA214	SC214	
2-1/2"	SA212	SC212	
2-3/4"	SA234	SC234	
3"	SA300	SC300	

Description	Specify Quick Code	Add or Deduct
Rabbeted front and strike	SR118	Add \$103.00 per lockset

\*If door thickness is standard or has been specified and no special door or frame condition exist, then only the first two characters of the optional strike Quick Code must be specified (e.g. "SC").  
The correct lip length will be determined by our order entry system based on the standard or specified door thickness.

**Miscellaneous Options**

Description	Specify Quick Code	Add or Deduct
Split designs and split finishes	Outside Trim x Inside Trim	Higher set price prevails
Spanner head screws	M02	Add \$24.00 per lockset
Torx® head screws	M04	Add \$30.00 per lockset
Less cylinder and with tailpiece for Schlage® fixed core cylinder (all designs) <sup>2</sup>	M06	No Charge
Lever to accept 6 or 7-pin SFIC <sup>2</sup> (all designs)	M08	No Charge
Lever to accept Sargent® fixed core cylinder (all designs) <sup>2</sup>	M09	No Charge
1-1/8" latch front, rounded corners	M13	Add \$2.50 per latch
3/4" throw fire latch x 2-3/4" backset (not available for CL3320, 29, 40, and 93 functions) <div style="display: flex; justify-content: space-between; margin-left: 20px;"> <div>                     Finishes Available                      605                      606                      626                 </div> <div>                     Matching Lock Finish                      605, 611                      606, 612, 613, 613L, 722                      613E, 618, 619, 625, 625, BSP, WSP                 </div> </div>	M16	Add \$100.00 per lockset
ANSI wrought strike box	M17	No Charge
Knurling outside and inside	M20	Add \$172.00 per lockset
Knurling outside only	M21	Add \$86.00 per lockset
Knurling inside only	M22	Add \$86.00 per lockset
Abrasive coat outside and inside	M23	Add \$108.00 per lockset
Abrasive coat inside only	M24	Add \$54.00 per lockset
Abrasive coat outside only	M25	Add \$54.00 per lockset
Lead lining (roses)	M28	Add \$195.00 per lockset
Lever to accept Schlage® LFIC <sup>2</sup> (FZD, NZD and PZD designs only)	M69	No Charge
Request to Exit (REX) Switch (CL33900 only)	M92	\$231.00
CL33900 Series electrified options		
12VAC/DC <sup>1</sup>	12AD	No Charge
24VAC/DC	24AD	

**Notes:**

1. Voltage is universal for AC or DC current.
2. Not available in CL3329 function.

**Standard Features**

**Handing**

Non-handed

**Door Thickness**

1-3/4"

**Backset**

2-3/4"

**Strike**

ANSI curved lip  
4-7/8" x 1-1/4" x 1-1/4" lip to center

**Cylinder**

Brass, 6-pin, L4 keyway  
0-bitted

**Keys**

Two nickel silver keys

**Case Quantity**

6

**Case Weight**

26 lbs

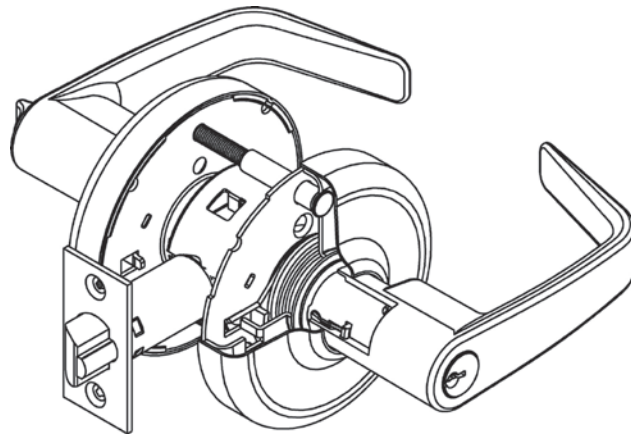

The CL3500 series is designed to meet ANSI/BHMA Grade 1 Certification.

**Ordering Examples**

**Stock Order**

Quantity	Series/Function	Trim	Finish	Hand
100	CL3555	NZD	626	RH

**Split Trim/Split Finish Order**

Quantity	Series/Function	Trim		Finish		Hand
		Outside	Inside	Outside	Inside	
12	CL3555	NZD	AZD	626	625	RH

**Contract/Detailed Order**

Quantity	Keyset	Series/Function	Trim	Finish	Hand	Strike	Misc. Options	Cylinder and Keying
24	AA1	CL3555	NZD	626	RH	SA112	M17	C6-VKC3

**Lever Designs: AZD**



**Lever:**  
Solid Cast Zinc

**Rose:**  
Wrought Brass



**AZD**

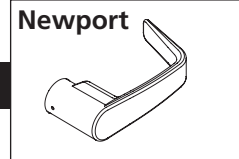

**Lever Designs: NZD**



**Lever:**  
Solid Cast Zinc

**Rose:**  
Wrought Brass



**NZD**

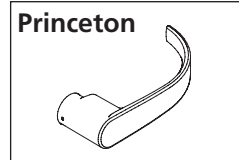

**Lever Designs: PZD**



**Lever:**  
Solid Cast Zinc

**Rose:**  
Wrought Brass



**PZD**

Function	Description		AZD, NZD, PZD	
			Finish: 613E, 626, BSP, WSP	Finish: 605, 606, 611, 612, 613, 613L, 618, 619, 625, 722
CL3510	Non-Keyed	Passage	\$554.00	\$570.00
CL3580		Passage x Blank Plate	\$660.00	\$676.00
CL3520		Privacy		
CL3550		Half Dummy		
CL3570		Full Dummy	\$481.00	\$497.00
CL3551	Single Cylinder	Entrance	\$773.00	\$789.00
CL3555		Classroom		
CL3557		Storeroom		
CL3561		Office or Entrance		
CL3581		Keyed x Blank Plate		
CL3582	Double Cylinder	Store Door	\$888.00	\$904.00

### Cylinder Options

Description	Specify Quick Code	Add or Deduct
Conventional 6-pin	(standard)	No Charge
Conventional 7-pin	7P	Add \$2.00 per cylinder
Less Cylinder	LC	Deduct \$98.00 per cylinder
<b>LFIC</b>		
LFIC 6-pin	C6	Add \$91.00 per cylinder
LFIC 6-pin Less Core	CL6	No Charge
LFIC 6-pin with Temporary Construction Core (Red)	CT6R	Add \$91.00 per cylinder
LFIC 6-pin with Temporary Construction Core (Blue)	CT6B	Add \$91.00 per cylinder
LFIC 6-pin with Temporary Construction Core (Green)	CT6G	Add \$91.00 per cylinder
LFIC 6-pin with Temporary Disposable Core	CT6D	No Charge
LFIC 7-pin	C7	Add \$93.00 per cylinder
LFIC 7-pin Less Core	CL7	No Charge
LFIC 7-pin with Temporary Construction Core (Red)	CT7R	Add \$93.00 per cylinder
LFIC 7-pin with Temporary Construction Core (Blue)	CT7B	Add \$93.00 per cylinder
LFIC 7-pin with Temporary Construction Core (Green)	CT7G	Add \$93.00 per cylinder
LFIC 7-pin with Temporary Disposable Core	CT7D	No Charge
<b>SFIC (all lever designs)</b>		
SFIC 6-pin	C6S	Add \$82.00 per cylinder
SFIC 6-pin with Temporary Construction Core (Blue)	CT6SB	Add \$82.00 per cylinder
SFIC 6-pin or 7-pin Temporary Disposable core	CTSD	No Charge
SFIC 7-pin	C7S	Add \$82.00 per cylinder
SFIC 7-pin with Temporary Construction Core (Blue)	CT7SB	Add \$82.00 per cylinder
<b>Security</b>		
Security	HS	Add \$135.00 per cylinder
Security LFIC	CHS	Add \$226.00 per cylinder
<b>Access 3</b>		
Access 3 Patented	AP	No Charge
Access 3 Security	AS	Add \$61.00 per cylinder
Access 3 High Security, UL 437	AHS	Add \$86.00 per cylinder
Access 3 LFIC Patented	ACP	Add \$91.00 per cylinder
Access 3 LFIC Security	ACS	Add \$147.00 per cylinder
Access 3 LFIC High Security, UL 437	ACHS	Add \$169.00 per cylinder
<b>Pyramid</b>		
Pyramid Security Fixed Core	PS	Add \$72.00 per cylinder
Pyramid Security LFIC	PCS	Add \$159.00 per cylinder
Pyramid High Security Fixed Core	PHS	Add \$106.00 per cylinder
Pyramid High Security LFIC	PCHS	Add \$196.00 per cylinder
Pyramid LFIC with Temporary Construction Core	CTP	Add \$91.00 per cylinder
Pyramid LFIC with Temporary Disposable Core	CTPD	No Charge
Pyramid LFIC Less Core	CLP	No Charge
<b>Other</b>		
Lockset furnished in Schlage® C Keyway <sup>1</sup>	C	No Charge
Lockset furnished in Sargent® LA Keyway <sup>2</sup>	LA	No Charge

Notes:

1. Available 0-bitted & key random (KR) only.
2. Available 0-bitted only.

*Continued on next page*



**Cylinder Options (continued) & Keying Options\***

Description	Specify Quick Code	Add or Deduct
<b>Keying and Keys</b>		
0-bitted with 2 Blank Keys	(standard)	No Charge
Keyed Random	KR	
Construction master keyed <sup>1,2</sup>	CMK	Add \$16.00 per cylinder
More than 2 Keys	KY# (e.g., KY6)	See page 31 - Cut Keys Section
<b>Master Keying</b>		
Master keyed (all cylinders except CR8000, CR8020, CR8027, CR8200, CR8500, CR8600, CR8700)	MK	Add \$16.00 per cylinder
Master keyed Pyramid (except CR8020, CR8027 LFIC cores)	MK	
Master keyed Security (including LFIC cylinder and core)	MK	
Master keyed Access 3 (except CR8500, CR8600, CR8700 LFIC cores)	MK	
Master keyed (CR8000, CR8020, CR8027, CR8200, CR8500, CR8600, CR8700)	MK-IC	No Charge
Master keyed to customer bittings or sample key	MK-CB	Add \$16.00 per cylinder
<b>Visual Key Control (VKC)</b>		
No bitting or keyset stamping on keys	VKC0	\$4.50
Keys only	VKC1	No Charge
Cylinder and Keys <sup>3</sup> (not for AS, AHS, ACS, ACHS, HS, CHS, PHS or PCHS)	VKC2	\$8.00
Cylinders only <sup>3</sup> (not for AS, AHS, HS, ACS, ACHS, CHS, PHS or PCHS)	VKC3	
<b>Concealed Key Control (CKC)</b>		
CKC cylinders with VKC keys	CKC2	\$8.00
CKC cylinders only (not for AS, AHS, ACS, ACHS, PHS, PCHS)	CKC3	

**Notes:**

1. CMK Construction master keying charge is in addition to master keying charge.
2. CMK Construction master keying is not available in interchangeable core, Access 3, Pyramid, or Security series.
3. VKC2, VKC3, CKC3 are not available in Access 3, Pyramid or Security series.

\*Double cylinder keying: unless otherwise specified, both cylinders of 32 and 82 functions will be keyed alike. The inside cylinder of 72 function will be keyed to the master key(s) only, while the outside cylinder will include the change key.  
 If different keying is required, specify outside cylinder first, then inside cylinder.  
 For key bows other than 10 and 90, specify 'KB' + bow number as Quick Code, e.g. KB12.

**Door Thickness Options**

Description	Specify Quick Code	Add or Deduct
1-3/4"	(standard)	No Charge
1-3/8"	D138**1	

**Backset Options**

Description	Specify Quick Code	Add or Deduct
2-3/8"	B238 <sup>1</sup>	No Charge
2-3/4"	B234 (standard)	
3-3/4"	B334	Add \$15.00 per lockset
5"	B500	Add \$24.00 per lockset

**Strike Options\*** (to purchase strike separately, see catalog or parts manual for part no.)

Lip Length	ANSI Curved Lip Specify Quick Code	Curved Lip Box Specify Quick Code	Full Lip Specify Quick Code	Add or Deduct
1"	SA100	SC100	SF118	No Charge
1-1/8"	SA118	SC118		
1-1/4"	SA114 (standard)	SC114		
1-3/8"	SA138	SC138		
1-1/2"	SA112	SC112		
1-3/4"	SA134	SC134	Add \$17.00 per cylinder	
2"	SA200	SC200		
2-1/4"	SA214	SC214		
2-1/2"	SA212	SC212		
2-3/4"	SA234	SC234		
3"	SA300	SC300		

Description	Specify Quick Code	Add or Deduct
Rabbeted front and strike	SR118	Add \$103.00 per lockset

\*If door thickness is standard or has been specified and no special door or frame condition exist, then only the first two characters of the optional strike Quick Code must be specified (e.g. "SC").

The correct lip length will be determined by our order entry system based on the standard or specified door thickness.

\*\*If D138 is specified, 2-3/8" backset latch will be supplied unless B234 option is also specified.

1. M14 and B238 (2-3/8" backset) standard with D138 (1-3/8" door thickness) option.

**Miscellaneous Options**

Description	Specify Quick Code	Add or Deduct
Split designs and split finishes	Outside Trim x Inside Trim	Higher set price prevails
Spanner head screws	M02	Add \$24.00 per lockset
Torx® head screws	M04	Add \$30.00 per lockset
Less cylinder and with tailpiece for Schlage® fixed core cylinder (all designs)	M06	No Charge
Lever to accept 6 or 7-pin SFIC (all designs)	M08	No Charge
Lever to accept Sargent® fixed core cylinder (NZD & PZD designs only)	M09	No Charge
Lever to accept Schlage® LFIC (NZD & PZD designs only)	M69	No Charge
1-1/8" latch front, rounded corners	M13	Add \$2.50 per latch
1" latch front, square corners <sup>1</sup>	M14	Add \$6.00 per lockset
1" latch front, rounded corners	M15	Add \$2.50 per latch
ANSI wrought strike box	M17	No Charge
Knurling outside and inside	M20	Add \$172.00 per lockset
Knurling outside only	M21	Add \$86.00 per lockset
Knurling inside only	M22	Add \$86.00 per lockset
Abrasive coat outside and inside only	M23	Add \$108.00 per lockset
Abrasive coat inside only	M24	Add \$54.00 per lockset
Abrasive coat outside only	M25	Add \$54.00 per lockset
1-1/8" latch front, square corners (standard for 2-3/4" and 5" backsets)	M32	No Charge

**Note:**

1. M14 and B238 (2-3/8" backset) standard with D138 (1-3/8" door thickness) option.

**Standard Features**

**Handing**

Non-handed

**Door Thickness**

1-3/8" - 1-7/8"

Available in 2" - 2-1/4" upon request

**Backset**

2-3/4" standard

**Strike**

ANSI curved lip  
4-7/8" x 1-1/4" x 1-1/4" lip to center

**Cylinder**

Brass, 6-pin, L4 keyway  
0-bitted

**Keys**

Two nickel silver keys

**Case Quantity**

6

**Case Weight**

32 lbs

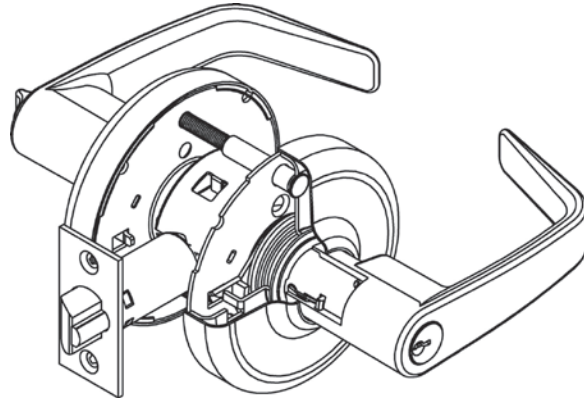

**Ordering Examples**

**Stock Order**

Quantity	Series/Function	Trim	Finish	Hand
100	CL3855	NZD	626	RHR

**Split Trim/Split Finish Order**

Quantity	Series/Function	Trim		Finish		Hand
		Outside	Inside	Outside	Inside	
12	CL3855	NZD	AZD	626	625	RHR

**Contract/Detailed Order**

Quantity	Keyset	Series/Function	Trim	Finish	Hand	Strike	Misc. Options	Cylinder and Keying
24	AA1	CL3855	NZD	626	RHR	SA112	M02	C6-VKC3

**Lever Designs: AZD, NZD, PZD**



**Lever:**  
Solid Cast Zinc

**Rose:**  
Wrought Brass

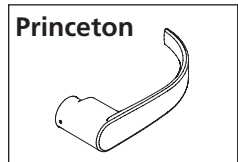
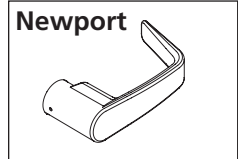
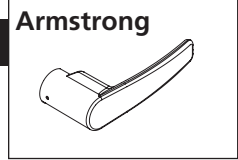

Function	Description		AZD, NZD, PZD	
			Finish: 613E, 626, BSP, WSP	Finish: 605, 606, 611, 612, 613, 613L, 618, 619, 625, 722
CL3810	Non-Keyed	Passage	\$265.00	\$281.00
CL3880		Passage x Blank Plate	\$285.00	\$301.00
CL3820		Privacy		
CL3850		Half Dummy		
CL3870		Full Dummy	\$277.00	\$293.00
CL3851	Single Cylinder	Entrance	\$341.00	\$357.00
CL3855		Classroom		
CL3857		Storeroom		
CL3861		Office		

<b>Cylinder &amp; Keying Options</b>		
<b>Description</b>	<b>Specify Quick Code</b>	<b>Add or Deduct</b>
Conventional 6-pin	(standard)	No Charge
Conventional 7-Pin	7P	Add \$2.00 per cylinder
Less Standard Cylinder	LC	Deduct \$98.00 per cylinder
<b>LFIC</b>		
LFIC 6-pin	C6	Add \$91.00 per cylinder
LFIC 6-pin Less Core	CL6	No Charge
LFIC 6-pin with Temporary Construction Core (Red)	CT6R	Add \$91.00 per cylinder
LFIC 6-pin with Temporary Construction Core (Blue)	CT6B	Add \$91.00 per cylinder
LFIC 6-pin with Temporary Construction Core (Green)	CT6G	Add \$91.00 per cylinder
LFIC 6-pin with Temporary Disposable Core	CT6D	No Charge
LFIC 7-Pin	C7	Add \$93.00 per cylinder
LFIC 7-Pin Less Core	CL7	No Charge
LFIC 7-Pin with Temporary Construction Core (Red)	CT7R	Add \$93.00 per cylinder
LFIC 7-Pin with Temporary Construction Core (Blue)	CT7B	Add \$93.00 per cylinder
LFIC 7-Pin with Temporary Construction Core (Green)	CT7G	Add \$93.00 per cylinder
LFIC 7-Pin with Temporary Disposable Core	CT7D	No Charge
<b>SFIC (all lever designs)</b>		
SFIC 6-pin	C6S	Add \$82.00 per cylinder
SFIC 6-pin with Temporary Construction Core (Blue)	CT6SB	Add \$82.00 per cylinder
SFIC 6-pin or 7-pin Temporary Disposable core	CTSD	No Charge
SFIC 7-pin	C7S	Add \$82.00 per cylinder
SFIC 7-pin with Temporary Construction Core (Blue)	CT7SB	Add \$82.00 per cylinder
<b>Security</b>		
Security	HS	Add \$135.00 per cylinder
Security LFIC	CHS	Add \$226.00 per cylinder
<b>Access 3</b>		
Access 3 Patented	AP	No Charge
Access 3 Security	AS	Add \$61.00 per cylinder
Access 3 High Security, UL 437	AHS	Add \$86.00 per cylinder
Access 3 LFIC Patented	ACP	Add \$91.00 per cylinder
Access 3 LFIC Security	ACS	Add \$147.00 per cylinder
Access 3 LFIC High Security, UL 437	ACHS	Add \$169.00 per cylinder
<b>Pyramid</b>		
Pyramid Security Fixed Core <sup>3</sup>	PS	Add \$72.00 per cylinder
Pyramid Security LFIC <sup>3</sup>	PCS	Add \$159.00 per cylinder
Pyramid High Security Fixed Core <sup>3</sup>	PHS	Add \$106.00 per cylinder
Pyramid High Security LFIC <sup>3</sup>	PCHS	Add \$196.00 per cylinder
Pyramid LFIC with Temporary Construction Core	CTP	Add \$91.00 per cylinder
Pyramid LFIC with Temporary Disposable Core	CTPD	No Charge
Pyramid LFIC Less Core	CLP	No Charge
<b>Other</b>		
Lockset furnished in Schlage® C Keyway <sup>1</sup>	C	No Charge
Lockset furnished in SARGENT® LA Keyway <sup>2</sup>	LA	No Charge
<b>Keying and Keys</b>		
0-bitted with 2 Blank Keys	(standard)	No Charge
Keyed Random	KR	No Charge
Construction master keyed <sup>1, 2</sup>	CMK	Add \$16.00 per cylinder
More than 2 Keys	KY# (e.g., KY6)	See page 31 - Cut Keys Section
<b>Master Keying</b>		
Master keyed (all cylinders except CR8000, CR8020, CR8027, CR8200, CR8500, CR8600, CR8700 LFIC cores)	MK	Add \$16.00 per cylinder
Master keyed Pyramid (except CR8020, CR8027 LFIC cores)	MK	
Master keyed Security (including LFIC cylinder and core)	MK	
Master keyed Access 3 (except CR8500, CR8600, CR8700 LFIC cores)	MK	
Master keyed (CR8000, CR8020, CR8027, CR8200, CR8500, CR8600, CR8700 LFIC cores)	MK-IC	No Charge
Master keyed to customer bittings or sample key	MK-CB	Add \$16.00 per cylinder
Notes:		Continued on next page.
1. Available 0-bitted & key random (KR) only.		
2. Available 0-bitted only.		
3. CMK Construction master keying charge is in addition to master keying charge.		
4. CMK Construction master keying is not available in interchangeable core, Access 3, Pyramid, or Security series.		
5. VKC2, VKC3, CKC3 are not available in Access 3, Pyramid or Security series.		
For key bows other than 10 and 90, specify "KB" + bow number as Quick Code, e.g. KB12. No extra charge.		

**Cylinder Options (continued) & Keying Options\***

Description	Specify Quick Code	Add or Deduct
<b>Visual Key Control (VKC)</b>		
No biting or keyset stamping on keys	VKC0	\$4.50
Keys only	VKC1	No Charge
Cylinder and Keys <sup>3</sup> (not for AS, AHS, ACS, ACHS, HS, CHS, PHS or PCHS)	VKC2	\$8.00
Cylinders only <sup>3</sup> (not for AS, AHS, HS, ACS, ACHS, CHS, PHS or PCHS)	VKC3	
<b>Concealed Key Control (CKC)</b>		
CKC cylinders with VKC keys	CKC2	\$8.00
CKC cylinders only (not for AS, AHS, ACS, ACHS, PHS, PCHS)	CKC3	

Notes:

3. VKC2, VKC3, CKC3 are not available in Access 3, Pyramid or Security series.

\*Double cylinder keying: unless otherwise specified, both cylinders of 32 and 82 functions will be keyed alike. The inside cylinder of 72 function will be keyed to the master key(s) only, while the outside cylinder will include the change key.

If different keying is required, specify outside cylinder first, then inside cylinder.

For key bows other than 10 and 90, specify 'KB' + bow number as Quick Code, e.g. KB12.

**Backset Options**

Description	Specify Quick Code	Add or Deduct
2-3/8"	B238 <sup>1</sup>	No Charge
2-3/4"	B324 (standard)	
3-3/4"	B334	Add \$12.00 per lockset
5"	B500	Add \$14.00 per lockset

**Door Thickness Options**

Description	Specify Quick Code	Add or Deduct
1-3/8" — 1-7/8"	(standard)	No Charge
2" — 2-1/4"	D214	No Charge

**Strike Options\*** (to purchase strike separately, see catalog or parts manual for part no.)

Lip Length	ANSI Curved Lip Specify Quick Code	Curved Lip Box Specify Quick Code	Full Lip Specify Quick Code	Full Lip Radius Corner Specify Quick Code	Add or Deduct
1"	SA100	SC100			No Charge
1-1/8"	SA118	SC118			
1-1/4"	SA114 (standard)	SC114	SF114	SFR114	
1-3/8"	SA138	SC138			
1-1/2"	SA112	SC112			Add \$17.00 per cylinder
1-3/4"	SA134	SC134			
2"	SA200	SC200			
2-1/4"	SA214	SC214			
2-1/2"	SA212	SC212			
2-3/4"	SA234	SC234			
3"	SA300	SC300			

\*If door thickness is standard or has been specified and no special door or frame condition exist, then only the first two characters of the optional strike Quick Code must be specified (e.g. "SC").

The correct lip length will be determined by our order entry system based on the standard or specified door thickness.

**Miscellaneous Options**

Description	Specify Quick Code	Add or Deduct
Split designs and split finishes	Outside Trim x Inside Trim	Higher set price prevails
Spanner head screws	M02	Add \$24.00 per lockset
Torx® head screws	M04	Add \$30.00 per lockset
Less cylinder and with tailpiece for Schlage® fixed core cylinder (all designs)	M06	No Charge
Lever to accept 6 or 7-pin SFIC (all designs)	M08	No Charge
Lever to accept Sargent® fixed core cylinder (NZD & PZD designs only)	M09	No Charge
1-1/8" latch front, rounded corners	M13	Add \$2.50 per latch
1" latch front, square corners <sup>1</sup>	M14	Add \$6.00 per lockset
1" latch front, rounded corners	M15	Add \$2.50 per latch
ANSI wrought strike box	M17	No Charge
Knurling outside and inside	M20	Add \$172.00 per lockset
Knurling outside only	M21	Add \$86.00 per lockset
Knurling inside only	M22	Add \$86.00 per lockset
Abrasive coat outside and inside only	M23	Add \$108.00 per lockset
Abrasive coat inside only	M24	Add \$54.00 per lockset
Abrasive coat outside only	M25	Add \$54.00 per lockset
1-1/8" latch front, square corners (standard for 2-3/4" and 5" backsets)	M32	No Charge
Lever to accept Schlage® LFIC (NZD & PZD designs only)	M69	No Charge

Note:

1. M14 and B238 (2-3/8" backset) standard with D138 (1-3/8" door thickness) option.

**Standard Features**

**Handing**

Field reversible

**Door Thickness**

1-3/4" - 2"

**Backset**

2-3/4"

**Strike**

ANSI curved lip 4-7/8" - 1-1/4" x  
1-1/4" lip to center

**Cylinder**

Brass, 6-pin, L4 keyway  
0-bitted

**Keys**

Two nickel silver keys

**Case Quantity**

10

**Case Weight**

32 lbs

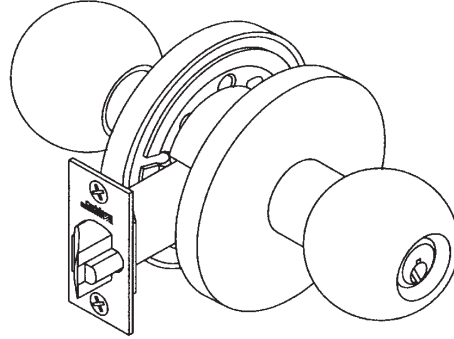

**Ordering Example**

**Stock Order**

Quantity	Series/Function	Trim	Finish	Hand
100	CK4355	GRD	630	RHR

**Contract/Detailed Order**

Quantity	Keyset	Series/Function	Trim	Finish	Hand	Strike	Misc. Options	Cylinder and Keying
24	AA1	CK4355	GRD	630	RHR	SA112	M02	VK3

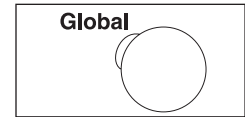

**Knob Designs: GRD**
**Knob:**  
Wrought  
Reinforced

**Rose:**  
Wrought  
Reinforced

Function	Description		GRD
			Finish: 605, 613E, 630
CK4310	Non-Keyed	Passage	\$733.00
CK4320		Privacy	\$823.00
CK4350		Half Dummy	\$315.00
CK4351	Single Cylinder	Entrance	\$910.00
CK4355		Classroom	
CK4357		Storeroom	
CK4332	Double Cylinder	Institution	\$991.00

**Cylinder Options**

Description	Specify Quick Code	Add or Deduct
Conventional 6-pin	(standard)	No Charge
Less (1) Cylinder	LC	Deduct \$98.00 per cylinder
Access 3 Patented	AP	No Charge
Access 3 Security	AS	Add \$61.00 per cylinder
Access 3 High Security, UL 437	AHS	Add \$86.00 per cylinder
Pyramid Security Fixed Core	PS	Add \$72.00 per cylinder
Pyramid High Security Fixed Core	PHS	Add \$106.00 per cylinder
Security	HS	Add \$135.00 per cylinder

**Keying Options\***

Description	Specify Quick Code	Add or Deduct
0-Bitted with 2 blank keys	(standard)	No Charge
Keyed random	KR	
Master keyed	Specify keyset	Add \$16.00 per cylinder
Master keyed Pyramid	Specify keyset	Add \$16.00 per cylinder
Master keyed Security	Specify keyset	Add \$16.00 per cylinder
Master keyed	Specify keyset	No Charge
Master keyed to customer bittings or sample key	Specify keyset	Add \$16.00 per cylinder
Construction master keyed <sup>1,2</sup>	CMK	Add \$16.00 per cylinder
Visual key control (VKC)		
-No stamping	VKC0	\$4.50
-Keys only	VKC1	No Charge
-Cylinder and Keys <sup>3</sup>	VKC2	\$8.00
-Cylinders only <sup>3</sup>	VKC3	\$8.00
Concealed key control (CKC)		
-CKC cylinders with VKC keys	CKC2	\$8.00
-CKC cylinders only <sup>3</sup>	CKC3	\$8.00
More than 2 keys per lock	KY# (e.g., KY6)	See page 31 - Cut Keys Section

**Notes:**

1. CMK Construction master keying charge is in addition to master keying charge.
2. CMK Construction master keying is not available in interchangeable core, Access 3, Pyramid, or Security series.
3. VKC2, VKC3, CKC3 are not available in Access 3, Pyramid or Security series.

\*Double cylinder keying: unless otherwise specified, both cylinders of 32 functions will be keyed alike.  
If different keying is required, specify outside cylinder first, then inside cylinder.  
For key bows other than 10 and 90, specify "KB" + bow number as Quick Code, e.g. KB12. No extra charge.

**Strike Options\***

To purchase strike separately, see catalog or parts manual for part number.

Lip Length	ANSI Curved Lip - Specify Quick Code	Curved Lip Box - Specify Quick Code	Add or Deduct
1 "	SA100	SC100	No Charge
1-1/8 "	SA118	SC118	
1-1/4 "	SA114 (standard)	SC114	
1-3/8 "	SA138	SC138	
1-1/2 "	SA112	SC112	
1-3/4 "	SA134	SC134	Add \$17.00 per cylinder
2 "	SA200	SC200	
2-1/4 "	SA214	SC214	
2-1/2 "	SA212	SC212	
2-3/4 "	SA234	SC234	
3 "	SA300	SC300	

\*If door thickness is standard or has been specified and no special door or frame condition exist, then only the first two characters of the optional strike Quick code must be specified(e.g. "SC").  
The correct lip length will be determined by our order entry system based on the standard or specified door thickness.

**Backset Options**

Description	Specify Quick Code	Add or Deduct
2-3/4 "	B324 (standard)	No Charge

**Door Thickness Options**

Description	Specify Quick Code	Add or Deduct
1-3/4 " - 2 "	(standard)	No Charge

**Miscellaneous Options**

Description	Specify Quick Code	Add or Deduct
Spanner head screws	M02	Add \$24.00 per lockset
Torx® head screws	M04	Add \$30.00 per lockset
ANSI wrought strike box	M17	No Charge

**Standard Features**

**Handing**

Field reversible

**Door Thickness**

1-3/8" - 1-3/4"

**Backset**

2-3/4"

**Strike**

ANSI curved Lip 4-7/8" x 1-1/4" x 1-1/4" lip to center

**Cylinder**

Brass, 6-pin, L4 keyway, 0-bitted

**Keys**

Two nickel silver keys

**Case Quantity**

20

**Case Weight**

40 lbs

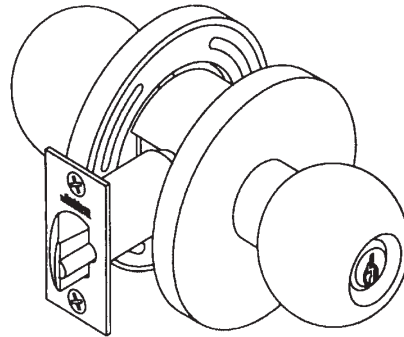

**Ordering Example**

**Stock Order**

Quantity	Series/Function	Trim	Finish	Hand
100	CK4451	GWC	630	RHR

**Contract/Detailed Order**

Quantity	Keyset	Series/Function	Trim	Finish	Hand	Strike	Misc. Options	Cylinder and Keying
24	AA1	CK4451	GWC	630	RHR	SA200	M17	VKC1

**Knob Designs: GWC**

**Knob:**  
Wrought

**Rose:**  
Wrought  
Reinforced

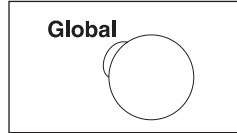

Function	Description		GWC
			Finish: 605, 613, 630
CK4410	Non-Keyed	Passage	\$22600
CK4430		Privacy	\$245.00
CK4450		Half Dummy	\$197.00
CK4451	Single Cylinder	Entrance	\$336.00
CK4455		Classroom	
CK4457		Storeroom	

**Cylinder & Keying Options**

Description	Specify Quick Code	Add or Deduct
Conventional 6-pin	(standard)	No Charge
Less cylinder	LC	Deduct \$98.00 per cylinder
0-Bitted with 2 blank keys	(standard)	No Charge
Keyed random	KR	No Charge
Master keyed	MK	Add \$16.00 per cylinder
Master keyed Pyramid	MK	Add \$16.00 per cylinder
Master keyed Security	MK	Add \$16.00 per cylinder
Master keyed to customer bittings or sample key	MK-CB	Add \$16.00 per cylinder
Construction master keyed <sup>1</sup>	CMK	Add \$16.00 per cylinder
<b>Visual key control (VKC)</b>		
-No stamping	VKC0	\$4.50
-Keys only	VKC1	No Charge
<b>Concealed key control (CKC)</b>		
-CKC cylinders with VKC keys	CKC2	\$8.00
-CKC cylinders only	CKC3	\$8.00
More than 2 keys per lock	KY# (e.g., KY6)	See page 31 - Cut Keys Section

Notes:

1. CMK Construction master keying charge is in addition to master keying charge.

For key bows other than 10 and 90, specify "KB" + bow number as Quick Code, e.g. KB12. No extra charge.

**Backset Options**

Description	Specify Quick Code	Add or Deduct
2-3/8"	B238	No Charge
2-3/4"	B234 (standard)	
3-3/4"	B334	Add \$12.00 per lockset
5"	B500	Add \$14.00 per lockset

**Strike Options\***

To purchase strike separately, see catalog or parts manual for part no.

Lip Length	ANSI Curved Lip Specify Quick Code	Curved Lip Box Specify Quick Code	Full Lip Specify Quick Code	Full Lip Radius Corner Specify Quick Code	Add or Deduct
1"	SA100	SC100			No Charge
1-1/8"	SA118	SC118			
1-1/4"	SA114 (standard)	SC114	SF114	SFR114	
1-3/8"	SA138	SC138			
1-1/2"	SA112	SC112			
1-3/4"	SA134	SC134			Add \$17.00 per cylinder
2"	SA200	SC200			
2-1/4"	SA214	SC214			
2-1/2"	SA212	SC212			
2-3/4"	SA234	SC234			
3"	SA300	SC300			

\*If door thickness is standard or has been specified and no special door or frame condition exist, then only the first two characters of the optional strike Quick Code must be specified (e.g. "SC").

**Miscellaneous Options**

Description	Specify Quick Code	Add or Deduct
1" latch front, square corners (for 2-3/8" backset only)	M14	Add \$6.00 per lockset
ANSI wrought strike box	M17	No Charge
Abrasive coat outside and inside	M23	Add \$108.00 per lockset
Abrasive coat inside only	M24	Add \$54.00 per lockset
Abrasive coat outside only	M25	Add \$54.00 per lockset

Blank Page

**Pre-Assembled Unit Locksets:**

UT5200 Series Standard Features & Ordering Examples	168
UT5200 Series Lever Designs	169
UT5200 Series Cylinder Options	170
UT5200 Series Keying Options	171
UT5200 Series Strike, Miscellaneous Options	172

**PL5000 Series Padlocks:**

PL5000 Series Standard Features & Ordering Example	173
PL5000 Series Cylinder & Keying, Miscellaneous Options	174

**DL2200 Series Cylindrical Deadlocks:**

DL2200 Series Standard Features & Ordering Example	175
DL2200 Series Cylinder & Keying Options	176
DL2200 Series Strike, Door Thickness, Miscellaneous Options	177

**DL3000 Series Cylindrical Deadlocks:**

DL3000 Series Standard Features & Ordering Example	178
DL3000 Series Cylinder & Keying Options	179
DL3000 Series Strike, Door Thickness, Miscellaneous Options	180

**DL3200 Series Cylindrical Deadlocks:**

DL3200 Series Standard Features & Ordering Example	181
DL3200 Series Cylinder & Keying Options	182
DL3200 Series Strike, Door Thickness, Miscellaneous Options	183

**DL4100 Series Mortise Deadlocks:**

DL4100 Series Standard Features & Ordering Example	184
DL4100 Series Cylinder & Keying Options	185
DL4100 Series Strike, Door Thickness, Miscellaneous Options	186

**Standard Features**

**Handing**

Specify hand

**Door Thickness**

1-3/4" only

**Backset**

2-3/4" only

**Strike**

ANSI curved lip 4-7/8" x 1-1/4"  
x 1-1/4" lip to center

**Cylinder**

Brass, 6-pin, L4 keyway,  
0-bitted

**Keys**

Two nickel silver keys

**Case Quantity**

6  
9

**Case Weight**

32 lbs

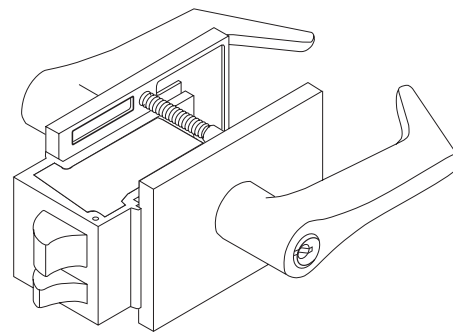

Now available with MicroShield® antimicrobial finish. Specify 626C finish (\$44.00 upcharge per lockset)

**Ordering Example**

**Stock Order**

Quantity	Series/Function	Trim	Finish	Hand
100	UT5251	ESE	626	RH

**Split Trim/Split Finish Order**

Quantity	Series/Function	Trim	Finish		Hand
			Outside	Inside	
12	UT5251	ESE	626	625	RHR

**Contract/Detailed Order**

Quantity	Keyset	Series/Function	Trim	Finish	Hand	Strike	Misc. Options	Cylinder and Keying
24	AA1	UT5251	ESE	626	RHR	SC200	M21	MR-VKC3



**Lever Designs: ESE**



**Essex**

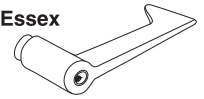

**Lever:**  
Forged

**Escutcheon:**  
Forged

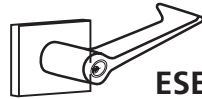

**ESE**

Function	Description		ESE
			Finish: 612, 613, 613E, 625, 626
UT5210	Non-keyed	Passage or Closet	\$1,612.00
UT5220		Privacy	\$1,694.00
UT5251	Single Cylinder	Entrance	\$1,780.00
UT5255		Classroom	
UT5257		Storeroom	
UT5282	Double Cylinder	Store Door	\$1,878.00

## Cylinder Options

Description	Specify Quick Code	Add or Deduct
Conventional 6-pin	(standard)	No Charge
Less Standard Cylinder	LC	Deduct \$98.00 per cylinder
<b>LFIC</b>		
LFIC 6-pin	C6	Add \$91.00 per cylinder
LFIC 6-pin Less Core	CL6	No Charge
LFIC 6-pin with Temporary Construction Core (Red)	CT6R	Add \$91.00 per cylinder
LFIC 6-pin with Temporary Construction Core (Blue)	CT6B	Add \$91.00 per cylinder
LFIC 6-pin with Temporary Construction Core (Green)	CT6G	Add \$91.00 per cylinder
LFIC 6-pin with Temporary Disposable Core	CT6D	No Charge
LFIC 7-pin	C7	Add \$93.00 per cylinder
LFIC 7-pin Less Core	CL7	No Charge
LFIC 7-pin with Temporary Construction Core (Red)	CT7R	Add \$93.00 per cylinder
LFIC 7-pin with Temporary Construction Core (Blue)	CT7B	Add \$93.00 per cylinder
LFIC 7-pin with Temporary Construction Core (Green)	CT7G	Add \$93.00 per cylinder
LFIC 7-pin with temporary Disposable Core	CT7D	No Charge
<b>SFIC</b>		
SFIC 6-pin	C6S	Add \$82.00 per cylinder
SFIC 6-pin with Temporary Construction Core (Blue)	CT6SB	Add \$82.00 per cylinder
SFIC 6-pin or 7-pin with Temporary Disposable Core	CTSD	No Charge
SFIC 7-pin	C7S	Add \$82.00 per cylinder
SFIC 7-pin with Temporary Construction Core (Blue)	CT7SB	Add \$82.00 per cylinder
<b>Security</b>		
Security	HS	Add \$135.00 per cylinder
Security LFIC	CHS	Add \$226.00 per cylinder
<b>Access 3</b>		
Access 3 Patented	AP	No Charge
Access 3 Security	AS	Add \$61.00 per cylinder
Access 3 High Security, UL 437	AHS	Add \$86.00 per cylinder
Access 3 LFIC Patented	ACP	Add \$91.00 per cylinder
Access 3 LFIC Security	ACS	Add \$147.00 per cylinder
Access 3 LFIC High Security, UL 437	ACHS	Add \$169.00 per cylinder
<b>Pyramid</b>		
Pyramid Security Fixed Core	PS	Add \$72.00 per cylinder
Pyramid Security LFIC	PCS	Add \$159.00 per cylinder
Pyramid High Security Fixed Core	PHS	Add \$106.00 per cylinder
Pyramid High Security LFIC	PCHS	Add \$196.00 per cylinder
Pyramid LFIC with Temporary Construction Core	CTP	Add \$91.00 per cylinder
Pyramid LFIC with Temporary Disposable Core	CTPD	No Charge
Pyramid LFIC Less Core	CLP	No Charge
<b>Other</b>		
Master Ring	MR	\$59.00

*Continued on next page*

<b>Cylinder Options (continued) &amp; Keying Options*</b>		
<b>Description</b>	<b>Specify Quick Code</b>	<b>Add or Deduct</b>
<b>Keying and Keys</b>		
0-bitted with 2 Blank Keys	(standard)	No Charge
Keyed Random	KR	
Construction master keyed <sup>1,2</sup>	CMK	Add \$16.00 per cylinder
More than 2 Keys	KY# (e.g., KY6)	See page 31 - Cut Keys Section
<b>Master Keying</b>		
Master keyed (all cylinders except CR8000, CR8020, CR8027, CR8200, CR8500, CR8600, CR8700)	MK	Add \$16.00 per cylinder
Master keyed Pyramid (except CR8020, CR8027)	MK	
Master keyed Security (including LFIC cylinder and core)	MK	
Master keyed Access 3 (except CR8500, CR8600, CR8700 LFIC cores)	MK	
Master keyed (CR8000, CR8020, CR8027, CR8200, CR8500, CR8600, CR8700)	MK-IC	No Charge
Master keyed to customer bittings or sample key	MK-CB	Add \$16.00 per cylinder
<b>Visual Key Control (VKC)</b>		
No bitting or keyset stamping on keys	VKC0	\$4.50
Keys only	VKC1	No Charge
Cylinder and Keys <sup>3</sup> (not for AS, AHS, ACS, ACHS, HS, CHS, PHS or PCHS)	VKC2	\$8.00
Cylinders only <sup>3</sup> (not for AS, AHS, HS, ACS, ACHS, CHS, PHS or PCHS)	VKC3	
<b>Concealed Key Control (CKC)</b>		
CKC cylinders with VKC keys	CKC2	\$8.00
CKC cylinders only <sup>3</sup> (not for AS, AHS, ACS, ACHS, PHS, PCHS)	CKC3	

**Notes:**

1. CMK Construction master keying charge is in addition to master keying charge.
2. CMK Construction master keying is not available in interchangeable core, Access 3, Pyramid, or Security series.
3. VKC2, VKC3, CKC3 are not available in Access 3, Pyramid or Security series.

\*Double cylinder keying: unless otherwise specified, both cylinders of 32, 62, 72 and 82 functions will be keyed alike. The inside cylinder of 52 function will be keyed to the master key(s) only, while the outside cylinder will include the change key. If different keying is required, specify outside cylinder first, then inside cylinder. For key bows other than 10 and 90, specify 'KB' + bow number as Quick Code, e.g. KB12.

### Strike Options\*

To purchase strike separately, see catalog for part no.

Lip Length	ANSI Curved Lip Specify Quick Code	T-Strike Curved Lip Box Specify Quick Code	Add or Deduct
1-1/4"	SA114 Standard	NA	No Charge
1-3/4"	N/A	SC134	Add \$17.00 per cylinder
2"	N/A	SC200	
2-1/8"	N/A	SC218	
2-1/4"	N/A	SC214	
2-1/2"	N/A	SC212	
2-3/4"	N/A	SC234	
3"	N/A	SC300	

Lip Length	ANSI Straight Lip For Door Pair** Quick Code	For Door Pair** Quick Code	Add or Deduct
1-13/16"	SA136	SP136	No Charge

Lip length	ANSI Straight Lip For Extended Lip Escutcheon Quick Code	For Extended Lip Escutcheon Quick Code	Add or Deduct
15/16"	Standard when Extended Lip Option is Specified	SX156	No Charge

\*If door thickness is standard or has been specified and no special door or frame condition exist, then only the first two characters of the optional strike Quick code must be specified (e.g. "SC").

The correct lip length will be determined by our order entry system based on the standard or specified door thickness.

\*\* Lip is measured from back of strike.

### Miscellaneous Options

Description	Specify Quick Code	Add or Deduct
Split designs and split finishes	Outside Trim x Inside Trim	Higher set price prevails
Spanner head screws	M02	Add \$24.00 per lockset
Torx® head screws (on strike)	M04	Add \$30.00 per lockset
Lever to accept 6 or 7-pin SFIC (ESE only)	M08	Deduct \$20.00 per lockset
Extended lip escutcheon (for single door reverse bevel; 630 finish to match 626 only)	M11	Add \$60.00 per lockset
Knurling outside and inside	M20	Add \$172.00 per lockset
Knurling outside only	M21	Add \$86.00 per lockset
Knurling Inside only	M22	
Abrasive coat outside and inside	M23	
Abrasive coat inside only	M24	Add \$54.00 per lockset
Abrasive coat outside only	M25	
Lead lining escutcheon	M28	Add \$115.00 per Escutcheon
Unstaked lever retainer	M33	No Charge

**Standard Features**

**Case**

Extruded Brass

**Shackle**

1 1/32" (8.7mm) diameter hardened steel (PL5000 Series), brass (PL5100 Series) or stainless steel (PL5200 Series)

**Locking**

Ball-bearing locking heel and toe

**Cylinder**

RFC model: 6-pin Fixed Core (2300)  
IC model: 6-pin & Pyramid IC (8000 series)  
L4 keyway standard

**Case Quantity**

36

**Case Weight**

27 lbs



**Ordering Example**

**Stock Order**

Quantity	Series/Function
10	PL5000R

**Access 3 Order**

Quantity	Series/Function	Misc. Options
8	PL5070	ACP M44

**Contract Order**

Quantity	Keyset	Series/Function	Shackle Length	Misc. Options
10	AA1	PL5080	258	M45

**Padlocks**

Hardened Steel Shackle	Brass Shackle	Description	List Price
PL5000R	PL5100R	Rekeyable Fixed Core (RFC)	\$126.00
PL5070*	PL5170*	Interchangeable core (IC), less core	\$132.00
PL5080	PL5180	IC 6-pin	\$223.00
PL5090	PL5190	IC security	\$358.00
PL5030	PL5130	Pyramid High Security (IC)	\$328.00
PL5037	PL5137	Pyramid Security (IC)	\$291.00

Stainless Steel Shackle	Description	List Price
PL5200R	Rekeyable Fixed Core (RFC)	\$131.00
PL5270*	Interchangeable core (IC), less core	\$137.00
PL5280	IC 6-pin	\$228.00
PL5290	IC security	\$363.00
PL5230	Pyramid High Security (IC)	\$333.00
PL5237	Pyramid Security (IC)	\$296.00

**Shackle Length Options with Padlocks**

Description	Specify Quick Code	Add or Deduct
7/8"	(standard)	No Charge
2-5/8"	258	Add \$5.00 to padlock

\* Access 3 is only available with Less Core.

**Cylinder Options (continued) & Keying Options\***

Description	Specify Quick Code	Add or Deduct
<b>Access 3</b>		
Access 3 LFIC Patented	ACP	Add \$91.00 per cylinder
Access 3 LFIC Security	ACS	Add \$147.00 per cylinder
Access 3 LFIC High Security, UL 437	ACHS	Add \$169.00 per cylinder
<b>LFIC</b>		
LFIC 6-pin with Temporary Construction Core (Red)	CT6R	No Charge
LFIC 6-pin with Temporary Construction Core (Blue)	CT6B	No Charge
LFIC 6-pin with Temporary Construction Core (Green)	CT6G	No Charge
<b>Keying and Keys</b>		
0-bitted with 2 Blank Keys	(standard)	No Charge
Keyed Random	KR	
Construction master keyed <sup>1,2</sup>	CMK	Add \$16.00 per cylinder
More than 2 Keys	KY# (e.g., KY6)	See page 31 - Cut Keys Section
<b>Master Keying</b>		
Master keyed (all cylinders except CR8000, CR8020, CR8027, CR8200, CR8500, CR8600, CR8700 LFIC cores)	MK	Add \$16.00 per cylinder
Master keyed Pyramid (except CR8020, CR8027 LFIC cores)	MK	
Master keyed Security (including LFIC cylinder and core)	MK	
Master keyed Access 3 (except CR8500, CR8600, CR8700 LFIC cores)	MK	
Master keyed (CR8000, CR8020, CR8027, CR8200, CR8500, CR8600, CR8700 LFIC cores)	MK-IC	No Charge
Master keyed to customer bittings or sample key	MK-CB	Add \$16.00 per cylinder
<b>Visual Key Control (VKC)</b>		
No bitting or keyset stamping on keys	VKC0	\$4.50
Keys only	VKC1	No Charge
Cylinder and Keys <sup>3</sup> (not for AS, AHS, ACS, ACHS, HS, CHS, PHS or PCHS)	VKC2	\$8.00
Cylinders only <sup>3</sup> (not for AS, AHS, HS, ACS, ACHS, CHS, PHS or PCHS)	VKC3	
<b>Concealed Key Control (CKC)</b>		
CKC cylinders with VKC keys	CKC2	\$8.00
CKC cylinders only <sup>3</sup> (not for AS, AHS, ACS, ACHS, PHS, PCHS)	CKC3	
More than 2 keys per lock	KY# (e.g., KY6)	See page 31 - Cut Keys Section

- Notes:
1. CMK Construction master keying charge is in addition to master keying charge.
  2. CMK Construction master keying is not available in interchangeable core, Access 3, Pyramid, or Security series.
  3. VKC2, VKC3, CKC3 are not available in Access 3, Pyramid or Security series.

\*Double cylinder keying: unless otherwise specified, both cylinders of 32, 62, 72 and 82 functions will be keyed alike. The inside cylinder of 52 function will be keyed to the master key(s) only, while the outside cylinder will include the change key. If different keying is required, specify outside cylinder first, then inside cylinder. For key bows other than 10 and 90, specify 'KB' + bow number as Quick Code, e.g. KB12.

**Miscellaneous Options**

Description	Specify Quick Code	Add or Deduct
Chain and clevis attached	M44	Add \$4.00 to padlock
Custom die stamped case* (specify existing die number or lettering specifications for artwork)	M45	Add \$5.50 to padlock

\*To create new die stamp, contact factory. Provide artwork with request for quotation.  
Die stamps remain the property of Corbin Russwin.

**ANSI/BHMA A156.36  
Grade 2**

**Standard Features**  
**Handing**  
Non-handed

**Door Thickness**  
1-3/8" - 2-1/4"

**Backset**  
2-3/4" (standard)  
2-3/8" available

**Strike**  
2-3/4" x 1-1/8"

**Cylinder**  
Brass 6-pin,  
0-bitted, L4 keyway

**Keys**  
Two nickel silver keys

**Case Quantity**  
12

**Case Weight**  
24 lbs

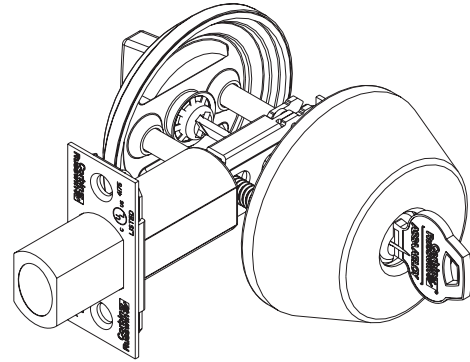

**Ordering Example**

**Stock Order**

Quantity	Series/Function	Finish
30	DL2213	626

**Contract Order**

Quantity	Keyset	Finish	Keyset	Optional Strike
30	DL2213	626	AA1	SS134

Function	Description	Finish: 613E, 626, BSP, WSP	Finish: 605, 606, 612, 613, 625
DL2213	Single Cylinder	\$133.00	\$140.00
DL2212	Double Cylinder	\$171.00	\$178.00
DL2217	Classroom	\$133.00	\$140.00
DL2211	Cylinder x Blank		
DL2260	Thumbturn x Blank	\$97.00	\$101.00

<b>Cylinder Options</b>		
<b>Description</b>	<b>Specify Quick Code</b>	<b>Add or Deduct</b>
Conventional 6-pin	(standard)	No Charge
Conventional 7-pin	7P	Add \$2.00 per cylinder
Less Standard Cylinder	LC	No Deduct
<b>LFIC</b>		
LFIC 6-pin	C6	Add \$91.00 per cylinder
LFIC 6-pin Less Core	CL6	No Charge
LFIC 6-pin with Temporary Construction Core (Red)	CT6R	Add \$91.00 per cylinder
LFIC 6-pin with Temporary Construction Core (Blue)	CT6B	Add \$91.00 per cylinder
LFIC 6-pin with Temporary Construction Core (Green)	CT6G	Add \$91.00 per cylinder
LFIC 6-pin with Temporary Disposable Core	CT6D	No Charge
LFIC 7-pin	C7	Add \$93.00 per cylinder
LFIC 7-pin Less Core	CL7	No Charge
LFIC 7-pin with Temporary Construction Core (Red)	CT7R	Add \$93.00 per cylinder
LFIC 7-pin with Temporary Construction Core (Blue)	CT7B	Add \$93.00 per cylinder
LFIC 7-pin with Temporary Construction Core (Green)	CT7G	Add \$93.00 per cylinder
LFIC 7-pin with temporary Disposable Core	CT7D	No Charge
<b>SFIC</b>		
SFIC 6-pin	C6S	Add \$82.00 per cylinder
SFIC 6-pin with Temporary Construction Core (Blue)	CT6SB	Add \$82.00 per cylinder
SFIC 6-pin or 7-pin with Temporary Disposable Core	CTSD	No Charge
SFIC 7-pin	C7S	Add \$82.00 per cylinder
SFIC 7-pin with Temporary Construction Core (Blue)	CT7SB	Add \$82.00 per cylinder
<b>Security</b>		
Security	HS	Add \$135.00 per cylinder
Security LFIC	CHS	Add \$226.00 per cylinder
<b>Access 3</b>		
Access 3 Patented	AP	No Charge
Access 3 Security	AS	Add \$61.00 per cylinder
Access 3 High Security, UL 437	AHS	Add \$86.00 per cylinder
Access 3 LFIC Patented	ACP	Add \$91.00 per cylinder
Access 3 LFIC Security	ACS	Add \$147.00 per cylinder
Access 3 LFIC High Security, UL 437	ACHS	Add \$169.00 per cylinder
<b>Pyramid</b>		
Pyramid Security Fixed Core	PS	Add \$72.00 per cylinder
Pyramid Security LFIC	PCS	Add \$159.00 per cylinder
Pyramid High Security Fixed Core	PHS	Add \$106.00 per cylinder
Pyramid High Security LFIC	PCHS	Add \$196.00 per cylinder
Pyramid LFIC with Temporary Construction Core	CTP	Add \$91.00 per cylinder
Pyramid LFIC with Temporary Disposable Core	CTPD	No Charge
Pyramid LFIC Less Core	CLP	No Charge

**Notes:**

1. CMK Construction master keying charge is in addition to master keying charge.

\*Both cylinders of double cylinder deadlocks are keyed alike, unless otherwise specified. If different keying is required, specify outside cylinder first, then inside cylinder.

For key bows other than 10 and 90, specify 'KB' + bow number as Quick Code, e.g. KB12.

Note: KB92 cannot be furnished with VKC or other markings.



### Cylinder Options (continued) & Keying Options\*

Description	Specify Quick Code	Add or Deduct
<b>Keying and Keys</b>		
0-bitted with 2 Blank Keys	(standard)	No Charge
Keyed Random	KR	
Construction master keyed <sup>1,2</sup>	CMK	Add \$16.00 per cylinder
More than 2 Keys	KY# (e.g., KY6)	See page 31 - Cut Keys Section
<b>Master Keying</b>		
Master keyed (all cylinders except CR8000, CR8020, CR8027, CR8200, CR8500, CR8600, CR8700)	MK	Add \$16.00 per cylinder
Master keyed Pyramid (except CR8020, CR8027 LFIC cores)	MK	
Master keyed Security (including LFIC cylinder and core)	MK	
Master keyed Access 3 (except CR8500, CR8600, CR8700 LFIC cores)	MK	
Master keyed (CR8000, CR8020, CR8027, CR8200, CR8500, CR8600, CR8700)	MK-IC	No Charge
Master keyed to customer bittings or sample key	MK-CB	Add \$16.00 per cylinder
<b>Visual Key Control (VKC)</b>		
No bitting or keyset stamping on keys	VKC0	\$4.50
Keys only	VKC1	No Charge
Cylinder and Keys <sup>3</sup> (not for AS, AHS, ACS, ACHS, HS, CHS, PHS or PCHS)	VKC2	\$8.00
Cylinders only <sup>3</sup> (not for AS, AHS, HS, ACS, ACHS, CHS, PHS or PCHS)	VKC3	
<b>Concealed Key Control (CKC)</b>		
CKC cylinders with VKC keys	CKC2	\$8.00
CKC cylinders only <sup>3</sup> (not for AS, AHS, ACS, ACHS, PHS, PCHS)	CKC3	

Notes: 1. CMK Construction master keying charge is in addition to master keying charge.  
 2. CMK Construction master keying is not available in interchangeable core, Access 3, Pyramid, or Security series.  
 3. VKC2, VKC3, CKC3 are not available in Access 3, Pyramid or Security series.

\* For key bows other than 10 and 90, specify 'KB' + bow number as Quick Code, e.g. KB12.

### Strike Options

To purchase strike separately, see catalog or parts manual for part no.

Lip Length	ANSI Straight Lip - Specify Quick Code	Add or Deduct
1"	SS100	No Charge
1-1/8"	SS118	
1-1/4"	SS114	
1-3/8"	SS138	
1-1/2"	SS112	
1-3/4"	SS134	Add \$17.00 per cylinder
2"	SS200	
2-1/4"	SS214	
2-1/2"	SS212	
2-3/4"	SS234	
3"	SS300	

### Door Thickness Options

Description	Specify Quick Code	Add or Deduct
1-3/8"	D138	No Charge
1-3/4"	(standard)	No Charge
2"	D200	No Charge
2-1/4"	D214	No Charge

### Miscellaneous Options

Description	Specify Quick Code	Add or Deduct
1" (25mm) bolt front, square corners	M14	Add \$6.00 per lockset
ANSI wrought strike box	M17	No Charge
Plastic box for standard strike	(standard)	No Charge
2-3/8" (60mm) backset bolt	B238	No Charge

**Standard Features  
Handing**

Non-handed, except DL3017  
function

**Door Thickness**

1-3/4" - 2-1/4"

**Backset**

2-3/4" (standard)

**Strike**

Wrought brass or bronze  
2-3/4" x 1-1/8" with  
wrought box

**Cylinder**

Brass 6-pin,  
0-bitted, L4 keyway

**Keys**

Two nickel silver keys

**Weight**

2.5 lbs each

**Case Quantity**

12

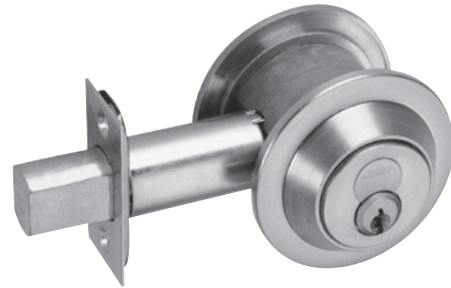

**Ordering Example**

**Stock Order**

Quantity	Series/Function	Finish
30	DL3013	626

**Contract Order**

Quantity	Keypad	Finish	Keypad	Optional Strike
30	DL3013	626	AA1	SD002

Function	Description	Finish: 605, 606, 612 613 613E, 618, 619, 625, 626, 722, BSP, WSP
DL3013	Single Cylinder	\$310.00
DL3012	Double Cylinder	\$415.00
DL3017	Classroom*	\$316.00
DL3011	Cylinder x Blank	\$310.00
DL3060	Thumbturn x Blank	

\*Thumbturn will not project deadbolt. Specify hand.

<b>Cylinder Options</b>		
<b>Description</b>	<b>Specify Quick Code</b>	<b>Add or Deduct</b>
Conventional 6-pin	(standard)	No Charge
Conventional 7-pin	7P	Add \$2.00 per cylinder
Less Standard Cylinder	LC	Deduct \$105.00 per cylinder
<b>LFIC</b>		
LFIC 6-pin	C6	Add \$91.00 per cylinder
LFIC 6-pin Less Core	CL6	No Charge
LFIC 6-pin with Temporary Construction Core (Red)	CT6R	Add \$91.00 per cylinder
LFIC 6-pin with Temporary Construction Core (Blue)	CT6B	Add \$91.00 per cylinder
LFIC 6-pin with Temporary Construction Core (Green)	CT6G	Add \$91.00 per cylinder
LFIC 6-pin with Temporary Disposable Core	CT6D	No Charge
LFIC 7-pin	C7	Add \$93.00 per cylinder
LFIC 7-pin Less Core	CL7	Add \$2.00 per cylinder
LFIC 7-pin with Temporary Construction Core (Red)	CT7R	Add \$93.00 per cylinder
LFIC 7-pin with Temporary Construction Core (Blue)	CT7B	Add \$93.00 per cylinder
LFIC 7-pin with Temporary Construction Core (Green)	CT7G	Add \$93.00 per cylinder
LFIC 7-pin with temporary Disposable Core	CT7D	Add \$2.00 per cylinder
UL LFIC 6-Pin Housing Less Core	CL6AH	Add \$91.00 per cylinder
UL LFIC 6-Pin Housing with Disposable Core	CTAHD	Add \$91.00 per cylinder
UL LFIC 6-Pin Housing with Temp Construction Core	CT6AH(R/B/G)	Add \$196.00 per cylinder
<b>SFIC</b>		
SFIC 6-pin	C6S	Add \$82.00 per cylinder
SFIC 6-pin with Temporary Construction Core (Blue)	CT6SB	Add \$82.00 per cylinder
SFIC 6-pin with SFIC Disposable Temporary Core	CT6SD	No Charge
SFIC 6-pin Less Core	CLS6	No Charge
SFIC 7-pin	C7S	Add \$82.00 per cylinder
SFIC 7-pin with Temporary Construction Core (Blue)	CT7SB	Add \$82.00 per cylinder
SFIC 7-pin with SFIC Disposable Temporary Core	CT7SD	Add \$2.00 per cylinder
SFIC 7-pin Less Core	CLS7	Add \$2.00 per cylinder
<b>Security</b>		
Security	HS	Add \$139.00 per cylinder
Security LFIC	CHS	Add \$226.00 per cylinder
<b>Access 3</b>		
Access 3 Patented	AP	No Charge
Access 3 Security	AS	Add \$61.00 per cylinder
Access 3 High Security, UL 437	AHS	Add \$86.00 per cylinder
Access 3 LFIC Patented	ACP	Add \$91.00 per cylinder
Access 3 LFIC Security	ACS	Add \$147.00 per cylinder
Access 3 LFIC High Security, UL 437	ACHS	Add \$169.00 per cylinder
<b>Pyramid</b>		
Pyramid Security Fixed Core	PS	Add \$74.00 per cylinder
Pyramid Security LFIC	PCS	Add \$159.00 per cylinder
Pyramid High Security Fixed Core	PHS	Add \$110.00 per cylinder
Pyramid High Security LFIC	PCHS	Add \$196.00 per cylinder
Pyramid LFIC with Temporary Construction Core	CTP	Add \$91.00 per cylinder
Pyramid LFIC with Temporary Disposable Core	CTPD	No Charge
Pyramid LFIC Less Core	CLP	No Charge

**Notes:**

1. CMK Construction master keying charge is in addition to master keying charge.

\*Both cylinders of double cylinder deadlocks are keyed alike, unless otherwise specified. If different keying is required, specify outside cylinder first, then inside cylinder.

For key bows other than 10 and 90, specify 'KB' + bow number as Quick Code, e.g. KB12.

Note: KB92 cannot be furnished with VKC or other markings.

**Cylinder Options (continued) & Keying Options\***

Description	Specify Quick Code	Add or Deduct
<b>Keying and Keys</b>		
0-bitted with 2 Blank Keys	(standard)	No Charge
Keyed Random	KR	
Construction master keyed <sup>1,2</sup>	CMK	Add \$16.00 per cylinder
More than 2 Keys	KY# (e.g., KY6)	See page 31 - Cut Keys Section
<b>Master Keying</b>		
Master keyed (all cylinders except CR8000, CR8020, CR8027, CR8200, CR8500, CR8600, CR8700)	MK	Add \$16.00 per cylinder
Master keyed Pyramid (except CR8020, CR8027 LFIC cores)	MK	
Master keyed Security (including LFIC cylinder and core)	MK	
Master keyed Access 3 (except CR8500, CR8600, CR8700 LFIC cores)	MK	
Master keyed (CR8000, CR8020, CR8027, CR8200, CR8500, CR8600, CR8700)	MK-IC	No Charge
Master keyed to customer bittings or sample key	MK-CB	Add \$16.00 per cylinder
<b>Visual Key Control (VKC)</b>		
No bitting or keyset stamping on keys	VKC0	\$4.50
Keys only	VKC1	No Charge
Cylinder and Keys <sup>3</sup> (not for AS, AHS, ACS, ACHS, HS, CHS, PHS or PCHS)	VKC2	\$8.00
Cylinders only <sup>3</sup> (not for AS, AHS, HS, ACS, ACHS, CHS, PHS or PCHS)	VKC3	
<b>Concealed Key Control (CKC)</b>		
CKC cylinders with VKC keys	CKC2	\$8.00
CKC cylinders only <sup>3</sup> (not for AS, AHS, ACS, ACHS, PHS, PCHS)	CKC3	

- Notes: 1. CMK Construction master keying charge is in addition to master keying charge.  
 2. CMK Construction master keying is not available in interchangeable core, Access 3, Pyramid, or Security series.  
 3. VKC2, VKC3, CKC3 are not available in Access 3, Pyramid or Security series.

\*For key bows other than 10 and 90, specify 'KB' + bow number as Quick Code, e.g. KB12.

**Strike Options\***

To purchase strike separately, see catalog or parts manual for part no.

Lip Length	ANSI Straight Lip - Specify Quick Code	Add or Deduct
7/8"	SS078	No Charge
1-1/8"	SS118	
1-1/4"	SS114	
1-3/8"	SS138	
1-1/2"	SS112	
1-3/4"	SS134	Add \$17.00 per cylinder
2"	SS200	
2-1/4"	SS214	
2-1/2"	SS212	
2-3/4"	SS234	
3"	SS300	

**Strike Options (No lip)**

Description	Specify Quick Code	Add or Deduct
2-3/4" x 1-1/8"	(standard)	No Charge
3-1/2" x 1-1/8"	SD001	

**Door Thickness Options**

Description	Specify Quick Code	Add or Deduct
1-3/8" (Not available in IC option)	D138	No Charge
1-3/4" - 2"	(standard)	
2-1/4"	D214	Add \$6.00 per lockset

**Miscellaneous Options**

Description	Specify Quick Code	Add or Deduct
ANSI wrought box	M17	No Charge
Ergonomic Thumbturn	M34	Add \$18.00 per TT
Plastic box for standard strike	PStdStrike	No Charge
2-3/8" backset	B238	

**Standard Features**  
**Handing**  
Non-handed

**Door Thickness**  
1-3/8" - 2-1/4"

**Backset**  
2-3/4" (standard)  
2-3/8" available

**Strike**  
2-3/4" x 1-1/8"

**Cylinder**  
Brass 6-pin,  
0-bitted, L4 keyway

**Keys**  
Two nickel silver keys

**Case Quantity** 12  
**Case Weight** 24 lbs

**ANSI/BHMA 156.36  
Grade 1**

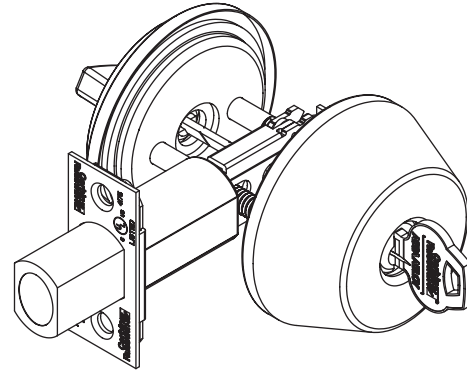

**Ordering Example**

**Stock Order**

Quantity	Series/Function	Finish
30	DL3213	626

**Contract Order**

Quantity	Keyset	Finish	Keyset	Optional Strike
30	DL3213	626	AA1	SS134

Function	Description	Finish: 613E, 626, BSP, WSP	Finish: 605, 606, 612, 613, 625
DL3213	Single Cylinder	\$242.00	\$249.00
DL3212	Double Cylinder	\$340.00	\$347.00
DL3217	Classroom	\$242.00	\$249.00
DL3211	Cylinder x Blank		
DL3260	Thumbturn x Blank	\$211.00	\$215.00

<b>Cylinder Options</b>		
<b>Description</b>	<b>Specify Quick Code</b>	<b>Add or Deduct</b>
Conventional 6-pin	(standard)	No Charge
Conventional 7-pin	7P	Add \$2.00 per cylinder
Less Standard Cylinder	LC	Deduct \$98.00 per cylinder
<b>LFIC</b>		
LFIC 6-pin	C6	Add \$91.00 per cylinder
LFIC 6-pin Less Core	CL6	No Charge
LFIC 6-pin with Temporary Construction Core (Red)	CT6R	Add \$91.00 per cylinder
LFIC 6-pin with Temporary Construction Core (Blue)	CT6B	Add \$91.00 per cylinder
LFIC 6-pin with Temporary Construction Core (Green)	CT6G	Add \$91.00 per cylinder
LFIC 6-pin with Temporary Disposable Core	CT6D	No Charge
LFIC 7-pin	C7	Add \$93.00 per cylinder
LFIC 7-pin Less Core	CL7	No Charge
LFIC 7-pin with Temporary Construction Core (Red)	CT7R	Add \$93.00 per cylinder
LFIC 7-pin with Temporary Construction Core (Blue)	CT7B	Add \$93.00 per cylinder
LFIC 7-pin with Temporary Construction Core (Green)	CT7G	Add \$93.00 per cylinder
LFIC 7-pin with temporary Disposable Core	CT7D	No Charge
<b>SFIC</b>		
SFIC 6-pin	C6S	Add \$82.00 per cylinder
SFIC 6-pin with Temporary Construction Core (Blue)	CT6SB	Add \$82.00 per cylinder
SFIC 6-pin or 7-pin with Temporary Disposable Core	CTSD	No Charge
SFIC 7-pin	C7S	Add \$82.00 per cylinder
SFIC 7-pin with Temporary Construction Core (Blue)	CT7SB	Add \$82.00 per cylinder
<b>Security</b>		
Security	HS	Add \$135.00 per cylinder
Security LFIC	CHS	Add \$226.00 per cylinder
<b>Access 3</b>		
Access 3 Patented	AP	No Charge
Access 3 Security	AS	Add \$61.00 per cylinder
Access 3 High Security, UL 437	AHS	Add \$86.00 per cylinder
Access 3 LFIC Patented	ACP	Add \$91.00 per cylinder
Access 3 LFIC Security	ACS	Add \$147.00 per cylinder
Access 3 LFIC High Security, UL 437	ACHS	Add \$169.00 per cylinder
<b>Pyramid</b>		
Pyramid Security Fixed Core	PS	Add \$72.00 per cylinder
Pyramid Security LFIC	PCS	Add \$159.00 per cylinder
Pyramid High Security Fixed Core	PHS	Add \$106.00 per cylinder
Pyramid High Security LFIC	PCHS	Add \$196.00 per cylinder
Pyramid LFIC with Temporary Construction Core	CTP	Add \$91.00 per cylinder
Pyramid LFIC with Temporary Disposable Core	CTPD	No Charge
Pyramid LFIC Less Core	CLP	No Charge

**Notes:**

1. CMK Construction master keying charge is in addition to master keying charge.

\*Both cylinders of double cylinder deadlocks are keyed alike, unless otherwise specified. If different keying is required, specify outside cylinder first, then inside cylinder.

For key bows other than 10 and 90, specify 'KB' + bow number as Quick Code, e.g. KB12.

Note: KB92 cannot be furnished with VKC or other markings.

## Cylinder Options (continued) & Keying Options\*

Description	Specify Quick Code	Add or Deduct
<b>Keying and Keys</b>		
0-bitted with 2 Blank Keys	(standard)	No Charge
Keyed Random	KR	
Construction master keyed <sup>1,2</sup>	CMK	Add \$16.00 per cylinder
More than 2 Keys	KY# (e.g., KY6)	See page 31 - Cut Keys Section
<b>Master Keying</b>		
Master keyed (all cylinders except CR8000, CR8020, CR8027, CR8200, CR8500, CR8600, CR8700)	MK	Add \$16.00 per cylinder
Master keyed Pyramid (except CR8020, CR8027 LFIC cores)	MK	
Master keyed Security (including LFIC cylinder and core)	MK	
Master keyed Access 3 (except CR8500, CR8600, CR8700 LFIC cores)	MK	
Master keyed (CR8000, CR8020, CR8027, CR8200, CR8500, CR8600, CR8700)	MK-IC	No Charge
Master keyed to customer bittings or sample key	MK-CB	Add \$16.00 per cylinder
<b>Visual Key Control (VKC)</b>		
No bitting or keyset stamping on keys	VKC0	\$4.50
Keys only	VKC1	No Charge
Cylinder and Keys <sup>3</sup> (not for AS, AHS, ACS, ACHS, HS, CHS, PHS or PCHS)	VKC2	\$8.00
Cylinders only <sup>3</sup> (not for AS, AHS, HS, ACS, ACHS, CHS, PHS or PCHS)	VKC3	
<b>Concealed Key Control (CKC)</b>		
CKC cylinders with VKC keys	CKC2	\$8.00
CKC cylinders only <sup>3</sup> (not for AS, AHS, ACS, ACHS, PHS, PCHS)	CKC3	

Notes: 1. CMK Construction master keying charge is in addition to master keying charge.  
 2. CMK Construction master keying is not available in interchangeable core, Access 3, Pyramid, or Security series.  
 3. VKC2, VKC3, CKC3 are not available in Access 3, Pyramid or Security series.

\* For key bows other than 10 and 90, specify 'KB' + bow number as Quick Code, e.g. KB12.

## Strike Options

To purchase strike separately, see catalog or parts manual for part no.

Lip Length	ANSI Straight Lip - Specify Quick Code	Add or Deduct
7/8"	SS078	No Charge
1-1/8"	SS118	
1-1/4"	SS114	
1-3/8"	SS138	
1-1/2"	SS112	
1-3/4"	SS134	Add \$17.00 per cylinder
2"	SS200	
2-1/4"	SS214	
2-1/2"	SS212	
2-3/4"	SS234	
3"	SS300	

## Door Thickness Options

Description	Specify Quick Code	Add or Deduct
1-3/8"	D138	No Charge
1-3/4"	(standard)	
2"	D200	
2-1/4"	D214	

## Miscellaneous Options

Description	Specify Quick Code	Add or Deduct
1" (25mm) bolt front, square corners	M14	Add \$6.00 per dead lock
ANSI wrought strike box	M17	No Charge
Plastic box for standard strike	(standard)	
2-3/8" (60mm) backset bolt	B238	

**Standard Features**

**Handing**  
Non-handed

**Door Thickness**  
1-3/4"

**Backset**  
2-3/4"

**Strike**

Wrought brass or bronze  
3-1/2" x 1-1/8"

**Cylinder**

6-pin, L4 keyway, 0-bitted

**Keys**

Two nickel silver keys

**Weight**

2.25 lbs each

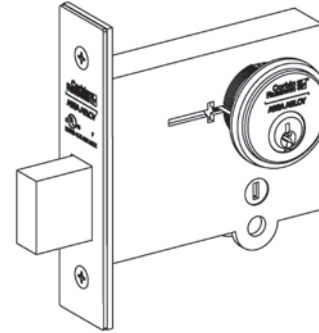

**Ordering Example**

**Stock Order**

Quantity	Series/Function	Finish
30	DL4113	626

**Contract Order**

Quantity	Keyset	Finish	Keyset	Optional Strike
30	DL4113	626	AA1	SS118

Function	Description	Finish: 613E, 626, BSP	Finish: 605, 606, 611, 612, 613, 618, 619 ,625
DL4113	Single Cylinder	\$421.00	\$426.00
DL4112	Double Cylinder	\$462.00	\$467.00
DL4117	Classroom*	\$421.00	\$426.00
DL4111	Cylinder x Blank	\$354.00	\$359.00
DL4122	Double Cylinder x Thumbturn*	\$528.00	\$533.00
DL4160	Thumbturn x Blank	\$313.00	\$318.00

\*Thumbturn will not project deadbolt.



<b>Cylinder Options</b>		
<b>Description</b>	<b>Specify Quick Code</b>	<b>Add or Deduct</b>
Conventional 6-pin	(standard)	No Charge
Conventional 7-pin	7P	Add \$2.00 per cylinder
Less Standard Cylinder	LC	Deduct \$105.00 per cylinder
<b>LFIC</b>		
LFIC 6-pin	C6	Add \$91.00 per cylinder
LFIC 6-pin Less Core	CL6	No Charge
LFIC 6-pin with Temporary Construction Core (Red)	CT6R	Add \$91.00 per cylinder
LFIC 6-pin with Temporary Construction Core (Blue)	CT6B	Add \$91.00 per cylinder
LFIC 6-pin with Temporary Construction Core (Green)	CT6G	Add \$91.00 per cylinder
LFIC 6-pin with Temporary Disposable Core	CT6D	No Charge
LFIC 7-pin	C7	Add \$93.00 per cylinder
LFIC 7-pin Less Core	CL7	Add \$2.00 per cylinder
LFIC 7-pin with Temporary Construction Core (Red)	CT7R	Add \$93.00 per cylinder
LFIC 7-pin with Temporary Construction Core (Blue)	CT7B	Add \$93.00 per cylinder
LFIC 7-pin with Temporary Construction Core (Green)	CT7G	Add \$93.00 per cylinder
LFIC 7-pin with temporary Disposable Core	CT7D	Add \$2.00 per cylinder
UL LFIC 6-Pin Housing Less Core	CL6AH	Add \$91.00 per cylinder
UL LFIC 6-Pin Housing with Disposable Core	CTAHD	Add \$91.00 per cylinder
UL LFIC 6-Pin Housing with Temp Construction Core	CT6AH(R/B/G)	Add \$196.00 per cylinder
<b>SFIC</b>		
SFIC 6-pin	C6S	Add \$82.00 per cylinder
SFIC 6-pin with Temporary Construction Core (Blue)	CT6SB	Add \$82.00 per cylinder
SFIC 6-pin with SFIC Disposable Temporary Core	CT6SD	No Charge
SFIC 6-pin with Less Core	CLS6	No Charge
SFIC 7-pin	C7S	Add \$82.00 per cylinder
SFIC 7-pin with Temporary Construction Core (Blue)	CT7SB	Add \$82.00 per cylinder
SFIC 7-pin with SFIC Disposable Temporary Core	CT7SD	Add \$2.00 per cylinder
SFIC 7-pin with Less Core	CLS7	Add \$2.00 per cylinder
<b>Security</b>		
Security	HS	Add \$139.00 per cylinder
Security LFIC	CHS	Add \$226.00 per cylinder
<b>Access 3</b>		
Access 3 Patented	AP	No Charge
Access 3 Security	AS	Add \$61.00 per cylinder
Access 3 High Security, UL 437	AHS	Add \$86.00 per cylinder
Access 3 LFIC Patented	ACP	Add \$91.00 per cylinder
Access 3 LFIC Security	ACS	Add \$147.00 per cylinder
Access 3 LFIC High Security, UL 437	ACHS	Add \$169.00 per cylinder
<b>Pyramid</b>		
Pyramid Security Fixed Core	PS	Add \$74.00 per cylinder
Pyramid Security LFIC	PCS	Add \$159.00 per cylinder
Pyramid High Security Fixed Core	PHS	Add \$110.00 per cylinder
Pyramid High Security LFIC	PCHS	Add \$196.00 per cylinder
Pyramid LFIC with Temporary Construction Core	CTP	Add \$91.00 per cylinder
Pyramid LFIC with Temporary Disposable Core	CTPD	No Charge
Pyramid LFIC Less Core	CLP	No Charge

**Notes:**

1. CMK Construction master keying charge is in addition to master keying charge.

\*Both cylinders of double cylinder deadlocks are keyed alike, unless otherwise specified. If different keying is required, specify outside cylinder first, then inside cylinder.

For key bows other than 10 and 90, specify 'KB' + bow number as Quick Code, e.g. KB12.

Note: KB92 cannot be furnished with VKC or other markings.

**Cylinder Options (continued) & Keying Options\***

Description	Specify Quick Code	Add or Deduct
<b>Keying and Keys</b>		
0-bitted with 2 Blank Keys	(standard)	No Charge
Keyed Random	KR	
Construction master keyed <sup>1,2</sup>	CMK	Add \$16.00 per cylinder
More than 2 Keys	KY# (e.g., KY6)	See page 31 - Cut Keys Section
<b>Master Keying</b>		
Master keyed (all cylinders except CR8000, CR8020, CR8027, CR8200, CR8500, CR8600, CR8700)	MK	Add \$16.00 per cylinder
Master keyed Pyramid (except CR8020, CR8027 LFIC cores)	MK	
Master keyed Security (including LFIC cylinder and core)	MK	
Master keyed Access 3 (except CR8500, CR8600, CR8700 LFIC cores)	MK	
Master keyed (CR8000, CR8020, CR8027, CR8200, CR8500, CR8600, CR8700)	MK-IC	No Charge
Master keyed to customer bittings or sample key	MK-CB	Add \$16.00 per cylinder
<b>Visual Key Control (VKC)</b>		
No bitting or keyset stamping on keys	VKC0	\$4.50
Keys only	VKC1	No Charge
Cylinder and Keys <sup>3</sup> (not for AS, AHS, ACS, ACHS, HS, CHS, PHS or PCHS)	VKC2	\$8.00
Cylinders only <sup>3</sup> (not for AS, AHS, HS, ACS, ACHS, CHS, PHS or PCHS)	VKC3	
<b>Concealed Key Control (CKC)</b>		
CKC cylinders with VKC keys	CKC2	\$8.00
CKC cylinders only <sup>3</sup> (not for AS, AHS, ACS, ACHS, PHS, PCHS)	CKC3	

Notes: 1. CMK Construction master keying charge is in addition to master keying charge.  
 2. CMK Construction master keying is not available in interchangeable core, Access 3, Pyramid, or Security series.  
 3. VKC2, VKC3, CKC3 are not available in Access 3, Pyramid or Security series.

\* For key bows other than 10 and 90, specify 'KB' + bow number as Quick Code, e.g. KB12.

**Strike Options**

To purchase strike separately, see catalog for part no.

Lip length	ANSI Straight Lip Specify Quick Code	Add or Deduct
7/8"	SS078	Add \$17.00 per cylinder
1-1/8"	SS118	
1-1/4"	SS114	
1-3/8"	SS138	
1-1/2"	SS112	
1-3/4"	SS134	
2"	SS200	
2-1/4"	SS214	
2-1/2"	SS212	
2-3/4"	SS234	
3"	SS300	

**Door Thickness Options**

Description	Specify Quick Code	Add or Deduct
1-3/4" - 2"	(standard)	No Charge
2-1/4"	D214	

**Miscellaneous Options**

Description	Specify Quick Code	Add or Deduct
Spanner head screws	M02	Add \$24.00 per lockset
Torx head screws	M04	Add \$30.00 per lockset
ANSI wrought box	M17	No Charge
Lead wrapped case	M29	Add \$328.00 per lockset
Ergonomic Thumbturn (specify door thickness)	M34	Add \$18.00 per TT
Box for standard strike	M40	No Charge

# Table of Contents

## Multi-Point Exit Device Latching System



USA & Canada Prices Effective February 1, 2022

### FE5400S Series Multi-Point Exit Device Latching System:

FE5400S Series Standard Features, Ordering Examples, Pricing	189
FE5400S Series Heavy-Duty Trim Designs: A9 Armstrong, C9 Citation, D9 Dirke, E9 Essex	190
FE5400S Series Heavy-Duty Trim Designs: L9 Lustra, N9 Newport, R9 Regis, PR9 Princeton	191
FE5400S Series Heavy-Duty Trim Designs: G9, TH900 Pull/Thumbpiece, P9 Pull	192
FE5400S Series Heavy-Duty Trim Designs: FR9 Frascati, M9 Merlot, Z9 Zinfandel	193
FE5400S Series Heavy-Duty Trim Designs: Museo® Georgia, Jackson, Laszlo, Marc, Salvador, Piet	194
FE5400S Series Electrically Controlled Trim Designs: A9 Armstrong, C9 Citation, D9 Dirke, E9 Essex	195
FE5400S Series Electrically Controlled Trim Designs: L9 Lustra, N9 Newport, R9 Regis, PR9 Princeton	196
FE5400S Series Electrically Controlled Trim Designs: FR9 Frascati, M9 Merlot, Z9 Zinfandel	197
FE5400S Series Electrically Controlled Trim Designs: Museo® Georgia, Jackson, Laszlo, Marc, Salvador, Piet	198
FE5400S Series Electrified Options & Accessories	199
FE5400S Series Cylinder & Keying Options	200
FE5400S Series Cylinder & Keying Options (Con't), Door Height, Door Width, Door Thickness, Miscellaneous Options	201
FE5400S Series Removable Mullions & Options	202

### MP6600 Series Multi-Point Latching System:

MP6600 Series Standard Features	203
MP6600 Series: Single Cylinder, Double Cylinder with Deadbolt, Non-Keyed, EAC: ASA, CSA, LSA, NSA, PSA, RSA, NSM, NSN, NSR Levers	204
MP6600 Series Designs: Escutcheons with Single, Double Cylinder with Deadbolt, Non-Keyed, EAC, Georgia, Jackson, Josef, Laszlo, Marc, Salvador Levers	205
MP6600 Series Designs: Roses with Single, Double Cylinder with Deadbolt, Non-Keyed, EAC, Georgia, Jackson, Josef, Laszlo, Marc, Salvador Levers	206
MP6600 Series Designs: Escutcheons with Single, Double Cylinder with Deadbolt, Non-Keyed, EAC, Josef, Georges Levers	207
MP6600 Series Designs: Roses with Single, Double Cylinder with Deadbolt, Non-Keyed, EAC, Josef, Georges Levers	208
MP6600 Series Designs: Escutcheons with Single, Double Cylinder with Deadbolt, Non-Keyed, EAC, Piet Levers	209
MP6600 Series Designs: Roses with Single, Double Cylinder with Deadbolt, Non-Keyed, EAC, Piet Levers	210
MP6600 Series Designs: Escutcheons with Single, Double Cylinder with Deadbolt, Non-Keyed, EAC, Piet Levers	211
MP6600 Series Designs: Roses with Single, Double Cylinder with Deadbolt, Non-Keyed, EAC, Piet Levers	212
MP6600 Series Cylinder & Keying Options	213
MP6600 Series Cylinder & Keying Options (Con't), Strike Options	214
MP6600 Series Door Thickness, Options, Thumbturn Options, Strike Options	215

### FE6600 Series Multi-Point Latching System:

FE6600 Series Standard Features	216
FE6600 Series: Single Cylinder, Double Cylinder with Deadbolt, Non-Keyed, EAC: ASA, CSA, LSA, NSA, PSA, RSA, NSM, NSN, NSR Levers	217
FE6600 Series Designs: Escutcheons with Single, Double Cylinder with Deadbolt, Non-Keyed, EAC, Georgia, Jackson, Josef, Laszlo, Marc, Salvador Levers	218
FE6600 Series Designs: Roses with Single, Double Cylinder with Deadbolt, Non-Keyed, EAC, Georgia, Jackson, Josef, Laszlo, Marc, Salvador Levers	219
FE6600 Series Designs: Escutcheons with Single, Double Cylinder with Deadbolt, Non-Keyed, EAC, Josef, Georges Levers	220
FE6600 Series Designs: Roses with Single, Double Cylinder with Deadbolt, Non-Keyed, EAC, Josef, Georges Levers	221
FE6600 Series Designs: Escutcheons with Single, Double Cylinder with Deadbolt, Non-Keyed, EAC, Piet Levers	222
FE6600 Series Designs: Roses with Single, Double Cylinder with Deadbolt, Non-Keyed, EAC, Piet Levers	223
FE6600 Series Designs: Escutcheons with Single, Double Cylinder with Deadbolt, Non-Keyed, EAC, Piet Levers	224
FE6600 Series Designs: Roses with Single, Double Cylinder with Deadbolt, Non-Keyed, EAC, Piet Levers	225
FE6600 Series Cylinder & Keying Options	226
FE6600 Series Cylinder & Keying Options (Con't), Strike Options	227
FE6600 Series Door Thickness, Options, Thumbturn Options, Strike Options	228

*Continued on next page.*

# Table of Contents

## Multi-Point Exit Device Latching System



USA & Canada Prices Effective February 1, 2022

### BL6600 Series Multi-Point Latching System:

BL6600 Series Standard Features	229
BL6600 Series: Single Cylinder, Double Cylinder with Deadbolt, Non-Keyed, EAC: ASA, CSA, LSA, NSA, PSA, RSA, NSM, NSN, NSR Levers	230
BL6600 Series Designs: Escutcheons with Single, Double Cylinder with Deadbolt, Non-Keyed, EAC, Georgia, Jackson, Josef, Laszlo, Marc, Salvador Levers	231
BL6600 Series Designs: Roses with Single, Double Cylinder with Deadbolt, Non-Keyed, EAC, Georgia, Jackson, Josef, Laszlo, Marc, Salvador Levers	232
BL6600 Series Designs: Escutcheons with Single, Double Cylinder with Deadbolt, Non-Keyed, EAC, Josef, Georges Levers	233
BL6600 Series Designs: Roses with Single, Double Cylinder with Deadbolt, Non-Keyed, EAC, Josef, Georges Levers	234
BL6600 Series Designs: Escutcheons with Single, Double Cylinder with Deadbolt, Non-Keyed, EAC, Piet Levers	235
BL6600 Series Designs: Roses with Single, Double Cylinder with Deadbolt, Non-Keyed, EAC, Piet Levers	236
BL6600 Series Designs: Escutcheons with Single, Double Cylinder with Deadbolt, Non-Keyed, EAC, Piet Levers	237
BL6600 Series Designs: Roses with Single, Double Cylinder with Deadbolt, Non-Keyed, EAC, Piet Levers	238
BL6600 Series Cylinder & Keying Options	239
BL6600 Series Cylinder & Keying Options (Con't), Strike Options	240
BL6600 Series Door Thickness, Options, Thumbturn Options, Strike Options	241

### FE6700 Series Storm Shutter Multi-Point Latching System:

FE6700 Series Standard Features, Ordering Example	242
FE6700 Series Designs	243
FE6700 Series Cylinder & Keying Options	244
FE6700 Series Cylinder & Keying Options (Con't), Shutter Thickness, Shutter Height, Miscellaneous Options	245

### MP9800 Series Multi-Point Vertical Rod Lock:

MP9800 Series Standard Features	246
MP9800 Series Levers: Armstrong, Citation, Dirke, Essex, Lustra, Newport, Regis, Princeton, Georgia, Jackson, Josef, Laszlo, Marc, Salvador Levers	247
MP9800 Series Levers: Armstrong, Citation, Dirke, Essex, Lustra, Newport, Regis, Princeton, Georgia, Jackson, Josef, Laszlo, Marc, Salvador Freewheeling Trim, Electromechanical	248
MP9800A Series Levers: Armstrong, Citation, Dirke, Essex, Lustra, Newport, Regis, Princeton, Georgia, Jackson, Josef, Laszlo, Marc, Salvador Levers	249
MP9800A Series Levers: Armstrong, Citation, Dirke, Essex, Lustra, Newport, Regis, Princeton, Georgia, Jackson, Josef, Laszlo, Marc, Salvador Freewheeling Trim, Electromechanical	250
MP9800 Series Piet Levers, Freewheeling Trim, Electromechanical	251
MP9800A Series Piet Levers, Freewheeling Trim, Electromechanical	252
MP9800 Series Josef, Georges Levers, Freewheeling Trim, Electromechanical	253
MP9800A Series Josef, Georges Levers, Freewheeling Trim, Electromechanical	254
MP9800 Series Cylinder Options, Keying Options	255
MP9800 Series Cylinder & Keying Options (Con't) Door Height Options, Door Width Options, Door Thickness, Motorized Electric Latch Retraction	256
MP9800 Series Miscellaneous Options	257
Blank Page	258

# FE5400S

## Multi-Point Exit Device Latching System



USA & Canada Prices Effective February 1, 2022

### Standard Features

#### Handing

Device is non-handed. Lever trim is handed.

#### Bar Length

Standard: 36" (914mm) bar fits 30" - 36" (762mm-914mm) door

#### Door Height

7'0" (2134mm) standard

#### Door Thickness

1-3/4" (44mm) standard

#### Stile

Minimum width 4-1/2" (114mm).

#### Projection

3-1/4" (83mm) active, 2-3/4" (70mm) dogged.

#### Cylinders

Cylinder not included unless specified.

#### Warranty

Seven-year limited



### Ordering Examples:

#### Exit Device Only

Quantity	Series/Function	Finish	Hand	Misc. Options
65	FE5400S	626	RHR	M51

#### Trim Only

Quantity	Trim/Function	Finish	Hand	Door Thickness
24	N955ET	625	RHR	D214

#### Exit Device with Trim

Qty	Exit Device	Trim/Function	Finish	Hand	Door Thickness	Door Width	Misc. Options
65	FE5400S	N955ET	605	LHR	D214	W048	M51

### Contract/Detailed Order — Exit Device with Trim

Qty	Keyset	Exit Device	Trim/Function	Finish	Hand	Door Height	Door Width	Misc. Options	Cylinder Option
36	AA1	FE5400S	C955ET	626	LHR	HO800	W048	M52	7P

### Pricing: 36" Device Only

Includes device, strike(s) and screw pack. No cylinder or trim.

FE5400S Series			
Function	Description	Finish: 613E, 630', BSP, WSP	Finish: 605, 606, 611, 612, 613, 618, 619, 625, 626, 629, 722
FE5400S	Panic	\$4,326.00	\$4,406.00
FE5400SA	3 Hour Fire Rated	\$4,528.00	\$4,608.00

Caution: Be sure of your measurements. Exit devices are NOT returnable.



# FE5400S

## Multi-Point Exit Device Latching System



### FE5400S Series Heavy-Duty Trim

USA & Canada Prices Effective February 1, 2022

Cylinder is not included.

#### Escutcheon Trim Design: A9 Armstrong



**Lever:** Cast

**Escutcheon:** Forged

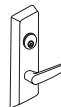

Function	Description	Finish: 605, 606, 611, 612, 613, 613E, 618, 619, 625, 626, 629 <sup>2</sup> , 630 <sup>1</sup> , 722, BSP, WSP
A910ET	Passage	\$805.00
A950ET	Dummy	
A955ET	Classroom <sup>3</sup>	
A959ET	Storeroom	

#### Escutcheon Trim Design: C9 Citation



**Lever:** Cast

**Escutcheon:** Forged

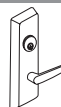

Function	Description	Finish: 605, 606, 611, 612, 613, 613E, 618, 619, 625, 626, 629 <sup>2</sup> , 630 <sup>1</sup> , 722, BSP, WSP
C910ET	Passage	\$805.00
C950ET	Dummy	
C955ET	Classroom <sup>3</sup>	
C959ET	Storeroom	

#### Escutcheon Trim Design: D9 Dirke



**Lever:** Cast

**Escutcheon:** Forged



Function	Description	Finish: 605, 606, 611, 612, 613, 613E, 618, 619, 625, 626, 629 <sup>2</sup> , 630 <sup>1</sup> , 722, BSP, WSP
D910ET	Passage	\$805.00
D950ET	Dummy	
D955ET	Classroom <sup>3</sup>	
D959ET	Storeroom	

#### Escutcheon Trim Design: E9 Essex



**Lever:** Cast

**Escutcheon:** Forged

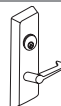

Function	Description	Finish: 605, 606, 611, 612, 613, 613E, 618, 619, 625, 626, 629 <sup>2</sup> , 630 <sup>1</sup> , 722, BSP, WSP
E910ET	Passage	\$805.00
E950ET	Dummy	
E955ET	Classroom <sup>3</sup>	
E959ET	Storeroom	

**Notes:**

1. 619 finish provided to match 630 finish
2. 618 finish provided to match 629 finish.
3. Classroom function trim may be converted to storeroom function by a simple field adjustment. No additional parts required.

Experience a safer  
and more open world

# FE5400S

## Multi-Point Exit Device Latching System

### FE5400S Series Heavy-Duty Trim

USA & Canada Prices Effective February 1, 2022

Cylinder is not included.

#### Escutcheon Trim Design: L9 Lustra

**Lever:** Cast      **Escutcheon:** Forged

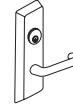

Function	Description	Finish: 605, 606, 611, 612, 613, 613E, 618, 619, 625, 626, 629 <sup>2</sup> , 630 <sup>1</sup> , 722, BSP, WSP
L910ET	Passage	\$805.00
L950ET	Dummy	
L955ET	Classroom <sup>3</sup>	
L959ET	Storeroom	

#### Escutcheon Trim Design: N9 Newport

**Lever:** Cast      **Escutcheon:** Forged

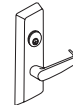

Function	Description	Finish: 605, 606, 611, 612, 613, 613E, 618, 619, 625, 626, 629 <sup>2</sup> , 630 <sup>1</sup> , 722, BSP, WSP
N910ET	Passage	\$805.00
N950ET	Dummy	
N955ET	Classroom <sup>3</sup>	
N959ET	Storeroom	

#### Escutcheon Trim Design: R9 Regis

**Lever:** Cast      **Escutcheon:** Forged

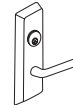

Function	Description	Finish: 605, 606, 611, 612, 613, 613E, 618, 619, 625, 626, 629 <sup>2</sup> , 630 <sup>1</sup> , 722, BSP, WSP
R910ET	Passage	\$805.00
R950ET	Dummy	
R955ET	Classroom <sup>3</sup>	
R959ET	Storeroom	

#### Escutcheon Trim Design: PR9 Princeton

**Lever:** Cast      **Escutcheon:** Forged

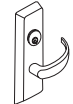

Function	Description	Finish: 605, 606, 611, 612, 613, 613E, 618, 619, 625, 626, 629 <sup>2</sup> , 630 <sup>1</sup> , 722, BSP, WSP
PR910ET	Passage	\$805.00
PR950ET	Dummy	
PR955ET	Classroom <sup>3</sup>	
PR959ET	Storeroom	

**Notes:**

1. 619 finish provided to match 630 finish. - Escutcheons only
2. 618 finish provided to match 629 finish. - Escutcheons only
3. Classroom function trim may be converted to storeroom function by a simple field adjustment. No additional parts required.

# FE5400S Multi-Point Exit Device Latching System



## FE5400S Series Heavy-Duty Trim

USA & Canada Prices Effective February 1, 2022

Cylinder is not included.

### Escutcheon Trim Design: G9

**Lever:** Cast      **Escutcheon:** Forged



Function	Description	Finish: 605, 606, 611, 612, 613, 613E, 618, 619, 625, 626, 629 <sup>2</sup> , 630 <sup>1</sup> , 722, BSP
G910ET	Passage	\$805.00
G950ET	Dummy	
G955ET	Classroom <sup>3</sup>	
G959ET	Storeroom	

**Notes:**

1. 619 finish provided to match 630 finish. - Escutcheons only
2. 618 finish provided to match 629 finish. - Escutcheons only
3. Classroom function trim may be converted to storeroom function by a simple field adjustment. No additional parts required.

### Escutcheon Trim Design: TH900 Pull/Thumbpiece

**Grip:** Extruded      **Escutcheon:** Forged



Function	Description	Finish: 605, 606, 611, 612, 613, 613E, 618, 619, 625, 626, 629 <sup>2</sup> , 630 <sup>1</sup> , 722, BSP
TH910ET	Passage	\$612.00
TH950ET	Dummy (No thumbpiece)	\$582.00
TH955ET	Classroom <sup>3</sup>	\$612.00
TH959ET	Storeroom	\$582.00

### Escutcheon Trim Design: P9 Pull

**Pull:** Extruded      **Escutcheon:** Forged

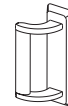

Function	Description	Finish: 605, 606, 611, 612, 613, 613E, 618, 619, 625, 626, 629 <sup>2</sup> , 630 <sup>1</sup> , 722, BSP
P950ET*	Dummy	\$528.00

\* Specify Hand. Field Reversible.



# FE5400S

## Multi-Point Exit Device Latching System

### FE5400S Series Heavy-Duty Trim

USA & Canada Prices Effective February 1, 2022

Cylinder is not included.

#### Escutcheon Trim Design: FR9 Frascati\*



**Escutcheon:** Forged

\* Handed Lever. Handing cannot be changed in the field.

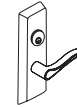

Function	Description	Finish: 605, 606, 611, 612, 613, 613E, 618, 619, 625, 626, 629 <sup>2</sup> , 630 <sup>1</sup> , 722, BSP
FR910ET	Passage	\$805.00
FR950ET	Dummy	
FR955ET	Classroom <sup>3</sup>	
FR959ET	Storeroom	

#### Escutcheon Trim Design: M9 Merlot



**Escutcheon:** Forged

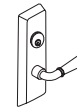

Function	Description	Finish: 605, 606, 611, 612, 613, 613E, 618, 619, 625, 626, 629 <sup>2</sup> , 630 <sup>1</sup> , 722, BSP
M910ET	Passage	\$805.00
M950ET	Dummy	
M955ET	Classroom <sup>3</sup>	
M959ET	Storeroom	

#### Escutcheon Trim Design: Z9 Zinfandel\*



**Escutcheon:** Forged

\* Handed Lever. Handing cannot be changed in the field.

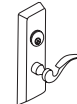

Function	Description	Finish: 605, 606, 611, 612, 613, 613E, 618, 619, 625, 626, 629 <sup>2</sup> , 630 <sup>1</sup> , 722, BSP
Z910ET	Passage	\$805.00
Z950ET	Dummy	
Z955ET	Classroom <sup>3</sup>	
Z959ET	Storeroom	

**Notes:**

3. Classroom function trim may be converted to storeroom function by a simple field adjustment. No additional parts required.

# FE5400S Multi-Point Exit Device Latching System

## FE5400S Series Heavy-Duty Trim

USA & Canada Prices Effective February 1, 2022

Cylinder is not included.

### Escutcheon Trim Design: Muséo®

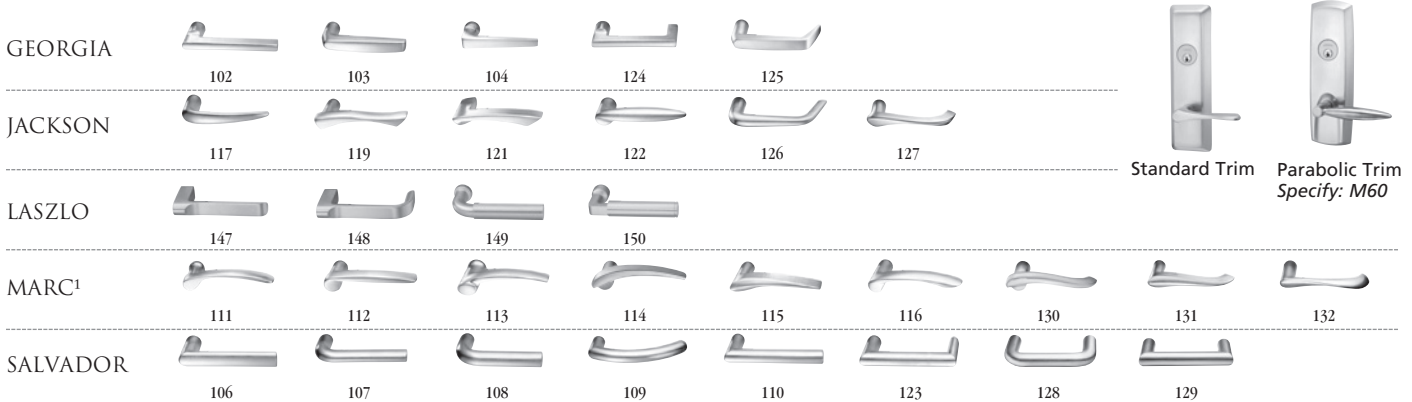

Function	Description	Finish: 605, 606, 611, 612, 613, 613E, 618, 619, 625, 626, 629², 630¹, 722, BSP
910ET	Passage	\$805.00
950ET	Dummy	
955ET	Classroom	
959ET	Storeroom	

\*629 and \*630 finish options are Not available for all Muséo levers. Please refer to page 20 for availability.

### Escutcheon Trim Design: Muséo®

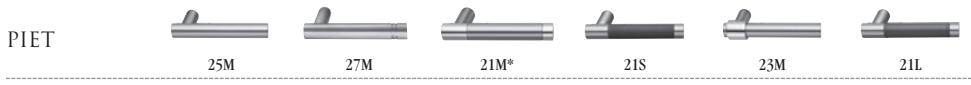

\*613E, BSP, WSP finishes are not available with 21M levers.

Function	Description	Finish: 613E, 629, 630, BSP, WSP
910ET	Passage	\$867.00
950ET	Dummy	
955ET	Classroom	
959ET	Storeroom	

# FE5400S

## Multi-Point Exit Device Latching System

### FE5400S Series Electrically Controlled Trim

USA & Canada Prices Effective February 1, 2022

Cylinder is not included.

#### Escutcheon Trim Design: A9 Armstrong



**Lever:** Cast    **Escutcheon:** Forged

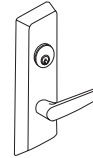

Function	Description	Finish: 605, 606, 611, 612, 613, 613E, 618, 619, 625, 626, 629 <sup>2</sup> , 630 <sup>1</sup> , 722, BSP, WSP
A9903ET*	Fail Safe	\$1,240.00
A9905ET*	Fail Secure	

#### Escutcheon Trim Design: C9 Citation



**Lever:** Cast    **Escutcheon:** Forged

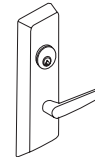

Function	Description	Finish: 605, 606, 611, 612, 613, 613E, 618, 619, 625, 626, 629 <sup>2</sup> , 630 <sup>1</sup> , 722, BSP, WSP
C9903ET*	Fail Safe	\$1,240.00
C9905ET*	Fail Secure	

#### Escutcheon Trim Design: D9 Dirke\*



**Lever:** Cast    **Escutcheon:** Forged

\* Handed Lever. Handing cannot be changed in the field.

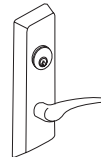

Function	Description	Finish: 605, 606, 611, 612, 613, 613E, 618, 619, 625, 626, 629 <sup>2</sup> , 630 <sup>1</sup> , 722, BSP, WSP
D9903ET*	Fail Safe	\$1,240.00
D9905ET*	Fail Secure	

#### Escutcheon Trim Design: E9 Essex



**Lever:** Cast    **Escutcheon:** Forged

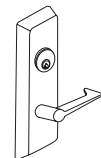

Function	Description	Finish: 605, 606, 611, 612, 613, 613E, 618, 619, 625, 626, 629 <sup>2</sup> , 630 <sup>1</sup> , 722, BSP, WSP
E9903ET*	Fail Safe	\$1,240.00
E9905ET*	Fail Secure	

**Notes:**

- 619 finish provided to match 630 finish. - Escutcheons only
- 618 finish provided to match 629 finish. - Escutcheons only

**\*ElectroLynx®**

As part of their promise to provide innovative, fast and effective high security solutions to their customers, certain ASSA ABLOY Group brands offer *ElectroLynx®*, a universal quick-connect system that simplifies the electrification of the door opening.

# FE5400S

## Multi-Point Exit Device Latching System

### FE5400S Series Electrically Controlled Trim

USA & Canada Prices Effective February 1, 2022

Cylinder is not included.

#### Escutcheon Trim Design: L9 Lustra



**Lever:** Cast    **Escutcheon:** Forged

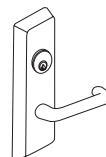

Function	Description	Finish: 605, 606, 611, 612, 613, 613E, 618, 619, 625, 626, 629 <sup>2</sup> , 630 <sup>1</sup> , 722, BSP, WSP
L9903ET*	Fail Safe	\$1,240.00
L9905ET*	Fail Secure	

#### Escutcheon Trim Design: N9 Newport



**Lever:** Cast    **Escutcheon:** Forged

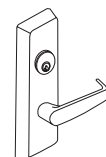

Function	Description	Finish: 605, 606, 611, 612, 613, 613E, 618, 619, 625, 626, 629 <sup>2</sup> , 630 <sup>1</sup> , 722, BSP, WSP
N9903ET*	Fail Safe	\$1,240.00
N9905ET*	Fail Secure	

#### Escutcheon Trim Design: R9 Regis



**Lever:** Cast    **Escutcheon:** Forged

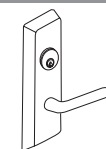

Function	Description	Finish: 605, 606, 611, 612, 613, 613E, 618, 619, 625, 626, 629 <sup>2</sup> , 630 <sup>1</sup> , 722, BSP, WSP
R9903ET*	Fail Safe	\$1,240.00
R9905ET*	Fail Secure	

#### Escutcheon Trim Design: PR9 Princeton



**Lever:** Cast    **Escutcheon:** Forged

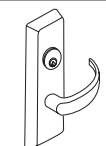

Function	Description	Finish: 605, 606, 611, 612, 613, 613E, 618, 619, 625, 626, 629 <sup>2</sup> , 630 <sup>1</sup> , 722, BSP, WSP
PR9903ET*	Fail Safe	\$1,240.00
PR9905ET*	Fail Secure	

**Notes:**

- 619 finish provided to match 630 finish. - Escutcheons only
- 618 finish provided to match 629 finish. - Escutcheons only

**\*ElectroLynx®**

As part of their promise to provide innovative, fast and effective high security solutions to their customers, certain ASSA ABLOY Group brands offer *ElectroLynx®*, a universal quick-connect system that simplifies the electrification of the door opening.

# FE5400S

## Multi-Point Exit Device Latching System

### FE5400S Series Electrically Controlled Trim

USA & Canada Prices Effective February 1, 2022

Cylinder is not included.

#### Escutcheon Trim Design: FR9 Frascati

**Lever:** Cast **Escutcheon:** Forged

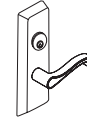

Function	Description	Finish: 605, 606, 611, 612, 613, 613E, 618, 619, 625, 626, 629 <sup>2</sup> , 630 <sup>1</sup> , 722, BSP, WSP
FR9903ET*	Fail Safe	\$1,240.00
FR9905ET*	Fail Secure	

#### Escutcheon Trim Design: M9 Merlot

**Lever:** Cast **Escutcheon:** Forged

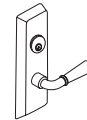

Function	Description	Finish: 605, 606, 611, 612, 613, 613E, 618, 619, 625, 626, 629 <sup>2</sup> , 630 <sup>1</sup> , 722, BSP, WSP
M9903ET*	Fail Safe	\$1,240.00
M9905ET*	Fail Secure	

#### Escutcheon Trim Design: Z9 Zinfandel

**Lever:** Cast **Escutcheon:** Forged

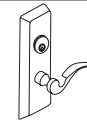

Function	Description	Finish: 605, 606, 611, 612, 613, 613E, 618, 619, 625, 626, 629 <sup>2</sup> , 630 <sup>1</sup> , 722, BSP, WSP
Z9903ET*	Fail Safe	\$1,240.00
Z9905ET*	Fail Secure	

**\*ElectroLynx®**

As part of their promise to provide innovative, fast and effective high security solutions to their customers, certain ASSA ABLOY Group brands offer *ElectroLynx®*, a universal quick-connect system that simplifies the electrification of the door opening.

# FE5400S



































## Multi-Point Exit Device Latching System

### FE5400S Series Electrically Controlled Trim

USA & Canada Prices Effective February 1, 2022

Cylinder is not included.







**Escutcheon Trim Design: Muséo®** 

GEORGIA						  Standard Trim    Parabolic Trim Specify: M60				
JACKSON										
LASZLO										
MARC <sup>1</sup>										
SALVADOR										

Function	Description	Finish: 605, 606, 611, 612, 613, 613E, 618, 619, 625, 626, 629 <sup>2</sup> , 630 <sup>1</sup> , 722, BSP, WSP
9903ET**	Fail Safe	\$1,240.00
9905ET**	Fail Secure	

\*629 and \*630 finish options are Not available for all Muséo levers. Please refer to page 20 for availability.

**Escutcheon Trim Design: Muséo®** 

PIET						
	25M	27M	21M*	21S	23M	21L

\*613E, BSP, WSP finishes are not available with 21M levers.

Function	Description	Finish: 629, 630
9903ET**	Fail Safe	\$1,240.00
9905ET**	Fail Secure	

#### \*\*ElectroLynx®

As part of their promise to provide innovative, fast and effective high security solutions to their customers, certain ASSA ABLOY Group brands offer *ElectroLynx*®, a universal quick-connect system that simplifies the electrification of the door opening.

# FE5400S Electrically Controlled Trim



## Electrified Options

USA & Canada Prices Effective February 1, 2022

Description	Specify Quick Code	Add or Deduct
Touchbar Monitoring or Signaling/Request to Exit (REX)	M92*	Add \$244.00
Outside Trim Monitoring or Signaling	M93*	Add \$244.00
SPDT Lock and Unlock security monitor switch (Electric Trim Only)	M98*	Add \$235.00
Trim gasket for exterior applications (Electric Trim Only)	M99	Add \$26.00

## Electrified Accessories

Part Number	Description	Specify	Price
709F649	Power Supply 1 Amp @ 12VDC Output	BPS-12-1	\$406.00
709F659	Power Supply 3 Amp @ 12VDC Output	BPS-12-3	\$826.00
709F609	Power Supply 2 Amp @ 24VDC Output	BPS-24-1	\$406.00
709F619	Power Supply 2 Amp @ 24VDC Output	BPS-24-2	\$826.00
709F629	Power Supply 4 Amp @ 24VDC Output	BPS-24-4	\$1,399.00
704F288	Concealed transfer (for over 120-degree swing door)	EPTL	\$160.00
709F689	(1) SPDT Maintained Switch (Includes LED)	MKA	\$160.00
709F709	(1) SPDT Momentary Switch (Includes LED)	MK	\$245.00
709F759	(1) SPDT Maintained (Alternating Action) Switch	PB3EA	\$144.00
709F729	DPDT Momentary Key Switch	2' MK2	\$282.00
704F719	Narrow Stile Momentary Key Switch	MKN	\$245.00
709F789	Sonalert 90db @ 2 ft. 12-24VDC Mounted on one gang stainless steel plate.	PZ1	\$122.00

### \*ElectroLynx®

As part of their promise to provide innovative, fast and effective high security solutions to their customers, certain ASSA ABLOY Group brands offer *ElectroLynx*®, a universal quick-connect system that simplifies the electrification of the door opening.

# FE5400S Electrically Controlled Trim Multi-Point Exit Device Latching System



USA & Canada Prices Effective February 1, 2022

<b>Cylinder Options*</b>		
Description	Specify Quick Code	Add or Deduct
Conventional 6-pin	6P**	Add \$105.00 per cylinder
Conventional 7-pin	7P	Add \$107.00 per cylinder
<b>LFIC</b>		
LFIC 6-pin	C6	Add \$196.00 per cylinder
LFIC 6-pin less core	CL6	Add \$105.00 per cylinder
LFIC 6-pin with temporary construction core (Red)	CT6R	Add \$196.00 per cylinder
LFIC 6-pin with temporary construction core (Blue)	CT6B	Add \$196.00 per cylinder
LFIC 6-pin with temporary construction core (Green)	CT6G	Add \$196.00 per cylinder
LFIC 6-pin with temporary disposable core	CT6D	Add \$105.00 per cylinder
LFIC 7-pin	C7	Add \$200.00 per cylinder
LFIC 7-pin less core	CL7	Add \$107.00 per cylinder
LFIC 7-pin with temporary construction core (Red)	CT7R	Add \$200.00 per cylinder
LFIC 7-pin with temporary construction core (Blue)	CT7B	Add \$200.00 per cylinder
LFIC 7-pin with temporary construction core (Green)	CT7G	Add \$200.00 per cylinder
LFIC 7-pin with temporary disposable core	CT7D	Add \$107.00 per cylinder
<b>SFIC</b>		
SFIC 6-pin	C6S	Add \$187.00 per cylinder
SFIC 6-pin with temporary construction core (Blue)	CT6SB	Add \$187.00 per cylinder
SFIC 6-pin with SFIC disposable temporary core	CT6SD	Add \$105.00 per cylinder
SFIC 6-pin with Less Core	CLS6	Add \$105.00 per cylinder
SFIC 7-pin	C7S	Add \$187.00 per cylinder
SFIC 7-pin with temporary construction core (Blue)	CT7SB	Add \$187.00 per cylinder
SFIC 7-pin with SFIC disposable temporary core	CT7SD	Add \$107.00 per cylinder
SFIC 6-pin with Less Core	CLS7	Add \$107.00 per cylinder
<b>Security</b>		
Security	HS	Add \$244.00 per cylinder
Security LFIC	CHS	Add \$331.00 per cylinder
<b>Access 3</b>		
Access 3 Patented	AP	Add \$105.00 per cylinder
Access 3 Security	AS	Add \$161.00 per cylinder
Access 3 High Security, UL 437	AHS	Add \$184.00 per cylinder
Access 3 LFIC Patented	ACP	Add \$196.00 per cylinder
Access 3 LFIC Security	ACS	Add \$252.00 per cylinder
Access 3 LFIC High Security, UL 437	ACHS	Add \$274.00 per cylinder
<b>Pyramid</b>		
Pyramid Security fixed core	PS	Add \$179.00 per cylinder
Pyramid Security LFIC	PCS	Add \$264.00 per cylinder
Pyramid High Security fixed core	PHS	Add \$215.00 per cylinder
Pyramid High Security LFIC	PCHS	Add \$301.00 per cylinder
Pyramid LFIC with temporary construction core	CTP	Add \$196.00 per cylinder
Pyramid LFIC with temporary disposable core	CTPD	Add \$105.00 per cylinder
Pyramid LFIC less core	CLP	Add \$105.00 per cylinder
<b>Keying and Keys</b>		
0-bitted with 2 Blank Keys	(standard)	No Charge
Keyed Random	KR	No Charge
Construction Master Keyed <sup>2</sup>	CMK	Add \$16.00 per cylinder
More than 2 Keys	KY# (e.g., KY6)	See page 31 - Cut Keys Section
<b>Master Keying</b>		
Master keyed (all cylinders except CR8000, CR8020, CR8027, CR8200, CR8500, CR8600, CR8700)	MK	Add \$16.00 per cylinder
Master keyed Pyramid (except CR8020, CR8027 LFIC cores)	MK	
Master keyed Security (including LFIC cylinder and core)	MK	
Master keyed Access 3 (except CR8500, CR8600, CR8700 LFIC cores)	MK	No Charge
Master keyed (CR8000, CR8020, CR8027, CR8200, CR8500, CR8600, CR8700)	MK-IC	
Master keyed to customer bittings or sample key	MK-CB	Add \$16.00 per cylinder

Continued on next page

\*Optional dogging cylinder will be furnished with the same mechanism and keyed alike with the trim cylinder, unless otherwise specified.

If different keying or cylinder type is required, specify outside (trim) first, then inside (dogging) cylinder.

\*\*6P cylinder option is supplied in 6-pin, L4 keyway, 0-bitted with two nickel silver keys.

\*For key bows other than 10 and 90, specify "KB" + bow number as Quick Code, e.g. KB12.

- Notes:
1. CMK Construction master keying charge is in addition to master keying charge.
  2. CMK Construction master keying is not available in interchangeable core, Access 3, Pyramid, or Security series.
  3. VKC2, VKC3, CKC3 are not available in Pyramid or Security series.



# FE5400S Electrically Controlled Trim Multi-Point Exit Device Latching System



USA & Canada Prices Effective February 1, 2022

Cylinder Options (continued) & Keying Options*		
Description	Specify Quick Code	Add or Deduct
<b>Visual Key Control (VKC)</b>		
No bitting or keyset stamping on keys	VKC0	\$4.50
Keys only	VKC1	No Charge
Cylinders and keys (not for AS, AHS, ACS, ACHS, HS, CHS, PHS or PCHS)	VKC2	\$8.00
Cylinders only (not for AS, AHS, HS, ACS, ACHS, CHS, PHS or PCHS)	VKC3	
<b>Concealed Key Control (CKC)</b>		
CKC cylinders with VKC keys	CKC2	\$8.00
CKC cylinders only (not for AS, AHS, ACS, ACHS, PHS, PCHS)	CKC3	

**Notes:**

- Not available in CLX3329 function.
- CMK Construction master keying charge is in addition to master keying charge and is not available in interchangeable core, Access 3, Pyramid, or Security series.

\*Double cylinder keying: unless otherwise specified, both cylinders of 32, 62, 72 and 82 functions will be keyed alike. The inside cylinder of 52 function will be keyed to the master key(s) only, while the outside cylinder will include the change key. If different keying is required, specify outside cylinder first, then inside cylinder. For key bows other than 10 and 90, specify 'KB' + bow number as Quick Code, e.g. KB12.

## Door Height Options

Door Height	Specify Quick Code	Add or Deduct
7'0"	(standard)	No Charge
7'2"	H0702	No Charge
7'6"	H0706	No Charge
8'0"	H0800	No Charge

## Door Width Options

Door Width	Specify Quick Code	Add or Deduct
32"	W032	No Charge
36"	(standard)	No Charge
42"	W042	No Charge
48"	W048	Add \$43.00 per device

## Door Thickness Options

Door Thickness	Specify Quick Code	Add or Deduct
1-3/4"	(standard)	No Charge
2"	D200	No Charge
2-1/4"	D214	No Charge

## Miscellaneous Options

Description	Specify	Add or Deduct
Knurling outside and inside (Embossed Touchbar - device side)	M20	Add \$175.00 per device
Knurling outside only (trim side) <sup>1</sup>	M21	Add \$82.00 per device
Knurling inside only (Embossed Touchbar - device side)	M22	Add \$93.00 per device
Abrasive coat outside and inside (trim and device)	M23	Add \$111.00 per device
Abrasive coat inside only (device side)	M24	Add \$58.00 per device
Abrasive coat outside only (trim side)	M25	Add \$53.00 per device
PathLite™ Photoluminescent Touchbar cover	M49	Add \$417.00 per device
Less dogging	M51	No Charge
Cylinder dogging (less cylinder)	M52	Add \$94.00 per device
Mullion stabilizer	M57	Add \$63.00 per mullion
Parabolic Design Exit Trim	M60	Add \$94.00 per device
MicroShield® Antimicrobial finish coating	626C	Add \$79.00 (Exit Devices & Trims (ordered separately) Add \$98.00 (Exit Devices & Outside Trims (ordered together)
MicroShield® Antimicrobial finish coating	630C	

1. Not available with Vineyard™ or Muséo® levers

# FE5400S

## Multi-Point Exit Device Latching System



### Removable Mullions

USA & Canada Prices Effective February 1, 2022

Door Height	Description	Specify	Price
Up to 7'0"	Steel Mullion - 3 Hour Fire Rated, Windstorm Certified	CRFE707A <sup>4</sup>	\$1,434.00
Up to 8'0"	Steel Mullion - 3 Hour Fire Rated, Windstorm Certified	CRFE708A <sup>4</sup>	\$1,444.00

**Note:**

- 4. For use with UL listed door assemblies that comply to FEMA 361 and ICC 500.  
For the latest listings on compliant door assemblies visit our website at [corbinrusswin.com](http://corbinrusswin.com)

### Options

Description	Specify Quick Code	Add or Deduct
Door frame filler block for double rabbetted frames	M95	Add \$42.00 per mullion
Door frame angle bracket for aluminum frames	M96	Add \$42.00 per mullion

# MP6600 Series Multi-Point Locks

USA & Canada Prices Effective February 1, 2022

<b>Door</b>	1-3/4" thick door only – MP6600 Series requires utilizing Ceco Door and Curries doors and frames. McKINNEY® hinges
<b>Mounting</b>	Supplied fasteners are for metal doors with thru-bolts for trim
<b>Hand</b>	Handed; specify RHR, LHR, RH or LH
<b>Lockbody</b>	Unique mortise lockbody assembly used for a variety of applications
<b>Top Bolt</b>	Adjustable stainless steel 3/4" square bolt with 11/16" engagement; 5/16" steel reinforcement plate
<b>Bottom Bolt</b>	Adjustable stainless steel 3/4" square bolt with 5/8" engagement; 1/4" steel reinforcement plate
<b>Center Bolts</b>	Latchbolt is stainless steel with 3/4" projection. One piece, anti-friction reversible catch. Deadbolt is one piece hardened stainless steel with 1" projection
<b>Lock Front</b>	1/8" steel mortise front reinforced with 13/64" thick lock edge stiffener
<b>Center Bolt Strike</b>	1/4" thick stainless steel
<b>Backset</b>	Lever: 2-3/4" standard; Rods: 5-1/4"
<b>Door Thickness</b>	1-3/4" standard
<b>Maximum Opening</b>	Single door 2'8" x 6'8" up to 4'0" x 10'0" and double doors 6'0" x 6'8" up to 8'0" x 10'0" (Double doors require 2-988CR surface bolts)
<b>UL Fire Listed</b>	UL 3-hour fire rating
<b>Trim</b>	Multiple sectional and escutcheon mortise trim with Standard or Muséo levers
<b>Cylinder</b>	Multiple mortise cylinders

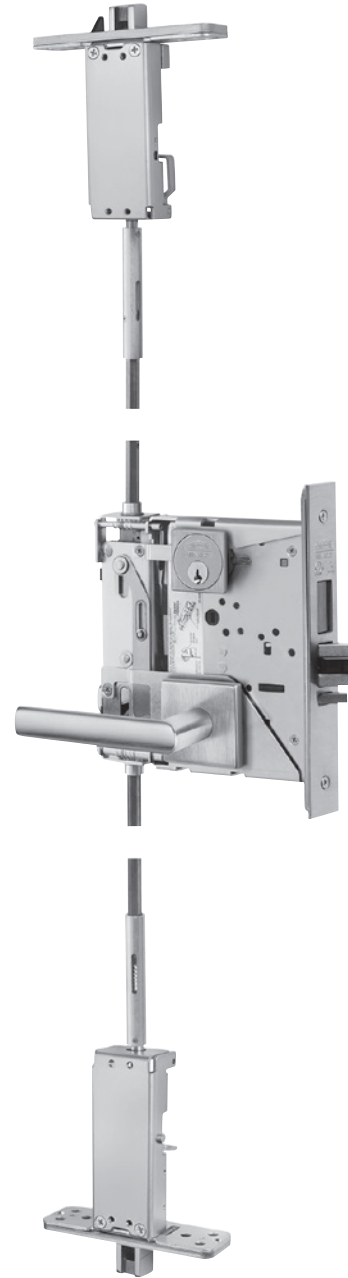

## How to Order Ordering Example

Quantity	Series/ Function	Trim	Finish	Hand
100	MP6618	ASM	626	RHR

Note: Concealed vertical rods, top & bottom latches, and the lockbody cassette will be factory installed. All other hardware components are shipped directly to the customer and must be installed by a factory trained installer. Invoices for the door will be separate from the hardware invoice. The hardware invoice will include the concealed vertical assembly and the trim components.

# MP6600 Series Multi-Point Locks



USA & Canada Prices Effective February 1, 2022

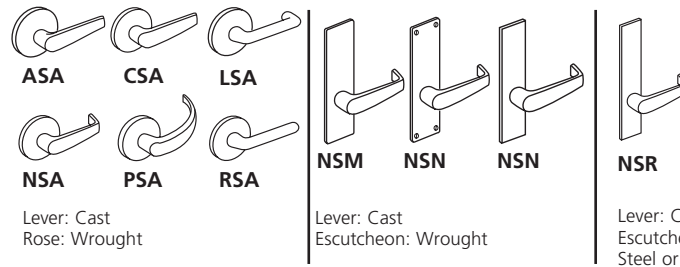

Available Functions	Description	Levers: AS, CS, ES, LS, NS, PS, RS Roses: A, G		Levers: AS, CS, ES, LS, NS, PS, RS Escutcheons: M, N, LW1		Levers: AS, CS, ES, LS, NS, PS, RS Escutcheons: RE1/RE2, RE3/RE4	
		613E, 626, BSP, WSP	605, 606, 611, 612, 613, 618, 619, 625, 629, 630, 722	613E, 626, BSP, WSP	605, 606, 611, 612, 613, 618, 619, 625, 629, 630, 722	613E, 626, BSP, WSP	605, 606, 611, 612, 613, 618, 619, 625, 629, 630, 722
<b>Single Cylinder without Deadbolt</b>							
MP6654 MP6655 MP6666 MP6656	Office/Entry Classroom Office & Inner Entry Lock Holdback	\$3,813.00	\$3,837.00	\$3,833.00	\$3,857.00	\$3,887.00	\$3,911.00
<b>Single Cylinder with Deadbolt</b>							
MP6618 MP6624 MP6665 MP6627	Classroom Storeroom Exit/Dormitory Closet or Storeroom	\$3,813.00	\$3,837.00	\$3,833.00	\$3,857.00	\$3,887.00	\$3,911.00
<b>Non-Keyed</b>							
MP6680 MP6609 MP6630 MP6620 MP6610 MP6660	Inside Passage Passage Privacy Bath Privacy Bedroom Passage or Closet Privacy Bath/Bedroom	\$3,813.00	\$3,837.00	\$3,833.00	\$3,857.00	\$3,887.00	\$3,911.00
<b>Double Cylinder with Deadbolt</b>							
MP6622 MP6662 MP6672 MP6673 MP6675	Store Door Classroom Security Intruder Deadbolt Classroom Security Intruder Aux. Deadbolt Classroom Security Intruder Deadlatch Security Deadbolt	\$3,813.00	\$3,837.00	\$3,833.00	\$3,857.00	\$3,887.00	\$3,911.00
<b>Double Cylinder without Deadbolt</b>							
MP6652 MP6691	Classroom Security Intruder Latchbolt Classroom Security Holdback	\$3,813.00	\$3,837.00	\$3,833.00	\$3,857.00	\$3,887.00	\$3,911.00
<b>EAC</b>							
MP66609 x NAC SAF / SEC	No Key Override With Deadbolt Fail Safe/Secure 12V/24V	\$4,033.00	\$4,057.00	\$4,053.00	\$4,077.00	\$4,107.00	\$4,131.00
MP66608 x NAC SAF / SEC	Key Override With Deadbolt Fail Safe/Secure 12V/24V	\$4,187.00	\$4,211.00	\$4,207.00	\$4,231.00	\$4,261.00	\$4,285.00
MP66932 SAF / SEC	NAC Fail Safe/Secure Lock, 12/24 Volt	\$4,033.00	\$4,057.00	\$4,053.00	\$4,077.00	\$4,107.00	\$4,131.00
MP66606 SAF / SEC	NAC Key Override And No Deadbolt Fail Safe/Secure 12V/24V	\$4,093.00	\$4,117.00	\$4,113.00	\$4,137.00	\$4,167.00	\$4,191.00
MP66934	NAC No Deadbolt And Key Override	\$4,187.00	\$4,211.00	\$4,207.00	\$4,231.00	\$4,261.00	\$4,285.00
MP66733	NAC No Deadbolt And No Key Override	\$4,127.00	\$4,151.00	\$4,147.00	\$4,171.00	\$4,201.00	\$4,225.00

# MP6600 Series Multi-Point Locks

USA & Canada Prices Effective February 1, 2022

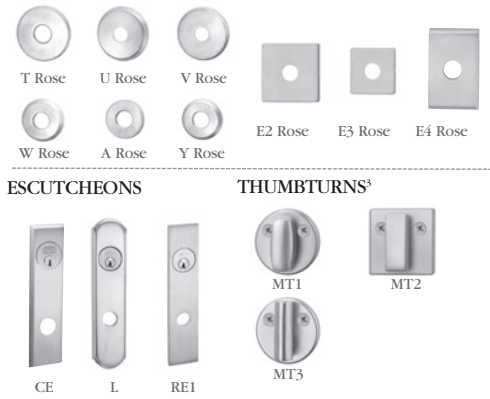
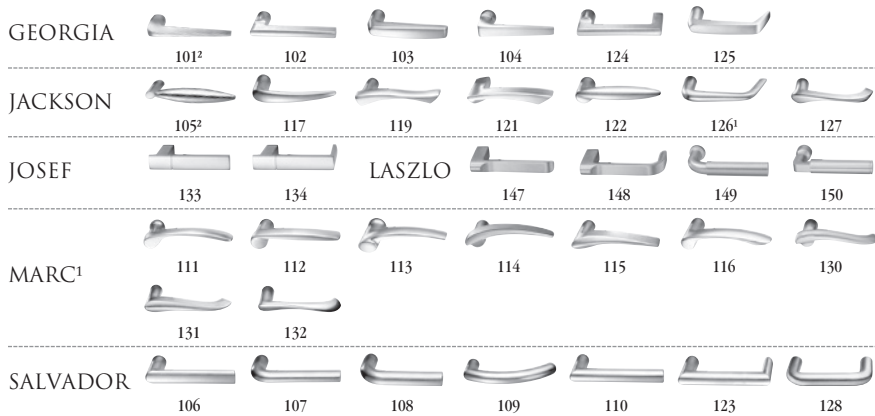

1. Handed: specify hand when ordering
2. Contact factory for current lead time
3. Specify thumbturn as quick code. Thumbturn backplate will match shape of rose chosen (i.e. round or square). Not available with escutcheons.

\*629 and \*630 finish options are Not available for all Muséo levers. Please refer to page 20 for availability.

613E	Dark Oxidized Satin Bronze - Equivalent	605	Bright Brass, Clear Coated	618	Bright Nickel Plated
626	Satin Chromium Plated	606	Satin Brass, Clear Coated	619	Satin Nickel Plated
BSP	Black Suede Powder Coat	611	Bright Bronze, Clear Coated	625	Bright Chromium Plated
WSP	White Suede Powder Coat	612	Satin Bronze, Clear Coated	629*	Bright Stainless Steel
		613	Dark Oxidized Satin Bronze, Oil Rubbed	630*	Satin Stainless Steel
		613L	Dark Oxidized Satin Bronze, Clear Coated	722	Black Oxidized Bronze, Oil Rubbed

Functions	Description		
<b>Single Cylinder without Deadbolt   ESCUTCHEONS: L, CE, RE1</b>			
MP6654 MP6655 MP6666 MP6656	Office/Entry Classroom Office & Inner Entry Lock Holdback	\$3,857.00	\$3,881.00
<b>Single Cylinder with Deadbolt   ESCUTCHEONS: L, CE, RE1</b>			
MP6618 MP6624 MP6665 MP6627	Classroom Storeroom Exit/Dormitory Closet or Storeroom	\$3,857.00	\$3,881.00
<b>Non-Keyed   ESCUTCHEONS: L, CE, RE1</b>			
MP6680 MP6609 MP6630 MP6620 MP6610 MP6660	Inside Passage Passage Privacy Bath Privacy Bedroom Passage or Closet Privacy Bath/Bedroom	\$3,857.00	\$3,881.00
<b>Double Cylinder with Deadbolt   ESCUTCHEONS: L, CE, RE1</b>			
MP6622 MP6662 MP6672 MP6673 MP6675	Store Door Classroom Security Intruder Deadbolt Classroom Security Intruder Auxiliary Deadbolt Classroom Security Intruder Deadlatch Security Deadbolt	\$3,857.00	\$3,881.00
<b>Double Cylinder without Deadbolt   ESCUTCHEONS: L, CE, RE1</b>			
MP6652 MP6691	Classroom Security Intruder Latchbolt Classroom Security Holdback	\$3,857.00	\$3,881.00
<b>EAC   ESCUTCHEONS: L, CE, RE1</b>			
MP66609 x NAC SAF / SEC	No Key Override With Deadbolt Fail Safe/Secure 12V/24V	\$4,077.00	\$4,101.00
MP66608 x NAC SAF / SEC	Key Override With Deadbolt Fail Safe/Secure 12V/24V	\$4,231.00	\$4,255.00
MP66932 SAF / SEC	NAC Fail Safe/Secure Lock, 12/24 Volt	\$4,077.00	\$4,101.00
MP66606 SAF / SEC	NAC Key Override And No Deadbolt Fail Safe/Secure 12V/24V	\$4,137.00	\$4,161.00
MP66934	NAC No Deadbolt And Key Override	\$4,231.00	\$4,255.00
MP66733	NAC No Deadbolt And No Key Override	\$4,171.00	\$4,195.00

**MP6600 Series  
Multi-Point Locks**

USA & Canada Prices Effective February 1, 2022

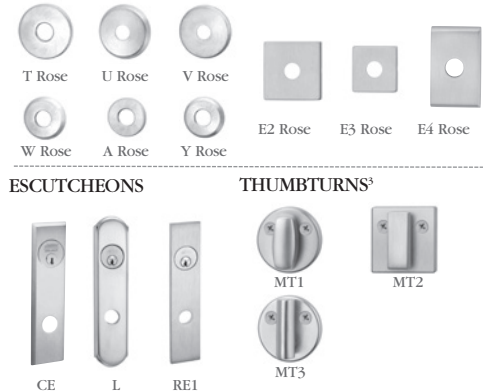
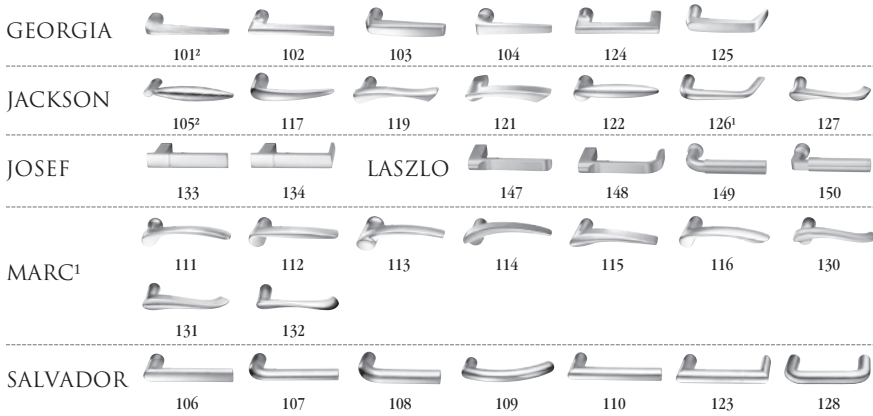

1. Handed: specify hand when ordering
  2. Contact factory for current lead time
  3. Specify thumbturn as quick code. Thumbturn backplate will match shape of rose chosen (i.e. round or square). Not available with escutcheons.
- \*629 and \*630 finish options are Not available for all Muséo levers. Please refer to page 20 for availability.

613E	Dark Oxidized Satin Bronze	- Equivalent	605	Bright Brass, Clear Coated	618	Bright Nickel Plated
626	Satin Chromium Plated		606	Satin Brass, Clear Coated	619	Satin Nickel Plated
BSP	Black Suede Powder Coat		611	Bright Bronze, Clear Coated	625	Bright Chromium Plated
WSP	White Suede Powder Coat		612	Satin Bronze, Clear Coated	629*	Bright Stainless Steel
			613	Dark Oxidized Satin Bronze, Oil Rubbed	630*	Satin Stainless Steel
			613L	Dark Oxidized Satin Bronze, Clear Coated	722	Black Oxidized Bronze, Oil Rubbed

Functions	Description		
<b>Single Cylinder without Deadbolt   ROSES: A, T, U, V, W, Y, E2, E3, E4</b>			
MP6654 MP6655 MP6666 MP6656	Office/Entry Classroom Office & Inner Entry Lock Holdback	\$3,813.00	\$3,837.00
<b>Single Cylinder with Deadbolt   ROSES: A, T, U, V, W, Y, E2, E3, E4</b>			
MP6618 MP6624 MP6665 MP6627	Classroom Storeroom Exit/Dormitory Closet or Storeroom	\$3,813.00	\$3,837.00
<b>Non-Keyed   ROSES ROSES: A, T, U, V, W, Y, E2, E3, E4</b>			
MP6680 MP6609 MP6630 MP6620 MP6610 MP6660	Inside Passage Passage Privacy Bath Privacy Bedroom Passage or Closet Privacy Bath/Bedroom	\$3,813.00	\$3,837.00
<b>Double Cylinder with Deadbolt   ROSES: A, T, U, V, W, Y, E2, E3, E4</b>			
MP6622 MP6662 MP6672 MP6673 MP6675	Store Door Classroom Security Intruder Deadbolt Classroom Security Intruder Auxiliary Deadbolt Classroom Security Intruder Deadlatch Security Deadbolt	\$3,813.00	\$3,837.00
<b>Double Cylinder without Deadbolt   ROSES: A, T, U, V, W, Y, E2, E3, E4</b>			
MP6652 MP6691	Classroom Security Intruder Latchbolt Classroom Security Holdback	\$3,813.00	\$3,837.00
<b>EAC   ROSES: A, T, U, V, W, Y, E2, E3, E4</b>			
MP66609 x NAC SAF / SEC	No Key Override With Deadbolt Fail Safe/Secure 12V/24V	\$4,033.00	\$4,057.00
MP66608 x NAC SAF / SEC	Key Override With Deadbolt Fail Safe/Secure 12V/24V	\$4,187.00	\$4,211.00
MP66932 SAF / SEC	NAC Fail Safe/Secure Lock, 12/24 Volt	\$4,033.00	\$4,057.00
MP66606 SAF / SEC	NAC Key Override And No Deadbolt Fail Safe/Secure 12V/24V	\$4,093.00	\$4,117.00
MP66934	NAC No Deadbolt And Key Override	\$4,187.00	\$4,211.00
MP66733	NAC No Deadbolt And No Key Override	\$4,127.00	\$4,151.00

# MP6600 Series Multi-Point Locks



USA & Canada Prices Effective February 1, 2022

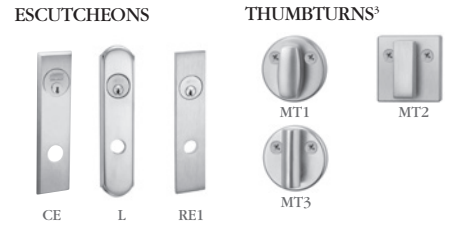
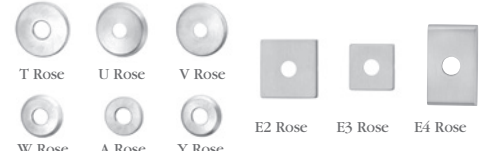
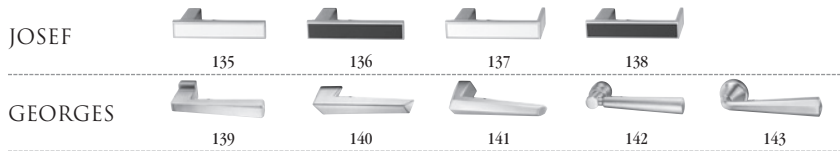

1. Handed: specify hand when ordering
2. Contact factory for current lead time
3. Specify thumbturn as quick code. Thumbturn backplate will match shape of rose chosen (i.e. round or square). Not available with escutcheons.

613E	Dark Oxidized Satin Bronze	605	Bright Brass, Clear Coated	618	Bright Nickel Plated
626	Satin Chromium Plated	606	Satin Brass, Clear Coated	609	Satin Nickel Plated
BSP	Black Suede Powder Coat	611	Bright Bronze, Clear Coated	625	Bright Chromium Plated
WSP	White Suede Powder Coat	612	Satin Bronze, Clear Coated	629	Bright Stainless Steel
		613	Dark Oxidized Satin Bronze, Oil Rubbed	630	Satin Stainless Steel
		613L	Dark Oxidized Satin Bronze, Clear Coated	722	Black Oxidized Bronze, Oil Rubbed

Functions	Description		
<b>Single Cylinder without Deadbolt   ESCUTCHEONS: L, CE, RE1</b>			
MP6654 MP6655 MP6666 MP6656	Office/Entry Classroom Office & Inner Entry Lock Holdback	\$3,954.00	\$3,978.00
<b>Single Cylinder with Deadbolt   ESCUTCHEONS: L, CE, RE1</b>			
MP6618 MP6624 MP6665 MP6627	Classroom Storeroom Exit/Dormitory Closet or Storeroom	\$3,954.00	\$3,978.00
<b>Non-Keyed   ESCUTCHEONS: L, CE, RE1</b>			
MP6680 MP6609 MP6630 MP6620 MP6610 MP6660	Inside Passage Passage Privacy Bath Privacy Bedroom Passage or Closet Privacy Bath/Bedroom	\$3,954.00	\$3,978.00
<b>Double Cylinder with Deadbolt   ESCUTCHEONS: L, CE, RE1</b>			
MP6622 MP6662 MP6672 MP6673 MP6675	Store Door Classroom Security Intruder Deadbolt Classroom Security Intruder Auxiliary Deadbolt Classroom Security Intruder Deadlatch Security Deadbolt	\$3,954.00	\$3,978.00
<b>Double Cylinder without Deadbolt   ESCUTCHEONS: L, CE, RE1</b>			
MP6652 MP6691	Classroom Security Intruder Latchbolt Classroom Security Holdback	\$3,954.00	\$3,978.00
<b>EAC   ESCUTCHEONS: L, CE, RE1</b>			
MP66609 x NAC SAF / SEC	No Key Override With Deadbolt Fail Safe/Secure 12V/24V	\$4,174.00	\$4,198.00
MP66608 x NAC SAF / SEC	Key Override With Deadbolt Fail Safe/Secure 12V/24V	\$4,328.00	\$4,352.00
MP66932 SAF / SEC	NAC Fail Safe/Secure Lock, 12/24 Volt	\$4,174.00	\$4,198.00
MP66606 SAF / SEC	NAC Key Override And No Deadbolt Fail Safe/Secure 12V/24V	\$4,234.00	\$4,258.00
MP66934	NAC No Deadbolt And Key Override	\$4,328.00	\$4,352.00
MP66733	NAC No Deadbolt And No Key Override	\$4,268.00	\$4,292.00

# MP6600 Series Multi-Point Locks

USA & Canada Prices Effective February 1, 2022

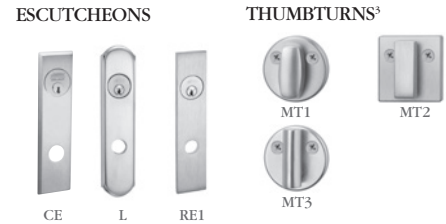
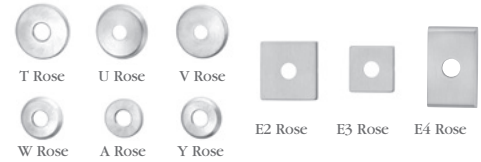
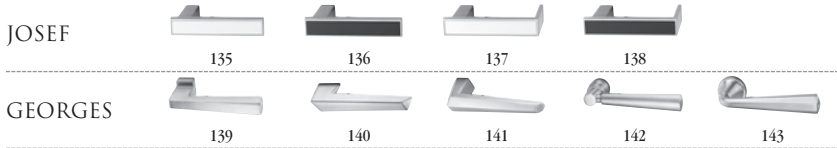

1. Handed: specify hand when ordering
2. Contact factory for current lead time
3. Specify thumbturn as quick code. Thumbturn backplate will match shape of rose chosen (i.e. round or square). Not available with escutcheons.

613E Dark Oxidized Satin Bronze - Equivalent	605 Bright Brass, Clear Coated	618 Bright Nickel Plated
626 Satin Chromium Plated	606 Satin Brass, Clear Coated	619 Satin Nickel Plated
BSP Black Suede Powder Coat	611 Bright Bronze, Clear Coated	625 Bright Chromium Plated
WSP White Suede Powder Coat	612 Satin Bronze, Clear Coated	629 Bright Stainless Steel
	613 Dark Oxidized Satin Bronze, Oil Rubbed	630 Satin Stainless Steel
	613L Dark Oxidized Satin Bronze, Clear Coated	722 Black Oxidized Bronze, Oil Rubbed

Functions	Description		
<b>Single Cylinder without Deadbolt   ROSES: A, T, U, V, W, Y, E2, E3, E4</b>			
MP6654 MP6655 MP6666 MP6656	Office/Entry Classroom Office & Inner Entry Lock Holdback	\$3,910.00	\$3,934.00
<b>Single Cylinder with Deadbolt   ROSES: A, T, U, V, W, Y, E2, E3, E4</b>			
MP6618 MP6624 MP6665 MP6627	Classroom Storeroom Exit/Dormitory Closet or Storeroom	\$3,910.00	\$3,934.00
<b>Non-Keyed   ROSES: A, T, U, V, W, Y, E2, E3, E4</b>			
MP6680 MP6609 MP6630 MP6620 MP6610 MP6660	Inside Passage Passage Privacy Bath Privacy Bedroom Passage or Closet Privacy Bath/Bedroom	\$3,910.00	\$3,934.00
<b>Double Cylinder with Deadbolt   ROSES: A, T, U, V, W, Y, E2, E3, E4</b>			
MP6622 MP6662 MP6672 MP6673 MP6675	Store Door Classroom Security Intruder Deadbolt Classroom Security Intruder Auxiliary Deadbolt Classroom Security Intruder Deadlatch Security Deadbolt	\$3,910.00	\$3,934.00
<b>Double Cylinder without Deadbolt   ROSES: A, T, U, V, W, Y, E2, E3, E4</b>			
MP6652 MP6691	Classroom Security Intruder Latchbolt Classroom Security Holdback	\$3,910.00	\$3,934.00
<b>EAC   ROSES: A, T, U, V, W, Y, E2, E3, E4</b>			
MP66609 x NAC SAF / SEC	No Key Override With Deadbolt Fail Safe/Secure 12V/24V	\$4,130.00	\$4,154.00
MP66608 x NAC SAF / SEC	Key Override With Deadbolt Fail Safe/Secure 12V/24V	\$4,284.00	\$4,308.00
MP66932 SAF / SEC	NAC Fail Safe/Secure Lock, 12/24 Volt	\$4,130.00	\$4,154.00
MP66606 SAF / SEC	NAC Key Override And No Deadbolt Fail Safe/Secure 12V/24V	\$4,190.00	\$4,214.00
MP66934	NAC No Deadbolt And Key Override	\$4,284.00	\$4,308.00
MP66733	NAC No Deadbolt And No Key Override	\$4,224.00	\$4,248.00



# MP6600 Series Multi-Point Locks



USA & Canada Prices Effective February 1, 2022



\*613E, BSP, WSP finishes are not available with 21M levers.

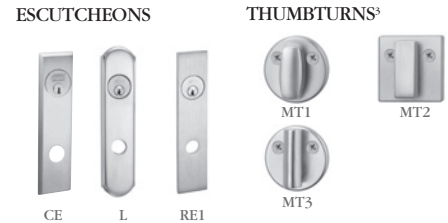
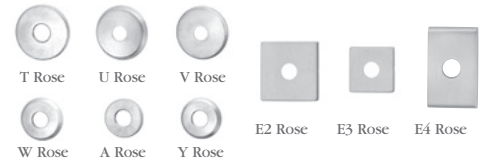

Specify thumbturn as quick code. Thumbturn backplate will match shape of rose chosen (i.e. round or square)

- 613E Dark Oxidized Satin Bronze – Equivalent
- 629 Bright Stainless Steel
- 630 Satin Stainless Steel
- BSP Black Suede Powder Coat
- WSP White Suede Powder Coat

Functions	Description	
<b>Single Cylinder without Deadbolt   ESCUTCHEONS: L, CE, RE1</b>		
MP6654 MP6655 MP6666 MP6656	Office/Entry Classroom Office & Inner Entry Lock Holdback	\$3,958.00
<b>Single Cylinder with Deadbolt   ESCUTCHEONS: L, CE, RE1</b>		
MP6618 MP6624 MP6665 MP6627	Classroom Storeroom Exit/Dormitory Closet or Storeroom	\$3,958.00
<b>Non-Keyed   ESCUTCHEONS: L, CE, RE1</b>		
MP6680 MP6609 MP6630 MP6620 MP6610 MP6660	Inside Passage Passage Privacy Bath Privacy Bedroom Passage or Closet Privacy Bath/Bedroom	\$3,958.00
<b>Double Cylinder with Deadbolt   ESCUTCHEONS: L, CE, RE1</b>		
MP6622 MP6662 MP6672 MP6673 MP6675	Store Door Classroom Security Intruder Deadbolt Classroom Security Intruder Auxiliary Deadbolt Classroom Security Intruder Deadlatch Security Deadbolt	\$3,958.00
<b>Double Cylinder without Deadbolt   ESCUTCHEONS: L, CE, RE1</b>		
MP6652 MP6691	Classroom Security Intruder Latchbolt Classroom Security Holdback	\$3,958.00
<b>EAC   ESCUTCHEONS: L, CE, RE1</b>		
MP66609 x NAC SAF / SEC	No Key Override With Deadbolt Fail Safe/Secure 12V/24V	\$4,178.00
MP66608 x NAC SAF / SEC	Key Override With Deadbolt Fail Safe/Secure 12V/24V	\$4,332.00
MP66932 SAF / SEC	NAC Fail Safe/Secure Lock, 12/24 Volt	\$4,178.00
MP66606 SAF / SEC	NAC Key Override And No Deadbolt Fail Safe/Secure 12V/24V	\$4,238.00
MP66934	NAC No Deadbolt And Key Override	\$4,332.00
MP66733	NAC No Deadbolt And No Key Override	\$4,272.00

# MP6600 Series Multi-Point Locks

USA & Canada Prices Effective February 1, 2022

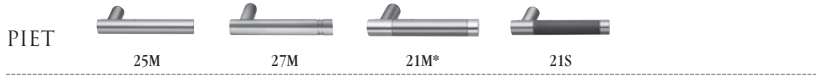

\*613E, BSP, WSP finishes are not available with 21M levers.

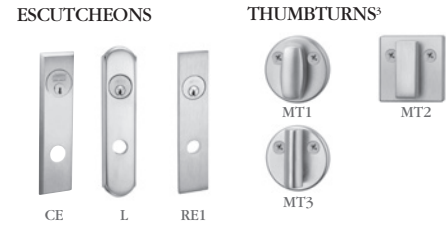
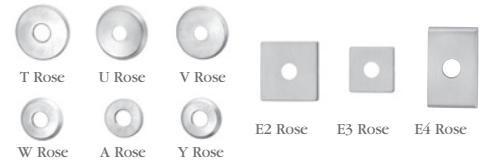

Specify thumbturn as quick code. Thumbturn backplate will match shape of rose chosen (i.e. round or square)

613E	Dark Oxidized Satin Bronze – Equivalent
629	Bright Stainless Steel
630	Satin Stainless Steel
BSP	Black Suede Powder Coat
WSP	White Suede Powder Coat

Functions	Description	
<b>Single Cylinder without Deadbolt   ROSES: A, T, U, V, W, Y, E2, E3, E4</b>		
MP6654 MP6655 MP6666 MP6656	Office/Entry Classroom Office & Inner Entry Lock Holdback	\$3,914.00
<b>Single Cylinder with Deadbolt   ROSES: A, T, U, V, W, Y, E2, E3, E4</b>		
MP6618 MP6624 MP6665 MP6627	Classroom Storeroom Exit/Dormitory Closet or Storeroom	\$3,914.00
<b>Non-Keyed   ROSES: A, T, U, V, W, Y, E2, E3, E4</b>		
MP6680 MP6609 MP6630 MP6620 MP6610 MP6660	Inside Passage Passage Privacy Bath Privacy Bedroom Passage or Closet Privacy Bath/Bedroom	\$3,914.00
<b>Double Cylinder with Deadbolt   ROSES: A, T, U, V, W, Y, E2, E3, E4</b>		
MP6622 MP6662 MP6672 MP6673 MP6675	Store Door Classroom Security Intruder Deadbolt Classroom Security Intruder Auxiliary Deadbolt Classroom Security Intruder Deadlatch Security Deadbolt	\$3,914.00
<b>Double Cylinder without Deadbolt   ROSES: A, T, U, V, W, Y, E2, E3, E4</b>		
MP6652 MP6691	Classroom Security Intruder Latchbolt Classroom Security Holdback	\$3,914.00
<b>EAC   ROSES: A, T, U, V, W, Y, E2, E3, E4</b>		
MP66609 x NAC SAF / SEC	No Key Override With Deadbolt Fail Safe/Secure 12V/24V	\$4,134.00
MP66608 x NAC SAF / SEC	Key Override With Deadbolt Fail Safe/Secure 12V/24V	\$4,288.00
MP66932 SAF / SEC	NAC Fail Safe/Secure Lock, 12/24 Volt	\$4,134.00
MP66606 SAF / SEC	NAC Key Override And No Deadbolt Fail Safe/Secure 12V/24V	\$4,194.00
MP66934	NAC No Deadbolt And Key Override	\$4,288.00
MP66733	NAC No Deadbolt And No Key Override	\$4,228.00

# MP6600 Series Multi-Point Locks



USA & Canada Prices Effective February 1, 2022

PIET

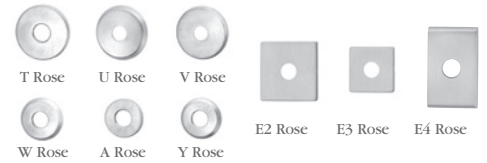

ESCUTCHEONS

THUMBTURNS<sup>3</sup>



Specify thumbturn as quick code. Thumbturn backplate will match shape of rose chosen (i.e. round or square)

- 613E Dark Oxidized Satin Bronze – Equivalent
- 629 Bright Stainless Steel
- 630 Satin Stainless Steel
- BSP Black Suede Powder Coat
- WSP White Suede Powder Coat

Functions	Description	
<b>Single Cylinder without Deadbolt   ESCUTCHEONS: L, CE, RE1</b>		
MP6654 MP6655 MP6666 MP6656	Office/Entry Classroom Office & Inner Entry Lock Holdback	\$3,978.00
<b>Single Cylinder with Deadbolt   ESCUTCHEONS: L, CE, RE1</b>		
MP6618 MP6624 MP6665 MP6627	Classroom Storeroom Exit/Dormitory Closet or Storeroom	\$3,978.00
<b>Non-Keyed   ESCUTCHEONS: L, CE, RE1</b>		
MP6680 MP6609 MP6630 MP6620 MP6610 MP6660	Inside Passage Passage Privacy Bath Privacy Bedroom Passage or Closet Privacy Bath/Bedroom	\$3,978.00
<b>Double Cylinder with Deadbolt   ESCUTCHEONS: L, CE, RE1</b>		
MP6622 MP6662 MP6672 MP6673 MP6675	Store Door Classroom Security Intruder Deadbolt Classroom Security Intruder Auxiliary Deadbolt Classroom Security Intruder Deadlatch Security Deadbolt	\$3,978.00
<b>Double Cylinder without Deadbolt   ESCUTCHEONS: L, CE, RE1</b>		
MP6652 MP6691	Classroom Security Intruder Latchbolt Classroom Security Holdback	\$3,978.00
<b>EAC   ESCUTCHEONS: L, CE, RE1</b>		
MP66609 x NAC SAF / SEC	No Key Override With Deadbolt Fail Safe/Secure 12V/24V	\$4,198.00
MP66608 x NAC SAF / SEC	Key Override With Deadbolt Fail Safe/Secure 12V/24V	\$4,352.00
MP66932 SAF / SEC	NAC Fail Safe/Secure Lock, 12/24 Volt	\$4,198.00
MP66606 SAF / SEC	NAC Key Override And No Deadbolt Fail Safe/Secure 12V/24V	\$4,258.00
MP66934	NAC No Deadbolt And Key Override	\$4,352.00
MP66733	NAC No Deadbolt And No Key Override	\$4,292.00

**MP6600 Series  
Multi-Point Locks**

USA & Canada Prices Effective February 1, 2022

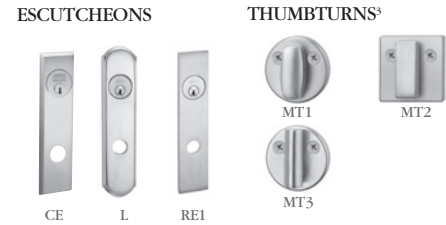
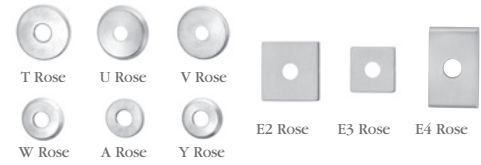

Specify thumbturn as quick code. Thumbturn backplate will match shape of rose chosen (i.e. round or square)

- 613E Dark Oxidized Satin Bronze – Equivalent
- 629 Bright Stainless Steel
- 630 Satin Stainless Steel
- BSP Black Suede Powder Coat
- WSP White Suede Powder Coat

Functions	Description	
<b>Single Cylinder without Deadbolt   ROSES: A, T, U, V, W, Y, E2, E3, E4</b>		
MP6654 MP6655 MP6666 MP6656	Office/Entry Classroom Office & Inner Entry Lock Holdback	\$3,934.00
<b>Single Cylinder with Deadbolt   ROSES: A, T, U, V, W, Y, E2, E3, E4</b>		
MP6618 MP6624 MP6665 MP6627	Classroom Storeroom Exit/Dormitory Closet or Storeroom	\$3,934.00
<b>Non-Keyed   ROSES: A, T, U, V, W, Y, E2, E3, E4</b>		
MP6680 MP6609 MP6630 MP6620 MP6610 MP6660	Inside Passage Passage Privacy Bath Privacy Bedroom Passage or Closet Privacy Bath/Bedroom	\$3,934.00
<b>Double Cylinder with Deadbolt   ROSES: A, T, U, V, W, Y, E2, E3, E4</b>		
MP6622 MP6662 MP6672 MP6673 MP6675	Store Door Classroom Security Intruder Deadbolt Classroom Security Intruder Auxiliary Deadbolt Classroom Security Intruder Deadlatch Security Deadbolt	\$3,934.00
<b>Double Cylinder without Deadbolt   ROSES: A, T, U, V, W, Y, E2, E3, E4</b>		
MP6652 MP6691	Classroom Security Intruder Latchbolt Classroom Security Holdback	\$3,934.00
<b>EAC   ROSES: A, T, U, V, W, Y, E2, E3, E4</b>		
MP66609 x NAC SAF / SEC	No Key Override With Deadbolt Fail Safe/Secure 12V/24V	\$4,154.00
MP66608 x NAC SAF / SEC	Key Override With Deadbolt Fail Safe/Secure 12V/24V	\$4,308.00
MP66932 SAF / SEC	NAC Fail Safe/Secure Lock, 12/24 Volt	\$4,154.00
MP66606 SAF / SEC	NAC Key Override And No Deadbolt Fail Safe/Secure 12V/24V	\$4,214.00
MP66934	NAC No Deadbolt And Key Override	\$4,308.00
MP66733	NAC No Deadbolt And No Key Override	\$4,248.00

# MP6600 Series Multi-Point Locks



USA & Canada Prices Effective February 1, 2022

Cylinder Options		
Description	Specify Quick Code	Add or Deduct
Conventional 6-pin	(standard)	No Charge
Conventional 7-pin	7P	Add \$2.00 per cylinder
Less Standard Cylinder	LC	Deduct \$105.00 per cylinder
Less Concealed Shell Cylinder	PO-LC	Add \$5.00 per lockset
<b>LFIC</b>		
LFIC 6-pin	C6	Add \$91.00 per cylinder
LFIC 6-pin Less Core	CL6	No Charge
LFIC 6-pin with Temporary Construction Core (Red)	CT6R	Add \$91.00 per cylinder
LFIC 6-pin with Temporary Construction Core (Blue)	CT6B	Add \$91.00 per cylinder
LFIC 6-pin with Temporary Construction Core (Green)	CT6G	Add \$91.00 per cylinder
LFIC 6-pin with Temporary Disposable Core	CT6D	No Charge
LFIC 7-pin	C7	Add \$93.00 per cylinder
LFIC 7-pin Less Core	CL7	Add \$2.00 per cylinder
LFIC 7-pin with Temporary Construction Core (Red)	CT7R	Add \$93.00 per cylinder
LFIC 7-pin with Temporary Construction Core (Blue)	CT7B	Add \$93.00 per cylinder
LFIC 7-pin with Temporary Construction Core (Green)	CT7G	Add \$93.00 per cylinder
LFIC 7-pin with Temporary Disposable Core	CT7D	Add \$2.00 per cylinder
<b>SFIC</b>		
SFIC 6-pin	C6S	Add \$82.00 per cylinder
SFIC 6-pin with Temporary Construction Core (Blue)	CT6SB	Add \$82.00 per cylinder
SFIC 6-pin with SFIC Disposable Temporary Core	CT6SD	No Charge
SFIC 6-pin with Less Core	CLS6	No Charge
SFIC 7-pin	C7S	Add \$82.00 per cylinder
SFIC 7-pin with Temporary Construction Core (Blue)	CT7SB	Add \$82.00 per cylinder
SFIC 7-pin with SFIC Disposable Temporary Core	CT7SD	Add \$2.00 per cylinder
SFIC 6-pin with Less Core	CLS7	Add \$2.00 per cylinder
<b>Security</b>		
Security <sup>4</sup>	HS	Add \$139.00 per cylinder
Security LFIC <sup>1,4</sup>	CHS	Add \$226.00 per cylinder
<b>Access 3</b>		
Access 3 Patented	AP	No Charge
Access 3 Security	AS	Add \$61.00 per cylinder
Access 3 High Security, UL 437	AHS	Add \$86.00 per cylinder
Access 3 LFIC Patented	ACP	Add \$91.00 per cylinder
Access 3 LFIC Security	ACS	Add \$147.00 per cylinder
Access 3 LFIC High Security, UL 437	ACHS	Add \$169.00 per cylinder
<b>Pyramid</b>		
Pyramid Security Fixed Core	PS	Add \$74.00 per cylinder
Pyramid Security LFIC	PCS	Add \$159.00 per cylinder
Pyramid High Security Fixed Core	PHS	Add \$110.00 per cylinder
Pyramid High Security LFIC	PCHS	Add \$196.00 per cylinder
Pyramid LFIC with Temporary Construction Core <sup>3</sup>	CTP	Add \$91.00 per cylinder
Pyramid LFIC with Temporary Disposable Core <sup>3</sup>	CTPD	No Charge
Pyramid LFIC Less Core	CLP	No Charge
<b>Other</b>		
Master Ring <sup>2</sup>	MR	Add \$79.00 per cylinder
Flex Head Cylinder, 6-pin (sectional trim)	FX6	Add \$95.00 per cylinder
Flex Head Cylinder, 7-pin (sectional trim)	FX7	Add \$97.00 per cylinder
Flex Head Master Ring (sectional trim)	FXM	Add \$154.00 per cylinder
Plug only to show, 6-pin (concealed shell) (available for M and R escutcheons and single cylinder functions only)	P06	Add \$105.00 per lockset
Plug only to show, 7-pin (concealed shell) (available for M and R escutcheons and single cylinder functions only)	P07	Add \$107.00 per lockset

**Notes:**

1. CHS ordered with CT6 option no charge.
3. Refer to Key construction core program, pg. 63 for example of CTP option pricing.
4. For existing systems only.

*Continued on next page*

## MP6600 Series Multi-Point Locks

USA & Canada Prices Effective February 1, 2022

### Cylinder Options (continued) & Keying Options\*

Description	Specify Quick Code	Add or Deduct
<b>Keying and Keys</b>		
0-bitted with 2 Blank Keys	(standard)	No Charge
Keyed Random	KR	
Construction Master Keyed <sup>2</sup>	CMK	Add \$16.00 per cylinder
More than 2 Keys	KY# (e.g., KY6)	See page 31 - Cut Keys Section
<b>Master Keying</b>		
Master keyed (all cylinders except CR8000, CR8020, CR8027, CR8200, CR8500, CR8600, CR8700)	MK	Add \$16.00 per cylinder
Master keyed Pyramid (except CR8020, CR8027 LFIC cores)	MK	
Master keyed Security (including LFIC cylinder and core)	MK	
Master keyed Access 3 (except CR8500, CR8600, CR8700 LFIC cores)	MK	
Master keyed (CR8000, CR8020, CR8027, CR8200, CR8500, CR8600, CR8700)	MK-IC	No Charge
Master keyed to customer bittings or sample key	MK-CB	Add \$16.00 per cylinder
<b>Visual Key Control (VKC)</b>		
No bitting or keyset stamping on keys	VKC0	\$4.50
Keys only	VKC1	No Charge
Cylinders and keys (not for AS, AHS, ACS, ACHS, HS, CHS, PHS or PCHS)	VKC2	\$8.00
Cylinders only (not for AS, AHS, HS, ACS, ACHS, CHS, PHS or PCHS)	VKC3	
<b>Concealed Key Control (CKC)</b>		
CKC cylinders with VKC keys	CKC2	\$8.00
CKC cylinders only (not for AS, AHS, ACS, ACHS, PHS, PCHS)	CKC3	

**Notes:**

1. CMK Construction master keying charge is in addition to master keying charge.
2. CMK Construction master keying is not available in interchangeable core, Access 3, Pyramid, or Security series.
3. VKC2, VKC3, CKC3 are not available in Pyramid or Security series.
4. Pyramid series is not available keyed random.
5. Security series is not available 0-bitted.

\*Double cylinder keying: unless otherwise specified, both cylinders of 32, 62, 72 and 82 functions will be keyed alike. The inside cylinder of 52 function will be keyed to the master key(s) only, while the outside cylinder will include the change key. If different keying is required, specify outside cylinder first, then inside cylinder. For key bows other than 10 and 90, specify 'KB' + bow number as Quick Code, e.g. KB12.

### Strike Options\*

Lip Length	ANSI Straight Lip - Specify Quick Code	ANSI Curved Lip - Specify Quick Code	Add or Deduct
7/8"	SS078	N/A	No Charge

\* If door thickness is standard or has been specified and no special door or frame condition exist, then only the first two characters of the optional strike Quick Code must be specified (e.g. "SA").

The correct lip length will be determined by our order entry system based on the standard or specified door thickness.

# MP6600 Series Multi-Point Locks



USA & Canada Prices Effective February 1, 2022

## Door Thickness with Locksets Mortised on Center

Door Thickness	Sectional Rose Trim Specify Quick Code	Escutcheon <sup>1,2</sup> Trim Specify Quick Code	Add or Deduct
1-3/4" (standard)	—	—	No Charge

## Options

Description	Specify Quick Code	Add or Deduct
Split designs and split finishes	Outside Trim x Inside Trim	Higher set price prevails
Spanner head screws	M02	Add \$24.00 per lockset
Torx® head screws (n/a with N escutcheon)	M04	Add \$30.00 per lockset
Single Occupancy Indicator - Secure/Unsecure (Outside)	M19S*	Add \$155.00 per lockset
Single Occupancy Indicator - Vacant/Occupied (Outside)	M19V*	Add \$155.00 per lockset
Double Occupancy Indicator - Secure/Unsecure (Outside) Secure/Unsecure (Inside)	M19SN*	Add \$310.00 per lockset
Double Indicator Vacant/Occupied (Outside) Secure/Unsecure (Inside)	M19VN*	Add \$310.00 per lockset
Knurling outside and inside	M20 <sup>1</sup>	Add \$172.00 per lockset
Knurling outside only	M21 <sup>1</sup>	Add \$86.00 per lockset
Knurling inside only	M22 <sup>1</sup>	Add \$86.00 per lockset
Abrasive coat outside and inside	M23 <sup>1</sup>	Add \$108.00 per lockset
Abrasive coat inside only	M24 <sup>1</sup>	Add \$54.00 per lockset
Abrasive coat outside only	M25 <sup>1</sup>	Add \$54.00 per lockset

## Thumbturn Options

Specify door thickness	Specify Quick Code	Add or Deduct
Ergonomic	M34 <sup>2</sup>	Add \$18.00 per TT
Decorative	MT1	No Charge
Decorative square	MT2	No Charge
Decorative cylinder	MT3	No Charge



MT1



MT2



MT3

### Notes:

1. Not available with Vineyard™ or Muséo® levers.
2. M34 is not available with M19N, M19VN or M19SN.

Note: Thumbturn backplate will match shape of rose chosen (i.e. round or square)

## Strike Options

Part Number	Description
726F577	Top Strike Pack
726F587	Bottom Strike Pack
726F607	Center Strike Pack

## Dogging Indicator Kit

AUX188 x FIN -Dogging Indicator kit if ordered separately.

**Price**

**\$591.00**

Note: Concealed vertical rods, top & bottom latches, and the lockbody cassette will be factory installed. All other hardware components are shipped directly to the customer and must be installed by a factory trained installer. Invoices for the door will be separate from the hardware invoice. The hardware invoice will include the concealed vertical assembly and the trim components.

# FE6600 Series

## Series Multi-Point Locks



USA & Canada Prices Effective February 1, 2022

Door	1-3/4" thick door only - FE6600 Series requires utilizing Ceco Door StormPro 361 and Curries StormPro 361 doors and frames. McKINNEY StormPro hinges are required when used as a certified tornado solution
Mounting	Supplied fasteners are for metal doors with throughbolts for trim
Hand	Handed; specify RHR, LHR, RH or LH
Lockbody	Unique mortise lockbody assembly used for a variety of applications
Top Bolt	Adjustable stainless steel 3/4" square bolt with 11/16" engagement; 5/16" steel reinforcement plate
Bottom Bolt	Adjustable stainless steel 3/4" square bolt with 5/8" engagement; 1/4" steel reinforcement plate
Center Bolts	Latchbolt is stainless steel with 3/4" projection. One piece, anti-friction reversible catch. Deadbolt is one piece hardened stainless steel with 1" projection
Lock Front	1/8" steel mortise front reinforced with 13/64" thick lock edge stiffener
Center Bolt Strike	1/4" thick stainless steel
Backset	2-3/4" standard
Door Thickness	1-3/4" standard
Door Height	7'0" - 8'0"
Maximum Opening	Single door 4'0" x 8'0" and double doors 8'0" x 8'0".
UL Fire Listed	UL 3-hour fire rating
Trim	Multiple sectional and escutcheon mortise trim with Standard or Muséo levers
Cylinder	Multiple mortise cylinders

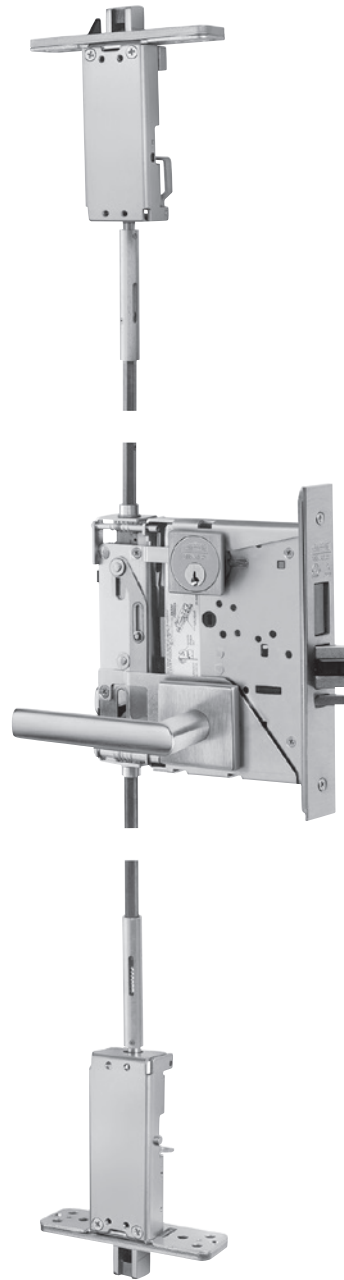

## How to Order

### Ordering Example

Quantity	Series/Function	Trim	Finish	Hand
100	FE6618	ASM	626	RHR

Note: Concealed vertical rods, top & bottom latches, and the lockbody cassette will be factory installed. All other hardware components are shipped directly to the customer and must be installed by a factory trained installer. Invoices for the door will be separate from the hardware invoice. The hardware invoice will include the concealed vertical assembly and the trim components.



# FE6600 Series Multi-Point Locks



USA & Canada Prices Effective February 1, 2022

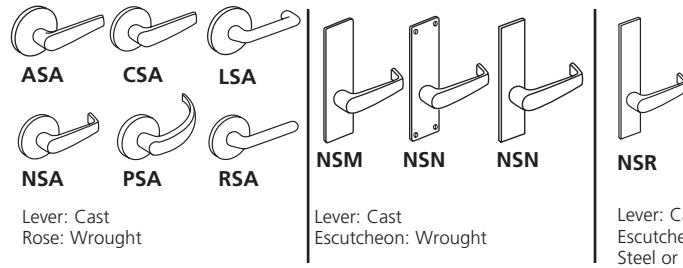

Available Functions	Description	Levers: AS, CS, ES, LS, NS, PS, RS Roses: A, G		Levers: AS, CS, ES, LS, NS, PS, RS Escutcheons: M, N, LW1		Levers: AS, CS, ES, LS, NS, PS, RS Escutcheons: RE1/RE2, RE3/RE4	
		613E, 626, BSP, WSP	605, 606, 611, 612, 613, 618, 619, 625, 629, 630, 722	613E, 626, BSP, WSP	605, 606, 611, 612, 613, 618, 619, 625, 629, 630, 722	613E, 626, BSP, WSP	605, 606, 611, 612, 613, 618, 619, 625, 629, 630, 722
<b>Single Cylinder with Deadbolt</b>							
FE6618 FE6624 FE6665	Classroom Storeroom Exit/Dormitory	\$4,253.00	\$4,277.00	\$4,273.00	\$4,297.00	\$4,327.00	\$4,351.00
<b>Non-Keyed</b>							
FE6680 FE6630 FE6620	Inside Passage Privacy Bath Privacy Bedroom	\$4,253.00	\$4,277.00	\$4,273.00	\$4,297.00	\$4,327.00	\$4,351.00
<b>Double Cylinder with Deadbolt</b>							
FE6622 FE6662 FE6672 FE6673 FE6675	Store Door Classroom Security Intruder Deadbolt Classroom Security Intruder Aux. Deadbolt Classroom Security Intruder Deadlatch Security Deadbolt	\$4,253.00	\$4,277.00	\$4,273.00	\$4,297.00	\$4,327.00	\$4,351.00
<b>EAC</b>							
FE66609 x NAC SAF / SEC	No Key Override With Deadbolt Fail Safe/Secure 12V/24V	\$4,473.00	\$4,497.00	\$4,493.00	\$4,517.00	\$4,547.00	\$4,571.00
FE66608 x NAC SAF / SEC	Key Override With Deadbolt Fail Safe/Secure 12V/24V	\$4,627.00	\$4,651.00	\$4,647.00	\$4,671.00	\$4,701.00	\$4,725.00

# FE6600 Series Multi-Point Locks

USA & Canada Prices Effective February 1, 2022

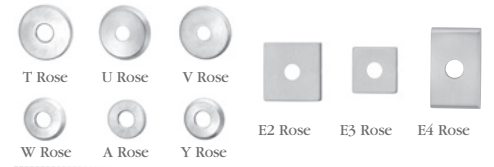
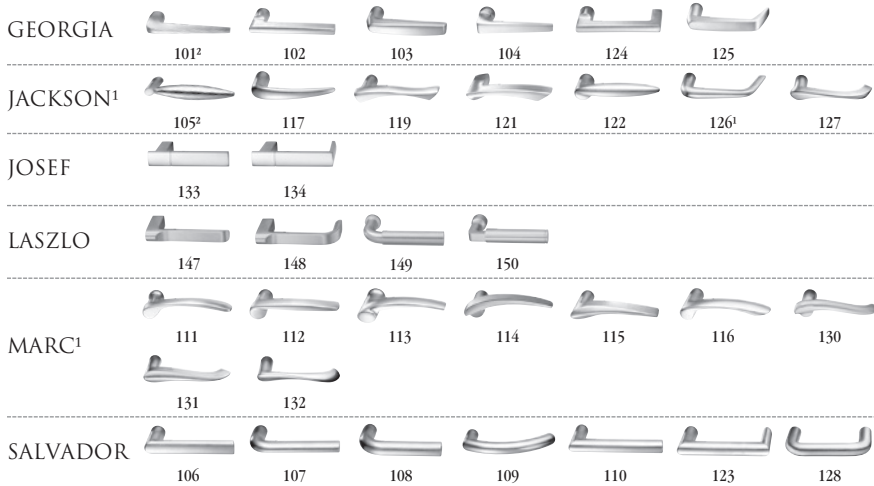

### ESCUTCHEONS



### THUMBTURNS<sup>3</sup>



1. Handed: specify hand when ordering
2. Contact factory for current lead time
3. Specify thumbturn as quick code. Thumbturn backplate will match shape of rose chosen (i.e. round or square). Not available with escutcheons.

\*629 and \*630 finish options are Not available for all Muséo levers. Please refer to page 20 for availability.

613E	Dark Oxidized Satin Bronze - Equivalent	605	Bright Brass, Clear Coated	618	Bright Nickel Plated
626	Satin Chromium Plated	606	Satin Brass, Clear Coated	619	Satin Nickel Plated
BSP	Black Suede Powder Coat	611	Bright Bronze, Clear Coated	625	Bright Chromium Plated
WSP	White Suede Powder Coat	612	Satin Bronze, Clear Coated	629*	Bright Stainless Steel
		613	Dark Oxidized Satin Bronze, Oil Rubbed	630*	Satin Stainless Steel
		613L	Dark Oxidized Satin Bronze, Clear Coated	722	Black Oxidized Bronze, Oil Rubbed

Functions	Description		
<b>Single Cylinder with Deadbolt   ESCUTCHEONS L, CE, RE1</b>			
FE6618 FE6624 FE6665	Classroom Storeroom Exit/Dormitory	\$4,297.00	\$4,321.00
<b>Non-Keyed   ESCUTCHEONS L, CE, RE1</b>			
FE6680 FE6630 FE6620	Inside Passage Privacy Bath Privacy Bedroom	\$4,297.00	\$4,321.00
<b>Double Cylinder with Deadbolt   ESCUTCHEONS L, CE, RE1</b>			
FE6622 FE6662 FE6672 FE6673 FE6675	Store Door Classroom Security Intruder Deadbolt Classroom Security Intruder Aux. Deadbolt Classroom Security Intruder Deadlatch Security Deadbolt	\$4,297.00	\$4,321.00
<b>EAC   ESCUTCHEONS L, CE, RE1</b>			
FE66609 x NAC SAF / SEC	No Key Override With Deadbolt Fail Safe/Secure 12V/24V	\$4,517.00	\$4,541.00
FE66608 x NAC SAF / SEC	Key Override With Deadbolt Fail Safe/Secure 12V/24V	\$4,671.00	\$4,695.00

# FE6600 Series Multi-Point Locks

USA & Canada Prices Effective February 1, 2022

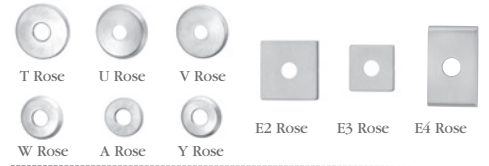
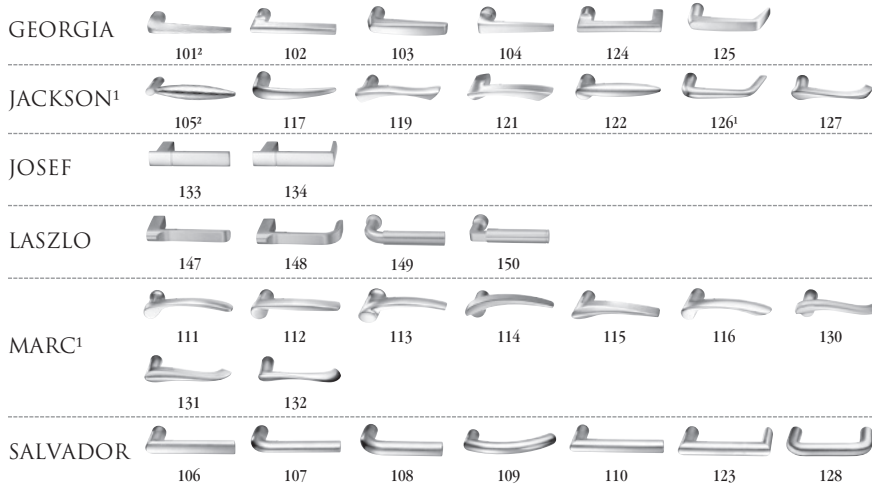

### ESCUTCHEONS



### THUMBTURN<sup>3</sup>



1. Handed: specify hand when ordering
2. Contact factory for current lead time
3. Specify thumbturn as quick code. Thumbturn backplate will match shape of rose chosen (i.e. round or square). Not available with escutcheons.

\*629 and \*630 finish options are Not available for all Muséo levers. Please refer to page 20 for availability.

613E Dark Oxidized Satin Bronze - Equivalent	605 Bright Brass, Clear Coated	618 Bright Nickel Plated
626 Satin Chromium Plated	606 Satin Brass, Clear Coated	619 Satin Nickel Plated
BSP Black Suede Powder Coat	611 Bright Bronze, Clear Coated	625 Bright Chromium Plated
WSP White Suede Powder Coat	612 Satin Bronze, Clear Coated	629* Bright Stainless Steel
	613 Dark Oxidized Satin Bronze, Oil Rubbed	630* Satin Stainless Steel
	613L Dark Oxidized Satin Bronze, Clear Coated	722 Black Oxidized Bronze, Oil Rubbed

Functions	Description		
<b>Single Cylinder with Deadbolt   ROSES: A, T, U, V, W, Y, E2, E3, E4</b>			
FE6618 FE6624 FE6665	Classroom Storeroom Exit/Dormitory	\$4,253.00	\$4,277.00
<b>Non-Keyed   ROSES: A, T, U, V, W, Y, E2, E3, E4</b>			
FE6680 FE6630 FE6620	Inside Passage Privacy Bath Privacy Bedroom	\$4,253.00	\$4,277.00
<b>Double Cylinder with Deadbolt   ROSES: A, T, U, V, W, Y, E2, E3, E4</b>			
FE6622 FE6662 FE6672 FE6673 FE6675	Store Door Classroom Security Intruder Deadbolt Classroom Security Intruder Aux. Deadbolt Classroom Security Intruder Deadlatch Security Deadbolt	\$4,253.00	\$4,277.00
<b>EAC   ROSES: A, T, U, V, W, Y, E2, E3, E4</b>			
FE66609 x NAC SAF / SEC	No Key Override With Deadbolt Fail Safe/Secure 12V/24V	\$4,473.00	\$4,497.00
FE66608 x NAC SAF / SEC	Key Override With Deadbolt Fail Safe/Secure 12V/24V	\$4,627.00	\$4,651.00

# FE6600 Series Multi-Point Locks

USA & Canada Prices Effective February 1, 2022

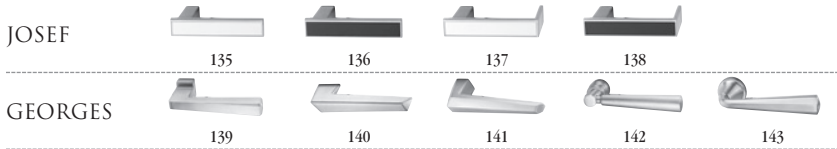

### ROSES

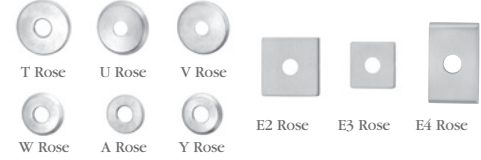

### ESCUTCHEONS



### THUMBTURNS<sup>3</sup>



1. Handed: specify hand when ordering
2. Contact factory for current lead time
3. Specify thumbturn as quick code. Thumbturn backplate will match shape of rose chosen (i.e. round or square). Not available with escutcheons.

613E	Dark Oxidized Satin Bronze - Equivalent	605	Bright Brass, Clear Coated	618	Bright Nickel Plated
626	Satin Chromium Plated	606	Satin Brass, Clear Coated	619	Satin Nickel Plated
BSP	Black Suede Powder Coat	611	Bright Bronze, Clear Coated	625	Bright Chromium Plated
WSP	White Suede Powder Coat	612	Satin Bronze, Clear Coated	629	Bright Stainless Steel
		613	Dark Oxidized Satin Bronze, Oil Rubbed	630	Satin Stainless Steel
		613L	Dark Oxidized Satin Bronze, Clear Coated	722	Black Oxidized Bronze, Oil Rubbed

Functions	Description		
<b>Single Cylinder with Deadbolt   ESCUTCHEONS L, CE, RE1</b>			
FE6618 FE6624 FE6665	Classroom Storeroom Exit/Dormitory	\$4,394.00	\$4,418.00
<b>Non-Keyed   ESCUTCHEONS L, CE, RE1</b>			
FE6680 FE6630 FE6620	Inside Passage Privacy Bath Privacy Bedroom	\$4,394.00	\$4,418.00
<b>Double Cylinder with Deadbolt   ESCUTCHEONS L, CE, RE1</b>			
FE6622 FE6662 FE6672 FE6673 FE6675	Store Door Classroom Security Intruder Deadbolt Classroom Security Intruder Aux. Deadbolt Classroom Security Intruder Deadlatch Security Deadbolt	\$4,394.00	\$4,418.00
<b>EAC   ESCUTCHEONS L, CE, RE1</b>			
FE66609 x NAC SAF / SEC	No Key Override With Deadbolt Fail Safe/Secure 12V/24V	\$4,614.00	\$4,638.00
FE66608 x NAC SAF / SEC	Key Override With Deadbolt Fail Safe/Secure 12V/24V	\$4,768.00	\$4,792.00

# FE6600 Series Multi-Point Locks

USA & Canada Prices Effective February 1, 2022

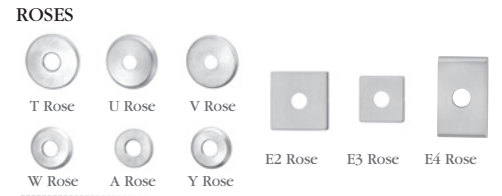
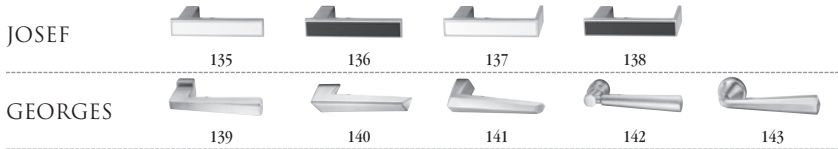

### ESCUTCHEONS



### THUMBTURNS<sup>3</sup>



1. Handed: specify hand when ordering
2. Contact factory for current lead time
3. Specify thumbturn as quick code. Thumbturn backplate will match shape of rose chosen (i.e. round or square). Not available with escutcheons.

613E	Dark Oxidized Satin Bronze - Equivalent	605	Bright Brass, Clear Coated	618	Bright Nickel Plated
626	Satin Chromium Plated	606	Satin Brass, Clear Coated	619	Satin Nickel Plated
BSP	Black Suede Powder Coat	611	Bright Bronze, Clear Coated	625	Bright Chromium Plated
WSP	White Suede Powder Coat	612	Satin Bronze, Clear Coated	629	Bright Stainless Steel
		613	Dark Oxidized Satin Bronze, Oil Rubbed	630	Satin Stainless Steel
		613L	Dark Oxidized Satin Bronze, Clear Coated	722	Black Oxidized Bronze, Oil Rubbed

Functions	Description		
<b>Single Cylinder with Deadbolt   ROSES: A, T, U, V, W, Y, E2, E3, E4</b>			
FE6618 FE6624 FE6665	Classroom Storeroom Exit/Dormitory	\$4,350.00	\$4,374.00
<b>Non-Keyed   ROSES: A, T, U, V, W, Y, E2, E3, E4</b>			
FE6680 FE6630 FE6620	Inside Passage Privacy Bath Privacy Bedroom	\$4,350.00	\$4,374.00
<b>Double Cylinder with Deadbolt   ROSES: A, T, U, V, W, Y, E2, E3, E4</b>			
FE6622 FE6662 FE6672 FE6673 FE6675	Store Door Classroom Security Intruder Deadbolt Classroom Security Intruder Aux. Deadbolt Classroom Security Intruder Deadlatch Security Deadbolt	\$4,350.00	\$4,374.00
<b>EAC   ROSES: A, T, U, V, W, Y, E2, E3, E4</b>			
FE66609 x NAC SAF / SEC	No Key Override With Deadbolt Fail Safe/Secure 12V/24V	\$4,570.00	\$4,594.00
FE66608 x NAC SAF / SEC	Key Override With Deadbolt Fail Safe/Secure 12V/24V	\$4,724.00	\$4,748.00

# FE6600 Series Multi-Point Locks

USA & Canada Prices Effective February 1, 2022



\*613E, BSP, WSP finishes are not available with 21M levers.

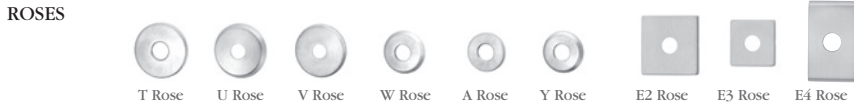

Specify thumbturn as quick code. Thumbturn backplate will match shape of rose chosen (i.e. round or square)

613E Dark Oxidized Satin Bronze – Equivalent  
629 Bright Stainless Steel  
630 Satin Stainless Steel  
BSP Black Suede Powder Coat  
WSP White Suede Powder Coat

Functions	Description	
<b>Single Cylinder with Deadbolt   ESCUTCHEONS L, CE, RE1</b>		
FE6618 FE6624 FE6665	Classroom Storeroom Exit/Dormitory	\$4,398.00
<b>Non-Keyed   ESCUTCHEONS L, CE, RE1</b>		
FE6680 FE6630 FE6620	Inside Passage Privacy Bath Privacy Bedroom	\$4,398.00
<b>Double Cylinder with Deadbolt   ESCUTCHEONS L, CE, RE1</b>		
FE6622 FE6662 FE6672 FE6673 FE6675	Store Door Classroom Security Intruder Deadbolt Classroom Security Intruder Aux. Deadbolt Classroom Security Intruder Deadlatch Security Deadbolt	\$4,398.00
<b>EAC   ESCUTCHEONS L, CE, RE1</b>		
FE66609 x NAC SAF / SEC	No Key Override With Deadbolt Fail Safe/Secure 12V/24V	\$4,618.00
FE66608 x NAC SAF / SEC	Key Override With Deadbolt Fail Safe/Secure 12V/24V	\$4,772.00

# FE6600 Series Multi-Point Locks

USA & Canada Prices Effective February 1, 2022



\*613E, BSP, WSP finishes are not available with 21M levers.

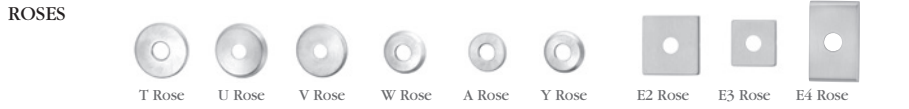

Specify thumbturn as quick code. Thumbturn backplate will match shape of rose chosen (i.e. round or square)

613E	Dark Oxidized Satin Bronze – Equivalent
629	Bright Stainless Steel
630	Satin Stainless Steel
BSP	Black Suede Powder Coat
WSP	White Suede Powder Coat

Functions	Description	
<b>Single Cylinder with Deadbolt   ROSES: A, T, U, V, W, Y, E2, E3, E4</b>		
FE6618 FE6624 FE6665	Classroom Storeroom Exit/Dormitory	\$4,354.00
<b>Non-Keyed   ROSES: A, T, U, V, W, Y, E2, E3, E4</b>		
FE6680 FE6630 FE6620	Inside Passage Privacy Bath Privacy Bedroom	\$4,354.00
<b>Double Cylinder with Deadbolt   ROSES: A, T, U, V, W, Y, E2, E3, E4</b>		
FE6622 FE6662 FE6672 FE6673 FE6675	Store Door Classroom Security Intruder Deadbolt Classroom Security Intruder Aux. Deadbolt Classroom Security Intruder Deadlatch Security Deadbolt	\$4,354.00
<b>EAC   ROSES: A, T, U, V, W, Y, E2, E3, E4</b>		
FE66609 x NAC SAF / SEC	No Key Override With Deadbolt Fail Safe/Secure 12V/24V	\$4,574.00
FE66608 x NAC SAF / SEC	Key Override With Deadbolt Fail Safe/Secure 12V/24V	\$4,728.00

# FE6600 Series Multi-Point Locks

USA & Canada Prices Effective February 1, 2022

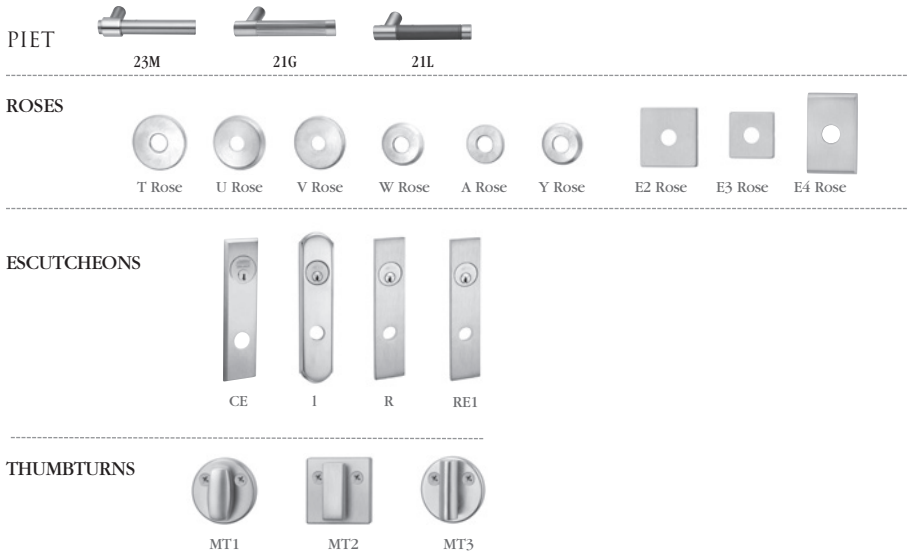

Specify thumbturn as quick code. Thumbturn backplate will match shape of rose chosen (i.e. round or square)

613E	Dark Oxidized Satin Bronze – Equivalent
629	Bright Stainless Steel
630	Satin Stainless Steel
BSP	Black Suede Powder Coat
WSP	White Suede Powder Coat

Functions	Description	
<b>Single Cylinder with Deadbolt   ESCUTCHEONS L, CE, RE1</b>		
FE6618 FE6624 FE6665	Classroom Storeroom Exit/Dormitory	\$4,418.00
<b>Non-Keyed   ESCUTCHEONS L, CE, RE1</b>		
FE6680 FE6630 FE6620	Inside Passage Privacy Bath Privacy Bedroom	\$4,418.00
<b>Double Cylinder with Deadbolt   ESCUTCHEONS L, CE, RE1</b>		
FE6622 FE6662 FE6672 FE6673 FE6675	Store Door Classroom Security Intruder Deadbolt Classroom Security Intruder Aux. Deadbolt Classroom Security Intruder Deadlatch Security Deadbolt	\$4,418.00
<b>EAC   ESCUTCHEONS L, CE, RE1</b>		
FE66609 x NAC SAF / SEC	No Key Override With Deadbolt Fail Safe/Secure 12V/24V	\$4,638.00
FE66608 x NAC SAF / SEC	Key Override With Deadbolt Fail Safe/Secure 12V/24V	\$4,792.00



# FE6600 Series Multi-Point Locks



USA & Canada Prices Effective February 1, 2022

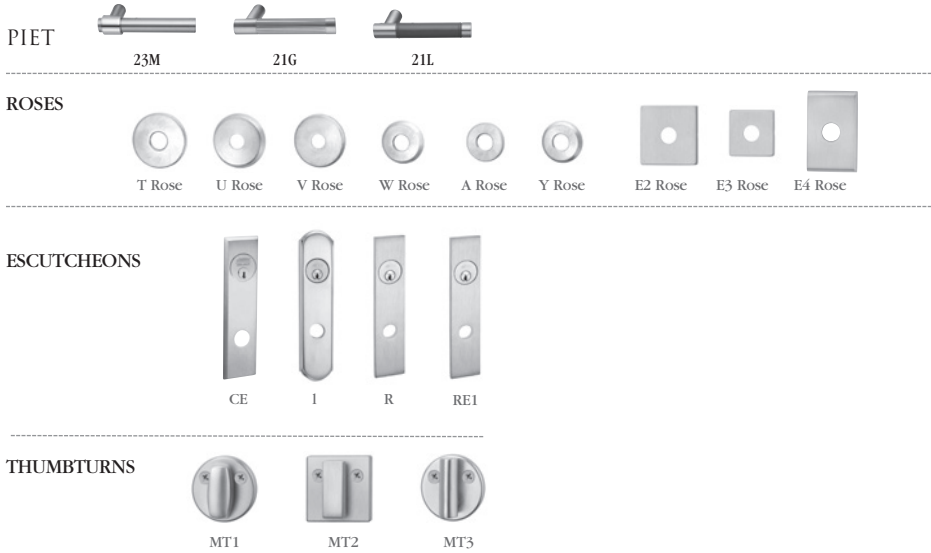

Specify thumbturn as quick code. Thumbturn backplate will match shape of rose chosen (i.e. round or square)

613E	Dark Oxidized Satin Bronze – Equivalent
629	Bright Stainless Steel
630	Satin Stainless Steel
BSP	Black Suede Powder Coat
WSP	White Suede Powder Coat

Functions	Description	
<b>Single Cylinder with Deadbolt   ROSES: A, T, U, V, W, Y, E2, E3, E4</b>		
FE6618 FE6624 FE6665	Classroom Storeroom Exit/Dormitory	\$4,374.00
<b>Non-Keyed   ROSES: A, T, U, V, W, Y, E2, E3, E4</b>		
FE6680 FE6630 FE6620	Inside Passage Privacy Bath Privacy Bedroom	\$4,374.00
<b>Double Cylinder with Deadbolt   ROSES: A, T, U, V, W, Y, E2, E3, E4</b>		
FE6622 FE6662 FE6672 FE6673 FE6675	Store Door Classroom Security Intruder Deadbolt Classroom Security Intruder Aux. Deadbolt Classroom Security Intruder Deadlatch Security Deadbolt	\$4,374.00
<b>ROSES: A, T, U, V, W, Y, E2, E3, E4</b>		
FE66609 x NAC SAF / SEC	No Key Override With Deadbolt Fail Safe/Secure 12V/24V	\$4,594.00
FE66608 x NAC SAF / SEC	Key Override With Deadbolt Fail Safe/Secure 12V/24V	\$4,748.00

# FE6600 Series Multi-Point Locks



USA & Canada Prices Effective February 1, 2022

Cylinder Options		
Description	Specify Quick Code	Add or Deduct
Conventional 6-pin	(standard)	No Charge
Conventional 7-pin	7P	Add \$2.00 per cylinder
Less Standard Cylinder	LC	Deduct \$105.00 per cylinder
Less Concealed Shell Cylinder	PO-LC	Add \$5.00 per lockset
<b>LFIC</b>		
LFIC 6-pin	C6	Add \$91.00 per cylinder
LFIC 6-pin Less Core	CL6	No Charge
LFIC 6-pin with Temporary Construction Core (Red)	CT6R	Add \$91.00 per cylinder
LFIC 6-pin with Temporary Construction Core (Blue)	CT6B	Add \$91.00 per cylinder
LFIC 6-pin with Temporary Construction Core (Green)	CT6G	Add \$91.00 per cylinder
LFIC 6-pin with Temporary Disposable Core	CT6D	No Charge
LFIC 7-pin	C7	Add \$93.00 per cylinder
LFIC 7-pin Less Core	CL7	Add \$2.00 per cylinder
LFIC 7-pin with Temporary Construction Core (Red)	CT7R	Add \$93.00 per cylinder
LFIC 7-pin with Temporary Construction Core (Blue)	CT7B	Add \$93.00 per cylinder
LFIC 7-pin with Temporary Construction Core (Green)	CT7G	Add \$93.00 per cylinder
LFIC 7-pin with Temporary Disposable Core	CT7D	Add \$2.00 per cylinder
<b>SFIC</b>		
SFIC 6-pin	C6S	Add \$82.00 per cylinder
SFIC 6-pin with Temporary Construction Core (Blue)	CT6SB	Add \$82.00 per cylinder
SFIC 6-pin with SFIC disposable temporary core	CT6SD	No Charge
SFIC 6-pin with Less Core	CLS6	No Charge
SFIC 7-pin	C7S	Add \$82.00 per cylinder
SFIC 7-pin with Temporary Construction Core (Blue)	CT7SB	Add \$82.00 per cylinder
SFIC 7-pin with SFIC disposable temporary core	CT7SD	Add \$2.00 per cylinder
SFIC 7-pin with Less Core	CLS7	Add \$2.00 per cylinder
<b>Security</b>		
Security <sup>4</sup>	HS	Add \$139.00 per cylinder
Security LFIC <sup>1,4</sup>	CHS	Add \$226.00 per cylinder
<b>Access 3</b>		
Access 3 Patented	AP	No Charge
Access 3 Security	AS	Add \$61.00 per cylinder
Access 3 High Security, UL 437	AHS	Add \$86.00 per cylinder
Access 3 LFIC Patented	ACP	Add \$91.00 per cylinder
Access 3 LFIC Security	ACS	Add \$147.00 per cylinder
Access 3 LFIC High Security, UL 437	ACHS	Add \$169.00 per cylinder
<b>Pyramid</b>		
Pyramid Security Fixed Core	PS	Add \$74.00 per cylinder
Pyramid Security LFIC	PCS	Add \$159.00 per cylinder
Pyramid High Security Fixed Core	PHS	Add \$110.00 per cylinder
Pyramid High Security LFIC	PCHS	Add \$196.00 per cylinder
Pyramid LFIC with Temporary Construction Core <sup>3</sup>	CTP	Add \$91.00 per cylinder
Pyramid LFIC with Temporary Disposable Core <sup>3</sup>	CTPD	No Charge
Pyramid LFIC Less Core	CLP	No Charge
<b>Other</b>		
Master Ring <sup>2</sup>	MR	Add \$79.00 per cylinder
Flex Head Cylinder, 6-pin (sectional trim)	FX6	Add \$95.00 per cylinder
Flex Head Cylinder, 7-pin (sectional trim)	FX7	Add \$97.00 per cylinder
Flex Head Master Ring (sectional trim)	FXM	Add \$154.00 per cylinder
Plug only to show, 6-pin (concealed shell) (available for M and R escutcheons and single cylinder functions only)	P06	Add \$105.00 per lockset
Plug only to show, 7-pin (concealed shell) (available for M and R escutcheons and single cylinder functions only)	P07	Add \$107.00 per lockset

**Notes:**

1. CHS ordered with CT6 option no charge.
3. Refer to Key construction core program, pg. 63 for example of CTP option pricing.
4. For existing systems only.

*Continued on next page*

# FE6600 Series Multi-Point Locks



USA & Canada Prices Effective February 1, 2022

Cylinder Options (continued) & Keying Options*		
Description	Specify Quick Code	Add or Deduct
<b>Keying and Keys</b>		
0-bitted with 2 Blank Keys	(standard)	No Charge
Keyed Random	KR	
Construction Master Keyed <sup>2</sup>	CMK	Add \$16.00 per cylinder
More than 2 Keys	KY# (e.g., KY6)	See page 31 - Cut Keys Section
<b>Master Keying</b>		
Master keyed (all cylinders except CR8000, CR8020, CR8027, CR8200, CR8500, CR8600, CR8700)	MK	Add \$16.00 per cylinder
Master keyed Pyramid (except CR8020, CR8027 LFIC cores)	MK	
Master keyed Security (including LFIC cylinder and core)	MK	
Master keyed Access 3 (except CR8500, CR8600, CR8700 LFIC cores)	MK	
Master keyed (CR8000, CR8020, CR8027, CR8200, CR8500, CR8600, CR8700)	MK-IC	No Charge
Master keyed to customer bittings or sample key	MK-CB	Add \$16.00 per cylinder
<b>Visual Key Control (VKC)</b>		
No bitting or keyset stamping on keys	VKC0	\$4.50
Keys only	VKC1	No Charge
Cylinders and keys (not for AS, AHS, ACS, ACHS, HS, CHS, PHS or PCHS)	VKC2	\$8.00
Cylinders only (not for AS, AHS, HS, ACS, ACHS, CHS, PHS or PCHS)	VKC3	
<b>Concealed Key Control (CKC)</b>		
CKC cylinders with VKC keys	CKC2	\$8.00
CKC cylinders only (not for AS, AHS, ACS, ACHS, PHS, PCHS)	CKC3	

**Notes:**

1. CMK Construction master keying charge is in addition to master keying charge.
2. CMK Construction master keying is not available in interchangeable core, Access 3, Pyramid, or Security series.
3. VKC2, VKC3, CKC3 are not available in Pyramid or Security series.
4. Pyramid series is not available keyed random.
5. Security series is not available 0-bitted.

## Strike Options\*

Lip Length	ANSI Straight Lip - Specify Quick Code	ANSI Curved Lip - Specify Quick Code	Add or Deduct
7/8"	SS078	N/A	No Charge

\* If door thickness is standard or has been specified and no special door or frame condition exist, then only the first two characters of the optional strike Quick Code must be specified (e.g. "SA").

The correct lip length will be determined by our order entry system based on the standard or specified door thickness.

**FE6600 Series  
Multi-Point Locks**

USA & Canada Prices Effective February 1, 2022

**Door Thickness with Locksets Mortised on Center**

Door Thickness	Sectional Rose Trim Specify Quick Code	Escutcheon <sup>1,2</sup> Trim Specify Quick Code	Add or Deduct
1-3/4" (standard)	—	—	No Charge

**Options**

Description	Specify Quick Code	Add or Deduct
Split designs and split finishes	Outside Trim x Inside Trim	Higher set price prevails
Spanner head screws	M02	Add \$24.00 per lockset
Torx® head screws (n/a with N escutcheon)	M04	Add \$30.00 per lockset
Single Occupancy Indicator - Secure/Unsecure (Outside)	M19S*	Add \$155.00 per lockset
Single Occupancy Indicator - Vacant/Occupied (Outside)	M19V*	Add \$155.00 per lockset
Double Occupancy Indicator - Secure/Unsecure (Outside) Secure/Unsecure (Inside)	M19SN*	Add \$310.00 per lockset
Double Indicator Vacant/Occupied (Outside) Secure/Unsecure (Inside)	M19VN*	Add \$310.00 per lockset
Knurling outside and inside	M20 <sup>1</sup>	Add \$172.00 per lockset
Knurling outside only	M21 <sup>1</sup>	Add \$86.00 per lockset
Knurling inside only	M22 <sup>1</sup>	Add \$86.00 per lockset
Abrasive coat outside and inside	M23 <sup>1</sup>	Add \$108.00 per lockset
Abrasive coat inside only	M24 <sup>1</sup>	Add \$54.00 per lockset
Abrasive coat outside only	M25 <sup>1</sup>	Add \$54.00 per lockset

**Thumbturn Options**

Specify door thickness	Specify Quick Code	Add or Deduct
Ergonomic	M34 <sup>2</sup>	Add \$18.00 per TT
Decorative	MT1	No Charge
Decorative square	MT2	No Charge
Decorative cylinder	MT3	No Charge



MT1



MT2



MT3

Notes:

1. Not available with Vineyard™ or Muséo® levers.
2. M34 is not available with M19N, M19VN or M19SN.

Note: Thumbturn backplate will match shape of rose chosen (i.e. round or square)

**Strike Options**

Part Number	Description
726F577	Top Strike Pack
726F587	Bottom Strike Pack
726F607	Center Strike Pack

**Dogging Indicator Kit**

AUX188 x FIN -Dogging Indicator kit if ordered separately.

**Price**  
**\$591.00**

Note: Concealed vertical rods, top & bottom latches, and the lockbody cassette will be factory installed. All other hardware components are shipped directly to the customer and must be installed by a factory trained installer. Invoices for the door will be separate from the hardware invoice. The hardware invoice will include the concealed vertical assembly and the trim components.

# BL6600 Series

## Series Multi-Point Locks

USA & Canada Prices Effective February 1, 2022

Door	1-3/4" thick door only – BL6600 Series requires utilizing Ceco Door and Curries Multi-Solution Opening doors and frames. McKINNEY® StormPro® hinges
Mounting	Supplied fasteners are for metal doors with thru-bolts for trim
Hand	Handed; specify RHR, LHR, RH or LH
Lockbody	Unique mortise lockbody assembly used specifically for blast applications
Top Bolt	Adjustable stainless steel 3/4" square bolt with 11/16" engagement; 5/16" steel reinforcement plate
Bottom Bolt	Adjustable stainless steel 3/4" square bolt with 5/8" engagement; 1/4" steel reinforcement plate
Center Bolts	Latchbolt is stainless steel with 3/4" projection. One piece, anti-friction reversible catch. Deadbolt is one piece hardened stainless steel with 1" projection
Lock Front	1/8" steel mortise front reinforced with 13/64" thick lock edge stiffener
Center Bolt Strike	1/4" thick stainless steel
Backset	Lever: 2-3/4" standard; Rods: 5-1/4"
Door Thickness	1-3/4" standard
Maximum Opening	Single door 2'8" x 6'8" up to 4'0" x 8'0" (only available as single door)
UL Fire Listed	UL 3-hour fire rating
Trim	Multiple sectional and escutcheon mortise trim with Standard or Muséo levers
Cylinder	Multiple mortise cylinders

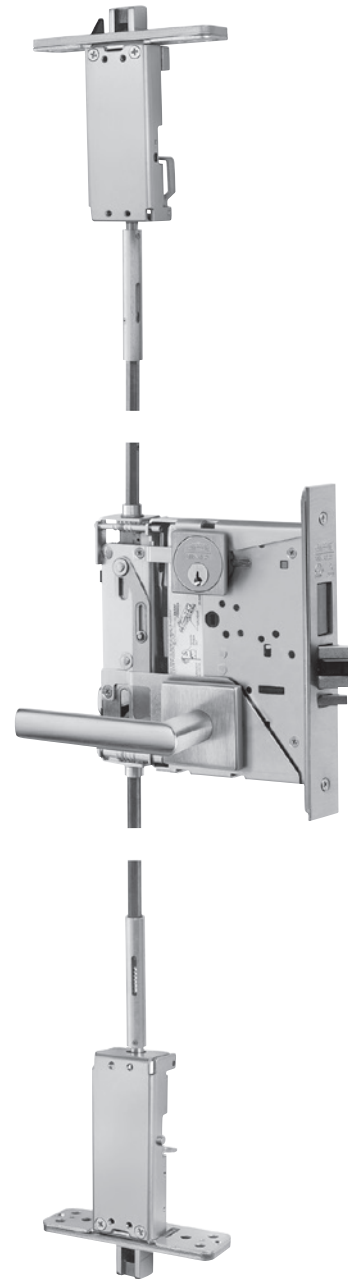

## How to Order

### Ordering Example

Quantity	Series/ Function	Trim	Finish	Hand
100	BL6618	ASM	626	RHR

Note: Concealed vertical rods, top & bottom latches, and the lockbody cassette will be factory installed. All other hardware components are shipped directly to the customer and must be installed by a factory trained installer. Invoices for the door will be separate from the hardware invoice. The hardware invoice will include the concealed vertical assembly and the trim components.

# BL6600 Series Multi-Point Locks



**ASSA ABLOY**

USA & Canada Prices Effective February 1, 2022

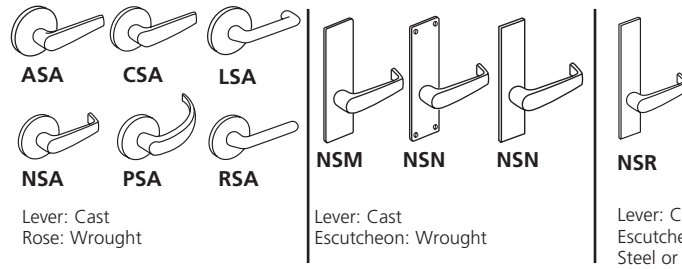

Available Functions	Description	Levers: AS, CS, ES, LS, NS, PS, RS Roses: A, G		Levers: AS, CS, ES, LS, NS, PS, RS Escutcheons: M, N, LW1		Levers: AS, CS, ES, LS, NS, PS, RS Escutcheons: RE1/RE2, RE3/RE4	
		613E, 626, BSP, WSP	605, 606, 611, 612, 613, 618, 619, 625, 629, 630, 722	613E, 626, BSP, WSP	605, 606, 611, 612, 613, 618, 619, 625, 629, 630, 722	613E, 626, BSP, WSP	605, 606, 611, 612, 613, 618, 619, 625, 629, 630, 722
<b>Single Cylinder with Deadbolt</b>							
BL6618 BL6624 BL6665	Classroom Storeroom Exit/Dormitory	\$4,693.00	\$4,717.00	\$4,713.00	\$4,737.00	\$4,767.00	\$4,791.00
<b>Non-Keyed</b>							
BL6680 BL6630 BL6620	Inside Passage Privacy Bath Privacy Bedroom	\$4,693.00	\$4,717.00	\$4,713.00	\$4,737.00	\$4,767.00	\$4,791.00
<b>Double Cylinder with Deadbolt</b>							
BL6622 BL6662 BL6672 BL6673 BL6675	Store Door Classroom Security Intruder Deadbolt Classroom Security Intruder Aux. Deadbolt Classroom Security Intruder Deadlatch Security Deadbolt	\$4,693.00	\$4,717.00	\$4,713.00	\$4,737.00	\$4,767.00	\$4,791.00
<b>EAC</b>							
BL66609 x NAC SAF / SEC	No Key Override With Deadbolt Fail Safe/Secure 12V/24V	\$4,913.00	\$4,937.00	\$4,933.00	\$4,957.00	\$4,987.00	\$5,011.00
BL66608 x NAC SAF / SEC	Key Override With Deadbolt Fail Safe/Secure 12V/24V	\$5,067.00	\$5,091.00	\$5,087.00	\$5,111.00	\$5,141.00	\$5,165.00

# BL6600 Series Multi-Point Locks

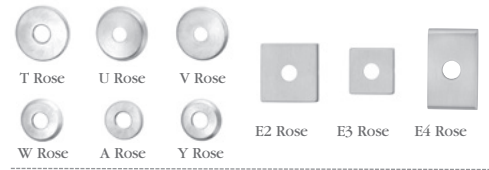
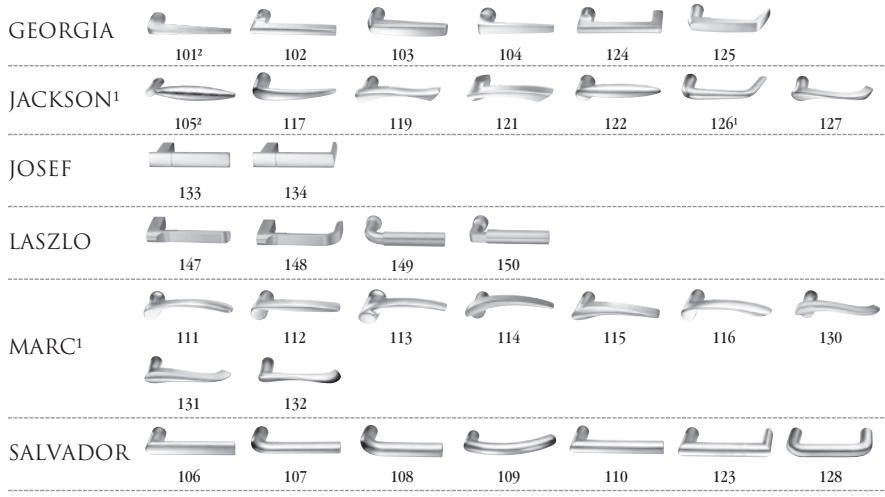

**ESCUTCHEONS**



**THUMBTURNS**



1. Handed: specify hand when ordering
2. Contact factory for current lead time
3. Specify thumbturn as quick code. Thumbturn backplate will match shape of rose chosen (i.e. round or square). Not available with escutcheons.

\*629 and \*630 finish options are Not available for all Muséo levers. Please refer to page 20 for availability.

613E Dark Oxidized Satin Bronze - Equivalent	605 Bright Brass, Clear Coated	618 Bright Nickel Plated
626 Satin Chromium Plated	606 Satin Brass, Clear Coated	619 Satin Nickel Plated
BSP Black Suede Powder Coat	611 Bright Bronze, Clear Coated	625 Bright Chromium Plated
WSP White Suede Powder Coat	612 Satin Bronze, Clear Coated	629* Bright Stainless Steel
	613 Dark Oxidized Satin Bronze, Oil Rubbed	630* Satin Stainless Steel
	613L Dark Oxidized Satin Bronze, Clear Coated	722 Black Oxidized Bronze, Oil Rubbed

Functions	Description		
<b>Single Cylinder with Deadbolt   ESCUTCHEONS: L, CE, RE1</b>			
BL6618 BL6624 BL6665	Classroom Storeroom Exit/Dormitory	\$4,737.00	\$4,761.00
<b>Non-Keyed   ESCUTCHEONS: L, CE, RE1</b>			
BL6680 BL6630 BL6620	Inside Passage Privacy Bath Privacy Bedroom	\$4,737.00	\$4,761.00
<b>Double Cylinder with Deadbolt   ESCUTCHEONS: L, CE, RE1</b>			
BL6622 BL6662 BL6672 BL6673 BL6675	Store Door Classroom Security Intruder Deadbolt Classroom Security Intruder Aux. Deadbolt Classroom Security Intruder Deadlatch Security Deadbolt	\$4,737.00	\$4,761.00
<b>EAC   ESCUTCHEONS: L, CE, RE1</b>			
BL66609 x NAC SAF / SEC	No Key Override With Deadbolt Fail Safe/Secure 12V/24V	\$4,957.00	\$4,981.00
BL66608 x NAC SAF / SEC	Key Override With Deadbolt Fail Safe/Secure 12V/24V	\$5,111.00	\$5,135.00

**BL6600 Series  
Multi-Point Locks**

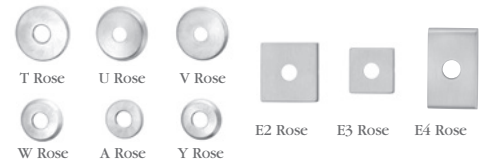
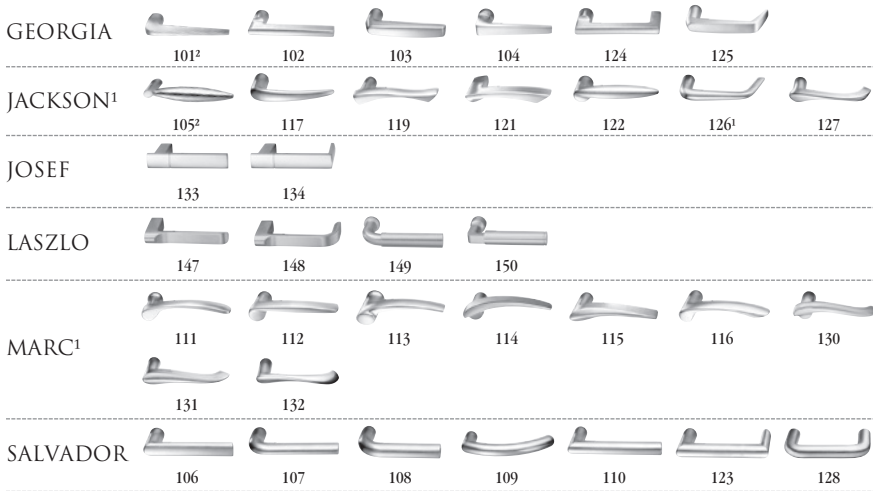

**ESCUTCHEONS**



**THUMBTURNS**



1. Handed: specify hand when ordering
2. Contact factory for current lead time
3. Specify thumbturn as quick code. Thumbturn backplate will match shape of rose chosen (i.e. round or square). Not available with escutcheons.

\*629 and \*630 finish options are Not available for all Muséo levers. Please refer to page 20 for availability.

613E	Dark Oxidized Satin Bronze	605	Bright Brass, Clear Coated	618	Bright Nickel Plated
626	Satin Chromium Plated	606	Satin Brass, Clear Coated	619	Satin Nickel Plated
BSP	Black Suede Powder Coat	611	Bright Bronze, Clear Coated	625	Bright Chromium Plated
WSP	White Suede Powder Coat	612	Satin Bronze, Clear Coated	629*	Bright Stainless Steel
		613	Dark Oxidized Satin Bronze, Oil Rubbed	630*	Satin Stainless Steel
		613L	Dark Oxidized Satin Bronze, Clear Coated	722	Black Oxidized Bronze, Oil Rubbed

Functions	Description		
<b>Single Cylinder with Deadbolt   ROSES: A, T, U, V, W, Y, E2, E3, E4</b>			
BL6618	Classroom	\$4,693.00	\$4,717.00
BL6624	Storeroom		
BL6665	Exit/Dormitory		
<b>Non-Keyed   ROSES: A, T, U, V, W, Y, E2, E3, E4</b>			
BL6680	Inside Passage	\$4,693.00	\$4,717.00
BL6630	Privacy Bath		
BL6620	Privacy Bedroom		
<b>Double Cylinder with Deadbolt   ROSES: A, T, U, V, W, Y, E2, E3, E4</b>			
BL6622	Store Door	\$4,693.00	\$4,717.00
BL6662	Classroom Security Intruder Deadbolt		
BL6672	Classroom Security Intruder Aux. Deadbolt		
BL6673	Classroom Security Intruder Deadlatch		
BL6675	Security Deadbolt		
<b>EAC   ROSES: A, T, U, V, W, Y, E2, E3, E4</b>			
BL66609 x NAC SAF / SEC	No Key Override With Deadbolt Fail Safe/Secure 12V/24V	\$4,913.00	\$4,937.00
BL66608 x NAC SAF / SEC	Key Override With Deadbolt Fail Safe/Secure 12V/24V	\$5,067.00	\$5,091.00



# BL6600 Series Multi-Point Locks



USA & Canada Prices Effective February 1, 2022

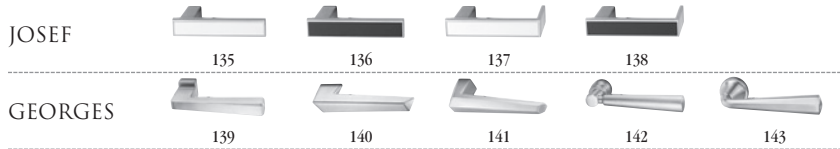

### ROSES

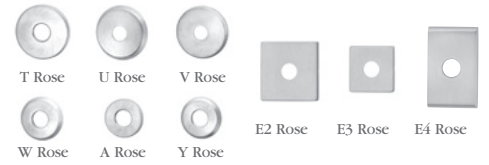

### ESCUTCHEONS



### THUMBTURNS\*



1. Handed: specify hand when ordering
2. Contact factory for current lead time
3. Specify thumbturn as quick code. Thumbturn backplate will match shape of rose chosen (i.e. round or square). Not available with escutcheons.

613E Dark Oxidized Satin Bronze	605 Bright Brass, Clear Coated	618 Bright Nickel Plated
626 Satin Chromium Plated - Equivalent	606 Satin Brass, Clear Coated	619 Satin Nickel Plated
BSP Black Suede Powder Coat	611 Bright Bronze, Clear Coated	625 Bright Chromium Plated
WSP White Suede Powder Coat	612 Satin Bronze, Clear Coated	629 Bright Stainless Steel
	613 Dark Oxidized Satin Bronze, Oil Rubbed	630 Satin Stainless Steel
	613L Dark Oxidized Satin Bronze, Clear Coated	722 Black Oxidized Bronze, Oil Rubbed

Functions	Description		
<b>Single Cylinder with Deadbolt   ESCUTCHEONS: L, CE, RE1</b>			
BL6618 BL6624 BL6665	Classroom Storeroom Exit/Dormitory	\$4,834.00	\$4,858.00
<b>Non-Keyed   ESCUTCHEONS: L, CE, RE1</b>			
BL6680 BL6630 BL6620	Inside Passage Privacy Bath Privacy Bedroom	\$4,834.00	\$4,858.00
<b>Double Cylinder with Deadbolt   ESCUTCHEONS: L, CE, RE1</b>			
BL6622 BL6662 BL6672 BL6673 BL6675	Store Door Classroom Security Intruder Deadbolt Classroom Security Intruder Aux. Deadbolt Classroom Security Intruder Deadlatch Security Deadbolt	\$4,834.00	\$4,858.00
<b>EAC   ESCUTCHEONS: L, CE, RE1</b>			
BL66609 x NAC SAF / SEC	No Key Override With Deadbolt Fail Safe/Secure 12V/24V	\$5,054.00	\$5,078.00
BL66608 x NAC SAF / SEC	Key Override With Deadbolt Fail Safe/Secure 12V/24V	\$5,208.00	\$5,232.00

# BL6600 Series Multi-Point Locks

USA & Canada Prices Effective February 1, 2022

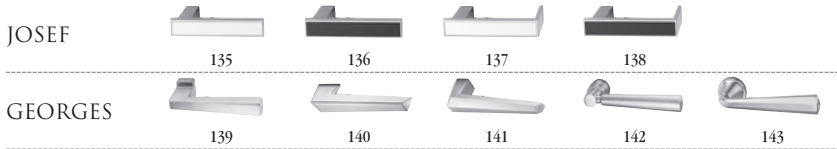

### ROSES

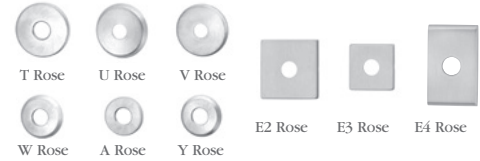

### ESCUTCHEONS



### THUMBTURNS\*



1. Handed: specify hand when ordering
2. Contact factory for current lead time
3. Specify thumbturn as quick code. Thumbturn backplate will match shape of rose chosen (i.e. round or square). Not available with escutcheons.

613E	Dark Oxidized Satin Bronze	605	Bright Brass, Clear Coated	618	Bright Nickel Plated
626	Satin Chromium Plated	606	Satin Brass, Clear Coated	619	Satin Nickel Plated
BSP	Black Suede Powder Coat	611	Bright Bronze, Clear Coated	625	Bright Chromium Plated
WSP	White Suede Powder Coat	612	Satin Bronze, Clear Coated	629	Bright Stainless Steel
		613	Dark Oxidized Satin Bronze, Oil Rubbed	630	Satin Stainless Steel
		613L	Dark Oxidized Satin Bronze, Clear Coated	722	Black Oxidized Bronze, Oil Rubbed

Functions	Description		
<b>Single Cylinder with Deadbolt   ROSES: A, T, U, V, W, Y, E2, E3, E4</b>			
BL6618 BL6624 BL6665	Classroom Storeroom Exit/Dormitory	\$4,790.00	\$4,814.00
<b>Non-Keyed   ROSES: A, T, U, V, W, Y, E2, E3, E4</b>			
BL6680 BL6630 BL6620	Inside Passage Privacy Bath Privacy Bedroom	\$4,790.00	\$4,814.00
<b>Double Cylinder with Deadbolt   ROSES: A, T, U, V, W, Y, E2, E3, E4</b>			
BL6622 BL6662 BL6672 BL6673 BL6675	Store Door Classroom Security Intruder Deadbolt Classroom Security Intruder Aux. Deadbolt Classroom Security Intruder Deadlatch Security Deadbolt	\$4,790.00	\$4,814.00
<b>EAC   ROSES: A, T, U, V, W, Y, E2, E3, E4</b>			
BL66609 x NAC SAF / SEC	No Key Override With Deadbolt Fail Safe/Secure 12V/24V	\$5,010.00	\$5,034.00
BL66608 x NAC SAF / SEC	Key Override With Deadbolt Fail Safe/Secure 12V/24V	\$5,164.00	\$5,188.00

# BL6600 Series Multi-Point Locks

USA & Canada Prices Effective February 1, 2022



\*613E, BSP, WSP finishes are not available with 21M levers.

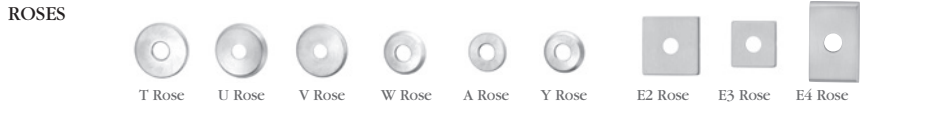

Specify thumbturn as quick code. Thumbturn backplate will match shape of rose chosen (i.e. round or square)

613E	Dark Oxidized Satin Bronze – Equivalent
629	Bright Stainless Steel
630	Satin Stainless Steel
BSP	Black Suede Powder Coat
WSP	White Suede Powder Coat

Functions	Description	
<b>Single Cylinder with Deadbolt   ESCUTCHEONS: L, CE, RE1</b>		
BL6618 BL6624 BL6665	Classroom Storeroom Exit/Dormitory	\$4,838.00
<b>Non-Keyed   ESCUTCHEONS: L, CE, RE1</b>		
BL6680 BL6630 BL6620	Inside Passage Privacy Bath Privacy Bedroom	\$4,838.00
<b>Double Cylinder with Deadbolt   ESCUTCHEONS: L, CE, RE1</b>		
BL6622 BL6662 BL6672 BL6673 BL6675	Store Door Classroom Security Intruder Deadbolt Classroom Security Intruder Aux. Deadbolt Classroom Security Intruder Deadlatch Security Deadbolt	\$4,838.00
<b>EAC   ESCUTCHEONS: L, CE, RE1</b>		
BL66609 x NAC SAF / SEC	No Key Override With Deadbolt Fail Safe/Secure 12V/24V	\$5,058.00
BL66608 x NAC SAF / SEC	Key Override With Deadbolt Fail Safe/Secure 12V/24V	\$5,212.00

# BL6600 Series Multi-Point Locks

USA & Canada Prices Effective February 1, 2022



\*613E, BSP, WSP finishes are not available with 21M levers.



Specify thumbturn as quick code. Thumbturn backplate will match shape of rose chosen (i.e. round or square)

613E Dark Oxidized Satin Bronze – Equivalent  
629 Bright Stainless Steel  
630 Satin Stainless Steel  
BSP Black Suede Powder Coat  
WSP White Suede Powder Coat

Functions	Description	
<b>Single Cylinder with Deadbolt   ROSES: A, T, U, V, W, Y, E2, E3, E4</b>		
BL6618 BL6624 BL6665	Classroom Storeroom Exit/Dormitory	\$4,794.00
<b>Non-Keyed   ROSES: A, T, U, V, W, Y, E2, E3, E4</b>		
BL6680 BL6630 BL6620	Inside Passage Privacy Bath Privacy Bedroom	\$4,794.00
<b>Double Cylinder with Deadbolt   ROSES: A, T, U, V, W, Y, E2, E3, E4</b>		
BL6622 BL6662 BL6672 BL6673 BL6675	Store Door Classroom Security Intruder Deadbolt Classroom Security Intruder Aux. Deadbolt Classroom Security Intruder Deadlatch Security Deadbolt	\$4,794.00
<b>EAC   ROSES: A, T, U, V, W, Y, E2, E3, E4</b>		
BL66609 x NAC SAF / SEC	No Key Override With Deadbolt Fail Safe/Secure 12V/24V	\$5,014.00
BL66608 x NAC SAF / SEC	Key Override With Deadbolt Fail Safe/Secure 12V/24V	\$5,168.00

# BL6600 Series Multi-Point Locks

USA & Canada Prices Effective February 1, 2022

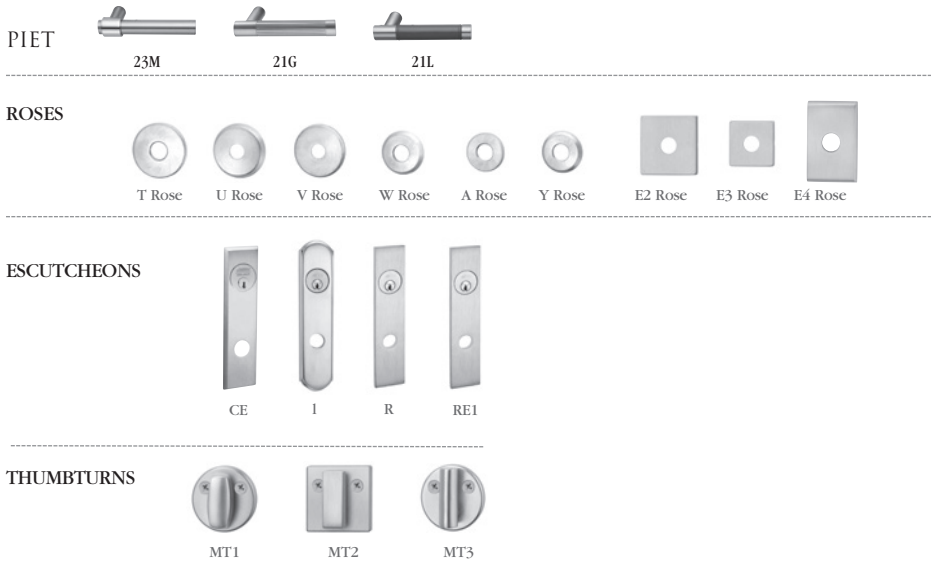

Specify thumbturn as quick code. Thumbturn backplate will match shape of rose chosen (i.e. round or square)

613E	Dark Oxidized Satin Bronze – Equivalent
629	Bright Stainless Steel
630	Satin Stainless Steel
BSP	Black Suede Powder Coat
WSP	White Suede Powder Coat

Functions	Description	
<b>Single Cylinder with Deadbolt   ESCUTCHEONS: L, CE, RE1</b>		
BL6618 BL6624 BL6665	Classroom Storeroom Exit/Dormitory	\$4,858.00
<b>Non-Keyed   ESCUTCHEONS: L, CE, RE1</b>		
BL6680 BL6630 BL6620	Inside Passage Privacy Bath Privacy Bedroom	\$4,858.00
<b>Double Cylinder with Deadbolt   ESCUTCHEONS: L, CE, RE1</b>		
BL6622 BL6662 BL6672 BL6673 BL6675	Store Door Classroom Security Intruder Deadbolt Classroom Security Intruder Aux. Deadbolt Classroom Security Intruder Deadlatch Security Deadbolt	\$4,858.00
<b>EAC   ESCUTCHEONS: L, CE, RE1</b>		
BL66609 x NAC SAF / SEC	No Key Override With Deadbolt Fail Safe/Secure 12V/24V	\$5,078.00
BL66608 x NAC SAF / SEC	Key Override With Deadbolt Fail Safe/Secure 12V/24V	\$5,232.00

# BL6600 Series Multi-Point Locks

USA & Canada Prices Effective February 1, 2022

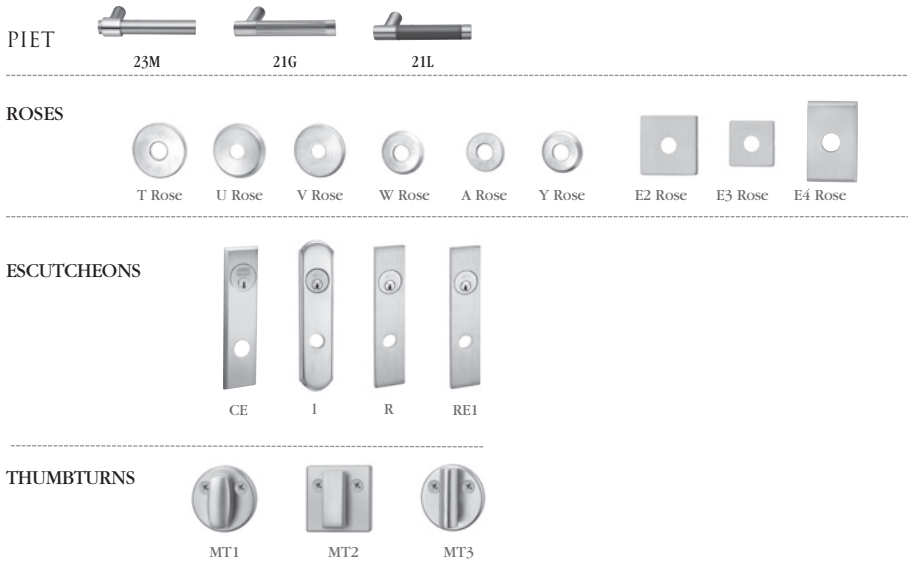

Specify thumbturn as quick code. Thumbturn backplate will match shape of rose chosen (i.e. round or square)

- 613E Dark Oxidized Satin Bronze – Equivalent
- 629 Bright Stainless Steel
- 630 Satin Stainless Steel
- BSP Black Suede Powder Coat
- WSP White Suede Powder Coat

Functions	Description	
<b>Single Cylinder with Deadbolt   ROSES: A, T, U, V, W, Y, E2, E3, E4</b>		
BL6618 BL6624 BL6665	Classroom Storeroom Exit/Dormitory	\$4,814.00
<b>Non-Keyed   ROSES: A, T, U, V, W, Y, E2, E3, E4</b>		
BL6680 BL6630 BL6620	Inside Passage Privacy Bath Privacy Bedroom	\$4,814.00
<b>Double Cylinder with Deadbolt   ROSES: A, T, U, V, W, Y, E2, E3, E4</b>		
BL6622 BL6662 BL6672 BL6673 BL6675	Store Door Classroom Security Intruder Deadbolt Classroom Security Intruder Aux. Deadbolt Classroom Security Intruder Deadlatch Security Deadbolt	\$4,814.00
<b>EAC   ROSES: A, T, U, V, W, Y, E2, E3, E4</b>		
BL66609 x NAC SAF / SEC	No Key Override With Deadbolt Fail Safe/Secure 12V/24V	\$5,034.00
BL66608 x NAC SAF / SEC	Key Override With Deadbolt Fail Safe/Secure 12V/24V	\$5,188.00

# BL6600 Series Multi-Point Locks



USA & Canada Prices Effective February 1, 2022

Cylinder Options		
Description	Specify Quick Code	Add or Deduct
Conventional 6-pin	(standard)	No Charge
Conventional 7-pin	7P	Add \$2.00 per cylinder
Less Standard Cylinder	LC	Deduct \$105.00 per cylinder
Less Concealed Shell Cylinder	PO-LC	Add \$5.00 per lockset
<b>LFIC</b>		
LFIC 6-pin	C6	Add \$91.00 per cylinder
LFIC 6-pin Less Core	CL6	No Charge
LFIC 6-pin with Temporary Construction Core (Red)	CT6R	Add \$91.00 per cylinder
LFIC 6-pin with Temporary Construction Core (Blue)	CT6B	Add \$91.00 per cylinder
LFIC 6-pin with Temporary Construction Core (Green)	CT6G	Add \$91.00 per cylinder
LFIC 6-pin with Temporary Disposable Core	CT6D	No Charge
LFIC 7-pin	C7	Add \$93.00 per cylinder
LFIC 7-pin Less Core	CL7	Add \$2.00 per cylinder
LFIC 7-pin with Temporary Construction Core (Red)	CT7R	Add \$93.00 per cylinder
LFIC 7-pin with Temporary Construction Core (Blue)	CT7B	Add \$93.00 per cylinder
LFIC 7-pin with Temporary Construction Core (Green)	CT7G	Add \$93.00 per cylinder
LFIC 7-pin with Temporary Disposable Core	CT7D	Add \$2.00 per cylinder
<b>SFIC</b>		
SFIC 6-pin	C6S	Add \$82.00 per cylinder
SFIC 6-pin with Temporary Construction Core (Blue)	CT6SB	Add \$82.00 per cylinder
SFIC 6-pin with SFIC disposable temporary core	CT6SD	No Charge
SFIC 6-pin with Less Core	CLS6	No Charge
SFIC 7-pin	C7S	Add \$82.00 per cylinder
SFIC 7-pin with Temporary Construction Core (Blue)	CT7SB	Add \$82.00 per cylinder
SFIC 7-pin with SFIC disposable temporary core	CT7SD	Add \$2.00 per cylinder
SFIC 7-pin with Less Core	CLS7	Add \$2.00 per cylinder
<b>Security</b>		
Security <sup>4</sup>	HS	Add \$139.00 per cylinder
Security LFIC <sup>1,4</sup>	CHS	Add \$226.00 per cylinder
<b>Access 3</b>		
Access 3 Patented	AP	No Charge
Access 3 Security	AS	Add \$61.00 per cylinder
Access 3 High Security, UL 437	AHS	Add \$86.00 per cylinder
Access 3 LFIC Patented	ACP	Add \$91.00 per cylinder
Access 3 LFIC Security	ACS	Add \$147.00 per cylinder
Access 3 LFIC High Security, UL 437	ACHS	Add \$169.00 per cylinder
<b>Pyramid</b>		
Pyramid Security Fixed Core	PS	Add \$74.00 per cylinder
Pyramid Security LFIC	PCS	Add \$159.00 per cylinder
Pyramid High Security Fixed Core	PHS	Add \$110.00 per cylinder
Pyramid High Security LFIC	PCHS	Add \$196.00 per cylinder
Pyramid LFIC with Temporary Construction Core <sup>3</sup>	CTP	Add \$91.00 per cylinder
Pyramid LFIC with Temporary Disposable Core <sup>3</sup>	CTPD	No Charge
Pyramid LFIC Less Core	CLP	No Charge
<b>Other</b>		
Master Ring <sup>2</sup>	MR	Add \$79.00 per cylinder
Flex Head Cylinder, 6-pin (sectional trim)	FX6	Add \$95.00 per cylinder
Flex Head Cylinder, 7-pin (sectional trim)	FX7	Add \$97.00 per cylinder
Flex Head Master Ring (sectional trim)	FXM	Add \$154.00 per cylinder
Plug only to show, 6-pin (concealed shell) (available for M and R escutcheons and single cylinder functions only)	P06	Add \$105.00 per lockset
Plug only to show, 7-pin (concealed shell) (available for M and R escutcheons and single cylinder functions only)	P07	Add \$107.00 per lockset

**Notes:**

1. CHS ordered with CT6 option no charge.
2. Refer to Key construction core program, pg. 63 for example of CTP option pricing.
3. For existing systems only.

*Continued on next page*

## BL6600 Series Multi-Point Locks

USA & Canada Prices Effective February 1, 2022

### Cylinder Options (continued) & Keying Options\*

Description	Specify Quick Code	Add or Deduct
<b>Keying and Keys</b>		
0-bitted with 2 Blank Keys	(standard)	No Charge
Keyed Random	KR	
Construction Master Keyed <sup>2</sup>	CMK	Add \$16.00 per cylinder
More than 2 Keys	KY# (e.g., KY6)	See page 31 - Cut Keys Section
<b>Master Keying</b>		
Master keyed (all cylinders except CR8000, CR8020, CR8027, CR8200, CR8500, CR8600, CR8700)	MK	Add \$16.00 per cylinder
Master keyed Pyramid (except CR8020, CR8027 LFIC cores)	MK	
Master keyed Security (including LFIC cylinder and core)	MK	
Master keyed Access 3 (except CR8500, CR8600, CR8700 LFIC cores)	MK	
Master keyed (CR8000, CR8020, CR8027, CR8200, CR8500, CR8600, CR8700)	MK-IC	No Charge
Master keyed to customer bittings or sample key	MK-CB	Add \$16.00 per cylinder
<b>Visual Key Control (VKC)</b>		
No bitting or keyset stamping on keys	VKC0	\$4.50
Keys only	VKC1	No Charge
Cylinders and keys (not for AS, AHS, ACS, ACHS, HS, CHS, PHS or PCHS)	VKC2	\$8.00
Cylinders only (not for AS, AHS, HS, ACS, ACHS, CHS, PHS or PCHS)	VKC3	
<b>Concealed Key Control (CKC)</b>		
CKC cylinders with VKC keys	CKC2	\$8.00
CKC cylinders only (not for AS, AHS, ACS, ACHS, PHS, PCHS)	CKC3	

**Notes:**

1. CMK Construction master keying charge is in addition to master keying charge.
2. CMK Construction master keying is not available in interchangeable core, Access 3, Pyramid, or Security series.
3. VKC2, VKC3, CKC3 are not available in Pyramid or Security series.
4. Pyramid series is not available keyed random.
5. Security series is not available 0-bitted.

### Strike Options\*

Lip Length	ANSI Straight Lip - Specify Quick Code	ANSI Curved Lip - Specify Quick Code	Add or Deduct
7/8"	SS078	N/A	No Charge

\* If door thickness is standard or has been specified and no special door or frame condition exist, then only the first two characters of the optional strike Quick Code must be specified (e.g. "SA").

The correct lip length will be determined by our order entry system based on the standard or specified door thickness.



# BL6600 Series Multi-Point Locks



USA & Canada Prices Effective February 1, 2022

## Door Thickness with Locksets Mortised on Center

Door Thickness	Sectional Rose Trim Specify Quick Code	Escutcheon <sup>1,2</sup> Trim Specify Quick Code	Add or Deduct
1-3/4" (standard)	—	—	No Charge

## Options

Description	Specify Quick Code	Add or Deduct
Split designs and split finishes	Outside Trim x Inside Trim	Higher set price prevails
Spanner head screws	M02	Add \$24.00 per lockset
Torx® head screws (n/a with N escutcheon)	M04	Add \$30.00 per lockset
Single Occupancy Indicator - Secure/Unsecure (Outside)	M19S*	Add \$155.00 per lockset
Single Occupancy Indicator - Vacant/Occupied (Outside)	M19V*	Add \$155.00 per lockset
Double Occupancy Indicator - Secure/Unsecure (Outside) Secure/Unsecure (Inside)	M19SN*	Add \$310.00 per lockset
Double Indicator Vacant/Occupied (Outside) Secure/Unsecure (Inside)	M19VN*	Add \$310.00 per lockset
Knurling outside and inside	M20 <sup>1</sup>	Add \$172.00 per lockset
Knurling outside only	M21 <sup>1</sup>	Add \$86.00 per lockset
Knurling inside only	M22 <sup>1</sup>	Add \$86.00 per lockset
Abrasive coat outside and inside	M23 <sup>1</sup>	Add \$108.00 per lockset
Abrasive coat inside only	M24 <sup>1</sup>	Add \$54.00 per lockset
Abrasive coat outside only	M25 <sup>1</sup>	Add \$54.00 per lockset

## Thumbturn Options

Specify door thickness	Specify Quick Code	Add or Deduct
Ergonomic	M34 <sup>2</sup>	Add \$18.00 per TT
Decorative	MT1	No Charge
Decorative square	MT2	No Charge
Decorative cylinder	MT3	No Charge



MT1



MT2



MT3

### Notes:

1. Not available with Vineyard™ or Muséo® levers.
2. M34 is not available with M19N, M19VN or M19SN.

Note: Thumbturn backplate will match shape of rose chosen (i.e. round or square)

## Strike Options

Part Number	Description
726F577	Top Strike Pack
726F587	Bottom Strike Pack
726F607	Center Strike Pack

Note: Concealed vertical rods, top & bottom latches, and the lockbody cassette will be factory installed. All other hardware components are shipped directly to the customer and must be installed by a factory trained installer. Invoices for the door will be separate from the hardware invoice. The hardware invoice will include the concealed vertical assembly and the trim components.

# FE6700

## Storm Shutter Multi-Point Latching System

USA & Canada Prices Effective February 1, 2022

### Standard Features

**Handing**  
Device is handed

**Shutter Thickness**  
FE6700 is for use with standard 1-3/4" thick shutters

**Cylinder Furnished with:**  
Brass, 6-pin, L4 keyway, 0-bitted, 1-1/8" standard for FE6755 Classroom Function. Optional cylinders available; see Quick Codes

**Warranty**  
Seven-year limited

**UL Approved**  
Meets FEMA P320 (2014), P361 (2015) and ICC 500-2014 for inswing shutters 2'8" w x 3'00" h min to 4'0" w x 6'8" h max.

Solid brass lever and heavy duty escutcheon

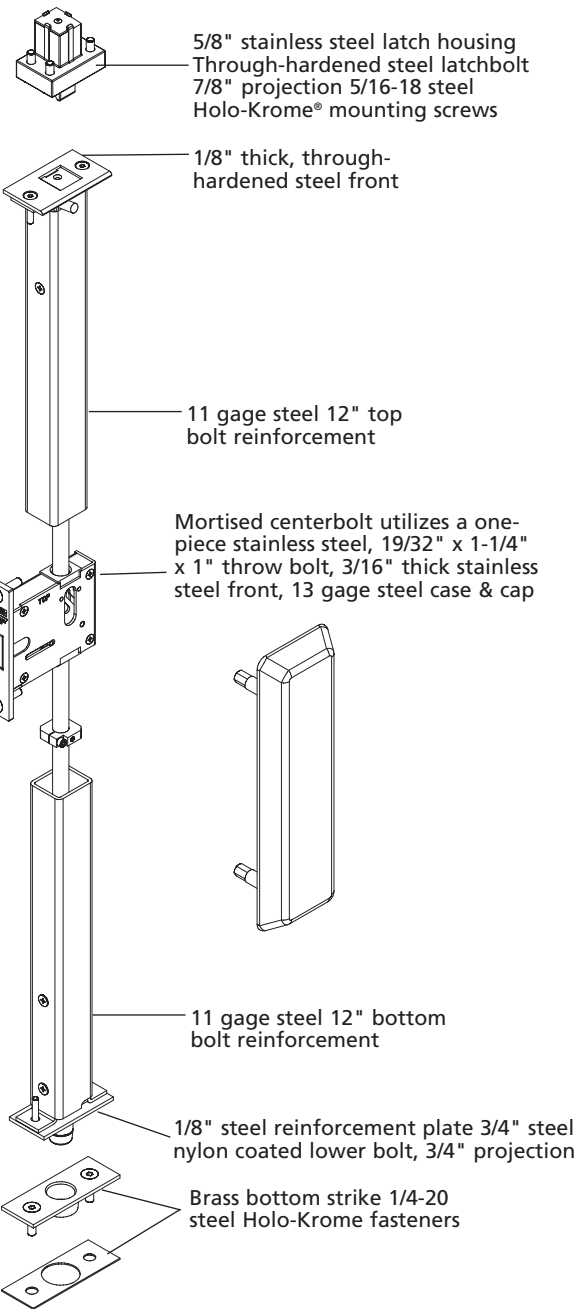
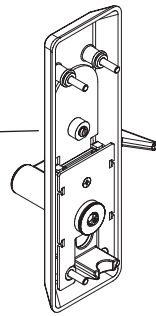

### Ordering Example

#### Stock Order

Quantity	Series/ Function	Trim	Finish	Hand	Shutter Height
100	FE6780	FSH	626	RH	H0400

# FE6700

## Storm Shutter Multi-Point Latching System

USA & Canada Prices Effective February 1, 2022

Lever: Solid cast  
Escutcheon: Forged

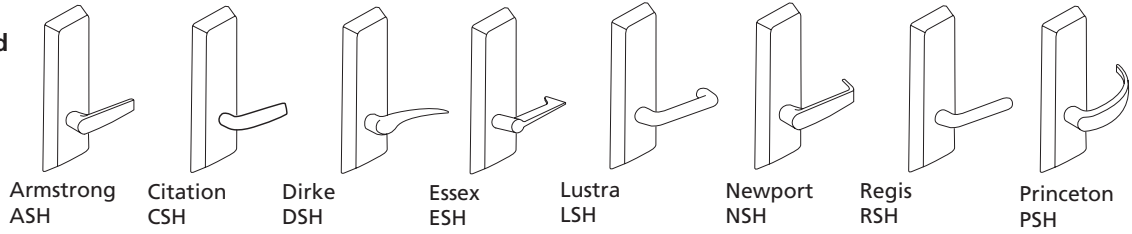

### FE6700 Series

Function	Description	ASH, CSH, DSH, ESH, LSH, NSH, PSH, RSH			
		Finish Group 1		Finish Group 2	
		613E Dark Oxidized Satin Bronze	605 Polished Brass	619 Satin Nickel	
		630 Satin Stainless Steel(1)	606 Satin Brass	625 Polished Chrome	
		BSP Black Suede Powder Coat	611 Polished Bronze	629 Polished Stainless Steel(1)	
		WSP White Suede Powder Coat	612 Satin Bronze	626 Satin Chrome	
			613 Oil Rubbed Bronze	722 Black Oil Rubbed Bronze	
			618 Polished Nickel		
<b>For Typical Shutter Applications</b>					
FE6780	Passage Lever x Blank Plate				
<b>Optional Functions</b>		\$4,315.00		\$4,325.00	
FE6710	Passage or Closet				
FE6755	Classroom <sup>3</sup>				

1. H escutcheon is a brass forging finished to match 629 and 630 finishes  
3. Collar is required depending on length and type of cylinder. See Miscellaneous Options section on page 245.

Lever: Solid Cast  
Escutcheon: Forged



### FE6700 Series

Function	Description	FSH, MSH, ZSH			
		Finish Group 1		Finish Group 2	
		613E Dark Oxidized Satin Bronze	605 Polished Brass	619 Satin Nickel	
		630 Satin Stainless Steel(1)	606 Satin Brass	625 Polished Chrome	
		BSP Black Suede Powder Coat	611 Polished Bronze	722 Black Oil Rubbed Bronze	
		WSP White Suede Powder Coat	612 Satin Bronze		
			613 Oil Rubbed Bronze		
			618 Polished Nickel		
<b>For Typical Shutter Applications</b>					
FE6780	Passage Lever x Blank Plate				
<b>Optional Functions</b>		\$4,315.00		\$4,325.00	
FE6710	Passage or Closet				
FE6755	Classroom <sup>3</sup>				

3. Collar is required depending on length and type of cylinder. See Miscellaneous Options section on page 245.

# FE6700

## Storm Shutter Multi-Point Latching System

USA & Canada Prices Effective February 1, 2022

Cylinder Options*		
Description	Specify Quick Code	Add or Deduct
Conventional 6-pin	6P**	No Charge
Conventional 7-pin	7P	Add \$2.00 per cylinder
Less Standard Cylinder	LC	Deduct \$105.00 per cylinder
Less Concealed Shell Cylinder	PO-LC	Add \$5.00 per lockset
<b>LFIC</b>		
LFIC 6-pin	C6	Add \$91.00 per cylinder
LFIC 6-pin less core	CL6	No Charge
LFIC 6-pin with temporary construction core (Red)	CT6R	Add \$91.00 per cylinder
LFIC 6-pin with temporary construction core (Blue)	CT6B	Add \$91.00 per cylinder
LFIC 6-pin with temporary construction core (Green)	CT6G	Add \$91.00 per cylinder
LFIC 6-pin with temporary disposable core	CT6D	No Charge
LFIC 7-pin	C7	Add \$93.00 per cylinder
LFIC 7-pin less core	CL7	Add \$2.00 per cylinder
LFIC 7-pin with temporary construction core (Red)	CT7R	Add \$93.00 per cylinder
LFIC 7-pin with temporary construction core (Blue)	CT7B	Add \$93.00 per cylinder
LFIC 7-pin with temporary construction core (Green)	CT7G	Add \$93.00 per cylinder
LFIC 7-pin with temporary disposable core	CT7D	Add \$2.00 per cylinder
<b>SFIC</b>		
SFIC 6-pin	C6S	Add \$82.00 per cylinder
LFIC 6-pin with temporary construction core (Blue)	CT6SB	Add \$82.00 per cylinder
SFIC 6-pin with SFIC disposable temporary core	CT6SD	No Charge
SFIC 6-pin with Less Core	CLS6	No Charge
SFIC 7-pin	C7S	Add \$82.00 per cylinder
LFIC 6-pin with temporary construction core (Blue)	CT7SB	Add \$82.00 per cylinder
SFIC 7-pin with SFIC disposable temporary core	CT7SD	Add \$2.00 per cylinder
SFIC 7-pin with Less Core	CLS7	Add \$2.00 per cylinder
<b>Security</b>		
Security <sup>4</sup>	HS	Add \$139.00 per cylinder
Security LFIC <sup>4</sup>	CHS	Add \$226.00 per cylinder
<b>Access 3</b>		
Access 3 Patented	AP	No Charge
Access 3 Security	AS	Add \$61.00 per cylinder
Access 3 High Security, UL 437	AHS	Add \$86.00 per cylinder
Access 3 LFIC Patented	ACP	Add \$91.00 per cylinder
Access 3 LFIC Security	ACS	Add \$147.00 per cylinder
Access 3 LFIC High Security, UL 437	ACHS	Add \$169.00 per cylinder
<b>Pyramid</b>		
Pyramid Security fixed core	PS	Add \$74.00 per cylinder
Pyramid Security LFIC	PCS	Add \$159.00 per cylinder
Pyramid High Security fixed core	PHS	Add \$110.00 per cylinder
Pyramid High Security LFIC	PCHS	Add \$196.00 per cylinder
Pyramid LFIC with temporary construction core <sup>3</sup>	CTP	Add \$91.00 per cylinder
Pyramid LFIC with temporary disposable core <sup>3</sup>	CTPD	No Charge
Pyramid LFIC less core	CLP	No Charge

Notes:

1. CMK Construction master keying charge is in addition to master keying charge.
2. CMK Construction master keying is not available in interchangeable core, Access 3, Pyramid, or Security series.
3. VKC2, VKC3, CKC3 are not available in Pyramid or Security series.
4. Pyramid series is not available keyed random.
5. Security series is not available 0-bitted.

\*Optional dogging cylinder will be furnished with the same mechanism and keyed alike with the trim cylinder, unless otherwise specified.  
If different keying or cylinder type is required, specify outside (trim) first, then inside (dogging) cylinder.

\*\*6P cylinder option is supplied in 6-pin, L4 keyway, 0-bitted with two nickel silver keys.

# FE6700

## Storm Shutter Multi-Point Latching System



USA & Canada Prices Effective February 1, 2022

Cylinder Options (continued) & Keying Options*		
Description	Specify Quick Code	Add or Deduct
<b>Keying and Keys</b>		
0-bitted with 2 Blank Keys	(standard)	No Charge
Keyed Random	KR	
Construction Master Keyed <sup>2</sup>	CMK	Add \$16.00 per cylinder
More than 2 Keys	KY# (e.g., KY6)	See page 31 - Cut Keys Section
<b>Master Keying</b>		
Master keyed (all cylinders except CR8000, CR8020, CR8027, CR8200, CR8500, CR8600, CR8700)	MK	Add \$16.00 per cylinder
Master keyed Pyramid (except CR8020, CR8027 LFIC cores)	MK	
Master keyed Security (including LFIC cylinder and core)	MK	
Master keyed Access 3 (except CR8500, CR8600, CR8700 LFIC cores)	MK	
Master keyed (CR8000, CR8020, CR8027, CR8200, CR8500, CR8600, CR8700)	MK-IC	No Charge
Master keyed to customer bittings or sample key	MK-CB	Add \$16.00 per cylinder
<b>Visual Key Control (VKC)</b>		
No bitting or keyset stamping on keys	VKC0	\$4.50
Keys only	VKC1	No Charge
Cylinders and keys (not for AS, AHS, ACS, ACHS, HS, CHS, PHS or PCHS)	VKC2	\$8.00
Cylinders only (not for AS, AHS, HS, ACS, ACHS, CHS, PHS or PCHS)	VKC3	
<b>Concealed Key Control (CKC)</b>		
CKC cylinders with VKC keys	CKC2	\$8.00
CKC cylinders only (not for AS, AHS, ACS, ACHS, PHS, PCHS)	CKC3	

**Notes:**

1. Not available in CLX3329 function.
2. CMK Construction master keying charge is in addition to master keying charge and is not available in interchangeable core, Access 3, Pyramid, or Security series.

\*Double cylinder keying: unless otherwise specified, both cylinders of 32, 62, 72 and 82 functions will be keyed alike. The inside cylinder of 52 function will be keyed to the master key(s) only, while the outside cylinder will include the change key. If different keying is required, specify outside cylinder first, then inside cylinder. For key bows other than 10 and 90, specify 'KB' + bow number as Quick Code, e.g. KB12.

### Shutter Thickness

Description	Specify
1-3/4"	(standard)

### Shutter Height Options

Description	Specify
2'8" - 4'6"	H0400
4'6" - 6'8"	H0500

### Miscellaneous Options

Description	Specify	Add or Deduct
Torx Screws	M04	Add \$30.00 per lockset
1-1/8" cylinder collar (for 6-pin mortise cylinder) <sup>12</sup>	721F36	No Charge
1-1/4" cylinder collar (for 7-pin mortise cylinder) <sup>12</sup>	721F37	No Charge
1-1/2" cylinder collar (for 7-pin IC mortise cylinder) <sup>12</sup>	721F38	No Charge
MicroShield® Antimicrobial finish coating	630C	Add \$98.00 per lockset
MicroShield Antimicrobial finish coating	626C	Add \$98.00 per lockset

**Notes:**

1. For optional FE6755 classroom function, collar is required depending on length and type of cylinder.
2. Specify as optional collar when ordering cylinders only.

# MP9800 Series Multi-Point Vertical Rod Lock

## Standard Features

### Handing

Field Reversible.

### Doors

1-3/4" (44mm) door thickness standard,  
2-1/4" backset standard.

### Mounting

Supplied fasteners are for metal doors with through-bolts for trim.

### Rods

Steel. Top and bottom bolt travels 7/16" (11mm)  
Projection adjustable up to 3/4" (19mm).

### Latching

Top and Bottom or Top only (M55).

### Trim

Available with all lever designs.

### Cylinder

See cylinders page 12.

### Applications

Single or Double Door.

### Thermal Pins

MP9800A x M55: devices are supplied with ONE thermal pin per  
fire-rated device, for installation on pairs of fire-rated doors.

### Warranty

5 year.

USA & Canada Prices Effective February 1, 2022

**Featuring Ecoflex Technology**



## Available Function Combinations:

	Outside Function (E)	Inside Function (N)								
		10	45*	49*	50	52	55*	59*	903*	905*
Blank Escutcheon Plate	01	X	X	X			X	X	X	X
Passage only (No cylinder)	10	X	X	X			X	X		
No outside Operation (No Cylinder); Pull Only	40+	X	X	X					X	X
Class Room Key Outside Unlocks/locks Trim	45	X	X	X						
Key unlocks Trim; Trim retracts latch; Trim relocks when key is removed	49	X	X	X					X	X
Freewheeling Trim; No Outside Operation	50						X	X		
Key outside unlocks/locks O/S trim; Key inside unlocks/locks O/S trim	52					X				
Freewheeling Trim; Key Outside Unlocks/locks Trim	55	X			X		X	X		
Freewheeling Trim; Key unlocks Trim; Trim retracts latch/Trim relocks when key is removed	59	X			X		X	X		
Electrified Trim - Fail Safe	903	X	X	X					X	X
Electrified Trim - Fail Secure	905	X	X	X					X	X

\* Not recommended for use on any door used for Life Safety egress + Rigid lever

\*Specify voltage desired for 903 and 905 functions (12VDC/24VDC)

## Ordering Examples

Qty	Device	Exterior Trim/Function			Interior Trim/Function			Finish	Hand	Door Thickness	Door Height	Misc. Options	Voltage for Electrified Trim
		Lever	Exterior	Function	Lever	Interior	Function						
65	MP9800	D	E	49	D	N	10	605	LHR	D214	H0800	M55	12V

## Contract/Detailed Order

Qty	Keyset	Series	Exterior Trim/Function			Interior Trim/Function			Finish	Hand	Door Thickness	Door Hght	Misc. Opts	Cyl Opts	Voltage for Electrified Trim
			Lever	Exterior	Function	Lever	Interior	Function							
36	AA1	MP9800A	101	E	50	101	N	55	626	LHR	D214	H1000	M93	7P	12V

Experience a safer  
and more open world

Copyright © 2002-2022 Corbin Russwin, Inc., an ASSA ABLOY Group company. All rights reserved.  
Reproduction in whole or in part without the express written permission of Corbin Russwin, Inc., is prohibited.  
Contact us at: 800-543-3658 or visit [www.corbinrusswin.com](http://www.corbinrusswin.com). In Canada contact us at: 800-461-3007 or visit [www.assaabloydss.ca](http://www.assaabloydss.ca)

# MP9800 Series

## Multi-Point Vertical Rod Lock



**ASSA ABLOY**

USA & Canada Prices  
Effective February 1, 2022

Lever: Solid Cast  
Escutcheon: Forged

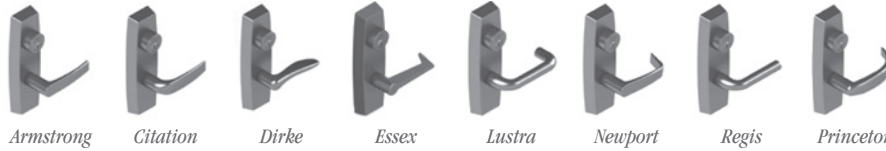

GEORGIA



JACKSON



JOSEF



LASZLO



MARC



SALVADOR



Note: Must designate E for exterior function or N for interior function when specifying order.

MP9800		613E, 626, BSP, WSP	605 606 611 612 613 618 625
Lever (E) x 01 x Lever (N) x *49	Blank Escutcheon Plate		
Lever (E) x 01 x Lever (N) x *45	Blank Escutcheon Plate		
Lever (E) x 01 x Lever (N) x 10	Blank Escutcheon Plate		
Lever (E) x 01 x Lever (N) x *55	Blank Escutcheon Plate		
Lever (E) x 01 x Lever (N) x 59	Blank Escutcheon Plate		
Lever (E) x 10 x Lever (N) x *49	Passage only (No cylinder)		
Lever (E) x 10 x Lever (N) x *45	Passage only (No cylinder)		
Lever (E) x 10 x Lever (N) x 10	Passage only (No cylinder)		
Lever (E) x 10 x Lever (N) x *55	Passage only (No cylinder)		
Lever (E) x 10 x Lever (N) x *59	Passage only (No cylinder)	\$2,485.00	\$2,565.00
Lever (E) x 40 x Lever (N) x *49	No outside Operation (No Cylinder); Pull Only		
Lever (E) x 40 x Lever (N) x *45	No outside Operation (No Cylinder); Pull Only		
Lever (E) x 40 x Lever (N) x 10	No outside Operation (No Cylinder); Pull Only		
Lever (E) x 45 x Lever (N) x *49	Class Room Key Outside Unlocks/locks Trim		
Lever (E) x 45 x Lever (N) x *45	Class Room Key Outside Unlocks/locks Trim		
Lever (E) x 45 x Lever (N) x 10	Class Room Key Outside Unlocks/locks Trim		
Lever (E) x 49 x Lever (N) x *10	Key unlocks Trim; Trim retracts latch; Trim relocks when key is removed		
Lever (E) x 49 x Lever (N) x *45	Key unlocks Trim; Trim retracts latch; Trim relocks when key is removed		
Lever (E) x 49 x Lever (N) x *49	Key unlocks Trim; Trim retracts latch; Trim relocks when key is removed		

\* Not recommended for use on any door used for Life Safety egress.

**MP9800 Series**  
**Multi-Point Vertical Rod Lock**

USA & Canada Prices Effective February 1, 2022

<b>MP9800 Freewheeling Trim</b>		<b>613E, 626, BSP, WSP</b>	<b>605 606 611 612 613 618 625</b>
Lever (E) x 50 x Lever (N) x *55	Freewheeling Trim; No Outside Operation		
Lever (E) x 50 x Lever (N) x *59	Freewheeling Trim; No Outside Operation		
Lever (E) x 52 x Lever (N) x 52	Key outside unlocks/locks O/S trim; Key inside unlocks/locks O/S trim		
Lever (E) x 55 x Lever (N) x *10	Freewheeling Trim; Key Outside Unlocks/locks Trim		
Lever (E) x 55 x Lever (N) x 50	Freewheeling Trim; Key Outside Unlocks/locks Trim		
Lever (E) x 55 x Lever (N) x *55	Freewheeling Trim; Key Outside Unlocks/locks Trim	\$2,485.00	\$2,565.00
Lever (E) x 55 x Lever (N) x *59	Freewheeling Trim; Key Outside Unlocks/locks Trim		
Lever (E) x 59 x Lever (N) x *10	Freewheeling Trim; Key unlocks Trim; Trim retracts latch/Trim relocks when key is removed		
Lever (E) x 59 x Lever (N) x 50	Freewheeling Trim; Key unlocks Trim; Trim retracts latch/Trim relocks when key is removed		
Lever (E) x 59 x Lever (N) x *55	Freewheeling Trim; Key unlocks Trim; Trim retracts latch/Trim relocks when key is removed		
Lever (E) x 59 x Lever (N) x *59	Freewheeling Trim; Key unlocks Trim; Trim retracts latch/Trim relocks when key is removed		
<b>MP9800 Electromechanical</b>			
Lever (E) x 01 x Lever (N) x *903	Blank Escutcheon Plate		
Lever (E) x 01 x Lever (N) x *905	Blank Escutcheon Plate		
Lever (E) x 40 x Lever (N) x *903	No outside Operation (No Cylinder); Pull Only		
Lever (E) x 40 x Lever (N) x *905	No outside Operation (No Cylinder); Pull Only		
Lever (E) x 49 x Lever (N) x *903	Key unlocks Trim; Trim retracts latch; Trim relocks when key is removed	\$2,652.00	\$2,732.00
Lever (E) x 49 x Lever (N) x *905	Key unlocks Trim; Trim retracts latch; Trim relocks when key is removed		
Lever (E) x 903 x Lever (N) x 10	Electrified Trim - Fail Safe		
Lever (E) x 903 x Lever (N) x *45	Electrified Trim - Fail Safe		
Lever (E) x 905 x Lever (N) x 10	Electrified Trim - Fail Secure		
Lever (E) x 905 x Lever (N) x *45	Electrified Trim - Fail Secure		
Lever (E) x 905 x Lever (N) x *903	Electrified Trim - Fail Secure		
Lever (E) x 905 x Lever (N) x *905	Electrified Trim - Fail Secure	\$2,819.00	\$2,899.00
Lever (E) x 903 x Lever (N) x *903	Electrified Trim - Fail Safe		
Lever (E) x 903 x Lever (N) x *905	Electrified Trim - Fail Safe		

\* Not recommended for use on any door used for Life Safety egress.



# MP9800 Series

## Multi-Point Vertical Rod Lock



**ASSA ABLOY**

USA & Canada Prices  
Effective February 1, 2022

Lever: Solid Cast  
Escutcheon: Forged

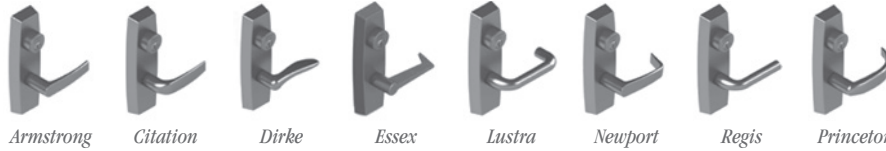

GEORGIA									
JACKSON									
JOSEF									
LASZLO									
MARC									
SALVADOR									

Note: Must designate E for exterior function or N for interior function when specifying order.

MP9800A/B		613E, 626, BSP, WSP	605 606 611 612 613 618 625
Lever (E) x 01 x Lever (N) x *49	Blank Escutcheon Plate		
Lever (E) x 01 x Lever (N) x *45	Blank Escutcheon Plate		
Lever (E) x 01 x Lever (N) x 10	Blank Escutcheon Plate		
Lever (E) x 01 x Lever (N) x *55	Blank Escutcheon Plate		
Lever (E) x 01 x Lever (N) x *59	Blank Escutcheon Plate		
Lever (E) x 10 x Lever (N) x *49	Passage only (No cylinder)		
Lever (E) x 10 x Lever (N) x *45	Passage only (No cylinder)		
Lever (E) x 10 x Lever (N) x 10	Passage only (No cylinder)		
Lever (E) x 10 x Lever (N) x *55	Passage only (No cylinder)		
Lever (E) x 10 x Lever (N) x *59	Passage only (No cylinder)	\$2,687.00	\$2,767.00
Lever (E) x 40 x Lever (N) x *49	No outside Operation (No Cylinder); Pull Only		
Lever (E) x 40 x Lever (N) x *45	No outside Operation (No Cylinder); Pull Only		
Lever (E) x 40 x Lever (N) x 10	No outside Operation (No Cylinder); Pull Only		
Lever (E) x 45 x Lever (N) x *49	Class Room Key Outside Unlocks/locks Trim		
Lever (E) x 45 x Lever (N) x *45	Class Room Key Outside Unlocks/locks Trim		
Lever (E) x 45 x Lever (N) x 10	Class Room Key Outside Unlocks/locks Trim		
Lever (E) x 49 x Lever (N) x *10	Key unlocks Trim; Trim retracts latch; Trim relocks when key is removed		
Lever (E) x 49 x Lever (N) x *45	Key unlocks Trim; Trim retracts latch; Trim relocks when key is removed		
Lever (E) x 49 x Lever (N) x *49	Key unlocks Trim; Trim retracts latch; Trim relocks when key is removed		

\* Not recommended for use on any door used for Life Safety egress.

**MP9800 Series**  
**Multi-Point Vertical Rod Lock**

USA & Canada Prices Effective February 1, 2022

<b>MP9800A/B Freewheeling Trim</b>		<b>613E, 626, BSP, WSP</b>	<b>605 606 611 612 613 618 625</b>
Lever (E) x 50 x Lever (N) x *55	Freewheeling Trim; No Outside Operation		
Lever (E) x 50 x Lever (N) x *59	Freewheeling Trim; No Outside Operation		
Lever (E) x 52 x Lever (N) x 52	Key outside unlocks/locks O/S trim; Key inside unlocks/locks O/S trim		
Lever (E) x 55 x Lever (N) x *10	Freewheeling Trim; Key Outside Unlocks/locks Trim		
Lever (E) x 55 x Lever (N) x 50	Freewheeling Trim; Key Outside Unlocks/locks Trim		
Lever (E) x 55 x Lever (N) x *55	Freewheeling Trim; Key Outside Unlocks/locks Trim	\$2,687.00	\$2,767.00
Lever (E) x 55 x Lever (N) x *59	Freewheeling Trim; Key Outside Unlocks/locks Trim		
Lever (E) x 59 x Lever (N) x *10	Freewheeling Trim; Key unlocks Trim; Trim retracts latch/Trim relocks when key is removed		
Lever (E) x 59 x Lever (N) x 50	Freewheeling Trim; Key unlocks Trim; Trim retracts latch/Trim relocks when key is removed		
Lever (E) x 59 x Lever (N) x *55	Freewheeling Trim; Key unlocks Trim; Trim retracts latch/Trim relocks when key is removed		
Lever (E) x 59 x Lever (N) x *59	Freewheeling Trim; Key unlocks Trim; Trim retracts latch/Trim relocks when key is removed		
<b>MP9800A/B Electromechanical</b>			
Lever (E) x 01 x Lever (N) x *903	Blank Escutcheon Plate		
Lever (E) x 01 x Lever (N) x *905	Blank Escutcheon Plate		
Lever (E) x 40 x Lever (N) x *903	No outside Operation (No Cylinder); Pull Only		
Lever (E) x 40 x Lever (N) x *905	No outside Operation (No Cylinder); Pull Only		
Lever (E) x 49 x Lever (N) x *903	Key unlocks Trim; Trim retracts latch; Trim relocks when key is removed	\$2,854.00	\$2,934.00
Lever (E) x 49 x Lever (N) x *905	Key unlocks Trim; Trim retracts latch; Trim relocks when key is removed		
Lever (E) x 903 x Lever (N) x 10	Electrified Trim - Fail Safe		
Lever (E) x 903 x Lever (N) x *45	Electrified Trim - Fail Safe		
Lever (E) x 905 x Lever (N) x 10	Electrified Trim - Fail Secure		
Lever (E) x 905 x Lever (N) x *45	Electrified Trim - Fail Secure		
Lever (E) x 905 x Lever (N) x *903	Electrified Trim - Fail Secure		
Lever (E) x 905 x Lever (N) x *905	Electrified Trim - Fail Secure	\$3,021.00	\$3,101.00
Lever (E) x 903 x Lever (N) x *903	Electrified Trim - Fail Safe		
Lever (E) x 903 x Lever (N) x *905	Electrified Trim - Fail Safe		

\* Not recommended for use on any door used for Life Safety egress.

# MP9800 Series

## Multi-Point Vertical Rod Lock

USA & Canada Prices Effective February 1, 2022

PIET\*



\*\*613E, BSP, WSP finishes are not available with 21M levers.

<b>MP9800</b>		<b>613E, 629, 630, BSP, WSP</b>
	<b>Piet 21G, 21L, 21M, 21S, 23M, 25M, 27M</b>	
Lever (E) x 01 x Lever (N) x *49	Blank Escutcheon Plate	\$2,669.00
Lever (E) x 01 x Lever (N) x *45	Blank Escutcheon Plate	
Lever (E) x 01 x Lever (N) x 10	Blank Escutcheon Plate	
Lever (E) x 01 x Lever (N) x *55	Blank Escutcheon Plate	
Lever (E) x 01 x Lever (N) x 59	Blank Escutcheon Plate	
Lever (E) x 10 x Lever (N) x *49	Passage only (No cylinder)	
Lever (E) x 10 x Lever (N) x *45	Passage only (No cylinder)	
Lever (E) x 10 x Lever (N) x 10	Passage only (No cylinder)	
Lever (E) x 10 x Lever (N) x *55	Passage only (No cylinder)	
Lever (E) x 10 x Lever (N) x *59	Passage only (No cylinder)	
Lever (E) x 40 x Lever (N) x *49	No outside Operation (No Cylinder); Pull Only	
Lever (E) x 40 x Lever (N) x *45	No outside Operation (No Cylinder); Pull Only	
Lever (E) x 40 x Lever (N) x 10	No outside Operation (No Cylinder); Pull Only	
Lever (E) x 45 x Lever (N) x *49	Class Room Key Outside Unlocks/locks Trim	
Lever (E) x 45 x Lever (N) x *45	Class Room Key Outside Unlocks/locks Trim	
Lever (E) x 45 x Lever (N) x 10	Class Room Key Outside Unlocks/locks Trim	
Lever (E) x 49 x Lever (N) x *10	Key unlocks Trim; Trim retracts latch; Trim relocks when key is removed	
Lever (E) x 49 x Lever (N) x *45	Key unlocks Trim; Trim retracts latch; Trim relocks when key is removed	
Lever (E) x 49 x Lever (N) x *49	Key unlocks Trim; Trim retracts latch; Trim relocks when key is removed	
<b>MP9800 Freewheeling Trim</b>		
Lever (E) x 50 x Lever (N) x *55	Freewheeling Trim; No Outside Operation	\$2,669.00
Lever (E) x 50 x Lever (N) x *59	Freewheeling Trim; No Outside Operation	
Lever (E) x 52 x Lever (N) x 52	Key outside unlocks/locks O/S trim; Key inside unlocks/locks O/S trim	
Lever (E) x 55 x Lever (N) x *10	Freewheeling Trim; Key Outside Unlocks/locks Trim	
Lever (E) x 55 x Lever (N) x 50	Freewheeling Trim; Key Outside Unlocks/locks Trim	
Lever (E) x 55 x Lever (N) x *55	Freewheeling Trim; Key Outside Unlocks/locks Trim	
Lever (E) x 55 x Lever (N) x *59	Freewheeling Trim; Key Outside Unlocks/locks Trim	
Lever (E) x 59 x Lever (N) x *10	Freewheeling Trim; Key unlocks Trim; Trim retracts latch/Trim relocks when key is removed	
Lever (E) x 59 x Lever (N) x 50	Freewheeling Trim; Key unlocks Trim; Trim retracts latch/Trim relocks when key is removed	
Lever (E) x 59 x Lever (N) x *55	Freewheeling Trim; Key unlocks Trim; Trim retracts latch/Trim relocks when key is removed	
Lever (E) x 59 x Lever (N) x *59	Freewheeling Trim; Key unlocks Trim; Trim retracts latch/Trim relocks when key is removed	
<b>MP9800 Electromechanical</b>		
Lever (E) x 01 x Lever (N) x *903	Blank Escutcheon Plate	\$2,836.00
Lever (E) x 01 x Lever (N) x *905	Blank Escutcheon Plate	
Lever (E) x 40 x Lever (N) x *903	No outside Operation (No Cylinder); Pull Only	
Lever (E) x 40 x Lever (N) x *905	No outside Operation (No Cylinder); Pull Only	
Lever (E) x 49 x Lever (N) x *903	Key unlocks Trim; Trim retracts latch; Trim relocks when key is removed	
Lever (E) x 49 x Lever (N) x *905	Key unlocks Trim; Trim retracts latch; Trim relocks when key is removed	
Lever (E) x 903 x Lever (N) x 10	Electrified Trim - Fail Safe	
Lever (E) x 903 x Lever (N) x *45	Electrified Trim - Fail Safe	
Lever (E) x 905 x Lever (N) x 10	Electrified Trim - Fail Secure	
Lever (E) x 905 x Lever (N) x *45	Electrified Trim - Fail Secure	
Lever (E) x 905 x Lever (N) x *903	Electrified Trim - Fail Secure	\$3,003.00
Lever (E) x 905 x Lever (N) x *905	Electrified Trim - Fail Secure	
Lever (E) x 903 x Lever (N) x *903	Electrified Trim - Fail Safe	
Lever (E) x 903 x Lever (N) x *905	Electrified Trim - Fail Safe	

\* Not recommended for use on any door used for Life Safety egress.

**MP9800 Series**  
**Multi-Point Vertical Rod Lock**

USA & Canada Prices Effective February 1, 2022



\*\*613E, BSP, WSP finishes are not available with 21M levers.

<b>MP9800A/B</b>		<b>613E, 629, 630, BSP, WSP</b>
	<b>Piet 21G, 21L, 21M, 21S, 23M, 25M, 27M</b>	
Lever (E) x 01 x Lever (N) x *49	Blank Escutcheon Plate	\$2,871.00
Lever (E) x 01 x Lever (N) x *45	Blank Escutcheon Plate	
Lever (E) x 01 x Lever (N) x 10	Blank Escutcheon Plate	
Lever (E) x 01 x Lever (N) x *55	Blank Escutcheon Plate	
Lever (E) x 01 x Lever (N) x 59	Blank Escutcheon Plate	
Lever (E) x 10 x Lever (N) x *49	Passage only (No cylinder)	
Lever (E) x 10 x Lever (N) x *45	Passage only (No cylinder)	
Lever (E) x 10 x Lever (N) x 10	Passage only (No cylinder)	
Lever (E) x 10 x Lever (N) x *55	Passage only (No cylinder)	
Lever (E) x 10 x Lever (N) x *59	Passage only (No cylinder)	
Lever (E) x 40 x Lever (N) x *49	No outside Operation (No Cylinder); Pull Only	
Lever (E) x 40 x Lever (N) x *45	No outside Operation (No Cylinder); Pull Only	
Lever (E) x 40 x Lever (N) x 10	No outside Operation (No Cylinder); Pull Only	
Lever (E) x 45 x Lever (N) x *49	Class Room Key Outside Unlocks/locks Trim	
Lever (E) x 45 x Lever (N) x *45	Class Room Key Outside Unlocks/locks Trim	
Lever (E) x 45 x Lever (N) x 10	Class Room Key Outside Unlocks/locks Trim	
Lever (E) x 49 x Lever (N) x *10	Key unlocks Trim; Trim retracts latch; Trim relocks when key is removed	
Lever (E) x 49 x Lever (N) x *45	Key unlocks Trim; Trim retracts latch; Trim relocks when key is removed	
Lever (E) x 49 x Lever (N) x *49	Key unlocks Trim; Trim retracts latch; Trim relocks when key is removed	
<b>MP9800A/B Freewheeling Trim</b>		
Lever (E) x 50 x Lever (N) x *55	Freewheeling Trim; No Outside Operation	\$2,871.00
Lever (E) x 50 x Lever (N) x *59	Freewheeling Trim; No Outside Operation	
Lever (E) x 52 x Lever (N) x 52	Key outside unlocks/locks O/S trim; Key inside unlocks/locks O/S trim	
Lever (E) x 55 x Lever (N) x *10	Freewheeling Trim; Key Outside Unlocks/locks Trim	
Lever (E) x 55 x Lever (N) x 50	Freewheeling Trim; Key Outside Unlocks/locks Trim	
Lever (E) x 55 x Lever (N) x *55	Freewheeling Trim; Key Outside Unlocks/locks Trim	
Lever (E) x 55 x Lever (N) x *59	Freewheeling Trim; Key Outside Unlocks/locks Trim	
Lever (E) x 59 x Lever (N) x *10	Freewheeling Trim; Key unlocks Trim; Trim retracts latch/Trim relocks when key is removed	
Lever (E) x 59 x Lever (N) x 50	Freewheeling Trim; Key unlocks Trim; Trim retracts latch/Trim relocks when key is removed	
Lever (E) x 59 x Lever (N) x *55	Freewheeling Trim; Key unlocks Trim; Trim retracts latch/Trim relocks when key is removed	
Lever (E) x 59 x Lever (N) x *59	Freewheeling Trim; Key unlocks Trim; Trim retracts latch/Trim relocks when key is removed	
<b>MP9800A/B Electromechanical</b>		
Lever (E) x 01 x Lever (N) x *903	Blank Escutcheon Plate	\$3,038.00
Lever (E) x 01 x Lever (N) x *905	Blank Escutcheon Plate	
Lever (E) x 40 x Lever (N) x *903	No outside Operation (No Cylinder); Pull Only	
Lever (E) x 40 x Lever (N) x *905	No outside Operation (No Cylinder); Pull Only	
Lever (E) x 49 x Lever (N) x *903	Key unlocks Trim; Trim retracts latch; Trim relocks when key is removed	
Lever (E) x 49 x Lever (N) x *905	Key unlocks Trim; Trim retracts latch; Trim relocks when key is removed	
Lever (E) x 903 x Lever (N) x 10	Electrified Trim - Fail Safe	
Lever (E) x 903 x Lever (N) x *45	Electrified Trim - Fail Safe	
Lever (E) x 905 x Lever (N) x 10	Electrified Trim - Fail Secure	
Lever (E) x 905 x Lever (N) x *45	Electrified Trim - Fail Secure	
Lever (E) x 905 x Lever (N) x *903	Electrified Trim - Fail Secure	\$3,205.00
Lever (E) x 905 x Lever (N) x *905	Electrified Trim - Fail Secure	
Lever (E) x 903 x Lever (N) x *903	Electrified Trim - Fail Safe	
Lever (E) x 903 x Lever (N) x *905	Electrified Trim - Fail Safe	

\* Not recommended for use on any door used for Life Safety egress.

# MP9800 Series

## Multi-Point Vertical Rod Lock

JOSEF



USA & Canada Prices Effective February 1, 2022

GEORGES



<b>MP9800</b>		613E, 626, BSP, WSP	605 606 611 612 613 618 625
	<b>Josef, Georges Levers</b>		
Lever (E) x 01 x Lever (N) x *49	Blank Escutcheon Plate		
Lever (E) x 01 x Lever (N) x *45	Blank Escutcheon Plate		
Lever (E) x 01 x Lever (N) x 10	Blank Escutcheon Plate		
Lever (E) x 01 x Lever (N) x *55	Blank Escutcheon Plate		
Lever (E) x 01 x Lever (N) x 59	Blank Escutcheon Plate		
Lever (E) x 10 x Lever (N) x *49	Passage only (No cylinder)		
Lever (E) x 10 x Lever (N) x *45	Passage only (No cylinder)		
Lever (E) x 10 x Lever (N) x 10	Passage only (No cylinder)		
Lever (E) x 10 x Lever (N) x *55	Passage only (No cylinder)		
Lever (E) x 10 x Lever (N) x *59	Passage only (No cylinder)	\$2,592.00	\$2,669.00
Lever (E) x 40 x Lever (N) x *49	No outside Operation (No Cylinder); Pull Only		
Lever (E) x 40 x Lever (N) x *45	No outside Operation (No Cylinder); Pull Only		
Lever (E) x 40 x Lever (N) x 10	No outside Operation (No Cylinder); Pull Only		
Lever (E) x 45 x Lever (N) x *49	Class Room Key Outside Unlocks/locks Trim		
Lever (E) x 45 x Lever (N) x *45	Class Room Key Outside Unlocks/locks Trim		
Lever (E) x 45 x Lever (N) x 10	Class Room Key Outside Unlocks/locks Trim		
Lever (E) x 49 x Lever (N) x *10	Key unlocks Trim; Trim retracts latch; Trim relocks when key is removed		
Lever (E) x 49 x Lever (N) x *45	Key unlocks Trim; Trim retracts latch; Trim relocks when key is removed		
Lever (E) x 49 x Lever (N) x *49	Key unlocks Trim; Trim retracts latch; Trim relocks when key is removed		
<b>MP9800 Freewheeling Trim</b>			
Lever (E) x 50 x Lever (N) x *55	Freewheeling Trim; No Outside Operation		
Lever (E) x 50 x Lever (N) x *59	Freewheeling Trim; No Outside Operation		
Lever (E) x 52 x Lever (N) x 52	Key outside unlocks/locks O/S trim; Key inside unlocks/locks O/S trim		
Lever (E) x 55 x Lever (N) x *10	Freewheeling Trim; Key Outside Unlocks/locks Trim		
Lever (E) x 55 x Lever (N) x 50	Freewheeling Trim; Key Outside Unlocks/locks Trim		
Lever (E) x 55 x Lever (N) x *55	Freewheeling Trim; Key Outside Unlocks/locks Trim	\$2,592.00	\$2,669.00
Lever (E) x 55 x Lever (N) x *59	Freewheeling Trim; Key Outside Unlocks/locks Trim		
Lever (E) x 59 x Lever (N) x *10	Freewheeling Trim; Key unlocks Trim; Trim retracts latch/Trim relocks when key is removed		
Lever (E) x 59 x Lever (N) x 50	Freewheeling Trim; Key unlocks Trim; Trim retracts latch/Trim relocks when key is removed		
Lever (E) x 59 x Lever (N) x *55	Freewheeling Trim; Key unlocks Trim; Trim retracts latch/Trim relocks when key is removed		
Lever (E) x 59 x Lever (N) x *59	Freewheeling Trim; Key unlocks Trim; Trim retracts latch/Trim relocks when key is removed		
<b>MP9800 Electromechanical</b>			
Lever (E) x 01 x Lever (N) x *903	Blank Escutcheon Plate		
Lever (E) x 01 x Lever (N) x *905	Blank Escutcheon Plate		
Lever (E) x 40 x Lever (N) x *903	No outside Operation (No Cylinder); Pull Only		
Lever (E) x 40 x Lever (N) x *905	No outside Operation (No Cylinder); Pull Only		
Lever (E) x 49 x Lever (N) x *903	Key unlocks Trim; Trim retracts latch; Trim relocks when key is removed	\$2,759.00	\$2,836.00
Lever (E) x 49 x Lever (N) x *905	Key unlocks Trim; Trim retracts latch; Trim relocks when key is removed		
Lever (E) x 903 x Lever (N) x 10	Electrified Trim - Fail Safe		
Lever (E) x 903 x Lever (N) x *45	Electrified Trim - Fail Safe		
Lever (E) x 905 x Lever (N) x 10	Electrified Trim - Fail Secure		
Lever (E) x 905 x Lever (N) x *45	Electrified Trim - Fail Secure		
Lever (E) x 905 x Lever (N) x *903	Electrified Trim - Fail Secure		
Lever (E) x 905 x Lever (N) x *905	Electrified Trim - Fail Secure	\$2,926.00	\$3,003.00
Lever (E) x 903 x Lever (N) x *903	Electrified Trim - Fail Safe		
Lever (E) x 903 x Lever (N) x *905	Electrified Trim - Fail Safe		

**MP9800 Series**  
**Multi-Point Vertical Rod Lock**

JOSEF



USA & Canada Prices Effective February 1, 2022

GEORGES



<b>MP9800A/B</b>		<b>613E, 626, BSP, WSP</b>	<b>605 606 611 612 613 618 625</b>
	<b>Josef, Georges Levers</b>		
Lever (E) x 01 x Lever (N) x *49	Blank Escutcheon Plate		
Lever (E) x 01 x Lever (N) x *45	Blank Escutcheon Plate		
Lever (E) x 01 x Lever (N) x 10	Blank Escutcheon Plate		
Lever (E) x 01 x Lever (N) x *55	Blank Escutcheon Plate		
Lever (E) x 01 x Lever (N) x 59	Blank Escutcheon Plate		
Lever (E) x 10 x Lever (N) x *49	Passage only (No cylinder)		
Lever (E) x 10 x Lever (N) x *45	Passage only (No cylinder)		
Lever (E) x 10 x Lever (N) x 10	Passage only (No cylinder)		
Lever (E) x 10 x Lever (N) x *55	Passage only (No cylinder)		
Lever (E) x 10 x Lever (N) x *59	Passage only (No cylinder)	\$2,794.00	\$2,832.00
Lever (E) x 40 x Lever (N) x *49	No outside Operation (No Cylinder); Pull Only		
Lever (E) x 40 x Lever (N) x *45	No outside Operation (No Cylinder); Pull Only		
Lever (E) x 40 x Lever (N) x 10	No outside Operation (No Cylinder); Pull Only		
Lever (E) x 45 x Lever (N) x *49	Class Room Key Outside Unlocks/locks Trim		
Lever (E) x 45 x Lever (N) x *45	Class Room Key Outside Unlocks/locks Trim		
Lever (E) x 45 x Lever (N) x 10	Class Room Key Outside Unlocks/locks Trim		
Lever (E) x 49 x Lever (N) x *10	Key unlocks Trim; Trim retracts latch; Trim relocks when key is removed		
Lever (E) x 49 x Lever (N) x *45	Key unlocks Trim; Trim retracts latch; Trim relocks when key is removed		
Lever (E) x 49 x Lever (N) x *49	Key unlocks Trim; Trim retracts latch; Trim relocks when key is removed		
<b>MP9800A/B Freewheeling Trim</b>			
Lever (E) x 50 x Lever (N) x *55	Freewheeling Trim; No Outside Operation		
Lever (E) x 50 x Lever (N) x *59	Freewheeling Trim; No Outside Operation		
Lever (E) x 52 x Lever (N) x 52	Key outside unlocks/locks O/S trim; Key inside unlocks/locks O/S trim		
Lever (E) x 55 x Lever (N) x *10	Freewheeling Trim; Key Outside Unlocks/locks Trim		
Lever (E) x 55 x Lever (N) x 50	Freewheeling Trim; Key Outside Unlocks/locks Trim		
Lever (E) x 55 x Lever (N) x *55	Freewheeling Trim; Key Outside Unlocks/locks Trim	\$2,794.00	\$2,832.00
Lever (E) x 55 x Lever (N) x *59	Freewheeling Trim; Key Outside Unlocks/locks Trim		
Lever (E) x 59 x Lever (N) x *10	Freewheeling Trim; Key unlocks Trim; Trim retracts latch/Trim relocks when key is removed		
Lever (E) x 59 x Lever (N) x 50	Freewheeling Trim; Key unlocks Trim; Trim retracts latch/Trim relocks when key is removed		
Lever (E) x 59 x Lever (N) x *55	Freewheeling Trim; Key unlocks Trim; Trim retracts latch/Trim relocks when key is removed		
Lever (E) x 59 x Lever (N) x *59	Freewheeling Trim; Key unlocks Trim; Trim retracts latch/Trim relocks when key is removed		
<b>MP9800A/B Electromechanical</b>			
Lever (E) x 01 x Lever (N) x *903	Blank Escutcheon Plate		
Lever (E) x 01 x Lever (N) x *905	Blank Escutcheon Plate		
Lever (E) x 40 x Lever (N) x *903	No outside Operation (No Cylinder); Pull Only		
Lever (E) x 40 x Lever (N) x *905	No outside Operation (No Cylinder); Pull Only		
Lever (E) x 49 x Lever (N) x *903	Key unlocks Trim; Trim retracts latch; Trim relocks when key is removed	\$2,961.00	\$2,999.00
Lever (E) x 49 x Lever (N) x *905	Key unlocks Trim; Trim retracts latch; Trim relocks when key is removed		
Lever (E) x 903 x Lever (N) x 10	Electrified Trim - Fail Safe		
Lever (E) x 903 x Lever (N) x *45	Electrified Trim - Fail Safe		
Lever (E) x 905 x Lever (N) x 10	Electrified Trim - Fail Secure		
Lever (E) x 905 x Lever (N) x *45	Electrified Trim - Fail Secure		
Lever (E) x 905 x Lever (N) x *903	Electrified Trim - Fail Secure		
Lever (E) x 905 x Lever (N) x *905	Electrified Trim - Fail Secure		
Lever (E) x 903 x Lever (N) x *903	Electrified Trim - Fail Safe	\$3,128.00	\$3,166.00
Lever (E) x 903 x Lever (N) x *905	Electrified Trim - Fail Safe		

\* Not recommended for use on any door used for Life Safety egress.

# MP9800 Series

## Multi-Point Vertical Rod Lock



USA & Canada Prices Effective February 1, 2022

Cylinder Options*		
Description	Specify Quick Code	Add or Deduct
Conventional 6-pin	6P**	Add \$105.00 per cylinder
Conventional 7-pin	7P	Add \$107.00 per cylinder
<b>LFIC</b>		
LFIC 6-pin	C6	Add \$196.00 per cylinder
LFIC 6-pin less core	CL6	Add \$105.00 per cylinder
LFIC 6-pin with temporary construction core (Red)	CT6R	Add \$196.00 per cylinder
LFIC 6-pin with temporary construction core (Blue)	CT6B	Add \$196.00 per cylinder
LFIC 6-pin with temporary construction core (Green)	CT6G	Add \$196.00 per cylinder
LFIC 6-pin with temporary disposable core	CT6D	Add \$105.00 per cylinder
LFIC 7-pin	C7	Add \$200.00 per cylinder
LFIC 7-pin less core	CL7	Add \$107.00 per cylinder
LFIC 7-pin with temporary construction core (Red)	CT7R	Add \$200.00 per cylinder
LFIC 7-pin with temporary construction core (Blue)	CT7B	Add \$200.00 per cylinder
LFIC 7-pin with temporary construction core (Green)	CT7G	Add \$200.00 per cylinder
LFIC 7-pin with temporary disposable core	CT7D	Add \$107.00 per cylinder
<b>SFIC</b>		
SFIC 6-pin	C6S	Add \$187.00 per cylinder
SFIC 6-pin with temporary construction core (Blue)	CT6SB	Add \$187.00 per cylinder
SFIC 6-pin with SFIC disposable temporary core	CT6SD	Add \$105.00 per cylinder
SFIC 6-pin with Less Core	CLS6	Add \$105.00 per cylinder
SFIC 7-pin	C7S	Add \$187.00 per cylinder
SFIC 7-pin with temporary construction core (Blue)	CT7SB	Add \$187.00 per cylinder
SFIC 7-pin with SFIC disposable temporary core	CT7SD	Add \$107.00 per cylinder
SFIC 7-pin with Less Core	CLS7	Add \$107.00 per cylinder
<b>Security</b>		
Security <sup>4</sup>	HS	Add \$244.00 per cylinder
Security LFIC <sup>4</sup>	CHS	Add \$331.00 per cylinder
<b>Access 3</b>		
Access 3 Patented	AP	Add \$105.00 per cylinder
Access 3 Security	AS	Add \$161.00 per cylinder
Access 3 High Security, UL 437	AHS	Add \$184.00 per cylinder
Access 3 LFIC Patented	ACP	Add \$196.00 per cylinder
Access 3 LFIC Security	ACS	Add \$252.00 per cylinder
Access 3 LFIC High Security, UL 437	ACHS	Add \$274.00 per cylinder
<b>Pyramid</b>		
Pyramid Security fixed core	PS	Add \$179.00 per cylinder
Pyramid Security LFIC	PCS	Add \$264.00 per cylinder
Pyramid High Security fixed core	PHS	Add \$215.00 per cylinder
Pyramid High Security LFIC	PCHS	Add \$301.00 per cylinder
Pyramid LFIC with temporary construction core <sup>3</sup>	CTP	Add \$196.00 per cylinder
Pyramid LFIC with temporary disposable core <sup>3</sup>	CTPD	Add \$105.00 per cylinder
Pyramid LFIC less core	CLP	Add \$105.00 per cylinder

**Notes:**

1. CMK Construction master keying charge is in addition to master keying charge.
2. CMK Construction master keying is not available in interchangeable core, Access 3, Pyramid, or Security series.
3. VKC2, VKC3, CKC3 are not available in Pyramid or Security series.
4. Pyramid series is not available keyed random.
5. Security series is not available 0-bitted.

\*Optional dogging cylinder will be furnished with the same mechanism and keyed alike with the trim cylinder, unless otherwise specified.

If different keying or cylinder type is required, specify outside (trim) first, then inside (dogging) cylinder.

\*\*6P cylinder option is supplied in 6-pin, L4 keyway, 0-bitted with two nickel silver keys.

## MP9800 Series

### Multi-Point Vertical Rod Lock

USA & Canada Prices Effective February 1, 2022

#### Cylinder Options (continued) & Keying Options\*

Description	Specify Quick Code	Add or Deduct
<b>Keying and Keys</b>		
0-bitted with 2 Blank Keys	(standard)	No Charge
Keyed Random	KR	
Construction Master Keyed <sup>2</sup>	CMK	Add \$16.00 per cylinder
More than 2 Keys	KY# (e.g., KY6)	See page 31 - Cut Keys Section
<b>Master Keying</b>		
Master keyed (all cylinders except CR8000, CR8020, CR8027, CR8200, CR8500, CR8600, CR8700)	MK	Add \$16.00 per cylinder
Master keyed Pyramid (except CR8020, CR8027 LFIC cores)	MK	
Master keyed Security (including LFIC cylinder and core)	MK	
Master keyed Access 3 (except CR8500, CR8600, CR8700 LFIC cores)	MK	
Master keyed (CR8000, CR8020, CR8027, CR8200, CR8500, CR8600, CR8700)	MK-IC	No Charge
Master keyed to customer bittings or sample key	MK-CB	Add \$16.00 per cylinder
<b>Visual Key Control (VKC)</b>		
No bitting or keyset stamping on keys	VKC0	\$4.50
Keys only	VKC1	No Charge
Cylinders and keys (not for AS, AHS, ACS, ACHS, HS, CHS, PHS or PCHS)	VKC2	\$8.00
Cylinders only (not for AS, AHS, HS, ACS, ACHS, CHS, PHS or PCHS)	VKC3	
<b>Concealed Key Control (CKC)</b>		
CKC cylinders with VKC keys	CKC2	\$8.00
CKC cylinders only (not for AS, AHS, ACS, ACHS, PHS, PCHS)	CKC3	

Notes:

1. Not available in CLX3329 function.
2. CMK Construction master keying charge is in addition to master keying charge and is not available in interchangeable core, Access 3, Pyramid, or Security series.

\*Double cylinder keying: unless otherwise specified, both cylinders of 32, 62, 72 and 82 functions will be keyed alike. The inside cylinder of 52 function will be keyed to the master key(s) only, while the outside cylinder will include the change key. If different keying is required, specify outside cylinder first, then inside cylinder. For key bows other than 10 and 90, specify 'KB' + bow number as Quick Code, e.g. KB12.



# MP9800 Series

## Multi-Point Vertical Rod Lock



USA & Canada Prices Effective February 1, 2022

Door Height Options	Specify	Add or Deduct
7'0"	Standard	No Charge
7'2"	H702	
7'6"	H706	
8'0"	H0800	
9'0"	H0900	
10'0"	H1000	
Door Thickness	Specify	Add or Deduct
1-3/4" (44mm)	Standard	No Charge
2" (51mm)	D200	No Charge
2-1/4" (57mm)	D214	No Charge
Motorized Electric Latch Retraction	Specify	Add or Deduct
Electric Latch Retraction	MELR	Add \$935.00
Miscellaneous Options	Specify	Add or Deduct
Spanner Head Screw	M02	Add \$41.00 per device
Torx® head screws	M04	Add \$55.00 per device
Knurling outside and inside	M20	Add \$175.00 per device
Knurling outside only <sup>1</sup>	M21	Add \$82.00 per device
Knurling inside only	M22	Add \$93.00 per device
Abrasive coat outside and inside (trim and device)	M23	Add \$111.00 per device
Abrasive coat inside only (device side)	M24	Add \$58.00 per device
Abrasive coat outside only (trim side)	M25	Add \$53.00 per device
Less bottom vertical rod	M55	No Charge
Latchbolt Monitoring	M91	Add \$260.00
O/S Lever Monitoring	M93	Add \$244.00
I/S Lever Monitoring	M92	Add \$244.00
Windstorm	M107	Add \$102.00 per device
Aluminum Door	MPAD	No Charge
Rectangular Back Plate (Required for Wood Door - MPWD)	MPER	
Back Plate (Required for Wood Door - MPWD)	MPES	
Lever Hold Back	MPHB	Add \$24.00 per device
Fire Rated Wood Door	MPWD	No Charge
aux control (classroom)	AUX155	Add \$746.00 per device
aux control (storeroom)	AUX159	Add \$746.00 per device
MicroShield® Antimicrobial finish coating	626C	Add \$79.00 (Exit Devices & Trims (ordered separately) Add \$98.00 (Exit Devices & Outside Trims (ordered together)
MicroShield® Antimicrobial finish coating	630C	Add \$79.00 (Exit Devices & Trims (ordered separately) Add \$98.00 (Exit Devices & Outside Trims (ordered together)

1. Not available with Vineyard™ or Muséo® levers

Blank Page

MicroShield® How to Order, Pricing	261
------------------------------------	-----

**ED3000 Crossbar Series:**

ED3000 Series Standard Features	262
ED3000 Series Ordering Examples	263
ED3000 Series: Rim ED3200	264
ED3000 Series: Surface Vertical Rod ED3400 Series, Mortise ED3600 Series	265
ED3000 Series Escutcheon Trim Designs: A33 Armstrong, C33 Citation, D33 Dirke, L33 Lustra	266
ED3000 Series Escutcheon Trim Designs: N33 Newport, PR33 Princeton, R33 Regis	267
ED3000 Series Escutcheon Trim Designs: T33 D Grip, T34 Round Grip, T35 Sectional Grip, Auxiliary Control/Inside Lever Assembly: 3357T Nightlatch	268
ED3000 Series Offset Pull Trim & Cylinder Options	269
ED3000 Series Keying Options	270
ED3000 Series Strike Options	271
ED3000 Series Miscellaneous, Door Width, Door Thickness, Door Height Options	272
ED3000 Series Mullions, Removable Mullions, Key Removable Mullions, Mullion Cylinder Options, Ordering Examples	273

**ED4000 Narrow Stile Pushpad Series:**

ED4000 Series How to Order	274
ED4000 Series Standard Features	275
ED4000 Series Ordering Example	276
ED4000 Series: ED4200S, ED4200, ED4400, ED4800	277

**ED4000 Series Museo Pushpad Exit Devices:**

ED4000 Series: Museo Levers with 800 Series Escutcheon: Georgia, Pablo, Jackson, Salvador, Josef Marc Levers	278
ED4000 Series: Museo Levers with 800 Series Escutcheon: Piet Levers	279

**ED4000 Narrow Stile Pushpad Series:**

ED4000 Series Escutcheon Trim Designs: A8 Armstrong, C8 Citation, D8 Dirke	280
ED4000 Series Escutcheon Trim Designs: E8 Essex, L8 Lustra, N8 Newport, R8 Regis	281
ED4000 Series Escutcheon Trim Designs: PR8 Princeton, G8 Global, F4 Plate, O8 Plate x Thumbturn	282
ED4000 Series Escutcheon Trim Designs: O14 Plate x Thumbturn, T14 Pull/Thumbpiece, P10 Pull, K1 Key Only	283
ED4000 Series Pull Trim & Accessories	284
ED4000 Series Cylinder & Keying Options	285
ED4000 Series Door Height Options for ED4400, ED4800 Series, Width, Thickness, Strike Options	286
ED4000 Series Miscellaneous Options, Removable Mullion	287

**ED5000 Pushpad Series:**

ED5000 Series How to Order	288
ED5000 Series Standard Features	289
ED5000 Series Ordering Examples	290
ED5000 Series: ED5200S, ED5200, ED5400, ED5600, ED5800, ED5000DB	291

**ED5000 Series: Museo Levers with 900 Series Escutcheon:**

ED5000 Series: Museo Georgia, Pablo, Jackson, Salvador, Marc Josef Levers with 900 Series Escutcheon	292
ED5000 Series: Museo Georges Levers with 900 Series Escutcheon	293
ED5000 Series: Museo Piet Levers with 900 Series Escutcheon	294

*Continued on next page.*

**ED5000 Pushpad Series:**

ED5000 Series Escutcheon Trim Designs: A9 Armstrong, C9 Citation, D9 Dirke	295
ED5000 Series Escutcheon Trim Designs: E9 Essex, L9 Lustra, N9 Newport, R9 Regis	296
ED5000 Series Escutcheon Trim Designs: PR9 Princeton, F9, G9, VT9	297
ED5000 Series Escutcheon Trim Designs: FR9 Frascati, M9 Merlot, Z9 Zinfandel	298
ED5000 Series Escutcheon Trim Designs: TH900 Pull/Thumbpiece, P9 Pull, K1 Key Only	299
ED5000 Series Escutcheon Trim Designs: A4M Armstrong, C9M Citation, D9M Dirke	300
ED5000 Series Escutcheon Trim Designs: E9M Essex, L9M Lustra, N9M Newport	301
ED5000 Series Escutcheon Trim Designs: R9M Regis, PR9M Princeton, F9, G9M	302
ED5000 Series Escutcheon Trim Designs: FR9M Frascati, M9M Merlot, Z9M Zinfandel	303
ED5000 Series Escutcheon Trim Designs: TH900, TH9M00 Pull/Thumbpiece, P9M Pull, VT9M, K1M Key Only	304
ED5000 Series Escutcheon Trim Designs: A4M Armstrong, C9M Citation, D9M Dirke, E9 Essex	305
ED5000 Series Escutcheon Trim Designs: L9 Lustra, N9 Newport, R9 Regis, PR9 Princeton	306
ED5000 Series Escutcheon Trim Designs: FR9 Frascati, M9 Merlot, Z9 Zinfandel	307
ED5000 Series Offset Pull Trim P12, P13, P14, Electrified Options, Delayed Egress Device, Retrofit MELR Kit:	308
ED5000 Series Electrified Accessories	309
ED5000 Series Cylinder & Keying Options	310
ED5000 Series Door Height, Door Width, Door Thickness, Strike Options	311
ED5000 Series Miscellaneous Options, Surface Bolt	312
ED5000 Series Mullions, Removable Mullions, Key Removable Mullions, Mullions Cylinder Options	313

**ED7000 Narrow Stile Crossbar Series:**

ED7000 Series Standard Features	314
ED7000 Series Ordering Example	315
ED7000 Series: ED7200, ED7400, ED7600, ED7800	316
ED7000 Series Pull Trim Designs: P4 D Grip Pull, P5 Round Grip Pull, P6 Pull, P7 Plate	317
ED7000 Series Escutcheon Trim Designs: C4 Citation, D4 Dirke, O3 D Grip Operator, O4 Round Grip Operator	318
ED7000 Series Escutcheon Trim Designs: O5 Operator, Offset Pull Trim: P12, P13, P14	319
ED7000 Series Cylinder & Keying Options	320
ED7000 Series Cylinder & Keying Options	321
ED7000 Series Strike Options	322
ED7000 Series Door Width, Door Thickness, Door Height, Miscellaneous Options	323
ED7000 Series Mortise Lock Only, Removable Mullion Ordering Example	324

**ED8000 Pushpad Series:**

ED8000 Series Standard Features	325
ED8000 Series Ordering Example	326
ED8000 Series: Rim ED8200, Vertical Rod ED8400	327
ED8000 Series Rose Trim Designs: A6 Armstrong, N6 Newport, PR6 Princeton	328
ED8000 Series Rose Trim G10 Global, Flat Plate Trim F1 Flat Plate, Pull Trim Design P1 Z-Pull	329
ED8000 Series Pull Trim: P2 Offset Pull, P8 Wing Pull, KO Key Only, Offset Pull Trim: P12, P13, P14	330
ED8000 Series Cylinder Options	331
ED8000 Series Keying, Door Width, Door Thickness, Door Height Options	332
ED8000 Series Miscellaneous & Strike Options	333
ED8000 Series Alarm Kit, Mullions, Door Height Options, Mullions Cylinder Options	334

# MicroShield®

Look for the *MicroShield* icon.

ED3000  
ED4000  
ED5000  
ED7000

## MicroShield®

As part of their promise to provide innovative solutions to their customers, certain ASSA ABLOY Group brands offer the MicroShield® technology, a silver-based antimicrobial coating designed to inhibit the growth of bacteria.

MicroShield® is a registered trademark of Yale Security Inc., an ASSA ABLOY Group company.

Product	Series	MicroShield® Coated Components
Exit Devices	ED4000 and ED5000 Series	Inside rail, push rail, head cover, end cap* Outside trim: levers/pull* and escutcheons
	ED3000 and ED7000 Series	Active/Inactive case covers, cross bar, arms Outside trim: levers/pull* and escutcheons

## AVAILABLE FINISHES

- MicroShield® is available on 626 and 630. Other finishes available by Special Product Application Request Form only.
- Specify 626C (satin chrome plated) or 630C (satin stainless steel) when ordering.
- MicroShield® coating will be applied over 626 and 630 finishes. All components will match 626.

*Note: MicroShield® coating will only be applied to "high touch" components.*

## HOW TO ORDER

Product	How to Order
Exit Devices & Outside Trims (ordered together)	ED5200 x C955ET x 630C x LHR
Exit Devices & Trims (ordered separately)	N955ET x 630C x RHR

Description	Add
Exit Devices & Outside Trims (ordered together)	Add \$98.00 (when ordered together)
Exit Devices & Trims (ordered separately)	Add \$79.00

**Standard Features**

**Handing**

Handed, specify hand

**Door Thickness**

1-3/4"

**Backset**

2-3/4"

**Projection**

5-3/4"; 4-1/2" depressed

**Trim**

Cylinder is not included.  
See page 288 for  
cylinder options.

**Rim**

ED3200  
ED3200A

Panic  
3 Hour Fire Rated

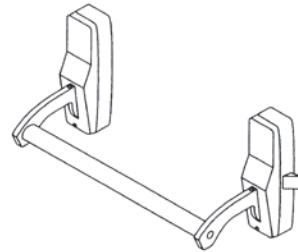

**Surface Vertical Rod**

ED3400    Panic  
ED3400A    3 Hour Fire Rated

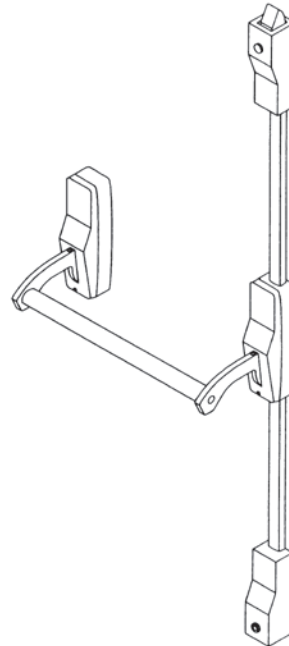

**Mortise**

ED3600    Panic  
ED3600A    3 Hour Fire Rated

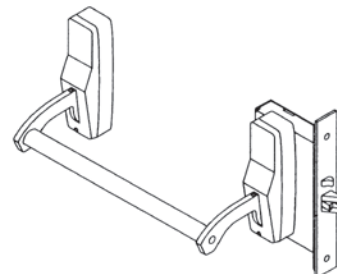

**Ordering Examples**
**Rim Exit Device**

Quantity	Exit Device	Finish	Hand	Misc. Options
20	ED3250	630	RHR	M51-M54

**Rim Exit Device with Trim**

Quantity	Exit Device	Trim	Finish	Hand	Door Thickness	Door Width	Misc. Options
50	ED3255A	A3355ET	630	RHR	D200	W048	M53

**Trim Only (Rim Exit Device or Vertical Rod)**

Quantity	Exit Device	Finish	Hand
10	L3310ET	606	RHR

**Surface Vertical Rod Exit Device with Trim**

Quantity	Exit Device	Trim	Finish	Hand	Door Thickness	Door Width	Misc. Options
50	ED3410	R3310ET	606	RHR	D214	W048	H1000

**Mortise Exit Device with Trim**

Quantity	Exit Device	Trim	Finish	Hand	Door Thickness	Strike	Door Width
50	ED3657	L3357ET	630	LHR	D200	SB200	W048

**Contract/Detailed Order - Rim Exit Device with Trim**

Quantity	Keypad	Exit Device	Trim	Finish	Hand	Door Thickness	Door Width	Optional Cylinders	Keying
50	AA1	ED3255	N3355ET	630	LHR	D200	W048	C6	VKC3

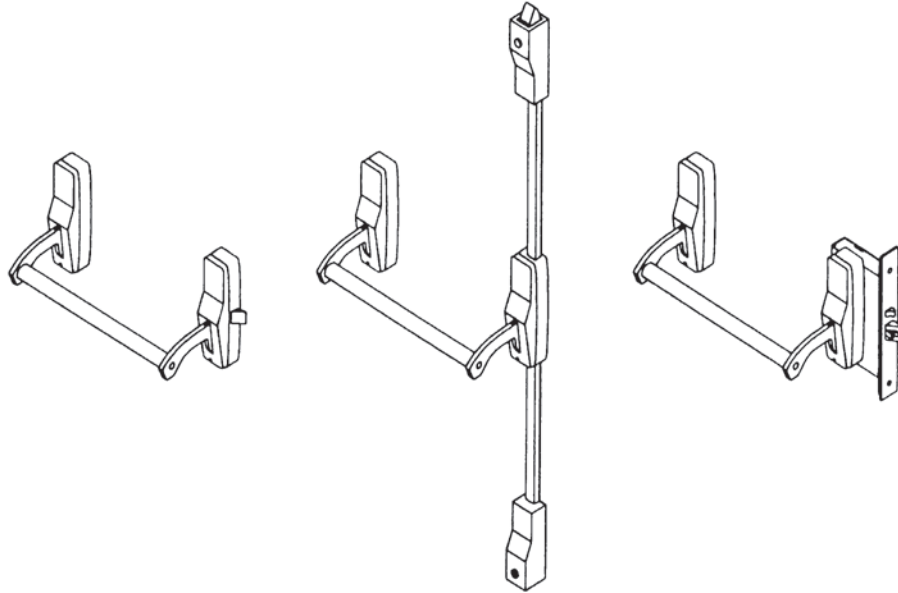

**36" Device Only**

Includes device, strike(s) and screw pack. No cylinder or trim.

**Rim ED3200 Series**

Function	Description	Finish: 613E	Finish: 605, 606, 611, 612, 613, 629, 630
ED3210	Panic device only (Passage)	\$2,294.00	\$2,464.00
ED3250	Panic device only (Dummy)		
ED3255	Panic (Classroom)		
ED3257	Panic (Nightlatch)		
ED3210T	Thumb Piece (Passage)		
ED3255T	Thumb Piece (Classroom)	\$2,496.00	\$2,666.00
ED3210A	3 Hour Fire Rated (Passage)		
ED3250A	3 Hour Fire Rated (Dummy)		
ED3255A	3 Hour Fire Rated (Classroom)		
ED3257A	3 Hour Fire Rated (Nightlatch)		
ED3210AT	Thumb Piece – 3 Hour Fire Rated (Passage)	\$2,496.00	\$2,666.00
ED3255AT	Thumb Piece – 3 Hour Fire Rated (Classroom)		

**Caution:** Be sure of your measurements. Exit devices are NOT returnable.

**Notes:**

For doors over 1-3/4" thick, a Special Application Request must be submitted to the factory prior to approval and pricing.



**Surface Vertical Rod ED3400 Series**

Function	Description	Finish: 613E	Finish: 605, 606, 611, 612, 613, 629, 630
ED3410	Panic (Passage)	\$2,852.00	\$3,022.00
ED3450	Panic (Dummy)		
ED3455	Panic (Classroom)		
ED3457	Panic (Nightlatch)		
ED3410T	Thumb Piece (Passage)		
ED3455T	Thumb Piece (Classroom)		
ED3410A	3 Hour fire rated (Passage)	\$3,054.00	\$3,224.00
ED3450A	3 Hour fire rated (Dummy)		
ED3455A	3 Hour Fire Rated (Classroom)		
ED3457A	3 Hour Fire Rated (Nightlatch)		
ED3410AT	Thumb Piece – 3 Hour Fire Rated (Passage)		
ED3455AT	Thumb Piece – 3 Hour Fire Rated (Classroom)		

**Mortise ED3600 Series**

Function	Description	Finish: 613E	Finish: 605, 606, 611, 612, 613, 629, 630
ED3610	Panic (Passage)	\$2,603.00	\$2,773.00
ED3650	Panic (Dummy)		
ED3655	Panic (Classroom)		
ED3657	Panic (Nightlatch)		
ED3610T	Thumb Piece (Passage)		
ED3655T	Thumb Piece (Classroom)		
ED3610A	3 Hour fire rated (Passage)		
ED3650A	3 Hour fire rated (Dummy)		
ED3655A	3 Hour Fire Rated (Classroom)		
ED3657A	3 Hour Fire Rated (Nightlatch)		
ED3610AT	Thumb Piece – 3 Hour Fire Rated (Passage)		
ED3655AT	Thumb Piece – 3 Hour Fire Rated (Classroom)		

**Caution:** Be sure of your measurements. Exit devices are NOT returnable.

**Notes:**

For doors over 1-3/4" thick, a Special Application Request must be submitted to the factory prior to approval and pricing.

**ED3200/ED3200A/ED3400/ED3400A/ED3600/ED3600A Rim, Surface Vertical Rod, and Mortise Trim**

Cylinder is not included.

**Escutcheon Trim Design: A33 Armstrong**



**Lever:** Cast    **Escutcheon:** Cast

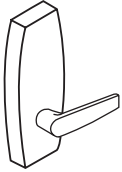

Function	Description	Finish: 605, 606, 611, 612, 613, 613E, 618, 619, 625, 626
A3310ET	Passage	\$687.00
A3350ET	Dummy	
A3355ET	Classroom	
A3357ET	Nightlatch – Rim	
A33V57ET	Nightlatch – SVR	
A33M57ET	Nightlatch – Mortise	

**Escutcheon Trim Design: C33 Citation**



**Lever:** Cast    **Escutcheon:** Cast

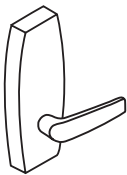

Function	Description	Finish: 605, 606, 611, 612, 613, 613E, 618, 619, 625, 626
C3310ET	Passage	\$687.00
C3350ET	Dummy	
C3355ET	Classroom	
C3357ET	Nightlatch – Rim	
C33V57ET	Nightlatch – SVR	
C33M57ET	Nightlatch – Mortise	

**Escutcheon Trim Design: D33 Dirke**



**Lever:** Cast    **Escutcheon:** Cast

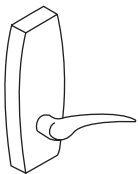

Function	Description	Finish: 605, 606, 611, 612, 613, 613E, 618, 619, 625, 626
D3310ET	Passage	\$687.00
D3350ET	Dummy	
D3355ET	Classroom	
D3357ET	Nightlatch – Rim	
D33V57ET	Nightlatch – SVR	
D33M57ET	Nightlatch – Mortise	

**Escutcheon Trim Design: L33 Lustra**



**Lever:** Cast    **Escutcheon:** Cast

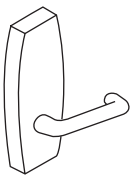

Function	Description	Finish: 605, 606, 611, 612, 613, 613E, 618, 619, 625, 626
L3310ET	Passage	\$687.00
L3350ET	Dummy	
L3355ET	Classroom	
L3357ET	Nightlatch – Rim	
L33V57ET	Nightlatch – SVR	
L33M57ET	Nightlatch – Mortise	

**ED3200/ED3200A/ED3400/ED3400A/ED3600/ED3600A Rim, Surface Vertical Rod, and Mortise Trim**

Cylinder is not included.

**Escutcheon Trim Design: N33 Newport**



**Lever:** Cast    **Escutcheon:** Cast

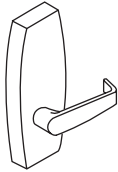

Function	Description	Finish: 605, 606, 611, 612, 613, 613E, 618, 619, 625, 626
N3310ET	Passage	\$687.00
N3350ET	Dummy	
N3355ET	Classroom	
N3357ET	Nightlatch – Rim	
N33V57ET	Nightlatch – SVR	
N33M57ET	Nightlatch – Mortise	

**Escutcheon Trim Design: PR33 Princeton**



**Lever:** Cast    **Escutcheon:** Cast



Function	Description	Finish: 605, 606, 611, 612, 613, 613E, 618, 619, 625, 626
PR3310ET	Passage	\$687.00
PR3350ET	Dummy	
PR3355ET	Classroom	
PR3357ET	Nightlatch – Rim	
PR33V57ET	Nightlatch – SVR	
PR33M57ET	Nightlatch – Mortise	

**Escutcheon Trim Design: R33 Regis**



**Lever:** Cast    **Escutcheon:** Cast

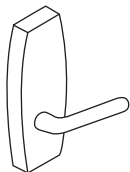

Function	Description	Finish: 605, 606, 611, 612, 613, 613E, 618, 619, 625, 626
R3310ET	Passage	\$687.00
R3350ET	Dummy	
R3355ET	Classroom	
R3357ET	Nightlatch – Rim	
R33V57ET	Nightlatch – SVR	
R33M57ET	Nightlatch – Mortise	

**ED3200/ED3200A/ED3400/ED3400A/ED3600/ED3600A Rim, Surface Vertical Rod, and Mortise Trim**

Cylinder is not included.

**Escutcheon Trim Design: T33 D Grip**

**Grip:** Extruded **Escutcheon:** Wrought



Function	Description	Finish: 629, 630
T3310ET	Passage	\$450.00
T3350ET	Dummy	
T3355ET	Classroom	
T3357ET	Nightlatch – Rim	
T33M55ET	Classroom – Mortise	
T33M57ET	Nightlatch – Mortise	

**Escutcheon Trim Design: T34 Round Grip**

**Grip:** Extruded **Escutcheon:** Wrought



Function	Description	Finish: 629, 630
T3410ET	Passage	\$450.00
T3450ET	Dummy	
T3455ET	Classroom	
T3457ET	Nightlatch – Rim	
T34M55ET	Classroom – Mortise	
T34M57ET	Nightlatch – Mortise	

**Escutcheon Trim Design: T35 Sectional Grip**

**Grip:** Extruded



Function	Description	Finish: 629, 630
T3510ET	Passage	\$480.00
T3550ET	Dummy	
T3555ET	Classroom	
T3557ET	Nightlatch – Rim	
T35M55ET	Classroom – Mortise	
T35M57ET	Nightlatch – Mortise	

**Auxiliary Control/Inside Lever Assembly: 3357T Nightlatch**

Auxiliary Control



Function	Description	Finish: 605, 606, 611, 612, 613, 613E, 618, 619, 625, 626
3357T	Auxiliary Control/Inside Lever Assembly	\$887.00

Inside Lever Assembly



**Offset Pull Trim: P12, P13, P14**

Offset Pull Trim	Part Number	Finish: 605, 606, 612, 613, 613E, 626, 629, 630, BSP
P12	716F50M X Finish	\$348.00
P13	716F51M X Finish	\$424.00
P14	716F52M X Finish	\$299.00

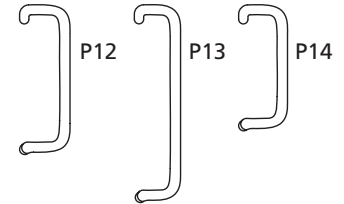
**Cylinder Options\***

Description	Specify Quick Code	Add or Deduct
Conventional 6-pin	6P*	Add \$105.00 per cylinder
Conventional 7-pin	7P	Add \$107.00 per cylinder
<b>LFIC</b>		
LFIC 6-pin	C6	Add \$196.00 per cylinder
LFIC 6-pin less core	CL6	Add \$105.00 per cylinder
LFIC 6-pin with temporary construction core (Red)	CT6R	Add \$196.00 per cylinder
LFIC 6-pin with temporary construction core (Blue)	CT6B	Add \$196.00 per cylinder
LFIC 6-pin with temporary construction core (Green)	CT6G	Add \$196.00 per cylinder
LFIC 6-pin with temporary disposable core	CT6D	Add \$105.00 per cylinder
LFIC 7-pin	C7	Add \$200.00 per cylinder
LFIC 7-pin less core	CL7	Add \$107.00 per cylinder
LFIC 7-pin with temporary construction core (Red)	CT7R	Add \$200.00 per cylinder
LFIC 7-pin with temporary construction core (Blue)	CT7B	Add \$200.00 per cylinder
LFIC 7-pin with temporary construction core (Green)	CT7G	Add \$200.00 per cylinder
LFIC 7-pin with temporary disposable core	CT7D	Add \$107.00 per cylinder
<b>SFIC</b>		
SFIC 6-pin	C6S	Add \$187.00 per cylinder
SFIC 6-pin with temporary construction core (Blue)	CT6SB	Add \$187.00 per cylinder
SFIC 6-pin with SFIC disposable temporary core	CT6SD	Add \$105.00 per cylinder
SFIC 6-pin with Less Core	CLS6	Add \$105.00 per cylinder
SFIC 7-pin	C7S	Add \$187.00 per cylinder
SFIC 7-pin with temporary construction core (Blue)	CT7SB	Add \$187.00 per cylinder
SFIC 7-pin with SFIC disposable temporary core	CT7SD	Add \$107.00 per cylinder
SFIC 7-pin with Less Core	CLS7	Add \$107.00 per cylinder
<b>Security</b>		
Security <sup>4</sup>	HS	Add \$244.00 per cylinder
Security LFIC <sup>4</sup>	CHS	Add \$331.00 per cylinder
<b>Access 3</b>		
Access 3 Patented	AP	Add \$105.00 per cylinder
Access 3 Security	AS	Add \$161.00 per cylinder
Access 3 High Security, UL 437	AHS	Add \$184.00 per cylinder
Access 3 LFIC Patented	ACP	Add \$196.00 per cylinder
Access 3 LFIC Security	ACS	Add \$252.00 per cylinder
Access 3 LFIC High Security, UL 437	ACHS	Add \$274.00 per cylinder
<b>Pyramid</b>		
Pyramid Security fixed core	PS	Add \$179.00 per cylinder
Pyramid Security LFIC	PCS	Add \$264.00 per cylinder
Pyramid High Security fixed core	PHS	Add \$215.00 per cylinder
Pyramid High Security LFIC	PCHS	Add \$301.00 per cylinder
Pyramid LFIC with temporary construction core <sup>3</sup>	CTP	Add \$196.00 per cylinder
Pyramid LFIC with temporary disposable core <sup>3</sup>	CTPD	Add \$105.00 per cylinder
Pyramid LFIC less core	CLP	Add \$105.00 per cylinder

\*6P cylinder option is supplied in 6-pin, L4 keyway 0-bitted with two nickel silver keys.  
<sup>3</sup>IC 6-pin with temporary construction core CT6.  
<sup>3</sup>IC 7-pin with temporary construction core CT7.  
<sup>4</sup>\*\*Not available with Rim or SVR Lever Trim – Classroom Function.  
or SVR Lever Trim – Night Latch Function.

**Cylinder Options (continued) & Keying Options\***

Description	Specify Quick Code	Add or Deduct
<b>Keying and Keys</b>		
0-bitted with 2 Blank Keys	(standard)	No Charge
Keyed Random	KR	
Construction Master Keyed <sup>2</sup>	CMK	Add \$16.00 per cylinder
More than 2 Keys	KY# (e.g., KY6)	See page 31 - Cut Keys Section
<b>Master Keying</b>		
Master keyed (all cylinders except CR8000, CR8020, CR8027, CR8200, CR8500, CR8600, CR8700)	MK	Add \$16.00 per cylinder
Master keyed Pyramid (except CR8020, CR8027 LFIC cores)	MK	
Master keyed Security (including LFIC cylinder and core)	MK	
Master keyed Access 3 (except CR8500, CR8600, CR8700 LFIC cores)	MK	
Master keyed (CR8000, CR8020, CR8027, CR8200, CR8500, CR8600, CR8700)	MK-IC	No Charge
Master keyed to customer bittings or sample key	MK-CB	Add \$16.00 per cylinder
<b>Visual Key Control (VKC)</b>		
No bitting or keyset stamping on keys	VKC0	\$4.50
Keys only	VKC1	No Charge
Cylinders and keys (not for AS, AHS, ACS, ACHS, HS, CHS, PHS or PCHS)	VKC2	\$8.00
Cylinders only (not for AS, AHS, HS, ACS, ACHS, CHS, PHS or PCHS)	VKC3	
<b>Concealed Key Control (CKC)</b>		
CKC cylinders with VKC keys	CKC2	\$8.00
CKC cylinders only (not for AS, AHS, ACS, ACHS, PHS, PCHS)	CKC3	

**Notes:**

1. CMK Construction master keying charge is in addition to master keying charge.
2. CMK Construction master keying is not available in interchangeable core, Access 3, Pyramid, or Security series.
3. VKC2, VKC3, CKC3 are not available in Pyramid or Security series.

**Custom Laser Engraving- LASER**
**Laser engraving processing charge (all engraving types)**

- \$250.00 net per order. Charge will be applied to production order when placed.

**Single Vanity, Logo or Other (same engraving on all parts)**

- Lever - \$10.00 net add each
- Mortise Escutcheon - \$10.00 net add each
- HPSK Paddle - \$10.00 net add each

**Unique laser engraving (i.e. Room Number, Apartment Number, etc)**

- \$12.00 net add each (per piece)

**Strike Options**

To purchase strike separately see catalog for part no.

Description	Specify Quick Code	Add or Deduct
Fire rated rim strike on ED3200	(standard)	No Charge
Mortised adjustable rim strike	S04	
Rim x vertical rod strike for pairs of doors	S02	Add \$44.00 per device
Vertical rod flush bottom strike (ED3400 only)	S03	No Charge
Vertical rod surface projecting bottom strike on ED3400 device	(standard)	
Fire rated vertical rod bottom strike on ED3400A device	(standard)	
Fire rated vertical rod bottom strike for threshold	S06	

Description	Door Thickness	Specify	Add or Deduct
Curved lip ANSI strike	1-3/4"	SA114 (standard)	No Charge
	2"	SA138	
	2-1/4"	SA158	

Description	Door Thickness	Specify	Add or Deduct
Mortise straight lip ANSI strike on ED3600, ED3600A	1-3/4"	SS118	No Charge
	2"	SS138	
	2-1/4"	SS158	

Description	Door Thickness	Specify	Add or Deduct
Mortise open back strike	1-3/4"	SB134	Add \$100.00 per device
	2"	SB200	\$160.00
	2-1/4"	SB214	\$160.00

**Miscellaneous Options**

Description	Specify	Add or Deduct
Spanner head screws	M02	Add \$41.00 per device
Torx® screws for rim, mortise	M04	Add \$55.00 per device
Torx® screws for surface vertical rod		Add \$103.00 per device
Abrasive coat outside and inside (trim and device)	M23	Add \$111.00 per device
Abrasive coat inside only (device side)	M24	Add \$58.00 per device
Abrasive coat outside only (trim side)	M25	Add \$53.00 per device
Steel reinforced crossbar	M53	Add \$82.00 per device
Sex nuts and bolts (SNBs)	M54	No Charge
Mullion stabilizer	M57	Add \$63.00 per mullion
Shim for 2-3/4" backset on doors with 1/2" stop (rim devices only)	M59	No Charge
Flush transom bracket	M67	Add \$35.00 per device

**Door Width Options**

Description	Specify	Add or Deduct
36"	(standard)	No Charge
48"	W048	Add \$43.00 per device

**Door Thickness Options**

Description	Specify	Add or Deduct
1-3/4"	(standard)	No Charge
2"	D200	
2-1/4"	D214	

**Door Height Options**

Description	Specify	Add or Deduct
7'0" H0700	H0700	No Charge
7'2" H0702	H0702	
7'6" H0706	H0706	
8' (Standard)	(standard)	
8'6" H0806 (ED3400 device only)	H0806	Add \$99.00 per device
9' H0900 (ED3400 device only)	H0900	
10' H01000 (ED3400 device only)	H1000	

**Mullions**

Cylinder not included

Ordering Example	
Quantity	Mullion Number
10	507

**Removable Mullion**

Description	Specify	Price
Up to 7'0" Steel Mullion - Panic Rated	CR907	\$827.00
Up to 8'0" Steel Mullion - Panic Rated	CR908	\$837.00
Up to 10'0" (ED3200 only), Steel Mullion - Panic Rated	CR910	\$998.00
Up to 7'0", Steel Mullion - 3 Hour Fire Rated	CR907A	\$1,150.00
Up to 8'0", Steel Mullion - 3 Hour Fire Rated	CR908A	\$1,160.00

**Key Removable Mullion**

Description	Specify	Price
Up to 7'0", key removable mullion, 1-1/2 Hour Fire Rated	CR907BKM <sup>1</sup>	\$1,771.00
Up to 8'0", key removable mullion, 1-1/2 Hour Fire Rated	CR908BKM <sup>1</sup>	\$1,781.00
Up to 10'0" (ED3200 only), key removable mullion, Panic Rated	CR910KM <sup>1</sup>	\$1,566.00
Door frame filler block for double rabbetted frames	M95	Add \$42.00 per mullion
Door frame angle bracket for aluminum frames	M96	Add \$42.00 per mullion

Note 1: Cylinder and collars not included, specify separately



**Mullions Cylinder Options**

Description	Specify Quick Code	Add or Deduct
Conventional 6-pin	6P	Add \$105.00 per cylinder
Conventional 7-pin	7P	Add \$107.00 per cylinder
<b>LFIC</b>		
LFIC 6-pin	C6	Add \$196.00 per cylinder
LFIC 6-pin less core	CL6	Add \$105.00 per cylinder
LFIC 6-pin with temporary construction core (Red)	CT6R	Add \$196.00 per cylinder
LFIC 6-pin with temporary construction core (Blue)	CT6B	Add \$196.00 per cylinder
LFIC 6-pin with temporary construction core (Green)	CT6G	Add \$196.00 per cylinder
LFIC 6-pin with temporary disposable core	CT6D	Add \$105.00 per cylinder
LFIC 7-pin	C7**	Add \$200.00 per cylinder
LFIC 7-pin less core	CL7	Add \$107.00 per cylinder
LFIC 7-pin with temporary construction core (Red)	CT7R**	Add \$200.00 per cylinder
LFIC 7-pin with temporary construction core (Blue)	CT7B**	Add \$200.00 per cylinder
LFIC 7-pin with temporary construction core (Green)	CT7G**	Add \$200.00 per cylinder
LFIC 7-pin with temporary disposable core	CT7D**	Add \$107.00 per cylinder
<b>Security</b>		
Security	HS	Add \$244.00 per cylinder
Security LFIC	CHS	Add \$331.00 per cylinder
<b>Pyramid</b>		
Pyramid Security fixed core	PS	Add \$179.00 per cylinder
Pyramid Security LFIC	PCS	Add \$264.00 per cylinder
Pyramid High Security fixed core	PHS	Add \$215.00 per cylinder
Pyramid High Security LFIC	PCHS	Add \$301.00 per cylinder
Pyramid Security IC	PCS	Add \$264.00 per cylinder

IC 7-pin with temporary construction core CT7.

\*\*Not available with Rim or SVR Lever Trim – Classroom Function. or SVR Lever Trim – Night Latch Function.

**Mortise Lock Only**

Lock Number	Description	Finish: 605, 606, 611, 612, 613, 613E, 625, 626
MLE012	Lockbody for Nightlatch/Dummy function	\$766.00
MLE013	Lockbody for Classroom function	
MLE014	Lockbody for Passage function	
MLE015	Lockbody for Passage Thumbpiece function	
MLE016	Lockbody for Classroom Thumbpiece function	
MLE016	Lockbody for Classroom Thumbpiece function	

**Ordering Example**

<b>Mortise Lock Only</b>			
Quantity	Lock Number	Finish	Hand
2	MLE013	630	LHR

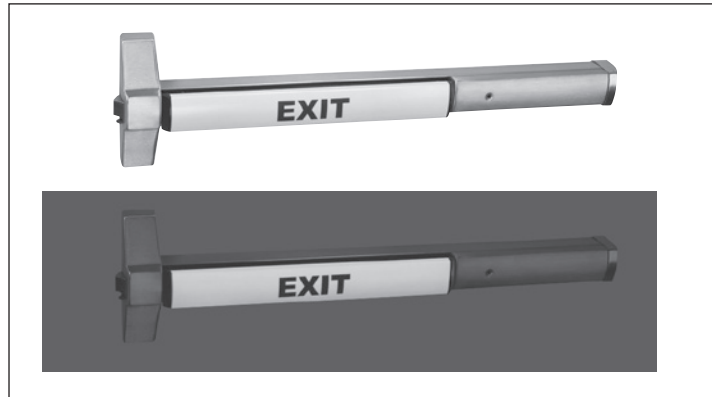

The PathLite™ patent pending technology offers a number of benefits:

- Requires no wiring or maintenance
- Recharges with exposure to ambient light
- Unaffected by heat or cold
- Non-toxic, will not rub or fade
- Vandal resistant
- Fire resistant and non-radioactive
- Green contrasting word "EXIT" centered on touchbar in 1-1/4" high lettering
- Cost effective; especially suited for existing buildings

PathLite™ photoluminescent exit devices meet New York City's newly adopted standards for requirement of photoluminescent signage and stairwell markings in all office buildings in excess of 75 feet in height.

**How To Order Complete Device**

Exit Device	Trim/Function	Finish	Hand	Misc. Options
ED4200	A810	630	RHR	M49

ED4200 x A810 x 630 x RHR x M49

Options	Specify	Price
24", 36" , and 48" PathLite™ Photoluminescent Touchbar Cover	M49	Add \$417.00 per device

**How to Order Touchbar Cover Only**

Options	Part Number	Price
24" PathLite™ Photoluminescent Touchbar cover	710F797	\$411.00
36" PathLite™ Photoluminescent Touchbar cover	710F737	
48" PathLite™ Photoluminescent Touchbar cover	710F747	

**Standard Features  
Handing**

Devices are field reversible;  
specify hand. Lever trims are  
handed; specify hand

**Door Thickness**

1-3/4"

Product	Minimum Stile
ED4200S	2"
ED4200SM	3 1/2"
ED4200SMA	3 1/2"
ED4200	2"
ED4200M	3 1/2"
ED4200MA	3 1/2"
ED4400	2"
ED4400M	3 1/2"
ED4400MA	3 1/2"
ED4800	2"
ED4800M	3 1/2"
ED4800MA	3 1/2"

**Projection**

3-1/4"; 2-3/4" dogged

**Trim**

Cylinder is not included.  
See page 302 for  
cylinder options

**Door Width**

36"

**SecureBolt®**

ED4200S      Panic  
ED4200SM    Panic  
ED4200SMA   3 Hour Fire  
Rated

**Rim**

ED4200      Panic  
ED4200M    Panic  
ED4200MA   3 Hour Fire Rated

**Surface Vertical Rod**

ED4400      Panic  
ED4400M    Panic  
ED4400MA   3 Hour Fire Rated

**Concealed Vertical Rod**

ED4800      Panic  
ED4800M    Panic  
ED4800MA   3 Hour Fire Rated

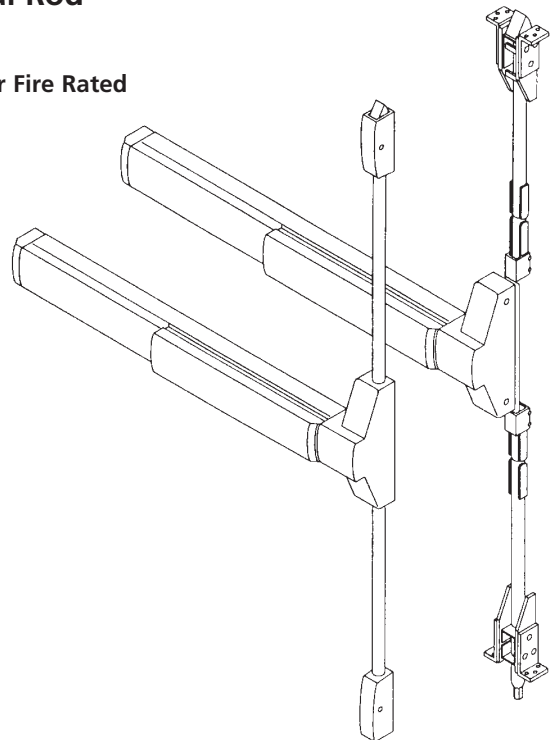
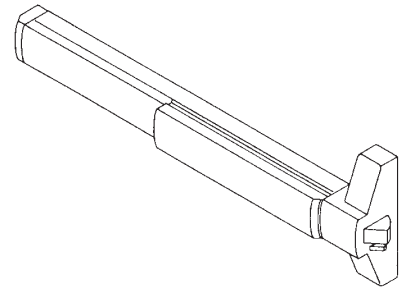

### Ordering Example

#### Exit Device Only

Quantity	Exit Device	Finish	Hand	Misc. Options
20	ED4200	606	RHR	M51-M54

#### Removable Mullions

Quantity	Mullion	Finish	Misc. Options
12	CR808	695	M57

#### Exit Device with Trim

Quantity	Exit Device	Trim/Function	Finish	Hand	Door Thickness	Door Width	Door Height	Misc. Options
10	ED4400	N855ET	605	LHR	D200	W048	H0706	M51-M54

#### Trim Only

Quantity	Trim/Function	Finish	Hand	Door Thickness
24	N855ET	625	RHR	D214

#### Contract/Detailed Order - Rim Exit Device with Trim

Quantity	Keypad	Exit Device	Trim/Function	Finish	Hand	Door Height	Optional Strike	Door Width	Misc. Options	Optional Cylinder
36	AA1	ED4400	C855ET	626	LHR	H0800	S09	W048	M52-M54	7P

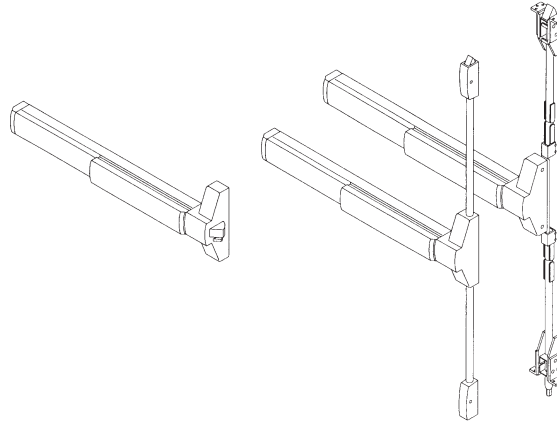

**36" Device Only, See Quick Code section for 24" and 48" door width options**

Includes device, strike(s) and screw pack. No cylinder or trim.

**SecureBolt® ED4200S Series**

Function	Description	Finish: 613E, 630, BSP, WSP	Finish: 605, 606, 611, 612, 613, 618, 619, 625, 629, 722
ED4200S	Panic	\$2,531.00	\$2,611.00
ED4200SM	Panic	\$2,531.00	\$2,611.00
ED4200SMA	3 Hour Fire Rated	\$2,733.00	\$2,813.00

**Rim ED4200 Series**

Function	Description	Finish: 613E, 630, BSP, WSP	Finish: 605, 606, 611, 612, 613, 618, 619, 625, 629, 722
ED4200	Panic	\$2,456.00	\$2,536.00
ED4200M	Panic	\$2,456.00	\$2,536.00
ED4200MA	3 Hour Fire Rated	\$2,658.00	\$2,738.00

**Vertical Rod ED4400 Series**

Function	Description	Finish: 613E, 630, BSP, WSP	Finish: 605, 606, 611, 612, 613, 618, 619, 625, 629, 722
ED4400	Panic	\$2,796.00	\$2,876.00
ED4400M	Panic	\$2,796.00	\$2,876.00
ED4400MA	3 Hour Fire Rated	\$2,998.00	\$3,078.00

**Concealed V.R. ED4800 Series**

Function	Description	Finish: 613E, 630, BSP, WSP	Finish: 605, 606, 611, 612, 613, 618, 619, 625, 629, 722
ED4800	Panic	\$3,083.00	\$3,163.00
ED4800M	Panic	\$3,083.00	\$3,163.00
ED4800MA	3 Hour Fire Rated	\$3,285.00	\$3,365.00

Caution: Be sure of your measurements. Exit devices are NOT returnable.

# Pushpad Exit Devices

ED4000 Series: Muséo Levers with 800 Series Escutcheon

USA & Canada Prices Effective February 1, 2022

contemporary levers to complement the interior design of your next project

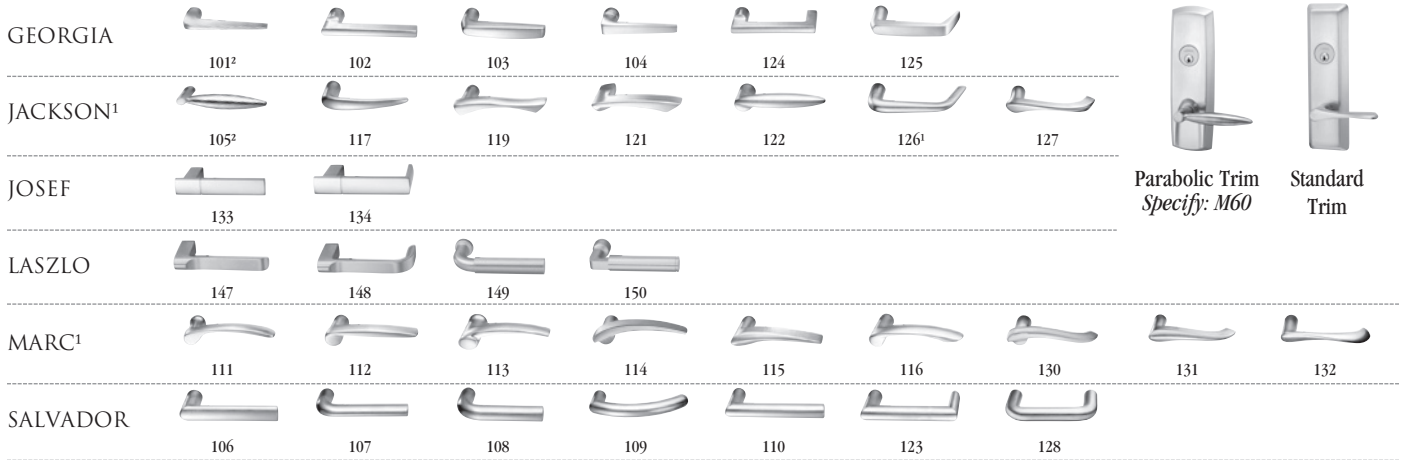

1. Handed: specify hand when ordering
2. Contact factory for current lead time

\*629 and \*630 finish options are Not available for all Muséo levers. Please refer to page 20 for availability.

605	Bright Brass, Clear Coated	613L	Dark Oxidized Satin Bronze, Clear Coated	BSP	Black Suede Powder Coat
606	Satin Brass, Clear Coated	618	Bright Nickel Plated	WSP	White Suede Powder Coat
611	Bright Bronze, Clear Coated	619	Satin Nickel Plated	722	Black Oxidized Bronze, Oil Rubbed
612	Satin Bronze, Clear Coated	625	Bright Chromium Plated		
613	Dark Oxidized Satin Bronze, Oil Rubbed	626	Satin Chromium Plated		
613E	Dark Oxidized Satin Bronze - Equivalent	629*	Bright Stainless Steel		
		630*	Satin Stainless Steel		

### Function

<b>Rim/SVR/CVR</b>	810 850 855 859	Passage Dummy Nightlatch	\$805.00
<b>Options</b>	M60	Parabolic Escutcheon	Add \$94.00 per device

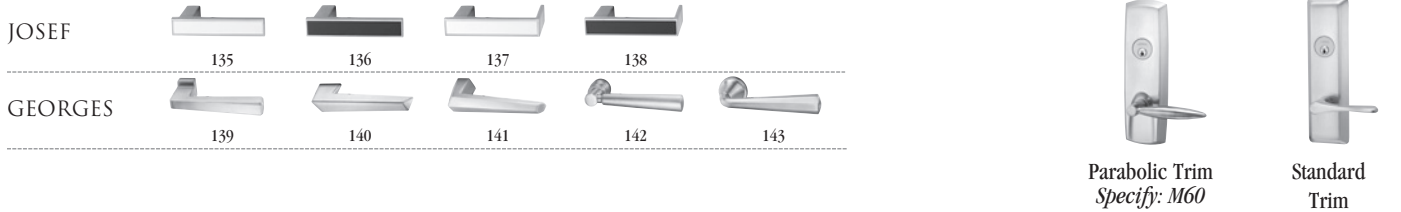

1. Handed: specify hand when ordering
2. Contact factory for current lead time

605	Bright Brass, Clear Coated	613L	Dark Oxidized Satin Bronze, Clear Coated	BSP	Black Suede Powder Coat
606	Satin Brass, Clear Coated	618	Bright Nickel Plated	WSP	White Suede Powder Coat
611	Bright Bronze, Clear Coated	619	Satin Nickel Plated	722	Black Oxidized Bronze, Oil Rubbed
612	Satin Bronze, Clear Coated	625	Bright Chromium Plated		
613	Dark Oxidized Satin Bronze, Oil Rubbed	626	Satin Chromium Plated		
613E	Dark Oxidized Satin Bronze - Equivalent	629*	Bright Stainless Steel		
		630*	Satin Stainless Steel		

<b>Rim/SVR/CVR</b>	810 850	Passage Dummy Nightlatch	\$867.00
<b>Options</b>	M60	Parabolic Escutcheon	Add \$94.00 per device



Experience a safer and more open world

# Pushpad Exit Devices

ED4000 Series: Muséo Levers with 800 Series Escutcheon

USA & Canada Prices Effective February 1, 2022

contemporary levers to complement the interior design of your next project

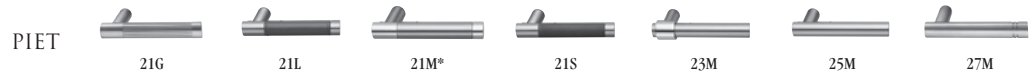

\*613E, BSP, WSP finishes are not available with 21M levers.



- 613E Dark Oxidized Satin Bronze – Equivalent
- 629 Bright Stainless Steel
- 630 Satin Stainless Steel
- BSP Black Suede Powder Coat
- WSP White Suede Powder Coat

**Function**

<b>Rim/SVR/CVR</b>	810 850 855 859	Passage Dummy Nightlatch		\$867.00
<b>Options</b>	M60	Parabolic Escutcheon		Add \$94.00 per device



Experience a safer and more open world

**ED4200S/ED4200/ED4400/ED4800 SecureBolt® , Rim, Surface and Concealed V.R. Trim**

Cylinder is not included.

**Escutcheon Trim Design: A8 Armstrong**



**Lever:** Cast

**Escutcheon:** Wrought

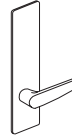

Function	Description	Finish: 605, 606, 611, 612, 613, 613E, 618, 619, 625, 626, 629, 630, 722, BSP
A810ET	Passage	\$781.00
A850ET	Dummy	
A855ET	Classroom <sup>1</sup>	
A859ET	Storeroom	

**Escutcheon Trim Design: C8 Citation**



**Lever:** Cast

**Escutcheon:** Wrought

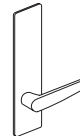

Function	Description	Finish: 605, 606, 611, 612, 613, 613E, 618, 619, 625, 626, 629, 630, 722, BSP
C810ET	Passage	\$781.00
C850ET	Dummy	
C855ET	Classroom <sup>1</sup>	
C859ET	Storeroom	

**Escutcheon Trim Design: D8 Dirke**



**Lever:** Cast

**Escutcheon:** Wrought

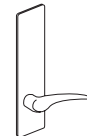

Function	Description	Finish: 605, 606, 611, 612, 613, 613E, 618, 619, 625, 626, 629, 630, 722, BSP
D810ET	Passage	\$781.00
D850ET	Dummy	
D855ET	Classroom <sup>1</sup>	
D859ET	Storeroom	

**Note:**

1. Classroom function trim may be converted to storeroom function by a simple field adjustment. No additional parts required.



**ED4200S/ED4200/ED4400/ED4800 SecureBolt®, Rim, Surface and Concealed V.R. Trim**

Cylinder is not included.

**Escutcheon Trim Design: E8 Essex**



**Lever:** Cast

**Escutcheon:** Wrought

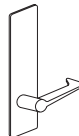

Function	Description	Finish: 605, 606, 611, 612, 613, 613E, 618, 619, 625, 626, 629, 630, 722, BSP
E810ET	Passage	\$781.00
E850ET	Dummy	
E855ET	Classroom <sup>1</sup>	
E859ET	Storeroom	

**Escutcheon Trim Design: L8 Lustra**



**Lever:** Cast

**Escutcheon:** Wrought

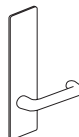

Function	Description	Finish: 605, 606, 611, 612, 613, 613E, 618, 619, 625, 626, 629, 630, 722, BSP
L810ET	Passage	\$781.00
L850ET	Dummy	
L855ET	Classroom <sup>1</sup>	
L859ET	Storeroom	

**Escutcheon Trim Design: N8 Newport**



**Lever:** Cast

**Escutcheon:** Wrought

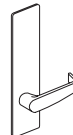

Function	Description	Finish: 605, 606, 611, 612, 613, 613E, 618, 619, 625, 626, 629, 630, 722, BSP
N810ET	Passage	\$781.00
N850ET	Dummy	
N855ET	Classroom <sup>1</sup>	
N859ET	Storeroom	

**Escutcheon Trim Design: R8 Regis**



**Lever:** Cast

**Escutcheon:** Wrought



Function	Description	Finish: 605, 606, 611, 612, 613, 613E, 618, 619, 625, 626, 629, 630, 722, BSP
R810ET	Passage	\$781.00
R850ET	Dummy	
R855ET	Classroom <sup>1</sup>	
R859ET	Storeroom	

Note: 1. Classroom function trim may be converted to storeroom function by a simple field adjustment. No additional parts required.

**ED4200S/ED4200/ED4400/ED4800 SecureBolt® , Rim, Surface and Concealed V.R. Trim**

Cylinder is not included.

**Escutcheon Trim Design: PR8 Princeton**



**Lever:** Cast

**Escutcheon:** Wrought



Function	Description	Finish: 605, 606, 611, 612, 613, 613E, 618, 619, 625, 626, 629, 630, 722, BSP
PR810ET	Passage	\$781.00
PR850ET	Dummy	
PR855ET	Classroom <sup>1</sup>	
PR859ET	Storeroom	

**Escutcheon Trim Design: F4 Plate**

**Plate:** Wrought



Function	Description	Finish: 605, 606, 611, 612, 613, 613E, 618, 619, 625, 626, 629, 630, 722, BSP
F450ET	Dummy	\$310.00
F457ET	Nightlatch	

**Escutcheon Trim Design: O8 Plate x Thumbturn**

**Plate:** Wrought

**Thumbturn:** Cast



Function	Description	Finish: 605, 606, 612, 613, 613E, 630, 722, BSP
O810	Passage	\$632.00
O855 <sup>1</sup>	Classroom	
O859	Storeroom	

**Note:**

1. Classroom function trim may be converted to storeroom function by a simple field adjustment. No additional parts required.

**ED4200S/ED4200/ED4400/ED4800 SecureBolt®, Rim, Surface and Concealed V.R. Trim**

Cylinder is not included.

**Escutcheon Trim Design: O14 Plate x Thumbturn**

**Pull:** Cast      **Escutcheon:** Wrought      **Thumbturn:** Cast



Function	Description	Finish: 605, 606, 611, 612, 613, 613E, 618, 619, 625, 626, 629, 630, 722, BSP
O1410ET	Passage	\$772.00
O1455ET <sup>1</sup>	Classroom	
O1459ET	Storeroom	

**Escutcheon Trim Design: T14 Pull/Thumbpiece**

**Grip:** Cast      **Escutcheon:** Wrought

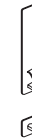

Function	Description	Finish: 605, 606, 611, 612, 613, 613E, 618, 619, 625, 626, 629, 630, 722, BSP
T1410ET	Passage	\$746.00
T1450ET	Dummy	\$676.00
T1455ET <sup>1</sup>	Classroom	\$746.00
T1457ET	Nightlatch (see note 2)	\$676.00

**Escutcheon Trim Design: P10 Pull**



**Pull:** Extruded      **Escutcheon:** Wrought



Function	Description	Finish: 605, 606, 611, 612, 613, 613E, 618, 619, 625, 626, 629, 630, 722, BSP
P1050ET	Dummy	\$751.00
P1057ET	Nightlatch (see note 2)	

**Escutcheon Trim Design: K1 Key Only**

Note: Available with cylinder option only. Example: K157 x 6P  
Cylinder option pricing applies.



Function	Description	Finish: 605, 606, 611, 612, 613, 618, 619, 622, 625, 626, 722
K157ET	Nightlatch <sup>2</sup>	\$71.00

Notes:

- Classroom function trim may be converted to storeroom function by a simple field adjustment. No additional parts required.
- Not recommended for use on surface or concealed vertical rod exit devices.

**Offset Pull Trim: P12, P13, P14**

Offset Pull Trim	Part Number	Finish: 605, 606, 611, 612, 613, 613E, 618, 619, 625, 626, 629, 630, 722, BSP	
P12	716F50M X Finish		\$348.00
P13	716F51M X Finish		\$424.00
P14	716F52M X Finish		\$299.00

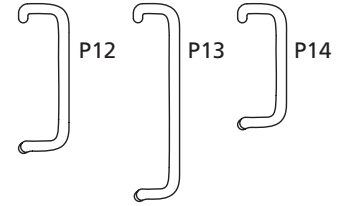

**Electrified Options for Exit Devices**

Description	Specify	Add or Deduct
Exit Alarm Device (cylinder is not included)	M61	\$883.00
Bolt Position Monitoring	M91*	Add \$260.00
Touchbar Monitoring or Signaling/Request to Exit (REX)	M92*	Add \$244.00
Outside Trim Monitoring or Signaling	M93*	
Motor Latch Retraction	MELR	Add \$935.00
Electric Dogging	M97	Add \$498.00

**Delayed Egress Device**

Description	Specify	Add or Deduct
Delayed Egress (Suffix the letter D to device. Ex: ED4200)	D	Add \$1917.00
30-Second Delay	M88*	\$133.00
BOCA 15-Second Delay	M89*	
BOCA 30-Second Delay	M90*	

**Electrified Accessories**

Part Number	Description	Specify	Price
709F609	Power Supply 1 Amp (controls 1 'D' device)	BPS-24-1	\$406.00
709F619	Power Supply 2 Amp (controls 2 'D' devices or 1 "D" with SAF or SEC)	BPS-24-2	\$826.00
709F269	Power Supply 4 amp 24VDC	BPS-24-4	\$1,399.00
704F288	Concealed transfer (for over 120-degree swing door)	EPTL	\$160.00
709F689	(1) SPDT Maintained Switch (Includes LED)	MKA	\$160.00
709F709	(1) SPDT Momentary Switch (Includes LED)	MK	\$245.00
709F749	(1) SPDT Momentary Switch (Illuminated)	PB2	\$188.00
709F759	(1) SPDT Maintained (Alternating Action) Switch	PB3EA	\$144.00
709F769	(1) SPDT Momentary Switch (Illuminated)	PB3	\$182.00
709F779	(1) SPDT Momentary Switch	PB3ER	\$122.00
709F729	DPDT Momentary Key Switch	MK2	\$282.00
709F699	Narrow Stile Key Switch (Alt. action)	MKAN	\$245.00
709F719	Narrow Stile Momentary Key Switch	MKN	\$245.00
709F789	Sonalert 90db @ 2 ft. 12-24VDC. Mounted on one gang stainless steel plate.	PZ1	\$122.00
	<b>Alarm Kit (cylinder is not included)<sup>1</sup></b>	ED40AK	\$1,004.00
709F679	Door Cord	TSB-C	\$52.00
741F739	Digital Entry System (4 users)	DK-12	\$262.00
709F809	Digital Entry System (59 users) ST finish	FADK-26SS	\$863.00
709F819	Digital Entry System (59 users) Black finish	DK-26BK	\$863.00

**Notes:**

1. Alarm kit cannot be installed in the field to surface vertical rod exit device. Any attempt to do so voids all warranties.

**\*ElectroLynx®**

As part of their promise to provide innovative, fast and effective high security solutions to their customers, certain ASSA ABLOY Group brands offer *ElectroLynx®*, a universal quick-connect system that simplifies the electrification of the door opening.

**Cylinder Options\***

Description	Specify Quick Code	Add or Deduct
Conventional 6-pin	6P*	Add \$105.00 per cylinder
Conventional 7-pin	7P	Add \$107.00 per cylinder
<b>LFIC</b>		
LFIC 6-pin	C6	Add \$196.00 per cylinder
LFIC 6-pin less core	CL6	Add \$105.00 per cylinder
LFIC 6-pin with temporary construction core (Red)	CT6R	Add \$196.00 per cylinder
LFIC 6-pin with temporary construction core (Blue)	CT6B	Add \$196.00 per cylinder
LFIC 6-pin with temporary construction core (Green)	CT6G	Add \$196.00 per cylinder
LFIC 6-pin with temporary disposable core	CT6D	Add \$105.00 per cylinder
LFIC 7-pin	C7	Add \$200.00 per cylinder
LFIC 7-pin less core	CL7	Add \$107.00 per cylinder
LFIC 7-pin with temporary construction core (Red)	CT7R	Add \$200.00 per cylinder
LFIC 7-pin with temporary construction core (Blue)	CT7B	Add \$200.00 per cylinder
LFIC 7-pin with temporary construction core (Green)	CT7G	Add \$200.00 per cylinder
LFIC 7-pin with temporary disposable core	CT7D	Add \$107.00 per cylinder
<b>SFIC</b>		
SFIC 6-pin	C6S	Add \$187.00 per cylinder
SFIC 6-pin with temporary construction core (Blue)	CT6SB	Add \$187.00 per cylinder
SFIC 6-pin with SFIC disposable temporary core	CT6SD	Add \$105.00 per cylinder
SFIC 6-pin with Less Core	CLS6	Add \$105.00 per cylinder
SFIC 7-pin	C7S	Add \$187.00 per cylinder
SFIC 7-pin with temporary construction core (Blue)	CT7SB	Add \$187.00 per cylinder
SFIC 7-pin with SFIC disposable temporary core	CT7SD	Add \$107.00 per cylinder
SFIC 7-pin with Less Core	CLS7	Add \$107.00 per cylinder
<b>Security</b>		
Security <sup>4</sup>	HS	Add \$244.00 per cylinder
Security LFIC <sup>4</sup>	CHS	Add \$331.00 per cylinder
<b>Access 3</b>		
Access 3 Patented	AP	Add \$105.00 per cylinder
Access 3 Security	AS	Add \$161.00 per cylinder
Access 3 High Security, UL 437	AHS	Add \$184.00 per cylinder
Access 3 LFIC Patented	ACP	Add \$196.00 per cylinder
Access 3 LFIC Security	ACS	Add \$252.00 per cylinder
Access 3 LFIC High Security, UL 437	ACHS	Add \$274.00 per cylinder
<b>Pyramid</b>		
Pyramid Security fixed core	PS	Add \$179.00 per cylinder
Pyramid Security LFIC	PCS	Add \$264.00 per cylinder
Pyramid High Security fixed core	PHS	Add \$215.00 per cylinder
Pyramid High Security LFIC	PCHS	Add \$301.00 per cylinder
Pyramid LFIC with temporary construction core <sup>3</sup>	CTP	Add \$196.00 per cylinder
Pyramid LFIC with temporary disposable core <sup>3</sup>	CTPD	Add \$105.00 per cylinder
Pyramid LFIC less core	CLP	Add \$105.00 per cylinder

\*Optional dogging cylinder will be furnished with the same mechanism and keyed alike with the trim cylinder, unless otherwise specified. If different keying or cylinder type is required, specify outside (trim) first, then inside (dogging) cylinder.

\*\*6P cylinder option is supplied in 6-pin, L4 keyway, 0-bitted with two nickel silver keys.

\*For key bows other than 10 and 90, specify "KB" + bow number as Quick Code, e.g. KB12.

Notes:

1. CMK Construction master keying charge is in addition to master keying charge.
2. CMK Construction master keying is not available in interchangeable core, Access 3, Pyramid, or Security series.
3. VKC2, VKC3, CKC3 are not available in Pyramid or Security series.

<b>Cylinder Options (continued) &amp; Keying Options*</b>		
Description	Specify Quick Code	Add or Deduct
<b>Keying and Keys</b>		
0-bitted with 2 Blank Keys	(standard)	No Charge
Keyed Random	KR	
Construction Master Keyed <sup>2</sup>	CMK	
More than 2 Keys	KY# (e.g., KY6)	See page 31 - Cut Keys Section
<b>Master Keying</b>		
Master keyed (all cylinders except CR8000, CR8020, CR8027, CR8200, CR8500, CR8600, CR8700)	MK	Add \$16.00 per cylinder
Master keyed Pyramid (except CR8020, CR8027 LFIC cores)	MK	
Master keyed Security (including LFIC cylinder and core)	MK	
Master keyed Access 3 (except CR8500, CR8600, CR8700 LFIC cores)	MK	
Master keyed (CR8000, CR8020, CR8027, CR8200, CR8500, CR8600, CR8700)	MK-IC	No Charge
Master keyed to customer bittings or sample key	MK-CB	Add \$16.00 per cylinder
<b>Visual Key Control (VKC)</b>		
No bitting or keyset stamping on keys	VKC0	\$4.50
Keys only	VKC1	No Charge
Cylinders and keys (not for AS, AHS, ACS, ACHS, HS, CHS, PHS or PCHS)	VKC2	\$8.00
Cylinders only (not for AS, AHS, HS, ACS, ACHS, CHS, PHS or PCHS)	VKC3	
<b>Concealed Key Control (CKC)</b>		
CKC cylinders with VKC keys	CKC2	\$8.00
CKC cylinders only (not for AS, AHS, ACS, ACHS, PHS, PCHS)	CKC3	

\*Optional dogging cylinder will be furnished with the same mechanism and keyed alike with the trim cylinder, unless otherwise specified. If different keying or cylinder type is required, specify outside (trim) first, then inside (dogging) cylinder.

\*\*6P cylinder option is supplied in 6-pin, L4 keyway, 0-bitted with two nickel silver keys.

\*For key bows other than 10 and 90, specify "KB" + bow number as Quick Code, e.g. KB12.

- Notes:
1. CMK Construction master keying charge is in addition to master keying charge.
  2. CMK Construction master keying is not available in interchangeable core, Access 3, Pyramid, or Security series.
  3. VKC2, VKC3, CKC3 are not available in Pyramid or Security series.

## Door Height Options

### ED4400 Device

Door Height	Specify	Add or Deduct
7'0"	(standard)	No Charge
7'2"	H0702	
7'6"	H0706	
8'0"	H0800	
9'0"	H0900	Add \$99.00 per device
10'0"	H1000	

### ED4800 Device

Door Height	Specify	Add or Deduct
8'0"	(standard)	No Charge
8'2"	H0802	
8'6"	H0806	
9'0"	H0900	Add \$99.00 per device
10'0"	H1000	

## Door Width Options

Door Width	Specify	Add or Deduct
24"	W024	Add \$349.00 per device
36"	(standard)	No Charge
48"	W048	Add \$43.00 per device

## Door Thickness Options

Door Thickness	Specify	Add or Deduct
1-3/4"	(standard)	No Charge
2"	D200	
2-1/4"	D214	

## Strike Options

Description	Specify	Add or Deduct
Surface or concealed vertical rod	S09	No Charge
Bottom strike for 1/2" threshold		
Flush transom top strike bracket	M67	Add \$35.00 per device

<b>Miscellaneous Options</b>		
<b>Description</b>	<b>Specify</b>	<b>Add or Deduct</b>
Torx® screws for rim, concealed vertical rod, mortise	M04	Add \$55.00 per device
Torx® screws for surface vertical rod	M04	Add \$103.00 per device
Knurling outside and inside (Embossed Touchbar - device side)	M20	Add \$175.00 per device
Knurling outside only (trim side) <sup>1</sup>	M21	Add \$82.00 per device
Knurling inside only (Embossed Touchbar - device side)	M22	Add \$93.00 per device
Abrasive coat outside and inside (trim and device)	M23	Add \$111.00 per device
Abrasive coat inside only (device side)	M24	Add \$58.00 per device
Abrasive coat outside only (trim side)	M25	Add \$53.00 per device
Pathlite™ Photoluminescent Touchbar cover	M49	Add \$417.00 per device
Less dogging	M51	No Charge
Cylinder dogging (less cylinder)	M52	Add \$94.00 per device
Sex nuts and bolts (SNBs)	M54	No Charge
Mullion stabilizer*	M57	Add \$63.00 per mullion
Shim kit (for vision light)		
- All rim and concealed vertical rod	M58	Add \$86.00 per device
- All surface vertical rod	M58	Add \$114.00 per device
End Cap Reinforcement (used with standard end cap only)	M109	Add \$94.00 per device
Flush End Cap	M110	No Charge

1. Not available with Vineyard™ or Muséo® levers

## Removable Mullion

### Ordering Example

<b>Quantity</b>	<b>Mullion Number</b>	<b>Finish</b>
10	CR808	628

<b>Door Height</b>	<b>Specify</b>	<b>Finish</b>	<b>Price</b>
Up to 8'0"	CR808	628	\$1,792.00
Up to 8'0"	CR808	695	\$2,058.00

\*Standard with all 808 mullions.

### Custom Laser Engraving- LASER

#### Laser engraving processing charge (all engraving types)

- \$250.00 net per order. Charge will be applied to production order when placed.

#### Single Vanity, Logo or Other (same engraving on all parts)

- \$10.00 net add each
- Mortise Escutcheon - \$10.00 net add each
- HPSK Paddle - \$10.00 net add each

#### Unique laser engraving (i.e. Room Number, Apartment Number, etc)

- \$12.00 net add each (per piece)

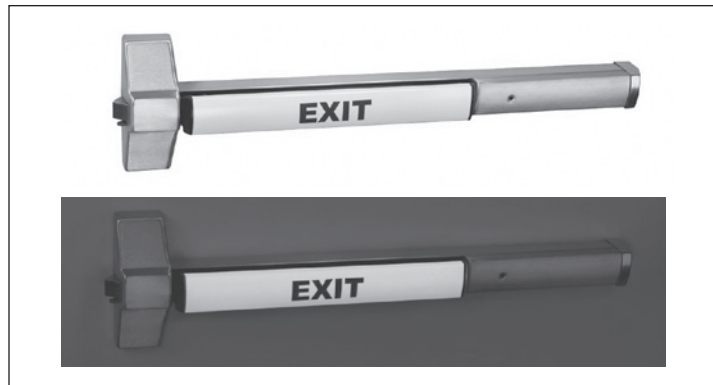

The PathLite™ patent pending technology offers a number of benefits:

- Requires no wiring or maintenance
- Recharges with exposure to ambient light
- Unaffected by heat or cold
- Non-toxic, will not rub off or fade
- Vandal resistant
- Fire resistant and non-radioactive
- Green contrasting word "EXIT" centered on touchbar in 1-1/4" high lettering
- Cost effective; especially suited for existing buildings

PathLite™ photoluminescent exit devices meet New York City's newly adopted standards for requirement of photoluminescent signage and stairwell markings in all office buildings in excess of 75 feet in height.

**How To Order Complete Device**

Exit Device	Trim/Function	Finish	Hand	Misc. Options
ED5200	N910ET	630	RHR	M49

ED5200 x N910 x 630 x RHR x M49

Options	Specify	Price
24", 36", and 48" PathLite™ Photoluminescent Touchbar Cover	M49	Add \$417.00 per device

**How to Order Touchbar Cover Only**

Options	Part Number	Price
24" PathLite™ Photoluminescent Touchbar cover	710F797	\$411.00
36" PathLite™ Photoluminescent Touchbar cover	710F737	
48" PathLite™ Photoluminescent Touchbar cover	710F747	



**Standard Features  
Handing**

Devices are field reversible;  
specify hand. Lever trims are  
handed; specify hand.

Note:  
Specify hand for all double cylinder  
exit devices

**Door Thickness**  
1-3/4"

**Door Width**  
36"

**Projection**  
3-1/4"; 2-3/4" dogged

**Trim**  
Cylinder is not included.  
See page 324 for  
cylinder options.

**SecureBolt®**

ED5200S	Panic
ED5200SA	3 Hour Fire Rated
ED5202S	Double Cylinder Panic, SecureBolt®
ED5202SA	Double Cylinder, Secure Bolt, 3 Hour Fire Rated

**RIM**

ED5200	Panic
ED5200A	3 Hour Fire Rated
ED5202	Double Cylinder Panic
ED5202A	Double Cylinder; 3 Hour fire rated

**Vertical Rod**

ED5400	Panic
ED5470	Panic
ED5400A	3 Hour Fire Rated
ED5470B	1-1/2 Hour Fire Rated

**Concealed Vertical Rod**

ED5800	Panic
ED5860	Panic
ED5800A	3 Hour Fire Rated
ED5860B	1-1/2 Hour Fire Rated

**Mortise**

ED5600	Panic
ED5600A	3 Hour Fire Rated
ED5602L	Double Cylinder Panic (Classroom Function)
ED5602AL	Double Cylinder (Classroom Function); 3 Hour Fire Rated

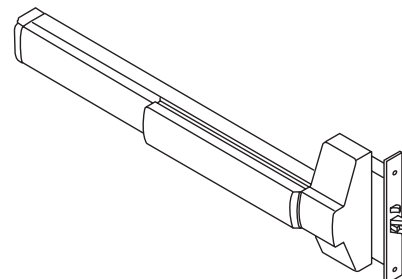
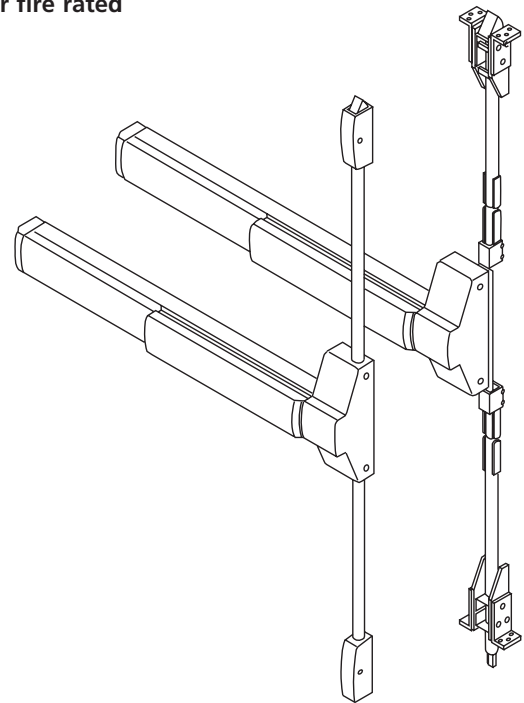
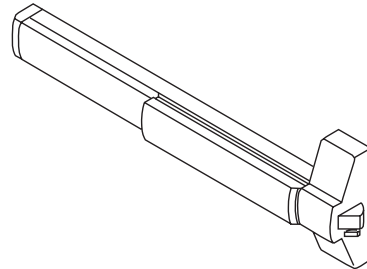

### Ordering Examples

#### Exit Device with Trim

Quantity	Exit Device	Trim/Function	Finish	Hand	Door Thickness	Optional Strike	Door Width	Misc. Options
36	ED5600L	N9M55ET	605	LHR	D200	SB134	W048	M51-M54

#### Trim Only

Quantity	Trim/Function	Finish	Hand	Door Thickness
24	N955ET	625	RHR	D214

#### Contract/Detailed Order - Rim Exit Device with Trim

Quantity	Keyset	Exit Device	Trim/Function	Finish	Hand	Door Thickness	Door Width	Misc. Options	Optional Cylinder
36	AA1	ED5200	C955ET	613E	LHR	D200	W048	M52-M54	6P

**Notes:**

M55 less bottom rod option is available on ED5470(B) and ED5860(B) devices only.  
 H0900 and H1000 options are available on ED5470(B) and ED5860(B) devices only.  
 Non fire rated devices do not have a door size limitation set by UL.

**36" Device Only**

Includes device, strike(s) and screw pack. No cylinder or trim.

**SecureBolt® ED5200S Series**

Function	Description	Finish: 613E, 630, BSP, WSP	Finish: 605, 606, 611, 612, 613, 618, 619, 625, 629, 722
ED5200S	Panic	\$2,009.00	\$2,105.00
ED5202S <sup>1</sup>	Double Cylinder Panic <i>Classroom function Trim only</i>	\$2,253.00	\$2,349.00
ED5200SA	3 Hour Fire Rated	\$2,211.00	\$2,307.00
ED5202SA <sup>1</sup>	Double Cylinder 3 Hour Fire Rated <i>Classroom function Trim only</i>	\$2,455.00	\$2,551.00

**Rim ED5200 Series**

Function	Description	Finish: 613E, 630, BSP, WSP	Finish: 605, 606, 611, 612, 613, 618, 619, 625, 629, 722
ED5200	Panic	\$1,934.00	\$2,030.00
ED5202 <sup>1</sup>	Double Cylinder Panic <i>Classroom function Trim only</i>	\$2,178.00	\$2,274.00
ED5200A	3 Hour Fire Rated	\$2,136.00	\$2,232.00
ED5202A <sup>1</sup>	Double Cylinder 3 Hour Fire Rated <i>Classroom function Trim only</i>	\$2,380.00	\$2,476.00

**Vertical Rod ED5400 Series**

Function	Description	Finish: 613E, 630, BSP, WSP	Finish: 605, 606, 611, 612, 613, 618, 619, 625, 629, 722
ED5400	Panic	\$2,534.00	\$2,630.00
ED5470	Panic	\$2,606.00	\$2,702.00
ED5400A	3 Hour Fire Rated	\$2,736.00	\$2,832.00
ED5470B	1-1/2 Hour Fire Rated	\$2,808.00	\$2,904.00

**Mortise ED5600 Series**

Function	Description	Finish: 613E, 630, BSP, WSP	Finish: 605, 606, 611, 612, 613, 618, 619, 625, 629, 722
ED5600L	Panic	\$2,498.00	\$2,594.00
ED5657L			
ED5600T			
ED5657T			
ED5602L <sup>1</sup>	Double Cylinder Panic <i>Classroom function Trim only</i>	\$2,742.00	\$2,838.00
ED5600AL	3 Hour Fire Rated	\$2,700.00	\$2,796.00
ED5657AL			
ED5600AT			
ED5657AT			
ED5602AL <sup>1</sup>	Double Cylinder 3 Hour Fire Rated <i>Classroom function Trim only</i>	\$2,944.00	\$3,040.00

**Concealed V.R. ED5800 Series**

Function	Description	Finish: 613E, 630, BSP, WSP	Finish: 605, 606, 611, 612, 613, 619, 625, 629, 722
ED5800	Panic	\$2,816.00	\$2,912.00
ED5860	Panic	\$2,961.00	\$3,057.00
ED5800A	3 Hour Fire Rated	\$3,018.00	\$3,114.00
ED5860B	1-1/2 Hour Fire Rated	\$3,163.00	\$3,259.00

**Inactive Bar ED5000DB Series**

Function	Description	Finish: 613E, 630, BSP, WSP	Finish: 605, 606, 611, 612, 613, 619, 625, 629, 722
ED5000DB	Inactive Bar	\$934.00	\$1,030.00

1. Specify handing for double cylinder devices  
 Only classroom function trim can be used with double cylinder devices.  
 Caution: Be sure of your measurements. Exit devices are NOT returnable.

# Pushpad Exit Devices

ED5000 Series: Muséo Levers with 900 Series Escutcheon

USA & Canada Prices Effective February 1, 2022

contemporary levers to complement the interior design of your next project

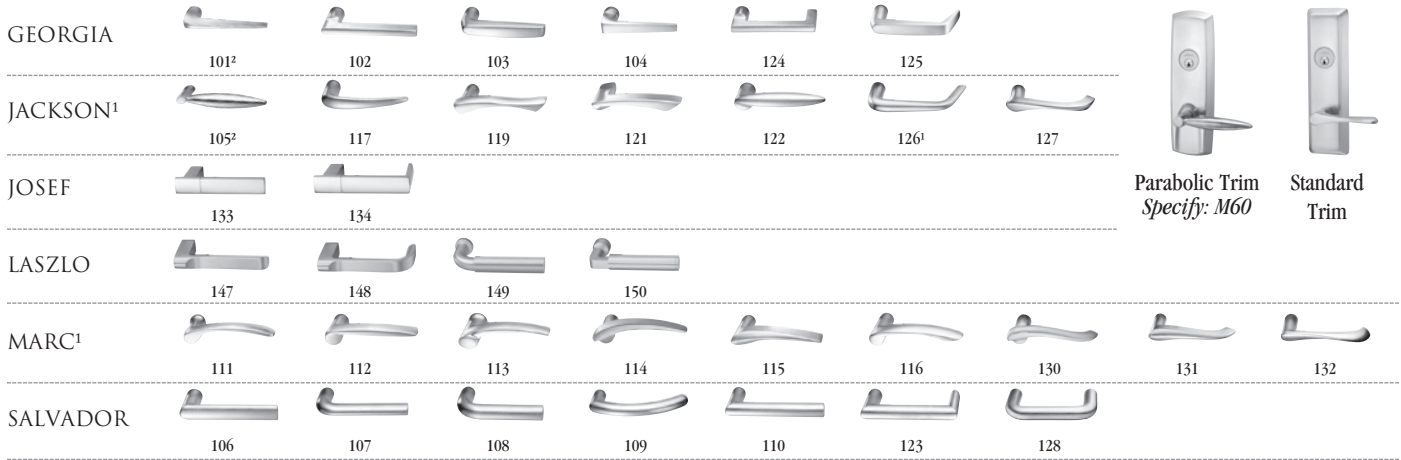

- 1. Handed: specify hand when ordering
- 2. Contact factory for current lead time

\*629 and \*630 finish options are Not available for all Muséo levers. Please refer to page 20 for availability.

605	Bright Brass, Clear Coated	613L	Dark Oxidized Satin Bronze, Clear Coated	BSP	Black Suede Powder Coat
606	Satin Brass, Clear Coated	618	Bright Nickel Plated	WSP	White Suede Powder Coat
611	Bright Bronze, Clear Coated	619	Satin Nickel Plated	722	Black Oxidized Bronze, Oil Rubbed
612	Satin Bronze, Clear Coated	625	Bright Chromium Plated		
613	Dark Oxidized Satin Bronze, Oil Rubbed	626	Satin Chromium Plated		
613E	Dark Oxidized Satin Bronze - Equivalent	629*	Bright Stainless Steel		
		630*	Satin Stainless Steel		

### Function

<b>Rim/SVR/CVR</b>	910	Passage	\$805.00
	950	Dummy	
	955	Classroom	
	957	Nightlatch	
	959	Storeroom	
<b>Mortise</b>	9M10	Passage	\$805.00
	9M50	Dummy	
	9M55	Classroom	
	9M57	Nightlatch	
<b>Electrified</b>	9903	Fail Safe	\$1,240.00
	9905	Fail Secure	
<b>Options</b>	M60	Parabolic Escutcheon	Add \$94.00 per device

### Ordering Example Details

- 111 Marc family lever
- 9M50 Dummy Trim; Mortise
- 625 Bright Chrome finish
- RHR Right Hand Reverse
- D214 2-1/4" Door Thickness
- M60 Parabolic Escutcheon Design (mechanical)



Trim Only						
Quantity	Trim/Function	Finish	Hand	Door Thickness	Option	
24	1119M50	625	RHR	D214	M60	



Experience a safer and more open world

# Pushpad Exit Devices

ED5000 Series: Muséo Levers with 900 Series Escutcheon

USA & Canada Prices Effective February 1, 2022



contemporary levers to complement the interior design of your next project

## JOSEF



## GEORGES



Parabolic Trim  
Specify: M60



Standard Trim

1. Handed: specify hand when ordering
2. Contact factory for current lead time

605	Bright Brass, Clear Coated	613L	Dark Oxidized Satin Bronze, Clear Coated	BSP	Black Suede Powder Coat
606	Satin Brass, Clear Coated	618	Bright Nickel Plated	WSP	White Suede Powder Coat
611	Bright Bronze, Clear Coated	619	Satin Nickel Plated	722	Black Oxidized Bronze, Oil Rubbed
612	Satin Bronze, Clear Coated	625	Bright Chromium Plated		
613	Dark Oxidized Satin Bronze, Oil Rubbed	626	Satin Chromium Plated		
613E	Dark Oxidized Satin Bronze - Equivalent	629*	Bright Stainless Steel		
		630*	Satin Stainless Steel		

### Function

<b>Rim/SVR/CVR</b>	910	Passage	\$867.00
	950	Dummy	
	955	Classroom	
	957	Nightlatch	
	959	Storeroom	
<b>Mortise</b>	9M10	Passage	\$867.00
	9M50	Dummy	
	9M55	Classroom	
	9M57	Nightlatch	
<b>Electrified</b>	9903	Fail Safe	\$1,334.00
	9905	Fail Secure	
<b>Options</b>	M60	Parabolic Escutcheon	Add \$94.00 per device

### Ordering Example Details

- 133 Josef family lever
- 9M50 Dummy Trim; Mortise
- 625 Bright Chrome finish
- RHR Right Hand Reverse
- D214 2-1/4" Door Thickness
- M60 Parabolic Escutcheon Design (mechanical)



Trim Only					
Quantity	Trim/Function	Finish	Hand	Door Thickness	Option
24	1339M50	625	RHR	D214	M60



Experience a safer  
and more open world

# Pushpad Exit Devices

ED5000 Series: Muséo Levers with 900 Series Escutcheon

USA & Canada Prices Effective February 1, 2022

contemporary levers to complement the interior design of your next project

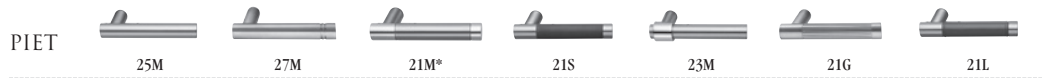

\*613E, BSP, WSP finishes are not available with 21M levers.



Parabolic Trim  
Specify: M60

Standard Trim

613E	Dark Oxidized Satin Bronze – Equivalent
629	Bright Stainless Steel
630	Satin Stainless Steel
BSP	Black Suede Powder Coat
WSP	White Suede Powder Coat

### Function

<b>Rim/SVR/CVR</b>	910	Passage	\$867.00
	950	Dummy	
	955	Classroom	
	957	Nightlatch	
	959	Storeroom	
<b>Mortise</b>	9M10	Passage	\$867.00
	9M50	Dummy	
	9M55	Classroom	
	9M57	Nightlatch	
<b>Electrified</b>	9903	Fail Safe	\$1,334.00
	9905	Fail Secure	
<b>Options</b>	M60	Parabolic Escutcheon	Add \$94.00 per device



### Ordering Example Details

21M Piet Family Lever - Polished with Satin Insert  
 9M50 Dummy Trim; Mortise  
 293029 Lever Finish  
 Polished with satin stainless steel insert (630), polished stainless steel (629) shank and polished stainless steel (629) grip  
 629 Lock Finish  
 D214 2-1/4" Door Thickness  
 M60 Parabolic Escutcheon Design (mechanical)

Trim Only						
Quantity	Trim/Function	Lever Finish	Lock Finish	Hand	Door Thickness	Option
2	21M9M50	293029	629	RHR	D214	M60



Experience a safer and more open world

**ED5200S/ED5200/ED5400/ED5800 SecureBolt®, Rim, Surface and CVR Heavy-Duty Trim**

Cylinder is not included.

**Escutcheon Trim Design: A9 Armstrong**



**Lever:** Cast

**Escutcheon:** Forged

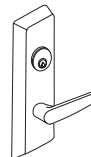

Function	Description	Finish: 605, 606, 611, 612, 613, 613E, 618, 619, 625, 626, 629 <sup>2</sup> , 630 <sup>1</sup> , 722, BSP
A910ET	Passage	\$805.00
A950ET	Dummy	
A955ET	Classroom <sup>3,4</sup>	
A957ET	Nightlatch <sup>5</sup>	
A959ET	Storeroom	

**Escutcheon Trim Design: C9 Citation**



**Lever:** Cast

**Escutcheon:** Forged

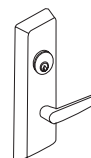

Function	Description	Finish: 605, 606, 611, 612, 613, 613E, 618, 619, 625, 626, 629 <sup>2</sup> , 630 <sup>1</sup> , 722, BSP
C910ET	Passage	\$805.00
C950ET	Dummy	
C955ET	Classroom <sup>3,4</sup>	
C957ET	Nightlatch <sup>5</sup>	
C959ET	Storeroom	

**Escutcheon Trim Design: D9 Dirke**



**Lever:** Cast

**Escutcheon:** Forged

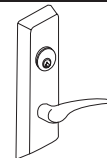

Function	Description	Finish: 605, 606, 611, 612, 613, 613E, 618, 619, 625, 626, 629 <sup>2</sup> , 630 <sup>1</sup> , 722, BSP
D910ET	Passage	\$805.00
D950ET	Dummy	
D955ET	Classroom <sup>3,4</sup>	
D957ET	Nightlatch <sup>5</sup>	
D959ET	Storeroom	

**Notes:**

1. 619 finish provided to match 630 finish
2. 618 finish provided to match 629 finish.
3. Classroom function trim may be converted to storeroom function by a simple field adjustment. No additional parts required.
4. Only Classroom function may be used with Double Cylinder exit devices.
5. Not recommended for use with surface or concealed vertical rod exit devices (ED5400, ED5800)

**ED5200S/ED5200/ED5400/ED5800 SecureBolt®, Rim, Surface and CVR Heavy-Duty Trim**

Cylinder is not included.

**Escutcheon Trim Design: E9 Essex**



**Lever:** Cast

**Escutcheon:** Forged

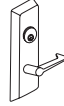

Function	Description	Finish: 605, 606, 611, 612, 613, 613E, 618, 619, 625, 626, 629 <sup>2</sup> , 630 <sup>1</sup> , 722, BSP
E910ET	Passage	\$805.00
E950ET	Dummy	
E955ET	Classroom <sup>3,4</sup>	
E957ET	Nightlatch <sup>5</sup>	
E959ET	Storeroom	

**Escutcheon Trim Design: L9 Lustra**



**Lever:** Cast

**Escutcheon:** Forged

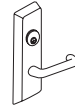

Function	Description	Finish: 605, 606, 611, 612, 613, 613E, 618, 619, 625, 626, 629 <sup>2</sup> , 630 <sup>1</sup> , 722, BSP
L910ET	Passage	\$805.00
L950ET	Dummy	
L955ET	Classroom <sup>3,4</sup>	
L957ET	Nightlatch <sup>5</sup>	
L959ET	Storeroom	

**Escutcheon Trim Design: N9 Newport**



**Lever:** Cast

**Escutcheon:** Forged

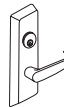

Function	Description	Finish: 605, 606, 611, 612, 613, 613E, 618, 619, 625, 626, 629 <sup>2</sup> , 630 <sup>1</sup> , 722, BSP
N910ET	Passage	\$805.00
N950ET	Dummy	
N955ET	Classroom <sup>3,4</sup>	
N957ET	Nightlatch <sup>5</sup>	
N959ET	Storeroom	

**Escutcheon Trim Design: R9 Regis**



**Lever:** Cast

**Escutcheon:** Forged

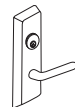

Function	Description	Finish: 605, 606, 611, 612, 613, 613E, 618, 619, 625, 626, 629 <sup>2</sup> , 630 <sup>1</sup> , 722, BSP
R910ET	Passage	\$805.00
R950ET	Dummy	
R955ET	Classroom <sup>3,4</sup>	
R957ET	Nightlatch <sup>5</sup>	
R959ET	Storeroom	

**Notes:**

1. 619 finish provided to match 630 finish. - Escutcheons only
2. 618 finish provided to match 629 finish. - Escutcheons only
3. Classroom function trim may be converted to storeroom function by a simple field adjustment. No additional parts required.

4. Only Classroom function trim may be used with Double Cylinder exit devices.
5. Not recommended for use with surface or concealed vertical rod exit devices (ED5400, ED5800)



**ED5200S/ED5200/ED5400/ED5800 SecureBolt®, Rim, Surface and CVR Heavy-Duty Trim**

Cylinder is not included.

**Escutcheon Trim Design: PR9 Princeton**



**Lever:** Cast

**Escutcheon:** Forged



Function	Description	Finish: 605, 606, 611, 612, 613, 613E, 618, 619, 625, 626, 629 <sup>2</sup> , 630 <sup>1</sup> , 722, BSP
PR910ET	Passage	\$805.00
PR950ET	Dummy	
PR955ET	Classroom <sup>3,4</sup>	
PR957ET	Nightlatch <sup>5</sup>	
PR959ET	Storeroom	

**Escutcheon Trim Design: F9**

**Lever:** Cast

**Escutcheon:** Forged



Function	Description	Finish: 605, 606, 611, 612, 613, 613E, 618, 619, 625, 626, 629 <sup>2</sup> , 630 <sup>1</sup> , 722, BSP
F950ET	Dummy	\$371.00
F957ET	Nightlatch <sup>5</sup>	

**Escutcheon Trim Design: VT9**

**Plate:** Stamped or Formed Stainless Steel



Function	Description	Finish: 630 <sup>1</sup>
VT957ET	Nightlatch <sup>6</sup>	\$739.00
VTL957ET	Nightlatch with Lip <sup>6</sup>	
VT950ET	Pull	
VTL950ET	Pull with Lip	

**Notes:**

1. 619 finish provided to match 630 finish. - Escutcheons only
2. 618 finish provided to match 629 finish. - Escutcheons only
3. Classroom function trim may be converted to storeroom function by a simple field adjustment. No additional parts required.

4. Only Classroom function trim may be used with Double Cylinder exit devices.
5. Not recommended for use with surface or concealed vertical rod exit devices (ED5400, ED5800)
6. VT957 and VTL957 trims are handed and not reversible

**ED5200S/ED5200/ED5400/ED5800 SecureBolt® , Rim, Surface and CVR Heavy-Duty Trim**

Cylinder is not included.

**Escutcheon Trim Design: FR9 Frascati\***



**Escutcheon:** Forged

\* Handed Lever. Handing cannot be changed in the field.

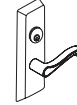

Function	Description	Finish: 605, 606, 611, 612, 613, 613E, 618, 619, 625, 626, 629 <sup>2</sup> , 630 <sup>1</sup> , 722, BSP
FR910ET	Passage	\$805.00
FR950ET	Dummy	
FR955ET	Classroom <sup>3,4</sup>	
FR957ET	Nightlatch <sup>5</sup>	
FR959ET	Storeroom	

**Escutcheon Trim Design: M9 Merlot**



**Escutcheon:** Forged

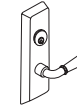

Function	Description	Finish: 605, 606, 611, 612, 613, 613E, 618, 619, 625, 626, 629 <sup>2</sup> , 630 <sup>1</sup> , 722, BSP
M910ET	Passage	\$805.00
M950ET	Dummy	
M955ET	Classroom <sup>3,4</sup>	
M957ET	Nightlatch <sup>5</sup>	
M959ET	Storeroom	

**Escutcheon Trim Design: Z9 Zinfandel\***



**Escutcheon:** Forged

\* Handed Lever. Handing cannot be changed in the field.

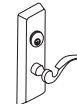

Function	Description	Finish: 605, 606, 611, 612, 613, 613E, 618, 619, 625, 626, 629 <sup>2</sup> , 630 <sup>1</sup> , 722, BSP
Z910ET	Passage	\$805.00
Z950ET	Dummy	
Z955ET	Classroom <sup>3,4</sup>	
Z957ET	Nightlatch <sup>5</sup>	
Z959ET	Storeroom	

**Notes:**

- 3. Classroom function trim may be converted to storeroom function by a simple field adjustment. No additional parts required.
- 4. Only Classroom function trim may be used with Double Cylinder exit devices.
- 5. Not recommended for use with surface or concealed vertical rod exit devices.

**ED5200S/ED5200/ED5400/ED5800 SecureBolt®, Rim, Surface and CVR Trim**

Cylinder is not included.

**Escutcheon Trim Design: TH900 Pull/Thumbpiece**

**Grip:** Extruded

**Escutcheon:** Forged



Function	Description	Finish: 605, 606, 611, 612, 613, 613E, 618, 619, 625, 626, 629 <sup>2</sup> , 630 <sup>1</sup> , 722, BSP
TH910ET	Passage	\$612.00
TH950ET	Dummy (No thumbpiece)	\$582.00
TH955ET	Classroom <sup>3,4</sup>	\$612.00
TH957ET	Nightlatch <sup>5</sup> (No thumbpiece)	\$582.00
TH959ET	Storeroom	\$612.00

**Escutcheon Trim Design: P9 Pull**



**Pull:** Extruded

**Escutcheon:** Forged

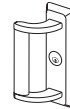

Function	Description	Finish: 605, 606, 611, 612, 613, 613E, 618, 619, 625, 626, 629 <sup>2</sup> , 630 <sup>1</sup> , 722, BSP
P950ET*	Dummy	\$528.00
P957ET*	Nightlatch <sup>5</sup>	

\* Specify Hand. Field Reversible.

**Escutcheon Trim Design: K1 Key Only**

**Note:** Only available with cylinder option. Example K157 x 6P  
Cylinder option pricing applies.



Function	Description	Finish: 605, 606, 611, 612, 613, 618, 619, 622, 625, 626, 722
K157ET	Nightlatch <sup>5</sup>	\$71.00

Note:

1. 619 finish provided to match 630 finish. - Escutcheons only
2. 618 finish provided to match 629 finish. - Escutcheons only
3. Classroom function trim may be converted to storeroom function by a simple field adjustment. No additional parts required.
4. Only Classroom function trim may be used with Double Cylinder exit devices.
5. Not recommended for use on surface or concealed vertical rod exit devices.

**ED5600 Mortise Heavy-Duty Trim**

Cylinder is not included.

**Escutcheon Trim Design: A4M Armstrong**



**Lever:** Cast

**Escutcheon:** Forged

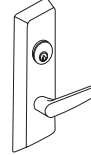

Function	Description	Finish: 605, 606, 611, 612, 613, 613E, 618, 619, 625, 626, 629 <sup>2</sup> , 630 <sup>1</sup> , 722, BSP
A9M10ET	Passage <sup>3</sup>	\$805.00
A9M50ET	Dummy <sup>3</sup>	
A9M55ET	Classroom <sup>4, 5</sup>	
A9M57ET	Nightlatch <sup>4</sup>	

**Escutcheon Trim Design: C9M Citation**



**Lever:** Cast

**Escutcheon:** Forged

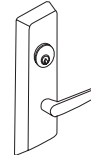

Function	Description	Finish: 605, 606, 611, 612, 613, 613E, 618, 619, 625, 626, 629 <sup>2</sup> , 630 <sup>1</sup> , 722, BSP
C9M10ET	Passage <sup>3</sup>	\$805.00
C9M50ET	Dummy <sup>3</sup>	
C9M55ET	Classroom <sup>4, 5</sup>	
C9M57ET	Nightlatch <sup>4</sup>	

**Escutcheon Trim Design: D9M Dirke\***



**Lever:** Cast

**Escutcheon:** Forged

\* Handed Lever. Handing cannot be changed in the field.

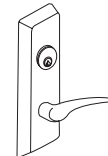

Function	Description	Finish: 605, 606, 611, 612, 613, 613E, 618, 619, 625, 626, 629 <sup>2</sup> , 630 <sup>1</sup> , 722, BSP
D9M10ET	Passage <sup>3</sup>	\$805.00
D9M50ET	Dummy <sup>3</sup>	
D9M55ET	Classroom <sup>4, 5</sup>	
D9M57ET	Nightlatch <sup>4</sup>	

Notes:

1. 619 finish provided to match 630 finish. - Escutcheons only
2. 618 finish provided to match 629 finish. - Escutcheons only
3. Dummy and passage functions are the same. For dummy function, mortise lock body must be installed in the locked mode. No additional parts required.
4. Classroom and nightlatch function trims are the same. Trim function must be specified when ordered with an exit device to ensure that the correct lock body is supplied.
5. Only Classroom function trim may be used with Double Cylinder exit devices.

**ED5600 Mortise Heavy-Duty Trim**

Cylinder is not included.

**Escutcheon Trim Design: E9M Essex**



**Lever:** Cast

**Escutcheon:** Forged

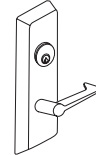

Function	Description	Finish: 605, 606, 611, 612, 613, 613E, 618, 619, 625, 626, 629 <sup>2</sup> , 630 <sup>1</sup> , 722, BSP
E9M10ET	Passage <sup>3</sup>	\$805.00
E9M50ET	Dummy <sup>3</sup>	
E9M55ET	Classroom <sup>4, 5</sup>	
E9M57ET	Nightlatch <sup>4</sup>	

**Escutcheon Trim Design: L9M Lustra**



**Lever:** Cast

**Escutcheon:** Forged

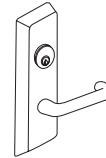

Function	Description	Finish: 605, 606, 611, 612, 613, 613E, 618, 619, 625, 626, 629 <sup>2</sup> , 630 <sup>1</sup> , 722, BSP
L9M10ET	Passage <sup>3</sup>	\$805.00
L9M50ET	Dummy <sup>3</sup>	
L9M55ET	Classroom <sup>4, 5</sup>	
L9M57ET	Nightlatch <sup>4</sup>	

**Escutcheon Trim Design: N9M Newport**



**Lever:** Cast

**Escutcheon:** Forged

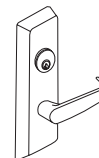

Function	Description	Finish: 605, 606, 611, 612, 613, 613E, 618, 619, 625, 626, 629 <sup>2</sup> , 630 <sup>1</sup> , 722, BSP
N9M10ET	Passage <sup>3</sup>	\$805.00
N9M50ET	Dummy <sup>3</sup>	
N9M55ET	Classroom <sup>4, 5</sup>	
N9M57ET	Nightlatch <sup>4</sup>	

**Notes:**

1. 619 finish provided to match 630 finish. - Escutcheons only
2. 618 finish provided to match 629 finish. - Escutcheons only
3. Dummy and passage functions are the same. For dummy function, mortise lock body must be installed in the locked mode. No additional parts required.
4. Classroom and nightlatch function trims are the same. Trim function must be specified when ordered with an exit device to ensure that the correct lock body is supplied.
5. Only Classroom function trim may be used with Double Cylinder exit devices.

**ED5600 Mortise Heavy-Duty Trim**

Cylinder is not included.

**Escutcheon Trim Design: R9M Regis**



**Lever:** Cast

**Escutcheon:** Forged

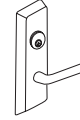

Function	Description	Finish: 605, 606, 611, 612, 613, 613E, 618, 619, 625, 626, 629 <sup>2</sup> , 630 <sup>1</sup> , 722, BSP
R9M10ET	Passage <sup>3</sup>	\$805.00
R9M50ET	Dummy <sup>3</sup>	
R9M55ET	Classroom <sup>4, 5</sup>	
R9M57ET	Nightlatch <sup>4</sup>	

**Escutcheon Trim Design: PR9M Princeton**



**Lever:** Cast

**Escutcheon:** Forged



Function	Description	Finish: 605, 606, 611, 612, 613, 613E, 618, 619, 625, 626, 629 <sup>2</sup> , 630 <sup>1</sup> , 722, BSP
PR9M10ET	Passage <sup>3</sup>	\$805.00
PR9M50ET	Dummy <sup>3</sup>	
PR9M55ET	Classroom <sup>4, 5</sup>	
PR9M57ET	Nightlatch <sup>4</sup>	

**Escutcheon Trim Design: F9**

**Escutcheon:** Forged



Function	Description	Finish: 605, 606, 611, 612, 613, 613E, 618, 619, 625, 626, 629 <sup>2</sup> , 630 <sup>1</sup> , 722, BSP
F950ET	Dummy	\$371.00
F9M57ET	Nightlatch <sup>4</sup>	

**Escutcheon Trim Design: G9M**

**Escutcheon:** Forged



Function	Description	Finish: 605, 606, 611, 612, 613, 613E, 618, 619, 625, 626, 629 <sup>2</sup> , 630 <sup>1</sup> , 722, BSP
G9M10ET	Passage <sup>3</sup>	\$805.00
G9M50ET	Dummy <sup>3</sup>	
G9M55ET	Classroom <sup>4, 5</sup>	
G9M57ET	Nightlatch <sup>4</sup>	

**Notes:**

1. 619 finish provided to match 630 finish. - Escutcheons only
2. 618 finish provided to match 629 finish. - Escutcheons only
3. Dummy and passage functions are the same. For dummy function, mortise lock body must be installed in the locked mode. No additional parts required.

4. Classroom and nightlatch function trims are the same. Trim function must be specified when ordered with an exit device to ensure that the correct lock body is supplied.
5. Only Classroom function trim may be used with Double Cylinder exit devices.

**ED5600 Mortise Heavy-Duty Trim**

Cylinder is not included.

**Escutcheon Trim Design: FR9M Frascati\***



**Lever: Cast**

**Escutcheon: Forged**



\* Handed Lever. Handing cannot be changed in the field.

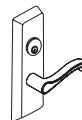

Function	Description	Finish: 605, 606, 611, 612, 613, 613E, 618, 619, 625, 626, 629 <sup>2</sup> , 630 <sup>1</sup> , 722, BSP
FR9M10ET	Passage <sup>1</sup>	\$805.00
FR9M50ET	Dummy <sup>1</sup>	
FR9M55ET	Classroom <sup>2, 3</sup>	
FR9M57ET	Nightlatch <sup>2</sup>	

**Escutcheon Trim Design: M9M Merlot**



**Lever: Cast**

**Escutcheon: Forged**

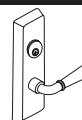

Function	Description	Finish: 605, 606, 611, 612, 613, 613E, 618, 619, 625, 626, 629 <sup>2</sup> , 630 <sup>1</sup> , 722, BSP
M9M10ET	Passage <sup>1</sup>	\$805.00
M9M50ET	Dummy <sup>1</sup>	
M9M55ET	Classroom <sup>2, 3</sup>	
M9M57ET	Nightlatch <sup>2</sup>	

**Escutcheon Trim Design: Z9M Zinfandel\***



**Lever: Cast**

**Escutcheon: Forged**



\* Handed Lever. Handing cannot be changed in the field.

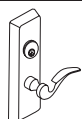

Function	Description	Finish: 605, 606, 611, 612, 613, 613E, 618, 619, 625, 626, 629 <sup>2</sup> , 630 <sup>1</sup> , 722, BSP
Z9M10ET	Passage <sup>1</sup>	\$805.00
Z9M50ET	Dummy <sup>1</sup>	
Z9M55ET	Classroom <sup>2, 3</sup>	
Z9M57ET	Nightlatch <sup>2</sup>	

**Notes:**

- Dummy and passage functions are the same. For dummy function, mortise lock body must be installed in the locked mode. No additional parts required.
- Classroom and nightlatch function trims are the same. Trim function must be specified when ordered with an exit device to ensure that the correct lock body is supplied.
- Only Classroom function trim may be used with Double Cylinder exit devices.

**Mortise Trim Design: ED5600**

Cylinder is not included.

**Escutcheon Trim Design: TH900, TH9M00 Pull/Thumbpiece**

**Grip:** Extruded      **Escutcheon:** Forged



Function	Description	Finish: 605, 606, 611, 612, 613, 613E, 618, 619, 625, 626, 629 <sup>2</sup> , 630 <sup>1</sup> , 722, BSP
TH9M10ET	Passage	\$612.00
TH950ET	Dummy (No Thumbpiece)	\$582.00
TH9M55ET	Classroom <sup>3</sup>	\$612.00
TH9M57ET	Nightlatch (No Thumbpiece)	\$582.00

**Escutcheon Trim Design: P9M Pull**



**Pull:** Extruded      **Escutcheon:** Forged

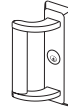

Function	Description	Finish: 605, 606, 611, 612, 613, 613E, 618, 619, 625, 626, 629 <sup>2</sup> , 630 <sup>1</sup> , 722, BSP
P950ET*	Dummy	\$528.00
P9M57ET*	Nightlatch	

\*Specify Hand. Field Reversible.

**Escutcheon Trim Design: VT9M**

**Plate:** Stamped or Formed Stainless Steel



Function	Description	Finish: 630
VT9M57ET	Nightlatch	\$739.00
VTL9M57ET	Nightlatch with Lip	

Note: For mortise exit dummy functions, specify VT950 and VTL950

**Escutcheon Trim Design: K1M Key Only**

Note: Available with cylinder option only. Example: K1M57 x 6P  
Cylinder option pricing applies.



Function	Description	Finish: 605, 606, 611, 612, 613, 618, 619, 622, 625, 626, 722
K1M57ET	Nightlatch	\$71.00

Note:  
1. 619 finish provided to match 630 finish. - Escutcheons only  
2. 618 finish provided to match 629 finish. - Escutcheons only  
3. Only Classroom function trim may be used with Double Cylinder exit devices.



**ED5200S/ED5200/ED5400/ED5800 SecureBolt®, Rim, Surface & CVR Heavy-Duty Trim**

Cylinder is not included.

**Escutcheon Trim Design: A9 Armstrong**



**Lever:** Cast    **Escutcheon:** Forged

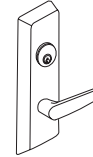

Function	Description	Finish: 605, 606, 611, 612, 613, 613E, 618, 619, 625, 626, 629 <sup>2</sup> , 630 <sup>1</sup> , 722, BSP
A9903ET*	Fail Safe	\$1,240.00
A9905ET*	Fail Secure	

**Escutcheon Trim Design: C9 Citation**



**Lever:** Cast    **Escutcheon:** Forged

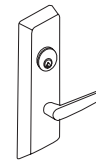

Function	Description	Finish: 605, 606, 611, 612, 613, 613E, 618, 619, 625, 626, 629 <sup>2</sup> , 630 <sup>1</sup> , 722, BSP
C9903ET*	Fail Safe	\$1,240.00
C9905ET*	Fail Secure	

**Escutcheon Trim Design: D9 Dirke\***



**Lever:** Cast    **Escutcheon:** Forged  
\* Handed Lever. Handing cannot be changed in the field.

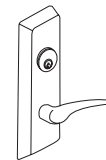

Function	Description	Finish: 605, 606, 611, 612, 613, 613E, 618, 619, 625, 626, 629 <sup>2</sup> , 630 <sup>1</sup> , 722, BSP
D9903ET*	Fail Safe	\$1,240.00
D9905ET*	Fail Secure	

**Escutcheon Trim Design: E9 Essex**



**Lever:** Cast    **Escutcheon:** Forged

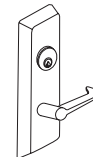

Function	Description	Finish: 605, 606, 611, 612, 613, 613E, 618, 619, 625, 626, 629 <sup>2</sup> , 630 <sup>1</sup> , 722, BSP
E9903ET*	Fail Safe	\$1,240.00
E9905ET*	Fail Secure	

Notes:  
1. 619 finish provided to match 630 finish. - Escutcheons only  
2. 618 finish provided to match 629 finish. - Escutcheons only

**\*ElectroLynx®**  
As part of their promise to provide innovative, fast and effective high security solutions to their customers, certain ASSA ABLOY Group brands offer *ElectroLynx®*, a universal quick-connect system that simplifies the electrification of the door opening.

**ED5200S/ED5200/ED5400/ED5800 SecureBolt® , Rim, Surface & CVR Heavy-Duty Trim**

Cylinder is not included.

**Escutcheon Trim Design: L9 Lustra**



**Lever:** Cast    **Escutcheon:** Forged

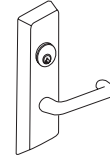

Function	Description	Finish: 605, 606, 611, 612, 613, 613E, 618, 619, 625, 626, 629 <sup>2</sup> , 630 <sup>1</sup> , 722, BSP
L9903ET*	Fail Safe	\$1,240.00
L9905ET*	Fail Secure	

**Escutcheon Trim Design: N9 Newport**



**Lever:** Cast    **Escutcheon:** Forged

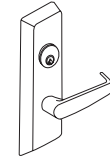

Function	Description	Finish: 605, 606, 611, 612, 613, 613E, 618, 619, 625, 626, 629 <sup>2</sup> , 630 <sup>1</sup> , 722, BSP
N9903ET*	Fail Safe	\$1,240.00
N9905ET*	Fail Secure	

**Escutcheon Trim Design: R9 Regis**



**Lever:** Cast    **Escutcheon:** Forged

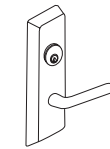

Function	Description	Finish: 605, 606, 611, 612, 613, 613E, 618, 619, 625, 626, 629 <sup>2</sup> , 630 <sup>1</sup> , 722, BSP
R9903ET*	Fail Safe	\$1,240.00
R9905ET*	Fail Secure	

**Escutcheon Trim Design: PR9 Princeton**



**Lever:** Cast    **Escutcheon:** Forged

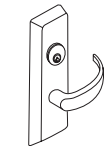

Function	Description	Finish: 605, 606, 611, 612, 613, 613E, 618, 619, 625, 626, 629 <sup>2</sup> , 630 <sup>1</sup> , 722, BSP
PR9903ET*	Fail Safe	\$1,240.00
PR9905ET*	Fail Secure	

**Notes:**  
 1. 619 finish provided to match 630 finish. - Escutcheons only  
 2. 618 finish provided to match 629 finish. - Escutcheons only

**\*ElectroLynx®**  
 As part of their promise to provide innovative, fast and effective high security solutions to their customers, certain ASSA ABLOY Group brands offer *ElectroLynx®*, a universal quick-connect system that simplifies the electrification of the door opening.

**ED5200S/ED5200/ED5400/ED5800 SecureBolt®, Rim, Surface & CVR Heavy-Duty Trim**

Cylinder is not included.

**Escutcheon Trim Design: FR9 Frascati**



**Lever:** Cast **Escutcheon:** Forged

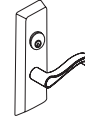

Function	Description	Finish: 605, 606, 611, 612, 613, 613E, 618, 619, 625, 626, 629 <sup>2</sup> , 630 <sup>1</sup> , 722, BSP
FR9903ET*	Fail Safe	\$1,240.00
FR9905ET*	Fail Secure	

**Escutcheon Trim Design: M9 Merlot**



**Lever:** Cast **Escutcheon:** Forged

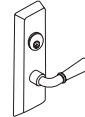

Function	Description	Finish: 605, 606, 611, 612, 613, 613E, 618, 619, 625, 626, 629 <sup>2</sup> , 630 <sup>1</sup> , 722, BSP
M9903ET*	Fail Safe	\$1,240.00
M9905ET*	Fail Secure	

**Escutcheon Trim Design: Z9 Zinfandel**



**Lever:** Cast **Escutcheon:** Forged

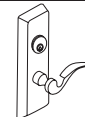

Function	Description	Finish: 605, 606, 611, 612, 613, 613E, 618, 619, 625, 626, 629 <sup>2</sup> , 630 <sup>1</sup> , 722, BSP
Z9903ET*	Fail Safe	\$1,240.00
Z9905ET*	Fail Secure	

**\*ElectroLynx®**

As part of their promise to provide innovative, fast and effective high security solutions to their customers, certain ASSA ABLOY Group brands offer *ElectroLynx®*, a universal quick-connect system that simplifies the electrification of the door opening.

**Offset Pull Trim: P12, P13, P14**

Offset Pull Trim	Part Number	Finish: 605, 606, 612, 613, 613E, 630, 626, 629, BSP, WSP
P12	716F50M X Finish	\$348.00
P13	716F51M X Finish	\$424.00
P14	716F52M X Finish	\$299.00

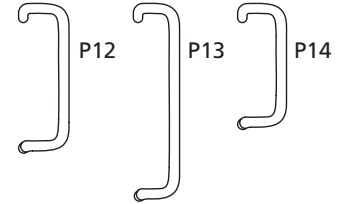
**Electrified Options for Exit Devices**

Description	Specify	Add or Deduct
Exit Alarm Device (cylinder is not included)	M61	\$883.00
Bolt Position Monitoring	M91*	Add \$260.00
Touchbar Monitoring or Signaling/Request to Exit (REX)	M92*	Add \$244.00
Outside Trim Monitoring or Signaling	M93*	
Motor Latch Retraction	MELR	Add \$935.00
Electric Dogging	M97*	Add \$498.00
SPDT Lock and Unlock security monitor switch (Electric Trim Only)	M98*	Add \$235.00
Trim gasket for exterior applications (Electric Trim Only)	M99	Add \$26.00
Mortise device lock with Outside Trim Control (Fail Safe)	SAF <sup>2</sup> *	\$888.00
Mortise device lock with Outside Trim Control (Fail Secure)	SEC <sup>2</sup> *	

**Delayed Egress Device**

Description	Suffix	Add or Deduct
Delayed Egress (Suffix the letter D to device. Ex: ED4200)	D	Add \$1917.00
30-Second Delay	M88*	\$133.00
BOCA 15-Second Delay	M89*	
BOCA 30-Second Delay	M90*	

**Notes:**

- Alarm kit cannot be installed in the field to surface vertical rod exit device. Any attempt to do so voids all warranties.
- Only available with ED5600(A) (Except knob trim)
- M88, M89 and M90 are available only as options for suffix "D" Delayed Egress Exit Devices.
- The following options cannot be ordered together on the same device: a) M94 or M97 & D; b) M94 x M97; c) M52 x M97; d) M97 x M107; e) M61 or M92 & D; f) M61 x M92; g) M61x M52; h) M52 & D; i) ED5600 x M91 & M93; j) ED5600 SAF or SEC x M91 or M93; k) Surface vertical rod exit devices with M61 x M91, M92 or M93.

**\*ElectroLynx®**

As part of their promise to provide innovative, fast and effective high security solutions to their customers, certain ASSA ABLOY Group brands offer *ElectroLynx®*, a universal quick-connect system that simplifies the electrification of the door opening.

**Retrofit Kit: MELR rail assy, no switches, no latch, with controller, touchbar end cap**

Description	Specify	Price
Device ASSY, MELR 36"	727F158	Add \$935.00
Device ASSY, MELR 36" NS (Narrow Stile)	727F228	
Device ASSY, MELR 48"	727F238	
Device ASSY, MELR WS 36" Device	727F248	
Device ASSY, MELR WS 48" Device	727F258	

**Electrified Accessories**

Part Number	Description	Specify	Price
709F609	Power Supply 1 Amp (controls 1 "D" device)	BPS-24-1	\$406.00
709F619	Power Supply 2 Amp (controls 2 "D" devices or 1 "D" with SAF or SEC)	BPS-24-2	\$826.00
709F629	Power Supply 4 amp 24VDC	BPS-24-4	\$1,399.00
704F288	Concealed transfer (for over 120-degree swing door)	EPTL	\$160.00
709F689	(1) SPDT Maintained Switch (Includes LED)	MKA	\$160.00
709F709	(1) SPDT Momentary Switch (Includes LED)	MK	\$245.00
709F749	(1) SPDT Momentary Switch (Illuminated)	PB2	\$188.00
709F759	(1) SPDT Maintained (Alternating Action) Switch	PB3EA	\$144.00
709F769	(1) SPDT Momentary Switch (Illuminated)	PB3	\$182.00
709F779	(1) SPDT Momentary Switch	2' PB3ER	\$122.00
709F729	DPDT Momentary Key Switch	2' MK2	\$282.00
709F699	Narrow Stile Key Switch (Alt. action)	MKAN	\$245.00
704F719	Narrow Stile Momentary Key Switch	MKN	\$245.00
709F789	Sonalert 90db @ 2 ft. 12-24VDC Mounted on one gang stainless steel plate.	PZ1	\$122.00
	Alarm Kit (cylinder is not included) <sup>1</sup>	ED50AK	\$1,004.00
709F679	Door Cord	TSB-C	\$52.00
741F739	Digital Entry System (4 users)	DK-12	\$262.00
709F809	Digital Entry System (59 users) SS finish	FADK-26SS	\$863.00
709F819	Digital Entry System (59 users) Black finish	DK-26BK	\$863.00
709F989	Remote Power Harness – 36"		\$160.00
709F999	Remote Power Harness – 48"		\$178.00

**Custom Laser Engraving- LASER**
**Laser engraving processing charge (all engraving types)**

- \$250.00 net per order. Charge will be applied to production order when placed.

**Single Vanity, Logo or Other (same engraving on all parts)**

- Lever - \$10.00 net add each
- Mortise Escutcheon - \$10.00 net add each
- HPSK Paddle - \$10.00 net add each

**Unique laser engraving (i.e. Room Number, Apartment Number, etc)**

- \$12.00 net add each (per piece)

<b>Cylinder Options*</b>		
Description	Specify Quick Code	Add or Deduct
Conventional 6-pin	6P*	Add \$105.00 per cylinder
Conventional 7-pin	7P	Add \$107.00 per cylinder
<b>LFIC</b>		
LFIC 6-pin	C6	Add \$196.00 per cylinder
LFIC 6-pin less core	CL6	Add \$105.00 per cylinder
LFIC 6-pin with temporary construction core (Red)	CT6R	Add \$196.00 per cylinder
LFIC 6-pin with temporary construction core (Blue)	CT6B	Add \$196.00 per cylinder
LFIC 6-pin with temporary construction core (Green)	CT6G	Add \$196.00 per cylinder
LFIC 6-pin with temporary disposable core	CT6D	Add \$105.00 per cylinder
LFIC 7-pin	C7	Add \$200.00 per cylinder
LFIC 7-pin less core	CL7	Add \$107.00 per cylinder
LFIC 7-pin with temporary construction core (Red)	CT7R	Add \$200.00 per cylinder
LFIC 7-pin with temporary construction core (Blue)	CT7B	Add \$200.00 per cylinder
LFIC 7-pin with temporary construction core (Green)	CT7G	Add \$200.00 per cylinder
LFIC 7-pin with temporary disposable core	CT7D	Add \$107.00 per cylinder
<b>SFIC</b>		
SFIC 6-pin	C6S	Add \$187.00 per cylinder
SFIC 6-pin with temporary construction core (Blue)	CT6SB	Add \$187.00 per cylinder
SFIC 6-pin with SFIC disposable temporary core	CT6SD	Add \$105.00 per cylinder
SFIC 6-pin with Less Core	CLS6	Add \$105.00 per cylinder
SFIC 7-pin	C7S	Add \$187.00 per cylinder
SFIC 7-pin with temporary construction core (Blue)	CT7SB	Add \$187.00 per cylinder
SFIC 7-pin with SFIC disposable temporary core	CT7SD	Add \$107.00 per cylinder
SFIC 7-pin with Less Core	CLS7	Add \$107.00 per cylinder
<b>Security</b>		
Security <sup>4</sup>	HS	Add \$244.00 per cylinder
Security LFIC <sup>4</sup>	CHS	Add \$331.00 per cylinder
<b>Access 3</b>		
Access 3 Patented	AP	Add \$105.00 per cylinder
Access 3 Security	AS	Add \$161.00 per cylinder
Access 3 High Security, UL 437	AHS	Add \$184.00 per cylinder
Access 3 LFIC Patented	ACP	Add \$196.00 per cylinder
Access 3 LFIC Security	ACS	Add \$252.00 per cylinder
Access 3 LFIC High Security, UL 437	ACHS	Add \$274.00 per cylinder
<b>Pyramid</b>		
Pyramid Security fixed core	PS	Add \$179.00 per cylinder
Pyramid Security LFIC	PCS	Add \$264.00 per cylinder
Pyramid High Security fixed core	PHS	Add \$215.00 per cylinder
Pyramid High Security LFIC	PCHS	Add \$301.00 per cylinder
Pyramid LFIC with temporary construction core <sup>3</sup>	CTP	Add \$196.00 per cylinder
Pyramid LFIC with temporary disposable core <sup>3</sup>	CTPD	Add \$105.00 per cylinder
Pyramid LFIC less core	CLP	Add \$105.00 per cylinder

\*For key bows other than 10 and 90, specify "KB" + bow number as Quick Code, e.g. KB12.

**Notes:**

1. CMK Construction master keying charge is in addition to master keying charge.
2. CMK Construction master keying is not available in interchangeable core, Access 3, Pyramid, or Security series.
3. VKC2, VKC3, CKC3 are not available in Pyramid or Security series.

<b>Cylinder Options (continued) &amp; Keying Options*</b>		
<b>Description</b>	<b>Specify Quick Code</b>	<b>Add or Deduct</b>
<b>Keying and Keys</b>		
0-bitted with 2 Blank Keys	(standard)	No Charge
Keyed Random	KR	
Construction Master Keyed <sup>2</sup>	CMK	Add \$16.00 per cylinder
More than 2 Keys	KY# (e.g., KY6)	See page 31 - Cut Keys Section
<b>Master Keying</b>		
Master keyed (all cylinders except CR8000, CR8020, CR8027, CR8200, CR8500, CR8600, CR8700)	MK	Add \$16.00 per cylinder
Master keyed Pyramid (except CR8020, CR8027 LFIC cores)	MK	
Master keyed Security (including LFIC cylinder and core)	MK	
Master keyed Access 3 (except CR8500, CR8600, CR8700 LFIC cores)	MK	
Master keyed (CR8000, CR8020, CR8027, CR8200, CR8500, CR8600, CR8700)	MK-IC	No Charge
Master keyed to customer bittings or sample key	MK-CB	Add \$16.00 per cylinder
<b>Visual Key Control (VKC)</b>		
No bitting or keyset stamping on keys	VKC0	\$4.50
Keys only	VKC1	No Charge
Cylinders and keys (not for AS, AHS, ACS, ACHS, HS, CHS, PHS or PCHS)	VKC2	\$8.00
Cylinders only (not for AS, AHS, HS, ACS, ACHS, CHS, PHS or PCHS)	VKC3	
<b>Concealed Key Control (CKC)</b>		
CKC cylinders with VKC keys	CKC2	\$8.00
CKC cylinders only (not for AS, AHS, ACS, ACHS, PHS, PCHS)	CKC3	

\*Optional dogging cylinder will be furnished with the same mechanism and keyed alike with the trim cylinder, unless otherwise specified. If different keying or cylinder type is required, specify outside (trim) first, then inside (dogging) cylinder.  
 \*\*6P cylinder option is supplied in 6-pin, L4 keyway, 0-bitted with two nickel silver keys.  
 \*For key bows other than 10 and 90, specify "KB" + bow number as Quick Code, e.g. KB12.

**Notes:**

1. CMK Construction master keying charge is in addition to master keying charge.
2. CMK Construction master keying is not available in interchangeable core, Access 3, Pyramid, or Security series.
3. VKC2, VKC3, CKC3 are not available in Pyramid or Security series.

**Door Height Options**
**ED5400, ED5400A, ED5470(B) Devices**

<b>Door Height</b>	<b>Specify</b>	<b>Add or Deduct</b>
7'0"	(standard)	No Charge
7'2"	H0702	
7'6"	H0706	
8'0"	H0800	

**ED5800, ED5800A, ED5860(B) Devices**

<b>Door Height</b>	<b>Specify</b>	<b>Add or Deduct</b>
8'0"	(standard)	No Charge

**ED5470(B), ED5860(B) Devices**

<b>Door Height</b>	<b>Specify</b>	<b>Add or Deduct</b>
9'0" <sup>1</sup>	H0900	Add \$99.00 per device
10'0" <sup>1</sup>	H1000	

**Note:**

1. H0900 and H1000 options for ED5470(B), ED5860(B) devices only

### Door Height Options (continued)

### Door Width Options

Door Width	Specify	Add or Deduct
24"	W024	Add \$349.00 per device
36"	(standard)	No Charge
48"	W048	Add \$43.00 per device

### Door Thickness Options

Door Thickness	Specify	Add or Deduct
1-3/4"	(standard)	No Charge
2"	D200	
2-1/4"	D214	

### Strike Options

Description	Specify	Add or Deduct
Rim x Vertical Rod on pairs of doors	S02	Add \$44.00 per device
Surface or Concealed Vertical Rod device bottom strike for 1/2" threshold	S09	No Charge
Flush transom top strike bracket	M67	Add \$35.00 per device
Mortise Device		
-ANSI wrought strike box	M17	No Charge
-ANSI strike for pair of doors w/ astragal (7/8" L to C)	SS078	
-Open back strike for 1-3/4" door	SB134	Add \$100.00 per device
-Open back strike for 2-1/4" door	SB214	\$160.00

### Miscellaneous Options

Description	Specify	Add or Deduct
Torx® screws for rim, concealed vertical rod, mortise	M04	Add \$55.00 per device
Torx® screws for surface vertical rod	M04	Add \$103.00 per device
Knurling outside and inside (Embossed Touchbar - device side) <sup>1</sup>	M20	Add \$175.00 per device
Knurling outside only (trim side) <sup>1</sup>	M21	Add \$82.00 per device
Knurling inside only (Embossed Touchbar - device side)	M22	Add \$93.00 per device
Abrasive coat outside and inside (trim and device)	M23	Add \$111.00 per device
Abrasive coat inside only (device side)	M24	Add \$58.00 per device
Abrasive coat outside only (trim side)	M25	Add \$53.00 per device
Pathlite™ Photoluminescent Touchbar cover	M49	Add \$417.00 per device
Less dogging	M51	No Charge
Cylinder dogging (less cylinder)	M52	Add \$94.00 per device
Sex nuts and bolts (SNBs)	M54	No Charge
Less bottom vertical rod <sup>2</sup>	M55	
Narrow stile cover	M56	No Charge
Shim kit (for vision light)		
- All rim and concealed vertical rod	M58	Add \$86.00 per device
- All surface vertical rod	M58	Add \$114.00 per device
- All mortise exit devices	M58	Add \$114.00 per device
Parabolic Design Exit Trim	M60	<b>Add \$94.00 per device</b>
Wood screws For use on fire rated solid wood or wood core doors	M64	No Charge
Lever to accept Schlage® interchangeable core (950 series trim only)	M69	No Charge
Windstorm Certified products for ED5200S(A) and ED5470(B) Only <sup>3,4,5</sup>	M107	Add \$102.00 per device
End Cap Reinforcement (used with standard end cap only)	M109	Add \$94.00 per device
Flush End Cap	M110	No Charge
5 lbs Pressure Release (Only available with RIM devices)	5CH	Add \$33.00

**Notes:**

1. Not available with VT9, VTL9, VT9M and VTL9M trim, ineyard™ or Muséo® levers.
2. Available with ED5470 and ED5860 series only.
3. ED5200S(A) x M107 requires through bolts.
4. ED5470(B) maximum opening height is 8'0".
5. Contact Ceco, Curries® or Fleming for detailed frame/door requirements and limitations.

### Surface Bolt™

Description	Specify	Price
Surface Bolt Kit – For Approved Windstorm Code Applications - bright zinc plated finish	988CR	\$177.00



**Mullions**
**Ordering Example**

Quantity	Mullion Number
10	907A

**Removable Mullions**

Door Height	Description	Specify	Price
Up to 7'0"	Steel Mullion - Panic Rated	CR907	\$827.00
Up to 8'0"	Steel Mullion - Panic Rated	CR908	\$837.00
Up to 10'0" (ED5200, ED5200S only)	Steel Mullion - Panic Rated	CR910	\$998.00
Up to 7'0"	Steel Mullion - 3 Hour Fire Rated	CR907A	\$1,150.00
Up to 8'0"	Steel Mullion - 3 Hour Fire Rated	CR908A	\$1,160.00
Up to 7'0"	Steel Mullion - 3 Hour Fire Rated, Windstorm Certified	CRFE707A <sup>1</sup>	\$1,434.00
Up to 8'0"	Steel Mullion - 3 Hour Fire Rated, Windstorm Certified	CRFE708A <sup>1</sup>	\$1,444.00

**Key Removable Mullions**

Door Height	Description	Specify	Price
Up to 7'0"	Steel Mullion - 1-1/2 Hour Fire Rated	CR907BKM <sup>2</sup>	\$1,771.00
Up to 8'0"	Steel Mullion - 1-1/2 Hour Fire Rated	CR908BKM <sup>2</sup>	\$1,781.00
Up to 10'0" (ED5200, ED5200S only)	Steel Mullion - Panic Rated	CR910KM <sup>2</sup>	\$1,566.00
Up to 7'0"	Steel Mullion - 3 Hour Fire Rated, Windstorm Certified	CRWS707AKM <sup>2</sup>	\$2,012.00
Up to 8'0"	Steel Mullion - 3 Hour Fire Rated, Windstorm Certified	CRWS708AKM <sup>2</sup>	\$2,022.00

**Notes:**

- For use with UL approved door assemblies that comply to FEMA 361 and FEMA 320 guidelines. For the latest listings on compliant door assemblies visit our website at [corbinrusswin.com](http://corbinrusswin.com)
- Cylinder and collars not included, specify separately

**Mullions Cylinder Options**

Description	Specify	Add or Deduct
Conventional 6-pin	6P	Add \$105.00 per cylinder
Conventional 7-pin	7P	Add \$107.00 per cylinder
LFIC 6-pin	C6	Add \$196.00 per cylinder
LFIC 7-pin	C7	Add \$200.00 per cylinder
Pyramid High Security Fixed Core	PHS	Add \$215.00 per cylinder
Pyramid Security Fixed Core	PS	Add \$179.00 per cylinder
Pyramid High Security IC	PCHS	Add \$301.00 per cylinder
Pyramid Security IC	PCS	Add \$264.00 per cylinder
Security	HS	Add \$244.00 per cylinder
Security IC	CHS	Add \$331.00 per cylinder
LFIC 6-pin with temporary construction core (Red)	CT6R	Add \$196.00 per cylinder
LFIC 6-pin with temporary construction core (Blue)	CT6B	Add \$196.00 per cylinder
LFIC 6-pin with temporary construction core (Green)	CT6G	Add \$196.00 per cylinder
LFIC 6-pin with temporary disposable core	CT6D	Add \$105.00 per cylinder
LFIC 6-pin less core	CL6	Add \$105.00 per cylinder
LFIC 7-pin with temporary construction core (Red)	CT7R	Add \$200.00 per cylinder
LFIC 7-pin with temporary construction core (Blue)	CT7B	Add \$200.00 per cylinder
LFIC 7-pin with temporary construction core (Green)	CT7G	Add \$200.00 per cylinder
LFIC 7-pin with temporary disposable core	CT7D	Add \$107.00 per cylinder
LFIC 7-pin less core	CL7	Add \$107.00 per cylinder

**Options**

Description	Specify	Add or Deduct
Door frame filler block for double rabbetted frames	M95	Add \$42.00 per mullion
Door frame angle bracket for aluminum frames	M96	Add \$42.00 per mullion
Mullion stabilizer	M57	Add \$63.00 per mullion

**Standard Features**

**Handing**

Handed, specify hand

**Door Thickness**

1-3/4"

**Backset**

2-3/4"

**Projection**

4-7/8"; 3-1/8" depressed

**Trim**

Cylinder is not included.  
See page 335 for  
cylinder options.

**Rim**

ED7200

Panic

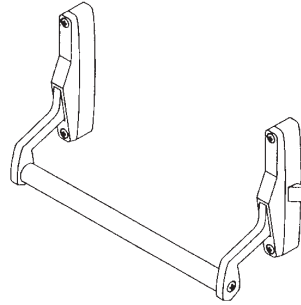

**Vertical Rod**

ED7400

Panic

**Concealed Vertical Rod**

ED7800

Panic

ED7800A

3 Hour Fire Rated

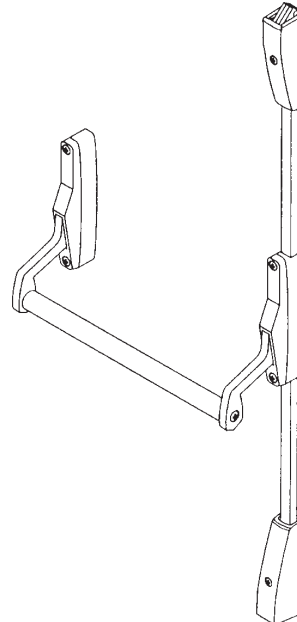

### Ordering Example

#### Rim Exit Device

Quantity	Exit Device	Finish	Hand	Misc. Options
20	ED7200	606	RHR	M51-M54

#### Rim Exit Device with Trim

Quantity	Exit Device	Trim/Function	Finish	Hand	Door Thickness	Door Width	Misc. Options
50	ED7200	P557ET	630	LHR	D214	W048	M53

#### Trim Only (Rim Device)

Quantity	Exit Device	Finish
10	P457ET	630

#### Vertical Rod Exit Device with Trim

Quantity	Exit Device	Trim/Function	Finish	Hand	Door Thickness	Door Width	Misc. Options
50	ED7401	C455ET	613	RHR	D214	W048	H1000

#### Contract/Detailed Order - Rim Exit Device with Trim

Quantity	Keyset	Exit Device	Trim/Function	Finish	Hand	Door Thickness	Door Width	Optional Cylinders	Keying
50	AA1	ED7200	P457ET	626	LHR	D200	W048	C6	VKC3

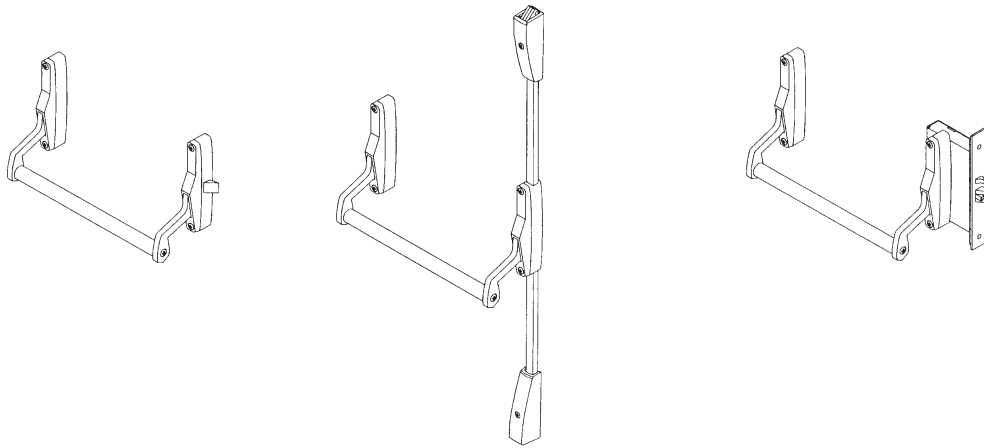

**36" Device Only**

Includes device, strike(s) and screw pack. No cylinder or trim.

**Rim ED7200 Series**

Function	Description	Finish: 613E, 626	Finish: 605, 606, 611, 612, 613, 618, 619, 625, 629, 630, 722
ED7200	Panic	\$3,458.00	\$3,535.00

**Vertical Rod ED7400 Series**

Function	Description	Finish: 613E, 626	Finish: 605, 606, 611, 612, 613, 618, 619, 625, 629, 630, 722
ED7400	Panic Exit Trim Only (accepts operator trim)	\$3,951.00	\$4,028.00
ED7401	Panic Exit Trim Only (accepts lever trim)		

**Concealed V.R. ED7800 Series**

Function	Description	Finish: 613E, 626	Finish: 605, 606, 611, 612, 613, 618, 619, 625, 629, 630, 722
ED7800	Panic	\$3,829.00	\$3,906.00
ED7800A	3 Hour Fire Rated	\$4,031.00	\$4,108.00

Caution: Be sure of your measurements. Exit devices are NOT returnable.

**ED7200 Rim Trim**

Cylinder is not included.

**Pull Trim Design: P4 D Grip Pull**



**Grip:** Extruded

**Escutcheon:** Wrought



Function	Description	Finish: 605, 606, 611, 612, 613, 613E, 618, 619, 625, 626, 629, 630, 722
P450ET	Dummy	\$487.00
P457ET	Nightlatch	

**Pull Trim Design: P5 Round Grip Pull**



**Grip:** Extruded

**Escutcheon:** Wrought



Function	Description	Finish: 605, 606, 611, 612, 613, 613E, 618, 619, 625, 626, 629, 630, 722
P550ET	Dummy	\$487.00
P557ET	Nightlatch	

**Pull Trim Design: P6 Pull**



**Grip:** Wrought  
MR option available

**Escutcheon:** Wrought



Function	Description	Finish: 605, 606, 611, 612, 613, 613E, 618, 619, 625, 626, 629, 630, 722
P650ET	Dummy	\$487.00
P657ET	Nightlatch	

**Pull Trim Design: P7 Plate**

**Escutcheon:** Wrought  
MR option available



Function	Description	Finish: 605, 606, 611, 612, 613, 613E, 618, 619, 625, 626, 629, 630, 722
P757ET	Nightlatch	\$479.00

**ED7400 Surface Vertical Rod Trim**

Cylinder is not included.

**Escutcheon Trim Design: C4 Citation**



**Lever:** Cast  
MR option available

**Escutcheon:** Wrought  
Available with ED7401 device only.



Function	Description	Finish: 605, 606, 611, 612, 613, 613E, 618, 619, 625, 626, 629, 630, 722
C455ET*	Classroom	\$997.00
C457ET*	Nightlatch	

\*1-3/4 doors only

**Escutcheon Trim Design: D4 Dirke**



**Lever:** Cast  
MR option available

**Escutcheon:** Wrought  
Available with ED7401 device only.

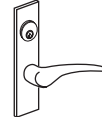

Function	Description	Finish: 605, 606, 611, 612, 613, 613E, 618, 619, 625, 626, 629, 630, 722
D455ET*	Classroom	\$997.00
D457ET*	Nightlatch	

\*1-3/4 doors only

**Escutcheon Trim Design: O3 D Grip Operator**



**Pull:** Extruded  
MR option available

**Escutcheon:** Cast  
Available with ED7400 only.



Function	Description	Finish: 605, 606, 611, 612, 613, 613E, 618, 619, 625, 626, 629, 630, 722
O355ET	Classroom	\$997.00
O356ET**	Nightlatch	
O357ET	Nightlatch	

**Escutcheon Trim Design: O4 Round Grip Operator**



**Pull:** Extruded  
MR option available

**Escutcheon:** Cast  
Available with ED7400 only.



Function	Description	Finish: 605, 606, 611, 612, 613, 613E, 618, 619, 625, 626, 629, 630, 722
O455ET	Classroom	\$997.00
O456ET**	Nightlatch	
O457ET	Nightlatch	

\*\*Key also used to hold top and bottom latchbolts in retracted position.

**ED7800 Concealed Vertical Rod Trim**

Cylinder is not included.

**Trim Design: O5 Operator**

**Escutcheon:** Cast



Function	Description	Finish: 605, 606, 611, 612, 613, 613E, 618, 619, 625, 626, 629, 630, 722
O557ET	Nightlatch	\$379.00

**Offset Pull Trim: P12, P13, P14**

Offset Pull Trim	Part Number	Finish: 605, 606, 612, 613, 613E, 626, 629, 630
P12	716F50M X Finish	\$348.00
P13	716F51M X Finish	\$424.00
P14	716F52M X Finish	\$299.00

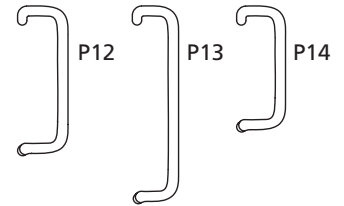

**Cylinder Options\***

Description	Specify Quick Code	Add or Deduct
Conventional 6-pin	6P*	Add \$105.00 per cylinder
Conventional 7-pin	7P	Add \$107.00 per cylinder
<b>LFIC</b>		
LFIC 6-pin	C6	Add \$196.00 per cylinder
LFIC 6-pin less core	CL6	Add \$105.00 per cylinder
LFIC 6-pin with temporary construction core (Red)	CT6R	Add \$196.00 per cylinder
LFIC 6-pin with temporary construction core (Blue)	CT6B	Add \$196.00 per cylinder
LFIC 6-pin with temporary construction core (Green)	CT6G	Add \$196.00 per cylinder
LFIC 6-pin with temporary disposable core	CT6D	Add \$105.00 per cylinder
LFIC 7-pin	C7	Add \$200.00 per cylinder
LFIC 7-pin less core	CL7	Add \$107.00 per cylinder
LFIC 7-pin with temporary construction core (Red)	CT7R	Add \$200.00 per cylinder
LFIC 7-pin with temporary construction core (Blue)	CT7B	Add \$200.00 per cylinder
LFIC 7-pin with temporary construction core (Green)	CT7G	Add \$200.00 per cylinder
LFIC 7-pin with temporary disposable core	CT7D	Add \$107.00 per cylinder
<b>SFIC</b>		
SFIC 6-pin	C6S	Add \$187.00 per cylinder
SFIC 6-pin with temporary construction core (Blue)	CT6SB	Add \$187.00 per cylinder
SFIC 6-pin with SFIC disposable temporary core	CT6SD	Add \$105.00 per cylinder
SFIC 6-pin with Less Core	CLS6	Add \$105.00 per cylinder
SFIC 7-pin	C7S	Add \$187.00 per cylinder
SFIC 7-pin with temporary construction core (Blue)	CT7SB	Add \$187.00 per cylinder
SFIC 7-pin with SFIC disposable temporary core	CT7SD	Add \$107.00 per cylinder
SFIC 7-pin with Less Core	CLS7	Add \$107.00 per cylinder
<b>Security</b>		
Security <sup>4</sup>	HS	Add \$244.00 per cylinder
Security LFIC <sup>4</sup>	CHS	Add \$331.00 per cylinder
<b>Access 3</b>		
Access 3 Patented	AP	Add \$105.00 per cylinder
Access 3 Security	AS	Add \$161.00 per cylinder
Access 3 High Security, UL 437	AHS	Add \$184.00 per cylinder
Access 3 LFIC Patented	ACP	Add \$196.00 per cylinder
Access 3 LFIC Security	ACS	Add \$252.00 per cylinder
Access 3 LFIC High Security, UL 437	ACHS	Add \$274.00 per cylinder
<b>Pyramid</b>		
Pyramid Security fixed core	PS	Add \$179.00 per cylinder
Pyramid Security LFIC	PCS	Add \$264.00 per cylinder
Pyramid High Security fixed core	PHS	Add \$215.00 per cylinder
Pyramid High Security LFIC	PCHS	Add \$301.00 per cylinder
Pyramid LFIC with temporary construction core <sup>3</sup>	CTP	Add \$196.00 per cylinder
Pyramid LFIC with temporary disposable core <sup>3</sup>	CTPD	Add \$105.00 per cylinder
Pyramid LFIC less core	CLP	Add \$105.00 per cylinder
<b>Other</b>		
Less master ring cylinder <sup>4</sup>	MR-LC	No Charge
Master Ring <sup>4</sup>	MR	Add \$164.00 per cylinder

\*6P cylinder option is supplied in 6-pin, L4 keyway, 0-bitted with two nickel silver keys.

Notes:

1. Available on outside trim only.
2. Not available on O5 trim.
3. Rim only. 4. Available on C4, D4, OBS, O3, O4 trims only.
5. Not available on ED7600 C4M, D4M, E4M B5M, G6M trims.
6. Pyramid is not available on ED7600 with door thicknesses over 2-1/4".
7. Not available on P4, P5, P5, P7 trims.



### Cylinder Options (continued) & Keying Options\*

Description	Specify Quick Code	Add or Deduct
<b>Keying and Keys</b>		
0-bitted with 2 Blank Keys	(standard)	No Charge
Keyed Random	KR	
Construction Master Keyed <sup>2</sup>	CMK	Add \$16.00 per cylinder
More than 2 Keys	KY# (e.g., KY6)	See page 31 - Cut Keys Section
<b>Master Keying</b>		
Master keyed (all cylinders except CR8000, CR8020, CR8027, CR8200, CR8500, CR8600, CR8700)	MK	Add \$16.00 per cylinder
Master keyed Pyramid (except CR8020, CR8027 LFIC cores)	MK	
Master keyed Security (including LFIC cylinder and core)	MK	
Master keyed Access 3 (except CR8500, CR8600, CR8700 LFIC cores)	MK	
Master keyed (CR8000, CR8020, CR8027, CR8200, CR8500, CR8600, CR8700)	MK-IC	No Charge
Master keyed to customer bittings or sample key	MK-CB	Add \$16.00 per cylinder
<b>Visual Key Control (VKC)</b>		
No bitting or keyset stamping on keys	VKC0	\$4.50
Keys only	VKC1	No Charge
Cylinders and keys (not for AS, AHS, ACS, ACHS, HS, CHS, PHS or PCHS)	VKC2	\$8.00
Cylinders only (not for AS, AHS, HS, ACS, ACHS, CHS, PHS or PCHS)	VKC3	
<b>Concealed Key Control (CKC)</b>		
CKC cylinders with VKC keys	CKC2	\$8.00
CKC cylinders only (not for AS, AHS, ACS, ACHS, PHS, PCHS)	CKC3	

- Notes:**
1. CMK Construction master keying charge is in addition to master keying charge.
  2. CMK Construction master keying is not available in interchangeable core, Access 3, Pyramid, or Security series.
  3. VKC2, VKC3, CKC3 are not available in Pyramid or Security series.

### Strike Options

To purchase strike separately, see catalog for part no.

Description	Specify	Add or Deduct
Open rim strike on ED7200	(standard)	No Charge
Rim strike	S07	
Rim strike for aluminum frames with blade stops	S08	
Mortised adjustable rim strike	S04	
Vertical rod top strike on ED7400 device	(standard)	
Vertical rod bottom strike on ED7400		
Vertical rod flush bottom strike on ED7400 device	S03	
Concealed vertical rod top strike on ED7800 device	(standard)	
Fire rated concealed vertical rod top strike on ED7800A device	(standard)	
Fire rated concealed vertical rod bottom strike on ED7800 and ED7800A devices	(standard)	

Description	Lip Length	Specify	Add or Deduct
Mortise straight lip ANSI strike on ED7600, ED7600A	1-1/8"	(standard)	No Charge
	1-1/4"	SS114	
	1-3/8"	SS138	
Mortise open back strike	1-3/4"	SB134	Add \$100.00 per device
	2"	SB200	\$160.00
	2-1/4"	SB214	

### Custom Laser Engraving- LASER

#### Laser engraving processing charge (all engraving types)

- \$250.00 net per order. Charge will be applied to production order when placed.

#### Single Vanity, Logo or Other (same engraving on all parts)

- Lever - \$10.00 net add each
- Mortise Escutcheon - \$10.00 net add each
- HPSK Paddle - \$10.00 net add each

#### Unique laser engraving (i.e. Room Number, Apartment Number, etc)

- \$12.00 net add each (per piece)

Door Width Options		
Description	Specify	Add or Deduct
36"	(standard)	No Charge
48"	W048	Add \$43.00 per device
Door Thickness Options		
Description	Specify	Add or Deduct
1-3/4"	(standard)	No Charge
2" (Not available for ED7800 Series)	D200	
2-1/4" (Not available for ED7800 Series)	D214	
Door Height Options		
Description	Specify	Add or Deduct
7'6" (ED7400 devices)	(standard)	No Charge
7'2" (ED7400A & 7800A devices)	(standard)	
8'6" (ED7800 devices)	(standard)	
10'0" (ED7400 devices only)	H1000	Add \$99.00 per device
10'8" (ED7800 devices only)	H1008	
Miscellaneous Options		
Description	Specify	Add or Deduct
Spanner head screws	M02	Add \$41.00 per device
ANSI wrought strike box (for mortise only)	M17	No Charge
Knurling outside and inside (trim and device)	M20	Add \$175.00 per device
Knurling outside only (trim side)	M21	Add \$82.00 per device
Knurling inside only (device side)	M22	Add \$93.00 per device
Abrasive coat outside and inside (trim and device)	M23	Add \$111.00 per device
Abrasive coat inside only (device side)	M24	Add \$58.00 per device
Abrasive coat outside only (trim side)	M25	Add \$53.00 per device
Stainless steel crossbar <sup>1</sup>		
- When ordered with 626 or 630 finish	M50	No Charge
- All other finishes	M50	Add \$89.00 per device
Less dogging	M51	No Charge
Steel reinforced crossbar	M53	Add \$82.00 per device
Sex nuts and bolts (SNBs)	M54	No Charge
Shim for 2-3/4" backset on doors with 1/2" stop (for ED7200 only)	M59	Add \$26.00 per device
Less latch hold-back (for ED7200 and ED7600 devices only)	M66	No Charge
<p><b>Note:</b></p> <p>1. Not available with M22 or M20 option.</p>		

**Removable Mullion**

**Ordering Example**

Quantity	Mullion Number
10	CR507

Mullion Number	Description	Price
CR510	For doors up to 10'	\$998.00

**Standard Features**

**Handing**

ED8200 Non-handed  
ED8400 Handed; specify hand

**Door Thickness**

1-3/4"

**Backset**

2-3/4"

**Bar Length**

36 standard; 30", 42" and 48"  
available. Easily field cut to  
size.

**Projection**

2-1/2"

**Trim**

Cylinder is not included.  
See page 346 for  
cylinder options.

**RIM**

ED8200	Panic
ED8200B	1-1/2 Hour Fire Rated
ED8200A	3 Hour Fire Rated

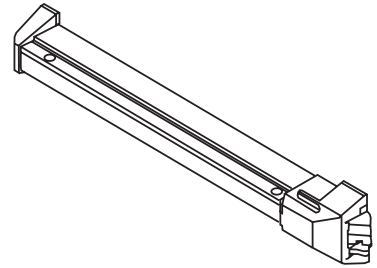

**VERTICAL ROD**

ED8400	Panic
ED8400A	3 Hour Fire Rated

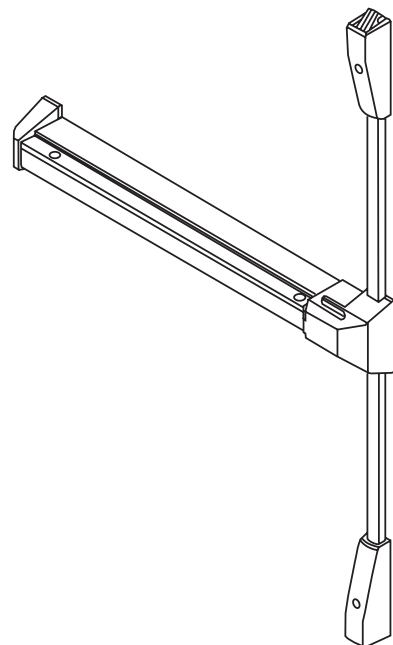

**Ordering Example**
**Rim Exit Device**

Quantity	Exit Device	Finish
20	ED8200	689

**Rim Exit Device with Trim**

Quantity	Exit Device	Trim/Function	Finish		Hand	Door Thickness	Door Width	Misc. Options
			Trim	Device				
50	ED8200A	A657ET	613	690	RHR	D200	W048	M58

**Trim Only (Rim or Vertical Rod)**

Quantity	Trim/Function	Finish	Hand
10	N655ET	606	RHR

**Vertical Rod Exit Device with Trim**

Quantity	Exit Device	Trim/Function	Finish		Hand	Optional Strike	Door Width	Height
			Trim	Device				
50	ED8400	PR610ET	626	689	RHR	S03	W048	H1000

**Contract/Detailed Order - Rim Exit Device with Trim**

Quantity	Keyset	Exit Device	Trim/Function	Finish		Hand	Door Thickness	Door Width	Optional Cylinder	Keying
				Trim	Device					
50	AA1	ED8200	N655ET	626	689	LHR	D200	W048	C6	VKC3

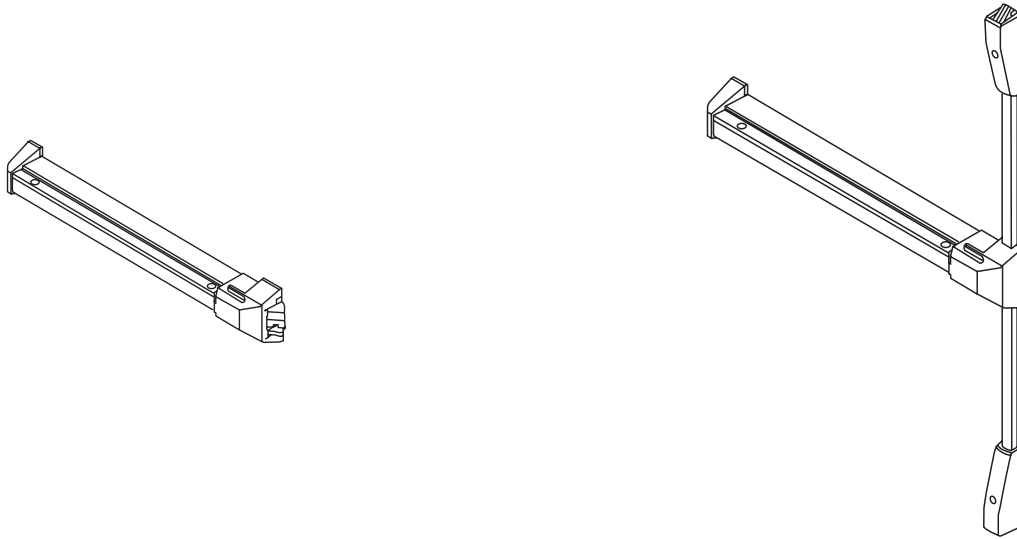

**30", 36" and 42" Exit Devices**

Includes device, strike(s) and screw pack. No cylinder or trim.

**Rim ED8200 Series**

Function	Description	Finish: 689, 690, 691
ED8200	Panic	\$637.00
ED8200B	1-1/2 Hour Fire Rated	\$716.00
ED8200A	3 Hour Fire Rated	\$805.00

**Vertical Rod ED8400 Series**

Function	Description	Finish: 689, 690, 691
ED8400	Panic	\$1,116.00
ED8400A	3 Hour Fire Rated	\$1,284.00

Caution: Be sure of your measurements. Exit devices are NOT returnable.

**ED8200/ED8400 Rim and Vertical Rod Trim**

Cylinder is not included, except where noted.

**Rose Trim Design: A6 Armstrong**



**Lever:** Die cast zinc  
Cylinder included

**Rose:** Wrought brass or bronze

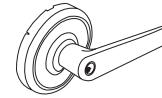

Function	Description	Finish: 605, 606, 611, 612, 613, 613E, 619, 625, 626, 722 BSP
A610ET	Passage	\$378.00
A650ET	Dummy	\$378.00
A655ET	Classroom	\$404.00
A657ET	Nightlatch <sup>1</sup>	
A659ET	Storeroom	

**Rose Trim Design: N6 Newport**



**Lever:** Die cast zinc  
Cylinder included

**Rose:** Wrought brass or bronze

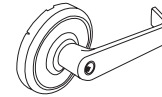

Function	Description	Finish: 605, 606, 611, 612, 613, 613E, 619, 625, 626, 722 BSP
N610ET	Passage	\$378.00
N650ET	Dummy	\$378.00
N655ET	Classroom	\$404.00
N657ET	Nightlatch <sup>1</sup>	
N659ET	Storeroom	

**Rose Trim Design: PR6 Princeton**



**Lever:** Die cast zinc  
Cylinder included

**Rose:** Wrought brass or bronze

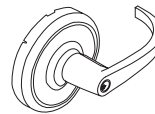

Function	Description	Finish: 605, 606, 611, 612, 613, 613E, 619, 625, 626, 722 BSP
PR610ET	Passage	\$378.00
PR650ET	Dummy	\$378.00
PR655ET	Classroom	\$404.00
PR657ET	Nightlatch <sup>1</sup>	
PR659ET	Storeroom	

Note:  
1. Not recommended for use with ED8400 and ED8400A surface vertical rod exit devices.



**ED8200/ED8400 Rim and Vertical Rod Trim**

Cylinder is not included, except where noted.

**Flat Plate Trim Design: F1 Flat Plate**

**Plate:** Steel

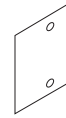

Function	Description	Finish: 605, 606, 611, 612, 613, 613E, 619, 625, 626, 722 BSP
F150ET	Dummy	\$107.00
F157ET	Nightlatch <sup>1</sup>	

**Pull Trim Design: P1 Z-Pull**



**Pull:** Extruded Aluminum



Function	Description	Finish: 605, 606, 611, 612, 613, 613E, 619, 625, 626, 722 BSP
P150ET	Dummy	\$306.00

Note:

1. Not recommended for use with ED8400 and ED8400A surface vertical rod exit devices.

**ED8200/ED8400 Rim and Vertical Rod Trim**

Cylinder is not included, except where noted.

**Pull Trim Design: P2 Offset Pull**



**Pull:** Extruded Aluminum



Function	Description	Finish: 605, 606, 611, 612, 613, 613E, 619, 625, 626, 722 BSP
P250ET	Dummy	\$346.00
P257ET	Nightlatch <sup>1</sup>	

**Pull Trim Design: P8 Wing Pull**



**Pull:** Extruded Aluminum

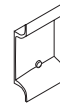

Function	Description	Finish: 689, 690, 691
P850ET	Dummy	\$100.00
P857ET	Nightlatch <sup>1</sup>	

**Trim Design: KO Key Only**

Note: Available with cylinder option only.  
Example: KO57 x 6P



Function	Description	Finish: 605, 606, 611, 612, 613, 619, 622, 625, 626, 722
KO57ET	Nightlatch <sup>1</sup>	\$66.00

**Offset Pull Trim: P12, P13, P14**

Offset Pull Trim	Part Number	Finish: 605, 606, 611, 612, 613, 613E, 619, 625, 626, 722 BSP
P12	716F50M X Finish	\$348.00
P13	716F51M X Finish	\$424.00
P14	716F52M X Finish	\$299.00

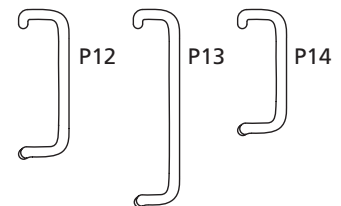

Note:

1. Not recommended for use with ED8400 and ED8400A surface vertical rod exit devices.

<b>Cylinder Options*</b>		
<b>Rim Cylinder Trim</b>		
<b>Description</b>	<b>Specify Quick Code</b>	<b>Add or Deduct</b>
Conventional 6-pin	6P**	Add \$105.00 per cylinder
Conventional 7-pin	7P	Add \$107.00 per cylinder
<b>LFIC</b>		
LFIC 6-pin	C6	Add \$196.00 per cylinder
LFIC 6-pin less core	CL6	Add \$105.00 per cylinder
LFIC 6-pin with temporary construction core (Red)	CT6R	Add \$196.00 per cylinder
LFIC 6-pin with temporary construction core (Blue)	CT6B	Add \$196.00 per cylinder
LFIC 6-pin with temporary construction core (Green)	CT6G	Add \$196.00 per cylinder
LFIC 6-pin with temporary disposable core	CT6D	Add \$105.00 per cylinder
LFIC 7-pin	C7	Add \$200.00 per cylinder
LFIC 7-pin less core	CL7	Add \$107.00 per cylinder
LFIC 7-pin with temporary construction core (Red)	CT7R	Add \$200.00 per cylinder
LFIC 7-pin with temporary construction core (Blue)	CT7B	Add \$200.00 per cylinder
LFIC 7-pin with temporary construction core (Green)	CT7G	Add \$200.00 per cylinder
LFIC 7-pin with temporary disposable core	CT7D	Add \$107.00 per cylinder
<b>SFIC</b>		
SFIC 6-pin	C6S	Add \$187.00 per cylinder
SFIC 6-pin with Temporary Construction Core (Blue)	CT6SB	Add \$187.00 per cylinder
SFIC 6-pin Disposable Temporary Core	CT6SD	Add \$105.00 per cylinder
SFIC 6-pin with Less Core	CLS6	Add \$105.00 per cylinder
SFIC 7-pin	C7S	Add \$187.00 per cylinder
SFIC 7-pin with Temporary Construction Core (Blue)	CT7SB	Add \$187.00 per cylinder
SFIC 7-pin Disposable Temporary Core	CT7SD	Add \$107.00 per cylinder
SFIC 7-pin with Less Core	CLS7	Add \$107.00 per cylinder
<b>Security</b>		
Security <sup>4</sup>	HS	Add \$244.00 per cylinder
Security LFIC <sup>4</sup>	CHS	Add \$331.00 per cylinder
<b>Access 3</b>		
Access 3 Patented	AP	Add \$105.00 per cylinder
Access 3 Security	AS	Add \$161.00 per cylinder
Access 3 High Security, UL 437	AHS	Add \$184.00 per cylinder
Access 3 LFIC Patented	ACP	Add \$196.00 per cylinder
Access 3 LFIC Security	ACS	Add \$252.00 per cylinder
Access 3 LFIC High Security, UL 437	ACHS	Add \$274.00 per cylinder
<b>Pyramid</b>		
Pyramid Security fixed core	PS	Add \$179.00 per cylinder
Pyramid Security LFIC	PCS	Add \$264.00 per cylinder
Pyramid High Security fixed core	PHS	Add \$215.00 per cylinder
Pyramid High Security LFIC	PCHS	Add \$301.00 per cylinder
Pyramid LFIC with temporary construction core <sup>3</sup>	CTP	Add \$196.00 per cylinder
Pyramid LFIC with temporary disposable core <sup>3</sup>	CTPD	Add \$105.00 per cylinder
Pyramid LFIC less core	CLP	Add \$105.00 per cylinder
<p>*Optional alarm unit cylinder and trim are keyed alike unless otherwise specified. If different keying is required, specify outside cylinder, then inside cylinder.</p> <p>**6P cylinder option is supplied in 6-pin, L4 keyway, 0-bitted with two nickel silver keys.</p> <p>*** Not available for G10 trim</p>		

Cylinder Options (continued) & Keying Options*		
Description	Specify Quick Code	Add or Deduct
<b>Keying and Keys</b>		
0-bitted with 2 Blank Keys	(standard)	No Charge
Keyed Random	KR	
Construction Master Keyed <sup>2</sup>	CMK	Add \$16.00 per cylinder
More than 2 Keys	KY# (e.g., KY6)	See page 31 - Cut Keys Section
<b>Master Keying</b>		
Master keyed (all cylinders except CR8000, CR8020, CR8027, CR8200, CR8500, CR8600, CR8700)	MK	Add \$16.00 per cylinder
Master keyed Pyramid (except CR8020, CR8027 LFIC cores)	MK	
Master keyed Security (including LFIC cylinder and core)	MK	
Master keyed Access 3 (except CR8500, CR8600, CR8700 LFIC cores)	MK	
Master keyed (CR8000, CR8020, CR8027, CR8200, CR8500, CR8600, CR8700)	MK-IC	No Charge
Master keyed to customer bittings or sample key	MK-CB	Add \$16.00 per cylinder
<b>Visual Key Control (VKC)</b>		
No bitting or keyset stamping on keys	VKC0	\$4.50
Keys only	VKC1	No Charge
Cylinders and keys (not for AS, AHS, ACS, ACHS, HS, CHS, PHS or PCHS)	VKC2	\$8.00
Cylinders only (not for AS, AHS, HS, ACS, ACHS, CHS, PHS or PCHS)	VKC3	
<b>Concealed Key Control (CKC)</b>		
CKC cylinders with VKC keys	CKC2	\$8.00
CKC cylinders only (not for AS, AHS, ACS, ACHS, PHS, PCHS)	CKC3	

**Notes:**

1. CMK Construction master keying charge is in addition to master keying charge.
  2. CMK construction master keying is not available in interchangeable core, Access 3, Pyramid, or Security series.
  3. VKC2, VKC3, CKC3 are not available in Pyramid or Security series.
- \*For key bows other than 10 and 90, specify 'KB' + bow number as Quick Code, e.g. KB12. No extra charge.

**Door Width Options**

Door Width	Specify	Add or Deduct
36"	(standard)	No Charge
30"	W030	
42"	W042	
48"	W048	Add \$43.00 per device

**Door Thickness Options**

Door Thickness	Specify	Add or Deduct
1-3/8" (G10, A6, N6, PR6 Trim only)	D138	No Charge
1-3/4"	(standard)	
2"	D200	
2-1/4"	D214	

**Door Height Options**

Door Height	Specify	Add or Deduct
7'6" (ED8400 devices)	(standard)	No Charge
8'0" (ED8400A devices)	(standard)	
10'0" (ED8400 devices only)	H1000	

**Miscellaneous Options**

Description	Specify	Add or Deduct
Less cylinder with tailpiece for Schlage® cylinder – (A6, N6, PR6 designs only)	M06	No Charge
Lever to accept 6- or 7-pin Best-type IC core (SFIC) – (N6, PR6 design only)	M08	No Charge
Lever to accept Sargent® cylinder – (N6, PR6 design only)	M09	
Lever to accept <i>Schlage</i> IC core – (N6, PR6 design only)	M69	
Knurling outside only (trim side)	M21	Add \$86.00 per lockset
Abrasive coat outside and inside (trim and device)	M23	Add \$108.00 per lockset
Abrasive coat inside only (device side)	M24	Add \$54.00 per lockset
Abrasive coat outside only (trim side)	M25	Add \$54.00 per lockset
Less dogging	M51	No Charge
Sex nuts and bolts (SNBs) <sup>1</sup>	M54	No Charge
Mullion Stabilizer	M57	Add \$63.00 per mullion
Shim kit (for vision light)		
- Rim device	M58	Add \$71.00 per device
- Vertical Rod device	M58	Add \$127.00 per device
Shim for 2-3/4" backset on doors with 1/2" stop	M59	Add \$34.00 per device

Note: 1. Not available with D138 option.

**Strike Options\***

Description	Specify	Add or Deduct
Rim strike on ED8200, ED8200B devices	(standard)	No Charge
Fire rated Rim strike on ED8200A devices		
Rim x Vertical Rod strike for pairs of doors	S02	Add \$44.00 per device
Vertical Rod top strike on ED8400 device	(standard)	No Charge
Vertical Rod surface projecting bottom strike on ED8400 device		
Vertical Rod flush bottom strike on ED8400 device	S03	No Charge
Fire rated Vertical Rod top strike on ED8400A device	(standard)	No Charge
Fire rated Vertical Rod bottom strike on ED8400A device	(standard)	No Charge

\*To purchase strike separately, see catalog or parts manual for part no.

**Custom Laser Engraving- LASER**
**Laser engraving processing charge (all engraving types)**

- \$250.00 net per order. Charge will be applied to production order when placed.

**Single Vanity, Logo or Other (same engraving on all parts)**

- Lever - \$10.00 net add each
- Mortise Escutcheon - \$10.00 net add each
- HPSK Paddle - \$10.00 net add each

**Unique laser engraving (i.e. Room Number, Apartment Number, etc)**

- \$12.00 net add each (per piece)

### Removable Mullion (Cylinder not included)

Cylinder not included

### Ordering Example

Quantity	Mullion Number
10	508

### Door Height Options

Door Height	Specify	Price
(SFIC) Up to 10'0" (ED8200 only)	CR510	\$998.00
Up to 7'0" Steel Mullion - Panic Rated	CR907	\$827.00
Up to 8'0" Steel Mullion - Panic Rated	CR908	\$837.00
Up to 10'0" (ED8200 only), Steel Mullion - Panic Rated	CR910	\$998.00
Up to 7'0", Steel Mullion - 3 Hour Fire Rated	CR907A	\$1,150.00
Up to 8'0", Steel Mullion - 3 Hour Fire Rated	CR908A	\$1,160.00

### Options

Description	Specify	Price
Up to 7'0", key removable mullion, 1-1/2 Hour Fire Rated	CR907BKM <sup>1</sup>	\$1,771.00
Up to 8'0", key removable mullion, 1-1/2 Hour Fire Rated	CR908BKM <sup>1</sup>	\$1,781.00
Up to 10'0" (ED8200 only), key removable mullion, Panic Rated	CR910KM <sup>1</sup>	\$1,566.00
Door frame filler block for double rabbetted frames	M95	Add \$42.00 per mullion
Door frame angle bracket for aluminum frames	M96	Add \$42.00 per mullion

Note 1: Cylinder and collars not included, specify separately

### Mullions Cylinder Options

Description	Specify	Add or Deduct
Conventional 6-pin	6P	Add \$105.00 per cylinder
Conventional 7-pin	7P	Add \$107.00 per cylinder
LFIC 6-pin	C6	Add \$196.00 per cylinder
LFIC 7-pin	C7	Add \$200.00 per cylinder
Pyramid High Security Fixed Core	PHS	Add \$215.00 per cylinder
Pyramid Security Fixed Core	PS	Add \$179.00 per cylinder
Pyramid High Security IC	PCHS	Add \$301.00 per cylinder
Pyramid Security IC	PCS	Add \$264.00 per cylinder
Security	HS	Add \$244.00 per cylinder
Security IC	CHS	Add \$331.00 per cylinder
LFIC 6-pin with temporary construction core (Red)	CT6R	Add \$196.00 per cylinder
LFIC 6-pin with temporary construction core (Blue)	CT6B	Add \$196.00 per cylinder
LFIC 6-pin with temporary construction core (Green)	CT6G	Add \$196.00 per cylinder
LFIC 6-Pin with temporary disposable core	CT6D	Add \$105.00 per cylinder
LFIC 6-pin less core	CL6	Add \$105.00 per cylinder
LFIC 7-pin with temporary construction core (Red)	CT7R	Add \$200.00 per cylinder
LFIC 7-pin with temporary construction core (Blue)	CT7B	Add \$200.00 per cylinder
LFIC 7-pin with temporary construction core (Green)	CT7G	Add \$200.00 per cylinder
LFIC 7-Pin with temporary disposable core	CT7D	Add \$107.00 per cylinder
LFIC 7-pin less core	CL7	Add \$107.00 per cylinder

**DC3000 Series:**

DC3000 Series Standard Features	336
DC3000 Series Arm Options, Miscellaneous Options, Brackets, Door Thickness, Drop Plates, Finish Options	337

**DC5000 Series (Cam Action Door Closer):**

DC5000 Series Standard Features	338
DC5000 Series Arm Options, Door Thickness, Handing, Finish Options, Miscellaneous Options, Drop Plate	339

**DC6000 Series:**

DC6000 Series Standard Features	340
DC6200 Series, DC6400 Series	341
DC6000 Series Arm Options, Door Width Options, Finish Options, Door Thickness, Handing	342
DC6000 Series Miscellaneous Options, Blade Stop Spacer, Miscellaneous Brackets, Drop Plates	343

**DC8000 Series:**

DC8000 Series Standard Features	344
DC8200 Series (Factory Pre-Sized)	345
DC8000 Series Arm Options, Door Width Options, Finish Options	346
DC8000 Series Miscellaneous Options, Blade Stop Spacer, Miscellaneous Brackets	347
DC8000 Series Drop Plates	348

**DC46900 Series:**

DC46900 Series Safeguard™ Door Controls: Ordering Example, DC46900 Series, Voltage	349
--	-----

**DC62900 Series:**

DC62900 Series Electromechanical Door Controls: Ordering Example, DC62900 Series, Miscellaneous Options, Voltage	350
--	-----

**Standard Features**

**Handing**

Non-handed

**Spring Power**

DC3200 Series: Non-sized  
fully adjustable 1 thru 6.

**Degree of Opening**

Up to 180° opening standard for  
regular, top jamb and  
parallel arm mounting.

**Case Quantity**

4

**Case Weight**

42 lbs

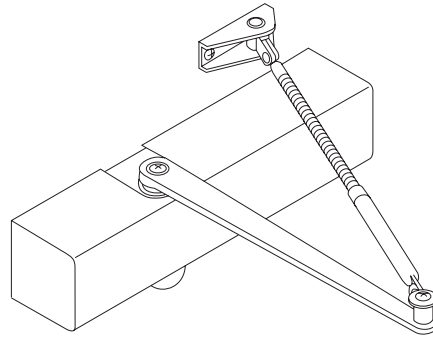

**Ordering Examples**

**Stock Order**

Quantity	Series/Mounting	Finish
48	DC3210	689

**Contract Order**

Quantity	Series/Mounting	Arm	Finish	Option
100	DC3210	A4	689	M54

**DC3200 Series**

Non-sized: full adjustability from sizes 1-6

Function	Description	Finish: 600, 689, 690, 691, 693, 696
DC3200	Regular arm	\$498.00
DC3210	Parallel arm	
DC3220	Top jamb	

DC3210 closers are tri-packed standard (for regular arm, top jamb or parallel arm mounting) unless specialty arm is requested.



**Arm Options**

Description	Specify Quick Code	Add or Deduct
Hold open arm	A1	Add \$88.00 per closer
Heavy-duty parallel arm with hold open	A2	Add \$113.00 per closer
Heavy-duty parallel arm	A3	Add \$56.00 per closer
Heavy-duty parallel arm with backstop	A4	Add \$105.00 per closer
Heavy-duty parallel arm with backstop & hold open	A5	Add \$198.00 per closer
Heavy-duty regular arm	A10	Add \$56.00 per closer

**Miscellaneous Options**

Description	Specify Quick Code	Add or Deduct
Sex nuts and bolts (SNB)	M54	No Charge
Backcheck intensity	(standard)	No Charge
Delayed Action	M71	Add \$53.00 per closer
Full ABS Cover	(standard)	No Charge
Corrosion protection	M75	Add \$50.00 per closer
Heavy-duty parallel arm flush transom bracket (499F30). Used with A2, A3, A4 & A5 arms)	M79	Add \$19.00 per closer

**Miscellaneous Brackets**

Description	Specify Quick Code	Add or Deduct
Parallel arm flush transom bracket	M82	Add \$36.00 per closer
Parallel arm offset bracket	M83	Add \$36.00 per closer
Mortise arm bracket for regular arm mounting	M84	Add \$36.00 per closer
Angle Support bracket	M85	Add \$36.00 per closer

**Door Thickness**

Description	Specify
1-3/4"	(standard)

**Drop Plates**

Closer Plates	Old Quick Ship #	Full Cover	List price
DC3210	M80	597F58	\$89.00
DC3220	M80	188F65	\$89.00

**Finish Options**

Description	Add or Deduct
600, 613E, 689, 690, 691, 693, 696, BSP, WSP	(standard)

**Standard Features**

**Handing**

Non-handed

**Spring Power**

DC5000 Series: sizes 1 thru 6 fully adjustable.

**Degree of Opening**

110° opening range for Push Side and Pull Side installations.

**Slide Track**

Standard

**Case Weight**

DC5230 8 lbs.

DC5240 8 lbs.



**Ordering Example**

**Stock Order**

Quantity	Series/Mounting	Finish
100	DC5230	689

**Contract Order**

Quantity	Series/Mounting	Arm	Finish
100	DC5240	A1	689

**DC5000 Series**

Non-sized: full adjustability from sizes 1-6

Function	Description	Finish: 689, 690, 691, 693, 696
DC5230	Pull Side Track	\$724.00
DC5240	Push Side Track	

**Arm Options**

Description	Specify Quick Code	Add or Deduct
Hold open arm	A1	\$34.00

**Door Thickness**

Description	Specify
1-3/4"	(standard)

**Handing**

Description	Specify
Left Hand	LH
Right Hand	RH
Left Hand Reverse	RH
Right Hand Reverse	LH

**Finish Options**

Description	Add or Deduct
Painted finishes: 689, 690, 691, 693, 696	(standard)

**Miscellaneous Options**

Description	Specify Quick Code	Add or Deduct
Sex nuts and bolts (SNB)	M54	No Charge

**Drop Plate**

Description	Part Number	Add or Deduct
Drop Plate (Push side)	754F80	\$61.00

**Standard Features**  
**Handing**

Non-handed

**Spring Power**

DC6200 Series: sizes 1 thru 6 non-sized fully adjustable.

DC6400 Series: sizes 1 thru 6 half-size adjustability.

**Degree of Opening**

Up to full 180° opening standard for regular, top jamb and parallel arm applications.

**Case Quantity**

4

**Case Weight**

DC6200 42 lbs

DC6400 42 lbs



**Ordering Example**

**Stock Order**

Quantity	Series/Mounting	Finish
100	DC6210	689

**Contract Order**

Quantity	Series/Mounting	Arm	Finish	Door Thickness
100	DC6406	A6	689	D138

**DC6200 Series**

Non-sized: full adjustability from sizes 1-6

Function	Description	Finish: 600, 613E, 689, 690, 691, 693, 696, BSP, WSP
DC6200	Regular arm	\$549.00
DC6210	Parallel arm	
DC6220	Top jamb	
DC6230	Pull side track**	\$632.00
DC6240	Push side track	

DC6210 closers are tri-packed standard (for regular arm, top jamb or parallel arm mounting) unless specialty arm is requested.  
 \*\*Minimum 3" top jamb required.

**DC6400 Series**

Sized: 1/2-size adjustability

Function	Description	Finish: 600, 613E, 689, 690, 691, 693, 696, BSP, WSP
DC6401	Regular arm	Size 1
DC6402		Size 2
DC6403		Size 3
DC6404		Size 4
DC6405		Size 5
DC6406		Size 6
DC6411	Parallel arm	Size 1
DC6412		Size 2
DC6413		Size 3
DC6414		Size 4
DC6415		Size 5
DC6416		Size 6
DC6421	Top jamb	Size 1
DC6422		Size 2
DC6423		Size 3
DC6424		Size 4
DC6425		Size 5
DC6426		Size 6
DC6433	Pull side track	Size 3
DC6434		Size 4
DC6435		Size 5
DC6436		Size 6
DC6443	Push side track	Size 3
DC6444		Size 4
DC6445		Size 5
DC6446		Size 6

Note: See page 366 for plated finishes.

DC641X closers are tri-packed standard (for regular arm, top jamb or parallel arm mounting) unless specialty arm is requested.

**Arm Options**

Description	Specify Quick Code	Add or Deduct
Hold open arm	A1	Add \$88.00 per closer
Heavy-duty parallel arm with hold open	A2	Add \$113.00 per closer
Heavy-duty parallel arm	A3	Add \$56.00 per closer
Heavy-duty parallel arm with backstop	A4	Add \$105.00 per closer
Heavy-duty parallel arm with backstop & hold open	A5	Add \$198.00 per closer
Deep reveal (3-1/4" - 7-1/4")	A6	No Charge
Deep reveal with hold open	A8	Add \$88.00 per closer
Heavy-duty regular arm	A10	Add \$56.00 per closer
Heavy-duty Unitrol®	A11*	Add \$285.00 per closer
Heavy-duty Unitrol® with hold open	A12*	Add \$374.00 per closer
Heavy-duty parallel arm with extra clearance	A13	Add \$47.00 per closer
Heavy-duty friction hold open arm	A14	Add \$112.00 per closer
Push side track with hold open	A1	Add \$88.00 per closer

\* Specify door width

**Door Width Options**

Description	Specify Quick Code	Add or Deduct
A11, A12 door width 28" - 32"	W28	No Charge
A11, A12 door width 33" - 41"	W33	
A11, A12 door width 42" - 48"	W42	

**Finish Options\***

Description	Add or Deduct
	<b>605, 606, 611, 612, 625, 626</b>
Painted finishes: 600, 613E, 689, 690, 691, 693, 696, BSP, WSP	(standard)
Plated finishes: specify 605, 606, 611, 612, 625, 626	
Regular, parallel, hold open:	
- Plated arm & cover*	Add \$653.00 per closer
- Plated cover (metal)	Add \$266.00 per closer
- Plated arm*	Add \$387.00 per closer

Heavy-Duty arms (A2, A3, A4, A5, A10, A11, A12, A13, A14) are not available plated.

Track & arm for track-type closers are not available plated.

\*For split finish of closer cover and arm, specify cover first, then arm finish; e.g. DC6200 x 625 x 689.

**Special Finishes**

<ul style="list-style-type: none"> <li>Contact factory for availability</li> <li>50 piece minimum order for non-standard sprayed or powder coat finishes</li> </ul>	Net add \$50.00 per closer
Additional charge per closer will be added to net/net charge	

**Door Thickness**

Description	Specify
1- 3/4"	(standard)
2"	D200

**Handing**

Description	Specify
Left Hand	LH
Right Hand	RH
Left Hand Reverse	RH
Right Hand Reverse	LH

**Miscellaneous Options**

Description	Specify Quick Code	Add or Deduct
Torx® Screws	M04	Add \$41.00 per closer
Sex nuts and bolts (SNB)	M54	No Charge
Backcheck intensity and location valves	(standard)	No Charge
Delayed Action	M71	Add \$53.00 per closer
Full ABS Cover	(standard)	No Charge
Full Metal Cover	M73	Add \$21.00 per closer
Extreme temperature fluid	(standard)	No Charge
Corrosion protection	M75	Add \$50.00 per closer
Security package*	M87	A2-Arm - Add \$175.00 per closer
		A3-Arm - Add \$118.00 per closer
		A4-Arm - Add \$167.00 per closer
		A5-Arm - Add \$260.00 per closer
		A10-Arm - Add \$118.00 per closer

\*M87 includes full metal cover, Torx® fasteners and A2, A3, A4, A5, or A10 arm. Specify arm when ordering.

**Blade Stop Spacer**

Description	Specify Quick Code	Add or Deduct
1/2" spacer (597F92)	M77	Add \$27.00 per closer
5/8" spacer (597F93)	M78	Add \$44.00 per closer

**Miscellaneous Brackets**

Description	Specify Quick Code	Add or Deduct
HD PA flush transom bracket (used with all parallel arms except the Unitrol®)	M79	Add \$47.00 per closer
Parallel arm flush transom bracket	M82	Add \$36.00 per closer
Parallel arm offset bracket	M83	Add \$36.00 per closer
Mortise arm bracket for regular arm mounting	M84	Add \$36.00 per closer
Angle support bracket	M85	Add \$36.00 per closer
Deep Reveal Reinforcement Kit	M103	Add \$36.00 per closer
Flush partition bracket	M104	Add \$30.00 per closer
Lead lined cover (metal cover only)	M108	Add \$218.00 per closer

**Drop Plates**

Closer Plates	Old Quick Ship #	Full Cover	List Price
DC6210, DC6410 (Parallel)	M80	597F58	\$89.00
DC6220, DC6420 (Top Jamb)	M80	188F65	
DC6230, DC6430 (Pull Side)	M81	597F59	
DC6240, DC6440 (Push Side)	M102	597F59	

**Standard Features**  
**Handing**

Non-handed

**Spring Power**

DC8200 Series: sizes 1 thru 6  
non-sized fully adjustable.

DC8200 Series: sizes 1 thru 6  
half-size adjustability.

**Degree of Opening**

Up to full 180° opening  
standard for regular, top jamb  
and parallel arm applications.

**Case Quantity**

4

**Case Weight**

DC8200 54 lbs



**Ordering Example**

**Stock Order**

Quantity	Series/Mounting	Finish
100	DC8210	689

**Contract Order**

Quantity	Series/Mounting	Arm	Finish	Door Thickness
100	DC8206	A6	689	D138



<b>DC8200 Series</b>			
Non-sized full adjustability from sizes 1-6			
<b>Function</b>	<b>Description</b>		<b>Finish: 600, 613E, 689, 690, 691, 693, 696, BSP, WSP</b>
DC8200	Regular arm		\$708.00
DC8210	Parallel arm		
DC8220	Top Jamb		
DC8230	Pull side track**		\$785.00
DC8240	Push side track		
DC8210 closers are tri-packed standard (for regular arm, top jamb or parallel arm mounting) unless specialty arm is requested. *Minimum 3" top jamb required.			
<b>Factory Pre-Sized (available upon request)</b>			
<b>Function</b>	<b>Description</b>		<b>Finish: 600, 613E, 689, 690, 691, 693, 696, BSP, WSP</b>
DC8201	Regular arm	Size 1	\$708.00
DC8202		Size 2	
DC8203		Size 3	
DC8204		Size 4	
DC8205		Size 5	
DC8206		Size 6	
DC8211	Parallel arm	Size 1	
DC8212		Size 2	
DC8213		Size 3	
DC8214		Size 4	
DC8215		Size 5	
DC8216		Size 6	
DC8221	Top Jamb	Size 1	
DC8222		Size 2	
DC8223		Size 3	
DC8224		Size 4	
DC8225		Size 5	
DC8226		Size 6	
DC8233	Pull side track	Size 3	\$785.00
DC8234		Size 4	
DC8235		Size 5	
DC8236		Size 6	
DC8243	Push side track	Size 3	
DC8244		Size 4	
DC8245		Size 5	
DC8246		Size 6	
DC821X closers are tri-packed standard (for regular arm, top jamb or parallel arm mounting) unless specialty arm is requested.			

**Arm Options**

Description	Specify Quick Code	Add or Deduct
Hold open arm	A1	Add \$88.00 per closer
Heavy-duty parallel arm with hold open	A2	Add \$113.00 per closer
Heavy-duty parallel arm	A3	Add \$56.00 per closer
Heavy-duty parallel arm with backstop	A4	Add \$105.00 per closer
Heavy-duty parallel arm with backstop & hold open	A5	Add \$198.00 per closer
Deep reveal (3-1/4" - 7-1/4")	A6	No Charge
Deep reveal with hold open	A8	Add \$88.00 per closer
Heavy-duty regular arm	A10	Add \$56.00 per closer
Unitrol® arm	A11*	Add \$285.00 per closer
Unitrol arm x hold open	A12*	Add \$374.00 per closer
Heavy-duty parallel arm with extra clearance	A13	Add \$47.00 per closer
Heavy-duty friction hold open	A14	Add \$112.00 per closer
Push side track with hold open	A1	Add \$88.00 per closer

\*Specify door width

**Door Width Options**

Description	Specify Quick Code	Add or Deduct
A11, A12 - door width 28" - 32"	W28	No Charge
A11, A12 - door width 33" - 41"	W33	
A11, A12 - door width 42" - 48"	W42	

**Finish Options\***

Description	Add or Deduct
	<b>605, 606, 611, 612, 625, 626</b>
Painted finishes: 600, 613E, 689, 690, 691, 693, 696, BSP, WSP	(standard)
Plated finishes: specify 605, 606, 611, 612, 625, 626 Regular, parallel, hold open:	
- Plated arm & cover*	Add \$653.00 per closer
- Plated cover (metal)**	Add \$266.00 per closer
- Plated arm*	Add \$387.00 per closer

Heavy-Duty arms (A2, A3, A4, A5, A10, A11, A12, A13, A14) are not available plated.  
Track & arm for track-type closers are not available plated.

\*For split finish of closer cover and arm, specify cover first, then arm finish; e.g. DC6200 x 625 x 689.

\*\*Price of M73 option is not included.

**Special Finishes**

<ul style="list-style-type: none"> <li>Contact factory for availability</li> <li>50 piece minimum order for non-standard sprayed or powder coat finishes</li> </ul>	Net add \$50.00 per closer
Additional charge per closer will be added to net/net charge	

<b>Miscellaneous Options</b>		
<b>Description</b>	<b>Specify Quick Code</b>	<b>Add or Deduct</b>
Torx® Screws	M04	Add \$41.00 per closer
Sex nuts and bolts (SNB)	M54	No Charge
Backcheck valve	(standard)	No Charge
Delayed Action	M71	Add \$53.00 per closer
Full ABS Cover	(standard)	No Charge
Full Metal Cover	M73	Add \$21.00 per closer
Extreme Temperature Fluid	(standard)	No Charge
Corrosion Protection	M75	Add \$50.00 per closer
Security Package*	M87	A2-Arm - Add \$175.00 per closer
		A3-Arm - Add \$118.00 per closer
		A4-Arm - Add \$167.00 per closer
		A5-Arm - Add \$260.00 per closer
		A10-Arm - Add \$118.00 per closer
*M87 includes full metal cover, Torx® fasteners and A2, A3, A4, A5, A10 or A13. Specify arm when ordering		
<b>Blade Stop Spacer</b>		
<b>Description</b>	<b>Specify Quick Code</b>	<b>Add or Deduct</b>
1/2" spacer (597F92)	M77	Add \$27.00 per closer
5/8" spacer (597F93)	M78	Add \$44.00 per closer
<b>Miscellaneous Brackets</b>		
<b>Description</b>	<b>Specify Quick Code</b>	<b>Add or Deduct</b>
HD PA flush transom bracket (used with all parallel arms except the Unitrol®)	M79	Add \$47.00 per closer
Parallel arm flush transom bracket	M82	Add \$36.00 per closer
Parallel arm offset bracket	M83	Add \$36.00 per closer
Mortise arm bracket for regular arm mounting	M84	Add \$36.00 per closer
Angle support bracket	M85	Add \$36.00 per closer
Deep reveal reinforcement kit	M103	Add \$36.00 per closer
Flush partition bracket (used with Unitrol® arm)	M104	Add \$30.00 per closer
Lead lined cover	M108	Add \$218.00 per closer

**Drop Plates**

<b>Closer Series</b>	<b>Part Number</b>	<b>List Price</b>
DC8200 (regular)	754F20	\$110.00
DC8200 (with concealed holder)	754F24	\$110.00
DC8210 (parallel)	754F25	\$110.00
DC8220 (top jamb)	754F24	\$110.00
DC8230 (pull side track)	754F20	\$110.00
DC8240 (push side track)	754F25	\$110.00

**Safeguard™ Door Controls**

Non-sized closer.  
 689 and 690 Finishes.

**Ordering Example**

Quantity	Series/Mounting	Finish	Voltage
10	DC46920	689	24A

**DC46900 Series**

Model	Description	Price
DC46920	Pull side for RH and LH single doors and pair of doors	\$1,739.00
DC46925	Push side for LHR double egress doors	
DC46928	Pull side holder body with push side closer for reverse bevel doors	

**Voltage**

Description	Specify Quick Code
24VAC	24A
24VDC	24D
120VAC	120A

**Electromechanical Door Controls**

Sex nuts and bolts are furnished standard.  
 689 Finish.

**Ordering Example**

Quantity	Series/Mounting	Finish	Voltage	Options
24	DC62930	689	24A	M54

**DC62900 Series**

Model	Quick Code	Description		Finish: 689, 690, 691, 693, 696
DC62930	ET	Pull Side	Support Unit	\$1,347.00
DC62940	ET	Push Side	Support Unit	\$1,347.00

**Miscellaneous Options**

Description	Specify Quick Code	Add or Deduct
Torx® machine screws	M04	Add \$41.00 per closer
Sex nuts and bolts		
- DC62930	(standard)	(standard)
- DC62940	(standard)	(standard)
Backcheck intensity valve	M70	Add \$42.00 per closer

**Voltage\***

Description	Specify Quick Code
24VAC	24A
24VDC	24D
120VAC	120A

# Parts Price List

Number 36  
USA & Canada Prices Effective  
February 1, 2022



**PLUGS AND SHELLS**

**6-PIN PLUGS, BULK PACKS**

606, 626

PART NO.	DESCRIPTION	LIST PRICE
----------	-------------	------------

These packages are priced at a savings over individual plug prices. Keyway availability is limited to L4, D1, H1, 60, 59A1 and 981.

492K90	25 Pack for 1-1/8" Mortise	\$905.00
492K91	25 Pack for 3000 Rim	
492K92	50 Pack for CK4200, UT5200	\$1,810.00
610K48	50 Pack for CL3300	

**5- AND 6-PIN INDIVIDUAL PLUGS**

X CLASS	STANDARD	USED IN	LIST PRICE
487K10	121K10	1" Mortise (5-pin)	\$46.00
487K11	121K11	1-1/8" Mortise	
606K73	193K09	3-1/4" Mortise	\$81.00
606K74	193K10	3-1/2" Mortise	\$83.00
606K75	193K11	3-3/4" Mortise	\$87.00
487K38	197K51*	1001 Hotel Mortise	\$49.00
488K99	488K98	CK4200, UT5200 (.552") and 2000051	\$46.00
564K53	574K05	CK4400, except below	
564K60	564K52	CK4429 Hotel, old tailpiece	\$57.00
564K59	579K14	CK4429, new tailpiece	
580K99	574K07	CK4455, CK4482, before 8/93	\$46.00
596K29	585K24	CL3300, CL3500, CL3600, CL3700, CL3800	
596K31	585K26	CL3329, CL3629 Hotel	\$59.00
489K49	186K75	2001051 (1429/3433EM)	\$59.00
534K25	245K37	2100/2160 (large head)	\$57.00
612K90	444K87	2200001 and 009	
612K91	444K89	2200002	
612K88	444K94	2200008	
612K93	444K88	2200054	
612K94	523K21	2200076	\$46.00
488K84	253K66	3000 Rim Cylinder	
610K46	146K80	4200002 for AR Pull	\$57.00
	195K68	4266 for MR Exit Operators	\$69.00
334K01	334K00	80006 Interchangeable Core	\$46.00
n/a	378K18	Fox Police Rim Cyl. (5-pin)	\$69.00

**7-PIN PLUGS**

606, 626

X CLASS	STANDARD	USED IN	LIST PRICE
487K13	292K95	1-1/4" Mortise	\$49.00
487K15	292K96	1-3/8" Mortise	
487K17	292K97	1-1/2" Mortise	
487K19	292K98	1-3/4" Mortise	\$63.00
487K21	292K99	2" Mortise	\$68.00
606K76	293K00	2-1/4" Mortise	
606K77	293K01	2-1/2" Mortise	
606K78	293K02	2-3/4" Mortise	
606K79	293K03	3" Mortise	\$70.00
596K30	585K25	CL3300 Non-Hotel	\$58.00
596K32	585K27	CL3329 Hotel	\$63.00
488K85	253K67	3000-7 Rim Cylinder	\$49.00
416K08	416K07	8000-7 Core	\$58.00

**SECURITY PLUGS (USE IN SECURITY SHELLS ONLY)**

PART NO.	DESCRIPTION	LIST PRICE
407K63	1-1/8" Mortise	\$70.00
407K64	1-1/4" Mortise	
415K73	1-3/8" Mortise	\$78.00
415K74	1-1/2" Mortise	
518K73	1-3/4" Mortise	\$90.00
518K74	2" Mortise	\$93.00
518K75	2-1/4" Mortise	
518K76	2-1/2" Mortise	\$97.00
518K77	2-3/4" Mortise	
409K12*	1011 Mortise Hotel	\$70.00
408K45	CK4200, UT5200	\$63.00
585K46	CL3300 Non-Hotel	\$78.00
444K97	2210001 and 009	\$78.00
444K98	2210002	\$70.00
444K96	2210008	\$78.00
444K99	2210054	\$70.00
407K65	3010 Rim Cylinder	\$63.00
483K01	3012 Rim	\$76.00
446K68	8010 Interchangeable Core	\$58.00

**PYRAMID STANDARD PLUGS**

696K43	Used with 1020	†Order 10-	\$63.00
798K912 x Fin	Used with 1020112	†Order 10-	
696K45	Used with 3020	†Order 10-	
696K46	Used with 2020	†Order 10-	
696K48	Used with 2020	†Order 10-	
696K52	Used with 8020, 8027	†Order 10-	
715K14	Used with 2220	†Order 10-	\$63.00

**PYRAMID SECURITY PLUGS**

716K43	Used with 1027	†Order 10-	\$63.00
798K922 x Fin	Used with 1027112	†Order 10-	
716K45	Used with 3027	†Order 10-	
716K46	Used with 2027 KIL	†Order 10-	
716K48	Used with 2027 KIK	†Order 10-	
716K16	Used with 2227	†Order 10-	\$63.00

**PYRAMID SIDE PIN PLUGS**

628K852 x Fin	Used with 1020114	†Order 10-	\$63.00
628K972 x Fin	Used with 1020112	†Order 10-	
628K872 x Fin	Used with 3020	†Order 10-	
628K902 x Fin	Used with 2020052	†Order 10-	
628K882 x Fin	Used with 202003x	†Order 10-	\$63.00
628K952 x Fin	Used with 2220	†Order 10-	
629K032 x Fin	Used with 8020, 8027	†Order 10-	\$63.00
628K992 x Fin	Used with 1027114	†Order 10-	
630K472 x Fin	Used with 1027112	†Order 10-	
629K002 x Fin	Used with 3027	†Order 10-	
629K022 x Fin	Used with 2027052	†Order 10-	
629K012 x Fin	Used with 202703x	†Order 10-	\$63.00
629K042 x Fin	Used with 2227	†Order 10-	

**6-PIN LOADED SHELLS, BULK PACKS**

Finishes available for rim and mortise shells: 605, 606, 612, 613, 625, 626		
493F76	25 Pack for 1000118 Mortise	\$1,688.00
677F42	25 Pack for 1000114 Mortise	
493F77	25 Pack for 3000 Rim	
493F78	50 Pack for CK4200, UT5200	\$1,688.00
610F49	50 Pack for CL3300, CL3700	

\*Not available in D1, D2, L1, L2, 752, 852 or A class keyways.  
†Sold only in multiples of the number indicated. Price is each.



**CYLINDER PARTS**

PART NO.	DESCRIPTION	LIST PRICE	SOLD IN MULT. OF		
<b>PYRAMID SHELLS</b>					
695F042 x Fin	Used with 1020114, 1027114, 3020058, 3027058	\$82.00	10†		
695F052 x Fin	Used with 3020, 3027 (Slotted)				
696F502 x Fin	Used with 8020, 8027				
696F472	Used with 2020, 2027 (KIL))	\$74.00			
696F499	Used with 2020, 2027 (KIK)				
715F152	Used with 2220, 2227	\$74.00			
<b>PYRAMID SHELLS - SIDE PINS</b>					
628F922 x Fin	Used with 8020, 8027	\$74.00			
629F062 x Fin	Used with 1020114, 1027114, 3020058, 3027058				
630F482 x Fin	Used with 1020112, 1027112				
628F912	Used with 2020052, 2027052	\$74.00			
628F892	Used with 2020, 2027 (Levers)				
628F962	Used with 2220, 2227 (Competitors)	\$74.00			
629F072 x Fin	Used with 3020, 3027 (Slotted)	\$74.00			
<b>PYRAMID SIDE PINS (VIAL OF 20 PINS)</b>					
630F494	Pyramid Side Pins - Vial Of 20 Pins	\$22.00			
<b>PYRAMID HIGH SECURITY PINS (VIAL OF 100 PINS)</b>					
<b>TOP PINS</b>					
695F257031 - .031"	695F257173 - .173"	\$57.00	1		
695F257047 - .047"	695F257189 - .189"				
695F257063 - .063"	695F257204 - .204"				
695F257078 - .078"	695F257220 - .220"				
695F257094 - .094"	695F257236 - .236"				
695F257110 - .110"	695F257252 - .252"				
695F257126 - .126"	695F257267 - .267"				
695F257141 - .141"	695F257283 - .283"				
695F257157 - .157"	695F257299 - .299"				
<b>BOTTOM PINS</b>					
695F247139 - .139"	695F247218 - .218"				
695F247155 - .155"	695F247234 - .234"				
695F247171 - .171"	695F247250 - .250"				
695F247187 - .187"	695F247265 - .265"				
695F247202 - .202"	695F247281 - .281"				
<b>PYRAMID SECURITY PINS (VIAL OF 100 PINS)</b>					
<b>TOP PINS</b>					
695F252031 - .031"	695F252173 - .173"	\$57.00	1		
695F252047 - .047"	695F252189 - .189"				
695F252063 - .063"	695F252204 - .204"				
695F252078 - .078"	695F252220 - .220"				
695F252094 - .094"	695F252236 - .236"				
695F252110 - .110"	695F252252 - .252"				
695F252126 - .126"	695F252267 - .267"				
695F252141 - .141"	695F252283 - .283"				
695F252157 - .157"	695F252299 - .299"				
<b>BOTTOM PINS</b>					
695F244139 - .139"	695F244218 - .218"				
695F244155 - .155"	695F244234 - .234"				
695F244171 - .171"	695F244250 - .250"				
695F244187 - .187"	695F244265 - .265"				
695F244202 - .202"	695F244281 - .281"				
<b>PINS (SPECIFY SIZE WHERE APPROPRIATE)</b>					
553F482 x length	Vial of 100 bottom pins (L Pins)	\$30.00	1		
553F502 x length	Vial of 100 spool top pins (J Pins)				
553F492 x length	Vial of 100 top pins (= master & Bu) (M Pins)				
546F978	Vial of 1500 construction balls	\$25.00	1		
197F527	Pin, blocking of 1001, 1011 (hotel)	\$2.50	50†		
<b>SECURITY BOTTOM PINS</b>					
407T414242	2L	\$6.00	20†		
407T424242	2R				
407T414270	3L				
407T424270	3R				
407T414298	4L				
407T424298	4R				
407T414326	5L				
407T424326	5R				
407T414354	6L				
407T424354	6R				

PART NO.	DESCRIPTION	LIST PRICE	SOLD IN MULT. OF
<b>SECURITY MASTER PINS</b>			
407T314097	2L	\$6.00	20†
407T324097	2R		
407T334097	2S		
407T314125	3L		
407T324125	3R		
407T334125	3S		
407T314153	4L		
407T324153	4R		
407T334153	4S		
<b>SECURITY TOP PINS</b>			
407T434193	Size 1 Long	\$6.00	20†
407T434158	Size 2 Short		
<b>BUMP-RESISTANT TOP SPOOL PINS (VIAL OF 100 PINS)</b>			
628F107171	Conventional	\$56.00	1
628F107142	Pyramid A	\$122.00	1
628F107236	Pyramid C	\$133.00	1
<b>SPRINGS AND SPRING COVERS</b>			
792F997	Spring, interchangeable core	\$0.30	100†
603F207	Spring, security and convent		
026F757	Spring, hotel mortise blocking pin		
585F327	Spring, cylinder cap pin for 2000034 type	\$0.40	100†
314F987	Spring for 2001034 indicator	\$0.30	100†
217F422	Spring Cover, 5-pin brass	\$0.50	100†
217F442	Spring Cover, 6-pin brass	\$0.50	100†
314F887	Spring Cover, 6-pin stainless for most 2000 Series	\$0.80	50†
217F432	Spring Cover, 7-pin brass	\$0.40	100†
585F397	Spring Cover for 20000347	\$2.50	10†
171F468	Spring for 1100 Series Cyl. Head	\$0.30	100†
697F507	Spring for all Pyramid Cyls	\$0.30	100†
<b>ACCESS 3 PINS (VIAL OF 100 PINS)</b>			
<b>Bottom Pins (BP)</b>			
763F002213	Bottom AP-0	\$30.00	1
763F002243	Bottom AP-1		
763F002273	Bottom AP-2		
763F002303	Bottom AP-3		
763F002333	Bottom AP-4		
763F002363	Bottom AP-5		
763F002393	Bottom AP-6		
<b>Master Pins (MP)</b>			
763F012030	Master AP&AS-1	\$30.00	1
763F012060	Master AP&AS-2		
763F012090	Master AP&AS-3		
763F012120	Master AP&AS-4		
763F012150	Master AP&AS-5		
<b>Top Pin - Bump Resistant</b>			
763F027120	Top-Spool AP-4	\$59.00	1
763F027150	Top-Spool AP-5		
763F027180	Top-Spool AP-6		
763F027210	Top-Spool AP-7		
763F027240	Top-Spool AP-8		
763F027270	Top-Spool AP-9		
763F027300	Top-Spool AP-10		
<b>Top Pin</b>			
763F012180	Top AP-6	\$30.00	1
763F012210	Top AP/BU-7		
763F012240	Top AP/BU-8		
763F012270	Top AP/BU-9		
<b>Build Up Pins (BU)</b>			
763F012300	BU-10	\$30.00	1
763F012330	BU-11		
763F012360	BU-12		
<b>CMK Wafer</b>			
763F072	CMK Wafer	\$53.00	1

†Sold only in multiples of the number indicated. Price is each.

**CYLINDER PARTS (CONT'D)**

PART NO.	DESCRIPTION	LIST PRICE	SOLD IN MULT. OF
<b>CAMS – CONVENTIONAL AND SECURITY</b>			
756F507	A01 Cloverleaf	\$7.40	10†
756F517	A02 Straight	\$7.40	10†
756F527	A03	\$7.40	10†
756F537	A04	\$7.40	10†
756F542	A05 AR4070	\$7.40	5†
756F557	A06	\$7.40	10
756F567	A07	\$8.60	10
756F582	A62	\$22.00	10
756F622	A92	\$6.00	10†
281F272	A93	\$9.70	10†
406F438	Cam for O5 Exit trim	\$15.00	1
<b>CAMS - LFIC VERSION</b>			
756F507	A01 Cloverleaf	\$7.40	10†
756F517	A02 Straight	\$7.40	
756F527	A03		
756F537	A04		
756F542	A05 AR4070		\$7.40
756F557	A06	\$7.40	10
756F567	A07	\$8.60	10
756F582	A62 Straight	\$22.00	10
756F622	A92	\$6.00	10
362F432	A93	\$11.0	10†
<b>MASTER RING</b>			
562F402	A61 New Cloverleaf (locks after 5/93)	\$6.00	10†
756F582	A62 Straight	\$22.00	10†
121F012	A63	\$6.00	5†
135F192	A64	\$9.70	5†
025F722	A65 Old Cloverleaf (was 11A)	\$7.40	5†
<b>TAILPIECES</b>			
444F748	A21	\$3.60	20†
461F108	A22	\$3.60	10†
520F358	A23	\$6.00	10†
444F758	A24	\$3.60	10†
365F968	A38 (Fox square)	\$4.90	5†
329F998	A39 (Fox round)	\$8.60	5†
484F958	A41	\$3.60	10†
484F928	A42		
484F918	A43	\$3.60	20†
484F968	A44	\$6.00	10†
484F938	A45	\$4.90	10†
484F948	A46	\$6.00	10†
146F788	A47	\$20.00	1
585F337	For 20010346	\$3.60	20†
585F358	For 20010347	\$4.90	10†
622F298	For 20000346	\$4.90	10†
596F898	For 2000038		
622F308	For 20000336, 20000347		
489F028	For 2000051	\$3.60	20†
682F298	For 20000337	\$3.60	20†
186F748	For 2001051	\$3.60	20†
622F328	For 2400033	\$8.60	1
682F398	For 2400034	\$23.00	1
685F098	For 2400037	\$8.60	1
616F208	For 2400039	\$9.70	1
616F218	For 2400039L		
490F558	For 3000138	\$4.90	10†
253F768	For 3000200	\$3.60	20†
413F488	For 3000200V	\$4.90	10†
253F778	For 3000312	\$3.60	20†
413F498	For 3000312V	\$4.90	10†
582F298	For 3080114 for exit alarm options M61 & M62	\$6.00	10†
253F858	For 3080178	\$6.00	10†
284F138	For 3080318	\$4.90	10†
599F389	Kit for Sargent® in CL3600	\$12.00	1
601F229	Kit for Sargent® in CL3400	\$13.00	1
622F328	For Schlage® cyl. in CL3400/CL3600	\$8.60	5†
715F108	P21	\$7.40	10†
715F118	P22		
715F128	P23		

PART NO.	DESCRIPTION	LIST PRICE	SOLD IN MULT. OF
<b>RETAINERS</b>			
173F798	.020" Plug Retainer-3300/5600,1400/4300	\$3.60	50†
368F918	.030" Plug Retainer-3000 and 3010 rim cylinders	\$3.60	20†
488F928	.032" Plug Retainer-2000052, 044 and 051	\$3.60	20†
333F998	Plug Retainer, LFIC, CK4400, 2200008, 2020 KIK	\$3.60	100†
655F415	Retainer, LFIC rim tailpiece	\$6.00	10†
365F958	Retainer, Fox Police rim cylinder	\$7.40	10†
250F088	Retainer for flex head cylinder	\$3.60	100†
680F645	Cap for 2000033, 034	\$6.00	10†
585F312	Cap Pin for 2000034	\$3.60	100†
219F888	Plug Retainer for 2060052	\$3.60	100†
<b>LFIC THROW MEMBERS</b>			
715F892	CK4200, UT5200	\$6.00	1
320F442	CK4200, UT5200 Best® knob	\$8.60	1
631F248	CL3400, CL3600 Series packet (before 6/2000) straight	\$8.60	10†
379F805	Used with 1030134, 1037134	\$53.00	1
628F825	Used with 1030114, 1037114, 1030138, 1037138, 3030, 3037	\$18.00	1
628F835	Used with 1030112, 1037112	\$21.00	1
362F153	Padlock	\$11.00	10†
<b>OTHER LFIC PARTS</b>			
353F868	Inner cam for 1071 (hotel)	\$11.00	5†
446F572	Control Sleeve for 8000 core	\$20.00	5†
446F582	Control Sleeve for 8010 core	\$23.00	5†
438F428	Mortise Cylinder Cam Screw	\$3.60	100†
334F128	Mortise Cylinder Cam Plate	\$3.60	20†
622F698	Security disk for CL3400, CL3600		
607F919	Spacer for 6-pin Best type core		
<b>OTHER MASTER RING CYLINDER PARTS</b>			
522F932	Adapter Bushing for MR	\$94.00	1
135F108	Backplate, MR rim	\$6.00	10†
158F062	Cam Spacer for A61, A62, A65	\$3.60	20†
700F575	Thumbturn Hub for A61 MR cam	\$42.00	1
562F422	Kit, A61 cam / hub conversion		
488F108	Mortise Cylinder Set Screw Pkt	\$3.60	20†
354F198	Thumbturn disk, A64 cam	\$112.00	1
197F357	Wave Washer for collar	\$6.00	10†
<b>OTHER MORTISE/RIM CYLINDER PARTS</b>			
253F758	Backplate, rim cylinder	\$3.60	20†
438F418	Cam Screw	\$3.60	100†
488F088	Mortise Cylinder Set Screw Pkt	\$3.60	20†
021F688	Screw, rim cyl. mounting, 2-9/32"	\$3.60	20†
021F718	Screw, rim cyl. mounting, 3-1/8"	\$6.00	10†
197F347	Wave Washer for collar	\$4.90	20†
129F848	Cylinder Nut	\$9.70	1
310F488	Thumbturn Disk, A02 cam	\$48.00	1
<b>OTHER KNOB/LEVER CYLINDER PARTS</b>			
596F879	Obsolete by new design		
585F387	2001034 Indicator fork	\$3.60	20†
585F377	2001034 Stabilizer Pin	\$3.60	20†
314F997	20010346 Indicator Pin	\$6.00	20†
585F407	20010347 Indicator Pin	\$9.70	1
585F367	Tailpiece Anchor, 2001034	\$3.60	20†
041F478	Key, hotel shut-out		
<b>PYRAMID CYLINDER PARTS</b>			
696F42	Blocking plate	\$6.00	20†
697F50	Tumbler spring	\$3.60	100†
217F43	Spring cover	\$3.60	100†
217F44	LFIC Spring cover	\$3.60	100†
696F51	Control sleeve	\$35.00	10†
628F932	Control sleeve - Used with 8020, 8027	\$37.00	10

†Sold only in multiples of the number indicated. Price is each.

**STANDARD DIAMETER CYLINDER COLLARS**

PART NO.	DESCRIPTION	LIST PRICE	SOLD IN MULT. OF
<b>STAMPED COLLARS</b>			
253F97	<b>Spring collar</b> 605, 606, 612, 613, 618, 619, 622, 625, 626	\$9.70	10†
428F66	<b>2-Piece (was 574 1/2, H)</b> 605, 606, 612, 613, 618, 619, 622, 625, 626	\$15.00	5† 1
549F52	<b>.219" Straight (was 154 1/2, H1)</b> 605, 606, 612, 613, 618, 619, 622, 625, 626	\$9.70	10†
605F43	<b>.350 Tapered spring collar</b> 605, 606, 612, 613, 618, 619, 622, 625, 626	\$9.70	
<b>SPACER FOR FLEXIBLE HEAD CYLINDER</b>			
370F29	.125" (1/8")	\$49.00	1
370F31	.250" (1/4")	\$49.00	1
252F82	.312" (5/16")	\$49.00	1
<b>SOLID, RECESSED FOR CYLINDER HEAD</b>			
447F41	<b>.031" (was 575 1/4, 910)</b> 605, 606, 612, 613, 618, 619, 622, 625, 626	\$23.00	1
270F15	<b>.156"</b> 605, 606, 612, 613, 618, 619, 622, 625, 626	\$31.00	1
447F42	<b>.172" (was 575 3/8, 9106)</b> 605, 606, 612, 613, 618, 619, 622, 625, 626	\$23.00	1
610F01	<b>.221" (was 5574 3/4, C)</b> 605, 606, 612, 613, 618, 619, 622, 625, 626	\$38.00	1
610F02	<b>.289" (was 5574 1/4, L)</b> 605, 606, 611, 612, 613, 618, 619, 625, 626	\$38.00	1
654F07	<b>.356" for ED4000/ED5000</b> 605, 606, 611, 612, 613, 622, 625, 626, 629, 630	\$31.00	1
447F43	<b>.375" (was 575 9/16, 9109)</b> 605, 606, 611, 612, 613, 618, 619, 625, 626	\$23.00	1
609F36	<b>.500"</b> 605, 606, 611, 612, 613, 618, 619, 625, 626	\$44.00	1

PART NO.	DESCRIPTION	LIST PRICE	SOLD IN MULT. OF
<b>SOLID, RECESSED FOR CYLINDER HEAD (Cont'd)</b>			
654F08	<b>.556" for ED4000/ED5000</b> 605, 606, 611, 612, 613, 622, 625, 626, 629, 630	\$31.00	1
609F37	<b>.650"</b> 605, 606, 611, 612, 613, 618, 619, 625, 626	\$44.00	1
609F38	<b>.850"</b> 605, 606, 611, 612, 613, 618, 619, 625, 626	\$44.00	1
134F05	<b>With lip, .510" ED7400, ED7800</b> 605, 606, 611, 612, 613, 618, 619, 622, 625, 626	\$44.00	1
267F97	<b>With lip, .635"</b> 605, 606, 611, 612, 613, 618, 619, 622, 625, 626	\$45.00	1
<b>OTHER CYLINDER COLLARS</b>			
416F39	<b>Security .172" (was 95)</b> 605, 606, 611, 612, 613, 618, 619, 625, 626	\$31.00	1
303F25	<b>Solid .312" (was 571/J)</b> 605, 606, 611, 612, 613, 618, 619, 625, 626	\$42.00	1
<b>RIM CYLINDER COLLARS</b>			
<b>Flush Mount (was 151/ R1290)</b>			
255F53	605, 606, 611, 612, 613, 618, 619, 622, 625, 626	\$23.00	10†
			10†
			1
<b>Surface Mount</b>			
422F88	605, 606, 611, 612, 613, 618, 619, 622, 626, 625	\$23.00	5† 1

†Sold only in multiples of the number indicated. Price is each.

**MASTER RING CYLINDER COLLARS**

PART NO.	DESCRIPTION	LIST PRICE	SOLD IN MULT. OF
<b>SOLID, RECESSED FOR CYLINDER HEAD</b>			
447F44	<b>.031" (was 576 1/4, MR910)</b>		1
	605, 606, 611, 612, 613, 618, 619, 625, 626	\$31.00	
447F45	<b>.172" (was 576 3/8, MR9106)</b>		1
	605, 606, 611, 612, 613, 618, 619, 625, 626	\$36.00	
447F46	<b>.375" (was 576 9/16, MR9109)</b>		1
	605, 606, 611, 612, 613, 618, 619, 625, 626	\$41.00	
<b>SPACERS FOR FLEXIBLE HEAD CYLINDERS</b>			
366F70	.090" tapered	\$15.00	5
370F33	.094"		
370F35	.281"	\$15.00	1
<b>RIM CYLINDER COLLARS</b>			
255F54	<b>(was 151 3/4, T)</b>		1
	605, 606, 612, 613, 619, 625, 626	\$23.00	

PART NO.	DESCRIPTION	LIST PRICE
<b>CYLINDER SERVICE TOOLS</b>		
See main price book		
<b>LOCKSET INSTALLATION TOOLS</b>		
574F158	CK4400 Series Knob Removal Tool	\$3.60
506F57	CK4400 Series Knob Cover Removal Tool	\$9.70
391F658	Knob Release Tool, CK4200, ML2200 †Order 100-	\$3.60

PART NO.	DESCRIPTION	LIST PRICE	PART NO.	DESCRIPTION	LIST PRICE
<b>ARMORED FRONT</b>			<b>AUXILIARY LATCH</b>		
Finish: 605, 606, 611, 612, 613, 619, 625, 626, 629**, 630**, BSP, WSP			403F677	Auxiliary latch	\$21.00
<b>Deadbolt</b>			<b>AUXILIARY LATCH LEVER</b>		
079F00	Armored front, 1-1/4" standard	\$45.00	678F548	Auxiliary latch lever	\$7.40
079F02	Armored front, 1-1/16"		<b>Auxiliary Latch Lever Spring</b>		
<b>Deadbolt, latchbolt, aux. latch, toggle</b>			678F677	Auxiliary latch lever spring. †Order 100-	\$3.60
402F29	Armored front, 1-1/4" standard	\$45.00	<b>CAP</b>		
402F33	Armored front, 1-1/16"		700F278	Cap	\$31.00
<b>Deadbolt, latchbolt, auxiliary latch</b>			<b>CYLINDER LATCH LEVER SA</b>		
402F30	Armored front, 1-1/4" standard	\$45.00	701F748	Cylinder latch lever	\$3.60
402F34	Armored front, 1-1/16"		753F098	Cylinder latch lever (functions 72, 73, 75 )	
<b>Deadbolt, latchbolt, toggle</b>			<b>CYLINDER LATCH LEVER STOP</b>		
402F31	Armored front, 1-1/4" standard	\$45.00	705F949	Cylinder latch lever stop	\$3.60
402F35	Armored front, 1-1/16"		<b>CYLINDER SET SCREW BRACKET</b>		
<b>Latchbolt, auxiliary latch, toggle</b>			402F738	Cylinder set screw bracket	\$7.40
681F31	Armored front, 1-1/4" standard	\$45.00	<b>DEADBOLT</b>		
681F30	Armored front, 1-1/16"		702F987	Deadbolt	\$53.00
681F41	LHB, 1-1/4"		753F697	Deadbolt ML2072	
681F40	LHB, 1-1/16"		<b>DEADBOLT SPRING</b>		
<b>Blank Front</b>			701F228	Deadbolt spring †Order 50-	\$3.60
720F43	Armored front, 1-1/4"	\$45.00	<b>DEADLOCKING LEVER</b>		
720F46	Armored front, 1-1/16"		602F198	Toggle Functions	\$6.00
<b>Filler Plate</b>			624F488	Non-Toggle Functions	
334F998	USP Filler, 8" x 1-1/4"	\$45.00	<b>DEADLOCKING LEVER SPRING</b>		
<b>Deadbolt, latchbolt</b>			700F907	Deadlocking lever spring	\$3.60
423F54	Armored front, 1-1/4" standard	\$45.00	<b>FIXED STOP</b>		
423F57	Armored front, 1-1/16"		684F559	Fixed stop	\$6.00
<b>Latchbolt only</b>			<b>HUB ALIGNMENT BRACKET</b>		
423F55	Armored front, 1-1/4" standard	\$45.00	404F868	Hub alignment bracket	\$8.60
423F58	Armored front, 1-1/16"		<b>HUB ALIGNMENT BRACKET SCREW</b>		
<b>Latchbolt, auxiliary latch</b>			269F088	FHUM-PH #8-32 X 3/8" Screw †Order 20-	\$3.60
624F49	Armored front, 1-1/4" standard	\$45.00	<b>HUB LEVER</b>		
624F53	Armored front, 1-1/16"		820F008	Non Panic Egress	\$7.40
			820F148	Panic Egress	

†Sold only in multiples of the number indicated. Price is each.  
 \*\*618, 619 finish provided to match 629, 630.

PART NO.	DESCRIPTION	LIST PRICE
<b>HUB LEVER SPRING</b>		
820F048	Hub lever spring †Order 10-	\$3.60
<b>HUB SPACER</b>		
684F119	Hub spacer	\$3.60
<b>KNOB HUB</b>		
820F088	Cap Side	\$26.00
820F168	Case Side	
<b>LATCHBOLT</b>		
688F177	Latchbolt	\$59.00
<b>LATCH LEVER SPRING</b>		
700F957	Latch lever spring	\$3.60
<b>LEVER HUB</b>		
820F068	Cap side	\$18.00
820F078	Case side	
<b>LEVER RETURN SPRING</b>		
404F858	Lever return spring †Order 20-	\$3.60
<b>LOCKING LEVER</b>		
852F307	ML2017 Locking Lever	\$30.00
852F318	ML2017 Spring	
<b>OCCUPANCY INDICATOR, ML2029</b>		
<b>605, 606, 611, 612, 613, 618, 619, 625, 626</b>		
416F84	1-3/4" door, sectional	\$105.00
429F08	1-3/8" door, sectional	\$105.00
484F74	2-1/4" door, sectional	\$105.00
416F49	Escutcheon trim - 1-3/4" door	\$80.00
<b>RETAINING RING</b>		
436F177	Retaining ring †Order 100-	\$3.60
<b>SCREW PACKETS</b>		
<b>Finish: 606, 612, 613, 619</b>		
429F41	Mounting screw pack, standard	\$6.00
488F09	Mounting screw pack, MR option	\$9.70
465F57	Mounting screw pack, M04 (VR)	\$31.00
616F12	Mounting screw pack, MR x M04	
<b>SPACER</b>		
466F229	Spacer	\$3.60
624F439	Spacer	
624F449	Spacer	
<b>SPACER SPRING</b>		
684F129	Spacer spring	\$2.50
<b>SPRINGS</b>		
403F568	Spring	\$11.00
688F017	Spring, kickoff	\$3.60
624F427	Spring	\$4.90

†Sold only in multiples of the number indicated. Price is each.

\*\*618, 619 finish provided to match 629, 630

PART NO.	DESCRIPTION	LIST PRICE
<b>STOP</b>		
684F055	Stop	\$6.00
<b>STOP LEVERS</b>		
700F708	Stop lever	\$3.60
624F478	Stop lever	\$7.40
681F448	Stop lever	\$3.60
682F018	Stop lever	\$7.40
700F748	Stop lever	\$3.60
753F078	Stop lever	
<b>STOP SCREW</b>		
684F067	Stop screw	\$3.60
<b>STOP SPRING</b>		
685F387	Stop spring	\$3.60
703F997	Stop spring	\$3.60
790F047	Aux Stop Spring	
<b>THUMBTURN LEVER HUB</b>		
624F455	Thumbturn lever hub	\$11.00
<b>TURNPIECE HUB – STANDARD</b>		
813F505	Turnpiece Hub, Standard	\$4.90
<b>TURNPIECE HUB – LARGE</b>		
701F705	Turnpiece Hub, Large	\$9.70
853F865	Turnpiece hub, large (ML2087 RH/RHR)	
853F875	Turnpiece hub, large (ML2087 LH/LHR)	
<b>STRIKES</b>		
<b>605, 606, 611, 612, 613, 619, 625, 626, 629**, 630**</b>		
<b>Latchbolt &amp; Deadbolt - Straight Lip</b>		
236L72M014FIN	7/8" Lip Length	\$44.00
236L72M016FIN	1" Lip Length	
236L72M018FIN	1-1/8" Lip Length	
236L72M020FIN	1-1/4" Lip Length	
236L72M022FIN	1-3/8" Lip Length	
236L72M024FIN	1-1/2" Lip Length	
236L72M028FIN	1-3/4" Lip Length	
236L72M032FIN	2" Lip Length	
236L72M036FIN	2-1/4" Lip Length	
236L72M040FIN	2-1/2" Lip Length	
236L72M044FIN	2-3/4" Lip Length	
236L72M048FIN	3" Lip Length	

PART NO.	DESCRIPTION	LIST PRICE
<b>STRIKES (Cont'd)</b>		
<b>605, 606, 611, 612, 619, 613, 625, 626, 629**, 630**</b>		
<b>Latchbolt &amp; Deadbolt - Curved Lip (RH)</b>		
340L60M018FIN	1-1/8" Lip Length RH	\$44.00
340L60M020FIN	1-1/4" Lip Length RH	
340L60M022FIN	1-3/8" Lip Length RH	
340L60M024FIN	1-1/2" Lip Length RH	
340L60M028FIN	1-3/4" Lip Length RH	
340L60M032FIN	2" Lip Length RH	
340L60M036FIN	2-1/4" Lip Length RH	
340L60M040FIN	2-1/2" Lip Length RH	
340L60M044FIN	2-3/4" Lip Length RH	
340L60M048FIN	3" Lip Length RH	
<b>Latchbolt &amp; Deadbolt - Curved Lip (LH)</b>		
340L61M018FIN	1-1/8" Lip Length LH	\$44.00
340L617020FIN	1-1/4" Lip Length LH	
340L61M022FIN	1-3/8" Lip Length LH	
340L61M024FIN	1-1/2" Lip Length LH	
340L61M028FIN	1-3/4" Lip Length LH	
340L61M032FIN	2" Lip Length LH	
340L61M036FIN	2-1/4" Lip Length LH	
340L61M040FIN	2-1/2" Lip Length LH	
340L61M044FIN	2-3/4" Lip Length LH	
340L61M048FIN	3" Lip Length LH	

PART NO.	DESCRIPTION	LIST PRICE
<b>STRIKE - OPEN BACK</b>		
<b>605, 606, 611, 612, 613, 619, 625, 626, 629**, 630**</b>		
411L63M016FIN	1-3/4" (016) Door RHR	\$139.00
411L63M018FIN	2" (018) Door LHR	
411L63M020FIN	2-1/4" (020) Door RHR	
411L62M016FIN	1-3/4" (016) Door LHR	\$208.00
411L62M018FIN	2" (018) Door RHR	
411L62M020FIN	2-1/4" (020) Door LHR	
<b>STRIKE - RABBETED FRONT</b>		
<b>605, 606, 611, 612, 613, 619, 625, 626, 629, 630</b>		
318F66	All Functions and Handing	\$239.00

†Sold only in multiples of the number indicated. Price is each.

\*\*618, 619 finish provided to match 629, 630, except on 1-1/4" length curved lip strike

PART NO.	DESCRIPTION	LIST PRICE
<b>TRIM ALIGNMENT (ADAPTER) PACKETS</b>		
Finish: 605, 606, 611, 612, 613, 619, 625, 626, 629**, 630**		
<b>"P" Escutcheon</b>		
<b>Knob or Lever Trim</b>		
466F73	1-3/8" door	\$72.00
466F74	1-3/4" door	
466F75	2-1/4" door	\$81.00
<b>Half Working Trim</b>		
439F25	1-3/8" door	\$45.00
439F26	1-3/4" door	
439F27	2-1/4" door	
<b>Lever/Knob (GZ/YZ) Half Dummy Trim</b>		
488F31	"P" Escutcheon	\$91.00
<b>Lever/Knob (GZ/YZ) Full Dummy Trim</b>		
854F19	"P" Escutcheon	\$91.00
<b>Knob Half Dummy Trim</b>		
437F28	"P" Escutcheon*	\$91.00
<b>Wrought Knob Half Dummy Trim</b>		
511F52	"P" Escutcheon*	\$81.00
<b>"M" and "N" Escutcheons</b>		
<b>Regularly Furnished with Working Trim</b>		
466F50	1-3/8" door	\$69.00
466F51	1-3/4" door	\$69.00
466F52	2-1/4" door	\$69.00
<b>Half Working Trim</b>		
428F32	1-3/8" door	\$44.00
428F33	1-3/4" door	
428F34	2-1/4" door	
<b>Half Dummy Trim</b>		
437F26	Knob*	\$78.00
438F37	Cast Knob*	\$86.00
854F27	Lever/Knob (GZ/YZ)	\$78.00
<b>Full Dummy Trim</b>		
854F15	Lever/Knob (GZ/YZ)	\$78.00

†Sold only in multiples of the number indicated. Price is each.

\*\*618, 619 finish provided to match 629, 630.

\*Discontinued product, only available as inventory allows.

PART NO.	DESCRIPTION	LIST PRICE
<b>TRIM ALIGNMENT (ADAPTER) PACKETS (Cont'd)</b>		
<b>Knob or Lever Trim Outside &amp; Blank Escutcheon Inside</b>		
466F45	1-3/8" door	\$53.00
466F46	1-3/4" door	
466F47	2-1/4" door	\$53.00
<b>Sectional Trim</b>		
<b>Regularly Furnished with Working Trim</b>		<b>No Finish</b>
466F40	1-3/8" door	\$35.00
466F41	1-3/4" door	\$35.00
466F42	2-1/4" door	\$35.00
<b>Half Working Trim</b>		
437F40	1-3/8" door	\$35.00
437F41	1-3/4" door	
437F42	2-1/4" door	
<b>Half Dummy Trim</b>		
438F38	Cast Knob*	\$89.00
854F23	Lever/Knob (GZ/YZ)	\$55.00
511F51	Wrought Knob*	\$69.00
<b>Full Dummy Trim</b>		
854F11	Lever/Knob (GZ/YZ)	\$19.00
<b>Inside Adapter Only - Lockbody</b>		
427F06	Knob Half Working Trim*	\$35.00
488F27	Lever/Knob (GZ/YZ) Half Working Trim	\$63.00
<b>Adjustable Locknut Assembly*</b>		<b>No Finish</b>
482F37	Adjustable Locknut Assembly	\$12.00
<b>Adjusting Bolt for Half Lever Trim</b>		<b>No Finish</b>
483F34	1-3/8" door	\$12.00
483F35	1-3/4" door	\$12.00
483F36	2-1/4" door	\$12.00
<b>Cylinder Set Screw Packet</b>		<b>No Finish</b>
488F088	Standard †Order 20	\$3.60
488F108	Master Ring	\$3.60
<b>Dowel Screw</b>		<b>No Finish</b>
483F30	for Inside Lever/Knob (GZ/YZ)	\$4.90
<b>Emergency Key</b>		<b>Finish: 619</b>
605F42	for ML2020, ML2030, ML2060	\$7.40
<b>E-Ring</b>		<b>No Finish</b>
427F078	for working half trim adapter. †Order 100-	\$3.60



PART NO.	DESCRIPTION	605, 606, 611, 612, 613, 613E, 618, 619, 625, 626, 629, 630, 722
<b>"R" ESCUTCHEON - CAST</b>		
<b>Blank</b>		
426F52	Outside	
545F79	Inside	
<b>For Cylinder only</b>		
427F45	Outside	
545F88	Inside	
<b>For Grip only</b>		
427F43	Outside	
545F87	Inside	
<b>For Cylinder &amp; Grip</b>		
427F39	Outside	
545F80	Inside	
<b>For Thumbturn Lever only</b>		
545F84	Inside-1-3/8" door	\$282.00
545F86	Inside-2-1/4" door	
545F85	Inside-1-3/4" door	
<b>For Thumbturn Lever &amp; Grip</b>		
545F81	Inside-1-3/8" door	
545F83	Inside-2-1/4" door	
545F82	Inside-1-3/4" door	
<b>For Grip &amp; Emergency Key</b>		
427F47	Outside	
<b>For Cylinder, Grip &amp; Indicator</b>		
427F37	Outside-1-3/4" door	
427F36	Outside-1-3/8" door	
485F74	Outside-2-1/4" door	
PART NO.	DESCRIPTION	605, 606, 611, 612, 613, 613E, 618, 619, 625, 626, 629, 630, 722
<b>"N" ESCUTCHEON - WROUGHT</b>		
<b>Blank</b>		
544F93	Inside or Outside	
<b>For Cylinder only</b>		
544F80	Inside or Outside	
<b>For Grip only</b>		
544F76	Inside or Outside	
<b>For Cylinder &amp; Grip</b>		
544F77	Inside or Outside	
<b>For Thumbturn Lever only</b>		
544F89	Inside-1-3/4" door	
544F92	Inside-1-3/8" door	
544F91	Inside-2-1/4" door	\$156.00
<b>For Thumbturn Lever &amp; Grip</b>		
544F85	Inside-1-3/4" door	
544F87	Inside-2-1/4" door	
544F88	Inside-1-3/8" door	
<b>For Grip &amp; Emergency Key</b>		
544F79	Outside	
<b>For Cylinder, Grip &amp; Indicator</b>		
544F82	Outside-1-3/8" door	
544F83	Outside-1-3/4" door	
544F84	Outside-2-1/4" door	

PART NO.	DESCRIPTION	605, 606, 611, 612, 613, 613E, 618, 619, 625, 626, 629, 630, 722
<b>"M" ESCUTCHEON - WROUGHT</b>		
<b>Blank</b>		
383F82	Outside	
545F45	Inside	
<b>For Cylinder only</b>		
488F07	Outside	
751F16	Outside - Master Ring	
545F00	Inside	
751F17	Inside - Master Ring	
<b>For Grip only</b>		
488F04	Outside	
544F95	Inside	
<b>For Cylinder &amp; Grip</b>		
488F05	Outside - Conventional	
557F29	Outside - Master Ring	
544F96	Inside - Conventional	\$156.00
377F80	Inside - Master Ring	
<b>For Thumbturn Lever only</b>		
545F42	Inside-1-3/8" door	
545F43	Inside-1-3/4" door	
545F44	Inside-2-1/4" door	
<b>For Thumbturn Lever &amp; Grip</b>		
544F97	Inside-1-3/8" door	
544F98	Inside-1-3/4" door	
544F99	Inside-2-1/4" door	
<b>For Grip &amp; Emergency Key</b>		
544F94	Outside	
<b>For Cylinder, Grip &amp; Indicator</b>		
433F48	Outside-1-3/8" door	
433F49	Outside-1-3/4" door	
484F90	Outside-2-1/4" door	
<b>"P" ESCUTCHEON - WROUGHT</b>		
<b>Blank</b>		
544F46	Inside	
384F11	Outside	
<b>For Cylinder only</b>		
488F03	Outside	\$156.00
544F43	Inside	

PART NO.	DESCRIPTION	605, 606, 611, 612, 613, 613E, 618, 619, 626, 625, 629, 630, 722
<b>"P" ESCUTCHEON - WROUGHT</b>		
<b>For Grip only</b>		
488F00	Outside	
544F39	Inside	
<b>For Cylinder &amp; Grip</b>		
488F01	Outside	
544F40	Inside	
<b>For Thumbturn Lever only</b>		
544F14	Inside-1-3/8" door	
544F44	Inside-2-1/4" door	
544F45	Inside-1-3/4" door	
<b>For Thumbturn Lever &amp; Grp</b>		
544F13	Inside-1-3/8" door	
544F41	Inside-2-1/4" door	
544F42	Inside-1-3/4" door	
<b>For Grp &amp; Emergency Key</b>		
544F38	Outside	
<b>For Cylinder, Grip &amp; Indicator</b>		
430F47	Outside-1-3/8" door	
435F00	Outside-1-3/4" door	
484F76	Outside-2-1/4" door	
<b>\$156.00</b>		

PART NO.	DESCRIPTION	613E, 630
<b>"V" ESCUTCHEON - CAST</b>		
<b>Blank</b>		
700F80	Outside	
700F40	Inside	
<b>For Cylinder only</b>		
700F83	Outside	
700F43	Inside	
<b>For Grip only</b>		
700F81	Outside	
700F41	Inside	
<b>For Cylinder &amp; Grip</b>		
700F82	Outside	
700F87	Outside - 7P & C6 (Use when collar is required)	
700F42	Inside	
700F47	Inside - 7P & C6 (Use when collar is required)	
<b>For Thumbturn Lever only</b>		
700F45	Inside	
<b>For Thumbturn Lever &amp; Grip</b>		
700F44	Inside	
<b>For Grp &amp; Emergency Key</b>		
700F84	Outside	
<b>For Cylinder, Grip &amp; Indicator</b>		
700F86	Outside	
700F46	Inside	
<b>\$318.00</b>		

PART NO.	DESCRIPTION	LIST PRICE
<b>Hex Wrench</b>		
<b>No Finish</b>		
264F698	Hex Wrench	<b>\$3.60</b>
<b>Key Plate Packet</b>		
438F90	Key Plate Packet: 605, 606, 611, 612, 613, 619, 625, 626, 629**, 630**	<b>\$32.00</b>

\*\*618, 619 finish provided to match 629, 630.

PART NO.	DESCRIPTION	605, 606, 611, 612, 613, 613E, 625, 626	PART NO.	DESCRIPTION	605, 606, 611, 612, 613, 613E, 625, 626
<b>"GZ" KNOB - CAST*</b>			<b>"YZ" KNOB - CAST*</b>		
<b>Inside Knob</b>			<b>Inside Knob</b>		
854F04		\$229.00	854F09		\$229.00
<b>Outside Knob &amp; Spindle Assembly</b>			<b>Outside Knob &amp; Spindle Assembly</b>		
854F01	for 1-3/4" door	\$229.00	854F06	for 1-3/4" door	\$229.00
854F00	for 1-3/8" door		854F05	for 1-3/8" door	
854F03	for 2-1/4" door		854F08	for 2-1/4" door	

<b>MISCELLANEOUS PARTS</b>		
PART NO.	DESCRIPTION	LIST PRICE
<b>Knob Release Tool</b>		
<b>No Finish</b>		
391F658	Knob Release Tool	\$3.60
<b>Knob Shank Adapter</b>		
<b>No Finish</b>		
483F118	Knob Shank Adapter	\$9.70
<b>Spring Clip</b>		
377F308	Spring Clip	\$3.60

<b>MORTISE INDICATOR PARTS</b>		
PART NO.	DESCRIPTION	LIST PRICE
855F649	Indicator Mechanism Retaining Pad (sectional)	\$5.00
856F049	Indicator Window	
855F619	Indicator Spindle Cam - Thumbturn	\$14.00
855F707	Indicator Spindle Cam - Cylinder / No Input-Blank (1-3/4" door thickness)	
855F697	Indicator Spindle Cam - Cylinder / No Input-Blank (1-3/8" door thickness)	
855F717	Indicator Spindle Cam - Cylinder / No Input-Blank (2-1/4" door thickness)	\$14.00
855F727	Indicator Spindle Cam - Cylinder / No Input-Blank - (door thickness greater than 2-1/4", must specify)	
855F747 x Finish	Indicator Spindle Cam - Coin Turn (1-3/4" door thickness)	\$17.00
855F737 x Finish	Indicator Spindle Cam - Coin Turn (1-3/8" door thickness)	
855F757 x Finish	Indicator Spindle Cam - Coin Turn (2-1/4" door thickness)	
855F767 x Finish	Indicator Spindle Cam - Coin Turn (door thickness greater than 2-1/4", must specify)	
858F241	Indicator Display Assembly - Unlocked/Locked, Green/Red	\$68.00
858F251	Indicator Display Assembly - Vacant/Occupied, Green/Red	
858F261	Indicator Display Assembly - Unlocked Icon/Locked Icon, Green/Red	
858F271	Indicator Display Assembly - Unlocked/Locked, White/Red	
858F281	Indicator Display Assembly - Vacant/Occupied, White/Red	
858F291	Indicator Display Assembly - Unlocked Icon/Locked Icon, White/Red	\$15.00
855F638	Escutcheon Indicator Backing Plate	
855F658	Sectional Indicator Surface Mount Backing Plate	\$13.00
858F517 x Finish	Escutcheon Indicator Screw Pack - Phillips, 1-3/4" Door	\$10.00
858F50M x Finish	Escutcheon Indicator Screw Pack - Phillips, 1-3/8" Door	
858F52M x Finish	Escutcheon Indicator Screw Pack - Phillips, 2" Door	
858F53M x Finish	Escutcheon Indicator Screw Pack - Phillips, 2-1/4" Door	
858F55M x Finish	Escutcheon Indicator Screw Pack - Phillips, 2-1/2" Door	
858F497 x Finish	Sectional Indicator Screw Pack - Phillips & Torx	
858F549	Sectional Indicator Template Kit	\$15.00
855F592 x Finish	Cylinder Plate Only - ML190 (Cylinder not included)	\$100.00
855F582 x Finish	CoinTurn Plate Only - ML193 (Assembly that includes cointurn)	\$97.00
859F052 x Finish	Thumbturn Plate Only - ML194 (Assembly that includes standard thumbturn)	\$100.00
859F062 x Finish	Sectional Thumbturn Plate Only (Assembly that includes ADA thumbturn)	\$119.00
859F072 x Finish	Sectional Thumbturn Plate Only (Assembly that includes T1 thumbturn)	\$100.00
859F082 x Finish	Sectional Thumbturn Plate Only (Assembly that includes T2 thumbturn)	
859F092 x Finish	Sectional Thumbturn Plate Only (Assembly that includes T3 thumbturn)	
855F602 x Finish	Sectional Blank/No Input Plate Only	

PART NO.	DESCRIPTION	605, 606, 611, 612, 613, 613E, 618, 619, 625, 626, 629, 630, 722
<b>"AS" LEVER - CAST</b>		
<b>Inside Lever</b>		
670F37		
<b>Outside Lever &amp; Spindle Assembly</b>		
670F64	for 1-3/8" door	\$247.00
670F73	for 1-3/4" door	
671F09	for 2-1/4" door	
<b>"CS" LEVER - CAST</b>		
<b>Inside Lever</b>		
670F30		
<b>Outside Lever &amp; Spindle Assembly</b>		
670F57	for 1-3/8" door	\$247.00
670F66	for 1-3/4" door	
671F02	for 2-1/4" door	
<b>"DS" LEVER - CAST</b>		
<b>Inside Lever</b>		
670F32	LH/LHR	
670F31	RH/RHR	
<b>Outside Lever &amp; Spindle Assembly</b>		
670F59	for 1-3/8" door	RH/RHR
670F68	for 1-3/4" door	RH/RHR
671F04	for 2-1/4" door	RH/RHR
670F58	for 1-3/8" door	LH/LHR
670F67	for 1-3/4" door	LH/LHR
671F03	for 2-1/4" door	LH/LHR
<b>"ES" LEVER - CAST</b>		
<b>Inside Lever</b>		
670F33		
<b>Outside Lever &amp; Spindle Assembly</b>		
670F60	for 1-3/8" door	\$247.00
670F69	for 1-3/4" door	
671F05	for 2-1/4" door	
<b>"LS" LEVER - CAST</b>		
<b>Inside Lever</b>		
670F34		
<b>Outside Lever &amp; Spindle Assembly</b>		
670F61	for 1-3/8" door	\$247.00
670F70	for 1-3/4" door	
671F06	for 2-1/4" door	
<b>"NS" LEVER - CAST</b>		
<b>Inside Lever</b>		
670F36		
<b>Outside Lever &amp; Spindle Assembly</b>		
670F63	for 1-3/8" door	\$247.00
670F72	for 1-3/4" door	
671F08	for 2-1/4" door	
<b>"PS" LEVER - CAST</b>		
<b>Inside Lever</b>		
670F38		
<b>Outside Lever &amp; Spindle Assembly</b>		
670F65	for 1-3/8" door	\$247.00
670F74	for 1-3/4" door	
671F10	for 2-1/4" door	
<b>"RS" LEVER - CAST</b>		
<b>Inside Lever</b>		
670F35		
<b>Outside Lever &amp; Spindle Assembly</b>		
670F62	for 1-3/8" door	\$247.00
670F71	for 1-3/4" door	
671F07	for 2-1/4" door	

PART NO.	DESCRIPTION	605, 606, 611, 612, 613, 613E, 618, 619, 625, 626, 629, 630, 722
<b>"LW" LEVER - WROUGHT</b>		
<b>Inside Lever</b>		
493F31		\$208.00
<b>Outside Lever &amp; Spindle Assembly</b>		
483F79	for 1-3/8" door	\$208.00
483F80	for 1-3/4" door	
483F81	for 2-1/4" door	
<b>"RW" LEVER - WROUGHT</b>		
<b>Inside Lever</b>		
493F34		\$208.00
<b>Outside Lever &amp; Spindle Assembly</b>		
483F82	for 1-3/8" door	\$208.00
483F83	for 1-3/4" door	
483F84	for 2-1/4" door	

PART NO.	DESCRIPTION	LIST PRICE
<b>NYLON BUSHING NO FINISH</b>		
698F22	Nylon Bushing †Order 100-	\$3.60
<b>ROSE PACKET</b>		
<b>Wrought Rose Packet- (Qty 2) 2-7/8" dia. (C)*</b>		
445F82	605, 606, 611, 612, 613, 613E, 618, 619, 625, 626, 722	\$90.00
<b>Wrought Rose Packet- (Qty 2) 3-1/2" dia. (D)*</b>		
445F83	605, 606, 611, 612, 613, 613E, 618, 619, 625, 626, 722	\$90.00
<b>Wrought Rose Packet- (Qty 2) 3" square (E)*</b>		
445F84	605, 606, 611, 612, 613, 613E, 618, 619, 625, 626, 722	\$90.00
<b>Cast Rose Packet - (Qty 2) 2-7/8" dia. (F)</b>		
447F24	605, 606, 611, 612, 613E, 618, 619, 625, 626, 629, 630, 722	\$221.00
<b>Cast Rose Packet- (Qty 2) 2-1/4" dia. (B)</b>		
447F25	605, 606, 611, 612, 613E, 618, 619, 625, 626, 629, 630, 722	\$114.00
<b>Wrought Rose Packet- (Qty 2) 2-1/4" dia. (A)</b>		
487F08	605, 606, 611, 612, 613E, 618, 619, 625, 626, 629, 630, 722	\$90.00
<b>Wrought Rose Packet- (Qty 2) 2-7/8" dia. (H)</b>		
853F05	605, 606, 611, 612, 613E, 618, 619, 625, 626, 629, 630, 722	\$90.00

PART NO.	DESCRIPTION	LIST PRICE
<b>ROSE REINFORCEMENT PACKET NO FINISH</b>		
445F869	Rose Reinforcement Packet*	\$8.60
<b>SCREW PACKET</b>		
<b>605, 606, 611, 612, 613, 619, 625, 626, 629, 630</b>		
569F45	For M & P half dummy trim*	\$9.70
429F317	Screw Packet for "N" Surface Mounted Escutcheon	\$12.00
616F088	Lock mounting, spanner	\$12.00
584F46	Escutcheon for 1-3/4" door, spanner	\$7.40
384F03	Escutcheon for 2" - 2-1/4" door, spanner	
616F078	T20 Torx® bit	\$18.00
269F098	Screw 1-32 x 1/4" OHMS-PH †Order 100-	\$3.60
<b>SPACER NO FINISH</b>		
497F528	Spacer for Cast Knob*	\$4.90
<b>SPINDLES NO FINISH</b>		
<b>LxL, KxK, LxK, KxL Spindle</b>		
499F828	1-3/8" door	\$45.00
499F838	1-3/4" door	
499F848	2-1/4" door	\$45.00

†Sold only in multiples of the number indicated. Price is each.

\*Discontinued product, only available as inventory allows.

PART NO.	DESCRIPTION	LIST PRICE	PART NO.	DESCRIPTION	LIST PRICE
<b>INSIDE SPINDLE FOR HALF LEVER TRIM*</b>			<b>ERGONOMIC THUMBTURN KIT FOR ESCUTCHEON TRIM</b>		
	<b>(Knob x Knob) Spindle*</b>			<b>605, 606, 611, 612, 613, 619, 625, 626, 629, 630</b>	
680F348	1-3/8" door	\$23.00	711F002	for up to 4" door (must be field cut to size)	\$87.00
680F358	1-3/4" door	\$7.40	<b>WASHER FOR VANDAL RESISTANT TRIM</b>		
680F368	2-1/4" door	\$16.00	700F378	Washer	\$4.90
<b>VANDAL RESISTANT SPINDLE &amp; SCREW PACK</b>			<b>RETAINING RING FOR VANDAL RESISTANT TRIM</b>		
700F65	1-3/4" door	\$21.00	700F168	Retaining ring	\$3.60
700F66	2" door		<b>LEVER SPINDLE SPRING FOR VANDAL RESISTANT TRIM</b>		
700F67	2 -1/4" door		700F367	Lever spindle spring	\$3.60
<b>THIMBLE PACKET</b>			<b>PART NO. X FINISH</b>		
432F86	<b>(Qty 2) for wrought escutcheon knob trim designs*</b>		<b>DESCRIPTION</b>		605, 606, 611, 612, 613, 613E, 618, 619, 625, 626, 629, 630, 722
	605, 606, 611, 612, 613, 619, 625, 626, 629, 630				
445F85	<b>(Qty 2) for sectional knob trim designs*</b>				
	605, 606, 611, 612, 613, 619, 625, 626				\$54.00
<b>THIMBLE WRENCH NO FINISH</b>			<b>M19 OPTION INDICATORS – KEYED FUNCTION (SECURE)</b>		
300F688	Thimble Wrench	\$5.50	720F21	for 1-3/8" (35mm) door	\$148.00
<b>THROUGHBOLT PACKET</b>			720F22	for 1-3/4" (44mm) – 2" (51mm) door	
	<b>605, 606, 611, 612, 613, 619, 625, 626, 629, 630</b>		720F24	for 2-1/4" (57mm) door	
	<b>"M" and "P" Escutcheons</b>		720F25	for over 2-1/4" (57mm) door	
433F76	1-3/8" door	\$9.70	<b>M19 OPTION INDICATORS – KEYED FUNCTION (VACANT)</b>		
433F77	1-3/4" door		741F21	for 1-3/8" door	\$148.00
433F78	2-1/4" door		741F22	for 1-3/4" to 2" doors	
	<b>"R" Escutcheon</b>		741F23	for 2-1/4" door	
439F33	1-3/8" door	\$9.70	741F24	for up to 3" door	
439F34	1-3/4" door		<b>M19 OPTION INDICATORS – NON-KEYED FUNCTION (SECURE)</b>		
439F35	2-1/4" door		721F16	for 1-3/8" (35mm) door	\$145.00
	<b>"T" Escutcheon (spanner head)*</b>		721F17	for 1-3/4" (44mm) – 2" (51mm) door	
445F318	1-3/4" door	\$20.00	721F18	for 2-1/4" (57mm) door	
498F928	2" to 2-1/4" door		721F19	for over 2-1/4" (57mm) door	
<b>THUMBTURN LEVER PACKET</b>			<b>M19 OPTION INDICATORS – NON-KEYED FUNCTION (VACANT)</b>		
	<b>605, 606, 611, 612, 613, 625, 626, 629, 630</b>		720F61	for 1-3/8" (35mm) door	\$145.00
519F09	for 1-3/8" door	\$59.00	720F62	for 1-3/4" (44mm) – 2" (51mm) door	
519F10	for 1-3/4" door		720F64	for 2-1/4" (57mm) door	
519F11	for 2-1/4" door		720F65	for over 2-1/4" (57mm) door	
519F12	for up to 3" door	\$77.00	<b>M19 OPTION THUMBTURN INDICATOR</b>		
581F96	for up to 3-1/2" door		723F69	for 1-3/8" (35mm) door	\$257.00
696F39	Blank Plate	\$77.00	723F26	for 1-3/4" (44mm) – 2" (51mm) door	
<b>ERGONOMIC THUMBTURN LEVER PACKET FOR SECTIONAL TRIM</b>			791F59	for 2-1/4" (57mm) door	
	<b>605, 606, 611, 612, 613, 619, 625, 626, 629, 630</b>		791F60	for over 2-1/4" (57mm) door	
707F57	for 1-3/8" door	\$87.00			
707F58	for 1-3/4" to 2" doors				
707F59	for 2-1/4" door				
707F60	for up to 3" door	\$87.00			
706F70	for up to 4" door				

\*Discontinued product, only available as inventory allows.

## VINEYARD™ COLLECTION TRIM

PART NO.	DESCRIPTION	605 , 606, 613E, 619, 625, 626
<b>INSIDE LEVERS</b>		
692F632	Frascati LH/LHR	\$324.00
692F642	Frascati RH/RHR	
692F662	Zinfandel LH/LHR	
692F672	Zinfandel RH/RHR	
692F652	Merlot	
<b>OUTSIDE LEVERS</b>		
692F762	Frascati for 1 3/4" door LH/LHR	\$324.00
692F752	Frascati for 1 3/4" door RH/RHR	
692F952	Zinfandel for 1 3/4" door LH/LHR	
692F942	Zinfandel for 1 3/4" door RH/RHR	
692F932	Merlot for 1 3/4" door	
<b>L ESCUTCHEON - CAST</b>		
<b>Blank</b>		
692F862	Inside	\$267.00
<b>For Cylinder Only</b>		
694F322	Inside	
694F522	Outside	
<b>For Grip Only</b>		
694F312	Inside	
694F442	Outside	
<b>For Cylinder &amp; Grip</b>		
694F332	Inside	
694F562	Outside	
<b>For Thumbturn Lever Only</b>		
694F352	Inside	
<b>For Thumbturn Lever &amp; Grip</b>		
694F392	Inside	
<b>For Grip &amp; Emergency Key</b>		
694F482	Outside	
<b>For Cylinder, Grip &amp; Indicator</b>		
694F602	Outside	
<b>For Grip x Plug Only</b>		
694F682	Outside	
<b>For Grip x Plug Only x Indicator</b>		
694F722	Outside	
<b>ROSES (PAIR)</b>		
694F802	G-Rose (All functions)	\$302.00



## LOCKSET PARTS

PART NO.	DESCRIPTION	LIST PRICE
<b>LEVERS-Finish: 605,606,611,612,613,613E,613L,618,619,625,626,722,BSP,WSP</b>		
790F215	NZ - Plain	\$105.00
790F225	NZ - Cylinder or Button	\$105.00
790F235	NZ - Emergency Key Hole	\$105.00
790F245	NZ - Intruder	\$105.00
790F335	NZ - Sargent® Cylinder Cutout	\$105.00
790F345	NZ - Sargent Cylinder Cutout - Intruder	\$105.00
790F395	NZ - Corbin Russwin LFIC - 6 Pin	\$105.00
790F405	NZ - Corbin Russwin LFIC - 6 Pin Intruder	\$105.00
790F415	NZ - Corbin Russwin LFIC - 7 Pin	\$105.00
790F425	NZ - Corbin Russwin LFIC - 7 Pin Intruder	\$105.00
790F515	NZ - SFIC Cutout	\$105.00
790F525	NZ - SFIC Cutout Intruder	\$105.00
790F575	NZ - Schlage® LFIC Cutout	\$105.00
790F585	NZ - Schlage® LFIC Cutout - Intruder	\$105.00
790F225	NZ - Yale® Cylinder Cutout 6/7 Pin	\$105.00
790F245	NZ - Yale® Cylinder Cutout 6/7 Pin - Intruder	\$105.00
774F925	NZ - Yale® LFIC Cutout 6 Pin	\$105.00
798F295	NZ - Yale® LFIC Cutout 6 Pin - Intruder	\$105.00
774F945	NZ - Yale® LFIC Cutout 7 Pin	\$105.00
798F305	NZ - Yale® LFIC Cutout 7 Pin - Intruder	\$105.00
780F215	NZ - Security - Plain	\$105.00
780F225	NZ - Security -Cylinder or Button	\$105.00
780F235	NZ - Security - Emergency Key Hole	\$105.00
780F245	NZ - Security - Intruder	\$105.00
780F335	NZ - Security - Sargent Cylinder Cutout	\$105.00
780F345	NZ - Security - Sargent Cylinder Cutout - Intruder	\$105.00
780F395	NZ - Security - Corbin Russwin LFIC - 6 Pin	\$105.00
780F405	NZ - Security - Corbin Russwin LFIC - 6 Pin Intruder	\$105.00
780F415	NZ - Security - Corbin Russwin LFIC - 7 Pin	\$105.00
780F425	NZ - Security - Corbin Russwin LFIC - 7 Pin Intruder	\$105.00
780F515	NZ - Security - SFIC Cutout	\$105.00
780F525	NZ - Security - SFIC Cutout Intruder	\$105.00
780F575	NZ - Security - Schlage® LFIC Cutout	\$105.00
780F585	NZ - Security - Schlage® LFIC Cutout - Intruder	\$105.00
776F215	AZ - Plain	\$105.00
776F225	AZ - Cylinder or Button	\$105.00
776F235	AZ - Emergency Key Hole	\$105.00
776F245	AZ - Intruder	\$105.00
776F335	AZ - Sargent® Cylinder Cutout	\$105.00
776F345	AZ - Sargent Cylinder Cutout - Intruder	\$105.00
776F395	AZ - Corbin Russwin LFIC - 6 Pin	\$105.00
776F405	AZ - Corbin Russwin LFIC - 6 Pin Intruder	\$105.00
776F415	AZ - Corbin Russwin LFIC - 7 Pin	\$105.00
776F425	AZ - Corbin Russwin LFIC - 7 Pin Intruder	\$105.00
776F515	AZ - SFIC Cutout	\$105.00
776F525	AZ - SFIC Cutout Intruder	\$105.00
776F575	AZ - Schlage® LFIC Cutout	\$105.00
776F585	AZ - Schlage® LFIC Cutout - Intruder	\$105.00
777F215	AZ Security - Plain	\$105.00
777F225	AZ Security -Cylinder or Button	\$105.00
777F235	AZ Security - Emergency Key Hole	\$105.00
777F245	AZ Security - Intruder	\$105.00
777F335	AZ Security - Sargent Cylinder Cutout	\$105.00
777F345	AZ Security - Sargent Cylinder Cutout - Intruder	\$105.00
777F395	AZ Security - Corbin Russwin LFIC - 6 Pin	\$105.00
777F405	AZ Security - Corbin Russwin LFIC - 6 Pin Intruder	\$105.00
777F415	AZ Security - Corbin Russwin LFIC - 7 Pin	\$105.00
777F425	AZ Security - Corbin Russwin LFIC - 7 Pin Intruder	\$105.00
777F515	AZ Security - SFIC Cutout	\$105.00
777F525	AZ Security - SFIC Cutout Intruder	\$105.00
777F575	AZ Security - Schlage® LFIC Cutout	\$105.00
777F585	AZ Security - Schlage® LFIC Cutout - Intruder	\$105.00

PART NO.	DESCRIPTION	LIST PRICE
<b>LEVERS-Finish:605,606,611,612,613,613E,613L,618,619,625,626,722,BSP,WSP</b>		
778F215	PZ - Plain	\$105.00
778F225	PZ - Cylinder or Button	\$105.00
778F235	PZ - Emergency Key Hole	\$105.00
778F245	PZ - Intruder	\$105.00
778F335	PZ - Sargent® Cylinder Cutout	\$105.00
778F345	PZ - Sargent Cylinder Cutout - Intruder	\$105.00
778F395	PZ - Corbin Russwin LFIC - 6 Pin	\$105.00
778F405	PZ - Corbin Russwin LFIC - 6 Pin Intruder	\$105.00
778F415	PZ - Corbin Russwin LFIC - 7 Pin	\$105.00
778F425	PZ - Corbin Russwin LFIC - 7 Pin Intruder	\$105.00
778F515	PZ - SFIC Cutout	\$105.00
778F525	PZ - SFIC Cutout Intruder	\$105.00
778F575	PZ - Schlage® LFIC Cutout	\$105.00
778F585	PZ - Schlage® LFIC Cutout - Intruder	\$105.00
778F225	PZ - Yale® Cylinder Cutout 6/7 Pin	\$105.00
778F245	PZ - Yale® Cylinder Cutout 6/7 Pin - Intruder	\$105.00
774F965	PZ - Yale® LFIC Cutout 6 Pin	\$105.00
798F395	PZ - Yale® LFIC Cutout 6 Pin - Intruder	\$105.00
774F985	PZ - Yale® LFIC Cutout 7 Pin	\$105.00
798F405	PZ - Yale® LFIC Cutout 7 Pin - Intruder	\$105.00
779F215	PZ Security - Plain	\$105.00
779F225	PZ Security -Cylinder or Button	\$105.00
779F235	PZ Security - Emergency Key Hole	\$105.00
779F245	PZ Security - Intruder	\$105.00
779F335	PZ Security - Sargent Cylinder Cutout	\$105.00
779F345	PZ Security - Sargent Cylinder Cutout - Intruder	\$105.00
779F395	PZ Security - Corbin Russwin LFIC - 6 Pin	\$105.00
779F405	PZ Security - Corbin Russwin LFIC - 6 Pin Intruder	\$105.00
779F415	PZ Security - Corbin Russwin LFIC - 7 Pin	\$105.00
779F425	PZ Security - Corbin Russwin LFIC - 7 Pin Intruder	\$105.00
779F515	PZ Security - SFIC Cutout	\$105.00
779F525	PZ Security - SFIC Cutout Intruder	\$105.00
779F575	PZ Security - Schlage® LFIC Cutout	\$105.00
779F585	PZ Security - Schlage® LFIC Cutout - Intruder	\$105.00

PART NO.	DESCRIPTION	LIST PRICE
<b>ROSES</b>		
<b>D ROSE</b>		
678F252 Fin	626/613E, BSP, WSP	\$59.00
	605,606,611,612,613,613L,618,619,625,722	
<b>C ROSE</b>		
779F97 Fin	626/613E, BSP, WSP	\$59.00
	605,606,611,612,613,613L,618,619,625,722	
<b>ROSETTE FOR C &amp; K ROSE</b>		
778F90 Fin	626/613E, BSP, WSP	\$59.00
	605,606,611,612,613,613L,618,619,625,722	
<b>E ROSE</b>		
779F98 Fin	626/613E, BSP, WSP	\$59.00
	605,606,611,612,613,613L,618,619,625,722	
<b>ROSETTE FOR E ROSE</b>		
778F97 Fin	626/613E, BSP, WSP	\$59.00
	605,606,611,612,613,613L,618,619,625,722	
<b>K ROSE</b>		
779F99 Fin	626/613E, BSP, WSP	\$59.00
	605,606,611,612,613,613L,618,619,625,722	

## LOCKSET PARTS

PART NO.	DESCRIPTION	LIST PRICE
<b>LATCH ASSEMBLIES</b>		
Standard		
780F81 Fin	10 Function	\$192.00
780F82 Fin	32, 40NT, 51, 52, 55, 57, 62, 72, and 80 Functions	
780F83 Fin	20 and 20H Functions	
780F84 Fin	29, 75, and 93 Functions	
780F85 Fin	61 Function	
3-3/4" Backset		
780F86 Fin	10 Function	\$192.00
780F87 Fin	32, 40NT, 51, 52, 55, 57, 62, 72, and 80 Functions	
780F88 Fin	20 and 20H Functions	
780F89 Fin	29, 75, and 93 Functions	
780F90 Fin	61 Function	
5" Backset		
780F91 Fin	10 Function	\$192.00
780F92 Fin	32, 40NT, 51, 52, 55, 57, 62, 72, and 80 Functions	
780F93 Fin	20 and 20H Functions	
780F94 Fin	29, 75, and 93 Functions	
780F95 Fin	61 Function	
3/4" Throw Fire Latch		
780F96 Fin	10, 51, 55, 57, 72, and 80 Functions	\$248.00

PART NO.	DESCRIPTION	LIST PRICE
<b>STRIKES</b>		
586L19	Curved Lip "T" Strike	\$31.00

PART NO.	DESCRIPTION	LIST PRICE
<b>SLEEVE ASSEMBLIES</b>		
STANDARD		
775F808	Outside Sleeve - 61 Function	\$205.00
776F002 Fin	Inside Sleeve - 51 Function	\$108.00
776F012 Fin	Inside Sleeve - 93 Function	\$108.00
776F022 Fin	Inside Sleeve - 61 Function	\$108.00
776F032 Fin	Inside Sleeve - 29 Function	\$205.00
776F042 Fin	Inside Sleeve - 20, 20H and 75 Functions	\$266.00
776F638	Outside Sleeve - 51,57,61,72, and 93 Functions	\$205.00
776F648	Outside Sleeve - 40NT Function	\$108.00
776F658	Outside Sleeve - 32 Function	\$192.00
776F668	Outside Sleeve - 55 and 62 Functions	\$192.00
776F678	Outside Sleeve - 29 Function	\$205.00
776F688	Outside Sleeve - 52 and 75 Functions	\$227.00
776F698	Outside Sleeve - 20 and 20H Functions	\$173.00
776F708	Inside Sleeve - 10, 55, and 80 Functions Outside Sleeve - 10 Function	\$94.00
776F848	Inside Sleeve - 52 and 72 Functions	\$266.00
776F858	Inside Sleeve - 32 Function	\$192.00
776F868	Inside Sleeve - 62 Function	\$192.00
776F878	Inside Sleeve - 40NT and 57 Functions	\$94.00

PART NO.	DESCRIPTION	LIST PRICE
<b>SLEEVE ASSEMBLIES</b>		
INTERCHANGEABLE CORE		
775F818	Outside Sleeve - 61 Function	\$205.00
776F718	Outside Sleeve - 51, 57, 72, 93 Functions	\$205.00
776F728	Outside Sleeve - 32 Function	\$192.00
776F738	Outside Sleeve - 55, 62 Functions	\$192.00
776F748	Outside Sleeve - 52, 75 Functions	\$227.00
776F918	Inside Sleeve - 61, 75 Functions	\$205.00
776F928	Inside Sleeve - 52, 72 Functions	\$192.00
776F938	Inside Sleeve - 32 Function	\$192.00
776F948	Inside Sleeve - 62 Function	\$188.00
3/4" THROW FIRE LATCH - STANDARD		
779F638	Outside Sleeve - 51, 57, 72 Functions	\$192.00
779F648	Outside Sleeve - 55 Function	\$192.00
779F658	Inside Sleeve - 72 Function Inside Sleeve - 57 Function	\$99.00
779F728	Inside Sleeve - 72 Function	\$266.00
779F738	Inside Sleeve - 57 Function	\$94.00
779F748	Inside Sleeve - 51 Function	\$192.00
3/4" THROW FIRE LATCH - INTERCHANGEABLE CORE		
779F758	Inside Sleeve - 72 Function	\$205.00
M111 SLEEVE ASSEMBLIES - STANDARD		
775F828	Outside Sleeve - 61 Function	\$205.00
776F758	Outside Sleeve - 51, 57, 72, 93 Functions	\$205.00
776F768	Outside Sleeve - 32 Function	\$192.00
776F778	Outside Sleeve - 55, 62 Functions	\$192.00
776F788	Outside Sleeve - 29 Function	\$205.00
776F798	Outside Sleeve - 52, 75 Functions	\$227.00
776F958	Inside Sleeve - 52, 72 Functions	\$266.00
776F968	Inside Sleeve - 32 Function	\$192.00
776F978	Inside Sleeve - 62 Function	\$192.00
M111 SLEEVE ASSEMBLIES - INTERCHANGEABLE CORE		
775F838	Outside Sleeve - 61 Function	\$205.00
776F808	Outside Sleeve - 51,57,61,72,93 Functions	\$205.00
776F818	Outside Sleeve - 32 Function	\$192.00
776F828	Outside Sleeve - 55, 62 Functions	\$192.00
776F838	Outside Sleeve - 52, 75 Functions	\$227.00
776F988	Inside Sleeve - 52, 72 Functions	\$192.00
776F998	Inside Sleeve - 32 Function	\$192.00
777F208	Inside Sleeve - 62 Function	\$192.00

PART NO.	DESCRIPTION	LIST PRICE
<b>COLLARS</b>		
778F888	Inside Collar	\$11.00
778F898	Outside Collar	\$11.00

PART NO.	DESCRIPTION	LIST PRICE
<b>TAILPIECES</b>		
778F788	Schlage® Fixed Core	\$23.00
780F658	SFIC Core	\$7.40
775F948	SARGENT Fixed Core	\$23.00
780F662	Schlage® LFIC	\$31.00
780F648	Corbin Russwin LFIC	\$3.60
774F878	Yale® LFIC 6-Pin	\$2.50
774F888	Yale® LFIC 7-Pin	\$2.50
780F808	Tail, Cylinder, 20H	\$3.60

## LOCKSET PARTS

PART NO.	DESCRIPTION	LIST PRICE
<b>MISCELLANEOUS</b>		
778F638	Collar/Rosette Installation Wrench	\$11.00
780F638	Allen Key Wrench	\$11.00
780F208	M111 Screwdriver	\$7.40
604F228 Fin	Screw Packet	\$8.60
775F908 Fin	Mounting Kit Packet (CL3150)	\$30.00
775F918 Fin	Mounting Kit Packet (CL3170)	\$30.00
753F598	Rose Installation Tool	\$9.70
778F868	Aligning Pin	\$3.60
779F787	Bearing Assembly	\$259.00
778F812	Emergency Release Cylinder	\$59.00
206F578	Screw, combo #8 PH	\$3.60
790F988	Inside Mounting Flange Assembly	\$149.00
790F998	Outside Mounting Flange Assembly	\$149.00
403F302 Fin	Cup Washer	\$4.90
305F318 Fin	Machine Screw 1/4-20 x 2-3/4"	\$6.00
269F808	Countersunk Flat Head Screw 10-24x3/8" (1-3/4" Door)	\$3.60
778F968	Anchor Plate	\$3.60
778F91 Fin	Rosette Plug	\$52.00
790F988	Flange SA, Mounting I/S	\$149.00
790F998	Flange SA, Mounting O/S	\$149.00
220F718	Screw, FHM-PH, 10-24X1/2"	\$3.60
779F797	Bearing SA, D200	\$259.00
779F807	Bearing SA, M16	\$229.00
790F208	Screw, FHM-PH, #4-40X1/2"	\$6.00
679F818	Emergency Release Tool	\$3.60
778F759	Cylinder Spacer for 6-Pin Fixed Core Corbin Russwin or Yale® Cylinder	\$3.60

## LOCKSET PARTS

### LOCKBODY ASSEMBLY, FREEWHEELING LEVER – ALL CYLINDER/CORE PREPS (ALL BACKSETS EXCEPT 2-3/8")

STANDARD/ FREEWHEELING	FUNCTION	LIST PRICE
861F708	CLX3310	\$239.00
861F748 Fin	CLX3320, CLX3320H, CLX3340	\$239.00
861F728 Fin	CLX3320TO	\$239.00
861F768 Fin	CLX3329	\$239.00
861F968	CLX3332	\$239.00
861F828 Fin	CLX3340NT, CLX3351, CLX3375, CLX3393	\$239.00
861F848	CLX3352, CLX3355	\$239.00
861F868	CLX3359	\$239.00
861F788 Fin	CLX3361	\$239.00
861F988	CLX3362	\$239.00
862F008	CLX3372	\$239.00
861F888 Fin	CLX3375	\$239.00
861F908 Fin	CLX3376	\$239.00
861F718	CLX3380, CLX3390	\$239.00
861F928	CLX3381	\$239.00
862F028	CLX3382	\$239.00
861F948	CLX3383	\$239.00

### LOCKBODY ASSEMBLY – RIGID LEVER, ALL CYLINDER/CORE PREPS (ALL BACKSETS EXCEPT 2-3/8")

RIGID LEVER	FUNCTION	LIST PRICE
861F758 Fin	CLX3320, CLX3320H, CLX3340	\$239.00
861F738 Fin	CLX3320TO	\$239.00
861F778 Fin	CLX3329	\$239.00
861F978	CLX3332	\$239.00
861F838 Fin	CLX3340NT, CLX3351, CLX3375, CLX3393	\$239.00
861F858	CLX3352, CLX3355	\$239.00
861F878	CLX3359	\$239.00
861F798 Fin	CLX3361	\$239.00
861F998	CLX3362	\$239.00
862F018	CLX3372	\$239.00
861F898 Fin	CLX3375	\$239.00
861F918 Fin	CLX3376	\$239.00
861F938	CLX3381	\$239.00
862F038	CLX3382	\$239.00
861F958	CLX3383	\$239.00

### LOCKBODY ASSEMBLY, FREEWHEELING LEVER – ALL CYLINDER/CORE PREPS (2-3/8" BACKSET ONLY)

STANDARD/ FREEWHEELING (B238 ONLY)	FUNCTION	LIST PRICE
866F028	CLX3310	\$239.00
866F068 Fin	CLX3320, CLX3320H, CLX3340	\$239.00
866F048 Fin	CLX3320TO	\$239.00
866F088 Fin	CLX3329	\$239.00
866F268	CLX3332	\$239.00
866F128 Fin	CLX3340NT, CLX3351, CLX3357, CLX3393	\$239.00
866F148	CLX3352, CLX3355	\$239.00
866F168	CLX3359	\$239.00
866F108 Fin	CLX3361	\$239.00
866F288	CLX3362	\$239.00
866F308	CLX3372	\$239.00
866F188 Fin	CLX3375	\$239.00
866F208 Fin	CLX3376	\$239.00
866F038	CLX3380, CLX3390	\$239.00
866F228	CLX3381	\$239.00
866F328	CLX3382	\$239.00
866F248	CLX3383	\$239.00

### LOCKBODY ASSEMBLY – RIGID LEVER, ALL CYLINDER/CORE PREPS (2-3/8" BACKSET ONLY)

RIGID LEVER (B238 ONLY)	FUNCTION	LIST PRICE
866F078 Fin	CLX3320, CLX3320H, CLX3340	\$239.00
866F058 Fin	CLX3320TO	\$239.00
866F098 Fin	CLX3329	\$239.00
866F278	CLX3332	\$239.00
866F138 Fin	CLX3340NT, CLX3351, CLX3375, CLX3393	\$239.00
866F158	CLX3352, CLX3355	\$239.00
866F178	CLX3359	\$239.00
866F118 Fin	CLX3361	\$239.00
866F298	CLX3362	\$239.00
866F318	CLX3372	\$239.00
866F198 Fin	CLX3375	\$239.00
866F218 Fin	CLX3376	\$239.00
866F238	CLX3381	\$239.00
866F338	CLX3382	\$239.00
866F258	CLX3383	\$239.00

### CYLINDER PARTS

PART NUMBER	DESCRIPTION	LIST PRICE
862F998	Corbin Russwin & Yale® fixed core cylinder tailpiece pack, 6-pin, 1-3/8" - 2" door	\$31.00
863F008	Corbin Russwin & Yale® fixed core cylinder tailpiece pack, 6-pin, 2-1/4" door	\$31.00
863F018	Corbin Russwin & Yale® fixed core cylinder tailpiece pack, 7-pin, 1-3/8" - 2" door	\$31.00
863F028	Corbin Russwin & Yale® fixed core cylinder tailpiece pack, 7-pin, 2-1/4" door	\$31.00
864F568	Hotel cylinder tailpiece, 6-pin, all doors	\$31.00
864F578	Hotel cylinder tailpiece, 7-pin, all doors	\$31.00
863F038	Schlage® & SARGENT keyway fixed core cylinder tailpiece pack, 1-3/8" - 2" door	\$31.00
863F048	Schlage® & SARGENT keyway fixed core cylinder tailpiece pack, 2-1/4" door	\$31.00
863F058	Corbin Russwin LFIC tailpiece pack, 6-pin, 1-3/8" - 2" door	\$8.80
863F068	Corbin Russwin LFIC tailpiece pack, 6-pin, 2-1/4" door	\$8.80
864F568	Hotel LFIC tailpiece pack, 6-pin, all doors	\$31.00
864F578	Hotel LFIC tailpiece pack, 7-pin, all doors	\$31.00
863F078	SFIC tailpiece pack, 6-or7-pin, 1-3/8" - 2" door	\$8.80
863F088	SFIC tailpiece pack, 6-or7-pin, 2-1/4" door	\$8.80
862F978	SARGENT fixed core tailpiece pack, 6-pin, 1-3/8" - 2" door	\$23.00
862F988	SARGENT fixed core tailpiece pack, 6-pin, 2-1/4" door	\$23.00
863F038	Schlage® fixed core tailpiece pack, 6-pin, 1-3/8" - 2" door	\$31.00
863F048	Schlage® fixed core tailpiece pack, 6-pin, 2-1/4" door	\$31.00
862F472	Schlage® LFIC tailpiece pack, 6-pin, 1-3/8" - 2" door	\$31.00
862F482	Schlage® LFIC tailpiece pack, 6-pin, 2-1/4" door	\$31.00
862F402	Yale® LFIC tailpiece pack, 6-pin, 1-3/8" - 2" door	\$31.00
862F412	Yale® LFIC tailpiece pack, 6-pin, 2-1/4" door	\$31.00
862F049	Spacer only - fixed core cylinder	\$3.60
627F009	Disposable cores, Corbin Russwin LFIC (10 pack)	\$61.00
707F299	Disposable cores, SFIC (10 pack)	\$54.00

## LOCKSET PARTS

PART NO.	DESCRIPTION	LIST PRICE	PART NO.	DESCRIPTION	LIST PRICE
<b>OUTSIDE SPRING HOUSING ASSEMBLIES (1-3/8" - 2-1/4" DOOR)</b>			<b>INSIDE SPRING HOUSING ASSEMBLIES (1-3/8" - 2" DOOR)</b>		
860F608	All Functions except CLX3380, CLX3381, CLX3383, CLX3350, CLX3370	\$239.00	860F618	All Functions except CLX3332, CLX3352, CLX3362, CLX3372, CLX3381, CLX3382, CLX3383, CLX3390, CLX3350, CLX3370	\$239.00
860F638	All Functions for Yale® LFIC	\$239.00	860F628	Functions CLX3332, CLX3352, CLX3362, CLX3372, CLX3381, CLX3382, CLX3383	\$239.00
<b>DUMMY SPRING HOUSING ASSEMBLIES</b>			860F648	All Functions for Yale® LFIC CLX3332, CLX3352, CLX3362, CLX3372, CLX3381, CLX3382, CLX3383	\$239.00
863F108	Outside CL3350, CL3370	\$239.00			
863F118	Inside CL3370	\$239.00			

## LEVERS 1-3/8" TO 2-1/4" DOORS

PART NO.	DESCRIPTION	LIST PRICE	PART NO.	DESCRIPTION	LIST PRICE
860F005	AZ - Passage/plain	\$142.00	860F465	PZ - LFIC (Corbin Russwin 6-pin)	\$142.00
860F055	AZ - Emergency key hole	\$142.00	860F475	PZ - LFIC (Corbin Russwin 6-pin inside CLX3352)	\$142.00
860F015	AZ - Fixed core cylinder (Corbin Russwin 6/7-pin, Yale® 6/7-pin, Schlage® 6-pin)	\$142.00	860F485	PZ - LFIC (Corbin Russwin 7-pin)	\$142.00
860F025	AZ - Fixed core cylinder (Corbin Russwin 6/7-pin, Yale® 6/7-pin, Schlage® 6-pin inside CLX3352)	\$142.00	860F495	PZ - LFIC (Corbin Russwin 7-pin inside CLX3352)	\$142.00
860F035	AZ - Push/turn button or fixed core cylinder (SARGENT® 6-pin)	\$142.00	860F525	PZ - LFIC (Schlage® 6-pin)	\$142.00
860F045	AZ - Fixed core cylinder (SARGENT® inside CLX3352)	\$142.00	860F535	PZ - LFIC (Schlage® 6-pin inside CLX3352)	\$142.00
860F065	AZ - LFIC (Corbin Russwin 6-pin)	\$142.00	860F545	PZ - LFIC (Yale® 6-pin)	\$142.00
860F075	AZ - LFIC (Corbin Russwin 6-pin inside CLX3352)	\$142.00	860F555	PZ - LFIC (Yale® 6-pin inside CLX3352)	\$142.00
860F085	AZ - LFIC (Corbin Russwin 7-pin)	\$142.00	860F505	PZ - SFIC 6/7-pin	\$142.00
860F095	AZ - LFIC (Corbin Russwin 7-pin inside CLX3352)	\$142.00	860F515	PZ - SFIC 6/7-pin (inside CLX3352)	\$142.00
860F125	AZ - LFIC (Schlage® 6-pin)	\$142.00	860F655	102 - Passage/plain	\$142.00
860F135	AZ - LFIC (Schlage® 6-pin inside CLX3352)	\$142.00	860F705	102 - Emergency key hole	\$142.00
860F145	AZ - LFIC (Yale® 6-pin)	\$142.00	860F665	102 - Fixed core cylinder (Corbin Russwin 6/7-pin, Yale® 6/7-pin, Schlage® 6-pin)	\$142.00
860F155	AZ - LFIC (Yale® 6-pin inside CLX3352)	\$142.00	860F685	102 - Push/turn button or fixed core cylinder (SARGENT® 6-pin)	\$142.00
860F105	AZ - SFIC 6/7-pin	\$142.00	860F715	102 - LFIC (Corbin Russwin 6-pin)	\$142.00
860F115	AZ - SFIC 6/7-pin (inside CLX3352)	\$142.00	860F735	102 - LFIC (Corbin Russwin 7-pin)	\$142.00
860F205	NZ - Passage/plain	\$142.00	860F755	102 - SFIC 6/7-pin	\$142.00
860F255	NZ - Emergency key hole	\$142.00	860F905	106 - Passage/plain	\$142.00
860F215	NZ - Fixed core cylinder (Corbin Russwin 6/7-pin, Yale® 6/7-pin, Schlage® 6-pin)	\$142.00	860F955	106 - Emergency key hole	\$142.00
860F225	NZ - Fixed core cylinder (Corbin Russwin 6/7-pin, Yale® 6/7-pin, Schlage® 6-pin inside CLX3352)	\$142.00	860F915	106 - Fixed core cylinder (Corbin Russwin 6/7-pin, Yale® 6/7-pin, Schlage® 6-pin)	\$142.00
860F235	NZ - Push/turn button or fixed core cylinder (SARGENT® 6-pin)	\$142.00	860F935	106 - Push/turn button or fixed core cylinder (SARGENT® 6-pin)	\$142.00
860F245	NZ - Fixed core cylinder (SARGENT® inside CLX3352)	\$142.00	860F965	106 - LFIC (Corbin Russwin 6-pin)	\$142.00
860F265	NZ - LFIC (Corbin Russwin 6-pin)	\$142.00	860F985	106 - LFIC (Corbin Russwin 7-pin)	\$142.00
860F275	NZ - LFIC (Corbin Russwin 6-pin inside CLX3352)	\$142.00	861F015	106 - SFIC 6/7-pin	\$142.00
860F285	NZ - LFIC (Corbin Russwin 7-pin)	\$142.00	861F035	123 - Passage/plain	\$142.00
860F295	NZ - LFIC (Corbin Russwin 7-pin inside CLX3352)	\$142.00	861F085	123 - Emergency key hole	\$142.00
860F325	NZ - LFIC (Schlage® 6-pin)	\$142.00	861F045	123 - Fixed core cylinder (Corbin Russwin 6/7-pin, Yale® 6/7-pin, Schlage® 6-pin)	\$142.00
860F335	NZ - LFIC (Schlage® 6-pin inside CLX3352)	\$142.00	861F065	123 - Push/turn button or fixed core cylinder (SARGENT® 6-pin)	\$142.00
860F345	NZ - LFIC (Yale® 6-pin)	\$142.00	861F095	123 - LFIC (Corbin Russwin 6-pin)	\$142.00
860F355	NZ - LFIC (Yale® 6-pin inside CLX3352)	\$142.00	861F115	123 - LFIC (Corbin Russwin 7-pin)	\$142.00
860F305	NZ - SFIC 6/7-pin	\$142.00	861F135	123 - SFIC 6/7-pin	\$142.00
860F315	NZ - SFIC 6/7-pin (inside CLX3352)	\$142.00	860F775	124 - Passage/plain	\$142.00
860F405	PZ - Passage/plain	\$142.00	860F825	124 - Emergency key hole	\$142.00
860F455	PZ - Emergency key hole	\$142.00	860F785	124 - Fixed core cylinder (Corbin Russwin 6/7-pin, Yale® 6/7-pin, Schlage® 6-pin)	\$142.00
860F415	PZ - Fixed core cylinder (Corbin Russwin 6/7-pin, Yale® 6/7-pin, Schlage® 6-pin)	\$142.00	860F805	124 - Push/turn button or fixed core cylinder (SARGENT® 6-pin)	\$142.00
860F425	PZ - Fixed core cylinder (Corbin Russwin 6/7-pin, Yale® 6/7-pin, Schlage® 6-pin inside CLX3352)	\$142.00	860F835	124 - LFIC (Corbin Russwin 6-pin)	\$142.00
860F435	PZ - Push/turn button or fixed core cylinder (SARGENT® 6-pin)	\$142.00	860F855	124 - LFIC (Corbin Russwin 7-pin)	\$142.00
860F445	PZ - Fixed core cylinder (SARGENT® inside CLX3352)	\$142.00	860F875	124 - SFIC 6/7-pin	\$142.00

## LOCKSET PARTS

PART NO.	DESCRIPTION	LIST PRICE	PART NO.	DESCRIPTION	LIST PRICE
<b>LEVERS 1-3/8" TO 2-1/4" DOORS WITH KNURLING</b>			<b>LEVERS 1-3/8" TO 2-1/4" DOORS WITH ABRASIVE COAT</b>		
860N005	AZ - Passage/plain	\$142.00	860R005	AZ - Passage/plain	\$142.00
860N055	AZ - Emergency key hole	\$142.00	860R055	AZ - Emergency key hole	\$142.00
860N015	AZ - Fixed core cylinder (Corbin Russwin 6/7-pin, Yale® 6/7-pin, Schlage® 6-pin)	\$142.00	860R015	AZ - Fixed core cylinder (Corbin Russwin 6/7-pin, Yale® 6/7-pin, Schlage® 6-pin)	\$142.00
860N025	AZ - Fixed core cylinder (Corbin Russwin 6/7-pin, Yale® 6/7-pin, Schlage® 6-pin inside CLX3352)	\$142.00	860R025	AZ - Fixed core cylinder (Corbin Russwin 6/7-pin, Yale® 6/7-pin, Schlage® 6-pin inside CLX3352)	\$142.00
860N035	AZ - Push/turn button or fixed core cylinder (SARGENT® 6-pin)	\$142.00	860R035	AZ - Push/turn button or fixed core cylinder (SARGENT® 6-pin)	\$142.00
860N045	AZ - Fixed core cylinder (SARGENT® inside CLX3352)	\$142.00	860R045	AZ - Fixed core cylinder (SARGENT® inside CLX3352)	\$142.00
860N065	AZ - LFIC (Corbin Russwin 6-pin)	\$142.00	860R065	AZ - LFIC (Corbin Russwin 6-pin)	\$142.00
860N075	AZ - LFIC (Corbin Russwin 6-pin inside CLX3352)	\$142.00	860R075	AZ - LFIC (Corbin Russwin 6-pin inside CLX3352)	\$142.00
860N085	AZ - LFIC (Corbin Russwin 7-pin)	\$142.00	860R085	AZ - LFIC (Corbin Russwin 7-pin)	\$142.00
860N095	AZ - LFIC (Corbin Russwin 7-pin inside CLX3352)	\$142.00	860R095	AZ - LFIC (Corbin Russwin 7-pin inside CLX3352)	\$142.00
860N125	AZ - LFIC (Schlage® 6-pin)	\$142.00	860R125	AZ - LFIC (Schlage® 6-pin)	\$142.00
860N135	AZ - LFIC (Schlage® 6-pin inside CLX3352)	\$142.00	860R135	AZ - LFIC (Schlage® 6-pin inside CLX3352)	\$142.00
860N145	AZ - LFIC (Yale® 6-pin)	\$142.00	860R145	AZ - LFIC (Yale® 6-pin)	\$142.00
860N155	AZ - LFIC (Yale® 6-pin inside CLX3352)	\$142.00	860R155	AZ - LFIC (Yale® 6-pin inside CLX3352)	\$142.00
860N105	AZ - SFIC 6/7-pin	\$142.00	860R105	AZ - SFIC 6/7-pin	\$142.00
860N115	AZ - SFIC 6/7-pin (inside CLX3352)	\$142.00	860R115	AZ - SFIC 6/7-pin (inside CLX3352)	\$142.00
860N205	NZ - Passage/plain	\$142.00	860R205	NZ - Passage/plain	\$142.00
860N255	NZ - Emergency key hole	\$142.00	860R255	NZ - Emergency key hole	\$142.00
860N215	NZ - Fixed core cylinder (Corbin Russwin 6/7-pin, Yale® 6/7-pin, Schlage® 6-pin)	\$142.00	860R215	NZ - Fixed core cylinder (Corbin Russwin 6/7-pin, Yale® 6/7-pin, Schlage® 6-pin)	\$142.00
860N225	NZ - Fixed core cylinder (Corbin Russwin 6/7-pin, Yale® 6/7-pin, Schlage® 6-pin inside CLX3352)	\$142.00	860R225	NZ - Fixed core cylinder (Corbin Russwin 6/7-pin, Yale® 6/7-pin, Schlage® 6-pin inside CLX3352)	\$142.00
860N235	NZ - Push/turn button or fixed core cylinder (SARGENT® 6-pin)	\$142.00	860R235	NZ - Push/turn button or fixed core cylinder (SARGENT® 6-pin)	\$142.00
860N245	NZ - Fixed core cylinder (SARGENT® inside CLX3352)	\$142.00	860R245	NZ - Fixed core cylinder (SARGENT® inside CLX3352)	\$142.00
860N265	NZ - LFIC (Corbin Russwin 6-pin)	\$142.00	860R265	NZ - LFIC (Corbin Russwin 6-pin)	\$142.00
860N275	NZ - LFIC (Corbin Russwin 6-pin inside CLX3352)	\$142.00	860R275	NZ - LFIC (Corbin Russwin 6-pin inside CLX3352)	\$142.00
860N285	NZ - LFIC (Corbin Russwin 7-pin)	\$142.00	860R285	NZ - LFIC (Corbin Russwin 7-pin)	\$142.00
860N295	NZ - LFIC (Corbin Russwin 7-pin inside CLX3352)	\$142.00	860R295	NZ - LFIC (Corbin Russwin 7-pin inside CLX3352)	\$142.00
860N325	NZ - LFIC (Schlage® 6-pin)	\$142.00	860R325	NZ - LFIC (Schlage® 6-pin)	\$142.00
860N335	NZ - LFIC (Schlage® 6-pin inside CLX3352)	\$142.00	860R335	NZ - LFIC (Schlage® 6-pin inside CLX3352)	\$142.00
860N345	NZ - LFIC (Yale® 6-pin)	\$142.00	860R345	NZ - LFIC (Yale® 6-pin)	\$142.00
860N355	NZ - LFIC (Yale® 6-pin inside CLX3352)	\$142.00	860R355	NZ - LFIC (Yale® 6-pin inside CLX3352)	\$142.00
860N305	NZ - SFIC 6/7-pin	\$142.00	860R305	NZ - SFIC 6/7-pin	\$142.00
860N315	NZ - SFIC 6/7-pin (inside CLX3352)	\$142.00	860R315	NZ - SFIC 6/7-pin (inside CLX3352)	\$142.00
860N405	PZ - Passage/plain	\$142.00	860R405	PZ - Passage/plain	\$142.00
860N455	PZ - Emergency key hole	\$142.00	860R415	PZ - Emergency key hole	\$142.00
860N415	PZ - Fixed core cylinder (Corbin Russwin 6/7-pin, Yale® 6/7-pin, Schlage® 6-pin)	\$142.00	860R425	PZ - Fixed core cylinder (Corbin Russwin 6/7-pin, Yale® 6/7-pin, Schlage® 6-pin)	\$142.00
860N425	PZ - Fixed core cylinder (Corbin Russwin 6/7-pin, Yale® 6/7-pin, Schlage® 6-pin inside CLX3352)	\$142.00	860R435	PZ - Fixed core cylinder (Corbin Russwin 6/7-pin, Yale® 6/7-pin, Schlage® 6-pin inside CLX3352)	\$142.00
860N435	PZ - Push/turn button or fixed core cylinder (SARGENT® 6-pin)	\$142.00	860R445	PZ - Push/turn button or fixed core cylinder (SARGENT® 6-pin)	\$142.00
860N445	PZ - Fixed core cylinder (SARGENT® inside CLX3352)	\$142.00	860R455	PZ - Fixed core cylinder (SARGENT® inside CLX3352)	\$142.00
860N465	PZ - LFIC (Corbin Russwin 6-pin)	\$142.00	860R465	PZ - LFIC (Corbin Russwin 6-pin)	\$142.00
860N475	PZ - LFIC (Corbin Russwin 6-pin inside CLX3352)	\$142.00	860R475	PZ - LFIC (Corbin Russwin 6-pin inside CLX3352)	\$142.00
860N485	PZ - LFIC (Corbin Russwin 7-pin)	\$142.00	860R485	PZ - LFIC (Corbin Russwin 7-pin)	\$142.00
860N495	PZ - LFIC (Corbin Russwin 7-pin inside CLX3352)	\$142.00	860R495	PZ - LFIC (Corbin Russwin 7-pin inside CLX3352)	\$142.00
860N525	PZ - LFIC (Schlage® 6-pin)	\$142.00	860R525	PZ - LFIC (Schlage® 6-pin)	\$142.00
860N535	PZ - LFIC (Schlage® 6-pin inside CLX3352)	\$142.00	860R535	PZ - LFIC (Schlage® 6-pin inside CLX3352)	\$142.00
860N545	PZ - LFIC (Yale® 6-pin)	\$142.00	860R545	PZ - LFIC (Yale® 6-pin)	\$142.00
860N555	PZ - LFIC (Yale® 6-pin inside CLX3352)	\$142.00	860R555	PZ - LFIC (Yale® 6-pin inside CLX3352)	\$142.00
860N505	PZ - SFIC 6/7-pin	\$142.00	860R505	PZ - SFIC 6/7-pin	\$142.00
860N515	PZ - SFIC 6/7-pin (inside CLX3352)	\$142.00	860R515	PZ - SFIC 6/7-pin (inside CLX3352)	\$142.00

## LOCKSET PARTS

PART NO.	DESCRIPTION	LIST PRICE
<b>MISCELLANEOUS</b>		
865F298	Emergency Release Tool (CLX3320)	\$3.60
867F388	1-3/8" Door Adapter Plates Pack (D138)	\$55.00
865F199	Hotel Adjustment Tool	\$3.60
041F478	Hotel Shut-out Key	\$3.60
<b>LATCH ASSEMBLY</b>		
<b>2 3/4" Backsets</b>		
867F20	Plain, square corner	\$94.00
867F26	Plain, rounded corner	
867F21	Deadlocking square corner	\$107.00
867F27	Deadlocking rounded corner	
601F69	3/4" Throw deadlocking fire latch square corner	\$137.00
<b>2 3/8" Backsets</b>		
599F91	Plain, square corner 1" front	\$82.00
599F97	Plain, square corner 1-1/8" front	
599F94	Plain, rounded corner 1" front	
600F00	Plain, rounded corner 1-1/8" front	
599F92	Deadlocking, square corner 1" front	
599F98	Deadlocking, square corner 1-1/8" front	
599F95	Deadlocking, rounded corner 1" front	
600F01	Deadlocking, rounded corner 1-1/8" front	
<b>3 3/4" Backsets</b>		
867F22	Plain, square corner	\$180.00
867F28	Plain, round corner	
867F23	Deadlocking square corner	\$190.00
867F29	Deadlocking rounded corner	
<b>5" Backsets</b>		
867F24	Plain, square corner	\$130.00
867F30	Plain, rounded corner	
867F25	Deadlocking square corner	\$137.00
867F31	Deadlocking rounded corner	
<b>LATCH &amp; STRIKE SCREW PACKS</b>		
604F228 Fin	Latch & ANSI (4 7/8") strike - phillips head	\$8.60
604F238 Fin	Latch & ANSI (4 7/8") strike - spanner head	\$19.00
604F248 Fin	Latch & ANSI (4 7/8") strike - Torx head	\$19.00
604F268 Fin	Latch & T (2 3/4") strike - phillips head	\$8.60
604F278 Fin	Latch & T (2 3/4") strike - spanner head	\$19.00
604F288 Fin	Latch & T (2 3/4") strike - Torx head	\$19.00
<b>MOUNTING SCREW PACKS</b>		
865F308	1 3/8" - 2" doors	\$8.60
865F398	Over 2"	\$12.00
867F73 Fin	CLX3390 1 3/8" - 2 1/4" phillips head	\$9.70
867F74 Fin	CLX3390 1 3/8" - 2 1/4" spanner head	\$19.00
867F75 Fin	CLX3390 1 3/8" - 2 1/4" Torx head	\$19.00
867F70 Fin	CLX3350 Half Dummy Trim - phillips head	\$12.00
867F71 Fin	CLX3350 Half Dummy Trim - spanner head	\$58.00
867F72 Fin	CLX3350 Half Dummy Trim - Torx head	\$58.00

PART NO.	DESCRIPTION	LIST PRICE	
<b>ROSES/ROSE LINERS</b>			
678F25 Fin	Rose	\$59.00	
598F59 Fin	Blank Rose/Plate CLX3380, CLX3381, CLX3383	\$37.00	
789F018	Rose liner I/S 1 3/4" - 2"	\$8.60	
789F028	Rose liner I/S over 2"	\$8.60	
789F058	Rose liner O/S 1 3/4" - 2"		
789F068	Rose liner O/S over 2"	\$8.60	
865F32 x Fin	Thumbturn ass'y 1 3/4" - 2"	\$114.00	
865F33 x Fin	Thumbturn ass'y over 2"		
789F228	Rose liner ass'y O/S CLX3380, CLX3381, CLX3383	\$35.00	
<b>STRIKES - 4 7/8" ANSI CURVED LIP</b>			
217L13M016	1" Lip Length	\$31.00	
217L13M018	1 1/8" Lip Length		
217L13M020	1 1/4" Lip Length		
217L13M022	1 3/8" Lip Length		
217L13M024	1 1/2" Lip Length		
217L13M028	1 3/4" Lip Length		
217L13M032	2" Lip Length		
217L13M036	2 1/4" Lip Length		
217L13M040	2 1/2" Lip Length		
217L13M044	2 3/4" Lip Length		
217L13M048	3" Lip Length		
120F768	4 7/8" strike box		\$6.00
<b>STRIKES - 2 3/4" T- CURVED LIP</b>			
586L19M016	1" Lip Length		\$31.00
586L19M018	1 1/8" Lip Length		
586L19M020	1 1/4" Lip Length		
586L19M022	1 3/8" Lip Length		
586L19M024	1 1/2" Lip Length		
586L19M028	1 3/4" Lip Length		
586L19M032	2" Lip Length		
586L19M036	2 1/4" Lip Length		
586L19M040	2 1/2" Lip Length		
586L19M044	2 3/4" Lip Length		
586L19M048	3" Lip Length		
<b>STRIKE - 2 3/4" FULL LIP</b>			
607F76	1-1/8" Lip Length	\$11.00	

## LOCKSET PARTS

PART NO.	DESCRIPTION	LIST PRICE
<b>CHASSIS ASSEMBLY STANDARD</b>		
785F008	CL3310	\$213.00
785F118 Fin	CL3320, CL3361	\$224.00
785F138 Fin	CL3320TO	\$187.00
785F078 Fin	CL3329	\$213.00
785F068	CL3332	\$254.00
785F028 Fin	CL3340	\$248.00
785F038	CL3340NT	\$226.00
785F018 Fin	CL3351, CL3357	\$226.00
785F048	CL3352, CL3355	\$263.00
785F148	CL3359	\$226.00
785F058	CL3362	\$254.00
785F088	CL3372	
785F158 Fin	CL3375	\$240.00
785F088	CL3380, CL3390	\$254.00
785F108	CL3381, CL3391	\$240.00
785F378 Fin	CL3393	\$240.00
785F188	CL33903-12AD	\$584.00
785F168	CL33903-24AD	\$584.00
785F198	CL33905-12AD	\$584.00
785F178	CL33905-24AD	\$584.00
<b>CHASSIS ASSEMBLY, LFIC</b>		
785F298	CL3361	\$254.00
785F268 Fin	CL3329	\$278.00
785F258	CL3332	\$271.00
785F218 Fin	CL3351, CL3357, CL3393	\$248.00
785F238	CL3352	\$271.00
785F228	CL3355	
785F308	CL3359	\$248.00
785F248	CL3362	\$271.00
785F278	CL3372	
785F318 Fin	CL3375	\$230.00
785F288	CL3381, CL3391	\$258.00
785F388 Fin	CL3393	\$230.00
785F348	CL33903-12AD	\$561.00
785F328	CL33903-24AD	\$561.00
785F358	CL33905-12AD	\$561.00
785F338	CL33905-24AD	\$561.00
<b>CYLINDER PARTS</b>		
622F308	Tailpiece 6-pin	\$3.60
682F298	Tailpiece 7-pin	\$3.60
631F248	Corbin Russwin LFIC core kit	\$8.60
682F958	SFIC tailpiece kit	\$8.60
682F969	Sargent® tailpiece kit	\$23.00
697F942	Schlage® LFIC tailpiece kit	\$31.00
682F398	Schlage® tailpiece kit	\$23.00
<b>HOUSING ASSEMBLIES</b>		
783F208	Spring housing O/S	\$45.00
783F308	Spring housing 1/5 1 3/4"-2"	\$37.00
783F408	Spring housing 1/5 2 1/4"	\$37.00
686F858	Dummy housing 1/5	\$137.00
686F868	Dummy housing O/S	\$125.00
<b>LEVERS 1-3/4" TO 2" DOORS</b>		
563F945	NZD - Plain	\$137.00
563F955	NZD - Cylinder button	
714F065	NZD - CL3352 inside	
563F965	NZD - Emergency key hole	
585F715	NZD - LFIC cylinder - 6 pin	\$137.00
714F365	NZD - LFIC cylinder - 6 pin CL3352 inside	
600F415	NZD - LFIC cylinder - 7 pin	
714F375	NZD - LFIC cylinder - 7 pin CL3352 inside	

PART NO.	DESCRIPTION	LIST PRICE
<b>LEVERS 1-3/4" TO 2" DOORS (Cont'd)</b>		
596F825	NZD - SFIC	\$137.00
714F425	NZD - SFIC CL3352 inside	
690F975	NZD - Schlage® LFIC	
714F455	NZD - Schlage® LFIC CL3352 inside	
578F435	NZD - Sargent Fixed Core Cylinder	\$137.00
714F125	NZD - Sargent Fixed Core Cylinder CL3352 Inside	
563F885	AZD - Plain	
563F895	AZD - Cylinder or button	\$137.00
714F005	AZD - CL3352 inside	
563F905	AZD - Emergency key hole	
585F705	AZD - Corbin Russwin LFIC - 6 pin	\$137.00
714F305	AZD - Corbin Russwin LFIC - 6 pin CL3352 inside	
600F425	AZD - Corbin Russwin LFIC - 7 pin inside	
714F315	AZD - Corbin Russwin LFIC - 7 pin CL3352 inside	
409F865	AZD - SFIC	
540F625	AZD - SFIC CL3352 inside	
695F075	AZD - Sargent Fixed Core Cylinder	
714F035	AZD - Sargent Fixed Core Cylinder CL3352 Inside	
799F505	PZD - Plain	\$137.00
799F515	PZD - Cylinder or button	
799F535	PZD - CL3352 inside	
799F525	PZD - Emergency key hole	\$137.00
799F565	PZD - Corbin Russwin LFIC - 6 pin	
799F575	PZD - Corbin Russwin LFIC - 6 pin CL3352 inside	
799F585	PZD - Corbin Russwin LFIC - 7 pin	
799F595	PZD - Corbin Russwin LFIC - 7 pin CL3352 inside	
799F805	PZD - SFIC	\$137.00
799F815	PZD - SFIC CL3352 inside	
799F825	PZD - Schlage® LFIC	
799F835	PZD - Schlage® LFIC CL3352 inside	\$137.00
799F545	PZD - Sargent Fixed Core Cylinder	
799F555	PZD - Sargent Fixed Core Cylinder CL3352 Inside	
712F205	FZD - LH plain	\$137.00
712F215	FZD - LH cylinder or button	
712F385	FZD - LH CL3352 inside	
712F225	FZD - LH emergency key hole	
715F245	FZD - LH Corbin Russwin LFIC - 6 pin	\$137.00
712F405	FZD - LH Corbin Russwin LFIC - 6 pin CL3352 inside	
714F255	FZD - LH Corbin Russwin LFIC - 7 pin	
712F415	FZD - LH Corbin Russwin LFIC - 7 pin CL3352 inside	
712F265	FZD - LH SFIC	\$137.00
712F425	FZD - LH SFIC CL3352 inside	
712F275	FZD - LH Schlage® LFIC	
712F435	FZD - LH Schlage® LFIC CL3352 inside	
712F235	FZD - LH Sargent Fixed Core Cylinder	\$137.00
712F395	FZD - LH Sargent Fixed Core Cylinder CL3352 Inside	
712F505	FZD - RH plain	
712F515	FZD - RH cylinder or button	\$137.00
712F685	FZD - RH CL3352 inside	
712F525	FZD - RH emergency key hole	
712F545	FZD - RH Corbin Russwin LFIC - 6 pin	\$137.00
712F705	FZD - RH Corbin Russwin LFIC - 6 pin CL3352 inside	
712F555	FZD - RH Corbin Russwin LFIC - 7 pin CL3352 inside	
712F715	FZD - RH Corbin Russwin LFIC - 7 pin CL3352 inside	
712F565	FZD - RH SFIC	\$137.00
712F725	FZD - RH SFIC CL3352 inside	
712F575	FZD - Schlage® LFIC	
712F735	FZD - Schlage® LFIC CL3352 inside	\$137.00
712F535	FZD - RH Sargent Fixed Core Cylinder	
712F695	FZD - RH Sargent Fixed Core Cylinder CL3352 Inside	



## LOCKSET PARTS

PART NO.	DESCRIPTION	LIST PRICE	PART NO.	DESCRIPTION	LIST PRICE	
<b>LEVERS 2 1/4" DOORS</b>			<b>LEVERS 2 1/4" DOORS (Cont'd)</b>			
684F825	NZD - Plain	\$137.00	712F335	FZD - LH Sargent Fixed Core Cylinder	\$137.00	
684F835	NZD - Cylinder or button		712F455	FZD - LH Sargent Fixed Core Cylinder CL3352 Inside		
714F215	NZD - CL3352 inside		712F605	FZD - RH plain	\$137.00	
684F845	NZD - Emergency key hole	712F615	FZD - RH cylinder or button			
684F865	NZD - Corbin Russwin LFIC - 6 pin	712F745	FZD - RH CL3352 inside			
714F545	NZD - Corbin Russwin LFIC - 6 pin CL3352 inside	\$137.00	712F625	FZD - RH emergency key hole	\$137.00	
685F875	NZD - Corbin Russwin LFIC - 7 pin		712F645	FZD - RH Corbin Russwin LFIC - 6 pin		
714F555	NZD - Corbin Russwin LFIC - 7 pin CL3352 inside		712F765	FZD - RH Corbin Russwin LFIC - 6 pin CL3352 inside		
684F885	NZD - SFIC	\$137.00	712F655	FZD - RH Corbin Russwin LFIC - 7 pin	\$137.00	
714F605	NZD - SFIC CL3352 inside		712F775	FZD - RH Corbin Russwin LFIC - 7 pin CL3352 inside		
690F985	NZD - Schlage® LFIC		712F665	FZD - RH SFIC		
714F635	NZD - Schlage® LFIC CL3352 inside	\$137.00	712F785	FZD - RH SFIC CL3352 inside	\$137.00	
684F855	NZD - Sargent Fixed Core Cylinder		712F675	FZD - RH Schlage® LFIC		
714F275	NZD - Sargent Fixed Core Cylinder CL3352 Inside		712F795	FZD - RH Schlage® LFIC CL3352 inside		
684F775	AZD - Plain	\$137.00	712F635	FZD - RH Sargent Fixed Core Cylinder	\$137.00	
684F785	AZD - Cylinder or button		712F755	FZD - RH Sargent Fixed Core Cylinder CL3352 Inside		
714F155	AZD - CL3352 inside		<b>EMERGENCY RELEASE TOOL</b>			
684F795	AZD - Emergency key hole	\$137.00	679F818	Emergency Release Tool (CL3320)	\$3.60	
684F805	AZD - Corbin Russwin LFIC - 6 pin		<b>LEVER INSERT</b>			
714F485	AZD - Corbin Russwin LFIC - 6 pin CL3352 inside		585F729	Lever insert (black)	\$3.60	
684F815	AZD - Corbin Russwin LFIC - 7 pin	\$137.00	<b>LATCH ASSEMBLY</b>			
714F495	AZD - Corbin Russwin LFIC - 7 pin CL3352 inside		<b>2 3/4" Backsets</b>			
409F875	AZD - SFIC		586F16	Plain, square corner	\$94.00	
540F685	AZD - SFIC CL3352 inside	596F66	Plain, rounded corner			
697F995	AZD - Sargent Fixed Core Cylinder	\$137.00	586F17	Deadlocking square corner	\$107.00	
714F185	AZD - Sargent Fixed Core Cylinder CL3352 Inside		596F67	Deadlocking rounded corner		
799F605	PZD - Plain		586F18	Throw-Off square corner		
799F615	PZD - Cylinder or button	\$137.00	596F68	Throw-Off rounded corner	\$137.00	
799F635	PZD - CL3352 inside		601F69	3/4" Throw deadlocking fire latch square corner		
799F625	PZD - Emergency key hole		<b>3 3/4" Backsets</b>			
799F665	PZD - Corbin Russwin LFIC - 6 pin	\$137.00	586F80	Plain, square corner	\$180.00	
799F675	PZD - Corbin Russwin LFIC - 6 pin CL3352 inside		586F86	Plain, rounded corner		
799F685	PZD - Corbin Russwin LFIC - 7 pin		586F81	Deadlocking square corner	\$190.00	
799F695	PZD - Corbin Russwin LFIC - 7 pin CL3352 inside	586F87	Deadlocking rounded corner			
799F845	PZD - SFIC	586F82	Throw-Off square corner			
799F855	PZD - SFIC CL3352 inside	\$137.00	586F88	Throw-Off rounded corner	\$130.00	
799F865	PZD - Schlage® LFIC		<b>5" Backsets</b>			
799F875	PZD - Schlage LFIC CL3352 inside		598F20	Plain, square corner		
799F645	PZD - Sargent Fixed Core Cylinder	\$137.00	601F24	Plain, rounded corner	\$137.00	
799F655	PZD - Sargent Fixed Core Cylinder CL3352 Inside		598F21	Deadlocking square corner		
712F305	FZD - LH plain		601F25	Deadlocking rounded corner		
712F315	FZD - LH cylinder or botton	\$137.00	598F22	Throw-Off square corner	\$137.00	
712F445	FZD - LH CL3352 inside		601F26	Throw-Off rounded corner		
712F325	FZD - LH emergency key hole		<b>2 3/4" Backsets</b>			
712F345	FZD - Corbin Russwin LFIC - 6 pin	\$137.00	586F16	Plain, square corner	\$94.00	
712F465	FZD - Corbin Russwin LFIC - 6 pin CL3352 inside		596F66	Plain, rounded corner		
712F355	FZD - Corbin Russwin LFIC - 7 pin		586F17	Deadlocking square corner	\$107.00	
712F475	FZD - Corbin Russwin LFIC - 7 pin CL3352 inside	596F67	Deadlocking rounded corner			
712F365	FZD - LH SFIC	586F18	Throw-Off square corner	\$137.00		
712F485	FZD - LH SFIC CL3352 inside	596F68	Throw-Off rounded corner			
712F375	FZD - LH Schlage® LFIC	\$137.00	601F69		3/4" Throw deadlocking fire latch square corner	
712F495	FZD - LH Schlage® LFIC CL3352 inside		<b>3 3/4" Backsets</b>			

# CL3300 Cylindrical Lock Series Extra Heavy-Duty Lever Lockset

USA & Canada Prices Effective February 1, 2022

## LOCKSET PARTS

PART NO.	DESCRIPTION	LIST PRICE
<b>LATCH &amp; STRIKE SCREW PACKS</b>		
604F228 Fin	Latch & ANSI (4 7/8") strike - phillips head	\$8.60
604F238 Fin	Latch & ANSI (4 7/8") strike - spanner head	\$19.00
604F248 Fin	Latch & ANSI (4 7/8") strike - Torx head	\$19.00
604F268 Fin	Latch & T (2 3/4") strike - phillips head	\$8.60
604F278 Fin	Latch & T (2 3/4") strike - spanner head	\$19.00
604F288 Fin	Latch & T (2 3/4") strike - Torx head	\$19.00
480F688 Fin	Rabbetted Strike - phillips head	\$8.60
596F618 Fin	Rabbetted Strike - spanner head	\$19.00
596F628 Fin	Rabbetted Strike - Torx head	\$19.00
<b>MOUNTING SCREW PACKS</b>		
682F608	1 3/4" - 2" doors (pre June 2004)	\$8.60
710F658	1 3/4" - 2" doors (after June 2004)	
682F618	Over 2" (pre June 2004)	\$12.00
710F668	Over 2" (after June 2004)	
682F628	CL3380, CL3381 1 3/4" - 2" doors	\$8.60
682F638	CL3380, CL3381 over 2" doors	\$12.00
682F64 Fin	CL3390, CL3391 1 3/4" - 2" phillips head	\$9.70
682F67 Fin	CL3390, CL3391 1 3/4" - 2" spanner head	\$19.00
682F68 Fin	CL3390, CL3391 1 3/4" - 2" Torx head	\$19.00
682F65 Fin	CL3390, CL3391 over 2" phillips head	\$58.00
682F86 Fin	CL3390, CL3391 over 2" spanner head	\$58.00
682F87 Fin	CL3390, CL3391 over 2" Torx head	\$58.00
684F44 Fin	CL3350 Half Dummy Trim - phillips head	\$12.00
684F45 Fin	CL3350 Half Dummy Trim - spanner head	\$58.00
684F46 Fin	CL3350 Half Dummy Trim - Torx head	\$58.00
684F528	CL3370 Half Dummy Trim	\$8.60
<b>BUTTONS</b>		
585F76 Fin	Turnbutton CL3351	\$26.00
585F77 Fin	Pushbutton CL3320, CL3320H, CL3320TO, CL3340, CL3361, CL3375	\$26.00
585F78 Fin	Hotel button CL3329	
585F79 Fin	Slotted button CL3393	

PART NO.	DESCRIPTION	LIST PRICE
<b>FRONT PLATE RABBETTED STRIKE</b>		
315F93 Fin*	606, 612, 619, 626, 605, 611, 613, 625	\$75.00
<b>RABBETTED STRIKE</b>		
315F94 Fin*	606, 612, 619, 626, 605, 611, 613, 625	\$75.00
601F283 Fin*	Rabbetted Strike & Front	\$115.00

<b>ROSES</b>		
678F25 Fin	Rose	\$59.00
598F59 Fin	Blank Rose	\$37.00
710F618	Rose liner I/S 1 3/4" - 2" after June 2004	\$8.60
710F628	Rose liner I/S over 2" after June 2004	\$8.60
678F248	Rose liner O/S 1 3/4" - 2"	
678F498	Rose liner O/S over 2"	\$8.60
586F51 Fin	Thumbturn ass'y 1 3/4" - 2"	\$114.00
686F88 Fin	Thumbturn ass'y over 2"	
682F788	Rose liner CL3380, CL3381	\$35.00

<b>STRIKES - 4 7/8" ANSI CURVED LIP</b>		
217L13M016	1" Lip Length	\$31.00
217L13M018	1 1/8" Lip Length	
217L13M020	1 1/4" Lip Length	
217L13M022	1 3/8" Lip Length	
217L13M024	1 1/2" Lip Length	
217L13M028	1 3/4" Lip Length	\$31.00
217L13M032	2" Lip Length	
217L13M036	2 1/4" Lip Length	
217L13M040	2 1/2" Lip Length	
217L13M044	2 3/4" Lip Length	
217L13M048	3" Lip Length	

<b>STRIKES - 2 3/4" T- CURVED LIP</b>		
586L19M016	1" Lip Length	\$31.00
586L19M018	1 1/8" Lip Length	
586L19M020	1 1/4" Lip Length	
586L19M022	1 3/8" Lip Length	
586L19M024	1 1/2" Lip Length	
586L19M028	1 3/4" Lip Length	\$31.00
586L19M032	2" Lip Length	
586L19M036	2 1/4" Lip Length	
586L19M040	2 1/2" Lip Length	
586L19M044	2 3/4" Lip Length	
586L19M048	3" Lip Length	

PART NO.	DESCRIPTION	LIST PRICE
<b>BUTTONS</b>		<b>ALL FINISH</b>
585F762	CL3551 (Turn Button)	\$26.00
585F772	CL3520, 61 (Push Button)	\$26.00
<b>CASSETTE HOUSING O/S</b>		<b>NO FINISH</b>
796F378	Standard	\$38.00
686F858	CL3550, 70	\$137.00
<b>CASSETTE HOUSING I/S</b>		<b>NO FINISH</b>
796F408	CL3580, 81	\$26.00
686F868	CL3570	\$125.00
796F398	Standard I/S Spring Housing	\$21.00
<b>CHASSIS ASSEMBLY, STANDARD</b>		<b>NO FINISH</b>
796F208	CL3510	\$117.00
796F218	CL3520, 61	\$164.00
796F248	CL3580	\$164.00
796F228	CL3551, 57	\$164.00
796F238	CL3555	\$164.00
796F258	CL3581	\$187.00
796F268	CL3582	\$222.00
<b>CHASSIS ASSEMBLY, LFIC</b>		<b>NO FINISH</b>
796F318	CL3561	\$164.00
796F328	CL3551, 57	\$164.00
796F338	CL3555	\$176.00
796F358	CL3581	\$195.00
796F368	CL3582	\$230.00
<b>CYLINDER PARTS</b>		<b>NO FINISH</b>
622F308	Tailpiece 6-Pin	\$3.60
682F298	Tailpiece 7-pin	\$3.60
682F398	M06 - Schlage® tailpiece kit	\$23.00
682F969	M09 - Sargent® tailpiece kit	\$23.00
631F248	C6/C7 - LFIC tailpiece kit	\$8.60
682F958	M08 - SFIC kit	\$8.60
697F942	M69 - Schlage® IC tailpiece kit	\$31.00
<b>HOUSING ASSEMBLIES</b>		
796F388	Housing Assembly, I/S, D134	\$23.00
796F398	Housing Assembly, I/S, D138	\$21.00

PART NO.	DESCRIPTION	LIST PRICE	
<b>LATCH ASSEMBLY</b>		<b>ALL FINISH</b>	
<b>Deadlocking Latches</b>			
599F92	2-3/8" backset x 1" front	\$82.00	
599F95	2-3/8" backset x 1" round corner		
599F98	2-3/8" backset x 1-1/8" front		
600F01	2-3/8" backset x 1-1/8" round corner		
600F04	2-3/4" backset x 1" front		
600F07	2-3/4" backset x 1" round corner		
600F10	2-3/4" backset x 1-1/8" front		
600F13	2-3/4" backset x 1-1/8" round corner		
600F63	3-3/4" backset x 1-1/8" front		\$114.00
600F66	3-3/4" backset x 1-1/8" round corner		\$114.00
600F69	5" backset x 1-1/8" front		
600F72	5" backset x 1-1/8" round corner		
<b>Deadlocking Latches with Release (CL3520)</b>			
599F93	2-3/8" backset x 1" front	\$82.00	
599F96	2-3/8" backset x 1" round corner		
599F99	2-3/8" backset x 1-1/8" front		
600F02	2-3/8" backset x 1-1/8" round corner		
600F05	2-3/4" backset x 1" front		
600F08	2-3/4" backset x 1" round corner		
600F11	2-3/4" backset x 1-1/8" front		
600F14	2-3/4" backset x 1-1/8" round corner		
600F64	3 3/4" backset x 1 1/8" front		\$114.00
600F67	3-3/4" backset x 1-1/8" round corner		\$114.00
600F70	5" backset x 1 1/8" front		
600F73	5" backset x 1-1/8" round corner		
<b>Plain Spring Latches (CL3510)</b>			
599F91	2-3/8" backset x 1" front	\$82.00	
599F94	2-3/8" backset x 1" rounded corner		
599F97	2-3/8" backset x 1-1/8" front		
600F00	2-3/8" backset x 1-1/8" rounded corner		
600F03	2-3/4" backset x 1" front		
600F06	2-3/4" backset x 1" rounded corner		
600F09	2-3/4" backset x 1-1/8" front		
600F12	2-3/4" backset x 1-1/8" rounded corner		
600F62	3-3/4" backset x 1-1/8" front		\$114.00
600F65	3-3/4" backset x 1-1/8" rounded corner		\$114.00
600F68	5" backset x 1-1/8" front		
600F71	5" backset x 1-1/8" rounded corner		

# CL3500 Cylindrical Lock Series Heavy-Duty Lever Lockset

*USA & Canada Prices Effective February 1, 2022*

PART NO.	DESCRIPTION	LIST PRICE
<b>LEVERS</b>		<b>ALL FINISH</b>
598F815	AZD x plain	\$113.00
598F825	AZD x cylinder or button	\$113.00
598F835	AZD x emergency hole	\$113.00
598F905	AZD x C6 LFIC 6-pin	\$113.00
599F275	AZD x C7 LFIC 7-pin	\$113.00
409F905	AZD x M08 SFIC	\$113.00
797F845	NZD x plain	\$113.00
797F855	NZD x cylinder or button	\$113.00
797F865	NZD x emergency hole	\$113.00
797F875	NZD x M09 Sargent® cylinder	\$113.00
797F915	NZD x C6 LFIC 6-pin	\$113.00
797F925	NZD x C7 LFIC 7-pin	\$113.00
797F935	NZD x M69 Schlage LFIC	\$113.00
797F945	NZD x M08 SFIC	\$113.00
798F115	PZD x plain	\$113.00
798F125	PZD x cylinder or button	
798F135	PZD x emergency hole	
798F145	PZD x M09 Sargent® cylinder	\$113.00
798F155	PZD x C6 LFIC 6-pin	
798F165	PZD x C7 LFIC 7-pin	
798F175	PZD x M69 Schlage® LFIC	\$113.00
798F185	PZD x M08 SFIC	
<b>LEVER INSERT</b>		<b>ALL FINISH</b>
598F809	Standard	\$3.60
<b>MOUNTING SCREW PACK</b>		
796F118	Standard	\$6.00
797F828	Standard - CL3580, 81	\$16.00
684F448	CL3550 (ALL FINISH)	\$12.00
684F528	CL3570	\$8.60

PART NO.	DESCRIPTION	LIST PRICE
<b>ROSES</b>		<b>ALL FINISH</b>
678F252	Standard	\$59.00
598F592	Blank - CL3580, 81	\$37.00
<b>ROSE LINER O/S</b>		<b>NO FINISH</b>
678F248	Standard	\$8.60
682F788	CL3580, 81	\$35.00
<b>SCREW PACKS FOR LATCH &amp; STRIKE</b>		
604F228	For Latch & ANSI Strike	\$8.60
604F268	For Latch & (T strike)	\$8.60
<b>STRIKES</b>		<b>NO FINISH</b>
<b>ANSI Curved Lip Strike</b>		
217L13M016	1" Lip Length	\$31.00
217L13M018	1-1/8" Lip Length	
217L13M020	1-1/4" Lip Length	
217L13M022	1-3/8" Lip Length	
217L13M024	1-1/2" Lip Length	
217L13M028	1-3/4" Lip Length	\$31.00
217L13M032	2" Lip Length	
217L13M036	2-1/4" Lip Length	
217L13M040	2-1/2" Lip Length	
217L13M044	2-3/4" Lip Length	
217L13M048	3" Lip Length	
<b>STRIKE BOX</b>		<b>NO FINISH</b>
025F858	Curved lip (T strike)	\$4.90

### CL3800 PARTS

PART NO.	DESCRIPTION	LIST PRICE
<b>BUTTONS</b>		<b>ALL FINISH</b>
585F762	CL3851 (Turn Button)	\$26.00
585F772	CL3820, 40, 61 (Push Button)	\$26.00
<b>CASSETTE HOUSING O/S</b>		<b>NO FINISH</b>
796F378	Standard	\$38.00
686F858	CL3850, 70	\$137.00
<b>CASSETTE HOUSING I/S</b>		<b>NO FINISH</b>
796F398	Standard - 1-3/8" to 1-7/8" door	\$21.00
797F808	D214 - 2" to 2-1/4" door	\$26.00
796F408	CL3880, 81	\$26.00
686F868	CL3870	\$125.00
<b>CHASSIS ASSEMBLY, STANDARD</b>		<b>NO FINISH</b>
797F618	CL3810	\$66.00
797F628	CL3820, 61	\$75.00
797F658	CL3880	\$66.00
797F668	CL3851, 57	\$79.00
797F688	CL3855	\$79.00
<b>CHASSIS ASSEMBLY, IC</b>		<b>NO FINISH</b>
797F638	CL3861	\$77.00
797F678	CL3851, 57	\$81.00
797F698	CL3855	\$81.00

PART NO.	DESCRIPTION	LIST PRICE	
<b>CYLINDER PARTS</b>		<b>NO FINISH</b>	
622F308	Tailpiece 6-Pin	\$3.60	
682F298	Tailpiece 7-pin	\$3.60	
682F398	M06 - Schlage® tailpiece kit	\$23.00	
682F969	M09 - SARGENT® tailpiece kit	\$23.00	
631F248	C6/C7 - LFIC tailpiece kit	\$8.60	
682F958	M08 - SFIC kit	\$8.60	
697F942	M69 - Schlage® LFIC tailpiece kit	\$31.00	
<b>LATCH ASSEMBLY</b>		<b>ALL FINISH</b>	
<b>Deadlocking Latches</b>			
599F92	2-3/8" backset x 1" front	\$82.00	
599F95	2-3/8" backset x 1" rounded corner		
599F98	2-3/8" backset x 1-1/8" front		
600F01	2-3/8" backset x 1-1/8" rounded corner		
600F04	2-3/4" backset x 1" front		
600F07	2-3/4" backset x 1" rounded corner		
600F10	2-3/4" backset x 1-1/8" front		
600F13	2-3/4" backset x 1-1/8" rounded corner		
600F63	3-3/4" backset x 1-1/8" front		\$114.00
600F66	3-3/4" backset x 1-1/8" rounded corner		\$114.00
600F69	5" backset x 1-1/8" front	\$114.00	
600F72	5" backset x 1-1/8" rounded corner	\$114.00	
<b>Deadlocking Latches with Release (CL3810)</b>			
599F93	2-3/8" backset x 1" front	\$82.00	
599F96	2-3/8" backset x 1" rounded corner		
599F99	2-3/8" backset x 1-1/8" front		
600F02	2-3/8" backset x 1-1/8" rounded corner		
600F05	2-3/4" backset x 1" front		
600F08	2-3/4" backset x 1" rounded corner		
600F11	2-3/4" backset x 1-1/8" front		
600F14	2-3/4" backset x 1-1/8" rounded corner		
600F64	3 3/4" backset x 1 1/8" front	\$114.00	
600F67	3-3/4" backset x 1-1/8" rounded corner	\$114.00	
600F70	5" backset x 1 1/8" front	\$114.00	
600F73	5" backset x 1-1/8" rounded corner	\$114.00	
<b>Plain Spring Latches (CL3810)</b>			
599F91	2-3/8" backset x 1" front	\$82.00	
599F94	2-3/8" backset x 1" rounded corner		
599F97	2-3/8" backset x 1-1/8" front		
600F00	2-3/8" backset x 1-1/8" rounded corner		
600F03	2-3/4" backset x 1" front		
600F06	2-3/4" backset x 1" rounded corner		
600F09	2-3/4" backset x 1-1/8" front		
600F12	2-3/4" backset x 1-1/8" rounded corner		
600F62	3-3/4" backset x 1-1/8" front	\$114.00	
600F65	3-3/4" backset x 1-1/8" rounded corner	\$114.00	
600F68	5" backset x 1-1/8" front	\$114.00	
600F71	5" backset x 1-1/8" rounded corner	\$114.00	

# CL3800 Cylindrical Lock Series Grade 2 Key-In-Lever Lockset

*USA & Canada Prices Effective February 1, 2022*

## CL3800 PARTS

PART NO.	DESCRIPTION	LIST PRICE
<b>LEVERS 1-3/8" to 1-7/8" Doors</b>		<b>ALL FINISH</b>
598F815	AZD x plain	\$113.00
598F825	AZD x cylinder or button	\$113.00
598F835	AZD x emergency hole	\$113.00
598F905	AZD x C6 LFIC 6-pin	\$113.00
599F275	AZD x C7 LFIC 7-pin	\$113.00
409F905	AZD x M08 SFIC	\$113.00
797F845	NZD x plain	\$113.00
797F855	NZD x cylinder or button	\$113.00
797F865	NZD x emergency hole	\$113.00
797F875	NZD x M09 Sargent® cylinder	\$113.00
797F915	NZD x C6 LFIC 6-pin	\$113.00
797F925	NZD x C7 LFIC 7-pin	\$113.00
797F935	NZD x M69 Schlage LFIC	\$113.00
797F945	NZD x M08 SFIC	\$113.00
798F115	PZD x plain	\$113.00
798F125	PZD x cylinder or button	\$113.00
798F135	PZD x emergency hole	\$113.00
798F145	PZD x M09 Sargent® cylinder	\$113.00
798F155	PZD x C6 LFIC 6-pin	\$113.00
798F165	PZD x C7 LFIC 7-pin	\$113.00
798F175	PZD x M69 Schlage® LFIC	\$113.00
798F185	PZD x M08 SFIC	\$113.00
<b>LEVERS 2" to 2-1/4" Doors - D214</b>		<b>ALL FINISH</b>
684F775	AZD x plain	\$137.00
684F785	AZD x cylinder or button	\$137.00
684F795	AZD x emergency hole	\$137.00
684F805	AZD x C6 LFIC 6-pin	\$137.00
684F815	AZD x C7 LFIC 7-pin	\$137.00
409F875	AZD x M08 SFIC	\$137.00
684F825	NZD x plain	\$137.00
684F835	NZD x cylinder or button	\$137.00
684F845	NZD x emergency hole	\$137.00
684F855	NZD x M09 Sargent® cylinder	\$137.00
684F865	NZD x C6 LFIC 6-pin	\$137.00
684F875	NZD x C7 LFIC 7-pin	\$137.00
690F985	NZD x M69 Schlage® LFIC	\$137.00
684F885	NZD x M08 SFIC	\$137.00
798F215	PZD x plain	\$137.00
798F225	PZD x cylinder or button	\$137.00
798F235	PZD x emergency hole	\$137.00
798F245	PZD x M09 Sargent® cylinder	\$137.00
798F255	PZD x C6 LFIC 6-pin	\$137.00
798F265	PZD x C7 LFIC 7-pin	\$137.00
798F275	PZD x M69 Schlage® LFIC	\$137.00
798F285	PZD x M08 SFIC	\$137.00

PART NO.	DESCRIPTION	LIST PRICE
<b>LEVER INSERT</b>		<b>ALL FINISH</b>
598F809	Standard - 1-3/8" to 1-7/8" door	\$3.60
684F539	D214 - 2" to 2-1/4" door	\$54.00
<b>MOUNTING SCREW PACK</b>		
796F118	Standard - 1-3/8" to 1-7/8" door	\$6.00
797F818	D214 - 2" to 2-1/4" door	\$21.00
797F828	Standard - CL3880, 81, 90, 91	\$16.00
797F838	D214 - CL3880, 81, 90, 91	\$21.00
684F448	CL3850 (ALL FINISH)	\$12.00
684F528	CL3870	\$8.60
<b>ROSES</b>		<b>ALL FINISH</b>
678F252	Standard	\$59.00
598F592	Blank - CL3880, 81	\$37.00
<b>ROSE LINER O/S</b>		<b>NO FINISH</b>
678F248	Standard - 1-3/8" to 1-7/8" door	\$8.60
678F498	D214 - 2" to 2-1/4" door	\$8.60
682F788	CL3880, 81	\$35.00
<b>SCREW PACK FOR LATCH &amp; STRIKE</b>		<b>ALL FINISH</b>
604F228	For Latch & ANSI Strike	\$8.60
604F268	For Latch & 'T' or Full Lip Strike	\$8.60
<b>STRIKES*</b>		<b>ALL FINISH</b>
680L52	ANSI Curved Lip Blank Strike	\$31.00
586L19	T-Strike	
680L50	Full Lip Strike	
680L51	Full Lip Strike 1/4" Radius (Available Only 1-1/4" Lip)	\$20.00
<b>STRIKE BOX</b>		<b>NO FINISH</b>
025F858	Curved lip (T strike)	\$4.90
<b>THUMBURNS</b>		<b>ALL FINISH</b>
586F512	Standard - 91	\$114.00
686F882	D214 - 91	\$114.00

\*Specify length and finish

### LOCKSET PARTS

PART NO.	DESCRIPTION	LIST PRICE
<b>SCREW PACKET</b>		
<b>605, 613E, 630</b>		
556F558	for CK4350 †Order 50-	\$3.60
604F268	for curved lip strike	\$8.60
604F278	for curved lip strike x spanner head (M02)	\$19.00
604F288	for curved lip strike x Torx® head (M04)	\$19.00
604F238	for spanner head (M02)	\$19.00
480F68	for SR118	\$7.40
596F618	for SR118 & spanner head (M02)	\$19.00
596F628	for SR118 & Torx head (M04)	
604F228	standard	\$8.60
604F248	for Torx head (M04)	\$19.00
224F008*	Screw, Sems Assembly #8 -32 X 1-1/4" †Order 100-	\$3.60

PART NO.	DESCRIPTION	LIST PRICE
<b>STRIKE (Cont'd)</b>		
<b>Curved Lip Box Strike</b>		
586L19M016	1" Lip Length	\$31.00
586L19M018	1-1/8" Lip Length	
586L19M020	1-1/4" Lip Length	
586L19M022	1-3/8" Lip Length	
586L19M024	1-1/2" Lip Length	
586L19M028	1-3/4" Lip Length	
586L19M032	2" Lip Length	\$31.00
586L19M036	2-1/4" Lip Length	
586L19M040	2-1/2" Lip Length	
586L19M044	2-3/4" Lip Length	
586L19M048	3" Lip Length	

<b>STRIKE</b>		
<b>605, 613E, 630</b>		
<b>ANSI Curved Lip Strike</b>		
217L13M016	1" Lip Length	\$31.00
217L13M018	1-1/8" Lip Length	
217L13M020	1-1/4" Lip Length	
217L13M022	1-3/8" Lip Length	
217L13M024	1-1/2" Lip Length	
217L13M028	1-3/4" Lip Length	
217L13M032	2" Lip Length	\$31.00
217L13M036	2-1/4" Lip Length	
217L13M040	2-1/2" Lip Length	
217L13M044	2-3/4" Lip Length	
217L13M048	3" Lip Length	

†Sold only in multiples of the number indicated. Price is each.

## CK4400 SERIES

PART NO.	DESCRIPTION	LIST PRICE
<b>STRIKES AND WROUGHT BOX</b>		
<b>ANSI TYPE</b>		<b>ALL FINISHES</b>
217L13M016	1" Lip to Center	\$31.00
217L13M018	1-1/8" Lip to Center	
217L13M020	1-1/4" Lip to Center (standard)	
217L13M022	1-3/8" Lip to Center	
217L13M024	1-1/2" Lip to Center	
217L13M028	1-3/4" Lip to Center	\$31.00
217L13M032	2" Lip to Center	
217L13M036	2-1/4" Lip to Center	
217L13M040	2-1/2" Lip to center	
217L13M044	2-3/4" Lip to Center	
217L13M048	3" Lip to Center	
<b>CURVED LIP BOX TYPE STRIKE</b>		<b>ALL FINISHES</b>
586L19M016	1" Lip Length	\$31.00
586L19M018	1-1/8" Lip Length	
586L19M020	1-1/4" Lip Length	
586L19M022	1-3/8" Lip Length	
586L19M024	1-1/2" Lip Length	
586L19M028	1-3/4" Lip Length	\$31.00
586L19M032	2" Lip Length	
586L19M036	2-1/4" Lip Length	
586L19M040	2-1/2" Lip Length	
586L19M044	2-3/4" Lip Length	
586L19M048	3" Lip Length	

PART NO.	DESCRIPTION	LIST PRICE
<b>ROSE</b>		<b>NO FINISH</b>
579F11	Screw Packet & Strike Box	\$7.40
<b>LATCH ASSEMBLY</b>		<b>ALL FINISHES</b>
574F29	2-3/8" deadlatch	\$49.00
574F30	2-3/8" Deadlatch With Throw-Off	
574F55	2-3/4" Deadlatch	
574F56	2-3/4" Deadlatch With Throw-Off	\$86.00
574F29 x574F25	3-3/4" Deadlatch	
574F30 x574F25	3-3/4" Deadlatch With Throw-Off	
574F29 x574F26	5" Deadlatch	
574F30 x574F26	5" Deadlatch With Throw-Off	
<b>BACKSET EXTENDER KIT</b>		
574F258	Extender ONLY (No Latch Unit) - Must be added to 2-3/8" Latch Unit	\$38.00
574F268	Extender ONLY (No Latch Unit) - Must be added to 2-3/8" Latch Unit	



LOCKSET PARTS					
PART NO.	DESCRIPTION	LIST PRICE	PART NO.	DESCRIPTION	LIST PRICE
<b>BUSHING</b> NO FINISH			<b>HUB SPACER</b> NO FINISH		
194F228	Bushing	\$4.90	060F338	for UT5210, 61 †Order 50-	\$3.60
<b>BUTTON ASSEMBLY</b> 612, 613, 619, 625, 626			070F428	for UT5220 †Order 50-	\$3.60
022F80	for UT5220	\$69.00	070F438	for UT5220 †Order 50-	\$6.00
157F11	for UT5251		606F038	for UT5255	\$3.60
156F43	for UT5261		067F428	for UT5257	\$4.90
<b>CHASSIS COVER</b> NO FINISH			<b>LEVER</b> 612, 613, 619, 625, 626		
138F888	Chassis Cover	\$8.60	582F122	cyl/button LH	\$250.00
<b>CHASSIS</b> 612, 613, 619, 625, 626			582F112	cyl/button RH	
496F33	for UT5210	\$402.00	582F142	cyl/button LH tactile	\$250.00
496F34	for UT5220		582F132	cyl/button RH tactile	
496F32	for UT5251, 55, 57, 72		489F892	LFIC 6-pin LH	\$250.00
198F71	for UT5261		489F882	LFIC 6-pin RH	
381F30	for UT5282		549F362	LFIC 6-pin LH tactile	\$259.00
<b>CORE HOUSING</b> NO FINISH			549F352	LFIC 6-pin RH tactile	
342F052	for 6-pin LFIC	\$15.00	613F232	LFIC 7-pin LH	\$250.00
442F952	for 7-pin LFIC	613F222	LFIC 7-pin RH		
613F352	for 6/7 pin Best-type LFIC	\$12.00	613F252	LFIC 7-pin LH tactile	\$259.00
<b>COUPLING</b> NO FINISH			613F242	LFIC 7-pin RH tactile	
131F278	Coupling	\$68.00	613F112	plain LH	\$250.00
<b>EMERGENCY KEY</b> NO FINISH			613F102	plain RH	
679F818	for UT5220	\$3.60	613F152	plain LH tactile	\$250.00
<b>ESCUTCHEON</b> 612, 613, 619, 625, 626			613F142	plain RH tactile	
144F33	for inside lever	\$194.00	613F132	priv. key hole LH	\$250.00
415F16	for outside knob		613F122	priv. key hole RH	
144F34	for outside lever		613F172	priv. key hole LH tactile	\$250.00
605F90	for inside lever, lead lined		613F162	priv. key hole RH tactile	
301F567	for outside lever, ext. lip 630 only		613F432	SFIC prep LH	\$276.00
<b>GRIP RETAINER</b> NO FINISH			613F422	SFIC prep RH	
078F078	Grip Retainer †Order 50-	\$3.60	<b>LEVER INSERT</b> NO FINISH		
<b>HUB</b> NO FINISH			613F029	Lever Insert †Order 50-	\$3.60
060F428	for all but UT5255	\$4.90	<b>LEVER SPRING ANCHOR</b> NO FINISH		
071F628	for UT5210	\$6.00	171F798	Lever Spring Anchor	\$21.00
081F778	for UT5220	\$7.40	<b>PIN</b> NO FINISH		
147F078	for UT5251, 55, 72	\$4.90	019F137	Pin, Spindle Drive †Order 50-	\$3.60
140F978	for UT5251, 57, 72	\$4.90	156F837	Pin, UT5261 shank †Order 50-	\$3.60
071F638	for UT5257	\$4.90	286F507	Pin, UT5282 spindle †Order 50-	\$3.60

†Sold only in multiples of the number indicated. Price is each.

# UT5200 Series Pre-Assembled Unit Locksets

USA & Canada Prices Effective February 1, 2022

PART NO.	DESCRIPTION	LIST PRICE
<b>PLUG DRIVER NO FINISH</b>		
144F888	Plug Driver & Spindle Assembly UT5282	\$51.00
168F818	Plug Driver Assembly	\$32.00
144F298	Plug Driver UT5251, 57, 72	\$20.00
606F018	Plug Driver UT5255	\$19.00
145F328	Plug Driver UT5282	\$51.00
<b>RETAINING RING NO FINISH</b>		
251F198	Retaining Ring for UT5282 Spindle †Order 100-	\$3.60
<b>SCREW 612, 619, 626, 613, 625</b>		
480F70	Screw Pkt. (strike mount'g) †Order 20-	\$3.60
<b>No Finish</b>		
249F768	Screw, Fixed Escutcheon †Order 50-	\$3.60
092F789	Screw, Strike Adjustment (nylon) †Order 50-	\$3.60
<b>SHANK, LEVER NO FINISH</b>		
102F198	for UT5210, 57 outside	\$59.00
102F378	for UT5220 inside	
114F678	for UT5220 outside	
188F758	for UT5251, 57, 72 outside	
188F738	for UT5251, 72 inside	\$68.00
605F768	for UT5255 inside	\$61.00
605F778	for UT5255 outside	\$61.00
156F658	for UT5261 inside	\$109.00
156F648	for UT5261 outside	\$74.00
102F278	for UT5282 inside	\$61.00
287F608	for UT5282 outside	\$91.00
<b>SHANK RETAINER NO FINISH</b>		
242F508	for lever †Order 50-	\$3.60

PART NO.	DESCRIPTION	LIST PRICE
<b>SPINDLE NO FINISH</b>		
201F188	for UT5220	\$9.70
144F308	for UT5251, 72	\$9.70
606F028	for UT5255	\$9.70
335F988	for UT5257	\$13.00
<b>SPRING NO FINISH</b>		
022F723	Spring, Button UT5220, 61 †Order 50-	\$3.60
103F458	Spring, Lever Return LH	\$12.00
103F448	Spring, Lever Return RH	\$12.00
060F053	Spring, Shoe UT5220, 61 †Order 100-	\$3.60
071F673	Spring, Spindle for UT5220 †Order 100-	\$3.60
249F773	Spring, Spindle for UT5251, 55, 57, 72 †Order 100-	\$3.60
261F118	Spring, Spindle for UT5282 †Order 100-	\$3.60
<b>STRIKE 612, 613, 625, 626</b>		
236L75M020	ANSI curved lip	\$30.00
610L44	ANSI straight lip	
610L43	ANSI straight lip for ext. esc.	
083L96M032	curved lip box, 2"	
083L96M036	curved lip box, 2-1/4"	
083L96M034	curved lip box, 2-1/8" (std)	
083L96M040	curved lip box, 2-1/2"	
083L96M048	curved lip box, 3"	
293L14	curved lip box for ext. lip esc.	
082L67	pairs of doors	
<b>THROUGHBOLT</b>		
222F85	Regular	\$7.40
223F29	Spanner head	\$7.40
<b>THROW MEMBER NO FINISH</b>		
320F442	for SFIC core	\$8.60
342F032	for Corbin Russwin core	\$8.60

† Sold only in multiples of the number indicated. Price is each.

## Padlocks and Deadlocks

<b>PADLOCKS</b>			
PART NO.	DESCRIPTION	LIST PRICE	SOLD IN MULT. OF
422L842144	Chain & clevis, 9" brass	\$26.00	1
422L848144	Chain & clevis, 9" steel	\$24.00	1
303F242	Pin chamber cap	\$3.60	100
228F348	Plug retainer, oversize Spirol pin	\$3.60	100
244F647	Plug retainer, standard solid pin	\$3.60	20
405F772	Security disc	\$3.60	50
756F963	Throw member, LFIC models	\$11.00	10
<b>DL4100 SERIES DEADLOCK PARTS</b>			
PART NO.	DESCRIPTION	LIST PRICE	SOLD IN MULT. OF
796F46 x Fin	Outside Front	\$109.00	
796F30 x Fin	Thumbturn Assembly	\$90.00	
791F51 x Fin	Ergonomic Thumbturn Assembly	\$82.00	
<b>Mouting Packs:</b>			
791F82 Fin	Screw Pack - Standard Strike	\$26.00	
791F83 Fin	Spanner Head crew Pack - Standard Strike	\$19.00	
791F84 Fin	Torx Head Screw Pack - Standard Strike	\$19.00	
791F85 Fin	Screw Pack - ANSI Strike	\$6.00	
791F86 Fin	Spanner Head crew Pack - ANSI Strike	\$19.00	
791F87 Fin	Torx Head Screw Pack - ANSI Strike	\$19.00	
<b>Strikes:</b>			
796F43	Standard Strike	\$18.00	
240L08018	ANSI Strike 1-3/4" Door	\$26.00	
240L08020	ANSI Strike 2" Door	\$26.00	
240L08022	ANSI Strike 2-1/4" Door	\$26.00	
466F279	Strike Box	\$12.00	

<b>DL3000 SERIES DEADLOCKS</b>			
PART NO.	DESCRIPTION	LIST PRICE	SOLD IN MULT. OF
261F298	Allen wrench 5/64"	\$4.90	10
467F36	Bolt front	\$21.00	1
467F345	Cylinder housing	\$63.00	1
467F338	Cylinder housing screw	\$3.60	20
480F708	Screw pack for ANSI strike	\$3.60	20
480F69	Screw pack for strikes 424F83 and 394F19	\$4.90	20
283F81	Collar Base / Rose	\$58.00	1
424F838	Strike, 2-3/4" x 1-1/8"	\$30.00	1
394F198	Strike, 3-1/2" x 1-1/8"	\$25.00	1
423L71	<b>Strike, ANSI</b> 611,613, and all other finishes	\$35.00	1
416F38	Security collar	\$53.00	1
467F358	Bolt, less front -2-3/4" B.S.	\$54.00	1
693F208	Bolt, less front -2-3/8" B.S.	\$54.00	1
467F378	Strike box	\$8.60	1
496F718	Strike box	\$7.40	1

DEVICE PARTS					
PART NO.	DESCRIPTION	LIST PRICE	PART NO.	DESCRIPTION	LIST PRICE
<b>ACTIVE HEAD (FIELD REVERSIBLE, WHERE HANDED)</b>			<b>NO FINISH</b>		
650F378	ED4200	\$306.00	<b>DELAYED EGRESS PC BOARDS</b>		
681F618	ED4200S	\$326.00			
650F418	ED4400 LHR	\$322.00			
650F408	ED4400 RHR				
650F468	ED4800 LHR	\$336.00			
650F458	ED4800 RHR				
650F358	ED5200	\$306.00			
650F368	ED5200A	\$322.00			
706F038	ED5202 RHR	\$360.00			
706F048	ED5202 LHR				
706F058	ED5202A RHR	\$374.00			
706F068	ED5202A LHR				
681F608	ED5200S(A)	\$326.00			
706F078	ED5202S(A) RHR	\$379.00			
706F088	ED5202S(A) LHR				
650F398	ED5400(A) LHR	\$322.00			
650F388	ED5400(A) RHR				
650F428	ED5600(A)	\$306.00			
706F098	ED5602(A) RHR	\$360.00			
706F108	ED5602(A) LHR				
650F448	ED5800(A) LHR	\$336.00			
650F438	ED5800(A) RHR				
<b>ARMORED FRONT 605, 606, 611, 612, 613, 619, 625, 626, 629, 630</b>			<b>COVER, BAR 605, 606, 611, 612, 613, 619, 625, 626, 629, 630</b>		
650F06	ED5600	\$22.00	650F07	36"	\$68.00
<b>BAR &amp; CARRIER ASSEMBLY</b>			<b>NO FINISH</b>		
650F248	All 48"	\$355.00	650F08	48"	\$68.00
650F238	ED4000 36"	\$337.00	<b>COVER, END</b>		
650F228	ED5000 36"				
<b>BAR CAP</b>			<b>NO FINISH</b>		
650F189	Black nylon	†Order 10-	\$6.00	<b>ED5000DB</b>	
<b>BOTTOM BOLT CASE</b>			<b>NO FINISH</b>		
650F588	ED4400, ED5400	\$55.00	605, 606, 611, 612, 613, 619, 625, 626, 629, 630		
650F598	ED5400A	\$59.00	<b>ED4000 36" cyl. dogging</b>		
<b>BOTTOM BOLT PACKET</b>					
650F778	ED4800	\$165.00	605, 606, 611, 612, 613, 619, 625, 626, 629, 630		
698F038	ED5800(A)	\$145.00	<b>ED4000 36" standard</b>		
<b>BOTTOM RAIL</b>					
650F21	48"	\$212.00	605, 606, 611, 612, 613, 619, 625, 626, 629, 630		
	606, 612, 630				
	605, 613				
	611, 625, 626, 629				
<b>BOTTOM ROD &amp; COUPLER ASSEMBLY</b>			<b>NO FINISH</b>		
650F798	ED4800, ED5800(A)	\$123.00	<b>ED5000 36" cyl. dogging</b>		
<b>BOTTOM ROD &amp; END PIN ASSEMBLY 605, 606, 611, 612, 613, 618, 619, 625, 626, 629, 630, 722</b>					
649F99 fin	Surface devices	\$198.00	605, 606, 611, 612, 613, 619, 625, 626, 629, 630		
<b>CARRIER BAR NO FINISH</b>			<b>NO FINISH</b>		
650F998	Internal	\$20.00	<b>ED5000(A) 36" standard</b>		
<b>COVER, ACTIVE HEAD 605, 606, 611, 612, 613, 619, 625, 626, 629, 630</b>					
650F00	ED5200	\$248.00	605, 606, 611, 612, 613, 619, 625, 626, 629, 630		
650F03	ED4200				
681F63	ED4200S				
650F04	ED4400				
650F05	ED4800				
681F62	ED5200S				
706F15	ED5602 RHR		\$262.00	<b>ED5000 36" bar</b>	
706F16	ED5602 LHR				
<b>COVER, TOP &amp; BOTTOM LATCH</b>			<b>NO FINISH</b>		
650F64	ED4400, ED5400(A)	\$104.00	605, 606, 611, 612, 613, 619, 625, 626, 629, 630		
<b>CYLINDER DOGGING KIT</b>					
653F13	ED4000 36" bar	\$183.00	605, 606, 611, 612, 613, 619, 625, 626, 629, 630		
	<b>DOGGING ASSEMBLY</b>				
653F12	ED5000 36" bar	\$183.00	605, 606, 611, 612, 613, 619, 625, 626, 629, 630		
	<b>DOGGING CYLINDER NUT</b>				
653F14	All 48" bar	\$194.00	605, 606, 611, 612, 613, 619, 625, 626, 629, 630		
	<b>DOGGING CYLINDER NUT</b>				
650F968	Cylinder type	\$49.00	605, 606, 611, 612, 613, 619, 625, 626, 629, 630		
650F528	Hex Key type				
697F862	Dogging Cylinder Nut	\$20.00	<b>NO FINISH</b>		

†Sold only in multiples of the number indicated. Price is each.

**DEVICE PARTS (Cont'd)**

PART NO.	DESCRIPTION	LIST PRICE
<b>DOGGING CYLINDER SLEEVE</b>		
650F959	Dogging Cylinder Sleeve	\$11.00
<b>DOGGING HOLE PLUG</b>		
650F279	Dogging Hole Plug †Order 50-	\$3.60
<b>DOGGING KEY, HEX</b>		
656F408	5/32"	\$4.90
<b>END CAP RETROFIT KIT</b>		
704F66	End Cap Retrofit Kit	\$104.00
<b>END CAP</b>		
704F62	End Cap	\$77.00
710F00M	Flush End Cap Retrofit Kit (M110)	\$97.00
<b>END CLAMP PACKET</b>		
592F338	ED4000, ED5000-D214	\$18.00
704F658	ED4200(S), ED5200S(A)	
704F648	ED4000, ED5000(A)	
<b>FLUSH STRIKE TRANSOM BRACKET</b>		
650F878	Flush strike transom brkt., ED5400(A)	\$68.00
<b>LATCH PACKET</b>		
654F218	Latch pkt, ED4400, ED5400 †Order 10-	\$6.00
<b>MORTISE LOCK BODY</b>		
655F488RR	ED5610 knob - RHR	\$419.00
655F488LR	ED5610 knob - LHR	
650F698RR	ED5602, ED5610, ED5655 lever - RHR	\$419.00
650F698LR	ED5602, ED5610, ED5655 lever - LHR	
678F008RR	ED5610, ED5655 thumbpiece - RHR	\$419.00
678F008LR	ED5610, ED5655 thumbpiece - LHR	
650F678RR	ED5650,57 knob, lever/thumbpiece - RHR	\$419.00
650F678LR	ED5650,57 knob, lever/thumbpiece - LHR	
710F318LR	ED5634L - LHR	
710F318RR	ED5634L - RHR	\$718.00
710F328LR	ED5634L - LHR - M91	
710F328RR	ED5634L - RHR - M91	
710F338LR	ED5634L - LHR - M93	\$698.00
710F338RR	ED5634L - RHR - M93	
<b>ADAPTER ASSEMBLY, MORTISE</b>		
706F462	ED5602(A)	\$37.00
<b>MOUNTING PACKET</b>		
650F578	ED4400, ED5400(A)	\$111.00
654F208	Non-rated, wood door †Order 20-	\$4.90
<b>900, WS700 &amp; FE700 SERIES MULLION PACKETS</b>		
<b>TOP RETAINER AND SCREW PACKET</b>		
713F518	907, 908, 910, 907A, 908A	\$260.00
713F938	FE707A, FE708A	\$269.00
713F948	907BKM, 908BKM, 910KM	\$260.00
713F958	WS707AKM, WS708AKM	\$269.00
<b>BOTTOM RETAINER AND SCREW PACKET</b>		
713F528	907, 908, 910, 907A, 908A	\$171.00
713F998	FE707A, FE708A	\$269.00
713F988	907BKM, 908BKM, 910KM	\$171.00
713F908	WS707AKM, WS708AKM	\$269.00
<b>LOCKING MECHANISM PACKET</b>		
744F258	907BKM, 908BKM, 910KM	\$561.00
744F208	WS707AKM, WS708AKM	\$582.00
<b>1-1/4" CYLINDER COLLAR PACKET<sup>1</sup></b>		
447F43	907BKM <sup>2</sup> , 908BKM <sup>2</sup> , 910KM <sup>2</sup>	\$24.00
610F01	WS707AKM <sup>2</sup> , WS708AKM <sup>2</sup>	\$38.00
<b>1-1/2" LFIC CYLINDER COLLAR PACKET<sup>1</sup></b>		
609F37	907BKM <sup>2</sup> , 908BKM <sup>2</sup> , 910KM <sup>2</sup>	\$44.00
609F36	WS707AKM <sup>2</sup> , WS708AKM <sup>2</sup>	\$44.00

Notes: 1. Cylinder collar packets contain a collar & spring washer.  
2. Specify finish when ordering packets.

PART NO.	DESCRIPTION	LIST PRICE
<b>ROD EXTENSION KIT (CONCEALED VERTICAL)</b>		
684F427	Rod Extension Kit, 24"	\$109.00
<b>ROD EXTENSION KIT (SURFACE VERTICAL)</b>		
<b>Rod Extension Kit, 2"</b>		
655F15	605, 606, 612, 613, 619, 625, 626, 629, 630	\$108.00
<b>Rod Extension Kit, 6"</b>		
655F16	605, 606, 612, 613, 619, 625, 626, 629, 630	\$123.00
<b>Rod Extension Kit, 12"</b>		
655F17	605, 606, 612, 613, 619, 625, 626, 629, 630	\$130.00
<b>Rod Extension Kit, 24"</b>		
684F42	605, 606, 612, 613, 619, 625, 626, 629, 630	\$132.00
<b>ROD GUIDE COVER</b>		
<b>Rod Guide Cover</b>		
650F63	605, 606, 612, 613, 619, 625, 626, 629, 630	\$42.00
<b>ROD GUIDE PACKET</b>		
<b>Rod Guide Packet</b>		
650F62	606, 612, 613, 626	\$25.00
<b>SCREWS</b>		
605, 606, 611, 612, 613, 619, 625, 626, 629, 630		
429F41	Pack, Armored Front †Order 20- 606, 612, 613, 619	\$6.00
704F63	Packet, Cover 606,612,613,630 finish	\$6.00
656F668	#10-24 x 1/4" PH †Order 100-	\$3.60
650F538	Dogging Assembly †Order 50-	\$3.60
650F518	Latch head to carrier †Order 50-	\$3.60
650F288	Touch bar caps (622 only) †Order 50-	\$3.60
650F508	Trim slide †Order 100-	\$3.60
<b>SCREW PACK, TORX® PIN</b>		
701F60	ED4200(S), ED4800, ED5200(S), ED5800	\$22.00
701F61	ED4400, ED5400, ED5470	\$22.00
701F62	ED5600	\$23.00
701F63	ED5860	\$22.00
<b>SEX NUT PACKET</b>		
652F298	Sex Nut Packet (4 sex nuts)	\$25.00
<b>SHIM KIT</b>		
697F338	ED5200(S)(A), ED5600(A), ED5800(A)	\$142.00
697F348	ED5400(A)	\$168.00
697F358	ED4200(S), ED4800	\$142.00
697F368	ED4400	\$168.00
<b>SPRING, TOUCH PAD</b>		
656F41	Spring, Touch Pad	\$4.90
<b>STRIKE PACKET 622 FINISH ONLY</b>		
650F888	bottom for 1/2" threshold (S09)	\$77.00
650F318	ED4200(S), ED4800	\$75.00
730F778	ED5200(S)(A), ED5202(S)(A)	\$107.00
650L65	ED5600	\$48.00
650L657020	Mortise strike for ED5602(A)	\$48.00
653L157014	Mortise strike for doors with astragal	\$42.00
655F718	ED5200 x S02	\$77.00
653L163016	open back straight lip for 1-3/4" door	\$116.00
653L163020	open back straight lip for 2-1/4" door	\$155.00
653L183016	open back curved lip for 1-3/4" door	\$116.00
653L183020	open back curved lip for 2-1/4" door	\$155.00

†Sold only in multiples of the number indicated. Price is each.

## DEVICE PARTS (Cont'd)

PART NO.	DESCRIPTION	LIST PRICE	PART NO.	DESCRIPTION	LIST PRICE
<b>TOP LATCH</b>			<b>TOP STRIKE PACKET</b>		
650F738	Top Latch & Bracket Assembly, ED4800	\$238.00	650F548	Top strike packet	\$101.00
650F718	Top Latch & Bracket Assembly, ED5800	\$240.00	681F708	Top strike packet for ED5470B	\$38.00
650F728	Top Latch & Bracket Assembly, ED5800A	\$258.00	681F778	Top strike for ED5860B	\$44.00
650F558	Top Latch, ED4400, ED5400, ED5470	\$224.00	<b>TOUCH PAD CAP 622 ONLY</b>		
650F568	Top Latch, ED5400A, ED5470B	\$236.00	724F278	Touch Pad Cap, front	\$44.00
681F768	Top Latch, ED5860B	\$269.00	650F095	Touch Pad Cap, rear	\$36.00
681F718	Top Mtg. Plate for ED5470B	\$68.00	<b>TRIM SLIDE NO FINISH</b>		
<b>TOP ROD NO FINISH</b>			650F498	Trim Slide Retainer †Order 10-	\$6.00
650F818	Top Rod Tube, concealed	\$122.00	650F489	Trim Slide, ED4000	\$8.60
650F808	Top Rod, concealed	\$104.00			
	<b>Top Rod, surface</b>				
650F60 fin	605, 606, 611, 612, 613, 619, 625, 626, 629, 630	\$163.00			

## TRIM PARTS, GRIPS

DESIGN	STANDARD PART NO.	STANDARD PRICE 605, 606, 611, 612, 613, 619, 625, 626, 629, 630	KNURLED PART NO.	KNURLED PART PRICE	ABRASIVE PART NO.	ABRASIVE PART PRICE
A7	652F78		652F79		652F80	
C7	652F66		652F67		652F68	
D7 RHR	652F69		652F70		652F71	
D7 LHR	652F72		652F73		652F74	
E7	652F57		652F58		652F59	
L7	652F60		652F61		652F62	
N7	652F75		652F76		652F77	
PR7	652F81		652F82		652F83	
R7	652F63		652F64		652F65	
A7M	653F71		653F72		653F73	
C7M	653F59		653F60		653F61	
D7M RHR	653F62		653F63			
D7M LHR	653F65		653F66			
E7M	653F50					
L7M	653F53	\$211.00	653F54	\$291.00	653F55	\$262.00
N7M	653F68		653F69		653F70	
PR7M	653F74		653F75		653F76	
R7M	653F56		653F57			
A8	653F05					
C8	652F93				652F95	
D8 RHR	652F96					
D8 LHR	652F99					
E8	652F84		652F85		652F86	
L8	652F87		652F88		652F89	
N8	653F02		653F03		653F04	
PR8	653F08		653F09		653F10	
R8	652F90				652F92	
08, 014	656F53		n/a		n/a	

†Sold only in multiples of the number indicated. Price is each.

### TRIM PARTS, GRIPS, ESCUTCHEONS (Cont'd)

DESIGN	STANDARD PART NO.	STANDARD PRICE 605, 606, 611, 612, 613, 619, 625, 626, 629, 630	KNURLED PART NO.	KNURLED PART PRICE	ABRASIVE PART NO.	ABRASIVE PART PRICE
A9	677F16	\$238.00	652F79	\$317.00	652F80	\$289.00
C9	677F15		652F67		652F68	
D9 RHR	677F26		652F70		652F71	
D9 LHR	677F27		652F73		652F74	
E9	677F13		652F58		652F59	
L9	677F04		652F61		652F62	
N9	677F05		652F76		652F77	
PR9	677F28		652F82		652F83	
R9	677F14		652F64		652F65	
A9M	653F71		653F72		653F73	
C9M	653F59		653F60		653F61	
D9M RHR	653F62		653F63			
D9M LHR	653F65		653F66			
E9M	653F50					
L9M	653F53		653F54		653F55	
N9M	653F68		653F69		653F70	
PR9M	653F74		653F75		653F76	
R9M	653F56		653F57			

DESIGN	PART NO.	LIST PRICE 605, 606, 613, 625, 626
FR9 RHR	698F64	\$238.00
FR9 LHR	698F66	
TS9	698F31	
Z9 RHR	698F68	
Z9 LHR	698F70	
M9	698F33	\$217.00
FR9M RHR	698F65	\$238.00
FR9M LHR	698F67	
TS9M	698F32	
Z9M RHR	698F69	
Z9M LHR	698F71	
M9M	698F34	\$217.00

PART NO.	DESCRIPTION	605, 606, 611, 612, 613, 613E, 619, 625, 626, 629, 630
656F58	x8 cyl. x thumbturn	\$173.00
656F59	x8 cyl. x lever	\$183.00
656F60	x8 plain x thumbturn	\$173.00
656F61	x8 plain x lever	\$183.00
651F00	F450	\$166.00
651F01	F457	
651F10	O14, T14 bottom	\$77.00
656F62	O1410 top	\$166.00
656F63	O1455/59 top	
651F09	T1410 top	\$150.00
651F06	T1450 top	\$145.00
651F08	T1455, T1459 top	\$150.00
651F04	T1457 top	\$145.00
733F41	F950	\$238.00
733F42	F957	
733F43	9M10, M50	
733F05	L910	
733F44	L950	
733F45	L955	
783F06*	L955 L959	
733F46	F9M57	
733F47	L957	
733F48	DL910	
733F49	DL9M10, DL9M50	
733F50	DL955, DL959	
733F51	DL9M55, DL9M57	
733F52	DL957	
733F53	DL950	

†Sold only in multiples of the number indicated. Price is each.

\*Not available in 630 Finish.

## TRIM PARTS (Cont'd)

PART NO.	DESCRIPTION	LIST PRICE
<b>BUSHING, NYLON</b> NO FINISH		
652F239	Bushing, Nylon †Order 20-	\$6.00
<b>CLUTCH LEVER</b> NO FINISH		
651F538	Clutch Lever †Order 20-	\$6.00
<b>COTTER PIN</b> NO FINISH		
677F098	Cotter Pin †Order 100-	\$3.60
<b>COVER PLATE</b> NO FINISH		
651F858	Cover Plate, x8, O14, T14	\$19.00
<b>CYLINDER COLLAR</b>		
	various	see page 355
<b>GEAR &amp; BLACK HOUSING ASSEMBLY</b> NO FINISH		
651F638	Gear & Black Housing Assembly (all but x750)	\$21.00
651F648	Gear, levers	\$8.60
655F548	Gear, dummy lever	
<b>HEX NUT/BUSHING</b> NO FINISH		
651F398	Hex Nut/Bushing for spring	\$7.40
<b>HOUSING</b> NO FINISH		
651F675	Housing & Cam Assembly, x755, T1355	\$56.00
651F965	Housing & Cam Assembly, x855, x859, O/T1455/59	\$46.00
651F425	Housing, Cylinder, F2, F3, T1357, O/T1457	\$9.70
651F545	Housing, Tailpiece Assembly	\$38.00
706F015	Housing, Cylinder ED5202(S)(A), ED5602(A)	\$11.00
706F005	Housing, Cylinder, Trim, ED5202(S)(A), ED5602(A)	\$55.00
<b>HUB</b> NO FINISH		
652F228	Hub	\$32.00
651F655	Hub, lever	\$9.70
656F64	Hub, G knob	\$9.70
<b>LOCK WASHER</b> NO FINISH		
651F448	for screw post †Order 50-	\$3.60
<b>NUT</b> NO FINISH		
651F888	Nut, Cover Plate †Order 50-	\$3.60
651F928	Nut, Spring Post	\$7.40
<b>PIN</b> NO FINISH		
651F838	Pin, Clutch Lever †Order 50-	\$3.60
651F988	Pin, Groove, 5/32" x 1-1/8" for T1410, T1455, T145 †Order 50-	\$3.60
651F587	Pin, Thumbpiece, T13M †Order 20-	\$3.60
<b>PULL</b>		
651F372	Pull, Offset - 605, 606, 611, 612, 613, 619, 625, 626, 629, 630	\$177.00
651F362	Pull, Straight - 605, 606, 611, 612, 613, 619, 625, 626, 629, 630	\$145.00
<b>RACK &amp; TAILPIECE ASSEMBLY</b> NO FINISH		
651F828	x810, x855, x859, O14, T14	\$113.00
652F218	x850	\$98.00
<b>RETAINER, CLUTCH LEVER PIN</b> NO FINISH		
651F898	Retainer, Clutch Lever Pin †Order 100-	\$3.60
<b>RETAINING RING</b> NO FINISH		
651F608	Retaining Ring, T13M †Order 50-	\$3.60
<b>ELECTRIFIED LOCKBODY USED WITH "SAF" &amp; "SEC" ED5600L DEVICES:</b>		
677F768LR 626	LOCK SA-L5 MORT.SAFE LHR	\$966.00
677F768RR 626	LOCK SA-L5 MORT.SAFE RHR	\$966.00
677F778LR 626	LOCK SA-L5 MORT.SEC. LHR	\$966.00
677F778RR 626	LOCK SA-L5 MORT.SEC. RHR	\$966.00
<b>SCREW</b> NO FINISH		
655F028	Screw, Cylinder Mounting †Order 100-	\$3.60
651F878	Screw, FHM-PH #8-32 x 7/16" †Order 50-	\$3.60

PART NO.	DESCRIPTION	LIST PRICE
<b>SCREW (CONT'D)</b> NO FINISH		
656F658	Screw, Function	\$3.60
651F418	Screw, RHM-PH #1/4-20 x 5/8" †Order 50-	\$3.60
651F508	Screw, Tailpiece Plate, PHT-T-PH #6 x 3/8 †Order 50-	\$3.60
<b>SCREW PACKET, MOUNTING</b>		
652F128	1-3/4" - 2" door - 606, 612, 613, 619, 626	\$11.00
652F108	1-3/4" - 2" door - 606, 612, 613, 619, 626	\$8.60
652F118	2-1/4" door - 606, 612, 613, 619, 626	\$8.60
652F138	2-1/4" door - 606, 612, 613, 619, 626	\$11.00
652F148	F3, T13 for 1-3/4" - 2" door - 606, 612, 613, 619, 626	\$15.00
652F158	F3, T13 for 2-1/4" door - 606, 612, 613, 619, 626	\$15.00
<b>SCREW POST</b> NO FINISH		
783F048	Screw Post	\$8.60
<b>SLIDER, THUMBPIECE</b> NO FINISH		
651F498	Slider, Thumbpiece	\$8.60
<b>SPINDLE BRACKET</b> NO FINISH		
652F048	Spindle Bracket, lever	\$8.60
<b>SPINDLE NUT</b> NO FINISH		
651F738	Spindle Nut, x7 †Order 20-	\$3.60
652F098	Spindle Nut, x7M lever †Order 50-	\$3.60
<b>SPINDLE WASHER</b> NO FINISH		
652F068	Spindle washer, G Knob	\$6.00
652F058	Spindle Washer, Levers	\$6.00
<b>SPRING</b> NO FINISH		
651F948	Spring, Extension	\$3.60
651F758	Spring, Grip Return, knob †Order 10-	\$6.00
651F618	Spring, Grip Return, lever, LHR (red)	\$6.00
651F628	Spring, Grip Return, lever, RHR (blue)	
651F938	Spring, Rack, lever †Order 50-	\$3.60
651F478	Spring, Thumbpiece, T13	\$7.40
678F028	Spring, Thumbpiece T13M	\$9.70
651F408	Spring, various trim †Order 20-	\$3.60
651F868	Spring, various trim †Order 50-	\$3.60
<b>TAILPIECE ASSEMBLY</b> NO FINISH		
677F068	1-3/4" door without shim kit	\$51.00
655F698	2" - 2-1/4" door or 1 3/4" door with shim kit - TH9 series trims	\$51.00
655F708	2" - 2-1/4" door or std. door with shim kit - All trims except TH9 series	\$51.00
<b>THIMBLE INSERT</b>		
651F389	Knob & thumbturn †Order 50-	\$3.60
118F299	Lever †Order 100-	\$3.60
<b>THUMBPIECE BRACKET</b>		
651F578	Thumbpiece Bracket, T13M	\$25.00
<b>THUMBPIECE TAB</b> NO FINISH		
651F568	Thumbpiece Tab, T13M	\$4.90
<b>THUMBPIECE</b> 605, 606, 611, 612, 613, 619, 625, 626, 629, 630		
566F50	Thumbpiece, T13, T14	\$59.00
566F51	Thumbpiece, T13M	\$69.00
<b>WASHER</b> NO FINISH		
651F708	Washer under tailpiece †Order 50-	\$3.60
651F848	Washer, Grip †Order 20-	\$3.60

## ED7000 Series Crossbar Exit Devices

USA & Canada Prices Effective February 1, 2022

### STRIKES FOR CROSSBAR EXIT DEVICES

PART NO.	DESCRIPTION	LIST PRICE
269F73	ED7000 LHR with dogging	\$1,085.00
269F74	ED7000 RHR with dogging	
269F75	ED7000 LHR less dogging	\$1,024.00
269F76	ED7000 RHR less dogging	
<b>VERTICAL ROD STRIKES 605, 606, 612, 613, 622, 626, 629</b>		
392F24	Top	\$117.00
392F22	Top	\$93.00
392F28	Bottom flush	\$76.00
392F29	Bottom surface	\$63.00
176F653	Top bracket	\$63.00
304F337	Bottom 630 only	\$42.00
304F347	Bottom 630 only	\$63.00
352F042	Bottom	\$42.00
352F05	Top	\$76.00
361F913	Bottom flush	\$76.00
123F22	Bottom	
183F857	Top 630 only	
502F75	Bottom mortised	\$45.00
502F96	Surface	\$57.00

### STRIKES FOR CROSSBAR EXIT DEVICES (Cont'd)

PART NO.	DESCRIPTION	LIST PRICE
<b>CONCEALED VERTICAL ROD STRIKES 605, 606, 612, 613, 622, 626</b>		
503F52	Bottom Strike	\$77.00
503F533	Fire Rated Bottom Strike	\$77.00
<b>RIM EXIT DEVICE STRIKES 605, 606, 612, 613, 622, 626</b>		
142F43	Adj. Packet	\$175.00
467F733	Pack, rim vert. rod	\$117.00
300F71	Packet	\$149.00
499F598	Adj.	\$111.00
<b>MORTISE STRIKES 605, 606, 612, 613, 619, 622, 625, 626</b>		
240L50	Stainless Mortise - LHR 629, 630 only	\$61.00
240L51	Stainless Mortise - RHR 629, 630 only	
411L63	Open Back - RHR	\$139.00
411L62	Open Back - LHR	\$139.00
<b>LOW PROFILE EXIT DEVICE STRIKES</b>		
416F355	Strike 622 689, 690, 691	\$57.00
436F038	Strike, bottom	\$23.00
487M048589	Top Rod (for 10' Doors)	\$166.00
463F918	Flush Bottom Strike	\$26.00



DEVICE PARTS					
PART NO.	DESCRIPTION	LIST PRICE	PART NO.	DESCRIPTION	LIST PRICE
122F188	Mounting Bracket	\$38.00	164F329	Nylon Washer †Order 50-	\$3.60
122F248	Washer †Order 100-	\$3.60	173F698	Stud	\$3.60
122F413	Lower Rod Guide	\$16.00	173F728	Nut	\$7.40
122F508	Lower Bolt Tube Sub Assembly	\$108.00	175F518	Rod Insert	\$25.00
122F518	Bottom Guide Sub Assembly	\$102.00	183F74	Top Latch Sub Assembly (with top rod doors 6'4" to 8'6")	\$477.00
122F568	Locking Lever	\$30.00	183F75	Top Latch Sub Assembly (with top rod door 8'6" to 10'8")	\$477.00
122F578	Locking Lever	\$21.00	184F825	Shim	\$25.00
122F593	Locking Lever Spring	\$32.00	184F948	Jam Nut	\$8.60
122F608	Locking Hub	\$18.00			
122F618	Locking Hub	\$8.60			
122F639	Spacer Washer (Nylon)	\$3.60			
122F643*	Handle Lever	\$149.00			
123F538	Dogging Key, 3/16" hex	\$4.90			
129F499	Sound Deadener	\$9.70			
129F848	Cylinder Nut	\$9.70			
134F05	Cylinder Collar	\$44.00			
140F528	Stud †Order 20-	\$3.60			
141L548	Reinforcing Tube	\$182.00			
141L59	<b>Crossbar</b>				
	605, 606, 611, 612, 613, 619, 622, 625, 626, 629, 630	\$413.00			
142F44*	Adj. Strike	\$97.00			
143F248	Spring †Order 50-	\$3.60			
145F543*	Strike Plate	\$105.00			
148F367	Release Plunger Sub Assembly	\$31.00			
148F448	Mounting Wrench	\$7.40			

**DEVICE PARTS (Cont'd)**

PART NO.	DESCRIPTION	LIST PRICE
213F117	Top Strike S/A (reveal less 5-1/2") <i>Obsolete</i> 629, 630	\$115.00
200F168	Screw 12-24 x 1/2" FHMS <i>Obsolete</i>	\$3.60
220F498	Screw 1/4-20 x 2" FHMS <i>Obsolete</i>	\$3.60
220F722	Screw 12-24 x 1/2" FHMS-PH <i>Obsolete</i> †Order 20-	\$3.60
220F75	<b>Screw 1/4-20 x 5/8" FHMS-PH</b> 606, 619, 622, 625, 626, 630	\$3.60
	605, 611, 512, 613, 629	\$4.90
220F778	<b>Screw</b> 622, CDC, MTD, 613	\$3.60
220F827	Screw 1/4-20 x 1" FHMS-PH	\$4.90
220F848	Screw 12-24 x 1-1/4" FHMS-PH	\$3.60
220F85*	Screw 1/4-20 x 1-1/4" FHMS-PH x Anchor <i>Obsolete</i>	\$4.90
221F948*	Mounting Screw	\$4.90
222F71*	Throughbolt	
224F348	Screw 12 x 1" FHWS †Order 20- <i>Obsolete</i>	\$3.60
224F392	Screw 14 x 1-1/4" FHWS †Order 20- <i>Obsolete</i>	
224F448	Screw 14 x 1-1/2" FHWS <i>Obsolete</i>	\$4.90
224F508	Screw 14 x 2" FHWS †Order 20- <i>Obsolete</i>	\$3.60
225F998	Screw 12 x 1-1/2" OHWS-PH <i>Obsolete</i>	\$3.60
228F188	Roll Pin †Order 100- <i>Obsolete</i>	\$3.60
228F497	Roll Pin (79028-1250343)	\$3.60
228F517	Roll Pin (79028-1250500 St'd) †Order 100-	\$3.60
228F528	Roll Pin †Order 100- <i>Obsolete</i>	\$3.60
228F558	Roll Pin 1/8 x 3/4" †Order 100- <i>Obsolete</i>	\$3.60
228F687	Roll Pin 156 x 9/16" †Order 50-	\$3.60
228F808	Roll Pin 187 x 3/4" †Order 100-	\$3.60
228F817	Roll Pin 187 x 1-15/16" †Order 20-	\$3.60
228F847	Roll Pin 187 x 1-3/8" †Order 20-	\$3.60
243F769	Stop Nut †Order 20- <i>Obsolete</i>	\$3.60
243F798	Spring Lock Washer †Order 100- <i>Obsolete</i>	\$3.60
243F808	1/4-20 x 5/8" FRMS-PH <i>Obsolete</i>	\$4.90
243F85	Top Cover Sub Assembly 605, 606, 611, 612, 613, 619, 625, 626, 629, 630	\$189.00
	<i>Obsolete</i>	
249F33*	1/4-20 NC-2A x 1-1/4" Lg. Phillips OHMS	\$6.00
253F118	Drive Screw †Order 100-	\$3.60
254F73	<b>Screw 8-32 x 3/8" OHMS-PH <i>Obsolete</i></b> 605, 606, 611, 612, 613, 619, 625, 626, 630	\$3.60
255F41*	Screw 12-24 x 2" FHMS-PH	\$7.40
261F288	Screw 8-32 x 3/8" HSS Cone-SOC <i>Obsolete</i>	\$4.90
261F318	<b>Screw 5/16-24 x 1-1/2" FHMS-SOC</b> 605, 611, 612, 613, 619, 625, 626, 630	\$4.90
261F54	Cylinder Collar	\$37.00
261F658	Screw 1/4-20 x 1/2" PHMS	\$4.90
262F901	River 3/32" x 5/32" †Order 100- <i>Obsolete</i>	\$3.60

PART NO.	DESCRIPTION	LIST PRICE
264F958	Screw 12-24 x 7/8" RHMS-PH <i>Obsolete</i> (Metal Doors) †Order 20-	\$3.60
268F647	Washer †Order 50-	\$3.60
268F848	Screw 6-32 x 5/8" RHMS †Order 20- <i>Obsolete</i>	\$3.60
268F878	Retainer Ring †Order 20-	
269F048	Cotter Pin †Order 50-	\$3.60
269F058	Lockwasher †Order 100-	\$3.60
269F08	<b>Screw 8-32 x 3/8" FHMS-PH</b> 605, 606, 611, 612, 613, 619, 625, 626, 630	\$3.60
	<b>Lever</b>	
269F31	605, 606, 611, 612, 619, 613, 619, 625, 626	\$390.00
269F32	605, 606, 611, 612, 619, 613, 619, 625, 626	
<b>COVER</b>		
269F33	605, 606, 611, 612, 613, 619, 625, 626, 629, 630	\$403.00
269F34	605, 606, 611, 612, 613, 619, 625, 626, 629, 630	\$403.00
269F35	605, 606, 611, 612, 613, 619, 625, 626, 629, 630	\$403.00
269F36	<b>Active Case Less Cover, ED7200 RHR &amp; LHR</b> 605, 606, 611, 612, 613, 619, 625, 626, 629, 630	\$434.00
269F378	Hub	\$53.00
269F393	Latch Retractor	\$48.00
269F403	Latch Retractor	\$53.00
269F413	Slide	\$61.00
269F42	<b>Inactive Case S/A, all ED7000</b> 605, 606, 611, 612, 613, 619, 625, 626, 629, 630	\$432.00
269F468	Hold Back Sleeve	\$53.00
269F479	Nyliner	\$4.90
269F488	Lever Pivot	\$4.90
269F499	Bushing	\$6.00
269F528	Hub Shank	\$7.40
269F538	Latch Spring	\$4.90
269F549	Button	\$3.60
269F559	Washer †Order 50-	\$3.60
269F569	Washer †Order 50-	
269F578	Spring Washer	\$8.60
269F587	Latch Pin	\$4.90
269F608	Inner Spring	\$8.60
269F91*	Screw Packet	\$119.00
269F92*	Screw Packet	\$88.00
270F01*	Screw Packet	\$119.00
270F02*	Screw Packet	\$91.00
270F11*	Through Bolt	\$6.00
282F325	Caulking Anchor <i>Obsolete</i>	\$6.00
282F357	Caulking Anchor	\$4.90
284F67*	Lever RH <i>Obsolete</i>	\$153.00

\*Specify Finish. Ø Subject to availability.

† Sold only in multiples of the number indicated. Price is each.

## DEVICE PARTS (Cont'd)

PART NO.	DESCRIPTION	LIST PRICE	PART NO.	DESCRIPTION	LIST PRICE
284F977	Roll Pin †Order 50-	\$3.60	351F72	<b>Bottom Latch Cover</b> 605, 606, 611, 612, 613, 619, 625, 626, 629, 630	\$293.00
291F498	Stop Plate	\$32.00	351F73	<b>Top Latch Cover</b> 605, 606, 611, 612, 613, 619, 625, 626, 629, 630	\$310.00
291F578	Screw 10-31 x 1" FHM-PH †Order 50-	\$3.60	351F797	Top Latch Sub Assembly	\$70.00
293F183	Slide Assembly	\$142.00	351F807	Roll Pin †Order 50-	\$3.60
306F068	Screw 10-24 x 5/16" RHMS-PH †Order 20-	\$3.60	351F823	Top Latch Backplate	\$130.00
306F078	Spring Lockwasher †Order 100-	\$3.60	351F833	Top Latch Slide	
321F907	Dogging Device Sub Assembly	\$57.00	351F849	Spacer	\$12.00
333F519	Screw	\$3.60	351F85*	Top Latch Sub Assembly No Cover	\$490.00
341F318	Shim	\$26.00	351F867	Bottom Latch	\$130.00
351F50*	<b>Active Case - less cover, ED7400 standard</b>		351F873	Latch Link	\$125.00
	606, 612, 619, 622, 626	\$269.00	351F883	Bottom Latch Backplate	\$130.00
	605, 611, 613, 625, 629, 630		351F897	Spring †Order 20-	\$3.60
351F51*	<b>Active Case - less cover, ED74000, ED7401, no bottom rod</b>		351F907*	Bottom Latch Sub Assembly	\$441.00
	606, 612, 619, 622, 626	\$269.00	351F988	Rod Connector Sub Assembly	\$7.40
	605, 611, 613, 625, 629, 630		352F021	Drive Rivet †Order 20-	\$3.60
351F528	10-32 x 7/16" FHUMS-PH Screw †Order 100-	\$3.60	352F068	1/4-20 x 3/4" BHUMS-PH Screw †Order 20-	\$3.60
351F553	Slide Sub Assembly	\$202.00	361F308	Anchor	\$8.60
351F56*	Active Case Sub Ass'y, ED7400 with dogging -RHR	\$1,111.00	362F498	Nut	\$31.00
351F57*	Active Case Sub Ass'y, ED7400 with dogging -LHR		362F918	Plate	\$9.70
			364F228	Washer	\$8.60
			364F272	Locking Slide	\$35.00
			364F288	Locking Lever Sub Assembly	\$46.00
			364F308	Lifting Lever	\$37.00
			364F36*	Escutcheon Assembly RHR, C4, D4, E4 - MR	\$373.00
			364F37*	Escutcheon Assembly LHR, C4, D4, E4 - MR	
			364F38*	Escutcheon Assembly RHR, C4, D4, E4 - Std	\$391.00
			364F39*	Escutcheon Assembly LHR, C4, D4, E4 - Std	
			365F003	Slide Extension S/A Door 1-3/4"	\$57.00
			365F013	Slide Extension S/A Door 2-1/4"	
			365F033	Slide Extension S/A Door 1-3/4" or Lever Trim	
			365F98*	1/4-20 x 2" OHTS-F-PH Metal Door	\$8.60
				<b>Latch Sub Assembly</b>	
			376F42	611, 612, 613, 619, 625, 626	\$68.00
				605, 606, 629, 630	\$68.00
			378F745	Tenon Sub Assembly	\$55.00

\*Specify Finish. Subject to availability.

† Sold only in multiples of the number indicated. Price is each.

## DEVICE PARTS (Cont'd)

PART NO.	DESCRIPTION	LIST PRICE	PART NO.	DESCRIPTION	LIST PRICE
392L19*	Adj. Bottom Rod Assembly	\$288.00	468F246	Active Backplate Assembly, RH	\$1,024.00
393L13-M672*	Top Rod	\$224.00	468F256	Active Backplate Assembly, LH	
399F188	Lower Bolt Assembly	\$447.00	468F266	Active Backplate Assembly, RH	
402F99*	Thumbpiece	\$58.00	468F276	Active Backplate Assembly, LH	
403F035	Slide x4M Trim	\$115.00	468F355	Cylinder housing	\$12.00
403F30*	Washer	\$4.90	480F128	Inactive Backplate Assembly	\$137.00
405F428	Anchor	\$8.60	480F13*	Lever	\$345.00
405F458	Mullion (507) 7'2" door	\$137.00	480F188	Spindle	\$56.00
Ø 405F466	Bottom Plate	\$132.00	480F198	Nut	\$12.00
405F476	Top Plate	\$122.00	480F208	Rollback	\$13.00
405F496	Bottom Plate Assembly				
Ø 409F836	Top Plate Assembly				
412F133*	Screw, 8-32 x 5/16"	\$4.90	480F28*	Lever & Spindle Assembly	\$321.00
412F157	Lever Pivot	\$16.00	480F30*	Lever & Spindle Assembly	\$321.00
412F167	Deadlocking Plunger	\$26.00	480F33*	Lever & Spindle Assembly	\$325.00
412F451	Inactive Backplate Assembly	\$134.00	480F375	Slide	\$63.00
416F818	Stud	\$11.00	482F442	*Bushing	\$70.00
418F288	Dogging Screw	\$8.60	482F49*	Escutcheon	
418F308	Rivet	\$4.90	482F73*	Escutcheon & Bushing	\$325.00
418F352	Hub	\$61.00	484F418	Rollback	\$22.00
418F368	Lever, RH	\$7.40	484F898	Knob Shank Sub Assembly	\$42.00
418F378	Lever, LH				
420F128*	Screw Packet	\$57.00	492F195	Slide	\$113.00
433F978	Lever Pivot	\$55.00	<b>BLANK PLATE FOR STOCK HOLLOW METAL DOORS</b>		
433F988	Lever Pivot				
434F008	Lever Pivot	\$32.00	561F29	<b>Blank Plate 14" x 3-1/2"</b> Used on the outside of stock cut-out hollow metal doors where no trim is desired	\$169.00
434F028	Screw 1/4-20 x 3/4" BUHC-SK	\$3.60		605, 606, 612, 613, 619, 625, 626, 630	
464F028	Mullion (508) 8' door	\$295.00	<b>BLANK FRONTS AND STRIKES FOR STOCK HOLLOW METAL DOORS AND FRAMES</b>		
464F915	Active Case Casting only	\$57.00	077F198	Front, 2-1/4" x 1-1/8"	\$11.00
467F942	Thumbpiece Lever RH	\$105.00	334F99	Front, 8" x 1-1/4"	\$26.00
467F952*	Thumbpiece Lever LH				
468F022*	Lever, inactive RH	\$156.00	Ø 236L718018	Strike, 4-7/8" x 1-1/4"	\$11.00
468F032*	Lever, inactive LH				
468F122	Thumbpiece Lever Assembly RH	\$269.00	321F24*	RHR Bracket for P3 trim	\$137.00
468F132	Thumbpiece Lever Assembly LH				
468F147	Latch Pin Assembly RH	\$105.00	393L13-M672*	Top Rod	\$224.00
468F157	Latch Pin Assembly LH				
468F162	Lever Assembly RH	\$99.00	Ø 399F168	Spindle Adapter	\$60.00
468F172	Lever Assembly LH				
468F202*	Lever Assembly RH	\$248.00	399F178	Lower Rod Assembly	\$224.00
468F212*	Lever Assembly LH				
			402F983	Extension Slide	\$45.00
			402F99*	Thumbpiece	\$58.00
			408F258	Guide Spring	\$3.60
			503F533	Bottom Strike	\$77.00
			503F557	Top Strike	\$72.00
			503F567	Top Strike - Fire Rated	
			376F37*	Sex Nut (For 1-3/4 & 2" doors)	\$8.60
			<b>MISCELLANEOUS</b>		
			148F228	Pin	\$3.60

\*Specify Finish. Ø Subject to availability.

† Sold only in multiples of the number indicated. Price is each.

PART NO.	DESCRIPTION	LIST PRICE
<b>ALARM DELAY SWITCH</b>		
696F318	for M62 option	\$69.00
<b>BAR</b> 689, 690, 691		
436F418	for ED8400, 30" door width, with dogging	\$433.00
436F428	for ED8400, 36" door width, with dogging	
436F438	for ED8400, 42" door width, with dogging	
436F448	for ED8400, 48" door width, with dogging	\$464.00
387F218	for ED8200, 30" door width, with dogging	\$406.00
387F248	for ED8200, 36" door width, with dogging	
387F278	for ED8200, 42" door width, with dogging	
387F308	for ED8200, 48" door width, with dogging	\$435.00
387F638	for ED8200, 30" door width, less dogging	\$399.00
387F668	for ED8200, 36" door width, less dogging	
387F698	for ED8200, 42" door width, less dogging	
387F728	for ED8200, 48" door width, less dogging	\$428.00
564F888	for ED8400, 30" door width, less dogging	\$426.00
564F898	for ED8400, 36" door width, less dogging	
564F908	for ED8400, 42" door width, less dogging	
564F918	for ED8400, 48" door width, less dogging	\$457.00
564F378	for ED8400A, 30" door width, less dogging	\$426.00
564F408	for ED8400A, 36" door width, less dogging	
564F438	for ED8400A, 42" door width, less dogging	
564F688	for ED8400A, 48" door width, less dogging	\$457.00
<b>BOTTOM ROD</b>		
436L328557	for ED8400, 40-5/16" Pushbar Height, for Door 7'6" high	\$228.00
526L518540	for ED8400A	
<b>BRACKET</b> 605, 606, 611, 612, 613, 619, 622, 625, 626		
321F23	LHR Bracket for P3 trim	\$158.00
321F24	RHR Bracket for P3 trim	
<b>FRAME PLATES</b>		
552F598	for ED8400 - RHR	\$206.00
552F608	for ED8400 - LHR	
552F468	for ED8400A - RHR	\$299.00
552F478	for ED8400A - LHR	
<b>FRONT COVER</b>		
564F345	for ED8400 (A) (not handed)	\$59.00
385F545	for ED8200(B) (not handed)	\$72.00
564F115	for ED8200A (not handed)	\$87.00
<b>LATCH</b>		
436F258	for ED8400, Top No Finish	\$238.00
436F298	for ED8400, Bottom No Finish	\$126.00
552F368	for ED8200(B) 626	\$148.00
552F416	for ED8200A	\$350.00
525F998	for ED8400A, top	\$256.00
526F168	for ED8400A, bottom	\$293.00
<b>LATCH COVER</b> 689, 690, 691		
526F321	for ED8400A, Top or Bottom Latches	\$114.00
446F231	for ED8400, Top or Bottom Latches	\$98.00

PART NO.	DESCRIPTION	LIST PRICE
<b>MISCELLANEOUS</b>		
650F279	Dogging Hole Plug	\$3.60
697F988	Sex Nut Pack (M54)	\$22.00
436F858	Latch Assembly Screw	\$3.60
558F528	Mounting packet for F1 and P8 Trim 689, 690, 691	\$30.00
482F798	ANSI fastening plate packet for G3 Trim No Finish	\$12.00
123F538	Dogging Key, 3/16" hex No Finish	\$4.90
267F348*	Mounting Screw †Order 20-	\$3.60
<b>MOUNTING PACKET</b> 605, 606, 611, 612, 613, 619, 622, 625, 626		
469F67	for F157, P857 trim	\$34.00
469F68	for F150, P150, P850 trim (dummy)	\$20.00
496F68	for P257 trim	\$36.00
496F69	for P250 trim (dummy)	\$34.00
<b>PLATES AND PULLS</b> 689, 690, 691		
436F828	for F1 Trim, plate - no cylinder hole	\$52.00
436F838	for F1 Trim, plate - with cylinder hole	
436F801	for P8 Trim, pull - no cylinder hole	\$58.00
436F811	for P8 Trim, pull - with cylinder hole	
602F151	Pull Grip (Black) for P2 622 Only	\$69.00
<b>605, 606, 611, 612, 613, 619, 622, 625, 626</b>		
270F13	Escutcheon for P3 trim without cylinder hole	\$135.00
492F20	Offset Pull for P1 trim without cylinder hole	\$167.00
492F21	Offset Pull for P1 trim with cylinder hole	\$192.00
602F181	Pull Base for P2 trim plate without cylinder hole	\$246.00
602F171	Pull Base for P2 trim plate with cylinder hole	\$269.00
328F80	Pull Tube for P3 trim	\$137.00
<b>REAR COVER</b> 689, 690, 691		
603F64	for ED8000 devices purchased AFTER Nov. 1, 1993	\$35.00
<b>ROD GUIDE PACKET SCREW PACKET</b>		
446F208	Rod guide packet	\$45.00
523F038	for ED8200(B) and ED8400(A), Packet for mounting bar & active case with SNB	\$45.00
484F208	for ED8400, Packet for mounting top latch	\$74.00
484F218	for ED8400, Packet for mounting bottom latch	\$31.00
261F308	for ED8200, Latch & Frame Plate Attachment Screw †Order 20-	\$4.90
<b>ROD GUIDE PACKET SCREW PACKET (Cont'd)</b>		
449F828	for ED8200(B) and ED8400 for bar & active case	\$31.00
492F59	Rear Side Screw Packet for P1 trim	\$7.40
564F128	for ED8200A, Packet for mtg. bar & active case with SNB	\$54.00
534F008	for ED8400A, Packet for mtg. Top & bottom latch	\$66.00
<b>SHIM KITS</b>		
557F928	for ED8200 (B)	\$108.00
557F938	for ED8200A	\$108.00
557F948	for ED8400	\$177.00
557F958	for ED8400A	\$177.00

\*Specify Finish.

†Sold only in multiples of the number indicated. Price is each.

## DEVICE PARTS (Cont'd)

PART NO.	DESCRIPTION	LIST PRICE
<b>STRIKE PACKET</b>		
391F575	for ED8200, Shim used with 1/2" Stop	\$37.00
446F21M	for ED8400, Packet for Top Latch.Strike 605, 606, 611, 612, 613, 622, 625, 626	\$57.00
446F228	for ED8400, Packet for Bottom Latch (Surface Mounting) 625 only	\$45.00
463F928	for ED8400, Packet for Bottom Latch (Flush Mounting) 625 only	\$40.00
386F453	for ED8200(B) Strike Packet 612, 613, 626	\$53.00
468F305	Packet for Rim by Vertical Rod 605, 606, 612, 613, 622, 625, 626, 689, 690, 691	\$45.00
518F067	for ED8200A	\$89.00
526F527	for ED8400A, Packet for Top Strike	\$58.00
526F533	for ED8400A, Packet for Bottom Strike	\$54.00
<b>TOP ROD</b>		
487L048697	for ED8400, 40-5/16" Pushbar Height, for Door 7'6" high	\$126.00
487M048589	for ED8400, 40-5/16" Pushbar Height, for Door 7'6" high to 10' high	\$166.00
526L928759	for ED8400A	\$110.00
<b>CHASSIS, 1-3/4" TO 2-1/4" DOORS NO FINISH</b>		
690F44	Dummy (50)	\$122.00
698F43	Passage (10)	
698F44	Classroom (55)	\$133.00
698F45	Nightlatch (57)	
698F46	Storeroom (59)	
698F51	Classroom - LFIC	\$139.00
698F52	Nightlatch - LFIC	
698F53	Storeroom - LFIC	
<b>MISCELLANEOUS 605, 606, 611, 612, 613,619, 625, 626</b>		
678F25	Rose for X6 trim	\$59.00
585F72	Lever Insert for X6 trim	\$3.60
682F91	Recore Driver Packet	\$8.60
696F05	Mounting Packet	\$6.00
<b>LEVERS ALL FINISHES STANDARD 1-3/8" TO 2-1/4" DOORS</b>		
563F955	N6 design x cylinder or button	\$137.00
563F965	N6 design x emergency key hole	
563F945	N6 design x plain	\$137.00
578F435	N6 x Sargent® cylinder cutout	
563F895	A6 design x cylinder or button	
563F905	A6 design x emergency key hole	\$137.00
563F885	A6 design x plain	
685F515	P6 design x cylinder or button	
685F525	P6 design x emergency key hole	
685F505	P6 design x plain	

PART NO.	DESCRIPTION	LIST PRICE
<b>LEVERS ALL FINISHES LFIC, 1-3/8" TO 2-1/4" DOORS</b>		
585F715	N6 x cylinder (LFIC core 6-pin)	\$137.00
600F415	N6 x cylinder (LFIC core 7-pin)	
596F825	N6 x Best® cylinder cutout	\$137.00
585F705	A6 x cylinder (LFIC core 6-pin)	\$137.00
600F425	A6 x cylinder (LFIC core 7-pin)	
685F535	P6 x cylinder (LFIC core 6-pin)	
685F545	P6 x cylinder (LFIC core 7-pin)	
685F555	P6 x Best cylinder cutout	\$137.00

†Sold only in multiples of the number indicated. Price is each.

# DC3000/DC5000 Series Door Closers

*USA & Canada Prices Effective February 1, 2022*

DC3000 CLOSER PARTS		
PART NO.	DESCRIPTION	LIST PRICE
<b>TOOLS</b>		
330F10	Hex wrench for closer valve, 3/32"	\$6.30
597F24	Torx tool kit	\$256.00
<b>CLOSER BODIES 600, 689, 690, 691, 693, 696</b>		
540F27	Closer body for DC3200	\$465.00
597F35	Closer body for DC3200 x M71	\$522.00
M71 = Delayed action		
<b>ARMS 600, 689, 690, 691, 693, 696</b>		
688F95	Regular arm	\$162.00
688F77	Regular arm with hold-open	\$240.00
688F95	Top jamb	\$162.00
688F77	Top jamb with hold-open	\$240.00
689F02	Heavy-duty parallel arm	\$244.00
689F01	Heavy-duty parallel arm with hold-open	\$273.00
597F52	Heavy-duty regular arm	\$244.00
689F03	Heavy-duty parallel arm with backstop	\$255.00
689F04	Heavy-duty parallel arm with backstop & hold-open	\$236.00
691F98	Reg. secondary arm assy.	\$57.00
691F99	Deep reveal secondary arm assembly	\$58.00
692F02	Reg. H.D. secondary arm assembly	\$215.00
692F03	Deep reveal H.D. secondary arm assembly	\$372.00
<b>BRACKETS 600, 689, 690, 691, 693, 696</b>		
188F03	Quik-Install™	\$24.00
188F41	Parallel arm	\$8.90
509F49	Parallel arm with hold-open	\$56.00
188F62	Parallel arm offset	\$38.00
188F63	Parallel arm for flush transom	\$56.00
244F17	Regular arm mortise	\$68.00
447F14	Angle Support Bracket and Spacer	\$56.00
<b>DROP PLATES 600, 689, 690, 691, 693, 696</b>		
188F65	For DC3220 x full cover	\$89.00
597F58	For DC3210 x full cover	\$89.00
<b>COVERS 600, 689, 690, 691, 693, 696</b>		
597F78	Full cover and insert packet (standard)	\$55.00
<b>PAINT (PER CAN)</b>		
597F94	Silver Aluminum - 689	\$71.00
597F95	Dark Bronze - 690	
597F96	Light Bronze - 691	
597F97	Satin Brass - 696	

DC5000 CLOSER PARTS		
PART NO.	DESCRIPTION	LIST PRICE
<b>CLOSER BODY 600, 689, 690, 691, 693, 696</b>		
754F68	Closer Body Only	\$594.00
<b>ARMS 600, 689, 690, 691, 693, 696</b>		
754F95	Pull Side Slide Track & Arm Assy., Non-Hold Open	\$245.00
754F96	Pull Side Slide Track & Arm Assy., Hold Open	\$369.00
754F97	Push Side Slide Track & Arm Assy., Non-Hold Open	\$245.00
754F98	Push Side Slide Track & Arm Assy., Hold Open	\$369.00
754F92	Hold Open Assembly	\$56.00
<b>COVER</b>		
754F79	Plastic Cover	\$56.00
<b>DROP PLATE</b>		
754F80	Push side, drop plate	\$60.00
<b>ANGLE BRACKET</b>		
754F93	Stop Mount Track Angle Bracket	\$109.00
<b>SCREW PACKETS</b>		
754F69	Closer Screw Pack	\$14.00
754F70	Spline Screw Pack	\$38.00
754F94	Track Screw Pack	\$19.00
261F298	Hex Key 5/64" †Order 10-	\$4.90

† Sold only in multiples of the number indicated. Price is each.

**CLOSER PARTS**

PART NO.	DESCRIPTION	LIST PRICE
<b>CLOSER BODIES 600, 689, 690, 691, 693, 696</b>		
689F12	Closer body for DC6200	\$509.00
689F13	Closer body for DC6200 x M71	\$562.00
689F14	Closer body for DC6401	\$509.00
689F15	Closer body for DC6402	
689F16	Closer body for DC6403	
689F17	Closer body for DC6404	
689F18	Closer body for DC6405	
689F19	Closer body for DC6406	
691F52	Closer body for DC6401 x M71	\$562.00
691F53	Closer body for DC6402 x M71	
691F54	Closer body for DC6403 x M71	
691F55	Closer body for DC6404 x M71	
691F56	Closer body for DC6405 x M71	
691F57	Closer body for DC6406 x M71	
M71 = Delayed action		
<b>ARMS 600, 689, 690, 691, 693, 696</b>		
688F95	Regular arm, consists of:	\$162.00
	688F99 main arm & tube assembly	\$101.00
	688F98 rod & shoe assembly	\$43.00
	688F92 hex screw pkg.	\$18.00
688F77	Regular arm with hold-open (A1), consists of:	\$240.00
	691F92 main arm & rod Assy	\$95.00
	540F40 hold-open bracket assembly	\$145.00
689F02	Heavy duty parallel arm (A3)	\$244.00
689F01	Heavy duty parallel arm with hold-open (A2)	\$273.00
597F52	Heavy duty regular arm (A10)	\$244.00
689F03	Heavy duty parallel arm with backstop (A4)	\$255.00
689F04	Heavy duty parallel arm with backstop & hold-open (A5)	\$236.00
615F52	HD Spring stop for Dr. width. 28"-32" (A11)	\$244.00
615F54	Unitrol® for Dr. width. 33"-41	
615F56	Unitrol® for Dr. width. 42"-48"	
615F51	Unitrol®/HO for Dr. width. 28"-32" (A12)	
615F53	Unitrol®/HO for Dr. width. 33"-41"	\$273.00
615F55	Unitrol®/HO for Dr. width. 42"-48"	
691F96	Heavy-duty offset arm (A13)	\$160.00
754F16	DC6230, DC6430 pull side - arm only	\$124.00
754F10	DC6230, DC6430 - track only (hold-open)	\$369.00
754F09	DC6230, DC6430 - track only (non hold-open)	\$245.00
754F44	DC6230, DC6430 pull side track assembly, non-hold open	\$522.00
754F45	DC6230, DC6430 pull side track assembly, hold open	\$653.00
754F12	DC6240, DC6440 push side track & arm (non hold open)	\$364.00
754F14	DC6240, DC6440 - track only (non hold-open)	\$245.00
754F13	DC6240, DC6440 track & arm (hold-open)	\$494.00
754F15	DC6240, DC6440 - track only (hold-open)	\$369.00
754F16	DC6240, DC6440 - arm only (hold-open)	\$124.00
691F72	Deep reveal arm (7-1/4" max), consists of:	\$148.00
	688F99 main arm and arm tube Assy	\$101.00
	691F75 rod & shoe assembly	\$47.00

PART NO.	DESCRIPTION	LIST PRICE
<b>ARMS 600, 689, 690, 691, 693, 696</b>		
691F74	Deep reveal arm w/hold-open (7-1/4" max), consists of:	\$197.00
	691F95 main arm & rod Assy- deep reveal	\$52.00
	540F40 hold-open bracket Assy.	\$145.00
615F58	Reinforcing bracket	\$47.00
615F59	Deep reveal reinforcing kit	\$61.00
615F60	Flush partition bracket	\$46.00
692F04	Friction, Hold Open Arm RH	\$149.00
692F05	Friction, Hold Open Arm LH	\$149.00
692F00	Reg. Secondary Arm Assy.	\$57.00
692F01	Top Jamb Secondary Arm Assy.	\$58.00
692F02	Reg. H.D. Secondary Arm Assy.	\$215.00
692F03	Deep Reveal HD. Secondary Arm Assy.	\$372.00
<b>BRACKETS 600, 689, 690, 691, 693, 696</b>		
188F03	Quik-Install™	\$24.00
188F41	Parallel arm	\$8.90
509F49	Parallel arm with hold-open	\$56.00
188F63	Parallel arm for flush transom	\$56.00
188F62	Parallel arm offset	\$38.00
244F17	Regular arm mortise	\$68.00
447F14	Angle support	\$56.00
499F30	Flush transom	\$35.00
691F78	Spacer	\$7.60
<b>COVERS 600, 689, 690, 691, 693, 696</b>		
597F78	Full cover and insert pkt. (standard)	\$55.00
603F55	Full metal cover RH/LHR	\$60.00
603F57	Full metal cover LH/RHR	
261F95	Cover screw pack	\$7.60
<b>DROP PLATES 600, 689, 690, 691, 693, 696</b>		
188F65	For DC6220 x full cover	\$89.00
	For DC6420 x full cover	
597F58	For DC6210, DC6410, DC6240, DC6440 x full cover	\$89.00
597F59	For DC6230, DC6240, x full cover	\$89.00
	For DC6430, DC6440 x full cover	
<b>BLADE STOP SPACER</b>		
597F92	1/2" Spacer block	\$27.00
597F93	5/8" Spacer block	\$46.00
<b>SCREW PACKETS 600, 689, 690, 691, 693, 696</b>		
691F93	Standard Screw Pack	\$17.00
691F94	Standard Screw Pack w/ Sex Nuts	\$26.00
468F34	SNB for 1-3/4" door	\$16.00
691F89	Torx® Screw Pack	\$38.00
691F90	Torx Screw Pack with Sex Nuts	\$42.00
597F24	Torx® tool kit	\$256.00
754F43	Screw pack (push or pull track)	\$24.00
<b>PAINT (PER CAN)</b>		
597F94	Silver Aluminum - 689	\$71.00
597F95	Dark Bronze - 690	
597F96	Light Bronze - 691	
597F97	Satin Brass - 696	



## CLOSER PARTS

PART NO.	DESCRIPTION	LIST PRICE	PART NO.	DESCRIPTION	LIST PRICE
<b>CLOSER BODIES</b>			<b>BRACKET</b>		
754F21	Closer body for DC8200	\$608.00	754F18	Quik-Install™	\$26.00
754F26	Closer body for DC8200 x M71	\$665.00	188F41	Parallel arm	\$8.90
<b>ARMS</b>			509F49	Parallel arm with hold-open	\$56.00
688F95	Regular arm, consists of:	\$162.00	188F63	Parallel arm for flush transom	\$56.00
	688F99 main arm & tube assembly	\$101.00	188F62	Parallel arm offset	\$38.00
	688F98 rod & shoe assembly	\$43.00	244F17	Regular arm mortise	\$68.00
	688F92 hex screw pkg.	\$18.00	447F14	Angle support	\$56.00
688F77	Regular arm with hold-open (A1), consists of:	\$240.00	499F30	Heavy duty parallel arm flush transom bracket	\$35.00
	691F92 main arm & rod assy	\$95.00	<b>COVERS</b>		
	540F40 hold open bracket assembly	\$145.00	754F84	Full ABS cover	\$35.00
689F02	Heavy-duty parallel arm (A3)	\$244.00	754F22	Full metal cover RH/LHR	\$83.00
689F01	Heavy-duty parallel arm with hold-open (A2)	\$273.00	754F23	Full metal cover LH/RHR	
597F52	Heavy-duty regular arm (A10)	\$244.00	754F17	Cover screw pack	\$7.60
689F03	Heavy-duty parallel arm with backstop (A4)	\$255.00	<b>DROP PLATES</b>		
689F04	Heavy-duty parallel arm with backstop & hold-open (A5)	\$236.00	754F20	For DC8200 (regular)	\$109.00
615F52	Unitrol® - Dr. width 28"-32" (A11)	\$244.00	754F24	For DC8200 (with concealed holder)	\$109.00
615F54	Unitrol® - Dr. width 33"-41" (A11)			For DC8220 (top jamb)	
615F56	Unitrol® - Dr. width 42"-48" (A11)		754F25	For DC8210 (parallel)	\$109.00
615F51	Unitrol® w/ Hold Open - Dr. width 28"-32" (A12)			For DC8230 (pull side track)	
615F53	Unitrol® w/ Hold Open - Dr. width 33"-41" (A12)	\$273.00		For DC8240 (push side track)	
615F55	Unitrol® w/ Hold Open - Dr. width 42"-48" (A12)		<b>BLADE STOP SPACER</b>		
691F96	Heavy-duty offset arm (A13)	\$160.00	597F92	1/2" Spacer block	\$27.00
692F04	Heavy duty friction hold open, RH (A14)	\$149.00	597F93	5/8" Spacer block	\$46.00
692F05	Heavy duty friction hold open, LH (A14)	\$149.00	<b>SCREW PACKETS</b>		
754F09	Pull side track only, non-hold open	\$245.00	754F37	Standard screw pack	\$18.00
754F10	Pull side track only, hold open	\$369.00	754F29	Standard screw pack (includes sex nuts)	
754F12	Push side track & arm, non-hold open	\$364.00	754F30	SNB for 1-3/4" door	\$23.00
754F13	Push side track & arm, hold open	\$494.00	754F38	Torx® screw pack	\$55.00
754F14	Push side track only, non-hold open	\$245.00	754F34	Torx screw pack (includes sex nuts)	
754F15	Push side track only, hold open	\$369.00	597F24	Torx® tool kit	\$256.00
754F16	Slide track assembly (non-hold open or hold open)	\$124.00	754F35	Main arm screw & washer	\$8.90
691F72	Deep reveal arm (7 1/4" max) consists of:	\$148.00	<b>RETROFIT PLATES</b>		
	688F99 main arm and arm tube assy	\$101.00	754F36	To Replace DC6000 (Reg. Arm)	\$121.00
	691F75 rod & shoe assembly	\$47.00	754F46	To Replace DC6000 (Par. Arm or Top Jamb)	\$121.00
691F74	Deep reveal arm with hold-open (7 1/4" max), consists of:	\$197.00			
	691F95 main arm & rod assy- deep reveal	\$52.00			
	540F40 hold open bracket assy.	\$145.00			
615F58	Reinforcing bracket	\$47.00			
615F59	Deep reveal reinforcing kit	\$61.00			
615F60	Flush partition bracket	\$46.00			

PART NO.	DESCRIPTION	LIST PRICE
<b>DC62900 SERIES ELECTROMECHANICAL CLOSERS</b>		
689F12	DC6000 Closer Body	\$509.00
188F03	Quik-Install Bracket	\$24.00
597F78	Full Cover	\$55.00
603F55	Full Metal Cover RH	\$60.00
603F57	Full Metal Cover LH	\$60.00
692F24	Standard Arm Assembly	\$119.00
692F25	Adjusting Head and Tube Assembly	\$150.00
692F14	Slide Assembly	\$129.00
692F15	Arm Stud Clip	\$13.00
692F16	Track Assembly End Cap	\$10.00
692F17	Solenoid Block Assembly, 24V	\$385.00
692F19	Adjusting Rod Assembly	\$61.00
692F20	Arm Stud	\$8.90
692F21	Retaining Ring	\$5.10
692F23	Arm Length Adjusting Screw	\$3.80
754F02	Double Egress Arm, RH	\$218.00
754F03	Double Egress Arm, LH	\$218.00
754F04	Adjusting Head and Tube Assembly, RH	\$148.00
754F05	Adjusting Head and Tube Assembly, LH	\$148.00
754F52	Track Assy. (Hinge Side) support units	\$478.00
754F53	Track Assy. (Stop Side) support units	
754F54	Hook-Up Board, Support, 24V	\$156.00
754F55	Hook-Up Board, Support, 120V	\$234.00
754F58	Hook-Up Box, Support unit, 24V, push side	\$401.00
754F59	Hook-Up Box, Support unit, 120V, push side	
754F63	Hook-Up Box, Support unit, 24V, pull side	\$414.00
754F64	Hook-Up Box, Support unit, 120V, pull side	
754F66	Fuse	\$24.00
754F72	Hook-Up Box Cover Kit (included cover & screws), Support	\$72.00

PART NO.	DESCRIPTION	LIST PRICE
<b>DC46920 SERIES ELECTROMECHANICAL DOOR HOLDER AND CLOSER</b>		
494F77	Arm Assembly "Pull side"	\$250.00
494F76	Arm Assembly "Push side"	
494F74	Holder - 120VAC	\$536.00
494F75	Holder - 24VAC/DC	\$536.00
494F72	Holder cover - Non Detector	\$205.00
494F92	System plug - 24VDC	\$124.00
494F94	Wire harness - 24VDC	\$101.00

PART NO.	DESCRIPTION	LIST PRICE
<b>Access 800® AC2 Series</b>		
794F509	Gaskets Exit device - Reader	\$14.00
794F519	Gaskets Exit device trim	\$14.00
794F529	Gaskets Cylindrical lock	\$19.00
794F539	Gaskets Mortise lock	\$19.00

PART NO.	DESCRIPTION	LIST PRICE
<b>Motorized</b>		
789F929	ECOFLEX, Motor SUB Assembly	\$167.00
728F709	Harness Fail Safe / Fail Secure	\$22.00
789F859	Motor Mortise ECOFLEX	\$135.00
728F759	ECOFLEX ET Harness A800 AC2	\$22.00
789F869	ECOFLEX ET Link Harness IN100	\$22.00
728F799	ECOFLEX ET Link Harness A800 WI1 & IP1	\$22.00
789F879	ECOFLEX ET Link Harness A700 PIP1, PWI1, IN120, IN220	\$22.00
728F809	ECOFLEX ET Link Harness A700 PAC1	\$22.00
728F939	ECOFLEX ET Link Harness A600 & SE LP10	\$22.00
728F799	ECOFLEX ET Ground Wire A800 WI1, IP1	\$22.00

Part Number	Page	Part Number	Page	Part Number	Page	Part Number	Page	Part Number	Page
019F137	385	144F34	385	217L13M022	383	236L72M024FIN	358	315F93 Fin	378
021F688	354	144F888	386	217L13M022	384	236L72M028FIN	358	315F94 Fin	378
021F718	354	145F328	386	217L13M024	375	236L72M032FIN	358	318F66	359
022F723	386	146F788	354	217L13M024	378	236L72M036FIN	358	320F442	354
022F80	385	147F078	385	217L13M024	380	236L75M020	386	320F442	386
025F722	354	156F43	385	217L13M024	383	240L08018	386	329F998	354
025F858	380	156F648	386	217L13M024	384	240L08020	386	333F998	354
025F858	382	156F658	386	217L13M028	375	240L08022	386	334F128	354
026F757	353	156F837	385	217L13M028	378	242F508	386	334F238	354
041F478	354	157F11	385	217L13M028	380	244F647	386	334F998	357
041F478	375	158F062	354	217L13M028	383	249F768	386	334K01	352
060F053	386	168F818	386	217L13M028	384	249F773	386	335F988	386
060F338	385	171F468	353	217L13M032	375	250F088	354	340L60M018FIN	359
060F428	385	171F798	385	217L13M032	378	251F198	386	340L60M020FIN	359
067F428	385	173F798	354	217L13M032	380	252F82	355	340L60M022FIN	359
070F428	385	176F653	392	217L13M032	383	253F758	354	340L60M024FIN	359
070F438	385	183F857	392	217L13M032	384	253F768	354	340L60M028FIN	359
071F628	385	186F748	354	217L13M036	375	253F778	354	340L60M032FIN	359
071F638	385	188F738	386	217L13M036	378	253F858	354	340L60M036FIN	359
071F673	386	188F758	386	217L13M036	380	253F97	355	340L60M040FIN	359
078F078	385	194F228	385	217L13M036	383	255F53	355	340L60M044FIN	359
079F00	357	195K68	352	217L13M036	384	255F54	356	340L60M048FIN	359
079F02	357	197F347	354	217L13M040	375	261F118	386	340L617020FIN	359
081F778	385	197F357	354	217L13M040	378	261F298	386	340L61M018FIN	359
082L67	386	197F527	353	217L13M040	380	264F698	363	340L61M022FIN	359
083L96M032	386	198F71	385	217L13M040	383	267F97	355	340L61M024FIN	359
083L96M034	386	201F188	386	217L13M040	384	269F088	357	340L61M028FIN	359
083L96M036	386	206F578	371	217L13M044	375	269F098	366	340L61M032FIN	359
083L96M040	386	217F422	353	217L13M044	378	269F73	392	340L61M036FIN	359
083L96M048	386	217F43	354	217L13M044	380	269F74	392	340L61M040FIN	359
092F789	386	217F432	353	217L13M044	383	269F75	392	340L61M044FIN	359
102F198	386	217F44	354	217L13M044	384	269F76	392	340L61M048FIN	359
102F278	386	217F442	353	217L13M048	375	269F808	371	342F032	386
102F378	386	217L13M016	375	217L13M048	378	270F15	355	342F052	385
103F448	386	217L13M016	378	217L13M048	380	281F272	354	352F042	392
103F458	386	217L13M016	380	217L13M048	383	283F81	386	352F05	392
114F678	386	217L13M016	383	217L13M048	384	284F138	354	353F868	354
118F299	391	217L13M016	384	219F888	354	286F507	385	354F198	354
120F768	375	217L13M018	375	220F718	371	287F608	386	361F913	392
121F012	354	217L13M018	378	222F85	386	293L14	386	362F153	354
123F22	392	217L13M018	380	223F29	386	300F688	367	362F432	354
129F848	354	217L13M018	383	224F008	383	301F567	385	365F958	354
131F278	385	217L13M018	384	228F348	386	303F242	386	365F968	354
134F05	355	217L13M020	375	236L720M40FIN	358	303F25	355	366F70	356
135F108	354	217L13M020	378	236L720M44FIN	358	304F337	392	368F918	354
135F192	354	217L13M020	380	236L720M48FIN	358	304F347	392	370F29	355
138F888	385	217L13M020	383	236L72M014FIN	358	305F318 Fin	371	370F31	355
140F978	385	217L13M020	384	236L72M016FIN	358	310F488	354	370F33	356
144F298	386	217L13M022	375	236L72M018FIN	358	314F887	353	370F35	356
144F308	386	217L13M022	378	236L72M020FIN	358	314F987	353	377F308	364
144F33	385	217L13M022	380	236L72M022FIN	358	314F997	354	377F80	362

Part Number	Page	Part Number	Page	Part Number	Page	Part Number	Page	Part Number	Page
378K18	352	408K45	352	432F86	367	466F229	358	487K15	352
379F805	354	409F865	376	433F48	362	466F279	386	487K17	352
381F30	385	409F875	377	433F49	362	466F40	360	487K19	352
383F82	362	409F875	382	433F76	367	466F41	360	487K21	352
384F03	366	409F905	382	433F77	367	466F42	360	487K38	352
384F11	362	409K12	352	433F78	367	466F45	360	488F00	363
391F658	356	411L62M016FIN	359	435F00	363	466F46	360	488F01	363
391F658	364	411L62M018FIN	359	436F177	358	466F47	360	488F03	362
392F22	392	411L62M020FIN	359	437F26	360	466F50	360	488F04	362
392F24	392	411L63M016FIN	359	437F28	360	466F51	360	488F05	362
392F28	392	411L63M018FIN	359	437F40	360	466F52	360	488F07	362
392F29	392	411L63M020FIN	359	437F41	360	466F73	360	488F088	354
394F198	386	413F488	354	437F42	360	466F74	360	488F088	360
402F29	357	413F498	354	438F37	360	466F75	360	488F09	358
402F30	357	415F16	385	438F38	360	467F338	386	488F108	354
402F31	357	415K73	352	438F418	354	467F345	386	488F108	360
402F33	357	415K74	352	438F428	354	467F358	386	488F27	360
402F34	357	416F38	386	438F90	363	467F36	386	488F31	360
402F35	357	416F39	355	439F25	360	467F378	386	488F928	354
402F738	357	416F49	358	439F26	360	480F68	383	488K84	352
403F302 Fin	371	416F84	358	439F27	360	480F688 Fin	378	488K85	352
403F568	358	416K08	352	439F33	367	480F69	386	488K99	352
403F677	357	422F88	355	439F34	367	480F70	386	489F028	354
404F858	358	422L842144	386	439F35	367	480F708	386	489F882	385
404F868	357	422L848144	386	442F952	385	482F37	360	489F892	385
405F772	386	423F54	357	444F748	354	483F118	364	489K49	352
406F438	354	423F55	357	444F758	354	483F30	360	490F558	354
407K63	352	423F57	357	444K96	352	483F34	360	492K90	352
407K64	352	423F58	357	444K97	352	483F35	360	492K91	352
407K65	352	423L71	386	444K98	352	483F36	360	492K92	352
407T314097	353	424F838	386	444K99	352	483F79	366	493F31	366
407T314125	353	424F838-B	386	445F318	367	483F80	366	493F34	366
407T314153	353	424F838-C	386	445F82	366	483F81	366	493F76	352
407T324097	353	426F52	361	445F83	366	483F82	366	493F77	352
407T324125	353	427F06	360	445F84	366	483F83	366	493F78	352
407T324153	353	427F078	360	445F85	367	483F84	366	496F32	385
407T334097	353	427F36	361	445F869	366	483K01	352	496F33	385
407T334125	353	427F37	361	446F572	354	484F74	358	496F34	385
407T334153	353	427F39	361	446F582	354	484F76	363	496F718	386
407T414242	353	427F43	361	446K68	352	484F90	362	497F528	366
407T414270	353	427F45	361	447F24	366	484F918	354	498F928	367
407T414298	353	427F47	361	447F25	366	484F928	354	499F828	366
407T414326	353	428F32	360	447F41	355	484F938	354	499F838	366
407T414354	353	428F33	360	447F42	355	484F948	354	499F848	366
407T424242	353	428F34	360	447F43	355	484F958	354	502F75	392
407T424270	353	428F66	355	447F43	388	484F968	354	502F96	392
407T424298	353	429F08	358	447F44	356	485F74	361	506F57	356
407T424326	353	429F317	366	447F45	356	487F08	366	511F51	360
407T424354	353	429F41	358	447F46	356	487K10	352	511F52	360
407T434158	353	429F41	388	461F108	354	487K11	352	518K73	352
407T434193	353	430F47	363	465F57	358	487K13	352	518K74	352

Part Number	Page	Part Number	Page	Part Number	Page	Part Number	Page	Part Number	Page
518K75	352	545F82	361	585F312	354	586L19M024	378	598F815	380
518K76	352	545F83	361	585F327	353	586L19M024	383	598F815	382
518K77	352	545F84	361	585F337	354	586L19M024	384	598F825	380
519F09	367	545F85	361	585F358	354	586L19M028	375	598F825	382
519F10	367	545F86	361	585F367	354	586L19M028	378	598F835	380
519F11	367	545F87	361	585F377	354	586L19M028	383	598F835	382
519F12	367	545F88	361	585F387	354	586L19M028	384	598F905	380
520F358	354	546F978	353	585F397	353	586L19M032	375	598F905	382
522F932	354	549F352	385	585F407	354	586L19M032	378	599F275	380
534K25	352	549F362	385	585F705	376	586L19M032	383	599F275	382
540F625	376	549F52	355	585F715	376	586L19M032	384	599F389	354
540F685	377	553F482 x length	353	585F729	377	586L19M036	375	599F91	375
544F13	363	553F492 x length	353	585F76 Fin	378	586L19M036	378	599F91	379
544F14	363	553F502 x length	353	585F762	379	586L19M036	383	599F91	381
544F38	363	556F558	383	585F762	381	586L19M036	384	599F92	375
544F39	363	557F29	362	585F77 Fin	378	586L19M040	375	599F92	379
544F40	363	562F402	354	585F772	379	586L19M040	378	599F92	381
544F41	363	562F422	354	585F772	381	586L19M040	383	599F93	379
544F42	363	563F885	376	585F78 Fin	378	586L19M040	384	599F93	381
544F43	362	563F895	376	585F79 Fin	378	586L19M044	375	599F94	375
544F44	363	563F905	376	585K46	352	586L19M044	378	599F94	379
544F45	363	563F945	376	586F16	377	586L19M044	383	599F94	381
544F46	362	563F955	376	586F17	377	586L19M044	384	599F95	375
544F76	361	563F965	376	586F18	377	586L19M048	375	599F95	379
544F77	361	564K53	352	586F51 Fin	378	586L19M048	378	599F95	381
544F79	361	564K59	352	586F512	382	586L19M048	383	599F96	379
544F80	361	564K60	352	586F80	377	586L19M048	384	599F96	381
544F82	361	566F50	391	586F81	377	592F338	388	599F97	375
544F83	361	566F51	391	586F82	377	596F618	383	599F97	379
544F84	361	569F45	366	586F86	377	596F618 Fin	378	599F97	381
544F85	361	574F158	356	586F87	377	596F628	383	599F98	375
544F87	361	574F258	384	586F88	377	596F628 Fin	378	599F98	379
544F88	361	574F268	384	586L19	370	596F66	377	599F98	381
544F89	361	574F29	384	586L19	382	596F67	377	599F99	379
544F91	361	574F29 x574F25	384	586L19M016	375	596F68	377	599F99	381
544F92	361	574F29 x574F26	384	586L19M016	378	596F825	376	600F00	375
544F93	361	574F30	384	586L19M016	383	596F879	354	600F00	379
544F94	362	574F30 x574F25	384	586L19M016	384	596F898	354	600F00	381
544F95	362	574F30 x574F26	384	586L19M018	375	596K29	352	600F01	375
544F96	362	574F55	384	586L19M018	378	596K30	352	600F01	379
544F97	362	574F56	384	586L19M018	383	596K31	352	600F01	381
544F98	362	578F435	376	586L19M018	384	596K32	352	600F02	379
544F99	362	579F11	384	586L19M020	375	598F20	377	600F02	381
545F00	362	580K99	352	586L19M020	378	598F21	377	600F03	379
545F42	362	581F96	367	586L19M020	383	598F22	377	600F03	381
545F43	362	582F112	385	586L19M020	384	598F59 Fin	375	600F04	379
545F44	362	582F122	385	586L19M022	375	598F59 Fin	378	600F04	381
545F45	362	582F132	385	586L19M022	378	598F592	380	600F05	379
545F79	361	582F142	385	586L19M022	383	598F592	382	600F05	381
545F80	361	582F298	354	586L19M022	384	598F809	380	600F06	379
545F81	361	584F46	366	586L19M024	375	598F809	382	600F06	381

Part Number	Page	Part Number	Page	Part Number	Page	Part Number	Page	Part Number	Page
600F07	379	604F228	380	610L43	386	628F912	353	650F388	387
600F07	381	604F228	382	610L44	386	628F922 x Fin	353	650F398	387
600F08	379	604F228	383	612K88	352	628F932	354	650F408	387
600F08	381	604F228 Fin	371	612K90	352	628F962	353	650F418	387
600F09	379	604F228 Fin	375	612K91	352	628K852 x Fin	352	650F428	387
600F09	381	604F228 Fin	378	612K93	352	628K872 x Fin	352	650F438	387
600F10	379	604F238	383	612K94	352	628K882 x Fin	352	650F448	387
600F10	381	604F238 Fin	375	613F029	385	628K902 x Fin	352	650F458	387
600F11	379	604F238 Fin	378	613F102	385	628K952 x Fin	352	650F468	387
600F11	381	604F248	383	613F112	385	628K972 x Fin	352	650F489	389
600F12	379	604F248 Fin	375	613F122	385	628K992 x Fin	352	650F498	389
600F12	381	604F248 Fin	378	613F132	385	629F062 x Fin	353	650F508	388
600F13	379	604F268	380	613F142	385	629F072 x Fin	353	650F518	388
600F13	381	604F268	382	613F152	385	629K002 x Fin	352	650F528	387
600F14	379	604F268	383	613F162	385	629K012 x Fin	352	650F538	388
600F14	381	604F268 Fin	375	613F172	385	629K022 x Fin	352	650F548	389
600F415	376	604F268 Fin	378	613F222	385	629K032 x Fin	352	650F558	389
600F425	376	604F278	383	613F232	385	629K042 x Fin	352	650F568	389
600F62	379	604F278 Fin	375	613F242	385	630F482 x Fin	353	650F578	388
600F62	381	604F278 Fin	378	613F252	385	630F494	353	650F588	387
600F63	379	604F288	383	613F352	385	630K472 x Fin	352	650F598	387
600F63	381	604F288 Fin	375	613F422	385	631F248	354	650F60 fin	389
600F64	379	604F288 Fin	378	613F432	385	631F248	376	650F62	388
600F64	381	605F42	360	616F078	366	631F248	379	650F63	388
600F65	379	605F43	355	616F088	366	631F248	381	650F64	387
600F65	381	605F768	386	616F12	358	649F99 fin	387	650F678LR	388
600F66	379	605F778	386	616F208	354	650F00	387	650F678RR	388
600F66	381	605F90	385	616F218	354	650F03	387	650F698LR	388
600F67	379	606F018	386	622F298	354	650F04	387	650F698RR	388
600F67	381	606F028	386	622F308	354	650F05	387	650F718	389
600F68	379	606F038	385	622F308	376	650F06	387	650F728	389
600F68	381	606K73	352	622F308	379	650F07	387	650F738	389
600F69	379	606K74	352	622F308	381	650F08	387	650F778	387
600F69	381	606K75	352	622F328	354	650F095	389	650F798	387
600F70	379	606K76	352	622F328	354	650F11	387	650F808	389
600F70	381	606K77	352	622F698	354	650F12	387	650F818	389
600F71	379	606K78	352	624F427	358	650F13	387	650F828	388
600F71	381	606K79	352	624F439	358	650F14	387	650F878	388
600F72	379	607F76	375	624F449	358	650F15	387	650F888	388
600F72	381	607F919	354	624F455	358	650F16	387	650F93	387
600F73	379	609F36	355	624F478	358	650F189	387	650F959	388
600F73	381	609F36	388	624F488	357	650F21	387	650F968	387
601F229	354	609F37	355	624F49	357	650F228	387	650F978	388
601F24	377	609F37	388	624F53	357	650F238	387	650F998	387
601F25	377	609F38	355	627F009	372	650F248	387	650L65	388
601F26	377	610F01	355	628F107142	353	650F279	388	650L657020	388
601F283 Fin	378	610F01	388	628F107171	353	650F288	388	651F00	390
601F69	375	610F02	355	628F107236	353	650F318	388	651F01	390
601F69	377	610F49	352	628F825	354	650F358	387	651F04	390
602F198	357	610K46	352	628F835	354	650F368	387	651F06	390
603F207	353	610K48	352	628F892	353	650F378	387	651F08	390

Part Number	Page	Part Number	Page	Part Number	Page	Part Number	Page	Part Number	Page
651F09	390	652F218	391	652F86	389	653F70	390	670F37	365
651F10	390	652F228	391	652F87	389	653F71	389	670F38	365
651F362	391	652F239	391	652F88	389	653F71	390	670F57	365
651F372	391	652F298	388	652F89	389	653F72	389	670F58	365
651F389	391	652F57	389	652F90	389	653F72	390	670F59	365
651F398	391	652F58	389	652F92	389	653F73	389	670F60	365
651F408	391	652F58	390	652F93	389	653F73	390	670F61	365
651F418	391	652F59	389	652F95	389	653F74	389	670F62	365
651F425	391	652F59	390	652F96	389	653F74	390	670F63	365
651F448	391	652F60	389	652F99	389	653F75	389	670F64	365
651F478	391	652F61	389	653F02	389	653F75	390	670F65	365
651F498	391	652F61	390	653F03	389	653F76	389	670F66	365
651F508	391	652F62	389	653F04	389	653F76	390	670F67	365
651F538	391	652F62	390	653F05	389	653L157014	388	670F68	365
651F545	391	652F63	389	653F08	389	653L163016	388	670F69	365
651F568	391	652F64	389	653F09	389	653L163020	388	670F70	365
651F578	391	652F64	390	653F10	389	653L183016	388	670F71	365
651F587	391	652F65	389	653F12	387	653L183020	388	670F72	365
651F608	391	652F65	390	653F13	387	654F07	355	670F73	365
651F618	391	652F66	389	653F14	387	654F08	355	670F74	365
651F628	391	652F67	389	653F50	389	654F208	388	671F02	365
651F638	391	652F67	390	653F50	390	654F218	388	671F03	365
651F648	391	652F68	389	653F53	389	655F028	391	671F04	365
651F655	391	652F68	390	653F53	390	655F15	388	671F05	365
651F675	391	652F69	389	653F54	389	655F16	388	671F06	365
651F708	391	652F70	389	653F54	390	655F17	388	671F07	365
651F738	391	652F70	390	653F55	389	655F488LR	388	671F08	365
651F758	391	652F71	389	653F55	390	655F488RR	388	671F09	365
651F828	391	652F71	390	653F56	389	655F548	391	671F10	365
651F838	391	652F72	389	653F56	390	655F698	391	677F04	390
651F848	391	652F73	389	653F57	389	655F708	391	677F05	390
651F858	391	652F73	390	653F57	390	655F718	388	677F068	391
651F868	391	652F74	389	653F59	389	656F408	388	677F098	391
651F878	391	652F74	390	653F59	390	656F41	388	677F13	390
651F888	391	652F75	389	653F60	389	656F53	389	677F14	390
651F898	391	652F76	389	653F60	390	656F58	390	677F15	390
651F928	391	652F76	390	653F61	389	656F59	390	677F16	390
651F938	391	652F77	389	653F61	390	656F60	390	677F26	390
651F948	391	652F77	390	653F62	389	656F61	390	677F27	390
651F965	391	652F78	389	653F62	390	656F62	390	677F28	390
651F988	391	652F79	389	653F63	389	656F63	390	677F42	352
652F048	391	652F79	390	653F63	390	656F64	391	677F768LR 626	391
652F058	391	652F80	389	653F65	389	656F658	391	677F768RR 626	391
652F068	391	652F80	390	653F65	390	656F668	388	677F778LR 626	391
652F098	391	652F81	389	653F66	389	670F30	365	677F778RR 626	391
652F108	391	652F82	389	653F66	390	670F31	365	678F008LR	388
652F118	391	652F82	390	653F68	389	670F32	365	678F008RR	388
652F128	391	652F83	389	653F68	390	670F33	365	678F028	391
652F138	391	652F83	390	653F69	389	670F34	365	678F248	378
652F148	391	652F84	389	653F69	390	670F35	365	678F248	380
652F158	391	652F85	389	653F70	389	670F36	365	678F248	382

Part Number	Page	Part Number	Page	Part Number	Page	Part Number	Page	Part Number	Page
678F25 Fin	375	682F788	382	686F858	376	695F252031 -.031"	353	698F69	390
678F25 Fin	378	682F86 Fin	378	686F858	379	695F252047 -.047"	353	698F70	390
678F252	380	682F87 Fin	378	686F858	381	695F252063 -.063"	353	698F71	390
678F252	382	682F958	376	686F868	376	695F252078 -.078"	353	700F168	367
678F252 Fin	369	682F958	379	686F868	379	695F252094 -.094"	353	700F278	357
678F498	378	682F958	381	686F868	381	695F252110 -.110"	353	700F367	367
678F498	382	682F969	376	686F88 Fin	378	695F252126 -.126"	353	700F378	367
678F548	357	682F969	379	686F882	382	695F252141 -.141"	353	700F40	363
678F677	357	682F969	381	688F017	358	695F252157 -.157"	353	700F41	363
679F818	371	684F055	358	688F177	358	695F257031 -.031"	353	700F42	363
679F818	377	684F067	358	690F975	376	695F257047 -.047"	353	700F43	363
679F818	385	684F119	358	690F985	377	695F257063 -.063"	353	700F44	363
680F348	367	684F129	358	690F985	382	695F257078 -.078"	353	700F45	363
680F358	367	684F42	388	692F632	368	695F257094 -.094"	353	700F46	363
680F368	367	684F427	388	692F642	368	695F257110 -.110"	353	700F47	363
680F645	354	684F44 Fin	378	692F652	368	695F257126 -.126"	353	700F575	354
680L50	382	684F448	380	692F662	368	695F257141 -.141"	353	700F65	367
680L51	382	684F448	382	692F672	368	695F257157 -.157"	353	700F66	367
680L52	382	684F45 Fin	378	692F752	368	696F39	367	700F67	367
681F30	357	684F46 Fin	378	692F762	368	696F42	354	700F708	358
681F31	357	684F528	378	692F862	368	696F472	353	700F748	358
681F40	357	684F528	380	692F932	368	696F499	353	700F80	363
681F41	357	684F528	382	692F942	368	696F502 x Fin	353	700F81	363
681F448	358	684F539	382	692F952	368	696F51	354	700F82	363
681F608	387	684F559	357	693F208	386	696K43	352	700F83	363
681F618	387	684F775	377	694F312	368	696K45	352	700F84	363
681F62	387	684F775	382	694F322	368	696K46	352	700F86	363
681F63	387	684F785	377	694F332	368	696K48	352	700F87	363
681F708	389	684F785	382	694F352	368	696K52	352	700F907	357
681F718	389	684F795	377	694F392	368	697F338	388	700F957	358
681F768	389	684F795	382	694F442	368	697F348	388	701F228	357
681F778	389	684F805	377	694F482	368	697F358	388	701F60	388
682F018	358	684F805	382	694F522	368	697F368	388	701F61	388
682F298	354	684F815	377	694F562	368	697F50	354	701F62	388
682F298	376	684F815	382	694F602	368	697F507	353	701F63	388
682F298	379	684F825	377	694F682	368	697F862	387	701F705	358
682F298	381	684F825	382	694F722	368	697F942	376	701F748	357
682F398	354	684F835	377	694F802	368	697F942	379	702F987	357
682F398	376	684F835	382	695F042 x Fin	353	697F942	381	703F997	358
682F398	379	684F845	377	695F052 x Fin	353	697F995	377	704F269	387
682F398	381	684F845	382	695F075	376	698F038	387	704F279	387
682F608	378	684F855	377	695F244139 -.139"	353	698F22	366	704F479	387
682F618	378	684F855	382	695F244155 -.155"	353	698F31	390	704F489	387
682F628	378	684F865	377	695F244171 -.171"	353	698F32	390	704F569	387
682F638	378	684F865	382	695F244187 -.187"	353	698F33	390	704F579	387
682F64 Fin	378	684F875	382	695F244202 -.202"	353	698F34	390	704F589	387
682F65 Fin	378	684F885	377	695F247139 -.139"	353	698F64	390	704F599	387
682F67 Fin	378	684F885	382	695F247155 -.155"	353	698F65	390	704F62	388
682F68 Fin	378	685F098	354	695F247171 -.171"	353	698F66	390	704F63	388
682F788	378	685F387	358	695F247187 -.187"	353	698F67	390	704F648	388
682F788	380	685F875	377	695F247202 -.202"	353	698F68	390	704F658	388



Part Number	Page	Part Number	Page	Part Number	Page	Part Number	Page	Part Number	Page
704F66	388	712F425	376	714F255	376	733F47	390	763F012150	353
705F949	357	712F435	376	714F275	377	733F48	390	763F012180	353
706F005	391	712F445	377	714F305	376	733F49	390	763F012210	353
706F015	391	712F455	377	714F315	376	733F50	390	763F012240	353
706F038	387	712F465	377	714F365	376	733F51	390	763F012270	353
706F048	387	712F475	377	714F375	376	733F52	390	763F012300	353
706F058	387	712F485	377	714F425	376	733F53	390	763F012330	353
706F068	387	712F495	377	714F455	376	741F21	367	763F012360	353
706F078	387	712F505	376	714F485	377	741F22	367	763F027120	353
706F088	387	712F515	376	714F495	377	741F23	367	763F027150	353
706F098	387	712F525	376	714F545	377	741F24	367	763F027180	353
706F108	387	712F535	376	714F555	377	744F208	388	763F027210	353
706F15	387	712F545	376	714F605	377	744F258	388	763F027240	353
706F16	387	712F555	376	714F635	377	744F688	388	763F027270	353
706F462	388	712F565	376	715F108	354	751F16	362	763F027300	353
706F70	367	712F575	376	715F118	354	751F17	362	763F072	353
707F299	372	712F605	377	715F128	354	753F078	358	774F225	369
707F57	367	712F615	377	715F152	353	753F098	357	774F878	370
707F58	367	712F625	377	715F245	376	753F598	371	774F888	370
707F59	367	712F635	377	715F892	354	753F697	357	774F945	369
707F60	367	712F645	377	715K14	352	756F507	354	774F965	369
710F00M	388	712F655	377	716K16	352	756F507	354	774F985	369
710F318LR	388	712F665	377	716K43	352	756F517	354	775F808	370
710F318RR	388	712F675	377	716K45	352	756F517	354	775F818	370
710F328LR	388	712F685	376	716K46	352	756F527	354	775F828	370
710F328RR	388	712F695	376	716K48	352	756F527	354	775F838	370
710F338LR	388	712F705	376	720F21	367	756F537	354	775F908 Fin	371
710F338RR	388	712F715	376	720F22	367	756F537	354	775F918 Fin	371
710F618	378	712F725	376	720F24	367	756F542	354	775F948	370
710F628	378	712F735	376	720F25	367	756F542	354	776F002 Fin	370
710F658	378	712F745	377	720F43	357	756F557	354	776F012 Fin	370
710F668	378	712F755	377	720F46	357	756F557	354	776F022 Fin	370
711F002	367	712F765	377	720F61	367	756F567	354	776F032 Fin	370
712F205	376	712F775	377	720F62	367	756F567	354	776F042 Fin	370
712F215	376	712F785	377	720F64	367	756F582	354	776F215	369
712F225	376	712F795	377	720F65	367	756F582	354	776F225	369
712F235	376	713F518	388	721F16	367	756F582	354	776F235	369
712F265	376	713F528	388	721F17	367	756F622	354	776F245	369
712F275	376	713F908	388	721F18	367	756F622	354	776F335	369
712F305	377	713F938	388	721F19	367	756F963	386	776F345	369
712F315	377	713F948	388	723F26	367	763F002213	353	776F395	369
712F325	377	713F958	388	723F69	367	763F002243	353	776F405	369
712F335	377	713F988	388	724F278	389	763F002273	353	776F415	369
712F345	377	713F998	388	730F778	388	763F002303	353	776F425	369
712F355	377	714F005	376	733F05	390	763F002333	353	776F515	369
712F365	377	714F035	376	733F41	390	763F002363	353	776F525	369
712F375	377	714F065	376	733F42	390	763F002393	353	776F575	369
712F385	376	714F125	376	733F43	390	763F012030	353	776F585	369
712F395	376	714F155	377	733F44	390	763F012060	353	776F638	370
712F405	376	714F185	377	733F45	390	763F012090	353	776F648	370
712F415	376	714F215	377	733F46	390	763F012120	353	776F658	370

Part Number	Page	Part Number	Page	Part Number	Page	Part Number	Page	Part Number	Page
776F668	370	778F245	369	780F225	369	785F138 Fin	376	791F51 x Fin	386
776F678	370	778F335	369	780F235	369	785F148	376	791F59	367
776F688	370	778F345	369	780F245	369	785F158 Fin	376	791F60	367
776F698	370	778F395	369	780F335	369	785F168	376	791F82 Fin	386
776F708	370	778F405	369	780F345	369	785F178	376	791F83 Fin	386
776F718	370	778F415	369	780F395	369	785F188	376	791F84 Fin	386
776F728	370	778F425	369	780F405	369	785F198	376	791F85 Fin	386
776F738	370	778F515	369	780F415	369	785F218 Fin	376	791F86 Fin	386
776F748	370	778F525	369	780F425	369	785F228	376	791F87 Fin	386
776F758	370	778F575	369	780F515	369	785F238	376	792F997	353
776F768	370	778F585	369	780F525	369	785F248	376	796F118	380
776F778	370	778F638	371	780F575	369	785F258	376	796F118	382
776F788	370	778F759	371	780F585	369	785F268 Fin	376	796F208	379
776F798	370	778F788	370	780F638	371	785F278	376	796F218	379
776F808	370	778F812	371	780F648	370	785F288	376	796F228	379
776F818	370	778F868	371	780F658	370	785F298	376	796F238	379
776F828	370	778F888	370	780F662	370	785F308	376	796F248	379
776F838	370	778F898	370	780F808	370	785F318 Fin	376	796F258	379
776F848	370	778F90 Fin	369	780F81 Fin	370	785F328	376	796F268	379
776F858	370	778F91 Fin	371	780F82 Fin	370	785F338	376	796F30 x Fin	386
776F868	370	778F968	371	780F83 Fin	370	785F348	376	796F318	379
776F878	370	778F97 Fin	369	780F84 Fin	370	785F358	376	796F328	379
776F918	370	779F215	369	780F85 Fin	370	785F378 Fin	376	796F338	379
776F928	370	779F225	369	780F86 Fin	370	785F388 Fin	376	796F358	379
776F938	370	779F235	369	780F87 Fin	370	789F018	375	796F368	379
776F948	370	779F245	369	780F88 Fin	370	789F028	375	796F378	379
776F958	370	779F335	369	780F89 Fin	370	789F058	375	796F378	381
776F968	370	779F345	369	780F90 Fin	370	789F068	375	796F388	379
776F978	370	779F395	369	780F91 Fin	370	789F228	375	796F398	379
776F988	370	779F405	369	780F92 Fin	370	790F047	358	796F398	379
776F998	370	779F415	369	780F93 Fin	370	790F208	371	796F398	381
777F208	370	779F425	369	780F94 Fin	370	790F215	369	796F408	379
777F215	369	779F515	369	780F95 Fin	370	790F225	369	796F408	381
777F225	369	779F525	369	780F96 Fin	370	790F225	369	796F43	386
777F235	369	779F575	369	783F048	391	790F235	369	796F46 x Fin	386
777F245	369	779F585	369	783F06	390	790F245	369	797F618	381
777F335	369	779F638	370	783F208	376	790F245	369	797F628	381
777F345	369	779F648	370	783F308	376	790F335	369	797F638	381
777F395	369	779F658	370	783F408	376	790F345	369	797F658	381
777F405	369	779F728	370	785F008	376	790F395	369	797F668	381
777F415	369	779F738	370	785F018 Fin	376	790F405	369	797F678	381
777F425	369	779F748	370	785F028 Fin	376	790F415	369	797F688	381
777F515	369	779F758	370	785F038	376	790F425	369	797F698	381
777F525	369	779F787	371	785F048	376	790F515	369	797F808	381
777F575	369	779F797	371	785F058	376	790F525	369	797F818	382
777F585	369	779F807	371	785F068	376	790F575	369	797F828	380
778F215	369	779F97 Fin	369	785F078 Fin	376	790F585	369	797F828	382
778F225	369	779F98 Fin	369	785F088	376	790F988	371	797F838	382
778F225	369	779F99 Fin	369	785F088	376	790F988	371	797F845	380
778F235	369	780F208	371	785F108	376	790F998	371	797F845	382
778F245	369	780F215	369	785F118 Fin	376	790F998	371	797F855	380

Part Number	Page	Part Number	Page	Part Number	Page	Part Number	Page	Part Number	Page
797F855	382	799F585	376	855F649	364	860F265	373	860N005	374
797F865	380	799F595	376	855F658	364	860F275	373	860N015	374
797F865	382	799F605	377	855F697	364	860F285	373	860N025	374
797F875	380	799F615	377	855F707	364	860F295	373	860N035	374
797F875	382	799F625	377	855F717	364	860F305	373	860N045	374
797F915	380	799F635	377	855F727	364	860F315	373	860N055	374
797F915	382	799F645	377	855F737 x Finish	364	860F325	373	860N065	374
797F925	380	799F655	377	855F747 x Finish	364	860F335	373	860N075	374
797F925	382	799F665	377	855F757 x Finish	364	860F345	373	860N085	374
797F935	380	799F675	377	855F767 x Finish	364	860F355	373	860N095	374
797F935	382	799F685	377	856F049	364	860F405	373	860N105	374
797F945	380	799F695	377	858F241	364	860F415	373	860N115	374
797F945	382	799F805	376	858F251	364	860F425	373	860N125	374
798F115	380	799F815	376	858F261	364	860F435	373	860N135	374
798F115	382	799F825	376	858F271	364	860F445	373	860N145	374
798F125	380	799F835	376	858F281	364	860F455	373	860N155	374
798F125	382	799F845	377	858F291	364	860F465	373	860N205	374
798F135	380	799F855	377	858F497 x Finish	364	860F475	373	860N215	374
798F135	382	799F865	377	858F50M FIN	364	860F485	373	860N225	374
798F145	380	799F875	377	858F517 x Finish	364	860F495	373	860N235	374
798F145	382	813F505	358	858F52M FIN	364	860F505	373	860N245	374
798F155	380	820F008	357	858F53M FIN	364	860F515	373	860N255	374
798F155	382	820F048	358	858F549	364	860F525	373	860N265	374
798F165	380	820F068	358	858F55M FIN	364	860F535	373	860N275	374
798F165	382	820F078	358	859F052 x Finish	364	860F545	373	860N285	374
798F175	380	820F088	358	859F062 x Finish	364	860F555	373	860N295	374
798F175	382	820F148	357	859F072 x Finish	364	860F608	373	860N305	374
798F185	380	820F168	358	859F082 x Finish	364	860F618	373	860N315	374
798F185	382	852F307	358	859F092 x Finish	364	860F628	373	860N325	374
798F215	382	852F318	358	860F005	373	860F638	373	860N335	374
798F225	382	853F05	366	860F015	373	860F648	373	860N345	374
798F235	382	853F865	358	860F025	373	860F655	373	860N355	374
798F245	382	853F875	358	860F035	373	860F665	373	860N405	374
798F255	382	854F00	364	860F045	373	860F685	373	860N415	374
798F265	382	854F01	364	860F055	373	860F705	373	860N425	374
798F275	382	854F03	364	860F065	373	860F715	373	860N435	374
798F285	382	854F04	364	860F075	373	860F735	373	860N445	374
798F295	369	854F05	364	860F085	373	860F755	373	860N455	374
798F305	369	854F06	364	860F095	373	860F775	373	860N465	374
798F395	369	854F08	364	860F105	373	860F785	373	860N475	374
798F405	369	854F09	364	860F115	373	860F805	373	860N485	374
798K912 x Fin	352	854F11	360	860F125	373	860F825	373	860N495	374
798K922 x Fin	352	854F15	360	860F135	373	860F835	373	860N505	374
799F505	376	854F19	360	860F145	373	860F855	373	860N515	374
799F515	376	854F23	360	860F155	373	860F875	373	860N525	374
799F525	376	854F27	360	860F205	373	860F905	373	860N535	374
799F535	376	855F582 x Finish	364	860F215	373	860F915	373	860N545	374
799F545	376	855F592 x Finish	364	860F225	373	860F935	373	860N555	374
799F555	376	855F602 x Finish	364	860F235	373	860F955	373	860R005	374
799F565	376	855F619	364	860F245	373	860F965	373	860R015	374
799F575	376	855F638	364	860F255	373	860F985	373	860R025	374

Part Number	Page	Part Number	Page	Part Number	Page	Part Number	Page	Part Number	Page
860R035	374	861F115	373	863F078	372	867F25	375		
860R045	374	861F135	373	863F088	372	867F26	375		
860R055	374	861F708	372	863F108	373	867F27	375		
860R065	374	861F718	372	863F118	373	867F28	375		
860R075	374	861F728 Fin	372	864F568	372	867F29	375		
860R085	374	861F738 Fin	372	864F568	372	867F30	375		
860R095	374	861F748 Fin	372	864F578	372	867F31	375		
860R105	374	861F758 Fin	372	864F578	372	867F388	375		
860R115	374	861F768 Fin	372	865F199	375	867F70 Fin	375		
860R125	374	861F778 Fin	372	865F298	375	867F71 Fin	375		
860R135	374	861F788 Fin	372	865F308	375	867F72 Fin	375		
860R145	374	861F798 Fin	372	865F32 x Fin	375	867F73 Fin	375		
860R155	374	861F828 Fin	372	865F33 x Fin	375	867F74 Fin	375		
860R205	374	861F838 Fin	372	865F398	375	867F75 Fin	375		
860R215	374	861F848	372	866F028	372				
860R225	374	861F858	372	866F038	372				
860R235	374	861F868	372	866F048 Fin	372				
860R245	374	861F878	372	866F058 Fin	372				
860R255	374	861F888 Fin	372	866F068 Fin	372				
860R265	374	861F898 Fin	372	866F078 Fin	372				
860R275	374	861F908 Fin	372	866F088 Fin	372				
860R285	374	861F918 Fin	372	866F098 Fin	372				
860R295	374	861F928	372	866F108 Fin	372				
860R305	374	861F938	372	866F118 Fin	372				
860R315	374	861F948	372	866F128 Fin	372				
860R325	374	861F958	372	866F138 Fin	372				
860R335	374	861F968	372	866F148	372				
860R345	374	861F978	372	866F158	372				
860R355	374	861F988	372	866F168	372				
860R405	374	861F998	372	866F178	372				
860R415	374	862F008	372	866F188 Fin	372				
860R425	374	862F018	372	866F198 Fin	372				
860R435	374	862F028	372	866F208 Fin	372				
860R445	374	862F038	372	866F218 Fin	372				
860R455	374	862F049	372	866F228	372				
860R465	374	862F402	372	866F238	372				
860R475	374	862F412	372	866F248	372				
860R485	374	862F472	372	866F258	372				
860R495	374	862F482	372	866F268	372				
860R505	374	862F978	372	866F278	372				
860R515	374	862F988	372	866F288	372				
860R525	374	862F998	372	866F298	372				
860R535	374	863F008	372	866F308	372				
860R545	374	863F018	372	866F318	372				
860R555	374	863F028	372	866F328	372				
861F015	373	863F038	372	866F338	372				
861F035	373	863F038	372	867F20	375				
861F045	373	863F048	372	867F21	375				
861F065	373	863F048	372	867F22	375				
861F085	373	863F058	372	867F23	375				
861F095	373	863F068	372	867F24	375				



ASSA ABLOY

# Notes

USA & Canada Prices Effective February 1, 2022





ASSA ABLOY

# Notes

USA & Canada Prices Effective February 1, 2022

For more information regarding Corbin Russwin Locksets, Exit Devices, Door Controls and Key Systems, contact your authorized Corbin Russwin Distributor or Sales Representative.



**Corbin Russwin Architectural Hardware**

225 Episcopal Road  
Berlin, CT 06037  
Phone 800-543-3658  
Fax 800-447-6714  
[www.corbinrusswin.com](http://www.corbinrusswin.com)

**Notice:** This price book takes precedence over the catalog as to the correctness and availability of items in our entire line.

Corbin Russwin and Design®, Corbin®, Russwin®, and Design® Access 800®, Muséo®, and SecureBolt® are registered trademarks of Corbin Russwin, Inc., an ASSA ABLOY Group company. Safeguard™, PathLite™ and Vineyard™ are trademarks of Corbin Russwin, Inc., an ASSA ABLOY Group company. Unitrol® is a registered trademark of Yale Security Inc., an ASSA ABLOY Group company. These materials are protected under US copyright laws. All contents current at time of publication. Corbin Russwin Inc., an ASSA ABLOY Group company reserves the right to change availability of any item in this catalog, its design, construction, and/or its materials. Other products' brand names may be trademarks or registered trademarks of their respective owners and are mentioned for reference purposes only.

Copyright © 2002-2022 Corbin Russwin, Inc., an ASSA ABLOY Group company. All rights reserved. Reproduction in whole or in part without the express written permission of Corbin Russwin, Inc. is prohibited.