



**Find a Local Distributor**

1-800-483-9628

8:00a to 6:00p CST

Monday-Friday

**Technical Service**

1-800-483-9628

**More Information Online**

[www.brickform.com](http://www.brickform.com)

[www.solomoncolors.com](http://www.solomoncolors.com)



**Table of Contents**

**Why Buy Brickform? ..... 3**  
**Contractor Highlight..... 4**  
**Web and Training..... 5**  
**Stamp App..... 6**  
**Texturing Products ..... 7-67**  
 Seamless Texture Skins ..... 7-17  
 Concrete Dimensions Stencils..... 18-19  
 Paladiano Texture Mats ..... 20-26  
 Stone Texture Mats ..... 27-40  
 Slate Texture Mats ..... 41-45  
 Brick Texture Mats ..... 45-47  
 Wood Texture Mats ..... 48-51  
 Tile Texture Mats..... 52  
 Border Tools..... 53  
 Creative Images Texture Mats ..... 54-57  
 Contractors Choice ..... 58  
 Gang Tools..... 59  
 Overlay Texture Mats ..... 60  
 Cal-Trans Series Texture Mats ..... 60  
 Graphic Warning Texture Mats ..... 60  
 Ultra-Liners ..... 61  
 Step-Liners ..... 62-63  
 Paper Stencils..... 64-65  
 Imprint Tools ..... 66  
 Texturing Accessories ..... 67  
**Coloring Products ..... 68-85**  
 Color Hardener ..... 68-69  
**Sample Combinations**  
 Antique Release ..... 70-71  
 FreestylePRO ..... 72  
 Cem-Coat ..... 73  
 Antique-It ..... 74  
**Standard Color Collection Guide**  
 DAY1..... 75  
 Liquid Release..... 76  
 Surface Deactivator ..... 77  
 Liquid Color..... 78  
**Powdered Integral Color Card**  
**Liquid Integral Color Card**  
**Solomon Colors Ready Mix Color Card**  
 Powdered Color ..... 79  
 Tinta' Seal..... 79  
 Blush-Tone Acid Stain ..... 80-81  
 E-Stain ..... 82-83  
 ARTesian Stain ..... 84-85  
**Polishing Products..... 86-89**  
 Lythic ..... 86-87  
 Pro Dye *PLUS* ..... 88-89  
**Finishing & Maintenance 90-91**  
 E-Etch ..... 90  
 Neutra Clean..... 90  
**Resurfacing Products ... 92-101**  
 Stampable Overlay ..... 92-93  
 Micro-Topping ..... 94-95  
 SM Professional Grade..... 96-97  
 Vertical Mix ..... 98-99  
 Triple Seven Bond Coat..... 100  
 Overlay Liquid Colorant ..... 100  
 Turtle Set ..... 100  
**Sealers..... 102**  
 UreMax WB ..... 102  
 Poly-Astic..... 102  
 DecoPoxy ..... 102  
 Stealth-Seal ..... 102  
 Stealth-Seal Premium..... 102  
 Gem Cure & Seal..... 103  
 Satin Cure & Seal ..... 103  
 Gem-Seal..... 104  
 Poly-Seal ..... 104  
 Safety-Seal ..... 104  
 Satin-Seal ..... 105  
 Strip-It ..... 105  
 Premium Acrylic Floor Finish ..... 105  
 Tinta' Seal ..... 106  
 Traction Grip ..... 106  
 Matte-Magic..... 106  
 Sealer Properties Checklist ..... 107  
**Systems Approach to  
 Decorative Concrete . 108-109**

## Why Buy BRICKFORM? Fast, Friendly, Expert Service

Experts are available to answer questions about our products and how they work as a system. Our Customer Service Department can help you to find a distributor in your area. Our Technical Support Team can answer application and installation questions. Call today for more information.

### Account Managers

Exceptional customer service is our goal. BRICKFORM strives to exceed expectations by resolving issues on the first call. We have dedicated, knowledgeable Account Managers to help make your project a success from start to finish.



### Technical Support

Have a technical or jobsite question? Contact a BRICKFORM Technical Support Representative or Account Manager for more information at 1-800-483-9628.

At BRICKFORM, we want to make sure you have the support you need. We are devoted to providing the most comprehensive information and education to architects, distributors, contractors, and installers.

BRICKFORM works with dealers nationwide to sponsor hands-on demonstrations where installers are presented with the latest in products and techniques.

Technical information, tips, and color charts are all available on our website. Up-to-the-minute schedules of our latest product demos are posted. We participate in many local and international trade shows where we showcase new products, instructional videos, and demonstrations for attendees.

Our technical specialists are only a phone call away and are trained to answer your questions. Area Managers are also available for jobsite consultations.

### Shipping & Traffic

Once you have placed your order, the BRICKFORM team of logistics specialists take over to ensure that your order is packaged and shipped. These experienced professionals ship your order in the fastest, most economical way possible. You may also choose your own trucking company or company truck for your shipment.

### Product Knowledge

BRICKFORM understands your desire to know how our systems work. Our Area Managers can arrange accredited architectural presentations or product knowledge meetings.

### Nationwide Sales Support

The BRICKFORM Area Manager provides ongoing superior service. BRICKFORM understands the meaning of quality support, so we have chosen Area Managers with the background, knowledge, and expertise to answer your questions quickly and correctly. Contact Customer Service at 1-800-483-9628 for the name and contact information for your local Area Manager.

### Find a Contractor/Installer

Need help getting started on your dream project? Call 1-800-483-9628 to be referred to a BRICKFORM distributor near you. Ask your local distributor to recommend a contractor who specializes in using BRICKFORM decorative concrete products or visit [myconcretecontractor.com](http://myconcretecontractor.com).

### Training

BRICKFORM supports hands-on training and demonstrations across the nation, where installers are presented with the latest in product knowledge and techniques. In order to ensure the highest quality customer service, our Area Managers participate in these training sessions. More information available at [brickformtraining.com](http://brickformtraining.com).



## Brickform Featured Contractors

Brickform is nothing without dedicated and skilled decorative concrete contractors. Brickform is proud to have been the contractors' choice for decades. Read these testimonials from some of the best contractors in the country about why they love using Brickform.



I like to use Brickform on my decorative concrete for a few reasons. The color is readily available to me, distribution is done well. The consistency in the color hardeners, release agents and other products has been excellent for years. I have been stamping since 1993 and have used a lot of other products and the only one who remains consistent in quality is Brickform. They do a great job with marketing when it comes to brochures and color charts. I will choose to use Brickform for many years to come.

Mike Ganos  
*Ganos Decorative Concrete, Inc.*



We started imprinting concrete around 2001-2002 and at that time we were buying LM Scofield products...we got into a pinch and needed product immediately and bought a few pallets of Rafco/Brickform products. We never looked back for multiple reasons. 1. The product was superior in performance and ease of use. 2. The products were 30% cheaper. 3. The back end support was phenomenal. 4. The stamps were superior by far. That relationship was cemented when Clark Branum was involved and really gave us some insight from the molecular level up. From that point to today we are 100% loyal to Brickform because they are loyal to us.

Tom Dombalis  
*Atlantic Coast Concrete*



I've been a part of the decorative concrete industry for 40 years. For the past 17 years I have been using products manufactured by the Brickform Company, a Division of Solomon Colors, Inc.

Brickform offers a wide variety of tooling with quality patterns and textures. We can compete in our marketplace with any company, to offer top quality concrete finishes.

The color hardeners & release agents used in the imprinted concrete process are second to none. We have always found the colors to be consistent and "streak free," which relates to their blending and quality control processes as meeting high industry standards. We have found the colors to be durable and wear resistant over the years.

Their stains and coating systems are also high quality, and will compete with any other manufacturer in the industry.

Our company has nothing but good reports for the Brickform and Solomon Colors companies.

Dave De Angelis  
*Architectural Paving Systems*



# BRICKFORM TRAINING

Learn more. Earn more.

Join us at one of our training seminars in Springfield, IL or Rialto, CA. You will receive in-depth instruction on cutting edge decorative concrete products and techniques. Seminars feature lectures, demonstrations, and hands-on training.



[www.brickformtraining.com](http://www.brickformtraining.com)





# stamp app

DECORATIVE CONCRETE  
AUGMENTED REALITY >



Search for **Brickform StampApp** on the Apple iTunes Store or Google Play!

**Solomon Colors** and **Brickform** are excited to bring you the decorative concrete augmented reality app that will revolutionize the way homeowners and contractors design decorative hardscapes.

Using advanced augmented reality technology, you can create your own custom stamped concrete, using the most popular textures, colors, and stamp patterns **Solomon Colors** and **Brickform** has to offer. See how your favorite patterns and color combinations work with your home, from the convenience of your tablet or phone. Best of all... It's **FREE** to download and use.

Once you've installed the Brickform StampApp on your tablet or phone, scan the above image from within the app to get started. If you would like to experience the full-size, 10'x10' augmented reality slab, just fill out the form available at [www.stampapp.net](http://www.stampapp.net)

## Engineered Texturing Systems

The BRICKFORM system of Texture Mats has introduced a whole new level of creative expression to decorative concrete. Precision engineered tools make possible a high degree of controlled creativity, making it possible to mimic and even enhance the look and feel of natural stone and many other surfaces. Anything from finely tooled slate to perfectly set cobbles, BRICKFORM has the tools to make it happen, with absolute control.

### Largest Selection and Best Value

#### Pattern

BRICKFORM manufactures the world's largest selection. Over 175 patterns, in stone, slate, brick, and even wood textures are available.

#### Texture

Over 30 textures have been designed to recreate the look and feel of natural materials. All tools, including random fieldstone, coarse wire-cut brick, heavily textured stone, and Mexican tile, are created with strict attention to detail.

#### Precision and Durability

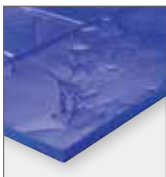

The resilient material used to create each texture is designed to retain pattern "memory." Consistent, well-defined, uniform texture is transferred, in every detail, onto the concrete surface imprint after imprint.



Our company is dedicated to the precise and unsurpassed consistency of each and every texturing tool. Strict standards are maintained so every tool is tight-fitting, reducing pattern lines and unsightly ridges.



Each tool is crafted from a high-quality polyurethane material that is flexible, yet retains high-tear strength. Sturdy handles are carefully placed according to tool-weight distribution to improve balance and maneuverability.

Disclaimer - All measurements are nominal. Skin and texture mat measurements are based on the Brickform mold size. Urethane has a natural tendency to shrink or expand, depending on environmental factors. This does not affect how the mats fit together.

## Seamless Texture Skins

### Standard-Flexible

Brickform Seamless Skins are made with a unique feathered edge that allows for a seamless texture with no start or stop point. Brickform Texture skins are available in 3 styles:

- **Ultra-Flexible**, for tight angles or rounded surfaces
- **Classic Flex**, an all-purpose use skin flexible enough to work around obstacles, yet stiff enough for the whole job
- **Standard Flex**, which is rigid enough to get on the slab at the optimum time

Mix and match or just chose one. Brickform has a skin that fits every need.

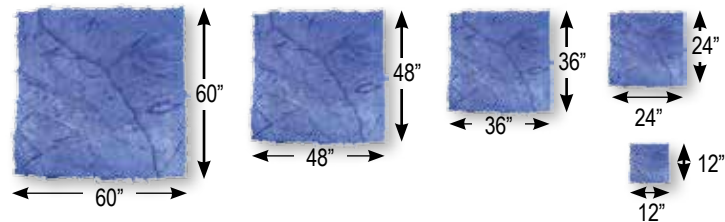

*\*60"x60" available in Limestone, Rough Stone, Heavy Stone, Sierra Seamless, and Desert Slate only*

**See page 98 for Vertical Mix skins and tools.**

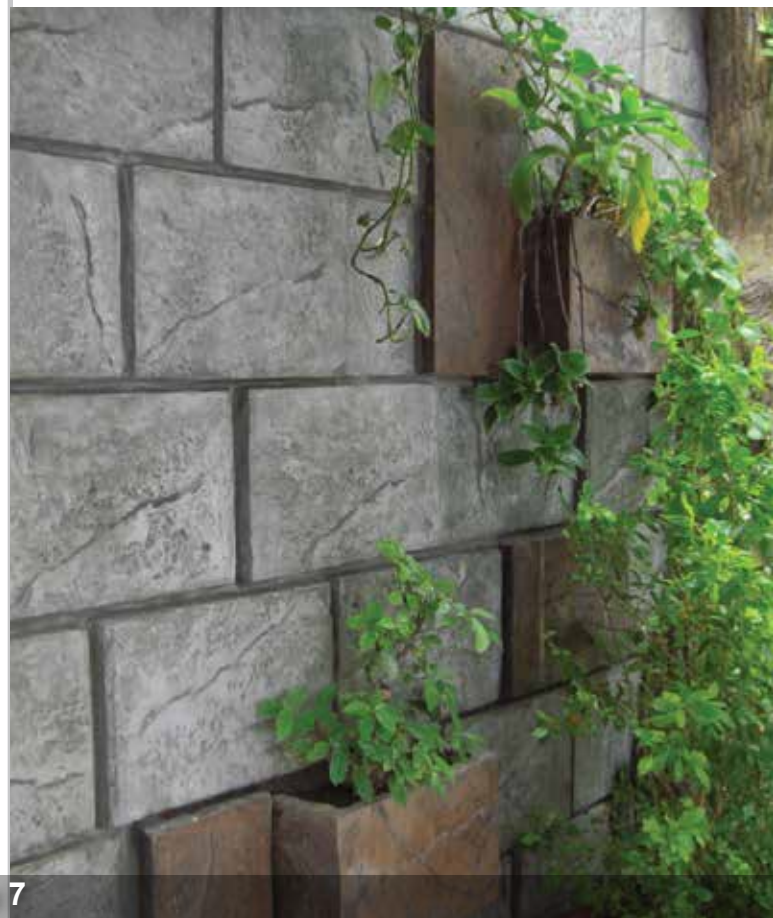

## Seamless Skins

BRICKFORM Seamless Skins™ are feathered-edged skins that produce continuous texture with no grout or joint lines. BRICKFORM texture skins are available in ultra-flexible, classic flex, and standard flex materials, all designed with unsurpassed quality. Seamless skins are compatible with BRICKFORM Stampable Overlay.



### **Rough Stone Texture (C)**

*A natural stone texture characterized by a continuous coarse surface with several distinguishing veins.*



See page 17 for ordering information.



**Blue Stone Texture (A)**  
*A natural stone surface with a sandy texture that includes clefts which leave a layered appearance.*



**Limestone Texture (B)**  
*A natural stone surface, similar to Veronica Stone but with a finer texture.*

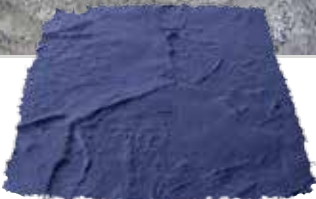

**Heavy Stone Texture (D)**  
*A rough, natural stone surface containing chips, fractures, pockmarks and veins.*



**Sanded Slate Texture (E)**  
*Similar to our slate texture with the addition of a lightly sanded appearance across the entire texture field.*



**Renaissance Slate Texture (F)**

*A natural stone surface with a slight sandstone texture that includes various veins, typically running in a similar direction.*

See page 17 for ordering information.



**Chiseled Slate Texture (G)**

*A naturally laminated stone texture, split along parallel planes, hand-tooled to create a chipped, fragmented look.*



**Yucatan Texture (J)**

*A stone surface consisting of deep chips, pits and fractures creating a continuously undulating texture.*



**Roman Slate Texture (H)**

*A slate stone surface that utilizes dips, ridges and veins to create a continuously changing texture across the entire surface.*



**Sierra Seamless Texture (K)**

*A natural stone texture with an ocean-worn surface that combines rough, heavy, stone appearance with water-washed ridges, veins and clefts.*



**Texas Sea Shells (N)**

*Random pieces of sea shells and coral of various sizes, shapes and types laid in a random fashion over a field of sand.*

See page 17 for ordering information.



**Rocky Mountain Stone Texture (L)**  
*A natural stone surface that incorporates a rough, uneven texture with naturally etched veins and ridges.*

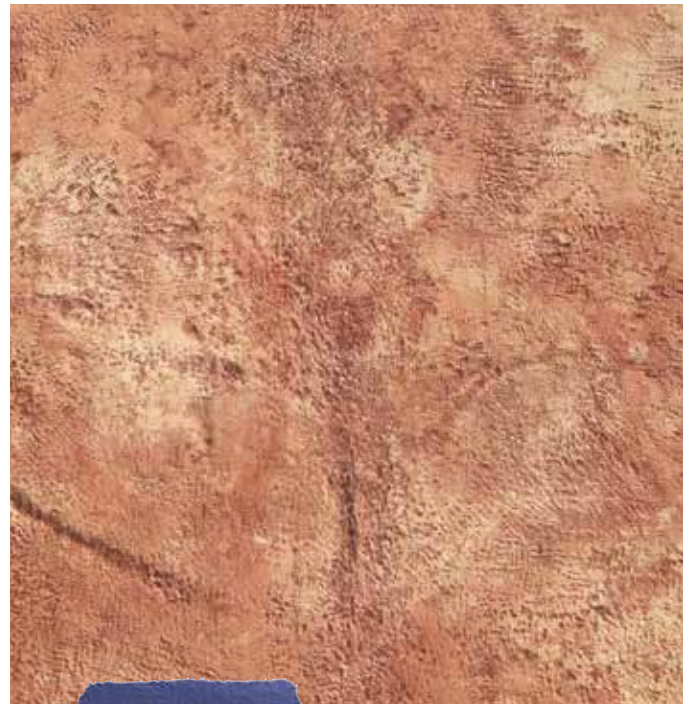

**Veronica Stone (M)**  
*The design is similar Bush Stone, and appears to be created by a mason's bush hammer with a pitted and irregular surface.*

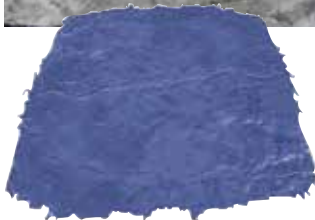

**Smooth Slate Texture (O)**  
*A naturally laminated stone texture, split along parallel planes, creating an uneven surface that incorporates various veins and ridges.*



**Desert Slate Texture (P)**  
*A simulated slate texture that combines numerous clefs and irregular surfaces to create the ideal concrete impressions.*

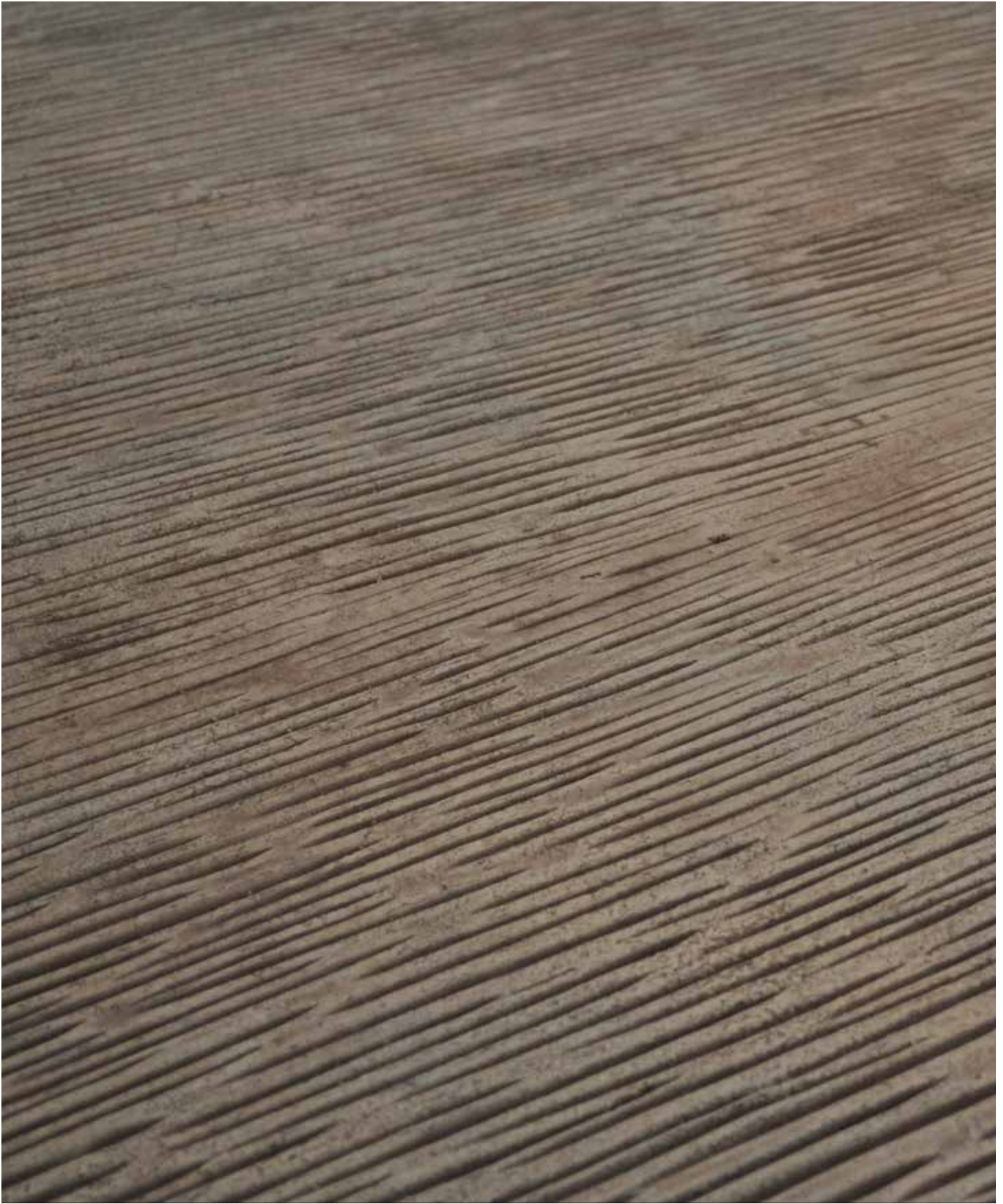

**Casa Rubia (Y)**

*A unique hand chiseled texture that yields a thatch-like appearance. Great for pool decks.*

See page 17 for ordering information.



**Elk Mountain Texture (Q)**  
*A consistent light stone texture, making it appealing for indoor and outdoor applications.*



**Elk Mountain Texture (veined) (R)**  
*A light stone texture with well placed fractures, making it appealing for indoor and outdoor applications.*



**Regal Ashlar Slate (S)**  
*A robust texture, with constantly changing ridges that bring a majestic and noble look to any surface.*



**Cracked Mud (T)**  
*A bold and daring, natural earth texture with a surface that looks and feels real.*

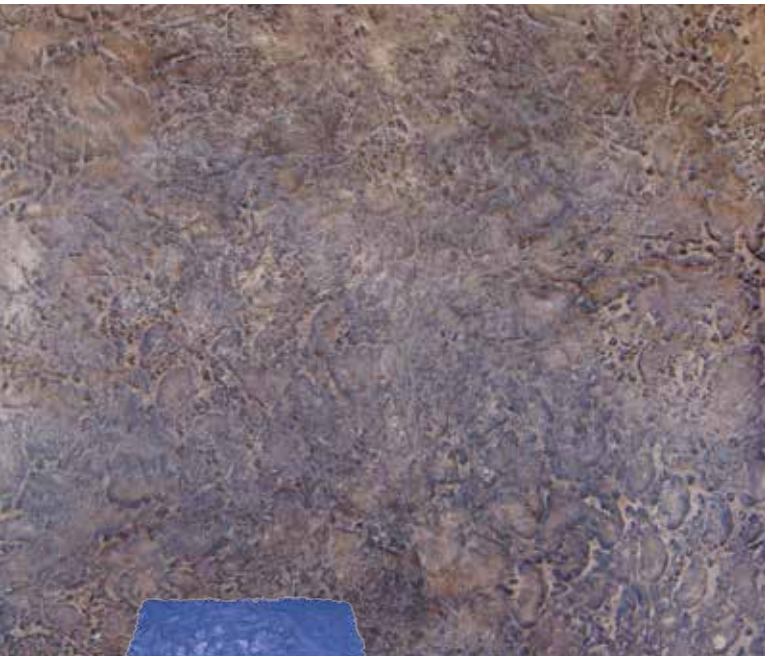

**Lunar Rock (U)**

*An out-of-this-world look that will transform any hardscape. The surface boasts a meteor shower of texture with a variety of impacted stones.*

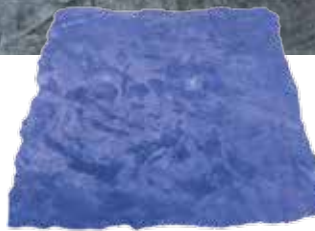

**Super Slate (V)**

*A blended slate pattern with enhanced highlights.*



**Sidewalk Stone (W)**

*A rustic blend of soft and strong textures, giving a traditional feel to any surface.*

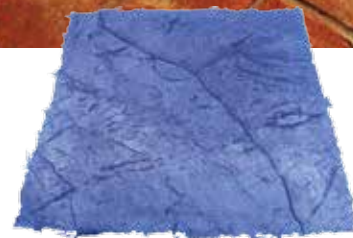

**Riviera Texture (X)**

*A naturally laminated stone texture, split along parallel planes, creating an uneven surface that incorporates various veins and ridges.*



# How To Order Texture Skins

Select the characteristics of your Texture Skin by choosing one option from each section and entering the order number or letter in sections A through E. Then build the part number.

**For more information and approximate lead times on special or custom orders, please contact Customer Service at 1-800-483-9628.**

## Section A. Choose the Texture Indicates Made-to-Order, additional production lead time)



- |   |   |  |
|---|---|--|
| <input type="checkbox"/> [A] Blue Stone   | <input type="checkbox"/> [J] Yucatan                                   | <input type="checkbox"/> [R] Elk Mountain (veined) |
| <input type="checkbox"/> [B] Limestone       | <input type="checkbox"/> [K] Sierra Seamless  | <input type="checkbox"/> [S] Regal Ashlar          |
| <input type="checkbox"/> [C] Rough Stone  | <input type="checkbox"/> [L] Rocky Mtn. Stone  (Large size is 36"x48") | <input type="checkbox"/> [T] Cracked Mud           |
| <input type="checkbox"/> [D] Heavy Stone  | <input type="checkbox"/> [M] Veronica Stone                            | <input type="checkbox"/> [U] Lunar Rock            |
| <input type="checkbox"/> [E] Sanded Slate   | <input type="checkbox"/> [N] Texas Seashell                            | <input type="checkbox"/> [V] Super Slate           |
| <input type="checkbox"/> [F] Renaissance Slate  | <input type="checkbox"/> [O] Smooth Slate   | <input type="checkbox"/> [W] Sidewalk Stone        |
| <input type="checkbox"/> [G] Chiseled Slate  | <input type="checkbox"/> [P] Desert Slate   | <input type="checkbox"/> [X] Riviera Slate         |
| <input type="checkbox"/> [H] Roman Slate  | <input type="checkbox"/> [Q] Elk Mountain   | <input type="checkbox"/> [Y] Casa Rubia            |

## Section B. Choose the Size of the Texture Skin

- |  |   |   |
|--|---|---|
| <input type="checkbox"/> [1] Extra Small (Approx. 12" x 12") | <input type="checkbox"/> [3] Medium (Approx. 36" x 36") | <input type="checkbox"/> [5] *Extra Large (Approx. 60" x 60")                       |
| <input type="checkbox"/> [2] Small (Approx. 24" x 24")       | <input type="checkbox"/> [4] Large (Approx. 48" x 48")  | <i>*Limestone, Rough Stone, Heavy Stone, Sierra Seamless, and Desert Slate only</i> |

**Approximate size based on hand pour of each tool.**

## Section C. Choose a Flex-Rating

- |  |   |  |
|--|---|--|
| <input type="checkbox"/> [S] Ultra Flexible (soft) <br><i>For finishing and corners</i> | <input type="checkbox"/> [C] Classic Flexible (medium) <br><i>Original BRICKFORM medium flexibility, detailed feathered edge</i> | <input type="checkbox"/> [M] Standard Flexible (firm)<br><i>Tough, rigid skin - tighter feathered edge</i> |
|--|---|--|

## Section D. Choose the shape of the Texture Skin

- |   |                                     |
|---|-------------------------------------|
| <input type="checkbox"/> [1] Free Formed (rounded) <br><i>Custom order – 2 week production lead time</i> | <input type="checkbox"/> [2] Square |
|---|-------------------------------------|

## Section E. Choose with or without handles (Ultra-Flexible not available with handles)

- |   |  |
|---|--|
| <input type="checkbox"/> [N] Without Handles<br><i>Custom order – 2 week production lead time</i> | <input type="checkbox"/> [Y] With Handles<br><i>(Sizes medium, large, and extra large)</i> |
|---|--|

PART NUMBER	Section A	Section B	Section C	Section D	Section E
FM- <small>(insert numbers/letters chosen from sections)</small>	_____	_____	_____	_____	_____

**Part number Sample: A4M2Y = Blue Stone, Large, Medium-Density, Square, With Handles**

Disclaimer - All measurements are nominal. Skin and texture mat measurements are based on the Brickform mold size. Urethane has a natural tendency to shrink or expand, depending on environmental factors. This does not affect how the mats fit together.

## Concrete Dimensions

BRICKFORM is proud to introduce Concrete Dimensions reusable urethane stencils, the latest innovation for decorative concrete. The new technology allows alternate ways to create shape and form in concrete surfaces, leaving behind crisp clean designs. Compass Roses, Medallions, Intricate Borders and most other line art are easily created with BRICKFORM Concrete Dimensions. Unlike other concrete textures or stamps, BRICKFORM Concrete Dimensions is floated into freshly placed concrete that can then be troweled smooth, broom finished, textured or exposed to reveal the concrete aggregate. The durable, flexible urethane allows BRICKFORM Concrete Dimensions stencils to be removed from the hardened concrete, rolled up and reused time and time again. BRICKFORM Concrete Dimensions opens up unlimited design potential.



Custom designs available, contact your BRICKFORM sales representative for more information.



**Celtic Knot**

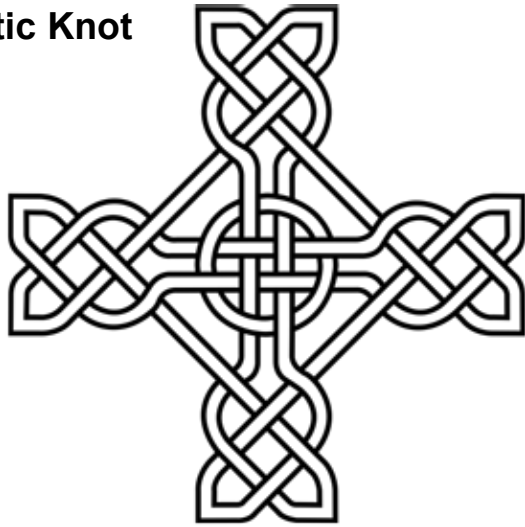

**Center Piece, CD-2004**  
12"x48"x48"

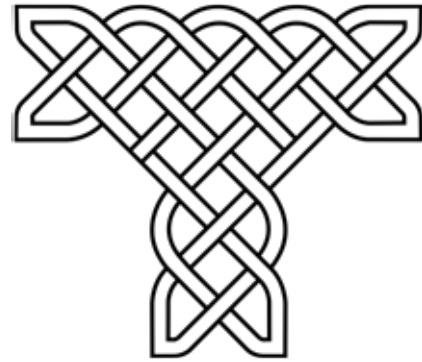

**T-piece, CD-2003**  
12"x36"x36"



**Linier Border, CD-2001**  
12"x36"



**Corner Piece, CD-2002**  
12"x36"x36"

**Basic Set, 21 Stencils, CD-2000S**

(12x Linier Border + 4x Corner Pieces + 4 T-pieces + 1 Center Piece)

**Trinity**

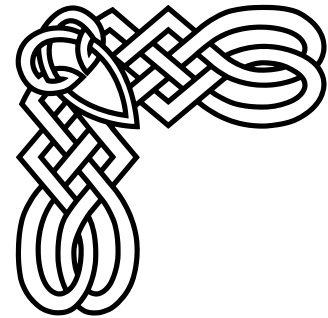
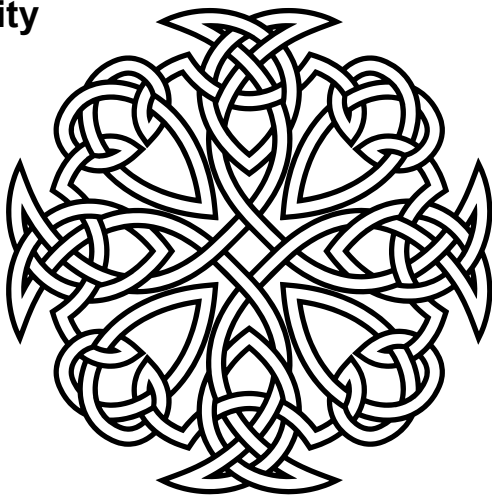

**Trinity Center, CD-3003, 48"x48"**  
**Trinity Linier Border, CD-3001, 36"x12"**  
**Trinity Corner, CD-2002, 30"x30"**

**Basic Set** (16x Linier Border + 4x Corner Pieces + 1 Center Piece)

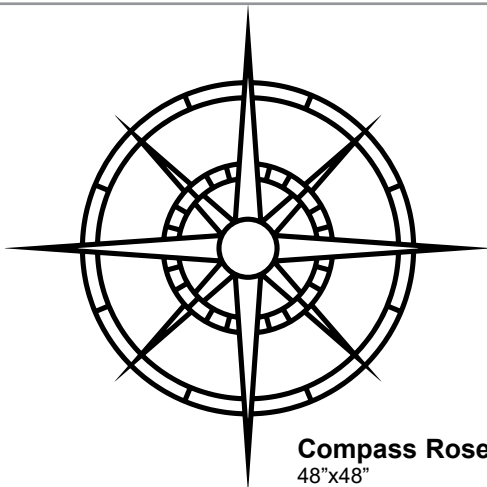

**Compass Rose Wide, CD-1000**  
48"x48"

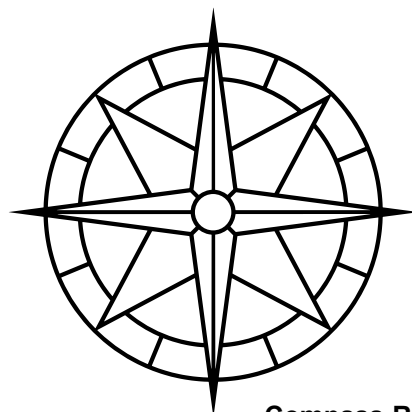

**Compass Rose Narrow, CD-1001**  
48"x48"

## Paladiano Texture Mats by Bob Harris

These speciality tools are cast from natural stones in historical regions with authentic textures and shapes that are pleasing to the eye from all angles. England, Italy, Bulgaria, Greece, Cyprus and France are the locations which inspired the "Wonders of the World" stamping tool line.



### Yorkshire Cobble

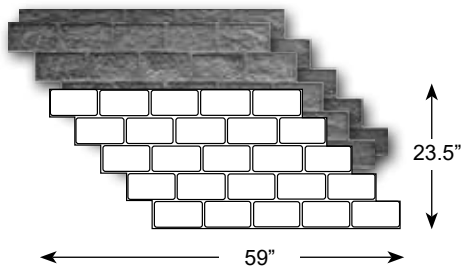

**Yorkshire Cobble  
Full Tool, PD-100**  
59" x 23.5"  
(149.9 x 59.7 cm)  
I, II

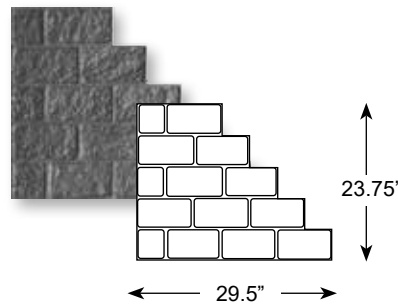

**Yorkshire Cobble  
Left Tool, PD-105**  
29.5" x 23.75"  
(74.9 x 60.3 cm)

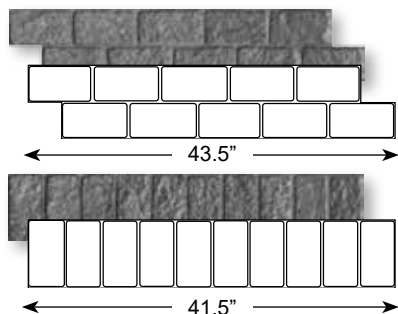

**Yorkshire Cobble  
Double Row Border, PD-115**  
43.5" x 9.5" (110.5 x 24.1 cm)

**Yorkshire Cobble  
Soldier Course Border,  
PD-120**  
41.5" x 8" (105.4 x 20.3 cm)

**Also Available:  
PD-110, Single Stone**  
8.5" x 4.75" (21.6 x 12.1 cm)



**Yorkshire Cobble  
Small Skin, PD-125**  
24" x 24"  
(61 x 61 cm)

**Also Available:  
PD-410, Extra-Small Skin**  
12" x 12" (30.5 x 30.5 cm)

# Fractured Cyprus Slate

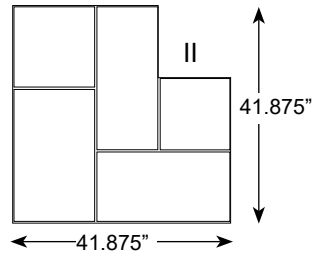
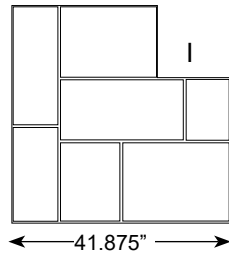
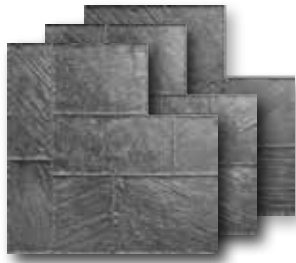

**Fractured Cyprus Slate  
Full Tool, PD-600**  
41.875" x 41.875"  
(106.4 x 106.4 cm)  
I, II, III, IV, V, VI, VII, VIII

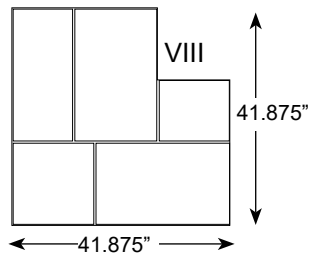
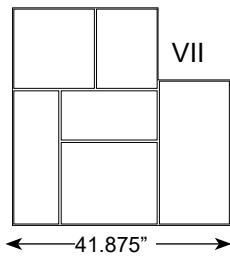
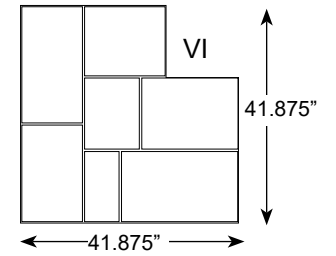
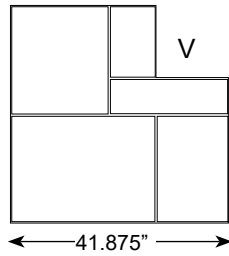
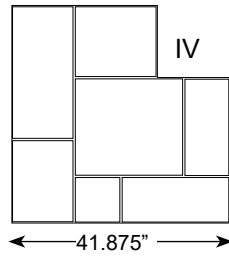
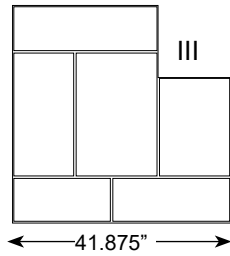

**Fractured Cyprus Slate  
Small Skin, PD-605**  
24" x 24"  
(61 x 61 cm)

**Also Available:**  
**PD-610, Extra-Small Skin**  
12" x 12" (30.5 x 30.5 cm)





**Stones of Athens** 

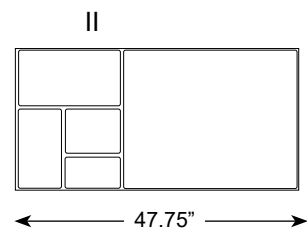
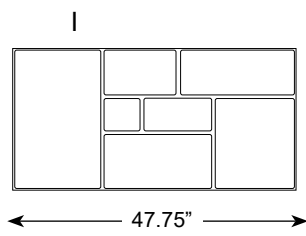

**Stones of Athens**  
**Full Tool, PD-400**  
 47.75" x 23.875"  
 (121.3 x 60.6 cm)  
 I, II, III, IV, V, VI, VII, VIII

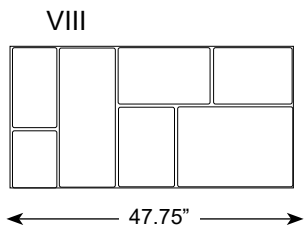
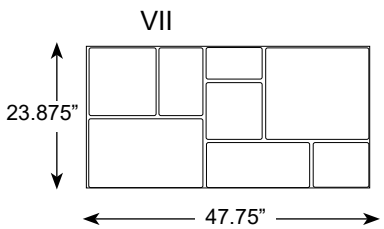
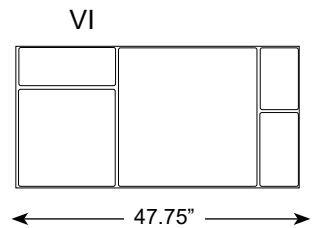
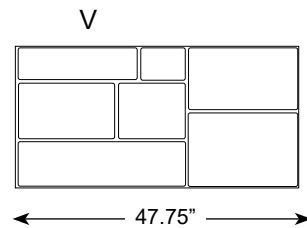
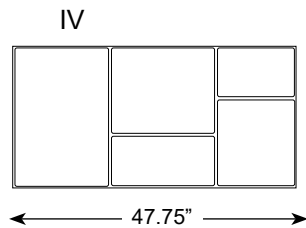
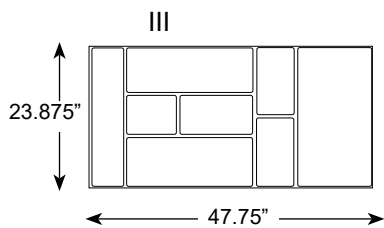

**Stones of Athens**  
**Small Skin, PD-405**  
 24" x 24"  
 (61 x 61 cm)

**Also Available:**  
**PD-410, Extra-Small Skin**  
 12" x 12" (30.5 x 30.5 cm)

# Rotating Venetian Marble

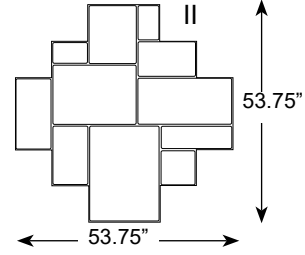
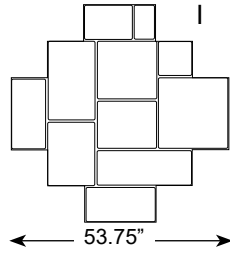
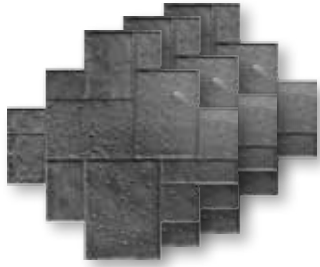

**Rotating Venetian Marble  
Full Tool, PD-500**  
53.75" x 53.75"  
(136.5 x 136.5 cm)  
I, II, III, IV, V, VI

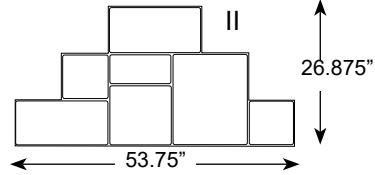
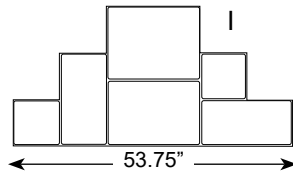
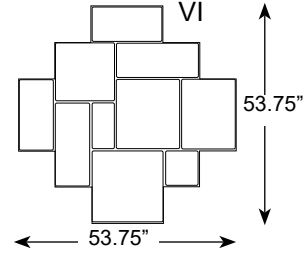
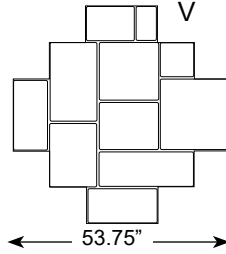
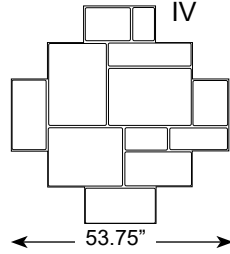
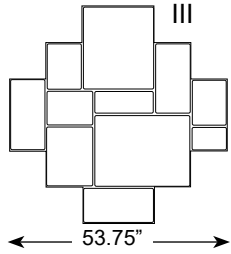

**Rotating Venetian Marble  
Half Tool, PD-505**  
53.75" x 26.875"  
(106.4 x 68.3 cm)  
I, II

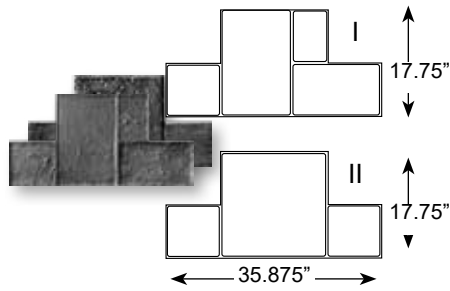

**Rotating Venetian Marble  
Quarter Tool, PD-510**  
35.875" x 17.75"  
(91.1 x 45.1 cm)  
I, II

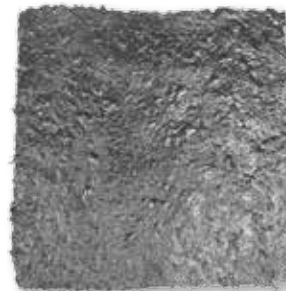

**Pavimento of Paris  
Small Skin, PD-515**  
24" x 24"  
(61 x 61 cm)

**Also Available:  
PD-520, Extra-Small Skin**  
12" x 12" (30.5 x 30.5 cm)



# Pavimento of Paris

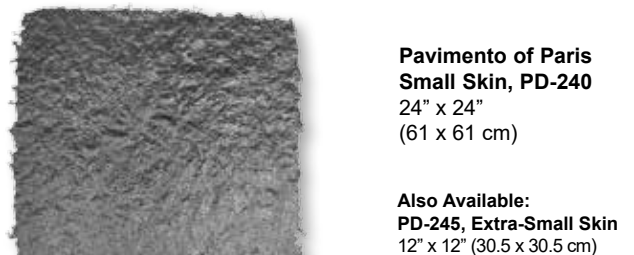
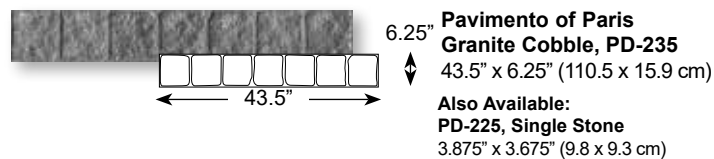
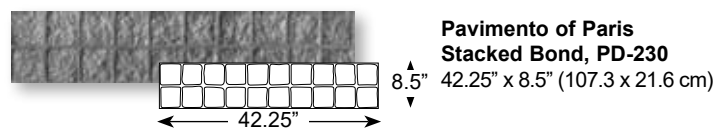
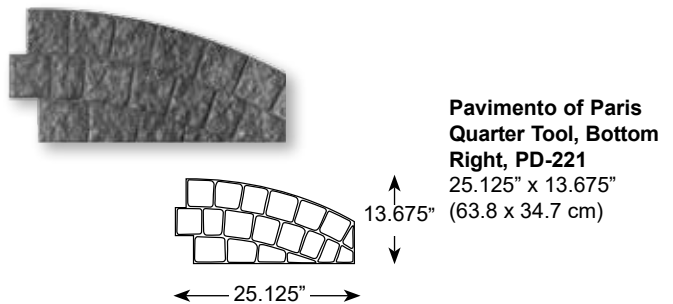
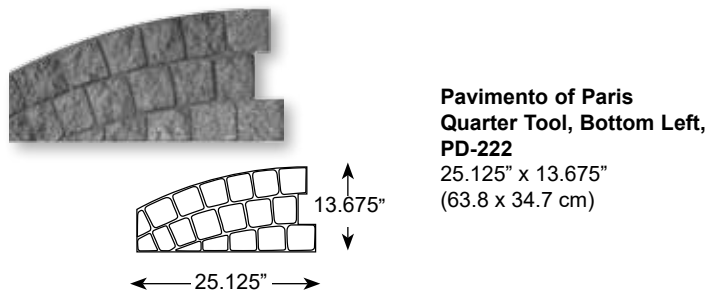
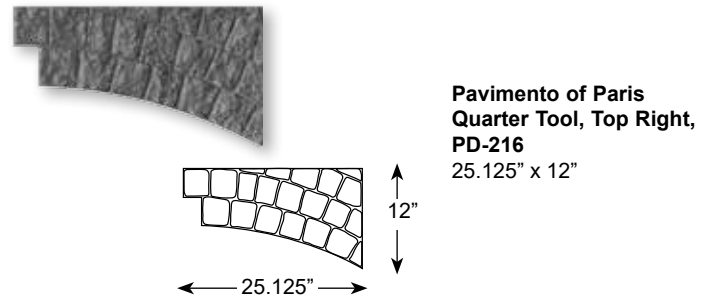
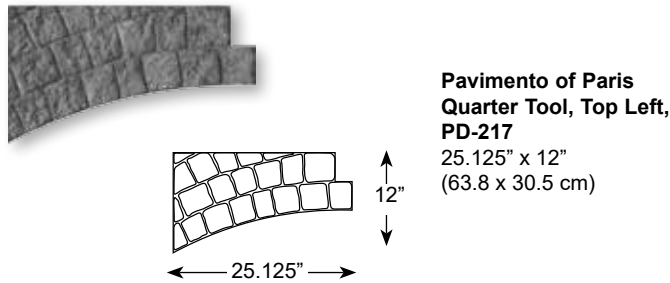
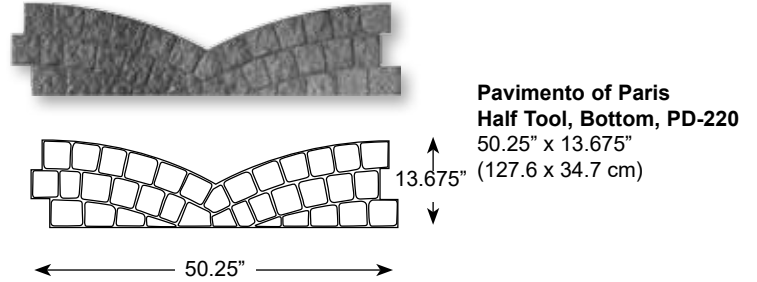
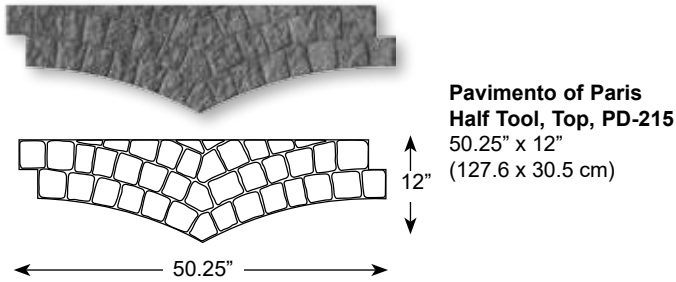
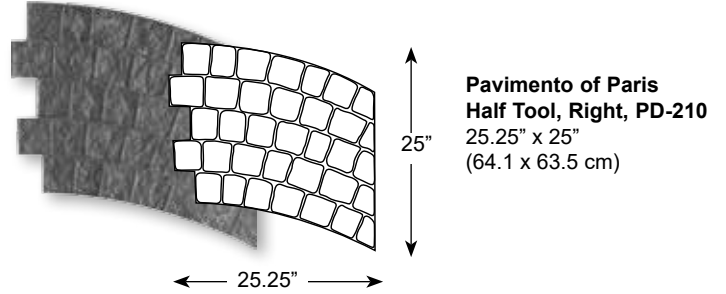
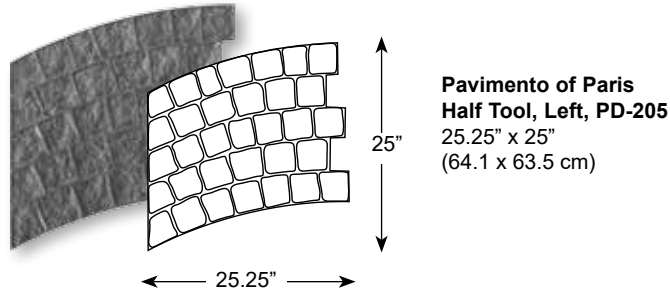
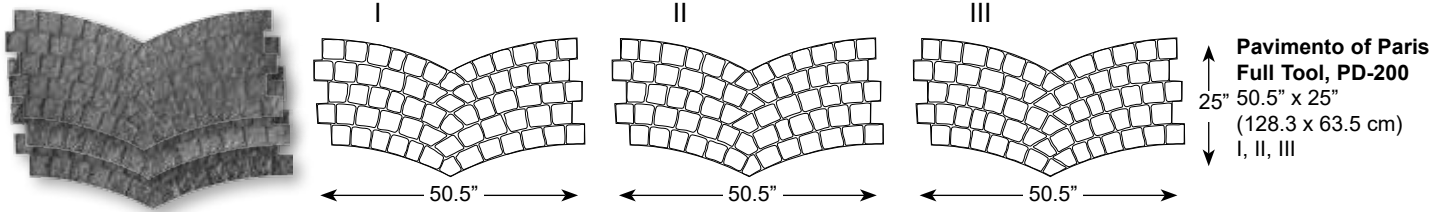





# Hammered Sofia Stone

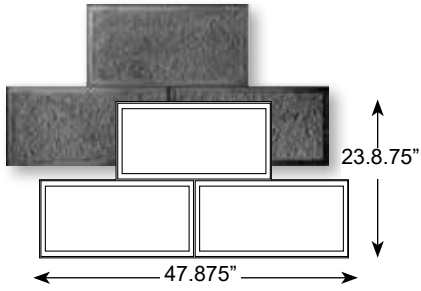

**Hammered Sofia Stone  
Full Tool, PD-300**  
47.875" x 23.875"  
(121.6 x 60.6 cm)

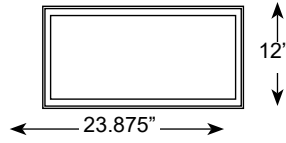

**Hammered Sofia Stone  
Single Stone, PD-305**  
23.875" x 12"  
(60.6 x 34.7 cm)

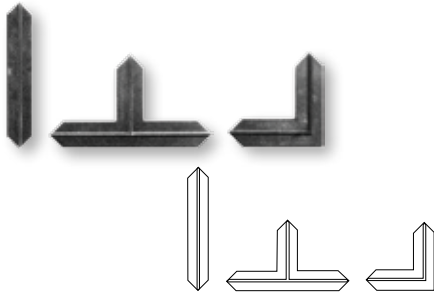

**Hammered Sofia Stone  
Joint Tools, PD-310**  
Assorted sizes



**Hammered Sofia Stone  
Small Skin, PD-315**  
24" x 24"  
(61 x 61 cm)

**Also Available:**  
**PD-320, Extra-Small Skin**  
12" x 12" (30.5 x 30.5 cm)



## Stone Texture Mats

Whether you want the look of granite, blue stone, old English cobblestone, Mexican tile, or pavers, BRICKFORM offers an array of texture mats that simulate a broad range of natural stone materials. Achieving these beautiful results with BRICKFORM precision tools is often more affordable and easier than it is with natural materials. BRICKFORM has a stone texture tool ready to complement any design theme from an Italian Villa to an English Country Garden.

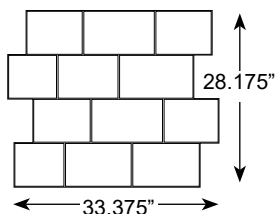
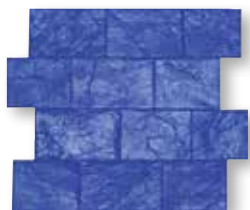

### **Large Cobble, FM-580**

28.125" x 33.375" (71.43 x 84.77 cm) Blue

*Larger rough-cut cobblestones*

Matching skin/touch-up wheel: Smooth Slate/TW-1

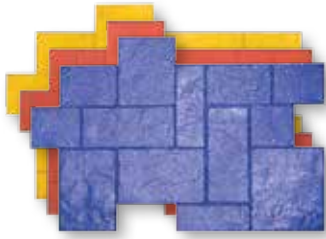

**Tuscany Stone, FM-1775**

28" x 40" (71.12 x 101.60 cm)

Red, Yellow and Blue

A large tool with a stone texture and interlocking joints on all four sides

Matching skin/touch-up wheel: Rough Stone/TW-5

Also Available: Tuscany Border, FM-1785, 48" x 12"

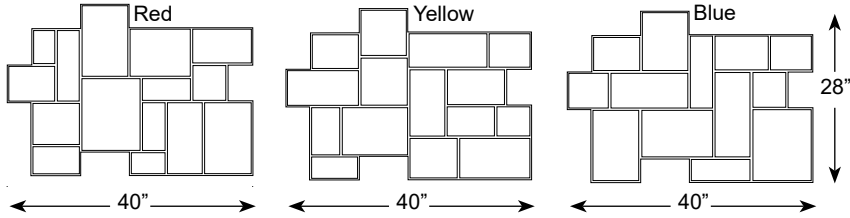

**Rough Cut Ashlar, FM-100 S/O**

24" x 24" (60.96 x 60.96 cm)

Red, Yellow and Blue

Rough hand-tooled stones arranged in an Ashlar pattern

Matching skin/touch-up wheel: Rough Stone/TW-2

Available as gang tool, see page 59 for details.

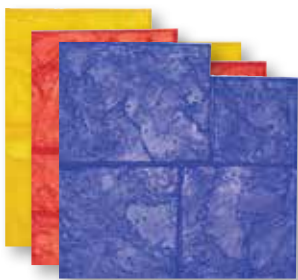
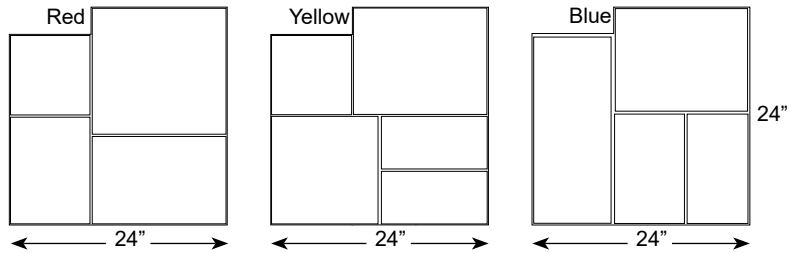

**Australian Ashlar Cut Stone, FM-150 S/O**

23.25" x 23.25" (59.05 x 59.05 cm)

Red, Yellow and Blue

A coarse rugged Blue Stone set in an Ashlar pattern

Matching touch-up wheel: TW-1

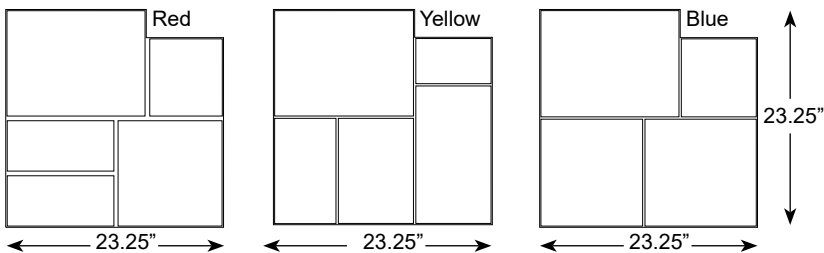

S/O - Compatible with BRICKFORM Stampable Overlay

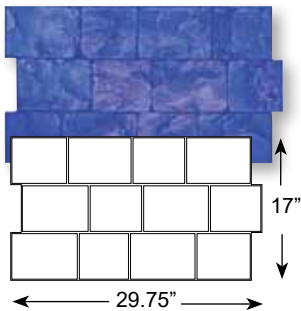

**London Cobble, FM-540 S/O**  
 17" x 29.75" (43.18 x 75.56 cm) Blue  
 A traditional lightly textured cobblestone pattern  
 Matching skin/touch-up wheel: Slate/TW-1

Available as gang tool, see page 59 for details.  
 Available as Contractors Choice, EF-540.

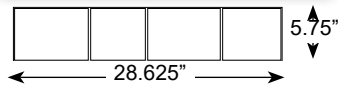

**London Cobble Strip, FM-560 S/O**  
 5.75" x 28.625"  
 (14.605 x 72.71 cm) Blue  
 A lightly textured cobblestone pattern in a single strip

S/O - Compatible with BRICKFORM Stampable Overlay

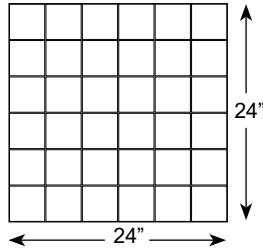

**4" x 4" Slate Sets, FM-200 S/O**

24" x 24" (60.96 x 60.96 cm) Red  
 Slate texture with a hand-chiseled edge  
 Matching skin/touch-up wheel: Smooth Slate/TW-1

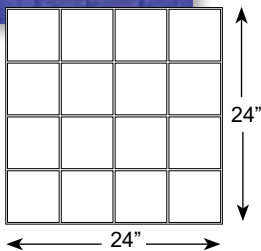
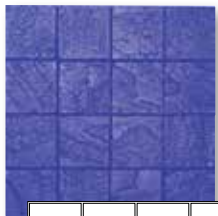

**6" x 6" Granite Sets, FM-250 S/O**

24" x 24" (60.96 x 60.96 cm) Blue  
 Rough Stone texture with a hand-chiseled edge  
 Matching skin/touch-up wheel: Rough Stone/TW-1

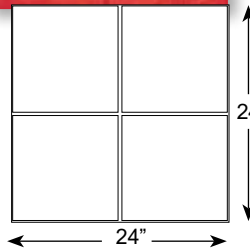
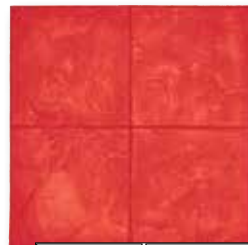

**12" x 12" Cut Stone, FM-300 S/O**

24" x 24" (60.96 x 60.96 cm) Red  
 A rough natural stone, hand-tooled to create a chipped and fragmented texture  
 Matching skin/touch-up wheel: Smooth Slate/TW-1

S/O - Compatible with BRICKFORM Stampable Overlay

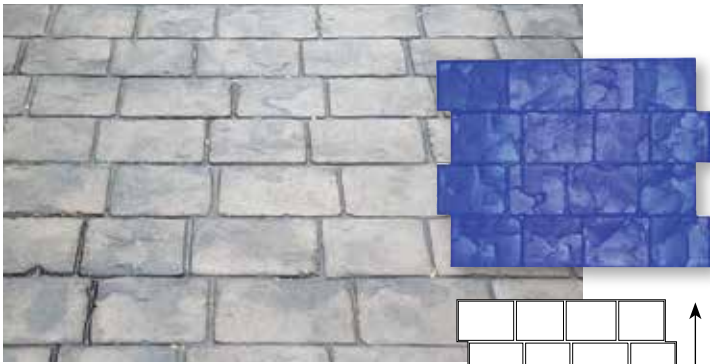

**Windsor Cobble, FM-500 S/O**  
 22.75" x 29.75" (57.78 x 75.56 cm) Blue  
 A traditional cobblestone pattern  
 with wider joints. Matching skin/touch-up wheel:  
 Smooth Slate/TW-2

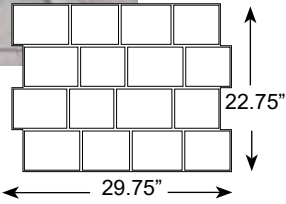

**6" x 6" Edinburgh Cobble, FM-520**  
 26" x 36" (66.04 x 91.44 cm) Yellow  
 A rugged weathered cobblestone pattern

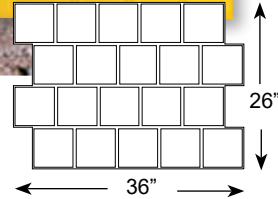

Available as Contractors Choice, EF-520

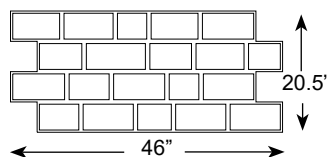

**Cheshire Cobble (Smooth Grout), FM-525**  
 20.5" x 46" (52.07 x 116.84 cm) Red  
 A traditional cobblestone pattern with  
 smooth, ungrouted joints  
 Matching touch-up wheel: TW-1

**HINT!** Matching thin mats "floppies" are available for all BRICKFORM Texture Mats

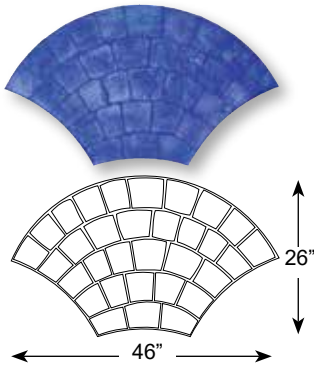

**European Fan, FM-650 S/O**  
 26" x 46" (66.04 x 116.84 cm) Blue  
 An elegant European fan pattern, consisting of slightly curved rectangular slate stones  
 Matching skin/touch-up wheel: Smooth Slate/TW-2  
 Available as Contractors Choice, EF-650

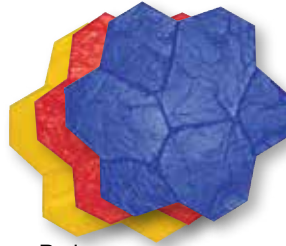

**Random Stone, FM-700**  
 29.125" x 29.125" (73.97 x 73.97 cm) Red, Yellow and Blue. Heavily textured random fieldstones  
 Matching skin/touch-up wheel: Rough Stone/TW-2

Available as Contractors Choice, EF-700

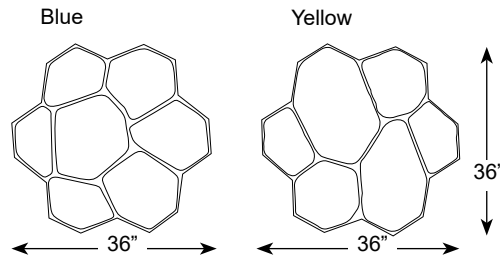
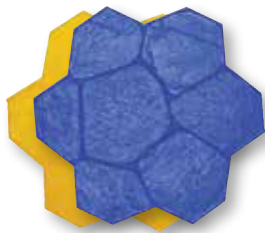
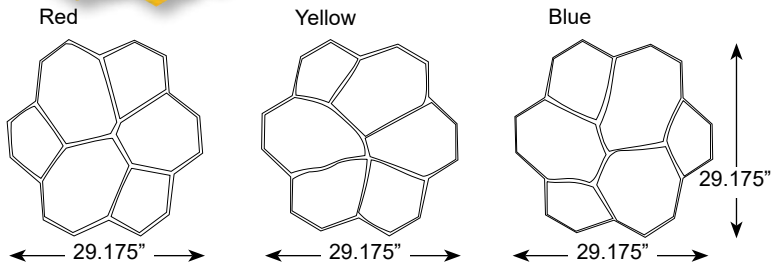

**Large Random Stone, FM-750**  
 36" x 36" (91.44 x 91.44 cm) Yellow and Blue  
 Similar to Random Stone but 40% larger  
 Matching skin/touch-up wheel: Rough Stone/TW-7





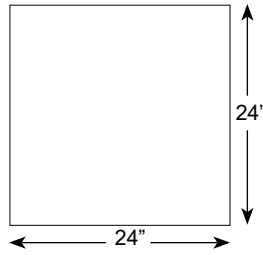

**24" x 24" Yucatan Stone, FM-1100 S/O**

24" x 24" (60.96 x 60.96 cm) Blue  
 A single square of rough Yucatan stone texture  
 Matching skin/touch-up wheel: Yucatan/TW-5

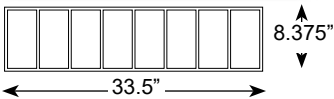

**4" x 8" Cut Stone Border, FM-1225**  
 8.375" x 33.5" (21.27 x 85.09 cm) Red  
 A border of slate rectangles laid side-by-side  
 Matching skin/touch-up wheel: Smooth Slate/TW-3

**Also Available: Cut Stone Single Brick  
 FM-1284, 4" x 8"**

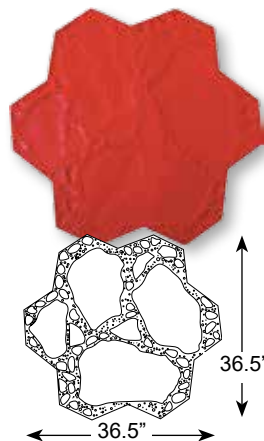

**Patio Stone, FM-1295 S/O**  
 36.5" x 36.5" (92.71 x 92.71 cm) Red  
 A roughly textured arrangement of random stones

**HINT! Matching thin mats "floppies" are available for all BRICKFORM Texture Mats**

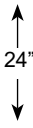
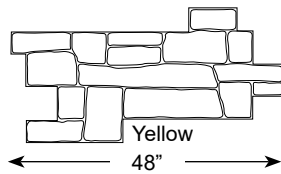
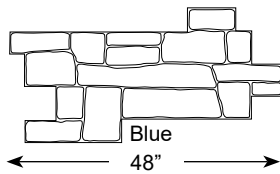

**Roman Cobble, FM-1465**

48" x 24" (121.9 x 61cm)

Blue and Yellow

*A historic reproduction of cobbles that have a variety of stone shapes for old world appeal.*

Matching skin/touch-up wheel:  
Rough Stone/TW-6

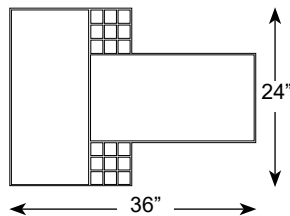
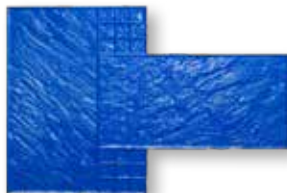

**Basket Weave  
New Stone**

**Weave Look, FM-460**

36" x 24" (91.44 x 61cm) Blue

Matching skin: Regal Ashlar Slate

S/O - Compatible with BRICKFORM Stampable Overlay

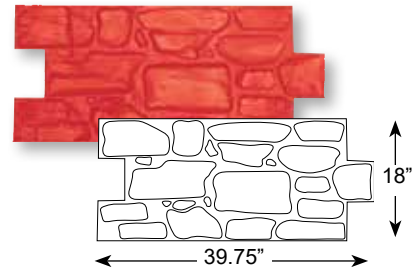

**English Field Stone, FM-1350**

18" x 39.75" (45.72 x 100.965 cm) Red  
*A natural arrangement of river rock, emulating the look of smooth English fieldstones*  
 Matching touch-up wheel: TW-6

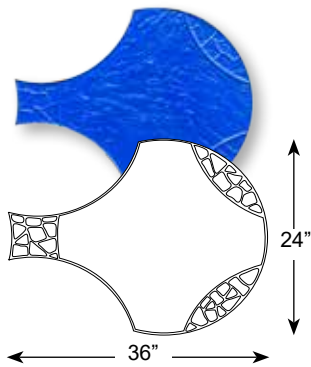

**Circulos Del Sol, FM-640**

24" x 36" (66.04 x 116.84 cm)  
 Blue  
 Matching skin: Regal Ashlar Slate

**Also Available:**  
 FM-640LR, Left/Right  
 FM-640TB, Top/Bottom



**Lincoln Trail Large Random, FM-760**

65" x 36" (165.1 x 91cm)  
 Blue

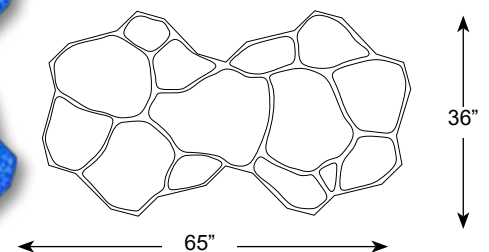

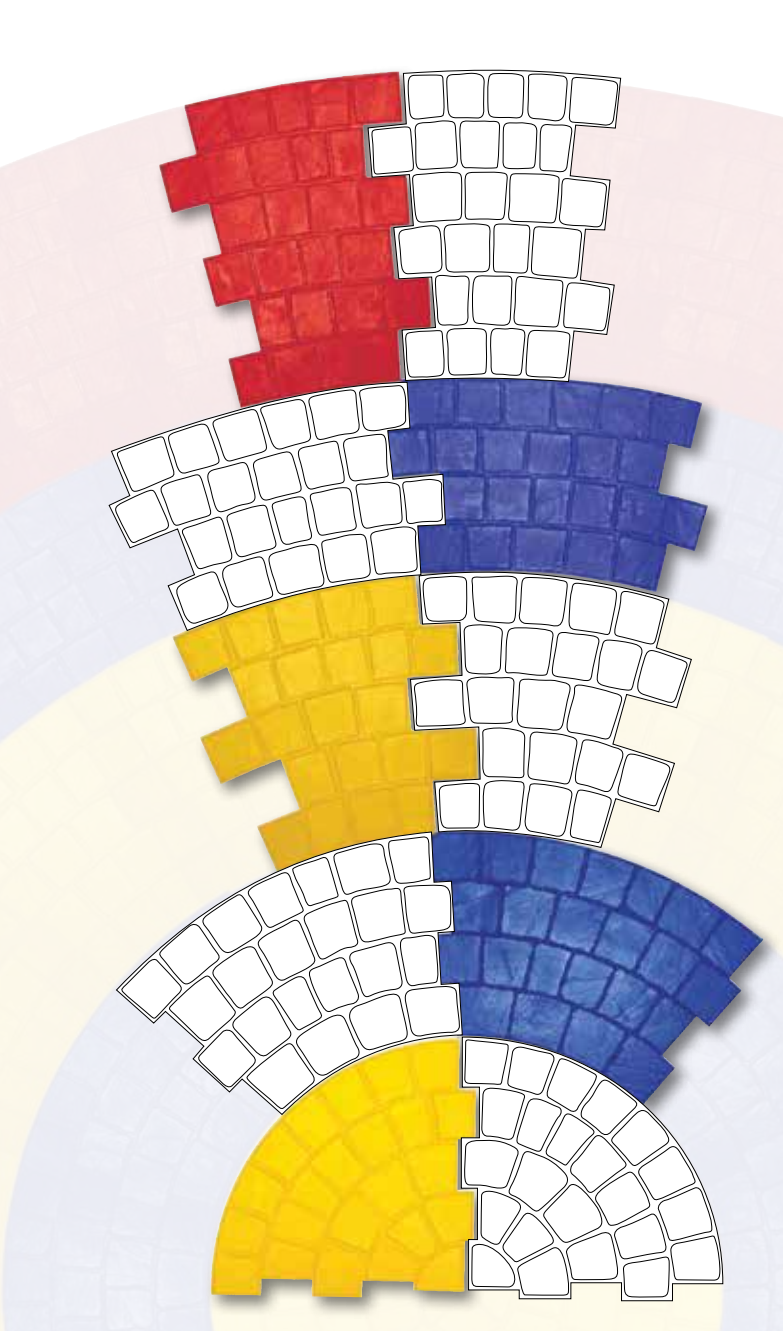

## Radius Tools

Matching skin/touch-up wheel: Smooth Slate/TW-5

### Cobble Stone Radius Tool - E

#### FM-1685 S/O

(Diameter - 286 3/4") 36" x 24" (68.58 x 60.96 cm) Red  
64 mats needed to complete full circle

### Cobble Stone Radius Tool - D

#### FM-1675 S/O

(Diameter - 214 3/4") 24" x 37" (60.96 x 93.98 cm) Blue  
32 mats needed to complete full circle

### Cobble Stone Radius Tool - C

#### FM-1665 S/O

(Diameter - 167 1/4") 30" x 30" (76.2 x 76.2 cm) Yellow  
16 mats needed to complete full circle

### Cobble Stone Radius Tool - B

#### FM-1655 S/O

(Diameter - 107 3/4") 23" x 43" (58.42 x 109.22 cm) Blue  
8 mats needed to complete full circle

### Cobble Stone Radius Tool - A

#### FM-1605 S/O

(Diameter - 59 3/4") 30" x 31" (76.2 x 78.74 cm) Yellow  
4 mats needed to complete full circle

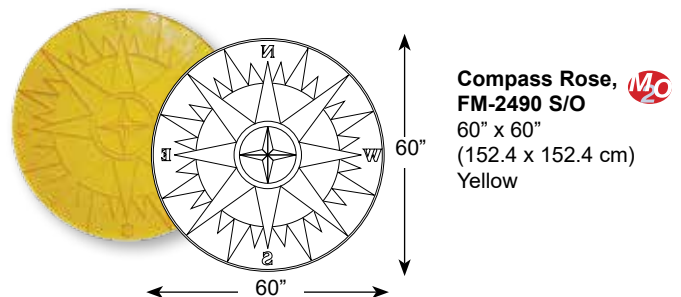
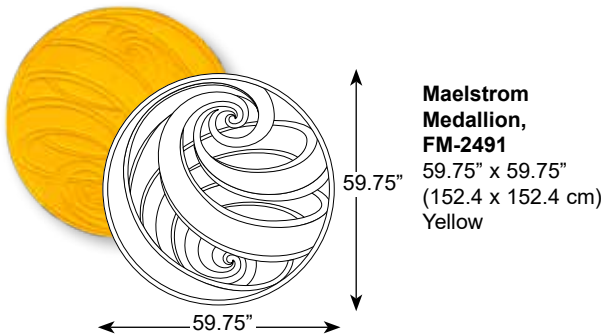

S/O - Compatible with BRICKFORM Stampable Overlay

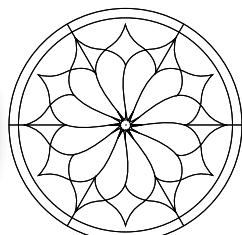

59.75"

59.75"

**Lotus Blossom Medallion, FM-2492**  
60" x 60" (152.4 x 152.4 cm) Yellow

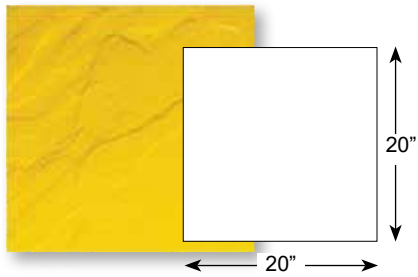

**Hand Tool-Stone Texture, FM-20Y S/O**  
 20" x 20"  
 (50.8 x 50.8 cm)  
 Yellow 

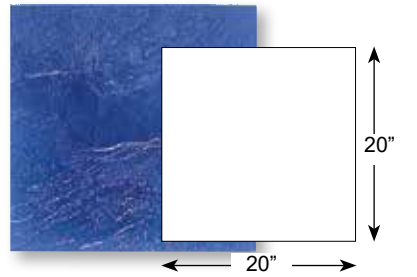

**Hand Tool-Slate Texture, FM-20SB S/O**  
 20" x 20"  
 (50.8 x 50.8 cm)  
 Blue   
 Matching skin: Smooth Slate

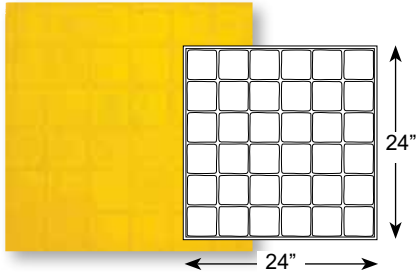

**Mountain Stone Granite Sets, FM-225 S/O**  
 24" x 24"  
 (60.96 x 60.96 cm)  
 Yellow   
 Matching skin/touch-up wheel: Rough Stone/TW-2

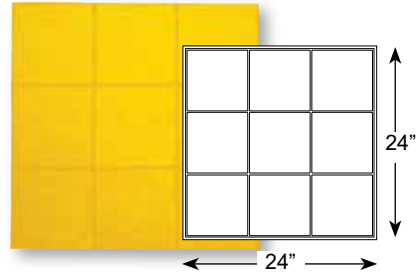

**Granite Sets, FM-275 S/O**  
 24" x 24"  
 (60.96 x 60.96 cm)  
 Yellow   
 Matching skin/touch-up wheel: Rough Stone/TW-1

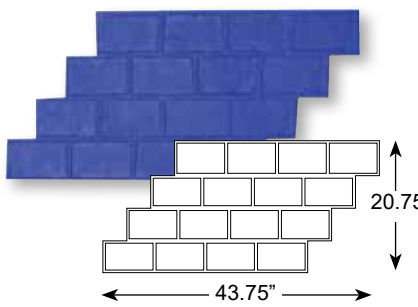

**Old English Cobblestone (Stair Step), FM-285**  
 20.75" x 43.5"  
 (52.7 x 110.5 cm)  
 Blue   
 Touch-up wheel: TW-6

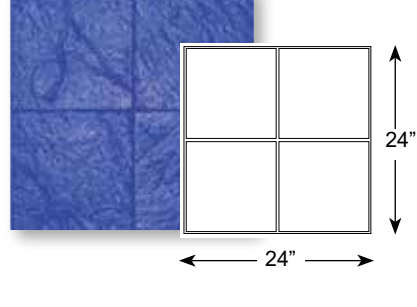

**12 x 12 Heavy Stone, FM-325 S/O**  
 24" x 24"  
 (60.96 x 60.96 cm)  
 Blue   
 Matching skin: Heavy Stone

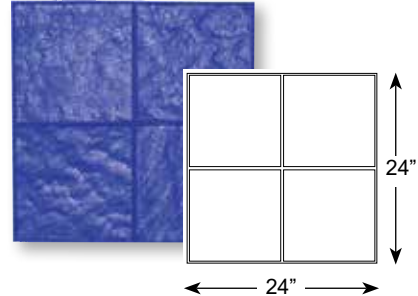

**12 x 12 Utah Stone, FM-350 S/O**  
 24" x 24"  
 (60.96 x 60.96 cm)  
 Blue   
 Matching skin/touch-up wheel: Utah Stone/TW-5

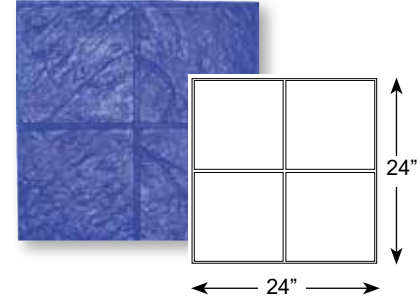

**Stone Texture with 1/2" Joints, FM-375**  
 24" x 24"  
 (60.96 x 60.96 cm)  
 Blue   
 Matching skin/touch-up wheel: Heavy Stone/TW-7

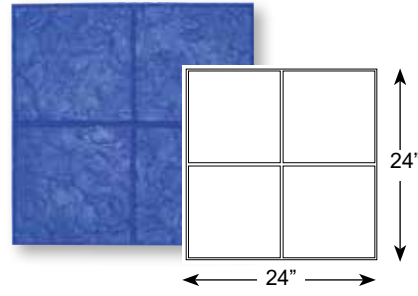

**12 x 12 Yucatan Tile, FM-400 S/O**  
 24" x 24"  
 (60.96 x 60.96 cm)  
 Blue   
 Matching skin/touch-up wheel: Yucatan/TW-5

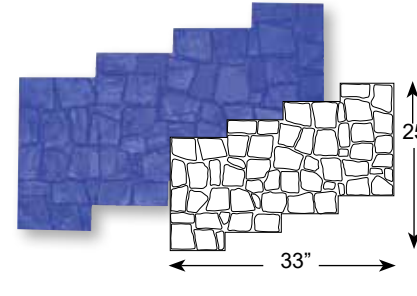

**Antiqua Stone (Stairstep), FM-450**  
 25" x 33"  
 (63.5 x 83.8 cm)  
 Blue   
 Touch-up wheel: TW-2

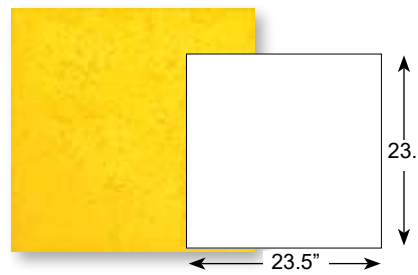

**24 x 24 Keystone (Coquina Stone), FM-660**  
 23.5" x 23.5"  
 (59.7 x 59.7 cm)  
 Yellow   
 Matching skin/touch-up wheel: Salt Finish/TW-1

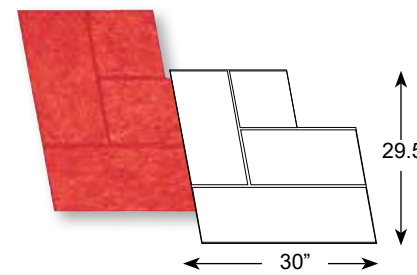

**San Juan Pavers, FM-675**  
 29.5" x 30"  
 (74.9 x 76.2 cm)  
 Red   
 Matching skin/touch-up wheel: Rough Stone/TW-5

**HINT! Matching thin mats "flopplies" are available for all BRICKFORM Texture Mats**

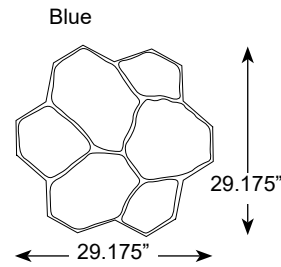
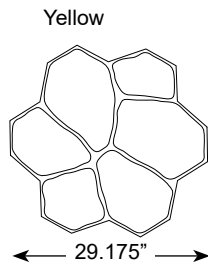
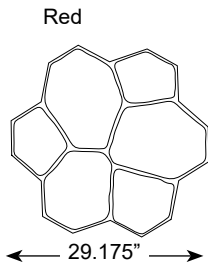
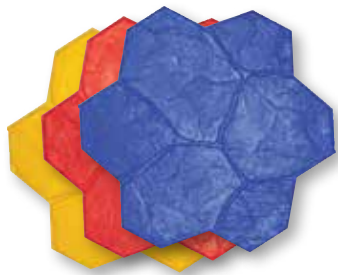

**Beverly Hills Random Stone, FM-725**  
 29.125" x 29.125"  
 (74 x 74 cm)  
 Red, Yellow and Blue  
 Heavily textured random fieldstones  
  
 Matching skin/touch-up wheel:  
 Rough Stone/TW-3

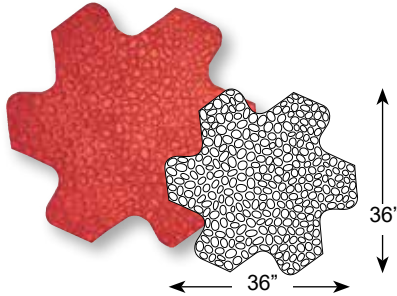

**Santa Fe Pebble, FM-795**  
 36" x 36"  
 (91.4 x 91.4 cm)  
 Red

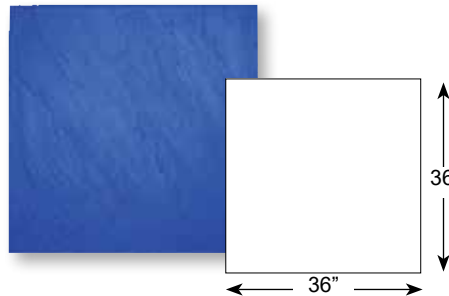

**Blue Stone, FM-800 S/O**  
 36" x 36"  
 (91.4 x 91.4 cm)  
 Blue  
  
 Matching skin/touch-up wheel:  
 Blue Stone/TW-5

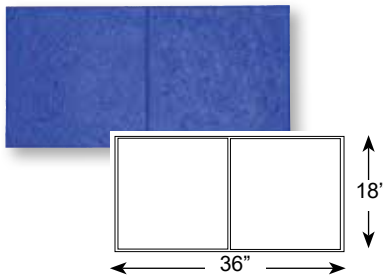

**18 x 18 Utah Stone, FM-900 S/O**  
 18" x 36"  
 (45.7 x 91.4 cm)  
 Blue  
  
 Matching skin/touch-up wheel:  
 Utah Stone/TW-5

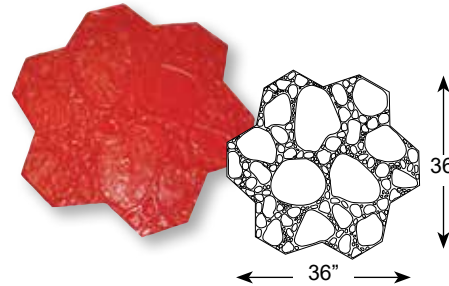

**Garden Stone, FM-1285**  
 36" x 36"  
 (91.4 x 91.4 cm)  
 Red

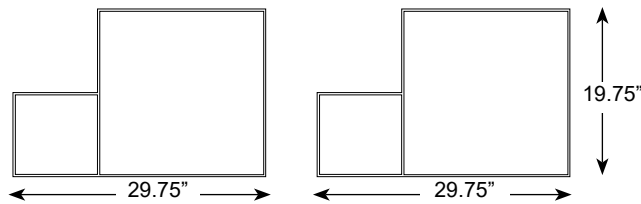
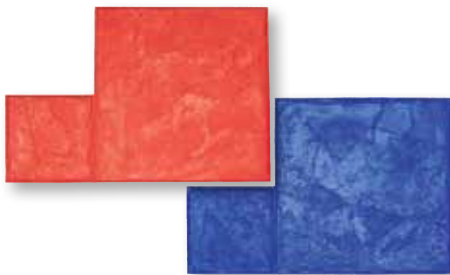

**Opa Locka Stone FM-1000 S/O**  
 19.75 x 29.75"  
 (50.2 x 75.6 cm)  
 Red and Blue  
  
 Matching skin/touch-up wheel:  
 Rough Stone/TW-5

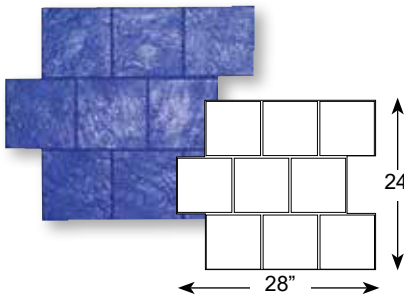

**Metro Cobble - 1, FM-1150 S/O**  
 24" x 28"  
 (60.96 x 71.1 cm)  
 Blue  
  
 Matching skin/touch-up wheel:  
 Rough Stone/TW-1

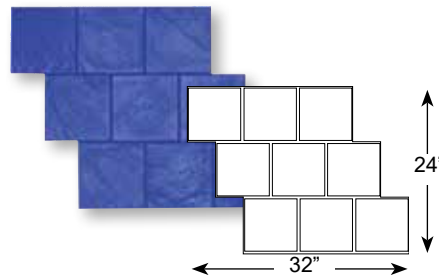

**Metro Cobble - 2, FM-1151 S/O**  
 24" x 32"  
 (60.96 x 81.3 cm)  
 Blue  
  
 Matching skin/touch-up wheel:  
 Smooth Slate/TW-1

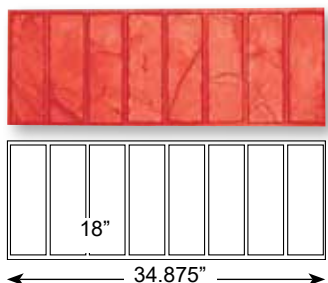

**Cut Stone Border, FM-1250 S/O**  
 13 x 34.875"  
 (33 x 88.6 cm)  
 Red  
  
 Matching skin/touch-up wheel:  
 Smooth Slate/TW-3

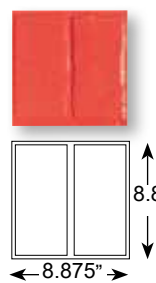

**Cut Stone Double, FM-1275 S/O**  
 8.875 x 8.875"  
 (10.2 x 20.4 cm)  
 Red  
  
 Matching skin/touch-up wheel:  
 Smooth Slate/TW-6



**Cut Stone Double, FM-1280 S/O**  
 8.875 x 12.875"  
 (10.2 x 30.6 cm)  
 Red  
  
 Matching skin/touch-up wheel:  
 Smooth Slate/TW-6

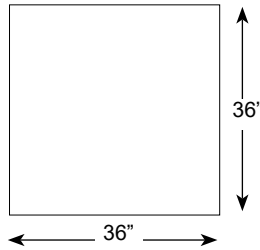
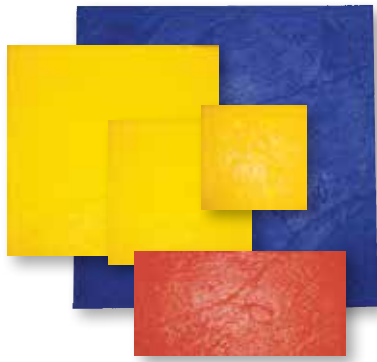

**Heavy Stone Texture, FM-1400**  
36 x 36"  
(91.4 x 91.4 cm)  
Yellow

Matching skin/touch-up wheel: Heavy Stone/TW-1

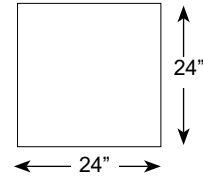

**Heavy Stone Texture**  
24 x 24", FM-1420  
(61 x 61 cm)  
Yellow

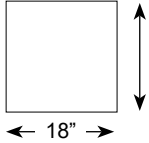

**Heavy Stone Texture, FM-1140**  
18 x 18"  
(45.7 x 45.7 cm)  
Yellow

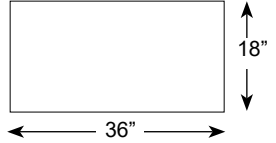

**Heavy Stone Texture, FM-1450**  
18 x 36"  
(45.7 x 91.4 cm)  
Red

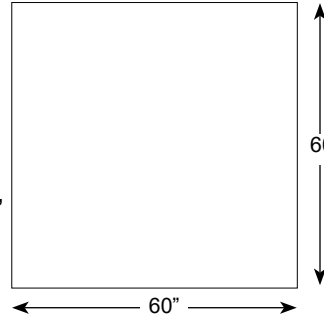

**Heavy Stone Texture, FM-1460**  
60 x 60"  
(152.4 x 152.4 cm)  
Blue

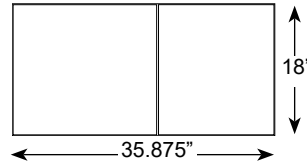
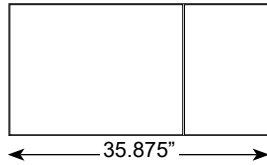
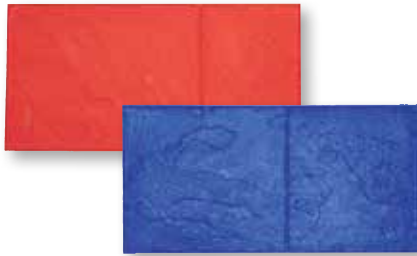

**Walkway Stone, FM-1500 S/O**  
18 x 35.875"  
(45.7 x 91.1 cm)

Red and Blue

Matching skin/touch-up wheel: Rough Stone/TW-2

**Yorkstone Set, FM-3175 S/O**

Includes 2 each of the below mats (One Blue and One Red)

*A natural, blue stone surface with a sandy texture that includes veins throughout, creating a layered composition*

Matching skin/touch-up wheel: Blue Stone/TW-5

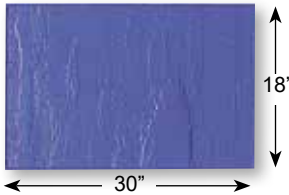

**18 x 30 Yorkstone, FM-3175E S/O**  
18" x 30"  
(45.72 x 76.2 cm)  
Red, and Blue

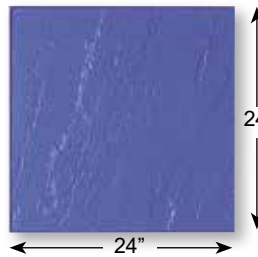

**24 x 24 Yorkstone, FM-3175G S/O**  
24" x 24"  
(60.96 x 60.96 cm)  
Red, and Blue

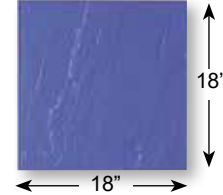

**18 x 18 Yorkstone, FM-3175D S/O**  
18" x 18"  
(45.72 x 45.72 cm)  
Red, and Blue

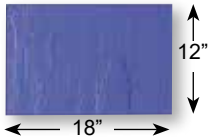

**12 x 18 Yorkstone, FM-3175C S/O**  
12" x 18"  
(30.48 x 45.72 cm)  
Red, and Blue

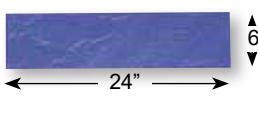

**6 x 24 Yorkstone, FM-3175A S/O**  
6" x 24"  
(15.24 x 60.96 cm)  
Red, and Blue

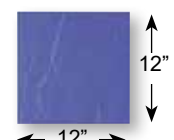

**12 x 12 Yorkstone, FM-3175B S/O**  
12" x 12"  
(30.48 x 30.48 cm)  
Red, and Blue

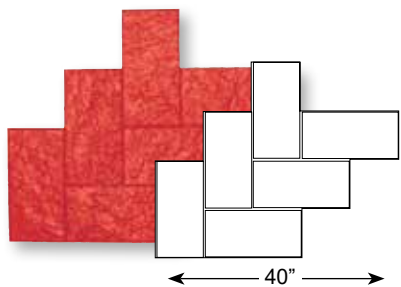

**Large Herringbone, FM-1700**  
32" x 40" (81.28 x 101.6 cm)  
Red

Matching skin/touch-up wheel: Rough Stone/TW-5

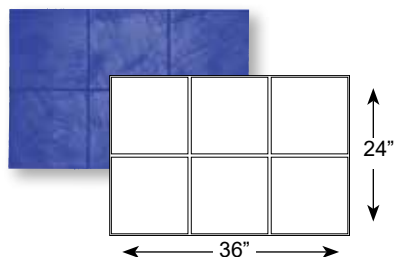

**12" x 12" Blue Stone, FM-2350**  
24" x 36" (60.96 x 91.44 cm)  
Blue

Matching skin/touch-up wheel: Blue Stone/TW-5

S/O - Compatible with BRICKFORM Stampable Overlay



## Slate Texture Mats

Slate is a sleek, metamorphic rock with fine veining patterns. The grain pattern of slate makes it a common resource for tile flooring because it is easily split into thin sheets. BRICKFORM slate texture tools recreate the elegant, clean design of slate without the expense and hassle of installing fragile natural stones. BRICKFORM Ashlar texture mats reflect the handcrafted, intricately-fitting stones of historic Ashlar configurations.



### 36" Ashlar Cut Slate, FM-3120 S/O

36" x 36" (91.44 x 91.44 cm)

Red, Yellow and Blue

*Stones with a slate surface, in an Ashlar pattern*

Matching skin/touch-up wheel: Smooth Slate/TW-5

Available as Contractors Choice, EF-3120.

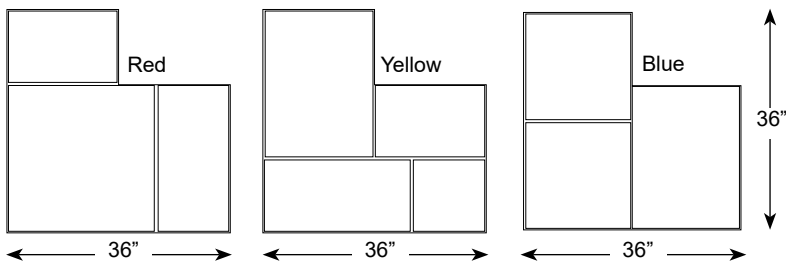

### Ashlar Cut Slate, FM-3125 S/O

23.125" x 23.125" (58.74 x 58.74 cm)

Red, Yellow and Blue

*A naturally laminated stone texture split along parallel planes, hand-tooled to create a more pronounced chipped fragmented texture with small deep joints*

Matching skin/touch-up wheel: Smooth Slate/TW-1

Available as Contractors Choice, EF-3125.



\* Available as gang tool, see page 59 for details.

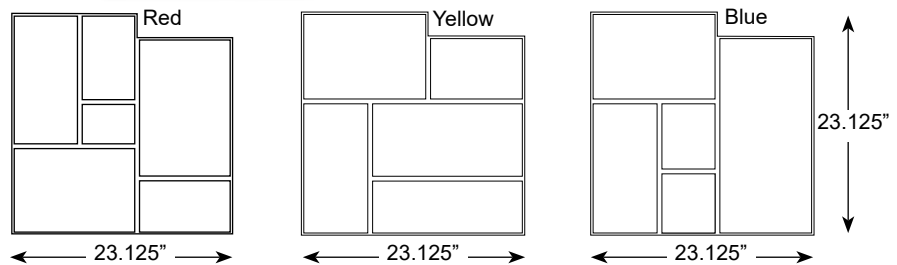

### Aidan Ashlar, FM-3130 S/O

23.125" x 23.125" (58.74 x 58.74 cm)

Red, Yellow and Blue

*Similar to the Ashlar Cut Slate but with broad shallow joints*

Matching skin/touch-up wheel: Smooth Slate/TW-5

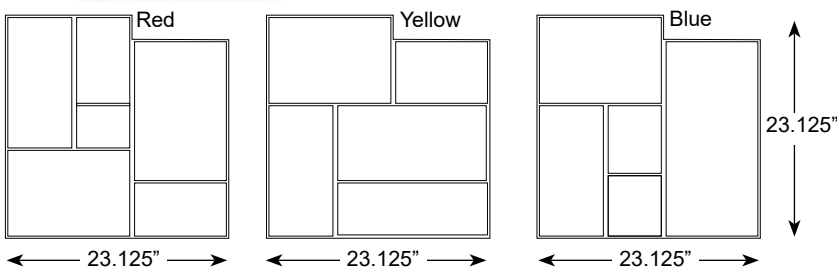

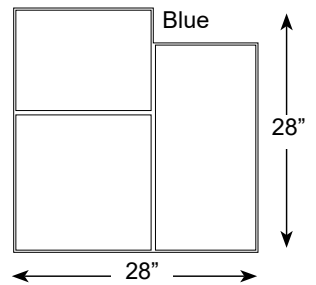
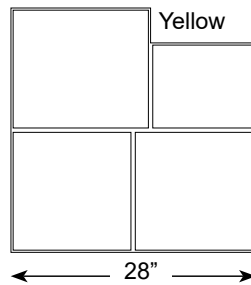
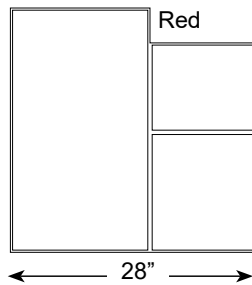

**Large Ashlar Cut Slate**  
**FM-3150 S/O**  
 28" x 28" (71.12 x 71.12 cm)  
 Red, Yellow and Blue

*Similar to Ashlar Cut Slate but the overall size is larger, with a softer texture*  
 Matching skin/touch-up wheel: Smooth Slate/TW-5

Available as Contractors Choice, EF-3150

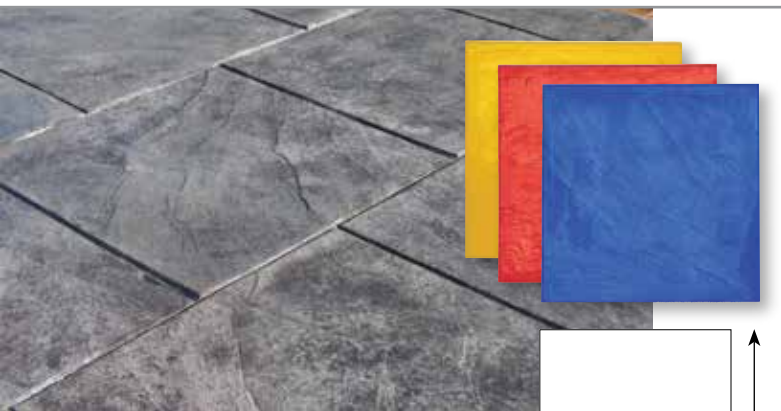

**24" x 24" Slate Texture, FM-3200 S/O**  
 24" x 24" (60.96 x 60.96 cm)  
 Red, Yellow and Blue  
*One complete stone with hand-tooled slate texture*  
 Matching skin/touch-up wheel: Smooth Slate/TW-5

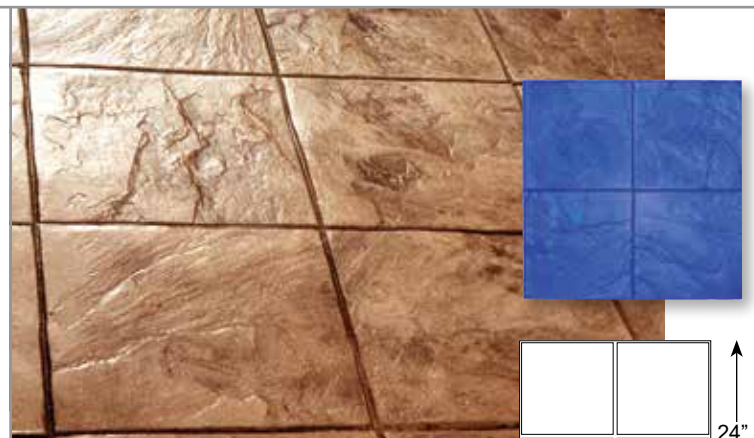
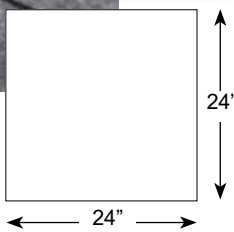

**12" x 12" Slate, FM-3250 S/O**  
 24" x 24" (60.96 x 60.96 cm) Blue  
*Slate tiles laid in a parallel pattern*  
 Matching skin/touch-up wheel: Smooth Slate/TW-5

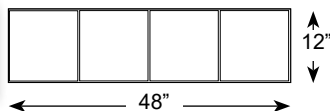
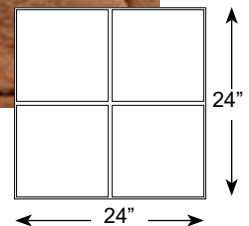

**12" x 12" Slate Border**  
**FM-3300 S/O**  
 12" x 48" (30.48 x 121.92 cm) Red  
*A border of four 12" slate squares in a row*  
 Matching skin/touch-up wheel: Smooth Slate/TW-5

S/O - Compatible with BRICKFORM Stampable Overlay

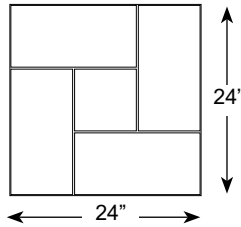

**California Weave, FM-3500 S/O**  
 24" x 24" (60.96 x 60.96 cm) Red  
*Slate bricks form a woven pattern around a slate square.*  
 Matching skin/touch-up wheel: Smooth Slate/TW-5

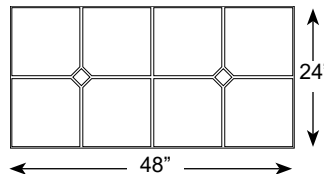

**Slate with Diamond Inset**  
**FM-3350 S/O**  
 24" x 48" (60.96 x 121.92 cm) Blue  
*An elegant arrangement of Italian slate, with diamond-shaped insets for added detail.*  
 Matching skin/touch-up wheel: Smooth Slate/TW-5



**Walkway Slate, FM-3400 S/O**

18" x 36" (45.72 x 91.44 cm)

\*Red, Yellow and Blue

\*Stone sizes vary

Square and rectangular slate tiles, of various sizes, set in parallel rows.

Matching skin/touch-up wheel: Smooth Slate/TW-5

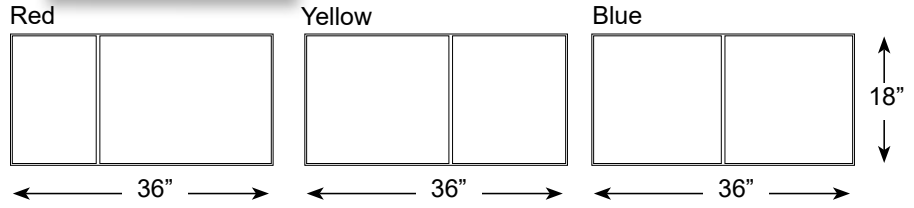

**Grand Ashlar, FM-3675**

36" x 36" (91.44 x 91.44 cm)

Red, Yellow and Blue

Stones of various shapes and sizes laid in an Ashlar pattern, with a slate texture

Matching touch-up wheel: TW-5

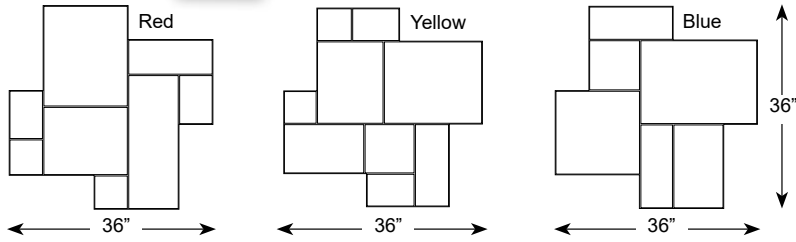

**New England Basket Weave FM-3600 S/O**

24" x 36" (60.96 x 91.44 cm) Blue

Hand-tooled slate in a basket weave pattern

Matching skin/touch-up wheel: Smooth Slate/TW-5

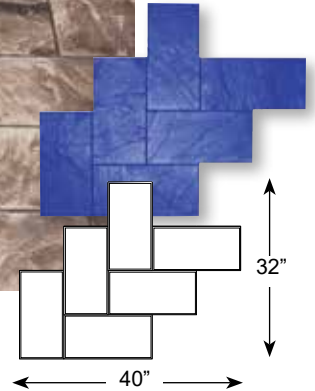
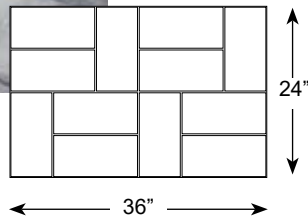

**Herringbone Slate, FM-3550 S/O**

32" x 40" (81.28 x 101.6 cm) Blue

A classic herringbone pattern of slate stones laid at right angles to each other

Matching skin/touch-up wheel: Smooth Slate/TW-5

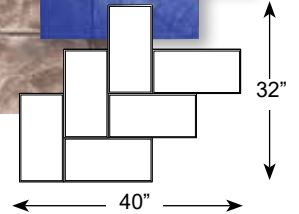

**American Ashlar Slate, FM-3160**

48" x 30" (121.9 x 61cm)

Red and Blue

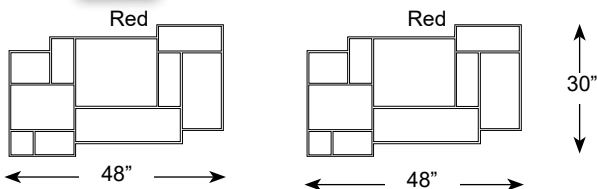

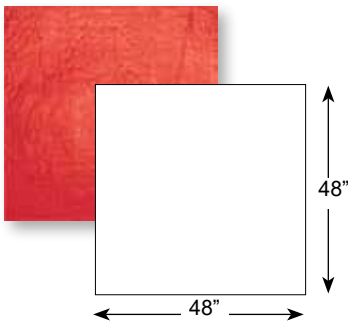

**Slate Texture Mats** *Made-to-Order*  *2-week production lead time*

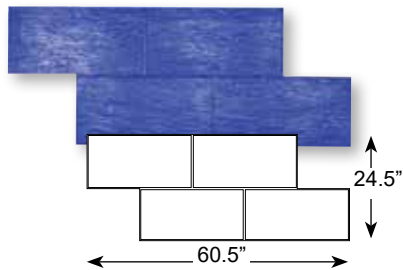

**48" x 48" Slate Texture w/joint,**  
**FM-3190 S/O**   
 48" x 48"  
 (121.92 x 121.92 cm) Red  
*A large single stone with slate texture and sharp cut corners and quarter inch surrounding joint*

Matching skin/touch-up wheel:  
 Smooth Slate/TW-5



**Running Bond Slate,**   
**FM-3575**  
 24.5" x 60.5"  
 (62.23 x 153.67 cm) Blue  
*Renaissance slate texture set in a running bond pattern*

Matching skin/touch-up wheel: Slate/  
 TW-3

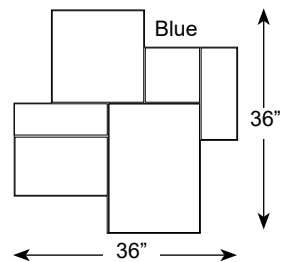
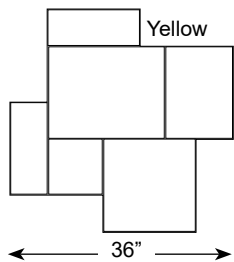
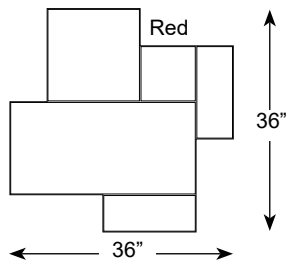
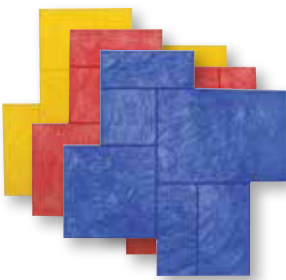

**Regal Ashlar (Blue Stone), FM-3650 S/O**   
 36" x 36" (91.44 x 91.44 cm) Red, Yellow, and Blue  
*Blue stone textured tiles, with worn beveled edges, arranged in an ashlar pattern*

Touch-up wheel: TW-5

**Brick Texture Mats**



**Herringbone Used Brick**  
**FM-5000 S/O**

32" x 36" (81.28 x 91.44 cm) Red  
*A weatherworn brick surface with an uneven texture and rounded broken edges*  
 Matching skin/touch-up wheel: Used Brick/TW-4

Available as gang tool, see page 59 for details.  
 Available as Contractors Choice, EF-5000 



**Herringbone New Brick**  
**(Fine Grout), FM-5050 S/O**

25.5" x 36" (64.77 x 91.44 cm) Red  
*A wire-cut common brick texture with sharp corners and few indentations or irregularities over the surface*

Matching skin/touch-up wheel: New Brick/TW-4

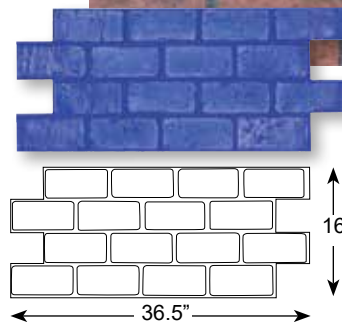

**Running Bond Used Brick**  
**FM-5100 S/O**

16" x 36.5" (40.64 x 92.71 cm) Blue  
*Used bricks laid end-to-end, with sandy joints*

Matching skin/touch-up wheel:  
 Used Brick/TW-4

Available as Contractors Choice, EF-5100   
 Available as gang tool, see page 59 for details.

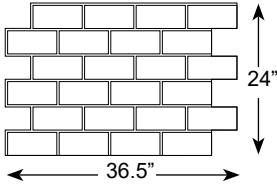

**Running Bond New Brick**  
**FM-5150 S/O**  
 24" x 36.5" (60.96 x 92.71 cm) Red  
*A running bond pattern with smooth joints*  
 Matching skin/touch-up wheel: New Brick/TW-4

Available as *Contractors Choice, EF-5150*

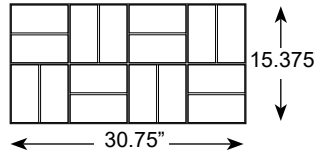

**Basket Weave Used Brick**  
**FM-5200 S/O**  
 15.375" x 30.75" (39.05 x 78.10 cm) Blue  
*Used bricks in a basket weave pattern with smooth ungrouted joints*

Matching skin/touch-up wheel:  
 Used Brick/TW-4

Available as gang tool, see page 59 for details.

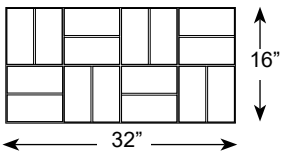

**Basket Weave New Brick**  
**FM-5250 S/O**  
 16" x 32" (40.64 x 81.28 cm) Blue  
*New bricks in a basket weave pattern with sandy joints*  
 Matching skin/touch-up wheel: New Brick/TW-4

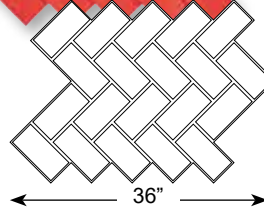

**Herringbone New Brick**  
**(Sanded Joint) FM-5900 S/O**  
 32" x 36" (81.28 x 91.44 cm) Red  
*New bricks with sandy joints*

Matching skin/touch-up wheel:  
 New Brick/TW-4



**4" x 8" New Brick Border,**  
**FM-5325, S/O**  
 8.5" x 32.25" (21.59 x 81.92 cm) Red  
*A border of new bricks laid side-by-side*  
 Matching skin/touch-up wheel: New Brick/TW-7

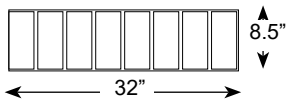

Also Available: **4" x 8" Used Brick Border, FM-5300 S/O**  
 8.5" x 32" (21.59 x 81.28 cm) Red  
*A border of used bricks laid side-by-side*  
 Matching skin/touch-up wheel: Used Brick/TW-4



**Single New Brick, FM-5550 S/O**  
 4" x 8" (10.16 x 20.32 cm) Red  
*A single new brick with sharp edges*  
 Also Available:  
**Single Used Brick, FM-5500 S/O**  
 4" x 8" (10.16 x 20.32 cm) Blue  
*A single used brick with rounded edges*

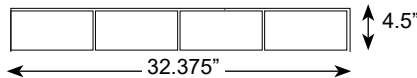
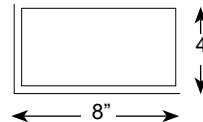

**Used Brick Runner, FM-5600 S/O**  
 4.5" x 32.375"  
 (11.43 x 82.23 cm) Blue  
*A border of used bricks laid end-to-end*

**HINT! Matching thin mats "flopies" are available for all BRICKFORM Texture Mats**

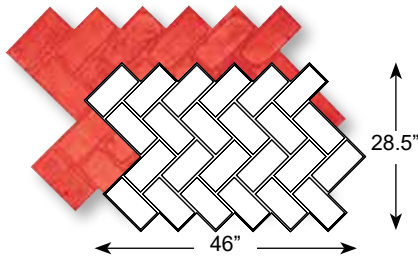

**Herringbone Used Brick, FM-5020**   
 28.5" x 46"  
 (72.39 x 116.84 cm)  
 Red  
*A more weathered used brick with ungrouted joints*  
 Matching skin/touch-up wheel:  
 Used Brick/TW-6

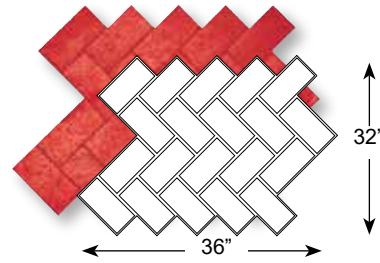

**Herringbone New Brick Butt Joint, FM-5080**   
 32" x 36" (81.28 x 91.44 cm)  
 Red  
*New bricks in a tight-fitting herringbone pattern*  
 Matching skin/touch-up wheel:  
 New Brick/TW-1

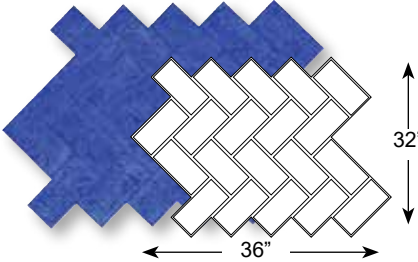

**Herringbone Used Brick Butt Joint, FM-5085**   
 32" x 36" (81.28 x 91.44 cm)  
 Blue  
 Matching skin/touch-up wheel:  
 Used Brick/TW-1

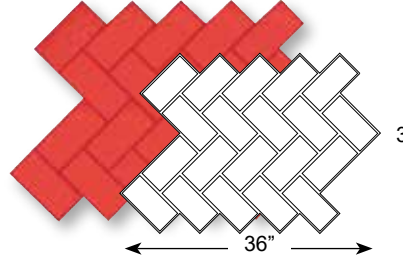

**Untextured Herringbone Brick with 1/2" V-Joint, FM-5090**   
 32" x 36" (81.28 x 91.44 cm)  
 Red  
*Smooth bricks with ungrouted v-joints*  
 Touch-up wheel: TW-5

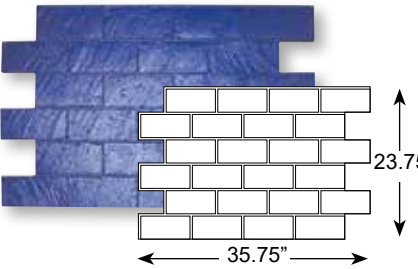

**Running Bond New Brick with 1/4" Joint, FM-5140**   
 23.75" x 35.75"  
 (60.3 x 90.8 cm)  
 Blue  
 Matching skin: New Brick

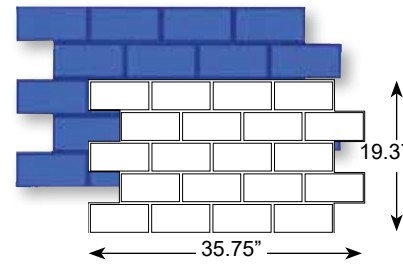

**Un-Textured Running Bond New Brick with 1/2" V-Joint, FM-5160**   
 19.375" x 35.75"  
 (49.2 x 90.8 cm)  
 Blue  
 Touch-up wheel: TW-5

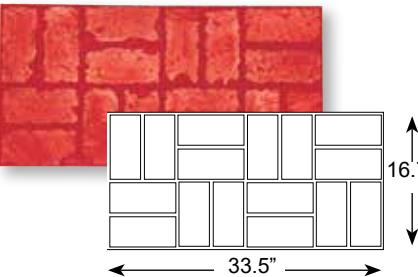

**Old English Basket Weave, FM-5225**   
 16.75" x 33.5"  
 (42.54 x 85.09 cm)  
 Red  
 Matching skin/touch-up wheel:  
 Used Brick/TW-7

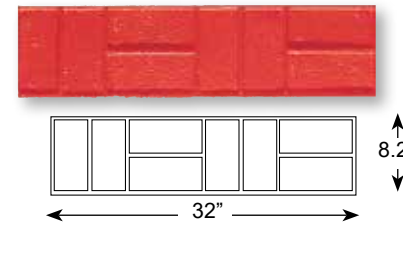

**4" x 8" Basket Weave Used Brick Border, FM-5350**   
 8.25" x 32"  
 (20.96 x 81.28 cm)  
 Red  
 Matching skin/touch-up wheel:  
 Used Brick/TW-2

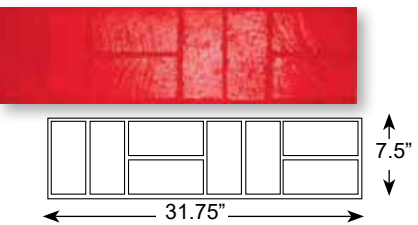

**4" x 8" Basket Weave New Brick Border, FM-5375**   
 7.5" x 31.75"  
 (19.1 x 80.6 cm)  
 Red  
 Matching skin/touch-up wheel:  
 New Brick/TW-4

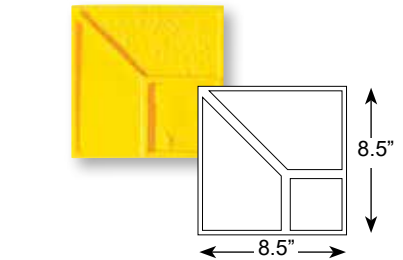

**Used Brick Corner, FM-5400**  
 8.5" x 8.5" (21.59 x 21.59 cm)  
 Yellow   
 Matching skin/touch-up wheel: Used Brick/TW-4

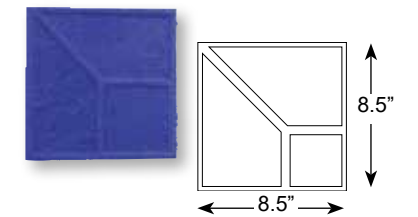

**New Brick Corner, FM-5450**  
 8.5" x 8.5" (21.59 x 21.59 cm)  
 Blue   
 Matching skin/touch-up wheel:  
 New Brick/TW-4

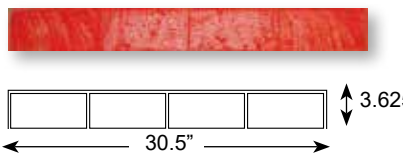

**4" x 8" New Brick Runner, FM-5650**  
 3.625" x 30.5" (9.21 x 77.47 cm)  
 Red   
 Matching skin: New Brick

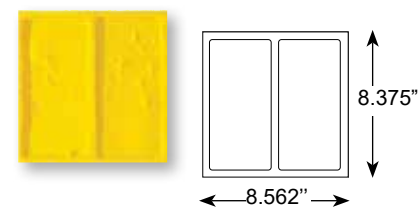

**Used Brick Double, FM-5700**   
 8.375" x 8.562"  
 (21.27 x 21.75 cm)  
 Yellow  
 Matching skin/touch-up wheel:  
 Used Brick/TW-4

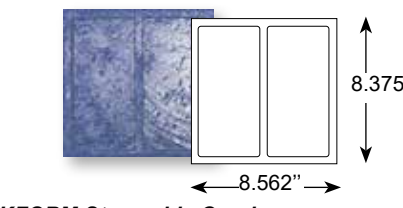

**New Brick Double, FM-5750**   
 8.375" x 8.562"  
 (21.27 x 21.75 cm)  
 Blue  
 Matching skin/touch-up wheel:  
 New Brick/TW-4

# Wood Texture Mats

Made-to-Order   
2-week production lead time

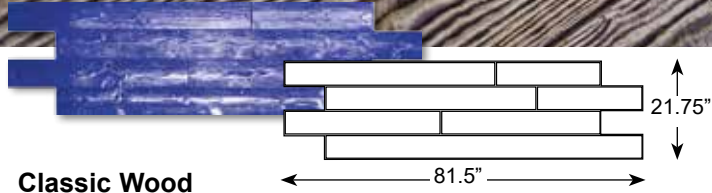

**Classic Wood**  
**FM-8700 S/O**

81.5" x 21.75" (207 x 55.2 cm) Blue

*Combining multiple wood grains to offer a bold, pronounced, exposed grain texture with six-inch wide planks*

Matching skin/touch-up wheel: FM-8700FE/TW-5

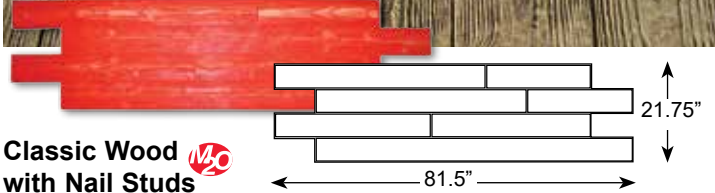

**Classic Wood**   
**with Nail Studs**  
**FM-8710 S/O**

81.5" x 21.75" (207 x 55.2 cm) Red

*Combining multiple wood grains to offer a bold, pronounced, exposed grain texture with six-inch wide planks and oversized nail heads*

Matching skin/touch-up wheel: FM-8700FE/TW-5

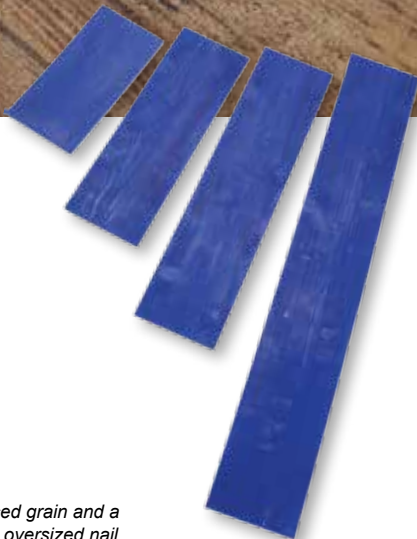

**2' Cedar Wood Plank, FM-8110 S/O**  
11.5" x 24" (29.21 x 60.96 cm) Blue

**3' Cedar Wood Plank, FM-8210 S/O**  
11.5" x 36" (29.21 x 91.44 cm) Blue

**4' Cedar Wood Plank, FM-8310 S/O**  
11.5" x 48" (29.21 x 121.92 cm) Blue

**6' Cedar Wood Plank, FM-8410 S/O**  
11.5" x 72" (29.21 x 182.88 cm) Blue

**8' Cedar Wood Plank, FM-8510 S/O**  
11.5" x 96" (29.21 x 243.84 cm) Blue

*A cedar wood texture with coarse, pronounced grain and a rough surface appearance that incorporates oversized nail heads at each end*

Matching skin/touch-up wheel: FM-8010FE/TW-5



**2' Wood Plank, FM-8100 S/O**   
12" x 24" (29.21 x 60.96 cm) Blue

**3' Wood Plank, FM-8200 S/O**  
12" x 36" (29.21 x 91.44 cm) Blue

**4' Wood Plank, FM-8300 S/O**  
12" x 48" (29.21 x 121.92 cm) Blue

**6' Wood Plank, FM-8400 S/O**  
12" x 72" (29.21 x 182.88 cm) Blue

**8' Wood Plank, FM-8500 S/O**  
12" x 96" (30.48 x 243.84 cm) Blue

*A wood grain texture with lightly pronounced veins and a mild surface texture*

Matching skin/touch-up wheel: FM-8000FE/TW-5

**S/O - Compatible with BRICKFORM Stampable Overlay**







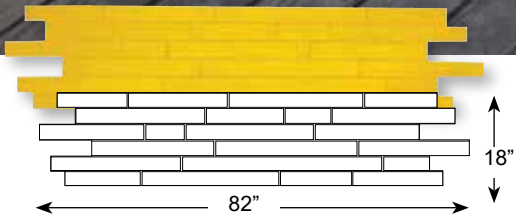

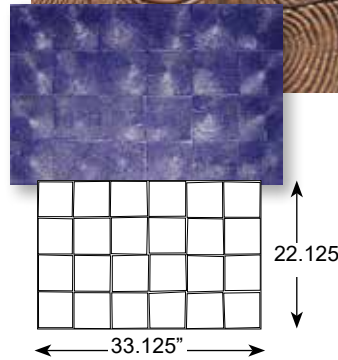

**3" Cedar Wood Flooring, FM-8015**   
 18" x 82" (45.72 x 208.28 cm) Yellow  
 Cedar wood planks laid end-to-end

Matching skin/touch-up wheel: FM-8000FE/TW-5



**Wood Block**   
**FM-8600 S/O**  
 22.125" x 33.125" (56.19 x 84.13 cm)  
 Blue  
 Wood blocks cut perpendicular to the grain  
 Matching skin/touch-up wheel:  
 FM-8000FE/TW-1



**Bridges of Madison County**

Deep in the American heartland reside the historic Bridges of Madison County. Subject of the eponymous novel, film, and musical, they are now the inspiration for Brickform's newest line of textures. These stamps were derived from real planks and timbers dating back to the late 19th century.

- 4' Wood Plank, FM-8320B S/O** \*floppy available  
 15" x 48"  
 (38.1 x 121.92 cm) Blue
- 6' Wood Plank, FM-8420 S/O**  
 15" x 72"  
 (38.1 x 182.88 cm) Blue
- 8' Wood Plank, FM-8520 S/O**  
 15" x 96"  
 (38.1 x 243.84 cm) Blue
- 10' Wood Plank, FM-8620 S/O**  
 15" x 120"  
 (38.1 x 304.8 cm) Blue

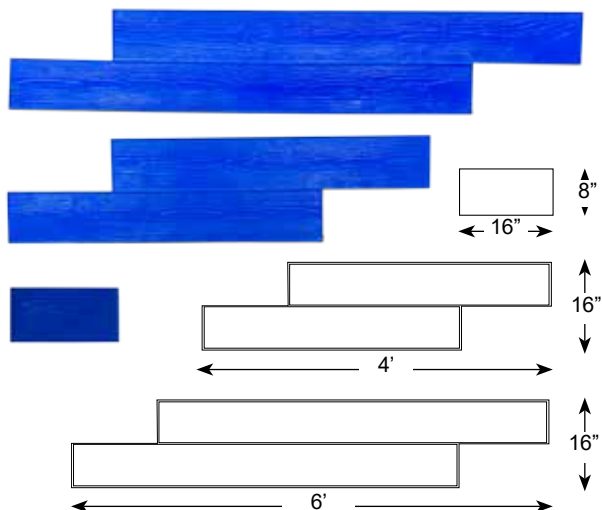

**8" Wood Plank, FM-8430**  
 6'x16" (182.88 x 40.64 cm)  
 Blue

**8" Wood Plank, FM-8330**  
 4'x16" (121.92 x 40.64 cm)  
 Blue

**8" Wood Plank, FM-8030**  
 16"x8" (40.64 cm x 20.32)  
 Blue

Matching skin: FM-8030FE  
 Floppies available.



# Tile Texture Mats

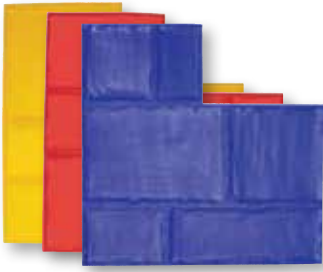

**Chateau Ashlar, FM-7450**  
36" x 36" (91.44 x 91.44 cm)  
Red, Yellow and Blue

*A smooth and elegant Ashlar pattern consisting of rounded stones with sandy joints*

Matching touch-up wheel: TW-7

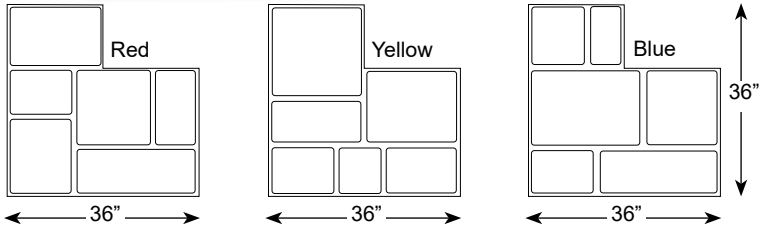

**Octagon Tile, FM-7100 S/O**  
37.5" x 37.5" (95.25 x 95.25 cm)  
Blue  
*A blue stone texture laid out in a highly decorative pattern*  
Matching skin/touch-up wheel: Blue stone/TW-2

Tile Texture Mats **M2C** Made-to-Order **M2C** 2-week production lead time

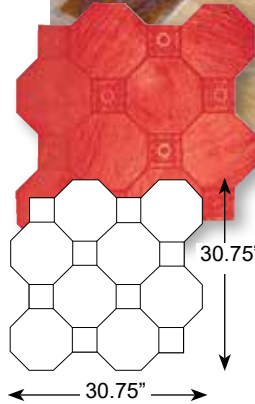

**Santa Barbara Tile, FM-7025 S/O** **M2C**  
30.75" x 30.75" (78.1 x 78.1 cm)  
Red  
*Slate textured octagons and rosette squares laid out in a unique, highly decorative pattern*  
Matching touch-up wheel: TW-4

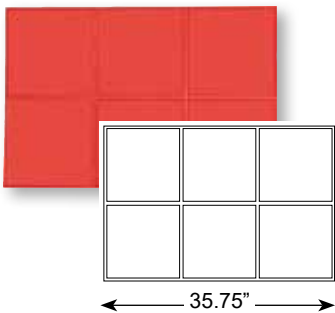

**12" x 12" Mexican Tile (Smooth Texture), FM-7000** **M2C**  
23.75" x 35.75"  
(60.32 x 90.80 cm)  
Red  
*A clay-tile texture that incorporates an irregular surface with pronounced, rounded edges*

Touch-up wheel: TW-6

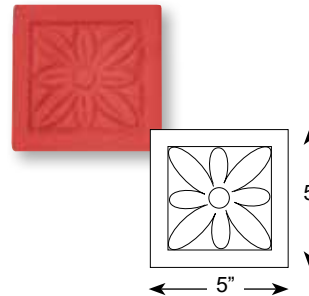

**Octagon Tile Flower, FM-7125** **M2C**  
5" x 5" (12.7 x 12.7 cm)  
Red  
*A decorative tile flower set within a small square*

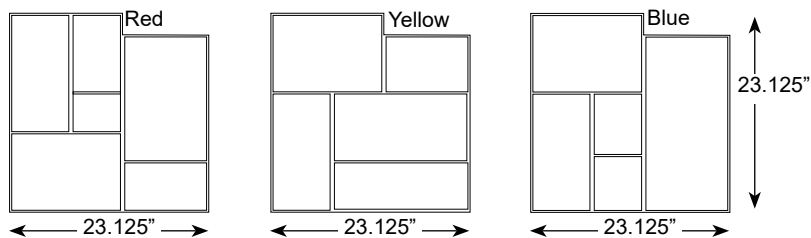
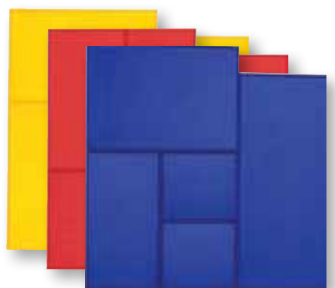

**Untextured Ashlar with 1/2" V-Joint, FM-7150** **M2C**  
23.125" x 23.125"  
(58.73 x 58.73 cm)  
Red, Yellow and Blue  
*Smooth untextured rectangles in a sharp Ashlar pattern*

Touch-up wheel: TW-5

S/O - Compatible with BRICKFORM Stampable Overlay

# Border Tools

Made-to-Order   
2-week production lead time

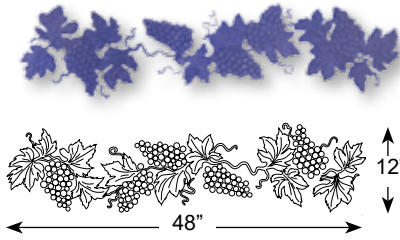

**Grapevine Strand, FM-912**  
12" x 48"  
(30.48 x 121.92 cm)  
Blue   
A stand-alone grapevine border

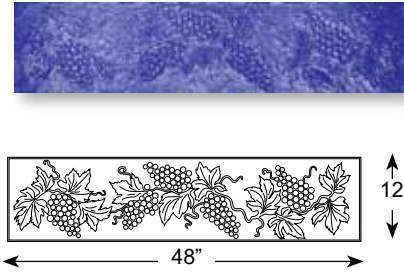

**Grapevine Border, FM-910**  
12" x 48"   
(30.48 x 121.92 cm) Blue  
A grapevine border with textured background

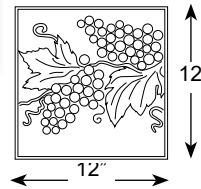

**Grapevine Border Corner, FM-911**   
12" x 12"  
(30.48 x 30.48 cm) Blue

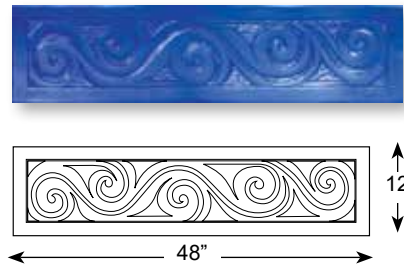

**Swirl Border, FM-925**   
12" x 48"  
(30.48 x 121.92 cm) Blue  
An elegant scrolling pattern with a surrounding smooth border

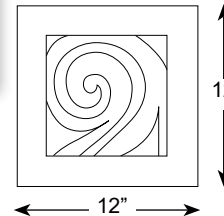

**Swirl Border Corner, FM-92**  
12" x 12" (30.48 x 30.48 cm)  
Blue 

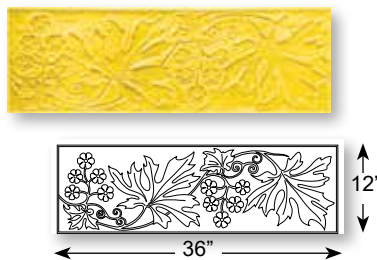

**Autumn Leaf Border, FM-915**   
12" x 36" (30.48 x 91.44 cm)  
Yellow  
A rustic pattern featuring autumn leaves and flowers

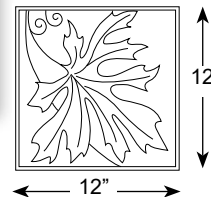

**Autumn Leaf Border Corner, FM-916**   
12" x 12" (30.48 x 30.48 cm)  
Yellow

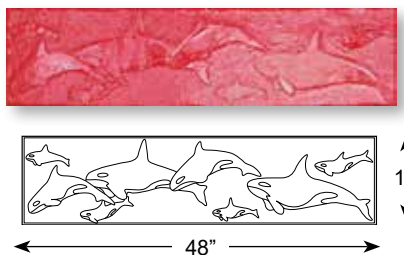

**Whale Border, FM-920**   
12" x 48"  
(30.48 x 121.92 cm)  
Red  
Orca whales of various sizes, swimming gracefully

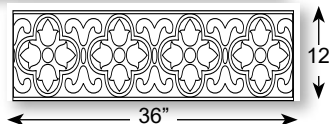

**Spring Medallion, FM-930**   
12" x 36"  
(30.48 x 121.92 cm)  
Yellow  
A classic geometric pattern with curved shapes

**HINT!** Matching thin mats "floppies" are available for all BRICKFORM Texture Mats

## Creative Images Texture Mats

BRICKFORM developed the Creative Images line of texture mats to incorporate the latest in textures, designs and usability. Creative Images mats are larger, an average of nine square feet, which means fewer placements and less touch-up work. Creative Images mats are made of firmer material, which allows you to begin stamping sooner. Choose Creative Images to create the best possible impression with the least amount of effort.



### Ashlar, TM-100

36" x 36" (91.44 x 91.44 cm)

Pattern: A, B and C

*An Ashlar pattern of blue stone slate*

Matching skin/touch-up wheel: Blue Stone/TW-5

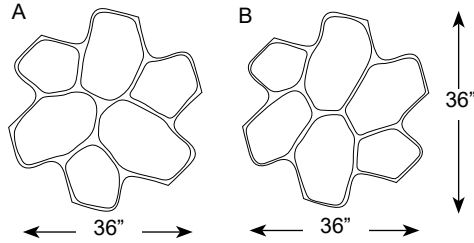
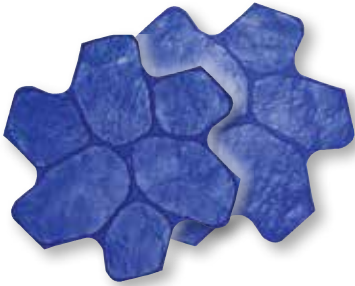
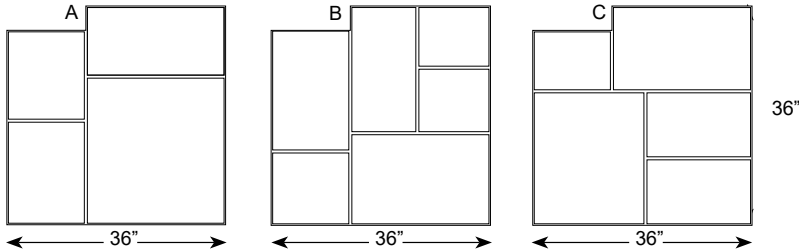

### Random Stone, TM-200

36" x 36" (91.44 x 91.44 cm)

Pattern: A and B

*A natural looking arrangement of slate-textured random stones*

Matching skin/touch-up wheel: Slate/TW-6





**16" x 16" Slate, TM-300**

32" x 48" (81.28 x 121.92 cm) Pattern: A  
Slate squares in two rows, with angled, ungrouted joints

Matching skin/touch-up wheel: Slate/TW-6

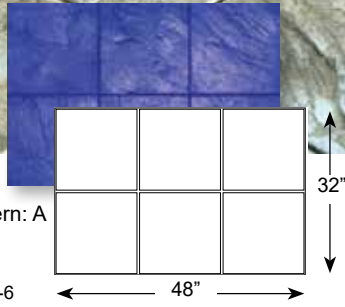

**European Fan, TM-400**

28" x 50" (71.12 x 127 cm) Pattern: A  
Curved slate bricks gracefully arranged in a European Fan pattern

Matching skin/touch-up wheel: Slate/TW-7

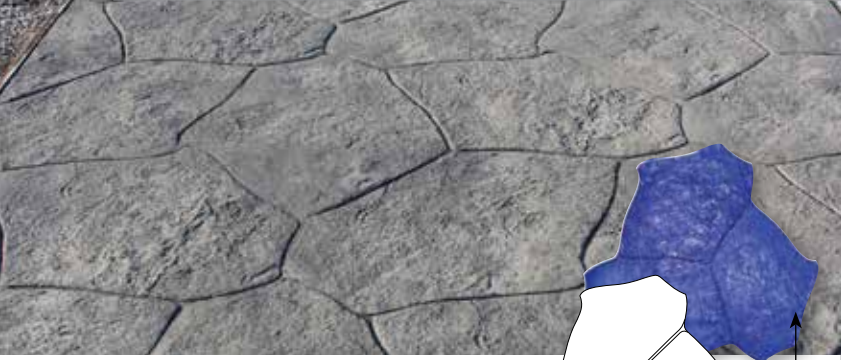
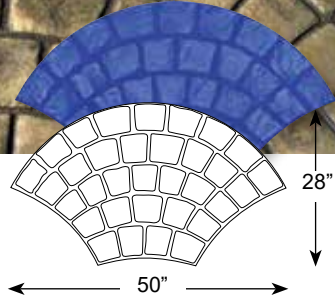

**Mesa Random Stone, TM-500**

61.75" x 61.75" (156.85 x 156.85 cm)  
Pattern: A

Random stones sculpted to have a rough, irregular shape. Matching skin: Mesa Stone

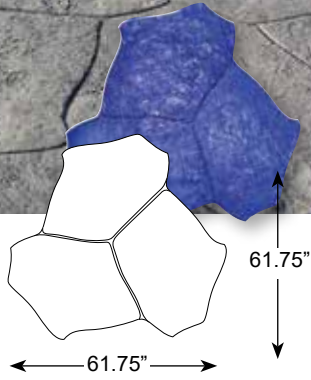

**12" x 12" Slate - 1/4" Joint, TM-600**

24" x 48" (60.96 x 121.92 cm) Pattern: A  
Rows of slate squares with beveled edges

Matching skin/touch-up wheel: Slate/TW-5

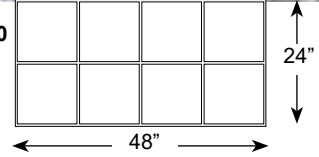

**Flagstone, TM-700**

48" x 48" (121.92 x 121.92 cm)

Pattern: A and B

Flagstones with hand chiseled edges grouped in a random formation

Matching touch-up wheel: TW-6

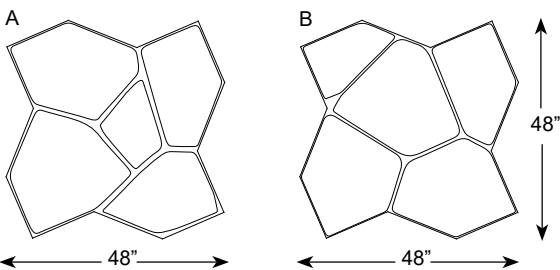
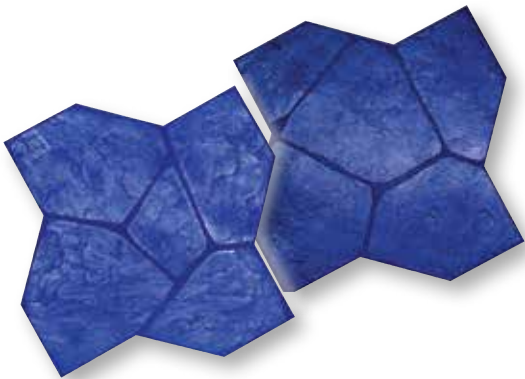



**Pennsylvania Cobble (Sanded Joint) TM-820**

31.5" x 47.5" (80.01 x 120.65 cm) Pattern: A  
*A staggered pattern of cobblestone with sandy joints and rounded edges*  
 Matching touch-up wheel: TW-7



**Pennsylvania Station Cobble (Smooth Joint) TM-840**

53.5" x 30.875" (135.89 x 78.42 cm) Pattern: A  
*A staggered pattern of cobblestone with smooth joints and rounded edges*  
 Matching touch-up wheel: TW-6

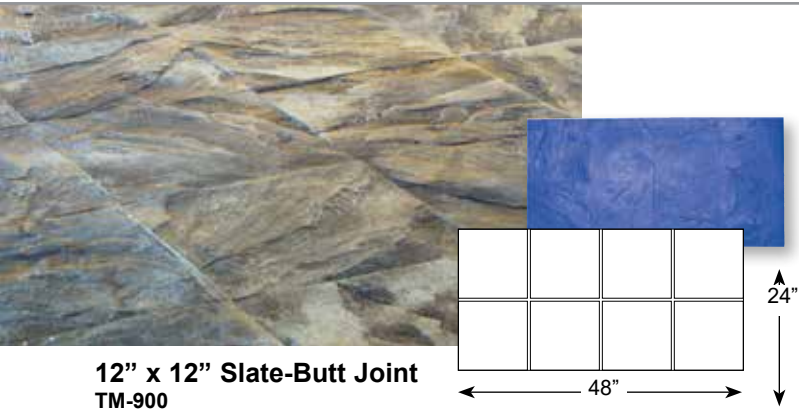

**12" x 12" Slate-Butt Joint TM-900**

24" x 48" (60.96 x 121.92 cm) Pattern: A  
*Sharp slate squares butted up against each other in two rows*  
 Matching skin/touch-up wheel: Slate/Chisel

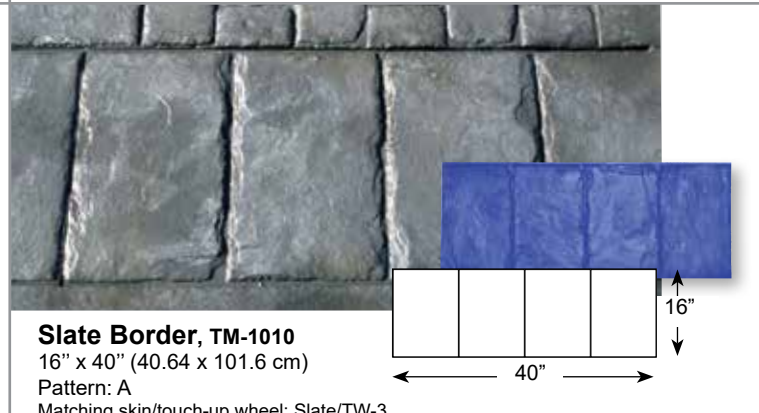

**Slate Border, TM-1010**

16" x 40" (40.64 x 101.6 cm) Pattern: A  
 Matching skin/touch-up wheel: Slate/TW-3

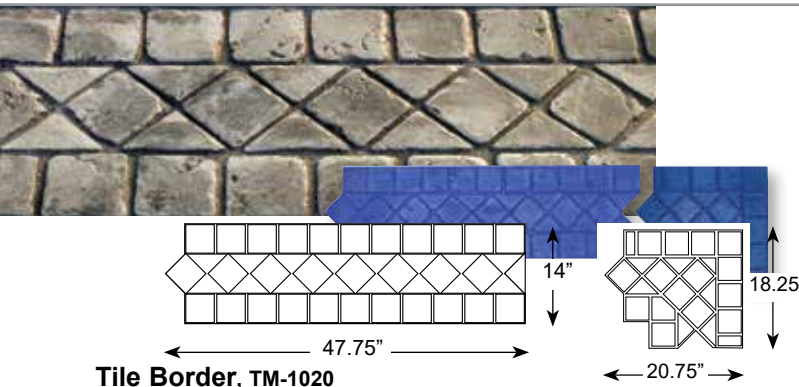

**Tile Border, TM-1020**

14" x 47.75" (35.56 x 121.28 cm) Pattern: A  
**TM-1020-1** Tile Border Corner Piece  
 18.25" x 20.75" (46.36 x 52.71 cm) Pattern: A  
 Matching touch-up wheel: TW-2

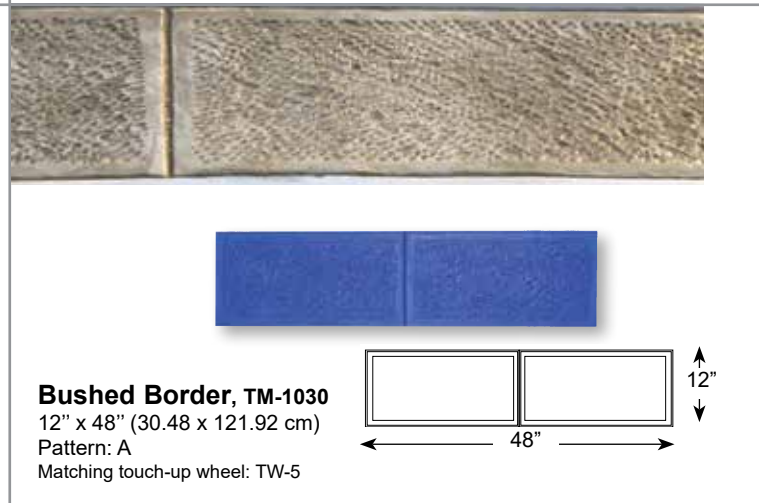

**Bushed Border, TM-1030**

12" x 48" (30.48 x 121.92 cm) Pattern: A  
 Matching touch-up wheel: TW-5

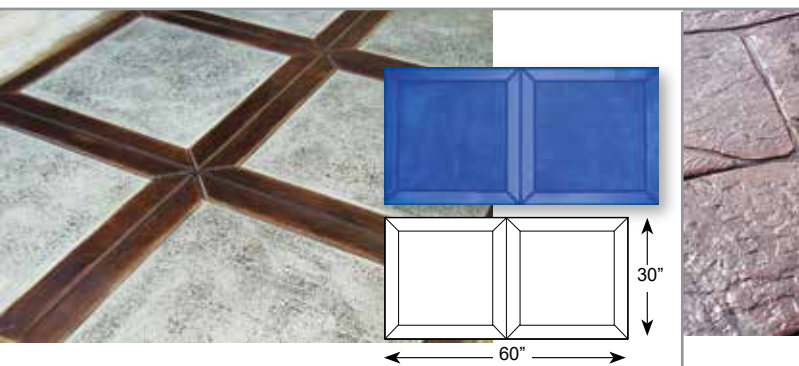

**30" x 30" Bushed Stone, TM-1200**

30" x 60" (76.2 x 152.4 cm) Pattern: A  
*Two bushed stones with square corners and sharp beveled edges*  
 Matching touch-up wheel: TW-5

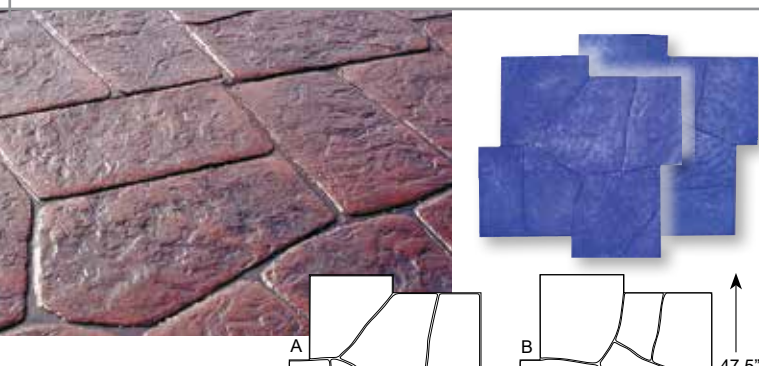

**Castle Stone, TM-1300**

47.5" x 47.5" (120.65 x 120.65 cm) Pattern: A and B  
*Irregular shaped natural stones*  
 Matching skin/touch-up wheel: Yucatan/TW-5



**Creative Images Mats *continued***

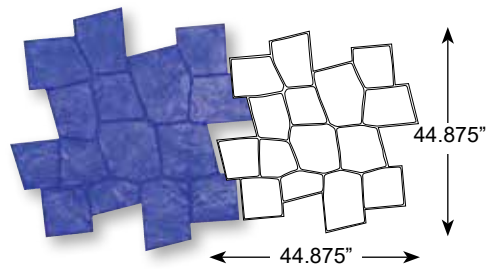

**Luccia Stone, TM-1350**

44.875" x 44.875" (113.98 x 113.98 cm) Pattern: A  
Slate stones with irregular edges, in a random pattern

Matching skin: Smooth Slate

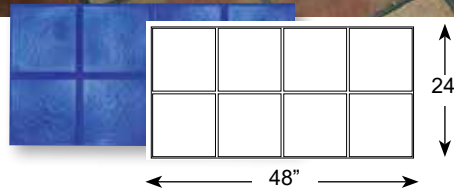

**12" x 12" Mexican Tile, TM-1400**

24" x 48" (60.96 x 121.92 cm) Pattern: A  
Beautiful Mexican tiles with sandy joints

Matching touch-up wheel: TW-7

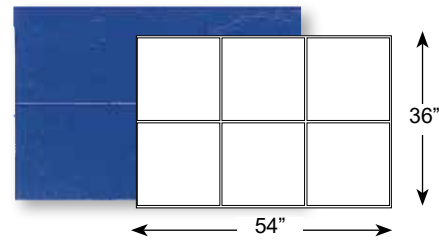

**18" x 18" Slate, TM-1620**

36" x 54" (91.44 x 137.16 cm) Pattern: A  
Three slates with sharp edges, laid in two rows

Matching skin/touch-up wheel: Slate/TW-5

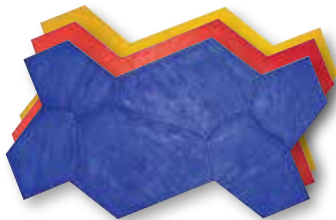

**Verona Stone, TM-1500**

42.75" x 68.5" (108.58 x 173.99 cm)

Red, Yellow and Blue  
A unique random pattern of irregular stones

Matching skin/touch-up wheel: Blue Stone/TW 2-3

Red

Yellow

Blue

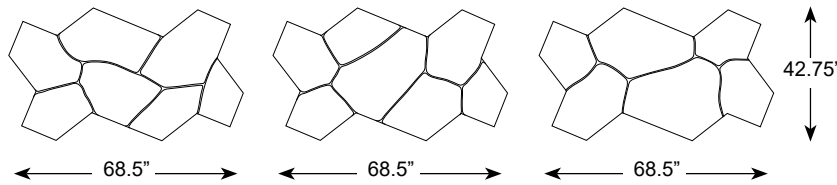

**Creative Images Mats *Made-to-Order*  2-week production lead time**

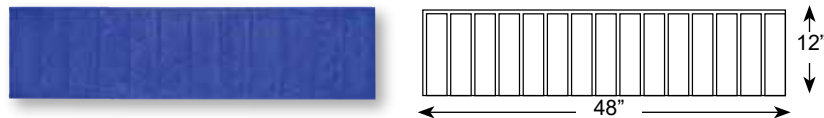

**4" x 12" Brick Border, TM-1000**

12" x 48" (30.48 x 121.92 cm) Pattern: A 

Matching skin/touch-up wheel: New Brick/TW-6

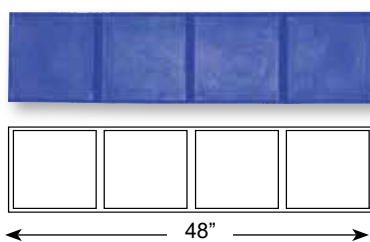

**12" x 12" Mexican Tile  Border, TM-1040**

12" x 48" (30.48 x 121.92 cm)  
Pattern: A

Matching skin/touch-up wheel:  
New Brick/TW-7

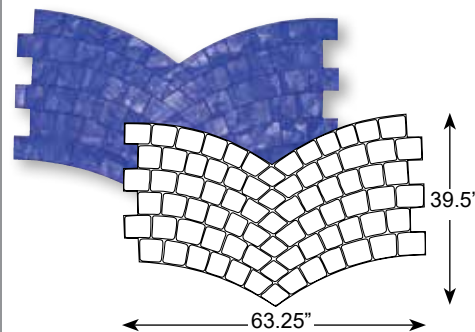

**Danish Fan, TM-1100 **

39.5" x 63.25" (100.33 x 160.65 cm)  
Pattern: A  
Rectangular stones of various sizes laid in a fan pattern with flat joints

Matching skin/touch-up wheel:  
Slate/TW-1

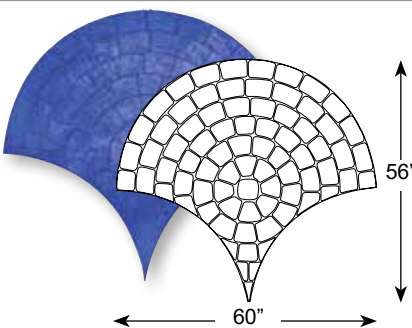

**Tear Drop Fan, TM-1600 **

56" x 60" (142.24 x 152.4 cm)  
Pattern: A  
Utah stones laid in a tear drop fan pattern

Matching skin/touch-up wheel:  
Utah Stone/TW-1

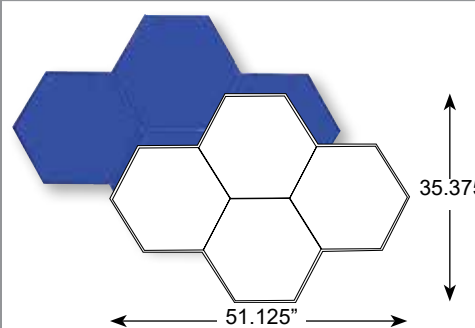

**Hexagon, TM-1660 **

Smooth with 1/2" Joints  
35.375" x 51.125" (89.85 x 129.85 cm)  
Pattern: A  
Smooth hexagon tiles in an interlocking pattern

Touch-up wheel: TW-6

## Contractor's Choice Texture Mats

Brickform recognized contractor feedback with the introduction of our Contractor's Choice line comprised of everyone's favorite textures. Contractor's Choice is a professional line of tools that are tough, slim, sleek and firm for a great feel on and off the slab. These new tools are both economically and ecologically friendly, emphasizing quality and dependability.



### European Fan, EF-650 S/O

26" x 46" (66.04 x 116.84 cm)

Black A

*An elegant European fan pattern, consisting of slightly curved rectangular slate stones*

Matching skin/touch-up wheel: Smooth Slate/TW-2



### Random Stone, EF-700 S/O

29.125" x 29.125"  
(73.97 x 73.97 cm)

Black A, B, C

*Heavily textured random fieldstones*

Matching skin/touch-up wheel: Rough Stone/TW-2



### 36" Ashlar Cut Slate, EF-3120 S/O Without Insert

36" x 36" (91.44 x 91.44 cm)

Black A, B, C

*Stones with a slate surface, in an Ashlar pattern*

Matching skin/touch-up wheel: Smooth Slate/TW-5

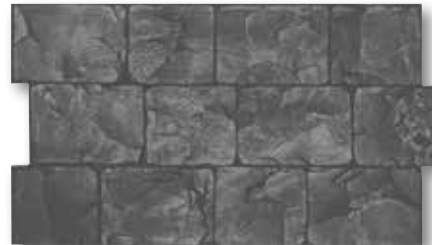

### London Cobble, EF-540 S/O

17" x 29.75" (43.18 x 75.56 cm)

Black A

*A traditional lightly textured cobblestone pattern*

Matching skin/touch-up wheel: Smooth Slate/TW-1



### Large Ashlar Cut Slate, EF-3150 S/O

28" x 28" (71.12 x 71.12 cm)

Black A, B, C

*Similar to Ashlar Cut Slate but the overall size is larger, with a softer texture*

Matching skin/touch-up wheel: Smooth Slate/TW-5

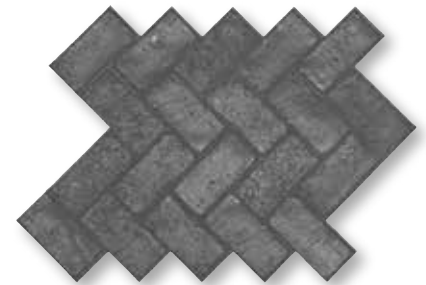

### Herringbone Used Brick EF-5000 S/O

32" x 36" (81.28 x 91.44 cm)

Black A

*A weathered brick surface with an uneven texture and rounded broken edges*

Matching touch-up wheel: TW-4



### Running Bond Used Brick EF-5100 S/O

16" x 36.5" (40.64 x 92.71 cm)

Black A

*Used bricks laid end-to-end, with sandy joints*

Matching touch-up wheel: TW-4



### Running Bond New Brick, EF-5150 S/O

24" x 36.5" (60.96 x 92.71 cm) Black A

*A running bond pattern with smooth joints*

Matching touch-up wheel: TW-6



### 6" x 6" Edinburgh Cobble, EF-520 S/O

26" x 36" (66.04 x 91.44 cm)

Black A

*A rugged weathered cobblestone pattern*

Matching touch-up wheel: TW-7

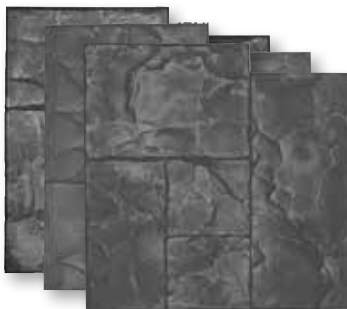

### Ashlar Cut Slate, EF-3125 S/O

23.125" x 23.125"  
(58.74 x 58.74 cm)

Black A, B, C

*A naturally laminated stone texture split along parallel planes, hand-tooled to create a more pronounced chipped fragmented texture with small deep joints*

Matching skin/touch-up wheel: Smooth Slate/TW-1

**S/O - Compatible  
with BRICKFORM  
Stampable Overlay**

Contractors Choice EF tools cannot be used in conjunction with rigid FM tools.  
Floppy tools are acceptable to use with EF only.



**Contractor's Choice European Fan**



**Contractor's Choice Ashlar Cut Slate**

## Custom Gang Tools

Extra-large, efficient, 2-in-1,  
3-in-1, or 4-in-1 texture mats.

ALL CUSTOM TOOLS/GANG TOOLS ARE MADE TO ORDER. THERE ARE NO RETURNS OR EXCHANGES *Made-to-Order*  2-week production lead time

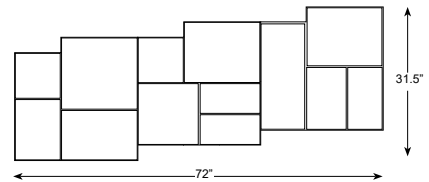

**FM-100GANG, Rough Cut Ashlar**  
Install photo on page 28. Floppy available.\*  
Also Available (4-in-1 FM-540QUAD)

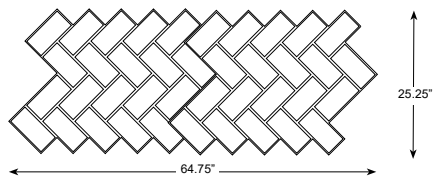

**FM-500GANG, Herringbone Used Brick**  
Install photo on page 45. Floppy available.\*

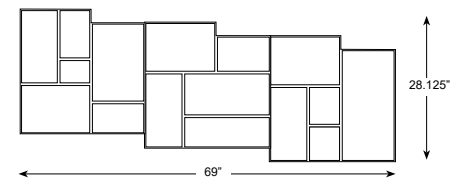

**FM-3125GANG, Ashlar Cut Slate**  
Install photo on page 41. Floppy available.\*

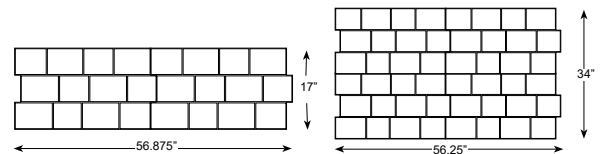

**FM-540GANG, FM-540QUAD, London Cobble**  
Install photo on page 29. Floppy available.\*

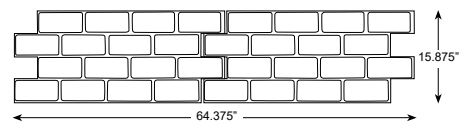

**FM-5100GANG, Running Bond Used Brick**  
Install photo on page 45. Floppy available.\*

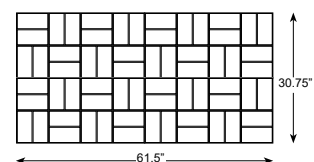

**FM-5200GANG, Basket Weave Used Brick**  
Install photo on page 46.  
Floppy available.\*

*\*Single tool floppy available.*

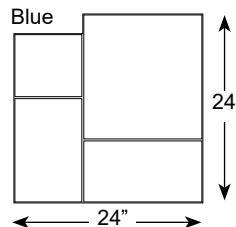
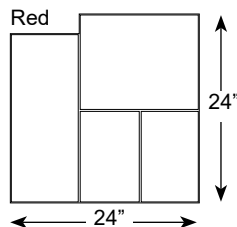
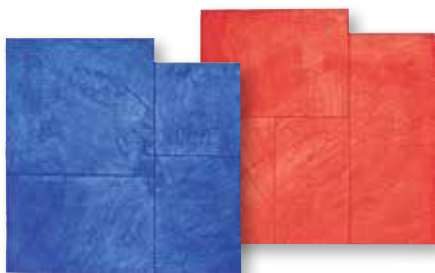

**Ashlar Stone, OL-100 S/O**   
 24" x 24" (60.96 x 60.96 cm)  
 Red and Blue  
 Rectangles with blue stone texture, arranged in an Ashlar pattern

Matching skin/touch-up wheel:  
 Blue Stone/TW-1

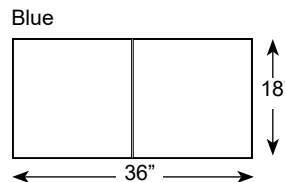
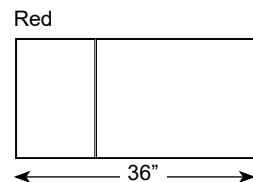
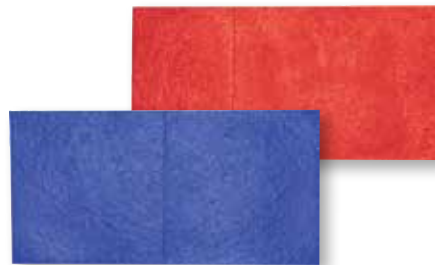

**Sidewalk Stone, OL-400 S/O**  
 18" x 36" (45.72 x 91.44 cm)  
 Red and Blue   
 Slate pieces laid side-by-side, with the fine texture of Utah stone

Matching skin/touch-up wheel:  
 Utah/TW-5

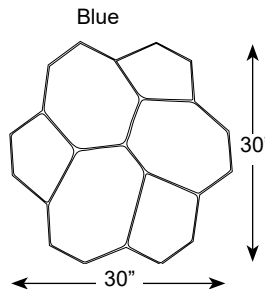
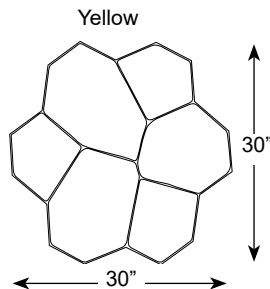
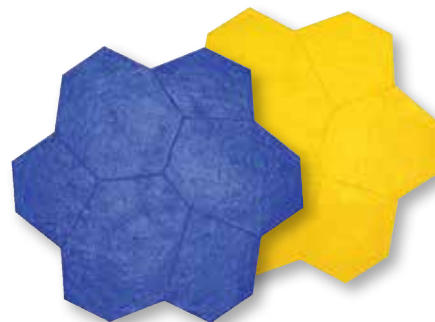

**Random Stone, OL-800 S/O**  
 30" x 30" (76.2 x 76.2 cm)  
 Yellow and Blue   
 Irregularly shaped, randomly sized stones with the texture of Utah stone, and smooth un-grouted joints

Matching skin/touch-up wheel:  
 Utah Stone/TW-1

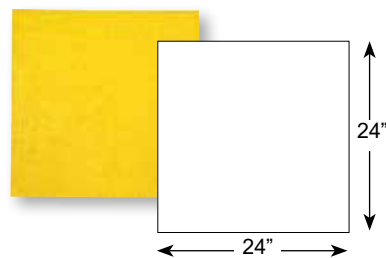

**24" x 24" Coquina Stone**   
 (Salt Finish), OL-700 S/O  
 24" x 24" (60.96 x 60.96 cm)  
 Yellow  
 A single stone with a fine salt finish and beveled edge  
 Matching skin/touch-up wheel:  
 Salt Finish/TW-5



## Cal-Trans Series Texture Mats (Made-to-Order

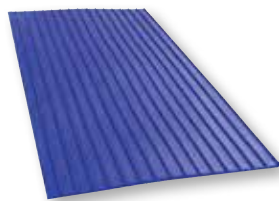

**Caltrans 1 1/2" Straight Grooves**  
**HR-100**   
 24.125" x 47.875" (61.27 x 121.60 cm) Blue  
 Smooth 1/4" grooves spaced 1 1/2" apart  
 Also Available:  
**HR-400**  
 Caltrans 3/4" Straight Grooves  
 12.25" x 48.25" (31.12 x 122.56 cm) Blue  
 Smooth 1/4" grooves spaced 1/2" apart

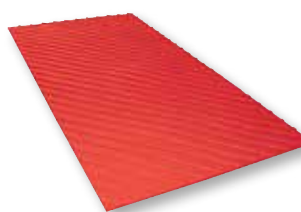

**Caltrans 45° Left**  
**HR-200L**   
 24.125" x 48.125"  
 (61.27 x 122.23 cm) Red  
 Smooth grooves running the entire length of the tool at a 45° angle (Left orientation)  
 Also Available:  
**HR-200 R**   
 Caltrans 45° Right  
 24.125" x 48.25" (61.27 x 122.56 cm) Yellow  
 Smooth grooves running the entire length of the tool at a 45° angle (Right orientation)

## Graphic Warning Imprints (Made-to-Order

BRICKFORM carries a complete line of graphic imprints.



**No Dumping Flows To River**   
**FM-6100**  
 12" x 33.937" (30.48 x 86.2 cm) Blue



**High Voltage**   
**FM-6240**  
 5.5" x 12" (13.97 x 30.48 cm)  
 Yellow



**Warning Post Tension**   
**FM-6210**  
 8" x 12" (20.32 x 30.48 cm)  
 Red

**Also Available:**  
**FM-6100**, No Dumping Flows to Creek, 6.375" x 34.25"  
**FM-6120**, No Dumping Flows to River 3/8", 12" x 34"  
**FM-6130**, No Dumping Drains to River, 11" x 22.575"  
**FM-6135**, No Dumping Drains to River 1/8", 7.75" x 22"  
**FM-6140**, No Dumping Flows to Bay, 7.5" x 32.75"  
**FM-6150**, No Dumping Drains to Delta, 6.375" x 33.785"  
**FM-6200**, Post Tension, 1.5" x 12"  
**FM-6220**, Warning Methane Gas Barrier, 21" x 34.5"  
**FM-6230**, Warning Vapor Control, 30" x 30"  
**FM-6250**, Structural Concrete, 4" x 17.785"

## Urethane Ultra-Liners

The next generation in cantilever bullnose forms is the Brickform Urethane Ultra-Liner. The new liner has been re-engineered from the ground up to give the Brickform contractor a competitive edge when it comes to step faces, wall caps, counter tops and pool copings.

- Made with a durable and dependable urethane system that will let you use them time and time again with the same quality results as the first use.
- Straight or curving around corners, these liners maintain their shape on even some of the sharpest turns.
- Solid urethane skin is rigid and strong without distortion; while a light-weight, high-density core keeps these forms flexible to contour to almost any shape.
- Non-porous face will not draw out moisture from your concrete and will leave a smoother face, reducing your finishing time.

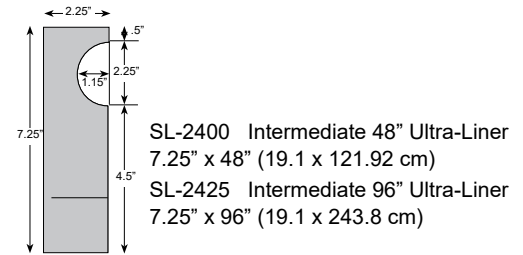
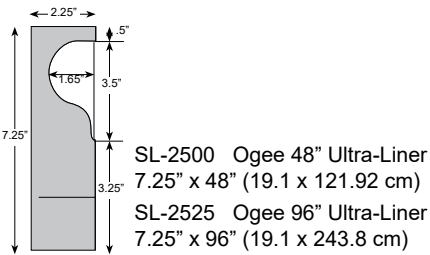
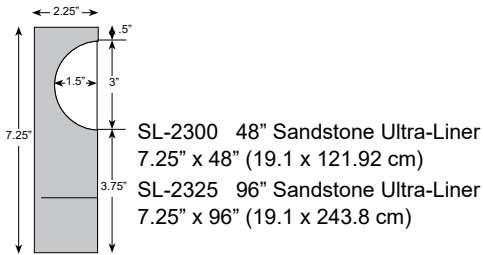

## Foam Urethane Ultra-Liners

With the contractor in mind, Ultra-Liners take the hassle out of decorative step faces.

- Reusable liner for steps, wall caps and counter-tops
- Creates smooth and easy-to-finish surfaces
- Foam urethane, long lasting liners
- Easy to bend and mold into shape
- Sized to dimensional lumber
- Offered in approximate 4' and 8' lengths for versatility and reduced shipping cost
- Works great with Brickform Liquid Release

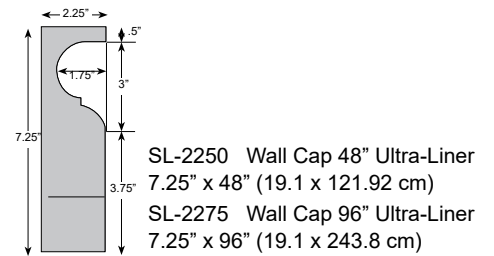
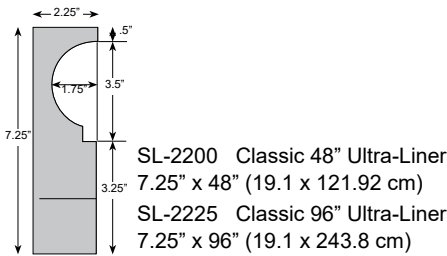
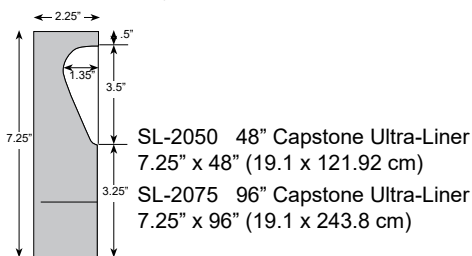

\*Lengths of Ultra-Liner tools are approximate, measured before placement. Sold 10 per case.

\*\*Also available: Twist-to-break wire kit (SL-2950), double-sided tape (SL-2975)

## Step-Liners

BRICKFORM Step-Liners are designed to produce texture on the edges of concrete steps, risers, terraces and even concrete countertops. These Step-Liners can be reused many times. Simply attach the liners to your riser forms to impart the beauty of natural stone. They have no top or bottom and can be reversed to reduce pattern repeat. BRICKFORM Step-Liners are high-quality, flexible polyurethane, engineered to be lightweight and extremely durable.

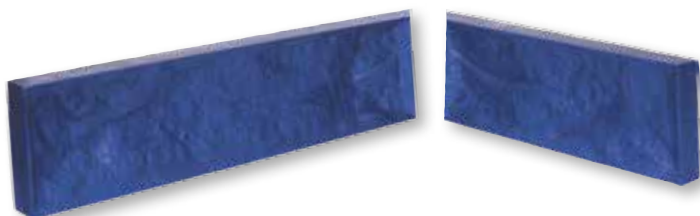

**45° Angle Step Liner** (Two shown to form corner)



**SL-350**  
**45° 24" Step Liner**  
6" x 26.375" (15.24 x 66.99 cm)  
Pattern: A or B



**SL-450**  
**45° 16" Step Liner**  
6" x 18.375" (15.24 x 45.72 cm)  
Pattern: A or B

*Hint: To reduce pattern repeat, use A and B together.  
Hint: Use as a curb edge to mimic split stone.*

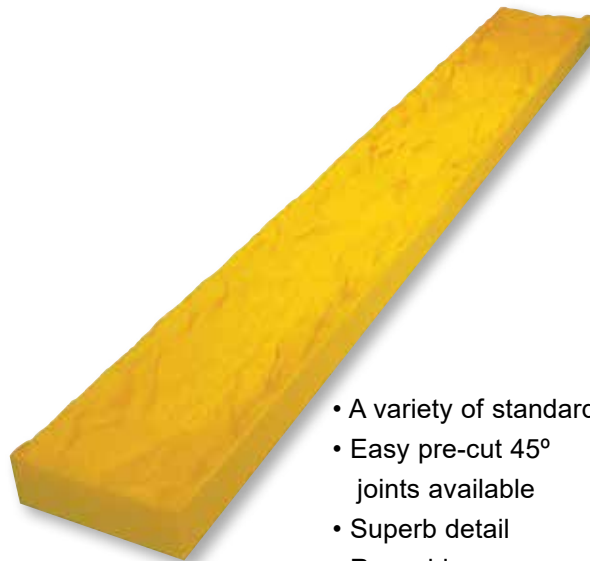

- A variety of standard sizes
- Easy pre-cut 45° joints available
- Superb detail
- Reusable
- Up to 1 1/2" of texture

### Also Available:

**SL-100**  
**48" Step Liner**  
6" x 48" (15.24 x 121.92 cm)  
Pattern: A or B

**SL-200**  
**72" Step Liner**  
6" x 72" (15.24 x 182.88 cm)  
Pattern: A

**SL-300**  
**24" Step Liner**  
6" x 24" (15.24 x 60.96 cm)  
Pattern: A or B

**SL-400**  
**16" Step Liner**  
6" x 16" (15.24 x 40.64 cm)  
Pattern: A or B



## Step Liners in Foam Urethane

- Lightweight
- Increased flexibility

**SL-3500**  
**45 degree 24" Step Liner In Foam Urethane**  
 6" x 26.375"  
 Pattern A or B

**SL-4500**  
**45 degree 16" Step Liner In Foam Urethane**  
 6" x 18.375"  
 Pattern A or B

**SL-1000**  
**48" Step Liner In Foam Urethane**  
 6" x 48"  
 Pattern A or B

**SL-3000**  
**24" Step Liner In Foam Urethane**  
 6" x 24"  
 Pattern A or B

**SL-4000**  
**16" Step Liner In Foam Urethane**  
 6" x 16"  
 Pattern A or B

**SL-5000**  
**72" Step Liner In Foam Urethane**  
 6" x 72"  
 Pattern A



## Countertop Liner

**FM-6610**  
**Stone Countertop Liner**  
 2" x 98"

## Dimensional Step Liners

- Sized to dimensional lumber
- Thin, approximately 2" thick
- Attach to forms
- Flexible for creating organic shapes

**SL-500A**  
**Stone Step Liner (Dimensional lumber)**  
 8" (7.25") x 6'

**SL-530A**  
**Stone Step Liner (Dimensional lumber)**  
 4" (3.5") x 6'

**SL-525A**  
**Stone Step Liner (Dimensional lumber)**  
 6" (5.5") x 6'



## Slim-Strip Step Liners

- Ultra-thin
- Super flexible for creating organic shapes
- Available in slate and stone textures
- Sized to dimensional lumber
- Approximately 1/2" thick

**SL-600A**  
**6" Stone Slim Strip**  
 6" (5.5") x 8'

**SL-615A**  
**4" Stone Slim Strip**  
 4" (3.5") x 8'

**SL-625A**  
**8" Stone Slim Strip**  
 8" (7.25") x 8'

**SL-650A**  
**6" Slate Slim Strip**  
 6" (5.5") x 8'

**SL-665A**  
**4" Slate Slim Strip**  
 4" (3.5") x 8'

**SL-675A**  
**8" Slate Slim Strip**  
 8" (7.25") x 8'

**SL-680A**  
**8" Wood Grain Slim Strip**  
 8" (7.25") x 8'

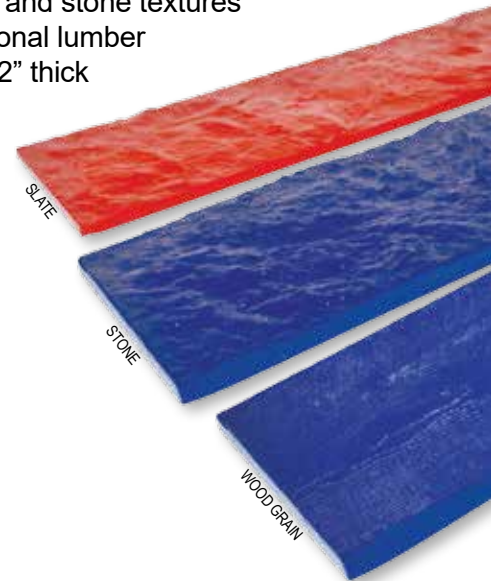

## Quick Strips

BRICKFORM Quick-Strips are perfect for creating a more decorative joint. By placing the BRICKFORM Quick-Strips into your control joints prior to stamping with our seamless skins, you can transform your slab from ordinary to extraordinary in no time. Average width .375"-1.5" (Sold 5 per case.)

**FM-6580** Chiseled V-Joint, Offered in 5 foot strips

**FM-6590** Sanded Stone Joint, Offered in 5 foot strips

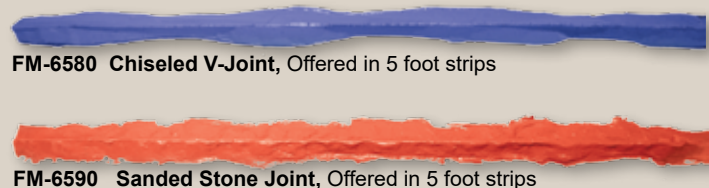

# Paper Stencils

Brickform paper stencils are made of thick, tear-resistant paper and come in a wide variety of popular patterns including stone, pavers, tile, cobblestone, and brick.

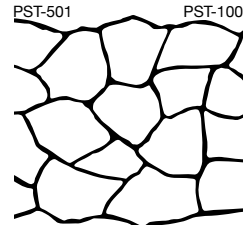

**BUSHROCK**  
AVERAGE STONE SIZE: 16" X 10"  
ROLL WIDTH: 36" JOINT WIDTH: 1/2"

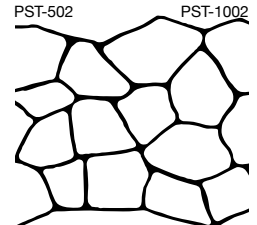

**FLAGSTONE**  
LARGEST STONE SIZE: 14" X 11"  
ROLL WIDTH: 32" JOINT WIDTH: 1/2" - 1 1/4"

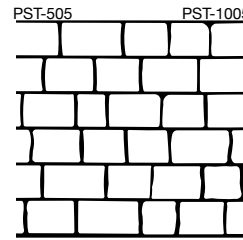

**ROMAN PAVER**  
AVERAGE BRICK SIZE: 10" X 5 1/2"  
ROLL WIDTH: 34" JOINT WIDTH: 1/2"

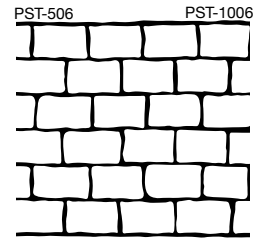

**COBBLEBRICK**  
AVERAGE BRICK SIZE: 5 1/2" X 8 1/2"  
ROLL WIDTH: 37" JOINT WIDTH: 1/2" - 3/4"

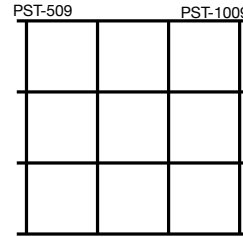

**LARGE TILE**  
TILE SIZE: 10 1/2" X 10 1/2"  
ROLL WIDTH: 33 1/2" JOINT WIDTH: 1/2"

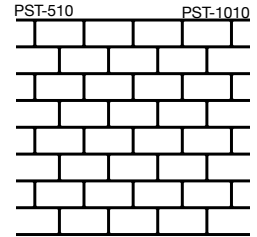

**RUNNING BOND**  
BRICK SIZE: 4" X 7 1/2"  
ROLL WIDTH: 36 1/2" JOINT WIDTH: 1/2"

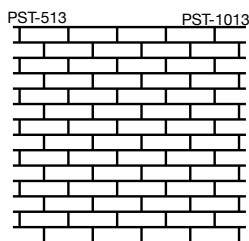

**FACE BRICK**  
BRICK SIZE: 2 3/16" X 7 7/16"  
ROLL WIDTH: 36 7/16" JOINT WIDTH: 1/16"

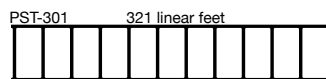

**BRICK HEADER** \*B  
BRICK SIZE: 3 7/8" X 7 3/8"  
ROLL WIDTH: 8 3/4" JOINT WIDTH: 1/2"

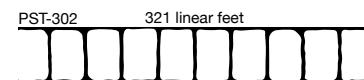

**COBBLE HEADER** \*B  
BRICK SIZE: 4 3/8" X 7 1/2"  
ROLL WIDTH: 8 3/8" JOINT WIDTH: 1/2"

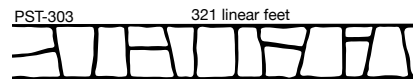

**KEystone HEADER** \*B  
STONE SIZE: RANDOM  
ROLL WIDTH: 8 1/2" JOINT WIDTH: 1/2"

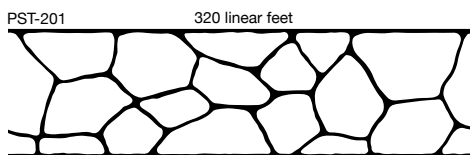

**18-INCH FLAGSTONE BORDER** \*B  
STONE SIZE: RANDOM  
ROLL WIDTH: 18" JOINT WIDTH: 1/2"



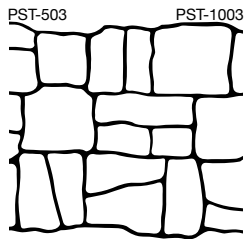

**LARGE KEYSTONE**  
LARGEST STONE SIZE: 12" X 10"  
ROLL WIDTH: 35" JOINT WIDTH: 1/2" - 1"

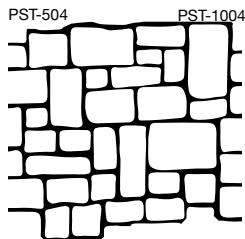

**RUSTIC ASHLAR**  
LARGEST STONE SIZE: 12" X 10"  
ROLL WIDTH: 35" JOINT WIDTH: 1/2" - 1"

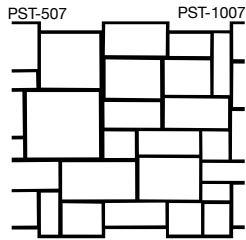

**ASHLAR TILE**  
LARGEST TILE SIZE: 12 1/2" X 11 1/2"  
ROLL WIDTH: 37" JOINT WIDTH: 1/2" - 1"

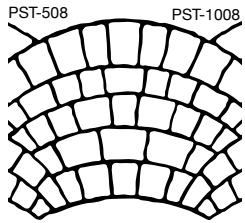

**COBBLE FAN**  
BRICK SIZE: RANDOM  
ROLL WIDTH: 34" JOINT WIDTH: 1/2" - 3/4"

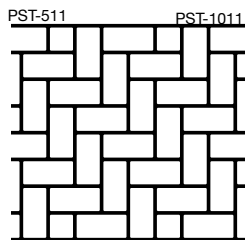

**ORIGINAL HERRINGBONE**  
BRICK SIZE: 3 1/2" X 7 1/2"  
ROLL WIDTH: 33 1/2" JOINT WIDTH: 1/2"

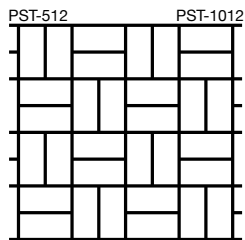

**BASKET WEAVE**  
BRICK SIZE: 3 1/2" X 7 1/2"  
ROLL WIDTH: 33 1/2" JOINT WIDTH: 1/2"

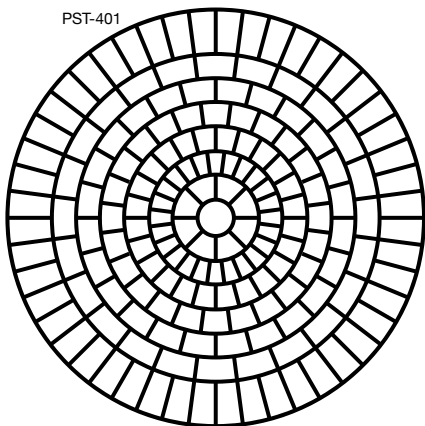

**LARGE BRICK ROSETTE**  
DIAMETER: 7' 2"  
JOINT WIDTH: 1/2" \*H

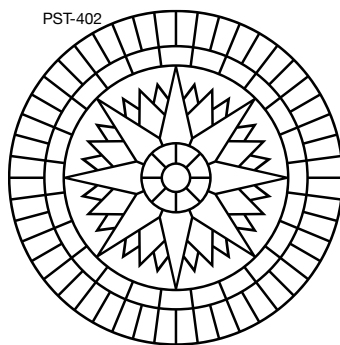

**COMPASS**  
DIAMETER: 5' 5" JOINT WIDTH: 1/2"  
DETACHABLE LETTERS INCLUDED (N, S, E, W) \*H

BRICKFORM Paper Stencil patterns are available in both 500 square foot rolls and 1000 square foot rolls.

\*Excluding Headers (H) and Borders (B)

# Imprint Texture Mats (Made-to-Order )

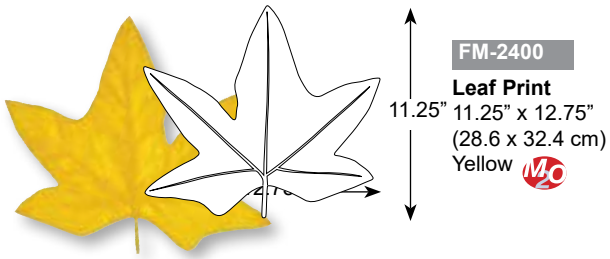

**FM-2400**



**Leaf Print**  
11.25" x 12.75"  
(28.6 x 32.4 cm)  
Yellow 

Also Available: 

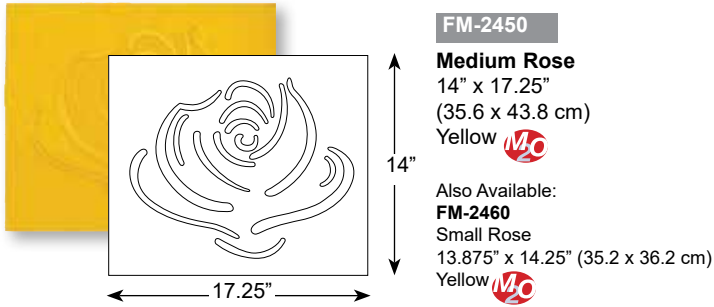
**FM-2410**, Leaf Print 2, 9.375" x 9.5", Yellow  
**FM-2420**, Leaf Print 3, 7.625" x 7.625", Yellow  
**FM-2430**, Leaf Print 4, 6.1875" x 6.75", Yellow  
**FM-2440**, Leaf Print 5, 5.625" x 9.5", Yellow



**FM-2450**

**Medium Rose**  
14" x 17.25"  
(35.6 x 43.8 cm)  
Yellow   
Also Available:  
**FM-2460**  
Small Rose  
13.875" x 14.25" (35.2 x 36.2 cm)  
Yellow 

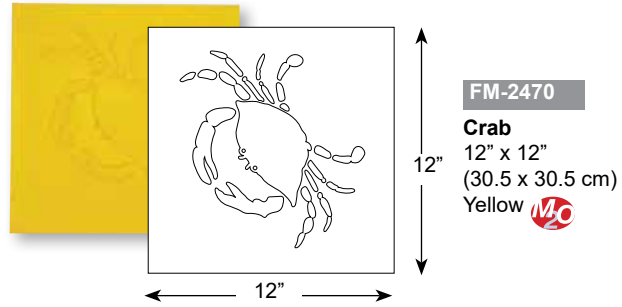

**FM-2470**

**Crab**  
12" x 12"  
(30.5 x 30.5 cm)  
Yellow 

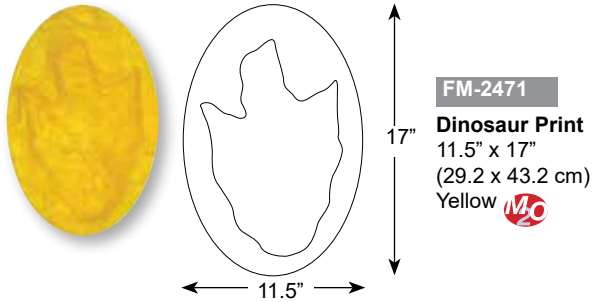

**FM-2471**

**Dinosaur Print**  
11.5" x 17"  
(29.2 x 43.2 cm)  
Yellow 

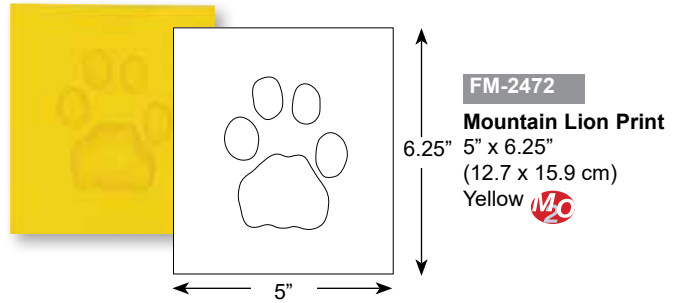

**FM-2472**

**Mountain Lion Print**  
5" x 6.25"  
(12.7 x 15.9 cm)  
Yellow 

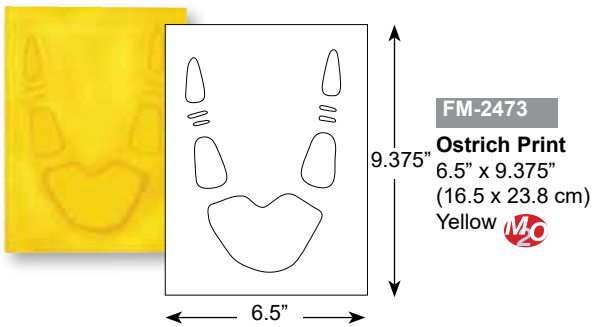

**FM-2473**

**Ostrich Print**  
6.5" x 9.375"  
(16.5 x 23.8 cm)  
Yellow 

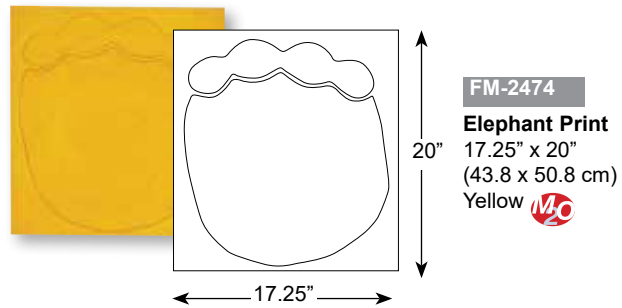

**FM-2474**

**Elephant Print**  
17.25" x 20"  
(43.8 x 50.8 cm)  
Yellow 

ABCDEFGHIJKLMNOPQRSTUVWXYZ1234567890-+

Also Available: 

**FM-6000**, Letter Stamp Small, 1.75" x 1.125"  
**FM-6010**, Letter Stamp Large, 3" x 3.875"  
**FM-6020**, Number Stamp Small, 1.75" x 1.125"  
**FM-6030**, Number Stamp Large, 3" x 3.785"

## Texturing Accessories

Available for your finishing needs, BRICKFORM has all the texturing accessories to complement the full-line of texture mats.

### BRICKFORM Touch-up Wheels

BRICKFORM Touch-up Wheels are part of the BRICKFORM Texture Mat System and are designed to help installers create clean, crisp grout lines. These wheels are versatile and lightweight, making them easy to use, even in the tightest areas. BRICKFORM Touch-up Wheels are available in seven styles to compliment the full range of BRICKFORM Texture Mats.

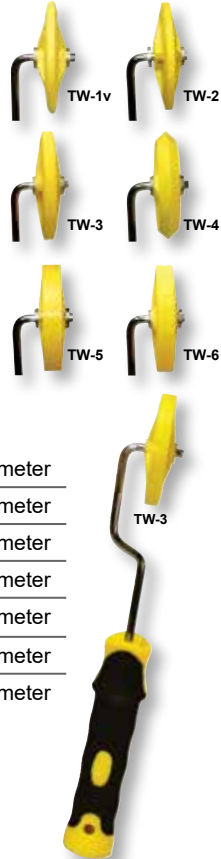

<b>TW-1</b>	FM-6510	1/4" Round Joint	2" Diameter
<b>TW-2</b>	FM-6520	3/16" Flat Joint	2" Diameter
<b>TW-3</b>	FM-6530	3/8" Flat Joint	2" Diameter
<b>TW-4</b>	FM-6540	3/8" Sanded Joint	2" Diameter
<b>TW-5</b>	FM-6550	1/2" Wedge Joint	2" Diameter
<b>TW-6</b>	FM-6560	1/2" Flat Joint	2" Diameter
<b>TW-7</b>	FM-6570	1/2" Sanded Joint	2" Diameter

### BRICKFORM Pounders

Find the pounder that is right for you and your job. The redesigned aluminum-handle pounder is ready to use right out of the box, with an internal spring system that absorbs shock, reducing the transfer to your hands. Increased side impact/miss strike recovery keeps the energy moving down, instead of off-center. Of course, you can't forget about the popular Original BRICKFORM Pounder that has a rigid head and fixed placed handle. Two great pounders to achieve optimum detail on the concrete surface.

<b>A.</b>	FP-100	Fiberglass Handle	10" x 10"	19 Lbs.
<b>B.</b>	FP-200	Fiberglass Handle	12" x 12"	20 Lbs.
<b>C.</b>	FP-300	Fiberglass Handle	15" x 15"	23 Lbs.
<b>D.</b>	FP-400	Aluminum Handle	12" x 12"	15 Lbs.
<b>E.</b>	FP-500	Aluminum Handle	15" x 15"	18 Lbs.



### BRICKFORM Aluminum Chisels

BRICKFORM Aluminum Chisels are lightweight, easy to handle and designed with the concrete finisher in mind. Cut control joints in wet concrete, create your own pattern or touch-up grout lines with ease. BRICKFORM Aluminum Chisels are available in seven different sizes to fit your needs.

<b>A.</b>	A-700	18" Chisel
<b>B.</b>	A-705	12" Chisel
<b>C.</b>	A-800	8" Chisel
<b>D.</b>	A-803	4" Chisel
<b>E.</b>	A-804	3" Chisel
<b>F.</b>	A-805	1 1/2" Chisel



### BRICKFORM Grouting Tools

BRICKFORM Grouting Tools create a sanded grout line. Use the rigid tool for straight lines and the flexible tool for curved or wavy grout lines.

<b>A.</b>	FM-6310	Rigid	3/8" x 8"
<b>B.</b>	FM-6300	Flexible	3/8" x 8"

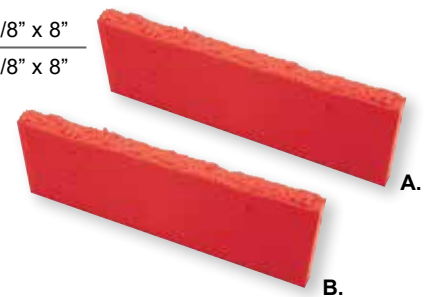

### Design Tape

- Create the patterns that mimic stone, tile or slate
- Will not disintegrate, shed fiber hairs or cause grout bleeds
- No glue residue
- Replicates most patterned surface affordably
- Strong and versatile
- Eliminates the need for chalk lines
- 180 feet per roll



LDT90	1/4" Grout Line Design Tape (36/ tube 144/ case)
LDT91	1/2" Grout Line Design Tape (18/ tube 48/ case)
LDT92	3/4" Grout Line Design Tape (12/ tube 48/ case)
LBT95	1/2" Brick Design Tape (18/ tube 72/ case)

# BRICKFORM Color Hardener

## Concrete Colorant and Hardener

BRICKFORM Color Hardener is manufactured with the finest UV-resistant pigments and premium aggregates. BRICKFORM Color Hardener is designed to work with imprinting tools to produce clear, sharp impressions that enhance the finished appearance of any hardscape. When properly applied and troweled into newly placed, fresh concrete, it forms a colored concrete surface that is resistant to weathering, wear and normal abrasion. Color Hardener HD (Heavy Duty) also available.



- Non-fading
- Denser, more durable surface
- Improves abrasion resistance
- Can be antiqued and stained
- 42 standard colors
- Custom colors available
- Compatible with Stampable Overlay OL-60

CH- 42 Standard Colors (Including black and white) 5 Gallon Bucket

- Custom Colors and Color Matching Available

*\* Use Day1 as a troweling aid, densifier and curing agent. See pg 75.*

*\* Liquid Release is a colorless bond-breaker. See pg 76.*

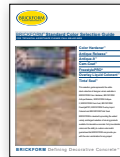

**Color chart located after page 74**



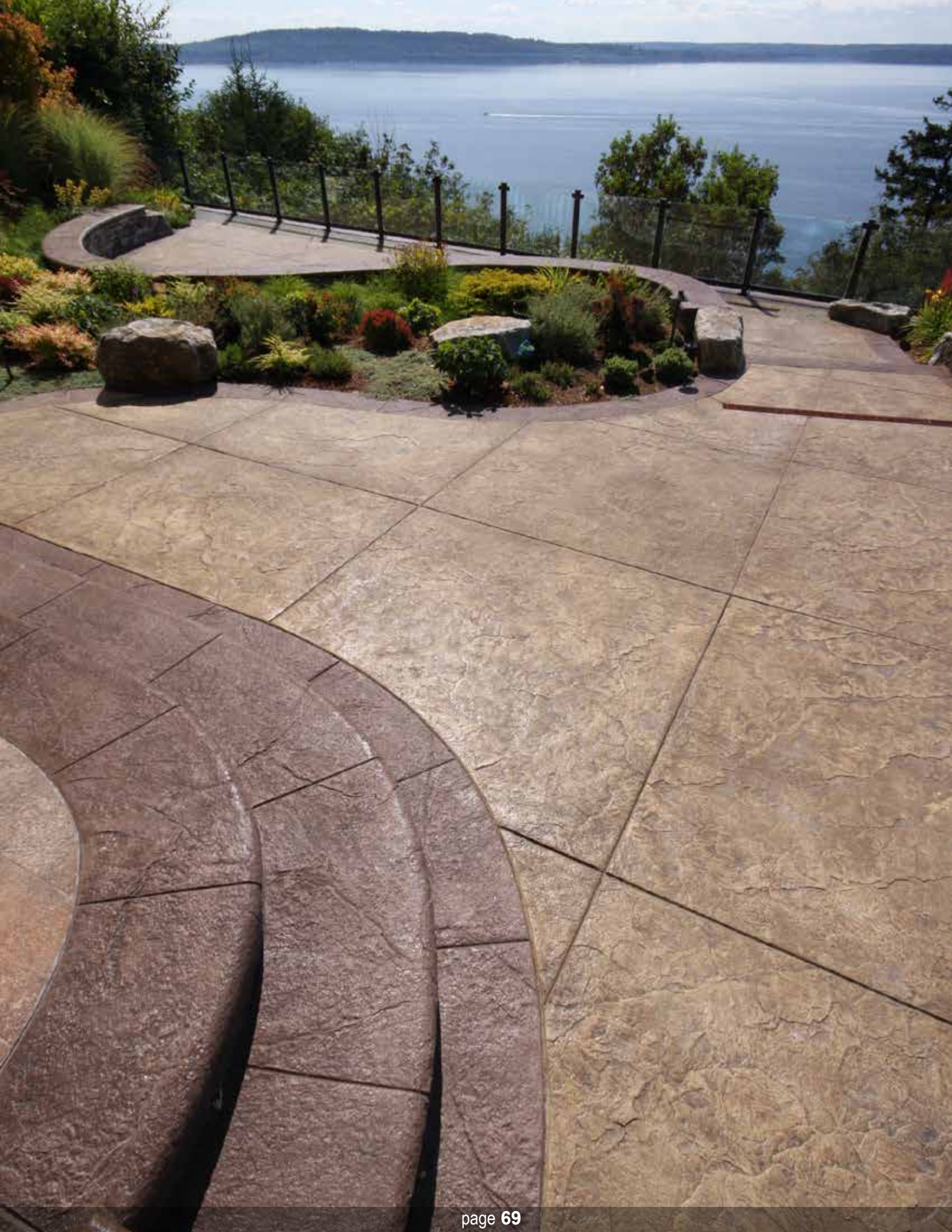



## BRICKFORM Antique Release

Colored Bond-Breaker

BRICKFORM Antique Release imparts a second color while serving as a bond breaker for stamping. It is made from a finely ground formula that creates beautifully antiqued and textured concrete surfaces. Antique Release is available in 42 standard colors to match or contrast with BRICKFORM Color Hardener. Custom colors and color matching are also available.



- Prevents concrete buildup
- Prolongs tool life
- Fade-resistant
- Unlimited effects and color combinations
- 42 standard colors
- Custom colors available

RA- 42 Standard Colors  
(Including black and white)

5 Gallon Bucket

- Custom Colors and Color Matching Available



**Color chart  
located after  
page 74**



## BRICKFORM FreestylePRO Stain

Penetrating Water-Based Stain

BRICKFORM FreestylePRO is a revolutionary concrete stain that penetrates and bonds with concrete surfaces in a way that no other coloring product can. This water-based, opaque stain is excellent for restoring or changing colors on previously colored surfaces and rejuvenating old, discolored concrete. BRICKFORM FreestylePRO allows you to create totally new color styles for your decorative concrete work in an environmentally sound, versatile and user-friendly way.

- Water-based stain that is environmentally friendly
- Penetrating bond with the concrete surface
- Excellent for changing colors, or rejuvenating old, discolored concrete
- No sealer required



FF-	Solid-Color Kit
FB-800	8" Applicator Brush
FB-1000	10" Applicator Brush
FB-1800	18" Applicator Brush

 Made-to-Order



*Color chart located after page 74*

## BRICKFORM FreestylePRO Highlighter

Antiquing agent for Freestyle Solid Color Stain

BRICKFORM FreestylePRO Highlighter Stains are designed for use over BRICKFORM FreestylePRO Solid-Color Stain as a contrasting color to create an antiqued look on textured concrete surfaces. BRICKFORM FreestylePRO Highlighter Kits can also be used to add contrast or additional colors to areas of relief on textured concrete or to create the look of faux finishes.

- Transparent color
- Water-based stain that is environmentally friendly
- Penetrating bond with the concrete surface
- No sealer required



FE- Highlighter Kit

 Made-to-Order



*Color chart located after page 74*







**BRICKFORM Cem-Coat** Made-to-Order   
Colored Cementitious Coating

Restore, refresh, or redo with Brickform Cem-Coat. Use Cem-Coat to color smooth and lightly textured concrete surfaces. Correct color mistakes, restore faded or damaged color, and add fresh color to old and new slabs alike. Use an airless sprayer for vertical applications. When applied in thin coats, Cem-Coat will provide brilliant color that will stand the test of time. Cem-Coat is a vital tool for decorative and colored concrete restoration.

Cem-Coat is a richly colored, opaque cementitious paint-like product that can be applied to any cementitious surface. Cem-Coat can be stained and antiqued using Brickform Antique-It. It is UV-resistant and resistant to fungus and mildew, making it great for outdoor applications. Cem-Coat is available in all of the Brickform Standard Colors. Custom color matching is available.

For more heavily texture surfaces, consider using Brickform Freestyle Pro.

- Richly pigmented colors
- UV-resistant
- Use to antique, marbleize, and faux paint
- Suitable for all cementitious surfaces

CC-	42 Standard Colors	1 Gallon Kit
CC4-	42 Standard Colors (Including black and white)	4 Gallon Kit

- Custom Colors and Color Matching Available



**Color chart located after page 74**

# BRICKFORM Antique-It

## Antiquing Agent

Antique and highlight without the dust. Brickform Antique-It is a fast and easy way to antique stamped and textured concrete. Use Antique-It to rejuvenate a tired old stamped concrete job that has lost its antiquing. When stamping with liquid release, use Antique-It for the appearance of a traditional powdered release agent.

Antique-It is a water soluble antiquing agent designed to impart a secondary color for an antiquing or mottling effect. It is easy to apply and fast drying, applied using a pump-up sprayer or brush. Antique it can be used over integral color, Color Hardeners, Stampable Overlays, and Brickform Cem-Coat. Antique-It is available in all of the Brickform Standard Colors with custom color matching available.

- Easy application
- Unlimited effects and color combinations
- 42 standard colors
- Custom colors available

AN- 42 Standard Colors 3 lb container  
• Custom Colors and Color Matching Available



## DAY1

### Colloidal Silica Technology

**Day1 is available in concentrate and Ready-To-Use formulas. In the new green labels, the Ready-To-Use formula is the quick and convenient way to apply Day1. The standard concentrate formula, in the red label, is a 4:1 concentrate, easy to store and ship.**

Save a slab with Day1, a reactive finishing aid that will not increase the water cement ratio. Will extend workable time under adverse conditions such as high wind, heat, or low humidity. Day1 eliminates the need to add water during finishing, which can be detrimental to surface performance. Highly effective when used to help finish shake-on hardeners in low bleedwater environments and when finishing high performance concrete. Day1 is an insurance policy that can breathe life back into unworkable concrete and save a slab.

Day1, applied when finishing concrete, provides a number of benefits starting with hardening and densification during the early placement stages. By nature of the colloidal silica chemistry, Day1 will reduce the potential for checking, crazing, scaling and dusting. This technology decreases the Moisture Vapor Emissions Rate which in turn decreases Alkali Silica Reaction. This also reduces efflorescence in colored and uncolored concrete, revealing more of a true finished color.

- Day1 will save a slab
- Aids application of shake on hardeners in low bleed water environments
- Reduces efflorescence on both colored & standard concrete
- Extends workability time under adverse conditions
- Reduces Moisture Vapor Emissions Rate (MVER)
- Designed for hot, dry, and windy conditions
- Hardening & densification during troweling
- Available in RTU and concentrate formulas
- Helps finish high performance concretes
- Minimizes checking, crazing & scaling
- Decreases alkali silica reaction - \*(ASR)
- Reduces potential for slab curling
- Reducing operator fatigue and trowel wear

LY-1001	1 Gallon Concentrate
LY4-1001	Case of four 1 Gallon Concentrate
LY-1005	5 Gallon Concentrate
LY4-1001RTU	Case of four 1 Gallon Ready-to-Use
LY-1005RTU	5 Gallon Ready-to-Use



## Liquid Release

### Colorless Bond-Breaker for Stamping

BRICKFORM Liquid Release is a colorless bond-breaker, formulated and recommended for use with all BRICKFORM Texture Mats and with many other architectural concrete texturing systems. BRICKFORM Liquid Release forms a lubricating barrier that prolongs the life of the imprinting tools by decreasing the friction between the mats and the concrete.

BRICKFORM Liquid Release is used in the texturing process of both colored and uncolored concrete. It is also used as an alternative to powdered release agents that may not be desirable in certain circumstances, such as interior projects. BRICKFORM Liquid Release should be considered for use on projects that are to be textured but colored later, with BRICKFORM Antique-It, Cem-Coat or Blush-Tone Acid Stain, after the concrete has cured.

- Prevents mats sticking to concrete
- Easy-to-apply liquid
- Prolongs tool life
- Interior/exterior use
- Apply with sprayer
- Solvent-based



- LR-1 1 Gallon Can
- LR4-1 Case of four 1 Gallon Cans
- LR-5 5 Gallon Can





## Surface Deactivator

Surface Deactivator by Solomon Colors makes exposed aggregate finishes easier and more consistent. It is typically applied to freshly placed concrete to prevent cement paste hardening and achieve more controlled exposed aggregate finishes. Unlike sugar-based retarders with uncertain levels of retardation, Surface Deactivator selectively halts the hydration process down to a controlled depth. Ten predetermined depths of exposure are available, color-coded for identification, to provide consistent, repeatable cement paste removal and aggregate reveal.

Surface Deactivator can also be applied to newly-placed concrete that is specified for diamond polishing. It softens surface cement paste, reducing heavy grinding stages up to 75%.

- SSD02-1..... Acid Etch Purple 0.2 mm, 1 gal
- SSD02-4..... Acid Etch Purple 0.2 mm, 1 case of 4
- SSD02-5..... Acid Etch Purple 0.2 mm, 5 gal
- SSD05-1..... Light Sandblast Blue 0.5 mm, 1 gal
- SSD05-4..... Light Sandblast Blue 0.5 mm, 1 case of 4
- SSD05-5..... Light Sandblast Blue 0.5 mm, 5 gal
- SSD10-1..... Medium Sandblast Brown 1 mm, 1 gal
- SSD10-4..... Medium Sandblast Brown 1 mm, 1 case of 4
- SSD10-5..... Medium Sandblast Brown 1 mm, 5 gal
- SSD20-1..... Heavy Sandblast Green 2 mm, 1 gal
- SSD20-4..... Heavy Sandblast Green 2 mm, 1 case of 4
- SSD20-5..... Heavy Sandblast Green 2 mm, 5 gal
- SSD25-1..... Exposure Yellow 2.5 mm, 1 gal
- SSD25-4..... Exposure Yellow 2.5 mm, 1 case of 4
- SSD25-5..... Exposure Yellow 2.5 mm, 5 gal
- SSD30-1..... Exposure Red 3 mm, 1 gal
- SSD30-4..... Exposure Red 3 mm, 1 case of 4
- SSD30-5..... Exposure Red 3 mm, 5 gal
- SSD40-1..... Exposure Gray 4 mm, 1 gal
- SSD40-4..... Exposure Gray 4 mm, 1 case of 4
- SSD40-5..... Exposure Gray 4 mm, 5 gal
- SSD50-1..... Exposure Mustard 5 mm, 1 gal
- SSD50-4..... Exposure Mustard 5 mm, 1 case of 4
- SSD50-5..... Exposure Mustard 5 mm, 5 gal
- SSD55-1..... Exposure White 5.5 mm, 1 gal
- SSD55-4..... Exposure White 5.5 mm, 1 case of 4
- SSD55-5..... Exposure White 5.5 mm, 5 gal
- SSD65-1..... Exposure Orange 6.5 mm, 1 gal
- SSD65-4..... Exposure Orange 6.5 mm, 1 case of 4
- SSD65-5..... Exposure Orange 6.5 mm, 5 gal

Product #	Color Code	Exposure Depth
SSD02	Purple	Acid Etch (0.2mm)
SSD05	Blue	Light Sandblast (1/64") (0.5mm)
SSD10	Brown	Medium Sandblast (1/32") (1mm)
SSD20	Green	Heavy Sandblast (1/16") (2mm)
SSD25	Yellow	Exposure (3/32") (2.5mm)
SSD30	Red	Exposure (7/64") (3mm)
SSD40	Gray	Exposure (5/32") (4mm)
SSD50	Mustard	Exposure (3/16") (5mm)
SSD55	White	Exposure (13/64") (5.5mm)
SSD65	Orange	Exposure (1/4") (6.5mm)

# Integral Color



## BRICKFORM Liquid Integral Color (Color based on 6-sack mix)

BRICKFORM Liquid Color is made from the finest UV-resistant pigments available. BRICKFORM Liquid Color is produced to a one-percent tolerance to established plant standards and also complies with ASTM C979, Pigments for Integrally Colored Concrete. BRICKFORM Liquid Color is designed to suspend and disperse the iron oxide pigments evenly. BRICKFORM Liquid Color is available in standard and designer colors. Custom colors and color matching are also available.



- Dust-free
- UV-resistant color
- Mixes evenly
- Meets ASTM C979



 Made-to-Order

LC-

24 Standard Colors

1 Cubic Yard

*\* Use Day1 as a troweling aid, densifier and curing agent. See pg 75.*

*\* Surface Deactivator makes exposed aggregate finishes easier and more consistent. See pg 77.*



## BRICKFORM Powdered Integral Color

BRICKFORM Powdered Color is a powdered-based pigment designed to color the cement paste in a concrete mixture. Powdered Color can be used for cast-in-place, pre-cast, and tilt-up, concrete block, pavers, and textured concrete. BRICKFORM Powdered Color is available in 25 standard colors. BRICKFORM Powdered Color is pre-packaged in a two-part system designed to reduce leaks and spills.

\* High volume orders may require bulk packaging

- Dissolvable interior plastic bag
- UV-resistant
- Mixes evenly
- Meets ASTM C979



Premium pricing applies to green Powdered Integral Colors.

**\* Use Day 1 as a troweling aid, densifier and curing agent. See pg 71.**

**\* Surface Deactivator makes exposed aggregate finishes easier and more consistent. See pg 77.**

## Solomon Ready Mix (Integral) Color

Solomon Colors offers unparalleled consistency, accuracy, dependability and customization. Our products are easy to use, stay consistent from batch to batch and provide lasting beauty to any colored concrete project. Whether you choose Color-Flo® liquid or dry integral color, you can count on Solomon Colors to offer top quality pigments backed by our unmatched customer service.



PC	25 Standard Colors	10# Bag
SOL	Integral Color	6.25# Bag
color no		25# Bag



## Tinta' Seal™ Color tint pack additive for solvent-based sealers

Tinta' Seal can enhance and correct the color of existing cementitious surfaces such as integral color concrete, stamped concrete, overlays or plain concrete. The BRICKFORM Tinta' Seal tint packs are designed to be used with any of our solvent base sealers including Gem Cure & Seal. It is packaged in a 16 oz can that is mixed onsite with a 5-gallon pail of either Gem-Seal, Poly-Seal or Gem Cure & Seal.



**Color chart located after page 74**



TAS-(color name)

Tinta' Seal, 16 Ounce



## Brickform Blush-Tone Acid Stain

BRICKFORM Blush-Tone Acid Stain lets you create colors with real depth that are unique and captivating. Thousands of different looks can be achieved, ranging from the understated elegance of burnished leather to the ageless beauty of natural stone. Blush-Tone Acid Stain will open the door to a whole new palette of creative expression.



JADE  
CS-100



EBONY  
CS-600



TURQUOISE  
CS-200

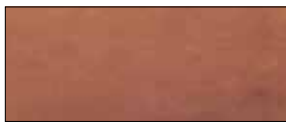

MISSION BROWN  
CS-700



COFFEE  
CS-300



AMBER  
CS-800



CARAMEL  
CS-400



OLIVE  
CS-900



MAHOGANY  
CS-500



WALNUT  
CS-1000

## BRICKFORM Blush-Tone Acid Stain Chemical Stain for Concrete

BRICKFORM Blush-Tone Acid Stain reacts with minerals that exist in newly cured or existing concrete. It penetrates the very top layer of the concrete surface with color that will not chip, crack, or peel. The colors produced in each section of concrete will be unique with captivating, multi-colored intensities that become a permanent part of the concrete. BRICKFORM Blush-Tone Acid Stain is available in 10 standard colors.



- Penetrating chemical stain
- Variegated color
- Will not chip, crack, or peel
- Use on floors and walls

CS- 10 Standard Colors 1 Gallon Bottle

CS4- 10 Standard Colors Case of four 1 Gallon Bottles

*\* Neutra Clean is a cleaning and neutralizing agent engineered for use on acid and reactive stained floors prior to sealing and to remove light oil, grease or other types of soils from colored, imprinted and natural concrete surfaces. See pg 90.*

**Disclaimer** - When choosing colors, use the appropriate BRICKFORM color selection guide for more accurate matching. Colors shown here display only the range of BRICKFORM options available. To confirm an exact color, have your contractor prepare a color sample for your approval before actual construction. BRICKFORM accepts no responsibility for color matching or misprints.







## Brickform E-Stain

BRICKFORM E-Stain is a water-based formulation containing reactive mineral compounds and proprietary admixtures. BRICKFORM E-Stain contains no hydrochloric acid, making it more environmentally friendly. BRICKFORM E-Stain is ideally suited for use in the Micro-Topping, SM Professional Grade, Stampable Overlay, and cast-in-place concrete.

## BRICKFORM E-Stain

Reactive Stain for Concrete

BRICKFORM E-Stains are penetrating, reactive stains that produce unique color effects in finished cementitious surfaces, simulating the natural shadings and aged appearance of stone or masonry. The color effect is unique to each stained surface and cannot be duplicated with other materials. Brickform E-Stain chemically reacts within the concrete substrate, slightly etching the concrete surface to provide deeper and more permanent color.

The color intensity of the stain can be reduced by blending the stain with E-Stain Plus. Special colors can be produced by blending two or more colors together.



EVERGREEN  
ES-100



SUNSET  
ES-500



BLUE DI MARE  
ES-200



EBONY  
ES-600



MOSS  
ES-300

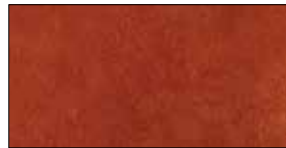

SADDLE  
ES-700



BRONZE  
ES-400



RUSTY BROWN  
ES-800



- Eco-friendly reactive stain
- Acid-like characteristics without the harmful acid effects
- All colors (except EBONY) are Sodium Dichromate-free (a known carcinogen)
- No harmful fumes
- D.O.T. non-hazardous shipping certified stain

ES-	8 Standard Colors	1 Gallon Bottle
ES4-	8 Standard Colors	Case of four 1 Gallon Bottles
ES-1100	E-Stain Plus	1 Gallon Bottle

**Disclaimer** - When choosing colors, use the appropriate BRICKFORM color selection guide for more accurate matching. Colors shown here display only the range of BRICKFORM options available. To confirm an exact color, have your contractor prepare a color sample for your approval before actual construction. BRICKFORM accepts no responsibility for color matching or misprints.





## Brickform ARTesian Stain

ARTesian stains are penetrating, water-based stains that produce unique color effects in finished cementitious surfaces, simulating the natural shadings and aged appearance of stone or masonry. ARTesian Stain may be applied over smooth troweled or textured concrete, cement-based overlays, vertical or horizontal concrete and masonry surfaces, artificial rock displays, water features and themed finishes.

\*Top left stain applied to gray concrete with a smooth finish, bottom right applied to gray concrete with a broom finish.



CAJUN RED AS-300



BURLAP AS-100



CAMELBACK AS-200



CHESTNUT AS-400



OLYMPIC BRONZE AS-500



EBONY AS-600



SCARLET AS-700



HARVEST GOLD AS-800



DEEP SEA AS-900



AGED WALNUT AS-1000



GREENBELT AS-1100

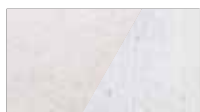

SANDBANK AS-1200



SALMON AS-1300



TIGEREYE AS-1600



DRIED THYME AS-1700



CAPRI AS-1800



AUTUMN AS-1900

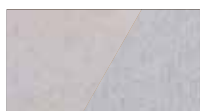

PEWTER AS-2000



MAGNET, AS-2100



METALLICA, AS-2200

## BRICKFORM ARTesian Stain

### Penetrating, Water-Based Stain

The color effect is unique to each stained surface and cannot be duplicated with other materials. ARTesian Stain contains no acids or harmful chemicals and works as an alternative to typical reactive acid stains. There are no acids or harmful chemicals integrated in its design.



- Zero VOC
- Water-based
- Interior/exterior use
- Apply with sprayer
- Must be sealed with solvent-based sealer (i.e. Gem-Seal)

AS- 20 Standard Colors 1 Gallon Bottle  
 AS4- 20 Standard Colors Case of four 1 Gallon Bottles

**Disclaimer** - When choosing colors, use the appropriate BRICKFORM color selection guide for more accurate matching. Colors shown here display only the range of BRICKFORM options available. To confirm an exact color, have your contractor prepare a color sample for your approval before actual construction. BRICKFORM accepts no responsibility for color matching or misprints.

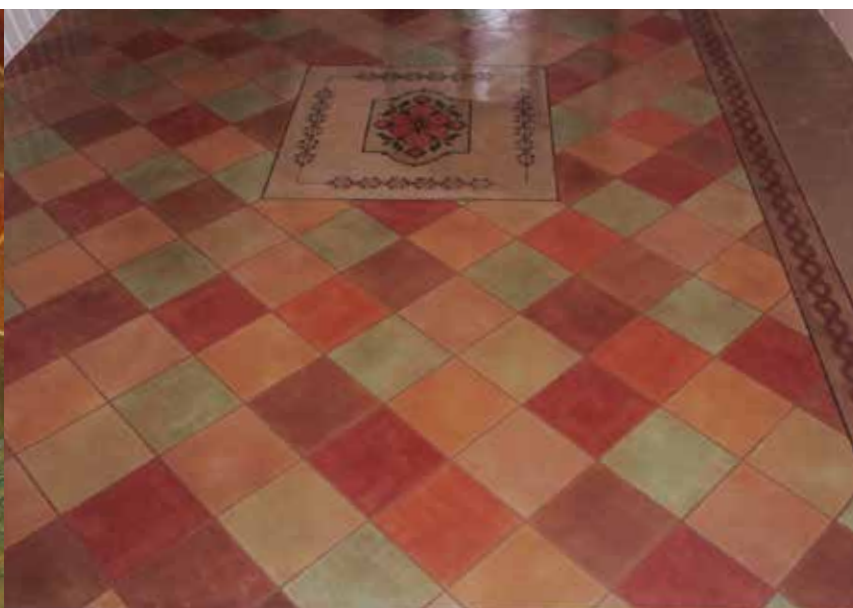



# LYTHIC POLISHING PRODUCTS



## Lythic Products



Lythic Protector



Lythic SPD Protector



Lythic Cleaner



Densifier & XL Concentrate



Densifier & XL RTU



By popular demand, Densifier and XL Densifier are available in concentrate and Ready-To-Use formulas. In the new green labels, the RTU formula is the quick and convenient way to apply Densifier and XL Densifier. The standard concentrate formula, in the red label, is a 4:1 concentrate, easy to store and ship.

Lythic began with the discovery of reactive Colloidal Silica as a new way to add strength and durability to concrete floors, by two veterans of concrete polishing in 2004. Intimately familiar with the advantages of exposed concrete floors, both polished and unpolished, they were also acutely aware of the drawbacks of the existing chemistry available. They recognized the benefits of this advance in concrete densification chemistry as they used it for their own projects. From this direct experience new products and processes were developed and have expanded possibilities for concrete floor finishes. Lythic is unique in providing expertise in product and processes that are advancing concrete flooring beyond the costs, risks, and limitations of polished concrete floors.

Lythic offers a comprehensive line of densifiers, Protectors, and Cleaners for polished concrete floors. For more information, reference the **Lythic catalog** or visit [www.lythic.com](http://www.lythic.com)



**Pro-Dye PLUS Standard Colors on smooth troweled concrete**

Swatches shown here represent Pro-Dye PLUS mixed with **acetone** (left) and **water** (right).

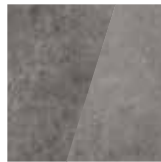

GRAY  
DSL-8010



SEPIA  
DSL-5010



JADE  
DSL-110



TURQUOISE  
DSL-210



COFFEE  
DSL-310



CARAMEL  
DSL-410



DEEP CARAMEL  
DSL-2510



SAND  
DSL-2710



TERRA COTTA  
DSL-3010



BURNT SIENNA  
DSL-4210



MAHOGANY  
DSL-510



EBONY  
DSL-610



MISSION BROWN  
DSL-710



AMBER  
DSL-810

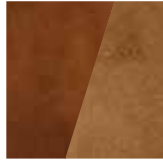

CHOCOLATE BROWN,  
DSL-3510



SADDLE BROWN  
DSL-3710



DEEP WALNUT  
DSL-4010



BLACK  
DSL-7210



OLIVE  
DSL-910



WALNUT  
DSL-1010



GOLD  
DSL-2010



RAW SIENNA  
DSL-2210



CHESTNUT  
DSL-4510



FOREST GREEN  
DSL-6710



PATRIOT BLUE  
DSL-5510



MIDNIGHT BLACK  
DSL-7010

**Polishing Systems**

The Lythic Polishing System is a simple, cost effective and environmentally friendly line of products designed to enhance, protect and beautify existing concrete floors with concrete polishing.

**Brickform Pro-Dye PLUS Penetrating Stain for Concrete**

BRICKFORM Pro-Dye PLUS has been reformulated to a liquid form and is now easier to use than before. Pro-Dye PLUS is available in the same 25 standard colors and produces the same beautiful results. Pro-Dye PLUS penetrates the surface of concrete, creating a layer of translucent color that dries quickly and will not chip, crack, or peel. Pro-Dye PLUS is packaged in liquid form to be mixed in proportion with acetone or water. Pro-Dye PLUS is designed to work with the *Lythic Polishing System* for the coloring process in polishing floors. Pro-Dye PLUS mixed with acetone is also excellent in vertical applications, stencils, and logos because it dries quickly. Pro-Dye PLUS colors are vivid with unique multi-colored intensities, similar to the mottling effect of acid stain. Colors can be combined to create an unlimited number of color variations.

DSL-

- Interior use only
- Easy to spray apply
- Dries quickly (acetone)
- Use any BRICKFORM spray-on sealer



**Disclaimer** - When choosing colors, use the appropriate BRICKFORM color selection guide for more accurate matching. Colors shown here display only the range of BRICKFORM options available. To confirm an exact color, have your contractor prepare a color sample for your approval before actual construction. BRICKFORM accepts no responsibility for color matching or misprints.







**Pro-Dye PLUS Standard Colors on polished concrete**

Swatches shown here represent Pro-Dye PLUS mixed with **acetone** (left) and **water** (right).



GRAY  
DSL-8010



SEPIA  
DSL-5010



JADE  
DSL-110

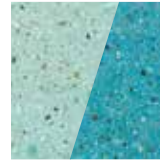

TURQUOISE  
DSL-210



COFFEE  
DSL-310



CARAMEL  
DSL-410



DEEP CARAMEL  
DSL-2510



SAND  
DSL-2710



TERRA COTTA  
DSL-3010



BURNT SIENNA  
DSL-4210



MAHOGANY  
DSL-510

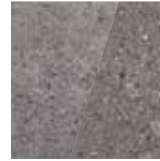

EBONY  
DSL-610



MISSION BROWN  
DSL-710

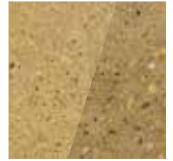

AMBER  
DSL-810



CHOCOLATE BROWN,  
DSL-3510



SADDLE BROWN  
DSL-3710

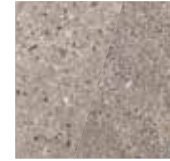

DEEP WALNUT  
DSL-4010



BLACK  
DSL-7210



OLIVE  
DSL-910



WALNUT  
DSL-1010



GOLD  
DSL-2010



RAW SIENNA  
DSL-2210



CHESTNUT  
DSL-4510



FOREST GREEN  
DSL-6710



PATRIOT BLUE  
DSL-5510



MIDNIGHT BLACK  
DSL-7010



## E-Etch

BRICKFORM E-Etch is an environmentally friendly industrial strength floor cleaner, degreaser and light etching product. It is ideal for cleaning and preparing cementitious surfaces for acid staining, decorative overlays, water-based stains, and coatings applications. It may also be used on concrete, stucco, terrazzo and most masonry surfaces to open up the pores on the surface and clean grime, dirt, grease, scuff marks and stains. E-Etch effectively removes excess Antique Release from textured concrete and can also be used as an efflorescence remover.

- Biodegradable
- Rinse with water
- Non-hazardous
- Non-abrasive
- Non-carcinogenic
- Antique Release/efflorescence remover

ES-1200     1 Gallon Bottle  
ES4-1200    Case of four 1 Gallon Bottles



## Neutra Clean™

BRICKFORM pH neutral cleaner is a cleaning and neutralizing agent engineered for use on acid and reactive stained floors prior to sealing and to remove light oil, grease or other types of soils from colored, imprinted and natural concrete surfaces. This product combines cleaning and light degreasing without the use of petroleum solvents and effectively loosens residues from the staining process, as well as loosening release powders from stamped concrete.

NC-1     1 Gallon Bottle  
NC4-1    Case of four 1 Gallon Bottles





# Resurfacing Products

BRICKFORM resurfacing products quickly rejuvenate concrete surfaces without disruption or high cost.

## BRICKFORM Stampable Overlay Concrete Overlay

BRICKFORM Stampable Overlay "White" is a single component (add water only) blend of white cement and special materials that forms a thin, concrete coating. BRICKFORM Stampable Overlay is specially designed to work with BRICKFORM Overlay Liquid Colorant. BRICKFORM Stampable Overlay is easy to install and forms a tough, durable topping that will withstand years of wear. When used on properly prepared surfaces, BRICKFORM Stampable Overlay will permanently bond to concrete surfaces.



- Creates a new 1/4" to 1/2" surface
- Use with overlay liquid colorant
- Durable
- Use with Triple Seven Bond Coat

SC-60 60 lb. bag (White Mix)

For use with Overlay Liquid Colorant and Liquid Release only



BRICKFORM Stampable Overlay "Gray" is a premixed blend of special materials that, when mixed with water, forms a thin, concrete coating. This overlay is intended for use with Color Hardener and Antique Release.

- Creates a new 1/4" to 1/2" surface
- Can be textured & colored
- Durable
- Use with Triple Seven Bond Coat

OL-60 5 Gallon Bucket (Gray Mix)

For use with Color Hardener and Antique Release only





## BRICKFORM Micro-Topping Smooth Grade

BRICKFORM Micro-Topping is used on interior or exterior cured concrete to create a durable surface that can be colored or stained. It is available as a white or gray dry powder in smooth grade, and mixed with BRICKFORM Liquid Polymer. The smooth grade is applied over SM Professional Grade for a smooth finish when desired. The mixed materials form a thin concrete coating that can be used to restore or repair any concrete surface.

- Creates a new surface
- Can be colored & stained



MT-1500 SG	Gray Smooth	40 Lb. Bag
MT-2500 SG	White Smooth	40 Lb. Bag
MT-3000	Liquid Polymer	5 Gallon Bucket
MT-KIT	Sample Kit	





**SM Professional Grade™**  
 Rough Grade Micro-Topping  
 Sprayable Cementitious Overlay

BRICKFORM SM Professional Grade is a white, sprayable cementitious overlay that is designed to be mixed with Brickform Liquid Polymer and applied with a hopper gun. It can be integrally colored using BRICKFORM Overlay Liquid Colorant. BRICKFORM SM Professional Grade can be used to create the look of brick, stone, tile or other unique specialty finishes.

- Ease of use
- Can be integrally colored
- Can be stained
- Spray or trowel
- Water resistant



**TIP: Use design tape to create patterns that mimic stone, tile or slate. See page 67 for details.**

MT-4000	SM Pro Grade	60 Lb. Bag
MT-3000	Liquid Polymer	5 Gallon Bucket
SM-KIT	Sample Kit	





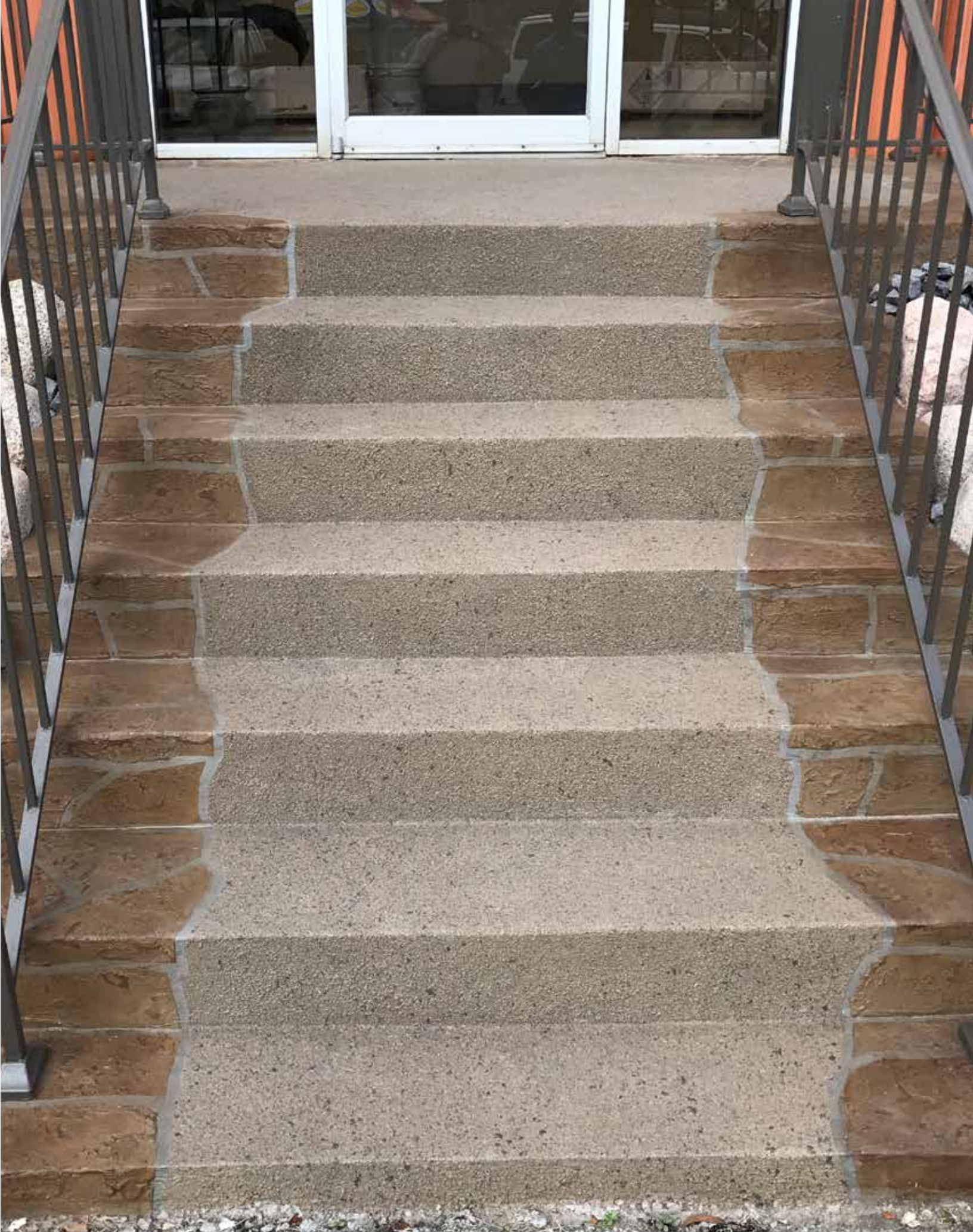

## Vertical Mix

BRICKFORM Vertical Mix is a lightweight vertical overlay mix designed for texturing vertical surfaces up to 2" and creating simulated stone, rock, tile, slate and other natural surfaces. It is composed of cement, polymers, lightweight aggregates and admixtures. It may be applied to vertical surfaces such as wood, drywall, concrete, blocks etc.

- Add-water only product
- Color with Overlay Liquid colorant or stain
- Easily textured by carving and stamping

**VM-1000, Vertical Mix**, 45 lb. bag



## Rock Fall, VM-125

27.75" x 12" (70.49 x 30.48 cm), Pattern: A, B and C

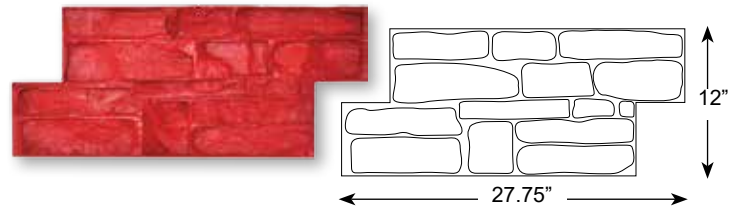

## Dry Stack, VM-100

27.75" x 12" (70.49 x 30.48 cm), Pattern: A, B and C

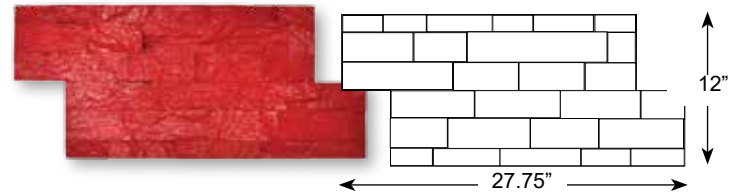

## Pebble Skin, VM-1075 A or B

16" x 16" (40.64 x 40.64 cm)

**Pebble Skin Roller, VM-2075, 8.5"**

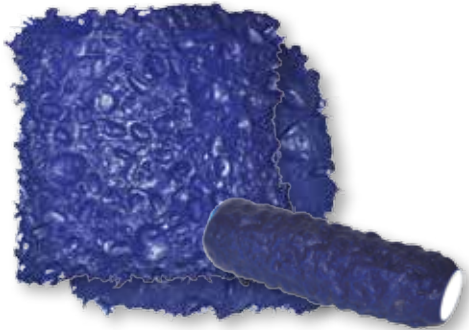

## Rough Stone Skin, VM-1025 A or B

16" x 16" (40.64 x 40.64 cm)

**Rough Stone Skin Roller, VM-2025, 8.5"**

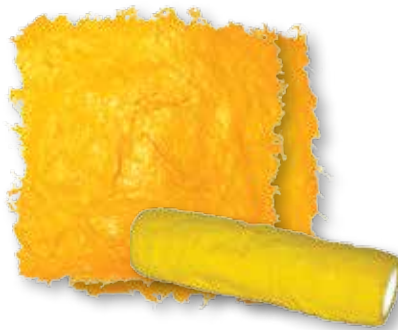

## Intensity Skin, VM-1050 A or B

16" x 16" (40.64 x 40.64 cm)

**Intensity Skin Roller, VM-2050, 8.5"**



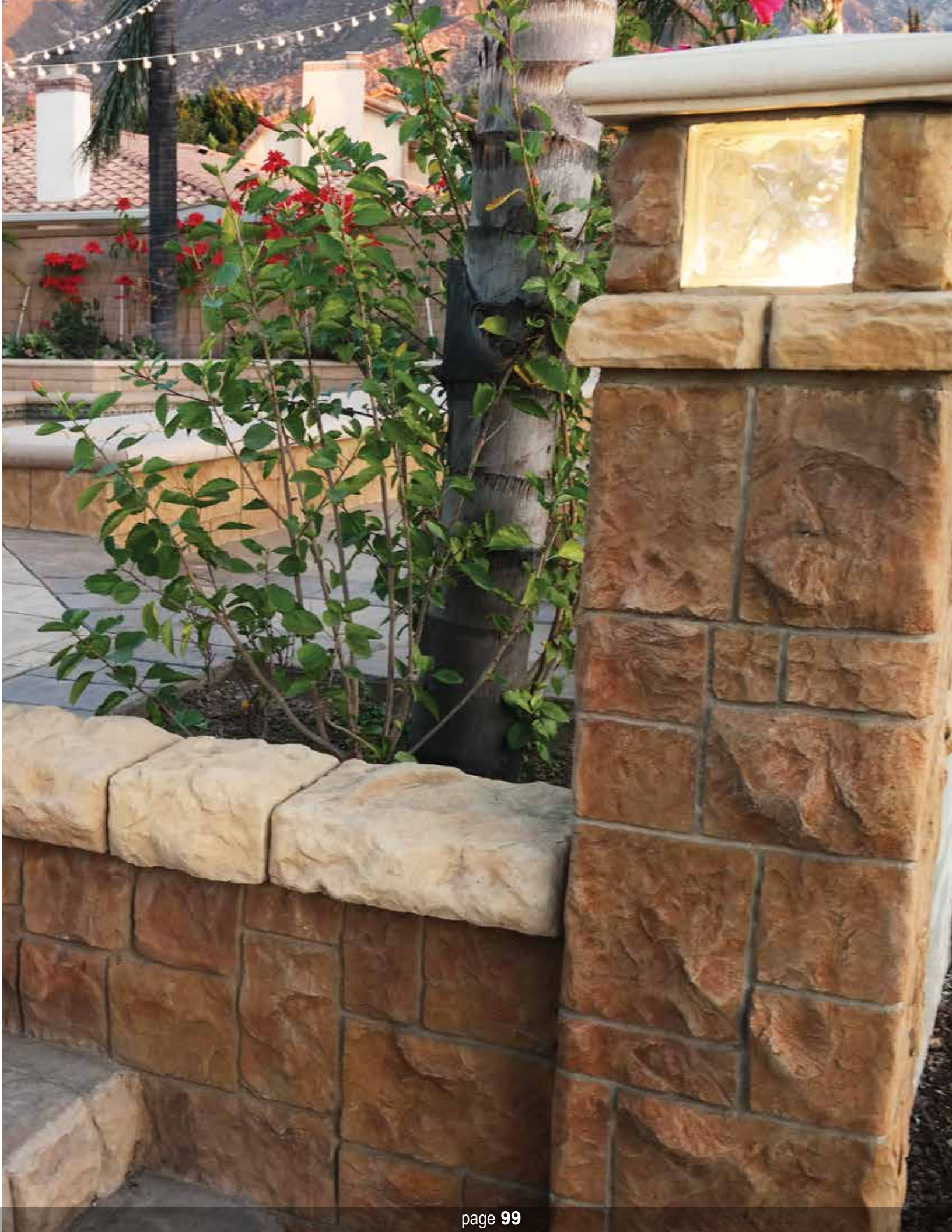

**BRICKFORM Triple Seven Bond Coat**  
Primer for Cementitious Overlays

BRICKFORM Triple Seven Bond Coat prevents the concrete from absorbing water from the overlay material making it easier to spread and achieve a smooth surface. Triple Seven Bond Coat is a reactive primer, remaining active for at least two hours after it is applied. Triple Seven Bond Coat increases the bond strength by creating a more efficient chemical link between the concrete and the overlay.

- “Reactive primer”
- Easy application
- Enhances bonding to concrete

BC-007	5 Gallon
BC-0071	1 Gallon
BC4-0071	Case of four 1 Gallon units



**Overlay Liquid Colorant**

Specifically designed for Brickform Micro-Topping, SM Professional Grade and Stampable Overlay (SC-60, White Mix). Use one bottle per bag. Available in 38 standard colors. (See color chart on pages 50-51) Six per case, cannot break cases. \*Overlay Liquid Colorant not available in Smokey Blue.

MTC-	10 Oz. Bottle
------	---------------



**Turtle Set™**

Brickform Turtle Set is a retardant designed for use with Brickform SM Professional Grade, Micro-Topping, OL-60 and SC-60 Stampable overlay products. Easily measured liquid form increases pot life and set times for greater control with resurfacing products in warm weather.

TS-1	1 Gallon Bottle
TS4-1	Case of four 1 Gallon Bottles

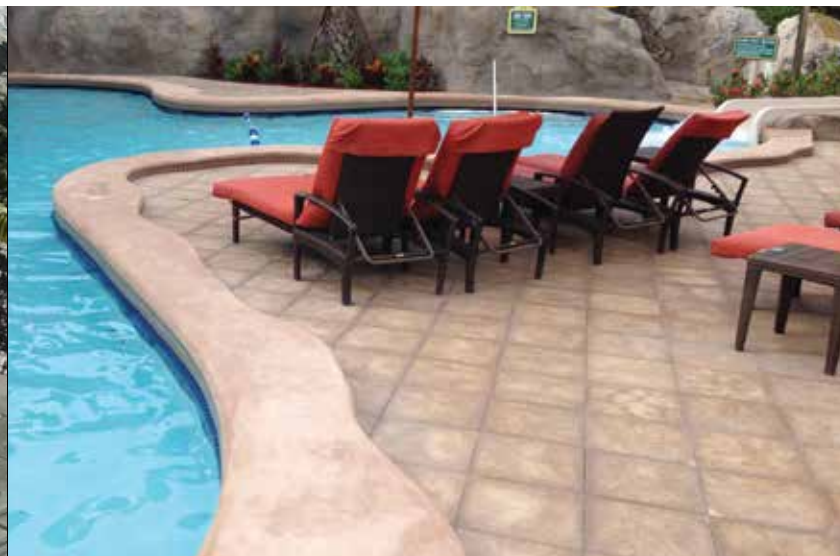



## Premium Sealers

Brickform sealers bring out the natural beauty of the textures and color unique to a decorative surface. These superior, durable sealers also protect the finish from sun damage, yellowing, scuffing and premature wear.

### HIGH PERFORMANCE SEALERS

#### UreMax WB™

BRICKFORM UreMax WB is a two-part, matte-finish, water-based polyurethane that forms a high-solids coating. UreMax WB preserves and protects any above-grade concrete, masonry or stone. It is the most durable, chemical-resistant barrier coating of the BRICKFORM sealers, without the odor typically found in solvent-borne sealers. Formulated to seal and protect concrete and masonry that is subject to heaviest use conditions, BRICKFORM UreMax WB is chemically resistant and highly durable.



#### Poly-Astic™

Premium, High-Build, Poly-Aspartic Sealer - Zero VOC

BRICKFORM Poly-Astic is a two-part high solids, high build sealer designed for interior use on concrete or masonry surfaces. Poly-Astic allows for single coat high film thickness in a water clear finish. Poly-Astic provides a very smooth, mirror-like finish not attainable with any other product.

- Non-yellowing, crystal clear
- Interior use only
- Enhances color
- Easy to apply



#### DecoPoxy™

DecoPoxy is a water-based, low VOC, penetrating epoxy coating that has been specifically formulated to protect interior cementitious floors for commercial and residential applications. It provides a high gloss, wear and chemical resistance, and an easy to maintain finish, while bringing up the full depth of color on acid stained or decorative floors.

- Helps prevent delamination
- Non-flammable, low-odor and toxicity
- Superior chemical resistance
- Easy to recoat



### PENETRATING SEALERS

#### Stealth Seal™

BRICKFORM Stealth-Seal is non-film forming water and oil repellent that effectively protects and preserves the natural appearance of any surface it's applied to. It works by creating an invisible barrier at the surface level through a chemical reaction between the sealer and the cement paste, allowing vapor transmission while strongly repelling water and oil. Stealth-Seal ideal for any surface that needs protection from stains and the elements. Apply to natural materials, concrete and any cementitious surface.

#### Stealth Seal Premium™

BRICKFORM Stealth-Seal Premium will repel water and oil more effectively, has greater stain resistance and has 50% longer service life than regular Stealth Seal.



*\* See pg 106 for part numbers.*





## CURE & SEALS

### Gem Cure & Seal™

Gem Cure & Seal is a medium- to high-gloss, solvent based, clear acrylate co-polymer curing compound, dust proofer and sealer. Gem Cure & Seal minimizes moisture loss from evaporation in newly placed concrete to provide maximum strength, hardness and protection. Reducing water evaporation loss will result in a stronger, denser, more durable concrete with higher compressive strength and better crack and freeze-thaw resistance.



### Satin Cure & Seal™

Satin Cure & Seal is a water based, clear acrylic co-polymer curing compound, dust proofer and sealer. Satin Cure & Seal minimizes moisture loss from evaporation in newly placed concrete to provide maximum strength, hardness and protection. Reducing water evaporation loss will result in a stronger, denser, more durable concrete with higher compressive strength, and better crack and freeze-thaw resistance.

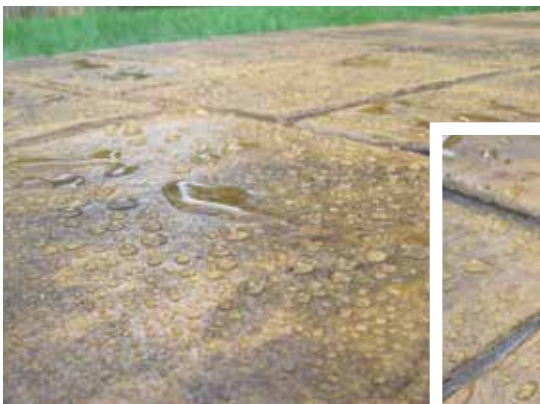

## SOLVENT-BASED SEALERS

### Gem-Seal™

High-Gloss Sealer -  
700, 400 or 100 VOC

BRICKFORM Gem-Seal is a high-gloss, solvent-based, non-yellowing sealer. A light coating of this UV-resistant sealer will protect and enhance colored and textured concrete. Use BRICKFORM Gem-Seal on porous concrete and masonry to form a shield against stains and mildew.

- Non-yellowing, crystal clear
- Dries to a “wet-look” finish
- Interior/exterior use
- Enhances color



### Poly-Seal™

Medium- to High-Sheen Sealer -  
650, 400 or 100 VOC

BRICKFORM Poly-Seal is a medium-to-high sheen, solvent-based, super-tough acrylic sealer that is easy to clean and maintain. Poly-Seal protects with a UV-resistant coating that penetrates the surface to retard efflorescence and resist oil, grease and food stains.

- Non-yellowing, crystal clear
- Medium-to-high sheen finish depending on porosity of surface
- Interior/exterior use



### Safety-Seal™

With Traction-Grip, Low-Sheen Sealer  
400 VOC or 100 VOC

BRICKFORM Safety-Seal is designed to be slip-resistant and is ideal around pool decks and areas where water or moisture can accumulate. Safety-Seal is a solvent-based sealer that protects concrete surfaces from stains and mildew. BRICKFORM Safety-Seal dries to a beautiful matte finish that is UV-resistant.

- Dries to a low-sheen finish
- Interior/exterior use
- Micronized slip-resistant additives



*\* See pg 106 for part numbers.*







## WATER-BASED SEALER

### Satin-Seal™ for use with overlays Satin-Finish “Natural-Look” Sealer - 100 VOC

BRICKFORM Satin-Seal is a non-flammable product, designed to protect concrete with a satin finish. This water-based acrylic VOC-compliant sealer reduces the effect of efflorescence on porous surfaces, while forming a non-yellowing, scuff-resistant finish that resists moisture penetration.

- Non-yellowing satin-finish
- Interior/exterior use
- Scuff-resistant

\* NOT RECOMMENDED FOR DECORATIVE APPLICATIONS SUCH AS STAMPED, STAINED OR DYED CONCRETE. Please review the TIS at [www.brickform.com](http://www.brickform.com) for applications and guidelines.



## SEALER STRIPPER

### Strip-It™

BRICKFORM Strip-It is an environmentally sound and user-safe stripper for water and solvent-based sealers and paints. Strip-It may be used on all masonry surfaces including concrete, quarry tile, ceramic tile, terrazzo, cementitious overlays and other surfaces. Strip-It meets 2005 California Air Resources Board VOC standards (less than 50% VOC by weight).

- Non-flammable
- Contains no methylene chloride



*\* See pg 106 for part numbers.*

## MAINTENANCE

### BRICKFORM Premium Acrylic Floor Finish

BRICKFORM Premium Acrylic Floor Finish is a finish that forms a long-lasting protective coating over a BRICKFORM sealer. It provides a wear-resistant sacrificial coating and stands up to the heaviest of traffic conditions. It is easily applied and can be re-coated up to 100 times without having to strip the floor. It will not powder and it can be mopped or cleaned time after time without damaging its original shine. BRICKFORM Premium Acrylic Floor Finish is ideal for ongoing maintenance.

- Super-tough film
- Semi-gloss
- Interior use only
- Slip-resistant

DW-1000	1 Gallon Bottle
DW4-1000	Case of four 1 Gallon Bottles
DW-5000	5 Gallon Bucket





## SEALER ADDITIVES

### Tinta' Seal™ Color tint pack additive for solvent-based sealers

Tinta' Seal can enhance and correct the color of existing cementitious surfaces such as integral color concrete, stamped concrete, overlays or plain concrete. The BRICKFORM Tinta' Seal tint packs are designed to be used with any of our solvent base sealers including Gem Cure & Seal. It is packaged in a 16-oz can that is mixed onsite with a 5-gallon pail of either Gem-Seal, Poly-Seal or Gem Cure & Seal.



Color chart located after page 74



### Traction Grip™

Traction Grip is an anti-slip micronized powder that adds texture to decorative sealers (BRICKFORM Gem-Seal, Poly-Seal, and Satin Seal). The lightweight, spherical shape and clarity gives Traction Grip its specific properties. Applications include inclined driveways, garages, steps, patios and pool decks.

- No sharp edges
- Disperses easily
- Does not affect color



### Matte-Magic™

#### Gloss Reducing Additive

BRICKFORM Matte-Magic is a powdered flattening agent additive for Brickform solvent based sealers. The original topcoat gloss is reduced based on the amount of additive used. The finished gloss reflectance can be varied from semi-gloss to satin. Matte-Magic comes in 16-oz units, with cases of 8 units. Each unit is added to a 5-gallon sealer for gloss reduction.

- Effectively reduces gloss
- Easy to measure and mix



DECOPOXY.....	DecoPoxy, 1.5 Gallon Kit	PS-5 .....	Poly-Seal 650 VOC, 5 Gallon
GCS1-65025 .....	Gem Cure & Seal 1315, 650 VOC, 1 Gallon	PS1-400 .....	Poly-Seal 400 VOC, 1 Gallon
GCS4-65025 .....	Case of four 1 Gallon units	PS4-400 .....	Case of four 1 Gallon units
GCS-65025 .....	Gem Cure & Seal 1315, 650 VOC, 5 Gallon	PS5-400 .....	Poly-Seal 400 VOC, 5 Gallon
GCS1-35025 .....	Gem Cure & Seal 1315, 350 VOC, 1 Gallon	PS1-100 .....	Poly-Seal 100 VOC, 1 Gallon
GCS4-35025 .....	Case of four 1 Gallon units	PS4-100 .....	Case of four 1 Gallon units
GCS-35025 .....	Gem Cure & Seal 1315, 350 VOC, 5 Gallon	PS5-100 .....	Poly-Seal 100 VOC, 5 Gallon
GCS1-35018 .....	Gem Cure & Seal 309, 350 VOC, 1 Gallon	SCS1-10018 .....	Satin Cure & Seal 309, 1 Gallon
GCS4-35018 .....	Case of four 1 Gallon units	SCS4-10018 .....	Case of four 1 Gallon units
GCS-35018 .....	Gem Cure & Seal 309, 350 VOC, 5 Gallon	SCS-10018.....	Satin Cure & Seal 309, 5 Gallon
GCS1-10018 .....	Gem Cure & Seal 309, 100 VOC, 1 Gallon	SCS1-10025 .....	Satin Cure & Seal 1315, 1 Gallon
GCS4-10018 .....	Case of four 1 Gallon units	SCS4-10025 .....	Case of four 1 Gallon units
GCS-10018 .....	Gem Cure & Seal 309, 100 VOC, 5 Gallon	SCS-10025.....	Satin Cure & Seal 1315, 5 Gallon
GS1-700.....	Gem-Seal 700 VOC, 1 Gallon	SR-1 .....	Strip-It, 1 Gallon
GS4-700.....	Case of four 1 Gallon units	SR4-1 .....	Strip-It, Case of four 1 Gallon units
GS5-700.....	Gem-Seal 700 VOC, 5 Gallon	SR-5 .....	Strip-It, 5 Gallon
GS-1.....	Gem-Seal 400 VOC, 1 Gallon	SS-5 .....	Satin-Seal, 5 Gallon Bucket
GS4-400.....	Case of four 1 Gallon units	ST-1.....	Stealth-Seal, 1 Gallon
GS-5.....	Gem-Seal 400 VOC, 5 Gallon	ST4-1.....	Stealth-Seal, Case of four 1 Gallon units
GS1-100.....	Gem-Seal 100 VOC, 1 Gallon	ST-5.....	Stealth-Seal, 5 Gallon
GS4-100.....	Case of four 5 Gallon units	STP-1 .....	Stealth-Seal Premium, 1 Gallon
GS5-100.....	Gem-Seal 100 VOC, 5 Gallon	STP4-1 .....	Case of four 1 Gallon units
MM .....	Matte-Magic, 1 lb. Jar	STP-5 .....	Stealth-Seal Premium, 5 Gallon
MM8 .....	Matte-Magic, Case of eight 1 lb. Jars	TAS-(color name).....	Tinta' Seal, 16 Ounce
MS-5.....	Safety-Seal 400 VOC, 5 Gallon	TG .....	Traction Grip, 1 lb. Jar
MS5-100.....	Safety-Seal 100 VOC, 5 Gallon	TG8 .....	Traction Grip, Case of eight 1 lb. Jars
PA-1.....	Poly-Astic, 2 Gallon Kit	UMS-1 .....	UreMax, 1 Gallon Kit
PA-25.....	Poly-Astic, 2 Quart Kit	UMS-4 .....	UreMax, 4 Gallon Kit
PS-1 .....	Poly-Seal 650 VOC, 1 Gallon		
PS4-650 .....	Case of four 1 Gallon units		

# Sealer Properties Checklist

	UreMax WB	Poly-Asitic	DecoPoxy	Stealth-Seal	Stealth-Seal Premium	Gem Cure & Seal	Satin Cure & Seal	Gem-Seal	Poly-Seal	Safety-Seal	Satin-Seal
High performance	✓	✓	✓		✓						
Penetrating/ Impregnating			✓	✓							
Cure and seal						✓	✓				
Solvent-based		✓				✓		✓	✓	✓	
Water-based	✓		✓	✓	✓		✓				✓
Use with Matte-Magic						✓		✓	✓	n/a	
Two-part	✓	✓	✓								
VOC in grams/ liter	<50	0	190	<20	<20	100/350/650	<100	100/400/700	100/400/650	100/400	100
Solids Content %	51	65	35	n/a	n/a	19-25	18-25	19-27	19	19	26
High-sheen		✓	✓	n/a	n/a			✓			
Medium-sheen						✓			✓		
Low-sheen	✓			flat	flat		✓			✓	✓
Satin-Sheen	✓			n/a	n/a						✓
Film-forming	✓	✓	✓			✓	✓	✓	✓	✓	✓
Non film-forming	n/a	n/a	n/a	penetrating	penetrating	n/a	n/a	n/a	n/a	n/a	n/a
Flammable		✓				✓		✓	✓	✓	
Roll-on	✓	✓	✓	✓	✓	✓	✓	✓	✓		✓
Spray-on	✓*		✓	✓	✓	preferred	✓	preferred	preferred	preferred	✓
Interior	✓	✓	✓	✓	✓	✓	✓	✓	✓	✓	✓
Exterior				✓	✓	✓	✓	✓	✓	✓	✓

\* Not a preferred method but possible with proper personal protection



## Stamped Concrete *Systems*

### Coloring

- Integral color
- Color Hardener
- Antique Release
- Antique-It
- Liquid Release

### Stamping

- Texture mats and skins
- Texturing accessories
- Pounder
- Touch-up wheels
- Cleaning: Etch-It

### Sealers

- Poly-Seal
- Gem-Seal
- Safety-Seal
- Stealth-Seal

### Maintenance (interior only)

- Premium Acrylic Floor Finish

### Aids

- DAY1 Troweling Aid

### Cure and Seals

- Gem Cure & Seal
- Satin Cure & Seal

### Interior Use Sealers

- DecoPoxy
- UreMax WB
- Poly-Astic
- Premium Acrylic Floor Finish

## Integral Color *Systems*

### Coloring

- Solomon Colors SG Granules, Color-Flo® liquid, liquid or dry integral color
- Antique Release
- Liquid Release

### Aids

- DAY1 Troweling Aid
- E-Etch
- Surface Deactivator

### Cure and Seals

- Gem Cure & Seal
- Satin Cure & Seal

### Sealers

- Poly-Seal
- Gem-Seal
- Safety-Seal
- Stealth-Seal

### Interior Use Sealers

- DecoPoxy
- UreMax WB
- Poly-Astic
- Satin-Seal

### Maintenance

- Premium Acrylic Floor Finish

## Restoration *Systems*

### Coloring

- Cem-Coat
- FreestylePRO
- Color Wax
- Tinta' Seal
- Antique-It

### Sealers

- Poly-Seal
- Gem-Seal
- Safety-Seal
- Stealth-Seal

### Interior Use Sealers for use with Cem-Coat

- DecoPoxy
- UreMax WB
- Poly-Astic
- Satin-Seal
- Premium Acrylic Floor Finish

### Maintenance (interior only)

- Premium Acrylic Floor Finish



## Resurfacing *Systems*

### Primer

- Triple Seven Bond Coat

### Overlay

- SM Professional Grade
- Micro-Topping
- Stampable Overlay

### Coloring

- Overlay Liquid Colorant
- Color Hardener and Antique Release (OL-60 "gray" only)
- Blush-Tone Acid Stain
- E-Stain
- ARTesian Stain
- Pro-Dye (interior use only)
- Cem-Coat
- FreestylePRO

### Sealers

- Poly-Seal
- Gem-Seal
- Safety-Seal
- Stealth-Seal

### Interior Use Sealers

- DecoPoxy
- UreMax WB
- Poly-Astic

### Maintenance (interior only)

- Premium Acrylic Floor Finish

## Staining *Systems*

### Surface Preparation

- E-Etch

### Coloring

- Blush-Tone Acid Stain
- E-Stain
- ARTesian Stain
- Pro-Dye (interior use only)

### Aids

- DAY1 Troweling Aid

### Sealer Preparation

- Neutra Clean
- Sealer/Surface Preparation
- Strip-It
- E-Etch

### Sealers

- Poly-Seal
- Gem-Seal
- Safety-Seal
- Stealth-Seal

### Interior Use Sealers

- DecoPoxy
- UreMax WB
- Poly-Astic
- Premium Acrylic Floor Finish

### Maintenance (interior only)

- Premium Acrylic Floor Finish

## Polishing *Systems*

### Densifier

- Lythic Densifier and XL Densifier

### Coloring

- Pro-Dye (interior use only)
- Solomon Colors SG Granules, Color-Flo® liquid, liquid or dry integral color

### Protector

- Lythic Protector and SPD Protector

### Cleaner

- Lythic Cleaner

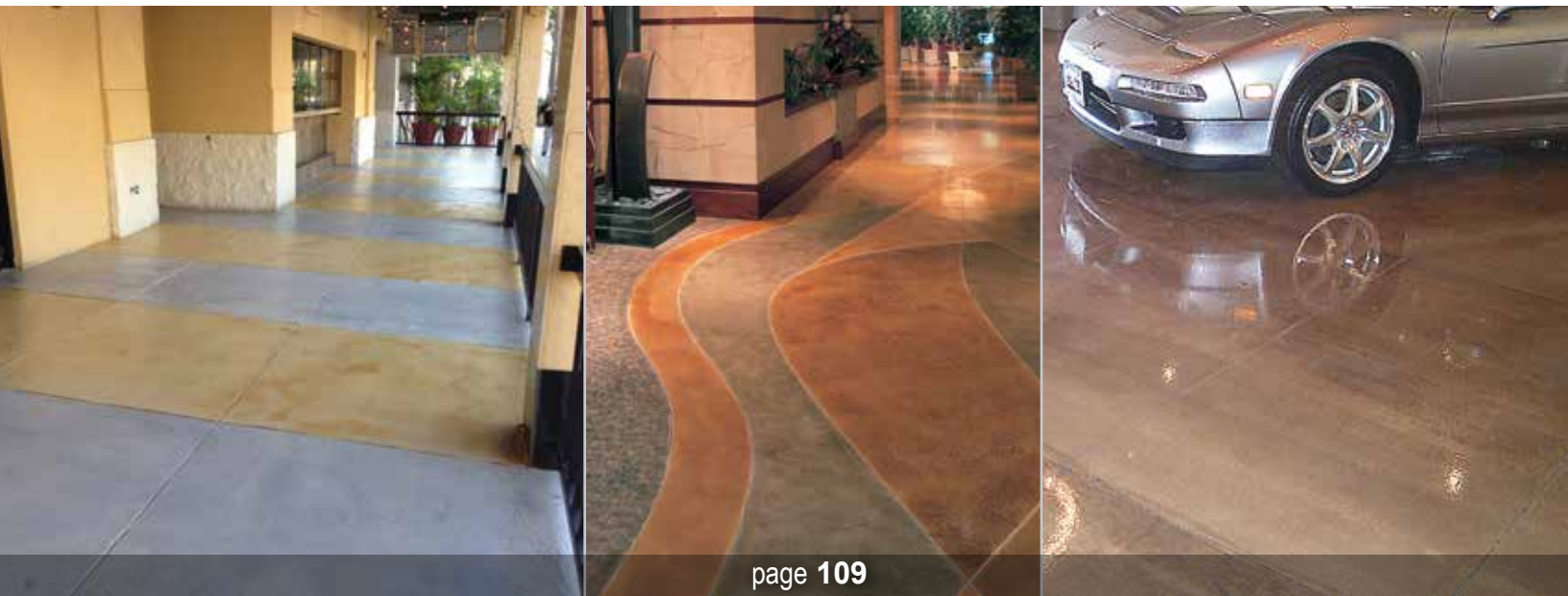



# BRICKFORM

*A Division of Solomon Colors, Inc.*

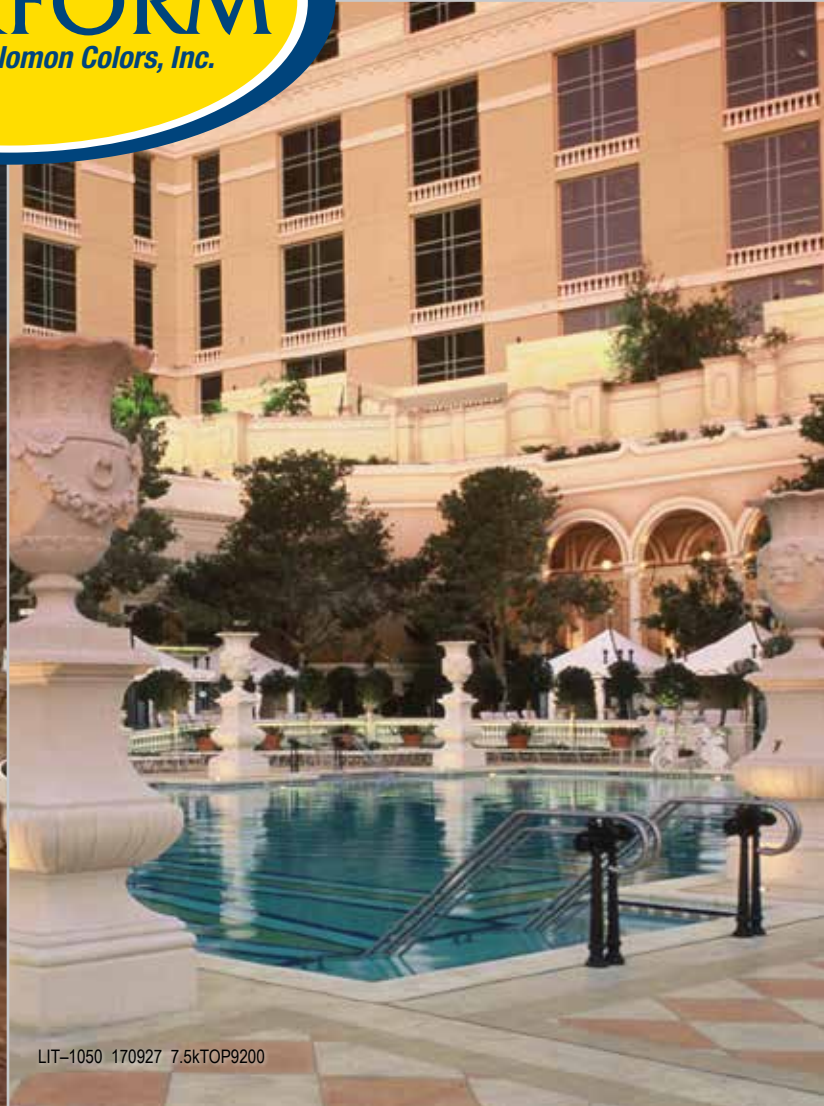

**Toll Free: 1-800-483-9628**

**Corporate Headquarters**  
4050 Color Plant Road  
Springfield, IL 62702

**Division Headquarters**  
1371 Laurel Avenue  
Rialto, CA 92376

**[www.brickform.com](http://www.brickform.com)**