

ELECTRONIC CASH REGISTER

# TK-6000/6500

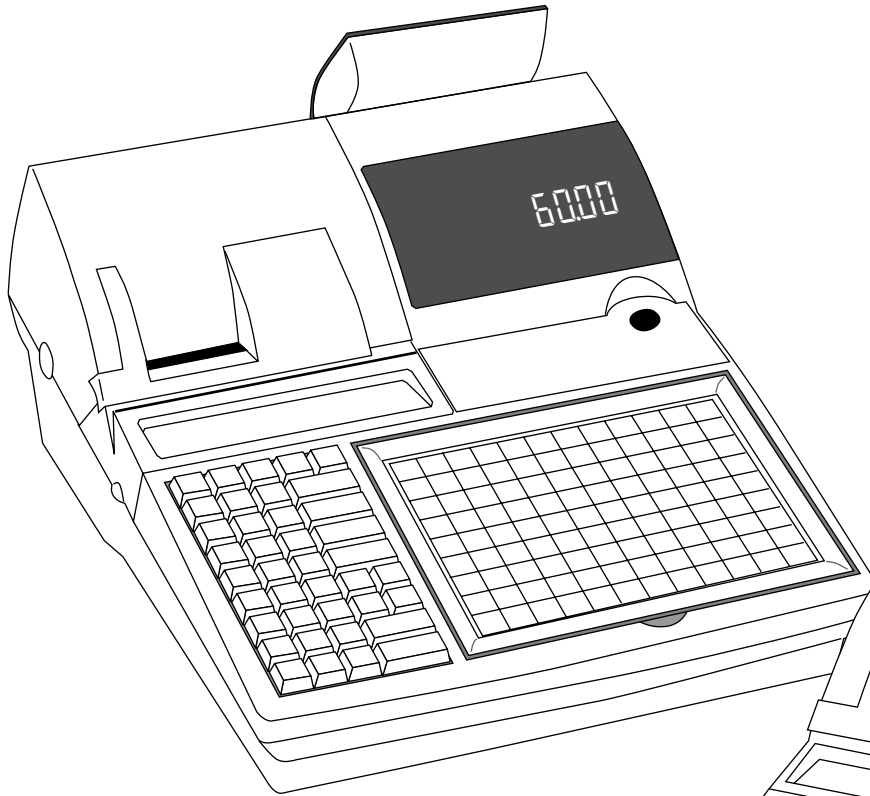

APPLE-  
PIE  
COFFEE

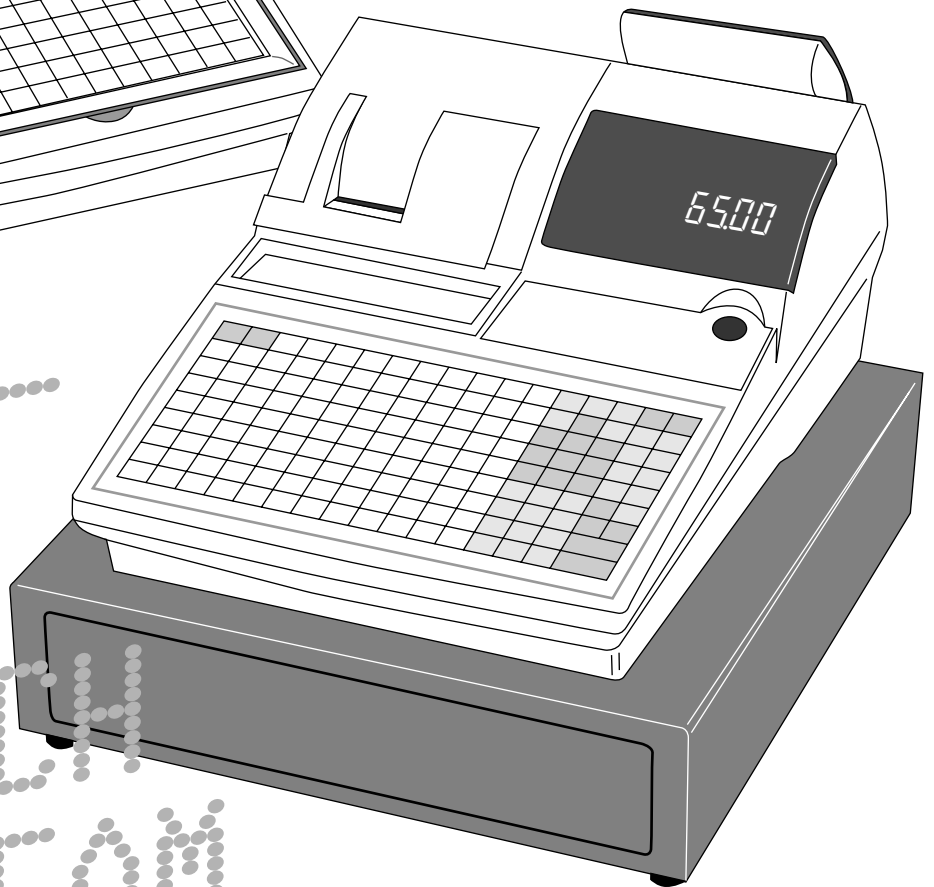

FRENCH-  
FRIED  
SANDWICH  
ICE CREAM

Eu Di U.K.  
Cl Canada

USER'S MANUAL

**CASIO®**

# Introduction & Contents

---

## Introduction

Congratulations on your selection of a CASIO TK-6000/TK-6500 series electronic cash register. This ECR is the product of the world's most advanced electronic technology, for outstanding versatility and reliability. Simplified operation is made possible by a specially designed keyboard layout and a wide selection of automated, programmable functions.

A specially designed keyboard layout and a bright, easy-to-read display help to take the fatigue out of long hours operation.

Notes for TK-6000-1



Casio Electronics Co., Ltd.  
Unit 6, 1000 North Circular Road  
London NW2 7JD, U.K.

**WARNING:** This is a Class A product. In a domestic environment this product may cause radio interference in which case the user may be required to take adequate measures.

*Please keep all information for future reference.*

Notes for TK-6000/6500

### **GUIDELINES LAID DOWN BY FCC RULES FOR USE OF THE UNIT IN THE U.S.A. (Not applicable to other areas)**

**WARNING:** This equipment has been tested and found to comply with the limits for a Class A digital device, pursuant to Part 15 of the FCC Rules. These limits are designed to provide reasonable protection against harmful interference when the equipment is operated in a commercial environment. This equipment generates, uses, and can radiate radio frequency energy and, if not installed and used in accordance with the instruction manual, may cause harmful interference to radio communications. Operation of this equipment in a residential area is likely to cause harmful interference in which case the user will be required to correct the interference at his own expense.

**FCC WARNING:** Changes or modifications not expressly approved by the party responsible for compliance could void the user's authority to operate the equipment.

The main plug on this equipment must be used to disconnect mains power. Please ensure that the socket outlet is installed near the equipment and shall be easily accessible.

**Important!**

Your new cash register has been carefully tested before shipment to ensure proper operation. Safety devices eliminate worries about breakdowns resulting from operator errors or improper handling. In order to ensure years of trouble-free operation, however, the following points should be noted when handling the cash register.

*Do not locate the cash register where it will be subjected to direct sunlight, high humidity, splashing with water or other liquids, or high temperature (such as near a heater).*

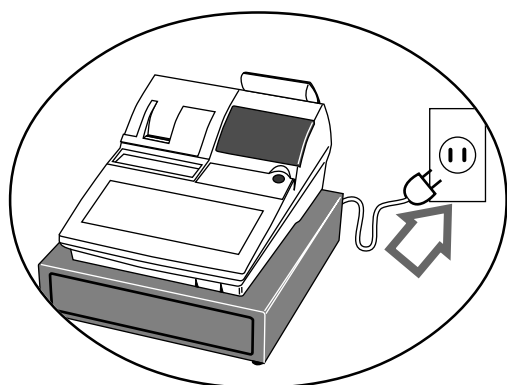
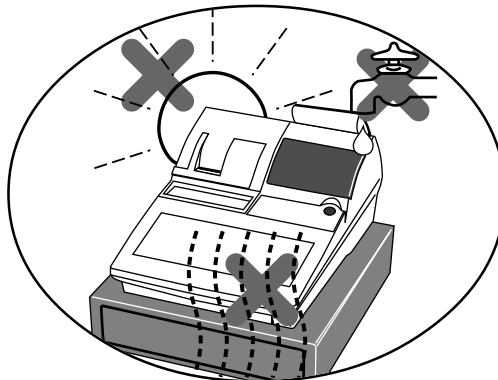

*Be sure to check the sticker on the side of the cash register to make sure that its voltage matches that of the power supply in the area.*

*Never operate the cash register while your hands are wet.*

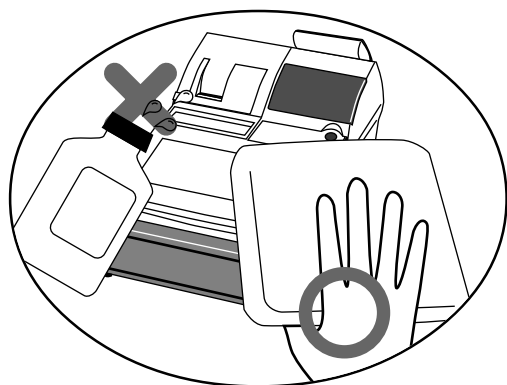
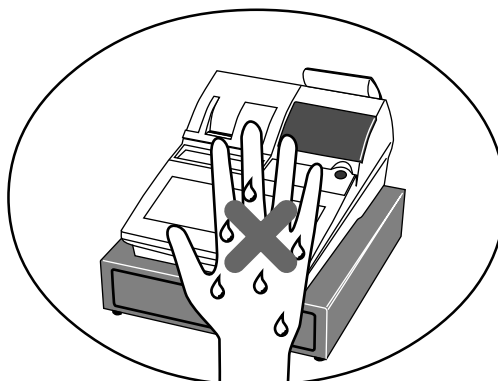

*Use a soft, dry cloth to clean the exterior of the cash register. Never use benzene, thinner, or any other volatile agent.*

*Never try to open the cash register or attempt your own repairs. Take the cash register to your authorized CASIO dealer for repairs.*

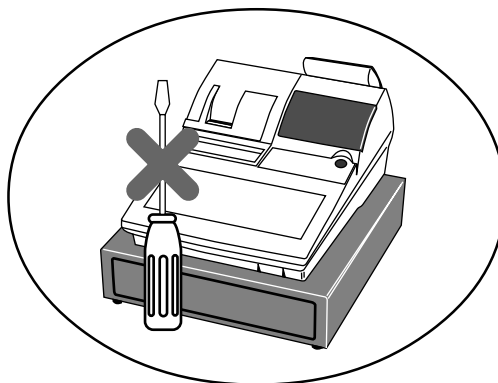

# Introduction & Contents

---

<b>Introduction &amp; Contents</b> .....	<b>2</b>
<b>Getting Started</b> .....	<b>8</b>
Remove the cash register from its box. ....	8
Remove the tape holding parts of the cash register in place. ....	8
Remove the cash drawer from its box. ....	8
Connect the drawer. ....	8
Mount the cash register. ....	9
Plug the cash register into a wall outlet. ....	9
Insert the mode key marked "OW" into the mode switch. ....	9
Install receipt/journal paper. ....	10
Set the date. ....	12
Set the time. ....	12
<b>Introducing TK-6000/6500</b> .....	<b>14</b>
General guide .....	14
Display (TK-6000/TK-6500) .....	18
Keyboard (TK-6000) .....	20
Keyboard (TK-6500) .....	22
Allocatable functions .....	24
How to remove/replace the sheet holder (TK-6000 only) .....	26
How to install a menu sheet in the sheet holder (TK-6000 only) .....	27
<b>Basic Operations and Setups</b> .....	<b>28</b>
How to read the printouts .....	28
How to use your cash register .....	29
Assigning a clerk .....	30
Clerk button .....	30
Clerk lock/clerk key .....	30
Clerk secret number key .....	30
Displaying the time and date .....	31
Preparing coins for change .....	31
Preparing and using department/flat-PLU keys .....	32
Registering department/flat-PLU keys .....	32
Programming department/flat-PLU keys .....	33
To program a unit price for each department/flat-PLU .....	33
To program the tax calculation status for each department/flat-PLU .....	33
To program high amount limit for each department/flat-PLU .....	34
Registering department/flat-PLU keys by programming data .....	35
Preset price .....	35
Preset tax status .....	35
Locking out high amount limitation .....	35
Preparing and using PLUs .....	36
Programming PLUs .....	36
To program a unit price for each PLU .....	36
To program tax calculation status for each PLU .....	36
Registering PLUs .....	37
Shifting the taxable status of an item .....	39
Calculation merchandise subtotal .....	39
Preparing and using discounts .....	40
Programming discounts .....	40
Registering discounts .....	40
Discount for items and subtotals .....	40

Preparing and using reductions .....	41
Programming for reductions .....	41
To program preset reduction amount .....	41
Registering reductions .....	41
Reduction for items .....	41
Reduction for subtotal .....	42
Registering credit and check payments .....	43
Check .....	43
Credit .....	43
Mixed tender (cash, credit and check) .....	43
Registering both the Euro and the local currency .....	44
Validation printing .....	46
Total amount validation .....	46
Validation sample .....	46
Registering returned goods in the REG mode .....	47
Registering returned goods in the RF mode .....	47
Normal refund transaction .....	47
Reduction of amounts paid on refund .....	48
Registering money received on account .....	48
Registering money paid out .....	48
Registering loan amounts .....	49
Registering pick up amounts .....	49
Changing media in drawer .....	49
Making corrections in a registration .....	50
To correct an item you input but not yet registered .....	50
To correct an item you input and registered .....	51
To cancel all items in a transaction .....	52
No sale registration .....	52
Printing the daily sales reset report .....	53
<b>Advanced Operations .....</b>	<b>54</b>
Clerk interrupt function .....	54
Single item cash sales .....	55
Addition .....	56
Addition (plus) .....	56
Premium (%+) .....	56
Tray total .....	57
Tray total premium/discount .....	57
Multiple item totalling function .....	57
Coupon transactions .....	58
Coupon registration using <COUPON> (coupon key) .....	58
Coupon registration using <COUPON2> (coupon 2 key) .....	58
Preset tender amount .....	59
Bottle link operation .....	60
Bottle returns .....	60
Bottle return key .....	60
Arrangement key registrations .....	61
Set menu .....	61

# Introduction & Contents

---

Currency exchange function .....	62
Registering foreign currency .....	62
Full amount tender in foreign currency .....	62
Partial tender in a foreign currency .....	63
Food stamp function .....	64
Food stamp registration .....	64
No change due .....	64
Mixed food stamp/cash change .....	65
Food stamp registration (Illinois rule) .....	67
No change due .....	67
Mixed food stamp/cash change .....	69
Electronic benefits transfer .....	72
About mixed EBT card tenders .....	72
No change due .....	72
Tips .....	73
Registering the second unit price .....	73
Inputting the number of customers .....	75
Text recall .....	76
Temporarily releasing compulsion .....	76
Printing slip .....	77
Printing slips .....	77
To perform auto batch printing 1 .....	78
To perform auto batch printing 2 .....	78
About the maximum number of slip lines .....	78
Check tracking systems .....	78
Check tracking system .....	78
Opening a check .....	79
Adding to a check .....	79
Issuing a guest receipt .....	80
Closing a check memory .....	80
New/old check key operation .....	81
Add check .....	82
Separate check .....	83
Clerk transfer .....	84
Table transfer .....	84
VAT breakdown printing .....	85
Deposit registrations .....	85
Deposit from customer .....	85
Deposit from customer during sales transaction .....	85
Bill copy .....	86
Programming to clerk .....	87
Programming clerk number .....	87
Programming trainee status .....	87
Programming commission rate .....	87
Programming descriptors and messages .....	88
Programming receipt message and clerk name .....	88
Machine number .....	88
Programming department/transaction key descriptor .....	90
Programming flat-PLU descriptor .....	91
Entering characters .....	92
Entering characters by code .....	92
Character code list .....	92
Using character keyboard .....	93

Printing read/reset reports .....	94
To print the individual department, PLU/flat-PLU read report .....	94
To print the financial read report .....	95
To print the individual clerk read/reset report .....	95
To print the daily sales read/reset report .....	96
To print the PLU/flat-PLU read/reset report .....	98
To print the hourly sales read/reset report .....	98
To print the monthly sales read/reset report .....	99
To print the group read/reset report .....	99
To print the periodic 1/2 sales read/reset reports .....	100
To print other sales read/reset reports .....	101
Reading the cash register's program .....	101
To print unit price/rate program (except PLU) .....	101
To print key descriptor, name, message program (except PLU) .....	102
To print the PLU/flat-PLU program .....	103
<b>Troubleshooting .....</b>	<b>104</b>
When an error occurs .....	104
In case of power failure .....	105
Clearing a machine lock up .....	106
When the register does not operate at all .....	106
<b>User Maintenance and Options .....</b>	<b>107</b>
To replace the ink ribbon .....	107
To replace journal paper .....	108
To replace receipt paper .....	109
To replenish the stamp ink .....	109
Options .....	109
<b>Specifications .....</b>	<b>110</b>
<b>Index .....</b>	<b>111</b>

# Getting Started

This section outlines how to unpack the cash register and get it ready to operate. You should read this part of the manual even if you have used a cash register before. The following is the basic set up procedure, along with page references where you should look for more details.

## 1. Remove the cash register from its box.

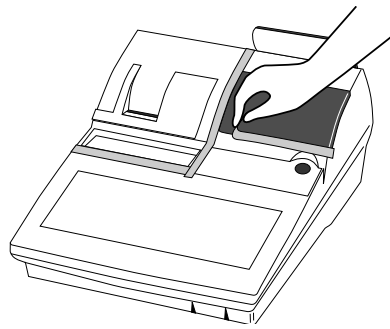
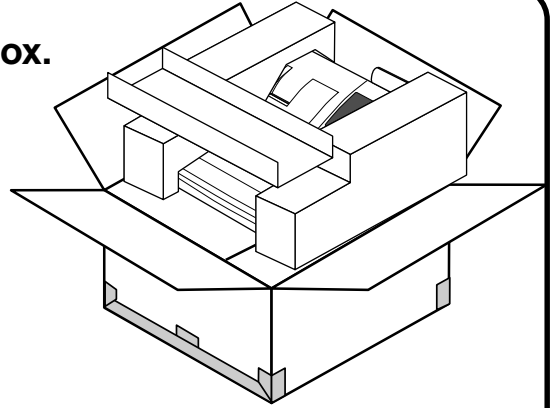

## 2. Remove the tape holding parts of the cash register in place.

Also remove the small plastic bag taped to the printer cover. Inside you will find the mode keys.

## 3. Remove the cash drawer from its box.

The cash register and cash drawer are packed separately.

## 4. Connect the drawer.

1. Connect drawer connector (three color lead on drawer) to the cash register.
2. Connect frame drawer connector (green lead on drawer) to the cash register.

### Note

If the cash register has already been equipped on the drawer, go to step 6.

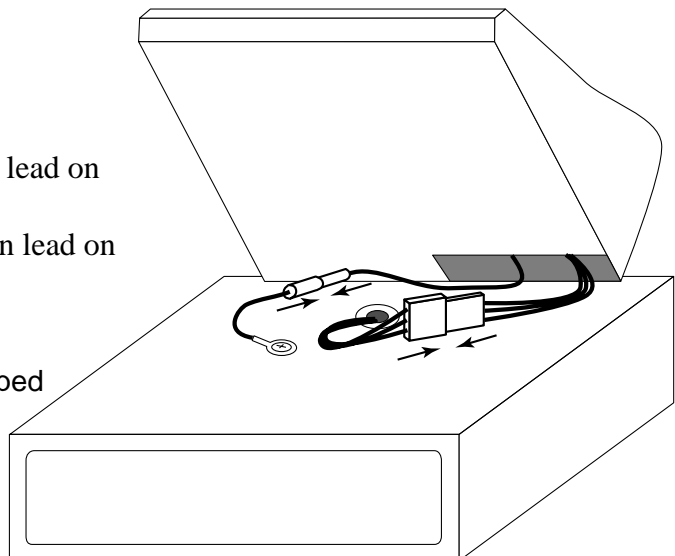



## 5. Mount the cash register.

1. Screw in 2 fixing screws bottom side of the register.
2. Stick rubber plate on the each corner of the bottom side of the register.
3. Mount the cash register on the top of the drawer, ensuring that the feet on the bottom of the cash register go into the holes on the drawer.

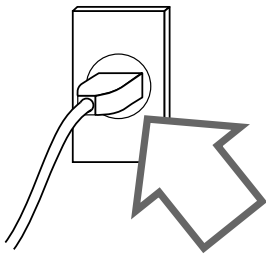
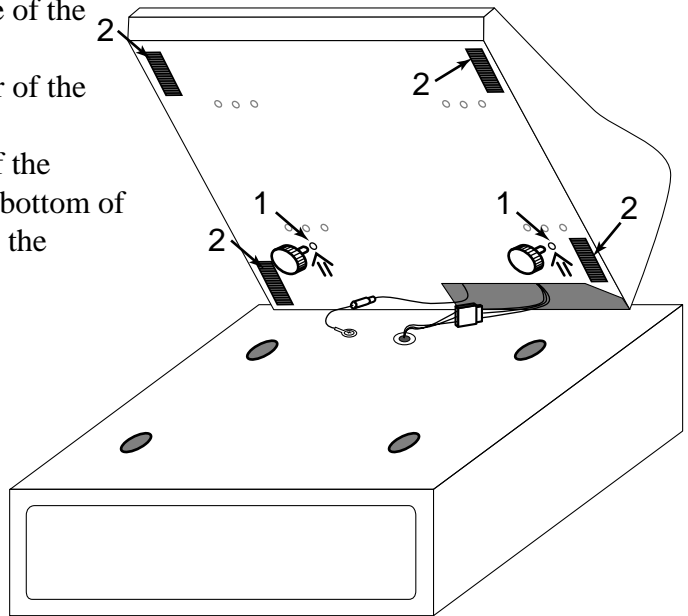

## 6. Plug the cash register into a wall outlet.

Be sure to check the sticker on the side of the cash register to make sure that its voltage matches that of the power supply in your area. The printer will operate for a few seconds. Please do not pass the power cable under the drawer.

## 7. Insert the mode key marked "OW" into the mode switch.

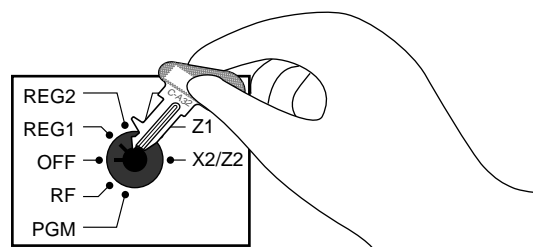

## 8. Install receipt/journal paper.

### Loading journal paper

The same type of paper (45 mm × 83 mm i.d.) is used for receipts and journal. Load the new paper before first operating the cash register or when red paper appears from the printer.

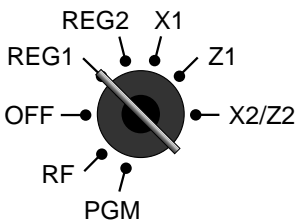

1

Use a mode key to set the mode switch to REG1 position.



2

Open the printer cover using the printer cover key.

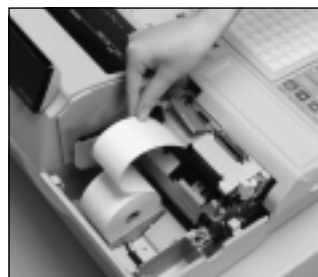

5

Drop the paper roll gently and insert paper to the paper inlet.



3

Cut off the leading end of the paper so it is even.

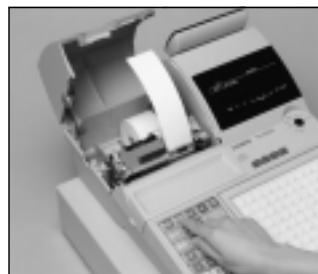

6

Press the **JOURNAL FEED** key until about 20 cm to 30 cm of paper is fed from the printer.



4

Ensuring the paper is being fed from the bottom of the roll, lower the roll into the space behind the printer.



7

Slide the leading end of the paper into the groove on the spindle of the take-up reel and wind it onto the reel two or three turns.

## Loading receipt paper

Follow steps ① through ③ under “Loading journal paper” on the previous page.



⑧ Place the take-up reel into place behind the printer, above the roll paper.



⑨ Press the **JOURNAL FEED** key to take up any slack in the paper.



⑩ Close the printer cover.



④ Ensuring the paper is being fed from the bottom of the roll, lower the roll into the space behind the printer.



⑤ Drop the paper roll gently and insert paper to the paper inlet.



⑥ Press the **RECEIPT FEED** key until about 20 cm to 30 cm of paper is fed from the printer.



⑦ Set the printer cover, passing the leading end of the paper through the paper outlet. Close the printer cover and tear off the excess paper.



### Important!

Never operate the cash register without paper. It can damage the printer.

## 9. Set the date.

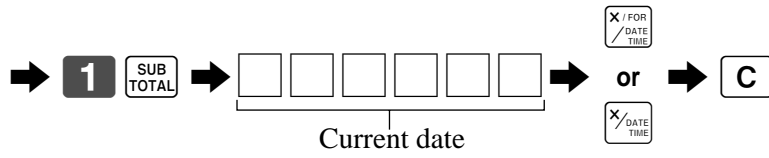
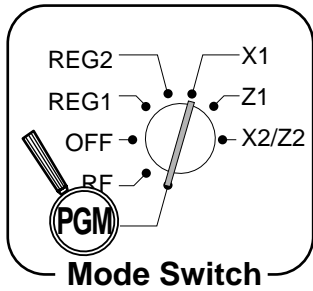

Example:

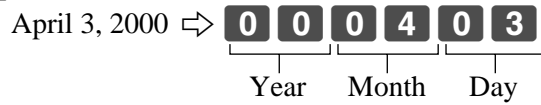

## 10. Set the time.

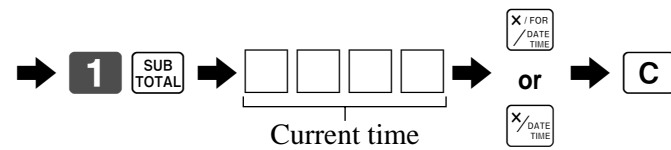
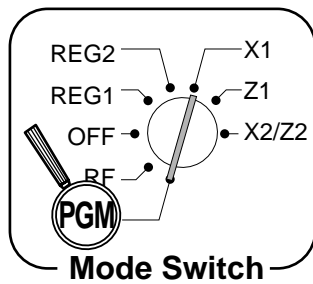

Example:

08:20 AM ⇒ 0 8 2 0

09:45 PM ⇒ 2 1 4 5

(24-hour military time)



# Introducing TK-6000/6500

## General guide

This part of the manual introduces you to the cash register and provides a general explanation of its various parts.

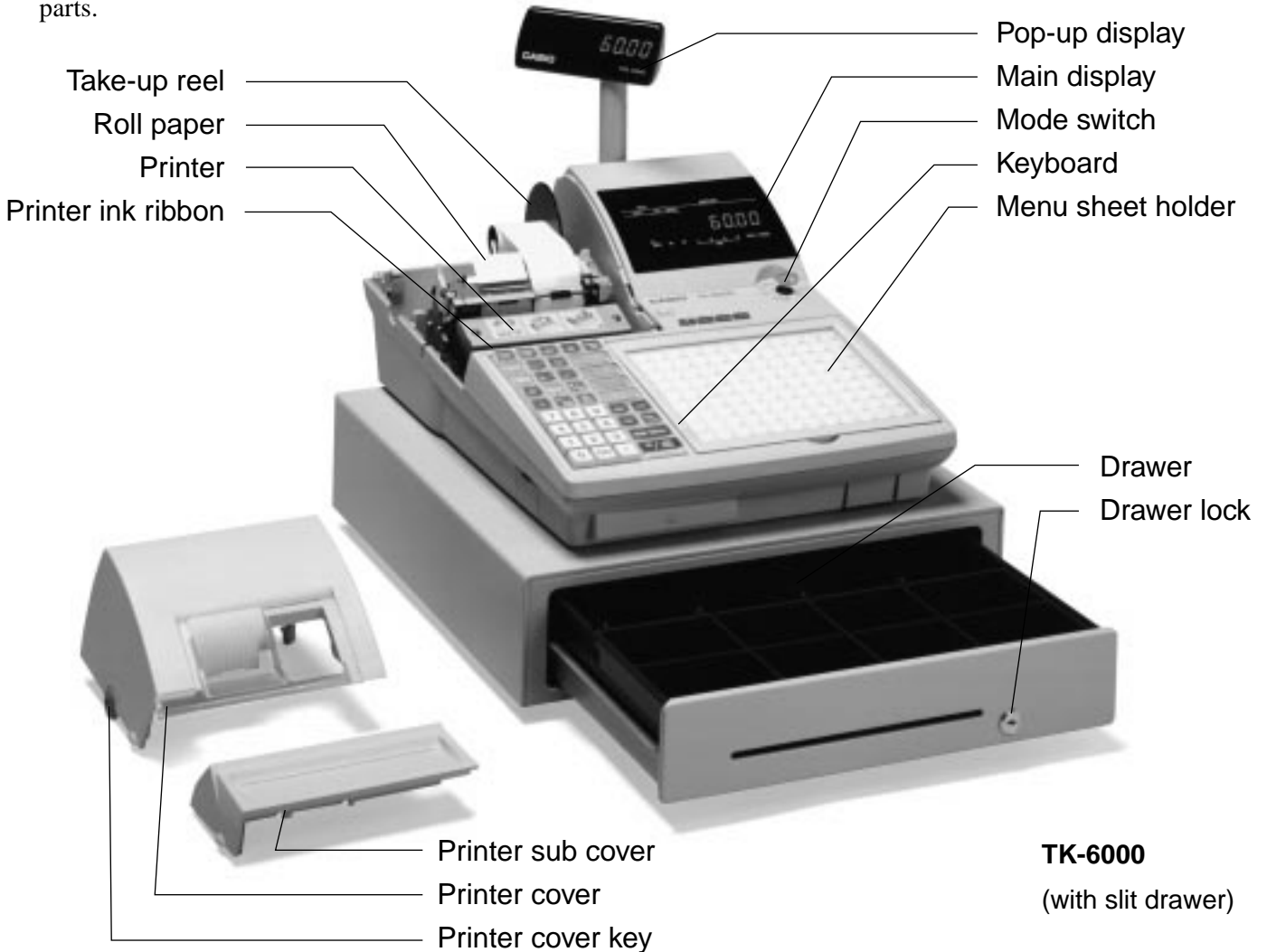

### Roll paper

You can use the roll paper to print receipts and a journal (pages 10 ~ 11).

### Printer ink ribbon

Provides ink for printing of registration details on the roll paper (page 107).

### Receipt on/off switch / key

Use the receipt on/off switch/key in REG1, REG2 and RF modes to control issuance of receipts. In other modes, receipts or reports are printed regardless the receipt switch/key setting.

A post-finalization receipt can still be issued after finalization when the switch/key is set to off. The cash register can also be programmed to issue a post-finalization receipt even when the switch/key is set to on.

### Receipt on/off switch

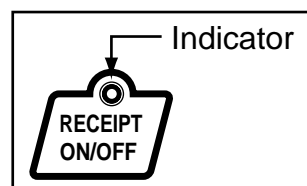

### Receipt on/off key

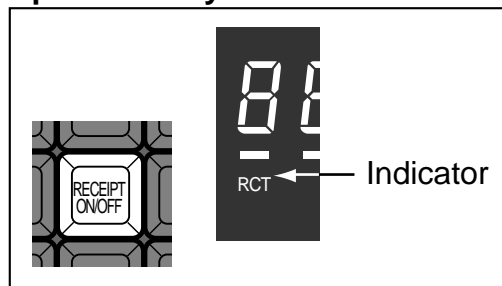

When the register issues receipts, this indicator is lit.

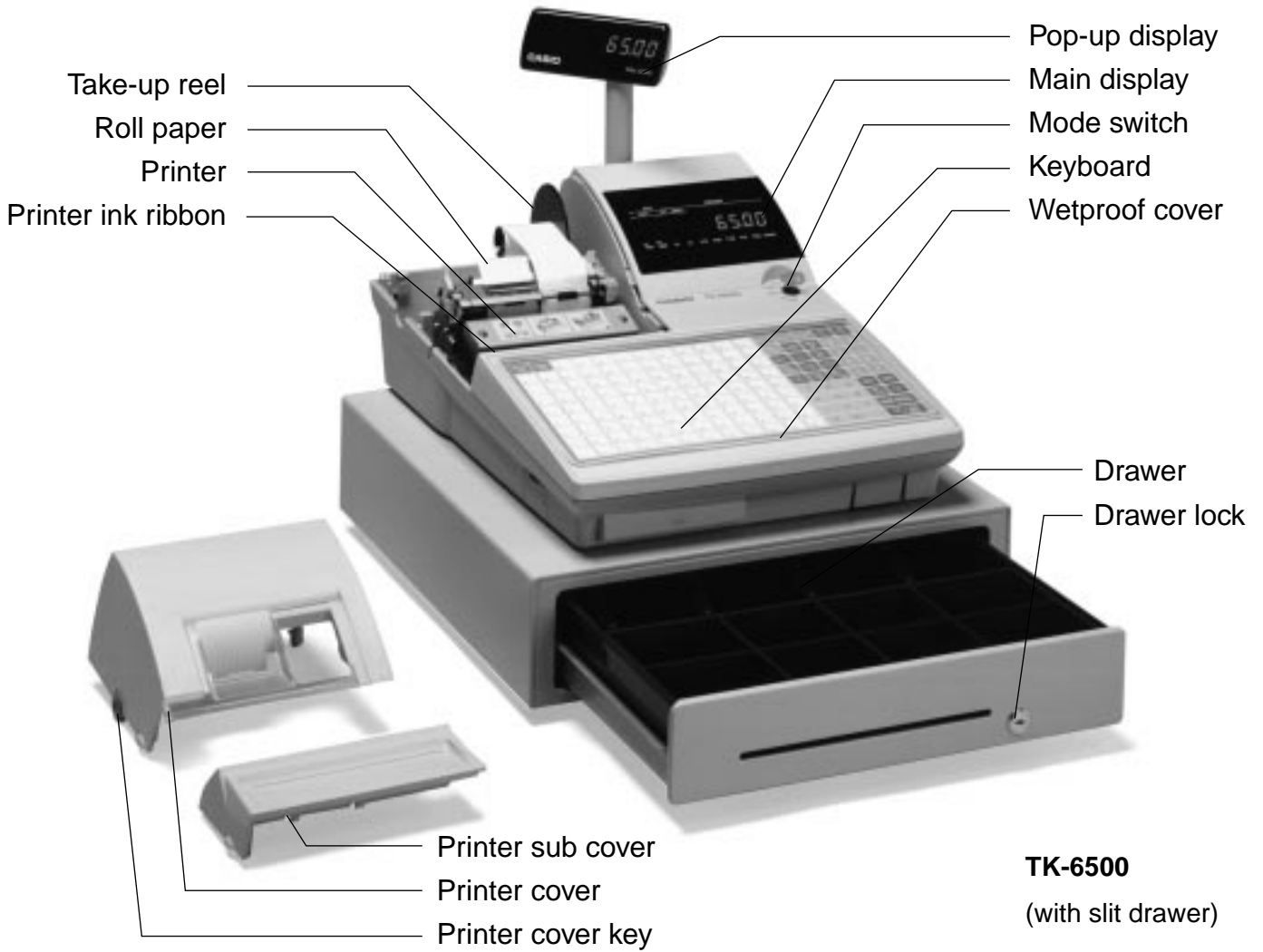

**TK-6500**  
(with slit drawer)

**Mode key (for U.K., U.S. and Canada)**

The following four types of mode keys are provided with the unit in the United Kingdom, the United States and Canada.

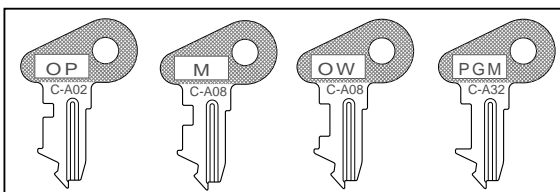

- a. OP (Operator) key  
Switches between OFF and REG1.
- b. M (Master) key  
Switches between OFF, REG1, REG2, X1 and RF.
- c. OW (Owner) key  
Switches between OFF, REG1, REG2, X1, Z1, X2/  
Z2 and RF.
- d. PGM (Program) key  
Switches to any position.

**Mode key (for other area)**

The following three types of mode keys are provided with the unit in areas outside of the United Kingdom, the United States and Canada.

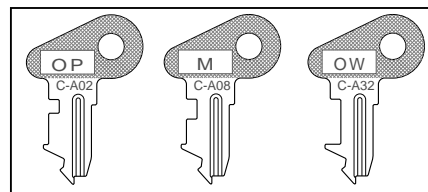

- a. OP (Operator) key  
Switches between OFF and REG1.
- b. M (Master) key  
Switches between OFF, REG1, REG2, X1 and RF.
- c. OW (Owner) key  
Switches to any position.

# Introducing TK-6000/6500

## Mode switch

Use the mode keys to change the position of the mode switch and select the mode you want to use.

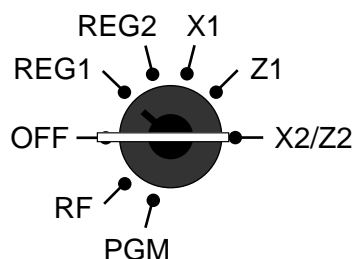

Mode switch	Mode name	Description
OFF	Stand-by	Any of the mode control keys can be inserted and removed from the mode switch in this position.
REG1	Register 1	Used for normal sales transactions. Any of the mode control keys can be inserted and removed from the mode switch in this position.
REG2	Register 2	Used for special operations. Since switching to REG2 requires a special key, such functions as discounts, credit sales, charge sales, check payments, and paid outs can be controlled by programming them as prohibited in REG1 and allowed in REG2.
RF	Refund Reg minus	Used for processing refunds. When the mode switch of the register is in RF position, you can access either the refund mode or the register minus mode.
X1	Daily sales read	Used to obtain daily reports without resetting (clearing) all total data.
Z1	Daily sales reset	Used to obtain daily reports while resetting (clearing) all total data.
X2/Z2	Periodic sale read/reset	Used to obtain periodic sales reports without resetting total data or while resetting all total data.
PGM	Program	Used when programming functions and preset data such as unit prices and tax rates. Also used when reading program data.

## Clerk key/button/lock

On models available in the United States and Canada, clerk or cashier assignment can be performed using clerk secret numbers only (clerk buttons are not equipped).

In Germany, you can assign clerks by using clerk key or by clerk secret number (clerk key is equipped).

In other areas, you can assign clerks by using clerk button or by clerk secret number.

The method you are assigning clerk depends on the programming of your cash register.



### Clerk secret number key

When the cash register is programmed to use clerk secret numbers for clerk or cashier assignment, the clerk buttons are not functional.

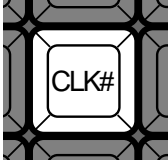

### Clerk button

You can assign the clerk or cashier using the four buttons located below the display panel.



### Clerk lock/key

You can assign the clerk or cashier inserting a clerk key into the clerk lock .

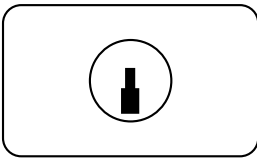

Clerk lock

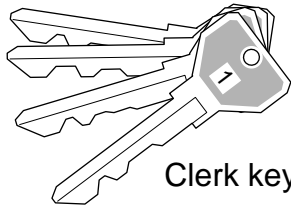

Clerk key

### Drawer

The drawer opens automatically whenever you finalize a registration and whenever you issue a read or reset report. The drawer will not open if it is locked with the drawer key.

### Drawer lock

Use the drawer key to lock and unlock the drawer.

### When the cash drawer does not open!

In case of power failure or the machine is in malfunction, the cash drawer does not open automatically. Even in these cases, you can open the cash drawer by pulling drawer release lever (see below).

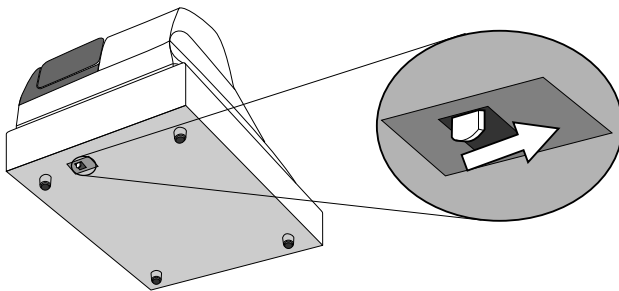

### Important!

The drawer will not open, if it is locked with a drawer lock key.

# Introducing TK-6000/6500

## Display (TK-6000/TK-6500)

### Display panel

Main display for the U.S.

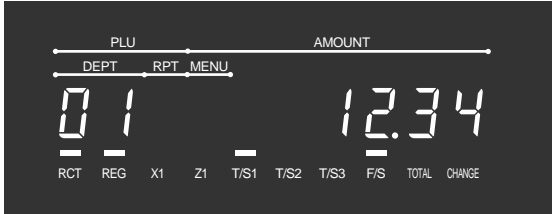

Customer display for all area



Main display for Canada, Germany and TK-6500 for U.K.



Main display for other area

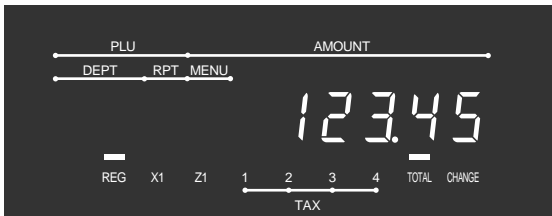

## Display example

### Item registration

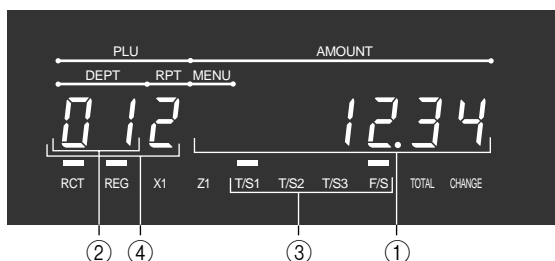

### Menu shift

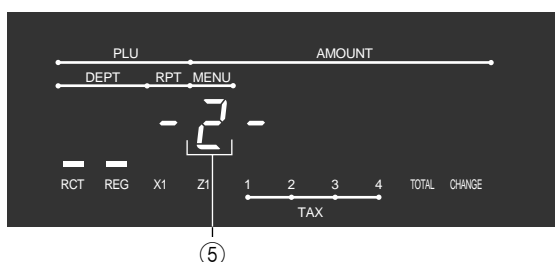

### Repeat registration

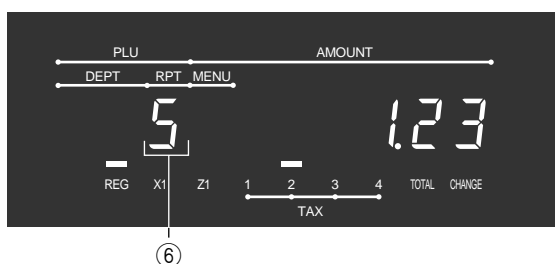

### Totalize operation

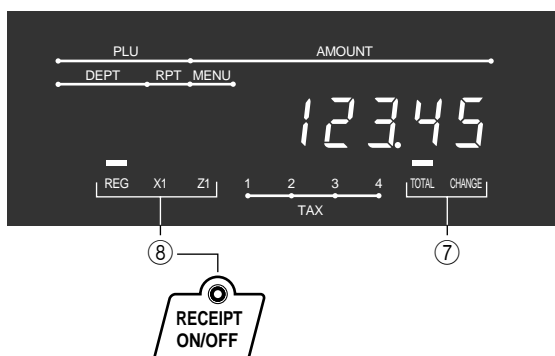

#### ① Amount/Quantity

This part of the display shows monetary amounts. It also can be used to show the current date and time.

#### ② Department number

When you press a department key to register a unit price, the corresponding department number (01 ~ 04, 08) appears here.

#### ③ Taxable sales status indicators

When you register a taxable item, the corresponding indicator is lit.

#### ④ PLU, flat-PLU number

When you register a PLU, flat-PLU item, the corresponding PLU, flat-PLU number appears here.

#### ⑤ Menu sheet number

When you press the **MENU** key to designate the 1st ~ 6th menu sheet, the corresponding number is displayed.

#### ⑥ Number of repeats

Anytime you perform a repeat registration (pages 32, 37), the number of repeats appears here. Note that only one digit is displayed for the number of repeats. This means that a "5" could mean 5, 15 or even 25 repeats.

#### ⑦ Total/Change indicators

When the TOTAL indicator is lit, the displayed value is monetary total or subtotal amount. When the CHANGE indicator is lit, the displayed value is the change due.

#### ⑧ RCT, REG, X1, Z1 indicators

RCT: When the register issues receipts, this indicator is lit.

X1: Indicates daily sales read mode

Z1: Indicates daily sales reset mode

# Introducing TK-6000/6500

## Keyboard (TK-6000)

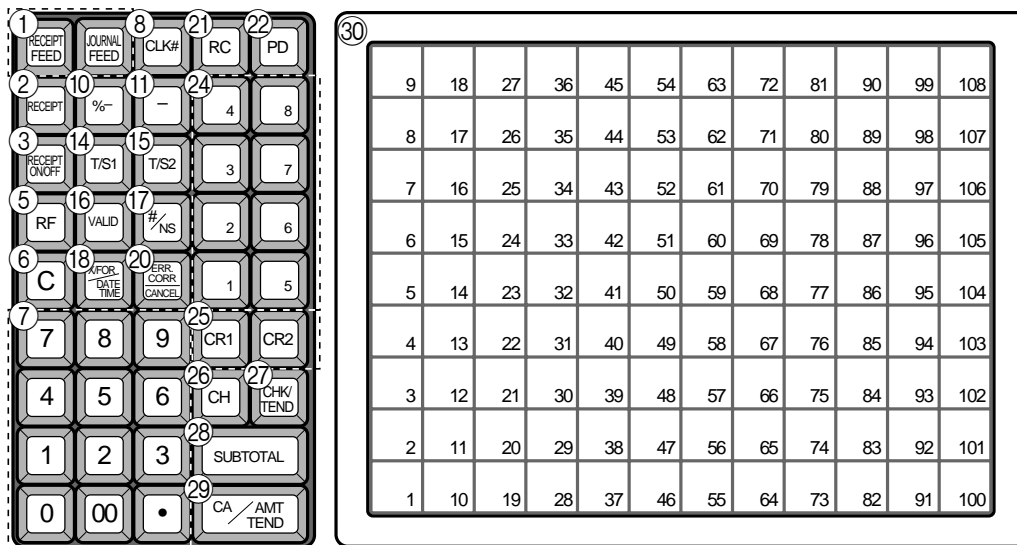

for the U.S. and Canada

### • Register Mode

- ① **Paper feed key** RECEPT FEED, JOURNAL FEED  
Hold this key down to feed paper from the printer.
- ② **Post receipt key** RECEPT  
Use this key to produce a post-finalization receipt .
- ③ **Receipt on/off key** RECEPT ON/OFF  
Use this key pressing two times to change the status “receipt issue” or “no receipt.” In case of “receipt issue”, the indicator is lit.
- ④ **Open key** OPEN  
Use this key to temporarily release a limitation on the number of digits that can be input for a unit price.
- ⑤ **Refund key** RF  
Use this key to input refund amounts and void certain entries.
- ⑥ **Clear key** C  
Use this key to clear an entry that has not yet been registered.
- ⑦ **Ten key pad** 0, 1 ~ 9, 00, •  
Use these keys to input numbers.
- ⑧ **Clerk number key** CLK#  
Use this key to sign clerk on and off the register.
- ⑨ **VAT key** VAT  
Use this key to print a VAT breakdown.
- ⑩ **Discount key** %-  
Use this key to register discounts.
- ⑪ **Minus key** -  
Use this key to input values for subtraction.
- ⑫ **Loan key** LOAN  
This key is used to input the amount of money provided for making change. This operation affects media totals, rather than sales totals. Loans are made for all types of money which can be specified by the finalize key.
- ⑬ **Pick up key** PICK UP  
When the amount in drawer exceeds the limit value (sentinel function), the manager performs a pick up operation. This key is used for this function. This operation affects media totals, rather than sales totals. Pick ups are made for all types of money which can be specified by the finalize key.
- ⑭ **Tax status shift 1 key** T/S1  
Use this key to change the Taxable 1 status of the next item.
- ⑮ **Tax status shift 2 key** T/S2  
Use this key to change the Taxable 2 status of the next item.
- ⑯ **Validation key** VALID  
Use this key to validate transaction amounts on slip.
- ⑰ **Non-add/No sale key** # / NS  
Non-add key: To print reference number (to identify a personal check, credit card, etc.) during a transaction, use this key after some numerical entries.  
No sale key: Use this key to open the drawer without registering anything.

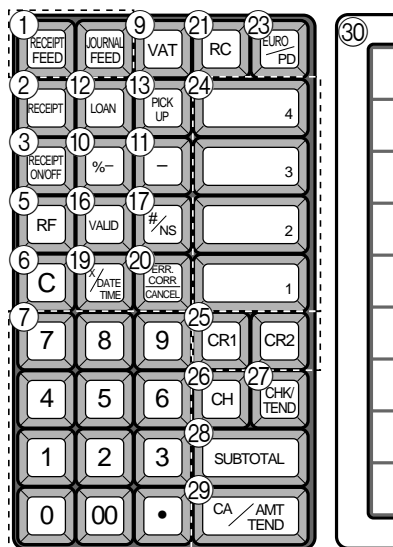

for German

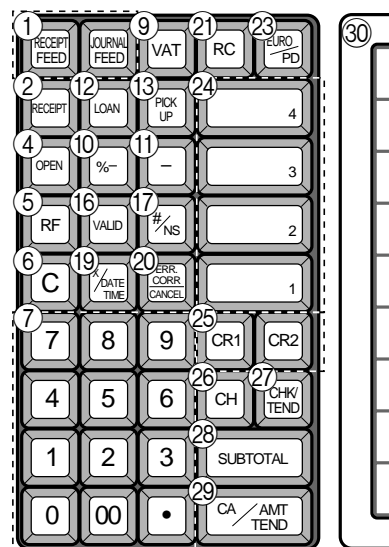

for other area

- 18 **Multiplication/For/Date/Time key** X / FOR  
DATE  
TIME  
Use this key to input a quantity for a multiplication operation and registration of split sales of packaged items. Between transactions, this key displays the current time and date.
- 19 **Multiplication/Date/Time key** X / DATE  
TIME  
Use this key to input a quantity for a multiplication operation. Between transactions, this key displays the current time and date.
- 20 **Error correction/Cancellation key** ERR CORR  
CANCEL  
Use this key to correct registration errors and to cancel registration of entire transactions.
- 21 **Received on account key** RC  
Use this key following a numeric entry to register money received for non-sale transactions.
- 22 **Paid out key** PD  
Use this key following a numeric entry to register money paid out from the drawer.
- 23 **Euro/Paid out key** EURO  
PD  
Euro key: Use this key to convert the main currency to the sub currency (the euro/the local money), when registering a subtotal amount. This key is also used for specifying sub currency while entering an amount of payment or declaration in drawers.  
Paid out key: Use this key following a numeric entry to register money paid out from the drawer.
- 24 **Department keys** 1, 2, 3 ~ 4, 8  
Use these keys to register items to departments.
- 25 **Credit key** CR1, CR2  
Use this key to register a credit sale.
- 26 **Charge key** CH  
Use this key to register a charge sale.
- 27 **Check key** CHK/  
TEND  
Use this key to register a check tender.
- 28 **Subtotal key** SUB  
TOTAL  
Use this key to display and print the current subtotal (includes add-on tax) amount.
- 29 **Cash/Amount tendered key** CA / AMT  
TEND  
Use this key to register a cash tender.
- 30 **Flat PLU key** 001, 002 ~ 108  
Use these keys to register items to flat PLUs.





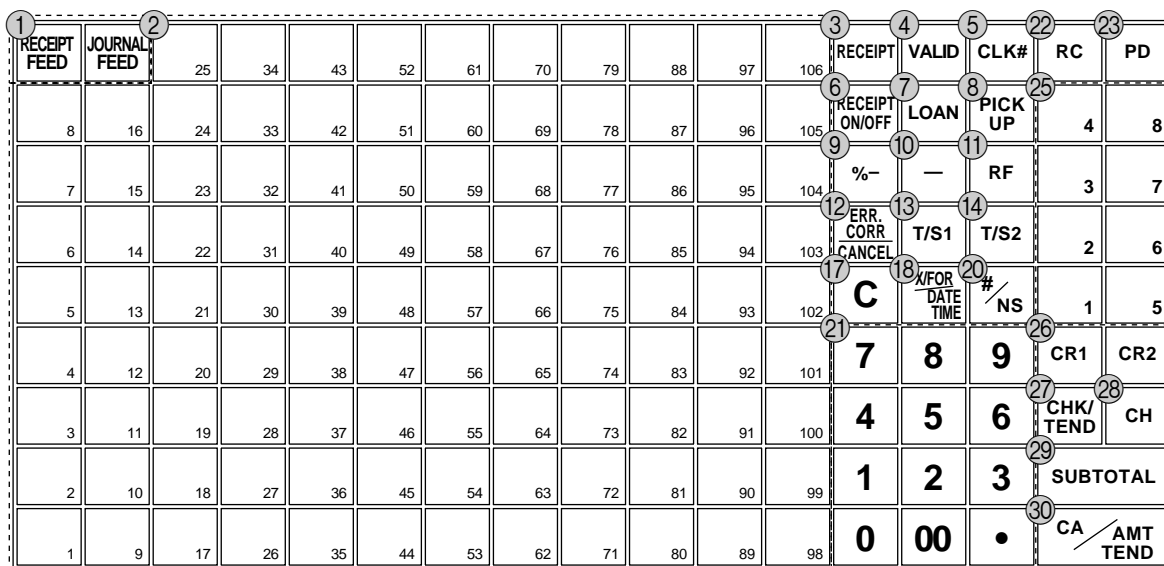















# Introducing TK-6000/6500

## Keyboard (TK-6500)



for the U.S.

### • Register Mode

- ① **Paper feed key** ,   
Hold this key down to feed paper from the printer.
- ② **Flat PLU key** ,  ~   
Use these keys to register items to flat PLUs.
- ③ **Post receipt key**   
Use this key to produce a post-finalization receipt .
- ④ **Validation key**   
Use this key to validate transaction amounts on slip.
- ⑤ **Clerk number key**   
Use this key to sign clerk on and off the register.
- ⑥ **Receipt on/off key**   
Use this key pressing two times to change the status “receipt issue” or “no receipt.” In case of “receipt issue”, the indicator is lit.
- ⑦ **Loan key**   
This key is used to input the amount of money provided for making change. This operation affects media totals, rather than sales totals. Loans are made for all types of money which can be specified by the finalize key.
- ⑧ **Pick up key**   
When the amount in drawer exceeds the limit value (sentinel function), the manager performs a pick up operation. This key is used for this function. This operation affects media totals, rather than sales totals. Pick ups are made for all types of money which can be specified by the finalize key.
- ⑨ **Discount key**   
Use this key to register discounts.
- ⑩ **Minus key**   
Use this key to input values for subtraction.
- ⑪ **Refund key**   
Use this key to input refund amounts and void certain entries.
- ⑫ **Error correction/Cancellation key**   
Use this key to correct registration errors and to cancel registration of entire transactions.
- ⑬ **Tax status shift 1 key**   
Use this key to change the Taxable 1 status of the next item.
- ⑭ **Tax status shift 2 key**   
Use this key to change the Taxable 2 status of the next item.
- ⑮ **Open key**   
Use this key to temporarily release a limitation on the number of digits that can be input for a unit price.
- ⑯ **VAT key**   
Use this key to print a VAT breakdown.
- ⑰ **Clear key**   
Use this key to clear an entry that has not yet been registered.
- ⑱ **Multiplication/For/Date/Time key**   
Use this key to input a quantity for a multiplication operation and registration of split sales of packaged items. Between transactions, this key displays the current time and date.

1	RECEIPT FEED	2	JOURNAL FEED	25	34	43	52	61	70	79	88	97	106	3	RECEIPT	4	VALID	5	CLK#	22	RC	24	EURO PD
8	16	24	33	42	51	60	69	78	87	96	105	104	103	6	RECEIPT ON/OFF	7	LOAN	8	PICK UP	25	4	8	
7	15	23	32	41	50	59	68	77	86	95	104	103	102	9	%-	10	-	11	RF	3	7		
6	14	22	31	40	49	58	67	76	85	94	103	102	101	12	ERR. CORR. CANCEL	15	OPEN	16	VAT	2	6		
5	13	21	30	39	48	57	66	75	84	93	102	101	100	17	C	19	X/DATE TIME	20	#/NS	1	5		
4	12	20	29	38	47	56	65	74	83	92	101	100	99	21	7	8	9	26	CR1	CR2			
3	11	19	28	37	46	55	64	73	82	91	100	99	98	4	5	6	28	27	CH	CHK/TEND			
2	10	18	27	36	45	54	63	72	81	90	99	98	97	1	2	3	29	29	SUBTOTAL				
1	9	17	26	35	44	53	62	71	80	89	98	97	96	0	00	•	30	30	CA/AMT TEND				

for the U.K.

19 **Multiplication/Date/Time key** 

Use this key to input a quantity for a multiplication operation. Between transactions, this key displays the current time and date.

20 **Non-add/No sale key** 

Non-add key: To print reference number (to identify a personal check, credit card, etc.) during a transaction, use this key after some numerical entries.

No sale key: Use this key to open the drawer without registering anything.

21 **Ten key pad** **0**, **1** ~ **9**, **00**, **•**

Use these keys to input numbers.

22 **Received on account key** **RC**

Use this key following a numeric entry to register money received for non-sale transactions.

23 **Paid out key** **PD**

Use this key following a numeric entry to register money paid out from the drawer.

24 **Euro/Paid out key** 

Euro key: Use this key to convert the main currency to the sub currency (the euro/the local money), when registering a subtotal amount. This key is also used for specifying sub currency while entering an amount of payment or declaration in drawers.

Paid out key: Use this key following a numeric entry to register money paid out from the drawer.

25 **Department keys** **1**, **2**, **3** ~ **8**

Use these keys to register items to departments.

26 **Credit key** **CR1**, **CR2**

Use this key to register a credit sale.

27 **Check key** 

Use this key to register a check tender.

28 **Charge key** **CH**

Use this key to register a charge sale.

29 **Subtotal key** 

Use this key to display and print the current subtotal (includes add-on tax) amount.

30 **Cash/Amount tendered key** 

Use this key to register a cash tender.

## Allocatable functions

You can tailor a keyboard to suit your particular type of business.

### Add check

Use this key in a check tracking system to combine the details of more than one check into a single check.

### Arrangement

Use this key to activate an arrangement program programmed in the arrangement file. Any operation that can be performed from the keyboard, as well as mode, can be programmed in an arrangement program, and can be performed merely by pressing this key. In addition, one numeric entry can be included in an arrangement program. In this case, input the number and press this key. The mode control function of this key can be programmed for all modes except for the OFF and PGM mode.

### Bill copy

Use this key to issue bill copy.

### Bottle return

Use this key to specify next item as bottle return.

### Cancel

Invalidates all preceding data registered for departments, PLUs and set menus within a transaction. This key must be pressed before the transaction involving the data to be invalidated is finalized. It is also effective even after calculation of subtotal amount.

### Check endorsement

Use this key to print a preset check endorsement message using the slip printer.

### Check print

Use this key to print the check on the slip printer.

### Clerk transfer

Use this key to transfer opened checks to another clerk.

### Coupon

Use this key for registering coupons.

### Coupon 2

Use this key to declare the next item registration as coupon.

### Cube

This key provides the same functions as the Square key. In addition, this key also has a cube multiplication function.

### Currency exchange

Use this key to convert foreign currency to local currency or vice versa using the exchange rate preset for the key and displays the result.

Use this key for conversions of a home currency subtotal or merchandise subtotal to equivalent of another country's currency.

Use this key for conversions of another country's currency to the equivalent of the home currency.

### Customer number

Use this key to register the number of customers.

### Declaration

Use this key to declare in drawer amount for money declaration.

### Deposit

Use this key to register deposits.

### Eat-in

Use this key to specify if the customer eats in the restaurant. Before closing a transaction press this key.

### EBT (electronic benefit transfer)

Use this key to register an EBT amount with a tender amount input.

### Food stamp shift

Use this key to change food stamp status.

### Food stamp subtotal

Use this key to obtain the food stamp applicable amount.

### Food stamp tender

Use this key to register a food stamp payment amount with a tender amount input.

### Ketten Bon

Use this key to enter quantities for multiplication. Multiplication by this key issues singular order prints.

### Manual tax

Use this key to register a tax amount.

### Menu shift

Use this key to shift key to the 1st ~ 6th menu.

### Merchandise subtotal

Use this key to obtain subtotal excluding the add-on tax amount and the previous balance.

### New balance

Use this key for adding the latest registered total amount to the previous balance to obtain a new balance.

### New check

Use this key in a check tracking system to input a new check number in order to open a new check under that number.

### New/Old check

Use this key in a check tracking system to input check numbers in order to open new checks and to reopen existing checks. When the clerk inputs a check number, the register checks to see if that number already exists in the check tracking memory. If there is no matching number in the memory, a new check is opened under the input number. If the check number input matches a number already stored in the memory, that check is reopened for further registration or finalization.

### No sale

Use this key to open the drawer between transaction.

### Non add

Use this key to print reference numbers (personal check number, card number, etc.)



**Normal receipt**

Use this key to change the order status from Bon to normal.

**Old check**

Use this key in a check tracking system to input the number of an existing check (previously created by the New check key) whose details are stored in the check tracking memory. Existing checks are reopened to perform further registration or to finalize them.

**Open 2**

Use this key to suspend the compulsory specifications.

**Open check**

Use this key to issue an open check report of an assigned clerk.

**Operator number**

Use this key to enter a clerk number during clerk transfer.

**Operator X/Z**

Use this key to issue a clerk's individual X/Z report.

**Plus**

Use this key for registering surcharge.

**Premium**

Use this key to apply a preset % or manual input % to obtain the premium amount for the last registered item or subtotal.

**Previous balance**

Use this key to register the previous negative/positive balance at the beginning of or during a transaction.

**Previous balance subtotal**

Use this key to obtain subtotal excluding the add-on tax amount and current balance.

**Price**

Use this key to register an open PLU.

**Price inquiry**

Use this key to confirm the price and descriptors of PLU without registering.

**Rate tax**

Use this key to activate the preset tax rate or manually input rate to obtain the tax for the preceding taxable status 1 amount.

**Recall**

Use this key for recalling the transferred check number by the store key. When this key is pressed, the check number will appear in order of the oldest record.

**Review**

Use this key to examine the current transaction by displaying item descriptor and registered amount. This key is also used for void operation.

**Separate check**

Use this key in a check tracking system to separate selected items from one check to another check.

**Slip feed/release**

Use this key to feed slips inserted into the slip printer. This is done by specifying the number of feed lines. This key is also used to release the slip paper holder if numbers are not entered.

**Slip back feed/release**

Use this key to back feed slips inserted into the slip printer. This is done by specifying the number of feed lines. This key is also used to release the slip paper holder if numbers are not entered.

**Slip print**

Use this key to execute a slip batch printing on the slip printer. Pressing this key prints the sales details. Actual printing is performed following receipt issuance.

**Square**

This key provides the same functions as the Multiplication key. In addition, this key also has a square multiplication function.

**Store**

Use this key for storing the check number of the registered items. When this key is pressed, registered item data will be stored, and then these data will transfer to the youngest check number.

**Table number**

Use this key to input table numbers.

**Table transfer**

Use this key to transfer the contents of a check to another check.

**Takeout**

Use this key to specify if the customer takes out items. Before total a transaction. Press this key for the tax exemption.

**Tax exempt**

Use this key to change taxable amounts to nontaxable amounts.

**Taxable amount subtotal**

Use this key to obtain taxable amount subtotal.

**Text print**

Use this key to enter characters to print.

**Text recall**

Use this key to print preset characters.

**Tip**

Use this key to register tips.

**Tray total**

Use this key to display the total amount for all registrations from the last registration until this key is pressed or registrations between presses of this key.

**Void**

Use this key to invalidate preceding item data registered.

# Introducing TK-6000/6500

---

## How to remove/replace the sheet holder (TK-6000 only)

### Remove the sheet holder

Follow steps 1 ~ 2.

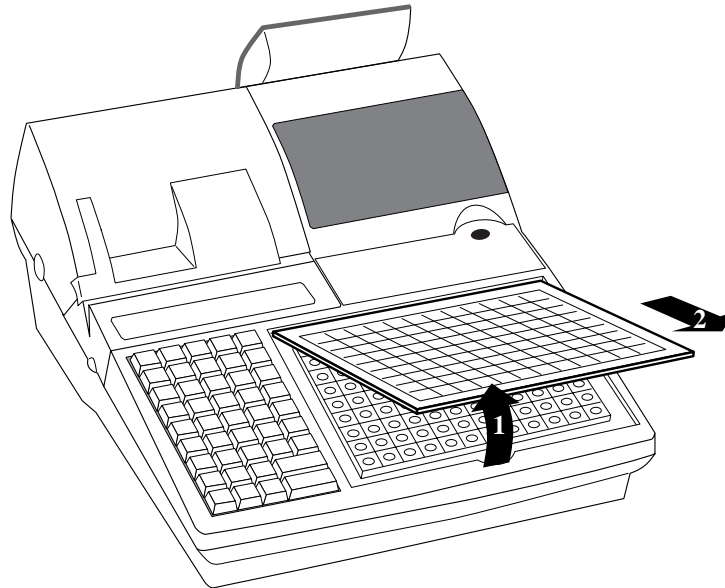

### Replace the sheet holder

Follow steps 3 ~ 4.

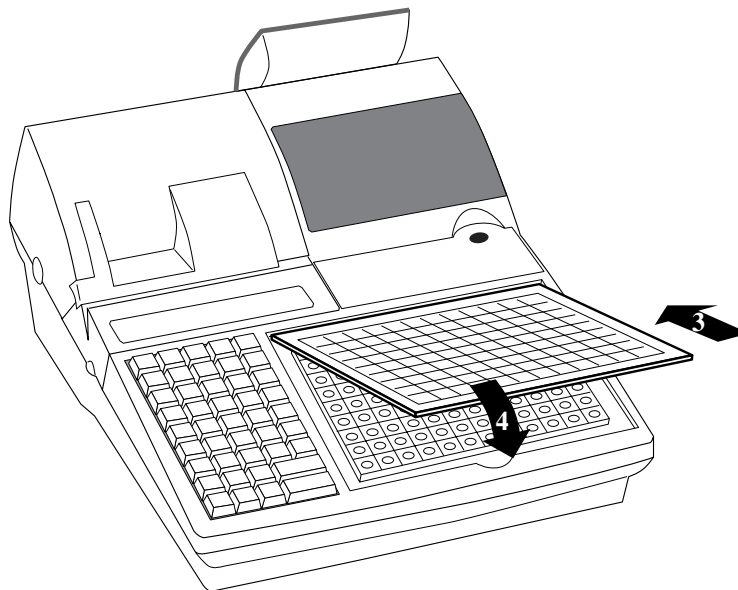

## How to install a menu sheet in the sheet holder (TK-6000 only)

### Open the sheet holder

Follow the steps 1 ~ 3.

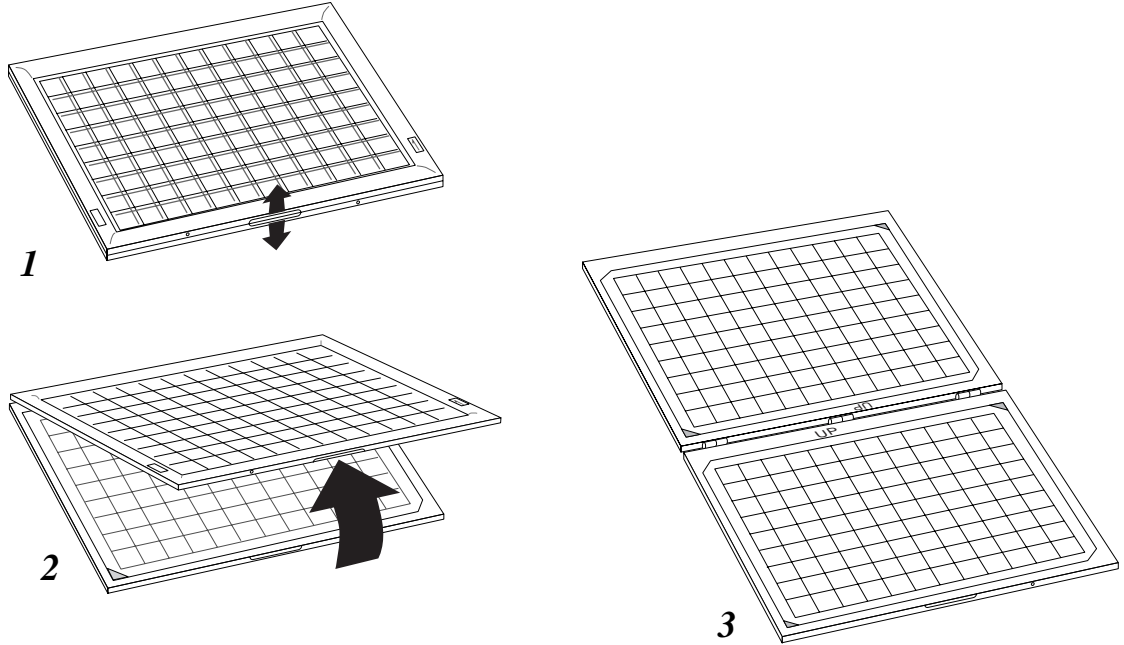

### Set a menu sheet in the sheet holder

Follow the steps 4 ~ 6.

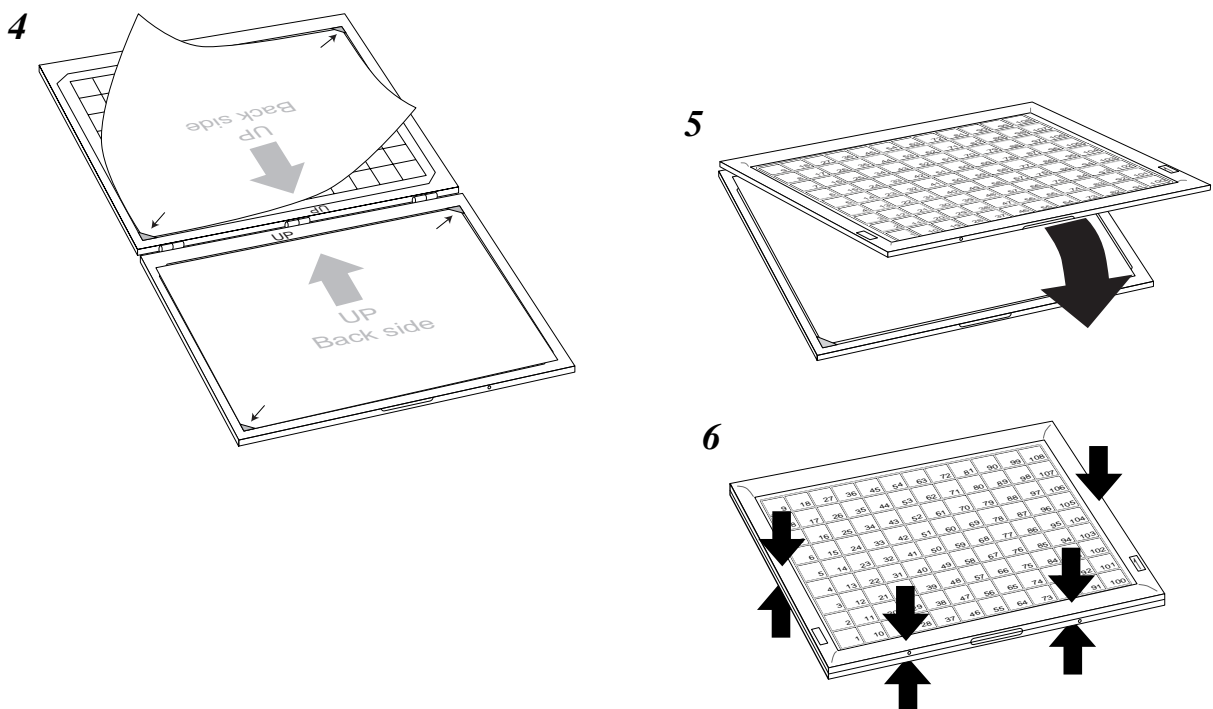

## How to read the printouts

- The journal and receipts are records of all transactions and operations.
- The contents printed on receipts and journal are almost identical.
- You can choose the journal skip function.

If the journal skip function is selected, the cash register will print the total amount of each transaction, and the details of premium, discount and reduction operations only, without printing department and PLU item registrations on the journal.

- The following items can be skipped on receipts and journal.
  - Consecutive number
  - Taxable status
  - Taxable amount
  - Item counter

**Receipt Sample**

```

*****
* THANK YOU *
** CALL AGAIN **
*****

* COMMERCIAL MESSAGE *
* COMMERCIAL MESSAGE *
* COMMERCIAL MESSAGE *
* COMMERCIAL MESSAGE *

REG 03-04-2000 11:58
C01 MC#01 000123

1 DEPT01 T1 -1.00
1 DEPT02 T1 -2.00
5 DEPT03 -5.00

7 No
TA1 -3.00
TX1 -0.15
TL -8.15
CASH -10.00
CG -1.85

*** BOTTOM MESSAGE ***
*** BOTTOM MESSAGE ***
*** BOTTOM MESSAGE ***
*** BOTTOM MESSAGE ***
    
```

Logo message

Commercial message

Mode/Date/Time

Clerk/Machine No.  
Consecutive No.

Q'ty/Item

Item counter

Bottom message

**Journal Sample  
(Item lines Included)**

```

REG 03-04-2000 11:58
C01 MC#01 000123
1 DEPT01 T1 -1.00
1 DEPT02 T1 -2.00
5 DEPT03 -5.00

7 No
TA1 -3.00
TX1 -0.15
TL -8.15
CASH -10.00
CG -1.85

REG 03-04-2000 11:59
C02 MC#01 000124
1 DEPT01 T1 -1.00
1 DEPT03 T1 -3.00
1 DEPT02 T1 -2.00
1 DEPT04 T1 -4.00
5 DEPT05 -5.00

9 No
TA1 -10.00
TX1 -0.50
TL -15.50
CASH -20.00
CG -4.50
    
```

**Journal Sample  
(Item lines Skipped)**

```

REG 03-04-2000 11:57
C01 MC#01 000123
7 No
TA1 -3.00
TX1 -0.15
TL -8.15
CASH -10.00
CG -1.85

REG 03-04-2000 11:57
C02 MC#01 000124
9 No
TA1 -10.00
TX1 -0.50
TL -15.50
CASH -20.00
CG -4.50

REG 03-04-2000 11:58
C01 MC#01 000125
7 No
TA1 -3.00
TX1 -0.15
TL -9.35
CASH -10.00
CG -0.45

REG 03-04-2000 11:59
    
```

In the operation examples contained in this manual, the print samples are what would be produced if the roll paper is being used for receipts. They are not actual size. Actual receipts are 45 mm wide. Also, all sample receipts and journals are printout images.

---

# How to use your cash register

The following describes the general procedure you should use in order to get the most out of your cash register.

## BEFORE business hours...

---

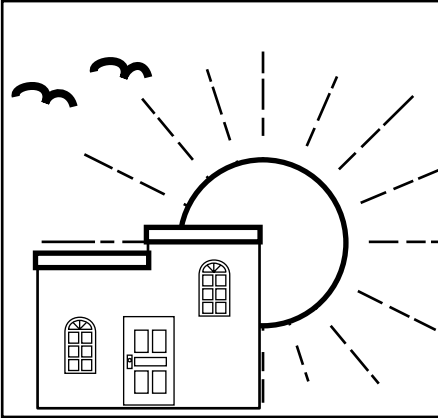

- Check to make sure that the cash register is plugged in securely. Page 9
- Check to make sure there is enough paper left on the roll. Pages 10, 11
- Read the financial totals to confirm that they are all zero. Page 95
- Check the date and time. Page 31

## DURING business hours...

---

- Register transactions. Page 32
- Periodically read totals. Page 94

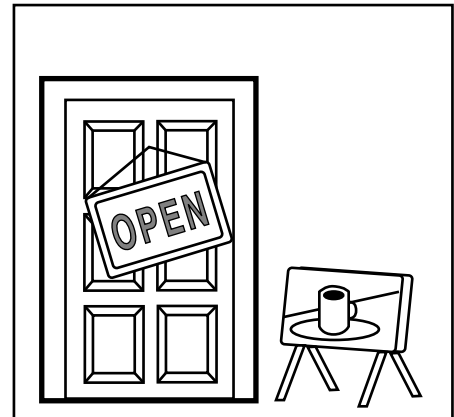

## AFTER business hours...

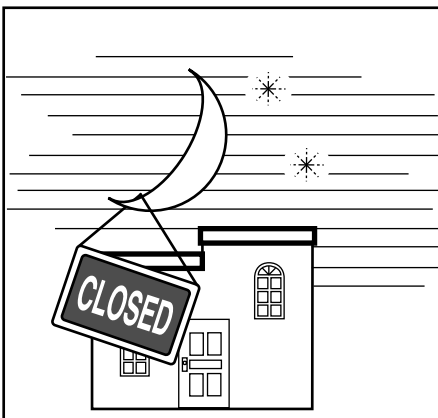

- Reset the daily totals. Page 53
- Remove the journal. Page 108
- Empty the cash drawer and leave it open. Page 17
- Take the cash and journal to the office.

# Basic Operations and Setups

## Assigning a clerk

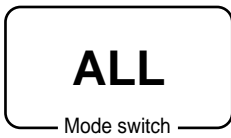

On models available in the United States and Canada, clerk or cashier assignment can be performed using clerk secret numbers only (clerk buttons are not equipped). In Germany, you can assign clerks by using clerk key or by clerk secret number (clerk key is equipped). In other areas, you can assign clerks by using clerk button or by clerk secret number. The method you of assigning clerk depends on the programming of your cash register.

### Clerk button

You can assign the clerk or cashier using the four buttons located below the display panel.

### Clerk lock/clerk key

You can assign the clerk or cashier inserting a clerk key into the clerk lock .

### Clerk secret number key

When the cash register is programmed to use clerk secret numbers for clerk or cashier assignment, the clerk buttons are not functional.

#### Clerk sign on

	OPERATION	RECEIPT
Signing clerk 1 on:	<b>1</b> → <input type="button" value="CLK#"/>	
Signing clerk 2 on:	<b>2</b> → <input type="button" value="CLK#"/>	
⋮	⋮	
Signing clerk 10 on:	<b>1 0</b> → <input type="button" value="CLK#"/> Clerk secret number (1 ~ 10 is set as default.)	

- If you do not want the clerk secret number to be shown on the display, press  before entering the number.

#### Clerk sign off

	OPERATION
Signing clerk off: (except PGM mode)	<b>0</b> → <input type="button" value="CLK#"/>

- The current clerk is also signed off whenever you set the mode switch to OFF position.

### Important!

- The error code “E008” appears on the display whenever you try to perform a registration, a read/ reset operation without signing on.
- A clerk cannot sign on unless other clerk is signed off.
- The signed on clerk is also identified on the receipt/journal.

## Displaying the time and date



You can show the time or date on the display of the cash register whenever there is no registration being made.

### To display and clear the time

OPERATION	DISPLAY
or	 Hour Minutes
Time appears on the display	
Clears the time display	

### To display and clear the date

OPERATION	DISPLAY
or	 (Time is displayed first)
or	
Date appears on the display	
Clears the date display	

## Preparing coins for change



You can use the following procedure to open the drawer without registering an item. This operation must be performed out of a sale. (You can use the key instead of the key. See page 52.)

### Opening the drawer without a sale

OPERATION	RECEIPT

## Preparing and using department/flat-PLU keys

### Registering department/flat-PLU keys



The following examples show how you can use the department/flat-PLU keys in various types of registrations.

### Single item sale

#### Example 1

Item	Unit price	\$1.00
	Quantity	1
	Dept.	1
Payment	Cash	\$1.00

**1 00**

Unit price

**1**

Department

CA/AMT  
TEND

REG 03-04-2000 09:05  
C01 MC#01 000002

1 DEPT01           -1.00  
TL                 -1.00  
CASH               -1.00

Date/time

Mode/consecutive No.

Department No./unit price

Total amount

#### Example 2 (Subtotal registration and change computation)

Item	Unit price	\$12.34
	Quantity	1
	Flat-PLU	1
Payment	Cash	\$20.00

**1 2 3 4**

Unit price

**001**

Flat-PLU

**SUB TOTAL**

**2 0 00** CA/AMT  
TEND

Amount tendered

REG 03-04-2000 09:10  
C01 MC#01 000003

1 PLU001           -12.34  
TL                 -12.34  
CASH               -20.00  
CG                 -7.66

Total amount

Amount tendered

Change

### Repeat

Item	Unit price	\$1.50
	Quantity	3
	Dept.	1
Payment	Cash	\$10.00

**1 5 0 1**

**1**

**1**

**SUB TOTAL**

**1 0 00** CA/AMT  
TEND

REG 03-04-2000 09:15  
C01 MC#01 000004

1 DEPT01           -1.50  
1 DEPT01           -1.50  
1 DEPT01           -1.50  
TL                 -4.50  
CASH               -10.00  
CG                 -5.50

Repeat

Repeat



## Multiplication

Item	Unit price	\$1.00
	<b>Quantity</b>	<b>12</b>
	Flat-PLU	1
Payment	Cash	\$20.00

**OPERATION**

1 2  /FOR DATE TIME

Quantity  
(4-digit integer/2-digit decimal)

1 00  /FOR DATE TIME

2 0 00  /FOR DATE TIME

SUB TOTAL

CA/AMT /TEND

**RECEIPT**

```
REG 03-04-2000 09:20
C01 MC#01 000005

12 PLU0001 -12.00
-----
12 @1/ 1.00
PLU0001 -12.00
-----
TL -12.00
CASH -20.00
CG -8.00
```

Quantity/result  
or  
Quantity/unit q'ty/@  
Result

- The model for the U.S./Canada, use  /FOR DATE TIME instead of  /DATE TIME.

## Split sales of packaged items

Item	Unit price	4 for \$10.00
	<b>Quantity</b>	<b>3</b>
	Dept.	1
	Taxable	No
Payment	Cash	\$10.00

**OPERATION**

3  /FOR DATE TIME

Quantity being purchased  
(4-digit integer/2-digit decimal)

4  /FOR DATE TIME

Package quantity  
(4-digit integer/2-digit decimal)

1 0 00  /FOR DATE TIME

Package price

1 0 00  /FOR DATE TIME

SUB TOTAL

CA/AMT /TEND

**RECEIPT**

```
REG 03-04-2000 09:25
C01 MC#01 000006

3 DEPT01 -7.50
-----
3 @4/ 10.00
DEPT01 -7.50
-----
TL -7.50
CASH -10.00
CG -2.50
```

Quantity/result  
or  
Quantity/unit q'ty/@  
Result

- If  /FOR DATE TIME is not allocated on the keyboard, key allocation is necessary.

## Programming department/flat-PLU keys

To program a unit price for each department/flat-PLU

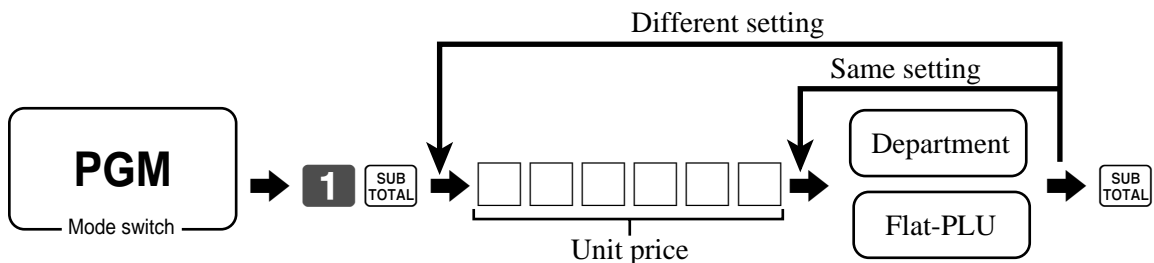

To program the tax calculation status for each department/flat-PLU

### Tax calculation status

This specification defines which tax table should be used for automatic tax calculation.

# Basic Operations and Setups

## Programming procedure

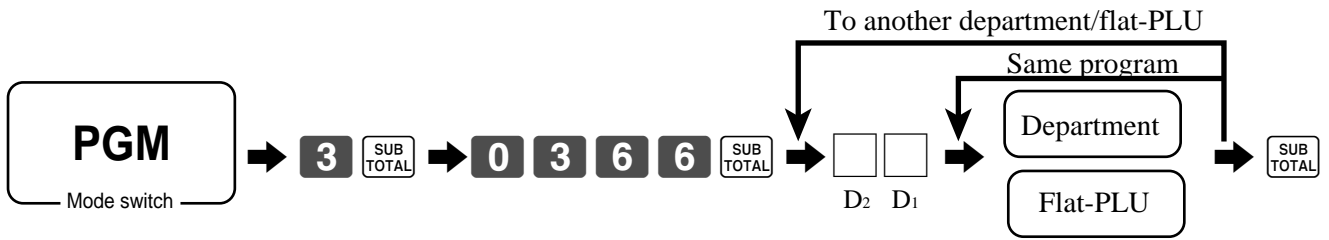

for the U.S./Singapore			
Food stamp (for Singapore, always "0")		Yes = 1 No = 0	<input type="checkbox"/> D <sub>2</sub>
Taxable 1 status	a	Yes = 1 No = 0	<input type="checkbox"/> (a+b+c) D <sub>1</sub>
Taxable 2 status	b	Yes = 2 No = 0	
Taxable 3 status	c	Yes = 4 No = 0	
for Canada			
Donuts status		Yes = 1 No = 0	<input type="checkbox"/> D <sub>2</sub>
Non tax = 0 Taxable 1 = 1 Taxable 2 = 2	Taxable 3 = 3 Taxable 4 = 4 Taxable 1 & 2 = 5	Taxable 1 & 3 = 6 Taxable 1 & 4 = 7	Significant number <input type="checkbox"/> D <sub>1</sub>
for other area			
Non tax = 0 Taxable 1 = 1 Taxable 2 = 2 Taxable 3 = 3	Taxable 4 = 4 Taxable 5 = 5 Taxable 6 = 6 Taxable 7 = 7	Taxable 8 = 8 Taxable 9 = 9 Taxable 10 = 10	Significant numbers <input type="checkbox"/> <input type="checkbox"/> D <sub>2</sub> D <sub>1</sub>

## To program high amount limit for each department/flat-PLU

### Programming procedure

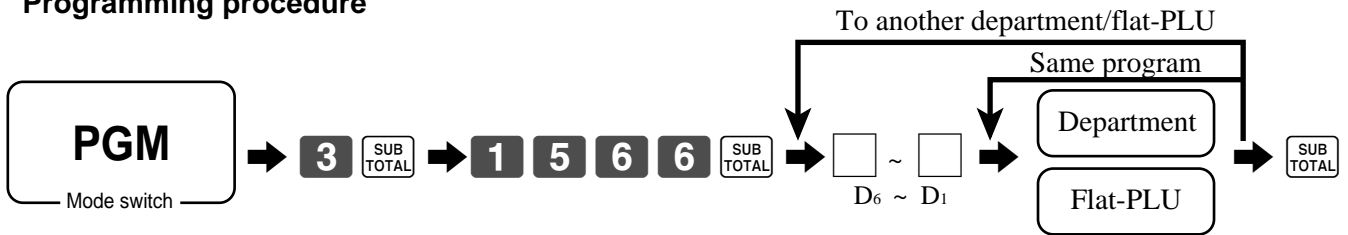

Description	Choice	Program code
High amount limit for entering unit price manually.	Significant numbers	<input type="checkbox"/> <input type="checkbox"/> <input type="checkbox"/> <input type="checkbox"/> D <sub>6</sub> D <sub>5</sub> ~ D <sub>2</sub> D <sub>1</sub>

## Registering department/flat-PLU keys by programming data

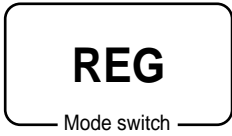

### Preset price

#### OPERATION

Item	Unit price	(\$1.00) <sub>preset</sub>
	Quantity	1
	Dept.	2
Payment	Cash	\$1.00

**2**  
CA/AMT  
TEND

#### RECEIPT

```
REG 03-04-2000 09:30
C01 MC#01 000007
1 DEPT02      -1.00
TL            -1.00
CASH         -1.00
```

Department No./unit price

### Preset tax status

#### OPERATION

Item 1	Unit price	(\$2.00) <sub>preset</sub>
	Quantity	5
	Dept.	3
	<b>Taxable</b>	<b>(1)</b> <sub>preset</sub>
Item 2	Unit price	(\$2.00) <sub>preset</sub>
	Quantity	1
	Dept.	4
	<b>Taxable</b>	<b>(2)</b> <sub>preset</sub>
Payment	Cash	\$20.00

**5** %DATE  
TIME  
**3**  
**4**  
SUB  
TOTAL  
**2 0 00** CA/AMT  
TEND

#### RECEIPT

```
REG 03-04-2000 09:35
C01 MC#01 000008
5 DEPT03 T1 -10.00
1 DEPT04 T2 -2.00
TA1      -10.00
TX1      -0.40
TA2      -2.00
TX2      -0.20
TL       -12.60
CASH     -20.00
CG       -7.40
```

Tax status  
Taxable Amount 1  
Tax 1  
Taxable Amount 2  
Tax 2

- The model for the U.S./Canada, use  FOR DATE TIME instead of  DATE TIME.

### Locking out high amount limitation

#### OPERATION

Item	Unit price	\$1.05
	Quantity	1
	Dept.	3
	<b>Max.amount</b>	<b>(\$10.00)</b> <sub>preset</sub>
Payment	Cash	\$2.00

**1 0 5 0 3**  
**ERROR ALARM(E037)**  
(Exceeding high amount)  
**C**  
**1 0 5 3**  
SUB  
TOTAL  
**2 00** CA/AMT  
TEND

#### RECEIPT

```
REG 03-04-2000 09:40
C01 MC#01 000009
1 DEPT03      -1.05
TL            -1.05
CASH         -2.00
CG           -0.95
```

## Preparing and using PLUs

This section describes how to prepare and use PLUs.

### CAUTION:

Before you use PLUs, you must first program the unit price and tax status.

### Programming PLUs

#### To program a unit price for each PLU

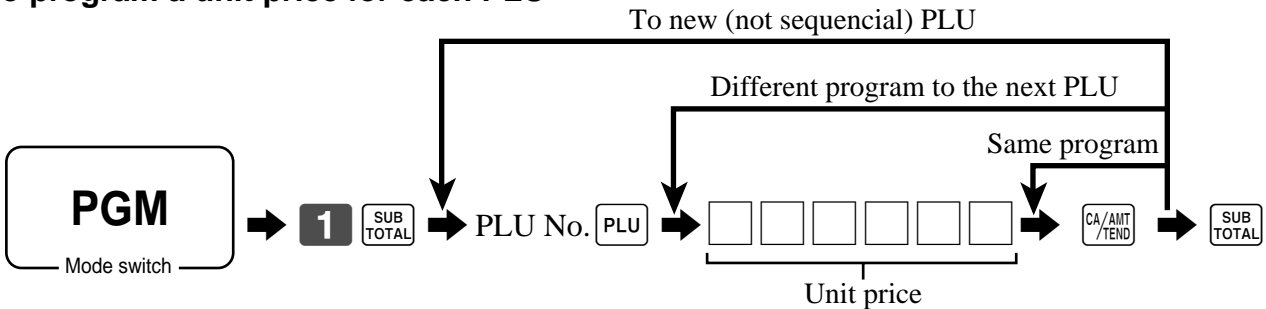

#### To program tax calculation status for each PLU

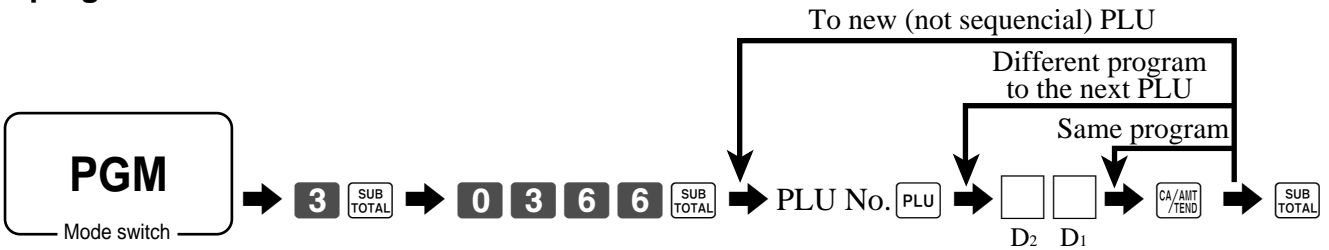

for the U.S./Singapore			
Food stamp (for Singapore, always "0")		Yes = 1 No = 0	<input type="checkbox"/> D <sub>2</sub>
Taxable 1 status	a	Yes = 1 No = 0	<input type="checkbox"/> (a+b+c) D <sub>1</sub>
Taxable 2 status	b	Yes = 2 No = 0	
Taxable 3 status	c	Yes = 4 No = 0	
for Canada			
Donuts status		Yes = 1 No = 0	<input type="checkbox"/> D <sub>2</sub>
Non tax = 0 Taxable 1 = 1 Taxable 2 = 2	Taxable 3 = 3 Taxable 4 = 4 Taxable 1 & 2 = 5	Taxable 1 & 3 = 6 Taxable 1 & 4 = 7	Significant number <input type="checkbox"/> D <sub>1</sub>
for other area			
Non tax = 0 Taxable 1 = 1 Taxable 2 = 2 Taxable 3 = 3	Taxable 4 = 4 Taxable 5 = 5 Taxable 6 = 6 Taxable 7 = 7	Taxable 8 = 8 Taxable 9 = 9 Taxable 10 = 10	Significant numbers <input type="checkbox"/> <input type="checkbox"/> D <sub>2</sub> D <sub>1</sub>

## Registering PLUs

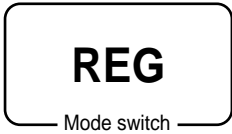

The following examples show how you can use PLUs in various types of registrations.

### PLU single item sale

Item	Unit price	(\$2.50) <sub>preset</sub>
	Quantity	1
	<b>PLU</b>	<b>14</b>
Payment	Cash	\$3.00

#### OPERATION

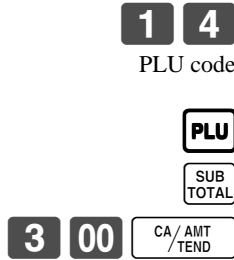

#### RECEIPT

```
REG 03-04-2000 09:45
C01 MC#01 000010
1 PLU0014 -2.50
TL -2.50
CASH -3.00
CG -0.50
```

PLU No./unit price

### PLU repeat

Item	Unit price	(\$2.50) <sub>preset</sub>
	Quantity	3
	PLU	14
Payment	Cash	\$10.00

#### OPERATION

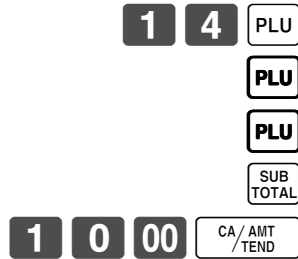

#### RECEIPT

```
REG 03-04-2000 09:50
C01 MC#01 000011
1 PLU0014 -2.50
1 PLU0014 -2.50
1 PLU0014 -2.50
TL -7.50
CASH -10.00
CG -2.50
```

### PLU multiplication

Item	Unit price	(\$2.00) <sub>preset</sub>
	Quantity	10
	PLU	7
Payment	Cash	\$20.00

#### OPERATION

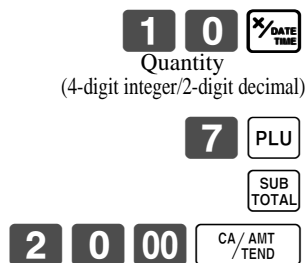

#### RECEIPT

```
REG 03-04-2000 09:55
C01 MC#01 000012
10 PLU0007 -20.00
10 @1/ 2.00
PLU0007 -20.00
TL -20.00
CASH -20.00
CG -0.00
```

Quantity/result  
or

Quantity/unit q'ty/@  
Result

- The model for the U.S./Canada, use instead of .

# Basic Operations and Setups

## Split sales of packaged item

Item	Unit price (5for\$20.00) <sub>preset</sub>	
	<b>Quantity</b>	<b>3</b>
	PLU	28
Payment	Cash	\$15.00

**3**  FOR DATE TIME

Quantity being purchased  
(4-digit integer/2-digit decimal)

**5**  FOR DATE TIME

Package quantity  
(4-digit integer/2-digit decimal)

**2 8**  PLU

SUB TOTAL

**1 5 00**  CA/AMT TEND

REG 03-04-2000 10:00  
C01 MC#01 000013

---

3 PLU0028 -12.00

---

3 @5/ 20.00  
PLU0028 -12.00

---

TL -12.00  
CASH -15.00  
CG -3.00

Quantity/result  
or  
Quantity/unit q'ty/@  
Result

- If  FOR DATE TIME is not allocated on the keyboard, key allocation is necessary.

## Open PLU

Item 1	Unit price	\$32.80
	Quantity	1
	PLU	30
Item 2	Unit price	\$13.00
	Quantity	2
	PLU	31
Payment	Cash	\$60.00

**3 0**  PLU

**3 2 8 0**  PRICE

Unit price

**3 1**  PLU

**1 3 00**  PRICE

Repeat  PRICE

SUB TOTAL

**6 0 00**  CA/AMT TEND

REG 03-04-2000 10:05  
C01 MC#01 000014

---

1 PLU0030 -32.80  
1 PLU0031 -13.00  
1 PLU0031 -13.00  
TL -58.80  
CASH -60.00  
CG -1.20

- Before registering an open PLU, it is necessary to preset it as an open PLU.

# Shifting the taxable status of an item

By pressing "Tax Shift" key, you can shift the taxable status of an item.

**REG**

Mode switch

## Calculation merchandise subtotal

### OPERATION

### RECEIPT

Item 1	Dept. 1	\$4.00
	Quantity	1
	<b>Taxable</b>	(2) <sub>preset</sub>
Item 2	Dept. 2	\$2.00
	Quantity	1
	<b>Taxable</b>	(No)→1
Item 3	Dept. 3	\$6.00
	Quantity	1
	<b>Taxable</b>	(1)→1, 2
Item 4	Dept. 4	\$7.00
	Quantity	1
	<b>Taxable</b>	(2)→No
Payment	Cash	\$20.00

4 00 1

T/S1

2 00 2

Pressing  changes the tax status from Nontaxable to Taxable 1

6 00 3

Pressing  changes the tax status from Taxable 1 to Taxable 1, 2

7 00 4

Pressing  changes the tax status from Taxable 2 to Nontaxable

SUB TOTAL

2 0 00 CA/AMT/TEND

```

REG 03-04-2000 10:10
C01 MC#01 000015

1 DEPT01 T2 -4.00
1 DEPT02 T1 -2.00
1 DEPT03 T12 -6.00
1 DEPT04 -7.00
TA1 -8.00
TX1 -0.32
TA2 -10.00
TX2 -0.50
TL -19.82
CASH -20.00
CG -0.18
    
```

### Important!

- To change the tax status of the next item to be registered, be sure to press , .
- If the last item registered is programmed as nontaxable, a discount () key) operation on this item is always nontaxable.
- In this case, you cannot manually change the tax status to Taxable 1 or 2 by pressing the ,  keys.

## Preparing and using discounts

This section describes how to prepare and register discounts.

### Programming discounts

To program a rate to the **%-** key

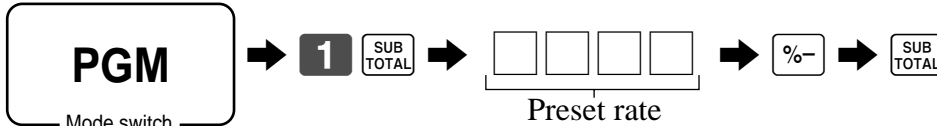

**Example:**

10% ⇨ **1 0**  
 5.5% ⇨ **5 . 5**  
 12.34% ⇨ **1 2 . 3 4**

### Registering discounts



The following example shows how you can use the **%-** key in various types of registration.

### Discount for items and subtotals

#### OPERATION

#### RECEIPT

Item 1	Dept. 1	\$5.00
	Quantity	1
	Taxable	(1) <sub>preset</sub>
Item 2	PLU 16	(\$10.00) <sub>preset</sub>
	Quantity	1
	Taxable	(2) <sub>preset</sub>
<b>Discount</b>	<b>Rate</b>	<b>(5%)<sub>preset</sub></b>
<b>Subtotal discount</b>	<b>Rate</b>	<b>3.5%</b>
	<b>Taxable</b>	<b>Nontaxable</b>
Payment	Cash	\$15.00

**5 00** **1**  
**1 6** **PLU**  
**%-**  
 Applies the preset discount rate to the last item registered.  
**SUB TOTAL**  
**3 . 5** **%-**  
 The input value takes priority of the preset value.  
**SUB TOTAL**  
**1 5 00** **CA/AMT/TEND**

```

REG 03-04-2000 10:15
C01 MC#01 000016
1 DEPT01 T1 -5.00
1 PLU016 T2 -10.00
5%
%- T2 -0.50
ST -14.50
3.5%
%- -0.51
TA1 -5.00
TX1 -0.20
TA2 -9.50
TX2 -0.48
TL -14.67
CASH -15.00
CG -0.33
    
```

- You can manually input rates up to 4 digits long (0.01% to 99.99%).

### Taxable status of the **%-** key

- Whenever you perform a discount operation on the last item registered, the tax calculation for discount amount is performed in accordance with the tax status programmed for that item.
- Whenever you perform a discount operation on a subtotal amount, the tax calculation for the subtotal amount is performed in accordance with the tax status programmed for the **%-** key.



# Preparing and using reductions

This section describes how to prepare and register reductions.

## Programming for reductions

You can use the **[-]** key to reduce single item or subtotal amounts.

### To program preset reduction amount

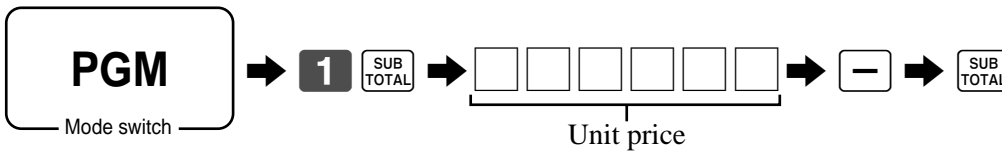

## Registering reductions



The following examples show how you can use the **[-]** key in various types of registration.

### Reduction for items

OPERATION			RECEIPT
	Dept. 1	\$5.00	<div style="display: flex; justify-content: space-around;"> <div style="text-align: center;"> <p><b>5 00</b> <b>1</b></p> <p><b>2 5</b> <b>[-]</b></p> <p>Reduces the last amount registered by the value input.</p> <p><b>4 5</b> <b>PLU</b></p> <p><b>[-]</b></p> <p><b>SUB TOTAL</b></p> <p><b>1 1 00</b> <b>CA/AMT TEND</b></p> </div> <div style="border: 1px solid black; padding: 5px;"> <pre> REG 03-04-2000 10:20 C01  MC#01  000017  1 DEPT01  T1   +5.00 -         T1   -0.25 1 PLU0045 T1   +6.00 -         T1   -0.50 TA1              -10.25 TX1              +0.41 TL              -10.66 CASH              -11.00 CG               +0.34                     </pre> </div> </div>
Item 1	Quantity	1	
	Taxable	(1) <sub>preset</sub>	
<b>Reduction</b>	<b>Amount</b>	<b>\$0.25</b>	
Item 2	PLU 45	(\$6.00) <sub>preset</sub>	
	Quantity	1	
	Taxable	(1) <sub>preset</sub>	
<b>Reduction</b>	<b>Amount</b>	<b>(\$0.50)<sub>preset</sub></b>	
Payment	Cash	\$11.00	

- You can manually input reduction values up to 7 digits long.
- If you want to subtract the reduction amount from the department or PLU totalizer, program “Net totaling.”

# Basic Operations and Setups

## Reduction for subtotal

			OPERATION	RECEIPT
Item 1	Dept. 1	\$3.00	3 00 1	REG 03-04-2000 10:25 C01 MC#01 000018  1 DEPT01 T1 -3.00 1 DEPT02 T2 -4.00 - -0.75 TA1 -3.00 TX1 -0.12 TA2 -4.00 TX2 -0.20 TL -6.57 CASH -7.00 CG -0.43
	Quantity	1	4 00 2	
	Taxable	(1) <sub>preset</sub>	SUB TOTAL	
Item 2	Dept. 2	\$4.00	7 5 -	
	Quantity	1	Reduces the subtotal by the value input here.	
	Taxable	(2) <sub>preset</sub>	SUB TOTAL	
<b>Subtotal</b>	<b>Amount</b>	<b>\$0.75</b>	7 00 CA/AMT/TEND	
<b>Reduction</b>	<b>Taxable</b>	(No) <sub>preset</sub>		
Payment	Cash	\$7.00		

# Registering credit and check payments

The following examples show how to register credits and payments by check.

**REG**

Mode switch

## Check

### OPERATION

### RECEIPT

Item	Dept. 1	\$11.00
	Quantity	1
Payment	Check	\$20.00

1 1 00 1  
SUB TOTAL  
2 0 00 CHK/TEND

```
REG 03-04-2000 10:30
C01 MC#01 000019
1 DEPT01 -11.00
TL -11.00
CHECK -20.00
CG -9.00
```

## Credit

### OPERATION

### RECEIPT

Item	Dept. 4	\$15.00
	Quantity	1
Reference	Number	1234
Payment	Credit	\$15.00

1 5 00 4  
SUB TOTAL  
1 2 3 4 #/NS  
CR1

```
REG 03-04-2000 10:35
C01 MC#01 000020
1 DEPT04 -15.00
#/NS 1234
TL -15.00
CREDIT1 -15.00
```

Reference No.

## Mixed tender (cash, credit and check)

### OPERATION

### RECEIPT

Item	Dept. 4	\$55.00
	Quantity	1
Payment	Check	\$30.00
	Cash	\$5.00
	Credit	\$20.00

5 5 00 4  
SUB TOTAL  
3 0 00 CHK/TEND  
5 00 CA/AMT TEND  
CR1

```
REG 03-04-2000 10:40
C01 MC#01 000021
1 DEPT04 -55.00
TL -55.00
CHECK -30.00
CASH -5.00
CREDIT1 -20.00
```

## Registering both the Euro and local currency

**REG**

Mode switch

The following example shows the basic operation using the currency exchange function between the Euro and the local currency.

### Case A

Main currency	Local
Payment	Euro
Change	Local
Rate	1 Euro = 0.5 FFr

#### OPERATION

**6 0 0** 



← Press the  key, which converts the subtotal amount into the sub currency by applying the preset exchange rate.



After you press the  key, the result is shown on the display.



← Press the  key if you enter the payment in the sub currency.

**1 5 00**



← Press the  key to finalize the transaction. The change amount is shown in the programmed currency.

#### DISPLAY

0.00E

12.00E

0.00E

15.00E

150

#### RECEIPT

```

REG 03-04-2000 10:45
C01  MC#01  000022

1 DEPT01      -6.00
  TL          -6.00
              (€12.00)

EURO money
CASH          €15.00
CG            -1.50
              (€3.00)
    
```

### Case B

Main currency	Euro
Payment	Local
Change	Euro
Rate	1 Euro = 0.5 FFr

#### OPERATION

#### DISPLAY

**1 2 00** 



← Press the  key, which converts the subtotal amount into the sub currency by applying the preset exchange rate.

0.00L



After you press the  key, the result is shown on the display.

6.00L



← Press the  key if you enter the payment in the sub currency.

0.00L

**6 00**



← Press the  key to finalize the transaction. The change amount is shown in the programmed currency.

6.00L

0.00

#### RECEIPT

```

REG 03-04-2000 10:50
C01 MC#01 000023

1 DEPT01 €12.00
TL €12.00
(-6.00)
LOCAL money
CASH -6.00
CG €0.00
(-0.00)
    
```

# Basic Operations and Setups

## Validation printing

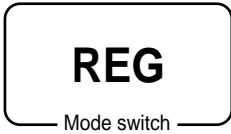

You can perform total amount validation following finalization using **CA/AMT/TEND**, **CH**, **CHK/TEND**, **CR1**, **CR2** keys and **RC**, **PD** keys. Also you can perform single item validation.

### Total amount validation

Item	Dept. 1	\$14.00
	Quantity	1
Payment	Check	\$20.00
<b>Validation</b>		

**1 4 00** **1**

**2 0 00** **CHK/TEND**

**OPERATION**

**RECEIPT**

```

REG 03-04-2000 10:55
C01 MC#01 000024

1 DEPT01      -14.00
  TL          -14.00
  CHECK       -20.00
  CG           -6.00
    
```

- ① Open the journal window.
- ② Insert paper.
- ③ Press **VALID**.

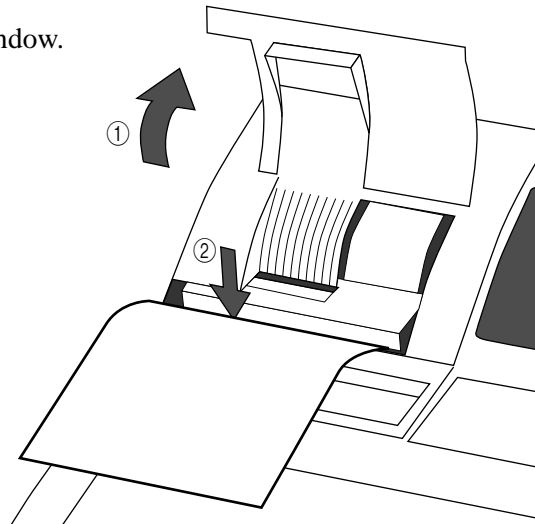

### Validation sample

135 mm ~ 210 mm

70 mm Min.

Format A REG C01 030400 1055 MC#01 000024 CHECK -14.00

Format B REG C01 030400 1055 MC#01 024 CHECK -14.00

Mode (4 digits)

Clerk name (6 digits)

Date (6 digits), Time (4 digits)

Machine/Cons. No. (6 digits ea.)

Key descriptor

Amount

# Registering returned goods in the REG mode



The following example shows how to use the **RF** key in the REG mode to register goods returned by customers.

## OPERATION

Item 1	Dept. 1	\$2.35
	Quantity	1
Item 2	Dept. 2	\$2.00
	Quantity	1
Item 3	PLU 1 (\$1.20) <sub>preset</sub>	
	Quantity	1
Returned Item 1	Dept. 1	\$2.35
	Quantity	1
Returned Item 3	PLU 1 (\$1.20) <sub>preset</sub>	
	Quantity	1
Payment	Cash	\$2.00

**2 3 5** **1**  
**2 00** **2**  
**1** **PLU**  
**RF**  
**2 3 5** **1**  
 Press **RF** before the item you want to return.  
**RF**  
**1** **PLU**  
**SUB TOTAL**  
**CA/AMT /TEND**

## RECEIPT

```

REG 03-04-2000 11:00
C01 MC#01 000025

1 DEPT01 -2.35
1 DEPT02 -2.00
1 PLU0001 -1.20
RF .....
1 DEPT01 -2.35
RF .....
1 PLU0001 -1.20
TL -2.00
CASH -2.00
    
```

# Registering returned goods in the RF mode

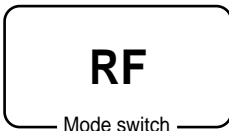

The following examples show how to use the RF mode to register goods returned by customers.

## Normal refund transaction

### OPERATION

Returned Item 1	Dept. 1	\$1.50
	Quantity	2
Returned Item 2	PLU 2 (\$1.20) <sub>preset</sub>	
	Quantity	6
Payment	Cash	\$10.20

**1 5 0** **1**  
**1**  
**6** **X/DATE TIME**  
**2** **PLU**  
**CA/AMT /TEND**

### RECEIPT

```

RF 03-04-2000 11:05
C01 MC#01 000026

1 DEPT01 -1.50
1 DEPT01 -1.50
6 PLU0002 -7.20
TL -10.20
CASH -10.20
    
```

RF mode symbol

- The model for the U.S./Canada, use **X/DATE TIME** instead of **X/DATE TIME**.

# Basic Operations and Setups

## Reduction of amounts paid on refund

OPERATION				RECEIPT		
Returned Item 1	Dept. 3	\$4.00	4	00	3	<pre> RF 03-04-2000 11:10 C01 MC#01 000027  1 DEPT03 T1 -4.00 - T1 -0.15 1 PLU0002 T2 -1.20 5% %- T2 -0.06 TA1 -3.85 TX1 -0.15 TA2 -1.14 TX2 -0.06 TL -5.20 CASH -5.20                     </pre>
	Quantity	1	1	5	-	
Reduction	Amount	\$0.15	2	PLU		
Returned Item 2	PLU 2	(\$1.20) <sub>preset</sub>		%-		
	Quantity	1		SUB TOTAL		
Discount	Rate	(5%) <sub>preset</sub>		CA/AMT TEND		
Payment	Cash	\$5.20				

### Important!

- To avoid miss registrations in the RF mode, return the mode switch to the former position immediately.

## Registering money received on account



The following example shows how to register money received on account. This registration must be performed out of a sale.

OPERATION			RECEIPT			
Received amount	\$700.00	7	00	00	RC	<pre> REG 03-04-2000 11:15 C01 MC#01 000028  RC -700.00                     </pre>
Amount can be up to 8 digits.						

## Registering money paid out



The following example shows how to register money paid out from the register. This registration must be performed out of a sale.

OPERATION			RECEIPT			
Paid out amount	\$1.50	1	5	0	PD	<pre> REG 03-04-2000 11:20 C01 MC#01 000029  PD -1.50                     </pre>
Amount can be up to 8 digits.						



## Registering loan amounts

Use this procedure to register loan or bank received from the office.

**REG**

Mode switch

### OPERATION

### RECEIPT

Item	Note	\$1.00
	Quantity	10
	Note	\$5.00
	Quantity	5
Media	Cash	\$35.00

DATE TIME  
**1 0**  DATE TIME  
**1 00** **LOAN**  
**5**  DATE TIME  
**5 00** **LOAN**  
 CA/AMT/TEND

```

REG 03-04-2000 11:25
C01 MC#01 000030

LOAN +10.00
LOAN +25.00
CASH +35.00
    
```

- The model for the U.S./Canada, use  FOR DATE TIME instead of  DATE TIME.

## Registering pick up amounts

Use this procedure to register pick up money from cash drawer.

**REG**

Mode switch

### OPERATION

### RECEIPT

Item	Coin	\$0.50
	Quantity	10
	Coin	\$0.10
	Quantity	5
Media	Cash	\$5.50

DATE TIME  
**1 0**  DATE TIME  
**5 0** **PICK UP**  
**5**  DATE TIME  
**1 0** **PICK UP**  
 CA/AMT/TEND

```

REG 03-04-2000 11:30
C01 MC#01 000031

P.UP +5.00
P.UP +0.50
CASH +5.50
    
```

- The model for the U.S./Canada, use  FOR DATE TIME instead of  DATE TIME.

## Changing media in drawer

Use this procedure to change media in drawer.

**REG**

Mode switch

### OPERATION

### RECEIPT

Media	Check	-10.00
	Cash	\$8.00
	Charge	\$2.00

MEDIA CHANGE  
**1 0 00**  CHK/TEND  
 Enter the amount to be changed.  
**8 00**  CA/AMT/TEND  
**2 00** **CH**

```

REG 03-04-2000 11:35
C01 MC#01 000032

MEDIA CHG .....
CHECK +10.00
CASH +8.00
CH +2.00
    
```

## Making corrections in a registration

**REG**

Mode switch

There are three techniques you can use to make corrections in a registration.

- To correct an item that you input but not yet registered.
- To correct the last item you input and registered.
- To cancel all items in a transaction.

### To correct an item you input but not yet registered

OPERATION

RECEIPT

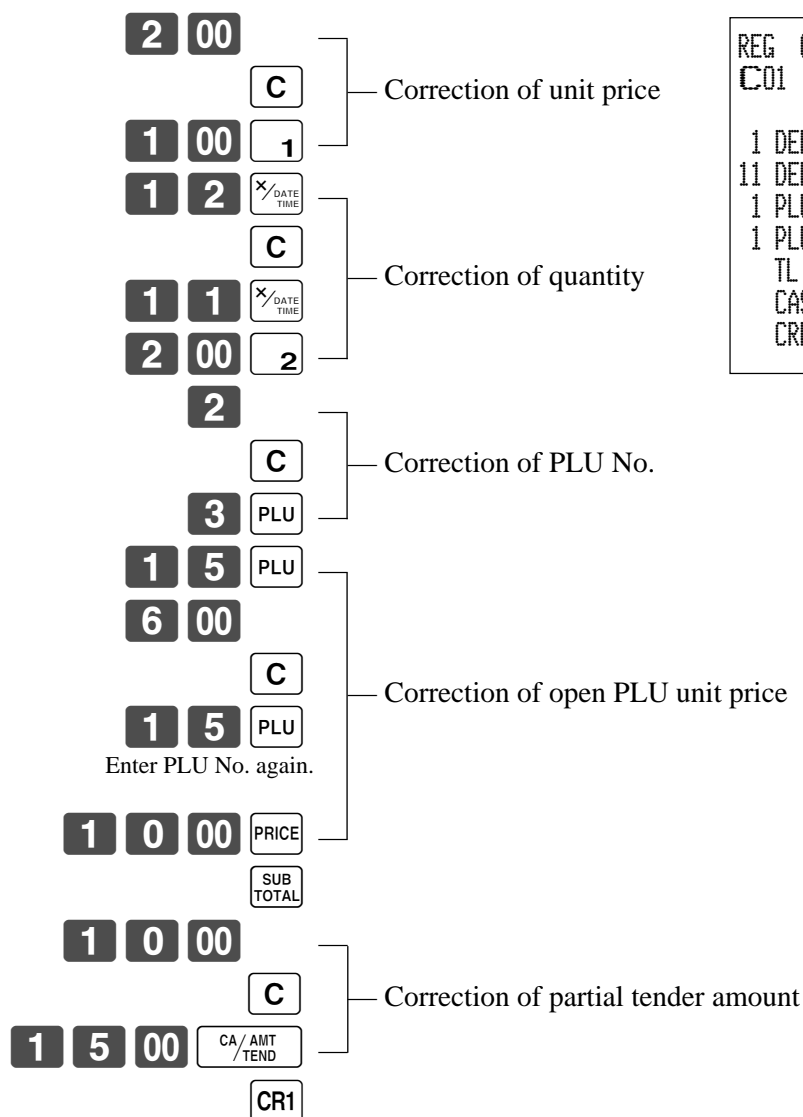

```

REG 03-04-2000 11:40
C01 MC#01 000033

1 DEPT01 -1.00
11 DEPT02 -22.00
1 PLU0003 -1.30
1 PLU0015 -10.00
TL -34.30
CASH -15.00
CREDIT1 -19.30
    
```

- The model for the U.S./Canada, use instead of .

## To correct an item you input and registered

### OPERATION

### RECEIPT

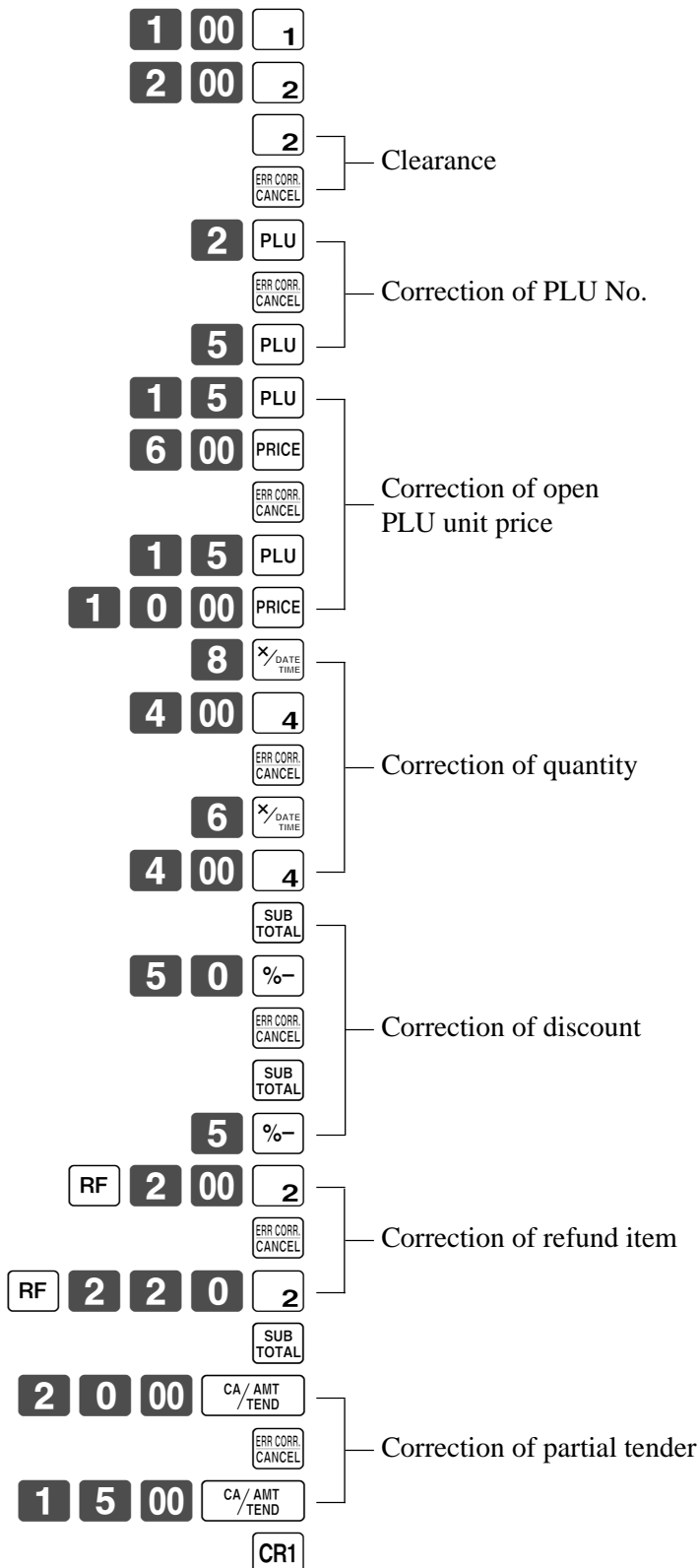

REG	03-04-2000	11:45
C01	MC#01	000034
1	DEPT01	-1.00
1	DEPT02	-2.00
1	DEPT02	-2.00
	CORR	-2.00
1	PLU0002	-1.20
	CORR	-1.20
1	PLU0005	-1.50
1	PLU0015	-6.00
	CORR	-6.00
1	PLU0015	-10.00
8	DEPT04	-32.00
	CORR	-32.00
6	DEPT04	-24.00
	ST	-38.50
	50%	
	%-	-19.25
	CORR	-19.25
	ST	-38.50
	5%	
	%-	-1.93
	RF	.....
1	DEPT02	-2.00
	CORR	-2.00
	RF	.....
1	DEPT02	-2.20
	TL	-34.37
	CASH	-20.00
	CORR	-20.00
	CASH	-15.00
	CREDIT1	-19.37

• The model for the U.S./Canada, use  FOR  DATE TIME instead of  DATE TIME.

# Basic Operations and Setups

## To cancel all items in a transaction

OPERATION	RECEIPT
<div style="display: flex; flex-direction: column; align-items: center;"> <div style="display: flex; gap: 5px;"> <div style="border: 1px solid black; padding: 2px;">1</div> <div style="border: 1px solid black; padding: 2px;">00</div> <div style="border: 1px solid black; padding: 2px;">1</div> </div> <div style="display: flex; gap: 5px;"> <div style="border: 1px solid black; padding: 2px;">2</div> <div style="border: 1px solid black; padding: 2px;">00</div> <div style="border: 1px solid black; padding: 2px;">2</div> </div> <div style="display: flex; gap: 5px;"> <div style="border: 1px solid black; padding: 2px;">3</div> <div style="border: 1px solid black; padding: 2px;">00</div> <div style="border: 1px solid black; padding: 2px;">3</div> </div> <div style="display: flex; gap: 5px;"> <div style="border: 1px solid black; padding: 2px;">4</div> <div style="border: 1px solid black; padding: 2px;">00</div> <div style="border: 1px solid black; padding: 2px;">4</div> </div> <div style="border: 1px solid black; padding: 2px; margin-top: 5px;">SUB TOTAL</div> </div>	<div style="border: 1px solid black; padding: 5px;"> <pre> REG 03-04-2000 11:50 C01   MC#01   000035  1 DEPT01      +1.00 1 DEPT02      +2.00 1 DEPT03      +3.00 1 DEPT04      +4.00 CANCEL        .....</pre> </div>
<p>Pressing <span style="border: 1px solid black; padding: 1px;">SUB TOTAL</span> key is necessary to cancel the transaction.</p> <div style="border: 1px solid black; padding: 2px; margin-top: 10px; width: fit-content; margin-left: auto;">ERR CORR. CANCEL</div>	

## No sale registration



You can use the following procedure to open the drawer without registering a sale. This operation must be performed out of a sale.

OPERATION	RECEIPT
<div style="border: 1px solid black; padding: 2px; margin-left: auto; margin-right: auto;"># / NS</div>	<div style="border: 1px solid black; padding: 5px;"> <pre> REG 03-04-2000 11:55 C01   MC#01   000036  # / NS      .....</pre> </div>

# Printing the daily sales reset report

This report shows daily sales totals.

## OPERATION

## REPORT

**Z1**

Mode switch



CA / AMT  
/ TEND

Z	03-04-2000	17:40	Date/time
C01	MC#01	000174	Clerk name/mc No./consecutive No.
-----			
Z	BATCH01		Report title
-----			
Z	FIX	0001	Fixed total report title/reset counter
		0001011	Report code
-----			
GROSS		981.25	Gross total *2
		-6,574.40	
NET	No	111	Net total *2
		-7,057.14	
CAID		-1,919.04	Cash in drawer *2
CHID		-139.04	Charge in drawer *2
CKID		-859.85	Check in drawer *2
CRID(1)		-709.85	Credit in drawer *2
-----			
RF	No	3	Refund mode *2
		-10.22	
CUST	CT	111	Number of customer *2
AVRG		-63.57	Average sales per customer *2
DC		-1.22	Discount total *2
REF		-2.42	Refund key *2
CLEAR	No	85	Clear key count *2
ROUND		-0.00	Rounding total *2
CANCEL	No	2	Cancellation *2
		-12.97	
-----			
TA1		-2,369.69	Taxable 1 amount *2
TX1		-128.86	Tax 1 amount *2
TA2		-2,172.96	Taxable 2 amount *2
TX2		-217.33	Tax 2 amount *2
-----			
GT1		-00000000125478.96	Grand total 1 *2
GT2		-00000000346284.23	Grand total 2 *2
GT3		-00000000123212.75	Grand total 3 *2
-----			
Z	TRANS	0001	Function key report title/reset counter
		0001012	Report code
CASH	No	362	Function key count/amount *1
		-1,638.04	

CH	No	56	
		-1,174.85	
RC	No	4	
		-810.00	
PD	No	5	
		-520.00	
-----			
CORR	No	14	
		-39.55	
VLD	No	19	
RCT	No	3	
NS	No	5	
-----			
Z	DEPT	0001	Department report title/reset counter
		0001015	Report code
-----			
DEPT01		203.25	Department count/amount *1
		-1,108.54	
DEPT02		183	
		-1,362.26	
-----			
DEPT04			
		-17.22	
-----			
TL		421.25	Department total count/total amount
		-2,872.28	
-----			
Z	CASHIER	0001	Clerk report title/reset counter
		0001017	Report code
-----			
C01		.....1	Clerk name/drawer No. *1
GROSS		421.25	Gross total *1
		-2,872.28	
NET	No	111	Net total *1
		-1,845.35	
CAID		-1,057.14	Cash in drawer *1
CHID		-139.04	
RF	No	1	Refund mode *1
		-1.00	
CLEAR	No	5	Clear key count *1
		-4.43	
-----			
C02		.....1	Clerk name/drawer No.

\*1 Zero totalled departments/functions/clerks are not printed by programming.

\*2 These items can be skipped by programming.

# Advanced Operations

This chapter describes more sophisticated operations that you can use to suit the needs of your retail environment.

## Clerk interrupt function

There are two types of clerk interrupt function, illustrated by PROCEDURE 1 and PROCEDURE 2 below.

- In PROCEDURE 1, each clerk possesses a unique clerk interrupt buffer, and so the clerk interrupt function gives each individual clerk the ability to perform an independent registration operation. In this case, each clerk is individually linked to a unique clerk interrupt buffer.
- In PROCEDURE 2, multiple clerks use the same clerk interrupt buffer, and so a single clerk interrupt operation (clerk change during registration) can be performed any registration is in progress. In this case, multiple clerks are linked to a single clerk interrupt buffer.

Note the following important points concerning the clerk interrupt function.

- The register must be programmed to allow the clerk interrupt function.
- To use the clerk interrupt function, a clerk interrupt buffer must be allocated with the memory allocation operation. Next the manager control operation (X1 mode) should be used to perform clerk assignment for the clerk interrupt function. The clerk interrupt operation cannot be performed by clerks who are not linked to a clerk interrupt buffer.
- You cannot use the clerk interrupt function on a register set up to function as part of a check tracking system. In the REG1, REG2, and RF modes, clerks can be changed while a transaction is in progress, making it possible for multiple clerks to simultaneously perform registrations in the same mode using a single register. For example, if clerk 1 is interrupted while registering a transaction, clerk 2 can use the same machine to register a different transaction. Then clerk 1 can continue the original registration from the point where it was interrupted.

### PROCEDURE 1



### PROCEDURE 2



### NOTES

- A guest receipt can be issued following clerk change, and receipts can be issued separately for each clerk.
- A cancel operation can be performed during registration by either of the clerks. When clerk 1 signs back on (after being interrupted by clerk 2), the cancel operation cancels only the items registered after signing back on (only this receipt) or from the top of the transaction. This is selectable by the key program.

# Single item cash sales

A department key or PLU programmed with single item sale status finalizes the transaction as soon as it is registered.

The single item sales function cannot work properly if the keyboard does not include <CASH> (the cash key). The single item sales function can only be used for cash sales.

## Example 1

OPERATION			RECEIPT			
Item	Dept. 1	\$1.00	<div style="display: flex; justify-content: center; gap: 5px;"> <span style="border: 1px solid black; padding: 2px 5px;">1</span> <span style="border: 1px solid black; padding: 2px 5px;">00</span> <span style="border: 1px solid black; padding: 2px 5px;">1</span> </div> <p>The transaction is immediately finalized.</p>	<pre> REG 03-04-2000 13:00 C01  MC#01  000101 1 DEPT01      -1.00   TL          -1.00   CASH        -1.00                     </pre>		Mode/date/time
	Quantity	1				Clerk/consecutive No.
	Status	S.I.S				Department No./unit price
Payment	Cash	\$1.00		Cash total amount		

## Example 2

OPERATION			RECEIPT			
Item	Dept. 1	(\$1.00)	<div style="display: flex; justify-content: center; gap: 5px;"> <span style="border: 1px solid black; padding: 2px 5px;">3</span> <span style="border: 1px solid black; padding: 2px 5px; font-size: x-small;">X/DATE TIME</span> <span style="border: 1px solid black; padding: 2px 5px;">1</span> </div> <p>The transaction is immediately finalized.</p>	<pre> REG 03-04-2000 13:05 C01  MC#01  000102 3 DEPT01      -3.00   TL          -3.00   CASH        -3.00                     </pre>		Mode/date/time
	Quantity	3				Clerk/consecutive No.
	Status	S.I.S				Department No./unit price
Payment	Cash	\$3.00		Cash total amount		

- The model for the U.S./Canada, use X/ FOR DATE TIME instead of X/ DATE TIME.

## Example 3

OPERATION			RECEIPT			
Item 1	Dept. 3	\$2.00	<div style="display: flex; justify-content: center; gap: 5px;"> <span style="border: 1px solid black; padding: 2px 5px;">2</span> <span style="border: 1px solid black; padding: 2px 5px;">00</span> <span style="border: 1px solid black; padding: 2px 5px;">3</span> </div> <div style="display: flex; justify-content: center; gap: 5px; margin-top: 5px;"> <span style="border: 1px solid black; padding: 2px 5px;">1</span> <span style="border: 1px solid black; padding: 2px 5px; font-size: x-small;">CA/AMT TEND</span> </div> <p>The transaction is not finalized. Because another item is registered before the single item sales department.</p>	<pre> REG 03-04-2000 13:10 C01  MC#01  000103 1 DEPT03      -2.00 1 DEPT01      -1.00   TL          -3.00   CASH        -3.00                     </pre>		Mode/date/time
	Quantity	1				Clerk/consecutive No.
	Status	Normal				Department No./unit price
Item 2	Dept. 1	\$1.00		Cash total amount		
	Quantity	1				
Payment	Cash	\$3.00				

# Advanced Operations

## Addition

### Addition (plus)

#### Example

Item 1	Dept. 1	\$1.00
	Quantity	1
	<b>Addition</b>	<b>\$0.10</b>
Item 2	Dept. 1	\$2.00
	Quantity	3
	<b>Addition</b>	<b>3 × (\$0.20)</b>
Payment	Cash	\$7.70

#### OPERATION

**1** **00** **1**  
**1** **0** **+**  
**3**  DATE TIME  
**2** **00** **1**  
**3**  DATE TIME  
**+**  
 CA/AMT /TEND

#### RECEIPT

```

REG 03-04-2000 13:15
C01 MC#01 000104

1 DEPT01      -1.00
+             -0.10
3 DEPT01      -6.00
+             -0.60
TL            -7.70
CASH          -7.70
  
```

- The model for the U.S./Canada, use  FOR DATE TIME instead of  DATE TIME.

### Premium (%+)

#### Example

Item 1	Dept. 1	\$1.00
	Quantity	1
	<b>Premium</b>	<b>10%</b>
Item 2	Dept. 1	\$2.00
	Quantity	3
<b>Subtotal</b>	<b>Premium</b>	<b>15%</b>
Payment	Cash	\$8.17

#### OPERATION

**1** **00** **1**  
**1** **0** **%+**  
**3**  DATE TIME  
**2** **00** **1**  
**SUB TOTAL**  
**%+**  
 CA/AMT /TEND

#### RECEIPT

```

REG 03-04-2000 13:20
C01 MC#01 000105

1 DEPT01      -1.00
10%
%+            -0.10
3 DEPT01      -6.00
ST            -7.10
15%
%+            -1.07
TL            -8.17
CASH          -8.17
  
```

- The model for the U.S./Canada, use  FOR DATE TIME instead of  DATE TIME.



# Tray total

## Tray total premium/discount

The buffer memory stores all items that fall into the prescribed range, starting from the first item registered for a transaction up to the point that <TRAY TOTAL> (the tray total key) is pressed to perform a tray total premium/discount operation. Following a premium/discount operation, the buffer is cleared and storage of new data starts from registration of the next item following the first premium/discount operation. The following operations clear the buffer memory.

- Press <TRAY TOTAL> twice.
- Press <TRAY TOTAL> and then perform a premium/discount operation. The contents of the buffer memory are restored if an error correction operation is performed to delete the premium/discount operation.

### Example

OPERATION				RECEIPT
<b>Group 1</b>	Dept. 1	\$1.00	<b>1</b> <b>00</b> <b>1</b>	REG 03-04-2000 13:25 C01 MC#01 000106  1 DEPT01 -1.00 1 DEPT03 -2.00 TRAY TL -3.00 5% %- -0.15 1 DEPT03 -3.00 1 DEPT04 -4.00 TRAY TL -7.00 10% %- -0.70 TL -9.15 CASH -9.15
	Dept. 3	\$2.00	<b>2</b> <b>00</b> <b>3</b>	
	Discount	(5%) <sub>preset</sub>	<b>TRAY TOTAL</b>	
<b>Group 2</b>	Dept. 3	\$3.00	<b>3</b> <b>00</b> <b>3</b>	
	Dept. 4	\$4.00	<b>4</b> <b>00</b> <b>4</b>	
	Discount	10%	<b>TRAY TOTAL</b>	
Payment	Cash	\$9.15	<b>1</b> <b>0</b> <b>%-</b>	
			<b>CA/AMT /TEND</b>	

## Multiple item totalling function

This function accumulates all items registered from the first item registered up to point that <TRAY TOTAL> is pressed, or all items between two presses of <TRAY TOTAL>. Pressing <TRAY TOTAL> displays the total amount with the tax included and prints it on the receipt and journal (printing on receipt and journal is programmable.)

### Example

OPERATION				RECEIPT
<b>Customer A</b>	Dept. 1	\$1.00	<b>1</b> <b>00</b> <b>1</b>	REG 03-04-2000 13:30 C01 MC#01 000107  1 DEPT01 -1.00 1 DEPT03 -2.00 TRAY TL -3.00 1 DEPT03 -3.00 1 DEPT04 -4.00 TRAY TL -7.00 TL -10.00 CASH -10.00
	Dept. 3	\$2.00	<b>2</b> <b>00</b> <b>3</b>	
<b>Customer B</b>	Dept. 3	\$3.00	<b>3</b> <b>00</b> <b>3</b>	
	Dept. 4	\$4.00	<b>4</b> <b>00</b> <b>4</b>	
Payment	Cash	\$10.00	<b>TRAY TOTAL</b>	
			<b>TRAY TOTAL</b>	
			<b>CA/AMT /TEND</b>	

# Advanced Operations

## Coupon transactions

Note that errors result when the result of a calculation is negative if the cash register is programmed to prohibit credit balances.

### Coupon registration using <COUPON> (coupon key)

#### Example

OPERATION			RECEIPT	
Item 1	Dept. 1	\$3.00	<b>2</b> <input type="checkbox"/> DATE TIME	REG 03-04-2000 13:35 C01 MC#01 000108  2 DEPT01 -6.00 CPN -1.00 1 DEPT03 -4.00 CPN -1.00 TL -8.00 CASH -8.00
	Quantity	2	<b>3 00</b> <input type="checkbox"/> 1	
	<b>Coupon</b>	<b>\$0.50 × 2</b>	<b>2</b> <input type="checkbox"/> DATE TIME	
Item 2	Dept. 3	\$4.00	<b>5 0</b> <input type="checkbox"/> CPN	
	Quantity	1	<b>4 00</b> <input type="checkbox"/> 3	
	<b>Coupon</b>	<b>(\$1.00)</b>	<input type="checkbox"/> CPN	
Payment	Cash	\$8.00	<input type="checkbox"/> CA / AMT / TEND	

- The model for the U.S./Canada, use  FOR DATE TIME instead of  DATE TIME.

### Coupon registration using <COUPON2> (coupon 2 key)

#### Example

OPERATION			RECEIPT	
Item 1	Dept. 1	\$15.00	<b>1 5 00</b> <input type="checkbox"/> 1	REG 03-04-2000 13:40 C01 MC#01 000109  1 DEPT01 -15.00 CPN2 ..... 1 DEPT01 -1.50 1 PLU0010 +5.00 CPN2 ..... 1 PLU0050 -0.50 TL -18.00 CASH -18.00
	Quantity	1	<input type="checkbox"/> CPN2 <b>1 5 0</b> <input type="checkbox"/> 1	
	<b>Coupon 2 Dept.1</b>	<b>\$1.50</b>	<b>1 0</b> <input type="checkbox"/> PLU	
Item 2	PLU 10	\$5.00	<input type="checkbox"/> CPN2 <b>5 0</b> <input type="checkbox"/> PLU	
	Quantity	1	<input type="checkbox"/> CA / AMT / TEND	
	<b>Coupon 2 PLU 50</b>	<b>(\$0.50)</b>		
Payment	Cash	\$18.00		

# Preset tender amount

An amount up to six digits long can be programmed to <CASH> (cash/amount tendered key). Then, when <CASH> is pressed without inputting a value, the programmed value is automatically registered and the transaction is finalized. When an amount is programmed to <CASH>, attempting to manually input an amount results in an error.

## Example 1

OPERATION			RECEIPT
	Dept. 1	\$8.00	<div style="display: flex; justify-content: space-around; align-items: center;"> <div style="text-align: center;"> <b>8 00</b> <span style="border: 1px solid black; padding: 2px;">1</span>  <div style="border: 1px solid black; padding: 2px; width: fit-content; margin: 0 auto;">CA/AMT TEND</div> </div> <div style="text-align: center;"> <p>The preset amount is tendered.</p> </div> </div> <div style="border: 1px solid black; padding: 5px; font-family: monospace; font-size: small;">           REG 03-04-2000 13:45            C01 MC#01 000110             1 DEPT01           -8.00            TL                   -8.00            CASH               -10.00            CG                   -2.00         </div>
	Quantity	1	
<b>Payment</b>	<b>Cash</b>	<b>(\$10.00)</b>	

## Example 2

OPERATION			RECEIPT
	Dept. 1	\$15.00	<div style="display: flex; justify-content: space-around; align-items: center;"> <div style="text-align: center;"> <b>1 5 00</b> <span style="border: 1px solid black; padding: 2px;">1</span>  <div style="border: 1px solid black; padding: 2px; width: fit-content; margin: 0 auto;">CA/AMT TEND</div> </div> <div style="text-align: center;"> <p>An error occurs by manual input</p> </div> </div> <div style="border: 1px solid black; padding: 5px; font-family: monospace; font-size: small;">           REG 03-04-2000 13:50            C01 MC#01 000111             1 DEPT01           -15.00            TL                   -15.00            CHECK             -5.00            CASH               -10.00            CG                   -0.00         </div>
	Quantity	1	
<b>Payment</b>	<b>Cash</b>	<b>(\$10.00)</b>	
	Check	\$5.00	
			<div style="border: 1px solid black; padding: 2px; width: fit-content; margin: 0 auto;">C</div> <div style="display: flex; justify-content: center; align-items: center; margin-top: 5px;"> <div style="text-align: center; margin-right: 5px;"><b>5 00</b></div> <div style="border: 1px solid black; padding: 2px; margin-right: 5px;">CHK/ TEND</div> <div style="border: 1px solid black; padding: 2px; margin-left: 5px;">CA/AMT TEND</div> </div>

## Bottle link operation

You can link PLU to a PLU.

### Example

OPERATION			RECEIPT		
Item 1	PLU 1	(\$8.00)	<b>1</b>	PLU	REG 03-04-2000 13:55 C01 MC#01 000112  1 PLU0001 -8.00 1 PLU0011 -0.80 3 PLU0002 -15.00 3 PLU0012 -1.50 TL -25.30 CASH -30.00 CG -4.70
	PLU 11 <sub>linked</sub>	(\$0.80)	<b>3</b>	X/DATE TIME	
	Quantity	1	<b>2</b>	PLU	
Item 2	PLU 2	(\$5.00)	<b>3</b>	0	
	PLU 12 <sub>linked</sub>	(\$0.50)	<b>00</b>	CA/AMT TEND	
	Quantity	3			
Payment	Cash	\$30.00			

- The model for the U.S./Canada, use  FOR DATE TIME instead of  DATE TIME.

## Bottle returns

### Bottle return key

You can use the linked bottle return key to register a bottle return. A PLU whose programmed unit price represents the contents of the bottle, can be linked with PLU whose programmed unit price represents the deposit on the bottle. In the following example, the bottle return key has been programmed to operate as a linked bottle return key.

The bottle return key must be pressed before input of each new linked bottle return.

### Example

OPERATION			RECEIPT		
Return Item 1	PLU 1	(\$8.00)	<b>BR</b>	<b>1</b>	REG 03-04-2000 14:00 C01 MC#01 000113  BR ..... 1 PLU0011 -0.80 BR ..... 3 PLU0012 -1.50 TL -2.30 CASH -2.30
	PLU 11 <sub>linked</sub>	(\$0.80)	<b>3</b>	X/DATE TIME	
	Quantity	1	<b>BR</b>	<b>2</b>	
Return Item 2	PLU 2	(\$5.00)		CA/AMT TEND	
	PLU 12 <sub>linked</sub>	(\$0.50)			
	Quantity	3			
Payment	Cash	\$2.30			

- The model for the U.S./Canada, use  FOR DATE TIME instead of  DATE TIME.

## Arrangement key registrations

Key operations can be assigned to an <ARRANGE> (arrangement key). Then, simply pressing <ARRANGE> performs all of the key functions assigned to it.

Key operations can also be assigned to an address code. Then, when you input the address code using <ARRANGE>, all of the key functions assigned to the address code are performed.

### Example 1

OPERATION			RECEIPT																
<table border="1"> <thead> <tr> <th colspan="3">Arrangement 1</th> </tr> </thead> <tbody> <tr> <td rowspan="2">Item 1</td> <td>PLU 1</td> <td>(\$8.00)</td> </tr> <tr> <td>Quantity</td> <td>1</td> </tr> <tr> <td rowspan="2">Item 2</td> <td>PLU 2</td> <td>(\$5.00)</td> </tr> <tr> <td>Quantity</td> <td>1</td> </tr> <tr> <td>Payment</td> <td>Cash</td> <td>\$13.00</td> </tr> </tbody> </table>			Arrangement 1			Item 1	PLU 1	(\$8.00)	Quantity	1	Item 2	PLU 2	(\$5.00)	Quantity	1	Payment	Cash	\$13.00	<div style="border: 1px solid black; padding: 5px; display: inline-block;">ARR</div> <pre> REG 03-04-2000 14:05 C01  MC#01  000114  1 PLU0001      -8.00 1 PLU0002      -5.00 TL              -13.00 CASH           -13.00                     </pre>
Arrangement 1																			
Item 1	PLU 1	(\$8.00)																	
	Quantity	1																	
Item 2	PLU 2	(\$5.00)																	
	Quantity	1																	
Payment	Cash	\$13.00																	

### Example 2

OPERATION			RECEIPT																
<table border="1"> <thead> <tr> <th colspan="3">Arrangement 5</th> </tr> </thead> <tbody> <tr> <td rowspan="2">Item 1</td> <td>Dept. 1</td> <td>\$1.00</td> </tr> <tr> <td>Quantity</td> <td>1</td> </tr> <tr> <td rowspan="2">Item 2</td> <td>Dept. 2</td> <td>\$2.00</td> </tr> <tr> <td>Quantity</td> <td>1</td> </tr> <tr> <td>Payment</td> <td>Cash</td> <td>\$3.00</td> </tr> </tbody> </table>			Arrangement 5			Item 1	Dept. 1	\$1.00	Quantity	1	Item 2	Dept. 2	\$2.00	Quantity	1	Payment	Cash	\$3.00	<div style="display: inline-block; border: 1px solid black; padding: 2px;">5</div> <div style="display: inline-block; border: 1px solid black; padding: 2px; margin-left: 5px;">ARR</div> <pre> REG 03-04-2000 14:10 C01  MC#01  000115  1 DEPT01      -1.00 1 DEPT02      -2.00 TL              -3.00 CASH           -3.00                     </pre>
Arrangement 5																			
Item 1	Dept. 1	\$1.00																	
	Quantity	1																	
Item 2	Dept. 2	\$2.00																	
	Quantity	1																	
Payment	Cash	\$3.00																	

## Set menu

When you register a set menu, its total amount is added to the PLU totalizer and counter. The price of each set menu item is also added to each respective PLU totalizer and counter.

### Example

OPERATION			RECEIPT																		
<table border="1"> <thead> <tr> <th>Set menu</th> <th>PLU 35</th> <th>\$5.00</th> </tr> </thead> <tbody> <tr> <td>Item 1</td> <td>PLU 1</td> <td>--</td> </tr> <tr> <td>Item 2</td> <td>PLU 2</td> <td>--</td> </tr> <tr> <td>Item 3</td> <td>PLU 3</td> <td>--</td> </tr> <tr> <td>Item 4</td> <td>PLU 4</td> <td>--</td> </tr> <tr> <td>Payment</td> <td>Cash</td> <td>\$5.00</td> </tr> </tbody> </table>			Set menu	PLU 35	\$5.00	Item 1	PLU 1	--	Item 2	PLU 2	--	Item 3	PLU 3	--	Item 4	PLU 4	--	Payment	Cash	\$5.00	<div style="display: inline-block; border: 1px solid black; padding: 2px;">3</div> <div style="display: inline-block; border: 1px solid black; padding: 2px; margin-left: 5px;">5</div> <div style="display: inline-block; border: 1px solid black; padding: 2px; margin-left: 5px;">PLU</div> <div style="border: 1px solid black; padding: 2px; margin-left: 5px; font-size: 8px;">CA / AMT / TEND</div> <pre> REG 03-04-2000 14:15 C01  MC#01  000116  1 PLU0035      -5.00   PLU0001   PLU0002   PLU0003   PLU0004 TL              -5.00 CASH           -5.00                     </pre>
Set menu	PLU 35	\$5.00																			
Item 1	PLU 1	--																			
Item 2	PLU 2	--																			
Item 3	PLU 3	--																			
Item 4	PLU 4	--																			
Payment	Cash	\$5.00																			

## Currency exchange function

When <CE> (currency exchange key) is pressed, a current subtotal including tax is converted directly into foreign currency and the result is displayed, and the subsequent finalization is handled using the foreign currency. The currency exchange function is released by finalizing a transaction, partial tender operation, receipt issuance, or by pressing <SUBTOTAL>.



Before using the currency exchange function, it is necessary to program the conversion rate.















### Registering foreign currency

#### Full amount tender in foreign currency

\* Pre-programmed exchange rate: ¥ 100 = \$0.9524

#### Important!

Tenders in a foreign currency can be registered using  and  only. Other finalize keys cannot be used.

OPERATION	DISPLAY	RECEIPT
<p><b>1 0 00</b>  ← Enter the unit price and press the applicable department key.</p>	 (Displays in \$)	<div style="border: 1px solid black; padding: 5px;"> <p>REG 03-04-2000 14:20 C01 MC#01 000117</p> <p>1 DEPT01           -10.00 2 DEPT02           -20.00 TL                   -30.00 CE CASH                ¥5,000 CASH                -47.62 CG                   -17.62</p> </div>
<p><b>2 0 00</b>  ← Enter the next unit price and press the applicable department key.</p>	 (Displays in \$)	
<p>  ← Press  and  without entering a numeric value. This operation converts the subtotal (including tax) dollar value into yen by applying a pre-programmed exchange rate. The result is shown on the display and printed on the receipt/journal by programming.</p>	 (Displays in ¥: 3,150)	
<p><b>5 0 00</b>  ← Enter the amount tendered in yen and press . This operation converts the entered yen amount into dollars by applying a pre-programmed exchange rate. The result is shown on the display.</p> <p>(5,000)</p>		
<p> ← Press to finalize the transaction. Note that you do not need to reenter the dollar amount. The register automatically calculates the change amount due in dollars and shows it on the display, receipts and journal.</p>	 (Displays in \$)	

## Partial tender in a foreign currency

\* Pre-programmed exchange rate: ¥ 100 = \$0.9524

### Important!

Partial tender in a foreign currency can be registered using **CA/AMT/TEND** and **CHK/TEND** only. Other finalization keys cannot be used, but the remaining tender can be finalized using any finalize key.

OPERATION	DISPLAY	RECEIPT																											
<b>1 0 00</b> <b>1</b> ← Enter the unit price and press the applicable department key.	<b>01 10.00</b> (Displays in \$)	<table border="1"> <tr> <td>REG</td> <td>03-04-2000</td> <td>14:25</td> </tr> <tr> <td>C01</td> <td>MC#01</td> <td>000118</td> </tr> <tr> <td>1 DEPT01</td> <td></td> <td>-10.00</td> </tr> <tr> <td>1 DEPT02</td> <td></td> <td>-20.00</td> </tr> <tr> <td>TL</td> <td></td> <td>-30.00</td> </tr> <tr> <td>CE</td> <td></td> <td></td> </tr> <tr> <td>CASH</td> <td></td> <td>¥2,000</td> </tr> <tr> <td>CASH</td> <td></td> <td>-19.05</td> </tr> <tr> <td>CHK</td> <td></td> <td>-10.95</td> </tr> </table>	REG	03-04-2000	14:25	C01	MC#01	000118	1 DEPT01		-10.00	1 DEPT02		-20.00	TL		-30.00	CE			CASH		¥2,000	CASH		-19.05	CHK		-10.95
REG	03-04-2000		14:25																										
C01	MC#01		000118																										
1 DEPT01			-10.00																										
1 DEPT02			-20.00																										
TL		-30.00																											
CE																													
CASH		¥2,000																											
CASH		-19.05																											
CHK		-10.95																											
<b>2 0 00</b> <b>2</b> ← Enter the next unit price and press the applicable department key.	<b>02 20.00</b> (Displays in \$)																												
<b>CE</b> <b>SUB TOTAL</b> ← Press <b>CE</b> and <b>SUB TOTAL</b> without entering a numeric value. This operation converts the subtotal (including tax) dollar value into yen by applying a pre-programmed exchange rate. The result is shown on the display and printed on the receipt/journal by programming.	<b>3.150</b> (Displays in ¥: 3,150)																												
<b>2 0 00</b> <b>CE</b> ← Enter the partial amount tendered in yen and press <b>CE</b> . (2,000) This operation converts the entered yen amount into dollars by applying a pre-programmed exchange rate. The result is shown on the display.	<b>2.000</b>																												
<b>CA/AMT/TEND</b> ← Press <b>CA/AMT/TEND</b> to specify cash tender for the yen partial tender. Note that you do not need to reenter the dollar amount. The register automatically deducts the dollar equivalent of the yen amount tendered from the total amount due and shows the amount on the display.	<b>10.95</b> (Displays in \$)																												
<b>CHK/TEND</b> ← Press to finalize the transaction.	<b>10.95</b> (Displays in \$)																												

## Food stamp function

### Food stamp registration

No change due



#### OPERATION

#### RECEIPT

Item 1	Dept. 1	\$1.00
	Taxable	1, F/S
Item 2	Dept. 2	\$2.00
	Taxable	2
Item 3	Dept. 3	\$3.00
	<b>Taxable</b>	<b>No → F/S</b>
Payment	<b>Food stamp</b>	<b>\$2.00</b>
	Cash	\$4.14

**1 00 1**  
**2 00 2**  
**F/S 3 00 3**  
 Shifting food stamp status, press **F/S** key.  
 Press **FSST**, at the top of the food stamp tender.  
**2 00 FS/ST**  
**CA/AMT/TEND**

REG	03-04-2000	14:30	
C01	MC#01	000119	
1 DEPT01	T1 F	\$1.00	
1 DEPT02	T2	\$2.00	
1 DEPT03	F	\$3.00	
TA1		\$1.00	
TX1		\$0.04	
TA2		\$2.00	
TX2		\$0.10	
TL		<b>\$6.14</b>	Subtotal
FSST		\$4.04	Food stamp subtotal
FSTD		\$2.00	Food stamp tendered
CASH		\$4.14	



## Mixed food stamp/cash change

### Example 1

OPERATION			RECEIPT		
Item 1	Dept. 1	\$1.00	<b>1 00</b>	<b>1</b>	REG 03-04-2000 14:35 C01 MC#01 000120  1 DEPT01 T1 F \$1.00 1 DEPT02 T2 F \$2.00 1 DEPT03 F \$3.00 TA1 \$1.00 TX1 \$0.04 TA2 \$2.00 TX2 \$0.10 TL <b>\$6.14</b> — Subtotal FSST \$6.14 — Food stamp subtotal FSTD \$7.00 — Food stamp tendered CG \$0.86 — Cash change
	Taxable	1, F/S	<b>F/S 2 00</b>	<b>2</b>	
Item 2	Dept. 2	\$2.00	<b>F/S 3 00</b>	<b>3</b>	
	Taxable	2, F/S		<b>FS/ST</b>	
Item 3	Dept. 3	\$3.00	<b>7 00</b>	<b>FS/ST</b>	
	Taxable	F/S		<b>FS/ST</b>	
<b>Payment</b>	<b>Food stamp</b>	<b>\$7.00</b>			

The change in food stamp transactions is automatically calculated as cash for amounts of \$1.00 or less, and as food stamps for amounts greater than \$1.00.

### Example 2

OPERATION			RECEIPT		
Item	Dept. 1	\$2.00	<b>2 00</b>	<b>1</b>	REG 03-04-2000 14:40 C01 MC#01 000121  1 DEPT01 T1 F \$2.00 TA1 \$2.00 TX1 \$0.08 TL <b>\$2.08</b> FSST \$2.08 FSTD \$5.00 FSCG \$2.00 CG \$0.92
	Taxable	1, F/S		<b>FS/ST</b>	
<b>Payment</b>	<b>Food stamp</b>	<b>\$5.00</b>	<b>5 00</b>	<b>FS/ST</b>	

In the above example, the total amount of change due is \$2.92; \$2.00 in food stamps and \$0.96 in cash.

# Advanced Operations

## Mixed food stamp/cash change (continued...)

### Example 3

			OPERATION	RECEIPT
Item 1	Dept. 1	\$2.00	<b>2</b> <b>00</b> <b>1</b>	<pre> REG 03-04-2000 14:45 C01   MC#01   000122  1 DEPT01    T1 F \$1.00 1 DEPT04    T2   \$0.50 TA1         \$2.00 TX1         \$0.08 TL          \$2.58 FSST        \$2.08 FSTD        \$5.00 FSCG        \$2.00 CG          \$0.42                     </pre>
	Taxable	1, F/S	<b>5</b> <b>0</b> <b>4</b>	
Item 2	Dept. 4	\$0.50	<b>FS/ST</b>	
	Taxable	No	<b>5</b> <b>00</b> <b>FS/TD</b>	
<b>Payment</b>	<b>Food stamp</b>	<b>\$5.00</b>		

When food stamp items are included in a transaction, the amount of change due in cash is applied as a cash amount tendered for cash (nonfood stamp) items. In this example, the \$0.50 purchased (department 4) is automatically deducted from the \$0.92 cash due in change from the food stamp purchase (department 4).

### Example 4

			OPERATION	RECEIPT
Item 1	Dept. 1	\$1.00	<b>1</b> <b>00</b> <b>1</b>	<pre> REG 03-04-2000 14:50 C01   MC#01   000123  1 DEPT01    T1 F \$1.00 1 DEPT02    T2   \$2.00 1 DEPT03    T3   \$3.00 TA1         \$1.00 TX1         \$0.04 TA2         \$2.00 TX2         \$0.10 TL          \$6.14 FSST        \$1.04 FSTD        \$5.00 FSCG        \$3.00 CASH        \$4.14                     </pre>
	Taxable	1, F/S	<b>2</b> <b>00</b> <b>2</b>	
Item 2	Dept. 2	\$2.00	<b>3</b> <b>00</b> <b>3</b>	
	Taxable	2	<b>FS/ST</b>	
Item 3	Dept. 3	\$3.00	<b>5</b> <b>00</b> <b>FS/TD</b>	
	Taxable	No	<b>CA/AMT/TEND</b>	
<b>Payment</b>	<b>Food stamp</b>	<b>\$5.00</b>		
	<b>Cash</b>	<b>\$4.14</b>		

The following calculation is performed internally to apply the cash change due on the food stamp transaction to the balance due of the cash transaction.

	Food stamp transaction	Cash transaction
Price items:	\$1.00	\$5.00
Tax:	\$0.04	\$0.10
Total due:	\$1.04	\$5.10
Amount tendered:	\$5.00 (food stamp)	\$4.14 (cash), \$0.96 (change from food stamp)
Amount due:	\$1.04	
Change amount due:	\$3.00 (food stamp), \$0.96 (cash)	
Total:		\$5.10

## Food stamp registration (Illinois rule)

### No change due

#### Example 1

			OPERATION	RECEIPT
Item 1	Dept. 1	\$1.00	<b>1</b> <b>00</b> <b>1</b>	REG 03-04-2000 14:55 C01 MC#01 000124  1 DEPT01 T1 F \$1.00 1 DEPT01 T1 F \$2.00 DEPT04 F \$3.00 TL <b>\$6.00</b> FSST \$6.00 FSTD \$6.00
	Taxable	1, F/S	<b>2</b> <b>00</b> <b>1</b>	
Item 2	Dept. 1	\$2.00	<b>3</b> <b>00</b> <b>4</b>	
	Taxable	1, F/S	FS/ST	
Item 3	Dept. 4	\$3.00	<b>6</b> <b>00</b> <b>FS/ST</b>	
	Taxable	F/S		
Payment	<b>Food stamp</b>	<b>\$6.00</b>		

#### Example 2

			OPERATION	RECEIPT
Item 1	Dept. 1	\$2.00	<b>2</b> <b>00</b> <b>1</b>	REG 03-04-2000 15:00 C01 MC#01 000125  1 DEPT01 T1 F \$2.00 1 DEPT01 T1 F \$3.00 1 DEPT04 F \$4.00 FSST \$9.00 FSTD \$5.00 TA1 \$4.00 TX1 \$0.16 CASH \$4.16
	Taxable	1, F/S	<b>3</b> <b>00</b> <b>1</b>	
Item 2	Dept. 1	\$3.00	<b>4</b> <b>00</b> <b>4</b>	
	Taxable	1, F/S	FS/ST	
Item 3	Dept. 4	\$4.00	<b>5</b> <b>00</b> <b>FS/ST</b>	
	Taxable	1, F/S		
Payment	<b>Food stamp</b>	<b>\$5.00</b>	CA/AMT /TEND	
	Cash	\$4.16		

# Advanced Operations

## No change due (continued...)

### Example 3

OPERATION			RECEIPT	
Item 1	Dept. 1	\$2.00	<b>2</b> <b>00</b> <b>1</b>	REG 03-04-2000 15:05 C01 MC#01 000126  1 DEPT01 T1 F \$2.00 1 DEPT02 T2 F \$3.00 FSST \$5.00 FSTD \$1.00 TA1 \$1.00 TX1 \$0.04 TA2 \$2.00 TX2 \$0.10 CASH \$4.14
	Taxable	1, F/S	<b>3</b> <b>00</b> <b>2</b>	
Item 2	Dept. 2	\$3.00	FS/ST	
	Taxable	2, F/S	<b>1</b> <b>00</b> <b>FS/TD</b>	
Payment	<b>Food stamp</b>	<b>\$1.00</b>	CA/AMT /TEND	
	Cash	\$4.14		

If the total of the food stamps tendered is less than the food stamp total, the food stamp tendered amount is deducted from the taxable 1 and 2 amount.

### Example 4

OPERATION			RECEIPT	
Item 1	Dept. 1	\$1.00	<b>1</b> <b>00</b> <b>1</b>	REG 03-04-2000 15:10 C01 MC#01 000127  1 DEPT01 T1 F \$1.00 1 DEPT02 T2 F \$5.00 FSST \$6.00 FSTD \$4.00 TA2 \$1.00 TX2 \$0.05 CASH \$2.05
	Taxable	1, F/S	<b>5</b> <b>00</b> <b>2</b>	
Item 2	Dept. 2	\$5.00	FS/ST	
	Taxable	2, F/S	<b>4</b> <b>00</b> <b>FS/TD</b>	
Payment	<b>Food stamp</b>	<b>\$4.00</b>	CA/AMT /TEND	
	Cash	\$2.05		

In this example, the result of the taxable 1 amount is "0".

## Mixed food stamp/cash change

### Example 1

			OPERATION	RECEIPT
Item 1	Dept. 1	\$1.50	<b>1 5 0</b> <input type="checkbox"/> 1	<pre> REG 03-04-2000 15:15 C01 MC#01 000128  1 DEPT01 T1 F \$1.50 1 DEPT01 T1 F \$2.00 1 DEPT04 F \$3.00 TL \$6.50 FSST \$6.50 FSTD \$10.00 FSCG \$3.00 CG \$0.50                     </pre>
	Taxable	1, F/S	<b>2 00</b> <input type="checkbox"/> 1	
Item 2	Dept. 1	\$2.00	<b>3 00</b> <input type="checkbox"/> 4	
	Taxable	1, F/S	<input type="checkbox"/> FS/ST	
Item 3	Dept. 4	\$3.00	<b>1 0 00</b> <input type="checkbox"/> FS/ST	
	Taxable	F/S		
<b>Payment</b>	<b>Food stamp</b>	<b>\$10.00</b>		

The change in food stamp transactions is automatically calculated as cash for amount of \$1.00 or less, and as food stamps for amounts greater than \$1.00. In the above example, the total amount of change due is \$3.50 (\$3.00 in food stamps and \$0.50 in cash).

### Example 2

			OPERATION	RECEIPT
Item	Dept. 1	\$2.00	<b>2 00</b> <input type="checkbox"/> 1	<pre> REG 03-04-2000 15:20 C01 MC#01 000129  1 DEPT01 T1 F \$2.00 TL \$2.00 FSST \$2.00 FSTD \$5.00 FSCG \$3.00                     </pre>
	Taxable	1, F/S	<input type="checkbox"/> FS/ST	
<b>Payment</b>	<b>Food stamp</b>	<b>\$5.00</b>	<b>5 00</b> <input type="checkbox"/> FS/ST	

# Advanced Operations

## Mixed food stamp/cash change (continued...)

### Example 3

			OPERATION	RECEIPT
Item 1	Dept. 1	\$2.00	<b>2 00</b> <input type="checkbox"/>	REG 03-04-2000 15:25 C01 MC#01 000130  1 DEPT01 T1 F \$2.00 1 DEPT01 T1 F \$1.20 1 DEPT03 T1 \$0.30 TA1 \$0.30 TX1 \$0.01 TL <b>\$3.51</b> FSST \$3.20 FSTD \$5.00 FSCG \$1.00 CG \$0.49
	Taxable	1, F/S	<b>1 2 0</b> <input type="checkbox"/>	
Item 2	Dept. 1	\$1.20	<b>3 0</b> <input type="checkbox"/>	
	Taxable	1, F/S	<input type="checkbox"/> FS/ST	
Item 3	Dept. 3	\$0.30	<b>5 00</b> <input type="checkbox"/>	
	Taxable	1		
Payment	Food stamp	\$5.00		

When food stamp items are included in a transaction, the amount of change due in cash is applied as a cash amount tendered for cash (nonfood stamp) items. In this example, the \$0.30 purchase is automatically deducted from the \$0.80 cash due in change from the food stamp purchase.

### Example 4

			OPERATION	RECEIPT
Item 1	Dept. 1	\$1.00	<b>1 00</b> <input type="checkbox"/>	REG 03-04-2000 15:30 C01 MC#01 000131  1 DEPT01 T1 F \$1.00 1 DEPT01 T1 F \$2.50 1 DEPT03 \$5.00 FSST \$3.50 FSTD \$5.00 FSCG \$1.00 CASH \$4.50
	Taxable	1, F/S	<b>2 5 0</b> <input type="checkbox"/>	
Item 2	Dept. 1	\$2.50	<b>5 00</b> <input type="checkbox"/>	
	Taxable	1, F/S	<input type="checkbox"/> FS/ST	
Item 3	Dept. 3	\$5.00	<b>5 00</b> <input type="checkbox"/>	
	Taxable	No		
Payment	Food stamp	\$5.00	<input type="checkbox"/> CA/AMT/TEND	
	Cash	\$4.50		

The following calculation is performed internally to apply the cash change due on the food stamp transaction to the balance due of the cash transaction.

	Food stamp transaction	Cash transaction
Price items:	\$3.50	\$5.00
Tax:	\$0.00	\$0.00
Total due:	\$3.50	\$5.00
Amount tendered:	\$5.00 (food stamp)	\$4.50 (cash), \$0.50 (change from food stamp)
Amount due:	\$3.50	
Change amount due:	\$1.00 (food stamp), \$0.50 (cash)	
Total:		\$5.00

**Mixed food stamp/cash change (continued...)**

**Food stamp + Taxable 1 + Taxable 2**

When food stamps are received as partial tender for items preset with the status “food stamp”, “taxable 1”, and “taxable 2”, the calculation are performed using one of the two cases described in this section. The case used depends on the food stamp amount received as partial tender.

**Case 1**

This case is used when the total amount of the items preset with the status “food stamp”, “taxable 1”, and “taxable 2” is greater than or equal to the food stamp amount received as partial tender. Case 1 subtracts the food stamp amount tendered from both the taxable 1 amount and taxable 2 amount.

**Example 5**

OPERATION			RECEIPT
Item 1	Dept. 1	\$2.00	<pre> REG 03-04-2000 15:35 C01    MC#01    000132  1 DEPT01    T1 F \$2.00 1 DEPT02    T2 F \$3.00 1 DEPT01    T12F \$2.00 FSST                \$7.00 FSTD                \$2.00 TA1                 \$2.00 TX1                 \$0.08 TA2                 \$3.00 TX2                 \$0.15 CASH              \$5.23                     </pre>
	Taxable	1, F/S	
Item 2	Dept. 2	\$3.00	
	Taxable	2, F/S	
Item 3	Dept. 1	\$2.00	
	Taxable	1/2, F/S	
Payment	<b>Food stamp</b>	<b>\$2.00</b>	
	Cash	\$5.23	

In this example, the food stamp received as partial tender is \$2.00, so that amount is deducted from both the taxable 1 amount and taxable 2 amount. This means that the remaining taxable 1 amount is \$2.00, while the remaining taxable 2 amount is \$3.00.

**Mixed food stamp/cash change (continued...)**

**Case 2**

This case is used when the total amount of the items preset with the status “food stamp”, “taxable 1”, and “taxable 2” is less than or equal to the food stamp amount received as partial tender.

**Example 6**

OPERATION			RECEIPT
Item 1	Dept. 1	\$2.00	<pre> REG 03-04-2000 15:40 C01    MC#01    000133  1 DEPT01    T1 F \$2.00 1 DEPT02    T2 F \$3.00 1 DEPT01    T12F \$2.00 FSST                \$7.00 FSTD                \$4.00 TA2                 \$1.00 TX2                 \$0.05 CASH              \$3.05                     </pre>
	Taxable	1, F/S	
Item 2	Dept. 2	\$3.00	
	Taxable	2, F/S	
Item 3	Dept. 1	\$2.00	
	Taxable	1/2, F/S	
Payment	<b>Food stamp</b>	<b>\$4.00</b>	
	Cash	\$3.05	

# Advanced Operations

## Electronic benefits transfer

In addition to standard food stamp tender finalizations, this model also allows finalization for tenders electronic benefits transfer (EBT) card.

EBT tenders can be accepted for New Jersey rule or Illinois rule food stamp tenders, as well as for food stamp tenders that do not follow these rules.

### About mixed EBT card tenders

When the register is programmed to prohibit an EBT amount tendered that exceeds the food stamp subtotal, nonfood stamp items cannot be paid for using an EBT card. In this case, the following applies:

- $ST - (EBT/TEND - FS/ST) = \text{Balance due}$  (the remaining balance due must be finalized using another finalize key.)  
When the register is programmed to allow an EBT amount tendered that exceeds the food stamp subtotal, nonfood stamp items can be paid for using an EBT card. In this case, there are two possible situations:
- $ST > EBT/TEND$   
 $ST - (EBT/TEND - FS/ST) = \text{Balance due}$  (the remaining balance due must be finalized using another finalize key.)
- $EBT/TEND > \text{or} = ST$   
 $EBT/TEND - ST = \text{cash change}$

### No change due

#### Example 1

OPERATION			RECEIPT	
Item 1	Dept. 1	\$1.00	<b>1</b> <b>00</b> <b>1</b>	<pre> REG 03-04-2000 15:45 C01    MC#01    000134  1 DEPT01    T1 F \$1.00 1 DEPT02    T2 F \$2.00 1 DEPT03    F \$2.00 TL          \$6.00 FSST          \$6.00 EBTTD          \$6.00                     </pre>
	Taxable	1, F/S	<b>2</b> <b>00</b> <b>2</b>	
Item 2	Dept. 2	\$2.00	<b>3</b> <b>00</b> <b>3</b>	
	Taxable	2, F/S	FS/ST	
Item 3	Dept. 3	\$3.00	<b>6</b> <b>00</b> <b>EBT</b>	
	Taxable	F/S		
<b>Payment</b>	<b>EBT</b>	<b>\$6.00</b>		

#### Example 2

OPERATION			RECEIPT	
Item 1	Dept. 1	\$1.00	<b>1</b> <b>00</b> <b>1</b>	<pre> REG 03-04-2000 15:50 C01    MC#01    000135  1 DEPT01    T1 F \$1.00 1 DEPT02    T1 F \$2.00 1 DEPT03    T1  \$3.00 FSST          \$3.00 EBTTD          \$5.00 TA1          \$3.00 TX1          \$0.12 CASH          \$1.12                     </pre>
	Taxable	1, F/S	<b>2</b> <b>00</b> <b>2</b>	
Item 2	Dept. 2	\$2.00	<b>3</b> <b>00</b> <b>3</b>	
	Taxable	1, F/S	FS/ST	
Item 3	Dept. 3	\$3.00	<b>5</b> <b>00</b> <b>EBT</b>	
	Taxable	1		
<b>Payment</b>	<b>EBT</b>	<b>\$5.00</b>	<b>CA/AMT</b>	
	<b>Cash</b>	<b>\$1.12</b>	<b>TEND</b>	



## Change due

			OPERATION	RECEIPT
Item 1	Dept. 1	\$1.00	<b>1 00</b> <b>1</b>	REG 03-04-2000 15:55 C01 MC#01 000136  1 DEPT01 T1 F \$1.00 1 DEPT02 T1 F \$1.20 1 DEPT03 T1 \$0.30 TA1 \$0.30 TX1 \$0.01 TL <b>\$2.51</b> FSST \$2.20 EBTDD \$5.00 CG \$2.49
	Taxable	1, F/S	<b>1 2 0</b> <b>2</b>	
Item 2	Dept. 2	\$1.20	<b>3 0</b> <b>3</b>	
	Taxable	1, F/S	<b>FS/ST</b>	
Item 3	Dept. 3	\$0.30	<b>5 00</b> <b>EBT</b>	
	Taxable	1		
<b>Payment</b>	<b>EBT</b>	<b>\$5.00</b>		

## Tips

### Example

			OPERATION	RECEIPT
Item 1	Unit price	\$3.00	<b>3 00</b> <b>1</b>	REG 03-04-2000 16:00 C01 MC#01 000137  1 DEPT01 -3.00 1 DEPT02 -5.00 TIP -0.80 TL <b>\$8.80</b> CASH \$10.00 CG \$1.20
	Dept.	1	<b>5 00</b> <b>2</b>	
Item 2	Unit price	\$5.00	<b>SUB TOTAL</b>	
	Dept.	2	<b>8 0</b> <b>TIP</b>	
<b>Tip</b>	<b>Amount</b>	<b>\$0.80</b>	<b>1 0 00</b> <b>CA/AMT TEND</b>	
Payment	Cash	\$10.00		

## Registering the second unit price

Second unit prices along with quantity modifiers can be programmed to PLUs. Pressing <PRICE SHIFT> (price shift key) calls up the second unit price, quantity modifier, and descriptor. Totalizers and inventory are adjusted by multiplying the number of items being registered by the quantity modifier programmed to the PLU being registered.

- <PRICE SHIFT> must be pressed before each registration of a PLU.
- Second unit price registration is no available with open PLUs when unit price is not preset.
- Second unit prices and quantity modifiers are assigned to PLUs using programming procedures described in the dealer's manual.
- Even if a PLU is programmed with a package quantity, the second unit price and quantity modifier are applied during registration following operation of <PRICE SHIFT>.

# Advanced Operations

## Example 1

	OPERATION	RECEIPT																	
<table border="1" style="width: 100%; border-collapse: collapse;"> <tr> <td rowspan="3" style="width: 15%;">Item 1</td> <td style="width: 15%;">PLU 1<sub>2nd@</sub></td> <td style="width: 15%;">(\$10.00)</td> </tr> <tr> <td>Quantity</td> <td style="text-align: center;">1</td> </tr> <tr> <td>Unit Q'ty</td> <td style="text-align: center;">1</td> </tr> <tr> <td rowspan="3">Item 2</td> <td>PLU 2<sub>2nd@</sub></td> <td>(\$5.00)</td> </tr> <tr> <td>Quantity</td> <td style="text-align: center;">1</td> </tr> <tr> <td>Unit Q'ty</td> <td style="text-align: center;">1</td> </tr> <tr> <td>Payment</td> <td>Cash</td> <td style="text-align: right;">\$15.00</td> </tr> </table>	Item 1	PLU 1 <sub>2nd@</sub>	(\$10.00)	Quantity	1	Unit Q'ty	1	Item 2	PLU 2 <sub>2nd@</sub>	(\$5.00)	Quantity	1	Unit Q'ty	1	Payment	Cash	\$15.00	<div style="text-align: center;"> <span>PRICE SHIFT</span> <span style="font-size: 24px; font-weight: bold;">1</span> <span>PLU</span> </div> <p>The operation declares that the next input is a second unit price.</p> <div style="text-align: center;"> <span>PRICE SHIFT</span> <span style="font-size: 24px; font-weight: bold;">1</span> <span style="font-size: 24px; font-weight: bold;">0</span> <span>PLU</span> </div> <div style="text-align: center; margin-top: 10px;"> <span>SUB TOTAL</span> </div> <div style="text-align: center; margin-top: 10px;"> <span>CA/AMT /TEND</span> </div>	<div style="border: 1px solid black; padding: 5px;"> <pre> REG 03-04-2000 13:45 C01    MC#01    000110  1 PLU001      -10.00 1 PLU010      -5.00 TL           -15.00 CASH         -15.00                     </pre> </div>
Item 1		PLU 1 <sub>2nd@</sub>	(\$10.00)																
		Quantity	1																
	Unit Q'ty	1																	
Item 2	PLU 2 <sub>2nd@</sub>	(\$5.00)																	
	Quantity	1																	
	Unit Q'ty	1																	
Payment	Cash	\$15.00																	

## Example 2

	OPERATION	RECEIPT										
<table border="1" style="width: 100%; border-collapse: collapse;"> <tr> <td rowspan="3" style="width: 15%;">Item</td> <td style="width: 15%;">PLU 2<sub>2nd@</sub></td> <td style="width: 15%;">(\$10.00)</td> </tr> <tr> <td>Quantity</td> <td style="text-align: center;">5</td> </tr> <tr> <td>2nd Q'ty</td> <td style="text-align: center;">3</td> </tr> <tr> <td>Payment</td> <td>Cash</td> <td style="text-align: right;">\$50.00</td> </tr> </table>	Item	PLU 2 <sub>2nd@</sub>	(\$10.00)	Quantity	5	2nd Q'ty	3	Payment	Cash	\$50.00	<div style="text-align: center;"> <span>PRICE SHIFT</span> <span style="font-size: 24px; font-weight: bold;">5</span> <span style="font-size: 18px;">X/DATE TIME</span> </div> <div style="text-align: center; margin-top: 10px;"> <span>PRICE SHIFT</span> <span style="font-size: 24px; font-weight: bold;">2</span> <span>PLU</span> </div> <div style="text-align: center; margin-top: 10px;"> <span style="font-size: 24px; font-weight: bold;">5</span> <span style="font-size: 24px; font-weight: bold;">0</span> <span style="font-size: 24px; font-weight: bold;">00</span> <span>CA/AMT /TEND</span> </div>	<div style="border: 1px solid black; padding: 5px;"> <pre> REG 03-04-2000 13:50 C01    MC#01    000111  5 PLU001      -50.00 TL           -50.00 CASH         -50.00 CG           -0.00                     </pre> </div>
Item		PLU 2 <sub>2nd@</sub>	(\$10.00)									
		Quantity	5									
	2nd Q'ty	3										
Payment	Cash	\$50.00										

• The model for the U.S./Canada, use X/DATE TIME instead of X/DATE TIME.

## Example 3

The procedure shown above are for when the cash register is programmed not to maintain a second unit price shift. It is programmed is performed to maintain a second unit price shift, the following procedure applies.

	OPERATION	RECEIPT																								
<table border="1" style="width: 100%; border-collapse: collapse;"> <tr> <td rowspan="3" style="width: 15%;">Item 1</td> <td style="width: 15%;">PLU 1<sub>2nd@</sub></td> <td style="width: 15%;">(\$10.00)</td> </tr> <tr> <td>Quantity</td> <td style="text-align: center;">1</td> </tr> <tr> <td>Unit Q'ty</td> <td style="text-align: center;">1</td> </tr> <tr> <td rowspan="3">Item 2</td> <td>PLU 2<sub>2nd@</sub></td> <td>(\$5.00)</td> </tr> <tr> <td>Quantity</td> <td style="text-align: center;">1</td> </tr> <tr> <td>Unit Q'ty</td> <td style="text-align: center;">1</td> </tr> <tr> <td rowspan="3">Item 3</td> <td>PLU 1</td> <td>(\$1.00)</td> </tr> <tr> <td>Quantity</td> <td style="text-align: center;">1</td> </tr> <tr> <td>Unit Q'ty</td> <td style="text-align: center;">1</td> </tr> <tr> <td>Payment</td> <td>Cash</td> <td style="text-align: right;">\$16.00</td> </tr> </table>	Item 1	PLU 1 <sub>2nd@</sub>	(\$10.00)	Quantity	1	Unit Q'ty	1	Item 2	PLU 2 <sub>2nd@</sub>	(\$5.00)	Quantity	1	Unit Q'ty	1	Item 3	PLU 1	(\$1.00)	Quantity	1	Unit Q'ty	1	Payment	Cash	\$16.00	<div style="text-align: center;"> <span>PRICE SHIFT</span> <span style="font-size: 24px; font-weight: bold;">1</span> <span>PLU</span> </div> <p>This operation shifts to registration of second unit price.</p> <div style="text-align: center; margin-top: 10px;"> <span>PRICE SHIFT</span> <span style="font-size: 24px; font-weight: bold;">2</span> <span>PLU</span> </div> <div style="text-align: center; margin-top: 10px;"> <span>PRICE SHIFT</span> <span>PRICE SHIFT</span> <span style="font-size: 24px; font-weight: bold;">1</span> <span>PLU</span> </div> <p>This operation shifts back to registration of normal (first) unit price.</p> <div style="text-align: center; margin-top: 10px;"> <span style="font-size: 24px; font-weight: bold;">1</span> <span style="font-size: 24px; font-weight: bold;">6</span> <span style="font-size: 24px; font-weight: bold;">00</span> <span>CA/AMT /TEND</span> </div>	<div style="border: 1px solid black; padding: 5px;"> <pre> REG 03-04-2000 13:55 C01    MC#01    000112  1 PLU001      -10.00 1 PLU002      -5.00 1 PLU001      -1.00 TL           -16.00 CASH         -16.00 CG           -0.00                     </pre> </div>
Item 1		PLU 1 <sub>2nd@</sub>	(\$10.00)																							
		Quantity	1																							
	Unit Q'ty	1																								
Item 2	PLU 2 <sub>2nd@</sub>	(\$5.00)																								
	Quantity	1																								
	Unit Q'ty	1																								
Item 3	PLU 1	(\$1.00)																								
	Quantity	1																								
	Unit Q'ty	1																								
Payment	Cash	\$16.00																								

# Inputting the number of customers

## Example 1

OPERATION			RECEIPT		
Item 1	Unit price	\$15.00	1	5	00
	Dept.	1			
Item 2	Unit price	\$5.00	5	00	
	Dept.	2			
Customer	Number	2			
Payment	Cash	\$20.00			

### OPERATION

### RECEIPT

1 5 00 1  
 5 00 2  
 2 CST  
 SUB TOTAL  
 CA/AMT /TEND

```

REG 03-04-2000 16:05
C01 MC#01 000138

CT 2
1 DEPT01 -15.00
1 DEPT02 -5.00
TL -20.00
CASH -20.00
  
```

## Example 2

You can only use the following operation to re-input the number of customers when <CUSTOMER> (customer number key) is preset to allow re-input. When programming prohibits re-input of the number of customers, this operation causes an error.

### OPERATION

### RECEIPT

1 5 00 1  
 5 00 2  
 2 CST  
 SUB TOTAL  
 2 0 00 CA/AMT /TEND

```

REG 03-04-2000 16:10
C01 MC#01 000139

CT 3
1 DEPT01 -15.00
1 DEPT02 -5.00
CT 2
TL -20.00
CASH -20.00
  
```

You can re-input the number of customers either immediately after the initial input or during later registration.

## Example 3

You can use the following operation to add customers to an original number of customers input (when addition to the number of the customer is allowed).

### OPERATION

### RECEIPT

1 5 00 1  
 5 00 2  
 2 CST  
 SUB TOTAL  
 2 0 00 CA/AMT /TEND

```

REG 03-04-2000 16:15
C01 MC#01 000140

CT 3
1 DEPT01 -15.00
1 DEPT02 -5.00
CT 5
TL -20.00
CASH -20.00
  
```

# Advanced Operations

## Text recall

This procedure is used to recall text by inputting the address where the text is stored. The recalled text is printed on the receipt and journal.

### Example

OPERATION			RECEIPT				
Item 1	Unit price	\$46.00	4	6	00	1	REG 03-04-2000 16:20 C01 MC#01 000141  CT 3 1 DEPT01 -46.00 MEDIUM SIZE 1 DEPT02 -10.00 SMALL SIZE TL -56.00 CASH +56.00
	Dept.	1				1	
Item 2	Unit price	\$10.00	1	0	00	2	
	Dept.	2				2	
Payment	Cash	\$56.00				SUB TOTAL	
Text 1	MEDIUM SIZE					CA/AMT TEND	
Text 2	SMALL SIZE						

## Temporarily releasing compulsion

<OPEN 2> (open 2 key) can be programmed to release specific compulsion.

### Example 1

OPERATION			RECEIPT				
Item	Unit price	\$10.00	1	0	00	1	REG 03-04-2000 16:25 C01 MC#01 000142  1 DEPT01 -10.00 TL -10.00 CHECK -10.00
	Dept.	1	1	0	00	CHK/ TEND	
Payment	Check	\$10.00				2	
Validation compulsory			2	00		2	
			Validation compulsory (E041)				
			Validation compulsory (E041)			Validation compulsory is temporarily released.	
			Validation compulsory (E041)			Validation compulsory is temporarily released.	

### Example 2

OPERATION			RECEIPT				
Input customer No. compulsory			1	0	00	1	REG 03-04-2000 16:30 C01 MC#01 000143  1 DEPT01 -10.00 TL -10.00 CHECK -10.00
Item	Unit price	\$10.00	Input customer No. compulsory (E019)				
	Dept.	1	Compulsory is temporarily released.			OPEN 2	
Payment	Check	\$10.00					
			1	0	00	1	
			1	0	00	CHK/ TEND	

---

## Printing slip

To perform batch printing on the slip printer, you must first use the memory allocation operation (see program 5 mode in the dealer's manual) to reserve slip buffer memory. The capacity of the slip buffer memory is determined by the number of units of slip buffer memory reserved by the memory allocation operation.

The register can be programmed to check the status of the registration buffer memory whenever slip batch printing is performed, and sound an alarm when the buffer memory is almost full. The alarm sounds when there are 12 lines or less remaining, and once it starts to sound, the only operation you can perform is the cancel operation or operations using one of the following keys.

- <CA/AMT TEND> (cash/amount tendered key) operation
- <CH> (charge key) operation
- <CHK/TEND> (check tendered key) operation
- <DEPOSIT> (deposit key) operation
- <NEW BALANCE> (new balance key) operation
- <SUBTOTAL> (subtotal key) operation

You must perform one of above operations when the registration buffer alarm sounds. Any other operations results in an error.

## Printing slips

The cash register can be connected to the optional SP-1300 slip printer, which features an automatic feed function and automatic back feed function.

### • Automatic feed function

This function makes it possible to program the number of line feeds that should be inserted from the normal print start position before starting slip printing of a new slip. Even if line feeds are programmed for this function, they are not inserted for validation printing, check endorsement printing, and check printing performed using the slip printer. Note also that line feeds are not inserted automatically at the beginning of a second slip when the transaction requires printing that extends from one slip to another.

### • Automatic back feed function

This function performs automatic back feed following slip printing, validation printing, and endorsement printing on the slip printer. The slip paper is released once the back feed operation is complete.

### • Manual feed function

<SLIP FEED/RELEASE> (slip feed/release key: assigned to the register's keyboard using the program 4 mode) can be used for manual feed of the slip paper. You perform manual feed by inputting a value for the number of lines (up to two digits in the range of 1 to 99) and then press <SLIP FEED/RELEASE>.

### • Manual back feed function

<SLIP BACK FEED/RELEASE> (slip back feed/release key: assigned to the register's keyboard using the program 4 mode) can be used for manual back feed of the slip paper. Manual back feed can be performed by inputting a value for the number of lines (up to two digits in the range of 1 to 99) and then press <SLIP BACK FEED/RELEASE>.

You can print slips using automatic or manual batch printing. The slip print operation can be performed in REG1, REG2, and RF modes only.

Finalizing a registration without inserting a slip paper into the slip printer when the register is programmed as "slip paper insertion into slip printer compulsory before finalizing registration" produces an error.

# Advanced Operations

## To perform auto batch printing 1

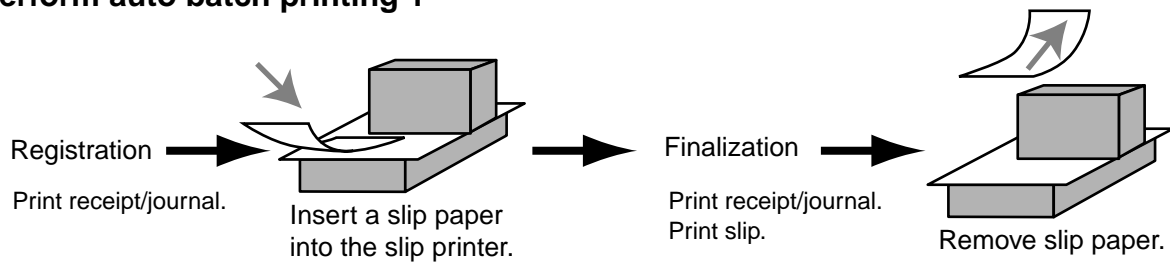

## To perform auto batch printing 2

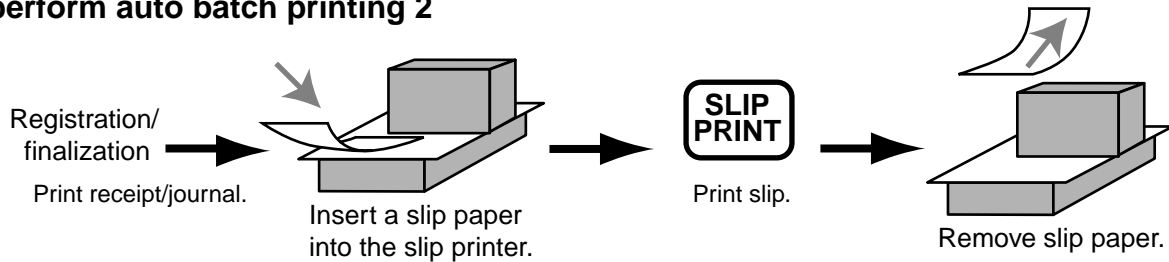

## About the maximum number of slip lines

You can program the maximum number of lines that can be printed on a slip. Once you do, any attempt to exceed the preset maximum results in an error. When such an error occurs, press <C>, change slip paper and press <SLIP PRINT> to restart printing.

# Check tracking systems

## Check tracking system

With the check tracking system, the amount, check number, number of slip print lines, store number, date/time and registration detail data are stored in two files (check tracking index file and check tracking detail file).

- Check tracking detail file and index file are cleared by the following timing:
  1. The check is cleared after printing finalized data on slip or guest check receipts, or the check is also cleared when the new or old check operation is made.
  2. The check is cleared after printing finalized data on slip or guest check receipt, or check is also cleared when the same finalized check number is assigned in new check operation.You can select one of these options by programming.
- Auto new balance function  
The register can be programmed so that whenever a clerk (by clerk key) signs off while a check is open, a <NEW BALANCE> operation is automatically performed to temporarily finalize the open check.
- You can specify a range of checks that can be opened by each clerk. Once you do, any attempt by a clerk to open a check using a number that is not within his specified range results in an error.
- Either of the following two operations can be used to correct input of a wrong check number.
  - <NEW CHECK>  
Re-input the correct check number, or cancel the original check number, issue a receipt, and then re-input the correct check number.
  - <OLD CHECK>, <NEW/OLD>  
Temporary finalize the original check number, issue a receipt, and then re-input the correct check number.

## Opening a check

### Example

	OPERATION	RECEIPT																					
<table border="1" style="width: 100%; border-collapse: collapse;"> <tr> <td style="width: 15%;"><b>Check#</b></td> <td colspan="2" style="text-align: right;">1234</td> </tr> <tr> <td><b>Table#</b></td> <td colspan="2" style="text-align: right;">33</td> </tr> <tr> <td rowspan="2">Item 1</td> <td>Dept. 1</td> <td style="text-align: right;">\$10.00</td> </tr> <tr> <td>Quantity</td> <td style="text-align: right;">2</td> </tr> <tr> <td rowspan="2">Item 2</td> <td>Dept. 2</td> <td style="text-align: right;">\$20.00</td> </tr> <tr> <td>Quantity</td> <td style="text-align: right;">2</td> </tr> <tr> <td rowspan="2">Item 3</td> <td>Dept. 3</td> <td style="text-align: right;">\$30.00</td> </tr> <tr> <td>Quantity</td> <td style="text-align: right;">1</td> </tr> </table>	<b>Check#</b>	1234		<b>Table#</b>	33		Item 1	Dept. 1	\$10.00	Quantity	2	Item 2	Dept. 2	\$20.00	Quantity	2	Item 3	Dept. 3	\$30.00	Quantity	1	<div style="display: flex; justify-content: space-around; margin-bottom: 5px;"> <span>1</span> <span>2</span> <span>3</span> <span>4</span> <span>NEW CHECK</span> </div> <div style="display: flex; justify-content: space-around; margin-bottom: 5px;"> <span>3</span> <span>3</span> <span>TABLE #</span> </div> <div style="display: flex; justify-content: space-around; margin-bottom: 5px;"> <span>1</span> <span>0</span> <span>00</span> <span>1</span> </div> <div style="display: flex; justify-content: space-around; margin-bottom: 5px;"> <span>2</span> <span>0</span> <span>00</span> <span>2</span> </div> <div style="display: flex; justify-content: space-around; margin-bottom: 5px;"> <span>3</span> <span>0</span> <span>00</span> <span>3</span> </div> <p>Insert slip</p> <div style="border: 1px solid black; padding: 2px; width: fit-content; margin: 0 auto;">NB</div> <p>Remove slip</p>	<pre> REG 03-04-2000 16:35 C01 MC#01 000144 CHECK No. 1234  TBL-# 000033 1 DEPT01 -10.00 1 DEPT01 -10.00 1 DEPT02 -20.00 1 DEPT02 -20.00 1 DEPT03 -30.00 + -0.50 SRVC TL -90.50                     </pre>
<b>Check#</b>	1234																						
<b>Table#</b>	33																						
Item 1	Dept. 1	\$10.00																					
	Quantity	2																					
Item 2	Dept. 2	\$20.00																					
	Quantity	2																					
Item 3	Dept. 3	\$30.00																					
	Quantity	1																					

Press <NEW BALANCE> to temporarily close the transaction. If you want to finalize a check immediately, use <CASH>, <CHARGE>, <CREDIT> or <CHECK>.

## Adding to a check

### Example

	OPERATION	RECEIPT																
<table border="1" style="width: 100%; border-collapse: collapse;"> <tr> <td style="width: 15%;"><b>Check#</b></td> <td colspan="2" style="text-align: right;">1234</td> </tr> <tr> <td><b>Table#</b></td> <td colspan="2" style="text-align: right;">33</td> </tr> <tr> <td rowspan="2">Item 1</td> <td>Dept. 1</td> <td style="text-align: right;">\$30.00</td> </tr> <tr> <td>Quantity</td> <td style="text-align: right;">1</td> </tr> <tr> <td rowspan="2">Item 2</td> <td>Dept. 2</td> <td style="text-align: right;">\$10.00</td> </tr> <tr> <td>Quantity</td> <td style="text-align: right;">1</td> </tr> </table>	<b>Check#</b>	1234		<b>Table#</b>	33		Item 1	Dept. 1	\$30.00	Quantity	1	Item 2	Dept. 2	\$10.00	Quantity	1	<div style="display: flex; justify-content: space-around; margin-bottom: 5px;"> <span>1</span> <span>2</span> <span>3</span> <span>4</span> <span>OLD CHECK</span> </div> <div style="display: flex; justify-content: space-around; margin-bottom: 5px;"> <span>3</span> <span>0</span> <span>00</span> <span>1</span> </div> <div style="display: flex; justify-content: space-around; margin-bottom: 5px;"> <span>1</span> <span>0</span> <span>00</span> <span>2</span> </div> <p>Insert slip</p> <div style="border: 1px solid black; padding: 2px; width: fit-content; margin: 0 auto;">NB</div> <p>Remove slip</p>	<pre> REG 03-04-2000 16:40 C01 MC#01 000145 TABLE No.000033 CT 1 CHECK No. 1234  ST -90.50 1 DEPT01 -30.00 1 DEPT02 -10.00 + -0.50 SRVC TL -131.00                     </pre>
<b>Check#</b>	1234																	
<b>Table#</b>	33																	
Item 1	Dept. 1	\$30.00																
	Quantity	1																
Item 2	Dept. 2	\$10.00																
	Quantity	1																

- The table number is stored in the check tracking index memory so its input is not required in this operation even if table number input is preset as compulsory. Table number input after inputting the check number may be performed, however, without generating an error.
- Once a check is opened under a number in a certain mode (REG1 or REG2), the same mode must be used to make additions to the check.

# Advanced Operations

## Issuing a guest receipt

The following operation can be used to print out the balance of a temporarily finalized check.

### Example

OPERATION	RECEIPT
<p> <input type="button" value="1"/> <input type="button" value="2"/> <input type="button" value="3"/> <input type="button" value="4"/> <input type="button" value="GUEST RECEIPT"/> </p> <p>Input the number of check you want.</p>	<pre> REG 03-04-2000 16:45 C01 MC#01 000146 TABLE No.000033 CT 1 CHECK No. 1234  1 DEPT01 -10.00 1 DEPT01 -10.00 1 DEPT02 -20.00 1 DEPT02 -20.00 1 DEPT03 -30.00 + -0.50 1 DEPT01 -30.00 1 DEPT02 -10.00 + -0.50 SRVC TL -131.00                     </pre>

## Closing a check memory

### Example

OPERATION	RECEIPT
<p> <input type="button" value="1"/> <input type="button" value="2"/> <input type="button" value="3"/> <input type="button" value="4"/> <input type="button" value="OLD CHECK"/> </p> <p> <input type="button" value="1"/> <input type="button" value="5"/> <input type="button" value="0"/> <input type="button" value="00"/> <input type="button" value="CA/AMT TEND"/> </p>	<pre> REG 03-04-2000 16:50 C01 MC#01 000147 TABLE No.000033 CT 1 CHECK No. 1234  ST -131.00 CASH -150.00 CG -19.00                     </pre>



**SLIP**

REG	03-04-2000	16:50
C01	MC#01	000147
TABLE No.	000033	CT 1
CHECK No.	1234	
1	DEPT01	+10.00
1	DEPT01	+10.00
1	DEPT02	+20.00
1	DEPT02	+20.00
1	DEPT03	+30.00
	+	+0.50
#13	SRVC TL	-90.50
1	DEPT01	+30.00
1	DEPT02	+10.00
	+	+0.50
#17	SRVC TL	-131.00
	TL	-131.00
	CASH	+150.00
	CG	+19.00

**New/old check key operation**

**Example 1**

When a check number is input and <NEW/OLD> is pressed, the key works as a new check key function if there is no matching check number in the check tracking memory.

**OPERATION**

Input a check number and press  
 <NEW/OLD>.

**RECEIPT**

REG	03-04-2000	16:55
C01	MC#01	000148
CHECK No.	3456	
1	DEPT01	+10.00
1	DEPT02	+20.00
	+	+0.50
	SRVC TL	-30.50

**Example 2**

When a check number is input and <NEW/OLD> is pressed, the key works as an old check key if there is matching check number in the check tracking memory.

**OPERATION**

**RECEIPT**

REG	03-04-2000	17:00
C01	MC#01	000149
CHECK No.	3456	CT 1
ST		+30.50
TL		-30.50
CASH		+31.00
CG		+0.50

# Advanced Operations

## Add check

This operation lets you combine the amounts of more than one check into a single check.

### Example

#### Registration for check number 1234

	OPERATION	RECEIPT													
Original check	<div style="display: flex; justify-content: space-around; align-items: center;"> <div style="display: flex; justify-content: space-between; width: 100%;"> <span>1 2 3 4</span> <span>NEW CHECK</span> </div> <div style="display: flex; justify-content: space-between; width: 100%;"> <span>3 3</span> <span>TABLE #</span> </div> <div style="display: flex; justify-content: space-between; width: 100%;"> <span>1 0 00</span> <span>1</span> </div> <div style="display: flex; justify-content: space-between; width: 100%;"> <span>2 0 00</span> <span>2</span> </div> <div style="text-align: center; margin-top: 10px;"> <span>NB</span> </div> </div>	<pre> REG 03-04-2000 17:05 C01 MC#01 000150 CHECK No. 1234  TBL-# 000033 1 DEPT01 -10.00 1 DEPT02 -20.00 + -0.50 SRVC TL -30.50                     </pre>													
<table border="1" style="width: 100%; border-collapse: collapse;"> <tr> <td style="width: 15%;"><b>Check#</b></td> <td colspan="2" style="text-align: right;"><b>1234</b></td> </tr> <tr> <td rowspan="2">Item 1</td> <td>Dept. 1</td> <td style="text-align: right;">\$10.00</td> </tr> <tr> <td>Quantity</td> <td style="text-align: right;">1</td> </tr> <tr> <td rowspan="2">Item 2</td> <td>Dept. 2</td> <td style="text-align: right;">\$20.00</td> </tr> <tr> <td>Quantity</td> <td style="text-align: right;">1</td> </tr> </table>	<b>Check#</b>	<b>1234</b>		Item 1	Dept. 1	\$10.00	Quantity	1	Item 2	Dept. 2	\$20.00	Quantity	1		
<b>Check#</b>	<b>1234</b>														
Item 1	Dept. 1	\$10.00													
	Quantity	1													
Item 2	Dept. 2	\$20.00													
	Quantity	1													

#### Registration for check number 3456

	OPERATION	RECEIPT								
Added check	<div style="display: flex; justify-content: space-around; align-items: center;"> <div style="display: flex; justify-content: space-between; width: 100%;"> <span>3 4 5 6</span> <span>NEW CHECK</span> </div> <div style="display: flex; justify-content: space-between; width: 100%;"> <span>3 0 00</span> <span>1</span> </div> <div style="text-align: center; margin-top: 10px;"> <span>NB</span> </div> </div>	<pre> REG 03-04-2000 17:10 C01 MC#01 000151 CHECK No. 3456  1 DEPT01 -30.00 + -0.50 SRVC TL -30.50                     </pre>								
<table border="1" style="width: 100%; border-collapse: collapse;"> <tr> <td style="width: 15%;"><b>Check#</b></td> <td colspan="2" style="text-align: right;"><b>3456</b></td> </tr> <tr> <td rowspan="2">Item</td> <td>Dept. 1</td> <td style="text-align: right;">\$30.00</td> </tr> <tr> <td>Quantity</td> <td style="text-align: right;">1</td> </tr> </table>	<b>Check#</b>	<b>3456</b>		Item	Dept. 1	\$30.00	Quantity	1		
<b>Check#</b>	<b>3456</b>									
Item	Dept. 1	\$30.00								
	Quantity	1								

#### Registration for check number 1234

	OPERATION	RECEIPT
<div style="display: flex; justify-content: space-around; align-items: center;"> <div style="border: 1px solid black; padding: 5px; width: 15%;">                 Check No. : 1234             </div> <div style="border: 1px dashed black; padding: 5px; width: 15%;">                 Check No. : 3456             </div> </div> <div style="margin-top: 20px; text-align: center;"> <div style="display: flex; justify-content: space-around; align-items: center;"> <div style="display: flex; justify-content: space-between; width: 100%;"> <span>1 2 3 4</span> <span>OLD CHECK</span> </div> <div style="display: flex; justify-content: space-between; width: 100%;"> <span>3 4 5 6</span> <span>ADD CHECK</span> </div> <div style="text-align: center; margin-top: 10px;"> <span>NB</span> </div> </div> </div>	<pre> REG 03-04-2000 17:15 C01 MC#01 000152 TABLE No.000033 CT 1 CHECK No. 1234  ST -30.50 ADD CHK 3456 ST -30.50 + -0.50 SRVC TL -61.50                     </pre>	

## Separate check

This operation makes it possible to split a single check into separate checks.

### Example

Check#		1234
Item 1	Dept. 1	\$10.00
	Quantity	1
Item 2	Dept. 2	\$20.00
	Quantity	1
Item 3	Dept. 3	\$30.00
	Quantity	1
Item 4	Dept. 4	\$40.00
	Quantity	1

→

↗

Check#		3456
Item 1	Dept. 1	\$10.00
	Quantity	1
Item 2	Dept. 3	\$30.00
	Quantity	1
Payment	Cash	\$40.00

### OPERATION

### RECEIPT

**3 4 5 6** NEW CHECK

This input of a temporary check number can be skipped.

**1 2 3 4** SEPARATE CHECK

Input the original check number by <SEP CHK>.

Display shows the 1st item which will be separated.

SEPARATE CHECK

After <SEP CHK>, this item is separated.

REVIEW

Display shows the 3rd item which will be separated.

SEPARATE CHECK

NB

**4 0 00** CA / AMT / TEND

```

REG 03-04-2000 17:20
C01 MC#01 000153
CHECK No. 3456

SEP CHK          1234
1 DEPT01         -10.00
1 DEPT03         -30.00
ST              -40.00
CASH             -40.00
CG               -0.00
    
```

# Advanced Operations

## Clerk transfer

This operation lets you change the clerk who is in charge of a specific open check number.

### Example

To change the clerk for check number 1234 from clerk 1 to clerk number 4.

OPERATION	RECEIPT
<p style="text-align: right; margin-right: 20px;"><b>CLK#</b></p> <p>Press this key if you do not want the clerk No. or clerk secret No. to appear on the display.</p> <p style="text-align: right; margin-right: 20px;"><b>1</b> <b>CLK TRANS</b></p> <p>Input the clerk No. of the clerk who is currently in charge of check No. 1234 (target check).</p> <p style="text-align: right; margin-right: 20px;"><b>4</b> <b>OP#</b></p> <p>Input the clerk No. of the clerk who will take over check No. 1234 (target check).</p> <p style="text-align: right; margin-right: 20px;"><b>1</b> <b>2</b> <b>3</b> <b>4</b> <b>NEW CHECK</b></p> <p>Input the target check No. that is transferred from clerk 1 to 4. You can use either &lt;OLD CHK&gt;, &lt;NEW/OLD&gt;. Note that if you skip this step, all check Nos currently assigned to clerk 1 are transferred to clerk 4.</p> <p style="text-align: right; margin-right: 20px;"><b>CLK TRANS</b></p>	<div style="border: 1px solid black; padding: 5px; margin-bottom: 10px;"> <p>REG 03-04-2000 17:25 C01 MC#01 000154</p> <p>CLK TRANS C01 C04 1234 +60.50</p> <hr style="border-top: 1px dashed black;"/> <p>TL +60.50</p> </div> <p style="text-align: right; margin-right: 20px;">Check No./NB amount</p>

## Table transfer

With this operation, you can change the number of a check.

### Example 1

To change the check number 1234 to 1111 (which is newly opened).

Check No: 1234

1111 <CHK TRN>

Check No: 1234

Check No: 1111

OPERATION	RECEIPT
<p style="text-align: right; margin-right: 20px;"><b>NEW CHECK</b></p> <p style="text-align: center;"><b>1</b> <b>2</b> <b>3</b> <b>4</b></p> <p style="text-align: center;"><b>1</b> <b>0</b> <b>00</b> <b>1</b></p> <p style="text-align: right; margin-right: 20px;"><b>CHECK TRANS</b></p> <p>Input the new check No.</p>	<div style="border: 1px solid black; padding: 5px;"> <p>REG 03-04-2000 17:30 C01 MC#01 000155 CHECK No. 1234</p> <p>1 DEPT01 -10.00 ST -10.00 TBL TRANS 1111 SRVC TL -10.00</p> </div>

### Example 2

To change the check number 3456 to 2222 (which has already been opened).

Check No: 3456

Check No: 2222

1111 <CHK TRN>

Check No: 3456

Check No: 2222

Added

OPERATION	RECEIPT
<p style="text-align: right; margin-right: 20px;"><b>OLD CHECK</b></p> <p style="text-align: center;"><b>3</b> <b>4</b> <b>5</b> <b>6</b></p> <p style="text-align: center;"><b>1</b> <b>0</b> <b>00</b> <b>1</b></p> <p style="text-align: right; margin-right: 20px;"><b>CHECK TRANS</b></p>	<div style="border: 1px solid black; padding: 5px;"> <p>REG 03-04-2000 17:35 C01 MC#01 000156 CHECK No. 3456</p> <p>ST -10.00 1 DEPT01 -10.00 TBL TRANS 2222 SRVC TL -30.00</p> </div>

# VAT breakdown printing

You can force printing of the VAT breakdown at the finalize stage, regardless of whether the cash register is programmed to print or skip printing of the VAT breakdown. Every time you want to have VAT breakdown, press <VAT>.

## Example

	OPERATION	RECEIPT													
<table border="1" style="width: 100%; border-collapse: collapse;"> <tr> <td rowspan="2" style="width: 15%;">Item 1</td> <td style="width: 15%;">Dept. 1</td> <td style="width: 15%;">\$1.00</td> </tr> <tr> <td>Taxable</td> <td>1</td> </tr> <tr> <td rowspan="2">Item 2</td> <td>PLU 1</td> <td>(\$2.00)</td> </tr> <tr> <td>Taxable</td> <td>2</td> </tr> <tr> <td>Payment</td> <td>Cash</td> <td>\$3.00</td> </tr> </table>	Item 1	Dept. 1	\$1.00	Taxable	1	Item 2	PLU 1	(\$2.00)	Taxable	2	Payment	Cash	\$3.00	<div style="display: flex; flex-direction: column; align-items: center;"> <div style="display: flex; gap: 5px;"> <span style="border: 1px solid black; padding: 2px;">1</span> <span style="border: 1px solid black; padding: 2px;">00</span> <span style="border: 1px solid black; padding: 2px;">1</span> </div> <div style="display: flex; gap: 5px; margin-top: 5px;"> <span style="border: 1px solid black; padding: 2px;">2</span> <span style="border: 1px solid black; padding: 2px;">PLU</span> </div> <div style="display: flex; gap: 5px; margin-top: 5px;"> <span style="border: 1px solid black; padding: 2px;">VAT</span> </div> <div style="border: 1px solid black; padding: 2px; margin-top: 5px;">CA/AMT TEND</div> </div>	<div style="border: 1px solid black; padding: 5px;"> <p>REG 03-04-2000 17:40 C01 MC#01 000156</p> <p>1 DEPT01 T1 -1.00 1 PLU0001 T2 -2.00 TA1 -0.90 TX1 -0.10 TA2 -1.90 TX2 -0.10 CASH -3.00</p> </div>
Item 1		Dept. 1	\$1.00												
	Taxable	1													
Item 2	PLU 1	(\$2.00)													
	Taxable	2													
Payment	Cash	\$3.00													

# Deposit registrations

Use the following procedures to register deposits.

## Deposit from customer

	OPERATION	RECEIPT			
<table border="1" style="width: 100%; border-collapse: collapse;"> <tr> <td style="width: 15%;">Deposit</td> <td style="width: 15%;">Cash</td> <td style="width: 15%;">\$50.00</td> </tr> </table>	Deposit	Cash	\$50.00	<div style="display: flex; flex-direction: column; align-items: center;"> <div style="display: flex; gap: 5px;"> <span style="border: 1px solid black; padding: 2px;">5</span> <span style="border: 1px solid black; padding: 2px;">0</span> <span style="border: 1px solid black; padding: 2px;">00</span> <span style="border: 1px solid black; padding: 2px;">DEPOSIT -</span> </div> <div style="border: 1px solid black; padding: 2px; margin-top: 5px;">CA/AMT TEND</div> </div>	<div style="border: 1px solid black; padding: 5px;"> <p>REG 03-04-2000 17:45 C01 MC#01 000157</p> <p>DEPO- -50.00 TL -50.00 CASH -50.00</p> </div>
Deposit	Cash	\$50.00			

## Deposit from customer during sales transaction

	OPERATION	RECEIPT											
<table border="1" style="width: 100%; border-collapse: collapse;"> <tr> <td rowspan="2" style="width: 15%;">Items</td> <td style="width: 15%;">Dept. 1</td> <td style="width: 15%;">\$10.00</td> </tr> <tr> <td>Dept. 2</td> <td>\$20.00</td> </tr> <tr> <td>Deposit</td> <td></td> <td>\$20.00</td> </tr> <tr> <td>Payment</td> <td>Cash</td> <td>\$10.00</td> </tr> </table>	Items	Dept. 1	\$10.00	Dept. 2	\$20.00	Deposit		\$20.00	Payment	Cash	\$10.00	<div style="display: flex; flex-direction: column; align-items: center;"> <div style="display: flex; gap: 5px;"> <span style="border: 1px solid black; padding: 2px;">1</span> <span style="border: 1px solid black; padding: 2px;">0</span> <span style="border: 1px solid black; padding: 2px;">00</span> <span style="border: 1px solid black; padding: 2px;">1</span> </div> <div style="display: flex; gap: 5px; margin-top: 5px;"> <span style="border: 1px solid black; padding: 2px;">2</span> <span style="border: 1px solid black; padding: 2px;">0</span> <span style="border: 1px solid black; padding: 2px;">00</span> <span style="border: 1px solid black; padding: 2px;">2</span> </div> <div style="display: flex; gap: 5px; margin-top: 5px;"> <span style="border: 1px solid black; padding: 2px;">2</span> <span style="border: 1px solid black; padding: 2px;">0</span> <span style="border: 1px solid black; padding: 2px;">00</span> <span style="border: 1px solid black; padding: 2px;">DEPOSIT +</span> </div> <div style="border: 1px solid black; padding: 2px; margin-top: 5px;">CA/AMT TEND</div> </div>	<div style="border: 1px solid black; padding: 5px;"> <p>REG 03-04-2000 17:50 C01 MC#01 000158</p> <p>1 DEPT01 -10.00 1 DEPT02 -20.00 DEPO+ -20.00 TL -10.00 CASH -10.00</p> </div>
Items		Dept. 1	\$10.00										
	Dept. 2	\$20.00											
Deposit		\$20.00											
Payment	Cash	\$10.00											

## Bill copy

### Example 1

To issue a copy of a bill dated February 1, 2000 in the amount of \$35.00 cash.

OPERATION	RECEIPT
<div style="display: flex; justify-content: space-around; align-items: center;"> <div style="display: flex; gap: 5px;"> <div style="border: 1px solid black; padding: 2px 5px;">0</div> <div style="border: 1px solid black; padding: 2px 5px;">2</div> <div style="border: 1px solid black; padding: 2px 5px;">0</div> <div style="border: 1px solid black; padding: 2px 5px;">1</div> <div style="border: 1px solid black; padding: 2px 5px;">2</div> <div style="border: 1px solid black; padding: 2px 5px;">0</div> <div style="border: 1px solid black; padding: 2px 5px;">0</div> <div style="border: 1px solid black; padding: 2px 5px;">0</div> </div> <div style="border: 1px solid black; padding: 2px 5px; font-size: 8px;">BILL COPY</div> </div> <p style="text-align: center; font-size: 10px;">Enter date by date order.</p> <div style="display: flex; justify-content: space-around; align-items: center; margin-top: 10px;"> <div style="display: flex; gap: 5px;"> <div style="border: 1px solid black; padding: 2px 5px;">3</div> <div style="border: 1px solid black; padding: 2px 5px;">5</div> <div style="border: 1px solid black; padding: 2px 5px;">00</div> </div> <div style="border: 1px solid black; padding: 2px 5px; font-size: 8px;">CA/AMT TEND</div> </div>	<pre style="font-family: monospace; font-size: 10px;"> * BILL TOP MESSAGE 1 * * BILL TOP MESSAGE 2 * * BILL TOP MESSAGE 3 * * BILL TOP MESSAGE 4 *  REG 02-01-2000 C01    MC#01 * BILL COPY MESSAGE 1 * * BILL COPY MESSAGE 2 * * BILL COPY MESSAGE 3 * * BILL COPY MESSAGE 4 *   TA1      -35.00   TX1      -3.50   TL      -38.50   CASH     -38.50  * BILL BTM MESSAGE 1 * * BILL BTM MESSAGE 2 * * BILL BTM MESSAGE 3 * * BILL BTM MESSAGE 4 *</pre> <div style="font-size: 8px; margin-top: 5px;"> <p>*<sup>1</sup> Programmable option</p> </div>

Note that you can finalize this operation using the cash amount tendered key.

### Example 2

To issue a copy of a bill dated February 1, 2000 in the amount of Euro 30.00 cash (sub-currency).

OPERATION	RECEIPT
<div style="display: flex; justify-content: space-around; align-items: center;"> <div style="display: flex; gap: 5px;"> <div style="border: 1px solid black; padding: 2px 5px;">0</div> <div style="border: 1px solid black; padding: 2px 5px;">2</div> <div style="border: 1px solid black; padding: 2px 5px;">0</div> <div style="border: 1px solid black; padding: 2px 5px;">1</div> <div style="border: 1px solid black; padding: 2px 5px;">2</div> <div style="border: 1px solid black; padding: 2px 5px;">0</div> <div style="border: 1px solid black; padding: 2px 5px;">0</div> <div style="border: 1px solid black; padding: 2px 5px;">0</div> </div> <div style="border: 1px solid black; padding: 2px 5px; font-size: 8px;">BILL COPY</div> </div> <div style="display: flex; justify-content: space-around; align-items: center; margin-top: 5px;"> <div style="border: 1px solid black; padding: 2px 5px; font-size: 8px;">EURO PD</div> </div> <div style="display: flex; justify-content: space-around; align-items: center; margin-top: 10px;"> <div style="display: flex; gap: 5px;"> <div style="border: 1px solid black; padding: 2px 5px;">3</div> <div style="border: 1px solid black; padding: 2px 5px;">0</div> <div style="border: 1px solid black; padding: 2px 5px;">00</div> </div> <div style="border: 1px solid black; padding: 2px 5px; font-size: 8px;">CA/AMT TEND</div> </div>	<pre style="font-family: monospace; font-size: 10px;"> * BILL TOP MESSAGE 1 * * BILL TOP MESSAGE 2 * * BILL TOP MESSAGE 3 * * BILL TOP MESSAGE 4 *  REG 02-01-2000 C01    MC#01 * BILL COPY MESSAGE 1 * * BILL COPY MESSAGE 2 * * BILL COPY MESSAGE 3 * * BILL COPY MESSAGE 4 *   TA1      €27.28   TX1      €2.72   TL      €30.00   CASH     €30.00  * BILL BTM MESSAGE 1 * * BILL BTM MESSAGE 2 * * BILL BTM MESSAGE 3 * * BILL BTM MESSAGE 4 *</pre> <div style="font-size: 8px; margin-top: 5px;"> <p>*<sup>1</sup> Programmable option</p> </div>

# Programming to clerk

You can program up to 4-digit assigning number (clerk number), trainee status of clerk (i.e. training cashier) and commission rate for each clerk.

## Programming clerk number

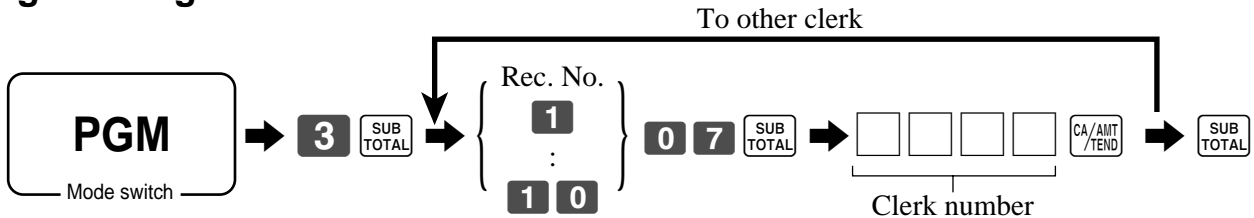

## Programming trainee status

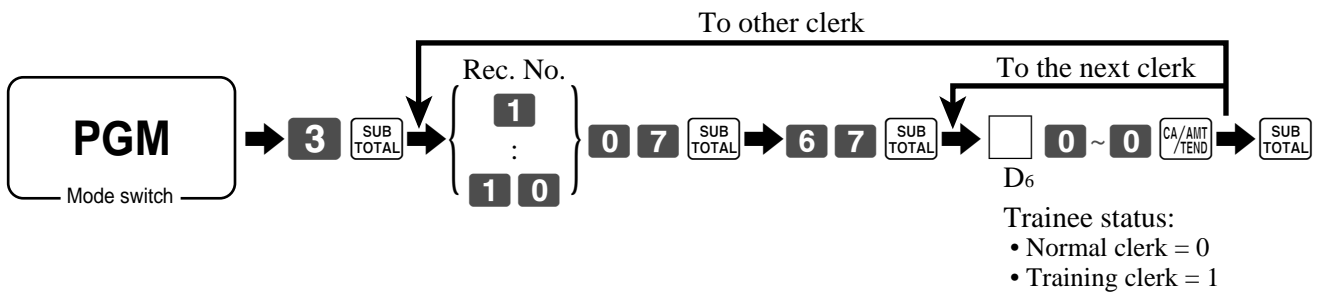

## Programming commission rate

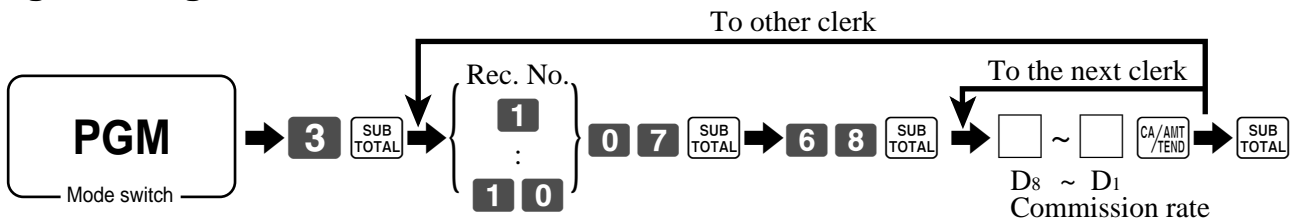

Record No.	Clerk number				Trainee status		Commission rate							
							Commission rate 1				Commission rate 2			
	D4	D3	D2	D1	D6	00000	D8	D7	D6	D5	D4	D3	D2	D1
1						00000								
2						00000								
3						00000								
4						00000								
5						00000								
6						00000								
7						00000								
8						00000								
9						00000								
10						00000								

# Advanced Operations

Character programming can be performed in two ways:

- Character keyboard programming (see page 93),  
or
- Entering characters by code (see page 92).

## Programming descriptors and messages

The following descriptors and messages can be programmed;

- Messages (Logo, commercial and bottom message)
- Clerk name
- PLU item descriptor
- Department key descriptor
- Machine number

### Programming receipt message and clerk name

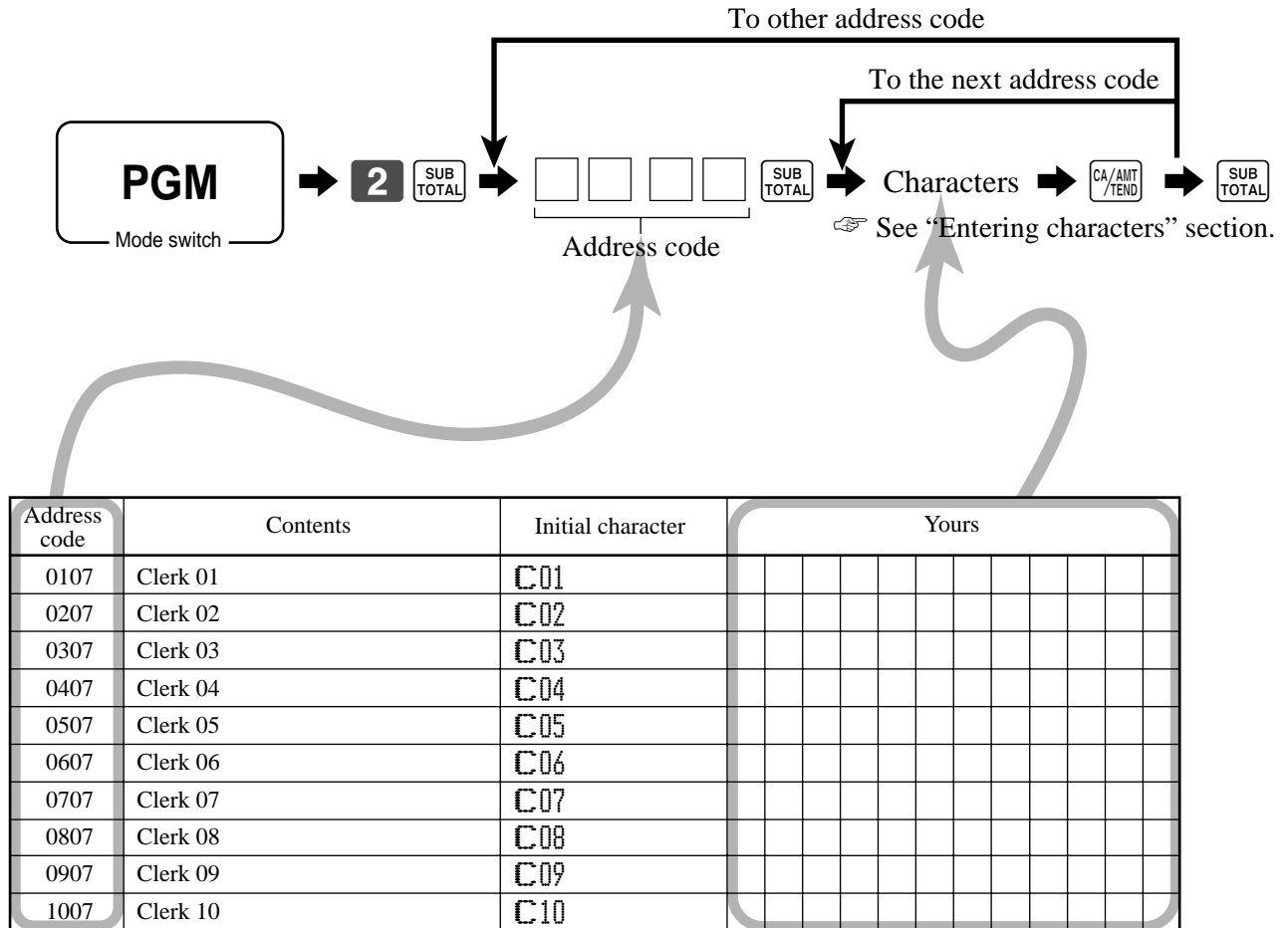

### Machine number

Up to 8 characters can be set.

Address code	Contents	Initial character
Machine number		
0191	Machine number	MC#01



Address code	Contents	Initial character	Yours
0132	1st line of logo message	YOUR RECEIPT	
0232	2nd line of logo message	THANK YOU	
0332	3rd line of logo message	CALL AGAIN	
0432	4th line of logo message		
0532	1st line of commercial message		
0632	2nd line of commercial message		
0732	3rd line of commercial message		
0832	4th line of commercial message		
0932	1st line of bottom message		
1032	2nd line of bottom message		
1132	3rd line of bottom message		
1232	4th line of bottom message		
1332	1st line of bill top message		
1432	2nd line of bill top message		
1532	3rd line of bill top message		
1632	4th line of bill top message		
1732	1st line of bill copy message		
1832	2nd line of bill copy message		
1932	3rd line of bill copy message		
2032	4th line of bill copy message		
2132	1st line of bill bottom message		
2232	2nd line of bill bottom message		
2332	3rd line of bill bottom message		
2432	4th line of bill bottom message		
2532	Post receipt message		
2632	1st line of guest intermediate msg.		
2732	2nd line of guest intermediate msg.		
2832	3rd line of guest intermediate msg.		
2932	4th line of guest intermediate msg.		
3032	1st line of guest bottom msg.		
3132	2nd line of guest bottom msg.		
3232	3rd line of guest bottom msg.		
3332	4th line of guest bottom msg.		
3432	5th line of guest bottom msg.		
3532	6th line of guest bottom msg.		
3632	7th line of guest bottom msg.		
3732	8th line of guest bottom msg.		
3832	9th line of guest bottom msg.		
3932	10th line of guest bottom msg.		

# Advanced Operations

## Programming department/transaction key descriptor

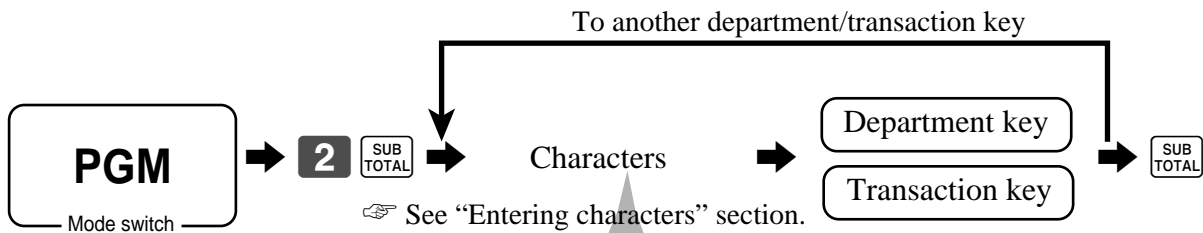

Contents	Initial character	Yours									
Department 01	DEPT01										
Department 02	DEPT02										
Department 03	DEPT03										
Department 04	DEPT04										
Department 05	DEPT05										
Department 06	DEPT06										
Department 07	DEPT07										
Department 08	DEPT08										

Contents	Initial character	Yours									
Cash/Amount tendered	CASH										
Charge	CHARGE										
Check	CHECK										
Credit 1	CREDIT1										
Credit 2	CREDIT2										
Loan	LOAN										
Received on account	RC										
Paid out	PD										
Pick up	P.UP										
Minus	-										
Discount	%-										
Refund	RF										
Correction	CORR										
Validation	VLD										
Receipt	RCT										
Non add/No sale	#/NS										
VAT	VAT										
Tax shift 1	T/S1										
Tax shift 2	T/S2										
Open	OPEN										
Clerk number	CLK#										
Subtotal	SUBTOTAL										
Receipt on/off	RCT ON/OFF										
Multiplication/Date time	X										
Multiplication/for/Date time	QT										
Two zero	00										
Decimal point	.										
Media change	MEDIA CHG										

## Programming flat-PLU descriptor

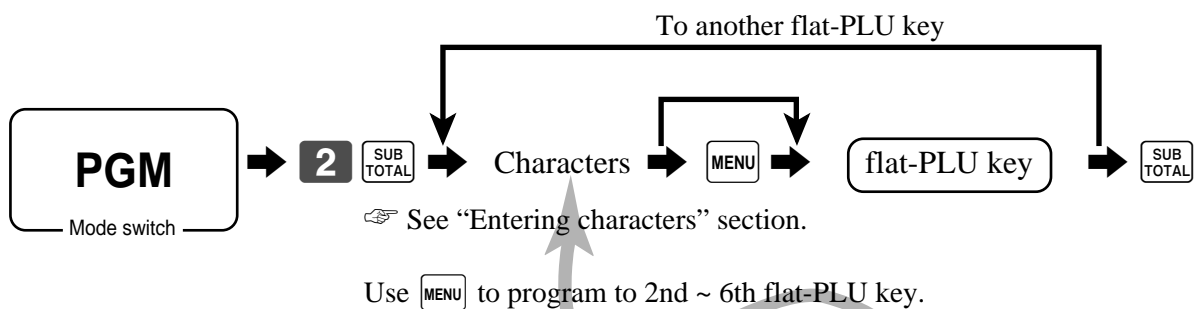

PLU No.	Contents	Initial character	Yours																	
001	PLU 001	PLU0001																		
002	PLU 002	PLU0002																		
003	PLU 003	PLU0003																		
004	PLU 004	PLU0004																		
005	PLU 005	PLU0005																		
006	PLU 006	PLU0006																		
007	PLU 007	PLU0007																		
008	PLU 008	PLU0008																		
009	PLU 009	PLU0009																		
010	PLU 010	PLU0010																		
011	PLU 011	PLU0011																		
012	PLU 012	PLU0012																		
013	PLU 013	PLU0013																		
014	PLU 014	PLU0014																		
015	PLU 015	PLU0015																		
016	PLU 016	PLU0016																		
017	PLU 017	PLU0017																		
018	PLU 018	PLU0018																		
019	PLU 019	PLU0019																		
020	PLU 020	PLU0020																		
021	PLU 021	PLU0021																		
022	PLU 022	PLU0022																		
023	PLU 023	PLU0023																		
024	PLU 024	PLU0024																		
025	PLU 025	PLU0025																		
026	PLU 026	PLU0026																		
027	PLU 027	PLU0027																		
028	PLU 028	PLU0028																		
029	PLU 029	PLU0029																		
106	PLU 106	PLU0106																		
107	PLU 107	PLU0107																		
108	PLU 108	PLU0108																		

## Entering characters

In this section, the method to enter descriptors or messages (characters) to the cash register during programming is described.

Characters are specified by character keyboard or by codes. In the first half of this section, inputting method by character code is described. In the latter half, the usage of character keyboard is described.

### Entering characters by code

Every time you enter a character, choose character codes by the character code list (below) and press the  key to settle it. After you complete entering characters, press the **00** key to fix them.

**Example:**

Input “  P P l e J u i c e ”,  
 enter “ 255  65  112  112  108  101  32  74  117  105  99  101  **00** ”

### Character code list

Chara	Code	Chara	Code	Chara	Code	Chara	Code	Chara	Code	Chara	Code	Chara	Code
Space	32	0	48	À	64	P	80	`	96	p	112	Ç	128
!	33	1	49	Á	65	Q	81	a	97	q	113	Ü	129
"	34	2	50	B	66	R	82	b	98	r	114	É	130
#	35	3	51	C	67	S	83	c	99	s	115	Â	131
\$	36	4	52	D	68	T	84	d	100	t	116	Ä	132
%	37	5	53	E	69	U	85	e	101	u	117	Å	133
&	38	6	54	F	70	V	86	f	102	v	118	Ä	134
'	39	7	55	G	71	W	87	g	103	w	119	Ç	135
(	40	8	56	H	72	X	88	h	104	x	120	È	136
)	41	9	57	I	73	Y	89	i	105	y	121	Ë	137
*	42	:	58	J	74	Z	90	j	106	z	122	È	138
+	43	;	59	K	75	[	91	k	107	{	123	Ï	139
,	44	<	60	L	76	\	92	l	108		124	Î	140
-	45	=	61	M	77	]	93	m	109	}	125	Ï	141
.	46	>	62	N	78	^	94	n	110	~	126	Ä	142
/	47	?	63	O	79	_	95	o	111		127	Å	143

É	144	á	160	ÿ	176	l	192	ò	208	ó	224	...	240
æ	145	í	161	ÿ	177	l	193	ð	209	ß	225	±	241
fl	146	ó	162	fl	178	r	194	Ê	210	Ô	226	...	242
õ	147	ú	163	l	179	l	195	Ë	211	Ò	227	fl	243
ö	148	ñ	164	l	180	...	196	È	212	Ö	228	fl	244
ò	149	ñ	165	Á	181	l	197	€	213	Õ	229	fl	245
û	150	ª	166	Â	182	ä	198	í	214	µ	230	÷	246
ù	151	º	167	Ã	183	Ä	199	î	215	þ	231	¸	247
ÿ	152	¿	168	Ø	184	ll	200	ï	216	Ð	232	º	248
ö	153	fl	169	fl	185	fl	201	j	217	Ó	233	...	249
ü	154	fl	170	ll	186	fl	202	r	218	Ô	234	...	250
ø	155	fl	171	fl	187	fl	203	fl	219	Ù	235	í	251
£	156	fl	172	fl	188	fl	204	fl	220	Ú	236	fl	252
fl	157	í	173	fl	189	...	205	l	221	Ý	237	fl	253
×	158	«	174	¥	190	fl	206	l	222	...	238	fl	254
f	159	»	175	l	191	fl	207	fl	223	,	239	Double size	255

# Using character keyboard

## Example:

Input “ **A** **P** **P** **I** **E** **J** **U** **I** **C** **E** ”,  
 enter “DBL” “A” “SHIFT” “p” “p” “I” “e” “SPACE” “CAP” “J” “SHIFT” “u” “I” “c” “e” **00** .

### TK-6000

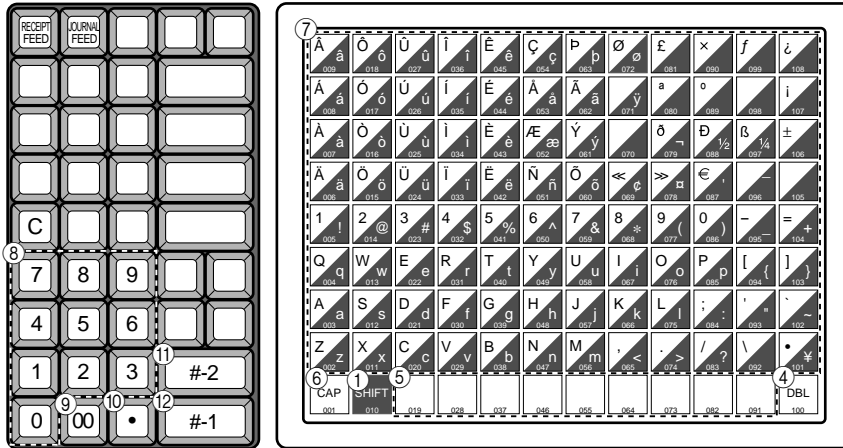

### TK-6500

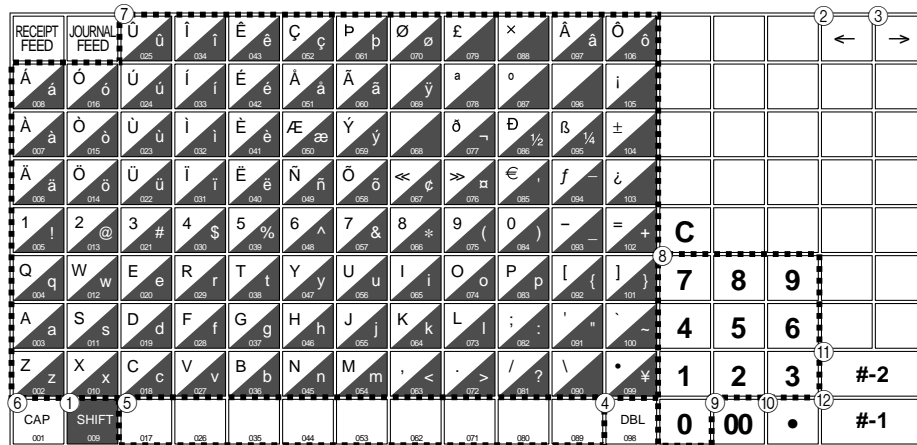

- ① **Shift key**  
Pressing this key shifts the character from the uppercase letter to lower case letter and returns to the uppercase letter in sequence.
- ② **Left cursor key**  
This key is not used for this model.
- ③ **Right cursor key**  
This key is not used for this model.
- ④ **Double size letter key**  
Specifies that the next character you input to a double size character.  
You must press this key before each double size character.
- ⑤ **Space key**  
Sets a space by depression.
- ⑥ **CAP key**  
Shifts the character to the upper case letter.
- ⑦ **Alphabet keys**  
Used input to characters.
- ⑧ **Numeric keys**  
Used to enter program codes, memory number and character codes.
- ⑨ **Character fixed key**  
Enters when the alphabetic entry for a descriptor, name or message has been completed.
- ⑩ **Backspace/Character code fixed key**  
Registers one character with code (2 or 3 digit).  
Clears the last input character, much like a back space key. (Does not clear the double size letter key entry.)
- ⑪ **Program end key**  
Terminates the character programming.
- ⑫ **Character enter key**  
Registers the programmed characters.

## Printing read/reset reports

- **Daily sales read report (“X1” mode)**

You can print read reports at any time during the business day without affecting the data stored in the cash register's memory.

- **Daily sales reset report (“Z1” mode)**

You should print reset reports at the end of the business day.

### Important!

- The reset operation issues a report and also clears all sales data from the cash register's memory.
- Be sure to perform the reset operations at the end of each business day. Otherwise, you will not be able to distinguish between the sales data for different dates.

### To print the individual department, PLU/flat-PLU read report

This report shows sales for specific departments or PLUs/flat-PLUs.

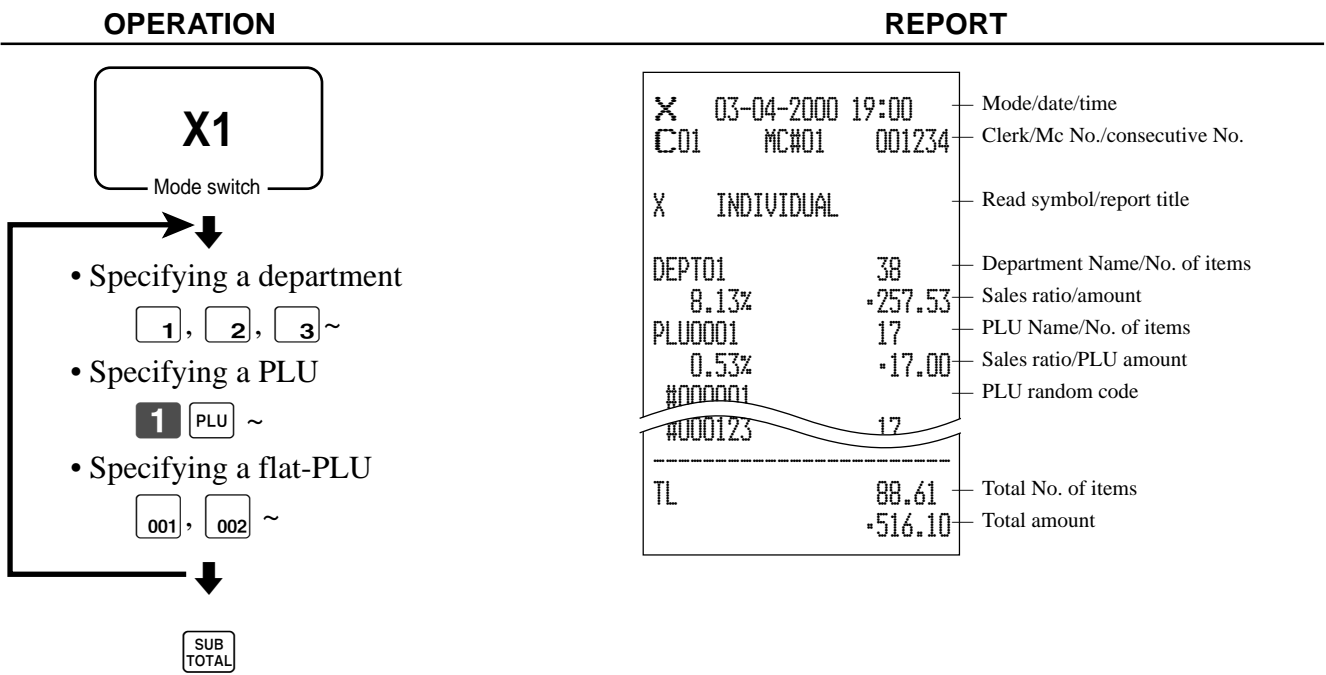

After you finish to select items, press SUB TOTAL to terminate.

## To print the financial read report

This report shows gross sales, net sales, cash in drawer and check in drawer.

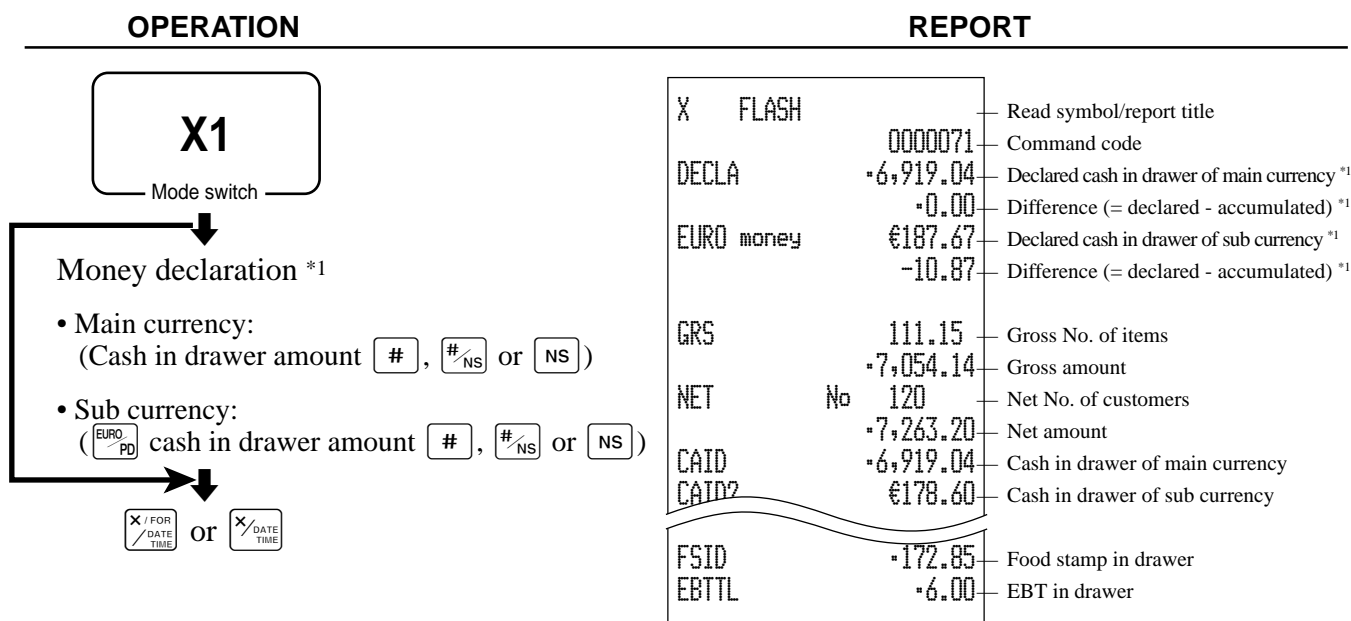

## To print the individual clerk read/reset report

This report shows individual clerk totals.

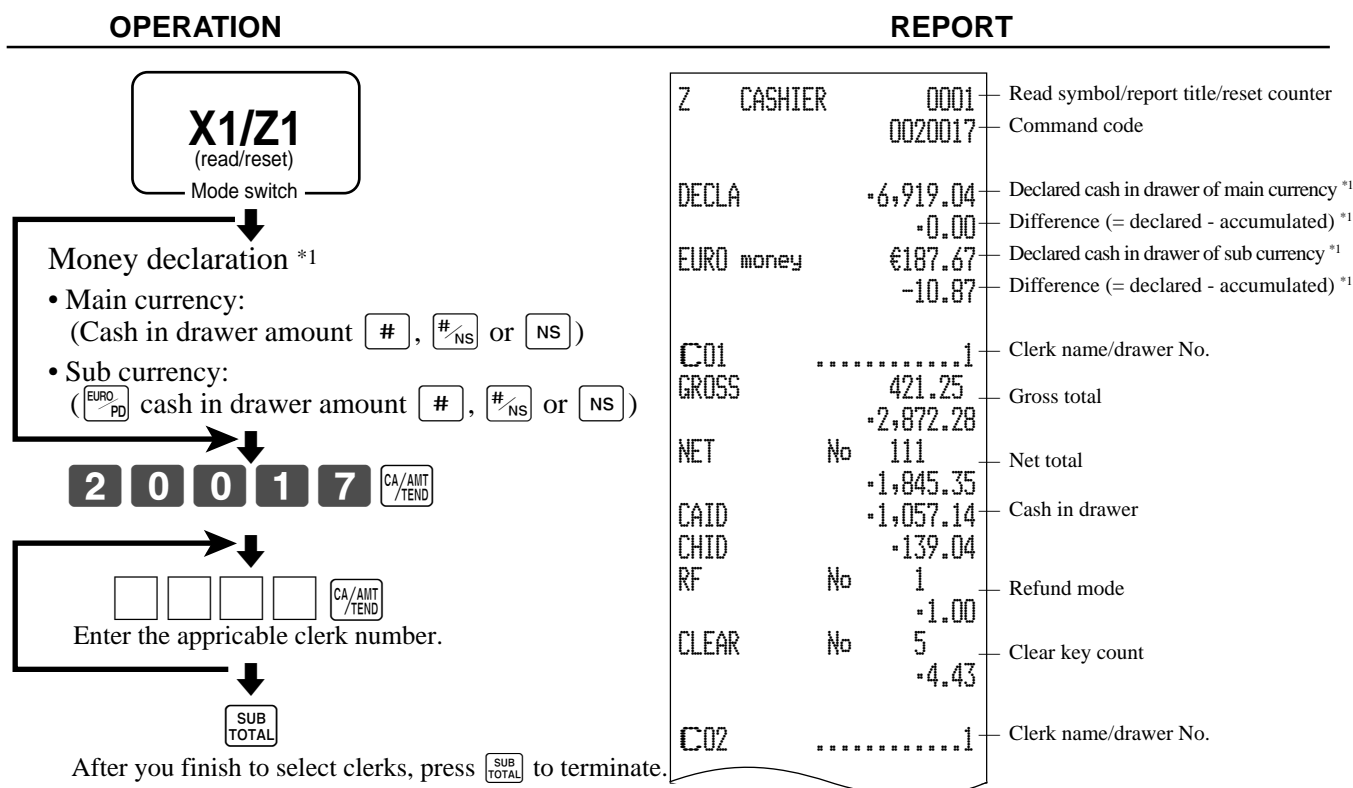

\*1 Money declaration:

Count how much cash is in the drawer and input this amount (up to 10 digits).

The cash register will automatically compare the input with the cash in drawer in the memory and print the difference between these two amounts.

Note that if money declaration is required by programming, you cannot skip this procedure.

# Advanced Operations

## To print the daily sales read/reset report

This report shows sales except for PLUs.

### OPERATION

**X1/Z1**

(read/reset)

Mode switch

Money declaration \*1

- Main currency:  
(Cash in drawer amount  ,  or  )
- Sub currency:  
(  cash in drawer amount  ,  or  )

CA/AMT  
TEND

### REPORT

Z	BATCH01		Report title
Z	FIX	0001	Fixed total report title/reset counter *4
		0001011	Report code
DECLA		+6,919.04	Declared cash in drawer of main currency *1
		-0.00	Difference (= declared - accumulated) *1
EURO money		€187.67	Declared cash in drawer of sub currency *1
		-10.87	Difference (= declared - accumulated) *1
GROSS		981.25	Gross total *3
		+6,574.40	
NET	No	111	Net total *3
		-7,057.14	
CAID		+6,919.04	Cash in drawer *3
CHID		-139.04	Charge in drawer *3
CKID		-859.85	Check in drawer *3
CRID(1)		-709.85	Credit in drawer *3
RF	No	3	Refund mode *3
		-10.22	
CUST	CT	111	Customer number *3
AVRG		-63.57	Average sales per customer *3
DC		-1.22	Discount total *3
REF		-2.42	Refund key *3
CLEAR	No	85	Clear key count *3
ROUND		-0.00	Rounding total *3
CANCEL	No	2	Cancellation *3
		-12.97	
TA1		+2,369.69	Taxable 1 amount *3
TX1		-128.86	Tax 1 amount *3
TA2		+2,172.96	Taxable 2 amount *3
TX2		-217.33	Tax 2 amount *3
GT1		+00000000125478.96	Grand total 1 *3
GT2		+00000000346284.23	Grand total 2 *3
GT3		+00000000123212.75	Grand total 3 *3
Z	TRANS	0001	Function key report title/reset counter



		0001012	Report code
CASH	No	362	Function key count/amount *2
		-1,638.04	
CH	No	56	
		-1,174.85	
RC	No	4	
		-810.00	
PD	No	5	
		-520.00	
		-5.00	
CORR	No	14	
		-39.55	
VLD	No	19	
RCT	No	3	
NS	No	5	
-----			
Z	DEPT	0001	Department report title/reset counter
		0001015	Report code
DEPT01		38	Department name/No. of items *2
8.13%		-257.53	Sales ratio/amount *2
DEPT02		183	
		1,362.04	
-----			
TL		88.61	Total No. of items
		-1,916.10	Total amount
-----			
Z	CASHIER	0001	Clerk report title/reset counter
		0001017	Report code
C01		.....1	Clerk name/drawer No.
GROSS		421.25	Gross total
		-2,872.28	
NET	No	111	Net total
		-1,845.35	
CAID		-1,057.14	Cash in drawer
CHID		-139.04	
RF	No	1	Refund mode
		-1.00	
CLEAR	No	5	Clear key count
		-4.43	
C02		.....1	Clerk name/drawer No.

\*1 Money declaration:

Count how much cash is in the drawer and input this amount (up to 10 digits).

The cash register will automatically compare the input with the cash in drawer in the memory and print the difference between these two amounts.

Note that if money declaration is required by programming, you cannot skip this procedure.

\*2 Zero totalled departments/functions (the amount and item numbers are both zero) are not printed.

\*3 These items can be skipped by programming.

\*4 The “\*” symbol is printed on the reset report, memory overflow occurred in the counter/totalizer.

# Advanced Operations

## To print the PLU/flat-PLU read/reset report

This report shows sales for PLUs.

OPERATION	REPORT																																												
<div style="border: 1px solid black; padding: 5px; width: fit-content; margin: 0 auto;"> <b>X1/Z1</b>                      (read/reset)                      Mode switch                 </div> <div style="text-align: center; margin: 5px 0;">↓</div> <div style="display: flex; justify-content: center; gap: 10px; align-items: center;"> <div style="border: 1px solid black; padding: 2px 10px; font-weight: bold;">0</div> <div style="border: 1px solid black; padding: 2px 10px; font-weight: bold;">1</div> <div style="border: 1px solid black; padding: 2px 10px; font-weight: bold;">4</div> <div style="border: 1px solid black; padding: 2px 5px; font-size: 8px;">CA/AMT /TEND</div> </div>	<table border="1" style="width: 100%; border-collapse: collapse;"> <tr> <td style="width: 10%;">X</td> <td style="width: 40%;">PLU</td> <td style="width: 10%;"></td> <td style="width: 40%;">Read symbol/report title</td> </tr> <tr> <td></td> <td></td> <td style="text-align: right;">0000014</td> <td>Report code</td> </tr> <tr> <td>PLU0001</td> <td></td> <td style="text-align: right;">17</td> <td>PLU name/No. of items</td> </tr> <tr> <td>0.53%</td> <td></td> <td style="text-align: right;">-17.00</td> <td>Sales ratio/PLU amount</td> </tr> <tr> <td>#000001</td> <td></td> <td></td> <td>PLU random code</td> </tr> <tr> <td>PLU0100</td> <td></td> <td style="text-align: right;">49</td> <td></td> </tr> <tr> <td>4.03%</td> <td></td> <td style="text-align: right;">-69.00</td> <td></td> </tr> <tr> <td>#000100</td> <td></td> <td></td> <td></td> </tr> <tr> <td colspan="4" style="border-top: 1px dashed black;"></td> </tr> <tr> <td>TL</td> <td></td> <td style="text-align: right;">188.61</td> <td>Total No. of items</td> </tr> <tr> <td></td> <td></td> <td style="text-align: right;">-516.10</td> <td>Total amount</td> </tr> </table>	X	PLU		Read symbol/report title			0000014	Report code	PLU0001		17	PLU name/No. of items	0.53%		-17.00	Sales ratio/PLU amount	#000001			PLU random code	PLU0100		49		4.03%		-69.00		#000100								TL		188.61	Total No. of items			-516.10	Total amount
X	PLU		Read symbol/report title																																										
		0000014	Report code																																										
PLU0001		17	PLU name/No. of items																																										
0.53%		-17.00	Sales ratio/PLU amount																																										
#000001			PLU random code																																										
PLU0100		49																																											
4.03%		-69.00																																											
#000100																																													
TL		188.61	Total No. of items																																										
		-516.10	Total amount																																										

## To print the hourly sales read/reset report

This report shows hourly breakdowns of sales.

OPERATION	REPORT																																																																				
<div style="border: 1px solid black; padding: 5px; width: fit-content; margin: 0 auto;"> <b>X1/Z1</b>                      (read/reset)                      Mode switch                 </div> <div style="text-align: center; margin: 5px 0;">↓</div> <div style="display: flex; justify-content: center; gap: 10px; align-items: center;"> <div style="border: 1px solid black; padding: 2px 10px; font-weight: bold;">0</div> <div style="border: 1px solid black; padding: 2px 10px; font-weight: bold;">1</div> <div style="border: 1px solid black; padding: 2px 10px; font-weight: bold;">9</div> <div style="border: 1px solid black; padding: 2px 5px; font-size: 8px;">CA/AMT /TEND</div> </div>	<table border="1" style="width: 100%; border-collapse: collapse;"> <tr> <td style="width: 10%;">X</td> <td style="width: 40%;">HOURLY</td> <td style="width: 10%;"></td> <td style="width: 40%;">Read symbol/report title</td> </tr> <tr> <td></td> <td></td> <td style="text-align: right;">0000019</td> <td>Report code</td> </tr> <tr> <td>00:00-&gt;01:00</td> <td></td> <td></td> <td>Time range</td> </tr> <tr> <td></td> <td>CT</td> <td style="text-align: right;">1</td> <td>No. of customers</td> </tr> <tr> <td>GROSS</td> <td></td> <td style="text-align: right;">-1.10</td> <td>Gross sales amount</td> </tr> <tr> <td>NET</td> <td>No</td> <td style="text-align: right;">1</td> <td>No. of receipt</td> </tr> <tr> <td>1.00%</td> <td></td> <td style="text-align: right;">-1.20</td> <td>Sales ratio/net sales amount</td> </tr> <tr> <td>23:00-&gt;00:00</td> <td></td> <td></td> <td></td> </tr> <tr> <td></td> <td>CT</td> <td style="text-align: right;">1</td> <td></td> </tr> <tr> <td>GROSS</td> <td></td> <td style="text-align: right;">-3.45</td> <td></td> </tr> <tr> <td>NET</td> <td>No</td> <td style="text-align: right;">1</td> <td></td> </tr> <tr> <td>3.90%</td> <td></td> <td style="text-align: right;">-3.59</td> <td></td> </tr> <tr> <td colspan="4" style="border-top: 1px dashed black;"></td> </tr> <tr> <td>TL</td> <td>CT</td> <td style="text-align: right;">280</td> <td>Total No. of customers</td> </tr> <tr> <td>GROSS</td> <td></td> <td style="text-align: right;">-1,937.61</td> <td>Gross total amount</td> </tr> <tr> <td>NET</td> <td>No</td> <td style="text-align: right;">25</td> <td>Total No. of receipt</td> </tr> <tr> <td></td> <td></td> <td style="text-align: right;">-2,096.80</td> <td>Net total amount</td> </tr> </table>	X	HOURLY		Read symbol/report title			0000019	Report code	00:00->01:00			Time range		CT	1	No. of customers	GROSS		-1.10	Gross sales amount	NET	No	1	No. of receipt	1.00%		-1.20	Sales ratio/net sales amount	23:00->00:00					CT	1		GROSS		-3.45		NET	No	1		3.90%		-3.59						TL	CT	280	Total No. of customers	GROSS		-1,937.61	Gross total amount	NET	No	25	Total No. of receipt			-2,096.80	Net total amount
X	HOURLY		Read symbol/report title																																																																		
		0000019	Report code																																																																		
00:00->01:00			Time range																																																																		
	CT	1	No. of customers																																																																		
GROSS		-1.10	Gross sales amount																																																																		
NET	No	1	No. of receipt																																																																		
1.00%		-1.20	Sales ratio/net sales amount																																																																		
23:00->00:00																																																																					
	CT	1																																																																			
GROSS		-3.45																																																																			
NET	No	1																																																																			
3.90%		-3.59																																																																			
TL	CT	280	Total No. of customers																																																																		
GROSS		-1,937.61	Gross total amount																																																																		
NET	No	25	Total No. of receipt																																																																		
		-2,096.80	Net total amount																																																																		

## To print the monthly sales read/reset report

This report shows monthly breakdowns of sales.

OPERATION	REPORT																																																																																				
<div style="border: 1px solid black; padding: 5px; width: fit-content; margin: 0 auto;"> <b>X1/Z1</b>                      (read/reset)                      Mode switch                 </div> <div style="text-align: center; margin: 5px 0;">↓</div> <div style="display: flex; justify-content: center; gap: 10px;"> <div style="border: 1px solid black; padding: 2px 10px; font-weight: bold;">0</div> <div style="border: 1px solid black; padding: 2px 10px; font-weight: bold;">2</div> <div style="border: 1px solid black; padding: 2px 10px; font-weight: bold;">0</div> <div style="border: 1px solid black; padding: 2px 5px; font-size: 8px;">CA/AMT /TEND</div> </div>	<table style="width: 100%; border-collapse: collapse;"> <tr> <td style="width: 10%;">X</td> <td style="width: 40%;">MONTHLY</td> <td style="width: 10%;"></td> <td style="width: 40%;">Read symbol/report title</td> </tr> <tr> <td></td> <td></td> <td style="text-align: right;">0001020</td> <td>Report code</td> </tr> <tr> <td></td> <td><b>1.....</b></td> <td></td> <td>Date of a month</td> </tr> <tr> <td>GROSS</td> <td></td> <td style="text-align: right;">1236.76</td> <td>Gross symbol/No. of items</td> </tr> <tr> <td></td> <td></td> <td style="text-align: right;">-12,202.57</td> <td>Gross sales amount</td> </tr> <tr> <td>NET</td> <td>No</td> <td style="text-align: right;">214</td> <td>Net symbol/No. of customers</td> </tr> <tr> <td></td> <td></td> <td style="text-align: right;">-12,202.57</td> <td>Net sales amount</td> </tr> <tr> <td colspan="4" style="border-top: 1px solid black; border-bottom: 1px solid black;"></td> </tr> <tr> <td></td> <td><b>31.....</b></td> <td></td> <td></td> </tr> <tr> <td>GROSS</td> <td></td> <td style="text-align: right;">2132</td> <td></td> </tr> <tr> <td></td> <td></td> <td style="text-align: right;">-14,187.57</td> <td></td> </tr> <tr> <td>NET</td> <td>No</td> <td style="text-align: right;">205</td> <td></td> </tr> <tr> <td></td> <td></td> <td style="text-align: right;">-13,398.76</td> <td></td> </tr> <tr> <td colspan="4" style="border-top: 1px dashed black;"></td> </tr> <tr> <td>TL</td> <td></td> <td></td> <td>Total symbol</td> </tr> <tr> <td>GROSS</td> <td></td> <td style="text-align: right;">9746.63</td> <td>Gross symbol/No. of items</td> </tr> <tr> <td></td> <td></td> <td style="text-align: right;">-161,022.49</td> <td>Gross sales amount</td> </tr> <tr> <td></td> <td></td> <td style="text-align: right;">-16.52</td> <td>Average daily gross sales</td> </tr> <tr> <td>NET</td> <td>No</td> <td style="text-align: right;">2351</td> <td>Net symbol/No. of customers</td> </tr> <tr> <td></td> <td></td> <td style="text-align: right;">-161,022.49</td> <td>Net sales amount</td> </tr> <tr> <td></td> <td></td> <td style="text-align: right;">-68.49</td> <td>Average daily net sales</td> </tr> </table>	X	MONTHLY		Read symbol/report title			0001020	Report code		<b>1.....</b>		Date of a month	GROSS		1236.76	Gross symbol/No. of items			-12,202.57	Gross sales amount	NET	No	214	Net symbol/No. of customers			-12,202.57	Net sales amount						<b>31.....</b>			GROSS		2132				-14,187.57		NET	No	205				-13,398.76						TL			Total symbol	GROSS		9746.63	Gross symbol/No. of items			-161,022.49	Gross sales amount			-16.52	Average daily gross sales	NET	No	2351	Net symbol/No. of customers			-161,022.49	Net sales amount			-68.49	Average daily net sales
X	MONTHLY		Read symbol/report title																																																																																		
		0001020	Report code																																																																																		
	<b>1.....</b>		Date of a month																																																																																		
GROSS		1236.76	Gross symbol/No. of items																																																																																		
		-12,202.57	Gross sales amount																																																																																		
NET	No	214	Net symbol/No. of customers																																																																																		
		-12,202.57	Net sales amount																																																																																		
	<b>31.....</b>																																																																																				
GROSS		2132																																																																																			
		-14,187.57																																																																																			
NET	No	205																																																																																			
		-13,398.76																																																																																			
TL			Total symbol																																																																																		
GROSS		9746.63	Gross symbol/No. of items																																																																																		
		-161,022.49	Gross sales amount																																																																																		
		-16.52	Average daily gross sales																																																																																		
NET	No	2351	Net symbol/No. of customers																																																																																		
		-161,022.49	Net sales amount																																																																																		
		-68.49	Average daily net sales																																																																																		

## To print the group read/reset report

This report shows PLU/subdepartment/department group totals.

OPERATION	REPORT																																																								
<div style="border: 1px solid black; padding: 5px; width: fit-content; margin: 0 auto;"> <b>X1/Z1</b>                      (read/reset)                      Mode switch                 </div> <div style="text-align: center; margin: 5px 0;">↓</div> <div style="display: flex; justify-content: center; gap: 10px;"> <div style="border: 1px solid black; padding: 2px 10px; font-weight: bold;">0</div> <div style="border: 1px solid black; padding: 2px 10px; font-weight: bold;">1</div> <div style="border: 1px solid black; padding: 2px 10px; font-weight: bold;">6</div> <div style="border: 1px solid black; padding: 2px 5px; font-size: 8px;">CA/AMT /TEND</div> </div>	<table style="width: 100%; border-collapse: collapse;"> <tr> <td style="width: 10%;">X</td> <td style="width: 40%;">GROUP</td> <td style="width: 10%;"></td> <td style="width: 40%;">Read symbol/report title</td> </tr> <tr> <td></td> <td></td> <td style="text-align: right;">0001016</td> <td>Report code</td> </tr> <tr> <td>GROUP01</td> <td></td> <td style="text-align: right;">203.25</td> <td>Group No./No. of items</td> </tr> <tr> <td></td> <td>33.87%</td> <td style="text-align: right;">-1,108.54</td> <td>Sales ratio/group amount</td> </tr> <tr> <td>GROUP02</td> <td></td> <td style="text-align: right;">183</td> <td></td> </tr> <tr> <td></td> <td>40.58%</td> <td style="text-align: right;">-1,327.80</td> <td></td> </tr> <tr> <td>GROUP03</td> <td></td> <td style="text-align: right;">12</td> <td></td> </tr> <tr> <td></td> <td></td> <td style="text-align: right;">-13.25</td> <td></td> </tr> <tr> <td colspan="4" style="border-top: 1px solid black; border-bottom: 1px solid black;"></td> </tr> <tr> <td>GROUP99</td> <td></td> <td style="text-align: right;">15</td> <td></td> </tr> <tr> <td></td> <td>0.54%</td> <td style="text-align: right;">-17.80</td> <td></td> </tr> <tr> <td colspan="4" style="border-top: 1px dashed black;"></td> </tr> <tr> <td>TL</td> <td></td> <td style="text-align: right;">862</td> <td>Group total No. of items</td> </tr> <tr> <td></td> <td></td> <td style="text-align: right;">-3,272.00</td> <td>Group total amount</td> </tr> </table>	X	GROUP		Read symbol/report title			0001016	Report code	GROUP01		203.25	Group No./No. of items		33.87%	-1,108.54	Sales ratio/group amount	GROUP02		183			40.58%	-1,327.80		GROUP03		12				-13.25						GROUP99		15			0.54%	-17.80						TL		862	Group total No. of items			-3,272.00	Group total amount
X	GROUP		Read symbol/report title																																																						
		0001016	Report code																																																						
GROUP01		203.25	Group No./No. of items																																																						
	33.87%	-1,108.54	Sales ratio/group amount																																																						
GROUP02		183																																																							
	40.58%	-1,327.80																																																							
GROUP03		12																																																							
		-13.25																																																							
GROUP99		15																																																							
	0.54%	-17.80																																																							
TL		862	Group total No. of items																																																						
		-3,272.00	Group total amount																																																						

# Advanced Operations

## • Periodic sales read report (“X2” mode)

You can print read reports at any time during the business day without affecting the data stored in the cash register's memory.

## • Periodic sales reset report (“Z2” mode)

You should print reset reports at the end of the business day.

## To print the periodic 1/2 sales read/reset reports

These reports show sales breakdowns of sales by any two kinds of period you want.

OPERATION	REPORT																																																																																																																																																																																																																
<div style="border: 1px solid black; padding: 5px; width: fit-content; margin: 0 auto;"> <p><b>X2/Z2</b> (read/reset) Mode switch</p> </div> <p style="text-align: center;">↓</p> <div style="display: flex; align-items: center; justify-content: center; gap: 10px;"> <div style="border: 1px solid black; padding: 2px 5px; font-weight: bold; font-size: 1.2em;">1</div> <div style="border: 1px solid black; padding: 2px 5px; font-size: 0.8em;">CA/AMT /TEND</div> </div>																																																																																																																																																																																																																	
<table style="width: 100%; border-collapse: collapse;"> <tr> <td style="width: 15%;">ZZ1 BATCH02</td> <td style="width: 15%;"></td> <td style="width: 15%;"></td> <td style="width: 55%;">Report title</td> </tr> <tr> <td>ZZ1 FIX</td> <td>0001</td> <td></td> <td>Fixed total report title/reset counter</td> </tr> <tr> <td></td> <td>0001111</td> <td></td> <td>Report code</td> </tr> <tr> <td>GROSS</td> <td>981.25</td> <td></td> <td>Gross total *2</td> </tr> <tr> <td>NET</td> <td>No 111</td> <td></td> <td>Net total *2</td> </tr> <tr> <td>CAID</td> <td>-6,574.40</td> <td></td> <td>Cash in drawer *2</td> </tr> <tr> <td>CHID</td> <td>-139.04</td> <td></td> <td>Charge in drawer *2</td> </tr> <tr> <td>CKID</td> <td>-859.85</td> <td></td> <td>Check in drawer *2</td> </tr> <tr> <td>CRID(1)</td> <td>-709.85</td> <td></td> <td>Credit in drawer *2</td> </tr> <tr> <td>RF</td> <td>No 3</td> <td></td> <td>Refund mode *2</td> </tr> <tr> <td></td> <td>-10.22</td> <td></td> <td></td> </tr> <tr> <td>CUST</td> <td>CT 111</td> <td></td> <td>Customer number *2</td> </tr> <tr> <td>AURG</td> <td>-63.57</td> <td></td> <td>Average sales per customer *2</td> </tr> <tr> <td>DC</td> <td>-1.22</td> <td></td> <td>Discount total *2</td> </tr> <tr> <td>REF</td> <td>-2.42</td> <td></td> <td>Refund key *2</td> </tr> <tr> <td>CLEAR</td> <td>No 85</td> <td></td> <td>Clear key count *2</td> </tr> <tr> <td>ROUND</td> <td>-0.00</td> <td></td> <td>Rounding total *2</td> </tr> <tr> <td>CANCEL</td> <td>No 2</td> <td></td> <td>Cancellation *2</td> </tr> <tr> <td></td> <td>-12.97</td> <td></td> <td></td> </tr> <tr> <td>TA1</td> <td>-2,369.69</td> <td></td> <td>Taxable 1 amount *2</td> </tr> <tr> <td>TX1</td> <td>-128.86</td> <td></td> <td>Tax 1 amount *2</td> </tr> <tr> <td>ZZ1 TRANS</td> <td>0001</td> <td></td> <td>Function key report title/reset counter</td> </tr> <tr> <td></td> <td>0001112</td> <td></td> <td>Report code</td> </tr> </table>	ZZ1 BATCH02			Report title	ZZ1 FIX	0001		Fixed total report title/reset counter		0001111		Report code	GROSS	981.25		Gross total *2	NET	No 111		Net total *2	CAID	-6,574.40		Cash in drawer *2	CHID	-139.04		Charge in drawer *2	CKID	-859.85		Check in drawer *2	CRID(1)	-709.85		Credit in drawer *2	RF	No 3		Refund mode *2		-10.22			CUST	CT 111		Customer number *2	AURG	-63.57		Average sales per customer *2	DC	-1.22		Discount total *2	REF	-2.42		Refund key *2	CLEAR	No 85		Clear key count *2	ROUND	-0.00		Rounding total *2	CANCEL	No 2		Cancellation *2		-12.97			TA1	-2,369.69		Taxable 1 amount *2	TX1	-128.86		Tax 1 amount *2	ZZ1 TRANS	0001		Function key report title/reset counter		0001112		Report code	<table style="width: 100%; border-collapse: collapse;"> <tr> <td style="width: 15%;">CASH</td> <td style="width: 15%;">No 362</td> <td style="width: 15%;"></td> <td style="width: 55%;">Function key count/amount *1</td> </tr> <tr> <td></td> <td></td> <td>-1,638.04</td> <td></td> </tr> <tr> <td>CH</td> <td>No 56</td> <td></td> <td></td> </tr> <tr> <td></td> <td></td> <td>-1,174.85</td> <td></td> </tr> <tr> <td>VLD</td> <td>No 19</td> <td></td> <td></td> </tr> <tr> <td>RCT</td> <td>No 3</td> <td></td> <td></td> </tr> <tr> <td>NS</td> <td>No 5</td> <td></td> <td></td> </tr> <tr> <td>ZZ1 DEPT</td> <td>0001</td> <td></td> <td>Department report title/reset counter</td> </tr> <tr> <td></td> <td>0001115</td> <td></td> <td>Report code</td> </tr> <tr> <td>DEPT01</td> <td>38</td> <td></td> <td>Department Name/No. of items *1</td> </tr> <tr> <td>8.13%</td> <td>-257.53</td> <td></td> <td>Sales ratio/amount *1</td> </tr> <tr> <td>DEPT02</td> <td>183</td> <td></td> <td></td> </tr> <tr> <td></td> <td>-1,362.24</td> <td></td> <td></td> </tr> <tr> <td>TL</td> <td>88.61</td> <td></td> <td>Total No. of items</td> </tr> <tr> <td></td> <td>-1,916.10</td> <td></td> <td>Total amount</td> </tr> <tr> <td>ZZ1 CASHIER</td> <td>0001</td> <td></td> <td>Clerk report title/reset counter</td> </tr> <tr> <td></td> <td>0001117</td> <td></td> <td>Report code</td> </tr> <tr> <td>C01</td> <td>.....1</td> <td></td> <td>Clerk name/drawer No.</td> </tr> <tr> <td>GROSS</td> <td>421.25</td> <td></td> <td>Gross total</td> </tr> <tr> <td></td> <td>-2,872.28</td> <td></td> <td></td> </tr> <tr> <td>NET</td> <td>No 111</td> <td></td> <td>Net total</td> </tr> <tr> <td></td> <td>-1,845.35</td> <td></td> <td></td> </tr> <tr> <td>CAID</td> <td>-1,057.14</td> <td></td> <td>Cash in drawer</td> </tr> <tr> <td>CHID</td> <td>-139.04</td> <td></td> <td></td> </tr> <tr> <td>RF</td> <td>No 1</td> <td></td> <td>Refund mode</td> </tr> <tr> <td></td> <td>-1.00</td> <td></td> <td></td> </tr> <tr> <td>CLEAR</td> <td>No 5</td> <td></td> <td>Clear key count</td> </tr> <tr> <td></td> <td>-4.43</td> <td></td> <td></td> </tr> <tr> <td>C02</td> <td>.....1</td> <td></td> <td>Clerk name/drawer No.</td> </tr> </table>	CASH	No 362		Function key count/amount *1			-1,638.04		CH	No 56					-1,174.85		VLD	No 19			RCT	No 3			NS	No 5			ZZ1 DEPT	0001		Department report title/reset counter		0001115		Report code	DEPT01	38		Department Name/No. of items *1	8.13%	-257.53		Sales ratio/amount *1	DEPT02	183				-1,362.24			TL	88.61		Total No. of items		-1,916.10		Total amount	ZZ1 CASHIER	0001		Clerk report title/reset counter		0001117		Report code	C01	.....1		Clerk name/drawer No.	GROSS	421.25		Gross total		-2,872.28			NET	No 111		Net total		-1,845.35			CAID	-1,057.14		Cash in drawer	CHID	-139.04			RF	No 1		Refund mode		-1.00			CLEAR	No 5		Clear key count		-4.43			C02	.....1		Clerk name/drawer No.
ZZ1 BATCH02			Report title																																																																																																																																																																																																														
ZZ1 FIX	0001		Fixed total report title/reset counter																																																																																																																																																																																																														
	0001111		Report code																																																																																																																																																																																																														
GROSS	981.25		Gross total *2																																																																																																																																																																																																														
NET	No 111		Net total *2																																																																																																																																																																																																														
CAID	-6,574.40		Cash in drawer *2																																																																																																																																																																																																														
CHID	-139.04		Charge in drawer *2																																																																																																																																																																																																														
CKID	-859.85		Check in drawer *2																																																																																																																																																																																																														
CRID(1)	-709.85		Credit in drawer *2																																																																																																																																																																																																														
RF	No 3		Refund mode *2																																																																																																																																																																																																														
	-10.22																																																																																																																																																																																																																
CUST	CT 111		Customer number *2																																																																																																																																																																																																														
AURG	-63.57		Average sales per customer *2																																																																																																																																																																																																														
DC	-1.22		Discount total *2																																																																																																																																																																																																														
REF	-2.42		Refund key *2																																																																																																																																																																																																														
CLEAR	No 85		Clear key count *2																																																																																																																																																																																																														
ROUND	-0.00		Rounding total *2																																																																																																																																																																																																														
CANCEL	No 2		Cancellation *2																																																																																																																																																																																																														
	-12.97																																																																																																																																																																																																																
TA1	-2,369.69		Taxable 1 amount *2																																																																																																																																																																																																														
TX1	-128.86		Tax 1 amount *2																																																																																																																																																																																																														
ZZ1 TRANS	0001		Function key report title/reset counter																																																																																																																																																																																																														
	0001112		Report code																																																																																																																																																																																																														
CASH	No 362		Function key count/amount *1																																																																																																																																																																																																														
		-1,638.04																																																																																																																																																																																																															
CH	No 56																																																																																																																																																																																																																
		-1,174.85																																																																																																																																																																																																															
VLD	No 19																																																																																																																																																																																																																
RCT	No 3																																																																																																																																																																																																																
NS	No 5																																																																																																																																																																																																																
ZZ1 DEPT	0001		Department report title/reset counter																																																																																																																																																																																																														
	0001115		Report code																																																																																																																																																																																																														
DEPT01	38		Department Name/No. of items *1																																																																																																																																																																																																														
8.13%	-257.53		Sales ratio/amount *1																																																																																																																																																																																																														
DEPT02	183																																																																																																																																																																																																																
	-1,362.24																																																																																																																																																																																																																
TL	88.61		Total No. of items																																																																																																																																																																																																														
	-1,916.10		Total amount																																																																																																																																																																																																														
ZZ1 CASHIER	0001		Clerk report title/reset counter																																																																																																																																																																																																														
	0001117		Report code																																																																																																																																																																																																														
C01	.....1		Clerk name/drawer No.																																																																																																																																																																																																														
GROSS	421.25		Gross total																																																																																																																																																																																																														
	-2,872.28																																																																																																																																																																																																																
NET	No 111		Net total																																																																																																																																																																																																														
	-1,845.35																																																																																																																																																																																																																
CAID	-1,057.14		Cash in drawer																																																																																																																																																																																																														
CHID	-139.04																																																																																																																																																																																																																
RF	No 1		Refund mode																																																																																																																																																																																																														
	-1.00																																																																																																																																																																																																																
CLEAR	No 5		Clear key count																																																																																																																																																																																																														
	-4.43																																																																																																																																																																																																																
C02	.....1		Clerk name/drawer No.																																																																																																																																																																																																														

\*1 Zero totalled departments/functions (the amount and item numbers are both zero) are not printed.

\*2 These items can be skipped by programming.

## To print other sales read/reset reports

The following reports can be issued.

### Procedure

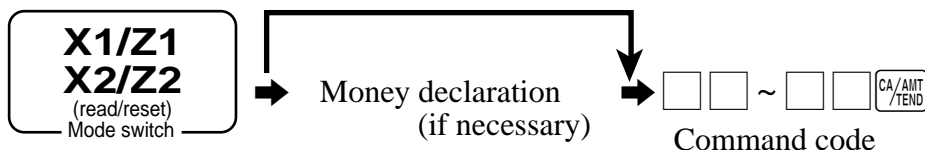

### Report/command code list

Report name	Command code	Report name	Command code
Fix totalizer <sup>*2</sup>	11	Department	15
Transaction key	12	best 50 (amount order)	60015
Subdepartment <sup>*1</sup>	13	best 50 (quantity order)	70015
PLU by record number (all)	14	Group	16
best 50 (amount order)	60014	Clerk <sup>*2</sup>	17
best 50 (quantity order)	70014	Hourly sales	19
menu (1st)	81	Monthly sales	20
menu (2nd) <sup>*1</sup>	82	Open check	25
menu (3rd) <sup>*1</sup>	83	Table analysis	28
menu (4th) <sup>*1</sup>	84		
menu (5th) <sup>*1</sup>	85		
menu (6th) <sup>*1</sup>	86		

<sup>\*1</sup> Memory allocation is necessary.  
<sup>\*2</sup> Input money in drawer, if the money decalration is compulsory.

## Reading the cash register's program

### To print unit price/rate program (except PLU)

#### OPERATION

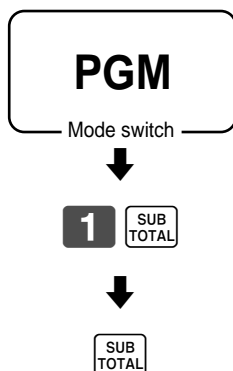

#### REPORT

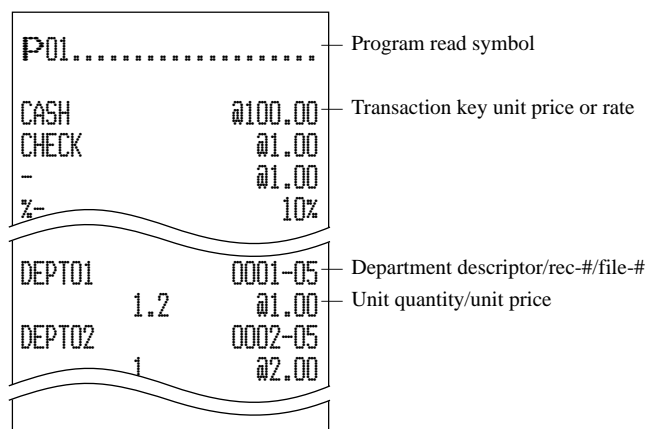

# Advanced Operations

## To print key descriptor, name, message program (except PLU)

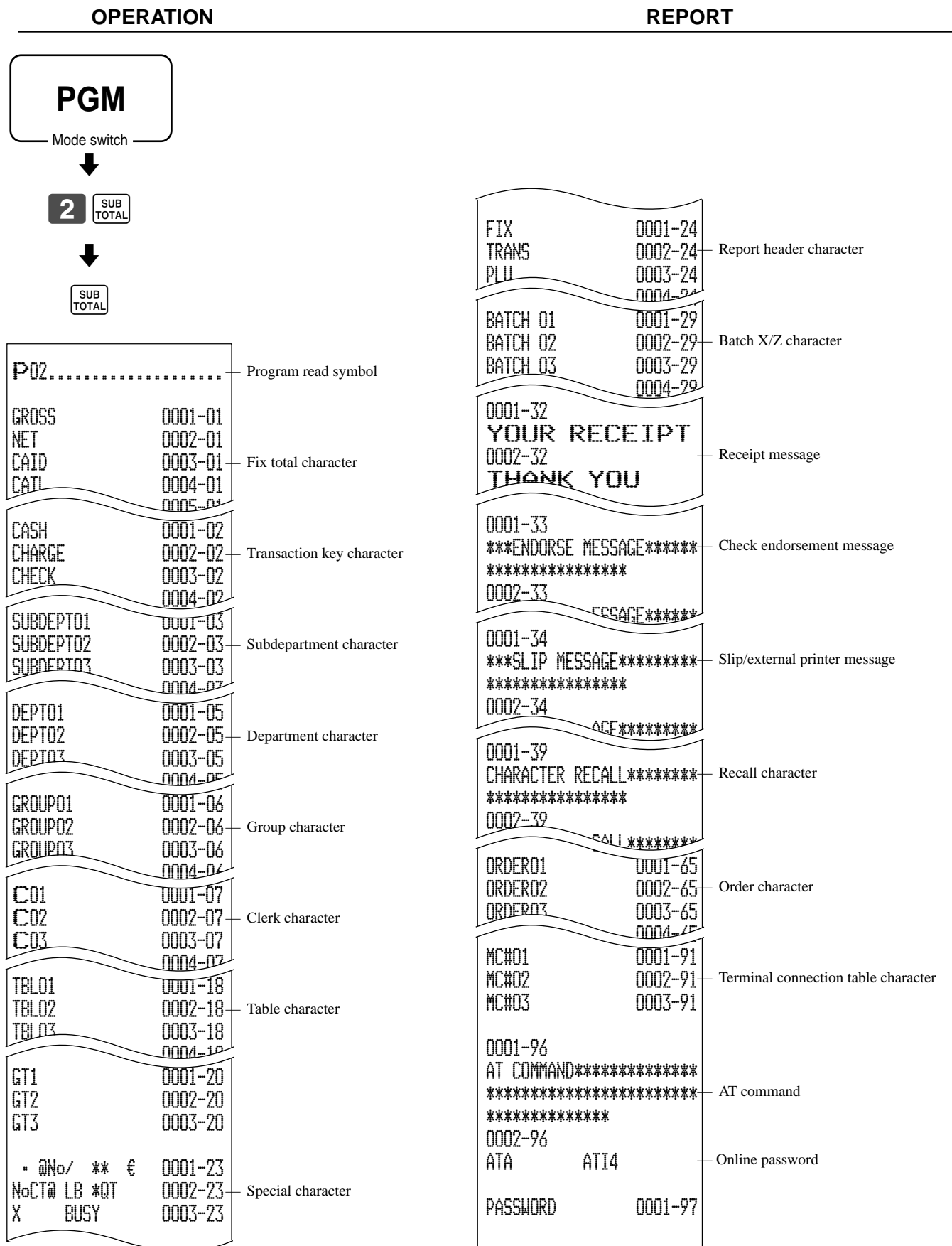

# To print the PLU/flat-PLU program

## OPERATION

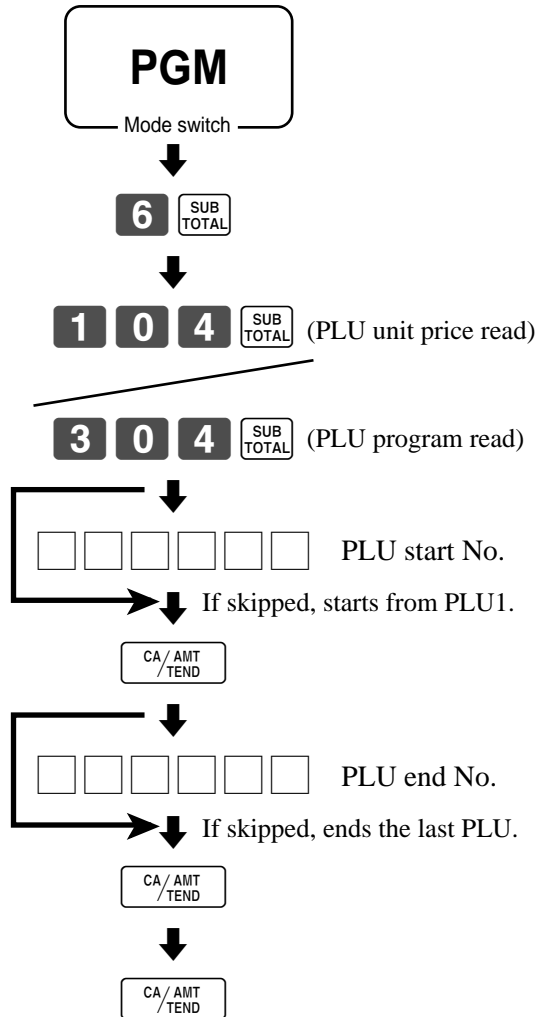

## REPORT

P01.....	Program read symbol
#000001 - #999999	Read range
PLU0001      0001-04	Item character/rec-#/file-#
#000001	Random code
1.2      @1.00	Unit quantity/unit price
PLU0002      0002-04	
#000002	
1        @2.00	
P03.....	Program read symbol
#000001 - #999999	Read range
PLU0001      0001-04	Item character/rec-#/file-#
0000000000000000	Batch program 01 ~ 1066, 18 ~ 1966
11-66           000000	Batch program 1166
12-66           #000001	Batch program 1266
13-66           <- 0001-28	Batch program 1366
14-66           0	Not used
15-66           @1234.56	Batch program 1566
16-66           000000	Not used
17-66           00	Not used
PLU0002      0002-04	
0000000000000000	
11-66           000000	

# Troubleshooting

This section describes what to do when you have problems with operation.

## When an error occurs

Errors are indicated by an error codes. When this happens, you can usually find out what the problem is as shown below.

Press **C** and check the appropriate section of this manual for the operation you want to perform.

Error code	Meaning	Action
E001	Mode switch position changed before finalization.	Return the mode switch to its original setting and finalize the operation.
E003	Clerk button pressed before finalization of a registration being performed under another clerk button. The signed on clerk differs from the clerk performed the tracking check registration.	Press the original clerk button and finalize the transaction before pressing another clerk button. Input correct check number or assign the proper clerk number.
E004	Initialization or unit lock clear operation in progress.	Complete operation.
E005	Memory allocation exceeds total memory capacity.	Reallocate memory or expand memory (if possible).
E008	Registration without entering a clerk number.	Enter a clerk number.
E009	Operation without entering the password.	Enter password.
E010	The drawer is left open longer than the program time (drawer open alarm).	Close the drawer.
E011	Attempt to register while the cash drawer is open.	Shut the cash drawer.
E013	Journal paper near end. (option)	Replace the journal paper.
E015	Printer error	
E016	Two consecutive transactions attempted in the refund mode.	Switch to another mode and then back to the RF mode for the next transaction.
E017	Attempt made to register an item without inputting a check number.	Input a check number.
E018	Attempt made to register an item without inputting a table number.	Input a table number.
E019	Finalize operation attempted without entering the number of customer.	Enter the number of customer.
E021	No department linked PLU is registered.	Correct the program.
E023	Actual stock quantity becomes less than the minimum stock quantity.	Perform stock maintenance.
E024	Actual stock quantity becomes/is negative.	Perform stock maintenance.
E026	No condiment/preparation PLU is registered.	Register condiment/preparation PLU.
E029	Item registration is prohibited, while partial tender.	Finalize the transaction.
E030	Finalization of a transaction attempted without registering rate-tax.	Register <RATE TAX>.
E031	Finalization of a transaction attempted without confirming the subtotal.	Press <SUBTOTAL>.
E032	Finalization of a transaction attempted without confirming of the food stamp subtotal.	Press <FS/ST>.
E033	Finalize operation attempted without entering amount tender.	Enter the amount tendered.
E035	Change amount exceeds preset limit.	Input amount tendered again.
E036	Contents of the drawer exceed programmed limit.	Perform pick up operation.
E037	High amount lock out/low digit lock out error	Enter correct amount.
E038	Read/reset operation without declaring cash in drawer. This error appears only when this function is activated.	Perform money declaration.
E040	Attempt to register a new transaction without issuing a guest receipt.	Issue a guest receipt.
E041	Attempt to register a new transaction without validation.	Perform validation operation.
E042	Validation paper (slip printer) has run out. No validation paper (slip printer) is inserted.	Insert new validation paper.
E044	Attempt to register a new transaction without printing check.	Perform check print.
E045	Attempt to register a new transaction without printing check endorsement.	Perform check endorsement.
E046	Registration buffer full. Separate check buffer full.	Finalize the transaction. Allocate sufficient separate check buffer.
E047	Attempt to register a new transaction without printing slip.	Perform slip printing operation.
E048	No paper is inserted or paper is out in the slip printer.	Insert new slip paper.
E049	Check tracking index memory full.	Finalize and close the check number currently used.
E050	Check tracking detail memory full.	Finalize and close the check number currently used.
E051	Attempt to made use <NEW CHECK> to open a new check using a number that is already used for an existing check in check tracking memory.	Finalize and close the check that is currently under the number that you want to use or use a different check number.
E053	Attempt made to use <OLD CHECK> reopen a new check using a number that is not used for an existing check in check tracking memory.	Use the correct check number (if you want to reopen a check that already exists in check tracking memory) or use <NEW CHECK> to open a new check.
E054	Check number range over.	Enter correct number.



Error code	Meaning	Action
E055	Normal registration is prohibited during separate check operation.	Terminate separate check operation.
E059	Attempt to finalize a transaction without specifying <EAT-IN> or <TAKEOUT>.	Press <EAT-IN> or <TAKEOUT>.
E060	External printer offline	
E061	External printer went down.	
E062	External printer paper end	Replace new paper.
E063	External printer is now printing.	
E064	Printing buffer full	
E066	Attempt to print the last separated transaction on slip.	Print from the beginning of the transaction.
E075	Attempt to finalize a transaction when balance is less than or equal to zero.	Register item(s) until the balance becomes positive amount.
E085	Data exists in the consolidation file.	Clear the data.
E100	Prohibit master operation.	Perform it at master terminal.
E121	Network startup error.	
E139	Attempt to register <-> or <CPN> when the balance becomes negative.	Enter proper minus/coupon amount.
E140	This sheet holder is prohibited by PGM.	Set correct sheet holder.
E146	Arrangement file is full.	Set the arrangement properly.
E200	No memory cassette is set.	Set memory cassette.
E202	Can not read, because no designated file is in the memory cassette or internal flash memory.	Check the operation and retry.
E203	Insufficient memory in the memory cassette or internal flash memory.	Use a vacant (formatted) memory cassette.
E204	Write protect switch of the memory cassette is on.	Check the write protect switch.
E205	Can not write, because designated file has already been in the memory cassette or internal flash memory.	Check the operation and retry.

## In case of power failure

If the power supply to the cash register is cut by a power failure or any other reason, simply wait for power to be restored. The details of any on-going transaction as well as all sales data in memory are protected by the memory backup batteries.

- Power failure during a registration  
The subtotal for items registered up to the power failure is retained in memory. You will be able to continue with the registration when power is restored.
- Power failure during printing a read/reset report  
The data already printed before the power failure is retained in memory. You will be able to issue a report when power is restored.
- Power failure during printing of a receipt and the journal  
Printing will resume after power is restored. A line that was being printed when the power failure occurred is printed in full.
- Other  
The power failure symbol is printed and any item that was being printed when the power failure occurred is reprinted in full.

The memory protection battery is constantly charging and discharging as you switch the cash register on and off during normal operations. This causes the capacity of the battery to decrease after approximately five years of use.

### **Important !**

- Remember ...a weak battery has the potential of losing valuable transaction data.
- A label on the back of the cash register shows the normal service period of the battery installed in your cash register.
- Have the battery replaced by your dealer within the period noted on this label.

## Clearing a machine lock up

If you make a mistake in operation, the cash register may lock up to avoid damage to programs and preset data. Should it happens, you can use the following procedure to clear the lock up without losing any data.

- 1 Power off the register.
- 2 Insert the PGM key in the mode switch.
- 3 Press down **RECEIPT FEED**, and turn the mode switch to PGM mode.
- 4 The display shows ten Fs, then release **RECEIPT FEED**.
- 5 Press **SUB TOTAL**. The display shows ten Fs and issue a receipt.

### Important!

- If the register does not show ten Fs, never press **SUB TOTAL** and call service representative.

## When the register does not operate at all

Perform the following check whenever the cash register enter an error condition as soon as you switch it on. The results of this check are required by service personnel, so be sure to perform this check before you contact a CASIO representative for servicing.

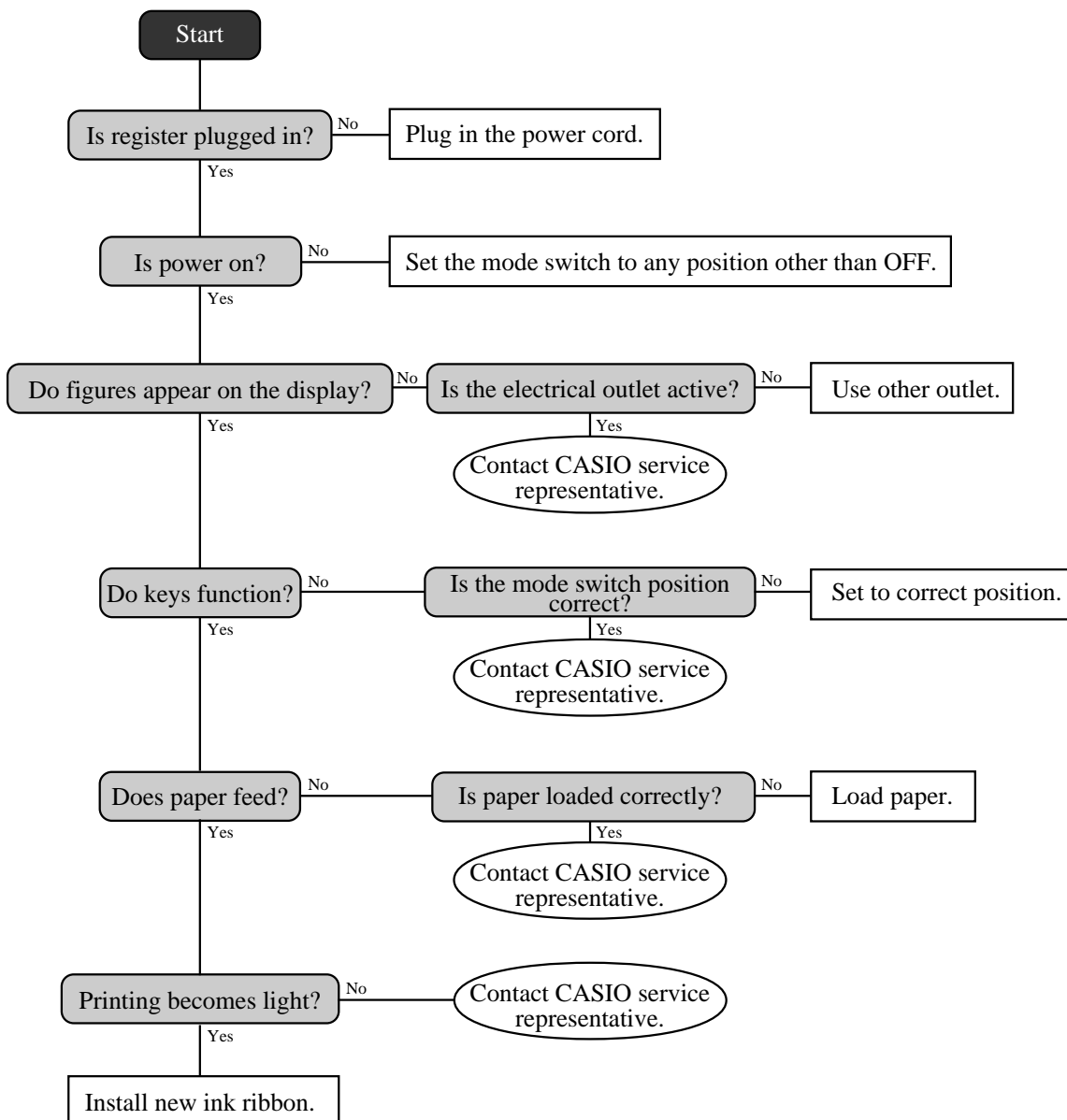

## To replace the ink ribbon



1

Open the printer cover.



4

Load a new ink ribbon cassette into the unit.



2

Remove the printer sub cover.

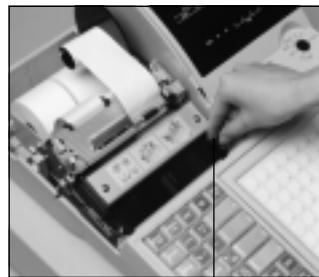

5

Turn the knob on the right side of the cassette to take up any slack in the ribbon.

Knob



3

Pull up the knob of the ribbon cassette.

6

Replace the printer cover and printer sub cover.

### Important!

Use only the ERC-32(P) ribbon (purple). Other types of ink ribbons can damage the printer. Never try to extend the life of an ink ribbon by replenishing the ink. Once an ink ribbon is in place, press <#/NS> or <NS> to test for correct operation.

## To replace journal paper

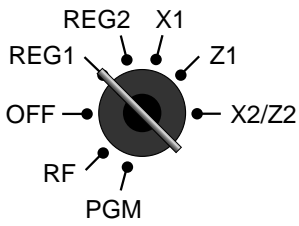

**1** Set the mode switch to the REG1 position and remove the printer cover.



**2** Press **JOURNAL FEED** to feed about 20 cm of paper.



**6** Cut the journal paper as shown in the photograph.



**3** Cut the journal paper at the point where nothing is printed.



**7** Press **JOURNAL FEED** to feed the remaining paper from the printer.



**4** Remove the journal take-up reel from its holder.

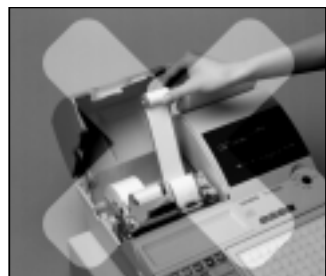

**8** Do not pull the paper out of the printer by hand. It can damage the printer.



**5** Slide the printed journal from the take-up reel.

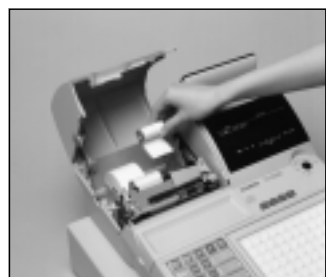

**9** Remove the old paper roll from the cash register.

**10** Load new paper as described on page 10 of this manual.

## To replace receipt paper

Follow step ① under “To replace journal paper” on the previous page.



② Cut the receipt paper as shown in the photograph.



④ Do not pull the paper out of the printer by hand. It can damage the printer.



③ Press **RECEIPT FEED** to feed the remaining paper from the printer.



⑤ Remove the old paper roll from the cash register.

⑥ Load new paper as described on page 11 of this manual.

## To replenish the stamp ink

Follow step ① under “To replace journal paper” on the previous page.



② Remove the stamp pad from its holder by lifting the knob.

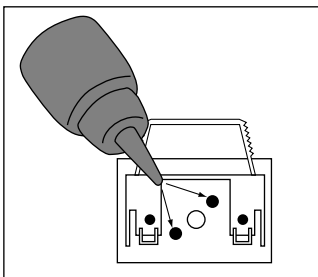

③ Squirt one or two drops of ink into the holes on the back of the stamp pad.

④ Replace the stamp pad on its holder.

## Options

Wetproof cover: WT-78,  
WT-79 (For TK-6000)  
Memory chip: RAM-610-10LL  
Memory cassette: RAC-9  
C-NET card: I/O-PB-14

Slip printer: SP-1300  
Cable: PRT-CB-8C  
External printer: UP-350, UP-250  
Cable: PRT-CB-8A or PRT-CB-8B  
Power supply: PS-170 and AC-170

Consult with your CASIO dealer for details.

# Specifications

## Input method

Entry: 10-key system, buffer memory 8 keys (2-key roll over)  
 Department: Full key system

## Display

Amount 10 digits (zero suppression); department No., PLU No., No. of repeats, total, change, receipt on/off, transaction indicator

## Printer

Receipt: Dot matrix alpha-numeric system 24 digits, receipt on/off switch (key)  
 Store name or slogan is printed automatically

Logo stamp: 20 (H) ¥ 30 (W) mm

Journal: Dot matrix alpha-numeric system 24 digits

Automatic take up roll winding

Journal paper near end sensor (option)

Validation: 55 digits, one line, for 135 mm (minimum) wide slip

Paper roll: 45 (W) ¥ 83 (D) mm

Paper feed: Separate for receipt and journal

Print speed: 3.0 l/s

## Listing capacity

Amount: 99999999

Quantity: 9999.999

Tendered amount: 9999999999

Percent: 99.99

Tax rate: 9999.9999

Numbers: 9999999999999999

## Chronological data

Date print: Automatic date printout on receipt or journal, automatic calendar

Time print: Automatic time printout on receipt or journal, 24-hour system/12-hour system

## Alarm

Key catch tone, error alarm, sentinel alarm

## Memory protection battery

48-hour full charge protects memories for approximately 90 days.

Battery should be replaced every five years.

## Power supply/power consumption

See the rating plate.

## Operation temperature

0°C ~ 40°C (32°F ~ 104°F)

## Humidity

10 ~ 90%

## Dimensions and weight

454mm (D) × 345mm (W) × 218mm (H) / 6.5kg

17 7/8" (D) × 13 9/16" (W) × 8 9/16" (H) / 14lbs. 5oz.

...without drawer

454mm (D) × 400mm (W) × 331mm (H) / 13kg

17 7/8" (D) × 15 3/4" (W) × 13" (H) / 28lbs. 11oz.

...with medium size drawer

Totalizers		Contents				
Category	No. of totalizers	Amount (10 digits)	No. of items (6 integer/3 decimal)	Count (4 digits)	No. of customers (6 digits)	Periodic totalizers
Department	Up to 10	✓	✓			✓
PLU	Up to 108	✓	✓			
Clerk	10	✓	✓	✓		✓
Hourly sales	24	✓			✓	
Monthly sales	31	✓	✓		✓	
Transaction	Variable with program	Variable with program				✓
Non resettable grand total	3	✓ (16 digits)				
Reset counter	12			✓		
Consecutive No.	1			✓ (6 digits)		

\* Specifications and design are subject to change without notice.

- A**
- add check 24, 82
  - adding to a check 79
  - addition (+) 56
  - alphabet key 93
  - arrangement 24, 61
  - assigning a clerk 30
- B**
- backspace key 93
  - bill copy 24, 86
  - bottle link 60
  - bottle return 24, 60
  - bottom message 28, 88
- C**
- cancel 21, 22, 24, 52
  - cash/amount tendered 21, 43
  - change 32
  - character code 92
  - character code fixed key 93
  - character enter key 93
  - character fixed key 93
  - character keyboard 93
  - charge 21, 23
  - check 21, 43
  - check endorsement 24
  - check print 24
  - check tracking 78
  - clearing a machine lock up 106
  - clerk button 17, 30
  - clerk interrupt 54
  - clerk key/button/lock 16, 30
  - clerk lock 17, 30
  - clerk name 30, 88
  - clerk number 20, 22, 87
  - clerk read/reset report 95
  - clerk secret number key 17, 30
  - clerk transfer 24, 84
  - closing a check 80
  - commercial message 28, 88
  - commission rate 87
  - consecutive No. 28
  - correction 50
  - coupon 24, 58
  - coupon II (2) 24, 58
  - credit 21, 23, 43
  - cube 24
  - currency exchange 24, 62
  - customer display 18
  - customer number 24
- D**
- daily sales read/reset report 96
  - daily sales reset report 53
  - date display 31
  - date set 12
  - declaration 24
  - department 21, 23, 32
  - deposit 24, 85
  - descriptor 88
  - discount 20, 22, 40
  - display 18
  - double size letter key 93
  - drawer 17
- E**
- eat-in 24
  - EBT (electronic benefits transfer) 24, 72
  - entering character 92
  - error code 104
  - error correction 21, 22, 51
  - Euro 21, 23, 44
- F**
- financial read report 95
  - flat PLU 21, 22, 32
  - food stamp 64
  - food stamp shift 24, 64
  - food stamp subtotal 24, 64
  - food stamp tender 24, 64
- G**
- group read/reset report 99
  - guest receipt 80
- H**
- high amount limitation 34
  - hourly sales read/reset report 98
- I**
- Illinois rule 67
  - indicator 19
  - individual clerk read/reset report 95
  - individual department, PLU/flat-PLU read report 94
  - ink ribbon 14, 107
  - item counter 28
- J**
- journal 10, 28, 108
  - journal skip 28
- K**
- Ketten Bon 24
  - keyboard (TK-6000) 20
  - keyboard (TK-6500) 22

# Index

---

## L

left cursor key 93  
loan 20, 22, 49  
logo message 28, 88

## M

machine No. 28  
main display 18  
manual tax 24  
media change 49  
menu shift 24  
merchandise subtotal 24, 39  
message 28, 88  
minus 20, 22, 41  
mixed tender 43  
mode key 15  
mode switch 16  
money declaration 95, 97  
monthly sales read/reset report 99  
multiplication 21, 23, 33, 37  
multiplication/for 21, 23, 33

## N

new balance 24, 79  
new check 24, 79  
new/old check 24, 81  
no sale 20, 23, 24, 52  
non add 20, 23, 24  
normal receipt 25  
number of customers 75

## O

old check 25, 79  
open 20, 22  
open check 25  
open II (2) 25, 76  
open PLU 38  
opening a check 79  
operator number 25, 84  
operator X/Z 25  
option 109

## P

paid out 21, 23, 48  
paper feed 20, 22  
periodic sales 100  
pick up 20, 22, 49  
PLU 36  
PLU/flat-PLU read/reset report 98  
plus 25  
post receipt 20, 22  
power failure 105  
premium (%+) 25, 56  
preset price 35  
preset tax status 35  
preset tender 59  
previous balance 25  
previous balance subtotal 25  
price 25, 38  
price inquiry 25  
printing slip 77  
program end key 93

## R

rate tax 25  
read report 94  
recall 25  
receipt 11, 28, 109  
receipt on/off 20, 22  
receipt on/off switch / key 14  
received on account 21, 23, 48  
reduction (-) 41  
refund 20, 22, 47  
repeat 19, 32, 37  
reset report 53, 94  
return 47  
review 25, 83  
RF mode 47  
right cursor key 93  
roll paper 14

## S

second unit price 73  
separate check 25, 83  
set menu 61  
shift key 93  
sign off 30  
sign on 30  
single item 32, 37, 55  
slip 77  
slip back feed/release 25, 77  
slip feed/release 25, 77  
slip print 25, 77  
space key 93  
split sales of packaged item 33, 38  
square 25  
stamp ink 109  
store 25  
subtotal 21



## T

- table number 25, 82
- table transfer 25, 84
- takeout 25
- tax exempt 25
- tax shift 20, 22, 39
- taxable amount subtotal 25
- text print 25
- text recall 25, 76
- time display 31
- time set 12
- tip 25, 73
- trainee status 87
- tray total 25, 57

## V

- validation 20, 22, 46
- VAT 20, 22, 85
- void 25

## W

- wetproof cover 15, 109

# MEMO

---



**CASIO®**

**CASIO COMPUTER CO., LTD.**  
6-2, Hon-machi 1-chome  
Shibuya-ku, Tokyo 151-8543, Japan

TK-6000E\*E  
SA0106-F Printed in Malaysia