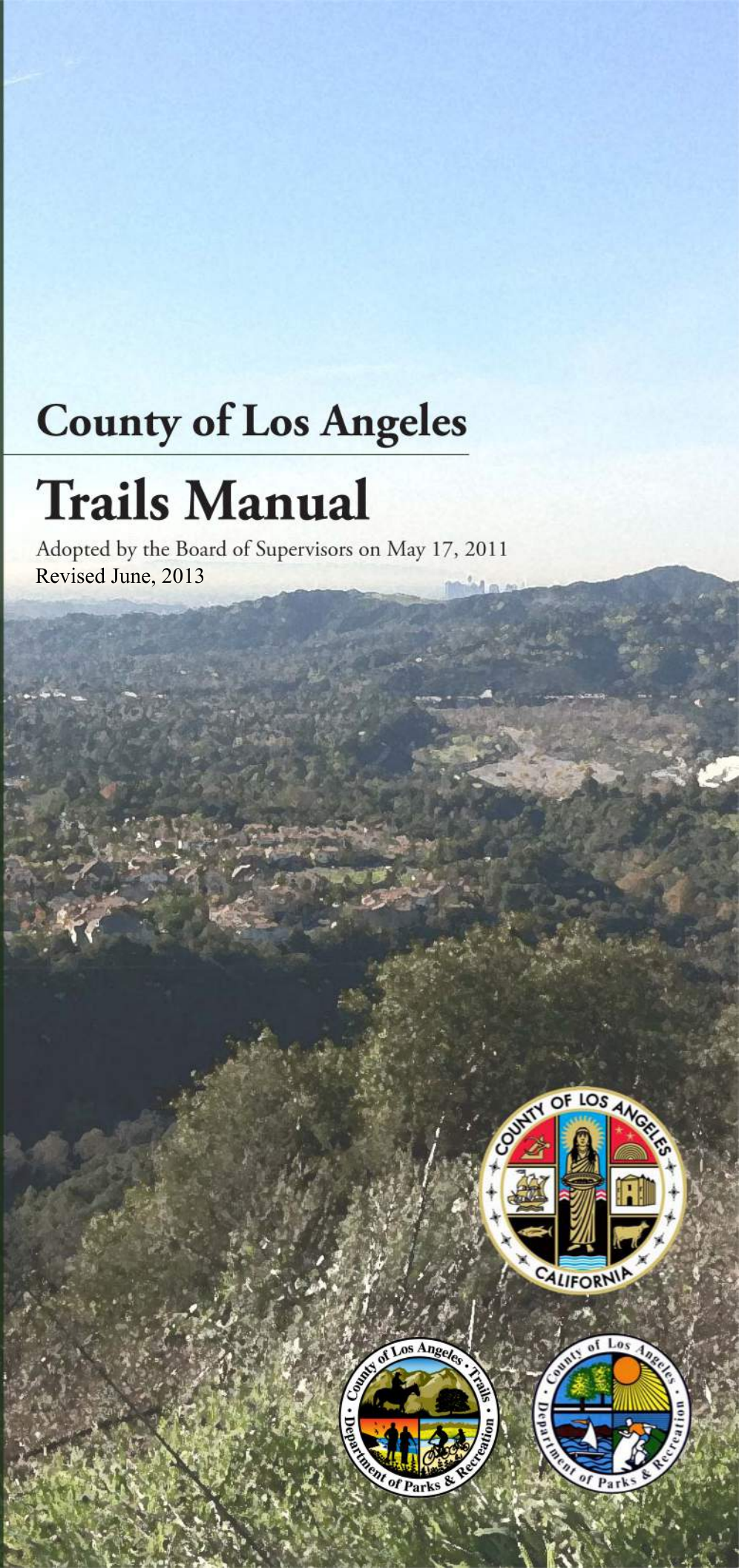


# County of Los Angeles

## Trails Manual

Adopted by the Board of Supervisors on May 17, 2011  
Revised June, 2013





**Note:**

The County of Los Angeles Department of Parks and Recreation's Trail Planning Section is currently revising the **County of Los Angeles Trails Manual**, adopted by the Board of Supervisors on May 17, 2011 and Revised in June 2013.

The proposed revisions are necessary to integrate new information and update content within specific sections of the manual. Revisions will include but are not limited to a new County-wide trail signage program and updates to typical trail related construction details.

If utilizing this manual for planning, design, or reference purposes addressing County of Los Angeles multi-use trails, please contact staff from the Trails Planning Section for further details or direction:

**Section Head: Frank Moreno**

[fmoreno@parks.lacounty.gov](mailto:fmoreno@parks.lacounty.gov) – 213-351-5136

**Trail Planner for First Supervisorial District: Zach Likins**

[zlikins@parks.lacounty.gov](mailto:zlikins@parks.lacounty.gov) – 213-351-5149

**Trail Planner for Second and Third Supervisorial Districts: Robert Ettleman**

[rettleman@parks.lacounty.gov](mailto:rettleman@parks.lacounty.gov) – 213-351-5134

**Trail Planner for Fourth Supervisorial District: Sarah Perez**

[Sperez2@parks.lacounty.gov](mailto:Sperez2@parks.lacounty.gov) – 213-639-6058

**Trail Planner for Fifth Supervisorial District: Olga Ruano**

[oruano@parks.lacounty.gov](mailto:oruano@parks.lacounty.gov) – 213-351-5141

---

**COUNTY OF LOS ANGELES  
TRAILS MANUAL**

**Prepared by:**

**County of Los Angeles Department of Parks and Recreation  
Planning and Development Agency  
510 South Vermont Avenue  
Los Angeles, CA 90020**

**With technical assistance by:**

**Sapphos Environmental, Inc.  
430 North Halstead Street  
Pasadena, CA 91107**

**Adopted by the Board of Supervisors on May 17, 2011  
Revised June, 2013**

---

**Selected graphics and text, as adapted, in this document were generously contributed by:**

**INTERNATIONAL MOUNTAIN BICYCLING ASSOCIATION**

Further information can be found in  
*Trail Solutions: IMBA's Guide to Building Sweet Singletrack.*  
P.O. Box 7578, Boulder, Colorado 80306  
Available at [www.imba.com](http://www.imba.com).

*Trail Solutions covers design, construction, and maintenance of multi-use trails with helpful illustrations and easy to understand explanations useful for agencies, designers, and volunteers.*

---

**ACKNOWLEDGMENTS**

**COUNTY OF LOS ANGELES BOARD OF SUPERVISORS**

Gloria Molina, District 1  
Mark Ridley-Thomas, District 2  
Zev Yaroslavsky, District 3  
Don Knabe, District 4  
Michael D. Antonovich, District 5

**COUNTY OF LOS ANGELES DEPARTMENT OF PARKS AND RECREATION**

Russ Guiney, Director

**Planning and Development Agency**

Norma E. Garcia, Deputy Director

**Planning Division**

Larry Hensley, Chief of Planning

**Research and Trails Planning**

Frank Moreno, Section Head

**TECHNICAL ASSISTANCE**

Sapphos Environmental, Inc.  
430 North Halstead Street  
Pasadena, CA 91107



---

The County of Los Angeles Trails Manual is dedicated to the County of Los Angeles Department of Parks and Recreation's  
First Planner involved with Trails, the First Trail Boss, and the Chief of Planning:

Riki Izumi  
First Planner Involved with Trails;

John Little  
First Trail Boss;

and

Larry Hensley,  
Chief of Planning

---

## ***LETTER FROM THE DIRECTOR***

---

### **Thank you for your interest in the County of Los Angeles Trails Manual.**

The County of Los Angeles Department of Parks and Recreation (LACO-DPR) is honored to oversee the County of Los Angeles (County) parks and recreation system, which includes 63,000 acres of parks, lakes, trails, natural areas, and gardens. These recreational opportunities have been identified as essential to the quality of life among Americans.

The availability of parks and recreational facilities is one of the most important factors in creating a high quality of life for residents in the County. Parks and recreational facilities create opportunities for people to access open space, natural resources, exercise, outdoor education, and new environments, promoting a connection with the environment, good health, and a sense of well being.

The benefits and quality of experience that LACO-DPR trails provide for equestrians, hikers, and mountain bikers are unparalleled. The diverse landscape within the County provides Southern Californians and visitors with unique opportunities to enjoy desert, foothill, urban, and coastal trails that cannot be experienced in any other location.

The Trails Manual provides the LACO-DPR staff, other County staff, and developers with guidelines and standards for trail planning, design, development, and maintenance of LACO-DPR trails. In consultation with numerous agencies, trails groups, and trail users, the Trails Manual is designed to continue the tradition of trails excellence in the County. The LACO-DPR is happy to present this Trails Manual to help guide and maintain the legacy of trail experiences that is unique to this County.

The preparation of this Trails Manual is a result of a wide-reaching public participation effort, including private citizens and trails organizations throughout the County representing many user groups. The County over time will review and revise this manual as needed. As always, we welcome your input.

Russ Guiney,

Director, County of Los Angeles Department of Parks and Recreation

# TABLE OF CONTENTS

<i>SECTION</i>	<i>PAGE</i>
1.0 INTRODUCTION.....	1-1
1.1 County Strategic Plan for 2010 Goals, Objectives, and Policies.....	1-1
1.2 Purpose and Need.....	1-2
1.3 Application of the Trails Manual.....	1-2
1.4 Trails Manual Development.....	1-2
1.5 Relationship of the Trails Manual to the Strategic Asset Management Plan for 2020.....	1-3
2.0 TRAIL PLANNING .....	2-1
2.1 Step 1: Define Project Goals and Objectives.....	2-1
2.1.1 Goal Statement.....	2-1
2.1.2 Project Objectives.....	2-1
2.2 Step 2: Evaluation of Recreational Trail Needs in the Service Area.....	2-2
2.2.1 Defining the Service Area.....	2-1
2.2.2 Sources of Data for Service Area Demand Analysis.....	2-3
2.2.3 Demand Analysis.....	2-3
2.2.4 Coordination with Stakeholders.....	2-3
2.3 Step 3: Inventory of Existing Trails and Recreational Resources .....	2-4
2.3.1 Sources of Information for Existing Trails and Recreational Resources .....	2-4
2.3.2 Supply Analysis.....	2-5
2.4 Step 4: Conceptual Trail Alignment .....	2-5
2.4.1 Trail Types.....	2-5
2.4.1.1 Trail Users .....	2-6
2.4.1.1.1 Accessible Trails .....	2-6
2.4.1.2 Trail Locations.....	2-6
2.4.1.3 Trail Purpose.....	2-7
2.4.1.4 Trail Site Conditions.....	2-8
2.4.1.5 Trail Type Identification.....	2-8
2.4.2 California State Parks Classification System .....	2-8
2.4.3 Alignment Layout.....	2-10
2.4.3.1 Control Points.....	2-10
2.4.3.2 Topography.....	2-10
2.4.3.3 Trail Experience.....	2-10
2.4.4 Easements.....	2-14
2.5 Step 5: Feasibility Analysis.....	2-14
2.5.1 Engineering Factors.....	2-14
2.5.1.1 Geology and Soils.....	2-14
2.5.2 Environmental Factors.....	2-14
2.5.2.1 Aesthetics.....	2-15
2.5.2.2 Biological Resources and Hydrology.....	2-15
2.5.2.3 Cultural Resources.....	2-16
2.5.2.4 Hazards and Hazardous Materials.....	2-16
2.5.2.5 Land Use and Land Ownership.....	2-17
2.5.3 Economic Factors.....	2-17
2.5.3.1 Construction Cost Considerations.....	2-17
2.5.4 Social Factors.....	2-17
2.5.4.1 Recreational Need.....	2-17



2.6	Identify and Engage with Stakeholders.....	2-19
2.6.1	Step 1.....	2-19
2.6.2	Step 2.....	2-20
2.6.3	Step 3.....	2-20
2.6.4	Step 4.....	2-20
2.6.5	Step 5.....	2-20
3.0	ENVIRONMENTAL COMPLIANCE FOR TRAILS .....	3-1
3.1	Define Project Goal and Objectives.....	3-2
3.2	Three-Step NEPA Process.....	3-2
3.2.1	Consideration of Categorical Exclusions .....	3-3
3.2.2	Preparation of Environmental Assessment.....	3-3
3.2.3	Preparation of an Environmental Impact Statement .....	3-3
3.3	Three-Step CEQA Process.....	3-4
3.3.1	Consideration of Categorical Exemptions .....	3-6
3.3.2	Preparation of an Initial Study .....	3-6
3.3.3	Preparation of an Environmental Impact Report (EIR) .....	3-7
3.4	Regulatory Agencies.....	3-7
3.5	Entitlement Process.....	3-7
3.5.1	Quimby Funds.....	3-9
3.5.2	Securing Easements.....	3-9
4.0	TRAIL DESIGN .....	4-1
4.1	Trail Mechanics .....	4-1
4.1.1	Tread Watershed .....	4-1
4.1.2	Compaction.....	4-3
4.1.3	Displacement.....	4-3
4.1.4	Erosion .....	4-4
4-4	4.2 Trail Longevity.....	4-5
4.2.1	The Half Rule .....	4-5
4.2.2	The 10-Percent Rule.....	4-6
4.2.3	Minimal Use of Switchbacks.....	4-6
4.2.4	Outsloping of the Trail.....	4-7
4.2.5	Maximum Sustainable Grade .....	4-7
4.2.6	Controlling Water on a Trail .....	4-9
4.2.7	Gaining Altitude on a Trail .....	4-10
4.3	Application of Design Guidelines.....	4-12
4.3.1	Trail Guidelines.....	4-12
4.3.1.1	ADA Compliance .....	4-14
4.3.2	Water Crossing Guidelines.....	4-15
4.3.2.1	Bridges.....	4-15
4.3.2.2	Culverts and Underdrains .....	4-15
4.3.2.3	Puncheon.....	4-16
4.3.3	Trail Guidelines Specific to Environments.....	4-16
4.3.3.1	Coastal Trails.....	4-16
4.3.3.2	Urban Trails .....	4-16
4.3.3.3	Desert Trails.....	4-17
4.3.3.4	Foothill Trails.....	4-18
4.3.4	Multi-Agency Trails.....	4-18
4.3.5	Retaining Structures Guidelines .....	4-18
4.3.6	Signs .....	4-18
4.3.6.1	Highway Signs.....	4-19

4.3.6.2	Regulatory Signs .....	4-19
4.3.6.3	Informational Signs.....	4-22
4.3.6.4	Trail Network Graphics and Maps.....	4-24
4.3.7	Road Crossings .....	4-24
4.3.8	Parking .....	4-24
4.3.8.1	Equestrian Parking Area and Staging Area Design.....	4-25
4.3.9	Restrooms .....	4-26
4.3.10	Landscaping.....	4-26
4.3.11	Drinking Water.....	4-26
4.3.12	Bicycle Racks .....	4-26
4.3.13	Shade Structures.....	4-26
4.3.14	Equestrian Amenities .....	4-26
4.3.15	Equestrian Arenas .....	4-26
4.3.16	Bleachers.....	4-27
4.4	Trailheads and Trail Support Features.....	4-27
4.4.1	Motorized Vehicle Trail Barriers and Trail Gates.....	4-27
4.4.2	Trail Kiosks.....	4-28
4.5	Constructability .....	4-28
4.5.1	Trail Construction Team .....	4-28
4.5.1.1	Trail Construction Professionals .....	4-29
4.5.1.2	Trail Construction Volunteers .....	4-29
4.5.2	Construction Scenario .....	4-29
4.5.2.1	Flag the Trail .....	4-29
4.5.2.2	Clear the Trail Corridor .....	4-30
4.5.2.3	Construct the Trail Tread .....	4-30
4.5.2.4	Construct Switchbacks and Climbing Turns .....	4-30
4.5.2.5	Compact the Trail .....	4-30
4.5.2.6	Construct Crossings and Retaining Structures.....	4-30
4.5.2.7	Construct Trailheads, Way-finding Signs, and Appurtenant Structures.....	4-31
4.5.3	Construction Tools .....	4-31
4.5.3.1	Hand Tools and Equipment .....	4-31
4.5.3.2	Mechanical Tools .....	4-31
5.0	TRAILS OPERATIONS AND MAINTENANCE .....	5-1
5.1	Trail Operation .....	5-1
5.1.1	Hours of Operation .....	5-1
5.1.2	Trail Users.....	5-1
5.1.3	Physical Resources.....	5-2
5.1.4	Parkland Uses.....	5-2
5.1.5	Emergency Response.....	5-2
5.1.6	Closure Policy .....	5-2
5.1.7	Modification to Operation Guidelines .....	5-2
5.2	Trail Assessment.....	5-2
5.2.1	Trail Surfaces.....	5-3
5.2.2	Trail Assessment .....	5-3
5.3	Trail Maintenance .....	5-7
5.3.1	Mowing and Spraying.....	5-7
5.3.2	Tree and Brush Trimming .....	5-7
5.3.3	Debris Removal .....	5-8
5.3.4	Culverts .....	5-8
5.3.5	Water Crossings and Bog Areas .....	5-8
5.3.6	Signs and Other Amenities.....	5-9

5.3.7	Graffiti Removal.....	5-9
5.3.8	Homeless Encampment Removal.....	5-9
5.3.9	Fire Mandated Brush Clearance.....	5-9
5.3.10	Pumping Out Flooded Tunnel Ways (Trailways).....	5-9
5.4	Working with Volunteer Groups.....	5-9
6.0	REPORT AUTHORS.....	6-1
6.1	Sapphos Environmental, Inc. ....	6-1
6.2	Special Thanks.....	6-2
7.0	REFERENCES.....	7-1

<b>TABLE</b>		<b>PAGE</b>
2.2.1-1	County Standards for Recreation Service Areas.....	2-3
2.4-1	Trail Types.....	2-5
2.4.1.1-1	Trail User Rating Planning Focus Worksheet.....	2-6
2.4.1.2-1	Trail Location Rating Planning Focus Worksheet.....	2-7
2.4.1.3-1	Trail Purpose Rating Planning Focus Worksheet.....	2-7
2.4.1.4-1	Trail Site Conditions Rating Planning Focus Worksheet.....	2-8
2.4.1.5-1	Example Trail Type Identification.....	2-8
2.4.2-1	State Parks Trail Maintenance Classification Matrix.....	2-9
2.5.3.1-1	Construction Cost Considerations.....	2-18
3.3.1-1	Potential CEQA Exemptions for Trail Projects.....	3-6
3.4-1	Regulatory Agencies and Trail Regulatory Nexus.....	3-8
4.1-1	Trail Mechanics.....	4-2
4.2.5-1	Properties and Behaviors of Common Tread Material.....	4-8
4.3.1-1	Trail Classification Guidelines.....	4-12
5.3-1	Seasonal Maintenance by Trail Surface.....	5-7
5.3-2	Annual Maintenance by Trail Surface.....	5-8

<b>FIGURE</b>		<b>PAGE</b>
2-1	Trail Planning Flowchart.....	2-2
2.4.1-1	Trail Type Identification.....	2-6
2.4.3.1-1	Example Control Points.....	2-11
2.4.3.3-1	Natural Shapes.....	2-12
2.4.3.3-2	Anchors.....	2-12
2.4.3.3-3	Edges.....	2-12
2.4.3.3-4	Gateways.....	2-12
2.4.3.3-5	Vistas.....	2-13
2.4.3.3-6	Playfulness.....	2-13
2.4.3.3-7	Harmony.....	2-14
2.5.2.1-1	Landscape Sections.....	2-15
2.5.2.2-1	Plant Communities Map.....	2-16
3.2.1	Determining NEPA Compliance for a Proposed Action.....	3-2
3.3-1	CEQA Process Flowchart.....	3-4
3.3-2	CEQA and NEPA Parallel Processes.....	3-5
4-1	Trail Implementation Flowchart.....	4-1
4.1-1	Trail Structure Terminology.....	4-1
4.1.1-1	Tread Watershed.....	4-2
4.1.1-2	Effects of Compaction and Displacement on Trail Tread.....	4-3
4.1.2-1	Compaction of Trail Tread.....	4-3

4.1.3-1	Displacement of Trail Tread.....	4-4
4.1.4-1	Fall Line.....	4-4
4.2.1-1	Half Rule.....	4-5
4.2.2-1	Average Trail Segment Grade.....	4-6
4.2.3-1	Switchbacks.....	4-6
4.2.4-1	Outslope.....	4-7
4.2.6-1	Knicks.....	4-9
4.2.6-2	Rolling Grade Dip.....	4-9
4.2.6-3	Grade Reversals.....	4-10
4.2.7-1	Climbing Turns.....	4-11
4.2.7-2	Rolling Crown Switchback.....	4-11
4.3.1-1	Recreational Pathway.....	4-12
4.3.1-2	Urban Pedestrian Path.....	4-13
4.3.1-3	Natural Trail 1.....	4-13
4.3.1-4	Natural Trail 2.....	4-13
4.3.1-5	Natural Trail 3.....	4-13
4.3.1-6	Multiuse Front Yard Trail on Secondary Roadway.....	4-14
4.3.1-7	Clearing Limits.....	4-14
4.3.1.1-1	Arroyo Pescadero Accessible Trail.....	4-15
4.3.3.1-1	Abalone Cove Coastal Trail.....	4-16
4.3.3.2-1	Walk for Health Urban Trail.....	4-17
4.3.3.3-1	PCT in the Mojave.....	4-17
4.3.6-1	Highway, Regulatory, and Informational Signs.....	4-18
4.3.6.1-1	Trail Intersection Signs.....	4-19
4.3.6.1-2	Trail Crossing Sign.....	4-19
4.3.6.2-1	Bonelli Park Permitted Use Sign.....	4-20
4.3.6.2-2	Bonelli Park Etiquette Sign.....	4-21
4.3.6.3-1	Abalone Cove Entrance Sign.....	4-21
4.3.6.3-2	Sara Wan Trail Entrance Sign.....	4-22
4.3.6.3-3	Arroyo Pescadero Kiosk.....	4-22
4.3.6.3-4	Arroyo Pescadero Wayside Exhibit.....	4-23
4.3.8.1	Bonelli Park Staging Area.....	4-25
4.5.2.3-1	Trail Tread Construction Types.....	4-30
5.2-1	Sample Trail Assessment and Repair Sheet.....	5-4
5.2-2	Trail Work Log.....	5-5
5.2-3	Trail Work Log Key.....	5-6

#### **APPENDICES**

A	History of Trail Development
B	Trail Resources
C	Stakeholder Coordination
D	Federal- and State-Listed Species with Potential to Occur within the County of Los Angeles
E	Trail Construction Costs
F	Recreational Funding
G	Sample Trail Easement
H	Conservation Easement Tax Information
I	Trail Accessibility Guidelines
J	Design Guidelines
K	Signage
L	Trail Assessment and Maintenance Forms

---

## SECTION ES EXECUTIVE SUMMARY

---

The County of Los Angeles Trails Manual (Trails Manual) project was initiated in July 2010. Prior to the Trails Manual development, a County-wide trails manual had not been written or adopted.

The County of Los Angeles Department of Parks and Recreation (LACO-DPR) manages the recreation system, including all soft (unpaved trails) with funding provided by the County of Los Angeles Board of Supervisors for planning, construction, operation, and maintenance of recreation facilities and programs in order to meet the diverse needs of the County of Los Angeles (County) residents and visitors.

The purpose of the Trails Manual is to provide guidance to County departments, specifically LACO-DPR, that interface with trail planning, design, development, and maintenance of hiking, equestrian, and mountain biking recreational trails, while addressing physical and social constraints and opportunities associated with the diverse topographic and social conditions that occur in the unincorporated territory of the County. LACO-DPR will use the planning process delineated in the Trails Manual in considering the development of future trails.

It is the policy of LACO-DPR that all trails in the County are multi-use (hiking, mountain biking, equestrian). The Trails Manual does not question the LACO-DPR multi-use policy. Rather, the Trails Manual accepts this policy and it is taken into consideration throughout the Trails Manual.

The Trails Manual does not provide guidelines for safety, volunteer programs, education programs, and trail etiquette. The Trails Manual is intended as a procedural document.

The Trails Manual is organized into seven sections and 13 appendices (A–M), which are referenced in the seven sections of the document:

**Section 1.0, Introduction.** The Introduction discusses the purpose and need for the Trails Manual, how the Trails Manual will be applied, and how the Trails Manual was developed.

**Section 2.0, Trail Planning.** Section 2.0 discusses the steps involved in planning a trail beginning with defining the goals and objectives for a project and including coordination with stakeholders, evaluation of recreational trail needs in the service area, and inventory of existing trails and recreational resources.

This section describes how to create a conceptual trail alignment.

**Section 3.0, Environmental Compliance for Trails.** Section 3.0 provides guidance to trail projects on complying with the National Environmental Policy Act (NEPA) as well as the California Environmental Quality Act (CEQA). This section contains a brief overview of the purposes of CEQA, the three-step CEQA process, descriptions of CEQA documents, and which regulatory agencies should be notified throughout the project.

**Section 4.0, Trail Design.** Section 4.0 presents guidelines for the design of future County trails. A detailed description of trail mechanics, trail longevity, application of design guidelines, and constructability is provided. This section discusses the requirements for different trail environments: coastal, desert, urban, foothill, and flood control right-of-way. This section also addresses issues that arise with trails that are located within the jurisdictions of more than one agency, such as trail name and multi-use inconsistencies.

**Section 5.0, Trails Operation and Maintenance.** Section 5.0 provides guidance on operating and maintaining trails. The guidelines are based on guidelines from established agencies and sources. A multi-year trail maintenance schedule and maintenance management system database is also discussed.

**Section 6.0, Report Authors.** This section contains the list of persons involved in the development of the Trails Manual and special thanks.

**Section 7.0, References.** This section contains the organizations and persons contacted or consulted during preparation of the document, a list of personnel involved in preparation of the environmental documentation, and a list of references. The list of references is annotated to identify the location of the cited reference material.

**Section 8.0, Index.** The index is an alphabetized list of key terms used throughout the Trails Manual, with page numbers on which each key term is mentioned.



# SECTION 1.0 INTRODUCTION

---

The County of Los Angeles Department of Parks and Recreation (LACO-DPR) manages the recreation system with funding provided by the County of Los Angeles Board of Supervisors for planning, construction, operation, and maintenance of recreation facilities and programs. LACO-DPR is responsible for providing parks and recreational facilities to meet the diverse needs of the County of Los Angeles (County) residents and visitors. Maintenance of existing trails and development of additional high-quality trails is one of the most cost-effective means of addressing the deficiency of recreational facilities identified in the County of Los Angeles Inventory of Parks Facilities and Areas of Jurisdiction and the Strategic Asset Management Plan (SAMP) for 2020.<sup>1,2</sup>

Trails offer multiple recreational opportunities to County residents and visitors, providing access to open space and related natural resources, and facilitating exercise, outdoor education, and opportunities to explore new environments. These assets are essential components of the quality of life valued by Southern Californians. The ability to provide these benefits within the County requires maintenance of existing trails and planning, design, development, and maintenance of new trails. The need and usefulness of encouraging healthy communities through the provision of recreational facilities has been exemplified by the “Healthy Parks” program coordinated by LACO-DPR, whose goal is to “improve the quality of life for all Los Angeles County residents” by “creating healthy communities through people, parks and programs.”<sup>3</sup>

## 1.1 COUNTY STRATEGIC PLAN FOR 2010 GOALS, OBJECTIVES, AND POLICIES

*A Parks and Recreation Strategic Plan for 2010* describes a goal, related objective, and policy to guide trail planning and development.<sup>4</sup>

---

<sup>1</sup> County of Los Angeles Department of Parks and Recreation. 2003. *County of Los Angeles Inventory of Park Facilities and Areas of Jurisdiction*. Contact: Department of Regional Planning, Hall of Records, 320 West Temple Street, Los Angeles, CA 90012.

<sup>2</sup> County of Los Angeles Department of Parks and Recreation. April 2004. *Strategic Asset Management Plan (SAMP) for 2020*. Prepared by: County of Los Angeles Chief Executive Office and County of Los Angeles Department of Parks and Recreation, with technical assistance by Sapphos Environmental, Inc.

<sup>3</sup> County of Los Angeles Department of Parks and Recreation. 6 December 2005. “Healthy Parks.” Web site. Available at: <http://parks.co.la.ca.us/HealthyParks.htm>

<sup>4</sup> County of Los Angeles Department of Parks and Recreation. May 1992. *A Parks and Recreation Strategic Plan for 2010*. Contact: 433 South Vermont Avenue, 4th Floor, Los Angeles, CA 90020.

**Goal:** Provide a system-wide level of planning processes for both long- and short-term solutions.

**Objective:** Provide a system of park and recreation facilities that meet the diversified needs of residents.

**Policy:** Provide a system of multi-use (equestrian, hiking, and mountain biking) trails for a diverse group of public users throughout the County that connect local, state, and federal trail systems and link recreational areas to residential, commercial, institutional, and industrial areas.

## 1.2 PURPOSE AND NEED

### Purpose

The purpose of this Trails Manual is to provide an accessible resource that can be used for trail planning, design, construction, and maintenance within the County of Los Angeles. This manual provides guidance to County departments that interface with trail planning, design, development, and maintenance of all trails subject to the discretionary land use authority of the County of Los Angeles. Specifically, these departments include the Department of Regional Planning, the Department of Public Works, and the Department of Parks and Recreation. This Trails Manual recognizes the existence of a broader regional trail network that exists in the County of Los Angeles and surrounding counties that provides access to recreational resources operated by federal, state, and local agencies. Thus, this Trails Manual provides guidelines for implementation of the goals, objectives, and purpose for the 2010 Strategic Plan related to trails.<sup>5</sup> Specifically, the manual provides sources of information and physical factors to be considered when analyzing the regional planning context, design, and development of trails that create the highest quality recreational experience and the capacity to serve the diverse recreational needs of County residents and visitors, while undertaking the necessary outreach with community and regulatory stakeholders.

---

<sup>5</sup> County of Los Angeles Department of Parks and Recreation. May 1992. *A Parks and Recreation Strategic Plan for 2010*. Contact: 433 South Vermont Avenue, 4th Floor, Los Angeles, CA 90020.

Trails are an integral part of the American and Southern California lifestyle. The Southern California climate allows County residents and visitors to enjoy trails throughout the year. Many of the County's trails were developed in the 1930s and continue to be in use today (Appendix A, *History of Trail Development*). This Trails Manual provides a framework for preserving and continuing this rich legacy of trail development and recreational trail uses.

## Need

The County of Los Angeles has many miles of existing (formal) and historic trails (informal) and roads for recreational use. Given current population trends, the County needs to build more than 1,000 miles of trails to meet the anticipated demand for trails by 2020. This Trails Manual establishes the necessary planning, design, construction, and maintenance guidelines to ensure the quality of the recreational experience provided by existing and proposed County trails.<sup>6</sup>

This Trails Manual provides a process to ensure quality planning and design that recognizes the opportunities and constraints represented by the physical environment; provides construction guidelines to ensure proper drainage and minimize erosion; and specifies maintenance procedures to ensure that trails are accessible, safe, and aesthetically pleasing.

## 1.3 APPLICATION OF THE TRAILS MANUAL

The guidelines provided in this Trails Manual are intended to be used by County departments engaged in the planning, design, construction, and maintenance of hiking, equestrian, and mountain biking recreational trails within the County of Los Angeles.

The Trails Manual sets the guidelines for reviewing plans and specifications for trails that are provided in conjunction with land use planning and the entitlement process for projects proposed for development within the County. Proposed developments will be reviewed for consistency with the Trails Manual. Proposed private development that includes a County trail would only be able to supersede the Trails Manual guidelines in its design and layout upon specific approval of the Board of Supervisors.

This manual was developed as a management and field tool for design, construction, operation, and maintenance of trails in the County of Los Angeles. It provides guidelines for both

<sup>6</sup> County of Los Angeles Department of Parks and Recreation. April 2004. *Strategic Asset Management Plan (SAMP) for 2020*. Prepared by: County of Los Angeles Chief Executive Office and County of Los Angeles Department of Parks and Recreation, with technical assistance by Sapphos Environmental, Inc.

supervisors and lead personnel responsible for trail design, construction, and maintenance activities. It also provides the County with a checklist of key factors that shall be considered in the estimation of costs for trail construction and maintenance programs. The establishment of well-defined trail types, guidelines, and priorities facilitates the provision of consistent, high-quality trail experiences to residents of and visitors to the County of Los Angeles.

The Trails Manual sets guidelines for all trails under the jurisdiction of the LACO-DPR. Trails within the jurisdiction of the LACO-DPR include unpaved trails, also known as soft trails; however, small portions of such trails may be paved (pavement can extend up to approximately 100 feet on a soft trail). Fully paved trails, also known as hard trails, are under the jurisdiction of the County of Los Angeles Department of Public Works (LACO-DPW).

The framework for planning, design, entitlement, construction, operation, and maintenance of trails will affect the network of trails within the County of Los Angeles, including unincorporated territories of the County. The framework is to provide County residents and visitors with an enjoyable recreational experience consistent with the provisions of the County of Los Angeles General Plan.

The geographic scope of the Trails Manual is limited to the unincorporated territory of the County of Los Angeles, while the incorporated cities in the County of Los Angeles have the purview to establish policies and guidelines that meet the needs of their respective jurisdictions. The Trails Manual is not retroactive to existing trails. The Trails Manual recognizes the entire Los Angeles County as a whole and not just a specific area or city. The Trails Manual is intended to provide guidelines for the diverse topography and environmental conditions that occur throughout the County of Los Angeles. The Trails Manual was specifically designed to be able to be adopted by cities who share the County's multi-use trail planning policy.

This manual does not intend to supplant, nor is it capable of supplanting, trained, experienced, and skilled trail supervisors and workers. For experienced personnel, the manual is intended only to supplement knowledge and provide a resource for operational guidance. However, the manual can provide a base knowledge of trail design, construction, and management practices for the inexperienced manager or supervisor.

**This manual does not create any binding legal or procedural requirements regarding trail planning, design, construction, or implementation, nor does it limit the discretion of the County of Los Angeles to deviate from the recommendations and guidelines contained in this Trails Manual based on specific situations or unique site**

**conditions. Consistent with the overarching goal of the County and the LACO-DPR to increase the number of trails available to users, the environment, topography, and many other factors may necessitate a deviation from the recommendations and guidelines contained in this Trails Manual.** [Emphasis added.]

## 1.4 TRAILS MANUAL DEVELOPMENT

The Trails Manual is an independent document and project, which references other County and Department documents for clarity. Preparation of the Trails Manual project was initiated in July 2010. The guidelines provided in this Trails Manual are based on an extensive literature review of trail design standards and specifications; outreach to trail planning, design, and maintenance professionals at federal, state, county, and local agencies; outreach to community-based trail advocacy groups, including the Altadena Crest Trail Restoration Working Group (ACTRWG) and the La Cañada Flintridge Trails Council; site-specific investigations of existing County trails and other trails located within the County; and consulting input from a variety of technical specialists, including landscape and trail planners and designers, environmental analysts, biologists, cultural resource specialists, geologists, and trail construction specialists. Numerous trail guidelines were evaluated, including U.S. Department of Agriculture Forest Service specifications and the Trail Construction and Maintenance Notebook,<sup>7,8</sup> California State Parks Trails Handbook,<sup>9</sup> Santa Monica Mountains Area Recreation Trails Coordination Project Final Summary Report,<sup>10</sup> San Diego County Trails Program,<sup>11</sup> and general trail design publications such as *Natural Surface Trails by Design*;<sup>12</sup> International Mountain Bicycling Association's

<sup>7</sup> U.S. Department of Agriculture Forest Service. September 1996. *Standard Specifications for Construction and Maintenance of Trails, EM-7720-103*. Contact: Forest Service, Engineering Staff, Washington, DC.

<sup>8</sup> U.S. Department of Agriculture Forest Service. April 2004. *Trail Construction and Maintenance Notebook*. Contact: Forest Service Missoula Technology and Development Center, 5785 Hwy, 10 West, Missoula, MT.

<sup>9</sup> California State Parks. 1998. *Trails Handbook*. Contact: California State Parks, Statewide Trails Office, P.O. Box 942896, Sacramento, CA.

<sup>10</sup> Santa Monica Mountains Area Recreation Trails Coordination Project. September 1997. *Final Summary Report*. Contact: SMMART Coordination Project, c/o Rivers, Trails and Conservation Assistance Program, National Park Service, 600 Harrison Street, Suite 600, San Francisco, CA 94107. Available at: <http://www.nps.gov/samo/parkmgmt/smmartreportsept1997.htm>

<sup>11</sup> San Diego County. 2005. *County Trails Program and the Community Trails Master Plan*. Contact: San Diego County Department of Parks and Recreation, Resource Management Division, 5201 Ruffin Road, Suite P, San Diego, CA.

<sup>12</sup> Parker, Troy Scott. 2004. *Natural Surface Trails by Design*. Boulder, CO: Natureshape LLC.

(IMBA) *Trail Solutions*;<sup>13</sup> *Trails for the Twenty-First Century: Planning, Design, and Management Manual for Multi-Use Trails*;<sup>14</sup> U.S. Forest Service's *Equestrian Design Guidebook for Trails, Trailheads and Campgrounds*;<sup>15</sup> and the Equestrian Trails, Inc.'s *Trails Manual*.<sup>16</sup>

The notice for the access to the Draft Trails Manual on the Trails Manual Web site and information on the six public meetings with at least one in each of the Supervisorial Districts was sent via e-mail to over five hundred (500) e-mail addresses, including all interested parties that participated in the scoping meetings for Trails Manual in fall of 2010. Approximately seventy-five (75) members of the public attended the six public meetings for the Draft Trails Manual in each of the Supervisorial Districts. The six public meetings in each of the Supervisorial Districts ended when all of the members of the public in attendance had provided all of their comments. Approximately three hundred (300) comments were received from the public meetings; via e-mail, Web site submissions, and letters; and from other agencies.

The County has determined that the Trails Manual is a ministerial project, consistent with the provision of Section 15268 of the State California Environmental Quality Act (CEQA) Guidelines and is exempt from CEQA. However, Section 3, Environmental Compliance for Trails, discloses that construction of a trail constitutes a "project" and is subject to the procedural provisions of CEQA.

Future updates of the Trails Manual are not anticipated on an annual basis, but will be conducted on an as-needed basis, at the discretion of the Director of the LACO-DPR or the Director's designee. The County would review the proposed updates to determine if they could potentially result in any environmental issues. If so, the project would undergo CEQA review, and if CEQA analysis is required, all required public scoping, noticing, and public review requirements would be undertaken. Environmental issues are defined in the State CEQA Guidelines.<sup>17</sup>

<sup>13</sup> International Mountain Bicycling Association. 2004. *Trail Solutions*. Boulder, CO: International Mountain Bicycling Association.

<sup>14</sup> Flink, Charles A., Kristine Olka, and Robert M. Searns. 2001. *Trails for the Twenty-First Century: Planning, Design, and Management Manual for Multi-Use Trails*. Washington, DC: Island Press.

<sup>15</sup> Hancock, Jan, Kim Jones Vander Hoek, Sunni Bradshaw, James D. Coffman, and Jeffrey Engelman. U.S. Department of Agriculture Forest Service, Technology and Development Program. 2007 [Reprinted 2009]. *Equestrian Design Guidebook for Trails, Trailheads, and Campgrounds*. Missoula, MT.

<sup>16</sup> Vogel, Charles. Equestrian Trails, Inc. 1982. *Trails Manual*. Sylmar, CA: Equestrian Trails, Inc.

<sup>17</sup> *California Code of Regulations*. Title 14, Division 6, Chapter 3, Sections 15000–15387, Appendix G.

---

## 1.5 RELATIONSHIP OF THE TRAILS MANUAL TO THE STRATEGIC ASSET MANAGEMENT PLAN FOR 2020

The SAMP<sup>18</sup> provides a strategic plan for development of recreational facilities and programs to serve the diverse needs of County residents and visitors through 2020, in light of existing deficiencies and anticipated population growth and recreation trends. The population of California is expected to grow to 45.4 million in 2020, leading the nation in job, population, and income growth.<sup>19</sup> Similarly, the incorporated and unincorporated population of the County is projected to grow to 11.6 million in 2020.<sup>20</sup> According to the SAMP, population growth, demographic shifts, and cultural variances cause changes in the need for passive and active recreational activities and programs to serve both the existing and future residents of the County.<sup>21</sup> The SAMP provides a tool for the prioritization of County resources for refurbishment of existing recreational facilities and the development of new facilities to meet the public demand and accommodate recreational programs over a planning horizon of 20 years. The data presented in the SAMP demonstrate that trail-based recreational activities, including hiking, horseback riding, and mountain biking, are expected to continue to increase in popularity, thus accelerating the wear and tear of existing trail facilities and exacerbating the existing Countywide deficiency for trails. In an effort to support advanced planning activities related to trails, the National Recreation and Park Association goal of providing 1 mile of trail per 1,000 people (approximately 50 feet of trail per person) and the assumed rate of 11 percent of the population engaged in the use of trails were used to anticipate existing and future demand for trails. As a reference, the County of San Diego utilizes a baseline level of service of 0.8 mile of trail per 1,000 residents.<sup>22</sup>

---

<sup>18</sup> County of Los Angeles Department of Parks and Recreation. April 2004. *Strategic Asset Management Plan (SAMP) for 2020*. Prepared by: County of Los Angeles Chief Executive Office and County of Los Angeles Department of Parks and Recreation, with technical assistance by Sapphos Environmental, Inc.

<sup>19</sup> U.S. Census Bureau. Last updated 15 July 2003. State and County QuickFacts, Los Angeles County, California. Web site. Available at: <http://quickfacts.census.gov/qfd/states/06/06037.html>

<sup>20</sup> U.S. Census Bureau. Last updated 15 July 2003. State and County QuickFacts, Los Angeles County, California. Web site. Available at: <http://quickfacts.census.gov/qfd/states/06/06037.html>

<sup>21</sup> County of Los Angeles Department of Parks and Recreation. April 2004. *Strategic Asset Management Plan (SAMP) for 2020*. Prepared by: County of Los Angeles Chief Executive Office and County of Los Angeles Department of Parks and Recreation, with technical assistance by Sapphos Environmental, Inc.

<sup>22</sup> San Diego County. 2005. *County Trails Program and the Community Trails Master Plan*. Contact: San Diego County Department of Parks and Recreation, Resource Management Division, 5201 Ruffin Road, Suite P, San Diego, CA.



## SECTION 2.0 TRAIL PLANNING

---

Consideration of regional context, project objectives, and the constraints and opportunities that each site presents is essential to the planning and construction of high-quality trails that will provide for the diverse needs of County of Los Angeles (County) residents and visitors. The trail planning process generally includes research and data gathering for the site, public outreach to stakeholders, and site-specific analysis and investigation of integration of and/interconnectivity of regional trail systems throughout Southern California. The results of the trail planning process will serve as the basis for a feasibility analysis of possible trail alignments that incorporate the goals and objectives of the project. Other factors that can be determined through the trail planning process and subsequent feasibility analysis are the anticipated cost for construction, operation, and maintenance of trails based on the physical characteristics of the site and the anticipated capacity of the trail. Recreation trends, as well as supply and demand data, can be used as the basis for analyzing the recreation planning objectives within a park planning area, a community plan, a specific plan, a master-planned community, or a project. Frequently, the trail planning process involves repeated refinement of trail segment options as new data are obtained and stakeholders are consulted. The quality of the final project will be directly related to the quality of the input provided during the project planning process (Figure 2-1, *Trail Planning Flowchart*). There are numerous useful trail construction and maintenance books, trail guidebooks, agencies that plan and direct trail projects, and suppliers of trail products that are useful during the trail planning process (Appendix B, *Trail Resources*).

It is the policy of the County of Los Angeles Department of Parks and Recreation (LACO-DPR) to accommodate multi-use trails (hiking, mountain biking, equestrian). Section 2 of the Trails Manual provides guidance for assessing the feasibility of accommodating multi-use as an element of the trail planning process. The Trails Manual acknowledges that it is not feasible, in all instances to accommodate all three uses on every trail. In addition, occasions arise where trails will not be open to multiple uses due to site-specific environmental constraints, which may necessitate limitations of a particular type of use.

### 2.1 STEP 1: DEFINE PROJECT GOALS AND OBJECTIVES

The first step in the trail planning process is to define the project goals and objectives that will guide the planning and design process. The LACO-DPR staff and developers will determine the goals and objectives of each trail or trail segment. There are several potential scenarios that result in the development of

trails within the unincorporated territory of the County. Where public funds are used to support the development of new trails, the County serves as the project proponent. In some instances, another federal, state, or local public agency may request an easement over lands administered by the County, and in that instance the public agency would be the project proponent. In some instances, a private entity may seek an easement across lands administered by the County, and in that instance the private entity would be the project proponent. Finally, when a party is seeking a discretionary land use entitlement from the County of Los Angeles, the approval of which is conditioned on providing a trail easement or construction, operation, and/or maintenance of a trail, the party seeking the entitlement is referred to as the developer. These goals and objectives may have to be updated as the project progresses and new data are obtained and stakeholders are consulted.

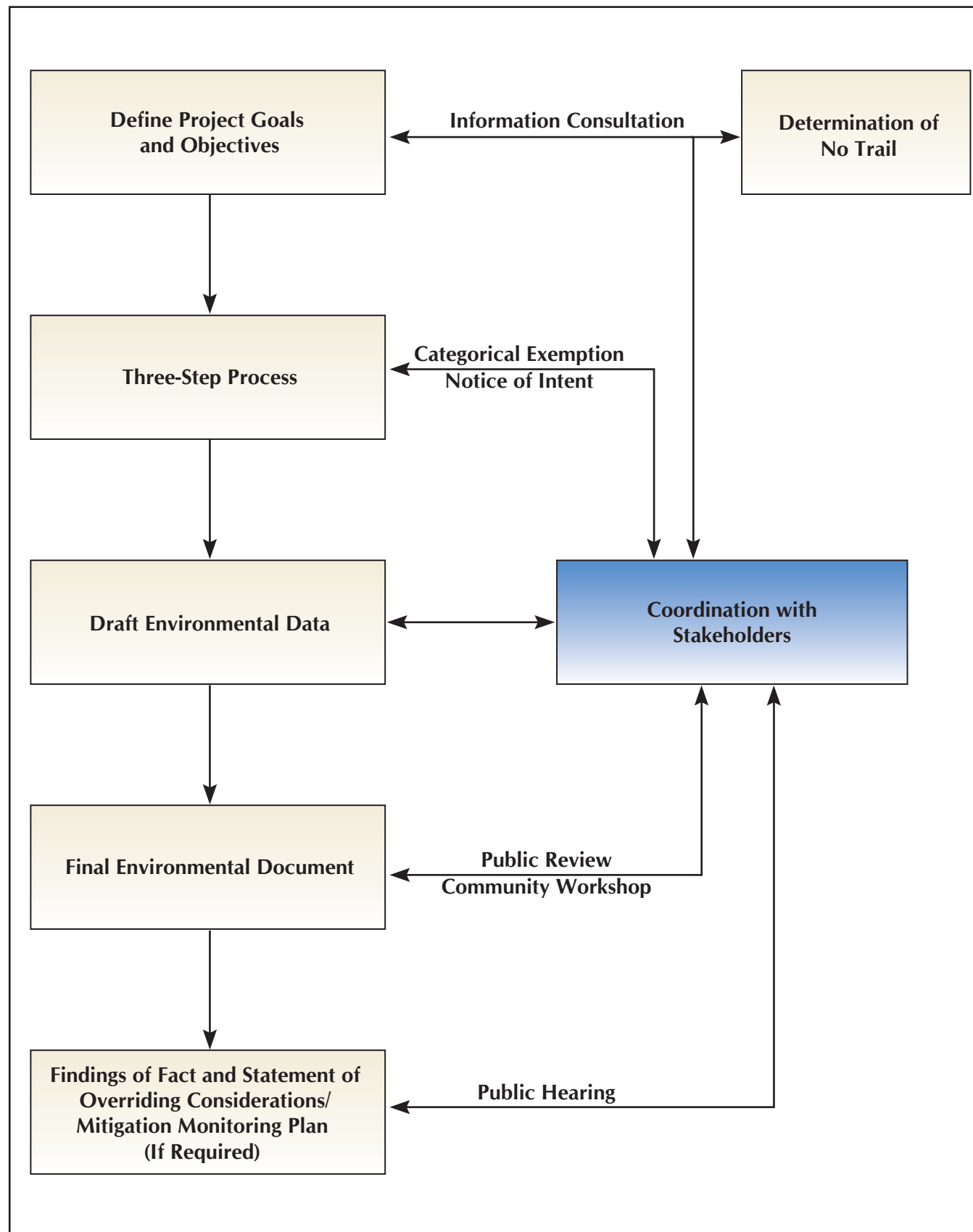
#### 2.1.1 Goal Statement

The goal statement is usually linked to an identified community need or in conjunction with a proposed development project. It is a statement of what the project is attempting to achieve. The goal statement for a trail project is linked to the type of need, as well as the geographic area where the need was identified.

#### 2.1.2 Project Objectives

The project objectives define standards that must be achieved for the project goals to be met. Project objectives are frequently linked to planning policies related to the level or quality of service that is intended to be provided to County residents and visitors. Whenever possible, the objectives should be tied into statutes, laws, and regulations; goals or policies of the adopted general plan; other relevant planning guidelines; and industry standards.

The stakeholder participation process is complex and affects all facets of project planning, entitlement, construction, operation, and maintenance. Appendix C, *Stakeholder Coordination*, provides additional information.



**Figure 2-1  
Trail Planning Flowchart**

**TABLE 2.2.1-1  
COUNTY STANDARDS FOR RECREATION SERVICE AREAS<sup>2</sup>**

Park Type	Characteristics
<b>Regional Facilities</b>	
Regional	Provide a service radius of up to 50 miles in distance or 1 hour in driving time Serve entire County population
Community Regional	Provide a service radius of up to 20 miles Serve an entire County population
<b>Local Parks</b>	
Community	Provide a service radius of 0.5 to 1.5 miles Serve a population of 4,000 to 25,000 residents
Neighborhood	Provide a service radius of up to 0.5 mile Serve a population of 1,250 to 5,000 residents

**2.2 STEP 2: EVALUATION OF RECREATIONAL TRAIL NEEDS IN THE SERVICE AREA**

The second step in the planning process is to determine the demand for trails within the service area. The County of Los Angeles General Plan establishes the goal and supporting policies to provide recreational resources to meet the diverse needs of County residents and visitors.<sup>1</sup> The demand for trails is a function of the size of the service area, the percent of the population who use trails, and number of miles of trails required to support each 1,000 people who are likely to be engaged in that activity.

**2.2.1 Defining the Service Area**

In general, the County uses a two-tier classification to defining the service area for recreational facilities: park types are characterized as either “regional facilities” or “local parks” (Table 2.2.1-1, *County Standards for Recreation Service Areas*). Trails can be developed to meet the needs of regional facilities or local parks. In addition, some trails are designed as part of the open space element of a community plan, specific plan, or master-planned community and, are by definition, intended to serve the anticipated residents and visitors within the land use planning area. Other trails may be designed as destination trails that would be expected to serve residents of, and visitors to, the entire County.

**2.2.2 Sources of Data for Service Area Demand Analysis**

There are a minimum of three sources of data to analyze existing land use and land use patterns that should be considered to define the existing population of the service area:

<sup>1</sup> County of Los Angeles Department of Regional Planning. 1965. *County of Los Angeles General Plan*. Contact: Department of Regional Planning, Hall of Records, 320 West Temple Street, Los Angeles, CA 90012.

- County of Los Angeles General Plan<sup>2</sup>
- Southern California Association of Governments Regional Comprehensive Plan<sup>3</sup>
- U.S. Census Bureau data

Use these same sources of information to determine projected demand in the service area through the planning horizon established by the appropriate planning guidance document. Existing and projected population should be based on the most recent data available from the U.S. Census Bureau at the census tract level, and supplemented as appropriate by project-specific planning data that reflect the number of anticipated residents, employees, and visitors.

**2.2.3 Demand Analysis**

The County Strategic Asset Management Plan (SAMP) provides the existing and anticipated demand for trails in the County in relation to national opinion polls, supplemented by statewide data, and directed surveys of County recreational users. An analysis of trails demand can be based on participation rates from the National Statistical Abstracts recreation participation rate.<sup>4</sup> These rates are derived from a survey conducted nationwide by the National Sporting Goods Association.<sup>5</sup> Actual participation rates in the County will vary from national data due to factors such as climate, topography, and demographics. For the purposes of evaluating and planning the demand for trails, the SAMP used the goal of providing 1 mile

<sup>2</sup> County of Los Angeles Department of Regional Planning. 1965. *County of Los Angeles General Plan*. Contact: Department of Regional Planning, Hall of Records, 320 West Temple Street, Los Angeles, CA 90012.

<sup>3</sup> Southern California Association of Governments. January 1995. *Regional Comprehensive Plan and Guide*. Los Angeles, CA.

<sup>4</sup> U.S. Census Bureau. Last updated 4 January 2006. “Arts, Entertainment, and Recreation.” In *Statistical Abstract of the United States: 2004-2005*. Available at: <http://www.census.gov/prod/2005pubs/06statab/arts.pdf>

<sup>5</sup> National Sporting Goods Association. Last updated 2006. *Sports Participation in 2002: Series I and Series II*. Mt. Prospect, IL.

per population of 1,000 (approximately 50 feet of trail for each trail user) and an assumption that approximately 11 percent of the population will engage in trail use, as specified by the National Recreation and Park Association.

### Calculation of Existing Demand

Existing demand (in miles) =  $\frac{\text{Existing population} \times 11 \text{ percent} \times 50 \text{ feet}}{5,280 \text{ feet/mile}}$

### Calculation of Planning Horizon Projected Demand

Projected demand (in miles) =  $\frac{\text{Projected population} \times 11 \text{ percent} \times 50 \text{ feet}}{5,280 \text{ feet/mile}}$

## 2.3 STEP 3: INVENTORY OF EXISTING TRAILS AND RECREATIONAL RESOURCES

The third step in the trail planning process is the inventory of existing trails, their features, and related recreational resources. The inventory consists of identifying existing trails in the service area that will serve as the basis for determining the number of miles of anticipated unmet need. The jurisdictional ownership of the trails should be noted. Changes in jurisdiction may occur along a trail, as it progresses through cities and various unincorporated communities. These changes should be taken into consideration in the trail planning process, particularly the importance of providing notification at trailheads that states allowable users or trail conditions that may change when crossing jurisdictional boundaries.

The LACO-DPR planning staff will also review Community Standards Districts (CSDs) when applicable. CSDs may help in providing useful information with regard to inventory. In addition, any applicable CSDs may have more stringent guidelines that are applicable in a particular community of the County. Where sufficient documentation of the existing network of trails is not available, a field inventory may be necessary. A field inventory would require surveying the existing trail network with global positioning system (GPS) units. Coordination with the Los Angeles Region Imagery Acquisition Consortium (LAR-IAC) should be undertaken to document the inventory of existing trails. Destination features such as unique biological, cultural, geological, hydrological, recreational resources, and viewpoints of interest within the proposed service area should be identified on the map. However, care should be taken in safeguarding localized data for historic or archaeological resources that may be vulnerable to vandalism or unauthorized collection. Schools, transportation hubs, and other special “nodes” may also need to be identified as potential links, destination points, access, and staging areas.

### 2.3.1 Sources of Information for Existing Trails and Recreational Resources

- County of Los Angeles General Plan<sup>6</sup>
- Community Standards Districts (CSDs)
- Los Angeles County Regional Recreation Areas Plan<sup>7</sup>
- “Shaping the Future 2025” Draft General Plan Conservation/Open Space element (in preparation)<sup>8</sup>
- Strategic Asset Management Program for 2020<sup>9</sup>
- County of Los Angeles Department of Parks and Recreation, A Parks and Recreation Strategic Plan for 2010<sup>10</sup>
- Los Angeles County Riding and Hiking Trails<sup>11</sup> - Planning Section
- County of Los Angeles Inventory of Park Facilities and Areas of Jurisdiction<sup>12</sup>
- Southern California Association of Governments Regional Comprehensive Plan<sup>13</sup>
- Metropolitan Transit Authority’s Long Range Transportation Plan<sup>14</sup>

<sup>6</sup> County of Los Angeles Department of Regional Planning. 1965. *County of Los Angeles General Plan*. Contact: Department of Regional Planning, Hall of Records, 320 West Temple Street, Los Angeles, CA 90012.

<sup>7</sup> County of Los Angeles Department of Regional Planning. 1986. *Los Angeles County Regional Recreation Areas Plan* Contact: Department of Regional Planning, Hall of Records, 320 West Temple Street, Los Angeles, CA 90012.

<sup>8</sup> County of Los Angeles Department of Regional Planning. 2005. *Draft General Plan Conservation/Open Space Element*, “Shaping the Future 2025.” Contact: Department of Regional Planning, Hall of Records, 320 West Temple Street, Los Angeles, CA 90012.

<sup>9</sup> County of Los Angeles Department of Parks and Recreation. April 2004. *Strategic Asset Management Plan (SAMP) for 2020*. Prepared by: County of Los Angeles Chief Executive Office and County of Los Angeles Department of Parks and Recreation, with technical assistance by Sapphos Environmental, Inc.

<sup>10</sup> County of Los Angeles Department of Parks and Recreation. May 1992. *A Parks and Recreation Strategic Plan for 2010*. Contact: 433 South Vermont Avenue, 4th Floor, Los Angeles, CA 90020.

<sup>11</sup> County of Los Angeles Department of Parks and Recreation. 2001. *Los Angeles County Riding and Hiking Trails*. Contact: 433 South Vermont Avenue, Los Angeles, CA 90020.

<sup>12</sup> County of Los Angeles Department of Parks and Recreation. 2003. *County of Los Angeles Inventory of Park Facilities and Areas of Jurisdiction*. Contact: Department of Regional Planning, Hall of Records, 320 West Temple Street, Los Angeles, CA 90012.

<sup>13</sup> Southern California Association of Governments. January 1995. *Regional Comprehensive Plan and Guide*. Los Angeles, CA.

<sup>14</sup> County of Los Angeles Metropolitan Transit Authority. 2001. *Long Range Transportation Plan for Los Angeles County*. Contact: Metropolitan Transit Authority, One Gateway Plaza, Los Angeles, CA

- Federal- and state-level recreational need assessment evaluations developed by federal and state resource agencies, including the U.S. Forest Service’s Angeles National Forest Land and Resources Management Plan,<sup>15</sup> the California Outdoor Recreation Resource Plan (CORRP),<sup>16</sup> and the 2005 California Recreation Policy<sup>17</sup>
- Universal Trail Assessment Process (UTAP)
- USGS topographic maps (1:24,000 scale) available at: <http://www.usgs.gov>
- Forest Service maps available at: <http://www.fs.fed.us/maps>
- Tom Harrison maps available at: <http://www.tomharrisonmaps.com>
- LAR-IAC maps available at: <http://planning.lacounty.gov/LARIAC/>
- Los Angeles River Revitalization Master Plan<sup>18</sup>
- San Gabriel River Master Plan<sup>19</sup>
- Puente Hills Landfill Native Habitat Preservation Authority (Habitat Authority) Resource Management Plan (RMP)

### 2.3.2 Supply Analysis

The analysis of trail supply is based on summing the total distance of all the trails available in the service area.

### Calculation of Existing Supply

Existing supply = Sum of all existing trail segments in the service area

<sup>15</sup> 90012. Available at: [http://www.mta.net/projects\\_plans/bikeway\\_planning/default.htm](http://www.mta.net/projects_plans/bikeway_planning/default.htm)

<sup>16</sup> U.S. Department of Agriculture Forest Service. 1987. *Angeles National Forest Land and Resources Management Plan*. Contact: Forest Service Pacific Southwest Region, 1323 Club Drive, Vallejo, CA 94592.

<sup>17</sup> California Department of Parks and Recreation. Revised June 1974. *California Outdoor Recreation Resource Plan (CORRP)*. Contact: California Department of Parks and Recreation, 1416 9th Street, Sacramento, CA 95814.

<sup>18</sup> California Department of Parks and Recreation. 2005. *2005 California Recreation Policy*. Contact: California Department of Parks and Recreation, 1416 9th Street, Sacramento, CA 95814. Available at: [http://www.parks.ca.gov/pages/795/files/rec\\_policy\\_final\\_2005.pdf](http://www.parks.ca.gov/pages/795/files/rec_policy_final_2005.pdf)

<sup>19</sup> City of Los Angeles. April 2007. *Los Angeles River Revitalization Master Plan*. Available at: <http://www.larivermp.org/>

<sup>20</sup> County of Los Angeles Department of Public Works. June 2006. *San Gabriel River Master Plan*. Available at: [http://dpw.lacounty.gov/wmd/watershed/sg/mp/docs/SGR\\_MP.pdf](http://dpw.lacounty.gov/wmd/watershed/sg/mp/docs/SGR_MP.pdf)

### Calculation of Planning Horizon Projected Supply

Projected supply = Sum of all existing and entitled trail segments

## 2.4 STEP 4: CONCEPTUAL TRAIL ALIGNMENT

The fourth step in the planning process is to develop a conceptual trail alignment capable of meeting the project goals and objectives. The trail planning process must recognize and work within the inherent environmental site conditions to achieve as many of the basic objectives of the project as possible. The trail must also be designed to meet the basic requirements of expected users, as well as connect with existing trail segments. In addition, the trail alignment must be designed with engineering and aesthetic factors in mind, such as the topography and soil types, and the desired experience. Site reconnaissance and walking the proposed trail alignment is essential in the planning process.

This section includes information on trail types established for design guidelines. It is meant to be used to determine trail type based on planning focus. The following planning focus tables are meant to be used as a scoring system by the LACO-DPR planning staff. The LACO-DPR planning staff will be responsible for the planning and design, or review of planning and design undertaken by third parties in association with a discretionary land use decision being undertaken by the County of Los Angeles. Conformance of construction with approved plans will be subject to inspection by the County of Los Angeles Department of Public Works (LACO-DPW), while maintenance will be overseen by the LACO-DPR. The design guidelines for trails provided in Section 4.3, Application of Design Guidelines, are based on best management practices (BMPs) and serve as a means of standardizing trail development. While it is the goal of the LACO-DPR to have sufficient width for trails, sometimes it is not feasible in certain situations. Therefore, portions of a trail may include combinations of trail types due to site-specific minimum and maximum trail tread widths that were developed based on a thorough literature review of established standards and guidelines utilized by federal, state, and local agencies, including the Forest Service Trail Handbook, and the State of California Department of Parks and Recreation Trail Handbook, as well as consultation with trail building professionals (Table 2.4-1, *Trail Types*).<sup>20,21</sup> Generally, an 8-foot-wide Natural Trail 2 is the recommended trail type to be utilized throughout the County where site

<sup>20</sup> U.S. Department of Agriculture Forest Service. April 2004. *Trail Construction and Maintenance Notebook*. Contact: Forest Service Missoula Technology and Development Center, 5785 Hwy, 10 West, Missoula, MT.

<sup>21</sup> California State Parks. 1998. *Trails Handbook*. Contact: California State Parks, Statewide Trails Office, P.O. Box 942896, Sacramento, CA.

**TABLE 2.4-1  
TRAIL TYPES**

Trail Type	Tread Width	Intensity of Use	Impact to Existing Conditions	Surface Type
A. Urban Pedestrian Path	10 to 11 feet	High	High	Crusher fines / decomposed granite
B. Recreational Pathway	8 to 10 feet	High	High	Natural surface
C. Natural Trail 1	7 to 10 feet	High	Medium	Natural surface
D. Natural Trail 2	5 to 8 feet	Medium to high	Low	Natural surface
E. Natural Trail 3	2 to 3 feet	Low	Minimal	Natural surface

conditions support its use. Consistent with the Department of Justice’s revised Americans with Disabilities Act (ADA) regulations regarding trails,<sup>22</sup> throughout the trail development process, the LACO-DPR staff will consider which types of motorized vehicles can feasibly use each type of trail to provide access to the mobility disabled. “Feasibly” is defined as capability of being accomplished in a successful manner within a reasonable period of time, taking into account economic, environmental, social, and technological factors.<sup>23</sup>

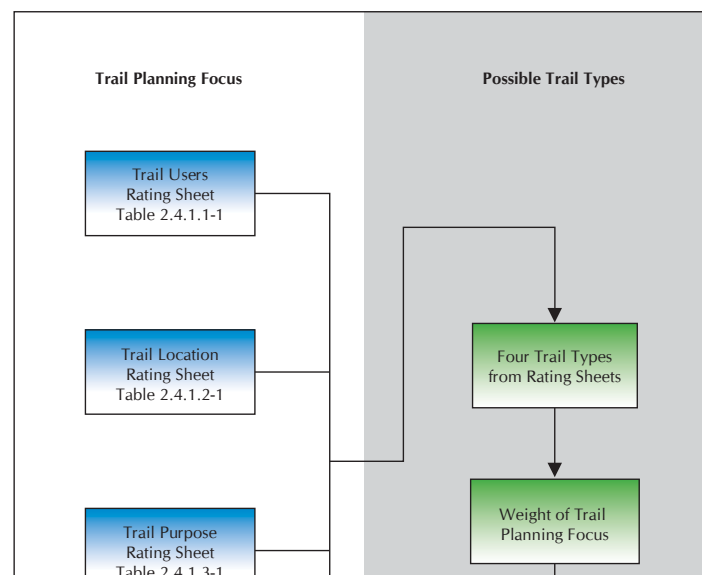
**2.4.1 Trail Types**

Trails can be categorized using multiple classification systems. This Trails Manual provides a method of classification based on planning and design criteria to determine the trail type appropriate for a particular site. This classification can also be utilized to determine trail maintenance priorities. It is at the discretion of the LACO-DPR staff to determine, on a case-by-case basis, the impact to users and which types of users can be accommodated on a trail. The LACO-DPR planning staff should evaluate a trail based on the four distinct planning focuses: trail user, trail location, trail purpose, and trail site conditions (Figure 2.4.1-1, *Trail Type Identification*). A trail may have four different recommended trail types. The final trail type is based on the particular planning focus of the project.

The planning focus of the trail can either be: 1) the trail users (hiker, equestrian, mountain biker, accessibility challenged) and their experience level, 2) the location (regional or local), 3) the purpose of the trail (connecting trails, interpretation, or a destination), and 4) the site conditions (sensitive areas). Well-planned, -designed, and -maintained trails are generally more dependant on site conditions such as soil type and slope. As a result, the trail site conditions planning focus should typically

<sup>22</sup> U.S. Department of Justice. Americans with Disabilities Act. “Revised ADA Regulations: Implementing Title II and Title III.” Available at: <http://www.ada.gov/regs2010/ADAregs2010.htm>

<sup>23</sup> California Code of Regulations. 2010. Title 14, Division 6, Chapter 2.5, Section 21061.1.



**Figure 2.4.1-1  
Trail Type Identification**

be the determining factor for the type of trail to construct. The four planning focus worksheets provide a scoring method to determine the type of trail that is suitable for a particular project. In addition, California State Parks has developed a unique classification system that provides guidance on setting maintenance priorities; this system is discussed later and cross-referenced with the trail types described in this Trails Manual.

**2.4.1.1 Trail Users**

The County of Los Angeles has an existing policy of accommodating multi-use trails wherever feasible, specifically hiking, mountain biking, and equestrian. Proper trail design should take into account the needs of expected user types, as well as the conditions of the proposed trail environment. Both the needs of the users and the conditions dictate the type of trail and trail-users. A goal of trail planning within the County is to design trails for use by hikers, equestrians, and mountain bikers. However, occasions arise where trails will not be open to multiple uses due to site-specific environmental constraints such as blue-line streams, which may necessitate limitations of

**TABLE 2.4.1.1-1  
TRAIL USER RATING PLANNING FOCUS WORKSHEET**

User Criteria	Criteria Ranking	Rating
Accessibility	5 to 1 (assign a higher number to more accessible trails)	
Frequency of use	3 to 1 (assign a higher number to more frequently used trails)	
User experience level	3 to 1 (assign a higher number when less experienced users are expected)	
Multiple user types	2 to 1 (assign a higher number when there are multiple user types)	
<b>Total:</b>		

**KEY:**  
 Total ≥ 11 equals Trail Type A, Urban Pedestrian Path  
 Total 10 to 11 equals Trail Type B, Recreational Pathway  
 Total 8 to 10 equals Trail Type C, Natural Trail 1  
 Total 6 to 8 equals Trail Type D, Natural Trail 2  
 Total < 6 equals Trail Type E, Natural Trail 3

a particular type of use. In such instances, hiking only or dual-use trails, such as hiking or mountain biking trails, may be appropriate. Table 2.4.1.1-1, *Trail User Rating Planning Focus Worksheet*, provides a list of criteria to determine the proper trail to develop based on users. Trails should be designed with the expected users in mind, and consider their experience level and recreational expectations. In highly urbanized areas, a lower user experience level can be anticipated and a trail of lower difficulty, such as Natural Trail 1 or Natural Trail 2, may be expected and welcomed by users.

**2.4.1.1.1 Accessible Trails**

In planning, trail usage steps should be taken to ensure accessibility for all potential trail users. Therefore, trail planning must take into account users’ various needs and conditions. In areas where it is feasible, trails should be located adjacent to already accessible trailheads and or accessible recreational elements, such as parks. It is also important to locate accessible trails that reach highly used destination areas such as waterfalls,

scenic vistas, or other points of interest. Trail alignments should be located in areas where grade and obstacles will not be a problem with accessible trails. This requires careful planning and route selection to ensure grades are ideally below 8 percent, widths are at least 36 inches, few protruding objects are present, tread obstacles are less than 2 inches in height, and that the surface is reasonably firm. Consistent with the Department of Justice’s revised ADA regulations regarding trails,<sup>24</sup> throughout the trail development process, the LACO-DPR staff will consider which types of motorized vehicles can feasibly use each type of trail to provide access to the mobility disabled. Additional information regarding designing accessible trails is provided in Section 4.3.1.1, *ADA Compliance*.

**2.4.1.2 Trail Locations**

The location of a trail in terms of its park setting or its distance from an urban or other open space setting may also determine the type of trail to be designed and designated. Table 2.4.1.2-1, *Trail Location Rating Planning Focus Worksheet*, provides a list

**TABLE 2.4.1.2-1  
TRAIL LOCATION RATING PLANNING FOCUS WORKSHEET**

Location Criteria	Criteria Ranking	Rating
Within local park	5 to 1 (assign a higher number to trails within or connected to a local park)	
Within regional park	3 to 1 (assign a higher number to trails close to a regional park )	
Adjacent to visitor facility	3 to 1 (assign a higher number to trails close to a visitor center)	
Parking access	2 to 1 (assign a higher number to trails with parking access)	
<b>Total:</b>		

**KEY:**  
 Total ≥ 11 equals Trail Type A, Urban Pedestrian Path  
 Total 10 to 11 equals Trail Type B, Recreational Pathway

<sup>24</sup> U.S. Department of Justice. Americans with Disabilities Act. “Revised ADA Regulations: Implementing Title II and Title III.” Available at: <http://www.ada.gov/regs2010/ADAregs2010.htm>



**TABLE 2.4.1.3-1  
TRAIL PURPOSE RATING PLANNING FOCUS WORKSHEET**

Purpose Criteria	Criteria Ranking	Rating
Connection of visitor centers	5 to 1 (assign a higher number to trails directly connecting to a visitor center)	
Connection of regional trails	2 to 1 (assign a higher number to trails connecting multiple trails)	
Interpretative trail	3 to 1 (assign a higher number to trails utilized for interpretative purposes within a park)	
Loop trail	2 to 1 (assign a higher number to loop trails)	
Destination trail	3 to 1 (assign a higher number to trails with a destination purpose, but reduce the number as the distance to the destination increases)	
<b>Total:</b>		

**KEY:**  
 Total ≥ 12 equals Trail Type A, Urban Pedestrian Path  
 Total 10 to 12 equals Trail Type B, Recreational Pathway  
 Total 8 to 10 equals Trail Type C, Natural Trail 1  
 Total 6 to 8 equals Trail Type D, Natural Trail 2  
 Total < 6 equals Trail Type E, Natural Trail 3

of criteria to determine the proper trail to develop based on the trail's location and distance to trail facilities. The type of trail to be built and maintained will differ depending on the location of the trail, such as in an urban park versus a National Forest or wilderness area. Urban trails, due to their locations in highly populated areas, are utilized by many people at different fitness levels for a range of reasons. Urban trails provide the public with better and healthier modes of transportation and easier access to nature and exercise. Specific considerations regarding urban trails can be found in Section 4.3.3.2, *Urban Trails*. Local trails will be utilized by local populations; therefore, depending on the expected intensity of use, Natural Trail 2 is recommended, but either Natural Trail 1 or 3 may be preferable based on site-specific conditions. Local trails can be close to areas with high population densities; therefore, local trails may experience a higher intensity of use and require a wider trail width to accommodate the increased number of users. Regional trails extend over large expanses of land, providing a continuous route around or through areas such as a mountain range or around the rim of a valley (e.g., Pacific Crest Trail is 2,650 miles long and passes through three states). Regional trails should typically be designed to adhere to guidelines for Natural Trail 2 or 3. Trails within parks should be designed for diverse users and therefore, utilize guidelines for Urban Pedestrian Path, Recreational Pathway, or Natural Trail 1.

**2.4.1.3 Trail Purpose**

The purpose of a trail is one of the most important considerations in design and construction. The purpose of a trail is a function of its intended result, end, aim, or goal, whether or not the purpose was a primary or secondary effect. Therefore, by definition, the purpose of a trail is a function of the location and the ability to serve as a stand-alone feature or provide a connection between features. The

purpose of a trail may be as simple as providing a walking / exercise path within a local park. Trails may also be a means of providing access to destination points of interest. A trail may serve as an educational or introspective venue when located in conjunction with natural or cultural resources. At the greatest scale, trails may serve as part of an infrastructure that provides an opportunity to explore regional resources by walking, hiking, horseback riding, or mountain biking. Trails within an urban park or adjacent to a visitor center should be designed for higher frequency of use and accessibility. The guidelines for Pedestrian Path, Recreational Pathway, and Natural Trail 1 are intended for these types of trails. The guidelines for Natural Trail 2 or 3 are intended for General LACO-DPR multi-use trails. Table 2.4.1.3-1, *Trail Purpose Rating Planning Focus Worksheet*, provides a list of criteria to determine the proper trail to develop based on the trail's intended purpose and connection to other trails or to trail facilities.

**2.4.1.4 Trail Site Conditions**

In addition to selecting a type of trail based on the expected user, trail location, and intended purpose, trail planning must also consider the specific site conditions and areas to avoid, specifically areas of steep terrain, areas adjacent to blue-line streams or oak trees, areas that cross wetlands, or areas with highly erodible soils or other environmentally sensitive features identified during the feasibility analysis for the trail. Table 2.4.1.4-1, *Trail Site Conditions Rating Planning Focus Worksheet*, provides a list of criteria to determine the proper trail to develop based on the physical environmental where the trail is located. Trails should be designed to avoid environmentally sensitive features by evaluating feasible alternative routes or at least minimize potential impacts to the maximum extent practicable. In areas where sensitive site conditions exist, a reduction in the impact of the trail will require a reduction

**TABLE 2.4.1.4-1  
TRAIL SITE CONDITIONS RATING PLANNING FOCUS WORKSHEET**

Site Conditions Criteria	Criteria Ranking	Rating
Sensitive environment	3 to 1 (assign a lower number to trails crossing or located in sensitive environments)	
Landslide and rock fall risk	5 to 1 (assign a higher number to trails where landslide and rock fall is an issue due to the high number of users or types of users)	
Developed or urban location	3 to 1 (assign a higher number to trails that occur in or originate in developed locations)	
<b>Total:</b>		

**KEY:**  
 Total ≥ 11 equals Trail Type A, Urban Pedestrian Path  
 Total 10 to 11 equals Trail Type B, Recreational Pathway  
 Total 8 to 10 equals Trail Type C, Natural Trail 1  
 Total 6 to 8 equals Trail Type D, Natural Trail 2  
 Total < 6 equals Trail Type E, Natural Trail 3

in the width of the trail. The design, construction, operation, and maintenance of trails must be in conformance with the applicable Basin Plan adopted by the Regional Water Quality Control Board. In areas with site-specific environmental constraints, trails should adhere to the guidelines for Natural Trail 3 to reduce impacts to the surrounding environment and reduce trail construction and maintenance costs.

**2.4.1.5 Trail Type Identification**

The final trail type is identified based on the rating sheets for trail user, trail location, trail purpose, and trail site conditions. Table 2.4.1.5-1, *Example Trail Type Identification*, provides an example of trail type identification using the four worksheets. After collecting the results of the four rating sheets, the LACO-DPR planning staff must determine which criterion is the most important for the trail and assign a correspondingly greater or lesser weight to each criterion. Typically, the trail site conditions criterion should be assigned the greatest weight for determining the trail type; however, if the trail will be located in a very densely populated area, have a high number of user types, and have a variety of user types, the trail user criterion should be assigned the greatest weight.

**TABLE 2.4.1.5-1  
EXAMPLE TRAIL TYPE IDENTIFICATION**

Criteria	Trail Type*	Score
Trail user	Trail Type C, Natural Trail 1	9
Trail location	Trail Type D, Natural Trail 2	7
Trail purpose	Trail Type D, Natural Trail 2	7
Trail site conditions	Trail Type E, Natural Trail 3	4
<b>Final Trail Type:</b>	Trail Type E, Natural Trail 3	

**KEY:**  
 \* From each of the four rating sheets

**2.4.2 California State Parks Maintenance Evaluation System**

The LACO-DPR reviewed the California State Parks Department's trail maintenance classification system and determined that many aspects of the trail maintenance classification are relevant to the County's consideration. The California State Parks Department includes a trail maintenance classification system (Table 2.4.2-1, *State Parks Trail Maintenance Classification Matrix*) to allow managers to follow maintenance and design standards, and to assign work priorities that are consistent with a trail's primary function, environmental sensitivity, and relationship to developed facilities and visitor use.<sup>25</sup> Managers can use this system to determine which trails should have priority for maintenance based on numerous criteria that include intensity of use, location, and types of users. The LACO-DPR staff will use this to follow maintenance and design standards. By utilizing the table, one can determine those trails that should have a higher trail maintenance priority on a typical basis. State Parks Class I trails are assigned the highest value for trail construction and maintenance, and therefore would have the highest priority.

<sup>25</sup> California State Parks. 1998. *Trails Handbook*. Contact: California State Parks, Statewide Trails Office, P.O. Box 942896, Sacramento, CA.

**TABLE 2.4.2-1  
STATE PARKS TRAIL MAINTENANCE CLASSIFICATION MATRIX**

Criterion	Point Value	Rating
Handicapped accessible	20	
Interpretive	20	
Within visitor use facility	20	
Equestrian and mountain bike	15	
Adjacent to visitor use facility		
a. 0–1/4 mile	12	
b. 1/4–1 mile	8	
c. 1–2 miles	4	
d. 2 or more miles	0	
Connection of visitor use facilities	5	
Parking access	5	
Destination oriented		
a. 0–1 mile	3	
b. 1–3 miles	2	
c. 3+ miles	1	
Connection with other agency trail	+3 to +5	
Special use or access	1	
Dead end trail	0 or –3	
Loop or connecting trail	+1 to +3	
Fragile environment		
a. Protected by lessening use	–1 to –3	
b. Protected by upgrading	+1 to +3	
Safety factors		
a. Encourage less use by not providing improvements	–1 to –5	
b. Provide and maintain improvements	0 to +5	
Staff determined use patterns		
a. Little or no use	–1 to –3	
b. Higher use	+1 to +3	
	<b>Total:</b>	

**KEY:**  
 Rating of 20+ = Class I trail  
 Rating of 10 to 19 = Class II trail  
 Rating of 5 to 9 = Class III trail  
 Rating of 0 to 4 = Class IV trail

However, situations may arise that would require work to be conducted on a State Parks Class IV trail before a State Parks Class I Trail. The placement of trails into these classes is determined by adding the values placed in the rating column for each criterion; the sum will determine into which class a trail falls. The LACO-DPR staff should regularly check for updates to these standards and use them accordingly.

**Class I**

This trail class includes ADA-accessible, equestrian, mountain biking, interpretive, and hiking trails. Consistent with the Department of Justice’s revised ADA regulations regarding trails,<sup>26</sup> throughout the trail development process, the LACO-DPR staff will consider which types of

<sup>26</sup> U.S. Department of Justice. Americans with Disabilities Act. “Revised ADA Regulations: Implementing Title II and Title III.” Available at: <http://www.ada.gov/regs2010/ADAREgs2010.htm>

motorized vehicles can feasibly use each type of trail to provide access to the mobility disabled. Class I trails may include gravel, turnpikes, puncheon, or other drainage structures in areas of trail trenching, trampling, multiple trails, or saturated trail beds for resource protection and visitor safety. The trail tread varies from 30 inches to 48 inches depending on site conditions. Due to the high use of this class of trail, numerous bridges, drainage structures, and retaining structures may be utilized. This trail class would include Urban Pedestrian Path, Recreational Pathway, Natural Trail 1, and Natural Trail 2.

**Class II**

This trail class includes hiking trails providing access into regions away from developed visitor use facilities. Native material is used for trail tread. The trail tread will be 18 to 24 inches. Some structures and bridges may be necessary for this trail class. This trail class would include Recreational Pathway, Natural Trail 1, and Natural Trail 2.

**Class III**

The trail class includes lightly used hiking trails. The trail tread ranges between 12 to 18 inches and utilizes native materials for the trail tread. These trails have little to no drainage or crossing structures. This trail class would include Natural Trail 1, Natural Trail 2, and Natural Trail 3.

**Class IV**

This trail class includes special use and access trails. The trail tread is minimal in size but wide enough to provide safe footing. The trail class should avoid use of any structure or drainage control. This trail class would include Natural Trail 3.

**2.4.3 Alignment Layout**

The trail conceptualization process must include the initial alignment layout, which is designed based on control points, topography, and desired trail experience. General design specifications, including visibility, steepness of trail alignment, adequate passing space, and turnouts in steep terrain, should be taken into consideration in developing a conceptual trail alignment in relation to providing a safe recreational experience.

**2.4.3.1 Control Points**

When aligning a trail, it is essential to develop a set of control points for a trail alignment. Positive and negative features should be used as control points to provide a richer trail experience, as well as protection for the surrounding open space and sensitive areas (Figure 2.4.3.1-1, *Example Control Points*). Positive features are those for which a trail should be designed to reach, such as a waterfall, historic site, scenic viewpoint, or a connection with another trail. Negative features are those that a trail should avoid, such as a critical habitat or hazardous terrain.<sup>27</sup> The most crucial positive control points are the starting and ending points for a trail. Consideration must be given to how users will access the trail. Oftentimes, parks and other recreation facilities with amenities such as parking, comfort stations, and other site amenities, serve as excellent trailheads. Control points should direct the path of a trail and ensure that trails avoid areas that will pose a hazard to users or will cause excessive damage to natural resources. In many instances, a blue-line stream and or wetland would be classified as a negative control point. However, in some instances the goal of the trail is to provide access to water bodies where the Basin Plan adopted by the Regional Water Quality Board identifies the water body as being suitable for body contact recreation

<sup>27</sup> International Mountain Bicycling Association. 2004. *Trail Solutions*. Boulder, CO: International Mountain Bicycling Association.

or the water body provides an important visual or aesthetic experience. In some instances, urban and suburban areas might be considered a positive control point. Moreover, facilities, and residential and commercial land uses may also qualify as positive control points. In general, trail alignments should be developed to avoid urban and suburban areas and provide the user with an open space experience. Choose an alignment that provides good opportunities for future realignment of the trail should that become necessary. Look for conveniently spaced flat areas where climbing turns and switchbacks can be easily built. Finally, create alignments that traverse slopes in a curvilinear fashion, and stagger switchbacks for a more attractive and durable trail. Switchbacks should be minimized to the maximum extent practicable through the initial design layout and utilized where required to gain elevation within a reasonable grade. Good initial design of a trail alignment is the best management tool available.

**Positive Control Points:**

- Existing trailheads
- Local parks
- Regional parks
- Federal and state parks and public lands
- Natural and open space areas
- Natural habitats
- Unique geological or natural features
- Existing trails
- Paleontological, archaeological, or historic sites
- Scenic vistas

**Negative Control Points:**

- Blue-line streams
- Wetlands
- Habitat for sensitive species
- Private landholdings
- Urban areas
- Street crossings
- Off-highway vehicle recreation areas

**2.4.3.2 Topography**

The conceptual alignment should strive to reduce excessive trail grades by following the natural contours of the land, thus reducing the need for and use of switchbacks. This can be accomplished by having the conceptual trail follow contour lines on a USGS topographic map or LAR-IAC imagery to the maximum extent practicable. When laying out a trail that must gain elevation, it is preferable to increase the length of the trail segment to progress across contour lines to ensure that the trail grade is not excessive. As the trail grade increases, erosion on the trail will become a constraint on trail development and



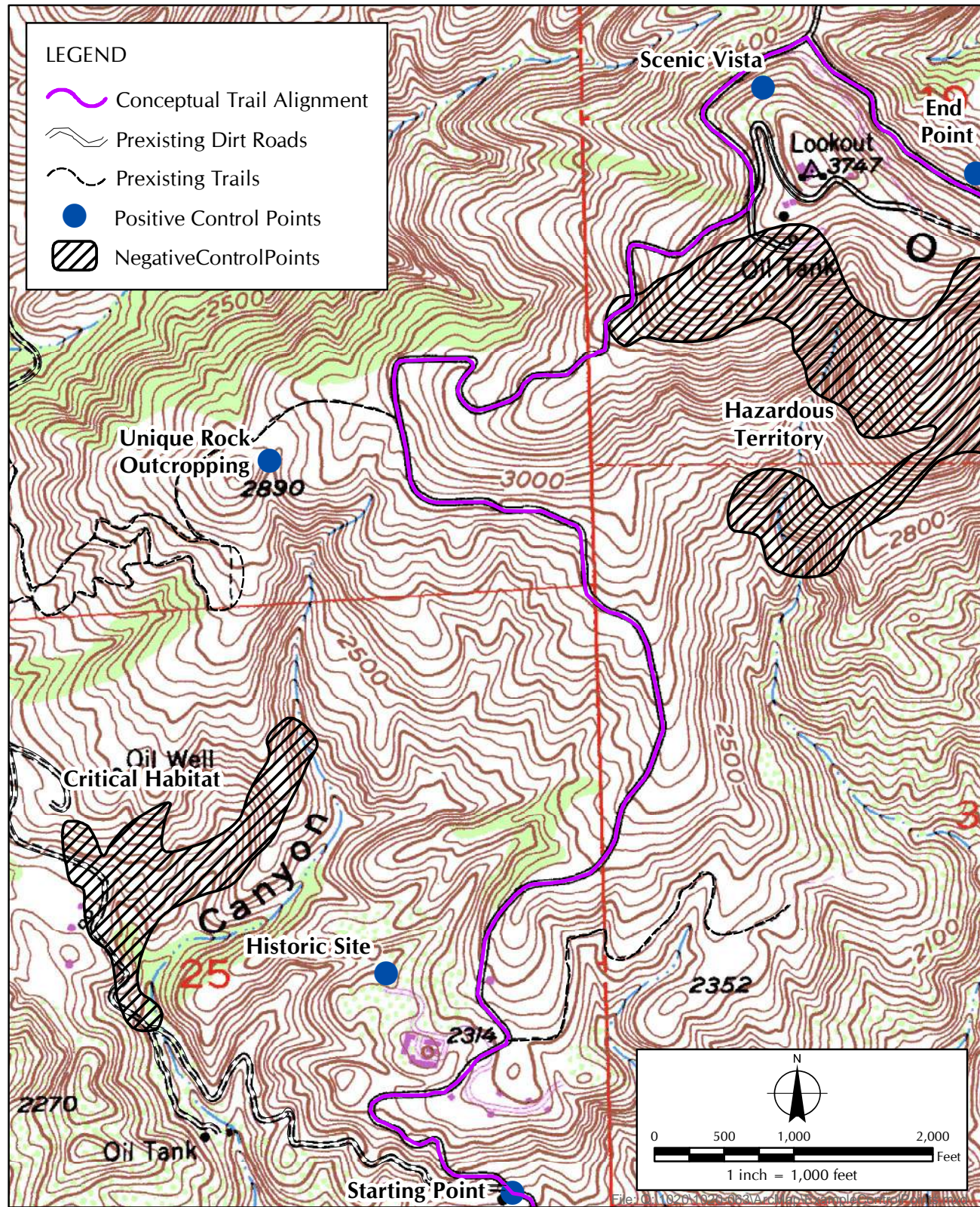


Figure 2.4.3.1-1 Example Control Points

maintenance.

### 2.4.3.3 Trail Experience

Many users, especially those from urban areas, expect a trail to provide more than a cleared path from one place to another. They are looking for an experience that may include the natural environment, beautiful landscape features and panoramic views, photographic opportunities, a place to have a picnic, a challenging physical experience, or simple serenity. Users may also wish to avoid dangerous cliffs, visual blight, or poisonous plants. To provide a good trail experience while protecting surrounding natural features, plants, and animals, land managers can identify sensitive areas where users would have negative impacts or where building a trail may contribute to washouts or mudslides.

In situations where a LACO-DPR soft, unpaved trail will parallel a flood control channel paved trail, at this time, the LACO-DPR does not have standards specific to trails along river channels.

Trail design, layout, and construction should strive for creating a stimulating and emotive experience at every turn. In order to provide the optimal recreational benefits for trail users, consider the following design strategies during trail design and utilize these strategies to create and blend the types of experiences for a trail user as described in *Natural Surface Trails by Design*.<sup>28</sup>

**Natural Shapes.** Natural shapes refers to designing a trail to incorporate natural forms and may be defined by words such as “rough,” “rustic,” and “wild.” Trails should follow the contours of the landform and general topography in a way that blends with the landscape. Straight lines, constant-radius curves, and predictable curvilinear lines should very rarely be used in trail design (Figure 2.4.3.3-1, *Natural Shapes*).



Figure 2.4.3.3-1 Natural Shapes

**Anchors.** Anchors are visual markers that attract a trail user’s attention and compel the trail user to move toward the anchor, be it an interesting rock, tree, or an exposed bluff. An anchor is similar to a control point for a trail in that it influences the path of the trail. Anchors should be located at the end of all trail switchbacks to provide an incentive to stay on the trail and reward the user with a point of interest. Anchors should be used intermittently throughout the trail to enhance the variety of experiences that the trail has to offer (Figure 2.4.3.3-



Figure 2.4.3.3-2 Anchors

2, *Anchors*).

**Edges.** Edges are a type of anchor because they capture a trail user’s interest. Edges occur at the intersection of two different features, for example, a river’s edge, a cliff’s edge, or the edge at a stand of trees. Edges are generally intriguing places to be, and trails should explore edgeways by following, crossing, crisscrossing, and interacting with them in a variety of ways



Figure 2.4.3.3-3 Edges

(Figure 2.4.3.3-3, *Edges*).

<sup>28</sup> Parker, Troy Scott. 2004. *Natural Surface Trails by Design*. Boulder, CO: Naturoshape LLC.



**Gateways.** Gateways occur when there are strong anchors on both sides of the trail. Gateways create a psychological threshold for the trail user and should be used to enhance the drama of major shifts in scenery or to introduce an interesting view. Gateways are used in a more standard way at the start of a trail as a psychological introduction to the natural world



**Figure 2.4.3.3-4 Gateways**

experience (Figure 2.4.3.3-4, *Gateways*).

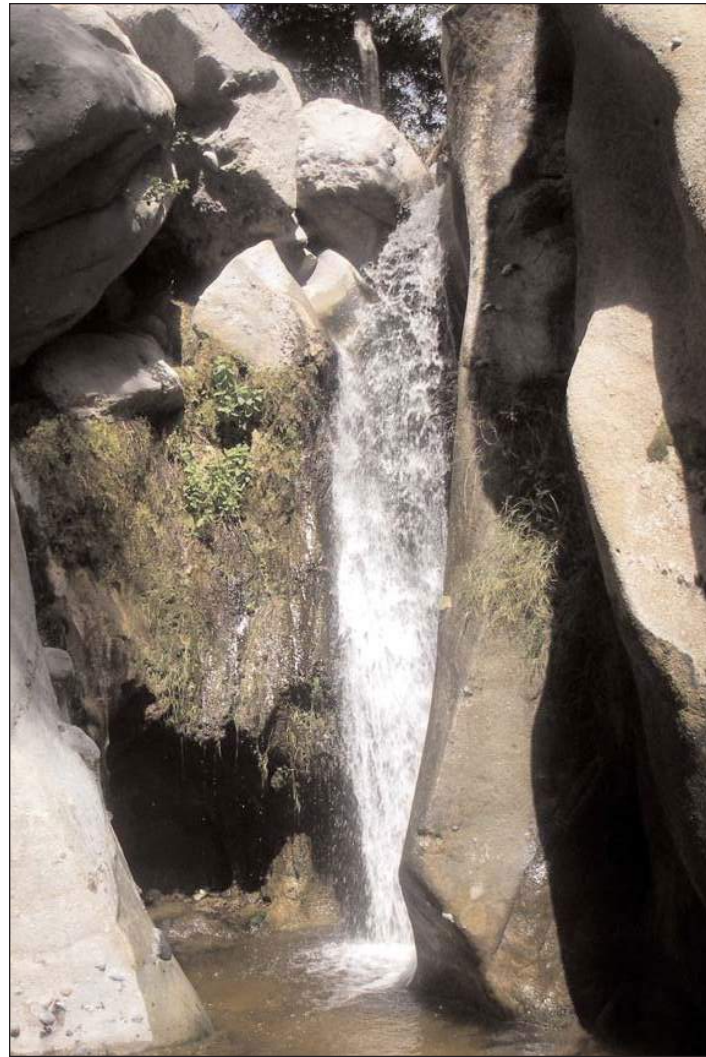
**Vistas.** A visually exciting composition can occur when a trail sets up an interesting combination of foreground and background views. Trails should introduce scenic views with



**Figure 2.4.3.3-5 Vistas**

a sense of layering and give views a sense of depth (Figure 2.4.3.3-5, *Vistas*).

**Playfulness.** Playfulness with trail planning means incorporating interesting features just for the sake of having trail users interact with them. This may be providing access to a group of rock outcroppings for opportunities to scramble up a boulder for sheer fun or to reach a higher vista point, or to



**Figure 2.4.3.3-6 Playfulness**

access a waterfall to take a refreshing splash in the pool (Figure 2.4.3.3-6, *Playfulness*).

**Harmony.** Harmony results from a properly designed trail that utilizes natural shapes, visual anchors, natural edges, gateways, and aesthetically pleasing combinations of views at different



**Figure 2.4.3.3-7 Harmony**

depths. Harmony is accomplished in trail design when the trail feels like it belongs to and was created by the natural landscape (Figure 2.4.3.3-7, *Harmony*).

#### 2.4.4 Easements

Conservation or trail easements are a commonly used strategy to help trail projects on private lands move forward. A conservation easement is a legal agreement between a landowner and an eligible organization, such as a public agency or nonprofit organization, which restricts future activities or uses on the land, such as development. If a private landowner creates an easement for trail use, the easement can be donated or granted directly to the County. Trail easements can also be overlain on fire road and flood control easements. However, not all granted trail easements have existing trails or pathways and, consequently, a trail must be constructed on those easements. The trail easement width and the trail tread width is site dictated. The trail easement width is larger than the trail tread constructed to provide a buffer for the private landowner and trail users.

### 2.5 STEP 5: FEASIBILITY ANALYSIS

The final step in the trail planning process is the assessment of feasibility. A feasibility analysis assesses the proposed trail alignment with regard to engineering, environmental, economic, and social opportunities and constraints. The County of Los Angeles has an existing policy of accommodating multi-use trails wherever feasible, specifically hiking, mountain biking, and equestrian. The feasibility analysis outlined in this section is a sample approach that can be modified by adding or removing particular parameters to make it applicable to a specific trail project. However, the general approach of analyzing engineering, environmental, economic, and social factors is recommended. The level of detail provided is not applicable to all situations and can be reduced or expanded where needed.

#### 2.5.1 Engineering Factors

Engineering opportunities and constraints should be analyzed by considering the various phases of the permitting, environmental review, design, and feasibility processes that must occur before and during trail construction. Some of these considerations include excavation, grading, drainage, and erosion control for trail construction. A “feasible” alignment would not require substantial engineering specifications or review. A “feasible, but constrained” alignment would require increased excavation, grading, installation of a bridge, drainage, and erosion control, leading to design modifications to trail specifications. An “infeasible” alignment is one that physically could not be constructed using standard design. Engineering constraints are based on geology and soils parameters for the proposed project site.

#### 2.5.1.1 Geology and Soils

Geology and soils address issues such as soil erosion, landslides, and earthquakes. The County of Los Angeles has an existing policy of accommodating multi-use trails wherever feasible, specifically hiking, mountain biking, and equestrian. This analysis sets forth a process for assessing the feasibility of accommodating multi-use trails on a case-by-case basis. Further, for this analysis, a geological ranking system should be developed to evaluate the geological conditions of each trail segment. The ranking system should utilize collected geologic information, including geologic formations, streams and drainage crossings, earthquake-induced landslide areas, and the surface gradients (slope). Record the geologic formations, the earthquake-induced landslide areas, slope stability, and drainage crossings within each segment to develop a ranking matrix that assigns feasibility scores for all evaluated trail segments. For each trail, the values should be summed and averaged to develop a ranking for each potential segment. Each score should be weighted by the importance attached to each category. The geology-based rankings should be more sensitive to ground surface slope and earthquake-induced landslide potential than geologic unit characteristics and stream crossing.

#### 2.5.2 Environmental Factors

Evaluate environmental opportunities and constraints for proposed trails based on site analysis and input regarding the following five factors: (1) aesthetics, (2) biological and hydrological resources, (3) cultural resources, (4) hazards and hazardous materials, and (5) land use and land ownership. The evaluation should consider the degree to which environmental documentation and permitting would be required to construct a specified trail alignment. Proposed trail alignments are expected to be “feasible” if no potential for significant environmental impacts would occur. Proposed trail alignments are expected to be “feasible, but constrained” if the potential for significant environmental impacts exists, but could be mitigated to below the level of significance. Trail alignments are deemed “infeasible” if the potential for significant environmental impacts is identified or if other factors would hinder the placement of the trail.

#### 2.5.2.1 Aesthetics

A site reconnaissance is a critical initial step in assessing the potential for scenic vistas or other visual amenities that shall be taken into consideration in the trail planning process. Analyze aesthetic factors by performing a visibility analysis in a



three-dimensional modeling program to determine if the trail would be visible by the surrounding area residences and other landowners living adjacent to proposed trails. Vantage points may be placed at important visual points of interest, known scenic vistas, or individual residences. The results should be presented as a percentage of the trail that would be visible from the vantage points. In addition, cross-sections depicting the

shall include a review of available records including 7.5-minute series topographic quadrangles for the study area, National Wetland Inventory Maps, Wieslander Vegetation Maps (where available), the California Wildlife Habitat Relationship systems, California Natural Diversity Database, and request for information to the U.S. Fish and Wildlife Service and the California Department of Fish and Game. When a study

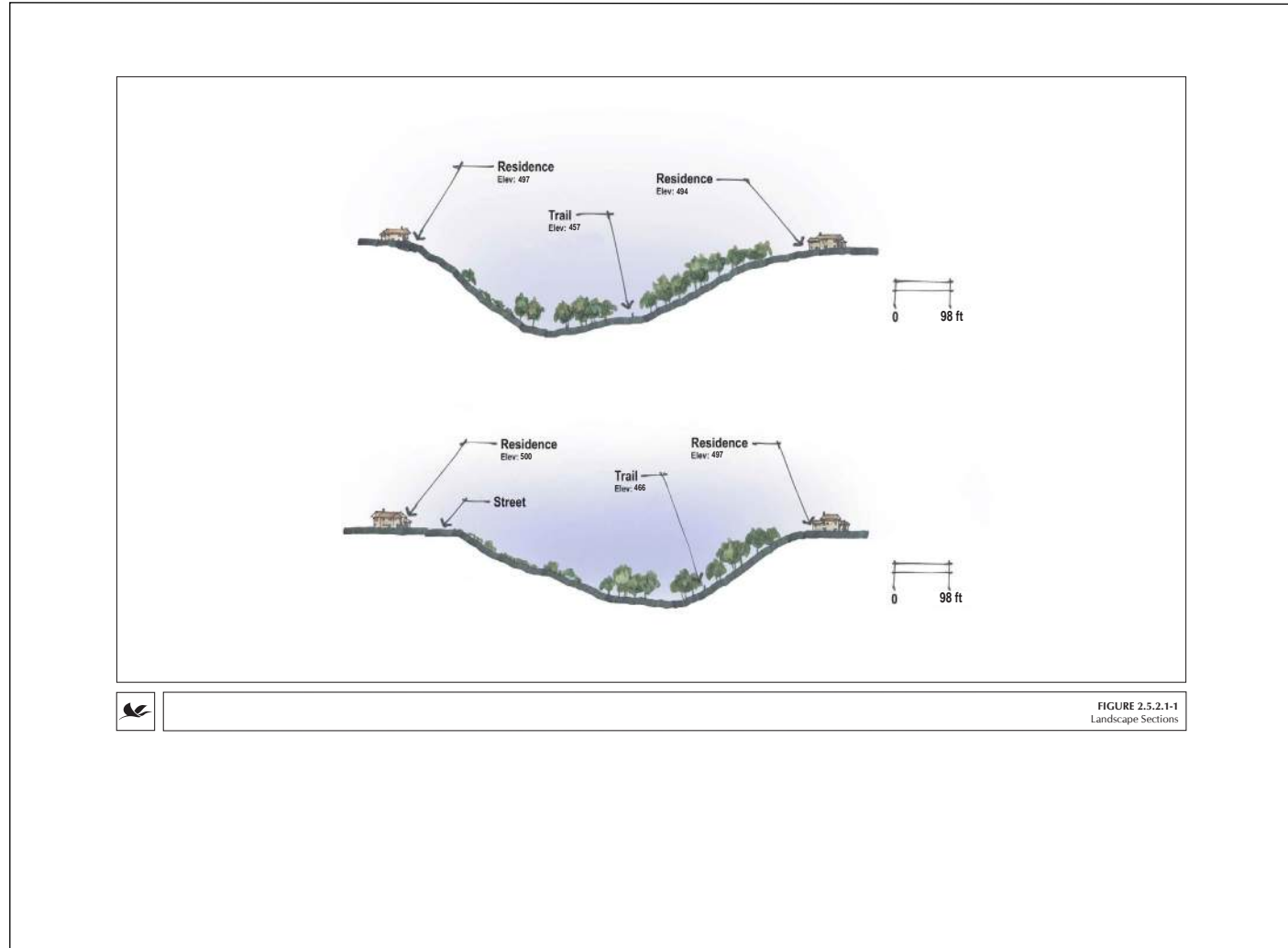


Figure 2.5.2.1-1 Landscape Sections

distance and the elevation of the trails from adjacent residences should be produced to provide a representation of the visibility of the trails by incorporating the landscape and vegetation (Figure 2.5.2.1-1, *Landscape Sections*).

**2.5.2.2 Biological Resources and Hydrology**

In addition to the intended use, trails are often used by terrestrial wildlife. The analysis of biological resources includes the consideration of the potential presence of sensitive species, habitats, and communities, particularly riparian and wetland resources, migratory corridors, and proximity to conservation areas. At a minimum, the evaluation of biological resources

includes or is adjacent to a property managed as open space, outreach to the federal, state, local, or private entity managing the property regarding the known or potential presence of biological resources shall be undertaken. If biological resources could potentially be affected by trail development, it is likely that a field investigation will be warranted to characterize the baseline resources. The consideration of biological resources should also include coordination with the County naturalist, the California Department of Fish and Game, and the U.S. Fish and Wildlife Service to understand the scope of special status species that may be affected by trail construction. Where trails cross lands managed by federal, state, or local agencies

or other private entities involved in open space conservation, contact should be made to obtain all available information related to biological resources. All available information should be reviewed to avoid and minimize, to the maximum extent practicable, impacts to federally and State-listed species, State species of special concern, and California Native Plant Society (CNPS) List 1 Plants; species afforded special protection by the State Fish and Game Code; the Bald and Golden Eagle Protection Act; the Migratory Bird Treaty Act; streams, wetlands and other waters of the United States, and hydrology; seasonal migratory corridors; and wildlife movement corridors.

Conduct the evaluation of biological resources by determining the plant communities through which the trails would pass, and the listed and sensitive species with the potential to occur within those plant communities and elevations, including any observed during biological field surveys (Figure 2.5.2.2-1, *Plant Communities Map*). The survey personnel should have experience in conducting biological field surveys, as well as be knowledgeable about the identification and ecology of all species surveyed. In addition, ensure that all survey personnel are familiar with both federal and state statutes related to listed and sensitive wildlife species, and have experience analyzing the impacts of development on listed and sensitive wildlife species. There are 164 federally and state-listed species that have a potential to occur within the County as of the date of this publication (Appendix D, *Federally and State-Listed Species*

*with Potential to Occur within the County of Los Angeles*). The listed and sensitive species should be ranked on a basis of “most likely,” “likely,” and “least likely” to occur in the trails area. Only those species deemed “most likely” and “likely” to occur should be included in the final numbers of species potentially occurring along a given trail alignment. If there are biological corridors located on proposed trail sites, the LACO-DPR will cooperate with developers to work around these corridors.

Determine the number of blue-line stream crossings by conducting a preliminary analysis. Tabulate the number of crossings to formulate any associated constraints from additional permitting for trails intersecting riparian habitat and blue-line streams.

**2.5.2.3 Cultural Resources**

Conduct a literature review for previously recorded archaeological and historic resources within the boundaries of the proposed trail area. The search should include a review of all known relevant cultural resource survey and excavation reports to determine potential impacts to archaeological and historic resources in the proposed trail area, also known as the area of potential effects (APE). As part of the literature review, search the 2005 editions of the California Historical Resources Inventory (HRI), the National Register of Historic Places (NRHP), the listing of California Historic Landmarks

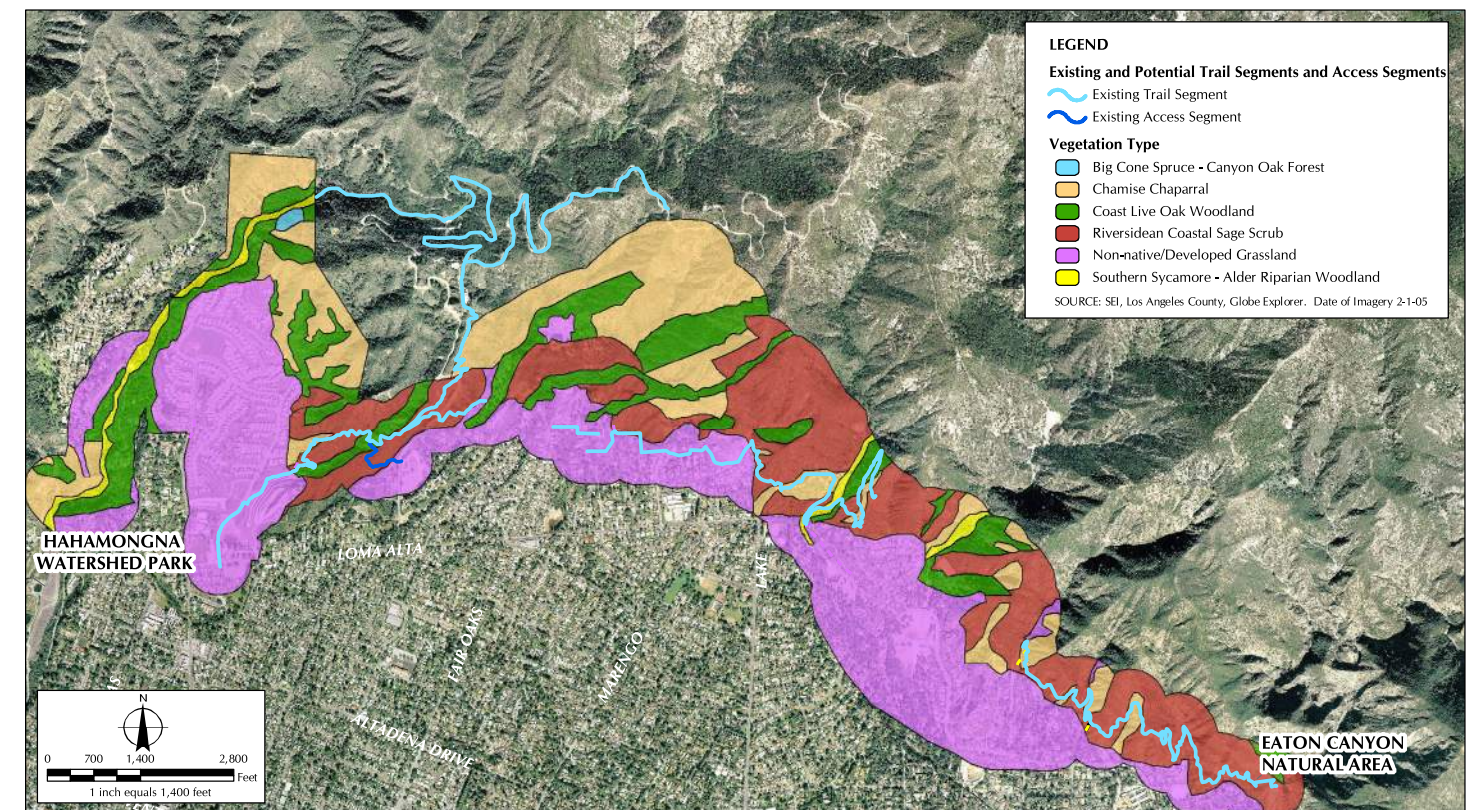


Figure 2.5.2.2-1 Plant Communities Map



(CHL), and the California Points of Historical Interest (CPHI) to determine the presence of historic resources potentially impacted as a result of the proposed trails. Record the results as the number of historic and archaeological sites occurring within a 25-foot buffer of each proposed trail. In areas determined to have a high sensitivity for archeological or paleontological resources, surveys along the trail path may be beneficial to ensure that sensitive resources are avoided.

#### 2.5.2.4 Hazards and Hazardous Materials

Relevant sources of information considered in the evaluation of hazards and hazardous materials should include a review of historical aerial photographs; historical topographic maps; and a compilation of federal, state, and local government records consistent with the American Society of Testing and Materials (ASTM) Standard E 1527-05, *Standard Practice for Environmental Site Assessments: Phase I Environmental Site Assessment Process* and the U.S. Environmental Protection Agency proposed due diligence standard regarding “all appropriate inquiry.” Conduct a Phase I Environmental Site Assessment along with site surveys for the proposed project area. The locations of all possible sites should be entered into a geographic information system (GIS) database to determine if any potential hazards or hazardous materials occurred along the proposed trail areas. Hazards and hazardous materials constraints are determined to exist if the proposed trail segment is adjacent to listed hazardous sites.

#### 2.5.2.5 Land Use and Land Ownership

Land use and land ownership address the existing land use plan and conservation plans produced by the agency with jurisdiction over the project and the existing owners of the lands in the study area. Land use considerations for the feasibility analysis should be determined through the review of the County General Plan and Community Plan Map if applicable. A review of these documents will assist in identifying land use regulations critical to the viability of the proposed project. In addition, zoning limitations and boundaries should be determined using the applicable County of Los Angeles or applicable jurisdictions zoning map. If the consulted documents reveal land use restrictions incompatible with trail usage, the project proponent may have to pursue either a change in land use designation and zoning or revision of the trail route.

Land ownership information and parcel information can be obtained from the County of Los Angeles Office of the Assessor (Assessor). In considering the development of a trail adjacent to developed properties, there should be at least two considerations:

1. Effects of the proposed trail on residents

including aesthetics, dust, noise, and security; and

2. Effects of the adjacent land use on the quality of the recreational experience for the trail user in relation to aesthetics, air quality, noise, and security.

A GIS database with property ownership data from the Assessor and LAR-IAC aerial imagery is useful to determine potential impacts to adjacent land uses, such as calculating the distance from the proposed trail to the closest residence within the proposed project area.

When considering trails near developed lands, every effort should be made to place trails in open space, fuel modification zones, or green belts. In more urban environments, where open space is not available, efforts should be made to provide a secure and aesthetically pleasing trail alignment.

#### 2.5.3 Economic Factors

Analyze the economic and fiscal opportunities and constraints according to the costs of trail construction, which may include rough construction costs and estimates of expected costs for completing the trail. Baseline costs should be developed on a project-by-project basis. Typically, the average cost for rough grading is used as the baseline, which excludes costs such as design, bridges, way-finding signs, permitting, and mitigation/restoration. Proposed trails can be deemed “feasible” if the cost per linear foot is not 20 percent greater than the baseline cost. Proposed trails can be deemed “feasible, but constrained” if the cost per linear foot is between 20 and 50 percent greater than the baseline cost. Proposed trails can be deemed “infeasible” if the cost per linear foot is 50 percent greater than the baseline cost.

Rough construction cost estimates should be based on previous development of trails in the surrounding area for developers and public agencies. More exact estimates should be based on the design for the trails that are being proposed.

##### 2.5.3.1 Construction Cost Considerations

There is a variety of factors that should be taken into consideration when estimating the cost of a trail project. The cost of building, rerouting, or maintaining a trail includes numerous associated costs from labor to materials (Table 2.5.3.1-1, *Construction Cost Considerations*). The California State Parks trail labor and materials construction worksheet is included with additional trail costs in Appendix E, *Trail Construction Costs*. The cost of constructing a trail depends

**TABLE 2.5.3.1-1  
CONSTRUCTION COST CONSIDERATIONS**

<b>Construction</b>
Trail construction (depends on site conditions)
Stream crossing
At-grade road crossing (includes signs and striping)
Mobilization
<b>Restoration</b>
Restoration
<b>Maintenance</b>
Annual maintenance
<b>Way-finding Signs</b>
Highway informational sign
Highway warning sign
Permitted use sign
Etiquette sign
“Crossing private lands” sign
Boundary sign/map
Temporary connector sign
Entrance sign
Trailhead information sign and kiosk
Reassurance marker
Direction change/juncture indicator
Interpretive sign
Wayside exhibit
Destination sign
Monument sign
Adopter sign
<b>Landscaping</b>
Landscaping
Temporary irrigation
Permanent irrigation
<b>Parking Lot</b>
Parking lot construction (pervious concrete)
Guardrail
<b>Support Structure</b>
Kiosk
Restroom with sewage lines
Composting restroom
<b>Additional Trail Amenity</b>
Drinking fountain
Equestrian fencing (staging areas, etc.)
Horse tie-up
Horse drinker
Trash receptacle
Vault toilet/regular-style toilet
Ramada
Bench
Solar-powered flashing beacon



on the type of trail, the terrain traversed by the trail, whether the trail crosses streams or roads, and the cost of mobilization to begin trail construction. After construction, a trail may require restoration of the vegetation disturbed during trail construction. Yearly maintenance is required to keep a trail safe and functional. Signs may include highway, regulatory, and informational signs. Some trailheads may require the construction of a parking lot to accommodate trail users. Additional costs include fencing, landscaping, temporary and permanent irrigation, trash receptacles, benches, drinking fountains, and solar-powered flashing beacons for traffic safety.

#### 2.5.4 Social Factors

Analyze the social feasibility of the trail based on the recreational needs of the area and the ability to meet the current and future recreational goals for the surrounding communities. Proposed trails would be deemed “feasible” if they meet recreational needs for which supply is insufficient to meet current and future needs. Proposed trails would be deemed “feasible, but constrained” if they provide for the recreational needs of many individuals but may not prove accessible for all user groups. Proposed trails would be deemed “infeasible” when they do not meet the recreational needs of the community.

##### 2.5.4.1 Recreational Need

Recreational needs for a trail project are based on numbers derived from the demand analysis and the analysis of existing trails in the area. The SAMP provides information on the recreational needs for the County and should be utilized to identify the needs in an area.<sup>29</sup> Therefore, the recreational need for each particular trail segment can be evaluated based on the difference between the current and expected demand for trails and the ability of a proposed trail segment to meet the needs for trails.

## 2.6 IDENTIFY AND ENGAGE WITH STAKEHOLDERS

### 2.6.1 Step 1

Identify and engage potential stakeholders early in the planning process. They should be informed of the project purpose and need and related goal statements. They should also be asked to provide their input on potential objectives to be considered by the County. Potential stakeholders include federal, state, county, and city representatives who manage resources in or

<sup>29</sup> County of Los Angeles Department of Parks and Recreation. April 2004. *Strategic Asset Management Plan (SAMP) for 2020*. Prepared by: County of Los Angeles Chief Administrative Office and County of Los Angeles Department of Parks and Recreation, with technical assistance by Sapphos Environmental, Inc.

adjacent to the proposed trail location; private landowners; as well as other interested parties that manage lands or represent recreational users in or adjacent to the proposed trail location. The trail planning and design process includes soliciting input from other departments to ensure consistency. Please consult with non-governmental organizations throughout each trail planning process as they are updated on a regular basis.

#### Federal Government

- National Park Service: <http://www.nps.gov/>  
Manages the Santa Monica Mountains National Recreation Area
- U.S. Army Corps of Engineers: <http://www.usace.army.mil/>  
Regulatory and permitting authority for navigable waterways, wetlands, and other waters of the United States that may include blue-line streams depending on topographic maps
- U.S. Department of Agriculture Forest Service (Forest Service): <http://www.fs.fed.us/>  
Manages the 650,000 acres of Angeles National Forest within the County
- U.S. Fish and Wildlife Service: <http://www.fws.gov/>  
Regulatory and permitting authority for special status species and associated designated critical habitat afforded protection pursuant to applicable federal regulations, particularly the Endangered Species Act, the Migratory Bird Treaty Act, and the Bald and Golden Eagle Protection Act

#### State of California

- California Coastal Commission: <http://www.coastal.ca.gov/>  
Plans and regulates the use of land and water in the coastal zone, typically within 5 miles of the coast
- California Department of Fish and Game: <http://www.dfg.ca.gov/>  
Regulatory authority for special status, national community conservation planning areas, and state waters with applicable state regulations, particularly the Endangered Species Act and the State Fish and Game Code (Sections

1600 and 2081)

- California Department of Parks and Recreation: <http://www.parks.ca.gov/>  
Manages California State Parks, including the development of trail networks
- Rivers and Mountains Conservancy: <http://www.rmc.ca.gov/>  
Works to preserve open space and habitat to provide for low-impact recreational and educational uses, wildlife habitat restoration and protection, and watershed improvements along the San Gabriel and Lower Los Angeles Rivers
- Santa Monica Mountains Conservancy: <http://smmc.ca.gov/>  
Seeks to establish an interlinking system of urban, rural, and river parks; open space; trails; and wildlife habitats that are easily accessible to the general public

#### Other Interested Parties Active in the County of Los Angeles

- The American Hiking Organization: <http://www.americanhiking.org/>  
A national organization that provides a comprehensive nationwide trails finder
- Equestrian Trails Inc., Sylmar, CA: <http://www.etinational.com/>
- Altadena Crest Trail Restoration Working Group (ACTRWG)
- California Riding and Hiking Trails Advisory Committee
- Concerned Off-Road Bicyclists Association (CORBA)
- International Mountain Bicycling Association (IMBA)
- Trail Groups (Equestrian, Hiking, and Mountain Biking)
- Marshall Canyon, Mounted Assistance Unit, County of Los Angeles: <http://marshallcanyonmau.com/>
- Mountains Restoration Trust: <http://www.mountainstrust.org/>  
Works to preserve, protect, and enhance the natural resources of the Santa Monica Mountains in the

County of Los Angeles

- The Watershed Conservation Authority
- Los Cerritos Wetlands Authority
- Mountains Recreation and Conservation Authority
- Bonelli Park, Mounted Assistance Unit, County of Los Angeles
- Whittier Narrows, Mounted Assistance Unit, County of Los Angeles
- Los Angeles County Sheriff's Department, Volunteer Mounted Unit
- Los Angeles County Sheriff's Department, Park Bureau, Patrol Unit
- The California Coastal Trail: <http://www.californiacoastaltrail.org/>  
An organization that provides information concerning the trail and its individual segments
- The Land Trust Alliance: <http://www.lta.org/>  
A national, nonprofit organization composed of several hundred nonprofit land trusts that assist interested landowners in finding ways to protect their land
- The Santa Monica Trails Council: <http://www.smmtc.org/>
  - A volunteer, nonprofit organization dedicated to establishing and maintaining the public trail system throughout the Santa Monica Mountains
- The Trust for Public Land: <http://www.tpl.org/>
  - A national, nonprofit, land conservation organization that conserves land for parks, community gardens, historic sites, rural lands, and other natural places
- The Rim of the Valley Trail
- The Puente Hills Landfill Native Habitat Preservation Authority (Habitat Authority)
- Private Property Owners
  - Private property owners who are interested in developing land
- Adjacent Private Property Owners
- Community Representatives
- Adjacent Counties and Cities to the County of Los Angeles (Specifically the Parks and Recreation Departments of the four surrounding Counties: Kern, Orange, San Bernardino, and Ventura)

---

### **2.6.2 Step 2**

Coordinate the results of the supply and demand analysis with stakeholders. This provides an opportunity to identify factors that are unique to the project site that may influence the supply and demand analysis [e.g., large private camps that use public trails as part of their programming, clubs (hiking clubs, cycling clubs, or equestrian units), schools and after-school programs that use trails for outdoor education programs, etc.)].

### **2.6.3 Step 3**

The documentation of existing and proposed trails and recreational resources in the service area should include outreach to federal, state, county, and city representatives, as well as other interested parties that manage lands or represent recreational users in or adjacent to the service area.

### **2.6.4 Step 4**

The conceptual trail alignment should be presented to federal, state, county, and city representatives, as well as other interested parties that manage lands or represent recreational users in or adjacent to the service area prior to initiating the detailed design process.

### **2.6.5 Step 5**

The results of the feasibility analysis should be presented to federal, state, county, and city representatives, as well as other interested parties that manage lands or represent recreational users in or adjacent to the service area prior to finalizing the alignment and initiating the construction process.

## SECTION 3.0 ENVIRONMENTAL COMPLIANCE FOR TRAILS

---

Environmental compliance is important in the trail planning process. The County of Los Angeles (County) in its role as a lead agency under the California Environmental Quality Act (CEQA) must consider the least environmentally damaging alternative that is feasible and capable of meeting most of the basic objectives of the project. Where a trail triggers the National Environmental Policy Act (NEPA) through the need for incidental take permits, Section 404 permits, or the use of federal land, similar requirements for exploring trail alignments that avoid or minimize impacts may be required. Therefore, this section of the Trails Manual describes the basic federal and State environmental compliance processes and provides recommendations for integrating the trail planning and environmental compliance processes. The County of Los Angeles Board of Supervisors (BOS) is the lead agency under CEQA and has the principal responsibility for carrying out or approving trail projects in the County. These specific trail projects are exclusive of others located on lands owned by the federal government or the State of California. As the lead agency, the County must make a determination regarding the appropriate level of environmental documentation to be prepared in accordance with criteria contained in the *Guidelines for the Implementation of the California Environmental Quality Act* (State CEQA Guidelines, Title 14 CCR, Chapter 3, Sections 15000–15387). In addition, County trail projects may also require environmental analysis pursuant to NEPA (42 USC 4321; 40 CFR 1500.1) where projects involve the use of federal funds or lands, require a federal permit or other authorization, or if the trail projects are carried out or partially carried out by the federal agency.

As described in Section 15002(k) of the State CEQA Guidelines, a lead agency undertakes a three-step approach in determining the type of analysis required for a project subject to CEQA.<sup>1</sup> The County has developed a set of CEQA Environmental Impact Report (EIR) Guidelines that should be consulted in preparation for and during the environmental review process if an EIR is warranted. During the course of trail planning and development, additional regulatory agencies that have jurisdiction over particular resources that intersect with trail development, such as streambeds, will need to be consulted and is typically integrated with the CEQA process.

---

<sup>1</sup> State of California. *California Code of Regulations*. Title 14, Chapter 3, “Guidelines for Implementation of the California Environmental Quality Act,” Article 1, Section 15002 (k): “General Concepts.” Sacramento, CA. Available at: [http://ceres.ca.gov/topic/env\\_law/ceqa/guidelines/art1.html](http://ceres.ca.gov/topic/env_law/ceqa/guidelines/art1.html)

The trails planning process identified in Section 2 is intended to provide for the integration of project planning and environmental analyses for all County trail projects consistent with the goals and policies of NEPA and CEQA.

The provisions of NEPA apply to an action that is to be carried out by a federal agency; requires a federal permit, entitlement, or authorization; requires federal funding; or will occur on federal land. There are four purposes stated in the NEPA statute:

- (1) Declare a national policy to encourage “productive and enjoyable harmony between humans and their environment”
- (2) Promote efforts that will prevent or eliminate damage to the environment and biosphere and stimulate human health and welfare
- (3) Enrich the understanding of the ecological systems and natural resources important to the nation
- (4) Establish a Council on Environmental Quality (CEQ)

The provisions of CEQA apply to all projects that require a discretionary decision by the Board of Supervisors, the use of County funds, or the use of County property, including those that provide benefit for the public, such as trail projects. There are four basic purposes at the heart of CEQA, described in Section 15002 of the State CEQA Guidelines:

- (1) Inform governmental decision-makers and the public about the potential, significant environmental effects of proposed activities.
- (2) Identify the ways that environmental damage can be avoided or significantly reduced.
- (3) Prevent significant, avoidable damage to the environment by requiring changes in projects through the use of alternatives or mitigation measures when the governmental agency finds the changes to be feasible.

- (4) Disclose to the public the reasons why a governmental agency approved the project in the manner the agency chose if significant environmental effects are involved.<sup>2</sup>

- Is to be carried out by a federal agency
- Requires a federal permit, entitlement, or authorization
- Requires federal funding
- Will occur on federal land

### 3.1 DEFINE PROJECT GOALS AND OBJECTIVES

The definition of the trail project goals and objectives developed during the planning process will also be used to meet the requirements of Section 15124 of the State CEQA Guidelines, which require the lead agency to define a statement of objectives sought by the proposed project.<sup>3</sup> This is a critical step in the environmental compliance process for an EIR, in that those projects involving significant impacts need only consider alternatives that are capable of avoiding or lessening significant impacts, and that are capable of meeting most of the basic objectives of the project.

### 3.2 THREE-STEP NEPA PROCESS

This section describes the three-step process for determining the appropriate environmental document to be prepared for an action under NEPA. NEPA applies when a proposed trail project involves the use of federal funds or lands, requires a federal permit or other authorization, or if the trail project is carried out or partially carried out by the federal agency. Examples include when the proposed trails are located on lands owned by the United States Forest Service (USFS), the Bureau of Land Management (BLM), or when the California Department of Transportation (Caltrans) is acting on behalf of the Federal Highway Administration (FHWA). Each federal agency has its own guidelines for implementing the procedural provisions of NEPA. The federal agency serves as the lead agency in determining through the three-step process if NEPA applies to the proposed trail project (Figure 3.2-1, *Determining NEPA Compliance for a Proposed Action*).

The first step in the NEPA process is to determine whether or not the proposed action is subject to NEPA. NEPA applies to a proposed action if it is subject to any one (or more) of the following situations:<sup>4</sup>

<sup>2</sup> State of California. *California Code of Regulations*. Title 14, Chapter 3, "Guidelines for Implementation of the California Environmental Quality Act," Article 1, Section 15002 (k): "General Concepts." Sacramento, CA. Available at: [http://ceres.ca.gov/topic/env\\_law/ceqa/guidelines/art1.html](http://ceres.ca.gov/topic/env_law/ceqa/guidelines/art1.html)

<sup>3</sup> State of California. *California Code of Regulations*. Title 14, Chapter 3, "Guidelines for Implementation of the California Environmental Quality Act," Article 9, Section 15124: "Project Description." Sacramento, CA. Available at: [http://ceres.ca.gov/topic/env\\_law/ceqa/guidelines/art9.html](http://ceres.ca.gov/topic/env_law/ceqa/guidelines/art9.html)

<sup>4</sup> Bass, Ronald E., Albert I. Herson, and Kenneth M. Bogdan. 1999 (with 2001 supplement). *The CEQA Deskbook*. Point Arena, CA: Solano Press Books.

If the proposed trail is found to be within the jurisdiction of NEPA, the federal lead agency will determine whether a Categorical Exclusion applies to the proposed trail.

#### 3.2.1 Consideration of Categorical Exclusions

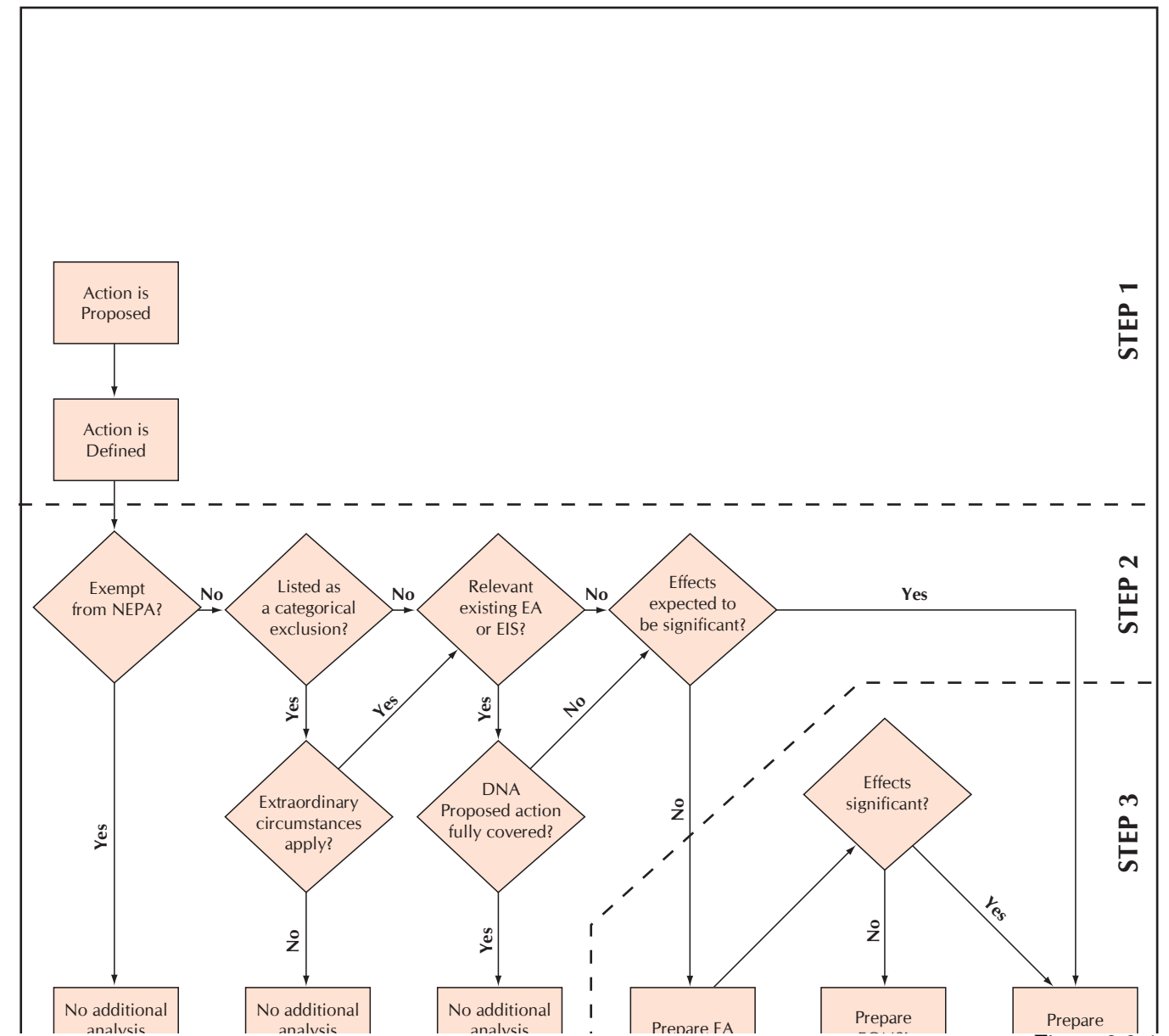
The availability of a Categorical Exclusion for a proposed trail and the potential for significant environmental impacts determines the extent of NEPA documentation required. The use of a Categorical Exclusion is conditioned on the ability to provide substantial evidence that the proposed trail project would not cause a significant direct, indirect, or cumulative effect on the environment due to unusual circumstances. However, each federal agency has its own specified Categorical Exclusions. The County must consult with the appropriate federal agency to determine if a proposed trail is consistent with the conditions for use of a Categorical Exclusion. If a Categorical Exclusion is applicable to a proposed trail, no further NEPA documentation is needed. However, the County of Los Angeles Department of Parks and Recreation (LACO-DPR) does not construct trails on federal land.

#### 3.2.2 Preparation of an Environmental Assessment

If the proposed trail is found to be within the jurisdiction of NEPA and is not exempt, the County takes the second step and prepares a written Environmental Assessment (EA) to determine if the proposed trail would pose significant impacts on the environment. Each federal agency may adopt its own checklist and format for an EA. Generally, these checklists are tailored to the type of action and impacts the agency oversees. The County must coordinate with the appropriate federal agency early in the proposed trail process to determine the checklist and format. An EA must discuss the following points:<sup>5</sup>

- The need for the proposed action
- The proposed action and alternatives
- Probable environmental impacts of the proposed action and the alternatives
- The agencies and persons consulted during preparation of the EA

<sup>5</sup> Council on Environmental Quality. *NEPA's Forty Most Asked Questions*, Question 8. Available at: <http://ceq.hss.doe.gov/nepalregs/40/40p3.htm>



**Figure 3.2-1**  
**Determining NEPA Compliance for a Proposed Action**

During preparation of an EA, though it is not required under NEPA, the County may find scoping useful.<sup>6</sup> After the EA is completed, a public Notice of Availability (NOA) must be published in the Federal Register for public review.

An EA can lead to different outcomes. An EA may determine that significant impacts are less than significant or that they can be reduced to less-than-significant levels with mitigation measures. In these cases, the EA leads to a Finding of No Significant Impact (FONSI) or mitigated FONSI, respectively. Each federal agency has specific guidelines for EA/FONSI preparation, review and decision making. The FONSI contains

<sup>6</sup> Paraphrased from *The NEPA Book: A Step-by-Step Guide on How to Comply with the National Environmental Policy Act*, Solano Press Books, 2001 (Second) Edition, p. 72.

an explanation as to why the proposed action will not have a significant environmental impact, a copy of the EA, and related environmental documents. In some cases, public review is required for a FONSI. Neither the EA nor the FONSI is a decision-making document. Each agency has its own decision-making format. Therefore, the County should coordinate with the appropriate federal agency to adhere to agency-specific guidelines when a proposed trail requires a FONSI and include public review when it is required.

#### 3.2.3 Preparation of an Environmental Impact Statement

If the information contained in the EA indicates that the proposed trail may have a significant direct, indirect, or cumulative impact on the environment, the County must

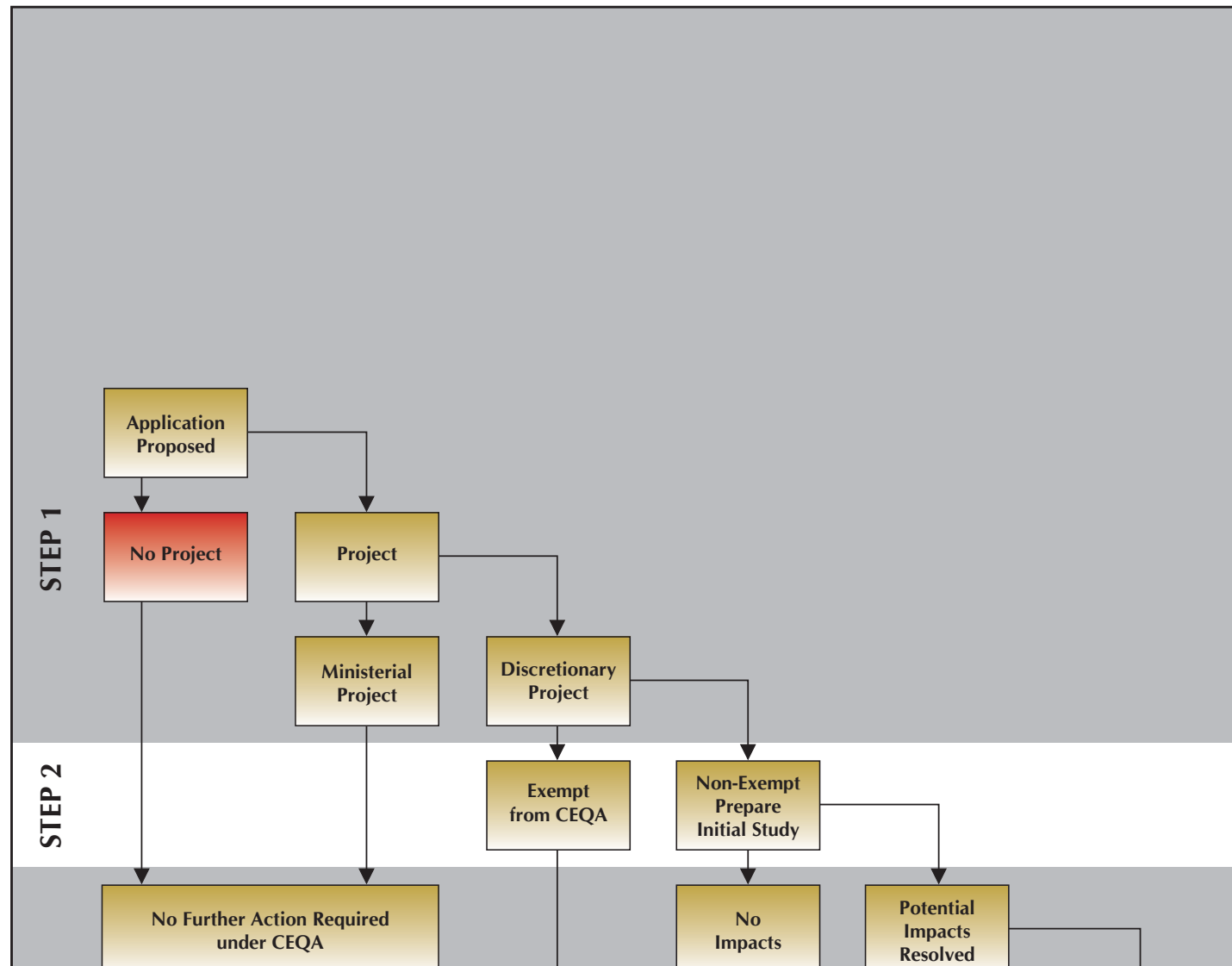


Figure 3.3-1  
CEQA Process Flowchart

take the third step and prepare an Environmental Impact Statement (EIS). Prior to preparation of the EIS, a Notice of Intent (NOI) to prepare the EIS must be published and a scoping process must be conducted. The results of the EA and scoping process can be used as the basis for determining the scope of environmental issues that need to be carried forward for detailed analysis in the Draft EIS. However, the document must include relevant CEQA checklist issues. The EIS should determine the direct, indirect, and cumulative effects for each issue. The scope will also evaluate a range of alternatives, including those eliminated from further study. After the Draft EIS is complete, the County will circulate and receive and respond to comments on the Draft EIS. The County will file the Draft EIS with the Environmental Protection Agency (EPA) and the EPA will review it. A public hearing will be held when appropriate to solicit comments from the public on the Draft EIS.

When this is complete, preparation of the Final EIS can begin. The Final EIS will address the comments on the Draft EIS from the public as well as reviewing agencies. The Final EIS will be circulated prior to adoption by the County. The federal agency will then make a decision on the proposed trail. Once the federal agency has come to a decision on the proposed trail, a Record of Decision will be prepared and filed. Based on the decision of the federal agency, the proposed trail can be constructed.

### 3.3 THREE-STEP CEQA PROCESS

This section describes the three-step process for determining the appropriate environmental document to be prepared for a project (Figure 3.3-1, *CEQA Process Flowchart*). The CEQA process is similar to the NEPA process as NEPA is the national statute on which CEQA was modeled. However, there are differences between the national process and the state process

TABLE 3.3.1-1  
POTENTIAL CEQA EXEMPTIONS FOR TRAIL PROJECTS

Guideline Section	Exemption Type	Exemption Title	Exemption relevant section	Examples
15262	Statutory	Feasibility and Planning Studies	Projects only involving feasibility or planning studies for possible future actions	Trail Feasibility Report
15300	Categorical	Ministerial Projects	Projects over which public agencies exercise only ministerial authority, nondiscretionary actions	Typically private projects involving minor actions such as a renovation project
15301	Categorical	Existing Facilities	Restoration or demolition of small existing structures, replacement of signage	Replacement of existing restrooms, kiosks, or trailheads
15302	Categorical	Replacement or Reconstruction	Replacement or reconstruction of existing structures or facilities located on the same site	Trail, kiosk, or restroom reconstruction
15303	Categorical	New Construction or Conversion of Small Structures	Accessory (appurtenant) structures	Fences, kiosks, restrooms
15304	Categorical	Minor Alterations to Land	Minor grading of slopes, replacement landscaping, bicycle lanes on existing right-of-way	Minor routine maintenance on trails, including clearing and revegetation

(Figure 3.3-2, *CEQA and NEPA Parallel Processes*). This process applies to both trail projects reviewed by the Regional Planning Commission and the Board of Supervisors pursuant to their discretionary land use decision-making authority and to those projects where the County, a County special district, or the redevelopment agency is involved as a project applicant, through the provision of County funds or leases, or the use of County land. Private projects typically intersect with CEQA in the process of obtaining financial assistance, a lease, a permit, a certificate, or other entitlement for use via the discretionary approval of a governmental agency.<sup>7</sup> In approving a permit or license, the County takes the role of the lead agency and is responsible for exercising its independent review of the environmental analysis and certifying the technical and procedural adequacy of the environmental documentation prepared to support the County's land use decision-making process. For the approval of projects, it is essential for documents and plans to maintain internal consistency as well as consistency with the County's general plan and community plans.

For both public and private projects, the County will normally undertake three steps in deciding the type of environmental

<sup>7</sup> State of California. *California Code of Regulations*. Title 14, Chapter 3, "Guidelines for Implementation of the California Environmental Quality Act," Article 20, Section 15377: "Private Project." Sacramento, CA. Available at: [http://ceres.ca.gov/topic/env\\_law/ceqa/guidelines/art20.html](http://ceres.ca.gov/topic/env_law/ceqa/guidelines/art20.html)

document to prepare for a trail project, or a larger project of which a trail is an element, component, mitigation measure, or condition of approval.

#### 3.3.1 Consideration of Categorical Exemptions

The County first evaluates the conceptual proposed project to determine whether it is subject to CEQA. There are a number of statutory, ministerial, and categorical exemptions provided in the State CEQA Guidelines (Table 3.3.1-1, *Potential CEQA Exemptions for Trail Projects*). The use of a Categorical Exemption is conditioned on the ability to provide substantial evidence that the proposed trail project would not cause a significant direct, indirect, or cumulative effect on the environment due to unusual circumstances (such as the presence of rare, threatened, endangered species, designated critical habitat, and the potential to substantially alter jurisdictional streams or wetlands), damages to resources within a state scenic highway, location on a hazardous waste site, or potential to cause significant impacts to any historical resource.<sup>8</sup>

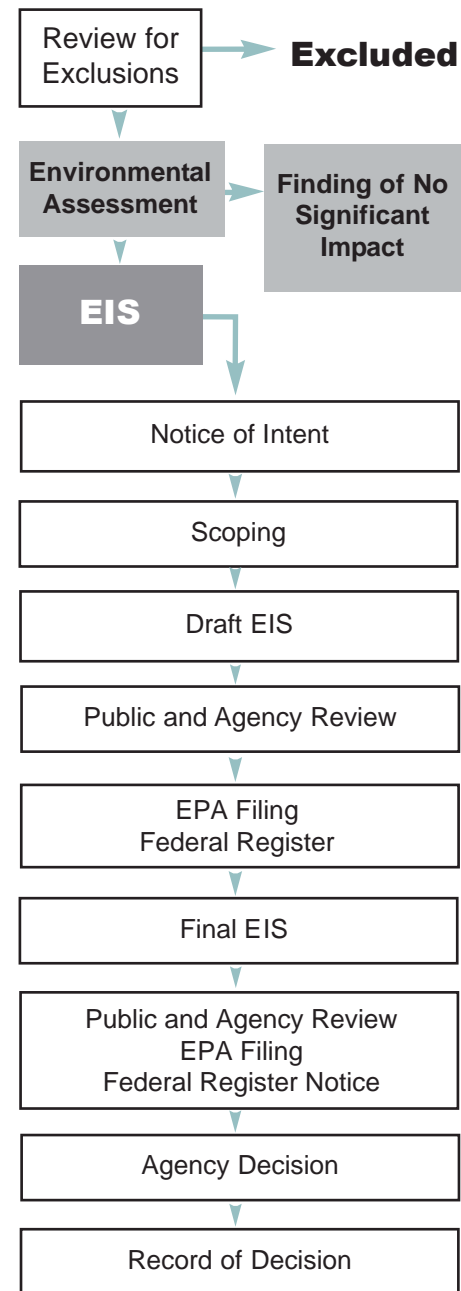
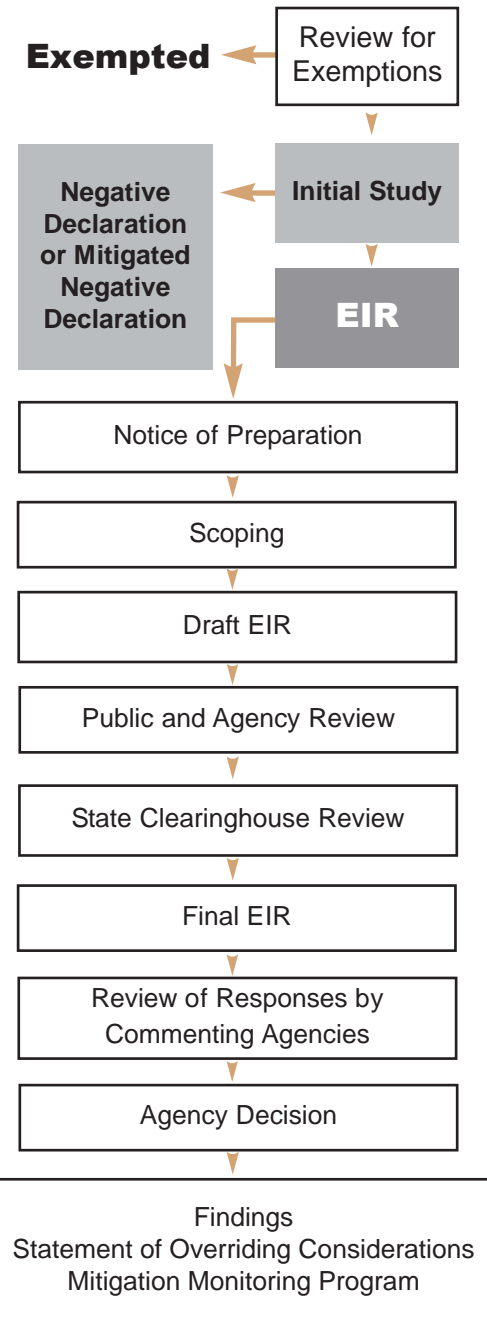
There are a wide variety of improvements to existing trail facilities and/or proposed trails that involve minor grading that

<sup>8</sup> State of California. *California Code of Regulations*. Title 14, Chapter 3, "Guidelines for Implementation of the California Environmental Quality Act," Article 19, Section 15300.2: "Exceptions." Sacramento, CA. Available at: [http://ceres.ca.gov/topic/env\\_law/ceqa/guidelines/art19.html](http://ceres.ca.gov/topic/env_law/ceqa/guidelines/art19.html)



# ENVIRONMENTAL COMPLIANCE

## CEQA PROCESS



## NEPA PROCESS

Figure 3.3-2  
CEQA and NEPA Parallel Processes

may be appropriate for consideration pursuant to the categorical exemptions described in Sections 15301 and 15304 of the State CEQA Guidelines. The environmental component of the feasibility analysis described in Section 2 of this Trails Manual should provide sufficient substantial evidence to determine if a proposed trail project is consistent with the conditions for use of a Categorical Exemption.

### 3.3.2 Preparation of an Initial Study

If the proposed trail project is not exempt, the County takes the second step and prepares an Initial Study (consistent with the provision of Section 15063 of the State CEQA Guidelines) to determine whether the proposed project may have a significant effect on the environment. Normally, the information compiled in the feasibility analysis described in Section 2 of this Trails Manual should be sufficient to support preparation of an Initial Study.<sup>9</sup> If the Initial Study demonstrates that there is no substantial evidence that the proposed project may have a significant effect on the environment, the County can prepare a Negative Declaration. Consistent with the provisions of Article 6 of the State CEQA Guidelines, the County is required to circulate the Notice of Intent to adopt a Negative Declaration for public review.

Similarly, where a proposed project involves impacts and the application of mitigation measures that are known to be capable of reducing the significant effects of the project to below the level of significance, the County can prepare a Mitigated Negative Declaration. Consistent with the provisions of Article 6 of the State CEQA Guidelines, the County is required to circulate the Notice of Intent to adopt a Mitigated Negative Declaration for public review. In addition, the County is required to prepare and implement a Mitigation Monitoring and Reporting Program for those mitigation measures required by the Regional Planning Commission or Board of Supervisors.

### 3.3.3 Preparation of an Environmental Impact Report

If the information contained in the feasibility analysis and Initial Study indicates that the proposed project may have a significant direct, indirect, or cumulative impact on the environment, the County takes the third step and prepares an Environmental Impact Report (EIR). The results of the Initial Study can be used as the basis for determining the scope of environmental issues that need to be carried forward for detailed analysis. Interested parties, including responsible and trustee agencies, special interest groups or organizations, and the public, are informed regarding the County's intent to

<sup>9</sup> Feasibility studies are not a requirement of CEQA. Depending on the scope of the proposed project, a feasibility study may not be warranted.

prepare an EIR through posting of the Notice of Preparation with the State Clearinghouse (within the Governor's Office of Planning and Research) and/or the County Clerk.

As described in Section 15083 of the State CEQA Guidelines, prior to completing the Draft EIR, the County may consult directly with any person or organization it believes will be concerned with the environmental effects of the proposed project. Early consultation allows the proactive identification and resolution of issues early in the project planning and environmental compliance process. This process is referred to as scoping.

The Draft EIR will address those environmental issues that may have a significant impact on the environment. Those issues will be addressed and mitigation measures will be included to reduce impacts to levels below the level of significance. The Draft EIR will also evaluate the environmental impacts from alternatives to the proposed project, including a no project alternative. The rationale for not using an alternative to the proposed project must also be included and evaluated based on the project's goals and objectives. The completion of the Draft EIR is announced through the posting of a Notice of Completion and a Notice of Availability with the State Clearinghouse (within the Governor's Office of Planning and Research) and/or the County Clerk.

A public review period is initiated with the Notice of Availability. During this review period, comments on the proposed project and the Draft EIR are taken from the general public via public meetings or letters. In addition, federal, state, and local agencies are consulted regarding the Draft EIR.

Comments and issues disclosed during the public comment period and through consultation will be addressed in the Final EIR. The Final EIR will document the impacts and mitigation measures set forth to reduce impacts to below the level of significance. However, the lead agency may make a finding of overriding consideration for those impacts from the project that will be significant and for which no mitigation measure will reduce to below the level of significance. In addition, a Mitigation Monitoring and Reporting Plan will often be developed to ensure that the mitigation measures set forth in the Final EIR will be administered.

The lead agency will then approve the project and adopt the EIR along with the Findings of Fact and Statement of Overriding Considerations and any other environmental documentation completed for the project. The approval of the project and the adoption of the EIR are announced to the public through the posting of the Notice of Determination with the State Clearinghouse (within the Governor's Office of Planning and Research) and/or the County Clerk.

**TABLE 3.4-1  
REGULATORY AGENCIES AND TRAIL REGULATORY NEXUS**

Regulatory Agency	Potential Trail Regulatory Nexus								
	Perceived Brownfields	Culturally Sensitive Areas	Riparian Vegetation	Streams	Wetlands	Flood Control Channels	Roadways	Oak Trees	Sensitive Habitats or Plant Communities
California Department of Fish and Game			X	X	X				X
U.S. Army Corps of Engineers				X	X				
California Office of Historic Preservation		X							
Regional Water Quality Control Board				X	X	X			
County Flood Control District						X			
County Department of Public Works						X	X		
County Department of Forestry								X	
California Department of Toxic Substances Control	X								
U.S. Fish and Wildlife Service									X
Native American Heritage Commission		X							
U.S. Environmental Protection Agency	X								
California Department of Transportation							X		

**3.4 REGULATORY AGENCIES**

In the planning stage and the initial development of a trail, it is necessary to understand those agencies that would have to be involved through either the need for permits or the process of notification. Numerous agencies maintain and have jurisdiction over resources within the County of Los Angeles. Table 3.4-1, *Regulatory Agencies and Trail Regulatory Nexus*, provides information on the nexus between certain regulatory agencies and trail planning. Throughout the trail planning process, identify the types of activities that are subject to the authority of these regulatory agencies and the types of Categorical Exclusions, Categorical Exemptions, and permits and agreements that can be used to cover maintenance activities that have the potential to affect sensitive environmental resources. The table is organized by questions to ask while a

trail is being developed and which agencies would be involved. Where there is federal agency involvement, that agency would be consulted. The federal agency would determine if NEPA applies and administer the federal three-step process. The NEPA process may run concurrently with CEQA and the environmental analysis may be combined into a joint CEQA/NEPA document, upon mutual agreement by the federal agency and the County.

**3.5 ENTITLEMENT PROCESS**

Typically, where the trail alignment traverses private land, the environmental review process is triggered by the initiation of the entitlement process for a private development project. The entitlement process involves many steps that typically include design reviews, plan checks, environmental reviews, and project approvals/disapprovals.

Recreational resources such as parks and trails are typically included as conditions of approval, mitigation measures, or additional agreements for the project to proceed, and are recorded as land or easement dedications on parcel maps or tract maps, both subdivision maps, approved by the County under the Subdivision Map Act. The inclusion of trails can either be a voluntary action by the project proponent, or imposed on the project proponent by the County at the time of project approval. If it is imposed by the County, it is typically an outcome of recreational funding of additional recreational resources to support the community by covering the costs of the environmental review, design, and construction of a trail. This is typically covered under the 1975 Quimby Act (California Government Code §66477). However, a project proponent may voluntarily choose to include a trail in the proposed project. Therefore, they may seek funding from alternative recreational funding sources to cover the additional costs (Appendix F, *Recreational Funding*). Regardless of whether the action is voluntary on the part of the project proponent or imposed by the County, the securing of trail easements and construction of trails is an essential step to ensuring that the trails will be completed.

Applications for subdivisions, such as tentative tract or parcel maps, submitted by private parties to the County Department of Regional Planning, are subject to review for park space, open space, and trails requirements. LACO-DPR reviews subdivision applications to ensure that trails planned for areas designated as future trails on trail plans are included as conditions of approval in the development process, and shown as dedicated trail easements on the subdivision map. This step is necessary to ensure that gaps in trails do not develop. Existing trails, either historic or presently in use, that may not yet be mapped on a trails plan, and that may be modified or eliminated by development, should also be evaluated by the County for possible conditioning as a requirement of the entitlement document for the subdivision, and included in all tentative, vesting, and final tract maps. Additionally, the County requires a trail easement or easements for trail alignments not displayed on a County trails map.

**3.5.1 Quimby Funds**

Since the passage of the Quimby Act in 1975, California cities and counties have been authorized to pass ordinances requiring that developers set aside land for parks, or pay in-lieu fees for park improvements.<sup>10</sup> The Quimby Act allows municipalities and park districts to levy a fee on local, new residential development construction for purchasing and developing

<sup>10</sup> State of California. 1975. California Government Code, §66477, "Quimby Act."

park land, including construction of recreational facilities and pathways, but not for ongoing maintenance or general labor. It also sets minimal standards for how much open space there should be per 1,000 residents. Typically, these funds are used for local park construction for active recreation activities and not trails, which are considered passive recreation. The Quimby Act in fact does not mention trails; and although trails are defined as "local park space" in the Los Angeles County Code under Title 21 because of the County's deficiency in actual park land, as a matter of policy, the Department typically does not consider trails when giving credit for an applicant's Quimby obligation. The Department chooses instead to focus attention on recommending Quimby obligations to be satisfied through the dedication and improvement of actual parks, or the payment in lieu fees used for these purposes.

The County, as well as most Southern California cities, includes the Quimby Act in their subdivision ordinance provisions.<sup>11</sup> Implementation of a Quimby ordinance begins once a developer files an application for a development project with a tentative subdivision parcel map. The developer pays the Quimby fees to the LACO-DPR prior to the Department clearing the final map for recordation and approval by all relevant agencies and the Board of Supervisors.

**3.5.2 Securing Easements**

Conservation or trail easements are a commonly used strategy to help trail projects on private lands move forward. A conservation easement is a legal agreement between a landowner and an eligible organization, such as a public agency or nonprofit organization, which restricts future activities or uses on the land, such as development. Easements protect the specific conservation values of a property according to the wishes of the individual landowner and easement holder (Appendix G, *Sample Trail Easement*).

Easements are acquired from landowners who either donate some or all of the value of the easement, or receive market-rate compensation for the property interest. Purchasing easements generally costs less than purchasing land outright. If public agencies do not have the funds to purchase all lands that need to be protected, purchasing easements can be a cost-effective acquisition alternative.<sup>12</sup> Easements require careful legal review and consideration.

<sup>11</sup> Governor's Office of Planning and Research. May 1997. "Jurisdictions Whose Subdivision Ordinance Provides for The Quimby Act, Tentative Parcel Maps, and Merger of Lots by Parcel Map." In *The California Planners' Book of Lists*. Sacramento, CA: Department of General Services. Available at: <http://ceres.ca.gov/planning/bol/1997>

<sup>12</sup> Byers, Elizabeth, and Karin Marchetti Ponte. 2005. *The Conservation Easement Handbook*. (Second Edition.) Washington, DC: Land Trust Alliance and Trust for Public Land.



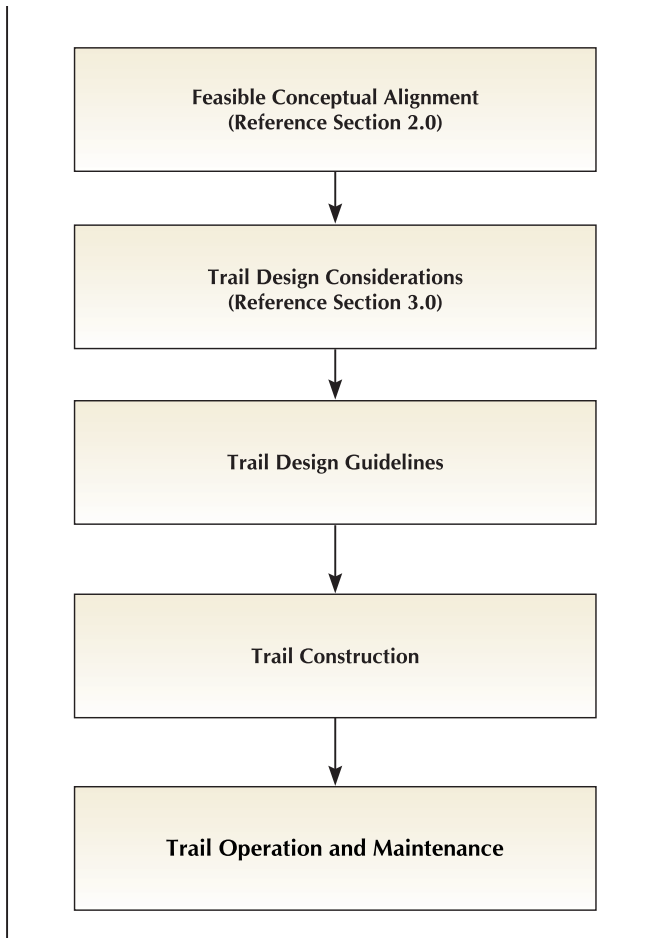
---

If a private landowner creates an easement for trail use, the easement can be donated or granted directly to the County. When the County agrees to accept a trail easement, the County will normally take on responsibility for trail operation and maintenance, which would be specified in the approval documents known as the Trail Grant Deed.

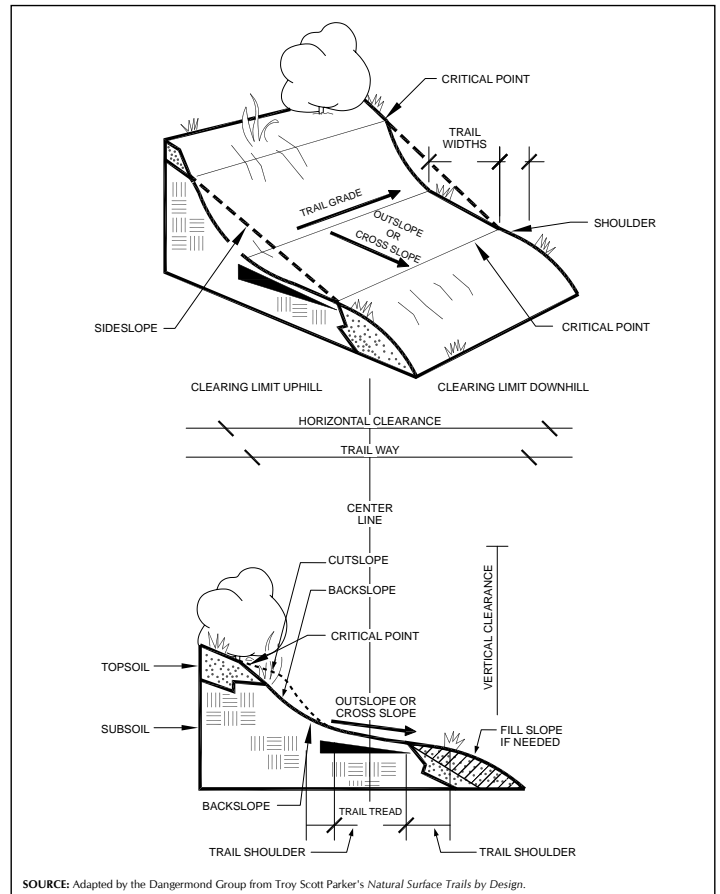
In many cases, a conservation easement can serve as a donation by the project proponent, for tax purposes. Further information regarding tax deductions for conservation easements can be obtained in Appendix H, *Conservation Easement Tax Information*.

## SECTION 4.0 TRAIL DESIGN

Adherence to trail design guidelines facilitates the ability to consistently provide high-quality trails to serve the diverse needs of County of Los Angeles (County) residents and visitors. Final trail design normally takes place after the identification of a feasible conceptual trail alignment and completion of the environmental review process. Waiting until the environmental compliance process is completed reduces the need for design modifications that may arise during review of the conceptual design by the public, regulatory oversight agencies, and the lead agency rendering the decision on the proposed project. The detailed design of the trail consists of four distinct considerations: (1) Trail Mechanics, (2) Trail Longevity, (3) Application of Design Guidelines, and (4) Constructability (Figure 4-1, *Trail Implementation Flowchart*). Trail design guidelines for tread materials, tread widths, drainage designs, and trail amenities are subject to modification in response to site-specific constraints and opportunities identified during the feasibility analysis. The Trails Manual design guidelines are intended to apply to trails under the jurisdiction of the County of Los Angeles Department of Parks and Recreation (LACO-DPR).



**Figure 4-1**  
**Trail Implementation Flowchart**



SOURCE: Adapted by the Dangermond Group from Troy Scott Parker's *Natural Surface Trails by Design*.

**Figure 4.1-1**  
**Trail Structure Terminology**

### 4.1 TRAIL MECHANICS

The beauty of a trail and the way a trail compels a person to enjoy and explore the natural world is at the core of the trail experience. The first consideration in designing a trail is mechanics. The best type of trail is not only aesthetically pleasing but also designed to sustain the mechanical forces induced by weather, compaction, plants, animals, and humans. The consideration of these mechanical forces is critical to the development of a detailed design that is compatible with the inherent environmental conditions, thus maximizing durability and longevity of the trail for recreational purposes while minimizing trail maintenance and reconstruction. Of particular importance is the consideration of trail mechanics in relation to the factors that affect the level of trail erosion and water damage, such as tread watershed size, compaction, and displacement (Table 4.1-1, *Trail Mechanics*). In addressing trail mechanics, this section uses numerous trail structure terminology that is illustrated in Figure 4.1-1, *Trail Structure Terminology*. Soil erosion on trails is caused primarily by the

**TABLE 4.1-1  
TRAIL MECHANICS**

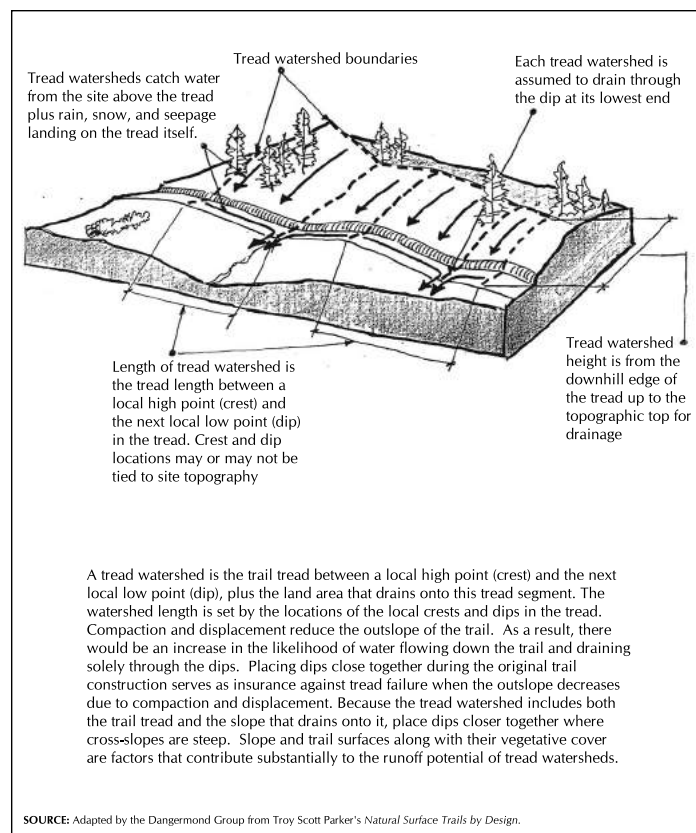
Tread Watershed Factor	Decreased Erosion and Water Damage Risk	Increased Erosion and Water Damage Risk
Tread watershed size	Smaller tread watershed	Larger tread watershed
Watershed slope	Shallow slopes	Steeper slopes
Runoff potential	Low runoff potential (thick forest litter)	High runoff potential (little cover, rocky)
Splash erosion	Tree canopy over tread	Tread open to sky
Tread width	Narrower tread	Wider tread
Weather, climate, microclimate	Light rains only, slow snowmelt	Downpours, heavy snows, rapid snowmelt
Water sources	No water sources, constant and/or limited water sources, low water table, water easily anticipated and accommodated	Unpredictable or highly variable water sources, high water table, water not easily drained or accommodated, floodplain
Tread texture	Compacted tread surface that is not easily displaced, some larger particles/rocky content, dry or moderately dry tread	Easily displaced and/or graded materials (all one size), no particles, too many round particles, wet or saturated tread
Trail use (compaction and displacement)	Low trail use, low displacement modalities, low likelihood of tread crest/dip failure	High trail use, high displacement modalities, higher likelihood of tread crest/dip failure
Tread grade	Shallow grades	Steeper grades
Tread length	Shorter tread length	Longer tread length
Dip trail longevity	Minimal sediment, quick drainage, wide outflow, minimal tread displacement, sufficient size	Too much sediment, slow drainage, narrow outflow, high displacement, insufficient size

SOURCE: Parker, Troy Scott. 2004. *Natural Surface Trails by Design*. Boulder, CO: Nature Shape, LLC.

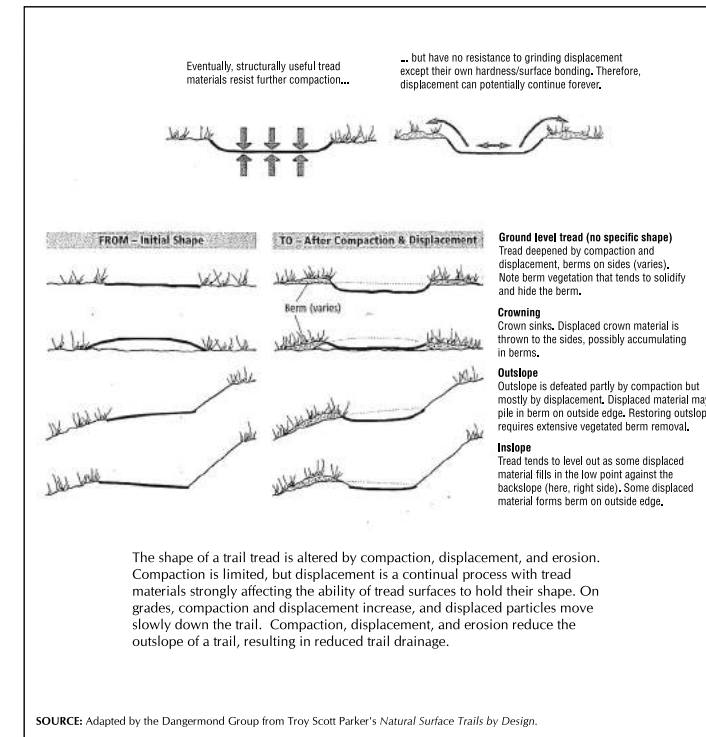
forces of water and wind, as well as physical displacement by plants, animals, and humans. Trail erosion removes soil from the tread and leaves behind ruts in the trail. Although soil erosion is inevitable, proper trail alignment minimizes the risk of erosion.

#### 4.1.1 Tread Watershed

The largest factor affecting the natural forces acting on a trail is the tread watershed for the trail (Figure 4.1.1-1, *Tread Watershed*). A trail's tread watershed is the portion of a trail segment between a local high point (crest) and a local low point (dip) along the trail, plus the land area above the trail that drains onto that segment of the trail. The length of the watershed is the distance between crest and the dip of that segment of trail. The side slope of the tread watershed, the soil type, and the vegetative cover contribute to the runoff potential of tread watersheds. As the outslope is lost due to compaction and displacement, water increasingly flows down the trail draining through the dips in the trail segment. Therefore, placing dips close together during initial trail construction can anticipate this condition. Steeper side slopes will increase the amount of water within the tread watershed, thereby making it necessary to place the dips closer together.



**Figure 4.1.1-1  
Tread Watershed**



SOURCE: Adapted by the Dangermond Group from Troy Scott Parker's *Natural Surface Trails by Design*.

**Figure 4.1.1-2  
Effects of Compaction and Displacement on Trail Tread**

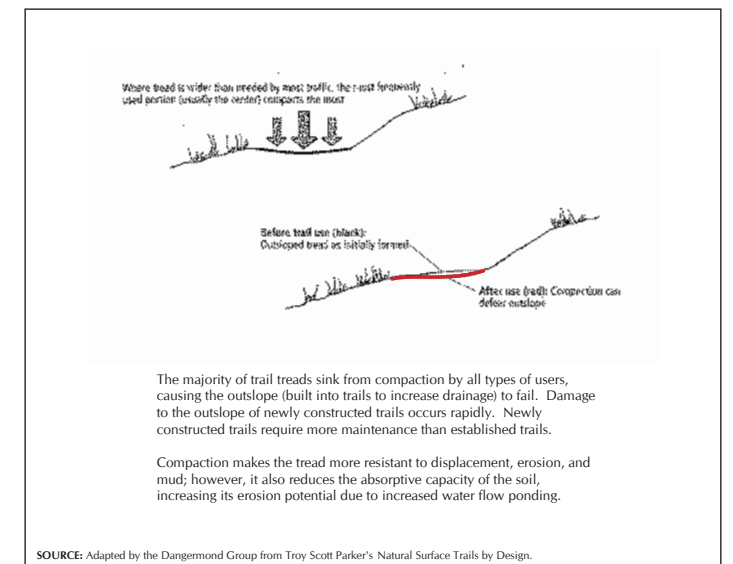
The shape of a trail is altered by compaction, displacement, and erosion. Compaction is normally limited to new trail segments, but displacement is a continual process with tread materials strongly affecting the ability of tread surfaces to hold their shape. On grades, compaction and displacement increase, and displaced particles move slowly down trail. Compaction, displacement, and erosion reduce the outslope of a trail, resulting in reduced trail drainage (Figure 4.1.1-2, *Effects of Compaction and Displacement on Trail Tread*).

#### 4.1.2 Compaction

Overbuilding the outslope<sup>1</sup> of a trail by 1 to 2 degrees, or crowning the center of the trail slightly, can offset the initial compaction caused by heavy use. An alternative strategy is mechanical soil compaction as a final step in building the trail. Sandy soils do not compact easily, and clay or other amendments can be added to sandy soils to reduce their susceptibility to erosion. Mechanical compaction should only be completed in areas where it is feasible to supply the water needed to complete the compaction process.

The majority of trail treads sink from compaction by all types of users, causing the outslope to fail (Figure 4.1.2-1, *Compaction of Trail Tread*). The outslope is the transition from the edge of the trail to a lower elevation that allows surface runoff to flow

<sup>1</sup> An outslope tilts the outer edge of a hillside trail down and away from the inner, higher edge and allows water to drain away without eroding the trail itself.



SOURCE: Adapted by the Dangermond Group from Troy Scott Parker's *Natural Surface Trails by Design*.

**Figure 4.1.2-1  
Compaction of Trail Tread**

off the edge of the trail. On firm dry soils, such as clays and silt, users can actually help compact a newly built trail tread. Clay and silt have chemical and mechanical properties that will cause them to bond and compact from pressure caused by walking, horseback riding, or bicycling.

#### 4.1.3 Displacement

Ideally, build new trails at the beginning of the dry season, so that users can compact it without displacement. Alternatively, mechanically compact the trails when building. In addition to walking, people have devised a variety of vehicles for traveling on trails. A simple way to understand the erosive forces that people have on trails is to study where the force of the foot or tire is directed. On a flat trail, the weight of a person is directed straight down into the trail tread (vertically). However, when a person begins to move, whether on foot, a bicycle, or a horse, a portion of the force is also directed either in front or behind that person (horizontally). If the trail tread is sloped, the direction of the horizontal force will be downhill. If the person is riding a bicycle, more of the force of the tire will be directed horizontally. At steady speeds, the horizontal force is minimal. However, when the bicycle accelerates, the horizontal force increases and the wheel will dig into the trail tread, throwing soil behind them. Generally, people are not strong enough to accelerate a bicycle appreciably when riding up a steep slope.

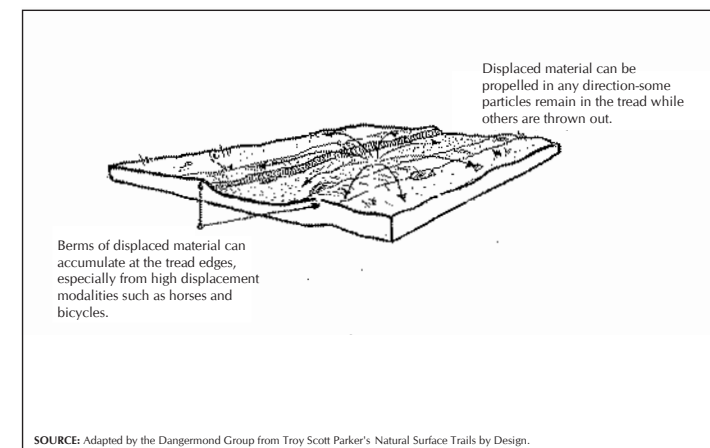
On dry, firm soils, compaction will occur with minimal displacement of soils to either side (Figure 4.1.3-1, *Displacement of Trail Tread*). However, user compaction is likely to occur in the center of the trail tread and may result in a shallow rut running down the center of the trail. On wet clay and silt soils, user impacts may help compact the trail tread, but due to the plasticity of these soils when wet, users also contribute to soil



displacement. In this limited case, if there is even moderately heavy use, due to the combination of compaction and extrusion, a rut will likely form down the center of the trail, creating a trough with the extruded soil building up along the sides. A trough will intercept water from the slope and cause it to flow down the trail tread, contributing further to erosion and rut formation.

#### 4.1.4 Erosion

Creating trails with a smaller tread watershed helps to reduce erosion. A trail that undulates with the landscape will have more frequent high and low points; therefore, tread watersheds for these types of trails will be smaller than the tread watersheds for steadily climbing trails, such as fall-line zone trails. Intentionally aligning trails to take advantage of the natural contours of the landscape helps to create smaller tread watersheds. In addition, trails built along contours require fewer switchbacks and are less likely to be stacked one on top of the other, separated by short vertical distances. Because stacked trails percolate water downward onto the trail treads below, a series of stacked trails effectively constitutes one larger tread watershed and must be avoided wherever possible.



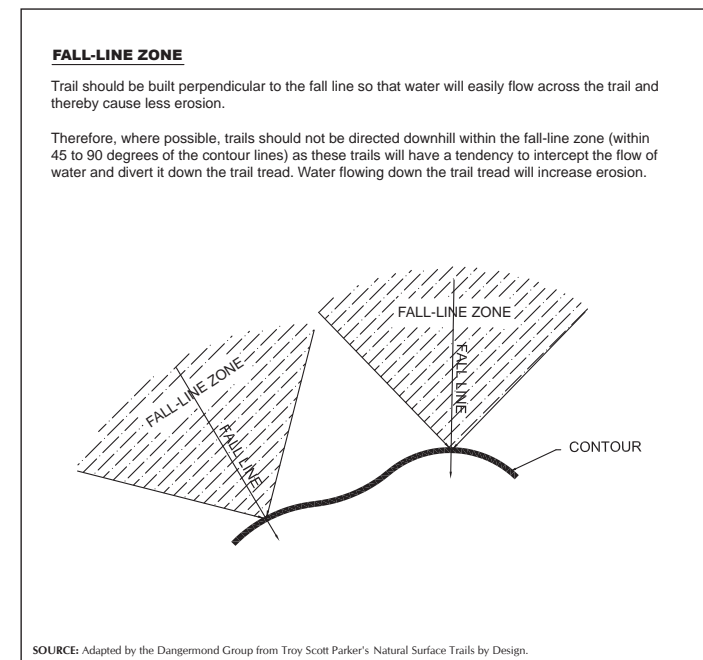
**Figure 4.1.3-1**  
Displacement of Trail Tread

Wherever practicable, design trail segments perpendicular to the fall line to allow surface runoff to flow across the trail and to minimize the area subject to erosion. In the County of Los Angeles, water from rainfall is a primary contributing factor to trail erosion. The County averages 15 inches of rain per year. However, the mountainous areas of the County receive much more rain, with portions averaging 33 inches.<sup>2</sup> The desert portions of the County receive approximately 4 inches, and the plains near the coast receive approximately 12 inches. The

<sup>2</sup> County of Los Angeles Department of Public Works. Accessed 6 April 2006. "Water Resources Precipitation Page." Web site. Available at: <http://www.ladpw.org/wrd/precip/>

vegetation found in the foothill areas of the County typically consists of shrubs, which do not provide a canopy to reduce the intensity of the impact of rain on a trail.

Wherever possible, avoid aligning trails with the fall line and fall-line zone. When trails are aligned with the fall-line zone, they have the tendency to intercept the flow of water and direct the water along the trail tread, resulting in maximum exposure to erosion. The fall line is the path of least resistance that is taken by surface runoff, and it lies perpendicular (90°) to the contours of the land. Water will also tend to follow any path that lies within the fall-line zone, which extends approximately 45° to each side of the fall line (Figure 4.1.4-1, *Fall Line*). The fall line of the slope is the steepest path down the slope, and unless directed elsewhere, water will flow down the fall line.



**Figure 4.1.4-1**  
Fall Line

Similarly, trails alignments through stable soils with high clay and silt fragments have the greatest capacity to withstand the erosive capacity of wind. Generally, trail surfaces built on stable soils such as clay and silt are more resistant to wind erosion, whereas trail surfaces built on sand or sandy loam soils have greater susceptibility to wind erosion. Wind works in two ways: (1) wind can directly displace soil by blowing it away, and (2) sand or gravel particles picked up by wind can scour the trail tread.

Wind and water in combination are particularly damaging because of the individual damage caused by each, and because wet soils are especially vulnerable to erosion caused by the scouring action of rain that falls at an angle to the trail.

Therefore, trail designers need to refine the conceptual trail alignment to utilize areas outside fall-line zones and to use stable soils wherever possible.

## 4.2 TRAIL LONGEVITY

The second consideration in the trail design process is trail longevity. Trails designed to withstand the erosive effects of water, wind, and users have increased longevity. The design of a durable, lasting trail works with the undulation (up and down) and meandering (back and forth) of the landscape to direct water off the trail as quickly as possible. The consideration of the Half Rule, the 10-Percent Rule, Minimal Use of Switchbacks, Outsloping of the Trail, Maximum Sustainable Grade, Controlling Water on a Trail, and Gaining Altitude on a Trail will optimize trail longevity. However, trail longevity must be balanced with accessibility. In specific projects where trails will be designated and designed for accessibility, as specified in Appendix I, *Trail Accessibility Guidelines*, trail grade should be 5 percent or less and no more than 30 percent of the trail should exceed 8 percent grade, and the trail grade should not exceed 8 percent for more than 200 feet, 10 percent for more than 30 feet, and 12.5 percent for more than 10 feet.

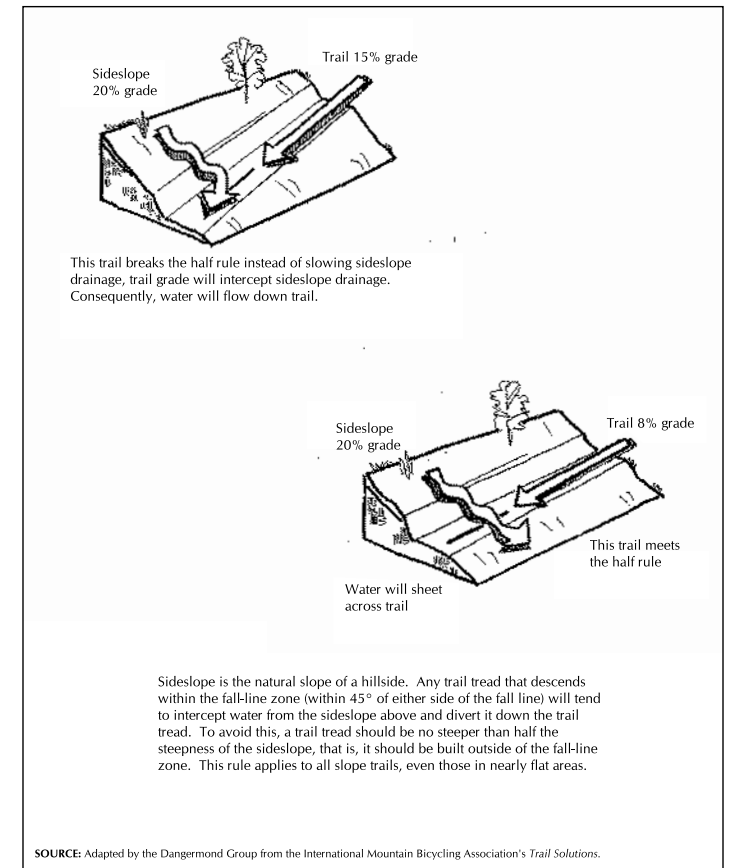
### 4.2.1 The Half Rule

**Guideline:** Design the trail grade at less than 50 percent of the grade of the sideslope traversed by the trail (Figure 4.2.1-1, *Half Rule*).

Sideslope is the natural slope of a hillside.<sup>3</sup> Any trail tread that descends within the fall-line zone (within 45° of either side of the fall line) will tend to intercept water from the sideslope above and divert it down the trail tread. To avoid this, design the trail tread to be no steeper than half the steepness of the sideslope; that is, build the trail tread outside of the fall-line zone. Thus, if a sideslope has a 20-percent grade, then the trail tread should not exceed 10-percent grade. Avoiding the fall-line zone by keeping the trail tread at no more than 50 percent of the sideslope grade is particularly important when building trails on low sideslope grades because, at low grades, water will move more slowly and remain on the trail longer. The duration of soil saturation increases the susceptibility to erosion by trail users.

On well-built trails that undulate and meander with the contours of the landscape, the trail tread slope will vary. However, on trail segments to be built with steep sideslopes,

<sup>3</sup> U.S. Department of Transportation, Federal Highway Administration. "Special Structures" *Trail Construction and Maintenance Notebook*. Available at: <http://www.fhwa.dot.gov/environment/fspubs/00232839/page10.htm>



**Figure 4.2.1-1**  
Half Rule

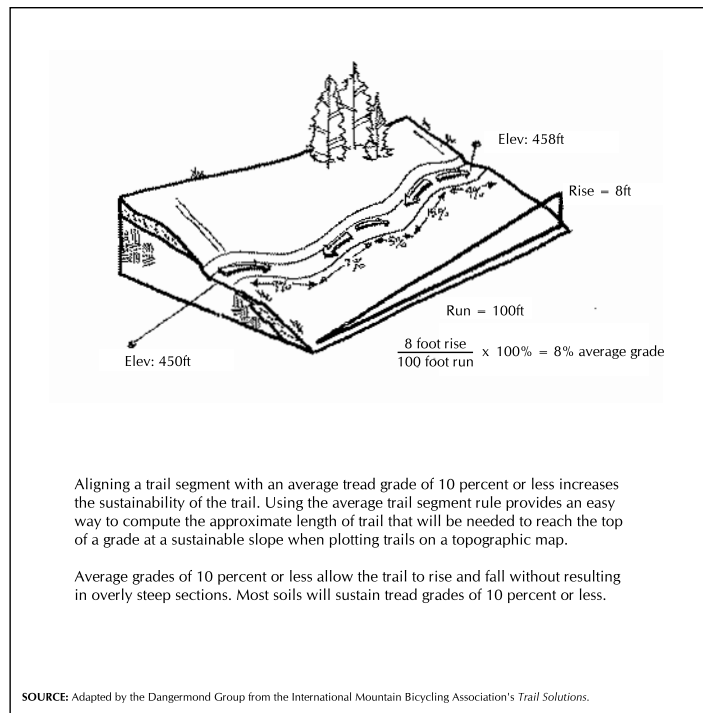
utilize the half rule up to the maximum sustainable grade. For example, a trail with a portion having a 30-percent sideslope will have a trail grade as high as 15 percent. However, trail grades should not exceed 15 percent since that is the maximum sustainable grade. In areas of excessive sideslopes, the use of switchbacks will be necessary, as switchbacks will enable the trail to be built at less than a 15 percent grade.

### 4.2.2 The 10-Percent Rule

**Guideline:** Design the trail such that the average trail grade (or critical climbing segment on long trails) is equal to or less than 10 percent (Figure 4.2.2-1, *Average Trail Segment Grade*).

Aligning a trail segment with an average tread grade of 10 percent or less increases the longevity and durability of the trail. Using the "average trail segment rule" provides an easy way to compute the approximate length needed to reach the top of a grade at a sustainable slope when plotting trails on a topographic map. Specifically, each 10 feet of elevation gain requires a run of at least 100 feet.

$$\text{Average Grade (percent)} = \frac{\text{Rise} \times 100}{\text{Run}}$$



**Figure 4.2.2-1**  
**Average Trail Segment Grade**

Because water moves faster on steeply sloped trail treads, its erosive capacity is increased. Limiting the average grade of the trail tread to 10 percent or less will help limit erosion. In addition, limiting a trail to a 10-percent grade will provide a trail that is accessible to more users.

#### 4.2.3 Minimal Use of Switchbacks

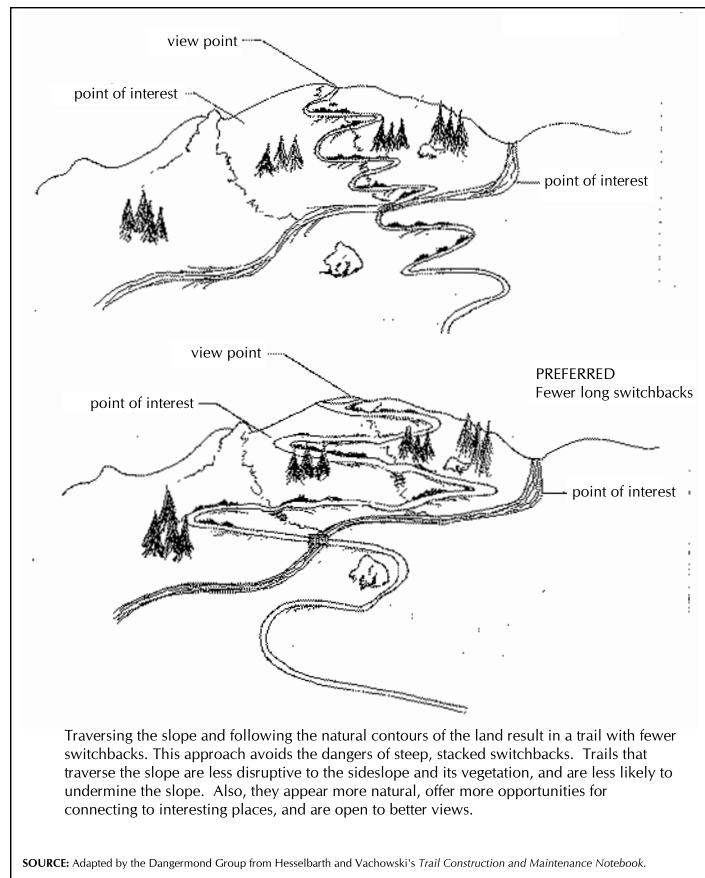
**Guideline:** Reduce the number of short, stacked switchbacks when traversing steep terrain; use fewer long switchbacks instead (Figure 4.2.3-1, *Switchbacks*).

Traversing the slope and following the natural contours of the land result in a trail with fewer switchbacks. This approach avoids the danger of steep, stacked switchbacks. Trails that traverse the slope are less disruptive to the sideslope and its vegetation, and are less likely to undermine the slope. They also appear more natural, offer more opportunities for connecting to interesting places, and are open to better views.

#### 4.2.4 Outsloping of the Trail

**Guideline:** Construct trails with an outslope of 2 to 5 percent. County preference is for 2-percent outslope (Figure 4.2.4-1, *Outslope*).

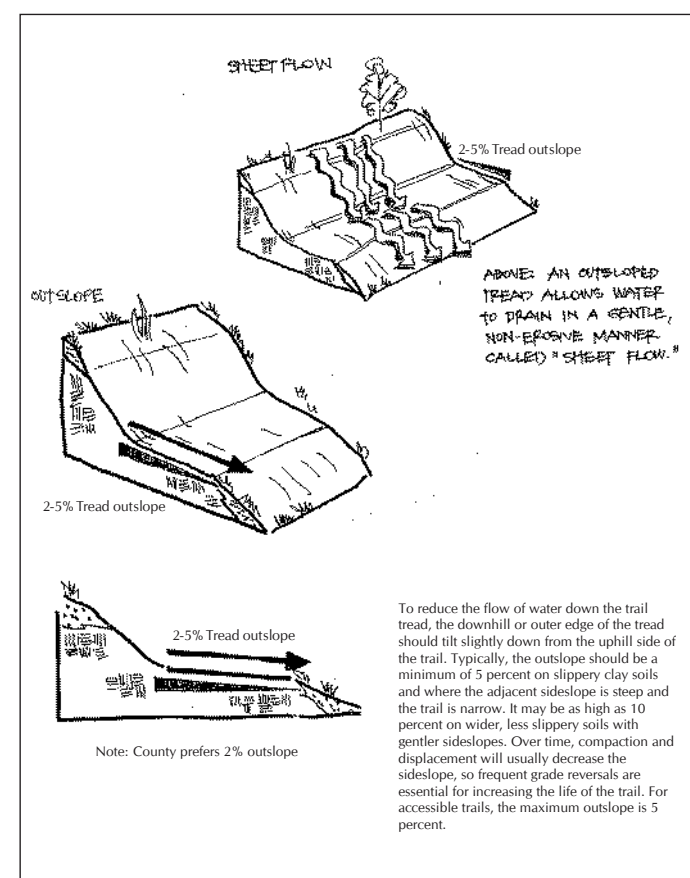
As water drains onto the trail tread from the sideslope above, even when the trail is built within 45° of the contours (outside of the fall-line zone), there will still be a tendency for water to be intercepted and diverted down the trail tread. To reduce the



**Figure 4.2.3-1**  
**Switchbacks**

flow of water down the trail tread, the downhill or outer edge of the trail should tilt slightly down from the uphill side of the trail. In general, 2 percent provides an adequate sideslope in steep terrain that makes it safe and comfortable for users. However, on a new hand-built trail where moderate to heavy use is anticipated during the rainy season, the trail may be built with up to 4 percent of outslope to overcompensate for the compaction and displacement that is likely to occur. Typically, an outslope should be a minimum of 5 percent on slippery clay soils and where the adjacent sideslope is steep and the trail is narrow. Over time, compaction and displacement will usually decrease the sideslope, so frequent grade reversals are essential for increasing the life of the trail.

An exception to this guideline is used for switchbacks. Water can flow perpendicularly across a series of switchbacks, causing damage to the trail. A solution is to inslope the uphill side of the trail, above the hairpin turn of the switchback, to direct water off the trail (see Section 5.0, *Trail Operation and Maintenance*, regarding construction of switchbacks).



**Figure 4.2.4-1**  
**Outslope**

#### 4.2.5 Maximum Sustainable Grade

**Guideline:** Trail grades should reflect the conditions of the trail, including soils, precipitation, erosion and use, and generally should not exceed 15 percent for up to 300 feet.

The maximum sustainable grade of a trail varies and depends on many factors, including soils, type and number of users, rainfall, tread watershed size, and trail difficulty level. Trail segments that exceed 10-percent grade will not be as durable or lasting and therefore should not be used frequently.

##### Soils

The characteristics of soils play a large role in determining the maximum practical grade of a trail. As seen in Table 4.2.5-1, *Properties and Behaviors of Common Tread Materials*, soils present a variety of characteristics that determine soil stability under wet and dry conditions.

Decaying vegetative materials have no chemical or mechanical binding properties. As these materials decay, they will compact to a thin slippery layer, ill-suited to steep slopes. Clay and silt form chemical and mechanical bonds that make them resistant to erosion when they are dry and compacted. On wet steep slopes, these soils can form slip planes that result in mudslides.

These soils are also subject to downhill displacement by users. Grains of sand do not bond chemically; however, the more ragged the grains, the better they hold together. They can be stable on gentler slopes, especially when wet. Ragged gravel has similar properties to sand. Although these soils tend to be permeable to water, trail erosion is likely to occur before water can percolate into the soil because water moves with greater velocity on steeper slopes. Combination soils such as loam are the most sustainable, with the bonding properties of clay and the permeable properties of sand and decayed vegetative matter.

##### User Impacts

User impacts increase on trails with steeper grades due to the force required to travel uphill and the force required to slow down the speed of descent while traveling downhill. The steeper the trail tread, the greater the potential damage from users.

##### Precipitation and Vegetative Cover

The duration, volume, and intensity of rainfall affect the maximum sustainable grade of the trail. Although annual rainfall in the County is relatively low, individual rainfall events can be quite intense, dropping a lot of water quickly, with substantial force, and creating splash erosion on the trail tread. The steeper the grade, the more crucial it is to have vegetative cover on both the sideslope and the trail tread to substantially increase the ability of soils to absorb and hold water. Tree and shrub canopies intercept water before it reaches the ground, allowing the water to evaporate from the leaves. In addition, much of the water that penetrates the soil is removed by the capillary action of the vegetative roots, and is transpired into the air.

#### 4.2.6 Controlling Water on a Trail

The best way to control water on a trail is by manipulating the tread watershed size by controlling the distance between low and high points of trail segments (Figure 4.1.1-1). On a rolling landscape, align the trail so that it undulates with the landscape to automatically produce high and low points on the trail, thereby creating smaller tread watersheds. Other methods used to control water on a trail include knicks, grade reversals, and water bars.



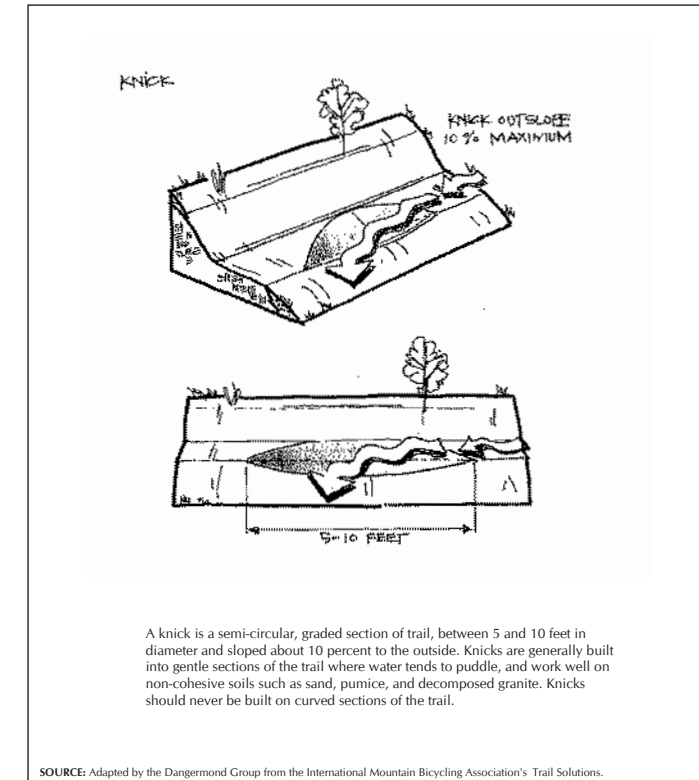
**TABLE 4.2.5-1  
PROPERTIES AND BEHAVIORS OF COMMON TREAD MATERIAL**

Material and Particle Size	Properties and Characteristics	Behavior in Trail Tread
Clay (0.002 mm)	Clay is very fine with a sandwiched structure that is ionically charged in the middle. Clay results in a slippery tread and is subject to slippage between layers on sloped surfaces.	Clay is stable when dry, but slippery when wet. It holds water well. Clay, such as that used in cat litter, can be used as a soil binder when mixed with less stable soil types.
Silt (0.05 to 2.0 mm)	Silt is fine- to medium-textured sediment from broken rock. Silts with larger particles tend to be less muddy when wet.	Silt is variable. In general, it tends to be stable when dry and slippery when wet. Silt can be dusty when dry. It can be added to less stable soil types as a binder.
Sand (0.05 to 2.00 mm)	Sand is coarse-textured broken rock that drains very well. Sand has little resistance to erosion and displacement due to its lack of ionic charge and binders. The more ragged the grains of the sand, the less likely it is subject to displacement and erosion.	Pure sand treads displace and erode easily. Sand can increase drainage and compaction resistance when added to other trail materials.
Loam (0.002 to 2.0 mm)	The most common soil, loam is a mix of clay, silt, and sand. Depending on the mixture, loam can provide a stable, well-drained surface.	A well-balanced loam is smooth, firm, and stable on treads when dry.
Gravel (2 mm to 6 cm)	Gravel is broken rock without binders. It provides good bearing strength. Angular particles provide some stability, which partially offsets its low binding properties.	Gravel increases bearing strength and load resistance when added to other soil mixtures. Gravel creates a rough bumpy trail that may encourage users to walk off the trail.
Cobbles (6 cm to 20 cm) Stones (20 cm to 48 cm)	Cobbles and stones are rocks that need smaller particles, dust, and compaction to fill voids and provide binding. However, cobbles and stones provide strength and load resistance. Rounder stones are easier to walk on.	Cobbles and stones add even more bearing strength and load resistance when added to other soil mixtures. They create a rough bumpy trail that may encourage users to walk off the trail.
Crushed stone / decomposed granite (size varies)	Crushed stone is mechanically crushed rock. Heavier stone such as decomposed granite provides greater resistance to displacement. Rock stones are easier to walk on.	Crushed stones have variable behavior, resistance to compaction, and moderate resistance to displacement. Crushed stones are easily eroded by moving water, but do not get muddy. Decomposed granite is commonly used in newly built trails, not in preexisting trails.
Humus (organic soil, no size)	Organic product of vegetation decay with no binders and little mineral content, which compacts to a thin layer over time.	Humus ruts easily. Humus is also easily displaced unless bound by roots. It is not generally recommended for use as tread.

SOURCE: Adapted by the Dangermond Group from Parker, Troy Scott. 2004. *Natural Surface Trails by Design*. Boulder, CO: Nature Shape, LLC.

**Knicks**

**Guideline:** Design knicks into straight flat sections of trails to drain water from locations that are likely to be subject to puddling (Figure 4.2.6-1, *Knicks*).



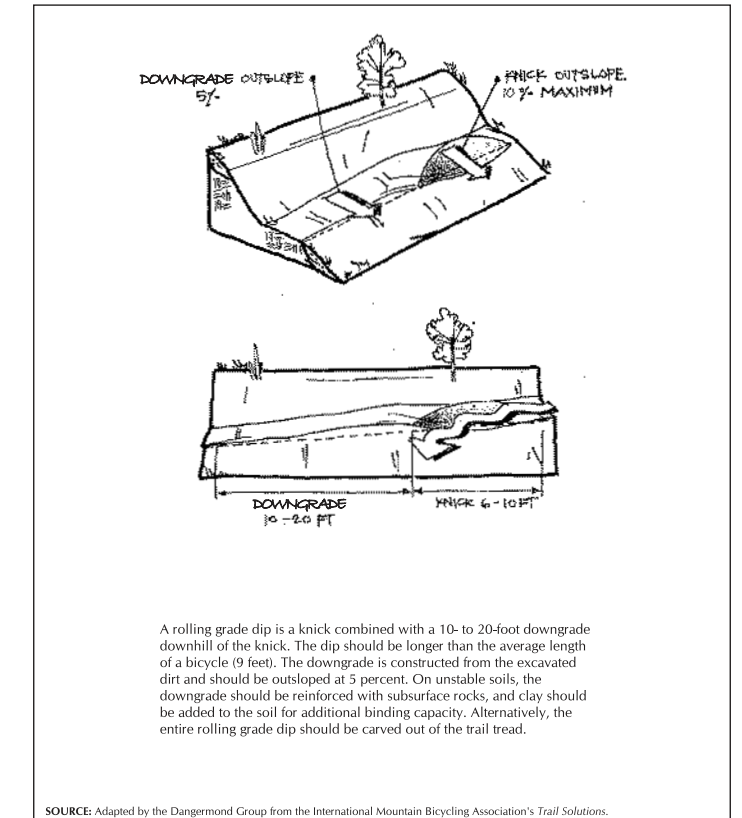
**Figure 4.2.6-1  
Knicks**

A knick is a semi-circular, graded section of trail, between 5 and 10 feet in diameter and sloped about 10 percent to the outside. Knicks work well on non-cohesive soils such as sand, pumice, and decomposed granite and are generally built into gentler sections of the trail where water tends to puddle. Decomposed granite is used when building new trails, not on preexisting trails. By effectively creating a low point on the trail, they provide drainage relief. As a safe practice, place knicks where they will be visible to all trail users. Never place knicks on or just past curved sections of the trail. Users, and particularly mountain bicyclists, will usually anticipate knicks by migrating toward the shallower, uphill side of the trail to pass across knicks.

**Rolling Grade Dip**

**Guideline:** Design rolling grade dips into straight inclined sections of trails to divert water from trail tread (Figure 4.2.6-2, *Rolling Grade Dip*).

A rolling grade dip is a knick combined with a 10- to 20-foot ramp downhill of the knick. Design the dip to be longer than the average length of a bicycle (9 feet). Construct the ramp from the excavated dirt; outslope the ramp at 5 percent. On unstable soils, reinforce the ramp with subsurface rocks. Add



**Figure 4.2.6-2  
Rolling Grade Dip**

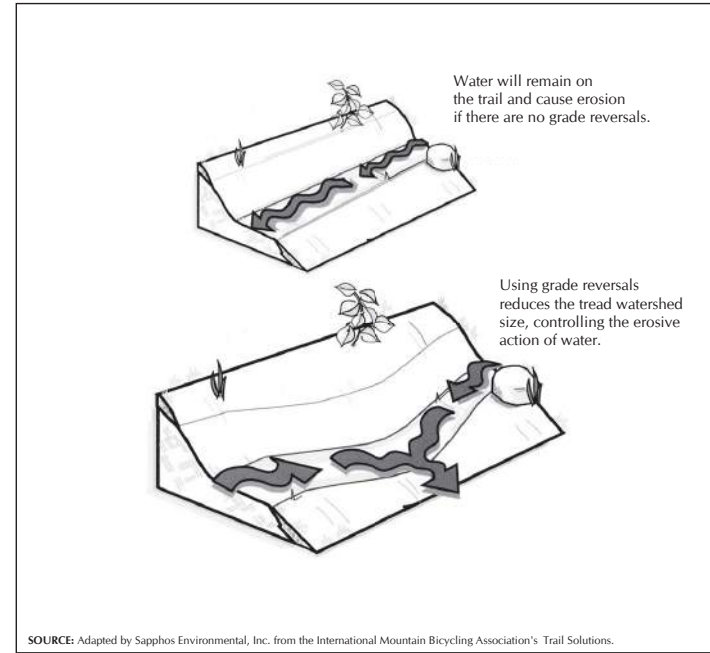
clay to the soil for additional binding capacity. Alternatively, carve the entire rolling grade dip out of the trail.

**Grade Reversals**

**Guideline:** Control the erosive action of water by using grade reversals to reduce tread watershed size (Figure 4.2.6-3, *Grade Reversals*).

A grade reversal is a segment along the trail where the trail levels out and then changes direction, dropping in elevation for 10 to 50 linear feet before rising again. Grade reversals can also be utilized as resting intervals. Build grade reversals into trails where the contours of the land naturally undulate, working with the natural flow of water down existing swales and ravines. Grade reversals create low points for the trail segment and therefore set the boundaries for tread watersheds. A careful assessment of the expected amount of water to drain from the slope determines the frequency of use of grade reversals. The use of frequent grade reversals creates smaller tread watersheds.

Another method for working with contours to get water off the trail is to take advantage of the meanders of the contours. Rounding a corner provides an opportunity for water to exit the trail. The combination of outslopes and meanders on the trail encourages water to exit the trail at curves. One caution



**Figure 4.2.6-3**  
Grade Reversals

is to keep tread watersheds short so that the amount of water washing off the trail at corners will not wash out the trail.

In addition to providing trail drainage, both undulations and meanders add to the natural feel of a trail and provide interest for the users.

### Water Bars

**Guideline:** Install water bars to divert water off the trail.

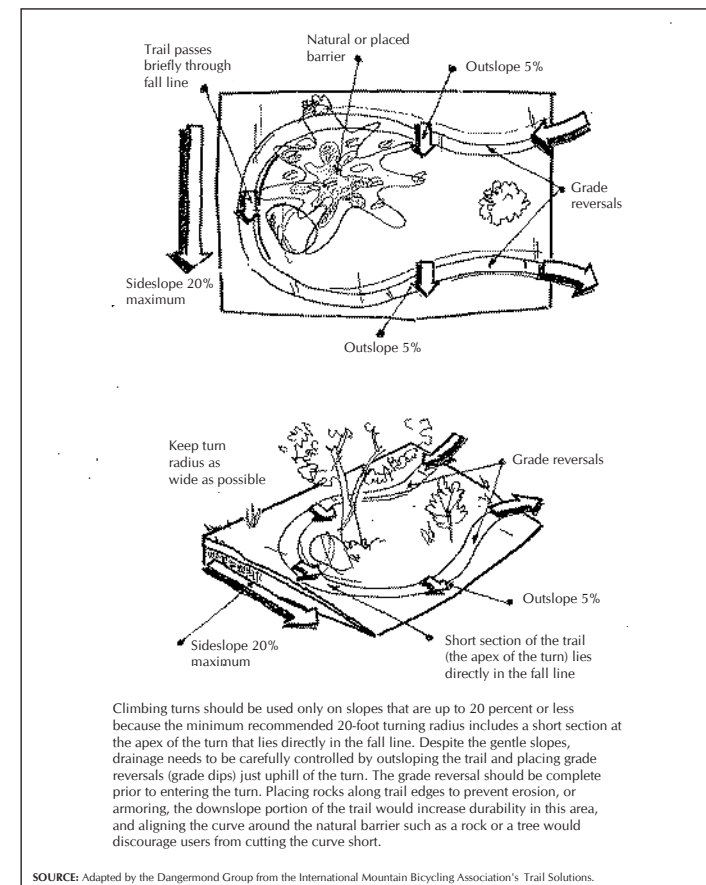
The use of water bars depends on the outslope, the inslope, and existing conditions of the proposed trail site. Water bars are usually formed by placing large stones or wood logs across the trail tread at a 20 percent to 30 percent angle from the normal right angle. Water moving down the trail is turned off the trail when it comes into contact with the water bar. Water stones or wood logs should be keyed or anchored in place with other stones or with 5/8-inch screws drilled in the logs and set approximately 3 feet in the ground. Water bars should be installed slightly above the trail tread and should be flushed with the top of the downhill slope of the trail tread.

### 4.2.7 Gaining Altitude on a Trail

Aligning trails with the contours of the landscape results in a durable trail. However, there are many reasons for aligning segments of a trail at angles to the contours. Destinations such as views, water features, rock formations, or mountain passes may require an uphill climb, and this may require the trail to reverse directions several times while climbing the slope. Although the half, 10-percent, and maximum sustainable grade rules provide guidance for aligning and building durable trails at angles to the contours, obstacles such as property lines, water features, rocks, and bogs may require the trail to reverse directions. Well-designed and well-placed climbing turns and switchbacks provide a practical way to redirect the trail.

#### Climbing Turns

**Guideline:** Redirect trails with climbing turns on trail segments with grades of 7 percent or less, where the half, 10-percent, and maximum sustainable grade rules are not feasible (Figure 4.2.7-1, *Climbing Turns*).



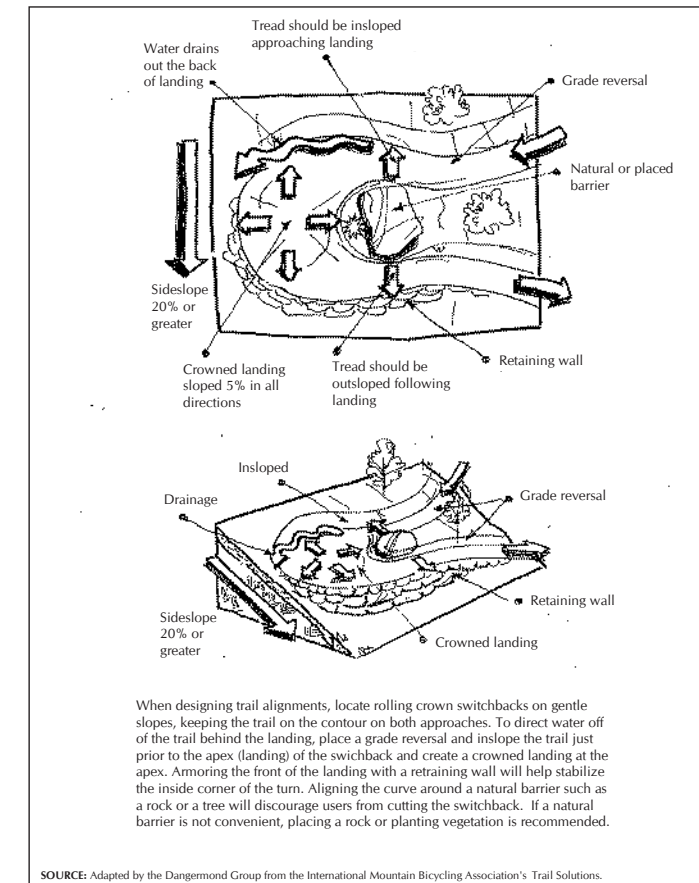
**Figure 4.2.7-1**  
Climbing Turns

Use climbing turns on slopes that are 7 percent or less because the minimum recommended 20-foot turning radius includes a

short section at the apex of the turn that lies directly in the fall line. Despite the gentle slopes, drainage needs to be carefully controlled by outsloping the trail and placing grade reversals (grade dips) just uphill of the turn. Placing rocks along trail edges to prevent erosion (also known as armoring) along the downslope portion of the trail will increase durability in this area, and aligning the curve around a natural barrier such as a rock or a tree will discourage users from cutting the curve short. When aligning the trail, selecting a level area for the turning platform will greatly improve the stability of the climbing turn. Nonetheless, construct the downhill portion of the turning platform by filling with excess soil. A stable base of adequately compacted soil for the turning platform is easily achieved when using machinery to build a trail. However, retaining walls are required for inadequately compacted soils when building a trail by hand.

#### Rolling Crown Switchbacks

**Guideline:** Use rolling crown switchbacks to turn trail segments back uphill, where the half, 10-percent, and maximum sustainable grade rules are not feasible (Figure 4.2.7-2, *Rolling Crown Switchback*).

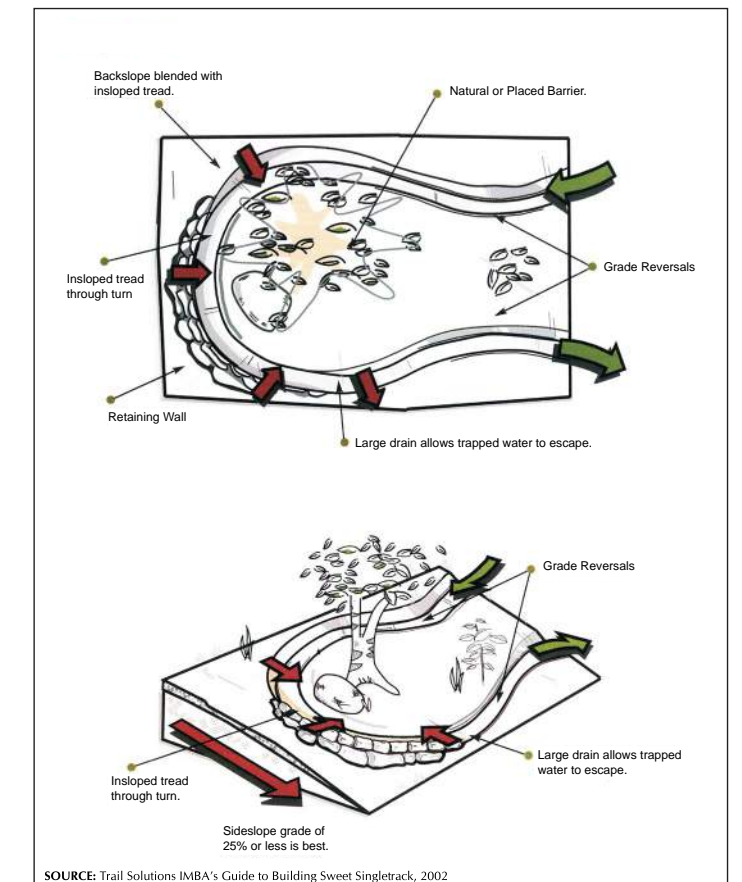


**Figure 4.2.7-2**  
Rolling Crown Switchback

When designing trail alignments, locate rolling crown switchbacks on the flattest area possible, keeping the trail on the contour on both approaches. To direct water off the trail behind the landing, create a grade reversal, inslope the trail just prior to the apex (landing) of the switchback, and create a crowned landing at the apex. Armoring the front of the landing with a retaining wall is necessary on hand-built trails. Depending on the steepness of the sideslope and the stability of the soil, this may not be necessary when using machinery to construct the trail. As with climbing turns, aligning the curve around a natural barrier such as a rock or a tree will discourage users from cutting the switchback. Include the placement of a rock or planting of vegetation in the design of the climbing switchback where there is not a conveniently located natural barrier.

#### Insloped Turns

**Guideline:** Use insloped turns to improve trail flow, reduce skidding, trail widening, and lateral soil displacement (Figure 4.2.7-3, *Insloped Turns*).



**Figure 4.2.7-3**  
Insloped Turns



Insloped turns are easiest to build on sideslope grades below 25 percent. On steeper slopes, the lower section of the turning platform should be raised. For every 10 percent of sideslope steeper than 25, the lower side of the turning platform should be raised by 1 foot. Turns should be constructed to improve a trail user's experience by allowing the user to retain speed and flow. When constructing a turning platform, the lower portion of the platform should be reinforced with a retaining wall. A retaining wall may also be needed to hold longer banks or berms in place and to withstand the forces riders apply as they push their mountain bikes through the turn. The wall should start after the grade reversal on the top leg of the turn and continue around the outside of the turn until it meets the lower leg. In addition, the turn radius of an insloped turn should range between 10 to 15 feet. This enables the user to move through the turn without a change in speed. Finally, very little inslope is required to accommodate a smooth flow through the turn. This may require as little as a 7-percent tilt towards the inside of the turn. While there is no standard height or recommended insloped angle to the bank, the steeper the side slope, the steeper and higher the bank should be.

#### 4.2.8 Traffic Calming Design

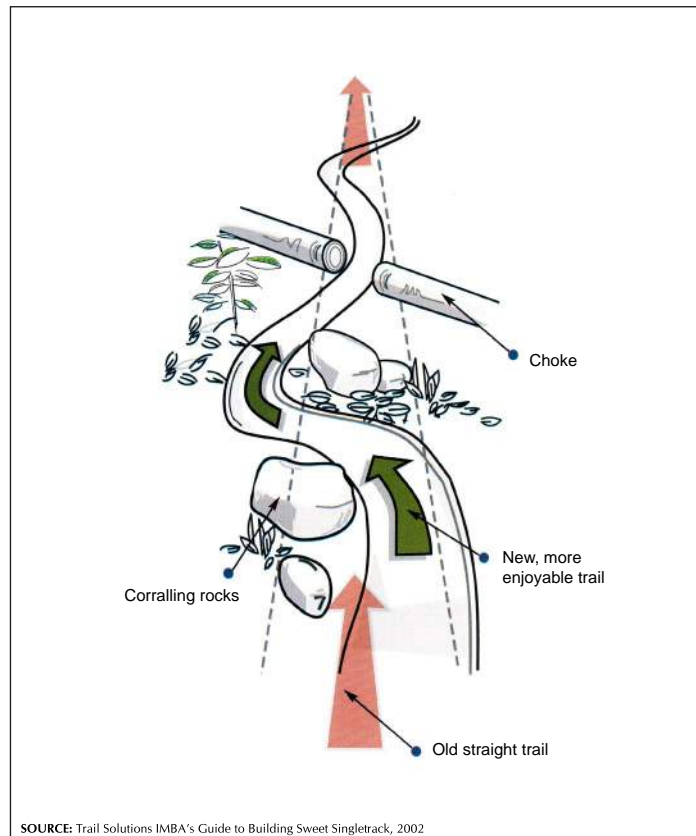
Trails attract many mountain bikers of varying skills. On a multi-use trail, experienced mountain bikers may ride too fast and make other visitors uncomfortable, while inexperienced mountain bikers may brake too suddenly when approaching a turn and cause damage to the trail. In order to preserve the recreational experience of a trail, features should be implemented to provide both traffic calming functionality along with an enjoyable experience (Figure 4.2.8-1, *Chokes and Corraling*).

##### Guideline: Corral the Trail

Include objects to define boundaries of the trail and to emphasize turns. These are also known as trail anchors. Natural elements should be used as trail anchors. This may include rocks, logs, or trees or any other natural feature that is prevalent throughout the trail area. These obstacles should be placed on either side of the trail to serve as both physical and visual barriers to keep visitors on the trail and to slow riders.

##### Guideline: Chokepoints

Create narrowing pathways along the trails with natural barriers such as rocks, plants, logs, and trees. These are also known as gateways and should be strategically placed where visitors should slow down, such as intersections or sharp turns. Chokepoints encourage mountain bikes to gradually apply their brake well in advance; as it provides the illusion of a technical challenge. It is important that these narrowing flows



SOURCE: Trail Solutions IMBA's Guide to Building Sweet Singletrack, 2002

Figure 4.2.8-1  
Chokes and Corraling

fit naturally with the trail so they do not become a nuisance to visitors.

##### Guideline: Use Turns

Designing a trail with many tightly bound twists and turns can assist in slowing user traffic. Since trail users must stay focused on an ever-changing trail, users may experience a challenging and quick-paced ride. However, tight and twisting turns only give off the illusion of speed without allowing trail users to ride at a fast pace.

#### 4.3 APPLICATION OF DESIGN GUIDELINES

The third consideration in the trail design process is the application of standard design guidelines. This section covers trail design guidelines for the various classifications of trails, water crossings, retaining structures, signs, and other appurtenances. These design guidelines facilitate the consistent design of high-quality County trails that are readily recognized by residents and visitors. To achieve this, it is important to maintain consistency throughout the trail network through standardization of design; quality of construction of trails, parking lots, rest areas, bridges, and other structures; and clear and consistent signs.

TABLE 4.3.1-1  
TRAIL CLASSIFICATION GUIDELINES

Trail Classification	Trail Grade (percent)	Surface	Tread / Trail Width (feet)	Outslope (percent)
Urban Pedestrian Path	< 5% < 8% for < 100' with rail	Asphalt* Crusher fines* Decomposed granite	10 to 11	2%
Recreational Pathway	< 5% < 8% for < 100' < 12% for < 50'	Natural surface	8 to 10	2% < 4%
Natural Trail 1	< 5% < 8% for < 150' < 12% for < 50'	Natural surface	7 to 10	2% < 4%
Natural Trail 2	< 5% < 8% for < 100' < 12% for < 50'	Natural surface	5 to 8	2% < 4%
Natural Trail 3	< 5% < 8% for < 200' < 12% for < 50' < 15% for < 20'	Natural surface	2 to 3	2% < 5%

NOTE: \*Asphalt and crusher fines used in trail surfaces cannot be road based and cannot contain toxic chemicals.

#### 4.3.1 Trail Guidelines

There are four categories of trail development within the County. The guidelines for each category are designed to accommodate a variety of users, sites, and trail materials (Table 4.3.1-1, *Trail Classification Guidelines*). There are differences with certain guidelines specific to the type of user. For each trail classification, a diagram has been provided that depicts the design guidelines for that particular trail classification (Figure 4.3.1-1, *Recreational Pathway*; Figure 4.3.1-2, *Urban Pedestrian Path*; Figure 4.3.1-3, *Natural Trail 1*; Figure 4.3.1-4, *Natural Trail 2*; and Figure 4.3.1-5, *Natural Trail 3*). This manual focuses on natural surface trails and therefore does not include guidelines for the Class I Bikeways referenced in the *Highway Design Manual*.<sup>4</sup>

For trails that are adjacent to streets, the guidelines will be slightly modified to accommodate a larger trail width of 10 feet (Figure 4.3.1-6, *Multi-use Front Yard Trail on Secondary Roadway*).

For all trail classifications, the clearing limits to the sides of the trail should be 2 feet, and the vertical clearance should be 10 feet for trails that exclude equestrian and 12 feet for trails that include equestrian (Figure 4.3.1-7, *Clearing Limits*).

It is the County's objective to have trails within the County be multi-use, which the County defines as including equestrians, hikers, and mountain bikers. In order to accommodate these users, it is recommended that trails be a minimum of 5 feet wherever possible; however, this does not preclude trails that are 3 feet wide from being designated a multi-use trail. Where trails are narrower than 5 feet or where 5-foot-wide trails will experience a high level of traffic, it is recommended that wider turnout areas of 6 to 10 feet be provided every quarter mile to allow for passage of trails users. In addition, it is recommended that where narrower trails cross terrain with excessive sideslope, typically greater than 45 degrees, the trail width be expanded to a minimum of 6 feet.

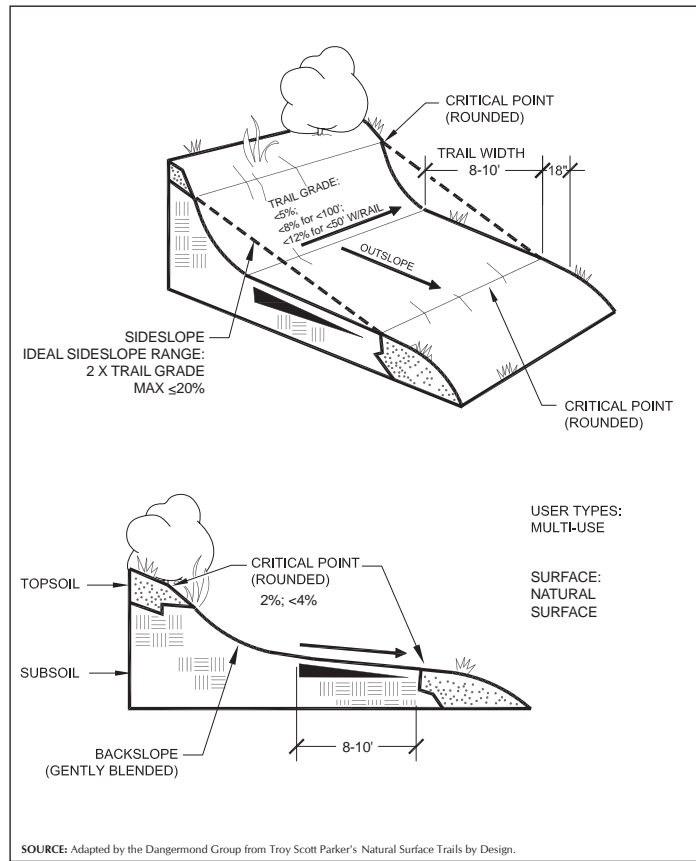
It is recommended that trails that are multi-use allow users sufficient line of sight to react to other trail users. The following line of sight guidelines are recommended:

1. Minimum +/- 85 feet for trail grades of 5–10 percent
2. Minimum +/- 50 feet for trail grades of 10–12 percent and at blind turns<sup>5</sup>

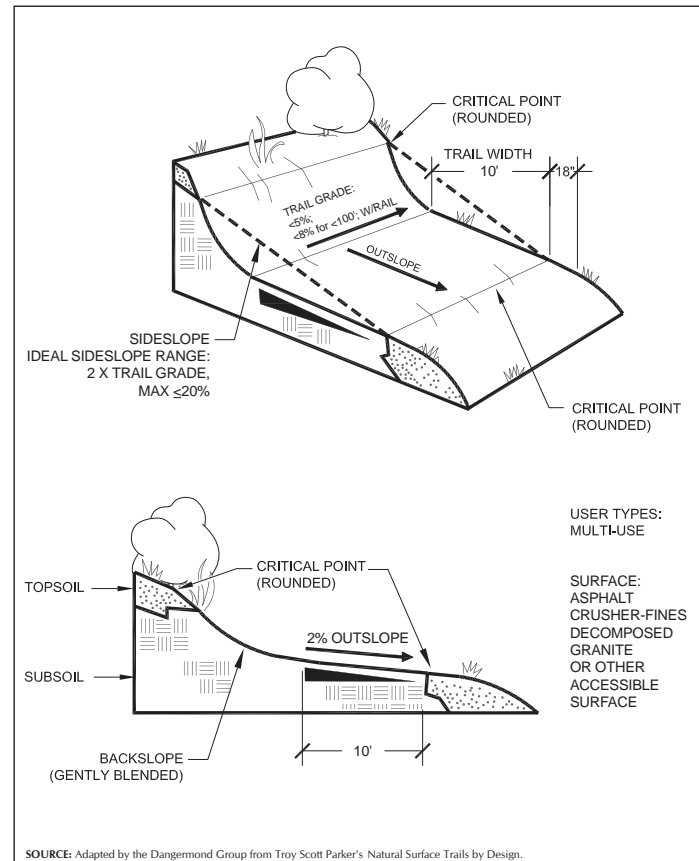
In order to address the concerns of all trail users, a design where soft-surface trails are located adjacent to hard surface trails for use of mountain bikes traveling at speeds in excess of equestrians may be considered.

<sup>4</sup> California Department of Transportation. 1 February 2001. *Highway Design Manual*, Chapter 1000. Bikeway Planning and Design. Sacramento, CA. Available at: <http://www.dot.ca.gov/hq/oppd/hdm/pdf/chp1000.pdf>

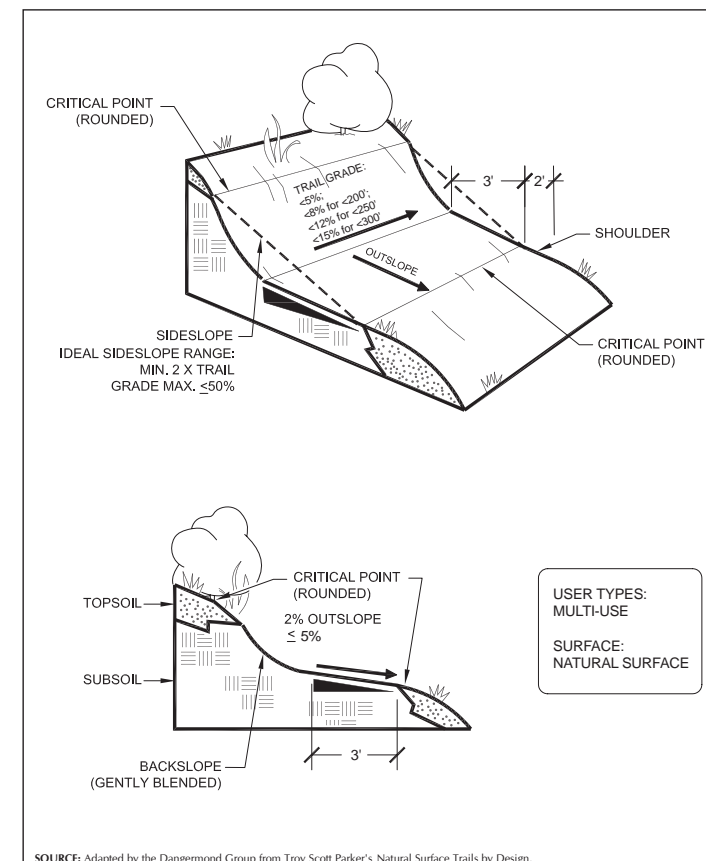
<sup>5</sup> Santa Monica Mountains Area Recreational Trails (SMMART) Coordination Project. September 1997. *Final Summary Report*.



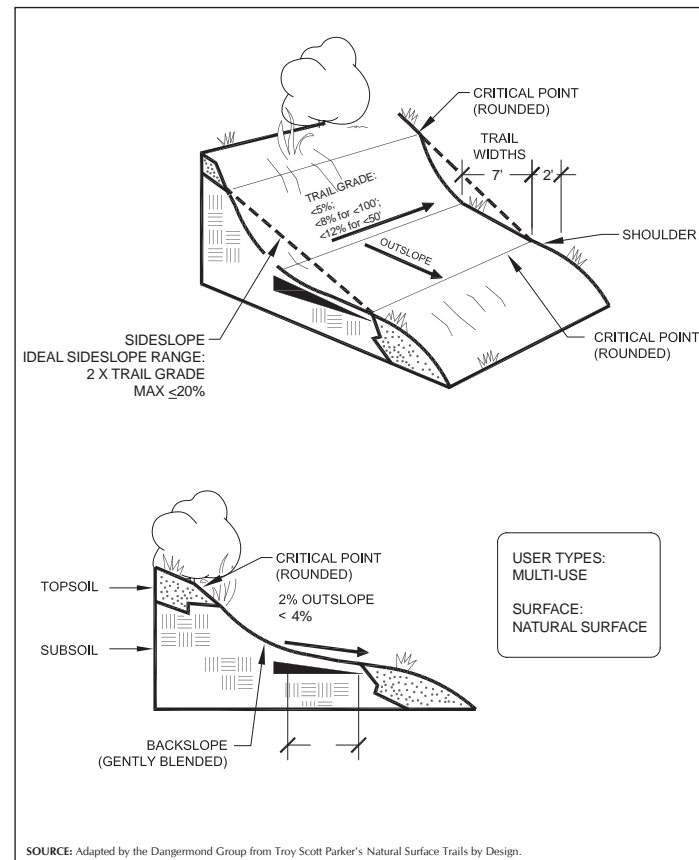
**Figure 4.3.1-1**  
Recreational Pathway



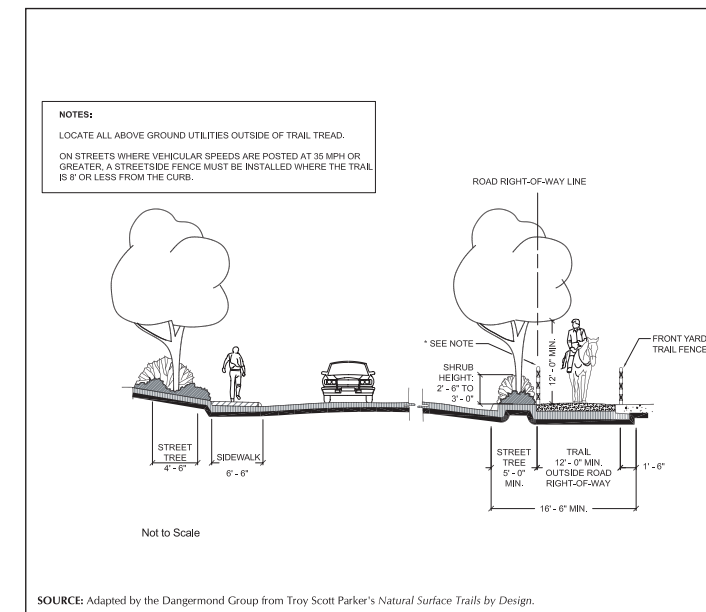
**Figure 4.3.1-2**  
Pedestrian Path



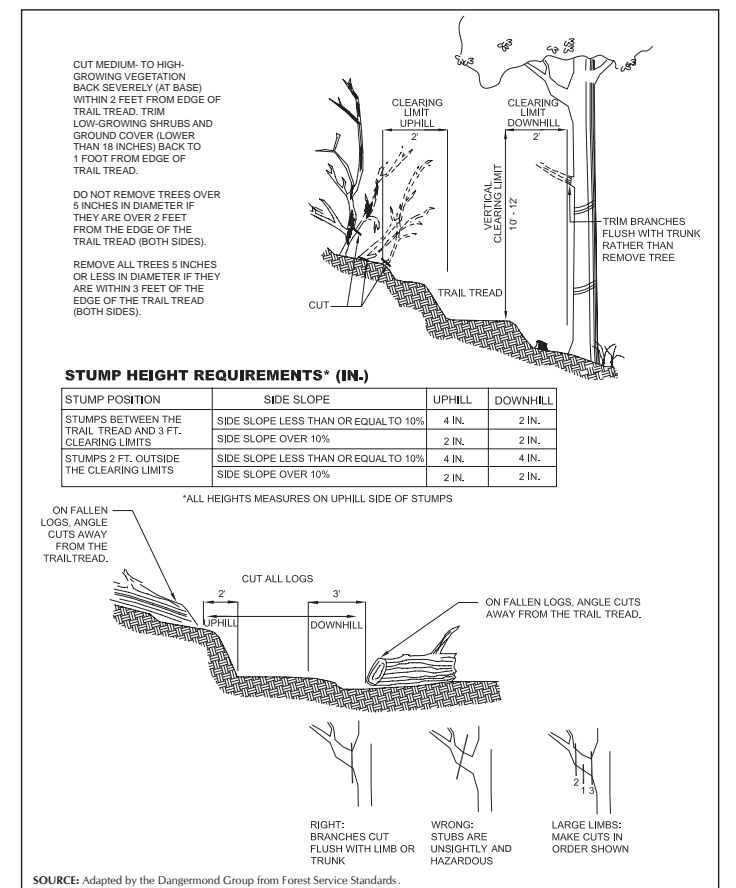
**Figure 4.3.1-3**  
Natural Trail 1



**Figure 4.3.1-4**  
Natural Trail 2



**Figure 4.3.1-5**  
Multi-use Front Yard Trail on Secondary Roadway



**Figure 4.3.1-7**  
Clearing Limits

#### 4.3.1.1 ADA Compliance

In 2002, the Federal Register published Americans with Disabilities Act (ADA) guidelines pertaining to recreation.<sup>6</sup> However, the guidelines do not cover outdoor facilities such as trails. The Architectural and Transportation Barriers Compliance Board (Access Board) is currently developing new guidelines for outdoor developed areas that will cover access to trails in addition to other outdoor areas. As of February 2008, the comment period for the *Proposed Guidelines for Federal Outdoor Developed Areas* (Guidelines) had ended and the final version was being developed.<sup>7</sup> According to the proposed Guidelines, trails that will have to be compliant with the ADA are those designed specifically for pedestrian use and multi-use, where pedestrian travel is one of the designated uses for which the trail was created. However, the guidelines will not be applicable to trails designated for another use, such as mountain biking or equestrian, whether or not pedestrians

<sup>6</sup> Architectural and Transportation Barriers Compliance Board. 3 September 2002. "ADA Accessibility Guidelines for Recreation Facilities." *Federal Register*, 36 CFR Part 1191 (Docket No. 98-5) RIN 3014-AA16. Available at: <http://www.access-board.gov/recreation/final.htm>

<sup>7</sup> U.S. Access Board. Accessed 1 February 2008. "Public Provides Input on Guidelines for Federal Outdoor Sites." Available at: <http://www.access-board.gov/news/outdoor-comments.htm>



will be utilizing the trails. Way-finding signs for these types of trails are necessary. The Arroyo Pescadero Trail in Whittier provides proper way-finding signs (Figure 4.3.1.1-1, *Arroyo Pescadero Accessible Trail*). The guidelines also recognize that full compliance with the guidelines will frequently be limited by environmental constraints.<sup>8</sup>

On September 15, 2010, the Federal Register published revised final regulations for ADA guidelines, known as the Final Rule.<sup>9</sup> The Department of Justice's revised ADA regulations regarding trails,<sup>10</sup> which became effective March 15, 2011, will affect the Trails Manual. The Trails Manual is not intended to serve as a policy document. As required by the 2011 ADA ruling, the LACO-DPR has established an interim policy that is available on the LACO-DPR Web site. The potential for appeals to the 2011 ADA rulings is beyond the scope of the Trails Manual. Given the potential for ADA compliance standards to continue to evolve over time, the LACO-DPR staff will consider ADA regulations during the planning phase of the project and demonstrate compliance with regulations that are in place at the time of the trail project planning effort.

#### 4.3.2 Water Crossing Guidelines

Incorporating out slopes and rolling grade dips into the trail design greatly reduces the amount of water channeling down a trail. Design trail alignments to avoid streams and wetlands in order to reduce potential impacts to those areas. Design the trail alignments, and related culverts and bridges, to avoid and minimize impacts to stream and wetland ecosystems to the maximum extent practicable. These ecosystems are protected by state and federal laws and subject to the regulatory jurisdiction of the U.S. Army Corps of Engineers and the California Department of Fish and Game. The California Coastal Commission has additional regulatory authority in the coastal zone. Undertake all feasible engineering solutions to maintain the baseline hydrologic conditions. In areas where a trail must traverse areas of surface water, consider design options such as the use of prefabricated clear-span bridges, culverts, underdrains, or puncheons.

##### 4.3.2.1 Bridges

One means of crossing a channel and water is via a bridge. Bridges that span the stream are preferable to in-stream crossing.

<sup>8</sup> U.S. Access Board. Accessed 1 February 2008. "Proposed Architectural Barriers Act Accessibility Guidelines for Outdoor Developed Areas." Available at: <http://www.access-board.gov/outdoor/nprm/>

<sup>9</sup> U.S. Department of Justice. Americans with Disabilities Act. "Revised ADA Regulations: Implementing Title II and Title III." Available at: <http://www.ada.gov/regs2010/ADAregs2010.htm>

<sup>10</sup> U.S. Department of Justice. Americans with Disabilities Act. "Revised ADA Regulations: Implementing Title II and Title III." Available at: <http://www.ada.gov/regs2010/ADAregs2010.htm>



Figure 4.3.1.1-1  
Arroyo Pescadero Accessible Trail

Bridges can take the form of small structures spanning a few feet to large structures spanning greater than 10 feet (Appendix J, *Design Guidelines*). Larger bridges are typically custom designed and manufactured, and are typically made of wood, metal, or composite materials. Design guidelines for large bridges (in terms of spacing of railings and location of footings outside of stream channels) should conform to those provided for a small bridge. Additionally, bridges must be designed to withstand the weight of the trail users, especially in equestrian trails. Bridges on equestrian trails must bare the weight of the horse and rider.

##### 4.3.2.2 Culverts and Underdrains

In areas with continuous or seasonal small amounts of water flows in channels, a culvert may be a better option than a bridge due to the cost of construction. However, do not attempt the use of culverts for medium to large streams, or any stream located in a sensitive habitat area. The size of the culvert pipe used is dependent on the volume of the flow of water and should be able to accommodate the peak flow. Utilize a minimum culvert pipe size of 24 inches in diameter. A typical design for a culvert is included in Appendix J.

In areas along a trail where water is pooling, another option is the installation of an underdrain system to increase the ability of water to flow through the trail tread and off the trail. A typical design for an underdrain is included in Appendix J.

Design culverts and pipes with an exit point that dissipates the flow and velocity of water, thus reducing the erosive potential of the discharged water. Use rocks harvested during construction of the trail to install rock spillways to dissipate water flows at culvert and pipe exit points. Details for a rock spillway are included in Appendix J.

#### 4.3.2.3 Puncheons

Design trails to avoid wetlands wherever possible. Use puncheon type trails to traverse unavoidable wetland areas, such as bogs and other permanently wet soils. A puncheon consists of an elevated wood boardwalk on posts that reduces the impacts of a trail on the natural hydrological regime of the area. An alternative to installing a puncheon is installing a tread, such as a large rock or log that does not pose a hazard to users and is capable of withstanding the flow of water for typically intermittent flows. In all cases, disturbance of an existing hydrologic regime should be reduced to the maximum extent possible. Appendix J includes details for the construction of a puncheon.

#### 4.3.3 Trail Guidelines Specific to Environments

##### 4.3.3.1 Coastal Trails

In designing coastal trails, the trail environments consist of stable and unstable terrain, fragile vegetation, and micro-environments. When determining the placement of the trail, avoid areas that would potentially impact sensitive habitats by using raised boardwalks or sand ladders. The County of Los Angeles recommends that trail builders consult the U.S. Forest Service's manual on Wetland Trail Design and Construction for appropriate construction methods in sensitive coastal environments.<sup>11</sup> Visual appeal is also an important design factor in coastal trails. Therefore, when additional structures are incorporated into the design of the trail, the structures should be kept low to the ground and use materials that blend with the landscape and are durable to avoid intruding trail users' vision.

As a result, construction of trails on unstable surfaces or environments that could become unstable with the construction of a trail should be avoided. An example of an existing coastal trail in the County of Los Angeles is the Abalone Cove Trail in Rancho Palos Verdes (Figure 4.3.3.1-1, *Abalone Cove Coastal Trail*).

##### 4.3.3.2 Urban Trails

Urban trails, due to their locations in highly populated areas, are utilized by many people at different fitness levels for a range of reasons. Therefore, safety is the most important consideration in designing urban trails. It is important that urban trails are designed in accordance with traffic engineering standards. The Metropolitan Transportation Authority Congestion Management Plan (CMP) and the Transportation element of the County of Los Angeles General Plan should be consulted to determine the traffic impacts of a trail. In addition, way-

<sup>11</sup> U.S. Department of Agriculture Forest Service. 2001. *Wetland Trail Design and Construction*. Available at: <http://www.fhwa.dot.gov/environment/fspubs/01232833/index.htm>

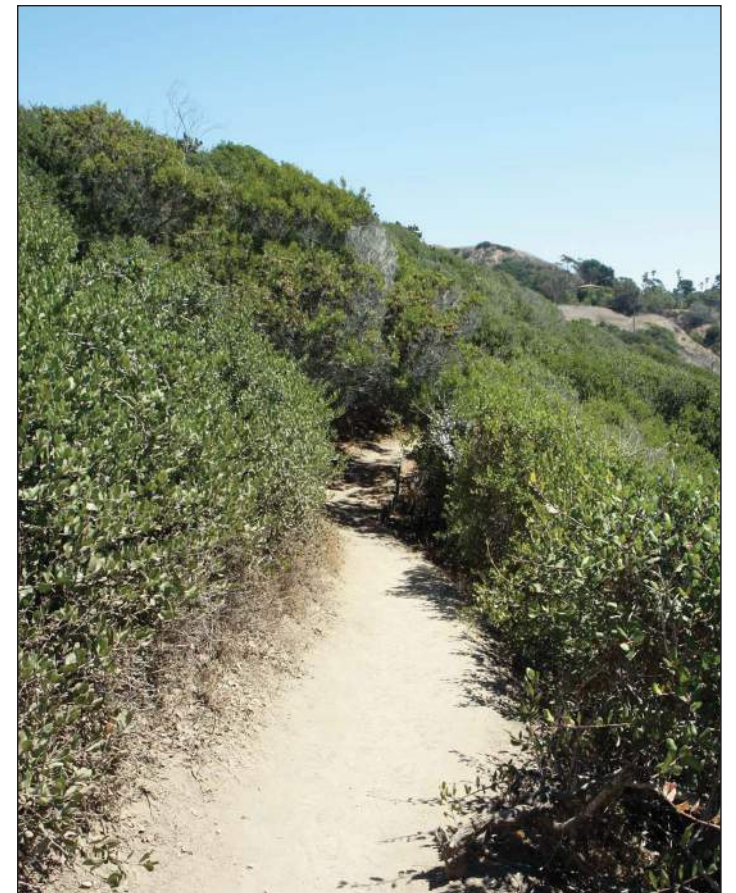


Figure 4.3.3.1-1  
Abalone Cove Coastal Trail

finding signs ensure the safety of urban trails. The purpose of urban trail signs is to indicate the required change in traffic, the behavior required of the trail users, and the need to switch gears at intersections.<sup>12</sup>

Fencing is also important in the design of urban trails. Fencing identifies the route of the trail as well as alerts motorists when trails are in the proximity of streets. Fencing should be shorter than 50 percent of the trail easement width and outside the trail tread and easement. Fencing over 30 inches in height should have a second rail to prevent ponies from ducking under a high top rail.<sup>13</sup> Fencing should also be smooth to prevent injuries to trail users. An example of an urban trail is the Walk for Health Trail in Kenneth Hahn State Recreation Area (Figure 4.3.3.2-1, *Walk for Health Urban Trail*).

<sup>12</sup> City of Los Angeles, Department of City Planning. February 2004. *Guide to Trail and Horsekeeping Specifications, New Construction, Private Property Easements, and Public Right of Way*. "Development of Trails." Prepared by the Foothill Trails District Neighborhood Council Ad Hoc Trails Committee.

<sup>13</sup> City of Los Angeles, Department of city Planning. February 2004. *Guide to Trail and Horsekeeping Specifications, New Construction, Private Property Easements, and Public Right of Way*. "Development of Trails." Prepared by the Foothill Trails District Neighborhood Council Ad Hoc Trails Committee.





**Figure 4.3.3.2-1**  
**Walk for Health Urban Trail**

Another concern with desert trails is identifying the trail for trail users. As there is generally less vegetation and an abundance of exposed rock within the desert the alignment of the trail is not as readily apparent as it is in other environments. Therefore, it is recommended that the trail be marked with postings every quarter mile to help prevent users from straying from the trail as is done along the portions of the Pacific Crest Trail (PCT) in the Mojave Desert (Figure 4.3.3.3-1, *PCT in the Mojave*).



**Figure 4.3.3.3-1**  
**PCT in the Mojave**

#### 4.3.3.4 Foothill Trails

The issue of most concern related to the design and construction of foothill trails is erosion. Preventing erosion will ensure the safety of all trail users and increase the longevity of the trail. When designing and constructing foothill trails, refer to all erosion guidelines. Specific erosion guidelines can be found in Section 4.1.4, *Erosion*, of this Trails Manual.

#### 4.3.4 Multi-Agency Trails

Trails within the County of Los Angeles are likely to cross into jurisdictions surrounding the County of Los Angeles, such as the numerous connections both to City of Los Angeles and occasional connections with the other 87 cities in the County and the U.S. Forest Service. Other jurisdictions may have trail

#### 4.3.3.3 Desert Trails

The greatest challenge in designing desert trails is erosion. In the desert, water causes erosion, which can be detrimental if the erosion occurs on trails. On non-desert trails, as indicated in Section 4.2, *Trail Longevity*, trail grade should be 5 percent or less and no more than 30 percent of the trail should exceed 8 percent grade, and the trail grade should not exceed 8 percent for more than 200 feet, 10 percent for more than 30 feet, and 12.5 percent for more than 10 feet. However, in desert trails, to prevent erosion the grade should be between 5 percent and 7 percent.<sup>14</sup>

Soil types are critical in the longevity of desert trails. In loose soils with low shear strength, minimal grads and buttressing features, such as crib walls and grade reversals should be incorporated where feasible.<sup>15</sup>

<sup>14</sup> Flint, Mark. *Desert Trails: Designing and Building Trails in a Harsh and Demanding Environment*. "Design."

<sup>15</sup> Flint, Mark. *Desert Trails: Designing and Building Trails in a Harsh and Demanding Environment*. "Design."

policies or standards that differ from those within the County of Los Angeles. For example, a multi-use trail may go from the County of Los Angeles, where pedestrians, equestrians, and mountain bikers are allowed, to the City of Los Angeles, where only pedestrians and equestrians are permitted. When a trail passes into another jurisdiction, the policies of the LACO-DPR, including the multi-use policy, no longer apply. When planning a trail, initially, it is recommended that outreach be made to the agencies involved with the goal of maintaining continuity for the duration of the trail. However, in situations where there will be differences either in the users allowed or in the trail design, such as a decrease in the trail width, it is recommended that the trail provide way-finding signs at the trailhead to notify users before they set out of the upcoming changes along the trail. Moreover, the County seeks to develop multi-use trails even where such trails connect to adjacent jurisdictions that do not accommodate multi-use trails. In such an event, signs will be used to notify trail users of a change in jurisdiction and any corresponding changes in allowable uses. In addition, in situations where there is a change in the users allowed, it is recommended that a turnout area be provided to allow for trail users to safely turnaround.

#### 4.3.5 Retaining Structure Guidelines

Use retaining structures to remediate areas expected to be temporarily unstable during construction, as well as inherently unstable site conditions. In areas of excessive slope, typically greater than 45 degrees, a retaining structure may be required. However, certain geologic materials, such as granitic rocks, bedrock, and older alluvium sediments, may be able to withstand slopes greater than 45 degrees. Design the placement of retaining structures consistent with the slope of the surface terrain, the underlying geologic structure, parent material and surface soils, and the space available for trail construction. In certain site-specific instances, a geotechnical engineer may be required to provide additional recommendations on design and placement of retaining structures for the protection of structures or life. Trail retaining structures can take the form of rock walls or I-beam walls as specified in Appendix J. Utilize a traditional retaining wall to protect trails and appurtenant structures from the movement of soils.

#### 4.3.6 Way-Finding Signs

Way-finding signs include the use of all informational graphics and text displays located along trail corridors. Way-finding signs should also include emergency response information, such as emergency phone numbers and trail addresses if applicable. Emergency response to County trails will be provided by various agencies, depending on the location. In many cases, the closest public agency will respond, which may include County sheriffs, local police, or national forest personnel.

Way-finding signs may be located in or on the ground, or suspended or attached to a structure. Way-finding sign poles should be higher to prevent vandalism, and constructed or treated to minimize the effects of graffiti.

The LACO-DPR has adopted a trail way-finding sign program. The intent of this primary trail way-finding sign program is to identify the typical County trail signs, which would be applied Countywide, cognizant of limited staff and funding resources. The trails logo was approved in 2010 by the LACO-DPR Director and has been applied in trail staging areas in a few locations. The goal is to apply this for "branding" purposes. The trail monumental signs include two styles, one reflecting a contemporary design and another more rustic version for application in either wilderness or rural depending on the surrounding contexts. The way-finding sign is new to the LACO-DPR; while being simplistic, it is intended to be easy to maintain and readable. Detailed examples of the trail way-finding sign program are provided in Appendix K, *Way-Finding Signs*.

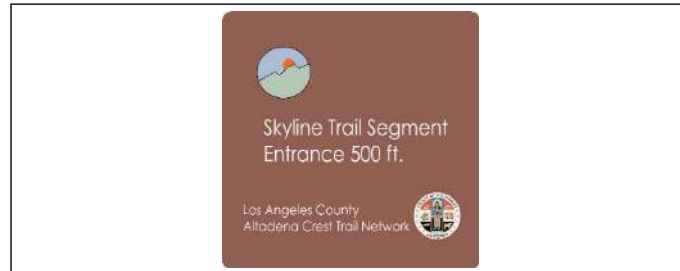
The directional and other way-finding sign configurations were developed to be simple, clean, and easy to read. County trail signs are broken down into highway, regulatory, and informational types (Figure 4.3.6-1, *Highway, Regulatory, and Informational Signs*). Other jurisdictions' trail signs are not included in the Trails Manual. This section provides a brief description and purpose of each sign type, as well as the recommended location and frequency for their placement. A detailed description of each individual sign type, including visual examples, is provided in Appendix K.

Integrate the appropriate sign type into the trail design. Well-designed signs serve many purposes:

- Provide positive exposure to attract more users
- Orient and educate the user to the trail
- Reassure the user that he or she is on the right trail and will not get lost
- Help with safety issues such as road crossings
- Trailheads include emergency response information, such as emergency phone number and trail address if applicable to facilitate dispatch of emergency response personnel when needed
- Alert users to unusual trail conditions (e.g., storm damage, hazards, trail closings)
- Provide information about geographic, environmental, biological, and historic features, and other types of interpretive way-finding signs where appropriate
- Describe etiquette for all users



- Indicate mileage
- Provide information for emergency responders (trail identification system)
- Demonstrate that, in natural areas, human impact should be minimized
- Sign poles should be placed high enough to prevent vandalism



Example Highway Informational Sign



Example Regulatory Permitted Use Sign



Example Informational Wayside Exhibit

Figure 4.3.6-1

### Highway Regulatory and Information Signs

#### 4.3.6.1 Highway Signs

Design must conform to the standards of the various agencies that regulate highway signs (e.g., state, county, municipalities).

##### Information Signs

**Description and Purpose:** Information signs provide basic trail information to motorists and trail users at the initial highway approach to the trailhead, public recreation area, and places of cultural interest. Design the signs so that approaching motorists are able to read the sign from the roadway and well in advance of the highway exit ramp.

**Location and Frequency:** Posting of signs falls under the jurisdiction of the relevant highway regulatory agency, such as the California Department of Transportation (Caltrans) or U.S. Department of Transportation. Coordinate with the appropriate highway agency regarding all highway signs.

##### Warning Signs

**Description and Purpose:** Warning signs provide a warning to motorists and trail users of approaching trail and street intersections (Figure 4.3.6.1-1, *Trail Intersection Signs*). Provide clear way-finding signs for both motorist and trail users well in advance of the intersection.

**Location and Frequency:** Place signs at every street and trail intersection. Posting of signs falls under the jurisdiction of the relevant highway regulatory agency, such as Caltrans or the U.S. Department of Transportation. Coordinate with the appropriate highway agency regarding all highway signs (Figure 4.3.6.1-2, *Trail Crossing Sign*).



Figure 4.3.6.1-1  
Trail Intersection Signs



Figure 4.3.6.1-2  
Trail Crossing Sign

#### 4.3.6.2 Regulatory Signs

Regulatory signs, produced by the County of Los Angeles, delineate the permitted uses on the trail, the operator of the trail, and the boundaries of the trail easement.

##### Permitted Use (Usage Control) Signs

**Description and Purpose:** Permitted use signs provide information to trail users about permitted and non-permitted uses of the trail. An example of a permitted use sign is located at Bonelli Park in San Dimas (Figure 4.3.6.2-1, *Bonelli Park Permitted Use Sign*). Signs should be posted to remind users that they are also using the trail at their own risk (Figure 4.3.6.2-2, *Own Risk Sign*).

**Location and Frequency:** Post signs at all access points.

##### Etiquette Signs

**Description and Purpose:** It is the policy of LACO-DPR that all trails in the County are multi-use (hiking, mountain biking, equestrian) wherever feasible. The Trails Manual does not question the LACO-DPR multi-use policy. Rather, the Trails Manual accepts this policy and it is taken into consideration throughout the manual. The Trails Manual is not meant to address etiquette issues on trails. Rather, the LACO-DPR understands that etiquette issues are best handled between trail users. On County trails, mountain bikers yield to both hikers and equestrians and hikers yield to equestrians. However, potential for soft surface trails to cross dedicated bike lanes and

bikeways where mountain bikes may be traveling at speeds in excess of those typical of soft surface trails must also be considered when posting etiquette signs. Etiquette signs provide reminders of polite trail behavior for all trail users and should be placed at all trailheads and locations where County trails join trails of other jurisdictions.

**Location and Frequency:** Post signs before narrow, blind, or contentious sections of trail where trail user conflicts are likely, such as between mountain bikers and equestrians and where soft surface trails cross dedicated bike lanes and bikeways. Examples of etiquette signs are located at Bonelli Park in San Dimas (Figure 4.3.6.2-3, *Bonelli Park Etiquette Sign*) and in the *Equestrian Design Guidebook for Trails, Trailheads, and Campgrounds*<sup>16</sup> (Figure 4.3.6.2-4, *Share the Road*, and Figure 4.3.6.2-5, *Trail Etiquette Rules*).

##### “Crossing Private Lands” Signs

**Description and Purpose:** There may be a need for “Crossing Private Lands” signs near the interface between a trail network and adjacent communities.

**Location and Frequency:** Post signs in and at edges of neighborhoods or private land that the trail crosses.

##### Boundary Signs

**Description and Purpose:** Boundary signs alert trail users and landowners to the presence of a trail easement.

**Location and Frequency:** Post signs at all beginnings and endings of easements along trails.

##### Temporary Connector Signs

**Description and Purpose:** Connector signs identify temporary trail segments and encourage their use.

**Location and Frequency:** Post signs at the junctures of existing trails and temporary trails.

<sup>16</sup> Hancock, Jan, Kim Jones Vander Hoek, Sunni Bradshaw, James D. Coffman, and Jeffrey Engelman. U.S. Department of Agriculture Forest Service, Technology and Development Program. 2007 [Reprinted 2009]. *Equestrian Design Guidebook for Trails, Trailheads, and Campgrounds*. Missoula, MT.





Figure 4.3.6.2-1  
Bonelli Park Permitted Use Sign



Figure 4.3.6.2-2  
Own Risk Sign



Figure 4.3.6.2-3  
Bonelli Park Etiquette Sign

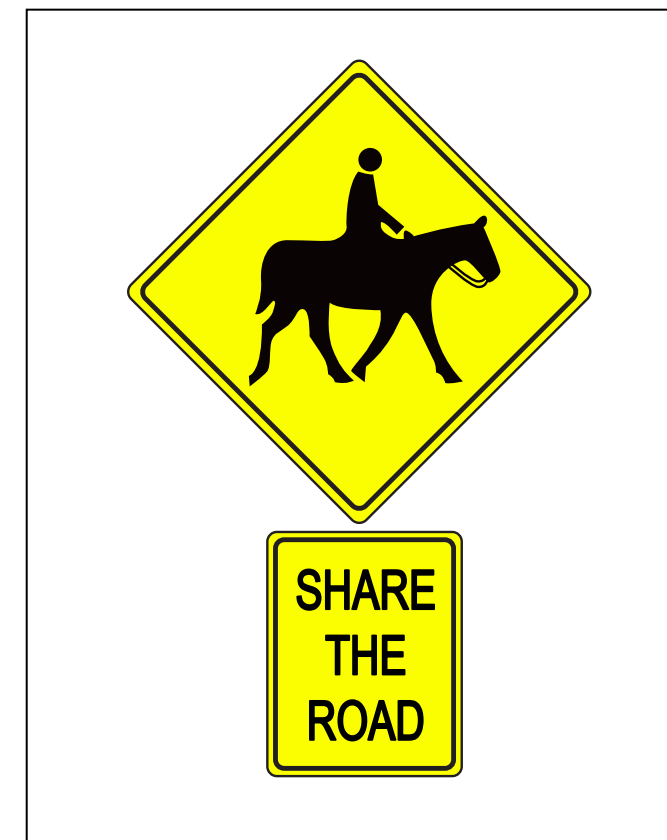


Figure 4.3.6.2-4  
Share the Road



Figure 4.3.6.2-5  
Trail Etiquette Rules



### 4.3.6.3 Informational Signs

Informational signs produced by the County provide information to trail users, including the locations of entrances, information on the surrounding natural resources, distances of a trail, distances to key destinations, and locations of connector trails.

#### Entrance Signs

**Description and Purpose:** Entrance signs mark the official entrance to a trail or recreational area. Examples of entrance signs in the County of Los Angeles are located at the Abalone Cove Trail in Rancho Palos Verdes and the Sara Wan Trail at Corral Canyon Park in Malibu (Figure 4.3.6.3-1, *Abalone Cove Entrance Sign*, and Figure 4.3.6.3-2, *Sara Wan Trail Entrance Sign*).

**Location and Frequency:** Post signs perpendicular to the road and at all primary trailhead locations.



Figure 4.3.6.3-1  
Abalone Cove Entrance Sign



Figure 4.3.6.3-2  
Sara Wan Trail Entrance Sign

#### Trailhead Information Kiosk Signs

**Description and Purpose:** Use trailhead information kiosk signs to provide general information about the trail, navigational aids, and safety bulletins. An example of a Trailhead Information Kiosk Sign in the County of Los Angeles is located at the Arroyo Pescadero Park (Figure 4.3.6.3-3, *Arroyo Pescadero Kiosk*). Trailhead information signs should indicate the number to contact in case of an emergency and provide a name of the trailhead that can be given to emergency responders.

**Location and Frequency:** Post signs at all primary trailhead locations within 50 feet of where the trail leaves the parking lot.

#### Reassurance Markers

**Description and Purpose:** Reassurance markers provide en route reassurance of trail identity and visually mark the trail line in areas where the trail blends seamlessly with the surrounding area.



Figure 4.3.6.3-3  
Arroyo Pescadero Kiosk

**Location and Frequency:** Post signs at points of confusion or at every 0.25 mile. Place signs on alternating sides of the trail. Post signs at eye level (62 inches above the ground surface).

#### Direction Change/Juncture Indicators

**Description and Purpose:** Direction change/juncture indicators alert trail users to a change in direction or juncture with another trail, and may include destinations and distances, features, regulations, warnings, and closures.

**Location and Frequency:** Post signs at ambiguous trail turns and at all junctures with other trails. Orient signs to face users approaching from all likely directions. Use signs sparingly and post within sight of a reassurance marker.

#### Interpretive Signs

**Description and Purpose:** Provide interpretive signs that display information regarding the natural or cultural resources of a particular site, trail, or scenic vista.

**Location and Frequency:** Post signs at important interpretative features along regional or local trails, or at regular intervals along interpretative loop trails.

#### Wayside Exhibits

**Description and Purpose:** Wayside exhibits describe interesting land features, plant and animal communities, historic events, and points of interest. An example of a wayside exhibit in the County of Los Angeles is located at the Arroyo Pescadero Trail in Whittier (Figure 4.3.6.3-4, *Arroyo Pescadero Wayside Exhibit*).



Figure 4.3.6.3-4  
Arroyo Pescadero Wayside Exhibit

**Location and Frequency:** Reserve wayside exhibits for major features located in high-traffic areas.

#### Destination Signs

**Description and Purpose:** These signs show directions and distances to various destinations accessed by the trail network.

**Location and Frequency:** Post destination signs at trailheads, major junctions, and spur trails (to water).



## Adopter Signs

**Description and Purpose:** Adopter signs acknowledge the volunteers who are responsible for trail maintenance along a designated section of the trail.

**Location and Frequency:** Post adopter signs on road crossing signs or at beginning of designated clean-up areas.

### 4.3.6.4 Trail Network Graphics and Maps

Include trail network graphics and the County logo on County regulatory and informational signs:

#### Confirmation/Identification Signs (Trail Logos)

**Description and Purpose:** Trail logos are graphic symbols used throughout the trail network to create consistency, identify the trail network, and orient trail users. Logos can also be standalone badges or blazes affixed to a post or a tree.

**Location and Frequency:** Include trail logos on all major signs throughout the trail network. Post blazes at eye level.

#### You-Are-Here Indicators

**Description and Purpose:** You-are-here indicators are optional markers that are included on interpretive signs or information kiosks to correlate the present physical location of a particular kiosk on a general trail map.

**Location and Frequency:** Symbolize you-are-here indicators, and include the symbol on the map legend.

### 4.3.7 Road Crossings

Design trail alignments that avoid road crossings where there is a potential for conflict between vehicles and trail users. However, potential for soft surface trails to cross dedicated bike lanes and bikeways where mountain bikes may be traveling at speeds in excess of those typical of soft surface trails must also be considered. The installation of a safe road crossing requires signs and sidewalk modifications, which can add substantial costs to a trail that intersects a street. There are two typical options for street crossings: at grade with the road or under the road through a culvert. Although expensive, bridges may be necessary in some settings to avoid the hazards of at-grade road crossings. Design all road crossings consistent with requirements of the applicable regulatory oversight body. The County of Los

Angeles Department of Public Works, Division of Traffic and Lighting is the regulatory oversight body in the unincorporated territory of the County. In addition, the LACO-DPR requires the use of a bush hammer (or equivalent) technique on the portion of the trail crossing the road surface to provide stability for trail users. However, road crossings on roadways under federal, state, or local jurisdiction must be coordinated with the appropriate authority, and plans and guidelines for the road crossing must be submitted for plan check and approval. Trail crossings have crossing buttons installed that are reachable for mountain bikers, hikers, and equestrians. According to the U.S. Federal Highway Administration, installation of a second push button for riders that is between 5 feet and 6 feet in road crossings is an option.<sup>17</sup> Any at-grade road crossing must allow for proper sightlines for both vehicles and trail users prior to the crossing. For trail users, place signs 100 feet before the crossing. For vehicles, place signs 500 feet before the crossing. Illustrations of street crossings at intersections, mid-block, and placement of bush hammer (or equivalent) are included in Appendix J.

In locations that provide a significant risk of conflict between trail users and vehicles, utilize a culvert undercrossing. The construction guidelines for the culvert undercrossing must meet applicable county and state codes. A licensed structural engineer must complete the design of a culvert undercrossing. A typical illustration of a culvert undercrossing is included in Appendix J.

### 4.3.8 Parking

Consider compatibility with the outdoor recreational experience and site characteristics when designing parking areas. In general, provide parking for trail users at 5- to 15-mile intervals.

The design of parking areas must consider the applicability of nine elements (Appendix J):

- Provide highway, street, or road signs that indicate turnouts for trailheads and parking.
- Select a parking surface that is natural and permeable. Avoid the use of gravel that has the potential to nick and scratch the paint on vehicles when kicked up.
- Install guardrails where needed to define parking edges for safety reasons.

<sup>17</sup> Hancock, Jan, Kim Jones Vander Hoek, Sunni Bradshaw, James D. Coffman, and Jeffrey Engelman. U.S. Department of Agriculture Forest Service, Technology and Development Program. 2007 [Reprinted 2009]. *Equestrian Design Guidebook for Trails, Trailheads, and Campgrounds*. Missoula, MT.

- Use natural logs or poles to define parking bumper stops and lot edges.
- Install post bollards at trailheads to mark trailhead entrances and discourage vehicular (including motorcycle) encroachment from the parking area into the trail area.
- Install and maintain a trailhead information kiosk.
- Place picnic tables, trash receptacles, and toilets where possible.
- Allow 300 square feet per car for a 90-degree parking lot (the most space efficient). A 90-degree parking area should have stalls 9 feet wide and 18 feet deep with a 24-foot lane for entering and exiting the parking lot. Allow for ADA-compliant parking.
- Provide parking spaces for the anticipated occupancy load of the trail, with a minimum of five spaces, where site conditions permit. Allow for ADA minimum requirements of parking ratios (a minimum of 1 accessible parking space for 1 to 25 spaces; a minimum of 2 accessible parking spaces for 26 to 50 spaces; and a minimum of 3 accessible parking space for 51 to 75 spaces).<sup>18</sup>

#### 4.3.8.1 Equestrian Parking Area and Staging Area Design<sup>19</sup>

##### Staging Areas

Popular equestrian sites need staging areas where it is easy and safe to unload, groom, and saddle stock. An example of a staging area in the County of Los Angeles is located at Bonelli Park in San Dimas (Figure 4.3.8.1-1, *Bonelli Park Staging Area*). This means providing extra length and width in parking spaces. Extra length allows riders to unload stock and tie them at the rear of the trailer. Extra width allows stock to be tied at the trailer's side. These additional guidelines should be considered where space permits and where trail users with horse trailers, trucks, or carriers are expected (Appendix J):

<sup>18</sup> U.S. Access Board. September 2002. *ADA Accessibility Guidelines for Buildings and Facilities*. Section 4.1.2 (5) (a): "Accessible Sites and Exterior Facilities: New Construction." Available at: <http://www.access-board.gov/adaag/html/adaag.htm#4.1>

<sup>19</sup> Hancock, Jan, Kim Jones Vander Hoek, Sunni Bradshaw, James D. Coffman, and Jeffrey Engelman. U.S. Department of Agriculture Forest Service, Technology and Development Program. 2007 [Reprinted 2009]. *Equestrian Design Guidebook for Trails, Trailheads, and Campgrounds*. Missoula, MT.



Figure 4.3.8.1-1  
Bonelli Park Staging Area

- Provide staging areas a minimum of 600 square feet per horse trailer and a maximum of 1- to 2-acre locations for high use locations adjacent to trail access points and where site conditions permit
- Provide entry structures with a lockable gate; the type of lockable gates used should depend on security requirements, type of material used, and location of the structure.
- Provide pull through or peripheral parking with minimum 40-foot-long stalls
- Provide a minimum of at least four hitching rails per staging locations as site conditions permit; each hitching rail should be 15 feet long by 4 feet high, of 3-inch steel pipe, and cemented 30 inches in the ground
- Provide an exercise ring when space and site conditions permit
- Provide trash cans and picnic tables at each location (four per site)
- Separate from other trail user parking
- Clearly indicate traffic circulation pattern so that there is room for loading and unloading
- Install a hardened (permeable) surface that safely accommodates equestrian uses
- Provide appropriate vertical clearance (maximum legal height for trailers is 13 feet, 6 inches)
- Provide parking spaces for anticipated occupancy load of the trail with a minimum of five spaces, where site conditions permit

## Open Parking Areas

Some riders prefer a parking area that does not have defined parking spaces. This allows drivers to arrange vehicles in a manner that best suits their needs. When space is plentiful and riders want flexibility, an open parking area is appropriate for a group camp or trailhead. Where possible, locate open parking areas in a large, sparsely vegetated area with a slope no steeper than 4 percent.

Riders want to park facing the exit as they arrive, orienting their vehicles for an easy departure. The parking area should be large enough for undefined parking spaces 28 feet by 78 feet and aisles that are 15 feet wide per lane. The generously sized parking area will allow many parking configurations. Designers may plan one parking configuration and riders may park in a very different way.

A variation of the open parking area concept incorporates several small parking areas. The small areas help break up the expanse of a large parking area and may be more attractive. In a group camp, having more than one parking area provides flexibility. A few different groups could use the site simultaneously or one large group could occupy all the parking areas.

## Small Parking Areas

The circulation pattern includes a loop turnaround to prevent vehicles from becoming trapped when all parking spaces are full. Because the parking area is not paved, arrows cannot mark the direction of traffic flow. Designers can use a counter-clockwise traffic flow that takes advantage of the familiar right-hand driving pattern. Landscape islands guide vehicle traffic and determine parking orientation. Directional signs may be a helpful addition, along with wheel stops (Appendix J).

## Parking Delineation

Because paved equestrian parking areas are not recommended, delineating the parking spaces becomes a challenge. Many agencies do not delineate parking spaces. Where delineation is necessary, striping is just one of several alternatives.

## 4.3.9 Restrooms

Incorporate restrooms into trailhead and parking locations where water lines and sewage conveyance is possible. In areas without available water, design restrooms to be pit toilets as per U.S. Forest Service guidelines (Appendix J).

## 4.3.10 Landscaping

Design plantings around trailheads and revegetation along trails in a manner that is consistent with the plant communities and species identified in the feasibility analysis. In general, design trails to avoid environmental impacts, while ensuring public safety and preserving community character. When designing the landscape, take into account the ability to provide fencing for safety, security, and delineation of the trail (Appendix J).

Where appropriate, use landscaping to screen a trail from adjacent residences, providing privacy to residents and enhancing the quality of the recreational experience. Where feasible, screen the first story of adjacent residences from a trail with plantings of native vegetation (Appendix J).

Where appropriate, native landscape will be used as fencing. However, the native landscape would not be used as barriers to prevent wildlife. Landscape elements of trails shall not use plants that are known to be toxic to humans or domesticated animals, particularly horses. Lists of toxic plants that will NOT be used can be found in Appendix M, *Toxic Plants*.

Design trail landscaping in a manner that facilitates resource conservation:

- Delineate trail edges in areas where there are fragile plant communities adjacent to the trail.
- Provide access to interesting features so that users will not take shortcuts.
- Block potential shortcut routes with landforms or vegetation.
- Landscape the trail to control erosion and ensure slope stability.
- Work with natural vegetation patterns to feather trail edges.
- Prevent invasion by non-native species.
- Preserve vegetation adjacent to the trail as much as possible in order to protect the aesthetic quality of the trail.
- Utilize species from plant communities native to the trail area.
- Use plant materials that are indigenous to the local native plant communities. Avoid the use of non-native species to the maximum extent practicable.
- Discourage use of herbicides and pesticides, unless required to eradicate non-native pest plants identified on the California Exotic Pest Plant Council list.

- Encourage responsibility for maintaining the planting along the trail and for monitoring the progress of new planting areas.
- Group plant material to simulate natural stands.
- Plant canopy trees to unify an area and choose a dominant tree type that is indigenous to the area.
- Arrange plant material by similar water needs.
- Use fire protection efforts that will not jeopardize the stability of slopes.
- Mitigate visual impact by planting areas adjacent to parking and residential lots at a greater density than on interior slopes.
- Arrange plantings in an informal manner to create a more natural setting.
- Prohibit denuding of slopes.
- Balance fire mitigation with habitat conservation and slope protection.
- Build bridges on trails near streams or rivers that are capable of withstanding weight of all trail users.<sup>20</sup>

## 4.3.11 Drinking Water

Provide drinking water sources at all trailheads and, where possible, every 5 miles along a trail, for human, horse, and pet use (Appendix J).

## 4.3.12 Bicycle Racks

Provide bicycle racks at trailheads for large regional trails. Provide bicycle racks in areas where transitions occur from Class I Bikeways to natural surface trails. Consider installing bicycle racks in areas where portions of a trail prohibit bicycle use. A typical bicycle rack is illustrated in Appendix J.

## 4.3.13 Shade Structures

Provide shade structures every 1 to 3 miles along trails in desert environments or in sparsely vegetated locations where shade is not readily available.

## 4.3.14 Equestrian Amenities

Provide equestrian amenities at popular equestrian trailheads and where feasible. Guidelines for horse tie-ups and hand pumps are included in Appendix J. Water amenities such as a trough, big bowl, tub, or any time stock share water sources, has a potential for disease transmission. Therefore, the Trails Manual proposes the installation of spigots or hydrants, with all trail users and vector issues bringing buckets or collapsible buckets for water (Figure 4.3.14-1, *Hydrant*, and Appendix J).<sup>21</sup> Another alternative, if the trail does not have sufficient plumbing, is a hand pump (Figure 4.3.14-2, *Hand Pump*, and Appendix J).<sup>22</sup> Additional equestrian amenities can include mounting platforms or manure disposal bunkers.

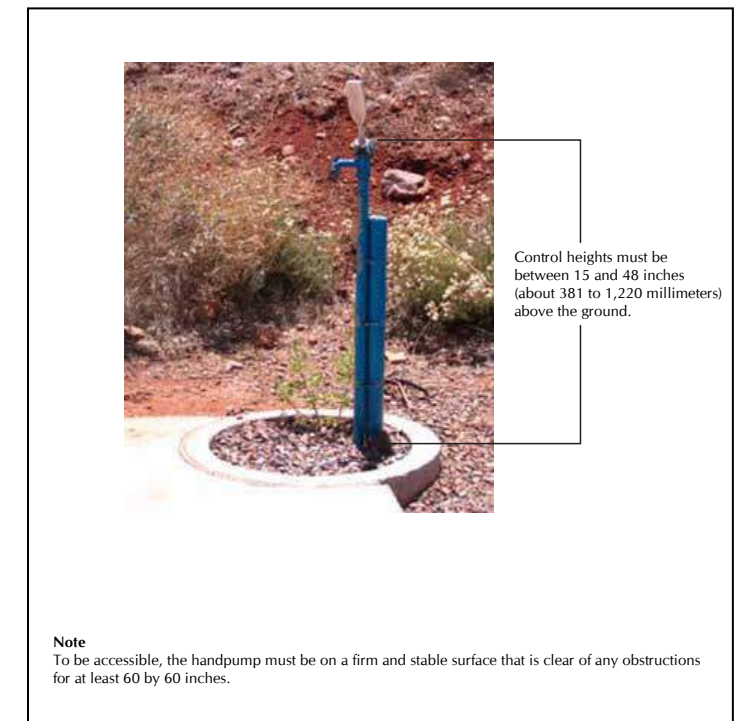


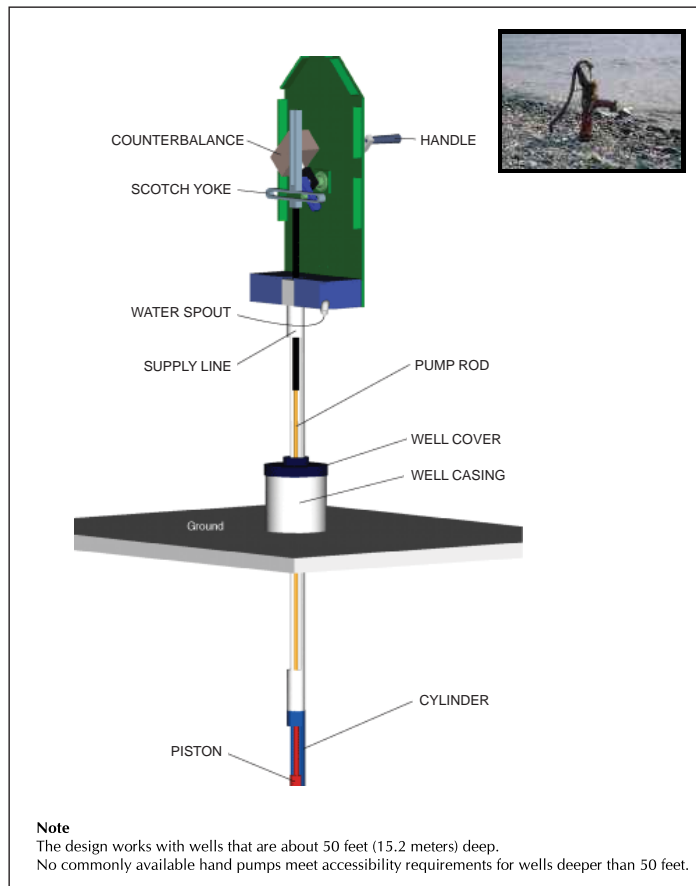
Figure 4.3.14-1  
Hydrant

<sup>20</sup> City of Burlington Recreation and Parks Departments and the Alamance County Recreation and Parks Department. August 2007. *General Design Guidelines and Schedule of Design Elements for the Haw River Trail*. "Conceptual Greenway Master Plan from the Indian Valley Golf Course to Glencoe Mill Village." Available at: <http://atfiles.org/files/pdf/HawRiverTrailguidelines.pdf>

<sup>21</sup> Hancock, Jan, Kim Jones Vander Hoek, Sunni Bradshaw, James D. Coffman, and Jeffrey Engelman. U.S. Department of Agriculture Forest Service, Technology and Development Program. 2007 [Reprinted 2009]. *Equestrian Design Guidebook for Trails, Trailheads, and Campgrounds*. Missoula, MT.

<sup>22</sup> Rife. "Hand Pump: Specifications of Rife Hand Pumps." Available at: <http://www.riferam.com/handpump/hpindex.html>





**Figure 4.3.14-2**  
**Hand Pump**

#### 4.3.15 Equestrian Arenas

Provide equestrian arenas that are a minimum of 150 feet wide and 300 feet long; smaller arenas should be 150 feet wide and 100 feet long, and oval shaped. Arenas should be provided for public equestrian events and training for the Equestrian Mounted Units, Marshall Canyon Mounted Unit, Bonelli Park Mounted Unit, Whittier Narrows Mounted Unit, and the Sheriff Mounted Units. Arena panels should be constructed with pipe panels that consist of 12-foot-long or 24-foot-long with 1 7/8-inch outer diameter pipe. Drive gates should be 2 3/8-inch pipe material, and support posts should be 2 3/8-inch steel pipe galvanized 15-gauge wall or .073. 6-foot 6-inch-high posts should be cemented in ground with 60 sacks of cement with a 2,500-pound per square inch (PSI) mix.

#### 4.3.16 Bleachers

Provide bleachers at all arenas for equestrian events and training purposes and install permanently with concrete anchors. Stationary bleachers should have a minimum 5-row seating capacity, with double foot planks on every row, and 2-inch by 10-inch anodized aluminum seat planks that have a 4.5-foot aisle with aluminum hand rails and standard fence railing on three sides.

#### 4.3.17 Security

Where trails are located adjacent to developed properties, security and privacy may need to be taken into consideration. Consideration should be given to the use of non-toxic native or ornamental plants to create an aesthetically pleasing visual barrier to developed land uses that are not intended to be publicly accessible. Lists of toxic plants that will NOT be used can be found in Appendix M.

A range of fencing material may be used in conjunction with vegetative screens. It is important that fencing not have jagged edges that could pose a threat to horses. Knuckle chain link fencing is preferable and safer for all users rather than twist (barb) chain link fencing (Figure 4.3.17-1, *Chain Link Fence with Vegetation*). In urbanized environments, vegetation in conjunction with fencing or other elements adding texture and color can be important in creating a visually interesting screening that provides security and privacy (4.3.17-2, *Concrete Wall with Vegetation*). The design of fencing and other screens must also take into consideration the integrity of the natural environment and the need for accessibility, as discussed in Section 4.4.1, *Trail Barriers and Trail Gates*.



**Figure 4.3.17-1**  
**Chain Link Fence with Vegetation**

#### 4.3.18 Lighting

Although the hours of operation for County trails are typically from dawn to dusk (County Code 17.04.330), lighting features may be desirable on some trails, particularly for safety and way-finding reasons. Where lighting is provided, such lighting shall be non-intrusive to adjacent uses, and avoid detracting from a natural outdoors experience for trail users. Lighting should be directed downward to avoid light pollution or spillover in general, avoiding impacts to adjacent land uses.



**Figure 4.3.17-2**  
**Concrete Wall with Vegetation**

### 4.4 TRAILHEADS AND TRAIL SUPPORT FEATURES

Trailheads not only provide users with access to a trail but also provide users with safety and educational information about the trail network. Trailheads may include other appurtenances such as parking, kiosks, drinking fountains, restrooms, and resources for various user types, such as tie-ups for equestrian users.

Design new and major renovations, alterations, and improvements to trailhead and appurtenances consistent with guidelines:

- Construct trailhead structures to be of scale and character appropriate to the trail area; their location shall be environmentally sensitive and integrated with the site
- Emphasize the natural setting and use natural materials indigenous or local to the site when designing trailhead facilities
- Design replacement structures to contribute to the environment without loss or degradation of habitat or open space
- Use the same color palette for all structures in the same trail segment
- Use sustainable materials when feasible
- Consistent with the Department of Justice's revised ADA regulations regarding trails,<sup>23</sup> throughout the trail development process, the LACO-DPR staff will consider which types

<sup>23</sup> U.S. Department of Justice. Americans with Disabilities Act. "Revised ADA Regulations: Implementing Title II and Title III." Available at: <http://www.ada.gov/regs2010/ADAregs2010.htm>

of motorized vehicles can feasibly use each type of trail to provide access to the mobility disabled. "Feasibly" is defined as capability of being accomplished in a successful manner within a reasonable period of time, taking into account economic, environmental, social, and technological factors.<sup>24</sup>

Locate trailheads at the beginning of trails and at points where major trails intersect. Design trailheads and kiosks to provide users with readily identifiable entrances and information regarding trail accessibility (Appendix I).

#### 4.4.1 Trail Barriers and Trail Gates

To ensure the safety of trail users and the integrity of the natural environment, the use of motorized trail vehicles (MTVs) may be prohibited in specific instances where the use of such vehicles cannot be feasibly accommodated or the use of such vehicles pose an unacceptable threat to recreational users or the environment. In such instances, the use of trail barriers may be used to prohibit access to MTVs. In other situations, MTVs may be a feasible means of providing access to individuals with mobility challenges but may require the use of gates to allow suitable access. Therefore, vehicle gates and barriers that are currently being used may not comply with the newest ADA/ABA Accessibility Guidelines. Consistent with the Department of Justice's revised ADA regulations regarding trails,<sup>25</sup> throughout the trail development process, the LACO-DPR staff will consider which types of motorized vehicles can feasibly use each type of trail to provide access to the mobility disabled.

The objective of a trail barrier or trail gate is to (1) allow access to all users and (2) be consistent with accessibility legislation. Effective trail vehicle barrier designs should take into consideration the following aspects:

- Materials used
- Size
- Installation and maintenance procedures
- Durability
- Type of environments in which the design is used
- Cost

<sup>24</sup> California Code of Regulations. 2010. Title 14, Division 6, Chapter 2.5, Section 21061.1.

<sup>25</sup> U.S. Department of Justice. Americans with Disabilities Act. "Revised ADA Regulations: Implementing Title II and Title III." Available at: <http://www.ada.gov/regs2010/ADAregs2010.htm>

The design of a trail barrier or trail gate will depend on the designs' suitability for various trail environments, accessibility to users with and without disabilities and feasibility.

### Trail Barrier

A trail barrier is intended to allow all trail users, with or without mobility impairments, to have access to trails. The trail barrier should be designed to allow trail access to all trail users and types of motorized vehicles that can feasibly use each type of trail to provide access to the mobility disabled.

### Inverted Bollard

An example of a trail barrier is the inverted bollard. This design typically has concrete bollards on 4-inch steel posts. The system consists of steel posts and forms to allow the installer to pour the concrete into the form upside down to create each inverted bollard. A steel framework would be mounted into the ground requiring hand excavation or use of a mini-excavator to a depth of at least 18 inches. The steel framework would then be installed into the ground, and the inverted bollards would be placed into position and pinned underground. Concrete would be poured into and around the anchor points of the steel framework (see Appendix J). Surfacing material would then be installed up to the trail tread surface.

### Trail Gates

Appendix J provides examples of several trail gate designs:

- Timber Kissing Gate with Wheelchair Accessibility
- Timber Kissing Gate Modification for Existing Fence Opening with Wheelchair Accessibility
- Chicane for Wheelchair Accessibility
- Horse-Friendly Forest Road Closure Gate with Horse and Wheelchair Accessibility
- Horse Gate with Wheelchair Accessibility
- "V" Horse Gate with Wheelchair Accessibility

#### 4.4.2 Trail Kiosks<sup>26</sup>

A kiosk is a small outdoor structure that incorporates trail maps, route data, and specific site historical and environmental information for trail users. The amount of way-finding signs will be determined by trailhead size, its projected use, and location.

<sup>26</sup> Bucher, Willis & Ratliff. *Northland Trails Vision Plan Design Criteria*. Available at: <http://www.co.platte.mo.us/northlandtrails/designcriteria.pdf> Pages 53-55.

### Level One Kiosks

Level one kiosks will be located primarily at the beginning and end of a route. These kiosks are intended to function as stand-alone structures that provide shade, seating, trail information, and site-specific data. This type of kiosk is useful at sites with existing structures where way-finding signs are otherwise difficult to incorporate. The design of this type of kiosks typically has four sides that will allow users to view trail maps and data simultaneously (see Appendix J).

### Level Two Kiosks

Level two kiosks are primarily located at major trail connections or intersections that allow users access to associated routes. The size of this type structure is typically smaller than level one kiosks in order to better blend with sites that are smaller in size and that offer less visual competition than larger sites. This type of kiosk should be located in close proximity to the trail for the convenience of trail users that are en route.

### Level Three Kiosks

Level three kiosks are typically located at rest areas for trail users and periodically throughout the trail system. They should be located immediately adjacent to the trail for convenient use. This type of kiosk should occur approximately every 2 to 3 miles according to the trail type and the terrain being traveled. Level three kiosks will help keep trail users aware of their location, intended destination, and their related distances (see Appendix J).

## 4.5 CONSTRUCTABILITY

The fourth consideration in the trail design process is the constructability of the trail in relation to available labor, time, equipment, and materials.

### 4.5.1 Trail Construction Team

The trail plans and guidelines need to consider the construction scenario and schedule in relation to the proposed composition of the trail construction team. Maintenance and construction of County trails can involve a range of resources, including County staff, contractors, work crews from agencies such as the California Department of Forestry (CDF), California Department of Corrections (CDC), the California Youth Authority (CYA), and the California Conservation Corps (CCC), as well as volunteers.<sup>27</sup> Trail contractors often utilize a small crew of three and machinery such as mini excavators to build trails. A professional, three-person trail crew using

<sup>27</sup> Bell, Roger. 2002. "New Models for Trail Contracting." *Trail Tracks*, 31(1): 6-9.

machinery can typically build a trail at a rate of 500 to 700 feet per day, but only 200 feet per day without machinery. The use of a professional team with machinery can add up-front cost in terms of hiring an experienced, qualified operator, but may ultimately be the most cost-effective due to significant reductions in total labor requirements when using only hand labor.

#### 4.5.1.1 Trail Construction Professionals

Trail designs and maintenance that require precise compliance with specifications for percent grade, outcropping, and switchbacks are best accomplished using trail construction professionals with the required qualifications. Ensure that trail construction professionals have demonstrated expertise and experience in constructing trails:

- Crew team leads must have at least 50 miles of trail construction and maintenance experience, and no less than 10 miles of new construction experience.
- Crew must be supported by at least one individual with sufficient survey skills to ensure that trail grades, outcrops, and other erosion control features conform to specifications.
- Operator must have experience with the specified construction equipment.
- Crew must have sufficient knowledge of soils and soil compaction to ensure the achievement of performance standards.

Professional trail construction teams may be composed of County staff and augmented by contractors on an as-needed basis. A list of trail contractors with experience in the County of Los Angeles can be obtained from the LACO-DPR.

#### 4.5.1.2 Trail Construction Volunteers

The County trail system has benefited greatly through the generous donation of time and materials by volunteers. The County may wish to augment professional trail and construction crews with volunteers. Brief and train trail construction volunteers regarding plans and guidelines to ensure the most effective contributions to the project. Ensure that volunteers undergo the County volunteer-training program and sign waivers for working as a volunteer. While there are a variety of site-specific issues that need to be addressed for each project, there are standard briefing issues that must be addressed for all projects involving the use of volunteers:

- Project goals and objectives
- Trail design or maintenance plans and guidelines
- Environmental constraints and related safeguards
- Chain of command
- Proper use of equipment
- Safety
- Emergency point-of-contact

Project initiation briefings ensure the provision of volunteers with accurate instructions on trail construction and maintenance. Supervision by qualified professionals ensures that volunteer trail construction and maintenance efforts are consistent with the design plans and guidelines. A list of possible volunteer organizations to utilize in a trail project can be obtained from the LACO-DPR.

#### 4.5.2 Construction Scenario

The trail plans and guidelines need to consider the construction scenario and schedule in relation to the timing of the rainy season and the steps required to construct a trail. Wherever possible, schedule trail construction and maintenance in accordance with County codes. Schedule daily construction activities for Monday through Saturday (excluding federal holidays) between the hours allowed by the County Noise Ordinance. In locations with steep sideslopes, loose soils and rocks, areas prone to destabilization, large retaining structures, or areas that require excessive annual maintenance work, grading and earthwork should be performed under the supervision of an engineering geologist or soils engineer to ensure proper subgrade preparation, selection of satisfactory materials, and placement and compaction of structural fills and to ensure that appropriate recommendations are made to remediate the site-specific conditions.

Wherever possible, schedule grading activities outside the normal rainy season of October 15 to April 15, which is applicable for most of the County, thus minimizing the potential for increased surface runoff and the associated potential for soil erosion. Estimate the number and type of equipment to be used in the plans and guidelines for the trail construction or maintenance project based on the maximum width of the trail.



There are seven basic steps required to construct a trail:

1. Flag the trail
2. Clear the trail corridor
3. Construct the trail tread
4. Construct switchbacks and climbing turns
5. Compact the trail
6. Construct crossings and retaining structures
7. Construct trailheads, way-finding signs, and appurtenant structures

#### 4.5.2.1 Flag the Trail

Flag the designated trail corridor with flagging tape or pin flags. Design the corridor to be 1 foot wider on each side than the desired width of the trail tread. Walk the initial path and check the grade with a clinometer to evaluate any potential problem areas that will not allow the trail's grade to fall within the accepted parameters. Use pin flags to delineate the final path before construction begins. Place pin flags on the downslope side of the trail if construction will occur by hand, and on the upslope side of the trail if construction will occur with machinery.

#### 4.5.2.2 Clear the Trail Corridor

The initial clearing of the trail includes preliminary removal of vegetation and major debris such as large stones. This process will allow the digging of the trail tread to move forward easier. When utilizing hand tools, clear vegetation prior to construction. However, machinery removes the vegetation while digging the tread.

#### 4.5.2.3 Construct the Trail Tread

Wherever practicable, balance the required cut and fill within the trail segment to minimize the need for import or export of soil. Trail treads are created by carving soil out of the sideslope above the trail (cut), by piling soil on the slope to create a platform (fill), or by a combination of both (cut and fill) (Figure 4.5.2.3-1, *Trail Tread Construction Types*). A full bench cut and retaining structure may also be an option.

##### Cut Trails

The most stable choice is to cut the trail tread out of the slope, providing a full bench trail. However, there are conditions that limit the width of trails built by this method. Carving soils out of the side of a hill is arduous work if done by hand, and requires either larger equipment or more passes when done by machine. In addition, a wider trail requires deeper cuts into the sideslope, resulting in steeper sideslopes, and creating a steeper

and less stable backslope.<sup>28</sup> To provide room to adjust the backslope to a sustainable grade, specify a deeper cut into the slope in the trail design. Alternatively, include a retaining wall in the trail design to hold back the backslope. Where cutting specified in the design requires greater disturbance of the upslope vegetation, the plans and guidelines or maintenance plan must provide for supplemental slope and erosion control measures until adequate slope vegetation exists (Figure 4.5.2.3-1).

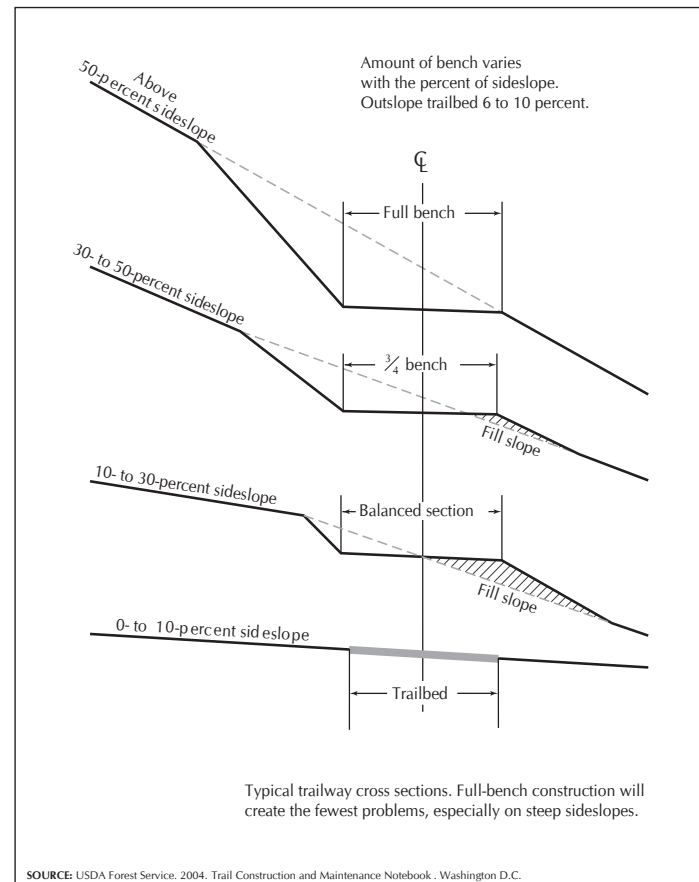


Figure 4.5.2.3-1  
Trail Tread Construction Types

##### Fill Trails

Fill soils are always less stable than cut soils, and a wider trail requires more fill. The steeper the sideslope, the more susceptible unstable soils will be to erosion and mudslides. Keeping the trail narrow reduces the amount of fill required. Alternatively, use a retaining wall on the downhill side to support the fill soil (4.5.2.3-1).

<sup>28</sup> The backslope is the bank on the uphill edge of the trail thread.

##### Cut-and-Fill Trails

A combination of cut and fill reduces the limitations of each technique. However, trails wider than 6 feet will have the unacceptable characteristics of each, particularly on steep slopes (Figure 4.5.2.3-1).

#### 4.5.2.4 Construct Switchbacks and Climbing Turns

In portions of a trail where the required grade of the trail cannot be achieved without the use of switchbacks or climbing turns, installation should occur as described in Section 4.2.7, *Gaining Altitude on a Trail*. The use of switchbacks and climbing turns should be limited.

#### 4.5.2.5 Compact the Trail

The final step in the construction of the trail tread is the compaction of the trail. This will reduce erosion of the trail tread. In addition, accessibility is increased because compacted trail surfaces provide a more sturdy tread capable of supporting greater forces. Mechanical compaction will not be feasible in natural areas where water is not easily available; therefore, in these areas, natural compaction will occur with normal trail building equipment and use over time. Check that all trail debris is removed and that no low obstacles, such as branches or roots, have been left in the trail corridor.

#### 4.5.2.6 Construct Crossings and Retaining Structures

Construct crossings such as culverts, bridges, and retaining structures during the construction of the trail tread. Construct these on a case-by-case basis following the design guidelines outlined in Appendix J.

#### 4.5.2.7 Construct Trailheads, Way-finding Signs, and Appurtenant Structures

The final step is to construct trailheads, way-finding signs, and appurtenant structures such as restrooms to provide recreational users with optimal resources.

### 4.5.3 Construction Tools

#### 4.5.3.1 Hand Tools and Equipment

A variety of tools and equipment are available to lay out, construct, and maintain trails. Location, physical site characteristics, and individual preferences often dictate the type of tools and equipment chosen for various tasks. Choosing the correct tools for the job, using them effectively and safely, caring for them, and storing them properly are all important aspects in trail construction.

There are several categories for tools used in constructing and maintaining trails, which include tools for grading, sawing, chopping, grubbing, digging and tamping, pounding and hammering, lifting and hauling, peeling, and shaping.

There are 10 essential hand tools for construction of a trail:<sup>29, 30</sup>

- **Clinometer:** Use a clinometer to measure the percent grade between two points, enabling determination of the steepness of the trail.
- **Flagging ribbon or wire-pin flag:** Use flagging ribbon to highlight trail alignment during trail construction. Specify removal of all ribbons and tapes at completion of trail construction.
- **Pulaski:** Use a Pulaski for loosening dirt, grubbing brush, cutting roots, and sculpting. Avoid the specification of Pulaskis in rocky soils.
- **Hoes:** Use an adze hoe, grub hoe, or hazel hoe to break up sod clumps when constructing new trail or when leveling an existing trail tread. These hoes also are useful in heavy duff. They generally work better than a Pulaski.
- **McLeod:** Use a McLeod, a flat, square-shaped blade with a cutting edge on one side and a rake on the other. The McLeod is a useful tool for completing a trail tread.
- **Rockbar (or pry bar):** Use a rockbar for prying heavy objects from the trail's path (e.g., boulders or logs).
- **Tape measure:** Use a tape measure, or equivalent or better measuring device, for accurate measurements of trail width and headway.
- **Level:** Use a manual or digital level for the inspection of outslope trail treads that meet specifications for shedding water and preventing erosion.
- **Hand pruner, lopper, and folding saw:** Use hand pruners, loppers, and folding saws for cutting and removing branches, protruding roots, and other vegetation for a clear trail tread.
- **Bow saw:** These saws are useful for clearing small downfall and for limbing. They

<sup>29</sup> International Mountain Bicycling Association. 2004. *Trail Solutions*. Boulder, CO: International Mountain Bicycling Association, pp. 108–109.

<sup>30</sup> U.S. Department of Agriculture Forest Service, Technology and Development Program. 2007. *Trail Construction and Maintenance Notebook 2007 Edition*. Available at: <http://www.fhwa.dot.gov/environment/fspubs/07232806/toc.htm#acknow>



consist of a tubular steel frame that accepts replaceable blades. The blades can be removed by loosening a wing nut or releasing a throw clamp.

- **Chain saw:** A chain saw can make short work of your cutting tasks—but it is not for wilderness use. Specialized instruction and certification are required.
- **Crosscut saw:** Symmetric crosscut saws, those designed for a sawyer at either end, follow two basic patterns. Felling crosscuts are light, flexible, and have concave backs that conform easily to the arc of the cut and the sawyer's arm. The narrowed distance between the teeth and back leaves room for sawyers to get wedges into the cut quickly. Bucking crosscuts have straight backs and are heavier and stiffer than felling saws. Bucking saws are recommended for most trail work because they are more versatile.
- **Bucking saw:** Bucking saws also are available as asymmetric saws, with a handle at one end that can be used by a single sawyer.
- **Pruning saw:** Pruning saws are useful for limbing, some brushing, and removing small downfall, especially where space is limited and cutting is difficult. Folding pruning saws are handy.
- **Axes:** Axes are of two basic types: single or double bit. Double-bit axes have two symmetrically opposed cutting edges. One edge is maintained at razor sharpness. The other edge usually is somewhat duller, because it is used when chopping around rocks or dirt. Mark the duller edge with a spot of paint.
- **Combination tools:** The combination or combi tool is basically a military entrenching tool on a long handle, developed for firefighting. It serves as a light-duty shovel and scraper.
- **Fire rakes (council tools):** The fire rake is another fire tool widely used for trail work.
- **Mattocks:** The pick mattock is often recommended as the standard tool for trail work. For many applications, it is much better than a Pulaski. It has a pointed tip for breaking rocks and a grubbing blade for working softer materials. The grubbing blade also may be used to cut roots or remove small stumps. With the edge of the tool, one can tamp dirt and loose rocks or smooth a new tread.

- **Picks:** Pick heads have a pointed tip that can break up hard rock by forcing a natural seam. They also have a chisel tip for breaking softer materials. Work the pick similar to the hoe on a Pulaski with short, deliberate, downward strokes. Avoid raising the pick overhead while swinging. Always wear safety goggles while using a pick for protection from flying rock chips. Use a grinder or mill bastard file to sharpen the pointed tip to a 3-millimeter (1/8-inch) square. When sharpening the chisel tip, maintain the factory bevel.
- **Shovel:** Use a shovel for excavating dirt and debris. There are many blade shapes and handle lengths for shovels. Different tasks call for specific blades and handle lengths.
- **Sledgehammer:** Use a stone sledge for crushing rocks. Use a driving sledge to drive spikes or pins, which is a less common task for trail construction.
- **Global Positioning System (GPS):** Most trail surveyors are using GPS receivers for accurate trail location, inventory, and contract preparation. Real-time correction is no longer necessary and prices have fallen. GPS is becoming the norm for locating trails.

#### 4.5.3.2 Mechanical Tools

Specifying the use of mechanical tools for trail construction reduces the required time and labor for trail construction. Small earthmoving machines provide increased speed and consistency of trail construction, even in tough areas such as rocky terrain. In developing the plans and specification for trail construction and maintenance projects, evaluate the potential cost efficiencies achieved with earthmoving equipment. The choice of utilizing mechanical equipment may also be dependent on the site conditions. The information presented below is a brief description of mechanized tools. A more formal application is presented in International Mountain Bicycling Association's Trail Solutions.<sup>31</sup>

The most important mechanized tool is the earthmoving equipment; the two major types are mini-dozers and mini-excavators:

- **Mini-dozers:** Mini-dozers provide a ride-on, scaled-down version of the typical dozer that is capable of pushing vast amounts of dirt, rocks, and debris. However, trails

<sup>31</sup> International Mountain Bicycling Association. 2004. *Trail Solutions*. Boulder, CO: International Mountain Bicycling Association, pp. 108–109.

constructed on steep sideslopes requiring more maneuverability may limit the use of a mini-dozer.

- **Mini-excavators:** Mini-excavators are also tracked like dozers, but they have an arm that allows dirt to be moved in a bucket. The arm can be swung around, thus allowing a full bench trail to be moved quickly.

Other mechanized equipment is used for maintaining and constructing trails:

- **Woodchippers:** Towable type, gas powered
- **Stump grinders:** Towable type, gas powered
- **Auger drills:** Portable type, gas powered
- **Skiploader tractors:** Rubber wheeled, gas powered
- **Water pumps:** Portable type, gas powered
- **Dump trucks:** Stakebed type, gas powered
- **Jackhammers:** Portable type, air or gas powered
- **Pole pruners:** Portable type, gas powered
- **Hedge trimmers:** Portable type, gas powered
- **Stump grinders:** Portable type, gas powered<sup>32</sup>

Additional mechanized tools useful in trail building include motorized wheelbarrows, chainsaws, and brush mowers. Motorized wheelbarrows allow for large and heavy rock and debris loads to be carried easily and quickly.

For more tools used to construct trails, please contact American Trails for updates.<sup>33</sup>

<sup>32</sup> U.S. Department of Agriculture Forest Service. Technology and Development Program. 2007. *Trail Construction and Maintenance Notebook 2007 Edition*. Available at: <http://www.fhwa.dot.gov/environment/fspubs/07232806/toc.htm#acknow>

<sup>33</sup> American Trails. Accessed 13 April 2011. Web site. Available at: <http://www.americantrails.org/>

## SECTION 5.0 TRAIL OPERATION AND MAINTENANCE

---

The management, maintenance, and operation of trails within the County of Los Angeles (County) may include local, county, and state management, and in some cases, federal management. The most important reason to properly maintain a trail is to maximize the safety of those using the trail and minimize the local landowners' concern regarding liability. Regular, routine annual maintenance ensures trail safety but also prolongs the life of the trail. Important maintenance and operation activities to consider include signs, sight distance and clearance for right-of-way, surface and tread repair, drainage, sweeping and cleaning, debris removal, upkeep of structural integrity, and proper illumination. Each strategy should maximize the trail's potential.

### 5.1 TRAIL OPERATION

These trail operation guidelines are based on guidelines from established agencies and sources.<sup>1</sup> Trails under County of Los Angeles jurisdiction are considered parks (County Code 17.04.130).

#### 5.1.1 Hours of Operation

The Trails Manual is not a policy document. Trails are considered to be parks under the County system. Pursuant to the County Code, parks, including trails, may be utilized between the hours of 8 a.m. and midnight. **THE HOURS OF OPERATION ARE AT THE DISCRETION OF THE DIRECTOR AND ARE TYPICALLY SIGNED FROM DAWN TO DUSK (COUNTY CODE 17.04.330).**

Requests for changes to the County policy are beyond the scope of the Trails Manual and should be directed to the Director of the County of Los Angeles Department of Parks and Recreation (LACO-DPR) or to an appropriate elected representative.

#### 5.1.2 Trail Users

It is the policy of LACO-DPR to accommodate multi-use trails (hiking, mountain biking, equestrian). Section 2 of the Trails Manual provides guidance for assessing the feasibility of accommodating multi-use as an element of the trail planning process. A goal of trail planning within the County is to design trails for use by hikers, equestrians, and mountain bikers. However, the Trails Manual acknowledges that it is not feasible in all instances to accommodate all three uses on every trail.

---

<sup>1</sup> East Bay Regional Park District. 17 May 2005. Ordinance 38, Chapter 1: "Definitions." Contact: East Bay Regional Park District, 2950 Peralta Oaks Court, P.O. Box 5381, Oakland, CA 94605. Available at: [http://www.ebparcs.org/district/ord\\_38/ord\\_38TOC.htm#chapterone](http://www.ebparcs.org/district/ord_38/ord_38TOC.htm#chapterone).

In addition, occasions arise where trails will not be open to multiple uses due to site-specific physical or environmental constraints, which may necessitate limitations of a particular type of use. In addition, in the event that trail users or any member of the public is aware of trail blocking, they can contact the LACO-DPR and the Los Angeles County Sheriff's Department Parks Bureau. All trail users use these trails at their own risk.

On multi-use trails, trail users must yield to other users following these established guidelines:

- Hikers yield to equestrians, and
- Mountain bikers yield to hikers and equestrians.

Signs before blind corners to avoid user conflicts may be an option, and will be incorporated into future trail design whenever possible.

Mountain bikes may be ridden on designated multi-use trails and bicycle trails unless otherwise posted. Certain regulations and suggestions also apply to the use of trails by mountain bikers:

- Bicycles are not permitted to be ridden in areas posted as No Bicycles. However, bicycles may be walked or carried in these areas.
- State law requires that all bicyclists under age 18 wear an approved helmet while riding on trails and roadways.
- Helmets are encouraged for riders of all levels and ages.
- Riders should call out "on your left" or "on your right" depending upon direction of passing or sound a warning when overtaking other trail users.
- Riders are encouraged to use bells to signal to passers, where to pass, when to pass, and actively solicit a response.
- Riders should slow at blind curves and other areas with limited sight distances.
- Signs should be posted for bicyclists to slow down at blind corners.



Equestrians may only lead or ride a horse, mule, donkey, or other similar animal on designated trails or in designated equestrian areas. Certain regulations and suggestions also apply (County Code 17.04.420):

- Horses, mules, donkeys, or other similar animals are not permitted, either ridden or walked, in areas posted as No Horses.
- Helmets are encouraged for riders of all levels and ages.

To clarify the distinction between motor vehicles and wheelchairs the following definitions of “motor vehicles” and “wheelchairs” are provided:

- Motorized Vehicles: “Motor vehicles” means any multi-wheeled, treaded, or sled-type vehicle that is propelled by a motor engine, including any vehicle commonly known as a “motorized recreation vehicle” (County Code 17.04.110).
- Wheelchair: “Wheelchair” means a device designed solely for use by a mobility impaired person for locomotion, that is suitable for use in an indoor pedestrian area.

In addition:

- Access for motorized vehicles on trails is limited to authorized vehicles, such as County maintenance vehicles and emergency response vehicles (County Code 17.04.370 and 17.04.1170)
- Motorized vehicles are restricted to designated parking areas and paved public roads
- Unauthorized motorized vehicles are prohibited, including dirt bikes and all-terrain vehicles (ATVs) (Ordinance Code 17.04)

Motor vehicles according to the Department of Justice’s revised Americans with Disabilities Act (ADA) regulations regarding trails,<sup>2</sup> which became effective March 15, 2011, are not yet included in the above definitions. As required, by the 2011 ADA ruling, the County has established an interim policy that is available on the LACO-DPR Web site, and updates will be provided as available.

<sup>2</sup> U.S. Department of Justice. Americans with Disabilities Act. “Revised ADA Regulations: Implementing Title II and Title III.” Available at: <http://www.ada.gov/regs2010/ADAREgs2010.htm>

### 5.1.3 Physical Resources

Operation standards for physical resources protect biological, geological, and cultural resources:

- Park property, vegetation, and animals, including sensitive plants; animals; and geological, archaeological, or historic objects are protected by law. Do not disturb or remove any of these features (County Code 17.04.340 and 17.04.470).
- Littering and dumping is prohibited. Any person who violates the littering laws may be arrested or issued a citation (County Code 17.04.500 and 1118.15).
- Dogs must be kept on leashes at all times on trails (County Code 17.04.410).
- A person shall not bring into a park any animal except as hereafter specifically provided or as otherwise permitted by the director (County Code 17.04.400).
- Do not feed or harm wildlife. They should be viewed from a distance (County Code 17.04.470).

### 5.1.4 Parkland Uses

Parkland uses cover group and individual activities that take place on or near trails, such as camping, picnicking, fishing, and hunting.

- Fires are only permitted in signed and designated areas (County Code 17.04.590).
- Fireworks or other combustible materials are not permitted along any trail (County Code 17.04.520 and 17.04.610).
- Camping is not permitted along County trails (County Code 17.04.380 and 17.04.390).
- Fishing requires a state license (County Code 17.04.560).
- Possession or acting under the influence of alcoholic beverages or drugs is not permitted (County Code 17.04.440 and 17.04.450).

- Nudity is not permitted along County trails (County Code 17.04.480)
- Assemblies, performances, special events, or similar gatherings may require a prior authorization.
- Paint ball guns or rifles are not permitted on County trails (County Code 17.04.600)
- Firearms, or bows and arrows, or other weapons are not permitted on County trails except in designated areas (County Code 17.04.620 and 17.08.300).
- Trail users and visitors are responsible for knowing and following trail rules.

For more information regarding fire roads, contact the County of Los Angeles Fire Department (LACO-FD). For more information regarding the flood control systems, please contact the County of Los Angeles Department of Public Works (LACO-DPW).

### 5.1.5 Emergency Response

Emergency response to County trails will be provided by various agencies, depending on the location. In many cases, the closest public safety agency will respond, which may include County sheriffs, local police, or national forest personnel. Way-finding signs should also include emergency response information, such as emergency phone numbers and trail addresses if applicable.

### 5.1.6 Closure Policy

Trails will be signed as closed when conditions no longer provide for the safe passage of authorized users. Trails and interactions with nature have impassible or imminent risks due to continuously changing natural conditions. Therefore, a trail will be closed only when risks are elevated above the inherent risk involved with hiking, mountain biking, or riding a horse on a trail. The length of time that a trail is expected to be closed will be shown along with the agency name and contact information at each end of the closed trail segment.

### 5.1.7 Modification to Operation Guidelines

Operation guidelines are subject to change with approval by the Director of the Department of Parks and Recreation.

## 5.2 TRAIL ASSESSMENT

Conduct the trail assessment process to ensure all trails are inventoried and the conditions are documented prior to conducting maintenance. This section outlines the process that can be utilized for trail assessment. In addition, the Universal Trail Assessment Process (UTAP), developed to determine which users may access a trail and the level of accessibility of a trail, is a useful tool in assessing trails, documenting maintenance needs, and determining schedules. The results of the UTAP process may also be useful for providing way-finding signs indicating the conditions of the trails ahead, which is helpful for individuals with disabilities. The UTAP process has been found to be useful, but the documentation requirements can be time and resource intensive. Therefore, this process may only be warranted for particular trails or portions of trails. The UTAP process is utilized by the U.S. Department of Agriculture Forest Service and by California State Parks.

As an alternative to the full UTAP process for trail assessment, a reduced assessment and repair form has been included in this document for use in assessing the type of repair, the crew and tools required, and the budget necessary (Figure 5.2-1, *Sample Trail Assessment and Repair Sheet*; Figure 5.2-2, *Trail Work Log*; and Figure 5.2-3, *Trail Work Log Key*). Blank forms for photocopying are included in Appendix L, *Trail Assessment and Maintenance Forms*. The three forms are to be used in conjunction to document needed maintenance and repair locations and types when conducting an assessment or when a repair is reported by other trail users. The Trail Assessment and Repair Sheet should be filled out at the site to record the extent and type of problem requiring repair. The form provides space to describe the maintenance issue and develop strategies to repair while taking notes on the trail, the location, sketches of the problem and solution, and the tools that will be required. The Trail Assessment and Repair Sheet includes an area to determine the type of repair (or feature) and the action to be taken, both of which should use as a reference the trail work log key. The Trail Assessment and Repair Sheet in combination with the trail work log key provides those conducting repairs with the necessary information required to assess the time, materials, and cost of the repair. An estimate of the trail repair cost can be based on the information contained in Section 2.5.3.1, *Construction Cost Considerations*, and Appendix E, *Trail Construction Costs*.

### 5.2.1 Trail Surfaces

Non-motorized trails are classified according to surface materials and width, as determined by anticipated use patterns and amount of side-hill disturbance involved in construction. In general, trails are made wider when they are located close to urban centers, in an open space area with topography conducive





Feature	Action	Unit	Comment
Asphalt placed	Install/Maintain	cy	
Bench	Maintain/Replace	ea	as specified
Bridge	Construct/ Reconstruct	Linear Ft	Varies by design
Bridge	Maintain	Linear Ft	as specified
Bridge	Remove	Linear Ft	Varies by design
Bridge - Mid-span supports	Construct/ Reconstruct		as specified
Causeway	Construct/ Reconstruct	cy	
Climbing Turn	Construct/ Reconstruct	ea	
Concrete	Install	cy	
Culvert	Install/Remove	Linear Ft	Varies by type & design
Culvert - Rock	Construct/ Reconstruct	cubic ft.	
Down Trees	Remove	diameter	
Drainage Dip	Construct/ Reconstruct	ea	foot excavation
Drainage Lense	Construct/ Reconstruct	cy	
Ford	Construct/ Reconstruct	cubic ft.	
Hand Rail Removal	Remove	Linear Ft	
Hand Rails	Construct/ Reconstruct	Linear Ft	
Puncheon	Construct/ Reconstruct	Linear Ft	
Puncheon	Maintain	Linear Ft	as specified
Retaining Wall - Causeway rock walls	Construct/ Reconstruct	cy/ton	
Retaining Wall - Cellular Confinement	Construct	cy/ton	
Retaining Wall - Cribbed Abutments	Construct/ Reconstruct	cy/ton	
Retaining Wall - Geotextile Fabric	Construct	sq. ft.	
Retaining Wall - Mortared Rock	Construct/ Reconstruct	yds/ton	
Retaining Wall - Mortared Rock	Maintain		as specified
Retaining Wall - Rock	Construct/ Reconstruct	cy	
Retaining Wall - Turnpike walls	Construct/ Reconstruct	sq. ft	
Retaining Wall - Wood	Construct/ Reconstruct	sq. ft	
Riprap - rock, dry wall	Construct/ Reconstruct	cubic ft.	drains, tread, step landings
Sign	Maintain/Replace	ea	as specified
Slide Removal	Remove	cubic ft.	
Soil Stabilizer Placed	Install/Maintain	sq. ft	
Split Rail Fence	Remove	Linear Ft	
Step	Maintain	ea	as specified
Step Removal	Remove	ea.	
Steps - Cable	Construct/ Reconstruct	ea	
Steps - Cut Out Stringer	Construct/ Reconstruct	ea	
Steps - Full Crib	Construct/ Reconstruct	ea	
Steps - Mortared Rock	Construct/ Reconstruct	cy/ton	
Steps - Rock	Construct/ Reconstruct	cy/ton	
Steps - Wood	Construct/ Reconstruct	ea	
Steps - Wood Interlocking Double	Construct/ Reconstruct	ea	
Steps - Wood Interlocking Single	Construct/ Reconstruct	ea	
Swale	Construct/ Reconstruct	ea	budget information
Switchback	Construct/ Reconstruct	ea.	
Trail	Brush	Linear Ft	
Trail	Construct	Linear Ft	
Trail Narrowing	Remove	sq. ft	
Trail Obliteration	Remove	sq. ft	
Trail Tread	Reconstruct	Linear Ft	
Trio Rehabilitation	Perform	Linear Ft	
Turnpike	Construct/ Reconstruct	sq. ft	
Wall-less Turnpike	Construct/ Reconstruct	sq. ft	
Water Bar - rock	Install/Remove/Maintain	cy/ton	
Water Bar - wood	Install/Remove/Maintain	ea	

Figure 5.2-3  
Trail Work Log Key

to wider trail tread, or when there are many anticipated users. The County of Los Angeles System of Riding and Hiking Trails includes a variety of County trails with variable widths and surfaces.

### 5.2.2 Trail Assessment

Regular maintenance is essential to ensuring user safety and extending the useful life of the trail system. Lack of such maintenance could lead to serious deterioration, which could increase, rather than reduce, long-term upkeep costs. All trails benefit from routine maintenance. In addition, the lack of regular maintenance damages the natural resources and outdoor recreation opportunities, and may create a safety hazard.

Map and inventory trail features using global positioning system (GPS) and geographic information system (GIS) technology, and enter these features into a maintenance management system database that tracks data on scheduling, time and cost estimates for repairs, actual work accomplished, and needs for large-scale repairs or desired reroutings. This database needs to be updated frequently based on monthly or at least quarterly inspections that note changes in trail conditions that may alter initial estimates.

An up-to-date maintenance database will assist with determining the amount and frequency of trail work needed, which reflects local conditions and trail types. Therefore, it is essential that each trail be identified by its type and by any special conditions that affect maintenance needs, such as weed growth, steepness, erosion potential, and stream crossings. A four step process maybe utilized to assess trail conditions:

#### Step 1: Create a Trail Assessment and Repair Sheet

A sample trail assessment and repair sheet is provided in this section. The purpose of the sheet is to prevent the ambiguity of maintenance work. It specifically identifies the trails needs and communicates those needs to others who would be performing the maintenance. This information can then be added to the maintenance database.

#### Step 2: Walk or Ride the Trail

Inspect trails on a routine basis to identify current conditions, erosion, and any water drainage devices that need repair. In addition, evaluate structural features such as fencing, restrooms, kiosks, and way-finding signs.

Begin walking or riding the trail from the trailhead in order to identify any maintenance or repairs required along the trail. A GPS device or a measuring wheel is recommended for recording the distance and location of a needed repair. Whenever a

location along the trail is in need of maintenance or repair, use the assessment sheet to identify the nature of the problem, the severity of the problem, location from the trailhead, and other necessary information. Prioritize repairs that would pose risks to visitors.

#### Step 3: Confer with the Land Manager

If applicable, for portions of a trail easement through private land holdings, discuss the trail maintenance and repair projects with the landowner prior to scheduling any maintenance or repairs. The assessment sheet will help describe the problems and develop a strategy and a timeline to complete the maintenance and repairs.

#### Step 4: Assign Work Crews

Assign a crew of workers to each maintenance project. Provide the crew with special training on how to perform the work, including how to identify potential hazards, most efficient methods of repair, what can be handled by in-house staff, and what may require the services of private contractors. Based on this information, staff should be in a position to develop annual costs for equipment, supervision, in-house labor, and outside contractor work, and thus arrive at the County's trail program budget projections.

With the assessment sheet, have the work crews answer the remaining questions in terms of who is on the crew, who is the leader, where is the work site, what are the tools required, and how to go about repairing the problem.

### 5.3 TRAIL MAINTENANCE

Design a multi-year trail maintenance schedule to ensure the continued up-keep, repair, and necessary replacement of trail sections and features. Update the schedule annually based on trail inspections occurring throughout the year. The schedule should be reflected in budget requests for the agency. Additionally, trail maintenance should be scheduled to protect federally and State-listed species.

A maintenance management system database can assist the County with tracking trail inventory and with producing and monitoring preventative maintenance work orders for specific maintenance tasks. The database can also generate work orders and allow managers to track hours, costs, and resources used to perform maintenance tasks, as well as account for curative maintenance tasks and renovation projects. Work orders can be initiated in several ways. A citizen may contact the County to report a problem or issue. At the LACO-DPR, a request form for maintenance is already in place, although to date, the trail-work request form has not been used. However, if trail maintenance

is needed, a request form can be sent to the appropriate crew for action. Preventive maintenance work orders are generated on daily, monthly, and yearly schedules, based on the frequency required. Maintenance staff can generate their own work orders for curative or non-preventive related tasks. Other County staff can request work to be performed and send the request directly to the appropriate crew through direct access to the maintenance database. The database should include aerial photos of the site, along with the number and location of culvert pipes, bridges, switchbacks, and other structures. This information is beneficial when planning maintenance activities on a particular trail network. The maps can also be distributed to the maintenance crews to help identify the exact area that needs to be maintained or repaired.

Maintaining trails are important, but funding trail repairs may be difficult. Possible funding alternatives include annual appropriations, open space and park district bonds and tax assessments, grants from various government and foundation programs, volunteer assistance, developer fees and required proffers, park user fees, and citizen donations. Assign a grant writer as part of the staff, and key the trail coordinator into the development assessment process so that trail maintenance is adequately funded.

Trail repairs may be as minor as fixing potholes in a trail or as major as a complete reconstruction or rerouting of an entire trail section. Low areas that channel water or are subject to inundation during heavy rain events need to be repaired immediately before they become significantly worse and begin to affect surrounding sections. Quickly clean and reestablish culverts and other drainage structures that become clogged.

On trails with equestrian usage, preventing compaction near step overs is essential. Sandy soils must be used on trail surfaces near step overs, as sandy soils do not compact easily. Workers would regularly replace the trail surface to prevent compaction. Moreover, step overs should have a marker to signify when trail surface is compacted and needs replacement.

Finally, trail maintenance schedules should be set to avoid unauthorized “take” of federally and State-listed species afforded protection pursuant to the Bald and Golden Eagle Protection Act and the Migratory Bird Treaty. (For more information please refer to Appendix D, *Federally and State-Listed Species with Potential to Occur within the County of Los Angeles*).

A guideline to the most common trail maintenance and repair procedures, along with recommended maintenance intervals for each, is provided in Table 5.3-1, *Seasonal Maintenance by Trail Surface*, and Table 5.3-2, *Annual Maintenance by Trail Surface*.

### 5.3.1 Mowing and Spraying

Mowing and spraying should be used as maintenance procedures on County-owned lands by qualified personnel with the appropriate State certifications. For lands that are not owned or administrated by the County of Los Angeles, coordination needs to be undertaken with the underlying property owner to get concurrence on the recommended maintenance strategies. Mowing can be used for certain kinds of recurring vegetation growth, including fire fuel buffers, fire control areas, and poison oak control areas. Schedule mowing and spraying regularly, based on knowledge of how fast such growth occurs so that trail use is not significantly inhibited. With some kinds of fast-growing brush, it may be necessary to consider use of herbicides, but special precaution and certified training must be essential components of any such spraying operations.

### 5.3.2 Tree and Brush Trimming

Pruning is performed for the safety of the trail user and to protect the trail and other associated assets. Workers must be knowledgeable about how to do such pruning in ways that provides for aesthetics and protects the health of the vegetation. Proper pruning and brushing allows operators to do a thorough and safe job. Such work usually can be done with clippers, string trimmers, and chainsaws, but in some situations, it may be necessary to chop out root systems or blade off the embedded plant material. Operators must have proper training to operate machinery and knowledge of safety issues in areas such as poison oak, safe disposal, and special equipment needed.

### 5.3.3 Debris Removal

Keeping the trail surface cleared is one of the most important aspects of trail maintenance. Mud and other sediment need to be removed along with fallen leaves, branches, and fallen trees to ensure the safety of the users and to increase the life expectancy of the trail itself. This maintenance task is required for all trail surfaces. Littering is prohibited under County Code 17.04.500 and 1118.15. Trail users are required to prevent littering. Trail users can report violations of litter laws to the Los Angeles County Sheriff's Department Parks Bureau. For debris removal from the trail surface, follow the same operations for mowing.

### 5.3.4 Culverts

Culverts often become clogged with trash and debris that must be removed before the start of the rainy season or late spring to prevent flooding and undercutting of trail surfaces. Culverts may also need to be upgraded in size or replaced because of deterioration or increased storm water flow resulting from

**TABLE 5.3-1  
SEASONAL MAINTENANCE BY TRAIL SURFACE**

Trail Surface	Task	Frequency	Methods
Native surface	Mowing of grasses	Three times annually (spring, summer, and fall)	Use a mower or weedwacker unit.
Asphalt, boardwalk, compacted decomposed granite, concrete, wood chips, native surface	Inspection of trails by walking	Monthly	Inspect trail surfaces, shoulder areas, trees, bridges, crossings, signs, and amenities.
Asphalt, boardwalk, compacted decomposed granite, concrete, wood chips, native surface	Tree and brush pruning	Twice annually	Cut down trees and prune limbs at least 1 foot beyond trail edges and provide a minimum 10-foot height clearance.

**TABLE 5.3-2  
ANNUAL MAINTENANCE BY TRAIL SURFACE**

Trail Surface	Task	Frequency	Methods
Asphalt	Asphalt trails pothole repair	Annually or as needed	Remove and replace old asphalt and compress new asphalt even with trail surface.
Concrete	Concrete trails pothole repair	Annually or as needed	Remove and replace old concrete and finish new concrete even with trail surface.
Compacted decomposed granite	Gravel trails pothole repair	Annually or as needed	Remove and replace old gravel and compress new gravel even with trail surface.
Native surface	Native soils trail replacement	Annually or as needed	Compress soils to be level with the trail surface.
Wood chips	Wood chips trails repair	Annually or as needed	Remove and replace old wood chips and compress and rake new chips to be level with the trail surface.
Asphalt, boardwalk, compacted decomposed granite, concrete, wood chips, native surface	Leaf and debris removal	Annually (fall) or as needed	Use a tractor-mounted blower.
Asphalt, boardwalk, compacted decomposed granite, concrete, wood chips, native surface	Cleaning and repair of culvert pipes	Annually or as needed in late spring	Clean by using a shovel. Repair or replace pipes if any erosion exists.
Asphalt, boardwalk, compacted decomposed granite, concrete, wood chips, native surface	Sign and other amenities repair	As needed	Replace or repair damaged posts, signs, benches, and tables.
Boardwalk, puncheon bridge, or turnpike trails	Water crossing maintenance	As needed in late spring	Divert water flow, clean eroded area, and replace missing or damaged surface material, and re-compact. Reestablish water flow.



weather or changes in vegetation cover, such as from fires, or from new development in the area.

### 5.3.5 Water Crossings and Bog Areas

Bridges, low water crossings, open box culverts, rock drains, and other drainage structures, including those at switchbacks, need regular inspection and attention. Debris should be removed before the start of the rainy season and on an as-needed basis throughout the non-rainy season. Keeping the trail area free of debris facilitates the free flow of surface run-off, thus minimizing and reducing the risk of flooding and related surface erosion. Eroded areas need to be re-graded as quickly as possible to prevent further deterioration. In badly deteriorated bog areas, the installation of erosion protection measures such as geotechnical soil stabilization materials should be evaluated.

### 5.3.6 Signs and Other Amenities

Kiosks, signs, benches, gates, fencing, bollards, and steps need to be kept in safe and aesthetically pleasing condition. Items that fall into disrepair often become the target of vandals. Prompt repairs are essential; anticipate lifecycle replacement.

The LACO-DPR has adopted a trail way-finding sign program. The intent of this primary trail way-finding sign program is to identify the typical County trail signs, which would be applied Countywide, cognizant of limited staff and funding resources. The trails logo was approved in 2010 by the LACO-DPR Director and has been applied in trail staging areas in a few locations. The goal is to apply this for “branding” purposes. The trail monumental signs include two styles, one reflecting a contemporary design and another more rustic version for application in either wilderness or rural depending on the surrounding contexts. The way-finding sign is new to the LACO-DPR; while being simplistic, it is intended to be easy to maintain and readable. Detailed examples of the trail way-finding sign program are provided in Appendix K, *Way-Finding Signs*.

### 5.3.7 Graffiti Removal

As discussed above, prompt repairs are essential. To avoid graffiti, way-finding sign poles should be higher to prevent vandalism, and constructed or treated to minimize the effects of graffiti. Trails without graffiti will be more aesthetically pleasing to trail users, compelling them to use the trails frequently. Trails without graffiti will also ensure the longevity of the trail. Once graffiti has been reported, graffiti removal should be completed as soon as possible within 24 hours.

### 5.3.8 Homeless Encampment Removal

Trail hours of operation prohibit overnight occupation on the trails. Therefore, homeless encampment is prohibited. The proper authorities should be notified when homeless encampment is occurring on trails to ensure removal. Currently, enforcement on trails is provided by the Los Angeles County Sheriff's Department Parks Bureau.

### 5.3.9 Fire Mandated Brush Clearance

In the County of Los Angeles, the Brush Clearance Program is a joint effort between the County of Los Angeles Fire Department and the County of Los Angeles Department of Agricultural Commissioner/Weights and Measures, Weed Hazard and Pest Abatement Bureau (Weed Abatement Division). The Brush Clearance Program enforces the removal of hazardous vegetation in Fire Codes. The Brush Clearance Program should be consulted for fire-mandated brush clearance.

### 5.3.10 Pumping Out Flooded Tunnel Ways (Trailways)

To ensure longevity and prevent erosion and closures of trails, pumping out flooded tunnel ways is vital for trail operation and maintenance.

## 5.4 WORKING WITH VOLUNTEER AND OTHER COMMUNITY BASED GROUPS

Trail groups may provide input into the design, development, and implementation of the trail network. They also provide trail maintenance and report maintenance needs to the staff through volunteer programs. However, recruiting and attracting volunteers can be a difficult task. Some park supervisors may already have organized members from the local community to assist with the maintenance and repair of the trails, whereas other parks may not.

For example, the County of Orange Adopt-A-Park program serves beaches, harbors, and parks in the county. The main objective for the Adopt-A-Park program is to provide volunteers with an opportunity to maintain, repair, and perform various operational functions for the parks in their communities. This could be integrated with the current volunteer program proposed by the County of Los Angeles. The main objective of the Adopt-A-Trail program would be for community volunteers to maintain, repair, and provide various operational functions for the County's trail networks. For more information on the Adopt-A-Trail program, please contact LACO-DPR directly. There are several potential sources of volunteers:

- College students
- High school students

- Girl and Boy Scouts of America
- National service organizations
- Corrections departments
- Cycling clubs
- Hiking clubs
- Equestrian (corral) clubs
- Multi-use trail clubs
- Trail running clubs
- Kiwanis clubs
- Conservation and environmental trail preservation organizations
- Regional trail councils
- Mounted assistance units - trained

Being prepared is essential to the effective and efficient mobilization of work crews. The first step in mobilizing work crews shall consist of clearly articulating the performance goal for the workday and the proposed strategies for attaining the goal. List all actions needed, including meeting with the land manager and organizing availability of tools. Estimate how much time it would take for the volunteer crews to complete each task. Delegate tasks and develop backup plans for things that may go wrong. Provide crew leaders with training in advance of the project initiation. Communicate and promote safe use of tools. Provide a sense of accomplishment; volunteers will return if they feel they have accomplished something. Make it enjoyable and fun, but above all, show appreciation for the efforts of volunteers.

It is essential that volunteers receive proper training prior to beginning a work effort to ensure that the quality of the work performed is maintained. In addition, when appropriate, the confidentiality of data that volunteer groups may have access to must be maintained. The Trails Manual is not designed to cover policies in regards to worker's compensation. The County of Los Angeles has prepared a manual for working with volunteers that provides further guidance to this process.<sup>3</sup>

<sup>3</sup> County of Los Angeles Department of Parks and Recreation. June 2009. *Volunteer Manual*. Los Angeles, CA.

## SECTION 6.0 MANUAL AUTHORS

---

Multiple authors are responsible for this manual and are recognized below. Many additional individuals contributed information to the production of this document and are thanked for their time and comments.

### 6.1 SAPPHOS ENVIRONMENTAL, INC.

<i>Contributor:</i>	<i>Title:</i>	<i>Area of Responsibility:</i>
Marie Campbell	President	Quality Assurance / Quality Control (QA/QC) Review
Laura Kaufman	Environmental Compliance Director	QA/QC Review
Eric Charlton	Manager of Planning and GIS	QA/QC Review
William Meade	Environmental Coordinator	Technical Writing
Edward Belden	Environmental Coordinator	Technical Writing
André Anderson	Senior Environmental Compliance Specialist	Technical Writing
Leanna Guillermo	Environmental Analyst	Project Management, Technical Writing, and Photography
Roland Ok	Environmental Compliance Intern	Technical Writing
Eugene Ng	Senior Graphics Specialist	Graphics and Photography
David Lee	Production and IT Manager	QA/QC Review Editing and Production
Samantha Ortiz	Senior Technical Editor	Editing and Production
Christina Poon	Senior Technical Editor	Editing and Production

### 6.2 SPECIAL THANKS

County of Los Angeles Department of Parks and Recreation - Research and Trails Planning Section staff for assistance with development of the manual:

Frank Moreno  
Jennifer Lee  
Francis Yee  
Jeremy Bok  
Robert Ettleman

International Mountain Bicycling Association for use of graphics in the manual



## SECTION 7.0 REFERENCES

---

- American Trails. 29 March 2006. Accessed 6 April 2006. *Products, Businesses and Consultants*. Available at: <http://www.americantrails.org/resources/consultants/index.html>
- Architectural and Transportation Barriers Compliance Board. 30 September 1999. *Accessibility Guidelines for Outdoor Developed Areas: Final Report*. Available at: <http://www.access-board.gov/outdoor/outdoor-rec-rpt.htm>
- Architectural and Transportation Barriers Compliance Board. 3 September 2002. "ADA Accessibility Guidelines for Recreation Facilities." *Federal Register*, 36 CFR Part 1191 (Docket No. 98-5) RIN 3014-AA16. Available at: <http://www.access-board.gov/recreation/final.htm>
- Architectural and Transportation Barriers Compliance Board. Accessed 6 April 2006. "Outdoor Developed Areas." Available at: <http://www.access-board.gov/outdoor/index.htm>
- American Trails. Accessed 13 April 2011. Web site. Available at: <http://www.americantrails.org/>
- Bass, Ronald E., Albert I. Herson, and Kenneth M. Bogdan. 1999 (with 2001 supplement). *The CEQA Deskbook*. Point Arena, CA: Solano Press Books.
- Bell, Roger. 2002. "New Models for Trail Contracting." *Trail Tracks*, 31(1): 6–9.
- Benti, Wynne. 1995. *Favorite Dog Hikes: In and Around Los Angeles*. Bishop, CA: Spotted Dog Press, Inc.
- Birkby, Robert C. 1996. *Lightly on the Land: The SCA Trail-Building and Maintenance*. Seattle, WA: The Mountaineers.
- Boten, Bill, Architectural and Transportation Barriers Compliance Board, Washington, DC. 11 April 2006. Personal communication via e-mail with Mr. Edward Belden, Sapphos Environmental, Inc., Pasadena, CA.
- Byers, Elizabeth, and Karin Marchetti Ponte. 2005. *The Conservation Easement Handbook*. (Second Edition.) Washington, DC: Land Trust Alliance and Trust for Public Land.
- California Civil Code, Division 2, Part 2, Title 3, Chapter 2, Section 846. Available at: <http://www.leginfo.ca.gov/cgi-bin/calawquery?codesection=civ&codebody=&hits=20>
- California Code of Regulations*. 2010. Title 14, Division 6, Chapter 2.5, Section 21061.1.
- California Department of Conservation. 1 January 1998. Division of Land Resources Program, *Williams Act Program*. Available at: [http://www.conservation.ca.gov/DLRP/lca/easement\\_exchanges/index.htm](http://www.conservation.ca.gov/DLRP/lca/easement_exchanges/index.htm)
- California Department of Parks and Recreation. Revised June 1974. *California Outdoor Recreation Resource Plan (CORRP)*. Contact: California Department of Parks and Recreation, 1416 9th Street, Sacramento, CA 95814.
- California Department of Parks and Recreation. 2005. *2005 California Recreation Policy*. Contact: California Department of Parks and Recreation, 1416 9th Street, Sacramento, CA 95814. Available at: [http://www.parks.ca.gov/pages/795/files/rec\\_policy\\_final\\_2005.pdf](http://www.parks.ca.gov/pages/795/files/rec_policy_final_2005.pdf)
- California Department of Transportation. 1 February 2001. *Highway Design Manual*, Chapter 1000, Bikeway Planning and Design. Sacramento, CA. Available at: <http://www.dot.ca.gov/hq/oppd/hdm/pdf/chp1000.pdf>
- California Government Code, Title 1, Division 3.6, Part 2, Chapter 2, Article 1, Section 830-831.9. Available at: <http://www.leginfo.ca.gov/cgi-bin/calawquery?codesection=gov&codebody=&hits=20>

California Resources Agency. June 2003. "California Agency Conservation Easements." In *California Environmental Information Catalog*. Sacramento, CA. Available at: <http://gis.ca.gov/catalog/BrowseRecord.epl?id=21063>

California State Parks. 1998. *Trails Handbook*. Contact: California State Parks, Statewide Trails Office, P.O. Box 942896, Sacramento, CA.

California State Parks. June 2002. *California Recreational Trails Plan*. Contact: State of California Department of Parks and Recreation, Planning Division, Statewide Trails Office, P.O. Box 942896, Sacramento, CA 94296-0001. Available at: <http://www.parks.ca.gov/pages/1324/files/Trails%20Plan%20final%203%206.5.pmd.pdf>.

California State Parks, Planning Division. May 2002. "Chasing State and Federal Funding." (Technical Assistance series.) Sacramento, CA. Available at: <http://www.parks.ca.gov/pages/795/files/chasing%20state%20and%20federal%20funding.pdf>

Centers for Disease Control and Prevention, National Center for Chronic Disease Prevention and Health Promotion; President's Council on Physical Fitness and Sports. 1996. *Physical Activity and Health: A Report of the Surgeon General*. Washington, DC: Centers for Disease Control and Prevention, National Center for Chronic Disease Prevention and Health Promotion; President's Council on Physical Fitness and Sports.

City of Burlington Recreation and Parks Departments and the Alamance County Recreation and Parks Department. August 2007. *General Design Guidelines and Schedule of Design Elements for the Haw River Trail*. "Conceptual Greenway Master Plan from the Indian Valley Golf Course to Glencoe Mill Village." Available at: <http://atfiles.org/files/pdf/HawRiverTrailguidelines.pdf>

City of Los Angeles. April 2007. *Los Angeles River Revitalization Master Plan*. Available at: <http://www.lariverrmp.org/>

County of Los Angeles Department of Parks and Recreation. May 1992. *A Parks and Recreation Strategic Plan for 2010*. Contact: 433 South Vermont Avenue, 4th Floor, Los Angeles, CA 90020.

County of Los Angeles Department of Parks and Recreation. 2001. *Los Angeles County Riding and Hiking Trails*. Contact: 433 South Vermont Avenue, Los Angeles, CA 90020.

County of Los Angeles Department of Parks and Recreation. 2003. *County of Los Angeles Inventory of Park Facilities and Areas of Jurisdiction*. Contact: Department of Regional Planning, Hall of Records, 320 West Temple Street, Los Angeles, CA 90012.

County of Los Angeles Department of Parks and Recreation. April 2004. *Strategic Asset Management Plan (SAMP) for 2020*. Prepared by: County of Los Angeles Chief Executive Office and County of Los Angeles Department of Parks and Recreation, with technical assistance by Sapphos Environmental, Inc.

County of Los Angeles Department of Parks and Recreation. 6 December 2005. "Healthy Parks." Web site. Available at: <http://parks.co.la.ca.us/HealthyParks.htm>

County of Los Angeles Department of Parks and Recreation. June 2009. *Volunteer Manual*. Los Angeles, CA.

County of Los Angeles Department of Public Works. Accessed 6 April 2006. "Water Resources Precipitation Page." Web site. Available at: <http://www.ladpw.org/wrd/precip/>

County of Los Angeles Department of Public Works. June 2006. *San Gabriel River Master Plan*. Available at: [http://dpw.lacounty.gov/wmd/watershed/sg/mp/docs/SGR\\_MP.pdf](http://dpw.lacounty.gov/wmd/watershed/sg/mp/docs/SGR_MP.pdf)

County of Los Angeles Department of Public Works. 2006. Accessed on 22 June 2006. "History of the Los Angeles River." Web site. Available at: <http://ladpw.org/wmd/watershed/LA/History.cfm>.

County of Los Angeles Department of Regional Planning. 1965. *County of Los Angeles General Plan*. Contact: Department of Regional Planning, Hall of Records, 320 West Temple Street, Los Angeles, CA 90012.

County of Los Angeles Regional Planning Commission. 29 July 1965. *Los Angeles County Regional Recreation Areas Plan: A Part of the Recreation Element of the General Plan*. Contact: Department of Regional Planning, Hall of Records, 320 West Temple Street, Los Angeles, CA 90012.

County of Los Angeles Department of Regional Planning. 1986. *Los Angeles County Regional Recreation Areas Plan*. Contact: Department of Regional Planning, Hall of Records, 320 West Temple Street, Los Angeles, CA 90012.

County of Los Angeles Department of Regional Planning. 2005. *Draft General Plan Conservation/Open Space Element, "Shaping the Future 2025."* Contact: Department of Regional Planning, Hall of Records, 320 West Temple Street, Los Angeles, CA 90012.

County of Los Angeles Metropolitan Transit Authority. 2001. *Long Range Transportation Plan for Los Angeles County*. Contact: Metropolitan Transit Authority, One Gateway Plaza, Los Angeles, CA 90012. Available at: [http://www.mta.net/projects\\_plans/bikeway\\_planning/default.htm](http://www.mta.net/projects_plans/bikeway_planning/default.htm)

Department of Treasury, Internal Revenue Service. *Internal Revenue Code § 170. Charitable, etc., contributions and gifts*. 2005. Available at: [http://www.law.cornell.edu/uscode/html/uscode26/usc\\_sec\\_26\\_00000170----000-.html](http://www.law.cornell.edu/uscode/html/uscode26/usc_sec_26_00000170----000-.html)

East Bay Regional Park District. 17 May 2005. Ordinance 38, Chapter 1: "Definitions." Contact: East Bay Regional Park District, 2950 Peralta Oaks Court, P.O. Box 5381, Oakland, CA 94605. Available at: [http://www.ebparks.org/district/ord\\_38/ord\\_38TOC.htm#chapterone](http://www.ebparks.org/district/ord_38/ord_38TOC.htm#chapterone)

ESRI. 2006. *ArcGIS Version 9.1*. (Software.) Contact: ESRI, 380 New York Street, Redlands, CA 92373.

Flink, Charles A., Kristine Olka, and Robert M. Searns. 2001. *Trails for the Twenty-First Century: Planning, Design, and Management Manual for Multi-Use Trails*. Washington, DC: Island Press.

Furuseth, Owen J. and Robert E. Altman. 1990. "Greenway Use and Users: An Examination of Raleigh and Charlotte Greenways." *Carolina Planning Journal*, 16(2): 37-43. Chapel Hill, NC: University of North Carolina at Chapel Hill, Department of City and Regional Planning.

Governor's Office of Planning and Research. May 1997. "Jurisdictions Whose Subdivision Ordinance Provides for The Quimby Act, Tentative Parcel Maps, and Merger of Lots by Parcel Map." In *The California Planners' Book of Lists*. Sacramento, CA: Department of General Services. Available at: <http://ceres.ca.gov/planning/bol/1997>

Hancock, Jan, Kim Jones Vander Hoek, Sunni Bradshaw, James D. Coffman, and Jeffrey Engelman. U.S. Department of Agriculture Forest Service, Technology and Development Program. 2007 [Reprinted 2009]. *Equestrian Design Guidebook for Trails, Trailheads, and Campgrounds*. Missoula, MT.

International Mountain Bicycling Association. 2004. *Trail Solutions*. Boulder, CO: International Mountain Bicycling Association.

International Mountain Bicycling Association. 2004. *Trail Solutions*. Boulder, CO: International Mountain Bicycling Association, pp. 108-109.

Kaplin, Larry, Trust for Public Land, San Francisco, CA. 19 December 2005. Personal communication concerning trail easements with Andrew Hall, Sapphos Environmental, Inc., Pasadena, CA.

Leman, Laurie and Chris. 1992. *Mountain Biker's Guide to Southern California*. Helena, MT: Falcon Press.

---

National Sporting Goods Association. Last updated 2006. *Sports Participation in 2002: Series 1 and Series II*. Mt. Prospect, IL.

Northern California Regional Land Trust. 2002. Web site. Contact: Northern California Regional Land Trust, 167 East Third Avenue, Chico, CA 95926. Available at: <http://www.landconservation.org>

Parker, Troy Scott. 2004. *Natural Surface Trails by Design*. Boulder, CO: Natureshape LLC.

Professional Trailbuilders Association. 2006. Accessed on 6 April 2006. *Contractors by Location*. Available at: <http://www.trailbuilders.org/location.html>

Project Play and Learning in Adaptable Environments. 1993. *Universal Access to Outdoor Recreation: A Design Guide*. Berkeley, CA: Project Play and Learning in Adaptable Environments.

Rice, Andrew. 1999. *Frommer's Great Outdoor Guide to Southern California and Baja*. New York, NY: IDG Books Worldwide.

Rife. "Hand Pump: Specifications of Rife Hand Pumps." Available at: <http://www.riferam.com/handpump/hpindex.html>

San Diego County. 2005. *County Trails Program and the Community Trails Master Plan*. Contact: San Diego County Department of Parks and Recreation, Resource Management Division, 5201 Ruffin Road, Suite P, San Diego, CA.

San Diego County, Department of Land Use and Planning. 12 January 2005. *County Trails Program, Community Trails Master Plan*. Available at: <http://www.sdcounty.ca.gov/dplu/trails.html>

Santa Monica Mountains Area Recreation Trails Coordination Project. September 1997. *Final Summary Report*. Contact: SMMART Coordination Project, c/o Rivers, Trails and Conservation Assistance Program, National Park Service, 600 Harrison Street, Suite 600, San Francisco, CA 94107. Available at: <http://www.nps.gov/samo/parkmgmt/smmartreportsept1997.htm>

Sapphos Environmental, Inc. 4 August 2006. *Altadena Crest Trail Improvements Feasibility Analysis*. Prepared for: County of Los Angeles. Pasadena, CA.

Schad, Jerry. 2004. *Top Trails Los Angeles*. Berkeley, CA: Wilderness Press.

Southern California Association of Governments. January 1995. *Regional Comprehensive Plan and Guide*. Los Angeles, CA.

State of California. 1975. California Government Code, §66477, "Quimby Act."

State of California. *California Code of Regulations*. Title 14, Chapter 3, "Guidelines for Implementation of the California Environmental Quality Act," Article 20, Section 15377: "Private Project." Sacramento, CA. Available at: [http://ceres.ca.gov/topic/env\\_law/ceqa/guidelines/art20.html](http://ceres.ca.gov/topic/env_law/ceqa/guidelines/art20.html)

State of California, Santa Monica Mountains Conservancy. 28 June 1990. *Rim of the Valley Trail Corridor Master Plan*. Prepared by: Dangermond & Associates, 2400 O Street Sacramento, CA 95816.

Tracy, Tammy, and Hugh Morris. January 1998. *Rail-Trails and Safe Communities: The Experience on 372 Trails*. Washington, DC: Rails-to-Trails Conservancy. Available at: [http://safety.fhwa.dot.gov/ped\\_bike/docs/rt\\_safecomm.pdf](http://safety.fhwa.dot.gov/ped_bike/docs/rt_safecomm.pdf)

U.S. Access Board. September 2002. *ADA Accessibility Guidelines for Buildings and Facilities*. Section 4.1.2 (5) (a): "Accessible Sites and Exterior Facilities: New Construction." Available at: <http://www.access-board.gov/adaag/html/adaag.htm#4.1>

U.S. Access Board. Accessed 1 February 2008. "Proposed Architectural Barriers Act Accessibility Guidelines for Outdoor Developed Areas." Available at: <http://www.access-board.gov/outdoor/nprm/>

---

U.S. States Access Board. Accessed 1 February 2008. "Public Provides Input on Guidelines for Federal Outdoor Sites." Available at: <http://www.access-board.gov/news/outdoor-comments.htm>

U.S. Census Bureau. Last updated 15 July 2003. State and County QuickFacts, Los Angeles County, California. Web site. Available at: <http://quickfacts.census.gov/qfd/states/06/06037.html>

U.S. Census Bureau. Last updated 4 January 2006. "Arts, Entertainment, and Recreation." In *Statistical Abstract of the United States: 2004-2005*. Available at: <http://www.census.gov/prod/2005pubs/06statab/arts.pdf>

U.S. Department of Agriculture Forest Service. 1987. *Angeles National Forest Land and Resources Management Plan*. Contact: Forest Service Pacific Southwest Region, 1323 Club Drive, Vallejo, CA 94592.

U.S. Department of Agriculture Forest Service. September 1996. *Standard Specifications for Construction and Maintenance of Trails, EM-7720-103*. Contact: Forest Service, Engineering Staff, Washington, DC.

U.S. Department of Agriculture Forest Service. April 2004. *Trail Construction and Maintenance Notebook*. Contact: Forest Service Missoula Technology and Development Center, 5785 Hwy, 10 West, Missoula, MT.

U.S. Department of Agriculture Forest Service. 5 May 2005. *Draft Forest Service Trails Accessibility Guidelines*. Contact: Forest Service, Mail Stop 1125, 1400 Independence Avenue, SW, Washington, DC 20250. Available at: <http://www.fs.fed.us/recreation/programs/accessibility/>

U.S. Department of Justice. Americans with Disabilities Act. "Highlights of the Final Rule to Amend the Department of Justice's Regulation Implementing Title III of the ADA." Available at: [http://www.ada.gov/regs2010/factsheets/title3\\_factsheet.html](http://www.ada.gov/regs2010/factsheets/title3_factsheet.html)

U.S. Department of Justice. Americans with Disabilities Act. "Revised ADA Regulations: Implementing Title II and Title III." Available at: <http://www.ada.gov/regs2010/ADAREgs2010.htm>

Vogel, Charles. Equestrian Trails, Inc. 1982. *Trails Manual*. Sylmar, CA: Equestrian Trails, Inc.



## SECTION 8.0

### INDEX

---

#### A

ADA compliance, 2-7, 4-15, 4-16  
anchors, 2-13, 2-14, 4-12, 4-30  
armorings, 4-11  
average trail segment grade, 4-5, 4-6

#### B

bench trails, 4-34, 4-37  
benches, 2-20, 5-6, 5-10, B-6, E-1  
benefits of trails, see Letter from the Director, 1-1, B-3, see Appendix C  
bicycle racks, 4-29  
bridges, 2-10, 2-18, 4-12, 4-16, 4-26, 4-29, 5-8, 5-10, B-6

#### C

CEQA, 1-3, See Section 3.0  
    categorical exemption, 3-5, 3-6  
    Environmental Impact Report, 3-7  
    Initial Study, 3-7  
    three-step process, 3-4-3-7  
climbing turns, 2-11, 4-10, 4-11, 4-34, 4-35, E-3  
compaction, 4-1-4-4, 4-6-4-8, 4-33, 4-35, 5-8  
conceptual trail alignment, 2-5-2-22  
conservation easement, 2-15, 3-9, 3-10, see Appendix H  
constructability, 4-1, 4-32-4-37  
construction scenario, 4-32-4-35  
control points, 2-11-2-13  
controlling water on a trail, 4-5, 4-7-4-10  
corridors, 2-16, 4-19, A-3, A-4, C-3, K-17  
culverts and underdrains, 4-16  
cut-and-fill trail, 4-35

#### D

design specifications, 2-11, see Appendix J  
displacement, 4-1-4-4, 4-6-4-8, 4-11, I-1  
drainage solutions, 2-15, 4-1, 4-3, 4-8-4-11, 5-6-5-8, 5-10, E-4  
drinking fountain, 2-20, 4-31, E-1, E-9, J-25

#### E

easements, 2-15, C-2, see Appendix H  
    securing, 3-9, 3-10  
    sample of, see Appendix G  
    types, 2-15  
edges, 2-13, 2-14, 4-11, 4-28  
enforcement, 5-10  
entitlement process, 1-2, 3-8-3-10, C-3  
environmental compliance, see Section 3.0  
equestrian amenities, 4-29  
erosion, 2-11, 2-15, 4-1-4-8, 4-11, 4-18, 4-28, 4-33-4-35, 5-7, 5-10

---

**F**

fall line, 4-4–4-6, 4-10, 4-11, A-1  
feasibility analysis, 2-1, 2-8, 2-15–2-20, 3-7, 4-1  
    economic factors, 2-18–2-20  
    engineering factors, 2-15  
    environmental factors, 2-15  
    social factors, 2-15–2-18  
flagging, 4-34, 4-35  
funding, 1-1, 3-1, 3-2, 3-9, 5-8, 5-10  
    sources, see Appendix F

**G**

gaining altitude on a trail, 4,5, 4-10–4-12  
gateways, 2-14, 4-12  
grade, 2-7, 2-11, 4-3, 4-5–4-15  
    calculating, 4-5, 4-12, 4-13  
    half rule, 4-5  
    maximum sustainable, 4-7  
    outslope, 4-6  
    reversals, 4-9  
    10% average guideline, 4-5  
grants, 5-8

**H**

half rule, see under “grade”  
harmony, 2-14, 3-1  
history of trail development, see Appendix A  
hitching post, J-28  
hitching rail, 4-27

**K**

kiosks, 4-24–4-27, 4-31, 4-32, 5-7, 5-10, E-9, J-34, J-35  
knicks, 4-7, 4-9

**L**

landscaping, 2-20, 4-28, B-5, C-4, E-1, E-9  
layout, 2-11–2-15  
listed species, 2-17, 5-7, see Appendix D  
local trails, 2-8, 4-25, A-1

**M**

maintenance, 5-7–5-11  
    construction cost, 2-18–2-20, see Appendix E  
    assessment and repair sheets, 5-4–5-6  
maximum sustainable grade, see under “grade”

**N**

natural shapes, 2-13, 2-14

**O**

outslope, see under “grade”

**P**

parking, 2-20, 4-12, 4-26–4-28, E-1, E-9, J-18–J-20  
playfulness, 2-14  
puncheon, 2-10, 4-16, 4-17, 5-6, E-4, E-5, J-5

**Q**

Quimby funds, 3-9

**R**

recreational funding, see Appendix F  
regional trails, 2-8, 4-29  
restrooms, 4-28, 4-35, 5-7, J-21, J-22  
retaining structures, 2-10, 4-12, 4-19, 4-33–4-35  
retaining walls, 4-11, E-4  
road crossings, 4-19, 4-26  
rolling crown switchbacks, 4-11  
rolling grade dips, 4-9, 4-16

**S**

service area, 2-3–2-5, 2-22  
    defining the service area, 2-3  
    demand analysis, 2-3  
    evaluation of recreational trail needs, 2-4  
    sources of data for service area demand characterization, 2-4  
    supply analysis, 2-5  
staging areas, 2-4, 4-19, 4-27, 5-10  
stakeholder, 1-1, 2-1, 2-2, 2-20–2-22  
    coordination, 2-20–2-22, see Appendix C  
    types, 2-20, 2-21  
Strategic Asset Management Plan, 1-1, 1-4, 2-3, 2-20  
switchbacks, see under “grade”

**T**

10-percent rule, see under “grade”  
tools, 4-34–4-37  
    construction tools, 4-35, 4-36  
    mechanized tools, 4-36, 4-37  
trail accessibility guidelines, see Appendix I  
trail construction team, 4-32, 4-33  
    professionals, 4-33  
    volunteers, 4-33  
trail design, see Section 4.0, see Appendix J  
trail maintenance, 5-7–5-11  
trail mechanics, 4-1–4-5  
trail operation, 5-1–5-3  
trailheads, 2-4, 2-7, 2-11, 2-20, 4-19, 4-21, 4-25–4-29, 4-31, 4-32, 4-34, 4-35  
tread watershed, 4-1, 4-2, 4-4, 4-7, 4-9, 4-10  
turns, 2-11, 4-10–4-13, 4-25, 4-34, 4-35, E-3, K-15  
    climbing, 2-11, 4-10, 4-34, 4-35, E-3  
    insloped, 4-11, 4-12  
    switchbacks, 4-11, 4-34, 4-35, E-3

---

**V**

vistas, 2-7, 2-11, 2-14–2-16, C-3

volunteers, 4-26, 4-32, 4-33, 5-10, 5-11, K-17

**W**

water crossings, 4-12, 5-10

way-finding signs, 2-20, 4-12, 4-16, 4-17, 4-19–4-26, 5-10, see Appendix K

types of

highway signs, 4-20

informational signs, 4-24

regulatory signs, 4-21



## APPENDIX A HISTORY OF TRAIL DEVELOPMENT

---

The history of trails in the western United States is primarily an account of trails in the backcountry, far away from cities and towns. Until the last century, the majority of country trail users expected to be on the trail for long periods of time. They were miners, ranchers, foresters, and trappers, and they came well prepared with ample provisions carried by pack animals. Because distances were far, and loads were heavy, most of the trails were built at low to moderate grades—grades preferred by horses, donkeys, and mules. The geography of the rugged western peaks lent themselves to gently climbing trails, which ran along the contour of the slopes, nearly perpendicular to the fall-line. An added advantage to this way of building trails was that, because they were more resistant to erosion, the trails required less maintenance—a service that was hard to provide in the backcountry.<sup>1</sup>

In the late 1800s and early 1900s, as the local trading posts, mining towns, and harbor cities grew, “city folk” sought ways to enjoy the solitude and beauty of nature, and recreational trails became popular.<sup>2</sup> These trails were built to the same standard as the working trails, as noted in an entry from the crew foreman’s report of the 1915 construction accomplished on the John Muir Trail in the Sierra National Forest.

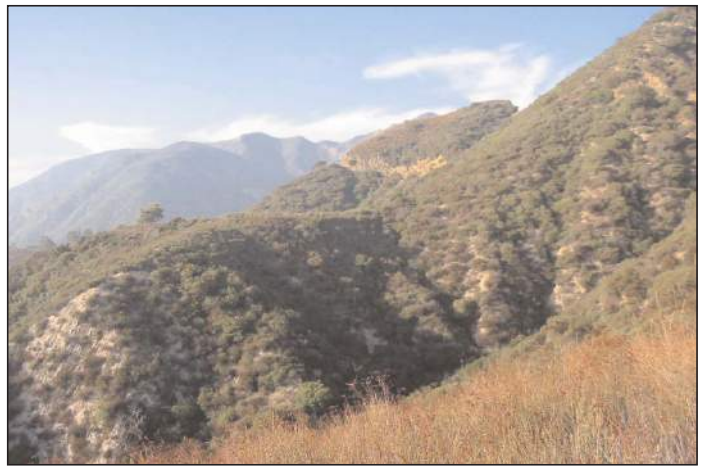
Tread, 30 inches minimum width. Plenty of turnouts provided in dangerous places. Grade in no case except under extraordinary conditions exceeding 15 percent. The exceptions so far as noted were extremely few.<sup>3</sup>

Carrying on this tradition, in the 1930s, local trails were built or improved through federal Works Progress Administration (WPA) programs. Examples of this work can be seen scattered throughout the foothills along creek beds, trails, and in campgrounds. Natural rock from the area was used to build walls, stairs, and small dams. Many of the trails built through the WPA programs still exist in good condition today and require minimal maintenance. Good examples of WPA work can be found in the foothills north of the Los Angeles Basin.

The County of Los Angeles (County) covers more than 4,000 acres of area that cover vast topographic differences, including numerous climatic regions from coastlines, alpine mountain regions, and deserts. The County provides residents and visitors with access to numerous outstanding and unique recreational resources from the Angeles National Forest to the Santa Monica Mountains National Recreation Area (Figure A-1, *Santa Monica Mountains National Recreation Area*; Figure A-2, *Angeles National Forest*). Also within the County are a combination of 18 state parks, state recreational areas, and state historical parks. The ability for individuals to access the multiple recreational assets within the County can be greatly enhanced through the development of trail standards and plans to develop new and connecting trails. The County of Los Angeles has many miles of existing (formal) and historic trails (informal) and roads for recreational use. (Figure A-3, *Los Angeles County Existing and Proposed Regional Trail Network*).



**Figure A-1**  
**Santa Monica Mountains National Recreation Area**



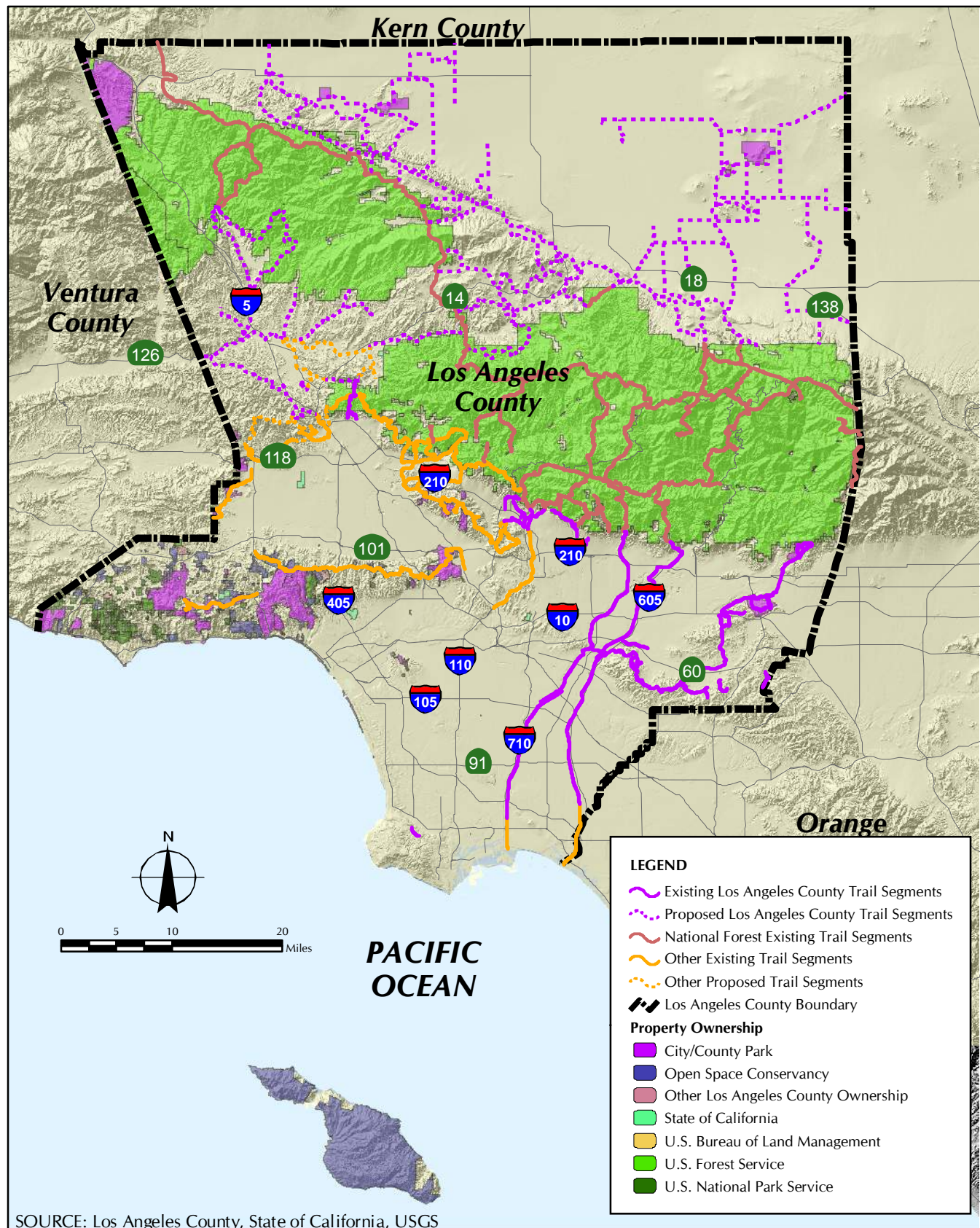
**Figure A-2**  
**Angeles National Forest**

<sup>1</sup> Birkby, Robert C. 1996. *Lightly on the Land: The SCA Trail-Building and Maintenance*. Seattle, WA: The Mountaineers.

<sup>2</sup> Birkby, Robert C. 1996. *Lightly on the Land: The SCA Trail-Building and Maintenance*. Seattle, WA: The Mountaineers.

<sup>3</sup> Birkby, Robert C. 1996. *Lightly on the Land: The SCA Trail-Building and Maintenance*. Seattle, WA: The Mountaineers.





**Figure A-3**  
**Los Angeles County Existing and Proposed Regional Trail Network**

Since the 1950s, trails within the County have become a very valued resource as has the conservation of open space. One of the largest County recreational trail assets is the 22-mile LARIO trail system, which was developed along the flood control channels of the Los Angeles River and Rio Hondo Channel, and which provides a major regional trail with access to seven parks adjacent to the Los Angeles River and Rio Hondo Channels. The LARIO trail is maintained by the County Department of Public Works and Department of Parks and Recreation.<sup>4</sup>

To assist the public in using the County trail system, the Riding and Hiking Trails of Los Angeles County<sup>5</sup> map was published in 1992 and was included in the Parks and Recreation Strategic Plan for 2010.<sup>6</sup> The Riding and Hiking Trails of Los Angeles County was updated in 2001 and provides the name and locations of major trails within the County, including those operated by the County, various other agencies, and the forest service.<sup>7</sup>

The conservation of open space within the County has been enhanced with the initiation of the Santa Monica Mountains National Recreation Area and the Santa Monica Mountains Conservancy. The Santa Monica Mountains National Recreation Area, the world's largest urban national park, was designated on November 10, 1978. More than 70 government agencies, including the County of Los Angeles, in collaboration with private landowners work together to provide places for people to live, work, and recreate while protecting the natural and cultural resources in the mountains and on the seashore. This cooperative effort has initiated the construction of the Backbone Trail, a 65-mile-long trail intended to unite the patchwork of public parklands. The Santa Monica Mountains Conservancy was established in 1980 by the California State Legislature. The mission of the conservancy is to work together with citizens; community-based organizations; federal, state, and local government; and other park agencies to buy back, preserve, protect, restore, and enhance land in Southern California in order to form a publicly accessible interlinking system of urban, rural and river parks, open space, trails, and wildlife habitats.

Another significant trail plan within the County was the Rim of the Valley Trail Corridor Master Plan, which provided a plan for the development of a trail system by the Santa Monica Mountains Conservancy around the San Fernando/La Crescenta Valleys. This trail, which is to be known as the Rim of the Valley Trail,<sup>8</sup> will encircle the San Fernando and La Crescenta Valleys unifying various parts of the corridors recreational system.

The County has continued to pursue additional trail planning and the provision of recreational trails through the development of the Antelope Valley Backbone Trail System and the Santa Clarita Backbone Trail System. These systems, finalized in 2006, were developed to ensure future trails are developed in a connected manner throughout the Antelope and Santa Clarita Valleys.

The Recreational Trails Plan produced by the California State Parks is developed to provide guidance for establishing and maintaining California's trail systems, including integrating with local agencies trail systems.<sup>9</sup> The first California Recreational Trails Plan was produced in 1978. The 1978 California Recreational Trails Plan directed the creation of trail corridors and provided a general guide for the future growth of California's trail system. The California Recreational Trails Plan was updated in 2001 and provides trail goals for the state in terms of funding, inventorying, planning, and encouraging use of the trails from multiple users. In addition, the plan includes the 2000 California Trail Corridors (Figure A-4, *California Trail Corridors*), which updates the 1978 Hiking and Equestrian Trails in California. The updated map includes nine trail corridors in the County, including the Pacific Coast, the Pacific Crest, the Backbone Trail, the Rim of the Valley, the LARIO, the San Gabriel River, the Santa Clara River, the Whittier-Ortega Corridor, and the Juan Bautista de Anza National Historic Trail.

<sup>4</sup> County of Los Angeles Department of Public Works. 2006. Accessed on 22 June 2006. "History of the Los Angeles River." Web site. Available at: <http://ladpw.org/wmd/watershed/LA/History.cfm>

<sup>5</sup> County of Los Angeles Department of Parks and Recreation. 1992. *Los Angeles County Riding and Hiking Trails*. Contact: 433 South Vermont Avenue, 4th Floor, Los Angeles, CA 90020.

<sup>6</sup> County of Los Angeles Department of Parks and Recreation. May 1992. *A Parks and Recreation Strategic Plan for 2010*. Contact: 433 South Vermont Avenue, 4th Floor, Los Angeles, CA 90020.

<sup>7</sup> County of Los Angeles Department of Parks and Recreation. 2001. *Los Angeles County Riding and Hiking Trails*. Contact: Contact: 433 South Vermont Avenue, 4th Floor, Los Angeles, CA 90020.

<sup>8</sup> State of California Santa Monica Mountains Conservancy. 28 June 1990. *Rim of the Valley Trail Corridor Master Plan*. Prepared by: Dangermond & Associates, 2400 O Street Sacramento, CA 95816.

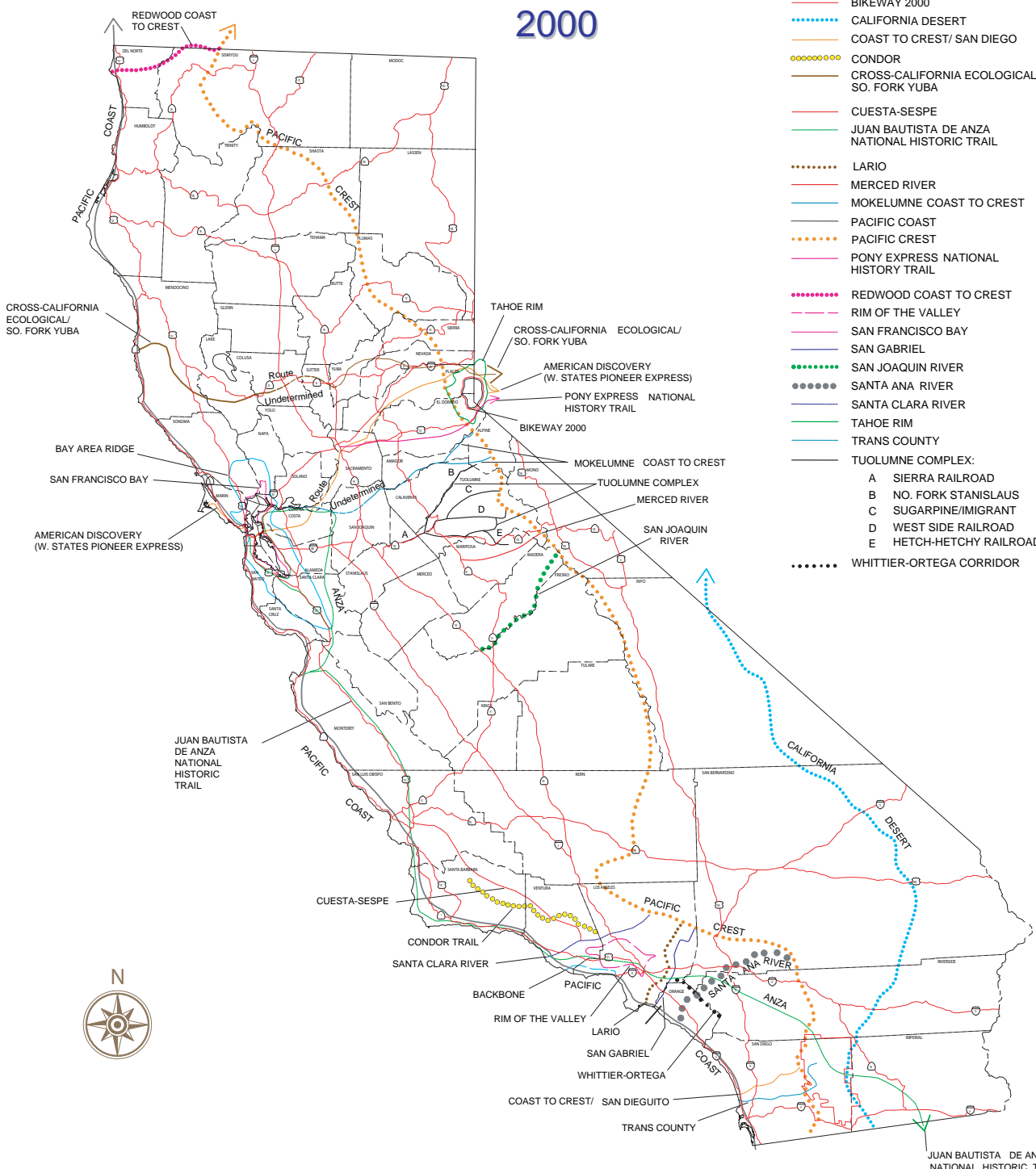
<sup>9</sup> California State Parks. June 2002. *California Recreational Trails Plan*. Contact: State of California Department of Parks and Recreation, Planning Division, Statewide Trails Office, P.O. Box 942896, Sacramento, CA 94296-0001. Available at: <http://www.parks.ca.gov/pages/1324/files/Trails%20Plan%20final%203%206.5.pmd.pdf>

# CALIFORNIA TRAIL CORRIDORS



## LEGEND

- AMERICAN DISCOVERY (W. STATES PIONEER EXPRESS)
- - - BACKBONE
- BAY AREA RIDGE
- BIKEWAY 2000
- ⋯ CALIFORNIA DESERT
- COAST TO CREST/ SAN DIEGO
- ⦿ CONDOR
- CROSS-CALIFORNIA ECOLOGICAL/ SO. FORK YUBA
- CUESTA-SESPE
- JUAN BAUTISTA DE ANZA NATIONAL HISTORIC TRAIL
- ⋯ LARIO
- MERCED RIVER
- MOKELUMNE COAST TO CREST
- PACIFIC COAST
- ⋯ PACIFIC CREST
- PONY EXPRESS NATIONAL HISTORY TRAIL
- ⋯ REDWOOD COAST TO CREST
- - - RIM OF THE VALLEY
- SAN FRANCISCO BAY
- SAN GABRIEL
- ⦿ SAN JOAQUIN RIVER
- ⦿ SANTA ANA RIVER
- SANTA CLARA RIVER
- TAHOE RIM
- TRANS COUNTY
- TUOLUMNE COMPLEX:
  - A SIERRA RAILROAD
  - B NO. FORK STANISLAUS
  - C SUGARPINE/IMIGRANT
  - D WEST SIDE RAILROAD
  - E HETCH-HETCHY RAILROAD
- ⋯ WHITTIER-ORTEGA CORRIDOR



SOURCE: California State Parks. June 2002. *California Recreation Trails Plan*. Sacramento, CA.

**Figure A-4**  
**California Trail Corridors**



## APPENDIX B

### TRAIL RESOURCES

---

This section contains lists of recommended sources for additional information such as trail building books and guides, means to find contractors, other agencies' trail standards, and additional local resources for information. It is understood that each region and or local area will obtain information regarding local resources.

#### B.1 SUGGESTED SOURCES OF INFORMATION

##### B.1.1 Recommended Books and Guides

###### *Construction and Maintenance*

Birchard, William, Jr., Robert Proudman, and Michael Dawson. 2000. *Appalachian Trail Design, Construction, and Maintenance*. (Second Edition.) Harpers Ferry, WV: Appalachian Trail Conservancy.

Birkby, Robert C. 1996. *Lightly on the Land: The SCA Trail-Building and Maintenance*. Seattle, WA: The Mountaineers.

Demrow, Carl, and David Salisbury. 1998. *The Complete Guide to Trail Building and Maintenance*. (Third Edition.) Boston, MA: Appalachian Mountain Club.

Fink, Charles A., Kristine Olka, and Robert M. Searns. 2001. *Trails for the Twenty-First Century: Planning, Design, and Management Manual for Multi-Use Trails*. Washington, DC: Island Press.

Fink, Charles A., Robert M. Searns, and Loring Lab Schwarz. 1993. *Greenways: A Guide to Planning, Design, and Development*. Washington, DC: Island Press.

Hesselbarth, Woody, and Brian Vachowski. 1996. *Trail Construction and Maintenance Notebook*. (9623-2833-MTDC.) Missoula, MT: U.S. Department of Agriculture, Forest Service, Technology & Development Program.

International Mountain Bicycling Association. 2004. *Trail Solutions*. Boulder, CO: International Mountain Bicycling Association.

Parker, Troy Scott. 20 January 1994. *Trails Design and Management Handbook*. (Open Space and Trails Program, Pitkin County, Colorado.) Boulder, CO: Natureshape LLC.

Parker, Troy Scott. 2004. *Natural Surface Trails by Design*. Boulder, CO: Natureshape LLC.

U.S. Department of Agriculture. 1996. *Standard Specifications for Construction and Maintenance of Trails*. (EM-7720-103 and EM-7720-104.) Washington, DC: U.S. Department of Agriculture, Forest Service.

---

### **General Trail Information Books**

Byers, Elizabeth, and Karin Marchetti Ponte. 2005. *The Conservation Easement Handbook*. (Second Edition.) Washington, DC: Land Trust Alliance and Trust for Public Land.

### **Guides to Existing Trails**

Adkison, Ron. 1986. *The Hiker's Guide to California*. Billings, MT: Falcon Press.

Benti, Wynne. 1995. *Favorite Dog Hikes: In and Around Los Angeles*. Bishop, CA: Spotted Dog Press, Inc.

Brown, Ann Marie. 1997. *California Waterfalls*. San Francisco, CA: Foghorn Press.

Brown, Ann Marie. 1998. *Easy Hiking in Southern California: 100 Places Anyone Can Hike This Weekend*. San Francisco, CA: Foghorn Press.

Chester, Tom. *Hikes in the San Gabriel Mountains and the Angeles National Forest*. Available at: [Tchester.org/sgm/hikes.html](http://Tchester.org/sgm/hikes.html)

Douglass, Don and Delaine Fragnoli, eds. 1998. *Mountain Biking Southern California's Best 100 Trails*. Bishop, CA: Fine Edge Productions.

Gagnon, Dennis R. 1992. *Hike Los Angeles*. Vol. 2. Santa Cruz, CA: Western Tanager Press.

Immler, Robert. 1990. *Mountain Bicycling around Los Angeles*. Berkeley, CA: Wilderness Press.

Immler, Robert. 1987. *Mountain Bicycling in the San Gabriels*. Berkeley, CA: Wilderness Press.

John W. Robinson. 1998. *Trails of the Angeles: 100 Hikes in the San Gabriels*. Berkeley, CA: Wilderness Press.

Leman, Laurie and Chris. 1992. *Mountain Biker's Guide to Southern California*. Helena, MT: Falcon Press.

McKinney, John. 1998. *Day Hiker's Guide to Southern California*. Santa Barbara, CA: Olympus Press.

Owens, Glen. 1999. *Six Historical Hiking Trails to Mount Wilson*. Arcadia, CA: Big Santa Anita Historical Society.

Rice, Andrew. 1999. *Frommer's Great Outdoor Guide to Southern California and Baja*. New York, NY: IDG Books Worldwide.

Rippens, Paul H. 1998. *Historic Mount Lowe: A Hiker's Guide to the Mount Lowe Railway*. Self-published.

Salcedo, Nancy. 1999. *A Hiker's Guide to California Native Places: Interpretive Trails, Reconstructed Villages, Rock-Art Sites, and the Indigenous Cultures They Evoke*. Berkeley, CA: Wilderness Press.

Schad, Jerry. 1996. *101 Hikes in Southern California: Exploring Mountains, Seashore and Desert*. Berkeley, CA: Wilderness Press.

Schad, Jerry. 2000. *Afoot and Afield in Los Angeles County*. Berkeley, CA: Wilderness Press.

Schad, Jerry. 2004. *Top Trails Los Angeles*. Berkeley, CA: Wilderness Press.

Stienstra, Tom and Ann Marie Brown. 1999. *California Hiking – The Complete Guide to 1000 of the Best Hikes in California*. San Francisco, CA: Foghorn Press.

Troy, Mike and Kevin Woten. 1997. *Mountain Biking the San Gabriel Mountains' Best Trails*. Bishop, CA: Fine Edge Productions.

Wheelock, Walt. 1973. Out of Print. *Southern California Peaks*. Glendale, CA: La Siesta Press.

### **Maps**

County of Los Angeles Department of Parks and Recreation. 2001. *Los Angeles County Riding and Hiking Trails*. Contact: 510 South Vermont Avenue, 2nd Floor, Los Angeles, CA 90020.

Fine Edge Productions. 1992. *San Gabriel Mountains Recreation Topographic Map, Western Section, ANF and the Verdugo Mountains*. Bishop, CA.

National Park Service. *Santa Monica Mountains National Recreation Area Map*. Available at: <http://www.nps.gov/samo/maps/mainmap.htm>. Thousand Oaks, CA.

Tom Harrison Maps. San Rafael, CA.

Six map titles covering portions of Los Angeles County:

- Zuma-Trancas Canyons
- Malibu Creek State Park
- Topanga State Park
- Angeles Front Country
- Mount Wilson
- Angeles High Country

U.S. Forest Service. 1995 (Minor Revisions 2002). *Angeles National Forest (The Official Forest Service Map)*. Arcadia, CA.

### **B.1.2 Web Sites**

The following Web sites can be consulted regarding the benefits of trails and greenways. Several of the Web sites host fact sheets on trails, and provide data, research, and other information about trails.

- American Trails: <http://www.americantrails.org/>
- Trails and Greenways Clearinghouse: [www.trailsandgreenways.org](http://www.trailsandgreenways.org)
- Greenways Incorporated: [www.greeways.com](http://www.greeways.com)
- National Park Service: [www.nps.com](http://www.nps.com)
- The online trails search engine supported by the Santa Monica Mountains Conservancy: [http://www.lamountains.com/parks\\_search.asp](http://www.lamountains.com/parks_search.asp)

## **B.2 AGENCIES INVOLVED WITH TRAILS**

### **B.2.1 Regional Contact Information**

#### **Federal**

##### **Angeles National Forest**

Supervisor's Office  
701 North Santa Anita Avenue  
Arcadia, CA 91006  
Tel: (626) 574-5200  
Fax: (626) 574-5233  
TDD: (626) 447-8992  
Trail contact: Howard Okamoto

---

**Bureau of Land Management****Palm Springs South Coast****Field Office CA-660**

Palm Springs South Coast Field Office  
690 West Garnet Avenue, P.O. Box 581260  
North Palm Springs, CA 92258-1260  
Tel: (760) 251-4800  
Fax: (760) 251-4899

**Santa Monica Mountains National Recreation Area**

401 West Hillcrest Drive  
Thousand Oaks, CA 91360  
Headquarters Recorded Message  
Tel: (805) 370-2300  
Visitor Information  
Tel: (805) 370-2301  
Trail contact: Melanie Beck

**U.S. Army Corps of Engineers**

915 Wilshire Boulevard  
Los Angeles, CA 90017  
Tel: (213) 452-3908/3333

**U.S. Fish and Wildlife Service**

2493 Portola Road, Suite B  
Ventura, CA 93003  
Tel: (805) 644-1766  
Web site: [www.fws.gov/ventura/](http://www.fws.gov/ventura/)

**State****California State Parks**

Angeles District  
1925 Las Virgenes Road  
Calabasas, CA 91302  
Tel: (818) 880-0350  
Trail contacts:

Portions of County of Los Angeles:  
North: Charlie Harris  
West: Victor Patino  
South: Ted Novak  
East: Juan Alban

**California Coastal Commission**

South Central Coast District Office  
89 South California Street, Suite 200  
Ventura, CA 93001-2801  
Tel: (805) 585-1800  
Web site: [www.coastal.ca.gov/](http://www.coastal.ca.gov/)

**Mountains Restoration Trust**

3815 Old Topanga Canyon Road  
Calabasas, CA 91302  
Tel: (818) 591-1701  
Web site: [www.mountainstrust.org](http://www.mountainstrust.org)

**Santa Monica Mountains Conservancy**

Los Angeles River Center and Gardens  
570 West Avenue Twenty-Six, Suite 100  
Los Angeles, CA 90065  
General Inquiries:  
Tel: (310) 589-3200 and (323) 221-8900  
E-mail: [info@smmc.ca.gov](mailto:info@smmc.ca.gov)

**Rivers and Mountains Conservancy**

100 North Old San Gabriel Canyon Road  
Azusa, CA 91702  
Tel: (626) 815-1019  
Web site: [www.rmc.ca.gov](http://www.rmc.ca.gov)

**California Department of Fish and Game**

4949 Viewridge Avenue  
San Diego, CA 92123  
Public Information: (858) 467-4201  
Fax: (858) 467-4299

**Regional and County****Los Angeles County Department of Public Works****Los Angeles County Flood Control**

Mapping and Property Division  
Right-of-Way Section  
900 South Fremont Avenue  
Alhambra, CA 91803  
Tel: (626) 458-7055

**Los Angeles County Metropolitan Transit Authority**

One Gateway Plaza  
Los Angeles, CA 90012-2952  
Tel: (213) 922-3068  
Trail contact: Lynn Goldsmith

**Los Angeles Regional Water Quality Control Board**

320 West 4<sup>th</sup> Street, Suite 200  
Los Angeles, CA 90013-2343  
Tel: (213) 576-6640

**Puente Hills Landfill Native Habitat Preservation Authority**

7702 Washington Avenue, Suite C  
Whittier, CA 90602  
Tel: (562) 945-0303

---

**B.3 LOCAL TRAIL CONTRACTORS AND SUPPLIERS**

This list of contractors and suppliers for trail construction is based on lists from the International Mountain Bicycling Association (IMBA),<sup>1</sup> the American Trails,<sup>2</sup> and the Professional Trailbuilders Association.<sup>3</sup> Additional resources may be available and should be investigated.

**B.3.1 Trail Builders*****Arrowhead Trails, Inc.***

11121 County Road 240  
Salida, CO 81201-9226  
Tel: (720) 244-7804  
Web site: [www.arrowheadtrails.com](http://www.arrowheadtrails.com)

***Bellfree Contractors, Inc.***

11716 Babbitt Avenue  
Los Angeles, CA 91344  
Tel: (818) 975-5120  
Web site: [www.bellfreecontractors.com](http://www.bellfreecontractors.com)

***Donald Hays Trail Contractor, Inc.***

P.O. Box 7672  
Tahoe City, CA 96145  
Tel: (530) 583-9128

***Roe Construction***

P.O. Box 8277  
Truckee, CA 96162  
Tel: (530) 587-9176

***Richard May Construction, Inc.***

Route 1, Box 34  
Mammoth Lakes, CA 93546  
Tel: (760) 935-4955

***Trail Design and Construction***

P.O. Box 219  
Forest Knolls, CA 94933  
Tel: (415) 488-1665

***Trails Unlimited***

105A Grand Avenue  
Monrovia, CA 91016  
Tel: (626) 233-4309  
Web site: [www.trailsunlimited.com](http://www.trailsunlimited.com)

**B.3.2 Trail Building Supplies*****A.M. Leonard***

241 Fox Drive  
Piquoa, OH 45356-0816  
Tel: (800) 543-8955  
Web site: [www.amleonard.com](http://www.amleonard.com)  
Provides landscaping tools.

***Arrowhead Trails, Inc.***

11121 County Road 240  
Salida, CO 81201-9226  
Tel: (720) 244-7804  
Web site: [www.arrowheadtrails.com](http://www.arrowheadtrails.com)  
Provides mechanized excavators.

***Ben Meadows Company***

P.O. Box 5277  
Janeville, WI 53547-5277  
Tel: (800) 241-6401  
Web site: [www.benmeadows.com](http://www.benmeadows.com)  
Provides complete line of tools and supplies for trail building.

***Country Home Products***

127 Meigs Road, P.O. Box 25  
Vergennes, VT 05941  
Tel: (800) 687-6575  
Web site: [www.countryhomeproducts.com](http://www.countryhomeproducts.com)  
Good source of field and brush mowers.

***Forestry Suppliers, Inc.***

P.O. Box 8397  
Jackson, MS 39284-8397  
Tel: (800) 647-5368  
Web site: [www.forestry-suppliers.com](http://www.forestry-suppliers.com)  
Provides complete line of tools and supplies for trail building.

***Forrest Tool Company***

P.O. Box 768  
Mendocino, CA 95460  
Tel: (707) 937-2141  
Web site: [www.maxax.com](http://www.maxax.com)  
Provides multi-use trail building tools.

---

<sup>1</sup> International Mountain Bicycling Association. 2004. *Trail Solutions*. Boulder, CO: International Mountain Bicycling Association.

<sup>2</sup> American Trails. 29 March 2006. Accessed 6 April 2006. *Products, Businesses and Consultants*. Available at: <http://www.americantrails.org/resources/consultants/index.html>

<sup>3</sup> Professional Trailbuilders Association. 2006. Accessed on 6 April 2006. *Contractors by Location*. Available at: <http://www.trailbuilders.org/location.html>



---

**Outdoor Creations, Inc.**

P.O. Box 50  
Round Mountain, CA 96084  
Tel: (530) 337-6774  
Manufactures pre-cast concrete signs, picnic tables, barbecues, benches, waste receptacles, etc.

**Sutter Equipment Co.**

80 Chamberlain Avenue  
Novato, CA 94947  
Tel: (415) 898-5955  
Provides tools, excavators, and patented retaining wall structures.

**Trail Services**

15 Westwood Road  
Bangor, ME 04401  
Tel: (207) 947-2723  
Web site: [www.trailservices.com](http://www.trailservices.com)  
Provides quality trail building tools that are often hard to find.

**Tree of Life Nursery**

33201 Ortega Highway  
P.O. Box 635  
San Juan Capistrano, CA 92693  
Tel: (949) 728-0685  
Provides a large selection of Southern California native plants.

**B.3.3 Bridge Sources****Echo Bridge, Inc.**

P.O. Box 89  
Elmira, NY 14902  
Tel: (888) 327-4343  
Web site: [www.echobridgeinc.com](http://www.echobridgeinc.com)  
Custom design and prefabrication of wood, steel, and concrete bridges.

**E.T. Techtonics, Inc.**

P.O. Box 40060  
Philadelphia, PA 19106  
Tel: (215) 592-7620  
Web site: [www.ettechtonics.com](http://www.ettechtonics.com)  
Designs lightweight fiberglass bridges.

**Naturetec**

505 West Cypress Avenue  
Redlands, CA 92373  
Tel: (909) 793-4501  
Web site: [www.naturetec.com](http://www.naturetec.com)  
Custom design and manufacturing of fiberglass bridges.

**Permapost Products Company**

4066 SE Tualatin Valley Highway  
P.O. Box 100  
Hillsboro, OR 97123  
Tel: (800) 828-0222  
Web site: [www.permapost.com](http://www.permapost.com)  
Custom design and prefabrication of wood bridges.

**Steadfast Bridges**

4021 Gault Avenue S.  
Fort Payne, AL 35967  
Tel: (256) 845-0154  
Web site: [www.steadfastbridge.com](http://www.steadfastbridge.com)  
Prefabricated bridge and overpasses.

**Western Wood Structures, Inc.**

20675 SW 105th Avenue  
P.O. Box 130  
Tualatin, OR 97062  
Tel: (503) 692-6900  
Web site: [www.westernwoodstructures.com](http://www.westernwoodstructures.com)  
Designs and supplies engineered wood bridges.

**B.3.4 Sign and Trail Marker Sources****Carsonite International**

605 Bob Gifford Boulevard  
Early Branch, SC 29916  
Tel: (800) 648-7915  
Web site: [www.carsonite.com](http://www.carsonite.com)

**Cross Alert Systems, Inc.**

3970 Post Road, Second Floor  
Warwick, RI 02886  
Tel: (866) 276-7725  
Web site: [www.crossalert.com](http://www.crossalert.com)

**Interpretive Graphics**

3590 Summerhill Drive  
Salt Lake City, UT 84121  
Tel: (801) 942-5812  
Web site: [www.interpretivegraphics.com](http://www.interpretivegraphics.com)

**Pannier Graphics**

345 Oak Road  
Gibsonia, PA 15044-8428  
Tel: (800) 544-8428  
Web site: [www.panniergraphics.com](http://www.panniergraphics.com)

**RockArt**

531 North Los Alamos  
Mesa, AZ 85213-7832  
Tel: (877) 718-7446  
Web site: [www.rockartsigns.com](http://www.rockartsigns.com)

**Scenic Signs**

2803 Emery Drive  
Wausau, WI 54401-9709  
Tel: (800) 388-4811  
Web site: [www.scenicssigns.com](http://www.scenicssigns.com)

**Voss Signs, LLC**

P.O. Box 553  
Manlius, NY 13104-0553  
Tel: (800) 473-0698  
Web site: [www.vosssigns.com](http://www.vosssigns.com)

**TABLE B.4-1  
ORGANIZATIONS ASSOCIATED WITH TRAILS  
IN LOS ANGELES COUNTY (BY DISTRICT)**

Group Name (Web site)	District	Activities						
		Maps	Bicycling	Hiking	Education	Equestrian	Construction/ Maintenance	Advocacy
Altadena Crest Trail Restoration Working Group (ACTRWG) (www.altadenahills.org)	1	X		X	X			
Equestrian Trails, Inc. (www.etinational.com)	All					X		X
Puente Hills Landfill Native Habitat Preservation Authority (www.habitatauthority.org)	1, 4		X	X	X	X	X	
La Cañada Flintridge Trails Council (lacanadaflintridgecouncil.org)	5	X	X	X	X	X	X	X
Mounted Assistance Unit	1, 4, 5					X		
International Mountain Biking Association (www.imba.com)	All		X				X	X
Los Angeles County Bicycle Coalition (www.labikecoalition.org)	All		X					X
Los Angeles Bike Paths (www.labikepaths.com)	All	X	X					

**TABLE B.4-1  
(Continue)  
ORGANIZATIONS ASSOCIATED WITH TRAILS  
IN LOS ANGELES COUNTY (BY DISTRICT)**

Group Name (Web site)	District	Activities						
		Maps	Bicycling	Hiking	Education	Equestrian	Construction/ Maintenance	Advocacy
Cycle Santa Monica	3	X						X
California Coastal Trail (www.californiacoastaltrail.org)	3, 4	X		X	X			X
Concerned Off-Road Bicyclists Association (www.CORBAMTB.org)	All		X				X	X
Mountain Biking in the Santa Monica Mountains (www.mtb-bike.com)	3	X	X					
Pasadena Mountain Bike Club (www.pmbc.org)	5		X					
SoCalMTB (www.socalmtb.com)	All	X	X					
Backcountry Horsemen of California (www.bchc.com)	5				X	X		X
California State Horsemen's Association (www.californiastatehorsemen.com)	All					X		X
Santa Monica Mountains Trail Council	3		X	X	X	X	X	X
Palos Verdes Peninsula Land Conservancy (www.pvplc.org)	4			X	X		X	

**TABLE B.4-1**  
**(Continue)**  
**ORGANIZATIONS ASSOCIATED WITH TRAILS**  
**IN LOS ANGELES COUNTY (BY DISTRICT)**

Group Name (Web site)	District	Activities						
		Maps	Bicycling	Hiking	Education	Equestrian	Construction/ Maintenance	Advocacy
San Gabriel and Lower Los Angeles Rivers and Mountains Conservancy (www.rmc.ca.gov)	1, 4, 5				X		X	
Hikes in the San Gabriel Mountains and the Angeles National Forest (tchester.org/sgm/hikes.html)	5	X		X				
Trail Runners Club (www.trailrunnersclub.com)	3			X				
San Gabriel Mountains Trail Builders (www.sgmtrailbuilders.org)	5						X	
Pacific Crest Trail Association (www.pcta.org)	5	X		X	X	X		
Sierra Club (angeles.sierraclub.org)	All			X	X			X



## APPENDIX C

### STAKEHOLDER COORDINATION

---

#### C.1 COORDINATION WITH STAKEHOLDERS

Coordination with stakeholders is essential both during and after the completion of a feasibility analysis. Trail stakeholders include members of the surrounding community, trail users, adjacent landowners, private developers, landowners being sought for trail right-of-ways, and the numerous agencies having jurisdiction over the land and resources that the proposed trail would traverse, such as the National Park Service, U.S. Department of Agriculture (USDA) Forest Service, California State Parks, California Department of Fish and Game, County of Los Angeles Flood Control District, and local cities. Successful implementation of public recreational assets and facilities is contingent on strong community involvement, and meeting the needs and understanding the concerns of the multiple stakeholders.

The relationship of trails to private lands is a complex one, and many benefits and concerns must be addressed. To ensure collaboration from stakeholders, it is helpful for the proposed trail project to communicate its goals and objectives early in the planning process. The initial outreach may take the form of a project mailer, brochure, or information pamphlet sent to all stakeholders and may include the following project information:

- Project description
- Recreational need for the project
- Project goals and objectives
- Project facts and statistics
- Complete and detailed map of the project and project's surrounding area
- Description of the planning process
- Invitation to a community meeting to discuss the project
- Contact information

##### C.1.1 Working with Private Landowners

A trail project must have support from landowners to effectively move forward. Understanding the concerns of landowners and preparing responses to their concerns demonstrate goodwill on the project's behalf and will encourage landowner support.

The proximity of a trail to a homeowner can foster apprehension about the trail's impact on that individual's quality of life. Landowner involvement can be achieved by sending out mailings about the proposed project details, scheduling public meetings, conducting design and objectives workshops, offering open houses, and/or involving the media or local newspapers.

Common concerns of landowners include crime, property value, liability, aesthetics/visual quality, noise, and privacy.<sup>1</sup> The concerns perceived as the most serious are discussed in detail:

- **Crime.** Security concerns from landowners often stem from fear of the unknown, and protests of the project usually fade away once the trail is opened. According to national crime statistics, parks and trails are among the safest places to be. People are two to three times safer on a trail than in a parking lot, on the street, or even inside their own homes.<sup>2</sup> Another study surveyed 371 trail managers about trail safety, and only 3 percent reported that major criminal activity (crimes against a person) had occurred on their trail.<sup>3</sup>

---

<sup>1</sup> Flink, Charles A., Kristine Olka, and Robert M. Searns. 2001. *Trails for the Twenty-First Century: Planning, Design, and Management Manual for Multi-Use Trails*. Washington, DC: Island Press.

<sup>2</sup> Tracy, Tammy, and Hugh Morris. January 1998. *Rail-Trails and Safe Communities: The Experience on 372 Trails*. Washington, DC: Rails-to-Trails Conservancy. Available at: [http://safety.fhwa.dot.gov/ped\\_bike/docs/rt\\_safecomm.pdf](http://safety.fhwa.dot.gov/ped_bike/docs/rt_safecomm.pdf)

<sup>3</sup> Tracy, Tammy, and Hugh Morris. January 1998. *Rail-Trails and Safe Communities: The Experience on 372 Trails*. Washington, DC: Rails-to-Trails Conservancy. Available at: [http://safety.fhwa.dot.gov/ped\\_bike/docs/rt\\_safecomm.pdf](http://safety.fhwa.dot.gov/ped_bike/docs/rt_safecomm.pdf)

- **User Demographics.** Another common security-related concern is that trails will attract undesirable users to the area. However, senior citizens, who are generally not considered a security risk, are the most active and frequent users of greenways. Furthermore, the majority of greenway users live within 5 miles of the facility, with usership decreasing with increasing distance from the greenway.<sup>4</sup>
- **Property Value.** Trails are most often used by local residents, and once established, trails are considered a neighborhood or property asset. Property values have been shown to increase due to the proximity of a trail. In some cases, realtors have used trail proximity as a selling point.<sup>5</sup> Furthermore, the donation of trail easements reduces property tax.
- **Liability.** Landowners may be concerned that they may be liable for trail user injuries that occur on their property. However, Recreational Use Statutes (RUS), which are considered established precedents in all 50 states, protect landowners from liability in cases of injury due to carelessness on private property permitted for public recreational use. In order for a trail user to claim injuries from a property owner, RUS require the injured person to prove “willful and wanton misconduct” on the part of the landowner.<sup>6</sup> To determine the current status of RUS in California, it is strongly recommended that a knowledgeable attorney or County counsel be consulted for trail projects. In California, the RUS can be found in the California Government Code, Section 830-831.9<sup>7</sup> and California Civil Code, Section 846.<sup>8</sup>

### C.1.1.1 Benefits of Trails to Private Landowners

Generating public support for trail projects is the best way to avoid major project schedule disruptions caused by public concerns. A dependable way to garner public support is to prepare public meetings with full disclosure of proposed project details and facts, highlighting benefits about the proposed project that address issues of public concern. Trails have been shown and are known to have many benefits:

- **Community.** Trails provide a much needed “third place” that is neither home nor work. Trails offer a space where “community” can actually happen, where people can meet, interact, and be free to explore nature, exercise, and contemplate together or alone at their leisure. Trails are also hands-on environmental classrooms. People of all ages can participate in the natural world from which they often feel far removed.
- **Public Health and Recreation.** Most people realize exercise is important for maintaining good health in all stages of life, but many do not regularly exercise. The U.S. Surgeon General estimates that 60 percent of American adults are not regularly active and another 25 percent are not active at all.<sup>9</sup> In communities across the country, people do not have access to trails, parks, or other recreation areas close to their homes. Trails provide a safe, inexpensive avenue for regular exercise for people living in rural, urban, and suburban areas.
- **Economic.** Trails provide countless opportunities for economic renewal and growth. Trails can provide direct and permanent benefits to adjacent landowners through increased property values and tax incentives for land donations and easements. The community can also benefit from providing a unique asset within an urban

<sup>4</sup> Furuseh, Owen J. and Robert E. Altman. 1990. “Greenway Use and Users: An Examination of Raleigh and Charlotte Greenways.” *Carolina Planning Journal*, 16(2): 37–43. Chapel Hill, NC: University of North Carolina at Chapel Hill, Department of City and Regional Planning.

<sup>5</sup> Flink, Charles A., Kristine Olka, and Robert M. Searns. 2001. *Trails for the Twenty-First Century: Planning, Design, and Management Manual for Multi-Use Trails*. Washington, DC: Island Press.

<sup>6</sup> Flink, Charles A., Kristine Olka, and Robert M. Searns. 2001. *Trails for the Twenty-First Century: Planning, Design, and Management Manual for Multi-Use Trails*. Washington, DC: Island Press.

<sup>7</sup> California Government Code, Title 1, Division 3.6, Part 2, Chapter 2, Article 1, Section 830-831.9. Available at: <http://www.leginfo.ca.gov/cgi-bin/calawquery?code=section=gov&codebody=&hits=20>

<sup>8</sup> California Civil Code, Division 2, Part 2, Title 3, Chapter 2, Section 846. Available at: <http://www.leginfo.ca.gov/cgi-bin/calawquery?code=section=civ&codebody=&hits=20>

<sup>9</sup> Centers for Disease Control and Prevention, National Center for Chronic Disease Prevention and Health Promotion; President’s Council on Physical Fitness and Sports. 1996. *Physical Activity and Health: A Report of the Surgeon General*. Washington, DC: Centers for Disease Control and Prevention, National Center for Chronic Disease Prevention and Health Promotion; President’s Council on Physical Fitness and Sports.

context. Popular trails can be tourist and local destinations and encourage recreation-related spending in the community.

- **Environmental.** Trails and their associated greenways protect important habitat, improve air and water quality, filter pollution, and provide corridors for people and wildlife. Trails offer a synergistic balance between the human and built environments, and natural communities and open spaces.
- **Transportation.** Communities with trails enjoy a safe transportation alternative to car travel, while reducing air pollution and promoting health.
- **Cultural and Historic Preservation.** Trails and greenways have the power to connect individuals and communities to the area’s heritage by preserving and providing access to historic passages. Trails can give people a sense of place and an understanding of human kind’s shared past, including often underappreciated areas such as Native American pathways.

### C.1.2 Working with Future Developments

Planned developments that are going through the entitlement process provide a valuable opportunity to increase the recreational resources to a local neighborhood and the County in general by providing land set aside for numerous uses, including gymnasiums, parks, and trails. Therefore, the initial meetings with those proposing development projects should include suggestions as to the placement of developed areas to conserve and preserve those natural resources that would be well suited for trail locations, such as scenic vistas, unique plant communities, other areas of interest, and areas with various terrains to provide recreational users with optimal resources.

### C.1.3 Working with Trail Advocacy Groups

Trail advocacy groups are an important outlet for individual trail users who are deeply invested in trail issues. They are also a valuable resource to trail planners. Advocacy groups can take many forms, including citizen advisory groups, nonprofit organizations, land trusts, and environmental commissions. These groups can provide useful insights about future trail needs, trail design, and management based on the conditions of existing trails, existing trail user patterns, and important local natural resources.

### C.1.4 Coordination between Stakeholders

The development of trails involves coordination between multiple private and public stakeholders, including multiple agencies and departments.

#### C.1.4.1 Coordination with Landowners

The involvement of those who own the land on which a proposed trail is routed should be involved in the planning phase as early as possible. This will ensure that they are able to become active in the project. It is essential that individual landowners feel that their opinions and concerns are heard by those who are proposing the trail route. In addition, encouraging landowners to become involved in the development of the trail helps them to see the potential benefits and understand the feelings of other landowners who have trails crossing their property. The Rails-to-Trails Conservancy has found that “Speaking directly with other landowners can do more to win people over than any statistics you can offer.”<sup>10</sup>

#### C.1.4.2 Coordination with Agencies

Multiple agencies will be involved with the development of trails, including the numerous departments within and outside of the County. Working with these agencies may include telephone conversations, notification letters, applications for permits, and participation in private and public meetings. Stakeholder agencies should be identified early on in the process to encourage

<sup>10</sup> Flink, Charles A., Kristine Olka, and Robert M. Searns. 2001. *Trails for the Twenty-First Century: Planning, Design, and Management Manual for Multi-Use Trails*. Washington, DC: Island Press.

---

involvement and to avoid any last minute costly changes to accommodate an agencies perspective. The County of San Diego has adopted a Trails Master Plan that includes an in-depth discussion of agency coordination in the Trails Planning Considerations chapter.<sup>11</sup>

### ***C.1.4.3 Public Meetings***

Either prior to or upon the determination of a feasible trail, public meetings should be held to provide all stakeholders with an opportunity to express their views of the proposed project. Public meetings must involve not just those landowners who are adjacent to a trail but also those who may be impacted by local trail traffic, the trail users themselves, public agencies involved in the project, or additional trail stakeholders in the area.

### **C.1.5 Land Use Compatibility**

Through proper trail planning and design, trail users and landowners adjacent to trails can receive all the benefits of having access to trails without any negative side effects. Parks, trails, and open spaces provide a number of design challenges for personal safety, as they are typically large and used by a variety of people. Direct monitoring is not always possible or desirable in natural settings. Designing for safety should be focused on pathways, parking areas, and other areas of concentrated activity. Crime Prevention Through Environmental Design (CPTED) is a crime prevention philosophy based on the theory that proper design and effective use of the built environment can enhance physical features, activities, and people in such a way as to maximize visibility, leading to a reduction in the fear and incidence of crime, as well as an improvement in the quality of life.

#### ***C.1.5.1 Natural Surveillance***

Natural surveillance is a key element in promoting safety and reducing crime along trails. The objective of natural surveillance is for trail visitors to be seen and heard, as well as seeing and hearing others if assistance is needed.

#### Design Strategies

- Locate parking lots, trails, and facilities used at night near streets and other activity centers so that they are easily observed by police patrols and other park users.
- Prune trees and trim shrubs regularly. Overgrown trees or shrubs can inhibit visibility along trails and offer a good hiding place for criminals.
- Locate structures and signs along trails to provide maximum surveillance opportunities.
- Provide good lighting for areas that will be used at night.
- Position some bike trails and walking paths near areas of park activity or at places where parks meet commercial or residential uses, or pair them with active streets, so that users will be more observable by others.
- Recognize that not all natural park areas can be observed or made safe during evening hours.

#### ***C.1.5.2 Natural Access Control***

Natural access control is the physical guidance of people coming and going from a space by the appropriate placement of entrances, fences, landscaping, and lighting. This principle helps deter access to a crime target or victim along trails and creates a perception of risk to a perpetrator.

---

<sup>11</sup> San Diego County, Department of Land Use and Planning. 12 January 2005. *County Trails Program, Community Trails Master Plan*. Available at: <http://www.sdcounty.ca.gov/dplu/trails.html>

---

#### Design Strategies

- Provide a clear distance of at least 10 feet between trails and wood-lines to offer decent sight lines and distance from potential attacks.
- Clearly mark the areas to be used only during the day with entrance signs or gates to control accessibility.
- Install trail signs with trail names, directional signs pointing toward areas of public activity, and mile markers to help orient users. Trails need to be marked for different users, such as bicyclists, hikers, or equestrians.



**APPENDIX D  
FEDERALLY AND STATE-LISTED SPECIES WITH POTENTIAL  
TO OCCUR WITHIN THE COUNTY OF LOS ANGELES**

**TABLE D-1  
FEDERALLY AND STATE-LISTED SPECIES WITH POTENTIAL  
TO OCCUR WITHIN THE COUNTY OF LOS ANGELES**

Common Name	Scientific Name	Taxa	Status (Federal/State/Other)	CNPS Rare Plant Rank
<b>Plants</b>				
Agoura Hills Dudleya	<i>Dudleya cymosa</i> ssp. <i>agouensis</i>	Plant	FT/---	1B.2
Alkali Mariposa-Lily	<i>Calochortus striatus</i>	Plant	-- / --	1B.2
Aphanisma	<i>Aphanisma blitoides</i>	Plant	-- / --	1B.2
Appressed Muhly	<i>Muhlenbergia appressa</i>	Plant	-- / --	2.2
Baja Rock Lichen	<i>Graphis saxorum</i>	Plant	-- / --	None
Ballona Cinquefoil	<i>Potentilla multijuga</i>	Plant	-- / --	1A
Beach Spectaclepod	<i>Dithyrea maritima</i>	Plant	SE	3.2
Big Bear Valley Woollypod	<i>Astragalus leucolobus</i>	Plant	-- / --	1B.2
Blair's Munzothamnus	<i>Munzothamnus blairii</i>	Plant	-- / --	1B.2
Blochman's Dudleya	<i>Dudleya blochmaniae</i> ssp. <i>blochmaniae</i>	Plant	-- / --	1B.2
Brand's Star Phacelia	<i>Phacelia stellaris</i>	Plant	FC/---	1B.1
Braunton's Milk-Vetch	<i>Astragalus brauntonii</i>	Plant	-- / --	1B.1
Bright Green Dudleya	<i>Dudleya virens</i> ssp. <i>virens</i>	Plant	-- / --	1B.2
Brown Fox Sedge	<i>Carex ipinoidea</i>	Plant	-- / --	2.2
California Dissanthelium	<i>Dissanthelium californicum</i>	Plant	-- / --	1B.2
California Muhly	<i>Muhlenbergia californica</i>	Plant	-- / --	4.3
California Orcutt Grass	<i>Orcuttia californica</i>	Plant	FE/SE	1B.1
California Satintail	<i>Imperata brevifolia</i>	Plant	-- / --	2.1
California Saw-Grass	<i>Cladium californicum</i>	Plant	-- / --	2.2
California Walnut Woodland	<i>California Walnut Woodland</i>	Plant		
Canyon Live Oak Ravine Forest	<i>Canyon Live Oak Ravine Forest</i>	Plant		
Catalina Crossosoma	<i>Crossosoma californicum</i>	Plant	-- / --	1B.2
Catalina Island Mountain-Mahogany	<i>Cercocarpus traskiae</i>	Plant	FE/SE	1B.1
Chaparral Ragwort	<i>Senecio aphanactis</i>	Plant	-- / --	2.2
Chaparral Sand-Verbena	<i>Abronia villosa</i> var. <i>aurita</i>	Plant	-- / --	1B.1
Cliff Spurge	<i>Euphorbia misera</i>	Plant	-- / --	2.2
Clokey's Cryptantha	<i>Cryptantha clokeyi</i>	Plant	-- / --	1B.1
Coast Woolly-Heads	<i>Nemacaulis denudata</i> var. <i>denudata</i>	Plant	-- / --	1B.2
Coastal Dunes Milk-Vetch	<i>Astragalus tener</i> var. <i>titi</i>	Plant	FE/SE	1B.1
Coulter's Goldfields	<i>Lasthenia glabrata</i> ssp. <i>coulteri</i>	Plant	-- / --	1B.1
Coulter's Saltbush	<i>Atriplex coulteri</i>	Plant	-- / --	1B.2

**TABLE D-1  
(Continue)  
FEDERALLY AND STATE-LISTED SPECIES WITH POTENTIAL  
TO OCCUR WITHIN THE COUNTY OF LOS ANGELES**

Common Name	Scientific Name	Taxa	Status (Federal/State/Other)	CNPS Rare Plant Rank
Davidson's Bush-Mallow	<i>Malacothamnus davidsonii</i>	Plant	-- / --	1B.2
Davidson's Saltscale	<i>Atriplex serenana</i> var. <i>davidsonii</i>	Plant	-- / --	2.2
Desert Cymopterus	<i>Cymopterus deserticola</i>	Plant	-- / --	1B.2
Dune Larkspur	<i>Delphinium parryi</i> ssp. <i>blochmaniae</i>	Plant	-- / --	1B.2
Estuary Seablite	<i>Suaeda esteroa</i>	Plant	-- / --	1B.2
Ewan's Cinquefoil	<i>Potentilla glandulosa</i> ssp. <i>ewanii</i>	Plant	FC/---	1B.3
Gambel's Water Cress	<i>Nasturtium gambelii</i>	Plant	FE/ST	1B.1
Golden-Spined Cereus	<i>Bergerocactus emoryi</i>	Plant	-- / --	2.2
Greata's Aster	<i>Symphyotrichum greatae</i>	Plant	-- / --	1B.3
Guadalupe Island Lupine	<i>Lupinus guadalupensis</i>	Plant	-- / --	1B.2
Hall's Monardella	<i>Monardella macrantha</i> ssp. <i>hallii</i>	Plant	-- / --	1B.3
Hot Springs Fimbristylis	<i>Fimbristylis thermalis</i>	Plant	-- / --	2.2
Intermediate Mariposa-Lily	<i>Calochortus weedii</i> var. <i>intermedius</i>	Plant	-- / --	1B.2
Island Cherry Forest	<i>Island Cherry Forest</i>	Plant		
Island Green Dudleya	<i>Dudleya virens</i> ssp. <i>insularis</i>	Plant	-- / --	1B.2
Island Ironwood Forest	<i>Island Ironwood Forest</i>	Plant		
Island Rush-Rose	<i>Helianthemum greenei</i>	Plant	FT	1B.2
Johnston's Buckwheat	<i>Eriogonum microthecum</i> var. <i>johnstonii</i>	Plant	---/SE	1B.2
Kern Canyon Clarkia	<i>Clarkia xantiana</i> ssp. <i>parviflora</i>	Plant	-- / --	4.2
Kusche's Sandwort	<i>Arenaria macradenia</i> var. <i>kuschei</i>	Plant		
Lancaster Milk-Vetch	<i>Astragalus preussii</i> var. <i>laxiflorus</i>	Plant	-- / --	1B.1
Lemon Lily	<i>Lilium parryi</i>	Plant	-- / --	1B.2
Los Angeles Sunflower	<i>Helianthus nuttallii</i> ssp. <i>parishii</i>	Plant	-- / --	
Lyon's Pentachaeta	<i>Pentachaeta lyonii</i>	Plant	FE/SE	1B.1
Mainland Cherry Forest	<i>Mainland Cherry Forest</i>	Plant		
Malibu Baccharis	<i>Baccharis malibuensis</i>	Plant	-- / --	1B.1
Many-Flowered Phacelia	<i>Phacelia floribunda</i>	Plant	-- / --	1B.2
Many-Stemmed Dudleya	<i>Dudleya multicaulis</i>	Plant	-- / --	1B.2
Marcescent Dudleya	<i>Dudleya cymosa</i> ssp. <i>marcescens</i>	Plant	FT/SR	1B.2
Marsh Sandwort	<i>Arenaria paludicola</i>	Plant	FE/SE	1B.1
Mason's Neststraw	<i>Stylocline masonii</i>	Plant	-- / --	1B.1

**TABLE D-1  
(Continue)  
FEDERALLY AND STATE-LISTED SPECIES WITH POTENTIAL  
TO OCCUR WITHIN THE COUNTY OF LOS ANGELES**

Common Name	Scientific Name	Taxa	Status (Federal/State/ Other)	CNPS Rare Plant Rank
Mesa Horkelia	<i>Horkelia cuneata</i> ssp. <i>puberula</i>	Plant	-- / --	1B.1
Mojave Riparian Forest	<i>Mojave Riparian Forest</i>	Plant		
Monarch Butterfly	<i>Danaus plexippus</i>	Plant		
Mt. Gleason Paintbrush	<i>Castilleja gleasonii</i>	Plant	---/SR	1B.2
Mud Nama	<i>Nama stenocarpum</i>	Plant	-- / --	2.2
Nevin's Barberry	<i>Berberis nevinii</i>	Plant	FE/SE	1B.1
Nevin's Woolly Sunflower	<i>Constancea nevinii</i>	Plant	-- / --	1B.3
Open Engelmann Oak Woodland	<i>Open Engelmann Oak Woodland</i>	Plant		
Orcutt's Linanthus	<i>Linanthus orcuttii</i>	Plant	-- / --	1B.3
Orcutt's Pincushion	<i>Chaenactis glabriuscula</i> var. <i>orcuttiana</i>	Plant	-- / --	1B.1
Pale-Yellow Layia	<i>Layia heterotricha</i>	Plant	-- / --	1B.1
Palmer's Grapplinghook	<i>Harpagonella palmeri</i>	Plant	-- / --	4.2
Palmer's Mariposa-Lily	<i>Calochortus palmeri</i> var. <i>palmeri</i>	Plant	-- / --	1B.2
Palos Verdes Blue Butterfly	<i>Glaucopsyche lygdamus palosverdesensis</i>	Plant		
Parish's Brittle-scale	<i>Atriplex parishii</i>	Plant	-- / --	1B.1
Parish's Gooseberry	<i>Ribes divaricatum</i> var. <i>parishii</i>	Plant	-- / --	1A
Parish's Popcorn-Flower	<i>Plagiobothrys parishii</i>	Plant	-- / --	1B.1
Parry's Spineflower	<i>Chorizanthe parryi</i> var. <i>parryi</i>	Plant	-- / --	1B.1
Peirson's Lupine	<i>Lupinus peirsonii</i>	Plant	-- / --	1B.3
Peirson's Morning-Glory	<i>Calystegia peirsonii</i>	Plant	-- / --	4.2
Plummer's Mariposa-Lily	<i>Calochortus plummerae</i>	Plant	-- / --	1B.2
Prostrate Vernal Pool Navarretia	<i>Navarretia prostrata</i>	Plant	-- / --	1B.1
Pygmy Leptosiphon	<i>Leptosiphon pygmaeus</i> ssp. <i>pygmaeus</i>	Plant	-- / --	1B.2
Riversidian Alluvial Fan Sage Scrub	<i>Riversidian Alluvial Fan Sage Scrub</i>	Plant		
Robinson's Pepper-Grass	<i>Lepidium virginicum</i> var. <i>robinsonii</i>	Plant	-- / --	1B.2
Rock Creek Broomrape	<i>Orobanche valida</i> ssp. <i>valida</i>	Plant	-- / --	1B.2
Rock-Loving Oxytrope	<i>Oxytropis oreophila</i> var. <i>oreophila</i>	Plant	-- / --	2.3
Ross' Pitcher Sage	<i>Lepechinia rossii</i>	Plant	-- / --	1B.2
Round-Leaved Filaree	<i>California macrophylla</i>	Plant	-- / --	1B.1
Sagebrush Loeflingia	<i>Loeflingia squarrosa</i> var. <i>artemisiarum</i>	Plant	-- / --	2.2

**TABLE D-1  
(Continue)  
FEDERALLY AND STATE-LISTED SPECIES WITH POTENTIAL  
TO OCCUR WITHIN THE COUNTY OF LOS ANGELES**

Common Name	Scientific Name	Taxa	Status (Federal/State/ Other)	CNPS Rare Plant Rank
Salt Marsh Bird's-Beak	<i>Cordylanthus maritimus</i> ssp. <i>maritimus</i>	Plant	-- / --	2.2
Salt Spring Checkerbloom	<i>Sidalcea neomexicana</i>	Plant	-- / --	2.2
San Antonio Milk-Vetch	<i>Astragalus lentiginosus</i> var. <i>antonius</i>	Plant	-- / --	1B.3
San Bernardino Aster	<i>Symphotrichum defoliatum</i>	Plant	-- / --	1B.2
San Bernardino Grass-Of- Parnassus	<i>Parnassia cirrata</i> var. <i>cirrata</i>	Plant	-- / --	1B.3
San Clemente Island Bedstraw	<i>Galium catalinense</i> ssp. <i>acrispum</i>	Plant	---/SE	1B.2
San Clemente Island Bird's- Foot Trefoil	<i>Lotus argophyllus</i> var. <i>adsurgens</i>	Plant	---/SE	1B.1
San Clemente Island Brodiaea	<i>Brodiaea kinkiensis</i>	Plant	-- / --	1B.2
San Clemente Island Buckwheat	<i>Eriogonum giganteum</i> var. <i>formosum</i>	Plant	-- / --	1B.2
San Clemente Island Bush- Mallow	<i>Malacothamnus clementinus</i>	Plant	FE/SE	1B.1
San Clemente Island Evening- Primrose	<i>Camissonia guadalupensis</i> ssp. <i>clementina</i>	Plant	-- / --	1B.2
San Clemente Island Hazardia	<i>Hazardia cana</i>	Plant	-- / --	1B.2
San Clemente Island Larkspur	<i>Delphinium variegatum</i> ssp. <i>kinkiense</i>	Plant	FE/SE	1B.1
San Clemente Island Lotus	<i>Lotus dendroideus</i> var. <i>traskiae</i>	Plant	FE/SE	1B.1
San Clemente Island Milk- Vetch	<i>Astragalus nevinii</i>	Plant	-- / --	1B.2
San Clemente Island Paintbrush	<i>Castilleja grisea</i>	Plant	FE/SE	1B.2
San Clemente Island Tritelia	<i>Triteleia clementina</i>	Plant	-- / --	1B.2
San Clemente Island Woodland Star	<i>Lithophragma maximum</i>	Plant	FE/SE	1B.1
San Fernando Valley Spineflower	<i>Chorizanthe parryi</i> var. <i>fernandina</i>	Plant	FC/SE	1B.1
San Gabriel Bedstraw	<i>Galium grande</i>	Plant	-- / --	1B.2
San Gabriel Linanthus	<i>Linanthus concinnus</i>	Plant	-- / --	1B.2
San Gabriel Manzanita	<i>Arctostaphylos gabrielensis</i>	Plant	-- / --	1B.2
San Gabriel Mountains Dudleya	<i>Dudleya densiflora</i>	Plant	-- / --	1B.1
San Gabriel River Dudleya	<i>Dudleya cymosa</i> ssp. <i>crebrifolia</i>	Plant	-- / --	1B.2
San Nicolas Island Lomatium	<i>Lomatium insulare</i>	Plant	-- / --	1B.2
Santa Barbara Honeysuckle	<i>Lonicera subspicata</i> var. <i>subspicata</i>	Plant	-- / --	1B.2

**TABLE D-1  
(Continue)  
FEDERALLY AND STATE-LISTED SPECIES WITH POTENTIAL  
TO OCCUR WITHIN THE COUNTY OF LOS ANGELES**

Common Name	Scientific Name	Taxa	Status (Federal/State/ Other)	CNPS Rare Plant Rank
Santa Barbara Morning-Glory	<i>Calystegia sepium</i> ssp. <i>binghamiae</i>	Plant	-- / --	1A
Santa Catalina Figwort	<i>Scrophularia villosa</i>	Plant	-- / --	1B.2
Santa Catalina Island Bedstraw	<i>Galium catalinense</i> ssp. <i>catalinense</i>	Plant	--/SE	1B.2
Santa Catalina Island Currant	<i>Ribes viburnifolium</i>	Plant	-- / --	1B.2
Santa Catalina Island Desert-Thorn	<i>Lycium brevipes</i> var. <i>hassei</i>	Plant	-- / --	1B.1
Santa Catalina Island Ironwood	<i>Lyonothamnus floribundus</i> ssp. <i>floribundus</i>	Plant	-- / --	1B.2
Santa Catalina Island Manzanita	<i>Arctostaphylos catalinae</i>	Plant	-- / --	1B.2
Santa Catalina Island Monkeyflower	<i>Mimulus traskiae</i>	Plant	-- / --	1A
Santa Catalina Lancetooth	<i>Haplotrema catalinense</i>	Plant		
Santa Cruz Island Ironwood	<i>Lyonothamnus floribundus</i> ssp. <i>aspleniifolius</i>	Plant	-- / --	1B.2
Santa Cruz Island Rock Cress	<i>Sibara filifolia</i>	Plant	FE/--	1B.1
Santa Monica Dudleya	<i>Dudleya cymosa</i> ssp. <i>ovatifolia</i>	Plant	FT/--	1B.2
Santa Susana Tarplant	<i>Deinandra minthornii</i>	Plant	--/SR	1B.2
Scalloped Moonwort	<i>Botrychium crenulatum</i>	Plant	-- / --	2.2
Short-Joint Beavertail	<i>Opuntia basilaris</i> var. <i>brachyclada</i>	Plant	-- / --	1B.2
Short-Sepaled Lewisia	<i>Lewisia brachycalyx</i>	Plant	-- / --	2.2
Showy Island Snapdragon	<i>Galvezia speciosa</i>	Plant	-- / --	1B.2
Slender Mariposa-Lily	<i>Calochortus clavatus</i> var. <i>gracilis</i>	Plant	-- / --	1B.2
Slender Silver Moss	<i>Anomobryum julaceum</i>	Plant	-- / --	2.2
Slender-Horned Spineflower	<i>Dodecahema leptoceras</i>	Plant	FE/SE	1B.1
Sonoran Maiden Fern	<i>Thelypteris puberula</i> var. <i>sonorensis</i>	Plant	-- / --	2.2
South Coast Saltscale	<i>Atriplex pacifica</i>	Plant	-- / --	1B.2
South Island Bush-Poppy	<i>Dendromecon harfordii</i> var. <i>rhamnoides</i>	Plant	-- / --	1B.1
Southern Alpine Buckwheat	<i>Eriogonum kennedyi</i> var. <i>alpigenum</i>	Plant	-- / --	1B.3
Southern Coast Live Oak Riparian Forest	<i>Southern Coast Live Oak Riparian Forest</i>	Plant		
Southern Coastal Bluff Scrub	<i>Southern Coastal Bluff Scrub</i>	Plant		
Southern Coastal Salt Marsh	<i>Southern Coastal Salt Marsh</i>	Plant		

**TABLE D-1  
(Continue)  
FEDERALLY AND STATE-LISTED SPECIES WITH POTENTIAL  
TO OCCUR WITHIN THE COUNTY OF LOS ANGELES**

Common Name	Scientific Name	Taxa	Status (Federal/State/ Other)	CNPS Rare Plant Rank
Southern Cottonwood Willow Riparian Forest	<i>Southern Cottonwood Willow Riparian Forest</i>	Plant		
Southern Dune Scrub	<i>Southern Dune Scrub</i>	Plant		
Southern Foredunes	<i>Southern Foredunes</i>	Plant		
Southern Island Mallow	<i>Lavatera assurgentiflora</i> ssp. <i>glabra</i>	Plant	-- / --	1B.1
<i>Southern Mixed Riparian Forest</i>	<i>Southern Mixed Riparian Forest</i>	Plant		
Southern Mountains Skullcap	<i>Scutellaria bolanderi</i> ssp. <i>austromontana</i>	Plant	-- / --	1B.2
Southern Riparian Forest	<i>Southern Riparian Forest</i>	Plant		
Southern Riparian Scrub	<i>Southern Riparian Scrub</i>	Plant		
Southern Sycamore Alder Riparian Woodland	<i>Southern Sycamore Alder Riparian Woodland</i>	Plant		
Southern Tarplant	<i>Centromadia parryi</i> ssp. <i>australis</i>	Plant	-- / --	1B.1
Southern Willow Scrub	<i>Southern Willow Scrub</i>	Plant		
Spreading Navarretia	<i>Navarretia fossalis</i>	Plant	FT	1B.1
Tehachapi Buckwheat	<i>Eriogonum callistum</i>	Plant	-- / --	1B.1
Thorne's Royal Larkspur	<i>Delphinium variegatum</i> ssp. <i>thornei</i>	Plant	-- / --	1B.1
Thread-Leaved Brodiaea	<i>Brodiaea filifolia</i>	Plant	FT/SE	1B.1
Trask's Cryptantha	<i>Cryptantha traskiae</i>	Plant	-- / --	1B.2
Valley Needlegrass Grassland	<i>Valley Needlegrass Grassland</i>	Plant		
Valley Oak Woodland	<i>Valley Oak Woodland</i>	Plant		
Ventura Marsh Milk-Vetch	<i>Astragalus pycnostachyus</i> var. <i>lanosissimus</i>	Plant	FE/SE	1B.1
Wallace's Nightshade	<i>Solanum wallacei</i>	Plant	-- / --	4.2
Walnut Forest	<i>Walnut Forest</i>	Plant		
Western Sedge	<i>Carex occidentalis</i>	Plant	-- / --	2.3
White Pygmy-Poppy	<i>Canbya candida</i>	Plant	-- / --	4.3
White Rabbit-Tobacco	<i>Pseudognaphalium leucocephalum</i>	Plant	-- / --	2.2
White-Bracted Spineflower	<i>Chorizanthe xanti</i> var. <i>leucotheca</i>	Plant	-- / --	1B.2
Wildflower Field	<i>Wildflower Field</i>	Plant		
Woolly Mountain-Parsley	<i>Oreonana vestita</i>	Plant	-- / --	1B.3
Woven-Spored Lichen	<i>Texosporium sancti-jacobi</i>	Plant	-- / --	None
<b>Mollusk</b>				
Catalina Mountain Snail	<i>Radiocentrum avalonense</i>	Mollusk	--/--/ CR	
Horseshoe Snail	<i>Xerarionta intercisca</i>	Mollusk	--/--/ --	



**TABLE D-1  
(Continue)  
FEDERALLY AND STATE-LISTED SPECIES WITH POTENTIAL  
TO OCCUR WITHIN THE COUNTY OF LOS ANGELES**

Common Name	Scientific Name	Taxa	Status (Federal/State/ Other)	CNPS Rare Plant Rank
Mimic Tryonia (= California Brackish Water Snail)	<i>Tryonia imitator</i>	Mollusk	--/--/ DD	
San Clemente Island Blunt-Top Snail	<i>Sterkia clementina</i>	Mollusk	--/--/ NT	
San Clemente Island Snail	<i>Micrarionta gabbi</i>	Mollusk	--/--/ --	
Shepard's Snail	<i>Pristiloma shepardae</i>	Mollusk	--/--/--	
Wreathed Cactus Snail	<i>Xerarionta redimita</i>	Mollusk	--/--/	
<b>Insect</b>				
Belkin's Dune Tabanid Fly	<i>Brennania belkini</i>	Insect	--/--/	
Busck's Gallmoth	<i>Carolella busckana</i>	Insect	--/--/--	
California Diplelectronan Caddisfly	<i>Diplelectrona californica</i>	Insect	--/--/--	
Dorothy's El Segundo Dune Weevil	<i>Trigonoscuta dorothea dorothea</i>	Insect	--/--/--	
El Segundo Blue Butterfly	<i>Euphilotes battoides allyni</i>	Insect	FE/--/ XERCES:CI	
El Segundo Flower-Loving Fly	<i>Rhaphiomidas terminatus terminatus</i>	Insect	--/--/--	
Globose Dune Beetle	<i>Coelus globosus</i>	Insect	--/--/ :	
Henne's Eucosman Moth	<i>Eucosma hennei</i>	Insect	--/--/--	
Lange's El Segundo Dune Weevil	<i>Onychobaris langei</i>	Insect	--/--/--	
San Gabriel Mountains Blue Butterfly	<i>Plebejus saepiolus aureolus</i>	Insect	--/--/--	
San Gabriel Mountains Elfin Butterfly	<i>Callophrys mossii hidakupa</i>	Insect	--/--/--	
Sandy Beach Tiger Beetle	<i>Cicindela hirticollis gravida</i>	Insect	--/--/--	
Santa Monica Grasshopper	<i>Trimerotropis occidentiloides</i>	Insect	--/--/ :EN	
Santa Monica Shieldback Katydid	<i>Aglaothorax longipennis</i>	Insect	--/--/ :CR	
Senile Tiger Beetle	<i>Cicindela senilis frosti</i>	Insect	--/--/--	
Western Beach Tiger Beetle	<i>Cicindela latesignata latesignata</i>	Insect	--/--/--	
<b>Arachnid</b>				
Gertsch's Socalchemmis Spider	<i>Socalchemmis gertschi</i>	Arachnid	--/--/	
<b>Fish</b>				
Arroyo Chub	<i>Gila orcuttii</i>	Fish	--/--/ AFS: DFG:SSC	
Mohave Tui Chub	<i>Siphateles bicolor mohavensis</i>	Fish	FE/SE/ AFS:EN DFG:FP	

**TABLE D-1  
(Continue)  
FEDERALLY AND STATE-LISTED SPECIES WITH POTENTIAL  
TO OCCUR WITHIN THE COUNTY OF LOS ANGELES**

Common Name	Scientific Name	Taxa	Status (Federal/State/ Other)	CNPS Rare Plant Rank
Santa Ana Speckled Dace	<i>Rhinichthys osculus</i> ssp. 3	Fish	--/ SSC / AFS:TH DFG: USFS:S	
Santa Ana Sucker	<i>Catostomus santaanae</i>	Fish	FT/SSC/ AFS:TH DFG: :	
Southern California Arroyo Chub/Santa Ana Sucker Stream	<i>Southern California Arroyo Chub/Santa Ana Sucker Stream</i>	Fish	FT/--/ AFS:TH DFG:SSC :	
Southern California Steelhead Stream	<i>Southern California Steelhead Stream</i>	Fish		
Southern California Threespine Stickleback Stream	<i>Southern California Threespine Stickleback Stream</i>	Fish		
Southern Steelhead - Southern California Esu	<i>Oncorhynchus mykiss irideus</i>	Fish	FT/--/ AFS:TH	
Tidewater Goby	<i>Eucyclogobius newberryi</i>	Fish	FE/--/ AFS:EN DFG:SSC :	
Unarmored Threespine Stickleback	<i>Gasterosteus aculeatus williamsoni</i>	Fish	FE/SE/ AFS:EN DFG:FP	
Wandering (= Saltmarsh) Skipper	<i>Panoquina errans</i>	Fish	--/--/ UCN:NT	
<b>Amphibian</b>				
Arroyo Toad	<i>Anaxyrus californicus</i>	Amphibian	FE/--/DFG: SSC, : EN	
California Red-Legged Frog	<i>Rana draytonii</i>	Amphibian	FE/--/DFG: SSC, :	
Coast Range Newt	<i>Taricha torosa torosa</i>	Amphibian	--/--/DFG: SSC	
San Gabriel Mountains Slender Salamander	<i>Batrachoseps gabrieli</i>	Amphibian	--/--/DD, USFS:S, :LC	
Sierra Madre Yellow-Legged Frog	<i>Rana muscosa</i>	Amphibian	FE/SE/DFG: SSC, :EN, USFS: S	
Western Spadefoot	<i>Spea hammondii</i>	Amphibian	--/--/BLM:S, DFG: SSC, :NT	
Yellow-Blotched Salamander	<i>Ensatina eschscholtzii croceator</i>	Amphibian	--/--/BLM: S, DFG: SSC, USFS: S	
<b>Reptile</b>				
California Mountain Kingsnake (San Diego Population)	<i>Lampropeltis zonata (pulchra)</i>	Reptile	--/--/DFG: SCC, : LC, USFS: S	

**TABLE D-1  
(Continue)  
FEDERALLY AND STATE-LISTED SPECIES WITH POTENTIAL  
TO OCCUR WITHIN THE COUNTY OF LOS ANGELES**

Common Name	Scientific Name	Taxa	Status (Federal/State/ Other)	CNPS Rare Plant Rank
California Mountain Kingsnake (San Bernardino Population)	<i>Lampropeltis zonata</i> ( <i>parvirubra</i> )	Reptile	-/-DFG: SCC, : LC, USFS: S	
Coast (California) Horned Lizard	<i>Phrynosoma coronatum</i> ( <i>frontale population</i> )	Reptile	-/-BLM:S, DFG: SSC, : NT	
Coast (San Diego) Horned Lizard	<i>Phrynosoma coronatum</i> ( <i>blainvillii population</i> )	Reptile	-/-BLM: S, SFG: SSC, : LC, USFS: S	
Coastal Western Whiptail	<i>Aspidoscelis tigris stejnegeri</i>	Reptile	-/-/-	
Desert Tortoise	<i>Gopherus agassizii</i>	Reptile	FT/ST/:	
Island Night Lizard	<i>Xantusia riversiana</i>	Reptile	FT/-/: LC	
Orange-Throated Whiptail	<i>Aspidoscelis hyperythra</i>	Reptile	-/-DFG: SSC, : LG	
Rosy Boa	<i>Charina trivirgata</i>	Reptile	-/-/: LC, USFS: S	
San Bernardino Ringneck Snake	<i>Diadophis punctatus modestus</i>	Reptile	-/-USFS:S	
Santa Catalina Garter Snake	<i>Thamnophis hammondi</i> ssp.	Reptile	-/-/-	
Silvery Legless Lizard	<i>Anniella pulchra pulchra</i>	Reptile	-/-DFG: SSC, USFS:S	
Southwestern Pond Turtle	<i>Actinemys marmorata pallida</i>	Reptile		
Two-Striped Garter Snake	<i>Thamnophis hammondi</i>	Reptile	-/-BLM:S, DFG: SSC, :LC, USFS:S	
<b>Bat</b>				
Big Free-Tailed Bat	<i>Nyctinomops macrotis</i>	Bat	-/-DFG: SSC, : LC, WBWG:MH	
California Leaf-Nosed Bat	<i>Macrotus californicus</i>	Bat	-/-BLM: S, DFG: SSC, : LC, USFS:S, WBWG:H	
Fringed Myotis	<i>Myotis thysanodes</i>	Bat	-/-BLM:S, : LC, WBWG: H	
Hoary Bat	<i>Lasiurus cinereus</i>	Bat	-/-/:LC, WBWG: M	
Long-Eared Myotis	<i>Myotis evotis</i>	Bat	-/-BLM: S, :LC, WBWG:M	
Long-Legged Myotis	<i>Myotis volans</i>	Bat	-/-/: LC, WBWG:H	
Pallid Bat	<i>Antrozous pallidus</i>	Bat	-/-BLM: S, DFG: SSC, : LC, USFS: S, WBWG: H	

**TABLE D-1  
(Continue)  
FEDERALLY AND STATE-LISTED SPECIES WITH POTENTIAL  
TO OCCUR WITHIN THE COUNTY OF LOS ANGELES**

Common Name	Scientific Name	Taxa	Status (Federal/State/ Other)	CNPS Rare Plant Rank
Pocketed Free-Tailed Bat	<i>Nyctinomops femorosaccus</i>	Bat	-/-DFG: SSC, : LC, WBWG:M	
Silver-Haired Bat	<i>Lasionycteris noctivagans</i>	Bat	-/-/: LC, WBWG:M	
Spotted Bat	<i>Euderma maculatum</i>	Bat	-/-BLM: S, DFG: SSC, : LC	
Western Mastiff Bat	<i>Eumops perotis californicus</i>	Bat	-/-BLM: S, DFG: SSC, WBWG: H	
Western Red Bat	<i>Lasiurus blossevillii</i>	Bat	-/-DFG: SSC, : LC, WBWG:M	
Western Small-Footed Myotis	<i>Myotis ciliolabrum</i>	Bat	-/-BLM: S, : LC, WBWG: M	
Western Yellow Bat	<i>Lasiurus xanthinus</i>	Bat	-/-DFG: SSC, : LC, WBWG:H	
Yuma Myotis	<i>Myotis yumanensis</i>	Bat	-/-BLM:S, : LC, WBWG:LM	
<b>Bird</b>				
American Peregrine Falcon	<i>Falco peregrinus anatum</i>	Bird	Delisted/DELIS TED/ CDF: S, DFG: FP, USFWS: BCC	
Ashy Storm-Petrel	<i>Oceanodroma homochroa</i>	Bird	-/-ABC: WLBCC, DFG: SSC, : EN	
Bald Eagle	<i>Haliaeetus leucocephalus</i>	Bird	Delisted/ST/CD F: S, DFG:FP , :LC, USFS: S, USFWS:BCC	
Belding's Savannah Sparrow	<i>Passerculus sandwichensis beldingi</i>	Bird	-/SE/-	
Black Swift	<i>Cypseloides niger</i>	Bird	-/-/ ABC:WLBCC DFG:SSC :LC USFWS:BCC	
Burrowing Owl	<i>Athene cunicularia</i>	Bird	-/-/ BLM:S DFG:SSC :LC USFWS:BCC	

**TABLE D-1  
(Continue)  
FEDERALLY AND STATE-LISTED SPECIES WITH POTENTIAL  
TO OCCUR WITHIN THE COUNTY OF LOS ANGELES**

Common Name	Scientific Name	Taxa	Status (Federal/State/ Other)	CNPS Rare Plant Rank
California Black Rail	<i>Laterallus jamaicensis coturniculus</i>	Bird	-/ST/ABC: WLBCC, DFG: SSC, : LC	
California Brown Pelican	<i>Pelecanus occidentalis californicus</i>	Bird	Delisted/Delist ed/DFG: FP	
California Condor	<i>Gymnogyps californianus</i>	Bird	FE/SE/ABC: WLBCC, CDF:S, : CR	
California Least Tern	<i>Sternula antillarum browni</i>	Bird	FE/SE/ABC: WLBCC, DFG: FP	
Coastal California Gnatcatcher	<i>Polioptila californica californica</i>	Bird	FT/-/ ABC:WLBCC DFG:SSC	
Cooper's Hawk	<i>Accipiter cooperii</i>	Bird	-/-/DFG: WL, :LC	
Ferruginous Hawk	<i>Buteo regalis</i>	Bird	-/-/DFG: WL, :LC, USFWS: BCC	
Golden Eagle	<i>Aquila chrysaetos</i>	Bird	-/-/CDF: S, DFG: FP, DFG: WL, : LC, USFWS: BCC	
Grasshopper Sparrow	<i>Ammodramus savannarum</i>	Bird	-/-/DFG: SSC, : LC	
Le Conte's Thrasher	<i>Toxostoma lecontei</i>	Bird	-/-/ABC: WLBCC, DFG: SSC, : LC, USFWS: BCC	
Least Bell's Vireo	<i>Vireo bellii pusillus</i>	Bird	FE/SE/ABC: WLBCC, : NT, USFWS: BCC	
Merlin	<i>Falco columbarius</i>	Bird	-/-/DFG: WL, : LC	
Mountain Plover	<i>Charadrius montanus</i>	Bird	FT/-/ ABC:WLBCC BLM:S DFG:SSC :NT USFWS:BCC	
Prairie Falcon	<i>Falco mexicanus</i>	Bird	-/-/ DFG:WL :LC USFWS:BCC	

**TABLE D-1  
(Continue)  
FEDERALLY AND STATE-LISTED SPECIES WITH POTENTIAL  
TO OCCUR WITHIN THE COUNTY OF LOS ANGELES**

Common Name	Scientific Name	Taxa	Status (Federal/State/ Other)	CNPS Rare Plant Rank
San Clemente Loggerhead Shrike	<i>Lanius ludovicianus mearnsi</i>	Bird	FE/-/DFG:SSC	
Short-Eared Owl	<i>Asio flammeus</i>	Bird	-/-/ ABC:WLBCC DFG:SSC :LC	
Southern California Rufous-Crowned Sparrow	<i>Aimophila ruficeps canescens</i>	Bird	-/-/ DFG:WL	
Southwestern Willow Flycatcher	<i>Empidonax traillii extimus</i>	Bird	FE/SE/ ABC:WLBCC	
Swainson's Hawk	<i>Buteo swainsoni</i>	Bird	-/ST/ABC WLBCC, :LC, USFS:S USFWS: BCC	
Tricolored Blackbird	<i>Agelaius tricolor</i>	Bird	-/-/ ABC:WLBCC BLM:S DFG:SSC :EN USFWS:BCC	
Western Snowy Plover	<i>Charadrius alexandrinus nivosus</i>	Bird	FT/-/ ABC:WLBCC DFG:SSC USFWS:BCC	
Western Yellow-Billed Cuckoo	<i>Coccyzus americanus occidentalis</i>	Bird	FC/SE/ USFS:S USFWS:BCC	
White-Faced Ibis	<i>Plegadis chihi</i>	Bird	-/- DFG:WL :LC	
White-Tailed Kite	<i>Elanus leucurus</i>	Bird	-/- DFG:FP :LC	
Yellow-Breasted Chat	<i>Icteria virens</i>	Bird	-/- DFG:SSC :LC	
<b>Mammals</b>				
American Badger	<i>Taxidea taxus</i>	Mammal	-/-/ DFG:SSC, :LC	
Lodgepole Chipmunk	<i>Neotamias speciosus speciosus</i>	Mammal	-/-/-	
Los Angeles Pocket Mouse	<i>Perognathus longimembris brevinasus</i>	Mammal	-/-/ DFG:SSC USFS:S	
Mohave Ground Squirrel	<i>Spermophilus mohavensis</i>	Mammal	-/ST/ :	
Nelson's Antelope Squirrel	<i>Ammospermophilus nelsoni</i>	Mammal	-/ST/ :EN	
Nelson's Bighorn Sheep	<i>Ovis canadensis nelsoni</i>	Mammal	-/-/ BLM:S USFS:S	



**TABLE D-1**  
**(Continue)**  
**FEDERALLY AND STATE-LISTED SPECIES WITH POTENTIAL**  
**TO OCCUR WITHIN THE COUNTY OF LOS ANGELES**

Common Name	Scientific Name	Taxa	Status (Federal/State/ Other)	CNPS Rare Plant Rank
Northwestern San Diego Pocket Mouse	<i>Chaetodipus fallax fallax</i>	Mammal	---/--/ DFG:SSC	
Pacific Pocket Mouse	<i>Perognathus longimembris pacificus</i>	Mammal	FE/---/ DFG:SSC	
Pallid San Diego Pocket Mouse	<i>Chaetodipus fallax pallidus</i>	Mammal	---/--/ DFG:SSC	
San Clemente Island Fox	<i>Urocyon littoralis clementae</i>	Mammal	---/ST/ :CR	
San Diego Black-Tailed Jackrabbit	<i>Lepus californicus bennettii</i>	Mammal	---/--/ DFG:SSC	
San Diego Desert Woodrat	<i>Neotoma lepida intermedia</i>	Mammal	---/--/ DFG:SSC	
San Joaquin Pocket Mouse	<i>Perognathus inornatus inornatus</i>	Mammal	---/--/ BLM:S	
Santa Catalina Island Fox	<i>Urocyon littoralis catalinae</i>	Mammal	FE/ST/ :CR	
Santa Catalina Shrew	<i>Sorex ornatus willetti</i>	Mammal	---/--/ DFG:SSC	
South Coast Marsh Vole	<i>Microtus californicus stephensi</i>	Mammal	---/--/ DFG:SSC	
Southern California Saltmarsh Shrew	<i>Sorex ornatus salicornicus</i>	Mammal	---/--/ DFG:SSC	
Southern Grasshopper Mouse	<i>Onychomys torridus ramona</i>	Mammal	---/--/ DFG:SSC	
Tehachapi Pocket Mouse	<i>Perognathus alticolus inexpectatus</i>	Mammal	---/--/ DFG:SSC :EN USFS:S	

**KEY:**

FE = federally endangered  
 FT = federally threatened  
 FC = federal candidate  
 SE = State endangered  
 ST = State threatened  
 SR = State rare  
 SSC = State species of concern

## APPENDIX E

### TRAIL CONSTRUCTION COSTS

---

Trail construction costs vary due to a variety of factors from site conditions to availability of resources and labor. The California State Parks trail labor and materials construction worksheet is included in the following appendix and will allow individuals to estimate trail construction costs based on 2006 estimated costs. The worksheets require knowledge of the type of construction efforts or repairs to take place. Repair information can be taken from the Trail Assessment and Repair Sheet and Work Logs in Section 5, *Trail Operation and Maintenance*, of the Trails Manual and Appendix L, *Trail Assessment and Maintenance Forms*. Additional associated costs of trail development are also included in this appendix.

The cost of constructing a trail depends on the type of trail, the terrain traversed by the trail, whether the trail crosses streams or roads, and the cost of mobilization to begin trail construction. After construction, a trail may require restoration of the vegetation disturbed during trail construction. Yearly maintenance is required to keep a trail safe and functional. Signs may include highway, regulatory, and informational signs. Some trailheads may require the construction of a parking lot to accommodate trail users. Additional costs include equestrian fencing, landscaping, temporary and permanent irrigation, trash receptacles, benches, drinking fountains, and solar-powered flashing beacons for traffic safety.

This appendix contains the following documents:

- California State Parks 2006 trail labor and materials construction worksheet
- California State Parks 2006 trail bridge construction worksheet
- Estimated 2006 trail construction costs

CALIFORNIA STATE PARKS  
2006 TRAIL LABOR AND MATERIALS CONSTRUCTION WORKSHEET

TRAIL: _____								
CONSTRUCTION ACTIVITY	TOTALS	UNIT		PER UNIT COST	LABOR COST	MATERIAL COST	MATERIAL COST INDEX	UNIT
<b>Trail Brushing and Clearing</b>								
Trail Brushing maint. (light)	0	260	ft	@ \$16.00	=	\$0.00	Shale Rock	\$22.00 yard
Trail Brushing maint. (medium)	0	160	ft	@ \$16.00	=	\$0.00		
Trail Brushing maint. (heavy)	0	120	ft	@ \$16.00	=	\$0.00		
Trail Brushing const. (light)	0	120	ft	@ \$16.00	=	\$0.00	Quarry Rock 3" - 8"	\$28.00 yard
Trail Brushing const. (medium)	0	60	ft	@ \$16.00	=	\$0.00		
Trail Brushing const. (heavy)	0	30	ft	@ \$16.00	=	\$0.00		
Clearing,tree& stob removal,light	0	80	ft	@ \$16.00	=	\$0.00		
Clearing,tree& stob removal,med.	0	40	ft	@ \$16.00	=	\$0.00		
Clearing,tree& stob removal,heavy	0	20	ft	@ \$16.00	=	\$0.00		
Down Tree Removal 1'- 3' chainsaw	0	2	hr	@ \$16.00	=	\$0.00		
Down Tree Removal 4'- 6' chainsaw	0	6	hr	@ \$16.00	=	\$0.00		
Down Tree Removal 7'- 9' chainsaw	0	12	hr	@ \$16.00	=	\$0.00		
Down Tree Removal 1'- 3' crosscut	0	6	hr	@ \$16.00	=	\$0.00		
Down Tree Removal 4'- 6' crosscut	0	20	hr	@ \$16.00	=	\$0.00		
Down Tree Removal 7'- 9' crosscut	0	40	hr	@ \$16.00	=	\$0.00		
<b>Trail Maintenance</b>	0	75	ft	@ \$16.00	=	\$0.00	CMP Culvert 18"	\$9.00 ft.
<b>Trail Reroute and Reconstruction</b>								
<b>Dozer Construction</b>								
Trail Reroute & Reconstruct (hand crew support dozer)	0	11.33	ft	@ \$16.00	=	\$0.00		
Trail Dozer Rental	0		hrs	@ \$45.00	=	\$0.00		
Dozer Operator	0		hrs	@ \$25.00	=	\$0.00		
<b>Hand Crew Construction</b>								
Trail Reroute & Recon (light) 2' or < tread	0	7	ft	@ \$16.00	=	\$0.00	Form Lumber	\$1.50 bd ft
Trail Reroute & Recon (med) 4' or < tread	0	5	ft	@ \$16.00	=	\$0.00	Quarry Rock 1ft -2ft	\$46.00 cu ft
Trail Reroute & Recon (heavy) 5' or < tread	0	4	ft	@ \$16.00	=	\$0.00		
<b>Trail Hardening</b>								
Trail Hardening Install ( Road Oyl)	0	68	sq ft	@ \$16.00	=	\$0.00		
Trail Hardening Material ( Road Oyl)	0	1	sq ft	@ \$0.75	=	\$0.00		
Trail Paving Contract (Asphalt) 4'x2.5"	0	1	sq ft	@ \$1.80	=	\$0.00	Pipe Bridge 8' section	\$850.00 ea.
Trail Paving Hand, Wheelbarrows								
Trail Paving Hand 4'x2.5" <300'	0	32	sq ft	@ \$16.00	=	\$0.00		
Trail Paving Hand 4'x2.5" >300'<800'	0	24	sq ft	@ \$16.00	=	\$0.00		
Trail Paving Hand 4'x2.5" >800'	0	16	sq ft	@ \$16.00	=	\$0.00		
Asphalt Cost 2.5" depth	0		sq ft	@ 0.55	=	\$0.00		
<b>Site Restoration</b>								
Bridge Removal	0	2	ft	@ \$16.00	=	\$0.00	Step Stringers 3"x12"	\$2.20 bd ft
Trail Obliteration	0	100	sq ft	@ \$16.00	=	\$0.00	Geotextile Fabric	\$0.08 sq ft
Trail Narrowing	0	100	sq ft	@ \$16.00	=	\$0.00	3/8" cable galvanized	\$0.90 lin ft
Wood Step Removal	0	4	ea	@ \$16.00	=	\$0.00	3/8" cable clamps	\$0.60 ea
Hand Rail Removal	0	30	lin ft	@ \$16.00	=	\$0.00	Rebar 5/8"	\$0.30 lin ft
Split Rail Fence Removal	0	30	lin ft	@ \$16.00	=	\$0.00		
Wood Retaining Wall Removal	0	30	sq ft	@ \$16.00	=	\$0.00	Retaining Wall Wood 4" x 8"	\$2.20 bd ft
<b>Switchback &amp; Climbing Turns</b>								
Switchback Construction 2' or < tread	0	40	hr	@ \$16.00	=	\$0.00	Hardening agent (road oyl)	\$0.75 sq ft
Switchback Construction 4' or < tread	0	56	hr	@ \$16.00	=	\$0.00	Redwood 4" x 6" surfaced	\$1.80 bd ft
Switchback Construction 5' or < tread	0	72	hr	@ \$16.00	=	\$0.00		
Climbing Turn Construction 2' or < tread	0	24	hr	@ \$16.00	=	\$0.00		
Climbing Turn Construction 4' or < tread	0	40	hr	@ \$16.00	=	\$0.00		
Climbing Turn Construction 5' or < tread	0	56	hr	@ \$16.00	=	\$0.00		
Switchback Reconstruction 2' or < tread	0	16	ea	@ \$16.00	=	\$0.00	Labor Rate	\$16.00 hr
Switchback Reconstruction 4' or < tread	0	24	ea	@ \$16.00	=	\$0.00		
Switchback Reconstruction 5' or < tread	0	32	ea	@ \$16.00	=	\$0.00		
Climb. Turn Reconstruction 2' or < tread	0	8	ea	@ \$16.00	=	\$0.00		
Climb. Turn Reconstruction 4' or < tread	0	16	ea	@ \$16.00	=	\$0.00		
Climb. Turn Reconstruction 5' or < tread	0	24	ea	@ \$16.00	=	\$0.00		
Log Barrier Installation	0	2.5	sq ft	@ \$16.00	=	\$0.00		
<b>Turnpikes and Causeways</b>								
<b>Turnpike/Causeway 3' tread</b>								
Turnpike/Causeway 6" Lift <300'	0	3	lin ft	@ \$16.00	=	\$0.00	Cement	\$24.00 cu ft
Turnpike/Causeway 6" Lift >300'<800'	0	2.25	lin ft	@ \$16.00	=	\$0.00	Mortar	\$8.00 bag
Turnpike/Causeway 6" Lift >800'	0	1.5	lin ft	@ \$16.00	=	\$0.00	Asphalt Materials	\$0.55 sq. ft.
Material cost	0		cu yd	@ \$22.00	=	\$0.00	Asphalt Contract	\$1.80 sq. ft.
Fabric underlayment	0		sq ft	@ \$0.08	=	\$0.00	Abutment Lumber	\$2.40 bd ft
<b>Turnpike/Causeway 4' tread</b>								
Turnpike/Causeway 6" Lift <300'	0	2.5	lin ft	@ \$16.00	=	\$0.00	Form Lumber	\$1.50 bd ft
Turnpike/Causeway 6" Lift >300'<800'	0	1.75	lin ft	@ \$16.00	=	\$0.00	Snap Ties	\$0.50 sq. ft.
Turnpike/Causeway 6" Lift >800'	0	1	lin ft	@ \$16.00	=	\$0.00	She Bolt All Thread	\$0.30 sq. ft.
							Misc. Form Hardware	\$100.00 per abutme



TRAIL: \_\_\_\_\_

CONSTRUCTION ACTIVITY	TOTALS	UNIT	PER UNIT COST	LABOR COST	MATERIAL COST	MATERIAL COST INDEX	UNIT
Material cost	0	cu yd	@ \$22.00 =		\$0.00		
Fabric underlayment	0	sq ft	@ \$0.08 =		\$0.00		
<b>Turnpike/Causeway 5' tread</b>							
Turnpike/Causeway 6" Lift <300'	0	2 lin ft	@ \$16.00 =		\$0.00		
Turnpike/Causeway 6" Lift >300'<800'	0	1.5 lin ft	@ \$16.00 =		\$0.00		
Turnpike/Causeway 6" Lift >800'	0	0.75 lin ft	@ \$16.00 =		\$0.00		
Material cost	0	cu yd	@ \$22.00 =		\$0.00		
Fabric underlayment	0	sq ft	@ \$0.08 =		\$0.00		
Wall-less Turnpike, Native Soils 3'or<	0	5 lin ft	@ \$16.00 =		\$0.00		
Wall-less Turnpike, Native Soils 4'or<	0	4 lin ft	@ \$16.00 =		\$0.00		
Wall-less Turnpike, Native Soils 5'or<	0	3 lin ft	@ \$16.00 =		\$0.00		
<b>Drainage Structures</b>							
Drainage Lenses	0	4 cu ft	@ \$16.00 =		\$0.00		
Quarry rock 4"-8"	0.0	cu yd	@ \$28.00 =		\$0.00		
Culvert Installation	0	lin ft	@ \$16.00 =		\$0.00		
Culvert cost 18"	0	lin ft	@ \$9.00 =		\$0.00		
Fabric for culvert and lenses	0	sq ft	@ \$0.08 =		\$0.00		
Drainage Ditch Construction	0	5 lin ft	@ \$16.00 =		\$0.00		
<b>Retaining Wall Construction</b>							
<b>Rock</b>							
Structural Multi-tier	0	1 cu ft	@ \$16.00 =		\$0.00		
Riprap (rock tread armoring)	0	1 cu ft	@ \$16.00 =		\$0.00		
Causeway wall/Single-tier	0	2 cu ft	@ \$16.00 =		\$0.00		
Non Structural (junk wall)	0	4 cu ft	@ \$16.00 =		\$0.00		
Rock for dry rock structure	0.0	cu yd	@ \$46.00 =		\$0.00		
Rock Gathering/Transport Time-Rock Retaining Walls	All 0.0	4 cu ft	@ \$16.00 =		\$0.00		
Bridge Abutments-Mortar	0	1.5 cu ft	@ \$16.00 =		\$0.00		
Rock for mortared abutment	0.0	cu yd	@ \$46.00 =		\$0.00		
Mortar	0	94 lb bags	@ \$8.00 =		\$0.00		
Mortar Wall	0	1.5 cu ft	@ \$16.00 =		\$0.00		
Rock for mortared wall	0.0	cu yd	@ \$46.00 =		\$0.00		
Mortar	0	94 lb bags	@ \$8.00 =		\$0.00		
<b>Wood</b>							
Standard, Structural 4" x 8"	0	1 sq ft	@ \$16.00 =		\$0.00		
Wood materials for wall	0	bd ft	@ \$2.20 =		\$0.00		
Log Crib ( Movement < 50' )	0	2.5 sq ft	@ \$16.00 =		\$0.00		
Log Crib ( Movement > 50' < 100' )	0	2 sq ft	@ \$16.00 =		\$0.00		
Log Crib ( Movement > 100' < 150' )	0	1.5 sq ft	@ \$16.00 =		\$0.00		
Turnpike Wall	0	5 lin ft	@ \$16.00 =		\$0.00		
Bridge Footings 4" x 8"	0	1 sq ft	@ \$16.00 =		\$0.00		
Wood materials for footing	0	bd ft	@ \$2.20 =		\$0.00		
Rebar for Turnpike Wall	0	lin ft	@ \$0.30 =		\$0.00		
Geotextile Fabric Wall	0	4 sq ft	@ \$16.00 =		\$0.00		
Geotextile Fabric	0	sq ft	@ \$0.08 =		\$0.00		
Cellular Confinement Wall	0	4 cu ft	@ \$16.00 =		\$0.00		
Cellular Confinement	0	cu ft	@ \$2.75 =		\$0.00		
Edge Protection (wood/log)	0	3 lin ft	@ \$16.00 =		\$0.00		
<b>Abutment Construction</b>							
Wood Cribbed (Cubic Feet)	0	1 cu ft	@ \$16.00 =		\$0.00		
Wood materials	0	bd ft	@ \$2.40 =		\$0.00		
Forming of Concrete Abut.(Sq. Feet)	0	5.5 sq ft	@ \$16.00 =		\$0.00		
Form Lumber	0	sq ft	@ \$1.50 =		\$0.00		
Snap Ties	0	sq ft	@ \$0.50 =		\$0.00		
She Bolt All Thread	0	sq ft	@ \$0.30 =		\$0.00		
Concrete Pour (Cubic Feet) 2' thick	0	9 cu ft	@ \$16.00 =		\$0.00		
Rebar	0	lin. Ft	@ \$0.30 =		\$0.00		
Concrete materials	0	cu ft	@ \$24.00 =		\$0.00		
Misc.Forming Hardware	0	sets	@ \$100.00 =		\$0.00		
<b>Step Construction</b>							
<b>Wood</b>							
Standard Step	0	1 ea	@ \$16.00 =		\$0.00		
Waterbar, wood	0	1 ea	@ \$16.00 =		\$0.00		
Interlocking Steps-Single	0	0.5 ea	@ \$16.00 =		\$0.00		
Interlocking Steps-Double	0	0.33 ea	@ \$16.00 =		\$0.00		
Full Crib Steps	0	0.2 ea	@ \$16.00 =		\$0.00		
Wood for steps	0	0 bd ft	@ \$2.20 =		\$0.00		
Rebar for steps	0	lin ft	@ \$0.30 =		\$0.00		
Cable Steps	0	1 ea	@ \$16.00 =		\$0.00		
Cable,clamps & wood for each step	0	ea	@ \$32.00 =		\$0.00		

Cellular Confinement	\$2.75	cu ft
Cable Step Unit	\$32.00	step
Puncheon Unit	\$735.00	ea 8' unit
Trail Bench	\$750.00	ea
Excavator Rental	\$25.00	hr
Dozer Rental	\$35.00	hr
Spike Camp Cost	\$750.00	wk
Cook Contract	\$4,800.00	mo
Move-in Move-out Cost	\$750.00	ea day
Helicopter Rental	\$8,000.00	hr portal to
Mule Packing Contract	\$125.00	day per mu
Van/CCV Rental	\$600.00	per month
Rigging Truck Cost	\$35.00	per hour

TRAIL: \_\_\_\_\_

CONSTRUCTION ACTIVITY	TOTALS	UNIT	PER UNIT COST	LABOR COST	MATERIAL COST	MATERIAL COST INDEX	UNIT
Cut-out Stringer Steps	0	0.75 ea	@ \$16.00 =	\$0.00			
3' x 12" wood stringer & step	0	0 bd ft	@ \$2.20 =		\$0.00		
Rock Steps Structural Framed	0	0.5 cu ft	@ \$16.00 =		\$0.00		
Rock Steps Non Structural	0	1.5 cu ft	@ \$16.00 =		\$0.00		
Mortar Rock Steps	0	0.5 cu ft	@ \$16.00 =		\$0.00		
Rock for Steps	0.0	cu yd	@ \$46.00 =		\$0.00		
Mortar for mortared steps	0	94 lb bags	@ \$8.00 =		\$0.00		
<b>Bridge Construction</b>							
Standard Design	0	0.2 lin ft	@ \$16.00 =	\$0.00			
Bridge #1 Material cost	0	ft	Based on bridge #1 cost sheet =		\$0.00		
Bridge #2 Material cost	0	ft	Based on bridge #2 cost sheet =		\$0.00		
Bridge #3 Material cost	0	ft	Based on bridge #3 cost sheet =		\$0.00		
Bridge #4 Material cost	0	ft	Based on bridge #4 cost sheet =		\$0.00		
Hand Transport Bridge Materials	0	Estimated Person Hours	@ \$16.00 =	\$0.00			
Bridge Stinger Transport <300'	0	32 hrs/set	@ \$16.00 =	\$0.00			
Rigging Truck Operation	0	4 hrs/set	@ \$35.00 =	\$0.00			
Bridge Stinger Transport >300' < 600'	0	40 hrs/set	@ \$16.00 =	\$0.00			
Rigging Truck Operation	0	6 hrs/set	@ \$35.00 =	\$0.00			
Bridge Stinger Transport >600' < 900'	0	48 hrs/set	@ \$16.00 =	\$0.00			
Rigging Truck Operation	0	8 hrs/set	@ \$35.00 =	\$0.00			
Bridge Stinger Transport >900' < 1,200'	0	64 hrs/set	@ \$16.00 =	\$0.00			
Rigging Truck Operation	0	10 hrs	@ \$35.00 =	\$0.00			
Pipe Bridge Construction	0	1 lin ft	@ \$16.00 =	\$0.00			
Pipe Bridge Materials	0	8' units	@ \$850.00 =	\$0.00			
Puncheon Construction	0	0.75 lin ft	@ \$16.00 =	\$0.00			
Puncheon Materials 5' wide	0	12' units	@ \$735.00 =	\$0.00			
<b>Safety Railings</b>							
4" x 6" Handrails Materials	0	10 lin ft	@ \$16.00 =	\$0.00			
4" x 6" Handrails Materials	0	bd ft	@ \$1.80 =	\$0.00			
Bench Construction	0	1 ea	@ \$750.00 =	\$0.00			
<b>Excavations</b>							
Excavation (Rock) soft	0	4 cu ft	@ \$16.00 =	\$0.00			
Excavation (Rock) hard	0	1 cu ft	@ \$16.00 =	\$0.00			
Excavation (Soil) soft	0	0.75 cu yd	@ \$16.00 =	\$0.00			
Excavation (Soil) hard	0	0.25 cu yd	@ \$16.00 =	\$0.00			
Export (soil) from drainage	0	20 cu ft	@ \$16.00 =	\$0.00			
Trail Excavator Rental	0	hrs	@ \$25.00 =	\$0.00			
Excavator Operator	0	hrs	@ \$25.00 =	\$0.00			
Helicopter Rental	0	hrs	@ \$8,000.00 =	\$0.00			
Mule Packing Contract	0	day	@ \$125.00 =	\$0.00			
<b>Spike Camps</b>							
If Spike Camp Put "1" in Box		2					
If No Spike Camp Put "2" in Box							
Spike Camp Move-in Move-out Cost	0.00	ea	@ \$750.00 =	\$0.00			
Spike Camp Overhead Costs	0.00	weeks	@ \$750.00 =	\$0.00			
Cook Contract	0.00	month	@ \$4,800.00 =	\$0.00			
<b>Vehicle Cost (Crew Van/CCV)</b>							
Vehicle Cost (Crew Van/CCV)	0	month	@ \$600.00 =	\$0.00			
<b>Trail Crew Management Information</b>							
Crew Size (number of workers)	10						
Work Day Hours ( 8 or 10 hour days)	8						
Average Daily Hiking Time on Project							
Display in increments of 15 minutes at .25 hours (ex .25, .50, .75, 1.00, 1.25, 1.50)	0.50						
<b>Administrative Overhead Percentage 12%</b>							
<b>TOTAL PROJECT COST</b>						<b>\$0.00</b>	

0

**BRIDGE # 1 MATERIALS WORK SHEET**

TRAIL: 0

LOCATION: \_\_\_\_\_

BRIDGE SPAN: 0 Feet

CALIFORNIA STATE PARKS  
2006 TRAIL BRIDGE CONSTRUCTION WORKSHEET

#	Item	EA Board Ft	Total Board ft	Total Lin ft	Unit	Unit Cost	Total Cost
0	gluelam pt stringers w/hardware	-	-	0	Lin Ft	\$55.00	\$0.00
0	3" x 12" x 64" rwd decking	16	0	0	Bd Ft	\$2.20	\$0.00
0	12" x 15" x 12' rwd mud sill	180	0	0	Bd Ft	\$2.40	\$0.00
0	6" x 8" x 12' rwd post sills	72	0	0	Bd Ft	\$2.20	\$0.00
0	4"x 6" x 6' rwd surfaced posts	12	0	0	Bd Ft	\$1.80	\$0.00
0	4" x 6" x 10' rwd surfaced rails	20	0	0	Bd Ft	\$1.80	\$0.00
0	4" x 6" x 12' rwd surfaced rails	24	0	0	Bd Ft	\$1.80	\$0.00
	misc hardware / fasteners	-	-	-	Package		\$0.00
						SUB TOTAL	\$0.00
						TAX	\$0.00
						TOTAL	\$0.00

ESTIMATED 2006 TRAIL CONSTRUCTION COSTS

ESTIMATED 2006 TRAIL CONSTRUCTION COSTS

Category	Cost
<b>Restoration</b>	
Vegetation restoration	\$1.00 per square foot
<b>Signs</b>	
Highway informational sign	\$1,500.00 per sign
Highway warning sign	\$2,000.00 per sign
Permitted use sign	\$1,500.00 per sign
Etiquette sign	\$1,500.00 per sign
"Crossing private lands" sign	\$2,000.00 per sign
Boundary sign	\$750.00 per sign
Temporary connector sign	\$750.00 per sign
Entrance sign	\$2,000.00 per sign
Trailhead information sign and kiosk	\$3,500.00 per sign
Reassurance marker	\$1,000.00 per sign
Direction change/juncture indicator	\$750.00 per sign
Interpretive sign	\$2,000.00 per sign
Wayside exhibit	\$2,500.00 per sign
Destination sign	\$750.00 per sign
Adopter sign	\$1,500.00 per sign
<b>Landscaping</b>	
Landscaping	\$80.00 per linear foot
Temporary irrigation	\$45.00 per linear foot
Permanent irrigation	\$80.00 per linear foot
<b>Parking Lot</b>	
Parking lot construction (pervious concrete)	\$9.50 per square feet
Guardrail	\$50.00 per linear foot
<b>Support Structure</b>	
Kiosk	\$3,500.00 per kiosk
Plumbed restroom	\$75,000.00
<b>Additional Trail Amenity</b>	
Drinking fountain	\$2,000.00 each
Equestrian fencing	\$15.00 per linear foot
Horse tie-up	\$120.00 each
Hand pump	\$500.00 each
Trash receptacle	\$500.00 each
Bench	\$300.00 each
Street crossing solar-powered flashing beacon	\$4,000.00 each



**APPENDIX F  
RECREATIONAL FUNDING**

Many funding opportunities for development of trails exist. Each funding mechanism has its own set of requirements and specific uses. Seven potential sources of recreational funding are identified in Table F-1, *Recreational Funding Sources*.<sup>1</sup>

**TABLE F-1  
RECREATIONAL FUNDING SOURCES**

Funds	Purpose	Department Contact
Habitat Conservation Fund (HCF)	Acquire, enhance, or restore specified types of lands for wildlife or open space.	Charlie Williard OGALS (916) 651-8597 cwill@parks.ca.gov  Warren Westrup Acquisition & Real Property Services (916) 653-9946 wwest@parks.ca.gov  Luan Aubin (916) 651-8573 laubi@parks.ca.gov  Sandy Berry (916) 651-7738 sberr@parks.ca.gov
National Historic Preservation Fund	Preserve properties that are significant in American history, architecture, archaeology, and culture.	Gene Itogawa Office of Historic Preservation (916) 653-8936 gitog@parks.ca.gov
Off-Highway Vehicle Fund	Plan, acquire, develop, construct, maintain, administrate, operate, and conserve and enforce lands in the system.	Don Fuller OHMVR (916) 324-1569 dfull@parks.ca.gov
Recreational Trails Program (RTP)	Provide funds for recreational trails and trail-related projects.	Doug Wilber Trails Section (916) 651-6916 dwilb@parks.ca.gov  Don Fuller OHMVR (916)324-1569 dfull@parks.ca.gov

**TABLE F-1  
(Continue)  
RECREATIONAL FUNDING SOURCES**

Funds	Purpose	Department Contact
Environmental Enhancement and Mitigation Program (EEMP)	Mitigate the environmental impacts of modified or new public transportation facilities.	Doug Wilber Trails Section (916) 651-6916 dwilb@parks.ca.gov
Transportation Enhancement Activities for the 21st Century (TEA-21)	Enhance transportation (e.g., facilities for pedestrians and bicycles, acquisition of scenic easements, and archaeological planning and research).	Doug Wilber Trails Section (916) 651-6916 dwilb@parks.ca.gov
National Recreation Trail Fund Act	The California Department of Parks and Recreation administers the federally funded National Recreation Trail Fund Act (NRTFA) grant program. NRTFA funds recreational trails acquisition and development projects. Roughly \$2.2 million is available annually with some matching required.	Luan Aubin (916) 651-8573 laubin@parks.ca.gov  Sandy Berry (916) 651-7738 sberr@parks.ca.gov
Land and Water Conservation Fund	States, cities, counties, and districts authorized to acquire, develop, operate, and maintain park and recreation areas. \$7.7 million for California, 60 percent allotted to Southern California (50 percent - reimbursement)	State Department of Parks and Recreation Don Shapiro (916) 651-8575 dshap@parks.ca.gov  Barbara Baker (916) 651-7743 bbaker@parks.ca.gov  Charlie Williard OGALS (916) 651-8597 cwill@parks.ca.gov
Rivers, Trails and Conservation Assistance (RTCA) Program	Corridor conservation plans: statewide rivers or trails assistance	National Park Service Southern California Field Office 570 West Avenue 26, Suite 175 Los Angeles, CA 90065 Phone (323) 441-2117/9307 Fax (323) 226-9235

<sup>1</sup> California State Parks, Planning Division. May 2002. "Chasing State and Federal Funding." (Technical Assistance series.) Sacramento, CA. Available at: <http://www.parks.ca.gov/pages/795/files/chasing%20state%20and%20federal%20funding.pdf>

APPENDIX G  
SAMPLE TRAIL EASEMENT

Chapter 21

21.11: Sample Trail Easement to Land Trust

KARIN MARCHETTI PONTE, LAND CONSERVATION LEGAL SERVICES

We, \_\_\_\_\_ and \_\_\_\_\_, of Town of \_\_\_\_\_, State of \_\_\_\_\_, (hereinafter referred to as the "Grantors," which word is intended to include jointly and severally, unless the context clearly indicates otherwise, the above-named Grantors, their personal representatives, heirs and assigns, and any successors in interest to the subject premises, and their respective personal representatives, successors, heirs and assigns, ),

**GRANT** as a gift, to LAND TRUST, a non-profit conservation organization existing under the laws of the State of \_\_\_\_\_, with a mailing address of \_\_\_\_\_ (hereinafter referred to as the "HOLDER," which word shall, unless the context clearly indicates otherwise, include the Holder's successors and assigns),

with **QUITCLAIM COVENANT**, in perpetuity, a **Trail Easement** pursuant to the Maine Uniform Conservation Easement Act at 33 M.R.S.A. Section 476 et seq., and Sections 170(h), 2031(c), 2522, and 2055 of the Internal Revenue Code, over our land on \_\_\_\_\_ Island, Town of \_\_\_\_\_, County, Maine, described in a deed to \_\_\_\_\_ from \_\_\_\_\_, dated \_\_\_\_\_, and recorded at the \_\_\_\_\_ County Registry of Deeds at Book \_\_\_\_\_, Page \_\_\_\_\_, over the trail or trails, being \_\_\_\_\_ feet in width, [[and over the beach that is accessed by said trails]] depicted in Exhibit B, which trails are contiguous with [[other trails on abutting parcels]] [[public roads]] [[other trail easements]] [[other traditional public access areas]] [[land owned by or dedicated to public use]] [[a public beach]]. This grant is made exclusively for conservation purposes, to wit: to provide outdoor recreational opportunities and education for the residents and visitors to \_\_\_\_\_ Island, in particular along a traditional contiguous trail network [[and in particular to provide access to \_\_\_\_\_,]] all in accordance with the following provisions:

**TRAIL EASEMENT:** Grantors, their heirs and assigns, agree to refrain from taking any action to prohibit or discourage or to exact a fee for pedestrian or cross country ski access over the trail easement established hereby. This easement should not be construed to permit mechanized or motorized equipment or vehicles of any nature on the Trail Easement without the express permission of Grantors, except for trail work by Holder and its agents or in emergency circumstances. Grantors and Holder have the right to require that public use is conducted in a manner that does not unreasonably disturb plant or wildlife habitat or the quiet use and enjoyment of nearby private property not subject to this Trail Easement. Grantors have the right to use the Trail Easement and to permit more intensive uses of the Trail Easement, such as motorized or bicycle access, provided that such use does not unreasonably interfere with the pedestrian uses granted hereby, and provided that more than a de minimis use of the Trail Easement for commercial outdoor recreation is prohibited, in accordance with Internal Revenue Code § 2031(c). Grantors and Holder may agree in writing to relocate trails as necessary and convenient over time to preserve the accessibility or contiguity of trail networks on \_\_\_\_\_ Island and other publicly accessible areas.

[[**Optional:** Grantors and Holder have the right to jointly agree to limit, restrict or prohibit public use of the all or any part of the Trail Easement or designated alternative locations, temporarily to assure safety or for maintenance purposes, and indefinitely as necessary or appropriate to achieve the purposes of this grant and to preserve other important conservation values of the Protected Property.]]

Grantors and Holder, and their respective heirs, successors, and assigns, claim all of the rights and immunities against liability for injury to the public to the fullest extent of the law under Title 14 M.R.S.A. Section 159-A, et seq. as amended and successor provision thereof (The Maine Recreational Use Statute),

and under any other applicable provision of law and equity. [[Nevertheless, Holder will secure, maintain and provide Grantors with evidence of general liability insurance covering the trail on the Protected Property, and will name Grantors, as owners of the Protected Property, as co-insured.]]

**HOLDER'S RIGHTS:** Holder, its authorized representatives, successors, or assigns, are granted the right to enter the land of Grantors described above and the trails [[and beach]] thereon, at any reasonable time and in any reasonable manner that is consistent with the conservation purposes hereof, including the right to enter over any rights-of-way pertaining to Grantors land, after making reasonable efforts to notify residents of said premises, for the following purposes:

1. \_\_\_\_\_ to monument, lay out, establish, maintain or (as limited above) to relocate a pedestrian trail no greater than [[ \_\_\_\_\_ ( \_\_\_\_\_ )]] feet in width, contiguous with trails on abutting properties now or hereafter established, including the right to make improvements to trails such as timber steps, boardwalks, railings, and bridges, barriers to discourage use by motorized vehicles, cairns, small signs, alterations necessary to prevent erosion, and to selective cut, prune and remove leaners and blowdowns to preserve safety and to provide scenic views. Holder has no obligation to exercise this right, and Grantors have a coextensive right to undertake these activities. This right may be delegated or assigned to another entity upon prior written notice to Grantors, their heirs and assigns.
2. \_\_\_\_\_ to inspect the Protected Property for violations of the terms of this Trail Easement, and to enforce the same by actions at law or in equity.

Holder is also granted the right to assign this Trail Easement, but only to an entity that as a condition of transfer agrees to uphold the conservation purposes of this grant, and satisfies the requirements of Section 170(h)(3) of the Internal Revenue Code, (or successor provisions thereof) and the requirements of Section 476(2) of Title 33 of the Maine Revised Statutes Annotated, as amended (or successor provisions thereof), and the right to its proportional share, as calculated in accordance with Federal Treasury Regulation 1.170-A-14(g)(6)(2), of the proceeds of any sale or taking of the premises underlying this Trail Easement, should this Trail Easement be extinguished, which may be accomplished only by court order.

**IN WITNESS WHEREOF**, \_\_\_\_\_ [[and \_\_\_\_\_, their spouses respectively, joining in this conveyance as Grantors and releasing all rights by descent or otherwise,]] have hereunto set their hands and seals this \_\_\_\_\_ day of \_\_\_\_\_, in the year \_\_\_\_\_.

Signed, sealed and delivered  
in the presence of:

\_\_\_\_\_  
\_\_\_\_\_

ACKNOWLEDGEMENT

HOLDER ACCEPTANCE & ACKNOWLEDGEMENT

ATTACHED EXHIBITS

**NOTE:** This model document is provided for the purpose of illustration and education and does not represent the variety of protection options that can be accomplished with Conservation Easements or Trail Easements.

## APPENDIX H CONSERVATION EASEMENT TAX INFORMATION

The information below is general information regarding donations and tax deductions associated with trail and conservation easements. However, a tax professional should always be contacted by the individual or entity seeking a tax deduction on a case-by-case basis. The information below in no way states a trail or conservation easement will be tax deductible.

California Revenue and Taxation Code Sections 421–430.5 address types of conservation easement tax benefits available in California.<sup>1</sup> The different easement types recognized by California are defined in California Government Code, Section 27255,<sup>2</sup> which describes the purpose of conservation easements as to “retain land predominantly in its natural, scenic, historical, agricultural, forested, or open-space condition.” Conservation easements are further defined in Section 815.1 of the Civil Code, and open space easements are also defined in Section 51075 of the Civil Code.<sup>3</sup> An agricultural conservation easement is defined in Section 10211 of the Public Resources Code,<sup>4</sup> and grant of an open space easement is discussed in Government Code 51051.<sup>5,6</sup>

Land donations by private owners offer the possibility for a state or federal tax incentive or write-off. The Internal Revenue Service (IRS) treats gifts of conservation easements in the same manner it treats other gifts of land to qualified recipients; the present value of the charitable (easement) gift is deducted from income.<sup>7</sup> The terms of federal taxes are covered under the IRS Internal Revenue Code (IRC) §170(h),<sup>8</sup> which sets forth the requirements that a conservation easement must meet to be eligible (i.e., charitable) for federal income and estate tax deductions. In general, the IRC outlines three basic requirements that must be met for an easement to qualify for tax benefits:

1. A qualified real property interest (a conservation easement must be perpetual). For the purposes of the tax code, the term, “qualified real property interest,” means any of the following interests in real property:
  - a. The entire interest of the donor other than the qualified mineral interest,
  - b. A remainder interest, or
  - c. A restriction (granted perpetuity) on the use that may be made of the real property.
2. Granted to a qualified organization (a government organization or public charity with conservation goals)
3. Granted exclusively for conservation purposes. It must meet at least one of the following four purposes:
  - a. Provides outdoor recreational or educational use for the general public
  - b. Protects a relatively natural habitat of fish, wildlife, or plants, or a similar ecosystem
  - c. Preserves open space (including farmland and forest land) where such preservation:
    - i. Provides scenic enjoyment for the general public, or is pursuant to a clearly delineated federal, state, or local governmental conservation policy, and
    - ii. Yields a significant public benefit
  - d. Preserves a historically important land area or a certified historic structure

<sup>1</sup> *West’s Annotated California Codes*. December 2005. California Revenue and Taxation Code, Sections 421–430.5. Eagan, MN: Thomson West. Available at: <http://law.justia.us/california/codes/rtc/421-430.5.html>

<sup>2</sup> *West’s Annotated California Codes*. December 2005. California Revenue and Taxation Code, Sections 421–430.5. Eagan, MN: Thomson West. Available at: <http://law.justia.com/california/codes/index.html>

<sup>3</sup> California Department of Conservation. 1 January 1998. Division of Land Resources Program, *Williams Act Program*. Available at: [http://www.conservation.ca.gov/DLRP/lca/easement\\_exchanges/index.htm](http://www.conservation.ca.gov/DLRP/lca/easement_exchanges/index.htm)

<sup>4</sup> California Department of Conservation. 1 January 1998. Division of Land Resources Program, *Williams Act Program*. Available at: [http://www.conservation.ca.gov/DLRP/lca/easement\\_exchanges/index.htm](http://www.conservation.ca.gov/DLRP/lca/easement_exchanges/index.htm)

<sup>5</sup> *West’s Annotated California Codes*. December 2005. California Revenue and Taxation Code, Sections 421–430.5. Eagan, MN: Thomson West. Available at: <http://law.justia.com/california/codes/index.html>

<sup>6</sup> California Resources Agency. June 2003. “California Agency Conservation Easements.” In *California Environmental Information Catalog*. Sacramento, CA. Available at: <http://gis.ca.gov/catalog/BrowseRecord.epl?id=21063>

<sup>7</sup> Byers, Elizabeth, and Karin Marchetti Ponte. 2005. *The Conservation Easement Handbook*. (Second Edition.) Page 83. Washington, DC: Land Trust Alliance and Trust for Public Land.

<sup>8</sup> Department of Treasury, Internal Revenue Service. *Internal Revenue Code § 170. Charitable, etc., contributions and gifts*. 2005. Available at: [http://www.law.cornell.edu/uscode/html/uscode26/usc\\_sec\\_26\\_00000170----000-.html](http://www.law.cornell.edu/uscode/html/uscode26/usc_sec_26_00000170----000-.html)

A sample trail easement form is included in Appendix E, *Sample Trail Easement Agreement*. This form is only an example. Each form should be revised to incorporate site-specific information and then reviewed by County Counsel prior to authorization. Several categories of conservation easements are eligible for IRS tax deductions:<sup>9</sup>

1. Public recreation or education easements
  - a. Public access is required.
  - b. Property must have value to the public.
2. Significant natural habitat easements
  - a. Property must be in a relatively natural state.
  - b. Property must exhibit one of the following characteristics:
    - i. Rare, endangered, or threatened species must be present, or
    - ii. The property must contribute to the ecological viability of a park or other conservation area, or
    - iii. The property must represent a high-quality native terrestrial or aquatic ecosystem.
3. Open space for scenic enjoyment easements
  - a. The property must indeed be scenic (i.e., development would impair the scenic character of the local rural or urban landscape or would interfere with a scenic panorama from a public viewpoint), and must be easily seen by the public
  - b. Protection of the property must yield a “significant public benefit,” as evidenced by such characteristics as:
    - i. The uniqueness of the property;
    - ii. The consistency of the proposed open space with federal, state, local, or private conservation programs in the region, including a legislatively mandated program identifying specific parcels for future protection;
    - iii. The intensity of existing and foreseeable development in the vicinity, and the likelihood that development of the property would lead to degradation of the area;
    - iv. The opportunity for public use or appreciation of the restricted land;
    - v. The likelihood that the donee will acquire valuable substitute property or property rights;
    - vi. The cost to the donee in enforcing the terms of the easement; and
    - vii. The population density in the area.
4. Open space pursuant to governmental policy easements (this includes farmland and timberland)
  - a. Protection of the property is “pursuant to a clearly delineated federal, state, or local governmental conservation policy” (e.g., agricultural land preservation).
  - b. Protection of the property must yield a significant public benefit.
5. Historic value easements
  - a. A “historically important land area” must be either independently significant or deemed to contribute to a registered historic district or adjacent to and contributing to the historic or cultural integrity of a property on the National Register of Historic Places (NRHP).
  - b. A “certified historic structure” must be listed on the NRHP or certified by the Secretary of the Interior as contributing to the historic character of the registered historic district in which it is located.

<sup>9</sup> Northern California Regional Land Trust. 2002. Web site. Contact: Northern California Regional Land Trust, 167 East Third Avenue, Chico, CA 95926. Available at: <http://www.landconservation.org>



---

## APPENDIX I ACCESSIBILITY GUIDELINES

---

These accessibility guidelines are based on the *Forest Service Trail Accessibility Guidelines*.<sup>1</sup> As stated in the Trail Accessibility Guidelines “the guidelines were developed to maximize accessibility, while recognizing and protecting the unique characteristics of the natural setting of each trail.”<sup>2</sup>

Trails are not required to be accessible. These guidelines do not limit the Department of Parks and Recreation to deviate from these guidelines based on specific situations. The following four conditions are instances that allow for exceptions to the implementation of the guidelines for portions of a trail in recognition of the unique and natural settings:

- Where compliance would cause substantial harm to cultural, historic, religious, or significant natural features or characteristics.
- Where compliance would substantially change the physical or recreational setting or the trail class, designed use, or managed use of the trail or trail segment or would not be consistent with the applicable forest land and resource management plan.
- Where compliance would require construction methods or materials that are prohibited by federal, state, or local law, other than state or local law whose sole purpose is to prohibit use by persons with disabilities.
- Where compliance would not be feasible due to terrain or prevailing construction practices.

The following specifications should be followed for all new trails. Exceptions to these standards should occur for portions of a trail that fall under one of the four exceptions listed above.

- **Surface.** The trail surface shall be firm and stable. Firmness refers to the penetration of the surface that occurs when force is applied; for example, when stepped on. On the other hand, stability refers to the displacement of the surface when a turning motion is applied to the surface, such as the twisting of a foot.
- **Clear Tread Width.** Tread width refers to the path or visible trail surface perpendicular to the direction of travel. The clear tread width of the trail is the width of the useable trail tread, measured perpendicular to the direction of travel and on or parallel to the surface of the useable trail tread. The clear tread width of the trail should be a minimum of 36 inches.
- **Openings.** This specification addresses openings in trail spaces. Openings in trail surfaces shall be of a size that does not permit passage of a 0.5-inch-diameter sphere. Elongated openings shall be placed so that the long dimension is perpendicular or diagonal to the dominant direction of travel.
- **Protruding Objects.** This specification addresses those with visual impairments. Protruding objects on trails shall comply with ADAAG (Americans with Disabilities Act Accessibility Guidelines) 4.4.1 and shall have 80 inches minimum clear head room.
- **Tread Obstacles.** Examples of tread obstacles include tree roots, rocks, brush, downed trees, or branches projecting from the trail. Where tread obstacles exist, they shall not exceed 2 inches high maximum.
- **Passing Space.** This specification allows people who use wheelchairs to pass other hikers easily. Where the clear tread width of the trail is less than 60 inches, passing spaces shall be provided at intervals of 1,000 feet

---

<sup>1</sup> U.S. Forest Service. 5 May 2005. *Draft USDA Forest Service Trail Accessibility Guidelines*. Available at: <http://www.fs.fed.us/recreation/programs/accessibility/>

<sup>2</sup> U.S. Forest Service. 5 May 2005. *Draft USDA Forest Service Trail Accessibility Guidelines*. Available at: <http://www.fs.fed.us/recreation/programs/accessibility/>

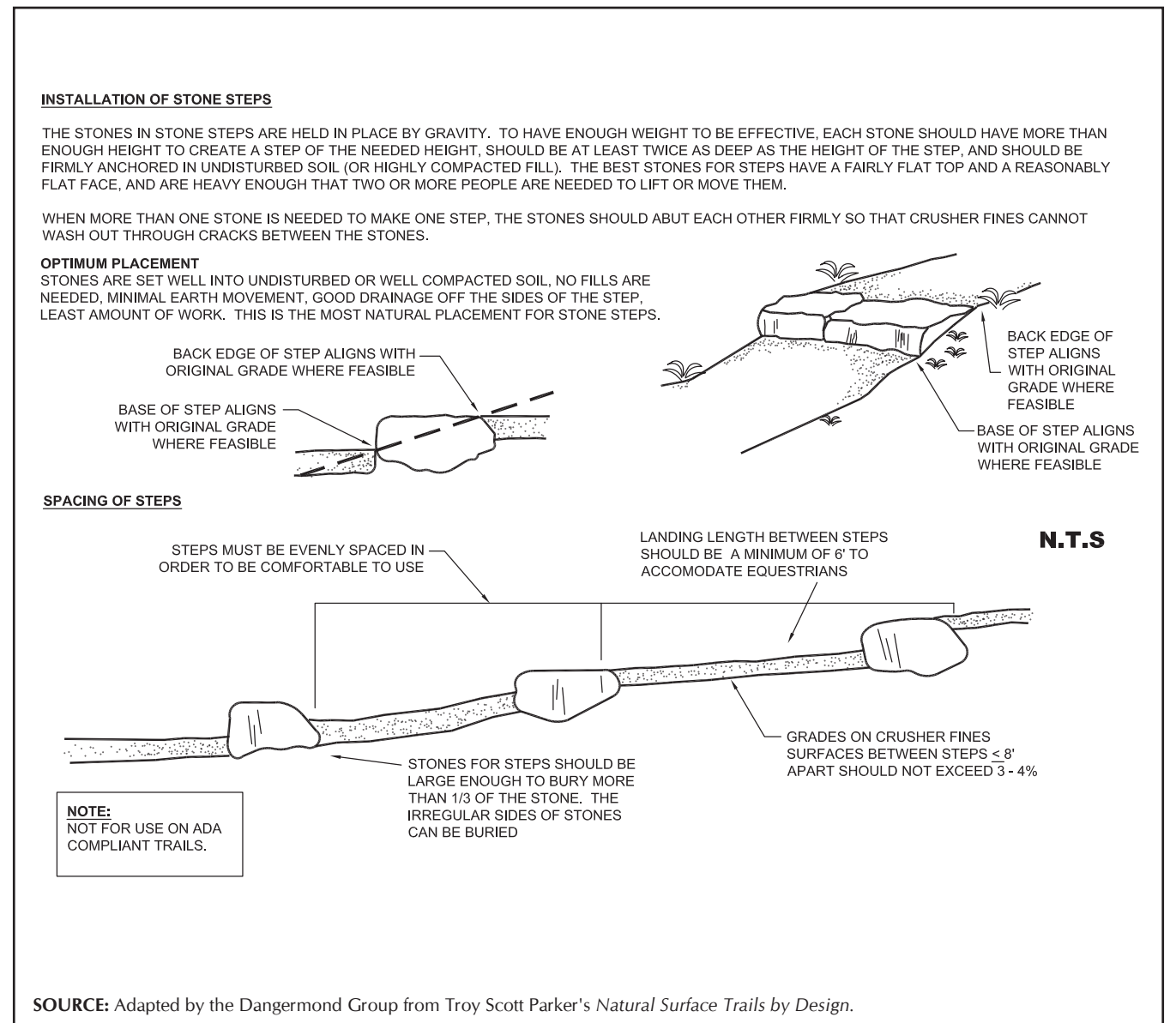
maximum. Passing spaces shall be either a 60-inch minimum by 60-inch minimum space, or an intersection of two walking surfaces that provide a T-shaped space complying with ADAAG 4.2.3, provided that the arms and stem of the T-shaped space extend at least 48 inches beyond the intersection.

- **Slopes.** This specification addresses two slopes that are crucial elements to people with mobility impairments.
  - **Outslope.** The outslope should not exceed 5 percent.
  - **Trail Grade.** The grade of the trail segments should comply with one or more of the provisions of this section. No more than 30 percent of the total trail length shall exceed a grade of 8 percent.
    - Trail grade should be 5 percent or less for any distance.
    - Trail grade should be 8 percent maximum for 200 feet maximum. Resting intervals complying with ADAAG 16.2.8 shall be provided at distances no greater than 200 feet apart.
    - Trail grade should be 10 percent maximum for 30 feet maximum. Resting intervals complying with ADAAG 16.2.8 shall be provided at distances no greater than 30 feet apart.
    - Trail grade should be 12.5 percent maximum for 10 feet maximum. Resting intervals complying with ADAAG 16.2.8 shall be provided at distances no greater than 10 feet apart.
- **Resting Intervals.** Resting intervals shall be 60 inches minimum in length, shall have a width at least as wide as the widest portion of the trail segment leading to the resting interval, and have a slope not exceeding 5 percent in any direction.
- **Edge Protection.** Where edge protection is provided along a trail, the edge protection shall have a height of 3 inches minimum.
- **Signs.** Newly constructed and altered trails and trail segments complying with ADAAG 16.2 shall be designated with a wheelchair symbol at the trailhead and at all designated access points. Signs identifying accessible trail segments shall include the total distance of the accessible segment and the location of the first point of departure from the technical provisions.

# APPENDIX J DESIGN SPECIFICATIONS

## FIGURES

- J-1 Stone Steps
- J-2 Timber Steps
- J-3 Bridge
- J-4 Puncheon
- J-5 Metal Culvert
- J-6 Underdrain
- J-7 Rock Spillway
- J-8 Rock Spillway with Culvert
- J-9 Stone Retaining Wall
- J-10 Detail of Stone Retaining Wall
- J-11 H-Beam Wall 1
- J-12 H-Beam Wall 2
- J-13 Trailhead Design
- J-14 Trail Crossing at Intersection
- J-15 Trail Crossing at Mid-block
- J-16 Culvert Undercrossing
- J-17 Automobile Parking
- J-18 Automobile and Equestrian Trailer Parking
- J-19 Loop Turnaround Parking
- J-20 Restroom with Hook-ups
- J-21 Composting Restroom
- J-22 Typical Trail Fencing
- J-23 Trail Residential Sightlines
- J-24 Drinking Fountain
- J-25 Bicycle Rack
- J-26 Hand Pump
- J-27 Hitching Post
- J-28 Timber Kissing Gate with Wheelchair Accessibility
- J-29 Chicane for Wheelchair Accessibility
- J-30 Horse-friendly Forest Road Closure Gate with Horse and Wheelchair Accessibility
- J-31 Horse Gate with Wheelchair Accessibility
- J-32 V Horse Gate with Wheelchair Accessibility
- J-33 Kiosk Level One Trailhead
- J-34 Kiosk Level Three



**Figure J-1  
Stone Steps**

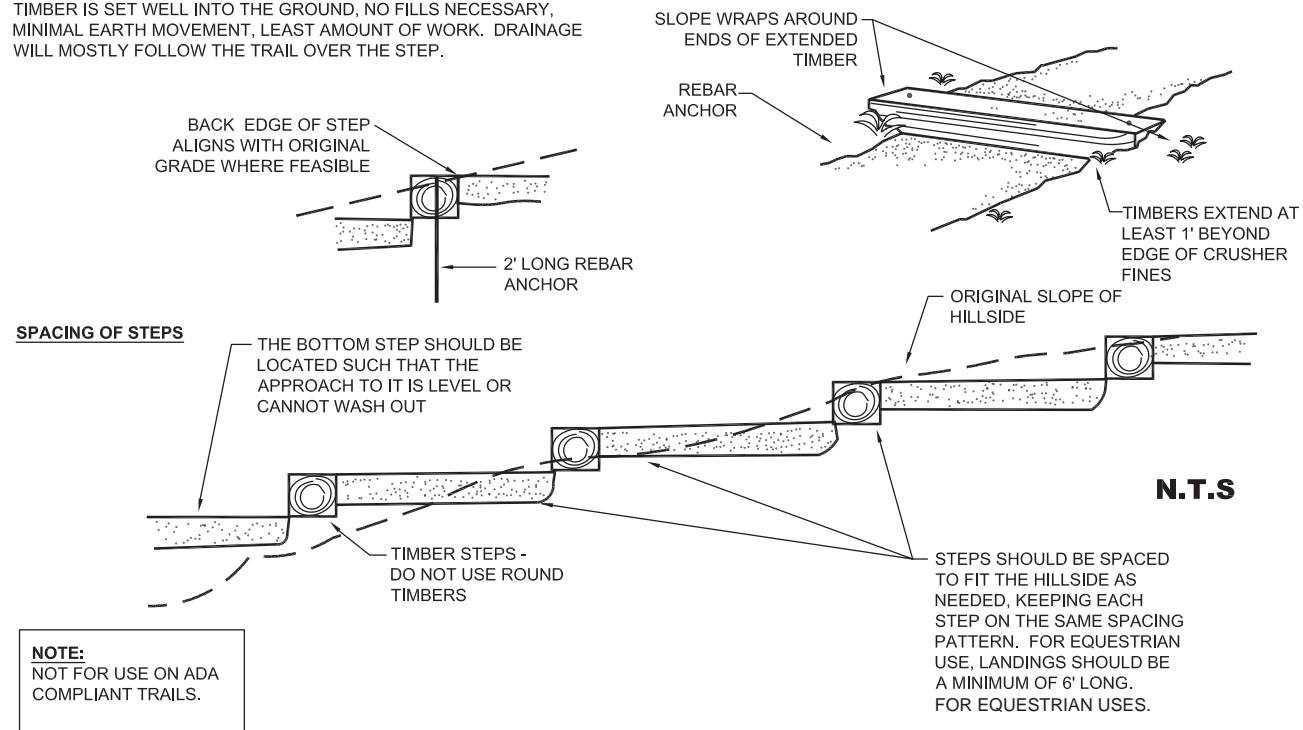
**INSTALLATION OF TIMBER STEPS**

USE PRESSURE-TREATED LANDSCAPE TIMBERS WHICH HAVE A ROUGH-SAWN FINISH. FOR AESTHETICS, AVOID PRESSURE TREATMENTS THAT PERFORATE THE WOOD WITH HUNDREDS OF SMALL SLITS. TYPICALLY, THE TIMBER USED FOR EACH STEP SHOULD BE AT LEAST 2' WIDER THAN THE TRAIL SO THAT THE TIMBER CAN FULLY RETAIN THE CRUSHER FINES ABOVE THE STEP.

SINCE TIMBER IS NOT HEAVY ENOUGH TO HOLD ITSELF IN PLACE, THEY ARE HELD IN PLACE BY 2' LONG SECTIONS OF REBAR DRIVEN STRAIGHT INTO THE GROUND, ONE AT EACH END. DRIVING THE REBAR CAN BE DIFFICULT OR IMPOSSIBLE IN ROCKY SOIL. IF THE REBAR BENDS AFTER IT IS SIGNIFICANTLY IN THE GROUND, SAW OFF THE UNDRIVEN PART RATHER THAN BEND IT OVER.

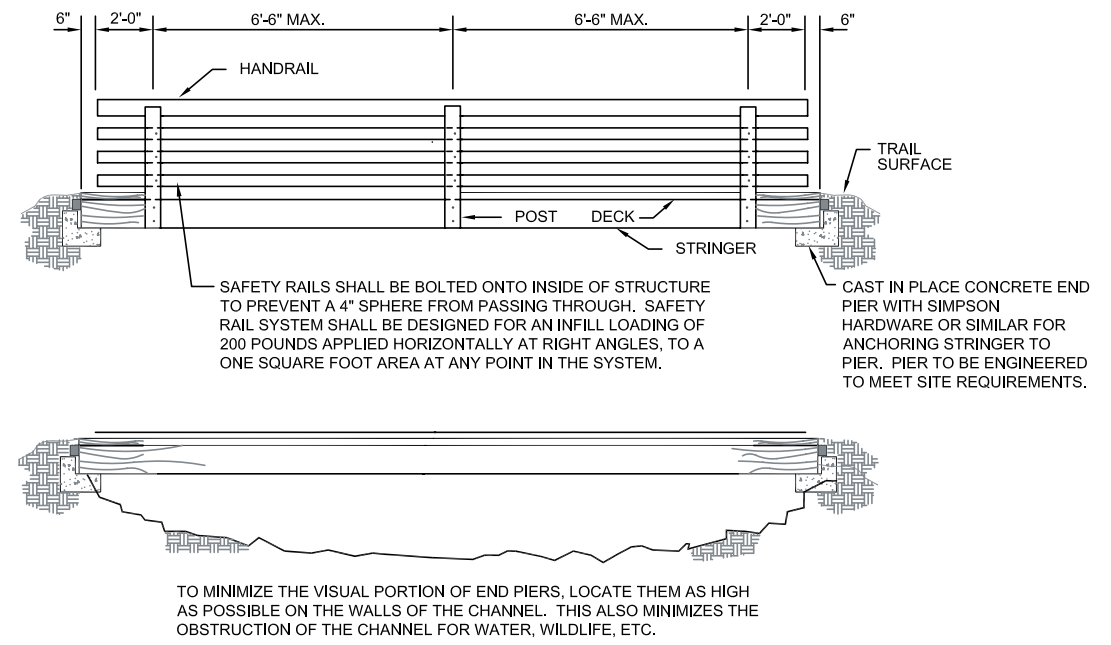
**OPTIMUM PLACEMENT**

TIMBER IS SET WELL INTO THE GROUND, NO FILLS NECESSARY, MINIMAL EARTH MOVEMENT, LEAST AMOUNT OF WORK. DRAINAGE WILL MOSTLY FOLLOW THE TRAIL OVER THE STEP.

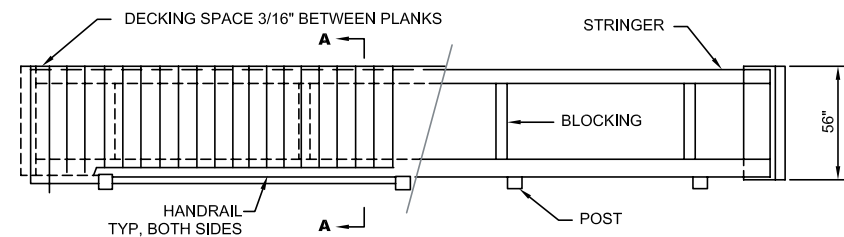


SOURCE: Adapted by the Dangermond Group from Troy Scott Parker's *Natural Surface Trails by Design*.

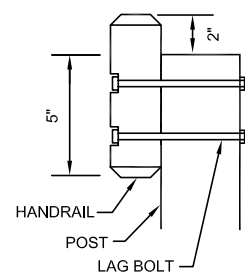
**Figure J-2  
Timber Steps**



**ELEVATIONS**



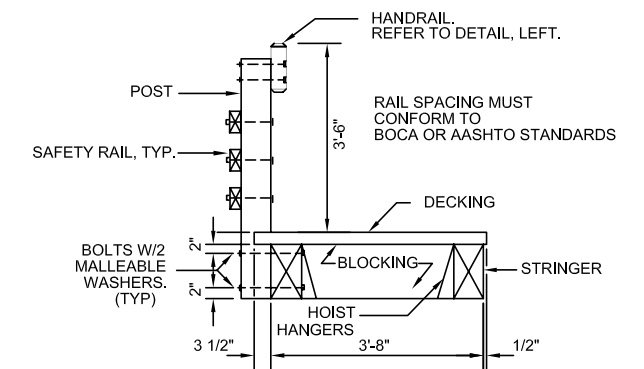
**PLAN**



HANDRAIL TO BE ATTACHED TO INSIDE OF POSTS. ELEVATE TOP OF RAIL 2" ABOVE TOP OF POST W/LAG BOLTS W/WASHER. COUNTER SINK BOLT HEADS.

2"x6" WEATHER RESISTANT HARDWOOD (I.E. CEDAR) S4S (SURFACED ON 4 SIDES) W/WEDGES EASED TO A RADIUS OF 1/8". THE RAIL SHALL BE SANDED SMOOTH & COATED W/A MINIMUM OF 2 COATS OF LINSEED OIL.

**HANDRAIL DETAIL**



**SECTION A-A**

**NOTE:** RAILS SHOULD BE SPACED TO PREVENT A 4" SPHERE FROM PASSING BETWEEN THE RAILS.

**\*\*IMPORTANT NOTE\*\***

THIS DRAWING IS CONCEPTUAL ONLY CONSULT WITH ENGINEERS FOR SPECIFICATIONS.  
PLANS OF SUCH A DISTANCE MUST BE APPROVED BY LOS ANGELES COUNTY BUILDING AND SAFETY

SOURCE: Adapted by the Dangermond Group from Troy Scott Parker's *Natural Surface Trails by Design*.

**Figure J-3  
Bridge**



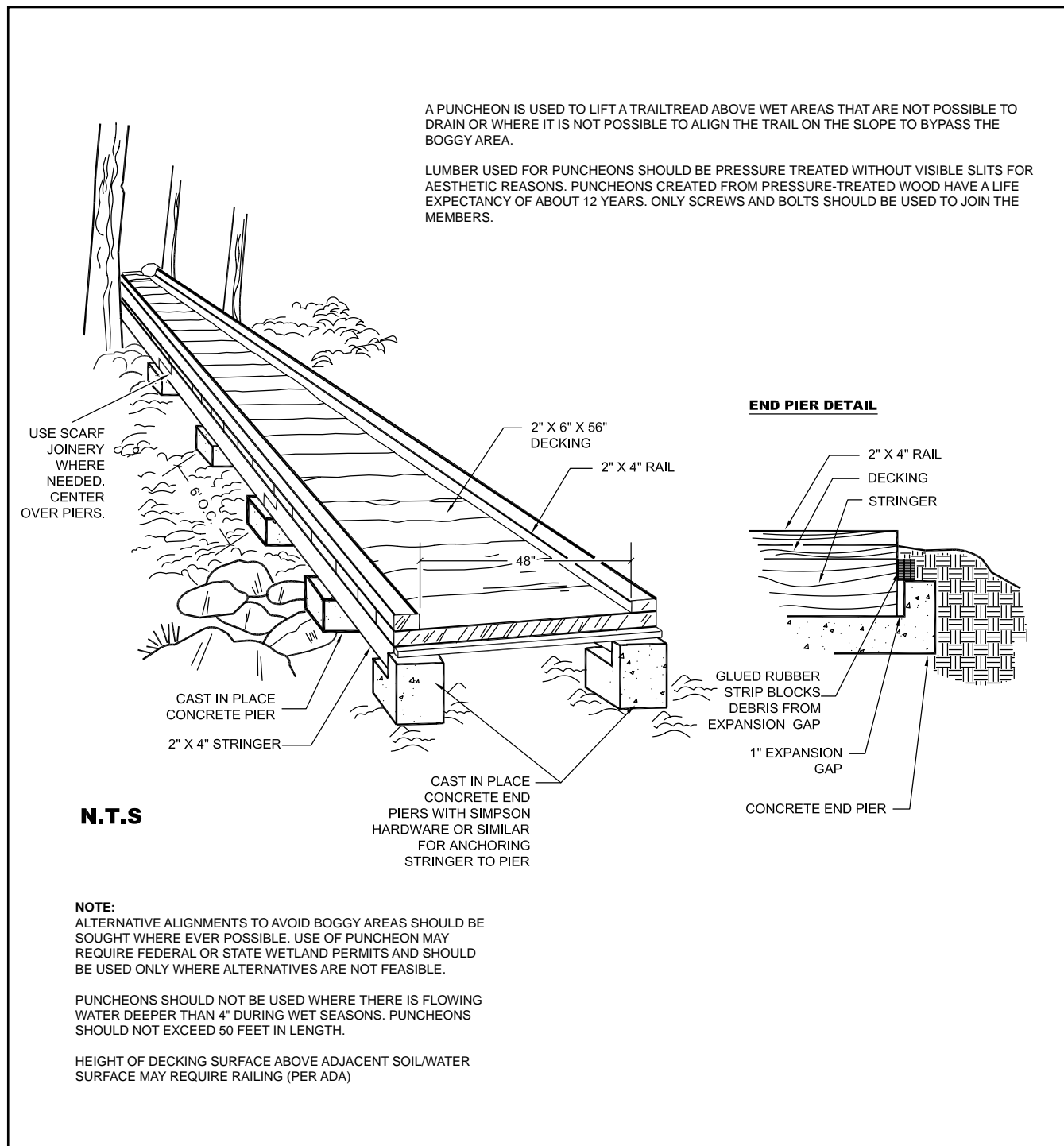


Figure J-4  
Puncheon

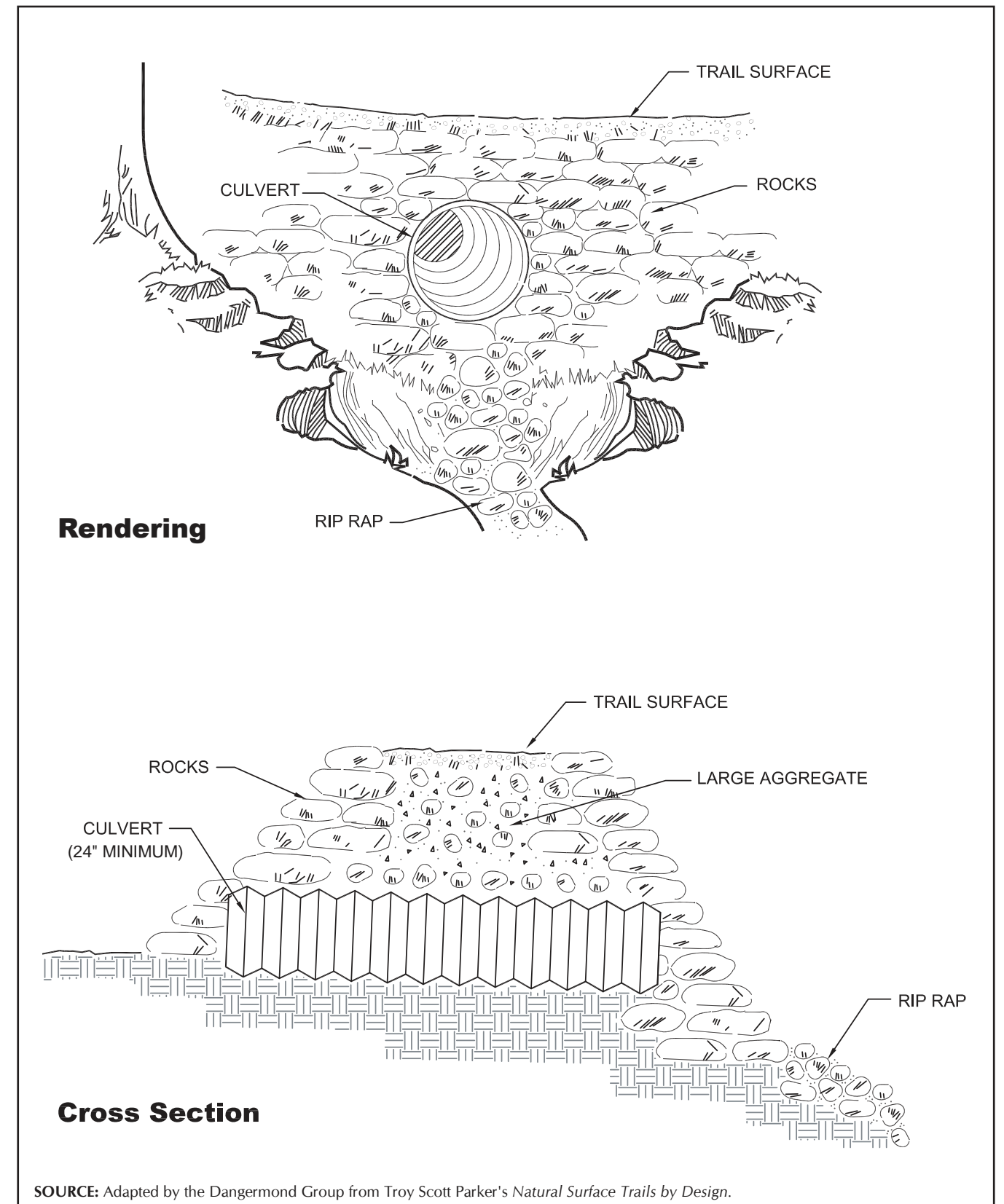
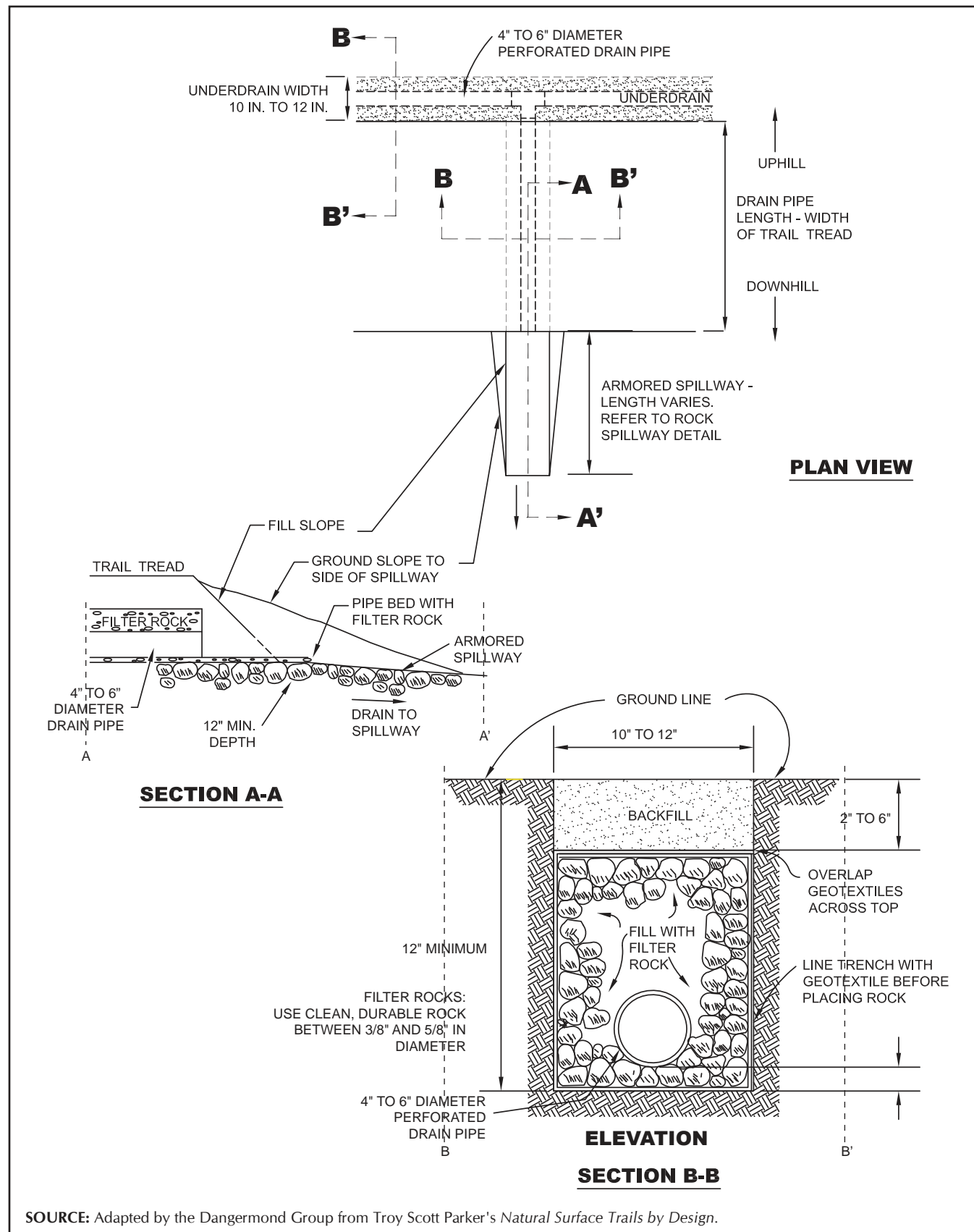
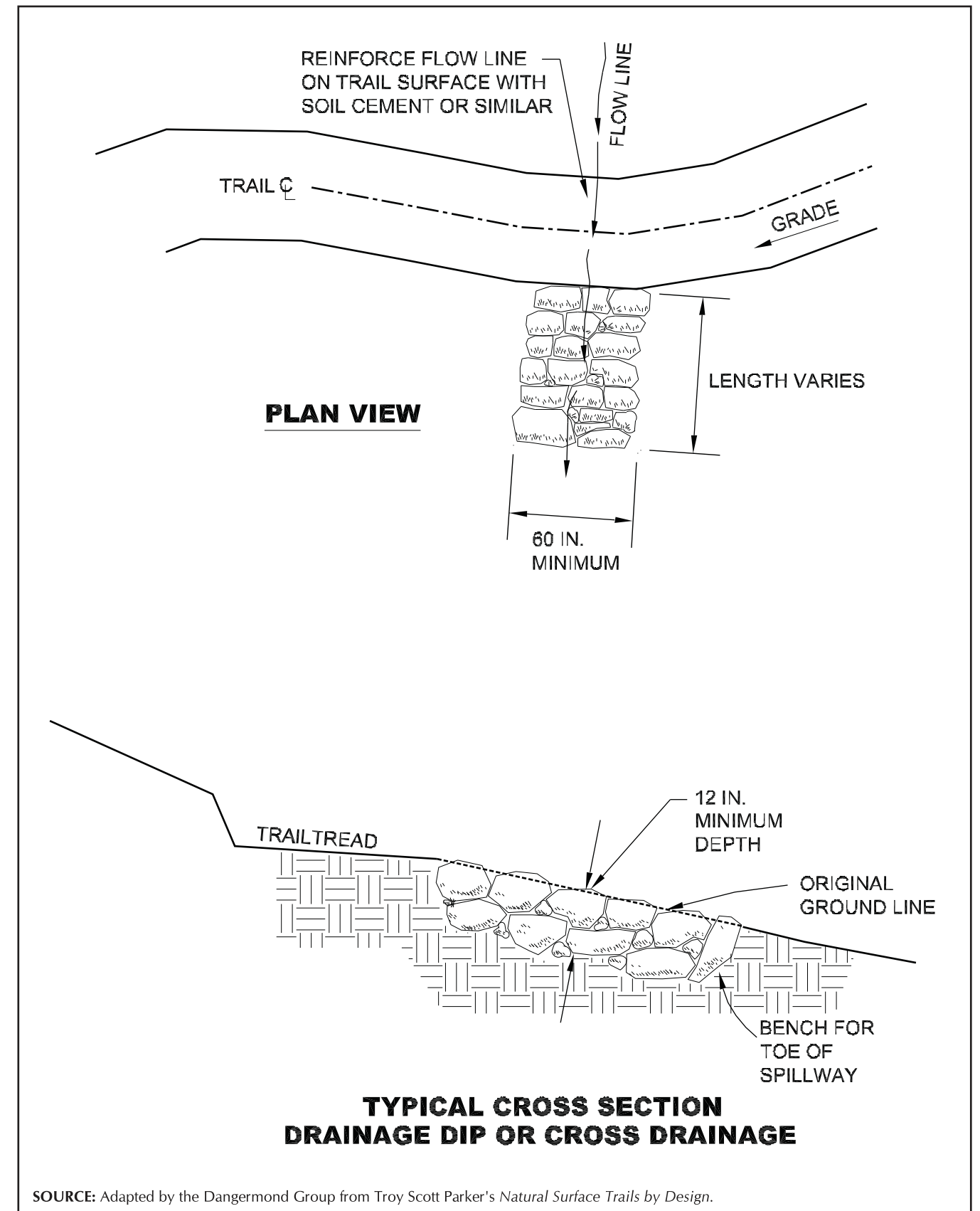


Figure J-5  
Metal Culvert



**Figure J-6**  
**Underdrain**



**Figure J-7**  
**Rock Spillway**

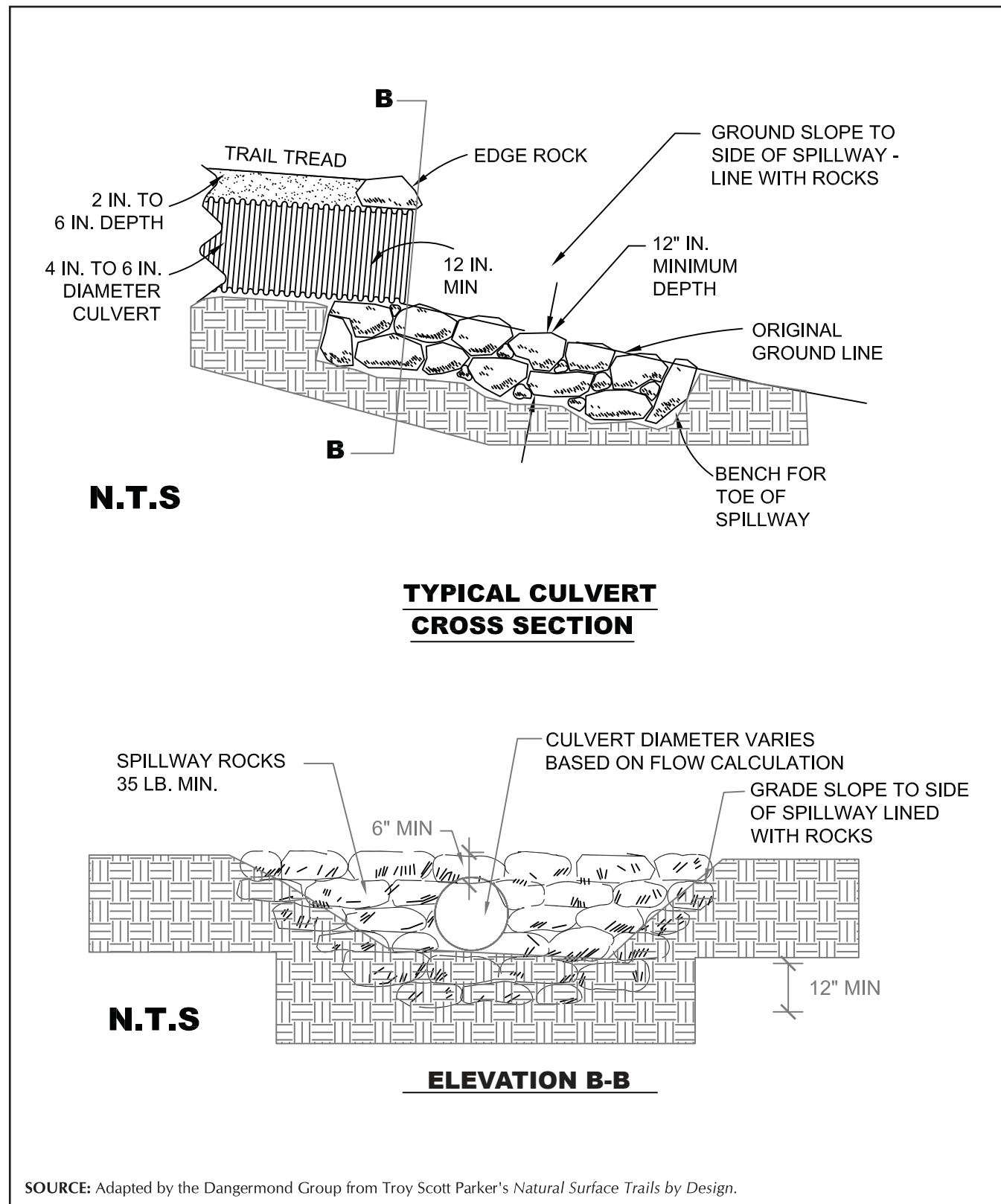


Figure J-8  
Rock Spillway with Culvert

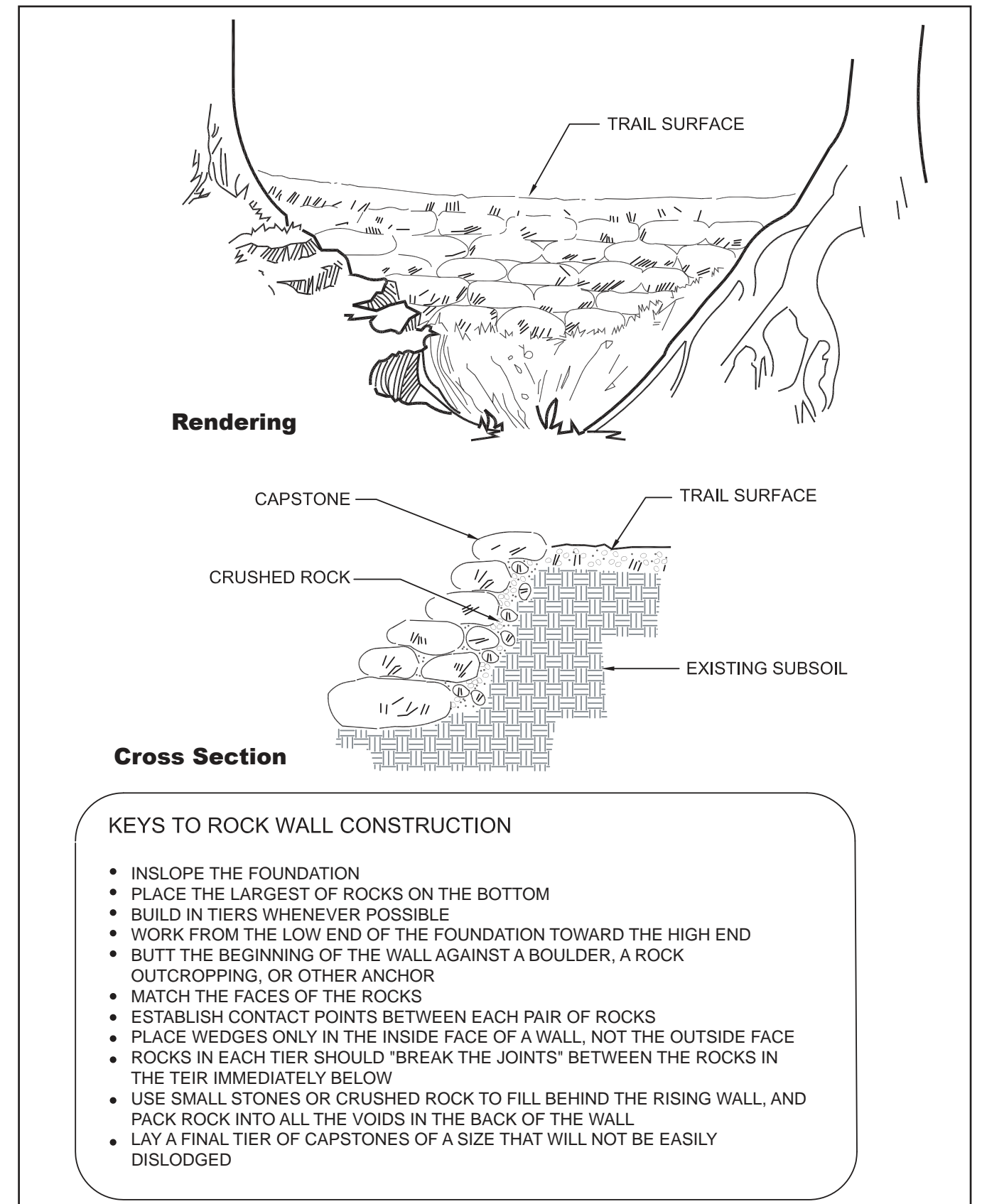
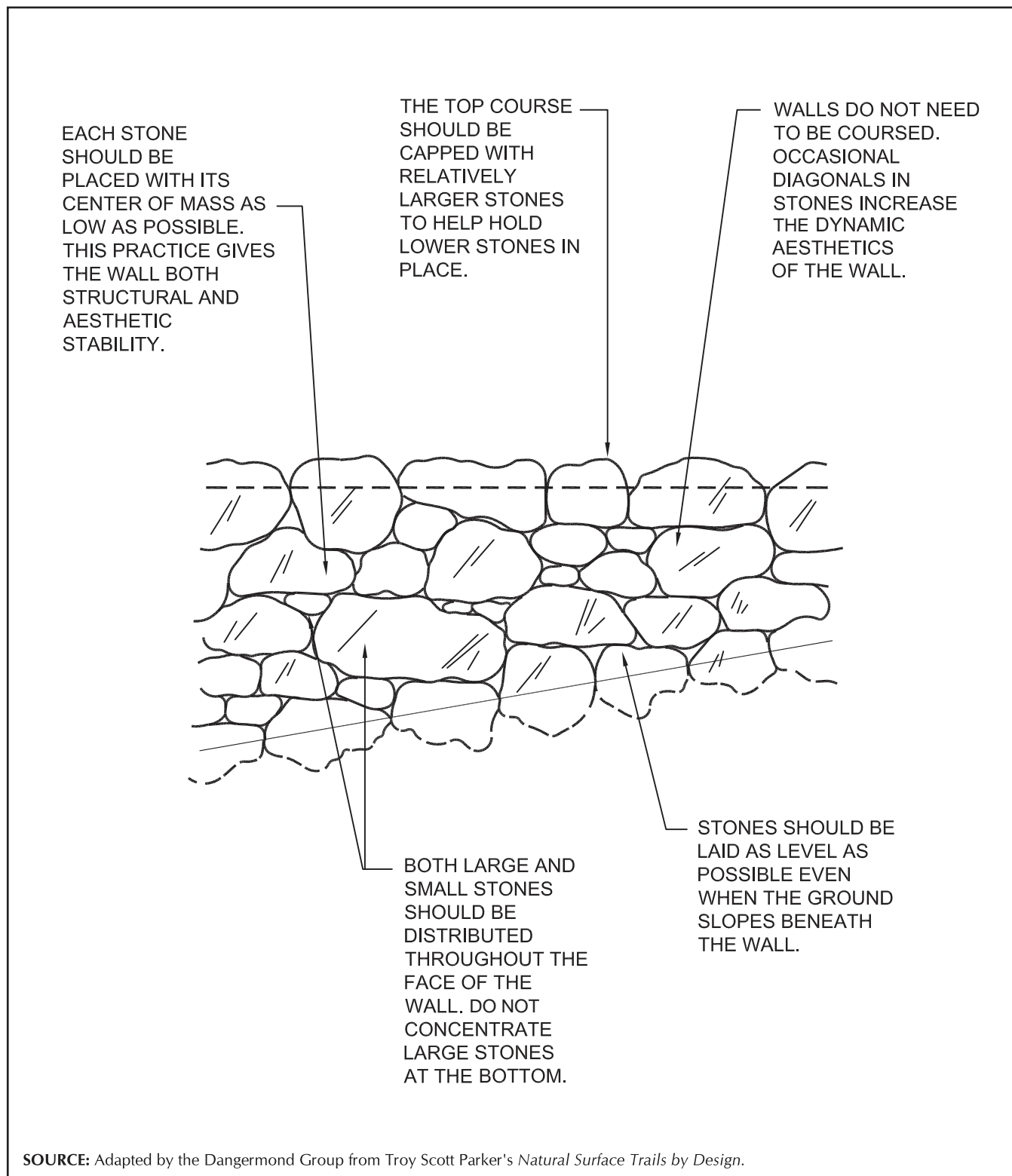
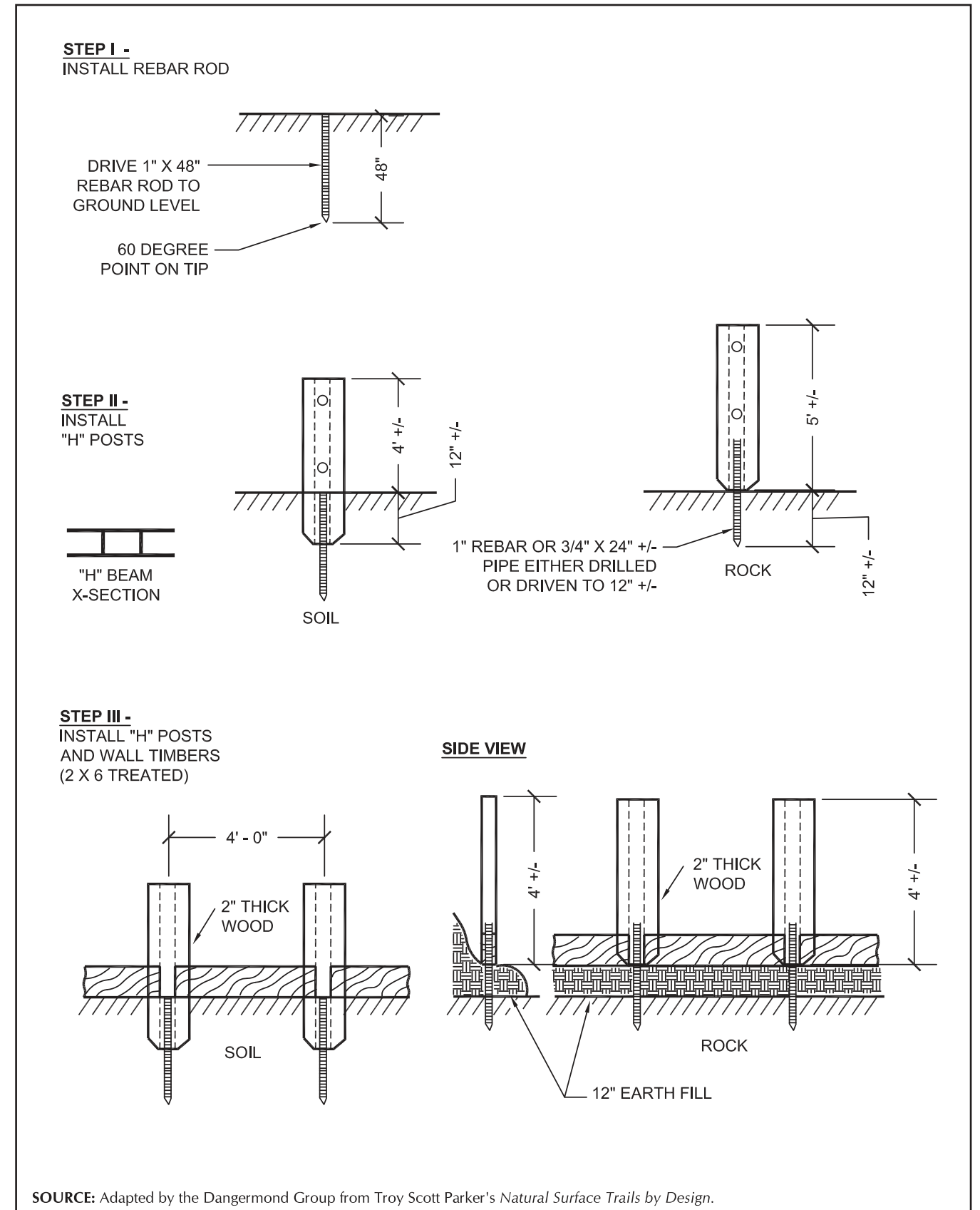


Figure J-9  
Stone Retaining Wall



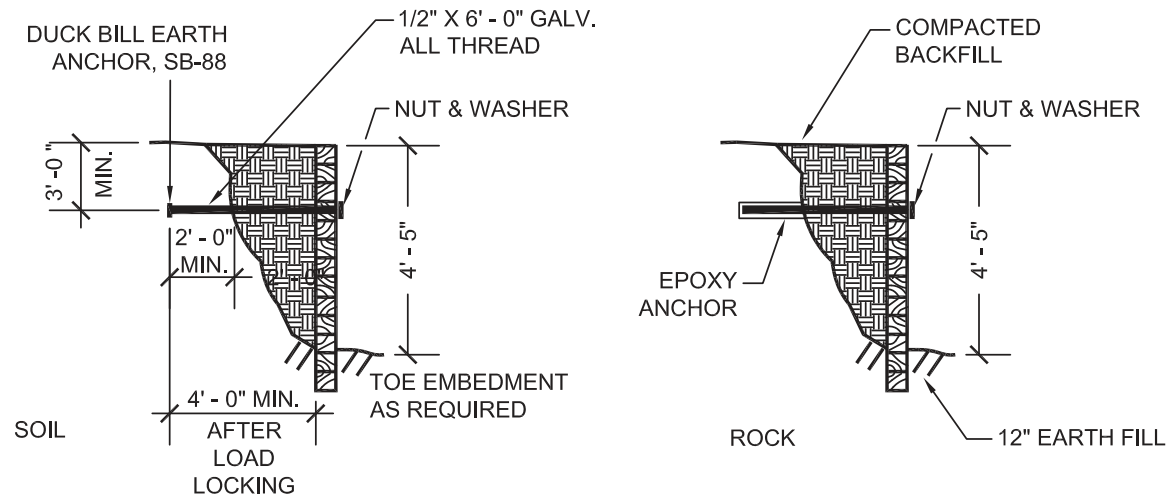


**Figure J-10**  
Detail of Stone Retaining Wall

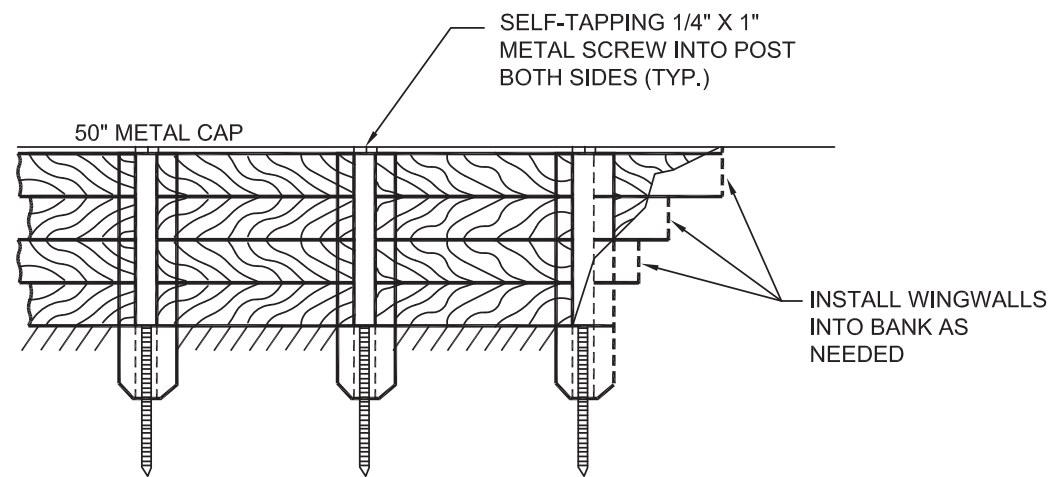


**Figure J-11**  
H-Beam Wall 1

**STEP IV -  
INSTALL ANCHORS  
AND BACKFILL**



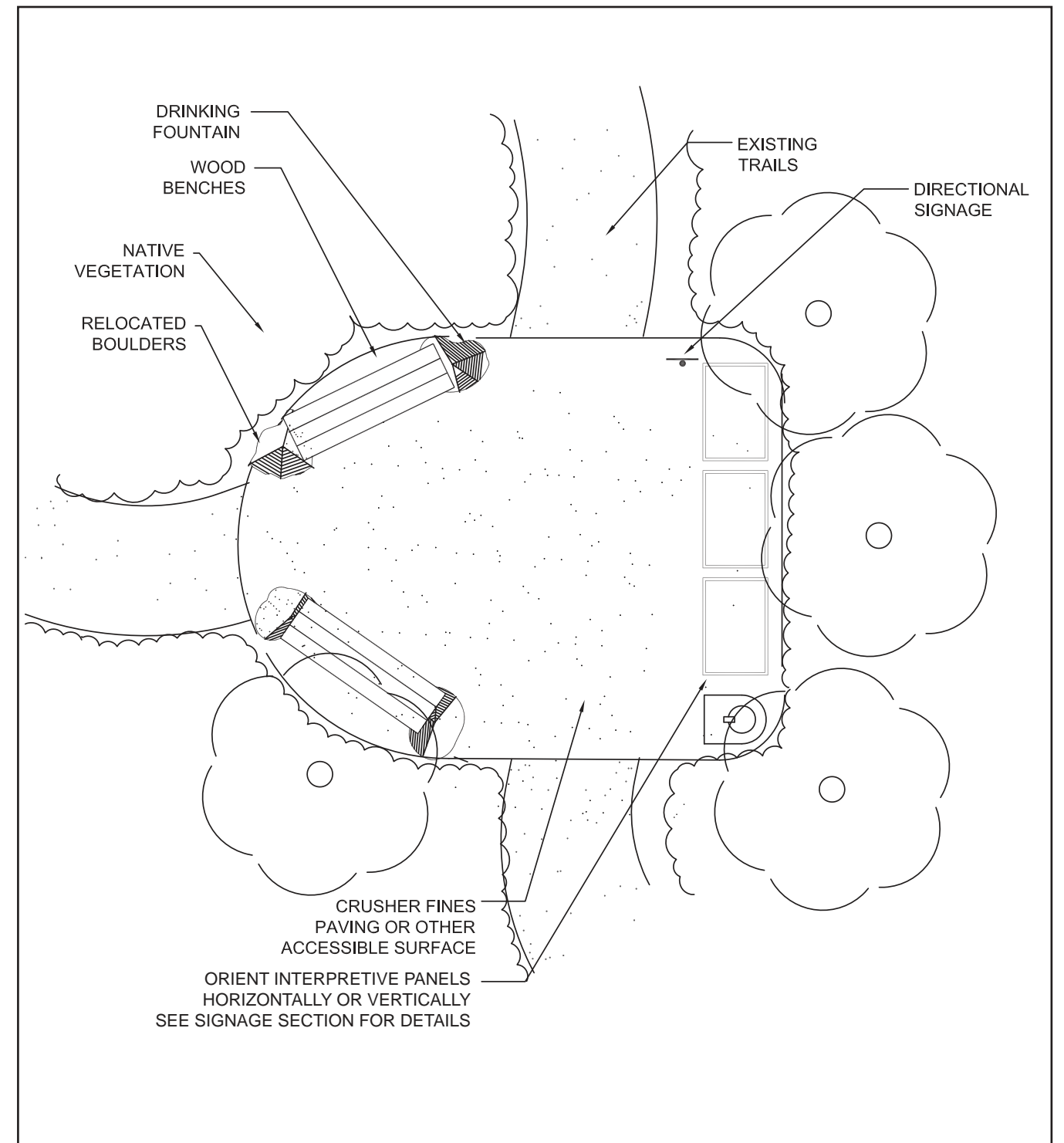
**STEP V -  
INSTALL CAPS**



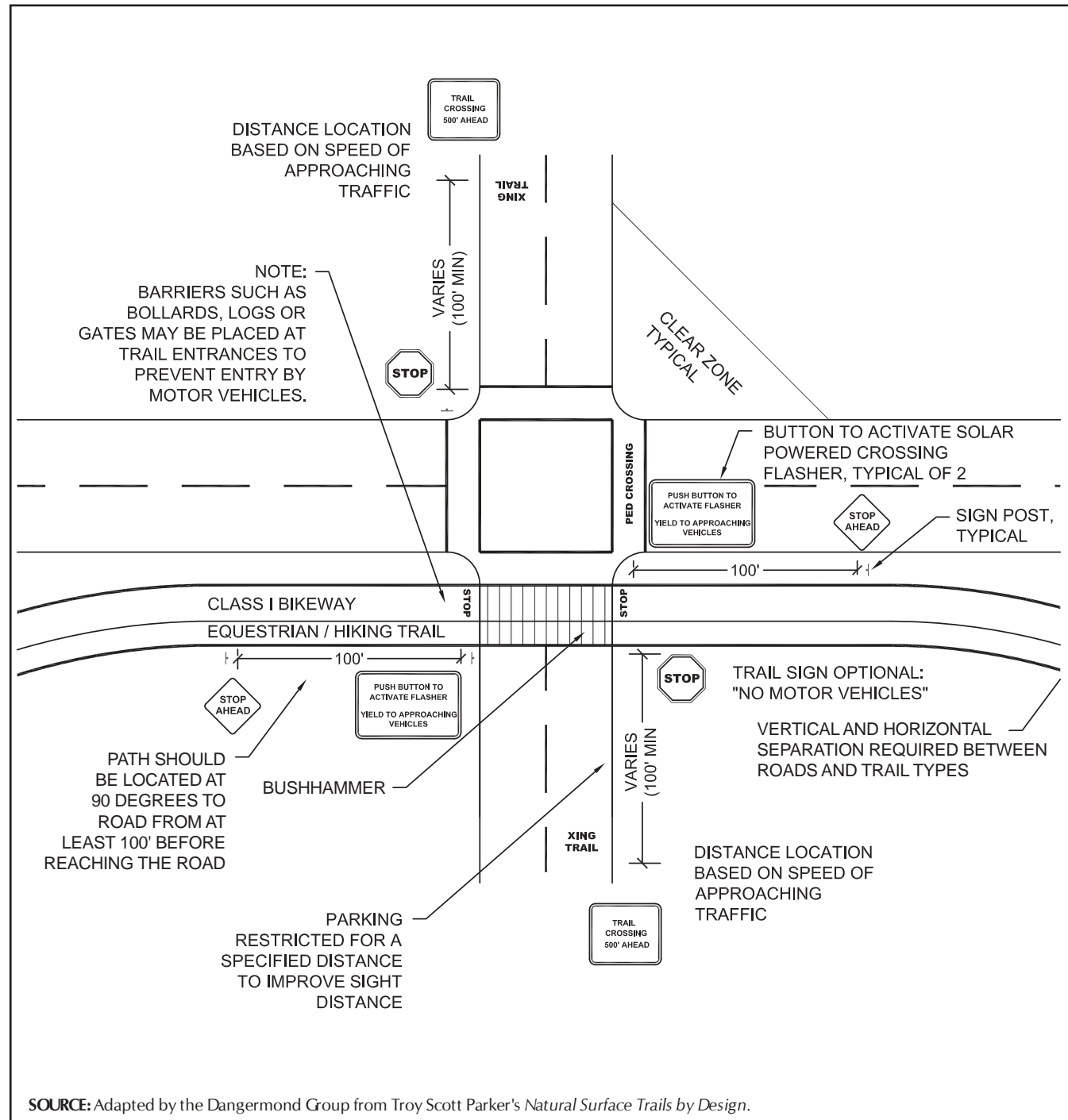
\*HEIGHT OF RETAINING WALL SHOULD NOT EXCEED 3'-0"  
WITHOUT ENGINEERING, PER BUILDING & SAFETY.

SOURCE: Adapted by the Dangermond Group from Troy Scott Parker's *Natural Surface Trails by Design*.

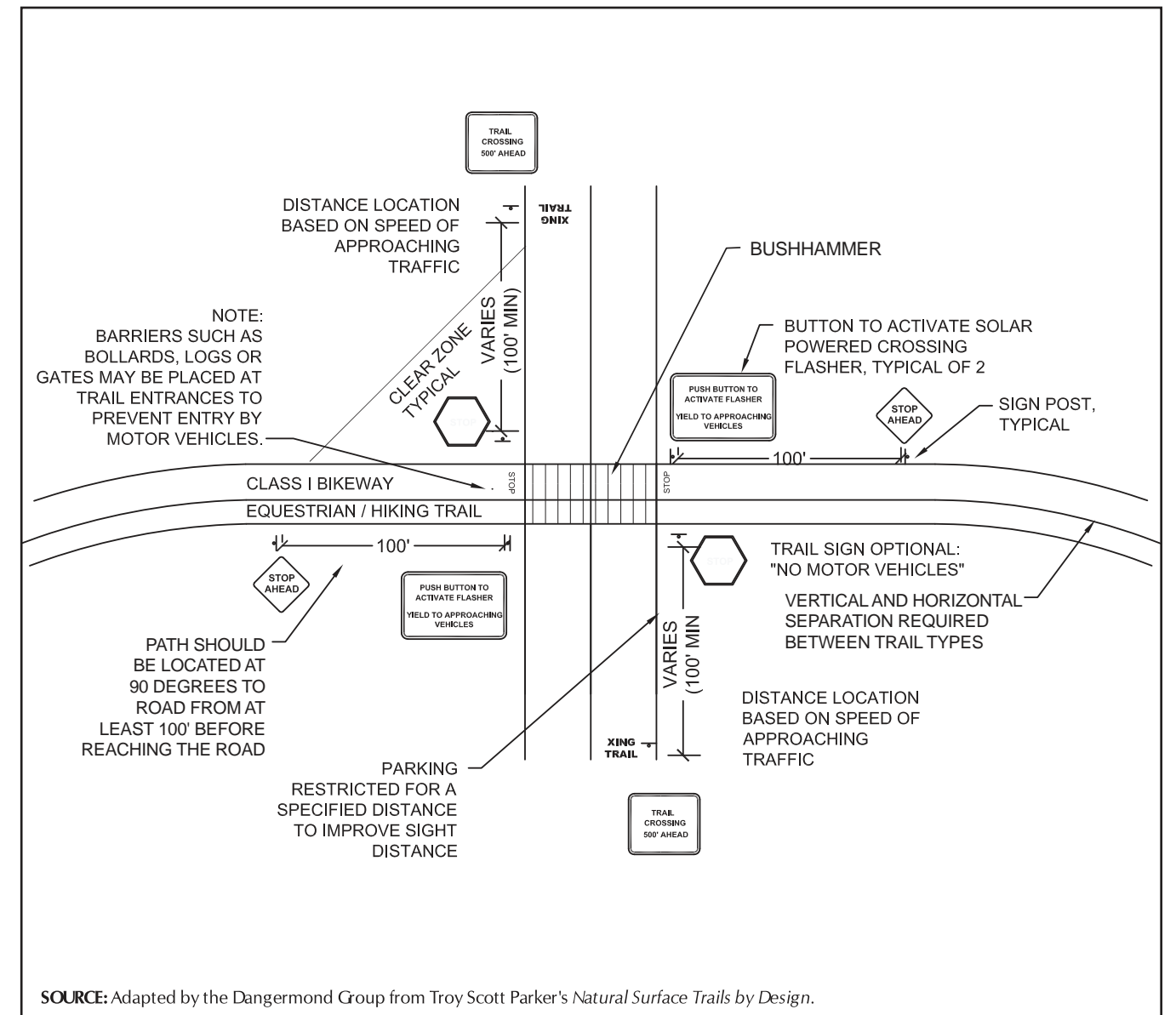
**Figure J-12  
H-Beam Wall 2**



**Figure J-13  
Trailhead Design**

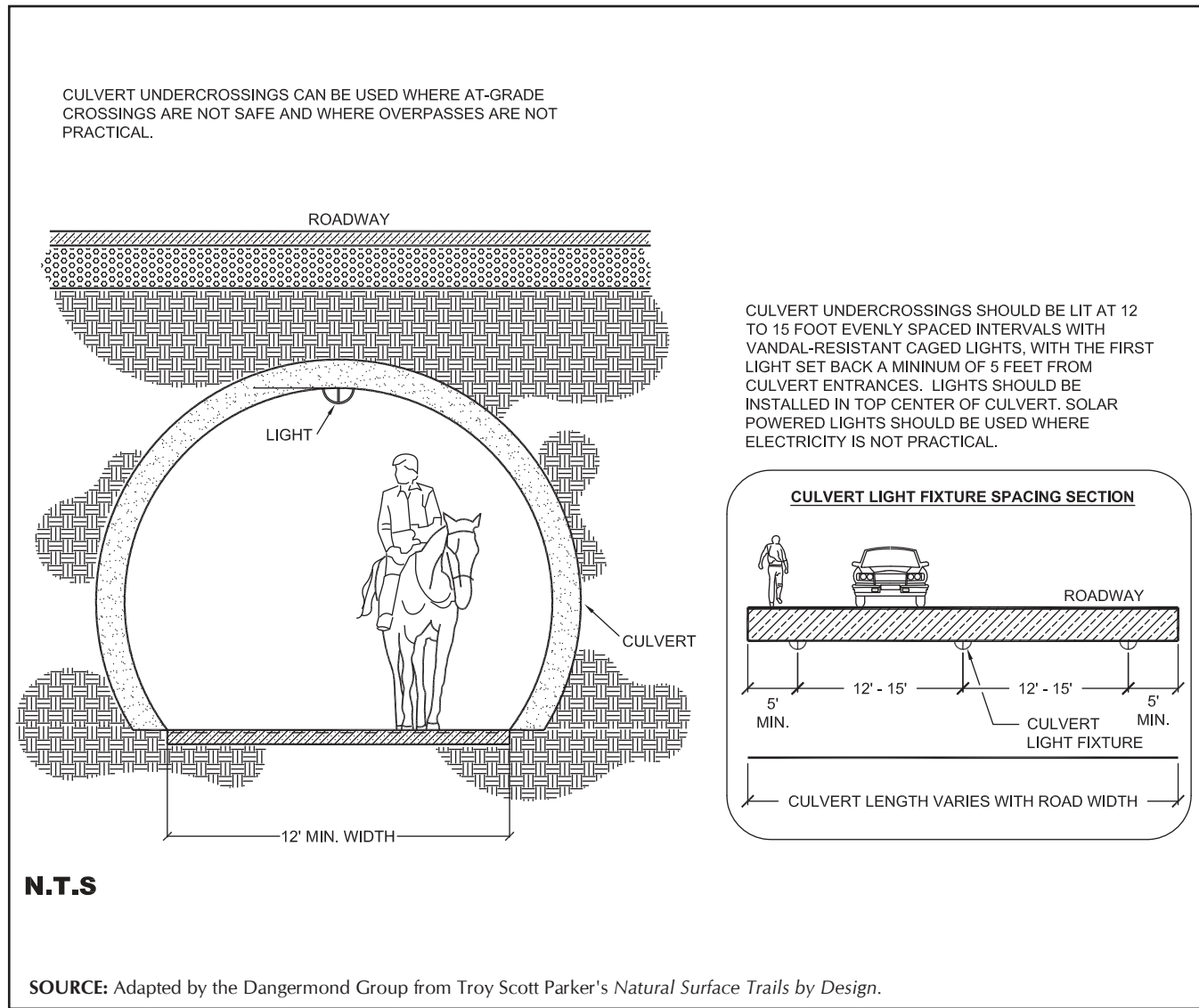


**Figure J-14**  
Trail Crossing at Intersection

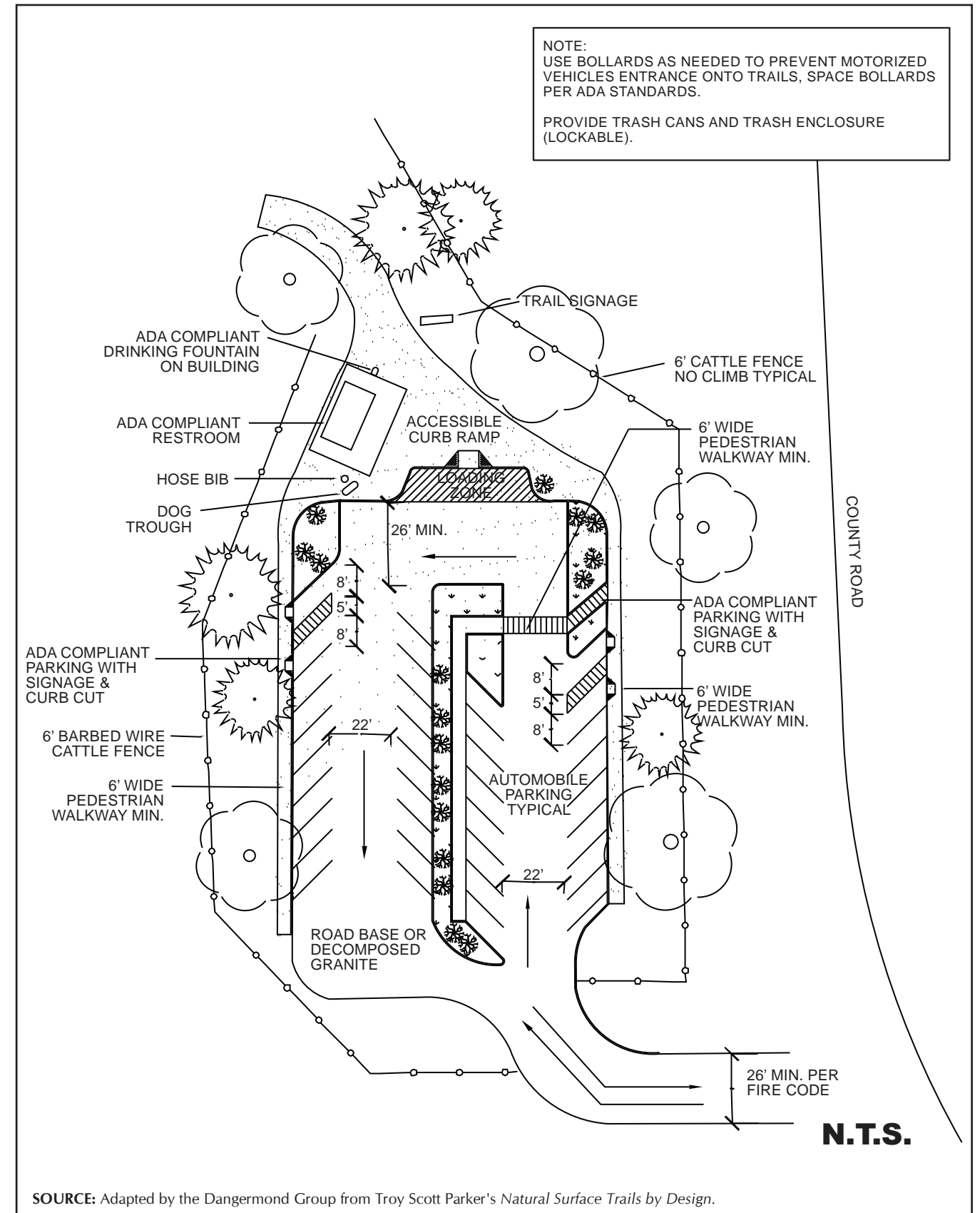


**Figure J-15**  
Trail Crossing at Mid-block

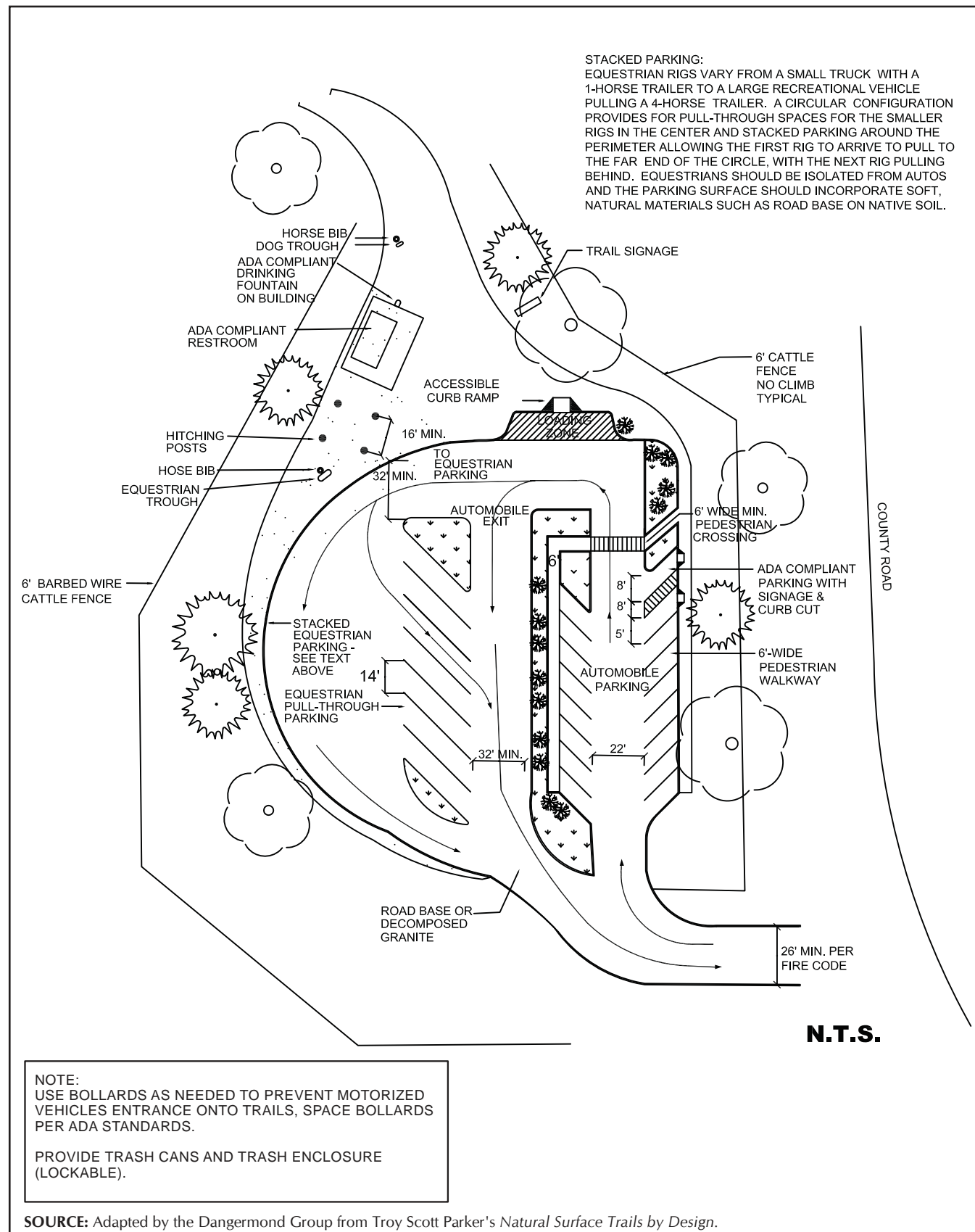




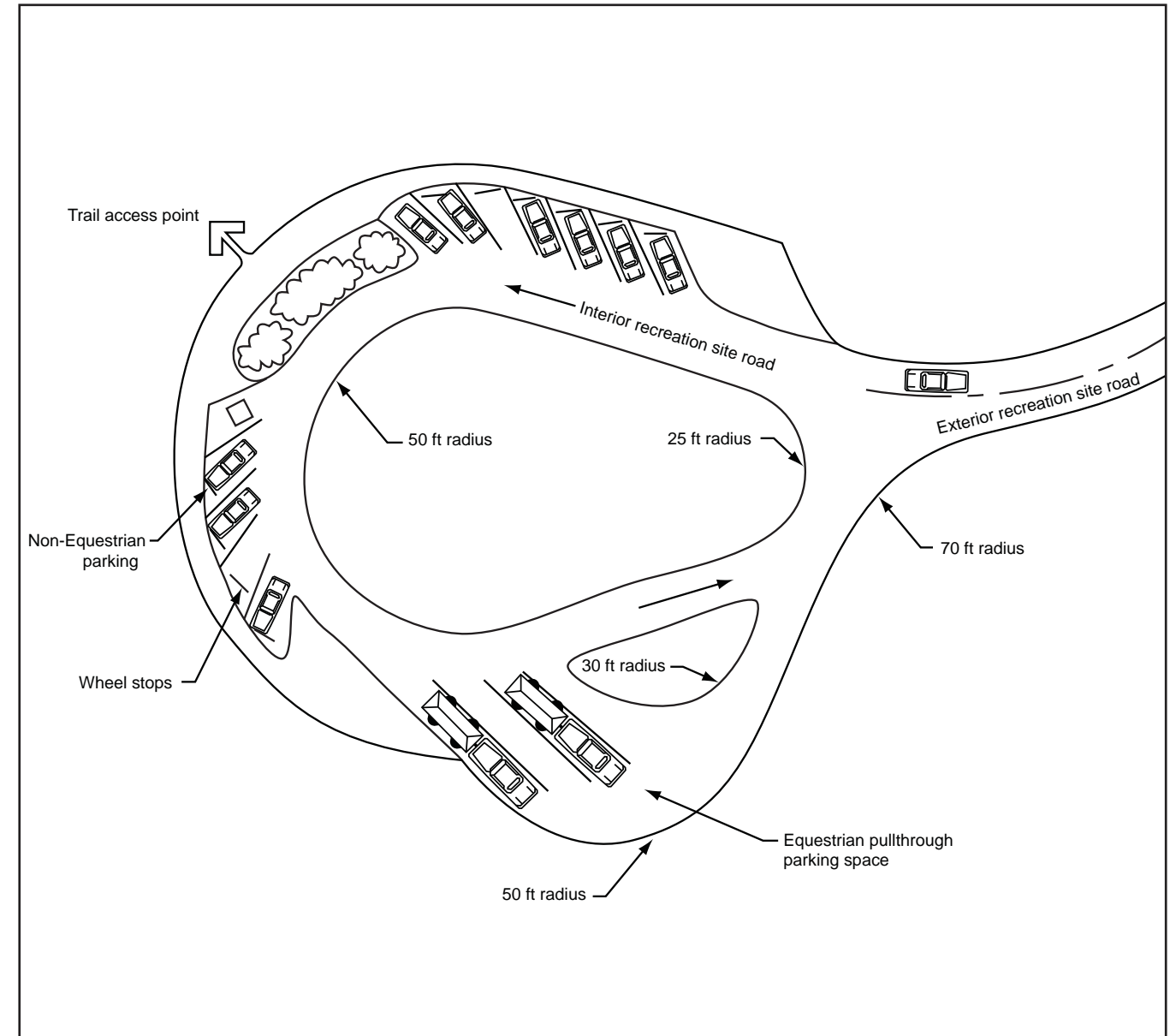
**Figure J-16**  
Culvert Undercrossing



**Figure J-17**  
Automobile Parking



**Figure J-18**  
**Automobile and Equestrian Parking**



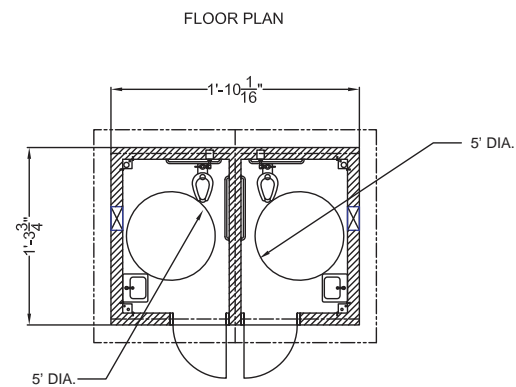
**Figure J-19**  
**Loop Turnaround Parking**

A PLUMBED RESTROOM MAY ONLY BE CONSTRUCTED WHERE WATER AND SEWER CONNECTIONS ARE AVAILABLE AND WHERE WEEKLY MAINTENANCE IS AVAILABLE.

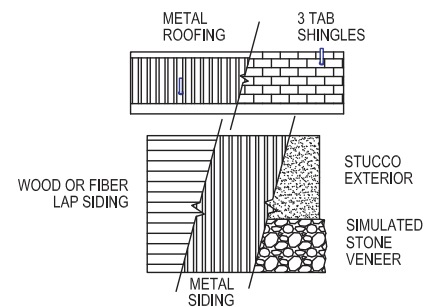
RESTROOMS SHOULD BE CONSTRUCTED WITH ACCESS FROM TRAIL AND PARKING AREAS AT 5% MAXIMUM GRADE.

THE DIMENSIONS AND LAYOUT ARE TYPICAL AND AMERICAN WITH DISABILITIES ACT (ADA) COMPLIANT.

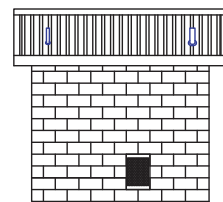
NOTE: CONSULT WITH LICENSED DESIGN PROFESSIONAL AND OBTAIN PLAN APPROVAL FROM LOS ANGELES COUNTY BUILDING AND SAFETY DEPARTMENT



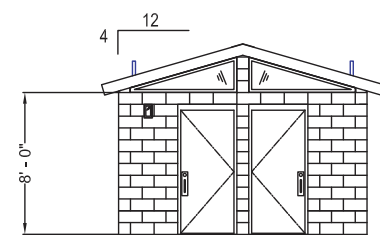
ROOFING CHOICES & OPTIONAL EXTERIORS



SIDE VIEW



FRONT VIEW



SOURCE: Romtec. 2008. Restroom Drawing. Roseburg, OR.

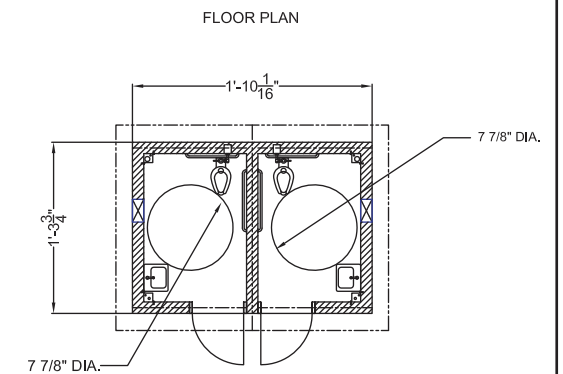
Figure J-20 Restroom with Hook-ups

A PLUMBED RESTROOM MAY ONLY BE CONSTRUCTED WHERE WATER AND SEWER CONNECTIONS ARE AVAILABLE AND WHERE WEEKLY MAINTENANCE IS AVAILABLE.

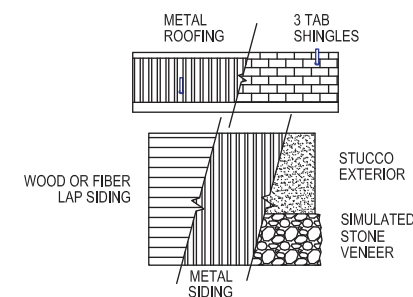
RESTROOMS SHOULD BE CONSTRUCTED WITH ACCESS FROM TRAIL AND PARKING AREAS AT 5% MAXIMUM GRADE.

THE DIMENSIONS AND LAYOUT ARE TYPICAL AND AMERICAN WITH DISABILITIES ACT (ADA) COMPLIANT.

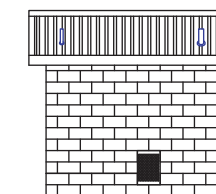
NOTE: CONSULT WITH LICENSED DESIGN PROFESSIONAL AND OBTAIN PLAN APPROVAL FROM LOS ANGELES COUNTY BUILDING AND SAFETY DEPARTMENT



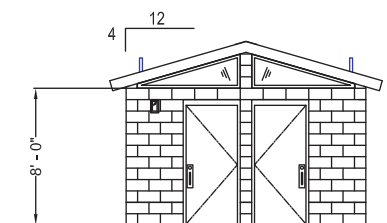
ROOFING CHOICES & OPTIONAL EXTERIORS



SIDE VIEW



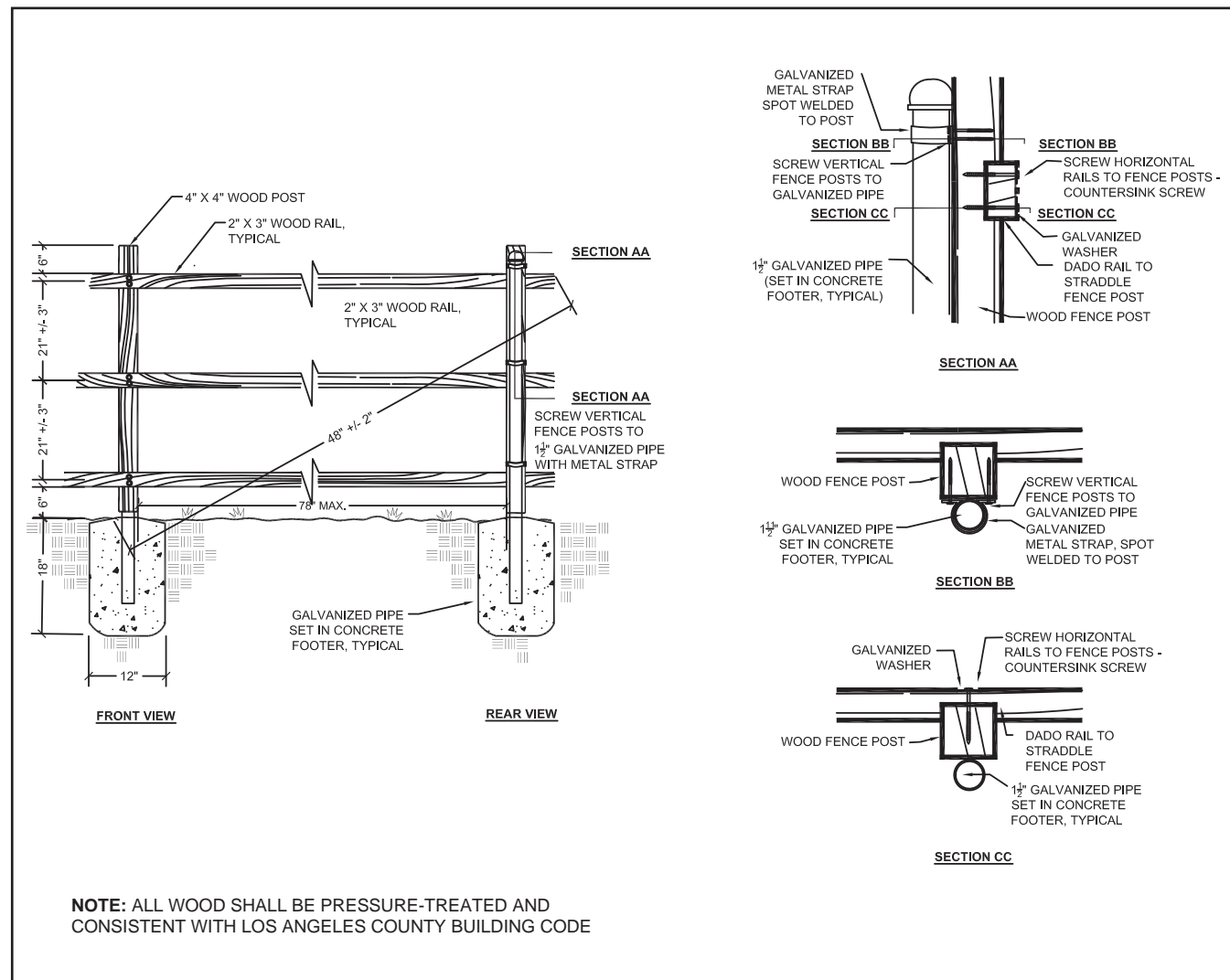
FRONT VIEW



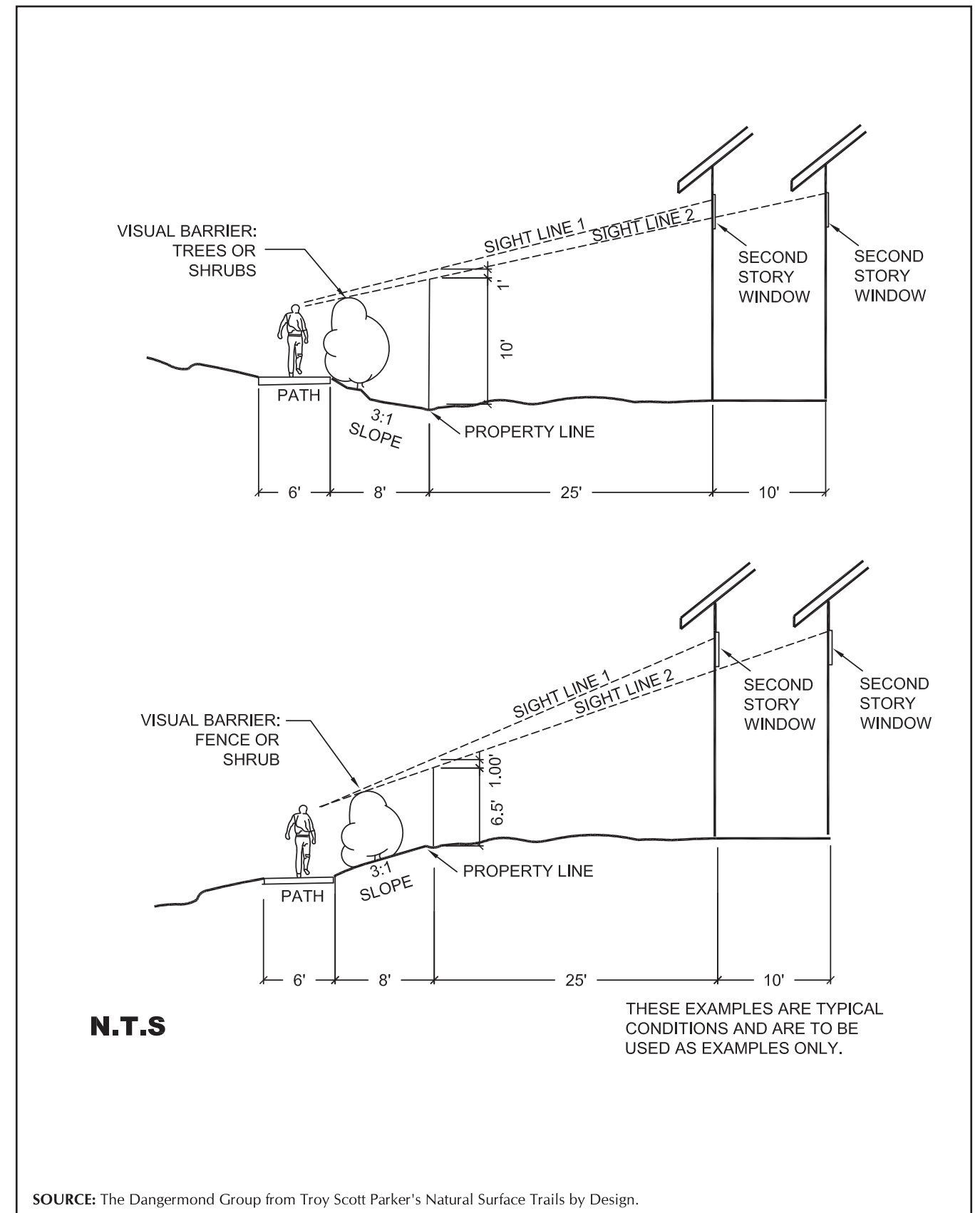
SOURCE: Romtec. 2008. Restroom Drawing. Roseburg, OR.

Figure J-21 Composting Restroom





**Figure J-22**  
**Typical Trail Fencing**

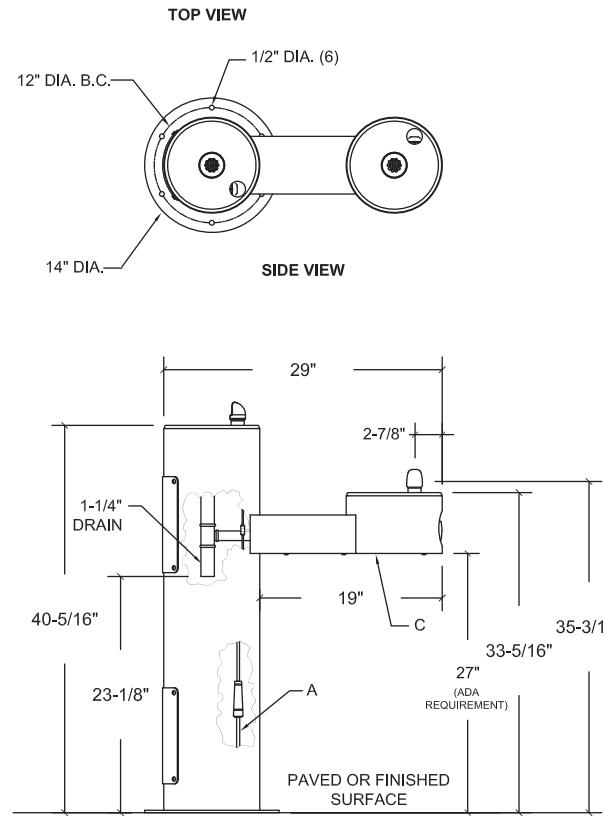


**Figure J-23**  
**Trail Residential Sightlines**

**BI-LEVEL TWIN RECEPTOR STEEL DRINKING FOUNTAIN**

FOUNTAIN WILL COMPLY WITH AMERICAN WITH DISABILITIES ACT REQUIREMENTS.

THE TYPICAL FOUNTAIN WILL HAVE A POWDER-COAT FINISH WITH IMMERSION COATING INSIDE AND OUTSIDE THE FOUNTAIN. THE FOUNTAIN WILL ALSO HAVE VANDAL-RESISTANT PUSH BUTTON, CORROSION-RESISTANT SELF-CLOSING AUTOMATIC STREAM HEIGHT REGULATOR, ONE-PIECE VANDAL-RESISTANT BUBBLER WITH HOOD GUARD AND INLET STRAINER.



**NOTES:**

PEDESTAL DRINKING FOUNTAIN SHALL ONLY BE USED WHEN NO RESTROOM BUILDING IS CONSTRUCTED.

APPROPRIATE SYSTEM SHOULD BE DESIGNED TO HANDLE EXCESS WATER (SEWER, SEPTIC SYSTEM, SUMP, ETC.)

IF POTABLE WATER IS NOT AVAILABLE, CONSIDER DESIGNING CISTERN OR TANK, AND CONNECTING TO DRINKING FOUNTAIN.

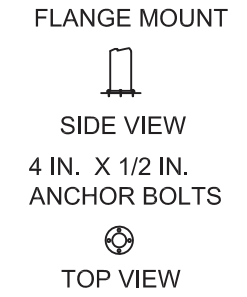
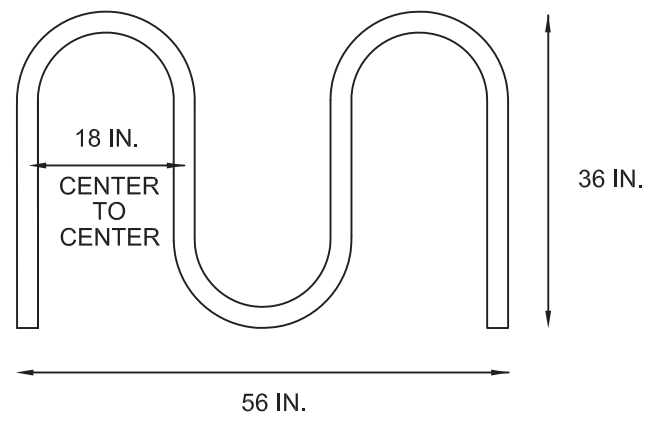
PLEASE USE MANUFACTURER'S SPECIFICATIONS TO DEVELOP FOOTINGS AND CONNECTIONS THAT COMPLY WITH THE LOS ANGELES COUNTY BUILDING CODE.

**LEGEND**

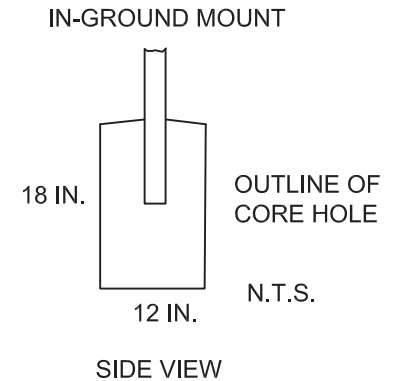
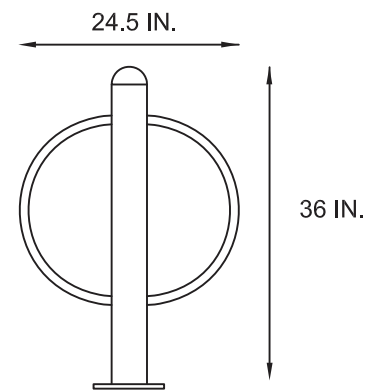
A = 3/8" O.D. UNPLATED COPPER TUBE CONNECT - SHUT OFF VALVE BY OTHERS  
 B = ACCESS PANEL (8" X 10")  
 C = REMOVABLE BOTTOM COVER

**Figure J-24**  
Drinking Fountain

**WAVE STYLE BICYCLE RACK**



**FULL CIRCLE BICYCLE RACK**



**N.T.S**

BICYCLE RACKS TO BE CONSTRUCTED OF CARBON OR STAINLESS STEEL PIPE. HOT-DIPPED GALVANIZED FINISH OR STAINLESS STEEL FINISH TYPICAL. POWDER COAT COLORS PER PROJECT STANDARDS.

WAVE RACK TO BE CONSTRUCTED OF 2-3/8 IN. OD, SCHEDULE 40 PIPE MINIMUM.

CIRCULAR RACK TO BE CONSTRUCTED OF 4 1/2 IN. OD SCHEDULE 40 PIPE FOR THE MAIN POST WITH 1 IN. OD STEEL BAR WELDED TO THE MAIN POST MINIMUM.

RACKS CAN BE MOUNTED EITHER BY EMBEDDING INTO CONCRETE OR SURFACE MOUNTED USING SURFACE FLANGED PIPE.

SOURCE: The Dangermond Group from Troy Scott Parker's Natural Surface Trails by Design.

**Figure J-25**  
Bicycle Rack

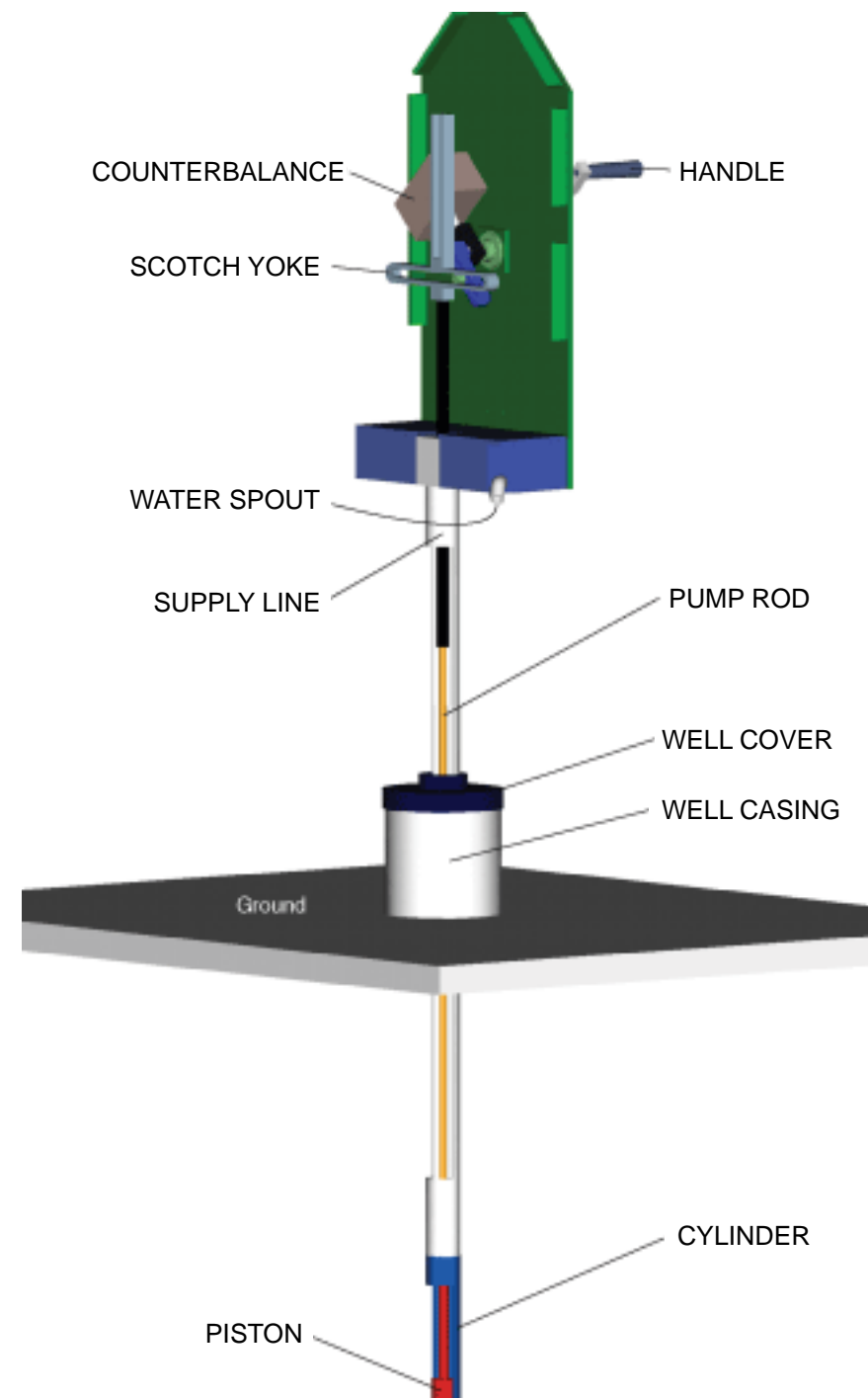


Figure J-26  
Hand Pump

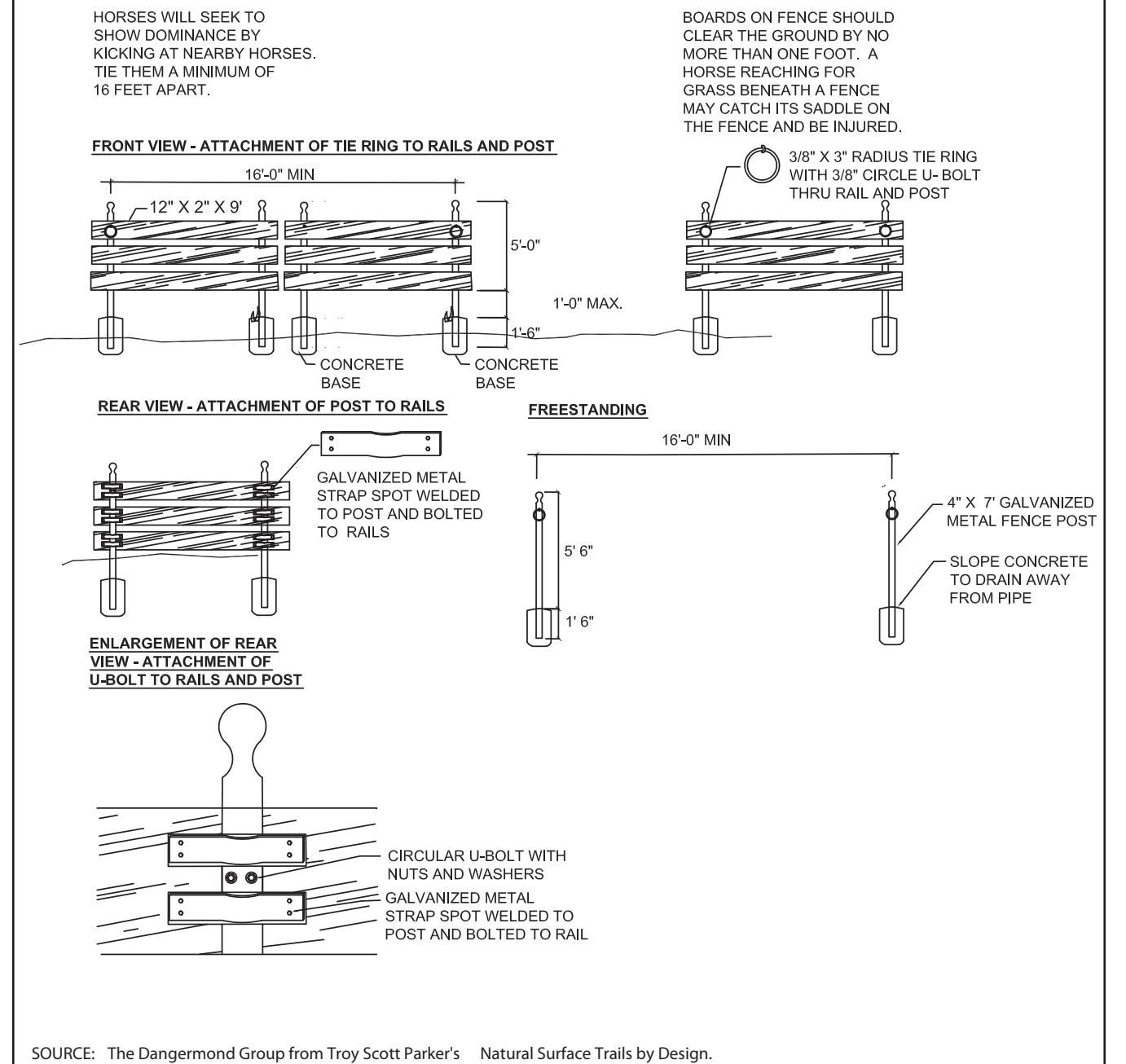
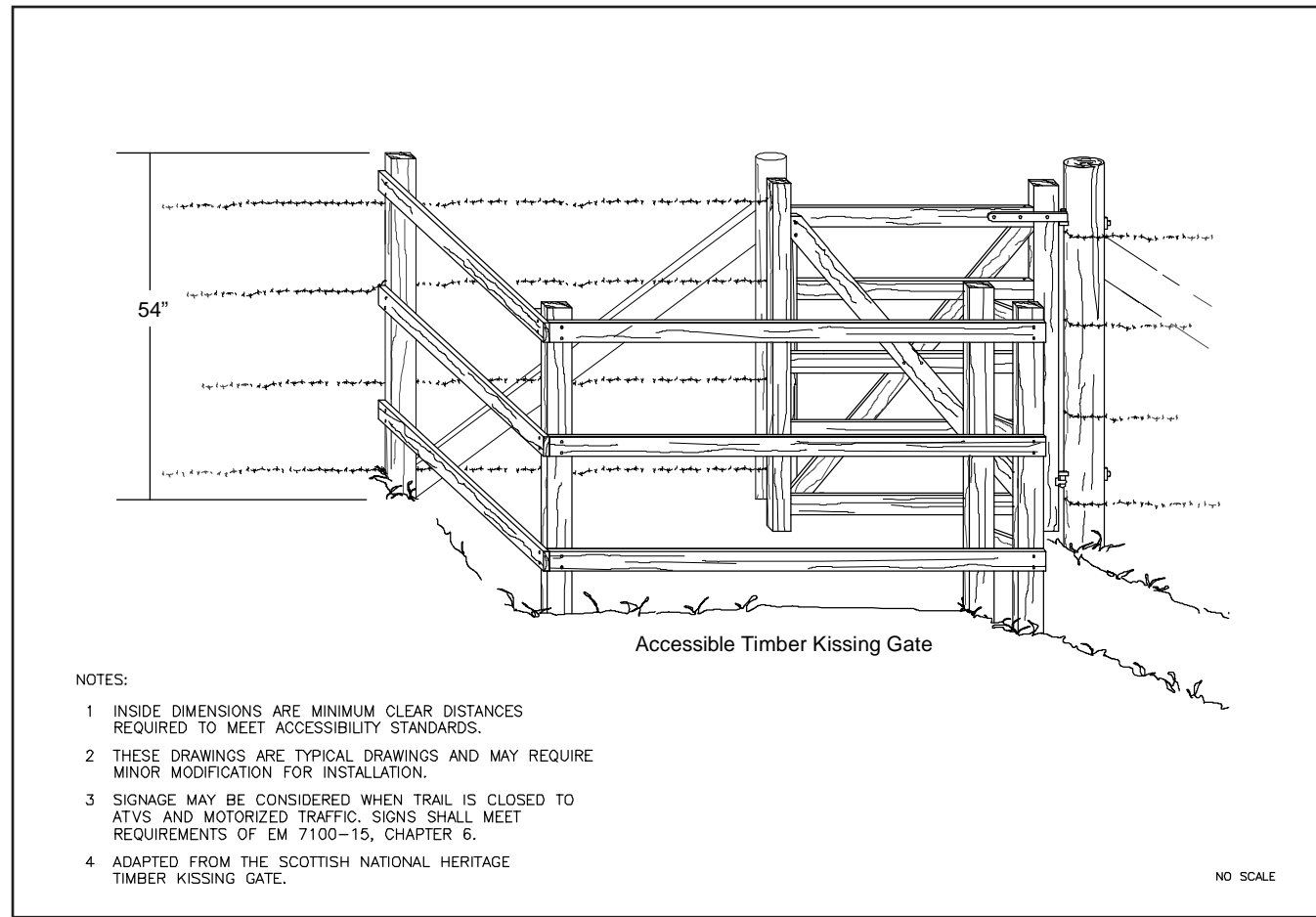
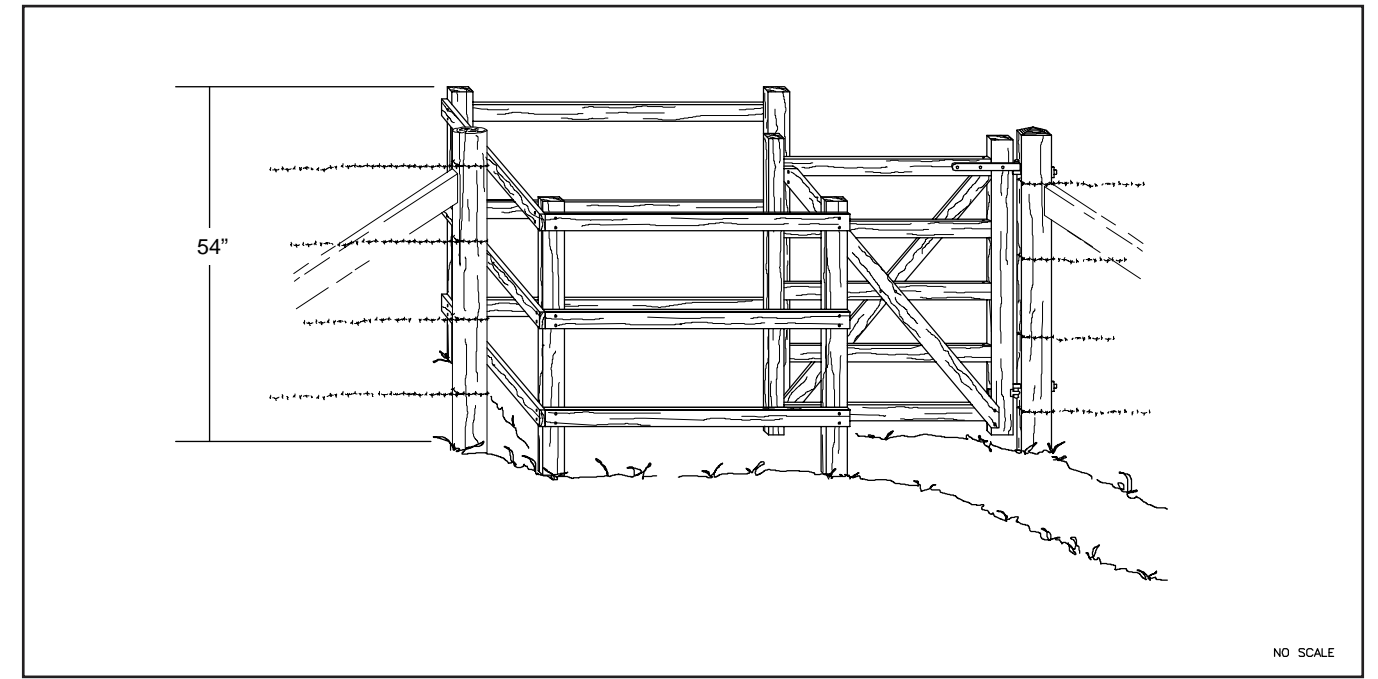


Figure J-27  
Hitching Post





**Figure J-28**  
**Timber Kissing Gate with Wheelchair Accessibility**



**Figure J-29**  
**Chicane for Wheelchair Accessibility**

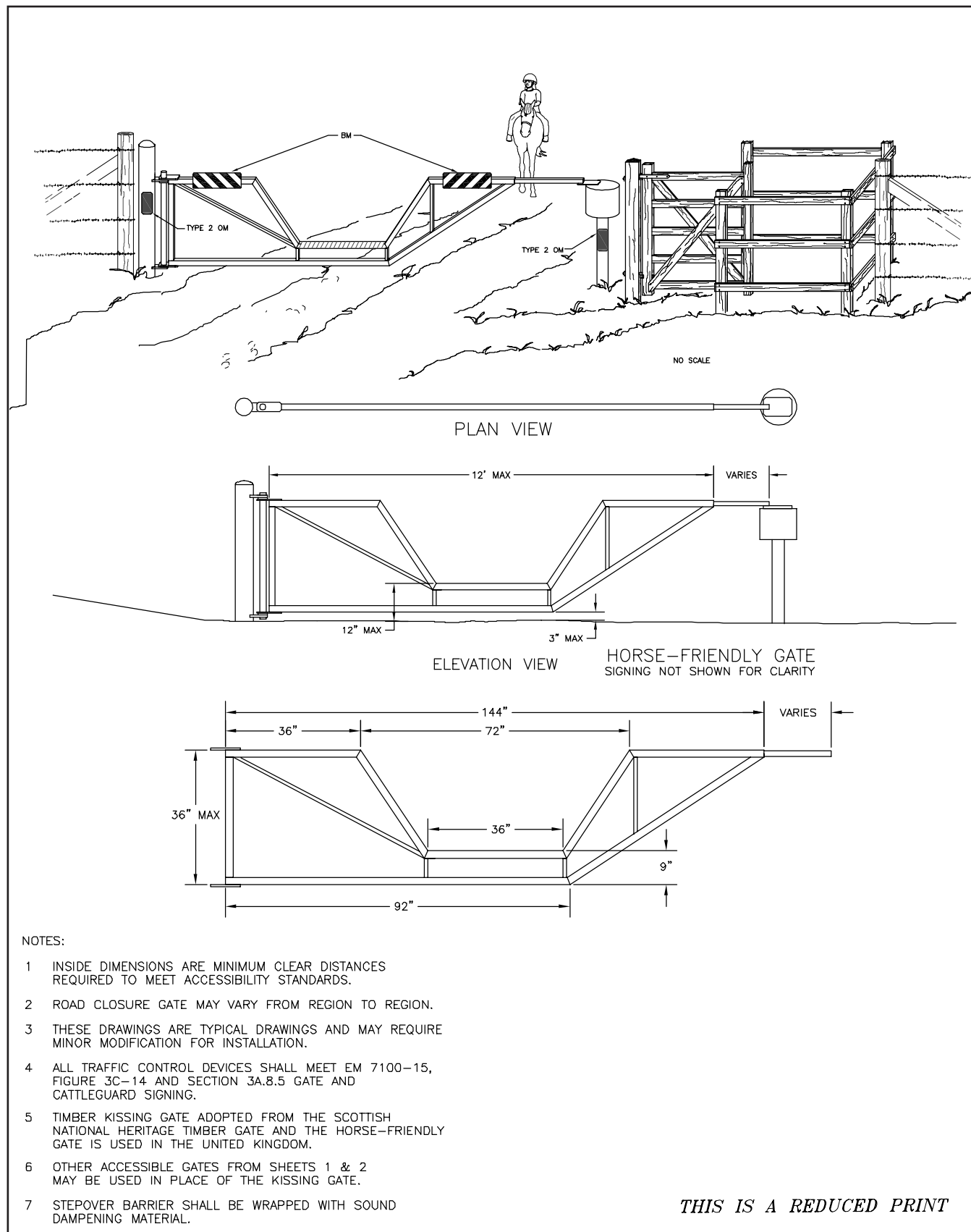


Figure J-30  
Horse Friendly Forest Road Closure Gate with Horse and Wheelchair Accessibility

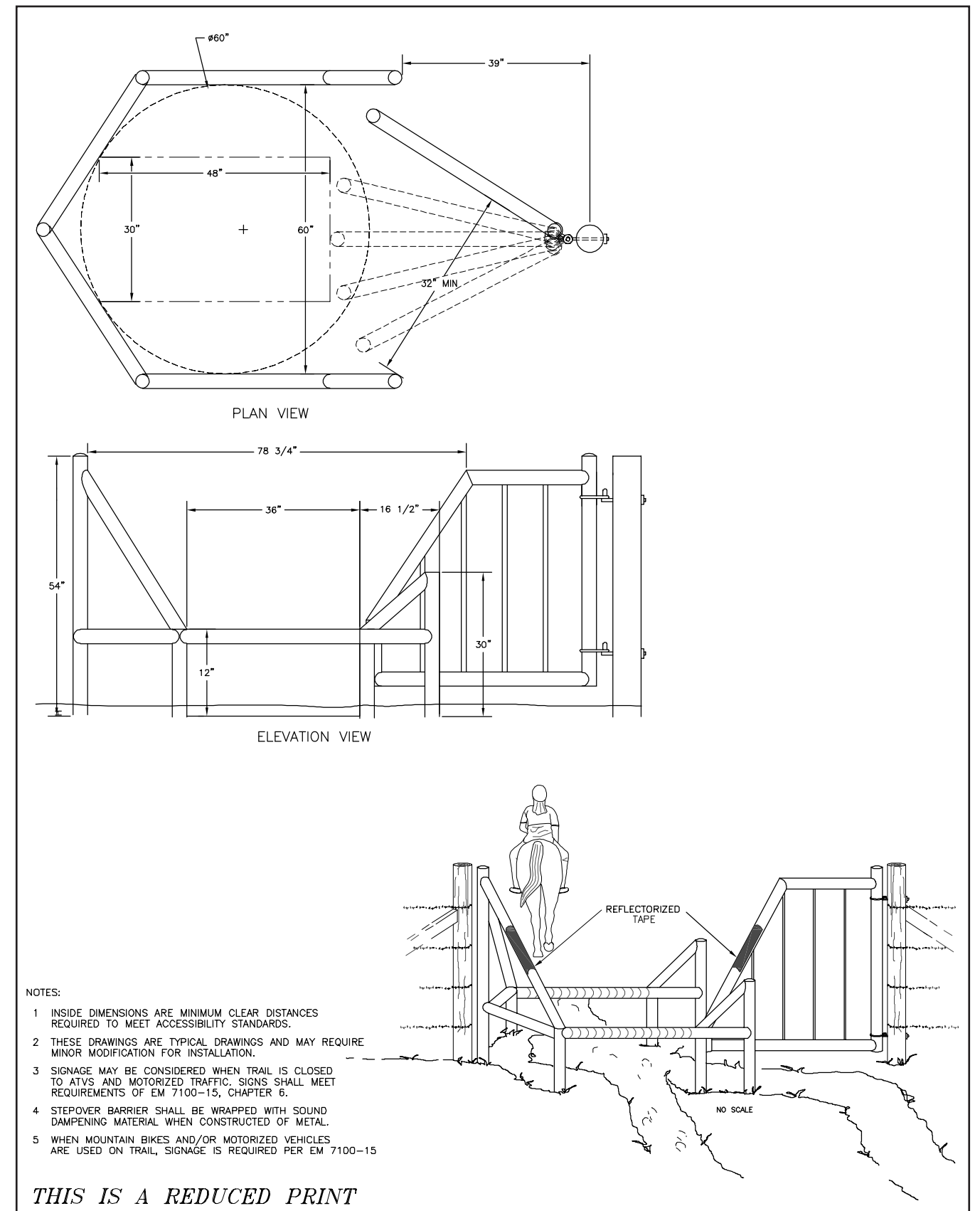
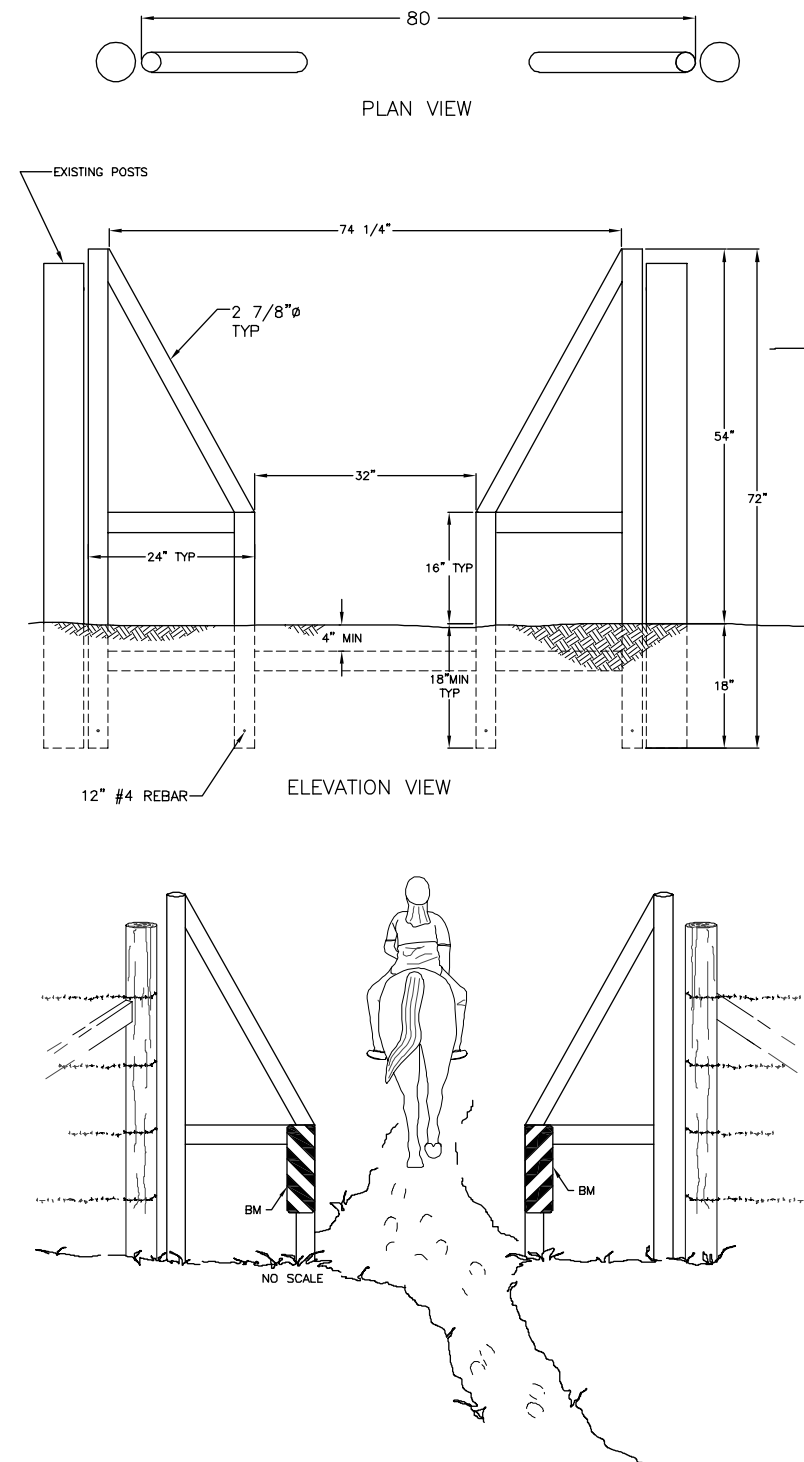


Figure J-31  
Horse Gate with Wheelchair Accessibility

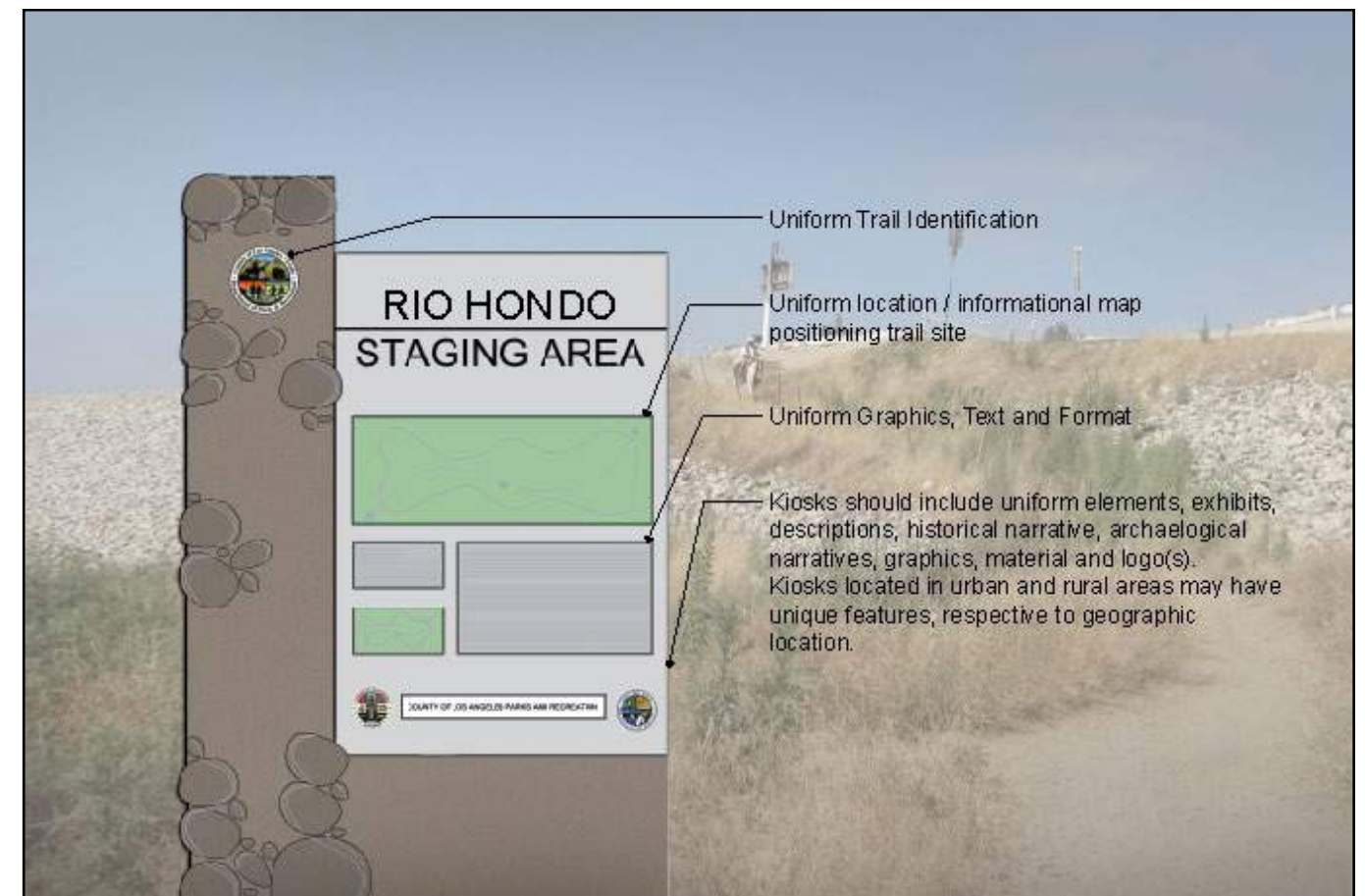


NOTES:

- 1 INSIDE DIMENSIONS ARE MINIMUM CLEAR DISTANCES REQUIRED TO MEET ACCESSIBILITY STANDARDS.
- 2 THESE DRAWINGS ARE TYPICAL DRAWINGS AND MAY REQUIRE MINOR MODIFICATION FOR INSTALLATION.
- 3 REQUIRED SIGNS SHALL FOLLOW REGIONAL GUIDANCE AND THE SIGN AND POSTER GUIDELINES FOR THE FOREST SERVICE EM 7100-15.
- 4 ADDITIONAL GATE FOR KEEPING LIVESTOCK OUT MAY BE ADDED BUT WILL NOT MEET ACCESSIBILITY REQUIREMENTS.
- 5 WHEN MOUNTAIN BIKES AND/OR MOTORIZED VEHICLES ARE USED ON TRAIL, SIGNAGE IS REQUIRED PER EM 7100-15.

*THIS IS A REDUCED PRINT*

**Figure J-32**  
**Horse Gate with Wheelchair Accessibility**



**Figure J-33**  
**Kiosk Level One Trailhead**



**Figure J-34**  
**Kiosk Level Three**



## APPENDIX K WAY-FINDING SIGNS

---

### LACO-DPR WAY-FINDING SIGN PROGRAM

The County of Los Angeles Department of Parks and Recreation (LACO-DPR) has adopted a trail way-finding sign program.

**Description and Purpose:** The intent of this primary trail way-finding sign program is to identify the typical County trail signs, which would be applied Countywide, cognizant of limited staff and funding resources. The trails logo was approved in 2010 by the LACO-DPR Director and has been applied in trail staging areas in a few locations. The goal is to apply this program for “branding” purposes. The trail monumental signs include two styles, one reflecting a contemporary design and another more rustic version for application in either wilderness or rural settings depending on the surrounding contexts. The way-finding sign is new to the LACO-DPR; while being simplistic, it is intended to be easy to maintain and readable.

**Graphic Example:** Figure K-1, *Typical Trail Sign Combinations*; Figure K-2, *Trail Name / Directional Sign with Community ID*; Figure K-3, *Typical Regulatory Sign*; Figure K-4, *Typical Trail Logo Sign Dimensions*; Figure K-5, *Typical Trail Way-Finding Sign*; Figure K-6, *Typical Trail Way-Finding Sign Mileage Marker*; Figure K-7, *Monument Trail Sign Alternative A-1*; and Figure K-8, *Monument Trail Sign Alternative B-2*

### HIGHWAY SIGNS

Highway signs are regulated by various agencies (e.g., state, county, municipalities) and should conform to relevant agency standards.

#### Information Signs

**Description and Purpose:** Information signs provide basic trail information to motorists and trail users at the initial highway approach to the trailhead, public recreation area, and places of cultural interest. Approaching motorists should be able to read the sign from the roadway and well in advance of the highway exit ramp.

**Sample Way-finding Sign Text:** “County of Los Angeles Wonderland Trail—1,000 feet” (in some applications, signs may include a County trails logo)

**Location and Frequency:** Posting of signs falls under the jurisdiction of the relevant highway regulatory agency, such as the California Department of Transportation (Caltrans) or U.S. Department of Transportation. All highway signs should be coordinated with the appropriate highway agency.

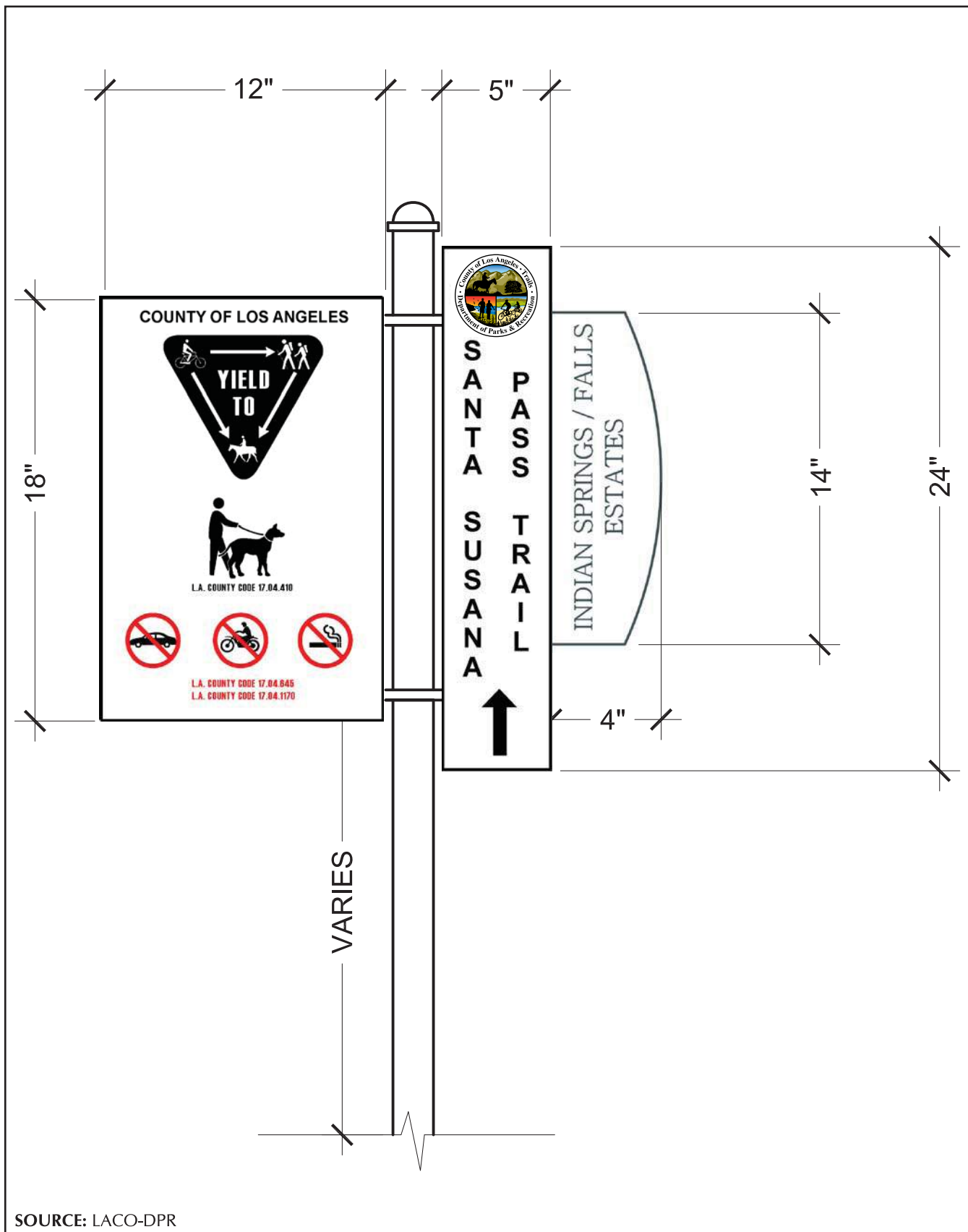
**Size and Color:** The size and color of signs fall under the jurisdiction of the relevant highway regulatory agency such as Caltrans or U.S. Department of Transportation, and all highway signs should be coordinated with the appropriate highway agency. Highway information signs, such as brown recreation signs, direct motorists and trail users to areas of public recreation and cultural interest. Signs should follow the U.S. Department of Transportation, Federal Highway Administration *Manual on Uniform Traffic Control Devices (MUTCD): Standard Highway Signs*.<sup>1</sup>

**Other Considerations:** Signs may be subtle if calling attention to the trail is not desirable (e.g., parking problems).

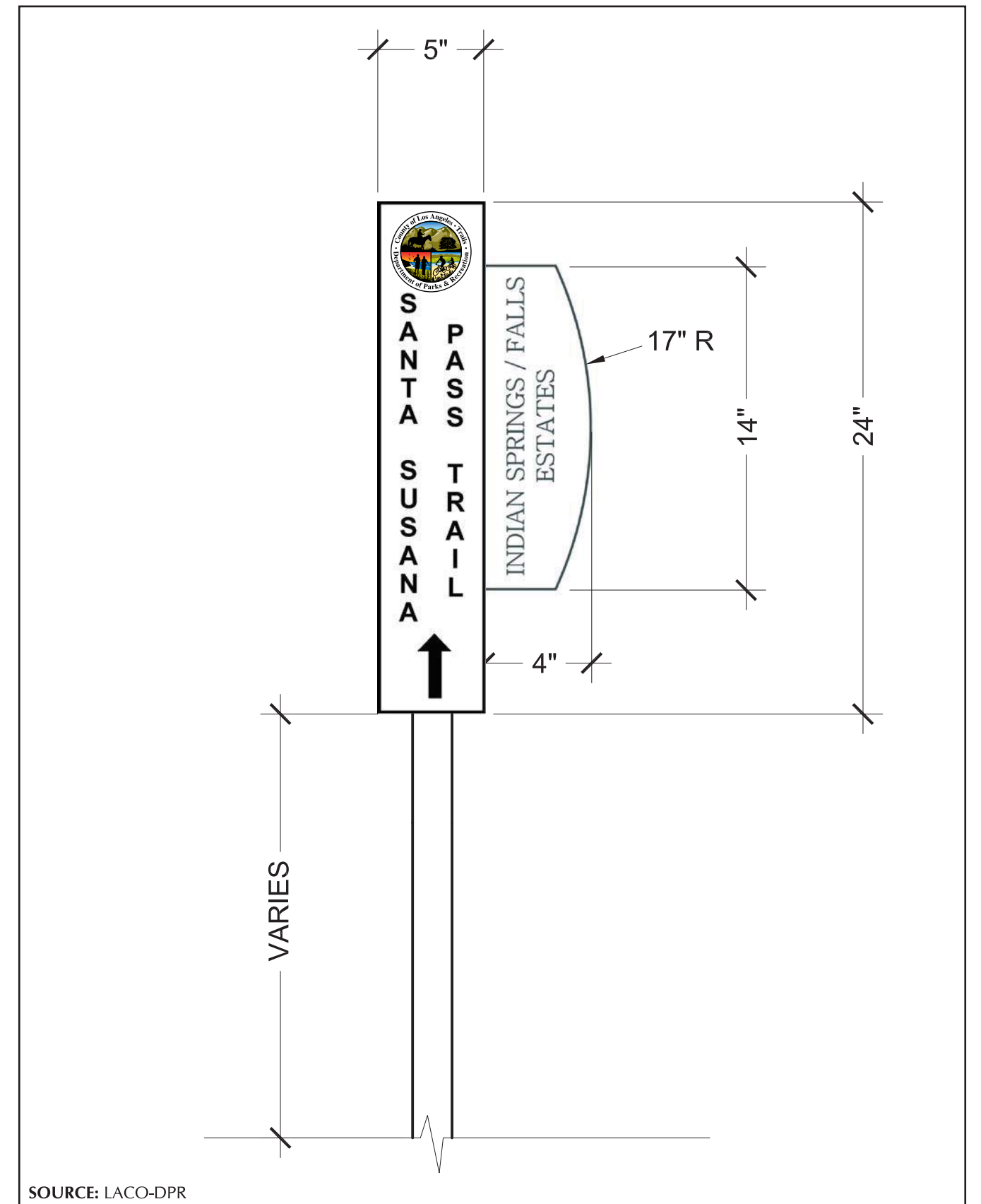
**Graphic Example:** Figure K-9, *Sample Highway Sign*; Figure K-10, *Standard MUTCD Sign*; Figure K-11, *Sample Trail Marker*; and Figure K-12, *Sample Trail Marker*

---

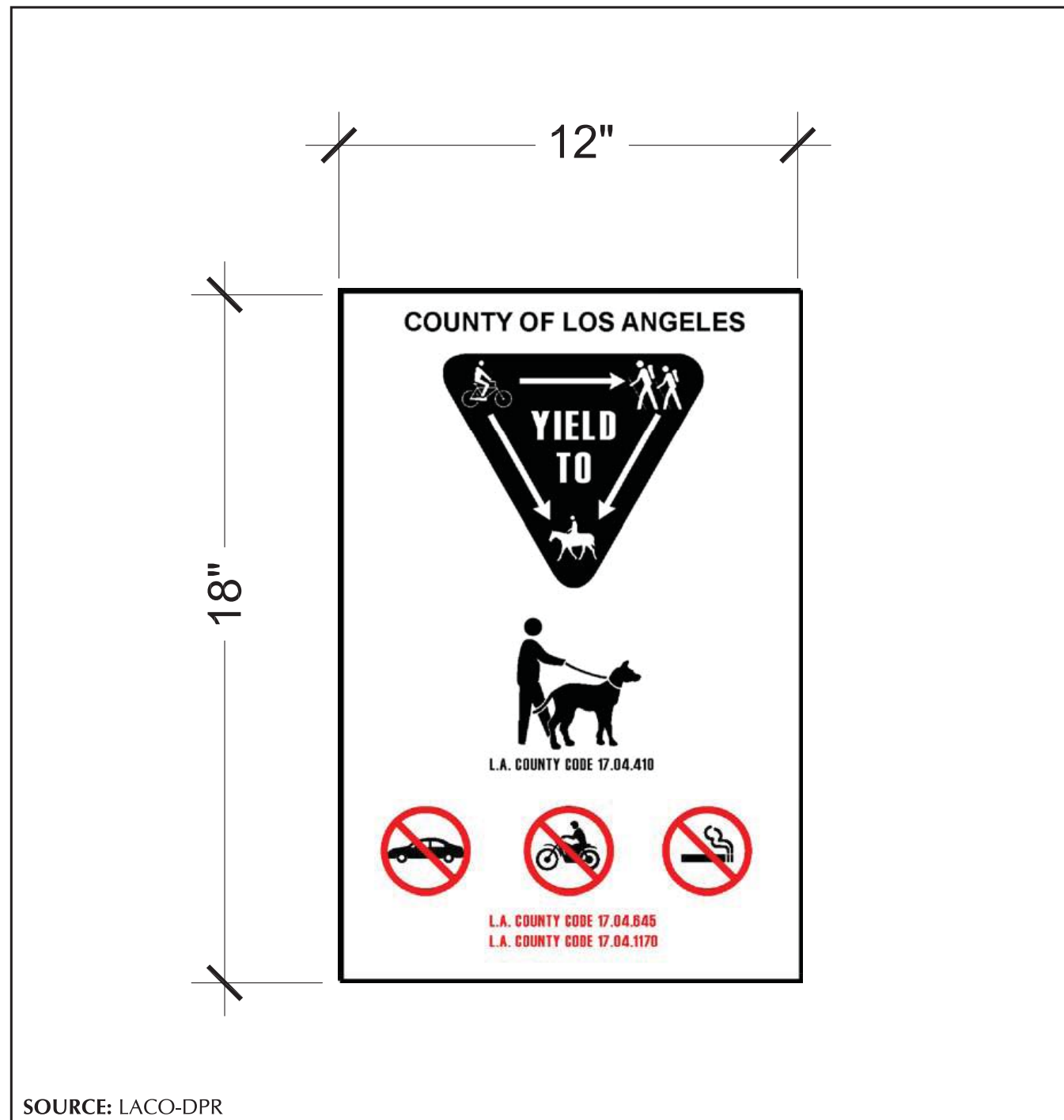
<sup>1</sup> U.S. Department of Transportation, Federal Highway Administration. 2004. *Manual on Uniform Traffic Control Devices: Standard Highway Signs, English Version*. Washington, DC.



K-1  
Typical Trail Sign Combinations

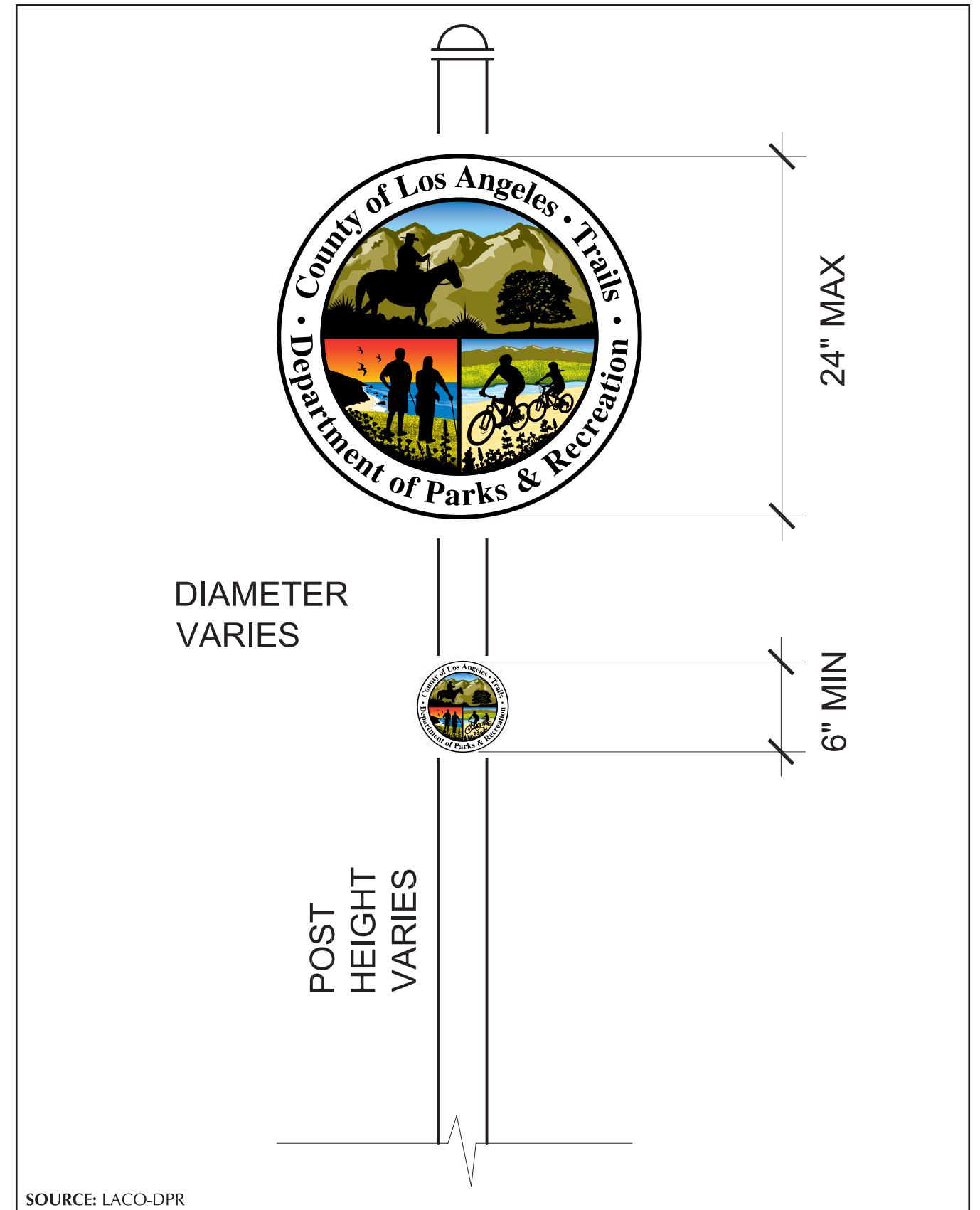


K-2  
Trail Name / Directional Sign with Community ID



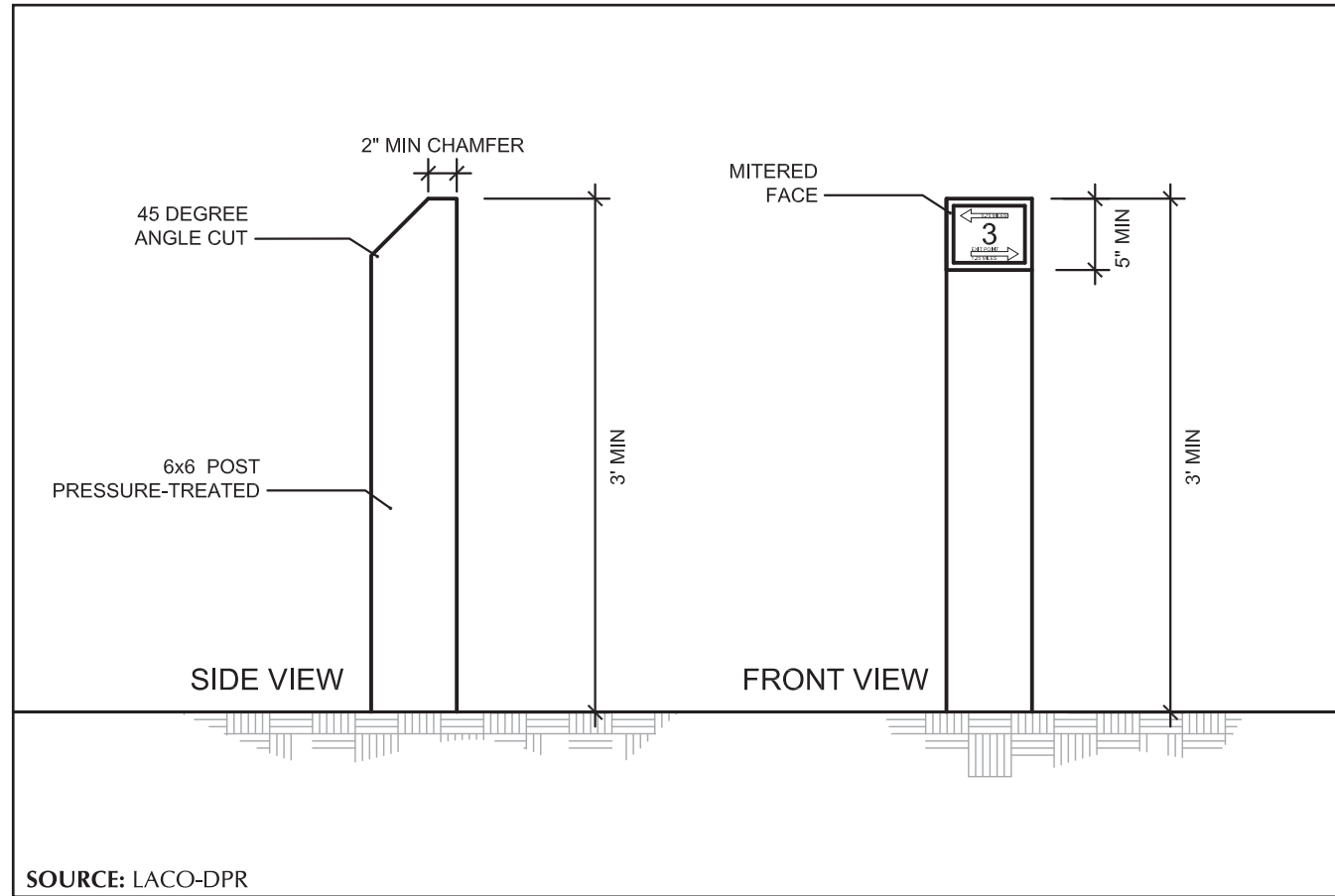
SOURCE: LACO-DPR

K-3  
Typical Regulatory Sign



SOURCE: LACO-DPR

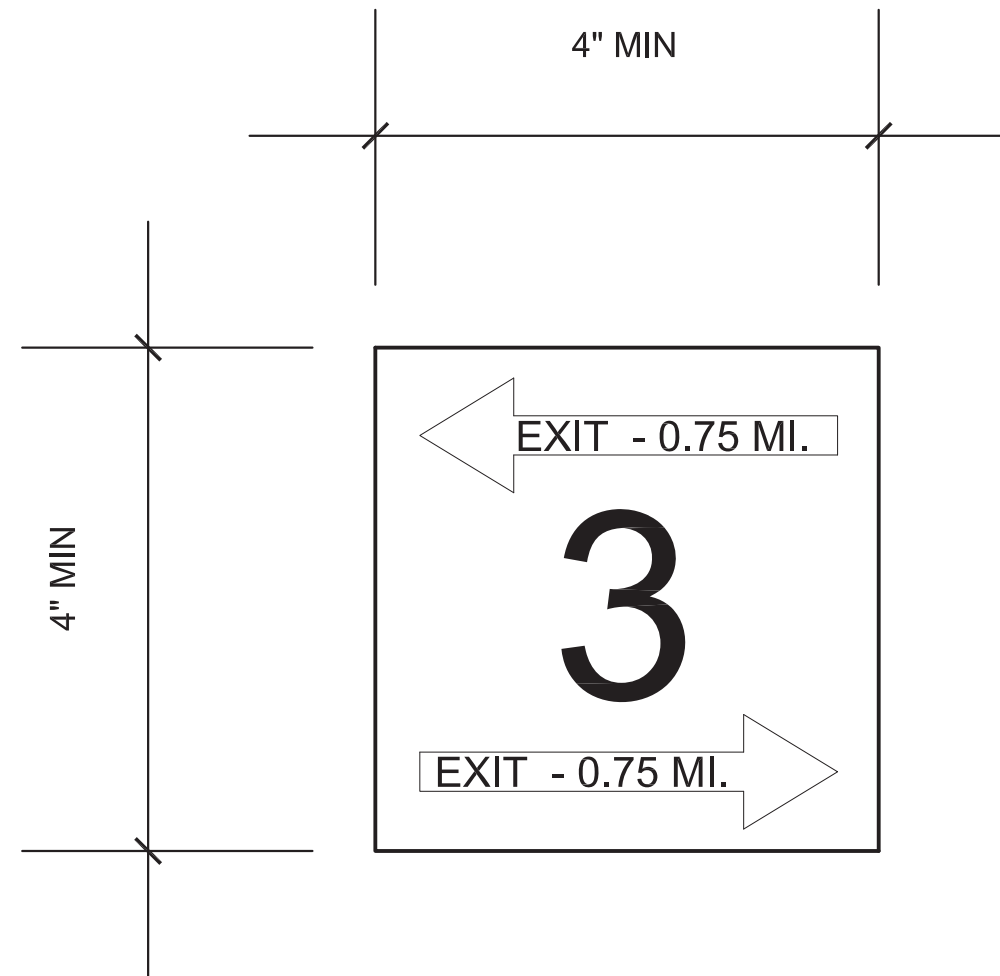
K-4  
Typical Trail Logo Sign Dimensions



**K-5**  
Typical Trail Way-Finding Sign

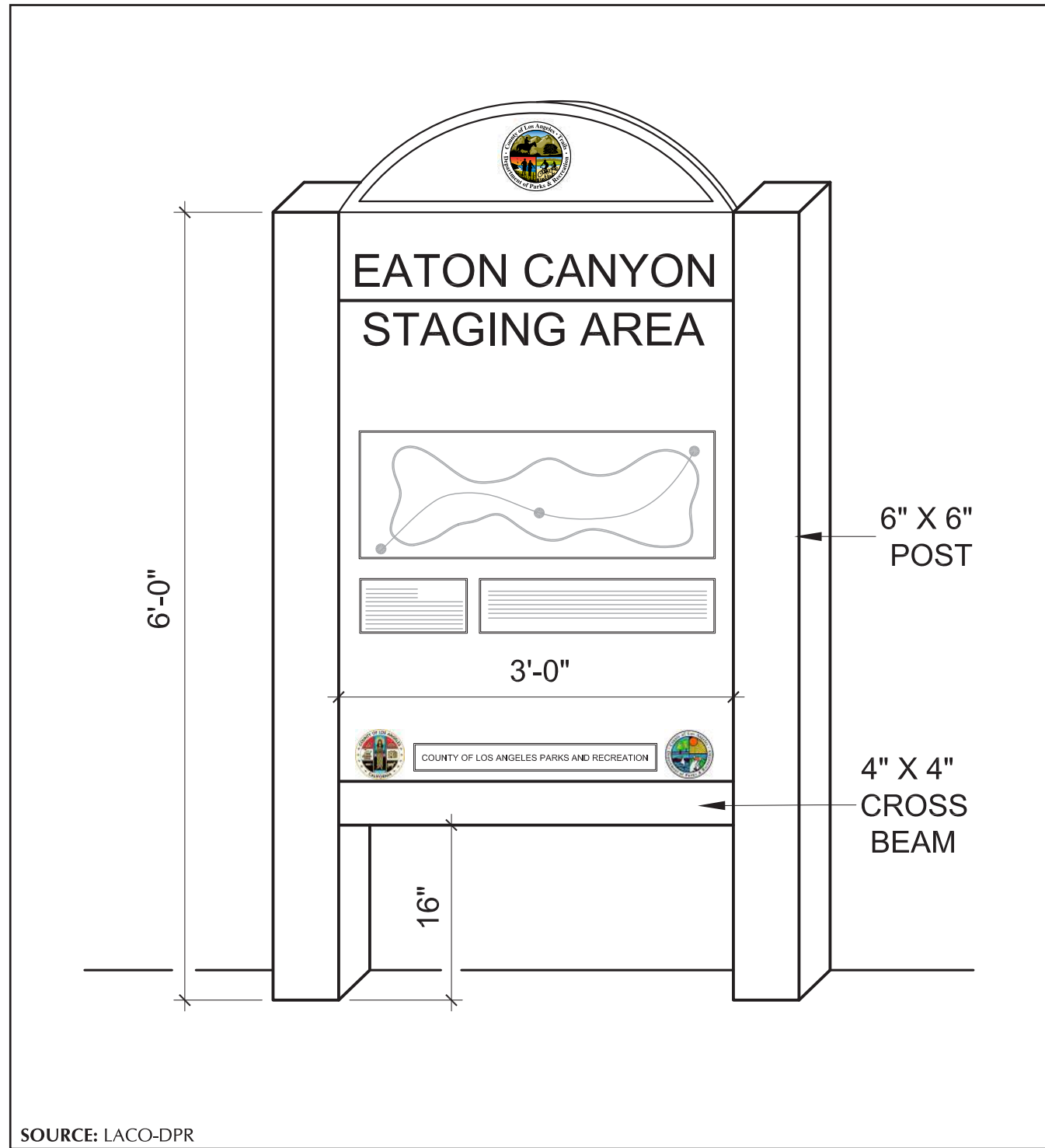
**TWO VERSIONS  
(MILEAGE MARKER SIGN):**

- 1) **VINYL APPLIQUE**  
TO BE APPLIED WHERE APPLICABLE.
- 2) **METAL SIGN**  
MOUNTED ON WOODEN POST OR AS APPROPRIATE.

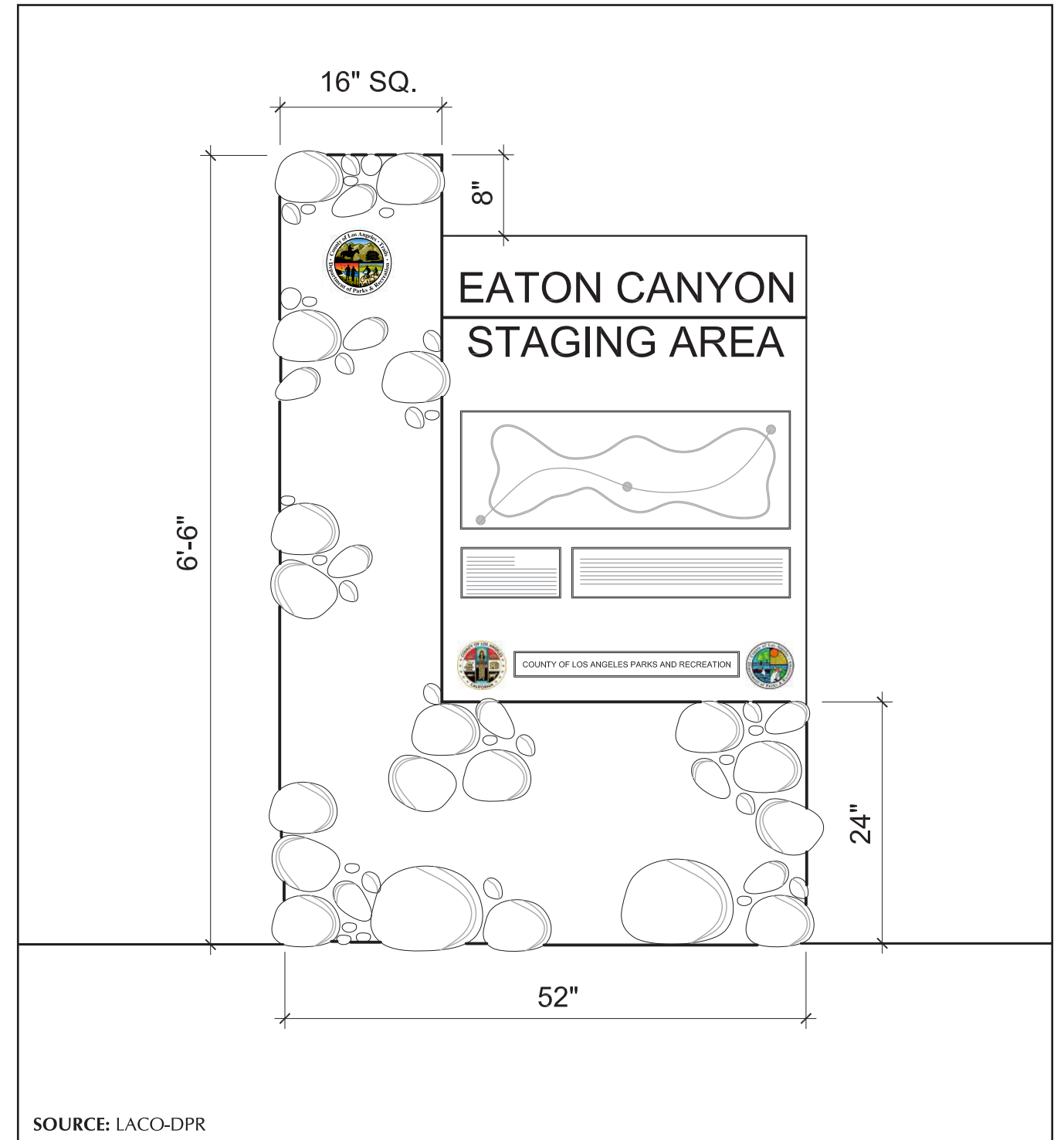


**K-6**  
Typical Trail Way-Finding Sign Mileage Marker

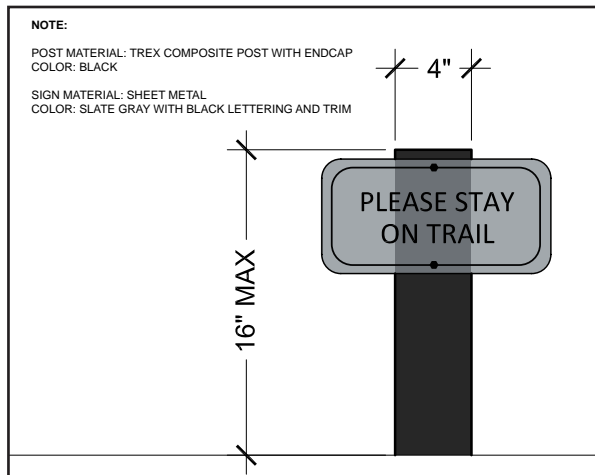




K-7  
Monument Trail Sign Alternative A-1



K-8  
Monument Trail Sign Alternative B-2



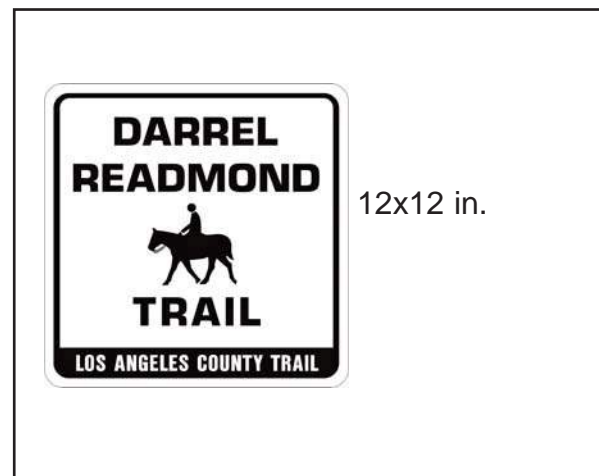
K-9  
 Stay on Trail Sign



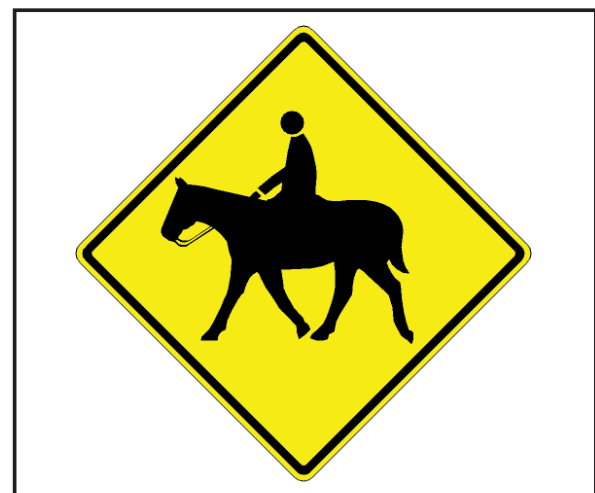
K-10  
 Existing Stay on Trail Sign



K-11  
 Sample Trail Marker



K-12  
 Sample Trail Marker



K-13  
 Equestrian Crossing



K-14  
 Pedestrian Crossing

Warning Signs

**Description and Purpose:** Warning signs provide motorists and trail users with a warning of approaching trail and street intersections. Way-finding sign should be clearly placed in advance of the intersection.

**Sample Way-finding Sign Text:** “Ped Xing” (in some applications, signs may include a County trails logo, directional arrows, usage signs, or the name of the road being crossed)

**Location and Frequency:** Signs should occur at every street and trail intersection. Posting of signs falls under the jurisdiction of the relevant highway regulatory agency such as Caltrans or U.S. Department of Transportation. All highway signs should be coordinated with the appropriate highway agency.

**Size and Color:** The size of signs falls under the jurisdictions of the relevant highway regulatory agency such as Caltrans or U.S. Department of Transportation. All highway signs should be coordinated with the appropriate highway agency. Typically, the *Manual on Uniform Traffic Control Devices* calls for black lettering on a yellow background.

**Other Considerations:** Warning signs are especially important where visibility is limited.

**Graphic Example:** Figure K-13, *Equestrian Crossing*, and Figure K-14, *Pedestrian Crossing*

REGULATORY SIGNS

Permitted Use (Usage Control) Signs

**Description and Purpose:** Permitted use signs provide trail users with information on permitted and non-permitted uses of the trail.

**Sample Way-finding Sign Text:** “Foot travel only—closed to all other uses” (emphasize permitted use; use a slash for non-permitted uses)

**Location and Frequency:** Post signs at all access points.

**Size and Color:** The color is typically black lettering or image on a white background. Images may include a red circle with a red slash placed diagonally through the image.

**Graphic Example:** Figures K-15, K-16, and K-17, *Sample Non-Permitted Use Sign*; and Figure K-18 and K-19, *Sample Permitted Use Sign*

Etiquette Signs

**Description and Purpose:** Etiquette signs provide reminders of polite trail behavior for all trail users.

**Sample Way-finding Sign Text:** “Yield to pedestrians,” “Ride and walk on the right,” “Warn others when passing from behind,” “Control speed!,” “Stay alert,” “Use caution around horses,” “Keep dogs on leash,” “No bicycles or horses”

**Location and Frequency:** Post signs before narrow, blind, or contentious sections of trail where trail user conflicts are likely, such as between cyclists and equestrians.

**Size and Color:** The size and color may vary depending on application. Sign should be 2 feet by 1 foot, 2 inches with brown lettering on a white background, bordered in brown. Signs in rural context shall be brown lettering on a white background, bordered in brown with a brown post. Signs in an urbanized neighborhood or suburban context shall be slate gray with black lettering with a black border affixed to a black post.

**Graphic Example:** Figure K-20, *Sample Yield Sign*

“Crossing Private Lands” Signs

**Description and Purpose:** There may be a need for “Crossing Private Lands” signs near the interface between a trail network and adjacent communities.

**Sample Way-finding Sign Text:** “Private land,” “Use of this land is a privilege and not your right,” “STAY ON TRAIL,” “The County depends on the cooperation of many private landowners, please respect the land you travel through,” “Camping, fires, hunting, straying from the trail is prohibited,” “Enforced by County Sheriff,” “Do not block driveways,” “Keep dogs on leash”

**Location and Frequency:** Post signs in and at edges of neighborhoods or private land that the trail crosses.

**Size and Color:** Mount signs on variable-height posts. Signs should be 2 feet by 1 foot, 2 inches with brown lettering on a white background, bordered in brown.



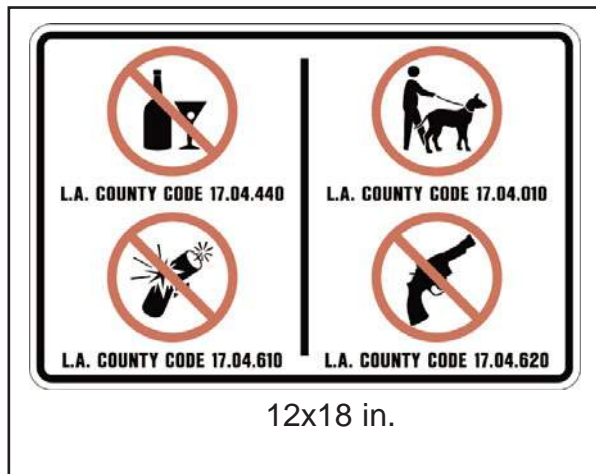
18x20 in.

K-15  
Sample Non-Permitted Use Sign



12x18 in.

K-16  
Sample Non-permitted Use Sign



12x18 in.

K-17  
Sample Non-permitted Use Sign



12x18 in.

K-18  
Sample Permitted Use Sign



K-19  
Sample Permitted Use Sign



12x12 in.

K-20  
Sample Yield Sign

**Other Considerations:** Signs should be bold and clear, but not unwelcoming or intimidating to trail users.  
**Graphic Example:** Figures K-9, *Stay on Trail Sign*, K-10, *Existing Stay on Trail Sign*, K-21 and K-22, *Sample Crossing/Boundary Sign*

Boundary Signs

**Description and Purpose:** Boundary signs alert trail users and landowners to the presence of a trail easement.  
**Sample Way-finding Sign Text:** “Private land behind this sign,” and on reverse, “Property boundary, Altadena Crest Trail, County of Los Angeles”  
**Location and Frequency:** Post signs at all beginnings and endings of easements along trails.  
**Size and Color:** Letters should be blue on a white background.  
**Other Considerations:** Signs should be two-sided.  
**Graphic Example:** Figures K-21 and K-22, *Sample Crossing/Boundary Sign*

Temporary Connector Signs

**Description and Purpose:** Connector signs identify temporary trail segments and encourage their use.  
**Sample Way-finding Sign Text:** “Temporary trail, use permitted”  
**Location and Frequency:** Post signs at the junctures of existing trails and temporary trails.  
**Size and Color:** Letters should be white on a brown background.  
**Other Considerations:** Connector signs should be used in connection with Direction Change/Juncture Indicator signs to show change in direction.  
**Graphic Example:** Figures K-21 and K-22, *Sample Crossing/Boundary Sign*

INFORMATIONAL SIGNS

Entrance Signs

**Description and Purpose:** Entrance signs mark the official entrance to a trail or recreational area.  
**Sample Way-finding Sign Text:** “Brown Mountain Trail Network—County of Los Angeles Department of Parks and Recreation,” “Lion’s Den Trailhead” (include trail logo)  
**Location and Frequency:** Post signs perpendicular to the road and at all primary trailhead locations.  
**Size and Color:** The color is typically white lettering on brown background. Signs may be two-sided so that both entering and exiting trail users can read it.  
**Other Considerations:** Coordination with relevant highway department authority such as Caltrans may be required.  
**Graphic Example:** Figure K-23, *Sample Entrance Sign*; and Figure K-24, *Entrance Sign Elevation*; and Figure K-25, *Trailhead Information*

Trailhead Information Kiosk Signs

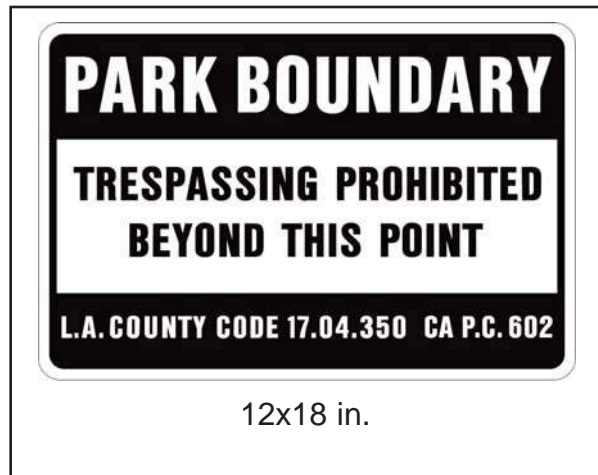
**Description and Purpose:** Trailhead information kiosk signs should provide general information about the trail, navigational aids, and safety bulletins.  
**Sample Way-finding Sign Text:** Trailhead kiosk signs should include trail-specific information.

Panel 1 Information:  
General trail information  
Map of trail network

Panel 2 Information:  
Description of local flora and fauna  
Topographical map and trail profile  
Trail length and elevation gain/loss  
Technical difficulty and expected conditions  
Safety information  
Cautionary notes, such as a buried cable  
Maintenance and emergency contact information

**Location and Frequency:** Post signs at all primary trailhead locations within 50 feet of where the trail leaves the parking

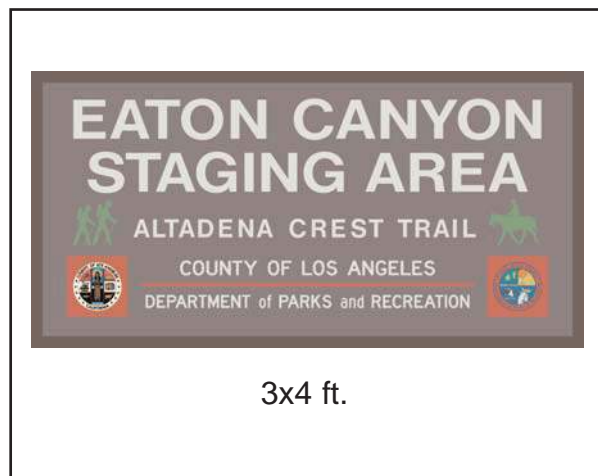




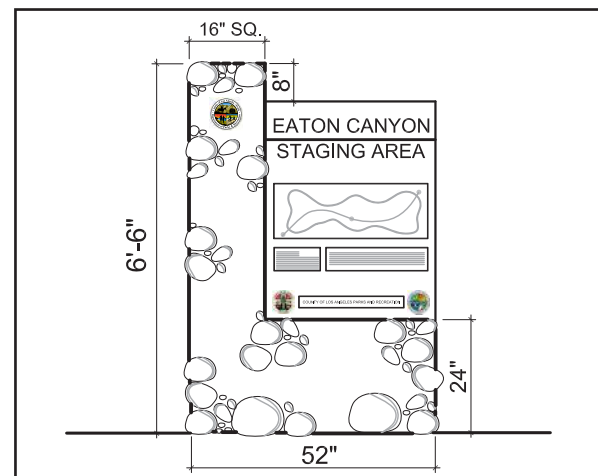
K-21  
Sample Crossing/Boundary Sign



K-22  
Sample Crossing/Boundary Sign



K-23  
Sample Entrance Sign



K-24  
Entrance Sign Elevation



K-25  
Trailhead Information



K-26  
Sample Kiosk

lot.  
**Size and Color:** The kiosk should include a roof and two to three information panels, or a roof with one two-sided panel.  
**Graphic Example:** Figure K-26, *Sample Kiosk*, and Figure K-27, *Sample Kiosk Elevation*

Reassurance Markers

**Description and Purpose:** Reassurance markers provide en route reassurance of trail identity and visually mark the trail line in areas where the trail blends seamlessly with the surrounding area.  
**Sample Way-finding Sign Text:** "Silver Cloud Trail—4.5 miles, moderate difficulty" (include trail logo and trail directional arrow)  
**Location and Frequency:** Post signs at points of confusion or at every 0.25 mile. Signs should alternate from one side of the trail to the other. Signs are usually posted at eye level.  
**Size and Color:** The color should be consistent and blend with the natural palette.  
**Graphic Example:** Figure K-28, *Sample Reassurance/Directional Sign*, and Figure K-29, *Reassurance/Directional Elevation*

Direction Change/Juncture Indicators

**Description and Purpose:** Direction change/juncture indicators alert trail users to a change in direction or juncture with another trail, and may include destinations and distances, features, regulations, warnings, and closures.  
**Sample Way-finding Sign Text:** "Cascade Trail closed," "7.9 miles to First Water Trail Junction"  
**Location and Frequency:** Post signs at ambiguous trail turns and at all junctures with other trails. Orient signs to face users approaching from all likely directions. Signs should be used sparingly and posted within sight of a reassurance marker.  
**Size and Color:** Signs are typically 4-foot-high wooden posts with trail information in relief along the sides. Sign information should be painted on the post in color. Alternatively, aluminum blazes can be nailed into the post.  
**Other Considerations:** Signposts should be placed in areas without erosion issues.  
**Graphic Example:** Figure K-28, *Sample Reassurance/Directional Sign*, and Figure K-29, *Reassurance/Directional Elevation*

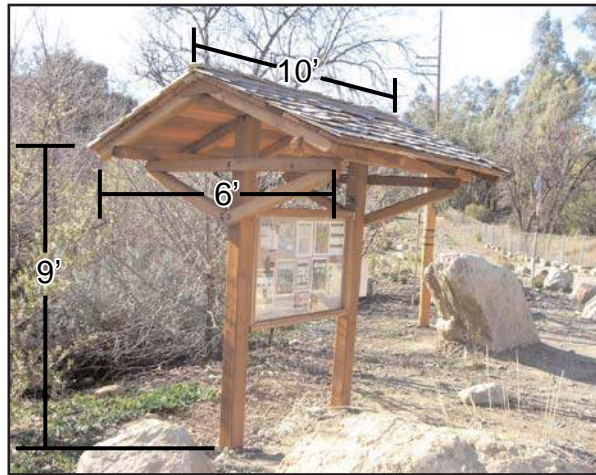
Interpretive Signs

**Description and Purpose:** Interpretive signs may display the entire trail network and identify major trail names and important interpretive features such as mountain peaks, streams, plant communities, or historic points of interest.  
**Sample Way-finding Sign Text:** "Birds of the San Gabriel Mountains"  
**Location and Frequency:** Post signs at major trailheads and destination features.  
**Size and Color:** Letters should be 1.25 inches high and blue, on natural 4-inch-thick wood boards.  
**Other Considerations:** An interpretive sign is expensive and can be included as part of the trailhead kiosk to save money on installation and maintenance.  
**Graphic Example:** Figure K-30, *Sample Interpretive Sign*, and Figure K-31, *Sample Interpretive Sign Elevation*

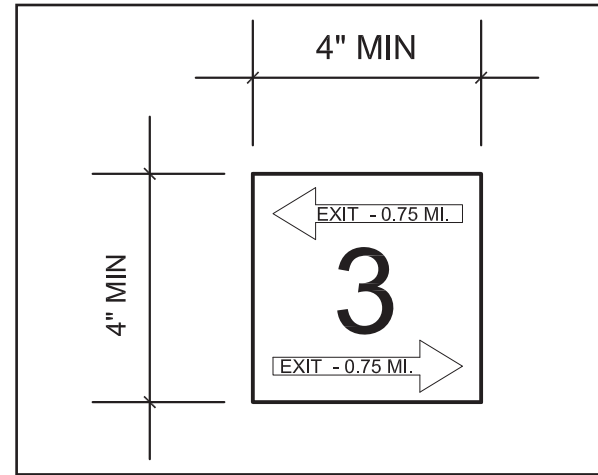
Wayside Exhibits

**Description and Purpose:** Wayside exhibits explain interesting land features, plant and animal communities, historic events, and points of interest.  
**Sample Way-finding Sign Text:** "Geological history of Vasquez Rocks" (Text can be several paragraphs in length and should be written in layman's terminology. Graphics should be integrated with textual explanations.)  
**Location and Frequency:** Reserve wayside exhibits for major features located in high-traffic areas.  
**Size and Color:** Wayside exhibits should feature native materials. For example, river stones should be used as a base building material if the wayside exhibit is located adjacent to a river.  
**Other Considerations:** Wayside exhibits are the most complex and expensive type of way-finding sign.  
**Graphic Example:** Figure K-32, *Sample Wayside Sign*, and Figure K-33, *Sample Wayside Elevation*

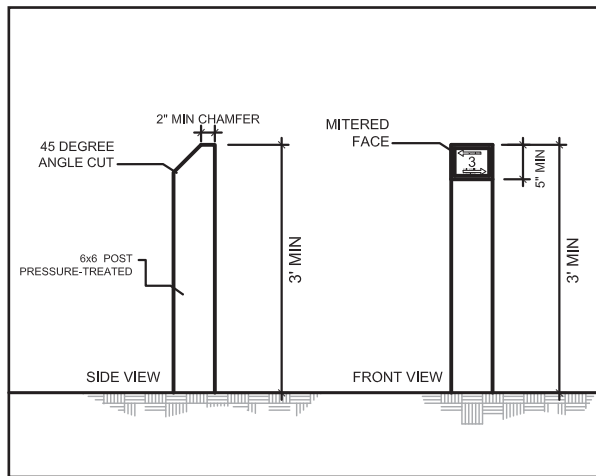




**K-27**  
Sample Kiosk Elevation



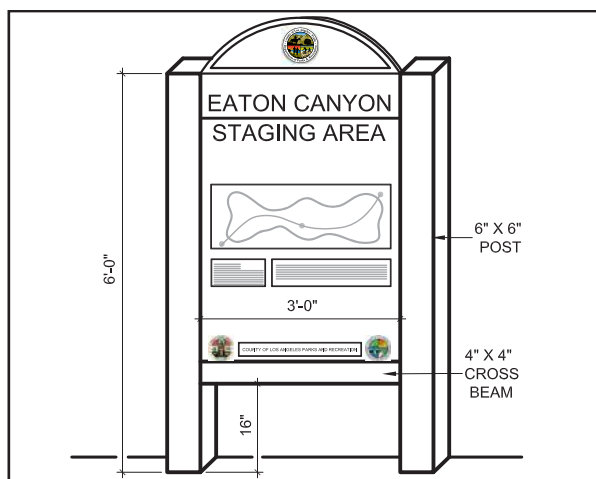
**K-28**  
Sample Reassurance/Directional Sign



**K-29**  
Reassurance/Directional Signs Elevation



**K-30**  
Sample Interpretive Sign



**K-31**  
Sample Interpretive Sign Elevation



**K-32**  
Sample Wayside Sign

Destination Signs

**Description and Purpose:** These signs show directions and distances to various destinations accessed by the trail network.  
**Sample Way-finding Sign Text:** “Horsetail Falls—0.2 miles ahead” (include a directional arrow to the destination)  
**Location and Frequency:** Post destination signs at trailheads, major junctions, and spur trails (to water).  
**Size and Color:** Letters should be blue and on natural wood boards.  
**Other Considerations:** Destination signs direct users to underutilized trail segments by tempting them with the possibility of seeing something special.  
**Graphic Example:** Figure K-28, *Sample Reassurance/Directional Sign*, and Figure K-29, *Reassurance/Directional Elevation*

Adopter Signs

**Description and Purpose:** Adopter signs acknowledge the volunteers who are responsible for trail maintenance along a designated section of the trail.  
**Sample Way-finding Sign Text:** “This section of the trail has been adopted by the International Mountain Bicycling Association”  
**Location and Frequency:** Post adopter signs on road crossing signs or at beginning of designated clean-up areas.  
**Size and Color:** Letters should be blue on a white background.  
**Other Considerations:** This is not intended to be an advertisement for the volunteer; adopter signs should be discreet, not a glaring promotion.  
**Graphic Example:** Figures K-21 and K-22, *Sample Crossing/Boundary Sign*

**TRAIL NETWORK GRAPHICS**

Confirmation/Identification Signs (Trail Logos)

**Description and Purpose:** Trail logos are graphic symbols that are used throughout the trail network to create consistency, identify the trail network, and orient trail users. Logos can also be standalone badges or blazes that are affixed to a post or a tree.  
**Sample Way-finding Sign Text:** “Altadena Crest Trail—County of Los Angeles”  
**Location and Frequency:** Include trail logos on all major signs throughout the trail network. Blazes are usually posted at eye level.  
**Size and Color:** Trail logos should be small (3 to 6 inches) and colorful.  
**Graphic Example:** Figure K-34, *Sample Trail Logo*

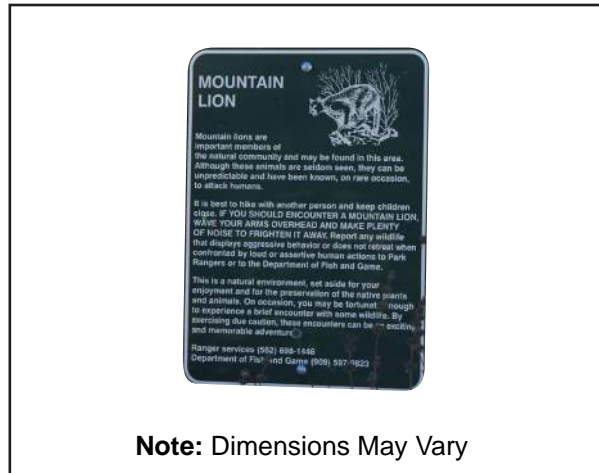
You-Are-Here Indicators

**Description and Purpose:** You-are-here indicators are optional markers that are included on interpretive signs or information kiosks to correlate the present physical location of a particular kiosk on a general trail map.  
**Sample Way-finding Sign Text:** “You are here” (include an arrow indicating the location of the sign)  
**Location and Frequency:** Symbolize you-are-here indicators, and include the symbol on the map legend.  
**Size and Color:** The text should be larger than other map text, but should not dominate or distract from the map graphic.

**SIGN CONSTRUCTION DETAILS AND MATERIALS**

Specifications for each sign type in terms of materials, background color, font color, and font size is included in Table K-1, *Sign Construction Details and Materials*. The choice of materials for signs and structures, as well as their structural engineering, should reflect materials indigenous to the immediate area. For example, use river rocks in lowland areas where there are water corridors and use horizontal ledge stones in higher, dryer elevations where that stone is more common (Figure K-35, *Sample Natural Materials*).





**Note:** Dimensions May Vary

**K-33**

**Sample Wayside Elevation**



**K-34**

**Sample Trail Logo**



**K-35**

**Sample Natural Materials**

**TABLE K-1  
SIGN CONSTRUCTION DETAILS AND MATERIALS**

Type	Material	Background Color	Font Color
Highway informational sign	Aluminum or HDP	Brown	White
Highway warning sign	Aluminum or metal	Yellow	Black
Permitted uses sign	Paint on aluminum or plastic, or decal	White	Black
Etiquette sign	Aluminum or plastic	White	Brown
“Crossing private lands” sign	Aluminum or plastic 2' x 1'2" (variable height)	White with font color border	Brown or black
Boundary sign	White carbonate post or 6" x 6" wood post	White	Medium blue (Pantone 308)
Temporary connector sign	Decal	Brown	White
Entrance sign	Aluminum or HDP	Brown	White
Trailhead information kiosk sign	Wood	Brown	White
Reassurance marker	Paint on aluminum or plastic, or decal blaze	White or natural wood	Medium blue (Pantone 308)
Direction change / juncture indicator	Paint on aluminum or plastic, or 6" x 6" wood post	White or natural wood	Medium blue (Pantone 308)
Interpretive sign	Wood, metal, or plastic with a plastic covering, approximately 3' x 25" x 3"	Buff	Multi-color
Wayside exhibit	Wood, metal, or plastic with a plastic covering	Buff	Multi-color
Destination sign	Wood	Natural wood	Medium blue (Pantone 308)
Adopter sign	Aluminum or plastic, no larger than 2' x 1' 2"	White	Medium blue (Pantone 308)
Confirmation/identification sign	Paint on aluminum or plastic, 3" to 6"	Colorful graphic	Colorful lettering

**KEY:** HDP = High-density plywood

APPENDIX L  
TRAIL ASSESSMENT AND MAINTENANCE FORMS

TRAIL ASSESSMENT AND REPAIR SHEET

<b>Trail Name/Number:</b>	<b>Location (include Marker#):</b>
<b>Priority:</b>	<b>Crew Leader:</b>

**Problem:**

---



---



---



---



---



---

**Repair Methods Description (See Trail Work Log):**

---



---



---



---



---



---

<b>Sketch Existing Trail:</b>          	<b>Sketch Repair:</b>          
---	---

<b>Crew Members:</b>	<b>Tools Required:</b>

TRAIL WORK LOG

Feet (from Marker)	Action (see Trail Log Key)	Feature (see Trail Log Key)	Size			Units	Comment	Total
			L	H	W			

**TRAIL LOG KEY**

Feature Distance	Feature	Action	Size/Quantity	Unit	Comment
	Asphalt placed	Install/maintain		Square foot	
	Bench	Maintain/replace		Each	As specified
	Bridge	Construct/reconstruct		Linear foot	Varies by design
	Bridge	Maintain		Linear foot	As specified
	Bridge	Remove		Linear foot	Varies by design
	Bridge—mid-span supports	Construct/reconstruct		Linear foot	As specified
	Causeway	Construct/reconstruct		Cubic foot	
	Climbing turn	Construct/reconstruct		Each	
	Concrete	Install		Cubic foot	
	Culvert	Install/remove		Linear foot	Varies by type and design
	Culvert; rock	Construct/reconstruct		Cubic foot	
	Down trees	Remove		Diameter (inches)	
	Drainage dip	Construct/reconstruct		Each	As specified—could be cubic foot excavation
	Drainage lense	Construct/reconstruct		Cubic foot	
	Ford	Construct/reconstruct		Cubic foot	
	Hand rail removal	Remove		Linear foot	
	Hand rails	Construct/reconstruct		Linear foot	
	Puncheon	Construct/reconstruct		Linear foot	
	Puncheon	Maintain		Linear foot	As specified
	Retaining wall—causeway rock walls	Construct/reconstruct		Cubic foot	
	Retaining wall—cellular confinement	Construct		Cubic foot	
	Retaining wall—cribbed abutments	Construct/reconstruct		bd. foot	
	Retaining wall—geotextile fabric	Construct		Square foot	
	Retaining wall—mortared rock	Construct/reconstruct		Cubic foot	

**TRAIL LOG KEY  
(Continue)**

Feature Distance	Feature	Action	Size/Quantity	Unit	Comment
	Asphalt placed	Install/maintain		Square foot	
	Bench	Maintain/replace		Each	As specified
	Bridge	Construct/reconstruct		Linear foot	Varies by design
	Bridge	Maintain		Linear foot	As specified
	Bridge	Remove		Linear foot	Varies by design
	Bridge—mid-span supports	Construct/reconstruct		Linear foot	As specified
	Causeway	Construct/reconstruct		Cubic foot	
	Climbing turn	Construct/reconstruct		Each	
	Concrete	Install		Cubic foot	
	Culvert	Install/remove		Linear foot	Varies by type and design
	Culvert; rock	Construct/reconstruct		Cubic foot	
	Down trees	Remove		Diameter (inches)	
	Drainage dip	Construct/reconstruct		Each	As specified—could be cubic foot excavation
	Drainage lense	Construct/reconstruct		Cubic foot	
	Ford	Construct/reconstruct		Cubic foot	
	Hand rail removal	Remove		Linear foot	
	Hand rails	Construct/reconstruct		Linear foot	
	Puncheon	Construct/reconstruct		Linear foot	
	Puncheon	Maintain		Linear foot	As specified
	Retaining wall—causeway rock walls	Construct/reconstruct		Cubic foot	
	Retaining wall—cellular confinement	Construct		Cubic foot	
	Retaining wall—cribbed abutments	Construct/reconstruct		bd. foot	
	Retaining wall—geotextile fabric	Construct		Square foot	
	Retaining wall—	Construct/reconstruct		Cubic	



**TRAIL LOG KEY**  
*(Continue)*

Feature Distance	Feature	Action	Size/Quantity	Unit	Comment
	mortared rock			foot	
	Retaining wall—mortared rock	Maintain		Cubic foot	As specified
	Retaining wall—rock	Construct/reconstruct		Cubic foot	
	Retaining wall—turnpike walls	Construct/reconstruct		Cubic foot	
	Retaining wall—wood	Construct/reconstruct		Square foot	
	Riprap—rock, dry wall	Construct/reconstruct		Cubic foot	Drains, tread, step landings
	Sign	Maintain/replace		Each	As specified
	Slide removal	Remove		Cubic foot	
	Soil stabilizer placed	Install/maintain		Square foot	
	Split rail fence	Remove		Linear foot	
	Step	Maintain		Each	As specified
	Step removal	Remove		Each	
	Steps—cable	Construct/reconstruct		Each	
	Steps—cut out stringer	Construct/reconstruct		Each	
	Steps—full crib	Construct/reconstruct		Each	
	Steps—mortared rock	Construct/reconstruct		Cubic foot	
	Steps—rock	Construct/reconstruct		Cubic foot	
	Steps—wood	Construct/reconstruct		Each	
	Steps—wood interlocking double	Construct/reconstruct		Each	
	Steps—wood interlocking single	Construct/reconstruct		Each	
	Swale	Construct/reconstruct		Each	Note as a feature, but not for budget information
	Switchback	Construct/reconstruct		Each	
	Trail	Brush		Linear foot	
	Trail	Construct		Linear foot	
	Trail narrowing	Remove		Square foot	
	Trail obliteration	Remove		Square foot	

**TRAIL LOG KEY**  
*(Continue)*

Feature Distance	Feature	Action	Size/Quantity	Unit	Comment
	Trail tread	Reconstruct		Linear foot	
	Trail rehabilitation	Perform		Linear foot	
	Turnpike	Construct/reconstruct		Cubic foot	
	Wall-less turnpike	Construct/reconstruct		Cubic foot	
	Water bar—rock	Install/remove/maintain		Cubic foot	
	Water bar—wood	Install/remove/maintain		Each	

## APPENDIX M TOXIC PLANTS

Fencing on trails is an important factor in trail design to ensure privacy and prevent trespassing for private property owners. As indicated in Section 4, *Trail Design*, where appropriate, native landscape will be used as fencing on trails. However, the native landscape would not be used as barriers to prevent wildlife. Landscape elements of trails shall not use plants that are known to be toxic to humans or horses.

This appendix contains the following documents with lists of toxic plants:

- University of California, Davis. “List of Plants Reported to be Poisonous to Animals in the United States.”
- Foster, Andi. “DVM Toxic Plants and Your Horse.”

### LIST OF PLANTS REPORTED TO BE POISONOUS TO ANIMALS IN THE UNITED STATES

Joseph M. DiTomaso  
Department of Soil, Crop and Atmospheric Sciences  
Cornell University, Ithaca, NY 14853

The following table contains a list of plants known to poison animals in the United States. It is organized into three categories; mechanically injurious plants, photosensitizers, and plants poisonous by ingestion. Each category is further organized alphabetically by family and by species within each family. The common name(s) is preceded by the species name. In many cases, an entire list of common names used for a particular species was not included. An attempt was made, however, to include the most widely used common names. The distribution for each species may vary within its geographical range. These designations are included only as a general guide. More detailed distributions can be found in local floras.

It is important to note that animal groups other than those listed here may also be susceptible to a particular plant species, although no records may exist in the literature. Only those plants reported to poison animals in the United States are considered here. It is also noteworthy that the frequency of reported cases may vary from region to region. An appendix is attached, listing the grass species known to be infested with the ergot fungus (*Claviceps* spp.) or to cause symptoms of grass tetany.

#### MECHANICAL INJURY

<u>Family/Scientific name</u>	<u>Common name</u>	<u>Cause of Injury</u>
<b>Euphorbiaceae</b>		
<i>Eremocarpus setigerus</i>	turkey mullein, dove weed	hairballs
<b>Gramineae (Poaceae)</b>		
<i>Aristida</i> spp.	poverty grass, three-awned grass	awns
<i>Bromus diandrus</i> (= <i>B. rigidus</i> )	ripgut grass	awns
<i>Hordeum jubatum</i>	squirreltail barley	barbed awns
<i>Setaria lutescens</i> (= <i>S. glaucum</i> )	yellow foxtail, foxtail grass	mucous erosion from barbs
<i>Stipa</i> spp.	needle grass	awns
<b>Leguminosae (Fabaceae)</b>		
<i>Pisum sativum</i>	pea, pea straw hay	impaction
<i>Trifolium incarnatum</i>	crimson clover	hairballs
<b>Ranunculaceae</b>		
<i>Anemone patens</i>	anemone	hairballs
<b>Rosaceae</b>		
<i>Rubus</i> spp.	blackberry	fruit lodged in nasal passages

**PHOTOSENSITIZING PLANTS****Primary**

<u>Family/Scientific name</u>	<u>Common name</u>	<u>Geographical Range in U.S.</u>	<u>Animals reported to be poisoned</u>	<u>Frequency of reported cases</u>
<b>Hypericaceae</b> <i>Hypericum perforatum</i>	St. Johnswort, Klamath weed	northwest	mainly cattle, also horses, sheep, goats	occasional
<b>Polygonaceae</b> <i>Fagopyrum sagittatum</i>	buckwheat	north and west	all classes	rare
<i>Polygonum</i> spp.	smartweed, knotweed	throughout	cattle	rare

**Hepatogenic**

<u>Family/Scientific name</u>	<u>Common name</u>	<u>Geographical Range in U.S.</u>	<u>Animals reported to be poisoned</u>	<u>Frequency of reported cases</u>
<b>Agavaceae</b> <i>Agave lecheguilla</i>	lechuguilla	southwest	sheep, goats	occasional
<i>Nolina texana</i>	sacahuiste	southwest	sheep, goats	occasional
<i>Nolina microcarpa</i>	sacahuiste	southwest	sheep, goats	occasional
<b>Compositae (Asteraceae)</b> <i>Tetradymia</i> spp.	horsebrush	west	sheep	Common
<b>Cruciferae (Brassicaceae)</b> <i>Brassica napus</i>	rape, mustard	north	cattle, sheep	infrequent
<b>Gramineae (Poaceae)</b> <i>Cynodon dactylon</i>	bermudagrass	throughout	cattle	rare
<i>Panicum</i> spp.	panic grass, panicum	throughout	sheep	rare
<b>Umbelliferae (Apiaceae)</b> <i>Ammi majus</i>	bishop's weed	southwest and west	all classes	rare
<i>Cymopterus watsonii</i>	spring parsley	Great Basin states, Nevada, Utah, etc.	cattle, sheep, fowl	infrequent

<u>Family/Scientific name</u>	<u>Common name</u>	<u>Geographical Range in U.S.</u>	<u>Animals reported to be poisoned</u>	<u>Frequency of reported cases</u>
<b>Verbenaceae</b> <i>Lantana</i> spp.	lantana	cultivated throughout	cattle, sheep	occasional
<b>Zygophyllaceae</b> <i>Tribulus terrestris</i>	puncture vine, caltrop	south and west	sheep	rare

**POISONING FROM INGESTION**

<u>Division/Family/Scientific name</u>	<u>Common name</u>	<u>Geographical Range</u>	<u>Animals reported to be poisoned</u>	<u>Frequency of reported cases</u>
<b>CYANOPHYTA</b> <i>Anabaena flos-aquae</i>	Annie	throughout	all classes	occasional
<i>Anabaena torulosa</i>	Annie	throughout	all classes	rare
<i>Aphanizomenon flos-aquae</i>	Fannie	throughout	all classes	occasional
<i>Coelosphaerium kuetzingianum</i>	---	throughout	all classes	rare
<i>Gloeotrichia echinulata</i>	---	throughout	all classes	rare
<i>Lyngbya birgei</i>	---	throughout	all classes	rare
<i>Microcystis aeruginosa</i>	Mike	throughout	all classes	occasional
<i>Microcystis incerta</i>	Mike	throughout	all classes	rare
<i>Nodularia spumigena</i>	---	throughout	all classes	rare
<i>Nostoc rivulare</i>	---	throughout	all classes	rare
<b>PYRRHOPHYTA (Dinoflagellates)</b> <i>Gonyaulax</i> spp.	shellfish poisoner	throughout coastal US	all classes	rare
<i>Gymnodinium</i> spp.	shellfish poisoner	throughout coastal US	all classes	rare
<i>Ptychodiscus brevis</i>	shellfish poisoner	Gulf of Mexico	all classes	rare



<u>Division/Family/Scientific name</u>	<u>Common name</u>	<u>Geographical Range</u>	<u>Animals reported to be poisoned</u>	<u>Frequency of reported cases</u>
<b>MYCOTA (Fungi)</b>				
<u>Ascomycetes</u>				
<i>Claviceps cinerea</i>	ergot	Texas	all classes, esp. cattle	rare
<i>Claviceps paspali</i>	ergot	south	all classes, esp. cattle	common
<i>Claviceps purpurea</i>	ergot	northeast, east, midwest, and California	all classes, esp. cattle	common
<i>Gibberella zeae</i> (= <i>Fusarium roseum</i> )	corn root rot	east, central and south	swine	rare
<u>Basidiomycetes</u>				
<i>Amanita</i> spp.	death angels, death cups, etc.	throughout	cattle, pets, esp. dogs	rare
<i>Gyromitra esculenta</i> (= <i>Helvella esculenta</i> )	false morel	throughout	cattle, pets, esp. dogs	rare
<i>Lactarius torminosus</i>	lactarius	throughout, esp. east	all classes	rare
<i>Entoloma lividum</i> (= <i>Rhodophyllus sinuatus</i> )	entoloma	throughout	all classes	rare
<i>Tricholoma paradinum</i>	tricholoma	west	all classes	rare
<u>Fungi imperfect</u>				
<i>Aspergillus flavus</i>	aspergillus	throughout	all classes, except Sheep	common
<i>Penicillium rubrum</i>	penicillium	throughout	cattle, sheep, fowl	common
<i>Stachybotrys atra</i>	stachybotrys	throughout	horses	common
<u>Lichens</u>				
<i>Parmelia molliuscula</i>	ground lichen	midwest and north	cattle, sheep	infrequent

<u>Division/Family/Scientific name</u>	<u>Common name</u>	<u>Geographical Range</u>	<u>Animals reported to be poisoned</u>	<u>Frequency of reported cases</u>
<b>PTERIDOPHYTA (Ferns)</b>				
<i>Dryopteris felix-mas</i> (= <i>Aspidium felix-mas</i> )	male fern	northeast and west	cattle, horses	rare
<i>Notholaena sinuata</i> var. <i>cochisensis</i>	Jimmy fern, cloak fern	southwest	mainly sheep, also cattle, goats	occasional
<i>Onoclea sensibilis</i>	sensitive fern, meadow fern	east and south	horses	rare
<i>Pteridium aquilinum</i>	bracken fern, brake fern	throughout	cattle, horses, some sheep	common
<b>SPHENOPHYTA (Horsetails)</b>				
<i>Equisetum arvense</i>	horsetail, scouring rush, jointed rush, foxtail	throughout	all classes, esp. horses	infrequent
<i>Equisetum palustre</i>	horsetail, scouring rush, foxtail	throughout	all classes, esp. cattle	infrequent
<b>GYMNOSPERMS</b>				
<b>Conifers</b>				
<u>Cupressaceae</u>				
<i>Cupressus macrocarpa</i>	Monterey cypress, Macrocarpa	California	cattle	infrequent
<i>Juniper virginiana</i>	juniper	central to east	cattle, sheep, horses	rare
<u>Pinaceae</u>				
<i>Pinus ponderosa</i>	Ponderosa pine, western yellow pine	west	cattle	occasional

<u>Division/Family/Scientific name</u>	<u>Common name</u>	<u>Geographical Range</u>	<u>Animals reported to be poisoned</u>	<u>Frequency of reported cases</u>
Taxaceae <i>Taxus</i> spp.	yew	cultivated and native throughout	cattle, horse	rare
<b>Cycads</b>				
Cycadaceae <i>Zamia integrifolia</i>	coonties, Florida arrow root	Florida	cattle	rare
<b>ANGIOSPERMS (Flowering plants)</b>				
Aceraceae <i>Acer rubrum</i>	red maple, swamp maple	east	cattle, horses	rare
Amaranthaceae <i>Amaranthus</i> spp.	pigweed, carelessweed	throughout	cattle, swine	infrequent
Amaryllidaceae <i>Zephyranthes atamasco</i>	atamasco lily, rain lily	throughout , mainly south	cattle, horses, swine	infrequent
Anacardiaceae <i>Toxicodendron diversilobum</i> <i>Toxicodendron radicans</i> <i>Toxicodendron vernix</i>	western poison oak poison ivy, poison vine, markweed poison sumac	west midwest and east mideast and east	all classes all classes all classes	rare rare rare
Apocynaceae <i>Apocynum androsaemifolium</i> <i>Apocynum cannabinum</i> <i>Nerium oleander</i>	spreading dogbane Indian hemp, dogbane oleander	throughout west cultivated in south, west and tropical US	all classes all classes all classes	rare rare occasional

<u>Division/Family/Scientific name</u>	<u>Common name</u>	<u>Geographical Range</u>	<u>Animals reported to be poisoned</u>	<u>Frequency of reported cases</u>
<i>Thevetia peruviana</i>	yellow oleander, be-still tree	tropics	all classes	rare
<i>Vinca</i> spp.	periwinkle	cultivated in south and Hawaii	all classes	rare
<b>Araceae</b>				
<i>Arisaema</i> spp.	Jack-in-the-pulpit	east	cattle, sheep, swine, goats	rare
<i>Dieffenbachia</i> spp.	dumbcane	cultivated throughout	pets	common
<i>Philodendron</i> spp.	philodendron	cultivated throughout	pets, esp. cats	common
<b>Araliaceae</b>				
<i>Aralia spinosa</i>	Hercules club, devils walking stick, angelica tree	east and mideast	all classes	rare
<i>Hedera canariensis</i>	Algerian ivy	cultivated throughout	all classes	rare
<i>Hedera helix</i>	English ivy	cultivated throughout	all classes	rare
<b>Asclepiadaceae</b>				
<i>Asclepias</i> spp.	milkweed	throughout	all classes	occasional
<b>Berberidaceae (= Podophyllaceae)</b>				
<i>Podophyllum peltatum</i>	mayapple, mandrake	mideast and east	all classes	rare
<b>Boraginaceae</b>				
<i>Amsinckia intermedia</i>	coastal fiddleneck, Tarweed	west	mainly horses, also cattle and swine	common
<i>Cynoglossum officinale</i>	hounds tongue	throughout	cattle, sheep, horses	rare
<i>Echium</i> spp.	viper's bugloss	California	sheep, horses, pets	rare

<u>Division/Family/Scientific name</u>	<u>Common name</u>	<u>Geographical Range</u>	<u>Animals reported to be poisoned</u>	<u>Frequency of reported cases</u>
<i>Heliotropium europaeum</i>	heliotrope	throughout	cattle, sheep, swine, fowl	infrequent
Buxaceae <i>Buxus sempervirens</i>	common box	cultivated throughout	sheep	rare
Calycanthaceae <i>Calycanthus fertalis</i>	Carolina allspice	southeast	cattle	rare
Campanulaceae <i>Lobelia</i> spp.	lobelia, cardinal flower, Indian tobacco	cultivated and native throughout	cattle, sheep	rare
Cannabaceae <i>Cannabis</i> spp.	marijuana, hemp, etc.	throughout, esp. north	pets, esp. dogs	rare
Capparidaceae <i>Wislizenia refracta</i>	jackassclover	southwest	cattle, sheep, horses	rare
Caprifoliaceae <i>Sambucus</i> spp.	elderberry, elder	throughout	cattle, swine	rare
Caryophyllaceae <i>Agrostemma githago</i>	corn cockle	throughout	all classes, esp. fowl and swine	infrequent
<i>Drymaria arenarioides</i>	alfombrilla	southwest	all classes, except Horses	occasional
<i>Drymaria pachyphylla</i>	inkweed, drymary	southwest	all classes, except Horses	occasional
<i>Saponaria officinalis</i>	bouncing bet	throughout	all classes	rare
Celastraceae <i>Celastrus scandens</i>	climbing bittersweet	central to east	esp. horses, also cattle and sheep	rare

<u>Division/Family/Scientific name</u>	<u>Common name</u>	<u>Geographical Range</u>	<u>Animals reported to be poisoned</u>	<u>Frequency of reported cases</u>
Chenopodiaceae <i>Atriplex</i> spp.	saltbush	throughout	cattle, sheep	rare
<i>Bassia hyssopifolia</i> <i>Beta vulgaris</i>	fivehook bassia beet, sugar beet, fodder beet, mangel, mangel-wurzel, mangold	east and west cultivated throughout	sheep cattle, sheep	rare infrequent
<i>Chenopodium album</i>	common lambsquarter	throughout	sheep, swine	infrequent
<i>Chenopodium ambrosioides</i>	wormseed	east	fowl	rare
<i>Chenopodium</i> spp.	goosefoot	throughout	all classes	rare
<i>Halogeton glomeratus</i>	halogeton, barilla	western Great Basin states	sheep	common
<i>Kochia scoparia</i>	burning bush, summer cypress, Mexican fireweed	throughout, esp. west	cattle, sheep, horses	rare
<i>Salsola australis</i> (= <i>S. petifera</i> , <i>S. kali</i> , <i>S. iberica</i> )	Russian thistle, tumbleweed	north, midwest, and west	all classes	infrequent
<i>Sarcobatus vermiculatus</i>	greasewood	west	sheep	occasional
<i>Suckleya suckleyana</i>	poison suckleya	Rocky Mountain states	cattle, sheep	rare
Compositae (Asteraceae) <i>Achillea</i> spp.	yarrow	throughout	cattle	rare
<i>Anthemis cotula</i>	dog fennel, mayweed, mayweed chamomil,	throughout	fowl	rare
<i>Artemisia filifolia</i>	sand sagebrush	midwest and west	horses	rare
<i>Artemisia tridentata</i>	big sagebrush	west	sheep, horses	rare

<u>Division/Family/Scientific name</u>	<u>Common name</u>	<u>Geographical Range</u>	<u>Animals reported to be poisoned</u>	<u>Frequency of reported cases</u>
<i>Aster</i> spp.	aster	throughout	sheep	rare
<i>Baccharis pteronioides</i>	yerba-de-pasmo	southwest	cattle, sheep	rare
<i>Baccharis</i> spp.	coyotebrush, Silvering, false-willow	throughout	cattle, sheep, fowl	rare
<i>Bahia oppositifolia</i>	plains bahia	west	cattle	rare
<i>Baileya multiradiata</i>	desert baileya, cloth of gold	southwest	sheep, goats	occasional
<i>Centaurea solstitialis</i>	yellow star thistle	south, east and west	horses	common
<i>Chrysothamnus nauseosus</i>	rubber rabbitbrush	west	cattle, sheep, horses	rare
<i>Conyza coulteri</i>	conyza	southwest	cattle	rare
<i>Eupatorium rugosum</i>	white snakeroot, Richweed	east to Texas	cattle, horses	occasional
<i>Eupatorium wrightii</i> (= <i>Isocoma wrightii</i> )	rayless goldenrod, snakeroot	southwest	cattle	occasional
<i>Flourensia cernua</i>	tarbush, blackbrush	southwest	cattle, sheep, goats	rare
<i>Franseria discolor</i>	white ragweed	west	cattle, sheep, horses	rare
<i>Grindelia</i> spp.	gumweed	west	cattle, sheep, horses	rare
<i>Gutierrezia microcephala</i> (= <i>Xanthocephalum microcephala</i> )	broomweed, perennial southwest, also westcattle, snake weed, slinkweed, turpentine weed		sheep, goats	common
<i>Haplopappus heterophyllus</i>	rayless goldenrod, Jimmyweed, burrow weed	southwest	cattle, sheep, horses	occasional

<u>Division/Family/Scientific name</u>	<u>Common name</u>	<u>Geographical Range</u>	<u>Animals reported to be poisoned</u>	<u>Frequency of reported cases</u>
<i>Helenium</i> spp.	sneezeweed	west and east cattle and goats	esp. sheep, also	common
<i>Hymenoxys odorata</i>	bitterweed, bitter Rubberweed	southwest	all classes, esp. sheep	common
<i>Hymenoxys richardsonii</i>	pingue, Colorado rubberweed	southwest Canada to Texas and Arizona	esp. sheep, also cattle and goats	common
<i>Hymenoxys lemmonii</i>	rubberweed	southwest	sheep	common
<i>Iva angustifolia</i>	narrowleaf sumpweed	south	cattle	rare
<i>Lactuca serriola</i> (= <i>Lactuca scariola</i> )	prickly lettuce, wild lettuce	throughout	cattle	rare
<i>Oxytenia acerosa</i> (= <i>Iva acerosa</i> )	copperweed	southwest	cattle, sheep	occasional
<i>Psathyrotes annua</i>	paperflower, Psathyrotes	southwest	sheep	rare
<i>Psilostrophe</i> spp.	paperflower	southwest	sheep	infrequent
<i>Rudbeckia laciniata</i>	golden glow, cone flower, thimbleweed	midwest to east	horse, sheep, swine	infrequent
<i>Sartwellia flaveriae</i>	sartwellia	southwest	cattle, sheep, goats	rare
<i>Senecio</i> spp.	groundsel, ragwort, Bitterweed	throughout	all classes, esp. horses	common
<i>Silybum marianum</i>	milk thistle, bull thistle, variegated thistle, St. Mary's thistle	California	esp. cattle, also sheep	infrequent
<i>Solidago</i> spp.	goldenrod	throughout	cattle, sheep, horses	infrequent



<u>Division/Family/Scientific name</u>	<u>Common name</u>	<u>Geographical Range</u>	<u>Animals reported to be poisoned</u>	<u>Frequency of reported cases</u>
<i>Tanacetum vulgare</i>	tansy	throughout	cattle	rare
<i>Tetradymia canescens</i>	spineless horsebrush	west	sheep	common
<i>Tetradymia glabrata</i>	littleleaf horsebrush, spring rabbitbrush, coal oil brush	west	sheep	common
<i>Viguiera annua</i>	annual goldeneye	southwest	cattle	rare
<i>Xanthium</i> spp.	cocklebur, clotbur	throughout	cattle, swine, fowl	occasional
<i>Xylorrhiza</i> spp.	woody aster	west	sheep	occasional
Crassulaceae				
<i>Cotyledon</i> spp.	cotyledon	occas. cultivated in US	goats	rare
Cruciferae (Brassicaceae)				
<i>Armoracia lapathifolia</i>	horseradish	east, midwest and occas. West	cattle, horses, swine	rare
<i>Brassica</i> spp.	mustard, wild mustard	throughout	cattle, sheep, swine	occasional
<i>Descurainia pinnata</i>	tansy mustard	south and southwest	cattle, horses	infrequent
<i>Erysimum cheiranthoides</i>	wormseed mustard	throughout	swine	rare
<i>Raphanus</i> spp.	radish, wild radish	throughout	cattle, sheep	rare
<i>Stanleya pinnata</i>	prince's plume	midwest to southwest	all classes	rare
<i>Thlaspi arvense</i>	fanweed, field pennycress, pennycress mustard	throughout	all classes	rare

<u>Division/Family/Scientific name</u>	<u>Common name</u>	<u>Geographical Range</u>	<u>Animals reported to be poisoned</u>	<u>Frequency of reported cases</u>
Cucurbitaceae				
<i>Momordica charantia</i>	balsam pear, balsam apple, bitter gourd	southeast	dogs	rare
Cuscutaceae				
<i>Cuscuta</i> spp.	dodder	throughout	cattle, horses	rare
Cyperaceae				
<i>Scirpus americanus</i>	bulrush, three-square	throughout	cattle	rare
Datisaceae				
<i>Datisca glomerata</i>	durango root	California	cattle, sheep	rare
Ericaceae				
<i>Kalmia</i> spp.	lambkill, sheepkill, calkill, laurel, wicky, calico bush, ivy bush	throughout	all classes, esp. sheep	infrequent
<i>Ledum</i> spp. <i>Leucothoe</i> spp.	Labrador tea laurel, black laurel, fetter bush	west throughout	all classes, esp. sheep all classes, esp. sheep	rare rare
<i>Lyonia</i> spp.	male berry, male blueberry, huckleberry staggerbush	east	all classes	rare
<i>Menziesia ferriginea</i>	mock azalea, rustyleaf, fools Huckleberry Huckleberry	west	all classes, esp. sheep	rare
<i>Pieris japonica</i>	Japanese pieris, andromeda	cultivated throughout	all classes, esp. sheep	rare
<i>Rhododendron</i> spp.	azalea, rhododendron	cult. and native throughout	all classes, esp. sheep	infrequent

<u>Division/Family/Scientific name</u>	<u>Common name</u>	<u>Geographical Range</u>	<u>Animals reported to be poisoned</u>	<u>Frequency of reported cases</u>
Euphorbiaceae				
<i>Aleurites</i> spp.	tung oil tree	south	cattle, horses, fowl	rare
<i>Croton</i> spp.	hogwort, croton	cult. throughout, native to southeast and tropics	cattle	rare
<i>Eremocarpus setigerus</i>	turkey mullein, dove weed	west	cattle	rare
<i>Euphorbia</i> spp.	spurge	throughout	cattle, sheep, horses	infrequent
<i>Hippomane mancinella</i>	manchineel tree	Florida	all classes	infrequent
<i>Phyllanthus abnormis</i>	spurge	Texas	cattle, also sheep, goat	occasional
<i>Reverchonia arenaria</i>	reverchonia	southwest	sheep	rare
<i>Ricinus communis</i>	castor bean, palma christi	south and west	all classes	infrequent
<i>Sapium sebiferum</i>	Chinese tallow tree	Atlantic coast, south to Calif	cattle, sheep, goats	rare
<i>Stillingia</i> spp.	queen's delight	southwest	sheep	rare
Fagaceae				
<i>Quercus</i> spp.	oak	throughout, esp. west and southwest	cattle, horses	common
Fumariaceae				
<i>Corydalis</i> spp.	fitweed, corydalis, Funitory	mainly west, occas. east	cattle, sheep, horses	rare
<i>Dicentra</i> spp. (= <i>Bikukulla</i> spp.)	staggerweed, dutchman's breeches, squirrel corn	cult. and native throughout	esp cattle, also horses	rare

<u>Division/Family/Scientific name</u>	<u>Common name</u>	<u>Geographical Range</u>	<u>Animals reported to be poisoned</u>	<u>Frequency of reported cases</u>
Genetianaceae				
<i>Centaurium</i> spp.	century, mountain pink	midwest to west	esp. sheep, also cattle and goats	rare
Gramineae (Poaceae)				
<i>Avena sativa</i>	cultivated oats	cultivated throughout	cattle, sheep	occasional
<i>Cynodon dactylon</i>	bermudagrass	throughout	cattle	infrequent
<i>Festuca arundinacea</i>	tall fescue	throughout	cattle, sheep	occasional
<i>Glyceria striata</i>	fowl mannagrass	throughout	cattle	rare
<i>Hilaria rigida</i>	galleta grass	southwest	cattle	rare
<i>Hordeum vulgare</i>	cultivated barley	cultivated throughout	swine, pets, esp. dogs	rare
<i>Lolium temulentum</i>	darnel	east and west	cattle, sheep	rare
<i>Lolium</i> spp.	ryegrass	throughout	cattle, sheep	infrequent
<i>Phalaris tuberosa</i>	canary grass, winter Harding grass	west coast and North Carolina	cattle, sheep	rare
<i>Setaria lutescens</i> (= <i>S. glauca</i> )	yellow foxtail, yellow bristle grass	throughout	cattle, horses	occasional
<i>Sorghum</i> spp.	Johnsongrass, Columbus grass, Sudan grass, sorghum	cult. and weedy throughout	esp. cattle, also sheep and horses	occasional
<i>Stipa viridula</i>	sleepy grass	north to southwest	horses	rare
<i>Stipa robusta</i> (= <i>S. vaseyi</i> )	sleepy grass	southwest	cattle, sheep	rare
<i>Zea mays</i>	corn, Indian corn, maize	cultivated throughout	cattle	rare

<u>Division/Family/Scientific name</u>	<u>Common name</u>	<u>Geographical Range</u>	<u>Animals reported to be poisoned</u>	<u>Frequency of reported cases</u>
Haemodoraceae <i>Lacnathes tinctoria</i>	bloodwort, redroot	east	swine	rare
Hippocastanaceae <i>Aesculus</i> spp.	buckeye, horsechestnut	cult. and native throughout	all classes, esp. cattle	infrequent
Hydrangeaceae <i>Hydrangea</i> spp.	hydrangea	cultivated throughout	all classes	rare
Iridaceae <i>Iris</i> spp.	iris, flag	cult. and native throughout	cattle	rare
Juncaginaceae <i>Triglochin maritima</i>	arrowgrass, sourgrass	throughout	cattle, sheep	occasional
<i>Triglochin palustris</i>	arrowgrass, sourgrass	throughout, except southeast	cattle, sheep	infrequent
Labiatae (Lamiaceae) <i>Glechoma hederacea</i>	ground ivy, creeping charlie, gill-over-the-ground	north and east	horses	rare
<i>Perilla frutescens</i>	cowmint, beef stick plant	east	all classes, esp. cattle	infrequent
<i>Salvia reflexa</i>	annual sage, mintweed	Wisconsin to Texas	cattle	rare
Lauraceae <i>Persea americana</i>	avocado	cultivated in Calif. and Florida	all classes	infrequent
Leguminosae (Fabaceae) <i>Abrus precatorius</i>	crab's eye, precatory bean, rosary pea, jequirity bean	Florida	cattle, horses	rare
<i>Acacia</i> spp.	guajillo, acacia	southwest, Texas	cattle, sheep, goats	rare
<i>Arachis hypogaea</i>	peanut, groundnut	cultivated in south	cattle, swine, fowl	rare

<u>Division/Family/Scientific name</u>	<u>Common name</u>	<u>Geographical Range</u>	<u>Animals reported to be poisoned</u>	<u>Frequency of reported cases</u>
<i>Astragalus</i> spp.	locoweed, milkvetch, poison vetch, rattleweed	midwest and west	all classes	common
<i>Baptisia</i> spp.	false indigo, baptisia	central states	esp. horses, also cattle	rare
<i>Cassia</i> spp.	senna, coffee weed	east, southeast to southwest, tropics	all classes	rare
<i>Crotalaria</i> spp.	rattlebox, crotalaria	central to east	all classes	common
<i>Glottidium vesicarium</i>	coffee weed, bagpod, coffee bean	Florida	cattle	rare
<i>Glycine max</i>	soybean, soyabean	culti. in midwest and east	esp. cattle, also sheep and horses	rare
<i>Gymnocladus dioica</i>	Kentucky coffee bean	midwest to east	cattle, sheep, horses	rare
<i>Indigofera endecaphylla</i> (= <i>I. spicata</i> )	creeping indigo	tropics	cattle, sheep, horses	rare
<i>Lathyrus</i> spp.	vetch, wild pea, pea	throughout	esp. horses, also cattle and sheep	common
<i>Lespedeza stipulacea</i>	lespedeza	central to east	cattle	infrequent
<i>Leucaena glauca</i>	koa haole, lead tree	south and Hawaii	all classes	infrequent
<i>Lupinus</i> spp.	lupin, bluebonnet	throughout	esp. sheep, also cattle and horses	common
<i>Medicago sativa</i>	alfalfa, lucerne	cultivated throughout	cattle, sheep, horses, and swine	occasional
<i>Medicago polymorpha</i> (= <i>M. hispida</i> )	burclover, trefoil	California	cattle, sheep, swine	infrequent
<i>Melilotus</i> spp.	sweetclover	throughout	esp. cattle, also sheep	occasional

<u>Division/Family/Scientific name</u>	<u>Common name</u>	<u>Geographical Range</u>	<u>Animals reported to be poisoned</u>	<u>Frequency of reported cases</u>
<i>Oxytropis</i> spp.	point locoweed, point vetch	midwest and west	all classes	common
<i>Phaseolus lunatus</i>	lima bean, Java bean, Burma bean, Sieva bean, etc.	cultivated throughout	cattle	infrequent
<i>Pisum sativum</i>	garden pea	cultivated throughout	cattle, sheep, horses, and swine	infrequent
<i>Prosopis juliflora</i>	mesquite, kiawe bean	California to Texas, Hawaii	cattle	infrequent
<i>Robinia pseudoacacia</i>	black locust	throughout, esp. east	all classes, esp. cattle and horses	rare
<i>Sesbania</i> spp. (= <i>Daubentonia</i> spp.)	correeweed, coffeebean, bag-pod, rattlebrush, rattlebox, sesbane, poison bean	Gulf Coast states	cattle, sheep, goats, and fowl	occasional
<i>Sophora</i> spp.	mescal bean, silky sophoramid	west and southwest	cattle, sheep	rare
<i>Thermopsis montana</i>	goldenpea, yellow pea	west	cattle	rare
<i>Trifolium</i> spp.	clover	throughout	all classes, esp. horses	occasional
<i>Vicia villosa</i>	hairy vetch	throughout	cattle, horses, fowl	infrequent
<i>Vicia</i> spp.	vetch, fava bean	throughout	horses	rare
<hr/>				
Liliaceae				
<i>Allium cepa</i>	cutivated onion	cultivated throughout	cattle, horses, pets	occasional
<i>Allium</i> spp.	wild onion	throughout	cattle, sheep, horses, dogs	rare
<i>Amianthium muscaetoxicum</i>	staggergrass, fly poison, crow poison	midwest to east	cattle, sheep	occasional

<u>Division/Family/Scientific name</u>	<u>Common name</u>	<u>Geographical Range</u>	<u>Animals reported to be poisoned</u>	<u>Frequency of reported cases</u>
<i>Asparagus officinalis</i>	cultivated asparagus	cult. mainly in west	cattle	rare
<i>Colchicum autumnale</i>	authumn crocus	cultivated throughout	all classes	rare
<i>Melanthium virginicum</i>	bunchflower	central to east	cattle, sheep, horses	rare
<i>Ornithogalum umbellatum</i>	Star-of-Bethlehem, Snowdrop	midwest to east	cattle, sheep, swine	infrequent
<i>Polygonatum multiflorum</i>	Solomon's seal	cult. mainly in east	pets, esp. dogs	rare
<i>Veratrum</i> spp.	false hellebore, corn lily, skunk cabbage	throughout, esp. west	esp. sheep, also cattle and goats	occasional
<i>Zigadenus</i> spp.	death camas	west, midwest to south	esp. sheep, also cattle and horses	common
<hr/>				
Linaceae				
<i>Linum neomexicanum</i>	yellow pine flax	southwest	cattle, sheep	rare
<i>Linum usitatissimum</i>	flax, linseed	cultivated throughout	cattle, sheep	rare
<hr/>				
Loganiaceae				
<i>Gelsemium sempervirens</i>	Carolina jessamine, yellow jessamine, evening trumpetflower	south	all classes	occasional
<hr/>				
Loranthaceae (= Viscaceae)				
<i>Phoradendron</i> spp.	mistletoe	west	cattle, pets	rare
<hr/>				
Malvaceae				
<i>Gossypium</i> spp.	cotton	cultivated in south and west	cattle, sheep, swine	occasional
<i>Malva parviflora</i>	mallow, cheeseweed	throughout	horses	infrequent
<i>Modiola caroliniana</i>	ground ivy	south to west	cattle, sheep, goats	rare



<u>Division/Family/Scientific name</u>	<u>Common name</u>	<u>Geographical Range</u>	<u>Animals reported to be poisoned</u>	<u>Frequency of reported cases</u>
Meliaceae <i>Melia azedarach</i>	chinaberry tree, white cedar	south and tropics	swine	rare
Moraceae <i>Maclura pomifera</i>	osage orange	south to southwest	cattle	rare
Myoporaceae <i>Myoporum</i> spp.	myoporum, boobialla	cultivated in west	all classes	rare
Oleaceae <i>Ligustrum</i> spp.	privet	cultivated throughout	cattle, sheep, horses, dogs	rare
Oxalidaceae <i>Oxalis pes-caprae</i>	Bermuda buttercup, Bermuda, oxalis, soursob, sorrel	Florida and California	sheep	rare
Papaveraceae <i>Papaver</i> spp.	poppy	cultivated throughout	all classes	rare
Phytolaccaceae <i>Phytolacca americana</i>	pokeweed, pokeberry, scoke, garget, pigeonberry	east, south and southwest	cattle, swine	rare
Polygalaceae <i>Polygala</i> spp.	snakeroot, milkwort	throughout	horses	rare
Polygonaceae <i>Rheum rhaponticum</i>	rhubarb	cultivated throughout	all classes	infrequent
<i>Rumex</i> spp.	dock, sorrel	throughout	cattle, sheep	rare
Primulaceae <i>Anagallis arvensis</i>	scarlet pimpernel	east and west coasts	cattle, sheep	rare

<u>Division/Family/Scientific name</u>	<u>Common name</u>	<u>Geographical Range</u>	<u>Animals reported to be poisoned</u>	<u>Frequency of reported cases</u>
Ranunculaceae <i>Aconitum</i> spp.	monkshood, aconite	throughout	cattle, horses	infrequent
<i>Actaea rubra</i>	baneberry	throughout	cattle, sheep	rare
<i>Anemone</i> spp.	anemone, windflower, pasque	cult. throughout, native in north	cattle, sheep	rare
<i>Caltha</i> spp.	marsh marigold	throughout	cattle, horses	rare
<i>Ceratocephalus testiculatus</i>	bur buttercup	northwest	sheep	rare
<i>Delphinium</i> spp.	larkspur	mainly west, occasionally east and midwest	cattle, rarely sheep	common
<i>Ranunculus</i> spp.	buttercup, crowfoot	throughout	horses, swine, goats	rare
Rhamnaceae <i>Colubrina texensis</i>	hogplum	Colorado to Texas	sheep	rare
<i>Karwinskia humboldtiana</i>	coyotillo	Texas to southern California	all classes	occasional
Rosaceae <i>Amelanchier</i> spp.	serviceberry	throughout	cattle	rare
<i>Cercocarpus</i> spp.	mountain mahogany	west	cattle, sheep	infrequent
<i>Heteromeles arbutifolia</i>	toyon, Christmas berry	west	cattle, horses	rare
<i>Malus sylvestris</i>	apple	cultivated throughout	cattle, horses	rare
<i>Prunus virginiana</i>	chokecherry	midwest and west	all classes	common
<i>Prunus</i> spp.	wild cherry, chokecherry	cult. and native throughout	all classes	occasional

<u>Division/Family/Scientific name</u>	<u>Common name</u>	<u>Geographical Range</u>	<u>Animals reported to be poisoned</u>	<u>Frequency of reported cases</u>
Rubiaceae <i>Cephalanthus occidentalis</i>	buttonbush	throughout	cattle	rare
Rutaceae <i>Citrus</i> spp.	citrus, orange, grapefruit, etc.	cultivated throughout	swine, fowl	rare
Scrophulariaceae <i>Digitalis purpurea</i>	foxglove	cult. throughout, weed in west	all classes	rare
Solanaceae <i>Cestrum diurnum</i>	day blooming jasmine, king-of-the-day	Florida	cattle, horses	rare
<i>Datura</i> spp.	datura, thornapple, jimsonweed, apple of Peru, stramonium	cult. and native throughout	all classes	occasional
<i>Hyoscyamus niger</i>	black henbane, henbane	north	all classes	rare
<i>Lycium halimifolium</i>	matrimony vine	north	cattle, sheep	rare
<i>Lycopersicon esculentum</i>	tomato	cultivated throughout	cattle, swine	infrequent
<i>Nicotiana</i> spp.	tobacco, wild tobacco	mainly west, cult. in east	esp. horses, also cattle, sheep, swine	occasional
<i>Physalis</i> spp.	groundcherry, tomatillo	throughout	sheep	rare
<i>Solanum</i> spp.	nightshade, bitterweet, potato, Jerusalem cherry, etc.	cultivated and native throughout	all classes	common

<u>Division/Family/Scientific name</u>	<u>Common name</u>	<u>Geographical Range</u>	<u>Animals reported to be poisoned</u>	<u>Frequency of reported cases</u>
Thymelaeaceae <i>Daphne</i> spp.	daphne, mezereon, cultivated spurge laurel	throughout	swine	rare
Umbelliferae (Apiaceae) <i>Aethusa cynapium</i>	fools parsley	northeast	swine	rare
<i>Apium graveolens</i>	celery	cult. throughout, esp. west	cattle	rare
<i>Cicuta</i> spp.	water hemlock	east and west	all classes	infrequent
<i>Conium maculatum</i>	poison or spotted hemlock	throughout	all classes	rare
<i>Sium suave</i>	water or hemlock parnsip	throughout	cattle, swine	rare
<i>Sphenosciadium capitellatum</i>	whitehead	west	cattle, horses	rare
Urticaceae <i>Urtica</i> spp.	stinging nettle	throughout	pets, esp. dogs	occasional
Verbenaceae <i>Aloysia lycioides</i> (= <i>Lippia ligustrina</i> )	whitebrush	southwest	horses	infrequent
Zygophyllaceae <i>Kallstroemia hirsutissima</i>	carpetweed, hairy caltrop	southwest to Kansas	all classes, esp. cattle	rare
<i>Peganum harmala</i>	African rue	southwest	cattle	infrequent
<i>Tribulus terrestris</i>	puncture vine, caltrop	east, south to southwest	cattle, sheep, goats	rare

## APPENDIX

## Species Involved in Grass Tetany

## Gramineae

<i>Agropyron</i> spp.	quackgrass, wheat grass
<i>Avena sativa</i>	cultivated oats
<i>Bromus mollis</i>	soft chess
<i>Dactylis glomerata</i>	orchardgrass
<i>Hordeum leporinum</i>	wild barley
<i>Hordeum vulgare</i>	cultivated barley
<i>Lolium perenne</i>	wild ryegrass, perennial ryegrass
<i>Phleum pratense</i>	timothy
<i>Secale cereale</i>	cultivated rye
<i>Triticum aestivum</i>	cultivated wheat

Species Infested with *Claviceps* spp. (ergot)

## Gramineae

<i>Agropyron</i> spp.	quackgrass, wheatgrass
<i>Agrostis alba</i> (= <i>A. gigantea</i> )	redtop
<i>Bromus inermis</i>	smooth brome grass
<i>Calamagrostis</i> spp.	reed grass, bluejoint grass
<i>Dactylis glomerata</i>	orchardgrass
<i>Elymus</i> spp.	wild rye
<i>Festuca arundinacea</i>	tall fescue, rescue grass
<i>Lolium perenne</i>	wild ryegrass, perennial ryegrass
<i>Paspalum dilatatum</i>	dallisgrass
<i>Phalaris arundinacea</i>	reed canarygrass
<i>Poa</i> spp.	bluegrass
<i>Secale cereale</i>	cultivated rye

## Toxic Plants and Your Horse

Andi Foster, DVM

Being the grazing, foraging animals that horses are, it is no wonder that horse owners get worried about toxic plants. Plant intoxication is a very real concern if your horse spends time out on pasture. In fact, it can be a risk even if your horse is always kept indoors because toxic plants can sometimes accidentally make their way into the hay you buy.

There are a handful of toxic plants to be aware of in California and they all vary in their level of toxicity; ie some plants are life threatening after only a few leaves are ingested, whereas others become toxic only after being eaten in large quantities over a longer period of time. Becoming aware of these toxic plants and to being able to recognize them in your pasture or hay can greatly reduce the chance that your horse will suffer from toxic ingestion.

Here is a list of some common toxic California plants that your horse may encounter:

Common Groundsel (*Senecio vulgaris*)

- **Body system affected:** Liver, Skin
- **Signs of toxicity:** Due to pyrrolizidine alkaloids (PA) present in the plant. Weight loss, poor appetite, jaundice, behavioral changes, incoordination, head pressing, dermatitis, skin sloughing over white-haired regions.
- **Toxic dose:** 1-4% body weight (10-40 pounds per 1000 pound horse) over several weeks to months. Higher doses can cause acute liver failure. Horses usually avoid PA containing plants unless no other food is available.
- **Toxic components:** Entire plant, fresh or dried, especially flowers.

Tansy Ragwort (*Senecio jacobea*)

- **Body system affected:** Liver, Skin
- **Signs of toxicity:** Another PA containing plant. Same signs as above.
- **Toxic dose:** Similar to Common Groundsel. 4-8% body weight (40-80 pounds per 1000 pound horse) over several days can be lethal.
- **Toxic components:** Similar to above.

Fiddleneck (*Amsinckia intermedia*)

- **Body system affected:** Liver, Skin
- **Signs of toxicity:** Another PA containing plant. Same signs as above.
- **Toxic dose:** Similar to above.
- **Toxic components:** Similar to above.

### St. John's Wort (*Hypericum perforatum*)



- **Body system affected:** Skin
- **Signs of toxicity:** Dermatitis, skin sloughing in white-haired areas. This plant does not contain PAs and therefore does not affect the liver.
- **Toxic dose:** Plant must be eaten over several days at doses similar to PA-containing plants.
- **Toxic components:** Mainly the leaves.

### Yellow Star Thistle (*Centaurea solstitialis*)



- **Body system affected:** Nervous system
- **Signs of Toxicity:** Difficulty eating/drinking, weight loss. Ability to swallow remains intact, but horses will have difficulty prehending food and chewing it. Horses usually die from starvation/dehydration. Horses can actually develop a preference for eating the plant and may eventually prefer it to hay.
- **Toxic dose:** Large quantities of about 600-1000 pounds eaten over several months.
- **Toxic components:** Entire plant, fresh or dried.

### Brackenfern (*Pteridium aquilinum*)



- **Body system affected:** Nervous system
- **Signs of toxicity:** Toxin causes a deficiency in thiamine (vitamin B1) which manifests as abnormal mentation, behavioral changes, incoordination, teeth grinding, blindness, convulsions.
- **Toxic dose:** Consumption of 3-5% of their diet in Brackenfern for at least 1 month.
- **Toxic components:** Roots are the most toxic followed by the leaves, fresh or dried.

### Poison Hemlock (*Conium maculatum*)



- **Body system affected:** Nervous system
- **Signs of toxicity:** Start as early as **30-60 minutes** after ingestion and include salivation, colic, incoordination, muscle tremors, respiratory distress and frequent urination and defecation. Death can occur from respiratory failure as soon as 2-3 hours after ingestion.
- **Toxic dose:** 4-5 pounds of hemlock for a typical 1000 pound horse can be fatal.
- **Toxic components:** Seeds are the most toxic followed by leaves and stems.

### Oleander (*Nerium oleander*)



- **Body system affected:** Gastrointestinal, Heart
- **Signs of toxicity:** Colic and diarrhea are common signs. Since Oleander is a cardiotoxic plant, arrhythmias almost always accompany GI signs. Thus other symptoms include irregular heart rate, anxiety, muscle trembling, collapse, death.
- **Toxic dose:** 0.005% body weight (0.8oz per 1000 pound horse). **Several leaves can be fatal!**
- **Toxic components:** Entire plant, fresh or dried.

### Nightshade (*Solanaceae*)



- **Body system affected:** Nervous system, Gastrointestinal
- **Signs of toxicity:** Excitation followed by depression, incoordination, tremors, colic, manure retention or diarrhea. Plant is typically eaten when no other food is present.
- **Toxic dose:** 0.1-0.3% of body weight (16-48oz per 1000 pound horse).
- **Toxic components:** Entire plant, especially the berries.

### Pigweed (*Amaranthus reytroflexus*)



- **Body system affected:** Kidney
- **Signs of toxicity:** Weight loss, lethargy, poor appetite, increased drinking and urination. May see trembling weakness, respiratory problems.
- **Toxic dose:** Toxicity occurs after ingestion of a relatively large amount over several days. Plant is not palatable and most horses will avoid it if food is available.
- **Toxic components:** Mainly the leaves, less in stems, roots, seeds.

### Pacific Yew (*Taxus brevifolia*)



- **Body system affected:** Heart
- **Signs of toxicity:** Slow heart rate, muscle trembling, anxiety, incoordination, colic, diarrhea, respiratory distress, acute death.
- **Toxic dose:** 0.1-0.5% body weight (about **8-16oz of leaves**) can be fatal! Yew poisoning in horses is not very common since they will usually not eat it as long as other food is present.
- **Toxic components:** Entire plant, fresh or dry, except for the red fleshy area around the seed.



### Johnsongrass/Sudan Grass (*Sorghum* family)



- **Body system affected:** Cardiovascular, Neurologic, Urinary
- **Signs of toxicity:**
  - **Acute:** From high levels of cyanide. Anxiety, trembling, respiratory distress, collapse, death. Signs can occur within minutes of ingestion.
  - **Chronic:** From chronic ingestion of plants containing lower levels of cyanide. Hind end incoordination, weight loss, urinary incontinence, urine scald/hair loss down hind legs.
- **Toxic components:** Leaves and stems, especially during regrowth after cutting.

### Black Walnut (*Juglans nigra*)



- **Body system affected:** Musculoskeletal, Gastrointestinal
- **Signs of toxicity:** Laminitis, colic, depression, respiratory difficulties.
- **Toxic dose:** Laminitis occurs when the plant is eaten or more commonly when wood shavings made of black walnut are used as bedding. Bodily contact with the shavings is enough to cause laminitis (ie the shavings don't need to be eaten in order to cause disease). Laminitis can occur with bedding containing 20% or more of black walnut.
- **Toxic components:** Bark, nuts, roots, pollen, wood shavings.

### Oak (*Quercus spp*)



- **Body system affected:** Gastrointestinal, Urinary
- **Signs of toxicity:** Lethargy, colic, firm feces or diarrhea, poor appetite, increased drinking, urination, red colored urine.
- **Toxic dose:** Toxicity occurs when large amount are ingested. Note that some horses can ingest large quantities and not show signs of illness.
- **Toxic components:** Leaf buds, flowers, acorns.

If you suspect your horse has ingested a toxic plant you should obtain a sample of the plant, determine how much was eaten (if possible) and how long ago and call your veterinarian right away, even if clinical signs are not present. The *ideal* time frame to have your horse examined (for acutely toxic plants, such as Oleander) is within 30 minutes (maximum of 2 hours) so that your horse can be treated before too many toxins are absorbed by the bloodstream.

Treatment is largely the same for most toxic plants, except in the few cases where a specific treatment is available. Since horses are physiologically unable to vomit, a gastric tube must be passed into the stomach for gastric lavage. If caught early enough, activated charcoal can be administered via a nasogastric tube to absorb toxins. Given the limited treatments available for plant toxicosis, the majority of therapy is mainly focused on supportive and symptomatic care with the use of IV fluids, electrolytes, close monitoring and good nursing care.

For a more complete listing of toxic plants consider the following resources:

#### Books:

- A Guide to Plant Poisoning of Animals in North America. 2001. A. P. Knight and R. G. Walter
- Poisonous Plants of California. Thomas C. Fuller and Elizabeth McClintock
- Horse Owners Field Guide to Toxic Plants. Sandra M. Burger

#### Websites:

- <http://vet.purdue.edu/depts/addl/toxic/cover1.htm>
- <http://cecalaveras.ucdavis.edu/toxic.htm>
- Canadian Poisonous Plant Information System  
[http://www.cbif.gc.ca/pls/pp/poison?p\\_x=px](http://www.cbif.gc.ca/pls/pp/poison?p_x=px)

#### References

1. A Guide to Plant Poisoning of Animals in North America. 2001. A. P. Knight and R. G. Walter. (*The majority of the information in this article was acquired from this resource*)
2. <http://cecalaveras.ucdavis.edu/toxic.htm>
3. <http://www.vet.uga.edu/VPP/clerk/elliott/index.php>
4. <http://alfalfa.ucdavis.edu/symposium/proceedings/2006/06-71.pdf>
5. Images courtesy of Google images

