



SABRE AG

Agricultural Product Catalogue



Walterscheid Australia
Ph: 1300 WALTER
www.walterscheid.com.au

DISCLAIMER

Disclaimer

The information and dimensions listed in these catalogues is correct to the best of our knowledge and belief, having been compiled from reliable and official sources of information. However Walterscheid Australia (HS Company Pty Ltd) accepts no responsibility for possible errors, omissions or unsuitable parts being listed or fitted to any vehicle. Dimensions listed are nominal throughout. Due to our continuous product and range development we reserve the right to alter the specification without prior notice.

We welcome any feedback re suspected errors or omissions to the information enclosed. We can be contacted via email walterscheid@walterscheid.com.au
Or via Ph 03 9580 7300 or Fax 03 9580 0379
Alternatively via mail at PO Box 4262, Dandenong South, Vic. 3164.



www.walterscheid.com.au

Document No:	SABRECAT
Issue:	3
Issue Date:	03/03/2021

This catalogue is the copyright of HS Company Pty Ltd

AGRICULTURAL

CONTENTS

DESCRIPTION:

QUICK REFERENCE GUIDE.....	B:7-3
COMPARISON GUIDE.....	B:7-7

EUROPEAN PTO SHAFTS

SINGLE JOINT ASSEMBLIES	B:7-8
COMPLETE SHAFTS.....	B:7-9
'T' SERIES SHAFT PARTS	B:7-14
'V' SERIES SHAFT PARTS	B:7-16
'E' SERIES SHAFT PARTS	B:7-18
'AGC' SERIES SHAFT PARTS.....	B:7-20
WIDE ANGLE 'V' SERIES SHAFT PARTS.....	B:7-22
QUICK RELEASE END YOKES.....	B:7-24
WIDE ANGLE QUICK RELEASE END YOKES	B:7-26
PINCH BOLT END YOKES	B:7-28
PLAIN BORE & KEY END YOKES	B:7-34
TUBE YOKES.....	B:7-36
WIDE ANGLE TUBE YOKES	B:7-40
DRIVE TUBE	B:7-42
FRICTION CLUTCH LININGS / FM DISC TYPE	B:7-46
CLUTCH - AFC / MF DISC TYPE.....	B:7-47
CLUTCH - F DISC TYPE.....	B:7-48
SHEAR BOLT TORQUE LIMITER.....	B:7-50
OVERLOAD RATCHET CLUTCH	B:7-52
OVERRUNNING CLUTCH.....	B:7-53
COVER SETS	B:7-54

NORTH AMERICAN PTO SHAFTS

NORTH AMERICAN SERIES SHAFT PARTS	B:7-56
NORTH AMERICAN COVER SETS.....	B:7-58
NORTH AMERICAN SHAFT OPTIONS	B:7-59
QUICK RELEASE END YOKES.....	B:7-60
PINCH BOLT END YOKES	B:7-61
PLAIN BORE & KEY END YOKES	B:7-62
NORTH AMERICAN SHEAR CLUTCH	B:7-64
NORTH AMERICAN OVERRUNNING CLUTCH	B:7-65
WIDE ANGLE SHAFT PARTS.....	B:7-66

GEARBOXES

SLASHER.....	B:7-71
RIGHT ANGLE	B:7-72
MULTIPLIERS	B:7-73
SLASHER KITS (GEARBOX, PTO & CLUTCH)	B:7-73

www.walterscheid.com.au

Document No:	SABRECAT
Issue:	3
Issue Date:	03/03/2021

CONTENTS

LINKAGE

TOP LINK	B:7-74
RATCHET ARM	B:7-74
LINKAGE PINS.....	B:7-74
DRAWBAR HITCH PIN	B:7-76
CONVERSION BUSHES.....	B:7-76
DRAWBARS.....	B:7-76
SAFETY LOCKING PINS AND ACCESSORIES.....	B:7-77

WELD ON BALLS.....	B:7-78
--------------------	--------

A FRAME QUICK HITCH.....	B:7-79
--------------------------	--------

FRONT LINKAGE

FRONT LINKAGE SYSTEMS	B:7-80
-----------------------------	--------

FRONT LINKAGE APPLICATIONS

CASE-IH / STEYR	B:7-81
CLAAS.....	B:7-83
JOHN DEERE	B:7-84
KUBOTA	B:7-85
MASSEY FERGUSON	B:7-86
NEW HOLLAND	B:7-88
RENAULT	B:7-89
VALTRA	B:7-90
ZETOR	B:7-91

BALER EMERGENCY RELEASE SYSTEM	B:7-92
--------------------------------------	--------

HYDRAULIC CYLINDERS.....	B:7-93
--------------------------	--------

Document No:	SABRECAT
Issue:	3
Issue Date:	03/03/2021

Document No:	SABRECAT
Issue:	3
Issue Date:	03/03/2021

This catalogue is the copyright of HS Company Pty Ltd

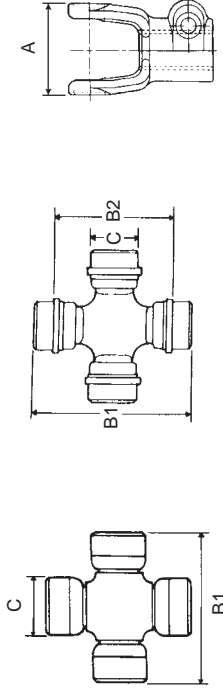

QUICK REFERENCE GUIDE

C	B1	B2	A Approx.	U/Joint Part No.	Comments	SPLINED QUICK RELEASE YOKES				TUBE YOKES			
						1 3/8 x 6	1 3/8 x 21	1 3/4 x 6	1 3/4 x 20	OUTER	INNER		
18.00	47.00		56.00	19.00.00 (K5-A587)	WALTERSCHEID W2000								
22.00	54.00		62.00	4B12054 (K5-A588)	COMER 10 BYPY SERIES 1								
22.00	55.00		63.00	4212000 (K5-A589)	WALTERSCHEID W100/W2100								
23.80	62.00		70.00	4222000 (K5-A64)	COMER 20 HARDY SPICER 1140 WALTERSCHEID W200/W2200 BYPY SERIES 2								T10-011-002 T20-012-002 V20-012-320#
23.80		37.70	60.00	RUJ-0600	NEAPCO 0600								
23.80		38.10	60.00	4702000 (5-170X)	NEAPCO N1000, SPICER 1000								
23.80 24.60		38.10 36.80		RUJ-0601	NEAPCO 0600 TO ROCKWELL L6N/JAYBEN 1AG								
24.60		36.80		4062000 (114-1004)	WEASLER 6 JAYBEN 1AG NEAPCO L600 ROCKWELL L6N Grease Nipple in Cap								
25.40		46.80		ASS-222 (RUJ-1798)	JAYBEN 2AG								
25.40		60.30		ASS-223 (114.2101)	JAYBEN 3AG								
26.99		46.04		4122000 (RUJ-1788)	WEASLER 12 ROCKWELL 12N NEAPCO 1200								
27.00	70.00		77.00	4B32070 (K5-A590)	COMER 30 WALTERSCHEID W1 BYPY SERIES 3								

Document No:	SABRECAT
Issue:	3
Issue Date:	03/03/2021

This catalogue is the copyright of HS Company Pty Ltd

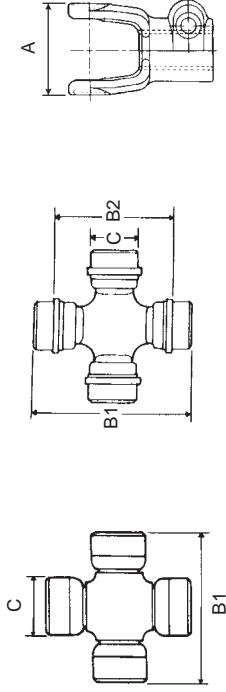

QUICK REFERENCE GUIDE

C	B1	B2	A Approx.	U/Joint Part No.	Comments	SPLINED QUICK RELEASE YOKES				TUBE YOKES	
						1 3/8 x 6	1 3/8 x 21	1 3/4 x 6	1 3/4 x 20	OUTER	INNER
						T40-024-001	T40-024-002			T40-014-006 V40-014-427	T40-014-007 V40-014-428
27.00	74.60		84.00	4232000 (K5-LGB36R)	COMER 40 HARDY SPICER 1300 WALTERSCHEID W210/W2300 BYPY SERIES 4 JAYBEN 4AG						
27.00	81.76		88.00	K5-A13XR 5-433-1X K5-A734	HARDY SPICER 1310 Grease Nipple in Cap COMER 40 WIDE ANGLE	2-4-A3641	2-4-A4221				
27.00	91.20 85.80		73.00	4142000 (CPL14N)	WEASLER 14 ROCKWELL 14N NEAPCO 2000 Grease Nipple in Cap	T40-024-261#	T40-024-272#			V40-024-433# T40-024-263#	V40-024-434# T40-024-269#
28.58	66.67			4142000-1X (CPL14N-1X)		14-100-1406 Collar Type	14-100-1421 Collar Type				
28.58	107.95 81.76			4352800 (K5-A798)	WEASLER 35 SERIES WIDE ANGLE	35-113-3506# Collar Type	35-113-3521# Collar Type		35-113-3520# Collar Type		
28.58		65.88	91.00	ASS-225 (114-3105)	HARDY SPICER 3R JAYBEN 5AG	5YB9-1375/6	5YB9-1375/21		5YB9-1750/20		
30.20	80.00		95.00	4B52079 (K5-A591) 4B52079-1X	COMER 50 BYPY SERIES 5 Grease Nipple in Cap	T50-025-001	T50-025-002#			T50-015-011	T50-015-012
30.20	92.03		101.00	4622000 (K5-A18R)	COMER 60 HARDY SPICER 1350 WALTERSCHEID W220 BYPY SERIES 6 Grease Nipple in Cap 4 x Grease Nipple in Cap	T60-026-001	T60-026-002	T60-026-003	T60-026-008	T60-016-028 V60-016-388	T60-016-029 V60-016-389
30.20	101.40 95.35			4622000-1X 4622000-4X (5-178-4X)							
30.20	106.30		120.00	K5-A735 23.00.00 (K5-A536)	COMER 60 WIDE ANGLE COMER 70 HARDY SPICER 1410 WALTERSCHEID W230 BYPY SERIES 7	T60-026-230	T60-026-504 Collar Type T70-027-002		T60-026-505 Collar Type T70-027-004	V60-026-390 T60-026-229 T70-017-007	V60-026-391 T60-026-249 T70-017-006

Document No:	SABRECAT
Issue:	3
Issue Date:	03/03/2021

This catalogue is the copyright of HS Company Pty Ltd

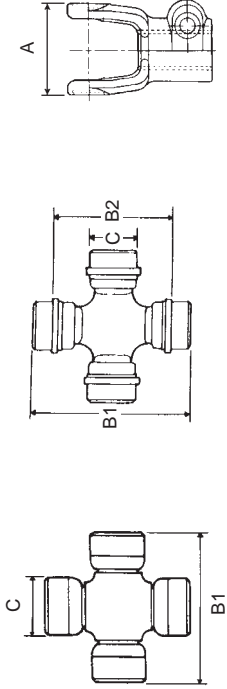

QUICK REFERENCE GUIDE

C	B1	B2	A Approx.	U/Joint Part No.	Comments	SPLINED QUICK RELEASE YOKES				TUBE YOKES	
						1 3/8 x 6	1 3/8 x 21	1 3/4 x 6	1 3/4 x 20	OUTER	INNER
31.75	81.36		90.00	4352000 (CP35N-3)	WEASLER 35 NEAPCO 2200 ROCKWELL 35R <i>Grease Nipple in Cap</i>	35-101-3506 Collar Type	35-101-3521 Collar Type	35-102-3528#	35-101-3520 Collar Type		
31.75 31.75	81.76 109.54			4352000-1X (CP35N-4)		44-111-3506# Collar Type	44-111-3521# Collar Type		44-111-3520# Collar Type		
32.00	76.00		86.00	4442800 (K5-A799)	WEASLER 44 SERIES WIDE ANGLE	AGC35.10.00	AGC35.10.02				
32.00 27.00	76.00 94.00			4242000 (K5-A592)	WALTERSCHEID W2400	AGC35.10.10	AGC35.10.12				
33.35		70.84		AGC35.06.00	WALTERSCHEID W2480	44-101-4406 Collar Type	44-101-4421 Collar Type		44-101-4420 Collar Type		
33.33 38.89	94.46	79.77		4552800 (K5-A800)	WEASLER 44 ROCKWELL 44R SERIES WEASLER 55 SERIES WIDE ANGLE	55-111-5506 Collar Type	55-111-5521# Collar Type		55-111-5520 Collar Type		
33.35		84.15	116.00	ASS-228 (114-5109)	JAYBEN 8AG	8YB9-1375/6	8YB9-1375/21		8YB9-1750/20		
34.00		56.00	90.00	12.00.00 (RUJ-3004)	WALTERSCHEID W11						
35.00	106.30		118.00	4B82006 (K5-A538)	COMER 80 HARDY SPICER 1480 WALTERSCHEID W240 BYBY SERIES 8	T80-028-001	T80-028-002	T80-028-003	T80-028-004	T80-018-133 V80-018-241	T80-018-134 V80-018-242
				4B82006HD (K5-A730W)	COMER 80 HEAVY DUTY						
				4B82006-1X 4B82006-4X (K5-A730W-4X)	<i>Grease Nipple in Cap</i> <i>4 x Grease Nipple in Cap</i>						
35.00	106.30 113.80			K5-A765	COMER 80 WIDE ANGLE	T80-028-358 Collar Type	T80-028-359 Collar Type	T80-028-361# Collar Type	T80-028-360 Collar Type	V80-028-248 T80-028-152	V80-028-249 T80-028-165

Many other parts not listed above are available on request.

Document No:	SABRECAT
Issue:	3
Issue Date:	03/03/2021

This catalogue is the copyright of HS Company Pty Ltd

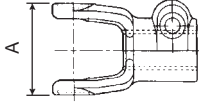
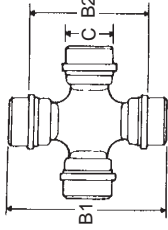
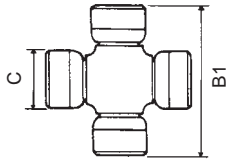

QUICK REFERENCE GUIDE

C	B1	B2	A Approx.	U/Joint Part No.	Comments	SPLINED QUICK RELEASE YOKES					TUBE YOKES					
						1 3/8 x 6	1 3/8 x 21	1 3/4 x 6	1 3/4 x 20	OUTER	INNER					
						T7N-027-001	T7N-027-002			T7N-017-012	T7N-017-011					
35.00	94.00		105.00	4B72094 (K5-A693)	BYPY SERIES N7											
36.00	89.00		100.00	4252000 (K5-A593)	WALTERSCHEID W2500	AGC36.10.00	AGC36.10.02		AGC36.18.02	AGC36.14.100	AGC36.13.100					
36.00 32.00	89.00 106.00			AGC36.06.00	WALTERSCHEID W2580	AGC36.10.10	AGC36.10.12		AGC36.18.12							
38.89	109.60			4552000 (CP55N) 4552000-1X (CP55N-1X)	WEASLER 55 ROCKWELL 58N NEAPCO N55 <i>Grease Nipple in Cap</i>	55-101-5506 Collar Type	55-101-5521 Collar Type	55-101-5528# Collar Type	55-101-5520 Collar Type							
39.70	115.90			25.00.00 (K5-A725)	WALTERSCHEID W250											
41.00	108.00		125.00	41209 (K5-A665)	COMER 90 BYPY SERIES 9	T90-029-319 Collar Type	T90-029-320 Collar Type	T90-029-317# Collar Type	T90-029-318 Collar Type	T90-019-127 V90-019-166	T90-019-128 V90-019-167					
41.00	118.00		135.00	41210 (K5-A594)	BYPY SERIES 10	572100351# Collar Type	572103751# Collar Type	572100451 Collar Type	572103851 Collar Type	204106851	204106852					
42.00	104.00		120.00	4262000 (K5-A595)	WALTERSCHEID W2600	AGC26.10.00	AGC26.10.02		AGC26.18.02	AGC26.14.00	AGC26.13.00					
42.00	107.50		120.00	4B0SH20-4X	COMER SERIES VP9 BYPY SERIES SH (4 x LUBE IN CAP)	5720N0355 Collar Type	5720N3755 Collar Type	5720N0455 Collar Type	5720N3855 Collar Type							
45.24	126.21			4772000	WEASLER 77 SERIES											
49.00	135.00			4B01220-4X (K5-A704)	BYPY SERIES 12 (4 X LUBE IN CAP)				507203852							
50.00	118.00			27.00.03 (K5-A752)	WALTERSCHEID W2700											
50.00	140.00			4120K0001	BYPY SERIES SK <i>2 x Grease Nipple in Cap</i>											
52.00	125.00		140.00	K5-A780	COMER 120			D120-220-005#	D120-220-001							

Many other parts not listed above are available on request.

INDENT ITEM ONLY

Document No:	SABRECAT
Issue:	3
Issue Date:	03/03/2021

This catalogue is the copyright
of HS Company Pty Ltd

COMPETITOR COMPARISON GUIDE

Standard Range				
Sabre	Hardy Spicer	Bypy	Walterscheid	Bareco
T10		101	W2100	1
T20	1140	102	W2200	2
T40	1310	104	W2300	4
T60	1350	106	W2400	6
T80	1480	108	W2500	8
T90		109	W2600	9

Wide Angle Shafts (1 x CVJ)				
Sabre	Comer	Bypy	Walterscheid	Bareco
	T20 or V20-CV	652 or 662	WWE2280	
	T40 or V40-CV	654 or 664	WWE2380	WB4
AGC2480	T60 or V60-CV	656 or 666	WWE2480	WB6
AGC2580	T80 or V80-CV	658 or 668	WWE2580	

Heavy Duty Range				
Sabre	Comer	Bypy	Walterscheid	Bareco
AGC2400	V60	406	P400	W2400
AGC2500	V80	408	P500	W2500
AGC2600	V90	409	P600	W2600

Wide Angle Shafts (2 x CVJ)				
Sabre	Comer	Bypy	Walterscheid	Bareco
	T20 or V20-2CV	672	WWZ2280	
	T40 or V40-2CV	674	WWZ2380	
	T60 or V60-2CV	676	WWZ2480	WB6
	T80 or V80-2CV	678	WWZ2580	

NOTE: 1. These comparisons are for ratings only. Parts are not interchangeable between all sizes.

Document No:	SABRECAT
Issue:	3
Issue Date:	03/03/2021

This catalogue is the copyright
of HS Company Pty Ltd

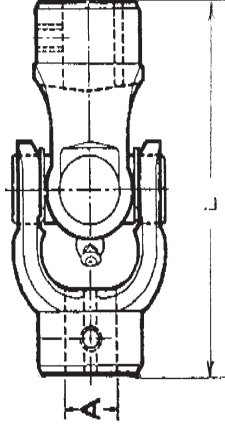

1000 SERIES SINGLE JOINT ASSEMBLY

Part Number	Hole Dia A	Key	Hub O.D.	Length L	Length Thru Hole	Angle	Comments
SKA-10750	19.05	4.78	41.28	127.00	27.00	60	
SKA-10875	22.23	6.35	41.28	127.00	27.00	60	
SKA-10100	25.40	6.35	41.28	127.00	27.00	60	
SKA-10250M	25.00	8.00	41.28	127.00	27.00	60	
	0.984	0.315	1.625	5.000	1.063		

1AGS SERIES SINGLE JOINT ASSEMBLY

Part Number	Hole Dia A	Key	Hub O.D.	Length L	Length Thru Hole	Angle	Comments
1AGS-YM-YM-3/4	19.05	4.78	47.50	127.00	27.00	60	
1AGS-YM-YM-7/8	22.23	4.78	47.50	127.00	27.00	60	
1AGS-YM-YM-3	25.40	6.35	47.50	127.00	27.00	60	
1AGS-YM-YM-25	25.00	8.00	47.50	127.00	27.00	60	
	0.984	0.315	1.870	5.000	1.063		

Note: More options and configurations in 1AGS series are available on request, contact your local branch for more information.

Document No:	SABRECAT
Issue:	3
Issue Date:	03/03/2021

This catalogue is the copyright
of HS Company Pty Ltd

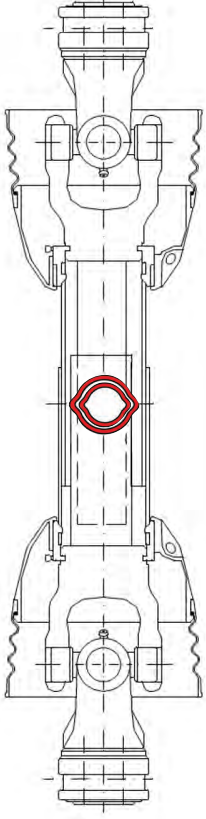

AG SERIES COMPLETE SHAFTS

Series	Horsepower Ratings		Length C - C of U/Joints		COMPLETE SHAFTS			Notes
	@ 540 RPM	@ 1000 RPM	Compressed mm	Extended mm	1 3/8 x 6 QR Both Ends (Collar Type)	1 3/8 x 6 QR One End Only (Collar Type)	No End Yokes	
AG1	16HP / 12kW	25HP / 18kW	510mm	710mm	AG1-510-SC2	AG1-510-SC1		
AG2	27HP / 20kW	42hp / 31kW	1010mm	1450mm	AG1-1010-SC2	AG1-1010-SC1		
			1010mm	1450mm	AG2-1010-SC2	AG2-1010-SC1		
			1510mm	1950mm	AG2-1510-SC2	AG2-1510-SC1		
AG3	38HP / 28kW	60HP / 45kW	1010mm	1410mm	AG3-1010-SC2	AG3-1010-SC1		Uses 0v/1 Tube
			1510mm	1910mm	AG3-1510-SC2	AG3-1510-SC1		Uses 0v/1 Tube
AG3H	38HP / 28kW	60HP / 45kW	1010mm	1410mm	AG3H-1010-SC2	AG3H-1010-SC1		Uses 1b/2a Tube
			1510mm	1910mm	AG3H-1510-SC2	AG3H-1510-SC1		Uses 1b/2a Tube
AG4	64HP / 47kW	100HP / 74kW	1010mm	1410mm	AG4-1010-SC2	AG4-1010-SC1		
			1510mm	1910mm	AG4-1510-SC2	AG4-1510-SC1		
AG5	90HP / 67kW	139HP / 103kW	1210mm	1610mm	AG5-1210-SC2	AG5-1210-SC1		Uses Star Tube S4 / S5

Document No:	SABRECAT
Issue:	3
Issue Date:	03/03/2021

This catalogue is the copyright
of HS Company Pty Ltd

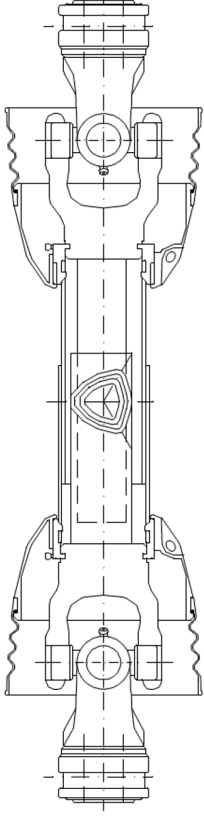

'T' SERIES COMPLETE SHAFTS

Series	Horsepower Ratings		Length C - C of U/Joints		COMPLETE SHAFTS		
	@ 540 RPM	@ 1000 RPM	Compressed mm	Extended mm	1 3/8 x 6 QR (Pin Type) Both Ends	1 3/8 x 6 QR (Pin Type) One End Only	No End Yokes
T10	16HP / 12kW	25HP / 18kW	1010mm	1450mm	T10-1010F112112	T10-1010F112000	T10-1010F000000
T20	21HP / 15kW	31hp / 23kW	1010mm	1450mm	T20-1010F112112	T20-1010F112000	T20-1010F000000
			1510mm	1950mm	T20-1510F112112	T20-1510F112000	T20-1510F000000
T40	35HP / 26kW	55HP / 40kW	1010mm	1410mm	T40-1010F112112	T40-1010F112000	T40-1010F000000
			1510mm	1910mm	T40-1510F112112	T40-1510F112000	T40-1510F000000
T60	64HP / 47kW	100HP / 74kW	1010mm	1410mm	T60-1010F112112	T60-1010F112000	T60-1010F000000
			1510mm	1910mm	T60-1510F112112	T60-1510F112000	T60-1510F000000
T80	95HP / 70kW	150HP / 110kW	1010mm	1410mm	T80-1010F112112	T80-1010F112000	T80-1010F000000
			1510mm	1910mm	T80-1510F112112	T80-1510F112000	T80-1510F000000
							T80-1010F112100 1 3/8 x 6 QR + Flange to suit Howard Friction Clutch

Document No:	SABRECAT
Issue:	3
Issue Date:	03/03/2021

This catalogue is the copyright of HS Company Pty Ltd

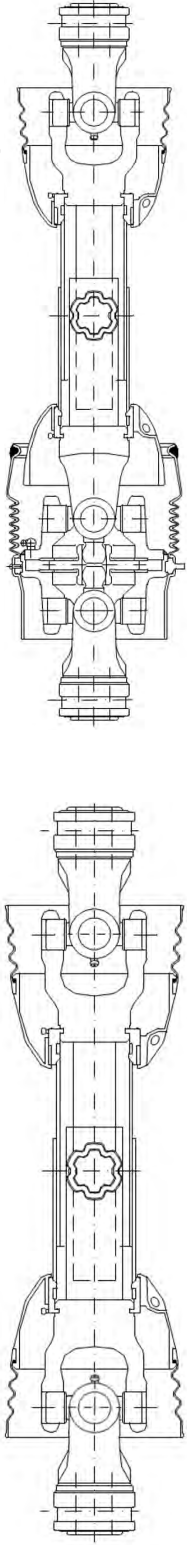

V SERIES COMPLETE SHAFTS

Series	Horsepower Ratings		Length C - C of U/Joints		COMPLETE SHAFTS		WIDE ANGLE COMPLETE SHAFTS	
	@ 540 RPM	@ 1000 RPM	Compressed mm	Extended mm	1 3/8 x 6 QR (Collar Type) Both Ends	1 3/8 x 6 QR (Collar Type) Both Ends	1 3/8 x 6 QR (Collar Type) Both Ends	1 3/8 x 6 QR (Collar Type) Both Ends
V60	67HP / 50kW	103HP / 77kW	1010mm	1410mm	V601010ENC12C12	V601010ENC12C12	V601010ENCVC12	V601010ENCVC12
V80	99HP / 74kW	151HP / 113kW	1010mm	1510mm	V801010ENC12C12	V801010ENC12C12	V801010ENCVC12#	V801010ENCVC12#
V90	118HP / 88kW	188HP / 140kW	1010mm	1480mm	V901010ENC12C12	V901010ENC12C12	V901010ENC12C12#	V901010ENC12C12#
			1510mm	2010mm	V801510ENC12C12	V801510ENC12C12		
			1510mm	2010mm	V901510ENC12C12	V901510ENC12C12		

Document No:	SABRECAT
Issue:	3
Issue Date:	03/03/2021

This catalogue is the copyright
of HS Company Pty Ltd

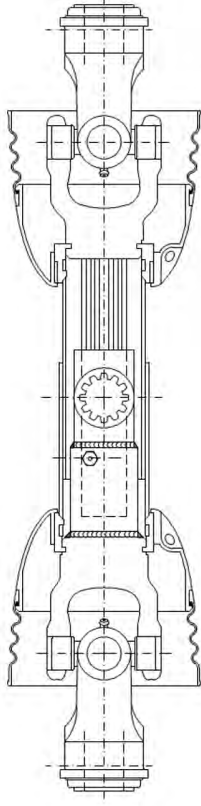

'D' SERIES COMPLETE SHAFTS

Series	Horsepower Ratings		Length C - C of U/Joints		COMPLETE SHAFTS	
	@ 540 RPM	@ 1000 RPM	Compressed mm	Extended mm		
D120	196HP / 144kW	300hp / 221kW	1010mm	1650mm	1 3/4 x 20 QR On One End Only	D121010ENC25000



Complete Double 50° CV PTO Shaft with Friction Overrun Clutch

Series	Horsepower Ratings		50° CV Clutch Yoke		Clutch Pack		50° CV Yoke		Complete Shaft Part Number
	Length C - C of U/Joints	@ 540 RPM	@ 1000 RPM	1 3/8 x 21Spl Clamp Bolt	1 3/8 x 21Spl Clamp Bolt	2	1 3/8 x 21Spl Clamp Bolt	3	
5550	Compressed mm	1917mm	117HP / 87kW	179HP / 134kW	1 Clutch Yoke Only	2 Clutch Pack Only	1 3/8 x 21Spl Clamp Bolt	3 End Yoke Only	1 3/8 x 21Spl CB 1 3/8 x 21Spl CB
									55-14605589

Note: Clutch pack # 57112000 utilizes M10 mounting holes. The four flange holes on the CV clutch yoke are 5/16". To accommodate clutch pack # 57112000, the flange holes need to be drilled out to suit 10mm bolts.

Note: Other end yokes are available on request.

INDENT ITEM ONLY

Document No:	SABRECAT
Issue:	3
Issue Date:	03/03/2021

This catalogue is the copyright
of HS Company Pty Ltd

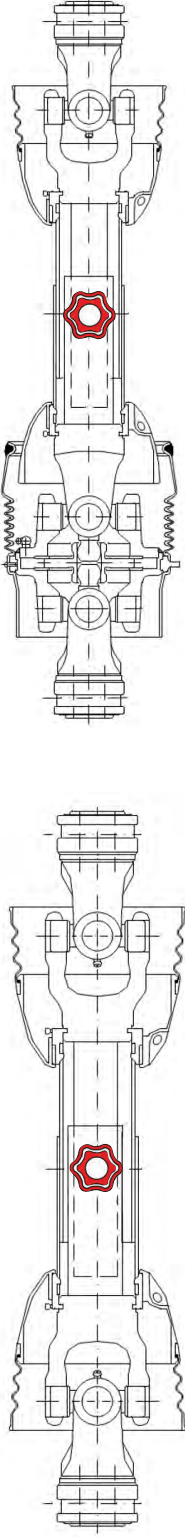

'AGC' SERIES COMPLETE SHAFTS

Series	Horsepower Ratings			Length C - C of U/Joints		COMPLETE SHAFTS	80° WIDE ANGLE COMPLETE SHAFTS	NOTES	
	@ 540 RPM	@ 1000 RPM	Extended mm	Compressed mm	No Yokes Fitted				1 3/8 x 6 QR Both Ends
	HP	kW							
AGC2400	64	47	100	74	1010mm	1410mm	AGC2400-SS-101	Star Profile	
					1510mm	1910mm	AGC2400-SS-151	Star Profile	
AGC2500	110	82	150	112	1010mm	1410mm	AGC2500-SS-101	Star Profile	
					1510mm	1910mm	AGC2500-SS-151	Star Profile	
AGC2600	120	90	166	124	1010mm	1380mm	AGC2600-SS-101	Star Profile	
					1410mm	1780mm	AGC2600-SS-141	Star Profile	
AGC2480	64	48	99	74	1210mm	1575mm	AGC2480-TT-121	Triangular Profile	
AGC2580	90	67	139	104	1210mm	1550mm	AGC2580-SS-121	Star Profile	
					1510mm	1850mm	AGC2580-SS-151	Star Profile	



A selection of AGC Series Yokes and Clutches are available in the relevant sections of the Walterscheid DLS and Sabre AG catalogues.

Note: Other end yokes are available on request.

INDENT ITEM ONLY

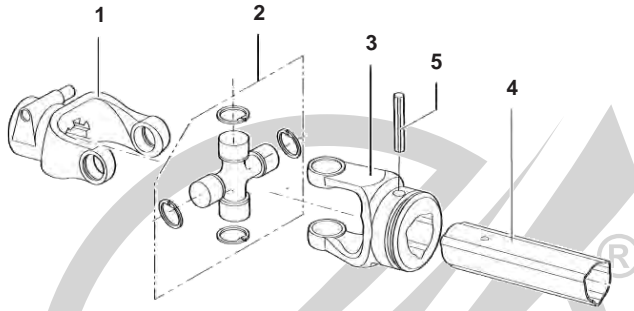
'T' SERIES OUTER SHAFT PARTS

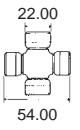
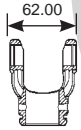
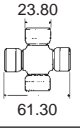
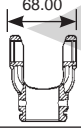
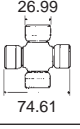
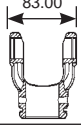
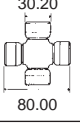
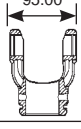
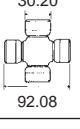
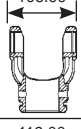
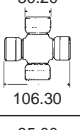
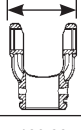
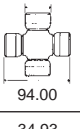
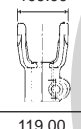
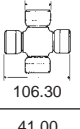
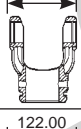
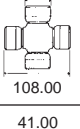
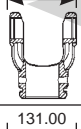

Shaft Identification			QR Yoke 1 3/8 x 6 1	Universal Joint 2	Outer Tube Yoke 3	Outer Tube 4	Outer Roll Pin 5
Series	U/Joint Size	Nominal Yoke Width					
1			T10-021-001	4B12054 (K5-A588)	T10-011-003	191-110-200	190-000-011 50 x 8
2			T20-022-001	4222000 (K5-A64)	T20-012-003	191-120-200	190-000-012# 55 x 8
4			T40-024-001	4232000 (K5-LGB36R)	T40-014-006	191-130-200	191-000-014 65 x 8
5			T50-025-001	4B52079 (K5-A591)	T50-015-011	191-150-200	190-000-016 70 x 10
6			T60-026-001	4622000 (K5-A18R)	T60-016-028	191-160-200	190-000-018 80 x 10
7			T70-027-001	23.00.00 (K5-A536)	T70-017-007	191-160-200	190-000-018 80 x 10
7N			T7N-027-001	4B72094	T7N-017-012	191-160-200	190-000-018
8			T80-028-001	4B82006 (K5-A538)	T80-018-133	191-198-850	190-000-243 90 x 12
9			T90-029-319 <i>Collar Type</i>	41209 (K5-A665)	T90-019-127	191-198-850	190-000-243 90 x 12
10			572100351 <i>Collar Type</i>	41210 (K5-A594)	204106851#		

European PTO





INDENT ITEM ONLY

Document No:	SABRECAT
Issue:	3
Issue Date:	03/03/2021

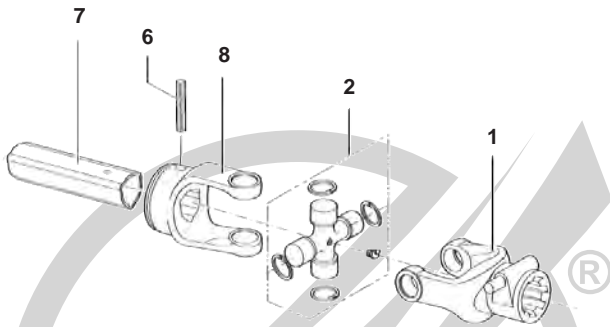
European PTO

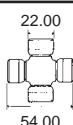
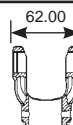
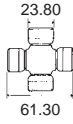
'T' SERIES INNER SHAFT PARTS

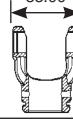
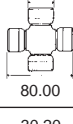
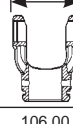
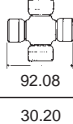
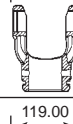
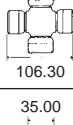
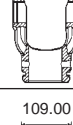
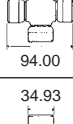
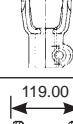
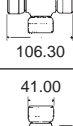

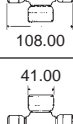
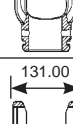
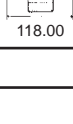
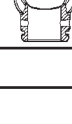
Shaft Identification			Inner Roll Pin 6	Inner Tube 7	Inner Tube Yoke 8	Complete Shaft 1 3/8x6 QR both Ends	
Series	U/Joint Size	Nominal Yoke Width					
1	 22.00 54.00	 62.00	190-000-010# 45 x 8	191-110-100	T10-011-002	T10-1010F112112 1010mm C-C	-
2	 23.80 61.30	 68.00	190-000-011 50 x 8	191-120-100	T20-012-002	T20-1010F112112 1010mm C-C	-
4	 26.99 74.61	 83.00	190-000-012 55 x 8	191-140-100	T40-014-007	T40-1010F112112 1010mm C-C	T40-1510F112112 1510mm C-C
5	 30.20 80.00	 95.00	190-000-394# 65 x 10	191-150-100	T50-015-012	-	-
6	 30.20 92.08	 106.00	190-000-016 70 x 10	191-150-100	T60-016-029	T60-1010F112112 1010mm C-C	T60-1510F112112 1510mm C-C
7	 30.20 106.30	 119.00	190-000-016 70 x 10	191-170-100	T70-017-006	-	-
7N	 35.00 94.00	 109.00	190-000-016 70 x 10	191-170-100	T7N-017-011	T7N-1010F112112 1010mm C-C	-
8	 34.93 106.30	 119.00	190-000-271 80 x 10	191-190-300	T80-018-134	T80-1010F112112 1010mm C-C	T80-1510F112112 1510mm C-C
9	 41.00 108.00	 122.00	190-000-243 90 x 12	191-190-300	T90-019-128	-	-
10	 41.00 118.00	 131.00	-	-	204106852	-	-







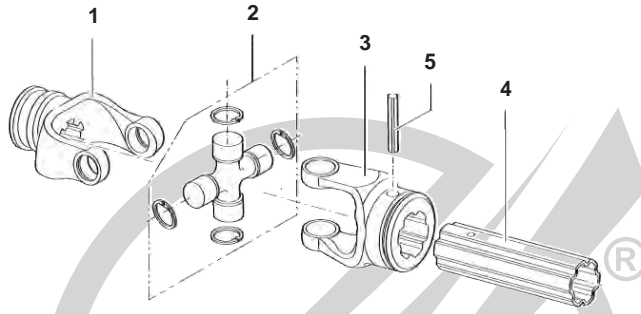

www.walterscheid.com.au

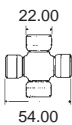
Document No:	SABRECAT
Issue:	3
Issue Date:	03/03/2021

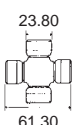
INDENT ITEM ONLY

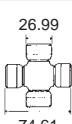
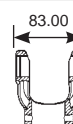
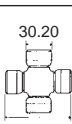
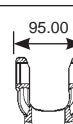
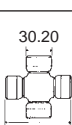
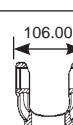
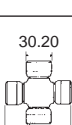
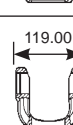
'V' SERIES OUTER SHAFT PARTS

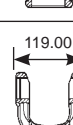

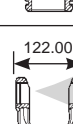
Shaft Identification		QR Yoke 1 3/8 x 6 1	Universal Joint 2	Outer Tube Yoke 3	Outer Tube 4	Outer Roll Pin 5
Series	U/Joint Size	Nominal Yoke Width				
1	22.00  54.00	62.00 				
2	23.80  61.30	68.00 	T20-022-001	4222000 (K5-A64)	V20-012-319#	191-120-800# 190-000-012# 55 x 8
4	26.99  74.61	83.00 	T40-024-001	4232000 (K5-LGB36R)	V40-014-427	191-140-800 190-000-014 65 x 8
5	30.20  80.00	95.00 	T50-025-001	4B52079 (K5-A591)	V50-015-361#	191-160-800 190-000-016 70 x 10
6	30.20  92.08	106.00 	T60-026-001	4622000 (K5-A18R)	V60-016-388	191-160-800 190-000-018 80 x 10
7	30.20  106.30	119.00 				
8	34.93  106.30	119.00 	T80-028-001	4B82006 (K5-A538)	V80-018-241	191-190-800 190-000-243 90 x 12
9	41.00  108.00	122.00 	T90-029-319 Collar Type	41209 (K5-A665)	V90-019-166	191-190-800 190-000-243 90 x 12

European PTO

INDENT ITEM ONLY

B:7-16

www.walterscheid.com.au



Document No:	SABRECAT
Issue:	3
Issue Date:	03/03/2021

This catalogue is the copyright of HS Company Pty Ltd

European PTO

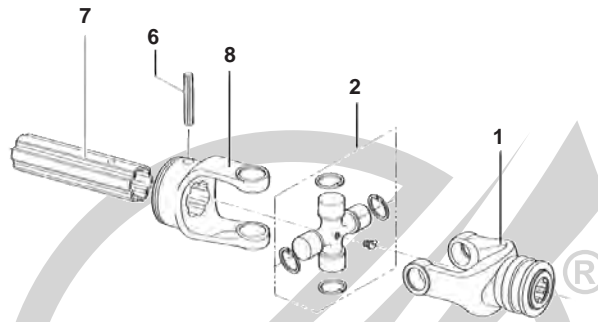
'V' SERIES INNER SHAFT PARTS

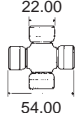
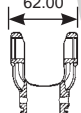
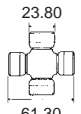
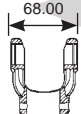
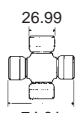
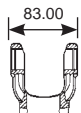
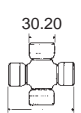
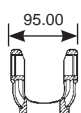
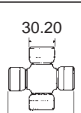
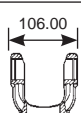
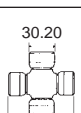
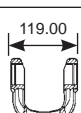

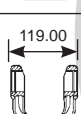
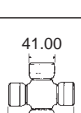
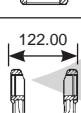
Shaft Identification			Inner Roll Pin 6	Inner Tube 7	Inner Tube Yoke 8	Complete Shaft 1 3/8x6 QR both Ends Collar Type Yokes	
Series	U/Joint Size	Nominal Yoke Width					
1	 22.00 54.00	 62.00	-	-	-		
2	 23.80 61.30	 68.00	190-000-011 50 x 8	191-120-700#	V20-012-320#		
4	 26.99 74.61	 83.00	190-000-012# 55 x 8	191-140-700	V40-014-428	V401010ENC12C12 1010mm C-C	V401510ENC12C12 1510mm C-C
5	 30.20 80.00	 95.00	190-000-394# 65 x 10	191-160-700	V50-015-362#		
6	 30.20 92.08	 106.00	190-000-016 70 x 10	191-160-700	V60-016-389	V601010ENC12C12 1010mm C-C	V601510ENC12C12 1510mm C-C
7	 30.20 106.30	 119.00	-	-	-		
8	 34.93 106.30	 119.00	190-000-271 80 x 12	191-190-700	V80-018-242	V801010ENC12C12 1010mm C-C	V801510ENC12C12 1510mm C-C
9	 41.00 108.00	 122.00	190-000-243 90 x 12	191-190-700	V90-019-167	V901010ENC12C12# 1010mm C-C	

www.walterscheid.com.au





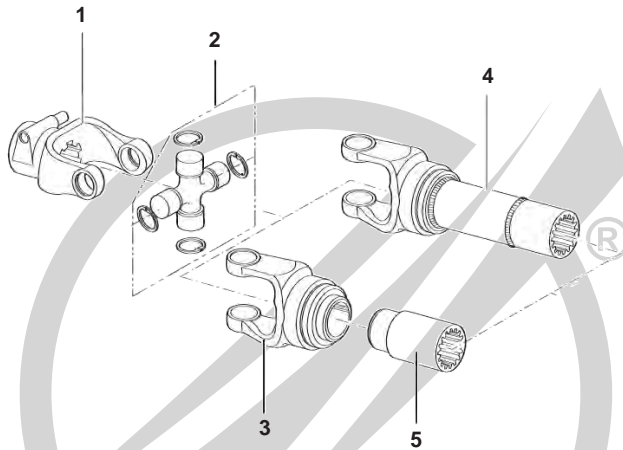

Document No:	SABRECAT
Issue:	3
Issue Date:	03/03/2021

This catalogue is the copyright of HS Company Pty Ltd

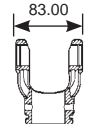
INDENT ITEM ONLY

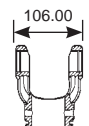
'E' SERIES OUTER SHAFT PARTS

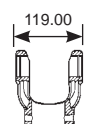

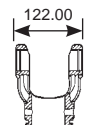
Shaft Identification			QR Yoke	Universal	Weld-in	Outer Tube	Splined
Series	U/Joint Size	Nominal Yoke Width	1 3/8 x 6 1	Joint 2	Tube Yoke 3	4	Sleeve 5
4	26.99  74.61	83.00 	T40-024-001	4232000 (K5-LGB36R)	E40-014-003#	50X4MM	E40-014-249#
6	30.20  92.08	106.00 	T60-026-001	4622000 (K5-A18R)	E60-016-035#	-	E60-016-032#
8	34.93  106.30	119.00 	T80-028-001	4B82006 (K5-A538)	E80-018-144	60X5MM	E80-018-014
9	41.00  108.00	122.00 	T90-029-319 <i>Collar Type</i>	41209 (K5-A665)	E90-019-055	63.5X5.5MM	E90-019-056

European PTO

INDENT ITEM ONLY

B:7-18

www.walterscheid.com.au

Document No:	SABRECAT
Issue:	3
Issue Date:	03/03/2021

This catalogue is the copyright of HS Company Pty Ltd

European PTO

'E' SERIES INNER SHAFT PARTS

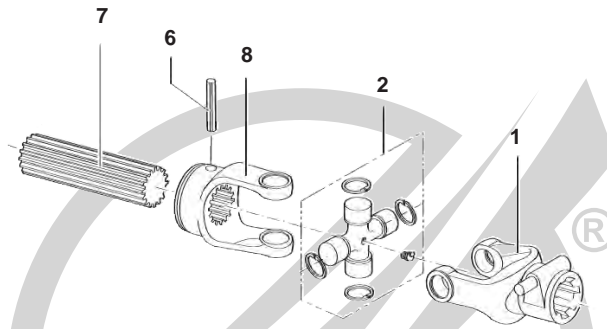

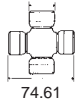
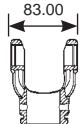
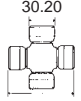
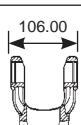
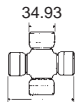
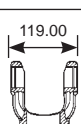
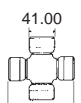
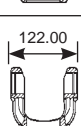
Shaft Identification			Inner Roll Pin 6	Inner Splined Bar 7	Inner Tube Yoke 8	Complete Shaft	Complete Shaft
Series	U/Joint Size	Nominal Yoke Width					
4	26.99  74.61	83.00 	190-000-012# 55 x 8	E40-140-611# 780mm	E40-014-250#	-	-
6	30.20  92.08	106.00 	190-000-016 70 x 10	E60-150-715# 765mm	E60-016-031#	-	-
8	34.93  106.30	119.00 	190-000-018 80 x 10	E80-170-688 735mm	E80-018-145	-	-
9	41.00  108.00	122.00 	190-000-243 90 x 12	E90-190-617 730mm	E90-019-054	-	-

www.walterscheid.com.au



Document No:	SABRECAT
Issue:	3
Issue Date:	03/03/2021

This catalogue is the copyright of HS Company Pty Ltd

INDENT ITEM ONLY

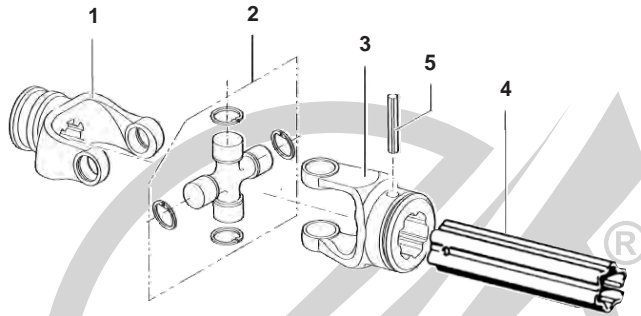
'AGC' SERIES OUTER SHAFT PARTS

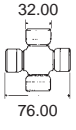

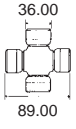
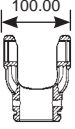
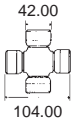
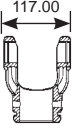

Shaft Identification			QR Yoke	Universal	Outer	Outer	Outer
Series	U/Joint Size	Nominal Yoke Width	1 3/8 x 6 1	Joint 2	Tube Yoke 3	Tube 4	Roll Pin 5
2400	 32.00 76.00	 85.00	AGC35.10.00	4242000 (K5-A592)	AGC35.14.100	AGC75.45.00	61.05.08
2500	 36.00 89.00	 100.00	AGC36.10.00	4252000 (K5-A593)	AGC36.14.100	AGC75.45.00	61.05.12
2600	 42.00 104.00	 117.00	AGC26.10.00	4262000 (K5-A595)	AGC26.14.00	AGC75.46.00	61.06.08

A selection of AGC Series Yokes and Clutches are available in the relevant sections of the Walterscheid DLS and Sabre AG catalogues.

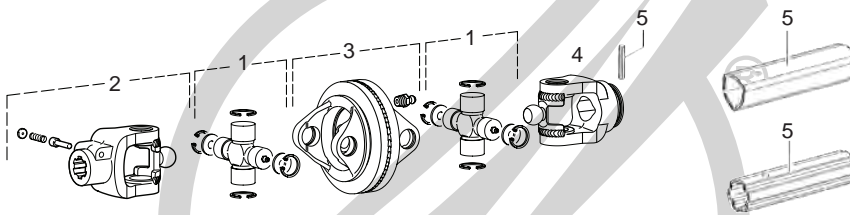
'AGC' WIDE ANGLE OUTER SHAFT PARTS

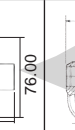

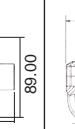
Shaft Identification			Universal	QR Yoke	Coupling	Outer Tube	Outer Tube
Series	U/Joint Size	Nominal Yoke Width	Joint 1	1 3/8 x 6 2	Yoke 3	Yoke 4	Tube 5
AGC2480	 32.00 27.00 76.00 94.00	 86.00 27.00	AGC35.06.00	AGC35.10.10	AGC35.41.05	-	191-160-500
AGC2580	 32.00 106.00	 100.00 30.00	AGC36.06.00	AGC36.10.10	AGC36.41.05	AGC36.14.116	AGC75.45.00

INDENT ITEM ONLY

European PTO

Document No:	SABRECAT
Issue:	3
Issue Date:	03/03/2021

'AGC' SERIES INNER SHAFT PARTS

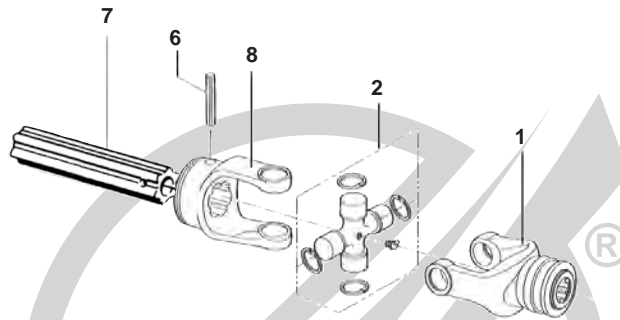

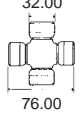
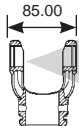
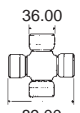
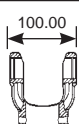
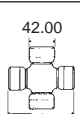
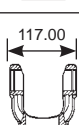
Shaft Identification			Inner Roll Pin 6	Inner Tube 7	Inner Tube Yoke 8	Complete Shaft (No Yokes)	Complete Shaft No Yokes
Series	U/Joint Size	Nominal Yoke Width					
2400	 32.00 76.00	 85.00	61.05.08	AGC75.44.00	AGC35.13.100	AGC2400-SS-101 1010mm	AGC2400-SS-151 1510mm
2500	 36.00 89.00	 100.00	61.05.12	AGC75.44.00	AGC36.13.100	AGC2500-SS-101 1010mm	AGC2500-SS-151 1510mm
2600	 42.00 104.00	 117.00	61.06.08	AGC75.45.00	AGC26.13.00	AGC2600-SS-101 1010mm	AGC2600-SS-141 1410mm

A selection of AGC Series Yokes and Clutches are available in the relevant sections of the Walterscheid DLS and Sabre AG catalogues.

'AGC' WIDE ANGLE INNER SHAFT PARTS

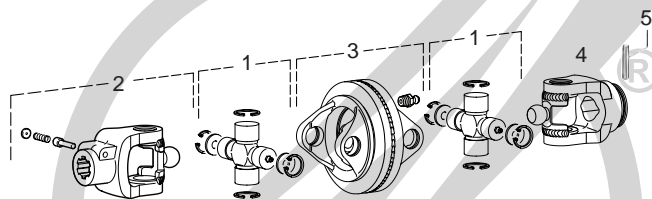

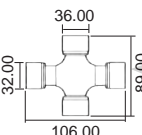
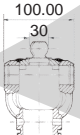
Shaft Identification			Universal Joint 1	QR Yoke 1 3/8 x 6 2	Double Yoke 3	Inner Tube Yoke 4	Roll Pin 5
Series	U/Joint Size	Nominal Yoke Width					
AGC2580	 36.00 32.00 89.00 106.00	 100.00 30	AGC36.06.00	AGC36.10.10	AGC36.41.05	AGC36.13.104	61.05.12

www.walterscheid.com.au

Document No:	SABRECAT
Issue:	3
Issue Date:	03/03/2021

This catalogue is the copyright of HS Company Pty Ltd

INDENT ITEM ONLY

WIDE ANGLE 'V' SERIES OUTER SHAFT PARTS

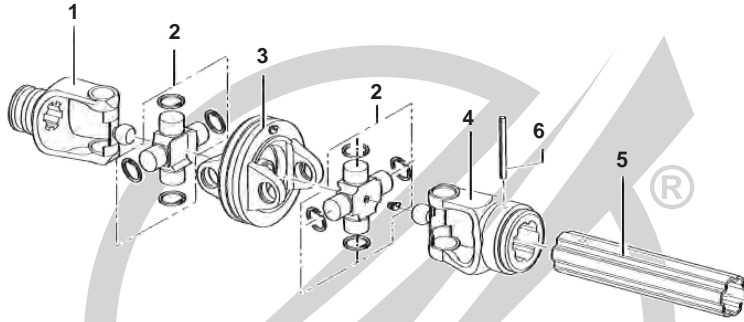

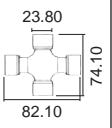
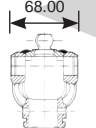
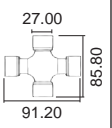
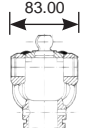
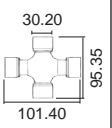
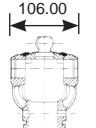
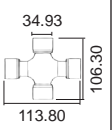
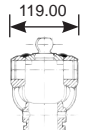
Shaft Identification		QR Yoke 1 3/8 x 6 1	Universal Joint 2	Coupling Yoke 3	Outer Tube Yoke 4	Outer Tube 5
Series	U/Joint Size	Nominal Yoke Width				
2			T20-022-162#	-	T20-022-160#	V20-022-325# 191-120-800#
4			T40-024-261	K5-A734	T40-024-259	V40-024-433 191-140-800
6			T60-026-230	K5-A735	T60-026-224	V60-026-390 191-160-850
8			T80-028-358	K5-A765	T80-028-157	V80-028-248 191-190-850

European PTO

INDENT ITEM ONLY

B:7-22

www.walterscheid.com.au

Document No:	SABRECAT
Issue:	3
Issue Date:	03/03/2021

This catalogue is the copyright of HS Company Pty Ltd

WIDE ANGLE 'V' SERIES INNER SHAFT PARTS

European PTO

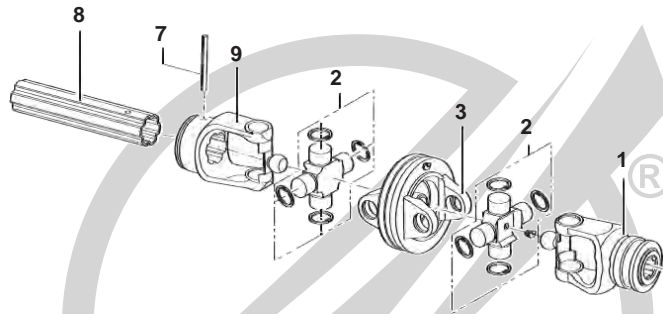

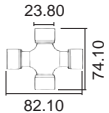
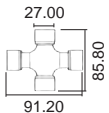
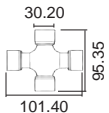
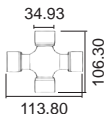
Shaft Id		Outer Roll Pin 6	Inner Roll Pin 7	Inner Tube <i>Rilsan Coated</i> 8	Inner Tube Yoke 9	Complete Shaft
Series	U/Joint Size					
2		190-000-012# 55 x 8	190-000-011 50 x 8	159-220-016# L=1300mm	V20-022-326#	
4		190-000-014 65 x 8	190-000-012# 55 x 8	159-240-018 L=1380mm	V40-024-434#	
6		190-000-018 80 x 10	190-000-016 70 x 10	159-260-179 L=1365mm	V60-026-391	
8		190-000-243 90 x 12	190-000-271 80 x 12	159-280-125 L=1335mm	V80-028-249	

www.walterscheid.com.au

Document No:	SABRECAT
Issue:	3
Issue Date:	03/03/2021



This catalogue is the copyright of HS Company Pty Ltd

INDENT ITEM ONLY

QUICK RELEASE PUSH PIN YOKES

Replacement Quick Release
Push Pin Sets (Original Comer Yokes Only)
1 3/8" Yokes **165-026-004**
1 3/4" Yokes **166-026-005**

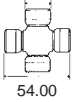
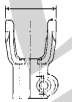
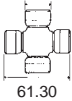
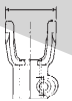
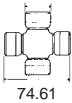
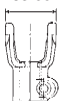
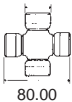
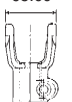
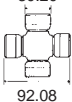
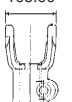
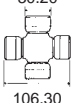
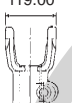
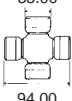
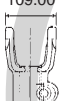
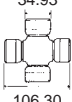
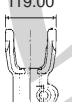
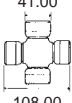

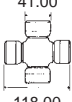
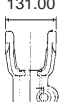
Shaft Identification			1 3/8 6 Spline	1 3/8 21 Spline	1 3/4 6 Spline	1 3/4 20 Spline
Series	U/Joint Size	Nominal Yoke Width				
1	22.00  54.00	62.00 	T10-021-001	T10-021-002	-	-
2	23.80  61.30	68.00 	T20-022-001	T20-022-002	-	-
4	26.99  74.61	83.00 	T40-024-001	T40-024-002	-	-
5	30.20  80.00	95.00 	T50-025-001	T50-025-002#	-	-
6	30.20  92.08	106.00 	T60-026-001	T60-026-002	T60-026-003	T60-026-008
7	30.20  106.30	119.00 	T70-027-001	T70-027-002	-	T70-027-004
7N	35.00  94.00	109.00 	T7N-027-001	T7N-027-002	-	-
8	34.93  106.30	119.00 	T80-028-001	T80-028-002	T80-028-003	T80-028-004
9	41.00  108.00	122.00 	T90-029-001	T90-029-040	T90-029-057	T90-029-058
10	41.00  118.00	131.00 	507100351#	507103751#	-	507103851

INDENT ITEM ONLY

B:7-24

European PTO

www.walterscheid.com.au

Document No:	SABRECAT
Issue:	3
Issue Date:	03/03/2021





















This catalogue is the copyright
of HS Company Pty Ltd

European PTO

QUICK RELEASE COLLAR YOKES

Replacement Quick Release
Collar Sets (Original Comer Yokes Only)
1 3/8" Yokes **165-000-628**
1 3/4" Yokes **165-000-629**



Shaft Identification			1 3/8	1 3/8	1 3/4	1 3/4
Series	U/Joint Size	Nominal Yoke Width	6 Spline	21 Spline	6 Spline	20 Spline
1	22.00  54.00	62.00 	T10-021-319	-	-	-
2	23.80  61.30	68.00 	T20-022-324	T20-022-327	-	-
4	26.99  74.61	83.00 	T40-024-430	T40-024-437	-	-
5	30.20  80.00	95.00 	-	-	-	-
6	30.20  92.08	106.00 	T60-026-544	T60-026-553	T60-026-554	T60-026-555
7	30.20  106.30	119.00 	-	-	-	-
7N	35.00  94.00	109.00 	4B71306	4B71321	-	4B71320
8	34.93  106.30	119.00 	T80-028-423	T80-028-426	T80-028-427	T80-028-428
9	41.00  108.00	122.00 	T90-029-319	T90-029-320	T90-029-317	T90-029-318
10	41.00  118.00	131.00 	572100351	572103751		572103851

www.walterscheid.com.au

Document No:	SABRECAT
Issue:	3
Issue Date:	03/03/2021

This catalogue is the copyright of HS Company Pty Ltd

INDENT ITEM ONLY

WIDE ANGLE QUICK RELEASE PUSH PIN YOKES

Replacement Quick Release
 Push Pin Sets (Original Comer Yokes Only)
 1 3/8" Yokes **165-026-004**
 1 3/4" Yokes **166-026-005**

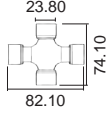
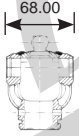
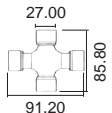
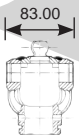
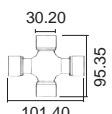
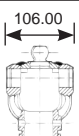
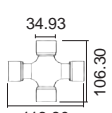
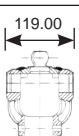

Shaft Identification			1 3/8 6 Spline	1 3/8 21 Spline	1 3/4 6 Spline	1 3/4 20 Spline
Series	U/Joint Size	Nominal Yoke Width				
2			T20-022-162#	T20-022-356#	-	-
4			T40-024-261	T40-024-272#	-	-
6			T60-026-230	T60-026-256#	T60-026-266#	T60-026-267#
8			T80-028-151#	T80-028-177#	T80-028-178#	T80-028-170#

European PTO

INDENT ITEM ONLY

B:7-26

www.walterscheid.com.au

Document No:	SABRECAT
Issue:	3
Issue Date:	03/03/2021

This catalogue is the copyright
 of HS Company Pty Ltd

European PTO

WIDE ANGLE QUICK RELEASE COLLAR YOKES

Replacement Quick Release
Collar Sets (Original Comer Yokes Only)
1 3/8" Yokes **165-000-628**
1 3/4" Yokes **165-000-629**

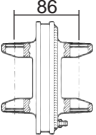
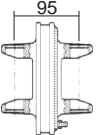
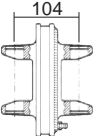
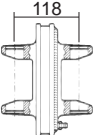

Series	COUPLING YOKE & CENTERING KIT TO SUIT	1 3/8 6 Spline	1 3/8 21 Spline	1 3/4 6 Spline	1 3/4 20 Spline
2	 T20-022-160#	T20-022-330#	T20-022-331#	-	-
4	 T40-024-259	T40-024-439#	T40-024-441#	-	-
6	 T60-026-224	T60-026-503#	T60-026-504	T60-026-557#	T60-026-505
8	 T80-028-157	T80-028-358	T80-028-359	T80-028-361#	T80-028-360

www.walterscheid.com.au

Document No:	SABRECAT
Issue:	3
Issue Date:	03/03/2021

This catalogue is the copyright of HS Company Pty Ltd

INDENT ITEM ONLY

INTERFERING PINCH BOLT YOKES

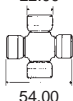
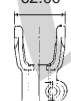
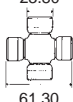
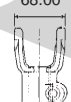
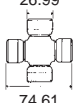
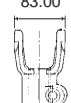
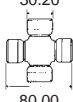
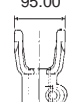
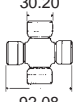
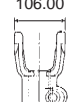
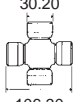
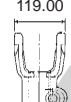
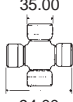
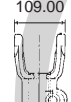
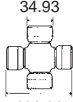
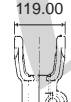
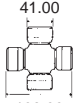
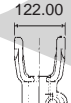
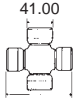
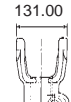

Shaft Identification			1 3/8 6 Spline	1 3/8 21 Spline	1 3/4 6 Spline	1 3/4 20 Spline
Series	U/Joint Size	Nominal Yoke Width				
1	22.00  54.00	62.00 	T10-021-056	-	-	-
2	23.80  61.30	68.00 	T20-022-008	-	-	-
4	26.99  74.61	83.00 	T40-024-014	T40-024-059#	-	-
5	30.20  80.00	95.00 	T50-025-027#	-	-	-
6	30.20  92.08	106.00 	T60-026-047	T60-026-048	T60-026-049#	T60-026-083
7	30.20  106.30	119.00 	T70-027-022#	T70-017-029#	T70-027-024#	T70-027-052#
7N	35.00  94.00	109.00 	-	-	-	-
8	34.93  106.30	119.00 	T80-028-028	T80-028-029	T80-028-030#	T80-028-065
9	41.00  108.00	122.00 	T90-029-022#	-	T90-029-024#	T90-029-068#
10	41.00  118.00	131.00 	-	-	-	-

European PTO

INDENT ITEM ONLY

B:7-28

www.walterscheid.com.au















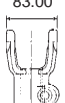



Document No:	SABRECAT
Issue:	3
Issue Date:	03/03/2021

This catalogue is the copyright of HS Company Pty Ltd

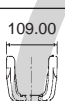
NON-INTERFERING PINCH BOLT YOKES

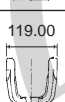

European PTO

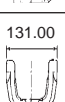
Shaft Identification			1 3/8 6 Spline	1 3/8 21 Spline	1 3/4 6 Spline	1 3/4 20 Spline
Series	U/Joint Size	Nominal Yoke Width				
1	22.00  54.00	62.00 	T10-021-059#	-	-	-
2	23.80  61.30	68.00 	T20-022-052#	-	-	-
4	26.99  74.61	83.00 	T40-024-060#	T40-024-061#	-	-
5	30.20  80.00	95.00 	-	-	-	-
6	30.20  92.08	106.00 	T60-026-084	T60-026-085#	-	-
7	30.20  106.30	119.00 	T70-027-053#	T70-027-054#	T70-027-055#	T70-027-056#
7N	35.00  94.00	109.00 	-	-	-	-
8	34.93  106.30	119.00 	T80-028-066#	T80-028-067#	-	T80-028-069#
9	41.00  108.00	122.00 	T90-029-069#	-	T90-029-071#	T90-029-072#
10	41.00  118.00	131.00 	-	-	-	-

www.walterscheid.com.au



















Document No:	SABRECAT
Issue:	3
Issue Date:	03/03/2021

This catalogue is the copyright of HS Company Pty Ltd

INDENT ITEM ONLY

INTERFERING PINCH BOLT BORE & KEY YOKES



Shaft Identification			3/4" Bore 3/16" Key	1" Bore 1/4" Key	1 1/4" Bore 5/16" Key	1 3/8" Bore 5/16" Key	1 1/2" Bore 3/8" Key
Series	U/Joint Size	Nominal Yoke Width					
1	22.00  54.00	62.00 	T10-021-074#	T10-021-075	-	-	-
2	23.80  61.30	68.00 	T20-022-069#	T20-022-070#	-	-	-
4	26.99  74.61	83.00 	-	-	T40-024-076	T40-024-077	-
5	30.20  80.00	95.00 	-	-	-	-	-
6	30.20  92.08	106.00 	-	-	T60-026-103	T60-026-104	-
7	30.20  106.30	119.00 	-	-	-		-
7N	35.00  94.00	109.00 	-	-	-	-	-
8	34.93  106.30	119.00 	-	-	-	T80-028-108	T80-028-109
9	41.00  108.00	122.00 	-	-	-	-	-

European PTO

www.walterscheid.com.au

Document No:	SABRECAT
Issue:	3
Issue Date:	03/03/2021

INDENT ITEM ONLY





B:7-30

This catalogue is the copyright of HS Company Pty Ltd

European PTO

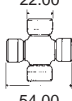
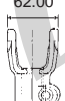
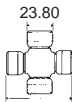
INTERFERING PINCH BOLT BORE & KEY YOKES

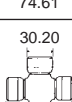
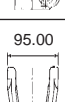
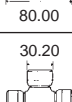
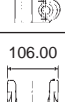
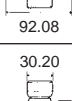
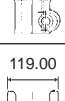
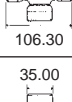
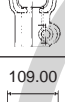
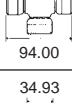
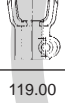
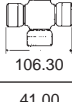
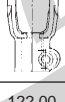

Series	U/Joint Size	Nominal Yoke Width	25mm Bore 8mm Key	30mm Bore 8mm Key	35mm Bore 10mm Key	40mm Bore 12mm Key
1	22.00  54.00	62.00 	T10-021-072#	T10-021-073#	-	-
2	23.80  61.30	68.00 	T20-022-067#	T20-022-068#	-	-
4	26.99  74.61	83.00 	T40-024-072#	T40-024-073#	T40-024-074#	-
5	30.20  80.00	95.00 	-	-	-	-
6	30.20  92.08	106.00 	-	T60-026-100#	T60-026-101#	T60-026-102#
7	30.20  106.30	119.00 	-	-	-	-
7N	35.00  94.00	109.00 	-	-	-	-
8	34.93  106.30	119.00 	-	-	T80-028-076#	T80-028-077#
9	41.00  108.00	122.00 	-	-	-	-

www.walterscheid.com.au



















Document No:	SABRECAT
Issue:	3
Issue Date:	03/03/2021

This catalogue is the copyright of HS Company Pty Ltd

INDENT ITEM ONLY

NON-INTERFERING PINCH BOLT BORE & KEY YOKES



Shaft Identification			3/4" Bore 3/16" Key	1" Bore 1/4" Key	1 1/4" Bore 5/16" Key	1 3/8" Bore 5/16" Key	1 1/2" Bore 3/8" Key
Series	U/Joint Size	Nominal Yoke Width					
1	22.00  54.00	62.00 	T10-021-077#	T10-021-078#	-	-	-
2	23.80  61.30	68.00 	T20-022-072#	T20-022-073#	T20-022-133	-	-
4	26.99  74.61	83.00 	-	-	T40-024-032	T40-024-080	-
5	30.20  80.00	95.00 	-	-	-	-	-
6	30.20  92.08	106.00 	-	-	T60-026-059	T60-026-106	T60-026-107
7	30.20  106.30	119.00 	-	-	-		-
7N	35.00  94.00	109.00 	-	-	-	-	-
8	34.93  106.30	119.00 	-	-	-	T80-028-106	T80-028-107
9	41.00  108.00	122.00 	-	-	-	-	-

European PTO

www.walterscheid.com.au

Document No:	SABRECAT
Issue:	3
Issue Date:	03/03/2021

INDENT ITEM ONLY





B:7-32

This catalogue is the copyright of HS Company Pty Ltd

European PTO

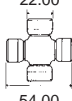
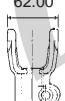
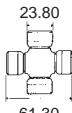
NON-INTERFERING PINCH BOLT BORE & KEY YOKES

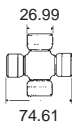
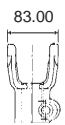
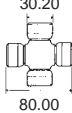
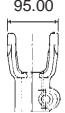
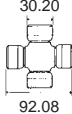
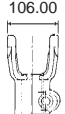
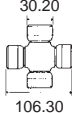

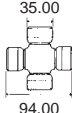
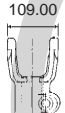
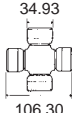
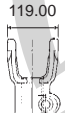
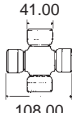
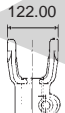
Series	U/Joint Size	Nominal Yoke Width	25mm Bore 8mm Key	30mm Bore 8mm Key	35mm Bore 10mm Key	40mm Bore 12mm Key
1	 22.00 54.00	 62.00	T10-021-037#	T10-021-038#	-	-
2	 23.80 61.30	 68.00	T20-022-021#	T20-022-022#	-	-
4	 26.99 74.61	 83.00	T40-024-078#	T40-024-029	T40-024-028	-
5	 30.20 80.00	 95.00	-	-	-	-
6	 30.20 92.08	 106.00	-	T60-026-040	T60-026-041	T60-026-052
7	 30.20 106.30	 119.00	-	-	-	-
7N	 35.00 94.00	 109.00	-	-	-	-
8	 34.93 106.30	 119.00	-	-	T80-028-042	T80-028-043
9	 41.00 108.00	 122.00	-	-	-	T90-029-079#

www.walterscheid.com.au

Document No:	SABRECAT
Issue:	3
Issue Date:	03/03/2021



















This catalogue is the copyright of HS Company Pty Ltd

INDENT ITEM ONLY

PLAIN BORE & KEY YOKES



Solid hub available, see next page. [®]

Shaft Identification			3/4" Bore 3/16" Key	1" Bore 1/4" Key	1 1/4" Bore 5/16" Key	1 3/8" Bore 5/16" Key	1 1/2" Bore 3/8" Key
Series	U/Joint Size	Nominal Yoke Width					
1	22.00  54.00	62.00 	T10-011-064	T10-011-065	T10-011-270#	-	-
2	23.80  61.30	68.00 	T20-012-057	T20-012-058	T20-012-059	-	-
4	26.99  74.61	83.00 	-	-	T40-014-065	T40-014-066	-
5	30.20  80.00	95.00 	-	-	T50-015-069#	T50-015-070#	-
6	30.20  92.08	106.00 	-	-	T60-016-091	T60-016-092	-
7	30.20  106.30	119.00 	-	-	-	[®]	-
7N	35.00  94.00	109.00 	-	-	-	-	-
8	34.93  106.30	119.00 	-	-	-	T80-018-306	T80-018-310
9	41.00  108.00	122.00 	-	-	-	-	-

European PTO

INDENT ITEM ONLY

B:7-34

www.walterscheid.com.au

Document No:	SABRECAT
Issue:	3
Issue Date:	03/03/2021

This catalogue is the copyright of HS Company Pty Ltd

European PTO

PLAIN BORE & KEY YOKES



Series	20mm Bore 6mm Key	25mm Bore 8mm Key	30mm Bore 8mm Key	35mm Bore 10mm Key	40mm Bore 12mm Key	Solid Hub
1	T10-011-061	T10-011-062	T10-011-063#	-	-	-
2	-	T20-012-055	T20-012-056	-	-	T20-012-000 K1-4-A0000 (35 DEGREE)
4	-	T40-014-062	T40-014-063	T40-014-064#	-	T40-014-000
5	-	-	T50-015-066#	T50-015-067#	-	-
6	-	-	T60-016-088	T60-016-089	T60-016-090	T60-016-000
7	-	-	-	-	-	T70-017-000
7N	-	-	-	-	-	-
8	-	-	-	T80-018-070	T80-018-071	T80-018-000
9	-	-	-	-	T90-019-073#	-

www.walterscheid.com.au











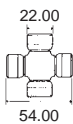
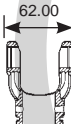

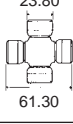
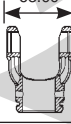



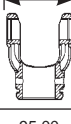

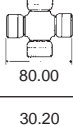
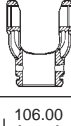

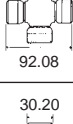
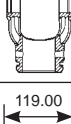
Document No:	SABRECAT
Issue:	3
Issue Date:	03/03/2021

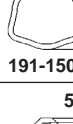
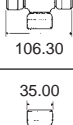
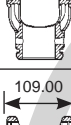
This catalogue is the copyright of HS Company Pty Ltd

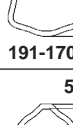
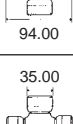
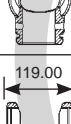
INDENT ITEM ONLY

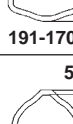
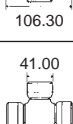
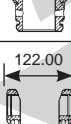
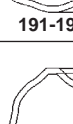
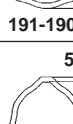
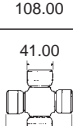
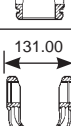
'T' SERIES TRI LOBE TUBE YOKES



Shaft Identification			Outer Tube Yoke	Outer Tube to Suit	Inner Tube Yoke	Inner Tube to Suit
Series	U/Joint Size	Nominal Yoke Width				
1	 22.00 54.00	 62.00	T10-011-003	 2.6 32.5 191-110-200	T10-011-002	 3.5 26.5 191-110-100
2	 23.80 61.30	 68.00	T20-012-003	 3.2 36.0 191-120-200	T20-012-002	 4.0 29.0 191-120-100
4	 26.99 74.61	 83.00	T40-014-006	 3.4 43.5 191-130-200	T40-014-007	 4.5 36.0 191-140-100
5	 30.20 80.00	 95.00	T50-015-011	 3.0 51.6 191-150-200	T50-015-012	 4.0 45.0 191-150-100
6	 30.20 92.08	 106.00	T60-016-028	 4.0 54.0 191-160-200	T60-016-029	 4.0 45.0 191-150-100
7	 30.20 106.30	 119.00	T70-017-007	 4.0 54.0 191-160-200	T70-017-006	 5.5 45.0 191-170-100
7N	 35.00 94.00	 109.00	T7N-017-012	 4.0 54.0 191-160-200	T7N-017-011	 5.5 45.0 191-170-100
8	 35.00 106.30	 119.00	T80-018-133	 4.0 63.0 191-198-850	T80-018-134	 5.0 54.0 191-190-300
9	 41.00 108.00	 122.00	T90-019-127	 4.0 63.0 191-198-850	T90-019-128	 5.0 54.0 191-190-300
10	 41.00 118.00	 131.00				

European PTO

INDENT ITEM ONLY

B:7-36

www.walterscheid.com.au











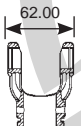

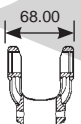
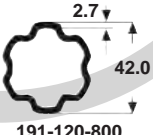
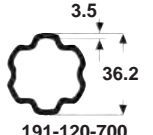

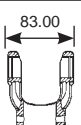
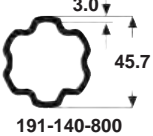
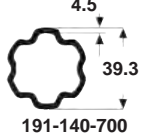

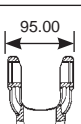
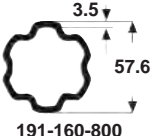
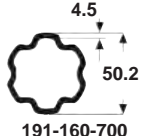
Document No:	SABRECAT
Issue:	3
Issue Date:	03/03/2021

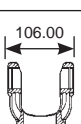
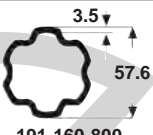
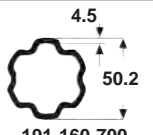
This catalogue is the copyright of HS Company Pty Ltd

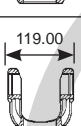
'V' SERIES MULTI LOBE TUBE YOKES

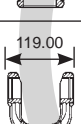
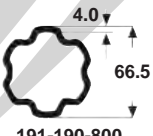
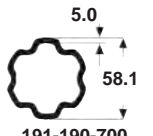

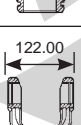
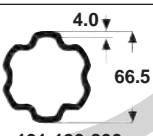
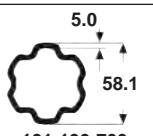
European PTO

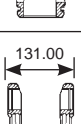
Shaft Identification			Outer Tube Yoke	Outer Tube to Suit	Inner Tube Yoke	Inner Tube to Suit
Series	U/Joint Size	Nominal Yoke Width				
1	22.00  54.00					
2	23.80  61.30		V20-012-319#	 2.7 42.0 191-120-800	V20-012-320#	 3.5 36.2 191-120-700
4	26.99  74.61		V40-014-427	 3.0 45.7 191-140-800	V40-014-428	 4.5 39.3 191-140-700
5	30.20  80.00		V50-015-361#	 3.5 57.6 191-160-800	V50-015-362#	 4.5 50.2 191-160-700
6	30.20  92.08		V60-016-388	 3.5 57.6 191-160-800	V60-016-389	 4.5 50.2 191-160-700
7	30.20  106.30					-
8	34.93  106.30		V80-018-241	 4.0 66.5 191-190-800	V80-018-242	 5.0 58.1 191-190-700
9	41.00  108.00		V90-019-166	 4.0 66.5 191-190-800	V90-019-167	 5.0 58.1 191-190-700
10	41.00  118.00					

www.walterscheid.com.au

Document No:	SABRECAT
Issue:	3
Issue Date:	03/03/2021

This catalogue is the copyright of HS Company Pty Ltd

INDENT ITEM ONLY

'E' SERIES SPLINES & TUBE YOKES



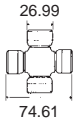

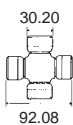

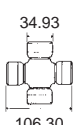
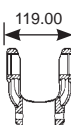

Fig 1.



Fig 2.

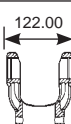

Fig 3.

Shaft Identification			Weld-in Tube Yoke Fig 1.	Splined Sleeve Fig 2.	Inner Bar Yoke Fig 3.	Inner Spline Bar to Suit
Series	U/Joint Size	Nominal Yoke Width				
4	26.99  74.61	83.00 	E40-014-003#	E40-014-249#	E40-014-250#	E40-140-611# 30mm x 10Spl 780mm
6	30.20  92.08	106.00 	E60-016-035#	E60-016-032#	E60-016-031#	E60-150-715# 35mm x 12Spl 765mm
8	34.93  106.30	119.00 	E80-018-144	E80-018-014	E80-018-145	E80-170-688 40mm x 14Spl 735mm
9	41.00  108.00	122.00 	E90-019-055	E90-019-056	E90-019-054	E90-190-617 45mm x 16Spl 730mm

European PTO

INDENT ITEM ONLY

B:7-38

www.walterscheid.com.au

Document No:	SABRECAT
Issue:	3
Issue Date:	03/03/2021

This catalogue is the copyright of HS Company Pty Ltd

'D' SERIES SPLINES & YOKES

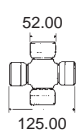
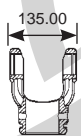

Fig 1.

Shaft Identification			Universal Joint	Splined Sleeve	Inner Bar Yoke Fig 1.	Inner Spline Bar to Suit
Series	U/Joint Size	Nominal Yoke Width				
120			NLA	NLA	D120-120-003#	D120-100-002# 50mm x 24 Spl 750mm

D120 SERIES SPLINED YOKES



Fig 1.



Fig 2.

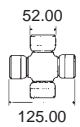
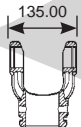

Fig 3.

Shaft Identification			Universal Joint	1 3/4 6 Spline QR (Pin Type) Fig 1.	1 3/4 20 Spline QR (Collar Type) Fig 2.	1 3/4 20 Spline PB Fig 3.
Series	U/Joint Size	Nominal Yoke Width				
120			NLA	D120-220-005	D120-220-001	D120-220-038

www.walterscheid.com.au

Document No:	SABRECAT
Issue:	3
Issue Date:	03/03/2021

This catalogue is the copyright of HS Company Pty Ltd

INDENT ITEM ONLY

WIDE ANGLE 'T' SERIES TRI LOBE TUBE YOKES



Shaft Identification			Outer Tube Yoke	Outer To Suit Inner Rilsan Coated Tube	Inner Tube Yoke	Inner Tube Rilsan Coated
Series	U/Joint Size	Nominal Yoke Width				
2			T20-022-166#		T20-022-172#	
4			T40-024-263		T40-024-269#	
6			T60-026-229		T60-026-249#	
8			T80-028-152		T80-028-165	

Note: Rilsan coated tube used on wide angle shafts.

European PTO

INDENT ITEM ONLY

B:7-40

www.walterscheid.com.au

Document No:	SABRECAT
Issue:	3
Issue Date:	03/03/2021

This catalogue is the copyright of HS Company Pty Ltd

European PTO

WIDE ANGLE 'V' SERIES MULTI LOBE TUBE YOKES



Shaft Identification			Outer Tube Yoke	Outer To Suit Inner Rilsan Coated Tube	Inner Tube Yoke	Inner Tube Rilsan Coated
Series	U/Joint Size	Nominal Yoke Width				
2			V20-022-325#		V20-022-326#	
4			V40-024-433#		V40-024-434#	
6			V60-026-390		V60-026-391	
8			V80-028-248		V80-028-249	

Note: Rilsan coated tube used on wide angle shafts.

www.walterscheid.com.au













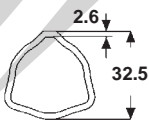
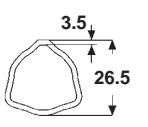

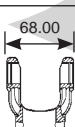
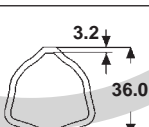
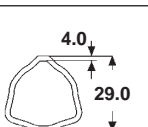

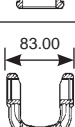
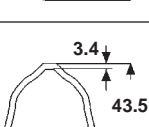
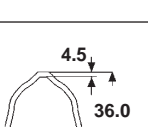

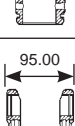
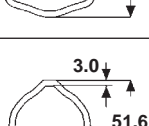
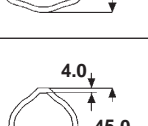

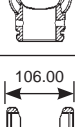
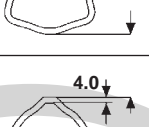
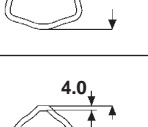
Document No:	SABRECAT
Issue:	3
Issue Date:	03/03/2021

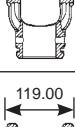
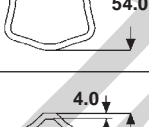
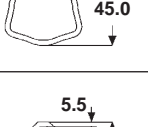
This catalogue is the copyright of HS Company Pty Ltd

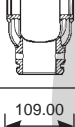
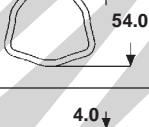
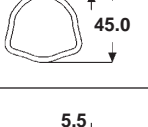
INDENT ITEM ONLY

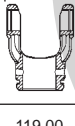
'T' SERIES TRI-LOBE TUBE

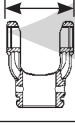
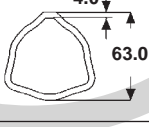
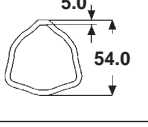

Shaft Identification			Outer Tube	Outer Tube Dimensions	Inner Tube	Inner Tube Dimensions
Series	U/Joint Size	Nominal Yoke Width				
1	22.00  54.00	62.00 	191-110-200	 2.6 32.5	191-110-100	 3.5 26.5
2	23.80  61.30	68.00 	191-120-200	 3.2 36.0	191-120-100	 4.0 29.0
4	26.99  74.61	83.00 	191-130-200	 3.4 43.5	191-140-100	 4.5 36.0
5	30.20  80.00	95.00 	191-150-200	 3.0 51.6	191-150-100	 4.0 45.0
6	30.20  92.08	106.00 	191-160-200	 4.0 54.0	191-150-100	 4.0 45.0
7	30.20  106.30	119.00 	191-160-200	 4.0 54.0	191-170-100	 5.5 45.0
7N	35.00  94.00	109.00 	191-160-200	 4.0 54.0	191-170-100	 5.5 45.0
8	34.93  106.30	119.00 	191-198-850	 4.0 63.0	191-190-300	 5.0 54.0
9	41.00  108.00	122.00 	191-198-850	 4.0 63.0	191-190-300	 5.0 54.0

European PTO

www.walterscheid.com.au

Document No:	SABRECAT
Issue:	3
Issue Date:	03/03/2021





This catalogue is the copyright of HS Company Pty Ltd

INDENT ITEM ONLY

European PTO

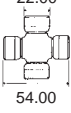
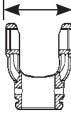
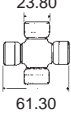
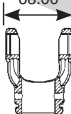
'V' SERIES MULTI-LOBE TUBE

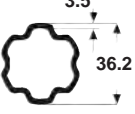
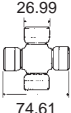

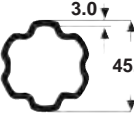
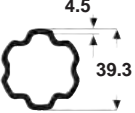
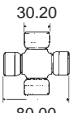
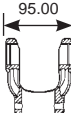
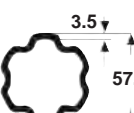
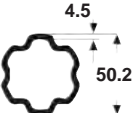
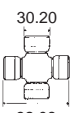
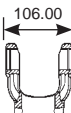
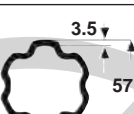
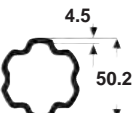
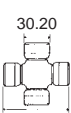
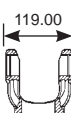
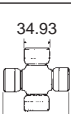
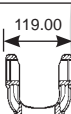
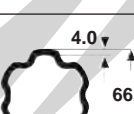
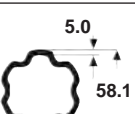
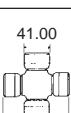
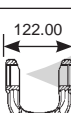
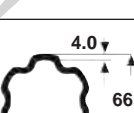
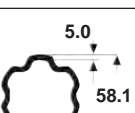
Shaft Identification			Outer Tube	Outer Tube Dimensions	Inner Tube	Inner Tube Dimensions
Series	U/Joint Size	Nominal Yoke Width				
1	22.00  54.00	62.00 	-	-	-	-
2	23.80  61.30	68.00 	191-120-800		191-120-700	
4	26.99  74.61	83.00 	191-140-800		191-140-700	
5	30.20  80.00	95.00 	191-160-800		191-160-700	
6	30.20  92.08	106.00 	191-160-800		191-160-700	
7	30.20  106.30	119.00 	-	-	-	-
8	34.93  106.30	119.00 	191-190-800		191-190-700	
9	41.00  108.00	122.00 	191-190-800		191-190-700	

www.walterscheid.com.au







Document No:	SABRECAT
Issue:	3
Issue Date:	03/03/2021

This catalogue is the copyright of HS Company Pty Ltd

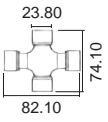
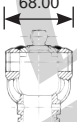
INDENT ITEM ONLY

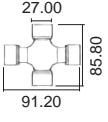
WIDE ANGLE 'T' SERIES TRI-LOBE TUBE

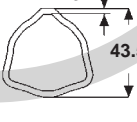
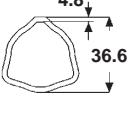
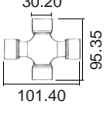
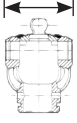
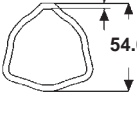
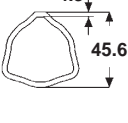
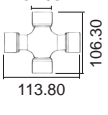
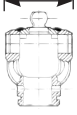
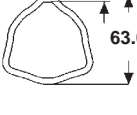

Shaft Identification			Outer To Suit Inner Rilsan Coated Tube	Outer Tube Dimensions	Inner Tube Rilsan Coated	Inner Tube Dimensions
Series	U/Joint Size	Nominal Yoke Width				
2			191-120-500#		152-120-261# Rilsan Coated 1300mm Long	
4			191-140-500		152-140-577# Rilsan Coated 1280mm Long	
6			191-160-500		152-160-847# Rilsan Coated 1265mm Long	
8			191-180-500		152-190-529# Rilsan Coated 1235mm Long	

Note: Rilsan coated tube used on wide angle shafts.

European PTO

INDENT ITEM ONLY

B:7-44

www.walterscheid.com.au



Document No:	SABRECAT
Issue:	3
Issue Date:	03/03/2021

This catalogue is the copyright of HS Company Pty Ltd

European PTO

WIDE ANGLE 'V' SERIES MULTI-LOBE TUBE

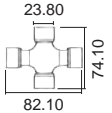
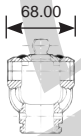
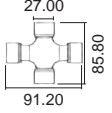

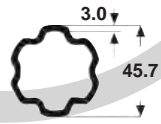
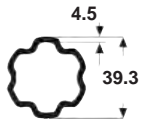
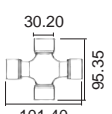
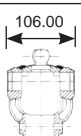
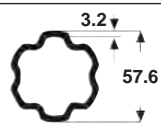
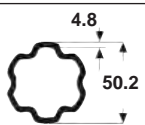
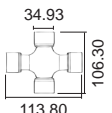
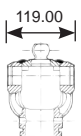
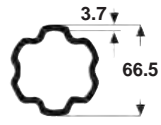
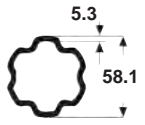
Shaft Identification			Outer To Suit Inner Rilsan Coated Tube	Outer Tube Dimensions	Inner Tube Rilsan Coated	Inner Tube Dimensions
Series	U/Joint Size	Nominal Yoke Width				
2			-	-	-	-
4			191-140-850		159-240-018 Nitrated Tube 1380mm Long	
6			191-160-850		159-260-179 Rilsan Coated 1365mm Long	
8			191-190-850		159-280-125 Rilsan Coated 1335mm Long	

Note: Rilsan coated tube used on wide angle shafts.

www.walterscheid.com.au

Document No:	SABRECAT
Issue:	3
Issue Date:	03/03/2021

This catalogue is the copyright of HS Company Pty Ltd

INDENT ITEM ONLY

FRICITION CLUTCH LININGS (To Suit Most Ag Clutches)

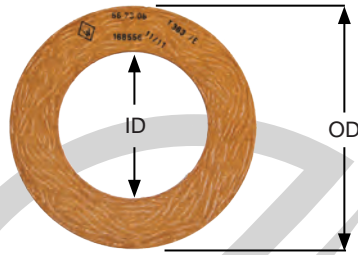
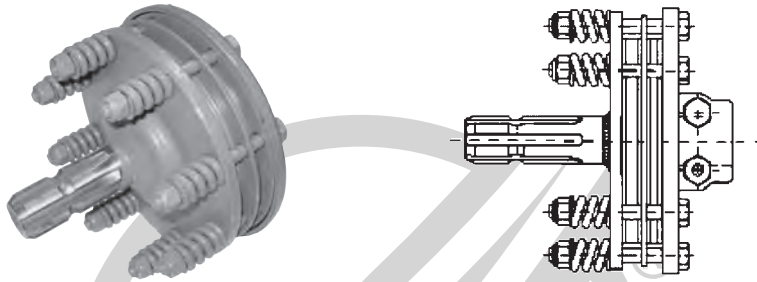

Fig. 1

Type	Fig.	OD mm	ID mm	Part Number
Comer F02	1	120	68	F02-014-019
Bypy FV22	1	124	67	247006151
Jayben 6"	1	127	45	P - 1023
Bypy FF1, FF3, FNV34	1	140	85	247000054
Bypy FV32, FV34	1	141	77	247006251
Comer F12	1	142	77.5	F12-015-019
Comer F22/42	1	152	90	F42-019-018
Comer RF	1	152	102	RFO-017-106
Weasler 7"	1	157	99	970-7000
Bypy FF2, FF4, FNV44	1	160	97	247000061
Bypy FV42, FV44	1	162	85	247006351
Jayben 8"	1	164	62	P - 1005
Weasler 9"	1	202	140	970-9000

Note: For more details on friction clutch linings, call Walterscheid Australia

EUROPEAN MADE M/F FRICTION DISC CLUTCH



Ratings			Male Spline Details	F/Male Spline Details	Complete Unit Part Number	Length E-E		OD	
540 RPM	1000 RPM	Torque				mm	inch	mm	inch
50 Hp	90 Hp	480 ft.lb 650 Nm	1 3/8" x 6	1 3/8" x 6	FM-231-003	189	7.441	150	5.905
65 Hp	125 Hp	665 ft.lb 900 Nm	1 3/8" x 6	1 3/8" x 6	FM-241-006	207	8.149	180	7.086
90 Hp	165 Hp	885 ft.lb 1500 Nm	1 3/8" x 6	1 3/8" x 6	FM-252-009	209	8.228	180	7.086
120 Hp	188 Hp	1475 ft.lb 2400 Nm	1 3/8" x 6	1 3/8" x 6	FM-264-005	209	8.228	200	7.874
			1 3/4" x 6	1 3/4" x 6	FM-284-001				
			1 3/4" x 20	1 3/4" x 20	FM-284-002				

INDENT ITEM ONLY

B:7-46

European PTO

www.walterscheid.com.au

Document No:	SABRECAT
Issue:	3
Issue Date:	03/03/2021

This catalogue is the copyright of HS Company Pty Ltd

European PTO

AUSTRALIAN MADE M/F FRICTION DISC CLUTCH

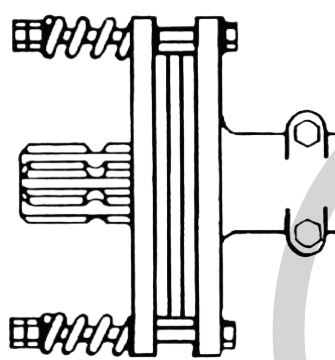
	KW / HP	Friction Plates	Description			Part Number
			Outside Dia	Male Spline	Female Bore / Spline	
	30KW 40HP	2	6 1/2" (165 Ø)	1 3/8" x 6Spl	Up to 1 1/2" Bore	AFC-500
					1 3/8" x 6Spl	AFC-512
	45KW 60HP	2	8" (203 Ø)		Up to 1 3/4" Bore	AFC-1000
					1 3/8" x 6Spl	AFC-1019
					1 3/4" x 6Spl	AFC-1039
					1 3/4" x 20Spl	AFC-1029
	90KW 120HP	4		Up to 1 3/4" Bore	AFC-2000	
				1 3/8" x 6Spl	AFC-2020	
			1 3/4" x 6Spl	AFC-2040		
			1 3/4" x 20Spl	AFC-2030		
			1 3/4" x 20Spl	AFC-2050		
			1 3/4" x 6Spl	AFC-2060		
			1 3/4" x 20Spl	AFC-2070		

Note: More spline options are available on request, contact your local branch for more information.

FRICTION CLUTCH COMPONENTS

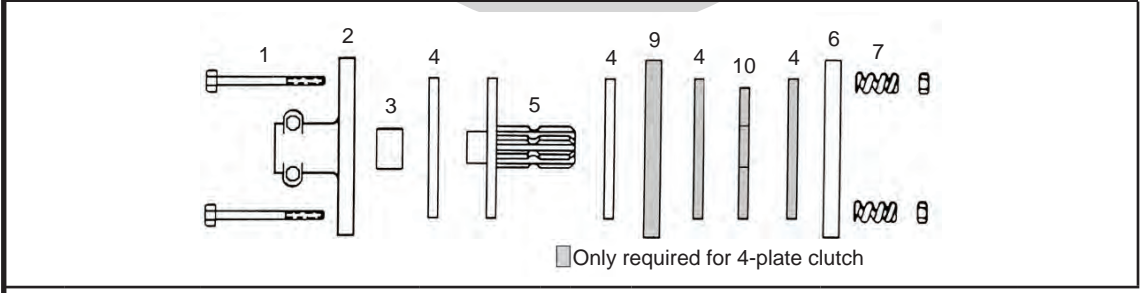

Ref #	Description		Part Number	Ref #	Description		Part Number	
	Clutch #	Description			Clutch #	Description		
1	AFC - 500	Bolt (6/8/assy)	B - 1001	5	AFC - 500	Drive Plate	P - 1024	
	AFC - 1029							
	AFC - 2000	Bolt (8/assy)	B - 1019		AFC - 1000/1019			
	AFC - 2030				AFC - 1029/1039			
2	AFC - 500	End Plate - Bore&Key	P - 1113		AFC - 2000/2020			P - 1084
	AFC - 512	End Plate - 1 3/8 x 6	P - 1091		AFC - 2030/2040			
	AFC - 1000	End Plate - Bore&Key	P - 1114	6	AFC - 500	Pressure Plate	P - 1025	
	AFC - 2000	End Plate - 1 3/8 x 6	P - 1096		AFC - 512			
	AFC - 1019				AFC - 1000			
	AFC - 2020	End Plate - 1 3/4 x 6	P - 1134	AFC - 2030	P - 1066			
	AFC - 1039			End Plate - 1 3/4 x 6		P - 1134	7	All Series
	AFC - 2040	End Plate - 1 3/4 x 20	P - 1108		8		All Series	Nut Nyloc (6/8 assy)
	AFC - 1029			End Plate - 1 3/4 x 20	P - 1108	9	AFC - 2000	Slider Plate
	AFC - 2030	AFC - 2030						
3	All Series	Bush - Self Lube	B - 1000	10	AFC - 2000	Spacer Plate	P - 1086	
	AFC - 2030				AFC - 2030			
	4	AFC - 500	Friction Disc 2/assy	P - 1023				
		AFC - 512						
AFC - 1000		Friction Disc 2/assy	P - 1005					
AFC - 2030				Friction Disc 4/assy				

www.walterscheid.com.au

Document No:	SABRECAT
Issue:	3
Issue Date:	03/03/2021

This catalogue is the copyright of HS Company Pty Ltd

INDENT ITEM ONLY

F TYPE FRICTION DISC CLUTCH

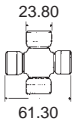
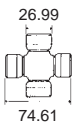
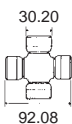
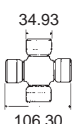
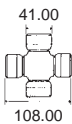

Series	U/Joint Size	Ref.	Spline Details	Part Number	Maximum Torque		Length C-E		OD	
					Nm	in.lb	mm	inch	mm	inch
2		F02	1 3/8" x 6	T20-221-001	650	5750	120	4.724	153	6.024
		F03	1 3/8" x 21	T20-221-002#						
4		F02	1 3/8" x 6	T40-241-002	650	5750	150	5.236	180	7.086
		F12	1 3/8" x 6	T40-241-001	900	7950	135	5.315		
		F13	1 3/8" x 21	T40-241-003#						
6		F22	1 3/8" x 6	T60-261-001	1200	10620	146	5.748	195	7.677
		F42	1 3/8" x 6	T60-264-001	1600	14150	156	6.142		
8		F42	1 3/8" x 6	T80-284-001	2000	17700	169	6.654	195	7.677
		F44	1 3/4" x 6	T80-284-013						
		F45	1 3/4" x 20	T80-284-004						
9		F42	1 3/8" x 6	T90-294-011	2000	17700	169	6.654	195	7.677
		F44	1 3/4" x 6	T90-294-013#						
		F45	1 3/4" x 20	T90-294-014#						

European PTO

INDENT ITEM ONLY

B:7-48

www.walterscheid.com.au

Document No:	SABRECAT
Issue:	3
Issue Date:	03/03/2021

This catalogue is the copyright of HS Company Pty Ltd

European PTO

F TYPE FRICTION DISC CLUTCH

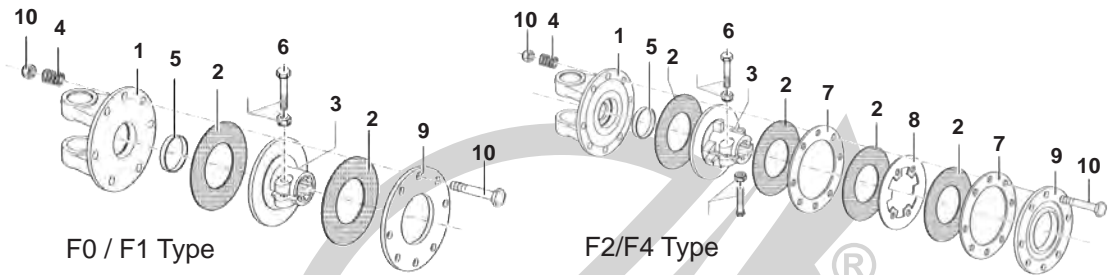

Components suit original Comer clutches only.

Series	Ref.	Flange Yoke 1	Clutch Lining 2	Lining Dia. mm OD / ID		Hub 3	Spring 4
2	F02	T20-012-139#	F02-014-019	120	68	F02-014-570#	F12-014-022
	F03					F02-014-592#	
4	F02	T40-014-017#	F02-014-019	120	68	F02-014-570#	F12-014-022
	F12	T40-014-009	F12-015-019	142	77.5	F12-015-018	F12-014-022
	F13					F12-015-010#	
6	F22	T60-016-037	F42-019-018	152	90	F22-018-018	F12-014-017
	F42	T60-016-037	F42-019-018	152	90	F42-019-011	F12-014-017
8	F42	T80-018-016	F42-019-018	152	90	F42-019-011	F12-014-022
	F44					F42-019-012	
	F45					F42-019-009	
9	F42	T90-019-059#	F42-019-018	152	90	F42-019-011	F12-014-022
	F44					F42-019-012	
	F45					F42-019-009	

EXTRA INTERNAL SPARE PARTS FOR DISC CLUTCHES

Clutch Type	Bush 5	Bolt Kit 6	Inner Plate 7	Intermediate Plate 8	Pressure Plate 9	Bolt Kit 10
F0 / F1	F12-015-020 <i>(55x51x10mm)</i>	165-000-502 <i>suit 1-3/8" spl hubs</i>			F12-015-021	165-000-501
F2 / F4	F42-019-019 <i>(65x59x15mm)</i>	165-000-502 <i>suit 1-3/8" spl hubs</i>	F42-019-014	F42-019-115	F42-019-116	165-000-548 <i>(for F4 type)</i>
		165-000-503 <i>suit 1-3/4" spl hubs</i>				165-000-549 <i>(for F2 type)</i>

www.walterscheid.com.au

Document No:	SABRECAT
Issue:	3
Issue Date:	03/03/2021

This catalogue is the copyright of HS Company Pty Ltd

Call Walterscheid Australia for further details on clutch spare parts

INDENT ITEM ONLY

SHEAR BOLT TORQUE LIMITER



Series	U/Joint Size	Ref.	Spline Details	Part Number	Maximum Torque		Length C-E	
					Nm	in.lb	mm	inch
2	 23.80 61.30	B02	1 3/8" x 6	T20-220-001#	650	5700	95	3.740
		B03	1 3/8" x 21	T20-220-002#				
4	 26.99 74.61	B02	1 3/8" x 6	T40-240-001#	1700	15000	97	3.819
		B03	1 3/8" x 21	T40-240-002#				
6	 30.20 92.08	B02	1 3/8" x 6	T60-260-001	2500	22100	137	5.394
		B03	1 3/8" x 21	T60-260-003#				
		B04	1 3/4" x 6	T60-260-002#				
		B05	1 3/4" x 20	T60-260-004#				
8	 34.93 106.30	B02	1 3/8" x 6	T80-280-001	3500	30900	146	5.748
		B03	1 3/8" x 21	T80-280-003#				
		B04	1 3/4" x 6	T80-280-002#				
		B05	1 3/4" x 20	T80-280-004				
9	 41.00 108.00	B02	1 3/8" x 6	T90-290-001#	4000	35400	152	5.984
		B03	1 3/8" x 21	T90-290-003#				
		B04	1 3/4" x 6	T90-290-002#				
		B05	1 3/4" x 20	T90-290-004#				

European PTO

INDENT ITEM ONLY

B:7-50

www.walterscheid.com.au

Document No:	SABRECAT
Issue:	3
Issue Date:	03/03/2021

This catalogue is the copyright of HS Company Pty Ltd

European PTO

SHEAR BOLT TORQUE LIMITER PARTS

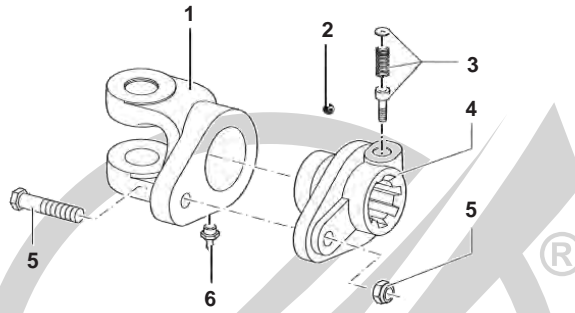

Series	Ref.	Yoke 1	Ball 2	QR Push Pin Set 3	Splined Hub 4	Bolt & Nut 5	Grease Nipple 6
2	B02	T20-012-005#	190-000-024# 7/32" DIA (24 Req)	165-026-004	T20-022-010#	165-000-509# M6x40 (ISO 8.8)	M8x1
	B03				T20-022-017#		
4	B02	T40-014-012#	190-000-022# 1/4" DIA (23 Req)	165-026-004	T40-024-013#	165-000-505# M8x50 (ISO 8.8)	M8x1
	B03				T40-024-026#		
6	B02	T60-016-042#	190-000-023# 5/16" DIA (24 Req)	165-026-004	T60-026-043#	165-000-507# M10x60 (ISO 8.8)	M10x1
	B03				T60-026-026#		
	B04			166-026-005	T60-026-044#		
	B05				T60-026-027#		
8	B02	T80-018-023#	190-000-023# 5/16" DIA (24 Req)	165-026-004	T80-028-024#	165-000-512# M12x65 (ISO 8.8)	M10x1
	B03				T80-028-037#		
	B04			166-026-005	T80-028-025#		
	B05				T80-028-038#		
9	B02	T90-019-136#	190-000-023# 5/16" DIA (24 Req)	165-026-004	T90-029-137#	165-000-512# M12x65 (ISO 8.8)	M10x1
	B03				T90-029-142#		
	B04			166-026-005	T90-029-141#		
	B05				T90-029-140#		

www.walterscheid.com.au



Document No:	SABRECAT
Issue:	3
Issue Date:	03/03/2021

This catalogue is the copyright of HS Company Pty Ltd

INDENT ITEM ONLY

OVERLOAD RATCHET CLUTCHES

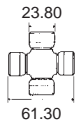
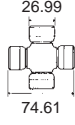

Series	U/Joint Size	Ref.	Spline Details	Part Number	Maximum Torque		Length C-E	
					Nm	in.lb	mm	inch
2	 23.80 61.30	U24	1 3/8" x 6	T20-226-001	600	5310	146	5.748
4	 26.99 74.61	U34	1 3/8" x 6	T40-246-001	900	7965	185	7.283
6	 30.20 92.08	U44	1 3/8" x 6	T60-266-029	1200	10620	220	8.66

European PTO

INDENT ITEM ONLY

B:7-52

www.walterscheid.com.au

Document No:	SABRECAT
Issue:	3
Issue Date:	03/03/2021

This catalogue is the copyright of HS Company Pty Ltd

European PTO

OVERRUNNING CLUTCH

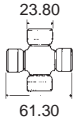
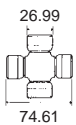
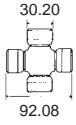
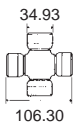

Series	U/Joint Size	Ref.	Splines Details	Part Number	Maximum Torque		Length C-E	
					Nm	in.lb	mm	inch
2		R12	1 3/8" x 6	T20-225-001#	3800	33630	146	5.748
		R13	1 3/8" x 21	T20-225-002#				
4		R12	1 3/8" x 6	T40-245-001	3800	33630	157	6.181
6		R12	1 3/8" x 6	T60-265-001	3800	33630	167	6.575
		R13	1 3/8" x 21	T60-265-004	3800	33630	167	6.575
8		R12	1 3/8" x 6	T80-285-001	3800	33630	176	6.929
		R13	1 3/8" x 21	T80-285-002	3800	33630	176	6.929

Call Walterscheid Australia for further details on overrunning clutch spare parts

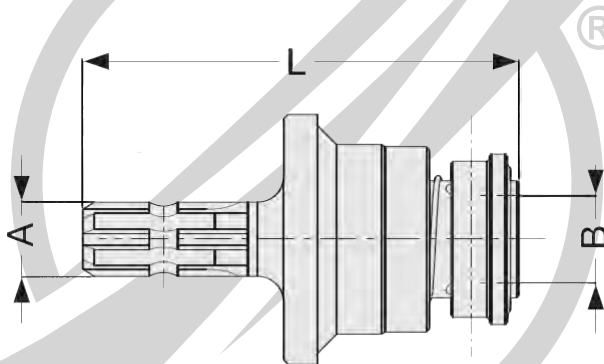

Ref	Splines Details A (Male)	Splines Details B (Female)	Part Number	Maximum Torque		Length L	
				Nm	in.lb	mm	inch
RM	1 3/8" x 6	1 3/8" x 6	RM-215-015	3800	33630	208	8.188

INDENT ITEM ONLY

www.walterscheid.com.au	
Document No:	SABRECAT
Issue:	3
Issue Date:	03/03/2021

This catalogue is the copyright of HS Company Pty Ltd

ALL PURPOSE TYPE COVER SET

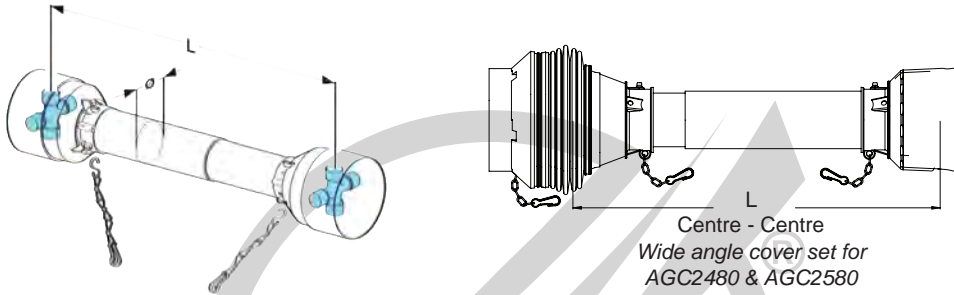

Series	Inner Bearing ID	Outer Bearing ID	Length	Complete Cover Set
10	34mm	40mm	1500mm	AGC10-100-1500
20	40mm	46mm	1500mm	AGC20-200-1500
30	47mm	54mm	1500mm	AGC40-400-1500
40				
50	54.5mm	62.5mm		-
60	60mm	69mm	1500mm	AGC60-600-1500
7N				
70				
80	69.5mm	81.5mm	1500mm	AGC80-800-1500
90				
AGC2600				
AGC2480	58.5mm	68.5mm	1500mm	85.248E-1500
AGC2580				85.258E-1500

European PTO

INDENT ITEM ONLY

B:7-54

www.walterscheid.com.au

Document No:	SABRECAT
Issue:	3
Issue Date:	03/03/2021

This catalogue is the copyright of HS Company Pty Ltd

European PTO

ORIGINAL COMER TYPE COVER SET

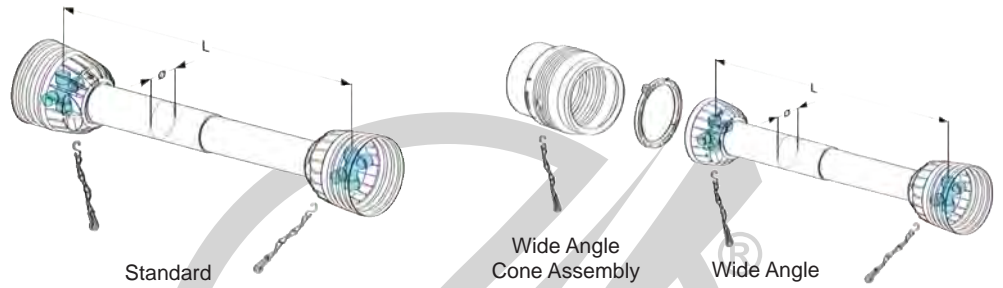

Series	Inner Guard Bearing	Outer Guard Bearing	Complete Cover Set		Wide Angle Cone Assy	Complete Cover Set Wide Angle
10	180-011-343 (34mm ID)	180-011-342 (40mm ID)	142-310-016		-	-
20	180-012-381 (40mm ID)	180-012-380 (46mm ID)	142-320-033		165-000-760	142-721-516
40	180-014-506 (47mm ID)	180-014-505 (54mm ID)	142-340-047		165-000-754	142-741-516
50	180-015-390 (54.5mm ID)	180-015-391 (62.5mm ID)	-		-	-
60	180-016-595 (60mm ID)	180-016-596 (69mm ID)	142-360-019		165-000-750	142-761-518
80	180-019-354 (69.5mm ID)	180-019-353 (81.5mm ID)	142-380-048		165-000-753	142-781-516
90	180-019-354 (69.5mm ID)	180-019-353 (81.5mm ID)	142-380-048		-	-

www.walterscheid.com.au









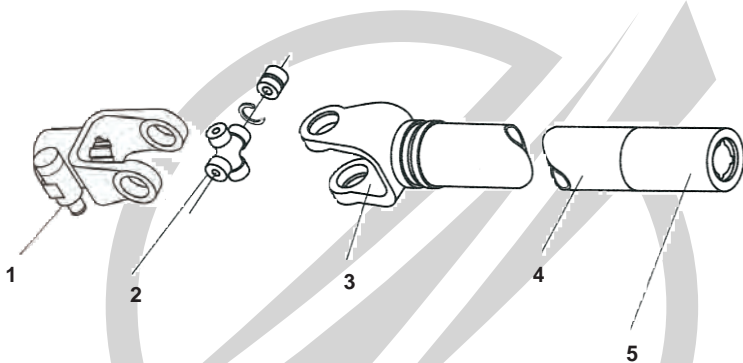

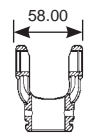
Document No:	SABRECAT
Issue:	3
Issue Date:	03/03/2021

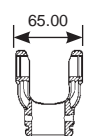
This catalogue is the copyright of HS Company Pty Ltd

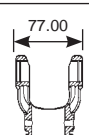
INDENT ITEM ONLY

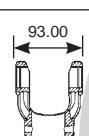
NORTH AMERICAN SERIES OUTER SHAFT PARTS

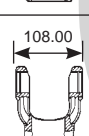

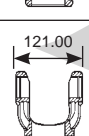
Shaft Identification			QR Yoke 1 3/8 x 6 Collar Type 1	Universal Joint 2	Weld-in Tube Yoke 3	Tube Size 4	Drive Nib 5
Series	U/Joint Size	Nominal Yoke Width					
06	24.61  36.80	 58.00	06-100-0606	4062000 <i>(114-1004)</i>	06-701-0600	06-604-0600 1 1/2" x .065"	06-510-0600 3/4" x 7/8"
12	26.99  46.04	 65.00	12-102-1206	4122000 <i>(RUJ-1788)</i>	12-701-1200	1614-0000 2" x .083"	14-500-1400 1" x 1 1/8"
14	28.58  66.67	 77.00	14-100-1406	4142000 <i>(CPL14N)</i>	14-701-1400	1614-0000 2" x .083"	14-500-1400 1" x 1 1/8"
35	31.75  81.36	 93.00	35-101-3506	4352000 <i>(CP35N-3)</i>	35-701-3500	1711-0000 2 1/8" x .120"	35-500-3500 1 3/16" x 1 3/16"
44	33.35  70.64	 108.00	44-101-4406	4442000 <i>(RUJ-3009)</i>	44-702-4400	2011-0000 2 1/2" x .120"	44-500-4400 1 5/16" x 1 5/16"
55	38.89  109.60	 121.00	55-101-5506	4552000 <i>(CP55N)</i>	55-704-5500	2011-0000 2 1/2" x .120"	44-500-4400 1 5/16" x 1 5/16"

Note: Other yokes and drive bar variations available

INDENT ITEM ONLY

B:7-56

North American PTO









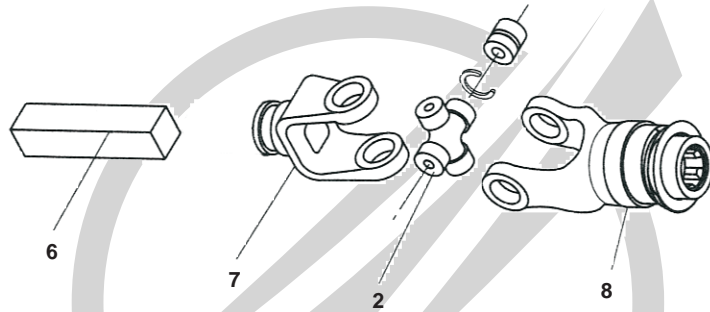

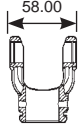
www.walterscheid.com.au

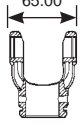
Document No:	SABRECAT
Issue:	3
Issue Date:	03/03/2021

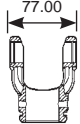
This catalogue is the copyright of HS Company Pty Ltd

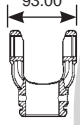
NORTH AMERICAN SERIES INNER SHAFT PARTS

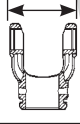

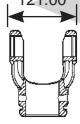
Shaft Identification			Inner Bar 36" Long 6	Inner Bar Yoke 7	QR Yoke 1 3/8 x 6 Collar Type 8	Cover Guard Bearing Kit 9	Cover Guard 10
Series	U/Joint Size	Nominal Yoke Width					
06	24.61  36.80	58.00 	06-404-1214 3/4" x 7/8"	06-300-0600# 3/4" x 7/8"	06-100-0606	921-0600	900-2560 60" Long
12	26.99  46.04	65.00 	14-404-1618 1" x 1 1/8"	12-300-1200 1" x 1 1/8"	12-102-1206	921-1200	900-2560 60" Long
14	28.58  66.67	77.00 	14-404-1618 1" x 1 1/8"	14-300-1400 1" x 1 1/8"	14-100-1406	921-1200	900-2560 60" Long
35	31.75  81.36	93.00 	35-404-0019 1 3/16" Square	35-300-3500 1 3/16" Square	35-101-3506	921-1200	900-2560 60" Long
44	33.35  70.64	108.00 	44-404-0021 1 5/16" Square	44-300-4400 1 5/16" Square	44-101-4406	921-4400	902-3560 60" Long
55	38.89  109.60	121.00 	44-404-0021 1 5/16" Square	55-300-5500 1 5/16" Square	55-101-5506	921-4400	902-3560 60" Long





Note: Other yokes and drive bar variations available

INDENT ITEM ONLY

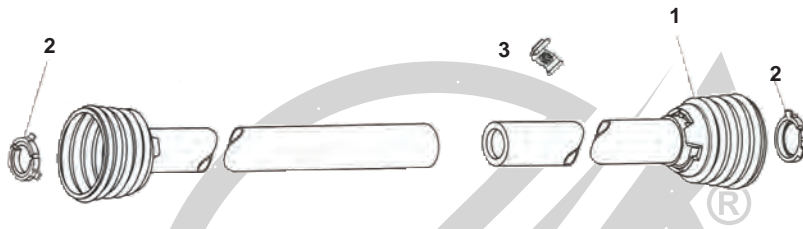
Document No:	SABRECAT
Issue:	3
Issue Date:	03/03/2021

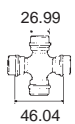
NORTH AMERICAN SERIES COVER SET

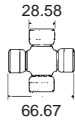

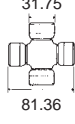
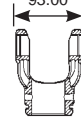
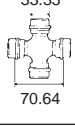
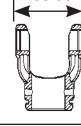
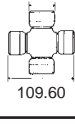
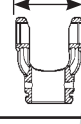
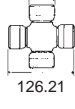
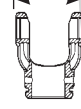
Shaft Identification			Cover Guard 1	Length	Cover Guard Bearing Kit (2 per Kit) 2	Easy Lock Retainer Clips (4 per Kit) 3
Series	U/Joint Size	Nominal Yoke Width				
12	 26.99 46.04	 65.00	900-2560	60" 1524mm	921-1200	13005000
14	 28.58 66.67	 77.00	900-2560	60" 1524mm	921-1200	
35	 31.75 81.36	 93.00	900-2560	60" 1524mm	921-1200	
44	 33.35 70.64	 108.00	902-3560	60" 1524mm	921-4400	
55	 38.89 109.60	 121.00	902-3560	60" 1524mm	921-4400	
77	 45.24 126.21	 139.00	900-4560#	60" 1524mm	961-4535	

North American PTO

INDENT ITEM ONLY

B:7-58



www.walterscheid.com.au

Document No:	SABRECAT
Issue:	3
Issue Date:	03/03/2021

This catalogue is the copyright of HS Company Pty Ltd

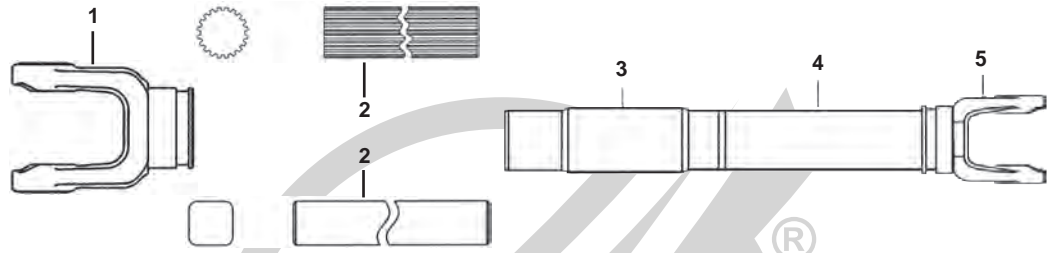
NORTH AMERICAN SERIES SHAFT VARIATIONS

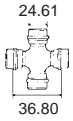
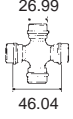

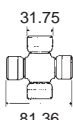
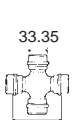
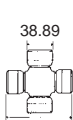
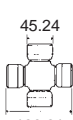
Shaft Identification			Bar Yoke	Drive Bar	Drive Nib	Drive Tube	Weld Yoke
Series	U/Joint Size	Drive Bar Dimension	1	2	3	4	5
06	 24.61 36.80	1" x 15 Spline	06-302-0600	06-404-1615H 36" Long	06-510-0615	06-604-0600 1.5" x .065"	06-702-0600 (No Groove) 06-701-0600 (Groove)
			12	 26.99 46.04	1" x 1 1/8"	12-300-1200	14-404-1618 36" Long
	12-300-1200	14-404-1618 36" Long	N/A			12-604-2022# 1 1/4" x 1 3/8" 36" Long	12-700-1200#
14	 28.58 66.67	1" x 1 1/8"	14-300-1400	14-404-1618 36" Long	14-500-1400	1614-0000 2" x .083"	14-701-1400
		34.90 x 20 Spline	14-301-1400#	35-404-2120 36" Long	35-501-1400	1711-0000 2 1/8" x .120"	14-701-1400
35	 31.75 81.36	1 3/16" Square	35-300-3500	35-404-0019 36" Long	35-500-3500	1711-0000 2 1/8" x .120"	35-701-3500
		34.90 x 20 Spline	35-301-3500#	35-404-2120 36" Long	35-502-3500#	1711-0000 2 1/8" x .120"	35-701-3500
		45.40 x 20 Spline	35-302-3500	44-404-2720 36" Long	35-503-3500	2011-0000 2 1/2" x .120"	35-704-3500# Hollow butt
44	 33.35 70.64	1 5/16" Square	44-300-4400#	44-404-0021 36" Long	44-500-4400	2011-0000 2 1/2" x .120"	44-701-4400#
		45.40 x 20 Spline	44-302-4400#	44-404-2720 36" Long	35-503-3500	2011-0000 2 1/2" x .120"	44-702-4400 Hollow butt
55	 38.89 109.60	1 5/16" Square	55-300-5500	44-404-0021 36" Long	44-500-3500	2011-0000 2 1/2" x .120"	55-701-5500#
		45.40 x 20 Spline	55-302-5500	44-404-2720 36" Long	35-503-3500	2011-0000 2 1/2" x .120"	55-704-5500 Hollow butt
77	 45.24 126.21	2" x 20 Spline	77-302-7700#	77-404-7720#	77-505-7700#	77-602-7700#	77-704-7700# Hollow butt

www.walterscheid.com.au

Document No:	SABRECAT
Issue:	3
Issue Date:	03/03/2021

This catalogue is the copyright of HS Company Pty Ltd

INDENT ITEM ONLY

NORTH AMERICAN QUICK RELEASE YOKES



Fig 1.
Push Pin Type

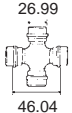
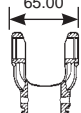
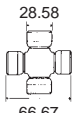
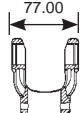
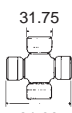
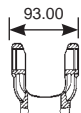
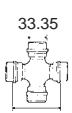
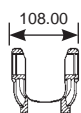
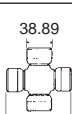
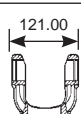
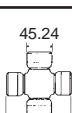
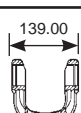

Fig 2.
Collar Type

Shaft Identification			Fig Ref.	1 3/8 6 Spline	1 3/8 21 Spline	1 3/4 6 Spline	1 3/4 20 Spline	1 1/8 HEX
Series	U/Joint Size	Nominal Yoke Width						
12	 26.99 46.04	 65.00	1	12-102-1206	12-102-1221	-	-	-
			2	12-100-1206#	12-100-1221#	-	-	-
14	 28.58 66.67	 77.00	1	14-102-1406#	14-102-1421#	-	-	14-102-1418
			2	14-100-1406	14-100-1421	-	14-101-1420#	-
35	 31.75 81.36	 93.00	1	35-102-3506#	35-102-3521#	35-102-3528#	35-102-3520	35-102-3518
			2	35-101-3506	35-101-3521	-	35-101-3520	-
44	 33.35 70.64	 108.00	1	44-102-4406#	44-102-4421#	-	44-102-4420#	-
			2	44-101-4406	44-101-4421	-	44-101-4420	-
55	 38.89 109.60	 121.00	1	55-102-5506#	55-102-5521#	55-102-5528#	55-102-5520#	-
			2	55-101-5506	55-101-5521	-	55-101-5520	-
77	 45.24 126.21	 139.00	2	77-110-7706	77-110-7721	-	77-110-7720	-

QUICK RELEASE YOKE LOCKING DEVICE KITS

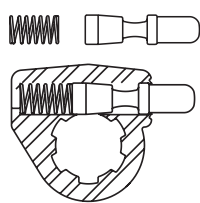
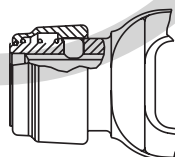
Quick Release Pin			Auto-Lok / Safety Slide Lock		
Image	Part No.	Description	Image	Part No.	Description
	13002006	Suit Weasler & Rockwell 6 Spl		13004000	Suit 6 Spl and 21 Spl Yokes
	13002806	Suit 1 3/4" x 6 Spl Yokes		13004020	Suit 20 Spl Yokes
	13002021	Suit 21 Spl and Weasler Hex QR		13004015	Suit 1" x 15 Spl Yokes
	13002020	Suit 20 Spl Yokes			

INDENT ITEM ONLY

B:7-60

North American PTO



www.walterscheid.com.au

Document No:	SABRECAT
Issue:	3
Issue Date:	03/03/2021

This catalogue is the copyright of HS Company Pty Ltd

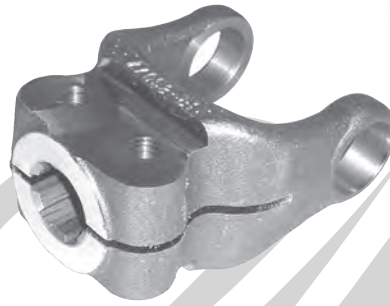

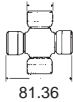
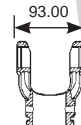
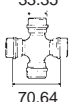
NORTH AMERICAN PINCH BOLT YOKES

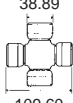
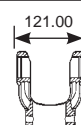
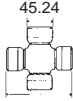
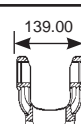

Shaft Identification			1 3/8 6 Spline	1 3/8 21 Spline	1 3/4 20 Spline	1 3/4 27 Spline
Series	U/Joint Size	Nominal Yoke Width				
35	31.75  81.36	93.00 	-	35-807-3521#	35-807-3520	35-807-3527#
44	33.35  70.64	108.00 	44-807-4406	44-807-4421	44-807-4420	44-807-4427#
55	38.89  109.60	121.00 	55-807-5506	55-807-5521	55-807-5520	55-807-5527#
77	45.24  126.21	139.00 	-	-	77-807-7720	-

NORTH AMERICAN 50° PINCH BOLT YOKES



Shaft Identification			1 3/8 6 Spline	1 3/8 21 Spline	1 3/4 20 Spline	1 1/2 23 Spline
Series	U/Joint Size	Nominal Yoke Width				
5550	38.89  109.60	121.00 	55-857-5506	55-857-5521	55-857-5520	55-857-5523

www.walterscheid.com.au



Document No:	SABRECAT
Issue:	3
Issue Date:	03/03/2021

This catalogue is the copyright of HS Company Pty Ltd

INDENT ITEM ONLY

NORTH AMERICAN BORE & KEY YOKES

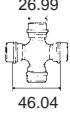
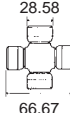
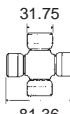
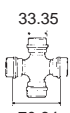

Shaft Identification		Pilot Bore No Key	3/4" Bore 3/16" Key	1" Bore 1/4" Key	1 1/4" Bore 1/4" Key	1 1/4" Bore 5/16" Key
Series	U/Joint Size					
12	26.99  46.04	12-809-1208 1/2" Bore Length=90.00mm	12-800-1212#	12-1135 Length=2.750"	12-800-1220#	12-1139 Length=2.750"
				12-4-1115 Length=3.500"		12-4-1119 Length=3.500"
14	28.58  66.67	14-809-1412 3/4" Bore Length=100.00mm	-	14-800-1416#	14-800-1420#	-
35	31.75  81.36	35-809-3516 1" Bore Length=108.00mm	-	35-800-3516#	35-800-3520#	-
44	33.35  70.64	44-809-4416 1" Bore Length=120.00mm	-	-	44-800-4420#	-
55	38.89  109.60	55-809-5516# 1" Bore Length=130.00mm	-	-	-	-

North American PTO

INDENT ITEM ONLY

B:7-62

www.walterscheid.com.au

Document No:	SABRECAT
Issue:	3
Issue Date:	03/03/2021

This catalogue is the copyright of HS Company Pty Ltd

NORTH AMERICAN BORE & KEY YOKES



Shaft Identification		1 3/8" Bore 5/16" Key	1 1/2" Bore 3/8" Key	1 5/8" Bore 3/8" Key	1 3/4" Bore 3/8" Key	2" Bore 1/2" Key
Series	U/Joint Size					
12		12-800-1222#	12-800-1224#	-	-	-
14		14-800-1422#	14-800-1424#	-	-	-
35		35-800-3522#	35-800-1424#	35-800-3526#	35-800-3528	-
44		44-800-4422#	44-800-4424#	44-800-4426#	44-800-4428#	44-800-4432#
55		55-800-5522#	55-800-5524#	55-800-5526#	55-800-5528#	55-800-5532#

www.walterscheid.com.au

Document No:	SABRECAT
Issue:	3
Issue Date:	03/03/2021

This catalogue is the copyright of HS Company Pty Ltd

INDENT ITEM ONLY

NORTH AMERICAN SHEAR CLUTCH

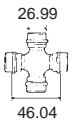
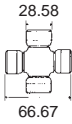
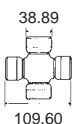

Series	U/Joint Size	Ref.	Splines Details	Part Number	Maximum Torque		Length C-E	
					Nm	in.lb	mm	inch
12	 26.99 46.04		1 3/8" x 6	12-104-1206	813	7200*	116	4.567
			1 3/8" x 21	12-104-1221#				
14	 28.58 66.67		1 3/8" x 6	14-104-1406	813	7200*	116	4.567
			1 3/8" x 21	14-104-1421#				
			1 3/4" x 20	-				
35	 31.75 81.36		1 3/8" x 6	35-104-3506	3140	27800*	141	5.551
			1 3/8" x 21	35-104-3521#			141	5.551
			1 3/4" x 20	35-104-3520#			154	6.063
44	 33.35 70.64		1 3/8" x 6	44-104-4406	3140	27800*	149	5.866
			1 3/8" x 21	44-104-4421#			149	5.866
			1 3/4" x 20	44-104-4420#			162	6.378
55	 38.89 109.60		1 3/8" x 6	55-104-5506	3140	27800*	155	6.102
			1 3/8" x 21	55-104-5521			155	6.102
			1 3/4" x 20	55-104-5520			168	6.614

* Higher torque settings available on request

North American PTO

INDENT ITEM ONLY

B:7-64

www.walterscheid.com.au

Document No:	SABRECAT
Issue:	3
Issue Date:	03/03/2021

This catalogue is the copyright of HS Company Pty Ltd

NORTH AMERICAN OVERRUNNING CLUTCH



NOTE: These overrunning clutches only operate in combination with the below mentioned clutch packs.

Series	U/Joint Size	Image Ref.	Spline Details	Part Number	Maximum Torque		Length C-E	
					Nm	in.lb	mm	inch
14			1 3/8" x 6	14-818-1406	1740	15400	179	7.047
			1 3/8" x 21	14-818-1421#			179	7.047
			1 3/4" x 20	14-818-1420#			189	7.441
35			1 3/8" x 6	35-818-3506#	2542	22500	187	7.362
			1 3/8" x 21	35-818-3521			187	7.362
			1 3/4" x 20	35-818-3520#			197	7.756
44			1 3/8" x 6	44-818-4406#	4070	36000	196	7.717
			1 3/8" x 21	44-818-4421			196	7.717
			1 3/4" x 20	44-818-4420#			206	8.110
55			1 3/8" x 6	55-818-5506#	4070	36000	205	8.071
			1 3/8" x 21	55-818-5521			216	8.504
			1 3/4" x 20	55-818-5520			205	8.071

CLUTCH PACK TO SUIT OVERRUNNING CLUTCH

	OD	PCD	in/lbs	Part Number
	A (mm)	B (mm)		
	177.8	134	9000	571-9000
	177.8	134	12000	57112000
	177.8	134	15000	57115000
	177.8	134	18000	57118000
	237.8	134	10000	59110000
	237.8	134	15000	59115000
	237.8	134	18000	59118000
	237.8	134	21000	59121000

www.walterscheid.com.au

Document No:	SABRECAT
Issue:	3
Issue Date:	03/03/2021

This catalogue is the copyright of HS Company Pty Ltd

INDENT ITEM ONLY

NORTH AMERICAN 80° WIDE ANGLE SHAFT PARTS
80° UNEQUAL U/JOINT

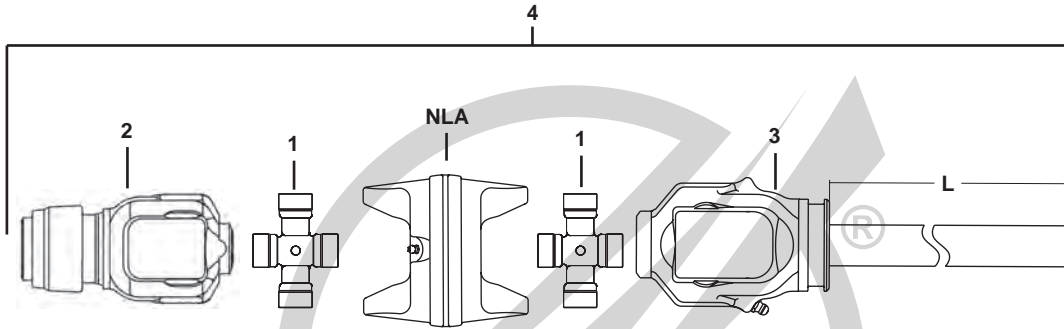

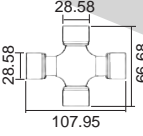
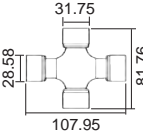
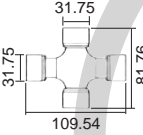
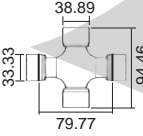
Shaft Identification		Universal Joint 1	QR Yoke Collar Type 2	Bar Yoke & Shaft 3	Half Shaft Including Cover 4
Series	U/Joint Size				
1480		4142800 (K5-A797)	14-111-1406# 1 3/8 x 6Spl	14-10101400# 1" x 1 1/8" Shaft L=27.250"	NLA *
			14-111-1421# 1 3/8 x 21Spl		NLA *
			14-111-1420# 1 3/4 x 20Spl		-
3580		4352800 (K5-A798)	35-113-3506# 1 3/8 x 6Spl	35-10103501# 34.90 x 20 Spl Shaft L=27.000"	NLA *
			35-113-3521# 1 3/8 x 21Spl		NLA *
			35-113-3520# 1 3/4 x 20Spl		NLA *
4480		4442800 (K5-A799)	44-107-3506# 1 3/8 x 6Spl	44-10103500# 45.40 x 20 Spl Shaft L=27.000"	NLA *
			44-107-3521# 1 3/8 x 21Spl		NLA *
			44-107-3520# 1 3/4 x 20Spl		NLA *
5580		4552800 (K5-A800)	55-111-5506 1 3/8 x 6Spl	55-10105500# 45.40 x 20 Spl Shaft L=27.000"	NLA *
			55-111-5521# 1 3/8 x 21Spl		NLA *
			55-111-5520 1 3/4 x 20Spl		NLA *

* Note: Unequal u/joint half shaft assemblies are no longer available, equal u/joint half shaft assemblies can be used as a complete replacement.

INDENT ITEM ONLY

www.walterscheid.com.au

Document No:	SABRECAT
Issue:	3
Issue Date:	03/03/2021

This catalogue is the copyright of HS Company Pty Ltd

NORTH AMERICAN 50°/80° WIDE ANGLE SHAFT PARTS

50° & 80° EQUAL & UNEQUAL U/JOINT

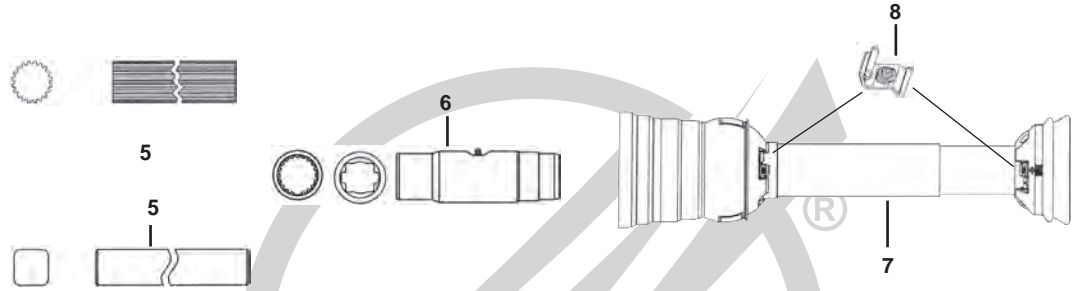

Shaft Identification		Drive Bar 5	Drive Nib 6	80° Cover Guard Incl Bearings 7	80° Cover Guard Bearing 8	50° Cover Guard Incl Bearings
Series	U/Joint Size					
1480		14-404-1618 1" x 1 1/8"	14-500-1400	912-1467 67" Long	921-1400#	14-950-1430
3580		35-404-2120 34.90 x 20 Spl	35-501-3500	912-1467 67" Long	921-1400#	14-950-1430
4480		44-404-2720 45.40 x 20 Spl	35-503-3500	912-3579 79" Long	921-3500	-
5580		44-404-2720 45.40 x 20 Spl	35-503-3500	912-5579 79" Long	921-5500	55-950-5548

www.walterscheid.com.au

Document No:	SABRECAT
Issue:	3
Issue Date:	03/03/2021

This catalogue is the copyright of HS Company Pty Ltd

INDENT ITEM ONLY

NORTH AMERICAN 80° WIDE ANGLE SHAFT PARTS
EQUAL U/JOINT

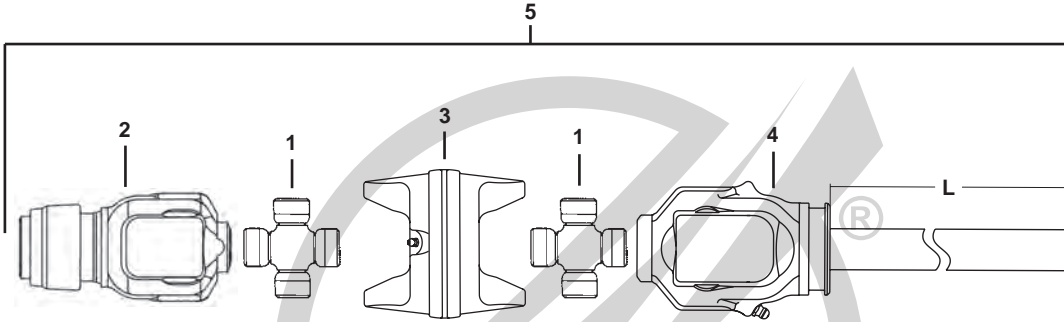

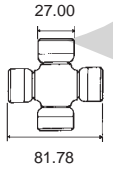
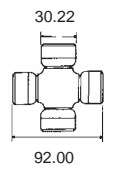
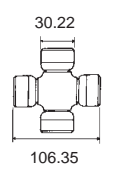
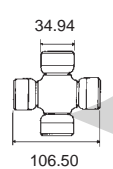
Shaft Identification		Universal Joint 1	QR Yoke Collar Type 2	Centre Yoke 3	Bar Yoke & Shaft 4	Half Shaft Incl. Cover 5
Series	U/Joint Size					
1480	 27.00 81.78	K5-A13XR 5-433-1X	14-121-1406# 1 3/8 x 6Spl	14-515-1430#	14-10103800# 1" x 1 1/8" Shaft L=27.250"	14-19553800#
			14-121-1421# 1 3/8 x 21Spl			14-19653800#
			-			-
3580	 30.22 92.00	4622000 4622000-1X 4622000-4X	35-111-8606# 1 3/8 x 6Spl	35-515-8600#	35-10108600# 34.90 x 20 Spl Shaft L=27.000"	35-19558600#
			35-111-8621# 1 3/8 x 21Spl			35-19658600#
			35-111-8620# 1 3/4 x 20Spl			35-19758600#
4480	 30.22 106.35	23.00.00	44-111-5806# 1 3/8 x 6Spl	44-515-5800#	44-10105800# 45.40 x 20 Spl Shaft L=27.000"	44-19505806#
			44-111-5821# 1 3/8 x 21Spl			44-19605821#
			44-111-5820# 1 3/4 x 20Spl			44-19705820#
5580	 34.94 106.50	4B82006 4B82006-1X 4B82006-4X	55-111-6806# 1 3/8 x 6Spl	55-515-6800#	55-10106800# 45.40 x 20 Spl Shaft L=27.000"	55-19556800#
			55-111-6821# 1 3/8 x 21Spl			55-19656800#
			55-111-6820# 1 3/4 x 20Spl			55-19756800#

North American PTO

www.walterscheid.com.au

Document No:	SABRECAT
Issue:	3
Issue Date:	03/03/2021

INDENT ITEM ONLY

B:7-68

This catalogue is the copyright of HS Company Pty Ltd

NORTH AMERICAN 50° WIDE ANGLE SHAFT PARTS

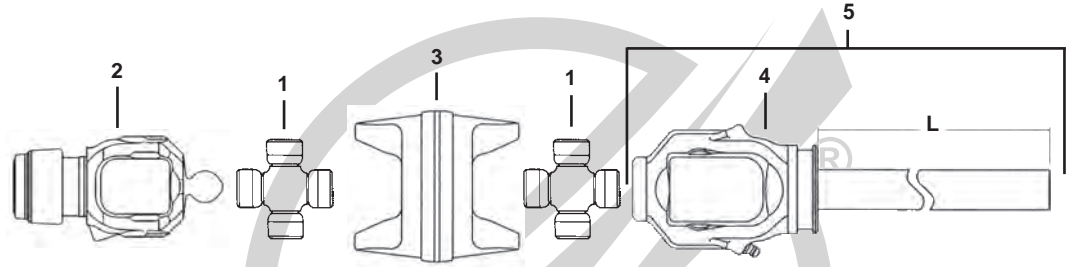

Shaft Identification		Universal Joint 1	QR Yoke Collar Type 2	Centre Yoke 3	Bar Yoke 4	Bar Yoke & Shaft 5
Series	U/Joint Size					
1450		4142000 <i>(CPL14N)</i>	14-150-1406 1 3/8 x 6Spl	14-555-1400	14-350-1400 1" Round	14-10501400 1" x 1 1/8" Shaft L=29.380"
			14-150-1421 1 3/8 x 21Spl			
			14-850-1420 1 1/4 x 1/4 Key 2 set screws			
3550		4352000 <i>(CP35N-3)</i>	35-151-3506 1 3/8 x 6Spl	35-555-3500	35-350-3500 1" Round	-
			35-151-3521 1 3/8 x 21Spl			
			35-151-3520 1 3/4 x 20Spl			
4450		4442000 <i>(RUJ-3009)</i>	-	-	-	-
			-			
			-			
5550		4552000 <i>(CP55N)</i>	55-151-5506 1 3/8 x 6Spl	55-555-5500	55-350-5500 1.3" Round	-
			55-151-5521 1 3/8 x 21Spl			
			55-151-5520 1 3/4 x 20Spl			
			55-850-5524 1/2 x 3/8 Key 2 set screws			

Note: Clamp bolt yokes are available in 5550 series

INDENT ITEM ONLY

Document No:	SABRECAT
Issue:	3
Issue Date:	03/03/2021

NORTH AMERICAN 80° WIDE ANGLE SHAFT PARTS
WALTERSCHEID REPLACEMENT TRACTOR HALF SHAFT

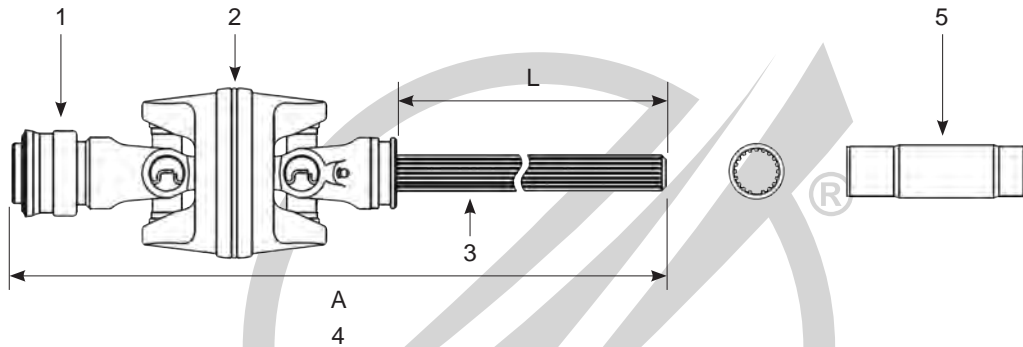

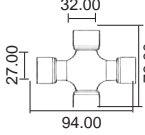
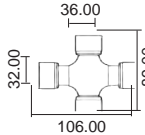
Shaft Identification		QR Yoke Collar Type	Centre Yoke	Splined Drive Bar	Half Shaft Assembly	Drive Nib
Series	U/Joint Size Part No.	1	2	3	A 4	5
2480 Alternate for 3580	 35.06.00	35.83.830 1 3/8 x 6Spl	35.41.05	44-404-2720 45.40 x 20 Spl L=895mm	AGH2480-SP-895 A=1200mm <i>(Alternate for 35-19558600)</i>	35-503-3500
		35.83.832 1 3/8 x 21Spl			-	
		35.84.112 1 3/4 x 20Spl			-	
2580 Alternate for 4480 and 5580	 36.06.00	36.83.110 1 3/8 x 6Spl	36.41.05	44-404-2720 45.40 x 20 Spl L=685mm	AGH2580-SP-685 A=1060mm <i>(Alternate for 44-19505806)</i> <i>(Alternate for 55-19556800)</i>	35-503-3500
		36.83.112 1 3/8 x 21Spl			AGH2580-SP-6851 A=1060mm <i>(Alternate for 44-19605821)</i> <i>(Alternate for 55-19656800)</i>	
		36.84.112 1 3/4 x 20Spl			AGH2580-SP-6852 A=1060mm <i>(Alternate for 44-19705820)</i> <i>(Alternate for 55-19756800)</i>	

Half Shafts are fitted with Walterscheid CV assemblies.

North American PTO

INDENT ITEM ONLY

B:7-70

www.walterscheid.com.au

Document No:	SABRECAT
Issue:	3
Issue Date:	03/03/2021

This catalogue is the copyright of HS Company Pty Ltd

GEARBOXES

SLASHER GEARBOX



Max H.P.		Input Torque Nm	Ratio	Mounting Holes			Input	Output	Part Number
kW	HP			Qty	PCD	Pattern			
22	30	197	1:1.92	4	171.50	Square	1 3/8" x 6	Hub Connection	MG-205-805
44	60	391	1:1.93	4	203.20	Evenly Spaced	1 3/8" x 6	Hub Connection	MG-140-804
44	60	756	1:1	6	177.80	Evenly Spaced	1 3/8" x 6	Hub Connection	9.132.007
55	75	516	1:1.83	6	203.20	Evenly Spaced	1 3/8" x 6	Hub Connection	9.227.804#
74.6	100	1030	1:1.22	4	203.20	Evenly Spaced	1 3/8" x 6	Hub Connection	U10.100.006.10
74.6	100	863	1:1.46	4	203.20	Evenly Spaced	1 3/8" x 6	Hub Connection	U10.100.005.10
74.6	100	686	1:1.83	4	203.20	Evenly Spaced	1 3/8" x 6	Hub Connection	U10.100.007.10

SLASHER GEARBOX (4 Way T-Box)



Max H.P.		Input Torque Nm	Ratio	Mounting Holes			Rotation	Input	Output	Part Number
kW	HP			Qty	PCD	Pattern				
66	88	615	1:1.84	6	177.80	Evenly Spaced	STANDARD	1 3/8" x 6	Hub Connection	9.266.008
66	88	615	1:1.84	6	177.80	Evenly Spaced	OPPOSITE	1 3/8" x 6	Hub Connection	9.266.012

Note: More gearbox options and configurations are available on request, contact your local branch for more information.

Walterscheid Australia recommends Gear Lube SAE 80W/90 Part #: **30551GW** (5 Litre)

INDENT ITEM ONLY

www.walterscheid.com.au

Document No:	SABRECAT
Issue:	3
Issue Date:	03/03/2021

This catalogue is the copyright of HS Company Pty Ltd

GEARBOXES

ALUMINIUM - COMPACT BEVEL RIGHT ANGULAR GEARBOX



Max H.P.		Input Torque Nm	Ratio	Mounting Holes			Input	Output	Part Number
kW	HP			Qty	PCD	Pattern			
2.2	3	39	3.3:1		90.00	Square	25mm	25mm	8301919
7	9	117	1.9:1		90.00	Square	25mm	25mm	8305015
11	15	195	1:1		90.00	Square	25mm	25mm	8305009
18	25	261	1:1		108.00	Square	35mm	35mm	8305024

STEEL - COMPACT BEVEL RIGHT ANGULAR GEARBOX



Max H.P.		Input Torque Nm	Ratio	Mounting Holes			Input	Output	Part Number
kW	HP			Qty	PCD	Pattern			
4	6	71	2.9:1		88.00	Square	30mm	30mm	8301942
12.5	17	221	2:1		88.00	Square	30mm	30mm	8301941
12.5	17	221	2:1		88.00	Square	1 3/8" x 6	1 3/8" x 6	8301934
26.5	36	468	1:1		88.00	Square	30mm	30mm	8301938
26.5	36	468	1:1		88.00	Square	1 3/8" x 6	1 3/8" x 6	8301933
26.5	36	468	1:1		88.00	Square	1 3/8" x 6	30mm	8301947
18	25	325	1.92:1		110.00	Square	1 3/8" x 6	1 3/8" x 6	8301956
29	40	520	1:1.92		110.00	Square	1 3/8" x 6	1 3/8" x 6	8301955
37	50	651	1:1.46		110.00	Square	1 3/8" x 6	1 3/8" x 6	8301953
49	66	859	1:1		110.00	Square	1 3/8" x 6	1 3/8" x 6	8301952
43	58	755	1:1.92		115.00	Square	1 3/8" x 6	1 3/8" x 6	8301925
66	90	1171	1:1		115.00	Square	1 3/8" x 6	1 3/8" x 6	8301924
77.2	103	2555	1:1.93		160.00	Square	1 3/4" x 20	1 3/4" x 20	9.301.281

Note: More gearbox options and configurations are available on request, contact your local branch for more information.

Walterscheid Australia recommends Gear Lube SAE 80W/90 Part #: **30551GW** (5 Litre)

INDENT ITEM ONLY

B:7-72

www.walterscheid.com.au

Document No:	SABRECAT
Issue:	3
Issue Date:	03/03/2021

This catalogue is the copyright of HS Company Pty Ltd

GEARBOXES

STEEL - COMPACT SPEED MULTIPLIER GEARBOX

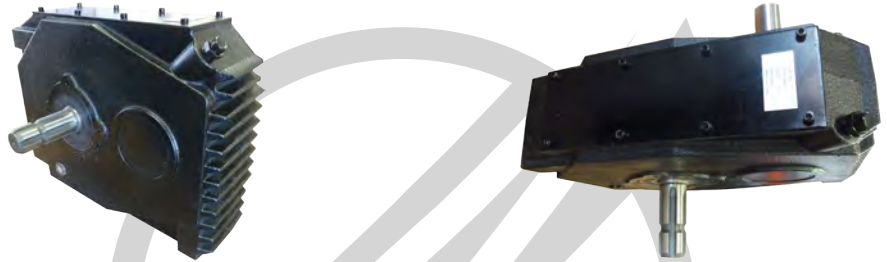

Max H.P.		Input Torque Nm	Ratio	Mounting Holes		Input	Output	Part Number
kW	HP			PCD	Pattern			
47.8	65	862	1:7		272mm x 76mm	1 3/8" x 6	35mm	8300420
58.8	80	1061	1:5		272mm x 76mm	1 3/8" x 6	35mm	8300418
58.8	80	1061	1:6		272mm x 76mm	1 3/8" x 6	35mm	8300419
62.5	85	1127	1:1		272mm x 76mm	1 3/8" x 6	35mm	8300412
62.5	85	1127	1:2.5		272mm x 76mm	1 3/8" x 6	35mm	8300415
62.5	85	1127	1:3		272mm x 76mm	1 3/8" x 6	35mm	8300416
62.5	85	1127	1:3.8		272mm x 76mm	1 3/8" x 6	35mm	8300417
66	90	1193	1:1.48		272mm x 76mm	1 3/8" x 6	35mm	8300413
66	90	1193	1:2		272mm x 76mm	1 3/8" x 6	35mm	8300414

Note: These boxes can be run in reverse to reduce speeds however the rating of the boxes will be greatly reduced.

Walterscheid Australia recommends Gear Lube SAE 80W/90 Part #: **30551GW** (5 Litre)

SLASHER KITS

GEARBOX ♦ PTO SHAFT ♦ CLUTCH ♦ IMPLEMENT GUARD



kW	HP	PTO Shaft Series	Friction Clutch Plates	Gearbox Ratio	Part Number
22	30	T40	2 Plate	1:1.92	T40-0760-SK
45	60	T60	2 Plate	1:1.93	T60-1010-SK
75	100	T80	4 Plate	1:1.83	T80-1010-SK

All Slasher Kits include an Implement Guard

INDENT ITEM ONLY

www.walterscheid.com.au

Document No:	SABRECAT
Issue:	3
Issue Date:	03/03/2021

This catalogue is the copyright of HS Company Pty Ltd

LINKAGE - MOUNTING ACCESSORIES

TOP LINKS

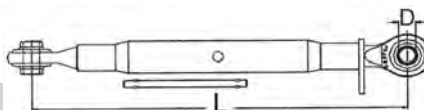

CAT	L LENGTH	D Eye Diameter	THREAD SIZE	PART NUMBER
0	340 - 460	16	3/4" x 10 UNC	8071692
1	430 - 610	19	1 1/8" x 7 UNC	8400002
1	530 - 710	19	1 1/8" x 7 UNC	8400011
2	535 - 785	25.4	1 1/8" x 7 UNC	8401610
2	640 - 925	25.4	1 1/8" x 7 UNC	8400012
2 HD	640 - 840	25.4	M36 x 3	8400008
3 HD	610 - 830	32	M36 x 3	8400009

Note : A further range of Top Links available in the Walterscheid TAS catalogue.

RATCHET ARM

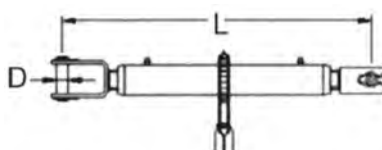

CAT	L Usable Length	D Eye Diameter	THREAD SIZE	PART NUMBER
2	510 - 720	25.4	1 1/4" ACME	8400052

TOP LINK IMPLEMENT PIN



CAT	A Pin Diameter	L Usable Length	D Diameter	PART NUMBER
0	16	80	7.5	8401603
1	19	92	12	8401512
1	19	101	12	8401513
2	25.4	83	12	8401605
2	25.4	115	12	8401557
2	25.4	142	12	8401518
3	32	125	12	8401558
3	36	125	12	8401G074

www.walterscheid.com.au

Document No:	SABRECAT
Issue:	3
Issue Date:	03/03/2021

INDENT ITEM ONLY

B:7-74

This catalogue is the copyright of HS Company Pty Ltd

LINKAGE - MOUNTING ACCESSORIES

LOWER LINK IMPLEMENT PIN

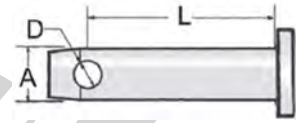

CAT	A Pin Diameter	L Usable Length	D Diameter	PART NUMBER
1	22	113	12	8401589
2	28.4	113	12	8401590

(DUAL CAT) LOWER LINK IMPLEMENT PIN

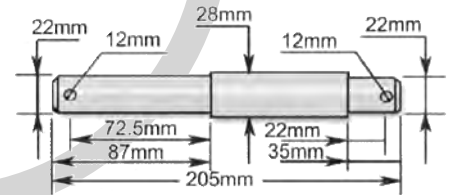
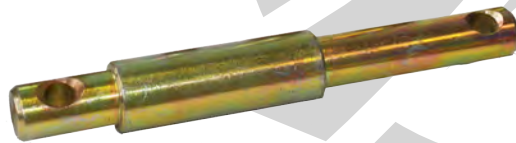

CAT	DIMENSIONS	PART NUMBER
1 - 2	Refer to Diagram	8401591

LOWER LINK BOLT-ON PIN

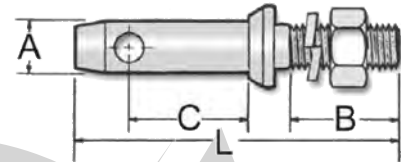

CAT	A	B Thread Length	L	C Usable Length	THREAD SIZE	PART NUMBER
1	22	40	140	50	M22	8401500
1	22	47	137	51	3/4 UNF	8066503
2	28.5	35	137	60	7/8 UNF	8401551
2	28.5	60	164	57	1 1/8 UNF	8066502
3	36.5	38	146	54	1 3/8 UNF	8066504

HINGE PIN

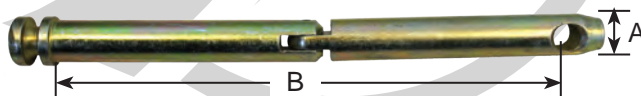

A	B	PART NUMBER
19	227	8076204

www.walterscheid.com.au

Document No:	SABRECAT
Issue:	3
Issue Date:	03/03/2021

This catalogue is the copyright of HS Company Pty Ltd

INDENT ITEM ONLY

LINKAGE - MOUNTING ACCESSORIES

DRAW BAR HITCH PINS

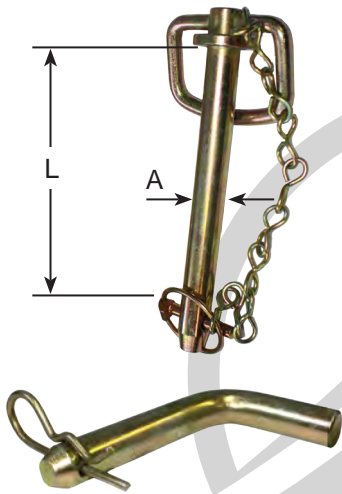

A	L Usable Length	PART NUMBER
19	98	8401559
19	159	8401506
22	159	8401507
25.4	159	8401508
28.6	159	8401594
32	159	8401595
35	183	8401592
38	185	8401593
A	L Usable Length	PART NUMBER
19	89	8401609

CONVERSION BUSHES

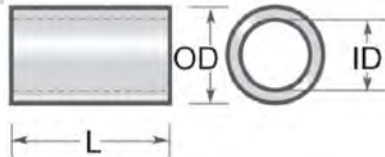
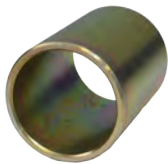

CAT	TYPE	OD	ID	L	PART NUMBER
1 - 2	Top Link	25.4	19	50.8	8401520
1 - 2	Lower Link	28.6	22	45	8401521
2 - 3	Lower Link	36.5	28.6	44.5	8401522
2 - 3	Top Link	31.75	25.4	49	8401579
3 - 4	Top Link	37	32	51	8401580
3 - 4	Lower Link	51	36.75	57	8401581
-	Adapter Sleeve	1 3/8" x 6 Spl	1 1/8" x 6 Spl	57	8401B002

DRAWBARS

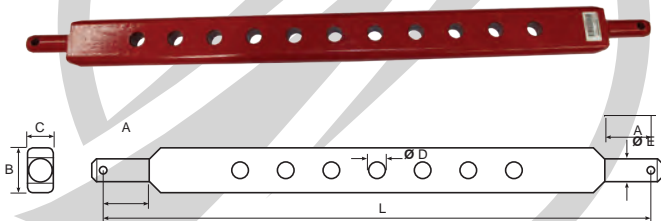

CAT	A	B x C	Ø E	LENGTH L	HOLE Ø D	NUMBER OF HOLES	PART NUMBER
1	50	62 x 29	22	550	20	7	8402001
2	70	62 x 29	28.5	760	22	9	8402003
2	70	62 x 29	28.5	660	22	9	8402002

www.walterscheid.com.au

Document No:	SABRECAT
Issue:	3
Issue Date:	03/03/2021

INDENT ITEM ONLY

B:7-76

This catalogue is the copyright of HS Company Pty Ltd

LINKAGE - MOUNTING ACCESSORIES

SAFETY LOCK HITCH PIN

	A	B	C	PART NUMBER
	12.7	108	152	8076198
	16	108	152	8076199
	19	108	152	8076200
	19	159	203	8076201
	22	159	203	8076202
25.4	159	203	8076203	

LOWER LINK IMPLEMENT PIN

A	B	PART NUMBER
6	63	8076208
8	63	8076207
10	63	8076206

LOWER LINK IMPLEMENT PIN

A	B	PART NUMBER
6	57	8076205
8	57	8401571
10	57	8401572

LINCH PIN

D	L Usable Length	PART NUMBER
4.5	32	8401523
6	36	8401524
8	36	8401526
11	36	8401529
11	40	8401N007 *
11	58	8401N021

* Heavy duty - 5mm wire diameter

R CLIP

D	L Usable Length	PART NUMBER
2	38	8401530
2.5	40	8401AP9
3	61	8401531
5	85.5	8401533
6	82.5	8401534
7	96	8401535

SPRING CLIP

TO SUIT PIN	PART NUMBER
21mm	8401606

TOWBALL

BALL	THREAD	PART NUMBER
2 inch	3/4"	8401608

www.walterscheid.com.au

Document No:	SABRECAT
Issue:	3
Issue Date:	03/03/2021

This catalogue is the copyright of HS Company Pty Ltd

INDENT ITEM ONLY

WELD ON BALLS

WELD ON BALL ENDS - STRAIGHT

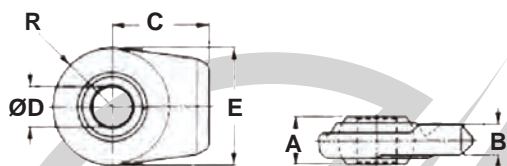

Dimensions

CAT	Dimensions						Part Number
	Ø D mm	A mm	B mm	C mm	E mm	R Radius (mm)	
1	19	44	10	50	50	25	8401S020
1	22	35	16	70	67	33.5	8401S006
2	25.4	38	19	80	83	41.5	8401S007
3	36.5	44	19	85	89	44.5	8401S005

WELD ON EYE BALL ENDS

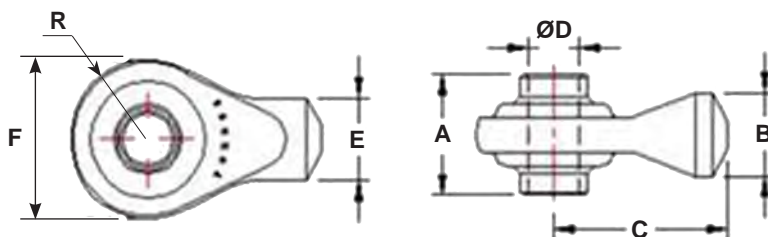

Dimensions

CAT	Dimensions							Part Number
	Ø D mm	A mm	B mm	C mm	E mm	F mm	R Rad (mm)	
1	19	44	30	65	30	57	28.5	8401S003
2	25.4	51	28.5	70	28.5	67	33.5	8401S004

INDENT ITEM ONLY

B:7-78

www.walterscheid.com.au

Document No:	SABRECAT
Issue:	3
Issue Date:	03/03/2021

This catalogue is the copyright of HS Company Pty Ltd

A FRAME QUICK HITCH



A Frame Quick Hitch Triangle System

The quick hitch triangle system provides a more efficient and safer method of hitching implements and tools to your tractor. A male triangle is permanently fixed to the 3 point linkage system on the rear or front of the tractor while all implements are fitted with a female triangle. The triangles are locked together using a latch mechanism which is safely activated by a handle and cord system connected to the cab.



A Frame Tractor Attachment (Male)

Part Number	CAT	Load Capacity	Notes
8401A001	2	1400kg	Auto locking and centralised rollers. All pins included. Suits implement attachment # 8401A002



A Frame Implement Attachment (Female)

Part Number	CAT	Load Capacity	Notes
8401A002	2	1400kg	Suits tractor attachment # 8401A001

Note: Other CAT sizes available on request

INDENT ITEM ONLY

www.walterscheid.com.au

Document No:	SABRECAT
Issue:	3
Issue Date:	03/03/2021

This catalogue is the copyright of HS Company Pty Ltd

FRONT LINKAGE SYSTEMS

Image / Application	Description	Part Number
 Claas Arion 610-660 T4	Front linkage and Front PTO kit Lifting capacity 42 kN, lifting cylinders double acting, lateral support up to transmission clutch housing, lower links foldable upwards - with Walterscheid link hooks cat. 3L, hydraulic hoses beginning at the control unit with shut-off valve, blockable float adapter, front tow bar, spindle top link with holder. 1000 rpm. - transmission ratio = 1.93 : 1, direction clockwise in driving direction, max. power of PTO 147 kW/200 HP, permissible continuous loading 110 kW/150 HP, integrated multiple disk clutch, running in an oil bath, smooth electrohydraulic activation, drive shaft with vibration reducing rubber element.	FL20.232.354101
 Massey Ferguson 7614 - 7626 Dyna 4 / 6 / VT	Front linkage and Front PTO kit Lifting capacity 42 kN, lifting cylinders double acting, lower links foldable upwards - with Walterscheid link hooks cat. 3L, hydraulic hoses beginning at the control unit with shut-off valve, blockable float adapter, front tow bar, spindle top link with holder. 1000 rpm. - transmission ratio = 1.93 : 1, direction clockwise in driving direction, max. power of PTO 147 kW/200 HP, permissible continuous loading 110 kW/150 HP, integrated multiple disk clutch, running in an oil bath, smooth electrohydraulic activation, drive shaft with vibration reducing rubber element.	FL20.321.354101
 New Holland T7.230-T7.270 T46 Case IH/Steyr Puma 185-240 CVT 6165-6240 et (See application listing for more)	Front linkage and Front PTO kit lifting capacity 42 kN (4,2 to.), lifting cylinders double acting, lower links foldable upwards - with Walterscheid link hooks cat. 3L, hydraulic hoses beginning at the control unit with shut-off valve, blockable float adapter, front tow bar, spindle top link with holder. 1000 rpm. - transmission ratio = 1,93 : 1, direction clockwise in driving direction, max. power of PTO 147 kW/200 HP, permissible continuous loading 110 kW/150 HP, integrated multiple disk clutch, running in an oil bath, smooth electrohydraulic activation, drive shaft with vibration reducing rubber element.	FL20.129.354102
 New Holland T7.220-T7.270 / T7000	Front linkage and Front PTO kit Lifting capacity 42 kN, lifting cylinders double acting, lower links foldable upwards - with Walterscheid link hooks cat. 3L, hydraulic hoses beginning at the control unit with shut-off valve, blockable float adapter, front tow bar, spindle top link with holder. 1000 rpm. - transmission ratio = 1.93 : 1, direction clockwise in driving direction, max. power of PTO 147 kW/200 HP, permissible continuous loading 110 kW/150 HP, integrated multiple disk clutch, running in an oil bath, smooth electrohydraulic activation, drive shaft with vibration reducing rubber element	FL20.131.354101

Multi fit Front Linkage also available. Part #: **FL10.000.254001**
 Call Walterscheid Australia for further details.

INDENT ITEM ONLY

B:7-80

www.walterscheid.com.au

Document No:	SABRECAT
Issue:	3
Issue Date:	03/03/2021

This catalogue is the copyright of HS Company Pty Ltd

FRONT LINKAGE SYSTEMS - CASE-IH / STEYR



Make	Tractor Type / Series	Part Number
Case-IH / Steyr	Farmall 55A	FL20.139.184101#
Case-IH / Steyr	Farmall 65A - 75A - 85A - 95A - 105A - 115A Tier 3 with casted front axle support	FL20.137.254101#
Case-IH / Steyr	Farmall 65A - 75A - 85A - 95A - 105A - 115A Tier 4 with welded front axle support frame	FL20.137.234101#
Case-IH / Steyr	Farmall 55C - 65C - 75C Tier 3 with welded front axle support frame Kompakt 4055 S et - 4065 S et - 4075 S et Tier3	FL20.135.234101#
Case-IH / Steyr	Farmall 55C - 65C - 75C Tier 4 w. welded front axle support frame and lateral fixing blocks Kompakt 4055 S et - 4065 S et - 4075 S et Tier 4	FL20.135.234102#
Case-IH / Steyr	Farmall 85C - 95C - 105C - 115C Tier 4 - w. welded front axle support frame and lateral fixing blocks Kompakt 4085 et - 4095 et - 4105 et - 4115 et Tier 4	FL20.138.234101#
Case-IH / Steyr	Farmall 85C - 95C - 105C - 115C Tier 3 & 4 with separable front axle support Kompakt 4085 et - 4095 et - 4105 et - 4115 et Tier 3 & 4	FL20.138.254101#
Case-IH / Steyr	Farmall 95U - 105U - 115U Tier 3 & 4 with separable front axle support	FL20.136.254101#
Case-IH / Steyr	Farmall 95U - 105U - 115U with non-separable front axle support	FL20.136.254103#
Case-IH / Steyr	Farmall 95U Pro - 105U Pro - 115U Pro Tier 3 & 4 with separable front axle support Multi 4095 - 4105 - 4115 Tier 3 & 4	FL20.136.254102#
Case-IH / Steyr	Maxxum (CVX) 110 - 120 - 130 / MXU 100 - 110 4-Zyl. Profi (CVT) 4110 - 4120 - 4130 / Profi 4100 - 4115	FL20.105.254102#
Case-IH / Steyr	Maxxum 115 - 125 - 140 / MXU 115 - 125 - 135 6-Zyl. Profi 6115 - 6125 - 6140 / Profi 6115 - 6125 - 6135	FL20.106.354103#
Case-IH / Steyr	Puma (CVX) 125 - 130 - 140 - 145 - 155 - 160 / Puma neu (CVX) 150 - 165 - 175 CVT 6130 et - 6145 et - 6160 et / CVT 6150 et - 6165 et - 6175 et	FL20.130.354102#
Case-IH / Steyr	Puma (CVX) 165 - 170 - 180 - 185 - 195 - 200 - 210 - 215 - 220 - 225 - 230 - 240 CVT 6165 - 6170 - 6180 - 6185 - 6200 - 6205 - 6210 - 6215 - 6220 - 6225 - 6230 - 6240 et	FL20.129.354102
Case-IH / Steyr	Quantum 65C - 75C - 85C - 95C Tier3 Kompakt 4065 - 4075 - 4085 - 4095 Tier3	FL20.103.234102#
Case-IH / Steyr	JX 1060C - JX 1065C - JX 1075C Tier2 Kompakt 360 - 370 - 375 / Kompakt 485 - 495 Tier2	FL20.103.234101#
Case-IH / Steyr	JXU 75 - 85 - 95 - 105 - 115 Tier3	FL20.132.254101#

www.walterscheid.com.au

Document No:	SABRECAT
Issue:	3
Issue Date:	03/03/2021

This catalogue is the copyright of HS Company Pty Ltd

INDENT ITEM ONLY

FRONT LINKAGE SYSTEMS - CASE-IH / STEYR



Make	Tractor Type / Series	Part Number
Case-IH / Steyr	JX 1070U - 1080U - 1090U - 1100U Tier2	FL20.102.254102#
Case-IH / Steyr	JX 70U - 80U - 90U - 100U Tier1	FL20.101.254102#
Case-IH / Steyr	JX 60 - 70 - 80 - 90 - 95 Tier3	FL20.133.254101#
Case-IH / Steyr	JX 65 - 70 - 75 - 80 - 85 - 90 - 95 Tier1 & Tier2	FL20.104.254101#
Case-IH / Steyr	CVX 140 - 150 - 160 - 175 - 195 Tier3 / CVX 1135 - 1145 - 1155 - 1170 - 1190 - 1195 Tier2 CVT 6140 - 6150 - 6160 - 6175 - 1695 Tier3 / CVT 6135 - 6145 - 6155 - 6170 - 6190 - 6195 Tier2	FL20.108.354102#
Case-IH / Steyr	CVX 120 - 130 - 150 - 170 Tier1 CVT 120 - 130 - 150 - 170 Tier1	FL20.107.354102#
Case-IH / Steyr	MXM 120 - 130 - 140 - 155 - 175 - 190	FL20.109.304101#
Case-IH / Steyr	CS 80 Pro - 90 Pro - 100 Pro CS 85 Pro - 95 Pro - 105 Pro 9080 MT - 9090 MT - 9100 MT 9085 MT - 9095 MT - 9105 MT	FL20.128.254101#
Case-IH / Steyr	CS 48 - 58 - 63 with Perkins-engine 948 - 958 - 963 with Perkins-engine	FL20.111.234102#
Case-IH / Steyr	CS 68 - 75 with Sisu-engine 968 - 975 with Sisu-engine	FL20.111.254102#
Case-IH / Steyr	CS 68 - 75 with MWM-engine 968 - 975 with MWM-engine	FL20.111.254103#
Case-IH / Steyr	CS 78 - 86 - 94 with Sisu-engine 9080M - 9090M - 9100M / 9078 - 9086 - 9094 with Sisu-engine	FL20.110.254102#
Case-IH / Steyr	CS 78 - 86 - 94 with MWM-engine 9078 - 9083 - 9086 - 9094 with MWM-engine	FL20.110.254103#
Case-IH / Steyr	C 64 - C 70 with MWM-engine 964 - 970 with MWM-engine	FL20.127.234102#
Case-IH / Steyr	CS 110 9105	FL20.112.254102#
Case-IH / Steyr	CS 110 CS 120 - 130 - 150 9105 9115 - 9125 - 9145	FL20.113.354102#
Case-IH / Steyr	CX 60 - 70 - 80 - 90 - 100	FL20.114.254102#
Case-IH / Steyr	MX 80C - 90C - 100C	FL20.115.254102#
Case-IH / Steyr	4210 - 4220 - 4230 - 4240 / 3210 - 3220 - 3230 - 3240	FL20.116.254102#
Case-IH / Steyr	MX 100 - 110 - 120 - 135 - 150 - 170	FL20.117.354102#
Case-IH / Steyr	Magnum 7110 - 7120 - 7130 - 7140 - 7150 / 7210 - 7220 - 7230 - 7240 - 7250	TBA
Case-IH / Steyr	743 - 745 - 844 - 856 XL / XL plus B-Family	FL20.119.254101#
Case-IH / Steyr	956 - 1056 XL C-Family	FL20.120.254101#
Case-IH / Steyr	1255 - 1455 XL D-Family	FL20.121.354102#

INDENT ITEM ONLY

B:7-82

www.walterscheid.com.au

Document No:	SABRECAT
Issue:	3
Issue Date:	03/03/2021

This catalogue is the copyright of HS Company Pty Ltd

FRONT LINKAGE SYSTEMS - CLAAS



Make	Tractor Type / Series	Part Number
Claas	Elios 210 - 220 - 230 - 240 (A48) Tier4	FL20.237.234101#
Claas	Elios 210 - 220 - 230 Tier3	FL20.229.234101#
Claas	Atos 220 - 230 - 240 / 330 - 340 - 350 (A78 / A79)	FL20.236.254101#
Claas	Arion 410 - 420 - 430 - 440 - 450 - 460 Tier4 (A32 / A43)	FL20.234.254101#
Claas	Arion 410 - 420 - 430 Tier3	FL20.230.254101#
Claas	Arion 530 - 540 - 550 Tier4 (A34)	FL20.233.254101#
Claas	Arion 510 - 520 - 530 - 540 Tier3	FL20.226.254101#
Claas	Arion 620 - 630 - 640 - 650 Tier4 (A36)	FL20.232.354101
Claas	Arion 610 - 620 - 630 - 640 Tier3 Arion 610C - 620C - 630C	FL20.227.354101#
Claas	Nexos 210 - 220 - 230 - 240 F / VL / VE - Tier3	FL20.231.184101#
Claas	Axos 310 - 320 - 330 - 340	FL20.228.254102#
Claas	Axion 810 - 820 - 830 - 840 - 850 Tier3	FL20.225.354101#
Claas	Celtis 426 - 436 - 446	FL20.201.254102#
Claas	Celtis 456	FL20.201.254104#
Claas	Ares 557 - 567 - 577 / Ares 546 - 556 - 566	FL20.202.254102#
Claas	Ares 617 - 657 - 697 / Ares 616 - 656 - 696	FL20.203.354102#
Claas	Ares 816 - 826 - 836	FL20.204.354102#
Claas	Nectis 217 - 227 - 237 - 247 - 257 - 267 F / VL / VE	TBA



www.walterscheid.com.au

Document No:	SABRECAT
Issue:	3
Issue Date:	03/03/2021

This catalogue is the copyright of HS Company Pty Ltd

INDENT ITEM ONLY

FRONT LINKAGE SYSTEMS - JOHN DEERE



Make	Tractor Type / Series	Part Number
John Deere	Series 5055E - 5075E / 5080G - 5090G/GH	<i>Avail on Request</i>
John Deere	Series 5080G - 5090G/GH (MY14)	<i>Avail on Request</i>
John Deere	Series 5075 - 5085 - 5100 GF / GN / GV (MY14)	<i>Avail on Request</i>
John Deere	Series 5075GL - 5085GL (MY14)	<i>Avail on Request</i>
John Deere	Series 5075M - 5085M - 5100M - 5115M (MY14)	<i>Avail on Request</i>
John Deere	Series 6090 - 6110 RC / MC / 6105 - 6125 R / M	<i>Avail on Request</i>
John Deere	Series 6130R/M - 6170R/M / 6190R - 6210R	<i>Avail on Request</i>
John Deere	Series 6175R - 6215R	<i>Avail on Request</i>
John Deere	Series 6105R/M - 6215R - Frontzapfwelle für JD Frontkraftheber	<i>Avail on Request</i>
John Deere	Series 7210R - 7310R (MY14) / 7200R - 7280R	<i>Avail on Request</i>
John Deere	Series 8245 - 8370 R / RT (MY14) / 8235 - 8360 R / RT 8225 - 8345 / 8030 / 8020	<i>Avail on Request</i>
John Deere	Series 5080 - 5090 - 5100 GF / GV	<i>Avail on Request</i>
John Deere	Series 5085M - 5095M - 5105M (USA)	<i>Avail on Request</i>
John Deere	Series 5070 - 5100 R / RN / M (Mannheim)	<i>Avail on Request</i>
John Deere	Series 5215 – 5515	<i>Avail on Request</i>
John Deere	Series 5215 - 5615 F / V	<i>Avail on Request</i>
John Deere	Series 5310 - 5510 N / SuperNarrow	<i>Avail on Request</i>
John Deere	Series 5620 - 5720 – 5820	<i>Avail on Request</i>
John Deere	Series 6010 - 6410 / 6100 – 6400	<i>Avail on Request</i>
John Deere	Series 6230 - 6430 / 6020 – 6420	<i>Avail on Request</i>
John Deere	Series 6510 - 6910 (S) / 6506 – 6900	<i>Avail on Request</i>
John Deere	Series 6530 - 6630 / 6520 – 6620	<i>Avail on Request</i>
John Deere	Series 6830 - 6930 / 6820 - 6920 (S)	<i>Avail on Request</i>
John Deere	Series 7430 – 7530	<i>Avail on Request</i>
John Deere	Series 7610 - 7810 / 7600 – 7800	<i>Avail on Request</i>
John Deere	Series 7730 - 7930 / 7720 – 7920	<i>Avail on Request</i>
John Deere	Zubehör	<i>Avail on Request</i>

INDENT ITEM ONLY

B:7-84

www.walterscheid.com.au

Document No:	SABRECAT
Issue:	3
Issue Date:	03/03/2021

This catalogue is the copyright of HS Company Pty Ltd

FRONT LINKAGE SYSTEMS - KUBOTA



Make	Tractor Type / Series	Part Number
Kubota	M 6060 - M 7060	FL20.654.234101#
Kubota	M 8560- M 9960	FL20.655.254101#
Kubota	M 100GX-11- M 110GX-11	FL20.653.254101#
Kubota	M 128GX- M 135GX	FL20.656.254101#
Kubota	M 6040 Narrow- M 7040 Narrow	FL20.652.184101#
Kubota	M 8540 Narrow	FL20.657.184101#
Kubota	M 6040 - M 7040	FL20.651.234101#
Kubota	M 8540- M 9540	FL20.653.254101#
Kubota	M 4062- M 4072	FL20.662.234101#
Kubota	ST341 - ST371 - ST401 - STW34 - STW37 - STW40 CAT.0	FL20.661.080101#
Kubota	ST341 - ST371 - ST401 - STW34 - STW37 - STW40 CAT.1	FL20.661.081101#
Kubota	M 6121 / M 7132 - M7152 - M 7172 M 7131 - M 7151 - M 7171	FL20.659.355101#

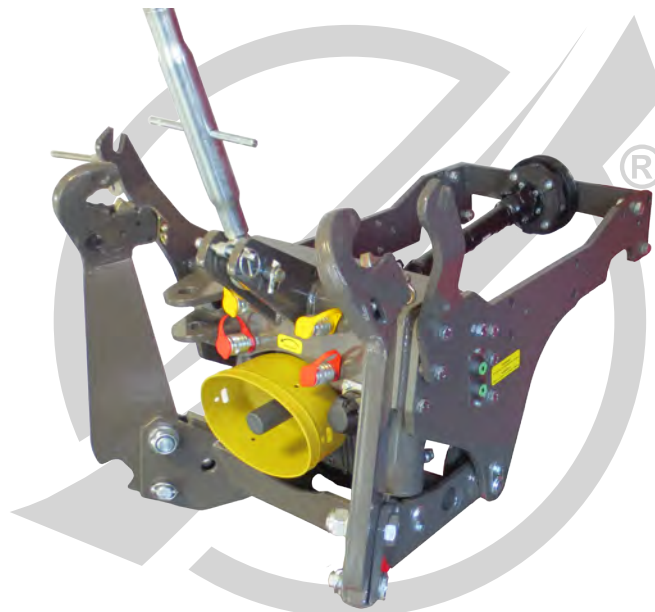

www.walterscheid.com.au

Document No:	SABRECAT
Issue:	3
Issue Date:	03/03/2021

This catalogue is the copyright of HS Company Pty Ltd

INDENT ITEM ONLY

FRONT LINKAGE SYSTEMS - MASSEY FERGUSON



Make	Tractor Type / Series	Part Number
Massey Ferguson	3615 - 3625 - 3630 - 3635 - 3640 - 3645 - 3650 - 3655	FL20.317.234101#
Massey Ferguson	3625 - 3635 - 3640 - 3645 - 3650 - 3655 - 3660 F / V / S / GE	FL20.319.184101#
Massey Ferguson	4707 - 4708 - 4709	FL20.326.254101#
Massey Ferguson	5608 - 5609 - 5610	FL20.322.254102#
Massey Ferguson	5611 - 5612 - 5613 Dyna 4 / 6 5710 SL - 5711 SL - 5712 SL - 5713 SL	FL20.325.254102#
Massey Ferguson	6612 - 6613 - 6614 - 6615 - 6616 Dyna 4 / 6 / VT	FL20.323.354101#
Massey Ferguson	7614 - 7615 - 7616 - 7618 - 7619 - 7620 - 7622 - 7624 - 7626 Dyna 4 / 6 / VT	FL20.321.354101
Massey Ferguson	7714 - 7715 - 7716 - 7718 - 7719 - 7720 - 7722 - 7724 - 7726 Dyna 4 / 6 / VT	FL20.327.354101#
Massey Ferguson	5410 - 5420 - 5430 - 5440 - 5450	FL20.320.254101#
Massey Ferguson	5425 - 5435 - 5445 - 5455 Tier2 and 3 (with standard-bonnet)	FL20.301.254102#
Massey Ferguson	5425 - 5435 - 5445 - 5455 Tier2 and 3 (with steep-nose-bonnet)	FL20.301.254101#
Massey Ferguson	5470 - 5480 Tier3	FL20.302.354101#
Massey Ferguson	5465 - 5475 Tier3	FL20.308.354101#
Massey Ferguson	6445 - 6455 Tier2 & 3 6460 - 6470 Tier2 (with standard-bonnet)	FL20.305.354102#
Massey Ferguson	6445 - 6455 Tier2 & 3 6460 - 6470 Tier2 (with steep-nose-bonnet)	FL20.305.354101#
Massey Ferguson	6445 - 6455 Tier2 & 3 (with standard-bonnet)	FL20.304.254102#
Massey Ferguson	6445 - 6455 Tier2 & 3 (with steep-nose-bonnet)	FL20.304.254101#
Massey Ferguson	6460 - 6470 Tier3	FL20.318.354101#

INDENT ITEM ONLY

B:7-86

www.walterscheid.com.au

Document No:	SABRECAT
Issue:	3
Issue Date:	03/03/2021

This catalogue is the copyright of HS Company Pty Ltd

FRONT LINKAGE SYSTEMS - MASSEY FERGUSON



Make	Tractor Type / Series	Part Number
Massey Ferguson	6465 - 6475 - 6480 7465 - 7475 - 7480 Tier3	FL20.308.354101#
Massey Ferguson	6465 - 6475 - 6480 - 6485 - 6490 - 6495 - 6497 - 6499 Tier3 with Sisu-Engine 7465 - 7475 - 7480 - 7485 - 7490 - 7495 - 7497 - 7499 Tier3 with Sisu-Engine	FL20.309.354101#
Massey Ferguson	2430 - 2435 - 2440 ST / GE	FL20.310.234101#
Massey Ferguson	4435 - 4440 - 4445 Tier2 & Tier3	FL20.311.254101#
Massey Ferguson	5465 Tier2	FL20.303.354101#
Massey Ferguson	6465 - 6475 - 6480 Tier2 with Perkins-Engine 7465 - 7475 - 7480 Tier2 with Perkins-Engine	FL20.306.354101#
Massey Ferguson	6485 - 6490 - 6495 Tier2 with Sisu-Engine 7485 - 7490 - 7495 Tier2 with Sisu-Engine	FL20.307.354101#
Massey Ferguson	6497 - 6499 Tier2	FL20.312.354101#
Massey Ferguson	8450 - 8460 - 8470 - 8480	FL10.313.354001#
Massey Ferguson	4315 - 4320 - 4325 - 4335 - 4345 - 4355 4215 - 4220 - 4225 - 4235 - 4245 - 4255 (with standard-bonnet)	FL20.314.254102#
Massey Ferguson	4315 - 4320 - 4325 - 4335 - 4345 - 4355 4215 - 4220 - 4225 - 4235 - 4245 - 4255 (with steep-nose-bonnet)	FL20.314.254101#
Massey Ferguson	4360 - 4370 (6-cyl.) 4260 - 4270 (6-cyl.)	FL20.314.254103#
Massey Ferguson	6235 - 6245 - 6255 - 6265 (with standard-bonnet)	FL20.315.254102#
Massey Ferguson	6235 - 6245 - 6255 - 6265 (with steep-nose-bonnet)	FL20.315.254101#
Massey Ferguson	6260 - 6270 - 6280 - 6290	FL20.316.354102#

www.walterscheid.com.au

Document No:	SABRECAT
Issue:	3
Issue Date:	03/03/2021

This catalogue is the copyright
of HS Company Pty Ltd

INDENT ITEM ONLY

FRONT LINKAGE SYSTEMS - NEW HOLLAND



Make	Tractor Type / Series	Part Number
New Holland	TD 5.65 - 5.75 - 5.85 - 5.95 - 5.105 - 5.115 Tier3	FL20.137.254101#
New Holland	TD 5.65 - 5.75 - 5.85 - 5.95 - 5.105 - 5.115 Tier4	FL20.137.234101#
New Holland	T 4.55 - 4.65 - 4.75 PowerStar Tier3	FL20.135.234101#
New Holland	T 4.55 - 4.65 - 4.75 PowerStar Tier4	FL20.135.234102#
New Holland	T 4.75 - 4.85 - 4.95 - 4.105 - 4.115 Tier4	FL20.138.234101#
New Holland	T 4.75 - 4.85 - 4.95 - 4.105 - 4.115 Tier3 & 4	FL20.138.254101#
New Holland	T 5.95 - 5.105 - 5.115 Tier3 & 4 with separable front axle support	FL20.136.254101#
New Holland	T 5.95 - 5.105 - 5.115 Tier3 & 4 with non-separable front axle support	FL20.136.254103#
New Holland	T 5.95 - 5.105 - 5.115 ElectroCommand Tier3 & 4	FL20.136.254102#
New Holland	T 6.120 - 6.140 - 6.150 - 6.160 4-Zyl. T 6010 - 6020 - 6040 - 6060 4-Zyl.	FL20.105.254102#
New Holland	T 6.155 - 6.165 - 6.175 6-Zyl. T 6030 - 6050 - 6070 - 6080 6-Zyl.	FL20.106.354103#
New Holland	T 7.170 - 7.185 - 7.200 - 7.210 - T 7.175 - 7.190 - 7.210 - 7.225 T 6090 (with high motor bonnet)	FL20.130.354102#
New Holland	T 7.220 - 7.235 - 7.250 - 7.260 - 7.270 - T 7.230 - 7.245 - 7.260 - 7.270 T 7030 - 7040 - 7050 - 7060 - 7070	FL20.131.354101
New Holland	T 4020 - 4030 - 4040 - 4050	FL20.103.234102#
New Holland	TN 60D-A - 70D-A - 75D-A - 85D-A - 95D-A	FL20.103.234101#
New Holland	TN 55D - 65D - 75D	FL20.126.234101#
New Holland	T 5030 - 5040 - 5050 - 5060	FL20.132.254101#
New Holland	TL 70A - 80A - 90A - 100A	FL20.102.254102#
New Holland	TL 70 - 80 - 90 - 100	FL20.125.254101#
New Holland	TD 5010 - 5020 - 5030 - 5040 - 5050	FL20.133.254101#
New Holland	TD 65D - 70D - 75D - 80D - 85D - 90D - 95D Tier1 & Tier2	FL20.104.254101#
New Holland	T 7510 - 7520 - 7530 - 7540 - 7550 - TVT 135 - 145 - 155 - 170 - 190 - 195	FL20.108.354102#
New Holland	TM 120 - 130 - 140 - 155 - 175 - 190	FL20.109.304101#
New Holland	T 3010 - 3020 - 3030 - 3040 Tier3	FL20.429.104101#

INDENT ITEM ONLY

B:7-88

www.walterscheid.com.au

Document No:	SABRECAT
Issue:	3
Issue Date:	03/03/2021

This catalogue is the copyright
of HS Company Pty Ltd

FRONT LINKAGE SYSTEMS - RENAULT



Make	Tractor Type / Series	Part Number
Renault	Celtis 426 - 436 - 446	FL20.201.254102#
Renault	Celtis 456	FL20.201.254104#
Renault	Ares 546 - 556 - 566 Ares 540 - 550	FL20.202.254102#
Renault	Ares 616 - 626 - 636 - 656 - 696 Ares 610 - 620 - 630 - 640	FL20.203.354102#
Renault	Ares 816 - 826 - 836 Ares 710 - 720 - 715 - 725 - 735 - 815 - 825	FL20.204.354102#
Renault	Pales 210 - 230 - 240 55-14 LB - 70-14 LB - 80-14 LB	FL20.207.234102#
Renault	Dionis 110 - 120 - 130 - 140 Fructus 110 - 120 - 130 - 140 55-14 F/V - 70-14 F/V - 80-14 F/V	FL20.209.154102#
Renault	Ceres 325 - 335 - 345 - 355 Powertech Cergos 335 - 345 - 355 Powertech	FL20.210.254101#
Renault	Temis 550	FL20.211.254102#
Renault	Temis 610 - 630 - 650	FL00.212.354102#
Renault	110-54 - 120-54 - 133-54 - 155-54 - 160-94 - 175-74 - 180-94 113-14 - 120-14 - 133-14 - 145-14 TX / TZ - 6-Zyl.	FL00.213.304102#
Renault	Ceres 320 - 330 - 340 mit DPS-Motor Ceres 65 - 75 - 85 - 95 mit DPS-Motor	FL20.215.254101#
Renault	Cergos 330 - 340 - 350 mit DPS-Motor	FL20.216.254101#
Renault	Ceres 65 - 75 - 85 - 95 mit MWM-Motor	FL20.217.254101#
Renault	106-14 SP	FL00.214.304101#
Renault	103-54 TX 106-54 TL	FL20.218.254101#
Renault	58-34 - 65-34 - 75-34 - 85-34 - 90-34 MX / TX	FL20.219.254101#
Renault	70-34 - 80-34 PX	FL20.220.254101#
Renault	95-14 - 103-14 TX	FL20.222.254101#
Renault	61-14 - 68-14 - 75-14 - 77-14 - 80-14 RS / TS / TX	FL20.221.254101#
Renault	55-14 - 65-14 - 75-14 - 85-14 LS 551-4 - 651-4 - 751-4 - 851-4 S	FL20.223.254101#

www.walterscheid.com.au

Document No:	SABRECAT
Issue:	3
Issue Date:	03/03/2021

This catalogue is the copyright of HS Company Pty Ltd

INDENT ITEM ONLY

FRONT LINKAGE SYSTEMS - VALTRA



Make	Tractor Type / Series	Part Number
Valtra	A53 C - A63 C - A73 C	FL20.809.234101#
Valtra	A72 - A82 - A92 A83 - A93 A75 - A85 - A95	FL20.311.254101#
Valtra	N93 - N103	FL20.807.254101#
Valtra	N104 - N114e - N124 - N134 - N154e - N174 N103.4 - N113 - N123 - N143 - N163	FL20.806.354101#
Valtra	T133 - T153 - T163e - T173 - T183 - T193 - T203 - T213 HiTech/Versu/Direct	FL20.808.354101#
Valtra	N82 - N92	FL20.803.254101#
Valtra	30kN N101 - N111e - N121 - N122 - N141 - N142 HiTech/Versu/Direct	FL20.805.254101#
Valtra	42kN N101 - N111e - N121 - N122 - N141 - N142 HiTech/Versu/Direct	FL20.805.354101#
Valtra	T121 - T131 - T132 - T151e - T152 - T161 - T162 - T171 - T172 - T182 - T191 - T202 HiTech/Versu/Direct	FL20.804.354101#
Valtra	3200 - 3300 - 3400 - 3500 C	FL20.802.234101#
Valtra	3200 - 3300 - 3400 - 3500 F / V	FL20.801.154101#



INDENT ITEM ONLY

B:7-90

www.walterscheid.com.au

Document No:	SABRECAT
Issue:	3
Issue Date:	03/03/2021

This catalogue is the copyright of HS Company Pty Ltd

FRONT LINKAGE SYSTEMS - ZETOR



Make	Tractor Type / Series	Part Number
Zetor	Forterra 100 - 110 - 120 - 130 - 140 - 150 HD/HSX Forterra 8641 - 9641 - 10641 - 11441 - 11741-4C - 12441	FL20.502.254101#
Zetor	Forterra 11741 with 6-Cyl. Same-Engine	FL20.503.254101#
Zetor	Proxima 90 - 100 - 110 - 120 Power/Plus Tier3 Proxima 70 - 80 - 90 - 100 Tier3	FL20.510.234101#
Zetor	Major 60 - 80 Tier3A	FL20.511.234101#
Zetor	Proxima Plus 7541 - 8541 - 9541 - 10541 Tier2	FL20.509.234101#
Zetor	Proxima 5441 - 6441 - 7441 - 8441 Tier2	FL20.501.234101#
Zetor	3341 - 4341 - 6341 - 7341 3340 - 4340 - 5340 - 6340 - 7340 with round bonnet Major Z450 - Z790 - with round bonnet	FL20.505.234102#
Zetor	3341 - 4341 - 6341 - 7341 3340 - 4340 - 5340 - 6340 - 7340 with angular bonnet Major Z450 - Z790 - with angular bonnet	FL20.504.234102#
Zetor	7540 - 8540 - 9540 - 10540 Forterra 8641 - 9641 - 10641 with angular bonnet	FL20.506.254101#
Zetor	Forterra 11641 with angular bonnet	FL20.508.254101#

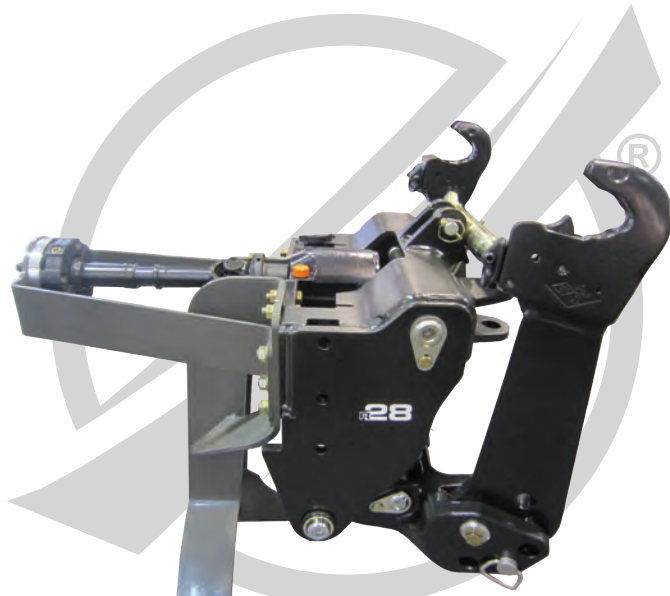

www.walterscheid.com.au

Document No:	SABRECAT
Issue:	3
Issue Date:	03/03/2021

This catalogue is the copyright of HS Company Pty Ltd

INDENT ITEM ONLY

BALER EMERGENCY RELEASE SYSTEM

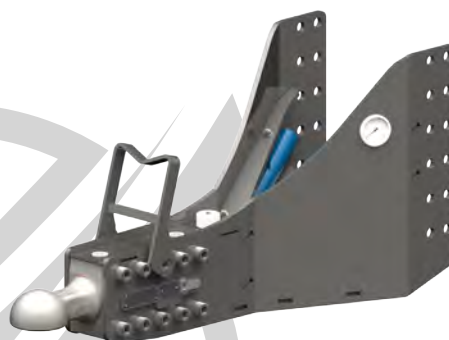

Make	Baler Type / Series	Part Number
Case IH New Holland	LBX 324, 334, 424XL, 434XL BB1270, BB1290, BB870, BB890	40.744.07.0-SET
Claas	Quadrant 5200	40.744.04.0-SET
Claas	Quadrant 5300	40.744.03.0-SET
Fendt Massey Ferguson	12130, 1270, 1290, 1290 XD, 1290 UD, 990 2200, 2370 Ultra HD	40.744.10.0-SET
Krone	Big Pack 12130, 1270, 1290, 1290 HDP, 1290 HDPII, 870, 890	40.744.06.0-SET
Kuhn	LSB 1270, 1290, 870, 890	40.744.08.0-SET

80mm ball coupling as standard (optional ring eye available if required)



INDENT ITEM ONLY

B:7-92

www.walterscheid.com.au

Document No:	SABRECAT
Issue:	3
Issue Date:	03/03/2021

This catalogue is the copyright of HS Company Pty Ltd

DOUBLE ACTING CYLINDERS (Fork Clevis Both Ends)



40mm Bore Cylinder with 22mm Rod Diameter

Part No.	Stroke	Closed Length	Open Length	Port Size	Pin Diameter	Weight
HC1-4-29-5	51mm - 2"	292mm - 11 1/2"	343mm - 13 1/2"	9/16" UN O-Ring	19.05mm - 3/4"	6.4kg
HC1-4-34-10	102mm - 4"	343mm - 13 1/2"	444mm - 17 1/2"	9/16" UN O-Ring	19.05mm - 3/4"	6.7kg
HC1-4-39-15	152mm - 6"	393mm - 15 1/2"	546mm - 21 1/2"	9/16" UN O-Ring	19.05mm - 3/4"	7.0kg
HC1-4-44-20	203mm - 8"	444mm - 17 1/2"	647mm - 25 1/2"	9/16" UN O-Ring	19.05mm - 3/4"	7.3kg
HC1-4-49-25	254mm - 10"	495mm - 19 1/2"	749mm - 29 1/2"	9/16" UN O-Ring	19.05mm - 3/4"	7.5kg
HC1-4-54-30	305mm - 12"	546mm - 21 1/2"	851mm - 33 1/2"	9/16" UN O-Ring	19.05mm - 3/4"	7.8kg
HC1-4-59-35	356mm - 14"	597mm - 23 1/2"	953mm - 37 1/2"	9/16" UN O-Ring	19.05mm - 3/4"	8.0kg
HC1-4-64-40	406mm - 16"	647mm - 25 1/2"	1053mm - 41 1/2"	9/16" UN O-Ring	19.05mm - 3/4"	8.3kg
HC1-4-69-45	457mm - 18"	698mm - 27 1/2"	1155mm - 45 1/2"	9/16" UN O-Ring	19.05mm - 3/4"	8.6kg
HC1-4-74-50	508mm - 20"	749mm - 29 1/2"	1257mm - 49 1/2"	9/16" UN O-Ring	19.05mm - 3/4"	8.9kg
HC1-4-80-55	559mm - 22"	800mm - 31 1/2"	1359mm - 53 1/2"	9/16" UN O-Ring	19.05mm - 3/4"	9.2kg
HC1-4-85-61	610mm - 24"	851mm - 33 1/2"	1460mm - 57 1/2"	9/16" UN O-Ring	19.05mm - 3/4"	9.4kg
HC1-4-100-76	762mm - 30"	1003mm - 39 1/2"	1765mm - 69 1/2"	9/16" UN O-Ring	19.05mm - 3/4"	10.2kg
HC1-4-115-91	914mm - 36"	1155mm - 45 1/2"	2069mm - 81 1/2"	9/16" UN O-Ring	19.05mm - 3/4"	11.0kg
HC1-4-146-121	1219mm - 48"	1460mm - 57 1/2"	2679mm - 105 1/2"	9/16" UN O-Ring	19.05mm - 3/4"	13.5kg

50mm Bore Cylinder with 32mm Rod Diameter

HC1-5-36-5	51mm - 2"	362mm - 14 1/4"	413mm - 16 1/4"	9/16" UN O-Ring	25.4mm - 1"	6.6kg
HC1-5-41-10	102mm - 4"	413mm - 16 1/4"	514mm - 20 1/4"	9/16" UN O-Ring	25.4mm - 1"	7.4kg
HC1-5-46-15	152mm - 6"	463mm - 18 1/4"	616mm - 24 1/4"	9/16" UN O-Ring	25.4mm - 1"	8.2kg
HC1-5-51-20	203mm - 8"	514mm - 20 1/4"	717mm - 28 1/4"	9/16" UN O-Ring	25.4mm - 1"	9.0kg
HC1-5-56-25	254mm - 10"	565mm - 22 1/4"	819mm - 32 1/4"	9/16" UN O-Ring	25.4mm - 1"	9.8kg
HC1-5-61-30	305mm - 12"	616mm - 24 1/4"	921mm - 36 1/4"	9/16" UN O-Ring	25.4mm - 1"	10.6kg
HC1-5-66-35	356mm - 14"	667mm - 26 1/4"	1022mm - 40 1/4"	9/16" UN O-Ring	25.4mm - 1"	11.2kg
HC1-5-71-40	406mm - 16"	717mm - 28 1/4"	1123mm - 44 1/4"	9/16" UN O-Ring	25.4mm - 1"	12.2kg
HC1-5-76-45	457mm - 18"	768mm - 30 1/4"	1225mm - 48 1/4"	9/16" UN O-Ring	25.4mm - 1"	13.0kg
HC1-5-81-50	508mm - 20"	819mm - 32 1/4"	1327mm - 52 1/4"	9/16" UN O-Ring	25.4mm - 1"	13.8kg
HC1-5-87-55	559mm - 22"	870mm - 34 1/4"	1429mm - 56 1/4"	9/16" UN O-Ring	25.4mm - 1"	14.6kg
HC1-5-92-61	610mm - 24"	921mm - 36 1/4"	1530mm - 60 1/4"	9/16" UN O-Ring	25.4mm - 1"	15.4kg
HC1-5-97-66	660mm - 26"	971mm - 38 1/4"	1631mm - 64 1/4"	9/16" UN O-Ring	25.4mm - 1"	16.2kg
HC1-5-102-71	711mm - 28"	1022mm - 40 1/4"	1733mm - 68 1/4"	9/16" UN O-Ring	25.4mm - 1"	17.0kg
HC1-5-107-76	762mm - 30"	1073mm - 42 1/4"	1835mm - 72 1/4"	9/16" UN O-Ring	25.4mm - 1"	17.8kg
HC1-5-122-91	914mm - 36"	1225mm - 48 1/4"	2139mm - 84 1/4"	9/16" UN O-Ring	25.4mm - 1"	20.2kg
HC1-5-137-106	1067mm - 42"	1378mm - 54 1/4"	2445mm - 96 1/4"	9/16" UN O-Ring	25.4mm - 1"	22.6kg
HC1-5-153-121	1219mm - 48"	1530mm - 60 1/4"	2749mm - 108 1/4"	9/16" UN O-Ring	25.4mm - 1"	25.0kg

Optional POA: • Hydraulic Hose Kit • Valve Block

INDENT ITEM ONLY

www.walterscheid.com.au

Document No:	SABRECAT
Issue:	3
Issue Date:	03/03/2021

This catalogue is the copyright of HS Company Pty Ltd

DOUBLE ACTING CYLINDERS (Fork Clevis Both Ends)



63mm Bore Cylinder with 40mm Rod Diameter

Part No.	Stroke	Closed Length	Open Length	Port Size	Pin Diameter	Weight
HC1-6.3-36-5	51mm - 2"	362mm - 14 1/4"	413mm - 16 1/4"	3/4" UN O-Ring	25.4mm - 1"	8.6kg
HC1-6.3-41-10	102mm - 4"	413mm - 16 1/4"	514mm - 20 1/4"	3/4" UN O-Ring	25.4mm - 1"	9.1kg
HC1-6.3-46-15	152mm - 6"	463mm - 18 1/4"	616mm - 24 1/4"	3/4" UN O-Ring	25.4mm - 1"	9.8kg
HC1-6.3-51-20	203mm - 8"	514mm - 20 1/4"	717mm - 28 1/4"	3/4" UN O-Ring	25.4mm - 1"	10.8kg
HC1-6.3-56-25	254mm - 10"	565mm - 22 1/4"	819mm - 32 1/4"	3/4" UN O-Ring	25.4mm - 1"	11.9kg
HC1-6.3-61-30	305mm - 12"	616mm - 24 1/4"	921mm - 36 1/4"	3/4" UN O-Ring	25.4mm - 1"	12.8kg
HC1-6.3-66-35	356mm - 14"	667mm - 26 1/4"	1022mm - 40 1/4"	3/4" UN O-Ring	25.4mm - 1"	13.6kg
HC1-6.3-71-40	406mm - 16"	717mm - 28 1/4"	1123mm - 44 1/4"	3/4" UN O-Ring	25.4mm - 1"	14.1kg
HC1-6.3-76-45	457mm - 18"	768mm - 30 1/4"	1225mm - 48 1/4"	3/4" UN O-Ring	25.4mm - 1"	14.8kg
HC1-6.3-81-50	508mm - 20"	819mm - 32 1/4"	1327mm - 52 1/4"	3/4" UN O-Ring	25.4mm - 1"	15.7kg
HC1-6.3-87-55	559mm - 22"	870mm - 34 1/4"	1429mm - 56 1/4"	3/4" UN O-Ring	25.4mm - 1"	16.6kg
HC1-6.3-92-61	610mm - 24"	921mm - 36 1/4"	1530mm - 60 1/4"	3/4" UN O-Ring	25.4mm - 1"	17.6kg
HC1-6.3-97-66	660mm - 26"	971mm - 38 1/4"	1631mm - 64 1/4"	3/4" UN O-Ring	25.4mm - 1"	18.6kg
HC1-6.3-102-71	711mm - 28"	1022mm - 40 1/4"	1733mm - 68 1/4"	3/4" UN O-Ring	25.4mm - 1"	19.7kg
HC1-6.3-107-76	762mm - 30"	1073mm - 42 1/4"	1835mm - 72 1/4"	3/4" UN O-Ring	25.4mm - 1"	20.6kg
HC1-6.3-122-91	914mm - 36"	1225mm - 48 1/4"	2139mm - 84 1/4"	3/4" UN O-Ring	25.4mm - 1"	23.2kg
HC1-6.3-137-106	1067mm - 42"	1378mm - 54 1/4"	2445mm - 96 1/4"	3/4" UN O-Ring	25.4mm - 1"	26.2kg
HC1-6.3-153-121	1219mm - 48"	1530mm - 60 1/4"	2749mm - 108 1/4"	3/4" UN O-Ring	25.4mm - 1"	29.1kg

Optional POA: • Hydraulic Hose Kit • Valve Block

INDENT ITEM ONLY

B:7-94

www.walterscheid.com.au

Document No:	SABRECAT
Issue:	3
Issue Date:	03/03/2021

This catalogue is the copyright of HS Company Pty Ltd

DOUBLE ACTING CYLINDERS (Fork Clevis Both Ends)



75mm Bore Cylinder with 40mm Rod Diameter

Part No.	Stroke	Closed Length	Open Length	Port Size	Pin Diameter	Weight
HC1-7.5-36-5	51mm - 2"	362mm - 14 1/4"	413mm - 16 1/4"	3/4" UN O-Ring	25.4mm - 1"	11.6kg
HC1-7.5-41-10	102mm - 4"	413mm - 16 1/4"	514mm - 20 1/4"	3/4" UN O-Ring	25.4mm - 1"	12.6kg
HC1-7.5-46-15	152mm - 6"	463mm - 18 1/4"	616mm - 24 1/4"	3/4" UN O-Ring	25.4mm - 1"	13.4kg
HC1-7.5-51-20	203mm - 8"	514mm - 20 1/4"	717mm - 28 1/4"	3/4" UN O-Ring	25.4mm - 1"	14.5kg
HC1-7.5-56-25	254mm - 10"	565mm - 22 1/4"	819mm - 32 1/4"	3/4" UN O-Ring	25.4mm - 1"	15.5kg
HC1-7.5-61-30	305mm - 12"	616mm - 24 1/4"	921mm - 36 1/4"	3/4" UN O-Ring	25.4mm - 1"	16.7kg
HC1-7.5-66-35	356mm - 14"	667mm - 26 1/4"	1022mm - 40 1/4"	3/4" UN O-Ring	25.4mm - 1"	17.4kg
HC1-7.5-71-40	406mm - 16"	717mm - 28 1/4"	1123mm - 44 1/4"	3/4" UN O-Ring	25.4mm - 1"	18.5kg
HC1-7.5-76-45	457mm - 18"	768mm - 30 1/4"	1225mm - 48 1/4"	3/4" UN O-Ring	25.4mm - 1"	19.3kg
HC1-7.5-81-50	508mm - 20"	819mm - 32 1/4"	1327mm - 52 1/4"	3/4" UN O-Ring	25.4mm - 1"	20.5kg
HC1-7.5-87-55	559mm - 22"	870mm - 34 1/4"	1429mm - 56 1/4"	3/4" UN O-Ring	25.4mm - 1"	21.6kg
HC1-7.5-92-61	610mm - 24"	921mm - 36 1/4"	1530mm - 60 1/4"	3/4" UN O-Ring	25.4mm - 1"	22.7kg
HC1-7.5-97-66	660mm - 26"	971mm - 38 1/4"	1631mm - 64 1/4"	3/4" UN O-Ring	25.4mm - 1"	23.9kg
HC1-7.5-102-71	711mm - 28"	1022mm - 40 1/4"	1733mm - 68 1/4"	3/4" UN O-Ring	25.4mm - 1"	25.2kg
HC1-7.5-107-76	762mm - 30"	1073mm - 42 1/4"	1835mm - 72 1/4"	3/4" UN O-Ring	25.4mm - 1"	26.4kg
HC1-7.5-122-91	914mm - 36"	1225mm - 48 1/4"	2139mm - 84 1/4"	3/4" UN O-Ring	25.4mm - 1"	30.0kg
HC1-7.5-137-106	1067mm - 42"	1378mm - 54 1/4"	2445mm - 96 1/4"	3/4" UN O-Ring	25.4mm - 1"	33.3kg
HC1-7.5-153-121	1219mm - 48"	1530mm - 60 1/4"	2749mm - 108 1/4"	3/4" UN O-Ring	25.4mm - 1"	36.9kg

90mm Bore Cylinder with 45mm Rod Diameter

HC1-9-46-15	152mm - 6"	463mm - 18 1/4"	616mm - 24 1/4"	3/4" UN O-Ring	25.4mm - 1"	18.1kg
HC1-9-51-20	203mm - 8"	514mm - 20 1/4"	717mm - 28 1/4"	3/4" UN O-Ring	25.4mm - 1"	19.4kg
HC1-9-56-25	254mm - 10"	565mm - 22 1/4"	819mm - 32 1/4"	3/4" UN O-Ring	25.4mm - 1"	20.7kg
HC1-9-61-30	305mm - 12"	616mm - 24 1/4"	921mm - 36 1/4"	3/4" UN O-Ring	25.4mm - 1"	22.2kg
HC1-9-66-35	356mm - 14"	667mm - 26 1/4"	1022mm - 40 1/4"	3/4" UN O-Ring	25.4mm - 1"	23.7kg
HC1-9-71-40	406mm - 16"	717mm - 28 1/4"	1123mm - 44 1/4"	3/4" UN O-Ring	25.4mm - 1"	24.2kg
HC1-9-76-45	457mm - 18"	768mm - 30 1/4"	1225mm - 48 1/4"	3/4" UN O-Ring	25.4mm - 1"	25.7kg
HC1-9-81-50	508mm - 20"	819mm - 32 1/4"	1327mm - 52 1/4"	3/4" UN O-Ring	25.4mm - 1"	27.2kg
HC1-9-92-61	610mm - 24"	921mm - 36 1/4"	1530mm - 60 1/4"	3/4" UN O-Ring	25.4mm - 1"	30.2kg
HC1-9-107-76	762mm - 30"	1073mm - 42 1/4"	1835mm - 72 1/4"	3/4" UN O-Ring	25.4mm - 1"	35.0kg
HC1-9-122-91	914mm - 36"	1225mm - 48 1/4"	2139mm - 84 1/4"	3/4" UN O-Ring	25.4mm - 1"	39.5kg
HC1-9-137-106	1067mm - 42"	1378mm - 54 1/4"	2445mm - 96 1/4"	3/4" UN O-Ring	25.4mm - 1"	44.0kg
HC1-9-153-121	1219mm - 48"	1530mm - 60 1/4"	2749mm - 108 1/4"	3/4" UN O-Ring	25.4mm - 1"	48.5kg

Optional POA: • Hydraulic Hose Kit • Valve Block

INDENT ITEM ONLY

www.walterscheid.com.au

Document No:	SABRECAT
Issue:	3
Issue Date:	03/03/2021

This catalogue is the copyright of HS Company Pty Ltd

DOUBLE ACTING CYLINDERS (Fork Clevis Both Ends)



100mm Bore Cylinder with 45mm Rod Diameter

Part No.	Stroke	Closed Length	Open Length	Port Size	Pin Diameter	Weight
HC1-10-51-20	203mm - 8"	514mm - 20 1/4"	717mm - 28 1/4"	3/4" UN O-Ring	25.4mm - 1"	22.0kg
HC1-10-56-25	254mm - 10"	565mm - 22 1/4"	819mm - 32 1/4"	3/4" UN O-Ring	25.4mm - 1"	23.5kg
HC1-10-61-30	305mm - 12"	616mm - 24 1/4"	921mm - 36 1/4"	3/4" UN O-Ring	25.4mm - 1"	25.0kg
HC1-10-66-35	356mm - 14"	667mm - 26 1/4"	1022mm - 40 1/4"	3/4" UN O-Ring	25.4mm - 1"	26.5kg
HC1-10-71-40	406mm - 16"	717mm - 28 1/4"	1123mm - 44 1/4"	3/4" UN O-Ring	25.4mm - 1"	28.0kg
HC1-10-76-45	457mm - 18"	768mm - 30 1/4"	1225mm - 48 1/4"	3/4" UN O-Ring	25.4mm - 1"	29.7kg
HC1-10-81-50	508mm - 20"	819mm - 32 1/4"	1327mm - 52 1/4"	3/4" UN O-Ring	25.4mm - 1"	31.4kg

100mm Bore Cylinder with 50mm Rod Diameter

HC1-10-92-61	610mm - 24"	921mm - 36 1/4"	1530mm - 60 1/4"	3/4" UN O-Ring	25.4mm - 1"	37.6kg
HC1-10-107-76	762mm - 30"	1073mm - 42 1/4"	1835mm - 72 1/4"	3/4" UN O-Ring	25.4mm - 1"	42.0kg
HC1-10-122-91	914mm - 36"	1225mm - 48 1/4"	2139mm - 84 1/4"	3/4" UN O-Ring	25.4mm - 1"	48.0kg
HC1-10-137-106	1067mm - 42"	1378mm - 54 1/4"	2445mm - 96 1/4"	3/4" UN O-Ring	25.4mm - 1"	52.5kg
HC1-10-153-121	1219mm - 48"	1530mm - 60 1/4"	2749mm - 108 1/4"	3/4" UN O-Ring	25.4mm - 1"	58.0kg

125mm Bore Cylinder with 50mm Rod Diameter

HC1-12-51-20	203mm - 8"	514mm - 20 1/4"	717mm - 28 1/4"	3/4" UN O-Ring	25.4mm - 1"	28.5kg
HC1-12-61-30	305mm - 12"	616mm - 24 1/4"	921mm - 36 1/4"	3/4" UN O-Ring	25.4mm - 1"	32.7kg
HC1-12-71-40	406mm - 16"	717mm - 28 1/4"	1123mm - 44 1/4"	3/4" UN O-Ring	25.4mm - 1"	36.9kg
HC1-12-76-45	457mm - 18"	768mm - 30 1/4"	1225mm - 48 1/4"	3/4" UN O-Ring	25.4mm - 1"	39.0kg
HC1-12-81-50	508mm - 20"	819mm - 32 1/4"	1327mm - 52 1/4"	3/4" UN O-Ring	25.4mm - 1"	43.4kg

125mm Bore Cylinder with 63mm Rod Diameter

HC1-12-92-61	610mm - 24"	921mm - 36 1/4"	1530mm - 60 1/4"	3/4" UN O-Ring	25.4mm - 1"	53.0kg
HC1-12-107-76	762mm - 30"	1073mm - 42 1/4"	1835mm - 72 1/4"	3/4" UN O-Ring	25.4mm - 1"	60.5kg
HC1-12-122-91	914mm - 36"	1225mm - 48 1/4"	2139mm - 84 1/4"	3/4" UN O-Ring	25.4mm - 1"	68.2kg
HC1-12-137-106	1067mm - 42"	1378mm - 54 1/4"	2445mm - 96 1/4"	3/4" UN O-Ring	25.4mm - 1"	75.9kg
HC1-12-153-121	1219mm - 48"	1530mm - 60 1/4"	2749mm - 108 1/4"	3/4" UN O-Ring	25.4mm - 1"	83.2kg

Optional POA: • Hydraulic Hose Kit • Valve Block

www.walterscheid.com.au

Document No:	SABRECAT
Issue:	3
Issue Date:	03/03/2021

INDENT ITEM ONLY

B:7-96

This catalogue is the copyright of HS Company Pty Ltd

DOUBLE ACTING CYLINDERS (Eyeballs Both Ends)



63mm Bore Cylinder with 40mm Rod Diameter

Part No.	Stroke	Closed Length	Open Length	Port Size	Pin Diameter	Weight
HC2-6.3-41-10	102mm - 4"	413mm - 16 1/4"	514mm - 20 1/4"	3/4" UN O-Ring	25.4mm - 1"	9.1kg
HC2-6.3-46-15	152mm - 6"	463mm - 18 1/4"	616mm - 24 1/4"	3/4" UN O-Ring	25.4mm - 1"	9.8kg
HC2-6.3-51-20	203mm - 8"	514mm - 20 1/4"	717mm - 28 1/4"	3/4" UN O-Ring	25.4mm - 1"	10.8kg
HC2-6.3-56-25	254mm - 10"	565mm - 22 1/4"	819mm - 32 1/4"	3/4" UN O-Ring	25.4mm - 1"	11.9kg
HC2-6.3-61-30	305mm - 12"	616mm - 24 1/4"	921mm - 36 1/4"	3/4" UN O-Ring	25.4mm - 1"	12.8kg

Optional POA: • Hydraulic Hose Kit • Valve Block

www.walterscheid.com.au

Document No:	SABRECAT
Issue:	3
Issue Date:	03/03/2021

This catalogue is the copyright of HS Company Pty Ltd

INDENT ITEM ONLY

B:7-97

DOUBLE ACTING CYLINDERS (Front End Loaders)



63mm Bore Cylinder with 40mm Rod Diameter

Part No.	Cylinder Type	Stroke	Closed Length	Open Length	Port Size	Pin Diameter	Weight
HC3-6.3-64-40	Bucket	406mm - 16"	641mm - 25 1/4"	1047mm - 41 1/4"	3/8" BSP	25.4mm - 1"	14.1kg
HC3-6.3-80-56	Bucket	565mm - 22 1/4"	800mm - 31 1/2"	1365mm - 53 3/4"	3/8" BSP	25.4mm - 1"	18.0kg
HC3-6.3-99-76R	Arm RH	762mm - 30"	997mm - 39 1/4"	1759mm - 69 1/4"	3/8" BSP	25.4mm - 1"	21.0kg
HC3-6.3-99-76L	Arm LH	762mm - 30"	997mm - 39 1/4"	1759mm - 69 1/4"	3/8" BSP	25.4mm - 1"	21.0kg

75mm Bore Cylinder with 45mm Rod Diameter

HC3-7.5-64-40	Bucket	406mm - 16"	641mm - 25 1/4"	1047mm - 41 1/4"	3/8" BSP	25.4mm - 1"	20.0kg
HC3-7.5-80-56	Bucket	565mm - 22 1/4"	800mm - 31 1/2"	1365mm - 53 3/4"	3/8" BSP	25.4mm - 1"	23.0kg
HC3-7.5-90-67R	Arm RH	673mm - 26 1/2"	908mm - 35 3/4"	1581mm - 62 1/4"	3/8" BSP	25.4mm - 1"	25.0kg
HC3-7.5-90-67L	Arm LH	673mm - 26 1/2"	908mm - 35 3/4"	1581mm - 62 1/4"	3/8" BSP	25.4mm - 1"	25.0kg
HC3-7.5-99-76R	Arm RH	762mm - 30"	997mm - 39 1/4"	1759mm - 69 1/4"	3/8" BSP	25.4mm - 1"	27.0kg
HC3-7.5-99-76L	Arm LH	762mm - 30"	997mm - 39 1/4"	1759mm - 69 1/4"	3/8" BSP	25.4mm - 1"	27.0kg

INDENT ITEM ONLY

B:7-98

www.walterscheid.com.au

Document No:	SABRECAT
Issue:	3
Issue Date:	03/03/2021

This catalogue is the copyright of HS Company Pty Ltd

NOTES

Large area with horizontal dotted lines for notes, overlaid with a large, faint Sabre logo watermark.

www.walterscheid.com.au

Document No:	SABRECAT
Issue:	3
Issue Date:	03/03/2021



INDENT ITEM ONLY

NOTES



INDENT ITEM ONLY

B:7-100

www.walterscheid.com.au

Document No:	SABRECAT
Issue:	3
Issue Date:	03/03/2021

This catalogue is the copyright of HS Company Pty Ltd

NOTES

Large watermark logo: SABRE® AG

Horizontal dotted lines for notes:

www.walterscheid.com.au

Document No:	SABRECAT
Issue:	3
Issue Date:	03/03/2021



INDENT ITEM ONLY

Victoria

17-31 Discovery Road, Dandenong South 3175

Email: melbourne@walterscheid.com.au

Web: www.walterscheid.com.au

Ph: (03) 9580 7300

Fax: (03) 9580 0379

New South Wales

Newcastle	2 Canavan Drive, Beresfield 2322 Email: newcastle@walterscheid.com.au	Ph: (02) 7909 5150 Fax: (02) 7909 5195
Illawarra	13 Glastonbury Avenue, Unanderra 2526 Email: wollongong@walterscheid.com.au	Ph: (02) 4229 2381 Fax: (02) 4226 3016

Queensland

Brisbane	12a Pradella Street, Darra 4076 Email: brisbane@walterscheid.com.au	Ph: (07) 3117 2850 Fax: (07) 3117 2851
Mackay	43 Margaret Vella Drive, Mackay 4740 Email: mackay@walterscheid.com.au	Ph: (07) 4914 2150 Fax: (07) 4914 2199
Townsville	602 Ingham Road, Bohle 4818 Email: townsville@walterscheid.com.au	Ph: (07) 4795 3450 Fax: (07) 4795 3499

South Australia

Adelaide	Unit 2, 479 - 481 South Road Regency Park 5010 Email: adelaide@walterscheid.com.au	Ph: (08) 7088 8980 Fax: (08) 8349 5264
-----------------	---	---

Tasmania

Hobart	10a Duncan Street, Montrose 7010 Email: hobart@walterscheid.com.au	Ph: (03) 6272 2255 Fax: (03) 6272 0671
---------------	---	---

Western Australia

Perth	49 Banksia Road, Welshpool 6106 Email: perth@walterscheid.com.au	Ph: (08) 6189 8050 Fax: (08) 9258 6311
Bunbury	10 Shanahan Road, Bunbury 6230 Email: bunbury@walterscheid.com.au	Ph: (08) 9725 7033 Fax: (08) 9725 7044