

NEWS AND TECHNOLOGY ■ INSTALLATION ■ SERVICING ■ DEVELOPMENTS

TELEVISION

PLQ / JPE

AND CONSUMER ELECTRONICS

MARCH 2005

PLQ
£3.20



Blu-ray prospects

Project: Cable tester

Vintage repairs:
the BUSH DAC10

Servicing:
the Philips MD2.2 chassis



FAULT FINDING FOR TV ■ AUDIO ■ SATELLITE ■ VIDEO ■ IT

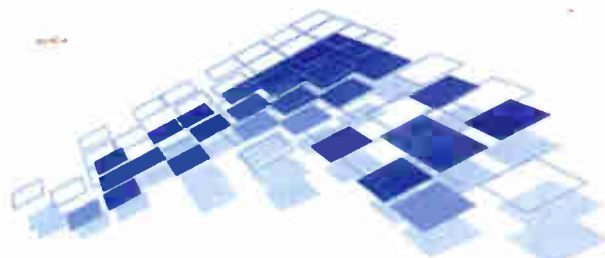

Digi Repairs
U K & I r e l a n d

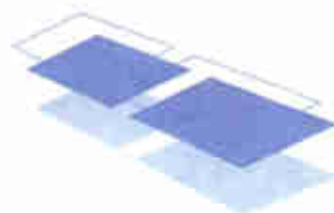

TRADE REPAIR SERVICE FOR THE UK & EIRE

Are you looking for a reliable company to repair your sky digiboxes?
We offer **FREE SAMEDAY** Collection when you send more than
one box for repair!

● **FIXED PRICES**

Pace, Grundig, Amstrad **Fixed price £38 + VAT includes return delivery**
Panasonic, Sony

Sky + (Standard repair) **Fixed price £45 + VAT includes return delivery**
(Hard Drive replacement) **Fixed price £75 + VAT includes return delivery**

- Prices include all faults Micro processor, Modem, Software corruption and BGA replacement. *Send more than one box at a time we collect for FREE.*
- Specialists in the repair of Amstrad & Sony digiboxes.
- Refurbished digiboxes for sale (subject to availability).
- Fast Turnaround Time.
- All repairs fully guaranteed (6 months).
- Collection arranged from anywhere in the United Kingdom and Eire.
- Authorised Sky Digital Repair Centre.

*Receive our latest Satellite and technical newsletter **FREE** through
email. Just send us an email with Newsletter in the Subject title to:
info@digirepairs.co.uk*

Contact:

DIGI REPAIRS (UK & Ireland)
UNIT 25, ENNISKILLEN BUSINESS CENTRE
TEMPO ROAD, ENNISKILLEN BT74 4RL
TEL: 02866327293 (NATIONAL RATE)
0845 6441628 (LOCAL RATE)
Email: info@digirepairs.co.uk

CONTENTS

March 2005

Vol. 55 No. 5

259 Comment

TV for tomorrow.

260 News

Cables companies launch VOD. Sharp adds to LCD capacity. Official HDTV-ready label. Industry news. Freeview update. Optical disc potential. Samsung develops 21in. OLED TV.

262 Cable testing

Faulty cables can be the cause of many confusing problems. The testing system described in this article, devised by Robert B. Kerr. GM4FDT, enables cable defects to be detected.

264 Test Case 507

266 Blu-ray developments

Although the Blu-ray optical disc system has yet to be launched in the US and Europe, its developers are already introducing format enhancements.



These include the use of a new scratch-resistant protective coating and multiple-layer discs with greatly increased data storage capacity. George Cole describes the latest developments.

272 Vintage repair: the Bush DAC10 radio

This is one of the classic valve radios from the early Fifties. Macolm Burrell describes a recent renovation project.

278 Servicing the Philips MD2.2 chassis

John Coombes provides fault-finding guidance for this high-specification TV chassis.

282 Help wanted

283 Bench notes

Adrian Gardiner on some TV/VCR and TV/DVD combi unit faults and a possible stock fault with the Sony FE2 chassis.

284 Letters

HDTV. DTT reception. Experts. Flowerbed aerials.

286 Working for the mob - and for others

Elaine Everest on the social and some financial aspects of being a self-employed TV engineer.

288 Service Casebook

Michael Maurice describes some recent TV problems.

289 Web service

Useful websites for TV professionals, technicians and enthusiasts.

290 A noisy time for Mr Wooster

By Brian Storm, with apologies to P.G. Wodehouse.

292 DX and Satellite Reception

Broadcast and satellite TV news. Yet more interference! DAB quality. More on the Roberts Gemini 6. Goodbye to the Southampton TV centre. Roger Bunney reports.

296 Audio faults

298 VCR clinic

300 TV fault finding

303 DVD and home cinema fault reports

304 Books to buy

The Television book service, with details of some of the titles you can order.

306 Extended fault reports

A few longer reports on complex or tricky TV faults.

308 What a Life!

Problems at the shop. The New Zealand scene. Trouble with a Sony PS-LX50 record deck. Donald Bullock's servicing commentary.

310 Satellite notebook

A cable problem. Digital channel update. Intelsat 603 (20°W). Digibox faults. The motorised dish saga. Something fell off. Missing channels.

314 Monitor faults

315 Next month in Television

Editor

John A. Reddihough

TVeditor@highburybiz.com

Deputy Editor

Tessa Winford

Production Editor

Jane Massey

Production Executive

Dean Turner

01322 611206

Group Advertisement

Sales Executive

Mike Traylen

01322 611 289

Fax 01322 616 376

Editorial Assistant

Ann Price

01322 611 365

Publishing Director

Tony Greville

Note that we are unable to answer technical queries over the telephone and cannot provide information on spares other than that given in our Spares Guide.

Disclaimer

We work hard to ensure that the information presented in *Television* is accurate. However, *Television's* publisher - Highbury Business - will not take responsibility for any injury or loss of earnings that may result from applying information presented in the magazine. It is your responsibility to familiarise yourself with the laws relating to dealing with your customers and suppliers, and with safety practices relating to working with electrical/electronic circuitry - particularly as regards electric shock, fire hazards and explosions.

Next issue,
dated April, on sale
March 16

GV 198

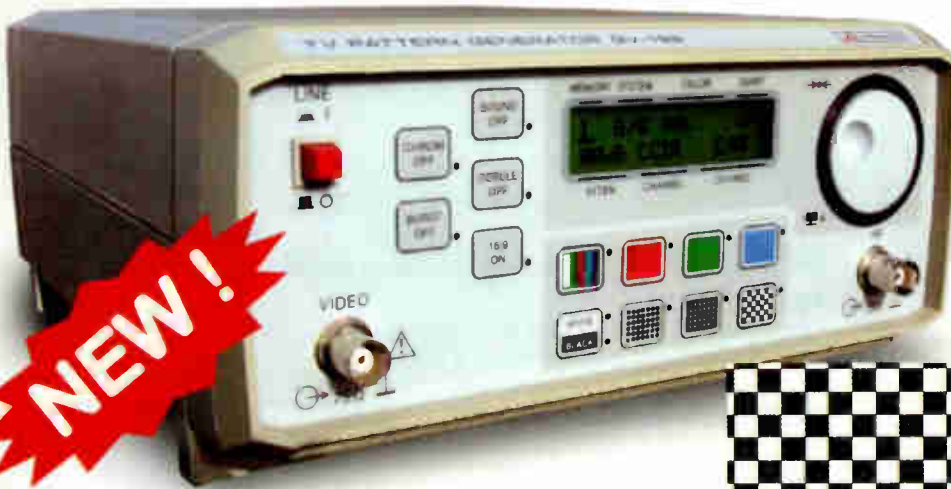

NEW!

TELEVISION TEST PATTERN GENERATOR

FEATURES INCLUDE :

- ◆ Suitable for Televisions, projectors and flat screens
- ◆ Covers 4:3 and 16:9 formats
- ◆ Tunable RF modulator between 37MHz and 865MHz
- ◆ Tunable by channel (CCIR, OIRT or FCC) or frequency
- ◆ PAL / SECAM / NTSC Colour Systems
- ◆ B / G / D / K / L / I / M / N Standards
- ◆ Composite Video and Sync outputs
- ◆ High Quality Construction
- ◆ 10 Front panel memories
- ◆ EUROCONNECTOR interface
- ◆ Electronic Attenuator
- ◆ Compact and Strong
- ◆ User friendly
- ◆ Attractive Price
- ◆ Clear LCD Display
- ◆ Available from Stock
- ◆ Full After Sales Service

WIDE SCREENS

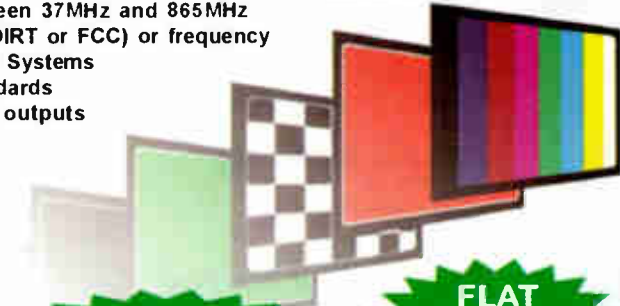

PROJECTORS

FLAT SCREENS



FOR ELECTRONIC TEST EQUIPMENT, THERE IS NO WIDER CHOICE THAN WITH PROMAX



ALBAN ELECTRONICS LIMITED

THE PROMAX SERVICE CENTRE

6 Caxton Centre, Porters Wood, St. Albans, Hertfordshire, AL3 6XT.

**TEL: 01727 832266
FAX: 01727 810546**

**WEB: www.albanelectronics.co.uk
EMAIL: info@albanelectronics.co.uk**

SALES + SERVICE + CALIBRATION



GV 241

COMPUTER MONITOR PATTERN GENERATOR

In the world of computer monitors, unlike those for televisions, there is a multiplicity of different systems involved. To satisfy this incredible demand, PROMAX has designed the GV-241, a universal generator for the testing of computer monitors, which greatly facilitates their adjustment, control and repair.

- ◆ Test Patterns : Colour Bars; Red; Green; Blue; Scale of Greys; Cross hatch; Multiburst and White
- ◆ Outputs : R; B; G; CVS; HS; VS; CS; C1, C2, and C3

AA 930 AUDIO ANALYSER



The AA-930 has been designed to facilitate the repair, tuning and analysis of audio frequency equipment in general. Hence, why the six indispensable measurement instruments from an audio service workshop have been combined into this one piece of test equipment. The AA-930 is equipped with RCA 600 Ω and DIN 47 kΩ connectors for the inputs and outputs. In addition, two BNC connectors on the front panel and two RCA connectors on the rear panel allow the user to view all of the signals measured by the instruments.

- ◆ Low Frequency Generator
- ◆ Wow and Flutter Measurement
- ◆ Distortion Meter
- ◆ Stereo Watt Meter
- ◆ Millivolt Meter
- ◆ Azimut



TA 903B CRT REJUVENATOR

The TA-903B has been designed to analyse and rejuvenate the cathode ray tubes (CRT) of colour and black and white televisions and monitors. The user can detect and depending upon circumstances repair the leakage or short circuits, simultaneously measure the current of the RGB cathodes in the cut off point, trace the voltage / current characteristics and rejuvenate each of the three cathodes independently.

COPYRIGHT

© Highbury Business, 2005. All rights reserved. No part of this publication may be reproduced, stored or transmitted in any form or by any means without the written permission of the publishers.

All reasonable precautions are taken by *Television* to ensure that the advice and data published are reliable. We cannot however guarantee it and we cannot accept legal responsibility for it.

CORRESPONDENCE

All correspondence regarding advertisements should be addressed to the Advertisement Manager, *Television*, Highbury Business, Media House, Azalea Drive, Swanley, Kent, BR8 8HU. Editorial correspondence should be addressed to *Television*, Editorial Department, Highbury Business, Media House, Azalea Drive, Swanley, Kent, BR8 8HU.

INDEXES AND BINDERS

Indexes for Vols. 38 to 53 are available at £3.50 each from SoftCopy Ltd., who can also supply an fifteen-year consolidated index on computer disc. For further details see page 187.

Binders that hold twelve issues of *Television* are available for £6.50 each from Modern Bookbinders, Pringle Street, Blackburn, BB1 1SA. Telephone: 01254 59 371
Make cheques payable to "Television Binders".

Newstrade Enquires

Distributed by COMAG

Telephone: 01895 444055

ISSN 0032-647X

Newstrade Hotline

If you are experiencing problems getting copies through your newsagent, please call Debbie Jenner on 01322 611210

SUBSCRIPTIONS

Highbury Fulfilment Services, Link House, 8 Bartholomew's Walk, Ely, Cambridge CB7 4ZD.

Telephone 01353 654 431

Fax 01353 654 400

Email hbc.subs@highbury-wyvern.co.uk

Please notify change of address.

Subscription rates:

UK 1 year £33.80

2 years £61.00

3 years £81.00

Republic of Ireland 1 year £38.95

2 years £70.00

3 years £94.00

Mainland Europe 1 year £49.00

2 years £88.00

3 years £118.00

Rest of World 1 year £63.50

2 years £114.00

3 years £152.00

Cheques should be made payable to *Television*.

BACK NUMBERS

If available issues are £4.00 each



HIGHBURY
BUSINESS

A HIGHBURY HOTELS COMMUNICATIONS PLC COMPANY

TV for tomorrow

The pace of technological development is such that it is particularly hard at present to envisage exactly what we will be using for radio and TV reception, and for audio and pictorial sources, in ten or even five years' time. About the only thing one can say for sure is that there will be a display of some sort and loudspeakers. The changeover to digital technology has meant that consumer electronics, computer systems and the internet are converging in ways that could, if the advantages prove to be worthwhile, change everything radically. Given time, digital technology seems to come up with the answers eventually: look at the way in which compression algorithms have evolved.

From the user point of view it mainly depends on how well and how soon the 'wrinkles' get sorted out. If it proves possible to get everything to work properly – and computer technology can in particular be temperamental – the public will go along the path to digital convergence. Instead of a receiver as such, you would have a sort of digital hub that would link you to whatever media you want – TV services, AV entertainment, communications or whatever. The key to it all is software – which is why Microsoft has spent some \$20bn over the past ten years on moving from basic PC systems to the digital media centre – with the Xbox thrown in to see how games can be brought into the fold.

Just think of it: call up the menu, select whatever you want, and enjoy! We are now used to software control of electronic systems, how a microcontroller and a bit of memory can control TV sets and almost any other device. Basically, it's a question of who gets it all to run smoothly and in a user-friendly way. Someone is going to end up playing a dominant role in all of this, so a great deal is at stake. Will it be Microsoft, as with PCs, or will someone else achieve the necessary breakthrough? This is likely to be the format battle of all time!

One advantage that Microsoft already has is its development of IPTV (Internet Protocol TV) to distribute video via the internet. Telecommunications companies in Canada, Italy, India and other countries are understood to be considering this as a way of breaking into the TV business. SBC, the second-largest US telecommunications company, has already announced a service based on the technology. It was demonstrated at the

You just need to have the right chip: a PC, a phone or some other terminal can then become your audio or TV set

Las Vegas Consumer Electronics Show in January, and the results seem to have been very impressive. You just need to have the right chip: a PC, a phone or some other terminal can then become your audio or TV set.

Takeover by the internet, with no further need to rely on terrestrial, satellite or other modes of transmission, is not certain to be the way in which things will go. It's still rather slow, and how will it cope with such unimaginably vast quantities of data? There have been breakdowns as it is, and there's the great worry that the internet is particularly vulnerable to hacking. Can it ever be made safe, or would internet TV be subject to the whims of some lunatic in a garret at the back of beyond (or maybe next door)?

One of the intriguing aspects is how the cable companies will react. This is particularly significant in the US, where cable operators have long played a far greater role than elsewhere in providing services of one sort or another, in particular TV. Bundling video, conventional telecommunications and data services has been a major way of promoting cable services, as opposed to the traditional telecomm ones. The US cable companies are at present spending fortunes on upgrading their infrastructure. It's a question of who will come out on top: they are both doing much the same thing, and share technology.

The possibility of providing all our communications and entertainment requirements via internet technology is there. Advances will come as the software evolves. Just how soon will it be before software makes all this an everyday matter, and will it be the way we actually go? Inevitably the economics of alternative approaches will be the deciding factor. Who will provide the best services at the lowest cost? One final intriguing thing is the effect of the internet on bandwidth, traditionally the limiting characteristic of communications systems. Somehow, the internet seems to be shrinking bandwidth. But we shall have to see. All that can be said right now is that the prospects are very interesting indeed.

Cable companies launch VOD

NTL and Telewest are both introducing improved video-on-demand (VOD) services, though the two companies have made it clear that this does not mean the start of joint operations. They have been running a strictly limited joint venture, Front Row, that provided multiple showings of twenty-three movies at quarter-hour staggered times throughout the day. This is being replaced by the new services.

NTL is investing up to £40m on its new service, which was initially launched in Glasgow. In addition to a library of hundreds of films, it offers hundreds of hours of extra TV programming such as advertisement-free children's TV, a selection of top

shows from the previous week and a music video jukebox. Content from the BBC, Jetix, Nickelodeon and Warner Music will be included. Telewest is to invest some £20m initially on its service, which has been launched at Bristol. It will initially provide films but will be extended to offer TV programmes as well.

The new services include pause, fast-forward and rewind functions. They will not require equipment upgrades, and will appear as part of the normal electronic programme guide. Some content will be free, but movies will cost up to £3.50 while music will cost between 20p and £1.50 per video.

The services constitute the first mass-market VOD to be launched outside the US. NTL's chief executive Simon Duffy said "This is a quantum step forward in terms of functionality and gives us a differentiation against other pay-TV companies. This really is what the cable network is for." The cable companies maintain that VOD services are more flexible and user-friendly than the use of a PVR such as Sky+, as there is no need to plan viewing and set recording instructions.

Telewest Broadband has nevertheless entered into an agreement with Scientific-Atlanta for the supply of new personal video recorder (PVR) set-top

boxes, which will be made available to its customers later this year. The new PVR will include a 160GB hard drive with the ability to store about 80 hours of programmes, and three TV tuners that will enable viewers to record two programmes simultaneously while watching a third. It will include functions such as pause and rewind. Telewest Broadband's digital TV service will also deliver high-definition TV content in the future. No price details have been announced.

Meanwhile BSKyB is adding new features to its Sky+ PVR. These could include the ability to set up recordings using a mobile phone.

Samsung's 21in OLED TV



Samsung has developed the world's largest active-matrix driven OLED (Organic Light Emitting Diode) display for digital TV sets. The 21in. screen has a resolution of 6.22 million pixels. At present OLED displays are mainly

used for mobile phones and instrumentation, but at the current rate of development they could challenge LCD and PDP displays within a few years. The OLED market is expected to increase to some £1.17bn by 2008.

BoxClever sold

State-owned German bank WestLB has sold the TV rental business BoxClever, which was formerly known as Radio Rentals, to a couple of US private-equity groups, Fortress Investment Group and Cerberus Capital. The deal represents a substantial loss for WestLB, which originally became involved with BoxClever when a London subsidiary arranged financing in 2000.

Sharp adds to LCD capacity

Sharp Corporation is to build the world's first eighth-generation LCD plant at its Kameyama site in Japan, an investment that will involve some ¥150bn (£0.8bn). It will join Sharp's existing sixth-generation facility at Kameyama. Production is expected to start in October 2006 at a rate of 15,000 panels a month. A second production line will then be added to double production. The eighth-generation glass substrates are the optimum size for the production of 40 and 50in. screens: eight 40in. or six 50in. panels can be obtained from a single eighth-generation substrate, whose sides measure more than 2m.

The decision to increase LCD production capacity at a time when there is a surplus (see News, December) and manufacturers are struggling to make profits emphasises Sharp's optimism about the market and its advantages as a

pioneer. The company expects to be able to cut costs sufficiently to be able to challenge the present dominance of plasma panels in large-screen flat-panel TV sets.

Production of Sharp's Aquos LCD range passed the five million mark at the end of December. This figure is the total number of sets produced at Sharp's two LCD plants in Japan and others in Spain, Mexico and China. Total worldwide demand for flat-panel TV sets from 2001 to 2004 is estimated to have been approximately 14m. This suggests that Aquos models account for about a third of all flat-panel TV sets produced. Sharp introduced the C1 series (LC-20C1, LC-15C1 and LC13C1) in January 2001 and has been increasing the size and resolution ever since. Model LC-45GD1, with a 45in. screen, was launched in Japan last August.

Industry news

Samsung and Sony have signed a cross-licence agreement for mutual use of patents owned by the two companies. The aim is for increased business growth through efficient product development: the agreement licenses patents that are considered to be basic for product development, covering semiconductor and industry-standard technologies. So-called 'differentiation technology patents' are excluded. These include patents related to Sony's Digital Reality Creation (DRC) and PlayStation technology, and Samsung's Digital Natural Image Engine (DNIE) and home networking technolo-

gy. In addition the agreement doesn't cover TFT-LCD and OLED (Organic Light Emitting Diode) display patents.

Sony has announced some 300 job losses at its plants in South Wales. The cause is said to be the move from CRT- to LCD- and PDP-based TV sets. While Sony expects the demand for CRT sets to remain significant in the medium term, it has decided to reassess its production needs. Sony's flat-panel TV sets for the European market are produced in Barcelona, Spain.

Sharp and Loewe have agreed to strengthen their col-

laboration in the European market to meet an expected rapid increase in the demand for LCD TV sets. The new agreement will increase Sharp's stake in Loewe from 8.9 to 29 per cent. The companies have established a "Joint European Development Centre" at Kronach, Germany to continue developing their digital electronics platform for LCD TV sets and peripheral devices. The focus will be on the DVB standard and the development of an integrated HDTV receiver.

Philips has sold its PC monitors business and part of its low-end flat-screen TV opera-

tions to TPV Technology, making the Taiwan-based company the world's largest PC monitor manufacturer. The deal will more than double TPV Technology's annual sales. TVP was already the world's second largest manufacturer of PC monitors, with sales of \$2bn last year. As part of the agreement, Philips will have a stake of about 15 per cent in TVP.

This seems to be part of a trend: a week before the announcement from Philips, IBM sold its PC manufacturing activities to the Chinese company Lenovo.

Optical disc potential

Researchers at Imperial College London claim to have devised a technique that enables 250GB of data per layer to be stored on a CD-sized disc, ten times more than the proposed Blu-ray disc. It's based on a new data encoding technique. A double-sided, dual-layer Multiplexed Optical Data Storage (MODS) disc would be able to store 1,000GB of data, enough for 472 hours of film. According to the researchers the playback system would be backwards compatible, i.e. the MODS system would be able to play CDs and DVDs.

Future-proof AV unit from Onkyo

Onkyo's latest AV receiver for home-cinema use, Model TX-NR5000E, has been designed for maximum upgradability, employing the techniques used in the IT industry – replaceable modules and upgradable software. The unit includes an HDMI (High Definition Multimedia Interface) and a pair of iLink digital inputs. The latter provide bit-for-bit digital transfer of DVD-Audio and SACD audio without violating copy-protection controls.



The unit can also be connected to a PC network via its rear Ethernet port. It provides 200W of power for each of seven audio channels and incorporates all the current audio processing modes – Dolby, DTS and THX. Price is around £4,000. For further details consult: www.onkyo.co.uk or phone 01494 681515.

Freeview update

Extra Freeview capacity that has just become available means that an additional channel able to broadcast for up 18 hours a day could be launched as soon as April. Freeview has now passed the five-million household mark. Sales of decoders during the last two weeks before Christmas reached 190,000 units, beating the previous record of 140,000, in 2003, by a wide margin. Because the profit margin is so low, Pace has decided to stop manufacturing Freeview digiboxes. It will focus on higher-end products, including new types of PVRs.

Add-on lenses

Amacrox has introduced a series of add-on lenses for use with web cams and mobile phones that include a camera. There are four lenses: close-up; Tele 2.0x zoom; Super Wide for long-distance images; and Micro + Wide 0.5x which is useful for short-distance work. The Super Wide and Tele 2.0x are currently available from Maplin at about £15 + VAT. For further information check at www.amacrox.com

Official HDTV-ready label

EICTA, the European industry organisation that represents the IT and CE sectors, has announced a new HD labelling system for display devices. The HD ready label is intended as a quality sign to differentiate display equipment that's capable of processing and display-



ing high-definition TV/video signals. Conditions for its use include a minimum resolution for the display or display engine (such as a digital light processor) of 720 lines with widescreen aspect ratio. The equipment should be able to receive HD signals via component video,

HDMI (High Definition Multimedia Interface) or DVI (Digital Video Interface) input sockets, and display 1,280 x 720 50/60Hz progressive-scan (720p) and 1,920 x 1,080 50/60Hz interlaced-scan (1,080i) material. The HDMI or DVI input socket should be able to handle the HDCP (High Definition Content Protection) system.

Cable testing

Defective cables can be the cause of many confusing faults. The testing system described in this article, devised by Robert B. Kerr, GM4FDT, enables cable defects to be detected

I am sure that you will all at one time or another have suffered from problems caused by an intermittent audio or RF cable, meter test lead or other bit of wire when a simple continuity test has failed to reveal the cause of the trouble. In just this situation I wracked my memory and recalled a rather sad wooden box that lay in the back of a BBC cupboard when, in about 1967, I was a young TA (technical assistant). It was faulty, but had been used to test microphone cables and PO jack patch leads. The box contained a rectangular cell with a brass terminal and a short black lead (a T cell), a pea bulb, and some sort of transformer (telephone induction coil). Failure could have been because of shorted turns caused by high transient voltages.

I decided to design a similar circuit using modern components, adding a diode peak limiter to protect the transformer and the operator's eardrums. Fig. 1 shows the outcome.

Circuit description

A 1.2V NiMH cell in series with a 2.5V lamp, a pair of good-quality



Photo 1: The cable tester (left) and cable box (right) with headphones ready for use. The 'portholes' in the tester are for the LEDs and lamp. The BD238 shunt-regulator transistor and its heatsink are mounted on the case at the top left.

terminals and the low-voltage windings of a 12V transformer drives a current of about 180-190mA through the cable being tested. Two types of headphones can be connected to the circuit. When you listen you will hear a click when a cable is connected or

disconnected, and the LEDs will flash. The lamp will glow when the circuit is made, but while it is made there should be silence. If the cable is faulty, disturbing it will cause crackles, microphony, frying noises etc. In addition the LEDs may flash. Medium- or high-impedance

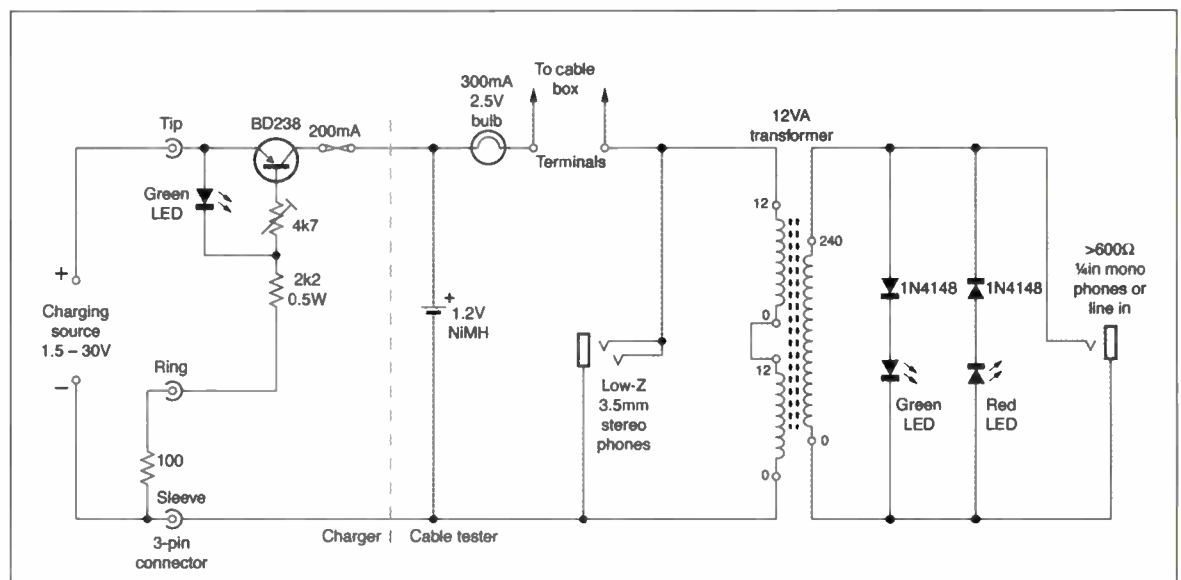

Fig. 1: Circuit diagram of the cable tester, which incorporates a charger circuit.

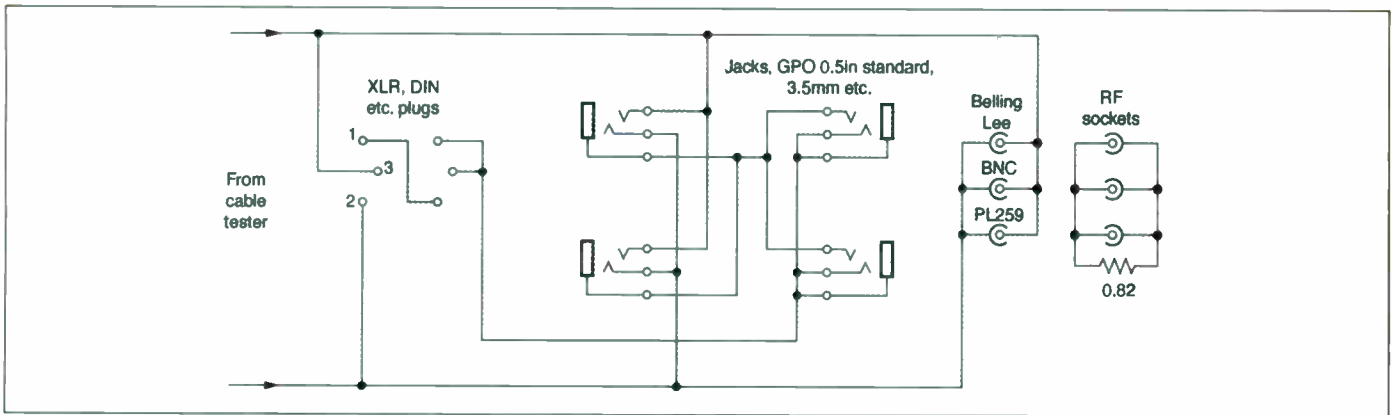

Fig. 2: Plug and socket cable box example. Conductors to be connected in series for test. Terminate RF cables at 0.85Ω.

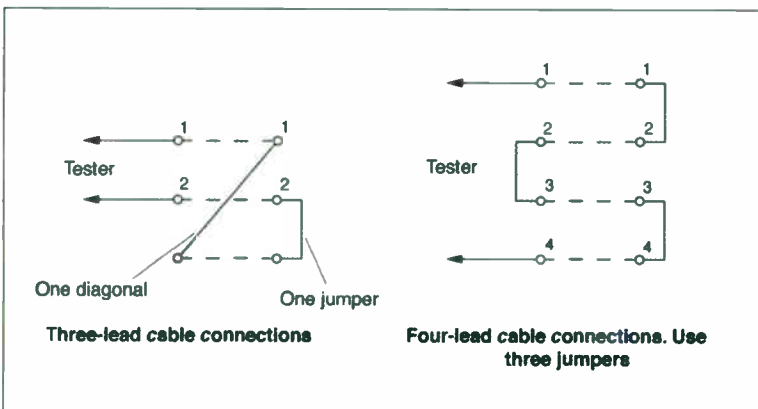

Fig. 3: Way of wiring three- and four-lead cables so that the leads are all in series.

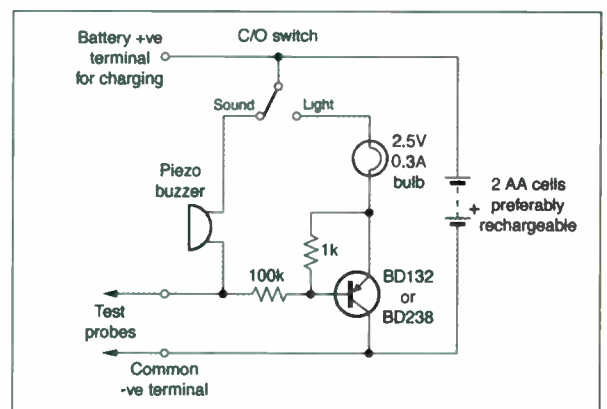
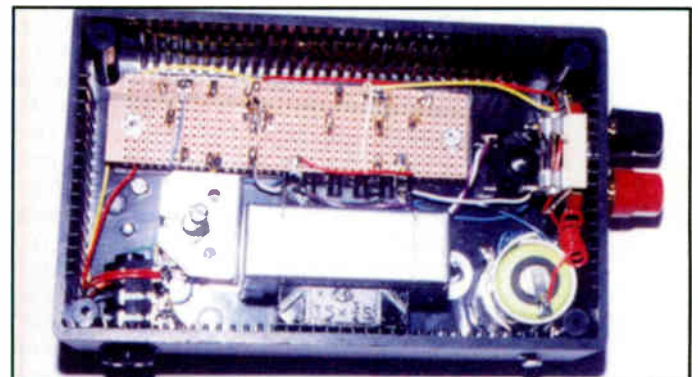
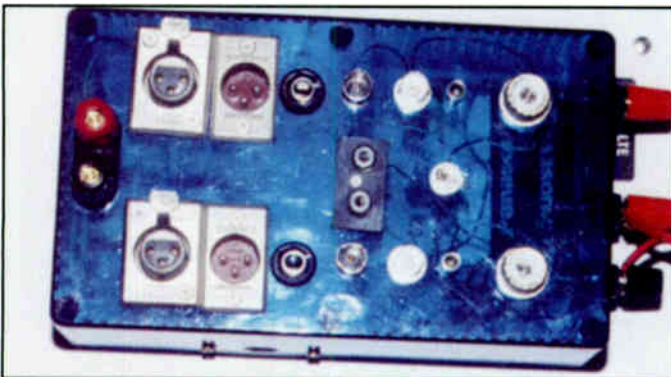

Fig. 4: Continuity tester circuit. The buzzer used is a Maplin CR34M.



headphones (greater than 600Ω) connected to the 240V side of the transformer give the best results. Alternatively low-impedance, e.g. 32Ω, headphones can be connected across the low-voltage side of the transformer.

To facilitate testing I made up a cable box (plastic) which is fitted with pairs of plugs and sockets, see Fig. 2. This is connected to the tester via solid wires. The wiring places all the conductors of a multi-lead cable in series, see Fig. 3. My box has standard and GPO jacks; meter test lead sockets; three XLR male and female connectors; phono sockets; and Belling Lee, BNC and PL259 RF sockets (an F connector could be added); also a pair of

gold-plated terminals for connection to the cable tester. For RF cables, rather than short one end I fitted an 0.82Ω resistor – so that shorts of an intermittent nature will produce sounds in the phones.

After designing and building the original prototype I added a simple continuity tester to the cable box, see Fig. 4. This is used to trace out unknown cables. It gives a sound or light (2.5V, 0.3A MES torch bulb) indication with a low test current and voltage (about 3mA at 3V maximum). The continuity tester is enclosed within the translucent blue case and is therefore fully protected. It has three terminals at the box end – cheap terminals are suitable here!

Charger

Returning to Fig. 1, I have included a simple shunt regulator to charge the cell at an almost constant current when the supply exceeds about 5V – charging is possible at down to 1.5V however. A three-pin connector is used to provide powering. Removal of this disconnects the transistor's base circuit to prevent cell discharge. A 100Ω resistor should be included, as shown, between the sleeve and ring if a jack is used, to prevent momentary shorting of the voltage source when unplugging this.

The charger cable should be unplugged when not in use. The 4.7kΩ preset sets the charging current (about 100mA).

Left – Photo 2: Detailed view of the cable box.

Right – Photo 3: Internal view of the cable tester. The preset is for adjusting the charging current. LEDs etc. are mounted on Veroboard. The charging jack is at the bottom left and the gold-plated test terminals are at the right. The transformer, fuse and sub-C cell can also be seen.

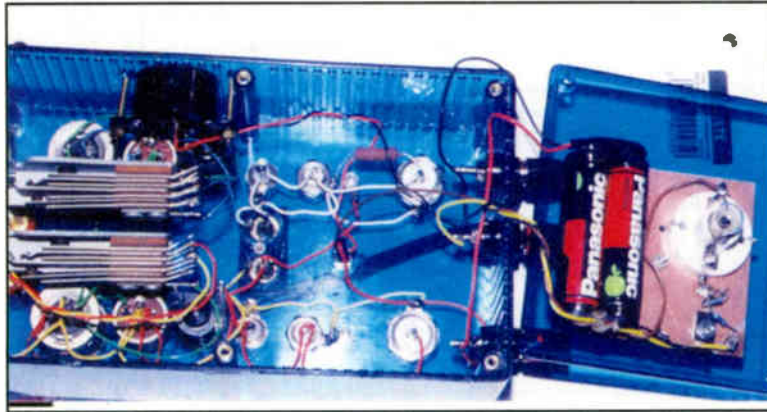

Photo 4: Internal view of the cable box with continuity tester added.

Construction

Layout is unimportant but the cell, lamp, terminals and transformer circuit should be connected by solid wire, and all connections

should be soldered. A wire-ended lamp such as the Maplin JX48C miniature krypton bulb works well, as does a soldered-in torch bulb. A tagged cell is recommended: I use a

sub-C 2.2AH NiMH unit. The terminals are gold-plated loudspeaker types with soldered connections.

The transformer is a 12VA mains type – the AC rating to be at least twice the DC test current of about 190mA. The LV windings are rated at 500mA AC.

The cable tester and box are housed in plastic cases for protection. The cable tester's LEDs and lamp are mounted behind a transparent Perspex strip and viewed through 'portholes' made in the black ABS case (Maplin type MB5). The cable box is Maplin type N68AL.

In conclusion

I have found the cable tester to be a very useful item and never cease to be amazed how microphonic test leads and cheap RF and audio cables can be.

Test Case 507

Philips could well be the longest-established manufacturer of consumer electronic equipment. The company has been at it since the early Twenties, but this eighty-odd years of experience hasn't saved Philips from the occasional disaster: of late these have included the 'painter' system control chip, certain widescreen CRTs and a recent range of DVD recorders. Over the years Philips has produced a range of products surpassed possibly only by Sony in terms of variety and choice. Amongst them, a while ago, was TV Model 28PT512A, which was fitted with chassis type GR2.2. One of these is the subject of our attention this month. Our man Todd had been asked to pay a home call to see it. When he found that it didn't work at all, he arranged for it to be brought into the workshop for investigation.

It was soon on the bench of Television Ted who, it must be admitted, is not as familiar with Philips TV sets as those of some other makes. Nevertheless he quickly established that the line output transistor Tr7545 was short-circuit. Why had it failed?

In many different makes and models dry-joints at the line driver transformer, T5541 in this case, are very often the cause of this sort of thing. Even though a close inspection failed to reveal anything amiss, Ted removed all the solder from the pins of the transformer, fluxed them then remade the joints with fresh solder. A new transistor, type BU508AF as originally fitted, was then installed. After that the set worked well, needing only a trim of the scan-control preset potentiometers (these date the set, don't they?) to get a good picture. The set was then

put to run on test for a few hours, after which it was declared fit for return: Todd and Adam from the shop took it back next day, collected the money and that was that. Or so they thought.

Two days later the set was reported to be faulty again. Symptom as before, said the customer. Damn, said Ted. The delivery crew, or rather re-collection crew this time, were not pleased either. They brought it back, and straight on to Ted's bench it went. Sadly to say, the new line output transistor was found to be short-circuit between all three leadouts. It was going to be one of those jobs!

To be sure that the line output transistor was suitable for the job, Ted ordered a replacement from Philips, quoting the part number in the manual. To be sure, or as sure as he could, that the supply to the line output stage was constant, he replaced the set-HT potentiometer RV3635. When the replacement transistor had arrived and been fitted, he adjusted this control for the correct HT voltage. He then left the set to run.

On day two of the soak test there was a sort of raucous burping sound for a split second, then collapse of the picture to a vertical line, followed by shutdown of the set. The line output transistor had once again failed. As Ted and Sage peered in at the back of the set they could smell a slight whiff of burning. But none of the components or soldered joints on the PCB showed any signs of overheating! Much closer inspection, with a big magnifying lamp, failed to reveal any problems with the board or the components. The cause of the trouble was finally found and rectified however. What was it? You can find the solution on [page 315](#).

Profilo Telra

Brand New PT92

**Complete Working PCB's
(Widescreen Version)**

As used in the following makes of TV
Bush, Fidelity, Wharfedale, Akura, JMB,
Naiko & Watson

BUY ONE GET ONE FREE

Buy one carton of Perfect PCB's and
get one carton of damaged PCB's FREE
for spares

Only £90 per carton + VAT

Carton content 9 panels

Next day Carriage £9.95

Most major credit cards accepted

Showroom ready B-grade stock
also available

For more information contact

Contact Ian Botterill

Key Electronics Ltd

01388 819525

Blu-ray

developments

Although the Blu-ray optical disc system has yet to be launched in the US and Europe, its developers are already introducing format enhancements. These include the use of a new scratch-resistant protective coating, multiple-layer discs with greatly increased data storage capacity, and new copy-protection technologies. **George Cole** describes the latest developments

High-definition video displayed on a Sony set.



Domestic video recording is moving from tape-based to disc-based formats. At the same time, more and more countries around the world are adopting high-definition TV systems. Consumer electronics companies are, therefore, developing high-density optical-disc systems capable of storing HDTV material. The best known is the Blu-ray disc, not least because it has been given the support of the majority of consumer-electronics manufacturing companies worldwide. Its success is by no means a foregone conclusion however – more on this later. The following article provides an update on Blu-ray disc system developments, which include disc

technology, hardware, software support and codecs.

Background

The Blu-ray disc first came to public attention in February 2002 when nine companies – Hitachi, LG, Matsushita, Pioneer, Philips, Samsung, Sony, Sharp and Thomson – announced the development of this new, high-definition video recording system. The name comes from the use of blue laser technology. The wavelength is 405nm: in comparison, DVD recorders use a red laser (wavelength 650nm) while CD recorders use an infra-red laser (wavelength 780nm). Additional basic characteristics of the Blu-ray disc system

are the use of MPEG-2 video compression and Dolby AC-3 audio (marketed as Dolby Digital) and MPEG-2, Layer 1 for audio encoding – DTS is an optional extra.

The first Blu-ray disc specifications were for single-layer discs that had data capacities of 23.3, 25 and 27GB, with the latter being able to store up to two hours of high-definition video at a data rate of 36Mbits/sec. The discs would also be stored in a protective caddy. The specification has been revised since then, with the addition of dual-layer technology and advanced video-compression codecs (coders/decoders). The format also now includes caddy-protected and bare discs. And more companies have pledged support for Blu-ray, including Mitsubishi, PC manufacturers Dell and Hewlett-Packard, and blank-disc media manufacturer TDK. Table 1 compares the basic DVD and Blu-ray formats.

Disc technology

There are three types of Blu-ray disc: rewritable, write-once and read-only (known as BD-ROM). Companies including Fuji Film, Maxell, Sony and TDK have launched blank rewritable discs in Japan. Much work has gone into the development of BD-ROMs, not least because the Hollywood studios assume that the market for prerecorded DVDs will decline over the years as consumers, with

some encouragement, trade up to a higher-specified (and higher-priced) video format. Whereas a DVD-18 disc, i.e. a dual-layer, double-sided one, can store up to 17GB of data, a single-sided, single-layer Blu-ray disc can hold 25GB. A typical DVD video release is stored on a 4.7 or 8.5GB disc.

Table 2 shows the content that can be stored on a BD-ROM disc using MPEG-2 compression. According to the supporters of the Blu-ray disc system, the capacity of a BD-ROM is such that a single disc could store the entire top ten best-selling DVDs for sale at Amazon.com's website in May 2004.

Codecs

Last year the Blu-ray Disc Association announced that it had added two additional codec (coder/decoder) specifications: the MPEG-4 AVC High Profile Video Codec, and Microsoft's VC-1 Advanced Video Codec. The official reason is that, because of their more powerful encoding and decoding compression algorithms, they can greatly increase the amount of video content that can be stored on a disc. Table 3 illustrates this. Some cynics have suggested that another reason for selecting VC-1 was to gain Microsoft's support for the Blu-ray disc.

Copy protection

Much work has gone into the development of the BD-ROM standard version 1.1 but one major issue has still to be decided – copy protection. Pre-recorded BD-ROMs will effectively put professional-quality video masters in the hands of consumers – and professional pirates. So a powerful anti-copying system will need to be included in the specification, and it will have to provide protection against both digital and analogue copying. There are rumours that the Hollywood studios are insisting that pre-recorded BD-ROMs should offer high-quality digital video only with players and recorders that include an HDMI (High Definition Multimedia Interface) or a DVI (Digital Video Interface) socket, because this will enable software companies to use HDCP (High-bandwidth Digital Content Protection) technology. This is a powerful encryption system that's designed to prevent unauthorised copying or sharing of digital content.

Table 1: DVD/Blu-ray disc format comparison

<i>Characteristic</i>	<i>DVD</i>	<i>Blu-ray disc</i>
Disc diameter	12cm	12cm
Disc thickness	1.2mm	1.2mm
Laser wavelength	650nm	405nm
Numerical aperture	0.6	0.85
Beam spot size at surface	1.32microns	0.58microns
Optical cover layer	0.6mm	0.1mm
Track pitch	0.74microns	0.32microns
Maximum mark length	0.4microns	0.149microns
Maximum bit rate	11Mbits/sec	36Mbits/sec
Capacity, single layer	4.7GB	25GB
Capacity, dual layer	8.5GB	50GB
Typical SD recording time*	2.25 hours	11 hours
Typical HD recording time*	n/a	2.25 hours @ 25Mbits/sec

*Single layer.

Table 2: BD-ROM disc capacity using MPEG-2 compression

<i>Single-layer BD-ROM (25GB)</i>	<i>Dual-layer BD-ROM (50GB)</i>
HD feature (135 minutes); audio (three languages); SD bonus material (two hours).	HD feature (three hours); audio (DTS, three languages); SD bonus material (nine hours).
HD feature (150 minutes); audio (three languages); SD bonus material (45 minutes).	HD feature (three hours); audio (DTS, three languages); HD bonus material (two hours).
SD TV features (11 hours) audio (three languages).	SD TV features (22 hours); audio (three languages).

Table 3: Blu-ray disc capacity using advanced codecs

<i>25GB disc</i>	<i>50GB disc</i>
HD feature (three hours); audio (three languages); SD bonus material (six hours).	HD feature (six hours); audio (three languages); SD bonus material (12 hours).
HD feature (four hours); audio (three languages); SD bonus material (105 minutes).	HD feature (eight hours); audio (three languages); HD bonus material (3.5 hours).
SD TV features (18 hours) audio (three languages).	SD TV features (35 hours); audio (three languages).

It is also likely that broadcasters will increasingly use the CPRM (Content Protection for Recordable Media) technology, which effectively binds digital content physically to a specific medium such as an optical disc. This means that the content cannot be copied or removed – its aim is to prevent video files being uploaded to the internet.

One can be certain that when high-definition TV and video reaches the home the days of being able to copy video from broadcasts



A TDK blank rewritable Blu-ray disc.

Fig. 1: Cross-section of the triple-layer Blu-ray/DVD disc developed by JVC.

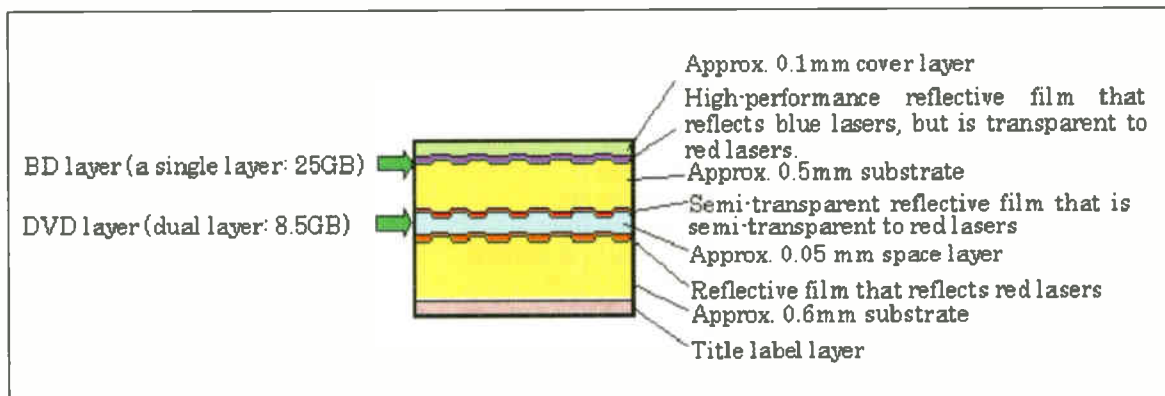

A prototype Pioneer Blu-ray recorder.



or prerecorded discs with virtual impunity will be over.

The first Blu-ray recorder, the Sony Model BDZ-S77, went on sale in Japan in the spring of 2003. Several models from different manufacturers are now available there. Despite costing the equivalent of some £1,500 each, they don't contain the copy protection circuitry required to read prerecorded Blu-ray discs. When this fact was pointed out to a Sony representative at a Blu-ray Disc meeting, he replied that early adopters of the technology wouldn't mind paying for a recorder that couldn't play prerecorded discs!

Disc protection

As previously mentioned, the original Blu-ray specification included disc storage in a protective caddy—a throwback to the early days of CD-ROMs, which also used caddies. But users don't like caddy systems that involve loading and unloading discs before and after playback. That's why the CD and DVD formats use bare discs. The problem is that a bare disc can be damaged by fingerprints, dust and general atmospheric pollution. It's

worse with the Blu-ray disc, because the data pits are so much smaller and the recording layer is just 0.1mm thick.

TDK has developed a disc-coating material that provides greatly improved protection against scratches, marks and fingerprints. For obvious reasons TDK is keeping much of this technology close to its chest, but the company has revealed that the protective layer is produced by a spin-coating system. In fact there are two layers. The first consists of silica particles that are just 50 microns in length and are mixed with a fluorine-based resin. This layer is spin-coated on to the disc at high speed. A second layer, which contains a fluorine-based resin and a curing agent (acetophenone), is then deposited on top. UV light is used in the curing process.

During a press presentation journalists were given an opportunity to try and damage discs protected in this way by scrubbing their surfaces with wire wool. Despite our best efforts, the discs remained unscathed! TDK says that the next step will be to make the discs more resistant to UV

light: the company is developing dyes that could be used to filter this out.

A TDK representative was asked whether the company planned to use this technology with CD and DVD discs. The company in fact uses a variation in its range of 'scratch-proof' blank DVD discs. These provide up to a hundred times greater protection against scratching than standard DVDs.

Creative opportunities

We were also given a glimpse of the creative opportunities that the Blu-ray disc offers. These include more advanced graphics menus than those with DVD, such as multiple-plane menus, pop-up menus and dynamic menu displays; slide shows; and Java programming. The latter offers increased interactivity and adds the potential to upgrade titles. Sun Microsystems, which developed Java, has joined the Blu-ray Disc Association.

BD-ROM discs and players could also be connected to broadband services, giving users the ability to download trailers, additional subtitles etc from the internet. Menu screens can also offer animated buttons and click sounds.

Disc developments

The Blu-ray Disc Association has recently approved the specification for an 8cm version of the disc that would hold up to 15GB of data per storage layer. It could be used for portable devices such as camcorders and personal video recorders. Sony and Sharp are understood to be developing products of this type.

JVC has developed an intriguing product: a combined Blu-ray/DVD ROM disc that can store up to 33.5GB of data. It has a triple-layer construction, with a Blu-ray recording layer that sits on top of a dual-layer DVD-9 system. The latter can store 8.5GB of data.

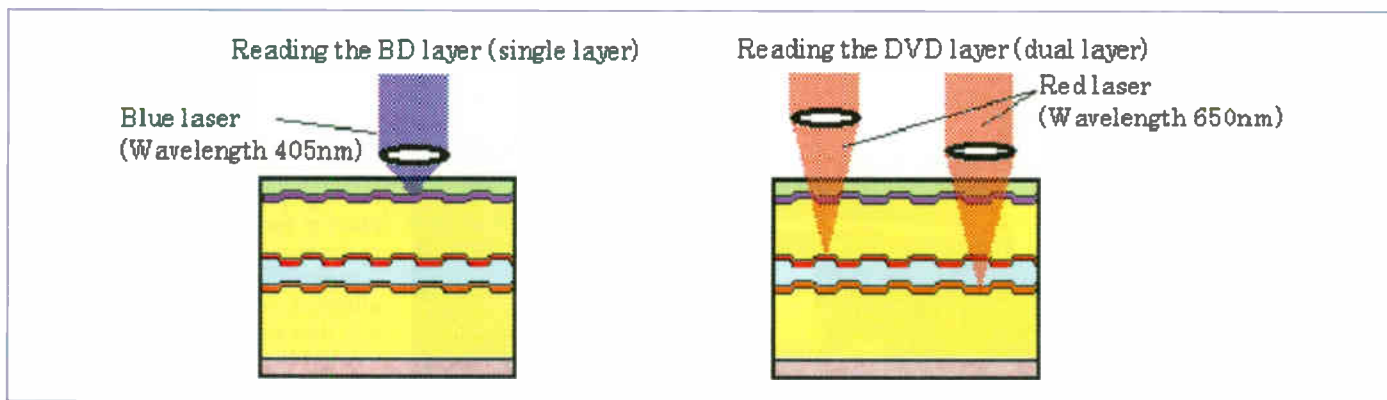

Fig. 1 shows a cross-section of the disc. The disc has been made possible by using a special film that reflects light from a blue laser (as used by Blu-ray) but is transparent to light from a red laser (see Fig. 2). According to JVC the disc could be used for various purposes, the most obvious being to combine a high-definition recording with a standard DVD recording. Consumers could buy the new discs for use with a standard DVD player then upgrade and see the high-definition version with a Blu-ray player. The additional data could also be used to combine Blu-ray video content with, for example, a game.

In addition JVC is developing a larger disc with a data storage capacity of 58.5GB. The idea is to combine a dual-layer 50GB Blu-ray layer with an 8.5GB dual-layer DVD structure. JVC has proposed the new disc to the Blu-ray Disc Association.

Hybrid-disc technology is not new. Back in the days of Compact Disc Interactive (CDi) video and interactive content were included on the same disc. CD Extra discs combine music and data, and SACD (Super Audio CD) discs have an SADC layer and a CD Red Book layer. Hybrid discs are fine in theory and should be welcome to retailers in offering a way of avoiding dual inventory stocking. But their success depends on whether they can be manufactured at a competitive price.

Even though the Blu-ray disc has much greater data capacity than DVD, there are already moves to increase the capacity greatly by multi-layering. Sony for example expects to be producing and selling four-layer discs with a capacity of 100GB from 2007, and has plans for an eight-layer version offering up to 200GB capacity. This, Blu-ray supporters say, means that the Blu-ray disc's capacity will be adequate for the next 10-20 years.

But there is some doubt about all this. Today's typical desktop PC has a hard-disk capacity of about 160GB, and it will certainly be much greater than this in twenty years' time! Even an eight-layer Blu-ray disc would struggle to back-up the data in many home PCs today. Another consideration is whether music, film and video companies would want to put vast amounts of content on a single disc. Boxed sets, which contain multiple discs, are very popular with consumers as they appear to offer good value for money: it's harder to add much perceived value to a single 12cm disc no matter how much data it contains. Even today most games companies have not adopted the DVD-ROM format, sticking to multiple-disc CD-ROM releases.

Hardware

Several Blu-ray recorders are now on sale in Japan, with more promised for this year and also for the US market. All models are backwards compatible with CD and DVD, and incorporate blue and red laser technology. Sony's first-generation BDZ-S77 is a bulky machine that's designed for discs with caddies. A replacement model is expected soon. It will have pro-

vision for bare discs and an HDMI input (the BDZ-S77 has IEEE 1394 sockets). The Panasonic DMR-E700BD can handle both bare and caddied discs. Sharp's BD-HD100 combines a twin Blu-ray/DVD disc drive with a 160GB hard disk that can store up to nineteen hours of HDTV programming. It offers six-way dubbing between the hard drive, the Blu-ray drive and the DVD drive. Other features include an HDMI socket and several recording modes that offer up to 218 hours of recording time for standard-definition broadcasts. It's also possible to record up to 300 hours of radio broadcasting. These products all cost the Japanese equivalent of about £1,500.

LG has announced plans to launch Model LG-XBG420, which will include a 200GB hard drive and a digital video interface that supports HDCP. It's expected to sell in the US for the equivalent of about £1,700. Pioneer also plans to launch a Blu-ray recorder, and Dell and Hewlett-Packard are expected to launch PCs with Blu-ray drives before the end of the year.

Blu-ray is unlikely to reach the UK this year, but 2006 is a good bet – not least because BSkyB will be starting its HDTV service via satellite then. Prices of Blu-ray

Fig. 2: Action of the special reflective film used by JVC for its triple-layer Blu-ray/DVD disc.



JVC's combined, triple-layer Blu-ray/DVD disc.

Sony's first-generation Blu-ray recorder Model BDZ-S77.



recorders could be reduced by the development by Nichia and Sony of a dual-wavelength optical coupler that makes it possible to include blue and violet lasers in a single component.

The future

On the face of it Blu-ray is a logical progression from DVD and, with such strong support from the consumer electronics industry, its success should have been assured. But the consumer electronics industry is anything but predictable. The main problem at present is the alternative format, HD DVD, supported by Toshiba, NEC and Sanyo. This is in fact the officially recognised successor to DVD, even though most of the companies that support Blu-ray are also members of the DVD Forum. Which format prevails could well depend on the support given by video providers. As reported in our News pages last month, several leading Hollywood studios have announced their support for HD DVD. On the other

hand Sony Pictures, MGM and Walt Disney have announced their support for Blu-ray. But none of the agreements reached so far are exclusive, and some studios could back both formats. It's all very much up in the air.

The HD DVD camp says that as its discs use the same structure as standard DVD discs, i.e. two 0.6mm discs bonded together, they can be produced on the same production lines with minimal alteration. In theory this should make them cheaper to produce. The Blu-ray camp naturally disputes this, and claims that the BD-ROM specification has the potential to reduce manufacturing costs and increase yields. According to Sony its PTR-3000 Blu-ray disc mastering system requires a fifth of the space taken up by a conventional DVD mastering system. In addition test lines have produced yields of 99 per cent for single-layer BD-ROMs and 92 per cent for dual-layer versions.

Toshiba has announced a hybrid HD DVD/DVD disc though, unlike

the JVC hybrid one, it has a single DVD recording layer. It combines a 15GB HD DVD layer and a 4.7GB DVD layer.

The next generation of games consoles will also support high-density optical formats, and Sony plans to incorporate a Blu-ray drive in the successor to the PlayStation 2 games console. This would be an effective way of getting the Blu-ray disc into millions of homes. But would Microsoft support Blu-ray by including drives in the next version of its Xbox games console? The outcome of the format battle could depend on what computer companies and in particular Microsoft decide to do. Before DVD was developed there was a similar situation when Sony and Philips proposed the Multimedia CD (MMCD) as a successor to the CD while Toshiba and others supported the Super Density Disc (SDD). Pressure from the PC industry, which wanted a single standard, helped to persuade the two camps to join forces and develop a single DVD format.

There have been several DVD recordable formats but, fortunately, the specifications of many of them are so close that it's possible to manufacture multi-format drives and players. This doesn't seem to be possible with the Blu-ray disc and HD DVD. They have different file formats and different disc specifications in terms of pit size, track layout and recording layer.

There is also the question of whether Blu-ray and HD DVD will become mass market or enthusiasts' formats. In the audio field there are two 'super CD' formats that offer superior audio quality, SADC and DVD-Audio, but both remain niche markets. The improvement offered by DVD in comparison with VHS is obvious, as are the benefits of a disc-based system over tape. But while the picture quality improvement that Blu-ray and HD DVD provide in comparison with DVD is impressive, it remains to be seen whether the vast majority of consumers will feel it necessary to upgrade from the latter. Perhaps a significant fall in the price of Blu-ray and HD DVD hardware would resolve this issue. It will be more difficult for consumers to decide if both formats are launched on the market.

It will be interesting to see how the market for next-generation optical disc technology evolves over the next year or so. ■



TDK's ScratchProof protected DVD-R disc.

Trade ElectroniX

30/34 RIVER STREET, DIGBETH, B'HAM B5 5SA
Tel: 0121 773 3300 Fax: 0121 773 2300
email: sales@tradeelectronix.co.uk

ONE OF THE
LARGEST
WHOLESALE
OF
ELECTRICAL
GOODS IN
THE UK

**UNBEATABLE PRICES
LOOK NO FURTHER!!**

**Export Enquiries
Welcome**



**14" TV'S FROM £25....TV/VCR COMB'S FROM £30....
TV/DVD COMB'S FROM £45**

**WE WHOLESALE IN BRAND NEW AND GRADED TV'S DVD'S VCR'S
HIFI'S SMALL APPLIANCES AND WHITE GOODS**

**Kenwood Kitchen Appliances Now
Available at Discount Prices!!!!**

CONTACT US FOR MORE INFO

SONY Panasonic TOSHIBA BEKO morphy richards akura



COLOUR TRADE

**POSSIBLY
LARGEST & OLDEST
EST. IN
THE UK EST FOR
30 YEARS**

Wholesaler Distributors & Expert Agents of
Domestic Electronics & Appliances

**FULL RANGE OF FACTORY
GRADED TV'S DVD / VIDEOS
HI-FI SMALL & LARGE
DOMESTIC GOODS**

www.colourtrade.com

**WHOLESALE MADE EASY ON LINE, SIGN UP
NOW FOR OUR WHOLESALE PRICES.
ALL ORDERS DISPATCHED ON THE SAME DAY.**

**Now Available
TV'S, DVD'S, VCR & AUDIO**

Over 40 years of genuine experience

Experts on:-

Thomson • Sanyo • Beko • LG • Tatung • Ferguson
Bush • Funai • Pacific • Dansai • Samsung & more

**TECHNICAL SUPPORT
0907 076 70 80**

Call cost 60p min

MAIN DEALER

- Thompson
- Sanyo
- Beko



Tel: 0121 359 7020 Fax: 0121 359 6344

Phoenix House, 190 Bridge St. West, Newtown, Birmingham B19 2YT

Email: inquiries@colourtrade.com

Vintage repair:

the Bush DAC10 radio

*Appearance of the
Bush Model DAC10.*



I bought this set at a radio 'swap meet' for purely nostalgic reasons. It's generally expected that such items will require attention unless otherwise stated. But I selected it because the exterior was in good condition, although the small, elliptical Bush 'Christmas tree' emblem was missing – detection of minute scratch marks later suggested that the loss was not accidental!

The radio has five push buttons at the rear of an ivory tuning-scale escutcheon which is at the top of the brown louvered cabinet, see accompanying photo. Three buttons were intended to be preset for the Home, Light and Third pro-

This is one of the classic valve radios from the early Fifties. Macolm Burrell describes a recent renovation

grammes: the other two provide manual selection of the MW or LW band, the tuning knob being at one side of the cabinet. The latter is robustly moulded in two halves. Most Bakelite Bush receivers dating from this period have a dark tortoiseshell 'mottling' in the finish, but this one is a simple chocolate brown.

Inspection

An elderly receiver should always be inspected before the application of power. Look for dangerous wiring, defective electrolytic capacitors and any signs of previous overheating. This receiver seemed odd, because the wiring from the loudspeaker was modern while the connections that emerged from the vicinity of the output stage consisted of older cable. In fact the loudspeaker leads were not connected. I then found, on referring to the service sheet, that the output transformer was missing! It's normally located in the front cabinet shell. Fortunately I found a substitute in a spares box.

All the original paper-dielectric capacitors were present. The original smoothing block, dated 'Sept/49', was in surprisingly good condition. My suspicions were that the set had been lashed together from at least two others. Most of the valves seemed to be original, and the UY41 rectifier looked as if it was soft. It was possible that failing valves had been substituted for working ones.

Testing

Once the output transformer had

*Rear view
of the Bush
Model
DAC10 with
the back
cover
removed.*



been connected it was time to apply power. The tuning-scale illumination was extremely dim. Most of the valve heaters began to glow, but there was no audio output. Checks revealed that there was no HT supply and that the UY41 rectifier was non-conductive. In addition I found that the mains cable had been replaced but was incorrectly wired so that the chassis was live!

There was an audio output, accompanied by hum, when a new rectifier valve had been fitted. Sensitivity was low however, while the loudspeaker had a displaced cone and the push-button switches were incredibly noisy. As the smoothing block was in order the most likely cause of the hum was the UL41 output valve – this type is prone to heater-cathode leakage. Voltage checks showed that it was loading the HT supply unacceptably. A replacement corrected this fault, with some improvement in the volume.

Replacement of the other valves produced little improvement in the sensitivity. I decided to clean the switches in the tuning section by scraping the contacts and smearing them with petroleum jelly. The front of the switchbank was readily accessible but removal of the assembly, a rather daunting step, would have been necessary to gain access to the rear. Instead, I found it possible to scrape and lubricate here using a fine point attached to the blade of a screwdriver.

An attempt was then made to tune the preset buttons. Reference to the service sheet revealed that all three were intended for MW operation – only later versions of the receiver had one for LW operation, usually tuned to the Light programme (1,500m, 198kHz). It was eventually possible to tune all the buttons, while manual tuning of the MW and LW ranges was usable.

At this stage I decided to replace all the paper capacitors, including those used for audio coupling (C20 and C23) and for AGC decoupling (C1 and C13). This produced only a marginal improvement in quality and sensitivity. Note that leakage in a coupling capacitor can seriously decrease valve life while in some cases loss of capacitance can affect the audio quality and volume.

While giving further consideration to the electronics, I decided to renovate the rest of the receiver. The two dial lamps are behind a translucent plastic diffuser. This was cleaned and the condition of the lamps was checked. Mysteriously, they were marked 6.5V, 0.3A. Shunted by a 250Ω resistor (R21), these three components provide the chassis return path to mains neutral – a common practice with sets of this vintage. Reference to the service sheet revealed that the dial lamps should be rated at 3.5V, 0.15A! The only type available was rated at 3.5V, 0.2A. These provided an immediate improvement in the tuning-scale illumination, sensitivity and volume!

Loudspeaker

The 6in. (15cm) diameter loudspeaker was a particularly slim 3Ω type with the speech coil housed within the diaphragm and supported by a stout perforated plate across the face. Gentle heating with a hairdryer restored reasonable reproduction and removed the need to look for a suitable replacement.

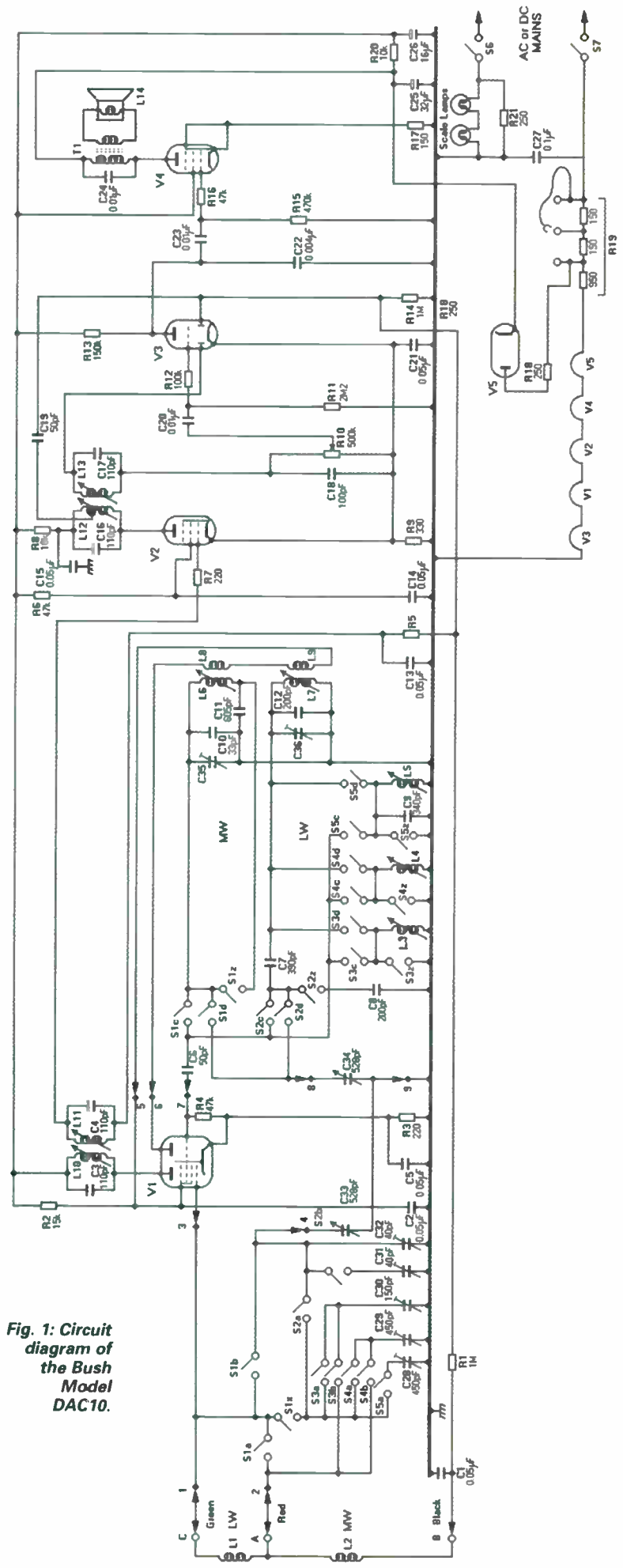

Fig. 1: Circuit diagram of the Bush Model DAC10.

The computer-generated Bush emblem.



The missing emblem

The Bush emblem is a small item inset in an elliptical moulding at the front. Its absence detracted considerably from the appearance of the receiver. So I decided to try to replicate it using a computer-generated image. The correct proportions were obtained by temporarily covering the edges of the ellipse moulding with white correction fluid (Tippex). When this had dried, the front of the cabinet was scanned. This provided information on the shape and area.

Purists might disagree with this, but I considered the exact size of the Christmas tree to be relatively unimportant – provided it was visible and pleasing aesthetically. Before the war however Bush published guidelines about the proportions for dealers who wished to reproduce the emblem (this is mentioned in the BREMA book *The Setmakers*, published in 1991). It was thus relatively easy to scan a piece of artwork then scale and superimpose it into the ellipse.

Having owned one of these sets in the early Sixties, I recalled that

the original DAC10 emblem had a green tree embossed on a silver-grey background printed on thin card. The pre-war Bush design included a band across the centre of the tree's pot.

After colouring the outline of the tree within the ellipse, I tinted the background a light grey (printing on to paper coated with silver paint had been tried, but much of the pigment was absorbed – perhaps a tinted art paper would have been better). The small image was printed on white photographic paper and scaled to the correct proportions, then carefully cut to fit the moulding. A standard impact adhesive was used to fasten it. The result was not perfect: it resembled an original that had been a little 'distressed'.

Push buttons

When the set was reassembled the push-button knobs seemed to sit rather low in relation to the escutcheon and, when pressed, sometimes became trapped. They seem to have been moulded from a translucent brown cellulose material. Although the visible portions appeared to be intact, they had begun to split around the bases. No doubt the receiver had been given a set of really poor buttons that were seated too far down on the shafts!

I filled the cracks with epoxy resin. A little probably drifted on to each shaft, with the result that they were now a little more proud and tighter in their seating. Where nec-

essary they were dabbed with brown paint and given a smear of varnish. This restored their appearance and correct operation, but building replacements may eventually be undertaken.

Tuning scale

The tuning scale consists of a rectangular glass window with a transfer for the wavelengths and station names. It was in reasonable condition, though there was some blistering at one side. Since this affected only the dark background, I repaired it with dark brown enamel paint. The 'clear' portions had a fogged appearance however. Any attempt at cleaning would have wiped the legends, so I lightly dusted it and left it intact. Its total restoration will be investigated at some point.

Conclusion

The IF alignment seemed to be correct, but I reset the oscillator and aerial trimmers for optimum reception at their respective frequencies.

Having cleaned up the cabinet I decided to provide some protection, as Bakelite tends to 'bloom' with age. Repeated cleaning with an abrasive will restore the finish but wear the surface. I applied a thin coating of satin varnish to preserve and protect the surface – perfectionists may raise their hands in horror at the thought! But it was a personal decision, as the set's restoration was not undertaken with resale in mind.

COLLEGE of NW LONDON Plasma Technology Course

Following its successful launch of the first **City and Guilds Course** on plasma display technology the College of North West London is now running two-day short courses for technicians, practitioners and others interested in the subject. Course tutor Fawzi Ibrahim thinks they are the first such courses to be offered to the industry, apart from the product-specific training provided by various manufacturers.

The two-day courses cover plasma panel technology, video processing for plasma displays, and DC power generation and distribution. The first day concentrates on plasma cell and panel construction and drive, sub-filed coding techniques, plasma AI and digital video processing. The second day is devoted to power generation, including zero-current and zero-voltage switching techniques



Instruction at the College of North West London

and power-factor correction, also faults and fault-finding.

Throughout the course the theory presented is backed by rigorous and substantial practical work. This includes observing and recording waveforms with a digital storage oscilloscope, signal tracing, and monitoring with a logic probe and an oscilloscope. Floppy discs are supplied to those taking the course so that they can store and keep waveforms captured by the storage oscilloscope.

The first of these two-day courses is scheduled to run on Monday and Tuesday March 21 and 22.

For further information and enrolment, please email Fawzi.Ibrahim@cnwl.ac.uk or phone 07976 350 724.

Grandata Ltd

distributor of electronic components

Tilttable Wall Bracket for Plasmas



Universal tilttable (+15% / -15%) wall support for large plasma and LCD TV's.

Max. display weight: 75kg

Display size: 30-63" (76-160cm)

Colour: Silver

Order Code : PLASBKT1S Price : £ 75.00 + vat

Carriage charged at £ 6.00 + vat

Swivel LCD Bracket



Inclinable wall bracket with one articulation.

Max. display weight 20kg

Tilttable: +20% / -20%

Display size: 10-30" (25-74cm)

Colour: Silver

Order Code : LCDBKT1S Price : £ 15.00 + vat

Carriage charged at £ 6.00 + vat

Double Swivel LCD Bracket



Inclinable wall bracket with two articulation.

Max. display weight 20kg

Tilttable: +20% / -20%

Display size: 10-30" (25-74cm) - Colour: Silver

Order Code : LCDBKT2S Price : £ 25.00 + vat

Carriage charged at £ 6.00 + vat

Universal Fibre Optic Cable 1.5m



Order Code :26477H

Price : £ 7.00 + vat

Carriage £ 2.00 + vat

Home Cinema Scart Cable 1.5m



Order Code :26481H

Price : £ 8.00 + vat

Carriage £ 2.00 + vat

Home Cinema 3 Phono Cable 1.5m



Order Code :26455H

Price : £ 7.00 + vat

Carriage £ 2.00 + vat

Home Cinema S-Video Cable 1.5m



Order Code :26495H

Price : £ 4.75 + vat

Carriage £ 2.00 + vat

Scart to 3 Phono



Order Code : PLG17

Price : £ 1.00 + vat

10 or more
£ 0.75 + vat each

3 Phono to Scart



Order Code : PLG18

Price : £ 1.00 + vat

10 or more
£ 0.75 + vat each

Scart to 3 Phono (Switched)



Order Code : PLG85

Price : £ 2.00 + vat

10 or more
£ 1.00 + vat each

Gold Scart to 3 Phono (Switched)



Order Code : PLG86

Price : £ 2.70 + vat

10 or more
£ 1.75 + vat each

Double Phono to Phono Adaptor



Order Code : PLG13

Price : £ 0.45 + vat

10 or more
£ 0.35 + vat each

Single Phono to Phono Adaptor



Order Code : 19011R

Price : £ 0.20 + vat

10 or more
£ 0.16 + vat each

Phono Splitter



Order Code : 19055R

Price : £ 0.25 + vat

10 or more
£ 0.21 + vat each

BNC to Phono Adaptor



Order Code : 19002R

Price : £ 0.40 + vat

10 or more
£ 0.30 + vat each

3.5mm Jack to 2 Phono



Order Code : PLG6

Price : £ 0.60 + vat

10 or more
£ 0.45 + vat each

6.3mm Stereo to 3.5mm Stereo



Order Code : 19012R

Price : £ 0.30 + vat

10 or more
£ 0.25 + vat each

High Quality Fully Shielded Foil Wrapped Scart Lead

Length : 1.5m Width : 12mm



Order Code : PLG26

Box of 25 Price **Box of 50 Price**

£ 30.00 + vat **£ 50.00 + vat**

Fully Shielded 2+1 Pin Connected Scart Lead

Length : 1.5m Width : 8mm



Order Code : PLG23

Box of 50 Price **Box of 100 Price**

£ 30.00 + vat **£ 55.00 + vat**

Coax Fly Lead Plug to Socket

Length : 2m



Order Code : COXCABLE

Box of 50 Price **Box of 100 Price**

£ 17.50 + vat **£ 30.00 + vat**

Home Cinema Installation

Cables and Connectors

48 Element Digital Compatible Aerial

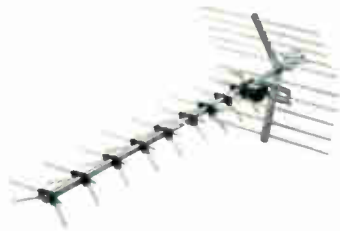

Receives both digital and analogue signals
 For poor to weak strength signal areas
 Robust design for low wind loading - 2 peices boom with aluminium wire rod elements
 Supplied with F connector and clamp for horizontal and vertical (fits up to 57mm masts)
 Ideal for areas with bad picture ghosting
 Supplied part assembled - no tools required

Order Code : 27884R Price : £ 20.00 + vat
 Carriage charged at £ 6.00 + vat

SLx Masthead Amplifiers

UHF TV and FM radio antenna preamplifiers designed for professional aerial installers.

1 way amplifiers come with screw terminals
 2 and 4 way amplifiers come with F connectors

Requires 12V DC power supply connected via a download



Description

- 1 way UHF TV Masthead Amplifier - 15dB Gain**
Order Code : 27830R Price : £ 4.30 + vat
- 1 way UHF TV Masthead Amplifier - 26dB Gain**
Order Code : 27831R Price : £ 4.50 + vat
- 2 way UHF TV Masthead Amplifier - 10dB Gain**
Order Code : 27837R Price : £ 9.00 + vat
- 4 way UHF TV Masthead Amplifier - 10dB Gain**
Order Code : 27838R Price : £ 9.50 + vat
- 4 way UHF TV & FM Masthead Amp - 10dB Gain**
Order Code : 27839R Price : £ 10.00 + vat

Masthead Amplifier Power Supply

Order Code : 27832R Price : £ 5.00 + vat

Carriage charged at £ 2.00 + vat or £ 6.00 + vat for 2 or more

SLx Distribution Amplifiers



A range of Aerial amplifiers designed to allow distribution of TV , Satellite and FM signal without the loss of picture and sound quality.

Available with intergrated Digital bypass - to allow the use of SKY™ digieye (B).

Main Operated , comes with full instructions

Description	Gain	Order Code	Price
2 way	18dB	SLX2	£ 8.00 + vat
2 way with Bypass	6dB	SLX2B	£ 9.25 + vat
4 way	12dB	SLX4	£ 13.00 + vat
4 way with Bypass	6dB	SLX4B	£ 14.00 + vat
6 way	12dB	SLX6	£ 18.00 + vat
6 way with Bypass	6dB	SLX6B	£ 19.00 + vat
8 way	12dB	SLX8	£ 18.50 + vat
8 way with Bypass	6dB	SLX8B	£ 20.00 + vat

Carriage charged at £ 2.00 + vat or £ 6.00 + vat for 2 or more

Satellite Finder



Compact design - Backlit meter scale
 Audible signal strength reading
 Adjustable level control
 Adjustable sensitivity adjustment
 Frequency Range : 950 - 2250Mhz

Order Code : 27860R
Price : £ 10.00 + vat

Coax Plug Aluminium



Order Code : PLG51
Bag of 10
Price : £ 1.25 + vat
Bag of 100
Price : £ 9.00 + vat

Screw Type Coax Plugs



Order Code : PLG62
Bag of 10
Price : £ 1.60 + vat
Bag of 100
Price : £ 12.50 + vat

Twist on F Connectors



Order Code : PLG101
Bag of 10
Price : £ 1.00 + vat
Bag of 100
Price : £ 6.00 + vat

Sky™ Remote Controls



Order Code : RCSKY
Price : £ 8.50 + vat

- 5 or more
£ 7.99 + vat each
- 10 or more
£ 7.50 + vat each
- 20 or more
£ 6.75 + vat each

Carriage charged at £ 6.00 + vat

Sky™ Remote Controls & SLx Link Eye



Order Code : SKYPACK2

- Price : £ 13.00 + vat**
- 5 or more
£ 11.50 + vat each
- 10 or more
£ 10.50 + vat each

Carriage charged at £ 6.00 + vat



RG6 Digital Satellite Coaxial Cable

Suitable for both TV and Satellite signal distribution

1mm Copper Conductor , Air Spaced dielectric , 64 strand copper braiding with aluminium foil shielding

Comes on 100m drum

Available in either black or white colour



Black - Order Code : SATCABLE
Price : £ 11.00 + vat each

Box of 4 - £ 40.00 + vat (£ 10.00 + vat each)

White - Order Code : SATCABLEW
Price : £ 11.00 + vat each

Box of 4 - £ 40.00 + vat (£ 10.00 + vat each)

Carriage charged at £ 6.00 + vat

Servicing the Philips MD2.2 chassis

John Coombes provides fault-finding guidance for this high-specification TV chassis

The Philips MD2.2 series chassis (MD2.21, 2.22 etc.) is a high-specification design for large-screen sets. It can provide a number of features such as 100Hz scanning, picture-in-picture, Dolby surround sound, a wireless Dolby output, dynamic bass enhancement etc. The exact specification depends on the model. The chassis was used in various models that were sold in the 1996-8 period.

A point worth noting is that there are two microcontroller chips, standby and main, which are on separate panels. The standby microcontroller chip IC7600 (TMP47C640/840) is on the small-signals panel K while the main microcontroller chip IC7200 (P90CE201ABB) is on the text/control panel J, along with various memory chips.

Power supply problems

In addition to the main chopper power supply many models have an additional one, with its own mains bridge rectifier, for the audio section. The main chopper power supply is conventional, see Figs. 1 and 2. It's based on an MC44604 control chip, IC7520, and a FET chopper device, Tr7541 (type STW9NA60/IRFPC48).

The most common cause of no results with these sets is a faulty on/off switch. To avoid further problems, make sure you replace it with the black type. Another fault that gives rise to the no results condition is failure of the 22V zener diode D6550, which is connected between pin 2 of the optocoupler IC7556 and chassis. This item is best checked by replacement.

A power supply repair kit is available, part no. 4822 3101 0649, to deal with the dead power supply situation. It includes the following items:

F1501	6-3AHT mains fuse. On mains filter panel
F1566	4AT fuse for 13V supplies
F1580	2.5AT fuse for 25V supply
C2540	220pF capacitor in parallel with Tr7520
R3505	1.5Ω, 7Ω surge-limiter resistor
R3546/7	0.39Ω resistors in series with Tr7520
D6510-3	1N5061 mains bridge rectifier diodes
D6545	BYV26C diode in snubber circuit
IC7520	MC44604 chopper control chip
Tr7541	Chopper FET
Thy7590	Standby-circuit 2N5064 thyristor

These items should all be replaced. Quote the model number when ordering as some components may vary.

Before carrying out this component replacement exercise, the chopper control chip IC7520 can be checked as follows to ascertain whether it's the cause of the failure. Disconnect the set from the mains sup-

ply and ensure that the mains bridge rectifier's reservoir capacitor C2505 is discharged. Connect the cathode of a BYD33D diode to pin 1 (supply) of IC7520 then connect a lead from pin 9 or 10 to chassis (live). Connect an external power supply between the anode of the BYD33C diode and chassis (live). Increase the DC input from the external power supply slowly while monitoring the chopper drive waveform at pin 3 of IC7520. The 48kHz drive should be present with the supply at between 14-17V. Above and below this voltage range the IC should shut down.

If there is no light from the LEDs and the power supply is pumping, check for a short-circuit in the line output stage (see later). If there is simply no output from the LEDs, the standby microcontroller chip IC7600 could be faulty. Check the DC conditions here, in particular for the standby 5V supply at pin 1. If nothing is obviously wrong, check IC7600 by replacement.

The LEDs give indications of various fault conditions. If the red standby light is flashing slowly this means that there's no communication with the main microcontroller chip. Check that the 5.2V supply is present at pin 11 of connector 56 on the text/control panel. If the voltage is missing or low, check D6520 (1N5822) which is on the 5V panel C and thyristor Thy7590 (2N5064) in the standby supply circuit – check it by replacement.

If the red LED flashes slowly at switch on then the green LED comes on during start up, check that the 5.2V supply is present at pin 11 of connector L50 on panel A (power supply etc.). If not, check that the 25V input to panel C is present at pin 1 of connector L50. If this is missing, trace back to source (D6581/C2580). If the 25V supply is present, check whether R3505 (2.2Ω) on panel C is open-circuit, then if necessary IC7508 (MC34163) which is also on panel C – check it by replacement. If the supplies are OK, check whether data is present of the I²C bus clock and data lines – there could be a short here.

If the red LED flashes fast, the set is in the protection mode. Check the error code with the dealer service tool (DST). If error code 44 is present and the green LED flashes four times before the red LED starts flashing again then the error code is 18, check the 5V supplies at pins 7, 14, 21 and 32 of the TDA9155 digital-deflection processor chip IC7315 on the DDP (digital-deflection processor/geometry) panel. If these voltages are incorrect, trace back to source or, if necessary, check IC by replacement. Also check the I²C data bus to the DDP panel.

If the green LED does not come on before the red LED flashes the error code is 47 and the cause of the

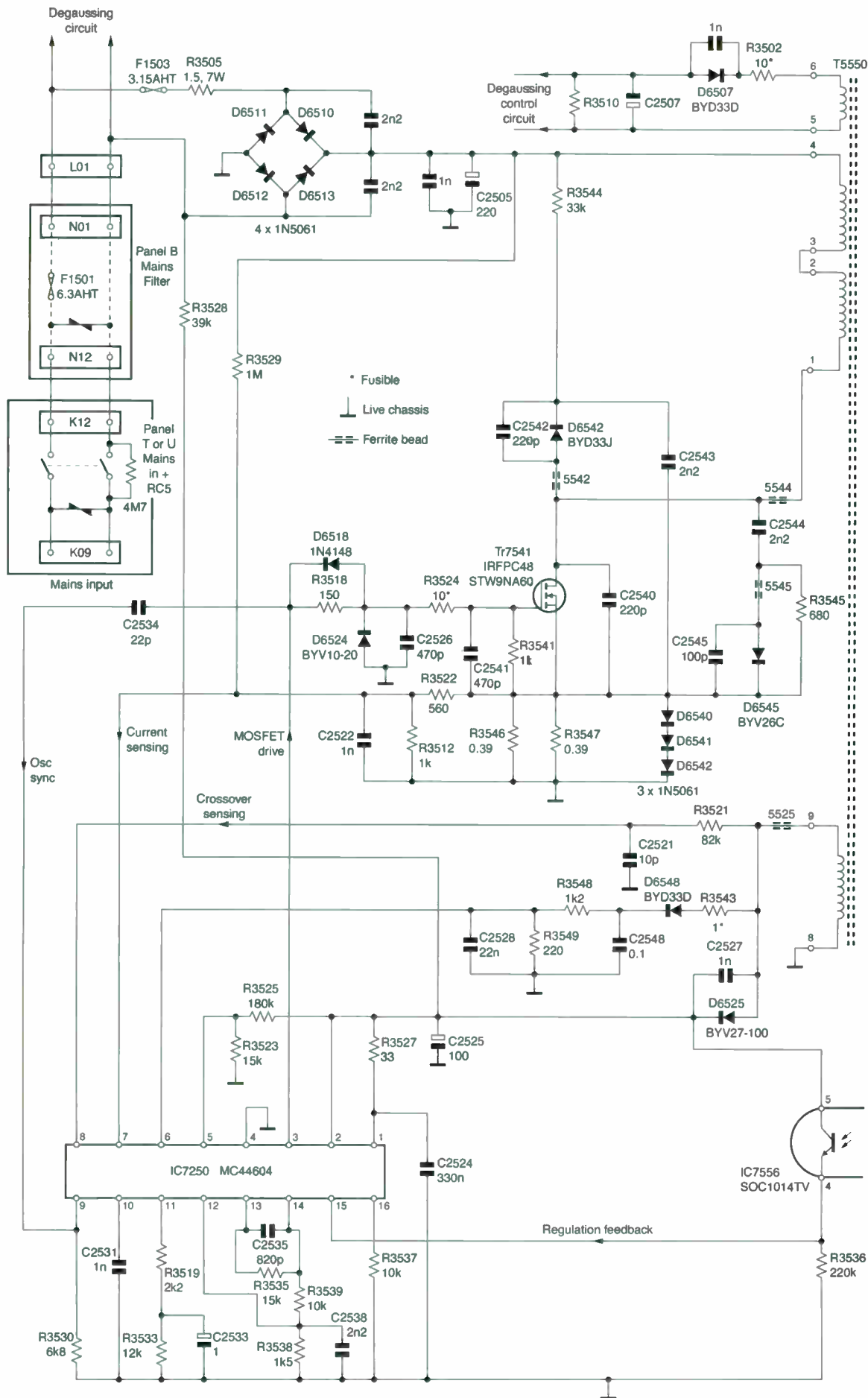

Fig. 1:
Circuitry on
the primary
side of the
main chopper
power supply.
Some compo-
nents may
vary depend-
ing on model
specification.

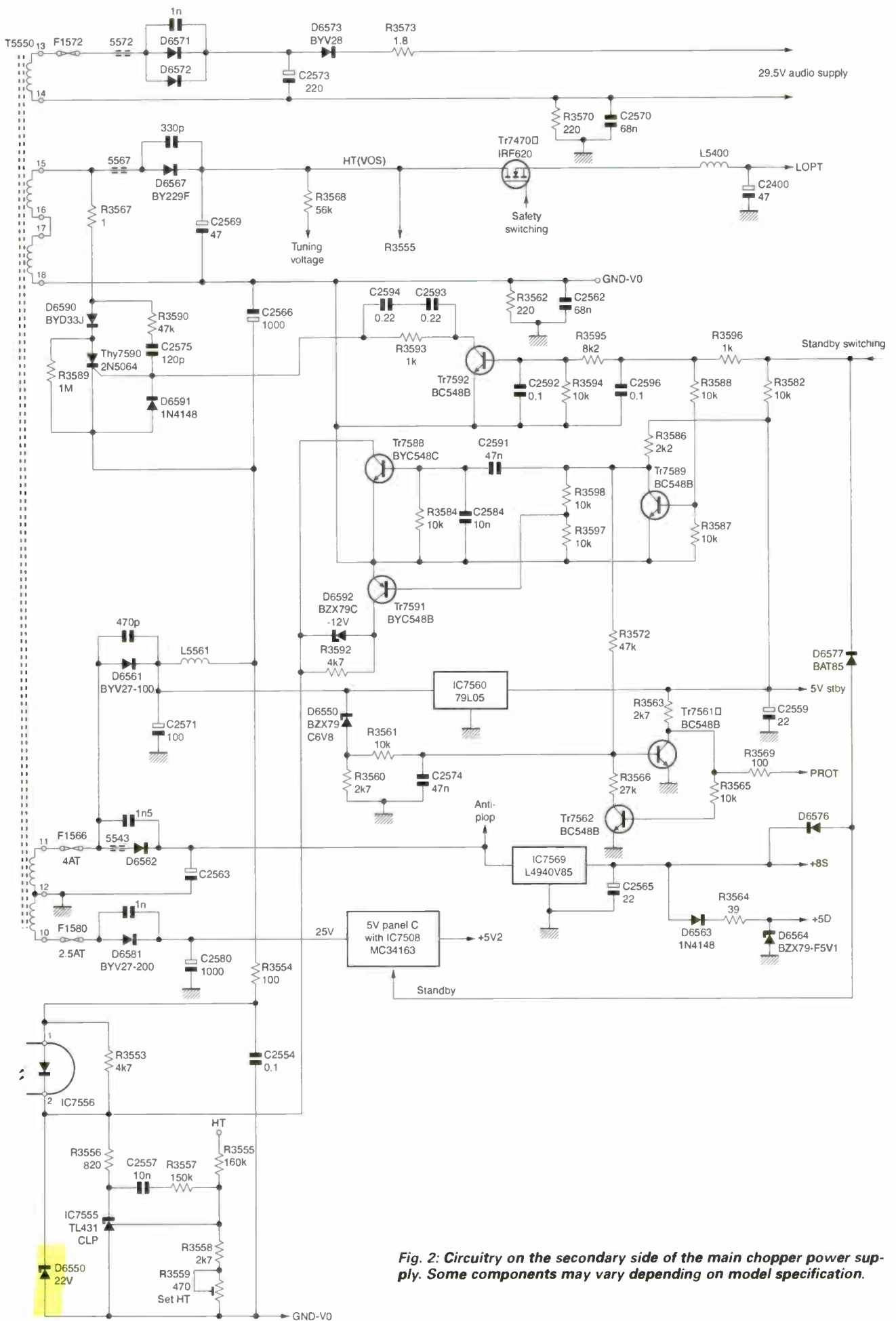

Fig. 2: Circuitry on the secondary side of the main chopper power supply. Some components may vary depending on model specification.

protection is in the line output stage.

If the red LED is flashing and the error code is 44, 47, 48 or 49, check whether R3415 (2.2k Ω or 2.7k Ω depending on the CRT) in the feed to the line driver stage is open-circuit.

If the power supply switches to the protection mode when the picture is clear or the sound is loud, check the chopper FET's source resistors R3546 and R3547 (both 0.39 Ω) by replacement.

If the power supply switches to the protection mode at start up, check C2524 (330nF) and C2525 (100 μ F) by replacement.

If the green LED comes on for a few seconds and is then replaced by the red LED, there is loss of power somewhere. Check for 8V at the output from IC7569 (L4940V85) and 5V at R3564 (39 Ω) on the main board and for 4.7V at pin 7 of connector S10 on small signal panel K. If the voltage comes up for a short time then starts to pulse there's a software problem. The cure is to replace the M27C4001 EPROM IC7202 (part no. 4822 9001 1058) on text/control board J.

If the set is dead except that the green LED lights for a few seconds, with no EHT crackle and no sound, check that 5.2V and 8V supplies are present and correct at the standby microcontroller chip IC7600. In one set we had the I²C bus data was present only briefly when the green LED lit: the main microcontroller chip IC7200 (P90CE201ABB) was faulty – a replacement restored normal operation.

If the start-up is temperamental with the standby LED flashing the SOC1014TV optocoupler IC7556 could be faulty. Use a variac to check. If IC7556 is operating correctly the set will start up with a mains input of only 60 per cent.

If the power supply whistles, add a 100pF capacitor in parallel with C2531, which is connected to pin 10 of IC7520.

When you have trouble with the power supply it can pay to listen carefully at switch on. If you can hear the degaussing, there is voltage at mains input panel B. If the EHT comes up, the digital deflection processor and the line output stage are working. The latter works only when 140V is present from the power supply. If the power supply is hiccupping, there's a short-circuit across the output, likely to be the line output transistor or an associated component.

There's an IRF620 switched protection FET in series with the 140V feed to the line output stage. If this item is faulty, the error code with the DST will be 47. It's tested at start up by the LM358 op-amp IC7360 on the DDP panel.

The line timebase

If there is a fault in the line output stage the error code shown by the DST will be 69. Check first whether the BU2520D line output transistor Tr7421 is short-circuit. Various faults can be responsible for the failure of Tr7421: shorted-turns in the line output transformer T5430; a faulty or dry-jointed TDA9155 digital deflection processor chip (IC7315); dry-joints at the line scan coils plug/socket L17; and shorted turns in the line scan coils.

Other possible causes of line output stage failure are the tuning capacitor C2418 (220pF) and the EW modulator diodes D6421 (BY359F-1500) and D6422 (BY229F-600).

If the set continues to hiccup after replacing Tr7421, try replacing the output transformer. In some cases it may be necessary to obtain the line repair kit, part no. 4822 3101 0707, and fit the parts included.

If the standby LED is flashing after start up and the error code is 47 or possibly 69 the set is in the protection mode, probably because the line pulse feedback signal (HFB) is missing. Check whether R3609 (4.7k Ω) is open-circuit.

If there's a screeching noise from the line output stage, the scan-correction capacitor C2433 is probably short-circuit. Its value depends on the tube type and size.

There will be no line output stage operation if the IRF620 FET Tr7470 in series with the supply is faulty. When the set is switched on it will cut out, showing error code 47.

Loss of line drive is another possibility. The line driver transistor Tr7408 is a FET device, type BSN304. Its feed resistor R3415 (2.2k Ω or 2.7k Ω depending on tube type) could be open-circuit. The problem is more likely to be in the pre-driver stage however, caused by failure of the transistor (Tr7409, type PH2369), its 2.2k Ω collector load resistor R3409 going open-circuit or zener diode D6409 (BZX79-C10) going short-circuit. If there is no drive at the base of Tr7409, suspect the TDA9155 digital deflection processor chip IC7315. Check the conditions at its pins.

EW faults

If there's an EW fault the diode modulator driver FET Tr7480 is probably faulty. You may also have to check its 1k Ω series gate feed resistor R3481. The fault caused by failure of Tr7480 can be EW distortion followed by switching to standby. Tr7480 has been changed to type IRF620F1, part no. 4822 1306 3546.

Field faults

The field output stage is based on a TDA8177 chip, IC7600, which receives positive and negative supplies, at pins 2 and 4 respectively, that are derived from the line output stage. There should be 12.5V at pin 2 and -14V at pin 4. Field collapse could be caused by failure of IC7600, but check whether its supplies are present. If the 12.5V supply is missing, check R3460/1 (both 1 Ω), D6463 (BYV27-200) and C2462 (470 μ F). If the -14V supply is missing, check R3462/3 (both 1 Ω), D6462 (BYV27-200) and C2466 (470 μ F). There should also be 12.5V at pin 6. If this voltage is missing, check the BYV27-200 flyback boost diode D6614.

Check for dry-joints at IC7600 and the field scan coils plug/socket L25 if the fault is intermittent field collapse.

No sound

The audio output arrangements depend on model, but the output ICs are all type TDA2616. In sets that have two of them, mounted on an audio output amplifier panel (AA), power is provided by a separate chopper power supply on panel AB. The chopper transistor here is Tr7302, type BU508AF. If it's short-circuit and the 6.8 Ω surge-limiter resistor R3300 is open-circuit, check for shorts across the \pm 16V lines. The cause is likely to be one of the audio output chips, IC7740 or IC7750. In sets that have a single audio output chip, IC7761, no sound usually means that this IC is short-circuit and F1572 (2.5A) is open-circuit.

CRT panel

If the fault condition is a bright raster with the sound OK, check that the 200V HT supply is present at pin 6 of connector R24 on the CRT/SCAVEM (scan velocity modulation) panel E. It's derived from pin 7 of the line output transformer. If this supply is missing, check

whether R3443 (6.8Ω) is open-circuit.

For intermittent loss of red, green or blue, check for dry-joints at the relevant RGB output chip, IC7330 blue, IC7340 green, IC7350 red. Replace the IC if necessary.

The tube itself can be the cause of a bright red, green or blue raster or intermittent loss of one colour, but check the RGB output ICs before condemning it.

Ringling on the picture

Philips recommends some component changes on the small-signals panel K. Change the value of R3537, R3538 and R3565 to 1kΩ, fit a 1kΩ resistor in position 4503 and remove coil L5501.

Bad focusing

Try shorting the CRT's focus and A1/G2 pins to the Aquadag then switching the set on for a few seconds only. Switch off, remove the shorts, switch on and check that the focus can be adjusted normally. If there's no adjustment, replace the CRT.

NS distortion at top

This symptom can be cured by adding the north/sound correction board, part no. 4822 2121 1564, in position 1091 on the main PCB. Remove bridge 9621 and fit bridges 9431, 9442 and 9443.

Degaussing faults

Degaussing faults produce red, green and blue circular patterns on the screen – a red spot surrounded by a green and then a blue circle. Philips recommends replacement of R3502 (2.2/10Ω), R3531 (2.2/4.7kΩ) and C2513 (100nF) in the degaussing circuit. We have also known the fault to be caused by the BT137-800E

triac 7507 in this circuit: check it by replacement – the part no. is 4822 1301 0195. Note that there are variations in the degaussing circuit depending on the type of tube fitted in the model concerned.

Intermittent loss of picture

The cause was traced to pin 12, the SCL data line, of connector S46 on the audio module PCB O. Check for dry-joints here and resolder as necessary.

No blue

The symptom was a red picture with no blue. Its cause was eventually traced to coil L5388 (56μH) on feature box PCB M. The part no. is 4822 1576 3316.

The Tuner

The tuner unit is very reliable. Snowy pictures or tuning drift can be caused by dry-joints around the tuner unit. A mechanical problem that can occur is a broken or dry-jointed aerial socket. This is sometimes repairable, but sometimes a replacement tuner unit is required.

Remote control

Dirty touch pads can be the cause of poor channel changing. No operation can be caused by faulty battery terminals or poor connections to the remote-control unit's PCB.

We've had no reaction to the remote-control unit though the green LED blinks all right, the input level at pin 54 of the main microcontroller chip IC7200 being too low. The cause was the 5.6V zener diode D6225, which is connected between pin 54 of IC7200 and chassis.



Wanted: A chopper transformer, circuit reference T1, part no. PELNO 301, for the JVC VCR Model HRS5800EK – it was also used in the JVC Model 720EK. Also a circuit diagram for the Aiwa NSX-S22 CD stereo system. F. Reeves, 5 Arnold Road, Clacton-on-Sea, Essex, CO15 1DD. Phone 01255 424 023.

Wanted: Service manual for the Acer Model 7156, a 15in. monitor that dates from about 1994. I need just one page from it, the circuit diagram titled A3, deflection circuit, showing the LOPT drive and the LOPT and CRT connections. An A4 size photocopy would do. Any help would be very gratefully received and costs reimbursed. Phone David Bolt on 01473 780 833 or email d.bolt@tesco.net

Wanted: M62445FP microprocessor IC for the Aiwa Model NSX-AV320, a 3-CD hi-fi. A complete board would be better, or a complete non-repairable unit. I also need a manual for the Panasonic Model SA-PM28 – the 5-CD mechanism is out of alignment. Has anyone managed to rebuild one of these? Mervyn Quilter, 23 Bearsdown

Close, Eggbuckland, Plymouth, PL6 5TX. Phone 01752 702 247 or email mquilter@eurobell.co.uk

Wanted: Does anyone know of a source of supply for the TDA7178 field output chip, or an alternative device or suitable transistor circuitry? Please phone Dowdell on 01752 663 289 (Plymouth).

Wanted: An STR1229 power-supply IC for the Sony SLF30 Beta video recorder, also a remote-control unit and video heads for this model; an M51436P IC for the Sanyo VTC-M20 Beta VCR; a bias oscillator coil (T701, part no. 1-433-272-00) for the Sony SLC40 linear-stereo Beta VCR; also any unwanted but intact Beta machines from Sanyo, Model VTC5000 onwards, and Sony, Model SLC9 onwards – will pay postage for them. Phone Colin McCormick on 01752 881 652 (Plymouth) weekends or 077 699 04857 evenings, or email colin99@bigfoot.com

Wanted: VIF pack, part no. 613 135 7884, for the Sanyo VCR Model VHR335E – new or second-hand as long as it works. Cedric Crook, 1 Carice Gardens, Clevedon, N. Somerset. BS21 5DG. Phone 01275 879 620.

Wanted: Old half-inch diameter ferrite rods. Must be six inches or more long. Will pay very good money for them. Peter Tankard, 16A Birkendale Road, Sheffield, S6 3NL. Phone 0114 231 6321.

Wanted: Circuit diagram for the Compaq V70 monitor; circuit diagram or any information on the Apple Multiscan 20 display

monitor family number 1823; circuit diagram or information for the Aiwa NSX-V70 digital audio system (three-disc player). Also can anyone supply some 22nF, 10%, 5kV capacitors – I need four to repair an oscilloscope? All costs will be reimbursed. Mike Quinn, 21 Hawarden Way, Mancot, Deeside, Flintshire, CH5 2EL. Phone 01244 531 639 or email mquinn2@hotmail.com

For sale: *Television* and *Wireless/Electronics World* magazines from 1975 to date. S. Jacovides, 20 Cheverton Road, London, N19 3AY. Phone 020 7272 7139 or email smj@freeuk.com

Wanted: Quad 33, 34 or 44 preamplifiers, 405 power amplifiers and FM3 tuners, for spares. Also boards and modules for these. Contact Mike on 01758 613 790.

Wanted: Upper and lower drum assembly for the Mitsubishi HSMX1B VCR, particularly the rotary transformer. The upper drum could be worn but left intact with the lower drum. Or, alternatively, a complete machine for spares. Roy Bailey, 22 Grebe Close, Waterlooville, Hants, PO8 9UT. Phone 023 92 783 811.

For disposal: *Television* magazines from Jan 1992 to Feb 2003, a total of 134 issues, eight years in binders. In good condition. Offers invited from anyone interested. John Langley, 125 Station Road, Burton Latimer, Kettering, Northants, NN15 5PA. Phone 01536 723 411.

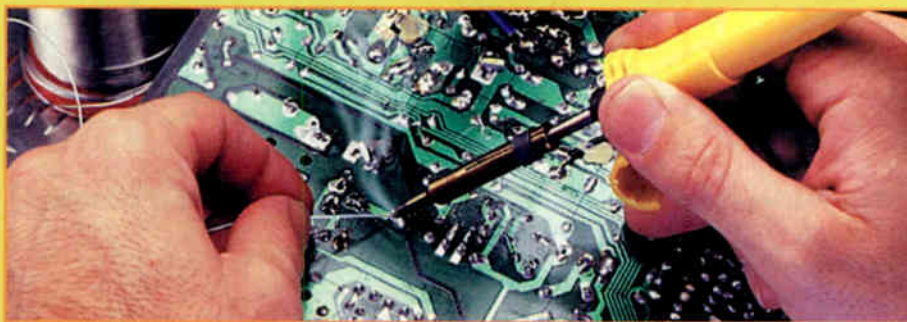

Adrian Gardiner on some TV/VCR and TV/DVD combi unit faults and a possible stock fault with the Sony FE2 chassis

Bench Notes

I ended last month by mentioning an Amstrad TVR2 TV/VCR combi unit that someone wanted to have repaired. Do you remember it? The TVR2 was one of the first combi units: it consisted of a VCR4000 series video with a portable TV set bolted on to the top. I didn't like it the first time round! In view of the age of the unit I had quoted, on the spot, about £100 to repair it, hoping that the owner would decide otherwise. After all, the local supermarket was selling a modern equivalent for £74.99. But he accepted. Will I never learn? And now here it was on the bench, after being delivered personally.

Repair or restoration?

The TV section of the unit was dead, though the VCR section powered up. Some quick checks in the TV power supply revealed the cause of the trouble: the STK7348 chopper chip was faulty. It's a large hybrid device (see Fig. 1) that was prone to failure at the best of times. I found that SEME could supply a replacement for just £2.60. A bargain, that. In addition I replaced the 2.2µF capacitor and carried out a general tidy up with respect to dry-joints etc.

I was pleased that the unit decided to behave itself when power was applied. It fired up and, apart from a slightly soft CRT, produced quite good results. Not bad for an eighteen year-old product.

I then decided to take a look at the VCR section. Although it worked all right, I didn't want the unit to come back as a bouncer. The deck was in surprisingly good condition and didn't really need any attention at all. I nevertheless decided to fit a replacement belt kit, pinch roller and back-tension band, and give the unit a good gen-

eral clean.

A long soak test after this work had been completed proved that all was well. The old-timer was ready for service once more. And the customer was doubly delighted, as the bill I finally presented to him was £40 below my original estimate. So it's ten out of ten, Amstrad. I didn't think these units would last, but you've proved me wrong. I wonder how many of today's combi units will remain in service in eighteen years time?

Bush TV/DVD units

I've had several of a different sort of combi unit in recently – the portable Bush TV/DVD model. These are fitted with the Vestel 11AK46 chassis, but the following notes also apply to the 11AK36 chassis. The units have all suffered from the same basic problem, which is caused by a flashover in models fitted with the CRT board type TP461-3. Symptoms are one or more of the following:

- (1) No picture.
- (2) Loss of one colour (red, blue or green).
- (3) A bright-colour screen.
- (4) No DVD playback picture, TV OK.
- (5) Picture shifted down vertically by about two inches.

The cause of any of the picture problems is failure of the video jungle chip IC403, which is type STV2246C. The picture-shift fault is caused by a base-emitter short in Q603, a surface-mounted transistor in the field drive circuit.

You will sometimes find that after replacing the jungle IC there's a sync problem when playing DVDs. The cause of this is a crushed video signal at pin 20 of the chip, the culprit being another surface-mounted transistor, Q1. Q1 and Q603 can both be replaced with a standard BC847A npn surface-mounted transistor.

Vestel recommends

that after repair the following modifications should be carried out to prevent a recurrence:

- (1) Modify the TP461-3 CRT base panel by adding three BA159 diodes between the 200V supply line and the RGB driver stages. The details are as follows:

Solder the anode of a BA159 diode to the cathode of D902 and its cathode to the collector of Q909 (intersection point with R913).

Solder the anode of a BA159 diode to the cathode of D903 and its cathode to the collector of Q908.

Solder the anode of a BA159 diode to the cathode of D901 and its cathode to the collector of Q907.

- (2) Connect an 8.2V, 400mW zener diode between the emitter of Q2 (at point of C424) and chassis (at point of C485). The zener diode's cathode should be connected to Q2.

- (3) Connect an 8.2V, 400mW zener diode between the collector of Q603 and chassis, cathode to Q603. Use sleeving to insulate the leads of the zener diode, and hot-melt glue to secure.

These five added diodes should be mounted on the print side of the PCBs.

Sony FE2 chassis

A Sony set, Model KV28LS36U, fitted with the FE2 chassis spent some happy hours on my bench recently. The complaint was "intermittently switches off".

In practice I found that it was difficult to get the set to come out of standby, with the front-panel LED flashing eleven times. According to the manual this means no 8V supply at the jungle chip, but in reality it can of course mean anything! I spent some time checking many possibilities, with no success. In fact I have to thank Sony technical for assistance with this one.

The culprit was C641 (470µF, 35V), the reservoir capacitor on the secondary side of the standby supply. When I checked it with my ESR meter the reading was 38Ω! A replacement restored reliable operation.

This is apparently becoming a stock fault, so it's one to watch out for. ■

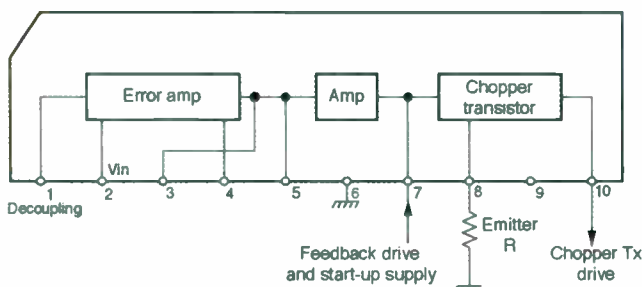

Fig. 1: STK7348 chopper chip pin connections.

LETTERS

Send letters to "Television", Highbury Business, Media House, Azalea Drive, Swanley, Kent, BR8 8HU or e-mail t.winford@highburybiz.com using subject heading 'Television Letters'.

Please send plain text messages. Do NOT send attachments. Be sure to type your full name, address, postcode, telephone and e-mail address (if any).

Your address and telephone number will not be published but your e-mail address will unless you state otherwise.



HDTV

I found the leader on HDTV (December issue, page 67) particularly interesting. As one of the many people who were rather dispirited by the loss of HDTV potential with the collapse of BSB a few years ago, I had grown sceptical of ever seeing it in the UK, at least in the forms that had been developed. I had tended to hold Sky responsible for this loss, as it not only ditched the MAC technology used by BSB but also adopted the policy of getting the maximum number of channels into the bandwidth available. So it's ironic that Sky now plans to introduce HDTV in the UK. In the current consumer electronics market the public seem to regard features and price as more important than improved picture quality. But Sky is smart: it will have carried out market research on this, and obviously believes that HDTV can be sold in the UK. This is good news.

While in the US at the end of last year I tried to get a feel for the public attitude towards HDTV there, and was surprised at the level of awareness. Some broadcasters are supporting HDTV well and publicising it. During a visit to the NBC Center in New York I noticed that HDTV sets are being demonstrated in the public areas, and that there's an HDTV theatre with a huge screen. This is being done in conjunction with Panasonic. But I wasn't over impressed with these demonstrations. They are clearly better than standard-definition TV, but not that much better. The theatre is certainly impressive, but can the public really associate this with the possibilities in their own lounges?

While at NBC I visited some of the TV studios and got talking to an NBC engineer about the transition to HDTV. One thing that came up is that as well as

having to replace cameras and other hardware it's necessary to replace many of the studio sets (we were talking on the set of *NBC Today*, the company's breakfast show). This is because, as so often with TV, sets incorporate much that is made of one material but is treated so that it looks like something else, for example silver-painted wooden rails look like metal on screen. Or at least they do with standard-definition TV, but the truth is apparent with HDTV! This is not something that might be immediately apparent when you consider the changeover to HDTV.

Nevertheless having seen the results in the US I'm quite optimistic for the UK – though not everything happens the same over here!

*Nick Beer,
Bideford, N. Devon.*

DTT reception

I think the answer to Dr Les May's problem (DTT reception, January) lies in the comment that his wife watches Welsh signals received from the side of the aerial. Here in Hampshire, some 36 miles from the London transmitter, I enjoy solid reception using a wideband aerial with just five director elements. The aerial is mounted 6ft above the ground on the back of the garden shed, keeping it away from the house electrics. It feeds the digibox via a Quantum 300 two-stage, line-fed amplifier.

One evening however all the digital channels were missing! Thinking that the amplifier had failed, I checked the analogue signals and found that skip propagation was present, with signals coming in from all over the UK. It seems that digibox decoders can't cope with shared analogue signals. So maybe Dr May's location is too good from the reception point of view!

*Esmond White,
Hook, Hants.*

I don't watch a great deal of TV myself but my wife had been frequently pointing out that we don't have ITV3 etc. So I decided to have a go at installing Freeview. Normally we get our signals from an NTL cable system, so this would mean installing a suitable aerial. Now it's always been my opinion that the best

thing to do with a ladder is to avoid going up it. As we are on a bit of a hill, I decided to try a loft installation instead. A Philips box was purchased from Currys (big cut-outs of Linda Barker everywhere), also a high-gain aerial, and within a few hours everything was ready for testing. The results with this initial set-up were spoilt by ghosting, and were a bit noisy – I had expected problems with drop-out etc. But when the box was tuned in I was rewarded with perfect pictures on all channels and, since the system is digital, it ignores whatever ghosts there are. The pictures are stunning with RGB connection.

There are a couple of irritations however. First, the receiver has trouble deciding on the aspect ratio. To correct this I have to go into the EPG menu and come back out again. Secondly the box locks out now and again, recovering only when a mains reset is carried out. But if it wasn't for the fact that daughter number two likes to watch Sky One now and again I'd kick the cable system into touch, such is the quality of DTT.

Incidentally we also went into the store next to Currys to look at its range of boxes. But we were faced with huge cut-outs of David Dickinson everywhere so promptly left!

*Mike Beddow,
Milton Keynes.*

I would like to concur with Dr Les May (January) regarding the long-term viability of DTT. We use a latest-generation DTT box that was inherited from my partner's elderly parents. They couldn't get on with it, finding that the extra programmes were by and large just repeats and being irritated by picture freezing. They live in a flat that's served by a communal aerial system.

I replaced my ten-element group C/D aerial with a quad array. Analogue reception remains perfect, while DTT signals show as half on the on-screen bar display. The picture quality is no different from analogue, but there is freezing from time to time. This is irritating but liveable with. During periods of high atmospheric pressure however analogue reception is marred, with co-channel interference apparent. I can often receive Dutch TV,

with no sound, and my aerial aligned with the Belmont transmitter produces near-perfect Tyne Tees TV on ch. 29. So I turn to DTT, and find that reception is non-existent! The signal level is still the same, but the system doesn't appear to be able to cope with the reception conditions we often encounter. Watching a programme with mild lines and interference is perfectly satisfactory compared to the almost continuous stopping with DTT.

I also wonder about the thousands of portable TV sets in kitchens and bedrooms, currently providing acceptable pictures using their indoor loop aerial or a £4.99 one on top of a cupboard. Yes, the picture may wobble as you walk about the room, but will a DTT box work with this sort of signal? I doubt it.

I'm not anti-digital. Indeed I think that CD and DVD are technically superb developments that warrant their success as reliable and consistent mass media storage formats. The difference is that a DVD player is connected to your TV set via a scart lead. A DTT box relies on a transmission path that's subject to all sorts of signal distortions. The system does not seem to be sufficiently robust to be able to cope with these. If and when analogue TV is switched off, will we be throwing the baby out with the bath water?

*Steve Ball,
Peterborough.*

I read with interest Dr Les May's article on DTT reception (January). I live at Crawley, 23km from the Crystal Palace transmitter, and installed a set-top box for digital reception about a year ago. The pictures sometimes suffer from pixellation and break up, but I think this must be because of poor signal conditions as reception is perfect for most of the time. It's possible that variations in ground conductivity can cause changes in the standing-wave ratio at the transmitter, particularly when the aerial is lower than eighteen wavelengths. As an ex civil aviation engineer I recall that we had trouble with instrument landing systems on the glide-path transmitter, using a frequency of 350MHz/wavelength 85.7cm. This is a lot longer than the TV broadcast wavelength.

It seems that the problem will cure itself when the analogue transmitters are switched off, as only the digital transmitters will be connected to the main aerial system. At the moment there are two aerials, for analogue and digital transmission.
*P.D. Somerville,
Crawley, W. Sussex.*

Experts

I've been in the TV repair trade for over

thirty years now. It can be very stressful and frustrating, but there's also a fair amount of humour to help things along.

In the early Eighties I was working as a bench engineer at the local Comet service department. One day a well-dressed chap left a portable TV for repair, saying that it had "gone off" after he had repaired the aerial socket.

In those days, before the advent of scart sockets and AV inputs, it was common for small TV sets to have a live chassis. The aerial socket would be isolated from dangerous mains voltages by small capacitors that were usually built into the socket itself. Our customer's DIY repair had involved soldering the coaxial cable from the tuner directly to the aerial socket, thus making it live. When he had connected it to an outside aerial and switched the set on, the set had gone bang, blowing the mains bridge rectifier diodes and the input fuse. Had the set been used with a portable aerial, someone could have received a nasty or even fatal electric shock.

After reporting the situation to the service manager I was told to phone the customer with the repair estimate and tell him just how dangerous his DIY bodge had been. The man came in a few days later, red-faced, to collect his now repaired set. He apologised profusely, saying that he should have known better than to mess about with electricity when he knew nothing about it, and that in future he would leave such jobs to the 'experts'

I subsequently learnt that he was the safety officer at a nearby chemical plant!
*Martin McCluskey,
Bishop Auckland, Durham.*

Flowerbed aerials

Back in the Sixties I had experienced poor BBC2 reception at a couple of resi-

dences and longed for Crystal clear reception! In 1969 I moved to a bungalow at a high location in Barnet and thought everything would be OK. But I was wrong! The existing aerial produced grainy pictures with my new colour TV set, so I carried out an investigation in the garden, using my valved Labgear signal-strength meter. I had already discovered that the output from the existing outdoor aerial was an unacceptable 120-150µV. I took the aerial, steps and the meter and searched around in the garden for something better. I was amazed to find a limited area that produced about 400-500µV, but at only 4ft from the ground. The signal strength decreased rapidly as the aerial was raised higher.

The only answer was to mount the array in a flowerbed. The result was excellent pictures! In fact I think this freak-area reception meant that the current aerial was largely useless. Presumably the signal was basically good but, being on the wrong side of the hill, it was maybe following the ground contours?

My doctor, who lived a few doors away, had also been suffering from poor reception. He thought that the need was for a higher aerial. I agreed, in theory, but not in this road! He agreed to try my approach, and later invited me around to view his fine picture. Having no convenient mast, he had used a piece of 2 x 2in. wood in a flowerbed. It certainly did the job!

A year or so later I discovered that if the aerials were turned north, to obtain reception from Sandy Heath (Bedfordshire), the results were better than with the aerials pointed south for London reception. The only problem was that some programmes were different (Anglia).

*Philip Bearman,
New Barnet, Herts.*

Articles welcome

Ever thought of writing an article for Television? If so, we'd be interested to hear from you. Maybe you've a project to describe, servicing information or know-how on a chassis or product we've not previously featured, or could write on some aspect of the technology we've not previously gone into. We cover audio as well as TV/video, and are interested in IT topics. If you have any ideas or want guidance, please email

t.winford@highburybiz.com

or write to The Editor, Television, Highbury Business, Media House, Azalea Drive, Swanley, Kent, BR8 8HU.

Payment for articles is made shortly after publication.

Working for the mob — and others

HAIRY EYESES on the social and some financial aspects of being a self-employed TV engineer

As so often, the dinner's ready to be dished up and he's "just popped out to return a television". Thank goodness for microwave ovens. A few years ago meals would have dried up in the oven or gone into the dog!

It must be lovely to be married to someone who works nine to five. You would know when to expect him home, allowing for train delays or hold-ups on the motorway of course. But the quick delivery to the lady two miles away will no doubt involve endless cups of tea, a chat about the family, and a quick look at her 'wireless' that makes a noise when she Hoovers the lino! But why should I worry? It's just another day, albeit New Year's Day, at the home of a TV engineer's wife.

A trip to Birmingham

That reminds me of the day he disappeared with the local mob. No, before you ask me he doesn't do the odd bank job in his spare time — though the money would come in handy! At one time he had a group of customers who were somewhat loosely related to each

other. They were such that you just arrived, did the repair, and left as soon as possible. You never asked questions, and took no notice of strange items around the house.

I had taken the phone call. Could he come and look at Ma's TV? "No problem" I said and booked the visit for next morning. They had wanted it done immediately, but I said "no".

Next morning himself left with his tool case and a fistful of calls to make. I expected him back for lunch. Now this was in the days before mobile phones (yes, believe me, that time did exist!). So, when he hadn't appeared by teatime I

didn't have any way of knowing what had happened to him. Other than phoning every customer or visiting the local morgue, I would just have to sit and wait. Eventually he rang.

"Have you started dinner yet?"

Aren't those the first words all men say! "Yes, why?" I replied.

"Because I may be a bit late."

"Where are you?" I asked.

"Birmingham."

Now I have nothing whatsoever against that great city, and in fact fond memories of many people who come from the area. But we live some 200 miles to the south, and our service area doesn't extend quite that far.

"What the bleep are you doing in Birmingham?" I responded.

"Repairing Big Bernie's Mum's telly."

"I suggest you climb straight into our car and come home. The three jobs I've booked for this afternoon are now screaming blue murder."

"I can't. BB and his brothers took me in their car!"

He arrived home in the early hours of the morning, with a Five-pound tip and a frosty welcome from me. Oh, and the dog enjoyed his steak and chips!

A wedding

Working strange hours can also play havoc with your social life. You accept that a self-employed person has to take work as and when it's offered. But it can cause problems. This happened to us when a rather worried customer rang asking for repairs to about six TV sets and videos at the same time. I've often wondered whether people save up their repairs and check my diary to make sure that we have an important event to go to before they phone!

We were due to go to a wedding that afternoon. Not a casual affair, but one of those elaborate affairs with top hats for the men and uncomfortable corsets for the

women. Fortunately himself had already bathed and been out for the required haircut. He was expecting a few hours' leisure before we left, but thought he could just pop out, do the job and get home to collect me in time for the Hail Marys and I dos.

But the best laid plans of mice and TV men went out of the window. He arrived home at about the time that the bride would be walking down the aisle. There was no time for him to change from his solder-splattered jeans and T-shirt. We threw his clothes into the car and sped to the church. With a bit of luck, he could change in the car and we could filter into the crowd as they emerged from the church.

No so as it turned out. Being over six feet tall, he couldn't change his trousers behind the driving wheel. He would have to jump out and do this quickly while no one was about. It didn't work out quite like that. He dropped his trousers just as the bride and groom made their exit from the church, surrounded by their proud families. Yes, you've guessed it, the only parking space was right in front of the church!

Fortunately the friend who was getting married found this highly amusing. It was talked about long after the wedding, and in fact the marriage, was over.

Occasional work

I inevitably mention meals from time to time in this column. But to eat you need to earn money. With the service industry being what it is today, there have been times when we have accepted work from the smaller local workshops on a weekly basis. Sometimes this has led to extended employment. Great! Himself would vanish, and our own jobs could be fitted in before and after the hours he worked. I'm sure that many of you have worked in this way.

But have you noticed something strange about such arrangements?

You will be able to fix my ma's telly, won't you?

I hope I'm home in time for tea!



Come Christmas, Easter and the hundred and one other bank holidays we have you are not required to work, as the workshop owner wants to lock up and disappear to his villa in the Maldives or his yacht moored at Nice. Take a look at your pay packet. I bet he's deducted the day's pay. Call me cynical, but if train drivers and postmen were treated like this the country would come to a standstill. So, being an irritating female, I've done a little questioning of the powers that be.

It seems that if you work for someone on a regular basis, and the work constitutes your main income at the time, the employer is liable to pay you for bank holidays and also pay your National Insurance etc. These are the questions you have to answer:

Does your employer set your hours?

Does your employer decide what your pay is?

Does your employer decide what your work is each day?

Does your employer supply materials for you to carry out the work?

Answer yes to most if not all of

these questions and you will be better off as, technically, you are classed as an employed person and are entitled to the benefits of employment.

So all you have to do is to present these facts to the chap who is employing you and you'll be quids in. That's what I told himself some time back when he was in this situation.

Himself's answer, well the printable version, was that if he was to do this he would, after the laughter had come to an end, be told "goodbye and thank you!"

Doesn't seem fair, but he is right. Many employment laws don't look after the single self-employed person. So, before you take up a 'long-term self-employed' position, remember to include your holiday leave etc. in any financial arrangements you make at the outset. It will be too late once the job has started.

Bouncing cheques

Fortunately we have not come across many uncaring employers over the years. But when we have, boy can they be nasty characters! One that comes to mind would pay

weekly by cheque. I would bank it on Monday, and it would bounce on Wednesday.

He had exhausted every excuse in the book, and each week promised that it wouldn't happen again. But of course he never had the cash to pay us – it was filtered away before the taxman could find it. This is very hurtful when you see his wife driving around in a brand new car, wearing designer cloths.

So devious means were required. The boss concerned had a part share in another business, one that always had a lot of customers present. A swift phone call was made to his partner, pointing out that if it happened the following week we would be sitting in the middle of the shop waving the offending cheque until it was cashed. We were never given a bouncing cheque again.

Next time

Handling dodgy bosses is, of course, easy compared to the precocious children that belong to customers. But I'll leave that for another time. I can smell his dinner burning!

FREEDOM OF VISION



LIBERTY - FTA 786

- Offering 4000 TV and Radio channels
- Separate TV / Radio List and Favorite group
- DiSEqC 1.2 function and USALS function
- Small size (260x180x55mm)
- Games Included: Tetris, Block out
- 12 languages OSD, (English, Arabic, Russian, French, German, Italian, Spanish, Polish, Turkish, Persian, Dutch and Greek.
- Fast channel switching and downloading



LIBERTY - CI 9800

- 2 slots common interface
- Offering 4000 TV and Radio channels
- Separate TV / Radio List and Favorite group
- DiSEqC 1.2 function and USALS function
- Small size (260x180x55mm)
- Games Included: Tetris, Block out
- 12 languages OSD, (English, Arabic, Russian, French, German, Italian, Spanish, Polish, Turkish, Persian, Dutch and Greek.
- Fast channel switching and downloading Liberty - CI 9800

MAIN DEALER:

Freddie's Satellite Shop

64 Chadwell Heath Lane

Romford, Essex RM6 4NP

Tel. 020 8586 4111

Fax: 020 8597 6295

E-mail - sales@liberty-sat.com

Web site - www.liberty-sat.com

DEALERS:

Kent: JAY'S Satellite and TV Tel: 01474 537746

Lncolnshire: T K Electronics Tel: 01525 344102

Dagenham: RTV Satellite Tel: 020 8592 5152

LIBERTY

Dishes, Cams, LNBs, and other satellite related equipment also available.



Service Casebook

Michael Maurice

Hitachi C2886TN

The reported fault with this TV set was no colour when the customer's DVDs and videocassettes were played back from his Panasonic DVD/VCR combi unit, though Sky TV was in colour. The TV set had an extended warranty. The DVD/VCR unit was within its first-year warranty, but had been bought from another dealer. The customer had called the service department for the TV set – it was one of the main multiples. Their engineer saw that Sky colour was present and said that the TV set must be OK (the customer didn't have a terrestrial TV aerial). He suggested that the fault must be with the DVD/VCR unit, or that there could be a compatibility problem. The DVD/VCR unit was checked with another TV set and found to be working correctly. This is where I was called in.

The TV set was indeed showing Sky in colour, while there was only black-and-white DVD/VCR playback. A quick investigation showed why! When I checked the Sky box's settings I found that the output was set, as I suspected, to RGB. When it was set to PAL there was a black-and-white picture with Sky as well. So the TV set was in fact the cause of the fault.

I removed the chassis, resoldered all the usual joints around the regulators and the earth links around the microcontroller chip, then turned my attention to the jungle chip. Amongst other things it's responsible for colour decoding. There are two associated crystals, also two small-value capacitors (don't ask me the reference numbers – it was ten o'clock at night!). One of the capacitors was also earthed on the component side of the PCB. I resoldered the crystals, capacitors and, for good measure, the earth plane. Then, when I reassembled the set, I was rewarded with both Sky and DVD/VCR colour.

I understand that a rather snotty letter is on its way to the warranty company, demanding that it pays my charges.

Bush WS6673SIL

It seems that these sets can be fitted with either the 11AK19 or the 11AK37 chassis, which is completely different! This one was an 11AK37 version. The fault symptoms were a very wide picture with no EW correction. It didn't take me long to find that C622 (12nF, 630V) was short-circuit. It's the lower capacitor in the EW diode modulator circuit.

Proline NV3200

The complaint with this set was intermittent loss of the picture, the sound remaining. The fault was present when I got to the house, and I found that there was no

EHT. While tapping around the signal PCB the line output stage started up and produced EHT. So I decided to resolder every joint in the vicinity of the jungle IC, including the pins of the IC itself. This seems to have cured the fault.

Mitsubishi HSM16

These older VCRs are built like tanks. The mechanism is based on a diecast chassis – those were the days! The symptoms with this machine had been no display for a while followed by no functions. It didn't take me long to discover that most of the electrolytic capacitors in the power supply were leaking and that R905 had been completely corroded. I cleaned up the mess on the PCBs and replaced C904, C905, C906, C909 and R905. After that the machine worked beautifully.

Hitachi C2976TN (A5 chassis)

This set ticked when it was switched on. I soon found that the line output transistor was short-circuit because of a dry-joint at the scan-correction capacitor, which had split open. As there were dry-joints at the EW loading coil, I replaced the TDA8350Q field/EW output IC as well. Fortunately no other damage had occurred.

Thomson 28VK24U

The fault symptom with this set was intermittent: the picture would sometimes become distorted, with zigzag lines and edges. Sometimes it reverted to standby. As the line output transformer was of the cream type, I decided to replace it. Fortunately this cured the fault.

LG RE-32FZ10PX

This beast would come on for a couple of seconds then revert to standby. It was up three flights of stairs, so it had to be repaired there or not at all! I soon found that the power supplies came up when the set was brought out of standby. Removal of the main board revealed the cause of the fault. The line output transistor's collector (Q402) was dry-jointed. All was well once this had been attended to.

Toshiba 55PJ6DB

There were two things wrong with this monster projection set: the convergence was very poor, and the picture was poor and rolled for the first few minutes. The convergence fault was cured by replacing both STK-392-110 ICs on the convergence board. The picture fault was cured by removing the IF module and replacing every electrolytic capacitor on it. These capacitors are not the standard type: they are small, miniature ones.

WEB SERVICE

To reserve your web site space telephone
 Tel: 01322 611291 Fax: 01322 616339
 E-MAILS m.traylen@highburybiz.com



Alltrade Aerial & Satellite Ltd

www.alltrade.co.uk

Leading distributor to the trade
 Full e-commerce site with over 1500 products
 with in-stock quantities!! We supply
 everything associated with Digital/Analogue
 Terrestrial & DTH/Motorised Satellite reception.
 All Antennas. All Brackets. All Cables.
 All Connectors. All Amplifiers.
 We provide a free MATV/SMATV planning
 service as well.
 Phone 0845 075 0751
 Fax 0870 770 9151

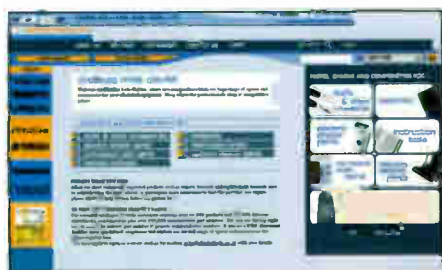

Charles Hyde & Son Ltd

www.charleshyde.co.uk

Search for both original and copy spare parts
 in our extensive database covering Akai,
 Alba, Bush, Ferguson, Goldstar, Hitachi, LG,
 Matsui, Nokia, Saisho, Sanyo, Sony, Sharp,
 Thomson, Panasonic, Philips, Samsung,
 Tascam, Teac, Toshiba, Yamaha and many
 more. In addition huge ranges of Lasers,
 Laptops, Remote controls and Semiconductors
 may be accessed.



College of North West London

www.cnw.ac.uk

The College of North West London is one
 of the largest further education colleges in
 the UK with three major centres in north
 west London. Most of our students use the
 College as a stepping stone to
 employment or higher education – we
 have links with Middlesex, Westminster
 and Thames Valley universities. Once they
 begin their careers they often come back
 to us for further qualifications and more
 specialised training. This means we are a
 College with a great mixture of ages,
 backgrounds and experience and this
 creates an interesting and lively
 atmosphere. One great benefit of our size
 is the exceptionally wide choice of
 courses. With few exceptions, whatever
 you want to do, and at whatever level,
 you can do it at the College of North West
 London. Most of our staff have
 considerable experience working in the
 area of their specialism and they know
 their industries thoroughly.

**See page 274 for details of our
 Plasma Technology Course.**

**For just £29.17 per month
 you could advertise your
 website in this section.**

**It will be seen by over
 8,000 repair and
 installation engineers.**

**Call Mike on
 01322 611291 to secure
 your space today.**



SOFTCOPY

www.softcopy.co.uk

As a PC data base or hard copy,
 SoftCopy can supply a complete index of
 Electronics World articles over the past ten
 years. Photo copies of articles from back
 issues are also available.



Swires Research

www.swires.com

Swires Research produce high quality
 instruments for the television industry,
 including portable signal level meters and
 spectrum analysers for digital and analogue
 RF signal measurements.



Wizard Distributors

www.wizard-distributors.co.uk

Main distributor for major brands. Search by
 make/model for LOPTX; switches; remotes etc.
 Find ICs; semiconductors; service kits; lasers;
 capacitors; resistors and a huge range of
 service aids, tools and other products.

A noisy time for Mr Wooster

By Brian Storm,
with apologies to P.G. Wodehouse

We Woosters are never at our cheery best first thing in the morning. So it was with some alarm and indeed trepidation that I awoke at an unseemly early hour to the sound of some Irish Johnny bellowing out from the radiogram.

"Jeeves!"

Jeeves materialised at the door. "Good morning, sir" he intoned.

"What the deuce is that bally row?"

"I take it that you are referring to Mr Wogan and his national morning broadcast, sir."

"I want it off, whatever his name is. Too dashed early for revelling."

"Very good sir. It appears that someone has programmed the radio to come on at this hour. It is a common occurrence with modern audiophonic equipment."

With that Jeeves trickled across to the offending object and calmly stifled it.

"Will that be all, sir?"

"Yes."

A proper start

I awoke some time later, at a more respectable hour. But I don't mind saying that the radiogram episode had rattled me. It seems no longer safe to visit country houses anywhere these days. They all seem to be chock full of noisy and unfathomable gadgets.

"Good morning, sir" said Jeeves.

"Morning, Jeeves" I replied.

He put the good old cup of tea on the bedside table soundlessly. I took a refreshing sip. Just right as usual. Never too hot or too cold, nor too much milk, and he seems to know by ESP when I am awake and dully arrives exactly two minutes later with the reviving brew. Jeeves is still a blessed marvel, even after all these years.

"Jeeves, can you make sure that bally radio gadget doesn't come on again while I'm here?"

If anyone can master these gadgets, surely someone as bright as Jeeves can.

"Sorry to say, sir, I am not familiar with the oper-

ation of these oriental radiograms. I have already taken the liberty of perusing the operations leaflet but, although the words are English, their grammatical nuances escape me. I will have it removed from your room presently."

With that he streamed out to fetch the eggs and b.

By the time I came to marmalade the good old toast things seemed much more right with the world. The sun streamed through the windows and fluffy white clouds were sauntering about in a bluish sky.

Guests

I dressed in a sprightly fashion and almost took the stairs down two at a time, which at my age can be a trifle risky. But the day was so blessed inviting. As I descended on to the hall carpet a tall gangly youth hove into view.

"What ho, topping morning, what!" I exclaimed.

But the youth walked past as if in some sort of a trance. I was about to admonish the ignorant young blither when I noticed that he was wearing one of those blasted stereo headset thingummies that are so darned popular with youths these days. So I proceeded onwards, holding my tongue.

Undeterred by the stillborn conversation, I pattered along to the drawing room, where there appeared to be a party going on before lunch. Various people seemed to be thumping on a pianoforte whilst simultaneously beating a set of jungle drums. As I opened the drawing-room door, the decibel count cranked up several notches further.

Inside, an assorted gathering of people were sitting in front of one of those blighted television things that are all the rage these days. I backed out promptly – no one had appeared to notice me enter.

Lord Mayfield

Feeling in need of a restorative before lunch I proceeded to locate the study of my host, Lord Mayfield. The Mayfields made a decent pile from the family publishing business in London, and he had recently invested a considerable chunk of it in this Hereford mansion where I am presently on the loose. He was friendly with two of my old aunts in the past, and thus keeps an open invitation to Betram should he require a convalescing



trip to the country.

"Ah, come in Mr Wooster" he said as I knocked and poked my head rather gingerly around the door.

In my days studies were places where a cove could park himself in a quiet oasis and ponder in peace and quiet. But Lord Mayfield's study appeared to contain working machinery. Cabinets whirred and hummed, screens glowed and diverse things chattered incessantly in the background.

"Fancy a quick one?" I said above the clatter.

Lord Mayfield took the hint and led me to a side room, where he uncorked the b. and soda.

"Topping weather, what" I proffered.

"Yes, but due to peter out into light showers by tomorrow and a strengthening westerly wind will make it feel a good deal cooler" he replied.

"Rather beats my bit of old seaweed for detail" I commented.

"Got it off the internet just minutes ago."

"Off what?" I was beginning to feel queasy.

"The internet. Best thing since sliced bread. Allows me to work from home for the family business in London, Marvellous invention. Wouldn't be without it."

I had led a long and carefree life without stumbling across this infernal internet thing, so I tried steering the conversation towards more familiar lines.

"Going to Goodwood next month?" I asked.

"No. Much too busy. But I might catch some of it on television. We've just had Sky installed."

Well, the blighter had lost me again. So I let the conversation lapse. No one discusses internets and televisions and Sky at my club – though we have in fact recently admitted a rather elegant Queen Anne style oaken radiogram to one of the club's rooms, and I have to say that I admire the mellow tone of the thing enormously, especially when Count Basie is playing quietly in the background. Marvellous what they can do with gramophone recordings these days.

Another shock

"Have a look at this, Mr Wooster" urged my host.

He opened the door to an adjoining room and prodded a light switch. "This, Mr Wooster, is my home cinema."

I was snookered by the announcement. To me, cinemas generally involve leaving the jolly old flat and legging it down to Leicester Square. Mind you I gave that up some years ago as, every time I ventured to sit through some interminable epic, someone had cranked up the sound a further couple of notches to the extent that I had blood trickling from the blasted ears before the first advertisements had even finished.

"Rather jolly place, what" I responded.

"Observe, Mr Wooster: a 60-inch plasma screen with five-channel surround sound."

I could feel the conversation veering away from me again as I barely understood one bally word of his pronouncement.

"1,000 watts RMS of power available through those electrostatic speakers."

"Jolly decent, what" I interjected, hoping for some English words to enter the conversation.

"Listen" he said, and poked at some sort of telephone handset.

The room erupted in a blaze of light and thunder, and I promptly proceeded to break the world record for the standing high jump by a respectable margin.

"Sorry, Mr Wooster" Lord Mayfield apologised, "I'll just turn the sound down. Must have left it a tad too loud after our last family film."

Lunch

Just as I had regained my full hearing again the luncheon

gong sounded. So we all scooted off sharpish to the dining room.

During the soup course I could hear some sort of persistent scratching noise to my left, but simply couldn't locate the source. Surprisingly, this persisted after the eating irons were downed. The scratching noises continued all through the next courses until the ladies left the table when, I'm blowed, the scratching noise went as well.

Then I located the root cause of the problem. Lord Mayfield's daughter Chloe had one of those stereo headset thingummies hidden in her hair. Dashed thing revealed itself as she trooped out of the room.

Retreat

After lunch I thought I would seek a bit of peace and quiet in the grounds, and read a rather spiffing detective novel that I had acquired recently. But I couldn't get away from some jabbering johnny who blared from the radio through various open windows. This incessant jabbering was interspersed by assorted thunderous cacophonies. Eventually I gave up seeking a quite glade and returned to my room – gratified to notice that the black plastic radio abomination was now absent.

"Jeeves!" I called hopefully.

"Good afternoon, sir" he immediately responded.

"Break out the Bentley, Jeeves, I desire some peace in this noise-blighted countryside."

"I have already taken the liberty, sir, of preparing the conveyance, as I was also desirous of removing myself to a more sedate part of the country until dinner is served this evening."

"Right ho then Jeeves, let's make tracks."

For many years I trundled about in a sports model, but the ravages of time have made me less fond of feeling every bump and divot rattling up the spine into my jaw. Comfort is now the top option.

There was a deuced odd thing though when the Bentley was first delivered. It had the impertinence to speak at you, telling you to administer seat belts and shut doors – in a strident female voice, not unlike me dear departed Aunt Agatha. Jeeves promptly returned the vehicle, and had the offending noises removed. I've never quite managed to operate the radio receiver inside though: seems to require some sort of technology degree, and damned good eyesight to read what's printed on the buttons. It also insists on barking out traffic reports at a brain-damaging volume, regardless of the station, so I never use it. It's a topping automobile nevertheless, like riding along on a soundless cloud.

I steered the Bentley in the general direction of London, thinking how quiet and peaceful it was in my distant flat.

"Jeeves", I said cautiously, "would it be too beastly to scarper back home without saying farewells?"

"I had anticipated your reluctance to return to his Lordship's abode, and have taken the liberty of confiding to him that you have been called away to important business back in London. To that end, I had already packed the luggage, which is now with us in the automobile's rear storage area."

"Jeeves, you're a marvel, a deuced marvel."

"One endeavours to please, sir."

"Jeeves, has the world changed for the worse with all these infernal noise-making gadgets and televisors that the great unwashed seem to gush over for positively hours?"

"Yes, sir. I'm sure it has changed in just the way you state."

"Jeeves, you may take the evening off. I will be dining at my club tonight."

"Thank you, sir."

"No Jeeves, thank you."



DX and Satellite Reception

Terrestrial DX and satellite TV reception reports. Broadcast and satellite TV news. Yet more interference! DAB quality. More on the Roberts Gemini 6. Goodbye to the Southampton TV centre. Roger Bunney reports



Protesting crowds in the main square, Kiev. Reception via Eutelsat W1 (10°E).

The year 2004 was a fair one for Sporadic E reception, considering the gradual demise of Band I as a TV transmission medium. A couple of auroral events added interest and, as an end-of-year bonus, a period of enhanced tropospheric propagation occurred from 6 December through to the 14th. The signals were good, with very strong, sustained French Band III/UHF reception along the south coast, and intense signals from Germany, Denmark, the Benelux countries and North East France in the east and south east. Cyril Willis (King's Lynn) reports very good Band III reception, including NRK (Norway) chs. E9, 10 and 11 on the 10th. The Band III channels were full of German transmissions. When he checked Band II/FM Cyril found DR (Denmark), NRK (Norway) and Swiss transmissions, while DAB provided reception from the Benelux countries and even Denmark. In the Netherlands Gosta van der Linden found that his local Wavre chs. E8/E28 and Saint Pieters-Leeuw chs. E10/E25 were totally wiped out by interference. Some old-stagers suggest that the December tropospheric opening was one of the best in recent years.

Not unexpectedly, SpE results in December were poor. Peter Schubert (Rainham) and I noted Band I activity on the 4th, in chs. E2 and E3, with sustained, low-level signals. The ch. E2 reception was with substantially vertical polarisation, suggesting possibly Madrid. There were again unidentified sustained, low-level ch. E2 signals on the 24th, in the late morning. An email from Hugh Cocks in the Algarve suggests that from early December TVE Madrid ch. E2 was either operating at very low power or had gone off-air. It's no longer being received at noise level at Hugh's location, where the only ch. E2 activity is from RTP. If TVE Madrid has closed down, it had long been expected. We were lucky that the closedown was so long delayed. But it will be missed: TVE Madrid was my first SpE reception back in May 1963!

Satellite sightings

Compensation for the poor terrestrial reception in recent weeks has been provided by a wealth of satellite sightings. Perhaps the most important event during the period was the move of Eutelsat W3 to 21.5°E, as a replacement for 2F3 whose inclined orbit exceeded 3.5°. 2F3 had been much used for UK outside broadcasts, such as SIS racing, and for SNG purposes. It provided cheap signal carriage as the unstable orbit called for the use of a tracking dish. During the late November period however there seems to have been a transfer of Eutelsat customers, with SIS, ITN and other UK operators appearing via the aged Intelsat 603 at 20°W. This satellite is also in an inclined orbit, running at about 2° from nominal.

A check at 20°W in the early afternoon on 4 December revealed SIS, Sky, BBC and ITV signals. At that time the optimum period for signal capture with a non inclined-tracking dish was between 1200-1500 hours. By late December it had moved forward, with signal loss, to around 1330 hours. Intelsat 603 seems to be very popular – perhaps it's a cheap bird to hire. Meanwhile Eutelsat W3 seems to be rather quiet, with only occasional customers plus the regular ITN feeder at 11.044GHz H (SR 4.224, FEC 7/8). It signs as ITN PATH 1 MAIN, but is unfortunately in MPEG 4:2:2 form.

On 9 December, finding a mid-evening signal via Eutelsat W2 (16°E) at 12.544GHz H (5,632, 3/4 NTSC), I monitored what was a remarkable, prolonged video that showed the training of anti-coalition Iraqi fighters – much of VHS quality. The 'students' were seen being trained in mortar ranging and firing at targets along a distant desert ridge; on the use of rocket-propelled grenades (RPGs); the use of AK47s and larger sniping guns; the assembly of small stick explosives and larger fused circular canister bombs; with examples of hitting moving US tanks, Humvees at speed on bridges and roads and civil targets such as petrol tankers; and in addition taking prisoners and the treatment of seized hostages. All this was accompanied with Arabic military songs and scrolling captions. The video eventually ended, then the CBS News Baghdad caption over colour bars appeared. It was clearly a propaganda video that had been handed to a reporter for

prospective showing in the States, though some of the content would certainly never have hit the airwaves.

Live pictures of hostages captured on a Marathon to Athens bus trip on 14 December, held for several hours then released when the captors surrendered, were seen via Eutelsat W1 (10°E) at 10.972GHz V (4,167, 5/6). A few days later the satellite carried live the sentencing to death of Scott Peterson in a Californian court room after a high-profile murder trial.

The second Ukrainian presidential election was held on 26 December. Prior to that, on the 20th, a face-to-face confrontation between the candidates was carried live by W1 at 10.972GHz V. This was produced by the Ukrainian TV station 'ictv'. Mr Yushchenko's face showed the ravages caused by his poisoning. Nevertheless the programme ended with the rivals shaking hands.

In comparison with perhaps twenty years ago when, if I recall correctly, Russian TV could be seen only via Gorizont (14°W), which carried the main channel at 3.675GHz (circular polarisation), it can today be monitored with ease via several satellites. A scan across the Israeli Amos 1 and 2 satellites (4°W) produced many Russian and Ukrainian TV channels between 10.700-11.650GHz H. These were H1, OTV, Kiev (Knib), TV Kiev, Kiev STB, M1, Tonis, IPlussi and NBM. They are not the easiest of satellites to receive. In the southern UK you will need at least a 1m dish with an 0.3dB noise LNB.

There were late-night pictures from an unknown airport on 21 December. An RAF Hercules aircraft landed, then the Israeli and Union Jack flags were wheeled out. This was for the unannounced visit of PM Tony Blair to Israel for a meeting with Ariel Sharon. It was further reception from Eutelsat W1 at 10.972GHz V.

On the 22nd GlobeCast Africa was transmitting colour bars via Europe*Star 1 (45°E) at 11.525GHz V (5,632, 3/4). Unfortunately nothing else materialised and the transmission was cut. Very little activity is seen via this satellite nowadays.

Later that night the Saudi-1 TV channel via ArabSat (26°E) featured a passing out parade for successful Saudi Royal Air Force graduates, with members of the Saudi Royal family present for the presentations. There was marching, also banner exchanges and a fly-past of jets. The event ended with aerobatics from the Saudi equivalent of the Red Arrows. It was an impressive outside broadcast. Saudi-1 TV appears at 12.012GHz V (18,500, 3/4) and 12.026GHz V (7,500, 7/8). Over fifty Arabic TV channels are available at 26°E: most are FTA. Again reception in the south of the UK will require a 1m dish.

Broadcast news

Band I: The BDXC reports that Zimbabwe is no longer using Band I. Gwelo ch. E2, which has often been received in the UK, Bulawayo ch. E3 and Harare ch. E4 have disappeared from the official ZTV listing. It seems likely that Zimbabwe has adopted the South African TV allocation arrangements, using Band III and UHF with system I. For more details check the ZTV site at www.zbc.co.zw/television/frequencies

But many Band I TV transmitters with reasonable power remain in operation in Africa, as follows: Benin E2 20kW; Ghana E2, E3 and E4, all 15kW; Malabo E2 1kW; Kenya E2 and E4, both 10kW; Mauritius E4 15kW; Morocco E4 240kW; Nigeria E2, E3, E4 (two transmitters) all 15kW; Sierra Leone E2 1kW; Swaziland E4 10kW; Tunisia E4 140kW; Zambia E2 and E3 1kW, E4 40kW. The Zimbabwe ch. E2 17.6kW, E3 1kW and E4 20kW transmitters have apparently also closed.

Sierra Leone E2 is often received in southern Europe via TE skip, also another ch. E2 station that has not been identified.

China: The government has announced that analogue TV transmissions will end in 2015, and is preparing for the changeover to digital TV. DTT is being evaluated in several larger cities. It seems that DTT will start in the larger cities and wealthier provinces along the Pacific coast, subsequently moving into central China and then the western provinces. A start will be made in Hainan province, which may switch off analogue TV before 2015.



Caption received via Atlantic Bird 1 (12.5°W) during President Bush's visit to Peru in November.

Norway: NRK has announced a rapid expansion of DAB across the country. Because the FM network is 'full', DAB is required to transmit the increasing number of radio channels. It should reach 80 per cent coverage by 2007. NRK considers that FM will eventually close down in favour of digital transmission. In readiness for this several popular radio channels will be moved from FM to DAB over the next two years. Norway is using 167kbits/sec for DAB.

PLT: Japan, which had previously banned the use of power line telecommunications (PLT) because of concern about HF interference across the 2-30MHz spectrum, is now considering lifting the ban – if further studies suggest that there will be no problems from about 2006.

Analogue communications: Analogue is still alive and well in the mobile radio sector despite the growth of digital telecommunications systems such as TETRA. In the year ending last June there was a 20.1 per cent year-on-year increase in the sale of analogue equipment, while "European analogue infrastructure sales" increased by 37.4 per cent in the first half of 2004 compared with the same period in the previous year. One reason for the continued use of analogue communications is that digital systems don't provide the level of dependability originally expected.

Satellite news

There have been some political manoeuvres in the satellite field recently. Eutelsat has removed the Lebanese broadcaster Al Manar from its Hot Bird satellites on the instruction of the French Council of State, which regards Al Manar as a mouthpiece for the Hizbollah terrorist organisation. The Al Manar downlink ceased on 14 December. It had been part of a multiplex that the ArabSat organisation uplinked to Hot Bird 4. ArabSat maintains that the loss of Al Manar via Hot Bird was caused by pressure from Israel, and hopes to restore the Hot Bird transmissions. Meanwhile Al Manar continues to be available via ArabSat (26°E) at 11.786GHz V (27,000, 3/4). In retaliation, fifty cable operators in Beirut have removed the French TV5 channel from their systems and are trying to persuade other Lebanese cable operators to take similar action.

The Israeli-based RR Satellite Communications group, which originally uplinked three TV channels from its play-out centre, has expanded its services to 43 channels. With the installation of a Neptune multi-channel play-out system the group intends to increase output to some hundred TV channels, on a global basis.

The Indian state broadcaster Doordarshan has been unable to start its intended UK service via Sky because of the cost of satellite distribution and failure to get government financial aid. Doordarshan is seeking a partner to help finance the project. The



The Euro lottery, via Telecom 2D (8°W).

intention had been to provide a two-channel package, with one channel for general entertainment and the other for news.

Intelsat 701 (180°E) has switched on a C-band downlink to provide several channels for Fiji courtesy of Fiji Sky Pacific. This will include Fiji TV as an FTA channel, the other channels being encrypted. The broad footprint will extend to the fringe of New Zealand and Australia, but those in NZ would require a 1.5m dish while their neighbours in Australia would require a dish of 2m upwards.

Yet more interference!

Christmas brought a new interference problem. It relates to the outdoor decorations sold by B&Q and other outlets, including flashing Father Christmases, reindeers, bells, ropes of icicles and so on. Over the Christmas period I found that there was strange interference in the MW band. A check with the Yaesu revealed wideband noises from LW to about 8MHz. They consisted of a staccato set of buzzing pulses, perhaps three-four a second, followed by a pause then more bursts of the pulses, which would sometimes rise in frequency.

About fifty yards from me there's a house that, during the festive season, looked like a domestic version of Las Vegas at night. It included an illuminated Father Christmas up in a tree and long strings of white-light ropes to the roof and down and along the fence at the rear. As the lights flashed, the display radiated these buzzes. All very jolly, and I can tolerate it for a brief period, but a letter in the local paper complained about MW radio programmes being lost. It seems to be another problem for Ofcom, but how to stop the flood of cheap, poor-quality imported products might be difficult – and perhaps too late.

DAB quality

I recently came across a website that's well worth a visit by DAB enthusiasts. Go to www.digitalradiotech.co.uk/worldwide_dab

An article here says that the UK has the "worst DAB implementation in the world", because the network uses an average bit rate of 128kbits/sec – set by the Radio Authority. In Germany, ARD advises the use of a minimum of 192kbits/sec for stereo transmission. A table in the article shows that the average bit rate in Germany is 180kbits/sec – Estonia tops the chart with a bit rate (at April 2004) of 256kbits/sec. In fairness, these averages relate to existing transmitters at the time: there were only 177 in Germany while there were 289 in the UK. In Canada the average bit rate is 209kbits/sec.

The website gives details of how the table was compiled, but the conclusion is that the low bit rate used in the UK gives the

lowest-quality DAB in the world. As a footnote, last June I visited a very upmarket UK hifi equipment manufacturer and, amongst other things, enquired about its involvement with DAB. I was told that the company would not consider making tuners for UK DAB and that for the quality it sought it would continue to supply analogue FM tuners. The company did not consider that this quality could be provided by the present UK DAB network.

More on the Roberts Gemini 6/RD6

In the September issue I reviewed the Roberts Gemini 6 FM/DAB radio receiver and commented on a low-level background hum present via headphones and the loudspeaker and a sharp buzzing when no programme was present. Subsequently, as previously mentioned in this column, the front-end failed, producing virtually no FM and only a very local DAB multiplex at a low level. The supplier, QED-UK, arranged for a replacement to be provided. This took several weeks, apparently because of lack of stock.

The replacement that eventually arrived is an updated version which is marked RD6R, though its external appearance is otherwise the same. The hum and buzz problem is no longer present, and the signal levels in both bands are noticeably better. With the previous RD6 version the remote-control unit has a mute button that simply removes the loudspeaker output. The new RD6R has a 'pauseplus' feature instead. This operates only with DAB. If you wish to mute the output while listening to a programme, say to answer the phone, the output is removed but the radio continues to record the programme. Thus when the mute is removed the programme starts where it left off. A further depression of the pause-plus button returns you to the real-time transmission. The RD6R can record in the pauseplus mode for up to 35 minutes, but the actual 'back-time' recording period depends on the radio station's preset parameters. I found that several local stations offered 17 minutes. All other features are as noted in the September review.

In conclusion, the performance of the RD6R is of a higher standard than the original model. The full European Band III DAB coverage, with both channel and frequency selection, makes it a useful receiver for DAB-DXing during enhanced tropospheric conditions, when signals may be available from Germany, Denmark and the Benelux countries. Not France however, which has opted to use Band L for DAB. Different from everyone else, as usual!

Goodbye to the Southampton TV Centre

There was a close-down party on 18 December for those who had worked at the Northam TV centre, Southampton, originally for Southern Television, then TVS and finally Meridian. Regional ITV has been contracting. As part of this, Meridian closed down its Newbury studio and the Maidstone news office has been temporarily moved to Vinters Park – the former TVS studio centre for the South East, now a facility company and uplink site. The Southampton studio centre has been closed, and all news production has moved to a new base at Whiteley near Fareham. There is no longer any Meridian programme making capacity in the region, apart from that for the news magazine programme and news.

The new, high-tech Whiteley centre has minimal staff. About 200 people were made redundant during the Meridian contraction. There's a suggestion that later this year Ofcom will allow ITV regional programming to be reduced to ninety minutes a week, and possibly less or nil thereafter. Whiteley may live for about three years. Welcome to national ITV! Tyne-Tees is winding down its operation, with the original studios being shut, and Anglia is holding "discussions".

I joined Southern Television in 1964, at what was originally the Rank Plaza cinema. We had a medium-size studio, a smaller one and a news studio, the latter a small room off the news room itself – it had two EMI vidicon cameras (don't move too quickly!). The studios hummed with 405-line activity, and a larger studio centre was clearly needed.

The studios were sited on the banks of the River Itchen, which was tidal and known to flood into the building during the high

spring tides! Immediately adjacent there was a small tidal inlet which was used by a timber company. This was obtained by our forward-looking programme controller Roy Rich and became the site of the new studio – it had to be dammed, drained and filled in. The new studio opened in December 1969, with 625-line colour operation. Programme making expanded, with epics such as *The Man who came to Dinner* (Orson Wells, Joan Collins, Lee Remick), *Caesar and Cleopatra* (Alec Guinness) and *Miss Nightingale* (Janet Suzman). There were many children's series, film series such as *Worzel Gummidge* and a host of other programmes and outside broadcasts.

In 1982 the franchise was awarded to TVS and things changed. James Gatward, the TVS managing director, went into programme making on a big scale. Money was ploughed into facilities, but TVS couldn't break the network hold and increase the hours allowed for a regional TV station. TVS even used a helicopter for live microwave news links back to Chillerton Down, IOW or Bluebell Hill, Kent. Tracking dishes were mounted on the masts at the two IBA transmitter sites, with remote control – all this before SNG appeared.

TVS was active for about ten years, then Meridian was awarded the franchise. It bought the Southampton studio, but employed few staff – enough for administration and to make the news programming. Other programmes were made by freelancers on a programme-by-programme basis. Programme making was much reduced, though the studios became very busy when Channel 5 opened up and several live weekend programmes were contracted out to Meridian. These lasted for about twelve-eighteen months, after which they were terminated. The studios were upgraded, with new equipment, but didn't attract any customers for programme making. When Granada acquired Meridian, the decision was made to close the centre. It has now been switched off, the remaining staff working out their notice by stripping out equipment. The site

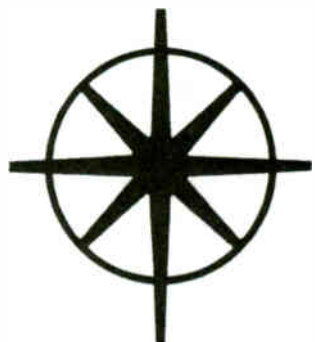

SOUTHERN

The Southern logo. The copyright is now held by Nic Ayling's company Southern Television Ltd. My thanks for his permission to reproduce it here.

is to be used for residential housing.

So ends 45 years of regional TV production – and a major part of my working life. I was made redundant from TVS in 1992 and found another career, but still freelanced at Meridian with occasional evening and more often weekend shows. The Southampton-based *Southern Daily Echo* newspaper has produced a large-format, 130-page publication, *The Dream Factory*, that chronicles the 45 years of commercial TV at Northam. It includes lots of old material, photographs and stories and is available at local shops for £10. Those interested farther afield can check for more information at www.thisishampshire.net

The leading repair and maintenance magazine Television and Consumer Electronics



If you are interested in television and consumer electronics, this is your chance to learn from the professionals. Sign up and every month you will find fault-finding guides for DVD, audio, satellite, TV, VCRs and test equipment reviews. *Television and Consumer Electronics* is a forum for the country's repair and installation engineers to trade ideas, solve problems and share information.

Risk-free offer

As a subscriber we offer you a money-back guarantee. So you may cancel at any time and receive a full refund on all unmailed magazines

Subscribe Now

Subscription Order Form

Yes - I would like to subscribe to *Television and Consumer Electronics* for:

- 1 year at: £33.80 (UK) €71 (Europe) US\$121 (Worldwide)
- 2 years at: £61 (UK) €127 (Europe) US\$218 (Worldwide) save 10%
- 3 years at: £81 (UK) €169 (Europe) US\$290 (Worldwide) save 20%

Three Ways to Pay:

- Invoice my company
- I enclose a cheque payable to *Television and Consumer Electronics*

Charge my: Visa Mastercard Amex Switch Delta

□□□□□□□□□□□□□□□□□□□□□□□□□□□□□□□□□□

Issue No. (Switch/Delta) □□ Expiry date □□/□□

Name:

Company name:

Address:

..... Postcode:

Telephone Number:

Fax Number

Email:

- Please tick here if you are happy for us to contact you by email

Post to: Debbie Jenner, Freepost SEA 11436, Television and Consumer Electronics, Media House, Swanley, Kent BR8 8BR (no stamp required) UK only

OVERSEAS SUBSCRIBERS please send to: Debbie Jenner, Television and Consumer Electronics, Media House, Swanley, Kent BR8 8BR, UK.

If you prefer not to receive promotional mailings from other companies, please tick box Ref: 119

AUDIO FAULTS

Reports from
Chris Bowers
Steve Roberts
Roy Blaber
Philip Rosbottom and
Geoff Darby

We welcome fault reports from readers – payment for each fault is made after publication.

Reports can be sent by post to:

Television Magazine Fault Reports,
Highbury Business,
Media House,
Azalea Drive, Swanley,
Kent BR8 8HU

or e-mailed to:
t.winford@highburybiz.com



Sony HCD-EP313

This unit wouldn't play CDs – it would say 'no disc' in the display. Checks inside showed that the cause was a faulty optical base assembly, reference number 604. All was well once a replacement, part no. 8-820-221-01, had been fitted. **C.B.**

Aiwa CX-NS888K

This unit's two cassette holders wouldn't close. Investigation inside revealed that both cassette heads were stuck in their raised position and that the capstan belt was slipping on the capstans – because grease had been transferred from one of the pulleys on to the belt. The only action required was to clean the belts. **C.B.**

Sony HCD-CP101

This unit's tape deck didn't work. A look inside the tape-holder mechanism revealed that the reversible tape-head mounting (reference no. 15), which rises up while playing, had snapped – possibly because a tape had been removed by force. A replacement tape mechanism assembly, part no. 179610112, restored normal operation. **C.B.**

Sony STR-KSL60

The fluorescent display didn't light up – only the function-indication LEDs lit. Multimeter checks on the display board showed that the supplies to the FL/LED driver IC were present and correct. A closer look at the pins of the tube (FL101), using an eyeglass, revealed the cause of the fault: there was a hairline crack across the track that leads to pin 64. I soldered a wire link between the pin and the small test pad on the track. **C.B.**

Sony SA-WMS315

There was no output from this active sub-woofer though the green power light lit up. When I inspected the PF>LP main board I found that there were dry-joints at R501 and R502. Resoldering these two resistors restored normal sound. **C.B.**

Sony HCD-H881

This unit was dead. Checks on the transformer board revealed the cause: the two 0-1Ω, 0.25W fusible resistors R1602 and R1604 were defective. Replacements restored the power. The part no. for these resistors is 1-219-134-11. **C.B.**

Sharp SD-EX200H

The customer complained that every so often this CD/tuner unit would shut down for no apparent reason. I took the unit to pieces, but could find no obvious reason for a shut-down. It's not an easy unit to work on, with interconnections via various plugs

and sockets.

On careful examination I found that nearly every multi-pin socket on the PCB was dry-jointed. The unit is controlled by a micro chip and seems to shut down if a signal/voltage is not present. A careful resolder of the sockets seems to have cured the problem, as the unit behaved itself during a prolonged soak test.

The display is one of those irritating ones that say 'hello' and 'goodbye' on receipt of a front-panel command. Hopefully it will now say hello more times than it says goodbye! **S.R.**

Technics SA-EH770

Tinny sound was the complaint with this tuner/amplifier. In fact there was no sound from the bass speaker, and a substitute made no difference. The cure was to replace the six-channel output chip, which is an RSN33W64 device. **R.B.**

Hi-fi from eBay

As a regular eBay buyer/seller I spotted someone who had thirty plus audio items for sale. So I put in a bid and was surprised when I was successful. They were all assumed to be for repair, apart from a Technics tuner that I was assured was in working condition. Having arranged to collect them, I travelled 100 miles to pick them up. With help from the seller to stuff them into the boot and on to the back seat they all fitted into the car. Then I returned and looked through the collection to decide what was worth repair and what was fit only to be thrown away. The Technics tuner turned out to be as good as the seller had said it was. If you bid for an item, make sure you ask the vendor about its actual condition: some sellers are vague with their descriptions, or economical with the truth.

The first item I looked at was an Aiwa AD-F770 three-head cassette deck. It was obviously in need of new belts – the old ones had turned into thin strips of Blue Tak. Once replacements had been fitted and the deck had been given a service/clean it made as good recordings as my Nakamichi deck. The next item was a Yamaha CR620 tuner/amplifier. The main problem here was that the speakers cut out intermittently as the protection system detected DC at the output. A blanket resolder in the power-amplifier section cured this – I never found the actual fault. A new lamp was needed for the tuning meter, and the screws that fasten the power transistors to the chassis/heatsink needed tightening. Once this had been attended to the performance was quite impressive.

Amongst the many other items there was a Cambridge Audio PI10 amplifier that dated from the Seventies. It produced no output because one of the fuseholders was loose. Once this had been attended to the relay pulled in but there was still no output. I then found that the filter toggle switch was broken. It uses long lever switches which are prone to being damaged (the internal contacts). If you need to get to the solder side of the PCB, remove the large heatsink at the bottom of the chassis: don't, as I did, try to work out how to remove the PCB from the top, as there are lots of wires to the controls and the input switch runs from front to back, making this almost impossible.

Several cassette decks were discarded. Others needed VU lamps or their pinch wheels cleaning. Some items will be resellable via eBay. Presentation is a major deciding feature in whether you will get bids and how much the item will fetch. Good pictures are a plus point too. P.R.

Kenwood RXD-M32

This unit was stuck in standby. It had come to me from another dealer who had suspected the output IC and removed it, to no avail. When an attempt was made to bring it out of standby it did come on initially – in as much as the display lit up and that quaint Kenwood message “Calling Me?” appeared. But the main power relay then dropped back out and the system returned to standby.

My first suspicion would also have been the output device but, as there was no longer one fitted, I had to look elsewhere for the cause of the problem. So I started with the power supply. More by luck than judgement I decided to check IC2, a 7812 regulator IC that's bolted to the same heatsink as the output IC. Checks at its pins showed that there was a good input level but only 3V at the output. It was also cold, so it was not in thermal shutdown because of an overload across the output. A replacement enabled the unit to power up normally, and refitting the output device completed the repair. G.D.

Sony HAR-D1000

The fault with this CD/HDD unit was not particularly interesting, but the technology it uses is. Basically, the unit was dead, the cause being nothing more than a blown mains fuse. I didn't really take much notice of the rest of the system until the owner started to ring up, desperate to know whether his 500+ (yes, that's five hundred plus!) albums were still on the hard drive.



The Aiwa cassette deck and tuner bought by Philip Rosbottom via eBay.

When I looked I found that he had 509 “discs” recorded on the hard drive, all catalogued carefully as “Hits, Year, Disc number”. They ranged from 1950 to the present. I gather that he's some sort of DJ, so I guess that this was his record collection. We tend to take this sort of thing for granted now, particularly since the advent of MP3, internet music download sites and now PVRs that use hard-disc technology – Sky+ and the old TiVo system. But only a couple of years back all this was the stuff of Doctor Who and science fiction. Imagine, in the Seventies, seeing a DJ come into a hall carrying his entire record collection in a small metal box, instead of hauling in fifteen three-foot long home-made plywood boxes full of 7in. records! G.D.

Intempo PG01

I wonder why the manufacturers of DAB radios have seen fit to put such advanced technology into such a horrible series of cabinets? They all seem to have gone down the same road: a beechwood box with a very unimpressive ‘industrial’ two-line LCD display and a carrying handle that's largely irrelevant – they consume so much power that they run only from the mains supply! Many models are not even stereo, unless you plug headphones in. This particular DAB/FM radio looked like something I might have built as an ‘apprentice piece’ (ask your dad!).

Regular readers of my jottings will know that I have strong reservations about the newfangled, environmentally-friendly lead-free solder. This unit's soldering did nothing to improve my feelings on the matter. The reported fault was “dropped – not working”.

Once I had got it apart (inside, it was full of pieces of bent metal with nuts and bolts to hold a couple of really quite neat-looking PCBs) I was able to examine the boards for typical signs of drop damage, but there weren't any. Sometimes, when

the unit was powered, a sensible greeting message appeared briefly in the display, and sometimes there was some garbage. The front-panel push-buttons didn't seem to function. The main PCB houses a sealed RF unit and a selection of surface-mounted ICs. Pressing the largest of these restored a certain amount of operation, so I removed the board from the box and got my trusty microscope on the job.

The joints on the board were all that dull, ‘dry-looking’ grey that I've come to associate with lead-free solder. Close examination of the IC pins revealed that many of them were very poorly soldered – a number of the joints looked distinctly ‘cracked away’ at their tips.

Using liquid flux, a fine-tipped iron and very fine solder, I reflowed every IC pin on the board. When it had been refitted the unit seemed to function all right, but I had reservations about the general sensitivity, both with regular FM and DAB. I was not very sure about this, because the FM signals are not very good at my location and the unit doesn't have an external aerial socket. So I decided to consult the shop from where it had been bought. They confirmed that they had also found the sensitivity of some dual-band sets to be poor, and had in fact decided to stop selling a couple of makes and models for this very reason.

Looking back at the fault, I feel that it was more to do with the soldering than the set having been dropped. The vibration caused by the drop had probably been the last straw that resulted in the IC pins parting company with the board. Perhaps it's a temperature thing, or maybe this type of solder just doesn't lend itself to current flow-soldering technology. But, whatever the reasons, I think that the manufacturing industry has to get to the bottom of these problems before a passenger jet falls out of the sky because a soldered joint has gone bad as a result of passing through some turbulence . . . G.D.



VCR CLINIC

Reports from
Eugene Trundle
Steve Hague
Roy Blaber
Martin McCluskey
and
Alun Rawson-Williams

We welcome fault reports from readers – payment for each fault is made after publication.

Reports can be sent by post to:

Television Magazine Fault Reports,
Highbury Business,
Media House,
Azalea Drive, Swanley, Kent BR8 8HU

or e-mailed to:
t.winford@highburybiz.com

JVC HR-S5956

The complaint with this machine was that waves of mistracking were sometimes present. This happened with both own recordings and bought/rented cassettes. On investigation we saw that the path of the tape over the ACE head was too high. The cure was to replace the pinch-roller assembly. E.T.

Sony SLVSE720G

Two of these machines came in with the same symptoms – no display, and incorrect deck functions. What happens is that the EEPROM part of the microcontroller chip becomes corrupted and has to be reset. Check whether C701 (470µF, 10V) has been fitted the wrong way round. It's at the front of the PCB, left of centre.

When you remove the front cover you will find a 'test' button on the left-hand side, but its function will have changed as a result of the corruption. In both of these machines it functioned as the standby/on button, while the record button now acted as the test button. The action required is first to connect the VCR to a TV set via a scart lead and switch on. Press the test button (in this case the record button, see above) and then immediately press and hold 'menu' on the remote-control handset. A table of numbers will appear: you can black out individual numbers using the handset's cursor and OK controls. In this model the numbers to be blanked out are: 3-14 inclusive, 19, 27, 33, 34, 35, 40, 41, 45, 47, 51, 60, 61, 63, 66, 69 and 72. Press menu to store.

The chances are that the head-switching point will need to be adjusted. Insert a test tape and play. Press the test button, which will really be test now, then SL/LP on the handset. Job completed. S.H.

Panasonic NVFJ620B (Z mechanism)

This new-generation silver VCR's picture was broken up by several bands of mistracking. I found that the tape entrance loading arm/tape guide was not reaching its full travel because a small plastic gear, 'arm loading take-up' (part no. VXL2670), had been worn away by the teeth on a metal rack that operates it. A replacement part restored normal operation.

The same part can also cause a mechanism jam-up, usually with a cassette inside the machine. It seems to be a weak point in an otherwise nice VCR. M.McC.

Aiwa HVFX2800

This Orion-based machine would shut off after three seconds in the play or fast-forward modes. Rewind was OK. As a quick check, I swapped over the reel-rotation optosensors Q1001 and Q1006. Play and fast-forward then worked but the VCR shut off in rewind. A new pair of sensors cured

the fault – they can be ordered from Charles Hyde and Son under code no. 14003SL. M.McC.

Sony SLVE700

The customer said that this VCR made a strange noise after rewinding then went to standby. On investigation I found that the auto-stop didn't work in either direction. The machine had been used for surveillance in a local shop, and the inside was very dirty. I removed the video deck and cleaned the plastic light conductors, the centre LED and both end sensors on the PCB thoroughly. This cured the problem. M.McC.

Toshiba V242

The playback pictures produced by this newish machine looked as if the heads needed cleaning, but the fault was intermittent. Remembering that older models suffered from deck earthing problems I soon found a single screw, at the rear of the deck, that needed to be tightened. R.B.

Proline TVC140S

This TV/VCR combi unit kept ejecting tapes. The fault was cured by replacing the mode switch. R.B.

Matsui VX1107A

Two of these budget machines came in for attention within days of each other. As the engineer who normally deals with VCRs was on holiday, I had to tackle them. Both were dead and, after removing the top of the first one, I noticed that the primary side of the chopper power supply is quite basic, with not quite a couple of handfuls of components and no control IC. The mains input fuse was intact, and there was 340V across the mains bridge rectifier's reservoir capacitor. But there were no outputs on the secondary side.

After checking for shorted semiconductor devices on both sides of the power supply I noticed a 220kΩ resistor, R503, which is mounted on the PCB between the reservoir capacitor and the cassette loading motor. It was open-circuit. To get at this component's soldered connections the deck and PCB have to be removed from the metalwork (nine screws, including one hidden under the cassette housing).

As these machines seem to be of quite recent manufacture, it might be prudent to fit a replacement with slightly heftier wattage and higher voltage ratings than the original 0.25W hi-stab device.

Incidentally, as I found to my cost when working on budget VCRs for a large TV rental company some years ago, I'd like to warn others who come across these machines that they have the same razor-sharp teeth on the edge of the metalwork.

The second machine had the same fault – and teeth. Which reminds me to replenish the plaster stock in the first-aid box! A.R.W.

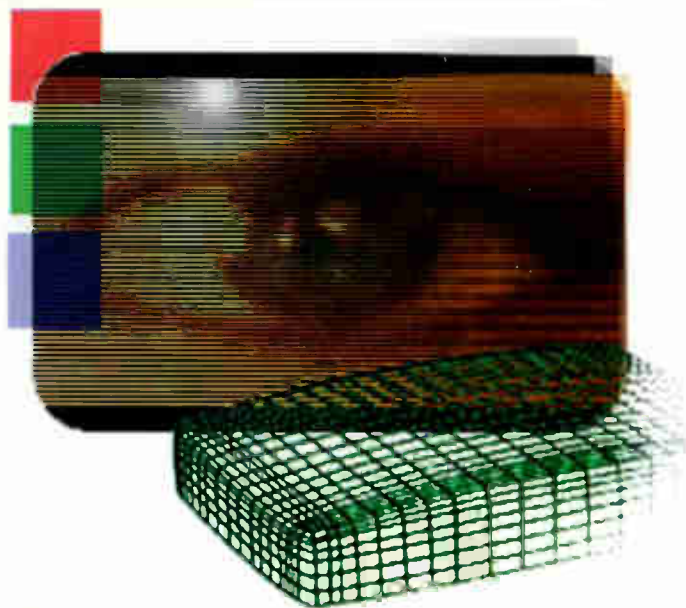

TV FAULT FINDING

Reports from
Michael Dranfield
Philip Salkeld
Glyn Dickinson
James Grant
Roy Blaber
Dave Husband
Philip Laws
B. Heathcote and
Eugene Trundle

We welcome fault reports from readers – payment for each fault is made after publication.

Reports can be sent by post to:

Television Magazine Fault Reports,
 Highbury Business,
 Media House,
 Azalea Drive, Swanley,
 Kent BR8 8HU

or e-mailed to:
t.winford@highburybiz.com

Bush 2138SIL (Beko chassis)

If you find that the 2SK2750 chopper FET is dead short, the cause will be that R606 (1M Ω) has gone open-circuit. This just out of guarantee set had a 1W resistor in this position but, when it comes to the crunch, it doesn't matter what size of resistor you fit – if it's not rated for 350V working it won't last. Farnell Electronic Components (Leeds) has available a good selection of metal-film resistors. M.D.

Tatung T32W441S (440 chassis)

The TDA8350Q field/EW output chip would fail every four weeks or so, along with a couple of safety resistors. Many components were replaced, and the HT voltage was correct. Eventually a call to Tatung technical produced the answer: replace the CRT. This was no problem, as the set was still under its four-year warranty. Otherwise it would have had to be scrapped. M.D.

Sharp 66GF-63H

If there's a white screen with flyback lines and the sound is OK, look no farther than Q912 (BC338-40) on the tube base PCB. It usually has an open-circuit emitter connection. M.D.

Tatung T21TF70 (F series chassis)

I was glad to see the back of this set, which was stuck in standby. After some

checks I found that if I disconnected pin 2 of the TEA8172 field output chip I401 the set would come on with field collapse. So I thought a new field output chip was required. Wrong! The set was still stuck in standby when a replacement had been fitted.

After wasting many hours and fitting many new components I decided to use my bench power supply to provide the +13V supply for the TEA8172 chip. The set then worked all right. But when the +13V supply from the line output stage was reconnected the set remained in standby.

I eventually found the cause of the problem: the HT voltage was low at 95V instead of 98V! I had already checked it and thought that 95V was near enough. So with F chassis sets it must be spot on. M.D.

Beko 284239NS

The symptoms with this set were field collapse and a smell of burning. As the TDA8359J field output chip IC501 showed signs of overheating I ordered a replacement, part no. 452976. But there was still field collapse when this had been fitted, and I had to disconnect the tube base panel to prevent a line being burnt on the screen. After that it didn't take me long to find that IC501's supply was missing. It's derived from the line output transformer via R526 (0.68 Ω , 0.5W) and D513 (RGP15J) which were both faulty, the resistor open-circuit and the diode short-circuit. Replacements restored full scanning. P.S.

Daewoo GB20F8T2

There was a strange problem with this combi unit. The picture was fine but if you went to teletext and selected the subtitle page 888 the picture went dark. Fortunately we had the service manual, which enabled us to sort it out. The remedy is to select teletext then press the menu button on the remote-control handset. The fastext colours appear along the bottom of the screen. The red is for brightness decrease and the green for brightness increase. By pressing the green fastext button the background brightness increases. Keep on adjusting until the brightness of the subtitle page picture is correct. P.S.

Sony KV32FX66U (AE6B chassis)

When this massive widescreen set was tried it was dead with the red LED flashing eight times. Where to start? It seemed a good idea to phone Sony technical. I was advised to replace the 0.01 μ F surface-mounted capacitor C6827 on board D2. Fortunately this proved to be the answer.

Another point about these horrible sets:

if the red LED flashes five times, the screen/A1 control on the line output transformer is incorrectly set. P.S.

Daewoo DWX28W5GB

The customer complained that the verticals were bent, in other words the EW correction was slightly out. You need to know the procedure to get into the service menu, otherwise you never will! Select Ch. 91 and tune into a station. Select sharpness and adjust to minimum. Exit all menus. Then press red/green/menu rapidly to get into the service menu. Use the up and down buttons to select east/west, left and right to adjust, and standby to store. P.S.

Philips 25PT4456/25 (SL9.1E chassis)

When this set was switched on the only sign of life came from the red LED, which flicked once. A quick check showed that the 148V HT supply was present and correct. I decided to scope the waveform at the collector of the line output transistor. At switch on a healthy pulse was present, then it vanished. The sensible thing to do seemed to be to order a line output transformer, part no. 2422 5310 2431. Fortunately the replacement brought the set back to life. P.S.

Samsung C120F12T

The customer reported that this set had gone off with a crack. I found that the 2SD2499 line output transistor was short-circuit and further investigation revealed that the line output transformer T445 (part no. AA26-00065A) had a hole in its side. The set worked once these two items had been replaced.

A point to note with these sets is that after the repair you should start with the A1 preset at minimum. Switch the set on, wait until the sound comes up, then slowly adjust the A1 preset until a picture appears. If you turn the A1 control up and then switch on you will upset the grey-scale and end up with a bright raster. You've been warned! P.S.

Daewoo DWX28W5GB

The picture was pulsating with scene changes. I noticed that the HT voltage was a bit high, but there is no HT preset control. I did some freezing in the power supply but this made no difference. Then I obtained some advice. It's a known problem and the cure is to change D830 (BYV95C) to type 1N4937 and D840 (1N4148) to type 1N4004. You can't beat a bit of help! P.S.

JVC AV32WFP1

This monster was tripping. I found that

the 2SC5552 line output transistor was short-circuit, the cause being a dry-joint at the nearby EW transformer. In view of the cost of the replacement transistor I temporarily fitted a BU2520, which has a similar specification. It worked, but overheated and failed within a minute. This was long enough to confirm that there was no other damage however. The correct JVC replacement transistor ran cool. G.D.

Alba CTV4860 (11AK19 small-screen chassis)

This set sat there chirruping in standby and wouldn't come on, though the standby light went out and the noise changed. Checks showed that the HT was low and varying. Prodding the power supply capacitors with a sharp stick (a reassuringly lo-tech process!) did help until I touched C829 (47 μ F, 200V). A replacement restored normal operation. G.D.

Sharp 37AM23

This set was rescued from beside some rubbish. It had been thrown out, complete with handset, because the owner had forgotten his PIN number! To change it, press volume down on the TV set and the key symbol on the remote-control unit together. Nothing appears to happen. Press menu and scroll down to 'lock' then press menu again. The display should have changed. Enter the new PIN, then exit. This procedure works with many Sharp TV sets. G.D.

Bush 2574NTX

This set was tripping, but in a slightly different way from the usual one. Standby was OK then, when the set was switched on, the LED flashed green. No shorts could be found, and I eventually discovered that R823, in the feed to the HT preset, had risen in value from 140k Ω to about 300k Ω . It's easy to overlook this resistor as its colours change with heat – and look like 270k Ω ! G.D.

Sharp 28HW-53 (DA50W chassis)

The customer's description of the fault was "the picture went bright yellow, came back on all right for about an hour, then the set died". When I tested the set on the bench the power supply seemed to be tripping, with the HT low at about 20V. No obvious faults could be found in the line output stage or the power supply, and there were no signs of overloading. Time to think a bit harder.

I thought about the customer's description of the fault and decided to investigate the yellow picture symptom. A look at the

circuit diagram showed that the HT supply for the STV5109 RGB output chip IC1801 on the CRT base panel is derived from pin 7 of the line output transformer, via R617 and D621. The set came to life when pin 7 was isolated. D621 proved to be innocent, the culprit being IC1801. It must have been breaking down under load, as cold checks didn't show any leakage. A new STV5109 restored normal operation. J.G.

Schneider TV9.1 chassis

A word of warning about this chassis. C307 (47nF, 100V), which forms part of a potential-divider network connected to the collector of the line output transistor, can go open-circuit. As a result, a large-amplitude flyback pulse is fed back, killing the microprocessor etc. I fit a capacitor with a working voltage of 400V. Also check R775 (10k Ω), which is in the same part of the circuit, for overheating. R.B.

Finlux 5810

This nice little 12V portable was dead apart from the standby LED being on. A quick check showed that there was no 11V supply at the line output stage. The cause was a dry-joint at L651, which is hidden under the screening can below the battery input socket. R.B.

Grundig GT2105 (G1000 chassis)

This set, which came from another dealer, had rather weird symptoms. There was a blank raster with just three red, green and blue lines through the centre of the screen, no sound and no graphics. The cure was simply to replace the TDA8170 field output chip IC200. R.B.

Schneider STV2802

This set was dead because there was no line drive – the power supply was OK. The line drive comes from IC501, pin 11 of which is used for protection and was high at 5V. Replacing Q721 (BC858) cured the fault. R.B.

Daewoo GB14HIN

The complaint with this combi unit was "went bang then dead". The cause of the bang was C804 (100 μ F, 400V) which had exploded, taking with it IC1801 (STR-F6653), Q801, Q802 (both KTC3207), D806 (12V zener) and R809 (0.27 Ω). The unit worked fine once these items and a new fuse (F801) had been fitted. R.B.

Ferguson 36K2 (TX89 chassis)

The fault symptoms were a flashing picture with the height varying. Meter checks revealed that the 12V supply was low at

9-8V and was unstable. The cause was TR26 (BC337) which was leaky. **R.B.**

Toshiba 2573DB

This set was dead, the cause being the STR-S6708 chopper chip Q801. When the IC was replaced the set worked, but with a loud whistle. The cause was R810 (1.2k Ω), which may have been the reason why Q801 had failed. **R.B.**

Thomson 25DG17 (TX807CS chassis)

This set's power supply worked but there was no sound or picture. A check on the line drive revealed that it was tripping, while the waveform at the collector of the line output transistor TL035 was distorted. The cure was to replace the line output transformer. **R.B.**

Hitachi C28W440N (11AK33 chassis)

There were several fault symptoms with this set, all caused by one component. The picture was an inch narrow at each side, the on-screen graphics rolled and, as the set warmed up, line foldover appeared. The culprit was C611 (3.9nF, 1.6kV) in the line output stage. It's part of the line flyback pulse feedback network, and was open-circuit. **R.B.**

Toshiba 32ZP18P

A bright blue screen with flyback lines usually means a faulty CRT with this set. But when the base drive to the blue output transistor on the tube base panel was disconnected there was a nice red and green picture! When I traced the drive back to the main PCB I came to Q428, which read OK except for a slightly high collector voltage, then Q204 which was also OK. This left only the TA1276AN video processor chip Q510. There should be 1.6V at pin 41 (blue output), but the voltage here was high at 9V. When the pin was isolated this high voltage remained. A new IC restored the picture, with correct colours. You can obtain it from SEME under part no. B0386208 – it's not cheap. **D.H.**

Sony KV32LS35U (FE2 chassis)

This monstrous widescreen set had failed during a lightning storm, so I didn't relish the thought of tackling it – or lifting it for that matter. Once I had got it back to the workshop I found that the set was dead because the standby power supply didn't work. It's a chopper circuit that uses a TOP209P IC and a tiny transformer that delivers 5V to a 3.3V regulator. Lots of

HT was being applied to the IC, but there was no voltage at the secondary side of the transformer. When I fed an external 5V supply to the regulator's input the set worked. So I replaced the chopper IC and several other components on the primary side, without success.

Sometimes it's easy to miss the obvious, which in this case was the 5V rectifier (type 1NL20U-TA2) on the secondary side of the circuit. It read OK when checked with a meter, but a replacement cured the fault. **D.H.**

Tatung 28W441

This set appeared to be dead, with no standby LED illumination, but the power supply voltages were all correct. So I carried out checks around the microcontroller chip and found that the reset circuit (pin 43) wasn't working. Reset is provided by transistor TP5 (BC847), which is positioned next to the regulator chip ICP3. I've come across hairline cracks around this IC before. This set was no exception: a small crack at the heatsink mounting, breaking the track between pin 6 of ICP3 and TP5's base connection, could be seen. The set worked perfectly once the track had been linked. I added some glue to strengthen the heatsink's mounting points. **P.L.**

Hitachi C2846TN

A fault I've had a few times recently with these sets can be hard to diagnose. The symptoms are very intermittent EW and width variations. Tapping the board doesn't seem to make much difference, but gently flexing it can sometimes instigate the fault. In every case the cause has been a poor connection at one end of R760 (the end connected to the collector of Q752) in the EW driver circuit. **P.L.**

Samsung T114-B7

The complaint with this fairly new-looking combi unit was that the picture disappeared after half an hour. Sure enough while it was on soak test the picture totally vanished. I removed the back cover and advanced the setting of the first anode preset, expecting to see field collapse, but there was nothing. Checks on the CRT base panel then revealed that the first anode supply was very low at about 50V. The decoupling capacitor C503 (1nF, 2kV) was the culprit. It's marked 102. **P.L.**

Panasonic TX24DX1 (EURO-4 chassis)

This set was very dead with no click from the relay at switch on. The standby

transformer was getting quite warm, with only 8V at its secondary winding. The cause of the fault was traced to C869 (100 μ F, 25V) in the start-up circuit. It had gone short-circuit. A replacement brought the set back to life. **B.H.**

Samsung WS28W6V

The fault symptom with this set was intermittent loss of green in the picture, leaving a lurid purple display. It could probably happen with any of the primary colours, because the cause was bad soldering at the pins of the thick-film assembly HIC203 on the main PCB. **E.T.**

Tatung T28NG80 (G chassis)

If the line output transistor Q403 in one of these sets is short-circuit the symptom will be a pumping power supply. To avoid early failure of the replacement transistor, check for dry-joints at the scan-coil connections to the PCB, adjacent to L404. **E.T.**

Sony KVM2101U (BE2A chassis)

A fault we've had with a number of these sets is no or intermittent colour. The culprit is the reference-oscillator frequency trimmer capacitor CT332 (part no. 1-141-418-11). Its value, not given in the service manual, is 5.50pF. **E.T.**

Tatung 170 series chassis

As these sets get older, their capacitors increasingly cause trouble. Intermittent failure to switch on from cold is now a common fault. The cure is simple: replace C806, C807 and C812 in the power supply. These are all 100 μ F, 25V capacitors. **E.T.**

Hitachi C2874TN

The problem with this old-timer was intermittent shutdown. We found that the fault could be instigated by tapping almost anywhere on the larger PCB. Resoldering the pins of the field output chip IC601 and the inter-board plug/socket connections largely solved the problem, but the cure was not complete until the legs of the 5V regulator transistor Q121 had been reflowed. **E.T.**

Goodmans W322NS

If you find one of these silver monsters with the no-go symptom, pumping very gently inside, the likelihood is that the line output transistor TR16 is leaky or short-circuit. To ensure that the replacement doesn't fail in the same way, check for bad jointing at capacitor C68. **E.T.**



DVD

**Fault reports from
Geoff Darby
Chris Bowers
and
John Coombes**

We welcome fault reports from readers – payment for each fault is made after publication.

Reports can be sent by post to:

**Television Magazine Fault Reports,
Highbury Business,
Media House,
Azalea Drive, Swanley,
Kent BR8 8HU**

**or e-mailed to:
t.winford@highburybiz.com**

Pioneer DVL909 DVD/LD player

I had had this unit before with exactly the same problem: the laser was jammed at the very front of its range of travel, the rollover cage guide pin on the side of the optical block being firmly wedged behind a vertical pin that comes up through the laser transport mechanism when this is in the down position for tray opening. On both occasions a home-recorded DVD was in the unit.

Once the pickup had been released from its jammed position the whole unit worked well with CDs and DVDs – until the home-burnt DVD was put back in. The difference was in the way in which the player handled the stop and open functions. When either stop or open was requested with a commercial recording, CD or DVD, the disc would come to a controlled halt, the laser would back off a little way until the guide pin was behind where the other pin would come through the mechanism, and only then did the mechanism drop down to initiate the unload/open sequence. With a home-burnt DVD, when the stop or open button was pressed the disc continued to rotate as the mechanism began to drop away, almost immediately and before the laser had a chance to back off to avoid the vertical pin. The optical block's pin then jammed firmly in front of the vertical pin.

I am indebted to Pioneer technical's product knowledge and helpful attitude towards dealer's servicing problems for their help with this difficulty. The man at Pioneer was able to explain the bizarre behaviour with absolute certainty. Part of the problem is to do with the lower reflectivity of MO-type discs in comparison with factory-pressed commercial ones. Because of this, with an MO disc the focus servo struggles a little to stay in lock. So the first thing to note is that any

discs played by a customer in one of these units should be top-quality ones, not the 'ten for a fiver' unknown bulk spindle pack type as, on both occasions, the one that caused the trouble in this unit had been.

The second problem is to do with the player. Tilt correction is accomplished by pivoting the whole laser transport mechanism, the correct amount of tilt being applied by a motor-driven cam. Two very stretched springs, right at the very back of the chassis, are used to keep the mechanism in contact with the cam. The springs weaken with the passage of time, and then do a poor job of maintaining the physical contact between the mechanism and the cam. The result is poor focus-servo performance. The combination of this and the low reflectivity of an inferior-quality MO disc means that focus lock is immediately lost when the player tries to start doing anything about stopping or opening. The servo then goes berserk, upsetting the system control. Focus lock should be maintained until the laser has started to drop away from the disc, resulting in a controlled stop and open sequence.

I ordered new springs, part no. VBH1274. When these were compared with the ones I had removed I found that they were considerably stronger, though there wasn't much in it in terms of relaxed length.

Once they had been fitted and the unit had been tested thoroughly with commercial discs, I gingerly inserted the owner's home-burn disc. This time the sequence, when stop or open was pressed, was exactly the same as with a commercial disc. After many test starts, stops and opens I was convinced that the unit had now been fixed. Thanks, Pioneer! **G.D.**

Philips DVD580M

The fault symptoms with this unit were as follows: there was an intermittent crackling sound from the rear left-hand speaker, also a low crackle from the sub-woofer. Meter checks on the MPEG board revealed the culprit, which was the DA converter chip U5. A replacement restored normal sound. **C.B.**

Sony DVP-S335

All mechanical functions worked correctly but there was no RGB output. The Y/V composite video output was OK. The cause of the trouble was a faulty 3V regulator, IC503. A replacement, part no. 875948655, restored the RGB video. **C.B.**

Sony DVP-NS300

The fault with this DVD player was simple: no sound. The cause was quickly traced – circuit protector PS402 (1A) was open-circuit. **J.C.**

TELEVISION BOOKS

AND HOME ELECTRONICS REPAIR

The Television Book Service offers access to our team of specialist publishing experts. We can order any book or CD-ROM currently in print from *War And Peace* to the *Newnes Guide to Television and Video Technology*. All books are delivered free of charge within the UK unless otherwise stated. Contact us at the numbers below:

Telephone: **01737 812727** or **01737 812676**

Fax: 01737 813526

Email: salesteam@boffinbooks.demon.co.uk

CLOSED CIRCUIT TELEVISION: CCTV INSTALLATION, MAINTENANCE AND OPERATION



Joe Cieszynski

CCTV surveillance is one of the fastest growing areas in the security industry, and this is a thorough guide to the technical side of CCTV – including installation, maintenance, video recording, cameras and monitors. The second edition is fully dual-standard for PAL and NTSC systems.

2nd edition ▲ Sept 2003 ▲ 256 pages
Glossary ▲ Index ▲ PB ▲ Published in UK

Code 0 7506 5728 6 **£24.99**

DICTIONARY OF VIDEO AND TELEVISION TECHNOLOGY



Jack Tsatsoulis

This work provides comprehensive and contemporary information on the essential concepts and terms in video and television, including coverage of test and measurement procedures. The CD accompanying the text includes an electronic version of the book.

Sept 2002 ▲ 365 pages & CD-Rom
Published in UK

Code 0 7506 5728 6 **£29.99**

DVD PLAYERS AND DRIVES

K F Ibrahim
(College of North West London)



This text is based on hands-on experience and acts as a guide to DVD technology and its application, with a special focus on design issues. The principles of the subject are introduced from the basics, and DVD applications are illustrated by genuine technical information.

Aug 2003 ▲ 256 pages ▲ Glossary ▲ Index
PB ▲ Published in UK

Code 0 7506 5738 7 **£24.99**

ELECTRONIC CLASSICS: COLLECTING, RESTORATION AND REPAIR

Andrew Emmerson



This text encompasses all aspects of buying, collecting, restoring, repairing, sourcing parts, professional services, clubs and societies. The first part covers technical aspects of restoration and details where components can be found; the second presents useful information for collectors.

Aug 1998 ▲ 256 pages ▲ Index
10 halftones ▲ 50 line illustrations ▲ PB
Published in UK

Code 0 7506 3788 9 **£21.99**

INTRODUCTION TO DIGITAL SYSTEMS

John Crisp



This self-study text introduces digital electronics from first principles, before going on to cover all the main areas of knowledge and expertise. It covers the practicalities of designing and building circuits, including fault-finding and the use of test equipment.

Feb 2000 ▲ 302 pages ▲ Glossary ▲ Index
PB ▲ Published in UK

Code 0 7506 4583 8 **£18.99**

NEWNES DICTIONARY OF ELECTRONICS

S W Amos; R S Amos



Aimed at engineers, technicians and students working in the field of electronics, this dictionary provides clear and concise definitions, including TV, radio and computing terms, with illustrations and circuit diagrams.

4th edition ▲ Mar 2002 ▲ 394 pages
100 illustrations ▲ PB ▲ Published in UK

Code 0 7506 5642 5 **£12.99**

NEWNES GUIDE TO TELEVISION & VIDEO TECHNOLOGY

Eugene Trundle



An exploration of television and video technology. It covers the fundamentals of digital television (satellite, cable and terrestrial) and digital video, as well as providing a grounding in analogue systems.

3rd edition ▲ Feb 2001 ▲ 432 pages ▲ Index
PB ▲ Published in UK

Code 0 7506 4810 4 **£17.99**

NEWNES GUIDE TO DIGITAL TV

Richard Brice



Covering all aspects of digital television, this text encompasses the electronics of the equipment, data compression, television production, servicing and the different transmission methods - terrestrial, satellite and cable. The text has been updated with developments since the 2000 edition.

2nd edition ▲ Oct 2002 ▲ 304 pages ▲ Index
45 illustrations ▲ 15 photographs ▲ HB
Published in UK

Code 0 7506 5721 9 **£24.99**

PRACTICAL ELECTRONIC FAULT FINDING AND TROUBLESHOOTING

Robin Pain (Design Engineer, Cotag International Ltd)



A text using simple circuit examples to illustrate principles and concepts fundamental to the process of analog and digital fault finding. It aims to help the reader tackle any job, from fixing a TV to improving the sound of a hi-fi. A digital multimeter and oscilloscope are needed for these jobs.

Apr 1996 ▲ 284 pages ▲ Index
50 line illustrations ▲ PB ▲ Published in UK

Code 0 7506 7441 2 **£21.99**

PRACTICAL ELECTRONICS HANDBOOK

Ian Sinclair



A collection of all the key data, facts, practical guidance and circuit design basics needed by a spectrum of students, electronics enthusiasts, technicians and circuit designers. It provides explanations and practical guidance, and includes new sections on SHF techniques and intruder alarms.

5th edition ▲ Feb 2000 ▲ 571 pages
11 illustrations ▲ PB ▲ Published in UK

Code 0 7506 4285 7 **£16.99**

RSGB RADIO & ELECTRONICS COOKBOOK

Radio Society of Great Britain



Only a basic knowledge of electronics is assumed for this collection of electronics projects, and it is ideal for all electronics and DIY enthusiasts and experimenters. Designed by the RSGB, the UK radio amateurs federation, the projects are clearly explained step by step.

Nov 2000 ▲ 336 pages ▲ PB ▲ Illustrations
Published in UK

Code 0 7506 5314 4 **£17.99**

REFERENCE DATA FOR ENGINEERS: RADIO, ELECTRONICS, COMPUTERS AND COMMUNICATIONS

Mac E Van Valkenburg; Edited by Wendy Middleton



Written by professionals for professionals, this is a complete reference for engineers. As well as addressing radio technology data, it covers digital electronics, computers and communications.

9th edition ▲ Aug 2001
1568 pages & CD-Rom ▲ 1385 line illustrations
HB ▲ Published in UK

Code 0 7506 7251 9 **£90.00**

SERVICE ENGINEER'S POCKET BOOK

Lewis & Sinclair



This title aims to provide the service engineer with all the necessary information to carry out work on domestic electronics equipment. The coverage ranges from satellite reception to NICAM. Both analogue and digital equipment are covered, and there are chapters on common problems.

Jan 1998 ▲ 238 pages ▲ HB

Code 0 7506 3488 8 **£14.99**

SERVICING TV, SATELLITE & VIDEO EQUIPMENT

Eugene Trundle



A practical hands-on guide for service engineers, installation technicians and servicing students, this text emphasises the practical business of fault diagnosis and repair of TV, satellite and video equipment.

Revised 2nd edition ▲ Nov 2001 ▲ 336 pages
Symptom index ▲ PB ▲ Published in UK

Code 0 7506 5307 0 **£21.99**

TELEVISION MICROPROCESSOR IC DATA FILES

J Edwards

Microprocessor ICs are the most complicated part of TV equipment and present special problems to the engineer. This text covers the most popular microprocessor ICs. Each device is presented graphically with the relevant data information given against each pin.

Mar 1997 ▲ 240 pages ▲ 200 line drawings
PB ▲ Published in UK

Code 0-7306-3333-2

£19.99

TELEVISION IC DATA FILES

J Edwards

A compendium of data on all the most common integrated circuits used in televisions. Each device is illustrated with a pin-out diagram, and all the measurements and signal data in the book were taken under actual working conditions. This second edition contains over 70 new ICs.

2nd edition ▲ Jan 2000 ▲ 245 pages
PB ▲ Published in UK

Code 0-7306-4581-4

£18.99

TV FAULT-FINDING GUIDE

Edited by Peter Marlow

A distillation of the most-used fault reports from 11 years of *Television* magazine. Arranged by make and model, it features over 200 reports on over 300 models of television, including diagnosis and repair advice.

Mar 2000 ▲ 387 pages ▲ Illustrations
PB ▲ Published in UK

Code 0-7306-4633-0

£20.99

VALVE AMPLIFIERS

Morgan Jones

The author's straightforward approach, using as little maths as possible, should be of use to those with only a limited knowledge of the field as well as being the standard reference for experts in valve audio. Design principles and construction techniques are also provided.

3rd edition ▲ Aug 2003 ▲ 624 pages ▲ Index
PB ▲ Published in UK

Code 0-7306-5494-8

£29.99

VCR FAULT-FINDING GUIDE

Edited by Peter Marlow

A distillation of the most-used fault reports from 11 years of *Television* magazine. Arranged by make and model, it features over 2000 reports on over 200 models of VCR, including diagnosis and repair advice.

Mar 2000 ▲ 447 pages ▲ Illustrations ▲ PB
Published in UK

Code 0-7306-4634-9

£20.99

VCR IC DATA FILES

J Edwards

This text aims to provide the workshop technician and the field engineer with a convenient method of fault-finding without the need to consult workshop manuals. The most popular ICs used in video recorders are covered. Each device is presented graphically with data given against each pin.

Jul 1998 ▲ 448 pages ▲ 200 line illustrations
PB ▲ Published in UK

Code 0-7306-3993-8

£20.99

VIDEO AND CAMCORDER SERVICING AND TECHNOLOGY

Steve Beeching

A comprehensive guide to domestic VCR technology and repair techniques. This edition brings the information fully-up-to-date, with expanded coverage of camcorders, sections on DVD equipment and the latest VCR technology.

5th edition ▲ Apr 2001 ▲ 323 pages
Illustrations ▲ PB ▲ Published in UK

Code 0-7306-5029-7

£20.99

VIDEO DEMYSTIFIED

Keith Jack

This edition has been updated to include information on digital television, datacasting, interactive video, digital camcorders and VCRs, and video interfacing. Coverage is international, including European, Asian and North/South American video standards, methods and techniques.

3rd edition ▲ Jul 2001 ▲ 784 pages & CD-Rom
References ▲ Glossary ▲ Index ▲ PB
Published in UK

Code 1-893707-34-6

£50.00

THE DIGITAL SATELLITE TV HANDBOOK

Mark E Long

A handbook and CD-ROM pack on digital satellite television. It provides an overview of all the digital TV platforms in use world-wide. It includes satellite coverage maps and transmission parameters that readers will need to receive digital TV services from any location in the world.

Sept 1999 ▲ 207 pages & CD-Rom ▲ PB

Code 0-7306-7171-8

£41.99

NEWNES GUIDE TO RADIO AND COMMUNICATIONS TECHNOLOGY

Ian Poole

This is a guide to the technology and applications of modern radio and communications equipment. The author's approach provides a useful foundation for college students and technicians seeking an update on the latest technology.

Jul 2003 ▲ 352 pages ▲ Index ▲ PB
Published in UK

Code 0-7306-5472-3

£16.99

VALVE RADIO & AUDIO REPAIR HANDBOOK

Charles Miller

A practical manual for collectors, dealers and service engineers of valve audio and radio equipment. This edition includes new material on restoration and valve amplifiers.

2nd edition ▲ Apr 2000 ▲ 280 pages
▲ 10 half-tones ▲ 50 line illustrations ▲ PB
Published in UK

Code 0-7306-3995-4

£20.99

NEWNES TV & VIDEO ENGINEER'S POCKET BOOK

Eugene Trundle

This updated text provides a pocket tool for service engineers. It presents a range of essential information in a compact form, covering television reception, satellite and cable television, video recorders, colour camera technology, teletext and fault-finding.

3rd edition ▲ Oct 1999 ▲ 512 pages ▲ HB

Code 0-7306-4194-0

£17.99

TELEVISION ORDER FORM

Please order or search the following:

Code	Description	Qty	Price

POSTAGE & PACKING **FREE** IN THE UK* **TOTAL**

Name _____ Daytime Tel _____
Address _____
Postcode _____

I enclose a cheque/postal order value £ _____ payable to 'Boffin Books Ltd'

Please debit my Access/Visa/Switch/Delta card Issue number (Switch only) _____
(date as applicable)

Card Number _____ Expiry Date _____

Signed _____

*Postage charges outside the UK available upon request or email: salesteam@boffinbooks.demon.co.uk

Post to: **Boffin Books Ltd, 24 Walton Street, Walton-on-the-Hill, Tadworth, Surrey KT20 7RT, UK**

If you are ordering by credit card, need further information, or would like to use our search facilities, call

01737 812727 Fax 01737 813526

We are open from 9am to 5pm, or leave your order on our out-of-hours answering line or email us at salesteam@boffinbooks.demon.co.uk

When placing orders please quote: Name • Address (Home & business) • daytime telephone number • debit/credit card number • Expiry date • Details of order. Please note that prices may change, but are correct at time of going to press.

Extended Fault Reports

Reports on complex or tricky TV fault conditions are sometimes too long for inclusion in our basic fault-finding section. We've put a few of them together in this extended fault report feature

Reports from
Michael Dranfield
Arthur Jackson
and
Martin McCluskey

We welcome fault reports from readers – payment for each fault is made after publication.

Reports can be sent by post to:

Television Magazine Fault Reports,
Highbury Business,
Media House,
Azalea Drive, Swanley,
Kent BR8 8HU

or e-mailed to:
t.winford@highburybiz.com

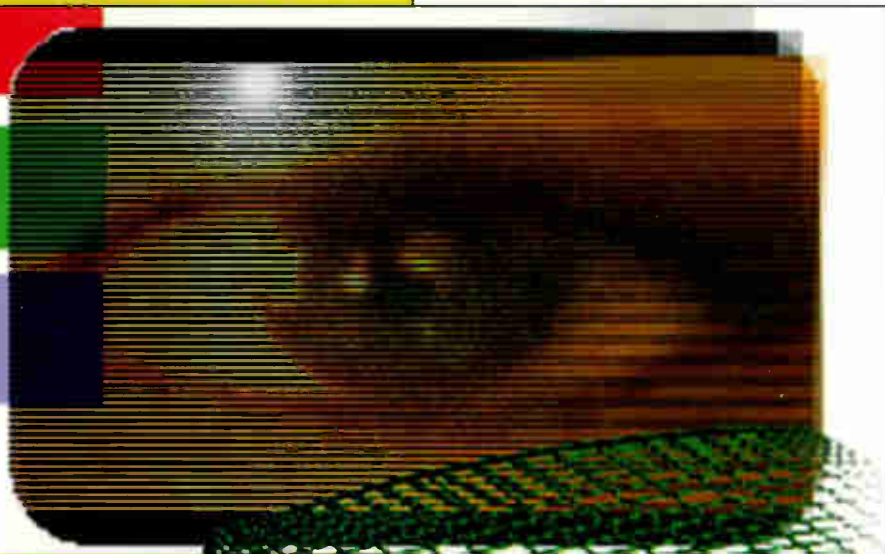

Bush 2867NTX (11AK19 chassis)

This set's standby LED was not lit, the voltage at supply pin 8 of the EEPROM was low, and the voltage on the main HT line was at only 35V. Now in standby the supply to the EEPROM and microcontroller chips is supplemented by the action of a thyristor, Q810, which is fed from the 150V secondary winding on the chopper transformer and is fired in bursts. The idea is to maintain the input to the 5V regulator IC804 at an adequate level – about 12V. This input is smoothed by C813 (4.700 μ F, 16V), which also takes a feed from D811. I decided to carry out a scope check at the cathode of Q810. This showed that a series of pulses was present here, so obviously C813 was open-circuit. Wrong!

I won't go into how much time was wasted and how many components were replaced while I was looking for the cause of the problem. I eventually found that R867, an 0.33 Ω safety resistor that's connected between the cathode of Q810 and C813, was open-circuit. Why hadn't I noticed such a simple thing at an earlier stage? Because R867 is not shown in my service manual!

On enquiry I find that there is quite a lot of variation in the circuit configuration in this area in the different versions of the 11AK19 chassis. In some the cathode of Q810 is connected to the other side of R867. And in some an LM317 regulator is used to provide a 3.3V supply – this depends on the microcontroller and EEPROM chips used. There are doubtless other differences. So beware! M.D.

Ferguson ICC9 chassis

The customer who brought this set in said the picture would go dark after fifteen minutes. I ran it every day for a week without any signs of a problem. Then, when I questioned the customer about the

fault, he said it occurred only when he was using a games console connected via the scart socket. Why on earth did he omit to mention this in the first place? Don't some customers make you mad?

When I connected a Sky digibox to the scart socket the fault put in an appearance after fifteen minutes or so. The luminance content started to drop, eventually leaving only the chroma content in the display. I scoped the AV luminance signal path as it passed through a series of surface-mounted transistors. The signal virtually disappeared at the output from the BC858B emitter-follower transistor TX11. Everything was OK once a replacement had been fitted.

The job would have been done a lot quicker if the customer had bothered to mention that the fault was present only when the set was used in the AV mode. M.D.

Panasonic TX28LD4DP (EURO-4 chassis)

This 28in. set is a Dolby Pro-Logic model that had been quite expensive to buy when new, so its owner was happy to have it repaired provided the fault was not a major one. The fault symptom was that the set would come on for approximately four seconds then revert to standby. As the set shut down, some raster was seen briefly towards the centre of the screen.

Checks failed to reveal any obvious shorts or incorrect supply voltages, but I found that when the symptom occurred relay RL801 switched off, removing the input to the main chopper power supply. In the standby mode a small mains transformer feeds a rectifier circuit that provides an input for a 5V regulator transistor, Q852. This produces a supply for the microcontroller chip IC1101, which generates the on/off command to operate the relay at pin 52. The voltage at this pin would go low, switching the set back to standby.

IC1101 has a vertical protection input at pin 71. This was the clue, so attention was turned to the field output stage. Checks here showed that during the brief period when the set was on the -14.9V supply was missing at pin 1 of the field output chip IC451. Further checks revealed that the feed resistor R559 (0.33 Ω , 0.5W) was open-circuit and the associated rectifier D558 (ISR124-4AT82) was short-circuit. Once these two components had been replaced and a few poor connections had been attended to the set produced excellent pictures and sound. A.J.

Thomson 52JW641 (ICC21 chassis)

The complaint with this 52in., widescreen rear-projection set was dead apart from the standby light flashing. A closer check on the LED showed that it was flashing error code 16. According to the manual this

means the "I²C bus_3 clock line held low". But we've found that these error codes can be very misleading, as a missing or incorrect voltage because of a power-supply or timebase problem is far more likely to be the cause rather than a bus-related fault.

This was the case here, as cold checks showed that the line output transistor TL010 (type ON4977 or BU2525AX) was short-circuit. Fortunately the reason for its failure was quite obvious. The flyback tuning capacitor CL031 (11.6nF, 2kV) was dry-jointed and scorched at one leg. Replacing these two components cured the fault. A.J.

Philips 14PV170

The complaint with this TV/VCR combi unit was that it would switch to standby after anything from ten minutes to an hour of operation. If the unit was switched off for a few minutes and then tried again, the fault would be repeated. When the unit was in operation all TV and VCR functions worked perfectly: turn your back and it would revert to standby.

I could find no dry-joints but, when using a hairdryer to try to instigate the fault, I obtained a clue. Just before switch off, the field scanning briefly collapsed. Continued use of the hairdryer, plus freezer, brought me to the BAV21 field

flyback boost diode D6513, which was going open-circuit. This activated the vertical-guard circuit within the field output chip IC7510, in turn biasing on transistor Tr7550 whose collector voltage went low. The voltage at the collector of Tr7550 is linked via pin 2 of connector 1923 to the microcontroller chip as a protection input. In normal operation the voltage here is approximately 3.5V: when it falls to 1.5V or less, protection is initiated and the unit switches to standby.

EHT voltage and beam current monitoring lines are also connected to pin 2 of connector 1923, so a problem in either of these areas could cause similar symptoms. In this case however replacement of D6513 cured the fault. A.J.

Sharp DV5180H (4BSB chassis)

This 21in. stereo sound set was in excellent condition physically but had failed for the first time after nine years' use, the complaint being stuck in standby. Initial checks showed that the 2SD1554 line output transistor Q601 was short-circuit. Further checks on the HT supply and the flyback/scanning components failed to reveal anything else amiss, so a replacement transistor was fitted. I connected a scope to its base to monitor the drive waveform at switch on.

When I tried the set it produced a high-pitched noise and the LED was

flashing amber instead of going green. The drive waveform was low and unstable, and was very poor when traced back to its source at pin 12 of IC2801 on the VCJ/text board. The cause of the problem was the supply at pin 6 of connector DB on this board. Instead of being 5V, it was low at 3.7V. The supply comes from IC751 (KA7805PI) on the main board. I suspected the capacitors at its input or output, but these proved to be OK. The trouble was with IC751 itself, despite the fact that it's a robust device that's mounted on a sturdy heatsink. All was well once a replacement had been fitted. A.J.

Hitachi C32W40TN

This widescreen set was dead with the 4A mains input fuse open-circuit. I couldn't find any shorts however and the set worked once a replacement fuse had been fitted. But there was a burning smell, which came from the mains on-off switch. It is of the same type that's fitted in certain Philips TV sets. These switches can burn up badly. The switch is mounted on the main PCB in this Hitachi model, so there could be big trouble if the board burns up as well.

After fitting a new switch I checked that the mains plug didn't have a 13A fuse fitted. I find it strange that in the 21st century no one seems to be able to make a reliable TV on-off switch. M.McC.

Tuner Repairs
+
IC Fitting Service
+
Digital
set top box repairs

For more information and latest prices
See our web site

www.mces.co.uk

MCES Digital

15 Lostock Road Davyhulme Manchester M41 0ES

E-mail: sales@mces.co.uk

Phone: 0161 746 8037

Fax: 0161 746 8136

Economic Devices

PO Box 73, Oakengates TF2 8WR Tel ++44 (0)1952 273130 Fax ++44 (0)1952 405478

Remote Controls ^{from} **£5.95 each**

Stock held for over 53000 different models

SEMICONDUCTORS
over **34,000** types of
transistors, IC's, diodes etc. or equivalents stocked

We take your hassle Some suppliers just won't help. We will work really hard to find those difficult parts - just ask and let our 'no holds barred' enquiry hound work for you!!!

...and look at the (strictly while stocks last)
special offers.....

BUT11A @ ~~49p~~ each BUT11AF @ ~~41p~~ each
BU508A @ ~~43p~~ each Fully wired scart lead ~~39p~~

a slight inconvenience....
....you must buy more than one.

BU208A X 5 75p ea	TEA2018A X 5 99p ea
BU508A X 5 79p ea	UC3842 X 5 59p ea
BU508AF X 5 85p ea	CNX62A X 5 29p ea
BU508D X 5 89p ea	S2000AF X 5 84p ea
BUT11A X 5 29p ea	TDA3653B X 5 55p ea
BUT11AF X 5 47p ea	TDA3654 X 5 82p ea
Philips type 1.2 volt Back up battery	X 5 59p ea
Philips type 2.4 volt Back up battery	X 5 120p ea
Scart - Scart lead 1.5m Fully wired	X 2 39p ea
Positor PT37, TH98009 (White)	X 5 59p ea
Thorn TX100 Chassis 110 DGR LOPTX	each £11.24
Philips CP90 Chassis LOPTX	each £11.63

...and now ask about our
value for money full price list.
Remember £1.50 post & handling
All major credit cards accepted

www.telepart.co.uk

The web page is here you can look up the price and order all things TV, VCR and Satellite. Web search by model for video parts, remote controls, LOPT's etc. overseas enquiries particularly welcome

New GCTV catalogue out NOW
cameras, monitors, switches
quads, multiplexers, the lot.

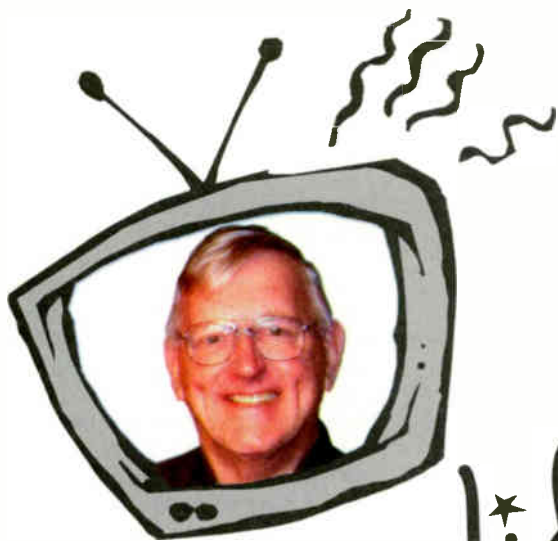

What a life!

Donald Bullock's servicing commentary

Problems at the shop ▶▶ The New Zealand scene ▶▶ Trouble with a Sony PS-LX50 record deck

Many moons ago I employed a brilliant but highly-strung engineer named Keith. For most of the time he was a barrel of laughs, but if anything upset him at the start of the day he would fly into a rage, fling his arms about and announce "oh, I see, it's going to be one of those days again!" And it always would be. He ensured that.

The other day I had to look after the shop on my own. Steven and Paul had sneaked off to look after the shop on my own. Steven and Paul had sneaked off to do some pike fishing. Funny, neither of them can flick a plug-bait on top of a pike swirl at twenty yards away as I could at their age – nor ride home with a few huge pike dangling from the handlebars of their bike.

I got up a bit on the late side and, as I was rushing around, Miss Nightingale dived under my feet. Miss Nightingale is Greeneye's nasty, new, pure-white and boss-eyed cat. It squealed crazily as though it was hurt and shot away at speed. Greeneyes said I was inhuman and needed the birch. Why she has to have so many animals about the place I don't know. Anyway we had a row about it and I got nasty. I won because I can shout loudest. I could see it was going to be one of those days again. I thought, as I slunk off to the workshop.

The man with the Sony TV

And it was. Shortly afterwards I drew up outside the shop. I didn't like the look of the fellow who was hanging about there. He was scruffy for a start, and had the red face of a habitual beer drinker.

As regular readers will know, I can't stand people who drink alcohol. But it was more than that. He was lounging against the window and was glaring at passers-by, as if he thought them beneath contempt. As I opened the shop door he was half a step behind me.

"What time you 'sposed to open this place, mate?" he growled, eyeing me with one eye screwed up. His breath almost sent me above the drink-driving limit. I looked at my watch. Two

minutes late!

"In the car" he mumbled, slouching off towards his banger. Fearful of being caught over the limit with my car keys on me, I hid them in the battery-stand before I followed him.

"It's a big 'un, mind, and I can't help on account of my bad back" he muttered. He was the seventy thousandth person who had said that to me. "But you looks strong enough" he added.

It was a massive 29in. Sony set, Model KVA2942U (AE2B chassis). By the time I'd struggled with it and got it on to the counter I was sweating.

"Dead" he said as I clutched the counter and gasped. "My missus wants 'im back tonight, and 'er said it's been a bad week. So don't get any fancy ideas. We ain't made of money."

Interlude

Meanwhile a tall, serene man had sailed into the shop. He was carrying a crumpled paper bag.

"Ah, you'll be Steven" he said, "I'm the Reverend Godsell, vicar of St. Luke's. The Reverend Goode of All Souls says he knows you well and that you're a good and helpful man. So rare these days, unfortunately."

Then he pulled an old office stapler out of the bag and pushed it towards me. "It keeps jamming" he explained, "no hurry. Shall we say a couple of hours? Oh, and here are some staples for you to try it with. Wants a drop of oil, I expect!"

Then he sailed off out. The chap with the Sony looked after him then turned to me.

"Yer gets some odd-balls 'ere, mate" he said.

Back to the Sony

Just then I caught a whiff of sooty smell that came from the back vents of the set. When I took the back off I saw that the repair wasn't going to be cheap.

"This set requires quite a rebuild" I explained, "and that means time and money. We've got the former if you've got the latter."



Photo 1: Don's Sony PS-LX50 record deck.

He sniffed at the set and looked at the chassis. "E'll 'av to be done" he said, "I mean what can you do with no telly?"

I reflected. Ours had died on us over Christmas, bringing us a happy relief. I hadn't got round to even thinking about it as yet. I reached for a job card.

"Ah, Maisey!" he commented I spun round, but there was no one else about. So I wrote down Mr Maisey while he breathed on me again and sent me over the limit.

"I wants a receipt for the set" he said. "E causted me 'undreds of pounds. You could pinch it off of me and say you'd never seen 'im in the first place."

I scribbled on a bit of paper and handed it to him. Then he departed.

The set had died a violent death. While I was wondering where to start the phone rang.

"Iris" a male voice said, "is that you, Iris dear?"

I slammed the phone down and started to work on the set. R609 was in a sorry state, cooked. It's a 15Ω resistor in the drive to the gate of the chopper FET Q601. R606 (270Ω) and R656 (220Ω) were in a similar state. Having replaced these three resistors I checked associated components. Q601 (BUZ91A) and Q604 (2SD2061) were both short-circuit. The fuse also looked a bit baked, and sure enough had failed.

The chopper power supply is controlled by a TDA4605-3 chip, IC601. I decided to take a look at this item as well, and noticed a couple of shiny black blobs on its slate-grey case. On further investigation I found that several of its pins were shorted together. So I fitted a replacement then had a good, leisurely check around the chassis before I dared to switch the set on. When I eventually did, I was greeted by the welcome sound of rustling EHT, followed by an excellent picture with good sound.

What next?

Feeling relieved, I started to box the set up. But the phone rang.

"Iris, speak to me. I didn't sleep a wink last night."

I threw the phone back on to its rest and looked around. "What now?" I thought as I fingered my chin and wished I was some-place else. Then I noticed the vicar's stapler.

I yanked a couple of jammed and twisted staples out of it, then applied a drop of oil. I was about to try it when a dark-suited chap in gumboots came in.

"Father O'Reilly's the name" he said.

"Oh, really" I said, a bit taken aback.

"No sorr, O'Reilly" he continued, "and I've come to offer you the opportunity to advertise in our parish magazine. Only ten pounds a page for a year! How about:

*If your picture's gone
don't carry on.
Just call for Steve or Paul or Don."*

"Not just at present" I muttered.
"OK then, how about

*So your set's gone dead
don't hang your head.
Call for Steve or Paul or Fred."*

"But we don't have a Fred" I replied.
"You want it to rhyme, don't you?" he said.
"Well to tell you the truth . . ." I began.
But he cut in. "Well how about

*Oh woe is me
with no TV..."*

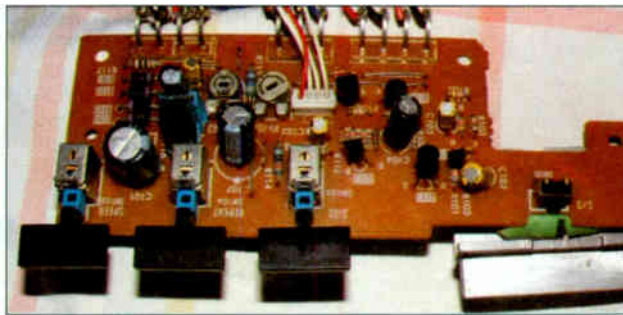

Photo 2: The faulty motor-control PCB.

At that the phone went again. I moved to pick it up, dithered, snatched a tenner from the till and passed it to Father O'Reilly. "OK" I said, "you decide what to put. No need for a receipt."

As he departed I picked up the ringing phone. It was the same fellow.

"Iris, don't forget you're mine. I'm thinking of suicide" the voice declared.

"A good idea" I said, "look, there's no Iris here, just stop this

nonsense" then banged the phone back down

New Zealand scene

I've just had an email from Bernard Fouhy in New Zealand. He's a self-employed TV engineer who's been working from home for the past twenty-five years.

"I don't know how much longer I'll be able stick at it" he comments, "the market has been flooded with cheap Chinese stuff. As a result customers write off sets that are perfectly repairable. The only bright spot is that many of my customers are getting older and need help with such things as tuning, how to connect a DVD player and so on. They are much more patient than the younger ones, who want everything done now or sooner.

One of my older and very patient customers, Mrs Flaherty, called me recently to look at her Sanyo set, which had a green picture. She mentioned that the picture had gone green on St. Patrick's day, and had assumed that this been done on purpose by the TV station as a gimmick. Only when it had remained green for a month did she decide that something must be wrong and gave me a call."

Your chance to help!

I've had a lesson recently on how customers feel when a trusted TV set or video recorder fails just when you want to use it, and how annoying it can be when spares aren't available and you have to do without the equipment for ages. Only in my case it's something I use much more often than the TV or video, my Sony PS-LX50 record player deck in fact. It's part of a Sony separates system, type LBT-V50W, that I bought in about 1988, and this is the first bit of trouble it has given me.

For several weeks the turntable had been sluggish when I switched on. But it would recover quickly and run normally, at the right speed, when I flicked it on its way with my finger. I had assumed that the motor, which bears a label saying DNR 7600A, had dried out, and promised myself more than once that I would clean and lubricate it. I eventually opened it, without carrying out any tests, only to find that it was not the cause of the trouble. There had in fact been nothing wrong with it, but I fear there may be now. While reassembling it I managed to distort the brushes, each of which consists of three strands of fine tempered wire. It now revolves all right when I apply a DC voltage, but I won't know whether it's doing its job properly until I've repaired the fault on the motor-control PCB.

This could be tricky, as the player is now about sixteen years old and I haven't as yet been able to locate a circuit diagram or learn anything at all about it. The faulty PCB is a bit larger than a playing card, with a 1in. wide extension at one of its short sides. It houses the on-off control and three press-buttons for turntable speed, record size and repeat. The two motor leads are connected to the outer legs of a four-leg semiconductor device that gets very warm in use. It bears the number C1420, and is about the size of a BD131 transistor. I can't find any reference to this item anywhere. Is it maybe an abbreviated number, and is there an equivalent?

If anyone can throw any light on this problem, I'd be very relieved to hear from them. Although the turntable is getting on a bit, it's slim, compact and performs well when working normally. The accompanying photos should aid identification. As mentioned before, you can email me at: donald@wheatleypress.com ■

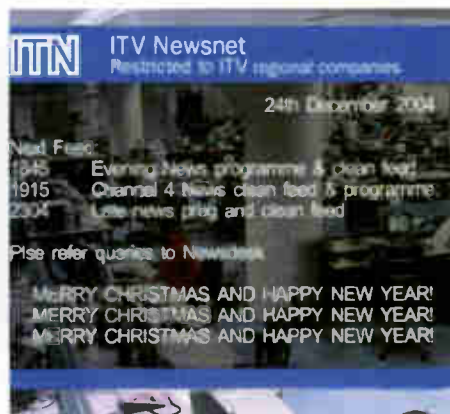

Photo 2: The ITN newsroom, from Intelsat 603 at 11.461GHz.



Photo 3: ITN Ch 3 news via Intelsat 603.

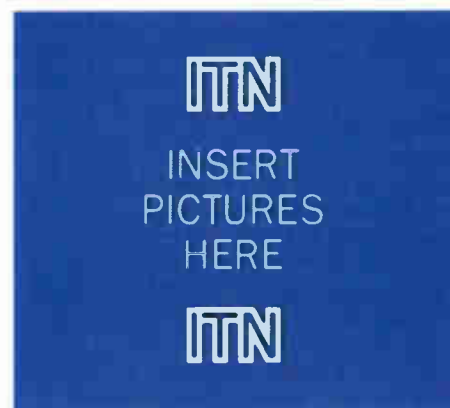

Photo 4: ITN news via Intelsat 603.

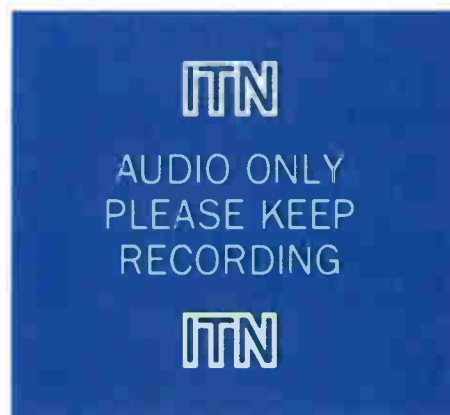

Photo 5: ITN news via Intelsat 603.

SATELLITE NOTEBOOK

Reports from
Christopher Holland
Michael Dranfield
 and
Pete Haylor

A cable problem

Once the coaxial cable between a dish and a digibox has been installed and everything works, it normally leads a reliable life and lasts for many years. But problems occur from time to time, often

when building work is being carried out. The cable may be damaged, the result being either a no-signal condition or intermittent reception. Fortunately the days when a DC short-circuit in the supply to the LNB could, with some early satellite receivers, result in the demise of the non-chopper mains transformer have long since passed. The transformer seemed to protect the fuse that should have blown!

Eustace James had an early Sky Digital installation, with a Pace 2200 digibox. It had given trouble-free service for several years, but odd problems had recently started to happen when changing channel, particularly when switching the polarisa-



Photo 1: Cable 'join' damaged during building work.



Photo 6: ITN news via Intelsat 603.



Photo 7: BBC Scotland (UKI-234) via Intelsat 603.



Photo 8: BBC Scotland via Intelsat 603.



Photo 9: SISLINK feed via Intelsat 603.

Table 1: Latest digital channel changes at 28.2°E

Channel and EPG no.	Sat	TP	Frequency/pol
ACTV	EB	C1	11.223GHz/H
Colour bars	2A	37	12.422GHz/H
Fizz TV	EB	C2	11.265GHz/H
Living TV + 1 (114)	2A	2	11.740GHz/V
Max TV	EB	C2	11.265GHz/H
One TV	EB	C3	11.305GHz/H
UKTV People + 1 (567)	2B	15	11.922GHz/H
2 Colour bars	EB	C2	11.265GHz/H

2A = Astra 2A 2B = Astra 2B EB = Eurobird

tion or going between high- and low-band channels. The no-signal message would sometimes be displayed, suggesting a power-supply or LNB fault. But the signals could be brought back by resetting the digibox (unplug it from the mains supply, wait for a short period, then reapply power). When the digibox was checked in the workshop it proved to be OK. When the LNB and digibox were substituted at the house there was no difference!

So we were left with the cable. The cause of the problem was eventually traced to a 'join' (see Photo 1) in the cable in a recessed box in the dining-room area. House extension work had been carried out some years previously, in the days of analogue satellite TV. The damage then done had remained ever since. When you consider the state of the join, it's amazing that the system had worked at all – and that the fault had taken so long to show up. C.H.

Digital channel update

The latest channel additions at 28.2°E are listed in Table 1. Where allocated, the EPG number is shown in brackets after the channel name. Note that Eurobird transponder C2 (11.265GHz H) uses 'non-standard' characteristics – symbol rate 22,000, FEC 2/3.

The Horror channel (EPG no. 330) has moved from transponder C2 to transponder C1.

Radio stations Classic FM (856), Classic Gold (859), Core (862), Planet Rock (861), The Mix (871) and The Storm (860) have moved from transponder 32 to transponder 36 (Astra 2B, 12.402GHz V). C.H.

Intelsat 603 (20°W)

Last month I mentioned the end of active life for Eutelsat 2F3, which is in an inclined orbit at 21.5°E, with the BBC's satellite news gathering activities being transferred to Atlantic Bird 1 (12.5°W) and Eutelsat W3 moving to 21.5°E to replace 2F3. While some news feeds remain at 21.5°E, the majority have moved to Intelsat 603 at 20°W.

603 is also in an inclined orbit though this is at present less than that of 2F3, being about 2°. The satellite can therefore be received for a considerable period during the day with a fixed-elevation dish. It was originally launched in 1990, using a Titan 3 rocket, but could not achieve proper separation from the rocket after launch and was left in an unusable low-earth orbit. Subsequently, in May 1992, a Space Shuttle rescue took place, when space-walking astronauts attached a new booster rocket assembly, enabling the satellite to be sent to the geostationary orbital position originally intended. The satellite was soon established at 24.5°W, and carried Barcelona Olympics traffic across the Atlantic that summer. It remained at 24.5°W until it was replaced there by Intel 905, when it moved to the present 20°W.

Most geostationary satellites carry on-board propellant that's used to keep their earth orbital position relatively stable. But the supply of gas becomes limited towards the end of the satellite's planned life, and correctional firings are then kept to a minimum. As a result the satellite wanders slightly above and below its orbital position during the 24-hour period.

Spectrum space on a satellite such as this one costs less than that aboard a satellite with a tightly-controlled orbital position, but the uplink and downlink dishes used need to be able to track the satellite. This doesn't present much of a problem for the broadcasters who use the satellites for electronic news-gathering activities.

Intelsat 603 is expected to have several more years of useful life in its inclined orbit, though the inclination angle may increase as time goes by – this is what happened with 2F3.

Finding 603

The easiest way to find Intelsat 603 is to look for the ITN feed at 11.461GHz H (symbol rate 4,224, FEC 7/8). This is always present, with a shot of the newsroom (see Photo 2) and clean feeds for ITV and Channel 4 news (see Photos 3-6), though it uses the MPEG 4:2:2 format.



Photo 10: ITV regional news feed via Intelsat 603.



Photo 11: ITV regional news feed via Intelsat 603.



Photo 12: Sky News feed via Intelsat 603.



Photo 13: Sky News feed via Intelsat 603.

Note that this format is most easily received using a PC-based satellite receiver: it won't produce pictures with a conventional MPEG 4:2:0 receiver. The Sky News feeds are generally the most active ones, with 11.181GHz H and 11.187GHz H seeming to be in greatest use.

At present Intelsat 603 is slightly above the geostationary arc in the early morning, crossing the arc at about mid-day then moving to a low position in the early evening. I find, in southern Portugal, that the signals are quite a lot weaker when 603 is above the geostationary arc and increase rapidly as the satellite starts its descent to being on or below the arc. No doubt this is because the whole footprint moves towards and away from my location.

Frequencies

The signals from Intelsat 603 are all horizontally polarised.

BBC Scotland uses 10.962 and 10.972GHz, with a symbol rate of 6,111 and 3/4 FEC, mainly for local news reporting at 18.30 (see Photos 7 and 8).

I've seen SIS horseracing feeds and some ITV regional news reporting at 11.121, 11.127, 11.133, 11.139, 11.145, 11.151, 11.157 and 11.163GHz, with a symbol rate of 4,224 and 7/8 FEC (see Photos 9-11).

Sky News uses 11.169, 11.175, 11.181 and 11.187GHz with the same SR and FEC. Occasionally 11.163GHz is used, which shows that there is some overlap between the frequencies used by the various broadcasters. See Photos 12-17.

As mentioned above the ITN newsroom camera is always present at 11.461GHz. ITN feeds and some ITV and GMTV reports have been seen at 11.466, 11.471, 11.476, 11.480, 11.484 and 11.504GHz. I suspect that 11.488, 11.492, 11.496 and 11.500GHz are used as well. See Photos 18-19.

I've seen one BBC news feed, at about 11.471GHz, when its satellite truck couldn't get a clear view of Atlantic Bird 1. I gather that the BBC was anxious to leave Intelsat 603 quickly after completing this news report as there was some uncertainty as to whether it had permission to use the satellite!

When news feed activity is slack, for example during the weekends, the occasional SIS racing feed can be found above 11.466GHz (SR 4,224, FEC 7/8). C.H.

Sony VTXS750

Loss of certain channels – usually Performance (202), Golf (423), Game in (226) and Tantalise TV (993) – is a very

common fault with this digibox. It's caused by a problem with the tuner unit, which can be repaired by MCES in Manchester (phone 0161 746 8037 or email sales@mces.co.uk). Be very careful when you remove the tuner, as the through-board links are easily damaged.

When you replace the assembly, make sure that the ribbon cable isn't sticking up as you slide the lid on the digibox. On one occasion a customer sent me a digibox in which he had replaced the tuner then cut the ribbon cable in half trying to replace the lid! M.D.

Amstrad DRX400

If the power supply is dead and the top hasn't been blown off the TOP243P chopper chip U1, look no farther than resistors R3 and R13, which are both 1MΩ. One will usually be open-circuit, but replace them both.

SatCure (www.satcure.co.uk) now has a kit to repair and upgrade the power supply in this model. M.D.

Amstrad DRX400

The RF modulator in this digibox produced a picture but there was no sound. It had been brought in because of a poor picture from the TV out scart socket and no sound. The picture from the video out scart socket was OK, but again there was no sound. The AV switching chip U704 (CXA2161R) was suspect, but I decided to check its supplies first. There should be 12V at pin 15 and 5V at pins 14, 44 and 48. All these supplies proved to be correct, with no ripple present. A new CXA2161R AV chip cured the fault. M.D.

The motorised dish saga

In the November issue (page 56) I described the initial stages of a job that started with a phone call asking "do you repair motorised?" There were no motor functions, mainly because of numerous problems outdoors – and the garden was a veritable jungle. Subsequently my colleague fitted a 2in. pole in the garden, concreting it in. This time it was upright!

A week later we returned to the job, with a machete to cut a path to the dish. Once there, we removed the polar mount from the old pole. Yet another fault was then found. Apart from missing or loose bolts, the polar mount was twisted. A large, heavy hammer quickly repaired it! With all the bolts replaced and the bearings freed and oiled, the polar mount worked. So the job of alignment began. When finished, the dish at least tracked east to west as well as the equipment allowed.

We then went back indoors to the



Photo 14: Sky News feed via Intelsat 603.



Photo 18: ITN/GMTV feed via Intelsat 603.



Photo 19: ITV regional news feed via Intelsat 603.



Photo 15: Sky News feed via Intelsat 603.



Photo 16: Sky News feed via Intelsat 603.



Photo 17: Sky News feed via Intelsat 603.

receiver. The first adjustments are to set the limits. Yet another fault was found – the feed to the reed switch was open-circuit. This was odd, as the switch had previously worked (after fitting a replacement). The break was traced to a joint in the cable outside.

The receiver worked all right when this had been repaired, and several satellites were tuned in. The face of the dish was dented however and, I suspect, not true. We struggled to get Arabsat at 26°E, though signals from the Astra positions (28.2°E and 19.2°E) romped in.

The job had at last been completed. We advised the customer that new cables were required and that a new dish and mount would provide him with better results, but he didn't want to pay any more.

So beware next time you get a call "do you repair motorised?" P.H.

Something fell off

"This thing has fallen off the dish" came the frantic phone call from a new customer. After talking to him for a bit I decided that it would be safe to wait until a suitable time for a visit could be found.

On arrival I discovered that the "thing" was the tube that has the two bearings attached to it so that the moving part of the dish can move. What had happened was that the small 90° bracket had become loose. By just twisting it back, the repair was completed – or so I thought!

When I tightened up the bolts and swung the dish I saw why it had become detached: the limit switch had not been set. So this was reset.

I then found that the signal from the 1.5m dish was terrible, with Hotbird showing only about twenty per cent signal strength. A check showed that the dish hadn't moved, so I suspected the LNB. The customer said he had had the problem before, because of spiders.

The difficulty was how to get to the LNB, as the dish was mounted at the

edge of the house with a glass greenhouse along the side. The customer explained that on the last occasion the ladder had been rested on the dish with one person footing the ladder while the other carried out the repair. When the ladder was positioned as suggested, it rested between the arms of the prime-focus dish quite securely. A trip was then made to the top and the LNB was removed. It was full of spiders, and took a long time to clear. The cause of the problem was that the 'mustard pot' cover was missing.

The next job was to retune the receiver. An attempt was made to update via Hotbird, but it wouldn't oblige. So all satellites were tuned and added to as required.

A further visit is to be made when new software that can be downloaded from a laptop is available via the internet. P.H.

Missing channels

The customer said that a few Hotbird channels were missing but the Astra channels were all OK. His system consists of an 80cm dish with two LNBs, for 19.2°E and 13°E: the feeds go to a two-way switch at the side of the satellite receiver. When I checked the system everything seemed to be OK except that two Hotbird frequencies were missing – 11.766 and 11.843GHz. This was the preset frequency list which, when selected, showed no signal strength.

A spectrum analyser check showed that there was no external interference, and a check around the house didn't reveal any of the usual causes, such as a wireless phone device or WiFi product.

The dish is mounted at the top of a chimney, and no access is available for LNB replacement. So the customer is going to check with the neighbours to find out whether they had any new 'Xmas gadgets' that might be the cause of the problem. If not, a visit will be arranged to replace the LNB. P.H.



MONITORS

Fault reports from

**Alun Rawson-Williams
Philip Blundell
and
Ian Field**

We welcome fault reports from readers – payment for each fault is made after publication.

Reports can be sent by post to:

Television Magazine Fault Reports,
Highbury Business,
Media House,
Azalea Drive, Swanley,
Kent BR8 8HU

or e-mailed to:
t.winford@highburybiz.com

IBM 6322-002

The above was the model number shown at the back: it said 14L10 at the front of the cabinet. The complaint was about display impurity, and operation of the degaussing circuit couldn't be heard. There was obviously a degaussing circuit fault.

Someone had tried to remove the case before the monitor arrived in our workshop, and had failed miserably. If you don't have the right IBM tools to release the cabinet's top clips, a pair can be cut from a piece of 3/16in. thick aluminium in about ten minutes. First cut two strips about 5-6in. long to fit loosely in the two slots at the top/back of the cabinet. Make a 30° cut at one end, then file the edges of the other ends to save cutting your hands.

Place the monitor face down on a piece of thick cloth and remove the two Torx screws at the bottom of the cabinet. Fit the pointed ends of the tools in both slots, at the same time, to engage with the internal locking tabs. Lever upwards to release them.

This is one of many IBM monitors that require such levers to release the cabinet back. Once you have gained entry to the inside of the cabinet, remove the PCB from the plastic chassis to obtain access to the print side. This involves removal of five 5.5mm screws. Take care not to damage the thin ribbon cable that connects the PCB to the front controls.

A replacement degaussing resistor (RT100, type 300NM3D) cured the fault. **A.R.-W.**

Proview PK770M

If one of these monitors is dead with only the front LED glowing, and you can hear the degaussing circuit operate at switch on, check all the rectifier diodes on the secondary side of the power supply for dry-joints. The usual culprit is the 55V supply rectifier D508. While the monitor is dismantled, check the switch connections to the mode-switching relay RL901 for solder crystallisation.

D508 is on a copper heatsink to the right of the mains bridge rectifier's reservoir capacitor while RL901 is forward of the line output transformer, both viewed from the back of the monitor. **A.R.-W.**

JVC TM-A10E

For reduced height, suspect dried-up electrolytic capacitors before replacing the LA7830 frame output IC. In most cases I've come across the capacitors near the frame output IC's heatsink need to be replaced. Start with C431, C527 and C525 then, if necessary, replace C935. **P.B.**

Gateway 2000 Vivitron (CPD-GF200)

This 17in. monitor was manufactured by Sony. Because of the flimsy and inadequate cabinet construction, the swivel base had pushed up through to the main PCB. The damage was not as bad as you get with the equivalent 15in. model, but affected two groups of very fine tracks between the corner of the TDA9103 IC and the point of impact with the single central support rib on the bottom chassis tray. The crack was just visible with a powerful magnifier and strong light, but had severed every track it crossed.

The tracks were very close together and very narrow, so the track-bracing repair method was not feasible. The only option was to trace each track back to the nearest solder pad at each side of the break and add point-to-point link wires. I use this method only as a last resort. A further concern was that the swivel base convex is integral with the cabinet bottom tray, which contributes to the inadequate construction! As a result the retaining mechanism, moving parts and all, are very close to the print side of the PCB – and also have two large steel springs attached!

While refitting the PCB I noticed that the detachable cabinet bottom tray was deformed – it was bowed upwards in the middle. At best this would bow the PCB upwards, preventing correct alignment with the front push-buttons. After careful consideration I decided that the only alternative to gluing the bottom tray to the front surround permanently was to bolt two large washers to the front edge to clamp it straight. The washers were the largest I could find, salvaged from CRT corner mountings. They were bolted on to the underside of the front edge of the tray, as closely as possible, at either side of the central PCB support rib. The screws, M4 dome-head, were inserted from the inside and covered with 'Moto-fill' glass-fibre compound (car body filler with ready-mixed glass filler). To ensure electrical insulation and that the screws could not fall inside the cabinet, after tightening the nuts and washers I cut the surplus thread off flush with the nuts so that the burr would prevent them working loose.

The exposed metal on the outside of the cabinet was also covered as neatly as possible with car-body filler. As it was not feasible to earth the washers, they had to be protected from any possibility of touching the internal circuitry – and covered to prevent anyone coming into contact with them. I had to warn the customer that he couldn't lump this monitor about like a box of spanners! **I.F.**

Solution to Test Case 507 - see page 264 -

Any sort of burning, sparking or poor connection in a line-scan stage can result in failure of the output transistor. Semiconductor devices, especially when working under such critical conditions as here, do not like spikes and surges – at least beyond the ones they generate and deal with in the normal course of operation. In this particular case it was obvious that some form of burning or arcing was taking place, but the difficulty was in establishing where it occurred – especially as the set shut down with a wrecked line output transistor whenever it happened.

The trouble-spot was finally located by Sage, who has a legendary sense of smell – he can detect cigarette smoke at several hundred yards, and certain types of cheese at much the same distance. What he sniffed out here was a dry and burning soldered joint on the little PC panel up on the scan yoke – it was between the feed plug and the line-scan coils. Ted repaired this with a ring of tinned copper wire, which surely cured the problem.

Since then the workshop crew has come across another Philips TV set, different model, different chassis, with the same yoke construction and the same fault. It's plainly worth looking out for this in any middle-aged Philips set you may encounter.

NEXT MONTH IN TELEVISION

CES Las Vegas 2005

This year's US Consumer Electronics show emphasised the growing convergence of CE and IT technology and products. There were keynote speeches from Bill Gates of Microsoft and Carly Fiorina of Hewlett-Packard. Masses of flat screens and gadgets were other features. George Cole reports on the highlights.

Sony TV chassis update

It's some time since we last provided a guide to the various chassis used in Sony TV sets. Giles Pilbrow brings us up to date on the latest chassis and models.

The Vestel thyristor

Not many people appreciate why there's a thyristor on the secondary side of many Vestel power supplies. Alan Dent explains its purpose and operation, with particular reference to the 11AK19 chassis, and also provides fault-finding guidance.

Satellite receivers with blind search

The new range of Fortec Star digital satellite receivers incorporates a blind search facility, an essential feature for those interested in satellite hopping. Nick Harrold reports on an extended test with the Lifetime Diamond DVB-S/T model, which also incorporates a terrestrial tuner.

TELEVISION INDEX & DIRECTORY 2005

Plus hard-copy index and reprints service

Here's the essential repair information you need! The Television Index & Directory 2005, in CD-ROM form, contains the text of over 16,000 high quality fault reports on TVs, VCRs, Camcorders, DVD players, Monitors, Satellite TV units, Audio equipment and CD players, searchable by make and model, plus the text of 200 Test Cases and over 300 major servicing articles, from seventeen years of Television magazine. It also contains a full seventeen-year index of Television, a Spares Guide, a directory of Trade and Professional Organisations, an International TV Standards guide, a satellite TV Channel Finder, a TV transmitter list and a compendium of internet resources for service engineers. The software is quick and easy to use, and runs on any PC with Windows 95, 98, ME, NT, XP or 2000.

Television Index & Directory 2005 CD-ROM, £199

Television Index & Directory 2005 CD-ROM upgrade, £47 (to qualify for this upgrade you need to have purchased a previous version of the Television Index on floppy disk or on CD-ROM)

A six-month update of the index and fault reports will be available in May 2005. If you wish to take advantage of this, £10 should be added to your order.

Television Index only, 1988–2004, £36

Television Index only upgrade from previous versions, £20

Hard-copy indexes of Television magazine are available for Volumes 38 (1988) to 54 (2004) at £3.50 per volume.

Reprints of articles from Television back to 1988 are also available, at the flat rate of £4.00 per article — you can order through our web site, or write to the address below.

The above prices include UK postage and VAT where applicable. Add an extra £1 postage for non-UK EC orders, or £5 for non-EC overseas orders, although Channel Island residents do not need to add any extra postage. Cheques should be made payable to SoftCopy Ltd. All major credit and debit cards are accepted. Please use our new secure website for your orders, details below. Allow up to 28 days for delivery (UK).

SoftCopy Limited, 1 Vineries Close, Cheltenham, GL53 0NU, UK

**Telephone 01242 241 455 Fax 01242 241 468
e-mail: sales@softcopy.co.uk**

web site: <http://www.televisionmag.co.uk>

Published on the third Wednesday of each month by Highbury Business, Media House, Azalea Drive, Swanley, Kent, BR8 8HU. **Highbury Business** is a division of **Highbury House Communications PLC**. **Filmsetting** by Impress, Unit 2, Parkway, Southgate Way, Orton Southgate, Peterborough PE2 6YN. **Printed** in England by William Gibbons Ltd, 26 Planetary Road, Willenhall, West Midlands, WV13 3XT. **Distributed** by Seymour Distribution Ltd, 86 Newman St, London, W1T 3EX. **Sole Agents** for Australia and New Zealand, Gordon and Gotch (Asia) Ltd.; South Africa, Central News Agency Ltd. **Television** is sold subject to the following conditions, namely that it shall not, without the written consent of the Publishers first having been given, be lent, resold, hired out or otherwise disposed of by way of Trade at more than the recommended selling price shown on the cover, excluding Eire where the selling price is subject to currency exchange fluctuations and VAT, and that it shall not be lent, resold, hired or otherwise disposed of in a mutilated condition or in any unauthorised cover by way of Trade or affixed to or as part of any publication or advertising, literary or pictorial matter whatsoever.

ELECTRONICS WORLD



The world's leading electronics magazine, Electronics World is a must read for any electronics professional or serious hobbyist.

Featuring every month most aspects of the global electronics industry, it covers research, technology, applications, products and theory in areas such as audio, RF, components, CAD design, simulation software, PC & micro based products, test and measurement, semiconductors and much much more...

● **Keep up to date with the latest information affecting the industry**

● **Essential reference and in-depth features covered monthly**

Make sure of your copy now...

Subscription rates for 1 year:

UK £38.95 ● Europe €93.52

USA \$106.40 ● Rest of the World £64.50

Subscription rates for 2 years

UK £62 ● Europe €150

USA \$170 ● Rest of the World £103.20

Contact

Highbury Fulfilment Services,
Link House, 8 Bartholomew's Walk, Ely, Cambridge CB7 4ZD.

Telephone 01353 654 431

Fax 01353 654 400

Email hbc.subs@highbury-wyvern.co.uk



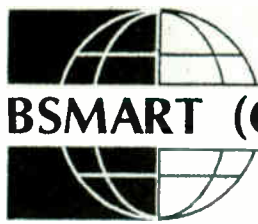

BSMART (CRAWLEY) LTD

**Largest selection
of**

**MAJOR MANUFACTURERS
NEW "B"
GRADE PRODUCTS**

**T.V. VIDEO AUDIO
MICROWAVE OVENS**

Contact Paul Bean

BSMART (CRAWLEY) LTD.
10/11 LLOYDS COURT, MANOR ROYAL,
CRAWLEY, SUSSEX RH10 2QX

Tel: (01293) 618000
Fax: (01293) 400133

DARTEL ELECTRONICS

8 Heather Park Parade, Heather Park Drive,
Alperton, Wembley, Middx HA0 1SL

**New/Graded stock
Direct from Manufacturers**

- VCR's, DVD/Combi's
- VCK combi's
- DVD/VCK combo
- DVD home theatre systems
- 28" widescreen TVs, latest models
- 28" Flatscreen TV's
- 32" Flatscreen TV's
- LCD projectors
- CCTV products
- Hi Fi systems, etc etc

**Please phone 0208 795 1735.
07831 407923 for further details.
or email: dartel.electronics@virgin.net**

This Magazine reaches over

**10,000
potential customers**

**To advertise in this space
call Steve on**

01322 611254

**WEB SITE WWW.JOHNSRADIO-UK.COM WWW.JOHNRAIO.COM
JOHNRAIO ELECTRONICS TEST AND COMMUNICATION EQPT**

LARGE QUANTITY SALE EX M.O.D.

MARCONI TF2019A Synthesized Signal Generators - 80Khz to 1040Mc/s
AM - FM - High Class with many functions - £285 each.

TEKTRONIX 2445 A OSCILLOSCOPE 150Mc/s Four Channel £300.

HP COMMUNICATION TEST SET 8922M - 10 - 1000Mc/s + GMS 83220E
Converter 1710 - 1900Mc/s - DCS - PCS - MS £500

HP COMMUNICATION TEST SET 8922M OPT 010(Dual) etc, £750.

**ALL UNITS AND PRICED EX WORKS WITH INSTRUCTIONS - TESTED BASIC
WORKING. CARR + PACKING IF REQUIRED EXTRA.**

*Phone for appointment or to request item lists, photos, site map.
All welcome, Private or Trade, sales, workshop repairs or calibration*

**PLEASE CONTACT PATRICIA AT WHITEHALL WORKS, 84 WHITEHALL ROAD
EAST, BIRKENSHAW, BRADFORD, WEST YORKSHIRE, BD11 2ER.**

Tel: 01274 684007 Fax: 01274 651160

WEB SITE WWW.JOHNSRADIO-UK.COM WWW.JOHNRAIO.COM

FRUSTRATED!

Looking for ICs TRANSISTORS?

A phone call to us could get a result. We offer an extensive range and with a World-wide database at our fingertips, we are able to source even more. We specialise in devices with the following prefix (to name but a few).



2N 2SA 2SB 2SC 2SD 2P 2SJ 2SK 3N 3SK 4N 6N 17 40 AD
ADC AN AM AY BA BC BD BDT BDV BDW BDX BF
BFR BFS BFT BFW BFX BFY BLY BLX BS BR BRX BRY BS
BSS BSV BSW BSX BT BTA BTB BRW BU BUK BUT BUV
BUW BUX BUY BUZ CA CD DX CXA DAC DG DM DS
DTA DTC GL GM HA HCF HD HEF ICL ICM IRF J KA
KLA L LA LB LC LD LF LM M M5M MA MAB MAX MB
MC MDA J MJE MJF MM MN MPS MPSA MPSH MPSU
MRF NJM NE OM OP PA PAL PIC PN RC S SAA SAB
SAD SAJ SAS SDA SG SI SL SN SO STA STK STR STRD
STRM STRS SV1 T TA TAA TAG TBA TC TCA TDA TDB
TEA TIC TIP TIPL TEA TL TLC TMP TMS TPU U UA
UAA UC UDN ULN UM UPA UPC UPD VN X XR Z ZN
ZTX + many others

**Please visit our website at
www.cricklewoodelectronics.com
17 thousand components in stock**

Mail, phone, Fax, Credit Card orders & callers welcome.



Cricklewood Electronics Ltd

40-42 Cricklewood Broadway, London NW2 3ET
Tel: 020 8452 0161 Fax: 020 8208 1441

**Visit our new www.cricklewoodelectronics.com
Email: sales@cricklewoodelectronics.com**

Test Patterns DVD SET-UP AND DIAGNOSTIC TOOL



The affordable alternative to expensive pattern generators!

Test Patterns DVD offers eighteen Industry Standard test patterns in both 4:3 and 16:9 formats, all with a 1Khz audio tone.

Ideal tool for use in field and workshop environments!

Bonus materials include:

- 5.1 Digital Surround System Test
- Test Cards Of Nostalgic Interest.

Enquiries: ahmet.h@btconnect.com

Order Form:

Enclose cheque for £19.99 made payable to A. Huseyin

Name (Block Caps): _____

Address: _____

Post Code: _____

Phone: _____

Email: _____

Send this form with your payment to:

A. Huseyin, Unit 1b Foxholes Ave, Hertford, Herts SG13 7JG

WATCH SLIDES ON TV MAKE VIDEOS OF YOUR SLIDES DIGITISE YOUR SLIDES (using a video capture card)



"Liesgang diatv" automatic slide viewer with built in high quality colour TV camera. It has a composite video output to a phono plug (SCART & BNC adaptors are available). They are in very good condition with few signs of use. For further details see www.diatv.co.uk

£91.91 + vat = £108.00

Board cameras all with 512x582 pixels 8.5mm 1/3 inch sensor and composite video out. All need to be housed in your own enclosure and have fragile exposed surface mount parts. They all require a power supply of between 10 and 12v DC 150mA.

47MIR size 60x36x27mm with 6 infra red LEDs (gives the same illumination as a small torch but is not visible to the human eye).....£37.00 + vat = £43.48

30MP size 32x32x14mm spy camera with a fixed focus pin hole lens for hiding behind a very small hole.....£35.00 + vat = £41.13

40MC size 39x38x27mm camera for 'C' mount lens these give a much sharper image than with the smaller lenses.....£32.00 + vat = £37.60

Economy C mount lenses all fixed focus & fixed iris

VSL1220F 12mm F1.8 12x15 degrees viewing angle.....£15.97 + vat = £18.78

VSL4022F 4mm F1.22 63x47 degrees viewing angle.....£17.85 + vat = £20.74

VSL6022F 6mm F1.22 42x32 degrees viewing angle.....£19.05 + vat = £22.36

VSL8020F 8mm F1.22 32x24 degrees viewing angle.....£19.90 + vat = £23.38

Better quality C Mount lenses

VSL1614F 16mm F1.6 30x24 degrees viewing angle.....£26.43 + vat = £31.06

VWL813M 8mm F1.3 with iris 56x42 degrees viewing angle.....£77.45 + vat = £91.00

1206 surface mount resistors E12 values 10 ohm to 1M ohm 100 of 1 value £1.00 + vat

1000 of 1 value £5.00 + vat

866 battery pack originally intended to be used with an orbital mobile telephone it contains 10 1.6Ah sub C batteries (42x22dia the size usually used in cordless screwdrivers etc.) the pack is new and unused and can be broken open quite easily.....£7.48+vat = £8.77



Please add 1.66 + vat = £1.95 postage & packing per order

JPG ELECTRONICS

Shaws Row, Old Road, Chesterfield, S40 2RB

Tel 01246 211202 Fax 01246 550959 Mastercard/Visa/Switch

Callers welcome 9:30 a.m. to 5:30 p.m. Monday to Saturday

inStore
ELECTRICS LIMITED

1043 LEEDS ROAD,
BRADFORD BD3 7DB

Tel: 01274 665670

01274 660196

01274 665246

Email: instorelectrics@btconnect.com

PHILIPS

AWARD WINNING PLASMA & LCD TV

AT COMPETITIVE PRICES RING FOR STOCK & PRICE

- * REAL FLAT TV'SFrom **£215**
- * INTEGRATED DIGITALFrom **£239**
- * 14" COMBIFrom **£65**
- * DVDFrom **£34**
- * VCRFrom **£39**
- * MICRO SYSTEMSFrom **£27**
- * DVD / VCR COMBI **£79**
- * DVD SURROUND SYSTEMSFROM **£96**

* Always a full selection of current models with slight marks at knock down prices

* **FAX your letter heading for bulk trade price list**

AS NEW MANUFACTURERS GRADED PRODUCT

NO MARKS • ORIGINAL PACKING • FULLY GUARANTEED

NEXT DAY DELIVERY • CREDIT CARDS WELCOME

TUBES

Widescreen 28"

Philips, Thomson, LG
and Panasonic

£99 plus carriage plus VAT

A limited quantity of working
pcb's available for Ferguson
M63171RI, Beko widescreen
and Bush AK19/AK37

Ring Harry or Irene

EXPRESS TV SUPPLIES LTD

The Mill, Mill Lane, Rugeley, Staffs WS15 2JW

Tel: 01889 577600 Fax: 01889 575600



Reader offer:
x1, x10 switchable
oscilloscope probes,
only £21.74 a pair,
fully inclusive*

*Additional pairs as part of the same order, only £19.24 each pair.

Please supply the following:

Probes

Total _____

Name _____

Address _____

Postcode _____ Telephone _____

Method of payment (please circle)

Cheques should be made payable to Electronics World
 Access/Mastercard/Visa/Cheque/PO

Credit card no _____

Card expiry date _____ Signed _____

Please allow up to 28 days for delivery

Seen on sale for £20 each, these high-quality oscilloscope probe sets comprise:

- two x1, x10 switchable probe bodies
- two insulating tips
- two IC tips and two sprung hooks
- trimming tools

There's also two BNC adaptors for using the cables as 1.5m-long BNC-to-BNC links. Each probe has its own storage wallet.

To order your pair of probes, send the coupon together with £21.74 UK/Europe to **Probe Offer, Caroline Fisher, Highbury Business, Media House, Azalea Drive, Swanley BR8 8HU**

Readers outside Europe, please add £2.50 to your order.

Specifications

Switch position 1

Bandwidth	DC to 10MHz
Input resistance	1MΩ – i.e. oscilloscope i/p
Input capacitance	40pF+oscilloscope capacitance
Working voltage	600V DC or pk-pk AC

Switch position 2

Bandwidth	DC to 150MHz
Rise time	2.4ns
Input resistance	10MΩ ±1% if oscilloscope i/p is 1MΩ
Input capacitance	12pF if oscilloscope i/p is 20pF
Compensation range	10-60pF
Working voltage	600V DC or pk-pk AC

Switch position 'Ref'

Probe tip grounded via 9MΩ, scope i/p grounded

Service Link

TELEPHONE 01322 611254 FAX 01322 616376

FOR SALE

inStore
ELECTRICS LIMITED
171 HAREHILLS LANE,
LEEDS LS8 3QE
Tel: 0113 240 1114

Tatung LCD 15".....£239
Philips LCD 15".....£299
Philips LCD 17".....£299

Other models available.
CALL FOR FULL PRICE LIST

**The television engineer's
wholesaler**

ICC17 LOPTX Kit
Ferguson W7023U etc.
Thomson 24WK23U etc
Pt no. 10608670P1 £24.95

GRUNDIG EHT TRAY
BG1899022644 £18.95

www.IrwinElectronics.co.uk
Telephone 0114 273 9622

**TV Electrical
Service Business**

South East Republic of Ireland
SERVICE AGENT
FOR MOST MAJOR BRANDS

FULLY EQUIPPED WORKSHOP WITH
SPARES AND SERVICE MANUALS

Email: electricalrepair@eircom.net
For more information please contact
Anthony on +353 (0) 5345918 or
+353 (0) 862 797169

For a **FREE** consultation on
how best to market your
products/services to a
professional audience contact
STEVE on 01322 611254

PROJECTOR SPARES

Spare parts and service
information for
VIDIKRON
video projectors from
PROJECTSPARES

Tel: 01444 831769
Fax: 01444 831580
E-mail:
projectspares@btinternet.com

SERVICE DATA

NEED HELP NOW?

Then ring the
★ **ELECTRON TECHNICAL
HELPLINE** ★

Genuine help available to all
repairers of
T.V. - V.C.R. - SAT - AUDIO
(Inc Valves)

Over 30 years experience and vast
data base

9 Chapel Street, Donisthorpe,
Derbyshire DE12 7PS
0906 470 1706
Calls cost 60p per minute

For a
FREE
consultation on how best to market
your products/services to a
professional audience contact
**MIKE on
01322 611291**

**OPEN
6 DAYS**

TV/VCR CIRCUITS
(WE DO NOT STOCK
AUDIO OR MONITOR
INFORMATION)

TEL A.T.V. on
0114 285 4254

CTV Circuits..... from £5.00
VCR Circuits..... from £7.00
CTV Manuals..... from £10.50
VCR Manuals..... from £14.50
User instructions also available
(P/P add £2.50 to each order)

**419 LANGSETT ROAD
SHEFFIELD S6 2LL**

MANUAL COLLECTIONS PURCHASED.
VISA (POST 1995)

**SERVICE
MANUALS**
and Service Sheets for
TV - VIDEO - AUDIO

Prices start at

CTV	s/sheet	5.00
VCR	s/sheet	7.00
CTV	s/man	10.00
VCR	s/man	13.00

No p/p or VAT
- Other items POA -
AMTEL
Huna,
Caithness KW1 4YL
01955 611313
www.amtel.co.uk

LINEAGE

PRIVATE RETAILER has excellent part
exchange colour televisions and videos to
clear. Tel: 01494 814317.

TECHNICAL ADVICE

**Technical Advice From
Service-Link.co.uk**

Missing Part? Burnt Out Part??
No Service Manual???

No Problem. Call Us Today.
We Have A Huge Database.
Most Consumer Electronics Covered.
Hard To Diagnose Fault?
Parts Hard To Find?
Call Us Now For Assistance.
Available Seven Days A Week.
9-00AM—11-00PM

See Website For Details
PO Box 7453 LE2 3XR

WANTED

**BEST CASH
PRICES PAID**

FOR VALVES KT88,
PX4 AND MOST
AUDIO/OTHER
TYPES.

Tel: 01403 784961

Billington Export Ltd
Sussex RH14 9EZ
Fax 01403 783519
Email: sales@bel-tubes.co.uk
Visitors by appointment

WANTED

WANTED Surplus or Obsolete Electronic Components

Turn your excess stock into instant cash!

SEND OR FAX YOUR LIST IN STRICTEST CONFIDENCE
Will collect anywhere in the UK

 **Mushroom
COMPONENTS**

28 College Street, Kempston, Bedfordshire, MK42 8LU
Tel: 01234 363611 Fax: 01234 326611
E-mail: sales@mushroom.co.uk
Internet: www.mushroom.co.uk

For a
FREE
consultation on
how best to
market your
products/services
to a professional
audience contact
**MIKE on
01322 611291**

CLASSIFIED TEL: 01322 611254



Freeview is great,
but lose or break
your remote and
the only red button
you'll want to press
will be this one...

**EVEN
MORE NEW
HANDSETS &
MODELS ADDED
THIS MONTH!**

With over 6 million Freeview boxes sold the market for remote controls offers your business enormous potential. Remember, for most Freeview boxes you need the remote to operate interactive services and EPG navigation.

Classic now have the solution. A range of remotes which carry out all the functions of the originals and are designed to be user friendly.

Classic remotes for the models listed are available now. Additional handsets for Freeview receivers are in development

To order your remotes contact your Classic distributor. For up to date cross reference information or for more information on the Classic range visit our website www.classic-serviceparts.com, phone us on 01635 278678 or email us at uksales@classic-serviceparts.com

Brand	Model	Classic remote
Alba	STB1X1	IRC83079
Black Diamond	BD65DSF	IRC83079
Bush	DFTA 1X1	IRC83079
Bush	DFTA1	IRC83079
Daewoo	DS608P	IRC83082
Dijam	32VU DVB-T	IRC83082
Ferguson	FDT2000	IRC83077
Ferguson	FDT500	IRC83077
Goodmans	GDB1	IRC83079
Goodmans	GDB2	IRC83079
Goodmans	GDB3	IRC83079
Goodmans	GDB4	IRC83079
Grundig	GDT1000	IRC83081
Grundig	GDT1500	IRC83081
Grundig	GDT2000	IRC83077
Hitachi	HDB60	IRC83079
Labgear	DTT100	IRC83082
Matsui	DTR 1	IRC83079
Matsui	DTR 2	IRC83079
Nokia	121T	IRC83078
Nokia	221T	IRC83078
Philips	DTR1500	IRC83083
Philips	DTX6370	IRC83087
Philips	DTX6371	IRC83087
Philips	DTX6372	IRC83087
Techwood	TWDFV1	IRC83079
Thomson	DTI1000	IRC83080
Thomson	DTI2300	IRC83086
Thomson	DTI550	IRC83080
Triax	DVB2000T	IRC83082



Technical helpline 01635 278678

TELEVISION TEST PATTERN GENERATORS

The new **GV 998** is a digital pattern generator offering more advanced features at again a realistic price. Those features include :

- ◆ MPEG-2 format Transport Stream generation
- ◆ Video and audio included in the TS
- ◆ Video and audio inputs
- ◆ Generation of a variable frequency sound carrier for decoding verification
- ◆ Multistandard and multisystem analogue TV signal generation
- ◆ Possibility to edit different fields of the TS database to present the name of the service provider
- ◆ Remote control via a personal computer
- ◆ Moving video patterns to check MPEG-2 decoders

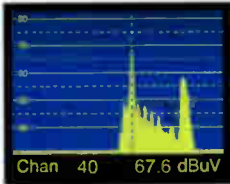
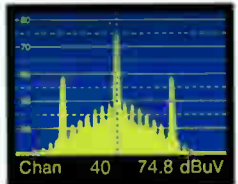

**IDEAL FOR
PLASMA
DISPLAYS**

**IDEAL FOR
WIDE SCREEN
DISPLAYS**

PROMAX GV SERIES

- ◆ Choice of 12 instruments
- ◆ NICAM and Teletext
- ◆ 4:3 and 16:9 Formats
- ◆ Full field and VITS
- ◆ Computer Controlled
- ◆ Front panel memories
- ◆ Own Company Logo
- ◆ Computer Monitor testers
- ◆ Hand Held Models
- ◆ Multi Standard, PAL, NTSC, SECAM
- ◆ High Quality Construction
- ◆ Attractive Price Levels
- ◆ Full After Sales Service
- ◆ Available from Stock



**FOR TELEVISION PATTERN GENERATORS,
THERE'S NO WIDER CHOICE THAN WITH PROMAX**



SELECTED ITEMS FROM THE PROMAX RANGE OF TEST EQUIPMENT



MS 250

Analogue and Digital Satellite Detector.



PRODIG 1+

Satellite Dish Installer's Meter
Does more than just BSkyB



PRODIG 2

Analogue & Digital Aerial Meter
Measures digital channel power and C/N



MC 577

Analogue & Digital, Satellite & Terrestrial
Measures channel power and C/N



PROLINK 3 + 4 PREMIUM

Satellite & Terrestrial, Analogue & Digital,
Spectrum Analyser with BER (optional on P3)



**AA 930
AUDIO ANALYSER**

**TA 903B
CRT
REJUVENATOR**



Alban

ALBAN ELECTRONICS LIMITED

THE PROMAX SERVICE CENTRE

6 Caxton Centre, Porters Wood,
St. Albans, Hertfordshire, AL3 6XT.

TEL: 01727 832266 FAX: 01727 810546

WEB: www.albanelectronics.co.uk

EMAIL: info@albanelectronics.co.uk

SALES + SERVICE + CALIBRATION