

TELEVISION

SERVICING·VIDEO·SATELLITE·DEVELOPMENTS

MAY 2000 £2.80

A REED BUSINESS PUBLICATION

FAULT REPORTS

TVs, VCRs, PC Monitors and Satellite

Servicing in-car audio equipment

Dealing with intermittent faults

Philips' 3D LCD video system

Thyristors and triacs - operation and use



9 770032 647092

05>

TV *Classic*

Range of Remote Controls from

KÖNIG
ELECTRONIC



THE BENEFITS.....

- 100% coverage from 1988 to the present
- Easy look-up facility on card or on the Internet
- No reason to lose a sale
- Works straight from the box - no programming required
- 100% compatible with the original product
- Provides an ideal income opportunity in an expanding market

NOW AVAILABLE

TOSHIBA, SANYO and HITACHI

ARRIVAL OF OTHERS IN THE RANGE

SONY June 2000

PANASONIC July 2000

.....More to follow

Visit our Website for more product information



www.konig.co.uk

Available from your KÖNIG CLUB Founder Members



Also available from your König Approved Stockist

the
KÖNIG

repair



Technical help line: 01635 278678

E-mail: technical@konig.co.uk

Satellite TV Finder

The following transponders currently provide signals that should be receivable in the UK with a 1-1.2m dish. Some transponders are used for feeds and are thus in intermittent use. Many channels are encrypted. The list gives frequency (GHz), polarisation and whether the signal is analogue or digital.

60°E Intelsat 604

11.474	V	D
11.512	V	D

42°E Turksat 1C

10.966	V	A
10.980	V	D
10.986	V	D
11.007	V	A
11.020	V	A
11.049	V	V
11.066	V	D
11.071	V	D
11.093	V	A
11.129	V	V
11.143	V	A
11.158	V	D
11.468	V	D
11.512	V	A
11.566	V	A
11.587	V	V
11.660	V	D
11.682	V	A

31.3°E Turksat 1B

10.972	H	D
10.980	H	D
10.986	H	D
10.990	H	D
10.995	H	D
11.015	H	D
11.022	H	D
11.028	H	D
11.041	H	D
11.123	H	D
11.129	V	D
11.136	V	D
11.137	H	D
11.143	H	D
11.148	V	D
11.151	V	D
11.169	V	D
11.177	V	D
11.453	H	D
11.459	H	D

28.5°E Kopernikus F2

11.477	H	R
11.622	H	D
11.674	H	D
12.514	V	D
12.525	V	D
12.574	V	D

28.2°E Astra 2A/1D

11.720	H	D
11.740	V	D
11.758	H	D
11.778	V	D
11.798	H	D
11.817	V	D
11.837	H	D
11.856	V	D
11.876	H	D
11.895	V	D
11.914	H	D
11.934	V	D
11.954	H	D
11.973	V	D
11.992	H	D
12.012	V	D
12.032	H	D
12.051	V	D
12.070	H	D
12.090	V	D
12.110	H	D
12.129	V	D
12.148	H	D
12.168	V	D
12.188	H	D
12.207	V	D
12.226	H	D
12.246	V	D
12.266	H	D
12.304	V	D
12.324	H	D
12.363	V	D
12.382	H	D
12.460	H	D

26°E Arabsat 2A/3A

11.767	H	D
11.856	H	D
12.034	H	D

23.5°E Kopernikus 3

11.466	H	D
11.498	H	D
11.541	V	D
11.573	V	D
11.616	H	D
11.648	H	D
11.680	H	D
12.559	H	D
12.658	V	D
12.692	H	D
12.725	V	D

19.2°E Astra 1A-C, E-G

10.714	H	A
10.728	V	A
10.744	H	A
10.759	V	A
10.773	H	A
10.788	V	A
10.803	H	A
10.818	V	A
10.832	H	A
10.847	V	A
10.862	H	A
10.877	V	A
10.891	H	A
10.906	V	A
10.921	H	A
10.934	V	A
10.964	H	A
10.979	V	A
10.994	H	A
11.009	V	A
11.023	H	A
11.038	V	A
11.053	H	A
11.068	V	A
11.082	H	A
11.097	V	A
11.112	H	A
11.127	V	A
11.141	H	A
11.156	V	A
11.171	H	A
11.186	V	A
11.214	H	A
11.229	V	A
11.244	H	A
11.258	V	A
11.273	H	A

11.288	V	A
11.303	H	A
11.318	V	A
11.332	H	A
11.347	V	A
11.362	H	A
11.377	V	A
11.391	H	A
11.406	V	A
11.421	H	A
11.436	V	A
11.464	H	A
11.479	V	A
11.493	H	A
11.508	V	A
11.523	H	A
11.538	V	A
11.553	H	A
11.568	V	A
11.582	H	A
11.597	V	A
11.612	H	A
11.627	V	A
11.641	H	A
11.656	V	A
11.671	H	A
11.686	V	A
11.720	H	A
11.740	V	A
11.758	H	A
11.778	V	A
11.798	H	A
11.817	V	A
11.837	H	A
11.856	V	A
11.875	H	A
11.895	V	A
11.934	H	A
11.954	V	A
11.973	H	A
11.992	V	A
12.012	H	A
12.032	V	A
12.051	H	A
12.070	V	A
12.090	H	A
12.129	V	A
12.148	H	A
12.168	V	A
12.188	H	A
12.207	V	A
12.226	H	A
12.246	V	A
12.266	H	A
12.285	V	A
12.304	H	A
12.324	V	A
12.334	H	A
12.363	V	A



FREE
with
TELEVISION

Pocket size
reference

12-382
12-402
12-422
12-441
12-480
12-515
12-522
12-552
12-574
12-581
12-610
12-670
12-692
12-699
12-722

16°E Eutelsat W2

10-958
10-968
10-972
11-019
11-043
11-090
11-095
11-108
11-133
11-148
11-163
11-178
11-190
11-303
11-446
11-474
11-489
11-515
11-554
11-572
11-598
12-507
12-554
12-568
12-608
12-642
12-703
12-728

13°E Hot Birds 1-5

10-719
10-722
10-758
10-775
10-796
10-815
10-834
10-853
10-872
10-892

10-911
10-914
10-933
10-949
10-974
10-990
11-027
11-034
11-054
11-079
11-095
11-114
11-131
11-148
11-163
11-178
11-196
11-205
11-224
11-242
11-283
11-304
11-322
11-331
11-338
11-345
11-366
11-371
11-390
11-404
11-422
11-431
11-446
11-464
11-474
11-492
11-516
11-530
11-566
11-585
11-604
11-623
11-642
11-662
11-681
11-727
11-747
11-766
11-785
11-804
11-823
11-843
11-862
11-881
11-900
11-919
11-938
11-958

11-996
12-015
12-034
12-054
12-073
12-092
12-111
12-130
12-149
12-169
12-188
12-201
12-211
12-235
12-245
12-265
12-284
12-303
12-322
12-341
12-360
12-380
12-399
12-418
12-437
12-476
12-485
12-520
12-539
12-558
12-573
12-581
12-590
12-597
12-615
12-635
12-673
12-692
12-731

10°E Eutelsat II F4

10-987
11-014
11-016
11-024
11-055
11-095
11-144
11-163
11-178

7°E Eutelsat W3

11-141
11-178
11-175
11-387

11-517
11-596
11-680
12-722

5.2°E Sirius 2/3

11-747
11-900
12-092
12-111
12-207
12-245
12-265
12-303
12-322
12-334
12-349
12-380
12-437
12-453
12-476

3°E Telecom 2C

12-522
12-543
12-552
12-564
12-585
12-606
12-627
12-648
12-669
12-690
12-711
12-732

1°W Intelsat 707

11-001
11-014
11-054
11-096
11-174
11-229
11-247
11-278
11-309
11-372
11-403
11-473
11-485
11-540
11-553
11-597
11-630
11-665
11-679
11-691

12-169
12-226
12-303
12-322
12-456

5°W Telecom 2B/D

11-598
11-619
11-651
11-671
11-676
12-522
12-543
12-564
12-585
12-606
12-648
12-669
12-690
12-732

8°W Telecom 2A

12-648

12.5°W Eutelsat II F2

12-521
12-558
12-574

15°W Telstar 12

11-120
11-141
11-546

21.5°W NSS K

11-472
11-499
11-531
11-531
11-619
11-619
11-652
11-665
11-679
12-535

27.5°W Intelsat 605

10-995
10-995
11-016
11-094
11-135
11-476
11-494

11-591
11-661
11-665

30°W Hispasat 1A-C

11-509
11-517
11-539
11-615
11-659
11-660
12-149
12-226
12-380
12-456
12-549
12-591
12-591
12-643
12-671
12-711
12-711

31.5°W Intelsat 801

10-966
11-595

34.5°W Intelsat 601

11-010

37.5°W Telstar 11

11-534
11-542
11-561
11-567
11-596
11-622
11-672
11-667
12-585
12-665

43°W PAS 3R

12-517
12-517
12-545
12-568
12-577
12-577
12-580
12-701
12-701
12-716
12-716
12-732

CONTENTS

May 2000

Vol. 50, No. 7

Switch-off doubts 387

The PCB Repair Debate 388

A selection of comments from readers on whether and, if so, how to go about repairing damaged PCBs.

What a Life! 390

A CD player problem and difficulty with an NTSC tape. **Donald Bullock's** servicing commentary.

Teletopics 392

A number of new and innovative products have been announced or released recently. The revised BEAB standard. Video and digital TV news.



Servicing in-car Audio Equipment 394

Above average profits can be made from repairs to in-car audio equipment. **Colin J. Guy** describes typical test procedures and repairs, and provides advice on how to generate this type of business.

Satellite Notebook 398

Problems with satellite equipment and installations.

DX and Satellite Reception 400

News from abroad and of developments in the satellite field. The strange satellite/terrestrial reception situation in Australia. **Roger Bunney** reports.

Book Review 407

Satellite Workshop 408

Jack Armstrong provides more information on the evolution and use of digiboxes.

Test Case 449 409

Toshiba Service Briefs 410

More know-how based on recent Toshiba Technical Bulletins.

Thyristors and Triacs 412

Mike Rutherford on the operation of these useful devices and some typical applications.

Service Notebook 415

John Edwards on TV servicing problems.

Web Service 416

Useful web sites for TV professionals, technicians and enthusiasts.

The Problem of Intermittent Faults 420

Intermittent faults cause a lot of difficulties in the workshop. **Paul Smith** suggests suitable diagnostic measures.

Help Wanted 421

VCR Clinic 422

Philips' 3D-LCD System 424

Philips has developed a 3D video system that provides a true stereoscopic field of view, allowing viewer movement and enabling several people to share a display. Prototype versions are now being supplied to

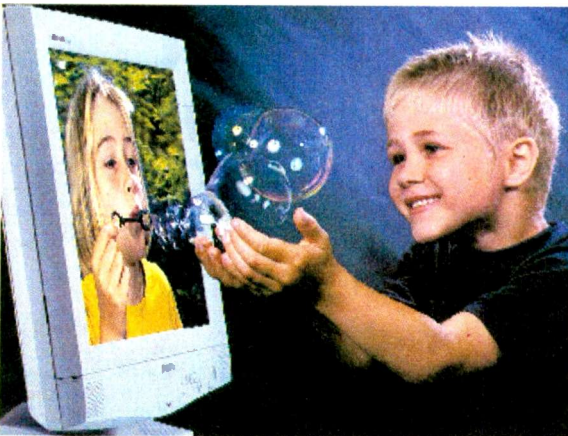

application developers. **Clarence Cartwright** outlines the principles and operation of the system.

Next Month in Television 427

TV Fault Finding 428

Interactive TV Technology 432

K.F. Ibrahim on the technology that makes interactive TV possible.

Test Report 434

Eugene Trundle takes a detailed look at the ProVision 8 modular CCTV surveillance system. It could help you to create new business opportunities.

Monitors 436

Hints and tips on servicing computer monitors and similar displays.

Letters 438

Registered Service Centres. Replacement line output transistors. Notes on moving-iron meter availability and the short locator and distribution amplifier projects.

Editor

John A. Reddihough

Production Editor

Tessa Winford

Consultant Editor

Martin Eccles

Publisher

Mick Elliott

Advertisement

Sales Manager

Matthew Harradine

0181-652 3033

Advertisement Group

Sales Executive

Pat Bunce

0181-652 8339

Fax 0181-652 3981

Editorial Office

0181-652 8120

Fax 0181-652 8111

Note that we are unable to answer technical queries over the telephone and cannot provide information on spares other than that given in our Spares Guide.

May issue on sale
April 19th.

Next issue,
dated June,
on sale May 17th.



30-DAY FREE TRIAL

DIFFICULTY GETTING THE TECHNICAL INFORMATION YOU NEED?

EURAS COULD HAVE THE ANSWER

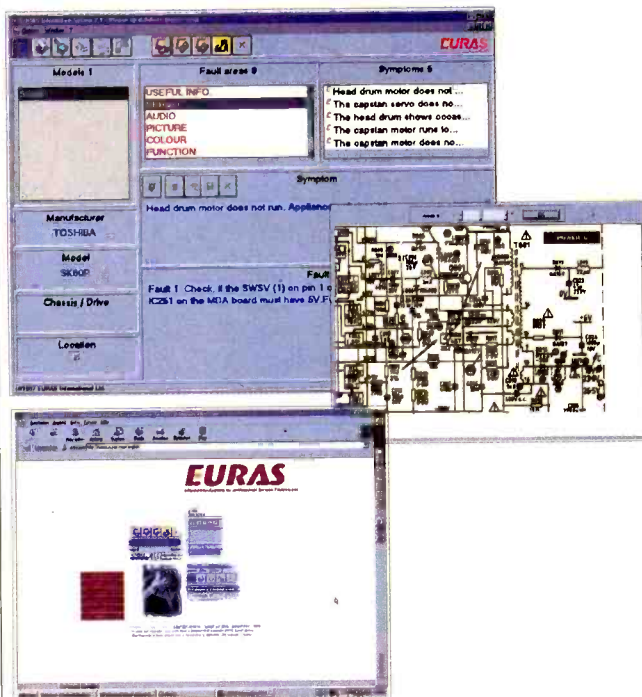

Save money and call us now on 0117 9860900 or fax us on 0117 9860343 for trial details or visit us on the Internet @ <http://www.euras.com>

Can't Find a Particular Remote?

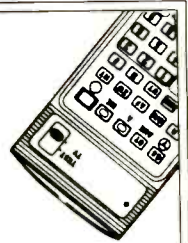

YOU CAN HAVE IT!



World's Largest Range
Over 60,000 References



Match or 'Make Free' Service



Competitive Prices From £4.95



'Point&Go' Simple Set-up
Universals

Wallis. Remote Controls
for TVs • VCRs • Satellite • Hi-Fi

For Further Information - Just Call Our Helplines

Tel: 020-8870 3388 • Fax: 020-8870 9988

Suddenly - You'll Love Selling Remote Controls

The headend that says YES to

- Quality
- Ease of use
- Agility
- Each module an almost total entity
- Superb value

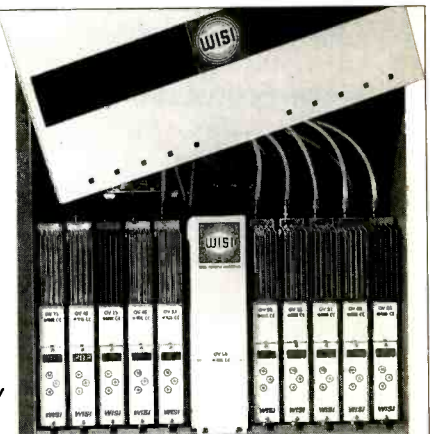

WISI's Tapline headend system is very competitively priced yet is of superior design and build. It is easy-to-use with high quality channel processing that allows the user to retain quality of vision and sound for both analogue and digital signal sources. There are processors for satellite TV, terrestrial TV and radio. Each individual module incorporates its own control system enabling quick and easy set up. These channel processors come together in an 'all-in-one' base unit which contains all necessary accessories for ease of ordering - no additional items required.

WISI TOPLINE HEADEND

CHECK THESE FEATURES

- Frequency agile freely selectable in the VHF of UHF range.
- Adjacent channel capable.
- TV standards 64 QAM B/G, D/X, I, L, M.
- Modular system for headend stations in SMATV and CATV systems.
- Modules for Analogue and Digital:
 - Satellite TV & Radio: Analogue & Digital
 - Terrestrial TV & Radio: Analogue & Digital
 - Satellite I.F. Converters: Analogue & Digital
 - Terrestrial TV Converters: Analogue & Digital
 - Terrestrial TV Modulators: Analogue & Digital
- Individually programmable modules.
- High output level.
- Wall mounting or 19" rack mount with lockable cabinet door.

May we send you full details?

U.K. STOCKIST

J.W. Hardy Communications



A Breakthrough in Headend Design

J.W. HARDY COMMUNICATIONS, 231 Station Road, Birmingham B33 8BB Telephone: 0121 784 8478 Fax: 0121 789 7931

Switch-off doubts

It is obviously wasteful to duplicate terrestrial TV transmissions in analogue and digital form. Sooner or later transmissions will all be digital, since this is a more efficient use of spectrum space. The question is when? It would suit some to switch off the analogue transmitters as soon as possible. 2006 has been suggested as a time to start, with analogue transmissions finally ending in 2010. All very neat and tidy. Whether it will work out in that way is another matter.

Strong doubts are already beginning to be aired. The government has, quite properly, laid down conditions to be met before the switch-off occurs. Basically that the digital signal coverage should equal that achieved for analogue TV, currently 99.4 per cent of the population, and that digital receiving equipment should be available at an affordable price. The real problem is that there is a difference between a coverage of 99.4 per cent and 99.4 per cent of the population actually having digital receiving equipment. Why should those who are interested in only free-to-air channels go out and buy/rent a digital receiver? It is already becoming evident that this represents a fair chunk of the population. The ITC has warned the government that the 2006-2010 timetable is in jeopardy. Peter Rogers, the ITC's chief executive, has said "we need to persuade people only interested in watching free-to-air television to switch to digital. Unless we do, there will be no switch-over." Well not quite, because the analogue receivers will eventually wear out and have to be replaced. But that could take a long, long time.

Meanwhile many people will expect to be able to continue to watch their usual TV fare using their existing analogue receivers. Research carried out by Culture Secretary Chris Smith's department has established that

between forty and fifty per cent of the population expects the BBC licence to cover their TV viewing, which means what they get at present in analogue form. A substantial percentage of the population simply isn't interested in going digital. In fact take up of integrated receiver-decoders, as opposed to the free digital set-top boxes, has so far been very slow. Of five million TV sets sold in the UK last year, only 10,000 were digital.

There are important factors apart from overall coverage and how many people have sets. There is the extension of coverage, which becomes more difficult to achieve economically as the number of those not covered decreases. There is the problem of reception quality. And there is the question of domestic arrangements and convenience.

Extending coverage to the last ten-fifteen per cent of the population by means of conventional terrestrial transmitters will be expensive. Mr Smith's department seems to have conceded that other methods of signal delivery may have to be adopted – by satellite, by microwave links or by cable. The latter has of course never been economic where few households are involved. The frequency planners have been trying to find ways of increasing coverage even to well-populated areas. There are so many areas where problems of one sort or another make the provision of DTT difficult. Satellite TV is the obvious solution. The time may well come when it is wondered why anyone bothered with DTT.

Signal quality is becoming an increasingly important factor as the digital roll out continues. In areas where the signal is marginal, viewers could experience the extreme irritation of picture break up or complete loss. This is quite apart from the actual quality of the channel, which depends on the number of bits per second used. There is a maximum number

of bits per multiplex, the total being shared by several channels. The fewer the bits, the poorer the picture in terms of definition and rendering. There have already been complaints about poor quality.

The question of domestic arrangements is one that has not so far received adequate public attention. Most households nowadays don't have just one TV set that the family watches. They have a main one, probably, almost certainly one or more VCRs, and several other sets around the house to serve various purposes. What 'the percentage of households that have digital TV' should really mean is the percentage willing to replace all this equipment. It will be expensive, and people would not be happy if they were told to throw away their other equipment when they get a single nice new all-singing all-dancing widescreen digital TV set. In fact there would be uproar. The move from analogue to digital is not like that from 405 to 625 lines, which went fairly smoothly. In those days few people had video equipment or a multitude of sets.

The transition to digital is not going to be smooth, and the suggestion of a switch-off during 2006-2010 already looks totally unrealistic. Unless the government subsidises or gives away digital TV sets – and why should it? – people will expect their existing equipment to continue to be usable. So it's likely that analogue TV will be with us for many years yet.

BSkyB, never hesitant to seize any advantage it sees, has sent a letter to the ITC and government departments urging that consideration be given to alternative ways of extending digital coverage. It points out that some £8bn could be raised by auctioning the DTT frequencies. But that would be the end of analogue too.

COPYRIGHT

© Reed Business Information Ltd., 2000. All rights reserved. No part of this publication may be reproduced, stored or transmitted in any form or by any means without the written permission of the publishers.

All reasonable precautions are taken by *Television* to ensure that the advice and data published are reliable. We cannot however guarantee it and we cannot accept legal responsibility for it.

CORRESPONDENCE

All correspondence regarding advertisements should be addressed to the Advertisement Manager, "Television", Reed Business Information, Quadrant House, The Quadrant, Sutton, Surrey SM2 5AS. Editorial correspondence should be addressed to "Television", Editorial Department, Reed Business Information, Quadrant House, The Quadrant, Sutton, Surrey SM2 5AS.

INDEXES AND BINDERS

Indexes for Vols. 38 to 48 are available at £3.50 each from SoftCopy Ltd., who can also supply an eleven-year consolidated index on computer disc. For further details see page 427.

Binders that hold twelve issues of *Television* are available for £6.50 each from Television Binders, 78 Whalley Road, Wilpshire, Blackburn BB1 9LF. Make cheques payable to "Television Binders".

BACK NUMBERS

Some back issues are available at £3.50 each. For further details see box on page 433.

SUBSCRIPTION ENQUIRIES

Telephone: 01444 445 566

Fax: 01444 445 447

Credit card orders: 01622 778 000

Address: Television, Subscriptions Dept, PO Box 302, Haywards Heath, West Sussex RH16 3YY, UK.

Make cheques payable to: Television

Subscription rates:

UK £32.00 per year

Airmail Eire £36.00 per year

Airmail Europe £46.00 per year

Airmail Rest of World £59.00 per year

NEWSTRADE ENQUIRIES

Distributed by MarketForce

Telephone: 0207 261 7704

WEB SITE

For a full list of RBI magazines:
<http://www.reedbusiness.com>

ISSN 0032-647X

 REED
BUSINESS
INFORMATION

The PCB Repair Debate

An article that provided some practical guidance on the repair of cracked PCBs appeared in our March issue. Last month a correspondent severely criticised, on safety grounds, the whole idea of repairing a cracked PCB. We have since received a number of letters on the subject. A selection appears below

A TLO writes

I think John Halstead's view (letters, April) on the subject of repairing cracked PCBs is rather over the top. In a perfect world where money is no object, TV sets are all insured and every manufacturer carries ten per cent of his production in spare, assembled boards it would be possible to replace every cracked PCB. In practice most manufacturers will, if they do have spare boards, charge well over the cost in real terms for a replacement. If the set is insured the insurance company will suggest a write-off. If not the customer, faced with the cost of a replacement board, will write the set off.

It seems that in about ninety per cent of cases a PCB cracks around the line output or chopper transformer or at the front, where fine tracks are grouped closely together. In my experience, having spent many years in the trade, I would say that satisfactory repairs can be carried out provided certain rules are observed. These are:

(1) Never try to repair a cracked board where carbonisation has occurred. This happens when there has been arcing because a track or pad has gone open-circuit. The problem usually occurs in high-voltage areas.

Arcing can occur in the line output stage or chopper power supply, where there are high pulse voltages or currents. Carbonisation increases radially, adding to itself continuously. I have never been happy about digging out the carbon, as it could be deep-seated.

(2) Never try to repair a *broken* board. These usually have the LOPT or other bits ripped out. If the board is cracked, always ensure that there is adequate support in the immediate area.

(3) Most board cracks take place when the set is being transported, for example from one room to another and the family cat/dog causes a disaster. The crack will thus occur under 'cold' conditions. These cracks can easily be repaired if care is taken.

Always clean the tracks well past the crack, on each side, and tin well. Select a gauge of tinned copper wire adequate to act as a splint, and solder it carefully into place. Provided it's well tinned, solder braid can be used with wider tracks that carry higher currents. Do not use a splint that's wider than the copper being repaired. Always clean between the tracks afterwards, to ensure that no insulation breakdown has occurred. Finally, after testing, coat the board underneath with an inert adhesive such as epoxy or hotmelt – the latter can be used only away from high-temperature areas.

Do not use the cheap way out, with insulated wires from pad to pad. Two inches or more is sometimes used: it looks terrible. If the

crack is in a densely packed area, with the tracks squeezed together tightly, fine wire with a PTFE coating can be used – provided it's economically viable of course. It must be reinforced with adhesive afterwards.

All equipment on sale in the UK should meet the ISO95 (BS415) directive. An important part of this directive concerns the flammability of PCB materials. Most manufactures use FR3 (Fire Resistant grade 3), which has self-extinguishing characteristics. But if an arc occurs and the power source is not removed the board will eventually burn, sometimes catastrophically.

I hope these comments are of practical use to those in the trade, which I have served for many years. Let's face it, there is a very wide gap between utopia and what's practical.

*Denis Mott,
Huddersfield.*

Adhesives

I have had to deal with the problem of PCB cracks for many years (I built my first set in time for the Winter Olympics in 1947!). Method (4) in Paul Smith's article is clearly the way to go. I would however recommend the use of cyanoacrylate adhesive. A low-viscosity one will penetrate any crack and set very quickly. A higher-viscosity type can be used for gap filling.

I remember in particular a 22in. set that had been 'involved' in a domestic dispute – it had been thrown across the room! The line output transformer had punched a circular hole in the PCB over about 340°. Once it had been glued back in position, the tracks were bridged land-to-land using single-strand PTFE-coated wire. This coating is much thinner than PVC, but enables the wire to be positioned along a track as it doesn't spring back after bending. Incidentally the set is still in use!

*Norman Jones,
Gillingham, Kent.*

Repairs (including CD) and safety

I was surprised to read the rather strong letter from John Halstead criticising Paul Smith's article on repairing cracked printed-circuit panels. While some of the points he raises are valid, to say that a cracked PCB must always be replaced is not. A replacement PCB may well cost more than the price of a new set.

I repair glass/epoxy panels used in industrial equipment. While I rarely come across a cracked panel, I often have to repair burn damage, usually where dampness or contamination has allowed 415V to arc across the board between conductors. I can't say "sorry Mr Factory Manager, you'll just have to put up with your line being down, with men idle, losing £500 plus an hour"! In this game you are only as good as your last job: if I can't get the job up and

running, next time my customer will probably go elsewhere. A replacement board may cost several thousand pounds (oh yes, some do!) and not be available for days. With old equipment a replacement PCB may simply be impossible to obtain. While I have all the equipment required to make a PCB, spending a couple of hours tracing out someone else's design is out of the question, let alone fitting a full set of new components (some of which I probably wouldn't have in stock) to the panel. One way or another, a replacement board may not be an option.

It's then down to digging out every last vestige of burnt material, filling the voids with epoxy resin, and making good any damage to circuit tracks with well-soldered (not just 'stitched') copper wire of equivalent or higher current rating. I find used desoldering braid excellent for repairs to heavy-current tracks: it provides a good low-resistance connection with high mechanical strength. I take great care to preserve the track spacing, particularly where high voltages are present. The repaired board is finally treated with a good-quality PCB varnish to discourage any new tracking and protect against further contamination.

Irresponsible bodging? I think not. The repair has been carried out with the same materials used to make the panel in the first place. The only bounces I've had are from one particular factory that handles carbon black, a very fine, penetrative, highly-conductive dust. Repeated failure of electrical and electronic equipment is regarded as an occupational hazard in this particular, very hostile environment. Even so a board repaired as described above can last up to a year before further work is needed.

Personally I don't see how a *competently* repaired board can represent a fire risk. As long as broken track is repaired with copper conductor of at least the same current-carrying capacity as the original, with the track spacing preserved, there can be no risk. The epoxy adhesive suggested by Paul Smith is of much lower flammability than the phenolic substrate. Indeed, I feel that the bad practice of hot-running components being mounted in contact with what is basically resin-soaked paper is cause for far greater concern. The resultant charring becomes slightly conductive, leading to tracking which causes yet more charring in a cumulative process that eventually leads to severe board damage and can end up with a fire. I would not repair a phenolic board in this state. Most if not all manufacturers of consumer equipment are guilty of this sin. Some of you may recall a report in this magazine on a major manufacturer's modification that involved fitting a replacement portion of PCB into an appropriately-sized hole cut in the original board. I rest my case!

Modern TV sets don't display the incendiary characteristics of the first colour jobs in the Sixties, nor do they have large, hot-running mains droppers mounted close to a cardboard back cover. While a fire officer could easily trace the seat of a fire to a TV set, the PCB (basically paper) and predominantly plastic components would be just so much ash. I doubt whether the most intensive forensic examination could pinpoint the actual component or part of the PCB that had been responsible. Even a glass/epoxy PCB will not survive a good blaze – believe me, I've seen several.

While safety is all-important, we have now reached the point of diminishing returns. No technology-based society can be made completely free from unforeseen risks. The safety zealots, in their endless quest to protect us from ourselves, have gone too far. They are to some extent responsible for our litigious society, in which no one expects to take responsibility for their own actions. Find someone else to blame, then sue. I would recommend *The Setmakers* for a good bedtime read, followed by reflection on how the early garden-shed entrepreneurs would have fared in today's safetyocracy. As far as domestic fires are concerned, most start in the kitchen, with overheated chip pans coming top of the league.

Equipment manufacturers have to cover themselves, otherwise they could be held responsible when Mr Have-a-go-Joe kills himself or burns his house down. Like Paul Smith's article, my recent piece on rebuilding battery packs was aimed solely at the professional readership of *Television*, most certainly not the DIY dabbler. Unskilled attempts to break open a battery pack run the risk of fire

as well as exposure to caustic potash and highly toxic cadmium. That's why most battery packs carry the warning "do not (amongst other things) disassemble".

Finally, on a completely different subject, one of the two CDs in my copy of Jeff Wayne's *War of the Worlds* suffered damage to its aluminium layer (I dropped it and accidentally trod on it!). This left a transparent area of two or three square millimetres. The title is a full-price double album and, as I can't afford to spend £20 plus on a replacement, I set about repairing the damaged disc. This was accomplished by using a fine artist's brush to apply, carefully, a spot of silver paint (sufficient to cover the affected area completely) to the *printed* side of the disc. The disc was then left overnight to dry. After that it worked without any problems in both my CD players. This trick may not always work, but in the case of an otherwise useless CD what is there to lose?

*Pete Roberts,
Runcorn, Cheshire.*

Repairs to burnt areas

Paul Smith's article was interesting. It's possible to go further however and replace patches of board that have completely burnt out. A couple of years ago I was surprised to find that my expensive German washing machine had not spun-dried my washing. When I opened it I found to my horror that the rubber drive belt was still as good as new. Closer inspection revealed a nasty burn up on the motor-drive board, possibly caused by dry-joints at the forward/reverse relay which had been ruined. It seemed incredible that such a small relay could drive the motor, but the idea is that it selects forward or reverse then the thyristor applies power. If the motor fails to turn, more power will be applied until the tachometer speed is reached – or something fails. In this case it was the PCB. It was made of ordinary SRBP with normal-thickness copper and was barely adequate for the job.

A washing machine engineer, Andy, was contacted but it turned out that Snoddys Refrigeration had the franchise and that spares were very expensive. Andy said that because of the spares situation he wouldn't touch these washing machines with a bargepole. The lowest estimate for a new board was £90 plus VAT – if it was still available. Several firms told me that to get the machine fixed would cost about £150.

So I took the board out and cleaned it gently with detergent and a soft paintbrush to remove the soot and ash. A sketch was then made, and the circuit diagram deduced. Stripping then commenced. One or two components had completely vaporised, but it was possible to guess what they had been as the circuit is simply a double-pole chageover relay with capacitor/resistor snubber networks and VDRs. Once the burnt area had been stripped the carbonised section was filed away until good board was reached. This left a thumb-sized hole!

India rubber was obtained, wrapped in polythene and attached to the component side of the PCB with rubber bands. Epoxy and various other types of glassfibre matting were tried as filler, but tended to produce a porcupine effect. I eventually discovered that ordinary glass wool, of the type used for loft insulation, was perfect: it 'dissolves' into regular Araldite to make a nice putty. After using a desk lamp to provide heat for the initial set, the board was baked in a *low* oven (most electric ovens will go as low as about 100°F). It was then drilled and the components were refitted. Missing tracks were replaced with wire. For good measure, all the tracks that carry motor current were reinforced by soldering on wire. The board was finally varnished.

It would have been easiest to fit an original-style relay, but instead a heavy-duty Schrack 15A type was wired in. This modification calls for a lower-value coil feed resistor, as these big relays are less sensitive.

Was it worthwhile? Yes, the machine is built like a tank. At least £100 was saved – a new machine would have cost several times as much!

*D. Benyon,
Bude, Cornwall.*

What

a Life!

It's mostly the larger TV sets that come in nowadays. We also had a CD player problem recently. And a problem with an NTSC tape. Don Bullock's servicing commentary

I was guarding the fort with Paul the other day. It wasn't long before we had a customer, Mr Hersey. "Which of you is Steven Bullock?" he asked.

"Neither" I replied, "Steven is out. I'm Don, and this is Paul."

Hersey nodded and jerked his thumb at his car. "I've brought the set in Steve" he said to me. Then he turned to Paul. "Give him a hand with it will you, Don?"

Big TVs

It was a massive Sony KV24WS1U widescreen model. I didn't fancy trying to yank it about on the bench and decided to leave it to Paul. "I'll do the next one that comes in" I said.

This was a mistake. The set was even larger, a 29in. JVC Model AV29SX1EK. It required the efforts of the customer and the two of us to get it on to the bench.

Paul's Sony set worked all right for a few minutes, then the picture began to break up intermittently with the standby light flickering. "Do you think it could be a bit of EHT discharge?" he asked.

"Dunno" I replied, "why not open it up?"

Naturally the moment he opened it and drew out the chassis the trouble stopped. He spent some time tapping here and there before he managed to instigate the fault by tapping around the tuner, which is on the horizontally-mounted tuner/IF panel. A careful examination of the panel, once it had been removed, revealed several dry-joints. After some careful resoldering Paul refitted the panel and tried again. The set now seemed to be OK, but he put it on soak test to check.

Meanwhile the JVC set was giving me trouble. The complaint was

field collapse. When I carried out a visual examination I saw that the TDA8350Q field and EW correction output chip IC401 had a burnt look about it, so I fitted a replacement and switched on. There was a noise like an exploding crackerjack and the front of the new IC shot past my ear.

Silly me. I should have checked more thoroughly. This chip requires two supplies, at 45V and 16V. Both are derived from the line output stage. The BYW95B-20 rectifier D552 for the 16V supply was short-circuit. After fitting a new diode and IC there were no bangs or earshots – but no field scanning either. The 16V supply was missing because the 0.82Ω, 2W safety resistor FR552 was open-circuit. Once this item had been replaced there was field scanning and a good picture.

"That's two done" Paul said with a smile as I boxed up my set. At this point the soak-testing Sony set's standby light flickered and its picture broke up. Its speaker crackled with laughter, and Paul's smile faded.

"It's done it again" he said. He soon had the panel out for a further check, but every joint looked good. To be sure, he resoldered the lot. But the fault was still present. A tap on the tuner made it worse, and a look inside revealed dry-joints aplenty.

After half an hour's further resoldering he reassembled the set and tried again. This time it behaved itself.

A CD Player

Mr Drain padded in. He had a blank expression and was followed by his wife. She looked at us and said "he's dim and he won't work".

I looked at Drain and understood. Then she popped a Toshiba CD player on to the counter, a Model XR9219.

"We're expert at CD player repairs, madam" I told her with a smile, "particularly our Mr Paul."

She grinned at Paul but he didn't notice. He was giving me some fierce looks.

"How the devil do I mend this?" he asked when they had shuffled off.

"No idea" I said as I struggled to get a 28in. Loewe 5128 on to the bench. It was dead and had a burnt smell about it.

Paul got into the CD player's power supply section and discovered that R901 (10Ω, 0.5W safety type) was open-circuit. Its output feeds several voltage regulators. To Paul's relief a replacement restored normal operation.

The Dead Loewe

I searched around inside the Loewe set but couldn't see anything that was obviously wrong. So I plugged it in and switched on. Forty fire-crackers exploded in my ears and Paul made for the door.

I switched off and surveyed the chassis. A wisp of smoke was climbing from a silver chimney in the power supply. When I took out the panel to see what was what I found that the silver chimney was C653 (47μF, 250V) in the 142V HT rectifier circuit. There was leakage from its base, and as a result arcing from the HT line to the earthed copper side of the double-sided PCB.

I removed the capacitor, carefully cleaned the spilt electrolyte and carbon from the board, then fitted a replacement. After that I switched the set on again and monitored the HT voltage. It was correct and

remained so during a soak test. Easy enough really.

The Sketch

"Dah de dah doe" sang the sketch who danced in with a 25in. Panasonic colour set. He looked at me.

"You'll be Steven, I suppose. Dah de dah de do."

"No, I'm Don" I replied. "Steven is out shopping, and Paul is working over there at the bench."

"Ah!" said the sketch. "I'm Dave, Paul. This is my set." He looked over at Paul. "OK Don?" he asked. "Dah de dah de dah dah dah."

Just then Greeneyes clopped in, followed by the cat.

"Ah!" exclaimed the sketch, "you'll be Steve's wife. Dah de dah de doe . . ."

"No" I said. "This is Greeneyes, my wife. Steven is still out."

"Of course" the sketch said, turning to Greeneyes and jerking his thumb at me.

"So this old-timer here is Paul, right? Dah de dah de dah . . ."

"No, no, no" she replied, "this, er, old-timer is Don, my husband. Steven is out. This is Twiddles the cat. You're Dave and that's Paul."

Steven came in.

"Who's this then? Asked the sketch. "Dah de dah de doe . . ."

"Steven" I replied.

"But I thought Steven was out?" said the sketch, "dah de dah de doe."

I wearily pulled the sketch's Panasonic TV on to the bench. It was a Model TX25MD1, which is fitted with the Euro 2 chassis. When I tried it I found that the picture was confined to the top half of the screen, and that a few red, green and blue lines shot across it intermittently. Perhaps there were two faults.

I decided to tackle the field fault first. The chassis uses a TDA8175 field output chip, IC451. I replaced it and tried again. There was an excellent picture, and I breathed a sigh of relief. The new chip had cured both the field fault and the flicking lines.

I boxed the set up and called over to the sketch. "Your set's ready, Paul" I said, "or is it Steve?"

"Oh, good-oh Dave" he replied. "I shall know where to come next time. Dah de dah de doe . . ."

As he danced off I turned to Greeneyes. "Come on Don" I said, "let's get out of here before we go mental too. Dah de dah de doe."

An NTSC Tape

While surfing the internet the other day with the help of my younger son James I discovered that one of my favourite films, *Cabin in the Sky*, was

available as a videotape in the UK. I ordered it, then searched other sites for *Stormy Weather*, which I'd never seen but had heard was just as magical. After some time I found that it was available from an American company, as were many other attractive tapes at good prices. I ordered this one as well.

When *Stormy Weather* arrived I tried to play it and soon discovered that it was an NTSC recording. All I got from my VCR were a few lines and no sound. The machine is a bit long in the tooth: it hadn't been replaced because I cannot work modern electronic models with complex control panels. But Stephen thought there was a Toshiba VCR that ordinary mortals like me can operate. The upshot was that he and Greeneyes went off to the shops to look for one that would play NTSC as well as PAL tapes.

Steven is a Toshiba fan. He reckons that the company's products are extremely well engineered. The spares service is excellent, and he finds that Toshiba is very helpful with technical advice and help, even with firms like ours that don't have a Toshiba account. Of how many companies can you say that?

Stephen and Greeneyes discovered a Toshiba V709B that appeared to fill the bill and was on offer at £179.99. But the only one the shopkeeper had was in the window. He seemed reluctant to disturb his display. The same machine was on offer, this time at £169.99, at a nearby shop which could supply one in its box. So they bought it and returned.

The machine is compact, well finished and simple to operate. It has four heads, one-touch recording, simple channel selection, a scart socket for AV input/output, another for satellite purposes and separate audio output sockets. Other features include automatic digital tracking, Nicam sound and Video Plus capabilities. The handset works even for me, and from the garden. The auto set-up works a treat.

There are lots of features that baffle me, so I don't think about them. I settled for being able to operate the controls necessary for simple recording and playback. It's an excellent machine to handle, with very good performance. We'll see how it behaves.

A Request

I've searched the internet for another videotape I nearly had once but have been unable to get since. Let me explain.

In the Seventies the BBC sent



Paul made for the door . . .

cameramen and actors to a nearby village and produced Laurie Lee's *Cider with Rosie*. It was to be transmitted one evening at a time when we had to be away. So I slipped out to get a new VHS180 tape, put it in the machine and set the timer carefully. We then departed. It was a Fujitape.

When we returned we found that the tape had moved only an inch or two then stopped. So we had no recording. I tried another tape, which worked, then tried the Fujitape again. The machine stalled. I tried the tape in another machine which also stalled. When I picked up the tape's box a tiny slip of paper fluttered out. It contained a warning, printed in red capitals, to fast forward and rewind the tape before use. I hadn't noticed this and of course hadn't done so.

My efforts over the years to get a copy of that programme have been unsuccessful. Recently James found a dealer who was offering it on the internet, so I ordered it by bank card. It turned out to be no longer available.

If any reader can find a copy for me I would be delighted. One final word about it. ITV recently produced a different version of *Cider with Rosie*. I have this one. It's the original BBC one I'm after.

TELETOPICS

Ingenuity

There was no lack of interesting new product launches and announcements last month, starting with Bush Internet TV sets at the beginning of the month and, towards the end, Amstrad's introduction of the e-m@iler. There was also the announcement, mentioned briefly in our leader page last month, that an agreement between BSkyB and the US firm TiVo will lead to the introduction of the latter's personal video recorders in the UK later this year.

A number of new and interesting products were to be seen at the ER Show on March 26-28th. These included a Sharp TV set with a 28in. widescreen LCD screen, a Samsung TV set with a ferro-electric liquid-crystal display, Toshiba sets that use the company's new Digital 100 DFS (Dynamic Frame Scan) technology, and Sony TV sets that feature Digital Reality Creation - Multi Function technology. This uses a proprietary digital signal-processing algorithm to

increase the resolution to HDTV standard, with improved colour accuracy and clarity. A full report on the ER Show will appear in next month's *Television*.

There are many possibilities for STB development. The problem here seems to be to decide what to select and market rather than how to go about implementing various features. Hard-disk video storage, as in the TiVo, is likely to become a fairly standard feature. One such box under consideration by BSkyB would incorporate two hard disks, one to store up to twelve hours of TV broadcasting and feed this to a VCR if required, and a second smaller-capacity disk that could be used to pause the programme. Dumping to a VCR could be programmed to occur overnight. These are helpful features, but what would the public be prepared to pay for them considering that basic STBs are provided free?

The first Bush Internet TV set, a 14in. model, will be available in June. It will be followed by 21 and 28in. 4:3 sets then, later in the year, 28 and 32in. widescreen models. Bush expects to sell about 750,000 of the sets during the first year. The aim of course is to provide internet access for those without a PC. Traditionally the disadvantage of using a TV set for the purpose is the poor web displays produced. The sets will use technology licensed from Pace Micro Technology however: this employs software designed to improve the web displays. Operation is by means of a simple infra-red remote control unit that incorporates a keyboard. The initial 14in. model is to sell for less than £200. Profit will come from new revenue sources rather than the sets - internet advertising, a percentage of the local telephone connection charge and a percentage of the rev-

enue produced by the associated portal (a tailor-made portal with news, entertainment and sports content has been developed by a joint venture with Virgin Net for use with the sets). There will also be an internet STB.

Bush is also planning to launch the Ultimate MMM this September. It's a multimedia unit which is connected to a TV set and can play CD and DVD discs, CD-ROMs and downloaded MP3 audio files. It will record broadcast TV programmes digitally, run PC programs and record on blank CDs.

The Amstrad e-m@iler, which was developed in conjunction with British Telecommunications, combines normal telephone services with voicemail, fax, e-mail operation using an attached keyboard and 22 x 18cm screen, and an electronic address book that can be downloaded to a portable databank. Its aim is to bring e-mail to the mass market. Sir Alan Sugar hopes that a million or more will be installed in UK homes over the next two years. It's being sold at a loss, about £80, "to get a lot of units into people's homes" according to Sir Alan. There are no connection or subscription charges. Income will be generated from advertising and a fifty per cent share of the charge BT makes for e-mail use. The product is being handled by a separate subsidiary, Amserve. It has not been too well received by the press and the markets. The feeling seems to be that the technology is moving so fast the e-m@iler could soon be overtaken.

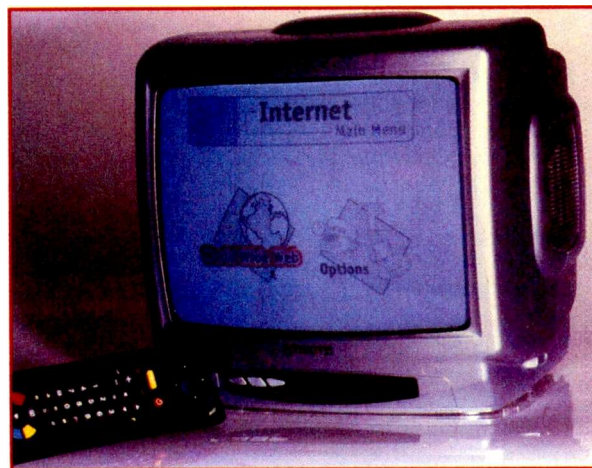

The Bush 14in. Internet TV.

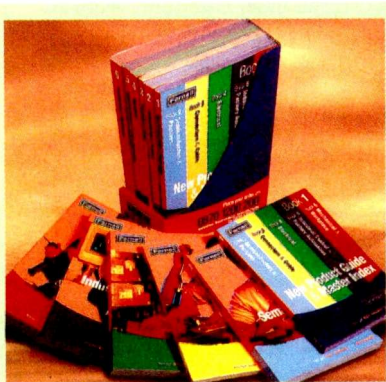

Following in-depth research into customer use of its catalogue, which now includes some 100,000 products, Farnell has adopted a revised design. The new catalogue is in six lightweight, fully colour-coded sections: there are five product books plus a separate new product guide and master index. For further details apply to Farnell Electronic Components Ltd., Canal Road, Leeds LS12 2TU. Phone 0113 263 6311, fax 0113 263 3411.

New BEAB Standard

The British Electrotechnical Approvals Board (BEAB) is urging TV manufacturers to start preparing for the new EN60065:1998 European safety standard which will replace EN60065:1993 on August 1st 2002. After that date only products designed and tested to the new standard will be able to use the CE mark.

The BEAB has studied the new standard and believes that most products designed to meet the 1993 version will need to be modified or redesigned. This leaves setmakers

with just two years to carry out the design and test work and start production.

Panasonic UK Ltd. has already received approval for a 9in. colour monitor that meets the new standard. The licence was granted last September. By drawing on the experience gained during that licensing process, and through its links with other European certification bodies, the BEAB is able to provide reliable advice on interpretation of the new standard.

Video News

Texas Instruments has introduced a new front-end processor, the TAFE1040, for use with CCD analogue imagers. It provides high-resolution analogue-to-digital video conversion for next-generation digital camcorders and still/video cameras. Up to 42 million samples per second of picture data are converted with ten-bit resolution per sample. This gives designers the data conversion speed and resolution needed to ensure optimum performance. In addition to conversion, the TAFE1040 maximises the dynamic range and corrects errors associated with the sensor. It operates as 3V, consuming typically 180mW. Battery life between charges is thus prolonged.

Complementary Technologies Ltd. has introduced the Video Traveller Plus to provide viewing as an in-car accessory, also a mobile Sony PlayStation kit. The Video Traveller consists of a 4in. thin-film transistor LCD colour TV/monitor and lightweight VCR. The TV section has bar tuning with channel up/down and video mute. Either aerial or AV input can be accepted. Price is about £470 including VAT and carriage. The Sony

PlayStation kit comes at about £635, or £535 without the console. For further details phone Comtech at 01942 851 800, fax 01942 851 808 or e-mail gworsley@ctl.bolton.com

B-Tech International Ltd. has introduced a scart management controller, the Quattro+ Model BT941. It can link up to four pieces of equipment with scart connectors, using remote control. The BT941 is S-VHS and RGB compatible, and auxiliary connections for a camcorder, hi-fi equipment etc. can be made via RCA phono sockets. When recording from one device to another, the Quattro+ uses an innovative electronic 'lock' that isolates inputs/outputs to provide uninterrupted recording, so that the remaining connections are still fully functional and controllable. The unit is expected to sell at about £90. For further details B-Tech International Ltd. can be reached on 01689 848 535, fax 01689 841 087.

Toshiba has announced that all its DVD players sold this year will incorporate the ability to have their firmware upgraded via a system disc that you insert in the tray.

Digital News

ONdigital has now launched its Onmail service that enables viewers to send and receive e-mail while watching TV – with most other TV-based e-mail systems the user has to switch off the programme. ONdigital plans to launch other interactive services later this year, including full internet access.

Sony is to introduce an optional modem for customers who wish to upgrade their free-to-air TV sets to

provide interactive digital terrestrial TV services.

Nokia Multimedia Services and SCM Microsystems have developed a PC digital terrestrial receiver that enables data and video to be delivered to a PC.

Microsoft has teamed up with Philips to develop a digital cable STB that will provide TV services, internet access, telephony via internet protocol, video streaming and hard-disk recording.



The latest Sharp ViewCam, Model VL-PD6H, is the most feature-packed digital camcorder yet to come from the company. It measures 72 x 104 x 37mm and weighs just 590g. One significant feature is the SmartMedia card storage facility. A SmartMedia card can be inserted in a special slot in the body of the VL-PD6H to record a still image which can then be transferred to a PC using a suitable adaptor. There is also an RS232C transfer option. Images stored on card can be inserted on video while recording by using the 'picture in picture' or the 'title screen' mode. The facility can also be used for indexing sections of the tape.

An f1.4 lens and 810,000 pixel CCD ensure excellent image quality, which can be enhanced by other features. The 'low lux' facility for example provides colour recording at light levels down to 0.5 lux, while the 'super cat's eye' circuit provides monochrome recording at down to 0 lux. Sharp's unique digital gamma correction option increases the contrast and detail in dark conditions. The 10x optical zoom can be increased to give magnification up to 200x digitally.

Audio performance is enhanced by the zoom microphone function. This uses a varying mixture of the outputs from an external and a built-in microphone. To emphasise the sound produced by the central subject, the record level from the external microphone is increased when the zoom lens is operated. The integral wideband microphone is used for wide-angle shots.

An easy-to-use menu system on the 62mm LCD screen gives the user access to the many functions, including manual ones. The camcorder can also be remotely controlled via the screen and a cable link. Further information can be obtained from Sharp on 0800 262 958.

A.R.D. appoints new director

Peter Gleave, FCA has been appointed to the board of A.R.D. Electronics Plc as a non-executive director. Mr Gleave's association with the Duckett family, which owns A.R.D., goes back to 1970. He has long experience of the trade and those in it.



The motor trade generates quite a lot of radio and cassette player repair business, which usually has to be subcontracted out. You can make above average profits from this type of work. **Colin J. Guy** describes typical testing procedures and repairs, and how to get into and develop this side of the business

Repairing In-car Audio Equipment

I have been repairing car radios for over twenty five years. In the early days most repairs were simple and straightforward. The odd vibrator (yes!) had to be changed, and Philips and Radiomobile hybrid models had to be converted from positive to negative earth. Later, those unreliable germanium audio output transistors had to be replaced.

Very few cars had radios fitted as standard in those days. They were a relatively expensive accessory. Many garages had a specialist radio department that was kept fully occupied fitting radios, which came as kits from the manufacturers, specifically designed for particular car models. The radios were generally fitted correctly and gave little trouble. Later, combination radiocassette players came along. Prices dropped, as this equipment was sold by car accessory shops. There were many DIY attempts at fitting, and the resultant damage increased the number of repairs required. Many of these came my way: the average mechanic seems to be

unable to fit a 13A plug let alone deal correctly with car electronics.

The situation is very different today, as all new cars have at least a radiocassette fitted. This will leave the dealership correctly wired and working. Yet I get more car audio units to repair than ever before. Why?

Causes of failure

First, today's products can be very sophisticated, containing one or more microcontroller chips. They have four-channel IC audio amplifiers which, because of the high power required, have bridge-type output stages. This means that the speaker wiring carries DC. The output ICs won't tolerate the speaker wiring being shorted to earth, so a good stock of output chips is essential.

Secondly, the often quite complex controls on modern equipment are of relatively flimsy construction in comparison with the 'brick outhouse' construction of yesteryear (this should sound familiar to VCR engineers). So many repairs consist of replacing or repairing buttons,

switches and cassette deck parts.

Thirdly the DIY yourself brigade is still out there, trying to add extra speakers, amplifiers and so on.

Fourthly, a few years ago manufacturers came to the conclusion that if radios needed a code to work them they wouldn't be stolen. This proved to be a fallacy of course. Coding has become a major problem, and has in my experience been the largest cause of increased business in this field.

What you require

What's required to repair car audio? Most obviously a 12V power supply able to deliver at least 5A, with short-circuit protection. It's useful to have an ammeter permanently connected. One of the cheap power supplies sold for CB transceivers will do at a push, but the regulators in these have a habit of going short-circuit – usually when you have the most expensive car radio in the shop connected to it. A proper workshop-type power supply is a better proposition. These often have built-in metering and excess-current

and over-voltage protection.

Virtually all radios need two 12V supplies, one that's on permanently (backup) and one which is present only when the car's ignition is switched on - this is often referred to as the 'acc' supply. It's necessary to be able to switch the latter separately (see Fig. 1).

The next requirement is a set of four decent speakers. I use 4Ω ones, as certain faults don't show up with 8Ω or higher-impedance speakers.

An aerial with lead and plug are required. There are two types of aerial connector in common use, the older type with a single pin, and a smaller, coaxial type. Adaptor leads to connect from the former to the latter are available from car accessory shops, so obtain an aerial with the older type of plug on it and clip this up on the wall away from the computer monitor and other sources of interference.

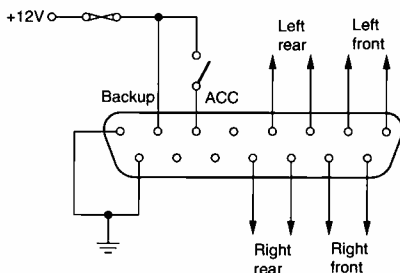

Fig. 1: The DB15 radio jig plug/ socket power supply and speaker connections used by Colin J. Guy.

You will need a range of connectors to fit the most common radios. There was once a multiplicity of different connectors in use, and some manufacturers employed the same connector but wired it differently for different models, so care is needed. Most of the car trade has now standardised on a small number of connectors that are wired in the same way. Three types cover most original equipment radios. These are as follows:

(1) The 'IEC' connector (see Fig. 2) which consists of two rectangular 8-pin sockets, one carrying the power supply and the other for the speaker wiring. A third socket often fitted to these radios carries connections specific to each model, often for remote control, audio in/out, CD control etc. Radios of this type will work with nothing connected to this latter socket.

(2) The 'Ford' connector, see Fig. 3. Origin obvious and again consisting

of two connectors, one for power and the other for speakers. The connections are standardised for radiocassettes, but some Ford CD players and amplifiers use the same power connector wired differently.

(3) The 'Philips' connector, see Fig. 4. Consists of two large and two or three smaller pins in a straight line for the power connector. These radios are getting rather old now but still turn up quite often. The system is also used by Blaupunkt. The speakers are individually connected to these radios, using plugs with the same pin configuration as the domestic hi-fi DIN speaker plug but with a smaller body.

Nissan, BMW and some other car manufacturers have their own connector systems, but you don't come across them very often. See Figs. 5 and 6.

Obtaining connectors

The best way to obtain the connectors is to visit your local scrapyards - with a pair of wirecutters tucked in your pocket. Those who run breakers yards will often be only too pleased to let you have the necessary connectors in exchange for a repair or two - they usually have heaps of radios that are unsaleable because they are faulty or decoding is required.

While there, look for one of the remote display units used in Vauxhall vehicles. You will find it useful as some radios don't have an on-board display: though they will work without one, it's much easier to see what is going on when a display is connected.

Once you have your connectors, the tidiest way to organise them is to wire each one up to a multipin plug and have a matching socket wired to your power supply and speakers. I use a DB15 connector, but anything you happen to have and is robust will do. See Fig. 1.

You will also need a plug connected to open-ended wires to cater for non-standard configurations. Fit insulated crocodile clips to the power leads but, despite this, you will eventually short them. Hence the need for a current-limited power supply.

Initial checks

When a radio comes in for repair, first determine which lead is required then check the resistance between the case and both positive pins. This will reveal any shorts. Most modern radios have a fuse fitted

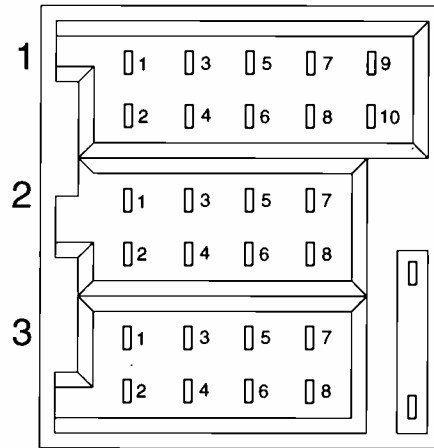

Fig. 2: The IEC car radio connector arrangement. Connector 1 auxiliary functions. Connector 2 speakers: 1 right rear LS +; 2 right rear LS -; 3 right front LS +; 4 right front LS -; 5 left front LS +; 6 left front LS -; 7 left rear LS +; 8 left rear LS -. Connector 3 power: 4 backup; 5 electric aerial; 6 illumination; 7 ACC 12V; 8 earth.

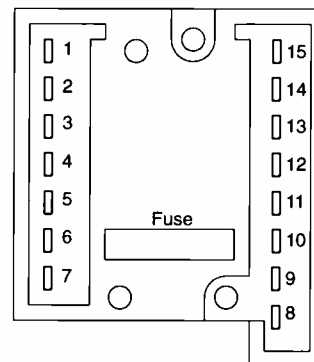

Fig. 3: Ford radio connector. 1 battery; 2 NC; 3 A+ ignition; 4 illumination; 5 NC; 6 earth; 7 SW A+ out; 8 right rear LS -; 9 right rear LS +; 10 right front LS -; 11 right front LS +; 12 left rear LS -; 13 left rear LS +; 14 left front LS -; 15 left front LS +.

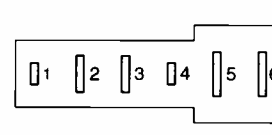

Fig. 4: Philips connector. 1 NC; 2 battery; 3 SW A+ out; 4 illumination; 5 A+ ignition; 6 earth.

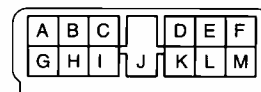

Fig. 5: Peugeot connector. A rear left LS -; B front left LS -; C NC; D ACC 12V; E front right LS +; F rear right LS +; G rear left LS +; H front left LS +; I backup; J electrical aerial; K earth; L front right LS -; M rear right LS -.

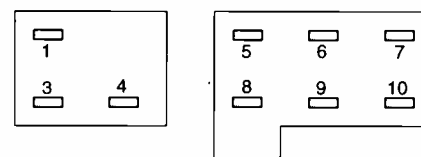

Fig. 6: Nissan connector. 1 earth; 2 no pin; 3 ACC 12V; 4 illumination; 5 electrical aerial; 6 right LS +; 7 left LS +; 8 backup 12V; 9 right LS -; 10 left LS -.

at the back – it's sometimes quite well concealed. Remove and test it. If it's open-circuit, replace it and check again for shorts.

Next check for zero resistance between the case and the negative supply pin. If you get an open-circuit reading you will find that the print is blown off around the connector: this is usually because someone has tried to connect the positive supply to the negative pin. It's a particularly easy mistake for those unfamiliar with Ford radios to make: this manufacturer uses brown wiring for earth and, for some reason, most folk associate brown with live!

If you find a short at either supply pin, look inside the radio. There is usually a diode across each supply, to provide reverse-polarity protection. These diodes sometimes short when attempts are made to jump-start a car. Replacement diodes are often all that's needed to restore the radio to working order.

Before you connect up the radio, remove the bottom cover and check whether water has been inside. This is quite common with radios that have been recovered from written-off cars. If there are signs of corrosion on the PCB, the radio is probably not worth repair.

If these checks are all OK, connect the radio. With luck it will light up then ask for its code, which of course you asked the customer for when the radio came in, didn't you? If not, get on the phone for it. See later.

Fault-finding procedure

If the radio draws several amperes, even when switched off, the output chip is faulty and will have to be replaced. These ICs are available from most of the usual suppliers, and most of them are not too expensive.

If the radio works, tune in and store the local FM and AM stations. Then switch the 'acc' supply off for only a couple of minutes. Switch it on again and see whether the radio works without asking for its code, also that the stations remain stored. If the radio asks for its code again there is a problem with the back-up supply. Check for damaged print or dry-joints in his area.

If all is well, insert your favourite cassette and leave it playing for a couple of minutes, in both directions if the deck is an auto-reverse type. Then sit back, relax and wait for the customer to return with his money!

More likely however you will find that there's a problem with the cassette deck. Faults here are almost always of a mechanical nature, such as defective belts, a bent cassette holder or just a badly glued head. Philips decks,

which are also used by other manufacturers, are prone to cracked or shattered flywheels. The result is wowy playback or belt shedding. Replacement flywheels, belts and most other mechanical parts for this deck are readily obtainable. In fact I buy belts and flywheels in fifties as this is such a common fault.

Another common fault, which customers often don't report but complain about if you fail to sort it out, is failure of the display illumination. The bulb is easily replaceable with Ford radios, being of the same push-in type that's used for all the dashboard illumination in these vehicles. Replacements are readily available from car accessory shops. Most other types of radios have tiny soldered-in lamps which are the very devil to replace, often requiring removal of the LCD display, but it's worth being patient and careful. The best source of these bulbs is RS Components. Bulbs from other sources have in my experience proved to be either expensive or unreliable.

Fortunately it's very rare for faults to occur in the tuner or microcontroller sections of modern radios. If such a fault is present, check for the correct supplies to the ICs and for stuck down buttons on the front panel. Some Philips-type radios have membrane-type keypads which are about as reliable as those used in Ferguson TV sets. They can be the cause of a 'dead' radio. Replacements are readily available. Other than this, before proceeding consider whether repair will be economically viable.

Decoding

Most original equipment radios require a three- or four-digit code before they will operate. This code is programmed into the radio during manufacture. When new, a card with the code on it is supplied with the vehicle. The selling dealer also keeps a record of the code against the registration or chassis number of the vehicle. That's the theory anyway. The reality is of course very different. Vehicles change hands, code cards are lost, radios get swapped around for in-guarantee repairs, and records are not updated – or not correctly kept in the first place. Because of all this, over half the radios that arrive in my workshop simply need 'decoding'.

The code is stored electronically in the radio's EEPROM. In older radios this is a separate IC, often of the 24C02 type familiar to TV engineers and with similar reliability. In later radios the EEPROM is built into the microcontroller chip, which makes life a little more difficult.

To read out codes, or rewrite the EEPROM if it has become corrupted, a PC with suitable software is needed together with an interface unit and connectors for each type of EEPROM. For a number of years I've used the decoding software and interface available from CDH Electronics of Cannock, Staffs (www.cdh.co.uk). It requires a fairly mundane PC – in fact some of the DOS software will not run on a Pentium PC, so I use my trusty old 386. The interface unit is connected to the PC's parallel port. You then select from the menus the radio's make and model, connect the appropriate lead, follow the on-screen instructions and diagrams and finally read out the code or rewrite the EEPROM as necessary. CDH provides a good technical assistance service by telephone for registered users of its software.

This software is expensive, approaching £1,000 for a full set-up, and needs to be regularly updated as new models come out. So, if you expect to decode only the occasional unit, the investment is probably not worthwhile. With many radios it's possible to remove the EEPROM and send it to CDH for reprogramming, which is a more economical solution for the occasional repairer.

By quoting the full model and serial number of the radio it's possible to get from a Ford main dealer, on payment of a fee, the code for a radio made after mid-1995. But this is of no help if the EEPROM is corrupt or the radio has 'locked out', which happens when someone makes more than a maximum number of attempts at guessing the code. The Ford codes provided are almost always correct, but occasional mistakes occur – possibly because the radio has been reprogrammed during a previous repair.

Installation

I'm frequently asked to install equipment in vehicles. As I have neither the time nor the space for this, I refer all such requests to another company. But at the prices charged for this work I suspect that it's another aspect of our trade that will remain profitable for some time to come.

Amplifiers and CD players

The large amplifiers some oddballs fit in cars seem to be generally reliable when properly installed. Some claim to have a power output in excess of 600W, though how this is possible with a normal car electrical system – or within the limits of human endurance – escapes me. Those I've come across that have failed usually contain obscure, unobtainable semiconductor devices. So I steer clear of them and advise their

owners to return them to the original supplier. This usually means that they will have to buy a new one, and will perhaps make a better job of installing it.

Car CD players, and particularly changers, seem to be particularly unreliable. Once you have repaired one it's likely to be a continual source of complaints. So I also advise owners to return these to the original supplier.

Sources of business

Most of my car radio repairs, and decoding work in particular, come from the motor trade. Many second-hand cars come into the trade from auctions, with the code card often missing from the paperwork. The radio usually works until the dealer services the car and disconnects the battery. He then finds that there's no code card. This tends to happen an hour before the customer is due to collect the car, at 5 p.m. on a Friday. So a 'while you wait' decoding service can pay dividends.

Autoelectrical companies are also a good source of work: they are often asked to sort out a radio when the owner has tried to install it, usually blowing up the output ICs in the

process. A recent TV ad for *Yellow Pages* summed this up well!

One thing to bear in mind however is that the motor trade generally has no loyalty to anyone. If a dealer thinks he can save a few pence by going elsewhere he will. Don't fall into the trap. Stick to your prices, do a good job and they will be back. An autoelectrical company once suddenly stopped bringing repairs to me. I heard on the grapevine that the work was being done elsewhere for a lower price. Some of these jobs eventually bounced, and the repairer disappeared from the scene. This left the autoelectrical company with a number of irate customers. When it came back to me, grovelling, I increased my prices. I am still doing work for the company ten years after that incident.

A source of more interesting work is classic car restorers. The cars have to be fitted with a radio of the correct period, often a valve type. These older radios are much more of a pleasure to repair than their modern counterparts. Even eight-track players turn up from time to time!

I have never had to advertise for this work. The jungle telegraph works

well in the motor trade, provided you do a good job. It can work against you if you don't!

Pricing

I find it best to charge a standard price for each job. The quickies make up for the less profitable repairs, and everyone knows where they stand. I give estimates only where a repair requires expensive parts that will take the cost above the standard repair charge, and charge for the estimate if it's refused.

The motor trade will generally pay no more than about £20 for a repair, as dealers can often get a radio from a written-off car for not much more than this. Occasionally a radio turns up for which a replacement cannot be obtained because it's a special type. As a car is virtually unsaleable without a working radio, you have a free hand with the repair charge when this happens.

If you go about it properly, car radio repairs can produce worthwhile extra income. Ten jobs a week should represent more than £100 in profit. With experience and a little luck, it's possible to do this number of jobs in less than a day.

<p>REMOTE CONTROLS FROM £5.99p REPLACEMENT FOR TV, VCR AND SATELLITE</p>	<p>CAPACITANCE METERS</p>  <p>An accurate capacitance meter providing measurement over a very wide range 0 to 2000uf Accuracy 0.5% PG015 £29.99p</p>	<p>ICs TRANSISTORS AT LOW PRICES</p>	<p style="text-align: center;">E.L.C. WHOLE SALERS (TRADE ONLY) IN THE EAST END JUST OFF GREEN STREET TWO MINUTES FROM UPTON PARK TUBE STATION 59 PLASHET GROVE, EAST HAM, LONDON E6 1AD TEL: 0181 472 8899 FAX: 0181 503 5026</p> <p style="text-align: center;">STOCKISTS OF AERIALS, BATTERIES, CABLES, LIGHT BULBS, LEADS, AUDIO AND VIDEO TAPES, CAR AMPS AND SPEAKERS, ALL ELECTRICAL ITEMS</p> <p style="text-align: center;">DISTRIBUTORS OF ALTAI, SOUNDLAB, PRO PLUS PRODUCTS</p> <p style="text-align: center;">*** CHECK OUT ***</p> <p style="text-align: center;">*** OUR PRICES ***</p> <p style="text-align: center;">CONTACT PAUL 0181 472 8899</p>
<p>FOUR-WAY UNIVERSAL REMOTE CONTROL £9.99p</p>	<p>Service/Cassette Transparent</p>  <p>£1.99 Special</p>	<p>VHS ALIGNMENT TAPE Band tracking, tape transport, FM pictu curve, audio sync head azimuth tracking, playback switching point £29.99p only</p>	
<p>OVER 500 MODELS AT LOW PRICES VIDEO HEADS FROM £4.99</p>	<p>Mitsubishi capstan motor pulley</p>  <p>£3.95p</p>	<p>PATTERN GENERATOR Colour bar, cross hatch Staircase compact portable £84.99p only</p>	
<p>LOPTs LINE OUTPUT TRANSFORMERS FROM £9.99</p>	<p>CAPACITOR KIT 40 MIXED £3.99</p>	<p>DEGUSSING ROD £29.99p</p>	
<p>CDR 680 MEG 74 MIN 0.89p EACH FOR 10 0.79p EACH FOR 100 0.69p EACH FOR 1000</p>	<p>33 PIECE TAMPER PROOF SECURITY BITS £5.99</p> 	<p>NIKKAI BABY 10 REGULATOR £11</p>	
<p style="text-align: center;">ELC EAST LONDON COMPONENTS 63 PLASHET GROVE, EAST HAM, LONDON E6 1AD TEL: 0181 472 4871 FAX: 0181 503 5926</p> <p><small>Two minutes walk from Upton Park Tube Station</small></p> <p>Add £1.50p p/p + 17.5% VAT VISA, ACCESS, SWITCH ACCEPTED MIN ORDER £5.00</p>	<p>CD TEST DISC £9.99p</p>	<p>REMOTE TESTER £12.99</p>	
	<p>MULTIMETER FROM £4.99</p>	<p>MULTIMETER FROM £4.99</p>	
	<p>GLUE GUN Special offer £4.99p</p>	<p>GLUE GUN Special offer £4.99p</p>	

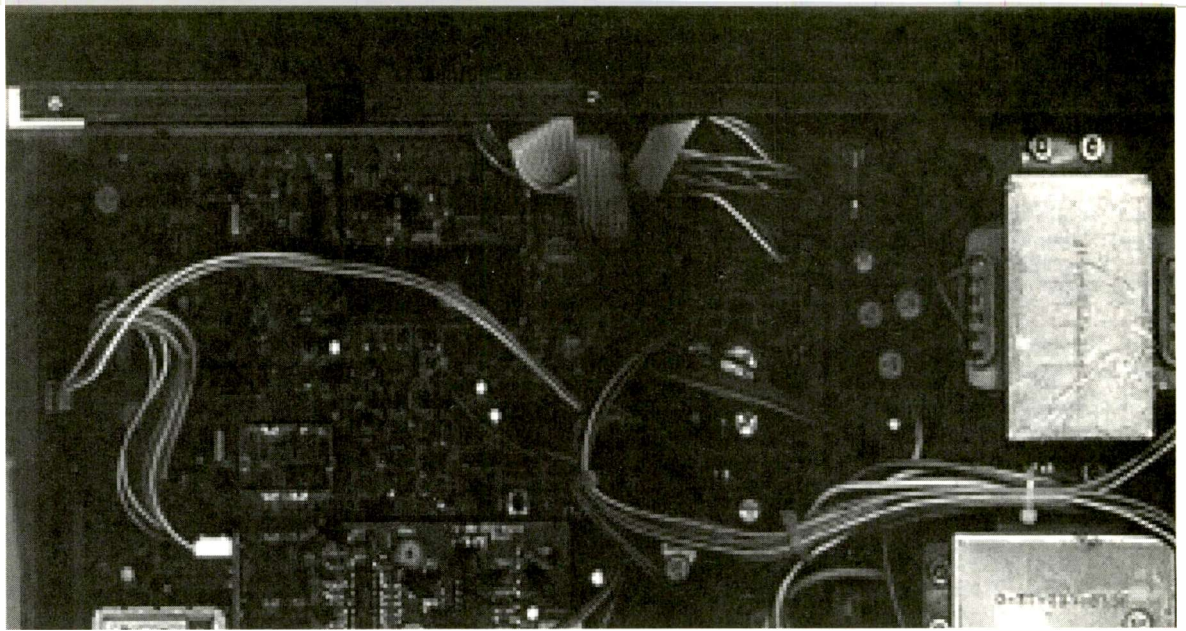

Satellite Notebook

*Reports from
Hugh Cocks and
Michael Maurice*

Digital FTA Problem

The owner of a free-to-air digital receiver had been using it for some months. He was a keen satzapper who was always finding new and obscure signals. Vast numbers of free-to-air digital TV and radio signals are available, but they tend to become encrypted, sometimes disappear, or their signal characteristics (symbol rate, forward error correction or packet identification) change. For this reason they are really suitable only for enthusiasts. The continued presence of a particular signal simply cannot be guaranteed. Various internet sites, particularly www.lyngsat.com, provide channel listings that are updated daily. These can be programmed into a digital receiver.

The problem with this receiver was that there were green blocks at the bottom of the screen, accompanied by a scrolling, hazy effect. The symptom was present with all signals. On-screen menus were OK, and the sound was normal. It was a most confusing symptom, one that could easily be put down to a receiver fault, and was something that should never be seen with say a Sky digibox built for the UK market only. The receiver was actually a Prodigy free-to-air MPEG-2 DVB model manufactured in the Far East for use throughout the world. Its UHF modulator can be switched via on-screen menus between all TV systems, and the receiver's video output can be set to 525-line NTSC or 625-line PAL.

MPEG-2 digital TV signals in 525- or 625-line form are available all over the world. In normal circumstances this receiver detects whether the signal is a 525- or 625-

line one and switches the video output to match the standard being received. However it's possible, using the options menu, to set the output to 525 or 625 lines only and not switch the lines/colour system to match the incoming signal. This was where the problem lay!

The receiver had been set to provide only an NTSC, 525-line output. This was fed to the TV set in RGB form via a scart lead. So the TV set was quite happily producing a colour picture display. The problem was that the input signals were in 625-line MPEG form, from the Hotbird slot at 13°E.

Unfortunately MPEG receivers don't standards-convert from one system to another. Instead a picture with deficiencies will be displayed, which was what this TV set was doing.

With standards selection set to "auto", the receiver produces a 525-line output when such a signal is being received. With RGB coupling the colour is OK whether or not the TV set has NTSC colour decoding capability. An NTSC output is available at RF and via the video output scart sockets. With an NTSC signal the subcarrier is normally at 3.58MHz, but a sub-menu option enables 4.43MHz NTSC to be selected. Some European sets are compatible with this standard, and modern sets will normally switch happily between 625/50 and 525/60 scanning. Further choices with this receiver are PAL M (525 lines, 3.58MHz as used in Brazil) and PAL N (625 lines, 3.58MHz used mainly in Argentina). With all these receiving permutations and combinations, there is great scope for confusion.

The on-screen effect with the opposite condition, a 525-line MPEG signal received by a 625-line MPEG receiver, is – at least with the Nokia 9600 – a very jerky picture with the very bottom section of the screen blank, the sound being OK though there is a brief picture and sound dropout every few seconds. If you want to see these effects in Europe, the PanAmSat 1 satellite (PAS 1) at 45°W provides a constant source of 525-line MPEG signals. **H.C.**

Coaxial Cable Degradation

The owner of an elderly Drake ESR250 movable dish system complained that there were poor pictures on most channels, particularly CNN which was hardly visible. When I arrived at the house I found that the symptoms were exactly as described. The higher channels, at a higher satellite IF, seemed to be generally worse, which suggested that either the tuner or the coaxial cable from the dish was the cause of the problem. When I went outside I saw that the black outer sheath insulation had perished all the way along the cable run. Quite a lot of it wasn't even present. What remained was brittle and broke up under the slightest hand pressure.

The cable would have been in place for some ten years. This does show that in a sunny climate (Portugal) it's best to use white cable, shielded from the sun as far as possible, to prevent degradation caused by ultra-violet radiation. I've come across black cable here before in older installations, but have never previously come across

Continued on page 407



Terrestrial DX and satellite TV reception. News from abroad and of developments in the satellite field. The strange satellite/terrestrial reception situation in Australia. Roger Bunney reports

DX and Satellite Reception

February was another very quiet month for terrestrial DX-TV reception. There were some reports of daytime Sporadic E signals (unidentified) being received – on the 12th, 13th and 27th, in ch. E3 only. For us in the south/SE, only ch. E4 provided evidence that our aerial systems were still OK, with fluttery, trop-aided reception from Lopik, Holland.

Robert Copeman (Melbourne) has sent me a list of his reception during the latest Australian SpE season. Results weren't too wonderful, with mainly repeated Band I/II signals, but on a few evenings transequatorial-skip propagation with SpE enhancement brought Chinese ch. C1/R1 signals to southern Australia, typically at around 1900-2100 local time.

Gareth Foster mentions that the trade outlets of Satellite Solutions are selling an aerial for DAB reception. It's a nine-element, Band III log-periodic aerial for horizontal mounting. Coverage is 165-

245MHz with a forward gain of 9dBd and a front-to-back ratio of 25dB. Price is £12.99 plus VAT – Satellite Solutions will sell to readers of *Television* over the counter for plastic or cash. DAB will use only a small section of Band III, at the upper end (ch. E12), but this compact, moderately-priced aerial should give good DX-TV results.

George Gaskin, who had a poor Band I reception problem, found that his WB4 aerial's insulator box was full of water. It's important for owners of this type of aerial to drill an 0.25in. hole through the underside of the insulator, to emerge inside the connection box itself. This enables air to circulate and prevents condensation and water build up. With the hole underneath, rain water is kept out – but spiders may well get in.

After asking for reports of satellite reception I was delighted to hear from Brian Lewis, a retired BBC engineer. In the late Fifties he worked at the Tatsfield monitoring station and says he heard the feeble 'beep-beep' from the first Sputnik as it tracked overhead in a low orbit. The signal was at about 20.8MHz and lasted for a minute and a half or so. Sputnik-1 didn't actually beep-beep: it keyed an AM beacon transmitter on-off, the beep being added by the BFO in the receivers then used, mainly AR88s. The Americans first became aware of Sputnik when they heard the Tatsfield recordings via the BBC's General Overseas Service at 0600 hours the following morning!

It looks as if the present solar cycle (no. 23) isn't going to break any records. A pity, as it's likely to be the last chance we'll get to receive, via F2 reflection, really

long-distance analogue TV signals. Next time round everything may well be digitised! A check with the NASA internet solar cycle page indicated a sunspot count of 201 on Monday February 28th: the graph I downloaded suggested that the peak could occur in mid-summer. You can check out the NASA site at <http://science.msfc.nasa.gov/>

Satellite Sightings

Just as I finished writing the column last month news broke of the Afghan Air passenger jet hijacking. A check with Eutelsat II F3 (36°E), which is commonly used for UK uplinking and domestic connections, proved that the media were already well entrenched at Stanstead, with ITN/Reuters, APTN, SISLink and Starbird in operation. During February 7-8th I monitored the feeds at 11-005, 11-080, 11-607, 11-678 and 11-687GHz, all horizontal and all digital (generally with SR 5,632 and FEC 3/4). They were being used mainly for the UK and US networks, though Arabic-language reports were seen via SISLink 37 (UKI-506) which was sharing ITN capacity for the MBC news service.

I have noticed that there's a tendency for an SNG system, once established and tuned in, to retain transmission parameters and stay on the same frequency. For example the Starbird (UKI-94) feed at 11-687GHz was using the same service ident (APTN BRIZE-PATH 1) and frequency that it used last June from Brize Norton airfield when the Harrier jets returned from the Balkans!

My receiver has about thirty memory locations for 36°E. Generally – but not always – the

News of the hijacked Afghan Air jet at Stanstead, provided by APTN News-force via Eutelsat II F3 at 36°E.



SNG signals via this satellite appear at these frequencies.

Another trend is for encryption to be used, which prevents reception of clear pictures by enthusiasts. This is especially the case with Reuters circuits, for both UK and Atlantic traffic. For example in early February the popular Atlantic Reuters circuits at 11.558 and 11.566GHz vertical via NSS K at 21.5°W were replaced by a single signal at 11.566GHz horizontal, apparently encrypted at all times. For complete security, Reuters may be making increased use of fibre-optic cable for transatlantic links.

I can confirm that UKI-149 ceased to provide analogue uplinks towards the end of January. It must have been one of the last of the UK analogue uplinkers, though BBC UKI-230 Belfast is still active in clear analogue form via Telcom 2B/D (5°W), seen recently at 11.574GHz V.

The Moscow feed via 36°E (11.6GHz H, 5,632, 3/4) provided several newsworthy items towards the end of February. This is normally the BBC Moscow Bureau but, at 0715 on February 25th, 'RTV Moscow 4' (Reuters) appeared with commentary and pictures relating to Russian war crimes in Chechnya.

The previous day there was an early evening report via SIS-33 (UKI-493) from the Britannic Stadium, Stoke-on-Trent on the life and times of Sir Stanley Matthews, who had just passed away and previously lived in the area. This was at 11.079GHz H, 5,632, 3/4. A check on an earlier sighting of UKI-493 showed that it had been using the same frequency and was being operated by SISLink-33. Although modern SNG trucks can doubtless change frequency, it's handy when a particular truck sticks to a specific channel.

BBC Scotland DSNG UKI-534 has now gone digital, via 36°E at 11.580GHz H, 5,632, 3/4. I saw it on the 28th during a GM food conference in Edinburgh.

It's still not all digital at 36°E however. The old Belgacom analogue 'booking-office' caption appeared on several days in late February, though there were no actual analogue feeds. You see more analogue signals just down the road at 28.5°E, via Kopernikus (DFS-2). On the 11th there was a live Shuttle launch from NASA at 11.597GHz V, time 1800 on. The 14th brought a fashion parade with all that cleavage etc. during an

early-evening NDR OB feed. This was at 11.590GHz V.

I've found a digital Arabic news broadcaster, Arabica News, at 16°E (Eutelsat W2). This signal appears at about 1730 GMT: tune to 11.131GHz H (5,632, 3/4). It seems to be a compilation of news in Arabic for other broadcasters. Horse racing and bookie clients should check the Snaits channel via the same satellite. It's part of an Italian digital multiplex at 12.609GHz H (27,500, 3/4) and covers events from around Europe. On the 23rd for example there were, amongst other things, racing highlights from the Lingfield, Surrey course. Unlike the rest of the channels in the multiplex, this one seems to stay in the clear.

Back in January Roy Carmen noticed Sky Sports using Intelsat 801 (31.5°W) for an uplink at 10.960GHz V from the Grosvenor House Hotel on the 17th prior to the Mike Tyson fight. Two days later from the same venue Sky was uplinking at 10.966GHz V (both with 5,632 and 3/4), suggesting either a frequency-agile uplinker or that another SNG truck had arrived.

Sports-spotter Dean Rogers comments on the mass of golf feeds from the USA during the past few weeks for the PGA tournaments. The Globecast digital multiplex via NSS K is a favourite to monitor.

I'm told that there is no longer any analogue activity via Telstar 12 at 15°W, which has a few regular digital customers and carries the occasional sporting event from the USA. While in the vicinity check for activity at the Eutelsat Atlantic Gate site (II F2 at 12.5°W). A Toronto City TV signal has been seen there at 11.185GHz V (SR 4,999, FEC 7/8) - this report was from the Stefan Hagedorn Internet Newsletter.

Can anyone comment on the following? Here at Romsey, Hants I get a good-quality analogue Iraqi Space Channel signal at 10.984GHz V from 36°E, using a 1.2m dish, but the digital equivalent at 11.013GHz H (SR 4,338, FEC 3/4) is much weaker, in fact below the digital threshold with my RSD ODM300 receiver.

Terrestrial News

RSL-TV Licences: The latest RSL-TV licence to be granted by the ITC is for Norwich-based Abacus Television, which intends to provide a seven-day, 24-hour service of local, bought-in and text programming. Abacus is now wait-



ing for a channel allocation. There may be a delay over this, as RSL allocations are on 'slow' while the needs of the expanding national digital networks are being assessed. This has produced complaints from the Local Independent Television Network, which is concerned about future prospects for RSL-TV stations. Channel M is now testing in the Manchester area however, on

Arabica News, an Arabic news service via Eutelsat W2 at 16°E. Tune to 11.131GHz H, SR 5,632, FEC 3/4. The service is available daily from approximately 1730 hours.

Aerial Techniques

UNIVERSAL DIGITAL VIDEO SYSTEMS CONVERTERS

"We specialise in multi-standard TVs & VCR's PAL-SECAM-NTSC"



BROADCAST QUALITY CDM-820

8M bit memory, two sets of S-VHS inputs & outputs, NTSC to PAL and PAL to NTSC, 500 lines dynamic & static resolution, full line & frame conversion, time base correction, AC operation.....**£599.00**



PROFESSIONAL QUALITY CDM-900

4M bit memory, two inputs & outputs, NTSC to PAL and PAL to NTSC also SECAM, 500 lines static resolution, dynamic 300 lines, full line & frame conversion, time base correction, AC operation ..**£449.00**



PALM SIZED CDM-630

4M bit memory, one input and output, NTSC to PAL and PAL to NTSC + PAL M, PAL N. Full line and frame conversion, time base correction, AC operation

£399.00



COMPACT MULTISYSTEM CDM-600

2M bit memory, single input & output, NTSC to PAL and PAL to NTSC also SECAM, 420 lines static resolution, dynamic 250 lines, full line & frame conversion, time base correction, AC operation ..**£299.00**



THOMSON 14" MULTI-SYSTEM TV + VCR COMBINATION WITH TELETEXT

Covers VHF/UHF PAL/SECAM L for use in UK France & Europe.

- Twin tuners
- 14" screen multi-standard
- PAL/SECAM (NTSC via scart)
- VHF-UHF hyperband tuner
- 59-channel memory
- Fasttext teletext
- S-VHS (via scart)
- 240V AC operation

£399.00

FULLY COMPREHENSIVE 35 PAGE CATALOGUE

Available by return of post for only £1.50 or ring with your credit card (fully refundable on first purchase over £20).

11 Kent Road, Parkstone, Poole, Dorset BH12 2EH
Tel: 01202-738232 Fax: 01202-716951 E-mail: atech@dircon.co.uk

(All prices are inclusive of VAT, delivery by courier £10.00)



PM5544 test pattern transmitted by the RTV Noord Holland station at Wormer, on ch. E55. Photo courtesy Ryn Muntjewerff, Holland.

ch. E39 from the Salford University campus. It's on air from 1000 to late evening. There's a phone number for enquiries: 0161 211 2916.

UK radio: The chief executive of Capital Radio has called on the government to set a date for the close-down of analogue radio broadcasting in the UK, suggesting the year 2015.

USA: The FCC has ruled out further debate on the system to use (ATSC) for digital terrestrial TV broadcasting despite further reservations being expressed. Tests conducted recently by national broadcaster NBC have confirmed the superiority of the European COFDM method of transmission.

New Zealand: The government has announced that it has no intention to go digital for the foreseeable future. TV New Zealand had intended to move to DVB-T in partnership with NTL.

The Netherlands: The new North Holland TV transmitter (RTV Noord Holland) at Wormer is in operation on ch. E55 with omnidirectional radiation (200kW ERP H) but reduced power to the west. The PM5544 test pattern had been in use but, now that programmes are being transmitted, only test pages are present during non-programme times. The new TV Oost transmitter at Zwolle is in operation on ch. E22, with the same power. Both are potential catches when there's a tropospheric opening.

Poland: Several FM stations continue to use the 68-73MHz band. The regulatory office is seeking suitable frequencies for them in the 88-108MHz band.

Satellite News

The FCC has issued uplink licences to Group W (CBS) and BT North America to use the Eutelsat Atlantic Gate slot (12.5°W) for their American clients. Atlantic Bird 1, to

be launched next summer (2001) with twenty Ku-band transponders, will expand capacity at 12.5°W. Meanwhile Eutelsat is leasing four transponders aboard the Loral Telstar 12 satellite at 15°W to supplement its II F2 capacity at 12.5°W. Eutelsat is also building up capacity for transatlantic services at the 8°W slot, using the Telecom 2A/D satellites initially then, in mid-2001, the recently-ordered Atlantic Bird 2.

Enthusiasts missed the Paris-Dakar rally this year. A press release from Intelsat explains why. This year the rally was held from Dakar to Cairo, and digital capacity via Intelsat 511 at 29.5°W was extensively used. This craft is rarely used as it's in an inclined orbit. You need a suitably equipped dish for reception.

A Scandinavian version of the US E!Entertainment pay-TV channel is to start on September 1st, based in Stockholm. It will form part of the Canal Digital service. The main programme language will be English, with subtitles to suit the various Nordic countries.

The first Europ*Star satellite is to be launched this summer. It will provide TV, internet and various multimedia services at powers suitable for use with 45-180cm domestic dishes. Coverage will include Europe, the Middle East, Africa, India and SE Asia. The Loral/Alcatel venture will provide one-hop Ku-band linking between SE Asia and Europe and be controlled from Toulouse, France. Europ*Star has filed for slots at 43, 45 and 47.5°E. Capacity aboard Europ*Star 1 is expected to be filled by the winter of 2002, when the plan is to launch Europ*Star 2.

The Egyptian government plans to establish a 'media village' near Cairo. Any satellite TV/radio company setting up a production operation there would have complete freedom and be exempt from local taxes.

Australian Quandary

An interesting, probably unique, situation has arisen in Australia over viewer access to channels that are transmitted both terrestrially and via satellite. Satellite transmission has made a number of terrestrial channels available to those in remote country areas and the outback. The Aurora digital package via the Optus B1 satellite (160°E) includes channels such as the Alice Springs-based Imparja service, Central 7, WIN-TV, GWN-TV and the Sky Australia coverage of horse racing.

Most of these channels were originally transmitted in MAC-B form, but are now transmitted digitally. Some regional terrestrial broadcasters have complained to the Australian Broadcasting Authority (ABA) about services being made available via satellite outside the original target area, for example Imparja in Tasmania and Victoria, far from Alice Springs.

Optus transmissions are not free-to-air: for reception an authorised card and a decoder are required. Authorisation depends on payment of a subscription and the area in which the subscriber lives. But because of increasing pressure from those in 'blackspot' areas, where a terrestrial service of acceptable quality cannot be received, requests can be made for clearance to receive satellite signals provided a technical assessment confirms lack of adequate terrestrial signals. If approved, an Aurora card is issued and authorised. This led to regional services starting sales campaigns elsewhere, further objections, and the ABA asking the government to sort out the confusion.

Amendments to the 1992 Broadcasting Services Act were introduced last December. They enable a viewer in a blackspot to gain access to local services via satellite, but the viewer must sign a 'Request for Reception of Broadcasting Services', which must be backed by a technical 'Assessment of Inadequate Reception of Broadcasting Services' form. The latter is usually completed by an aerial rigger/contractor, and includes details of the decoder, smart card, reception quality/problem and a signal-level measurement of the relevant channel using a test aerial 10m above ground level – a modest-gain wideband aerial to be used, with no preamplifier, a figure of less than 40dBµV vision carrier being considered as an unacceptable terrestrial signal level. The forms, signed – and witnessed by a JP! – have to be sent to the Director of Planning at the ABA. Once approved, the decoder can be switched on.

There's another subtlety. When satellite receiving equipment is bought for use in a blackspot in a rural area receiving the Homestead and Community Broadcasting Services, sales tax is exempt as a local terrestrial service is not available. But if the blackspot is within a terrestrial transmitter's service area the tax must be paid: all hardware and installation charges are subject to a 10 per cent surcharge.



Satellite PSU Repair Kits

MAKE & MODEL	CODE	MAKE & MODEL	CODE	MAKE & MODEL	CODE	MAKE & MODEL	CODE
ALBA SAT6600	SATPSU2	FINLUX SR5700 SR5100	SATPSU12 SATPSU23	MATSUI RD600	SATPSU20	PHILIPS STU802/05M, STU804, STU811, STU824	SATPSU1
AMSTARD SAT250, SR950, SRD2000, SRD700, SRD950, SRX1002, SRX2001, SRX301, SRX501, SRX502	SATPSU16	GOODMANS ST700	SATPSU1	MITSUBISHI ST-PB10	SATPSU1	STU801	SATPSU2
SRD510, SRD520, SRD540, SRD545, SRD550	SATPSU3	GRANADA KR1, LR1, LR2, M/N92MR1/A	SATPSU1	NOKIA SAT1500, SAT1600	SATPSU2	STU3301	SATPSU20
SRD500	SATPSU4	HR 1, JR1	SATPSU2	SAT1700, SAT2200, SAT2202	SATP-	STU909	SATPSU22
BRITISH TELECOM SVS300	SATPSU17	NR2, PR2	SATPSU8	SU23		STU350	SATPSU9
BUSH IRD150	SATPSU12	M92MR2	SATPSU9	PACE PRD700, PRD800, PRD900, PSR800, PSR900, MRD950, MRD960	SATPSU1	SONY SAT301	SATPSU10
ECHOSTAR SR5500 EARLY PSU WITH ADJ.	SATPSU12	GRUNDIG STR1	SATPSU1	MSS500, MSS1000 MRD920, SS9000, SS9010, SS9200, SS9210, SS9220	SATPSU10	THOMSON SRD11, SRD 14	SATPSU1
FERGUSON SRD 5, SRD16	SATPSU1	GIRD2000, GIRD3000	SATPSU2	SU2		SRD7/8, SRS3, SRS4	SATPSU2
SRD4	SATPSU11	GRD150, GRD250, GRD280, GRD300, STR200S	SATPSU20	MSS100, PRIMA	SATPSU8	THORN SAT99, SAT120	SATPSU1
SRV1	SATPSU2	HITACHI SR-1050D	SATPSU1	APOLLO, MSS200, MS290, MSS300	SATPSU9	TOSHIBA SAT99, TU-SD200	SATPSU1
		MASPRO SRE250S/1, SRE 350S/1	SATPSU1	TU-SD200	SATPSU1	TS540	SATPSU10
		SRE250S, SRE350S, SRE450S	SATPSU2	TU-SD250	SATPSU9		
		ST5, ST-12	SATPSU20				

CODE	PRICE	CODE	PRICE	CODE	PRICE	CODE	PRICE	CODE	PRICE
SATPSU1	600p	SATPSU4	600p	SATPSU10	1230p	SATPSU16	1250p	SATPSU22	1050p
SATPSU2	550p	SATPSU8	650p	SATPSU11	650p	SATPSU17	850p	SATPSU23	650p
SATPSU3	600p	SATPSU9	900p	SATPSU12	1600p	SATPSU20	600p		

Replacement Video Heads

AMSTRAD	NATIONAL PANASONIC	SHARP
VCR1000, VCR2000, VCR6000, VCR6100, VCR6200, VCR8600, VCR8602, VCR8700, VCR9005, DD8900, DD8904, TVR4 ORDER CODE : VH93 PRICE : £7.00 + VAT	NV300, NV322, NV332, NV333, NV340, NV390, NV2000, NV2010, NV3000, NV7000, NV7200, NV7500, NV7800, NV7850, NV8170, NV8200, NV8400, NV8600, NV8610, NV8620 ORDER CODE : VH10 PRICE : £6.25 + VAT	VC671, VC779 VC 787, VC790ET, VCA50, VCA501S, VCA505, VCA6 0, VCA602, VCA6C5, VCA615, VCD806, VCD810, VCD815, VCT610 ORDER CODE : VH240 PRICE : £14.00 + VAT
FISHER FVHP420, FVHP510, FVHP520, FVHP530, FVHP615, FVHP618, FVHP620, FVHP622, FVHP710, FVHP711, FVHP715,etc ORDER CODE : VH16 PRICE : £9.00 + VAT	NV100, NV200, NV370, NV380, NV630 ORDER CODE : VH35 PRICE : £6.00 + VAT	VC108, 208, 382, 402, 405, 408, 500, 550, 571, 573, 581, 582, 583, VC5W20E, VC603,etc, VCA10, VCA100, VCA102, VCA103, VCA1 031, VCA103, VCF104, VCA105, VCA106, VCA111, VCA113,etc ORDER CODE : VH56 PRICE : £8.50 + VAT
HINARI VXL8, 9, 10, VXL11, VXL19, VXL90, VCR34H, VTV100, VTV200, H13V ORDER CODE : VH94 PRICE : £11.00 + VAT	AG5150, AG5250, NVF65, NVH75, NVH77 ORDER CODE : VH405 PRICE : £18.00 + VAT	SONY SLV275, SLV373, SLV410, SLV412, SLV427, SLV474 ORDER CODE : VH42 PRICE : £9.25 + VAT
HITACHI VT522, VTM212, VTM620, 622, 720, 722, 822, 922, 925 ORDER CODE : VH400 PRICE : £11.00 + VAT	NVJ30, NVHJ33, NVL10, 20, NVL21, NVG30, NVG31, NVG40, NVG130, NVJ37, NVG40, NVG42, NVSD30, NVSD10EE, NVSD11, NVSD2, NVSD30, NVSD35 ORDER CODE : VH41 PRICE : £7.50 + VAT	SLVE7, SLVE8, SLVE9 ORDER CODE : VH588 PRICE : £36.00 + VAT
VT540, VT545, VT546, VT548, VT D660, VT D665, VTM598, VTM640, VTM645, VTM646, VTM730, VTM731, VTM735, VTM736,etc ORDER CODE : VH533 PRICE : £14.00 + VAT	AG6024, NVG33, NVG46, NVL23, NVL25, NVL28, NVJ47, NVJ49, NVJ700PX, NVSD20EE, NVSD400, NVSD44, NVSD45 ORDER CODE : VH42 PRICE : £9.25 + VAT	SLV615, SLV625, SLVE600, SLVE700, SLVE800 ORDER CODE : VH590 PRICE : £34.50 + VAT
JVC & FERGUSON BR1600, HRD140, HRD141, HRD142, HRD143, HRD150, HRD152, 8947, 8948, 3V42, 3V44, 3V45, 3V46, 3V47, 3V52, 3V54, 3V55, 3V56 ORDER CODE : JVC3HSSVA PRICE : £8.00 + VAT	NVG20, NVG21, NVG22, NVG25, NVG28, NVG29, NVG48 ORDER CODE : VH82 PRICE : £10.00 + VAT	TOSHIBA V71, V73, V74, V7E, V77, V80, V81, V82, V83, V84, V85, V86, V87, V88 ORDER CODE : VH126 PRICE : £8.00 + VAT
HRD154, HRD160, HRD170, HRD171, HRD210, HRD211, HRD217, HRD310, HRD320, HRD321, HRD350, HRD521, HRD522,etc 8950, 8951, 3V64, 3V65, FV10, FV11, FV20, FV21, FV26 ORDER CODE : VH04 PRICE : £7.50 + VAT	NVG7, NVG9, NV230 ORDER CODE : VH111 PRICE : £7.00 + VAT	DV90, DV96, DV97, NM3, V108, V109, V199, V200, V202, V205, V207, V209, V80, V93 V54 ORDER CODE : VH127 PRICE : £9.00 + VAT
HRD725, HRD755, 3V43, 3V53 ORDER CODE : VH08 PRICE : £18.00 + VAT	NVSD40 ORDER CODE : VH505 PRICE : £10.50 + VAT	
8930, 8931, 8933, 8940, 3V29, 3V30 ORDER CODE : VH200 PRICE : £5.50 + VAT	NVJ45, NVJ47 ORDER CODE : VH498 PRICE : £10.00 + VAT	
BR9060, HRD330, 337, 440, 441, 637, 641, 660, 670, 723, 730, 740, 820 HRFC100, SR3300MS, FV44L ORDER CODE : VH379 PRICE : £11.50 + VAT	PHILIPS VR6460, VR6520, 64VR60, VR6420 ORDER CODE : VH77 PRICE : £7.25 + VAT	
MITSUBISHI HS349, HSE27, HSE31, HSE32, HSB27, HSB31, HSB32, HSM33, HSM34, 35, 37G ORDER CODE : VH324 PRICE : £14.50 + VAT	20DV1, 20DV2, 20RW7, 21DV1, 21DV2, 21DV3, 2SB01, 2SB02, 2SB 11, 2SB12, 30DV2, VR201, VR202, VR203, VR2115, VR212,etc ORDER CODE : VH555 PRICE : £46 + VAT	
HSE30, HSB30 ORDER CODE : VH326 PRICE : £14.50 + VAT	SANYO VTC5000, VTC5400, VTC600, VTC6000, VTC6010, VTC6500, VTCM10, VTCM11, VTCM20, VTCM21, VTCM25,etc ORDER CODE : VH45 PRICE : £18 + VAT	
HSB12, HSE12, HSE22, HSM18G, HSM18, HSM23, HSM25, HSM30 ORDER CODE : VH380 PRICE : £14.00 + VAT	VHR1110, VHR1150, VHR1300, VHR1700, VHR2300, VHR2370 ORDER CODE : VH121 PRICE : £8.00 + VAT	
HSM20, HSM55 ORDER CODE : VH548 PRICE : £15.00 + VAT	VHR3200, 3270, 3100, 3110, 3150, 3300, 3400, 3310, VHRD500 ORDER CODE : VH122 PRICE : £11.00 + VAT	
HSB52, HSE50, 52G, HSM36, 50, 54, 55, 57, 58, 60 ORDER CODE : VH450 PRICE : £27.00 + VAT	VHR120, VHR130, VHR14, VHR141, VHR143G, VHR145P, VHR151 VHR15, VHR16, VHR171, VHR220, VHR23,etc, VHRD4400, VHRD4410, VHRD4500, VHRD4600, VHRD4610, VHRD6700,etc ORDER CODE : VH469 PRICE : £31 + VAT	

Many of our video head prices have been reduced.... Please call us for our latest prices !!!

We stock over 650 different video heads covering over 2500 different models for the following makes :

AIWA, AKAI, FLBA, AMSTRAD, BAIRD, BLAUPUNKT, DAEWOO, CECCA, FERGUSON, FISHER, FUNAI, GEC, GOLDSTAR, GRANADA, GRUNDIG, HINARI, HITACHI, JVC, LUXOR, MATSUI, MITSUBISHI, ORION, PANASONIC, PHILIPS, SAISHO, SAMSUNG, SANYO, SHARP, SONY, TOSHIBA...AND MANY MANY MORE

K.P. House, Unit 15, Pop In Commercial Centre, Southway, Wembley, Middlesex. HA9 0HB England

Tel : (020) 8900 2329 Email : grandata.ltd@btinternet.com
Fax : (020) 8903 6126 Website : http://www.grandata.co.uk



Remote Controls

Universal Preprogrammed Remote Control

Preprogrammed to cover all major Brands of TV, Video, Satellites and CD Players.

Replaces upto 8 different remote controls

With teletext & fasttext functions

Order Code : RC9
Price : £10 + vat



Genie Universal Remote Control

Replaces 3 infrared remotes

Covers 1000's of models

Controls TV, VCR and Satellite

Auto Code Search

Simple to use

Order Code : GENIE
Price : £9 + vat



Wizard Universal Remote Control

Easy to use

Fully illuminated keypad

Full learning facility

Modern ergonomic design

Replaces upto 8 different infrared remote controls

Pre-programmed for convenient setup

Order Code : Wizard
Price : £16.50 + vat



Universal Brand Replacement Remote Controls

Brand for Brand Replacement
Codeless set-up

Teletext and Fasttext

Pre-Programmed for the latest models

Replaces broken and lost remotes

Brand	Order Code
Panasonic TV	RCUNI01M
Scny TV	RCUNI02M
Philips TV	RCUNI03M
Hirachi TV	RCUNI04
Mitsubishi TV	RCUNI05
Nokia TV	RCUNI06
Samsung TV	RCUNI07
Toshiba TV	RCUNI08
Ferguson TV	RCUNI09
Grundig TV	RCUNI10
Goodmans/Alba/Bush TV	RCUNI13M
Matsui/Inarui/Orion TV	RCUNI14M
Satellite	RCUNI17

Price : £7.50 + vat



Bulk Prices

5 pieces £45 + vat
12 pieces £96 + vat
24 pieces £168 + vat

We also stock replacement remote controls for 5,000 different models at very competitive prices, contact us for all our remote control requirements. Many of our remote control prices have been reduced.....Please call us for our latest prices

SLx4.....4 Way Aerial Amplifier

.....the first choice for the professional aerial installer

Now Available !!

SLX2 (2 way)
£8.00 + vat

SLX6 (6 way)
£18.50 + vat

SLX8 (8 way)
£20.00 + vat

- * Designed for TV, Satellite and FM Receivers
- * 10.5db Gain on all ports
- * Isolation between outputs > 22db
- * Separate UHF/VHF inputs
- * Noise figure < 4db
- * Digital Compatible
- * Frequency Range : UHF 470-863 Mhz
VHF 47-230 Mhz
- * CE and EMC Test Certified

Order Code : SLX4 Price : £13 + vat

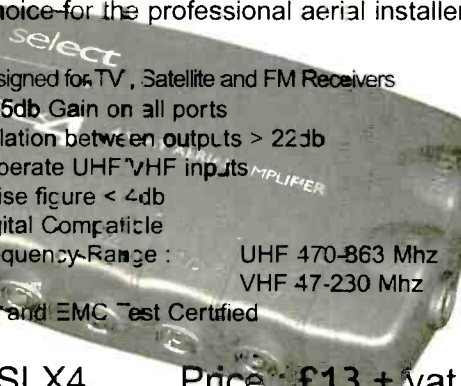

Magician Sky Digital Remote Control

Operates all SKY digital TV box functions

Operates combinations of TV, VCR & Cable/Satellite systems

Covers 1000's of popular brands

Full teletext and fasttext functions

Backlit device indicator keys

Order Code : MAGICIAN4

Price : £10 + vat



Solder Seal Kits / Hot Air Guns

SOLDER SEAL KIT

DON'T CRIMP IT ...SOLDER IT !!!

FOR QUICK AND SAFE CABLE CONNECTION SOLDERING, GLUEING AND SHRINKING WITH A HOT AIR GUN ALL IN ONE ACTION

HOT AIR GUN WITH PIEZO ELECTRONIC IGNITION

REFILLABLE WITH COMMON LIGHTER GAS

BLOWS HOT AIR UPTO 650C

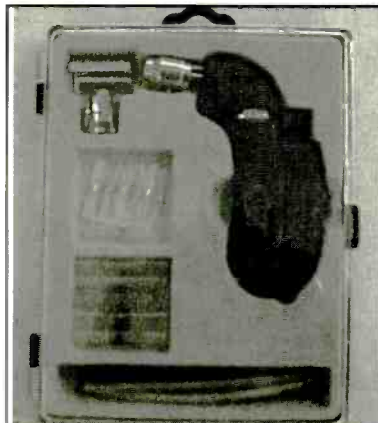

ORDER CODE: TOOL53 PRICE : £13.00 + VAT

HOT AIR GUN

FLAMELESS...ONLY HOT AIR

IDEAL FOR THE FOLLOWING :

SHRINKING TUBES

SOLDER SEALS

HEATING AND DRYING

HOBBY & MODELLING

BENDING PLASTICS

SMD SOLDERING

BLOWS HOT AIR UPTO 650C



ORDER CODE : TOOL54 PRICE : £7.50 + VAT



Scart Kits / Scart Cables / Phono Leads



Scart Adaptor Kit
(Economy 5 piece kit)
An inexpensive but versatile connector kit for TV, Video, Satellite, Hi Fi & some Camcorder connections.

ORDER CODE : PLG1
PRICE : £4.50 + vat

Ultimate Scart Kit
(Standard 11 piece kit)
A comprehensive & practical connector kit for TV, Video, Camcorder & Hi Fi (including NICAM Stereo) connections.

ORDER CODE : PLG3
PRICE : £10.00 + vat

Scart to Phono Adaptors

Output
Code : PLG17
Price : £1.00 + vat

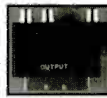

Input
Code : PLG18
Price : £1.00 + vat

Scart Cables

Description	Code	Price
Standard 9 Pin Connected (1.5 m)	PLG20	90p
Fully Shielded 9 Pin Connected (1.5m)	PLG21	£2.20
Flat Cable 9 Pin Connected (1.5m)	PLG22	£1.80
Standard 21 Pin Connected (1.5m)	PLG23	70p
Standard 21 Pin Connected (0.5m)	PLG24	85p
Standard 21 Pin Connected (5m)	PLG25	£3.00
Fully Shielded 21 Pin Connected (1.5m)	PLG26	£3.70
Gold 21 Pin Connected (1.5m)	PLG27	£4.20
Flat 21 Pin Connected (1.5m)	PLG28	£3.50

Scart to Phono Cables

Description	Order Code	Price
Scart to scart & 4 phono plugs 1.5m (Stereo 2 way)	PLG37	300p
Scart to 2 phono plugs 1m (Stereo Audio Only)	PLG38	120p
Scart to 2 phono plugs 5m (Stereo Audio Only)	PLG39	200p
Scart to 3 phono plugs Gold 1.5m (Stereo /Video 1 way)	PLG40	250p
Scart to 3 phono plugs 1.2m (Stereo /Video 1 way)	PLG41	175p
Switched scart to 3 phono plugs Gold 1.5m	PLG42	300p
Switched scart to 3 phono plugs 1.5m	PLG43	200p

Phono to Phono Leads

Description	Order Code	Price
2 phono plugs to 2 phono plugs heavy duty cable 10m	PLG29	300p
Standard Leads and Moulded Connectors		
Phono plug to phono plug 1.2m	PLG30	40p
Phono plug to phono plug 5m	PLG31	90p
Phono plug to phono socket 5m	PLG32	90p
2 phono plugs to 2 phono plugs 1.2m	PLG33	75p
2 phono plugs to 2 phono plugs 5m	PLG34	100p
2 phono plugs to 2 phono sockets 1.5m	PLG35	75p
3 phono plugs to 3 phono plugs 1.2m	PLG36	90p



Transistors / Linear IC's



BU208A 75p	BUT18AF 65p	MJ15003 250p	TIP31A 22p	LM2406T 400p	STR10006 450p	TA8427K 200p	TEA2164 160p	UC3843AN 80p
BU2508A 100p	BUT56A 65p	MJ15004 300p	TIP32A 21p	LM2416T 650p	STR20005 450p	TA8718N 550p	TEA2260 225p	UC3844 70p
BU2508AF 110p	BUW13A 200p	MJ15015 250p	TIP33 50p	LM324 30p	STR40090 350p	TDA1170N 85p	TEA2261 185p	UC3844AN 80p
BU2508D 130p	BUZ80 135p	MJ15016 350p	TIP33C 60p	LM339 35p	STR4211 315p	TDA1175 175p	TEA2262 275p	UC3845AN 80p
BU2508DF 120p	BUZ80AF 200p	MJ15022 400p	TIP34C 60p	LM393 45p	STR440 800p	TDA1180 120p	TEA5101A 300p	UPC1188H 350p
BU2520AF 170p	BUZ90A 180p	MJ15023 400p	TIP35C 65p	LM723 40p	STR441 950p	TDA1518BQ 240p	TEA5101B 175p	UPC1488H 115p
BU2520DF 225p	BUZ90AF 280p	MJ15024 400p	TIP36C 65p	SAA1293 550p	STR44115 475p	TDA1557Q 300p	TEA5170 200p	
BU2525A 325p	BUZ91A 260p	MJ2501 100p	TIP41A 20p	SAB3035 275p	STR451 800p	TDA1558Q 300p	UC3842N 60p	
BU2525AF 220p	IRF510 70p	MJ2955 55p	TIP41C 22p	STK4131 480p	STR4512 400p	TDA2004 150p	UC3842AN 80p	
BU2525D 240p	IRF520 75p	MJE13007 100p	TIP42C 22p	STK4141 II 420p	STR50103A 260p	TDA2005 150p	UC3843 80p	
BU2527AF 400p	IRF530 75p	MJE13009 100p	TIPL791A 80p	STK4142 530p	STR54041 320p	TDA2030 80p		
BU426A 70p	IRF540 100p	MJE18004 125p	AN5151 200p	STK4151 680p	STR58041 250p	TDA2030H 100p		
BU508APH 60p	IRF610 80p	MJF18004 175p	AN5601K 750p	STK4152 650p	STR59041 300p	TDA3562A 260p		
BU508D 75p	IRF620 100p	MJF18006 200p	BA5406 180p	STK4171 900p	STR6020 270p	TDA3653B 80p		
BU508DF 85p	IRF630 75p	MJF18204 350p	BA6209 85p	STK4172 II 680p	STR61001 475p	TDA3653C 85p		
BU508V 110p	IRF640 150p	MJW16206 600p	HA13150A 1150p	STK4191 700p	STR81145 375p	TDA3654 80p		
BUF405A 200p	IRF710 150p	MJW16212 350p	HA13151 875p	STK4332 365p	STRD1706 360p	TDA4565 150p		
BUH1215 450p	IRF720 85p	S2000A3 175p	HA13152 800p	STK5331 300p	STRD1806 360p	TDA4600 200p		
BUH315 200p	IRF730 125p	S2000AF 90p	HA13153A 900p	STK5332 180p	STRD1816 350p	TDA4600 II 160p		
BUH315D 175p	IRF740 90p	S2000N 150p	HA13155 920p	STK5333 650p	STRD4420 550p	TDA4601 120p		
BUH515 200p	IRF820 90p	S2055A 175p	HA13157 950p	STK5337 500p	STRD6108 450p	TDA4605 190p		
BUH515D 250p	IRF830 85p	S2055AF 175p	LA4440 200p	STK5481 470p	STRS6707 1000p	TDA4950 100p		
BUH517 275p	IRF840 85p	S2055N 150p	LA4445 200p	STK5482 285p	STRS6708 575p	TDA8170 170p		
BUH517D 175p	IRF9610 95p	TIP121 35p	LA4460 120p	STK73410 350p	STRS6709 600p	TDA8171 230p		
BUH715 425p	IRF9620 85p	TIP122 30p	LA4461 120p	STK73410 II 500p	STV9379 400p	TDA8172 200p		
BUT11A 35p	IRFBC30 120p	TIP125 30p	LA4705 400p	STK7348 400p	TA8207K 175p	TDA8350Q 275p		
BUT1AF 35p	IRFBC40 210p	TIP127 35p	LA7830 90p	STK73605 375p	TA8215 300p	TDA8362N3 1200p		
BUT12A 80p	IRFZ44 160p	TIP2955 50p	LA7851 200p	STK73907 700p	TA8221AH 600p	TEA1039 150p		
BUT12AF 90p	MJ11015 250p	TIP29A 22p	LM1207N 450p	STK7406 650p	TA8227 250p	TEA2018A 80p		
BUT18A 80p	MJ11016 300p	TIP3055 50p	LM2405T 625p	STK7563F 650p	TA8251AH 700p	TEA2037 200p		

CAN'T FIND WHAT YOU'RE LOOKING FOR ?

Japanese Transistors, Diodes, Voltage regulators, LEDs, Triacs, Thyristors..etc

RING US AS THIS IS JUST A SELECTION OF THE 50,000 ITEMS THAT WE STOCK

This advertisement is just a selection of our stock.

We also stock the following :

Video Heads, Pinch Rollers, Belt Kits, Idlers, Service Kits, Video Motors, Cassette Housings, Audio Control Heads, Mode Switches, Video Lamps, Satellite Spares, LNB's, Back Up Batteries, Servicing Tools and Aids, Digital Multimeters, TV Switches, Line Output Transformers, Japanese Transistors, Linear IC's, Computer IC's, CMOS and 74 Series and much much more !!!.....All at competitive prices

Please contact us if you cannot find the part you are looking for.

* Please add £1 p+p and VAT to all orders

* All components are brand new

* We accept payment by Access, Switch, Visa, Cheque and Postal Order

* All prices quoted are subject to availability and may be changed without prior notice

K.P. House, Unit 15, Pop In Commercial Centre, Southway, Wembley, Middlesex. HA9 0HB England

Tel : (020) 8900 2329 Email : grandata.ltd@btinternet.com
Fax : (020) 8903 6126 Website : http://www.grandata.co.uk

Continued from page 398

insulation degraded to this extent. H.C.

Simple UHF Modulator Solution

We were recently asked to provide signal distribution around the house from a French satellite receiver. In common with most French video and satellite equipment however there is no provision for an RF output. Here's a simple solution to the problem. If you have a scrap Pace SS9200 satellite receiver panel you can use the UHF modulator (the same modulator was used in the D100/D150 series of Pace MAC decoders). It's of Far Eastern origin, with a somewhat old-fashioned trimmer that enables the output to be tuned from approximately ch. 30 to above ch. 40. Power requirements are not critical: anything from 9-12V will do. The modulator can be fitted in a small plastic box with holes drilled for the input and RF output sockets and access to the output tuning trimmer. Note that pins 2 and 4 both need to be connected to the positive supply.

As the modulator's video input impedance is rather high, I used a 75Ω terminating resistor soldered between the video input pin and the can. Two small 1μF, 50V capacitors on the PCB are best replaced as they will have been subjected to heat from inside the receiver for some years.

The video bias preset should already be in its optimum position. If it is advanced too far the picture

PACE SS 9200/D100 RF MODULATOR PIN DATA

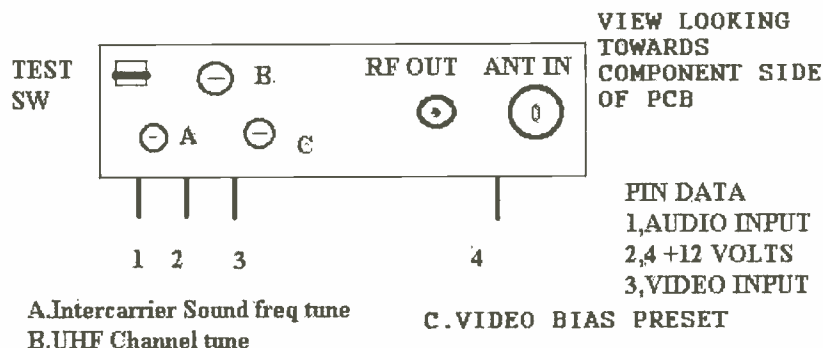

Fig. 1: The UHF modulator used in the Pace SS9200 satellite receiver.

becomes excessively contrasty and there's buzz on sound. If the preset is not advanced far enough the picture can look a bit dim. The intercarrier sound coil can be adjusted for either 6MHz (UK) or 5.5MHz (Continental) operation. See Fig. 1. The core is fairly fragile, so take care with any adjustment required.

The modulator used in the earlier Pace SS9000 receivers was similar but had two intercarrier sound coils, one for 5.5MHz and the other for 6MHz, so the layout is not the same as in the later type. H.C.

Finlandia MN92LR1/A (Pace PRD800)

This receiver was dead. A Pace power supply kit restored power but the receiver couldn't be set up. First the background colour was pink, though there is no way of setting the background in the menu. Secondly going into LNB set up to adjust the frequencies made no difference. Thirdly you couldn't change from

horizontal to vertical polarisation. If you were in say horizontal and tried to switch to vertical all you got was H (or V) preceded by a positive (or negative) number.

As I couldn't work out what was going on I decided to download from a known good PRD800 receiver. Then, when I switched on again, the background was blue, you could adjust the LNB frequencies, and could switch between horizontal and vertical polarisation.

What had happened originally I don't know. When I returned the receiver I found that the LNB was faulty, so maybe there had been a lightning strike. M.M.

Pace MSS1001

This receiver had died because of some power surges. Its power supply came back to life when C5 and C6 had been replaced. New capacitors in positions C10, C11 and C12 on the secondary side of the power supply restored good, clear pictures. M.M.

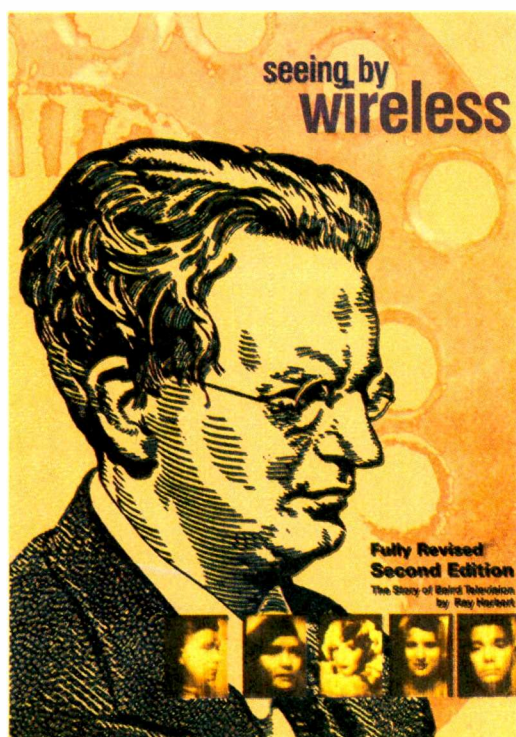

BOOK REVIEW

Seeing by Wireless, The Story of Baird Television, by Ray Herbert. Second edition fully revised. Published by PW Publishing Ltd., Arrowsmith Court, Station Approach, Broadstone, Dorset BH18 8PW (01202 659 930). £3.50 including post and packing. 28 A4 pages.

Anyone interested in Baird's contributions to TV will find this a fascinating publication. It can best be described as a record of what Baird and his companies achieved between his initial experiments in 1923, just one year after the start of regular radio broadcasting in the UK, and his death in 1946. The lengths to which he went in adapting mechanical TV to provide every possibility are extraordinary. There were phonovision recording, colour TV with three primary-colour scanning-hole spirals in the Nipkow disc, and a stereo version with two sets of holes and viewing via a stereoscopic colour filter. All were blind alleys.

In 1933 the Baird Company moved to new premises at Crystal Palace to develop higher-definition TV, starting with 180 lines. It produced telecine equipment, CRTs for display and transmitters. But one vital item was missing: an electronic camera. Work with flying-spot cameras and the intermediate-film technique could not make up for this.

Despite the disappointment of the Baird Company's brief foray into TV broadcasting in 1936-7, Baird continued to experiment, often reworking earlier ideas with newer and more advanced technology. The Telechrome tube developed during the war years was something quite new and different. It was unwieldy however, and would never have competed with tubes that use the shadowmask principle.

This well-illustrated book tells us much about Baird's work. Essential reading for those interested in the history of TV. J.A.R.

Satellite WORKSHOP

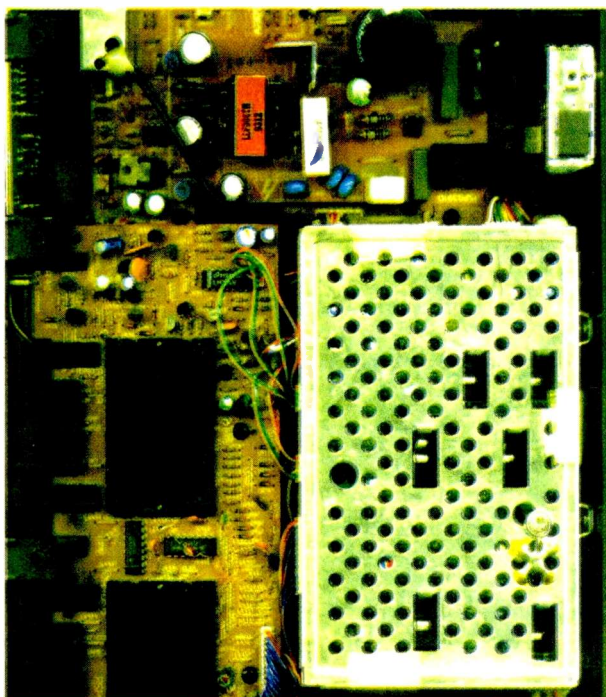

Jack Armstrong

More on Digiboxes

Last month I provided a survey of the current digibox repair scene. I thought it would be an idea to follow up with some notes on digiboxes and their use. Some significant changes have occurred since the units were first sold but, equally, some very desirable ones have not. The most notable change came with the introduction of Open, which gives users access to a kind of 'mini internet' where companies such as Ford advertise their products. The telephone connection sends the user's requirements to the main computer, pictures and text then being transmitted back to the digibox. I suspect that this involves a combination of satellite transmission and use of the telephone line, but don't have details of the exact technical arrangements.

An e-mail address can also be obtained. This enables you to type, send and receive messages via the internet. A separate infrared remote-operation keyboard can be bought, making the task much easier to carry out from the comfort of

your armchair. The cost of using the Open service is "normal BT rates plus 1p per minute" while your telephone line is in use. You can tell when it's in use by looking at the tell-tale LED on the digibox's front panel.

Unfortunately the digibox does not provide true internet access, apart from e-mail. You can't visit web sites and you can't access Usenet News Groups. Both of these provide a valuable source of information for children and adults: children need to be monitored however as they can soon find questionable material as well as useful information. In this respect, parents might be thankful that internet access is not currently provided.

The digibox also provides a very useful EPG (Electronic Programme Guide). It's a sort of enhanced Teletext service that lists current and future programmes: you can select the one you want without having to push numbered buttons. In addition a few programmes carry subtitles. This feature has not yet been fully implemented, and with some manufacturers' software it doesn't work properly. Such problems will, hopefully, have been resolved by the time that this is read.

Software Updates

The reason for such problems is that each of the four digibox manufacturers provides similar but not identical hardware. The BSkyB software that deals with encryption and access has to be matched to the manufacturers' software, which interfaces directly with the hardware. As BSkyB continually downloads software updates via satellite transmission, each manufacturer has to provide BSkyB with its own modified software for downloading in order to maintain compatibility. It seems that BSkyB and the manufacturers can get 'out of step'. In fact a digibox that's installed after sitting in a warehouse for a month might not work at all until the latest software has been downloaded.

While everyone involved has worked hard to get the Open service running for British Interactive

Broadcasting (did you accept discount in the form of a "BIB subsidy"?), work on other features seems to have taken a back seat.

Timer Problem

There is, for example, no timer facility to enable you to set the digibox to select a particular programme at a specific time, so recording is a headache. In addition some Pay Per View (PPV) movies have a special pulse added to prevent a modern VCR recording them. This can be overcome by buying a special 'picture enhancing' box or by using an extremely old VCR to record the pictures (a good reason to get your old VCR repaired?).

I suspect that a timer facility might never be added to the software with current digiboxes, but that instead it will be introduced with a new generation of digiboxes that have a built-in hard-disk drive which can save several hours of programmes in compressed form. The advantage of this technology to the programme provider is that subsequent recordings will erase current ones, so you won't be able to build up your own video library. The advantage to the user is that the current 'spaghetti junction' of wires behind the TV set will be reduced.

Scart Switching

Incidentally you can get a scart switching box that enables you to select any one of up to four devices. So pictures and sound from a DVD player, digibox, VCR or ONdigital box can be fed to your TV set. You can find a switching box that's semi-automatic and has a remote-control handset at the TopSat web site (<http://www.topsat.co.uk>). For a low-cost, manually-operated scart switching box contact SatCure (<http://www.satcure.co.uk>).

Panasonic has come up with an answer to the lack of a timer facility by building into its latest VCRs, Models NVHD675 and NVHD685, the ability to control a digibox via infrared signals. No doubt other manufacturers will follow suit. It is also possible to use a slightly older VCR with the infrared control fea-

ture to control a digibox even when the digibox control codes are not included. A special interface has to be built to do this however, a chore that might be beyond the capability of most users. Information on the codes and how to build the interface can be found at web site <http://website.lineone.net/~dezellis>

Stereo Sound

Digiboxes will provide stereo sound, but there's no provision for Dolby Digital surround sound – though Sky News reported in mid-February that BSkyB is investigating the possibility of an upgrade in the future.

Use Overseas

I am often asked whether a digibox can be used outside the UK. The answer is a qualified yes. Bear in mind that BSkyB is obliged to try to prevent this. The company pays fees to broadcast programmes to a specific region. If the reception area is increased, a much larger fee has to be paid to film suppliers. The result could be UK subscribers effectively subsidising the viewing of a relatively small number of expatriates. As always, it comes down to a question of money.

You can of course buy a digibox, install it in the UK, get a smart

card by subscription and have it authorised then move elsewhere and take it with you. BSkyB will find out only if someone passes on the information or you connect the digibox to a telephone line, in which case BSkyB will be obliged to take steps to prevent you viewing its programmes. If this is done, don't expect a refund as you will have been in breach of contract! And don't sign the BIB subsidy agreement as you won't have a telephone connection. This means that PPV programmes will not be readily available to you and you won't have access to Open.

Use with other Satellites

Another common question is whether a digibox can be used to view programmes from other satellites? The SkyDigital broadcasts come from the Astra satellite cluster at orbital position 28.2°E. It is possible to watch some unencrypted programmes that are not part of the SkyDigital package. But the ability of the digibox to cater for different symbol rates is very limited, and the software tends to be somewhat unreliable when the dish is not pointing at 28.2°E.

Genie ESR Meter

The Genie ESR meter, which was

Jack Armstrong is willing to try to sort out readers' satellite TV receiver problems by e-mail. You can reach him via the Internet web site at:

<http://www.ukstay.com/jack>

If you have no Internet access you can write to him c/o Television, Room L302, Quadrant House, The Quadrant, Sutton, Surrey SM2 5AS. Please enclose two first-class stamps. envelopes.

reviewed in the January 1999 issue of *Television*, is still available from SatCure, PO Box 12, Sandbach CW11 1XA (01270 753 311). The kit price is £61.63, the fully-built and tested price being £73.38. The Genie Plus version, with audible tone, is available built and tested at £82.19. These prices are fully inclusive of postage and VAT.

A Correction

There was an editorial error in last month's column. BSkyB has been offering to replace out-of-warranty Amstrad DRX100 digiboxes for £300 when they fail, as there are no spares or service information. The editor misconstrued this as "300 customers" etc. The problem is that the £ sign doesn't come through with copy e-mailed to the editorial computers.

Test Case 449

The changeover from Sky analogue to digital is gathering pace as the closedown date for the analogue transmissions – about two years away now it seems – draws closer. The rewards for dealers who get involved with the Sky organisation are precious little. Nevertheless the Test Case workshop has been reluctantly drawn in, if only because of the spin-off sales of widescreen TV sets, accessories and so on.

So it was that we were called to check an installation previously, and hastily, carried out by Sky In-home Service. Two problems had been reported. One was about direct reception of programmes, the other with recording them on VHS tape. Colin the Doc was otherwise engaged that day, so the job was given to Cathode Ray. He roared off in a big white van, complete with ladders, heading for Ikledown. This is where Mr Sands, an Amstrad digibox and a shiny new elliptical dish lived.

When he arrived he was soon made aware that he was being held responsible for all the problems, even though it was the first time he'd seen or touched the equipment! He was told that the first, and most serious, trouble was intermittent picture freezing with some channels. This condition might last for a fraction of a second or several seconds, but on some occasions the picture would remain frozen until the set-top box was turned off then on again. Sometimes the fault symptom took the form of one or more streaks of unrelated picture that cut up the main one. A nasty fault, especially as Cathode Ray had no means of carrying out any tests on the box itself. His spirits sunk further when he was told that Sky Services had already replaced the receiver

without any beneficial effect. A solution to this one was found, but not on that day – and not without considerable trouble. The dish had a clear line-of-sight into the sky at 28.2°E. What's your guess as to the culprit?

When Ray had failed to sort that one out he was next invited to watch a tape playback on Mr Sands' VCR. It was a recording that had been made the previous evening, from Sky Premier, MovieMax or something like that. The picture was unwatchable. It fluttered and fluctuated in brightness, had virtually no colour and frequently lost line sync. Ray made a recording from a satellite channel and played it back: the picture was fine. He was told that the trouble occurred only sometimes, and only on some channels. There was never a problem with playing back prerecorded tapes or recordings made of analogue terrestrial TV programmes. The Sands household did not have ONdigital reception gear. Thank goodness for that!

Cathode Ray promised to go back and consult. He didn't know the answers, but knew a man who, hopefully, did.

Before he went, could he answer another question? Since the changeover to SkyDigital, Mr Sands had sorely missed some of the programmes exclusive to 19.2°E, primarily the German ones. Since the analogue box was still available and worked (the Sky people had used the original download) was there a way of using them both? The Sky installer had said definitely not from their dish, and the town planning office had added that only one dish per dwelling is permissible. Could it be done? How about the other problems? For the solutions, turn to page 427.

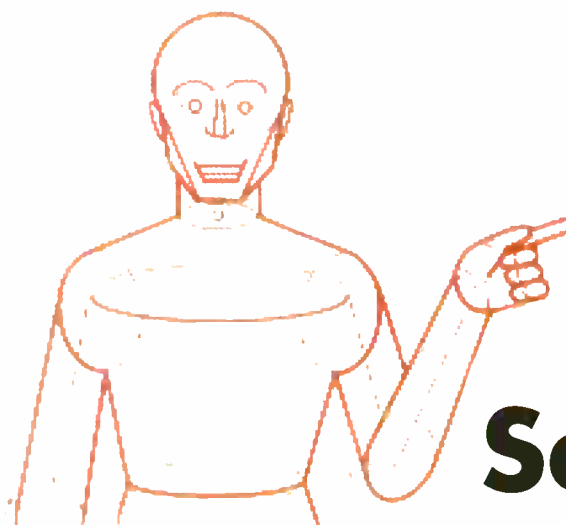

Toshiba

Service Briefs

More know-how from Toshiba, based on Technical Bulletins AH78 and AH79

TV Sets

Models 1400TBT, 2100TB and 2500TB

Picture stretched at top of screen and cramped at the bottom: This occurs when the 2.2 μ F field ramp charging capacitor C303 is defective. Replace C303, part no. 24617912.

Note that any model of this vintage, using a similar chassis, could suffer from the problem.

Models 2557DB, 2857DB and 3357DB

No surround or centre sound: This can occur when the 2SA1015 headphone mute transistor Q611 is leaky or short-circuit. The part no. is 23314791N.

Models 28MW7DB and 32MW7DB

Picture is shifted to the right-hand side by approximately three-four inches. The effect seems to be correctable with HPOS in the service mode but the OSD remains shifted: Capacitor C4403 which is connected

to pin 4 of the deflection chip Q420 is dry-jointed. Resoldering C4403 will clear the fault.

Model 28W8DB (C7SS chassis)

A thin horizontal white line is present across the centre of the picture: The cure for this fault is to move capacitor C314 from the component side of the PCB to a new position on the print side as shown in Fig. 1.

Models 28W8DB, 32W8DB and 28W93B

Sound mutes when the picture has highly-saturated colour: This fault can be extremely intermittent, and may occur only with very highly-saturated single colours such as red. As a result the symptom may be reported as appearing only on certain programmes or possibly advertisements. The solution is to add a 120pF capacitor in the vacant position originally occupied by resistor RV49 on the rear terminal PCB. RV49 is not fitted in these models.

Models 40PW8DB, 40PW8DG, 56PW8DB and 56PW8DG (C8SS chassis)

Hum and buzz from the rear speakers: A production change was made on signals PCB type no. 23536538A – a jumper wire was added on the component side as shown by the broken line in Fig. 2. Because of this, a low-level hum may be noticeable in the surround sound speakers. The following measures will reduce the level of this hum:

(1) Replace the added jumper wire with a new one of 480mm length routed as shown by the solid line in Fig. 2. Secure with hot-melt glue as shown.

(2) Add a jumper lead of 140mm length between pin 3 of PD30A on the Dolby Digital module and BB21 GND as shown in Fig. 3.

VCRs

Models V228B and V428B

Dim front display, no picture and no mechanical operation: If a quick check on the outputs from the

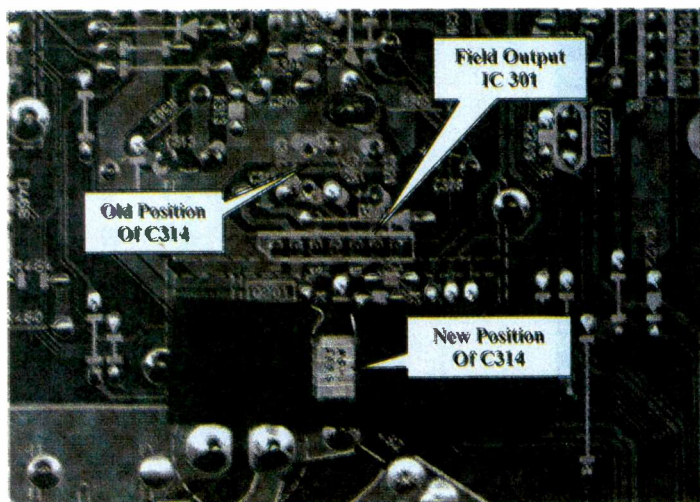

Fig. 1: New position for C314 on the print side of the PCB, Model 28W8DB.

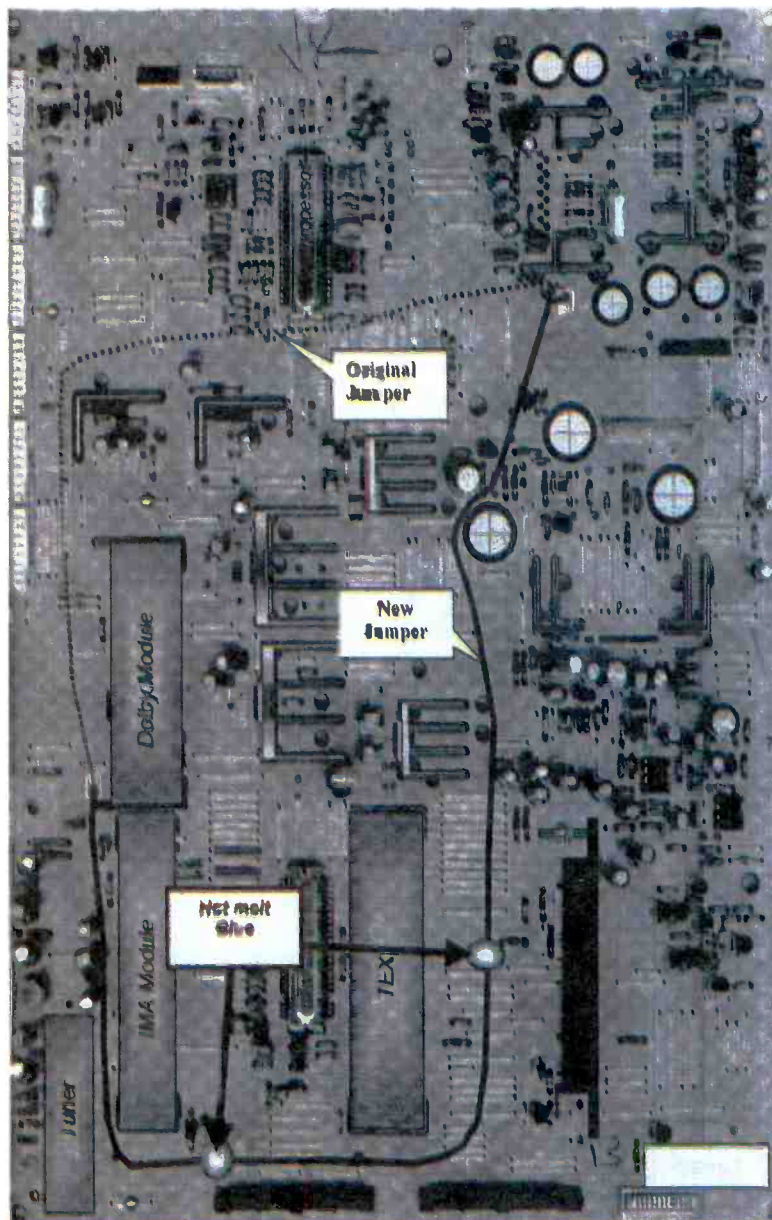

Fig. 2: Position of the jumper wire, shown with broken line, added as a production modification with signals panel 23536538A in the C8SS chassis. Remove this jumper wire and instead fit a 480mm jumper wire as shown (solid line).

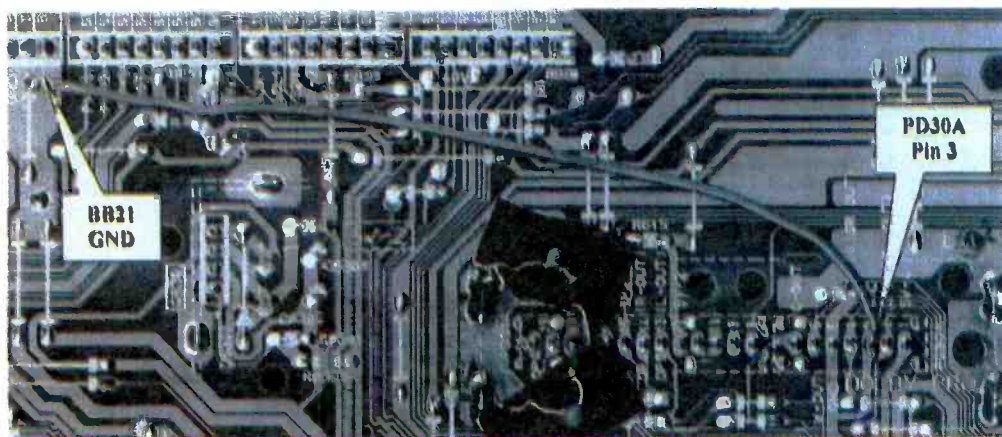

Fig. 3: In addition, add a 140mm jumper wire on the print side of the Dolby Digital module, between pin 3 of PD30A and BB21 GND.

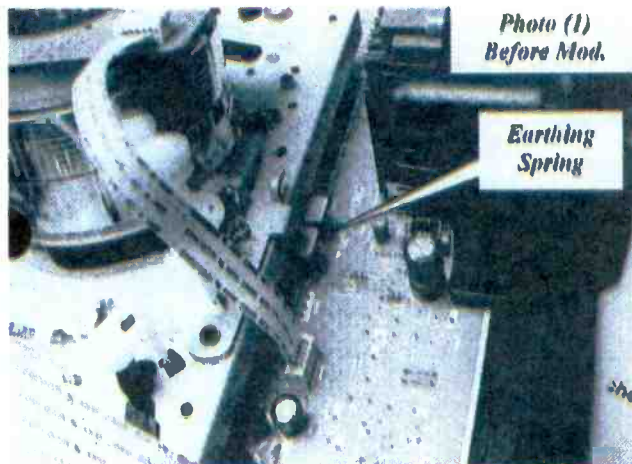

Fig. 4: Position of the earthing spring, VCR Models V229B, V429B, V709B and V729B.

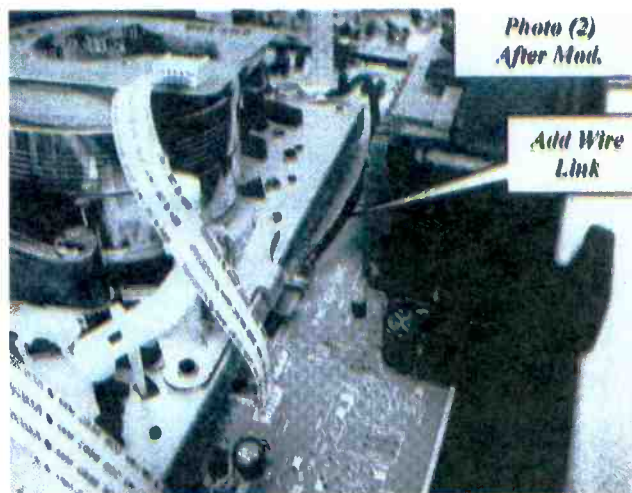

Fig. 5: Position of the wire link to be added between the earthing spring and the mechanism fixing screw.

power supply reveals that they are all at approximately two-thirds of the correct level the optocoupler IP50 is faulty, causing incorrect regulation. Replace IP50, part no. 70012802.

Models V229B, V429B, V709B and V729B

White, flashing horizontal interference specs on the playback picture: Cause is the earthing spring (see Fig. 4) making poor contact with the mechanism base plate. The cure is to clean and retension the spring and add a wire link as shown in Fig. 5 between the earthing spring and the mechanism fixing screw.

Models V726B and V727B

No playback picture (blank raster with flashing white lines that run vertically through the picture): This occurs when chip jumper RV048, a resistor-type link, goes open-circuit. As a result there is no video input to IV001. Replace RV048, part no. 70241096.

Thyristors and Triacs

Mike Rutherford takes a look at the operation of these useful devices and describes some typical applications

These often overlooked semiconductor devices have some useful applications. They are both three-terminal, four-layer (pnpn) devices that can be used for power control. The thyristor, or silicon controlled-rectifier, has a unidirectional characteristic. It can be used as a rectifier that's switched on by applying a bias current briefly to its gate terminal. The odd thing is that to switch a thyristor off its anode voltage has to be reduced to zero. This is no problem when the device is used to rectify an AC supply, because the anode voltage crosses through zero every half cycle. If DC is applied to a thyristor it will act as a latch. In this application, to switch off (reset) the device you have to turn off the DC.

The difference with a triac is that it will pass current in both directions. It can be thought of as a pair of thyristors wired in reverse-parallel. Because of this its main terminals are referred to as MT1 and MT2 (main terminal one and two) rather than the anode and cathode. As with the thyristor, its third terminal is called the gate. AC is generally used to trigger a triac: unidirectional triggering results in unidirectional operation. The triac is useful for AC control.

A triac chops up the AC waveform a bit, so the form factor of the original AC (the ratio of the RMS value of the waveform to its average content) is somewhat altered, but the device is invaluable for controlling

brush-type motors. It can also be used to make a variable-voltage unregulated power supply and to control the brightness of an incandescent lamp.

Both devices have fast turn on/off times and will produce RF interference unless simple suppression circuitry is used.

Thyristor with DC Operation

The action of a thyristor can be simulated by the relay circuit shown in Fig. 1. With the push-button switch SW1 open-circuit the relay is de-energised and no current is drawn from the supply. When the button is pushed to close the switch, the relay's coil is energised and contact A1 closes to maintain the supply. The relay is said to be latched. Contact A2 also closes, feeding DC to the lamp which lights. To de-energise the relay, its supply voltage has to be removed momentarily. This is done by the reset switch SW2.

Now look at Fig. 2, which uses a thyristor instead of a relay to perform the same task. With the push-button switch open-circuit there is no current flow. When the switch is closed DC is fed to the gate of thyristor Q1 via R1. Q1 latches on and the lamp lights. To turn off the thyristor and lamp the reset switch SW2 has to be opened.

The important difference between the relay and thyris-

Fig 1: Latching circuit with relay.

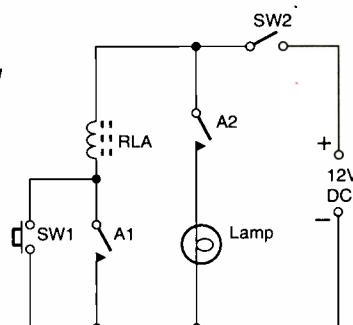
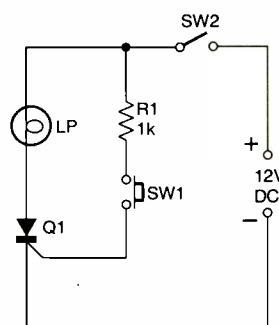

Fig. 2: Equivalent thyristor latching circuit.



tor arrangement is that the former requires a contact to maintain current through the coil whereas the thyristor is self-latching. Its anode voltage must be reduced to near zero for switch off to occur. Another difference is that the thyristor is not isolated from the circuit it controls (the lamp in this example). With relay operation the controlled circuit is isolated from the coil and can be several in number so that different circuits are switched simultaneously. For some applications therefore thyristors and relays are used together.

Latching circuits are used whenever the requirement is to maintain the on state until a manual reset is carried out.

There is an alternative way in which a DC-operated thyristor can be switched off – when it's used as a simple relaxation oscillator, see Fig. 3. This particular circuit is used to drive a loudspeaker that gives a fairly low output at a frequency set by capacitor C1. When DC is applied to the circuit, C1 charges via R1. When the voltage across C1 reaches a certain level, Q1 will be turned on by current via VR1. At this point C1 will be discharged via Q1 and the loudspeaker. The voltage across C1 falls to a very low value, at which point Q1 switches off and C1 starts to charge again. The oscillatory operation will continue until the DC supply is removed. VR1 adjusts Q1's gate voltage. Adjusting it therefore alters the frequency of operation. C1 could be between say 0.22-4.7 μ F, depending on the frequency required. Alternative oscillator circuits will give a greater output from the 8 Ω speaker: the use of a thyristor here is merely to illustrate the possibility.

Thyristor Power Supplies

The thyristor can be used as the basis of a cheap, simple regulated power supply that's rugged and stands up well to continuous operation. I've used one such supply for over 25 years to power a succession of CCTV systems and maintain a back-up battery, providing a steady 12.4V at 2-3A. The basic circuit is shown in Fig. 4. Operation relies on the fact that the thyristor switches off when its anode voltage goes negative, and cannot switch on again until its cathode voltage falls with respect to its gate voltage because the reservoir capacitor C1 has discharged slightly.

When an AC supply is connected to the anode of Q1 it will switch on during positive-going half cycles of the input, charging C1. This continues until the voltage across C1 is close to the zener voltage of ZD1. At this point Q1 will cease to switch on, because its gate-cathode voltage is insufficient. C1 discharges as it supplies current to the load. As a result Q1's gate-cathode voltage rises and it begins to conduct again, recharging C1.

This half-wave circuit is inefficient but can, fortunately, be incorporated into a bridge rectifier arrangement as shown in Fig. 5. To obtain a 12V supply, the zener diodes should be rated at 13V with a power rating sufficient to be able to withstand continuous operation at the supply's maximum output current. To some extent this depends on the sensitivity of the thyristors. Modern devices are excellent in this respect, but if you are making up the circuit from spares rack oddments some trial-and-error may be necessary.

Assume that the zener diode requires a minimum current of 5mA to establish a stable zener voltage, and that the thyristor requires a minimum gate current of say 10mA to turn it on. The AC voltage applied to the thyristor's anode next has to be considered. If we assume a 15V RMS sinewave input, the peak voltage

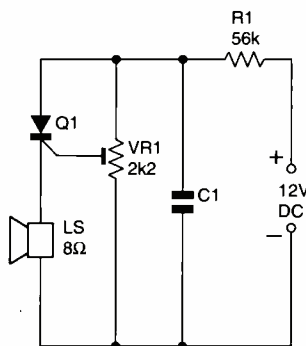

Fig. 3: Relaxation oscillator circuit using a thyristor.

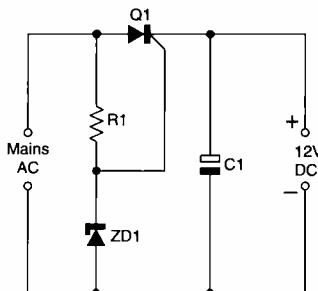

Fig. 4: Use of a thyristor to provide a regulated DC supply.

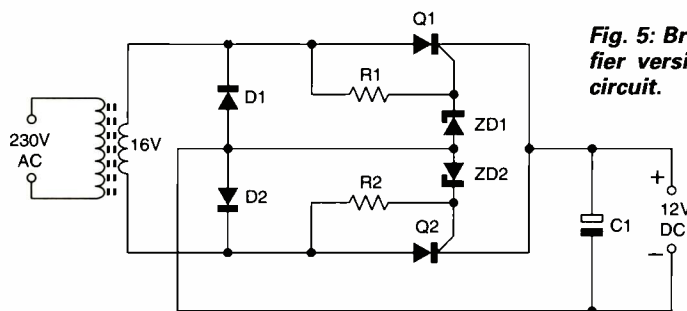

Fig. 5: Bridge rectifier version of the circuit.

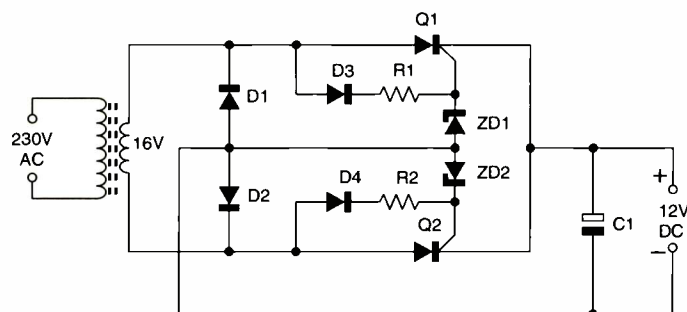

Fig. 6: Practical circuit. Q1 and Q2 are rated at 50V, 6A. D1 and D2 need a PIV rating of 50V at 5A. D3 and D4 can be type 1N4001 (50V PIV at 1A). ZD1 and ZD2 are 13V, 600mW zener diodes. R1 and R2 have a value of 100 Ω and a power rating of 0.5W. C1's specification is 680 μ F, 25V, 110°C.

will be $15 \times 1.414 = 21.2$ V. R1 will pass current on both half cycles: on the negative-going half cycles the zener diode will act as a forward-biased diode, but on the positive-going half cycles the current flow will be distinctly non-linear, depending on the point at which the thyristor switches on – this is when the anode voltage exceeds the cathode voltage by about 0.5V and the gate bias current is sufficient. This could involve some com-

Fig. 7: Model railway loco-motive drive circuit using a thyristor for control.

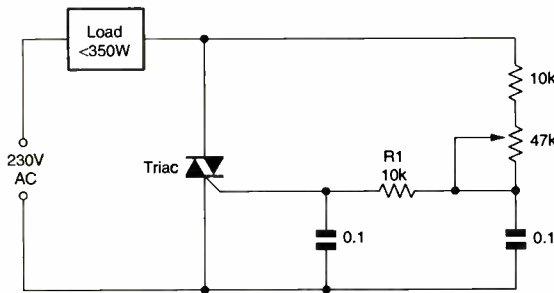
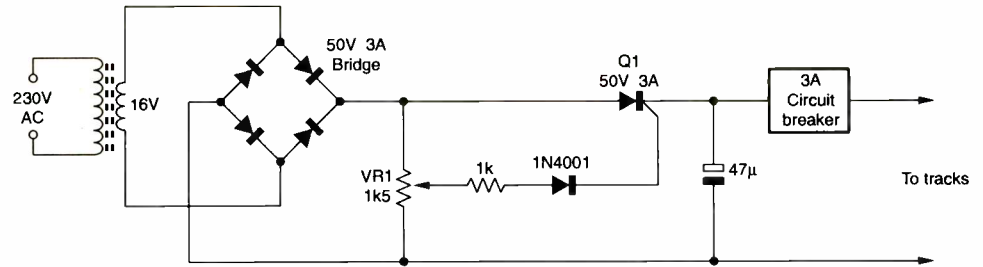

Fig. 8: Basic triac speed control/lamp dimmer circuit.

plicated calculations. It's safer to assume that the full RMS voltage will be present across R1 all the time: this will build in a safety margin.

The value of R1 depends on the supply's voltage headroom. With our assumed 15V RMS input, we must also assume that the required 15mA bias current to switch the thyristor on is present when its anode voltage swings above 15V. This gives us a figure of $(15 - 13) \times 1,000/15 = 130\Omega$.

15V RMS across 130Ω means a power rating for R1 of 1.7W, which is rather a lot. Some saving can be made by including a diode (D3 in Fig. 6) in series with R1 to prevent current flow during the negative half cycles. But the diode's barrier voltage has to be considered. This reduces the value of R1 to 86Ω . The current via R1 is now much less, flowing only when the positive-going anode voltage exceeds 15V. This reduces the dissipation in R1 to about 250mW or less.

The foregoing describes the conditions for one half of the bridge rectifier: the other half is of course identical. The full circuit of this power supply is shown in Fig. 6. Though little heat is generated in operation, it's a wise precaution to provide the thyristors with adequate heatsinks to ensure cool running and a long life. Bolting the thyristors to a piece of sheet metal is often sufficient. Though drawn aluminium heatsinks look good and work well, they are expensive.

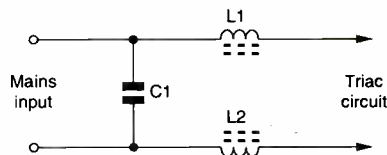

Fig. 9: An RFI filter for use with triac circuits. L1 and L2 are suppression chokes, typically $100\mu H$. C1 is an X-type capacitor with a typical value of $0.1\mu F$. Fit the filter as close as possible to the triac control circuit.

Model Railway Supply

Model railways are a popular low-voltage power supply application. They have traditionally used a variable-resistance controller fed from a DC source. This arrangement has the disadvantage of poor low-speed performance and erratic starting. Because the starting and low-speed motor currents are high and unpredictable, the supply voltage required varies wildly.

A constant-voltage circuit solves these problems and provides smooth control of speed over the full range. Fig. 7 shows a simple, easily constructed circuit that can again be made from spares-rack oddments. The transformer should deliver 1A per motor in simultaneous use: the thyristor should obviously match this current requirement.

A feature of this circuit is that the voltage will rise with increased load, which is the exact opposite of the resistance controller, making it ideal for starting and low-speed control. A small circuit-breaker is included in the output to prevent damage to the circuit under heavy load or short-circuit conditions. Don't forget to provide the thyristor with a heatsink – if a metal controller case is used, this may be adequate for the purpose.

Many other uses of thyristors in power supply arrangements will no doubt occur to the constructor.

Triac AC Control

The triac, a close cousin of the thyristor, provides a handy means of controlling the AC supplied to a load. Uses include incandescent lamp dimmers, motor-speed controllers (for brush-type motors only) and heater controls.

Fig. 8 shows a simple circuit for this type of application, with the triac's gate driven by a phase-shift network. It can be used for mains-powered electric drills, lighting and low-power heating up to 350W. With a larger triac the controlled power can be increased to 1kW: it's a matter of selecting the right device and upgrading the heatsink. A 6A triac requires a gate current of typically 25mA – the value of R1 may need to be altered to provide this.

Remember that these devices are connected directly to the mains supply, and should be isolated before any attempt is made to work on them. Some commercial designs even have live heatsinks, so be doubly vigilant when the design is not your own!

Interference

Devices that switch abruptly, such as thyristors and triacs, generate considerable RF interference in operation. For this reason suppression components must be fitted in the mains input. An RF interference suppression circuit that's suitable for triac use is shown in Fig. 9. Suitable chokes and mains-rated capacitors are readily available. The capacitor should be an X class type with a value between $0.02-0.1\mu F$.



John Edwards' Casebook

Mitsubishi CT25B2STX (Euro 12 chassis)

Field collapse was the problem with this set. As you may know, the original TDA8178S field output chip is no longer available. A TDA8171 can be used instead however, provided the tube size is less than 29in. For convenience I fitted a kit from Charles Hyde (MODKIT2). It's very cheap and contains the chip and two other components. You can imagine my disappointment when I switched on and found that the fault was still present.

As I didn't have a circuit diagram I traced the print from each pin, looking for a route towards the line output transformer. Well, that's the usual source of the supply for the field output stage, isn't it? Not in this chassis. I eventually restored full scanning after tracing the source of the missing 28V supply to the chopper power supply circuit, via R976 (0.82Ω) which was open-circuit.

Hitachi C1414T

The power supply was working normally but there was no line drive, so the set was stuck in standby. Some quick checks revealed that the 8V supply at pin 10 of the multi-function TDA8361 chip IC201, which produces the line drive at pin 37, was missing. The supply comes from the chopper circuit via Q953, the 9V regulator IC951 and D213. Q953 is switched on and off by the microcontroller chip IC001, via Q952, for on/standby purposes. In standby the base of Q952 is low, which was the case here.

The base of Q952 is also connected to the anode of thyristor Q703 (TS0820-20) in the safety circuit. This monitors the 200V supply, the audio output stage supply, the beam current and the field timebase. I thought that the field output chip was the most likely suspect and replaced it, but this made no difference. To my surprise disconnecting all the safety sensing inputs, by unsoldering the gate of Q703, also made no difference. When I unsoldered its anode however and switched on I had a normally functioning set.

The next step was obviously to check the thyristor. I know that checking a thyristor with the ohmmeter or diode-test functions of a standard multimeter can be misleading – unless there's a short-circuit or severe leakage between the pins. This was no exception: the suspected short-circuit between the device's anode and cathode was not there. Once again I switched the set on, this time with the thyristor removed, and once again it worked perfectly. But the set couldn't be left without safety protection, so a new thyristor was fitted. It now worked correctly.

Curiosity got the better of me (it often does). I removed the new thyristor to carry out comparison measurements with the original one. No difference could be found. More surprisingly, my trusted oscilloscope component tester

revealed no difference in the waveforms produced by the two thyristors. I went as far as fitting the original thyristor back in the set to prove the point. The set of course failed to come on again. I can only assume that the defective thyristor failed when subjected to voltages higher than those applied with test equipment

Philips G90AE Chassis

The picture and sound were very good but a permanent and very annoying loud squeal came from the power supply area. Quiet operation returned once the following components had been replaced: R3614 (360kΩ), R3618, R3620 (both 180kΩ) and C2630 (47μF). C2630 is the HT (95V) reservoir capacitor. The resistors provide the chopper start-up feed.

Sanyo CTP7134 (80P chassis)

Although there was no picture or sound there were signs of life – a regular popping noise came from the speaker. It seemed likely that there was a fault in the line output stage, and when I got around to the transformer I found that there was a short-circuit between pin 7, the connection to the line output transistor, and pin 1. The original transformer costs over £50 plus VAT, which would have placed the job firmly in the "beyond economic repair" category. A cheaper pattern type is available however, and when I obtained and fitted one the set sprang to life. For a brief moment I dared contemplate carrying out a TV repair and actually making a profit. But a glance at the picture brought me back to reality. There was no EW correction, the sides of the raster bowing in towards the centre.

I marked the position of the slider of the pincushion correction preset VR4001 (a wise thing to do, I have learnt), then rotated it back and forth. As this had no effect, I returned the slider to its original position. Here we go I thought, this is where profit turns to loss, as usual. But it was a case of no repair, no money, so back to the job in hand.

The EW driver transistor Q4005, mounted on its large heatsink, was cold. It was obviously not conducting. The area in which it's situated was littered with dry-joints, and the components were covered with a thick layer of dust. I set about resoldering all suspect joints, then used a 2in. paintbrush to clean the component side of the PCB. While doing this I noticed that R4012 (2.2Ω) was tarnished and sad-looking. It measured open-circuit. A replacement was soon installed, and there was then a full, linear raster. R4012 is in series with the drive to the EW diode modulator circuit.

I find there's something appealing about a PCB that's been cleaned up after being buried for years under dust and grime. I can't explain it, but the board seems to take on a new lease of life.



Amstrad

<http://www.amstrad.co.uk>

<http://web.ukonline.co.uk/clifflawson>

Amstrad now has its own official web site covering current products. For information on older products the Cliff Lawson web site is essential viewing.

All Tech Tips

<http://www.skyeinteractive.net/tech tips/>

Another US technical tips site which deals with subjects related to repair of the whole range of consumer electronic items. The site is being updated and plans to include current repair articles, books on repair, schematics and links to manufacturers technical repair sites. There's also a chat room.

Anatekcorp

<http://www.anatekcorp.com/>

A US site selling computer databases of fault reports and schematics, but it has some interesting articles for free download - you can even submit your own. There's a technicians forum but you have pay \$60/year to be a member.

Andrew Wiseman's TV Room

<http://625.simplenet.com>

An informative personal site about TV past and present. There's a discussion about the future of digital TV. There's also a logo gallery where you can listen to the old BBC and ITV intros, and see logos from cult programmes

such as the Prisoner and Dr Who. You can even watch old public information films (although I had a problem connecting to the server). There are useful sections explaining Digital Television and Programme Delivery Control for video recorders (thanks to Laurence Day for bringing this site to my attention).

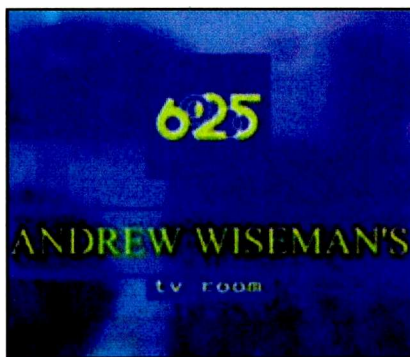

Baird 30 Line Recordings

<http://www.dfm.dircon.co.uk>

For history buffs and the curious here's a fascinating site containing early TV recordings and their background.

BBC

<http://www.bbc.co.uk/info/reception>

<http://www.bbc.co.uk/enginfo>

If you need any help with your reception go to this site - both of the addresses point here. There's special advice for people with loft installations, and caravanners and boating enthusiasts.

Darren Meldrum's Home Page

<http://www.meldrum.co.uk/mhp/index2.html>

This excellent site is dedicated to television especially the bits in-between - the announcements, idents and, for the nostalgic among you, the Test Cards. It also contains some useful links to other sites (as do many other sites).

Doknet Service manuals

<http://www.doknet.com>

This Dutch site says it has 350,000 service manuals and 1 million service parts.

You interrogate the data base by filling out an order form, with the "request" box ticked, and then wait for an email to arrive back on your computer. However, an on-line index would be useful and maybe on-line downloading of the manuals.

Electronic Repair Tips

<http://elmswood.guernsey.net/index.html>

Here's growing source of free repair tips shared by visitors to the site. You can search by manufacturer or type of equipment. A short description of the fault is given and you can click for further details. However, my only criticism is that when you click to go back from a fault you seem to lose your original results list.

ICHE

<http://www.iche.com>

See Bill's problem page which is a forum for engineers and technicians to post their problems, tips, advice etc to. All submissions are at Bill's discretion.

MB21

<http://www.mb21.co.uk/index.html>

Another enjoyable site with a "telenostalgia" section about the technical aspects of television. There's also a section on transmitter sites, teletext "then and now", and a "rough guide" to widescreen television

Newsgroups

uk.tech.broadcast

uk.tech.digital-tv

uk.tech.tv.sky

If you have never got into newsgroups then these are worth a look. You "subscribe" (free of charge) to a newsgroup through your e-mail software (eg. Outlook Express). If it's not obvious how to do it then check out the help section on your Internet Service Provider's front page. Newsgroups are like notice boards where subscribers can send an

To reserve your web site space contact Pat Bunce

Tel: 020 8652 8339 Fax: 020 8652 3981

To reserve your web site space contact Pat Bunce

Tel: 020 8652 8339 Fax: 020 8652 3981

Email to be viewed by everyone else. They are generally a source of help and advice, with plenty of humour too! Maybe there should be a TV engineer specific newsgroup called "uk.tv.engineers". Any thoughts? (thanks to Iain Dobie for this information)

Newnes

<http://www.newnespress.com>

Check out this site for the latest book titles on TV & Video Servicing and Technology and their famous Pocket Book series. You can shop on-line and

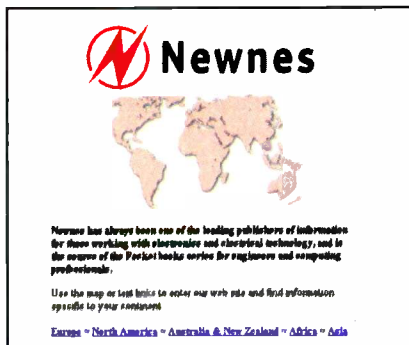

also register for an Email service to tell you when relevant new titles are published.

NTL

<http://www.ntl.co.uk>

Go to this site for information on NTL's Broadcast, Interactive and Telecom services, including packages for home area by area. There's also a useful transmitter site map and database,

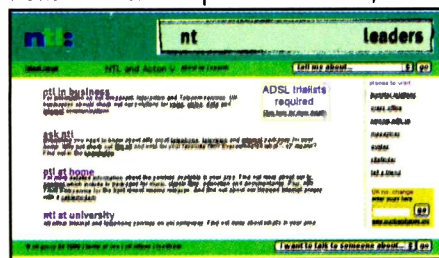

giving locations and information. The site also contains useful documents, which describe digital TV, interactive TV and digital Radio. There's also a useful contacts list.

M.C.E.S.

<http://www.mces.co.uk>

The MCES site gives details of our range of service including Tuners, Video Heads, RF & IF Modules plus latest prices and special offers.

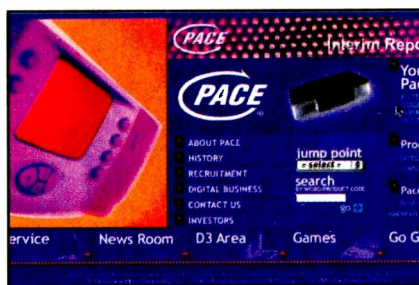

Pace

<http://www.pace.co.uk/trade/index.htm>

The Pace site has a product finder. On servicing, there is a restricted access area for Pace retailers and service partners. If you are a member of the trade and you deal with Pace products you can apply for access by following the instructions. The free access area contains some useful Frequently Asked Questions and links to other useful sites such as the Lyngmark Satellite Chart at <http://www.lyngsat.com>.

Philips

<http://www.philips.com>

<http://www.semiconductors.com/products/>

Take a look at the impressive Philips home page which leads to a product listing and detailed information. Perhaps more useful to the technician is the semiconductor data "tree" where data sheets can be downloaded on all Philips integrated circuits.

Servicing Advice

http://www.repairfaq.org/REPAIR/F_Repair.html

Here are some frequently asked questions about servicing consumer electronic equipment, with a US bias. But there's some good material on monitors and CD players and CD-ROM drives. (thanks to David Edwards for this information)

Sature

<http://www.netcentral.co.uk>

Packed with frequently asked questions (FAQ) about common faults and cures for faulty satellite receivers and decoders. Repair kits, upgrade kits, spare parts, surplus components plus links to other satellite information sites. Also audiophile components, electronic hobby kits, dolls house and model

railway electrical stuff, a beginners' electronics course and lots of other information that will keep you occupied for days! The entire web site is also available on CD for just a £5 note.

Taxan

<http://www.taxan.com>

<http://www.valuevision.co.uk>

Look here for information on Taxan monitors and their new Valuevision range, with information on servicing, spares and latest software drivers.



Texas Instruments

<http://www.ti.com>

Data is also available from Texas Instruments where you can quickly search their site for the information you need. Quality Electrical Direct <http://www.qed-uk.com> Here's a new retail site with a very interesting feature - not only can you purchase from a huge range of consumer goods but you can also request price information on your mobile phone. For example, you could be looking around your local branch of Dixons and see something you want. You can then send a message to QED via the Short Message Service (SMS) on your mobile phone to request a price and delivery from QED. The information is sent back to your phone including how many they have in stock. It will be interesting to see if this new E-commerce approach succeeds.

Timecast

<http://realguide.real.com/stations/>

Television of the future? This site contains listings of TV and Radio stations available on the Internet. There are quite a few TV stations of US origin available to watch. The video quality isn't very good at the moment, but this is sure to improve. There are also some fixed cameras positioning in locations ranging from game park, high streets and people's houses - not exactly captive viewing! But an interesting

thought - are PCs and TVs going to eventually "get married"?

Transmitter Alignment Programme

<http://www.tvtap.mcmail.com>

This site contains the timetable of work on the TV Transmitter Adjustment Programme or TAP. The programme's aim was reported earlier in Teletopics, but briefly it is to maintain existing analogue services as work progresses on digital television UK "to fulfil official regulatory licence requirements". When transmitters are being worked on there are local messages.

Televés

<http://www.televés.com/ingles/ingles.htm>

Televés website was launched as an



easier way to keep in contact with our World-wide Network of Subsidiaries and Clients. This site is constantly updated with useful information/news plus you can download info on our range: TV Aerials & accessories, Domestic and Distribution amplifiers,

Systems Equipment for DTT and Analogue TV, Meters and much more.

UK Electrical Direct

<http://www.uked.com>

For a comprehensive on-line directory, buyers guide and resource locator for the UK Electrical Industry look at this site. Many of the companies listed have links to their own web sites, making this a one-stop shop for a huge amount of information.

UK Mailing List Group

<http://www.egroups.com/list/uktvrrepair>

Following on from the newsgroup discussion last month there is a UK Email group for TV technicians where you can send an Email to everyone in the group. There's just over 30 people in the group at present. For more details and how to register look at the egroup home page. Just a general comment though - you do have to be careful who you give your Email address to so that you can avoid "spamming" - that is getting lots of unwanted Email about dubious Russian site (amongst others).

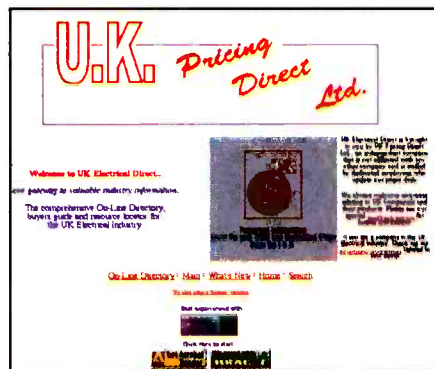

Reed Connect

<http://www.reedconnect.net/>

Another free internet access site, this time from Reed Business Information. However the site possesses a useful UK People and Business Finder, with an e-mail search. There's also business news and local information, and some good links to directory sites.

Repairworld

<http://www.repairworld.com>

Repairworld is a sophisticated US based fault report database which is updated bi-weekly. It operates on a subscription basis and describes itself as an "affordable solution for all technicians". There is apparently no minimum number of months for which you have to subscribe. You can see some samples of the material for free, monitors, VCR, DVD and Camcorders being of particular relevance to UK users. The site even provides a "chat room" where you can talk via your keyboard to others "in the room".

Put your web address in front of 21000 electronics enthusiasts and experts.

Television acknowledges your company's need to promote its web site, which is why we are now dedicating pages in every issue to announce your WEB ADDRESS.

This gives other readers the opportunity to look up your company's name, to find your web address and to browse the magazine page to find new sites.

We understand that cost is an important factor, as web sites are an added drain on budgets. But we are sure you will agree that the following rates make all the difference:

FOR 12 ISSUES:

Lineage only will cost £150 for a full year, just £12.50 per month.

This includes your company's name, web address and a 25-word description.

Lineage with colour screen shot costs £350 for

a full year, which equates to just £29.17 per month.

This price includes the above mentioned information, plus a 3cm screen shot of your site, which we can produce if required.

To take up this offer or for more information ring:

Pat Bunce on 020 8652 8339
or fax on 020 8652 3981.
or e-mail: pat.bunce@rbi.co.uk

Company name	Web address

The Problem of Intermittent Faults

Intermittent faults can be difficult to locate and cause much uncertainty. Paul Smith suggests suitable diagnostic measures

The diagnosis of faults that are intermittent can be extremely time consuming. In addition, to ensure that the work carried out has completely cured the fault the equipment will occupy space on the soak-test bench for longer than usual.

The first clues to help with diagnosis can normally be obtained from the customer who may, for example, tell you that the fault appears after so many minutes or hours, that a tap on the side will temporarily cure it and so on. Such information can save valuable time and is worth asking for if it hasn't been noted down on the job card. A quick call could save you much time. If the description is rather vague – “the TV has palpitations” and “the picture is sometimes dizzy” are two that come to mind – a run on the soak-test bench may be a better move than a journey straight to the workstation.

One of the difficulties with an intermittent fault is being sure that it has been permanently cured. Just because it doesn't occur again during several days of soak testing could be merely a coincidence or because something has been disturbed during the repair process so far carried out. If you can find a way of instigating the fault before work commences, this will aid diagnosis and be can be used afterwards as a check on whether the repair has been successful.

Vibration checks

If a bang on the side of the equipment will cure the symptoms, gentle tapping on the relevant PCB will sometimes – but not always – instigate the fault. Try to narrow down the area of search by using lighter and lighter taps.

If vibration does cure/bring on the fault, the most likely cause is a dry-joint or a hairline crack in the print. A strong magnifying glass (we use x9.0) can be useful for checking joints and track continuity.

Heat

A hairdryer, heat gun or soldering iron can quickly bring an appliance or component up to a temperature equivalent to that after running for several hours under normal conditions. Use of a shield (a service manual may do) can help direct the heat on to a particular area.

Freezer

Freezer spray, when used in conjunction with heat, can help to establish whether a component has a thermally-sensitive fault. The advantage of this method of diagnosis is that it can be more specific, narrowing the search to a particular component rather than a more general area. The disadvantages are the cost of aerosols (which are best bought in bulk) and the fact that some semiconductor devices won't function correctly below a certain temperature, which can be misleading.

A similarly misleading condition is when a component that shows up as being thermally sensitive reads OK when checked out of circuit, malfunctioning only when under load or within a certain temperature range. Heat used during its removal can temporarily cure a leaky diode or transistor or a reduced-value capacitor.

Surface-mount ICs

These are becoming increasingly common in all types of equipment. Poor soldering of the legs of a surface-mounted IC to the PCB is a recurrent cause of intermittent faults. Symptoms we have encountered include intermittent CD operation; loss of display, sound or VideoCrypt decoding; and VCRs that cut out when warm. Inspection of the solder may not reveal any signs of deterioration, but gentle pressure on top of the IC can provide the required clue by curing the fault.

After resoldering, check carefully for bridges between adjacent legs. If solder gets into the gap between the IC's body and the PCB it can be melted out by using desoldering braid at its edge.

Component destruction

This is perhaps the most serious problem: it can be very expensive when an intermittent fault destroys several costly parts. Unless a specific cause is known, or can be found by reference to fault guides, an allowance needs to be built into the estimate to take into account the components that may fail during diagnosis.

Many manufacturers and suppliers provide kits which contain all likely parts that could fail in a particular stage, for example a chopper power supply or a field or line output stage. If things still go wrong after all the parts have been correctly fitted, it may be better to consider cutting your losses than continue with the repair.

There are, unfortunately, occasions when new parts fail after the equipment has been returned to the customer and is still under the repair guarantee. This is another possible cause of loss making. Such events are rare however – and can occur in many types of business. A check through our own records shows that the loss ratio is three in every thousand jobs (0.3 per cent). Use of good-quality components, in particular manufacturers' originals, can help you to avoid this situation.

Test equipment

If you suspect that the fault is caused by a voltage rail going high or low, the use of a digital meter with a storage function and a warning buzzer will alert you when things are starting to go wrong. An oscilloscope can be used to provide clues when there's an intermittent signal fault.

The use of a video camera in conjunction with test equipment can be helpful. Eugene Trundle described this technique in the May 1993 issue of *Television*.

Faults that don't show

If an intermittent fault doesn't put in an appearance during several days in the workshop, even after tapping, heating, etc., rather than keeping it for an indefinite period it will probably be best to ask the customer to collect the equipment and return it when the fault puts in more frequent appearances. This will avoid the problem of the soak-test benches being cluttered with lots of problem equipment. In addition the customer doesn't become frustrated by the long wait, and the cause of the trouble will probably be easier to trace when the equipment is brought back.

It is also possible that there's nothing actually wrong with the equipment, the cause of the trouble being incorrect operation or an external condition such as interference or a faulty wall socket.

Environmental problems

There are occasions when an appliance will not show

any signs of being faulty in the workshop but the customer reports that the symptoms have returned immediately or soon after its reinstallation at his/her home. In such a case a field call might well shed light on the cause of the problem.

Here are some examples we've had: a set cut out every evening because the mains supply to the house then dropped below 200V – a loan set worked perfectly while the 'faulty' one was in the workshop; the cause of 'vibration and booming sound' was traced to hollow tubes in a rack system close to the TV set; and the VCR's remote control unit was the cause of a TV set changing channels by itself.

In conclusion

Many intermittent faults have fairly obvious causes and do not present much of a problem. The rest call for a lot of patience and resolve. Remember that each visit to the workstation is progress, even if only by elimination.

The last words of the customer should also help to keep things in perspective – "it's probably only a loose wire". Good luck.

Help Wanted

Wanted: Information and/or circuit diagram for the Dell monitor Model D1522-LS. Phone Norman on 01420 563 395 or e-mail jnorman@pgen.net

Wanted: Service manuals (photocopies OK) for the following: Granada CTV Model C51H26; Portland Model DV-K2A0P VCR; Technics Model SU-V2X-KEK amplifier. B. Marsden, 25 St Georges Road, Newquay, Cornwall TR7 1RE. 01637 876 298.

Wanted: Marantz CV55 (or Philips equivalent) CD Video player for spares or repair, new or second-hand, working or not, or an optical unit for this machine. Michael Alexander, 84 Tadcaster Road, York YO20 2LR. 01904 700 484.

Wanted: Someone to service a Sony SL-C9 Betamax VCR with a sound recording fault. John D. Skelton. Please phone 01142 890 328 after 6 p.m. or e-mail skelton.john@talk.21.com

Wanted: AVO valve characteristic meter (tester) Mk 1-4 (Fifties-Sixties version). Must be in good working order and with data manual. Would also be interested in any spare data manuals for the above. Phone John Langley on 01536 723 411.

For sale: Engineer who has had enough has for sale over 600 service manuals for TV sets, VCRs, camcorders, audio equipment and microwave ovens, covering a wide range of brands/makes. Call R. Bains on 01733 242 188 or list available by e-mail from mra@firesafe.idps.co.uk

Wanted/for disposal: To complete my library I require a March 1990 issue of *Television*. Have for disposal Euras repair tip books – please contact me for list. John Stacey, 3 West Park, South Molton, North Devon EX36 4HJ. 01769 573 382.

Wanted: Has anyone got a new or scrapped back light for the Casio pocket-size colour TV Model TV1500. What I require is the 3in. fluorescent tube, which operates at 6V. Or does anyone know a supplier? Brian Lawler, Britina, 6 Chindit Close, Formby,

Liverpool L37 2JH. 01704 832 396.

For sale: Because of retirement I have the following for sale: 22 volumes of *Radio and Television Servicing*, 1965-66 to 1986-87; *U-View Television Servicing* books 1987-88 and 1993-94; a 30MHz Hameg oscilloscope; and general servicing equipment. For more details phone 01539 723 810. G.B. Graveson, Electronic Domestic Services, Unit 7, Camden Building, Yard 23, Stramongate, Kendal LA9 4BH.

Wanted: Circuit diagram or any other technical information for a Slim Gym controller which was bought in Australia. Can anyone identify the function of an IC marked MCT2 040F. It could be an optocoupler. P. Guarini, 31 Alderson Avenue, Rawmarsh, Rotherham, South Yorkshire S62 7DE.

For sale: Promax TA901 CRT rejuvenator/tester with eight adaptors and manuals. £145 ONO. V. Buffin, 57 Lakeview Drive, Plymouth PL5 4LW. 01752 215 536 or e-mail vinceboo@niffub.freemove.co.uk

Wanted: 21in. CRT in reasonable condition for the ITT Model TX3447 (Digi-3 chassis). Also circuit diagram for a CRT rejuvenator. Ron Bruce, 11 New Zealand Way, Rainham, Essex RM13 8JP. 01708 558 792.

Wanted: Service manual/circuit diagram (photocopy OK) for the Vega mono portable TV Model 402D. Ron Avery, 54 Hereford Court, Brighton, E. Sussex BN2 1LF. 01273 623 409.

Wanted: Circuit diagram for the Saisho TCR600. Is there a known cause of field bounce/jitter with the Thorn/Ferguson TX9 (text) chassis. I've tried really hard to cure sound distortion with the GEC 1407/Hitachi CPT1455/1474 without success. The cause seems to be in the driver stage for the weird discrete-component output stage. Any ideas? Mr Roy, 22 Grebe Close, Waterlooville, Hants PO8 9UT. 01705 783 811.

Wanted: Can anyone help with a no-record fault with a JVC Model GRC1 camcorder? I've checked the record safety switch which is OK, but there is no joy on pressing the button. All other functions appear to be OK – there's E-E in standby and the camcorder plays a known good tape. F.O. Tester, 31 Longsands Road, St. Neots, Cambridgeshire PE19 1SS.

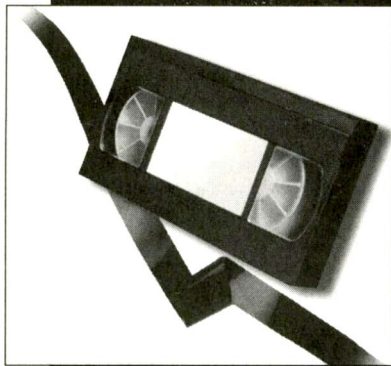

Reports from
Andy Barkley
Michael Maurice
Kevin Green, TMIE
Colin J. Guy
Michael Dranfield
Pete Gurney, LCGI and
Adrian Spriddell

Saisho VR1000 etc

The capstan motor in these machines is no longer available. Unfortunately it's prone to failure. We have found that the SEME motor type MOTOR4156 at about £4.50 is a good replacement. Although it's physically larger, it is a comfortable fit.

Remove the old motor by undoing the three screws that hold its mounting plate to the main deck, then remove the motor from the mounting plate by sawing through its shaft (you will need to re-use the plate). Fit the replacement motor on the mounting plate – you will need to find three suitable screws, as the ones from the old motor are too small. Connect the wires and slip the belt over the shaft.

Once you've done a few you will find it a twenty-minute job. We have found that these machines, which are otherwise reliable, are much favoured by customers who prefer a nice, simple VCR. Equivalents in other ranges include the **Hinari VXL3**, the **Matsui VX800** and the **Orion VHL**. **A.B.**

Daewoo DVF932P

You could insert a cassette but the machine then shut down. It also shut down when a function was selected. Checks in the workshop revealed that the 12V and 14V outputs from the power supply were high: the 6V output was slightly low, but there was no ripple.

VCR Clinic

Further checks revealed that when a function was selected the 5V supply to the microcontroller chip dipped – only slightly, but it was enough to trigger the reset ICs.

The power supply consists of a pack that's soldered to the main PCB. The idea is that 330V DC goes in and low DC voltages come out. I didn't have a circuit diagram, but it was obvious that the cause of the problem was within this pack. The 6V line decoupling capacitor looked suspect. A 470µF, 16V replacement cured the fault. **M.M.**

Philips VR1541

A thunderstorm had killed this VCR. When I checked it I found that the power supply was dead with the chopper transistor short-circuit. Once the optocoupler, Q1 (2SC4517A), Q2 (2SC3616) and the mains fuse had been replaced the machine worked normally. **M.M.**

Mitsubishi HSMX1

The initial complaint was that the tape would stop after a few seconds then the machine would switch off. When I got it the machine was dead. Cold checks showed that there was an open-circuit resistor in the power supply and that the resistor that feeds the 5V regulator on the main PCB had also failed. There was power when these resistors had been replaced, but the machine wouldn't lace up fully. This was because the grease on the pinch roller and helter-skelter gear shafts had hardened. So these were stripped, cleaned and regreased.

After that the machine powered up and laced up, then promptly unlaced and switched off. The cause was loss of the drum flip-flop pulse input at the microcontroller chip. Further checks showed that pulses were coming from the drum but there was no output from the BU2820S servo chip. Replacement

of this item finally restored correct operation. **M.M.**

Hitachi VTF150

If the tape appears to be running slow and you hear a grumbling sound from the capstan motor, replace C12 and C13 in the power supply. They are both 470µF, 16V electrolytic capacitors. **M.M.**

Panasonic NVJ35

This VCR came in because it was dead. The power supply worked once C909 (1µF, 400V) had been replaced, but the machine remained dead apart from a ticking noise. Microcontroller chip IC7501 on the front panel PCB was the cause, a replacement restoring normal operation. **M.M.**

JVC HRJ655

This machine's power supply made a very faint whistle for a split second then went into a slumber. The cause of the problem was found to be the 15V zener diode D5301, which was short-circuit. **K.G.**

Panasonic NVHD630

The complaint with this machine was very intermittent failure to record colour, for some strange reason only in the LP mode. I had to leave it recording for many hours before the fault showed up. Replacement of IC3001 was tried, but the fault was still present. I then tried replacing three surface-mounted capacitors, C3075, C3076 and C3078. After a soak test that lasted for several days it was time to celebrate. **K.G.**

Sharp VCA36HM/ VCA46HM

This was an odd problem. When the machine was put in the visual search forward mode, then the play button was pressed to release this mode, the machine just carried on in search forward but with some

garbled sound from our monitor TV. After checking many things I found that the capstan motor was the cause of the fault. **K.G.**

JVC HRFC100

This is one of those dual-mode machines that will accept both VHS and VHS-C cassettes. Only this one didn't. If a cassette was inserted it went in but not down. If play was selected it came back out again. The cause of the problem was one of the sensors, PS2, on the top of the housing. It was dry-jointed. **C.J.G.**

Sharp VCM21 etc

The owner complained that this machine chewed tapes. I inserted my dummy cassette and looked to see what happened. The capstan motor rotated in reverse whatever mode was selected. So I removed the deck, then the PCB and reconnected the two. The capstan motor now failed to rotate at all! I then noticed that all the connections to the capstan motor socket were dry-jointed. Resoldering them cured the fault completely.

I've since had a similar fault on a couple of other models in this range, so it looks as if there's a stock fault here. **C.J.G.**

Daewoo V31

There was no playback colour with this machine. It was recording colour, proved by playing back a recording on another machine. The cause of the fault was eventually traced to C409, a tiny surface-mounted 0.022 μ F capacitor on the YC daughter board. It had a leak that measured about 30k Ω . **C.J.G.**

Panasonic NVSD200

This machine was brought to the workshop several times before the fault put in an appearance. The machine's owner complained that it would switch itself on at random, make all manner of mechanical noises, then switch itself off again – without any action on her part. She was not impressed with my theory that some people emit radiation that affects electronic equipment, and I had already suggested that she cover the machine to rule out the possibility of interference from fluorescent lights etc.

I eventually discovered that the sensor LED in the middle of the deck was going open-circuit very intermittently. As a result, the machine thought that someone was inserting a cassette. A replacement LED cured the problem and

restored the owner's and my sanity. **C.J.G.**

Bush BTV14

This TV-VCR combi unit was dead apart from a plopping noise that came from the speaker. Voltage checks revealed that there was a low 5V supply on the video deck PCB. The cause was the KIA7805 regulator chip IC661. It was given away by the fact that the PCB was scorched. **M.Dr.**

Philips VR727

This machine was dead with no outputs from the power supply, though voltages were present on the primary side of the circuit and scope checks revealed some bursts of life in the secondary windings. Most problems with this switch-mode power supply result in multiple component failure and a blown mains fuse. A service kit, part no. ES7051, is available. It contains all the parts required when this occurs.

In this case however the fuse was intact. I noticed that all the electrolytic capacitors on the secondary side of the circuit were leaking electrolyte. When I'd replaced them the power supply still refused to start, though the voltages on the primary side of the circuit were not far from those expected. At this stage I decided to fit the service kit, as it contains all the semiconductor devices likely to fail, but the fault was still present.

After extensive component checking I eventually found that the cause of the trouble was the mains bridge rectifier's reservoir capacitor C2117 (100 μ F, 375V). Although it was still able to hold a charge, and the voltage you would expect was developed across it, an ESR meter check produced a reading of 58 Ω . Once this capacitor had been replaced the power supply started up. **P.G.**

Hitachi VTF540

This machine intermittently looped tapes on eject, and occasionally chewed them. When I checked it the machine appeared to work normally, with no evidence of anything amiss apart from a loud mechanical noise during wind/rewind. When the deck was removed for examination of the lower mechanism all became clear. The clutch unit, which is secured on its shaft by two small moulded pins, had fallen apart. How the machine had worked at all is a mystery: I can only assume that the unit had been partly held together

by the proximity of the main PCB.

A replacement unit is available from Chas Hyde under part no. 12017AX. **P.G.**

Sony SLVE220 etc

This machine refused to power up. When it was plugged in the clock appeared briefly then faded out as the deck attempted to initialise. The cycle repeated itself, as if the power supply was in the trip mode, but the voltages on the secondary side of the supply were correct.

When faced with strange happenings in this series of VCRs my first suspect is usually the 1A fuselink J5130 in the 5V supply. It has a habit of going open-circuit progressively, causing all manner of symptoms depending on the voltage drop across it. In this case I found that the fuse read 2.5 Ω . A replacement restored normal operation. **P.G.**

JVC HRD180

There was a high-pitched whistle on sound and a Venetian-blind effect on the E-E picture and on playback of the machine's own recordings. Playback of prerecorded tapes was OK. The cause was C5 (47 μ F) in the power supply: its value had fallen to 4 μ F. **A.S.**

Toshiba V213

There was poor E-E and playback video, with low contrast, tearing and pulling. The cause of the problem was in the playback video path where coupling capacitor CW97 (10 μ F) had fallen in value. **A.S.**

Samsung VIK310

When faced with a blown mains fuse we used to replace just the STR11006 chopper chip, R101 and C110. We've now widened the net to include C109, C122 (a low-impedance type) and the X2 capacitor C101. **A.S.**

Ferguson FV10B

This machine was dead with the mains fuse open-circuit. The customer had replaced the fuse several times before finally bringing the VCR to us for attention. A complete cure was achieved by resoldering IC801. **A.S.**

Toshiba V204

There was erratic operation, with tapes being ejected and/or the machine shutting down at odd times. The faults were cured by replacing all the electrolytic capacitors in the power supply, using low-impedance types. **A.S.**

Philips' 3D-LCD System

Prototype versions of a 3D video system that's relatively simple yet provides a true stereoscopic field of view are now being supplied by Philips to application developers and academic institutions. Video data processing is used to create a suitable drive for the 3D-LCD panel. Clarence Cartwright outlines the principles and operation of the system



A number of visual clues enable us to see the world around us in three-dimensional (3D) form. They include perspective (apparent size being dependent on distance), occlusion (things in front hide what's behind) and atmospheric effects (distant objects appear hazy). These and several others help us to make sense of the 3D

world. Many of these clues are also present in two-dimensional displays, for example those provided by photographs and TV screens. They enable us to achieve a 3D assessment of what is actually 2D information. The real clue that's missing with a 2D display is stereopsis, the fact that our two eyes see the world from a slightly different angle. Each eye presents a slightly different picture to the brain, which integrates them to produce the sense of visual depth.

An attempt to present two slightly different images to our eyes is the basis of all 3D systems. Some have used glasses that provide differential filtering of the input to each eye, or separate displays mounted directly in front of each eye. Others, called autostereoscopic, avoid these impositions on the viewer but impose other restrictions: either the viewer has to remain in one fixed position or, where movement is possible, the effect is limited to one

viewer. The Philips multiview 3D-LCD system is truly autostereoscopic: no headgear is involved, there is freedom of movement for the viewer, and a number of people can use the system at the same time.

The Display

The display device is an LCD panel with, at the front, a sheet that consists of cylindrical (lenticular) lenses, see Fig. 1. The two are aligned so that the focal points of the lenses fall on the LCD pixels beneath. When the viewer's eye looks at a lens perpendicularly, it focuses the eye on the portion of the LCD in the middle beneath the lens. The other eye will be focused on a slightly different, off-centre part of the LCD. The LCD section behind each lenticular lens consists of a number of subpixels. The eyes are thus focused on different sets of subpixels. By arranging for different picture information to be applied to these sets of pixels, a stereoscopic pair of images

Fig. 1: Basic arrangement of the 3D display panel. A lenticular lens sheet is positioned in front of an LCD panel.

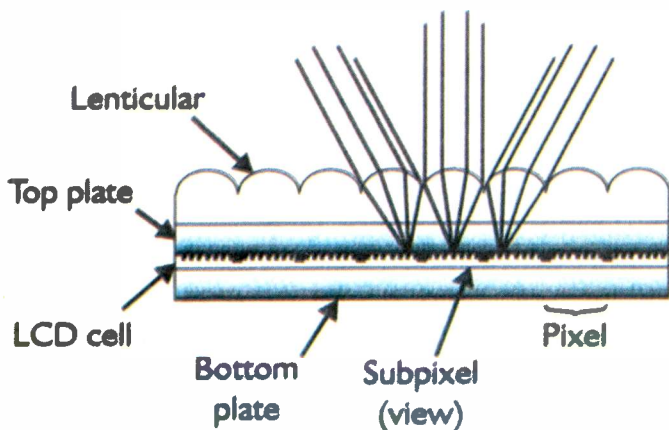

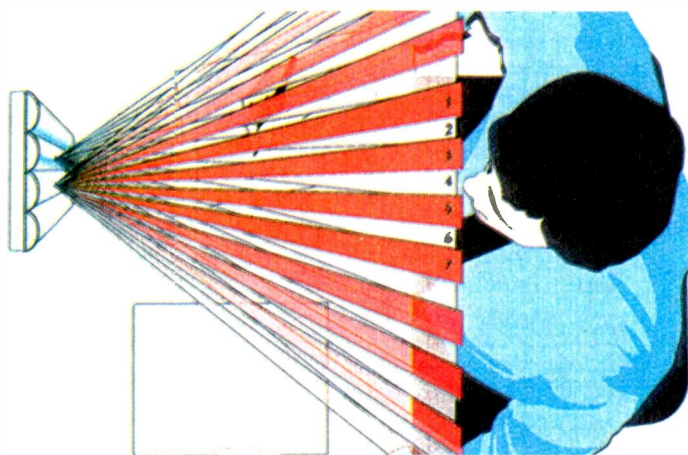

Fig. 2: How the lenticular lenses project a 3D display for viewers.

is produced and the viewer sees a 3D display. This is a somewhat simplified account of the way in which the system works. In particular, instead of a pair of images the system creates seven different 'views'.

Fig. 2 illustrates in more detail the operation of the Philips 3D-LCD system. The use of a lenticular lens is not new, but in the past there have been problems with this type of lens. First moiré-type patterning: the viewer sees dark bands because of the black spaces between the LCD pixels. And secondly uneven use is made of the LCD display's horizontal and vertical pixel resolution. Various steps taken by the Philips researchers have resolved these problems.

Each lenticular lens projects light from the pixels behind it into the space in front. With the viewer in the position shown in Fig. 2, his left-hand eye sees one set of subpixels and his right-hand eye another set. Every lens in the array acts in this way. As a result, in the field of view in front of the display there are overlapping images from the sets of subpixels.

The problem of the gaps between the subpixels being magnified by the lenses, creating gaps in the views, has been overcome by positioning the adjacent lenses so that the pixel images are interspersed rather than simply overlapping. The result is a continuous view without gaps.

In Fig. 2 the subpixel views from the lenticular lenses have been numbered one to seven. From the viewer position shown, the lens to the left produces odd-numbered views and the lens to his right even-numbered views. When the viewer's left-hand eye sees view five, his right-hand eye sees view three. If he should move slightly sideways to the right, the view at his left-hand eye will change to four while the view at his left-hand eye will change to two. His eyes are

therefore still presented with different pictures, maintaining the stereoscopic view. The system allows unrestricted head movement with no loss of the 3D effect.

The viewing zone is maintained because, when the display is viewed at larger angles, the lenses project not only the image pixels immediately beneath them but also the pixels beneath adjacent lenses. This in effect creates a succession of viewing zones, in which the views (one to seven) are repeated continuously with sideways movement. This point is of great importance: it means that the display can be shared by a number of viewers at the same time.

Lens Slanting

Interspersal of the odd- and even-numbered views is achieved by aligning the lenticular lenses at a slight angle (9.46°) with respect to the underlying pixel arrangement. This is illustrated in Fig. 3. The dashed lines illustrate how the LCD pixels are grouped to produce the different views.

Because the LCD is at the focal point of the lens system, positions in the display plane correspond with a certain viewing angle. Thus all points along dashed line A are seen simultaneously by one of the viewer's eyes at one viewing angle. Line A corresponds with a position at which view three pixels are seen. Beneath each lenticular lens, the view three pixels occur on alternate rows. Line C illustrates an alternative position where view four pixels are seen.

As a viewer's eye moves between positions corresponding with lines A and C, a changeover is seen as view three fades out and view four simultaneously fades in. This smooth transition creates the illusion of a solid object rather than producing a succession of discrete views that flipping

from one to another.

Seven-view 3D-LCD

Philips Research at Redhill has built a number of prototype displays using the system described above. One version uses an XGA LCD panel from the Philips and Hosiden Display Corporation with a lenticular lens sheet manufactured by Philips Optics. The specification for this version is as follows:

LCD: 14.5in. diagonal with a resolution (pixel count) of $1,024 (x3) \times 768$. The subpixel pitch (μm) is 96×288 . A total of 262,144 colour shades can be displayed.

Lenticular sheet: Size $260 \times 210\text{mm}$, pitch $331\mu\text{m}$, focal length 0.99.

Overall: Seven views, resolution/view $438 \times 256 \times \text{RGB}$, viewing range 300-1,500mm.

In the prototype design the lenticular lens magnification factor was chosen so that next nearest neighbour views, for example two and four, are projected to the right and left eyes respectively at the specified working distance. Because of this the crosstalk between views inherent with a slanted lenticular lens does not become interocular crosstalk. With an interocular distance of 65mm, the magnification factor is 677. The pitch of the cylindrical lenses is measured perpendicular

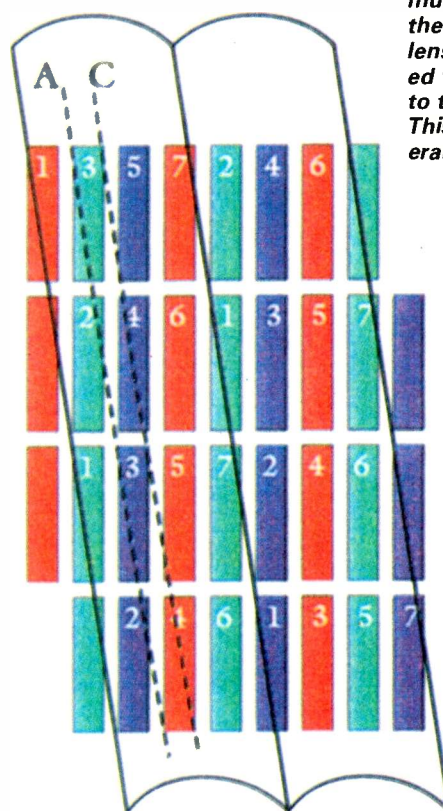

Fig. 3: To achieve the required multi-view effect, the lenticular lenses are slanted with respect to the LCD pixels. This confers several advantages.

Answer to Test Case 449 - see page 409 -

While digital TV has, for the present at least, taken the need for receiver repair out of the hands of the independent dealer, it is nevertheless producing some nasty problems. Their solution seldom brings any profit to the independent dealer or service technician.

In this case however there was some profit for the workshop, because the grumbling, scapegoat-seeking Mr Sands had to pay for the work carried out by Cathode Ray - after Ray had been given some guidance and suggestions on his return to the workshop.

The picture-freezing and streaking effects were caused by a shortcoming of some sort in the download cable, which the Sky installers had re-used. Mr Sands had experienced intermittent sparkly trouble with his previous analogue reception, but had never let on about it to anyone. Ray solved this problem with a new run of CT100 cable. He installed two runs in fact, because he fitted a second LNB, a new 80cm offset dish and a special bracket to support the extra LNB at an angle of 9°. With this arrangement reception from 19.2°E and 28.2°E via a single dish proved to be practical and successful.

The cause of the bad recordings of some movie broadcasts was Sky's use of the Macrovision anti-copying system with some films broadcast digitally. Mr Sands solved this problem himself - with a 'sync-cleaner' gadget he bought by mail-order.

NEXT MONTH IN TELEVISION

Digital camcorders

The digital camcorder must be about the ultimate in sophisticated consumer electronic technology. You will want to know what's involved, even though there is little that most of us can do should a fault occur - servicing requires a considerable investment in test gear. Steve Beeching became involved at the start, when the JVC GR-DVI was launched. Who better to explain this new technology!

Blumlein, inventor extraordinary

Alan Blumlein, inventor of stereo sound and co-inventor of radar and modern television, was one of the most significant engineers of the twentieth century. Yet following his death in 1942 his work was shrouded in secrecy. He received neither obituary nor tributes. Robert Alexander's article is based on his book *The Life and Works of Alan Dower Blumlein*, the first comprehensive biography of Blumlein.

The ER Show

Last month's ER Show at the NEC saw the launch of much new and innovative equipment in the brown goods field. Advances in display and other technologies were on show. George Cole was there to report for us.

Promoting your business

There are many ways in which a local repair service can increase its business. Some represent good value for money, but others may not even return the investment. Paul Smith makes some suggestions and compares alternative approaches.

PLUS ALL THE REGULAR FEATURES

TELEVISION INDEX/DIRECTORY AND FAULTS DISCS PLUS HARD COPY INDEXES & REPRINTS SERVICE

INDEX DISC

Version 8 of the computerised Index to TELEVISION magazine covers Volumes 38 to 49 (1988-1999). It has thousands of references to TV, VCR, CD, satellite and monitor fault reports and articles, with synopses. A TV/VCR spares guide, an advertisers list and a directory of trade and professional organisations are included. The software is quick and easy to use, and runs on any PC with Microsoft Windows or MS-DOS. Price is £36 (supplied on a 3.5" HD disc). Those with previous versions can obtain an upgraded version for £16. Please quote the serial number of the original disc. See the CD-ROM offer below.

FAULT REPORT DISCS

Each disc contains the full text for television VCR, monitor, camcorder, satellite TV and CD fault reports published in individual volumes of TELEVISION, giving you easy access to this vital information. Note that the discs cannot be used on their own, only in conjunction with the Index disc: you load the contents of the Fault Report disc on to your computer's hard disc, then access it via the Index disc. Fault Report discs are now available for:

Vol 38 (Nov 1987 - Oct 1988); Vol 39 (Nov 1988 - Oct 1989);
Vol 40 (Nov 1989 - Oct 1990); Vol 41 (Nov 1990 - Oct 1991);
Vol 42 (Nov 1991 - Oct 1992); Vol 43 (Nov 1992 - Oct 1993);
Vol 44 (Nov 1993 - Oct 1994); Vol 45 (Nov 1994 - Oct 1995);
Vol 46 (Nov 1995 - Oct 1996); Vol 47 (Nov 1996 - Oct 1997);
Vol 48 (Nov 1997 - Oct 1998); Vol 49 (Nov 1998 - Oct 1999).

Price £15 each (supplied on 3.5" HD discs).

FAULT FINDING GUIDE DISCS

These discs are packed with the text of vital fault finding information from TELEVISION - fault finding articles on particular TV chassis, VCRs and camcorders, Test Cases, What a Life! and Service Briefs. There are now three volumes, 1, 2 and 3. They are accessed via the Index disc. Price £15 each (supplied on 3.5" HD discs).

COMPLETE PACKAGE ON CD-ROM

The Index and all the Fault Report and Fault Finding Guide discs are available on one CD-ROM at a price of £196 (this represents a huge saving). Customers who have the previous CD-ROM can upgrade on CD-ROM for £46 (other customers call for a quotation). Please quote the serial number of your disc when you order.

REPRINTS & HARD COPY INDEXES

Reprints of articles from TELEVISION back to 1986 are also available: ordering information is provided with the Index, or can be obtained from the address below. Hard copy indexes of TELEVISION are available for Volumes 38 to 49 at £3.50 each.

All the above prices include UK postage and VAT where applicable. Add an extra £1 postage for non-UK EC orders, or £5 for non-EC overseas orders. Cheques should be made payable to SoftCopy Ltd. Access, Visa or MasterCard Credit Cards are accepted. Allow 28 days for delivery (UK).

SoftCopy Limited,

1 Vineries Close, Cheltenham, GL53 0NU, UK.

Telephone 01242 241 455.

Fax 01242 241 468.

e-mail: sales@softcopy.co.uk

Web site: <http://www.softcopy.co.uk>

TV

Fault Finding

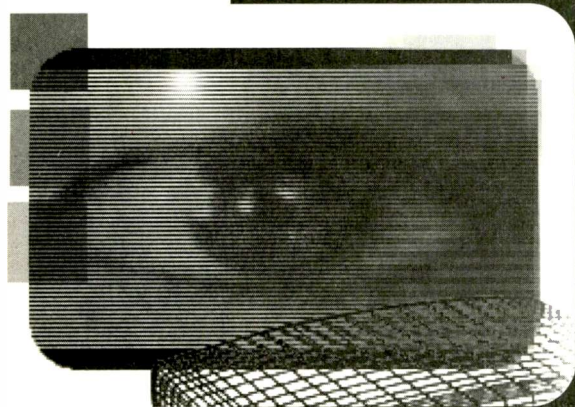

Reports from
Andy Barkley
Gerry Mumford
Michael Dranfield
Mike Leach
Colin J. Guy
Paul Hardy
Bob Longhurst
Graham Colebourn
Paul Smith
Adrian Williams
Michael Maurice and
Adrian Farnborough

Sharp 66CS03H

If you find that the line output transistor in one of these sets is short-circuit, it's vital to replace C604 in the line timebase and C714 in the secondary side of the power supply as well. Also unclip the scan coil PCB and check for dry-joints. **A.B.**

Bush 2857NTX

"Bang, dead, smoke" summarises the customer's fault report. A look inside showed that the workmanship and build quality were very similar to that of the widely-used Onwa chassis. A quick comparison between the circuits in the Bush manual and the Grove Farm Publications Onwa manual showed many similarities.

The bang and smoke were caused by C925 (1,000 μ F, 25V) and C926 (22 μ F, 160V), both of which had literally blown their tops. R916 (0.68 Ω , 1W safety) was open-circuit. These components are all on the separate power supply panel, which is very convenient to work on. With the Onwa fault history in mind I checked C910 (47 μ F, 25V) whose ESR was high. I then set to and replaced all the components that corresponded with those known to be unreliable in the Onwa

chassis. The set has since given reliable operation. **A.B.**

Thomson 28WS23U (ICC17 chassis)

Two of these nice 28in. widescreen sets came in recently. The complaint with the first one was excessive width and EW bowing. I found that the BD241C PIN output transistor TL41 was badly dry-jointed. As a result, the BYW76 PIN output diode DL22 was short-circuit (the reading was 10 Ω). Once the diode had been replaced and the transistor resoldered there was a perfect display. The problem with the second set was no sound. It was being muted because the surface-mounted BC847B transistor TS81 was leaky (measured 100 Ω) collector-to-emitter. **G.M.**

Sony KV21X4U (BE5 chassis)

Although this set appeared to be totally dead its power supply was running. But the outputs were all really low and were falling steadily. Obviously there was something amiss in the feedback loop, and fortunately a replacement SE135N error amplifier chip (IC601) cured the problem. The set then worked all right until it was put into standby, when it whined loudly and a small raster was faintly visible in the centre of the screen. The power supply was not being shut down completely in the standby mode because the 2SC2389S switching transistor Q603 was short-circuit base-to-emitter. **G.M.**

Decca/Tatung 190 Chassis

This portable powered up and displayed a peak-white raster with flyback lines for a few seconds, after which there was partial field collapse before it finally shut down. When the first anode control was set at minimum the set ran stably,

just displaying the peak-white raster with flyback lines. In this condition there was about 2V at the tube's cathodes. R201 (8.2 Ω , 0.5W) in the feed to the RGB output stages was open-circuit. The set worked normally once R201 had been replaced and the first anode control had been reset. **G.M.**

Hitachi G8Q Chassis

Most of this set's picture was obscured by a white, liney mass that gradually faded away after a few hours. The 200V supply to the RGB output stages was found to be noisy and low (82V) because the relevant reservoir capacitor C720 (4.7 μ F, 250V) had dried up. **G.M.**

Grundig P45-540 (CUC5301 chassis)

This portable had a strange on-screen display fault. When a signal was tuned in the OSD appeared colourless and there was just a dim outline of all graphics in the same colours as the picture background. When the picture was blanked because of no aerial input signal etc. the multi-coloured OSDs were perfect. After many inconclusive tests I replaced the TDA3566 colour decoder chip IC2541 in desperation. Fortunately this cured the fault. **G.M.**

Toshiba 218D9B

There was sound but no picture. When the setting of the first anode control was advanced a blank raster with flyback lines appeared. I carried out some checks around the TA8659N timebase generator/colour decoder chip and found that the sandcastle pulse was missing at pin 35. When I traced the source back to the line output stage I came to C410 (2,700pF) which had line pulses at one end but not the other. It wasn't faulty however, just dry-jointed at one end. You'll find it

under the plastic frame around the line output transformer. **M.Dr.**

Matsui 21VIN (Grundig CUC7350 chassis)

Failure of the expensive IRFBC40 chopper MOSFET was mentioned in the March issue. The usual cause of this is a dry-joint at C60029 (470pF) in the associated snubber network. To avoid bounces, this point should always be checked. In addition it's wise to replace R60027 and R60028 (both 0.46Ω) as they can change value. The result is a tripping set. Also replace R60022 (10Ω) and the following 1N4007 diodes: D6011-14 and D60023-24 – they tend to go short-circuit. **M.Dr.**

Samsung CI5373Z

If you find that the SMR40200 chopper IC in one of these sets is faulty you will also have to replace the HC801 hybrid IC with the newer, modified type HIS0169C and the R2K avalanche diode on the secondary side of the power supply. **M.Dr.**

JVC CY21EK

Intermittent return to standby was the complaint with this set. It took three sessions in the workshop to finally establish the cause. This was loss of line drive from the STV2116A chip IC401 because of a dry-joint at the ceramic resonator X401. **M.Dr.**

Philips 14CT2206/255 (CTX-E chassis)

Despite their age these sets still produce a better picture than a £99 supermarket special. This one would search tune but wouldn't stop when a station was found. I discovered that pin 1 of the LM339N quad op-amp chip IC7830 on the VST panel didn't go low when the search button was pressed. A new LM339N chip cured the problem. As a quick check, short pin 1 to chassis when the set is tuning. **M.Dr.**

Hitachi C2514TE

The off-air sound and picture were OK but in the AV mode there was only a hiss on the sound and the video level was low. As in most modern sets the AV switching is complicated. If you encounter similar problems, try the two transistors mounted just to the right-hand side of the scart socket first. They are Q005 and Q007, both type 2SC3413. A BC639 seems to be a suitable replacement and, as the pin

configuration is the same, it just slots in. **M.L.**

Sony KVA2922 (AEIC chassis)

Intermittent start up was the symptom with this heavy monster. I've found by experience with this chassis that resoldering all the many common dry-joints will often cure a problem but may sometimes mask another one: while doing the resoldering, I've heated up sections of the power supply where capacitors have dried up, so the problem has returned at a later date. It's a good idea to replace C605, C608, C611 and C617. They tend to dry up and cause intermittent problems. **M.L.**

Philips 28PW9623/05 (MD2.25 AA chassis)

After tube replacement because of an internal short this set would work only in the service default mode (SDM). The standby light would flash quickly, and the set would refuse to come on. To enter the SD mode you have to short out the two test pins on the small signal panel. To cut a long story short, the IRF620 FET 7470 that controls the 140V supply switching was leaky. It's on the large heatsink at the centre of the chassis. **M.L.**

Bush 2020T

There was no teletext but when 'mix' was selected page 100 would appear, line by line, over a period of several minutes. It was floating instead of being synchronised with the picture. The cause of this strange symptom was the VAD1250 chip IC01 on the text panel. **C.J.G.**

Matsui 1436/Bush 2004

There was no colour and a streaking effect on the left-hand side of the screen. It was rather reminiscent of a fault one used to get with the Thorn 3000 chassis! The cause turned out to be C318 (2.2μF, 50V), which is connected to pin 12 of the TA7698AP timebase generator/colour decoder chip IC301. **C.J.G.**

Ferguson B14R (TX80 chassis)

There was a buzzing noise, a weak, narrow raster with a hum bar, and the word 'lock' was just visible. The cause of the main problem was that DP15 (1N4001) was open-circuit. It's one of three series-connected diodes in the base drive coupling to the chopper/line output transistor TP10. A new diode brought up a full raster: child lock

was released by using the remote control unit to switch to standby then back on again. **C.J.G.**

Tatung B Chassis

This set was dead with no activity from the power supply. A check at pin 7 of the UC3844A chopper control chip IC801 produced a low reading of 7V. The two start-up resistors were OK, and a new chip made no difference. The cause of the trouble was D807 (1N4148), which takes over from the start-up resistors to supply IC801 once the power supply is up and running. It had turned itself into quite an effective 7V zener diode! **C.J.G.**

Hitachi C2558 (GQ8 chassis)

The problem with one of these sets was repeated failure of the TDA3654 field output chip, at intervals of about a month. I eventually discovered that there was an almost indiscernible dry-joint at one of the tags of the scan coils.

Incidentally when this chip has to be replaced in any set it's a good idea to replace the electrolytic capacitor connected to pin 6 (fly-back boost) as well. The usual value is 47 or 100μF. **C.J.G.**

Sharp C3720H

There appeared to be tuning drift and, sure enough, I found that the 33V supply was varying. Someone had used a TAA550 as a replacement for the stabiliser IC1003. The correct replacement is type IX0037CE, which I didn't have in stock. A ZTK33 was pressed into service and proved to be able to do the job. I've found that the ZTK33 is far more effective than the old TAA devices. **P.H.**

Philips 21PT166B (AA5 AB chassis)

This set had been left in standby while its owner was on holiday. When he came back it wouldn't respond to remote control commands or do anything else. The outputs from the power supply were all OK, and a new ST24C02CP EEPROM chip restored response to remote control commands. There was no line drive however. Checks around the multi-function TDA8361 chip IC7015 proved that its supplies were present, but there was no line drive output at pin 37. A new chip cured this. Then, a few moments later, the green output stage on the CRT panel suffered a burn up. This model is fitted with a narrow-neck

CRT. Transistors 7245 and 7275, diodes 6275 and 6278, and resistors 3254, 3276 and 3270 had to be replaced. **P.H.**

Sharp 51AT-15H (5BSA chassis)

The customer complained that this set would go off intermittently. Lots of poor joints required attention, and R611 (3.3k Ω , 0.5W safety) in the line scan circuit was replaced as it had changed value to 2.5k Ω . The set then worked for several days without incident. It was sent on its way, but was back again a couple of weeks later. Fortunately this time the fault was permanent. There was no line drive, with the base of the line output transistor biased at -7V. Checks around the timebase generator/colour decoder chip IC801 revealed that its 5V supply was missing at pin 35. It comes from regulator transistor Q708 (BC338-40) which was open-circuit. **P.H.**

Goodmans VN6000

This set was dead: I was told that the fault had previously been intermittent. I'd no circuit, and some quick checks failed to reveal anything amiss. The obvious thing to do was to investigate the capacitors in the power supply. Both C822 and C823 were low in value, recording a significant loss when checked with a bridge. Replacement with 105°C types cured the problem. **P.H.**

Bush 2114T

Intermittent loss of the picture was the fault with one of these sets. The cause was the TDA3562A colour decoder chip. These sets use the TDK version, which is no longer available. There seem to be several ways of persuading a non-TDK chip to work in this and other sets that use it, the easiest being to connect an 820k Ω resistor between pins 1 and 19. The picture is then fine, but teletext is slightly brighter than normal. As sets that use this chip are getting on in years, customers don't mind so long as the repair is cheap. **P.H.**

Matsui 1407

For no sound, replace the audio output transistors Q351 and Q352 then carry out the following upgrade. Locate the two surface-mounted resistors that are in series adjacent to the replaced transistors. One is 150 Ω (151), the other 1k Ω (102) or 1.5k Ω (152). The higher-value resistor has to be replaced with a 180 Ω resistor. Unfortunately these

components are not marked on the PCB, but R358 is the circuit reference number of the resistor that has to be replaced. **B.L.**

Mitsubishi CT14MS1TX

The complaint was inability to tune and store channels. I initially found that the raster blacked out every time a remote-control command was transmitted. When the set was eventually tricked into entering the tuning mode the symptom corresponded with the complaint.

Various tests were inconclusive but, bearing in mind microcontroller system faults in other sets with the same symptoms, I decided to replace the X24C04P EEPROM chip IC702. Once a replacement had been fitted the set was happy to tune and store channels etc. **B.L.**

Akura CX5

There was no sound, so I started at IC621. Voltage checks showed that there was only 4V at pin 9, though my data books indicated that 17V should be present here. With no circuit diagram I had to trace the voltage source by following the copper print. This took me to a vertically-mounted power supply subpanel, where D810 was burnt up. As no short-circuits were apparent, I fitted a 1N4007 and switched the set on. Perfect sound burst forth and a prolonged test proved that all was now well. **B.L.**

Matsui 1403

The screen would occasionally go blank. Tapping the PCB would then cure the fault. The cause was service switch S301. The simplest course was to remove it and solder wire jumper links across the PCB holes. **B.L.**

Sony KV27XRTU (5X chassis)

There was cramping and foldover at the top of the screen. The cause turned out to be C563 (3.3 μ F, 160V), which is the reservoir capacitor for the supply to the discrete component field output stage. **B.L.**

Sony KV29FIU (BE3D chassis)

There was no picture or sound and the LEDs didn't light. But there was unregulated HT, and some power supply outputs were present. The voltage at the cathode of the HT rectifier D609 was low at 24V instead of 135V. The reading at the cathode of the 8V rectifier D610 was 9V. This supply feeds the L4941BV 5V standby regulator

IC604. There was no output from this chip, and no short to chassis across its output. A new regulator restored normal operation. **G.C.**

Unimor OTC M651TS

This Polish TV set was made by Gdanskie Zaklady Electroniczne, so it was a complete stranger to me. Built in 1994, it's a relatively modern and well-made stereo set (not Nicam) that was bought in Germany. The 24in. FST tube is of Philips manufacture. It arrived in the workshop with a note that said "dead". But the set did select and display programme numbers, and the standby mode worked.

Checks inside revealed that various supplies were present, including the 144V rail. But the 15V supply from D508 was missing. This diode is linked to the chopper transformer via an 0.1 Ω resistor, R521. The solder joint at one end of it was cracked, probably because a 470 μ F capacitor was glued to the top of it. You often find cracked joints where components have been glued in place.

If you need to convert the set to UK 6MHz sound, fit a Sharp RFILC0084CEZZ (WV27049B) four-pin filter in position FC104 and adjust the core of coil L104 about one turn anticlockwise to maximise the output from the discriminator. **G.C.**

Matsui 1436/Bush 2004

When this set was switched on there was no picture or sound. After a while a very faint raster was discernible, with horizontal foldover in the middle. The EHT was low, and the tube's heaters barely glowed. There's an 0.5 Ω , 0.5W resistor, R756, in series with the base of the line output transistor. It was either faulty or dry-jointed, because fitting a replacement cleared all the symptoms. **G.C.**

Bush 1402/Alba CTV840

This set would shut down intermittently. In the fault condition all three outputs from the power supply (112V, 16V and -55V) were present, and the standby relay stayed closed. But there was no line drive output at pin 20 of the TDA8718 chip IC301, though the 9V start-up supply was present at pin 21. The cause of the problem was at pin 19. A 500kHz ceramic resonator is connected between this pin and chassis, via a 390 Ω resistor (R313). The connection at one end of this resistor was unreliable because the wire was too short to

have been soldered properly. G.C.

Mitsubishi C28C7B (EE3 chassis)

Another dealer had replaced the S2055N line output transistor because it was leaky, but had been unable to restore the line drive. Voltage checks in the driver stage showed that Q551 was fully conductive, as its base was at 0.75V instead of 0.4V. Tracing back I came to Q501, which is labelled 'H. Drive 1' – its input comes from pin 12 of IC202. The voltage at the collector of this JC501-R transistor was higher than it should have been. A replacement restored correct bias at the base of Q551 and normal line drive. P.S.

Matsui 2199N

At switch on the standby LED flashed and there was a motorboat sound from the loudspeaker. After a blast from the workshop hairdryer the set would come on and operate normally. It wasn't long before the cause of the problem was narrowed down to the reservoir capacitor in the 11V supply, C541 (22 μ F, 50V).

We weren't finished yet however. When the set was switched to standby the line output stage continued to run. The culprit this time was the HT switching transistor Q503 (2SC4160) which was leaky. P.S.

Huanyu 37C2

We still see a fair number of these ageing Chinese manufactured sets, which are based on the Hitachi NP82CQ chassis. This one would only squeal at switch on. I initially suspected the LOPT, but routine voltage checks revealed that there was no supply at the line driver transformer. R786 (2.4k Ω , 2W) was open-circuit.

A few days later another of these sets came in with the same symptoms. This time there was no supply to the timebase generator chip IC701 because R710 (10k Ω , 3W) was open-circuit. P.S.

Akai CT2137 (11AK10 chassis)

There was greatly reduce field scan, in fact only an inch in the middle of the screen. No fault could be found in the field output stage, and the TDA8362 IF/colour decoder/timebase generator chip IC401 seemed to be OK. The scan could be temporarily restored by touching pins 41, 42 and 43 of this chip with a finger. Pin 43 is the field ramp generator pin, which is

fed from the 33V rail via R442. This supply was missing. It's derived from the 149V line via 5D1, 5R16, 5R99 and a few other components. The cause of the problem was that 5R16 (8.2k Ω) was open-circuit. A.W.

Sharp CS Chassis

Line output transistor failure is occasionally experienced with this chassis. A repair kit with ten components is available to prevent a repeat performance. The part number is 51CSCHASSISKIT for sets with 51cm tubes, 59CSCHASSISKIT for the 59cm version. A.W.

Orion TV400

The chassis used in this model appears to be of Philips manufacture. A customer who brought one in for repair said there was no sound or picture after a storm. The cause of the trouble turned out to be the 8V regulator chip IC7016. A.W.

Toshiba 285T8

At switch on there was a blank raster and no sound. There were also no lights at the front and no response to remote-control commands. The set has two chopper power supplies, the main one and a sub power supply for standby operation, powering the microcontroller chip. The voltages on the secondary side of this latter power supply were very low. Tests suggested that the cause was on the primary side of the circuit.

After checking many components I was getting nowhere. Before giving up however I made the power supply turn on hard by reducing the value of the chopper transistor's emitter resistor, then looked to see where the smoke came from. It wasn't long before I found that C832 (330pF, 2kV) had a small pinhole in it. A replacement, with the emitter resistor restored to its correct value, produced normal operation. C832 is part of the snubber network. M.M.

NordeMende 3038

This set was dead apart from the standby light, which lit briefly at switch off. The cause was RP42 in the power supply – it was open-circuit. The chassis in this set is either the Thomson/Ferguson ICC5 or something very similar. M.M.

Philips 21GR2552 (G90AE chassis)

At switch on all you got was a popping sound from the speakers. The

cause was one of the 47 μ F, 250V HT reservoir/smoothing capacitors C2630/31. Normal operation was obtained when they had been replaced (if one has failed the other will be on the way out). M.M.

Panasonic TX28A1 (Alpha 2W chassis)

Picture pulling to the right-hand side was the complaint with this set. Fortunately the customer phoned me as soon as it started. The cause was dry-joints at the line driver transformer. Had the condition been left unchecked, the line output transistor and fuse link would have failed. M.M.

Mitsubishi CT25M1

A juddering raster will be familiar to those who remember the Philips G8 and Rank A823 chassis. With this Mitsubishi model the usual cause is the 4 μ F, 25V chopper drive capacitor C906. It leads a hard life and is best replaced whenever one of these sets comes in for service. A.F.

Toshiba 211R3B

The main symptom with this set was an extraordinarily large heringbone pattern on the picture. When I studied the screen I noticed that the verticals weren't perpendicular. The cause of the trouble was the mains bridge rectifier's 240 μ F, 400V reservoir capacitor. A.F.

Grundig CUC3800 Chassis

We've had the no sound symptom with several of these sets, and on each occasion the cure has been to replace IC2210 on the stereo board. If you are tempted to use a TBA229-2 in this position, as suggested in some catalogues, don't. It may cause you some heartache. If the original is type U2829B, fit this device. It's available from Willow Vale. A.F.

Mitsubishi CT2525

In our experience these sets are reliable. But you can get some peculiar faults: not starting up from standby; the channel display at the extreme right of the screen in the tuning mode; contrast, colour and/or brightness all at maximum; and suchlike odd faults – all intermittent. The thing to do is to remove the power supply module and inspect the electrolytics visually. There are too many for comfort, but the ones troubling the set can usually be identified by signs of physical distress. Pay particular attention to C956, C959, C962 and C964. If in a quandary, use a scope to check the rails. A.F.

Interactive TV Technology



- 1 Shopping
- 2 Entertainment
- 3 Money
- 4 Information
- 5 Email
- 6 How to use
- 7 Promotions

Open....

Go to

Organiser

K. F. Ibrahim takes a look at the technology that makes interactive TV possible

This article will look at 'interactive TV' applications that require a return path from the viewer to the service provider, for example home banking or video-on-demand (VOD). The path may be via an ordinary telephone line, an RF link or a network cable. In each case some form of interface is required to link the IRD or STB to the return path. With a telephone service the interface will be a simple modem or a terminal adapter.

Interactive football, which was first broadcast by BSkyB, does not require a return path as all the camera angles and additional information (statistics etc.) that the viewer may wish to select are included in the transmission's data transport stream. Since any inset video occupies only a small part of the screen, i.e. a small number of pixels, only a low bit rate is required for it. Few

MPEG packets are therefore required in comparison with the full-screen transmission. The packets are incorporated within the transmitted channel using statistical multiplexing. This enables them to be extracted, decoded and displayed when called up by a remote control handset.

A modem interface is used where the return path is via a conventional telephone system and the information to be exchanged between the user and the service provider is of limited quantity and thus requires a relatively low bit rate – examples are home shopping and banking. Modem operation was covered in a previous article (see *Television*, January 1999 page 206).

VOD

The basic principle of video-on-demand is very simple. Digitised

video information stored on magnetic disks is called up by a video server and delivered to the viewer's home or office, where it is decoded by either a PC or an IRD/STB and used to drive a TV display.

One approach to video distribution is to use several channels (typically ten) to broadcast the same video programme, such as a film, with staggered starting times – say every five or ten minutes. This method, known as near video-on-demand (NVOD), enables the viewer to choose the viewing time within specified limits. With true video-on-demand the viewer has full choice of the viewing time plus VCR-type features such as fast forward, rewind, replay and so on. Applications such as this require a bit rate in the region of 2-5Mbits/sec, depending on the reception quality required, which

K.F. Ibrahim is a Training Consultant and Senior Lecturer at the College of North West London and author of several books including *Television Receivers*.

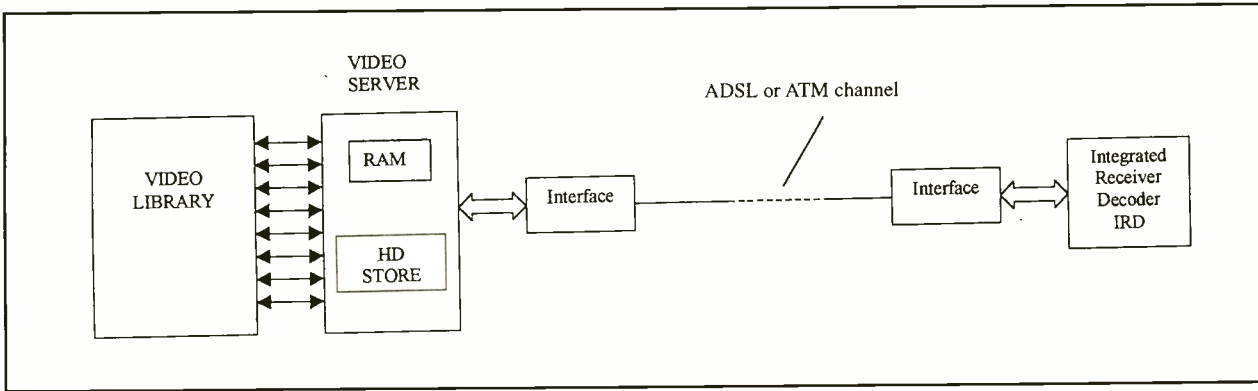

Fig. 1: Block diagram of the basic VOD arrangement.

is far higher than a modem's capability. Hence the need for a different type of interface, used with either an asymmetrical digital subscriber line (ADSL) or asynchronous transfer mode (ATM) technology.

ADSL

With ADSL, data at a rate of 2Mbits/sec can be delivered by the service provider to a customer's IRD/STB at a distance of up to 3km. A 9.6kbits/sec data and control channel is also provided. Because the extra services are modulated on to carriers above the AF band, there is no interference to the normal analogue telephone channel.

ATM

Unlike ADSL, which has a fixed network capacity in terms of the bit rate to the subscriber, ATM can automatically adjust the network capacity to meet the needs of the service required. With ATM the data is divided into small segments that are sent via the network within fixed-size units called cells. All the connections via which the cells travel to and from their destinations are based on 'virtual circuits', so called because the transmission path is not dedicated to the individual connection but instead relies on sufficient transmission resources being available for assignment as required.

Prior to the start of a transmission, the ATM user's interface negotiates a 'traffic contract' specifying the network involved, the data rate and the service quality required for the complete end-to-end link. If the network is overloaded, a request for connection may be refused. This ensures that the negotiated quality for transmissions already in progress is maintained. ATM can operate at up to a bit rate of 622Mbits/sec.

A simple VOD system

Fig. 1 shows the basic elements of a VOD system. The viewer server contains storage devices and control mechanisms that hold video data in MPEG compressed form for playback on request. RAM chips, hard disks or tape can be used for storage. The original programmes are held in a video library.

The server performs a number of functions in addition to playback. These include admission control, request handling, data retrieval, guaranteed stream transmission, stream encryption and support for VCR-type functions such as fast forward.

A basic requirement of the video server is that it can supply the same programme to many users for viewing at different, maybe overlapping times. One way of achieving this is to have many identical copies of a programme, with each one available for separate transmission. Another is to use a technique known as data stripping. The video information is divided up into small chunks which are stored on different hard disks. When different users view the same programme or access different parts of it at different times, the server can retrieve different chunks of the programme simultaneously from the various hard disks.

The process of requesting a video programme starts with the subscriber making a selection from a menu on his TV screen. This request is sent via the control channel to the head-end, where the server authenticates the request, retrieves the MPEG data from the hard disk and feeds it via an interface to the telephone line. The interface is a terminal adaptor which converts MPEG video and audio data into a form suitable for transmission via either an ADSL or an ATM channel to the subscriber.

BACK ISSUES

We have available a limited stock of the following back issues of *Television*:

- 1997** January, February, March, April, May, June, July, August, October and December
- 1998** January, February, March, April, May, June, August, September, November and December
- 1999** January, February, March, July, September, October, November and December
- 2000** January, February, March and April

Copies are available at £3.50 each including postage. Send orders to:

Reed Business Information Ltd.,
Television Back Issues,
Room L302,
Quadrant House,
The Quadrant,
Sutton,
Surrey
SM2 5AS.

Make cheques/postal orders payable to Reed Business Information Ltd.

Test Report

ProVision 8 CCTV



Eugene Trundle takes a detailed look at a modular CCTV surveillance system that could open up new prospects for technicians and independent retailers in these difficult times

The brown-goods servicing industry is at present suffering from a downturn, with repair work dwindling. On the sales side, it's increasingly difficult to make a reasonable profit in the current highly-competitive conditions. All this is making it harder for the smaller operator to stay in business, much less to prosper.

Reduced demand for spares and other service-related equipment has led component suppliers to explore other possibilities for doing business: some are handling ever-wider ranges of components and specialist spares, while others have become wholesalers of finished goods. SEME Ltd. sees opportunities for itself and its customers in the field of surveillance and security, specifically CCTV equipment. This specialist industry is a growing one that's well suited to readers of *Television* magazine. It's not affected by the ever-widening sales activities of the supermarkets, catalogue merchants and mail-order companies, and offers better returns than the meagre handouts digital TV broadcasters provide for contract sales and dish installations.

Description

From the wide range of CCTV equipment available from SEME, the choice for this review was the ProVision 8 system. It consists of a number of modules designed primarily for residential property but also suitable for business and other premises. The most basic and inexpensive setup combines a monochrome camera with a 'distribution module' that interfaces the camera with an ordinary TV set and VCR: the pair cost about £60 trade. At the opposite end of the scale the system can be built up to provide a comprehensive network with eight colour cameras, PIR-detection and auto-latching, auto-sequential switching of cameras, auto-VCR recording on PIR trigger, provision of

time/date/location data on recordings, wireless linking and remote control.

There are fifteen modules in all in the range, the most expensive being colour cameras at about £125. All items can be fitted together with plug-and-socket connectors: the 'black boxes' (switchers, distribution module, remote receiver, wireless transmitter, RF modulator) interlock together via side-mounted, mating 15-pin D-type connectors that carry power, command and feedback signals between them.

Cameras

The cameras have 90mm-diameter circular, black weatherproof housings with mounting brackets and multicore cable (20 or 25m) supplied. Their angle of view can be preset in both planes. They use one-third inch CCD sensors with 330-line resolution, rated at 20 lux minimum for a colour and 0.5 lux minimum for a monochrome camera. A microphone and preset volume control are fitted in the bracket: connection is via a six-pin DIN plug.

Three types of camera are currently available: colour, monochrome and monochrome with built-in PIR detector. A separate PIR unit is available for use with the colour camera: it wires into the camera bracket. The PIR detectors, in conjunction with suitable modules in the system, can do four things: switch the TV set to camera operation via its scart pin 8; switch a VCR on to record whatever has triggered operation; 'pull' an electronic scene-switcher on to the appropriate camera; and activate a sound/light buzzer to draw attention to a visitor or intruder.

Modules

The only essential black box is a distribution module, which comes with a separate 'in-plug' 12V mains unit.

The module acts as an interface between any of the three types of camera and the scart socket of a TV set or VCR. There are two types of distribution module: standard, for a one camera system, capable of triggering light/buzzer and VCR control units, at £7; and expandable, able to cater for one-four cameras, doubling up to eight, at £34. The expandable module has a plug-in facility for time/date and on-screen programming modules, and caters for the VCR controller and light/buzzer accessories. It can be connected in line with four other optional black-box units: a picture sequence switcher (up to two), a remote receiver module, a wireless link transmitter and an RF modulator.

The VCR controller is an IR-learning device that's capable of repeating up to four sequential commands, typically on/select AV/record/stop, when triggered by a PIR detector. It has an extension LED for use in a 'concealed' position. The switcher modules sequentially route video and sound to the TV/VCR from each camera in turn, but jump to any one whose PIR detector has triggered. The channel-adjustable RF modulator has an aerial loop-though facility. To complete the ensemble for set-top use there's a time/date generator at £25 and an on-screen programming module which controls camera sequencing and camera picture labelling.

Remote Control Links

The 'static' modules can all be mounted in the loft or in a secure area if required. For this application there are wireless link transmitter and receiver modules to trigger the light/buzzer and VCR-control modules, and a wireless remote-control link to operate the sequence-switcher, time/date and on-screen programming modules. Both wireless systems have a range of about 25m.

In Practice

In all then this is quite a versatile collection. The system can be extended and updated as required, with no need to discard anything other than a £7 distribution module. I had no difficulty in hooking up the equipment and getting it going – the instruction books and system manual are excellent, simple enough for a DIY layman to follow.

Camera definition is marginally better than VHS playback, with good colour rendering, and the angle of view is well chosen. The monochrome camera has a larger field of view than the colour type. Just enough to introduce a degree of barrel distortion in the picture. It actually sees better than the naked eye (mine anyway) in low-light conditions. The colour camera naturally needs more light to produce an acceptable picture: had I actually carried out an installation I would probably have found a way for the PIR detector to switch on an outdoor floodlight. I found that the auto-contrast control (not iris control) works well so long as the scene is illuminated fairly evenly. The fixed lens focuses from infinity down to about 20cm. These are good cameras, though the definition is not as sharp as with some I've come across.

The four-input switcher modules worked well. They have good dwell-time and PIR-trigger hold-time ranges. When two are used one becomes the master and the other the slave for sequential switching of up to eight cameras. The light and buzzer unit works well in both hard-wired and wireless operation, and is useful where the TV set doesn't have auto picture switching, for instance when the RF modulator is in use.

I tried the VCR controller with a wide range of VHS decks, old and new, and found that it worked with them all. There's an inevitable delay between the triggering outside and the start of recording on tape, while the

machine threads up or at least while the drum runs up to speed. The effect of this delay can be minimised by careful siting and adjustment of the PIR detector and the use of a fast-acting (generally more recent) video deck.

Modulator

The only 'loft' system component with which I was not impressed was the RF modulator. It's very useful for distributing camera pictures and sound all over the premises (without the auto-AV switching feature of course, though the light/buzzer trigger works), but it can be difficult if you want to use an RF channel other than the factory-default UHF ch. 65. This is done by up/down keys, with no indication of the channel in use, and the modulator jumps back to ch. 65 if power is removed even for a moment. This is no fun if the modulator is in the attic and the mains supply is unreliable, or even when it's in the lounge and the user accidentally switches off or pulls out the plug.

I would have been happier with a six-DIP switch to set and hold the output channel, or perhaps a little EEPROM channel-memory.

Remote Control

A neat, minimal handset provides remote control of the system. Its signal penetration was adequate between the lounge and the loft of my solid old house, though I couldn't achieve a full 25m operating distance. The DIP switch security coding means that neighbouring systems can use different codes. The same applies with the wireless-link transmitter.

Opportunities

You can use this system for your shop and repair room, sell it to the public – with a good mark-up – for DIY installation, or use it as the basis of a complete service, designing, installing and maintaining systems that are tailor-made for various customers, who need not of course be domestic householders. This latter approach is the most satisfying and profitable one.

It's amazing how many people don't realise that an ordinary TV set or VCR can be used for CCTV surveillance, with date/time information superimposed as well. They are often staggered by the picture quality a system like this can provide, having been conditioned by the blurry, jerky images shown on TV crime programmes – taken in poor conditions and jumped-through in a time-lapse VCR.

Summary

This is a good system with clever modular construction and excellent prices. It's easy to understand and to install and easy to use, even by the elderly and bewildered. As there are no moving parts and solid-state image sensors are used the system should last well – the only wearing parts are in the customer's TV set and VCR! Apart from the minor criticisms noted above, I was very satisfied with the operation and performance of the whole outfit.

SEME currently has a comprehensive back-up package available for ProVision equipment, including a one-year extendable guarantee, website advertising, leaflets, point-of-sale material, training support information, a manufacturer's helpline and a Business Builder scheme with a five per cent price reduction.

The sample prices quoted in this test report are approximate, available only to the trade and are subject to VAT.

SEME can be contacted on 01664 484 000, fax 01664 563 976 or check the website www.seme.co.uk

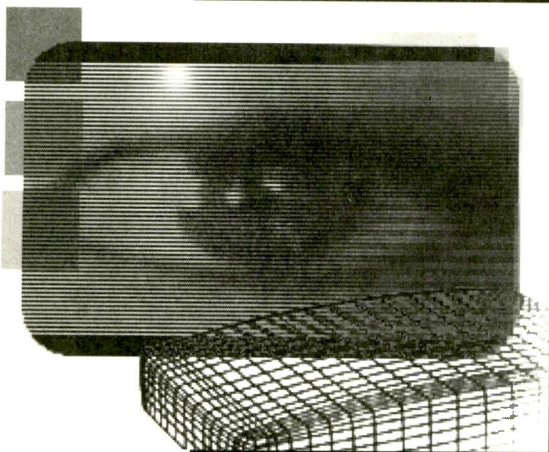

Reports from
Ian Field
Tim Edwards, I.Eng.
Russ Phillips and
Adrian Spriddell

SM785F

This 17in. monitor had no brand name, just the model number and identification KTASM785F. The customer's complaint was that there was "an unusual jitter at the bottom". When I tried the monitor with a standard test pattern it displayed this flawlessly. So I switched to a full-white raster test to see what effect a heavier load had. The result was a white raster that flailed wildly at the edges. This gave me the impression that there was a faulty reservoir capacitor on the secondary side of the power supply or possibly a faulty diode in the bridge rectifier circuit. Scope checks on the secondary side of the power supply seemed to suggest that the cause of the problem was on the primary side: the worst mush on any of the supply rails was at 1.5V peak-to-peak, but the multiple traces indicated that there was a heavy ripple at a much lower frequency.

I haven't had much need for my mains-isolating transformer since I started to concentrate on monitors, but I had to look at the primary side smoothing. The mains rectifier diodes were all OK, and a new reservoir capacitor made no difference. Just this once, I decided to 'lift' the earth lead to the scope. After connecting the scope's prod earth clip to the monitor's hot chassis, initially via a 60W bulb to confirm that there was no fault current, then giving myself a reminder not to touch the monitor chassis and

Monitors

scope at the same time, I began to take some readings.

The ripple across the mains reservoir capacitor was 8V peak-to-peak. This didn't seem to be sufficient to cause a symptom as severe as that displayed, so I moved on. Intending to check the ripple at pin 7 of the KA3842B chopper control chip IC101, I stuck the prod on to the nearest capacitor to pin 2. At the instant the probe made contact the picture went out, then before I had time to panic it reappeared – without the wobble! C114 (1.5nF), which is connected between pins 1 and 2 to provide frequency compensation for the error voltage sensing op-amp within the IC, was dry-jointed. It hadn't looked too good, but felt sound when I had tried to lift it with my thumb during the initial inspection, so I had left it alone. Applying pressure with the probe had revived an invisibly poor contact however. Some attention with the iron and fresh solder made the cure permanent. **I.F.**

Elonex XV17

"Rustles up but no picture" the job card said. Once again this was because P598 and P593 on the video amplifier module (the one with the finned heatsink) had been swapped over. When this had been corrected the picture appeared, but shortly afterwards broke up horizontally, while a quiet 'screaming' noise came from the main PCB. The obvious solution was mass cleaning and resoldering, but unfortunately several areas of the board were plastered with silicone sealant – and the most likely suspect as dry-joints go was lurking under one of the blobs. After scraping off all the silicone and remaking all the solder it was no longer possible to instigate the fault. **I.F.**

Royal X1448

A customer brought two of these monitors along recently. They had both been converted for Atari use. He said that one was dead, the

other too bright. The dead one had the remains of the line output stage's HT reservoir capacitor (1,000µF, 50V) strewn all over the PCB. I assume that the cause had been the dry-joint I found at the chassis pin of the chopper transformer's secondary winding. Fortunately there was no other damage to the power supply, so a new capacitor plus resoldering had the monitor up and running.

The cause of the second monitor's excessively bright display was the BA159 rectifier that produces a scan-derived negative supply for the bottom of the brightness control network. It was open-circuit. Fault-finding was severely hampered by the fact that the PCB was plastered with white glue. I knew that use of thinners was the only way of removing this, but it would also take the markings off the electrolytic capacitors. So I had to identify all these first, in case any had to be replaced. What I didn't expect was that the thinners also took the screen print off the PCB! The BA159 diode concerned is in the corner, between the LOPT and the chassis metalwork. The associated reservoir capacitor had become detached because the copper pad had severed around the solder fillet.

While all this work was going on the monitor was powered up for several minutes at a time to take voltage readings. During one of these power-on occasions the BYT56M rectifier for the LOPT's HT supply failed without warning. As I didn't have one in stock I fitted a BY329-1200. This is a TO220-style device, rated at about 6A, with an adequate reverse-recovery speed for modern SVGA monitors, so I was surprised to find how hot it ran. As the situation improved once the brightness fault had been cured I left the diode in place. **I.F.**

Magnilink

There is no model number for this equipment, which is sold as an aid

for the partially-sighted. The machine resembles a microfiche reader, but uses a mono monitor instead of being purely 'optic'. The complaint was no picture.

On test the CRT's heaters lit and the LOPT was operating, so checks were carried out at the CRT base. The voltages at pins 6 and 7 (anodes 1 and 3) were very low. They come from a common 2.2M Ω preset of the square, blue plastic type, which is fed via a green wire from the main PCB. Back on the main PCB I found a 1k Ω fusible resistor and a rectifier circuit that gets its input from the LOPT. The resistor was open-circuit. As there were no faults in the rectifier circuit I replaced the resistor, which failed at switch on. When I checked the preset control I found that it read only 9k Ω , though there was no visible sign of damage. I replaced it with a ceramic type salvaged from a monitor.

Once this had been done all that was left was to replace the fusible resistor and set up the focus. **I.F.**

Mesh LM1564

Two of these monitors were brought in with the same fault: they were both dead with the 2SC5251 line output transistor short-circuit and no obvious cause of either failure. In my view the most likely cause would be poor soldering. Although it didn't appear to be that bad overall, some of the joints were beginning to look like sub-miniature crazy paving!

I started with the line driver transformer and the multitude of wire links in the path to the driver transistor. Pay attention to all the TO220-pack devices and the larger rectifiers.

I found that in one of the monitors the fixing screw for the line output transistor was only finger tight. As the heatsink compound was adequate, this probably didn't matter as much as I initially thought. **I.F.**

AST LR14

One of these monitors had a tube with a loose shadowmask. The repair should have been easy, since I had a scrap LR14 with a dud LOPT. I assumed that its CRT was OK – but it wasn't! It produced results that were exactly the same. The original CRT was an Hitachi one, the replacement being one of Chunghwa manufacture.

In desperation I pounced on a scrap IBM 6314-002 which had an Hitachi tube with a similar number

to the original CRT. The scan plug didn't fit, but the wire colours were the same and in the same order. So I cut the plug from one of the faulty CRTs and, with the help of some heatshrink sleeving, grafted it on to the tube from the IBM monitor. When this had been installed I had, much to my surprise and relief, a correctly proportioned and coloured picture. The monitor produced a strikingly crisp display once the grey-scale and focus had been set up. **I.F.**

Belinea 104010

The complaint was no picture. My initial impression that the contrast was set at minimum turned out to be correct. The other preset functions were also corrupt, and the CRT emission appeared to be rather dubious – though the grey-scale came right as the tube reached its full operating temperature. Heater behaviour improved when C167 (1,000 μ F, 16V) in the supply had been replaced. I also added 0.22 μ F, 63V Mylar capacitors across C167/8. The tube's emission recovered well when the monitor was left on overnight displaying a peak-white test pattern. Even a grey-scale setup was unnecessary.

As there was no further problem with the preset memory, and no obvious cause of the fault could be found, I came to the conclusion that the CRT had been flashing over internally at switch on. **I.F.**

Data General CM1414T

Two of these old-timers turned up recently. They were dead because of arced contacts in the on/off switch. It's easy to establish whether this is the cause. With the monitor plugged in and switched on, give the switch flylead a gentle but vigorous wiggle. The switch will make a spluttering noise.

C823 (470 μ F, 25V) and C824 (47 μ F, 16V) should be replaced as a matter of course. There are numerous versions of this Liteon produced chassis, which appears with many different badges, so the component reference numbers may vary. The two capacitors concerned are associated with the 6.3V heater supply, which is also used by the optocoupler. So failure of the capacitors plays havoc with the regulation. This can give a good imitation of, or even cause, LOPT failure.

The other common fault with these monitors is failure of the first anode supply. Note that the A1 preset on the LOPT doesn't do any-

thing, because the supply is obtained by rectifying the pulses at the collector of the line output transistor. Depending on the model, you will find a single 2M Ω or two 1M Ω resistors just inside the metalwork that surrounds the LOPT. The fault occurs because they go high in value. The A1 preset is just the other side of the heatsink. **I.F.**

Unbadged VGA Monitor

This monitor came in with the 6N60E chopper MOSFET Q802 short-circuit and R812 (2.2 Ω) open-circuit. The latter is one of three parallel-connected 1W resistors that are in series with Q802. Unfortunately the MC44605 chopper control chip IC801 had also failed. Once these items had been replaced the monitor worked correctly. It seems to have been made in Turkey, the only identification being Vestel with the number 15AK15-9 on the PCB. **T.E.**

Philips 4CM2789

If there's EHT and frame scanning but no picture, the BUV28 transistor 7615 on the line output board is probably short-circuit. **R.P.**

AOC CM335

For a dim screen or no display, check the value of R729. It should be 15k Ω (0.125W) but goes high in value, up to about 75k Ω . On a couple of occasions when I've had this fault the CRT has also been defective.

A spectacularly blown mains fuse is often caused by a short in the mains bridge rectifier. **R.P.**

AOC CM335

The complaint was pincushion distortion: the actual fault was reduced height, which had been masked by use of the front controls. Replacement of C209 (2,200 μ F, 16V) in the frame timebase restored the height. Caution: there are two capacitors marked C209, half an inch apart. The other one has a value of 220 μ F, 25V. **A.S.**

GoldStar Studioworks 56M

The fault description that accompanied this smart monitor was "goes pink". In fact the blue drive dropped out when running at 1,600 x 1,200 for a few minutes – the display seemed to be OK for hours when running at 640 x 480. The fault was cured by replacing the CVA2417TX IC on the tube base panel. Although unlisted, it should be available from CPC under part no. GSOICG241700A. **A.S.**



We welcome letters from our readers and try to publish as many as we can. You can send them typed, handwritten or on disc. Address them to the Letters Editor, Room L302, Quadrant House, The Quadrant, Sutton, Surrey SM2 5AS.

Registration and the Future

Having read the letters and articles on current conditions in the trade in the March issue of *Television* I would like to add my views. First, I must point out that there will be no future for those in the trade who don't embrace change, which is the only certainty in business. If you don't take this into account and invest accordingly, your business will die. The market, and technology, are forcing upon us as never before changes in the way in which we provide services to customers.

One change that was suggested in your March issue was to introduce licensing for those who offer repair services to the public. When I was Retra President in 1997 we organised a study tour in New Zealand, where such a system is in operation. On our return I discussed the idea with many of those in the service trade here. It soon became clear that the diminishing number of engineers in our trade were not prepared to pay large amounts of money for the satisfaction of being registered engineers, along the lines of the CORGI system. They would rather leave the industry, which was the opposite of what we were trying to achieve. Because of the political climate at the time, there was no chance of funding from government sources.

It is documented in the minutes that I have fought for Retra to investigate the registration of Service Centres. Last year Retra gave permission for a Service Action Team to be formed, with myself as chairman. The outcome of various meetings is that, provided a pilot scheme at present running is successful, a voluntary Registration Scheme will be launched at the Retra Service Conference in July this year.

Letters

It will give us the tools to fight against the cowboys, and provide repairers with a quality service logo that they can display in their windows. Those participating can emphasise this logo to enhance their business, gaining recognition from consumers and manufacturers alike. Safety assurance for repairs will provide customers with peace of mind. Engineers can become Registered Service Centres only if they are Retra members, follow a strict Code of Practice and meet high standards. The introduction of registration will represent a positive step forward. By helping exclude cowboys, the survival in the trade of those registered will be enhanced. I am sure that *Television* will be reporting on the conference, so will say no more about this here.

I accept the view that the industry as we know it is a dying one, especially the traditional way of doing things. But those, fewer in number, who have invested in their business and have set themselves high standards will survive. They will be able to tackle new technology with confidence as it emerges, and get a return on their investment. Because of their own internal cutbacks, it is in manufacturers' interest to support those who register. They won't support those who fail to invest – this is already becoming evident.

Training and recruitment will play a big part in our future. Hopefully, with the support of those who register, these will be high on the commitment priorities of all interested parties.

*Brian McPherson,
Alan H. Goodrick, Ltd., Darlington.*

I read with dismay the call for licensing of engineers (letters, March). It would only help the cowboy, who will continue to trade regardless. The good engineer would become overburdened with more bureaucracy and costs. The introduction of stricter controls would only tip the balance against us. Cowboys have become scapegoats for a general decline in trade.

I feel that the suggestion of licensing is the thin edge of the wedge. Might all trades and occupations in future be restricted and segmented by licence?

We have moved into the computer field, in which I am fully qualified. With licensing it will be more difficult to seek opportunities in new fields. As it is, with

so many people spending £1,000 or more on computers etc. a reasonably price can be asked for any repairs required.

Just recall the old days with board swappers called rental TV engineers. Fixing computers is the same. You can learn very quickly how to repair something like this with no idea of how it works. A fortune awaits those who can understand some of the software.

*M. Thorpe, AHE,
Welling, Kent.*

Naming Names

Although it pains me to say so, it must be admitted that the future of our servicing trade is bleak indeed. In a free market one cannot rationally criticise ever lower prices or, to a certain extent, the increasing complexity of products. Double-sided print, surface-mounted devices, centre-load mechanisms and, worst of all, digital circuitry mean that equipment is now harder to service than ever before.

Bearing this in mind, the number of manufacturers who give no technical help to those who do not have a direct account (even Retra members such as ourselves) is absolutely scandalous. Because of this we advise our customers to avoid the guilty brands, particularly Sony, Hitachi, Philips, Sharp and, now, JVC. We recommend more helpful manufacturers such as Panasonic, Toshiba, Sanyo, Aiwa and the major Korean firms – Samsung, Daewoo and LG/GoldStar.

In all our interests I urge independent service companies to do likewise.

*Justin Smith, ATV,
Hillsborough, Sheffield.*

Line Output Transistors

Further to the comments by M.J. Bennett (April) and R.F. Weston (March), I would like to add that a similar problem occurs when non-original spare parts are used in the Ferguson/Thomson ICC5 chassis. A few months ago I was forced to use a non-original 2SC3892A transistor in the line output stage (TL31). After replacing the tuning capacitor CL48 I left the set on test. A couple of hours later TL31's heatsink was found to be extremely warm. Many hours were spent on tests and carrying out checks before TL31 was replaced with the original type. The temperature then

returned to its normal operating level. Looking closely at the rogue 2SC3892A, I noticed that its body height was shorter than the original type.

Despite being more expensive, one should use only the original spare parts supplied by manufacturers. In the long run it saves both time and money. The direct, official equivalents for the 2SD1546, S2000, S2000AF etc. are the 2SC3892A and now the 2SC5339 – both are supplied by the manufacturer.

On a separate note, the BU1508AX used in the Philips L6.2 chassis should always be replaced with the AX version, not the DX type. Instantaneous destruction will occur if the latter is fitted.

Lastly, when if ever will manufacturers apply more solder to their assembled PCBs? Many, many problems are caused by the dryness and very poor quality and quantity of the soldering. Whatever happened to good old shiny solder joints?!
*Vincent Power,
Gibraltar.*

Moving-iron Meter

Alan Willcox mentioned the use of a 1A moving-iron meter in his article on line output transformer testing (February). Unfortunately the one from Maplin is no longer available and this type of meter appears to be hard to find. One can be ordered from Greenweld Limited however, under part number X7426. It's type no. OFQ0307, made by Iskra. The price is just £3.50 plus £3 post and packing. Greenweld can be reached on 01277 811 042, fax 01277 812 419, or e-mail bargains@greenweld.co.uk
*Martin T. Pickering, B.Eng,
satcure@netcentral.co.uk*

Short Locator

There were a couple of errors in the components list for this project (April 1999). First, the second D1 should obviously be D2. Secondly no type was specified for D3 and D4. There is nothing critical about these diodes: type 1N4148 is suitable. D3 is used as a level shifter, D4 being a DC restorer.

Incidentally we've had a number of commercial power amplifiers in for repair recently. They have had banks of FETs or bipolar transistors, up to ten connected in parallel, with resistors as low as 0.1Ω between them. It can be difficult/impossible, without unsoldering every component, to find out which one(s) have failed when there is a short across the rails. The short

locator has proved to be a real boon in identifying the culprit in this situation, dramatically reducing the time taken to turn round an amplifier.

Commercial repairs now form a high percentage of our work, with intelligent lighting equipment now becoming a feature. DAT and Mini Disc players are on the increase, but I think these are of little interest to most service departments. We increasingly find that many domestic items we are asked to repair are not worth the bother. Turbo deck VCRs just out of guarantee are usually a waste of time, also cheap supermarket TV sets. 14in. SVGA computer monitors can now be bought for £70, making anything other than the simplest repair uneconomic. We can charge up to £40 an hour for working on news-gathering kit, so why burst a gut working on a piece of junk for little reward? The trade is certainly in a bad way at present. I thank heaven that I saw this coming ten years ago and took the decision to pursue theatre and studio work in preference to domestic equipment. That, along with acceptance of almost any assignment as long as we feel we can do a good job at a sensible price, has stood us in good stead.
*Adrian Spriddell,
Micomicon Electronics,
Diss, Norfolk.*

Distribution Amplifier

I have a number of criticisms to make in connection with the distribution amplifier design published in the December issue (page 110).

First the 75Ω resistor shown at the output of the video emitter-followers should be in series with the output, not in parallel. If wired as shown, the transistor's input impedance would be roughly $3k\Omega$ with a load connected. This in itself would not be serious, but with a $3.3\mu\text{F}$ input coupling capacitor, as shown, field tilt would be evident. The LF response is further compromised by the small supply decoupling capacitors. The output impedance would swing between $0.97\text{--}0.83\Omega$ over the 1V video signal excursion. It's more than likely that the transistor would oscillate when a coaxial cable is connected (is this why RF filtering is included in the audio channels?).

An emitter-follower works well as a buffer at low levels, but with a 1V video signal driving a 75Ω load serious differential gain arises. This type of circuit is not really suitable for the job, which is why video op-amps were designed.

Secondly the audio amplifiers have an output impedance of $3.9k\Omega$. The voltage gain, when loaded with $10k\Omega$ as shown, would be roughly 0.66. The $10k\Omega$ resistors are superfluous: without them the gain rises to 0.85.

The power requirement is 28.6mA per video buffer and 0.94mA per audio buffer. Where does the expression $12\text{V}/340\Omega$ (35mA) come from?

*Chris Cory, T. Eng., Tekelex,
Thatcham, Berks.*

Denis Mott writes: The buffer amplifier was designed to distribute video and audio to TV sets at exhibitions and in show-rooms, where the quality did not need to be of studio standard but adequate for the purpose. Several of these units were built and used at the NEC without any noticeable problems. As there were no published designs when these amplifiers were originally designed, the circuit was devised to fill our need. The video output 75Ω resistors should have been in series, sorry about that. The input coupling capacitor could be increased to whatever value might best suit. The audio buffers were given protection with RF chokes to prevent radio pickup with longer runs.

$12\text{V}/340\Omega$ comes from the fact that the supply is at 12V and the total current consumed by the unit was found to be 175mA (measured, not calculated). Divide the current by the number of stages (five) and you get $12\text{V}/0.035\text{A} = 340\Omega$, or $12\text{V}/340\Omega = 35\text{mA}$ per stage. The calculation was included to show the requirements.

Encouragement

As the wife of a once self-employed TV engineer I feel I must write to give encouragement to John Hepworth, Michael Maurice and others who have commented on the sad state of the trade. My husband side-stepped into working for our local Education Authority and now repairs school office and classroom equipment. Most of his colleagues were at one time in the TV and video repair sector. We also find that independent companies which repair industrial electronics equipment advertise vacancies in the local press from time to time. A recent example (Advanced Technical Services Ltd.) stated that "many of our most successful engineers are recruited from a TV and radio repair background". So keep your chins up!

*Christine Skipp,
Cotton End, Bedfordshire.*

Published on the third Wednesday of each month by Reed Business Information Ltd., Quadrant House, The Quadrant, Sutton, Surrey SM2 5AS. **Filmsetting** by JJ Typographics Limited, Unit 4, Baron Court, Chandlers Way, Temple Farm Industrial Estate, Southend-on-Sea, Essex SS2 5SE. **Printed** in England by Polestar (Colchester) Ltd., Newcomen Way, Severalls Industrial Park, Colchester, Essex CO4 4TG. **Distributed** by MarketForce (UK) Ltd., 247 Tottenham Court Road, London W1P 0AU (0171 261 7704). **Sole Agents** for Australia and New Zealand, Gordon and Gotch (Asia) Ltd.; South Africa, Central News Agency Ltd. **Television** is sold subject to the following conditions, namely that it shall not, without the written consent of the Publishers first having been given, be lent, resold, hired out or otherwise disposed by way of Trade at more than the recommended selling price shown on the cover, excluding Eire where the selling price is subject to currency exchange fluctuations and VAT, and that it shall not be lent, resold, hired or otherwise disposed of in a mutilated condition or in any unauthorised cover by way of Trade or affixed to or as part of any publication or advertising, literary or pictorial matter whatsoever.

WILTSGROVE LTD

28/29 River Street, Digbeth, Birmingham B5 5SA
 Tel : 0121 772 2733 Fax : 0121 766 6100
 e-mail : sales@wiltsgrove.co.uk

CORDLESS 'B' Grade PHONE

- User friendly MMI
- Memory Dialling
- Tone Dial switchover
- Register recall
- Key tone On/Off
- Baby call
- Handset lock
- Incoming call priority
- Call transfer
- Call time display
- Paging handset feat.
- Different ring tones

Phones are supplied in original packaging

SPR-5100 Cordless Phone
£29.99

WIDESCREEN TV
 JAPANESE GRADED STOCK

28" from **£279.00**
 32" from **£439.00**

AIWA Brand New Stock

Only **£59.99** each
 Model : LCX137KS

Only **£99.99** each
 Model : NSXSZ20KS

Jamo

SPEAKER RANGE

JAMO D-165 . . . £37.99 each
 CORNET 165 . . . £34.99 each
 STUDIO 170 . . . £69.99 Per Pair
 SURROUND 160 . £39.99 Per Pair

GRADED STOCK

REC-800 Multi-Region DVD Player

Millennium BARGAIN **£159.99**

SATIN GOLD FINISH. COMPLETE WITH REMOTE CONTROL. AUDIO/VIDEO LEADS & 12 MONTHS G'TEE

EX-RENTAL STOCK TELEVISION'S

Plastic Black Cabinet :-
 21" Remote from **£29.99**
 21" NICAM Text from **£34.99**

Electra AWM1100 Eco Spin AutoWash -Washing Machine
 (Graded Stock)

Power Supply : 230V-240V 50Hz »
 Heater : 1950W

- » Main Motor : Tumble 200Watts, Spin 550rpm 450Watts, 1100rpm 450Watts.
- » Spin Speed : 550 or 1100rpm.
- » Height : 84.5cm. »
- » Width : 59.5cm. »
- » Depth : 55.0cm. »
- » Capacity : 4.5Kg (10lb).
- » Water Supply : Hot or Cold.

£129.00 + Vat
 with 12 Months On-site Guarantee

SONY GRADED TELEVISIONS IN STOCK !

TELEVISION BARGAINS
 GRADED STOCK IN THE BOX - AS GOOD AS NEW

ALL SETS ARE IN WORKING CONDITION

Description	1+	5+
14" CTV R/C	£42.50	£39.99
14" Text R/C	£49.99	£44.99
21" CTV NICAM	£74.99	£69.99
28" CTV NICAM	£129.99	£119.99
28" Widescreen	£184.99	£174.99

WHITE GOODS
 NOW IN STOCK
 RING FOR DETAILS

CDTV50
 5" COMBINED PORTABLE TV/CD PLAYER

Amstrad

Only **£34.99** each
£29.99 each

GRADED STOCK

- 5" Black & white TV
- Top loading CD player
- Repeat play
- MW/FM stereo radio
- 20 track programmable CD
- Skip mode

Panasonic 4 Speaker Surround Package

Surround sound speaker package. Power: 15W

Contents :

- 2 x Front Speakers
- 2 x Rear Speakers
- 2 x Front connector wire
- 2 x Rear connector wire

Package Price : **£29.99**

QUANTITY DISCOUNTS AVAILABLE !



SPARES AVAILABLE FOR THE FOLLOWING BRANDS :

AWIA, ALBA/BUSH, GOLDSTAR, FERGUSON, LG, TOSHIBA, THOMSON, HITACHI, JVC, DAEWOO, HINARI, NIKKAI, BEKO, SANYO, TATUNG, THORN, SONY, PHILIPS, PANASONIC, DECCA, PYE, GEC, CROWN, SAMSUNG, MITSUBISHI, GOODMANS, GRANADA, GRUNDIG, NOKIA, FIDELITY, ITT, MATSUI & MORE.....

TRADE ONLY. Offers subject to change without prior notice. Items Subject to Availability, Carriage and V.A.T.

Freefax Orderline : 0500 55 05 05

Tavcom

Have you considered offering
Closed Circuit TV
to your customers?

We have a wide range of training courses which will teach you to install, service, commission and maintain the very latest CCTV systems

Learn with our expert tutors in the comfort of our fully equipped training centre or we will come to your premises. Anywhere – worldwide

For a copy of our new portfolio
Telephone 44 (0) 1489 895099
Fax 44 (0) 1489 894400
Email sales@tavcom.com
Visit our website at
www.tavcom.com

Training

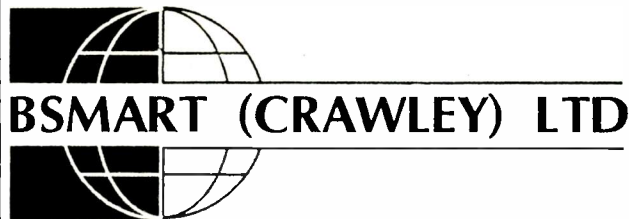

Largest selection of

MAJOR MANUFACTURERS NEW "B" GRADE PRODUCTS T.V. VIDEO AUDIO MICROWAVE OVENS

Contact Fred Bean

BSMART (CRAWLEY) LTD.
10/11 LLOYDS COURT, MANOR ROYAL,
CRAWLEY, SUSSEX RH10 2QX

Tel (01293) 618000
Fax (01293) 400133

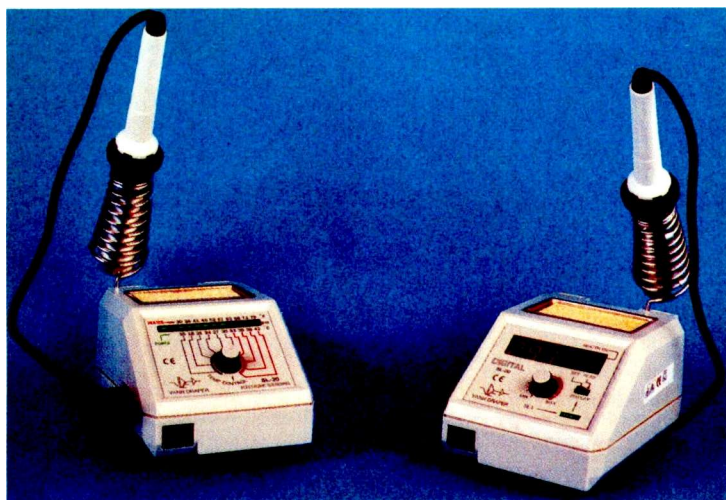

Vann Draper is offering over 20% discount for a limited period to readers of **Television** magazine on their temperature controlled soldering stations.

The SL20 bar graph display soldering station normally sells at £69.33 and is available to readers of TV at only **£55** fully inclusive of vat & delivery.

The SL30 digital display version is normally priced at £81.08 but for readers of TV the price is just **£65** fully inclusive.

Both soldering stations feature 24V 48W elements for rapid heating and have full electronic temperature control between 150C and 420C (SL20), 160C and 480C (SL30).

The SL20 and SL30 are supplied ready to use complete with a 48W iron, 0.8mm long life bit, mains lead, operating instructions and a 12 month guarantee.

To order simply post the coupon to **Vann Draper Electronics Ltd** at **Stenson House, Stenson, Derby DE73 1HL**. Alternatively -
Tel 01283 704706, Fax 01283 704707 or Email sales@vanndraper.co.uk

20% discount for TV readers

Temperature controlled soldering stations



Vann Draper Electronics Ltd
The test & measurement specialists
www.vanndraper.co.uk

Grundig, Kenwood, Hitachi, Fluke, Avo, Advance

Use this coupon for your order

Please supply me

- SL20 soldering station(s) at £55 inc vat & del
- SL30 soldering station(s) at £65 inc vat & del
- Extra 0.8mm bit(s) at £1.65 inc vat & del
- 1.6mm bit(s) at £1.65 inc vat & del
- 3.2mm bit(s) at £1.65 inc vat & del

Name

Address

Tel No.

Total £

Cheques payable to Vann Draper Electronics Ltd
or debit my visa, mastercard or switch card

Card type:

Card No

Expiry date:

Switch iss No

Signature

Overseas readers can still obtain this discount but carriage charges vary according to country. Please telephone, fax, email or write to Vann Draper.

Electronicworld TV AND VIDEO LTD

A Better chance to make a profit!

Incredible prices for incredible stock! That was our theme for our April advert. Our 2000 price list has given traders the bargains they've been looking for to sustain their business.

With massive price reductions for the new millennium on our top quality graded stock, you have more room to make that all important profit.

Now it's time for you to make some money!

SONY KV32WF1U widescreen	£350	PANASONIC TXW28R3	£225	SHARP DV5131H Fastext	£50
FERGUSON T78N	£250	HITACHI C24W1TN	£140	TOSHIBA 2577DB	£155
PHILIPS 28PW6332 widescreen	£225	SONY KV29F3U	£195	PANASONIC TX21S3R	£60
SHARP 66CS03H	£125	FERGUSON T59N	£95	HITACHI 2548TN	£65
TOSHIBA 2987DB	£285	PHILIPS 28PT6770	£185		

SPECIAL DEALS

BUSH 28" widescreen	£125	21" NICAM TV's from	£65
LONG PLAY VCR's	£35	NICAM VCR'S	£45
CAMCORDERS from	£95	DIGITAL CAMCORDERS from	£125

Please note all prices are based on a quantity of 5 units and are liable to VAT.
Stock subject to availability. Pro-logic stands and speakers are sold separately

Head Office: - BIRMINGHAM - 208 Bromford Lane, Erdington, Birmingham B24 8DL Tel: 0121 327 3273 Fax: 0121 322 2011
CLEVEDON - Unit 20, 5C Business Centre, Concorde Drive, Clevedon, North Somerset BS21 6AU Tel: 01275 341789
PRESTON - Unit 439, Oakshott Place, Walton Summit Industrial Estate, Preston PR5 8AU Tel: 01772 312101



Wholesale Distributors & Export Agents
of Domestic Electronics & Appliances

Possibly the Largest and Oldest Establishment in the UK

THOMSON, FERGUSON, SANYO, MITSUBISHI, BUSH, ALBA, GOODMAN'S

FACTORY GRADED (MINT)

14" R/c TV.....	from £45
20"/21" Text Nicam.....	£59
28" Nicam.....	£135
28" Wide.....	£225
32" Wide.....	£300
VCR.....	from £45
CD Radio Cassette.....	from £15
CD Micro Hi-Fi.....	from £25
CD Multi Disc.....	from £39
CD Walkman.....	from £12.50
BT Phones.....	from £15
BT Dect Phones.....	from £35
BT Dect Answerphones.....	from £45

SANYO/SHARP

Microwaves.....	from £35
Microwave Grill.....	from £45
Microwave Combi.....	from £69
Hoover Vac.....	from £29.50
One Year Warranty	
Ferguson 25" OP.....	complete £200

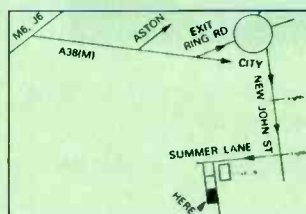

NEW HIGH STREET RETURNS

164 LINES

Irons, Kettles, Toasters.....	from only £3.82
Lava Lamps, Table Lamps, Floor/Wall Lamps, Touch Lamps, etc.....	from £6
R/C Toy Cars.....	from £7.50
Trimmers, Foot Spa, Phones, Car Battery Chargers, Audio Karaoke, Massager, Facial Saunas, etc.	

Send for List Now

MANY MORE OFFERS AVAILABLE

Quantity based on stock availability and all prices are plus VAT

NATION-WIDE NEXT DAY DELIVERY SERVICE - VISITORS BY APPOINTMENT

Phone 0121-359 7020

Fax 0121-359 6344

PHOENIX HOUSE, 190 BRIDGE ST. WEST,
BIRMINGHAM B19 2YT



PERIFELEC

MC 30 A Spectrum Analyser

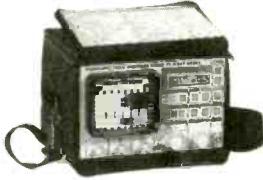

- Synthesized satellite cable and TV field strength meter with panoramic reception on 14 cm (5.5") screen and digital carriers measurement.
- Complete microprocessor and lqPLSI logic control.
- Continuous frequencies from 46 to 860 MHz and from 920 to 2150 MHz on 4 bands.
- Selectable 4, 1 and 0.2 MHz spectrum band-width, picture measurement 1 MHz.
- Display of picture of selected synthesized channel.
- FM (Radio) L/L, B/G, I, D/K/K', M/N TV standards and Ku and C satellite standards.
- Possibility of 32 programs memorized per frequency band.
- Display (2 Lines of 16 characters).
- Range of measurement of signal strength from 20 to 120 dBµV, manual or automatic attenuator.
- Battery life about 1 hour 20 minutes, weight 5,8 Kg.

- Display of full-band and 4 possible expanded spectrums.
- Channels and frequency plans of cable and TV standards memorized.
- Frequency, signal strength in dBµV or bargraph, displayed on a digital display (2 lines of 16 characters).
- Voltage of remote power supply in 14v or 18v and 22 KHz in satellite + DiSeq C™ v1.2 switching.

The panoramic field strength meter MC30A combines in one instrument all the functions necessary for installing and checking TV or satellite reception, both analogue and digital. The visualization of the spectrum and the picture allows the carrying out of all the necessary adjustments with this one instrument. The high technology used in the MC30A allows a range of possibilities unheard of in a instrument in this price category.



TC 80 A/D

The TC 80 A/D has been designed for the reception of TV Satellite systems.

- Analogue and digital measurement.
- Full Band Frequency Sweep.
- Switchable 14 v or 18 v LNB power supply + 22 KHz tone switching
- Rechargeable 12 v / 2,5 Ah Battery
- Weight including batteries: 3,3 Kg.

The TC80 A/D has been designed to aid the installation of analogue and digital satellite systems. This high quality meter has video and audio output via scart socket on rear and video only via BNC socket on front panel. The built in speaker delivers demodulated audio from any analogue satellite signals.

Full catalogue of meters available, please phone for details.

COASTAL AERIAL SUPPLIES

Unit X2, Rudford Industrial Estate, Ford, Arundel BN18 0BD
Telephone: 01903 723726 Fax: 01903 725322 Mobile: 0976 241505

Sole Import Distributors

Due to its weight and size, the TC-402 A/D is the ideal instrument for the installation of FM and terrestrial TV aerials as well as CATV systems.



TC 402 A/D

- Peak detection.
- Built in loudspeaker for AM and FM reception
- Frequency indication with 4 digit LCD display
- Analogue and digital measurement.
- Multi-turn potentiometer to enable tuning.
- Weight including batteries: 1,9 Kg.

TUBES

14" from £25

16" from £25

20" from £50

21" from £60

Price **INCLUDES** carriage and VAT

Other Sizes – POA

De-Scratching Service



Ring Irene



EXPRESS TV

The Mill, Mill Lane

RUGELEY, STAFFS WS15 2JW

TEL: 01889 577600

FAX: 01889 575600

Setbacks



Technical Specification	
Reference	5371 5372
Inputs(2)	UHF/FM UHF/FM
Outputs	6 (+1) 7 (+1)
Gain UHF	10 (-24) 10 (+24)
Noise Figure	2.5dB
Line Power	12Vdc
Output	89dBµV

Features

- Ideal for digital installations
- Low noise figure
- F connectors
- Fully shielded

Technical Specification	
Reference	8130 8131 8132
out 1	23 17 7.5
Gain (dB)	- 15 7.5
out 2	- - 12
out 3	- - 16
out 4	- - 4
Outputs	1 2 4
Input	1
Noise Figure	< 3.5dB

Features

- Design for individual installations
- Proven reliability and performance
- IEC connectors
- CE conforms with EN55013, EN55082-1, EN60065

Technical Specification	
Reference	4381 4382 4383
Amp. band(MHz)	5-380/470-860
VHF Gain (dB)	26 13 13 0.5
UHF Gain (dB)	30 20 23 9 15
Var. gain VHF (dB)	>20 >20 >20
Var. gain UHF (dB)	>15 >15 >15
Max.output level (dBµV)	99 88 90 76 82
Noise Figure (dB)	<2.8dB <2.8dB <2.8dB

Features

- High output level/Low noise figure
- UHF and VHF variable attenuator (0-20 dB)
- IEC connectors
- Fully shielded

All these products are available from UK's main distributors and wholesalers

Televes

Televes UK Ltd Tel. 01633 875821 Fax 01633 866311
televes.uk@televes.com www.televes.com

Repair SMDs on PCBs in seconds with the NEW Hot Jet 'S'

Desoldering and soldering of SMDs by hot air and without contact is the fast and efficient way for the modern repair workshop. And now, Welwyn Tool can offer the complete package - a range of hot air tools, SMD Rework Stations, nozzles to suit all SMD requirements, free demonstrations and free colour instructional brochure ... all available from Distributors nation-wide.

For further information, please ask for Reference No. TMS

WELWYN TOOL CO. LTD.

4 SOUTH MUNDELLS,
WELWYN GARDEN CITY
HERTS AL7 1EH.
TEL: (01707) 331111.
FAX: (01707) 372175.

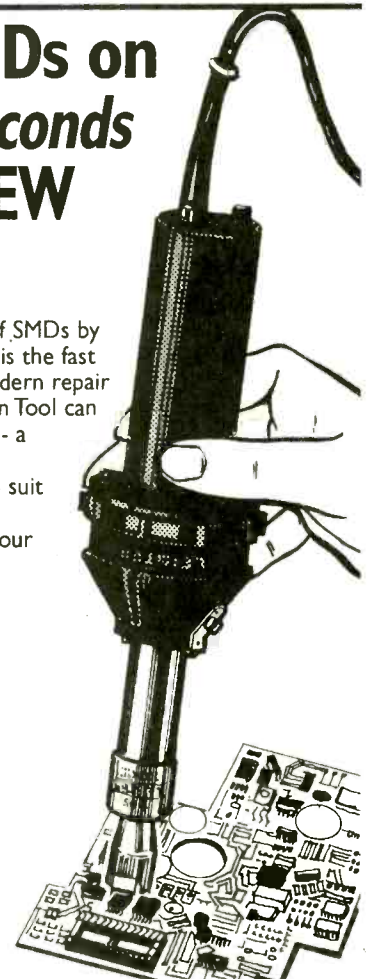

PUT HOT AIR TO WORK FOR YOU



ELECTRONICS

WHOLESALE DISTRIBUTORS
OF DOMESTIC
ELECTRONIC APPLIANCES

Unit 15 Marks Hall Margaret Roding Dunmow Essex CM6 1QT
Telephone: 01245 231684 Facsimile: 01245 231862

NEW B GRADE STOCK AT BELOW TRADE PRICE

Large **WIDE SCREEN** 16 x 9 Format Televisions from £450

Large **REAR PROJECTION** Televisions 52" from £1,500

*We also carry a Large selection of
televisions and videos all at below trade price.*

- 36cm portables.....from £70
- 51cm televisions nicam.....from £150
- 59cm televisions nicam.....from £200
- 68cm televisions nicam.....from £250
- 78cm televisions nicam.....from £500
- 95cm televisions nicam.....from £800
- videos 2 head mono.....from £70
- videos 4 head nicam.....from £110
- videos 6 head hi-fi nicam.....from £130
- 36cm combined TV and video.....from £170
- dvd players.....£160

LARGE QUANTITY DISCOUNTS AVAILABLE

25cm televisions with DC 12/24 volt suitable for
caravans - mobile homes - cars - kitchen use from £120

- ALL PRODUCTS ARE FULLY GUARANTEED -

YOU WILL NOT GET A BETTER DEAL ANYWHERE

We stock a great many other items in the TV and Video
range so if you don't see what you are looking for,
give us a call, *we will save you pounds.*

Visitors by appointment only

FRUSTRATED!

Looking for ICs TRANSISTORS?

A phone call to us could get a
result. We offer an extensive
range and with a World-wide
database at our fingertips, we are able
to source even more. We specialise in
devices with the following prefix
(to name but a few).



2N 2SA 2SB 2SC 2SD 2P 2SJ 2SK 3N 3SK 4N 6N 17 40 AD
ADC AN AM AY BA BC BD BDT BDV BDW BDX BF
BFR BFS BFT BFW BFX BFY BLY BLX BS BR BRX BRY BS
BSS BSV BSW BSX BT BTA BTB BRW BU BUK BUT BUW
BUW BUX BUY BUZ CA CD CX CXA DAC DG DM DS
DTA DTC GL GM HA HCF HD HEF ICL ICM IRF J KA
KIA L LA LB LC LD LF LM M M5M MA MAB MAX MB
MC MDA J MJE MJF MM MN MPS MP5A MP5H MP5U
MRF NJM NE OM OP PA PAL PIC PN RC S SAA SAB
SAD SAI SAS SDA SG SI SL SN SO STA STK STR STRD
STRM STRS SV1 T TA TAA TAG TBA TC TCA TDA TDB
TEA TIC TIP TIPL TEA TL TLC TMP TMS TPU U UA
UAA UC UDN ULN UM UPA UPC UPD VN X XR Z ZN
ZTS + many others

We can also offer equivalents (at customers' risk).

We also stock a full range of other electronic components.

Mail, phone, Fax, Credit Card orders & callers welcome.



Cricklewood Electronics Ltd

40-42 Cricklewood Broadway London NW2 3ET

Tel: 0181 452 0161 Fax: 0181 208 1441

CAMPION WHOLESALE LTD.

UK's Largest Electrical Wholesaler

For Both the UK and Export

Ex-Rental and Graded

TV's, Videos, Satellite,

Hi-Fi Equipment and White Goods

FREE Delivery Service to most areas of the UK

World-Wide Export Service

Experts in UHF / VHF Conversion

TEL: 01299 879642 FAX: 01299 827984

CALL TODAY FOR A BROCHURE OR COME AND SEE OUR LARGE WAREHOUSE

Unit 75 Barracks Rd, Sandy Lane Ind. Est. Stourport,

Worcestershire DY13 9QB

Just 10 minutes from M5 Junction 6 - Worcester North



TV's
From £5.00

Video's
From £5.00

Satellite's
From £5.00

TV / Video
Stands
From £1.50

Major
Credit
Cards
Accepted

Service Link

No other consumer magazine in the country can reach so effectively those readers who are wholly engaged in the television and affiliated electronics industries. They have a need to know of your products and services.

PHONE 0208-652 8339

FAX 0208-652 3981

The prepaid rate for semi-display setting is £15.00 per single column centimetre (minimum 4 cm). Classified advertisements £2.00 per word (minimum 20 words), box number £22.00 extra. All prices plus 17 1/2% VAT. All cheques, postal orders etc., to be made payable to Reed Business Information. Advertisements, together with remittance, should be sent to Television Classified, 12th Floor, Quadrant House, The Quadrant, Sutton, Surrey SM2 5AS.

SERVICE MANUAL LIBRARY

£5 loan fee any Service Manual or keep for £10 (even if priced £50 or more). Lifetime membership £99. FREE Manual listing dozens of 1000's of models audio, tv, video, etc. cross referenced to correct manufacturer's chassis (£9.95 on its own). We trade other manuals so that members can get new manuals for only the cost of postage.

Phone 01357 440280 (fax 440384) for full details or write to: **INFOTECH**, Midlinbank Farm, Ryelands, Strathaven, Lanarks ML10 6RD. World's largest stock of Service Manuals (TV VCR Combis, Test Eqpt, Audio, CD, Satellite, Dom Eq) Complete Repair Data (Not the few faults offered everywhere else) & Technical Literature. *Any items asked - free quote - free gift with every order during 2000.*

SPECIAL OFFER UNTIL END OF APRIL 2000

Any 20 full service manuals from stock (1 at a time or in any quantity you wish) only £199 including 1st class post. Includes those priced at £50/£60!!!
Includes FREE Data Reference Manual.

100's of offers and prices FREE on request

Practical Radio Repairs for £2 (free with any other order)

Any of the famous McCourt or Tunbridge TV Repair Manuals for only £5 each - all for £29 post free till end 2000.
Any 10 complete VCR chassis fault/repair manuals from our list for only £25 - with all circuits £49.99

ACCESS, CONNECT, DELTA, EUROCARD, MASTERCARD, SOLO, SWITCH, VISA, etc.
£2.50 postage any non-free order.

SERVICE MANUALS

Thousands of models available
For most UK European, Far East and USA makes

Service manual prices

B/W TV - £6 CTV/VCP - £10
VCR - £15 Camcord - POA

Service sheets/circuits also available for some models
+data for satellite, audio and camera

* 50+ CTV PSU Circs Compilation (A4) - £10 *

Please telephone to check availability

Payment by Cheque/PO only please

Add £2 P/P etc, to order total. Do not add any VAT.

D-TEC

PO BOX 1171, FERNDOWN, DORSET NH22 9YG
Tel: 01202 870656

NEW FAX BACK SERVICE NOW AVAILABLE
TEL/FAX A.T.V. on
0114 285 4254

SAT/CTV Circuits £5.00
VCR Circuits £7.00
CTV Manuals £10.50
VCR Manuals £14.50
(P/P add £2.50 to each order)

**419 LANGSETT ROAD,
SHEFFIELD S6 2LL**



SERVICE MANUALS

Available for most equipment.
Check out our web site at
<http://www.mauritron.co.uk/mauritron/>
for the full listing of the thousands of manuals we have
or send 4 x first class stamps for our catalogue and index on disc.

Mauritron Technical Services

8 Cherry Tree Road, Chinnor
Oxon OX9 4QY

Tel: 01844-351694. Fax: 01844-352554
Established since 1986

SERVICE MANUALS

Have you ever turned away work for want of a Service Manual?

Have you ever bought a Service Manual and never used it more than once?

Then why not join...

THE MANUALS LIBRARY

For details and membership application form write, phone or fax:

HARVEY ELECTRONICS

43 Loop Road, Beachley, Chepstow, Gwent NP6 7HE
Tel: 01291 623086 Fax: 01291 628786
Visa, Access accepted

Elusive faults - Fixed!!

E.C.S. Celebrates 10 years supplying service data. Helping engineers complete repairs in record time.

New release: Edition 23 Fault Index books.

Now Available Edition 23 of the Television Magazine Index Covers over 14,000 Television, Video, Satellite, Camcorder & Monitor faults, Large easy to read A4 format The latest addition to a highly acclaimed & recommended series. In daily use in workshops around the world !!

ISBN 1 898394 30 X Edition 23: Complete set £14.75

Brand New: Fault indexes on disk - Version 1.9

Latest faults together with all data from all previous versions, Covering a MASSIVE 22,500 !! Television, Video, Camcorder, Satellite, CD & Monitor faults listed in 20 years of Television.

Version 1.9: Indexes on Disk £17.50

Low cost updates are available for all Book & Disk fault indexes.

SPECIAL OFFER: Kwik Tips Fault Database

A valuable service resource for workshops large or small, Kwik Tips Version 1.1 is our LARGEST FAULTS & REMEDIES database EVER, Compiled from over 20,000 !! Entries & covering 1,435 Chassis & Models, This concisely Edited TV & Video repair database will easily pay for itself with just one repair.

Kwik Tips on disk: Millenium offer price - only £22.95

Latest release: Model / Chassis / Equivalent book.

The latest Best Selling 3rd Edition of the Equivalent guides containing 7,500 ENTRIES covering TV Models to chassis and Television, Video, Camcorder, Satellite & Monitor Equivalents. comprehensive A4 book.

ISBN 1 898394 29 6 3rd Edition Equivalent £6.95

E.C.S. (Est 1985)

Technical Publishing

316, Upton Road,
Noctorum, Wirral,
Merseyside. CH43 9RW

Tel / Fax 0151 522 0053

Please add £1.75 P & P to total (Europe £2.75. r.o.w please enquire).

CLASSIFIED TEL: 0208 652 8339

Fryerns

Service
Information



Circuit
Diagrams

TV's, VCR's
SATELLITE
AUDIO & HI-FI
Most Models Covered

Prices are from £4.00 + £2.50 P/P
1 item - total £6.50 inc
2 items - total £10.50 inc
3 items - total £14.50 inc
4 items - total £18.50 inc

Payment by credit card or Postal
Order for next day delivery.
Cheques to clear.
Tel/Fax 01206 211570



2 The Lodge
Easthorpe Green
Marks Tey, Colchester
CO6 1HA

THE STORY OF BAIRD TELEVISION

Read about the pioneering work
of John Logie Baird.

30 Page A4 publication
"SEEING BY WIRELESS"
£3.50 in P&P

For mail order:

Tel: 01202 659930

Fax: 01202 659950

e-mail:

books@pwpublishing.ltd.uk

REPAIRS

accént

TECHNIC

CAMCORDER REPAIRS

Collection and delivery any-
where in the UK.

All makes, fast service.

Phone free for details.

Fax: 01905 796385

(0800) 281009

WANTED

Top Cash Prices Paid for Valves

E.9 KT88, PX25, EL37, DA100 and
Valve Tester VCM163

Ask for our free wanted list
Wide range of obsolete valves stocked

Visitors please phone for an appointment

Email:

billingtonexportltd@brinternet.com

Billington Export Ltd

Billingshurst, Sussex RH14 9EZ

Tel: 01403 784961

Fax: 01403 783519

PROPERTY

UNIQUE OPPORTUNITY

TELEVISION SPARES BUSINESS

Due to retirement - well established (25 years) TV Spares company can offer £80k gross profit per annum plus £100k spares inventory. Established web site with 1,000 hits per day for further development and links to your existing web site. 80% of sales are CWO. All business transacted via telephone - no representation or catalogue provided therefore represents a unique opportunity for absorbing into another company with existing overheads, representatives and catalogues. Can operate from any location.

Circa £120,000

As above but with the benefit of Warehouse, Wholesale Distribution and Office premises totalling 3810 sq.ft. Retail front - Trade counter selling security and satellite products adding to the above turnover. 2000 sq.ft. spare accommodation suitable as Midlands Depot for TV refurb. company. Excellent access to M6 - M5, the Midlands and Wales. Parking for 8 cars with large NCB car park next door.

Circa £240,000

(or may let property with option to purchase)

CONTACT BOX NUMBER B8197

Television Magazine, Quadrant House, The Quadrant,
Sutton, Surrey SM2 5AS

To Advertise
in Television Classified
Telephone Pat Bunce
on 0208-652 8339
or Fax on 0208-652 3981

LINEAGE

AVO MULTIMETER Model 8, £45.00. 500 volt meggers £30.00. Prices plus VAT and p. & p. Send SAE for lists of surplus instruments and scopes etc. A. C. Electronics, 17 Apleton Grove, Leeds LS9 9EN. Tel: 0113 249 6048.

PRIVATE RETAILER has excellent part exchange colour televisions and videos to clear. Tel 01494 814317.

SEASIDE OPPORTUNITY NORTH WALES. TV and video repair business established 30 years. Lucrative contract with local holiday centre for the past 15 years. Scope for development, retiring abroad 01745 855521.

TWELVE BOOKS ON radio and TV servicing, running from 1955 to 1958, 1965 to 1974, contact 01745 855521.

FOR SALE

SWITCH - IT - ON

TV, Video, DVD

Technical
Sales/Repairs

DVD Upgrades

Trade and Public

Tel: 0208 764 6638

Fax: 0208 764 6166

To Advertise
in Television Classified
Telephone Pat Bunce
on 0208-652 8339
or Fax on 0208-652 3981

SPARES &

COMPONENTS

RCS VARIABLE VOLTAGE D.C.
BENCH POWER SUPPLY



£45 INC VAT - POST & INS £4
Up to 20 volts DC at 1 amp continuous, 1.5 amps peak
Fully variable from 1 to 20 volts.
Twin voltage and current meters for easy read out.
240 Volt AC input. Fully smoothed.

RADIO COMPONENT SPECIALISTS

337 WHITEHORSE ROAD, CROYDON, SURREY, UK

Tel: 0181 684 1665

Lot of transformers, high volt caps, valves, speakers, in stock. Phone or send your wants list for quote.

Are you urgently looking
for:

**TECHNICIANS
BENCH ENGINEERS
FIELD SERVICE
ENGINEERS, etc.**

Then why not let Television
Magazine help you find the right
person that you are looking for.

Call Pat Bunce on

020 8652 8339

020 8652 3981 (Fax)

RECRUITMENT

Bench Technician

McMichael Bros, are a leading independent retailer of Sony Consumer products with a modern well equipped service facility in Alloa, Central Scotland.

We are looking for an experienced bench technician with a good knowledge of Sony Television Video and Hi-Fi products to join our Sony Accredited Service Centre.

You should hold a current driving licence, be a good communicator, self-motivated and be prepared to provide a high standard of customer care and commitment. Experience in camcorders, minidisc and latest technologies would be an advantage.

An excellent package, including training, commensurate with experience and skill is available.

Please send your CV complete with present salary and conditions to:

Jim McMichael

McMichael Bros, Service Centre
3-7 Mill Street, Alloa, Clacks. FK10 1DT

Tel: 01259 724230

McMICHAEL
SONY CENTRES
BROS

PARAGON

Paragon Technical Services are the UK's leading maintenance and repair company specialising in the field of document scanning and storage systems.

WORKSHOP ENGINEER - DISPLAY MONITORS

The ideal candidate should have a proven history in the repair of TV's, Monitors etc to component level.

A formal qualification such as BTEC/City & Guilds would be preferred.

Please apply in writing enclosing your current CV to:

Mr Steve Thompson

Technical Services Director, Paragon Technical Services Ltd
Paragon House, Gatehouse Close, Aylesbury, Bucks HP19 3DE

CLASSIFIED TEL: 0208 652 8339

RECRUITMENT



Electronics Service Technicians (South County Dublin)

The **Gavins Service Centre**, part of the All Ireland Group, is recruiting Service Technicians for its expanding consumer products servicing business.

We require people who are self motivated, who can work well in a closely knit team, and who possess good inter-personal and time management skills. A minimum of one year's previous experience is required.

If you feel that you meet the requirements outlined above and wish to move to a productive, progressive environment, send a detailed CV to;

**The Personnel Manager,
Gavins Service Centre,
All Ireland Group Ltd.,
Unit 2, Baldonnell Business Park,
Naas Road, Co. Dublin,**

to reach us by no later than 31st May, 2000.

ELECTRONICS ENGINEER (A/V PRODUCTS)

We specialise in sales and service of high quality A/V products and are looking for a qualified engineer to join our service department based at Pinner in Middlesex. Applicants should have a relevant qualification and previous experience. Technical training on current and older products is available.

A good basic salary and other benefits is available to suitable applicant. If you are working or have worked in the service side of this industry and would like to know more please call **Kevin Enskat** on **0181 868 3233** or **07771 710471**.

EXPERIENCED BENCH/FIELD ENGINEER

Required Brook Domestic Services
Established over 20 years family owned business.
Rapidly expanding repair centre (contract work) good knowledge of all makes of TV, VCR, audio equipment repair essential.
Clean driving licence
Please apply in writing with current cv and current salary to:
**Brook Domestic Services, Unit 4
Woodward House, Cambridge Street,
Bletchley, Bucks MK2 2TH
Telephone 01908 640221**

To Advertise
in Television Classified
Telephone Pat Bunce
on 0208-652 8339
or Fax on 0208-652 3981

EXPERIENCED ENGINEERS Bench or Field

for either TV, VCR, Audio
or Camcorder.
Excellent Salary.
Modern workshop.
Staff discounts.

**Please send CV to:
'A' One Digital Domain
Unit 2B,
Aberconway Road,
Morden, Surrey
SM4 5LN
Telephone
0208 543 8888**

Move up in the world and become part of a growing, committed team of Workshop Engineers. Photo-Scan lead the UK market in the design and installation of leading edge CCTV systems.

**Position:
WORKSHOP REPAIR TECHNICIAN**

**Location:
SUNBURY ON THAMES**

Qualifications: City & Guilds 224 Electronic Servicing or equivalent combined with a proven track record in the Radio & Television Servicing or CCTV field. Practical experience in servicing VCRs down to component level is essential.

Package: As an Investors in People company we offer training, career development, a competitive salary and benefits package.

Please apply in writing, enclosing your CV and current salary package to Sandra Dunn, Photo-Scan Systems Ltd., Dolphin Estate, Windmill Road, Sunbury, Middlesex TW16 7HG.



PHOTO-SCAN

ADVERTISERS' INDEX

Aerial Techniques.....401	König Electronic.....IFC
A.R.D. Electronics.....BC	
BSMART441	L.A. Electric.....449
Campion Wholesale TV....449	
Coastal Aerial Supplies.....443	Philex.....IBC
Colour Trade.....442	
Cricklewood Electronics.....449	
	Senz Components 448
	Stewarts of Reading.....419
East London Components.....397	
Economic Devices.....399	
Electronic Sound Systems419	Tavcom Training.....441
Euras.....386	Televés Ltd.....443
Express TV.....443	T.W. Electronics.....IFC
Grandata Ltd..... 403-406	Vann Draper.....441
Hardy J.W.....386	Wallis Universal.....386
HCTV.....442	Welwyn Tool Co.....443
	Wiltsgrove Ltd.....448
J.J. Components.....426	

CLASSIFIED TEL: 0208 652 8339

Bring CONTROL to your UNIVERSE with a PHILEX REMOTE CONTROL

If your customers are looking for a Universal Remote Control that combines style, quality and value in an award winning package, Philex have what you are looking for!

NEW

The 4-way Magician-4 and 8-way Magician-8 Universal Remote Controls

- Operates all SKY digital TV box functions and all ON DIGITAL functions (Magician 8 only)
- Ergonomic, tactile design in gunmetal grey (Magician-4) or petrol blue (Magician 8)
- Operates any combination of up to 4 (Magician-4) or 8 (Magician-8) TV, VCR and Cable/ Satellite systems
- Pre-programmed for easy set-up
- Covers 1000's of popular brands
- Full teletext and fasttext functions
- MACRO function (Magician-8 only)
- Backlit device indicator keys
- Powered by 2 x AAA batteries

Part No. RCO21 (Magician-4)
RCO22 (Magician-8)

NEW

The 8-way Wizard Universal Remote Control

- Replaces any combination of up to 8 different infra-red controls, including TVs, VCRs, Cable, satellite and hi-fi systems
- Pre-programmed for easy set-up
- Red backlit keypad for use in the dark
- Up to 8 different MACRO functions
- Stylish, innovative design in gunmetal grey
- Powered by 3 x AAA batteries
- Full learning facility
- Which? Best Buy Award, Video Camera Best Buy award (8 out of 10), Stuff Magazine (4 out of 5), What Hi Fi (5 out of 5)

Part No RCO14

The 3-way Genie Universal Remote Control

- Operates any combination of up to 3 TV, VCR or Satellite Systems
- Pre-programmed for easy set-up
- Covers 1000's of popular brands
- Stylish, innovative design available in silver, red, yellow, green and blue
- Backlit device indicator keys
- Powered by 2 x AAA batteries
- Which? BestBuy award winner

Part No RCO12 (Silver),
RCO126GREEN (Green),
RCO12YELLOW (Yellow),
RCO12BLUE (Blue),
RCO12RED (Red).



For more on our range of Universal, Uni and Replacement Remote controls, call Philex Now!

Philex Electronic. Tel: 020 8202 1919 / 07000 PHILEX Fax: 020 8202 0015
e-Mail: sales@philex.com Website: http://www.philex.com



A.R.D. ELECTRONICS

'Our aim is your next order'
The easiest way to source parts is with our

600 PAGE FREE USER FRIENDLY TRADE CATALOGUE

It has comprehensive technical information with pictures to help in product identification.

All products are clearly and logically presented to make the items easy to find.

We have a highly trained and caring staff and perfect systems to try and make every contact with A.R.D. Electronics a pleasurable and problem free experience.

- Aerials & Audio Accessories
- Batteries & Accessories
- Cable & Accessories ● Capacitors
- Computer Components & Accessories ● EHT Components
- Electrical Accessories
- Filters/Surge Protectors
- Fuses & Holders
- Games Consoles & PC Game Accessories
- Intercommunication Equipment
- Loudspeakers & Accessories
- Optoelectronics
- Power Supplies & Adaptors
- Relays ● Remote Control Handsets
- Remote Control Konig Cross Reference Chart
- Resistors, Positors & Trimmers
- Satellite Spares & Accessories
- Security Products Semiconductors
- Service Aids ● Soldering Equipment
- Stands & Brackets
- Storage Systems ● Switches
- Test Equipment ● Tools ● Transformers
- Video Accessories ● Video Heads

Warehouse at Altham



In response to your requests we have changed our delivery charge policy.

The UK's favourite distributor again leads the way by launching a new Customer based initiative. We now provide

FREE

DELIVERY ON ALL ORDERS OVER £20

Universal

Remote

Controls by **ONE FOR ALL**

A.R.D. Electronics are delighted to announce their appointment as a distributor for One-for-All products and we look forward to bringing you many exciting new products over the next few months.

We can now offer you the following pre-programmed products from the worlds largest manufacturer of universal remote controls:

Zapper 1: Simple zapping functions for TV only.

Zapper 2: Simple zapping functions for TV and satellite only.

Zapper 3: Simple zapping functions for TV, Satellite/Cable and Video Recorders.

Audio Zapper: Simple zapping functions for all types of audio equipment.

One-for-All 3: Standard functions including fasttext for TV, Video Recorders and 1 extra device.

One-for-All 4: Standard functions including fasttext for TV, Satellite/Cable, Video Recorders and 1 extra device.

One-for-All 5: Standard functions including learnable keys, fasttext, LCD backlit screen with clock for TV, Satellite/Cable, Video Recorders, CD Players and Amplifiers/Tuners.

One-for-All 6: Standard functions including learnable keys, fasttext, built-in modem for new codes for TV, Satellite/Cable, Video Recorders, CD Players DVD Players and Amplifiers/Tuners.

Type	Order Code	Offer Price Each
Zapper 1	322-00001	7.10
Zapper 2	322-00002	9.85
Zapper 3	322-00003	10.60
Audio Zapper	322-00004	12.95
One-for-All 3	322-00005	10.80
One-for-All 4	322-00006	12.95
One-for-All 5	322-00007	18.85
One-for-All 6	322-00008	24.95

Compatible Remote Controls

Features

- Modern, yet extremely robust housing.
- Rubber Keypad.
- Reverse Polarity Protection.
- CE Approved.
- Hardwearing etched printing.
- 100% Testing.
- Manufactured in China.

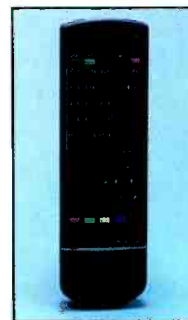

Type	Replaces
RC314/HL	Ferguson RHT01, RHT09, RHT30
RC400/HL	Philips RC5991, 218-20831
RC508/HL	Sanyo MXE, Sony RM632, RM635

Type	Order Code	Offer Price Each
RC314/HL	321-00191-34	2.95
RC400/HL	321-00190-34	2.95
RC508/HL	321-00192-34	3.40

EASY ORDERING

Open a Trade Account today or pay by Credit Card.

We accept Visa, Mastercard or Switch



BACs

FREE DELIVERY

on all orders over £20. No Hidden Charges

A.R.D. Electronics Plc, Shorten Brook Way, Altham Business Park, Altham, Accrington, BB5 5YL e-mail: sales@ardelectronics.com

Tel: 01282 683000 Fax: 01282 683010

Trade Website: www.ardelectronics.com