

THE LEADING UK CONSUMER ELECTRONICS TECHNOLOGY MAGAZINE

TELEVISION

SERVICING • VIDEO • SATELLITE • DEVELOPMENTS

OCTOBER 2000 £2.90



Building and upgrading PCs

New technology, new business

Servicing the Sony BE4 chassis

Spares storage and management

Conditional-access and Interactive-TV technology

Fault reports

TVs, VCRs, PC Monitors and Satellite

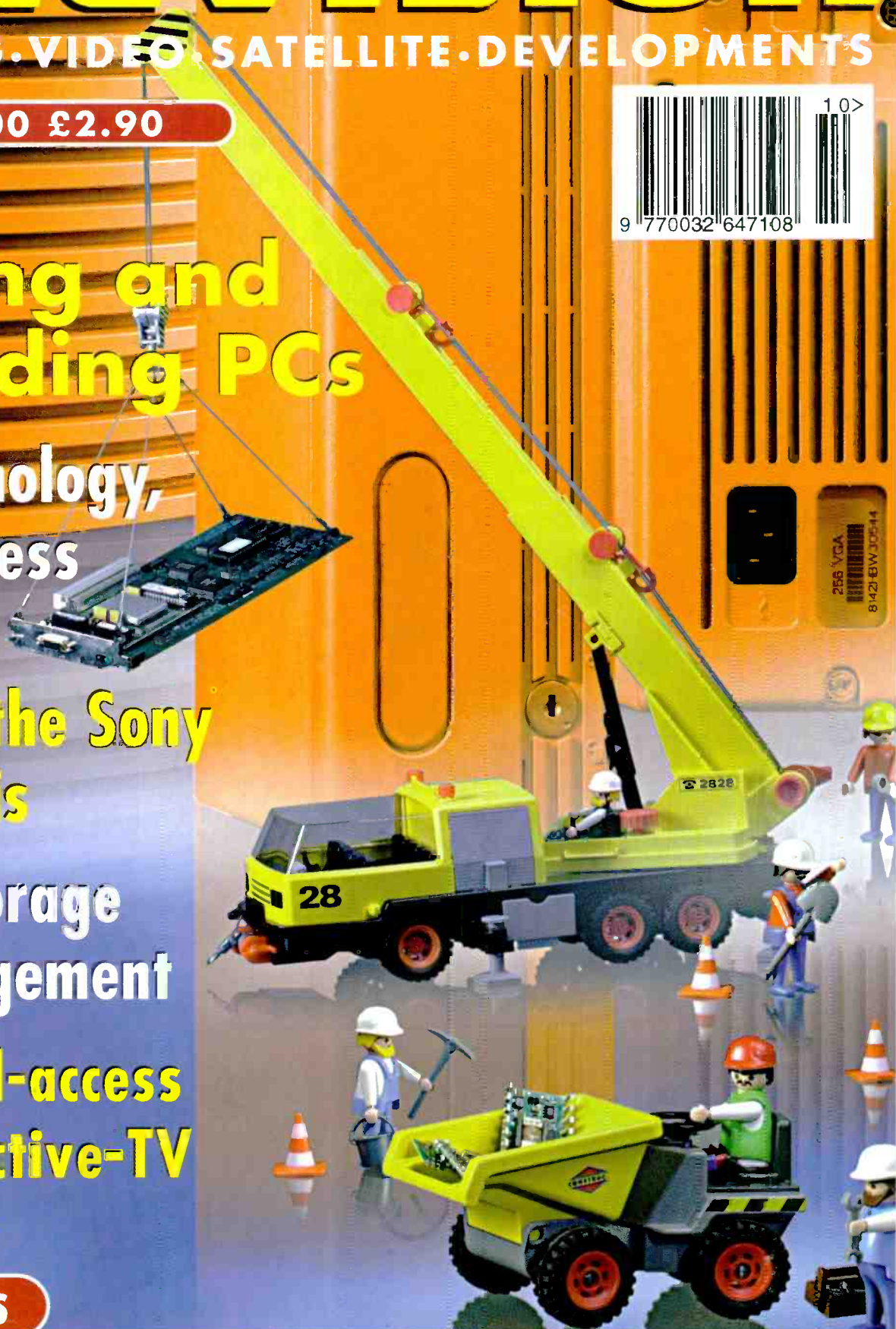

KÖNIG
ELECTRONIC

Maxi Master IV

Simplicity itself, the Maxi Master IV Controls television, satellite, video and auxillaries all from one handset. Preprogrammed for all common UK brands, it's easy to use and quick to set up. Slim design and durable casing provides lasting protection.

- Retains memory when batteries are removed.

TV Classic

Europe's largest range of remote controls. The TV Classic range has been designed to carry out all of the functions of the original handset without any programming, just insert the batteries and go! The range includes many new designs covering the very latest models currently selling in the high street.

- User friendly button layouts.
- Reverse battery protection (accidentally inserting the batteries in the wrong way round will not damage the handset).

Visit our Website for more information

www.konig.co.uk

Available from your KÖNIG CLUB Founder Members



WILLOW VALE
ELECTRONICS LIMITED

Also available from your König Approved Stockist

Technical help line: 01635 278678

Email: technical@konig.co.uk

the
KÖNIG
repair



CONTENTS

October 2000 Vol. 50, No. 12

707 Comment

New prospects and changing attitudes.

708 Teletopics

Going digital. Sharp to give up CRTs. Aids to TV viewing. Double Density CDs. Video and DVD updates.

710 What a life

Was the TV trade such a good choice? Donald Bullock on how he and his contemporaries have fared. Also some aerial trouble at a caravan site, and a few video problems.

714 New technology, new business?

Geoff Lewis explores a new technology, wireless networking for data signals, that's likely to provide a new source of business for those involved in electronics servicing and repair.

718 Building and upgrading PCs

As they use modular construction, today's PCs are relatively easy to build and understand. Work on PC hardware should be easy for TV technicians, and can be a source of extra income. Russ Phillips provides a guide to PC basics, from specifications to the range of peripherals available. Part 1 of a two-part series.

721 Storing spares

Spares management is essential for efficient servicing. Otherwise time is wasted despite speedy fault diagnosis. Paul Smith on how to run an efficient system.

722 Servicing the Sony BE4 chassis

This was Sony's basic small-screen TV chassis from 1994

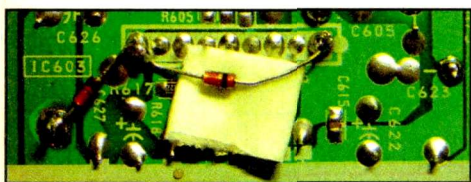

until quite recently, so there are many of these sets around. Giles Pilbrow provides a detailed servicing guide that includes the complete power supply circuit, details of the service mode and LED error codes, and a known-faults table.

727 Letters

Progress with TV PSU servicing? LNB cooling. The sinister side of digital TV.

728 What is DVD?

Steve Beeching explains the mysteries of the DCT and the digital signal compression system used by the DVC format.

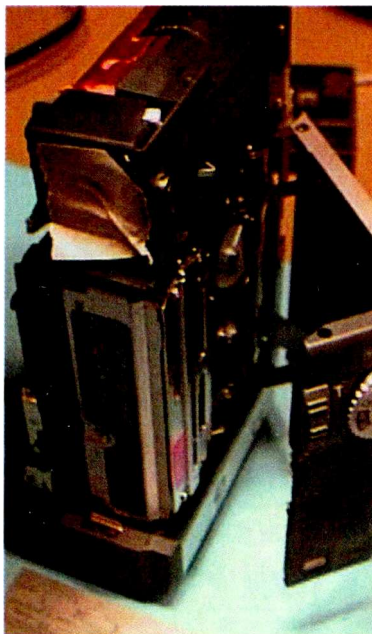

732 Satellite workshop

Jack Armstrong's column on satellite receiver servicing. Also, this month, notes on motorised dish problems.

733 Test case 454

734 A visit to NDS

NDS is a world leader in conditional-access technology and is developing various systems that will increase the range of services available via TV. George Cole reports on a



visit to the company's technology centre.

738 DX and satellite reception

Terrestrial DX and satellite TV reception reports. News on terrestrial and satellite TV transmission changes. Maplin's two-stage UHF signal amplifier tested. Roger Bunney reports.

742 Satellite Notebook

Problems with satellite equipment and installations and a SkyDigital channel update.

744 Monitors

Hints and tips on servicing computer monitors.

746 VCR Clinic

748 TV fault finding

752 Help wanted

753 Audio faults

Fault diagnosis with audio equipment.

754 Web service

Useful web sites for TV professionals, technicians and enthusiasts.

758 Next month in Television

Next issue, dated November, on sale October 18th.



COVER PHOTOGRAPHY
Mark Swallow

Editor

Martin Eccles

Consultant Editor

John A. Reddihough

Publisher

Mick Elliott

Advertisement Sales Manager

David Wilson
0208 652 3033

Group Advertisement Sales Executive

Pat Bunce
0208 652 8339
Fax 0208 652 3981

Editorial Office

01782 870684
Fax 01782 878233

Note that we are unable to answer technical queries over the telephone and cannot provide information on spares other than that given in our Spares Guide.

The headend that says **YES** to

- Quality
- Ease of use
- Agility
- Each module an almost total entity
- Superb value

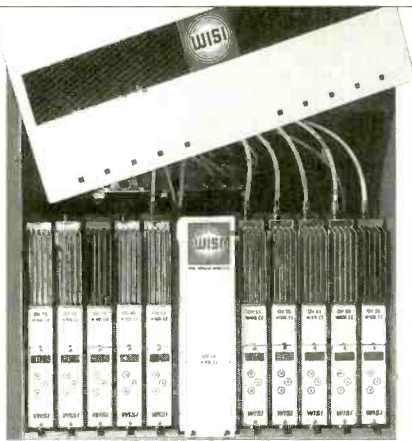

WISI TOPLINE HEADEND

CHECK THESE FEATURES

- Frequency agile freely selectable in the VHF of UHF range
- Adjacent channel capable
- TV standards 64 QAM B/G, D/K, I, L, M
- Modular system for headend stations in SMATV and CATV systems
- Modules for Analogue and Digital:
 - Satellite TV & Radio: Analogue & Digital
 - Terrestrial TV & Radio: Analogue & Digital
 - Satellite I.F. Converters: Analogue & Digital compatible
 - Terrestrial TV Converters: Analogue & Digital compatible
 - TV Modulators: Analogue & Digital
- Individually programmable modules
- High output level
- Wall mounting or 19" rack mount with lockable cabinet door

May we send you full details?

WISI's Topline headend system is very competitively priced yet is of superior design and build. It is easy-to-use with high quality channel processing that allows the user to retain quality of vision and sound for both analogue and digital signal sources. There are processors for satellite TV, terrestrial TV and radio. Each individual module incorporates its own control system enabling quick and easy set up. These channel processors come together in an 'all-in-one' base unit which contains all necessary accessories for ease of ordering - no additional items required.

U.K. STOCKIST

J.W. Hardy Communications



A Breakthrough in Headend Design

J.W. HARDY COMMUNICATIONS, 231 Station Road, Birmingham B33 8BB Telephone: 0121 784 8478 Fax: 0121 789 7931

M.C.E.S.

Specialists in the service and repair of all types of:

Digital Tuner Units

(Including Amstrad DRX 100)

Analogue Tuner Units

IF amplifier modules

RF Modulators & Booster amps

Video Heads

L.N.B.'s

FOR LATEST INFORMATION and CURRENT PRICES SEE OUR WEB SITE

[HTTP://WWW.MCES.CO.UK](http://www.mces.co.uk)

Telephone: 0161 746 8037

Fax: 0161 746 8136

Email: sales@mces.co.uk

15 Lostock Road, Davyhulme Manchester M41 0ES

Economic Devices

32 Temple Street, Wolverhampton, WV2 4AN, UK Tele ++ 44 (0)1902 773122 Fax ++ 44 (0)1902 429052

We take your hassle Some suppliers just won't help. We will work really hard to find those difficult parts - just ask and let our 'no holds barred' enquiry hound work for you.!!!

...and look at the (strictly while stocks last) special offers.....

BUT11A @ ~~99p~~ each BUT11AF @ ~~49p~~ each
BU508A @ ~~69p~~ each Fully wired scart lead ~~99p~~

a slight inconvenience....

....you must buy more than one.

BU208A X 5 £3.75	TEA2018A X 5 £3.70
BU508A X 5 £3.00	UC3842 X 5 £2.95
BU508AF X 5 £4.25	CNX62A X 5 £1.45
BU508D X 5 £4.45	S2000AF X 5 £4.20
BUT11A X 5 £1.45	TDA3653B X 5 £2.75
BUT11AF X 5 £2.35	TDA3654 X 5 £4.10
Philips type 1.2 volt Back up battery X 5 £2.95	
Philips type 2.4 volt Back up battery X 5 £6.00	
Scart - Scart lead 1.5m Fully wired X 2 £1.98	
Positor PT37,TH98009 (White) X 5 £2.95	
Thorn TX100 Chassis 110 DGR LOPTX each £11.24	
Philips CP90 Chassis LOPTX each £11.63	

...and now ask about our value for money full price list.

Remember £1.50 post & handling

All major credit cards accepted

MAJOR STOCKIST PHOENIX

PSU repair - refurb kits
Look for the PHOENIX stamp of approval

Over 200,000 kits sold



New Pace Digibox PSU refurb kit

Remote Controls from £5.95 each

Stock held for over 5000 different models

SEMICONDUCTORS

over 34,000 types of transistors, IC's, diodes etc. or equivalents stocked

www.telepart.co.uk

The web page where you can look up the price and order all things TV, VCR and Satellite. Web search by model for video parts, remote controls, LOPT's etc., overseas enquiries particularly welcome

New **CCTV** catalogue out NOW
cameras, monitors, switches
quads, multiplexers, the lot.

New prospects

As several readers and the September leader have pointed out, TV repair is rapidly becoming a thing of the past. When a line output transformer is considered as a percentage of the retail price of a new receiver, fitting a replacement in a 21in. set is clearly not economically viable. Joe Public is far more likely to decide to buy a new set. There will also be a full twelve months' parts and labour guarantee, as opposed to the three months on repair work. VCRs are viewed by customers in the same way. A brand new remote-controlled, long-play VideoPlus machine can be bought for £70, so unless a repair can be carried out for a maximum of £25 the customer isn't interested.

I've found that customers seem to develop a more personal relationship with their Hi-Fi equipment. Probably because of this, I now find myself doing more audio than video repairs. Vacuum cleaners can put money in the till. I estimate that 85-90 per cent of the problems with them can be cured by unblocking hoses, replacing broken belts or cleaning filters. Some engineers will protest that they didn't study hard for many years to end up removing dog hairs from hosepipes! Noble sentiments indeed, but not designed to put food on the table.

PC upgrades can provide an answer. Despite the fact that the majority of upgrades come with detailed instructions, many customers prefer to have the installation done by "an expert". Those who do take the job upon themselves seem to think that the instructions are provided for the guidance of others – they have no need to refer to them!

I keep a monitor, keyboard, mouse and speakers under my front counter. Whenever an upgrade comes in, I boot up the PC in the customer's presence and look in the Device Manager for any conflicts. This is to protect myself. You would be sur-

prised how many people claim that the modem hasn't worked since you installed their graphics card! If you've already pointed out that the Device Manager shows a conflict with the modem, you can ask the customer if he wants you to resolve it – for a small fee, naturally.

Ask the customer to bring in his master boot floppy and master CDs. Get him to sign a form acknowledging that, should you need to remaster the PC, all personal files will be lost. If the customer hasn't already backed them up, give him the opportunity to do so and return the PC afterwards. Personally, I will deal with

only hardware issues: software problems are best left to a software engineer.

Don't forget that some PC users can be terminally stupid! You will have to deal with the customer who complains about the cursor being at the centre of the screen despite the fact that he's reached the edge of the mouse pad! There is also the chap who, no matter how he tries, cannot get the mouse to stick on the screen!

There is still money to be made out there. But it's no good waiting for an upturn in the TV repair business. There isn't going to be one.

D.A. Blount and another .com

Changing attitudes

With reference to comments on the state of the trade in previous issues, it's important to keep the discussion going. If it hasn't already done so, the situation will affect your livelihood in the very near future.

Buying habits are changing, as the difficulties experienced by some clothes store chains prove. More supermarkets are selling TV sets etc. as just another line. It would be unprofitable for an independent dealer to sell a TV set at say £15 profit, with all the strings attached. But to a supermarket this is a good profit. Supermarket groups have the purchasing power to demand a no-strings policy with the supplier or manufacturer. Their only commitment is the one-year guarantee, which means that a small proportion of the equipment sold will be returned to the supplier for exchange, possibly at no cost.

The attitude of manufacturers is also changing. Fewer allow their circuit diagrams to be copied, and it's not so easy to follow one on the web. They don't seem to be backing up their equipment too well either. Here's an example quoted recently in a trade magazine. An independent deal-

er sold a £2,500 TV set and, when it failed, asked the manufacturer for a replacement panel. The dealer was told to fault-find to component level, as panels were not available. When this was done the manufacturer was unable to supply the components required at short notice.

The same magazine quoted a report that a high-street rental firm is going to introduce a new scheme, insuring white and brown goods at a monthly charge of £8 for any three items, £10 for any five or £15 for all of them, up to eight years old. Maybe this is the reason for the increased vacancies for TV engineers in contracting firms, see recent advertisements in this very magazine.

With the advance of digital TV, more analogue sets are becoming available in the second-hand market. As the year 2010 approaches, they will be increasingly worthless and uneconomic to repair.

But I hope that this magazine will continue to supply the trade with technical information. More exchanges by engineers through the web will also help us.
Carlos Deus, King's Lynn, Norfolk.

COPYRIGHT

© Reed Business Information Ltd., 2000. All rights reserved. No part of this publication may be reproduced, stored or transmitted in any form or by any means without the written permission of the publishers.

All reasonable precautions are taken by *Television* to ensure that the advice and data published are reliable. We cannot however guarantee it and we cannot accept legal responsibility for it.

CORRESPONDENCE

All correspondence regarding advertisements should be addressed to the Advertisement Manager, "Television", Reed Business Information, Quadrant House, The Quadrant, Sutton, Surrey SM2 5AS. Editorial correspondence should be addressed to "Television", Editorial Department, Reed Business Information, Quadrant House, The Quadrant, Sutton, Surrey SM2 5AS.

INDEXES AND BINDERS

Indexes for Vols. 38 to 49 are available at £3.50 each from SoftCopy Ltd., who can also supply an eleven-year consolidated index on computer disc. For further details see page 758.

Binders that hold twelve issues of *Television* are available for £6.50 each from Television Binders, 78 Whalley Road, Wilpshire, Blackburn BB1 9LF. Make cheques payable to "Television Binders".

BACK NUMBERS

Some back issues are available at £3.50 each.

SUBSCRIPTION ENQUIRIES

Telephone: 01444 445 566
Fax: 01444 445 447
Credit card orders: 01622 778 000
Address: Television, Subscriptions Dept, PO Box 302, Haywards Heath, West Sussex RH16 3YY, UK.
Make cheques payable to: Television
Subscription rates:
UK £32.00 per year
Airmail Eire £36.00 per year
Airmail Europe £46.00 per year
Airmail Rest of World £59.00 per year

NEWSTRADE ENQUIRIES

Distributed by MarketForce
Telephone: 0207 261 7704

WEB SITE

For a full list of RBI magazines:
<http://www.reedbusiness.com>

ISSN 0032-647X

TELETOPICS

Going digital

There's been renewed speculation about when and how the government might authorise the end of analogue TV broadcasting. It apparently stemmed from leaks about a report commissioned by the Department of Trade and Industry from the Digital TV Group. There have been estimates that the government could raise some £29 billion by selling off surplus UHF bandwidth once analogue transmissions have come to an end. Much of the UHF band will however probably be required to extend digital coverage. If the government could persuade viewers to move to digital TV quickly, possibly by offering free or subsidised digital decoders, it has been suggested that the analogue switch-off date could be brought forward from the present estimated 2006-2010 to say 2004. According to a recent OfTel survey one in five households now subscribes to digital TV, the main incentive being extra channels – fewer than one in five digital subscribers uses interactive services such as e-mail and home shopping.

Digital boxes would have to be available at a very low cost to make it worthwhile issuing them freely, even if the government was prepared to take this course. Many viewers would require

several boxes, for additional TV sets and VCRs. They would have to purchase them, which would hardly be popular. The timing of an analogue switch-off remains a very touchy subject, and for the moment the government does not seem to be committed to any particular time scale.

Meanwhile the BBC has been considering future services and has announced plans for two new digital channels, BBC3 for younger viewers and BBC4 for cultural material. But the BBC says plans are still at "an early stage". The BBC is also considering the development of an internet portal that would enable viewers to download films and other programmes on a pay-per-view basis.

The Anytime-TV Forum, a group of about a hundred broadcasters, electronics manufacturers and software companies, has published a draft specification on content referencing for personal digital recorders (PDRs) – hard-disc recorders that can store hours of programmes and record them automatically. Content referencing is the process by which PDRs will store, identify and find programmes. Future specifications will cover Metadata (descriptive data) and content rights management and protection.

Sharp to give up CRTs

Sharp plans to discontinue the production of TV sets with CRT displays for the Japanese market by the year 2005. LCD TV sets currently account for approximately four per cent (by volume) of the Japanese market. Sharp sold about 70,000 LCD TV sets in Japan last year, and expects sales to increase to 160,000-170,000 in the present trading year. By 2001 output should be running at 700,000 sets a year. LCD sets are at present far more expensive than ones that use a CRT display: a 20in. LCD set costs about eight times as much as a 21in. CRT set in Japan.

Sharp is to launch LCD sets in Europe this autumn. Models and approximate prices are: LC-12A2E (£1,500), LC-15A2E (£2,000) and LC-20A2E (price to be announced). Sharp hopes to sell about 1,000 LCD TV sets a month in Europe. In addition Sharp plans to start mass-production of displays using PALC (Plasma Addressed Liquid Crystal) technology this autumn. More details of Sharp's plans will appear in a future issue of Television.

TV aids

A new technology to make TV viewing easier for those with hearing difficulties has been developed by researchers in the UK. It deals with the problem of distinguishing dialogue in the presence of background sound effects. Called Diction (Digitally Improving the Clarity of Television Narrative), the system uses an algorithm that learns to distinguish between actors' voices and background sounds, followed by digital signal processing to lower the background sounds without degrading the foreground sounds. The developers hope that the technique will become an integral feature of TV sets, but expect it to start off as a plug-in set-top unit. They expect the system to become available commercially within two years. The research has been carried out at the University of Surrey in conjunction with the ITC, the University of Manchester's Age and Cognitive Performance Research Centre, Premier Electronics and Broadcast Project Research.

The BBC has signed a deal with electronics company NXT and the government's Defence Evaluation and Research Agency aimed at adding automatic subtitling to live TV programmes. NXT and DERA will provide smart speech recognition software that will operate in real time to deliver the subtitle captions.

The Federal Communications Commission has voted in favour of the four major US TV networks offering video description services for the benefit of those with impaired sight by April 2002. Cable companies will also have to offer the service for their most popular programmes. Video descriptions will be transmitted for about four hours a week. The descriptions will be available by tuning into one of the stereo channels.

Digiboxes

BSkyB has signed an agreement with Sony for the supply of 200,000 set-top boxes by the end of the year. It has also given approval to a low-cost set-top box to be supplied by Amstrad. This will use a new reduced chip set (ST5512).

Pace has signed an agreement to develop a digital set-top box that uses Microsoft's TV Advanced software. The company will supply a minimum of 55,000 boxes to TV Cabo, Portugal's national cable operator, for the launch on an interactive service in 2001. The deal follows an agreement between Pace and Microsoft to co-operate on enhanced TV technology. The boxes will incorporate NagraVision conditional access and a DOCSIS cable modem.



Vann Draper Electronics has released three new fully-programmable DC power supplies from Grundig, Models PN400, PN300 and PN200. The PN400 provides two outputs at 0-40V, 0-4A and one at 0-6V, 0-5A. The PN300 has two outputs at 0-30V, 0-2-3A and one at 0-5V, 0-2A. Model PN200 provides two 0-20V, 0-5A outputs. For further details of these well specified units apply to Vann Draper Electronics, Stenson House, Stenson, Derby DE73 1HL. Phone 01283 704 706, fax 01283 704 707 or e-mail sales@vanndraper.co.uk

Double Density CDs

Sony has announced plans to develop Double Density CD-ROM, CD-R (recordable) and CD-RW (rewritable) discs, providing a data capacity of 1.3Gbytes. With many PCs now using high-performance processors and high-capacity hard discs, enabling them to handle large-file formats such as audio, video and still images, Sony sees a demand for a higher-capacity CD.

The Double Density CD will involve a few simple modifications to the standard CD format. Both are based on a 12cm diameter, 1.2mm thick disc with an infra-red laser (wavelength 780nm), but the numerical aperture of the objective lens has been increased from 0.45 to 0.50 for playback and 0.50 to 0.55 for record/playback. This enables the laser in a Double Density player or drive to focus on a smaller area. The DD discs have smaller minimum pit lengths (0.623 instead of 0.833µm) and a track pitch of 1.1 instead of 1.6µm. The scanning velocity with the DD disc is 0.90m/sec compared with the standard rate of 1.2-1.4m/sec. Both formats use eight-to-fourteen modulation, but DD has an enhanced error-correction system, CIRC7. A copy-control scheme will be included in the new format.

Philips and Sony are licensing the DD CD format.

Video news

Hitachi has launched an alternative to the current rather expensive range of MiniDV camcorders. Model VM-D865LE records digitally on Hi-8 format tape. The recording time is reduced by a third, but the same high digital picture quality is achieved. The camcorder is backwards compatible with Hi-8 and 8mm tapes and has a digital zoom capable of 500x magnification. Its digital signal processor has been designed to provide more accurate image analysis to reduce image distortion at this level of magnification. There are several digital effects, such as 16:9 which gives a widescreen look.

Philips plans to launch its first D-VHS VCR in Europe this year. Model DF420 will be able to record up to 21 hours of VHS-quality video on an E240 tape.

Canon has launched what it claims to be the world's smallest digital camcorders, Models DM-MV3, DM-MV3i, DM-MV3MC and DM-MV3MCi. The latter two models are equipped with a MultiMediaCard slot for transferring still images to a PC, using a PC card adaptor or card reader. Both are equipped with an 800,000 pixel CCD imager, an image stabiliser and a 10x zoom lens. All models weigh 390g and have dimensions 48 x 106 x 86mm.

Samsung has launched a 43in. LCD rear-projection TV set, Model SP-43J6HD. It has a depth of 39.9cm and sells at about £2,300.

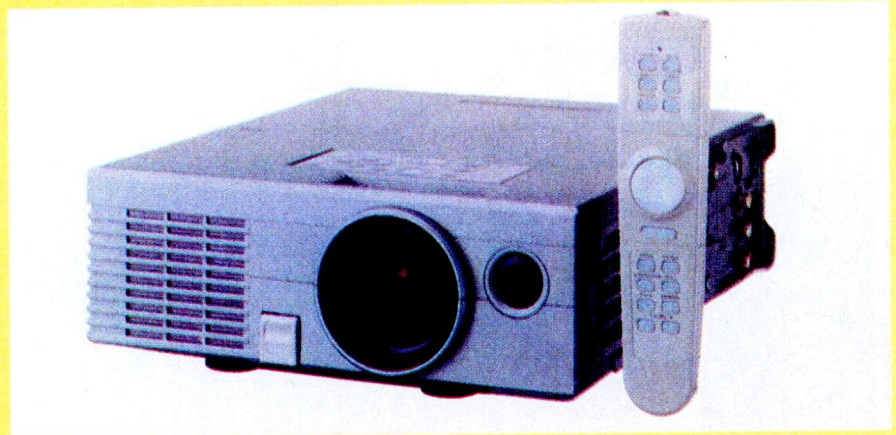

The LVP-X70U is one of a series of new ultra-portable, high-performance LCD projectors introduced by Mitsubishi Electric. The units can project on to a screen, or just a plain wall, to provide pictures from 40in. to a massive 25ft diagonally. There are built-in speakers. Prices of the units start at £3,000. They provide XGA resolution (1,024 x 768 pixels) with SXGA capability. The built-in Cineview line doubler smooths out video motion. Other features include a specially-designed natural colour matrix and manual, digitally-expanded zoom to enable any section of the image to be enlarged. The units auto-sync with PC signals and can be used with video, PC or Mac inputs. More advanced models include features such as picture-in-picture and a system to correct for distortion when the projector has to be tilted. Power consumption is 230W, fan noise 37dB.

Full details of the Mitsubishi range of display projectors is available from Mitsubishi Electric Europe, Visual Information Systems, Travellers Lane, Hatfield, Herts AL10 8XB. Phone 01707 276 100, fax 01707 278 541 or check at www.mitsubishi.co.uk/evs

DVD update

JVC is to launch its first DVD-Audio/DVD-Video player this year. Model XV-D723. It will include Dolby Digital, DTS and MPEG decoders, a 13-step zoom function and provide RGB outputs.

The first Panasonic and Technics DVD-Audio players have gone on sale in Japan and the USA, though there is some controversy over the watermark system used to protect DVD-Audio discs from unauthorised copying and duplication. The system, developed by US company Verance, has been criticised by some audio engineers who say it affects the music. Verance and the DVD Forum do not accept this. No DVD-Audio titles have so far been launched.

The DVD Forum has announced a plan that's designed to remove confusion about the various DVD formats available. Known as DVD Multi, the plan consists of a set of hardware specifications to ensure the compatibility of virtually all official DVD formats. A DVD Multi logo is to be introduced. The DVD Multi specifications mean that consumer DVD players will be able to read DVD-Video, DVD-Audio, DVD-RAM, DVD-R and DVD-RW discs. A DVD-ROM drive will be able to read all these plus DVD-ROM discs, though decoders will be required for DVD-Video and DVD-Audio discs. The first DVD Multi products are due to be launched in early 2001. The DVD Forum forecasts that the global DVD market will be worth some \$20 billion (£14 billion) this year.

twice last year's figure.

Sharp has launched, in Japan, the first DVD player with the ability to use DVD-RW discs. Model DV-L80TV is a portable DVD player with an 8in. LCD screen, a built-in UHF/VHF tuner and three-stage electronic zoom.

Sony has launched two portable DVD-Video players, Models DVP-FX1 and DVP-F5. The former has a 7in. LCD screen and several virtual surround-sound systems. The latter omits the screen.

LG has launched two DVD players, Models DVD-335E and DVD-3200E. The former has a built-in MP3 decoder, Dolby Digital/MPEG-2 decoders and a DTS digital output. The DVD-3200E has 4x and 6x zoom functions.

Philips has announced that it will include in future DVD-Video recorders a watermark detector based on a system developed by the Millennium Group (Philips, Digimarc and Macrovision). The watermark serves as a copy protection system, enabling a recorder to recognise and prevent unauthorised copying of protected material. The watermark remains even when the digital video signal has been converted to analogue form. Millennium's system also provides play control using Wobbletrack, a proprietary method of producing copy-protected discs. Playback equipment can use watermark and Wobbletrack to discriminate between authentic and illegally-copied discs and prevent playback of illegal copies.



WHAT A LIFE

Was the TV trade such a good choice?

Donald Bullock's contemporaries seem to have done rather better. Some aerial trouble at a caravan site, and a few video problems

obviously secure. How proud I was that things had turned out that way, and how sorry I was for my schoolmates – the sports-mad Will Horner, who couldn't walk and chew gum at the same time, and old Muddy Mawson whose people ran a back-street fish-and-chip shop. He was decent enough, but slightly thicker than a chimp. Where are they now, I mused?

Ah yes. Old Horner's retired to Bermuda with his young wife, having just sold his chain of sportswear shops to a national group. And the last time old Mawson brought me his set to fix he came dressed in hunting gear.

"I've got no interest in foxes. I'm only into this to kill time" he'd said modestly. "I've nothing else to do but spend my money. My managing director runs all the fish-and-chip shops of course, and looks after my investments."

No picture, see

Still, they probably haven't had the fun I've had. I remember the Saturday morning a bossy and rough-voiced woman who called herself Mrs Craddock called me to a country mansion to fix her set. It was ten or twelve miles away but was a sunny day, so why not? Off I cruised and, when I got there, the house was very impressive indeed. I rang the polished brass bell-pull beside the wide, dark blue front door. Out came a maid dressed in a black and white uniform.

"Can I speak to Mrs Craddock, please?" I asked.

The maid faltered then went inside. Eventually a tall, stern woman with blue hair appeared.

It had been a tiring day. Mrs Macham had just told me that her set had never been right since I'd done it and she was going to have me seen to. Mr Pugh had bowled me out for incompetence because his aerial blew down just after I'd done his set. And old Mrs Vigner had told me that I knew nothing about television and had always been a fool.

I hadn't felt much like entertaining the Browns, but we had to as we'd already invited them. We'd just seen them off and I was slumped in my chair. I asked Greeneyes to get me a whiskey.

"It had better be a small one" she said as she trickled me a thimbleful of happiness, "don't forget it's high time you began your article for *Television*. If it was me I'd have them written and sent off by the first of every month, without fail. The trouble with you – amongst all the many others I could think of – is that you've got no system.

Reflections

When she clopped off to the kitchen I systematically topped up my glass to a reasonable level and settled the bottle at my elbow. Then I sat back and reflected.

What a life this trade has given me. I'd been handy with wires and things at school, and often made the odd half-crown by knocking up crystal sets in matchboxes. I also made telephones that worked, using wooden switchblocks to make the microphones and earpieces. Other chaps would have had to run errands for hours to equal such earnings. And whenever a group of us went camping up the hill the others had to get the fires and food organised while I merely had to sling up an aerial and conjure Dick Barton's adventures into our tent.

Yup, I'd an aptitude for the intricacies of electronics, the essence of things to come, and it was already paying off. My future was

"What is it you want?" she asked in a clear, plummy voice.

"Are you Mrs Craddock?" I asked.

She looked horror-struck. "The Craddocks are to be tenants of ours" she declared. "They arrived here last evening and are in the orchard. Go through the gate at the bottom of the lane beside the house. Oh, and please remove your van from the drive."

I did as she asked and found an orchard full of mostly expensive caravans. Mrs Craddock's caravan was a rather shabby looking one at the back. She was clearly a traveller.

"Come in luv" she rasped, "I can't get no picture, see."

There was a skimpy aerial outside on a pole. Its download was cut short. I had no aerial equipment with me, so I went off to the next village to buy some coaxial cable. When I returned I set about dismantling the guy wires. It was an ancient rig, and it was ages before I had her set working.

"My daughter's got no picture either, luv" she said. "Course 'er 'usband's skidaddled, so you'll have to tack any charge on to my bill.

She led me to an even shabbier caravan. Her scruffy daughter gave me a smile and a wink, so I thought of England. It was again aerial trouble – this time there was no download at all.

"It must have got lost in the move like" her daughter said.

Fortunately I'd bought enough cable. The guy-wire fittings were rusty, so I had to borrow some oil. When I got the aerial down I saw that it was fractured and that its connection box was missing. This meant another visit to the dealer. When I eventually finished the job I saw that Mrs Craddock and her daughter were dressed for going out.

"Just make sure her picture's right, there's a dear" Mrs Craddock said. I did, and it was.

"Now check mine again, luv" she said.

It was OK. As I came out both women locked their doors. This didn't look too hopeful.

"I'll just do you a bill" I said, reaching for my pen.

"Good idea" said Mrs Craddock, "post 'im on to me, luv." Then a bus came along and the women rushed off to get it.

The telephone was ringing when I arrived at the workshop after the weekend. It was Mrs Craddock.

"Don't bother sending me a bill luv" she rasped. "I knows you done yer best, but both aerals 'ave fell down. We've 'ad to get someone else." The line went dead.

Payment

Over the next month or two I sent bills and reminders, but got no response until I wrote a letter which was to the point. This produced a phone call.

"I've told you I ain't paying 'cos it all fell down. You shouldn't 'ave left it like that."

"Listen, Mrs Craddock" I said, "I came ten or twelve miles to The Gables and found you on a caravan site. Instead of coming away I spent some hours running about and renovating your makeshift aerals and leads. And I left you with pictures. I've raised a bill and I want it paid. Are you going to pay it nicely, or do I take steps?"

"You ain't gettin' nuthin" she replied then hung up.

I phoned The Gables and spoke to the blue-haired lady. "I'm about to issue a summons against two of your tenants" I said, "am I right in assuming that their address is The Gables?"

Twenty minutes later the phone rang. It was a man who sounded like a traveller.

"Hello boss" he said, "oi've got some money to pay you for the work you kindly done for Mrs Craddock and her daughter, and I want to pay it quick like. That's the way we pays our bills. 'Ow do I find you?"

Half an hour later the money was in the till. He was a genial fellow, a gentleman.

Beans

Mrs Crabbright called into the workshop with a JVC VCR and her boy, who was about five.

"This 'un was all right until this little perisher pushed his spoonful of beans into it" she said.

"Don't like beans" blurted the boy. I flexed my right hand.

The recorder was an HRFC100EK, and was dead. I decided to give it to Steven, our video expert, to deal with. He opened it up and took out the spoon and beans, then moved over to the power supply. There were no outputs, and a quick check on the 2SC4517A chopper transistor Q1 showed that it was short-circuit. He replaced it with a BUT11AF, but this made no difference. A check on Q2, which was a 2SD2144S, revealed that it was leaky. He replaced it with a BC637 then carried out some further checks. R10, an 0.27Ω, 1W resistor, was open-circuit. Once this had been replaced the machine worked perfectly.

Tape chewing

It has been commented that people get to look like their dogs, or vice versa. It seems that you can also get a behavioural link with a VCR. Mr Postgate is a nice enough old boy, but he has a wet chin and he chews away. He brought in his VCR, another JVC machine, Model GRAX55EK.

"How are you these days, Mr Postgate" said Steven.

The old boy put his VCR on the counter. "I'm all right, but this 'un here started chewing tapes yesterday evening" he replied. "Try as I might I can't stop it."

Steven soon had the top off and immediately saw the cause of the trouble. The back-tension arm had snapped in half, so there was no tape tension.

We've had this fault several times. The arm can be obtained from SEME, part no. YQ43377A, at a modest cost and is easy to fit: remove the back-tension band, fit the arm

and refit the band.

Toshiba V709B

Last spring Greeneyes and Steven went out to buy a new VCR for us and came back with a Toshiba V709B. I said I would let you know how it behaved itself. It was all right until the other day, when Greeneyes played a C60 tape and said there were white flecks all over the picture.

"I'll clean the heads" I said.

"Shouldn't need it" said Jamie, "there's a built-in cleaning device."

But I cleaned them anyway, and Greeneyes settled down to watch *Gone with the Wind*, which is on a four-hour tape. The VCR behaved perfectly.

Next day Greeneyes tried her C60 tape again. The white flecks were back. I gave the heads another clean and Greeneyes tried the C60 tape once more. There were white flecks.

"Have you another C60 tape?" I asked. She produced one and tried it. White flecks.

"Try *Gone with the Wind* again" I said. No white flecks.

I came to the conclusion that the problem had to be to do with the tape and decided to try a C180. There were white flecks, but far fewer.

Jamie opened the machine up. The tape carriage sits in the middle of the main PCB. He discovered that pressing and lifting the panel affected the fault. So he assumed that dry-joints or a print crack were likely to be the cause of the trouble and spent a good while with a magnifier and his soldering iron trying to bring about a cure, all to no avail.

He eventually found that pressure applied to the tape carriage affected the fault. No pressure, lots of flecks. Moderate pressure, fewer flecks. A lot of pressure, no flecks. Hence the different fault symptoms depending on the length, and hence the weight, of the tapes we'd tried.

The tape carriage is secured to the main panel by its connecting plugs and sockets only, and can easily be lifted up and out from the panel. Once this had been done the cause of the problem was evident. The carriage is earthed to the panel by means of a flexible earthing leaf which, in this case, was tarnished and thus made poor contact. Jamie cleaned and reflexed the leaf, which completely cured the fault.

Had we been average customers, I reflected, we would have called the dealer out, which would have been one service call to set against his profit. I wonder what percentage of these machines have given this trouble, or are about to do so, and how much running about this small fault could cause?

Otherwise the machine has behaved well and gives excellent results. There are however features that I still can't work, like the one that permits programmes to be recorded when I'm out by previously feeding in a VideoPlus number. I can't get this right, so I have to bribe one of the boys to stand in for me and do it manually. ■

Grandata Ltd

distributor of electronic components



Television Repair / Modification Kits



MODEL	KIT TYPE	ORDER CODE
ALBA		
1452T	PSU	ONWAKIT
1427T	PSU	ONWAKIT
1402	PSU	ONWAKIT
1455T	PSU	ONWAKIT
1456T	PSU	ONWAKIT
1458T	PSU	ONWAKIT
1459T	PSU	ONWAKIT
2002	PSU	ONWAKIT
2009B	PSU	ONWAKIT
2052T	PSU	ONWAKIT
2152T	PSU	ONWAKIT
CTV501	PSU	ONWAKIT
CTV701	PSU	ONWAKIT
CTV840	PSU	ONWAKIT
CTV841	PSU	ONWAKIT
CTV485	PSU	ONWAKIT

MODEL	KIT TYPE	ORDER CODE
AKAI		
CT1417	PSU	ONWAKIT
CT2159U	PSU	ONWAKIT
CT2162UNT	PSU	ONWAKIT
CT2863UNT	PSU	ONWAKIT

MODEL	KIT TYPE	ORDER CODE
GOODMANS		
147TT	PSU	ONWAKIT
149T	PSU	ONWAKIT
1430RA	PSU	ONWAKIT
1430RS	PSU	ONWAKIT
1430RW	PSU	ONWAKIT
1450T	PSU	ONWAKIT
1455TS	PSU	ONWAKIT
2019R	PSU	ONWAKIT
2029T	PSU	ONWAKIT
2029TA	PSU	ONWAKIT
F16 CHASSIS	FRAME	GOODKIT1
F16 CHASSIS	LINE	GOODKIT1
F16	PSU	GOODKIT1
F16	VIDEO	GOODKIT1

MODEL	KIT TYPE	ORDER CODE
GRUNDIG		
CUC 7350		GRUNDIGKIT1

MODEL	KIT TYPE	ORDER CODE
HINARI		
HIT14RC	PSU	ONWAKIT
JVC		
AV29SX1EK	FIELD O/P KIT	JVCKIT1
AV29SX1EN	FIELD O/P KIT	JVCKIT1
AV29SX1EN1	FIELD O/P KIT	JVCKIT1
AV29SX1P	FIELD O/P KIT	JVCKIT1
AV29TSIE1	FIELD O/P KIT	JVCKIT1
C14E1EK	PSU	ONWAKIT
C14T1EK	PSU	ONWAKIT
C21ET1EK	PSU	ONWAKIT
CS21M3EK	PSU	ONWAKIT

MODEL	KIT TYPE	ORDER CODE
MATSUI		
1455	PSU	ONWAKIT
1498	PSU	ONWAKIT
2086	PSU	ONWAKIT
2098	PSU	ONWAKIT
21V1N		GRUNDIGKIT1
21V1T		GRUNDIGKIT1

MODEL	KIT TYPE	ORDER CODE
MITSUBISHI		
AV1 SERIES	PSU	MITSKIT3
CT1M5B	PSU	MITSKIT3
CT21M5BT	PSU	MITSKIT3
CT25M5BT	PSU	MITSKIT3
CT21A2STX	TDA 8178S	MITSKIT1
CT21AX1B	PSU	MITSKIT3
CT21A3STX	TDA 8178S	MITSKIT1
CT21AV1BS	PSU	MITSKIT3
CT25A2STX	TDA 8178S	MITSKIT1
CT25A3STX	TDA 8178S	MITSKIT1
CT25A4STX	TDA 8178S	MITSKIT1
CT25A6STX	TDA 8178S	MITSKIT1
CT25AV1B	PSU	MITSKIT3
CT25AV1BS	PSU	MITSKIT3
CT25AV1BD	PSU	MITSKIT3
CT25AV1BDS	PSU	MITSKIT3
CT28AV1B	PSU	MITSKIT3
CT28AX1BD	PSU	MITSKIT3
CT28AV1BDS	PSU	MITSKIT3

MODEL	KIT TYPE	ORDER CODE
MITSUBISHI continued		
CT29AS1	TDA 8178S	MITSKIT2
CT29A4	TDA 8178S	MITSKIT2
CT29A6	TDA 8178S	MITSKIT2
CT29B2	TDA 8178S	MITSKIT2
CT29B3	TDA 8178S	MITSKIT2
CT29B6	TDA 8178S	MITSKIT2
CT33B3	TDA 8178S	MITSKIT2
M5 SERIES	PSU	MITSKIT3

MODEL	KIT TYPE	ORDER CODE
NEI/NIKKAI		
CE25 CHASSIS	PSU	NIKKAIKIT1
C289FTXN	PSU	NIKKAIKIT1
C28F41FXN	PSU	NIKKAIKIT1

MODEL	KIT TYPE	ORDER CODE
PANASONIC		
IC561	TDA 8175	PANKIT1
TX25XD60	VERTICAL O/P IC	PANKIT2
TC28XD60	VERTICAL O/P IC	PANKIT2
TX28XD70	VERTICAL O/P IC	PANKIT2
TX29XD70	VERTICAL O/P IC	PANKIT2
TX-W26D3	VERTICAL O/P IC	PANKIT2

MODEL	KIT TYPE	ORDER CODE
PHILIPS		
310.10708		PHILKIT3
310.20491		PHILKIT2
310.20496		PHILKIT10
310.31994		PHILKIT6
310.32252		PHILKIT5
310.32253		PHILKIT4
310.32254		PHILKIT9
310.32255		PHILKIT7
310.32262		PHILKIT8
310.62264		PHILKIT1
ANUBIS A	SOPS	PHILKIT2
CP110 CHASSIS	SOPS	PHILKIT8
G90A CHASSIS	SOPS	PHILKIT10
G90B CHASSIS	SOPS	PHILKIT10
G110 CHASSIS	SOPS	PHILKIT3
GR2.1 CHASSIS	SOPS	PHILKIT1

MODEL	KIT TYPE	ORDER CODE
PHILIPS continued		
GR2.2 CHASSIS	SOPS	PHILKIT1
D-16 CHASSIS	SOPS	PHILKIT6
HSM VIDEO	SOPS	PHILKIT5
JSM VIDEO	SOPS	PHILKIT4
KSM VIDEO	SOPS	PHILKIT9
LSM VIDEO	SOPS	PHILKIT7

MODEL	KIT TYPE	ORDER CODE
SAMSUNG		
C15944	FRAME OUTPUT	SAMKIT2
C16844	FRAME OUTPUT	SAMKIT2
VIK310	PSU	SAMSUNGKIT
VIK320	PSU	SAMSUNGKIT
VIK350	PSU	SAMSUNGKIT
VI375	PSU	SAMSUNGKIT
VI395	PSU	SAMSUNGKIT
WINNER 1	PSU	SAMSUNGKIT

MODEL	KIT TYPE	ORDER CODE
SHARP		
51CS03H	POWER / LINE	SHARPKIT1
51CS05H	POWER / LINE	SHARPKIT1
59CS03H	POWER / LINE	SHARPKIT2
59CS05H	POWER / LINE	SHARPKIT2
59CSD8H	POWER / LINE	SHARPKIT2
66CS03H	POWER / LINE	SHARPKIT2
66CS05H	POWER / LINE	SHARPKIT2
66CSD8H	POWER / LINE	SHARPKIT2

MODEL	KIT TYPE	ORDER CODE
THOMSON		
35029400		THOMKIT2
35065920		THORNKIT1
FV70	PSU	THORNKIT1
ICC7 CHASSIS	TDA 8178FS	THOMKIT1
ICC7 CHASSIS	FRAME KIT	THOMKIT3
ICC8 CHASSIS	TDA 8178FS	THOMKIT1
ICC8 CHASSIS	FRAME KIT	THOMKIT3
R3000	PSU	THOMKIT2
R4000	PSU	THOMKIT2

ORDER CODE	PRICE
GRUNDIGKIT1	£ 10.50
GOODKIT1	£ 11.00
JVCKIT1	£ 11.00
MITSKIT1	£ 3.00
MITSKIT2	£ 15.00
MITSKIT3	£ 6.00
NIKKAIKIT1	£ 12.00

ORDER CODE	PRICE
ONWAKIT	£ 12.00
PANKIT1	£ 7.00
PANKIT2	£ 9.00
PHILKIT1	£ 7.60
PHILKIT10	£ 8.50
PHILKIT2	£ 2.50
PHILKIT3	£ 4.00

ORDER CODE	PRICE
PHILKIT4	£ 4.25
PHILKIT5	£ 5.75
PHILKIT6	£ 5.50
PHILKIT7	£ 7.60
PHILKIT8	£ 4.25
PHILKIT9	£ 7.50
SAMKIT2	£ 8.00

ORDER CODE	PRICE
SAMSUNGKIT	£ 16.00
SHARPKIT1	£ 11.00
SHARPKIT2	£ 11.00
THOMKIT1	£ 7.00
THOMKIT2	£ 12.00
THOMKIT3	£ 9.00
THORNKIT1	£ 12.75

GENUINE PHOENIX KITS SUPPLIED



GENUINE PHOENIX KITS SUPPLIED

WE STOCK A FULL RANGE ON TELEVISION SPARES INCLUDING LINE OUTPUT TRANSFORMERS , ON / OFF SWITCHESetc



CD Pick Ups



Part No	Price
KSS 152 A	£13.00
KSS 210 A	£10.50
KSS 210 B	£15.00
KSS 240 A	£24.00

Part No	Price
KSS 213 B	£11.50
KSS 213 C	£11.50
OPTIMA 6 S	£11.50
OPTIMA 5	£11.50

Part No	Price
RCTRTH8151	£20.00
RCTRTH8112	£15.00
CDM12.1	£15.00
CDM12.1 MECH.	£20.00

Tel : (020) 8900 2329 Email : grandata.ltd@btinternet.com
 Fax : (020) 8903 6126 Website : http://www.grandata.co.uk

Grandata Ltd

distributor of electronic components



Remote Controls



Universal Preprogrammed Remote Control

Preprogrammed to cover all major Brands of TV, Video, Satellites and CD Players.

Replaces upto 8 different remote controls

With teletext & fastext functions

Order Code : RC9
Price : £10 + vat

Bulk Prices

5 pieces £45 + vat
12 pieces £96 + vat
24 pieces £168 + vat



Magician Sky Digital Remote Control

Operates all SKY digital TV box functions
Operates combinations of TV, VCR & Cable/Satellite systems
Covers 1000's of brands
Teletext and fastext functions
Backlit device indicator keys
Order Code : MAGICIAN4
Price : £10 + vat

We also stock replacement remote controls for 5,000 different models at very competitive prices, contact us for all our remote control requirements. Many of our remote control prices have been reduced....Please call us for our latest prices

Universal Brand Replacement Remote Controls

Brand for Brand Replacement

Codeless set-up

Teletext and Fastext

Pre-Programmed for the latest models

Replaces broken and lost remotes

Brand	Order Code
Panasonic TV	RCUNI01M
Sony TV	RCUNI02M
Philips TV	RCUNI03M
Hitachi TV	RCUNI04
Mitsubishi TV	RCUNI05
Nokia TV	RCUNI06
Samsung TV	RCUNI07
Toshiba TV	RCUNI08
Ferguson TV	RCUNI09
Grundig TV	RCUNI10
Goodmans/Alba/Bush TV	RCUNI13M
Matsui/Hinari/Orion TV	RCUNI14M
Satellite	RCUNI17

Price : £7.50 + vat

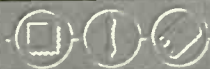

Accessories / Tools



SLx4.....4 Way Aerial Amplifier

.....the first choice for the professional aerial installer

Now Available !!

SLX2 (2 way)
£8.00 + vat

SLX6 (6 way)
£18.50 + vat

SLX8 (8 way)
£20.00 +vat

- * Designed for TV, Satellite and FM Receivers
- * 10.5db Gain on all ports
- * Isolation between outputs > 22db
- * Separate UHF/VHF inputs
- * Noise figure < 4db
- * Digital Compatible
- * Frequency Range : UHF 470-863 Mhz
VHF 47-230 Mhz
- * CE and EMS Test Certified

Order Code : SLX4 Price : £13 + vat

SOLDER SEAL KIT

DON'T CRIMP IT....SOLDER IT !!!

FOR QUICK AND SAFE CABLE CONNECTION SOLDERING, GLUEING AND SHRINKING WITH A HOT AIR GUN ALL IN ONE ACTION

HOT AIR GUN WITH PIEZO ELECTRONIC IGNITION

USES LIGHTER GAS

BLOWS HOT AIR UPTO 650C

ORDER CODE: TOOL53
PRICE : £13.00 + VAT



HOT AIR GUN

FLAMELESS...ONLY HOT AIR IDEAL FOR THE FOLLOWING :

SHRINKING TUBES

SOLDER SEALS HEATING AND

DRYING

HOBBY &

MODELLING

BENDING

PLASTICS

SMD SOLDERING

BLOWS HOT AIR UPTO 650C

ORDER CODE : TOOL54
PRICE : £7.50 + VAT



We stock over 650 different video heads covering over 2500 different models for the following makes :

AIWA, AKAI, ALBA, AMSTRAC, BAIRD, BLAUPUNKT, DAEWOO, DECCA, FERGUSON, FISHER, FUNAI, GEC, GOLDSTAR, GRANADA, GRUNDIG, HINARI, HITACHI, JVC, LUXOR, MATSUI, MITSUBISHI, OFION, PANASONIC, PHILIPS, SAISHO, SAMSUNG, SANYO, SHARP, SONY, TOSHIBA...AND MANY MANY MORE

This advert is just a small selection of our stock.

We also stock the following :

Full Range of Video Spares	Full Range of Satellite Spares	Multimeters
Full Range of TV Spares	Scart and Phono cables	Service Aids
Transistors	Linear IC's	Computer IC's
Japanese Transistors..2SA,2SB...etc & much much more !!!!!		

All at very competitive prices !!

Please contact us if you cannot find the part you are looking for.

* Please add £1 p+p and VAT to all orders

* All components are brand new

* We accept payment by Access, Switch, Visa, Cheque and Postal Order

* All prices quoted are subject to availability and may be changed without prior notice

K.P. House, Unit 15, Pop In Commercial Centre, Southway, Wembley, Middlesex. HA9 0HB England

Tel : (020) 8900 2329 Email : grandata.ltd@btinternet.com
Fax : (020) 8903 6126 Website : http://www.grandata.co.uk

Geoff Lewis explores whether new technology, designed to bring wireless networking into the domestic environment, has the potential to provide a new source of business for those of you involved in servicing and repair



New technology New business?

Recent technical developments in the entertainment electronics industry have created many problems for service departments and engineers. The use of dense integrated circuits and the introduction of digital techniques have worked in the end-user's favour by increasing reliability, thus reducing the service engineer's work load and the income for the service department.

Set-top boxes (STBs) given away by digital broadcasters to drive the introduction of their new services will add to these problems. How many customers will pay perhaps £150 to repair a faulty STB that is apparently worthless?

Help with retraining for new developments, which was previously provided by local Colleges of Technology, is also now virtually a thing of the past. Journals such as *Television* will have a much more significant role to play in this area in future years.

There are, however, various other areas of work that can be financially rewarding and with which radio and television service engineers should already be fairly well acquainted.

Within the next year or so, information-technology businesses are likely to become involved with wireless links to add to their local-area networks (LANs). In this case, the important point is to get a faulty system up and running again quickly, with cost for once being a secondary consideration.

These digital radio options operate at low power in the familiar UHF or low microwave frequency ranges, thus calling for very little extra by way of service equipment or expertise.

Low-power radio links

A number of small segments of the VHF/UHF part of the frequency spectrum have been allocated to the operation of unlicensed low-power radio communications systems. These employ equipment that has been type-approved by a suitable test house.

All units of this type must meet the EU standards provided by the EMC Directive. They are used for applications such as alarms; radio

microphones; access control; industrial, medical and biological services; and general telemetry and telecommand services that come under the heading of 'supervisory control and data acquisition', more commonly known as SCADA.

Telemetry is the technique of automatically collecting or recording data from distant measurements via radio signals. Similarly telecommand systems are used for managing distant systems by remote control via a radio network.

The data collection and control functions are carried out by transmitter-receiver modem units that are powered from the electrical supply mains (if available), batteries or even solar panels or wind generators. The radio units may operate in pairs at either end of a simple network. Alternatively they could be arranged in a cluster, scattered over an area, that can be coupled into a LAN.

In fact the low-power radio concept has many advantages where network extensions are needed. Wireless radio modems can be used where normal wiring extensions are not possible, such as across rivers, through hostile environments and in inhospitable regions. By connecting these devices via serial interfaces they can be very easily linked to personal computers. The UK standards have been harmonised with those of Europe (EU) and are included in the ETS-300 group.

The section of the spectrum from 417.9MHz to 418.1MHz, covered by the MPT1340 standard in the UK, is allocated to the use of industrial telemetry, telecommand and in-building security. A further section, 433.72MHz to 434.12MHz, is reserved for in-vehicle equipment and radio keys. Both sections are covered in the UK by the MPT1340 standards.

The choice of frequencies used within these bands is left to the discretion of equipment manufacturers, but the EIRP (effective isotropically-radiated power) is restricted to 0.25mW for the 417.9 to 418.1MHz and 10mW for the 433.72 to 434.12MHz segment. Transmission frequencies

must however be maintained within better than $\pm 50\text{Hz}$.

A further service is carried within the band 458.5MHz to 458.95MHz, which is divided into channels so that specific frequency segments can be allocated to each of the units employed. To avoid overspill, each channel carrier is allocated within the above spectrum.

This service is covered by the UK MPT1329 standard. There is provision for either $32 \times 12.5\text{kHz}$ or $15 \times 25\text{kHz}$ channels. Within this range there are three taboo channels, which are covered by MPT1361 and centred on 458.825MHz, 458.8375MHz and 458.900MHz. These are allocated to fixed, mobile or transportable alarms or vehicle paging systems.

The maximum frequency error for each carrier must not exceed $\pm 2\text{kHz}$ for the 25kHz channels and $\pm 1.5\text{kHz}$ for the 12.5kHz channels with handheld devices, and $\pm 1\text{kHz}$ for 12.5kHz base station units.

Maximum carrier power is restricted to 500mW, but the EIRP is unspecified as directional antennas may be used. The maximum path length for transmissions is also unspecified, and may extend to 18-20km under favourable propagation conditions. The adjacent channel interference rejection ratio should be better than 90dB for the 25kHz and better than 80dB for 12.5kHz channels respectively.

These wireless radio modems commonly operate in the half-duplex mode, although a few devices can employ full-duplex working. The typical upper bit rate is 9.6kbit/s, using either frequency-shift keying (FSK) or phase-shift keying (PSK) for modulation.

New band for short-range uses

A further 2MHz of bandwidth, centred on 867MHz, has recently been allocated for short-range radio applications. Nine sub-bands, ranging from 25kHz to 600kHz in width, are provided for specific applications.

Bit rates range from 9.6kbit/s up to 50kbit/s, with individual maximum power outputs from 10mW to 500mW. The maximum reach ranges from about 100m inside buildings up to 700m in open space.

Units are also available for operation in the 2.4GHz band. These use direct-sequence spread-spectrum (DSSS) techniques, where each digital one or zero is represented by a unique code stream or its inverse. Data rates can be as high as 2Mbit/s, with an EIRP of 100mW.

These units are capable of working

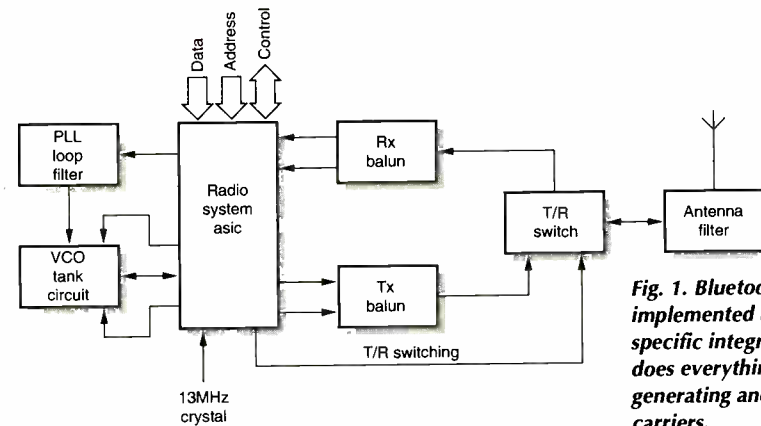

Fig. 1. Bluetooth's radio system is implemented using an application-specific integrated circuit. This ASIC does everything associated with generating and controlling the sub-carriers.

in either half- or full-duplex modes. Usually, the transmitter/receiver units share a common synthesised PLL oscillator circuit for both modes, using a mixing process to obtain transmit and receive frequencies.

To achieve the necessary adjacent-channel rejection ratio, these receivers operate with a double-conversion process typically employing intermediate frequencies (IF) of 45MHz and 465kHz. The antenna is isolated between receive and transmit by PIN switching diodes.

Because these modems are intended for LAN working, each device has an address that can be programmed at installation time, along with the selected channel numbers. This is usually achieved by setting a series of DIP switches.

Such modems can often function in either a transparent mode, where the received data is automatically transmitted without delay, or in a store-and-forward mode with data transmitted only upon interrogation by a base station.

Bluetooth

Bluetooth is the title used for an 'open-specification' system. It is designed to provide fast and secure short-range radio interconnection between portable devices and a local-area network (LAN) through the use of spread-spectrum techniques.

The services provided include internet, e-mail, image and data transmission, together with voice applications, and can handle up to three 64kbit/s PCM telephony channels simultaneously.

Bluetooth has been adopted by about 2,000 diverse user organisations. It is supported by many of the major semiconductor chip manufacturers including Intel, Toshiba, VLSI, Nokia, Texas Instruments, Ericsson, Thomson (ST), Lucent and Siemens.

In addition, the Bluetooth standards have gained the approval of the Federal Communications

Commission (FCC), European Telecommunications Standards (ETSI), the Institute of Electrical and Electronic Engineers (IEEE) and the Infrared Data Association (IrDA) for global use.

The user portable-terminal devices can include mobile phones, headsets, printers, digital cameras, PDAs (personal digital assistants) and lap/palm top and notebook computers. The idea is to provide a robust worldwide system capable of providing a virtual cable type of replacement at low cost, with plug and play capabilities.

Bluetooth transmission technology

The system operates in the licence-free industrial, scientific and medical (ISM) band from 2.4GHz to 2.5GHz. It involves frequency-hopping spread-spectrum (FHSS) technology. For this application FHSS is preferred to the more common direct-sequence spread-spectrum (DSSS) system. Though it's somewhat slower, it is much easier to implement using a frequency synthesiser.

Power output of the transmitters ranges from 1 to 2.5mW (0dBm to 4dBm). This gives a coverage of at least 10m. The range can be increased to 100m by using an RF power amplifier.

A prime number (79) of sub-carriers, spaced at 1MHz, occupies the band 2.402MHz to 2.480MHz. Each subcarrier is frequency modulated with a deviation of either -40kHz to -175kHz for binary 0 or $+140\text{kHz}$ to $+175\text{kHz}$ for binary 1. This modulation method is referred to as Gaussian frequency-shift keying, or GFSK for short, because the base-band digital signal is filtered to provide a Gaussian bell-shaped response pulse with at least 90 per cent of the pulse energy contained within its 3dB bandwidth. The resulting signal has good spectrum efficiency and resilience to co-channel interference (CCI).

Fig. 2. Baseband signal processing in Bluetooth is also carried out by an ASIC. This device contains a computer for controlling the radio section and inputs from the i/o interfaces.

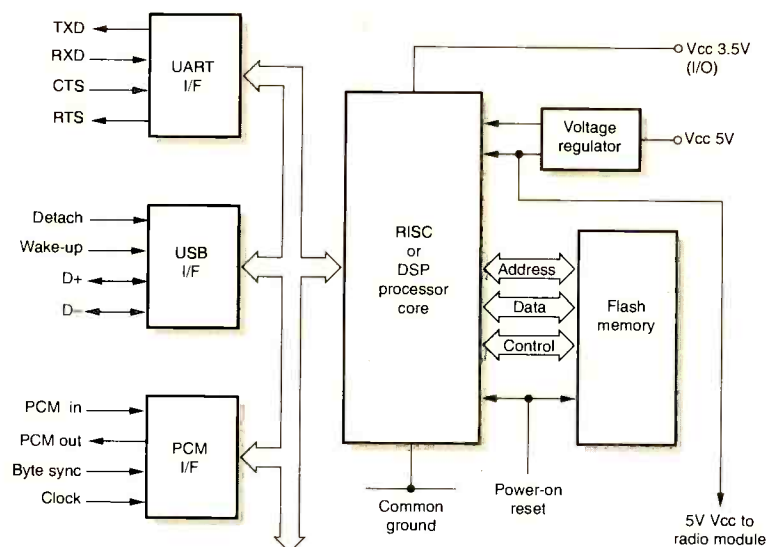

Each subcarrier can be switched at 1,600 frequency hops a second to provide a spread-spectrum signal with a hop period of 625µs. The maximum bit rate is currently 1Mbit/s but, because each subcarrier can carry multiple bits during each time slot, this figure might be doubled in the near future.

A bandwidth bit period ($B_w \times T_{bit}$) product of 0.5 has been set for Bluetooth. So, with a maximum bit rate of 1Mbit/s, this yields a signal bandwidth of 0.5×10^6 , which is 500kHz. Under these conditions, the system has an adjacent carrier interference (ACI) ratio of better than -20dBm. If the bit rate is increased to 2Mbit/s, this ACI protection ratio will be reduced.

Radio module

As currently configured, each Bluetooth terminal is based on a highly integrated module. The module contains an application specific integrated circuit (ASIC) designed to handle the radio functions, with a second one for baseband signal processing.

The module is constructed on a small six-layer ceramic substrate with seven metallic layers. It then connects to a PCB via ball grid array (BGA) mounts.

The lower metal layer acts as a ground plane, while the component side carries a pair of metal screens to complete the electromagnetic shielding. In order to maintain good interference rejection, the various earth points are distributed around the ground plane.

On the demonstration/evaluation model that I examined, the main PCB carried a significant number of low-voltage, high-value capacitors. In the future, these might well be a source of problems.

As shown in Fig. 1, the radio-system ASIC carries out all the functions associated with the generation and control of the sub-carrier frequencies. This is achieved by using a voltage-controlled oscillator (VCO) linked to a phase-locked loop (PLL) circuit. In turn, the PLL is locked to the output of a 13MHz crystal oscillator.

A VCO tank circuit forms part of the PLL circuit: its tuned load is laser trimmed for accuracy. A loop filter is used to remove any ripple from the output of the PLL circuit.

For receive purposes this IC employs a heterodyne technique to generate a low IF at 3MHz. The spread-spectrum frequency-hopping modulation is performed directly on the VCO.

A pair of balun circuits converts the balanced signals used within the ASIC into the unbalanced format used externally for transmission and reception. An antenna switch diverts the signals between the baluns and the antenna input and output for the transmit/receive functions.

The antenna filter reduces harmonic radiation from the terminal during transmit and helps to minimise unwanted interference effects during receive. The antenna feed is designed to match a 50Ω impedance load.

Baseband signal processing

A simplified block diagram of the baseband signal processor is shown in Fig. 2. The ASIC in this stage contains an embedded RISC (reduced instruction set computer) core which controls the operation of the radio section and the inputs from either of the input/output interfaces.

A flash reprogrammable memory carries the software that provides the overall control of the system. The supply voltage is well regulated and

filtered to provide power for both the signal interfaces and the transceiver.

Power requirements are low enough to permit battery operation. The 13MHz clock signal from the radio section is used to synchronise the action of the processor ASIC.

The universal asynchronous receiver-transmitter (UART) interface operates as a DCE (data circuit equipment) device under the control of an RTS (request to send) or CTS (clear to send) signal. In turn, these handshaking signals control data flow via the TXD (transmit data) or RXD (receive data) port. This interface can handle all the standard data rates from 300bit/s up to 460.8kbit/s.

In addition to the standard bi-directional ports D+ and D-, the universal serial bus (USB) interface has two additional inputs to provide for the control of a lap/notebook computer. The 'wake-up' signal advises the host computer that the terminal has become operative, the 'detach' signal indicating suspend-operation mode. While the USB port is capable of running at 12Mbit/s, the Bluetooth operation is limited to 1Mbit/s.

The PCM interface operates at the standard sample rate of 8kHz and can handle linear PCM samples of from 13 to 16 bits, plus both the µ-law and A-law 8-bit companded samples used for telephony.

Software and protocol

The code stored within the flash memory provides control of both the host controller interface and the local link manager for the USB, UART and PCM ports. The operational protocol provides for link set-up and configuration with authentication.

To maintain a secure transmission system and a high data rate in what might well be a noisy environment, Bluetooth operates with a packet switching protocol that includes forward error control and encryption.

Piconets

Bluetooth terminals are organised into small groups referred to as 'piconets'. Each group contains up to eight peer devices with one acting as a master for the group. The simplest network is just two devices linked by a virtual cable.

Piconets may be linked together via a terminal device that is common to two groups, but this must not be one of the masters. Each piconet has a different frequency-hopping sequence. A collection of piconets is known as a 'scatternet'. ■

SPECIAL OFFERS

TEKTRONIX 2445A

4 Channel 150MHz delay sweep; cursors/readout
£750

TEKTRONIX 475

Dual Trace 200MHz delay sweep
£400

MARCONI 2610 TRUE RMS VOLTMETER

Digital LCD + analogue meter 5Hz - 25MHz + DC autorange
£195

AVO 8 Mk 6 MULTIMETER

In Ever Ready case with leads and batteries
Other AVOS from
£80 £50

RACAL/AIM 9343M LCR Databridge. Digital Auto measurements of R, C, L, Q, D

HUNTRON TRACKER Model 1000 £125

H.P. 5315A Universal Counter 1GHz 2Ch. £80

FLUKE 8050A DMM 4 1/2 digit 2A True RMS. £75

FLUKE 8010A DMM 3 1/2 digit 10A. £40

FLUKE 8012A DMM 3 1/2 digit 2A. £50

RACAL TRUE RMS VOLTMETERS

9300 5Hz-20MHz usable to 60MHz 10 volts 316V
£95

9300B version
£150

GOODWILL GVT427 DUAL CHANNEL AC MILLIVOLTMETER
10µV 300V in 12 ranges Frequency 10Hz-1MHz
Used **£100** Unused **£125**

SINAD MEASUREMENTS

for only
MARCONI 893C AF POWER METER
300µ watts-30 watts; 20Hz-35KHz.
2.5 Ohm - 20K Ohms
£60

Marconi 893C unused, boxed
£100

Marconi 893B - to 10 watts max NO SINAD
£30

GOULD J3B SINE/SQ OSCILLATOR

10Hz-1200KHz. Low distortion. Balanced metered output. Attenuator
£75-£125

SOLARTRON 7150

DMM 6 1/2 digit. TRUE RMS. High accuracy IEEE
£95-£150

HIGH QUALITY RACAL COUNTERS

9904 Universal timer counter 50MHz
£50

9916 Counter 10Hz-520MHz
£75

9918 Counter 10Hz-560MHz. 9 digit.
£50

FARNELL AMM255

Automatic Mod Meter AM/FM 1.5MHz-2GHz 3.5 digit LCD Display Unused
£400

Also available:
FARNELL AMM2000 Automatic Mod Meter 10Hz-2.4GHz. Unused
£950

MARCONI 2305 Mod Meter 500KHz-2GHz
from **£750**



MARCONI 2022E
SYN AM/FM SIG GEN 10KHz - 1.01GHz
Up to +10dBm output, phase mod. LCD display, keyboard entry etc. Small, lightweight
£525-£600-£750

RADIO COMMUNICATIONS TEST SETS

MARCONI 2955 £2900
MARCONI 2955A £2500
MARCONI 2019 Synth AM/FM Sig Gen 80KHz-104MHz £475
H.P. 8657A Synth Sig Gen 100KHz-104MHz £2500
H.P. 8658B Synth Sig Gen 100KHz-990MHz £1350
H.P. 8656A Synth Sig Gen 100KHz-990MHz £995
GIGATRONIC 7100 Synth Sig Gen 10MHz-20GHz £5000
MARCONI 2017 AM/FM Phase Locked Sig Gen 10KHz-1024MHz £1200

Good Signal Purity
H.P. 8640A AM/FM Sig Gen 500KHz-1024MHz £400
H.P. 8640A AM/FM Sig Gen 500KHz-512MHz £250
PHILIPS PM5328 Sig Gen 100KHz-180MHz with 200MHz Freq Counter IEEE £650
RACAL 9081 Synth AM/FM Sig Gen 5-520MHz £350
H.P. 3325A Synth Function Gen 21MHz £600
MARCONI 6500 Amplitude Analyser £1500
H.P. 4275A LCR Meter 10KHz-10MHz £2750
H.P. 8903E Distortion Analyser £750
WAYNE KERR Inductance Analyser 3245 £2000
H.P. 8112A Pulse Generator 50MHz £1250
DATRON AutoCal Multimeter 5 1/2 digit 1065/1061A/1071 £1200

MARCONI 2440 Frequency Counter 20GHz £1000
H.P. 5350B Frequency Counter 20GHz £2000
H.P. 5342A 10Hz-18GHz Freq Counter £900
FARNELL AP100/30 Power Supply £1000
FARNELL AP70/30 Power Supply £800
PHILIPS PM5418TX Colour TV Pattern Generator £1750
PHILIPS PM5418TX Colour TV Pattern Generator £2000
B&K Accelerometer type 4366 £300
H.P. 11692D Dual Directional Coupler 2MHz-18GHz £1600
H.P. 11691D Dual Directional Coupler 2MHz-18GHz £1250
TEKTRONIX P6109B Probe 100MHz Readout. Unused £90
TEKTRONIX P6106A Probe 250MHz Readout. Unused £85

SPECTRUM ANALYSERS

H.P. 8562A 1KHz-22GHz £9000
ADVANTEST R3261 A 9KHz-2.6GHz Synthesised £4000
EATON/AILTECH 757 0.001-22GHz £2500
TEKTRONIX 492 50KHz-18GHz £3500
H.P. 8558B with Main Frame 100KHz-1500MHz £1250
H.P. 853A (Dig Frame) with 8559A 100KHz-21GHz £2750
MARCONI 2382 100Hz-400MHz High Resolution £2000
B & K 2033R Signal Analyser £1500
ADVANTEST TR4131 10KHz-3.5GHz £2750
MARCONI 2370 30Hz-110MHz from £500
HP141 Systems 8553 1KHz-110MHz from £500.
8554 500KHz-1250MHz from £750; 8555 10MHz-18GHz. from £1000

UNUSED OSCILLOSCOPES

TEKTRONIX TDS350 Dual Trace 200MHz 1GS/Sec £1500
TEKTRONIX TAS485 4 Channel 200MHz etc. £1100
H.P. 54600B Dual Trace 100MHz 20MS/s £1000

OSCILLOSCOPES

PHILIPS PM3092 2+2 Ch 200MHz Delay TB etc. £950
PHILIPS PM3082 2+2 Ch 100MHz Delay etc. £800
TEKTRONIX TAS485 Dual Trace 100MHz Delay etc. £800
TEKTRONIX 2465 4 Ch 300MHz Delay Sweep Cursors. £1250
TEKTRONIX 2430 Dual Trace 150MHz 100MS/s Cursors etc. £800
TEKTRONIX 2232 Dual Trace 100MHz 100MS/s Cursors etc. £800
TEKTRONIX 2212 Dual Trace 60MHz 20MS/s Cursors etc. £850
TEKTRONIX 2210 Dual Trace 500MHz 20MS/s £1450
H.P. 54200A Digitising 50MHz 20MS/s £800

PHILIPS PM3217 - Very good oscilloscope including 2 probes, Pouch and Front Cover
Dual Trace 50MHz Delay
£250-£300

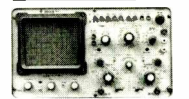

THIS IS THE BEST CHEAP SCOPE YOU WILL EVER BUY!!!
£200

GOULD OS1100 Dual trace, 30MHz delay, very bright. Supplied with manual and 2 probes. **£200**

STEWART of READING

110 WYKEHAM ROAD, READING, BERKS RG6 1PL

Telephone: (0118) 9268041 Fax: (0118) 9351696

Callers welcome 9am-5.30pm Monday to Friday (other times by arrangement)



UNUSED EQUIPMENT - GUARANTEED. Manuals supplied

This is VERY SMALL SAMPLE OF STOCK. SAE or telephone for lists. Please check availability before ordering. CARRIAGE all units £16. VAT to be added to total of goods and carriage.

FRUSTRATED!

Looking for ICs TRANSISTORS?

A phone call to us could get a result. We offer an extensive range and with a World-wide database at our fingertips, we are able to source even more. We specialise in devices with the following prefix (to name but a few).

2N 2SA 2SB 2SC 2SD 2P 2SJ 2SK 3N 3SK 4N 6N 17 40 AD ADC AN AM AY BA BC BD BDT BDV BDW BDX BF BFR BFS BFT BFV BFX BFLY BLX BS BR BRX BRY BS BSS BSV BSW BSX BT BTA BTB BRW BU BUK BUT BUY BUW BUX BUY BUZ CA CD CX CXA DAC DG DM DS DTA DTC GL GM HA HCF HD HEF ICL ICM IRF J KA KIA L LA LB LC LD LF LM M M5M MA MAB MAX MB MC MDA J MJE MJF MM MN MPS MP5A MP5H MP5U MRF NJM NE OM OP PA PAL PIC PN RC S SAA SAB SAD SAJ SAS SDA SG SI SL SN SO STA STK STR STRD STRM STRS SV1 T TA TAA TAG TBA TC TCA TDA TDB TEA TIC TIP TIPL TEA TL TLC TMP TMS TPU U UA UAA UC UDN ULN UM UPA UPC UPD VN X XR Z ZN ZTS + many others

We can also offer equivalents (at customers' risk).

We also stock a full range of other electronic components. Mail, phone, Fax, Credit Card orders & callers welcome.



Cricklewood Electronics Ltd

40-42 Cricklewood Broadway, London NW2 3ET

Tel:020 8452 0161 Fax: 020 8208 1441

Setbacks

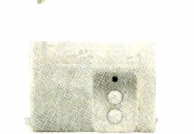

Reference		5371	5372
Inputs(2)		UHF/FM	UHF/FM
Outputs		6 (+1)	7 (+1)
Gain UHF		10 (+24)	10 (+24)
Noise Figure		2.5dB	
Line Power		12Vdc	
Output		890µV	

Features

- Ideal for digital installations
- Low noise figure
- F connectors
- Fully shielded

Reference		8130	8131	8132
Gain (dB)		23	17	7.5
Gain (dB)		-	15	7.5
Gain (dB)		-	-	12
Gain (dB)		-	-	16
Outputs		1	2	4
Input		1		
Noise Figure		< 3.5dB		

Features

- Design for individual installations
- Proven reliability and performance
- IEC connectors
- CE conforms with EN55013 EN55082-1, EN60065

Technical Specification

Reference		4381	4382	4383
Ampl Band(MHz)		5-380/470-860		
VHF Gain (dB)		26	13	13 0 9
VHF Gain (dB)		30	20	23 9 15
Var. gain VHF (dB)		>20	>20	>20
Var. gain UHF (dB)		>15	>15	>15
Max. output level (dBµV)		99	88	90 76 82
Noise Figure (dB)		<2.8dB	<2.8dB	<2.8dB

Features

- High output level/Low noise figure
- UHF and VHF variable attenuator (0-20 dB)
- IEC connectors
- Fully shielded

All these products are available from UK's main distributors and wholesalers

Televes

Televes UK Ltd Tel. 01633 875821 Fax 01633 866311
televes.uk@televes.com www.televes.com



Today's PCs use modular construction. They are therefore relatively easy to build and understand. This should enable you to add PC servicing to the range of your workshop activities. **Russ Phillips** provides a guide to PC basics, from specifications to the range of peripherals available

Building and Upgrading PCs

The purpose of this article is to offer advice and help for TV engineers who want to build a PC or upgrade an existing one, possibly bought second-hand. I assume that most readers will want to use the PC for workshop and office tasks, such as testing monitors, writing letters and keeping accounts. Where relevant however I will explain why alternative items may be more suitable for certain tasks. The idea is that the reader can use the guidance provided to build a system that's ideally suited to the purposes he has in mind.

Building a PC from modules bought individually, as opposed to buying a pre-built system, can have several advantages. It's often cheaper, while the modular construction of a modern PC enables you to build one that will meet your particular

needs rather than having to buy one that's been built to suit as wide a range of requirements as possible.

In some cases a PC built from second-hand parts (with possibly some new parts) may be more suitable, especially if it's difficult to justify the expense of a new machine. Alternatively it may be possible to upgrade an older computer. I will discuss the use of older components where appropriate.

Note that virtually every part in a PC is sensitive to static, so the usual precautions should be taken when handling these parts.

Specification

The PC specification you need depends on what you are going to use it for. If it's going to be used solely for testing moni-

tors and office work, the specification will be mainly determined by the operating system you intend to install.

If the computer is likely to be used for playing modern games, or for graphic design or video editing, a more capable (and expensive) machine will be required. In this case, find out the recommended hardware requirements for the software to be used and take this as the absolute minimum specification. If possible, build a better system. Software tends to run very slowly on a PC that's only as good as the recommended minimum, so a higher specification may well be preferable. When using this type of software, the most important parts are the system memory, the video card, the processor, the hard drive and the monitor, which should be as good as your budget will allow. While

being a good, low-cost choice for many applications, the Cyrix and IDT range of processors are not generally recommended for this type of work.

Operating system

Microsoft Windows, in its various versions, is the best-known PC operating system (OS). Others are available however. Windows has the advantage that lots of software has been written for it. It is also easy to install and use. If you are using a relatively old, second-hand system, Windows 3.11 is probably the best version to use. It will run happily with a system that has a 386 processor, 4MB of memory and a 250MB hard drive. To install Windows 3.11 you will first have to install a version of DOS (Disk Operating System). Microsoft DOS (MS-DOS) is generally used, but if you can gain access to the internet a free, Microsoft-compatible DOS can be downloaded from the FreeDOS web site at <http://www.freedos.org/>

One disadvantage of Windows 3.11 is that it is becoming increasingly difficult to get software that can be used with it, though suitable software can often be purchased from second-hand suppliers. Another potential problem is that it may not be compatible with relatively new hardware, such as a CD writer. Windows 95 and 98 do not suffer from these problems, but to run satisfactorily they need a more advanced system specification. A practical minimum is a Pentium-class processor (e.g. Intel Pentium, AMD K6, Cyrix 6x86 or IDT WinChip), 32MB of memory and an 800MB hard drive. The two OS versions are very similar, Windows 98 being largely an updated version of Windows 95 with better support for newer technologies such as DVD and USB (the Universal Serial Bus).

Windows 95 and 98 both have reputations for unreliability. If you want to be able to use the mass of software that has been written for Windows on a more stable system, Windows NT 4.0 Workstation could be the solution. NT was originally written for business networks, where reliability was very important. But some software written for other versions of Windows won't work with NT, especially hard-drive utilities, as NT handles hard drives in a different way to the other versions. NT doesn't support as wide a range of hardware as Windows 95 and 98 so, if you decide to use NT, make sure that all your hardware is compatible. NT has relatively high hardware requirements: a reasonably fast (200MHz plus) Pentium-class processor, 64MB or memory and an 800MB hard drive being the practical minimum.

The most recent version of Windows to be released is Windows 2000. It's a development of NT aimed at home as well as business users. A practical minimum

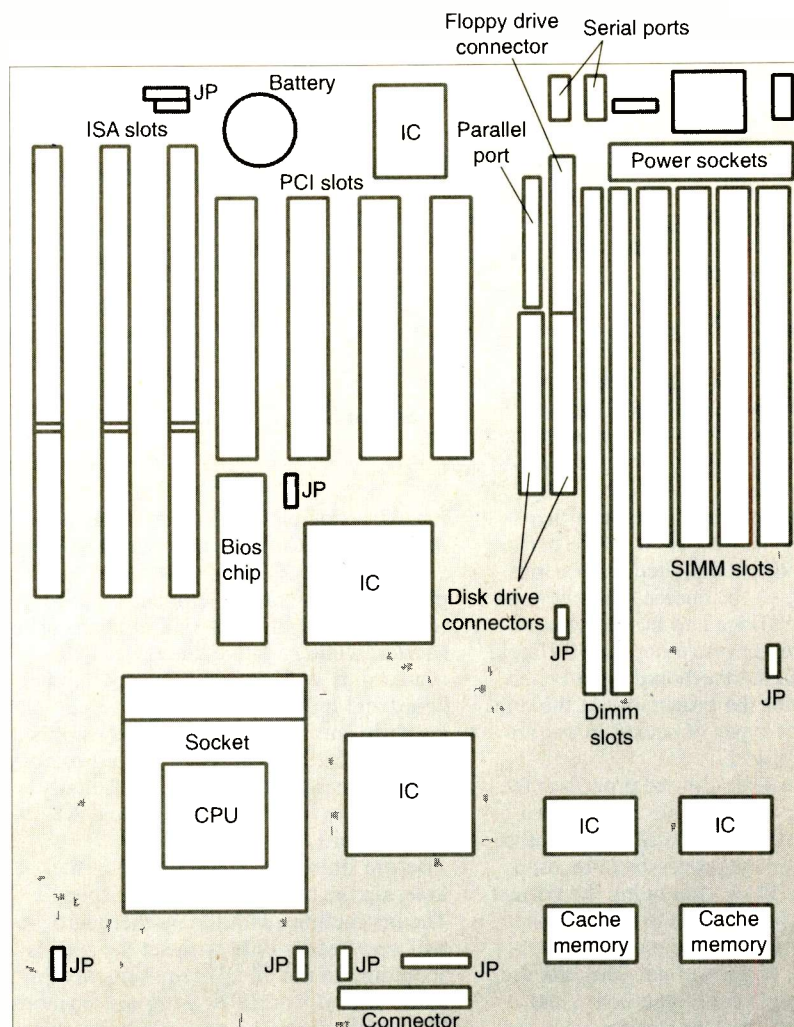

Fig.1: Typical layout of an AT-type motherboard.

specification is likely to be a 300MHz processor, 64MB of memory and a 2-1GB hard drive. Although Windows 2000 was originally intended to replace Windows 98 and Windows NT, a development of Windows 98 called Windows Millennium is due and may well be available by the time you read this.

Although Windows is the most popular OS there are others, with Linux rapidly gaining popularity. Linux is very reliable and stable, often being used for large corporate networks. It can be downloaded free by anyone with access to the internet, though this can take a very long time. Despite being a very capable system it's not as user-friendly as Windows, though this aspect is improving all the time.

As well as being available free via the internet, several commercial versions of Linux are available. In addition to the OS itself, they have full instructions on how to install Linux. Many extra programs are often included in the price. These packages provide excellent value for money: they are generally cheaper than Windows and often include commercial-quality office software, common examples being Sun StarOffice and Corel WordPerfect.

If you use Linux, make sure that all your hardware supports it. One advantage of buying a commercial version of Linux is that things like hardware compatibility

should be covered in the documentation. A minimum practical specification for Linux is a 66MHz 486 processor, 32MB of memory and a 750MB hard drive. If you can get access to the internet, Linux can be downloaded from <http://www.red-hat.com/download/>

The various hardware specifications given above are intended as a practical guide. While lower specifications could be used, the resulting system would be slow. Use of a faster or later-generation processor and/or increased memory will provide a faster system.

Other operating systems are available, such as UNIX, BeOS and OS/2. They tend to be more specialised however.

Case and power supply

Broadly speaking, PC cases come in two basic styles: desktop and tower. A desktop case is designed to lie flat on a desktop and can usually be positioned with the monitor on top, saving desk space. Tower cases are designed to stand on end, either on the desk or on the floor. They usually have more drive bays than desktop cases. This could be important, especially if you are likely to want to add extra drives in the future. Both types of case will normally have the power supply already fitted.

It's important that the case has mounting points and power supply connectors that

fit the motherboard you select. There are two styles of mounting, AT and ATX. Until fairly recently the AT case was the standard, but the ATX style is becoming more widespread. Some cases can accept either type of motherboard.

CPU (processor) and motherboard

The AT-style case was the type normally used with 386, 486 and early Pentium systems. The newer ATX style has some advantages and is likely to replace the AT standard eventually. If you are buying new components, an ATX type is therefore probably the best choice. The performance of motherboards generally varies only slightly, so the choice is likely to be determined by price and the features offered. Different processors use different sockets, so the motherboard must be the correct type for the processor. At the time of writing, the types of socket in use are as listed in Table 1.

If you buy a second-hand processor the motherboard will probably be supplied with it. It is vital that the selected motherboard supports the processor to be used. In addition to the socket being the correct type, it must be possible to set the bus speed and clock multiplier to the appropriate values. If you are not sure, ask the supplier whether the motherboard and processor combination is compatible.

Various manufacturers produce processors, Intel probably being the best known. Other manufacturers generally make chips that are equivalent to a particular type of Intel processor. For example the AMD K6 is equivalent to the Intel Pentium. Until recently Intel processors were generally the fastest, but processors from other manufacturers were often cheaper. At the time of writing however the AMD Athlon is the fastest processor available for PC use: it costs less than the Intel Pentium II, making it a good choice if processor speed is important.

Some motherboards have built-in sound and/or graphics chips. This is usually a cheaper option than buying separate cards. However a built-in graphics chip will require some of the system memory, i.e. the memory mounted on the motherboard as SIMMs or DIMMs (see below), to be used as video memory. So, for example, if your system has 64MB of memory and 8MB is used as video memory, only 56MB is left for use by the OS and applications. Video cards have video memory on the card, so the system memory does not have to be used for this purpose. It can be more difficult to upgrade or replace the sound and/or video systems where they are built in, so this type of motherboard may prove to be more expensive in the long run – and should definitely be avoided if future upgrades are likely.

The motherboard will have several slots

Table 1: Types of processor socket in use.

Socket	Processor
Super socket 7	AMD K6-2 and K6-III, Cyrix MIII, IDT WinChip
Slot 1	Intel Pentium II and Pentium III and early Celerons
Slot A	Used only by the AMD Athlon. Physically identical to the Slot 1 but the electrical connections differ, so the two are <i>not</i> interchangeable
Socket 370	Used by newer Intel Celerons

for expansion cards. They are normally coloured black, white or brown. The black slots are for ISA cards, which are being phased out but are sometimes still used for sound cards and internal modems. The shorter, white slots are the newer PCI standard. If you are buying a new motherboard and it doesn't have a built-in graphics chip, one with a brown (AGP) slot is a good choice. This standard is used solely for video cards, so there should be only one of them. Fig. 1 shows a typical AT motherboard layout.

Before fitting the motherboard in the case, set the bus and CPU clock speeds. The instructions with the motherboard will give details of how to set the speeds according to the CPU's requirements. In most cases it's done by using one or more jumpers to connect a pair of pins together, though some modern boards are 'jumperless' and set the bus and clock speeds automatically. The settings needed by the CPU may be printed on the device itself or supplied on a small instruction sheet.

The CPU should next be attached to a heatsink and/or fan and mounted in its socket. The method of fitting the processor depends on the type of socket. Super socket 7, socket 370, 386 and 486 motherboards use ZIF (Zero Insertion Force) sockets. You lift the lever at the side, align the processor's pins then insert it. Lower the lever to lock the processor in place. Slot 1 and Slot A devices on the other hand have an edge connector and are mounted vertically. A bracket to secure the CPU, along with instructions on how to mount it, should be supplied. Finally, plug the processor's fan into the appropriate connector on the board.

Fit the motherboard in the case using the fixings provided. These may be screws with spacers or plastic spacers. It's unlikely that all the mounting holes in the motherboard will line up with the holes in the case. This shouldn't matter as long as enough of them do to provide a good, solid mounting.

Several items built into the case will need to be plugged into the motherboard, such as the power supply and various LEDs. The motherboard's instructions will give details of where to connect these items. If the motherboard has built-in sound and/or video chips there will be a

backplate, with appropriate connectors, for each. The case will have several blanking plates. Each backplate replaces a blanking plate, which should be easy to remove. The motherboard's instructions will indicate where the connectors should be plugged in on the board.

Memory

Memory (RAM – Random Access Memory) is supplied on small PCBs known as SIMMs (Single In-line Memory Modules) or DIMMs (Dual In-line Memory Modules). You will have to check which type your motherboard takes, though it may have both types of socket.

SIMMs can have 30 or 72 pins, so make sure that you get the correct type for the motherboard. All processors from the Pentium class onwards (i.e. not the 386 or 486 class) must have SIMMs fitted in pairs, though DIMMs can be fitted individually. DIMMs are available to operate at 66MHz, 100MHz and 133MHz, all of which are more efficient than SIMMs. It is important that the speed of the memory modules at least equals that of the motherboard's bus speed. If the price difference is not large, and the processor is likely to be upgraded in the future, it may be worthwhile using faster memory modules than is strictly necessary. This will not improve the performance but will make future upgrades easier and cheaper, since faster memory will not need to be fitted. Expanding the memory is the simplest and, usually, the most cost-effective way of upgrading an older machine.

The two types of memory module are fitted in different ways. Both types are polarised to prevent them from being fitted the wrong way round. To install a SIMM, insert it into the socket at an angle of about 45°. When it has been fully inserted, tilt it so that it is at right-angles to the motherboard. Lock it in place with the metal clips. To install a DIMM, first pull the retaining clips away from the socket. Insert it, keeping it at a right-angle to the motherboard, then lock it in place with the retaining clips. ■

Continued next month.

Spares management is essential for efficient servicing. Otherwise time saved by speedy diagnosis is wasted during actual repairs.
Paul Smith on how to go about it

Storing Spares

You diagnose the cause of a fault in record time, then spend twice as long rummaging in your spares box for a suitable replacement, or order it and find some days later that one was there all the time, hiding in the corner. Sounds familiar? Read on!

If you have to spend more than a couple of minutes finding a spare part you probably waste many hours a month and several days a year. There is in addition the money spent on duplicating parts which are already in stock.

Parts Management

A parts management system can be inexpensive to set up and easy to maintain. The biggest problem is the time it might take to convert from your present arrangement. I estimate however that a day spent right now, introducing a new set up, will pay for itself many times over. There's also the option that, once the hardware is in place, the actual sorting of parts can be carried out over a longer period of time.

Plastic tray storage units in groups of sixteen cost about £2.99 for two sets, and are available from most DIY stores. Twenty six of these units, i.e. thirteen sets, would be sufficient for most purposes, providing a total of 416 separate trays. A suggested arrangement for using the trays is listed in Table 1. It leaves 31 trays spare to provide overflow capacity when ordering minimum quantities, special price offers etc.

You will notice that pinch rollers are stored by size rather than make/model. This is to prevent unnecessary duplication. For example a pinch roller for the Akai VS-S99 also fits a Mitsubishi HSB10, HSE10, Salora SV7400 etc.

In Practice

With one exception the system has worked well in practice over many years, ensuring that stock is easily located and renewed when it has fallen to a minimum level. The one occasion when the system failed was because of back-ordering. A batch of capacitors was placed on back order. This went unnoticed, and two subsequent duplicate orders were placed for the same items during the following weeks. The mistake came to light only when the parts eventually arrived in triplicate. This is where those spare capacity trays come in handy!

Larger parts, including tuners, video heads, laser pickups, motors, transformers etc., can be stored in a 'pigeon hole' rack assembly (see Fig. 1). These can be picked up cheaply at auction or home made. The advantage of the latter is that the sizes can be customised to suit installation and the dimensions of the parts to be stored. An inner hole size of 8 x 8cm with a depth of 10cm is adequate for most items, but some larger slots will be needed for maintenance kits etc.

The outer edges of the boxes can be made from 18mm

plywood, with grooves on the inner side to take thinner plywood for the shelves and dividers.

Large plastic ice-cream or butter containers can be used to store such items as belt kits (kept in order), mains switches, nuts, bolts, screws, batteries etc.

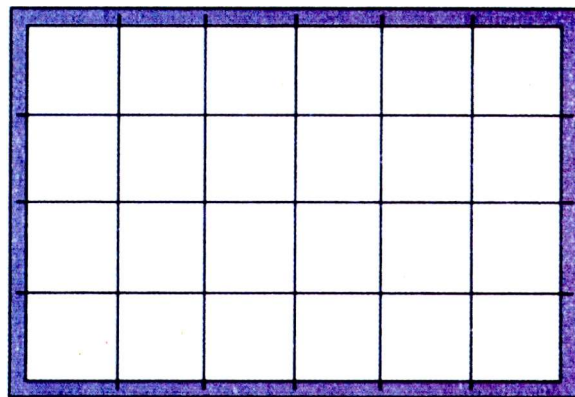

Fig. 1:
Pigeon-hole box. Grooves on the inside of the outer skin enable the inner shelves and dividers to be slotted in place.

Table 1: Suggested allocation of trays for spares storage.

Trays	Use	Sort into
56	Capacitors	Preferred values, 10pF to 3,300µF
27	Fuses/IC protectors	Ratings 50mA to 13A
72	0.5W resistors	Preferred values 1Ω to 10MΩ
42	WW resistors/presets	Preferred values, two to each tray >1Ω, 1-4.9Ω, 5-9.9Ω etc.
6	Safety/fusible resistors	Make/model
52	VCR small parts	Size (see text)
10	VCR pinch rollers	Mixed
2	Inductors	Mixed
1	Crystals	Mixed
1	Resonators	Mixed
40	ICs/regulators	Numerical, e.g. TDA3562 = 3000 series
34	Transistors/thyristors	Alphabetical, e.g. BA, BB, BC etc.
8	Diodes	Alphabetical
2	Bridge rectifiers	Mixed
1	LEDs	Mixed
1	Infra-red diodes	Mixed
4	Zener diodes	Value, e.g. >5V, 5-10V etc.
3	Filters	Mixed
2	Delay lines	Mixed
8	Coaxial plugs/sockets	Male/female plugs/sockets
2	Solder spares	Elements, tips
2	Relays	Mixed
1	Bulbs	Mixed
2	Jack/speaker plugs	Mixed
2	Remote-control spares	Mixed
1	Terminal blocks	Mixed
1	Small switches	Mixed
2	Thermistors	Degaussing/start-up

Servicing the Sony BE4 Chassis

This chassis was used in Sony small-screen (up to 21 in.) models from 1994 until quite recently, so there are many of these sets around. One feature is teletext decoding by the microcontroller chip. Giles Pilbrow provides a detailed servicing guide

The Sony BE4 chassis has been in production since 1994. Extensive use of I²C and microprocessor control virtually eliminates the need for preset controls. All models fitted with the chassis use the RM836 remote-control unit. The following models are fitted with the chassis:

KV14M1U	KV14T1U
KVM1440	UKVM1441U
KV16WT1U	KV21M1U
KV21M3U	KV21T1U
KV21T3U	KV2170U
KV2171U	

The Power Supply

Fig. 1 shows the power supply circuit, which is based on the Sanken STRS5706 switching-regulator chip (IC601). This device contains all the active circuitry on the primary side of the power supply, including the chopper transistor. It uses the free-running flyback converter principle: the mark-space ratio and frequency of its output both vary depending on the load conditions. The switching frequency is between 100kHz for standby operation and 30kHz at high beam current. There is no direct feedback from the secondary side of the circuit. Full output voltage is maintained when the set is in the standby mode.

R604 and D601 charge C607 to provide a start-up voltage at pin 9 of IC601. Once this voltage has reached 8V, the device starts to produce a chopper drive output at pin 8. This is fed to the base of the internal chopper transistor at pin 3, via R609 and C610. When the chopper transistor conducts, current flows via

the primary winding (pins 3 and 1) of the chopper transformer T602. At a point determined by the timing circuitry within IC601 the drive is cut off. The chopper transistor switches

off and the magnetic flux built up within T602 collapses, producing voltages across the secondary windings. Once start-up has been achieved IC601 is powered from

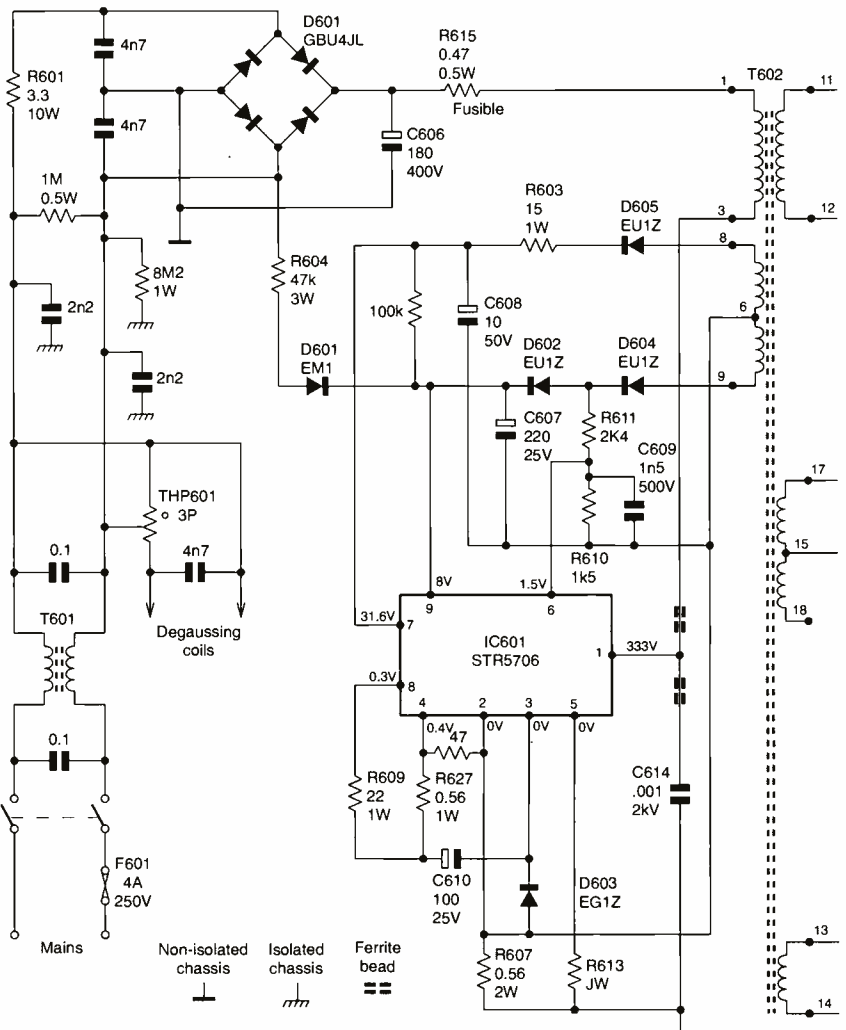

winding 6-9 of the transformer, with D602 taking over from D601 to charge C607.

Regulation of the outputs relies on the voltage developed across winding 8-6 of the transformer. This voltage is rectified by D605/C608 and applied to pin 7 (sense) of IC601. The voltage here is about 31.6V when the power supply is running normally and 32.5V in standby. This voltage is used to control the charging of an internal capacitor: when the charge reaches a threshold, the output drive is cut off. The 'on' time of the chopper drive is in this way controlled.

The magnetic flux within T602 must have decayed completely before another drive pulse is produced, otherwise the chopper transistor will be destroyed. So the 'off' time of the drive must also be controlled. Winding 6-9 of the transformer is connected via D604 and R611 to pin 6 (inhibit) of IC601: once the voltage here falls below a threshold the next drive pulse can start. The voltage at pin 6 is about 1.5V when the power supply is run-

ning normally and 0.9V in standby.

With no load (standby) the +B (HT) rail voltage will rise slightly, to about 126V for 14in. and 144V for 21in. sets. Connecting a 100W bulb as a load should bring the voltage down to the correct level. Note that some manuals for 21in. models incorrectly show the HT voltage as 118V: in fact the voltage is 135V. With 14in and 16in. sets the HT when working normally is 118V.

Protection

The chassis incorporates a full range of protection features as follows:

Overvoltage: Since IC601 is powered from a winding on T602, its supply voltage is related to the output voltages on the secondary side of the circuit. Should the voltage at pin 9 exceed 9.2V, IC601 will shut down and latch. It will not function again until the feed from the mains supply has been interrupted.

Excess current, primary side: The emitter of the internal chopper transistor is returned to the non-isolated

earth via R607. The voltage developed across this resistor is thus related to the total power taken from the supply. Should the voltage exceed an internal threshold, IC601 will reduce the chopper drive.

The primary-side excess-current protection does not latch, so a persistent overload will result in the power supply tripping. This protection circuit usually operates only when there is a dead short across the HT rail.

Temperature: IC601 shuts down when its internal temperature exceeds 150°C.

Excessive +B current: The earthy side of the HT winding on the chopper transformer (pins 12-11) is returned to the mains-isolated chassis via R600. The voltage developed across this resistor is applied to the emitter of Q600. As the HT current increases, the emitter of Q600 becomes more negative with respect to chassis. At a certain point it will switch on, in turn switching Q602 on. The collector of Q602 is con-

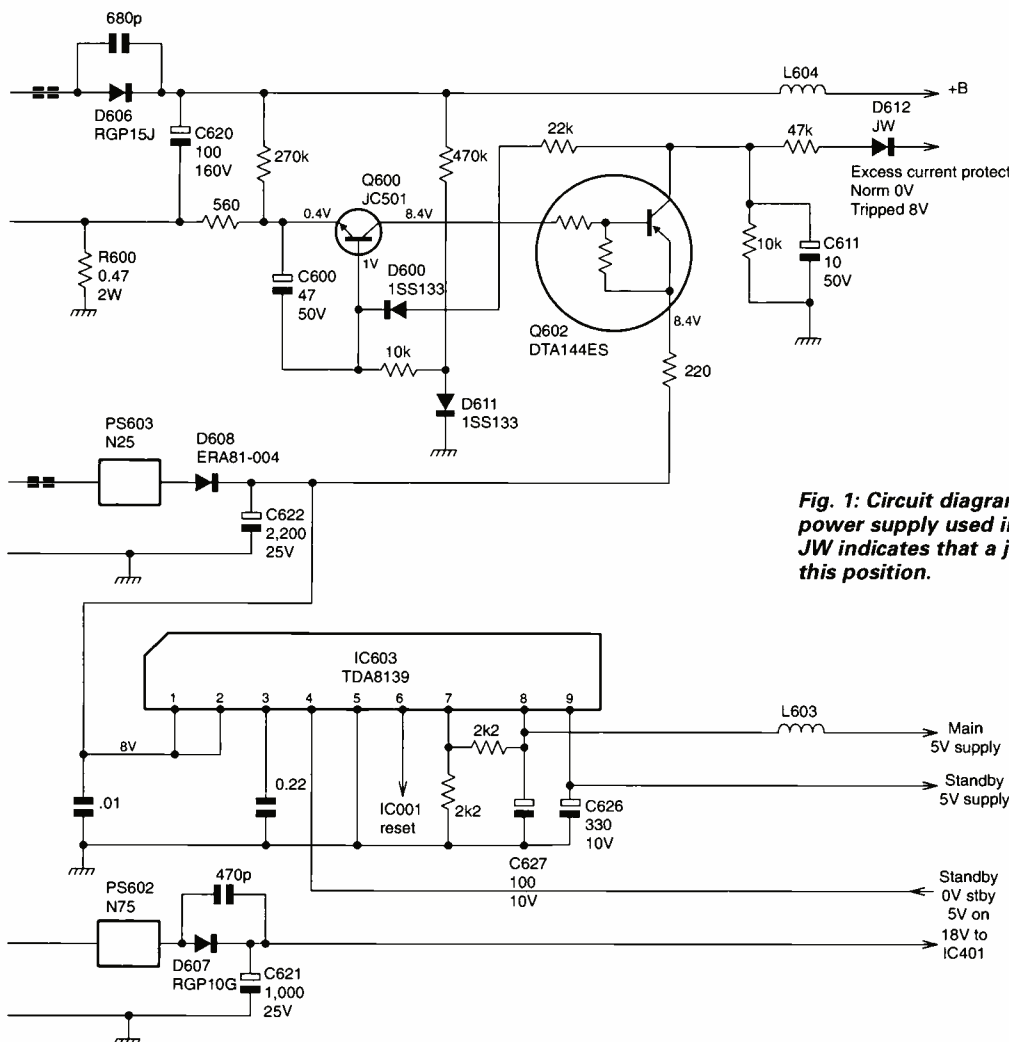

Fig. 1: Circuit diagram of the chopper power supply used in the Sony BE4 chassis. JW indicates that a jumper wire is fitted in this position.

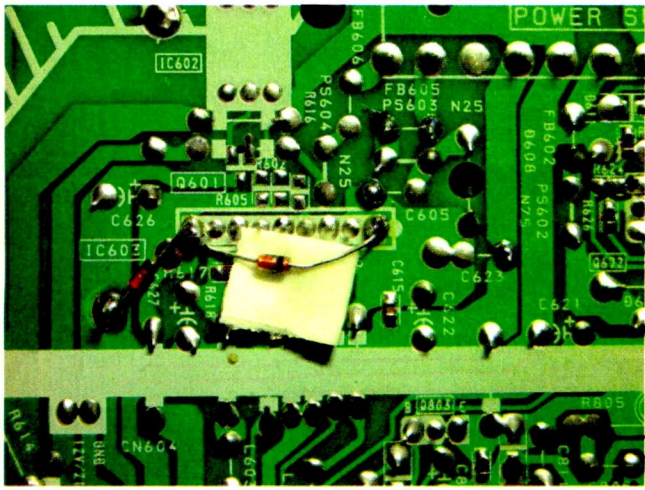

Fig. 2:
Modification to PS603.

connected to pin 52 (X-ray protect) of the microcontroller chip IC001. Once this pin is taken high, the set will be put in the standby mode and the standby LED will flash six times to indicate what has occurred. The line drive is also inhibited, by Q803, which grounds the base of the line driver transistor Q801.

Note that the voltage at the base of Q602 is normally 8.4V, with 0V at the collector. These voltages are shown incorrectly in the service manuals.

LT Regulator

IC603 (TDA8139) is a dual-output regulator which is configured to provide two 5V supplies. The standby 5V supply at pin 9 is present whenever mains power is switched on. It's used for the remote control sensor (IC003), the NV memory (IC002) and the microcontroller chip (IC001). The main 5V output is produced at pin 8: it powers the signal processing and timebase generator circuits, also the teletext section of IC001.

Standby switching is achieved by using the disable input (pin 4) of IC603. When this pin is taken low, the main 5V supply is switched off

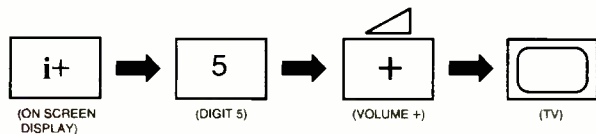

Fig. 3:
Entering the service mode.

and the set enters the standby mode. The switching is controlled by pin 51 of IC001 (some circuit diagrams show pin 4 of IC603 connected to the standby 5V supply!).

A further function of IC603 is to provide the reset pulse for the microcontroller chip. This is produced at pin 6 and is active low.

Servicing

Before carrying out any cold checks on the primary side of the power

supply, ensure that the mains bridge rectifier's reservoir capacitor C606 is completely discharged. An isolation transformer should always be used when working on the primary side of the power supply.

If the set appears to be dead, the first thing to check is the HT (+B) voltage. If this is present, the primary side of the power supply is OK and attention should be turned to the 8V rail. It is not uncommon to find that this supply is missing because PS603 (N25, 1A) is open-circuit. To prevent a recurrence, uprate PS603 to N75 (2.5A) and add two 5.6V zener diodes as shown in Fig. 2.

If no voltages are present on the secondary side of the power supply, check the voltages at the pins of IC601. There should be about 330V at pin 1. If this voltage is missing, check R615. If this resistor is open-circuit, IC601 is likely to be faulty. Confirm this by checking the internal chopper transistor: access is at pins 1, 2 and 3 (collector, emitter and base respectively). If the chopper transistor has failed, carefully check all the other components on the primary side of the circuit. Pay particular attention to R611, D602, C609, R610 and C614. It's also wise to replace C610 and R607 – the latter can be responsible for random cutting out and tripping problems.

If the chopper transistor is OK, check the voltage at pin 9. During normal operation there should be 8V here. When the supply is not running however the voltage at this pin will ramp between 5V and 8V (seen on an oscilloscope). This could be because the overvoltage protection latch has operated, which can be seen by monitoring IC601 with an oscilloscope at switch on: a very brief burst of drive can be detected at pin 3 (base) and pin 9 will exceed 9V for an instant, after which the set will remain dormant until the mains feed is switched off and on again. If the overvoltage latch has operated, check the condition of the feedback components between pin 8 of the chopper transformer and pin 7 of IC601.

If there is no voltage at pin 9, check R604. It's more likely however that pin 9 has developed an internal short to earth.

Finally, IC601 can be checked in-circuit (with no mains supply feed of course) by connecting a 9V battery between pins 9 (positive side of battery) and 2 (negative side of battery). A drive waveform should then be seen at pins 8 and 3, at a frequency of about 20kHz.

Service Mode

Entry to the service mode is by putting the set into standby then pressing the following keys on the remote-control unit: i+, 5, volume +, TV (see Fig. 3). Once the set is in the service mode, TT_ will be displayed on the screen. This is known by Sony as test mode 2, and is primarily intended for use on the production line where it's necessary to be able to make tests and perform adjustments quickly without having to wade through menus. Entering various two-digit numbers enables certain functions: some of the more useful ones are listed in Table 1.

Other adjustments are available by pressing the menu key. Selecting 'adjust' enables the geometry and drive levels to be altered. The 14 and 21in. models share the same software, so not all controls are operative. East-west controls apply only to the 21in. models. 'V cen/EW' controls the width with 21in. models, the vertical centring with 14in. sets.

Adjustments are made using the four 'cursor' keys in the same way as with the normal customer menus and are stored automatically. Should the service menu obscure the screen, pressing the mute key will clear the screen leaving the current adjustment active.

NVM Reset

Incorrect settings in the NVM chip can cause some strange fault symptoms, ranging from no picture to operation at twice the line frequency (perhaps leading to failure of the line output transistor). To erase and reprogram the NVM with default data is a simple task, as follows:

Select program 59. Enter the service mode, then TT49. Switch the set off, wait for about thirty seconds, then switch back on. The microcontroller chip will now send new data to the memory. Once a picture has appeared it should be possible to see if the faults have been cured. All that remains is to set the system (TT26 for the UK) and switch teletext on as appropriate (TT18).

Service Connector

An alternative to resetting data manually is to use a device known as an I²C link. This is a PC-based product that interfaces with the TV set via service connector CN001. It enables complete NVM contents to be transferred from one set to another, without having to spend time on readjustment, should the NVM prove to be OK.

The I²C jig can be used if the set

won't switch on provided the standby +5V supply is present and the microcontroller chip is working.

System Control

The BE4 chassis was one of the first to use a new type of Philips microcontroller chip that incorporates a teletext decoder, thus making it possible to build a teletext set without any additional components. The only differences are the setting of TT18 and the version of IC001 fitted. Although IC001 is quite expensive, it might make sense to fit the teletext version should a replacement be required because of a fault. Adding teletext might help offset the cost of an expensive repair.

Apart from teletext, IC001 is fairly conventional. Sweep tuning is carried out in the usual way: a PWM output appears at pin 1 and is converted to 0-30V by Q001 and the associated filter. The tuner AGC is obtained from IC001 as a 0-5V output at pin 4.

IC001 produces the on-screen displays, with RGB outputs at pins 32, 33 and 34 respectively and blanking at pin 35. These outputs are fed via buffer transistors to the colour decoder/timebase generator chip IC301. Line- and field-frequency pulses (approximately 5V peak-to-peak) are fed in at pins 36 and 37. If these are incorrect the result will be an unstable display.

If a problem occurs either at start-up or during normal operation, IC001 may shut the set down and produce an error code. The LED will flash a number of times, pause then the cycle will be repeated. The number of flashes indicates the cause of the problem, see Table 2. Note that when the LED is flashing the set is actually in standby, so the main 5V supply is not present.

Field Output Stage

The field output stage is based on a TBA9302H chip (IC501) in 14in. models or an STV9379 chip in 21in. sets. Unlike some previous designs, the output stage is AC coupled to the scan coils, so no special protection circuits are required. To prevent phosphor burn in the event of field collapse the picture is blanked.

Field collapse with 21in. models can be caused by R814 (0.47 Ω) in the 24V supply going open-circuit. An improved replacement is available, part no. 1-249-443-11.

Line Output Stage

The line output stage is conventional, employing an S2055 output transistor (Q802). It's very efficient, so

Table 1: Code numbers in test mode 2.

Code	Function
TT00	Clears the service mode
TT08	Despatch condition. All customer controls are reset to their factory preset values
TT17	Enables/disables the sharpness control
TT18	Toggles teletext on and off. Non-text sets display only P100 when text is turned on
TT26	Set to PAL I (UK) operation
TT33	Auto AGC adjust normally on – AGC can be adjusted manually if required
TT38	CRT A1 (G2) adjustment mode. Adjust the first anode voltage (RV703) until two dashes are displayed
TT49	Loads default data into the NVM at power on
TT74	Adjusts horizontal position of text/OSDs

Q802 doesn't require a heatsink. The 14in. models don't have EW correction, but 21in. models have an EW diode modulator that's driven by a simple circuit consisting of Q804 and Q805 (curiously, they are labelled V OUT in the circuit diagram). The EW drive originates at pin 8 of IC301, adjustments being made in the service mode.

One common problem with 21in. sets is increased width that cannot be adjusted, because IC301 has been damaged by a CRT flashover. The solution is to replace IC301 and add a 470 Ω resistor in place of wire link JW101 (between pin 8 and the base of Q805).

The 14in. sets can suffer from failure of Q802 with, sometimes, damage to the chopper chip IC601 and its feed resistor R615. To prevent a recurrence increase the value of R806, which is in series with Q802's base, from 1.5 Ω to 1.8 Ω .

The line output transformer T802 provides six supplies. Pin 10 feeds rectifier D806 which produces the 24V supply for the field output chip IC501. Pin 4 feeds rectifier D802

which produces 190V for the RGB output stages. The EHT is produced in the normal way, and a separate winding supplies the CRT's heaters. The focus voltage is obtained from a tapping within T802. The A1/G2 supply is derived from either a tapping within the transformer and controlled by a potentiometer on it, or from pin 1 which feeds rectifier D804, in which case the control is mounted on the CRT base panel.

Jungle Chip

IC301 carries out video signal processing and generates the timebase drive signals. UK sets are fitted with an MC44007 which can decode both PAL and NTSC signals. It provides a complete colour decoder in conjunction with the MC44140P delay line chip IC302. Secam sets use an MC44002 chip in position IC301. For UK operation only a PAL crystal is fitted, but NTSC operation can be obtained by adding a 14.32MHz (4 x 3.58MHz) crystal in position X301 and enabling NTSC in the service mode (TT19). If NTSC is enabled without fitting a crystal the

Table 2: LED error codes.

Flashes	Meaning	Possible cause
2	IC301 no acknowledge IC603 or IC301 faulty	Main +5V supply missing.
3	IC301 internal self-check failed	IC301 faulty
4	No line flyback pulse at IC301	No line drive or excess-current trip operating. See error code six
5	IC301 stack overflow	IC301 faulty
6	+B excess-current protection	LOPT has shorted turns or IC501 is short-circuit
7	NVM fault, IC301 OK	IC002 faulty
8	NVM and IC301 error	IC002 and IC301 are <i>both</i> faulty
9	General I ² C error	IC001, IC002 or IC301 faulty

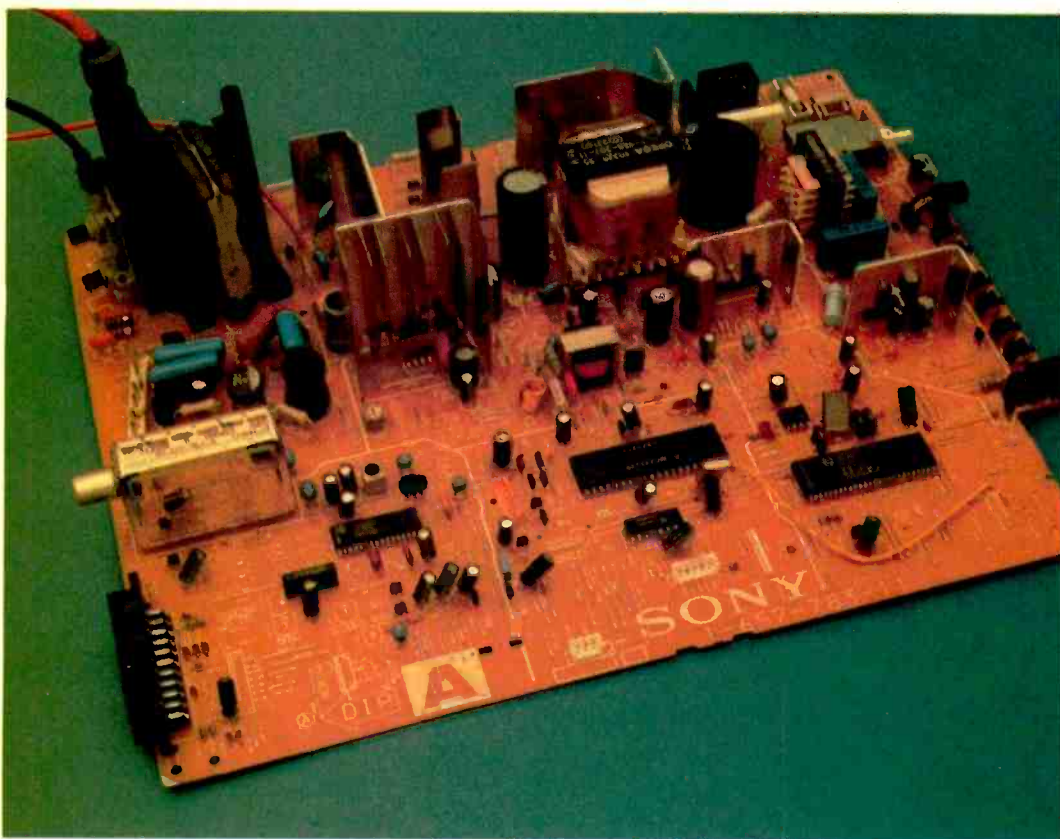

a Sony PlayStation, the picture may be too dark. This can be rectified by changing the value of R318 from 56Ω to 68Ω and R358 from 22Ω to 10Ω.

Tuner and IF circuitry

The BE4 chassis will work with tuners from various different sources, though Philips and Sony types only are used in UK sets. The tuner operates from a single 5V supply rather than the normal 12V.

Tuning operates on the voltage-synthesis principle, a voltage of between 0 and 28V being applied to pin 2 of the tuner. The tuning voltage is derived from the +B rail and is regulated by the 33V stabiliser diode D002. Microcontroller chip IC001 produces a PWM tuning output at pin 1. This is fed to the base of Q001 which supplies, at its collector, a filter that produces the required tuning voltage.

Audio

The TDA1013B audio output chip IC401 is powered from the 18V rail. A volume control voltage is applied to pin 7, and is held at 0V when the sound mute is on. IC401 is always powered, so some very slight background noise may be audible when the set is in standby.

Audio switching is ingenious. Inputs from the scart socket and tuner are AC coupled to double-diode D100. The two audio signals are switched by changing the DC conditions at D100. ■

result is a bright white raster with flyback lines – this also happens if the PAL crystal is faulty.

The colour may drop out with a poor signal. To overcome this, increase the value of C326, which is connected to pin 38, from 0.1μF to 0.47μF. The time-constant of the auto colour system selection within the chip is then increased.

Video Inputs

External video from the scart or front input is fed directly to pin 2 (V2 in) of IC301. This pin can be

software configured to accept either composite video or the Y input of an S-video signal.

RGB signals from the scart socket are fed directly to IC301. To display RGB signals, pin 8 (AV select) and 16 (fast blanking) of the socket both have to be high. Sync is taken from the composite video input at pin 20. There is no compensation for the difference in timing of RGB signals, so pictures viewed in the RGB mode will be displaced slightly to the right.

With some RGB sources, such as

Fault Summary

The following is a list of faults known to occur from time to time with sets that use this chassis.

Set powers up briefly then returns to standby with the LED flashing six times: The cause is usually the line output transformer. Disconnect the supply to the field output chip IC501 first, as it can cause the same symptom when faulty.

No operation, HT OK: Check whether PS603 (8V supply) is open-circuit. Alternatively X001 (12MHz) could be faulty.

Power supply tripping, HT low at about 70-80V when the feed to the line output transformer is disconnected: Chopper chip IC601 is faulty.

Intermittent operation, with the LED flashing four times: Caused by dry-joints

at the line driver transformer T801 or at R806 in the line output transistor's base circuit.

Field collapse: Resistor R814 in the 24V supply open-circuit.

Excessive width that cannot be adjusted in the service mode: Replace IC301 and add a 470Ω resistor in place of link JW101.

Dark picture: C823 (22nF, 250V) in the beam limiter system short-circuit.

Bright raster in either red, green or blue, with the set switching to standby (LED flashes six times): Heater-cathode short within the CRT.

Picture OK, no teletext or on-screen displays: C810 (1nF, 400V) open-circuit. This affects the line pulses at pin 36 of IC001.

No B - Y or R - Y: Replace IC302 (MC44140P).

R, G or B missing from the teletext display: Check Q012, Q013 and Q014 respectively.

No picture via scart input: D407 (RD6-8ESB2 zener diode) short-circuit.

Distorted audio: R405 (4.7Ω 5% non-flammable) open-circuit.

Tuning drift: D002 (μPC574J) leaky or setting of the PLL adjustment in the service mode incorrect.

No remote-control operation: Replace the remote sensor IC003 (SBX1790-11) and fit a 5.6V zener diode in position D003.



LETTERS

Send letters to
"Television", Room L514,
Quadrant House,
The Quadrant, Sutton,
Surrey, SM2 5AS
e-mail
jackie.lowe@rbi.co.uk
using subject heading
'Television Letters'.

Progress

During a chat with a dealer friend of mine the subject of power supplies came up. He mentioned a recent repair to a 'state of the art' modern colour TV set. It went as follows:

- (1) Lady calls in the shop to say that her TV set has stopped working. Didn't know the make but says there can't be much wrong as it is only two years old.
- (2) Engineer calls next day to find a modern, large-screen CTV with a power fault.
- (3) Managed with difficulty to convince customer that the set had to go back to the workshop.
- (4) Called next day with an assistant to carry the large set down several flights of stairs then a few hundred yards to the van.
- (5) Got set back to workshop and removed the stand (special Allen key required).
- (6) Spent two hours plus rebuilding the power supply then checking with a variac etc. Completed repair and put set on test over a couple of days.
- (7) Arranged for delivery.
- (8) Arrived with set to a cool reception. Customer has missed a few episodes of EastEnders.
- (9) Set installed and proved to be working OK. Customer given £65 bill. She was appalled as her husband had said it was probably only a fuse. Spent some time trying

to explain what was involved, all to no avail. She said her husband would send us a cheque. (10) Finally left and, because of the delay, found we'd been given a £40 parking fine. (11) After two reminders we received a cheque with a note expressing dissatisfaction.

In the bad old days of the early Seventies we had both handled large quantities of Bush and Murphy CTVs (A823 chassis) in which the power unit could be exchanged on the spot in a few minutes while the lady of the house made us a cup of tea.

Any comments?

Max, TV Hire Ltd.,
London SW4.

LNB Cooling

In the September issue Roger Bunney mentioned that signal quality can be improved by reducing LNB temperature. He was commenting on a report in the NZ magazine *SatFACTS*. I would like to make the following points.

First, Peltier devices are available from Farnell Electronics. They can handle 0.5-70W as a heat pump depending on size, but they need a heatsink to remove the heat pumped out. A 5W pump requires 8W of electrical input, which has to be dissipated. Secondly, I doubt whether attaching a heatsink by means of tie wraps to a device that's already in freely circulating air will have much effect, as the limiting thermal resistance will be between the LNB regulator and the ambient air. It will, perhaps, be 50°C/W. Adding even a 5°C/W heatsink will produce a small effect. There's possibly more to be gained from a sun shade.

Thirdly, a slide-on plastic tube to exclude rain may reflect some solar heat but will insulate the LNB's body and reduce internal heat loss. A cover which is spaced to allow air circulation is required.

On the subject of holes to prevent condensation, the hole needs to be of at least 8mm diameter to prevent a meniscus of water sealing it over through surface tension. Try this with a colander when you are next in the kitchen. The reason for providing holes in a 'sealed' box is to prevent pressure changes, due to temperature increase and decrease, acting as a pump that sucks in water. Condensation will occur on a cooled surface in damp air regardless of holes. Look at your car windows on an autumn morning.
Ray Porter, M.Sc., C.Eng., MIEE,
Stourbridge, West Midlands.

Marapet

After being involved in the specific spares business for over eleven years, and supplying a vast number of readers of *Television*, I have had to wind down considerably the business you all know as Marapet. For the moment it's being operated on a Mail Order only basis trading as P.A. Hawkins. The telephone and fax numbers previously advertised in these pages and in the annual *Spares Guide* have been discontinued.

Any enquiries should be sent to P.A. Hawkins, 1 Hornbeam Mews, Gloucester

GL2 0UE. In due course I hope to be able to announce an e-mail address, and will endeavour to place this within the magazine's advertisement pages. Our remaining stock is available at prices to please! Simply send a stamped, addressed envelope for more information.

I would like to thank our thousands of valued customers for their loyalty to Marapet since it was started in 1989. I realise that many people will be upset, and I shall miss their excellent conversation and friendly voices very much. Incidentally I've often been asked where the name Marapet came from. Quite simple: it was made up from MARTyn And PETer!

May I end, for the time being, by saying "keep on the bright side". We all know that the trade isn't what it was, with the public opting to buy cheap new equipment rather than asking you to do a repair. But let's hope that things will one day turn full circle!
Peter Hawkins.

Marapet Electronic Components.

Backwards step

For years there was steady progress in the world of TV broadcasting. Improved semiconductor devices and multi-standard receivers enabled many people to receive transmissions from neighbouring countries. Here in Aberaeron I can receive up to four Irish channels. Satellite TV added countless more channels, in all sorts of languages. All in all, very much in the spirit of greater international understanding.

How sad then that the digital revolution looks likely to put all this sharply into reverse. Encryption and the consequent control of who can see what will take away the freedom of the skies. Despite paying the licence fee for access to 'free-to-air' programming, we are going to be controlled by country/postcode as to what we can watch. From the satellite belt, Sky sells given packages only to those within defined geographical areas. Those who have moved abroad cannot receive their own country's channels, despite them being beamed down from the skies. This is totally at odds with the spirit of free movement of goods, services and people being encouraged in other areas of human activity.

The main reason given for this control seems to be copyright law – who has the right to broadcast programmes to particular countries. Why can't there be transeuropean rights? Why not charge on the basis of the total number of potential viewers rather than where they live? Obviously advertisers don't want to advertise to those in countries where their good/services aren't available: but should our viewing be determined by advertisers' convenience?

The implications are rather sinister, particularly when one considers the future of radio, where analogue transmissions at MF/HF may also disappear. It all seems to be so retrograde, and one shudders at the possibilities for censorship.

Philip Lane,
Aberaeron, Dyfed.

This month Steve Beeching, I.Eng., explains the mysteries of DCT and the digital signal compression system used by the DVC format

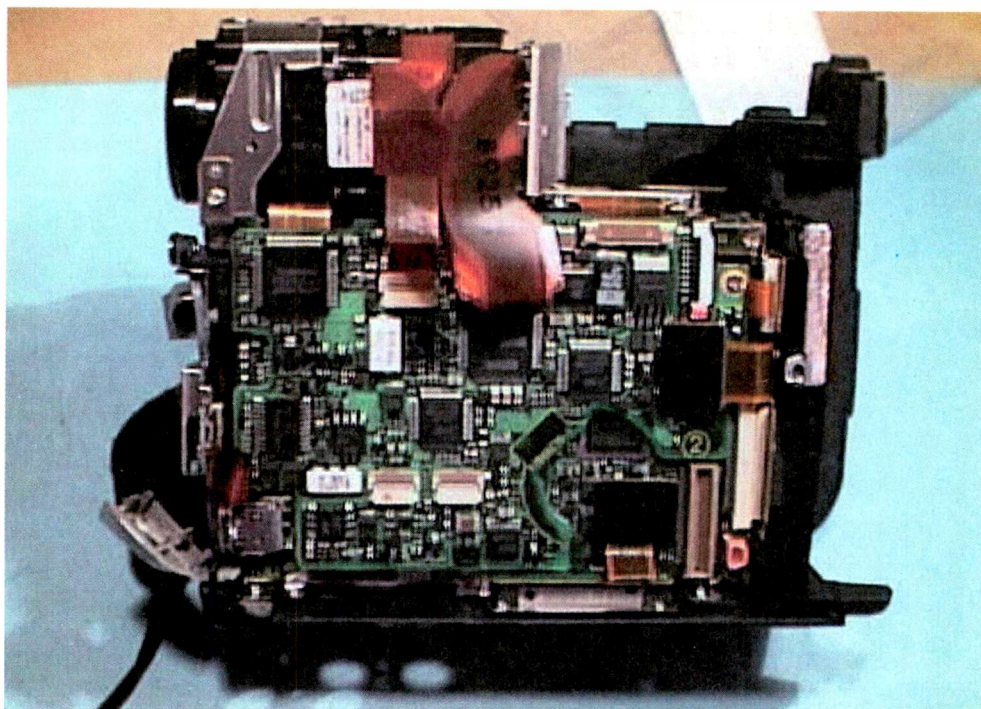

What is DVC?

In last month's instalment I described how the picture obtained from the CCD imager in a DVC camcorder is arranged as macro blocks, each of which consists of four Y blocks, an R - Y and a B - Y block (Y is the luminance signal, R - Y and B - Y being the colour-difference signals). These are the DCT (I'm about to come to this!) blocks. The macro/DCT blocks from different parts of the picture are shuffled to provide a fairly constant data flow, then data compressed by 5:1.

This month we'll take a look at the technique used for data compression. It's basically the same as the method used for compression with JPEG still pictures and MPEG-2 I (intra) frames, the difference being that the rules applied to the various

frequencies being compressed, or not, more than others (to achieve weighting) are not the same in the three cases.

Discrete Cosine Transformation (DCT)

This is basically the transformation of a signal that's varying with time into one that consists of the equivalent frequency components (a squarewave can be analysed as consisting of a fundamental sinewave plus a number of harmonics - this is called a Fourier analysis). It's the most complex part of the DVC system and, although it can be split into several sections, you have to appreciate that a number of these procedures take place simultaneously.

DCT is a complex mathematical process that separates the DC and AC components of an $N \times N$ data signal block matrix (in the case of DVC $N = 8$) and places the cosine functions in the block in ascending frequency order.

DCT is the first part of the data compression system, though the process itself doesn't contribute anything to the compression. The simplest explanation is that it splits the video data into a DC component and AC components by applying a Fourier transform (analysis).

If you consider a very small selection of video samples, see Fig. 1, you can see that, because the average DC level is the same for each sample, there's a great deal of redundancy. So it's not necessary to

encode and pass on the DC component for each sample. Instead, you can define the DC average for the set of video samples just once and then say it's the same for the rest of them. In this way the total amount of data can be reduced without there being any loss of information.

The amplitude variations between each sample, above the average DC level, are then transformed by the DCT process into frequency coefficients. This is done by calculating the cosine for each sample change (hence "discrete cosine") and keeping just the coefficients. The frequency coefficients represent the change in amplitude and the rate of change as a multiple of the average DC value. Fig. 1 shows the DC level redundancy and the cosine angles of the AC components. It is important to note that the frequency coefficients represent the frequency by value and sign: these are frequency-domain created by the DCT process.

To take an example, if we consider a small sample of the picture such as an 8×8 block (see Fig. 2) and pair up the pixels as P1 and P2 in the horizontal (line) and vertical (frame) direction, there is likely to be very little change of value between the P1 and P2 pixels because they are next to each other. The levels of P1 and P2 can be plotted (Fig. 3), showing that the amplitude changes little except where there is a sudden change. This is an AC component part of the samples.

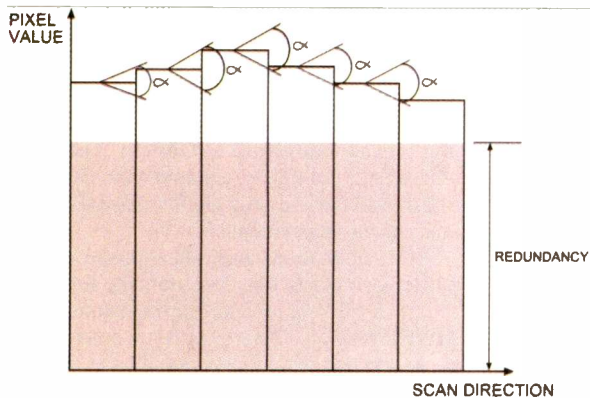

Fig. 1: Values of a small number of adjacent pixels - DC levels and cosine angles.

DCT Frequency Distribution

DCT takes the assumption that P1 and P2 have the same level a step farther. If the sample pairs of P1 and P2 are plotted on a graph (see Fig. 4) with P1 on the vertical axis and P2 on the horizontal axis, the result is that the points are grouped along a 45° slope. This shows that there is a strong amplitude correlation, i.e. the amplitude of adjacent pixels in the horizontal and vertical directions is similar.

If the slope in the graph is rotated by 45° to become a new axis X', see Fig. 5, with a Y' axis at 90°, you get a different viewpoint. The energy concentrated along the X' axis is of near constant value – the DC level. On the Y' axis the energy is concentrated at a point, which represents the AC component. So the two components, AC and DC, are separated on the X' and Y' axes.

This is the basic Fourier transform that's carried out on the DCT blocks. Figs. 4 and 5 show two-dimensional graphs, but in practice it is a three-dimensional function relative to the 8 x 8 matrix, with horizontal, vertical and amplitude axes, as shown in Fig. 6 (the weighting diagram, see next paragraph).

The vertical and horizontal components are reassembled into a DCT block in an 8 x 8 matrix of 64 pixels. At the top left-hand corner, see Fig. 7, there is a single data sample that represents the average DC level of the whole block of original video samples. In both the vertical and horizontal directions the samples are set in ascending frequency coefficient order, with the highest-frequency coefficient at the bottom right-hand corner. At the same time weighting is applied (1, 0.72, 0.51) as shown in Fig. 6.

To summarise so far, in the DCT Fourier transform the analogue signal samples are transformed into a series of cosine harmonic coefficients that represent only the AC components of a block – these are in phase with the signal. If all the cells in the 8 x 8 block have the same level, because they represent say a sample of scene consisting of blue sky, all the DCT coefficients are zero and only the DC block in the top left-hand corner has a value. The other 63 squares have no values in them as there are no AC variables.

Fig. 8 shows a DCT block consisting of an 8 x 8 matrix, a small sample of the picture, with analogue values. Black is taken as 0 and white as 100. Fig. 9 shows the block after digitisation and the application of DCT. A value of 230 has been given to the DC level at the top left-hand

corner square. This represents the average DC level of all the other 63 squares. All the other values in the 8 x 8 matrix are the AC coefficients calculated by the Fourier transform. In reality they represent the change in value level between each sample and its neighbour and the original signal frequency.

The basic principle that "what the eye doesn't see the heart doesn't grieve over" is used. Certain frequencies and details that the CCD imager picks up within a scene can be made redundant as we don't notice them. Take for example a fast-moving car with lots of small logos along its side. When the car passes by very fast, the eye cannot pick out the details. These details are fast-moving, low-level high frequencies, so they can be deleted.

The next stage in the process does just that. Areas of the DCT block are selected in accordance with the laws of human eye response and allocated a division ratio. Mathematical division in this weighting process reduces the AC coefficients in these areas.

Adaptive Quantisation

After DCT, the DC sample and the frequency coefficients are still in an 8 x 8 matrix. What has been done so far is mathematically reversible, so no data loss has taken place. Only frequency weighting has been applied.

In an average picture the higher-frequency coefficients are much smaller in amplitude and decrease with increased frequency. The eye is not responsive to low-level high frequencies. In the weighting process, amplitudes that are lower than a fixed threshold are discarded.

The next stage is adaptive quantisation. In this, three processes are carried out in one move. First, to reduce its volume the data is divided according to its frequency and position within the grid block. Secondly the quantisation, i.e. the number of 'steps', is varied according to the data classification and frequency component. Thirdly, either of the previous two is varied in accordance with the data volume produced by the adaptive quantisation: if the data volume is too great, the quantisation value is reduced to a coarse condition so that the number of samples and hence the data volume is reduced.

The first data reduction step takes place after the data has been transformed into a DCT block. To understand the next step, you have to be sure of the arrangement of a DCT block.

Within the block in our example,

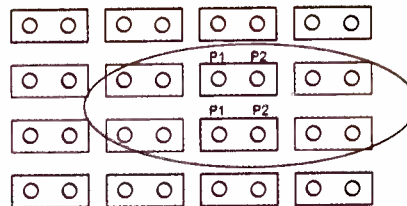

Fig. 2: Pair of pixels in an 8 x 8 macro block

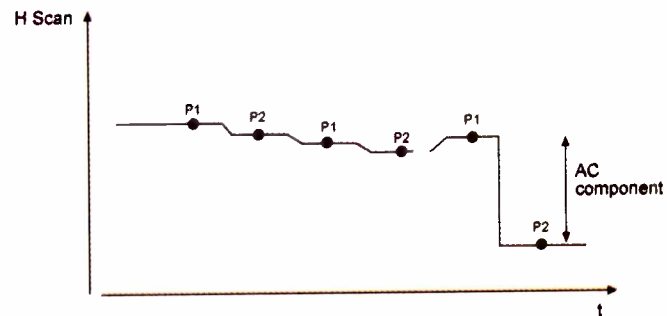

Fig. 3: Plot of adjacent pixel values.

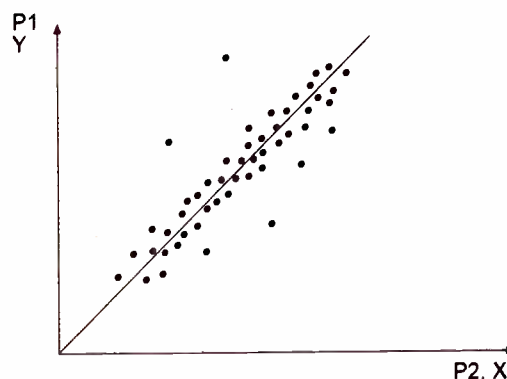

Fig. 4: Graph with P1 values plotted vertically, P2 values horizontally. The values are grouped along a 45° slope.

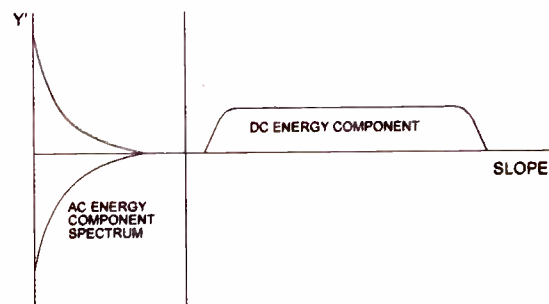

Fig. 5: Graph rotated by 45°, to X' and Y' axes.

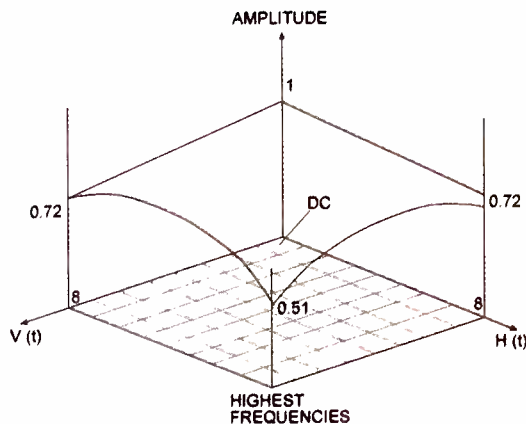

Fig. 6: Three-dimensional plot, which also shows weighting factors.

Frequency distribution in the horizontal and vertical directions H



Fig. 7: The 8 x 8 DCT block.

60	60	60	61	61	61	61	62
60	60	60	60	61	62	62	62
60	60	60	61	61	62	63	64
60	60	60	62	62	63	63	64
60	60	61	62	62	63	63	64
60	60	61	62	63	63	64	64
60	60	61	62	63	63	64	64
60	60	61	62	63	63	64	64

Fig. 8: An 8 x 8 block of 64 samples in analogue form. Peak white = 100.

230	-37	-6	-1	-2	-3	-2	0
-52	-2	2	1	1	0	1	1
-7	8	1	-1	1	0	0	0
-5	0	-1	-2	1	1	1	0
0	-1	-1	0	0	1	0	0
0	-1	1	1	0	1	1	0
0	0	0	1	0	0	1	1
0	0	0	0	1	0	-1	0

Fig. 9: DCT block after analogue-digital encoding. The DC value is 230, peak white is 255. All other values are frequency coefficients, in ascending order from top left to bottom right.

DC	2	2	2	4	4	4	8
2	2	2	4	4	4	8	8
2	2	4	4	4	8	8	8
2	4	4	4	8	8	8	16
4	4	4	8	8	8	16	16
4	4	8	8	8	16	16	16
4	8	8	8	16	16	16	16
8	8	8	16	16	16	16	16

Fig. 10: Data division ratio according to the positions of the frequency coefficients in the block.

see Fig. 10, the data division is according to frequency. DC at the top left-hand corner is largely unaffected: the division ratio is taken as 1. No change here. Data division ratios are shown for the lower frequencies, i.e. 2, 4 and 8 for the mid frequencies and 16 for the highest frequencies. This division prepares the data for the next process, by decreasing the coefficients of the higher frequencies. Fig. 11 shows the DCT block after frequency division weighting: the low-level high frequencies, below a fixed threshold, are discarded.

Once the block has been through the adaptive quantisation process the amount of data has been reduced. Because of the data loss, the process is not reversible.

Note that the adaptive quantisation is not linear. It's designed to accord with the characteristics, i.e. sensitivity, of the human eye. In the range 1-2MHz, quantisation errors would be very noticeable, so the quantisation level is higher in this region. This operation is called "psycho-visual masking".

The next step is to read out the data in serial form for the final stage of processing, variable-length coding. A zigzag scan is used to read out the data from the DCT block. As shown in Fig. 12, the DC level and the important lower frequencies are read out first, the higher and less important frequencies last. This gives the adaptive quantisation system the option to discard the higher frequencies if the maximum allowable data volume of the block is exceeded. If there is a lot of movement in the picture at that sample block, loss of HF data will not be noticeable to the eye. Should a bird fly across the picture for example, the eye will not notice the fine details of the feathers, only that a bird is flying past.

Variable-length Coding

Variable-length coding is based on the Huffman algorithm. It works on the probability of occurrence of any given symbol. Those that occur most often are given a low bit count whereas those that occur least are given a higher bit count. If for example you were to check the frequency

The DVC cam

Digital camcorders were first launched in the UK about four years ago, when JVC introduced the GR-DV1. I started to work on them in early 1997: after several intense training courses at JVC, I and three others were allowed to continue working on our own. To do so it was necessary to invest in some expensive equipment, including a 150MHz digital storage oscilloscope and two types of desoldering station. Various extension cable sets and test jigs were required for setting up, also a laptop PC.

Things have progressed since then. Because of software-controlled real-time information coming from digital camcorders, the PC has had to be upgraded. The desoldering equipment has been upgraded to make possible the removal and replacement of ICs with no legs. These are called 'ball-gate arrays' or 'chip-size packages'. Over the last three years the size of discrete components has been reduced, and a microscope is now an essential part of a desoldering

station. Under the microscope even a soldering iron with an 0.4mm tip looks big compared to the spacing of any ICs that actually have legs!

It's essential to have the right equipment and training before any attempt is made to repair digital camcorders, as the likelihood of damage to either the fragile FPC connection cables or PCBs is high. I speak from experience here. I remember once, after partially reassembling a digital camcorder and switching it on, watching in horror as one of the cables burnt away like a firework fuse. That camcorder never worked again...

As with some other modern technology, the PCBs have six layers or more, each layer being connected to another by a fine through-plated hole. The PCBs do not stand any flexing. If you think of tearing a stamp off a sheet, that's how a digital PCB feels when you flex it. It will never work again after being flexed, as the layers lose their integrity.

	H							
	230	-37	-5	0	-1	0	0	0
	-52	-2	1	0	0	0	0	0
	-7	6	1	0	0	0	0	0
	-5	0	-1	-1	0	0	0	0
	0	-1	0	0	0	0	0	0
	0	0	0	0	0	0	0	0
	0	0	0	0	0	0	0	0
	0	0	0	0	0	0	0	0
V								

Fig. 11: DCT block after frequency-division weighting has taken place.

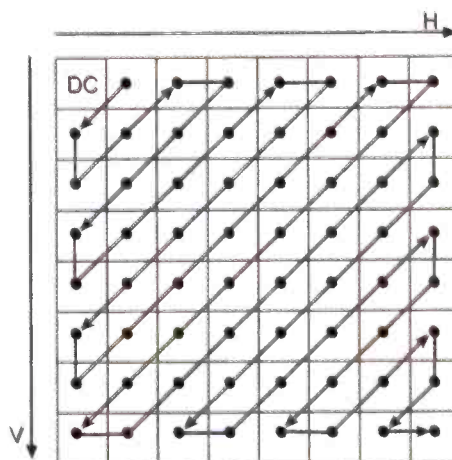

Fig. 12: Zigzag readout scan of the DCT block.

of occurrence of the various letters in the alphabet on a given page of text in a book, you would find that certain letters (A, E, I, O, U, S and T) occur more often than others (Q, X, V and Z). If the page were to be digitised, the data volume could be reduced by assigning a low number of bits (quantisation) to the higher-probability letters and a higher number of bits to the letters occurring least often. In the video field it has

been determined, by experiments with 'average' pictures, which data symbols occur most and those that occur least. This information has been stored in a 'look-up table'.

Data is read out of the DCT blocks in serial form and fed to the VLC circuit for reduction by using the table. A DCT block with 512 bits is reduced to 100 bits, a reduction of 5:1.

We are approaching the bit limita-

tion set by the capacity of the tape. 8 x 8 blocks have been digitised and compressed to 100 bits and a video segment (track) consisting of 5 macro blocks has been reduced to some 3,000 bits. This is within the permitted maximum of 3,080 bits per segment.

After this the audio, sub-code and ITI data have to be added. The digitised signal can then be recorded on the tape. ■

camcorder servicing scene

Digital camcorders don't bounce and don't like any liquid ingress whatsoever. As I told one customer who complained that his camcorder should be repaired under warranty after it had been dropped in the sea: "Sir, your guarantee ran out just before it hit the water." Another customer put his camcorder under his sun bed at the poolside. This was fine until the attendant went around the pool hosing down the surrounding area and washed his camcorder out from beneath him...

Apart from digital camcorder mishandling by customers, the symptoms produced by faults can beggar belief. They defy normal fault-finding logic. IC failure is rare: not that rare, but rare enough. Environmental problems are more common, because users don't read the 'precautions' section of the instruction handbook. The last four years have been a learning curve, and the learning continues.

The tape is very thin, the mechanisms are small and the motors do not have a lot of torque: this is a recipe, in humid conditions, for disaster. So much so that I have been forced to manufacture a system to recover mangled tapes of the 'holiday of a lifetime'. The system consists of a fast computer and DV download software. It enables a customer's tape to be copied on to a hard drive (22GB), the mess sorted out, and the material copied back on to digital tape with no visual impairment.

I have produced information sheets for customers to show what the effect of clogged heads looks like, why auto white balance does not function in all conditions, and what affects the accuracy of auto-focus lenses.

Once a video picture has been converted to the digital domain, all things are possible for the user - if he ever works his way through the menus. Special effects are

available in both record and playback, and cause lots of difficulties. One customer phoned to say that his picture was black-and-white, but not when he switched the digital image stabiliser on. Many thoughts went through my mind - memory or clock signal failure, or even an EEPROM problem. But the answer was simple. He had set the camera special effects menu to B&W. As the camera had only one memory store, it didn't allow two digital functions at the same time. So when he switched the digital image stabiliser on, it disabled the special effect!

The latest digital camcorders have very high-density PCBs and many more legless chips. No one is allowed to replace anything on the PCBs, there are no circuits or parts lists, and the manufacturer's law is simple: "you touch it, then you own it". Same goes for the mechanisms. No individual parts are available: you have



to replace the whole thing then set it up. These major items are available as exchange parts, but only if the failed part is untouched in any way, shape or form - no soldering, physical or water damage.

What you can do if you have a customer with a faulty JVC or Panasonic digital camcorder is to log on to newarkvideoservice.co.uk and send an e-mail. **S.B.**

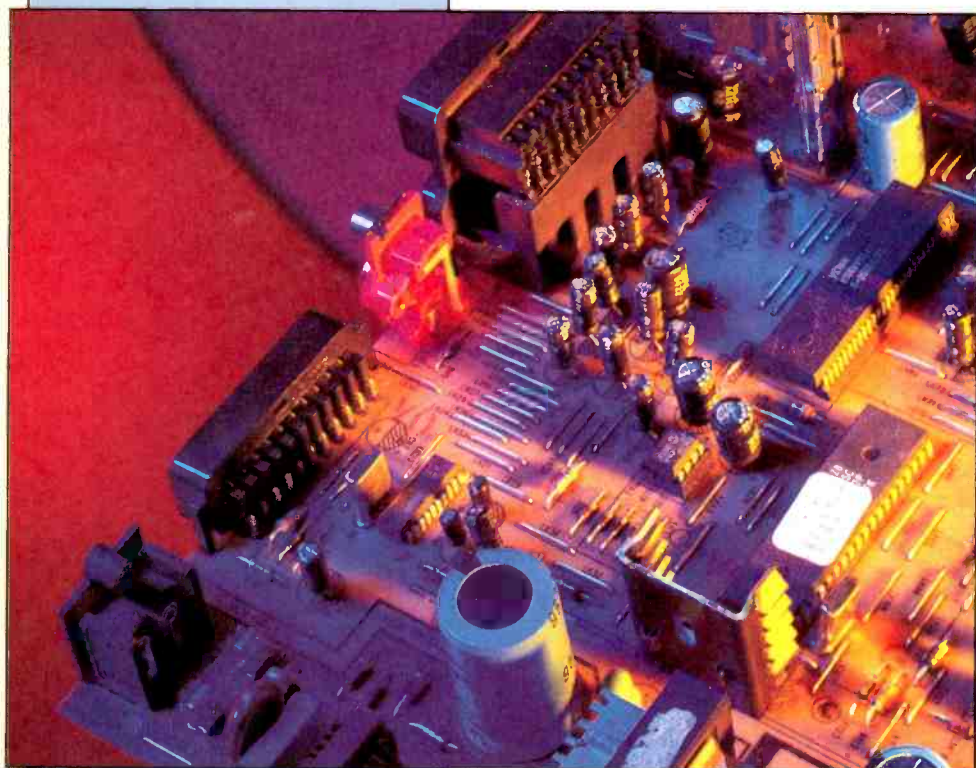

SATELLITE WORKSHOP

JACK ARMSTRONG

SkyDigital EPG

The BSkyB digibox Electronic Programme Guide (EPG) software was updated during July by transmissions from the satellite. The first update was for Pace digiboxes. Afterwards some owners complained that remote control no longer worked correctly. The new software apparently takes notice of a 'low-battery' signal that the remote-control handset transmits when its cell voltages are low. As a result the box doesn't give direct access to a channel, i.e. the digibox decides to ignore the remote-control command before you have time to enter a three-digit number.

The cure is to fit new batteries, preferably of the high-energy type. It's a pity the

Jack Armstrong is willing to try to sort out readers' satellite TV receiver problems by e-mail. You can reach him via the internet web site at:

<http://www.ukstay.com/jack>

If you don't have internet access you can write to him c/o Television, Room L514, Quadrant House, The Quadrant, Sutton, Surrey SM2 5AS. Please enclose two first-class stamps.

software change couldn't have included an on-screen message to tell the user that the batteries must be replaced. This would have saved a lot of calls to the Sky help line. Still, I bet BT made a profit. "It's an ill wind . . ." as they say!

Panasonic TU-SD200 digibox

A Panasonic TU-SD200 digibox was brought in for repair. According to the owner it had "gone off". On inspection the reason for the failure was obvious. There were burn marks and vaporised copper on the power supply board and on the metal case below it. The receiver had clearly been subjected to a brief pulse of several thousand volts via the mains input. Fuse F801 (ceramic T2AH type) was open-circuit, varistor Z801 (type V10751U) showed significant leakage when tested, and the 2SK2718 chopper transistor was short-circuit.

The 2SK2718 transistor is manufactured by Toshiba. The only UK stockist I could find on the internet failed to reply to an e-mail order I sent at 10 a.m. According to the web site the company had 27 of these transistors in stock, but no price was quoted. I phoned the stockist at 4.50 p.m.

"Hi. You haven't responded to my e-mail order, sent this morning."

"Who did you speak to?"

"I didn't speak to anyone. I used e-mail."

"You can't use e-mail just like that!"

You have to phone for a price."

"I didn't need a price. I require two 2SK2718 mosfets tomorrow and am not concerned about the price."

"You'd care if we charged you a hundred pounds each!"

"That's silly. I'm willing to pay any reasonable price with carriage and VAT."

"So who did you speak to?"

"I spoke to no one. I sent an e-mail."

"Who to?"

"Well, to the 'sales@' address given in your web site."

"You should have phoned for a price. We get 1,500 e-mails every day and can't possibly reply to them."

"Maybe you should find a way. You must be losing a lot of business. Anyway, can you send me these transistors tonight?"

"They're probably not in stock. Who told you they were?"

"Your web site shows the current stock at 27 pieces."

"You don't want to believe that! They are probably allocated. Anyway I couldn't possibly post them today – it's much too late."

I put the phone down at that point, before I said a rude word. This company came top of the search-engine list, but is wasting its internet presence. I've never seen the supplier listed or mentioned in *Television*.

I was forced to hand the receiver back to the customer, with apologies. To be honest I wasn't too keen to repair the power supply, because the mains voltage surge might have found a path to earth through the telephone connection or some other part of the circuit, destroying every semiconductor device in its path. Even if the receiver had worked after replacing the items found to be faulty on first examination, its reliability could have been compromised.

If anyone does know of a supplier of the 2SK2718, please let me know. It's a high-voltage mosfet with an internal diode in a TO220 plastic case. I would prefer a supplier that's able to reply to e-mail messages within a few hours and can handle small-quantity orders. Even some well-known stockists are, unfortunately, unable to handle e-mail – even to the extent of preventing their operators replying via this method.

Motorised dishes

I've dealt with a lot of enquiries about motorised dishes over the years. The dishes are mounted on a swivel, so that a motor can push them back and forth to align with different satellites. See nearby box for an explanation of basic terms. The following rules should help to minimise problems:

(1) Dish cables must be shielded. You can't expect a positioner to work reliably if the cables aren't correctly shielded. If you've found one that does, you were lucky. It probably had good input filtering.

(2) The longer the cable, the greater its resistance and the less current the motor can draw. The motor will run slower, which is generally a good thing – up to a point. A long unshielded cable is very bad news.

A long cable is beneficial because it slows the motor: the pulse count is therefore slower and easier for the positioner to handle. I've heard of problems, especially with Jaeger horizon-to-horizon motors, because the thing went so fast the positioner lost count. If you get this problem, the answer is to fit a resistor in one of the wires to slow the motor down.

Properly earthed shielding is essential because: (a) it stops motor interference being counted along with the actual pulses, or the interference blanking some of the pulses (unusual but possible); (b) it stops the motor interfering with other equipment, including neighbours' TV sets; and (c) it stops the motor interfering with the polariser current (if any) – this can cause weird effects, albeit usually only while the dish is

moving. The cable shields should be connected to the earth terminal (GND) at the positioner: they should *not* be connected to the metal parts of the dish.

Earth the metal parts of the dish separately. The whole point of earthing a dish is to get rid of the static charge that builds up when charged particles (e.g. dust) are blown across it. As a secondary measure, a good earth might help prevent damage inside the house in the event of a nearby lightning strike (but not a direct hit, unless you use a solid copper bar at least 25mm in diameter!).

Hammer a long copper rod into the soil, and use the thickest wire you can find to connect it to the dish. Use bolts, not solder. Do *not* earth the dish to any house wiring earth cable. This would be a good way of getting lightning or static discharge into the house!

The LNB should be mounted in an insulating clamp. Connect the LNB coaxial cable to the receiver earth via the F connector only. Do *not* earth it outside. All motorised cable shields should be connected to the ground terminal at the rear of the receiver/positioner only, *not* to the dish.

This is the best compromise to ensure safety and freedom from interference caused by the dish motor.

Technical terms

Actuator/linear actuator/dish motor:

The motorised 'telescope' that pulls and pushes the dish to alter its position.

Positioner/ACU/antenna control unit:

This is the box that supplies current to the dish motor (the circuitry may be inside the receiver). It contains a power supply that can provide 24-36V at 2-4A, and often a circuit that feeds a small voltage/current (usually 5V at a few mA) to the magnetic reed switch inside the actuator. When the motor turns, a rotating magnet opens and closes the reed switch contacts. The pulses produced in this way are fed back to the positioner where they are counted to determine the dish position (relative to where you set the 'limit' or 'start point'). The DC voltage is reversible to enable the motor to move the dish in either direction.

I have been asked about changes for digital reception. The dish is not affected. All that's necessary is a digital receiver. The LNB will probably have to be replaced with a Universal type however – one that switches its internal oscillator to 10-6GHz when it receives a 22kHz tone signal from the receiver. The analogue receiver can remain in use. This is made easier if both receivers are connected to the LNB via a 'priority switch', such as the one made by Global Communications Ltd.

Test Case 454

George pressed the stop key of his ancient VCR. Once more he heard that sickening, rustling noise as the precious tape crumpled up on its way out of the machine. A loop of chewed ribbon hung from the flap of the cassette – the Abba Gold one, his favourite. Thirty minutes later he was in our shop, credit card in hand. Forty five minutes after that he was back home with a new Samsung VCR under his arm.

George hooked it up and tuned his TV set to its UHF output, which was some way up the band from the ch. 35 slot used by the old machine. He was dismayed to find that the picture was snowy, the sort of effect you get with a weak signal. The sound was OK however, and so were the pictures and sound with 'live' broadcast TV reception – with the signal from the aerial looped through the VCR. George returned to the shop to complain that the new machine was faulty. Ace salesman Sydney Slick sold him a scart lead: this will solve all your problems said Syd, and give better pictures and stereo sound into the bargain: a snip at a fiver!

And so it did. Playback of off-air recordings and prerecorded material was excellent, better than the old machine had ever achieved. Even Abba Gold shone again, repaired and spliced by Sage as part of the sales deal. But the snowy-picture remained when George piped the playback signal to the 14in. portable TV in his bedroom – the scart solution couldn't be used with this set. So George got on to us and we started our lose-money exercise by despatching Cathode Ray (Doc Colin was on holiday) to

George's house to investigate the problem, 'under guarantee'. For convenience, Ray worked with a UHF link to the main TV set. He found that the situation was just a George had described it: there were snowy pictures with everything that came via the Samsung VCR's modulator, whether it was off-tape or off-air. To his surprise, Ray found that tape playback reverted to normal when he disconnected the aerial lead from the back of the VCR! So he loaded the machine into his van and drove the seven miles back to the workshop with it.

Within an hour the gleaming new VCR was on TechnoCrat's bench. But the fault had, it seemed, disappeared! Although the workshop is out-of-range of George's local transmissions, playback through the tuner of a TV set was fine, with grain-free pictures. A pattern generator, tuned to the VCR's preset BBC1 frequency, also produced a clear image via the Samsung's modulator which, it was noted, was providing its UHF output in ch. 60. The fault couldn't be instigated. And so it was that, bright and early next day, Cathode Ray headed south with the machine to George's pad. Ray had taken the precaution of loading up another (new and boxed) Samsung machine of the same type.

On site the symptom was exactly the same as before, and the new machine gave the same results, clearing up when the connection to the roof-top aerial was removed. The harassed Ray was rescued by a phone call from Doc Colin, just back from holiday. He had the simple answer to the puzzle. Do you? The answer will be found on page 758.

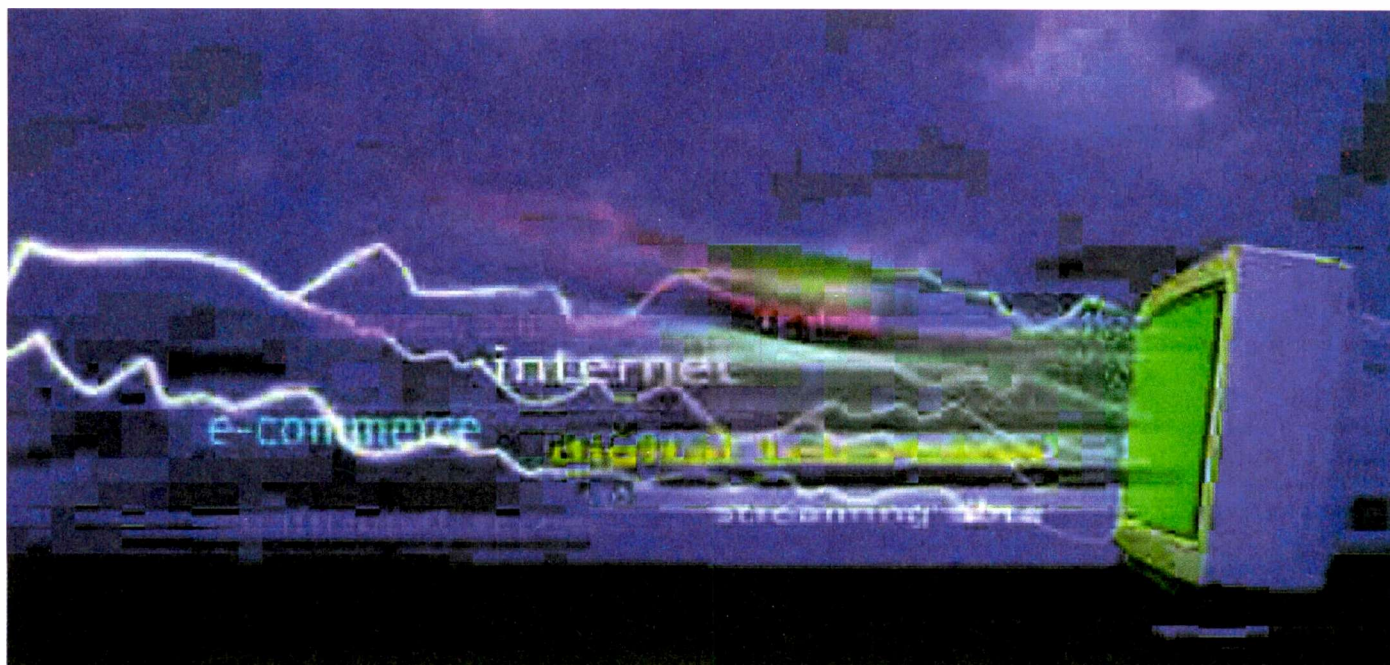

A Visit to NDS

NDS is a world leader in conditional-access technology and is developing various systems that will increase the range of services available via TV.

George Cole reports on a visit to the company's technology centre in Israel

NDS is the world's leading supplier of conditional-access technology to the digital TV market. The company is also involved in interactive television, data broadcasting and the new type of personal video recorder (PVR) which is based on the use of a hard disk. NDS was founded in Israel in 1988 and was acquired by News Corporation, which is BSkyB's largest shareholder, in 1990. The company now has its headquarters in London and has some 1,000 employees. My visit was to the company's technology centre in Jerusalem however, where many scientists and engineers are engaged in developing and enhancing NDS's technology portfolio.

Conditional-access Systems

Abe Peled, NDS's president and chief executive officer, points out that conditional-access technology (CAT) is what makes pay-TV possible. It enables broadcasters and content holders to protect their programmes and services. In a nutshell, CAT works by encrypting content which can then be decrypted and viewed only by those authorised to watch it. Dr Peled illustrated the problem of using poor CAT by describing how one pay-TV operator noticed that as the number of satellite dishes around the country increased, the number of subscribers fell.

NDS's VideoGuard CA system is used by broadcasters all over the world, including BSkyB in the UK, Stream in Italy, DirecTV in the USA and Galaxy in Latin America. NDS has signed a contract for a new cable TV service in China. Over 16.8 million pay-TV subscribers around the world use NDS technology, and the company claims to have 47 per cent of the digital TV market. NDS's first analogue CA customer was BSkyB, in 1990; its first digital customer was DirecTV in 1994.

The basis of CAT is encryption, which involves using 'keys'. These are basically very long and complex strings of numbers. One principle of pay-TV CA system design is to make the system unprofitable to crack or hack rather than being unbreakable. This is summed up as "making them spend \$20 to produce a fake \$1 bill".

Many CA systems simply use key-based encryption. With this approach the encryp-

tion key is transmitted over-air to the set-top box, where it is decrypted. NDS uses an algorithm-based system however. An algorithm is transmitted to the decoder, where it's used to create a key inside a smart card. NDS says this approach offers far greater protection. If a transmitted key is broken all the smart cards have to be replaced, which is expensive. If an algorithm is cracked, a new one can be created and transmitted to the smart cards.

NDS has produced more than fifty million CA smart cards – the number is expected to reach 60 million by the end of the year. Science is involved in making smart cards as secure as possible. One approach is to create multiple smart cards for multiple services, such as cable, satellite and terrestrial. This makes it harder and more expensive for pirates and hackers to get their products on the market.

NDS custom-designs its cards rather than using off-the-shelf (OTS) ones. The company says there are three stages to hacking. The first involves reading a smart card's contents. This involves reverse engineering and other techniques. The second stage is to understand the contents, the third to clone or modify the card. According to NDS this takes about twenty five weeks for an OTS card, 21-32 months for a non-OTS card.

The risks of using OTS cards were brought home to NDS in 1994/5 when it used a product, which was hacked, from a major chip manufacturer. BSkyB replaced the cards at great cost, but three months later the system was again hacked. NDS

used its own smart card designs for subsequent systems, and also developed counter measures. The pirated cards, which had cost tens of millions of pounds to produce (piracy on this scale involves considerable investment and resources), were put out of action by adding four bytes of data to the new algorithm. The pirate cards had insufficient memory to be able to store this small amount of additional data and thus didn't work. NDS estimates that over 200,000 pirate cards were disabled in this way.

But CA is a moving target. As computer processing power increases and the price of the technology decreases, the tools for hacking and piracy become more affordable. NDS has to enhance its CAT constantly to stay ahead of the pirates.

We also learnt that one of the biggest problems for companies like NDS is the postal system! Most smart cards are posted to customers, and some of the machinery used in post rooms can bend or break a smart card inside an envelope. Protective packaging has to be used.

NDS is looking at the use of its CA technology for other digital systems such as cable and DSL (Digital Subscriber Line) high-speed digital telephony. It also hopes to move into other markets that require CAT, such as PCs, audio players, games stations and electronic books.

Interactive TV

Conditional access is the core of its business, but the company also provides technologies designed to enhance broadcast services. One of these is interactive television. This enables viewers to play an active role while watching a TV programme or advertisement. The aim is for smooth integration of the television and interactive activity: interactive TV developers talk of providing 'lean-back' interactivity rather than the 'lean-forward' interactivity involved with a PC.

Dr Peled is critical of interactive TV systems, like Open, that force the viewer to leave the main TV programme and go off to a separate service for interactive use. He also dislikes the idea of offering full internet access via TV, arguing that a TV screen is not capable of presenting adequately text and graphics designed to be shown on a high-resolution PC monitor display. He adds that viewers don't want to access the web via their TV sets. NDS believes in offering Enhanced TV services, which enable viewers to use interactive features while still tuned to the programme. This could include on-screen quizzes or even selected internet pages that have links with the programme.

NDS calls its interactive service Value@TV, to emphasise that broadcasters can create new business by offering interactivity. The company has developed a number of interactive services, the first of which was SportsActive, used by Sky Sports Extra. Sky SportsActive viewers can watch



Part of the NDS SkyDigital laboratory used for compatibility testing.

several different video windows displayed simultaneously on their TV screens and select them at will. They can for example choose to watch different camera angles, follow a player around the pitch using a 'player-cam' facility, call up statistics and so on. SportsActive has proved successful, with over a third (35 per cent) of Sky Sports Extra viewers using the facility. SkyDigital has since launched a Sky NewsActive service.

Before an active TV service is launched it has to be tested to ensure compatibility with the existing broadcasting technology, such as set-top boxes. NDS has set up a SkyDigital laboratory, which replicates BSkyB's head-end system, at its Israel-based operation. The lab is very impressive, with rows of PCs, decoders, multiplexers and other equipment. NDS confirmed that although Sky digiboxes are manufactured to the same specifications there are differences between models. Not much was dis-

closed about this, except to say that Panasonic's box runs faster because it has a higher-speed processor.

Another interactive system, developed for ScreenOne, is an on-screen entertainment guide. Viewers have access to film and theatre listings and use an on-line ticket ordering service. A system developed for Discovery Networks gives viewers access to extra programme information, such as text and photographs, while viewing a programme. QVC Direct is an interactive home shopping service.

Data Broadcasting

The worlds of television and computing are nevertheless converging, and NDS has developed a system, called Mediastorm, that enables video, data and multimedia to be broadcast to a TV set or PC. As more and more homes acquire a broadband connection to the internet (e.g. a cable modem and DSL technology), it becomes feasible

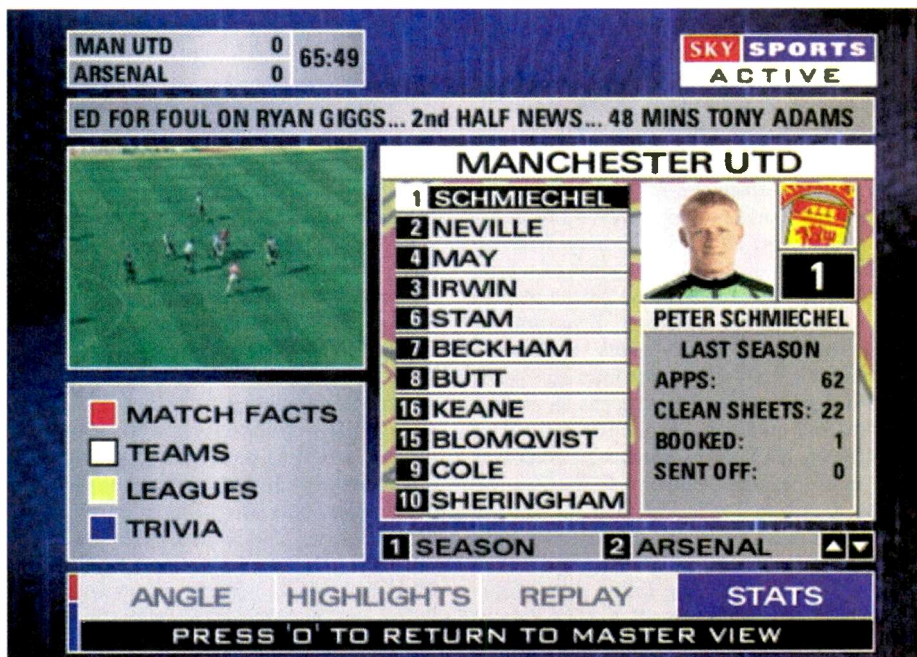

The SportsActive system developed by NDS and used by Sky Sports Extra.

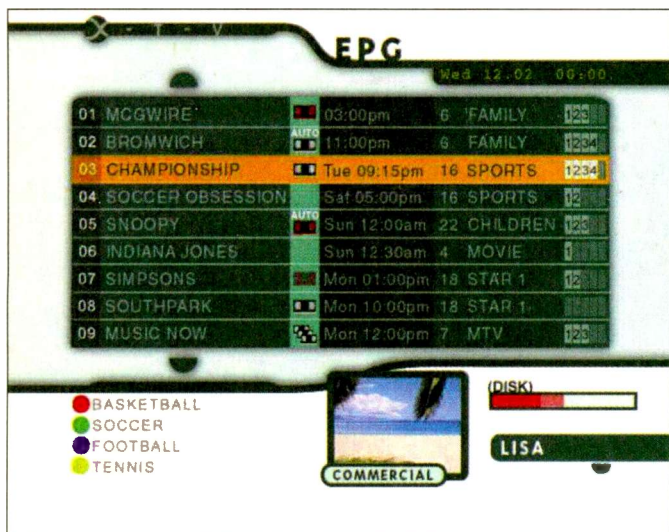

The Mediastorm electronic programme guide.



Prototype XTV box.

to offer TV-like services in this way. Mediastorm uses IP (Internet Protocol) technology with software inside a PC or set-top box decoder to create a personal EPG (Electronic Programme Guide).

One of the benefits of the internet is that it's a global network. So broadcasters can reach a world audience. This can however introduce problems for companies whose broadcasting rights are restricted to certain territories/regions. NDS has developed VideoGuard.IP and VideoGuard for DVB level systems for data broadcasting services.

NDS says that Mediastorm could be used for providing file delivery, streaming media, digital-quality TV, webcasting and fast internet services.

XTV

NDS and Pace Micro Technology have developed XTV (Xtended TV) for a new generation of digital set-top boxes that have built-in storage capacity. It uses hard-disk technology to store many hours of TV programming and offers a number of new features.

A growing number of set-top devices use hard-disk storage. Microsoft's WebTV, launched in North America and Japan, uses a hard disk to store web pages and other content taken from the internet. TiVo and Replay Networks supply PVRs (Personal Video Records) in the USA: they store up to thirty hours of TV programmes on a hard disk and can be programmed by the user to record and store favourite programmes automatically. BSkyB plans to launch TiVo-enabled set-top boxes later this year. But NDS points out that whereas TiVo-like devices are under the exclusive control of the viewer, XTV gives viewers, advertisers and broadcasters control of the set-top boxes.

Products like XTV and TiVo have been made possible by advances in hard-disk technology. Prices have fallen while storage capacity has increased. A \$100 (about £70) hard drive currently offers between 24-26 hours of MPEG-2 video storage capacity: industry forecasts suggest that by

2005 the storage capacity will have increased to 600-1,440 hours. Modern hard drives are quieter and more robust, enabling them to survive within the hostile environment of a digital set-top box.

How does XTV work and what does it offer? XTV has two main components, the head-end technology and the digital set-top box. It uses metadata, which is data that describes data. By reading the metadata, an XTV box can carry out a number of intelligent functions such as automatically recording all football matches that feature the viewer's favourite team. NDS is working with industry bodies to create a broadcasting standard for metadata.

Broadcasters or content providers create the metadata at the head-end operation. It's used to tag or identify programmes, advertisements or services. Conditional access templates are used to control access to the content – more on this below. An XTV analyser provides data warehousing and data mining facilities for analysing how users interact with the XTV box.

NDS showed us a prototype XTV product. It was a rather rough-and-ready box, but the important functions lie beneath the surface. An XTV set-top box will have two tuners and a 20Gbyte hard disk capable of storing about twenty hours of programmes – future ones will have much larger storage capacities. The prototype I saw had a scart socket, a phono composite video socket, a serial bus port and phono connectors. Commercial offerings could have different arrangements.

Note that there is no digital output socket, as the data stored by XTV is intended to remain inside the set-top box. XTV will also use the Macrovision copy protection system which is designed to prevent analogue copying. Broadcasters could however decide that some programmes can be stored on VHS tape. This is similar to the way in which SkyDigital protects its pay-per-view films but not its general programming. Dr Peled stresses that XTV is not a replacement for the VCR, which is often used for archiving and long-term programme storage.

Viewers use a remote-control handset to operate the XTV box, and will be able to programme it to record specific types of programmes automatically. Once it is stored on the hard drive, video material can be paused, replayed, fast-forwarded and skipped. Advertisers can download advertisements that may suit the viewer's age profile or interests.

This is where the data mining system comes into play. An advertiser can control a number of parameters, such as the minimum viewing time, whether an advertisement can be skipped, the maximum number of postponements before the advertisement must be viewed, the frequency that the advertisement is shown and so on. Broadcasters can deliver to the hard disk programmes that are targeted at the viewer.

XTV provides numerous payment systems for watching programmes. Viewers could for example pay for each viewing, or payment can be time-based (like video rental). Once the payment period has expired, the programme becomes scrambled.

Will viewers be happy with a set-top box that learns so much about them and can pass this information back to the broadcaster? NDS's answer is that viewers can watch the programmes and advertisements they want and that appeal to them. Further, users will be able to decide whether information is passed back to the broadcaster and whether they can be identified.

NDS says that free-to-air broadcasters such as the BBC are interested in using XTV technology. Liberate Technologies, one of the leading providers of interactive TV software, is to make XTV a standard part of its software for set-top boxes with hard-disk drives. NDS forecasts that within two years XTV will be a standard feature with many set-top boxes.

Acknowledgement

My thanks to Dr Abe Peled, president of NDS, and various product managers for the provision of information used in this article.

BOOK TO BUY

The definitive biography of the century's godfather of invention—from the pre-eminent Edison scholar "Israel's meticulous research and refusal to shy away from the dodgier aspects of Edison's personality offers a fresh glimpse into the life of the inventor."—
New Scientist

"Remarkable."— **Nature**

"An authoritative look into Edison's working methods, here leavened by enough personal detail to give the achievements shape."—**Publishers Weekly**

"Israel's book should go a long way toward taking Edison out of the shadows and placing him in the proper light."—**Atlanta Journal-Constitution**

"Exhaustively researched, with strong emphasis on Edison's methods and achievements."—**Kirkus Reviews**

The conventional story of Thomas Edison reads more like myth than history: With only three months of formal education, a hardworking young man overcomes the odds and becomes one of the greatest inventors in history.

But the portrait that emerges from *Edison: A Life of Invention* reveals a man of genius and astonishing foresight whose career was actually a product of his fast-changing era. In this peerless biography, Paul Israel exposes for the first time the man behind the inventions, expertly situating his subject within a thoroughly realized portrait of a burgeoning country on the brink of massive change. Informed by Israel's unprecedented access to workshop diaries, notebooks, letters, and more than five million pages of archives, this definitive biography brings fresh insights to a singularly influential and triumphant career in science.

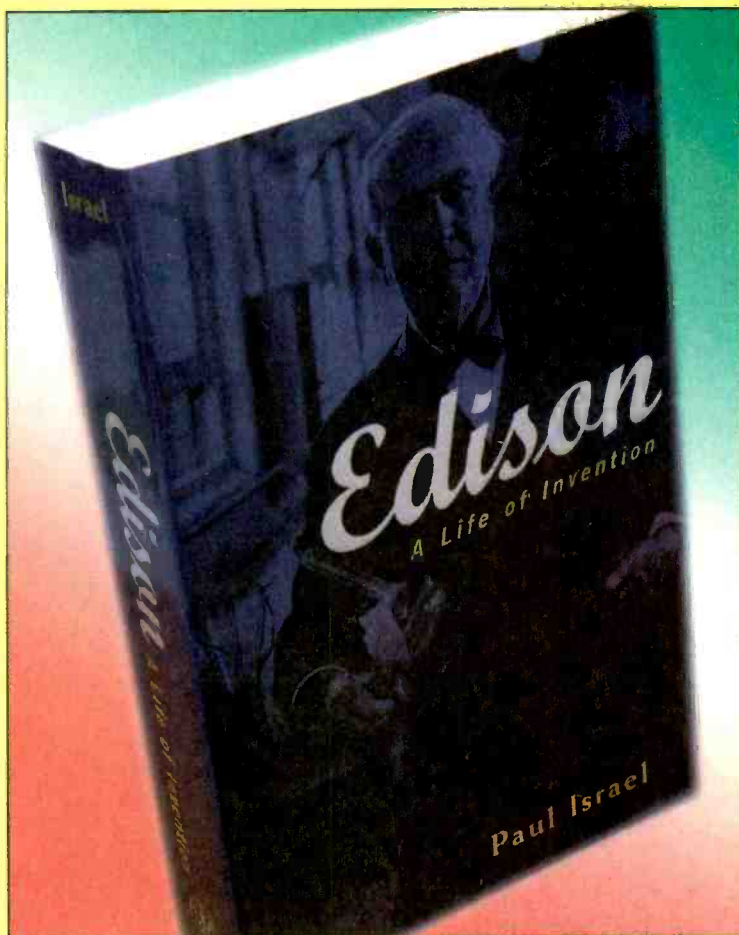

**Post your completed order form to:-
Jackie Lowe, Room L514, Quadrant House,
The Quadrant, Sutton, Surrey, SM2 5AS**

**Fax your completed order form to 020 8652 8111
UK Price: £15.00 Europe £17.00 ROW £19.00
Price includes delivery**

How to pay (Edison) paperback

I enclose a cheque/bank draft for £ _____
(payable to Reed Business Information)

Please charge my credit/charge card

Mastercard American Express Visa Diners Club

Credit Card No: _____

Expiry Date: _____

Signature of Cardholder _____

Cardholder's statement address: (please use capitals)

Name _____

Address _____

Post Code _____ Tel: _____



Terrestrial DX and satellite TV reception reports. News on terrestrial and satellite transmission changes. Maplin's two-stage UHF signal amplifier tested and found to be an efficient and useful reception aid. Roger Bunney reports

DX and Satellite Reception

Sporadic E-layer propagation continued well into July: there were many days during which sustained, high-level Band I signals were received. The trend for propagation to be mainly along a north-south path continued, though more long-distance signals from Russia were seen towards the end of the period under review. The log is as follows:

- 3/7/00 RTL (RTL Klub, Hungary) ch. R2; LRT (Lithuania) R2; RAI (Italy) IA, B; TVA (Italy) E3; Video (Italy) E2.
- 4/7/00 TVE (Spain) E3.
- 9/7/00 RAI IA, B; Video E2; TVA IA: RTL R2; NRK (Norway) E4; HRT (Croatia) E4; ORT (Russia) R2.
- 10/7/00 LRT E2; ORT R2; TVR (Rumania) R2; RAI IA; Video E2; TVE E2-4; C+ (France) L2.

A live insert for the Meridian Tonight programme, received via Intelsat 605 (31.5°W). The insert was made using Meridian's BT lease truck.



- 11/7/00 RAI IA, B; Video E2; C+ L2, 3; TVE E3; PTP (Russia) R2; SVT (Sweden) E2.
- 12/7/00 TVE E3, 4; RTP (Portugal) E2, 3; Video E2; RAI IA.
- 13/7/00 PTP R2, 3; LRT R2; BTV (Belarus) R2.
- 17/7/00 TVE E3; RAI IA.
- 18/7/00 BTV R2; PTP R2.
- 21/7/00 RAI IA; Video E2.
- 22/7/00 RTP E3; TVE E2-4.
- 23/7/00 TVA IA: RAI IA.
- 24/7/00 RAI IA, B; Video E2; TVE E3; ORF (Austria) E4; LRT R2; SVT E2-4; NRK E2.
- 25/7/00 YLE (Finland) E3; SVT E2-4; NRK E2-4; PTP R2; ETV (Estonia) R2; RAI IA; TVA IA: Video E2; TVE E2-4; RTP E3; an unidentified Arabic ch. E2 signal with English audio and subtitles; a ch. E2 programme with the video at 47.95MHz and the sound at 51.85MHz!
- 28/7/00 RAI IA, B; TVE E2.
- 29/7/00 RAI IA, B; TVA IA.
- 30/7/00 RAI IA; HRT E4.

During the evening of the 21st, Cyril Willis received Band III and UHF signals from Germany and the Netherlands. The odd ch. E2 signal on the 25th, with the video carrier some 0.5MHz low and the sound spaced 3.9MHz away, was also received by Cyril who checked the frequencies with his scanner. The bandwidth was clearly too narrow to work with a system B TV set. A suspected Greek pirate is apparently operating in ch. E2 with an unstable carrier and an ERP of about 1kW,

but this is unlikely to be the explanation.

During the very intense SpE opening on the 25th I noticed the SVT test card in chs. E2, E3 and E4 (twice). A further ch. E4 transmitter could be tuned in separately at a frequency above the other ch. E4 signals present. Unfortunately it was a working day for me, so I was unable to loiter at home. Annoying when things are humming!

Ryn Muntjewerff (the Netherlands) queries a Russian signal in ch. R3 with the logo TBU. Has anyone any information as to the source?

Those with internet access can check the *TV DX Weblist* for up-to-date information. Another source of news/reception information is the FM and TV DX Plaza, a Finnish website at

<http://www.fmdx.com>
The information on the Greek pirate was obtained from this source.

Satellite Sightings

I heard the news of the Concorde crash on the 25th when I arrived home at 1640. Satellite News Gathering (SNG) trucks were soon at the scene. A check at the most likely satellite to be used, Telecom 2C at 3°E, failed to reveal SNG activity but CNN was already running a live two-way analogue /NTSC feed to/from Atlanta at 12.644GHz H. I suspect that this feeder was to a transatlantic uplink elsewhere. RTL appeared after 1700, at 12.602GHz V, with a live analogue report for its German network.

The Reuters Paris downlink (11.161GHz H) via Eutelsat II F4 (10°E) remained on colour bars. John Locker (Wirral) had been

monitoring the situation from the start however and reported on a scattering of SNG feeds across the sky. Eutelsat II F3, which had in recent weeks moved from 36°E to 21.5°E, taking many of its customers with it, carried news feeds on the crash at 11-056GHz H and the ITN core service at 11-096GHz H. Telecom 2B (5°W) carried a BBC feed at 12-534GHz H in a package of other signals (service identification OCCITC2B). NSS K (21.5°W) carried feeds at 11-497GHz H and 11-550GHz H. At 31.5°W Intelsat 801 included crash update material in the Sky News feed from the Farnborough air show (10-998GHz V). Digital parameters were mostly the usual 5,632 SR, 3/4 FEC.

While the Concorde tragedy was unfolding in France, President Clinton reported, at a White House press conference, on the failure of the Middle East peace moves. As usual the press call was carried live to Europe via the NSS K Reuters lease (11-558GHz H, SR 5,632, FEC 3/4) – the service identification was a new one from Washington, 'Reuters DC-H62'. The Palestinian/Jerusalem situation was featured at 2200 on the previous evening via Arabsat 2B (31.5°E, 4-129GHz RHC) with a protracted two-way interview that was obviously feeding an unidentified Arabic network somewhere. The carrier just cut out abruptly, without the required (in theory) statutory source identification.

The often seen 'CNN this morning Berlin' studio insert has been appearing since the end of July from about 0700 via NSS K, at 11-468GHz H (SR 6,116, FEC 3/4) with the identification 'n-tv BERLIN'. While typing these lines on the 28th CNN carried news of riots in Peru. A check on the Reuters NSS K lease (11-462GHz V, SR 5,632, FEC 3/4) produced live footage of army armour driving around the streets of Lima, with soldiers everywhere, smoke and occasional gunfire. This was at 2010, but the feed suddenly cut to prerecorded music for the local Channel 13. At 2020 the recording went into fast rewind, and after several short payout runs went to colour bars! Confusion at the TV centre. It's not often that breaking news happens while I am typing this article! At 2100 there was live camera coverage from Reuters' office window, with gunfire, crowds running and smoke.

A phone call from John in East Sussex on the 15th, during the early afternoon, suggested a check at Eutelsat W2 (16°E). I found a digital multiplex (SR 30,000, FEC 3/4) at 11-304GHz V, with five channels signing BTV-1 to BTV-5. BTV-1 and -2 were blank with the caption 'encrypted' – NDS 422 encoding strikes again! BTV-4 had colour bars with the identification 'TWIch1'. BTV-5 carried the identification 'Georgian Remux'. There were pop videos and later in the day programming from Georgia (Black Sea). BTV-3 was of greatest interest however: it was carrying the Channel 4 *Big Brother* programme as a live feed from London.

For me the most entertaining occasional feed seen was Reno Rodeo from ESPN Sport (NSS K) on the 9th. There is obviously a rodeo circuit in North America, perhaps similar to golf and car racing, and it's big business.

Some time back I reported what appeared to be an aircraft hijacking at a tropical airfield (on April 22nd). Thanks to Jonathan Garratt, head of Broadcast and Satellite Operations for Image Unlimited in Rome, I can now explain what happened. A wheel dropped off as a Quantas airliner prepared for take-off at the Fuimicino-Leonardo da Vinci airport, Rome. The stricken plane was then moved to a remote part of the airport for discreet repair. Image Unlimited found the location and managed to get live shots, from a distance, in the 35°C heat. The news was uplinked to Channel 7, Australia via SISlink and the BT Tower. My thanks to Jonathan for his help in clearing this up.

What has been lacking this year is dramatic, live coverage of the Tour de France. TV5 carried live pictures via Telecom 2B (5°W) at 12-585GHz – Edmund Spicer (Littlehampton) comments that the pictures are so much better than the Channel 4 digital pixelations! The Tour de France was also carried by Hispasat (30°W). The coverage, at 11-568GHz H, was digital with the unusual SR of 10,847 (FEC 3/4).

Roy Carman (Dorking) suggests a check at Telstar 12 (15°W). He found Maharishi Open University in session (11-500GHz V, SR 6,671, FEC 7/8), also Chinese Television Network (CTN) at 12-600GHz V, NTSC, SR 1,808, FEC 3/4. When I checked the satellite I found several very strong signals. They showed nearly 100 per cent signal-strength levels with

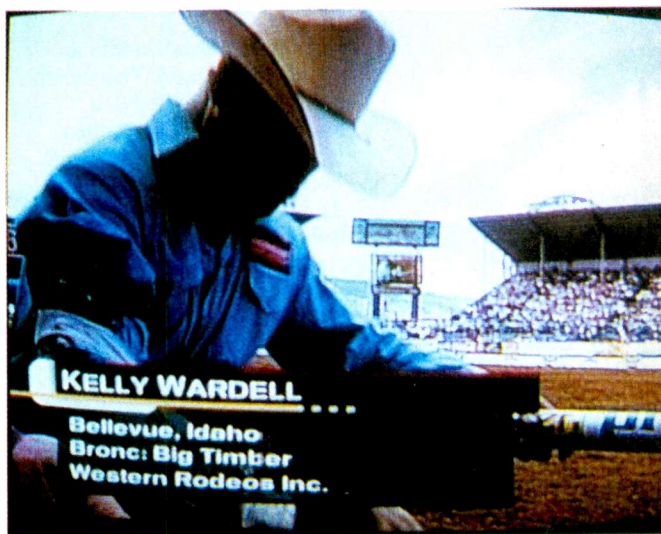

A wild-west rodeo cowboy, received during an ESPN Sport programme via NSS K (21.5°W).

my RSD ODM300 but refused to lock pictures. Roy gets this effect with his Echostar 3000 receiver. I wonder whether it's because of the use of MPEG 4:2:2 encoding?

Terrestrial News

UK: APP Broadcast, a London-based company, provided an RSL-TV service – The Sailing Channel – during Cowes week. News about yachts, race reports and live action

Aerial Techniques

59 Watcombe Road, Southbourne, Bournemouth, Dorset BH6 3LX
Tel: 01202-423555 Fax: 01202-425055
E-mail: atech@dircon.co.uk

Panasonic TU-DSB30

Digital Satellite Receiver.

Complete system including 60cm dish kit

For reception of BBC1, BBC2, Channel 4, Channel 5, BBC Choice, BBC Knowledge and BBC News 24.

£399.00
inc VAT

You may also subscribe to Sky pay to view channels.

No subscription to pay. No phone line connection required.

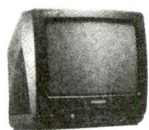

THOMSON

MULTI-SYSTEM
14" PAL/SECAM/
NTSC colour TV

(with infra-red remote control)
■ 14" screen multi-standard ■ PAL/SECAM
■ NTSC (via Scart) ■ VHF-UHF hyperband tuner
■ 59-channel memory ■ Fasttext teletext ■ S-VHS (via Scart) ■ Headphone socket ■ 240V AC operation.
Covers VHF (bands 1, 2 & 3), UHF, plus in between cable channels. PAL system 1 (for UK). PAL systems B/G (for Europe); SECAM L (for France); SECAM B/G. Including NTSC 4.43MHz via the scart.

£269.00 inc VAT

MULTI-SYSTEM PAL/SECAM/NTSC
video recorder (with infra-red remote control)

■ Tuner reception: PAL L, /G, D/K, SECAM B/G, L, L' ■ Nicam hi-fi stereo ■ 99 channel memory ■ Hyperband tuner ■ 4 head dual azimuth ■ Auto long play ■ NTSC via scart ■ Video plus ■ 8 event - 1-year ■ Satellite control ■ 2 Eurocart sockets ■ 3 phono video/audit L/R ■ Autoprogramming ■ Jog shuttle Multi-system compatibility. Covers VHF, UHF and cable channels.

£399.00 inc VAT

FULLY COMPREHENSIVE 35 PAGE CATALOGUE

Available by return of post for only £1.50 or ring with your credit card (fully refundable on first purchase over £20).

WE SUPPLY/STOCK THE VARIOUS EQUIPMENT WITHIN.

Overnight delivery by insured courier
£10.00

pictures from a small studio at Cowes were featured. The signals were microwave linked to a transmitter at East Cowes then transmitted back to Cowes on ch. 57 (vertical). Too late for DXing!

The Newport-based RSL-TV station TV 12 recently brought into operation a small relay station at East Cowes. It has a directional aerial beamed at Cowes, with output on ch. 63 (vertical). Orders have been placed for equipment to extend coverage to the Sandown Bay and Ventnor area.

France: The Vannes, Lorient and Rennes (Bretagne) main UHF transmitters are currently carrying out digital terrestrial TV test transmissions. The daytime to early evening tests use both the 4:3 and the 16:9 format.

Gibraltar: The new 1,458kHz MW transmitter is now on test and is due to increase power from 0.5kW to 5kW shortly. BBC World Service programming is used after 2000

hours local time.

Sweden: Swedish Radio and equipment manufacturers have expressed concern over lack of listener take-up in areas that have DAB coverage. There seem to be a number of reasons for this, including the high cost of receivers, an inadequate supply, signal quality and slowness in making frequency space available.

IEM Equipment: Another UHF intruder! The 798-833MHz band is now available for use by IEM (Inner Ear Monitoring) equipment. This is used by pop groups and others as a discreet programme sound or talkback feed for miming, two-way TV interviews etc. The Beyer Dynamics system for example has 64 selectable frequencies within this band. Trantec also supplies IEM equipment. A base station transmits the signal to small pocket receivers which, in turn, feed very small earpiece(s) – either mono or stereo.

Solar activity: We are now approaching the peak of the present solar cycle, with high levels of sunspot activity and their related solar flares. During July there were several days when flares produced ionospheric dropout. We also experienced, coincidentally (?), several very intense SpE openings during these periods, with a noticeable bias to reception from the north (Scandinavia). Concern has been expressed about possible damage to satellites at such times, but there has been no evidence of this to date. Auroral activity is an associated phenomenon, with Northern Lights and related VHF signal propagation. Never observe the sun directly with a telescope, smoked glasses etc. This is very dangerous.

Orbital News

Eutelsat has acquired Ku-band capacity aboard the soon-to-be-launched Russian Express A3

Review: Maplin UHF Amplifier

While searching through the packed shelves of the local Maplin store I came across a blister-packed two-stage aerial-signal amplifier, Model 6431. It's fitted with a quarter-wave stub aerial and claims to have full UHF coverage with a lowish noise figure (under 4dB) and a gain of 20dB. At £6.99 including VAT, I decided it was worth buying one to try out.

The black plastic case measures 88mm wide, 55mm deep and 38mm high. When the stub aerial is removed you have a standard Belling-Lee input socket. Output is via a 1m length of 'coaxial cable': this is more like screened single audio cable, with a coaxial plug at the end. There's a small on-off push-button switch and, at the rear, a 3.5mm mono socket to connect an external 3V power supply and a click-on flap for access to two AA cells. There is also a miniature red LED.

When the plastic shell is opened you find a DC input electrolytic decoupling capacitor and a very smart sealed mild-steel module, the preamplifier itself. After removing the lid I found a PCB with surface-mounted chip components, etched striplines and three coils. The input is fed via a bandpass filter to a four-pinout device (marked 415N) which is presumably a MOSFET. After this there's a second, unmarked three-pinout device. It looked impressive for a domestic amplifier. How well does it perform?

I checked with the signal from the 'local' RSL-TV station, TV 12. This is about thirty miles distant, on the Isle of Wight, and runs at 2kW ERP on channel E54 (horizontal). As the accompanying photographs show, the preamplifier

Internal view of the Maplin 6431 two-stage UHF amplifier.



satellite at 11°W. The capacity is being leased for the lifetime of the Russian Satellite Communications Company's (RSCC) craft, and will be used mainly to expand business in Southern Europe, North Africa and the Arab countries. A joint venture between Eutelsat and RSCC will deploy a new satellite at 40°E, probably in early 2002. This satellite will carry one L-band and eight C-band transponders for use by RSCC, and at least sixteen Ku-band transponders for use by Eutelsat. Eutelsat's W4 craft is now in operation at 36°E, with twelve of its 31 transponders dedicated to the African market. Some of these have been leased by MultiChoice, a world leader in digital pay-TV systems, for DTH TV transmissions. The Russian pay-TV service NTV-Plus is to use sixteen transponders aboard W4 for digital DTH broadcasting.

Eutelsat II F3 has moved from 36°E to 21.5°W, taking with it

various UK downlink services. Eutelsat II F2, at present at 12.5°W, will move to 48°E this winter to replace II F1. Eutelsat W1R is to replace II F4M at 10°E: the displaced craft is to be parked in an inclined slot at 25.5°E.

German broadcasters are taking over vacant Astra analogue capacity at 19.2°E. B.TV, a regional station, has started an FTA TV service using transponder 58 (10.847GHz V). Viva Zwei will open on 11.303GHz H and Viva on either 11.171GHz V or 11.127GHz H. Discovery is to launch a travel channel, and the popular Onyx music channel will open shortly. BSkyB is still pressing ITV to join the digital services at 28.2°E: ITV claims that 28.2°E cannot accommodate all the regional variations it currently offers. Astra's owner SES has bought a fifty per cent share in the Swedish firm Nordic Satellite Company (NSAB) as part of a 'geographic

expansion' programme.

Canal Plus has taken over from TV5 at 12.648GHz aboard Telecom 2B (5°W). This is an analogue Secam service with the sound at 6.5MHz. TV5 is now at 12.584GHz in clear PAL with the sound at 5.8MHz. At a date still to be decided, Telecom 2C will be moved from 3°E to 5°W to take over from the elderly 2B.

Construction and launch of Hispasat 1D has been approved. It will be placed in orbit at 30°W towards the end of 2002, providing coverage of Europe, North Africa and the Americas.

PAS-8 (166°E) has just started the first Chinese-language DTH TV service to Australia. It's being run on a 24-hour day basis by Hong Kong operator TVB1.

Comsat International has launched Comsat Max, which will build and run internet/communications teleports in five main Indian cities. ■



Reception of the TV 12 RSL-TV signal at thirty miles without amplification.

certainly improves reception.

I cannot measure noise figures, but checked the gain across the band: at 460MHz the gain was 15dB, at 500MHz 15dB, at 550MHz 16dB, at 600MHz 19.5dB, at 700MHz 20.5dB, at 800MHz 21.5dB and at 860MHz 17dB.

The input bandpass filtering is used to provide optimum gain in the UHF TV band. I checked at 260MHz to see whether the unit could be used to provide wider-band coverage, with lower gain of course, for scanner use etc. But at this frequency the throughput was -6dB.

The Model 6431 "portable UHF amplifier" is efficient and works. For practical use however I recommend that the following points are observed.



The Maplin 6431 amplifier considerably improved reception of the TV 12 signal.

First, discard the stub aerial. It's ineffective and displays a tendency to produce instability on some channels when touched or brought close to the output cable. Secondly, replace the 1m output lead with something more suitable for UHF use. Finally, the current consumption of 23mA at 3V from the two internal AA batteries (not supplied) is relatively heavy. Use of a mains power supply is therefore the better option.

Apart from the battery current consumption, the amplifier is efficient and good value. I can recommend it as a cheap indoor aerial-signal amplifier when used with a 3V mains power supply. The Maplin order number is TB07. It's referred to as an "active TV amplifier".

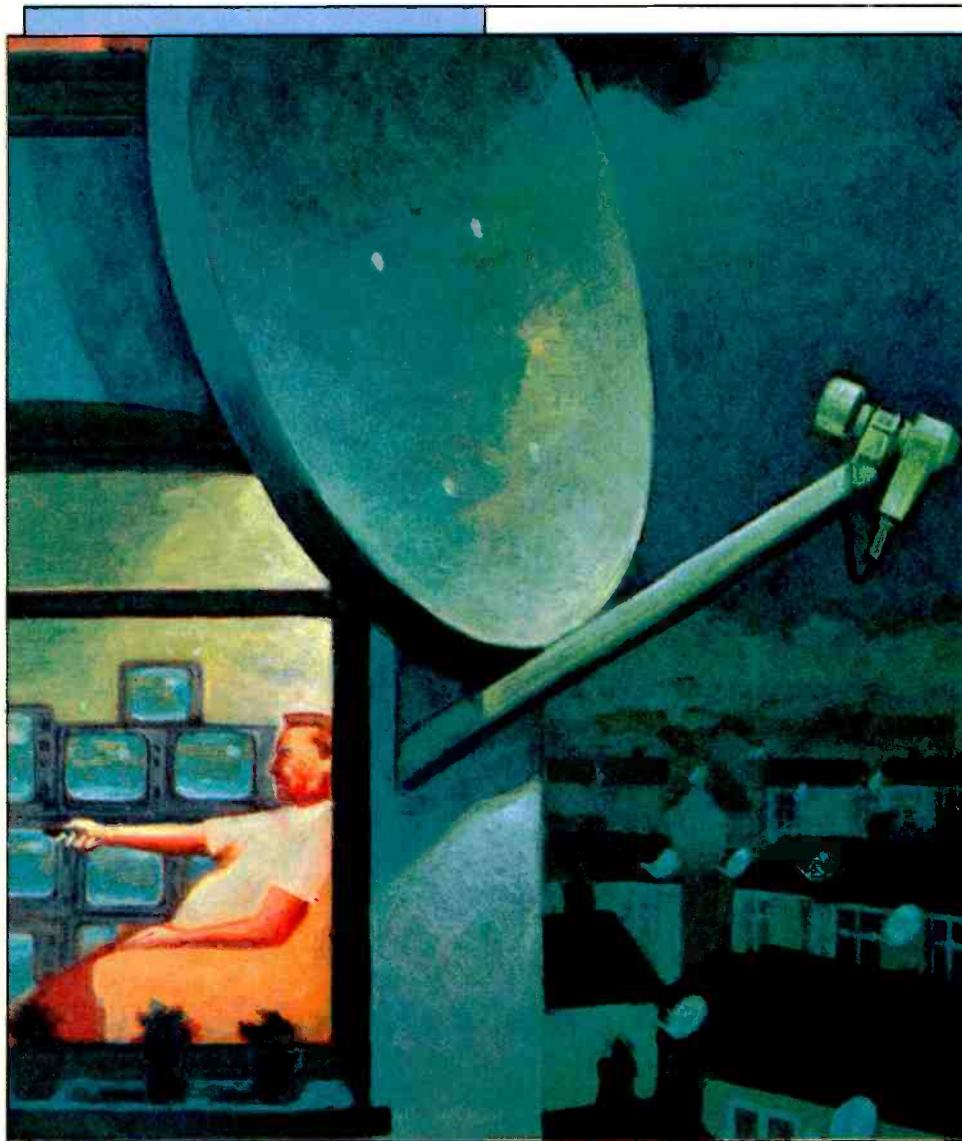

Satellite Notebook

Reports from
**Hugh Cocks and
 Christopher Holland**

Dutch digital changes

The Dutch Multichoice digital TV package was one of the first to become available in Europe, via Astra at 19.2°E. It dates back to 1996. Unusually, most of the channels in this package are broadcast simultaneously with two different encryption systems. The reason for this was the merger of the original Filmnet company with Canal Plus. Filmnet-Multichoice uses the Irdeto system while Canal Plus uses its own Mediaguard system. Not all channels continue to be available with Irdeto, whose use will be phased out over the next few years. Irdeto decoders will have to be replaced, because the conditional-access system is, as with a Sky digibox, embedded in the Canal Plus decoder – a removable module is used with Irdeto.

The receiver default frequency was recently changed from the old setting of 12.012GHz with vertical polarisation to 12.515GHz with horizontal polarisation. Unfortunately this had to be entered manually with the older Irdeto receivers, together with the symbol rate and forward-error correction type. This left many viewers totally

confused when the changeover day came, leaving some channels blank – though a caption did, helpfully, appear giving the new frequency. Once the new default frequency had been keyed in, the channels generally appeared in a different order to the previous one. This called for some channel sorting. With this system, unlike the SkyDigital one, channels can be sorted and deleted. Any changes to the transmission characteristics will no doubt be sent to the digibox for automatic updating.

Updating the newer Canal Plus decoders merely required a fresh channel scan – very similar to scanning for new channels with an ONdigital decoder. Most owners were aware of the need for this, as an information banner appeared at the bottom of the screen when changing stations. **H.C.**

RC digibox problems

Older Sky digiboxes have been around long enough for the batteries in the remote-control units to start being in need of replacement. A confusing symptom occurs with Pace receivers as the battery runs low. When a channel number is keyed in, the first digit of the number appears in the small blue rectangle at the lower left-hand side of the screen as normal. But as soon as the second digit of the number is entered the entire rectangle, with the first number, disappears! Channel selection via the 'favourite' mode, or use of the up/down buttons, works normally.

In every case a new battery has cured the problem. What can be confusing is that the remote-control unit's front red LED still has bright emission when the battery is exhausted. My initial step when I came across the problem for the first time was to reset the receiver by disconnecting it from the electricity supply then reconnecting it. Not surprisingly, this made no difference.

Another problem you occasionally get is an older digibox remote-control unit that doesn't work because one of the four green buttons which surround the round 'select' button, usually the top one, has been pushed in very hard, trapping its top edge under the plastic casing. It's easy enough to extract the offending button. Then show the owner how to do it in future. **C.H.**

SkyDigital update

The changes shown in Table 1 have been noted since my last report (see September issue page 679). Use the information to supplement that provided in the April, July and September issues. The transponder number is shown in brackets after the frequency while the EPG number is shown in brackets after the channel name.

Sky News Active has been moved from transponder 40 to transponder 26 because of reported reception problems with some digiboxes. Sky News has ceased to be transmitted at 12.070GHz H – this frequency is no longer linked to the Sky News EPG channel no. 501. ITN News 24, listed last month, is channel 525 in the EPG. **C.H.**

Drake receivers

Drake receivers have in the main been very reliable over the years. One problem we have had is blown fuses, possibly because the mains power supply here in Portugal can be 'spikey'. Quite often a receiver is dead after a power cut and a new fuse restores normal results. If customers have experienced this several times, we often leave them with replacement fuses if they feel able to carry out the replacement.

The early Model ESR3240E is a sturdily built manually-tuned receiver with 24 preset positions. Unfortunately it has only wideband audio. You can modify to narrow-band audio by replacing the 10.7MHz ceramic filter on the PCB. A normal/J17 audio de-emphasis switch is prominently placed on the front panel. The 24-position switch can seize up: remove it and the PCB assembly from the front chassis and lubricate it. Replacement switches are probably now impossible to obtain. For DX purposes excellent sensitivity can be achieved by reducing the IF drive from the tuner (via a preset accessible at the rear) – there's a critical setting. The preset can be brought out to the front panel along with a variable tuning potentiometer. The only polariser drive is mechanical, though modification for voltage switching is easy to arrange. The matching dish positioner, Model APS3240E, is reliable though difficult to set up. An earlier receiver (silver coloured instead of a black cabinet) did not have such good sensitivity.

Table 1: SkyDigital channel update.

Frequency (GHz)	Pol	Channel
11-740 (2)	V	TV Travel Shop 1 (653). Moved from transponder 13.
11-876 (9)	H	Discovery Health (196). New channel.
11-954 (13)	H	TV Travel Shop 2 (654). New channel.
12-032 (17)	H	TV Job Shop (testing, provisional EPG number 654). ITN Radio News (943). New radio station.
12-207 (26)	V	Sky News Active (501). Moved from transponder 40.
12-480 (40)	V	Sky Sports Extra (404). Used in conjunction with transponder 39 for different camera angles.

The subsequent ESR4240E was built like a battleship but had fairly limited mono wide/narrow audio facilities. It has a separate positioner unit (there was also a fixed-dish option). One problem we had with the receiver was failure of the dish to move. Power for the LNB comes from the positioner box, and the receiver and positioner units 'talk' to each other by means of LF RF via the cable. If there is poor contact at the tuner socket in the receiver, the HF signals pass with almost no attenuation but the LF dish communication signals stop. This could be confusing, as the positioner box and motor would usually check out OK. A horror fault was when one rectifier diode went short-circuit: the transformer would cook itself to oblivion, protecting the mains fuse – though

this would eventually blow.

The ESR4240S has on-screen graphics and stereo audio. The graphics could go hay-wire or, worse, the receiver would switch off and refuse to come on again when it became hot. The answer is better ventilation.

One problem in the early days of the ESR receivers was poor contact at the pins that link the vertical audio to the main PCB, the result being no or intermittent audio.

The dish could move off position when a heavy mains spike came along. To fix this, go to programme mode 5 then reposition the dish on a known channel number.

The advent of Astra changed installations here from mainly motorised to mainly the fixed-dish type. We didn't sell many Drake receivers after that. H.C.

ONLINE SHOPPING CHEAPER AND EASIER

www.elclondon.co.uk

TV, VIDEO SPARES AND ELECTRICAL ITEMS



ELC EAST LONDON COMPONENTS
59/63 PLASHET GROVE, LONDON E6 1AD.
TWO MINUTES WALK FROM UPTON PARK TUBE STATION

TEL: 020 8472 4871 OR 020 8472 8899

FAX: 020 8503 5926

E-mail: sales@elclondon.co.uk

Repair SMDs on PCBs in seconds with the NEW Hot Jet 'S'

Desoldering and soldering of SMDs by hot air and without contact is the fast and efficient way for the modern repair workshop. And now, Welwyn Tool can offer the complete package - a range of hot air tools, SMD Rework Stations, nozzles to suit all SMD requirements, free demonstrations and free colour instructional brochure ... all available from Distributors nation-wide.

For further information, please ask for Reference No. TMS

**WELWYN
TOOL
CO.LTD.**

4 SOUTH MUNDELLS,
WELWYN GARDEN CITY
HERTS AL7 1EH.
TEL: (01707) 331111.
FAX: (01707) 372175.

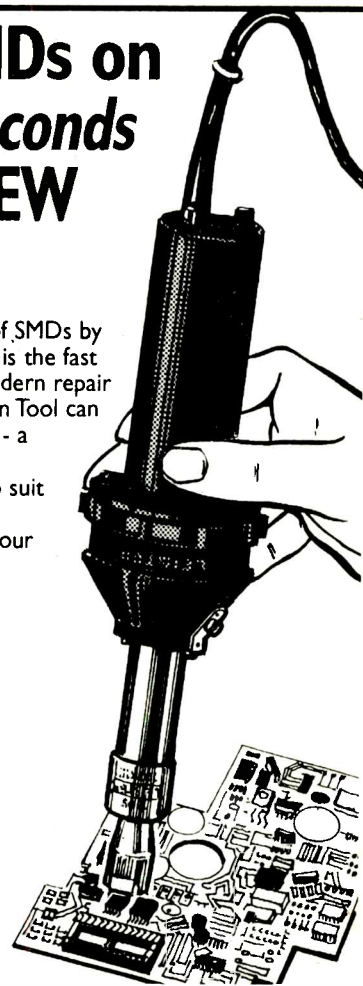

PUT HOT AIR TO WORK FOR YOU

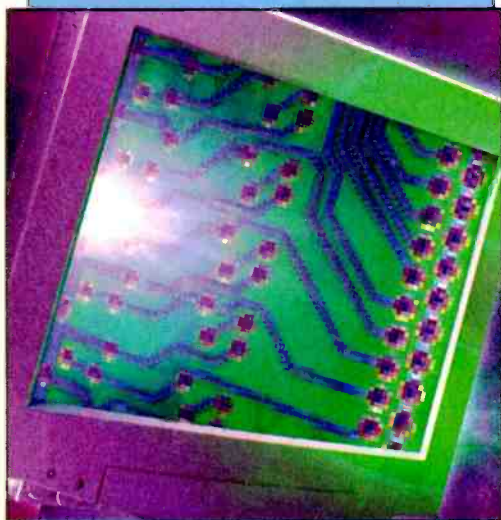

MONITORS

Fault reports from
Geoff Butcher and
Ian Field

AST TE1764G

This monitor's fault was initially intermittent, the symptom being a green streaking effect that was visible on a Windows display but not with a colour-bar signal. The effect extended across the whole width of the screen, but was apparent only where highlights were present. I eventually found that the fault was caused by the 2SC3953 driver transistor Q219 in the green output stage. It had an open-circuit collector when hot but, because of the design of the circuit, there was very little effect on the DC conditions.

The equivalent transistors in the red and blue stages, Q217 and Q221 respectively, could presumably cause a similar effect. **G.B.**

KDS KD1440G

This monitor was completely dead. There was 340V across the mains bridge rectifier's reservoir capacitor, but the power supply didn't start because there was only a 4V supply at the control IC. The usual cause of this kind of fault is failure of a start-up bias resistor – the types commonly fitted are not up to the job. The manufacturer of this monitor had fitted a couple of substantial 35kΩ wirewound resistors to avoid the problem however. But the ship had been spoilt by the use of a normal 0.5W 680kΩ resistor (R815) in another part of the start-up circuit. This resistor had gone open-circuit because of the continuous high voltage across it. **G.B.**

Blaze/Jenor TC1566D

This job had me tearing out what's left of my hair. The customer's complaint was that when the monitor had been on for a few minutes the picture would start to shake up and down, especially at the top. The monitor worked perfectly on the bench, but on its return to the customer the same problem was experienced. When tried on the bench again it was fine, so I thought I'd set it up in the shop to enable the customer to see it working properly. Almost as soon as I switched on, the fault was there. When it was taken back to the workshop the fault had gone! I eventually established that there were no problems with the monitor connected via the bench isolating transformer, but when it was connected to the mains supply directly the fault appeared.

The cause of the problem was found to be leakage through the PCB, from the isolated part of the power supply. Because of this the frame timebase was affected by mains hum. The leakage was not sufficient to fail a safety test, but when the PCB was heated with a hot-air blower the insulation resis-

tance (mains to ground) fell to about 20MΩ. Thorough board cleaning didn't help.

The monitor should probably have been rejected as not repairable, but I decided to make a cut about 8in. long right through the PCB, between the 'live' part of the power supply and the rest of the circuitry. The cut extended from C105 to T101. It cured the fault and in no way compromised the electrical safety – in fact it enhanced this. I reinforced the board with epoxy adhesive across the gap. **G.B.**

Belinea 107050

There was no supply to the line output stage because fusible resistor R3958 was open-circuit. The cause was not hard to find – the line output transistor Q314 was short-circuit. Before replacing it I made a few more checks and found that Q312 was also short-circuit. Once these two transistors had been replaced and a number of dodgy-looking joints in this area had been repaired the unit ran properly. **G.B.**

Time GRV560DM (LG chassis)

The customer who brought this monitor in complained that it was "flashing at the back". When I tried it out I found that the focusing was very poor and adjustment of the focus preset on the LOPT seemed to have an all or nothing effect. The monitor wouldn't produce the sparking effect for me but I noticed that the focus lead, which pushes into a solderless latch-type receptacle on the CRT connector, was not securely fitted – despite being under copious amounts of hot-melt glue. Refitting the lead restored an excellent picture once the focus preset had been restored to its original position. **I.F.**

Compaq PS2021

A local computer-fair trader has been selling these monitors at very low prices, so a number have been brought in for repair. The last one I had in wouldn't work because the start-up resistors were open-circuit. They are both 62kΩ, 1W and are next to the two mains-bridge rectifier reservoir electrolytics.

This one had a short-circuit rectifier on the secondary side of the power supply, CR2 (FEP16CT). The fixing screws are inaccessible unless the heatsink assembly is unsoldered and lifted out, so it's as well to check all the rectifiers and the n-channel MOSFET. The TO3-P style rectifier is a Schottky-barrier type, so some testers will give a false faulty indication. The reverse resistance is likely to be between 110-130kΩ and the forward resistance about 5-6kΩ. It's better to use a DMM diode test:

Vf less than about 200mV, Vr infinity.

If you think that semiconductor devices are running close to their thermal limit, dissipation can be improved by using fine emery paper to roughen the heatsink – the shiny aluminium finish is not the most efficient heat radiator. Use of a marker pen to make the heatsink matt black also improves the radiation efficiency.

However I suspect that RF instability was the more likely culprit in this case, since the UC3844 control chip's supply smoothing electrolytic C18 (100µF, 25V) produced an ESR reading of about 1Ω. As a precaution the replacement was fortified with a parallel 0.1µF multilayer ceramic capacitor just in case. **I.F.**

CTX 1565D

The complaint with this monitor was "sometimes fails to start up". When I tried it there was no "sometimes" about it: the EHT rustled up and immediately died every time. Inspection of the main PCB revealed numerous dry-joints, particularly around the B+ chopper MOSFET and in the mains input filter circuitry. There was no improvement after an extensive resolder of the main PCB, so attention was turned to the CRT panel. The worst soldering here was at the plugs along the bottom edge. The usual procedure of defluxing and resoldering any joints that looked the least bit suspicious was carried out, after which there was no problem. The prime suspect was the heater supply feed. **I.F.**

Elonex MN041

The screen display took nearly two minutes to appear. Even then it was just about visible in good light. It was difficult to see whether the heaters were alight, so the voltage was checked. It was just under 5V. The 6.3V supply has only one electrolytic smoother, C211 (220µF, 35V), which has a 10nF capacitor in parallel (C218). With a 1,000µF, 16V replacement for C211, and an 0.47µF, 63V replacement for C218, the heater voltage rose to 6.33V and the display was very much better, but the CRT had obviously suffered from a long period of being under run.

The 6.3V supply starts with a rectifier circuit that produces over 8V. R217/8 (5.1Ω and 5.6Ω) in parallel, giving approximately 2.67Ω, act as a dropper. Replacing them with a white ceramic 2.2Ω resistor produced just the boost needed.

When C211 was checked with an ESR meter the pointer didn't move!

The customer had attached a note explaining that the picture was fuzzy in the top left-hand corner and worse with higher resolutions. This was certainly true, but

how could he tell with the picture barely visible? The only solution was to run Windows in the highest available resolution and balance the focus in the top left-hand corner with the rest of the screen. **I.F.**

Dell Vi1428EBP/VC10CEN

The only way in which I can tell the difference between these two models is to look at the model number. Originally, nearly every example of either model that came into the workshop had a short-circuit line output transistor with no apparent cause. A replacement invariably got the monitor going, and I had no returns. All recent examples have come in because of power supply shut down, the reason for this being the three small electrolytics on the primary side of the power supply having a high ESR. The capacitors are C108 (68µF, 25V), C109 (100µF, 25V) and C110 (10µF, 50V). Regardless of which capacitor is the cause of the fault, the problem is that thyristor Q102 (MCR100-6) clamps the supply voltage at pin 7 of the '3842 control IC. Unsoldering any two pins of Q102 proves the point. It's easier to replace all three electrolytics than waste time finding out which one is faulty. **I.F.**

Gateway 2000 Crystal Scan (CS1572FS)

There was no green: the red and blue weren't too clear either. Since this monitor had been in for service about eight months previously there wasn't much point in looking for dry-joints, and I would have made sure that the electrolytics in the 6.3V supply were in good order.

When the screening was removed from the CRT base it was clear that the three 1µF 250V bipolar electrolytics were getting tired. The shrink-plastic sleeve on the one for the green output had started to shrivel! The three capacitors are C424/5/6. If non-electrolytic types that are small enough to fit the available space can be found, using them will ensure that the problem never occurs again. There will also be sharper contrast in fine-detail areas of the picture. **I.F.**

Dell Ultrascan 15TX (DI526TX-HS)

There was no green with this Trinitron tube monitor. The green drive signal was at least getting as far as the LM1207 chip, which ruled out a break in the signal cable (I've had this on a previous occasion). Although flexing and twisting the CRT PCB didn't make any difference, and the condition of the soldering appeared to be adequate, it was still at the back of my mind that this was the most likely cause of the fault – particularly when I recalled Sony TV sets with

obscure faults that disappeared after resoldering nearly every joint on the board!

I began by searching for any solder joints I could find an excuse to rework, then carried out some voltage checks. The CRT's green cathode was at about 140V while the red and blue cathodes were at 98-104V. During the voltage checks the meter probe slipped and skated across the PCB. When I looked at the front I found that the green had reappeared but was now intermittent. So it was back to the 'old-fashioned' way – resolder every joint from the LM1207 chip onwards. Doing this brought the green back permanently.

The display now had all its colours but I noticed that the scan was too wide, even when set at minimum. Including two on the scan-coil tagboard, this monitor has a grand total of five presets, none of which has anything to do with the width. So the main PCB had to be removed and every MOSFET checked. As none of them were faulty, I resorted to resoldering everything here as well. The result was a just acceptable width adjustment range. I wish Dell still got its monitors from Samsung! **I.F.**

Elonex MN044/D2W (JUP7276E)

When this monitor was switched on the green LED lit then faded out slowly. There was no other sign of life. As far as I could see the power supply was in working order, the shutdown being due to a circuit that senses an out-of-specification condition. This caused mild inconvenience during fault diagnosis, since eliminating possible short-circuit components made no difference. None of the line output stage power transistors or MOSFETs were short-circuit, so track tracing commenced.

R750 is actually a wire link and R752 (print side marking/J013 (component side marking) an axial-lead ICP-type fuse, "be14AMQ125V", which feeds HT to the flyback-type B+ regulator. This fuse had blown, and further checks revealed that the B+ flyback rectifier D308 (UG4D) was short-circuit. This presented a problem: the diode is an incredibly fast one (15nsec trr) and I had nothing like it in stock. The best I had was an assortment of 50nsec devices, mostly UF540X and HER30X types. The highest-rated one was an HER307. To be on the safe side I slipped a couple of ferrite beads on to its leads before fitting it. This rectifier seems to be perfectly happy, and my theory is that the UG4D was too fast for its own good! It may have been more vulnerable to spikes than a slower device. As a precaution, the monitor was given a lengthy soak test with the 4A fuse downgraded to 3A. **I.F.**

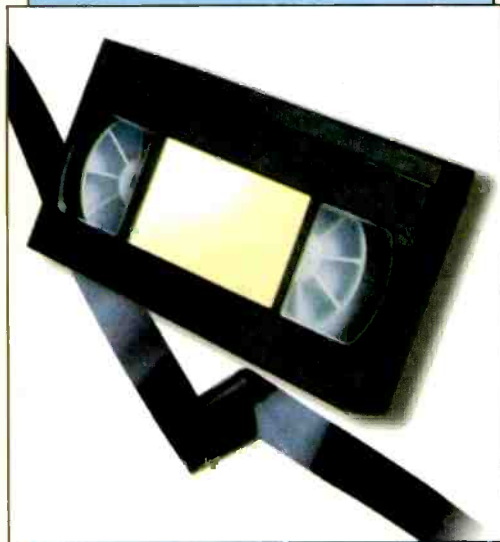

VCR CLINIC

Reports from
Eugene Trundle
Mike Leach
Ronnie Boag
Paul Smith
Derek Bogicin
P.J. Roberts and
Pete Gurney, LCGI

Sony SLVSE70 etc

If you find that there's a tape chewed or jammed in the fully loaded position with the loading motor stalled, followed by machine shut down, check the 'press block assembly, pinch' whose cam-follower shaft has probably snapped off. The part number is A6759-615-A.

This note applies to all Sony VCRs that use the S mechanism. **E.T.**

Mitsubishi HS550V

Playback pictures were fine, but recordings made by this machine played back in black and white – the record colour-under signal was missing. The cause turned out to be a hairline crack on the PCB between TP2N and R2D1. **E.T.**

Sharp VCMH711

The complaint was no results with no display. It turned out to be an interesting fault. The cause was Q704, a surface-mounted transistor. One of its legs had never been soldered. **M.L.**

Toshiba V854B

This machine was dead with no front display and no motor functions. Voltage checks showed that the 12.5V input at pin 1 of the AN7805F 5V regulator IC598 was missing. The 18Ω safety resistor R591 in the supply line was open-circuit. I expected the replacement to blow at switch on, but all was OK: the old resistor had simply failed. **M.L.**

Samsung SV213

The complaint with this machine was that it would intermittently revert to standby. The cause was found to be dry-joints at the end sensors. **R.B.**

Tatung TVR844N

This machine wouldn't load properly and left tape out of the cassette on eject. The cure was to replace the back-tension band. **R.B.**

Akai VSG878

This VCR was dead and I found that TR1 in the power supply was short-circuit. The other items that had to be replaced were D1-4, R2, R3, C13 and TR2. **R.B.**

Sony SLVE720

This VCR wouldn't accept tapes. The cure was to replace the mode-state switch. **R.B.**

JVC HRS9500

There was tape spilling when stop was pressed in the fast-forward or rewind mode. The items I had to replace to cure the fault were: the main brake (S) assem-

bly, part no. LP40110.002H; and the main brake (T), part no. LP40111-002C. **R.B.**

Ferguson FV61LV

The complaint with this VCR was intermittent shut down during record or playback. We tested it for several days before the fault put in an appearance. When it did I noticed that the drum slowed and eventually stopped. The fault was cured by resoldering BT02 on the lower PCB.

If you need to alter the output frequency of the RF modulator in one of these machines, the procedure is as follows. Hold down the remote control unit's green or B button for eight seconds. The display will then show the current channel used for the output, usually ch. 60. Press the + button to select a new channel, then press the exit or E button to store the channel. If you need to fine tune the new frequency, use the tracking + or – while the machine is in the RF mode. **P.S.**

Samsung V1710

There were two faults with this machine: a blank screen during E-E operation, as if the machine was in auxiliary mode, and no playback sound. Voltage checks at connector CN101 proved that the power supply was OK. When I moved on to CN301 I discovered that the PC 9V supply at pin 2 was low at only 4.3V. This voltage originates from the KSC2328Y transistor Q109, which was open-circuit. A replacement cured both faults. **P.S.**

Amstrad UF30

This VCR was dead with the internal 1.6A fuse blown. Meter checks showed that Q1002 (2SC4517) was short-circuit and Q1001 (2SC4204) open-circuit. No other faults could be found. Two replacement transistors and a new fuse restored normal operation. **P.S.**

Akai VSG24EK

The reported fault with this machine was "not taking a cassette". I loaded one manually and checked the functions. Almost everything worked well, but during rewind the sensor failed to recognise that tape end had been reached. Once the take-up photo-sensor D2 on the PCB under the deck had been replaced the VCR accepted tapes and worked normally. **P.S.**

Panasonic NVDA1

This camcorder's manual focusing didn't work. It's done by turning a focus ring at the front of the lens, movement being detected by two photo-interrupters. I soon found that while one phototransistor switched on and off as the ring was turned

the other one didn't. There was a 10kΩ leak across its collector and emitter, so the output was always high. The opto-interrupter itself was fine.

The leak between the feed to the collector of the non-operative phototransistor and the sensing output back from its emitter was in the FPC between the camera operation unit and the front CBA. It's one of those opaque blue ones, and a visible black spot could be seen between the two adjacent lines. Correct operation was restored once a new FPC had been fitted. **D.B.**

Panasonic NVJ45

All functions operated correctly except rewind search. If this was selected the machine would stop, unthread the tape and select the rewind mode. The reel sensors and reel table encoders were checked and found to be OK. The cause of the trouble was found to be the mode switch. I went for this item last as it had been replaced recently during a full service. The part number of the mode switch is VSS0175A. **P.J.R.**

Sony SLV715UB

There was no power though the fuse was OK. When I inspected the power supply I

found a mass of dry-joints and capacitor leakage. If you get this problem it's necessary to replace all the electrolytic capacitors on the secondary side of the power supply: Sony has a kit of the capacitors required (part no. A-675-957-4A).

Once the electrolyte had been cleaned from the PCB, the new capacitors had been fitted and the dry-joints had been attended to the machine worked. A new pinch roller and general service completed the repair. **P.J.R.**

Hitachi VTF150E

This machine appeared to be dead, with no display and a laced-up tape stuck inside. I made some quick checks at the power supply connector PG1. It's quite common for the power supply in these machines to shut down because of faulty capacitors on the primary side of the circuit. In this case however the power supply was working but there was no -30V output at pin 3 of the connector. This supply feeds the display unit and has to be present for other functions to work.

There are only a few components in the -30V supply. Rectifier diode D11 and the fusible resistor R36 were both OK, and

there was a waveform at the diode. The cause of the trouble was eventually found to be the chopper transformer, which had developed high resistance between pins 11 and 12. This is the end of a large winding that also provides feeds for the 14V and 44V rails. When I removed the transformer and examined the connections to the pins I found that almost all of them were dry. Some looked as if they had never been soldered.

Resoldering the pins cured the fault, restoring the -30V supply and enabling the machine to initialise again. In the interests of reliability I replaced all the electrolytic capacitors in the power supply. **P.G.**

Fidelity VCR4000

This problem is becoming quite common with these budget-price machines. The symptoms are tape chewing with no rotation of the take-up spool. When the deck is removed you will usually find that the capstan belt pulley has parted company with the flywheel. Careful application of Araldite provides a permanent cure. I dread to think of the cost of a motor assembly in comparison with the price of the machine. **P.G.**

How to pay

(VCR Fault Finding Guide) paperback

I enclose a cheque/bank draft for £ _____
(payable to Reed Business Information)

Please charge my credit/charge card

Mastercard American Express Visa Diners Club

Credit Card No: _____

Expiry Date: _____

Signature of Cardholder _____

Cardholder's statement address: (please use capitals)

Name _____

Address _____

Post Code _____ Tel: _____

Television magazine's VCR Clinic column is a unique forum for practical servicing tips, with the UK's leading service engineers and servicing writers contributing their observations and recommendations month by month. But try finding those faults reports for the Amstrad XYZ123 that's on your bench. Even with an index you will be chasing through a pile of magazines... until now. Peter Marlow's VCR Fault Finding Guide is a distillation of the most used fault reports from 11 years of Television magazine. Arranged by make and model the information is extremely easy to access, and the book is a convenient size for the bench or to carry with you. This will undoubtedly become one of the service engineer's most useful tools. Unlike other fault guides, this one is based on top quality information from leading authorities, and genuine repair case studies. This is real-life servicing information, not just a compilation of manufacturers' manuals.

Approximately 2,000 reports on 193 models from 35 different manufacturers. Instant on-the-spot diagnosis and repair advice. Television magazine's leading writers' wit and wisdom available for the first time in book form.

**Post your completed order form to:-
Jackie Lowe, Room L514, Quadrant
House, The Quadrant, Sutton, Surrey,
SM2 5AS**

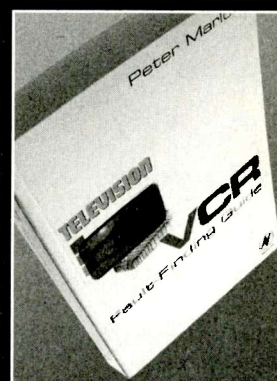

VCR Fault Finding Guide

Peter Marlow

This book is an essential repair tool, not just another volume for the shelf

Pages: 464pp

Price: £22.50

TV FAULT FINDING

Reports from

D. Hodgetts

Geoff Butcher

Michael Maurice

Paul Smith

Stephen Leatherbarrow

Colin J. Guy

Ian Bowden

Andy Barkley

Roger F. White and

Gerald Smith

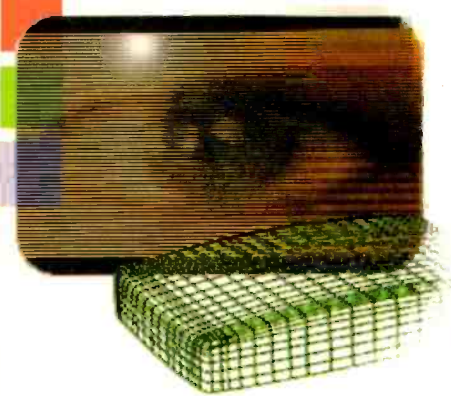

Panasonic TX25MD1 (Euro 2L chassis)

One of these digital sets came into the workshop because of field collapse. After carrying out a few voltage checks around the field output chip IC451 I decided to scope the drive signal from the main signals processor chip IC601 (VDP3108-25). The waveform was very noisy, so I looked up the price of this IC. I suddenly lost the will to live – it was £35! Was I to risk it or give the set back to the customer?

Then I remembered that I had a stock set that was stuck in standby. So swapped over the VDP chips. The customer's set was now stuck in standby, while the stock set had field collapse! I had accidentally repaired the fault in the stock set and proved that what both of them required was a new VDP chip. I could order a couple with confidence. Result: two working TX25MD1s! **D.H.**

Mitsubishi CT21M5BT (EE4 chassis)

According to the customer the original fault with this set was that it would sometimes cut out completely. It would usually come back on if it was left switched off for a while. Now however it wouldn't start at all. During several days of soak testing in the workshop the fault failed to put in an appearance. So the set was returned, but as soon as it was switched on the fault returned.

Back in the shop, I found that the symptom was still present: the green LED would flash momentarily, then nothing. I tried resoldering a number of possibly bad joints but got nowhere. There's a useful troubleshooting article on this chassis in the January 1999 issue of *Television*. Although the present symptoms were not covered, the article does have a circuit diagram of the power supply and a description of how it works.

I found that at switch on the HT rose momentarily to 150V: the power supply would then shut down. Checks around the HT regulation circuit brought me to the opto-isolator PC951. While probing this the set came to life again. Careful examination with a high-power magnifier revealed very fine cracked solder joints at some of its pins. Since resoldering these the fault has not recurred. **G.B.**

Grundig CUC6330 chassis

The symptoms with this set were no picture with arcing inside the CRT base. Someone had already had a go, and for a while I feared that the tube itself might be the cause of the trouble: the EHT was OK but the focus voltage was way too high, as though there was a leak from the final anode to the focus pin.

Connection of an external focus supply produced a normal picture however. The focus/A1 potentiometer (it's separate from the LOPT in this model) turned out to be OK, so it appeared that the fault must be in the LOPT itself. Replacement proved that this was the case: the original type is rather expensive, but König have a replacement (type FAT30329) at a very reasonable price. **G.B.**

Sony KV14TIU (BE4 chassis)

The set would very occasionally trip off, with the LED giving a diagnostic indication of six flashes. Switching it off then back on again would restore normal operation, sometimes for hours or even days. The usual cause of this sort of thing is bad soldering in the field timebase. So some resoldering was carried out, after which the set was soak tested then returned to the customer. A couple of weeks later it was back with the same symptoms.

One difficulty had been that the set would fail only when I wasn't looking at it. This time however I managed to see that immediately before cut off the screen became bright blue. I eventually found that light tapping on the CRT neck would sometimes produce blue flashes on the screen or, on occasions, the full fault. At other times tapping the tube's neck had no effect at all. Sadly it appeared that the problem was being caused by a short within the tube. As the fault was so very intermittent, I didn't feel that I could guarantee any repair short of tube replacement. This would obviously be uneconomic. **G.B.**

Mitsubishi CT2125 TX (Euro 10 chassis)

There was severe patterning over the whole screen. When the power supply panel was removed I saw that there was considerable corrosion of the tracks beneath C952, in fact parts of the copper were completely eaten away. There was no sign of leakage from components near the damaged area but C956 (2,200µF, 16V), which is about 30mm away, was bulging and had leaked electrolyte over the top of the board.

I could see no connection between the leakage on the top of the board and the corrosion beneath, so the sequence of events remains something of a mystery. Cleaning and repairing the damaged tracks and a replacement for C956 restored normal operation. **G.B.**

Hitachi C2508T

This set took a long time to come on. I found that the mains bridge rectifier's 150µF, 400V reservoir capacitor was virtually open-circuit. A replacement from Hitachi is very expensive, and because of

the height restriction you have to be very careful about the replacement. Fortunately RS Components has a capacitor of similar height, stock no. 839-224.

That wasn't the end of the story. There was now EHT but it took a long time before a stable picture was obtained. C922 was the cause of this problem. **M.M.**

Salora M Chassis

The symptom with this set was line collapse. At first glance it seemed that the cause was the melted scan coil plug and socket, so these were replaced. The fault was still present however, the cause being traced to the scan coupling capacitor CB531 (250nF, 250V) which was open-circuit. Once this had been replaced the set went dead when asked to come out of standby. DB525 (BYV95C), which is in series with the line output transistor, was short-circuit. Replacing it along with the usual capacitors in the power supply restored normal operation.

Note that CB531 is 330nF with 90° models. **M.M.**

Ferguson A51F (IKC2 chassis)

There was EHT when this set was switched on, but before anything could come up on the screen the set went to standby. It did this a few times, at approximately four-second intervals. The line output transistor was also getting very hot.

To cut a long story short, I found that though field pulses were reaching the TL082 field driver chip IF01 nothing but DC came out of it. This turned the field output thyristor hard on. A new TL082 chip cured the fault. **M.M.**

Philips 14PV163/05

This TV/VCR combi unit suffered from what appeared to be line pairing with off-air pictures. It was not present with prerecorded tape playback or input via the scart socket. The distortion could be seen at the video output from the IF section. The cause was the tuner, type U944C-IEC. **M.M.**

Goodmans 2043T (GoldStar PC04A chassis)

At switch on there were what can only be described as two black blobs towards the top part at either side of the screen. The cause was eventually traced to C406 (1µF, 160V) in the line scan coupling circuit. **M.M.**

Philips 25PT4103/07 (L6.2AA chassis)

This set came in dead with a short-circuit line output transistor and blown up power supply. I used Alan Roberts' write-up (L6.1 chassis) in the January 2000 issue of *Television* to help with the repair and, to

ensure a lasting job, also replaced the line output transformer. The set then worked well for the rest of the day.

At switch on next morning however I was greeted with squealing, lack of width and line tear. I switched off hurriedly and carried out cold checks in the line output stage. L5420 (15µH) in the 14V supply gave strange readings in-circuit – and even stranger ones when removed! There were also two visible rings around its body. A replacement restored correct line drive which, with hindsight, was probably the initial cause of the problem. **P.S.**

Philips 14CT2006/05S (CTX-S chassis)

This set produced a good monochrome picture. But when the colour was turned up the picture was marred by thin black lines across the screen. I decided to concentrate on the area around the TDA3560 colour decoder chip IC7192. Fault-finding consisted mainly of component substitution. The fault disappeared when C2218 (2.2µF, 63V) was replaced. It's between pins 4 and 5 of IC7192. **P.S.**

GoldStar CF25C28F (PC58A chassis)

Field collapse was the initial fault with this set. I replaced the TDA8350Q chip (IC351) used for field output and also fitted the modification kit (LG part no. KITPC58A). This brought back full vertical scanning, but there was bowing at the sides. IC351 also carries out EW correction, so I needed to look elsewhere.

The voltages at pins 11 and 12 of IC351 were negligible – pin 11 should be at 14.2V and pin 12 at 0.7V. When I traced back I came to Q351 (KTB988Y) which was short-circuit emitter-to-collector. The new fusible resistor FR359 supplied with the kit was also found to be high. Correct picture geometry was restored once Q351 had been replaced and a new 22Ω, 0.5W fusible resistor had been fitted. **P.S.**

Goodmans 1430

When R302 goes open-circuit the set will be stuck in standby. It provides a DC feed to pin 21 the colour decoder/timebase generator chip IC301. With this feed missing there's no line drive output from the IC. **S.L.**

Ferguson D59N (ICC9 chassis)

There was a very nasty fault with one of these sets. The effect was similar to that produced by a loose aerial plug, and the chassis was tap-sensitive. I removed the tuner and IF modules with the idea of resoldering dry-joints, but eventually traced the cause of the fault to the BC858B surface-mounted transistor TC03.

I've had numerous surface-mounted transistor failures (TP66 and TP69 for example) in this and other Thomson chassis, but few in chassis from other manufacturers. **S.L.**

JVC AV29SX1 (JA chassis)

In the event of field collapse because of failure of the TDA8350Q field output chip IC401, check which version of this chip was fitted. If it's a version 3, the following modifications should be carried out – these are not necessary with a version 5 chip.

- (1) Change the IC to version 5.
- (2) Change FR553 from part no. QRH127J-5R6M to part no. QRH017J-180M.
- (3) Add C411, part no. QFLC2AK-103MZ.
- (4) Add C407, part no. QFLC2AK-103MZ. Note that this does not apply to Model AV29SX1.
- (5) Change R560 from part no. QRG019J-332S to part no. QRG019J-222S.
- (6) Add zener diode part no. RD62E(B)-T2 between pins 8 and 9 of IC401, cathode to pin 8.
- (7) Change FR552 from part no. QRH027K-R82M to part no. QRH027J-1R8M.

If a version 3 IC is fitted, change C402 from 100pF to 4,700pF (part no. QCY31HK-472AZ. **S.L.**

Proline 1415T

The complaint with this set was no sound, picture OK. After various checks it became apparent that the EEPROM was faulty or corrupted. No problem I thought, phone Comet and obtain either details on how to reprogram it or a new programmed EEPROM. Comet denied all knowledge of this model however.

It's fitted with the Thomson/Ferguson TX807 chassis, so I contacted CHS who supplied a programmed device at modest cost within 24 hours. This was not the end of the story however. After fitting the new chip there was sound but the height was now reduced. Obviously when these devices are programmed they are provided with default values and our VA (vertical amplitude) needed a tweak.

To put the chassis in the service mode, proceed as follows: (1) Switch the set on. (2) Use the remote control unit to put it in standby. (3) Switch the set off. (4) Switch on again while holding down the magenta handset key. (5) When the picture appears, press the magenta key again. It is then a simple matter of following the on-screen information. All adjusted values are stored automatically. My thanks to Thomson Technical who were most helpful. **S.L.**

Sanyo CBP2576/2876 (EDO chassis)

No sound was caused by the TDA7253 audio output chip IC1680 being short-circuit.

As a result, protector ICP853 was open-circuit. For the bright raster, sound OK symptom check the 22Ω safety resistor R534. If it's open-circuit, check or replace the TEA5101A RGB output chip IC500. S.L.

JVC AV21H2EK

There were no signals and no graphics, but input via the scart socket produced a normal display. Checks revealed that there was no input at IC522, a 5V regulator sited close to the line output transformer. The cause of the loss of input was the 6.8Ω fusible resistor R527, which was open-circuit. Although the regulator seemed to be blameless I replaced it for my own peace of mind. S.L.

Goodmans 2580/2880 (Ferguson TX92 chassis)

Loss of sound has become a common fault with these sets. The cause is usually failure of the surface-mounted BC848B transistor TS90. It's in the mute circuit. S.L.

JVC CS2191EKT

The owner of this set was convinced that the CRT had failed, and indeed the picture gave this impression. Scope checks revealed that the luminance signal fed to the CRT panel was very crushed however. It was OK where it emerged at pin 4 of the colour decoder/timebase chip IC201. On its way to the CRT panel the luminance signal is applied to a circuit where the on-screen display RGB signals are inserted. D804 (1SS133) in this circuit turned out to be leaky. When a replacement 1N4148 diode was fitted there was an excellent picture. The owner seemed to be most disappointed about this: I can only conclude that he was expecting to have to buy a new set. C.J.G.

Hitachi C2114T

After half an hour or so the remote-control system would lock up. Checks around the microcontroller chip revealed that the supply was high at 5.35V. Replacement of the 5.1V zener diode ZD001 reduced the supply to 5.1V and cured the fault. C.J.G.

Ferguson B59N (ICC8 chassis)

The cause of lines on the picture was traced to C131 (10μF) in the IF can. Strange, as it decouples pin 3 of the sound IF chip! C.J.G.

Akai CT2185 (Sanyo A5 chassis)

This set would go to standby a few seconds after being switched on. Checks around the microcontroller chip revealed that pin 19, the protect input, was low though all the supply lines came up correctly. The pull-up resistor for this pin was open-circuit. It's R748 (100kΩ). C.J.G.

Ferguson A14R (TX80 chassis)

Weak distorted sound was caused by C104, a surface-mounted 10nF capacitor, which

fell in half when removed. It's in series with the sound detector coil LI02. C.J.G.

Tatung TN1901 (190 series chassis)

This portable bounced, with the complaint that the tuning drifted slightly from cold, after we'd fitted a new keyboard membrane. I found that R005 (5.6MΩ) in the AFC circuit was missing and had never been fitted from new. Adding this resistor cured the fault, but the customer was adamant that the set had never drifted before we fitted the new keyboard. C.J.G.

Ferguson ICC8 Chassis

As it's no longer available, Thomson now supply a kit to replace the TDA8178/F field output IC used in this chassis. The kit consists of an STV9379 IC, a 2.1V zener diode and a 390Ω resistor. After adding one of these kits I found that the field linearity was poor. It took me a while to discover that the zener diode supplied with the kit was faulty. C.J.G.

Ferguson D59F (ICC9 chassis)

When this set had been running for a few minutes the sound would increase to full volume. The OSD came up and worked normally when the volume control was operated, but it had no effect on the volume except at the minimum position when the sound muted. The cause of the trouble was yet another surface-mounted BC848B transistor, TR55. It became open-circuit when warm. C.J.G.

Philips 21PT1653 (L6.2 chassis)

This set was dead part from a buzz from the power supply. Fuse F1502 was found to be open-circuit and the rectifier it feeds, D6503 (BYD33D), short-circuit. Once these items had been replaced the result was the same. I then found that the drive to the line output transistor was missing. This comes via an optocoupler, IC7420. There appeared to be sufficient drive at the input to IC7420 but there was nothing at the base of the driver transistor Tr7421. I came to the conclusion that the optocoupler was faulty, and a replacement restored normal operation.

The optocoupler is used for mains isolation, the line output stage being live. There's a slight delay at switch on, when you hear a buzz from the power supply, before the line output stage starts up. I.B.

Goodmans GD2880A (Ferguson ICC9 chassis)

When this set had been on for about five minutes a bad line 'waterfall' effect was noticed. With the fault present, the line drive was found to have a near sinewave superimposed on it. I noticed that the fault was never present when the set was first switched on. I also noticed that the 7809 regulator IP03 had been getting very hot: the PCB around it was brown, and it had been resoldered during a previous repair.

This regulator provides a standby supply and a start-up supply, via TL65, for the line driver stage. Once the line output stage is in operation, it provides a 7.5V supply for the line driver stage and the start-up supply is switched off. The problem was that the start-up supply wasn't being switched off because TL65 remained on. It's controlled by a BC858B surface-mounted pnp transistor, TL64, which should be switched off by a 13V bias derived from the line output stage. It was leaky from base-to-collector however, and as a result TL65 remained on.

For reference, when the set is running the base of TL65 should be at about 10.5V. In this case the voltage here was low at about 7.25V. Once a new BC858B transistor had been fitted the fault cleared and IP03 ran cold. I.B.

Philips 41GR884 (projection G110 chassis)

This set was reported as being dead. It started up however, but shut down again after a very short delay. I found that the protection circuit on the main PCB was being triggered. The source of this triggering is on the front convergence/protection board, where R3818 (180kΩ) was open-circuit. It's connected between the 200V supply and the cathode of D6819, which it should keep reverse biased. I.B.

JVC C14ET1EK (Onwa chassis)

This set tripped rapidly when switched on. The cause was C402 (4.7nF, 500V), which is part of the protection network in parallel with the HT rectifier D401. The capacitor was leaky – the reading I obtained when I checked it was 160Ω. To improve reliability, C909 and C911 on the primary side of the power supply were also replaced. I.B.

Sony KVM14U (BE1 chassis)

The reported problem with this set was the usual loss of tuning because of dry-joints in the IF can. Once these had been attended to another fault became apparent. On certain scenes there was hooking at the top of the picture: a buzzing noise in time with this could be heard coming from the line output stage.

Checks around the TDA2579A timebase generator chip IC551 showed that the line drive pulses were disturbed when the fault was present. I also found that there was a flat 2.8V DC level with S-shaped bursts in time with the hooking at pin 8 (phase detector) of the chip. The set was OK when cold, and cooling IC551 would clear the fault. The chip was thermally faulty. I.B.

Bush 1408

The problem with this set was excessive height. You will find a parallel RC network connected to pin 13 of the TA8718N colour decoder/timebase generator chip IC201. The R section of this network consists of R240 in series with the height control VR202. R240 is shown as 10kΩ in the circuit diagram but the resistor fitted was actu-

ally 18kΩ. It had risen in value to about 54kΩ. An 18kΩ replacement cured the fault. **A.B.**

Alba T14

I have had a number of these sets in, all with the same fault: the mains fuse is open-circuit and the chopper FET Q1 short-circuit. The cause is R294 (270kΩ) going high in value. I had difficulty finding the P5NA80F1 FET, but RS lists the isolated version (STP5NA80F1) under order code 313-2857. **R.F.W.**

Sanyo CBP2180 (A5 chassis)

This was a strange fault. The set would produce either a picture or sound though not both – the on-screen displays were OK. There was a clue: when there was a picture, it was displaced to one side and had a vertical band of colour. After checking for the usual dry-joints on the regulators I subsequently found that the horizontal shift potentiometer VR411 was the cause of the trouble. **R.F.W.**

Samsung CI5013 (P58S chassis)

This set wouldn't come on and a strange noise came from the power supply, which is of the TDA4601 control chip type. The cause of the trouble was failure of two

electrolytic capacitors on the primary side of the power supply, C808 (100μF, 16V) and C817 (100μF, 25V). **R.F.W.**

Ferguson TX9 Chassis

There was field collapse with this old set, the cause being something I've not seen mentioned before. I replaced the TDA1170S field timebase chip IC55 and the 100μF flyback boost capacitor C208 but this had no effect. The cause of the fault was R294 (18kΩ) in the DC feedback network. **R.F.W.**

Philips 14PT1532 (L6 series chassis)

This dead set had been got at by a battery fitter! The chopper FET had been replaced with a BUT12AF and, to make life interesting, here were signs of liquid spillage. After cleaning the PCB and fitting a SOPS kit the LED would come on then fade out. Voltage checks showed that the HT supply was trying to get there but didn't make it. The cause of the trouble was the HT smoothing capacitor C2515 (47μF, 200V). **R.F.W.**

Mitsubishi CT2525 (Euro 10 chassis)

This set was intermittently dead, more so from cold, because the power supply was

reluctant to start up and run. Normal operation was restored by replacing three leaky capacitors in the power supply: C905 (220μF), C906 (47μF) and C912 (4.7μF). **G.S.**

Finlux 3000 Series Chassis

The problem with one of these sets was an intermittently snowy picture. Resoldering the dry-joints in the large tuner/IF can made no difference, but replacing the SDA3202-3 tuning chip IC1 did. If this chip is not available, use a TSA5511. **G.S.**

Nokia Stereo Plus Chassis

To start with there was just a two-inch band of lines at the centre of the screen. A new TDA8350Q field/EW correction output IC (NS10) restored the picture, but with two inches of flyback/foldover at the top. The supply to the chip (pin 8) was low at about 16V instead of 42V. RK68 (10Ω) in the supply's smoothing circuit had gone high in value. **G.S.**

Finlux 3000 Series Chassis

There was field cramping with lines at the top of the screen. It was worse from cold, when there could be just lines across the screen. The cause of the trouble was the flyback boost reservoir capacitor Ck4 (100μF, 35V) which was leaky. **G.S.**

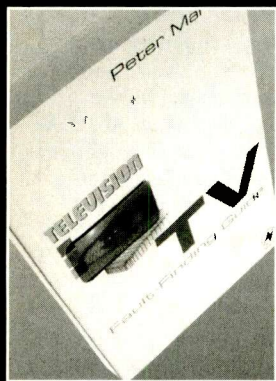

TV Fault Finding Guide

Peter Marlow

Contents: Introduction; A-Z of manufacturers and models

Readership: Professional service engineers, some college courses.

Pages: 400pp

Price: £22.50

Unique expert authorship and trusted Television magazine identify Real repair and troubleshooting info – not just cribs from manufacturers' data sheets. Ease of reference – this book is an essential repair tool, not just another volume for the shelf, Television magazine's TV Fault Finding column is a unique forum for practical servicing tips, with the UK's leading service engineers and servicing writers contributing their observations and recommendations month by month. But try finding those faults reports for the Amstrad CTV2200 that's on your bench. Even with an index you will be chasing through a pile of magazines... until now. Peter Marlow's TV Fault Finding Guide is a distillation of the most used fault reports from 11 years of Television magazine. Arranged by make and model the information is extremely easy to access, and the book is a convenient size for the bench or to carry with you. This will undoubtedly become one of the service engineer's most useful tools. Unlike other fault guides, this one is based on top quality information from leading authorities, and genuine repair case studies. This is real-life servicing information, not just a compilation of manufacturers' manuals.

Over 2,000 reports covering over 300 models Instant on-the-spot diagnosis and repair advice Television magazine's leading writers' wit and wisdom available for the first time in book form.

How to pay

(TV Fault Finding Guide) paperback

I enclose a cheque/bank draft for £ _____
(payable to Reed Business Information)

Please charge my credit/charge card

Mastercard American Express Visa Diners Club

Credit Card No:

Expiry Date:

Signature of Cardholder _____

Cardholder's statement address: (please use capitals)

Name _____

Address _____

Post Code _____ Tel: _____

**Post your completed order form to:-
Jackie Lowe, Room L514, Quadrant House,
The Quadrant, Sutton, Surrey, SM2 5AS**

HELP

The help wanted column is intended to assist readers who require a part, circuit diagram etc. that's not generally available. Requests are published at the discretion of the editor. Send them to Television, Help Wanted, Room L514, Reed Business Information, Quadrant House, The Quadrant, Sutton, Surrey SM2 5AS. Do not write to or phone the advertisement department about this feature.

Wanted: N/S transducer, part no. 8014059 (circuit ref. 8T1), for the B&O Model 6002. The transducer is mounted on convergence panel PC8 (part no. 8003204). Please phone L. Cook on 02380 237 373.

Wanted: Does anyone know of an equivalent to the Granada VHSFS4 VCR? I'd like to know the manufacturer and any equivalent model number. This ex-rental VCR has picture-in-picture, channel scan, time and timer set via remote control etc. Alan A. Fox, 2 Westbank Avenue, Marton, Blackpool FY4 5BT.

Wanted: Mains transformer, part no. 83-NF5-608-018, for the Aiwa CX-N520K audio system. Tony Rogers, 10 Clod Lane, Haslingden, Rossendale, Lancs BB4 6LR. Phone 01706 220 971.

Wanted: Collector of early TV sets would like to acquire Marconiphone 707 7in. and 5in. sets and a 1950 12in. Baird Countryman or Townsman console, in any condition. G. Holden, 5 Craigour Avenue, Torphins, Banchury, Scotland AB31 4JA. Phone 01339 882 979.

Wanted: A BU508AT transistor for the Hitachi Model C28-P759. Also data on this device, i.e. does it have an internal diode between the collector and emitter like some other transistors in this family? Noel Smith, 33 South Hermitage, Shrewsbury SY3 7JS. Phone 01743 356 430.

Wanted: A working Philips N1700 VCR. Will collect. J.A. Smith, Cherry Hinton, Watermill Lane, Beckley, East Sussex TN31 6SH. Phone 01797 252 399.

WANTED

Wanted: A capstan motor pulley (nylon metal) or good capstan motor with pulley for the Osaki VR410 (Amstrad VCR6000 etc.); inductor L404 for the Akai VS422 and any information on the correct voltages in this area (the display doesn't light up); and photocopies of the service data for the Amstrad VCR4600. M. Roy, 22 Grebe Close, Waterlooville, Hants PO8 9UT. Phone 02392 783 811.

Wanted: Dual-trace plug-in unit V4 for the Telequipment Model D83 oscilloscope, or any equivalent unit. Phone Mark Killingback on 01508 499 009 or e-mail mark@threeways51.freereserve.co.uk

Wanted: Power supply unit for the Panasonic VCR Model NVJ35. A complete VCR would be OK as long as the power supply works. Phone M. Payne on 0191 537 2062.

Wanted: Switch-mode power supply for the Ricoh fax machine type FAX07, or information on where to obtain one. Phone R. Fullerton on 02879 468 477 or e-mail rfulle5318@aol.com

Wanted: Someone with equipment to clear a heater-cathode short in a 510JGB22TC01 tube or alternatively a good second-hand or new tube. The TV set is a Sharp Model C1851H (18in. with touch-tune buttons). J. Reed, 88 Conway Road, Llandudno LL30 1PP.

Wanted: Thick-film focus unit U3158 (part no. 21827464) and two BY210-800 diodes for the line scan panel in a Philips Model G26C672 (G11 chassis). C.R. Tomlinson 24 Kelmscott Gardens, Leeds LS15 8HL.

Wanted: Inverter, 12-24V DC in, 230V AC out, fair output 300W etc., for field trials. Ron White, 29 Nunnery Street, Castle Hedingham, Essex CO9 3DN. Mobile phone 07773 222 735 after 6 p.m.

Wanted: Nakamichi BX series (ideally BX-2) cassette deck for spares. Steve Burgess. Phone 020 7306 8723 (days), 01483 480 283 (evenings) or e-mail sburgess@channel4.co.uk

Wanted: Power units for the following VCRs: Ferguson Model FV71 and Samsung Model VIK320. Keith M. Twamley. Phone 0121 426 4471 (Birmingham) or e-mail keithmtwamley@davena.freereserve.co.uk

Wanted: Advice on the following CCTV colour camera problem. Has anyone bought a Panasonic Model WV-CL110AE (suffix may differ) in recent times? Despite being told by the trader that it's a PAL product the manufacturer says it was never sold in the UK and could be an import that uses a different PAL system. This could explain why the camera has consistently refused to work properly and produce a colour picture with UK PAL monitors and TV sets. Any comments

about these cameras, good or bad, would be of interest. Also where obtained. Malcolm Perry (G8AKX), 216 Marlpool Lane, Kidderminster DY11 5DL.

Wanted: Teletext boards for the Philips Models 21CE1250/05B and C59CP2. J. Chare, Naunton Farm, Holt Heath, Worcester WR6 6NG. Phone 01905 620 945.

For disposal: 32 volumes of Newnes' *Radio and Television Servicing*, from the first volume (circa 1950) to volume 1984-85. Best offer considered. Phone Richard Bogazzi (Croydon) on 020 8658 3838 (office) or 020 8776 0476 (home), or e-mail richard@kemo.com

Work experience: Mature student in his 40s with HNC level seeks to gain repair/diagnostic experience to component level on a voluntary basis. Would any TV/video engineer or small repair business be willing to help/advise, preferably in Essex/Herts borders or London post-code districts E1-E18 and IG or N1-N20 and EN? Please contact Peter Punter on 01279 869 903.

Wanted: Remote control unit and operating instructions for the Orion JRD2001 satellite receiver. F. Nedza, 40 Brynhyfryd, Glynneath, Neath, West Glamorgan SA11 5BA.

Wanted/for disposal: Require remote control units for the Sony SLV373 and JVC HRD820 VCRs; a frame panel for the Grundig CUC740 chassis; and an A51-EAF-00X01 CRT (ITT) in reasonable condition. Have for disposal *Radio and Television Servicing* books, 1970-80. Ron Bruce, 11 New Zealand Way, Rainham, Essex RM13 8JP. 01708 558 792.

Wanted/for disposal: Require JVC HRD520EK/Ferguson FV37H for spares, also circuit diagram; power supply for the Grundig GV201-1; remote control unit for the Mitsubishi HSB11 (any condition); and a circuit diagram for the Sansui SV77. Have for disposal *Television* magazines 1990-99 complete in perfect condition plus some very old copies of *Practical Wireless*. Best offer secures. Phone Ian Livingstone on 01482 887 946 (Beverly, E. Yorkshire).

Wanted: Microcontroller card or complete chassis for the Philips Model 33CE7533/45R (3A chassis). Phone Jane Eccles on 01394 460 589.

Wanted/for disposal: Require digital video panel (working or repairable) for the Sharp CTV Model DV5103. Have for disposal 200 copies of *Practical Wireless*, *Practical Television* and *Radio Constructor*, 1958-68; a quantity of 19in. mono sets; some dual-standard TVs. Am moving so all must go. Best offer please. J. Webberley, Broomhill, Hendra Road, St. Dennis, Cornwall PL26 8EQ. Phone 01726 822 222.



AUDIO FAULTS

Reports from
**Paul Smith and
Russell J. Fletcher**

Panasonic SAHD52

The CD player would work normally for about an hour. It would then start to jump and skip tracks before it stopped altogether until it was left to cool down. I noticed that in the fault condition the spindle motor became very sluggish, so I fitted a new motor. Unfortunately this didn't alter the situation. Freezing Q131 and Q132 on the PCB at the right-hand side of the CD deck seemed to restore normal operation. The diagnosis was confirmed by fitting two new 2SD2037 transistors. **P.S.**

Sony TA-F450D

The protection circuit was in operation, so the output relay wouldn't click in. It was doing its job well: the output line was at

45V DC, which would have destroyed the loudspeakers. Cold checks revealed that the following transistors were short-circuit: Q506 (2SD1585), Q508 (2SC2275A), Q509 (2SA985A), Q511 (2SA1215), Q513 (2SC2785) and Q514 (2SA1175). In addition R518 (100Ω), R520 (22Ω), R533 (1kΩ) and R536 (10Ω) were open-circuit. After replacing these ten components everything checked OK but the relay still wouldn't activate – until I refitted the screws to ground the heatsink! **P.S.**

Studiomaster 1 6-8-16 Mixdown

What seemed to be a very peculiar fault with this unit turned out to be something quite straightforward. Though not admitted, it was most likely to have been caused by an unauthorised meddler. After much playing with signals and routings, I noticed that group outputs 6 and 7 seemed to be interactive and very distorted. The cause was a short on the group bus, actually a solder splash at one of the connector strips.

As the bus is connected to all 24 cards, the best way to find the source of the problem is to run the desk with the fault present and remove the bus connectors one by one until the fault clears. When it has cleared, check the connector/PCB tracks on the faulty card. **R.J.F.**

Denon DMD1000

This MiniDisc recorder wouldn't accept a disc. The display said "MECH ERR 1M". This happens with some early-issue machines because the eject mechanism spring is a fraction too long and doesn't provide enough tension. You will find the spring at the left-hand side of the mechanism. Simply bend the lugs to which it is attached. Alternatively, replace the disc holder with the updated version – holder arm 04/9370216415 (the lug on this is repositioned slightly).

The same fault afflicts some **Sharp** machines. It's the same mechanism, and you get the same message in the display. **R.J.F.**

Denon DCD825

There was poor playback with this CD player. The symptoms included skipping, not recognising certain discs etc. Premature failure of the laser unit was the cause. Use type KSS240. **R.J.F.**

Soundlab CDJ500

The left-hand tray of this professional twin CD player wouldn't operate (open/close). It's a two-box system that consists of a twin-

tray unit and a remote-mountable dual control unit. The two are connected via a pair of 25-way D cables. The cause of the fault was quickly traced to cracked joints at the control unit's left-side 25-way D socket. **R.J.F.**

Denon DRM535/DRM555/ DRW580/DRW585

A fault you sometimes get with these cassette decks is intermittent stopping in any deck mode, accompanied by intermittent counter operation. The tape motion sensor is the most likely cause. You will find it on the small PCB attached to the cassette mechanism. Hayden Laboratories can supply the complete board as a replacement part. **R.J.F.**

Denon DN2000F

This is a professional twin CD player. We've had two in for repair recently. The complaint with the first one was that the left tray intermittently failed to read the TOC. The cause was a faulty spindle motor.

Intermittent or no deck functions with one or both trays was the complaint with the other player. The ribbon cables that link the mechanism to the PCB were faulty. **R.J.F.**

Beringer Eurodesk

You sometimes get the following symptoms: excessive noise, rhythmic oscillation (loud clicking) or no response from individual inputs. The most likely cause is a faulty buffer/differential amplifier at the relevant balanced input. The amplifiers are on separate PCBs, with the relevant socketry, separated from the main boards and arranged in groups of twelve. There's a single-in-line dual op-amp, type NJM4580L, for each pair of inputs. **R.J.F.**

Denon DCM260

This is a multiplay CD machine. The complaint "noisy when changing discs" is caused by a faulty turret motor – the one that turns the five-disc tray.

The symptoms with one machine that came in recently were display lit, no functions and the disc tray continuously rotating. I found that ICP501 and ICP502 were open-circuit because servo transistors TR202 and TR203 had failed.

We've often had the report "tray jammed". What has happened is that the operator has opened the tray and noticed an empty space. He has then inserted another CD, not realising that the space belongs to the CD that's being played! The 'fault' is not limited to this make/model. **R.J.F.**

WEB SERVICE

AcquiVision

<http://www.acquivision.com>

Acquivision solutions, including XY-Plotting, Oscilloscope (with FFT), Data Logging and Custom Software, have been getting the most from computers since 1994, Download software. Telephone (01903) 830502

All Tech Tips

<http://www.skyeinteractive.net/tech>
<https://www.skyeinteractive.net/tech>

Another US technical tips site which deals with subjects related to repair of the whole range of consumer electronic items. The site is being updated and plans to include current repair articles, books on repair, schematics and links to manufacturers technical repair sites. There's also a chat room.

Anatekcorp

<http://www.anatekcorp.com/>

A US site selling computer databases of fault reports and schematics, but it has some interesting articles for free download - you can even submit your own. There's a technicians forum but you have pay \$60/year to be a member.

A.R.D. Electronics Plc

<http://www.ardelectronics.com>



A.R.D.'s Website details all the information you need to know about this new and exciting electronic component distributor. It shows how to: open an account (credit or cash), obtain a trade catalogue and place orders (both online and direct)

Baird 30 Line Recordings

<http://www.dfm.dircon.co.uk>

For history buffs and the curious here's

a fascinating site containing early TV recordings and their background.

BBC

<http://www.bbc.co.uk/info/reception>

<http://www.bbc.co.uk/enginfo>

If you need any help with your reception go to this site - both of the addresses point here. There's special advice for people with loft installations, and caravaners and boating enthusiasts.

Doknet Service manuals

<http://www.doknet.com>

This Dutch site says it has 350,000 service manuals and 1 million service parts.

You interrogate the data base by filling out an order form, with the "request" box ticked, and then wait for an email to arrive back on your computer. However, an on-line index would be useful and maybe on-line downloading of the manuals.

EURAS International Ltd

<http://www.euras@euras.co.uk>



"The definitive fault index... based on feedback from manufacturers, technicians and workshops throughout Europe" IER Magazine. Available on CD-ROM including ECA vrt-disk 2000. Subscription includes free Internet access for update downloading, access to pin board, discussion forums and classified ad section. Monitor database also available.

Goot Products

<http://www.kieagoot.co.uk>

Kiea Trading Company is the sole agent of Goot products, We specialise in supplying the soldering and desoldering product range manufactured by Goot Japan for the UK market. Goot



uses advanced production technology to manufacture high quality soldering iron products for industrial, professional and general purpose use.

MB21

<http://www.mb21.co.uk/index.html>

Another enjoyable site with a "telenostalgia" section about the technical aspects of television. There's also a section on transmitter sites, teletext "then and now", and a "rough guide" to widescreen television

Newsgroups

uk.tech.broadcast

uk.tech.digital-tv

uk.tech.tv.sky

If you have never got into newsgroups then these are worth a look. You "subscribe" (free of charge) to a newsgroup through your e-mail software (eg. Outlook Express). If it's not obvious how to do it then check out the help section on your Internet Service Provider's front page. Newsgroups are like notice boards where subscribers can send an Email to be viewed by everyone else. They are generally a source of help and advice, with plenty of humour too! Maybe there should be a TV engineer specific newsgroup called "uk.tv.engineers". Any thoughts? (thanks to Iain Dobie for this information)

Newnes

<http://www.newnespress.com>

Check out this site for the latest book titles on TV & Video Servicing and Technology and their famous Pocket Book series. You can shop on-line and also register for an Email service to tell

To reserve your web site space contact Pat Bunce

Tel: 020 8652 8339 Fax: 020 8652 3981

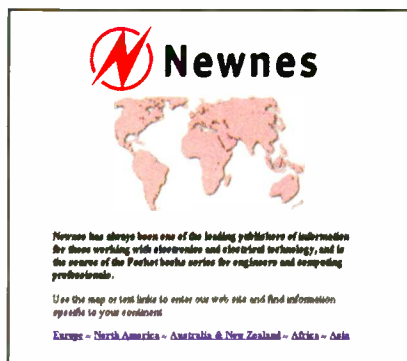

you when relevant new titles are published.

NTL

<http://www.ntl.co.uk>

Go to this site for information on NTL's Broadcast, Interactive and Telecom services, including packages for home area by area. There's also a useful

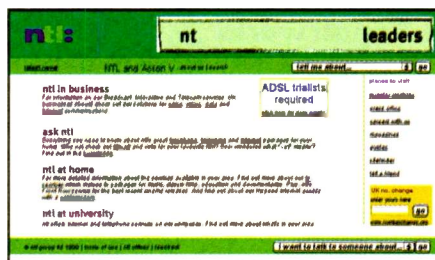

transmitter site map and database, giving locations and information. The site also contains useful documents, which describe digital TV, interactive TV and digital Radio. There's also a useful contacts list.

M.C.E.S.

<http://www.mces.co.uk>

The MCES site gives details of our range of service including Tuners, Video Heads, RF & IF Modules plus latest prices and special offers.

Mauritron Technical Services

<http://www.mauritron.co.uk>

The UK's leading independent supplier of Service Manuals and Operating Guides from valve to video. Also available on CD Rom or download direct from the internet.



Pace

<http://www.pace.co.uk/trade/index.htm>

The Pace site has a product finder. On servicing, there is a restricted access area for Pace retailers and service partners. If you are a member of the trade and you deal with Pace products you can apply for access by following the instructions. The free access area contains some useful Frequently Asked Questions and links to other useful sites such as the Lyngemark Satellite Chart at <http://www.lyngsat.com>.

Philips

<http://www.philips.com>

<http://www.semiconductors.com/products/>

Take a look at the impressive Philips home page which leads to a product listing and detailed information. Perhaps more useful to the technician is the semiconductor data "tree" where data sheets can be downloaded on all Philips integrated circuits.

Sky digital repairs

<http://www.horizonsatellites.co.uk>

The Horizon site gives details of our range of products and services including Sky Digital Receiver Repairs.

Servicing Advice

http://www.repairfaq.org/REPAIR/F_Repair.html

Here are some frequently asked questions about servicing consumer electronic equipment, with a US bias. But there's some good material on monitors and CD players and CD-ROM drives. (thanks to David Edwards for this information)

Satcare

<http://www.netcentral.co.uk>

Packed with frequently asked questions (FAQ) about common faults and cures

for faulty satellite receivers and decoders. Repair kits, upgrade kits, spare parts, surplus components plus links to other satellite information sites. Also audiophile components, electronic hobby kits, dolls house and model railway electrical stuff, a beginners' electronics course and lots of other information that will keep you occupied for days! The entire web site is also available on CD for just a £5 note.

Texas Instruments

<http://www.ti.com>

Quality Electrical Direct

<http://www.qed-uk.com> Here's a new retail site with a very interesting feature - not only can you purchase from a huge range of consumer goods but you can also request price information on your mobile phone. For example, you could be looking around your local branch of Dixons and see something you want. You can then send a message to QED via the Short Message Service (SMS) on your mobile phone to request a price and delivery from QED. The information is send back to your phone.

Timecast

<http://realguide.real.com/stations/>

Television of the future? This site contains listings of TV and Radio stations available on the Internet. There are also some fixed cameras positioning in locations ranging from game park, high streets and people's houses - not exactly captive viewing! But an interesting thought - are PCs and TVs going to eventually "get married"?

Televés

<http://www.televés.com/ingles/ingles.htm>

Televés website was launched as an

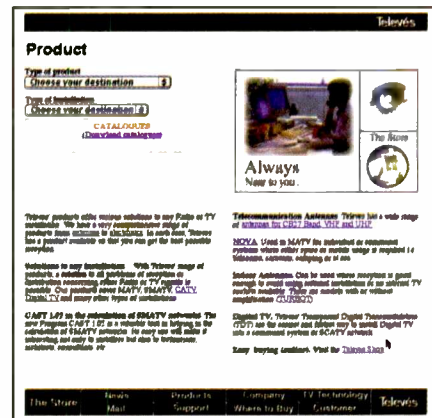

easier way to keep in contact with our World-wide Network of Subsidiaries and Clients. This site is constantly updated with useful information/news plus you can download info on our range: TV Aerials & accessories, Domestic and Distribution amplifiers, Systems Equipment for DTT and Analogue TV, Meters and much more.

The Service Engineers Forum

<http://www.E-repair.co.uk>

A brand new site dedicated to the needs of service engineers containing detailed servicing articles, circuits & repair tips. The site also includes for sale, wanted & special offer sections, industry news & much more. An impressive site well worth visiting.

For customers without net access, servicing product details are also available by ringing Mike on 0151 522 0053

UK Electrical Direct

<http://www.uked.com>

For a comprehensive on-line directory, buyers guide and resource locator for the UK Electrical Industry look at this site. Many of the companies listed have links to their own web sites, making this a one-stop shop for a huge amount of information.



UK Mailing List Group

<http://www.egroups.com/list/uktvrrepair>

Following on from the newsgroup discussion last month there is a UK Email group for TV technicians where you can send an Email to everyone in the group. There's just over 30 people in the group at present. For more details and how to register look at the egroup home page. Just a general comment though - you do have to be careful who you give your Email address to so that you can avoid "spamming" - that is getting lots of unwanted Email about dubious Russian site (amongst others).

PSA

<http://www.psaparts.com>

This web site gives details of various



specialist parts for repairers, from rare semiconductors to compute batteries and printer parts. The vast majority of items are in stock, and can be purchased on-line via this site's shopping facility.



Reed Connect

<http://www.reedconnect.net/>

Another free internet access site, this time from Reed Business Information. However the site possesses a useful UK People and Business Finder, with an e-mail search. There's also business news and local information, and some good links to directory sites.

Repairworld

<http://www.repairworld.com>

Repairworld is a US based fault report database which is updated bi-weekly. It operates on a subscription basis and describes itself as an "affordable solution for all technicians". There is apparently no minimum number of months for which you have to subscribe. You can see some samples of the material for free, monitors, VCR, DVD and Camcorders being of particular relevance to UK users. The site provides a "chat room" where you can talk via your keyboard to others "in the room".

Put your web address in front of 21 000 electronics enthusiasts and experts. **Television** acknowledges your company's need to promote its web site, which is why we are now dedicating pages in every issue to announce your **WEB ADDRESS**. This gives other readers the opportunity to look up your company's name, to find your web address and to browse the magazine page to find new sites.

We understand that cost is an important factor, as web sites are an added drain on budgets. But we are sure you will agree that the following rates make all the difference:

FOR 12 ISSUES:
Lineage only will cost £150 for a full year, just £12.50 per month.
This includes your company's name, web address and a 25-word description.
Lineage with colour screen shot costs £350 for

a full year, which equates to just £29.17 per month.
This price includes the above mentioned information, plus a 3cm screen shot of your site, which we can produce if required.

To take up this offer or for more information ring:

**Pat Bunce on 020 8652 8339
or fax on 020 8652 3981.
or e-mail: pat.bunce@rbi.co.uk**

Company name	Web address



Unique reader offer:
x1, x10 switchable
oscilloscope probes,
only £21.74 a pair,
fully inclusive*

*Additional pairs as part of the same order, only £19.24 each pair.

Seen on sale for £20 each, these high-quality oscilloscope probe sets comprise:

- two x1, x10 switchable probe bodies
- two insulating tips
- two IC tips and two sprung hooks
- trimming tools

There's also two BNC adaptors for using the cables as 1.5m-long BNC-to-BNC links. Each probe has its own storage wallet.

To order your pair of probes, send the coupon together with £21.74 UK/Europe to Probe Offer, Electronics World Editorial, Quadrant House, The Quadrant, Sutton, Surrey SM2 5AS. Readers outside Europe, please add £2.50 to your order.

Please supply the following:

Probes

Total _____

Name _____

Address _____

Postcode _____ Telephone _____

Method of payment (please circle)

Cheques should be made payable to Reed Business

Information

Access/Mastercard/Visa/Cheque/PO

Credit card no _____

Card expiry date

Signed

Please allow up to 28 days for delivery

Specifications

Switch position 1

Bandwidth DC to 10MHz
 Input resistance 1MΩ - i.e. oscilloscope i/p
 Input capacitance 40pF+oscilloscope capacitance
 Working voltage 600V DC or pk-pk AC

Switch position 2

Bandwidth DC to 150MHz
 Rise time 2.4ns
 Input resistance 10MΩ ±1% if oscilloscope i/p is 1MΩ
 Input capacitance 12pF if oscilloscope i/p is 20pF
 Compensation range 10-60pF
 Working voltage 600V DC or pk-pk AC

Switch position 'Ref'

Probe tip grounded via 9MΩ, scope i/p grounded

Answer to Test Case 454

- see page 733-

This seemed to be a very strange situation! It had certainly baffled Cathode Ray, though perhaps the workshop staff should have twigged what was happening.

The key to the problem was that the playback picture snow disappeared when the aerial lead was disconnected from the new Samsung VCR.

If Ray had had the benefit of one of those fancy UHF spectrum analysers or 'panoramic monitors', he would have been able to see that the signal from the aerial contained several digital transmissions, one of which was on ch. 60. A spectrum analyser display shows these digital transmissions as 8MHz-wide blocks of noise. Their effect on the screen of an analogue TV set is also like random noise - a 'snow' effect. At George's house this strong DTTV signal was being superimposed on the VCR's ch. 60 (factory default setting) output. It naturally disappeared when the aerial download was disconnected.

Once it was understood, the problem was easily solved by resetting the Samsung VCR's UHF output to a quiet spot in the band - this is done via an installation/set-up menu, using the remote-control unit - and retuning the upstairs portable TV to conform. George still uses the scart link with his main TV set, and of course didn't pay a bean for the two 'under-guarantee' house calls . . .

NEXT MONTH IN TELEVISION

VHF INTERFERENCE TO TV

The vast proliferation of VHF transmissions in the UK in recent times has resulted in increased TV interference. There are also problems with VHF radio. The main trouble with TV sets is cross-modulation because of overloading, particularly where a signal amplifier is in use. There are various ways of tackling the problem, including aerial alignment and the use of filters. Bill Wright on what can be done to minimise interference effects.

SERVICING THE PHILIPS FL SERIES CHASSIS

John Coombes provides a servicing guide that covers the more common problems encountered with these complex sets.

SATELLITE BAND SCANNER

Denis Mott has managed to build an analogue satellite receiver module into a 14in. monochrome portable. It provides a panoramic display of signals detected in the satellite band.

COMPONENT ANALYSER TEST REPORT

The Atlas DCA55 component analyser has recently become available from Peak Electronics. It is more versatile than its predecessor, the DCA50: in addition to transistors and diodes it can check and identify triacs, thyristors, diode networks, LEDs and even bipolar transistors with an integrated efficiency diode. Michael Dranfield finds the DCA55 an essential servicing aid.

TELEVISION INDEX/DIRECTORY AND FAULTS DISCS PLUS HARD COPY INDEXES & REPRINTS SERVICE

INDEX DISC

Version 8 of the computerised Index to TELEVISION magazine covers Volumes 38 to 49 (1988-1999). It has thousands of references to TV, VCR, CD, satellite and monitor fault reports and articles, with synopses. A TV/VCR spares guide, an advertisers list and a directory of trade and professional organisations are included. The software is quick and easy to use, and runs on any PC with Microsoft Windows or MS-DOS. Price is £36 (supplied on a 3.5" HD disc). Those with previous versions can obtain an upgraded version for £16. Please quote the serial number of the original disc. See the CD-ROM offer below.

FAULT REPORT DISCS

Each disc contains the full text for television VCR, monitor, camcorder, satellite TV and CD fault reports published in individual volumes of TELEVISION, giving you easy access to this vital information. Note that the discs cannot be used on their own, only in conjunction with the Index disc: you load the contents of the Fault Report disc on to your computer's hard disc, then access it via the Index disc. Fault Report discs are now available for:

Vol 38 (Nov 1987 - Oct 1988); Vol 39 (Nov 1988 - Oct 1989);
Vol 40 (Nov 1989 - Oct 1990); Vol 41 (Nov 1990 - Oct 1991);
Vol 42 (Nov 1991 - Oct 1992); Vol 43 (Nov 1992 - Oct 1993);
Vol 44 (Nov 1993 - Oct 1994); Vol 45 (Nov 1994 - Oct 1995);
Vol 46 (Nov 1995 - Oct 1996); Vol 47 (Nov 1996 - Oct 1997);
Vol 48 (Nov 1997 - Oct 1998); Vol 49 (Nov 1998 - Oct 1999).

Price £15 each (supplied on 3.5" HD discs).

FAULT FINDING GUIDE DISCS

These discs are packed with the text of vital fault finding information from TELEVISION - fault finding articles on particular TV chassis, VCRs and camcorders, Test Cases, What a Life! and Service Briefs. There are now three volumes, 1, 2 and 3. They are accessed via the Index disc. Price £15 each (supplied on 3.5" HD discs).

COMPLETE PACKAGE ON CD-ROM

The Index and all the Fault Report and Fault Finding Guide discs are available on one CD-ROM at a price of £196 (this represents a huge saving). Customers who have the previous CD-ROM can upgrade on CD-ROM for £46 (other customers call for a quotation). Please quote the serial number of your disc when you order.

REPRINTS & HARD COPY INDEXES

Reprints of articles from TELEVISION back to 1986 are also available: ordering information is provided with the Index, or can be obtained from the address below. Hard copy indexes of TELEVISION are available for Volumes 38 to 49 at £3.50 each.

All the above prices include UK postage and VAT where applicable. Add an extra £1 postage for non-UK EC orders, or £5 for non-EC overseas orders. Cheques should be made payable to SoftCopy Ltd. Access, Visa or MasterCard Credit Cards are accepted. Allow 28 days for delivery (UK).

SoftCopy Limited,
1 Vineries Close, Cheltenham, GL53 0NU, UK.
Telephone 01242 241 455.
Fax 01242 241 468.
e-mail: sales@softcopy.co.uk
Web site: http://www.softcopy.co.uk

Published on the third Wednesday of each month by Reed Business Information Ltd., Quadrant House, The Quadrant, Sutton, Surrey SM2 5AS. **Filmsetting** by JJ Typographics Limited, Unit 4, Baron Court, Chandlers Way, Temple Farm Industrial Estate, Southend-on-Sea, Essex SS2 5SE. **Printed** in England by Polestar (Colchester) Ltd., Newcomen Way, Severalls Industrial Park, Colchester, Essex CO4 4TG. **Distributed** by MarketForce (UK) Ltd., 247 Tottenham Court Road, London W1P 0AU (0171 261 7704). **Sole Agents** for Australia and New Zealand, Gordon and Gotch (Asia) Ltd.; South Africa, Central News Agency Ltd. *Television* is sold subject to the following conditions, namely that it shall not, without the written consent of the Publishers first having been given, be lent, resold, hired out or otherwise disposed of by way of Trade at more than the recommended selling price shown on the cover, excluding Eire where the selling price is subject to currency exchange fluctuations and VAT, and that it shall not be lent, resold, hired or otherwise disposed of in a mutilated condition or in any unauthorised cover by way of Trade or affixed to or as part of any publication or advertising, literary or pictorial matter whatsoever.

BOOK TO BUY



Post your completed order form to:-

Jackie Lowe, Room L514, Quadrant House,
The Quadrant, Sutton, Surrey, SM2 5AS

Phone your credit card order: 020 8652 3614

Fax your completed order form to 020 8652 8111

UK Price: £17.50 Europe £20.00 ROW £22.00

Paperback price includes delivery

How to pay

(Blumlein) paperback

I enclose a cheque/bank draft for £ _____
(payable to Reed Business Information)

Please charge my credit/charge card

Mastercard American Express Visa Diners Club

Credit Card No: _____

Expirey Date: _____

Signature of Cardholder _____

Send my order to: (please use capitals)

Name _____

Address _____

Post Code _____ Tel: _____

This book is the definitive study of the life and works of one of Britain's most important inventors who, due to a cruel set of circumstances, has all but been overlooked by history.

Alan Dower Blumlein led an extraordinary life in which his inventive output rate easily surpassed that of Edison, but whose early death during the darkest days of World War Two led to a shroud of secrecy which has covered his life and achievements ever since.

His 1931 Patent for a Binaural Recording System was so revolutionary that most of his contemporaries regarded it as more than 20 years ahead of its time. Even years after his death, the full magnitude of its detail had not been fully utilized. Among his 128 patents are the principal electronic circuits critical to the development of the world's first electronic television system. During his short working life, Blumlein produced patent after patent breaking entirely new ground in electronic and audio engineering.

During the Second World War, Alan Blumlein was deeply engaged in the very secret work of radar development and contributed enormously to the system eventually to become 'H2S' – blind-bombing radar. Tragically, during an experimental H2S flight in June 1942, the Halifax bomber in which Blumlein and several colleagues were flying crashed and all aboard were killed. He was just days short of his thirty-ninth birthday.

For many years there have been rumours about a biography of Alan Blumlein, yet none has been forthcoming. This is the world's first study of a man whose achievements should rank among those of the greatest Britain has produced. This book provides detailed knowledge of every one of his patents and the process behind them, while giving an in-depth study of the life and times of this quite extraordinary man.

Contents

Earliest days
Telegraphy and telephony
The audio patents
Television
EMI and the Television Commission
The high- definition television period
From television to radar
The story of radar development
H2S - The coming of centimetric radar
The loss of Halifax V9977
Legacy
To Goodrich Castle and beyond

'Electronics and Computing Principles V7'

New version for 2000

Studying electronics or computing or just want to keep up-to-date in a easy and enjoyable way, then this is the software for you.

eptsoft.com

Including all the previous version six topics, many of which are revised and updated, from DC and AC theory, transistors, OpAmps, electrical, filters, digital techniques, microprocessors, programming the PIC micro controller, where the architecture and full instruction set can be explored. More than a thousand interactive electronics, electrical, mathematics topics (just five shown above), now including computer science. V7 (developed in the UK) is a huge source of electronic and computing information.

Our software is used in colleges and universities at home and overseas to support electronics and computing courses from GCSE, A' Level, City & Guilds, BTEC to Degree level. It's extremely easy to use, making it ideally suited to the novice just starting out, up to the qualified engineer who is looking to access hundreds of formula covering practically every aspect of electronics. Telephone for a full list.

ADDITIONAL TOPICS: Computer Science from how a CD-ROM works to calculating the placement of data on a hard disk drive, to file handling and data management systems, Component Testing, Physical Science, More Electronics, Self Assessment Questions, Electronics Lab software and a completely new Component and Equipment Dictionary. A 700 slide PowerPoint presentation is included on the CD-ROM.

PLUS: Changes to graphical presentation, function selection toolbar, number formatting and printing.

eptsoft limited. Pump House, Lockram Lane, Witham, Essex. UK. CM8 2BJ.

Tel: +44 (0)1376 514008. Fax: +44 (0)870 0509660 Email: info@eptsoft.com

Switch, Delta, Visa and MasterCard payments accepted.

Cheques and P.O. made payable to eptsoft limited. UK and OVERSEAS POSTAGE ARE FREE

PERIFELEC

MC 30 A Spectrum Analyser

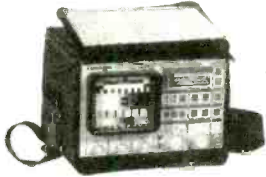

- Synthesized satellite cable and TV field strength meter with panoramic reception on 14 cm (5.5") screen and digital carriers measurement.
- Complete microprocessor and IspLSI logic control.
- Continuous frequencies from 46 to 860 MHz and from 920 to 2150 MHz on 4 bands
- Selectable 4, 1 and 0.2 MHz spectrum band-width, picture measurement: 1 MHz
- Display of picture of selected synthesized channel.
- FM (Radio) L/L, B/G, I, D/K/K, M/N TV standards and Ku and C satellite standards.
- Possibility of 32 programs memorized per frequency band
- Display (2 Lines of 16 characters).
- Range of measurement of signal strength from 20 to 120 dBuV, manual or automatic attenuator.
- Battery life about 1 hour 20 minutes, weight 5,8 Kg.

- Display of full-band and 4 possible expanded spectrums.
- Channels and frequency plans of cable and TV standards memorized.
- Frequency, signal strength in dBuV or bargraph, displayed on a digital display (2 lines of 16 characters).
- Voltage of remote power supply in 14v or 18v and 22 KHz in satellite + DiSeq C™ v1.2 switching.

The panoramic field strength meter MC30A combines in one instrument all the functions necessary for installing and checking TV or satellite reception, both analogue and digital. The visualization of the spectrum and the picture allows the carrying out of all the necessary adjustments with this one instrument. The high technology used in the MC30A allows a range of possibilities unheard of in a instrument in this price category.



TC 80 A/D

The TC 80 A/D has been designed for the reception of TV Satellite systems.

- Analogue and digital measurement.
- Full Band Frequency Sweep.
- Switchable 14 v or 18 v LNB power supply + 22 KHz tone switching
- Rechargeable 12 v / 2,6 Ah Battery.
- Weight including batteries: 3,3 Kg.

The TC80 A/D has been designed to aid the installation of analogue and digital satellite systems. This high quality meter has video and audio output via scart socket on rear and video only via BNC socket on front panel. The built in speaker delivers demodulated audio from any analogue satellite signals.

Full catalogue of meters available, please phone for details.

COASTAL AERIAL SUPPLIES

Unit X2, Rudford Industrial Estate, Ford, Arundel BN18 0BD
Telephone: 01903 723726 Fax: 01903 725322 Mobile: 0976 241505

Sole Import Distributors

Due to its weight and size, the TC-402 A/D is the ideal instrument for the installation of FM and terrestrial TV aerials as well as CATV systems.



TC 402 A/D

- Peak detection.
- Built in loudspeaker for AM and FM reception.
- Frequency indication with 4 digit LCD display.
- Analogue and digital measurement.
- Multi-turn potentiometer to enable tuning
- Weight including batteries: 1,9 Kg.

TUBES

14" from £25

16" from £25

20" from £50

21" from £60

Price **INCLUDES** carriage and VAT

Other Sizes – POA

De-Scratching Service



Ring Irene



EXPRESS TV

The Mill, Mill Lane

RUGELEY, STAFFS WS15 2JW

TEL: 01889 577600

FAX: 01889 575600

B GRADE AT LOWEST PRICES EVER! (All boxed working and complete)

14in remote £40
14in text £50

LP/SP VCR £40
Video + £45
Nicam V+ £55

20in remote £65
20in text £70
20in nicam £80

25in Nicam £110

14in Televideo's £105
14in Twin Tuner £130
20in Twin Tuner £165

10in remote mains/battery £75

28in Pro Logic £145
33in Nicam £275

21in remote £70
21in text £80
21in nicam £90

28in Nicam £120

CD Radio Cass £20
CD Micro £30
CD Midi £30

Mechanical Microwaves £28
Coloured Microwaves £35
Silver Touchpad Microwaves £45

Makes inc. Crown, Naiko, Samsung, Ferguson, etc.

GOGGLEBOX
DISCOUNT ELECTRICAL
WAREHOUSE LTD.

TEL: LEEDS
(0113) 2638804
FAX: LEEDS
(0113) 2310337

All prices plus VAT and based on quantity of 10+
ASK FOR ROBERT

NEW COLOUR PICTURE TUBES COST LESS THAN YOU THINK!

Our new tubes all carry a one-year warranty, they have the scan coils already fitted, and we don't need your old tubes in exchange. All types and sizes in stock, including a vast range of widescreen. All sent on a 24 hour service direct to your door. Some graded tubes also in stock.

Call David now for a quote, if the quote I give you is not acceptable then let's negotiate!

D'Lec Components Ltd,
206 Springhead Road, Northfleet,

Kent DA11 8HS.

Tel: 01474 320450

Fax: 01474 320345

E-mail: david@dlecsales.freeserve.co.uk.

Electronicworld TV AND VIDEO LTD

THE COUNTRY'S LARGEST WHOLESALE

NOW OFFERS

DOUBLE-DISCOUNTED PRICES!

Our BULK PURCHASES at very low prices ensure that we can offer further major reductions on the stock we sell. Our trade needs a boost to ensure it continues to thrive for many years to come. Just look at this small selection of prices to see what we mean.

20" Fastext and Nicam Tv's from £40-£50
25" Nicam Tv's from £85
28" Tv's from £100
WIDESCREEN Tv's from £110-£120
33" Tv's from £180
Long Play and Video Plus VCR's from £30
Nicam VCR's from £40

THIS IS GRADED WORKING STOCK

Please note all prices are based on a quantity of 5 units and are liable to VAT. Stock subject to availability. Pro-logic stands and speakers are sold separately.

We now have 3 additional locations and you can contact the manager on the numbers shown below!

NEW LONDON LOCATION OPENING SOON-WATCH THIS SPACE FOR DETAILS

Head Office
 BIRMINGHAM
 208 Brontford Lane
 Erdington
 Birmingham
 B24 8DL
 0121-327-3273
 FAX 0121-322-2011

CLEVEDON
 Unit 20 5C Business Centre
 Concorde Drive
 Clevedon
 North Somerset
 BS21 6AU
 01275-341789

PRESTON
 Unit 434
 Runglet Road
 Walton Summit Ind Est
 Preston
 PR5 8AR
 01772-316066

Erdington
 0121-328-0623
 Ask for Menswear

Acocks Green
 0121-706-3075
 Ask for Shoukai

Small Heath
 0121-772-5507
 Ask for Tony



ELECTRONICS

WHOLESALE DISTRIBUTORS
 OF DOMESTIC
 ELECTRONIC APPLIANCES

Unit 15 Marks Hall Margaret Roding Dunmow Essex CM6 1QT
 Telephone: 01245 231684 Facsimile: 01245 231862

NEW B GRADE STOCK AT BELOW TRADE PRICE

Large **WIDE SCREEN** 16 x 9 Format Televisions from £450

Large **REAR PROJECTION** Televisions 52" from £1,500

We also carry a Large selection of televisions and videos all at below trade price.

36cm portables from **£60.00**
 51cm televisions nicam from **£150.00**
 59cm televisions nicam from **£180.00**
 68cm televisions nicam from **£200.00**
 78cm televisions nicam from **£450.00**
 95cm televisions nicam from **£800.00**
 Videos 2 head mono from **£65.00**
 Videos 4 head nicam from **£70.00**
 Videos 6 head hi-fi nicam from **£110.00**
 36cm combined TV and video from **£150.00**
 dvd players from **£150.00**

LARGE QUANTITY DISCOUNTS AVAILABLE

25cm televisions with DC 12/24 volt suitable for caravans - mobile homes - cars - kitchen use from **£120**

- ALL PRODUCTS ARE FULLY GUARANTEED -

YOU WILL NOT GET A BETTER DEAL ANYWHERE

We stock a great many other items in the TV and Video range so if you don't see what you are looking for, give us a call, *we will save you pounds.*

Visitors by appointment only



SERVICE AND REPAIR PARTS FOR SECURITY VIDEO RECORDERS

Service kits and repair parts in stock for all major models.

Kit prices start from only £13.22+vat.

Commercial grade Video heads custom made for security applications, not available from any other supplier.

Head Prices start from only £27.00 +vat.

To order your FREE catalogue or to place an order/enquiry



Telephone: 01642 895488
Fax: 01642 351634
Email: sales@t-v-s.co.uk
Web: www.t-v-s.co.uk
(Catalogue can be ordered on-line.)

WILTSGROVE LTD

28/29 River Street, Digbeth, Birmingham B5 5SA

Tel : 0121 772 2733 Fax : 0121 766 6100

e-mail : sales@wiltsgrove.co.uk

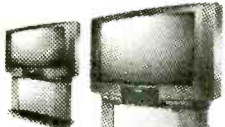

Toshiba 28W8DB

- Widescreen Nicam
- Super scene control
- Picture Size Adjustment
- Auto set up
- 3 Shelf Cabinet stand

Price..... **£325.00** each

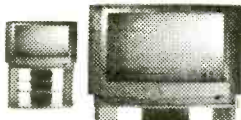

Toshiba 28W93DB

- Widescreen Nicam
- Super scene control
- Picture Size Adjustment
- Auto set up
- Cabinet stand

Price..... **£299.00** each



Toshiba 32ZD98B

- Widescreen FST
- 100Hz digital scan
- Dolby Digital
- Digital Pic. Process.
- On-Screen Display

Price..... **£749.00** each

• DVD PLAYERS • DVD PLAYERS • DVD PLAYERS • DVD PLAYERS •



HITACHI DVP-250E

- Region2 Player (can be modified for multi-region playback).
- Trick Play
- S-Video Output
- Digital Outputs
- Analog Audio Out
- S-Card Output
- Shuttle Navigation
- On Screen Menu

£149.99
GRADED STOCK with No Guarantee



SONY DVP-S325

- Region2 Player (can be modified for multi-region playback).
- Trick Play
- On Screen Menu
- DTS Stream out
- Dolby Digital Stream
- Sony Precision Drive
- Available in Black

£159.99
GRADED STOCK with 12 Mths G'tee



REC-800

- Multi-region
- Trick Play
- On Screen Menu
- Dolby Digital Decoder
- Sony Precision Drive
- Available in Satin Gold finish

£149.99
BRAND NEW with 12 Mths G'tee



REC-600

- Multi-region
- Trick Play
- On Screen Menu
- Dolby Digital Decoder
- Sony Precision Drive
- Available in Black

£139.99
BRAND NEW with 12 Mths G'tee



SONY WEGA

- KV28/32DS20 features :**
- FD Trinitron WEGA tube • Integrated Digital Terrestrial Tuner • 50Hz digital picture • Dolby Pro-logic Sound • New Auto Start Up tuning • Electronic Programme Guide with Smartlink (to control a Smartlink VCR)
 - Analogue and Digital Tuning • Digital Text compatible • NICAM • Multi Zoom modes • PCMCIA Input for pay channels module

- KV28/32DX20 features :**
- FD Trinitron WEGA tube • Integrated Digital Terrestrial Tuner • 50Hz digital picture • Digital Stereo Sound • NICAM • New 3D Sound system • Auto tuning • PCMCIA Input for pay channels module • Multi Zoom modes • PCMCIA Input for pay channels module
 - Digital Text compatible
 - Auto labelling and Sorting

GRADED STOCK with 12 Months Guarantee

KV28DS20 ... **£525.00** KV28DX20 ... **£449.00**
KV32DS20 ... **£649.00** KV32DX20 ... **£625.00**

HITACHI GRADED STOCK

14" Remote control	£57.50
14" Remote, Fastext	£67.50
21" NICAM	£129.99
25" NICAM	£169.99
28" NICAM	£199.99
28" Widescreen	£259.99
32" Widescreen with Cabinet	£399.99
LP/SP	£44.99
LP/SP, Videoplus	£49.99
LP/SP, Videoplus, NICAM	£79.99

CD TV50

• 5" Black & White TV
• Top loading CD Player
• Repeat Play function
• MW/FM stereo radio
• 20 track programmable CD
• Skip mode

£34.99

SAMSUNG SP-R5100 DECT Cordless Phone

£29.99

SONY MDR-RF830R/PC CORDLESS HEADPHONES

• Vertical transmitter with built in charger.
• Select from 2 channels for optimum signal reception.
• Auto ON/OFF
• Transmission up to 100m.

£13.99

AIWA HiFi Brand New with 12 months G'tee

Model : LCX137KS only **£54.99** each
Model : NSXS320K Only **£94.99** each

NSX-S22

• Power Output : 70W
• Remote Control
• Radio
• 3CD Changer
• Twin cassette Deck

£69.99

NSX-S16

• Remote Control
• Radio
• 3CD Changer
• Twin cassette Deck

£59.99

MIXED BRAND QUANTITY BARGAINS

14" GRADED PORTABLES FROM £32.50 LP/SP VIDEO'S FROM £39.99
20" R/C TEXT TV'S FROM £49.99 LP/SP VIDEOPLUS VCRS FROM £44.99
28" WIDESCREEN TV'S FROM £159.99 AND MUCH MUCH MORE IN STOCK!!!

SONY Alkaline Batteries

• High performance alkaline batteries. Available in different sizes. Come in packs of 4.

(AAA) Bat-3006 ... **69p** Per Pack
(AA) Bat-3011 ... **69p** Per Pack

Universal 8 Way Remote Control

• Universal 8 Way Pre-programmed Remote control. TV, VCR, SAT, AUX. Also Operates normal and Fast Text.

1+ ... **£7.95**
5+ ... **£7.50**
10+ ... **£6.95**
100+ ... **£5.95**

ORDER CODE **URM-380**

Replacement Video Head

• Suitable for the following :-
Original Part no. : 8059-01-20
Amstrad : DD8900, VCR1100/6000/6200/8600/8700
Bush : VCR3401, VCR3402
Funai : VCR4530, VCR6100
Granada : VHSF63
Hinari : VTV100, VTV200
VXL8/9/10/11/19/90.
Nokia : VR5250
Proline : DX3300
TVVC : VR800

£4.95

ORDER CODE **VHD-1060F**

Replacement Cassette Housing

• Suitable for the following :-
Aiwa : HVGX150.
Matsui : VX1100, VX1000Y, VCP500, VP9301, TVR151.
Orion : D4095, D1195, D3000, D1500.

ORDER CODE **CH-53**

£6.95

Replacement CD Laser Pickup

• Replacement CD Laser pickup
Part no. KSS210A

ORDER CODE **AP-1002T**

1+ ... **£11.95**
5+ ... **£10.95**

Replacement HR LOPT

• Suitable for the following :-
Original Part no. : AT2079/10
PHILIPS : CP90 & G90 CHASSIS

*Picture for illustration only

ORDER CODE **LT-137P**

£6.95

FERGUSON Replacement Remote Control

• Suitable for the following :-
FERGUSON : 20H3, 26H3, 66H5, 66H4, 59H5, 59H4, 59H3, 51H5, 51H4, 51G2, 51H3, 59G2, 22H3, 66H3, 22H5, 59J7, 51K7.

1+ ... **£4.95**
5+ ... **£4.50**
10+ ... **£3.95**

ORDER CODE **RM7890**

3 Pin Degauss Positor

• Degauss Positor suitable for many Makes & Models. Original Part no. 96209.96009. 98009

1+ ... **69p**
10+ ... **59p**
50+ ... **45p**

ORDER CODE **DT-1**

TRADE ONLY. Offers subject to change without prior notice. Items Subject to Availability, Carriage and V.A.T.

Freefax Orderline : 0500 55 05 05



Wholesale Distributors & Export Agents
of Domestic Electronics & Appliances

Possibly the Largest and Oldest Establishment in the UK

THOMSON, FERGUSON, SANYO, MITSUBISHI, BUSH, ALBA, GOODMAN'S

FACTORY GRADED (MINT)

- 14" R/c TV.....from £45
- 20"/21" Text Nicam.....£59
- 28" Nicam.....£135
- 28" Wide.....£225
- 32" Wide.....£300
- VCR.....from £45
- CD Radio Cassette.....from £15
- CD Micro Hi-Fi.....from £25
- CD Multi Disc.....from £39
- CD Walkman.....from £12.50
- BT Phones.....from £15
- BT Dect Phones.....from £35
- BT Dect Answerphones.....from £45

SANYO/SHARP

- Microwaves.....from £35
- Microwave Grill.....from £45
- Microwave Combi.....from £69
- Hoover Vac.....from £29.50

One Year Warranty

Ferguson 25" OP.....complete £200

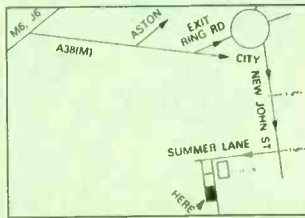

NEW HIGH STREET RETURNS

164 LINES

Irons, Kettles, Toasters.....
.....from only £3.82

Lava Lamps, Table Lamps, Floor/
Wall Lamps, Touch Lamps, etc
.....from £6

R/C Toy Cars.....from £7.50

Trimmers, Foot Spa, Phones, Car
Battery Chargers, Audio Karaoke,
Massager, Facial Saunas, etc.

Send for List Now

MANY MORE OFFERS AVAILABLE

Quantity based on stock availability and all prices are plus VAT

NATION-WIDE NEXT DAY DELIVERY SERVICE - VISITORS BY APPOINTMENT

Phone 0121-359 7020

Fax 0121-359 6344

PHOENIX HOUSE, 190 BRIDGE ST. WEST,
BIRMINGHAM B19 2YT



**CAMPION
WHOLESALE LTD.**

UK's Largest Electrical Wholesaler

For Both the UK and Export

Ex-Rental and Graded

TV's, Videos, Satellite,

Hi-Fi Equipment and White Goods

FREE Delivery Service to most areas of the UK

World-Wide Export Service

Experts in UHF / VHF Conversion

TEL: 01299 879642 FAX: 01299 827984

CALL TODAY FOR A BROCHURE OR COME AND SEE OUR LARGE WAREHOUSE

Unit 75 Barracks Rd, Sandy Lane Ind. Est. Stourport,
Worcestershire DY13 9QB

Just 10 minutes from M5 Junction 6 - Worcester North

TV's
From £5.00

Video's
From £5.00

Satellite's
From £5.00

TV / Video
Stands
From £1.50

Major
Credit
Cards
Accepted

Service Link

No other consumer magazine in the country can reach so effectively those readers who are wholly engaged in the television and affiliated electronics industries. They have a need to know of your products and services.

PHONE 020-8652 8339

FAX 020-8652 3981

The prepaid rate for semi-display setting is £15.00 per single column centimetre (minimum 4 cm). Classified advertisements £2.00 per word (minimum 20 words), box number £22.00 extra. All prices plus 17 1/2% VAT. All cheques, postal orders etc., to be made payable to Reed Business Information. Advertisements, together with remittance, should be sent to Television Classified, 12th Floor, Quadrant House, The Quadrant, Sutton, Surrey SM2 5AS.

U-View

TECHNICAL PUBLISHERS

Information includes
Service Adjustments, Parts Views
& Lists, Alignments, Scope
Readings, Diagrams, Fault-
Finding, Voltage Charts etc.

Current Titles

TELEVISION SERVICING

1989-90	£49.00
1993-94	£95.00
1995-96	£99.00
Book 5	£99.00
Book 5(CD)	£79.00

VIDEO SERVICING

1993-94	£89.00
Book 5	£99.00
Book 6	£99.00
Book 6(CD)	£79.00

SATELLITE SERVICING

1993-94	£39.00
Book 4	£59.00

VIDEO SERVICING

Book Six

£99.00

AVAILABLE
IN BOOK & CD-ROM
FORMATS

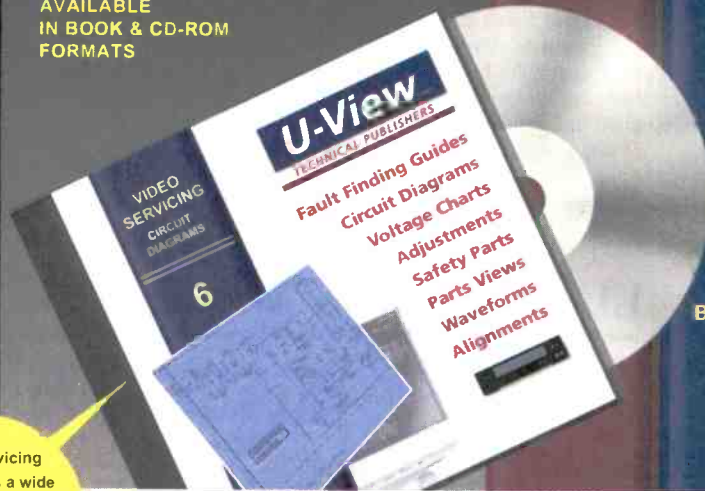

Video Servicing
Six includes a wide
range of mechanisms &
alignment procedures
for Aiwa, Panasonic,
Samsung etc.

Professionally Produced with the Manufacturers Full Co-operation

CALL US FOR A BROCHURE WITH FULL MODEL LISTINGS

or visit www.u-view.co.uk e-mail: u-view@office-mail.co.uk

All prices include
UK postage & packing.

U-View Limited 3F Plumtree Farm Ind. Est. Bircotes Doncaster Yorkshire DN11 8EW Tel: 01302 719997 Fax: 01302 719995

SERVICE MANUALS

Thousands of models available
For most UK European, Far East and USA makes

Service manual prices

B/W TV	– £6	CTV/VCP	– £10
VCR	– £15	Camcorder	– POA

Service sheets/circuits also available for some models
+data for satellite, audio and camera

* 50+ CTV PSU Circs Compilation (A4) – £10 *

* 50+ VCR PSU Circs Compilation (A4) – £10 *

Payment by Cheque/PO only please

Add £2 P/P etc, to order total. Do not add any VAT.

D-TEC

PO BOX 1171, FERNDOWN, DORSET BH22 9YG

Tel: 01202 870656

NEW FAX BACK
SERVICE NOW
AVAILABLE
TEL/FAX A.T.V. on
0114 285 4254

SAT/CTV Circuits £5.00

VCR Circuits £7.00

CTV Manuals £10.50

VCR Manuals £14.50

(P/P add £2.50 to each order)

**419 LANGSETT ROAD,
SHEFFIELD S6 2LL**



Fryerns

Service
Information

FES

Circuit
Diagrams

TV's, VCR's
SATELLITE
AUDIO & HI-FI

Most Models Covered

Prices are from £4.00 + £2.50 P/P

1 item – total £6.50 inc

2 items – total £10.50 inc

3 items – total £14.50 inc

4 items – total £18.50 inc

Payment by credit card or Postal

Order for next day delivery.

Cheques to clear.

Tel/Fax 01206 211570

2 The Lodge
Easthorpe Green
Marks Tey, Colchester
CO6 1HA



SERVICE MANUALS

Have you ever turned away from a Service Manual?
Have you ever bought a Service Manual and never used it more than once?
Then why not join

THE MANUALS LIBRARY

For details and membership application form write, phone or fax:

HARVEY ELECTRONICS

43 Loop Road, Beachley, Chepstow, Mon., NP16 7HE
Tel: 01291 623086 Fax: 01291 628786
Visa: Access accepted

VCR "Repair Aid"

CD's From £12.99



sample screenshots & full range of models at:
www.valleydigitalvideo.dial.pipex.com

High quality digital motion video...

Dismantling - aligning - great close up's, helpful arrows, pointers, notes and comments. plus...
Faults and tips from our huge database

No PC? Tel 01661 843389 for a VHS tape version

FOR SALE

inStore 1043 Leeds Road
BRADFORD BD3 7DB
Tel: 01274 665670/660196
ELECTRICS LIMITED Fax: 01274 665246
E-Mail: tradesales@instoreelec.fsnet.co.uk

MANUFACTURERS NEW GRADED STOCK
MINT IN ORIGINAL PACKING
EVERYTHING FULLY GUARANTEED

14" COMBI TVCR from only.....	£99
25" COMBI SHD Prologic B/L Tube.....	£299
32" WIDE SCREEN green/blue/silver.....	£649
28" INT. DIG Dolby Prologic - on Dig Card.....	£389
32" INT. DIG Dolby Prologic - on Dig Card.....	£544
28" DDLBY DIGITAL Audio FM Cordless Spkrs.....	£559
32" DDLBY DIGITAL Audio FM Cordless Spkrs.....	£699

Audio • DVD • CDR • Cameras • Fax • MWO
CREDIT CARDS WELCOME • 48 HR DELIVERY

SPARES & COMPONENTS

RCS VARIABLE VOLTAGE D.C. BENCH POWER SUPPLY



£45 INC VAT - POST & INS £4

Up to 20 volts DC at 1 amp continuous, 1.5 amps peak
Fully variable from 1 to 20 volts.
Twin voltage and current meters for easy read out.
240 Volt AC input. Fully smoothed.

RADIO COMPONENT SPECIALISTS

337 WHITEHORSE ROAD, CROYDON, SURREY, UK
Tel: 0181 684 1665

Lot of transformers, high volt caps, valves, speakers, in stock. Phone or send your wants list for quote.

REPLACEMENT VIDEO HEADS

At very low prices

Panasonic, JVS, Mitsubishi, Sony, Ferguson, Hitachi, Amstrad, Granada, etc

Over 3,000 models covered

FREE Catalogue on request

No VAT

Pay by Cheque or Credit Card

Accounts Welcome

N.A.V. SPARES

237 Thornton Road
Bradford, West Yorks BD1 2JS
Tel: 01274 772249 Fax: 01274 772249
E-mail: sales@navspares.co.uk

MISCELLANEOUS

THE JOULE A400 RADIO DECODING SYSTEM

The highly acclaimed A-400 car radio decoding system has just got even better - and so has the price!

Latest version 9.4 software now covers an even broader range of radios including:- Philips, Ford, Grundig, Blaupunkt, Kenwood, Becker, Clarion, Pioneer, Panasonic, J.V.C. Volvo and Hitachi.

There is also a new Misc. section covering a variety of 'odd ball' radios.

The latest addition to our decoding system is the X3000 - a stand alone device for decoding the new Ford Traffic 3000 and 4000 models - even if they are displaying 'Lock 13'

Contact us now for further information and prices on 01325 310278 or visit our web site at www.elecsys.com where you can download a brochure and demo software or purchase a decoding system on-line.

Joule Electronics, Hilton Road, Aycliffe Industrial Park, Newton Aycliffe, Co. Durham DL5 6EN

EX-HOLIDAY PARK SHARP 14" COLOUR TV

Model C1430H
(White Cabinet)

ONLY £19.99 each
in QTY's of 10

Carmarthen Electronics
01267 223955

Buyers Collect
All prices exclude VAT

As an advertiser you can be certain that your advertisement is going to be read by

Decision Making Electronic Professionals with Power to Purchase Your Products

Why not let Television help you?

Call Pat Bunce

Tel:

020 8652 8339

Fax:

020 8652 3981

Email:

Pat.bunce@rbi.co.uk

REPAIRS

accént

TECHNIC

CAMCORDER REPAIRS

Collection and delivery anywhere in the UK.

All makes, fast service.

Phone free for details.

Fax: 01905 796385

(0800) 281009

To Advertise in Television Classified Telephone Pat Bunce on 0208-652 8339 or Fax on 0208-652 3981

LINEAGE

AVO MULTIMETER Model 8, £45.00. 500 volt meggers £30.00. Prices plus VAT and p. & p. Send SAE for lists of surplus instruments and scopes etc. A. C. Electronics, 17 Apleton Grove, Leeds LS9 9EN. Tel: 0113 249 6048.

PRIVATE RETAILER has excellent part exchange colour televisions and videos to clear. Tel 01494 814317.

TV-VIDEO REPAIRS AND SALES business for sale. Has been trading 10 years and must sell for health reasons. Good customer base. £45,000 ono. Tel: 0207 358 0002.

WANTED

WANTED!

EX-RENTAL
F.S.T. TVS
MODERN VIDEOS

GENUINE BUYER
NO JUNK PLEASE

RING NOW
01482 587747

PROPERTY

DUE TO RETIREMENT

Business Closing
All Stock, Service Manuals
Service Equipment and
many more to clear
No reasonable offer refused
Telerite Audio Visual
Tel: 020 8674 2175 or
07958 351 727

TOP CASH PRICES PAID FOR VALVES

e.g. KT88, PX25, EL37, DA100
and Valve Tester VCM163

Ask for our free Wanted List

WIDE RANGE OF
OBSOLETE VALVES
AND SOME CRT STOCKED

Visitors please phone for an appointment

billingtonexportltd@btinternet.com

Billington Export Ltd,
Billingshurst, Sussex RH14 9EZ
Tel: 01403 784961 Fax: 01403 783519

Do you have a web site?

If the answer is yes then why not let our readers know about it by advertising in our new Web Directions Pages

If you would like to know more then please give me a call.

Pat - Tel: 020 8652 8339 Fax: 020 8652 3981 Email: Pat.bunce@rbi.co.uk

RECRUITMENT

JOB VACANCY

Hyperactive Broadcast Limited is a small, friendly Ash Vale based company which operates in the hectic world of broadcast television equipment hire.

Broadcast Television Engineer

This is a rare opportunity for someone to learn about the repair, testing, set-up and adjustment of Broadcast Television Equipment. It would be an advantage if the applicant has experience in personal computers.

If you would like to work as part of a team and feel you have the self-discipline and energy required to keep on top of the fast moving Television and Film industry, then please write with your C.V. to:

**The Managing Director
Hyperactive Broadcast Limited
5 The Royston Centre
Lynchford Lane
Ash Vale
Surrey GU12 5PQ**



“Secure your future.”

Here at ScottishPower we're known for our excellent customer care. We also take pride in our commitment to our own staff. In a supportive environment, we will help you to expand your skills to ensure that you can develop your career and secure your future working for one of the UK's leading retailers.

FIELD AND BENCH ENGINEERS

ATTRACTIVE SALARIES + BENEFITS NATIONWIDE

Right now we're looking for skilled Field and Bench Engineers, qualified to City & Guilds 224 or equivalent, with good technical skills and experience of repairing brown goods. In this job it's all about getting it right first time and minimising inconvenience for the customer - and that's where you come in. Listening to our customers, solving problems and providing a first class service, you'll gain a real sense of achievement at seeing a job well done.

For both roles we offer all the training and support you need to help your career advance, and if your skills need updating, we offer support there too - including full back-up from the manufacturers, plus an excellent salary and competitive benefits. For the Field Engineer roles a fully expensed company car is available. All we ask in return is enthusiasm and a flexible approach.

Secure your future. For an informal discussion, please telephone 01977 605295. Please write, enclosing your CV and current salary details stating clearly which post you are applying for, to Mark Perrier, Recruitment & Training Manager, ScottishPower, California Drive, Whitwood Industrial Estate, Castleford, West Yorkshire WF10 5QX. E-mail mark.perrier@scottishpower.com



EXPERIENCED ENGINEERS Bench or Field

for either TV, VCR, Audio or Camcorder.
Excellent Salary.
Modern workshop.
Staff discounts.

Please send CV to:
**'A' One Digital Domain
Unit 2B,
Aberconway Road,
Morden, Surrey
SM4 5LN
Telephone
0208 543 8888**



FIELD SERVICE ENGINEERS Throughout London

As one of the UK's largest independent consumer electronics service companies, we are looking to recruit qualified and experienced field service engineers to join our existing team. You should be qualified to C&G 224 or equivalent, and be able to repair to component level.

Full training, company vehicle and an attractive salary package will be provided, together with excellent career prospects in one of the fastest growing companies in the industry.

Please apply in writing, enclosing your current CV to:-
**Alex Peacock, Operations Manager, Video Techs,
5 Kimpton Road, Sutton, Surrey SM3 9QP.**



INVESTOR IN PEOPLE

IMPACT AV LTD

AV FIELD SERVICE ENGINEER REQUIRED

Job requirements:

- Audio Visual experience
- Training provided
- Computer skills (beneficial)
- Clean driving licence
- European work opportunities

Enclose CV to:
jread@impact.com

IMPACT-AV.COM

VIDEO BENCH TECHNICIANS (Contract / Permanent)

The Capital Group is one of the UK's leading recruitment companies in the Avionics and Electronics sector. Our client is an Avionics Services Company, seeking experienced "bench" engineer / technicians to repair to component level a range of In Flight Entertainment Equipment (IFE). The equipment includes video players, projectors and monitors (LCD & CRT). Opportunities exist for Contract and Permanent staff to work in modern purpose built workshops (tools and test equipment supplied) on a 3 shift basis. Immediate starts subject to passing a written technical test related to video equipment and a practical SMT soldering test. In return our client offers Contract staff a competitive hourly rate with a generous overnight allowance (for those who live away) and Permanent staff a starting salary of £17K, plus shift allowance, overtime, 23 days holiday, sick pay, PPP and a contributory pension.



Capital Aviation Services
Broadway House, 112-134 The Broadway,
Wimbledon, London SW19 1RL
Tel: 020 8542 8131 Fax: 020 8540 7385
Email: cts@cap-recruit.co.uk



Clements Technical Recruitment Limited
Bench and Video repair technicians required. Must have experience of fault-finding and repair to component level of audio analogue/digital electronics or video players. Good soldering skills essential. ONCHNC an advantage. Near Heathrow.
Tel: 023 9261 0885

www.clemtech.co.uk (agy)

CLASSIFIED TEL: 0181 652 8339

Special Offer Sale - 20 Remote Controls £20.00 (mixed all well known brands)

FERGUSON ICC 7 HAND SET £3.00 FERGUSON VIDEO FV90 LV HAND SET £3.00 FV80 LV HAND SET £3.00 FERGUSON BATTERY CONVERTER TA606 £15.00 24V DC/240V AC £15.00 BENCH POWER SUPPLY VARIABLE 0-30V 3A-TWIN METERS P/P £5.00 ea £50.00 BRIDGE RECTIFIERS 10 FOR £1.00 BURGLAR ALARM KIT Full description £7.00 CAMCORDER-UNIVERSAL BATTERY 9.6V - 1400MA FOR JVC-PANASONIC-PHILIPS £5.00 CAMCORDER-RIPOD SHOULDER POD CAPACITORS: £3.00 11M/2KV, 2N/2KV, 4N/4KV EACH 15p 5N/2KV, 6N/2KV, 9N/2KV EACH 15p 35V-22UF, 50V-4.7UF, 50V-100UF EACH 25p AA BATTERIES 1.5 VOLT STC ALKALINE 10p DESOLDER PUMP £2.00 DIGITAL CAPACITANCE METER CMC200 - 200PF-20MF £28.00 FILTERS - 455 & 480 EACH 10p GAS SOLDER IRON-PORTASOL HOBBY £10.00 INFRA RED DETECTOR WIDE/SHORT ANGLE WITH RELAY £5.00 INFRA RED RECEIVER-MATSUAMI MINIATURE MILLI VOLT-METER-ELECTRONIC LEADER LMV-181A 40V A/C IN-IMV F/S £5 P&P £5.00 IMV-300V CALIBRATED - COST £225.00 £5 P&P COLOUR TV BATTERY CONVERTER IN 240V TO 230V OUT £15.00 MODULATOR-TUNABLE SATELLITE-TV £1.00 PANEL-1K2-FM2211 STEREO £5.00 PANEL-CVC80-POWER £5.00 POSTOR 18 2 PIN 20p POSTOR-2322 662 98012 50p POWER SUPPLY - 12V DC & 24V DC-REGULATED £2.00 POWER SUPPLY-REGULATED 3-12V 500MA £5.00 PSU A/C 12V 500MA £1.50 PSU AC 9V 1A £1.50 QUARTZ HALOGEN - 500V 200V FOR OUTDOOR LAMPS £1.00 R.S. SAFE BLOC £1.00 RELAYS-SUB MINIATURE 25p SATELLITE TUNER UNIT - 2427611 BA 9% BAND/VIDEO OUT £3.00 SCART TO 4 PHONO LEADS 1.5M £3.00 SCART TO 6 PHONO LEADS £3.00 SCART TO "D" PLUG £3.00 SCART TO SCART LEADS - ALL PINS CONNECTED - 1.5 METRES £2.00 SOUND 5.5MHZ MP4 1000T £1.00 SOUND 6.0MHZ MP4 1040 £1.00 TRANSFORMER-RS ENCAPSULATED MAINS 0-120V-0-120V (R10) 0V-0.9V SEC £1.00 TRIPLER KIT/R30 £1.00 TRIPLER - UNIVERSAL £5.00		CARDIOID CAMERA MICROPHONE-VA SUPER £5.00 218 TELESCOPIC BOOM & STAND £5.00 CHASSIS-TX80-NEW-NO TUNER P/P £5.00 ea £15.00 CHOKO-MAINS INPUT-TX9-TX10 £4.00 CHROME BOARD-ICCS IC- U1647TKF OR HA11408 £6.00 DECK AND CAPSTAN MOTOR - FV61LV, FV62LV, FV67LV, FV68LV EACH £30.00 FV70LV, FV71LV, FV72LV, FV74LVX EACH £30.00 FV77HV £30.00 FV31R £12.00 HEAD AND DRUM MODULATOR-SATELLITE-T1040-SRD3/4 £2.00 PANEL-10 MIXED FROM TX9 TO ICES £20.00 PANEL-DECODER-ICCS £5.00 PANEL-FRONT-TX100 £4.00 PANEL-IF-TX9, TX10 £4.00 PANEL-REMOTE AND POWER SUPPLY FV31R DISPLAY P/P £2.00 ea £5.00 PANEL-REMOTE-TX9, TX10 EACH £5.00 PANEL-REMOTE-TX10-54001 £5.00 PANEL-REMOTE-TX10, WITH BATTERY AND 4 ICS - 1544-033C £7.00 PANEL-REMOTE TX90 139.001 ICS M293B1 AND MS1000 £10.00 PANEL-REMOTE TX100 £5.00 IC M293B1-SAA5012 £5.00 PANEL-REMOTE TX100 WITH STAND-BY BATTERY AND ICS £5.00 PANEL-T1228B TEXT £1.00 FOR TX89, TX98, TX99, TX100 £6.00 PANEL-TX90 THORN FRONT - - 8 BUTTONS 01M4-515-012 £5.00 PANEL-TUBE BASE-ICCS £5.00 PANEL-TUBE-BASE-TX89, TX98, TX99 £5.00 PANEL-TUNING 1509G-TX9, TX10 £5.00 POWER SUPPLY 12V-3A FOR VIDEOSTAR CAMERA PP3 £4.00 PUSH BUTTON UNIT-TX85, TX86 - 8 BUTTONS £5.00 RECEIVER - INFRA-RED - ICSL486-TX100 50p TRANSFORMERS-SWITCH MODE: TX85, TX86, TX89 EACH £4.00 TX100 EACH £5.00 473190-00, 40153000 EACH £5.00 ICCS 3112-338 326842 EACH £4.00		SAMSUNG TECU5983 VA24A VHF-Tuner with Aerial Socket Fit most new TV's £5 35-VICK DESOLDERING BRAID 1.5 meter Size AA (2), Size AB (3), Size BB (4) £1 5 VIDEO HEADS FOR £20 Amstrad 6000, Amstrad 8900, Heads & Drum FERGUSON NICAM MODULE III Art No 989 591-E00 £5 L.O.P.T. 36661, 36162, 36362, 36383, 36481 36482, 36761, 36831, 36832 36943, 36962 243221, 2432351, 2432491, 2432851 2432871, 2432981, 2432984 2433952, 2434141, 2434393 2434451, 2434492 2435016, 2435062 2435064, 2435085, 2435121 2435372, 2435701, 2436773 2436792, 2436795, 2436797, 3216001 243666, 243663 3220029, 3714016, 47003481 AT207678, AT207688, AT207825 AT207781 DSTR1N243472593-00 DSTR8523547328700 & 40153200 DSTR8N234400086AD, & 478052200L DSTR8N234473200A1, & 47317590 DST186N243473058-00 TFB3035D, TFB3069D, TFB4023AD TFB4039AD, TFB4066AD FERGUSON TX9 TX85, TX86 TX89, TX98, TX99 Y260781 FTY260482 LOPT RED SPOT LOPT WHITE SPOT & YELLOW SPOT PANASONIC TC2203, TLF 1456B TLF1457B, TLF7016 TOSHIBA TFB 3035D, TFB 4023AD, TFB 4032BD TFB 4038AD, TFB 410AD TFB 3089D, TFB 4088AD AIWA 1500 MAISUI VX4 1100 MAISUI 1500 ORION D1094 ORION D1096 ORION D2096 ETC EACH £20.00 CAPSTAN MOTOR FOR ABOVE DECKS £15.00 AND HAND SETS £3.00 4 HEAD DECK FOR 1500 £20.00 20 HIGH VOLTAGE CAPS 1500V - 2000V MIXED £10.00 VIDEO PATERN GENERATOR MODEL T9535 240V MAINS SMALL £5.00 PAL TV ADAPTOR - RGB IN UFH OUT £5.00 MOTOR 12V 10p		NOKIA RC202 £4.00 VP9401 D1096 VXA1100 AND VIDEO PLUS ORION TV AND VIDEO £2.00 VIDEO WITH LCD - 1992/93 MODELS £5.00 PANASONIC EUR51142 £10.00 TC1632, TC1642, TC23232 TX2034, TX2044, TX2200, TX2234 EACH £8.00 TX2244, TX2300, TX2636, TX3300 EACH £8.00 RC201 - TV - REPLACES TNZ1411/2 PERDIO PV 1188 £3.00 PHILIPS NEW TYPE UNIVERSAL £8.00 (3 in 1) RC4001 SAMSUNG HANDSETS, TV & VIDEO - 12 TYPES EACH £3.00 SANYO UNIVERSAL VIDEO £3.00 SIEMENS TV/VIDEO - 1994 MODEL £5.00 THORN 9100, 9600, TX9, TX10, TX100 TEXT AND NON-TEXT EACH £10.00 CPT1408T, CPT2176, CPT2178 EACH £5.00 CPT2476, CPT2478 EACH £5.00 TEXT, REPLACES PHILIPS KT3, K30, K4 ETC UAV £8.00 PHILIPS 3 IN 1 HAND SET £8.00 FERGUSON WITH TEXT IKZ CHASSIS P/P £5.00 £10.00 TX86 CHASSIS £10.00 ORION AND MATSUI CARRIAGE 1500 TYPE D1096 ETC £6.00 3ANYO LOPT P/P £2.00 4 FOR £5.00 140V ADAPTOR 9V AC 1A £1.00 COMPLETE REPAIR KIT, CLUTCH AND PINCH ROLLER, IDLER D2906 £7.00 TUNERS IF TERC8-022A TB/ZA-002A-ALPS £3.00 SATELLITE SXT2302180968 £3.00 SATELLITE WITH BASE BAND MIN SXT2302234 £4.00 SMALL UNF/VHF £3.50 VHF/UHF - TEKE4-112A £4.00 4944 U321, U341, U342, U343 U344, U411, U412, U944 £2 EACH U743, 7744 AMSTRAD UE33-BO1 £3.00 MRF7-7E33 MATSUI ORION VIDEO TUNER IF £5.00 FERGUSON IF2105-RE £5.00 MTP2011-AF00 £5.00 UHF - ICES £5.00 VHF - ICES £5.00 VHF - ICES £5.00 TX85, TX86, TX89, TX90 EACH £4.00 TX98, T99, TX100 EACH £4.00 ORION 1500 - UE33 B09 £4.00 PANASONIC SMALL UHF/VHF £3.00 FERGUSON DOUBLE SIDE NICAM £10 ICCS NICAM SINGLE BOARD ICES £10 SHARP TUNER AND IF 1810587 PA1 UK £3.00 TATUNG UNIVERSAL 205 OR EQUIVALENT WITH AERIAL SOCKET £3.00 HITACHI CAPSTAN 150E £3.00 MATSUI CAPSTAN IC NO M56730 ASP £15.00 2 TYPES 1995 TO 1997 MODELS MATSUI VIDEO DECKS WITH CAPSTAN MOTOR AND HEAD P/P £5.00 £20.00 MITSUBISHI MOD MRF7-UF32 £5.00 MOD TMUG3-103A £5.00 MITSUBISHI CAPSTAN-HSE41-IC M51782ASP £2.00 Treble A Batteries 12 for £1	
AMSTRAD HEAD AND DRUM - 6000 £12.00 HEAD AND DRUM - NICAM £12.00 PANEL-CLOCK DISPLAY - 8900 £5.00 PLASTIC FRONT WITH FLAT - 8900 £3.00 POWER SUPPLY-VS1000-VS1100 £5.00 POWER SUPPLY, LONG OR SHORT CHASSIS 1991/1992 MODELS £3.00 POWER SUPPLY - SWITCH MODE - DOUBLE DUCKER £5.00 20 OFF MIXED NOKIA ITT SALORA FINLEX SERVICE MANUAL £10.00 POST 4.00 MAINS ADAPTOR 12V AT 500 M/A £1.00 NEGATIVE CENTRE £1.00 NEGATIVE CENTRE £1.00 POSTOR EQV 98009 - SALE PRICE 25p FERGUSON ADAPTOR - VPT - TEXT - VA354 £2.00 AC MAINS & BATTERY-VA365 P/P £3.00 ea CAMCORDER BATTERY, HIGH CAPACITY 9.6V 1800MA-VA310 £3.00 CAMCORDER BATTERY CHARGER 9.6 VOLTS VZAS EACH £6.00 CAMCORDER CAR ADAPTOR CHARGER - AND BATTERY VA308 £5.00 CAMCORDER LENS 2 OFF - TELE-CONVERSION LENS x1.4 & x0.7 £1.00		HITACHI TELETEXT PC232A5 - ISSUE 4 £15.00 HEAD AND DRUM - 620E £12.00 MAINS SWITCH WITH STAND-BY £5p MODULATOR No 5587881 £5.00 OSCILLOSCOPE 20MHZ DOUBLE BEAM - V212 £188.00 PANEL-TELETEXT GRP - ISSUE 6 £10.00 PANEL-TELETEXT PC15-11 - ISSUE 7 £15.00 PANEL-TEXT-VT753E £20.00 POWER SUPPLY TV SWITCH MODE STR 4211 ISSUE 10 £8.00 POWER SUPPLY VIDEO SWITCH MODE VTM12ELM £10.00 THICK FILM-HM9204A £3.50 HOSIDEN TUBE BASE - MIXED 10 for £1.00 AA Batteries made by STC Group of Companies 10p each		ITT IF MODULES - 5827-01-51, 5827-03-51 EACH £3.00 5828-04-10, 5829-02-58 EACH £3.00 5929-02-41 EACH £3.00 TELETEXT CONVERSION KIT £3.00 CORE 2 90" ITT TEXT PANEL £3.00 1996/7 MATSUI VIDEO DECK COMPLETE P/P £5.00 ea £16.00 MATSUI - ORION DECKS WITH HEADS - D1096 VXA110 VP 9401 £16.00 HEAD-VSR1500 - ORION D2096 £5.00 PANEL-MAIN-VSR 1500 P/P £5.00 ea £3.00 POWER SUPPLY-VSR 1500 £5.00 POWER SUPPLY & REG - TYPE STK 5343-VP9501 £8.00 POWER SUPPLY-SWITCH MODE-1500 £3.00 PHILIPS DECODER-TEXT-K40-KT3 £5.00 IF PANEL FOR CP90-CP110 £6.00 TEXAS NICAM BOARDS MK II £3.00		AIWA 1500 MAISUI VX4 1100 MAISUI 1500 ORION D1094 ORION D1096 ORION D2096 ETC EACH £20.00 CAPSTAN MOTOR FOR ABOVE DECKS £15.00 AND HAND SETS £3.00 4 HEAD DECK FOR 1500 £20.00 20 HIGH VOLTAGE CAPS 1500V - 2000V MIXED £10.00 VIDEO PATERN GENERATOR MODEL T9535 240V MAINS SMALL £5.00 PAL TV ADAPTOR - RGB IN UFH OUT £5.00 MOTOR 12V 10p HANDSETS AMSTRAD 4600 £3.00 4700 £5.00 6000 £15.00 6800 £4.00 UNIVERSAL £3.00 DECCA NICAM LCD £4.00 FERGUSON BSB £1.50 VSR 1500 £4.00 FV41R/FV42 - FV51-52 £10.00 ICCS £7.00 IK2000, IK7000 EACH £4.00 SRD12, SRD3, SRD4 EACH £1.00 T780 £2.00 TV/SATELLITE WITH FST £3.00 HITACHI CPT158 (NO REPLACEMENT) £5.00 VIDEO RM933E VIDEO PLUS £30.00 MATSUI 1500 £5.00 VSR 1500 £4.00 VX3000 £3.00 3000/ORION - TV AND VIDEO £2.00 RC - PACE 900, FERGUSON, SONY, GRUNDIG £5.00 MITSUBISHI RM35 - VIDEO £5.00	
7805 20p 2SD1432 £1.00 BU204 60p BUT11AF 50p BYW29/50 15p HDE140425J 50p 7806 20p 2SD1453 £1.00 BU205 75p BUT12A 20p BYW95 10p HDE140815 £1.00 7809 20p 2SD1576 £1.00 BU206 £1.00 BUT13 £1.00 BYW95C 15p HE4528BP 15p 7812 20p 2SD1577 £2.00 BU207 £1.00 BUT18AF £1.00 BYW62A 100V 8p HEF4029BP 20p 7812F 20p 2SD180T03 15p BU208 80p BUT17/800 15p BYX10 10p HEF4093 20p 25C940 £1.00 2SD1878 £1.00 BU208A £1.50 BUW11 40p BYX38/300 25p HGA1124A 50p 25C3795 £1.00 2SK1460 £1.00 BU208D 90p BUW84 60p BYX55/350 10p HM6264 25C973B £1.00 2SK1464 £1.00 BU222 £1.00 BUX39 £1.00 BYX5960 10p AL P15 £3.50 25C4313 £5.00 25C4891 £1.00 BU326 £5.00 BUX71/650 20p IK75T 6931 B1 £3.00 25C4589 £1.00V/15A £2.00 BU407 90p BUX84AF 50p BYZ106 10p 10A11900V £2.00 AN5521 £1.00 BU508A £1.00 BYZ4/110 5p 25C7350 £1.00 AN5551 £1.00 BU508AF £1.00 BYZ8/420 15p 25D200 £1.00 AN5831 20p BU509D 80p BY208-800 8p CA3123Q 50p 25D401 40p BC550C £2.00 BU508DF £1.00 BY228 15p CD4558BE 20p 25D716 £1.00 BDV648 50p BU705 £1.00 BY229 6p CE871A £1.00 25D787 30p BDV658 50p BU822 £1.00 BY255 5p FE3B 4p 25D789 30p BF8695 20p BU806A £1.00 BY299-200 15p HA1140 £5.00 25D820 £1.00 BF870 20p BU807 50p BY299-800 30p HA1185 50p 25D868 75p BPW41 15p BU808DF £1.00 BYT71-800 15p HA1196 50p 25D890 30p BT Phone Batteries £1 BU828AF £1.00 BYV19-30 15p HA1485ANT £1.50 25D1264 50p BU10504 80p BU826 £1.00 BYV28-200 15p HA11804INT £1.50 25D1398 £1.00 BU124 80p BUK444/800 £2.00 BYV95B 10p HA51338SP1 £2.00 25D1415 £1.00 BU126 80p BUK445/600 £2.00 BYV95C 12p HA51338SP3 £2.00 25D1427 £1.00 BU180A 65p BUT11 50p BYW20-08-9 £1.00 HCF4520 50p 25D1427 £1.00 BU180A 65p BUT11 50p BYW20-08-9 £1.00 HCF4520BE 50p		No accounts No Credit Cards <h2>SENDZ COMPONENTS</h2> 63 BISHOPSTEIGNTON, SHOEBURYNNESS, ESSEX SS3 8AF. Tel: 01702 338894 Fax: 01702 338805 Specific P/P charges are PER ITEM • For UK addresses add P/P to order then 17.5% VAT to total. This applies to EC unless VAT No. is given • Exports - P/P at cost • Postal Order/Cheque with order. Unless otherwise specified add £1.70 P/P to SMALL ORDERS + Additional P/P for HEAVIER GOODS. Technical information by telephone only • Government/School Orders on official headings. Callers to shop - 212 London Road, Southend-on-Sea. Open Saturday Only 10-12noon - 2.5pm.					
PLEASE ADD 17.5% VAT TO BOTH THE GOODS TOTAL AND P/P CHARGE							

a REMOTE for EVERY occasion...

UNIVERSAL REMOTE CONTROLS

Need to control up to 3 devices?

- The GENIE

- Will control TV, VCR and Satellite/Cable boxes
- Available in Silver, Red, Blue, Green and Yellow
- Simple set-up - covers 1000's of popular brands
- Backlit device indicator keys

The 3-way Genie - Part No. RCO12 (silver) RCO12RED (red)
RCO12BLUE (blue) RCO12GREEN (green) RCO12 (yellow)

Need to control up to 4 or 8 devices and digital TV?

- the MAGICIAN

- Operates all SKY™ (Magician-4) and ON-DIGITAL™ digital TV boxes (Magician-8)
- Replaces up to 4 (Magician-4) or 8 (Magician-8) TV, VCR and Cable/Sat
- Simple set-up - covers 1000's of popular brands
- Teletext and Fasttext functions
- MACRO function (Magician-8)
- Backlit device indicator keys
- Video Camera Best Buy award (9 out of 10) (Magician-4)

The 4 and 8 way Magician - Part No. RCO21 (Magician-4)
RCO22 (Magician-8)

Need to learn commands from an existing remote?

- the WIZARD

- Full learning facility - can duplicate most IR commands
- Replaces up to 8 different infra-red controls, including TVs, VCRs, Cable, satellite and hi-fi systems
- Simple set-up - covers 1000's of popular brands
- Red backlit keypad for use in the dark
- Up to 8 different MACRO functions
- Video Camera Best Buy award (8 out of 10),
- Stuff Magazine (4 out of 5), What Hi Fi (5 out of 5)

The 8-way Wizard - Part No. RCO14

Eliminate the need to stock hundreds of different replacement remotes with the UNI range of Brand for Brand replacements. Each UNI remote contains the codes to cover the TV's or Satellite receivers for an individual brand or range of brands

PART NO.	REPLACEMENT FOR
RCUNI01M	Panasonic TV's, Menu functions Included
RCUNI02M	Sony TV's, Menu functions Included
RCUNI03M	Phillips TV's, Menu functions Included
RCUNI04	Hitachi TV's
RCUNI05	Mitsubishi TV's
RCUNI06	Nokia TV's
RCUNI07	Samsung TV's
RCUNI08	Toshiba Uni TV's
RCUNI09	Thomson/Ferguson TV's
RCUNI10	Grundig TV's
RCUNI11	Sanyo Uni TV's
RCUNI12	Sharp Uni TV's
RCUNI13M	Goodmans/Alba/Bush TV's, Menu functions Included
RCUNI14M	Matsui/Hinari/Orion TV's, Menu functions Included
NEW!!! RCUNI15	Sky Digital Satellite
NEW!!! RCUNI16	On Digital Satellite
RCUNI17	Analogue Satelllites-Most Brands

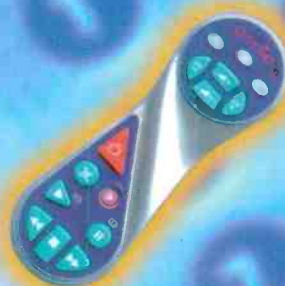

AVAILABLE FROM



For details of your nearest stockist contact us on
Tel: 020 8202 1919 / 07000 PHILEX or Fax: 020 8202 0015
Philex Electronic e-mail: sales@philex.com
Website: http://www.philex.com



Order your FREE Trade Catalogue Now!



NEW **OUT NOW**
900 page+

**FREE USER FRIENDLY
TRADE CATALOGUE**

**Featuring
Electronic,
Electrical
Components
& Accessories**

Telephone: 01282-683000
Fax: 01282-683010
E.mail: sales@ardelectronics.com

**1,000's of New
products all at
competitive prices**

Order your copy of this essential Trade Catalogue NOW and we will send it to you absolutely FREE - Simply Telephone us on 01282 683000 or fax us on 01282 683010 at A.R.D. Electronics, Now! and enjoy a £250 credit limit from day one



28,000 Sq.Ft. Warehouse

SUPERB PRODUCT RANGE

Aerials & Accessories	Relays
Audio & Video Accessories	Remote Control Handsets
Audio Spares	Resistors, Potentiometers & Trimmers
Batteries & Accessories	Satellite Spares & Accessories
Books	Security Products
Cable & Accessories	Semiconductors
Capacitors	Service Aids
Car Products	Soldering Equipment
Clocks & Timers	Stands & Brackets
Computer Components & Accessories	Stationery & Office Equipment
Computer Software	Storage Systems
Disco & PA Equipment	Switches
EHT Components	Telephones, Fax Machines & Accessories
Electrical Accessories	Telephones - Cellular
Enclosures	Accessories
Filters/Surge Protectors	Test Equipment
Fuses & Holders	Tools
Intercommunication Equipment	Transformers
Lamps & Lighting	TV Spares & Repair /Service Kits
Loudspeakers & Accessories	Video Heads
Optoelectronics	Video Spares
PCB Accessories	
Power Supplies & Adaptors	

**A.R.D.
ELECTRONICS**

'Our aim is your next order'

◆ Same day despatch ◆ Local Trade Counter

**A.R.D. Electronics Plc, Shorten Brook Way,
Altham Business Park, Altham, Accrington, Lancashire. BB5 5YL.**

Telephone: 01282 683000 Fax: 01282 683010

E.mail: sales@ardelectronics.com