

Tips, guides and reports for people repairing televisions and electronic equipment

1

TELEVISION

PLQ ! JPE !

cl PLQ

SION

AND HOME ELECTRONICS REPAIR

JUNE 2002 £3.10

Home networking



TEST REPORT:

Hauppauge TV add-on for PCs

Servicing the Sony AE1C chassis

New AV connector system

Satellite, PC, Monitor, TV, VCR and DVD faults



landing on a desk near you soon..!



Our latest Mains Switch and Transformer guide is now available. Containing a fully indexed listing of over 15,000 entries, each cross referenced against the manufacturers original part, make and model number. Also included are 95 of our unique Mains Switch technical drawings to help you identify the switch you require. Covering almost every television since the 80s, this guide will provide you with an invaluable reference to sourcing your replacement parts and what's more it's completely free!

If you haven't yet received your free copy, would like any additional copies or would like further information on the Classic range of components call us on **01635 278678**, email us on sales@classic-electronics.co.uk, visit our web site www.classic-electronics.co.uk or contact your nearest Classic distributor.

classicTM

Technical helpline 01635 278678

CONTENTS

June 2002

Vol. 52, No.8

451 Comment

Funny old world, digital.

452 Teletopics

End of ITV Digital, new VHS format, MPEG-4 progress, DVD recording and other news.

454 Home networking

Mark Paul provides an update on consumer networking technology, covering the three basic approaches – use of existing wiring as the transmission medium, installing new wiring, and RF techniques. Some of this technology is already being built into equipment, but there are many intriguing prospects.

460 New dual-function AV connector

Steve Beeching describes the operation of a new type of dual-function connector that's now coming into use, mainly in DV camcorders.

462 Test report: Digital TV STB for PCs

The Hauppauge WinTV Nova-t unit plugs into a PC's USB port and takes an input from a TV aerial. You



can then view all the free-to-air terrestrial digital TV channels – and hear the radio channels – via your computer. Peter Marlow reports on its installation and performance.

464 Servicing the Mitsubishi TFS6705K monitor

This 17in. Trinitron-tube monitor's production run lasted for several years. Large numbers were sold as the Dell VC7EN. In Part 3 of his series Donald M. Henry looks at the operation of the EHT generator section with its two transformers and describes some workshop experiences.

467 Help wanted

468 Audio faults

475 ER Show report

George Cole reports on the latest product developments and releases seen at the brown goods industry's UK showcase.



478 Sony AE1C chassis fault-finding guide

John Coombes on how to tackle the various faults you might encounter with sets that use this chassis.

480 DX and Satellite Reception

Terrestrial DX and satellite TV reception. News on international broadcast TV and satellite band changes. Digital receivers for the enthusiast. Roger Bunney reports.

484 Satellite notebook

Digibox faults. Digital channel update. Some installation problems.

485 Test Case 474

486 DVD fault reports

488 Monitors

Guidance on repairing monitors and related equipment.

490 VCR Clinic

492 Jack's Workshop

How to earn £60 an hour. Business efficiency, marketing and ways of making a success of it.

494 TV fault finding

498 Web service

Useful websites for TV professionals and enthusiasts.

500 Letters

Cost of spares. SkyLink installations. Philips televideo RC handsets. A Sony TV problem. Scams.

502 Next month in Television

511 What a life

Various TV faults, a spot of bother with a camcorder and a note on domestic appliances. Donald Bullock's servicing commentary.

Editor

Martin Eccles

Consultant Editor

John A. Reddihough

Advertisement Sales

0208 722 6028

Fax 0208 770 2016

Note that we are unable to answer technical queries over the telephone and cannot provide information on spares other than that given in our Spares Guide.

Next issue,
dated July, on
sale June 19th.

THE WALLIS

REMOTALOG

Available NOW!

The 'Ultimate' Remote Control Catalogue for TV's, VCR's, Combi's, Satellites, STB's, Camcorders, DVD's and Hi-Fi.

- 30,000 Equipment references • 6,000+ New models
- User-friendly layout • Sourcing and Product information
- Dedicated Remotes • 'Point & Go' Universal Remotes
- 'Point & Go' Compatibility information • New lower prices

If you sell Remotes the 'REMOTALOG 2001' is a 'Must-Have' tool that will save you Time and Money.

Interested? Then, Don't Delay – Contact us today.

WALLIS UK, A109 RIVERSIDE BUSINESS CENTRE, LONDON, SW18 4UQ

TEL: 020 8870 3388 • FAX: 020 8870 9988

EMAIL: sales@wallis-universal.co.uk

Wallis UK



ONLINE SHOPPING CHEAPER AND EASIER www.elclondon.co.uk

TV, VIDEO SPARES AND ELECTRICAL ITEMS



ELC EAST LONDON COMPONENTS
63 PLASHET GROVE, LONDON E6 1AD.
TWO MINUTES WALK FROM UPTON PARK TUBE STATION
TEL: 020 8472 4871 FAX: 020 8503 5926
E-mail: sales@elclondon.co.uk

PERIFELEC

MC 30 A Spectrum Analyser



- Synthesized satellite cable and TV field strength meter with panoramic reception on 14 cm (5.5") screen and digital carriers measurement.
- Complete microprocessor and IsplSI logic control.
- Continuous frequencies from 46 to 860 MHz and from 920 to 2150 MHz on 4 bands.
- Selectable 4, 1 and 0,2 MHz spectrum band-width, picture measurement 1 MHz.
- Display of picture of selected synthesized channel.
- FM (Radio) L/L', B/G, I, D/K/K', M/N TV standards and Ku and C satellite standards.
- Possibility of 32 programs memorized per frequency band.
- Display (2 Lines of 16 characters)
- Range of measurement of signal strength from 20 to 120 dBµV, manual or automatic attenuator.
- Battery life about 1 hour 20 minutes, weight 5,8 Kg.

- Display of full-band and 4 possible expanded spectrums.
- Channels and frequency plans of cable and TV standards memorized.
- Frequency signal strength in dBµV or bargraph, displayed on a digital display (2 lines of 16 characters).
- Voltage of remote power supply in 14v or 18v and 22 KHz in satellite + DiSeq C™ v1.2 switching.

The panoramic field strength meter MC30A combines in one instrument all the functions necessary for installing and checking TV or satellite reception, both analogue and digital. The visualization of the spectrum and the picture allows the carrying out of all the necessary adjustments with this one instrument. The high technology used in the MC30A allows a range of possibilities unheard of in a instrument in this price category.

SADELTA



TC 80 A/D

The TC 80 A/D has been designed for the reception of TV Satellite systems.

- Analogue and digital measurement
- Full Band Frequency Sweep
- Switchable 14 v or 18 v LNB power supply + 22 KHz tone switching
- Rechargeable 12 v / 2,6 Ah Battery
- Weight including batteries: 3,3 Kg.

The TC80 A/D has been designed to aid the installation of analogue and digital satellite systems. This high quality meter has video and audio output via scart socket on rear and video only via BNC socket on front panel. The built in speaker delivers demodulated audio from any analogue satellite signals.

Full catalogue of meters available, please phone for details.

COASTAL AERIAL SUPPLIES

Unit X2, Rudford Industrial Estate, Ford, Arundel BN18 0BD
Telephone: 01903 723726 Fax: 01903 725322 Mobile: 0976 241505

Sole Import Distributors

Funny old world, digital

The pay-TV business plans that digital TV transmission were supposed to have made possible have been found wanting. That's putting it mildly, in view of the huge losses run up by ITV Digital before its demise. Let's try to see how things were supposed to have gone. We started off with analogue TV, which occupied rather a lot of spectrum space and provided viewers with a somewhat restricted number of channels from which to choose. Then along comes the possibility, thanks to signal compression techniques, of digital transmission. It makes far more channels possible within the available spectrum, along with interactivity and, assuming optimal transmission and reception conditions, superior pictures and sound.

It was assumed by broadcasters that people would love this new world of TV and, hopefully, would be prepared to pay to enable the possibilities to be exploited. Everyone would benefit: viewers, broadcasters and the providers of programme material. Only it hasn't worked out like that. Broadcasters have found it hard to make a profit, suppliers of viewing material have by and large made very little out of it and, if anything, people are viewing less and less TV.

Why hasn't it worked? There's a simple reason: the changes have been technology rather than demand driven. It's all very well to make things possible, which the change to digital technology has done. But in the absence of genuine viewer demand there will be commercial failure. By and large viewers seem to be happy with their traditional channels plus a bit more to cater for the undoubted demand for more sport and films.

What exactly do people want of TV? A bit of entertainment to help them relax; some news and information; sport; and a bit of culture. Take a look at the contents of the average daily newspaper. It serves a similar function and provides similar ingredients. There was that famous prophesy in the early days that TV would never, in the US at any rate, catch on because people simply wouldn't have time for it. That was as inaccurate as the prophesy that the world would only ever need five or so powerful computers to do all the computing that was required. But the opposite, more recent view, that there is an insatiable appetite for TV of all sorts, has proved to be equally unrealistic. There are still only 24 hours in the day, and most of us find that we have little enough time to get done what we have to do during those hours. You simply can't fit in a lot more viewing, however many channels there may be.

Most people probably didn't get what they wanted from the five analogue chan-

nels. But how many more channels could be made to pay for themselves? Not all that many, it has become clear. Digital channels are constantly being withdrawn because there is simply no significant demand for them. There are and always will be minority tastes, but these can be served in other ways, in particular by the internet. It's interesting that this has also

What exactly do people want of TV? A bit of entertainment to help them relax; some news and information; sport; and a bit of culture.

met with lack of commercial success – the dot.com mania was no more realistic than the idea that dozens or hundreds of TV channels could survive, or the earlier view that cabling everyone up would lead to a huge growth of information passing provision and use.

A lot of extra channels was obviously a marketing attraction that helped to get digital pay TV off the ground, but most of the extra channels weren't really wanted. This seems to have been understood by the broadcasters, who organised the extra channels in various packages. Doing this made the sales promotion look good, but people were simply annoyed that they couldn't choose exactly what they wanted. In the end, what it seems to have boiled down to is that the analogue system just about met people's requirements and the extra channels made possible by digital TV are largely superfluous. But there has also been a dilution effect, which has put peo-



ple off TV. By spreading good material across more channels, each channel becomes that much less attractive. You end up by switching off!

If you cream off the best material and put it in premium channels, people can be made to pay extra for their TV. But as long as there are free-to-air channels this isn't going to be a very successful. To get round this, some broadcasters have tried paying excessive amounts to get exclusive rights to broadcast popular material. That hasn't worked either.

Digital transmission makes more efficient use of spectrum space and has greater potential than the analogue approach. But now that we are well into the digital era it can be seen that the change to digital TV will not provide huge benefits for most viewers. The hype that accompanied its advent has proved to be a great disappointment. Not only that, but a lot of money and a lot of jobs have been lost. Digital TV

COPYRIGHT

© Highbury Business Communications. All rights reserved. No part of this publication may be reproduced, stored or transmitted in any form or by any means without the written permission of the publishers.

All reasonable precautions are taken by *Television* to ensure that the advice and data published are reliable. We cannot however guarantee it and we cannot accept legal responsibility for it.

CORRESPONDENCE

All correspondence regarding advertisements should be addressed to the Advertisement Manager, *Television*, Highbury Business Communications, Anne Boleyn House, 9-13 Ewell Road, Cheam, Surrey, SM3 8BZ. Editorial correspondence should be addressed to *Television*, Editorial Department, Highbury Business Communications, Anne Boleyn House, 9-13 Ewell Road, Cheam, Surrey, SM3 8BZ.

INDEXES AND BINDERS

Indexes for Vols. 38 to 50 are available at £3.50 each from SoftCopy Ltd., who can also supply an thirteen-year consolidated index on computer disc. For further details see page 502.

Binders that hold twelve issues of *Television* are available for £6.50 each from *Television* Binders, Pringle, Street Blackburn, BB1 1SA. Make cheques payable to "Television Binders".

BACK NUMBERS

If available issues are £3.50 each.

SUBSCRIPTION ENQUIRIES

Telephone: 01444 445 566

Fax: 01444 445 447

Credit card orders: 01622 778 000

Address: *Television*, Subscriptions Dept, PO Box 302,

Haywards Heath, West Sussex RH16 3YY, UK.

Make cheques payable to: *Television*

Subscription rates:

UK £33.00 per year

Airmail Eire £36.00 per year

Airmail Europe £46.00 per year

Airmail Rest of World £59.00 per year

NEWSTRADE ENQUIRIES

Distributed by COMAG

Telephone: 01895 444055

ISSN 0032-647X



TELETOPICS

End of ITV Digital

As we go to press ITV Digital's pay-TV channels ceased to be transmitted. The administrator announced that he was unable to find a buyer for ITV Digital as a going concern, so it is now likely to go into liquidation. The free digital channels will continue to be available. Though the 1.2m set-top boxes that have been supplied to subscribers could be recalled, it seems unlikely that this will be practicable. Towards the end the service had been losing 4,000 subscribers a day and had been

New VHS format

JVC has developed yet another VHS format. This one, called D-VHS D-Theatre, is intended for the high-definition TV and prerecorded video markets. It includes a new proprietary encryption system to prevent unauthorised duplication of video content. The format has been added as a D-VHS option for products aimed at the North American market.

D-Theatre enables high-definition video material to be recorded in D-VHS form at the HS (high speed) data rate. The encryp-

tion system ensures that tapes are recorded only with equipment licensed by JVC.

The DTT broadcasting licences now revert to the ITC, which is anxious to award them to new operator(s) as soon as possible. An announcement is expected to be made by June 12th.

A similar situation has arisen in Spain, where the only DTT pay-TV service Quiero TV has closed down. No purchaser for the business came forward, and losses were running at 24m euros a month.

The Kirch Gruppe in Germany has filed

running up losses of £3.2m a week. The Kirch Gruppe in Germany has filed

for insolvency and been placed in administration. Amongst the group's complex business operations it had been running Germany's satellite pay TV service.

NTL, the UK's largest cable TV operator which was on the brink of collapse, has arranged a £7.3bn debt-for-equity swap with its bondholders. By slashing the interest bill it should be possible to keep the company going, though the £5bn bank debt remains. It represents the world's largest ever corporate bond default.

TiVo problem

According to an on-line news sheet the new TiVo software version 2.5.5 has been causing problems with some recent wide-screen Philips TV sets and also a few Toshiba sets. TiVo users have been upgraded with the new software. It seems that data from the TiVo unit causes the TV set's microcontroller chip to crash.

The symptoms include intermittent sound muting and receiver switch-off, and could be very confusing. TiVo is understood to be working on a solution.



Thomson Multimedia's new PC sender enables high-quality pictures and stereo sound to be sent from a PC to any other room in the house with no need for interconnecting leads. The signals sent from the PC can be picked up and fed to a TV set or hi-fi unit. There are many possible uses for the sender. For example a DVD can be played by the PC and watched via the main TV set in another room; MP3 files can be downloaded from the internet and sent to a hi-fi unit elsewhere; and parents can monitor their children surfing the internet when using a TV set in another room in the house. The universal remote-control unit that comes with the sender enables certain PC functions to be controlled from the room where the transmitted signal is being viewed or listened to. Being a multibrand, multiproduct unit, it can be used to control a wide range of other equipment. The sender transmits in the 2.4GHz band and has a range of 30m.

The sender is available at a price of about £100. It comes with Boom 2000 software and is easy to install.

DVD recording

Hitachi is to launch three new DVD-RAM camcorders this year. Models DZ-MV200E, DZ-MV230E and DZ-MV270E. They will use 8cm DVD-RAM discs that provide up to thirty minutes' recording time on each side. The camcorders will also be able to use DVD-R discs. Hitachi maintains that its DVD players and those manufactured by Panasonic are 100 per cent compatible with DVD-R discs, but says that compatibility is closer to 85-90 per cent with players produced by other manufacturers. A new generation of DVD-Video players will provide complete DVD-R readability.

Model DZ-MV200E's features include the ability to store up to 1,998 JPEG still images at 1,024 x 768 resolution on a DVD-RAM disc. 12x optical zoom, 240x digital zoom, an 800,000-pixel CCD image sensor, an electronic image stabiliser, a 2.5in. LCD screen, a USB 1.1 port and remote-con-

trol operation. The DZ-M230E has an improved specification that includes an 0.25in. 1:1 megapixel CCD image sensor, a variable bit-rate recording system designed to provide optimum picture quality when recording fast-moving objects (the faster the movement, the greater the number of bits allocated), and the ability to store up to 1,998 JPEG still images at 1,280 x 960 resolution. The DZ-MV270E also has a three-in-one feature that enables it to be used as a DVD camcorder, DVD recorder or DVD burner, a 3.5in. LCD screen, a colour viewfinder, audio and video input sockets and a USB 2.0 port.

Microsoft has announced its support for the DVD+RW format, which it will incorporate in its Windows operating system. Hewlett-Packard and Dell also support DVD+RW, but Apple and Compaq support DVD-RW, DVD-R and DVD-RAM.

Technicalities

NTL Broadcast has completed successful technical trials of mobile digital terrestrial TV. The trials, held in Oxford, involved a multi-channel service broadcast over a single-frequency network. They showed that consistent high-quality video, audio and data transmissions can be received in moving vehicles using currently allocated frequencies. Different transmission modes were evaluated, and the performance of various demodulator chips was assessed.

Initial Bluetooth products that were launched about eighteen months ago suffered from severe interoperability problems. The latest Bluetooth specification, version 1.1, was confirmed a year or so ago and is the basis of the chips and systems now coming on to the market. According to one product manager it has improved interoperability to better than 95 per cent.

A new version of the FireWire interconnection bus, IEEE 1394b, has been approved. It enables data to be sent at 800Mbps/sec over distances up to 100m. Various different types of cabling can be used and a new form of signalling is included in the specification.

Bell Labs scientists claim to have doubled the distance record for wideband fibreoptic transmission, sending

2.56Tbits/sec over a distance of 4,000km. The previous record was 1.6Tbits/sec over 2,000km. The technique used was to send 64 channels of 40Gbits/sec data using DWDM (dense wavelength division multiplexing). The cable had repeaters every 100km, which Bell says is typical of terrestrial networks.

Mitsubishi is to use high-power LEDs from Lumileds to provide background lighting for monitor-sized TFT liquid-crystal displays, replacing conventional cold-cathode fluorescent lamps (CCFLs). Lumileds says the LEDs provide more saturated and lifelike colour, are twice as bright as fluorescent lamps and can self-adjust their brightness. Their 50,000-hour lifetime is twice that of a CCFL. The technology could eventually replace the use of CCFLs.

The Soundbug, launched at this year's CeBIT show, can turn almost any surface such as a table, door or window into a sound transmitter. The device is about the size of a mobile phone. It uses the principle of magnetostriction – certain materials change their physical dimensions when subjected to a magnetic field. The Soundbug uses a tiny sliver of Terfenol-D, a crystalline combination of iron and rare-earth metals.



Bush has added this 15in. LCD TV/monitor, Model LCD15TV, to its range. The set's specification includes teletext, Nicam and digital stereo, a VGA input and a 100-programme memory. There is also a new range of widescreen IDTV receivers with 24, 28 and 32in. CRTs.

Satellite news

Astra is now serving over 90m households in Europe – some 44 per cent of all TV homes on the Continent receive its transmissions. In the UK and Ireland 6.5m homes receive Astra's digital transmissions.

Eutelsat W5 will be launched this summer, carrying 24 wideband Ku-band transponders. Its orbital position is still being considered.

MPEG-4 progress

The MPEG-4 Industry Forum (M4IF) has announced that 29 manufacturers have successfully carried out three rounds of interoperability tests of products that use the standard, which was originally devised as a low bit-rate compression system for non-broadcast applications. Participants in the interoperability programme included Apple Computer, Cirrus Logic, IBM, Philips, Samsung and Thomson Multimedia. All participants are committed to producing interoperable MPEG-4 products.

The equipment tests began in early 2001 and included raw video and audio bitstreams, MP4 files with video and audio.

and MPEG-4 bitstreams. There are various profiles (this means the compression applied) including Simple, Simple Scalable, Advanced Simple Video and High Quality Audio. The next step with interoperability testing will be with live streaming that accords with the Internet Streaming Media Alliance specification.

M4IF is also working on a self-certification programme that will allow manufacturers to test the compliance of their products which, if satisfactory, will have the right to carry the recently-finalised M4IF logo. MPEG-4 is being offered with a growing number of digital cameras and camcorders as a way of providing video e-mails that can be stored on a memory card and transferred to a PC.

Spares Guide Update

The information in our May issue Spares Guide supplement should be updated as follows.

Akai spares are available from Prima International plc, Premier Park, Oulton, Leeds S26 AZA. Telephone 0113 251 1535 Fax 0113 251 1515 e.mail: akaispares@akai.eu.com



TTi (Thurlby Thandar Instruments) has launched a new range of Audio Precision computer interface cards. Originally the cards were available only as part of the APWIN audio analysis software package, which was initially supplied with some versions of the Audio Precision System One or System Two analysis systems and also as a separate kit for units purchased earlier or for general use. They are now available separately.

There are three cards in the range. ISA-WIN is an ISA interface card for use with APWIN software. PCI-WIN is a PCI interface card for use with APWIN software: it's not compatible with Windows 95 and is compatible with System Two, System Two Cascade and analogue versions of System One. PCM2-WIN is a PCMCIA interface card. ISA-WIN and PCM2-WIN are compatible with System One, System Two and System Two Cascade. The cards are available at £185 plus VAT each. There's a complete range of compatible connecting cables.

For further details apply to Thurlby Thandar Instruments, 2 Glebe Road, Huntingdon, Cambs PE29 7DR. Phone 01480 412 451 or e-mail sales@tti-test.com

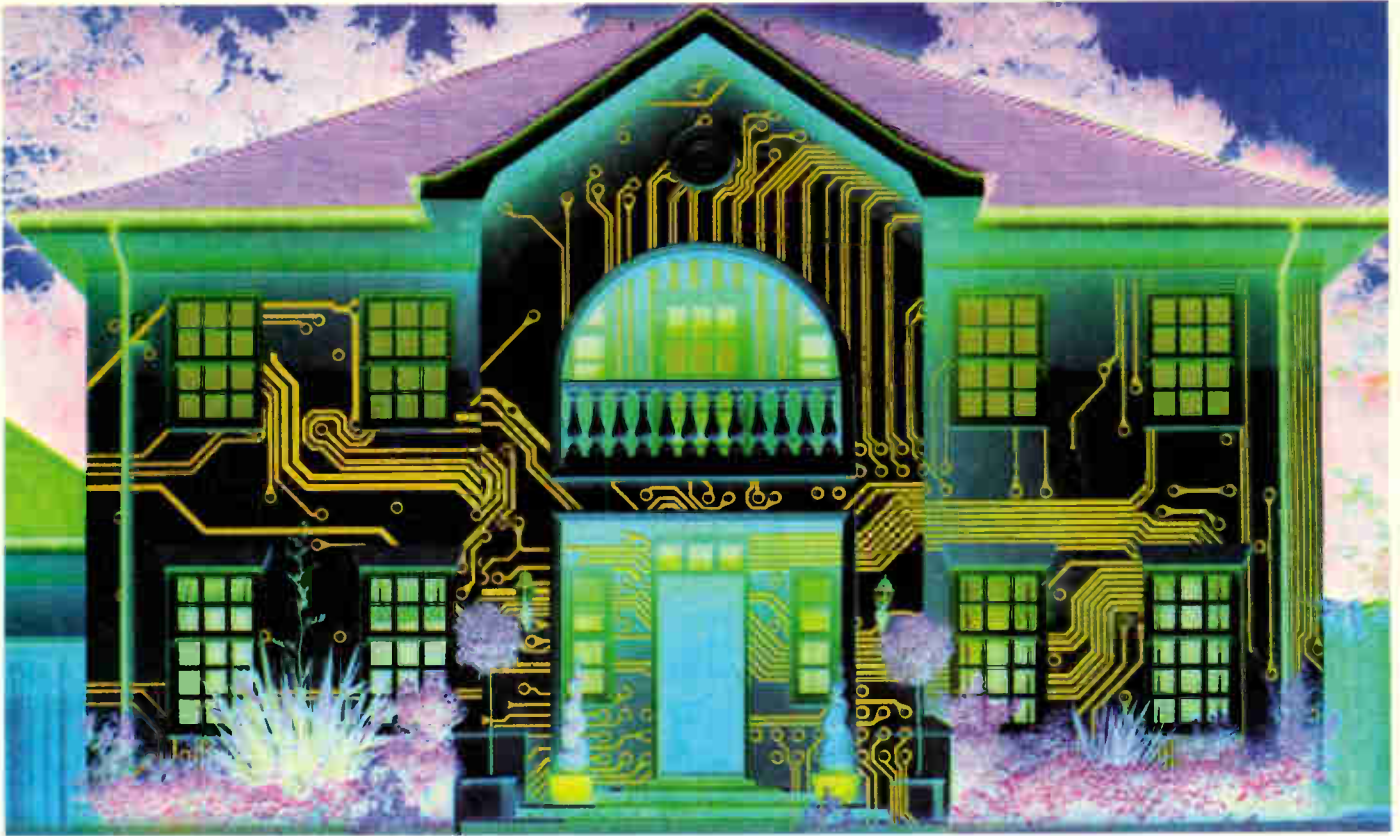

Home networking

Mark Paul provides an update on consumer networking technology, covering the three basic approaches – use of existing wiring as the transmission medium, installing new wiring, and RF techniques. Some of this technology is already being built into equipment, but there are many intriguing prospects

Home networking is at present being held back by failure of those active in this field to agree to a common standard. The basic alternatives are to use old wires, e.g. the existing mains wiring or phone lines; to install new wiring; or to use RF technology.

Whatever the medium used, there are certain basic requirements if this technology is to come into wide use: the system must be inexpensive, unobtrusive, idiot-proof, abuse-tolerant, able to handle fairly high transmission rates (tens of Mbits/sec) and have good EMC (electromagnetic compatibility) performance. The latter is the ability of hardware to tolerate interference from other equipment and not contribute to such interference, and is essential for correct and safe operation.

The following notes summarise the current situation with each approach to the provision of home networking.

Use of mains distribution systems

An advantage of using existing mains wiring is flexibility, with power outlets being present in most rooms in a house. But there are a number of fundamental problems that have to be overcome. First, the presence of electrical noise. Transient noise, which is rich in harmonics, is always present with mains distribution systems and can severely disrupt data transmission. Then there are the medium's transmission characteristics. Poor impedance matching and inherently bad cable balancing causes data distortion and signal loss. The result is data

corruption and limited bandwidth capability. The electrical safety of equipment connected to a system that carries mains voltages is another, paramount problem. 'Gateways' that interface the low-voltage electronic signals with the raw mains voltage are required.

Early systems had limited bandwidth and thus a low bit rate. This didn't matter too much with some 'smart-home technology' that was used simply for control purposes. The higher bit-rate systems that were developed tended to suffer from EMC problems. So, up to now, data transmission via power lines has been slow and unreliable. But this has changed, according to the HomePlug Power Alliance, a consortium that was set up just over a year ago.

The HomePlug Power Alliance

The Alliance is backed by more than eighty leading consumer and IT companies including Intel, Cisco, SonicBlue, Motorola, Hewlett-Packard, Panasonic, Compaq and Tandy/Radio Shack. Its first home networking specification, HomePlug 1.0, was released in June 2001, providing file transfers at "10baseT-like rates" (see later), with a theoretical maximum data transfer rate of 14Mbits/sec. This includes network protocol data, which means that the signal data is reduced to 8.2Mbits/sec. The average will be lower: in over 80 per cent of the 500 homes the Alliance used in a test in the US and Canada the signal data rate was 5Mbits/sec. The specification was nevertheless met by 98 per cent of all operational electrical outputs, such as audio and media streaming, sharing computer peripherals and files, multiplayer gaming and VOI (voice-over-internet) protocol: high-definition video over power networks is still in the future. But several PCs can share a single broadband internet connection, either DSL or cable, with everyone on the network having simultaneous internet or e-mail access. This provides cost savings and makes internet security easier to manage.

The technology that's made this stride forward possible comes from Intellon Corp., which designed and is now supplying a chipset called PowerPacket-INT5130. It uses OFDM signal processing, with FEC, to provide very high-speed data transmission. The chipset can detect changes within the power line and instantly adapt to such fluctuations, keeping the network connection on line. The technology is similar to that used for cable modems, using a 56-bit data encryption security (DES) standard to isolate and protect the network. This prevents unauthorised access to networks that share wiring or power transformers, for example apartment buildings. PowerPacket-INT5130's data rate of 14Mbits/sec makes it the fastest power-line network solution currently available.

Rival networks

There are other systems however, based in North America. For example Consumer Electronic's R7.3 Committee is reportedly close to issuing a specification which, being a wideband powerline network technology, will include a large number of nodes to make possible simultaneous entertainment activities such as streaming audio and video and provision for multicasting and broadcasting. According to R7.3, HomePlug hasn't proved that it can provide these services.

Then there is the Novell spin-off Inari Corporation, which has developed a 2Mbits/sec chipset that's already being supplied to manufacturers including Mitsubishi, Interactive Objects and Telocity. The latter, a DSL provider, is to

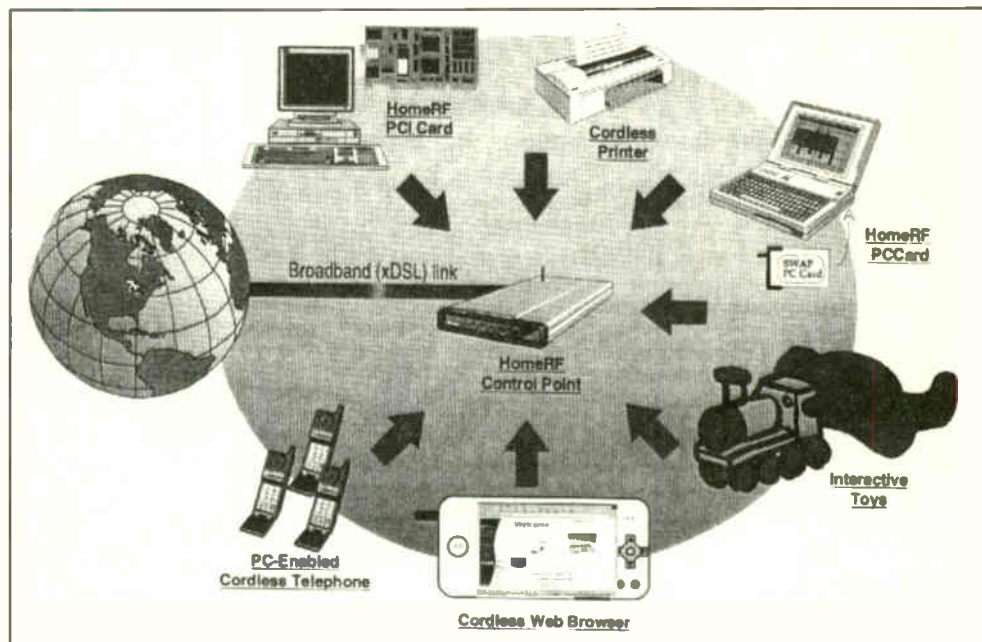

Home networking possibilities at RF.

use it in home gateway products, in conjunction with Thomson Multimedia's RCA System Link home network adaptor, which is also built around the Inari chipset. Inari is in addition working with major networking companies to develop internet-enabled power-in-line devices, and with both the R7.3 Committee and the European-based PLC (Power Line Communications) Forum to establish a global standard. Inari engineers are developing a second-generation 12Mbits/sec chipset which, like the 2Mbits/sec version, will use a discrete carrier system, but with the total number of carriers raised to 24 instead of four.

Use of phone lines

The use of phone lines is an alternative to power-line communication, and in this field the HomePNA (Home Phoneline Networking Association) has developed a specification. The HomePNA was set up in June 1998 and has over 150 company members that span the networking, telecommunications, hardware, software, service provider and consumer electronics industries. They include 3Com, AMD, Broadcom, Compaq, Conexant, Hewlett-Packard, IBM, Intel, Lucent Technologies and Tut Systems.

Phone-line networking uses the same basic transmission technology as traditional Ethernet (see below). A recent increase in data speed from 1Mbits/sec to 10Mbits/sec has given this technology increased momentum.

New cable options

Ethernet technology provides the highest data rates and is reasonably priced, but is not well-suited to the domestic environment. It usually requires the installation of new wiring, which can be

expensive, inconvenient and location-limiting. Perhaps a word of explanation about Ethernet should be included, as those involved with consumer electronics will probably not be familiar with it. Ethernet is the most widely used LAN (Local Area Network) technology, because it strikes a good balance between speed, cost and ease of installation. It was originally developed by Xerox and subsequently by Xerox, DEC and Intel: IEEE 802.3 defines the standard.

The basic idea is as follows. All stations connected to the network are linked to a common bus. Each station continuously monitors the messages transmitted via the bus, and collects those with its own address. Before a station transmits a message it checks the common medium – the Ether. If the medium is found to be busy, no station introduces new messages. If the medium is idle, any station can transmit messages. This arbitrary access to a common medium can sometimes cause collisions between messages. If a station detects such a collision, it pauses and retransmits the message after a period of time.

An Ethernet LAN may use coaxial cable or, as a cheaper option, twisted copper pair wires that conform to special Cat standards (see below). The most commonly installed Ethernet systems are called 10base-T, providing data transmission at up to 10Mbits/sec. Stations are connected to the cable and gain access using the CSMA/CD (Carrier Sense Multiple Access with Collision Detection) protocol. Fast Ethernet, referred to as 100base-T, provides transmission at speeds up to 100Mbits/sec. It's generally used for LAN backbone systems, with workstations that have 10base-T cards. Gigabit Ethernet gives backbone support at 1Gbits/sec. The

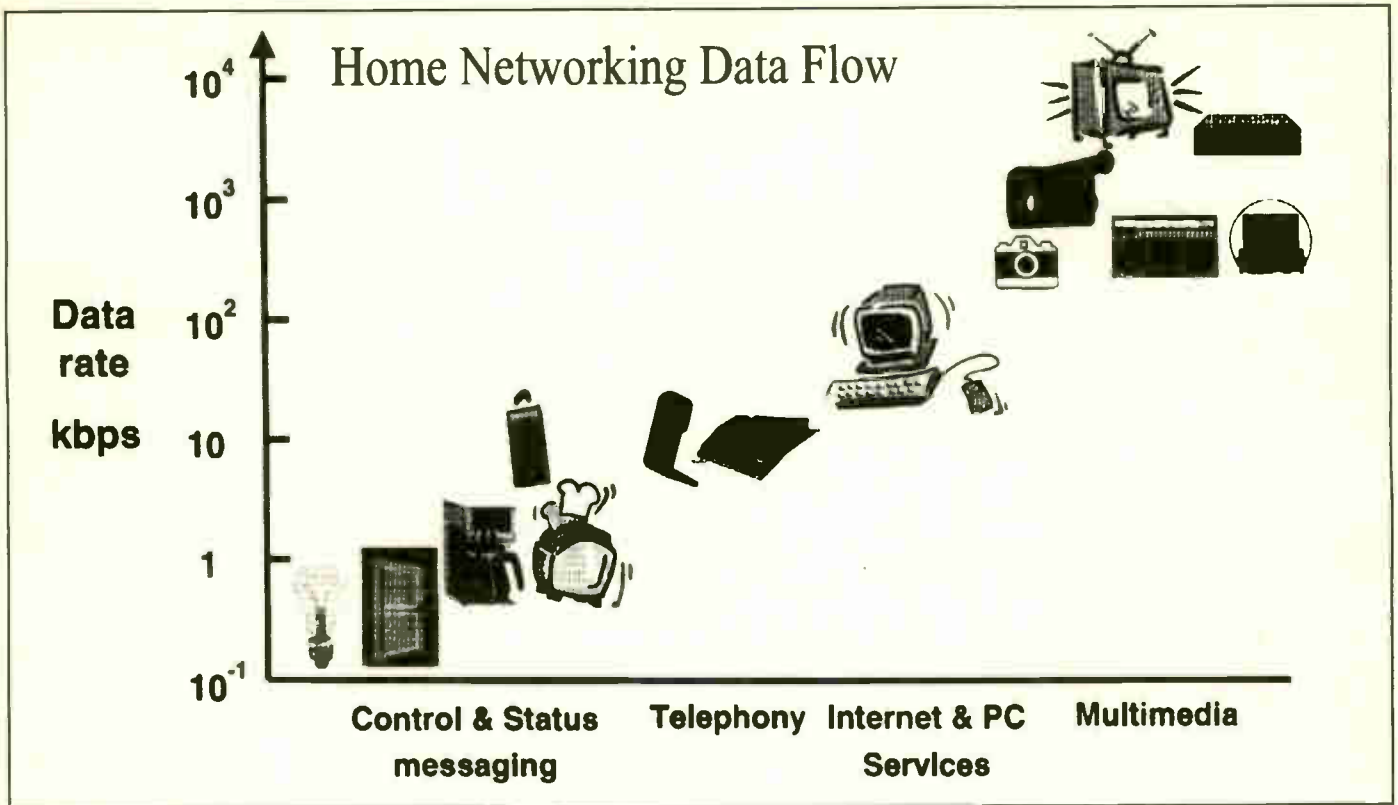

Home network data flow, data rate vs application.

IEEE is currently working on a specification for 10 Gigabit Ethernet using optical cable of either the multi- or single-mode type.

Options for new wiring include Ethernet-based Category (Cat) 5 (or variants) unshielded twisted pair (UTP) cable, coaxial cable, optical fibre, IEEE 1394 (see later) or a structured design using a combination of all these. The choice of carriers depends on likely future needs.

Cat standards

Cat 3 is an older industry standard cable for connecting hardware devices, with the basic specification 16MHz bandwidth and digital transmission at 10Mbps/sec. Its primary use today is for backbone cabling to carry voice and low-speed data transmissions.

The current Cat 5 standard was first specified in the early 1990s for applications up to and including FDDI (Fibre Distributed Data Interface), a LAN access method involving a nominal 100MHz bandwidth and digital data transmission at 100Mbps/sec. With the introduction of the bi-directional Giga Ethernet, the Cat 5 standard was reviewed. This led to the enhanced Cat 5e standard, with specification 100MHz bandwidth, data rate 1Gbps/sec.

Cat 6 cable is more difficult to install and more difficult to test than anything that has gone before. Based on the four-pair RJ45 cable, it promises a bandwidth of 250MHz and is designed to provide lower-cost implementation with a data rate of 1Gbps/sec. The idea is to achieve

maximum future proofing. The situation with respect to backwards compatibility with Cat 5e links is not clear however. Will a Cat 6 to Cat 5e connection perform to Cat 5e standards? Data transmission via unshielded copper cable can't get any faster than Cat 6, hence the development of Cat 7.

Cat 7, also in the process of standardisation, is specified as having a bandwidth of up to 600MHz with two-pair cable and up to 475MHz with four-pair cable. This has not been confirmed however, and there is at present no current system of testing at this level. Cat 7 requires fully shielded cable with individual pair shielding. So the cable is expensive and bulky, and may require a non-RJ45 connector. Germany favours this standard but, as the US will not accept it, Cat 7 is unlikely to emerge as a world standard.

Optical fibre

Once the limits of copper cabling have been reached, further performance enhancement calls for a shift to the use of optical-fibre cable. A vast quantity of it has been installed and at present only five per cent of this is in use.

Optical fibre, silica or plastic, comes in two formats, single-mode and multi-mode. The single-mode type has a core diameter of less than 10 microns and is primarily used for high-speed transmission over long distances. Its bandwidth is greater, but light-source coupling is more difficult. The multi-mode type has a much larger core diameter, anything between 50-100

microns. It's the more commonly used optical fibre, and is optimised for LAN operation. As light can enter the core at different angles, connection to a less well-defined source such as an LED is easier. The downside is that the light follows multiple reflective paths as it travels along the fibre. This leads to what is called 'modal dispersion': the pulses are broadened between the transmission and reception points, making them less easy to interpret. The result is a reduction in the maximum transmission distance.

Enhanced-bandwidth multi-mode optical fibre, classified as OM3, promises usable transmission distances for 10Gbps/sec Ethernet operation, but there is no guarantee of extra performance at lower data rates and the delivery of voice services is a problem. OM3 fibre carries a cost premium of 20-40 per cent. It could offer an attractive compromise in multi-Gigabit applications using fibre-to-hub and copper-to-desk links.

Bandwidth can be increased by using WDM (Wavelength Division Multiplexing) or DWDM (Dense Wavelength Division Multiplexing). The idea is to upgrade the capacity of installed fibre by transmitting data at different light wavelengths. Until now long-distance WDM has involved the use of two wavelength bands simultaneously, C band in the 1.550nm region and L band in the 1.580nm region. To provide a further increase in capacity, NEC has been carrying out intense research on optical amplifiers that operate in the 1.490nm region, known as S band. In fact NEC has

come up with the world's first S-band amplifier, making three-band transmission via a single fibre possible. This technology, along optimised three-band transmission system design and polarisation multiplexing/demultiplexing technology, has enabled simultaneous transmission of 273 channels, each with a 40Gbits/sec data speed, to be demonstrated – a total throughput of 10.9Tbits/sec. There could be further to go yet: recent research from Bell Laboratories suggests that the theoretical limit to the amount of information that can be carried by one fibre is 100Tbits/sec.

Interconnectivity

Several standards have been developed for interconnections between networked equipment, including IEEE 1394 and the Universal Serial Bus (USB).

IEEE 1394

This is often referred to as FireWire (red-hot data!) and was originally developed by Apple Computers. The IEEE 1394 high-performance serial bus uses a complex protocol to link devices to a PC via a single, simple plug-and-socket connection using a thin cable. It provides hot-plug and plug-and-play capability without disturbing the PC, and the ability to chain devices together – up to sixteen devices can be attached, without the need for terminators or complicated setting up, all operating at data transfer rates of up to 400Mbits/sec. Two twisted-pair conductors are used to carry a variety of different types of digital signals, for example compressed video, digitised audio and device control commands. A number of products with IEEE 1394 connectors have already been launched, including digital cameras and camcorders, DVD players and music systems. As IEEE 1394 is a peer-to-peer interface, one camcorder can for example dub to another without being plugged into a PC.

There are two levels of IEEE 1394 interface, one for the backplane bus within a device and another for the point-to-point interfacing between devices via the serial cable: a simple bridge links the two. The serial bus functions as if devices were slots within a PC, sharing a common memory space. The 64-bit device address allows a great deal of flexibility in configuring devices in chains and trees from a single socket.

FireWire provides two types of data transfer, asynchronous and isochronous. The former is for conventional load-and-store applications, where data transfer can be initiated and an application interrupted as a given length of data arrives in a buffer. Isochronous transfer ensures that data flows at a preset rate, so that it can be processed in a 'timed' way, with no buffer required. It allows for a continuous presentation of data. It's sometimes referred to as 'quasi-synchronous', being used for time-critical data such as

multimedia applications.

The IEEE 1394 standard requires that a linked device be within 4.5m of the bus socket. As previously mentioned, up to sixteen devices can be connected via a single chain, each with a 4.5m maximum (before signal attenuation occurs). So, theoretically, the last device could be 72m away from the PC.

FireWire can work with the PC PCI (Peripheral Component Interconnect) internal bus standard, but higher data rates may require special design considerations to minimise buffering for transfer rate mismatches.

The Universal Serial Bus

An alternative approach to connecting devices is provided by the USB (Universal Serial Bus): the current standard is USB 1.1. It was developed by Compaq, Hewlett-Packard, Intel, Lucent, Microsoft, NEC and Philips to simplify and replace PC input/output port connections. It has the same hot-plug and auto-installation capability as IEEE 1394 and is less expensive, but the data transfer is limited to 12Mbits/sec. The new USB 2.0 specification is forty times faster however, while retaining full compatibility with USB 1.1 cables and connectors. This new standard, just coming into use, boasts a data speed of 480Mbits/sec.

The USB promoters see no conflict with FireWire, as the USB is intended primarily for PC peripherals while the latter is aimed at consumer digital AV devices.

The UPnP Forum

The Universal Plug and Play (UPnP) Forum is an industry initiative to provide easy, robust connectivity between standalone devices and PCs from many different suppliers. It was set up in June 1999, with a steering committee whose members include Axis Communications, Compaq, Echelon Corporation, Hewlett-Packard, Honeywell, IBM, Intel, Matsushita Electric, Mitsubishi Electronics America, Panja, Philips, Siemens, Sony, Thomson Multimedia and Microsoft. The aim is comprehensive connectivity between PCs, intelligent appliances and wireless devices, using principles derived from PC operating systems and the internet.

UPnP is based on the successful co-operative multi-supplier approach, called Plug and Play, that was first provided with the Microsoft Windows 95 operating system. It embraces the same peripheral device connectivity model but goes much farther. The idea is to build inexpensive computing technology into the design of many of the common electronic devices in use today. The result should be reliable, inexpensive networking that creates opportunities for new products and functionality. It could be used for remote control, to move digital data between devices, and share information amongst them and the internet, and also exchange

secure data to support electronic commerce.

The 'universality' is based on the fact that the approach uses common protocols with no device drivers, can be implemented using any programming language and with any operating system, is compatible with http and the family of browser technologies and with conventional application program control, and is independent of the physical medium. The scope is broad, taking in home networks, proximity networks and networks in small businesses and commercial buildings.

The system features 'automatic discovery', whereby a device can join a network of its own accord, obtain an IP (internet protocol) address, announce its name, convey its capabilities on request, and learn about the presence and capabilities of other devices. It can disconnect itself from a network smoothly and automatically, without leaving any unwanted conditions behind. Supplier collaboration would establish standard Device Control Protocols (DCPs), similar to the internet.

UPnP makes use of existing protocols and technology wherever possible. In particular the internet provides proven, well-understood and open networking technology that can be used easily.

The RF option

Amongst the advantages of the RF approach are easy retrofitting, with no physical infrastructure, and maximum user flexibility with no fixed cables and socketry. It provides a low-cost solution that's easy to use and simple to install. RF networks can be designed to communicate seamlessly with phone lines or Ethernet networks. The disadvantages at present are limited data rates, currently 11Mbits/sec though 54Mbits/sec should be available shortly, and potential interference problems.

Several systems already exist: DECT (Digital European Cordless Telecommunications); IEEE 802.11; homeRF; and Bluetooth/infra-red technology. We'll take a brief look at each of these.

DECT

This European digital standard for business and domestic cordless telephones and for public network access has achieved worldwide support. It was conceived in the mid Eighties as a standard for domestic phones, to be based on digital technology aimed at improving speech quality, with security against eavesdropping and immunity from radio interference between nearby cordless phones. By the time the standard was finalised in 1992, its scope had widened to include cordless business phones and an access system for subscribers to public telecom networks.

Since 1993 DECT has been a mandatory standard throughout the EU, and the

frequency band 1.88-1.9GHz has been allocated to it. Many countries outside the EU have adopted DECT, which is now the most widely used digital standard for cordless communications. For this reason its name has been changed to Digital Enhanced Cordless Telecommunications.

Here are some details of the system. It's based on multi-carrier TDMA (Time Division Multiple Access), the same technology that's used by the main digital cellular systems. In addition to its use for home and business cordless phones, it has also been used as a radio alternative to wired subscriber access in public fixed telecom networks – known as Wireless Local Loop (WLL). DECT cells are 'pico-

cells' compared to a main cellular network: this makes possible much higher user densities, typically 100,000 per km². There's seamless handover of calls as the user moves from one pico-cell to another during a call – the phone rather than the network initiates the handover. Pre-transmission encoding with 32kbit ADPCM (Adaptive Differential Pulse-Code Modulation) provides high speech quality. The standard handles data as well as voice, creating the possibility of cordless LANs, but is not designed for WLAN. Coverage is between 50-300m at 250mW. DECT interfaces with a number of other systems, e.g. GSM. Because of the encryption techniques, radio

eavesdropping is almost impossible. The maximum data rate is up to 500kbits/sec. There are 120 bi-directional channels. A maximum of two out of eight users have access at the same time.

IEEE 802.11

This is a family of wireless LAN standards first introduced in 1997. IEEE 802.11 provides 1-2Mbits/sec transmission in the 2.4GHz band, using either FHSS (Frequency Hopping Spread Spectrum) or DSSS (Direct Sequence Spread Spectrum) modulation, which is also known as CDMA (Code Division Multiple Access). IEEE 802.11b, sponsored by the Wireless Ethernet Compatibility Alliance (WECA),

FURTHER INFORMATION

The following sources of information should help those who want to delve deeper into home networking and keep abreast of developments in this field.

Books

Essential Guide to Home Networking by Gerard O'Driscoll. A well-regarded book that covers a wide range of home networking technologies and configurations.

Home Networking Bible by Sue Plumley. Claimed to be the "complete resource". It's certainly comprehensive.

Home Networking for Dummies by Kathy Ivens. Takes you through setting up the adaptors and cables required for a home network. You'll also find everything you need to know about getting your PC to share files, printers and internet connections.

Home Networking! I Didn't Know You Could Do That ... by Erik Sherman. Published by Sybex, 2000. Concentrates more on what you can do with a network than on how to get one working. Includes a CD with lots of useful software.

Mastering Home Networking by Mark Henricks, published by Sybex, 2000. A hefty volume with much detail.

Web sites

3Com (www.3com.com). 3Com is a leading networking equipment company with a wide range of products for home networks.

Extremetech (www.extremetech.com). This site goes into the technology deeply. Looks at products and the technology they use.

There are expert articles with follow-up discussion.

Home Networking with Linux (www.inuxgazette.com/issue28/journeay.html). You could install the Linux operating system on a PC and connect it to your network. This page, part of Linux Gazette, describes the process. Not for the faint-hearted.

HomeToys (www.hometoys.com). This site features good articles on home networking technologies and products.

Intelogis (www.intelogis.com). This company specialises in power-line networking equipment.

NetGear (www.netgear.com). NetGear manufactures home networking products.

Technocopia (www.technocopia.com). This is the site for the wired home. It includes reviews of networking-related products and discusses other items. Written in language that's easy to understand and follow.

ZD Net (www.zdnet.com). ZD Inc. produces publications such as PC Week and Computer Shopper. This well-known site is excellent for general information and product reviews.

Zoom Telephonics (www.zoomtelephonics.com). Zoom Telephonics manufactures wireless networking cards and DSL and cable modems.

Newsgroups

The following are worth checking out:

comp.home.automation
comp.os.ms-windows.networking.misc
comp.os.ms-windows.networking.windows

Online publications

Connected Home Online. From the publishers of Windows 2000. A well-done publication that focuses on home networking technologies, products and possibilities.

Electronic House. The group publishes several online magazines that cover all aspects of the connected home, including *Electronic House*, *Popular Home Automation*, *CE Pro*, *TecHome Builder* and *Home Networking News*.

Home Automation Times. Covers household technology in the broadest sense, with particular emphasis on home automation topics such as smart toys, alternative energy, smart transportation, assistive technologies, distance learning and cyber medicine.

Practically Networked. This site provides 'how-to' information on setting up internet sharing. Takes you through the whole process from setting up and debugging a network, through selecting a sharing method to securing the shared LAN. There are also detailed home-networking product evaluations.

has an increased data rate of 11Mbps/sec. IEEE 802.11a has a data rate of 24Mbps/sec and operates in the 5GHz band.

FHSS, DSSS and CDMA are techniques used to maximise spectrum use. Spread spectrum is a generic term for a variety of RF transmission systems that change frequencies or signal patterns continuously. They are used in most WLAN systems, and were originally developed for military use to provide reliable, secure communications. Spread spectrum trades bandwidth for reliability, integrity and security of the transmitted signal – provided the receiver knows the parameters of the signal being transmitted. If a receiver is not tuned to the right frequency, the spread-spectrum signal looks like background noise. There are two types of spread spectrum, frequency hopping and direct sequence.

DSSS, which is used with CDMA, multiplies the data bits by a very fast pseudo-random pattern that 'spreads' the data into a large coded stream which occupies the full channel bandwidth. With FHSS the centre frequency of a conventional RF carrier changes several times per second, following a pseudo-random channel pattern. A variation on this theme, called Chirp Spread Spectrum, changes the actual carrier frequency. As, in either case, a fixed frequency is not used, illegal monitoring of the signals is extremely difficult if not impossible.

Use of such techniques in a digital transmission system enables a lot more information to be carried, with excellent reception fidelity and security. The technique is used for cellular phone and other technologies such as Bluetooth.

IEEE 802.11 is essentially a global-standard wireless Ethernet. The maximum distance with the basic version is 100m: the 11b version, with its higher data rate, has a maximum distance of 40m at 11Mbps/sec.

IEEE 802.11b was originally designed to support roaming in a large office or business campus environment. Providing 10-100 access points, its primary application is high-performance data networking, e.g. file or internet sharing. It has the advantage of secure, high-speed data transfer but is more expensive than other technologies. In addition, the use of DSSS inhibits its performance in high-density situations. The result could be interference in blocks of flats and similar environments unless the base stations are very strategically placed. IEEE 802.11b has limited voice capability – it can provide digital VoIP, though at present the quality is poor. In addition the specification does not cater for key telephony features such as caller ID. For these reasons, many consider that 802.11b does not offer a complete solution for homeowners who want to use a single wireless network for all their networking needs.

HomeRF

While IEEE 802.11b was designed for corporate use, HomeRF was developed for home networking. In addition to its technical features, simplicity, security and ease of use, it's designed to be affordable to domestic users. A HomeRF network has a range of up to 150ft, sufficient to cover the typical home, garage and garden. The second-generation 2.0 specification enables new types of devices, applications and services to be added, such as whole-house CD-quality audio distribution to wireless speakers and video streaming. Backward compatibility ensures that all current HomeRF products will operate with future ones.

HomeRF provides the expected benefits of networking, such as shared internet access, PCs, data files, and printers. In addition, by providing integrated high-quality voice and data transmission, it opens up a host of other possible applications.

The HomeRF specification incorporates the DECT standard, which provides all the telephone features consumers expect plus a full range of enhanced features useful in both home and small business applications. With HomeRF there is no need for multiple base units to be tied to individual phone jacks, as with traditional cordless phones: only one connection to a single jack is required, and additional handsets can be bought and placed wherever convenient. The ability to expand the network by simply adding handsets provides savings in comparison with purchasing multiple cordless phones.

HomeRF is being promoted by Proxim, Aironet, Lucent, Symbol and ninety other firms. Its operational protocol is SAWP (Share Wireless Access Protocol) while its transmission protocol is derived from DECT and IEEE 802.11. It uses the 2.4GHz band and has a data speed of 1Mbps/sec (version 1.0) or 10Mbps/sec (version 2.0), with these standards reverse compatible. Advantages include security from illegal tapping, low power consumption with battery-powered devices, a capability of using 127 devices per network for voice and data transmission, and operation in high-density environments.

Bluetooth and infra-red technologies

While it is often thought of as a wireless networking specification, Bluetooth actually provides a Personal Area Network (PAN), with short-range, point-to-point connectivity.

Like infra-red transmission, Bluetooth is designed for cable replacement rather than home networking. While these technologies do not provide such capabilities as file and device sharing, which you get with LAN systems, they do provide quick-file copy and data synchronisation, enabling data to be exchanged between mobile PCs, mobile

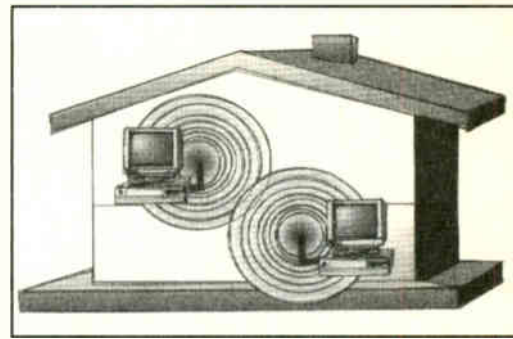

Wireless connectivity within the home.

phones and other portable devices such as PDAs. One drawback with infra-red is that connectivity is line-of-site. Bluetooth, using RF, can link devices up to 30ft apart.

Infra-red technology, using frequencies just below visible light to carry data, is little used in commercial LANs. As it conforms to the laws of light it cannot penetrate opaque objects, and can be either directional or diffuse. Inexpensive directional systems are very limited, typically used as PANs and occasionally in wireless LAN applications. IR is often used in smart-home technology for presence sensing, non-mechanical control operation, security etc.

Bluetooth is being promoted by Ericsson, Nokia, Intel, IBM, Toshiba and some eight hundred other companies. It's intended as cable replacement technology for voice and data traffic with home networking in the limited sense mentioned above. The cost is low and falling. Operation is in the 2.4GHz band with maximum distances of 10m at 1mW and 100m at 100mW. The maximum data rate is 720kbps/sec.

HomeRF-Bluetooth comparison

HomeRF is optimised for home wireless, providing voice and data requirements. Bluetooth is optimised for cellphone use. HomeRF has a higher data rate and is centred around a desktop PC, while Bluetooth is centred on the mobile phone. Thus while HomeRF offers a unique solution to home computing/internet needs, Bluetooth centres on personal connectivity.

In conclusion

How soon and how far will home networking develop? Pushing technology in the consumer market is a bit like leading a horse to water: you can't make it drink! Excellent technology may be available, but unless there is a real consumer desire it won't translate into everyday products.

Home networks will evolve as consumers begin to expect products to communicate with each other. Manufacturers who recognise this and develop smart-technology network products will be the ones who succeed in this market – which is larger than the value of the networking element. What is at stake basically is the next generation of consumer products.



Steve Beeching describes the operation of a new type of dual-function connector that's now coming into use, mainly in DV camcorders

New dual-function AV connector

Our heading picture shows the Samsung VP-D590i digital camcorder. It comes in a sleek upright design and is one of the smallest MiniDV camcorders on the market. A number of features, such as memory stick compatibility, make it perfect for holiday makers.

A new dual-function AV output jack-socket connector is coming into use, mainly with digital camcorders. To save space in an already packed product, it also serves as a headphone connector. It's important to appreciate that the dual-function switching is not carried out by the jack-socket's internal contacts. A fault in the switching system can cause most unusual problems: if you have no information on how changeover is achieved, such problems can be very misleading – for both the customer and the repairer.

Output sensing

Whether the connector is being used for AV (composite video and audio) outputs or headphones is determined by the impedance to chassis at pin 2 of the jack-socket

presented by the plug that's been inserted. For either AV or headphone use, pin 2 of the socket is the left audio channel connection. Fig. 1 shows the switching system in block diagram form. The system is depicted as consisting of several separate items, but in practice the relevant electronics are contained within a single IC.

When a plug is inserted in the jack socket, the internal switch (see Fig. 2) between pins 4 and 5 closes and pin 30 of IC1 goes low. This puts the IC into the detect mode: detection section output pins 21 and 22 are pulsed low, while switching section input pins 9 and 10 are pulsed high. Within the switching section of IC1, output pin 3 is connected to pin 4 and thus to pin 85 of the detection section.

Pin 85 is connected to an internal potential divider which consists of

two resistors whose values are about 20-30kΩ. The open-circuit standing voltage at pin 85 is greater than 2.5V.

If an AV connector is plugged in, the input impedance of the left-channel of the equipment on the other end of the lead will be about 100kΩ. There will be little or no loading of the potential divider, so the voltage at pin 85 remains above 2.5V.

When headphones are connected, the load impedance is very low. The voltage at pin 85 drops to less than 2.5V, say about 0.3V.

The voltage at pin 85 is checked internally, and tells the detection section of IC1 whether the connection is to an AV or headphone plug. Detection is very quick, during the pulse period of a few milliseconds that's applied to pins 21 and 22. Once IC1 has decided whether the connection is an AV output or to headphones, the logic at pins 21/10 and 22/9 determines the switch positions within the switching section of IC1 and the action of SW1 and SW2.

Table 1 shows the AV/headphone switching conditions at the relevant pins of IC1 (see Fig. 1).

AV operation

In the AV mode pins 21 and 22 of

Table 1: AV/headphone switching conditions.

Condition	IC1 switching	Pins 30	21	22	9	10
Off	3-2, 13-15	H	H	L	H	L
Detect	3-4	L	L	L	H	H
AV	3-1, 13-12	L	H	H	L	L
Phones	3-5, 13-15	L	L	H	L	H

Connector

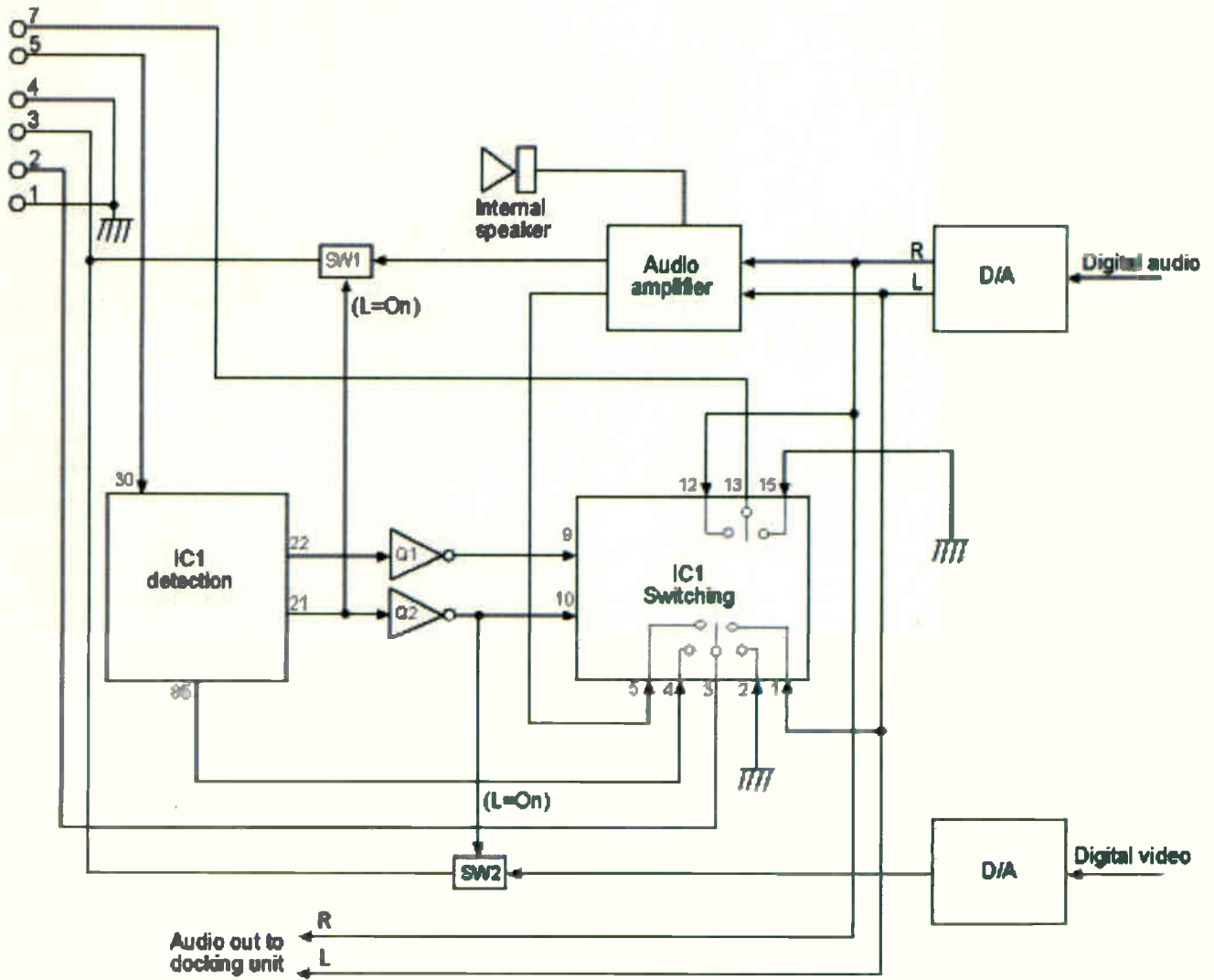

Fig. 1: Block diagram of the AV/headphone switching system.

IC1 are both high, thus pins 9 and 10 are both low. SW1 is in the off position, so R-channel audio does not pass via this route. Instead, pins 12 and 13 of IC1 route R-channel audio to connection 7 and the rear body of the plug. Pins 3 and 1 of IC1 are connected, routing L-channel audio to connection 2 and the tip of the jack plug. SW2 is in the on position, routing video to connection 3 and the video segment of the plug. The chassis link is via connection 1.

Headphone operation

For headphone use the L and R audio signals are amplified by the headphone driver, which might be but is not always a separate IC. R-channel audio is passed via SW1 to connection 3 of the socket, switched by the low at pin 21 (high at pin 10) of IC1. L-channel audio is routed via pins 5 and 3 of IC1 to connection 2 of the socket and the

jack plug's tip. SW2 is in the off position, as pin 10 of IC1 is high, blocking the video signal.

What goes wrong?

Plenty can go wrong, as I've found! First, if the headphones have a volume control the detection voltage at pin 85 of IC1 can be adversely affected. In this case the right-hand ear can be bombarded by a loud buzzing noise – the video signal. Other fault symptoms are lack of either audio channel, or the video signal in the AV mode.

While this might seem to be an easy problem to sort out, in practice the cost may be several hundred pounds. The reason for this is that most of the operations described above are integrated into a single IC on the main PCB. There is no circuit information, and a complete PCB may be required to cure the fault. ■

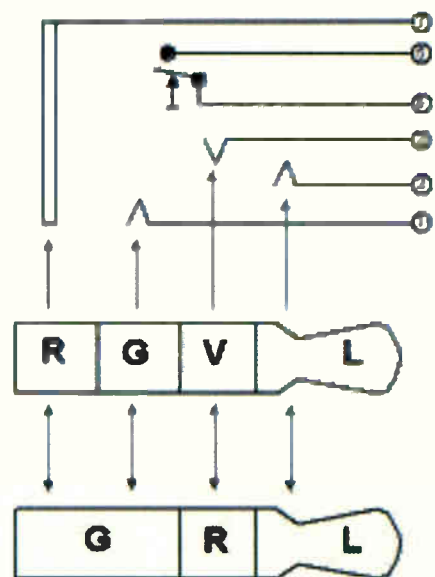
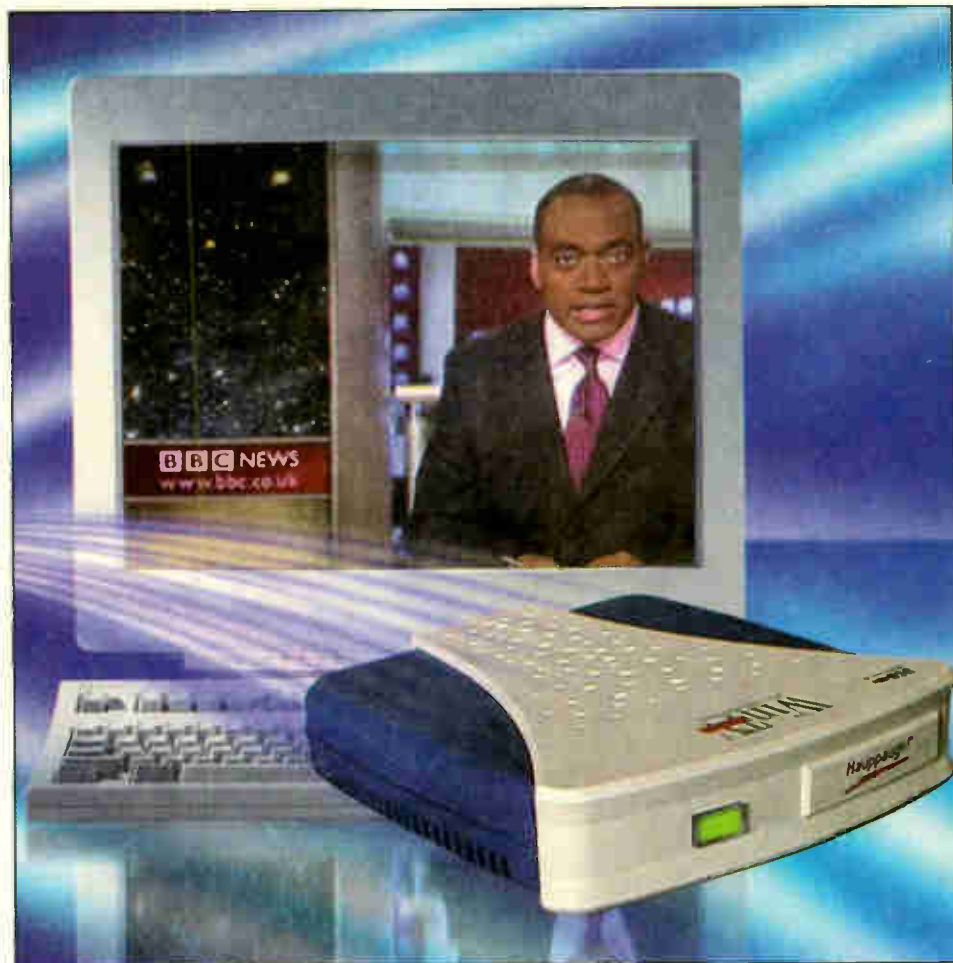

Fig. 2: The jack-plug and socket connections. R = right audio, G = chassis potential, V = video signal, L = left audio.

The Hauppauge WinTV Nova-t unit plugs into a PC's USB port and takes an input from a TV aerial. You can then view all the free-to-air terrestrial digital TV channels - and hear the radio channels - via your computer. Peter Marlow reports on its installation and performance

test report:



Digital TV STB for PCs

This seems to be the year of the free-to-air digital terrestrial TV set-top box, with units now available or due shortly from Pace, Netgem and Nokia. The one under review, from Hauppauge Computer Works, plugs into a PC's USB port and has the advantage that you can record up to three hours of digital TV on a recordable DVD disc or approximately twenty hours of video on a 30GB hard disk.

Hauppauge produces a whole range of

TV add-on units for PCs, either as PCI cards for fitting internally or as units for connection to the USB port. Various models receive analogue TV with teletext and Nicam sound, free-to-air digital satellite transmissions with an option to have broadband internet connection, and digital terrestrial TV. For more information on the range, see the company's website at www.hauppauge.co.uk

The WinTV Nova-t USB measures

204mm deep, 148mm wide and 37mm high and sits nicely next to a PC. It runs quite hot however, and should not be stacked under other devices. The "WinTV DVB - terrestrial" logo on top seems to be printed the wrong way up for normal use! It's probably printed that way for packaging purposes. The front panel is pleasantly curved and has a red LED to indicate power on (unlike the accompanying picture). The rear panel has a standard UHF aerial input socket. a

System requirements

The unit's packaging indicates that it works with Windows 95/98/ME or Windows 2000. Windows 95 users must have full USB support installed however - this is not made clear. The full system requirements are as follows:

A PC with a Pentium processor (Pentium III 500 or higher recommended).

A USB port.

Minimum 64MB of RAM.

64MB of free space on the hard disk.

A graphics card with a minimum resolution of 800 x 600 pixels in either 'High Colour' (16 bits) or 'True Colour' (24 or 32 bits).

An active speaker or soundcard/speaker combination.

Soundcard or OnBoardSound.

A CD-ROM drive (required only for software installation).

Microsoft Windows 98/ME or Windows 2000.

DirectX 7 or higher.

Microsoft Internet Explorer 5.0 or higher.

In addition a connection to a high-gain TV aerial system is required. To check on digital TV coverage in your area, visit the sophisticated postal code database at www.dtg.org.uk/retailer/coverage.html

UHF output socket, a 12V power supply input connector and the USB socket.

Installation

The Nova-t comes with a 12V mains power supply, a quick Installation Guide, software on a CD-ROM with a fuller manual, and a USB cable.

I set up the hardware carefully following the installation instructions, but was concerned that my system would not be fast enough as I have a USB four-port hub attached to my PC. Fortunately speed was not a problem, though the scanner that shares the hub causes interruptions to the picture when it operates. It's therefore better to connect the WinTV unit to its own PC USB socket – most PCs have two these days.

Software installation appeared to be straightforward from the manual, but I ended up doing it twice before it was successful! The installation also puts InterVideo WinDVD player on your machine to provide playback of recordings.

A PC reboot was needed after installation. I then clicked Start, Programs to find the Hauppauge WinTV Nova-t USB program. Three items were listed under this heading. DVB Data Control, TV Digital, and Uninstall. TV Digital is the one you want. DVB Data Control doesn't work – according to the Hauppauge technical help line it's there because the software also covers satellite systems. If you do select it, odd messages appear and it can mess up the TV start-up. There's nothing in the manual about this.

When I clicked on TV Digital the TV screen window appeared. The next step was to click on the satellite icon, which produced a dialog box that asked for my local transmitter location. A click on Start Scan produced a long list of TV channels. I stored the list and returned to the TV screen window. Choosing BBC News 24, I was rewarded with a good picture, in full widescreen format, and stereo sound.

Operation

The TV screen window is nicely laid out, with programme selection at the left, the picture at the top right and programme information at the bottom right – see accompanying photo. Icons at the top right enable the picture to be expanded to fill a window or occupy the full screen. Double-clicking the picture restores the main TV screen window. I found that these icons didn't always work first time however, the result being a blank screen. Also, restoring a minimised window didn't always bring back the picture. The record controls are at the bottom left.

To select a channel, you click on the station name. There is rather a long delay

before the picture and sound appear. Encrypted channels are not shown of course – a small key appears at the top left.

Recorded programmes are captured digitally in MPEG-2 form. A one-hour programme takes approximately 1.6GB of hard-disk space. You can record up to three hours of digital TV on a DVD recordable disc, or approximately twenty hours of video on a 30GB hard disk. When you click the record button at the bottom left of the screen a dialog box appears. It requests the hard-disk location where the recording should be placed. It's not clear whether you can dump recordings straight to a CD-ROM or DVD 'on-the-fly'. Plyback is via the WinDVD player – the icon for this is placed on the desktop during the software installation process. Note that duplication of digital programmes is subject to copyright laws and cannot be made without written authority from the rightful owners.

Conclusions

The average mail-order price of the Hauppauge WinTV Nova-t USB is £199 including VAT. I enjoyed using it, and it worked well and reliably, but I can't help feeling that it is over-priced in comparison with alternatives. It could also do with some extra features, such as remote control and a larger programme information window. A hardware slot (or maybe software?) could be provided for access to pay-TV channels. The recording system should have a timer.

I found it worthwhile carrying out a regular scan of the digital channels, as

new stations appear from time to time, for example BBC4, CBeebies and CBBC. The unit also picks up radio transmissions, but more digital radio stations should be made available – this is not within Hauppauge's control of course.

For more information, contact Hauppauge Computer Works Ltd., 6-10 Bank Chambers, Borough High Street, London SE1 9QQ. Telephone 020 7378 1997. The technical support line is on 020 7378 0202. See earlier in this review for the website address.

For information on what's available free via digital terrestrial and digital satellite TV take a look at the following website <http://www.freetoview.co.uk/>

Currently available free-to-view digital transmissions

Television

BBC1	ITV1
BBC2	ITV2
BBC Choice	Channel 4
BBC News 24	Channel 5
BBC4	Shop!
CBBC	ITN News Channel
CBeebies	TV Travel Shop

Stereo radio:

BBC Parliament



The TV screen window.

This 17in. Trinitron-tube monitor's production run lasted for several years. Large numbers were sold as the Dell VC7EN. In Part 3 of his series Donald M. Henry looks at the operation of the EHT generator section with its two transformers and describes some workshop experiences

Servicing

the Mitsubishi TFS6705K monitor

So far we have covered the video channels and related control arrangements, and the timebases and raster correction circuitry system. This month we'll tackle the complex EHT generator. The power supply section of the monitor and the processor board will be the subject of further articles in the series.

The EHT section

Last month I mentioned that there are separate line output and EHT stages and covered the former in some detail. I also mentioned the surprise fact that two separate transformers are used to generate the EHT. Fig. 1 shows the circuitry involved. The DC potential developed by T601-2 is fed via a white rubber-insulated lead to the EHT winding on T601-1. Thus the total EHT fed to the CRT's final anode is the sum of voltages produced by T601-2 and T601-1.

T601-2 is driven by Q801, which is in turn driven by a secondary winding on T601-1. T601-1 is driven by Q603. The EHT drive comes from the line oscillator, which as we saw last month is in IC502. It's fed via D609 to the gate of Q611 (2SK982). The drain of this transistor is connected to a couple of protection systems that can shut down the EHT, so we need to make a brief diversion at this point to consider the protection

arrangements. The situation when line collapse causes EHT shut down was described in Part 2.

Protection

In Part 1 beam-limiter action to reduce the contrast level was described. This action occurs when the beam current, checked at pin 3 of T601-2 flowing via R810, exceeds 0.6mA. The beam current through R812 is also monitored. Should it exceed about 1mA, the voltage at pin 6 (inverting input) of IC801 will switch this operational amplifier's state. The voltage at pin 7 will rise and, via D802, fire the TF341M thyristor Q606. This shorts the drain of Q611 to chassis, as with line output failure protection (see D529 at the top right corner of Fig. 7 last month), and will remain on until the monitor is switched off then on again.

The winding at pins 5-6 of T601-2 feeds rectifier D808 which charges C803 (47 μ F). The voltage developed here is proportional to the EHT output, as driven by Q801 from pin 2 of T601-1. The EHT itself is sampled by R610, which is in series with the focus and G2/A1 controls. The voltage across R610 is applied to the base of Q608, which thus produces at the slider of VR602 a DC level which is proportional to the sampled overall EHT voltage. These overdrive or overvoltage conditions are

fed via D807 and D806 respectively to pin 3 of IC801. This is the non-inverting input to the other operational amplifier in the chip. The inverting input is held at a stable reference voltage established by zener diode D811 (HZ5C3). If the voltage at the anode of either D806 or D807 rises to about 6V, the voltage at pin 1 of IC801 will rise and, via D803, fire Q606, shutting down Q611 in exactly the same way as described above. Note that VR602 is sealed under a rubber pot – do not disturb it. Note also that many of the resistive components in the protection area are marked with a safety triangle. Thus in the event of failure of any of them the replacement must be of identical type.

In the event of excess current through the primary winding of T601-1, perhaps because of failure of Q603, if the power supply doesn't go into the trip mode R623 (0.22 Ω) will go open-circuit. This protects the large, expensive transformer – successfully, too, as I've had to replace hundreds of short-circuit Q603s but have never had a transformer failure. Otherwise, excess current for any reason will increase the voltage across R623 with the result that Q610 (2SC3621) switches on, shorting the drain of Q611 to chassis. The same action is undertaken by Q604 (another 2SC3621) should the voltage across winding 5-

4 of the transformer indicate that there is excessive peak voltage at the drain of Q603. This might happen if D605 is open-circuit or dry-jointed.

Operation of T601-1

Having seen how the EHT is stopped, let's see how it gets started. In a conventional line, EHT or combined line/EHT output stage the transistor acts as a switch, generating energy in the transformer's core when it switches on. When the tran-

sistor is switched off, a high pulse voltage is generated at its collector. This half cycle of oscillation is produced as energy is transferred from the transformer to the tuning capacitor and back again. At the end of the half cycle the efficiency diode switches on to prevent further oscillation and produce a controlled current decay in the winding. In the TFS6705K the efficiency diode doesn't appear to be across the tuning capacitance. Also in a conven-

tional circuit the amplitude of the current pulse at the collector of the output transistor will decrease should the frequency increase. In the TFS6705K the peak pulse amplitude at the drain of Q603 is maintained constant regardless of frequency (within the operating limits). How is this achieved?

Unlike the line output stage described last month, the DC supply to T601-1 is a fixed 168V. The drain of the n-channel output MOSFET

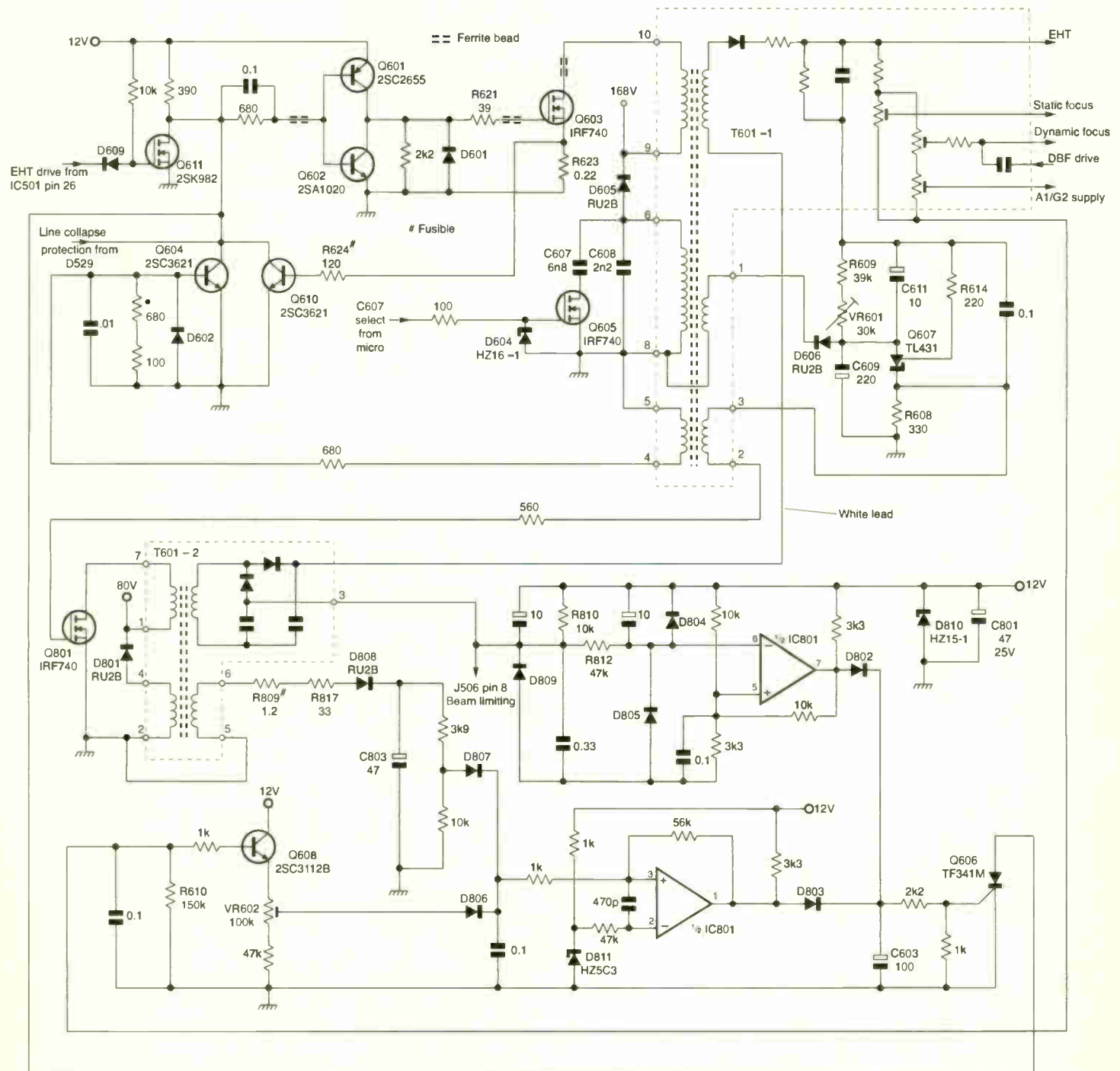

Fig. 1: The EHT generator circuit.

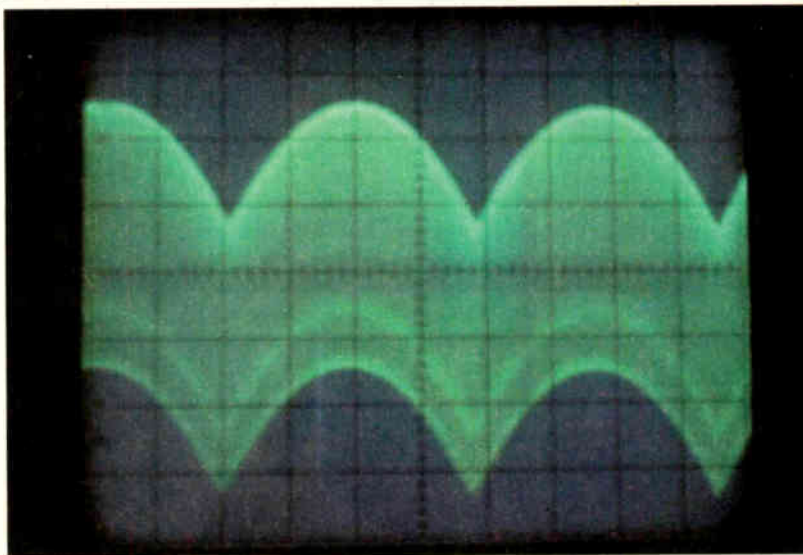

Fig. 2: The dynamic beam focusing waveform at J706.

Q603 is connected to pin 10 of the transformer, but there's no tuning capacitor to be seen here. For simplicity, disregard Q605 for the moment and think of capacitors C607 and C608 as being connected in parallel. The latter is always in circuit anyway at line frequencies below 38.8kHz.

When Q603 is switched on, current flows via pins 9-10 of the transformer, supplied by capacitors C616, C617 and C606, and flux is developed in the core of the transformer. D605 is open-circuit during this action. The winding between pins 6-8 has a 1:1 relationship to that between pins 9-10. As a result the tuning capacitors C607/8 are charged to the value of the HT supply (168V), but in reverse polarity. When Q603 is switched off, the field in T601-1 collapses and the energy is transferred, via winding 6-8, charging C607/8. As they have already been charged, they end up with double the HT voltage but, remember, in reverse polarity. So D605 is still reverse biased and non-conductive. D605 does not conduct until the amplitude of the next pulse at the drain of Q603 reaches that of the voltage across C607/8. When the pulse rises to 336V, D605 conducts, joining the two windings. The amplitude of the pulses at the drain of Q603 are thus effectively capped, achieving output stability.

The resonant-circuit rules apply to EHT generation of course as much as they do with the line output stage. With higher frequencies (above 38.8kHz) a lower capacitance value is required. The microprocessor therefore switches Q605 off, leaving C607 open-circuit with only C608 to provide the tuning. This has the effect of maintaining the amplitude

of the pulses at the drain of Q603, so that the EHT output from T601-1 remains constant with operation above 38.8kHz. Thus the EHT obtained from the winding is constant regardless of frequency – cunning stuff!

EHT regulation

The EHT is sampled within T601-1 by a network that includes the external components R609, VR601 and C611, which sit on a negative voltage produced by D606 and C609. The TL431 programmable voltage reference device Q607 acts as a current shunt, developing a DC voltage across R608. The higher the EHT the more Q607, whose reference 'electrode' is connected to the sampling network at the junction of R609 and C611, conducts and the lower the DC level at R608 becomes (i.e. more negative with respect to chassis). This voltage is fed back to the gate of Q801, via winding 3-2 on T601-1, as bias. The effect is to alter the point at which Q801 conducts during the switching cycle, thus altering its on time and the contribution to the EHT made by T601-2 via the white rubber-insulated wire. To sum this up, EHT regulation is contributed by T601-2, T601-1's contribution to the EHT remaining constant.

Focusing

The Trinitron tube is provided with static and dynamic focusing (it's called a dual-astigmatism focus CRT). Brian Storm described DAF (dynamic auto-focusing) in the August 2001 issue of *Television* (see Fig. 1, page 597, August 2001). I'm not familiar with the Panasonic chassis Brian was discussing, but the idea of modulating the focus voltage with a frame-rate parabola is also used in

the TFS6705K monitor. It's referred to as DBF (dynamic beam focusing).

The Sony tube used in this monitor has two focus electrodes, static and dynamic, which is how the term dual-astigmatism focusing arises. In addition to the two thickly insulated focus leads (red and white) from T601-1 there's an orange lead that carries the DBF modulation. The thick red A1/G2 supply lead is soldered to the back of the video PCB, and there are thick wires to and from the H-stat control. Prepare for a thick head when you come to investigate it all!

The waveforms used for DBF are generated by IC705 on the PWB-DEFL-SUB panel. DBF-V and DBF-H were amongst the items listed in Table 6, Part 1 (LED chart for factory-mode adjustments, page 334 April). The microcontroller chip, via DA conversion, controls the vertical and horizontal components of the DBF waveform. IC708 (DAC8840) on the PWB-DEFL-SUB panel sets the H sawtooth/parabolic and V parabolic levels, after which the waveforms are combined in IC702 (C4082) and fed to an output amplifier. A picture is always worth a thousand words. The output obtained from Q717 (2SC4632) in the output stage can be scoped at J706. You should see the waveform shown in Fig. 2. 390V of modulation is applied to the focus voltage (at the dynamic focus electrode) throughout each line, the amplitude of the parabolic component during each frame being 180V.

Workshop experiences

If the power supply is tripping, with an audible whine, at power on, measure the resistance between pin 10 of EHT transformer T601-1 and chassis (first remove the plastic tray beneath the main PCB, by sliding it forwards and pulling it down). A short-circuit reading will usually mean that the IRF740 MOSFET Q603 is faulty. To remove it is not a two-minute job. Unless you repair these monitors frequently, I suggest that you make a careful note of where the various screw types come from. The procedure is as follows:

- (1) Remove the chassis from the CRT – four screws and seven cables.
- (2) Remove the vertical plastic guides at the side of the power panel – two screws.
- (3) Remove the plastic rail and sheet above the processor control panel. Unplug cables here to ease main PCB removal.

(4) Remove the four corner screws (short) on the main chassis and the three EHT transformer screws (long). Use a magnetic screwdriver or lose the screws in the jungle!

(5) Remove the main PCB from the plastic frame.

(6) Remove the screw and nylon washer from Q603.

(7) Apply solder to the underside of the main PCB at Q603, heat all three legs simultaneously and withdraw the transistor. Be careful not to pull out the feed-through holes between the double-sided print layers.

(8) Clear the holes with a sucker.

(9) Install a new IRF740 and reassemble, with a new nylon washer and insulation.

Normally only Q603 fails. But some later production models seem to suffer from additional component failure in this area when Q603 goes short-cir-

cuit. Miss one part and you have to begin again. The tell-tale signs are a small burn-up at R621. Replace the following: R621 (39 Ω), R623 (0-22 Ω), R624 (120 Ω), Q601 (2SC2655), Q602 (2SA1020), Q603 (IRF740) and Q610 (2SC3621).

I have encountered a short across the 12V rail following replacement of the foregoing items. Be warned: the 12V rail goes everywhere in this chassis. Unplugging and removing the PWB-DEFL-SUB panel from the main PCB eliminates a great deal in one go. Do the same with the PWB-SYNC-SUB and PWB-VIDEO panels then, if the short remains, prepare to get out the iron! In one example the HZ15-1 protection zener diode D810 was the culprit (see Fig. 1). You might as well check C801 at the same time.

With less complex models it's typical for the line output transistor to fail and take with it the B+ regulator, in this case Q952. The reliability of these components in the TFS6705K is truly outstanding however. Should you encounter such a failure, I suggest a check on the 11.3V zener diode D961

which, in a similar circuit position in other designs, I have on rare occasions found leaky or shorted.

With the second common cause of tripping the whine doesn't start as soon as you switch on. Instead, you hear the static bristle of rising EHT, the degaussing 'bonk', then shut down and whine about seven seconds later, followed by the discharge of EHT static. The cause of the trouble is the cooling fan.

Yes! It's a 12V DC fan with three wires. The fan has a strobe which must send to the microcontroller chip a signal at about 1,600 revs/min, otherwise the whole show stops. There is access to a small circlip under the label on the top side. Dismantle the fan, withdraw the fan blades, and you will be able to lubricate the bearings. This is only a temporary measure, for desperate computer anoraks. A sticky or noisy fan should be replaced, even if it runs fast enough.

Next month

Our next look at this monitor will cover the power supply circuitry.

HELP

The help wanted column is intended to assist readers who require a part, circuit etc. that's not generally available. Requests are published at the discretion of the editor. Send them to the editorial department - address on Letters page.

WANTED

Wanted: Small transformer for the DC-DC converter board LD702 in the Ferguson 10R TX80 chassis. The part no. is 0XXL0341-400. Also circuit diagrams for the old Ferguson valve TV Model 968T and the Heathkit SW717 radio. H.S. Downing, 16 Mayfield Crescent, Lower Stondon, Henlow, Beds SG16 6LF. Phone 01462 850 244.

For disposal: Ex-BBC 625- to 405-line standards converter (discrete transistor type). With some spare circuit boards and the manuals, circuit diagrams etc. Phone Steve Giess on 01684 540 348 (Malvern).

Wanted: Circuit diagram, layout and parts list for the EHT circuitry in the TEK465M oscilloscope serial no. B055208. It's apparently the same as in an early plain 465. I have a manual for the later 465, serial no. B250000 and after, but it's different. David Hoare, 53 Main Road, Nottingham NG4 3HS.

Wanted: Information on how to put the Decca 20TKG K-series TV sets in the service mode for height etc. adjustment. Phone Mr Denny on 0117 964 6687.

Wanted: Circuit diagram for the HP890C printer power supply. Phone D.J. Long on 01274 877 211 or e-mail valid@tesco.net

Wanted/for disposal: Require circuit diagrams for the Acer 7257C monitor (manufactured in February 1999) and a remote-control unit for the Toshiba VCR Model V215B. Have for disposal a Gould dual-trace, 30MHz oscilloscope Model OS1100. Phone Vince Buffin on 01752 215 536.

Wanted: Complete chassis assembly, working if possible, for the Hitachi Model C32WD2TN2-311. Phone Doug Westland on 0161 223 9724 or e-mail dwstlnd@aol.com

Wanted: Someone to repair a Maplin JTR240P surveillance recorder, make unknown. Preferably someone local to London E6. E-mail roger @jivemaster.fsnet.co.uk

Wanted/for disposal: Require operating instructions for the Dawe Universal Impedance Bridge type 314C; service information/operating instructions for an Optimus TVP-343 TV/video combi unit (similar to a Goodmans model?); and RCA valve amplifier circuit references. Have for disposal a Philips PM5506 pattern generator and a Scopex oscilloscope Model 4D-10B. Phone Ken on 01323 500 174.

Wanted: Service manual for the Panasonic TV Model TX28W2 (Alpha 3

chassis). Phone Graham Presley on 0161 487 2842 or mobile 07887 552 523.

Wanted: Circuit diagram or service manual for the Ferguson FV82LV VCR (photocopies OK); also a teletext board, working or not, for the Philips 2A TV chassis. K. Howells, 81 Wye Court, Thornhill, Cwmbran, Gwent NP44 5UL. Phone 01633 838 464.

For disposal: Television magazines from 1984-1990, free. Phone R. Flitcroft on 0161 684 1214 (Manchester).

Wanted: Mitsubishi TV Model CK3751TX or VS451B. Condition of chassis unimportant but cabinet must be in mint condition. Phone Leslie Hine on 01229 582 557 (Lake district).

Wanted: Chopper transformer for the Matsui CTV Model 1422, part no. 5914-06002A-AA (also marked KV89157). An A51JXH61X 21in. CRT for the Sony Model KV-X2152U, part no. 8-738-758-05. Must be in good condition - not scratched or low-emission. LA6358S ICs for the power supply in Amstrad SRX100/200 satellite receivers. Part no. 240015, circuit reference IC004. Please call Steve Roberts on 01687 462 198 (Inverness-shire) any time.



AUDIO FAULTS

Reports from
Eugene Trundle
Lee Archer
and
Geoff Darby

We welcome fault reports from readers – payment for each fault is made after publication. See page 488 for details of where and how to send reports.

Sony HCD-H551

There was mains-frequency hum on both channels with all functions. It disappeared only at the zero setting of the volume control. Scope checks revealed that there was ripple on the $-7.7V$ supply and very heavy ripple on the $-13.5V$ supply. The culprit was C1002, which was weeping slightly and bulged at the top. E.T.

Yamaha SPX90 FX unit

This unit had no LCD or seven-segment displays, the bar graph was permanently lit at 0dB, and there was no audio output. The cause of the problem was the 15DF2 rectifier diode D7, which went open-circuit under load. As a result here was then no $-18V$ supply and the $+18V$ and $+5V$ supplies were low, as a reference is fed back from the $-18V$ supply. As I didn't have a 15DF2 in stock I used a BY299 as the replacement. L.A.

Sony MZ-R70

If it was left alone this personal MD unit would play discs perfectly. But if it was moved, picked up or tilted it would usually, though not always, just die with a blank display. How it was held when it was being moved seemed to be related to the problem.

The symptoms were much harder to instigate when the bottom case had been removed. PCB prodding and probing produced inconclusive results, but I eventually discovered that the problem didn't occur when the door was held to the main body. The cause of all this trouble was the bent-round 'foot' on the right-hand door hinge. It presses on the door open/close switch, and was not of quite the right profile. As a result it only just closed the switch when the door was closed. Any movement that flexed the case or PCB by even the smallest amount would open the switch momentarily. The unit then stopped and the display went blank. As soon as the unit was turned the right way up the switch remade and the disc restarted, as if it had just been inserted.

The cure was simply to bend the foot into the correct shape, so that it maintained firm but not excessive pressure on the switch at all times. G.D.

JVC CA-EX70R system

I've had several of these three-disc CD changers now with the same problem and a common cause. Customer complaints may be "won't play some discs", "won't play some discs in some positions" or a "scraping noise when playing some discs".

If the customer hasn't provided a sam-

ple disc that offends in the way described, you may find that you have to go through several of your own before you find one that produces the problem. When the disc spins at the full rate you will see it wobbling to such an extent that its edge catches on the tray. It's so bad you would think that either the turntable or the motor shaft is bent. But put another disc in and it will be fine.

The cause of the problem is that the diameter of the centre boss of the turntable is at the upper limit of its moulding tolerance. This doesn't itself cause a problem. The difficulty arises when the centre-hole diameter of the disc is at the lower limit. You then get a slight 'stick' situation, and the magnetic pull of the disc clamp is not quite enough to force the disc down on to the turntable – hence the wobble.

The problem is easy to cure. First, remove the disc clamp. Load the top tray into the 'play' condition, then disconnect the power. Place a bad disc on the turntable and push it firmly down. Next use the tip of a scalpel to lift, gently, an edge of the disc. You will feel it 'pop' off the turntable as it unsticks. Hold the scalpel straight against the vertical face of the turntable's centre boss and, pressing firmly, rotate the turntable a few turns by hand. This will pare a very fine and uniform layer of plastic off the boss. G.D.

Sony XR-C6220R

There was an interesting fault with this car radio-cassette unit. Its owner said that the volume control crackled at some points, the sound would go off completely, and the 'D-bass' function was intermittent. I was sceptical about this, as the volume control is electronic, controlled by a rotary encoder. But, sure enough, when the unit had been on for a while certain click points on the control produced a nasty interference, while with others the sound disappeared.

Further assessment revealed that the onset of the symptoms had nothing to do with the actual rotational position of the encoder. Instead, it was individual discrete steps in the volume-control characteristic that caused the trouble. As the fault didn't show up until the unit had been on for a while, judicious use of freezer seemed the best way of pursuing the diagnosis. There were immediate results when the surface-mounted TDA7462D chip IC401 on the main PCB, under the tape deck, was sprayed. In fact individual drops of freezer and heating with the tip of a soldering iron made the fault come and go. A replacement IC cured the fault. G.D.

Grandata Ltd

distributor of electronic components

CD Pick Ups and Mechanisms



Part No	Price	Part No	Price
KSS 210A Original	£14.00	KSS 213 F	£12.00
KSS 210A Replacement	£11.00	KSS 240 A	£30.00
KSS 210 B	£15.00	NKS 240 A	£20.00
KSS 213 B	£11.50	Replacment for KSS240A	£20.00
KSS 213 C	£11.50	OPTIMA 6 S	£11.50
KSS 213 D	£16.00	OPTIMA 5	£11.50
		RCTRTH8151	£20.00
		RCTRTH8112	£15.00

CD Mechanisms

KSL 2101 ABM Mechanism	Code : KSL2101ABM	Price : £ 18.00
KSM 213 CCM Mechanism	Code : KSM 213 CCM	Price : £ 15.00
RCTRH8147 Mechanism	Code : RCTRH8147MECH	Price : £ 10.00
CDM 12.1 Mechanism	Code : CDM121MECH	Price : £ 16.00
SF91 Mechanism	Code : SF91MECH	Price : £ 20.00
SF91 Carriage & Mechanism	Code : SF91CARR	Price : £ 20.00

105°C Radial Electrolytic Capacitors

VALUE	CODE	PRICE	PER PACK	VALUE	CODE	PRICE	PER PACK	VALUE	CODE	PRICE	PER PACK	VALUE	CODE	PRICE	PER PACK
10 Volts				35 Volts				63 Volts				160 Volts... continued			
100uF	CAP118	£0.45	10	1uF	CAP130	£0.40	10	0.22uF	CAP145	£0.45	10	22uF	CAP148	£1.80	10
470uF	CAP29	£1.20	10	3.3uF	CAP131	£0.40	10	0.47uF	CAP73	£0.35	10	33uF	CAP149	£2.30	10
1000uF	CAP119	£1.50	10	4.7uF	CAP132	£0.45	10	1uF	CAP74	£0.35	10	100uF	CAP150	£3.25	5
2200uF	CAP120	£2.10	10	10uF	CAP52	£0.50	10	2.2uF	CAP75	£0.35	10	200 Volts			
16 Volts				50 Volts				100 Volts				400 Volts			
22uF	CAP121	£0.35	10	1uF	CAP137	£0.35	10	0.47uF	CAP91	£0.50	5	1uF	CAP107	£2.15	5
33uF	CAP122	£0.35	10	2.2uF	CAP138	£0.35	10	1uF	CAP92	£0.85	10	2.2uF	CAP108	£2.25	5
47uF	CAP123	£0.35	10	3.3uF	CAP139	£0.35	10	1uF	CAP93	£0.70	5	4.7uF	CAP109	£3.15	5
100uF	CAP124	£0.60	10	4.7uF	CAP140	£0.35	10	1.5uF	CAP94	£0.50	5	10uF	CAP110	£4.00	5
220uF	CAP125	£0.80	10	10uF	CAP63	£0.50	10	2.2uF	CAP95	£0.50	5	22uF	CAP111	£2.50	2
330uF	CAP30	£1.75	10	22uF	CAP64	£0.70	10	3.3uF	CAP96	£0.50	5	47uF	CAP112	£3.50	2
470uF	CAP31	£1.75	10	33uF	CAP141	£0.85	10	4.7uF	CAP97	£0.95	10	100uF	CAP160	£4.00	2
680uF	CAP32	£2.10	5	47uF	CAP65	£0.85	10	10uF	CAP98	£1.05	10	220uF	CAP161	£7.00	2
1000uF	CAP33	£2.10	10	68uF	CAP142	£0.90	10	22uF	CAP99	£1.55	5	450 Volts			
2200uF	CAP34	£5.25	10	100uF	CAP66	£0.85	10	47uF	CAP100	£1.75	10	1uF	CAP113	£2.80	5
3300uF	CAP35	£5.00	5	220uF	CAP67	£1.75	10	100uF	CAP101	£2.10	10	2.2uF	CAP114	£3.20	5
4700uF	CAP36	£6.10	10	330uF	CAP68	£2.45	10	220uF	CAP102	£6.00	5	4.7uF	CAP115	£4.95	5
25 Volts				100 Volts				160 Volts				220 Volts			
10uF	CAP37	£0.45	10	1uF	CAP71	£5.25	10	2.2uF	CAP146	£0.45	10	10uF	CAP116	£5.50	5
22uF	CAP38	£0.45	10	1000uF	CAP72	£3.25	2	10uF	CAP147	£1.40	10	22uF	CAP117	£4.15	2
33uF	CAP126	£0.40	10	1500uF	CAP143	£4.50	5								
47uF	CAP39	£0.48	5	2200uF	CAP72	£3.25	2								
68uF	CAP127	£0.55	10	3300uF	CAP62	£10.00	5								
100uF	CAP40	£0.70	10	4700uF	CAP36	£6.10	10								
120uF	CAP128	£0.85	10												
150uF	CAP41	£0.95	5												
220uF	CAP42	£1.20	10												
330uF	CAP43	£1.40	5												
470uF	CAP44	£1.90	10												
680uF	CAP45	£3.15	5												
1000uF	CAP46	£3.65	5												
101500uF	CAP47	£3.90	5												
2200uF	CAP48	£2.00	2												
3300uF	CAP49	£2.20	2												
4700uF	CAP50	£3.65	2												
6800uF	CAP51	£3.90	2												

Digital Capacitance Meter



3.5 Digit LCD 1999 Count
 9 Selectable ranges from 200pF to 20mF
 Supplied with Holster
 High Accuracy
 (0.5% < 2000uF, 1%:2000uF, 2%:20mF)
 External control for zero adjustment
 Overload indication
 Safety designed test probe
 Powered by 9V battery

Order Code : 2450AS
Price : £ 28.00 + vat
Postage : £ 3.00 + vat

K.P. House , Unit 15 , Pop In Commercial Centre , Southway , Wembley , Middlesex . HA9 0HB England

Tel : (020) 8900 2329

Email : sales@grandata.co.uk

Fax : (020) 8903 6126

Website : http://www.grandata.co.uk

Grandata Ltd

distributor of electronic components

Television Repair / Mod Kits

MAKE & MODEL	KIT TYPE	CODE	MAKE & MODEL	KIT TYPE	CODE	MAKE & MODEL	KIT TYPE	CODE
ALBA			JVC			PHILIPS		
1452T	POWER SUPPLY	ONWAKIT	AV29SX1EK	FIELD OUTPUT KIT	JVCKIT1	310.10708		.PHILKIT3
1427T	POWER SUPPLY	ONWAKIT	AV29SX1EN	FIELD OUTPUT KIT	JVCKIT1	310.20491		.PHILKIT2
1402	POWER SUPPLY	ONWAKIT	AV29SX1EN1	FIELD OUTPUT KIT	JVCKIT1	310.20496		.PHILKIT10
1455T	POWER SUPPLY	ONWAKIT	AV29SX1PF	FIELD OUTPUT KIT	JVCKIT1	310.31994		.PHILKIT6
1456T	POWER SUPPLY	ONWAKIT	AV29TSIE1	FIELD OUTPUT KIT	JVCKIT1	310.32252		.PHILKIT5
1458T	POWER SUPPLY	ONWAKIT	C14E1EK	POWER SUPPLY	ONWAKIT	310.32253		.PHILKIT4
1459T	POWER SUPPLY	ONWAKIT	C14T1EK	POWER SUPPLY	ONWAKIT	310.32254		.PHILKIT9
1499Y	STANDBY FAULT	MODKIT37	C21ET1EK	POWER SUPPLY	ONWAKIT	310.32255		.PHILKIT7
2002	POWER SUPPLY	ONWAKIT	CS21M3EK	POWER SUPPLY	ONWAKIT	310.32262		.PHILKIT8
2009B	POWER SUPPLY	ONWAKIT	MATSUI			310.62264		.PHILKIT1
2052T	POWER SUPPLY	ONWAKIT	1455	POWER SUPPLY	ONWAKIT	ANUBIS A	SOPS	.PHILKIT2
2152T	POWER SUPPLY	ONWAKIT	1498	POWER SUPPLY	ONWAKIT	CP110 CHASSIS	SOPS	.PHILKIT8
2099TX	STANDBY FAULT	MODKIT37	2086	POWER SUPPLY	ONWAKIT	G90A CHASSIS	SOPS	.PHILKIT10
BTV17	STANDBY FAULT	MODKIT37	2098	POWER SUPPLY	ONWAKIT	G90B CHASSIS	SOPS	.PHILKIT10
CTV501	POWER SUPPLY	ONWAKIT	211V1N (BUZ90)	POWERSUPPLY	GRUNDIGKIT2	G110 CHASSIS	SOPS	.PHILKIT3
CTV701	POWER SUPPLY	ONWAKIT	21V1T (MJF18004)	POWER SUPPLY	GRUNDIGKIT3	GR2.1 CHASSIS	SOPS	.PHILKIT1
CTV840	POWER SUPPLY	ONWAKIT	TVR180RT/2080	STANDBY FAULT	MODKIT37	GR2.2 CHASSIS	SOPS	.PHILKIT1
CTV841	POWER SUPPLY	ONWAKIT	DAIICHI			D-16 CHASSIS	SOPS	.PHILKIT6
CTV485	POWER SUPPLY	ONWAKIT	AV1 SERIES	POWER SUPPLY	MITSKIT3	HSM VIDEO	SOPS	.PHILKIT5
AKAI			CT1M5B	POWER SUPPLY	MITSKIT3	JSM VIDEO	SOPS	.PHILKIT4
CT1417	POWER SUPPLY	ONWAKIT	CT21M5BT	POWER SUPPLY	MITSKIT3	KSM VIDEO	SOPS	.PHILKIT9
CT2159U	POWER SUPPLY	ONWAKIT	CT25M5BT	POWER SUPPLY	MITSKIT3	LSM VIDEO	SOPS	.PHILKIT7
CT2162UNT	POWER SUPPLY	ONWAKIT	CT21A2STX	TDA 8178S	MITSKIT1	SAMSUNG		
CT2863UNT	POWER SUPPLY	ONWAKIT	CT21AX1B	POWER SUPPLY	MITSKIT3	CI5944	FRAME OUTPUT	SAMKIT2
DECCA/TATUNG			CT21A3STX	TDA 8178S	MITSKIT1	CI6844	FRAME OUTPUT	SAMKIT2
TVC563	STANDBY FAULTY	MODKIT37	CT21AV1BS	POWER SUPPLY	MITSKIT3	VIK310	POWER SUPPLY	SAMSUNGKIT
GOLDSTAR			CT25A2STX	TDA 8178S	MITSKIT1	VIK320	POWER SUPPLY	SAMSUNGKIT
CF25A50F	FRAME OUTPUT	MODKIT36	CT25A3STX	TDA 8178S	MITSKIT1	VIK350	POWER SUPPLY	SAMSUNGKIT
CF25C22C	FRAME OUTPUT	MODKIT35	CT25A4STX	TDA 8178S	MITSKIT1	VI375	POWER SUPPLY	SAMSUNGKIT
CF28A50F	FRAME OUTPUT	MODKIT36	CT25A6STX	TDA 8178S	MITSKIT1	VI395	POWER SUPPLY	SAMSUNGKIT
CF28C22F	FRAME OUTPUT	MODKIT35	CT25AV1B	POWER SUPPLY	MITSKIT3	WINNER 1	POWER SUPPLY	SAMSUNGKIT
CF28C28F	FRAME OUTPUT	MODKIT36	CT25AV1BS	POWER SUPPLY	MITSKIT3	SHARP		
CF29C42F	FRAME OUTPUT	MODKIT35	CT25AV1BD	POWER SUPPLY	MITSKIT3	51CS03H	POWER / LINE	SHARPKIT1
GOODMANS			CT25AV1BDS	POWER SUPPLY	MITSKIT3	51CS05H	POWER / LINE	SHARPKIT1
147TT	POWER SUPPLY	ONWAKIT	CT28AV1B	POWER SUPPLY	MITSKIT3	59CS03H	POWER / LINE	SHARPKIT2
149T	POWER SUPPLY	ONWAKIT	CT25AV1BD	POWER SUPPLY	MITSKIT3	59CS05H	POWER / LINE	SHARPKIT2
1430RA	POWER SUPPLY	ONWAKIT	CT28AX1BD	POWER SUPPLY	MITSKIT3	59CSD8H	POWER / LINE	SHARPKIT2
1430RS	POWER SUPPLY	ONWAKIT	CT28AV1BDS	POWER SUPPLY	MITSKIT3	66CS03H	POWER / LINE	SHARPKIT2
1430RW	POWER SUPPLY	ONWAKIT	CT29AS1	TDA 8178S	MITSKIT2	66CS05H	POWER / LINE	SHARPKIT2
1450T	POWER SUPPLY	ONWAKIT	CT29A4	TDA 8178S	MITSKIT2	66CSD8H	POWER / LINE	SHARPKIT2
1455TS	POWER SUPPLY	ONWAKIT	CT29A6	TDA 8178S	MITSKIT2	THOMSON		
2019R	POWER SUPPLY	ONWAKIT	CT29B2	TDA 8178S	MITSKIT2	35029400		.THOMKIT2
2029T	POWER SUPPLY	ONWAKIT	CT29B3	TDA 8178S	MITSKIT2	35065920		.THORNKIT1
2029TA	POWER SUPPLY	ONWAKIT	CT29B6	TDA 8178S	MITSKIT2	FV70	POWER SUPPLY	.THORNKIT1
F16 CHASSIS	FRAME	GOODKIT1	CT33B3	TDA 8178S	MITSKIT2	ICC7 CHASSIS	TDA 8178FS	.THOMKIT1
F16 CHASSIS	LINE	GOODKIT1	M5 SERIES	POWER SUPPLY	MITSKIT3	ICC7 CHASSIS	FRAME KIT	.THOMKIT3
F16	PSU	GOODKIT1	NEI/NIKKAI			ICC8 CHASSIS	TDA 8178FS	.THOMKIT1
F16	VIDEO	GOODKIT1	CE25 CHASSIS	POWER SUPPLY	NIKKAIKIT1	ICC8 CHASSIS	FRAME KIT	.THOMKIT3
GRUNDIG			C289FTXN	POWER SUPPLY	NIKKAIKIT1	ICC9 CHASSIS	EAST/WEST	.THOMKIT4
CUC 7350		GRUNDIGKIT1	C28F41FXN	POWER SUPPLY	NIKKAIKIT1	R3000	POWER SUPPLY	.THOMKIT2
CUC 7301/3			PANASONIC			R4000	POWER SUPPLY	.THOMKIT2
(BUZ90)	POWER SUPPLY	GRUNDIGKIT2	TC561	TDA 8175	PANKIT1	TX92F CHASSIS	EAST/WEST	.THOMKIT4
CUC 7301/3			TX25XD60	VERTICAL O/P IC	PANKIT2			
(MJF18004)	POWER SUPPLY	GRUNDIGKIT3	TC28XD60	VERTICAL O/P IC	PANKIT2			
HINARI			TX28XD70	VERTICAL O/P IC	PANKIT2			
HIT14RC	POWER SUPPLY	ONWAKIT	TX29XD70	VERTICAL O/P IC	PANKIT2			
			TX-W26D3	VERTICAL O/P IC	PANKIT2			

ORDER CODE	PRICE
GRUNDIGKIT1	£ 10.50
GRUNDIGKIT2	£ 10.50
GRUNDIGKIT3	£ 10.50
GOODKIT1	£ 11.00
JVCKIT1	£ 11.00
MITSKIT1	£ 3.00
MITSKIT2	£ 15.00
MITSKIT3	£ 6.00
MODKIT35	£ 9.50
MODKIT36	£ 5.00
MODKIT37	£ 6.50
NIKKAIKIT1	£ 12.00

ORDER CODE	PRICE
ONWAKIT	£ 12.00
PANKIT1	£ 7.00
PANKIT2	£ 9.00
PHILKIT1	£ 7.60
PHILKIT10	£ 8.50
PHILKIT2	£ 2.50
PHILKIT3	£ 4.00
PHILKIT4	£ 4.25
PHILKIT5	£ 5.75
PHILKIT6	£ 5.50
PHILKIT7	£ 7.60
PHILKIT8	£ 4.25

ORDER CODE	PRICE
PHILKIT9	£ 7.50
SAMKIT2	£ 8.00
SAMSUNGKIT	£ 16.00
SHARPKIT1	£ 11.00
SHARPKIT2	£ 11.00
THOMKIT1	£ 7.00
THOMKIT2	£ 12.00
THOMKIT3	£ 9.00
THOMKIT4	£ 4.00
THORNKIT1	£ 12.75

Grandata Ltd

distributor of electronic components

Aerial & Digital Satellite Accessories

SLx Distribution Amplifier Range

25mA Line powering on UHF Socket
Designed for TV, Satellite and FM Receivers
Isolation between outputs > 22db
Noise figure < 4db

Frequency Range : UHF 470-863 Mhz
VHF 47-230 Mhz

Auto line powering for masthead amps

10.5db Gain on all ports
Separate UHF/VHF inputs
Digital Compatible
CE and EMC Test Certified



	Order Code	Price	Order Code	Price	
2 Way	SLX2	£ 8.00 + vat	4 Way	SLX4	£ 13.00 + vat
6 Way	SLX6	£ 18.00 + vat	8 Way	SLX8	£ 18.50 + vat

SLx Masthead Amplifiers



UHF TV antenna pre amplifier designed for the professional aerial installer

15dB gain masthead amplifier ideal for majority of domestic installations

26dB gain masthead amplifier for longer cable runs (loss of more than 3dB) or if connected to passive splitters

Requires 12V DC power supply via downlead either via dedicated power supply unit or from a distribution amplifier with line powering

SLx 15dB Gain Masthead Amp

Order Code : 27830R Price : £ 4.30 + vat

SLx 26dB Gain Masthead Amp

Order Code : 27831R Price : £ 4.50 + vat

SLx Masthead Amplifier Power Supply

Order Code : 27832R Price : £ 5.00 + vat

** Postage when Ordering 3 or more of the above is charged at £ 5.00 + vat and will be sent by Parcel Force **

SLx Link Eye

Allows control of Sky™ Digibox via the signal feed for second TV



Fully compatible with Sky™ Digital Link

Order Code : 27833R

1 - 9 Price : £ 6.50 + vat each

10 - 24 Price : £ 5.50 + vat each

25 + Price : £ 4.50 + vat each

SLx Amp By Pass Kit

For use with aerial amplifiers and Sky™ Digibox

Allows for operation of Link Eye in conjunction with a distribution amplifier



Order Code : 27829R

Price : £ 5.00 + vat

SLx Link Eye and Magician 4 Combination Pack

Make use of the SLx Link Eye in combination with the Magician 4 Remote Control to control your Sky™ Digibox

Magician 4 controls upto 4 different devices including full function on Sky™ Digibox

Comes in Retail Clam Pack



Order Code : 27834R

1 - 4 Price : £ 16.00 + vat

5 + Price : £ 14.50 + vat



Sky Digital Remote Control

Order Code
RCSKY

Price
£ 10.75 + vat



Sky Digital Remote & TV Link Eye Combination

Price : £ 18.50 + vat

5 + £ 17.00 + vat each

Sky Digital TV Link Eye

Order Code : TVLINKYE

Price
£ 10.75 + vat

5 +
£ 7.99 + vat each

10+
£ 6.99 + vat each



Grundig GDS200 Digital Satellite Receiver Repair Kit

EARLY PSU
MODEL : DSO - 0385 REV C

Order Code : SATKIT34A
Price : £ 10.00 + vat

Grundig GDS200/300 Digital Satellite Receiver Repair Kit

LATER PSU TYPE REV 03
DSO - 0375 REV A
DSO - 0385 REV 5

Order Code : SATKIT34B
Price : £ 10.00 + vat

Grandata Ltd

distributor of electronic components

**KONIG
ELECTRONIC**

Konig Electronic Spares

**KONIG
ELECTRONIC**

To mark our new association with Konig Electronics we are glad to offer the following Konig Remote Controls at Special Prices !!!

<u>Konig No.</u>	<u>Make</u>	<u>Model/Part No.</u>
IR 9480	Daewoo	DMQ14A1 , DMQ20A1 , DMQ2195
IR 9584	Ferguson	RCU1734 , RCU1742 .etc , T742 , T752 , T758
IR 9594	Ferguson	RH880 , T789
IR 9325	Ferguson	RH885
IR 9259	Ferguson	RHT01 , RHT30
IR 9639	Ferguson	RHT10
IR 9719	Funai	30T1 , 30T2 , 31T1
IR 9403	Goldstar	105-068 , CBT2190E , CBT4902 , CBT9905
IR 9854	Goldstar	105-219J , 105-224V , 105-229H , 105-230C
IR 9614	Grundig Metz Siemens	CUC5200 , CUC5303 , CUC5310 ,
IR 9529	Grundig Matsui Siemens	CUC5301 , CUC5302
IR 9479	Grundig	TP715 , TP770 , TP771 , TP800 ,
IR 9715	Grundig	TRC1 , TRC2
IR 9602	Hitachi	CLE871A , CLE871B , CLE874A , CLE874B
IR 9476	Hitachi	CLE876A , CLE876B
IR 9477	Hitachi	CLE876C , CLE876D , CLE876E , CLE876G
IR 9982	Hitachi	CLE922A , CLE922B
IR 9576	Hitachi	CPT1556 , CPT1557 , CPT1560 , CPT1561 , CST1430 , CST1435 , CST1560
IR 9575	Hitachi	CPT2155 , CPT2164 , CPT2558 , CPT2564 , CPT2566 , CPT2669 , CPT2785
IR 9490	Matsui	076L067240 , 2076R , 2092T
IR 9573	Nokia	FS4/1 , FS4/2 , FS5/1 , FS9 , FS10
IR 9640	Orion	RC37 , RC56 , RC565633 , RCQ
IR 9826	Panasonic	EUR37211 , EUR50100 EUR50370 , EUR51140 .etc
IR 9834	Panasonic	TNQ8E0461
IR 9553	Philips	RC5410 , RC5420 , RC5801
IR 9556	Philips	RC5901 , RC5902 , RC5903 , RC5904 , RC5905

<u>Konig No.</u>	<u>Make</u>	<u>Model/Part No.</u>
IR 9864	Philips	RC7512 , RC7535
IR 9546	Samsung Akura Daewoo Goodmans	RM100
IR 9432	Samsung	RM104 , CX532WT , CX534WT , CX5312W , CX5325W
IR 9457	Sanyo	JXBA , JXFF , RC307 , RC317 , RC318 , RC321 , RC612 , RC625 , RC628
IR 9530	Sanyo Mitsubishi	JXCL , JXCR , RC258 , RC642 939P036050
IR 9139	Sanyo	JXGA , JXGE , RC700 , RC702
IR 9460	Sanyo	JXGT , JXGW , JXGY , JXLB , JXLG , RC711 , S02 , S03
IR 9487	Sharp	C1421 , C2021 , CV2121 , CV3707 , CV3709 , CV3710 , DV1416 , SV2044 , SV2145
IR 9711	Sharp	RRMCG0739BMSA , G1014BMSA RRMCG1023BMSA , G1036BMSA
IR 9788	Sharp	RRMCG1031BMSA , G1046BMSA RRMCG1048BMSA , G1050BMSA
IR 9321	Sony	RM640 , RM641 , RM641A , RM642A
IR 9336	Sony	RM650 , RM651 , RM652 , RM654
IR 9448	Sony	RM656 , RM677 , RM687B , RM687C , RM717 , RM719
IR 9123	Sony	RM670 , RM671 , RM672 , RM673
IR 9442	Sony	RM681 , RM682 , RM683 , RM684 RM685 , RM686 , RM698
IR 9452	Sony	RM694 , RM820 , RM828 , RM834
IR 9441	Sony	RM816 , RM817 , RM826
IR 9443	Sony	RM830 , RM831 , RM832
IR 9451	Sony	RM833 , RM837
IR 9871	Sony	RM836 , RM839 , RM883 , RM886
IR 9624	Telefunken	FB330 , FB340 , FB345 , FB1330 , FB1340 , FB1345
IR 9639	Thomson	14GM53 , 14GM56 , 14MS70 , 21DS70 , 21MG51 , 21MS76
IR 9953	Toshiba	CT9626 , CT9784 , CT9785 , CT9859

**£ 6.50 + vat
each**

**Buy 5 or more
£ 6.00 + vat each**

Grandata Ltd

distributor of electronic components

KONIG
ELECTRONIC

Konig Electronic
Spares

KONIG
ELECTRONIC

Replacement Line Output Transformers

<u>Make</u>	<u>Part No.</u>	<u>Konig No.</u>	<u>Our Code</u>	<u>Price</u>
Ferguson	..06 D-3-093-001 , 06 D-3-512-001	FAT 3837LOT204	...£ 14.00
Hitachi2433291	FAT 3664LOT172	...£ 13.50
Hitachi2434002	FAT 30095	..LOT226	...£ 14.50
ITT/Nokia	..4515 0340 , D 059/37 , ME/6237-00	FAT 3727LOT200	...£ 12.50
ITT/Nokia	..4515 0345 , 4515 0378 , D070/37 , D071/37	FAT 3790LOT328	...£ 16.00
ITT/Nokia	..4515 0348 , D 076/37	FAT 3843LOT330	...£ 16.00
Panasonic	TLF 14584 F , TLF 14586 , TLF 14586 F.....	FAT 30106LOT41	...£ 15.50
Philips1352.5003 , 4822 140 10544 , 4822 140 10566 , OV 2094/40	FAT 30186	..LOT433	...£ 12.00
Philips3111 258 30021 , 4822 140 10474	FAT 30192	..LOT562	...£ 15.50
Philips37770 , 37771 , 37772 , AT 2079/15	FAT 30184	..LOT129	...£ 14.00
Philips4812 140 10294 , 4822 140 10294	FAT 3820LOT125	...£ 16.00
Philips4812 140 10325 , 4822 140 10325	FAT 30167	..LOT132	...£ 15.00
Philips4822 140 10353 , 4822 140 10356	FAT 3830LOT284	...£ 14.00
PhilipsAT 2079/21 , AT 2078/21 , TFB 4090 AD	FAT 30179	..LOT395	...£ 12.00
PhilipsAT 2079/17	FAT 30171	..LOT288	...£ 14.00
PhilipsAT 2079/23	FAT 30170	..LOT289	...£ 13.00
Sony1-439-332-42	FAT 3925LOT100	...£ 12.00
Sony1-439-493-11 , 1-439-423-11 , 1-439-423-12	FAT 30089	..LOT369	...£ 15.50

This is just a selection of Konig Line Output Transformers .
Please call us on 020 8900 2329 for any that are not listed.

Replacement Television Mains Switches

KN658304



For Sony and Sony
Price : £ 2.50 + vat

KN668500



Replacement for Grundig 29703-291.07
Price : £ 2.50 + vat

KN668800



For Daewoo
Price : £ 2.50 + vat

If you cannot find the Konig Spares you want in this advert please call us on
020 8900 2329 as this is just a small selection

Grandata Ltd

distributor of electronic components

Remote Controls

Brand Replacement Remote Controls

*Codeless set-up	*Teletext and Fastext	*Pre-Programmed for the latest models	* Replaces broken and lost remotes
Brand	Order Code	Brand	Order Code
Panasonic TV	RCUNI01M	Grundig TV	RCUNI10
Sony TV	RCUNI02M	Sanyo TV	RCUNI11
Philips TV	RCUNI03M	Sharp TV	RCUNI12
Hitachi TV	RCUNI04	Goodmans/Alba/	
Mitsubishi TV	RCUNI05	Bush TV	RCUNI13M
Nokia TV	RCUNI06	Matsui/Hinaril/Orion TV	RCUNI14M
Samsung TV	RCUNI07	Sky Digital	RCUNI15
Toshiba TV	RCUNI08	On Digital	RCUNI16
Ferguson TV	RCUNI09	Satellite	RCUNI17
Grundig TV	RCUNI10		

Price : £7.50 + vat each

Buy any 5 of the above and get a Special Price of £ 7.00 + vat each

We stock Replacement Remote Controls for over 23,000 different models

Prices start from £ 5.50 + vat each

**Please call for a copy of our latest Remote Control Catalogue on
020 8900 2329**

New Arrivals

Semiconductor Comparison CD

A database of over 100,000 devices
Lists transistors , diodes , thyristors and IC's
Contains pin assignments for discrete semiconductors
Permits searching and selecting according to type , casings ...etc

System requirement

Pentium PC , 16Mb memory , Windows 3.1/95/98/NT
and a CD Rom Drive



Order Code : VRTCDROM

Price : £ 35.00 + vat

DVD Laser Lens Cleaner

Comes with Full On Disc sound
and Picture Set Up



Order Code:DVDCLEANER

Price : £ 5.00 + vat

Displex Display Polish

"Displex" is an innovative polish
that has been designed to remove
scratches from the screens of
Mobile Phones .

"Displex" is available in 5g tubes ,
with one tube being sufficient for
approx 8 to 10 applications.

Order Code : DISPLEX

Price : £ 2.50 + vat

Check out our New Online Catalogue at

www.grandata.co.uk

We are stockist of all the following brands :

**Remote Controls
Accessories**



**Remote Controls , TV & Video
Spares , CD Pick Ups ,Accessories**



**Remote Controls
TV & Video Spares
CD Pick Ups**



Line Output Transformers



**This advertisement is just a selection of our stock.
Please contact us if you cannot find the part you are looking for.**

- * Please add £1 p+p and VAT to all orders (Unless Otherwise stated) * All components are brand new
- * We accept payment by Access , Switch , Visa , Cheque and Postal Order
- * All prices quoted are subject to availability and may be changed without prior notice

E & OE

K.P. House , Unit 15 , Pop In Commercial Centre , Southway , Wembley , Middlesex . HA9 0HB England

Tel : (020) 8900 2329

Email : sales@grandata.co.uk

Fax : (020) 8903 6126

Website : <http://www.grandata.co.uk>

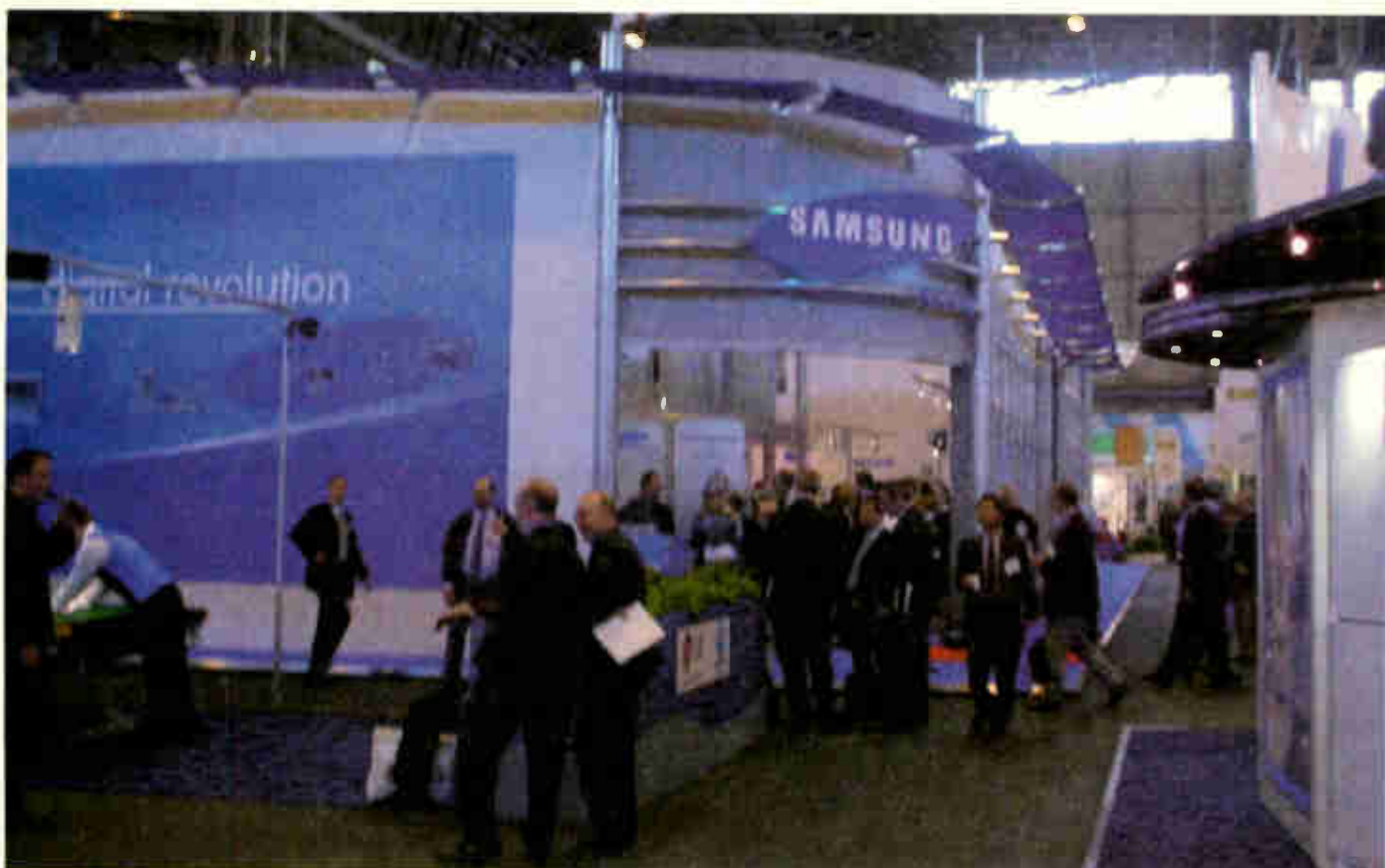

ER Show report

George Cole reports from the brown goods industry's UK showcase on the latest developments and product releases

This year's Electrical Retailing Show was held at the NEC Birmingham on April 21st-23rd. There were new products from a number of manufacturers and some prototypes were also on display.

DTT
Despite ITV Digital's troubles there was considerable interest in digital terrestrial TV. Barry Cox, chairman of the Digital TV Stakeholders Group, presented one of the Show's

seminars. He maintains that people are beginning to wake up to the value of digital TV as a free-to-air medium rather than seeing it as a pay-TV operation. This year there will be seven FTA set-top boxes on the market (see below), with two more on the way. Barry urged the government to announce firm plans for the analogue TV switch-off. The two big DTT issues are coverage and reception quality. He didn't see much likelihood of substantial coverage extension until the analogue broadcasts come to an end, but improved reception quality should be achieved with the roll-out of more transmitters.

Barry Cox believes that the government's plan to start the switch-off during 2006-2010 is still possible, though he suspects that it will be closer to 2009-2010 before the first phase begins. It will probably be on a rolling basis, like the conversion to North Sea gas and the Channel 5

retuning operation. With some eighty million analogue TV sets and VCRs in people's homes it will be a massive exercise. Barry Cox maintained that the switch-off will be possible only when people start going into stores to buy digital TV equipment without thinking about it. For this to happen he suggested that the price of digital TV adaptors needs to fall to about £50 each and IDTV sets need to be on offer at the same price as analogue ones. He doesn't think the government should subsidise the cost of digital TV equipment, as people will have plenty of time to purchase adaptors before the switch-off.

It was pointed out that with some digital TV broadcasts the picture quality is inferior to that of an analogue transmission. This occurs when the broadcaster uses excessive data reduction in order to maximise the number of channels provided. Barry Cox pointed out that the ITC has not set any quality thresholds for



Barry Cox presenting the DTT seminar.

DTT transmissions, though it could do if it wanted. He mentioned that broadcasters are concerned about this issue. The BBC believes that there are too many DTT channels and has proposed a bandwidth reduction from 24Mbits/sec to 18Mbits/sec to deal with the problem.

Barry Cox maintained that ITV Digital's problems would not affect the digital TV market in the longer term. Some people at the show felt that its demise would actually help the FTA campaign, as consumers would no longer think they had to pay for DTT services.

DTT adaptors

The Digital Television Group's stand was promoted as *freetoview.com*, with the emphasis on free DTT services. The centre-piece was a display of digital TV adaptors. Pace and Nokia showed products that were already in the shops. Other companies, including Grundig, Netgem, Novapal, Hauppauge and Panasonic, had prototypes on display. I was surprised by the variety of shapes and sizes. Pace has the smallest product, Nokia the largest, Netgem the most stylish and Grundig the most functional. There are also important differences inside the boxes.

The Pace Digital TV Adapter (DTVA) at £100 has a CPU that operates at 100 million instructions per minute (mips) and a single scart connector. Nokia's Mediamaster Free-to-View at £150 uses a 32-bit RISC processor, 2MB of RAM, 4MB of SDRAM and 4MB of flash memory. It has a common interface slot for features such as an audio description module, and can be upgraded for pay-TV operation. Other features include an internal modem (2,400 bps), an RS232 serial port for connection to a PC, RF loopthrough and two scart sockets.

The Netgem Digital TV Player is a high-end product designed for viewing digital TV programmes and interactive operation. It uses an IBM Vesta processor that runs at 150 mips, and has an embedded Linux operating system, 16MB of RAM and 8MB of flash memory. Other features include an integrated 56 kbps modem, a USB host connector, Ethernet connectivity (via a USB accessory) and ADSL compatibility (via a USB accessory). It also has a DVB common interface and a smart-card reader. No price details have been released but the specification suggests something in the region of £200-£250.

The different specifications suggest

that there will be different groups of DTT viewers, some requiring greater interactivity than others. Power consumption levels also differ. Pace's Adapter consumes 8W in the operating mode, 1W in standby. For the Nokia STB the figures are 24W and 5W respectively while for the Netgem product they are 18W and 5W.

There were many IDTV sets on show, but the minimum screen size was 28in. As things stand at present, the cost of adding a digital tuner/decoder to a TV set means that it is difficult to produce small-screen digital sets that are price-competitive with analogues ones.

Around the stands

Toshiba unveiled its new Strata TV range. The sets incorporate 100Hz DFS (Digital Frame Scan) technology and widescreen, flat-face CRTs. There are three Dolby Digital IDTV and three Nicam models, with 28, 32 and 36in. screen sizes. Some of the sets have closed cabinet stands to keep a VCR, DVD player etc. out of sight. Input sockets include component video (chrominance and luminance) and coaxial and optical digital audio. Toshiba also had on display widescreen plasma sets with 42 and 50in. screens. These have a 3,000:1 contrast ratio and a viewing angle of 160°. The company will be launching a 35in. plasma set next year. In addition a 15in. LCD TV set is to be launched in the UK next year: it will have scart and component video inputs but no PC input socket. Some massive projection sets with screen sizes ranging from 42 to 57in. were on display.

Toshiba was demonstrating a parental control/censorship system that's likely to be used with future digital TV broadcasting. Data tags that indicate the age suitability of material (e.g. 5, 15 or 18) are added



One of Toshiba's new Strata range of flat-face, widescreen TV receivers, which incorporate 100Hz DFS technology.

to the programme data. Parents will be able to set up a TV set for reception of programmes that are appropriate for a particular age group.

The Toshiba RD-X1 combined DVD-RAM recorder and hard-disk drive can use DVD-RAM or DVD-R discs, the latter for archiving and to provide compatibility with standard DVD-Video players. Its 80GB hard disk can store up to 75 hours of video and offers Dolby Digital 1 audio (at 192 kbps) and Dolby Digital 2 audio (at 384 kbps). There are three record settings, SP, LP and manual. The latter enables the user to set the recording data rate at between 2 and 9.2 Mbps. There's a 32-event timer with VideoPlus.

Toshiba plans to launch a DVD-Audio player but admits that few DVD-Audio titles are available – about sixty in the UK, a hundred worldwide. Only about thirty outlets in the UK stock DVD-Audio titles. There is talk of relaunching DVD-Audio later this year, and Toshiba hasn't ruled out adding SACD operation to its future DVD-Audio prod-



The LG DV-2000 combined DVD player and VCR, shown with surround-sound speaker system.



Display of digital TV adaptors at the Digital Television Group's stand.

ucts. Other Toshiba DVD products include a DVD-Video/VCR combi unit, Model SD22VB, and the SD220E which includes a component video output socket. Model V852UK is a home-cinema editing deck that includes jog/shuttle control and audio dubbing.

Samsung

The world's largest LCD TV, with a 40in. screen, was displayed on the Samsung stand. It has a 170° viewing angle and a contrast ratio of 600:1. Weight is 24kg and the price about £8,000. A 50in. version is under development. Other Samsung TV products on show included a 63in. plasma set with panoramic zoom and Dolby Digital audio, and a 50in. set that uses Texas

Instruments' DLP (Digital Light Processing) technology. The latter is due to be released later this year. CRT sets in the current Samsung range include pure flat-screen models with screen sizes ranging from 21 to 32in.

The Samsung DVD-H40 is a combined DVD player and 40GB hard-disk recorder, the latter providing a recording time of up to 40 hours. The 'scene-again' system enables the user to watch a DVD programme while simultaneously recording it on the hard disk. This feature could be useful for someone renting a DVD and wanting to view it again at a later stage. Even titles with Macrovision protection can be recorded, but Samsung says that an encryption system prevents stored video data being transferred to VHS tape. Other Samsung DVD products on show included the DVD-L100 portable player with 10in. LCD screen, the DVD-R3000 DVD-RAM recorder which can also use DVD-R discs, the SV-DVD3E combined DVD-Video player and VHS recorder, and the DVD-V505 which incorporates a Nuon processor chip to provide additional interactive features.

There weren't many camcorders at the show, but one of interest was the Samsung VP-D851. It includes MPEG-4 e-mail, Memory Stick compatibility and Worldwide Output. The latter enables the output to be in PAL or NTSC form to suit the local TV standard.

LG

A 60in. plasma TV set, Model MZ-60PZ13, with XGA (1,280 x 720) resolution and a 160° viewing angle was on show at the LG stand. There were also 40 and 42in. plasma sets. The company's TV range includes 15 and 20in. LCD models, with a

30in. model due by the end of the year. Model 20CB10X is a 20in. CRT set with a novel football design, to coincide with this year's World Cup.

Model LV713 is a talking VCR or, more accurately, a VCR with an embedded voice chip that guides you through the timer setting process. It can store about sixty voice commands. Model DV-2000 is a combined DVD player and VCR. DVD player Model DVD-5095 also provides MP3 playback and incorporates a Dolby Digital decoder. The company plans to launch a DVD recorder that can use DVD-RAM, DVD-RW, DVD+RW and DVD-R discs by the end of the year.

Sony

Sony's offerings included the HAR-D1000 hard-disk audio recorder that can store the contents of up to 500 CDs on a 40GB hard drive. The linear CD PCM audio is converted to compressed Atrac 3 files. CD text can be copied with the music. The company launched its first plasma sets with integrated tuners and speakers, Models KZ-32TS1 (32in.) and KZ-42TS1 (42in.). Model DVP-F41MS is a DVD player with a Memory Stick interface: it can read JPEG data and MP3 files.

The smart home

A smart-home exhibition highlighted many of the networked products now available, including internet refrigerators, wireless devices and home automation systems. Wireless technologies included Bluetooth, IEEE 802.11b and Powerline. The exhibition was designed to show what's available today rather than what's promised for tomorrow. Many more products aimed at the networked home are likely to be on display at next year's ER Show. ■



The LG DVD-5095 DVD player also provides MP3 playback and incorporates a Dolby Digital decoder.

John Coombes on how to tackle the various faults you might encounter with sets that use this chassis

Sony AE1C chassis fault-finding guide

The Sony AE1C was the last of the AE1 series chassis. It was used in a number of models released during the 1991-2 period, including the KVA2112U, KVA2122U, KVA2512U, KVA2522U, KVA2912U, KVA2922U, KVC2122U, KVC2522U, KVE2922U, KVE2925U, KVM2521U, KVM2531U, K VX2142U, K VX2152U, K VX2542U, K VX2545U, K VX2552U, K VX2942U and K VX2952U. There are differences in detail between these models, in particular some have a sophisticated colour decoder with a digital comb filter in a screening can. The following notes are based primarily on the KVA2122U/KVA2522U/KVA2922U.

Power supply problems

No results should first lead to a check on the 4AT mains fuse F1601, which could be OK, open-circuit or blown. If it's open-circuit, try another: it may have failed through age or a lazy fuse wire. If a replacement goes open-circuit, check whether the mains on/off switch S1701 is arcing. If the fuse has blown, the mains switch may be faulty, the degaussing resistor THP601 may be short-circuit, or the mains bridge rectifier D601 (D4SB60L-F) and/or the chopper transistor Q602 (2SD1548) may be short-circuit. On rare occasions D601 and Q602 can go short-circuit because of shorted turns in the chopper transformer T601. THP601 can cause intermittent fuse blowing as a result of internal arcing.

If there are no results and F1601 is OK, check whether the surge limiter resistor R1603 (2.7 Ω , 7W) or the start-up resistor R608 (18k Ω , 3W) is open-circuit. R608 could also be dry-jointed.

When the chopper transistor Q602 goes short-circuit R643, which is in series with its emitter, may well have gone open-circuit. The value is 0.15 Ω with 21in. models, 0.12 Ω with 25 and 29in. models. Also check R600 (1 Ω) if fitted. Failure of Q602 can be caused by its base drive coupling

capacitor C611 (47 μ F) being faulty. When there is trouble in this area, make sure that R651 (100 Ω) is OK.

Failure of the chopper control chip IC601 (TEA2260) is another possible cause. On the primary side of the chopper circuit, if no results. If there is no drive output at pin 14 and R608 (18k Ω , 3W) is OK, check it by replacement. You may find that the red LED lights up but the excess-current detection trips the power supply. IC601 can be the cause of this symptom. Again, check it by replacement.

Items to check on the secondary side of the power supply in the event of no results include the HT rectifier D611 (ERD29-08J) and its reservoir capacitor C621 (100 μ F, 160V). Check whether circuit protector PS603 (0.6A), which is in series with the 2SD2096 12V regulator transistor Q607, is open-circuit. If so, Q607 could be short-circuit. Otherwise, check for dry-joints at all its legs – remove the transistor and clean its legs to ensure that there is no tarnish that may cause further dry-joints. If Q607 is OK, check IC501 (TEA2028B) which can go short-circuit internally.

Failure to switch on from standby can be caused by paint or silicone dripping down from the CRT, during production, on to the +B preset RV501 (2.2k Ω). In time this paint may become conductive, lowering the HT feedback control voltage. The result can be excessive power consumption, with the set going into the excess-current trip mode. The only way to overcome this problem is to remove the affected components and clean the complete area.

If the power supply hiccups several times then cuts out, check C605 (220 μ F, 35V) and C617, which may be 100 μ F or 220 μ F depending on tube size. It's a good idea to replace these capacitors, also C611 and C608 (4.7 μ F), as a matter of course as they can all be troublesome.

If the symptom is no results with the standby light lit, which may be intermittent, check the 5V regulator IC604

(TEA7605) for a fault condition or dry-joints, and circuit protector PS602 (2A) which could be open-circuit.

If there's a snowy raster and noise from the loudspeakers check for dry-joints at the 12V regulator IC608 (MC7812C), whether circuit protector PS601 (2A) is open-circuit and whether IC604 is OK (it could be dry-jointed at all three pins).

The 5V regulator IC604 can also, when dry-jointed, be responsible for horizontal bars when the receiver is first switched on. Another possible cause of this is dry-joints at the 8V rectifier diode D612 (CTU-12S). Poor contact at IC604's chassis connection can cause flickering on-screen graphics, intermittent sound crackles or sound distortion when the receiver is cold.

If the HT is high at about 160V instead of 135V, there will be lack of height with the corners of the picture rounded. In this event check R522 (100k Ω) which is in series with the +B preset RV501. Note that all the outputs from T601 will be high when this fault occurs. The best way to avoid HT drift is to replace R522 with a 47k Ω , 0.25W resistor and a 56k Ω , 0.25W resistor in series, then adjust RV501 for 135V at TP91 (cathode of D611).

For intermittent operation check for dry-joints at IC604, IC608, D610 and D612.

No results can also be caused by line output stage failure, while a blank screen will be the result when there is field collapse – see following sections.

Line timebase faults

If the symptom is no results with the HT line low at 60V, check whether the line output transistor Q804 (BU508-AS1H or 2SD1941-06) is short-circuit. Check for dry-joints at the legs of the driver transformer T801 before switching on after fitting a replacement. Alternatively the tuning capacitor C821 (680pF, 2kV) could be short-circuit or the line output transformer T802 or the scan coils could have shorted turns.

If there is no line drive check the supply

to the line driver transformer T801: the fusible resistor R822 (1k Ω) could be open-circuit or C810 (33 μ F, 160V) short-circuit. Check whether the line driver transistor Q805 (2SC2688-L) is dry-jointed or short-circuit. If Q805 is OK but there are no line drive pulses at its base, check back to pin 10 of IC501 (TEA2028B). If the DC conditions around this chip are OK but there is no line drive output, fit a replacement.

Line output stage failure can be caused by the HT supply going high or varying (see above). If, after repairs have been carried out, there is no EW correction IC1501 (TEA2031A) on board J1 is probably faulty. If the vertical lines are bent inwards in the corner of the picture, check C1514 (0.022 μ F) on this board.

If there is horizontal distortion of the picture and an audible rattle, check C506 (0.022 μ F, 250V) in the line phase control circuit.

Field timebase faults

The most common fault is field collapse which, with this chassis, produces a blank screen. The first thing to check is whether R802 (0.47 Ω) in the 27V supply is open-circuit and that D801 (RGP10G) is OK. Then trace through to R530 (1.2 Ω) which could be open-circuit. If the 27V supply is OK, check the DC conditions around the field output chip IC502 (TDA8170) and for dry-joints. If necessary check IC501 by replacement.

Lack of height with cramping at the centre of the screen will be the result when the 27V supply is low. Check whether R802 has gone high-resistance because D801 is leaky.

The usual cause of field linearity problems, e.g. cramping at the bottom of the picture, is the field coupling capacitor C531 (680 μ F). The replacement should be rated at 50V, 105 $^{\circ}$ C (Sony part no. 1-111-123-11). If the linearity at the top of the picture is poor, check the flyback

boost capacitor C532 (100 μ F). If the picture is stretched at the top and collapsed at the bottom, check C521 (0.1 μ F, 100V).

Linearity problems can also be caused by dry-joints or poor connections at the scan coil plug/sockets.

Purity/geometry trouble

Because of the method of mounting, there is a tendency for the scan coils to move down the tube neck. The result is bad purity and geometry errors. Look for a gap between the coils and the rubber location wedges. To cure, reposition the yoke.

Sound faults

There are two TDA2050 audio output chips, IC251 (left) and IC261 (right). If there is loss of sound in one channel, check the relevant IC for dry-joints. If there is no sound from either channel, check that the 20V supply is present at pin 5 of these ICs. If the supply is missing, circuit protector PS604 (2A) could be open-circuit or IC251/261 short-circuit. For intermittent loss of one channel or crackling on one or both channels, check IC251/261 for dry-joints.

Loss of sound or spontaneous volume changes can be caused by a faulty memory chip, IC005 (SDA2546). Check by replacement. If the sound mutes shortly after switch on, check the sync separator transistor Q004 (2SA1037K). It can distort the sync input to the microcontroller chip IC001, which initiates muting. Muting can also be caused by ripple on the 15.5V line because C615 (1.500 μ F, 25V) is faulty. Low sound will be the result when D271 (13V zener diode) goes open-circuit. If there is no audio in certain modes, the cause may be muting which can occur when returning to a channel from a blank one. In this case check the SDA20560-AE1C microcontroller chip by replacement.

If there is intermittent loss of sound or a buzz on sound, check for dry-joints in the IF unit and resolder as necessary.

Distortion in one channel can be caused by a faulty loudspeaker.

In some models there may be hum in certain modes and standby because of a malfunctioning sound mute circuit. Look for R637 (1k Ω , 1W) and, if fitted, remove it. Connect a 27k Ω , 2W resistor (R631) between pins 3 (+B) and 4 (chassis) of connector D86 on board D then adjust the standby +B control RV601 for 135V at TP91.

Picture faults

For loss of red, green or blue check Q704, Q707 or Q710 respectively by replacement. They are type 2SA10910.

If there is a dark screen, possibly with a smell of burning, check D803 (RGP02-17) and R807 (1k Ω , 1W) in the A1/G2 supply. They may have burn up or gone open-circuit.

Teletext faults

For poor text reception check whether the 5V regulator transistor Q2 (2SD2096) on board V (teletext) is short-circuit collector-to-emitter.

If there is no picture and one of the text colours is missing, check the relevant 0.22 μ F, 100V sample-and-hold capacitor C301 (red), C302 (green) or C304 (blue).

Tuner replacement

The original tuner was type SUF944PLL. Type U944C is supplied as a replacement. For it to work, R107 has to be changed from 0 Ω to 22k Ω and R193 from 10k Ω to 100 Ω . Some later AE1C sets may have been fitted with the U944C tuner initially.

Earlier chassis

Much of the circuitry in the AE1C chassis is common to the earlier A and B versions of the chassis. In particular the power supply and timebase circuitry are virtually identical. So much of the information in this article is also applicable to earlier models.

Intermittent faults

If there are intermittent horizontal bars when switching channels and the receiver switches off intermittently, check for dry-joints at rectifier D612 and the 5V regulator IC604 (TEA7605) on board D.

If there are intermittent black horizontal lines in the middle of the picture, C527 (0.1 μ F, 100V) is probably faulty. As a result there is oscillation in the TDA8170 field output chip IC502 which overheats.

If there are black horizontal lines on the picture more noticeable the longer the receiver remains on and, after a long period of time, remote control operation no longer works, check the microcontroller chip IC001 (SDA20560-AE1C) by replacement.

For intermittent loss of the raster with

the sound OK, check the video signal processor IC301 (TDA4580) by replacement.

Intermittent loss of video can be caused by a dry-joint at pin 24 of IC2 (SAA5246E) on teletext board V.

If there is tuner/IF failure and the picture intermittently blacks out, check for dry-joints at IC608 (MC7812CT) on board D. If there's what looks like incorrect tuning and the set goes to mute, check for dry-joints in and around the IF unit VIF101 on board A. T1, T2 and T5 in the unit should be resoldered and the board checked throughout for dry-joints to avoid intermittent loss of picture and/or sound.

For loss of picture with correct channel numbers, check for dry-joints at the luminance and chroma buffer transistors

Q1403 (JC501) and Q1404 (2SA1037K) on board J1.

In sets that incorporate a digital comb filter (on board B1), a flashing picture and pulling sideways at the top, which can be very intermittent, and colour dropout can be caused by dry-joints at the legs of the screening can.

For intermittent loss of colour, suspect trimmers TC301 and TC302 which are associated with the colour decoder chip IC304 on board B1.

If there is a flickering picture, popping on sound and the on-screen display is constantly mixed up, the SDA line is overloaded because the audio control chip IC201 (TDA6200) on board J1 is faulty. You will find the voltage at pin 25 low – about 2.5V instead of 4.5V.



DX and Satellite Reception

Terrestrial DX and satellite TV reception. News on international broadcast TV and satellite band changes. Digital receivers for the enthusiast. An Australian TV-DXpedition. Roger Bunney reports



A Palestinian gunman seen during an APTN feed via Eutelsat at 10°E.

During the period under review early morning F2-layer reception, reaching the lower Band I channels, slowly faded away, as expected. By the middle of March there were no longer any early-morning F2 signals. But there had been some quite dramatic reception while the signals lasted, as follows:

- 1/3/02 Unidentified signals in chs. E2 and R1; IRIB (Iran) ch. E2.
- 2/3/02 Unidentified signals in chs. E2 and R1; IRIB (Iran) ch. E2.
- 3/3/02 Unidentified signals in chs. E2 and R1.
- 5/3/02 Dubai ch. E2; Dutch radio harmonic at 41.033MHz.
- 9/3/02 Unidentified programme material in ch. E2.
- 10/3/02 Unidentified programme material in ch. E2.
- 11/3/02 Two unidentified ch. E2 programmes from SE Asia, floating together; at 1530 GMT a ch. E2 signal (48.2505MHz) was received from the SE*, followed by TVGE (Malabo, Equatorial Guinea) ch. E2 (48.2504MHz), very weak*.
- 12/3/02 IRIB TV2 (Iran) ch. E2 (48.2396MHz); at 0845 GMT RTQ-0 (Queensland, Australia) ch. 0 (46.1717MHz)*; at noon three ch. E2 signals were received, frequencies being 48.2502MHz, 48.2504MHz (TVGE) and 48.2507MHz*.
- 15/3/02 Unidentified Sporadic E signal in ch. R1 (49.7396MHz).

Congratulations to Cyril Willis (King's Lynn) for his dramatic catches, marked with an asterisk. During active F2 openings the use of a scanner is essential, to be able to measure video-carrier offsets and thus identify the source of signals. Peter Schubert (Rainham, Essex) also logged IRIB (Iran) on several occasions, using just crossed dipoles for reception.

A log from Robert Copeman (Victoria, Australia) mentions repeated reception of Black Sea radar at 32.1-34.035MHz – Russia uses over-the-horizon radar, operating at low VHF. This is received on a scanner as noise (it resembles an LF buzzing): measurements put the source in the Black Sea area. The log also mentions a "woodpecker" at 43.649MHz, the source being the Philippines. Robert mentions that the frequency offset used by RTQ-0 Darling Downs, Queensland is 46.17165MHz.

Satellite sightings

Europe*Star-1 at 45°E continues to provide interesting coverage from Afghanistan, but there are far fewer feeds than in previous months and you really have to hunt for them. CNN and Fox News continue to send regular reports however and, with large numbers of marines now being over there, it's likely that feeds to the UK will increase. For reports from Afghanistan check at 11.555GHz and 11.470GHz initially, both vertical with SR 5.632 and FEC 3/4. A new one for me, in mid-March, was a "Feed point Coord, Bagram airbase CNN Afghanistan" at 11.478GHz V, with the service identification "News Source" and an unusual VPID of 33 and APID of 34 and a more usual PCR (programme clock reference) of 8190. This was a link back to CNN with interviews and on-air-field activities.

Europe*Star-1 carries other news. For example on March 9-11th there was the "Taridan Scopus" uplink on the Zimbabwe elections, from the border town of Messina. This news site, with a view of the steel bridge crossing to South Africa, was featured in many live feeds to European and American networks, including the BBC at 11.503GHz V (5.632, 3/4). The downlink signal was very strong, producing a reading of 10 per cent on the signal scale of my RSD ODM-300 receiver. Roy Carmen (Dorking) reports that "Telemedia Teleport" also provided Zimbabwe coverage, at 11.513GHz V.

Headline news continues to come from Israel/Palestine. The APTN news links previously carried by Hot Bird (13°E) can now be found via Eutelsat W1 (10°E) at 12.629GHz V (5.632, 3/4), with the service identification APTVGVW +442074827430. Raw news is at times rather dramatic and is usually edited for viewing

in the UK. This feed often carries news from elsewhere in the Middle East and nearer parts of Asia. Stefan Hagedorn's internet newsletter suggests checking Eutelsat W2 (16°E) at 12.628GHz (2,222, 3/4) for a new Israeli TV programme, Channel 26. When I tuned in late one afternoon there was, through to about 1900 GMT, religious discussion and puppet entertainment for children. The station logo remained after 1900 – the service identification is "Ragley Mavaser".

As ever, NSS K (21.5°W) has had much to offer. NASA-TV was seen for several hours in early March covering the latest Columbia shuttle mission (STS-109) to carry out repairs to the Hubble telescope. The pictures were incredible. There was also a lengthy item on the findings from the Mars Odyssey – mapping and surface analysis. On the 13th there was a colour-bar pattern with the caption "HUD HEADQUARTERS 03/10/02 1023 hours". Anyone know what Hud is? This was all seen via the Globecast multiplex at 11.590GHz V (20,145, 3/4).

George Bush has been seen getting around. On the 21st he was attending a large supporters' meeting at El Pasco, Texas. The feed was via Reuters at 11.462GHz V (5,632, 3/4). Two days later Reuters carried a report of George Bush's visit to Lima, Peru. On landing he walked the red carpet to his previously flown in limousine – which still has a forest of aerials on the boot lid!

Dave Dyson (Accrington) reports seeing a bible punching programme at 1715-1830 GMT via NSS K when tuned to 11.689GHz V (6,625, 3/4), also a news report from Palestine to Bonn via Intelsat 801 (31.5°W). Most unusual. Dave viewed Formula 1 racing in the clear from Australia via Telstar-11, at 12.270GHz V (20,000, 3/4). There were two video channels, the main feed and a pit camera, the latter with two audio channels one of which provided "glorious surround sound, with the cars screaming past". He mentions a suggestion in *Flight International* magazine, early March, that the third World Space satellite, Ameristar, might not be launched. Other press comment suggests that charges might be introduced. It seems that there are financial problems.

A reader mentions that the Portuguese channel Intimo has been transmitting FTA porn via Hispasat (30°W) at 11.891GHz after midnight GMT.

Digital receivers

During the past eighteen months or so virtually all news feeds have become digital, but the search continues for a receiver that's suitable for hobbyists/enthusiasts – one that's simple to use and enter in search data, has lots of memories that are easy to change, is reasonably sensitive and doesn't cost the earth.

Edmund Spicer has been using the Manhattan FTA DigiPlaza successfully, with a 65cm dish. It's compact and very easy to operate, versatile and with auto FEC (never revealed) but not auto SR. The RSD ODM series and the earlier Nokia 9200s with Dr. Overflow are to my knowledge the only receivers with auto SR detection. I recently obtained a version 3 DigiPlaza and my experience with it to date is as follows.

Entering the SR is at best an educated guess. This is OK with news feeds that generally use a symbol rate of 5,632 or 6,111 with 3/4 FEC, but try locking up the Israeli Channel 26 with its 2,222 SR – it's perhaps more of a DigiCyclops! The DigiPlaza will lock to say SR 5,632 even if you enter 5,665, so the pull-in range is about ±30Mbits/sec either way of the true SR, but it's a clumsy operation in this day and age.

Success with digital satellite DXing requires simple parameter awareness and entry. No auto SR is the DigiPlaza's main shortcoming. Another, lesser one is inability to read out the signal's FEC. But the DigiPlaza costs about £150-£160, which is good value for a hobbyist receiver (if you accept the SR shortcomings).

I hope to test the Korean GbSat FTA receiver soon. It's available from HiSat of Bristol and has been rated OK by SatcoDX, which says that it is fast and easy to use.

Broadcast news

France: Announcements about the new digital TV licences have been postponed until later this summer while the programming



NASA-TV relayed by Globecast via NSS K at 21.5°W.

content is being decided. The authorities intend that at least three local DTT stations should be available in any given area.

Germany: The Munich TV channel Tele 5 is to be revived as a general entertainment offering. It was bought some years back by the Kirch Gruppe, which revamped it as the DSF (DeutscheSportFernsehen) channel. The new Tele 5 is due to open early this summer.

Russia: There have been at least fifteen applicants to run the replacement for the recently closed independent Channel 6 TV station.

China: The broadcasting authorities plan to have a DTT network

www.Aerial-Techniques.com

THOMSON Multi-Standard 21" and 25" Nicam Televisions

- PAL/Secam/NTSC colour TV
- Multi-system reception (8 systems)
- On screen menu
- 21" Model - £299.00 inc VAT
- 25" Model - £329.00 inc VAT

Silver cabinet only

- International fast text
- Nicam stereo sound
- On screen menu
- Infra red remote control
- Scart connection
- Front connector jacks

Silver & Black cabinets available

Covers VHF (Bands 1, 2 & 3)
UHF, plus in between channels, PAL system 1 (for UK), PAL Systems B/G (for Europe), PAL System D (for China), Secam L, For France, Secam D/K (For Eastern Bloc), Secam B/G including NTSC 3.58 MHz via the scart.

THOMSON 14"/36cm Multi-Standard Colour TV with Integrated VCR

Covers VHF/UHF/PAL/Secam For use in the UK, France, & Europe

- Two integrated tuners
- International Teletext
- Built in TV guide
- Video plus
- NTSC play back
- On screen menu
- Silver cabinet
- Infra red remote control

NEW

Only £399.00 inc VAT
Including a FREE inverter enabling you to run it off 12v DC.

Overnight delivery for all items by insured courier £10.00

NEW GRUNDIG GDS-3000 Digital satellite receiver

Complete digital satellite system available for **only £399.00**

This includes:

- 60cm mesh dish kit
- Plus all connection cables & plugs
- Free viewing card accessing BBC1, BBC2, ITV-1, Channels 4 & 5, all the BBC radio stations
- Plus many other channels

Additional extras available:

- New collapsible tripod - £49.95
- Satellite signal finder - £29.95
- Folding 64cm dish (including digital LNB) - £79.95
- Folding 88cm dish (including digital LNB) - £89.95
- all inc VAT

MULTI-STANDARD SPECIALISTS

FULLY COMPREHENSIVE 35 PAGE CATALOGUE AVAILABLE BY RETURN OF POST FOR £1.50

59 Watcombe Road, Southbourne, Bournemouth, Dorset BH16 3LX
Tel: 01202-423555 Fax: 01202-425055
E-mail: aitech@direc.co.uk Est. 1979



The new Israeli Channel 26, received via Eutelsat W2 at 16°E.

fully operational by the end of 2010, running in parallel with analogue services which will be closed in 2015. All network digital TV channels should be available via satellite by 2005. The DTV standard has still to be defined and decided.

Vietnam: Experimental digital TV transmissions, using the European DVB-T standard, started in Hanoi and Ho Chi Minh City in early April. The plan is to expand the service to cover the whole country by the end of 2004. Six regional DTV transmitters have already been installed, and a further 42 are to be installed over the next two and a half years. According to the WRTVHB NTSC and Secam are at present in use while the Central programme is transmitted only in monochrome.

India: Tandberg Television is supplying transmission equipment to public-service broadcaster Doordarshan for the second phase of its DTT expansion. Doordarshan plans to transmit six digital channels in each area. No firm plans for closure of the analogue TV services have been announced.

Satellite news

Intelsat 904 was successfully launched into orbit at 60°E earlier this year and is now operational, covering Europe, Asia and Australia with 22 Ku-band transponders. There are also 76 C-band transponders. It replaced Intelsat 604 which has been moved to 157°E.

Hughes Global Services is currently offering "low-cost bandwidth" aboard the Anatolia-1 satellite at 50°E. The satellite's footprint covers much of Western Europe, Africa and the Middle East, with very strong signals in the UK. In theory the satellite is well-placed to provide single hop transmission between the UK and Australia. It could supply interesting news and OB feeds if customers can be found – the satellite is virtually empty at present. If you can see Europe*Star-1 at 45°E it will be an easy bird to find.

German TV, a new pay-TV channel that offers a mixture of programmes from the main German TV networks, opened in early April. It's initially focused on the USA but coverage is to be extended to Canada and Central America. The Bosnian analogue TV service at 11.148GHz V via Eutelsat (16°E) has closed down because of lack of cash. Polish channels Wizja TV and Cyfra+ have been merged to form Nowa Cyfra+ but, as a result of the high price of the new service, the churn level has increased.

KoreaSat-3 (116°E) is now transmitting the Skylife service from Korea Digital Satellite Broadcasting (KDB). There are over 140 TV, PPV and radio channels including several international TV channels – CNN, AFN, NHK and CCTV (China).

Indian public-service broadcaster Doordarshan is transferring its services from Insat 2C at 93°E to Insat 3C at 74°E, with C-band downlinking – the older 2C used S- and C-band downlinking.

Australian TV-DXpedition

DXpeditions are better known to radio amateurs than TV-DXers. The idea is for a group to travel to a distant, usually remote site where the radio conditions are better. UK Medium Wave DXers for example travel to the Sheigra area in West Scotland, where interference is non-existent and long wire aerials, perhaps over 1,000m, can be run out for reception of low-power MW transmitters in the USA. Radio amateurs often travel to remote islands to operate temporary radio stations. Such activity is almost unheard of amongst TV-DXers. Taking a wideband UHF aerial and TV set to a local hill site while on holiday is about it with regard to TV!

Last September however a couple of well-known Australian TV-DXers, Anthony Mann and Todd Emslie, noting reports of TE reception in Northern Australia with very high evening MUFs, organised a TV-DXpedition to Melaleuca Homestead, Howard Springs, approximately 30km east of Darwin. The site is 13° south of the equator and is notably free of interference. The equipment they took with them included an Icom R8500 VHF/UHF receiver, a TV-DX D100 converter, a Toshiba TV set, a 45-230MHz log-periodic aerial with 5m mast, and other related hardware.

TE (transequatorial skip) propagation occurs at and after local sunset when the daytime F1 and F2 layers, having lost their ionisation source, merge to form a single F layer at about 400km above the earth's surface. As the separate F layers collapse, the MUF (maximum usable frequency) rises above that of the daytime F2 layer. For some hours, signals at up to 100MHz or more are reflected as the newly created F layer stabilises.

Anthony and Todd arrived at their TV-DXpedition location, installed their receiving equipment and awaited the evening period. Their report says: "Typically we found that DX signals didn't appear until after dark, i.e. just after sunset, then switched on almost like a light: the band from 30-88MHz was suddenly full of signals. As the evening progressed, signals in the 88-108MHz FM band started to appear." Signal propagation generally started at about 1915 local time.

Initially reception was more from the east, KHON Honolulu ch. A2 and the Hawaii 50MHz amateur beacon. As the ionisation tracked westwards, Japanese and Korean signals appeared, followed by signals from China, Malaya and Russia, most showing the characteristic flutter you get with multipath reflection.

These signals were generally received across the equator but, towards midnight, signals from a shorter east-west skip path appeared, at up to the VHF-FM band and without the flutter experienced with true TE skip signals. Propagation was perhaps a form of ducting. One night Japanese ch. J1 TE signals were received until 0300 hours.

Darwin's closeness to the equator minimised mid-afternoon TE however. This can occur at locations farther from the equator. For example when Anthony noted strong Chinese ch. C1 (R1) signals at Alice Springs, 24° south of the equator and 800 miles from Darwin, Todd in Darwin saw nothing.

Apart from F2 backscatter signals from Australian stations, during their TV-DXpedition Anthony and Todd received TV and utility signals from Syria, the Gulf region (particularly Dubai), India, Asia, Korea, Japan, Malaysia, China, the Hawaiian Islands and even the San Bernardo police. The TV channels received were in Band I through to the Japanese Band III ch. J13 at just below 230MHz!

What chance for us back in the UK? In the Algarve, Portugal (37°N) Hugh Cocks reports that TE/F2 reception is possible at up to the middle of Band I on most winter evenings after midnight. But for those of us above say 52°N there is little chance of success. During solar peaks ch. E2 can occasionally be heard at scanner level from perhaps 1700-1800 hours local time in the south of the UK.

The above notes on the Australian TV-DXpedition are based on *VHF Expedition to Darwin, North Australia – a DXers Paradise* by Todd and Anthony. You will find the full story, dated 22nd October 2001, at the following internet address:

http://www.geocities.com/toddemslie/Darwin_VHFdxpedition.html

BOOKS TO BUY

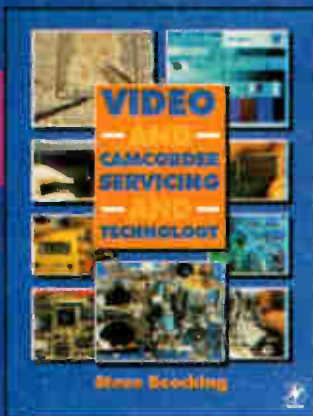

VIDEO AND CAMCORDER SERVICING AND TECHNOLOGY

This book provides fully up-to-date coverage of the whole range of current home video equipment, analogue and digital. As well as essential information for repair and troubleshooting, the author provides clear explanations of the technology of video equipment, which will enable the service engineer to gain a thorough knowledge of the equipment with which they are working. As well as traditional VCRs the book includes the full range of video cameras designed for home use and editing systems, and the latest DVD and hard-disk equipment.

READERSHIP: Service engineers, servicing students, advanced electronics DIY.

Price UK £23.00 EUR £25.00



well covered elsewhere: here the emphasis is on the practical business of fault diagnosis and repair.

Price UK £35.00 EUR £37.00

SERVICING AUDIO AND HI-FI EQUIPMENT

Service engineers and technicians have come to regard this book as essential to their work. As a bench-side companion and guide it has no equal. Its purpose is to ease and speed up the processes of fault diagnosis, repair and testing of all classes of home audio equipment: receivers, amplifiers, recorders and playback machines. The mechanics and electronics of domestic audio are examined by Nick Beer in a down-to-earth and practical way, concentrating on what goes wrong, how to track down problems, and how to solve them.

READERSHIP: Service technicians and engineers, audio engineers.

Price UK £35.00 EUR £37.00



SERVICING SATELLITE TV EQUIPMENT

This is the definitive practical guide to fault-finding, troubleshooting and servicing satellite television equipment, both indoors and outdoors. It will take you through all areas of satellite television system servicing from the simplest fixed dish to fully motorised systems. From PAL to Mac to MPEG all contemporary systems are covered.

READERSHIP: Service engineers, satellite equipment designers and manufacturers audio engineers.

Price UK £35.00 EUR £37.00

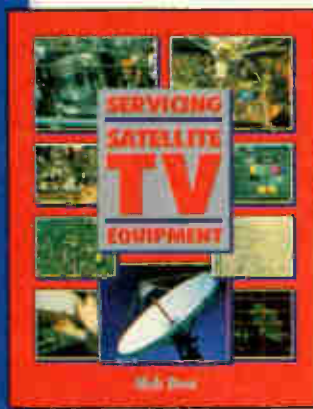

SERVICING TV SATELLITE AND VIDEO EQUIPMENT

The first edition of this unique 'hands-on' fault-finding book became the guide and mentor for thousands of service technicians and engineers in many countries and was widely adopted as a college text. In its new and updated form its usefulness is enhanced by five new chapters, including fault diagnosis in digital TV and video equipment, satellite-receiver repair and interfacing/hookup. All the chapters have been based on many years of practical bench and field experience, the book wastes little space on theoretical principles and circuit description where it is

UNDERSTANDING AND SERVICING CD PLAYERS

Engineers who need to achieve a better understanding of CD technology will find this book an essential tool for fault diagnosis, adjustment and repair. This book not only covers the mechanical design but also the integrated circuits within a CD player. It is written for immediate application and is well illustrated, so it should become a welcome addition to the rack of tools available to the service engineer. Ken Clements has extensive experience of the service industry both as a service manager and later in technical training with Sony and Pioneer. It is his hands-on knowledge that makes the book so valuable, not only as a wide-ranging reference but also as a benchtop manual to be kept within reach at all times when working with CD players.

Price UK £35.00 EUR £37.00

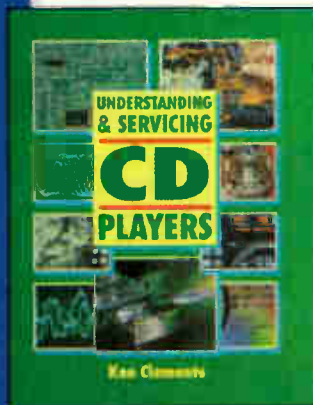

Post your completed order form to:-

Jackie Lowe, Cumulus Business Media, Anne Boleyn House, 9-13 Ewell Road, Cheam, Surrey, SM3 8BZ
Price includes delivery

How to pay

Title _____

I enclose a cheque/bank draft for £ _____
 (payable to TELEVISION)

Please charge my credit/charge card

Mastercard American Express Visa Diners Club

Credit Card No: _____

Expiry Date: _____

Signature of Cardholder _____

Cardholder's statement address: (please use capitals)

Name _____

Address _____

Post Code _____ Tel: _____

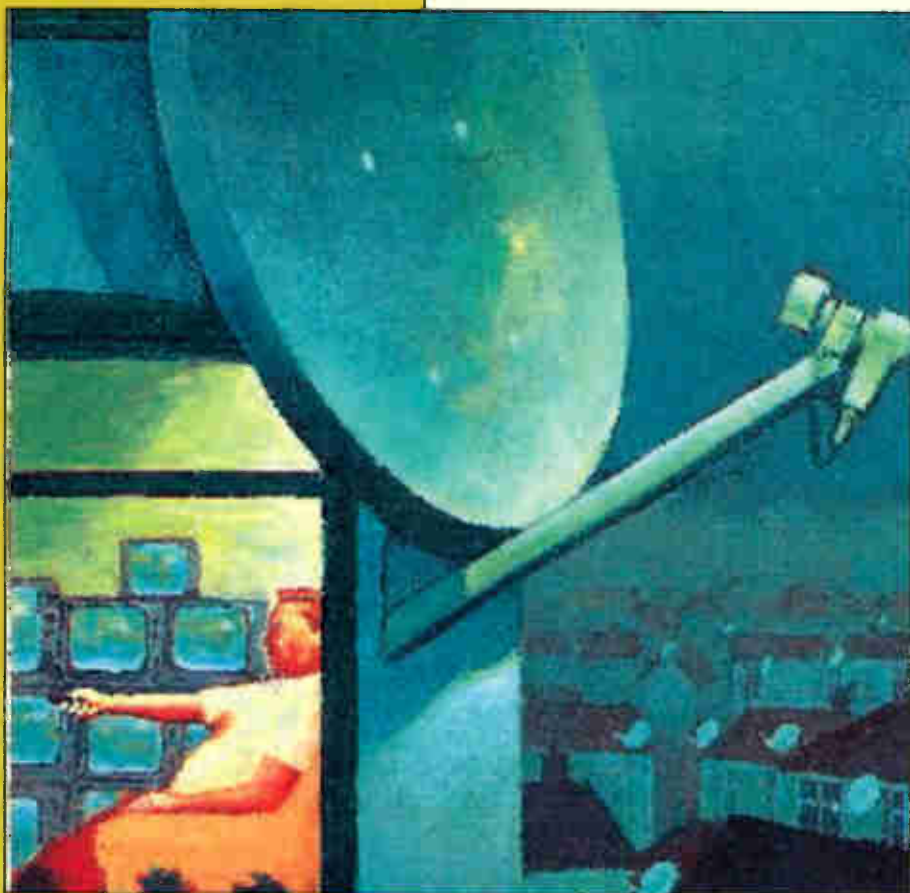

SATELLITE NOTEBOOK

Reports from
Michael Dranfield
Christopher Holland
and Pete Haylor

Grundig GDS200/1

The picture produced by this digibox was pixelating and breaking up into blocks. You often get the problem as a result of a power supply fault (check the electrolytics). Not this time however: the STi-3520 MPEG audio/video decoder chip U40 was faulty. M.D.

Pace ZIF tuner module

How to check whether the ZIF tuner module used in many Pace digiboxes is faulty was discussed in this section last month. I have some additional information to pass on. The signal frequency at the four test points shown in Photo 1 last month should also be checked, using a digital frequency counter connected via a x10 probe. On home page channel 998 the reading should be between 8.5-8.9MHz.

If the frequency of the down-converted analogue signal is outside this range, the tuner is faulty and there will be no digital outputs at pins 18-25 of the ZIF tuner unit.

I have recently come across a batch of tuners in which the down-converted signal

has been at 2MHz or 14MHz. As a result you get the "no satellite signal is being received" message on the screen. M.D.

Digital channel update

The latest channel additions at 28.2°E are listed in Table 1 – the EPG number is shown in brackets after the channel name.

There have been some changes to the sports and Asian channel EPG numberings. Amongst others, Eurosport has moved from 419 to 412, Sky Sports News from 413 to 408 and Zee TV from 676 to

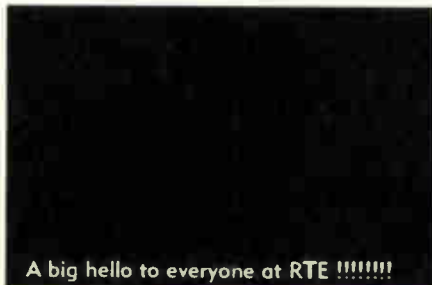

Photo 1: Tara TV's closedown caption.

808. The Sky Sports numbering remains unchanged.

Transponder 43 on Astra 2D (10.744GHz H) has been activated and has been carrying out tests with Irish broadcaster RTE's radio and TV channels, which are expected to be available in the EPG by the end of April. RTE's availability with UK cards is uncertain at the time of writing this, but now that Tara TV has ceased transmissions (see below) RTE will no doubt want to be available in some form to Irish expatriates living in the UK.

The Irish channel Tara TV, which was on EPG no. 178, ceased transmissions suddenly on April 4th, apparently because of financial difficulties. It had been transmitting from Ireland to the Sky uplink site via Intelsat 601 (34.5°W). The caption shown in Photo 1 was seen on the morning after the closedown (it was not visible on no. 178).

During the past month ITV channels have been blocked with Irish cards – they could previously be added via the extra channels menu.

Eurobird transponder D6S (11.567GHz V) is currently transmitting PCNE Chinese and Bloomberg TV tests in clear MPEG-2, but at present reception is not possible with a Sky digibox. Transponder D3S (11.508GHz H) has for several weeks been carrying some unusually-captioned Sky colour bars, see Photo 2. The channel is labelled 'atr' and can be found by entering the frequency in the extra channels menu.

Tests are being carried out via Astra 2A transponder 8 (11.856GHz V) using a Sky caption and the French channel TV5 programme information, so this channel may become available shortly. See Photo 3.

Occasional ITV feeds have been seen via transponder 54 (10.906GHz V) on the '3-6' channel, which can be accessed via a digibox's extra channels menu. See Photo 4. C.H.

RIK channel missing

The complaint was that the RIK (Greek) channel was missing though the other channels were OK. The inputs to the receiver came from two dishes. One supplied RIK via a tone switch. The second dish supplied Astra signals via the switch's other port. It also provided Hotbird reception, using a twin LNB arrangement.

Whoever had carried out the installation had fitted the tone switch so that it



Photo 2: Unusually-captioned Sky colour bars transmitted via Eurobird transponder D3S.



Photo 3: Sky caption with French channel TV5 programme information used for tests via Astra 2A transponder 8.



Photo 4: ITV feed seen via transponder 54.

was lying sideways, held by the cables being tight, instead of being clipped to the arm. Rain had got in and filled the switch.

Table 1: Latest digital channel changes

Channel and EPG	Sat	TP	Frequency (GHz)/pol
Apna Radio (913)	2B	33	12.344/H
Purple Radio (912)	EB	D11S	11.662/H
Shop on TV (652)	EB	D5S	11.546/H
South for You (686)	EB	D11S	11.622/H
Thane Direct (835)	EB	D5S	11.546/H

TP = transponder, 2B = Astra 2B, EB = Eurobird.

A replacement cured the problem. P.H.

Pace oldies

Old favourites such as the Pace PRD800/900 analogue receivers still appear in the workshop from time to time, with the usual power supply blowups. One MSS1000 had me going round the bend.

The symptoms were no RF output from the receiver and lines on pictures fed out via the scart sockets. After a long time I traced the cause of the fault to two leaky capacitors, C101 (22µF) and C103 (1µF). P.H.

No RIK

"The Greek channel is missing" was the message I was given. A visit confirmed this, but RIK was available via the other dish at the location. The receiver was an old Pace PRD900, which doesn't have a tone switch to go to high band. This pre-

sented a problem: how, without a 22kHz generator, was the receiver switching between the low and high bands? I checked from the dish to the receiver, but found no sign of a 22kHz generator. Then I removed the top of the receiver to check whether a tone generator had been fitted internally. Again no.

When I studied the picture carefully, I noticed that there was a lot of background noise. As the capacitors in the power supply were the original ones, I assumed that an increase in the ripple was 'seen' by the LNB as 22kHz. The customer said he would soon be replacing the receiver and didn't want to spend money on it.

The cause of the missing Greek channel turned out to be the two-way switch contacts: once the switch had been operated several times the picture was restored.

P.H.

Test Case 474

What had our long-suffering receptionist Pam done to deserve the abuse from the man on the other end of the phone? In fact nothing – he was going on about the alleged sins of Cathode Ray! Ray had returned a satellite box last Saturday, after repair, and the chickens had come home to roost as it were. Mr Happy (we'll call him that) described how he had lost his on-screen captions and was therefore unable to control his box. He also maintained that the new VCR the shop had delivered last week had caused his digibox to fail three times. He vented his opinion of Test Case Repairs, Test Case Retail and Rental, its works and personnel. Colin Doc was dispatched post-haste to provide first aid . . .

When he arrived, Colin found that the satellite box Ray had returned was actually an old Pace analogue type. It was being used in a bedroom to receive those analogue programmes of interest to UK viewers still being broadcast. Sure enough the on-screen graphics had disappeared, making channel selection somewhat difficult. But Colin discovered that normal operation was restored when he switched on the VCR and the TV set (both were connected to the satellite box by scart leads) and selected button 6 on the latter instead of the AV key used by Mr Happy. In effect the VCR was now acting as an RF modulator for the input from the satellite receiver, and was somehow 'adding' the elusive captions and graphics. Colin gave this some thought, and very soon had things working normally again – without need to pipe the satellite signals through the VCR or the TV set's tuner. What had gone wrong, and how

was it down to Cathode Ray?

Colin then went down to the living room where he found a Sony TV set, an Amstrad Sky digibox and the new VCR, a JVC HRJ785, that was claimed to be upsetting the digibox. The actual symptom with the digibox was that it kept 'going off the rails' in various ways – freezing with menus and pictures, failing to come out of standby, etc. It could be made to behave by interrupting the mains supply, but only until it had another tantrum! The new VCR was not responsible for this, but it couldn't be denied that the trouble had started after its installation. The gear had all worked perfectly before that. To solve this one Colin had to pop along to the local DIY store three blocks away and spend £4.95, which he subsequently reclaimed from the shop's till, on some basic hardware. What was it, and how did it solve the problem?

His mood a little better as a result of the Doc's efforts, Mr Happy shared another problem with him. Our Colin's a lucky man, isn't he? There followed a little demonstration of how the picture was centred on the screen when the Sony TV set was receiving an ordinary terrestrial TV transmission, or displaying a playback input from the VCR or a Sky Digital signal via an AV feed: but, when the TV set and the digibox were configured for RGB operation, the picture moved to one side. What could Colin do about *that*? What indeed! Mr Happy was not completely satisfied when the Doc left, but he didn't phone again.

For Colin's solutions, and a compromise, turn to page 502 – but not before you've made at least two suggestions yourself!



DVD

**Fault reports from
Geoff Darby and
and Jeff Herbert**

We welcome fault reports from readers – payment for each fault is made after publication. See page 488 for details of where and how to send reports.

Sony DVP-S725D

A disc was stuck inside this unit. The owner couldn't remove it because the display said "locked" when the open/close button was pressed. I couldn't find any reference to this condition in either the user or the service manual so, eventually, I called Sony Technical for advice.

I was given the following fix. With the machine in standby, enter '1410' then 'power' using the remote-control handset. The unit then unlocks. When I asked Sony how the unit might get locked in the first place, the answer was "by entering the same sequence quickly". The mind boggles at the chances of the customer doing this accidentally. **G.D.**

Thomson DPL800VD

This gigantic DVD player/home theatre amplifier would play CDs but not DVDs, which is a typical symptom when the optical block is faulty. The deck is not as difficult to get at as it appears at first. Start by opening the tray and removing the fascia trim from its front edge. Remove all the screws from the front main fascia panel, at the top, bottom and sides, then pull it forwards. It doesn't need to come right off. Remove the metal bottom cover panel. From the top, disconnect CP208, CP202, CP402, CP404 and CP411. Back underneath, undo the two screws at the rear of the deck sub-chassis and the two at the front, farthest forward. The deck can then be withdrawn from underneath, after disconnecting the mains plug to the sub power supply.

The replacement optical block comes as a deck, ready mounted on the plastic carrier. When I fitted it however it didn't line up correctly with the disc clamp. The reason for this turned out to be that the hinge pins for the carrier were moulded in a slightly different place from those on the original. This pushed the deck back from its correct position. There was no alternative to putting the new deck in the old carrier, which didn't introduce any mechani-

cal alignment problems. Fitting was then straightforward and, after reassembling the unit, it worked correctly. **G.D.**

Sony HCD-S300

When the DVD mode or any DVD-related function was requested this unit just sat there for a while, with the "DAV-S300" identifier in the display if it had just been powered or "DVD" if you had gone from another mode, such as 'tuner', by using the function key. The display would then blank, followed by the error code "C81". This is another general error code that means nothing more specific than "I can't do anything".

A quick check on the motor 12V supply at pin 1 of CN902 showed that it was very low. The cause was D911, which was high-resistance, in the power supply. It's one of three diodes that are connected in series with the output from the motor-supply switch transistor Q907. Their function is presumably to drop a couple of volts to reduce the supply to 12V from the nominal 14V at the switch transistor's input. A replacement diode restored DVD operation. **G.D.**

SMC DVD530

I'd never come across this brand before. According to the label on the back of the unit the manufacturer is based in the British Virgin Islands. It seemed a solidly-built unit however, and as the complaint was "no power" I opened it up for a look inside.

The deck consisted of a standard computer DVD drive, but with a smart, black escutcheon at the front of the tray. On the left inside there was a fairly conventional-looking chopper power supply. A quick check across the output from the mains bridge rectifier, which conveniently stood about an inch off the board with bare legs, produced a reading of 380V. There was no supply at the UC3842 chopper control chip however. The cause was quickly traced to the 120kΩ start-up resistor R35, which was open-circuit. A replacement got the unit working again. **G.D.**

Toshiba SD110

No sound and no front display were the symptoms with this DVD player. The deck functions and playback picture were perfectly normal. A quick check on the power supply outputs revealed that the -9V line was low at -1.5V while the -31V supply was low at -24V. After much fruitless checking on the power supply PCB I eventually found that the culprit was C928 (100µF, 16V) on the main PCB. It was short-circuit. A replacement restored both the sound and the display.

I have also had C929 go short-circuit. The symptom in this event is no sound with the front display OK.

It's best to replace both of these capacitors as they seem to be developing into something of a stock fault. **J.H.**

RO.VE.R Digital Meters

TDA 6 DTT Meter

Digital and Analogue
Near and Far Carrier to Noise
Multiplex flatness
PASS-FAIL-MARGINAL
FM & DAB
The meter used by the broadcasters
11 hour battery life
Supplied complete with chargers
and Case

The most accurate way to analyse
DTT
With this meter you know its
right



MTD *Your connection to the digital future*

Martin Turner Direct Ltd
Ty Coch, Llanwern, Monmouth, UK, NP15 1HD
+44 1291 650367, Fax +44 1291 650702
martin.turner@ukonline.co.uk

SDM 1 Satellite Meter

Designed with Sky
Simple and accurate.
Twin measurement. Level + Quality
C/N, FEC, S/N, Level computes to
give quality indication
**Long battery life up to eight
hours, Quads three hours**
Ten pre programmed satellites
Program version available
Radical new design for Skyplus
Impossible to align to the incorrect
satellite
The most accurate way to set up a
dish!
Call backs drop by half!

Available Now...



The **NEW**
SALI 9
CD Catalogue
Over 750,000 products.
Brown Goods...
White Goods...
Spares & Accessories.
Finished Products.
CCTV.
Over 7,000 colour pictures.
Exploded View Diagrams.

Order Code **SALICD**

Benefit from...

Stock & Price Check prior to order submission
SALI's Account Information page
Giving you access to your Account Status, Parcel
Despatch Information & Outstanding Back Orders.

**Note: Users of SALI 8 will
automatically receive SALI 9**

If you would like **SALI 9** including the
Seme General Spares Catalogue
please contact sales
and add **CAT2002** to your next order.

FREE CARRIAGE* on all **SALI** orders of
£12.00 or more as well as **NEW SALI Pricing**

*Applicable to Electronic orders only, excluding orders from credit
account customers.

*Carriage rates exclude Seme Trade Supplies.

Tel: 01664 484000
Fax: 01664 563976

email: sales@seme.co.uk



TELETEST Video & Computer Test Equipment



£159.95 ex VAT

**OZT1500:
TELETEST PC**
8 test patterns
VGA, S-VGA outputs
9V battery powered

OZT1110: TELETEST 2
6 test patterns, 1kHz audio
Composite, S-video, RF outputs
9V battery powered



Optional
accessories



£159.95 ex VAT

Tel: 01202 759911
Fax: 01202 759922
Intl: +44 1202 etc

Free Info Pack
www.teletest.co.uk

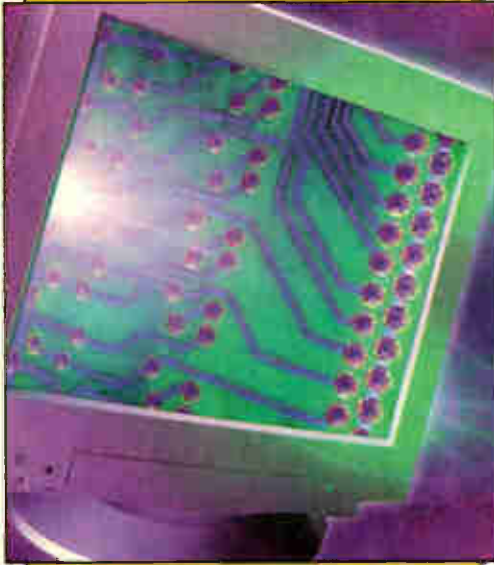

MONITORS

**Fault reports from
Dean Ratcliffe
Dave Gough and
Ian Field**

We welcome fault reports from readers – payment for each fault is made after publication.

Reports can be sent by post to:

Television, Fault Reports,
Anne Boleyn House,
9-13 Ewell Road,
Cheam,
Surrey SM3 8BZ

or e-mailed to:
tessa2@btinternet.com

CTX 1765D

This monitor powered up but there was no display and the EHT was very low. I found that Q336, which should be type 2SK1377, was short-circuit and also had to replace D327 (BYV26C), R460 (1 Ω) and R470 (0.68 Ω). Someone had fitted a BUZ77B with mica washer in the Q336 position. This device has an inadequate voltage specification. **D.R.**

Elonex XV17

There was a screeching sound and no LED illumination. I found that the 2SC3688 line output transistor Q410 was short-circuit. Q416 (2SD1138), C609 (47 μ F, 250V), D895 and R807 should also be checked, also C821 if present. **D.R.**

Acer 7176i

There was no EHT because Q311 (2SC4542) was short-circuit and the power supply relays operated. R458 (2.7 Ω , 3W) also had to be replaced. When this happens it's as well to check Q312 (2SD699) and Q313 (TIP47) as well.

If there's no voltage at pin 2 of P607, check D707 in the power supply. It's mounted on a heatsink near T602. **D.R.**

Elonex SV14LR

The chopper power supply had blown up. It had probably failed during a storm, because the mains bridge rectifier was short-circuit. I had to replace I802 (UC3842), R810 (47 Ω), R811 (20k Ω), D806 (18V zener diode), R825 (0.39 Ω , 2W) and the 2SK794 FET in the chopper circuit. 1N5398 diodes can be used in the mains bridge rectifier circuit.

Once the monitor was back in operation I found that there was a flooded screen. The tube's first anode voltage is derived from flyback pulses but not from the line output transformer. There's an A1 preset on a separate PCB beside the heatsink. Adjustment of this preset had no effect. Next to it, beside the heatsink, there's a 2M Ω resistor which was open-circuit. A replacement enabled the correct A1 voltage to be obtained. **D.R.**

Tatung C7T2R

This 17in. SVGA monitor would power on then sit there with its orange LED flashing. Visual checks in the power supply revealed the cause: R802 was severely charred. A replacement restored normal operation. **D.G.**

Project LM1564

The complaint with this monitor was "dull picture with no green". I decided to check the waveforms on the CRT base panel. They seemed to have both LF and HF limitations, with drooping DC levels, pronounced rounding on negative-going tran-

sitions and large overshoots on positive-going transitions. But there was nothing significant to identify the cause of the lack of green. The only clue was that the load resistors in all three of the class A RGB output stages were running cold.

When I disconnected the collector of Q762 (2N3904) in the green output stage from the emitter of the associated class A transistor Q761 (2SC2953) there was normal red and blue but still no green. The 2N3904 transistor was checked for leakage but proved to be OK. The 2SC2953 transistor also gave normal readings when checked for leakage, but a check on its base-emitter junction, using the diode V_f range of a DMM, produced a reading of 0.016V instead of approximately 0.6V as expected. Once a replacement had been fitted the monitor produced a flawless picture with an excellent grey-scale.

The bases of the three class A RGB output transistors in this monitor are connected together and the blanking pulses are applied here. So a short-circuit base-emitter junction would severely disrupt the biasing of all three output stages, as happened here. **I.F.**

Axion CF1754

The power supply was pulsing and I soon found that the BU2525AF line output transistor Q411 was short-circuit. It was a replacement that a previous repairer had fitted without removing the chassis, by taking out the fixing screw and clipping the leads of the previous transistor, leaving enough to solder the replacement to! Clearly a new line output transistor was not the complete answer: something else was making it fail.

The flyback tuning capacitor C418 (3.9nF, 2kV) looked OK, but I fitted a replacement to be sure. The B+ PWM MOSFET could be ruled out since this chassis uses the flyback configuration. There's an electrolytic capacitor in the line output transistor's base drive coupling circuit, C341 (4.7 μ F, 50V). I disconnected this and checked its ESR, which was not too bad at just under 2 Ω . But to remove any doubt I fitted a 63V polycarbonate replacement. I also decided to check the two small electrolytic capacitors on the primary side of the UC3842-based chopper power supply. These are C115 (100 μ F, 50V), the chip's LT supply reservoir capacitor, and C112 (22 μ F, 50V), the auxiliary supply smoothing capacitor. C115 had an ESR of less than 1 Ω , but C112 was a little worse. So I replaced it and added an 0.1 μ F decoupling capacitor across each of these electrolytics to reduce heating caused by any remaining ESR. Once these various items had been checked/replaced the monitor worked normally. So I left it

on soak test.

On my return to the workshop some hours later the monitor was again dead, but switching it off and on again would restore operation – for a few seconds. On further investigation I discovered that I had missed a fracture-ring around the solder on the scan connector. When this had been dealt with the monitor wouldn't produce any display at all! The line and B+ PWM drives would start at switch on but shut down after a few seconds.

During attempts at checking voltages and waveforms D413 (FR104) smoked, and I was back with a pulsing power supply! A replacement took me only one step forward, so I started to check the CRT base voltages. Everything seemed more or less normal except the first anode voltage, which was only 146V. The 1nF, 1kV decoupling capacitor C519, a ridiculously small disc ceramic capacitor, was leaky. I replaced it with a more realistically proportioned component. This restored the display and cured the shut-down after a few seconds.

Unfortunately the picture was now too wide, and this couldn't be adjusted. D408 (31DF6), the lower diode in the EW bridge, had failed. In view of the state of the soldering (a tinplated 'trestle' riveted to the line-output stage heatsink) I suspect that this item may also have received attention from the previous repairer, and it may not have been the correct type. A 600V rating seemed over-generous, while the 3A current rating looked 'only-just' for a monitor of this size. My solution was to use the much 'fatter' diode used in the equivalent position in a 17in. Samsung monitor – I obtained it from a scrap chassis.

At long last the monitor worked correctly! **I.F.**

Atin Electronics AM148

This is a monochrome VGA monitor that had been converted to Atari. The complaint was "goes grey after twenty minutes". Some people just don't seem to care! My first impression when I looked inside was that it had been an amateur 'home-brew' conversion. The added loud-speaker was lying on the main PCB because it had been stuck on with 'gaffa tape'!

Dismantling the monitor had been difficult because I couldn't separate the swivel base from the cabinet. When I finally got the back off I found out why. Mono VGA screens converted for Atari often need additional horizontal or vertical shift. Most people who convert these monitors obtain the additional V shift by feeding DC from the power supply through the frame scan coils via a suitable resistor, typically 220Ω, 5W. In this case

the resistor had been soldered to the print side of the main PCB, with a flylead to the V-output connector on the deflection yoke. The resistor had been left resting on the bottom of the plastic cabinet, where it had melted a hole in the bottom and welded the back cover to the swivel base. The way to avoid this damage is to mount the resistor vertically on the solder tag of the yoke. Here, the resistor has better convection – and can't melt anything.

While I was attending to all this I noticed several very bad dry-joints and dealt with them. By the time I considered the monitor to be in a fit state to apply power there was little evidence of the reported fault. But during the soak test a slight picture fluctuation was observed. No amount of prodding, tapping or flexing seemed to have any influence on this effect. By the time it had been cured, almost every solder joint that's accessible without removing the chassis from the front surround had been remade. **I.F.**

Acer JUP7145E

Someone else had already got at this dead monitor but, as the workmanship looked reasonably tidy, I decided to proceed. The flyback-type B+ PWM MOSFET Q317 (2SK2161) had been left with its pins unsoldered. In this condition the monitor should produce a narrow display. When the B+ regulator is working, the supply to the LOPT will be more than the 50V input to the regulator and the scan will widen.

The usual cause of failure of the regulator is shorted turns in L304 or faulty transistors (2SC945/2SA733) in the complementary-symmetry emitter-follower stage Q305/6. The linked bases of these two transistors are fed via a 10kΩ resistor, so it takes a catastrophic failure for damage to occur farther back than this. But when Q317 blows, it can take out Q305 and/or Q306.

After checking on these possibilities there was a growing pile of dead 2SK2161 transistors on the bench. What I wanted to know next was whether the mark-space ratio of the PWM drive waveform varied to correct the pulse voltage at the LOPT? In the present situation, with the line output stage running at slightly less than its minimum input voltage, the mark-space ratio of the PWM drive should have been at maximum. Would it change with an increase in the input voltage?

There's a 90V output available at the secondary side of the power supply (the normal stepped-up B+ supply is probably no more than 60-70V). So I linked the 90V supply to the cathode of D317, via a 60W test bulb. As this had no effect I used a series resistor instead, trying dif-

ferent values. An 18Ω resistor produced a display that was wider than that obtained with the unboosted supply, but there was clear evidence of overloading and the BU2520AX line output transistor Q310 was overheating. It failed before I could switch off. When a replacement was fitted the power supply wouldn't start. I checked the new line output transistor and found that it hadn't been damaged. There was only one likely explanation for this situation: the line output transformer had been flashing over internally, and the collector winding was now permanently shorted to an earthed winding. **I.F.**

Jean JD156H

The customer said this monitor had smoked so copiously that a member of the office staff had had to be restrained from blasting it with a fire extinguisher! The smoke had all been produced by R492, which now had a wide burn ring all the way round, exposing the bare ceramic tube. My best guess as to its value, after studying the remains, was 100Ω, 2W, a self-extinguishing type. The cause of this incendiary event appears to have been the RGP02-18 diode D420, which was short-circuit. The nearest reference I could find was to type RGP01-10... 20: 1-2kV, 100mA, <300μS. This suggests that an RGP02-18 would be rated at 1.8kV, 200mA, but I doubt if 300μS is fast enough!

The series combination D420/R492 is connected from a tap on the line output transformer's primary winding to chassis. It's a different tap from that to which the line output transistor's collector is connected. This latter tap has the usual EW diode pair, that doubles as the efficiency diode, connected to it. Since I was unsure about D420's specification and didn't know of a supplier, I decided to use a pair of UF4007 diodes in series.

As the monitor had originally shut down instantly at switch on, I suspected that there might be a more serious problem in the line output stage. The B+ PWM regulator is a step-up flyback type, so I disconnected the MOSFET Q810 to reduce the power supplied to the LOPT. When I switched on again the display was of almost full width, but with severe pin-cushion distortion. What I had failed to appreciate is that the EW drive circuitry is of the closed-loop servo type, with plenty of negative feedback. This was the reason for the unexpected width with Q810 disconnected, not a width modulation fault. When Q810 was reconnected the display was completely normal.

The input to the B+ PWM regulator is 47V. In the DOS default mode the HT supply to the LOPT is 65V: it will be different at other scan frequencies. **I.F.**



VCR CLINIC

Reports from
G.W. Roper
Steve Barlow
Ivan Levy, LCGI
Michael Maurice
and **Bob Flynn**

We welcome fault reports from readers – payment for each fault is made after publication. See page 488 for details of where and how to send reports.

Amstrad TVR3

With tape playback there were, in the top third of the picture, two or three solid white lines about 3/4in. apart followed by a blanked out line, with the same symptom repeated in the bottom third of the picture. Applying slight pressure to the drum earthing brush made no difference, so I decided to try replacing the electrolytic capacitors in the head amplifier. This didn't improve matters either. I recalled an early Ferguson mechanical VCR that produced a solid white line on the picture because of a faulty video head, but a replacement didn't alter the display.

Wondering whether bonding the head amplifier's case to the earthing brush might help, I held a piece of wire on them. Then fate gave a helping hand: the wire slipped off the brush on to the drum shaft, clearing the fault.

There was no improvement when I cleaned the brush and the drum shaft. Then, looking for a suitable brush in my box of useful bits, I found one of the caps that early JVC machines and their clones used on the drum shaft for contact with the earthing brush. Once I had fitted this the fault cleared. The cap was slightly too long but, rather than risk ruining it by trying to cut it down, I decided to put a set into the brush and, with the slotted mounting, centre it on the shaft cap. The drum bearings felt OK. A very big sigh of relief – and another happy customer! **G.W.R.**

Mitsubishi HS621V

This machine was dead with no display. Checks showed that there were some voltages on the secondary side of the power supply. As always these days, the ESR meter was brought out to check the electrolytics in the power supply. Before long C9A3 was found to be faulty. Once this capacitor had been replaced the VCR sprang back to life. What did we do before the advent of the ESR meter? **S.B.**

Panasonic NVSD40

When an unprotected tape was used this machine went into play but wouldn't go into record. Easy I thought, quickly removing the deck to inspect the record protect switch. It was OK however. So I dug out the manual to trace the path from this switch. It was not long before I found that the track on the main PCB was black by the side of the back-up cell, which had leaked and damaged the print, preventing the record-protect signal reaching the microcontroller chip.

This seems to be a common fault – I've now had it three times. **S.B.**

Mitsubishi HS821

This machine had a tape stuck in it and

error code 1 in the display. I removed the tape manually and reset the EPROM. This removed the error code, but the VCR wouldn't lace up tapes. When I checked the mechanism I discovered a piece of plastic in the loading worn gear slots. Removing it cleared the fault and a soak test confirmed that everything was now OK. **I.L.**

Panasonic AG526

This machine would accept a tape but not lace up. On investigation I found that the drum didn't rotate and the capstan was pulsating. Checks on the light sensor signals to the system control chip showed that these were normal. The IC was sending the correct drive signal to the drum, but the drum-drive circuit wasn't responding. The cause was inductor L2301, which was open-circuit. It's on the main board. **I.L.**

Sony SLV401

Intermittent loss of colour was cured by replacing CV801 on the YC board. The type is similar to that used in some Grundig sets. I used a replacement from RS Components. **M.M.**

JVC HRJ645

When an attempt was made to load a tape there would be a squealing noise from the loading belt then the machine would revert to standby. The cause of the trouble was dry-joints at the beginning-of-tape sensor. **M.M.**

Sony SLVE920

There was no display. A quick inspection of the power supply PCB revealed that Q612 had never been soldered. Resoldering restored the display. **M.M.**

Hitachi VTF150E

There appeared to be several faults with this machine: it wouldn't go into the record mode, the Nicam lights were flashing, and the playback picture produced with known-good tapes was poor with a graunching noise from the capstan motor. I dismantled the power supply and replaced all the electrolytic capacitors on the secondary side of the circuit. The machine then worked correctly. **M.M.**

Philips VR686/07

This machine would very intermittently stop and eject the tape, in either the play or the record mode. The cause was the clutch assembly, which sprang apart when I removed it. **M.M.**

Mitsubishi HS640V

The right-hand carriage lever had broken. This fault is not uncommon, but was made worse by the fact that the plastic guides, which are part of the chassis, had cracked.

When this happens the only remedy is a new mechanism. Fortunately Mitsubishi has recognised this and supplies new decks, minus the head-drum assembly, at a reasonable cost. M.M.

Samsung TVP5050IST

This TV/VCR combi unit was stuck in standby with a tape stuck inside. The cause was a faulty pinch cam lever. I obtained a replacement from Chas. Hyde, part no. 15003BL. M.M.

Matsui VX1105

Intermittent tape chewing, in play or record, was caused by the back-tension band. As so often with modern VCRs, the felt had parted company with its plastic backing, exposing the supply spool to its glue. A replacement back-tension band and spool surface clean cured the problem.

When you replace the band you will find that there's a metal plate in the way. Remove the cassette housing, then loosen two of the plate's screws just enough to get the band into place. B.F.

Toshiba V854B

A tape had been stuck in this machine and, as usual, the customer had forced it

out. The cause of the trouble was found to be the cam lever, item K470, which had broken – it's a very common failure.

When I reassembled the main cam gear I found that it wouldn't sit down in position. The reason for this was that the loading slider assembly, item B490, which is underneath the deck, had jumped one tooth out of alignment where it engages with the take-up loading arm, item B470. This was obviously the result of the tape having been forced out. Although these two items appeared to be undamaged I fitted replacements obtained from a scrap machine. Everything worked well after reassembly. B.F.

Philips 14TVCR240 (Turbo deck)

The faults listed here were: leaving a loop of tape out when the cassette was ejected, noisy wind and rewind, and damaging tapes while playing. A new pressure roller cured the tape damage in play, but the cause of the other faults was less obvious. I inserted a dummy cassette and tried wind and rewind. This seemed to prove that the tape spools were OK – they wouldn't both be noisy. As the clutch, item 115, can be troublesome I replaced this, and also cleaned

and lubricated its shaft and that of the large pulley which fits over the top of it. A very long test proved that all faults had been cleared. B.F.

JVC HRFC100EK

This model's cassette drawer takes VHS and VHS-C cassettes. With rough treatment, it's easy for problems to arise. Because of a child's mishandling, one side of the drawer had come adrift. The reason for this was clear when the front had been removed and the machine had been turned upside down. A metal spigot on the underside of the drawer had come out of its runner. All that was required was to push it back into place, but I had wasted a lot of time looking around the top of the mechanism. B.F.

Sharp VCM311HM

When a tape was inserted this machine would go into rewind, then wind, and finally just sit there. It would eject the tape all right, but no other function was possible when requested. The only clue while all this winding and rewinding was going on was that the drum was pulsing, not rotating. A replacement drum drive chip, IC702 (BA6977S), cured the fault. B.F.

How to pay

(VCR Fault Finding Guide) paperback

I enclose a cheque/bank draft for £ _____
(payable to Cumulus Business Media)

Please charge my credit/charge card

Mastercard American Express Visa Diners Club

Credit Card No: _____

Expiry Date: _____

Signature of Cardholder _____

Cardholder's statement address: (please use capitals)

Name _____

Address _____

Post Code _____ Tel: _____

Television magazine's VCR Clinic column is a unique forum for practical servicing tips, with the UK's leading service engineers and servicing writers contributing their observations and recommendations month by month. But try finding those faults reports for the Amstrad XYZ123 that's on your bench. Even with an index you will be chasing through a pile of magazines... until now. Peter Marlow's VCR Fault Finding Guide is a distillation of the most used fault reports from 11 years of Television magazine. Arranged by make and model the information is extremely easy to access, and the book is a convenient size for the bench or to carry with you. This will undoubtedly become one of the service engineer's most useful tools. Unlike other fault guides, this one is based on top quality information from leading authorities, and genuine repair case studies. This is real-life servicing information, not just a compilation of manufacturers' manuals.

Approximately 2,000 reports on 193 models from 35 different manufacturers Instant on-the-spot diagnosis and repair advice Television magazine's leading writers' wit and wisdom available for the first time in book form.

**Post orders to: Jackie Lowe,
Cumulus Business Media,
Anne Boleyn House, 9-13 Ewell Road,
Cheam, Surrey SM3 8BZ**



VCR Fault Finding Guide

Pete Marlow

This book is an essential repair tool, not just another volume for the shelf

Pages: 464pp

Price: £22.50

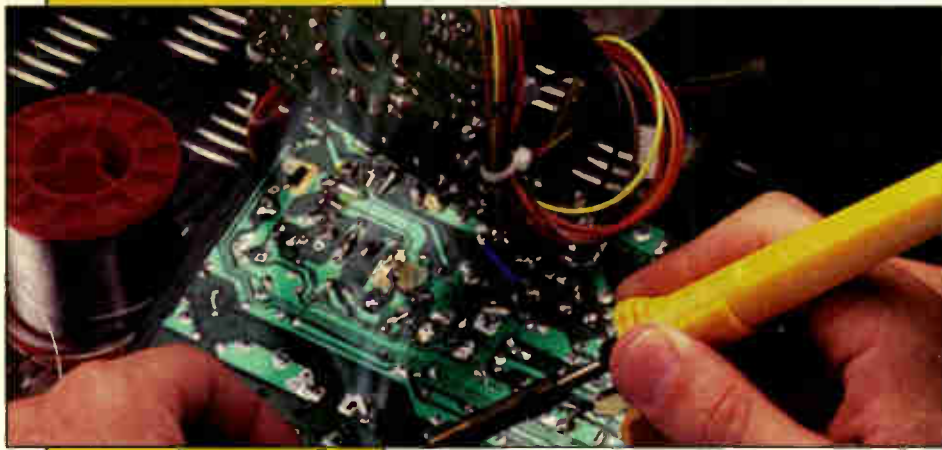

JACK'S WORKSHOP

Jack Armstrong

How to earn £60 an hour

In my March issue column I mentioned charging £60 an hour. Several correspondents queried this figure, suggesting that it was impractical. So more needs to be said on the subject. First, that most electronics servicing and installation engineers undervalue their work. As a result, its value goes down in customers' perception. After all, if you seem to be willing to work for £6 an hour, why should anyone pay more?

At present my personal minimum target is £60 an hour. It's important to have a target, and to set it a little higher than you think you can achieve. You can't, of course, expect to earn £60 an hour initially for 24 hours each day. But please believe me when I say that it's achievable in the long run. Before I explain how, let me tell you about some acquaintances of mine.

Harry's aerials

Young Harry is an independent aerial and satellite system installer who did contract work for Colorvision until it went out of business. Colorvision paid him about £24 per dish installation. A dish and a receiver were supplied, but Harry had to supply the cable, clips, brackets and the transport to get to each installation. From this you can see that his profit, after deductions, wasn't very high.

I met Harry shortly after the demise of Colorvision, when he was advertising satellite dish installations for £25. He phoned me one evening at 10pm, desperate for some cable as he'd run out. When I asked him why he was still working so late he told me that he had to complete at least twelve installations a day in order to pay his wage and that of his assistant. My reply was unprintable, but I told him to double his price. "But I'd lose half my customers!" he said.

This was probably true, but he'd failed to see the 'big picture'. By doubling his price and losing half his customers he

would maintain the same income! Better still, he would be working for half the number of hours and, as he would be buying half the amount of equipment and fuel, his profit would increase significantly.

When I explained this to him he seemed to see my point and tried my suggestion. It transpired that he had to employ a second assistant, because the number of jobs fell by only 25 per cent. He didn't lose "half his customers".

Martin's story

How can you make money come in 24 hours a day? Here's Martin's story.

"I'd been made redundant twice in three years and was fed up with big companies. So I posted a leaflet to all the TV repair shops within 50 miles, telling them that I would collect and repair satellite receivers at a fixed price. It took about six months for a few of them to respond. Most didn't reply at all, and very little work came in. My next step was to pay each of the shops a personal visit, to introduce myself and explain what I could do and how I could save them time, money and hassle. On the first day I arrived home with twenty receivers to repair. The business grew from there.

Over the following year business increased dramatically, and on a typical day I was handling about twelve repairs a day. I could fix about four receivers an hour, charging £20 each. That's £60 profit an hour for three hours a day. The rest of my time was spent collecting, delivering, typing invoices and ordering parts. The administration time required was unbelievably high, and I needed several hours each Sunday to do the accounts.

Since I already kept lots of parts in stock, I decided to offer them to other dealers. Most of them wanted a 'turnkey' solution, so I made up parts into little repair kits, one for each model. As this was time consuming, I licensed a mail-order company to make up and sell the kits in return for a royalty.

I have always made copious notes on each repair, and I used these to write my

famous *Satellite Repair Manual*, which sold over 1,000 copies a year. It took six months to write the first edition, and six weeks to revise it each year. This brought me thousands of pounds for very little work.

When Sky Digital arrived my repair business almost disappeared. The digital receivers were all under guarantee, and very few people wanted an analogue receiver fixed. But I had foreseen this problem, and was already selling accessories via an internet website. This business grew and grew until, one day, I found myself groaning each time an order arrived. I was now working from 8am to midnight each day, and was sick of stuffing padded bags with orders. This attitude wasn't helpful. I couldn't very well employ the best marketing tactics to sell more when, subconsciously, I was thinking "please don't let there be any more orders today". The solution was to reach an agreement with a mail-order specialist who would process the orders from my website and pay me a royalty.

That left me free to deal with my books. I now had several, which I had converted to PDF (Portable Document Format) files so that they could be downloaded direct from my website by purchasers. Credit card payments are taken automatically by arrangement with a Californian company that sends me a monthly cheque.

My income is now about £800 a month from 'virtual books' and about £2,000 a month for mail-order sales which another company handles for me. This may not sound like much, but it's £33,600 a year for almost *no work* on my part! All I have to do is to answer technical queries via e-mail and get other writers to produce books for sale. I can go on holiday knowing that I am still earning £90 a day. But I now have free time to increase this as much as I like. Look at it this way: I'm earning £60 an hour for 90 minutes a day, and the rest of my time is free for leisure or for earning even more money."

Marketing

You've now read two people's stories. Let me tell you about Chris who runs a local TV retail shop and does very well indeed. He ran an advertisement in the local newspaper, with the wording shown in Fig. 1.

I phoned him and said "I suspect that this is a stupid question, but what's the difference between a standard and a super deluxe installation?"

"Fifty quid" he replied.

"And how many people choose super deluxe?"

"All of 'em."

I knew it was a stupid question! You see Chris may not be a very good aerial installer (I don't know) but he has a natural flair for marketing. His advertisement highlights several important principles:

(1) Give the customer a choice of prices, but make them all high enough so that even

the lowest will give you a good profit.

(2) Tell the customer he can afford the price (this implies that prices are higher elsewhere).

(3) Tell the customer he'll get the best quality materials and service.

(4) Tell them they can have it *today*. Many people are impatient and impulsive. They want it *now*.

The keys to business success

By now many of you will probably be thinking: "This doesn't apply to me. I can't write. I can't increase my prices. I can't just close my repair business and start selling things.

You owe it to yourself to try. Ask yourself: "Am I running this business to make lots of money, to get by or simply as a hobby?" If your answer was not the first one, you clearly have no ambition. Even if you think you don't need lots of money yourself, think of what you could do with it. How happy you could make your friends and family. You can do it!

Anyway, assuming that you do run our sort of business, the aim must be to get it into good profitability then look at ways to progress from there.

There are two main steps to achieving success: (1) automate, (2) delegate.

Consider automation first. If you don't already have a computer and printer, get one. Better still, get two: they can be unreliable! A computer will enable you to carry out many tasks more efficiently. You can:

Type several 'form' letters in which you simply change the name before printing out.

Keep your accounts and automate the associated calculations.

Keep your stock records and lists of parts, suppliers and prices.

Order via the internet, saving time and money.

Use the Euras fault database for fast diagnosis.

Join e-mail help groups to get repair information, spares, manuals and moral support.

Get an answerphone, and use e-mail daily. Both can take messages while you are out.

Next, delegation. Look at the tasks you currently do yourself. Imagine that you are earning £60 an hour, and delegate the jobs you don't have to do to someone who earns less than that. For example, I employ a bookkeeper for just a few hours a month. I pay her £40 and she gets the accounts done four times faster than I can, leaving me hours free to earn more money.

Delegate some tasks to your customers. How often have you handed a VCR back only to get a phone call from the customer an hour later because he can't figure out how to reconnect it or tune it in? Type out instructions on your computer and give a

print-out to each customer who collects something. Explain all the common problems such as dampness in equipment – leave it in a warm room for two hours before using it. Explain about RF tuning, scart leads and how to fit connectors.

These things can all be done by the customer once he understands how. He'll think you are wonderful, because you gave him this free information! You don't have to type it all yourself. Some standard sheets are available for downloading from the SatCure website at

<http://www.satcure.com>

You can also put information like this on your own website and give your customers the URL (web address).

Alternatively, give them the SatCure website URL.

Things to avoid

Don't advertise free call-outs. It never ceases to amaze me how many otherwise sensible people do this. Most customers realise that you can't drive to their premises without paying for fuel and running costs. Tell them that you charge a very reasonable £15 call-out fee (up to ten miles) to cover an engineer's time and running costs, but that this charge will be refunded if the subsequent work comes to more than say £60. Notice that this serves two purposes, as it also suggests to the customer that £60 is a perfectly reasonable amount to pay. Tell them that they will have no more than the call-out fee to pay if the engineer can carry out the necessary adjustments in less than ten minutes, but that parts must be paid for. Word this carefully. The only business you will lose by doing this is that of time-wasters, and you're better off without them.

Avoid lengthy phone conversations. Time is money, so don't waste it. You can chat in the pub later. If you want to get rid of a caller and can't do so politely, cut off the phone connection while you are still speaking – preferably half way through a sentence. That way the customer will think you were genuinely cut off by a fault.

Do it politely: "I'm terribly sorry that you were unhappy with the service. Mrs Smith. Of course we'll be round to fix it as soon as possible. In the meantime what I (click)." At this point you've said enough to tell her that you are concerned and will attend to the problem. That's all she needs to know. Leave the phone off the hook until you hear the 'howler'.

Avoid free verbal estimates. Practice this: "As you'll realise, Mrs Smith, it's impossible for a real engineer to estimate the cost of a repair until he's actually done it. Cowboys can make a wild guess and many do, thinking of an excuse to charge more later. We are more realistic. We charge just fifteen pounds to dismantle the equipment and investigate. We're then in a better position to make a sensible judgement and phone the supplier to get the price of any parts required. If you agree to have the repair carried out, you don't have to pay for the estimate."

Nicam Stereo TV Aerials you can afford!

Standard installation £95
De luxe installation £125
Super de luxe installation £145

The highest quality materials fitted by experienced installers

Phone XXX XXX XXX for same day service

Fig. 1: Chris's TV aerials advertisement in the local newspaper.

Avoid an itemised list of parts. If you include a list with your estimate, the customer can go elsewhere and ask someone to fit the parts specified. If you itemise the parts on your bill, the customer gets a chance to question you on the prices and on the need to replace those specific parts. Keep details in your own notebook, but don't divulge it to anyone! Be vague. Don't get involved in technical explanations. You'll only make the customer feel ignorant and confused.

General advice

Be proud of your skills, and make sure the customer understands that you are the best. If he doesn't want to pay for a good job, he can go elsewhere. I tell reluctant customers: "You've a choice of two cowboys in town. They'll do a nice cheap job for you which might get the equipment going for a couple of months. If you want a high-quality, reliable job done, come back here." Say it politely, with a serious expression. Don't let them think you are joking or "taking the mickey".

If you are the best, you simply do not need to compete on price. If you are not the best, it could be that you don't bother to learn. Read everything available in books and magazines. Attend training courses where possible. Discuss faults with repairers outside your local area. Keep notes of every repair that you do, so that you don't have to rely on memory when the same fault turns up again. Sell your fault reports to *Television!*

Visit all local shops that don't have their own repair facilities and offer them your services. You can offer a discount for quantity. Make it clear that all they have to do is to get the customer to complete the fault report slip and take the customer's money. You will do the rest and guarantee your work. Offer a mail-order repair service if that is viable. You'll need room to store boxes and packing materials.

The repair trade is never going to make you rich, but it can make you a handsome living if you can ensure a steady supply of work. Above all, keep your suppliers happy by paying them promptly.

If you are not proud of your work you are probably in the wrong job. Do something else! Arrange to pass customers to another repairer in return for a small percentage. You can then turn your attention to something that you can enjoy and will earn you a better profit.

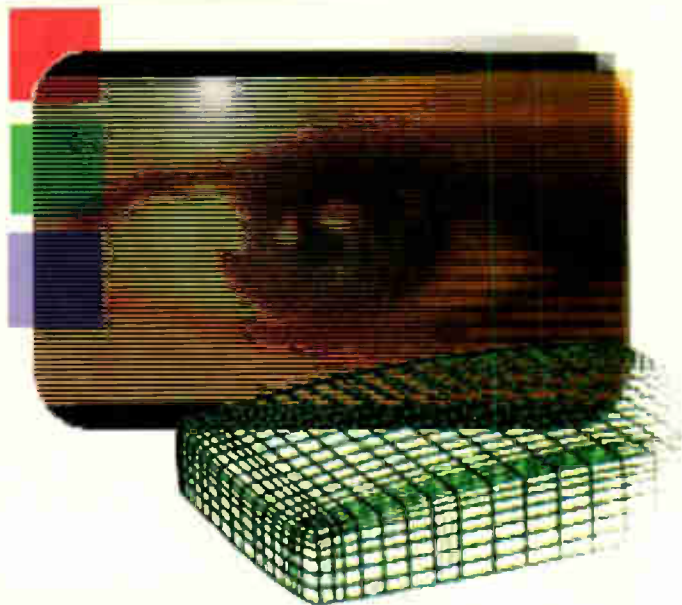

TV FAULT FINDING

Reports from
Mike Leach
Philip Salkeld
Graham Boor
Ian White
Glyn Dickinson
David I. Scott
Ivan Levy LCGI
Stuart Vick and
Bob Flynn

We welcome fault reports from readers – payment for each fault is made after publication. See page 488 for details of where and how to send reports.

Hitachi C28W510SN-311 (A7 chassis)

The complaint with this widescreen set was low sound output. On test I found that the sound didn't reach its maximum level though the on-screen graphics indicated that it did. The cause was straightforward, a dry-joint at R4005 where it's soldered through the panel. This resistor can also be the cause of audio popping and varying audio levels. You will find it just behind the audio output chip. To ensure a reliable repair, solder both sides of the contact. M.L.

Sharp 37ET-35H

This set produced a bright raster with fly-back lines. The sound and remote-control functions were OK. Checks at the tube base panel showed that it was receiving hardly any drive from the TDA8840H jungle chip IC201, which is a surface-mounted device. The voltages around it were either wrong or non-existent. A new chip cured the fault. M.L.

Philips 28PW6305/05 (A10E chassis)

The picture was spoiled by a bad ghosting effect. It looked like another picture superimposed on the one being watched. In fact it was a ghost of the channel being watched. The chroma shift was most evident, being displaced about two inches to the right of the main picture. Occasionally, on channel change, the effect would right

itself – as if the AFC was pulling it in. This would happen more often as the set warmed up.

This led me to suspect the small sub-panel that contains the micro and control sections. A little freezer applied to the main microcontroller chip IC7064 made the symptom worse, and a replacement cured the problem.

This chip can be responsible for several different fault conditions. I've had to replace it to cure poor remote-control operation, poor/intermittent sound, and sound distortion when used with a DVD player. The correct microcontroller type must be identified before ordering. Three types are in use, identified by the label on the front of the chip. They are ED, EP and ET. It is essential to fit the correct type. Part nos. are

A10ED1-1.2	part no. 9965 000 10425
A10EP1-1.6	part no. 3111 250 54501
A10ET1-1.6	part no. 3111 250 54511

It's perhaps worth mentioning that the faults listed above were all caused by failure of an EP type chip. If the paper label has been removed and you are unsure about the type to fit, consult Philips Service. I've noticed that the numbers (1.2, 1.6 etc) may vary, but the important thing is the ED, EP or ET type. M.L.

Tatung T14TD40 (D series chassis)

There were no results with this 14in. portable apart from the faint weep of the power supply when it was first switched on. A check on the HT voltage showed that it was high at 138V instead of 115V. Further checks revealed that there was no 8V supply at pin 10 of the TDA8361 jungle chip IC503, because D811 (BY396) in the chopper power supply was open-circuit. A replacement restored normal operation. M.L.

Bush WS6671

Set dead with the green LED blinking is becoming a regular fault with this widescreen set. If the line output transistor isn't short-circuit the transformer probably has shorted turns. CPC supply it. P.S.

JVC AV25F1EK (JX chassis)

These have been reliable sets. The only common fault, which has been mentioned in these pages before, is a dry-joint at the regulator on the heatsink that runs up the middle of the chassis. This set was stuck in standby however. In this state all the outputs from the power supply were present. When the set was brought out of standby these voltages disappeared. They remained when the feed to the line output

transformer was disconnected.

The transformer was the cause of the trouble. I decided to order a compatible one rather than the original, which would have been too expensive in view of the age of the set. When it had been fitted there was, as usual, an excellent picture. **P.S.**

Panasonic TX29AD2 (Euro-2 chassis)

This set produced a bright screen then reverted to standby. The first step was to check whether there was a supply to the RGB output transistors on the CRT's base panel. There was next to nothing and, when I traced back to source, I found that R366 (100 Ω , 0.5W) was open-circuit. **P.S.**

Sony KVX2932U (AE1C chassis)

Blowing of the 2SD1548 chopper transistor Q602 can be a problem. Cold checks normally show that R600 (1 Ω), which is in series with it, is open-circuit. The four electrolytics in the chopper circuit could well be leaky and should be replaced. They are C605 (220 μ F), C608 (4.7 μ F), C611 (47 μ F) and C617 (100 μ F). Also replace the TEA2260 chopper-control chip IC601. After that you should be OK. **P.S.**

Bush WS6671

The problem with this relatively new widescreen set was that the picture was pulsing then the set would shut down. After checking a couple of items I noticed that the electrodes in the neck of the tube were arcing together. Fortunately the set was under warranty. **P.S.**

Sharp 37DM23H

This set was totally dead. A nice easy one for a change. There was no start-up voltage at the chopper transistor because R404 (560k Ω , 0.5W) was open-circuit. As a precaution I also replaced R405, which has the same value. **P.S.**

JVC AV25SX1EK (JA chassis)

The cause of no sound is usually the MSP3410-SDIL multi-sound processor chip IC601. Not on this occasion however. A phone call to JVC put me right. Replace the KIA7805PI 5V regulator IC952. The no-sound symptom occurs when its output drops to 4.5V. **P.S.**

Sharp 66ES03H (CA10 chassis)

We are starting to see a few of these sets now. This one was stuck in standby. The line output transistor was getting hot and was not operating correctly, while R613 (2.2k Ω) was also overheating. When I

looked at the network of components in this circuit I decided to check the capacitors first, using a capacitance meter. C613 (680nF, 250V) was found to be open-circuit. A replacement restored normal operation. **P.S.**

Samsung CI5013T (P58SC chassis)

Two of these sets came in during the same day, both dead. When they were switched on you could hear the power supply trying to start. Both were cured by replacing C808 (100 μ F, 16V), C811 (10 μ F, 50V), C813 (100 μ F, 16V) and C817 (100 μ F, 25V), which are all on the primary side of the TDA4601-type chopper power supply. **G.B.**

Ferguson T59F (TX92 chassis)

The job sheet said intermittent picture or lines on picture. I left it on test while attending to some other jobs. After a while the picture became snowy/off-tuned. A replacement tuner cured the fault, which is becoming quite common with these sets. **G.B.**

Mitsubishi CT21A2STX (Euro 12 chassis)

This set was brought in after the owner bought a new VCR: he couldn't tune it to the output from his new VCR. When I checked it on the bench I found that previously tuned channels were OK, but in the search mode it wouldn't stop at a station. The cure was to replace the 0.47 μ F capacitors in the IF circuit. **G.B.**

Philips 25PT4521

This set was dead, and from the smell that still lingered in the back it was obvious that some arcing or burning of the PCB had taken place. Attention was quickly focused on the burnt-up on/off switch and PCB. Easy I thought, new board and off we go. Philips told me that it's no longer available, but I found that CHS (Charles Hyde) can still supply, the part number being P11973. **G.B.**

Hitachi C2509T (G7PS chassis)

The problem with this set was very poor field linearity, and from the evidence of fresh solder around the field output IC it was obvious that recent work had been done. The cure for this fault is to replace the field scan coupling capacitor C606 (680 μ F). **G.B.**

Matsui 2107/2109 series

I've come across the following fault several times now: the set cuts out when the aerial plug is inserted or moved in its socket. The action to take is to check all the earthing connections around the IF

screening can – in fact remake them all. **I.W.**

Bush 1433 (11AK20 chassis)

This set would work for up to a minute then trip off, with the LED flashing. Freezing almost anything in the power supply would get it going again. I replaced the 330k Ω and 820k Ω resistors as a matter of course, using metal-film components, and also the TDA4605 chopper control chip, but there was no change. The cause of the trouble was eventually traced to two 1N4148 diodes, D807/8. **G.D.**

Sony KVX2502U (BE3B chassis)

This set had been the victim of a storm, and had a dead power supply. Replacement of the STR-S6708 (Sony specification) chopper chip IC600, the TLP721 optocoupler IC601, and the SE135 error-detector chip IC602 usually does the trick in this event. This time the power supply then worked, but only in standby. The switching line from the digital panel varied randomly, though the panel worked when tried in another set. The cause of the trouble was the standby switching transistors Q603, Q604 and Q606, which were all leaky. **G.D.**

Hitachi C2114

Whenever the problem is an intermittent fault with an Hitachi set, it's worth checking the inevitable afterthought components you find glued to the underside of the PCB. This set would make an arcing noise and subsequently damage the line output transistor. I eventually found that C428 (470nF) under the jungle chip was soldered to the IC pin but made intermittent contact with the PCB. **G.D.**

Decca D14TFG5

As soon as the picture appeared, looking decidedly 'tubby', the set would trip off with the LED flashing four times. Adjustment of the first anode control brought back a reasonable picture without tripping, but the teletext display had no red. Replacing R909 (180k Ω , high-stability) on the CRT base panel restored a good picture but, to be on the safe side, I also replaced R913 and R922 in the green and blue channels. When I told the customer the good news he replied "don't bother, they're so cheap new". I failed to convince him that paying nearly three times the cost of my repair for the same result was hardly sensible economics.

By the way, if you do need to replace the CRT in these sets, make sure that you use the correct type, as the scan coils

form a hot/cold isolation barrier and are a safety item. G.D.

Panasonic TX21MD3 (Euro-2 chassis)

This set produced a very grainy picture. In fact Channel 5, our weakest local signal, was unviewable. Playback of a good tape via the scart socket was fine however, so it seemed that there was a tuner fault. As its supply was OK, I came to the conclusion that a new tuner would be required. Fortunately I was wrong. An internal examination revealed several poorly-soldered joints. Normal reception was obtained once these joints had been resoldered.

I couldn't help noticing that the picture quality was generally under par for the first five minutes or so. A check on the tube's operating conditions failed to reveal anything unusual, so I had to conclude that the tube was no longer at its best. As so often, the owner didn't seem to be aware of the degraded picture. D.I.S.

Sony KVDX2112U (AE1 chassis)

This Nicam set had a long, unattended history of intermittent sound drop-out, affecting both channels. The cause was traced to a single embrittled joint on the audio output chip IC251. During a prolonged test after remaking the joint distortion of the left-hand channel sound set in: it worsened to an LF oscillation when hot air was applied to IC251. A new chip cured the fault, and I can only assume that the long-term effect of the poor connection had in some way been to stress the silicon. D.I.S.

Grundig CUC3400 chassis

This old but reliable set's power supply was tripping. The cause was traced to C667 (2.2 μ F, 385V) in the snubber network. It was short-circuit. We were recommended to fit a replacement rated at 400V. S.D.

Mitsubishi CT21A3STX (Euro 12 chassis)

For field collapse with the sound OK, replace the TDA8178S field output chip IC451 and R976 (0.82 Ω , 0.5W fusible) in its 30V supply, which is obtained from the chopper circuit.

If the HT rises above 122V, replace the chopper drive coupling capacitor C906 (47 μ F, 63V, 105°). S.D.

Seleco 25SM631

This set was dead. Checks showed that the HT supply was high at 162V instead of 130V because there was no line drive. I then found that the 15V supply was missing because R20 (1 Ω) was open-circuit and IC1402 short-circuit between pin 2 and chassis. When replacements had

been fitted there was still no line drive from IC501. Its supply was low at only 1.5V, this time because R500 (4.7 Ω) was open-circuit.

Once this item had been replaced the set worked, but there was lack of contrast. D2501 in the beam-limiter network was open-circuit. I.L.

Ferguson D78N (ICC9 chassis)

This huge set produced a pink display – there was very little green drive at the tube. The green output at pin 36 of IV01 was OK but the following BC858B buffer transistor TV76 was leaky. I.L.

Thomson 24WK23U (ICC17 chassis)

This set was dead with the standby light on. The BUH516TH16 line output transistor TL34 was short-circuit. I.L.

Ferguson 68K4 (ICC5 chassis)

This set produced a blank raster with no sound, and there was no 7-segment display. The Ferg 07 microcontroller chip IR01 was faulty. I.L.

Steepletone BTV510

This monochrome portable was brought in because there was a "silver-rope effect" at the left-hand side of the picture. Close examination around the line output transformer revealed a dry-joint at pin 1, which is connected to D601 and C604. Resoldering cleared the fault. I.L.

Philips 28CL6770/25Z (FL1.10 chassis)

When this set was switched on the green LED lit for fifteen seconds then the set reverted to standby with the red LED on. There were no shorts, so I carried out some checks in the protection circuit and found that Tr7380 was short-circuit e-b-c, Tr7480 was short-circuit e-b and Tr7542 short-circuit e-c. After replacing these items I switched on and found that there was line collapse. A check at the scan-coil PCB revealed that the print at 2A01 was open-circuit and burnt. When this had been repaired I switched on and smoke came from Tr7512. Further checks showed that Tr7512, Tr7513 and D6516 were short-circuit while R3516 was open-circuit. These items are in the line-shift circuit. Once they had been replaced the set worked normally. S.V.

Mitsubishi CT21AV1BD (EE3 chassis)

After a minute or so the picture would black out, with no sound. Before doing so it would break up, like an IF fault. The same results were obtained with a signal fed in via the scart socket. I found that flexing or prodding the main board anywhere would produce or cure the fault. Many connections were resoldered before

I cured the problem by resoldering the connections to the TDA8137 regulator chip IC951 – even though they appeared to be OK. B.F.

Sanyo C28EH27NB (EB3-A chassis)

There was a faint blank raster, with a gap at the top and bottom, also no sound. The outputs from the power supply were all correct, but a 5V supply that's derived from a separate transformer, T381, was missing. This transformer was the cause of the trouble, with an open-circuit primary winding. Its part no. is PT0146A. Checks on the replacement showed that the primary measured 2.7k Ω while the secondary measured 15 Ω . B.F.

Finlandia C/D66KZ6/F (Nokia Euro Stereo 2 chassis)

Intermittent loss of the picture's red content was caused by a poor connection at R47, a surface-mounted resistor on the CRT base panel. Being such a small component, this poor connection could be seen only with the aid of a magnifying glass. B.F.

B&O 3923 (LX4500)

This set was dead with the 5A fuse blown. Checks showed that the BUT12F chopper transistor Tr1 was short-circuit. It had failed because of a poor connection at C5. B.F.

JVC AV21F1EK (JX chassis)

There was a blank raster with the sound OK. Checks showed that the 200V supply at pin 5 of the TEA5101A RGB output IC on the CRT base panel was missing. FR521 (47 Ω , 1W fusible) in the feed had gone open-circuit, but the cause of the fault was the IC. The picture was back once these two items had been replaced. B.F.

Panasonic TC2233 (U4W chassis)

Although the field scanning looked perfect with a test card, an annoying one line of text would intermittently appear about half an inch from the top. It was barely noticeable with normal pictures, but when a programme was transmitted in the 'widescreen mode' it was smack in the middle of the blacked out top section. The fault was cured by replacing C453 (100 μ F, 35V) and C454 (47 μ F, 25V). B.F.

Amstrad CTV1410 (Onwa chassis)

The sound was OK but the screen was blacked out. When the setting of the first anode control was advanced a blank raster with flyback lines appeared. The conditions around the video processor chip IC301 were incorrect, the cause being R316 (12k Ω). B.F.

WEB SERVICE

To reserve your web site space telephone

Tel: 020 8722 6028 Fax: 020 8722 6060

E-MAILS j.thorpe@cumulusmedia.co.uk



Alltrade Aerials & Satellite Ltd

<http://www.alltrade.co.uk>

Phone 01273 413798 Fax 01273 425700
Full e-commerce site with over 1500 products with in-stock quantities!! We supply everything associated with Digital/Analogue Terrestrial & DTH/Motorised Satellite reception. All Antennas. All Brackets. All Cables. All Connectors. All Amplifiers. We provide a free MATV/SMATV planning service as well.

A.R.D. Electronics Plc

<http://www.ardelectronics.com>



A.R.D.'s Website details all the information you need to know about this new and exciting electronic component distributor. It shows how to: open an account (credit or cash), obtain a trade catalogue and place orders (both online and direct).

Cricklewood Electronics

<http://www.cricklewoodelectronics.co.uk>

Cricklewood Electronics stock one of the widest ranges of components, especially semiconductors including ICs, transistors, capacitors, resistors. all at competitive prices.

Charles Hyde & Son Ltd

<http://www.charleshyde.co.uk>

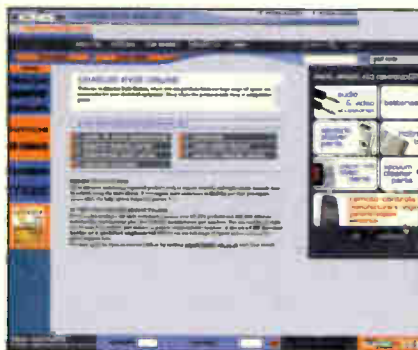

Search for both original and copy spare parts in our extensive database covering Akai, Alba, Bush, Ferguson, Goldstar, Hitachi, LG, Matsui, Nokia, Saisho, Sanyo, Sony, Sharp, Thomson, Panasonic, Philips, Samsung, Tascam, Teac, Toshiba, Yamaha and many more. In addition huge ranges of Lasers, Loptos, Remote controls and Semiconductors may be accessed.

Dönberg Electronics

<http://www.donberg.ie>

<http://www.donberg-electronics.com>

<http://www.electronic-spare-parts.com>



As the leading distributor for the TV, Video and Audio trade in Ireland, we supply over 2000 shops & service dept with Audio-Video and TV spares, Semiconductors, Test Equipment, Service Manuals, Remote Controls etc. At present we stock over 35,000 different lines. We hold agencies for: Panasonic, Sharp, Mitsubishi, Sanyo, Beko, Ersa, Müter, Diemen HR, Philex, PRF, König-

electronics. We specialise in parts for all continental sets and obsolete semiconductors.

EURAS International Ltd

<http://www.euras.co.uk>



This website offers you a comprehensive online Repair Information System, including Technical Repair Information, Discussion Forum, Tech-Chat and a valuable Pinboard System. Visit the site and apply for a free 30 day trial (no deposit required)

J W Hardy Communications

<http://www.jwhardy.co.uk>



R.F. Network Specialist. Shop online - for R.F. network components. We supply a full range of TV, radio reception equipment to receive analogue/digital signals from both terrestrial and satellite sources. We provide a free planning service for your R.F. networks, MATV and SMATV etc

Holderness Solutions Ltd

<http://www.digisatsolutions.com>

Suppliers of over 3000 lines of equipment to the aerial and satellite trade. All major brands stocked from coax plug to 1.8mtr + dishes.

Matrix Multimedia Ltd

<http://www.matrixmultimedia.co.uk>

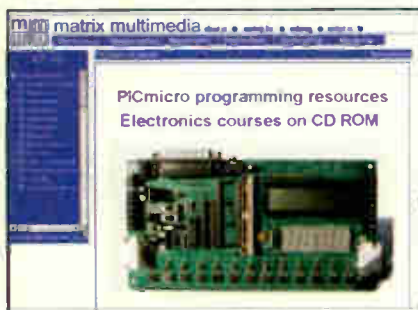

Matrix Multimedia produces courses in electronics and PICmicro programming. Products include a flexible PICmicro development board and Flowcode - which converts flowcharts into PIC programs.

M.C.E.S.

<http://www.mces.co.uk>

The MCES site gives details of our range of service including Tuners, Video Heads, RF & IF Modules plus latest prices offers.

MMWafercards

<http://www.mmwafercards.com>



Smartcards and programmers for all access-controlled applications. Incorporating www.satstore.co.uk The Enthusiasts Satellite Store. Tel 01386 48731 Fax 01386 765875

Radio Restoration Company

Edinburgh

Specialist repairs to Hacker & Roberts radios, postal service if required. All valve and transistor radios & rebuilds undertaken. Free estimates - trade welcome, large selection of radios large & small Etc, from 1920s on always available. Contact:- Jamie Gillan 0131 2251475

Service Engineers Forum

<http://www.E-repair.co.uk>

The forum is now visited by Thousands of engineers every week, over 3000

pages of content including new repair tips, servicing articles, circuits, help, for sale, wanted & industry news sections, open access to the site is free to all engineers.

Our product mailing list is also available free of charge for engineers without net access, ring Mike on 0151 522 0053 with your address details.

Switch-it-on

<http://www.switch-it-on.co.uk>

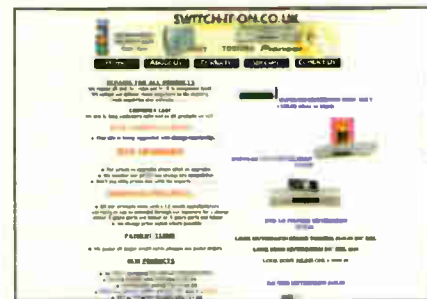

We sell multi-region dvd players to trade and public, also tv, videos, hifi and playstation 2. We design our own upgrades on dvd and we sell all spare parts. All makes and most models stocked.

Swires Research

<http://www.swires.com>



Swires Research produce high quality instruments for the television industry, including portable signal level meters and spectrum analysers for digital and analogue RF signal measurements.

Televés

<http://www.televés.com/ingles/ingles.htm>

Televés website was launched as an easier way to keep in contact with our World-wide Network of Subsidiaries and Clients. This site is constantly updated with useful information/news plus you can download info on our

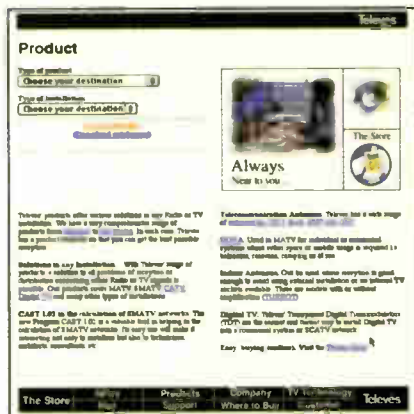

range: TV Aerials & accessories, Domestic and Distribution amplifiers, Systems Equipment for DTT and Analogue TV, Meters and much more.

Transworld Satellite

<http://www.transworldsatellites.co.uk>

Fifteen years experience serving enthusiast hobbyist, broadcasters, trade, complete range receivers, cams, programmers, cars, dishes, motors. with excellent technical support and friendly service. Telephone 01947 820999

Vintage Wireless Co London

<http://www.vintagewirelesslondon.co.uk>



Phone 0207 2583448 Fax 0207 2583449

Supplies of vintage hi-fi, wireless, sales & service, spare parts, valves, components, transformers, knobs, ceramic cartridges, stylus and more. Vintage hi-fi literature, magazines, circuits. Wanted tannoy's & early hi-fi audio valves for cash.

To reserve your web site space telephone

Tel: 020 8722 6028 Fax: 020 8722 6060

E-MAILS j.thorpe@cumulusmedia.co.uk



LETTERS

SkyLink installations

Most readers will be familiar with the Sky magic-eye remote-control extender system, which for example enables a viewer in his bedroom to change the digibox channel downstairs in the main room. Installation is quite easy, but calls for a full-thickness coaxial cable from the digibox to the bedroom and probably involves drilling through floors or window frames.

I was recently asked to install a couple of these magic-eye systems in a large house that already had a very good aerial distribution system which I didn't want to disturb. Both digibox signals were already available to all the TV sets in the house. The customer was a bit of a tyrant, and wouldn't allow any drilling or mess!

As I wanted to convey only the control signal on the 'return path' and not the RF from the digibox, I decided to try using a thin, screened audio cable instead of full-sized coaxial cable. It worked a treat, in fact far more reliably than using coax!

A Sony TV problem

I know what level of performance to expect from the Sony Models KV28FX60 and KV28FX65: they are amongst the best 28in. sets available. But I'm concerned about a couple of defects that Sony seems to be unwilling to acknowledge.

First, with many of these sets there's a purity problem at the bottom left of the screen. No amount of degaussing helps.

Secondly, with the KV28FX65 (and FX65 range models with other screen sizes) there is ghosting to the right of all images, regardless of their source. Even the internally-generated menus are affected. You do not get this with FX60 range sets, so presumably a design change is the cause. Maybe an impedance mismatch in the video processing circuitry introduces signal reflection?

I have a web page (<http://mop.to/colin99>) that mentions these problems, and have had dozens of e-mails asking whether a solution has been found. I usually recommend having the set exchanged under warranty for the purity problem, but this is not a solution for the ghosting that affects all FX65 sets.

Has anyone else been troubled by these problems? More importantly, has anyone found a cure or had Sony admit that there is a problem?

Colin McCormick,
colin99@bigfoot.com

Send letters to "Television", Highbury Business Communications, Anne Boleyn House, 9-13 Ewell Road, Cheam, Surrey SM3 8BZ or e-mail tessa2@btinternet.com using subject heading 'Television Letters'.

Please send plain text messages. Do NOT send attachments. Be sure to type your full name, address, postcode, telephone and e-mail address (if any). Your address and telephone number will not be published but your e-mail address will unless you state otherwise. Please send ONLY text intended for the letters page. Correspondence relating to subscriptions and other matters must be sent to the office address given above.

Both ends of the connection have to be soldered of course. I soldered the wire directly to the coaxial socket hole in the remote eye itself, having removed the socket first. The other end is connected via a soldered coaxial plug to the digibox's second RF output - this is available with all Sky digiboxes.

The advantage of this arrangement is that thin audio cable can be pushed into cracks in floorboards, under carpets etc. where a full size coaxial cable would be far too obtrusive. Also, standing on coaxial cable is not recommended if you want to get the signal out at the other end!

I have since used this 'thin wire' technique at a number of premises where a signal-distribution system was already present. It has proved to be a hundred per cent reliable. The audio cable I use is Alcatel audio cable, RS order no. 367-246 or 367-252, which provides a reliable and durable connection. The control signal will travel through a 100m roll of this with no trouble at all, so the average house or even a small mansion is no problem!

My next job will be to make up a small infra-red transmitter that can be used with a Sky magic-eye sender to control other items remotely in the same way. All that's needed is a 9V supply and a small emitter. Perhaps a modified redundant remote-control unit would do the job? With the

increasing amount of RF interference present, the use of hard-wired remote extenders seems to be the best way of ensuring a trouble-free installation without callbacks.
*Robert Philpot,
Haywards Heath, West Sussex.*

Cost of spares

I recently asked a major spares distributor and Sony agent the price of a new transformer for a Sony Mini Hi-Fi and was quoted £109.34 plus VAT. This made the unit uneconomic to repair. My customer was very keen to have the unit repaired however, so I contacted Sony in London. The price I was quoted this time was just £51.48 plus VAT. How can distributors justify such inflated prices? I've had an account with the firm concerned since 1982.

It seems that retail prices are being quoted, and even so very high. It sometimes pays to enquire around.
*R. Pawley, TV Video and Electrical Repairs,
Bognor Regis, West Sussex.*

That scam

With reference to John Priest's description of a scam perpetrated on one of his customers (Letters, May) I must mention that it has been widely practised in my area over the past five-six years. It first came to my attention via another scam that's often used in markets and car-boot sales. A set is seen working and sold, but the customer decides to leave it while he goes browsing around. When he returns the seller hands him an identical non-working set.

I even had to call the police once when I showed a customer the inside of a set he had brought to the shop earlier on for repair. There were panels missing, wires cut etc. and he blamed me for the butchery. He said it had been working perfectly before he brought it to the shop, and wanted to sort me out there and then. When the police arrived his wife, who had bought the set, explained that she saw it working at the market and collected it later after doing some shopping. When the police had left the poor woman was given terrible abuse by her husband in the street outside.

This other scam then started to appear. It's given away by the fact that the remote-control unit is usually of a different brand to the set itself. I even had a man who bought two TV sets and two VCRs for himself and his parents one Christmas, paying £300. It was all junk.

The perpetrators of this scam go around repair and retail shops offering to buy non-working sets, as long as they are modern and with good cabinets, no matter what is inside, and claim to export them to Africa "to help the economy over there". It's not advisable to sell anything to them, as they won't leave you alone and use bully tactics to get what they want somehow. Their greatest problem is a lack of equipment to sell, not a lack of punters.

I am amazed that while it's difficult nowadays to sell a modern second-hand set with a full guarantee for £45, these merchants are able to sell junk for twice as much without the buyer seeing that the equipment works. No one would buy a car without trying to start it. The sales are conducted outside factories, industrial estates, etc., sometimes with the claim that a 'job' has been done in a big town and the equipment has to be disposed of quickly. This means that the buyer can hardly complain to the police.

My advice is to smash your unwanted cabinets rather than help this scam to spread farther and farther.

*Carlos Deus,
King's Lynn.*

The scam mentioned by John Priest is not new – I mentioned it in an article not long since. Several of my customers have been taken in. I was even approached on one occasion outside the local Peugeot dealer. When I said I wasn't interested the seller became rather menacing. I walked away, went into a shop and persuaded the owner to let me out the back way. During that time I had managed to get the registration number of the van involved, a fairly new, unmarked Transit. These sellers tend to frequent pubs, clubs, factories and other places where large numbers of people congregate. The products appear to be well presented, and are usually wrapped in cling film. They may well have been sprayed.

Another scam is the Guarantee Voucher which tells the customer that, in the event of a fault, the product should be taken to the local TV shop where it will be repaired free-of-charge. I understand that this has led to blazing rows and, in one case, a near fight between an innocent trader and someone who had bought such rubbish.

One guy bought a boxed 'Sony' TV set that was filled with thermalite bricks. Another bought a Sony KV-E2912 which had no speakers and no tuner/IF/Nicom modules. I gather that the people who are sold these sets are told they are either

Philips televideo remote-control units

Several of your correspondents have mentioned a problem with Philips VCR and TV/VCR combi unit remote-control handsets, where TV operation is OK but remote control of VCR transport functions (play/stop/fast forward/rewind) is lost. There is no need to replace the remote-control unit. The cause of the problem is that the unit has switched from the VCR1 to the VCR2 mode. It can happen when the battery voltage is low, or when batteries are removed and replaced. There's no fault: it's an aspect of the multi-use of these handsets.

To return to the VCR1 mode, press and hold down the stop button and the number 1 button simultaneously for five seconds – or, depending on the remote-control unit version, the stop and number 2 buttons.

These remote-control units can operate two separate VCRs in the same room without interaction – to toggle to the other VCR, stop and button 2 are pressed.

*Larry James,
Weston-super-Mare.*

Editorial note: A number of readers have written in to explain the situation with these remote-control units. Our thanks to you all.

stolen or returned stock. Either way, if people are foolish enough to buy they deserve what they get. One woman told me she was given a lift to the cash machine. Those who engage in this activity often sell more sets in a day than a legitimate trader manages in a month.

I used to buy ex-rental TV sets from a wholesaler. I and other traders would be notified that a lorry was coming in from say Granada. We would pick out, check and test the items we were interested in. After we had picked our stock others would come along and buy the rubbish, i.e. sets with no or a broken chassis, a duff CRT etc. We all knew what was going on. I know that non-working and non-repairable sets were being bought from other shops and dealers.

There have been a few prosecutions, mainly for trademark offences (it's illegal to say rebadge an Alba set as a Sony one). But this is just the tip of the iceberg.

When buying such products, people should remember the phrase caveat emptor (let the buyer beware). I hope John Priest charged appropriately for his call-out – just because a customer gets ripped off doesn't mean that his time is worth less. Until people come to their senses and stop buying this rubbish, the traders involved will continue to do well. Often very well.

*Michael Maurice,
Wembley, Middx.*

I have been in this business for over forty years and, over the past five years, have had many customers who have brought in bubble-wrapped TV sets and VCRs bought off the back of a van, mostly with major components missing. Because of the poor profit margins with new equipment, I nowadays mainly deal in refurbished stock. When customers come in to purchase something they generally go over it with a fine-tooth comb, pointing out any little marks on the case, then try to find something wrong with the equipment's operation before finally trying to

knock the price down. They also want a year's guarantee. Yet a large number of people will buy a pile of bubble-wrapped junk from the back of a van without trying it, and will pay more than I charge without getting any guarantee.

I have had many people come into my shop offering to buy my old scrap equipment. They openly admit what they are going to do with it. I did on one occasion contact the local police, but they were not interested. They said that if a member of the public is that stupid, they deserve what they get! It's buyer beware.

*Tony Hoskins,
Chandler's Ford, Hants.*

Spelling

Everywhere I look on the internet, people seem to be loosing things. Some complain that they loose connection every hour or so. Some are nastily referred to as losers. Fearing that I was losing my mind, I consulted an English dictionary. No, lose was not lost: it was still there between lorry and loss. Perhaps this was the American way to lose? So I checked an American on-line dictionary. Lose was there too, so was loose.

Then, in the April leader, we read that "Premiere is loosing something like 80m euros a month" and that "Quiero is loosing 15-18m euros a month".

The only explanation I can think of is that there's a virus on the loose, invading computers and adding an extra 'o', then spreading via e-mail!

I don't usually worry unduly about spelling, but would like to keep the 'lose' I've lived with all these years.

*Ron Mitchell, Newtonhill Electronics,
Newtonhill, Aberdeen.*

Editorial comment: Several readers have taken me to task about this. I only wish I could blame those viruses but no, it's simple human error. I'll be more careful in future, honest. But, as one correspondent pointed out, I promised him that twenty years ago! **JAR.**

Answer to Test Case 474

- page 485 -

Three 'faults' for the price of one, and not a penny in the till for this visit - in fact it extracted 495 pennies from the shop's till!

Problem number one was certainly down to Cathode Ray. When he had installed the newly-repaired Pace analogue set-top box he had interchanged the TV and VCR scart leads. This box suppresses the captions and graphics in the AV feed to the VCR. Colin swapped the leads back.

The second problem was, well, down to the shop staff who had called to install the new VCR. With no spare mains sockets available it had been connected - together with the digibox and a fan heater! - via a three-way 13A adaptor block. This was old, worn and tarnished inside. The resulting 'splashes' on the mains feed were upsetting the control chip in the digibox. Doc Colin connected the fan heater to a socket on the other side of the room, discarded the block adaptor, gave the set-top box a mains socket of its own and fed the other gear through a 13A, four-way strip distributor.

The horizontal displacement of video fed to the TV set in RGB form via its scart socket could not be cured in the absence of separate horizontal shift controls for the two modes, whose sync pulses are subjected to different delay times. The best that could be done was to adopt a compromise setting.

NEXT MONTH IN TELEVISION

A guide to the Thomson ICC17 chassis

The Thomson ICC17 replaced the ICC9 and TX92F chassis in Thomson's core range of TV receivers, for both 4:3 and widescreen models. It represented a major re-engineering operation, taking into account the current trend in TV receiver technology and the latest silicon available. Mark Paul starts a new series which will provide a detailed guide to circuit operation.

New technology from Panasonic

A number of new products are expected from Panasonic later this year, using a variety of technologies. They include flat-screen TV sets, digital TV adaptors, IDTV sets, hard-disk recorders, DVD-RAM recorders, DVD-Audio players and SD Memory Card audio and video devices. George Cole takes a look at the company's latest developments.

Windows 2000

K.F. Ibrahim describes the operating system, the boot-up process and faults. There are standalone and server versions of Windows 2000: this article concentrates on the former version, which Microsoft calls Professional.

TELEVISION INDEX & DIRECTORY 2002 Plus hard-copy index and reprints service

Here's the essential repair information you need! The **Television Index & Directory 2002**, in CD-ROM form, contains the text of over 14,000 high quality fault reports on TVs, VCRs, Camcorders, DVD players, Monitors, Satellite TV units, Audio equipment and CD players, searchable by make and model, plus the text of 168 Test Cases and over 200 major servicing articles, from fourteen years of Television magazine. It also contains a full fourteen year index of Television, a Spares Guide, a directory of Trade and Professional Organisations, an International TV Standards guide, a satellite TV Channel Finder, a TV transmitter list and a compendium of internet resources for service engineers. The software is quick and easy to use, and runs on any PC with Windows 95, 98, ME, NT or 2000.

Television Index & Directory 2002 CD-ROM, £199

Television Index & Directory 2002 CD-ROM upgrade, £46 (to qualify for this upgrade you need to have purchased a previous version of the Television Index on floppy disk or on CD-ROM)

A six-month update of the index and fault reports will be available in May 2002. If you wish to take advantage of this, £10 should be added to a full update order.

Television Index only, 1988 - 2001, £36

Television Index only upgrade from previous versions, £16

Hard-copy indexes of Television magazine are available for Volumes 38 (1988) to 51 (2001) at £3.50 per volume.

Reprints of articles from Television back to 1988 are also available, at the flat rate of £3.50 per article - you can order through our web site, or write to the address below.

The above prices include UK postage and VAT where applicable. Add an extra £1 postage for non-UK EC orders, or £5 for non-EC overseas orders, although Channel Island residents do not need to add any extra postage. Cheques should be made payable to SoftCopy Ltd. Access, Visa or MasterCard Credit Cards are accepted. Allow up to 28 days for delivery (UK).

**SoftCopy Limited,
1 Vineries Close, Cheltenham, GL53 0NU, UK**

Telephone 01242 241 455 Fax 01242 241 468
e-mail: sales@softcopy.co.uk web site:
<http://www.softcopy.co.uk>

Published on the third Wednesday of each month by Highbury Business Communications, Anne Boleyn House, 9-13 Ewell Road, Cheam, Surrey SM3 8BZ. **Highbury Business Communications** is a division of **Highbury Communications PLC**. **Filmsetting** by G&E A1 Parkway, Southgate Way, Orton Southgate, Peterborough PE2 6YN. **Printed** in England by Polestar (Colchester) Ltd., Newcomen Way, Severalls Industrial Park, Colchester, Essex CO4 4TG. **Distributed** by Comag, Tavistock Road, West Drayton, Middlesex UB7 7GE (tel. 01895 444 055). **Sole Agents** for Australia and New Zealand, Gordon and Gotch (Asia) Ltd.; South Africa, Central News Agency Ltd. **Television** is sold subject to the following conditions, namely that it shall not, without the written consent of the Publishers first having been given, be lent, resold, hired out or otherwise disposed of by way of Trade at more than the recommended selling price shown on the cover, excluding Eire where the selling price is subject to currency exchange fluctuations and VAT, and that it shall not be lent, resold, hired or otherwise disposed of in a mutilated condition or in any unauthorised cover by way of Trade or affixed to or as part of any publication or advertising, literary or pictorial matter whatsoever.



OFFICIAL
DISTRIBUTORS

WILTSGROVE LTD

35/38 River Street, Digbeth, Birmingham B5 5SB, UK.

Tel: 0121 772 2733
e-mail: sales@wiltsgrove.co.uk

Fax: 0121 766 6100
http://www.wiltsgrove.co.uk



CD LASERS

Order code: AP-1017G Qty 1 Qty 5 Qty 10
Genuine Model No: KSS213B £8.95 £8.75 £8.45



Order code: AP-1002G
Genuine Model No: KSS210A £10.78 £10.45 £9.95

DVD LASERS

Order code: AP-1092 Qty 1 Qty 3 Qty 5
Model Number: DVD 709, DVD 909, Thomson DTH 3300. £22.50 £21.95 £19.95

DVD LASERS

Order code: AP-1094
Model Number: DVD 305, DVD 511. £24.95 £24.75 £22.95

LOPTS

• PHILIPS - AT2079110
• CP90 Chassis

Order code: LT-137P £6.95

MAINS SWITCH - WHARFDALE

1 £1.65
5 £1.50
10 £1.45

Order code: SW-1031

SONY PLAYSTATION LEAD

• Sony Playstation 2 & PSone

1 £1.95
5 £1.85
10 £1.25

Order code: LD-1037A

UNIVERSAL TV RF SWITCH

• Sony Playstation 1 & 2
• PSone, Sega Dreamcast and Nintendo 64

1 £3.95
3 £3.85
5 £3.75

Order code: LD-1038A

REPLACEMENT REMOTE CONTROL



• RC5911

1 £3.50
5 £3.25
10 £2.95

Order code: RM1160

REPLACEMENT MAINS SWITCH



• Alba Bush Goodmans

1 £1.25
5 £1.10
10 £0.95

Order code: SW-1009

PANASONIC REAR SPEAKERS



• 15 W max.
• 8 Ω

1 £9.95
5 £9.45
10 £8.95

Order code: SPK-1005

GENUINE SKY DIGI REMOTE

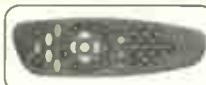

Order code: IR-1086G

1 £7.95
5 £7.45
10 £6.95

SKY MAGIC EYE



Order code: SPS-3200P

1 £4.75
5 £4.25
10 £3.95

SATELLITE RECEIVER



• Free - Air Channel
• High Quality video & audio
• Remote control unit included

Order code: AE-7235

£99.95

GENUINE REMOTE CONTROLS

STOCK CLEARANCE!



• Model HSM57

Order code: IR-1191G

£4.95

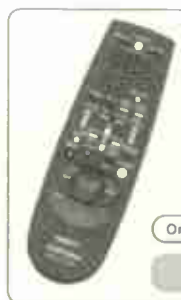

• Model HS621
HS640

Order code: IR-2183G

£4.95

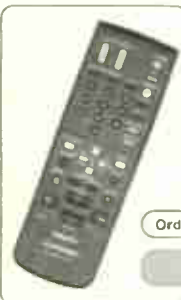

• Model HSM50V

Order code: IR-2095G

£4.95



• Model HSM16

Order code: IR-2196G

£4.95

REPLACEMENT MEMBRANE



FERGUSON

• A59F
• A51
• RR5191
• A59N
• B51F
• B51NX

Order code: SPT-1111R

£4.95

REPLACEMENT MEMBRANE



DECCA

• DN8951
• TN8901

TATUNG

• DN1951
• TN1901
• TN1951
• TO8903

MTEC

• EMT1951

VIBRANT

• VN89A1

BOOTS

• CTV1411

Order code: SPT-1110R

£7.95

REPLACEMENT MEMBRANE



DECCA

• DU8957

TATUNG

• DT8955
• TT8905
• TT1905
• TN8901

Order code: SPT-1115R

£8.95

BABY10 REGULATOR



Order code: IC-402

£7.75

SCHNEIDER LOPTS - HR



• OEM 13525033
• Model CTV 2790,
CTV 2816,
PTV 2701
STV2801T
SRV2802T
Chassis TV9

Order code: LT-844

£12.45

SCHNEIDER LOPTS - HR



• OEM 13525025
• Model PTV 7001

Order code: LT-833P

£12.45

*THIS OFFER IS VALID UNTILL THE END OF JUNE 2002

*PRICES SUBJECT TO AVAILABILITY, VAT & CARRIAGE.

CALL US NOW ON **0121 772 2733** - WHILE STOCKS LAST!!

Possibly largest
& oldest est. in
the UK
Est for
29 years



Wholesale Distributors & Export Agents

TV's with
integrated
DVD's
Now in stock

42" - 56"
Rear
Projection TV's
Now in stock
From only!
£849.99



FULL RANGE OF
FACTORY GRADED
TV'S
DVD / VIDEO
HI-FI



SMALL AND LARGE
DOMESTIC GOODS

Over
1000
different
lines

CT ARE MAIN DEALERS OF

BEKO AND **SANYO**
AND MANY OTHER BRANDS



Nationwide next day delivery service. Visitors by appointment.

Tel: 44 (0)121 359 7020 Fax: 44 (0)121 359 6344

Phoenix House, 190 Bridge Street West, Newtown, Birmingham B19 2YT
colourtrade@btinternet.com



The
headend
that says
YES to



- Quality
- Ease of use
- Agility
- Each module an almost total entity
- Superb value

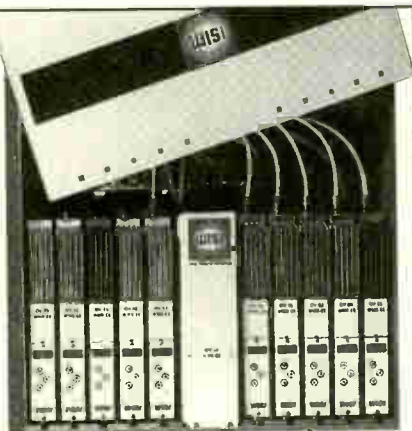

WISI's Topline headend system is very competitively priced yet is of superior design and build. It is easy-to-use with high quality channel processing that allows the user to retain quality of vision and sound for both analogue and digital signal sources. There are processors for satellite TV, terrestrial TV and radio. Each individual module incorporates its own control system enabling quick and easy set up. These channel processors come together in an 'all-in-one' base unit which contains all necessary accessories for ease of ordering - no additional items required.

U.K. STOCKIST

J.W. Hardy
Communications

WISI TOPLINE HEADEND
CHECK THESE FEATURES

- Frequency agile freely selectable in the VHF of UHF range.
- Adjacent channel capable.
- TV standards 64 QAM B/G, D/K, I, L, M.
- Modular system for headend stations in SMATV and CATV systems.
- Modules for Analogue and Digital.
- Satellite TV & Radio, Analogue & Digital Terrestrial TV & Radio, Analogue & Digital Satellite I.F. Converters, Analogue & Digital compatible Terrestrial TV Converters, Analogue & Digital compatible TV Modulators, Analogue & Digital.
- Individually programmable modules.
- High output level.
- Wall mounting or 19" rack mount with lockable cabinet door.

May we send you full details?



A Breakthrough
in Headend Design

J.W. HARDY COMMUNICATIONS, 231 Station Road, Birmingham B33 8BB Telephone: 0121 784 8478 Fax: 0121 789 7931

FRUSTRATED!

Looking for ICs TRANSISTORS?

A phone call to us could get a result. We offer an extensive range and with a World-wide database at our fingertips, we are able to source even more. We specialise in devices with the following prefix (to name but a few).



2N 2SA 2SB 2SC 2SD 2P 2SJ 2SK 3N 3SK 4N 6N 17 40 AD
ADC AN AM AY BA BC BD BDT BDV BDW BDX BF
BFR BFS BFT BFW BFX BFY BLY BLX BS BR BRX BRY BS
BSS BSV BSW BSX BT BTA BTB BRW BU BUK BUT BUY
BUW BUX BUY BUZ CA CD DX CXA DAC DG DM DS
DTA DTC GL GM HA HCF HD HEF ICL ICM IRF J KA
KIA L LA LB LC LD LF LM M M5M MA MAB MAX MB
MC MDA J MJE MJF MM MN MPS MPSA MP SH MPSU
MRF NJM NE OM OP PA PAL PIC PN RC S SAA SAB
SAD SAJ SAS SDA SG SI SL SN SO STA STK STR STRD
STRM STRS SV1 T TA TAA TAG TBA TC TCA TDA TDB
TEA TIC TIP TIPL TEA TL TLC TMP TMS TPU U UA
UAA UC UDN ULN UM UPA UPC UPD VN X XR Z ZN
ZTX + many others

We can also offer equivalents (at customers' risk).

We also stock a full range of other electronic components.

Mail, phone, Fax, Credit Card orders & callers welcome.



Cricklewood Electronics Ltd

40-42 Cricklewood Broadway, London NW2 3ET

Tel: 020 8452 0161 Fax: 020 8208 1441

www.cricklewoodelectronics.co.uk

E-mail: sales@cricklewoodelectronics.com

**MARKET TRADERS
WHOLESALERS
WELCOME**

VISION TECH

**EXPORT CATERED FOR:
AFRICA, EAST EUROPE,
MIDDLE EAST ETC.**

*Wholesalers, Distributors and Export Agents
of Electronic Domestic Appliances*

Tel: (+44) 121 554 8282

Fax: (+44) 121 554 2121

49 Harford Street, Hockley, Birmingham B19 3EB

ONE STOP CASH 'N' CARRY

Discounts Always Available on Quantity

All we ask is for one visit. We promise you will not be disappointed with our quality and prices.

PLEASE RING FOR LATEST OFFERS. 0121 554 8282

TELEVISIONS



ALL TOP BRANDS/SIZES - SONY - HITACHI - SANYO - JVC
TOSHIBA - BEKO - WHARFEDALE - AMSTRAD - PANASONIC ETC

HI-FI



MIDI MICRO SEPARATES - ALL BRANDS

DVD/VIDEO



REGION 1 - MULTI-REGION

SMALL AUDIO



PERSONAL CD - MINI DISC - RADIO/CASS - SINGLE/TWIN/MONO,
CD, RADIOS, WALKMAN - CLOCKS ETC

LARGE/SMALL DOMESTIC



MICROWAVES - HOOVERS - KETTLES - IRONS - TOASTERS

VAST RANGE OF OTHER PRODUCTS TOO MUCH TO LIST

TOSHIBA
Panasonic
SHARP
SONY
PHILIPS
HITACHI



CENTRAL

WHOLESALE DISTRIBUTION LTD

WEBSITE:
WWW.CENTRALWD.CO.UK
EMAIL:
SALES@CENTRALWD.CO.UK

MAIN GRANADA TV & VIDEO DEALERS

SMALL DOMESTIC

IRONS, KETTLES,
TOASTERS, MIXERS,
FRYERS, BLENDERS,
FOOD PROCESSORS



DVD / VIDEO

DVDS, CDS, VIDEO
RECORDERS, COMBIS
PORTABLES



LARGE DOMESTIC

FRIDGE FREEZERS,
COOKERS, DRYERS,
WASHING MACHINES



TELEVISIONS

TOSHIBA
HITACHI
SONY
WHARFDALE
PHILIPS



AUDIO EQUIPMENT



EX-RENTAL TVS AND VIDEOS

20" WORKING Television,
Teletext from **£20**

Video recorders WORKING
Hitachi, Akai, Panasonic **£19**

FOR ALL EXPORT ENQUIRIES CALL OUR BIRMINGHAM OFFICE.
Market traders and wholesalers welcome.

HEAD OFFICE: 2-22 Adelaide Street, Digbeth, Birmingham, B12 0SH
TEL:0121 622 2525 FAX: 0121 666 6177

LONDON DEPOT: 9A Nobel Road, Eley Estate, Edmondon, London, N18 3BH
TEL:0208 807 4090 FAX: 0208 884 1314

NEW STOCK
ARRIVING
DAILY!

Discounts
available
on quantity!

Electrolux
AEG
BOSCH



WHOLESALE

13 Old Marston Road,
Marston,

Oxford OX3 0JR

Tel: 01865 727555

Fax: 01865 728555

STOCKISTS IN SONY,
TATUNG, TOSHIBA, HITACHI
PHILIPS.

Delivery anywhere in the UK.

High quality products

VCR'S, TELEVISIONS, HI-FI'S,
DVD'S

TELEPHONE FOR DETAILS
OR VIEW BY APPOINTMENT.

29 LONSDALE ST,
STOKE-ON-TRENT
ST4 4DT

CONTACT SASH
01782-848153
MOB: 07970-728844

CHROMA VISION

Est 22 years

ALSO NOW IN BIRMINGHAM

94 SOHO HILL

HOCKLEY - B'HAM B19 1AD

BEFORE HOCKLEY FLYOVER

TOWARDS B'HAM

CONTACT GURBAKSH

0121 551 2233

MOB: 0795144 7520

ALL WORKING - WITH REMOTE'S

14" text port	£40
14" Combi remote	£75
28" Nicam F/text	£85
28" Nicam F/text W/screen	£130
32" Nicam F/text W/screen	£200
VCR's available from	£39.50

TOP BRAND

WIDESCREEN SANYO - HITACHI - JVC ETC
ONLY AVAILABLE FROM STOKE BRANCH



WIDESCREEN TV'S



TV/VIDEO COMBI'S



VCR'S

Electronicworld

TV AND VIDEO LTD

THE TV & AUDIO CENTRE NEW WAREHOUSE NOW OPEN

BANKRUPT STOCK AVAILABLE - TOP BRANDS AT SILLY PRICES

New but Graded Projection TV's from £450

New but Graded Ferguson 33" TV's £150

New but Graded 32" Widescreen Nicam TV's from £175

New but Graded 28" Widescreen Nicam TV's from £90

New but Graded 28" Nicam Fastext TV's from £60

New but Graded DVD s HIFI's and VCR's in stock

Over 1000 TV's In Stock All Brands Available

Ring for Details

0121-665 6336

All prices are Exclusive of VAT

BIRMINGHAM

208 Bromford Lane, Erdington, Birmingham
B24 8DL

Tel: 0121 327 3273 Fax: 0121 322 2011

LONDON

221 Kenton Road, Middlesex HA3 0HD
Tel: 020 8907 9387

PRESTON

Unit 434 Rangle Road, Walton Summit,
Preston PR5 8AR

Tel: 01772 316066



TOP BRANDS



HI-FI SYSTEMS



DVD



ELECTRONICS

WHOLESALE DISTRIBUTORS
OF DOMESTIC
ELECTRONIC APPLIANCES

Unit 15 Marks Hall, Margaret Roding, Dunmow, Essex CM6 1QT
Telephone: 01245 231684 Facsimile: 01245 231862

NEW B GRADE STOCK AT BELOW TRADE PRICE

LARGE 28in wide screen 16 x 9 format televisions .. from £190.00

LARGE 32in wide screen 16 x 9 format televisions .. from £275.00

LARGE rear projection televisions 52" from £1,000.00

WE ALSO CARRY A **LARGE** SELECTION OF
TELEVISIONS & VIDEOS ALL AT **BELOW TRADE PRICES**

36cm portables from £50.00

51cm televisions fast/t from £100.00

59cm televisions nicam from £135.00

68cm televisions nicam from £150.00

78cm televisions nicam from £350.00

videos 2 head mono from £50.00

videos 4 head nicam from £60.00

videos 6 head hi-fi nicam from £110.00

36cm combined TV & video from £100.00

dvd players £108.00

25cm televisions with DC 12/24 volt suitable for caravans -
mobile homes - cars - kitchen use **FROM £85.00**

IN ADDITION WE ALSO CARRY:

● Microwaves from £39.00

● Upright/cylinder/bagless vacuum cleaners from £23.00

● A large range of audio/Hi-Fi equipment from £23.00

LARGE QUANTITY DISCOUNTS AVAILABLE

ALL PRODUCTS ARE FULLY GUARANTEED

We stock a great many other items in the TV, Video and domestic
appliance range so if you don't see what you are looking for give us a call, we
will save **YOU POUNDS**.

Visitors by appointment only

Campion Electronics Ltd.

Ex-Rental
TV's and Videos
From £5

FREE Delivery Service to
Most Areas of the UK
**WORLDWIDE EXPORT
SERVICE**

Experts in UHF/VHF Conversions

Tel: 01299 250880

Fax: 01299 250889

Unit 17c Hartlebury Trading Estate
Kidderminster, Worcs DY10 4JB

Just 10 mins from M5 - Junction 6



Www.TradeElectronix.com
info@tradeelectronix.co.uk

TV's

14" r/c from £39.99
20" text from £54.99
21" text from £59.99
24" wide Nicam text from £159.99
28" 4:3 Nicam text from £89.99
28" wide Nicam text from £149.99
32" Wide Nicam text from £299.99

Plus wide range of Makes in stock at unbeatable value

Vcr's

Vcr basic from £34.99
Vcr Nicam from £39.99

Plus more in stock call for details

Audio

Sony portable CD/Cassette radio player From **£42.50**
Sony Portable/ Recordable Md players From **£84.99**
Sony Home cinema speaker system From **£124.99**
Sony Hifi Brand new!! From **£99.99**
Sony Amp 50w per speaker Brand New!! From **£124.99**

Dvd

Dvd Basic Multiregion From £59.99

Speacial offer Hitachi Dvd Multiregion £74.99

More Multiregion machines in stock names like ,Hitachi,Sony,Toshiba Pioneer, Wharfedale and Minato

Morphy Richards

Breadmakers from £19.99
2 slice Toaster from £6.49
4 slice Toaster from £8.99
Deep fat fryer from £19.99
Vacs from £13.95
Cd/clock/radios from £13.25

All Sony Products come with 12months manufactures Warranty

All Goods are subject to Vat,carriage & availability Prices subject to change without prior notice

TUBES

Widescreen:-

28" Thomson	W66EGV
28" Panasonic	W66EHK
28" LG	W66QBD
28" Thomson	W66EJU
28" Philips	W66ESF/ECK
32" Thomson	W76EDX
32" Thomson	W76EGV
32" Philips	W76ESF

Standard:-

25" Panasonic	59ECF
25" Philips	59EAK
25" Samsung	59KPR
26" Panasonic	66ECF
26" Thomson	66ECY, 66EHJ
29" Philips	68ESF

Ring Irene for prices

EXPRESS TV

The Mill, Mill Lane,
Rugeley, Staffs WS15 2JW

Tel: 01889 577600 Fax: 01889 575600

NEED A PICTURE TUBE?

We have huge stocks of all 24, 28 & 32" Widescreen types, including:
Thomson W66EGV/EJU and the W76 size;
Philips W66ESF/ERF/ECK and the W76 size;
also the Philips A68ESF range;
4:3 (non-widescreen) types are now heavily discounted to clear!

Special rates for Retro members.

Suppliers to OEM Service Centres, Insurance Companies and OEM factories for production,
Sole UK agents for Vista Electronics.

"Give us a call and we will try to beat any previous quote you have been given"

Tel: 01474 361276 Tube enquiries

Tel: 01474 816717 General

Fax: 01474 335228

D'Lec Components Limited

3 Manor Court, Sale Street, Cobham,
Kent, England DA13 9BU

SUMMER CLOSDOWN DATES
22nd JUNE TO 1st JULY

Service Link

PHONE 020-8722 6028
FAX 020-8770 2016

FOR SALE

IN STORE 171 Hardhills LN
Electrics Leeds Ltd Leeds L58 3QE
Tel: 0113 2401114 Fax: 0113 2407275

DISTRIBUTORS OF QUALITY
GRADED PRODUCTS
ORIGINAL PACKAGING
FULLY GUARANTEED

Portables	from	£53
Combis	from	£99
4:3	from	£89
Widescreen	from	£165
Flatscreen	from	£286
Widescreen	from	£299
Digital integrated		
Flatscreen	from	£376
DVD integrated		

CALL NOW FOR FULL TRADE PRICE LIST
NEXT DAY DELIVERY
CREDIT CARDS WELCOME

STORAGE BOXES FOR SALE

Treston
50 compartment
Cost £50+VAT
34 For Sale
Inc. Rotary Stands
OPEN TO OFFERS
Tel. 077100 80126
SPARES DIRECT

REPAIRS

Trade repairs to Sky digiboxes

Pace, Amstrad, Grundig, Panasonic, (including Fluid Ingress).
All makes repaired at a fair fixed price.

Scan Digital Services

For details

Give Alan a ring on

Tel/Fax: 01633 25 40 50

E-Mail: alan@scansat.globalnet.co.uk

LINEAGE

PANASONIC, MITSUBISHI, SONY, TOSHIBA, PHILIPS ETC, fully refurbished TVs. Trade only. Pearsons Television. Tel: 01484 863489

CHEAPEST: CABLETIES, FUSES, plug-tops, crimps, tapes, tv/video, remote handsets, microwave, fax, printers.
Tel: 020 7232 2266 Mobile: 0781 5974592

PRIVATE RETAILER has excellent part exchange colour televisions and videos to clear. Tel: 01494 814317.

SERVICE DATA

OPEN 6 DAYS
TV/VCR CIRCUITS (WE DO NOT STOCK AUDIO OR MONITOR INFORMATION)
TEL A.T.V. on
0114 285 4254
SAT/CTV Circuits £5.00
VCR Circuits £7.00
CTV Manuals £10.50
VCR Manuals £14.50
(P/P add £2.50 to each order)
419 LANGSETT ROAD, SHEFFIELD S6 2LL

SERVICE DATA

SERVICE SHEETS AND MANUALS

For most makes and models of TV - Video - SAT - CD - Audio

Complete S/Man	Service Sheet
CTV - 10.00	4.00
VCR - 15.00	6.00

Service sheets include circuits and essential electrical/VCR mechanical set-up information.

All other items - price on application.

Add P/P of £2.00 to order total. No VAT.

Payment by cheque or P.O. only please.

D-TEC

PO BOX 1171, FERNDOWN, DORSET BH22 9YG
Tel: 01202 870656

ELECTRONIC SURPLUS CLEARANCE SALE

SCOOP PURCHASES
FLUKE HAND HELD DIGITAL MULTIMETER MODEL 8024B
Cancelled export 750V AC/DC 2 amp AC/DC Resistance 20 Megohm plus Siemens range. Also measures temperature -20°C + 1265°C Temp probe not included. Calibrated for K-type thermocouple. Peak hold facility. Supplied brand new and boxed but with original purchasing organisation's small identifying mark on case. Test leads and handbook included. Offered as a fraction of original price: £47.50 p&p £6.50

A DIGITAL HAND HELD LCR METER
Measuring inductance, capacitance and resistance. 3.5 digit 1999 count. I.e.d. display. inductance range 2mH to 20H. Capacitance range 2000pF to 200µF. Resistance range 20kΩ to 20 megohms. Brand new and boxed with test alligator clip leads and user manual. £44 + £3.50 p&p
(Dept T), CHEVET SUPPLIES LTD
157 Dickson Road, BLACKPOOL FY1 2EU
Tel: (01253) 751858. Fax: (01253) 302979
E-mail: chevett@globalnet.co.uk. TELEPHONE ORDERS ACCEPTED

Service Information **FES** Circuit Diagrams
TV's, VCR's SATELLITE AUDIO & HI-FI
Most Models Covered
Prices are from £4.75 + £2.75 P/P
1 item - total £7.50 inc
2 items - total £12.25 inc
3 items - total £17 inc etc
note: some items priced individually
Payment by credit card. P.O. or cheque
Tel/Fax: 01206 211570
e-mail: colin@fryerns.fsbusiness.co.uk
2 The Lodge
Easthorpe Green
Marks Tey, Colchester
CO6 1HA

SERVICE MANUALS

Have you ever turned away work for want of a Service Manual? Have you ever bought a Service Manual and never used it more than once?

Then why not join ...

THE MANUALS LIBRARY

For details and membership application form write, phone or fax:

HARVEY ELECTRONICS
43 Loop Road, Beachley, Chepstow, Mons, NP16 7HE

Tel: 01291 623086 Fax: 01291 628786

Visa: Mastercard accepted

THE TV & AUDIO CENTRE NEW WAREHOUSE NOW OPEN

BANKRUPT STOCK AVAILABLE - TOP BRANDS AT SILLY PRICES

New but Graded Projection TV's from £450

New but Graded Ferguson 33" TV's £150

New but Graded 32" Widescreen Nicam TV's from £175

New but Graded 28" Widescreen Nicam TV's from £90

New but Graded 28" Nicam Fastext TV's from £60

New but Graded DVD's HIFTS and VCR's in stock

Over 1080 TV's In Stock... All Brands Available

Ring for Details
0121-665-6336

RECRUITMENT

BIRMINGHAM SPECIALISED SERVICES LIMITED

REGIONAL SONY SERVICE CENTRE

Require:

Bench Engineer: Camcorder
Bench Engineer: CTV/Audio

Must be qualified.

We offer a very attractive salary: 5% Pension Contribution, 20 days plus Stat holidays, Mon-Fri working

Tel: 0121 608 5700
Eves 0121 706 1171

NEED HELP NOW?

Then ring the

★ ELECTRON TECHNICAL HELPLINE ★

Genuine help available to all repairers

of
T.V. - V.C.R. - SAT - AUDIO (Inc Valves)
- MICROWAVE - MONITOR AND
MOST ELECTRONIC EQUIP

Over 30 years experience and vast data base

0906 470 1706

Calls cost 60p per minute

Hours of Business Mon to Fri
9.00 am-12.30 pm : 2.15 pm-5.30 pm
Sat Morn 9 am-12 noon
ELECTRON G.T.
9 CHAPEL ST. DONISTHORPE,
SWADLINCOTE, DERBYSHIRE DE12 7PS

WANTED

BEST CASH PRICES PAID

For ALL valves especially KT88, PX4 and other audio types.

Tel: 01403 784961

Billington Export Ltd
Sussex RH14 9EZ
Fax 01403 783519
Email: sales@bel-tubes.co.uk
Visitors by appointment

CLASSIFIED TEL: 020 8722 6028

WHAT A LIFE!

Various TV faults, a spot of bother with a camcorder and a note on domestic appliances. Donald Bullock's servicing commentary

donald@bullock-bros.com

"Can't stand it any longer, Mr Bellows" said the chap with the dewdrop noise who'd just come into the shop. "It's up all the time. Driving me crazy it is." Then he paused.

"Must be awful" I said, "er, ah is there something you think we can do to help?"

"I should 'ope so" he continued. "You comes 'ighly recommended to me. Wife's brother has a set like it. When he came to you with the same trouble you 'ad it fixed in no time."

I then noticed the 20in. Ferguson set he'd put on the counter before starting off on his moan. "What's up with the set?" I asked.

"Sound won't turn down, like I said" he replied. "Up all the time. It's not so funny, you know, when the likes of Esther Ramsden comes on."

I filled in a card and told him we'd get in touch. Steven took the job on. It was a T49F (TX91 chassis) and, sure enough, the audio gain was at maximum and couldn't be adjusted.

"Think we've had this one before" Steven said. "It was TV02 then. A little surface-mounted transistor in the sound strip. It's a BC858, mounted on the print side of the panel. I fitted a BC858C which is probably a bit more rugged."

It didn't take him long to do the same with the present set, again curing the trouble.

A dead Mitsubishi

Meanwhile Mr Mellows had come in. He was laughing, as if he had just heard a cracking good joke.

"It was as sprightly as anybody's Mr Bumkin" he gurgled. "then it died. Just died. Me telly, I mean. It's in the car."

Paul and Steven went out to collect it. When they brought it in we noticed that it was a 29in. Mitsubishi set, Model CT29B2STX. Paul pulled it over and switched it on. The sound came up, followed by the rustle of EHT.

This suggested field collapse, which is common with these sets. When Paul turned the tube's first anode voltage up a horizontal line appeared. It didn't take him long to establish that the field output chip IC451 had failed. The problem is that it's a TDA8178S: the S indicates a Mitsubishi special, which is no longer available. There's a kit, specially for this model, part no. H27PO14010. It includes a different chip, type STV9379, and a few other bits and pieces. Fortunately we had one in stock.

Field scanning was normal once the parts in the kit had been fitted, but the picture displayed severe NS bowing. These sets have a small correction board that's mounted vertically at the right of the main PCB. It's common for the small electrolytic capacitors on this board to leak. In this case C4014 was faulty, and had damaged the 2SA950 transistor Q4009. Once these two components had been replaced the geometry was perfect.

Another dead set

Our next caller was Paddy Afron. He must weigh twenty stone: his roomy old clothes look like part of a building site, and he has a voice like a concrete mixer. He was carrying a 21in. Matsui set as though it was made of paper.

"Hello boys" he started off. "I've been in a fine pub, the Five Bells. Good beer. Must have knocked back fifteen pints at lunch time." Then he steadied himself.

"E's dead as a dodo, my Hitachi telly. I hope you can get 'im right, otherwise we'll 'ave to 'ave a funeral! Ha ha!"

"This set's dead" he continued, placing it on the counter. "But don't let's discuss it, 'cause I've an awful thirst coming on. Just give me a call at the Five Bells. OK?"

His set was a 2107NS Mark 2. I decided to take a look at it and found that there was some 300V across the mains bridge rectifier's reservoir capacitor but little else. So I concentrated on the chopper circuit and found an open-circuit 1M Ω resistor. It was presumably part of the start-up system, and a replacement got the set working again.

I tried phoning him to give him the good news, but the noise was too great for me to make myself clear. So we put the set aside to wait for a personal visit from Paddy.

An Hitachi camcorder

We then saw a scruffy young man mincing along the pavement as though he was riding an invisible bike. It was Albert Crust, who was carrying a plastic bag. He came in and held the bag aloft.

"This 'un don't take pictures of nobody" he announced.

"Not many plastic bags do, Al" I pointed out.

"Nah, nah, it's me girlfriend's camcorder thing" he replied. "Told 'er I was going to mend it meself" he confided, breaking into a strange laugh.

As he left I took the camcorder and passed it to Steven. It was an Hitachi VME330E.

Steven tested it and found that it stopped intermittently in play and record. When he opened it he discovered that the take-up spool was faltering. As a result the sensor would shut the camera down.

When he investigated further he found that there was mechanical trouble in the take-up spool itself. The spool incorporates a clutch to allow a certain amount of slipping in the play and record modes, to avoid forcing the tape through the pinch roller. Because the felt pad in the clutch was worn, the slippage was excessive. A replacement cured the problem.

"Fancy him telling his lovely girlfriend – what she sees in him is beyond me – that he was going to mend it himself" I said to Steven. "we'll charge him forty quid."

A little later Albert's girlfriend Marina came along. "Did Albert bring that camcorder of mine along?" she asked. "said he was going to mend it himself. Silly boy. Don't s'pose you've been able to find out what was wrong with it?"

It was waiting on the shelf. Steven and Paul made a lurch for it but got tangled up. So I picked it up and presented it to her. "Mended it myself" I said.

"That's kind of you" she replied. "how much are you going to charge for being so clever?"

"Er, twenty pounds" I said.

An oldie

Wally Wingnut brought along a rather old Hitachi TV set. That's not his real name. I call him that because he has ears like wingnuts.

"E's dead as a dodo, my Hitachi telly. I hope you can get 'im right, otherwise we'll 'ave to 'ave a funeral! Ha ha!"

It was an Hitachi CPT2476 (G6P chassis). Steven pulled it over, connected it up and switched it on. "Might be dead, but I can hear a quiet singing sound coming from the innards" he said. "maybe it's gone to heaven. Let's take a look."

The singing sound came from the series chopper circuit, and a check on the HT volt-

age showed that it was very low at only about 20V. Steven disconnected the feed to the line output transformer, but this made no difference. Then he began to check the diodes in the chopper circuit. The ES1A efficiency diode D902 proved to be the cause of the trouble, with a high forward resistance. A replacement got the set working again.

Mr Moorside

I don't know what Mr Moorside's business is, but he seems to have been successful. He's put on more weight than is good for him, and his cigars can't help his health either. He drew up in his new S-type Jaguar. Its back seat was occupied by an oldish TV set and Mrs Downe, his girlfriend.

"Bring the set in, boys" he ordered as he came in, reaching for his card. "Fix it and give me a ring, if you would" he said, then departed.

It was a Samsung W124W6VN. A picture appeared when Paul switched it on. After a few minutes the picture faded to darkness, then became brighter again. This variation continued. Paul checked the voltages on the CRT's base panel and found that the first anode supply was varying wildly. The first anode potentiometer is part of the line output transformer. When he turned it to maximum there was a stable picture, but it was

too bright of course. The potentiometer was at fault, which meant a new line output transformer.

Paul ordered one and subsequently fitted it. The brightness level was then stable. He phoned Mr Moorside.

This time Mr Moorside brought his girlfriend in with him when he called. "It's costing me over forty pounds my dear" he told her, "but never mind. What would you do without me, eh?"

Domestic appliances

I've been trying my hand lately at a bit of vacuum cleaning, because Greeneyes claims to have twisted her ankle, and have been using her fairly new Dyson DC103. The DC103 certainly emits very clean air. Much better than the cleaner we had before - that one used to fill the air with something resembling snuff, which made me wheeze.

But, having used the Dyson quite a lot now and marvelling at the dust it takes out of a carpet that already looks clean to me. I still feel it could be improved. Perhaps it's too gentle. It is a bit unwilling to pick up things from our marble floor, and tends to push tiny bits of debris - like the little berries and leaves that fall from Greeneyes' forest of houseplants - along rather than sucking them up. The remedy is to lift the cleaner up and place it over them, but I've had to

devise a little scraper on a long stick to move away the bits I've pushed up against the wall. And another thing. The long and gentle revolving brush at the front of the cleaner tends to be rather easily disabled by the long, fine strands of hair that Rebecca sheds about the place, while its bearings often seem to be dry and jammed. Over to you, Alan.

While on the subject of domestic appliances, the two-year old Morphy Richards jug-kettle that we keep in Spain recently blew a hole through the casing under the element. The Spanish don't drink tea of course, and buying a kettle of any sort isn't easy there. So we asked a friend to buy and bring over for us on her next visit any jug-kettle that took her eye.

She went to Argos and chose one I'd never heard of, a two-litre Cookworks Model K8396. It's much like the rest, perhaps a little more rugged than some, and I notice that it has a metal plate between its element and the plastic base. But what surprised us was the price, an astonishingly low £8.95

Now I'm as much as anyone against the tendency of our trade's products to become ever cheaper, with minimal profit unless you sell on a mass scale, but I have to hand it to this British company for making available a first-class product that sells at so much less than the competition. I wonder how they do it?

What's On?

at

www.mces.co.uk

Amstrad, Pace, Grundig.

Digital set Tuner / PSU fault £35.00 plus VAT
top Box Major fault £65.00 plus VAT

Amstrad DRX 100 tuner repairs £12.50 plus VAT
Fault symptom "No Satellite Signal Received"

Pace "ZIF" tuner repairs £18.00 plus VAT
Fault symptom "Picture freezes" or "No Satellite Signal Received"

Grundig Power Supply repairs £16.00 plus VAT
Fault symptom "missing channels" and "No Satellite Signal Received"

M.C.E.S. Digital

E-mail: sales@mces.co.uk

Phone: 0161 746 8037

Fax: 0161 746 8136

WATCH SLIDES ON TV MAKE VIDEOS OF YOUR SLIDES DIGITISE YOUR SLIDES

(using a video capture card)



"Liesgang diatv" automatic slide viewer with built in high quality colour TV camera. It has a composite video output to a phono plug (SCART & BNC adaptors are available). They are in very good condition with few signs of use. For further details see www.diatv.co.uk
.....£91.91+ vat = £108.00

Board cameras all with 512x582 pixels 8.5mm 1/3 Inch sensor and composite video out. All need to be housed in your own enclosure and have fragile exposed surface mount parts. They all require a power supply of between 10 and 12v DC 150mA.

47MIR size 60x36x27mm with 6 infra red LEDs (gives the same illumination as a small torch but is not visible to the human eye).....£37.00 + vat = £43.48

30MP size 32x32x14mm spy camera with a fixed focus pin hole lens for hiding behind a very small hole.....£35.00 + vat = £41.13

40MC size 39x38x27mm camera for 'C' mount lens these give a much sharper image than with the smaller lenses.....£32.00 + vat = £37.60

Economy C mount lenses all fixed focus & fixed iris
VSL1220F 12mm F1.6 12x15 degrees viewing angle.....£15.97 + vat = £18.76

VSL4022F 4mm F1.22 63x47 degrees viewing angle.....£17.65 + vat = £20.74

VSL6022F 6mm F1.22 42x32 degrees viewing angle.....£19.05 + vat = £22.38

VSL8020F 8mm F1.22 32x24 degrees viewing angle.....£19.90 + vat = £23.38

Better quality C Mount lenses
VSL1614F 16mm F1.6 30x24 degrees viewing angle.....£26.43 + vat = £31.06
VWL813M 8mm F1.3 with Iris 56x42 degrees viewing angle.....£77.45 + vat = £91.00

1206 surface mount resistors E12 values 10 ohm to 1M ohm 100 of 1 value £1.00 + vat
1000 of 1 value £5.00 + vat

866 battery pack originally intended to be used with an orbital mobile telephone it contains 10 1.6Ah sub C batteries (42x22dia the size usually used in cordless screwdrivers etc.) the pack is new and unused and can be broken open quite easily.....£7.46+vat = £8.77



Please add 1.66 + vat = £1.95 postage & packing per order

JPG ELECTRONICS

Shaws Row, Old Road, Chesterfield, S40 2RB

Tel 01246 211202 Fax 01246 550959 Mastercard/Visa/Switch

Callers welcome 9:30 a.m. to 5:30 p.m. Monday to Saturday

EURAS REPAIR INFORMATION SYSTEM

ON CD-ROM AND THE INTERNET

LOOK WHAT **EURAS** HAS TO OFFER YOU!

800,000 REPAIR TIPS FOR
OVER 700 MANUFACTURERS

NOT JUST REPAIR TIPS!

WWW.EURAS.CO.UK

EURAS INTERNET SYSTEM INCLUDES

- PINBOARD SYSTEM** Offers you the expertise of Technicians worldwide
- DISCUSSION FORUM** Discuss issues relative to the trade
- TECH-CHAT** Join in real-time chats in the chatroom
- WEEKLY UPDATES** Supplement the CD-ROM version with regular updates

If you subscribe to the CD-ROM version of *EURAS* you can have access to the Internet System free of charge. Alternatively you can subscribe to the *EURAS* Internet System only. We offer a **FREE TRIAL** on both systems, and require a £50 refundable deposit for the CD-ROM version.

APPLY BEFORE JUNE 30th AND QUALIFY FOR A SPECIAL 60 DAY TRIAL

I am interested in a free trial of the EURAS Internet System, please forward me details of how to apply.

I am interested in a free trial of the *EURAS* System on CD ROM (which will include access to the *EURAS* Internet System) and enclose a cheque for £50.

Contact Name..... Company name.....

Address.....

Phone no..... Fax no.....

email address.....

EURAS INTERNATIONAL LTD

EURAS HOUSE, 51 BRISTOL ROAD, KEYNSHAM, BRISTOL, BS31 2BP

TELEPHONE: 0117 9860900 FAX: 0117 9860343 EMAIL: sales@euras.com

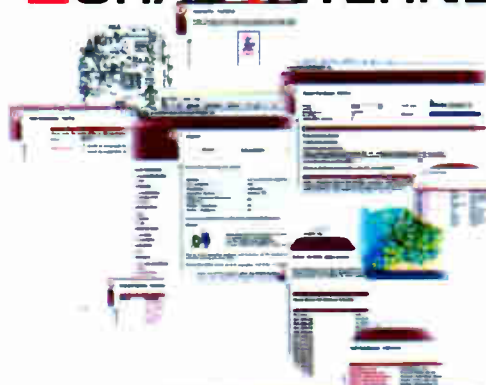
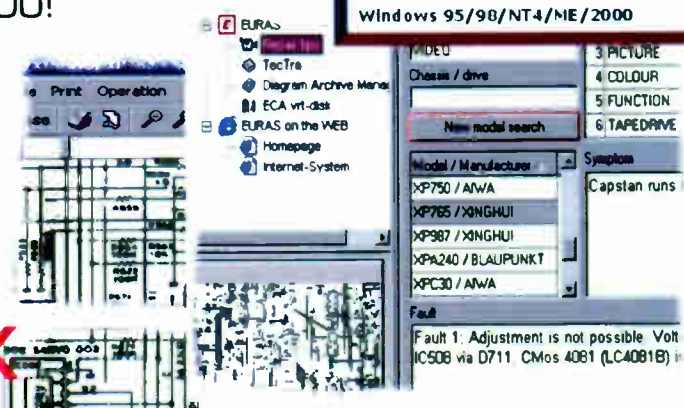

EURAS



TELEVISION TEST PATTERN GENERATORS

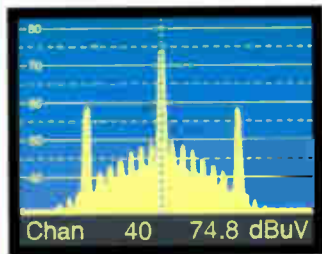

The new pattern generators **GV 798** and **GV 898** offer advanced features at realistic prices. They produce 16:9 and 4:3 formats, output level set in 1 dB steps, multistandard, VITS, WSS, VPS, PDC, Teletext and much more. GV 898 uses vestigial side band modulation.

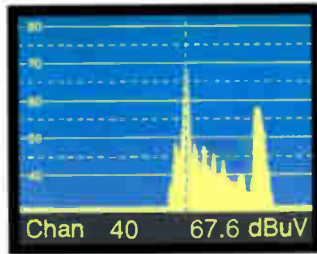

PROMAX GV SERIES

- ◆ Choice of 12 instruments
- ◆ NICAM and Teletext
- ◆ 4:3 and 16:9 Formats
- ◆ Full field and VITS
- ◆ Computer Controlled
- ◆ Front panel memories
- ◆ Multi Standard, PAL, NTSC, SECAM
- ◆ Own Company Logo
- ◆ Computer Monitor testers
- ◆ Hand Held Models
- ◆ High Quality Construction
- ◆ Attractive Price Levels
- ◆ Full After Sales Service
- ◆ Available from Stock

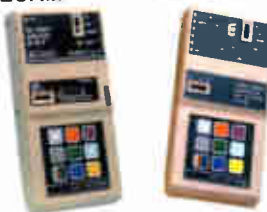

FOR TELEVISION PATTERN GENERATORS, THERE'S NO WIDER CHOICE THAN WITH PROMAX



SELECTED ITEMS FROM THE PROMAX RANGE OF TEST EQUIPMENT



MS 250

Analogue and Digital Satellite Detector.



PRODIG 1

Satellite Dish Installer's Meter Does more than just BSkyB



PRODIG 2

Analogue & Digital Aerial Meter Measures digital channel power and C/N



MC 377+

Analogue & Digital, Satellite & Terrestrial Measures channel power and C/N



PROLINK 3 SERIES

Satellite & Terrestrial, Analogue & Digital, Spectrum Analyser with Optional BER

Alban

ALBAN ELECTRONICS LIMITED

THE PROMAX SERVICE CENTRE

6 Caxton Centre, Porters Wood, St. Albans, Hertfordshire, AL3 6XT.

TEL : 01727 832266

FAX : 01727 810546

EMAIL : albanelectronics@cs.com

SALES + SERVICE + CALIBRATION



AA-930

Audio Analyser

TA-901
CRT Rejuvenator



TA-903B CRT Rejuvenator