

Tips, guides and reports for people repairing televisions and electronic equipment

TELEVISION

AND HOME ELECTRONICS REPAIR

MARCH 2003 £3.20

PC-camcorder interconnections

**Introduction
to PC
servicing**

**The coherer
revisited**

Test report

**Evoke-1
DAB radio**



TELEVISION

PLQ ! JPE ! ! ! !

! ! ! !

c1 PLQ

Satellite, Audio, Monitor, TV, VCR and DVD faults



The good news is, we can replace it..!

Ah, Man's best friend... A loving, loyal companion but not averse to taking a fancy to those fun looking chew things sat near the television set. And, when the fun's over, the chances of the handset being able to function are, if you excuse the pun, pretty remote to say the least. Fortunately, Classic supply a wide range of replacement handsets covering just about every make and model of television, video and satellite.

Manufactured to provide a high quality, reliable alternative to the original and fully supported through our technical helpline, the Classic range offers a realistic, cost effective solution.

Available through our nationwide network of distributors. Call us on 01635 278678 for your nearest distributor or for your free copy of our handy remote control booklet detailing all the manufacturers models with the most suitable Classic replacement.



classic

Technical helpline 01635 278678

CONTENTS

March 2003

Vol. 53, No. 5

259 Comment

In-store TV

260 Teletopics

MPEG-4 developments. Freeview and those ITV digiboxes. Radio repair service. Sony's camcorder developments. DVD update. New products from JVC. DAB radio.

262 Test report: The Pure Evoke-1 DAB radio

Digital audio broadcasting transmissions have been available since 1995 but, because of the high cost of



receivers, the service has been slow to take off. This situation has been overcome with the advent of the Evoke-1 receiver from Pure, the first to sell at under £100. Peter Marlow reports on its operation and performance.

266 PC-camcorder connection problems

As the cost of digital camcorders has fallen, more consumers are buying them and then exploring the facility to carry out editing with a PC. This is done via an IEEE 1394 link, but many users find that plug-and-play doesn't work. Steve Beeching, I.Eng., M.I.E.E., describes the technology and the problems that can arise.

277 Service Casebook

Michael Maurice selects interesting items from his notebook.

278 The coherer revisited

The coherer was one of the earliest forms of radio detector. Ian Rees outlines its history and describes a modern version he was able to devise.

280 Test Case 483

282 Television 2003 Accessories Guide

In the second part of this guide Eugene Trundle takes a look at videography (camcorder work), computer video, care products, TV-PC convergence, home security and several other topics.

288 Letters

Dealing with CRT heater-cathode shorts. Restricted spare parts. Magnetised solenoid problem. Microwave ovens.

289 Help wanted

290 DX and satellite reception

Terrestrial DX and satellite TV reception reports. News items relating to TV and nearby bands. Satellite dish maintenance. Roger Bunney reports.

294 Satellite notebook

'Dead' digiboxes. Radio volume levels. Digital channel update. C-band reception from Intelsat 706 and 805. Digibox fault reports.



298 VCR Clinic

300 Monitors

Guidance on repairing monitors and related equipment.

302 TV fault finding

306 Web service

Useful websites for TV professionals, technicians and enthusiasts.

308 Audio faults

Hints and tips on repairing professional and consumer equipment.

310 Bench notes

Introduction to PC servicing. Adrian Gardiner starts a new series.

312 What a life!

A field call in the countryside involved some navigational problems. Back at the shop there were problems with a jammed VCR and some more widescreen TV sets. Donald Bullock's servicing commentary.

314 DVD faults

315 Next month in Television

Editor

John A. Reddihough

Advertisement Sales

Reuben Guranlian
0208 722 6028
Fax 0208 770 2016

Publishing Director

Tony Greville

Managing Director

Roy Greenslade

Note that we are unable to answer technical queries over the telephone and cannot provide information on spares other than that given in our Spares Guide.

Disclaimer

We work hard to ensure that the information presented in *Television* is accurate. However, *Television's* publisher - Highbury Business Communications - will not take responsibility for any injury or loss of earnings that may result from applying information presented in the magazine. It is your responsibility to familiarise yourself with the laws relating to dealing with your customers and suppliers, and with safety practices relating to working with electrical/electronic circuitry - particularly as regards electric shock, fire hazards and explosions.

Next issue, dated
April, on sale
March 19



Export Enquiry Only

Genuine Returns

**Tv's ,Vcr's ,Dvd's ,Audio, Small Appliances
Iron's , Toasters Etc Container load Available!!**

LARGE QUANTITY!!

Also Available for UK Market

Products from

**SONY HITACHI TOSHIBA PANASONIC DAEWOO
BEKO SVA MORPHY RICHARDS PHILIPS KINGAVON
& TRADEX**

Call- 07836 520036



In-store TV

Most of us have probably been irritated by Muzak from time to time. Why should we have to listen to music we don't particularly want to listen to, just because we happen to be going about our business in a store, shopping mall, pub or wherever? The creators of Muzak programmes seem to be aware of the possibility of negative reactions, which is presumably why they tend to make their offerings so indescribably bland. Usually tired old bits of tunes from long ago, played at a level that doesn't intrude too much but can't be heard properly should, by some miracle, something you'd actually like to hear come along. Technology always being able to take things further, Muzak started to follow us around – into lifts and loos! No way of getting away from it!

For a time the irritation was meted out at railway stations, via those awful speakers that can't deliver an intelligible message let alone a few musical notes. We now seem to have been saved from this horror at least. It's a long time since I heard this rubbish at the one mainline station I use regularly, Victoria. Maybe those who use other stations aren't so fortunate. And maybe the reason we've been saved this irritation is not regard for our feelings but to save costs!

But what's this I come across? It seems that the order of the day is to be 'TV Muzak'. TV-type displays in public places have been a feature for some time. Quite interesting for those of us of a technical mind, to see the technologies used and how well they perform under what are quite often adverse conditions. And you can always turn or rather lower your head: you don't have to pay attention, an option that's not possible with public music. Now Tesco, the largest of our supermarket groups, has announced that it is to create its own private in-store TV network.

This is a bit puzzling. Shopping for the basics is something we all have to do and, usually, try to get it done as quickly as possible. You try to plan your way around the store so that you don't have to waste too much time, and agonise over which till is the quickest moving to be able to get out as soon as practicable. While negotiating the aisles, it's a matter of grab this, grab that, get on with it and try not to get too irritated by the trolley in front. How could you fit TV into this procedure?

Tesco seems to think it can. Even more puzzling, the aim is to make money, not to entertain or amuse us. The company has hired the Instrumental Media Group to work on a trial at three stores in different parts of the country. IMG is to decide on the best way in which to distribute screens around a store, and will assess customer reaction to the 'new medium'. If all goes well, Tesco plans to have its service in a hundred stores by the end of the year. There would be no technical problems in installing screens and feeding

signals around, nor in providing microwave links to distribute material to stores. The big problem is how Tesco can exploit the possibilities and make a profit out of the 'service'.

Tesco is not alone in trying out 'in-store TV'. Screen Network is installing a TV service in seven shopping centres around the country, after a trial at The White Rose

If all goes well, Tesco plans to have its service in a hundred stores by the end of the year.

Centre in Leeds. Shoppers are provided with local and national advertising, features, news and traffic information. Screen Network expects to be able to deliver an audience of 2.2m to advertisers by the end of the year.

TV networks are also run by the Toni & Guy hairdressing group, which is providing its service in some 220 salons in the UK and Ireland, and Welcome Break, which has screens in 38 service stations. These seem to make more sense. Toni & Guy's customers spend an average of 90 minutes while receiving hair treatment, and there's not a lot else you can do during this time. Welcome Break claims that each of its 95 million annual 'visitors' has a screen-access time of 23 minutes. But you don't hang around like this in a supermarket, so the offering must be rather carefully organised if the message isn't going to get lost. It seems to be recognised that content is important. Bob Clarke, founder of



IMG, says "we know from experience that if you don't create a context you're not going to maximise your opportunities". And screens in different parts of a store might well need different content and advertisements. It could be quite a tall order.

Tesco's main aims are to generate additional advertising revenue and increased sales. Whether this will work and to what extent remains to be seen. A case, probably, of 'suck it and see'. There are good prospects for advertising revenue when you have a captive audience, as with Toni & Guy's salons, but it will be more difficult in a busy marketplace. At least in a supermarket this sort of TV shouldn't be as intrusive as Muzak. And it will provide work for technicians in designing and carrying out installations, also for studio personnel in producing programme material, something that's welcome in these difficult times.

COPYRIGHT

© Highbury Business Communications, 2003. All rights reserved. No part of this publication may be reproduced, stored or transmitted in any form or by any means without the written permission of the publishers.

All reasonable precautions are taken by *Television* to ensure that the advice and data published are reliable. We cannot however guarantee it and we cannot accept legal responsibility for it.

CORRESPONDENCE

All correspondence regarding advertisements should be addressed to the Advertisement Manager, *Television*, Highbury Business Communications, Anne Boleyn House, 9-13 Ewell Road, Cheam, Surrey, SM3 8BZ. Editorial correspondence should be addressed to *Television*, Editorial Department, Highbury Business Communications, Anne Boleyn House, 9-13 Ewell Road, Cheam, Surrey, SM3 8BZ.

INDEXES AND BINDERS

Indexes for Vols. 38 to 52 are available at £3.50 each from SoftCopy Ltd., who can also supply an fifteen-year consolidated index on computer disc. For further details see page 315.

Binders that hold twelve issues of *Television* are available for £6.50 each from Modern Bookbinders, Pringle Street, Blackburn, BB1 1SA. Telephone: 01254 59 371. Make cheques payable to "Television Binders".

Newstrade Enquires
Distributed by COMAG

Telephone: 01895 444055

ISSN 0032-647X

SUBSCRIPTIONS

Highbury Subscription Services, Link House, 8 Bartholomew's Walk, Ely, Cambridge CB7 4ZD.
Telephone 01353 654 431
Fax 01353 654 400
Email hbc.subs@highbury-wyvern.co.uk
Please notify change of address.

Subscription rates:

UK 1 year £33.80, 2 years £54.00, 3 years £71.00.
Republic of Ireland 1 year £38.95, 2 years £62.00, 3 years £81.85.
Mainland Europe 1 year £49.00, 2 years £78.40, 3 years £102.90.
Rest of World 1 year £63.50, 2 years £101.00, 3 years £133.00.
Cheques should be made payable to *Television*.

BACK NUMBERS

If available issues are £4.00 each.



HIGBURY
Business Communications

A SUBSIDIARY OF HIGBURY HOUSE COMMUNICATIONS PLC

TELETOPICS

MPEG-4 developments

There is a lot of interest in a newly developed MPEG-4 codec that could be used for both High-Density DVD discs and digital broadcasting. Warner Bros and Toshiba have proposed using MPEG-4 for a new generation of HD DVD discs that would use red-laser technology rather than the blue-laser technology proposed for other HD formats such as the Blu-ray disc. The DVD Forum is expected to announce whether it supports the proposed Warner/Toshiba format, provisionally known as HD/DVD-9, early this year.

The new MPEG-4 codec has been developed by two standards bodies, the ISO/IEC and the International Telecommunications Union (ITU). ISO/IEC was developing the MPEG-4 Part 10 standard and the ITU a codec known as H.26L: the two groups formed the Joint Video Team (JVT), hence the fact that MPEG-4 Part 10 is sometimes known as the JVT codec. The JVT has now settled on the name H.264/MPEG-4 AVC (Advanced Video Codec) for the new codec.

MPEG-4 requires twice as much processing power as MPEG-2, but the falling cost of processing chips means that this is not a major issue. The MPEG licensing body MPEG LA has identified eighteen companies that hold patents for

MPEG-4 technology, including Sony, Philips, Canon and Microsoft, and has proposed a licensing and royalty arrangement.

The MPEG-2 digital compression standard, used for current digital broadcasting and DVD discs, was set in 1995. While it has been refined since then – modern MPEG-2 encoders offer 50 per cent more compression than the first products – better compression systems have since been developed. MPEG-2 and MPEG-4 use the same basic compression techniques of breaking a frame down into blocks of pixels, with motion compensation and motion-vector prediction to reduce the amount of data. But MPEG-4 can select smaller block sizes for motion compensation, greatly increasing encoder accuracy and efficiency. Improved motion-vector prediction makes it easier for the encoder to process fast-moving objects within a frame. Whereas MPEG-2 uses frame-by-frame compression, MPEG-4 can compress objects within a frame, giving it an improvement of about fifty per cent over MPEG-2 on a like-for-like basis. While MPEG-2 requires a data rate of about 2-3Mbits/sec for broadcast video and 4-8Mbits/sec for DVD video, MPEG-4 requires only about 750kbits/sec-

1.5Mbits/sec for broadcast video and 2-3Mbits/sec for DVD-quality video. In addition to improved compression efficiency, object-based compression enables viewers to interact with specific on-screen items. Clicking on an image for example could produce a pop-up menu or an advertisement. For this reason there has been much interest in using MPEG-4 on the internet and for interactive TV services.

MPEG-4 video is not compatible with MPEG-2 decoding but could be used alongside other systems such as DVD blue-laser technology and, in the case of broadcast video, MPEG-2 set-top boxes. The Digital Video Broadcasting Project (DVB) says that, with more than 25 million MPEG-2 decoders in use worldwide, MPEG-2 will remain the predominant digital broadcasting compression technology for a long time. The DVB sees MPEG-4 as co-existing with MPEG-2 and being used for niche applications such as streaming video on demand.

The MPEG-4 standard is due to be set early this year – the original aim had been to establish the low bit-rate standard by the end of 1998. Prototype MPEG-2/MPEG-4 chip sets could be in production by the middle of the year, with set-top box products being developed before the end of the year.

Sony's camcorder developments

Sony is to launch two new camcorders that use DVD-disc technology this summer. Models DCR-DVD100 and DCR-DVD200 will record on 8cm DVD-R and DVD-RW discs that can be played back via most DVD players, PC DVD-ROM drives and

later versions of the PlayStation 2 games console. Both models will use a USB 2.0 interface, which is backwards compatible with the USB 1.1 standard used by most PC equipment. Features of the new camcorders will include an hour's recording

time, a 10x optical zoom, 120x digital zoom and a 2.5in. LCD screen. No price details have been announced.

Sony is also to launch two new MiniDV recorders with 2 Megapixel resolution, Models DCR-TRV60 and DCR-TRV80. Both will include progressive-scan recording. Four new Digital-8 camcorders, Models DCR-TRV-145, DCR-TRV245, DCR-TRV250 and DCR-TRV355, will include USB streaming and software to enable users to burn Video CD discs for playback via most DVD players.

Sharp has introduced this entry-level home cinema projector, Model XV-Z90E, which uses a Texas Instruments' DLP (Digital Light Processor) chip for deflection. Images can be projected in 16:9 or 4:3 format, the resolution is 800 x 600 pixels, the contrast ratio 1,200:1 and the brightness up to 600 ANSI lumens. Light from a 150W

source is directed to the DLP chip via a six-speed, six-segment primary-colour filter wheel for improved colour rendition. Video input can be from any of the usual sources, in composite, component, S or RGB form. Set-up is simple, using the unit's tilting base, lens-shift function and on-screen menu controls. Price is about £2,395.

Radio repair service

A repair service to the trade for radios, of any age from World War II to the present day, has been started by Pete Roberts who can be contacted on 01928 711 848 or via email at

PeteRoberts007@aol.com

All types of receiver are accepted for repair – domestic and communications receivers, CB and marine transceivers.



DVD update

The British Video Association reports that some 3.8m DVD players were bought in the UK in 2002, twice as many as in 2001. Almost a quarter of all households now has one. DVD has been an even greater success in the US.

Philips has launched a DVD player that incorporates progressive-scan technology.

Model DVD963SA has a progressive-scan output in RGB form via a scart connector. Other features include multi-channel SACD playback, Dolby Digital and DTS decoders, Video-CD and Super Video CD playback, MP3 playback and CD-R/RW compatibility. The machine also supports CD and SACD Text.

Freeview and those ITV digiboxes

Between the launch of the Freeview digital TV service on October 30 and the end of December over 300,000 digiboxes for its reception were sold. According to data from retailers and manufacturers, sales were running at over 33,300 a week. In comparison, ITV Digital signed up 110,000 subscribers during the first four months after its launch in 1999.

Digiboxes originally loaned to subscribers by ITV Digital can be kept free of charge for Freeview reception. ITV Digital's parent companies Granada and Carlton have paid £2.8m to the liquidators of ITV Digital for the 990,000 digiboxes still out on loan. Anyone who has made a payment at the request of the liquidators will receive a refund.

New products from JVC

JVC is to launch a range of TV sets that feature its DIST (Digital Image Scaling Technology) system. This involves line doubling to 1,250 interlaced with 75Hz anti-flicker technology. The first set will be Model HV-32D37SJE, which has a 32in. widescreen tube; Dolby Digital 3D Phonic; picture-and-picture, picture-in-picture and multiple picture (1 + 3, 12) displays; a dual picture and text display; nicam sound decoding; a component video input; a 500-page text memory and three scart sockets. It will be followed by 28in. and 36in. versions. There will also be plasma-screen sets with DIST, including Model PD-42D30ES with a 42in. display (XGA - 768 x 1,024 pixel - resolution), 3D sound, PAP, PIP, a 1,500-page text memory and a component video input. This is to be followed by a 36in. version.

New video equipment announced by JVC includes Model HR-XV2EK, a combined DVD player and VHS recorder; Model HM-HDS4, a hard-disk (80GB) recorder combined with an S-VHS recorder; and Model XV-DDV1, a hard-disk (80GB) recorder combined with a DVD player. The XV-NP1 DVD player can read a variety of discs including DVD-Video, DVD-R, DVD-RW, DVD+RW, CD, SVCD, VCD and CD-R/RW. It can also read WMA and MP3 files and JPEG images on CD-R/RW discs, and has slots for five different memory cards - Compact Flash, Smart Media, SD, MultiMediaCard and Memory Stick. Model XV-C5SL is a DVD player that can be placed vertically, horizontally or wall-mounted. Model XV-NA77 is a DVD-Audio player that also reads DVD-Video discs and MP3 files.

New-generation Memory Sticks

Sony has announced a new-generation Memory Stick, the Memory Stick Pro, which provides a data storage capacity of up to 1GB. This is sufficient for up to six hours of MPEG-4 video (at 384kbits/sec) or 24 minutes of DVD-quality MPEG-2 video. According to Sony this equates with about sixteen audio CDs or 360 JPEG images in 5 Megapixel quality, which is more than ten rolls of film.

Memory Stick Pro has been developed by Sony and Sandisk, and the first Memory Stick Pro enabled devices are due to be launched this spring. Sony says that a number of existing products, including the DSC-F717, -F77 and -FX77 digital cameras and the DCR-TRV355, -TRV22, -TRV33, -TRV60 and -TRV80 digital camcorders, will be able to accept the new Memory Stick format directly. Some products will be able to use Memory Stick Pro after a software update.

Memory Stick Pro cards will be available with capacities of 256MB, 512MB and 1GB. The largest capacity type is expected to sell for about eight hundred pounds. Sony is also launching a 256MB standard Memory Stick card in April.

DAB radio

The first pocket-size portable DAB receivers have now been released, priced at about £100. They use a chip called Diablo, which has been developed by The Technology Partnership of Cambridge and is distributed by Frontier Silicon of Royston, Hertfordshire. Brands include Goodmans and Ministry of Sound.

DAB radios are still in very short supply. It's thought that some 135,000 DAB products have been sold to date in the UK, and sales this year are expected to be between 300,000 and 500,000.

Obituary

Many dealers and service organisations will be saddened to learn of the death of Peter Kennaugh of Pace Micro Technology plc. Peter was Pace's training officer and, as such, was well known to hundreds of satellite-orientated dealers throughout the UK and beyond. He leaves a widow, Denise, and two sons, to whom we extend our deep sympathy.



The first LCD TV with combined DVD player, Model TX15LV1, has been launched by Panasonic. The DVD section is at the right-hand side, with auto-loading. ALC (Active Light Control) automatically detects the brightness level of the input signal and adjusts the back-lighting accordingly. The brightness range of the screen itself is claimed to be wider than with conventional LCD systems, increasing the dynamic range. ASC (Active System Control) adjusts the video signal dynamically according to the image contrast, working with the ALC system. There are also progressive scanning and 3D YC comb filtering (to remove dot crawl and hanging dots). A comprehensive audio system, with DTS and Dolby Digital, is incorporated. The screen can be mounted on a stand or wall-mounted with optional brackets.

Test report:

Digital audio broadcasting transmissions have been available since 1995 but, because of the high cost of receivers, the service has been slow to take off. This situation has been overcome with the advent of the Evoke-1 receiver from Pure, the first to sell at under £100. Peter Marlow reports on its operation and performance

The Pure Evoke-1 DAB radio

Digital Audio Broadcasting (DAB) has been with us for some time now: the first regular transmissions started in London in 1995. But because of the high price of receivers the public has shown little interest. The extra channels available, and mostly CD-quality audio, have not been enough to persuade customers to part with several hundred pounds for a tuner. Late in 2001 however an experiment was carried out to see if there was a demand for receivers at about £100. VideoLogic, now

called Pure, manufactured a batch of 300 radios and put them on sale at £99 each. A website was set up to sell the receivers at an aptly named address – www.grabonequick.com. How right the name was! Within hours all the receivers had been sold.

So plans for a £99 receiver production line were hurriedly put together. The result was the Pure Evoke-1 receiver, which was launched last July. Demand for it is still outstripping supply. The set can be ordered from many high street

audio retail outlets, as well as over the web, but at the time of writing there is a lead time of several weeks. It's suitable for use in the UK, Spain, Denmark, Scandinavia, Singapore and Korea.

About DAB

There is plenty of information about DAB on the web. See the accompanying list of sites. Put simply, with DAB a single frequency carries a multiplex of several digital transmissions, i.e. stations. Each multiplex can handle up to ten stereo and mono radio channels plus services such as text and data. The digital packets include identification that enables the receiver to sort out the data relating to a specific station – the same as with digital TV. By international agreement the UK has been allocated seven of the forty one DAB channel frequencies in Band III (217.5-230MHz) – ITV's old 405-line home.

The data services are still at the pilot stage, but the idea is that the user of each multiplex can allocate 20 per cent of its capacity to data other than audio. Electronic Programme Guides (EPGs) are one such service and are just becoming available in some areas. A number of broadcasters are experimenting with interactive multi-media radio.



Photo 1: Front view of the Pure Evoke-1 DAB receiver.

There will be more on this in coming months.

In many areas up to twice as many digital stations are available as via FM. National radio services broadcast digitally in the UK include BBC Radio 1-4, BBC Radio 5 Live, BBC Radio 5 Live Sports Extra, Classic FM, talkSPORT and Virgin Radio. In some areas as many as fifty digital radio stations are available, including local stations. There are Heart 106.2, Jazz FM, Capital Radio and unique-to-digital stations such as BBC 6 Music, BBC 7, Oneworld, and Ministry of Sound.

Virgin Radio uses a data rate of 160kbits/sec. This puts all but BBC Radio 3, at 192kbits/sec, to shame. Most stations use a data rate of 128kbits/sec, but some go as low as 64kbits/sec or even 48kbits/sec.

First impressions and set-up

The Evoke-1 is a compact and affordable mains-powered portable digital radio receiver whose design is based on the Chorus DAB chip from Frontier Silicon. This advanced chip contains the equivalent of 25 million transistors. The receiver's appearance could be described as 'retro', with a real maple wood veneer and metallic finish – it looks a bit like one of the home-brew products that Heathkit used to sell in the Sixties. Measurements are just 212mm wide by 92mm deep by 145mm high, the weight being 1.4kg. Table 1 lists the basic specification.

The front panel has a single loudspeaker, a two-row backlit LCD screen for station selection and text messages, knobs for tuning and volume, an on/off button and nine pushbuttons – six station presets and three for menus. There's an unusual hole in the base of the unit: this is a built-in reflex port for enhanced bass performance.

The rear panel, see Photo 2, has a 3.5mm socket for stereo headphones, a socket for a second passive speaker box to provide stereo sound, a line-out 3.5mm socket for connection to a hi-fi installation, a 12V power input socket (supplied from the plug-mount mains adaptor), and an RF input F-type connector for the telescopic aerial supplied or an external aerial. DAB transmissions are vertically polarised.

Setting up is really easy. I connected the mains adapter and plugged it in, extended the telescopic aerial, pressed the on/off

Table 1: Pure Evoke-1 DAB radio specification.

Basic: Stereo digital radio (stereo operation requires an auxiliary speaker) for reception of all UK DAB broadcasts, with full Band III reception capability. Fully compliant with ETS 300 401, and capable of decoding DAB transmission modes 1-4. Analogue stereo output and headphone socket.

Frequency range: Band III (174-240MHz), with auto-tune feature.

Tuner sensitivity: -96dBm.

Speaker: One full-range 3in. loudspeaker.

Input connectors: DAB radio aerial F-connector, 75Ω.

Output connectors: 3.5mm connectors for stereo analogue audio, headphones and auxiliary stereo speaker.

Controls: Power on/off, tune, auto-tune, display, set-up, volume, six presets.

LCD screen: High-visibility LCD screen with 16 x 2 characters.

Audio frequency range: 80Hz-20kHz.

Power and distortion figures: 3.4W RMS at 10% THD; 2.8W RMS at 0.1% THD.

Power supply: External 240V AC to 12V DC power adaptor.

Approvals: CE marked. Compliant with the EMC and Low Voltage Directives (89/336/EEC and 73/23/EEC).

Dimensions: 212 x 145 x 92mm.

Aerial: Telescopic DAB aerial supplied.

Technical support: Telephone support hotline and internet website.

Warranty: Two years.

switch, waited ten seconds then a station could be heard. Its name appeared at the top of the front-panel LCD screen, and a scrolling text message ran below. When the 'tune' knob was turned the other stations available appeared in the display while the radio continued with the original station: to move to a new station you press the tuning knob. It's very impressive – I wish computers would work like this! The sound quality from such a small box is excellent.

Features

When the Evoke-1 is switched on for the first time an auto-tune process starts. A progress indicator shows, in the display, that this is under way. To repeat the process you press the 'auto-tune' button on the front panel. All frequencies in the UK channel allocation are then scanned. This is useful if you go elsewhere from your normal area. It's also possible to do a full auto-tune, which scans all frequencies – hold the auto-tune button down for about two seconds. You might be able to pick up some foreign stations. If you move the set and can't receive certain stations a question mark appears in front of their names in the display.

Up to six stations can be preset for selection by the buttons provided. To store, just press and hold down the button for about two seconds.

To select, just press the button.

The 'display' button on the front panel enables you to cycle through six different display modes as follows:

- (1) Scrolling text messages that accompany the audio.
- (2) Programme type, a label that describes the type of content being broadcast.
- (3) Multiplex name where the current service is included.
- (4) Data and time from the current multiplex.
- (5) Channel, displays the identifier and frequency for the station to which the receiver is 'tuned'.
- (6) Mode, displays stereo or mono and the data rate.
- (7) Signal error rate. 0-15 is good, 16-30 is borderline, 31 or more means poor reception.

There are some advanced set-up options that can be accessed by pressing the 'set-up' button on the front panel. Stations can be arranged in alphabetical order or as favourite/most listened to. Manual tuning is available. Another option is DRC (Dynamic Range Control): this provides alteration of the

Photo 2: The rear-panel connections to the Evoke-1 DAB receiver.



Verdict

The Evoke-1 is an excellent product – which my children have now discovered. As a result I don't get much of a look in during the evenings. As with everything, a few improvements could be made to the next version. For example it could have a rechargeable battery to provide full portability, the headphone socket could be on the front instead of the back panel, and a bigger text display for the new EPG and multimedia services would be nice – as would remote control.

Digital radio is an interesting new world. One wonders how long it will be before the first pirate multiplex starts operating. ■

dynamic range of the received audio.

Support

There is support via the phone, though you are not allowed to hold on if all the operators are busy – you have to call back. There is also an email address for support.

Useful websites for DAB information

www.ukdigitalradio.com/stations for station listings.
www.ukdigitalradio.com/coverage for a coverage map.
www.simplyradios.com the sales outlet for Purley Radio, which stocks the Evoke-1 – there could be an appreciable lead time for supply.
www.pure-digital.com Pure Digital, formerly VideoLogic, but the support page doesn't cover the Evoke-1 yet ??

I know where to find repair solutions!

500,000 MAKE/MODEL

TV VCR DVD AUDIO ORIGINAL & COPY PARTS

combinations online

remote controls

laser units

Shop where the professionals shop - at competitive prices -

EURAS em

Homepage | Help | FAQs | Settings

John Smith
 3 Technicians online
 9 Technicians in Chat

Repair-Databases
 Consumer Electronics
 (902826 records)

Monitor
 (50811 records)

Submit a repair tip

Community
 Pinboard System
 Technician chart
 TechChat

Tech-KnowHow
 TechTix
 ECA semiconductor data
 2000

Addresses

Repairtip-Database: Consumer Electr...

Model data
 FERGUSON
 14C1
 TV (cathode ray tube)

FERGUSON/14C1
 FERGUSON/14C2
 FERGUSON/14CB25UT
 FERGUSON/14D1
 FERGUSON/14D2

13. Appliance is dead and when line out
 14. Appliance trips quickly.
 15. Excessive HT and cannot be adjuste
 16. 25V rail is high and cannot be set u
 17. HT rail is high, voltages cannot be re
 18. HT is low.
 19. 12V rail
 20. Picture

Apply for YOUR 30-DAYS FREE TRIAL OFFER NOW!!!

www.euras.com

CHARLES HYDE AND SON LTD

ABOUT US | SERVICES | OUR RANGE | CONTACT US | LINKS

HOME | PLACE ORDER

HOME
 TASCAM
 SANYO
 PHILIPS
 EURAS
 HITACHI
 YAMAHA
 THOMSON
 SIBAO
 SURE

CHARLES HYDE ONLINE
 Welcome to Charles Hyde Online, where you can purchase from a huge range of electrical equipment spares, remote controls, instruction books and accessories for your electrical equipment. Shop where professionals shop at competitive prices.

parts from many manufacturers for:

audio & video accessories
 electric shaver parts
 iron/steamer iron parts
 remote controls

instruments
 instruction books
 vacuum cleaner parts

FINDING WHAT YOU NEED
 All of our best community require parts for such as remote controls, accessories and replacement manuals in our shop. If you require more appliance spares please click the help button on the left.

Do it online

www.charleshyde.co.uk

Special Offer Sale - 20 Remote Controls £20.00 (mixed all well known brands)

HITACHI A-A BATTERIES 10p each NEW TYPES MAIN SWITCHES 10 MIXED £2.00 VT311-VT210-VT311 REEL DRIVE £2.00 ZSK2761 600v/10amp N FETS £1.00 TDA 8362N £5.00 24CO2 15p TDA8178S £5.00 TDA2653A £3.00 TDA4866 £3.00 MITSUBISHI VIDEO HEAD & DRUM 948B231820 £10.00 HEAD 928B654080 £5.00 UNIT GUM IDLER £2.00 LOPT CT2145 £5.00 CT246 £5.00 PHILIPS TUNERS NTSC FS936E £3.00 PHILIPS TUNER U1343/5 31-39-147-15281 £3.50 10 OFF NEW TYPE HAND SETS MITSUBISHI £5.00 + £5.00 POST NEW CHASSIS TUNER ALL COMPONENTS AND LOPT CT21AVIBS } £6.00 POST £5.00 CT28AVIBS } CAR IMMOBILISER WITH KEY £5.00 TUNER UE25-B56D £3.00 FERGUSON ICC 7 HAND SET £3.00 FERGUSON VIDEO FV90 LV HAND SET £3.00 FV80 LV HAND SET £3.00 BRIDGE RECTIFIERS 10 FOR £1.00 CAMCORDER-UNIVERSAL BATTERY 9.6V - 1400MA FOR JVC-PANASONIC-PHILIPS £5.00 DESOLDER PUMP £2.00 FILTERS - 455 & 480 EACH 10p GAS SOLDER IRON-PORTASOL HOBBY £10.00 INFRA RED DETECTOR WIDE/SHORT ANGLE WITH RELAY £5.00 INFRA RED RECEIVER-MATSUMI MINIATURE £1.00 PANEL-1K2-FM2211 STEREO £5.00 PSU AC 9V 1A £1.50 QUARTZ HALOGEN - 500W 200V FOR OUTDOOR LAMPS £1.00 RELAYS-SUB MINIATURE 25p SATELLITE TUNER UNIT -2427611 BASE BAND/VIDEO OUT £3.00 HITACHI AC ADAPTOR 19v DC 2.5A SW MODE £3.00 SCART TO 4 PHONO LEADS 1.5M £3.00 SCART TO 6 PHONO LEADS £3.00 SCART TO "D" PLUG £1.00 SCART TO SCART LEADS - ALL PINS CONNECTED - 1.5 METRES MODULATORS £2.00 SOUND 5.5MHZ MPM 1000T £1.00 SOUND 6.0MHZ MPM 1040 £1.00	FERGUSON ADAPTOR - VPT - TEXT - VA354 £2.00 CAMCORDER BATTERY HIGH CAPACITY 9.6V 1800MA-VA310 £3.00 CAMCORDER BATTERY CHARG- ER 9.6 VOLTS VAZ65 EACH £6.00 CAMCORDER CAR ADAPTOR CHARGER - AND BATTERY- VA308 £5.00 CAMCORDER LENS 20FF - TELE-CONVERSION LENS x1.4 & x0.7 £1.00 CARDIOID CAMERA MICRO- PHONE-VA SUPER 218 TELE- SCOPIC BOOM & STAND £5.00 CHROME BOARD-ICCS I/Cs U4647TKF OR H41498 £6.00 DECK AND CAPSTAN MOTOR: FV61LV - FV62LV, FV67LV FV68LV EACH £30.00 FV70B, FV71LV, FV72LV, FV74LVX EACH £30.00 FV77HV £30.00 FV31R £12.00 HEAD AND DRUM MODULATOR-SATELLITE-T1040- SRD3/4 £2.00 PANEL-T1228B TEXT FOR TX89, TX98, TX99, TX100 £6.00 PANEL-TUBE BASE-ICCS £5.00 PANEL-TUBE-BASE-TX89, TX98, TX99 £5.00 PANEL-TUNING 1509G-TX9, TX10 £5.00 PUSH BUTTON UNIT-TX85, TX86 - 8 BUTTONS £5.00 HITACHI DECODER-TELETEXT PC232A5 - ISSUE 4 £15.00 HEAD AND DRUM - 620E £12.00 TELETEXT CONVERSION KIT £3.00 CORE 2 90° ITT TEXT PANEL £3.00 1996/7 MATSUI VIDEO CHASSIS WITH TUNER-IR POST £4.00 £5.00 MATSUI - ORION DECKS WITH HEADS - D1096 VXA110 VP 9401 £16.00 HEAD-VSR 1500 = ORION D2096 £5.00 PANEL-MAIN-VSR 1500 P/P £5.00ea £3.00 SAMSUNG TECUS983 VA24A VHF-Tuner with Aerial Socket UHF Fit most new TV's £5.00 FERGUSON NICAM MODULE III Art No 989 591-E00 £5.00	VIDEO DECKS AIWA 1500 MATSUI VXA 1100 } MATSUI 1500 } £5 £9 POST ORION D1094 } ORION D1096 } ORION D2096 ETC } CAPSTAN MOTOR FOR ABOVE DECKS £8.00 20 HIGH VOLTAGE CAPS 1500V - 2000V MIXED £1.00 FILTERS FERITE CABLE CLAMPS EACH 30p HANDSETS 3 IN ONE PHILIPS UNIVERSAL HANDS SET £5.00 DECCA NICAM LCD £4.00 FERGUSON BSB £1.50 FV41R/3V59 £10.00 FV41R/FV42-FV51-52 } ICC5 £7.00 IK2000, IK7000 EACH £4.00 SRD2, SRD3, SRD4 EACH £1.00 T780 £2.00 TV/SATELLITE WITH FST £3.00 HITACHI CPT2158 (NO REPLACEMENT) £5.00 VIDEO RM933E VIDEO PLUS £30.00 MATSUI 1500 £5.00 VSR 1500 £4.00 VX3000 £3.00 3000/ORION - TV AND VIDEO £2.00 RC = PACE 900, FERGUSON, SONY, GRUNDIG £5.00 MITSUBISHI RM35 - VIDEO £5.00 NOKIA RC202 £4.00 VP9401 D1096 VXA 1100 AND VIDEO PLUS SAMSUNG HANDSETS, TV & VIDEO - 12 TYPES EACH £3.00 COMPLETE REPAIR KIT, CLUTCH AND PINCH ROLLER, IDLER D2906 MATSUI £7.00 TUNERS IF TERC8-022A TBJZA-00ZA-ALPS £3.00 SATELLITE SXT2302 180968 £3.00 SATELLITE WITH BASE BAND MIN SXT2302234 £4.00 SMALL UNF/VHF £3.50 VHF/UHF - TEKE4- 112A £4.00 4944 U321, U341, U342, U343 } U344, U411, U412, U944 } EACH £2 U743, 7744	AMSTRAD UE33-BO £3.00 MRF7-7E33 MATSUI CRION VIDEO TUNER IF £5.00 FERGUSON 1F2105-RE £5.00 MTP2011-AP00 £5.00 UHF - ICC5 £5.00 VHF - ICC5 £5.00 TX85, TX86, TX89, TX90 EACH £4.00 TX98, T99, TX100 EACH £4.00 ORION 1500 - UE33 BO9 £4.00 PANASONIC SMALL UH 7VHF £3.00 FERGUSON DOUBLE SIDE NICAM £10 ICC5 NICAM SINGLE BOARD ICC5 £10 TATUNG UNIVERSAL 205 OR EQUIVALENT WITH AERIAL SOCKET £3.00 MOTORS HITACHI CAPSTAN 150E £3.00 MATSUI CAPSTAN I/C NO. M56730 ASP £15.00 2 TYPES 1995 TO 1997 MODELS MATSUI VIDEO DECKS WITH CAPSTAN MOTOR AND HEAD P/P £5.00 £20.00 MITSUMI MOD MRF7-L F32 £5.00 MOD TMUG3-103A £5.00 MITSUBISHI CAPSTAN-HSE41-I/C MSI782ASP £2.00 12v to 15 D.C. TV MODULATOR WITH LEADS VIDEO IV 75F. AUDIO IV 10F. HV100 £3 EACH TV AERIAL AMPS VHF /UHF 1 WAY 20dB EACH £5 2 WAY 18dB EACH £5 4 WAY 10dB EACH £5 8 WAY 4dB EACH £5 240v MAINS COMPUTER 3 PIN MAINS LEADS 2 1/2 METRES LONG - GREY EACH £1.50 2 METRES LONG - BLACK EACH £1 SCART TO SCART - ALL PINS -1 METRE EACH 60p
--	--	--	---

No accounts

SENDZ COMPONENTS

No Credit Cards

63 BISHOPSTEIGNTON, SHOEBURYNESSE, ESSEX SS3 8AF

Tel: 01702 332992 Fax: 01702 338805

Specific P/P charges are PER ITEM ● For UK addresses add P/P to order then 17.5% VAT to total.
 This applies to EC unless VAT No. is given ● Exports - P/P at cost ● Postal Order/Cheque with order.

Unless otherwise specified add £1.70 P/P to SMALL ORDERS ●

Additional P/P for HEAVIER GOODS. Technical information by telephone only Government/School Orders on official headings.

Callers to shop - 212 London Road, Southend-on-Sea

Open Saturday Only 10-12 noon - 2-5pm.

PLEASE ADD 17.5% VAT TO BOTH THE GOODS TOTAL AND P/P CHARGE



PC-camcorder connection problems

As the cost of digital camcorders has fallen, more consumers are buying them and then exploring the facility to carry out editing with a PC. This is done via an IEEE 1394 link, but many users find that plug-and-play doesn't work. Steve Beeching, I.Eng., MIEE, describes the technology and the problems that can arise

As the price of digital camcorders has fallen, more consumers are buying them then exploring the facility provided for connection to a PC for editing purposes. The means to do this is provided by the IEEE 1394 communication protocol, and is referred to as DV communication, FireWire or i-Link. It's a 'hot' connection, i.e. the camcorder and PC can be connected while they are powered. Both devices then recognise the connection, and communication can commence. The camcorder comes up as an icon in the PC's 'my computer' box: its pictures can be monitored by double-clicking on the icon and running the initialisation software. A card and editing software package, once affordable only in

broadcast circles, can now be bought for much less than £100.

So people are purchasing these cards and upgrading their PCs. They might then find that plug-and-play doesn't work. The camcorder is not shown as connected or identified, therefore the camcorder is faulty. That's when I get a call!

Most camcorder manufacturers have a software consultant in their customer services departments to deal with computer drivers and internal conflicts. IRQ (interrupt request) conflicts can often be resolved by moving the card to another free PCI slot in the PC and checking that the IRQ allocated to the card is 9, 10 or 11.

The basic requirements for a PC for this use are: a 350MHz processor; UDMA so that the front

side bus can run at 66MHz or more; and a hard drive that's large enough (40GB), DMA enabled and has a rotational speed of 7,200 RPM – if not, the read/write speed is too slow.

Damage to camcorders

Some time ago I mentioned my suspicions that the DV communication chips in digital camcorders were being damaged by connection to a PC. This occurrence is on the increase, and at present is taken care of by manufacturers' warranties. Out of warranty the cost of repair is quite high, up to £300 in some cases – to replace the main PCB, exchange data and set up. As this cost approaches the initial price of the camcorder, the viability of repair becomes questionable.

Why not simply replace the damaged IC? Unfortunately or not, depending on your point of view, board circuit diagrams and layouts are not published by manufacturers, who consider the board itself to be the spare part.

Digital data transfer

Data transfer between digital products is achieved using the communication protocol known as

Fig. 1: 4- and 6-pin IEEE 1394 cable connectors.

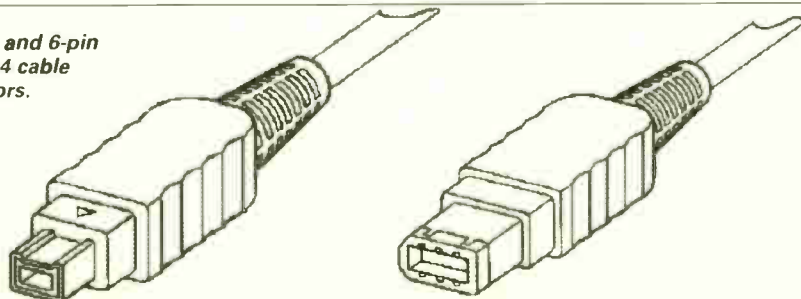

IEEE 1394, also FireWire and i-Link depending on manufacturer. There are three data transfer rates, 93.304Mbits/sec (S100), 196.608Mbits/sec (S200) and 393.216Mbits/sec (S400). Equipment specified for the higher rates can also communicate at the lower rates.

Maximum cable length, which depends on data rate and cable construction, is about 4.5m but can be increased by using repeaters. At the S100 data rate the length, using suitable high-quality cable, can extend to 10m. There are two types of cable and connector: a 4-pin connector for cables with two communication pairs, commonly used with the DVC (digital video cassette) system; and a 6-pin connector for cables with two power wires as well as the communication pairs, enabling power to be supplied to repeaters and PC peripherals. Fig. 1 shows the two types of connector, Fig. 2 a cross-section of the 6-wire type of cable. For camcorder-PC connection the cable is usually 2m long with a 4-pin connector for the camcorder at one end and a 6-pin connector for the PC at the other end.

A unique advantage of the IEEE 1394 specification is that connections can be made with the power on, which is known as 'hot plug-in'. Each product searches for the specified recipient before transferring data. As mentioned later however, this may not be such a good idea.

For data transfer to succeed the data must be of the appropriate type. For example MPEG-2 transport streams cannot be sent to a DVC product or vice versa as the data will not be recognised by the recipient, even though MPEG-2 is closely related to the DVC standard.

There are two main protocols for DV and PC communications, DVC-SD (SD = standard definition) and SBP-2. The former is for transferring real-time AV signals and basic system operation controls, i.e. play, record, fast-forward etc. The latter is for PCs and peripherals. Data transfer may be isochronous, for real-time AV data packets, or asynchronous, for computer peripherals and for function control and file transfer.

The AV protocol has rules for DVC-SD digital video communication, MPEG-2 and audio or music transfer between devices. The basic types of signal are as follows:

DVC-SD, for audio and video

data in the DV format.

MPEG-2-TS (TS = transport stream), for audio and video data being broadcast via terrestrial or satellite means.

Audio and music for audio and data signals from CDs and MiniDiscs.

Signals used for operational control commands with cameras, VCRs, DBS receivers, CD and MD players, TV sets and monitors.

Home AV interoperability

A standard that enables all types of digital consumer electronics equipment and home appliances to communicate with each other has been developed by an organisation known as HAVi. IEEE 1394 has been adopted as the method of interconnection. To date, manufacturers who have agreed to use this system include Grundig, Hitachi, Matsushita (Panasonic), Philips, Sharp, Sony, Thomson and Toshiba.

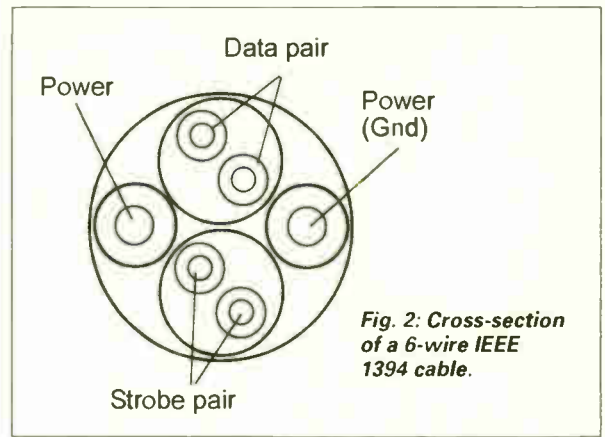

Fig. 2: Cross-section of a 6-wire IEEE 1394 cable.

Interoperability means that any device connected to a HAVi network can be controlled from any other device connected to the same network. For example a VCR can be programmed to make a timed recording by using a TV set-up menu, or a camcorder can be controlled by a PC for editing purposes. Devices from different

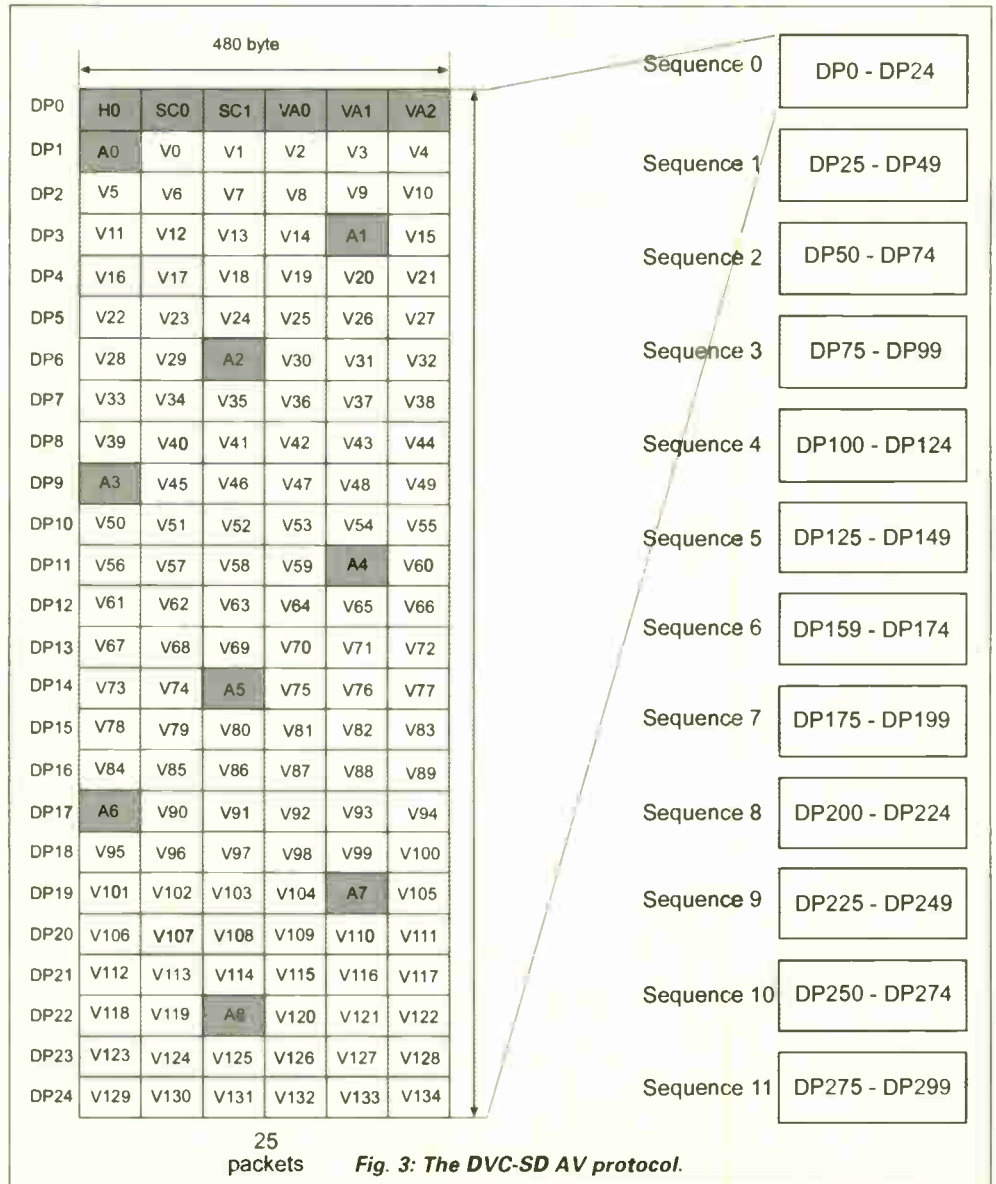

Fig. 3: The DVC-SD AV protocol.

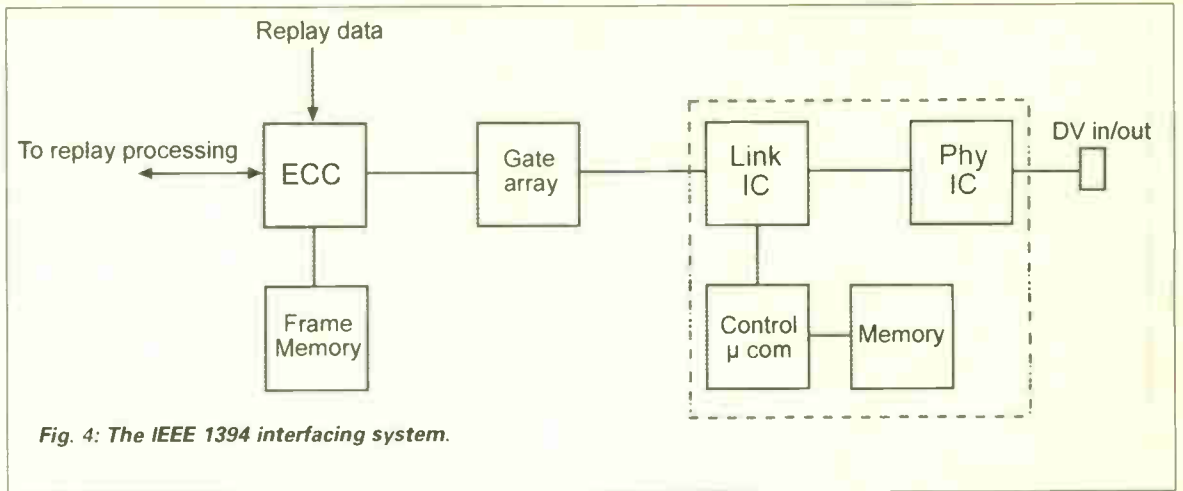

Fig. 4: The IEEE 1394 interfacing system.

manufacturers can communicate with each other, i.e. the system is independent of brand.

The DVC-SD AV protocol

The DVC-SD AV protocol is illustrated in Fig. 3. Each of the twelve DVC tape tracks that make up a frame has 135 macro blocks of video data, an audio data section, and sub-code and auxiliary video data sections. These are kept together in a DVC data transfer block called a sequence. As the DVC tape has twelve tracks per frame, there are twelve sequence blocks, 0-11, for DVC-SD protocol transfer to maintain AV compatibility.

Each sequence block consists of 25 data packets, labelled DP0-DP24 for sequence block 0 up to DP275-DP299 for sequence block 11. In

turn each data packet consists of six digital interface (DIF) blocks, each of which has 80 bytes of data. Thus each packet contains 480 bytes of data.

There are 150 DIF blocks (6 x 25) in a sequence, consisting of a sequence header (H0), 135 video data blocks (V0-V134), nine audio data blocks (A0-A8), three video auxiliary blocks (VA0-VA2) and two sub-code blocks (SC0 and SC1). The latter carry the time and data and time-code information.

Each sequence commences with a packet that contains the header block (H0) to identify the sequence, followed by two blocks of sub-code and three blocks of auxiliary-video data. The following packets contain video blocks V0-V134 interspersed with audio blocks A0-A8. This first sequence is followed by eleven

more to complete the frame.

IEEE 1394 interfacing

Fig. 4 shows in block diagram form the basic IEEE 1394 interface system. The link IC, Phy IC and control microcomputer may be incorporated within a single IC. When a tape is played back the data is assembled into single frames in the ECC (error correction and control) memory, after error correction, along with the audio data.

Control of the DVC-SD protocol is carried out by the link IC and the associated micro. The ECC data signal from the camcorder's internal data bus is fed to the link IC, where it is converted to DVC-SD sequence blocks and the header is added. Conversion from DVC to IEEE 1394 DVC-SD protocol is

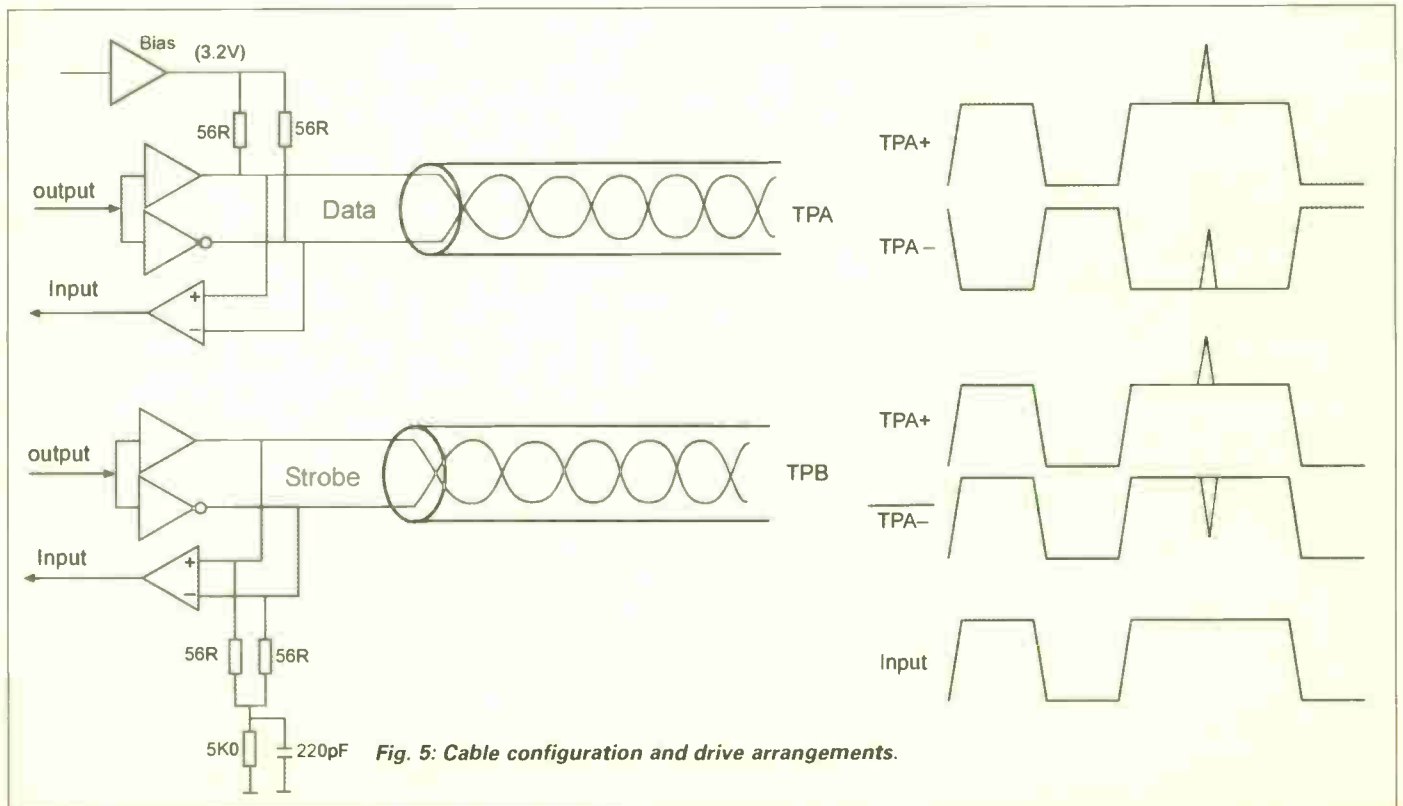

Fig. 5: Cable configuration and drive arrangements.

carried out by the microcomputer section, assisted by an additional memory for temporary data storage during the process. Within the link IC there are data transmit and receive sections that are connected to the cable via the Phy IC. The latter incorporates a transmit encoder and receive decoder and matching circuits for the twisted-pair cables. This IC also provides transceiver control of other devices, providing bus initialisation and arbitration to ensure that only one device sends data at any time.

Cable transmission and drive

The data is transmitted via a twisted-pair, see Fig. 5. It's sent in normal and inverted form along each leg of the pair. TPA is the data pair and TPB the strobe signal pair. Any noise picked up along the cable route is of the same polarity in both legs of the twisted pair. At the receiving end the signal via one leg is inverted and added to that from the other leg. The noise is also inverted and cancels with the noise via the other leg, while the addition strengthens the data. This technique is applied to both the data and the strobe twisted pairs.

Instead of transmitting a data stream and a clock stream as separate signals, the data and clock streams are combined in an exclusive-or gate to generate a strobe signal stream, see Fig. 6. This is done to reduce timing errors. The data and strobe streams are sent via the two twisted pairs and are combined at the receiving end in another exclusive-or gate to recover the clock signal.

There are usually two or more IEEE 1394 connectors on a PC card, each with six terminals, the two differential-data pairs and two power connectors. The latter are for use with computer peripherals such as external hard drives, and are not used by camcorders. So the DV connection leads have a 6-pin connector at the PC end and a 4-pin connector at the camcorder end, see Fig. 7.

The circuit at the camcorder end, see Fig. 5, is identical to that at the PC end. The data and strobe signals are sent as differential outputs with bias from a constant-current source. Both legs are biased at about 3V. The signal is at about 200mV and is classified as a non-return-to-zero (NRZ) data signal.

What kills camcorder DV communication?

Enough about the basics. What goes wrong that kills the DV

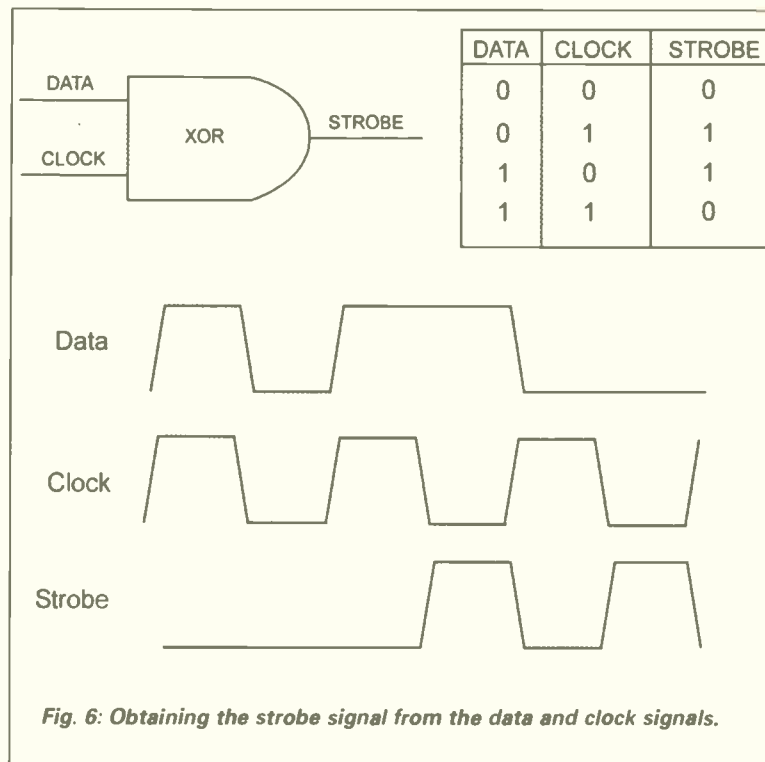

Fig. 6: Obtaining the strobe signal from the data and clock signals.

communications IC in the camcorder but doesn't affect the PC? Initially it was difficult to work this out, as there are no circuit details in camcorder service data. One particular situation provided a few clues however.

Last year a Panasonic NVS28 digital camcorder arrived from a dealer with the complaint "no DV communication". At the time no main circuit boards were available, so it sat in the rack. Then another one came from the same dealer, also from the same customer – a university. Alarm bells rang in the back of my mind. I told the dealer to inform the university that there was a problem with a PC. This was dismissed by the university, which promptly sent back a third camcorder with the same problem.

When the first replacement board came and was fitted there was still no DV communication, so the connections from the board to the DV connector were checked. Funny how the manufacturer marks these ribbon cables with a brown felt pen. Hang on a minute – that's a track burnt to a crisp! All three camcorders had burnt tracks on the TPB pair of the ribbon cable. An estimate was prepared for each camcorder.

I found out later that other camcorders had been damaged by the same PC, including an expensive semi-professional Sony camcorder. Unfortunately I was unable to find out what had happened to the PC, as the manufacturer was being pressed

for compensation. And if you ask, no the estimates were not accepted.

Since that first incident more and more digital camcorders have been returned damaged. One possibility is that the 6-pin connector, which is polarised by its shape, can nevertheless be inserted the wrong way round. This would put 12V on to one of the TPB legs. The ICs in the camcorder are supplied at 3V, and tend to object to 12V by dying.

Other possibilities are leakage across the PC connector or cable or that the cable is wired incorrectly. More investigation is required into this.

Compatibility problems

It has been reported that there can be compatibility problems between a camcorder and a PC 1394 card. Not all cards comply with the OHCI (open host controller interface) specification. They may work with some models, but not others. Any card that's supplied with its own driver is not OHCI compliant and may fail to communicate with some earlier digital camcorders.

There have been reports of incidents where certain laptops with i-Link connections have failed to communicate with third-party digital camcorders. Not all such laptops are OHCI compliant, and the specific driver may have to be replaced with the Texas Instruments DV class driver or the Microsoft DV class driver supplied with the operating system. This may also relate to editing software

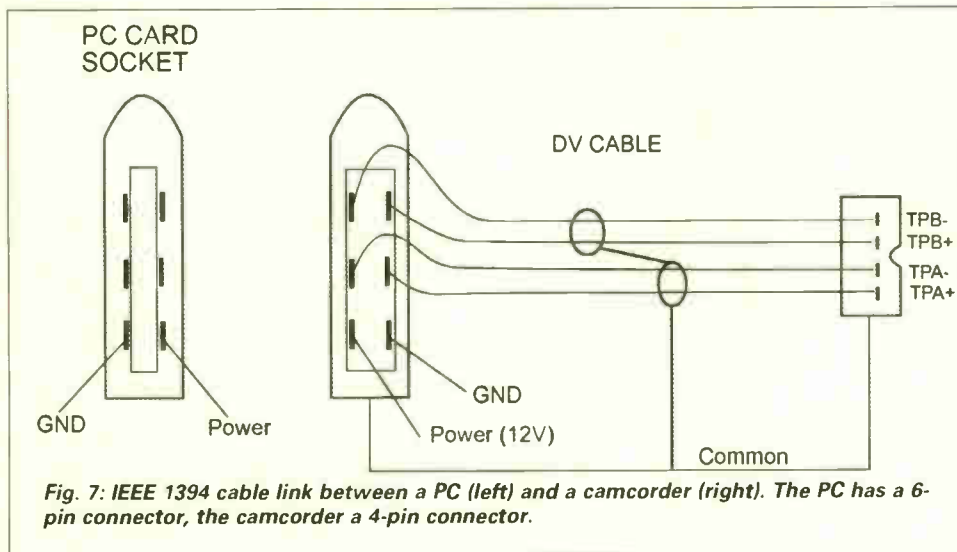

Fig. 7: IEEE 1394 cable link between a PC (left) and a camcorder (right). The PC has a 6-pin connector, the camcorder a 4-pin connector.

that can be particular about the class of driver in use.

A Sony VAIO laptop is best used with a Sony camcorder and the DVGate editing software, using a Sony DV class driver, as it may not recognise other manufacturers' camcorders, though later VAIOs are OHCI compliant. The driver can be changed using the SonySwitcher software, but not always successfully. For further information check the Adobe Premier website at

www.adobe.com/support and navigate through the technical documents, or go to

www.pinnaclesys.com and navigate through support by product. There are also user forums at the Pinnacle site.

Mains supply problems

Another danger lies with a camcorder AC adaptor that's not earthed and a PC that's connected to mains earth. Out of a sample of AC power units all had some AC leakage voltage between the DC output and mains earth: the minimum was 20V AC, the highest measured just over 80V AC – that's about 220V peak-to-peak!

Now consider hot connection. The PC end of the cable is usually permanently connected because access is at the rear, so the camcorder end is connected and disconnected as required. If the data or strobe lines should connect before the common shielding of the plug and socket, the power supply leakage voltage will be applied to the ports of the communications IC with catastrophic results. Even if the common is earthed when the DV plug is inserted the leakage

voltage will discharge via the DV output connector and a damaging voltage can still appear across the IC ports.

Customers must be told to connect the camcorder to the PC before plugging the AD adaptor into the mains socket at the wall. Connecting an AC-powered digital camcorder to a PC is a risky business.

Recognition

When a camcorder is successfully connected to a PC it sends to the PC an ID data tag that contains the manufacturer, model and product code. It's up to the PC's software to recognise this information. If it doesn't, the PC will decide that the camcorder is not connected, switched off or not in the VCR mode.

At least one editing application uses the ID tag to detect the make and model in order to determine which features within that model are useful to the software. Mainly this is to check that the model has DV input facilities. If the ID is not recognised and a model is inputted to the PC manually, the user may accidentally quote a UK model that does not (officially) have DV input. As a result the software will not transmit back to the camcorder.

If a camcorder streams video and audio data to the PC and the model has been recognised, full communication is confirmed. It's possible however that the PC software may stream data back to the camcorder, visible on the LCD panel, but may not put the camcorder into the record mode. This is a software problem and may be caused by a model conflict. I have had a camcorder fault where the software couldn't

send data back to the camcorder, acting as though it had no DV input capability, but this was unusual.

Windows XP

Windows XP has not been without difficulties. Cards that previously worked with WIN98SE have failed to communicate with a camcorder when the PC has been upgraded. The cause is not fully understood, but the theory is that the driver with XP doesn't support certain camcorders or cards, or doesn't recognise the data tag from the camcorder.

Pixellation and audio problems

Pixellation during transfer to the PC is almost certainly a software problem whereas pixellation when recording back to the camcorder is a PC resources shortage. When recording back, the PC has to take the audio file and match it up with the video file and interleave the data into the DVC-SD format for transmission back to the camcorder. This calls for a lot of computing power. If the PC has anti-virus or other applications running at the same time, it may not have the spare capacity required to carry out the data encoding fully.

Another problem that has been reported is loss of audio/video timing, or loss of lip-sync. When the data is in the PC the audio and video data packets are separate and remain so in the edited time-line. When the edited information is recorded back to the camcorder the audio and video data have to be remixed: software errors can cause loss of lip-sync during playback.

The user also has to be careful when the camcorder can use 12- or 16-bit audio encoding. These will not mix, or allow CD audio files to be added as background music.

In conclusion

In conclusion, there are many problems with supposed interoperability between DV camcorders, PC drivers and editing software, particularly when different manufacturers' products, different types of product and different editing software are mixed. I'm sure that more complex problems will arise as we start mixing products and IEEE 1394 and wireless interconnections on our way to the interconnected, PC-controlled home. ■

Grandata Ltd

distributor of electronic components

Slimline Multi-Regional DVD Player

Modern looking , silver design

Supports Dolby Digital sound

Optical Digital Audio output

Range of Video output options

Scart lead included

Plays DVD / VCD / MP3 / CD / CD-R / SVCD

Comes with a 2 year Guarantee



Order Code : DVD28

Price : £ 72.50 + vat

(Postage £ 5.00 + vat)

PLEASE CALL FOR QUANTITY PRICES

Digital Multimeters

High Performance Digital Multimeter

- * 3.5 digit display 1999 count
- * Large LCD display
- * Low battery indication
- * Auto power off
- * Overload protection
- * Audible continuity and diode test
- * Temperature measurement
- * Capacitance measurement



Technical Specification

Value	Range	Accuracy
DCV	200mV, 2V, 20V, 200V, 1000V	+/- 0.5 %
ACV	200mV, 2V, 20V, 200V, 700V	+/- 0.8 %
DCA	200uA, 2mA, 20mA, 200mA, 2A, 10A	+/- 0.8 %
ACA	200uA, 2mA, 20mA, 200mA, 2A, 10A	+/- 1.2 %
Resistance	400, 2k, 20k, 200k, 2M, 20M	+/- 0.8 %
Capacitance	2000pF, 20nF, 200nF, 20uF, 20uF	+/- 2.5 %
Temperature	50C to 1000C	+/- 0.75%

Order Code : 24506S

Price : £ 25.00 + vat

Digital Capacitance Meter

- * 3.5 digit LCD 1999 count
- * 9 selectable ranges from 200pF to 20mF
- * Supplied with holster
- * High accuracy (0.5%<2000uF, 1.0%:2000uF, 2.0%:20mF)
- * External control for zero adjustment
- * Overload indication
- * Safety designed test probe
- * Powered by 1 x 9V battery



Order Code : 24504S

Price : £ 28.00 + vat

Postage on Meters charged at £ 3.00 + vat

105°C Radial Electrolytic Capacitors

VALUE	CODE	PRICE	PER PACK	VALUE	CODE	PRICE	PER PACK	VALUE	CODE	PRICE	PER PACK	VALUE	CODE	PRICE	PER PACK	VALUE	CODE	PRICE	PER PACK
10 Volts				35 Volts...continued				50 Volts...continued				63 Volts...continued				200 Volts			
100uF	.CAP118	£0.45	10	470uF	.CAP44	£1.90	10	2.2uF	.CAP138	£0.35	10	68uF	.CAP83	£1.30	5	100uF	.CAP151	£3.25	5
470uF	.CAP29	£1.20	10	680uF	.CAP45	£3.15	5	3.3uF	.CAP139	£0.35	10	100uF	.CAP84	£1.20	10	220uF	.CAP152	£0.60	10
1000uF	.CAP119	£1.50	10	1000uF	.CAP46	£3.65	10	4.7uF	.CAP140	£0.35	10	150uF	.CAP85	£2.80	5	3.3uF	.CAP104	£1.75	10
2200uF	.CAP120	£2.10	10		.CAP47	£3.90	5	10uF	.CAP63	£0.50	10	220uF	.CAP86	£2.80	10	10uF	.CAP105	£2.60	10
16 Volts				2200uF	.CAP48	£2.00	2	22uF	.CAP64	£0.70	10	330uF	.CAP87	£4.00	10	22uF	.CAP153	£2.30	10
22uF	.CAP121	£0.35	10	3300uF	.CAP49	£2.20	2	33uF	.CAP141	£0.85	10	470uF	.CAP88	£5.25	10	47uF	.CAP106	£4.35	10
33uF	.CAP122	£0.35	10	4700uF	.CAP50	£3.65	2	47uF	.CAP65	£0.85	10	680uF	.CAP89	£5.00	10	100uF	.CAP154	£4.50	5
47uF	.CAP123	£0.35	10	6800uF	.CAP51	£3.90	2	68uF	.CAP142	£0.90	10	1000uF	.CAP90	£5.40	5	220uF	.CAP155	£2.00	2
100uF	.CAP124	£0.60	10	35 Volts				100uF	.CAP66	£0.85	10	100 Volts				1uF	.CAP156	£0.70	10
220uF	.CAP125	£0.80	10	1uF	.CAP130	£0.40	10	220uF	.CAP67	£1.75	10	0.47uF	.CAP91	£0.50	5	350 Volts			
330uF	.CAP126	£1.75	10	3.3uF	.CAP131	£0.40	10	330uF	.CAP68	£2.45	10	1uF	.CAP92	£0.85	10	1uF	.CAP157	£1.50	10
470uF	.CAP127	£1.75	10	4.7uF	.CAP132	£0.45	10	470uF	.CAP69	£4.35	10	1.5uF	.CAP93	£0.70	5	3.3uF	.CAP158	£2.25	10
680uF	.CAP128	£2.10	5	10uF	.CAP52	£0.50	10	680uF	.CAP70	£4.90	5	2.2uF	.CAP94	£0.50	5	10uF	.CAP159	£2.30	10
1000uF	.CAP129	£2.10	10	22uF	.CAP53	£0.45	10	1000uF	.CAP71	£5.25	10	3.3uF	.CAP95	£0.50	5	47uF	.CAP110	£4.00	5
2200uF	.CAP130	£2.50	10	33uF	.CAP54	£0.50	5	1500uF	.CAP143	£4.50	5	4.7uF	.CAP96	£0.50	5	22uF	.CAP111	£2.50	2
3300uF	.CAP131	£5.00	5	47uF	.CAP55	£0.85	10	2200uF	.CAP72	£3.25	2	10uF	.CAP97	£0.95	10	47uF	.CAP112	£3.50	2
4700uF	.CAP132	£6.10	10	68uF	.CAP133	£0.55	10	3300uF	.CAP144	£3.25	2	22uF	.CAP98	£1.05	10	100uF	.CAP160	£4.00	2
25 Volts				100uF	.CAP56	£0.85	10	63 Volts				470uF	.CAP100	£1.75	10	220uF	.CAP113	£2.00	2
10uF	.CAP37	£0.45	10	150uF	.CAP57	£0.95	5	0.22uF	.CAP145	£0.45	10	100uF	.CAP101	£2.10	10	4.7uF	.CAP114	£3.20	5
22uF	.CAP38	£0.45	10	220uF	.CAP58	£1.45	5	0.47uF	.CAP73	£0.35	10	220uF	.CAP102	£6.00	5	10uF	.CAP115	£4.95	5
33uF	.CAP126	£0.40	10	330uF	.CAP134	£1.60	10	1uF	.CAP74	£0.35	10	470uF	.CAP103	£6.00	5	22uF	.CAP116	£5.50	5
47uF	.CAP39	£0.48	5	470uF	.CAP135	£1.75	10	2.2uF	.CAP75	£0.35	10	160 Volts				10uF	.CAP117	£4.15	2
68uF	.CAP127	£0.55	10	680uF	.CAP59	£6.50	10	3.3uF	.CAP76	£0.50	10	2.2uF	.CAP146	£0.45	10	2.2uF	.CAP118	£3.20	5
100uF	.CAP40	£0.70	10	1000uF	.CAP60	£4.35	10	4.7uF	.CAP77	£0.35	10	10uF	.CAP147	£1.40	10	4.7uF	.CAP119	£4.95	5
120uF	.CAP128	£0.85	10	2200uF	.CAP61	£2.45	2	10uF	.CAP78	£0.50	10	22uF	.CAP148	£1.80	10	10uF	.CAP120	£5.50	5
150uF	.CAP41	£0.95	5	3300uF	.CAP62	£10.00	5	15uF	.CAP79	£0.95	5	33uF	.CAP149	£2.30	10	22uF	.CAP121	£6.00	2
220uF	.CAP42	£1.20	10	4700uF	.CAP136	£3.50	2	22uF	.CAP80	£0.75	10	100uF	.CAP150	£3.25	5	450 Volts			
330uF	.CAP43	£1.40	5	50 Volts				33uF	.CAP81	£0.85	10	160 Volts				1uF	.CAP122	£6.00	2
				1uF	.CAP137	£0.35	10	47uF	.CAP82	£0.95	10	2.2uF	.CAP151	£0.45	10	1uF	.CAP123	£6.00	2

K.P. House , Unit 15 , Pop In Commercial Centre , Southway , Wembley , Middlesex . HA9 0HB England

Tel : (020) 8900 2329

Fax : (020) 8903 6126

Email : sales@grandata.co.uk

Grandata Ltd

distributor of electronic components

Television Repair / Mod Kits

MAKE & MODEL	KIT TYPE	CODE	MAKE & MODEL	KIT TYPE	CODE	MAKE & MODEL	KIT TYPE	CODE	MAKE & MODEL	KIT TYPE	CODE
ALBA			GOODMANS..Continued			MITSUBISHI..Continued			PHILIPS..Continued		
1452T	PSU	ONWAKIT	2029T	PSU	ONWAKIT	CT21AV1BS	PSU	MITSKIT3	310.32262		PHILKIT8
1427T	PSU	ONWAKIT	2029TA	PSU	ONWAKIT	CT25A2STX	TDA 8178S	MITSKIT1	310.62264		PHILKIT1
1402	PSU	ONWAKIT	F16 CHASSIS	FRAME	GOODKIT1	CT25A3STX	TDA 8178S	MITSKIT1	ANUBIS A	SOPS	PHILKIT2
1455T	PSU	ONWAKIT	F16 CHASSIS	LINE	GOODKIT1	CT25A4STX	TDA 8178S	MITSKIT1	CP110 CHASSIS	SOPS	PHILKIT8
1456T	PSU	ONWAKIT	F16	PSU	GOODKIT1	CT25A6STX	TDA 8178S	MITSKIT1	G90A CHASSIS	SOPS	PHILKIT10
1458T	PSU	ONWAKIT	F16	VIDEO	GOODKIT1	CT25AV1B	PSU	MITSKIT3	G90B CHASSIS	SOPS	PHILKIT10
1459T	PSU	ONWAKIT	GRUNDIG			CT25AV1BS	PSU	MITSKIT3	G110 CHASSIS	SOPS	PHILKIT3
1499Y	STANDBY	MODKIT37	CUC 7350		GRUNDIGKIT1	CT25AV1BD	PSU	MITSKIT3	GR2.1 CHASSIS	SOPS	PHILKIT1
2002	PSU	ONWAKIT	CUC 7301/3		(BUZ90)	CT25AV1BDS	PSU	MITSKIT3	GR2.2 CHASSIS	SOPS	PHILKIT1
2009B	PSU	ONWAKIT		PSU	GRUNDIGKIT2	CT28AV1B	PSU	MITSKIT3	D-16 CHASSIS	SOPS	PHILKIT6
2052T	PSU	ONWAKIT	CUC 7301/3			CT28AX1BD	PSU	MITSKIT3	HSM VIDEO	SOPS	PHILKIT5
2152T	PSU	ONWAKIT	CUC 7301/3			CT28AV1BDS	PSU	MITSKIT3	JSM VIDEO	SOPS	PHILKIT4
2099TX	STANDBY	MODKIT37	(MJF18004)		PSU	GRUNDIGKIT3	CT29A1	TDA 8178S	KSM VIDEO	SOPS	PHILKIT9
BTV17	STANDBY	MODKIT37	HINARI			CT29A4	TDA 8178S	MITSKIT2	LSM VIDEO	SOPS	PHILKIT7
CTV501	PSU	ONWAKIT	HIT14RC		PSU	ONWAKIT	CT29A6	TDA 8178S			
CTV701	PSU	ONWAKIT	JVC			CT29B2	TDA 8178S	MITSKIT2			
CTV840	PSU	ONWAKIT	AV29SX1EK	FIELD O/P	JVCKIT1	MAKE & MODEL					
CTV841	PSU	ONWAKIT	AV29SX1EN	FIELD O/P	JVCKIT1	CT29B3	TDA 8178S	MITSKIT2			
CTV485	PSU	ONWAKIT	AV29SX1EN1	FIELD O/P	JVCKIT1	CT29B6	TDA 8178S	MITSKIT2			
			AV29SX1PF	FIELD O/P	JVCKIT1	CT33B3	TDA 8178S	MITSKIT2			
			AV29TSIE1	FIELD O/P	JVCKIT1	M5 SERIES	PSU	MITSKIT3			
			C14E1EK	PSU	ONWAKIT	NEI/NIKKAI					
			C14T1EK	PSU	ONWAKIT	CE25 CHASSIS	PSU	NIKKAIKIT1			
			C21ET1EK	PSU	ONWAKIT	C289FTXN	PSU	NIKKAIKIT1			
			CS21M3EK	PSU	ONWAKIT	C28F41FXN	PSU	NIKKAIKIT1			
			MATSUI			PANASONIC					
			1455	PSU	ONWAKIT	IC561	TDA 8175	PANKIT1			
			1498	PSU	ONWAKIT	TX25XD60	VERT OUTPUT	PANKIT2			
			2086	PSU	ONWAKIT	TC28XD60	VERT OUTPUT	PANKIT2			
			2098	PSU	ONWAKIT	TX28XD70	VERT OUTPUT	PANKIT2			
			21V1N (BUZ90)	PSU	GRUNDIGKIT2	TX29XD70	VERT OUTPUT	PANKIT2			
			21V1T (MJF18004)	PSU	GRUNDIGKIT3	TX-W26D3	VERT OUTPUT	PANKIT2			
			TVR180R/T/2080	STANDBY	MODKIT37	PHILIPS					
			MITSUBISHI			310.10708		PHILKIT3			
			AV1 SERIES	PSU	MITSKIT3	310.20491		PHILKIT2			
			CT1M5B	PSU	MITSKIT3	310.20496		PHILKIT10			
			CT21M5BT	PSU	MITSKIT3	310.31994		PHILKIT6			
			CT25M5BT	PSU	MITSKIT3	310.32252		PHILKIT5			
			CT21A2STX	TDA 8178S	MITSKIT1	310.32253		PHILKIT4			
			CT21AX1B	PSU	MITSKIT3	310.32254		PHILKIT9			
			CT21A3STX	TDA 8178S	MITSKIT1	310.32255		PHILKIT7			

ORDER CODE	PRICE	ORDER CODE	PRICE	ORDER CODE	PRICE	ORDER CODE	PRICE	ORDER CODE	PRICE
GRUNDIGKIT1	£ 10.50	MITSKIT3	£ 6.00	PANKIT2	£ 9.00	PHILKIT6	£ 5.50	SHARPKIT2	£ 11.00
GRUNDIGKIT2	£ 10.50	MODKIT35	£ 9.50	PHILKIT1	£ 7.60	PHILKIT7	£ 7.60	SHARPKIT3	£ 9.00
GRUNDIGKIT3	£ 10.50	MODKIT36	£ 5.00	PHILKIT10	£ 8.50	PHILKIT8	£ 4.25	THOMKIT1	£ 7.00
GOODKIT1	£ 11.00	MODKIT37	£ 6.50	PHILKIT2	£ 2.50	PHILKIT9	£ 7.50	THOMKIT2	£ 12.00
JVCKIT1	£ 11.00	NIKKAIKIT1	£ 12.00	PHILKIT3	£ 4.00	SAMKIT2	£ 8.00	THOMKIT3	£ 9.00
MITSKIT1	£ 3.00	ONWAKIT	£ 12.00	PHILKIT4	£ 4.25	SAMSUNGKIT	£ 16.00	THOMKIT4	£ 4.00
MITSKIT2	£ 15.00	PANKIT1	£ 15.00	PHILKIT5	£ 5.75	SHARPKIT1	£ 11.00	THORNKIT1	£ 12.75

Satellite Repair / Mod Kits

Amstrad DRX100 Tuner Repair Kit Order Code SATKIT35 Price £ 1.40 + vat	Amstrad DRX100 Power Supply Reliability Kit Order Code SATKIT36 Price £ 12.00 + vat	Amstrad DRX100 Power Supply Repair Kit Order Code SATKIT37 Price £ 13.50 + vat	Grundig GDS200 Digital Satellite Receiver Repair Kit Early psu MODEL : DSO - 0385 REV C Order Code: SATKIT34A Price : £ 10.00 + vat	Grundig GDS200/300 Digital Satellite Receiver Repair Kit LATER psu TYPE REV 03 DSO - 0375 REV A DSO - 0385 REV 5 Order Code: SATKIT34B Price : £ 10.00 + vat
--	--	---	--	--

Digital Satellite Receivers Fan Kit
 Suitable for
 Amstrad DRX100 , DRX200
 Grundig GDR200 , GDS200
 Pace Digibox
 plus many more analogue makes and models
Order Code : FANKIT1
Price : £ 10.00 + vat

Panasonic Digital Satellite Receiver Fan Kit
 Suitable for Panasonic TU-DSB20/30 , TU-DSB31/35
Order Code : FANKIT2
Price : £ 15.00 + vat

Grandata Ltd

distributor of electronic components

Aerial & Digital Satellite Accessories

Sky™ Digital Remote & TV Link Eye Combination

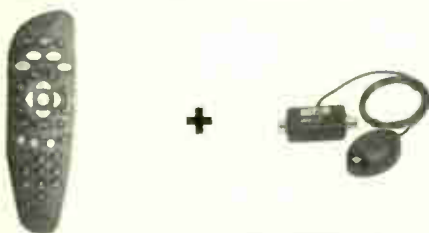

Order Code : SKYPACK1

Price : £ 16.00 + vat each

5 +

£ 14.50 + vat each

Sky™ Digital Remote Controls



Order Code : RCKSKY

1 + 5 +
£ 7.95 + vat each £ 7.45 + vat each

10 +

£ 6.95 + vat each

Sky™ Digital Remote & SLx Link Eye Combination

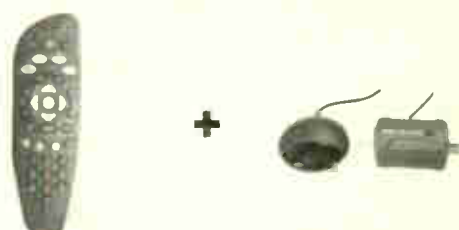

Order Code : SKYPACK2

Price : £ 13.00 + vat each

5 +

£ 11.50 + vat each

SLx Aerial Amplifiers

Now with built in Digital ByPass Operates with Sky™ DigiEye

Class leading noise figure of 4dB or less

6dB signal amplification on all models



Integrated Digital By Pass

Description

Order Code

Price

2 Way - No Bypass	SLX2	£ 8.00 + vat
2 Way - With Bypass	SLX2B	£ 9.25 + vat
4 Way - No Bypass	SLX4	£ 13.00 + vat
4 Way - With Bypass	SLX4B	£ 14.00 + vat
6 Way - No Bypass	SLX6	£ 18.00 + vat
6 Way - With Bypass	SLX6B	£ 19.00 + vat
8 Way - No Bypass	SLX8	£ 18.50 + vat
8 Way - With Bypass	SLX8B	£ 20.00 + vat

SLx Masthead Amplifiers



UHF TV antenna pre amplifier designed for the professional aerial installer

15dB gain masthead amplifier ideal for majority of domestic installations

26dB gain masthead amplifier for longer cable runs (loss of more than 3dB) or if connected to passive splitters

Requires 12V DC power supply via download either via dedicated power supply unit or from a distribution amplifier with line powering

15dB Amp Order Code : 27830R
Price : £ 4.30 + vat

26dB Amp Order Code : 27831R
Price : £ 4.50 + vat

SLx Masthead Amp PSU
Order Code : 27832R
Price : £ 5.00 + vat

Postage for 2+ £ 5.00 + vat

Coax Plug Aluminium



Order Code : PLG51
Bag of 10
Price : £ 1.25 + vat
Bag of 100
Price : £ 9.00 + vat

Screw Type Coax Plugs



Order Code : PLG62
Bag of 10
Price : £ 1.60 + vat
Bag of 100
Price : £ 12.50 + vat

Twist On F Connectors



Order Code : PLG101
Bag of 10
Price : £ 1.00 + vat
Bag of 100
Price : £ 6.00 + vat

Coax Coupler Socket to Socket



Order Code : PLG54
Bag of 10
Price : £ 1.50 + vat

Coax Coupler Plug to Plug



Order Code : PLG55
Bag of 10
Price : £ 1.50 + vat

Y Splitter Inductive 3 way



Order Code : YSPLITTER
Price : 40p + vat
Bag of 10
Price : £ 3.00 + vat

SLx Link Eye

Allows control of Sky™ Digibox via the signal feed for second TV

Order Code : 27833R

1 - 9
£ 6.50 + vat each

10 - 24
£ 5.50 + vat each



Sky™ Digital TV Link Eye

Order Code : TVLINKKEYE

Price
£ 10.75 + vat
5 +
£ 7.99 + vat each
10 +
£ 6.99 + vat each



SLx Amp By Pass Kit

For use with aerial amplifiers and Sky™ Digibox

Allows for operation of Link Eye in conjunction with a distribution amplifier

Order Code : 27829R
Price : £ 5.00 + vat



Digital Satellite splitters 5 - 2400 MHz



Item	Code	1 +	10 +
2 way splitter (Power Pass 1 Port)	27900R	£ 2.40	£ 2.00
3 way splitter (Power Pass 1 Port)	27901R	£ 2.70	£ 2.25
4 way splitter (Power Pass 1 Port)	27902R	£ 2.80	£ 2.40
6 way splitter (Power Pass 1 Port)	27903R	£ 5.00	£ 4.00
8 way splitter (Power Pass 1 Port)	27904R	£ 5.60	£ 4.65





Service Casebook

Michael Maurice

Panasonic TX25X1 (Alpha 4 chassis)

This set was stuck in standby. As there's a separate standby power supply you can normally, when the main power supply fails, bring the set out of standby (i.e. the LED goes out) by using the remote-control unit – though the set remains off. Not this time: it was permanently stuck in standby. If you earth the standby/on control optocoupler D826 on the primary side the set should start. It didn't, so I fitted a new STR56041M chopper chip. When I switched the set on the power supply started up but there was field collapse and smoke came from the audio output chip. There was a raster and no smoke when the relatively cheap field and audio output ICs had been replaced, but the set was still stuck in standby.

Further checks made me suspect the microcontroller chip IC1213. But by this time the customer wanted to be rid of the set and asked me to dispose of it. I decided to persevere, and replaced

IC1213. After that the set came on but there was no sync. Checks showed that video was present at the input to the TDA2579B timebase generator chip IC501, which ruled out a fault in the text module. A new TDA2579B chip restored good pictures and sound.

Why all these devices had failed I will never know. Was the effort worthwhile? Yes, I sold the set a few days later.

Philips STU3600

There's not much call for repairs to analogue satellite receivers nowadays, but occasionally a customer asks for one to be repaired – usually, as in this case, to be able to receive foreign stations. A feature of this receiver is its two LNB inputs. It appeared to be dead.

Checks showed that the power supply worked, but the main microcontroller chip's 12MHz crystal oscillator had failed. A new crystal didn't get the receiver going however. By chance my local satellite stockist had a second-hand Grundig GRD300, which is almost identical to the Philips model but not quite. I didn't want to get too involved with retuning the whole receiver, so I took a chance and fitted the EEPROM from the Grundig model in the Philips receiver. Bingo, it was back in operation.

Sony KVX2575U (AE2 series chassis)

In a previous Casebook feature (January) I mentioned this troublesome set, to which I had been called three times because of dry-joint problems. The final problem had been a dry-joint at a resistor in the line deflection circuit. After attending to that the set had been all right for a few weeks. But I then came across the customer again and, on asking, I was told that the set had given more trouble. He had decided to buy another set, and gave me the Sony.

I decided to start by rechecking all my previous work and double-checked for dry-joints, but couldn't find any. I next disconnected the protection circuit. When I powered the receiver the EHT rustled up then died. But the Nicam light stayed on. When I did get the EHT to come up and stay up, I found that the set would die if board A or D was tapped. Again careful inspection failed to reveal any dry-joints, but what I did notice was that when the

EHT came up the static was fiercer than normal. So there appeared to be a power supply problem. When I used my trusty hairdryer to heat up the primary side of the chopper circuit the EHT came up and stayed up. The cure was to replace all the small electrolytic capacitors on the primary side of the power supply.

Goodmans 285DPL

This Nokia-based set was stuck in standby because of a problem in the field output stage. Normal operation was restored once the TDA8350Q field/EW output chip NS10, the 10Ω fusible resistor RK68 and the BY399 diode VK71 had been replaced.

Sony SLV715UB

The customer didn't want to spend much money on this machine, so he gave it to me. It was dead, the cause being the usual electrolytic capacitors in the power supply. But when the power supply was opened the damage turned out to be much more serious. The electrolyte had corroded a number of print tracks and burnt one of the connectors and the plug of the wiring loom.

Undeterred, I removed all the old capacitors and one or two other components and cleaned the board thoroughly with isopropyl alcohol. I then fitted new capacitors and linked parts of the print where the tracks had broken. A connector and cable loom from a scrap machine were fitted. When I switched the machine on it didn't come on fully and smoke came from the power supply. This smoke wasn't produced by component overheating: there was PCB conduction between print lines. I cut out the offending track and linked it across with wire.

The power supply then started up and the machine ran, but in both playback and E-E the audio was very low. The cause of this was on the hi-fi module, where there are several purple electrolytics. They were all leaking in various degrees, so I replaced the lot. The machine now worked correctly, and a new pinch roller and head-cleaning roller completed the job.

Was it worthwhile? I quite like these older machines. The build quality is excellent, and the performance far superior to that of modern VCRs. So the machine now sits in my hi-fi cabinet! ■

Photo 1: Practical implementation of Fig. 4. This coherer uses screws as the electrodes.

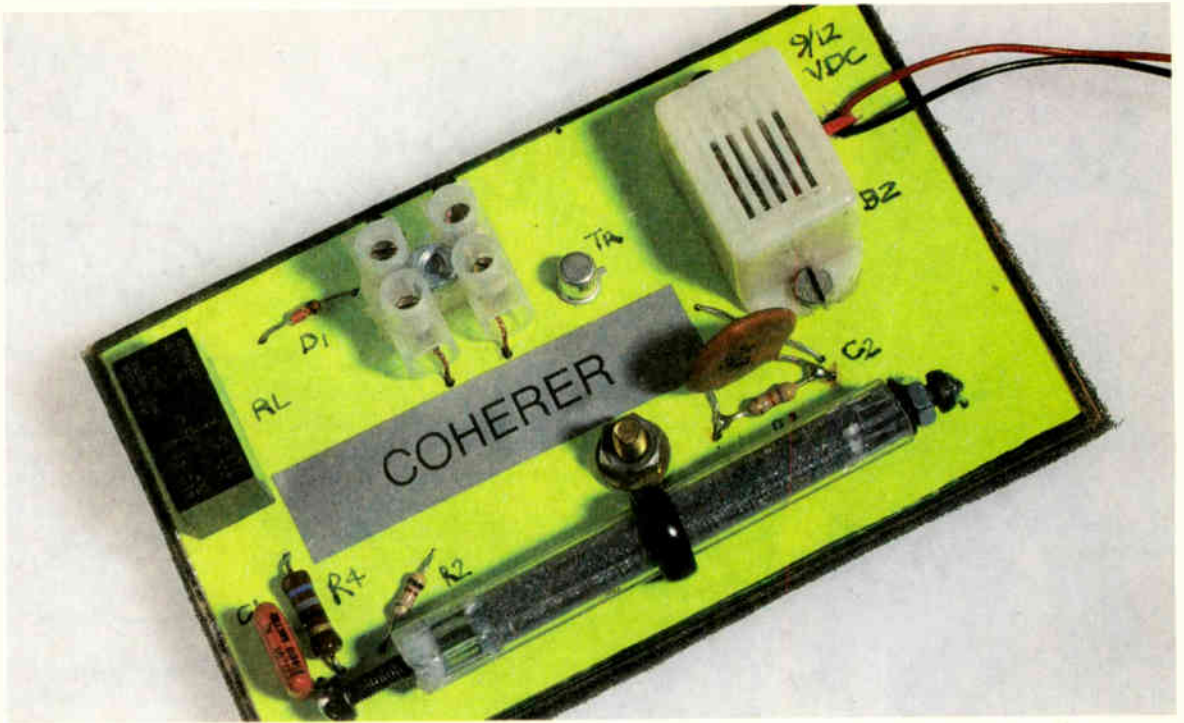

The coherer revisited

The coherer was one of the earliest forms of radio detector. Ian Rees outlines its history and describes a modern version he was able to devise

While I was still at school in the early Sixties I was given a book by a friend who was keen to encourage me in my new-found interest, radio. The book was entitled *Principles and Practice of Radio Telegraphy*. It was printed in about 1910 and seemed, at the time, to be very confusing. It introduced spark-transmission techniques and a strange device called a coherer. I no longer have the book, but its contents stayed with me in memory. I've only recently had the time to investigate its revelations.

Pre-coherer period

Michael Faraday (1791-1867) dominated the science of electricity and magnetism in the Nineteenth century. His work laid the foundation for just about all the

advances that followed. He disagreed with his contemporaries, who held the view that electricity was a material fluid that flowed along wires. Instead, he regarded the flow to be a wave or vibration force that somehow moved through the conductor.

His work with Sir Charles Wheatstone, on the nature of sound vibration, led to the discovery of electrical induction and in turn the whole theory of the relationship between electricity and magnetism. But it was for others to take his discoveries forward, and in particular to prove the existence of electromagnetic waves that could travel outwards from their source.

James Clerk Maxwell had predicted the existence of electromagnetic waves mathematically in 1864, but it was not until 1888 that Heinrich Hertz demonstrated the existence of radio waves (Hertzian waves). His transmitting equipment consisted of a high-voltage induction coil that fed a spark gap, and a parabolic metal reflector. The receiver was a loop aerial whose two ends formed a small spark gap. When a spark jumped across the gap at the transmitter, a small discharge occurred about two metres away in the gap connected to the receiving aerial. From the type and description of the

equipment, Hertz would have been transmitting at a frequency in the VHF/UHF bands (60-500MHz). This simple arrangement enabled Hertz to establish many of the important principles of electromagnetic waves.

The coherer

In 1879, fifteen years after Maxwell's prediction and nine years before Hertz proved the existence of radio waves, a British-born Music Professor living in Kentucky, David E. Hughes, made an interesting discovery. He noticed that a glass tube filled with iron filings became more conductive when a high-voltage spark discharge was triggered nearby. Using a battery and a pair of headphones connected to the tube, he heard a click, induced by the spark gap at a distance of 500m, as the resistance of the filings inside the tube dropped. Although he is remembered for the invention of an early version of the carbon microphone, and a printing telegraph, his radio-detector findings were never published. The effect was to be attributed to induction by Sir George Stokes, and Hughes was dissuaded from continuing with his experiments.

In 1894 Sir Oliver Joseph Lodge gave a series of lectures at the Royal Institute in London. The

subject was "The work of Hertz and some of his successors". Hughes was not mentioned, but a device similar to his was: it was called a "coherer", was invented in 1890 and was attributed to a French professor, Edourd Branly. This was considered to be the cutting edge at the time, "the most astonishingly sensitive detector of Hertzian waves".

Like Hughes' device, the coherer consisted of a glass tube that was filled with metal filings, see Fig. 1. Electrodes were inserted at each end and poked into the filings. Lodge coined the word coherer because of the tendency of the filings to coalesce, or cohere together, in the presence of an electrical discharge. Once the metal particles had coalesced, their resistance fell dramatically. A problem with the coherer is that it's a single-shot device: once it has changed state from high- to low-resistance the tube has to be given a mechanical knock or shake to break the bonds between the filings and regain its original high resistance.

Development of the device continued in many countries. Lodge added a mechanism he called a de-coherer. It consisted of a bell clapper that tapped the glass tube each time a signal was detected, thus restoring the coherer to its high-resistance state. Various mixes of metal filings were tried, and the design of the electrodes was changed. Wedge-shaped electrodes enabled the tube to be tilted, varying the contact with the filings and thus the sensitivity of the device. To prevent condensation and oxidation of the filings, the glass tube was evacuated of air.

Popov and Marconi

In 1895 Professor A.S. Popov demonstrated the use of a coherer as a thunderstorm detector at the Institute of Forestry in St Petersburg, see Fig. 2. When the equipment detected the radio wave produced by a lightning discharge, the coherer's low resistance closed a relay that operated a bell. A year later, at the University of St Petersburg, Popov is reported to have demonstrated radio communication using an induction-coil spark discharge to transmit, as Morse Code, the words "Heinrich Hertz" between the lecture theatre and another room in the building. After that Popov became interested in experimenting with Röntgen rays (X-rays), which had just been discovered, and abandoned his

work with the coherer for some time. East and West will ever dispute who was the first to invent and use radio communication, Popov or Marconi. The scale of Marconi's achievements were to dwarf Popov's efforts (if true) however.

Guglielmo Marconi was an incredibly optimistic entrepreneur who succeeded, against all odds, while his peers scorned his massive project for communication without wires. In 1894 Marconi started to experiment with Heinrich Hertz's famous induction-coil spark transmitting equipment. By 1900 he had reached its limits, having made contact between the UK and France using massive tuned-aerial arrays. Apparently unaware of the work of Popov, he started to use the coherer for his most ambitious project of all, which resulted in his successful transatlantic transmissions.

During its ten-year reign the coherer evolved in several different ways and was extensively used for radiotelegraphy. It was used to receive many historic messages, including the arrest of Dr Krippin and the distress call from the Titanic. It was finally replaced as a detector by newer devices, initially the Galena crystal and later the thermionic valve.

Making a coherer

I wondered how difficult it would be to make a coherer, and was surprised to find that the effect is very simple to replicate. My very first device worked straight away. To keep to the spirit of the original glass coherer, I settled on the construction shown in Fig. 3. Steel filings were found to work, and were collected as follows. Fold a postcard in half and clamp it in a vice with a piece of thin steel in the centre. Bend each side of the card back just enough to cause filing of the metal. The filings will fall into the V of the card. Some frantic action, using a fine-tooth file, produces enough filings for use.

A clear, plastic Bic ballpoint pen body was cut to a length of 60mm. A piece of 2mm diameter copper wire bent back 25mm on itself was then inserted in one end as an electrode. It was held in place by melting the plastic tube end on to it. The tube was then turned on end and two-thirds filled with steel filings – the filings need to be loosely packed. Finally, a second electrode was inserted in the other end and sealed in place in the same way as before. A gap of 10mm was

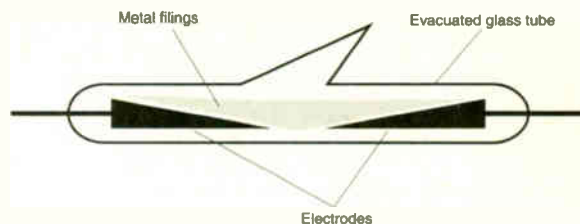

Fig. 1: The original coherer design.

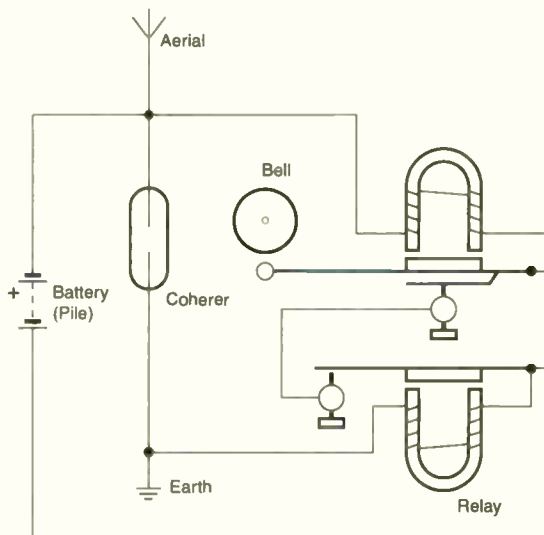

Fig. 2: Popov's lightning-detector circuit.

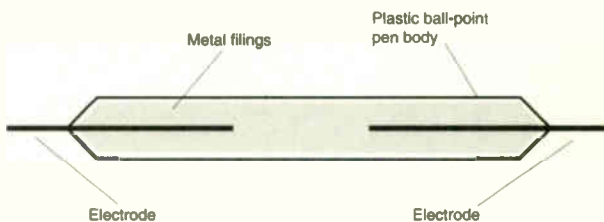

Fig. 3: How to make a replica coherer using a ballpoint pen as the body.

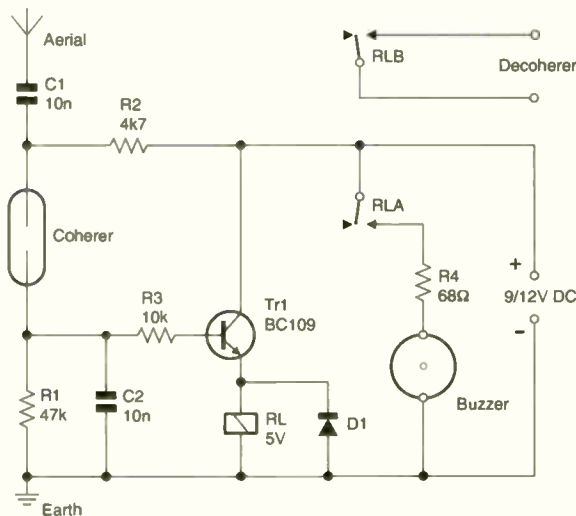

Fig. 4: A modern version of the lightning-detector circuit.

maintained between the electrodes. The filings were then distributed along the body and over the electrodes by tapping the tube.

Testing

I connected a digital multimeter, set to its 20M Ω range, to each of the electrodes. As the electrodes were buried in the steel filings I expected to read some resistance, but the reading was infinity. The coherer tube operates in the horizontal position. A discharge was obtained by using a flash tester set to 12kV. When an electric arc was drawn at a distance of 5m, the resistance of my coherer immediately dropped to 100 Ω or less. The coherer would sometimes recover by itself, but usually a light tap on the table on which the tube was resting was required for it to revert to the high-resistance state – just like the original.

Not everyone has a flash tester that can go this high. An alternative way of triggering your coherer is to use a mains transformer back-to-front. I was able to feed 12V DC from a power supply to the 18V AC winding of such a transformer. Two pieces of copper wire were

soldered to the mains input tags and brought together, leaving a spark gap of about 1mm. By touching the 12V momentarily to the 18V AC winding a small spark will jump the gap. If a length of wire is connected as an aerial to one side, with the other side earthed, the effectiveness is greatly increased.

Almost any inductive spark discharge at short range will make the coherer change state. My little 12V drill held close to the aerial sets it off. So, I expect, would a piezo-gas igniter, though I've not tried this.

I wanted to reproduce Popov's circuit (Fig. 2), but unfortunately didn't realise that the original coherer must have run hot. When I connected mine to a relay the plastic tube began to melt. But even with a melted tube and the filings bulging out it continued to work. The original glass tube would not have melted so easily.

A modern coherer lightning-detector circuit

To overcome this problem I redesigned the circuit, see Fig. 4, with the coherer connected to an

emitter-follower transistor that drives a relay. This keeps the current through the coherer very low. The aerial is connected to one end of the tube via the isolation capacitor C1. C2 bypasses RF to earth at the other end. A buzzer could be substituted for the relay. The reason for using a relay is to enable a de-coherer to be fitted, using the second set of contacts.

I found that the spark produced by a conventional bell with an interrupter can retrigger the coherer after it has been cleared by a tap. Use of a solid-state buzzer prevents this if it's mounted close to the tube, as in the prototype.

A length of wire 10m long hung out of the window works as an aerial, and a good earth connection completes the circuit.

The arrangement certainly works. It was triggered several times during winter storms even when lightning wasn't seen or thunder heard. Interestingly, while typing this article Popov's lightning detector started bleeping, followed a few minutes later by a complete loss of mains power. Maybe it has got another use! ■

Test Case 483

Is it worth repairing a ten-year old VCR? Yes, sometimes. Repair of the JVC HRD910 we're concerned with this month was felt to be viable so long as the cost would be no more than £50. We managed that. The HRD910 was a very well-made and well-specified model of its day, with Nicam/hi-fi sound and multi-brand remote control, missing out only on VideoPlus programming. That didn't seem to bother Mr Dickens however. Maybe he never went out?

JVC video recorders are more engineer-friendly than those from some manufacturers, especially this older model whose deck does not have to be removed to gain access to the underside. The reported fault symptom suggested that diagnosis and repair would not be too difficult. The machine chewed tapes, and crumpled them further during the cassette-eject operation. This is exactly what it did when it was fired up on the bench – there was nothing intermittent about the fault.

The bottom cover was removed and a dummy cassette was fed in so that we could see what went on. Rotation of the capstan motor was very weak and irregular, suggesting that this item was faulty. Sage went to the scrap pile to search for another motor to try as a substitute, but couldn't find one. Just as well, because there was nothing wrong with the one in the machine!

Further examination, this time at the upper side of the deck, revealed that the head drum also moved slowly and spasmodically. As both motors were behaving in this way, Sage delved into the power supply/stabiliser sections of the machine to check the motor supply lines. They were OK – voltages correct and no ripple – as were the other lines

derived from the chopper power supply.

Our ace technician then went back to the servo/system-control section. He found that instead of the normal steady DC voltages the motor-speed control lines carried a series of ragged pulses at the rate of perhaps two or three a second. They were being produced by the servo-control chip IC1 on servo panel 48, quite separate from the microcomputer control system itself, though the capstan control voltage is modified by the latter in certain modes, as the excellent block diagram in the service manual makes clear. Attention was therefore focused on the servo-control chip. Its supply at pin 28 was found to be correct at 5.4V, and there was feedback, though distorted and attenuated, from the capstan and drum motors.

Even though this chip uses a pulse-counting system for servo control, and is governed by an I²C bus, there are a lot of peripheral components – resistors, diodes and capacitors. Sage would like to have substituted the entire plug-in panel, but there was nothing of the sort amongst the scrap machines or in the component store.

As he restacked the tottering piles of VCRs a thought occurred to Sage. The cause of the fault probably wasn't on the servo panel at all he speculated. And he was right! Apart from supply voltages there is something else that's common to the running and regulation of the capstan and drum motors. He pursued this idea and, after a little while, achieved a correct diagnosis and a successful repair. It involved replacement of one inexpensive electrical component. Even so, there was little change from Mr Dickens's £50! Where and what was the culprit? For the solution, go to page 315.

The headend that says **YES** to

- Quality
- Ease of use
- Agility
- Each module an almost total entity
- Superb value

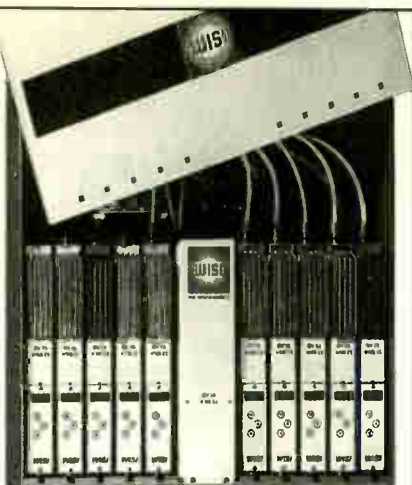

WISI's Topline headend system is very competitively priced yet is of superior design and build. It is easy-to-use with high quality channel processing that allows the user to retain quality of vision and sound for both analogue and digital signal sources. There are processors for satellite TV, terrestrial TV and radio. Each individual module incorporates its own control system enabling quick and easy set up. These channel processors come together in an 'all-in-one' base unit which contains all necessary accessories for ease of ordering - no additional items required.

WISI TOPLINE HEADEND

CHECK THESE FEATURES

- Frequency agile freely selectable in the VHF of UHF range.
- Adjacent channel capable.
- TV standards 64 QAM B/G, D/K, I, L, M.
- Modulator system for headend stations in SMATV and CATV systems.
- Modules for Analogue and Digital:
 - Satellite TV & Radio: Analogue & Digital
 - Terrestrial TV & Radio: Analogue & Digital
 - Satellite I.F. Converters: Analogue & Digital compatible
 - Terrestrial TV Converters: Analogue & Digital compatible
 - TV Modulators: Analogue & Digital
- Individually programmable modules.
- High output level
- Wall mounting or 19" rack mount with lockable cabinet door.

May we send you full details?

U.K. STOCKIST

J.W. Hardy
Communications



**A Breakthrough
in Headend Design**

J.W. HARDY COMMUNICATIONS, 231 Station Road, Birmingham B33 8BB Telephone: 0121 784 8478 Fax: 0121 789 7931



ELECTRONICS

WHOLESALE DISTRIBUTORS
OF DOMESTIC
ELECTRONIC APPLIANCES

Unit 15 Marks Hall, Margaret Roding, Dunmow, Essex CM6 1QT
Telephone: 01245 231684 Facsimile: 01245 231862

NEW B GRADE STOCK AT BELOW TRADE PRICE

- LARGE** 28in wide screen 16 x 9 format televisions . . . from **£170.00**
LARGE 32in wide screen 16 x 9 format televisions . . . from **£250.00**
LARGE rear projection televisions 52" from **£1,000.00**

WE ALSO CARRY A LARGE SELECTION OF TELEVISIONS & VIDEOS ALL AT BELOW TRADE PRICES

- 36cm portables from **£50.00**
 51cm televisions fast/t from **£87.00**
 59cm televisions nicam from **£125.00**
 68cm televisions nicam from **£135.00**
 78cm televisions nicam from **£252.00**
 videos 2 head mono from **£44.00**
 videos 4 head nicam from **£55.00**
 videos 6 head hi-fi nicam from **£60.00**
 36cm combined TV & video from **£85.00**
 dvd players **£80.00**

25cm televisions with DC 12/240 volt suitable for caravans - mobile homes - cars - kitchen use **FROM £85.00**

IN ADDITION WE ALSO CARRY:

- Microwaves from **£35.00**
- A large range of audio/Hi-Fi equipment from **£23.00**

LARGE QUANTITY DISCOUNTS AVAILABLE
ALL PRODUCTS ARE FULLY GUARANTEED

We stock a great many other items in the TV, Video and Domestic Appliance range so if you don't see what you are looking for give us a call, we will save **YOU POUNDS.**

Visitors by appointment only

For RGB and component video connections

KEENE
ELECTRONICS

SYNCBLASTER

RGB to component video transcoder

Another in-house product from Keene Electronics, the RGB2C can convert an RGB input to a component (Y Pb Pr/Y Cb Cr) output, or, at the push of a switch, a component input to an RGB output. It caters for sync on green or composite sync input and also provide sync on green or composite sync output. LED indicators provide useful information on the type of signals present and which process is being performed. Designed to be installed in-line with the signal path, has SCART input and output connectors to make connection simple. Supplied complete with UK mains adaptor and KA150 scart to 3 phono adaptor. **What Video** 'Best Buy', order [RGB2C] **£89.99**
Also available c/w choice of 2m output cable (phono, 15pin HD or BNC) **£114.99**



Keene SyncBlaster RGB cables

Use SyncBlaster cables to connect RGB scart equipment directly to projectors, plasma screens and LCD screens, most of which struggle to work on the paltry 0.3V sync provided from an ordinary RGB scart. The scart connecting plug of these cables incorporates a fully functional sync separator and amplifier which can draw its power directly from the scart socket (pin 8) so for most applications there's no power supply to worry about either!
Available in a choice of configurations : SyncBlaster scart/15 pin HD male, SyncBlaster scart/5 x phono plugs and SyncBlaster scart/5 x BNC plugs, each in four lengths from 1.5m to 10m. Prices from **£69.99**



SyncBlaster Black Box RGB Sync Processor

Take whatever RGB sync your input device throws at you, and convert it into whatever RGB sync your output device requires. Truly the ultimate RGB problem solver. [SBBX] **£74.99**
Also available c/w choice of 2m output connecting cable (phono, 15pin HD or BNC) **£99.99**



SVGA distribution amplifier

Display an SVGA signal on up to four monitors.
Use with plasma displays to build video walls.
Master output allows PC to detect monitor type.
High quality high bandwidth components for maximum transparency in operation.
Includes mains power adaptor, input connecting cable and full instructions.



£69.99

RGB to S-Video convertor

RGB is a great for sending video, with picture resolution as good as S- and much better than composite video. Trouble is, not everything can accept an RGB signal. Problem solved! This box converts the RGB scart output of Sky Digital/ITV Digital boxes, DVD players etc into S-video. Ideal for making high resolution connections to AV amps, S-VHS/D-VHS recorders and plasma screens. Order [RGB2S] **£59.99**



Scart Commander 4:1 scart switchbox

A high quality AV switcher from Keene, designed to allow connection of multiple sources to one display, all via scart connections. With 4 video, 2 audio, 2 data and 2 control channels it can handle component, composite, s-, and RGB video, even digital audio (with the correctly configured cable). Inputs can be selected manually (by IR remote, included, or push button) or automatically via auto signal detect. Use a single switchbox to switch any of four inputs to one output, or two units may be used together in a master/slave arrangement providing 7:1 switching. Visual LED indication of selected output. Programmable default input auto selected on power up. Separate mains adaptor for improved mains isolation. Solid metal case for enhanced screening. Order [KSC] **£149.99** Twin pack (7:1 switching) [KSCT] **£249.99**



Visit www.syncblaster.com for more about RGB, component video and SyncBlaster solutions

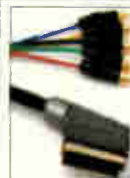

Ready made high spec RGB & component video cables

Scart, phono, 15 pin HD and BNC end connector options, full range of lengths.
Leads to Go custom RGB/Component video leads in any length and configuration.
Special RGB cable 3- or 5-core + stereo audio, from 1 metre to drum length.

Order by phone 0870 990 9000 any time (24hr staffed sales line), by fax 01332 830551, by email sales@keene.co.uk or on-line at www.keene.co.uk. Prices do not include delivery: Standard delivery (Royal Mail 2nd Class post to any UK address) £2.50 per order. Faster options 1st Class post £4.50 per order, next working day delivery (UK mainland only, remote areas may take longer) £8.00 per order. Overseas deliveries by airmail charged at cost.

KEENE Tel **0870 990 9000**
ELECTRONICS **www.keene.co.uk**

58050203

Unit 9, Old Hall Mills Business Park, Little Eaton DE21 5DN UK



Television 2003

Accessories Guide

In Part 2 of this guide **Eugene Trundle** takes a look at videography (camcorder work), computer video, care products, TV-PC convergence, home security and several other topics

In Part 1 of this guide last month we covered a lot of ground, including aerials and RF distribution, remote-control systems, home cinema arrangements and satellite TV equipment. There's a lot more that can provide the TV/video supplier and installer scope for business. In this concluding instalment we'll start off with aids to videography, that is items for the camcorder enthusiast. Contact details for the various firms mentioned in this and the previous part are listed in the panel towards the end of the present instalment.

Aids to videography

Sadly the repair of camcorders is, like satellite digiboxes, beyond the bounds of what is practical for most service providers, largely because of the specialised and expensive test gear required. But a knowledge of hook-ups, programming, specifications and so on gives you scope in the video field much beyond standard bubble-packed (and, very often, inferior and low-priced) accessories and add-ons. There's in fact quite a lot that you can supply in this field.

Very soon after purchasing a camcorder, with its minimal quota of in-box accessories, the keen videographer – they are all keen, at least to start with! –

finds himself in need of various bits and pieces. His battery will die, possibly at some critical moment in the field: you can provide him with a bigger one or a battery belt/pack from Keene, Jem or DSM. The mains unit supplied with a camcorder recharges batteries quickly but not so well as a trickle- or pulse-charger. Many designs also incorporate an auto-discharge feature to avoid 'memory' effects. Camcorder-man will also discover that his wonder electronic-zoom feature merely expands the pixels, so he'll look for an auxiliary lens to reach farther and wider. Several companies make and/or sell these, though only those provided by the actual camcorder manufacturer are guaranteed to be fully compatible.

Optex Direct offers many lighting and lens accessories, including anamorphic adaptors with which a camcorder can be converted, without loss of optical 'real estate', for use with today's widescreen TV sets. Sony is probably the most popular camcorder brand: genuine accessories can be obtained from Sony or from Wakefield Sony Centre, which specialises in these. No sooner is a lens fitted than hand-tremble upsets the images. Time for a tripod! Wildlife videographers seem to abound in my neck of the woods. Many of them are pleased to buy mini-LCD monitor screens (N-Trac, Roadstar) and remote LANC controllers (e.g. Keene's Model KLR) in order to avoid disturbing their unwitting subjects. Outdoor types are also potential buyers of car power cords, battery-powered lights and waterproof camera jackets. The mail-order company Video Action Ltd. specialises in 'home-video' accessories.

The audio aspect of videography is also ripe with opportunities. Integral microphones pick up motor and handling noise, and are necessarily a compromise in terms of price and sound-capture performance. High-quality external microphones do much better and come in many forms, including cordless (radio) types. Professional microphones usually have XLR connectors, for which mini-jack adaptors are available. The Sennheiser MKE300D is a very good general-purpose wired microphone for digital camcorder use. Whatever sort of microphone the videographer uses, it will pick up wind noise on blowy days. So he'll need a gag or muff. All these things are out there, waiting for you to suggest and supply!

These bits can be discarded back indoors, their place taken by a range of tackle that in many cases provides good margins. Audio mixers make copying of footage

Photo 1: Scart adaptor cables – often required for home-cinema use.

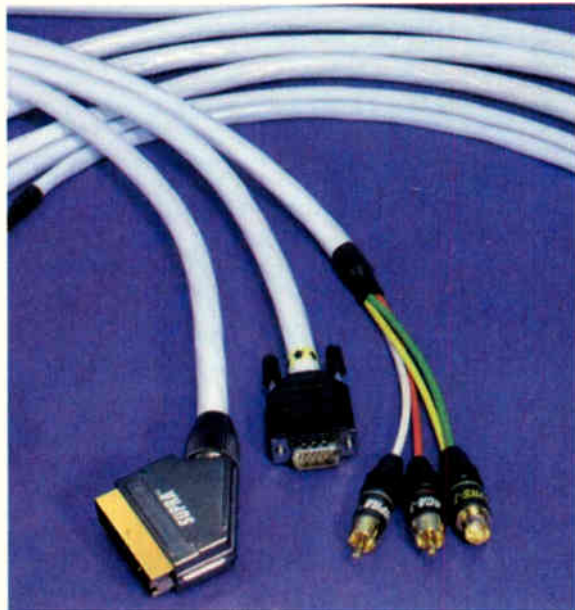

with dubbed music, commentary or whatever possible. CD recordings of copyright-free music and sound effects are available to further enhance the audio side of the production. Colour correctors and enhancers (GTH Electronics make very good ones) permit some degree of cleaning up, while optical cine converters and 35mm slide scanners, available from the Widescreen Centre and elsewhere, facilitate splicing in archive and legacy images. A very good value-for-money 'second-user' auto slide scanner is available from JPG Electronics. Near-essential accessories for the electronic stills camera user include a mains power unit, also a USB card reader (see Photo 2) and large-capacity memory cards that may store five times as many pictures as the one which came in the box.

Computer video

Having come to the topic of digital storage and computer video systems we find another huge raft of bits and pieces that are within the province of PC-orientated technicians and dealers. A software package is required for any sort of image processing. For still cameras MGI Photosuite is good, JASC Paint Shop Pro better. These are disc-based programs that are generally used with a USB feed to a PC. A hybrid package is required for processing home-movie footage. This consists of a capture card – these are available for analogue and digital/FireWire inputs, and there are even dual-standard ones – and editing software. Pinnacle Systems is the foremost supplier but there are half a dozen others, virtually all of whose offerings require a Windows 98SE or later operating system in the PC, also a reasonably fast central processor, generous RAM provision and a very large hard-disk storage capacity.

Apart from the supply of an editing system the customer who takes up this interest often presents the technician with an excellent opportunity to provide computer upgrading and reconfiguring. This may include the provision of an auxiliary hard-disk drive and a DVD burner, plus authoring software for the latter. A very good patch-bay for PC-video use is available from Keene Electronics: product PCPB costs £50 and presents all the required ports (video, audio line, microphone, USB, FireWire) at the PC's front panel. This is much more convenient than having to fumble about at the rear of the PC box.

Several A/D/A converters are now available for those who want to convert analogue (composite and S) video signals to IEEE 1394 data and vice versa. They are useful for copying digital masters from a PC to VHS tape and to go in-line with an analogue camcorder in the absence of a suitable capture card, perhaps when a DV camcorder is the primary source. There are the Dazzle Hollywood Bridge, the Canopus ADC100 and



Photo 2: A USB card reader for PC use.

its little brother the ADC50, which works in one way only, and several others.

Video editing, especially with fully-featured and sophisticated systems, is difficult using a 15 or even a 17in. monitor screen. There's the opportunity here to upgrade your customer to a 19in. high-definition type, or even one of those wonderful and expensive flat-screen LCD jobs. Most videographers seem to like gadgets and high-performance equipment, but don't necessarily know what to choose or how to install or commission it. There can be greater rewards here than from mending old PCs or tinkering with tellys and tinpot audio gear!

Care products and recording media

Relatively minor accessories displayed prominently can be small but usually regular earners in the shop or service reception area. Head-cleaning cassettes for tape recorders, both audio and video, can carry over 100 per cent profit, along with disc-type OPU cleaners for CD and DVD players: these latter have something similar to a false eyelash bonded to the surface, or a series of little, hairy spikes, to remove dust from the reading lens. One I know has a voice guide in eleven languages!

Protective films are now available for cherished optical discs, to cover the surface during storage and play. They are made by Alcon and CDfender and are marketed by CPC. There's even an optical disc repair kit with micro-abrasive cloth and restorer polish – type ODR from Keene Electronics.

As we've seen, videographers are great enthusiasts for bits and pieces. Many of them are concerned about camcorder wear during tape rewinding. Several standalone rewinders can be supplied to allay their



Photo 3: A programmable multi-system standards converter.

Photo 4: A 'ragged' video signal, time-shifted to show the line and field blanking periods.

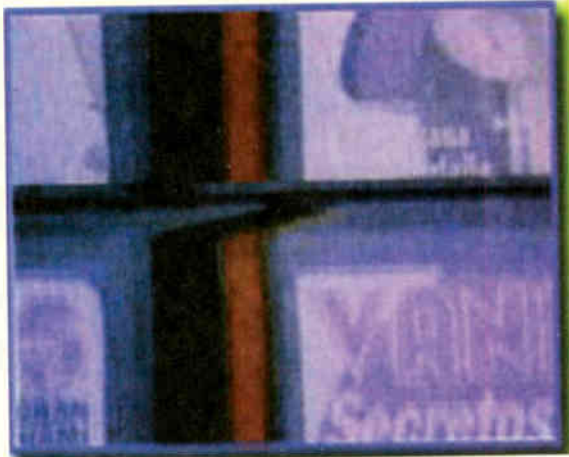

Photo 5: Effect of a timebase corrector in curing ragged video.



fears, at about £38 a go with VAT, £16 of which is profit for you. Full-size adaptors in motorised form for legacy VHS-C tapes are available from CPC (order code AV0008345, £12.56 net). Lens cleaning, at the front and back of a camcorder and the LCD monitor screen, is best done with special little tools like CPC's puffer brush or mini-vacuum cleaner. Keene also does a lens brush, along with cleaning cloths and tissues.

Some people still prefer to use Betamax VCRs but find it difficult to get cassettes. They are stocked by KVJ Fairdeal, along with the special (for example 15- and 30-minute, 'high-grade' etc.) tapes in other formats demanded by professionals and enthusiasts. Library, slip and presentation cassette and DVD cases are available from Warehouse Video Services.

Video processing

We've already mentioned all sorts of widgets and thingamys for video and sound processing, but have by

Photo 6: The Keene Electronics SVGA distribution amplifier.



no means exhausted them in terms of types! TV standards converters and transcoders have become much easier to design since the advent of high-capacity digital memory chips, and progressively cheaper and better as the cost of these chips has fallen. NTSC/PAL bi-directional converters are now readily available at prices as low as £225, containing 2MB of storage. Devices that have larger stores provide better performance with 'busy' and fast-moving pictures: 4MB models can be bought for about £400 while 8MB ones cost about £600. These are very cheap compared with professional- and broadcast-standard converters! See Photo 3.

Digital storage is also the main element in timebase correctors, which write a 'ragged' signal into a field-store memory and almost instantaneously read it out again under the control of a crystal oscillator. The result is stable pictures and steady copies to both analogue and digital recording media. See Photos 4 and 5. The frame synchroniser, a kind of poor-man's genlock, uses the same principle to lock two autonomous picture sources together, e.g. for mixes, wipes, picture-overlay or chroma-key. Timebase correctors and synchronisers are available from Datavideo via Keene Electronics and others at prices ranging from £200 upwards.

Sync cleaners don't need memory stores: they merely strip out the sync pulses and porches from the video waveform and insert clean, locally-generated ones. These devices are often used to facilitate copying of Macrovision-protected video signals – this is against the law and should not be condoned. They cost typically about £45 for composite-video use, £55 for S-capable versions, and £65ish upwards for types that also incorporate detail enhancers and colour correctors. The Lektropacks' Models CM1 and CM2 are examples of the latter type.

Also of interest to videographers and others are multi-output AV distribution amplifiers. Kramer is a major player in this field, providing types with five, ten and more outputs. They handle both sound and vision signals, the latter in composite or S-video form. Keene Electronics (see Photo 6) and Lektropacks supply them, along with more modest types intended for domestic use and costing as little as £70 for a 4-way scart type.

TV-PC convergence

We've heard a lot about the convergence of TV and PC technology and use. Many items facilitate this in a practical way. The most obvious are those that adapt TV pictures for PC monitor display and vice versa. Grand Magic View from CPC is a hardware-based PC-TV converter for PCs and Macs, with resolution up to 1,600 x 1,200 pixels. Video-to-PC live picture conversion is provided by Lektropacks' CM340 at £120 – it caters for the VGA, XGA and SVGA standards.

TV tuner/receiver cards effectively turn a PC into a very sophisticated TV set. The ATI type (order code CS07997 from CPC) boasts a 125-channel memory, full-screen picture, a zoom feature and stills capture capability. Costing just £30, it fits a PCI interface slot.

USB adaptors come in many forms. Keene Electronics stocks USB-TV and USB-serial types, while USB-linked editors from Belkin and Trust can be obtained via CPC. 'Widget' adaptors and PC software programs to provide DV-in for consumer DV camcorders that are not supplied with this feature are available from Datavision, Smart DV and Anything Digital Ltd.: the ability to record digital AV data back

on tape in the camcorder is vital for 'transparent' off-line video editing with a PC. See Photo 7.

Home security

Over the past few years this magazine has suggested that people like us should not confine ourselves to TV, video and audio equipment, and pointed to many opportunities in other, technically similar fields. Home security is one example.

Major component suppliers and wholesalers such as CPC and SEME have given increasing attention to this of late. CCTV kits are readily available, cheap to buy and easy to install. A package deal with system selection, supply, installation and set up can be offered by technicians in the same way that satellite installation is carried out. All the hardware for a colour system can be bought at trade prices from little more than £140 (excluding VAT) when the domestic TV set is used with an auto-scart switcher like the Keene Electronics PNVSCART device. A VCR record controller, PNVVCR, that captures 'events' on an ordinary domestic VCR is available from the same company.

These days you don't even need a video cable from the remote camera! Lektropacks has a wireless colour camera, with audio, that costs £99 complete with receiver module. The order code is VScam. There's also a PC-based interface, for up to eight cameras, that converts the images to an AVI file for PC viewing and hard-disk recording. PIP (picture-in-picture) converters are available for use with CCTV cameras and other picture sources, along with sequential switchers, quad- and octuple-picture processors, movement alarms and so on. These are more relevant to retail and industrial than domestic premises, but who says that we must confine ourselves to the likes of Mrs Wilkins at no. 23?!

Domestic automation

For use in more prosperous private dwellings there are 'controller' modules with the capacity to reach beyond the equipment in the lounge – indeed they can link up with almost anything electrical in the home.

Programming devices, for timing and remote control, and even voice-control (via the phone if necessary), are marketed by Keene Electronics, using the X10 protocol with a PC and supplied software program. Add-ons include a telephone modem, IR command centre, appliance module and radio transceiver, plus home-security modules such as PIR sensors, break-glass detectors, door/window sensors etc. The X10 system is compatible with the Pronto and RC5000 IR remote-control consoles mentioned last month.

Home automation is a growing industry, about which several articles have appeared in this magazine in recent months. If there are stumbling blocks in this field, they probably relate to persuading older, better-off people that they need this sort of gear, and the number of competing and incompatible systems and protocols that set out to provide automation. This sort of thing, and home theatre come to that, is more advanced in North America than here in the UK. But its time will come. Perhaps you can be a pioneer in this field?

Custom solutions

There can be times when even the myriad of gadgets in the catalogues of the suppliers fails to turn up what's required for some customers' situations and cherished equipment, or combinations of it. Then, so long as the price is right and your client has a proper appreciation



Photo 7: This unit from Datavision can program a camcorder for DV in by rewriting its software.

of what is being done on his behalf, it may be time to roll up your sleeves and produce a 'tailored' solution right there on your bench. It might be a 5-DIN-to-phono-plus-scart-bypass lead, a -38dB stereo attenuator built into a scart plug, a switch to turn the listening-room soundfield through 90°, a remote-control adaptor to roll back the screen curtains and dim the room lights simultaneously, or even a gadget to scare off next door's cat supersonically when it comes into the garden and your customer presses the F1 key on his zapper.

If you take on this type of work, don't stint yourself – bear in mind that a washing-machine service callout costs £75 and a pre-holiday injection by a doctor (or rather practice nurse) will set you back £35, even having taken yourself to the surgery. It's easy to put a price on repairing a Philips TV set or a Matsui VCR.

**Do you have DV-IN
on your Digital Camcorder?
If not get £10 off any of our
hardware widgets!**



**Call us now on 01525 406886 and
quote 'TVMAG' to receive a £10 discount**



**Web: www.datavision.co.uk
E-mail: info@datavision.co.uk
Tel: 01525 406886 Fax: 01525 840066
Russell Farm, New Road, Maulden, Bedfordshire, MK45 2BG**



Photo 8: A 'bespoke' scart cable from Ixos, with screened conductors and gold-plated contacts.

but not this type of skilled work.

There is no shortage of material for these interesting projects. Plugs, sockets, cable, heat-shrink sleeving, tagstrips, copper-printed and punched stripboard, enclosures, interface devices and little general-purpose modules are available from many of the suppliers mentioned above and in the contacts panel, also of course from Farnell, Maplin, RS Components and others.

Here are some recent projects of this sort I've been told about or involved in: an in-scart double 'matching-pad' to equalise the sound volume level with TV-tuner and TV-external inputs; a little box that contains the sound of two dogs barking and growling, recorded in an audio memory chip and triggered when two outdoor PIR detectors are activated within a preset time window; auto-diallers that relay an alarm message to a mobile- or land-line when an intruder sets off a security detector; internal and external flashing-light and -LED displays to simulate a burglar alarm system which doesn't really exist, though the lights provide an effective deterrent; parabolic sound reflectors for recording birdsong out of doors, based on a prime-

focus or Gregorian satellite dish with a microphone in place of the LNB, and an added swivel stand; the design and fitting up of home video editing suites, complete with PC, custom-software and all peripherals by way of mixers, sound/vision sources etc.; and so on. None of these things were done for ninepence or nine pounds. Nevertheless they gave satisfaction to their buyers and interest to those who devised them.

In perspective

Accessories can make a positive contribution to your pocket and your interest in your job. They usually offer a good percentage profit, and are not necessarily small or cheap. There's not the cut-price ethos associated with TV sets, VCRs and similar standard products, especially when these bits and pieces can be made part of a design/supply/install deal. They don't even have to be held in stock – their suppliers all provide a fast delivery service.

An increasing trend with enlightened companies involved in TV/video servicing is to allow field engineers and installation technicians to run their own sideline in small accessories, supplying them with leads and other bits and pieces at trade price and permitting them to retail at whatever prices they feel appropriate. This is good for the customer, who gets the right part properly fitted, and for the technician, who can supplement his wage – though it's important to declare to the tax man what is being done.

Whatever your role in this field, always keep in mind that you are using your knowledge and expertise to provide solutions to problems and/or facilitate the lifestyle the customer seeks, not just selling bits and bobs. When you specify, select, order, maybe deliver, install, commission and then perhaps program items, the retail prices are only part of the payment you have earned. How much does the amalgam used by your dentist in filling a tooth cost? What percentage of the bill is it? Solving problems, providing the solutions, facilitating a lifestyle – that's the perspective. ■

Contact details

AEI Security & Communications Ltd.	01424 813 222
Aerial Techniques	01202 423 555
Alphason Designs	01942 885 600
Antiference Ltd.	01543 267 160
Anything Digital Ltd.	0800 731 4524
Audiofile	01279 506 576
Canopus	www.canopus-uk.com
CPC plc	08701 202 530, 01772 654 455
Customcable	0208 942 9124
Datavision	01525 406 886
Dazzle	www.dazzle.com
DRH Screens Ltd.	0208 885 5504
DSM	01942 820 438
Economic Devices	01952 273 130
Global Communications (TV Link)	01621 744 322
Grandata	0208 900 2329
GTH Electronics	01473 625 547
HiSat	0117 972 1814
Holderness Solutions Ltd.	01482 222 295
Ikon AVS	01299 250 991
Ixos	0121 745 1115
J.W. Hardy	0121 784 8478
Jem	01942 820 438
JPC Electronics	01246 211 202
JS Technology	01294 850 238

Keene Electronics	0870 990 9000
KVJ Fairdeal Ltd.	0207 247 6029
Lektropacks	08700 711 911
Maxview Aerials	01553 811 000
N-Trac	01270 662 087
One-for-All	08701 202 530 (CPC)
Optex Direct	0208 370 0567
Pinnacle Systems	www.pinnacle.sys.com
Plasma Direct	0207 586 1909
Pulsat	07010 702 935
QED Audio Products Ltd.	01483 747 474
Roadstar	08701 202 530 (CPC)
SatCure	www.satcure.co.uk
Scantec	01592 630 635
SEME Ltd.	01644 484 000
Sennheiser	01494 551 551
Smart DV	0208 346 8023
Soundstyle	01279 719 959
Stands Unique	01933 412 227
Televés	01633 875 821
Triax	01443 778 908
Triskom Sales Ltd.	0208 900 2000
Video Action Ltd.	0208 209 0909
Wakefield Sony Centre	01924 385 285
Wallis Universal	0208 870 9988
Warehouse Video Services	01753 823 425
Widescreen Centre	0207 935 2580



Get your DigiSender™ products now...

For retail sales please contact your nearest stockist including all **Argos** stores and leading electrical retailers.

Installers please contact **CPC** or **Farnell** for sales.

To become an *authorised stockist* or for *export enquiries* please open an account on-line at www.easylife.co.uk.

For general info call:
01424 813222

"...picture and sound quality is just as good on the second TV"

Satellite TV Europe

"I tested the product and it's so good I'm not giving it back!"
Digital Spy

THE WORLDS LARGEST RANGE OF VIDEO SENDERS

at www.videosender.net

DG-200 & DG-220 DigiSender™ The UK's number 1 video sender

- ✓ GETS **SKY®**, **NTL®** OR **TELEWEST®** TO ANOTHER TV
- ✓ 100% WIRE-FREE AND SIMPLE TO INSTALL
- ✓ STUNNING PICTURE AND HI-FI STEREO SOUND
- ✓ TRANSMITS THROUGH WALLS AND CEILINGS
- ✓ USE YOUR **SKY®**, VCR, OR DVD REMOTE CONTROL
- ✓ EXPANDABLE WITH ADDITIONAL RECEIVERS (DG-20RX)
- ✓ AVAILABLE IN SINGLE (DG-200) AND TWIN RX PACKS (DG-220)



innovation...

The revolutionary **DigiConnector™** unique to the DigiSender™, means you don't need any spare SCART sockets on your digibox.

DG-10DE DigiEye™ The Intelligent Remote Extender

- ✓ WORKS WITH **NTL®** & **TELEWEST®** DIGITAL CABLE REMOTES
- ✓ COMPATIBLE WITH **SKY®** REMOTES
- ✓ TRANSMITS **IRDA** & **RC5** REMOTE CONTROL SIGNALS
- ✓ 16 DIGITAL CHANNELS
- ✓ ADD ADDITIONAL TRANSMITTERS FOR EXTRA ROOMS



DV-200 PCSender™ The PC to TV Wireless Video Sender

- ✓ GET IMAGES AND SOUND FROM YOUR PC ONTO YOUR TV
- ✓ WATCH DVD MOVIES FROM YOUR PC ON YOUR TV
- ✓ CHECK ON YOUR KIDS SURFING THE NET
- ✓ GET INTERNET MOVIES AND RADIO ONTO YOUR TV & HI-FI
- ✓ **NO NEED TO OPEN YOUR PC OR PURCHASE A TV OUT CARD**



DigiSender
the wirefree video system

DigiSender, DigiConnector and all associated logos are trademarks of AEI Security & Communications Ltd

HUGE RANGE OF ACCESSORIES AVAILABLE!

DG-20RX *DigiSender™ Receiver*
 DG-20TX *DigiSender™ Transmitter*
 DGR-01 *DigiSender™ Remote Control*

MCD01PIS *DigiSender™ UHF Aerial Converter*
 SCT03 *DigiSender™ SCART Breakout*
 DG-20TXR *DigiSender™ Transmitter w/Remote*

LETTERS



Heater-cathode shorts

The problem of CRT heater-cathode shorts has been mentioned in several recent issues of *Television*. The fix I use to cure the problem is to add an isolated winding on the open core of the line output transformer – two or three turns are usually all that's required.

The first step is to ensure that the HT supply to the line output stage is correct. If you don't have a CRT heater tester, you will next need an oscilloscope to measure the existing heater supply. Adjust the scope for 2V/cm and connect it to the heater pins on the CRT's base socket. Switch on the TV set and make a note of the peak-to-peak value of the scope's display.

Switch off the TV set and cut the track between the line output transformer and the ballast resistor in the heater supply, also the ground track to the heater pin on the CRT's base socket. Now wind two turns on the open core of the transformer: connect one end to the ballast resistor and the other end to the ground pin on the CRT's base socket. Switch on the TV set and measure the heater voltage.

If the voltage is low, decrease the value of the ballast resistor or add an extra winding and increase the value of the ballast resistor. You may have to experiment with the value of the ballast resistor. For example, with a recent repair the value of the existing ballast resistor was 5.6Ω. To get the correct heater voltage I had to reduce it to 2.2Ω with two turns wound on the line output transformer.

Send letters to "Television", Highbury Business Communications, Anne Boleyn House, 9-13 Ewell Road, Cheam, Surrey SM3 8BZ or e-mail tessa2@btinternet.com using subject heading 'Television Letters'.

Please send plain text messages. Do NOT send attachments. Be sure to type your full name, address, postcode, telephone and e-mail address (if any).

Your address and telephone number will not be published but your e-mail address will unless you state otherwise.

Please send ONLY text intended for the letters page. Correspondence relating to subscriptions and other matters must be sent to the office address given above.

Finally, connect a 4.7MΩ resistor between chassis and the now-isolated ground heater pin.

*Charles Ritchie,
Birr, Co. Offaly.*

Restricted spare parts

In the January issue A. Jaques complained about Belinea's policy of supplying spare parts only to authorised repairers. The situation needs to be seen in perspective. The policy is not necessarily one that's forced on everyone by manufacturers, but rather one that's often demanded by their Accredited Agents. All manufacturers need a network of dealers to support and distribute their products. Dealers who take on an agency demand a degree of exclusiveness with the products and all that goes with them, i.e. technical data, spare parts supply and participation in advertising campaigns. This, after all, is sound business sense. Agents who are prepared to risk their reputation and money on branded products want something in return.

If a manufacturer is a big player or a brand leader in the market place and has outlets that don't specialise in servicing, relying instead on service agents, then spares will be distributed via companies such as CPC and Charles Hyde.

I appreciate that this is a difficult and apparently short-sighted policy when seen from the point of view of the independent service engineer. Might I suggest that in such cases a strongly-worded letter from the customer to the managing director of the company concerned will often achieve a better result than complaining to a spares order clerk.

*B. Hinton,
Former TLO, Ferguson Ltd.*

Magnetism problem

In the February issue audio faults pages Nick Beer mentioned a problem with a magnetised solenoid armature plate in the

CD section of a Denon DC30 mini system. It was cured by demagnetisation. But Nick might find that the job comes back again. The CD player in this equipment is made by JVC, and is used in several of this company's players. JVC is familiar with the problem. While demagnetisation may well provide a temporary cure, the official recommendation from JVC Technical is to replace the plate. It's reasonably easy to do, though a little fiddly to get at. The metal plate slides into moulded slots on the plastic armature lever, and is retained by a tiny latch. I always keep a couple of these plates in stock, and have never had a repeat of the trouble after replacement.

Like Nick, when I first encountered the problem some years back my first thoughts were of demagnetisation, but I was assured by JVC Technical that this had been tried and found to be unreliable. The replacement part is called 'control plate' and its cost is a matter of pence. The JVC part no. is 30070228T.
*Geoff Darby,
Earls Barton, Northampton.*

Microwave ovens

Some points need to be made in connection with the microwave oven notes in the December issue, page 113. In Fig. 1 diode D1 is shown the wrong way round. With the cathode of D1 connected to ground, C1 is charged to the peak voltage on the positive-going half-cycles. On the negative-going half-cycles the charge stored in C1 is added in series with the secondary voltage, giving up to double the peak secondary voltage. As this voltage is applied to the anode of D1, it doesn't conduct. The magnetron, shown the correct way round, receives the sum of the secondary voltage and the charge on C1 and so conducts. I've never attempted to measure the voltage in the HV section of a microwave oven but, if the secondary voltage is 2kV, then the voltage at the cathode of the magnetron (also present on the loop of wire that

forms the heater overwinding) will be up to -4kV peak. Speaking of the heater winding, I seem to remember that the heater voltage is about 3-15V, at quite a few amperes.

Other points are of much less consequence and not particularly relevant to servicing. The usual magnetron frequency is 2.45GHz. There is no hole in the case of the magnetron: the microwave energy exits via a tuned stub at one end of the device. This stub protrudes into a

short waveguide fabricated on to the side of the oven compartment. The radiating stub is in effect a half-wave dipole.

The internal structure of the magnetron consists of a drilled and machined block of copper. It has a central hole for the cathode, surrounded by a radial array of axial tuned cavities, each of which is coupled to the electron stream by a slot milled in the inner wall. The axial magnetic field makes the electron stream rotate around the cathode. This

sets up eddies in the cavities. A coupling loop brazed into one of the cavities is used to convey the microwave energy to the output stub.

*Ian Field,
Letchworth, Herts.*

Editorial note: See also the letter on page 182 of the January issue. No attempt should be made to measure the EHT voltage. Unforgivable of us to have got the diode the wrong way round.

HELP WANTED

The help wanted column is intended to assist readers who require a part, circuit etc. that's not generally available. Requests are published at the discretion of the editor. Send them to the editorial department or email to tessa2@btinternet.com - do not write to or phone the advertisement department about this feature.

Wanted: Circuit diagram or service manual for the Nokia D-box satellite receiver Model DVB9500S. I have a problem with low voltage at the LNB socket and cannot get help from the manufacturer. Please phone Barry on 01522 696 061 or email barry@sagainternet.co.uk

Wanted/for sale: Require an optocoupler type K1150PG for a set fitted with the Philips GR2.25 chassis. Have for sale a two-year old 24in. widescreen Sharp set with remote-control unit and new line output transformer, for spares or repair, £25. H. Foyne, 7 Ennerdale, Tanhouse, Skelmersdale, Lancashire WN8 6AG. Phone 01695 555 455.

Wanted: Help with my Pace Sky digibox. The green LED at the front, marked 'online', flashes briefly every few seconds. Anyone know why? Charles Coultas, 47 Lowther Road, Wokingham, Berkshire RG41 1JB. Phone 01189 785 713 or email

charles.coultas@recite.co.uk

Wanted/for disposal: Require service manuals for the Goodmans Stereomax and Pye HFT300 AM/FM tuners and the Labgear E5180A TV pattern generator (405/625); a Cossor CR1200U MW/LW valve table radio (circa 1959) in moulded cabinet; and a line output transformer for the Pye TV11/Ekco T418 series (405/625) TV receivers, part no. AL21003 or I40 17072 (DY86 EHT rectifier version), circa 1964.

Have for disposal free a Mullard Colourex A56-410X reprocessed tube and a new ITT 22in. 560ATB22-TC02 tube. Also a Luxor 22in. multistandard CTV (SX9 chassis) with teletext and 'video control unit' at £30. Items would have to be collected from the Swindon area. Phone David Hazell on 01793 765 390.

Wanted: Toshiba Beta VCR Model VB-31 for spares. Ron White, 29 Nunnery Street, Castle Hedingham, Essex C09 3ND. Phone mobile 07751 674 650.

Wanted: New old stock, or good condition used, Mitsubishi VCRs, particularly Models HS-B82, B52, M57, M59, M68 and M1000. Might also consider Model HS-871, but only if new old stock. Please send details to S.

MacLean at hootsmon34@hotmail.com

Wanted: Can anyone tell me where I could get television or movie films of the 350cc Junior Isle of Man TT motorcycle race and 250cc Lightweight Isle of Man motorcycle race in the years 1964, 1965, 1966 and 1967, when Mike Hailwood, Phil Read and Jim Redman were racing? Malcolm Shaw, 11 Clarke Court, Lough Road, Antrim, Co. Antrim, N. Ireland BT41 4JS.

Wanted: Spares for the Sanyo mini component system Model DC-F450U - side PCB, amplifier and tape deck. Might be interested in a complete unit, working or not. Please phone Leon Bradley on 01903 265 503. Buyer will collect.

Wanted: Expert VCR service engineer for comprehensive fault diagnosis, repair and servicing of Mitsubishi VCRs to the highest standard. Please send details to S.

MacLean at hootsmon34@hotmail.com

Wanted: TMP47C-410AN IC for the Toshiba Deltawave III microwave oven Model ERG-8869EW. It's mounted on the control panel, component reference no. IC01. Alternatively a known good panel. Rod Proctor, 8A Maliston Road, Great Sankey, Warrington WA5 1JR. Mobile phone no. 07931 913 726.

Wanted: A 32in. widescreen tube for the Toshiba Model 32Z13B; widescreen tubes type W66ESF/W66ECK; a standard tube type 68ESF. Good price will be paid. Phone Anthony Weekes on 01582 571 121 (Luton) or email anthony.weekes@virgin.net

Wanted: Chopper transformer for the Philips CTV Model 25ST2761/05B (GR2.1/2 chassis). Alternatively does anyone know where I could obtain this? The set concerned belongs to an OAP who tells me that this is the first fault since he bought the set 18 years ago, and that the picture is still very good. All expenses paid. Reg Stroud, 2A Linden Road, Gloucester. Phone no. 01452 503 581.

Wanted: I understand that the Panasonic UK TV Model TX-32PK20 (Euro-5 chassis) can be modified in software for use on the Continent. My customer is moving to Switzerland. Can anyone tell me how to access the 'service mode2'? Please contact Peter Solomon at peter@solomonpa.screaming.net

Wanted: Circuit diagram or service manual for the Canon E600E camcorder. The unit is completely dead, including eject. Prior to this fault, when the unit was first turned on the viewfinder tube defocused and flared (as valved mono TVs did when the EHT circuit was faulty). I have been told that leaky capacitors are a problem with these units. Have for disposal several Philips V2021 VCRs, no charge. B. Ross, 85 Cornwallis Road, Rugby CV22 7HL. Phone 02476 204 838 daytime, 01788 816 326 evenings.

Wanted: Chopper transformer for the Ferguson 59H4 (TX100 chassis). Chris Hart, email chartelectron@aol.com

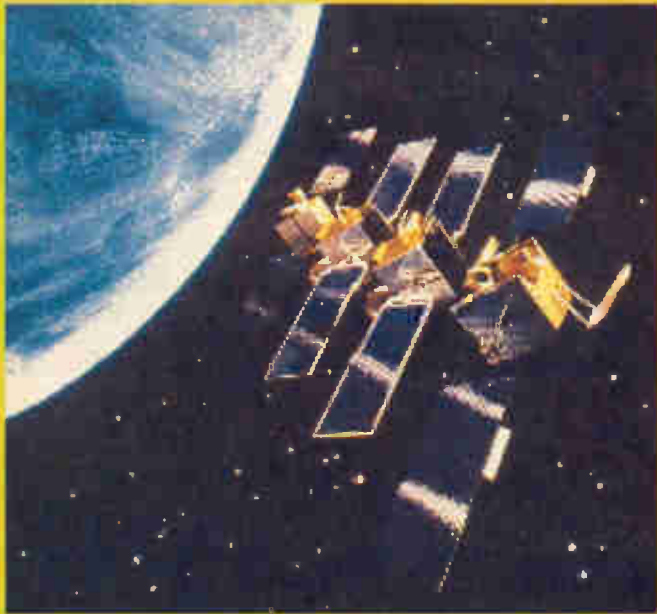

DX and Satellite Reception

Terrestrial DX and satellite TV reception reports. News items relating to TV and related bands. Satellite dish maintenance. Roger Bunney reports



The Filipino package via NSS-7 didn't last long.

December 2002 will go down in the record books as one of the wettest months ever in the UK. Unfortunately DXing will not find a place in any such books: it was a truly dead period. My early-morning monitoring, up to 0845 hours, for any signs of F2-layer propagation proved a blank. On several days the MUF reached about 35MHz in mid-afternoon. Cyril Willis (King's Lynn) found that the MUF rose to over 40MHz in the middle of the month, peaking at about 43MHz on one day with reports that 6m (50MHz) amateur radio activity from distant parts of Europe and two-way contacts in the US had been heard in the UK. Hugh Cocks reported from the Algrave that TE/F2 propagation is "dying down a bit now", but on good nights he was able to receive signals up to the US ch. A3 (61.25MHz vision carrier), though weak and the source usually unidentified. The only Sporadic E reception I noted was on December 17, when SVT-1 (Sweden) ch. E2 was present in the mid-afternoon.

Christmas is a time when I hear from old friends. Gareth Foster (Whitton) tells me he visited Hong Kong and China recently. China now has a lot of cable TV, offering 30-50 unscrambled channels in the VHF/hyperbands for the equivalent of about £1 a month. There are twelve national Chinese TV (CCTV) channels – CCTV-9 is an English-language channel with many commercial breaks. Hotels carry many overseas TV channels. Konko is a popular TV brand, with most models being dual-standard D/K/I PAL/NTSC 4-43. A few models have D/K/I/B/G/M and PAL/Secam/NTSC (both 4-43 and 3-58).

I was sorry to learn that Fred Robins' wife Beryl has passed away. Fred, who lives at Fareham, worked for many years on the design side at the Thorn Gosport site, where I first met him. Many trade readers probably received help from him at one time or another with Thorn receiver problems. When Thomson took over, the plant was closed down. Fred then retired and became involved with an EMC consultancy and the RSGB's EMC committee. He is now very active with hospital charity work. Our best wishes to Fred.

Satellite sightings

A Joint Terrorism Task Force in Dallas, Texas captured about seven immigrants who were involved in a money-laundering operation. On December 18 the CNN Newsource lease (11.562GHz H, SR 6.117, FEC 3/4) via NSS-7 (21.5°W) presented a spokesman from each of the security services involved. It appears that millions of US dollars were fed into the system from Syria and Libya. The group were sentenced to jail terms totalling over 400 years with a substantial fine.

As I type these lines on December 27 news is coming through via Reuters Moscow Channel 1 of the bomb blast in Chechnya, with pictures showing the damage. The Moscow TV news and adjacent domestic programming can often be seen via NSS-7 in the late afternoon, at about 1700 hours GMT. Check the BT Washington feed at 11.690GHz H (5.632, 3/4). This may change the service identification to 'Reuters Moscow'.

When I checked NSS-703 at 57°E with my Spectralook monitor for any new signals I found that the power of all the signals from this source was varying up and down over a two-three second cycle – perhaps 6dB or so on the TV screen display. A check at 45°E (Europe*Star-1) produced stable signals, so the problem was with NSS-703 and not my equipment! Over the Christmas break I changed my receiver set-up, with two 'new' RSD 302 units installed. These were from the last factory run at RSD, Stirling, which now designs digital receiving equipment that's manufactured by Eisen in Korea. They have the latest Eisen/NewWave software loaded however.

The Anglia/Meridian evening magazine TV inserts that were downlinked via Intelsat 801 (31.5°W) until recently have moved to Telecom 2D at 8°W. Dave Dyson (Lancs) first noted them at 12.579GHz and 12.570GHz respectively but, by mid-December, Anglia had moved to 12.600GHz H (BT TES-42) and Meridian to 12.591GHz H (8MBIT, TES9-Meridian) – both with SR 5,632 and FEC 3/4. Intelsat 801 now seems to carry only occasional



NSS-7 often carries the Russian Channel 1 network news from Moscow in the late afternoon.

sports feeds, e.g. football, for Sky Sports and many French local news reports. The French seem to be moving to MPEG 4:2:2 rapidly (the majority of regionals on a recent night were all of this type). A sports 'best of 2002' type presentation, Les Menuires, Micro D'or, featuring outward-bound type action, was carried from 1800 hours onwards on December 18 for a French TV channel, replaying VT inserts and judging: curiously, this prolonged feed was carried by BT-TES-37 UK1 409 – at 11.001GHz V (5.632, 3/4).

A frequency worth checking is 11.570GHz V (2,894, 3/4) via Telstar 11 (37.5°W). This was in operation all day on December 23, feeding trailers for CNBC financial news (identification 'Auto 6Mbits'). Another frequency worth checking is 10.991GHz V (3.261, 3/4) via Atlantic Bird-1 (12.5°W). It produces the on-screen identification 'News One Channel', for ABC New York (service identification 'Service 1'). On the 26th it carried a prolonged speech from the US Secretary of State, discussing Middle East investment by The Heritage Foundation. Picture quality suffered, with sticking from time to time. The same lease may identify as 'Washington News Bureau Remotes Router, abc feeder'.

Can anyone explain why a Manhattan DigiPlaza receiver produces the service identification 'Service 1' when, with the same signal, an RSD receiver displays the service identification 'P 10991 V 01'?

In early December the Fox News Jerusalem uplink via SESAT (36°E) moved to Amman, Jordan. The downlink parameters remain the same, 10.960GHz V (3.258, 5/6), and signals are present during much of the 24 hours. Regular but short two-way presentations are carried out with the Fox News network in the US.

Roy Carman (Dorking) has noted African signals recently – TV 'Cote D'Ivoire International' – via PAS-1R (45°W) at 11.576GHz H (2,920, 1/2). Other African TV services have been seen at times via this satellite.

Another report says that the delights of Amateur Babes and XXX TV have been seen FTA via Sirius (5°E) at 12.111GHz H. I haven't been told the digital parameters and dare not look, so you'll need an auto-search receiver!

As one thing lights up in the Clarke Belt another goes dim. The Filipino Channel via NSS-7 has gone dark. But another delight, Sexy Sat, has been reported testing FTA via the Globecast lease at 12.345GHz V (27,500, 3/4)!

News items

RSL: The Isle of Wight station Solent TV (ch. E54 H, at 2kW ERP from Rowridge) started its second phase in mid-December, with news reports and local programming. There's an edited video

recording of the popular Isle of Wight Radio phone-in twice a week – essential viewing of the control room/presenter operation for radio enthusiasts! Full programming, also full-power transmission, was due to start in January.

Amateur radio: During 2002 high-power, two-way transatlantic transmission tests at 144MHz (2m) were carried out, using packet PSK31, to establish whether direct contact was possible. An analysis of the results was undertaken to see if the propagation experienced was ionospheric, tropospheric or a combination of both, in conjunction with weather patterns. Initial results suggest that the 'best path' is between the Caribbean and Portugal, the warmer waters producing evidence of high-level ducting at 4,000+ feet. This in turn suggests that a launch site high in the hills is better than on the coast.

The US east coast experiences fluctuating weather fronts, the lack of tropospheric stability minimising long-duration signal propagation. As a result high-power transmission is necessary, to exploit tropospheric ducting, scatter and ionospheric enhancements including Sporadic E. Further tests are to be carried out this year. Information from radio amateur Ev. Tupis (W2EV) and the RSGB journal *Radcom*.

Satellite: Immarsat is offering high-speed data links via its regional broadband global area network (RBGAN), with access rates at 144kbits/sec, using the Thuraya satellite which covers Europe, Africa, the Middle East and central Asia, downlinking back to Fucino, Italy. From late 2003 the data rate will be increased to 4Mbits/sec. Immarsat capacity carried live TV news

www.Aerial-Techniques.com

MANHATTAN 15" /38cm LCD Multi-Standard PAL SECAM Colour TV

NEW



£699.00

- 240v AC/12v DC operational
- Automatic tuning
- International teletext
- 2 x 1.5w nican digital speakers
- Scart connection
- PC compatible
- Remote control
- Silver cabinet
- Wall mountable
- Slim and lightweight
- The ideal size for travelling

Reception covers:- PAL system I (for UK); PAL systems BIG (for Europe); PAL system D (for China); SECAM L (for France); SECAM D/K (for Eastern Europe); and SECAM BIG.

Also available in 20" screen.

GRUNDIG MULTI-STANDARD AC/DC 14" PORTABLE TV

For use in the UK, France and Europe

NEW



£299.00
inc. VAT

- Light grey cabinet
- International text
- Scart socket
- Automatic standby
- Six watts music output
- Satellite compatible
- PAL/SECAM
- 14" (34cm) picture tube
- Dual voltage/220-240v
- 12/24DC, 50/60Hz
- Multi-system reception
- ATS tuning system
- Infra-red remote control

Overnight delivery for all items by insured courier £12.00

NEW GRUNDIG GDS-3000 Digital satellite receiver



Complete digital satellite system available for **only £399.00**

This includes:

- 60cm mesh dish kit.
- Plus all connection cables & plugs.
- Free viewing card accessing: BBC1, BBC2, ITV-1, Channels 4 & 5, all the BBC radio stations.
- Plus many other channels.

Additional extras available:

- New collapsible tripod - £49.95
- Satellite signal finder - £29.95
- Folding 64cm dish (including digital LNB) - £79.95
- Folding 88cm dish (including digital LNB) - £89.95
- all inc VAT

MULTI-STANDARD SPECIALISTS

FULLY COMPREHENSIVE 35 PAGE CATALOGUE AVAILABLE BY RETURN OF POST FOR £1.50

59 Watcombe Road, Southbourne, Bournemouth, Dorset B116 3LX
Tel: 01202-423555 Fax: 01202-425055
E-mail: atech@direon.co.uk Est 1979
Callers by Appointment please





from the Afghan war front. The increased capacity will enhance picture quality.

Astra 1K and Hot Bird-7 were both lost in recent weeks, but NSS-6 was successfully launched via an Ariane 4L rocket on December 17. Astra 1K was written off despite initial thoughts that it could be saved, and was 'de-orbited' on December 16, i.e. pushed back into the Earth's atmosphere, where it burnt out over the Pacific Ocean.

Programming from the Nigerian TV network Africa Independent Television (AIT) is being downlinked across the US/Canada via Telstar 5 (97°W) by GlobeCast WorldTV, which specialises in transmissions from Asia, Africa, the Middle East and Europe to North America. It currently provides sixty entertainment radio and TV channels via Telstar 4, 5 and 6.

Satellite dish maintenance

Prior to my current installation I always used aluminium satellite dishes, of either the spun or petal type. Living in a near-countryside atmosphere there is no problem from industrial and other pollution, though the dishes have suffered from occasional bird droppings. This is easy to wash off when fresh. If it's baked on by the summer sun it can be removed after soaking in fresh

water. Never scrape dried bird droppings off, as this will damage the surface of the dish.

An earlier 1.5m spun-aluminium dish I had, painted matt white, suffered because sticky aphid discharge from an overhanging apple tree branch fell on its face and produced small patches of corrosion. Washing with Fairy Liquid helped, but there was excessive discharge in summertime. As the tree was old and beyond salvation I cut it down.

With a tracking dish that faces south the rear will always be in shadow. I had trouble with a mildew-type growth and found it beneficial to wash the back of the dish every few months. The actuator arm assembly and polar mount were covered with a plastic/oilcloth type sheeting. The extending arm had a polythene tube cover. Thus the mechanics and the extending arm were protected from aphids, rain and leaf debris.

When I moved to my present house I acquired a new aluminium prime-focus dish. After two years there was a problem with excessive secondary lobes, so I bought a 1.2m Channel Master offset dish which is made of grey GRP material. The face of the dish has a slightly roughened, dimpled profile while the rear consists of smooth grey plastic with a reinforcing rib structure. After eighteen months both sides of the dish had become grubby. Washing with Fairy Liquid wasn't too successful so, being uncertain of the best method of cleaning GRP, I checked with Channel Master. Peter Gardner, Channel Master chief engineer in the US, replied with a detailed procedure and has kindly allowed me to include the details here.

You need rubber gloves, buckets, a soft-bristled brush and a sponge – and I recommend long overalls and boots! The two cleaning agents suggested are TSP-PF, which is an all-purpose heavy-duty cleaner (Savorgran or equivalent), and chlorine bleach (Clorox or equivalent). These brands may be US products.

To remove dirt and mildew wash the entire surface, not just the contaminated area, with a solution consisting of half a cup of TSP-PF dissolved in three quarts of warm water, with one quart of



The Dallas police chief reports, via the CNN Newsource feed, the successful capture of a money-laundering gang.

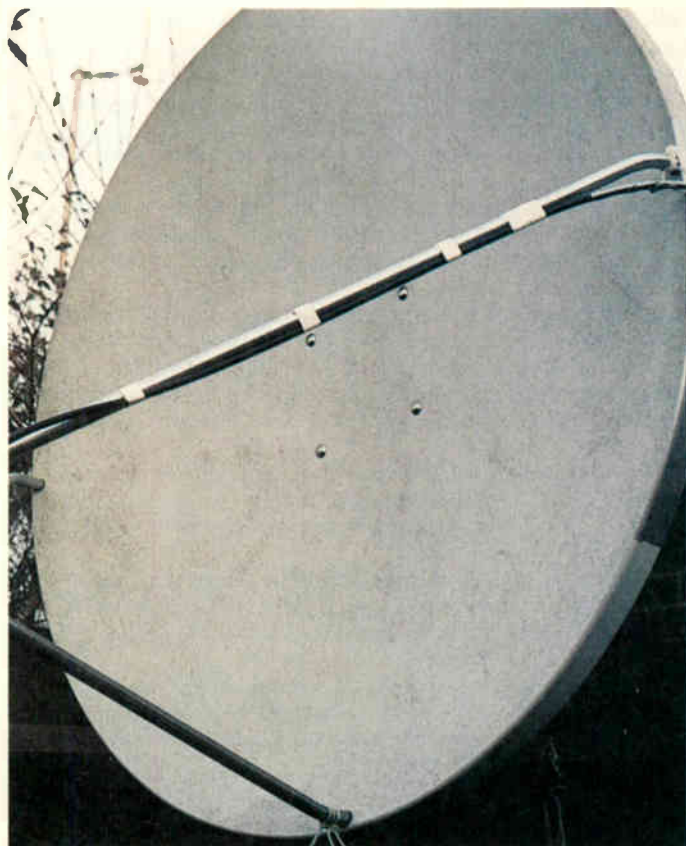

Dirt on the rear side of the dish. Note PVC covers used to protect the actuator arm.

After eighteen months this Channel Master dish looked decidedly grubby, despite the country environment.

chlorine bleach then added. Use this solution to scrub the whole area thoroughly, using a sponge or soft-bristle brush. The bleach should kill fungus/mildew growth and clean off any stains. TSP-PF removes dirt and grime and wets (primes) the surface so that the bleach can get to work. If any stains prove resistant, use a second application of the solution. Once the dish has been restored to pristine condition, devoid of marks, wash it thoroughly with fresh warm water. This procedure will clean the dish thoroughly but not prevent return of mildew in the long term.

Channel Master also recommends repainting the dish. First scuff over the whole area lightly with fine sandpaper or a pad, to help paint adhesion. Wipe all dust off the surface then apply an even coat, 1-1.5 mils, of water-based acrylic paint. Allow to dry, then if necessary apply a second coat of similar thickness. Note 1-1.5 mils = 0.0010-0.0015in. = 0.025-0.040mm, i.e. a thin coat!

Roy Carmen comments that he has used Tesco All Purpose Cleaner many times to clean his dish.

I have always used a protective covering to take care of my LNBs. My first dish had an IRTE in-line polariser and a 2.2dB noise EchoStar LNB with F plug output. This rather long assembly was neatly covered with Marley drain downpipe, with a slot and hole cut underneath for cables and the drainpipe capped at the 'sky' end. The drainpipe slotted on to the scalar-ring mounting hub neatly. As a result, the internal assembly remained dry and warm in winter, cool in summer – and provided a hostel for local spiders.

Once the digital age had arrived my LNB cover creations went into overdrive. The essential hardware consists of empty washing-up liquid bottles, which are easy to cut and shape into accurate LNB and feed profiles. Anchor with gaffer tape and, if desired, paint white afterwards – see accompanying photograph. The effort is worthwhile, as the LNB and F-output socket remain dry in all weather and are protected from the extremes of frost and direct



A washing-up liquid plastic bottle, with gaffer tape, can be fashioned to provide a protective cover for your LNB. Apply white spray paint to improve the appearance.

sunlight, always looking new. Washing-up liquid bottles will eventually harden as a result of UV radiation, but they are cheap and easy to replace.

I consider it important to apply just a hint of silicone grease to the thread of the F socket and a minute spot to the inner conductor of the F plug. And don't forget the self-amalgamating tape on the F output termination. ■

TRADE ONLY

POSSIBLY
LARGEST & OLDEST
EST. IN
THE UK EST FOR
29 YEARS

TVS
WITH INTEGRATED
DVD'S NOW
IN STOCK

COLOUR
TRADE

Wholesale Distributors & Export Agents
of Domestic Electronics & Appliances

**FULL RANGE OF FACTORY
GRADED TV'S DVD / VIDEOS
HI-FI SMALL & LARGE
DOMESTIC GOODS**



WE ARE MAIN DEALERS OF
BEKO & SANYO
AND MANY OTHER BRANDS



NATIONWIDE NEXT DAY DELIVERY SERVICE. VISITORS BY APPOINTMENT.
Phoenix House, 190 Bridge St. West, Newtown, Birmingham B19 2YT
Tel: 0121 359 7020 Fax: 0121 359 6344
Email: Colourtrade@btinternet.com

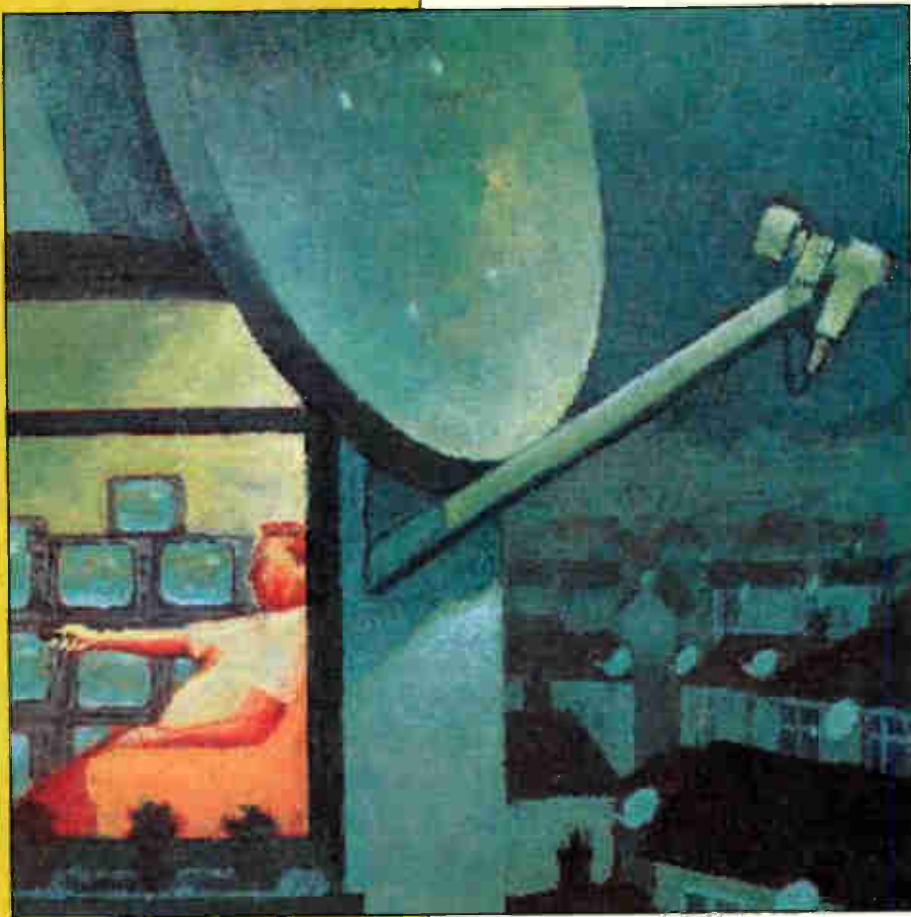

SATELLITE NOTEBOOK

Reports from
Christopher Holland
Hugh Cocks
John Coombes
and
Michael Dranfield

'Dead' digiboxes

A customer phoned to say that his Grundig GDS310/2 digibox appeared to be dead after a power cut, with neither a red or a green LED display on the front panel. I asked him to carry out the standard digibox reset procedure: unplug from the mains supply, wait a minute, then reconnect the unit. This restored normal operation.

I've come across the 'apparently dead' digibox problem on previous occasions. One digibox had pin 8 of its TV scart socket stuck at 12V. This forced the TV set to switch to AV input which of course was dead because nothing came out of the digibox. The customer assumed that there was a problem with the TV set as well, as terrestrial reception wasn't possible. **C.H.**

Radio volume levels

When you zap through the radio stations available via Sky Digital you encounter quite a wide spread of different volume levels. Strangely, one of the worst examples is the difference between various BBC stations. Radio 1 (EPG 851) and Radio 6 (EPG 911) are particularly high compared with some of the others. I don't know whether this is because of 'audio-processing' techniques or it's just that the station output levels are set differently. Switching between Radio 6 (EPG 911) and Radio 3 (EPG 853) demonstrates this very well. **C.H.**

Digital channel update

The latest channel additions at 28.2°E are listed in Table 1. The EPG number is shown in brackets after the channel name.

EPG no. 448 has been allocated to The Music Factory via transponder 10 (Astra 2A), while EPG no. 827 has been allocated to Asia TV via transponder D9S (Eurobird).

In December a GlobeCast Philips test pattern the same as last month's photo appeared via transponder D12S (Eurobird, 11.680GHz V). In early January it was replaced by Christian TV, EPG no. 655.

Colour bars with the 'William Road' identification, labelled 'G54', have appeared via ITV's Astra 2D transponder 54 (10.906GHz V). A colour-bar/grey-scale pattern labelled TMZ1 has appeared via Eurobird transponder D5S (11.546GHz H). See Photo 1. **C.H.**

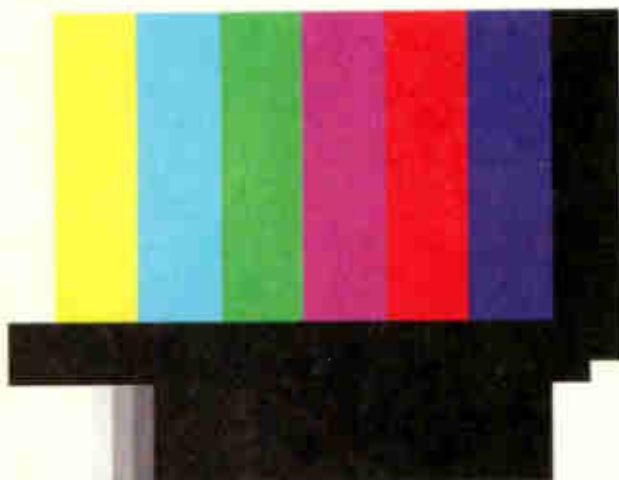

Photo 1: Colour-bar/grey-scale pattern via Eurobird transponder D5S.



Photo 2: ORTB TV from Benin, Nigeria via Intelsat 706 at 53°W.

C-band reception

This month we'll look at two adjacent satellites at 53/55.5°W. They have a lowish though usable elevation in the western sky. Both are operated by Intelsat.

Intelsat 706 at 53°W has only one TV signal for us in Europe, ORTB TV from Benin. Nigeria, via its eastern hemispheric beam. The frequency is 3.830GHz, with right-hand circular polarisation, a low symbol rate (SR) of 2,711 and 1/2 FEC (forward error correction). See Photo 2. The transmissions produce pixellation effects when there's a lot of movement on the screen. No pictures are transmitted overnight, though the signal remains on-air. Colour bars are transmitted for a few minutes prior to



Photo 3: XHTVL TV Canal 9 Mexico via Intelsat 805 at 55.5°W.



Photo 4: Telesistema TV Mexico via Intelsat 805.



Photo 5: Amazonas State University TV, Brazil via Intelsat 805.

Table 1: Latest digital channel changes at 28.2°E

Channel and EPG no.	Sat	TP	Frequency GHz/pol
Christan TV (655)	EB	D12S	11.680/V
Dubai TV Multiplex*	EB	D10S	11.642/V
FTN (tests)	2A	13	11.954/H
Performance TV (tests)	2B	30	12.285/V

* EDTV 1, EDTV Sport, EDTV Business.

TP = transponder. 2A = Astra 2A. 2B = Astra 2B. EB = Eurobird.

the start of programmes at about 0800 UK time.

The satellite also carries various C- and Ku-band channels via its western hemispheric and spot beams, but these cannot be seen in Europe.

The nearby Intelsat 805 at 55.5°W transmits a lot of strong South American signals, with the coverage extending into Europe. 805 differs from most of its fellow Intelsat craft in using linear (horizontal/vertical) instead of circular polarisation, the North American C-band norm. Removing the circular Teflon depolariser plate in the feedhorn will improve reception. Some cross-polarisation interference can occur when the plate is left in. It can degrade digital signals to the point of no reception, even when only a relatively low amount of the opposite polarisation is present. The satellite also has an extended frequency range, going down to 3.400GHz. Most modern LNBs will cover this without much degradation in their performance, but there may be interference from terrestrial microwave services.

In view of the number of channels, it's simplest to list them, see Table 2. All use the 525-line format. H.C.

Amstrad DRX100

If one of these digiboxes is stuck in standby, go to the power supply and check C19 and C20 (both 220µF, 50V), also C9, C10 and C12 (all 1,000µF, 10V). All or any combination of these capacitors can be the cause of the fault. The best check is with an ESR meter for high ESR readings. Alternatively use a capacitance meter to check for low-capacitance readings. J.C.

Grundig GDS310/2

There was no light from the standby LED on the front panel. The LNB was being powered however and the tuner



Photo 6: TV Capixaba Brazil via Intelsat 805.



Photo 7: TV Cancao Nova Brazil via Intelsat 805.



Photo 8: Red Global TV Peru via Intelsat 805.

Table 2: Intelsat 805 (55.5°W) frequency allocations

Frequency GHz/pol	SR/FEC	Service	Country
3.426/H*	3,333 3/4	Repretel	Mexico
3.431/H	3,500 3/4	XHTVL TV Canal 9	Mexico. See Photo 3
3.436/H	3,333 3/4	Telesistema	Mexico. See Photo 4
3.450/H*	14,250 2/3	Guatemalan multiplex **	Guatemala
3.714/H*	6,668 7/8	Feeds	-
3.795/V	1,807 3/4	Amazonas State University TV	Brazil. See Photo 5
3.799/V	3,254 3/4	TV Capixaba	Brazil. See Photo 6
3.840/H*	6,668 7/8	Feeds	-
3.912/V	1,807 3/4	Amazonas State University	Brazil‡
3.918/V*	4,400 3/4	Rede Record	Brazil
3.937/V	5,918 2/3	TV Cancao Nova	Brazil. See Photo 7
3.940/H	2,475 3/4	Red Global	Peru. See Photo 8
4.119/H*	3,720 7/8	Panamericana TV¶	Peru
4.128/H	3,040 3/4	Andina TV	Peru. See Photo 9
4.140/V	4,700 5/6	Frecuencia Latina	Peru. See Photo 10

* Scrambled channels.

** Four TV and four radio stations. Radio Galaxia La Picoza is scrambled, Radio Ranchera, Radio Fiesta and Radio Sonora are not scrambled.

‡ Duplication of 3.795GHz/V at present. The service is expected to leave 3.795GHz/V shortly, then being available only at 3.912GHz/V.

¶ Plus RPP Radio (not scrambled).



ANDINA 4128 H

Photo 9: Andina TV Peru via Intelsat 805.



FREQ LATINA PERU 4140V

Photo 10: Frecuencia Latina TV Peru via intelsat 805.

was producing an 8-bit digital output, so the digibox was working to some extent. When I compared the digital waveforms around the 87C52X2-MC front-panel microcontroller chip U5 with those in a working digibox I found that the signals at R6 and R7 were missing. A new microcontroller chip cured the problem. M.D.

Amstrad DRX100

In the January issue I mentioned intermittent picture freezing with these digiboxes when they have been on for a while. The basic cause is oscillation on the 3.3V supply to the QPSK chip. It will be cured by replacing the 3.3V regulators U104 and U105 using type LM1117DT3.3. If you use the original type MC33269 as the replacement however you will be faced with the same problem.

The true cause of the fault is the capacitors that decouple the output from these regulators, C112 in the case of U104 and C113 with U105 (they are both 47µF). When they fall in value the regulators tend to oscillate. Failure of these capacitors can also result in the digibox displaying the 'no satellite signal' message. Use a scope to check the 3.3V outputs. It seems that the LM1117DT3.3 tolerates poor output decoupling better. M.D.

Pace 2200

This digibox worked all right apart from the fact that it didn't respond to remote-control signals. The front-mounted IR sensor produced an output, which was also present at pin 6 of SK600, the front panel plug/socket, but IR data didn't reach the emitter of Q601. The cause of the problem was traced to an open-circuit through-board link near the card-reader assembly. A bit of hard wiring cured it. M.D.

Amstrad DRX300

I've had this problem a few times now. The picture freezes for a split second, usually when the digibox has been on for about twenty-thirty minutes. The cause is a hiccup in either the Q or the I data from pins 22 and 35 respectively of the ZIF chip. The problem can be cured by replacing the Connexant 24108-20ES chip.

This budget unit has no silk-screen print on the PCB, so don't forget which way the chip came off. And don't forget to solder the underneath of the chip to the ground plane. There's a hole in the PCB for this purpose – unlike the chips in Pace tuners (these require the use of infra-red heating to solder the RF ground plane to the chip). M.D. ■

BOOKS TO BUY

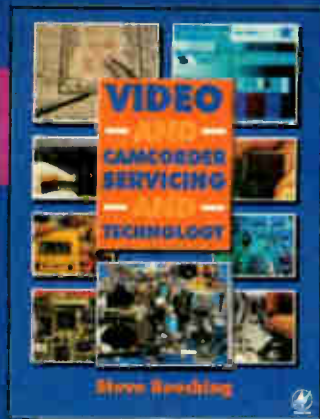

VIDEO AND CAMCORDER SERVICING AND TECHNOLOGY

This book provides fully up-to-date coverage of the whole range of current home video equipment, analogue and digital. As well as essential information for repair and troubleshooting, the author provides clear explanations of the technology of video equipment, which will enable the service engineer to gain a thorough knowledge of the equipment with which they are working.

As well as traditional VCRs the book includes the full range of video cameras designed for home use and editing systems, and the latest DVD and hard-disk equipment.

READERSHIP: Service engineers, servicing students, advanced electronics DIY.

Price UK £23.00 EUR £25.00

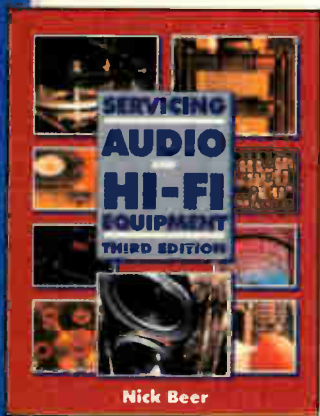

well covered elsewhere: here the emphasis is on the practical business of fault diagnosis and repair.

Price UK £23.00 EUR £25.00

SERVICING AUDIO AND HI-FI EQUIPMENT

Service engineers and technicians have come to regard this book as essential to their work. As a bench-side companion and guide it has no equal. Its purpose is to ease and speed up the processes of fault diagnosis, repair and testing of all classes of home audio equipment: receivers, amplifiers, recorders and playback machines. The mechanics and electronics of domestic audio are examined by Nick Beer in a down-to-earth and practical way, concentrating on what goes wrong, how to track down problems, and how to solve them.

READERSHIP: Service technicians and engineers, audio engineers.

Price UK £35.00 EUR £37.00

UNDERSTANDING AND SERVICING CD PLAYERS

Engineers who need to achieve a better understanding of CD technology will find this book an essential tool for fault diagnosis, adjustment and repair. This book not only covers the mechanical design but also the integrated circuits within a CD player. It is written for immediate application and is well illustrated, so it should become a welcome addition to the rack of tools available to the service engineer. Ken Clements has extensive experience of the service industry both as a service manager and later in technical training with Sony and Pioneer. It is his hands-on knowledge that makes the book so valuable, not only as a wide-ranging reference but also as a benchtop manual to be kept within reach at all times when working with CD players.

Price UK £35.00 EUR £37.00

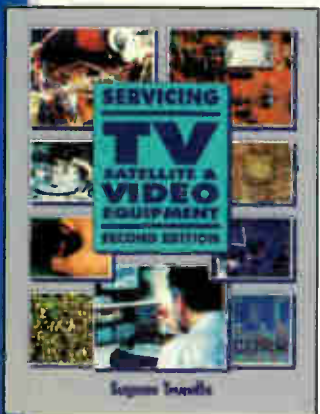

SERVICING SATELLITE TV EQUIPMENT

This is the definitive practical guide to fault-finding, troubleshooting and servicing satellite television equipment, both indoors and outdoors. It will take you through all areas of satellite television system servicing from the simplest fixed dish to fully motorised systems. From PAL to Mac to MPEG all contemporary systems are covered.

READERSHIP: Service engineers, satellite equipment designers and manufacturers audio engineers.

Price UK £35.00 EUR £37.00

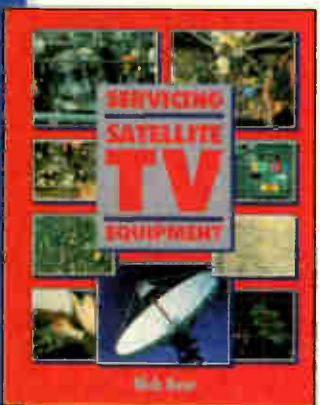

SERVICING TV SATELLITE AND VIDEO EQUIPMENT

The first edition of this unique 'hands-on' fault-finding book became the guide and mentor for thousands of service technicians and engineers in many countries and was widely adopted as a college text. In its new and updated form its usefulness is enhanced by five new chapters, including fault diagnosis in digital TV and video equipment, satellite-receiver repair and interfacing/hookup. All the chapters have been based on many years of practical bench and field experience, the book wastes little space on theoretical principles and circuit description where it is



Post your completed order form to:-

Jackie Lowe, Highbury Business Communications,
Anne Boleyn House, 9-13 Ewell Road, Cheam, Surrey,
SM3 8BZ

Price includes delivery

How to pay

Title

I enclose a cheque/bank draft for £ _____
(payable to TELEVISION)

Please charge my credit/charge card

Mastercard American Express Visa Diners Club

Credit Card No: _____

Expiry Date: _____

Signature of Cardholder _____

Cardholder's statement address: (please use capitals)

Name _____

Address _____

Post Code _____ Tel: _____



VCR CLINIC

Reports from
Eugene Trundle
Dean Ratcliffe
Garry Laidler
K.V. Cunliffe
Bob Flynn
 and
J.S. Ogilvie

We welcome fault reports from readers – payment for each fault is made after publication. See page 300 for details of where and how to send reports.

Sony SLV-E710UX

This and many other contemporary Sony VHS machines use the H deck. Two of them I've had recently chewed tapes because of lack of reel drive: the toothed pulley had fallen off the capstan flywheel. Sticking the pulleys back on with epoxy resin worked for me, with no bounce-backs. E.T.

Hitachi VTF360

This machine produced no signs of life at all, but an ear close to the power section detected a faint whistle, indicating that the mains fuse at least was intact. The cause of the trouble turned out to be failure of the electrolytic capacitors C865 and C866 – no surprise in such a hot spot! The electrolytics on the secondary side of the power supply were also tired, so I fitted replacements. Access to the components inside this module is frustratingly difficult. E.T.

Sony SLV-E80UX

This machine's deck did nothing because fuse PS201 had blown. Inside there was a tape stuck in the fully-laced position. When I connected an ammeter in place of the fuse and switched on the reading was 1.3A. The culprit was the loading motor. When I sniffed it I detected a pong that replicated something quite unmentionable! E.T.

Sony SLV-SE710

This machine was completely dead because R156 in the power supply was open-circuit. It's best to replace R156 and R157, which are both 2.2M Ω .

A service kit is available from Sony spares, part no. A6705-263-A, for this and similar models (SLV-SE600/700/800) that tend to suffer from the fault. E.T.

Panasonic G deck

There was low/muffled sound because of a worn audio/control head. Ensure that the replacement is type VBR0125 with the G21/25 models. With later models the head is supplied without its PCB, so this will have to be transferred from the old one. Check the audio bias each time a head is replaced or adjusted. D.R.

JVC HRJ205

This machine was dead. ICP failure is a common cause. If the display shows an arrow or three dashes, check CP1, replace control cam part no. PQ32413-1-6 and the half-loading arm part no. PQ48570B then realign. D.R.

Toshiba V710

This machine was dead with the standby

LED pulsing. A faint, fast tripping noise could be heard coming from the power supply. The cure was to replace D15531 (FIT4) and C15535 (1,000 μ F, 10V). D.R.

Philips VR6490

There were no functions because of a faulty power supply. The items to check/replace are as follows: T7101 (BC548C), T7102 (BC558C), T7103 (BC635), T7104 (BUT11AF), D6101-4 (all type 1N5062), zener diode D6108 (BZV85-C5V1) and resistors R3118/3104. D.R.

NEC N895

When a cassette was inserted this machine went to playback for one second then the capstan speed increased as in fast-forward. The tape continued to be loaded around the video heads. The rewind, fast-forward, pause and slow functions were all OK. The cause was found to be the BA6305 mechacon servo chip IC415 on the motherboard.

Watch out for open-circuits on this board, for example between pin 7 of IC410 and the jumper J64. D.R.

Thomson VTH6021U

This machine was dead after the customer unplugged her VCR instead of her Sky digibox. For once the cause of the trouble wasn't capacitors or high-value resistors on the primary side of the power supply. Cold checks showed that DP066 (1N5822) on the secondary side of the chopper transformer was short-circuit. G.L.

Samsung SV245B and others

I have had a few of these VCRs with the power supply blown up, possibly because of varying mains supply voltages after storms. Before you replace the defective items on the hot side of the power supply it's as well to check for shorts on the cold side, where you will almost always find that the 43V zener diode ZD1SS1 is short-circuit. In this event the machine will not work after repairing the hot side.

When this power supply failure occurs, the items that have to be replaced are Q1SR01 (2SC4517A), Q1SR02 (KTC3203), DISR11 (1N4148), DISD11 (FIT4), R1SR11 (0.68 Ω , 2W), R1SS10 (2.7 Ω , 2W) and C1SR12 (22 μ F, 16V). Note that this is not a polarised electrolytic: it's a special non-polarised type, part no. 2401-000905.

This fault also occurs with derivative models SV643 and SV647 and the earlier SV230, SV233 and SV630/3/7. K.V.C.

Sharp VCA63HM

When this machine had been on for

twenty minutes or more its power supply would usually shut down, with just a whistling noise. Power could be restored once the machine had cooled down. The power supply is easy to remove and work on. I eventually found that the cause of the trouble was C913 (47µF, 16V). **B.F.**

Panasonic NVSD230 (Z deck)

There were various fault symptoms with this machine. Amongst them the tape would go down then eject; or go into the play position then unlatch and eject; or, if the tape did stay in, when the machine was asked to wind or rewind it would do so at only a slow speed. The fault was eventually cured by replacing the two reel sensors IC1501 and IC1502. They are both type RPI354N. **B.F.**

Matsui VP9405

The tape would go into the play position and then just sit there, with the play symbol at the front still lit. A few seconds later the machine would turn off. When the machine was asked to eject the tape this would get to the eject position then, again, the machine would turn off.

Although the mode switch looked to be OK, cleaning the contacts inside and out cured the fault. **B.F.**

Sharp VCA72HM

A tape was stuck in the cassette housing because the rack sliders at the right-hand side had broken away. They are held in place by three plastic spigots, one of which had broken off. Fortunately I had a scrap housing but, if you need to order the side piece, it's item 302, frame R, part no. LHLDX1025AJ00. **B.F.**

Hitachi VTFX980

This machine was brought in because it was wrecking tapes. When the deck was removed the answer was in bits on the main PCB. It was the clutch assembly, which had fallen apart because the plastic locating lugs had worn away. A replacement clutch is the cure for this one. As these are quite new machines, I think this could become quite a common fault. **J.S.O.**

Philips VP28/55

This multi-standard machine would load a tape then shut down. When it was switched on again it would eject the tape, leaving a loop of tape out of the cassette. On examination I found that the pinch roller assembly was jamming. Its spring guide had jumped out of the

groove on the main cam.

When you relocate it, bend the spring down slightly to prevent a recurrence. **J.S.O.**

Matsui VP9601N

If the power supply is dead or squeaky, check C514 (330µF, 16V). **J.S.O.**

Goodmans VP2500/2500A

This machine would load a tape then eject it and go to standby, leaving out a loop of tape. The cure is to remove the loading-motor assembly to gain access to the mode switch, clean it and refit. It's a quick job to do. **J.S.O.**

Nokia VCR3785UK

The symptom with this Nicam stereo machine was a venetian-blind effect on E-E video. Playback was fine. When you get this problem open up the tuner/IF module then remove and check C205 (1µF, 50V). It's in the top corner of the IF section, by the 6MHz filters. You will usually find that it's open-circuit. A replacement clears the fault. **J.S.O.** ■

How to pay

(VCR Fault Finding Guide) paperback

I enclose a cheque/bank draft for £ _____
(payable to *Television*)

Please charge my credit/charge card

Mastercard American Express Visa Diners Club

Credit Card No: _____

Expiry Date: _____

Signature of Cardholder _____

Cardholder's statement address: (please use capitals)

Name _____

Address _____

Post Code _____ Tel: _____

Television magazine's VCR Clinic column is a unique forum for practical servicing tips, with the UK's leading service engineers and servicing writers contributing their observations and recommendations month by month. But try finding those faults reports for the Amstrad XYZ123 that's on your bench. Even with an index you will be chasing through a pile of magazines... until now. Peter Marlow's VCR Fault Finding Guide is a distillation of the most used fault reports from 11 years of Television magazine. Arranged by make and model the information is extremely easy to access, and the book is a convenient size for the bench or to carry with you. This will undoubtedly become one of the service engineer's most useful tools. Unlike other fault guides, this one is based on top quality information from leading authorities, and genuine repair case studies. This is real-life servicing information, not just a compilation of manufacturers' manuals.

Approximately 2,000 reports on 193 models from 35 different manufacturers Instant on-the-spot diagnosis and repair advice Television magazine's leading writers' wit and wisdom available for the first time in book form.

**Post orders to: Jackie Lowe,
Highbury Business Communications,
Anne Boleyn House, 9-13 Ewell Road,
Cheam, Surrey SM3 8BZ**



VCR Fault Finding Guide

Peter Marlow

This book is an essential repair tool, not just another volume for the shelf

Pages: 464pp

Price: £22.50



MONITORS

Fault reports from

Ian Field

Bob Bradley

Ian French

and

Gerry Mumford

We welcome fault reports from readers – payment for each fault is made after publication.

Reports can be sent by post to:

Television, Fault Reports,
Anne Boleyn House,
9-13 Ewell Road,
Cheam,
Surrey SM3 8BZ

or e-mailed to:
tessa2@btinternet.com

Project PD697

According to the fault report this monitor's display kept collapsing to a vertical line. By the time the monitor arrived on my bench however it would shut down when switched on, before anything had time to appear on the screen. The soldering was poor in appearance, but reworking it didn't cure the fault. Having attended to that I carried out a more detailed examination of the component side of the board and found that C301 (47 μ F, 250V) was bulging slightly at the top. Once a replacement had been fitted the monitor stayed on long enough for the heaters to warm up and show the vertical-line symptom. Some checks with my live-test ESR checker then showed that C851, which is also 47 μ F, 250V, was defective. The monitor was OK once this item had been replaced.

The first of these two electrolytic capacitors is immediately after the B+ regulator while the second is immediately before the B+ pin on the line output transformer. In fact there's only a choke between them. I.F.

Packard Bell 1412SL

There was a red cast in the background, except with any group of horizontal lines that had a bright-red picture element in them. Any such lines had the red cast blanked out. An even more weird effect was that with a 256-step pattern showing the three primary colours separately the brightest half of the blue and green wedges was normal but, instead of stepping down to black level, the darker steps faded out to the complementary colour! So the green wedge faded to a dull purple and the blue to a sort of murky brown.

The symptom was similar to the effect produced when one of the class-A output transistors develops a base-emitter short-circuit. This effect can be very variable, depending on how the blanking pulses are applied. But checks here drew a blank. The reservoir electrolytic capacitor for the video HT supply had an ESR of about 2 Ω , but a replacement made no difference. The 1 μ F video coupling capacitors were of the non-electrolytic type and seemed to be OK. The fault was cured by replacing the LM1203AN chip. The AN suffix appears to be part of the Texas Instruments' numbering method: a Mitsumi replacement had no suffix and worked fine.

A couple of additional servicing notes on this model. When removing the loud-speaker units from the sides of the cabinet, watch out for the nylon inserts that remain in the screw recesses until you turn the speaker over! Secondly, with the monitor I had there was more silicone glue to hold the base panel to the CRT than there was

base panel! The metal screening had to be removed to enable the CRT socket to be unsoldered from the PCB, giving sufficient access for the silicone rubber to be cut away in slabs. The socket could then be separated from the CRT and soldered back on the PCB. I.F.

Atari SM124

Several chassis were used in the genuine Atari versions of the SM124. This one was of GoldStar manufacture. A common failure is the line scan coupling capacitor C716 (2.2 μ F, 50V non-polarised electrolytic). It's best to replace it with one of the many suitable types of metalised-film capacitor (2.2 μ F rated at 100V or 250V) that are available. Replace C912 (1 μ F, 50V) in the power supply while the PCB is out – before the TDA4601 chip blows up! The one in this monitor read just over 2 Ω when checked with an ESR meter. This isn't bad, considering! Once again it's best to use a metalised-film replacement. I.F.

Taxan Ergo-vision 730

This monitor would revert to standby intermittently until it had warmed up. The main PCB has a strong similarity to the AST style of design and assembly. The solder was not generously applied, and had a pale, granular appearance – like cheap 'silver' paint. Some pins, including ones on low-power DIL ICs, had darker haloes around the solder joints, suggesting that the solder was beginning to crystallise. All was well once the soldering had been reworked. I.F.

AST TE1764G

According to the customer this monitor had "double vision", but only in the high-resolution modes. This description was inaccurate and slightly misleading. The display actually had very long 'comet-tails', the effect was present in all video modes, and checks with various test patterns showed that the blue gun was not being switched off completely after high-contrast transitions.

Tests on the transistors on the CRT base panel revealed that Q222 (2SA1538E) had an open-circuit base-emitter junction. Note that any old video output transistor won't do here. The 2SA1538/2SC3953 complementary-symmetry pair have an ft of 400MHz and the V_{ceo}/V_{cb0} is 120V. The E suffix indicates the second highest hfe group, at 100-200.

Once the blue-drive problem had been sorted out it was time to turn attention to the rather peculiar whining noise the monitor produced during the first few seconds of warm up. The solder side of the main PCB is accessible via a removable cover

plate in the bottom steel pan. With the plate removed I could see, by the discoloration of the PCB and the crystallisation of a number of solder joints, that several components had been running hot. A slender soldering iron is required to reach under the edges of the aperture to get at some of the solder joints, but it was worth the effort as resoldering cured the peculiar noise. **I.F.**

Compaq V90

Arcing or flashover with the Sampo FEA662 line output transformer in this 19in. monitor is a common occurrence. What then happens is that the BU2520DF transistor Q831 blows along with the 2-2 Ω fusible resistor R866. Replacement of these three items should restore normal operation. Strip-down of the monitor is an art in itself however, as it is heavily screened. Here are a few tips.

First, carefully lay the monitor down on its screen. Remove the four back screws and the back cover, then remove the stand together the mounting brackets by taking out screws at either side of the chassis. Next remove all metalwork above chassis level. Finally remove the bottom metal plate to reveal the PCB. Reassembly is in the reverse order. **B.B.**

IBM 6540

At switch-on this monitor indicated that it was suffering from some sort of frame fault. There was stretching and jittering similar to what you would expect with a feedback problem. My first action was to replace the TDA8172 frame output chip, but this made no difference. I then noticed that the chip got very hot very quickly at power up. Scope checks confirmed what could be seen on the screen, that a lot of noise was being generated in the output stage.

Component checks in the frame output stage then revealed that the 0.22 μ F, 100V polyester capacitor C323 was open-circuit. Along with the 1.5 Ω resistor R341 it forms an RC filter network between the chip's output pin and chassis. Normal service was resumed once this capacitor had been replaced. **B.B.**

Compaq 171FS

The owner of this 17in. monitor complained that the on-screen display ballooned in and out as the brightness setting was varied. In addition I noticed that the sides of the display were distorted when the width setting was increased to maximum, and that the EW controls had little or no effect.

The cause of all this was low output from the B+ regulator that feeds the line output stage. For correct operation the

output voltage should be about 65V. The B+ reservoir capacitor C838 (47 μ F, 250V electrolytic) was the culprit – it's located near the line output transformer. A replacement cleared the symptoms. **B.B.**

Medion MD1772ie (Acer 7277)

This monitor squealed and clicked at switch-on. There was no display, and a wisp of smoke came from R356 (10k Ω). Suspecting a short-circuit in the line output stage, I disconnected the collector of the BU2520AF output transistor Q302, checked that it was OK, then ran the monitor with Q302 disconnected. The power supply ran normally with no smoke. I suspected the line output transformer, and removed it to carry out a ringing test to check for shorted-turns, using the transformer tester featured in the September 1993 issue of *Television*. I have always got good results when using this tester, and this time got the impression that there were no shorted turns.

Another fault which can occur with these transformers is failure of the internal HV capacitor that's connected between the 25kV EHT output and chassis. This can be confirmed by checking the resistance between the rubber final-anode cap and the chassis connection. Before doing this it is important to discharge any stored charge by disconnecting the rubber cap from the CRT and momentarily connecting it to the chassis connection. The resistance reading is normally very high, i.e. greater than 500M Ω , but in this case it was 25k Ω , so the transformer was faulty.

Before spending money on this repair I wanted confirmation that the LOPT was the only defective item. I thought that if I removed the offending capacitor I might get some sort of display. This is easier than you might think. It can be done with a hacksaw to cut open the black case, a screwdriver to lever the capacitor out, and a Dremel Multipro or similar drill fitted with a rotary file to remove the last bits of wire connected to the EHT output. The capacitor is potted in an oval-section bulge close to where the EHT lead emerges from the transformer. The exposed EHT connection was then insulated with a liberal coating (about 10mm thick) of general-purpose glue from a hot-glue gun. Araldite or another epoxy resin might be better for this, but I was in a hurry! The transformer was then refitted, along with a replacement for R356, and the monitor was switched on.

The monitor produced surprisingly good results. In fact I wonder why these capacitors are fitted in the first place. I am not however suggesting removal of the capacitor for anything other than diagnostic purposes.

Circuit diagrams for various Acer models, including this one, can be obtained free at the following website:
<http://rv6llh.rsuh.ru/acer/>
I.Fr.

Iiyama Visionmaster 501 (S101GT)

This 20in. monitor just clicked at switch-on. I suspected a short in the line output or EHT generator stage – they are separate in this monitor. It turned out that the 2SC5294 line output transistor Q5A2 and the 2SA1673 (or 2SA1988) horizontal size control transistor Q5A5 were both short-circuit. But why?

The line output transformer is a small device and a shorted turn in it would cause excessive current to flow and thus damage these transistors. I carried out a ringing test, using the transformer tester featured in the September 1993 issue of *Television*. This confirmed that the transformer did have a shorted turn.

A replacement was obtained from Iiyama (UK) Ltd. (01438 745 482) and fitted, along with two new transistors. A two-hour soak test then proved that all was well.

The 2SA1673 and 2SA1988 seem to be difficult to obtain. A suitable replacement for this application, with a similar specification, appears to be the 2SA1294. **I.Fr.**

Digital VRT17-W3 (Sony chassis)

This monitor displayed a single blue horizontal line at the very top of the screen, the remainder of the screen being totally black. At first I assumed that this was a type of frame collapse, but the frame scan waveform appeared to be normal when checked with a scope at the deflection coils.

Attention was therefore turned to the CRT base board, where I found virtually no video drive at the cathodes. Replacement of the VSP12 hybrid video power amplifier IC005 restored an acceptable display. The grey-scale was not particularly good, but without special software it's impossible to carry out the adjustments normally required after replacing components in the video amplifier circuitry. Fortunately it was only a slight, and therefore acceptable, error. **G.M.**

CTX PL7+

This monitor was basically dead, though the green power LED lit up briefly when it was first switched on. Checks in the chopper circuit revealed that the HER305 rectifier diode D106 in the -12V supply was short-circuit. A replacement restored normal operation. **G.M.** ■

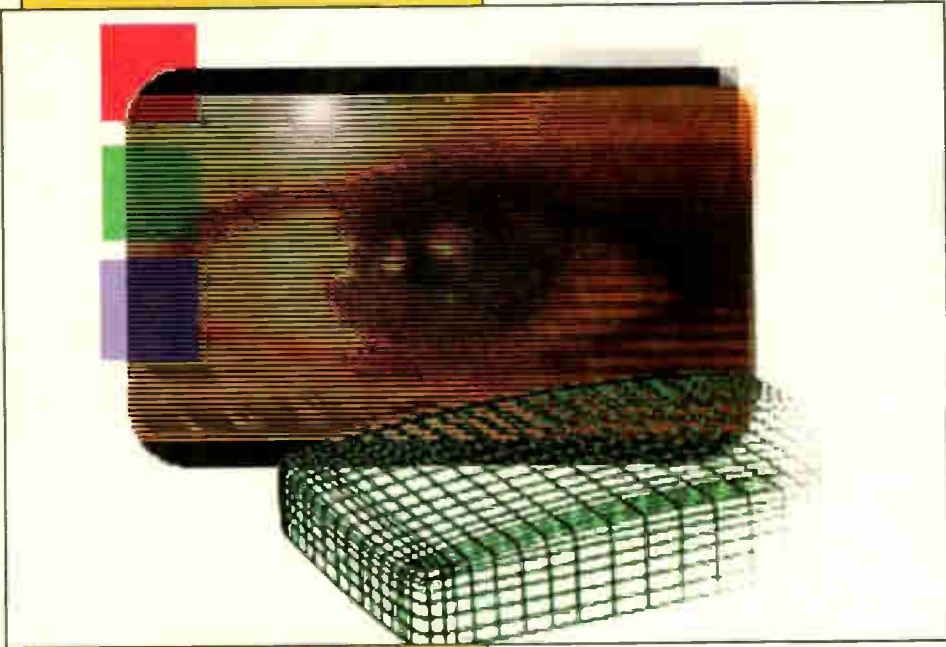

TV FAULT FINDING

Reports from
Michael Dranfield
Philip Salkeld
Denis Foley
Martyn S. Davis
Bob Flynn
Arthur Jackson
Glyn Dickinson
 and
K.V. Cunliffe

We welcome fault reports from readers – payment for each fault is made after publication. See page 300 for details of where and how to send reports.

Protech 5131NT (Vestel chassis)

The complaint with this set was sound but no picture. When I advanced the setting of the A1 control a picture appeared: all the colours were present, but it looked very poor with all the symptoms of a low-emission tube. The tube's cathode voltages were all on the high side however. I then remembered what the customer had said: "flashing colours before the set went off". So I replaced the TDA6107Q RGB output chip on the CRT's base panel. After doing that there was an excellent picture.

The low-emission CRT look about the picture was a red herring, so beware!
 M.D.

Bush 1473T (11AK08 chassis)

If the 0.47Ω safety resistor R809 in the power supply blows at switch on and the BUZ77 MOSFET chopper transistor is not short-circuit, the chopper transformer is faulty. A meter check may say that the transformer is OK however, so what I do is to flash-test between its primary and feedback windings at 2.5kV AC. This will show up any intermittent insulation breakdown. Replacement transformers can be obtained from SEME at £7.75 plus VAT. The part no. is PTX6074. M.D.

Tatung F series chassis

You quite often get one of these sets in with a power supply blow up. Tatung now provides a power supply service kit with eleven components. Unfortunately

the BF423 error-amplifier transistor Q803 is not included, and if you don't replace this transistor your new kit may self-destruct at switch on.

Poor soldering at T802, T401 and the degaussing resistor may have been the cause of the demise of the chopper transistor Q801 in the first place, so attend to this before you switch on. M.D.

Samsung CI5052

There was no reception and partial field collapse with this set. The basic problem was that water had been running down the aerial lead and had shorted the tuner's 12V supply (B+) to the tuning pin. After cleaning this up the fault was still present.

The voltage at the tuner's B+ supply pin was now 1.4V. The same reading was obtained at the output of the 12V regulator IC402, whose input was also low. I traced the cause to the 10Ω safety resistor R419, which was open-circuit. I say "traced" because this resistor is not shown in the service manual. A replacement brought the set back to life – fortunately no other damage had been done. M.D.

Bush 2867NTX (11AK12 chassis)

This set was apparently dead. A quick check at the collector of the line output transistor produced a reading of 150V, which suggested that the line drive was missing. Next step was a check on the LT rails. The 12V supply was low because rectifier diode D812 (BYV27) was leaky.
 P.S.

Sony KV32DS60U (GE1A chassis)

There was an EW fault with this set. I noticed that Q1510 (2SK2518) was cracked and R1604 (390Ω, 1W) had burnt out. In addition the 2A circuit protector PS1502 was open-circuit. The set worked correctly once these three items had been replaced. Part nos. are 872903409, 126032371 and 153359331 respectively.
 P.S.

Beko NR2541ND

When you have repaired one of these sets you will generally have to adjust the vertical picture shift. There are no controls, so you have to go into the service menu. The customer remote-control unit won't do: you need to order service remote control unit 14.1, part no. 7MZ187. SEME can supply it. P.S.

Thomson 32WT45U

The complaint with this set was flyback lines. I reduced the setting of the screen/A1 control on the line output transformer, which seemed to provide a cure

for a short time, then noticed that the picture had started to pulsate. The set was relatively new and both problems appeared to be associated with the line output transformer. A replacement, part no. 10675710, put matters right. **P.S.**

Bush 2866NTX

I thought I knew all the dead-set faults with this chassis. On this occasion however I found that R103 (47k Ω , 1W) in the power supply was open-circuit. All was well once a replacement had been fitted. **P.S.**

Philips 14PV330/07 (SAA chassis)

This TV/VCR combi set was dead. My usual procedure with dead combi sets is to carry out cold checks in the power supply and line output stages. In this case I found that D6391 (BYW98/200) in the power supply was short-circuit. **P.S.**

Bush WS6673 (11AK37 chassis)

The fault symptom with this fairly new set was excessive width. A general check in the line output stage revealed that C622 (12nF, 350V) was short-circuit. This set is nothing like the earlier 11AK19 chassis. **P.S.**

Sharp 66DS-03H (CA10 chassis)

If you get the dreaded faulty optocoupler fault, which causes excessive HT (similar problem to Model 56FW-53H) and blows a few parts in the power supply (Q702, Q703 etc.), then replace these parts and switch on only to find that that there is still excessive HT, you've damaged the optocoupler with your soldering iron.

Sharp Technical has issued a bulletin, CTV20010101, which gives advice on the temperature so that this problem can be avoided. **P.S.**

Philips 25PT4495/05 (L6.3AA chassis)

This set was tripping because of a short-circuit in the line output stage. Capacitor C2912 (2.2nF) was charred and evidently shorted. I fitted a replacement rated at 3kV. **D.F.**

Philips 25PT4495/05 (L6.3AA chassis)

There was intermittent failure of front-control and remote-control operation with this set – the microcontroller chip would intermittently seize up. If the mains supply was switched off then on again the fault would clear, usually for the rest of the day. The cause of the trouble was traced to the BC337/40 5V regulator transistor Tr7505.

If the customer is in the habit of leaving

the set on in standby for long periods this transistor seems to cook the board. I might have got away with simply resoldering it but decided to fit a replacement and leave the pin-out leads extra long. **D.F.**

Toshiba 50PJ98B (C9SS chassis)

The fault symptom with this very large projection set was sound but no picture. In view of the size of the set I was under great pressure to carry out repair at the customer's house. I've come across the symptom in the past when the rear AV panel has been poorly connected, usually because of heavy-handed insertion of scart leads etc.

When I removed the back panel, undid the four or so retaining screws and slid the chassis out as far as I could, I was rewarded with a picture that soon faded. As the receiver was connected to raw mains and I enjoy life, I wriggled leads and pressed plugs into sockets very gingerly, using only one hand with the other hand behind my back. As a safety warning to younger technicians, never ever poke about with two hands or place two hands anywhere near a live TV chassis.

An hour later, after removing and resoldering several boards, the penny dropped. None of the tube heaters were alight. The heater supply goes from the deflection panel via P903A to the central green CRT, where it's distributed to the red and blue CRTs. The connector on the base of the green tube had never been properly pushed home! The set was about eighteen months old and had been like this from new. **M.S.D.**

Thomson 28DT73H (TX92 chassis)

This five-year old set would run for a couple of minutes then revert to standby. I feared a complicated fault involving optocouplers and leaking bits and pieces, but decided to carry out a quick check for dry-joints. Pins 1 and 2 of the line output transformer were just sufficiently dry to be the cause of the fault. After resoldering these pins I gave the set a lengthy soak test and then declared it to be OK. **M.S.D.**

Bush WS6671 (11AK19 chassis)

After replacing the line output transistor and resoldering the usual poor joints in this area the set worked for about a day. The picture then vanished, leaving a blacked out screen with just the three RGB test lines moving up and down in the top half of the screen. A replacement TDA8351 field output chip restored the picture but, as I could find no apparent

reason for its failure, I resoldered all the connections in its supply and the peripheral circuitry. A long soak test proved that it was then OK. **B.F.**

Ferguson M3615UT (TX807 chassis)

There was no sign of life apart from the red LED at the front pulsing. This was not actually a fault: the set was in the child-lock mode. To get it out of this mode, switch the set on at the mains while holding the magenta text key on the remote-control unit till it comes on. **B.F.**

Sharp DV5107H (Deco 4 chassis)

This set was dead with the 2A mains fuse blown. A dead short could be measured across the chopper transistor Q702, but it was OK. The short was between pins 2, 4 and 6 of the chopper transformer T700. A new fuse and transformer produced power for all of three seconds, then the fuse failed again. Once more there was a short across Q702. This time it was faulty, presumably having been weakened by the original problem. In addition to fitting a new MJF18006 transistor I replaced the TEA1039 chopper control chip IC700, just in case. **B.F.**

Panasonic TX25X1 (Alpha 4 chassis)

The outputs from the power supply would briefly rise then die, with an even briefer glimpse of field collapse. The cause of the problem was the VDP3108-A-29 video/deflection processor chip, which is no longer available. A replacement kit is supplied with the new chip and is not too difficult to fit. **B.F.**

Amstrad CTV3128N

There was no power and nothing was blown. The cause of the problem was traced to R103 (47k Ω). Replacement of this resistor was all that was required. **B.F.**

Amstrad CTV1410 (Onwa chassis)

If this set was left in standby it would sometimes switch itself back on again! The fault could be produced by flexing the main board. While looking for cracks I noticed that R920 and R302 were shorting together physically, thus bypassing the relay. Parting these resistors cured the fault. **B.F.**

Bush 2872NTX (11AK19 chassis)

The customer said that the picture would intermittently increase in size with bowed sides. With a fault like this I always look for a possible cause before leaving the set

on test – in case it develops into something worse. While examining the print with a magnifying glass I came across a barely visible dry-joint at L602 in the line scan circuit. A long soak test after resoldering L602 proved that all was now well. **B.F.**

Hitachi CPT2178 (G6P chassis)

The cause of very intermittent loss of line and field sync was finally traced to poor connections at IC2110, the 5V regulator on the teletext board. **B.F.**

Nokia 3724UKFX (Mono Plus chassis)

This set produced a normal picture when cold, but after a short time it became very dull with poor video content. Scope checks showed that there was a good video signal at pin 7 of the TDA8362 IF/colour decoder/timebase generator chip DD01, but the signal was crushed when it re-entered at pin 13. The signal path between these two pins is via the teletext panel, and the cause of the problem was proved to be on this panel by shorting across component position JL03. In non-text versions this is a link, but in text sets the link is omitted.

The cause of the fault was the surface-mounted transistor VR14 (BC848B), which was very leaky all ways round. **A.J.**

Sanyo 32WN5B (EB6A chassis)

This set would come out of standby briefly but would then shut down again, with the LED flashing red and amber. The HT was normal at 145V during the brief on time, and no shorts could be detected across any of the supply rails.

Pin 19 of IC801 is a protection input that monitors several supply lines and should normally be in the high state. In this case it was low, because the +9V supply from IC642 was low. In turn this chip's 15V input from the chopper power supply was low at 7V. The cause of the problem was simply a dry-joint at the smoothing capacitor C640. **A.J.**

Samsung CI3352XT (P68SC chassis)

We still have some of these sets out on rental. They often come in now with the line output transistor Q402 (2SD1651) short-circuit. It's advisable to connect a dummy load across the 125V HT rail and increase the mains input voltage slowly, using a variac, as the HT voltage can quickly rise to over 160V. This is almost always because C852 (470µF, 16V) on the primary side of the chopper circuit has a very high ESR.

In some cases the tube has been damaged, so this component should be checked when any repair or servicing is done. **A.J.**

Toshiba 32Z13P

This 32in. (100Hz) widescreen set had a

very unusual picture fault symptom. Approximately 2in. in from each side of the screen the picture was over-bright: the next 5in. in at each side was about normal; and the centre section was quite dark with flyback lines. As happens all too often, the fault cleared when the back cover was removed. It could be instigated easily with movement anywhere on the CRT base panel however.

The CRT's cathode waveforms remained normal when the fault was present, but I found that a large ripple waveform was present at the G2/A1 supply pin. The cause was simply a very poor joint at the decoupling capacitor C902. **A.J.**

Ferguson T59N (TX92 chassis)

These sets often give the impression that the tuner is intermittent. While the tuner does tend to suffer from internal dry-joints, the most common cause of the symptom is the surface-mounted transistors in the IF circuit. Blanket reworking, plus ensuring that the earthing screen is well soldered, usually provides a cure. **G.D.**

Sharp 51DT-25H (CA1 chassis)

This set was stuck in standby with a loud motorboating noise from the speaker. Checks showed that the outputs on the secondary side of the chopper circuit were all present, but the 10V supply was a little low with a large, noisy waveform superimposed on it. The reservoir capacitor C712 (220µF, 16V) was virtually open-circuit. **G.D.**

Bush 2020

A wooden set!! The complaint was very poor sound so, ignoring the advice (it must be the valve) I replaced the TDA2006 audio output chip IC601. Great idea, but the cause of the fault was that the 100kΩ feedback resistor R608 was open-circuit. **G.D.**

Ferguson T68N (TX92 chassis)

A flashing LED with no results is common with these sets. The line output transformer (there are two types) is usually at fault, but replacement often leaves the same symptom. If RL08 (10kΩ, surface-mounted) has burnt out, the safety circuit has been damaged. Check DL08, DL80 and DL81 (all type LL4148), TL80 (BC548) and DL83 (24V). Sometimes the microcontroller chip and/or EEPROM is damaged as well. **G.D.**

Samsung CI593CN3X (S51A chassis)

There was no sound or picture, though a very snowy picture and sound could be obtained from the scart socket. I suspected the tuning, but was wrong as the voltages were correct. The cause of the problem was the 24W16 EEPROM IC902.

The replacement supplied by Samsung is a 24C16, which contains VHF and UHF tuning but on system 'CK' (PAL/Secam B/G). You have to enter the service mode, select the option byte table, change to system 'CI' (UK version), select menu and enter the reset mode. If you fail to do this you will end up with a picture but no sound.

The service mode is entered by using the remote-control unit. With the set on, the sequence is as follows. Press standby, display, menu, mute and power on. To leave the service mode, switch the set to standby. **K.V.C.**

Mitsubishi CT14MV1 (Philips chassis)

This set was dead though the power supply was OK. When the standby button was pressed the set started up then immediately shut down. The protection circuit was obviously being activated. To disable the protection, simply pull plug 1923 on the TV/LTB board. This enables the set to run.

When I did this the symptom looked like field timebase failure, except that there was a two-inch band of scanning across the centre of the screen. Voltage checks around the field output chip IC7510 produced normal readings except at pin 8, which was at 1.5V instead of 11V. Suspecting the IC, I fitted a replacement. This made no difference, so it was time to look a bit deeper. After checking a number of voltages on the TV board I found that the 32V line was at only 11V. This was obviously upsetting the field ramp generator, which is in IC7200 (TDA8361).

The cause of the trouble turned out to be the TL431CLP regulator IC7331. Once this had been replaced the 32V supply was correct and so was the field scanning. One to watch out for with other Philips-derived sets. **K.V.C.**

Hitachi C2842N (11AK19PP chassis)

This set took me by surprise – I had no idea that Hitachi has been using Vestel chassis in its large-screen models. The set was dead with D823, which is not shown in the circuit diagram, blown in two. It's in series with D822 and is either a UF5407 or a 1N5407. When I fitted a replacement the set remained dead, but no short-circuits could be found and the chopper FET Q802 was OK. So it seemed that the MC44604P chopper-control chip IC802 had failed. All was well once a replacement had been fitted, but to be sure the set was subjected to a long soak test.

I recently had the same fault with a **Bush 28in. widescreen set, Model WS6673**, but this time the FET had failed as well as D823. It seems that the 11AK19 chassis is turning up in all makes. **K.V.C.**

FRUSTRATED!

Looking for ICs TRANSISTORS?

A phone call to us could get a result. We offer an extensive range and with a World-wide database at our fingertips, we are able to source even more. We specialise in devices with the following prefix (to name but a few).

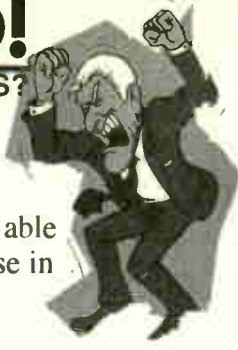

2N 2SA 2SB 2SC 2SD 2P 2SJ 2SK 3N 3SK 4N 6N 17 40 AD
 ADC AN AM AY BA BC BD BDT BDV BDW BDX BF
 BFR BFS BFT BFW BFX BFY BLY BLX BS BR BRX BRY BS
 BSS BSV BSW BSX BT BTA BTB BRW BU BUK BUT BUV
 BUW BUX BUY BUZ CA CD DX CXA DAC DG DM DS
 DTA DTC GL GM HA HCF HD HEF ICL ICM IRF J KA
 KIA L LA LB LC LD LF LM M M5M MA MAB MAX MB
 MC MDA J MJE MJF MM MN MPS MPSA MPSH MPSU
 MRF NJM NE OM OP PA PAL PIC PN RC S SAA SAB
 SAD SAJ SAS SDA SG SI SL SN SO STA STK STR STRD
 STRM STRS SV1 T TA TAA TAG TBA TC TCA TDA TDB
 TEA TIC TIP TIPL TEA TL TLC TMP TMS TPU U UA
 UAA UC UDN ULN UM UPA UPC UPD VN X XR Z ZN
 ZTX + many others

We can also offer equivalents (at customers' risk).
**A LARGE RANGE OF ELECTRONIC COMPONENTS ON
 OUR CD ROM - LIST AVAILABLE ON REQUEST**
 Mail, phone, Fax, Credit Card orders & callers welcome.



Cricklewood Electronics Ltd

40-42 Cricklewood Broadway, London NW2 3ET
 Tel: 020 8452 0161 Fax: 020 8208 1441
 www.cricklewoodelectronics.co.uk
 E-mail: sales@cricklewoodelectronics.com

NEW Available Now..

The **NEW**
SALI 10
CD Catalogue



Over 800,000 products.
 Brown Goods...
 White Goods...
 Spares & Accessories.
 Finished Products.
 CCTV.
 Over 8,000 colour pictures.
 Exploded View Diagrams.

Order Code **SALICD**

Benefits from...
 Stock & Price Check prior to order submission. **SALI**
 Account information page
 Giving you access to your Account Status, Parcel Dispatch
 Information & Outstanding Back Orders.
SALI *Save* Special Discounts
 Use the check order facility. If you select products having
 current **SALI** *Save* Special discounts applied a message will
 appear on your screen providing details of the discounts
 available.



Adds. Users of **SALI** will automatically receive **SALI**

If you would like **SALI** including the
Seme General Spares Catalogue
 please contact sales and add CAT2002 to your next order.

FREE CARRIAGE* on all **SALI** orders of £12.00 or more as well
 as **NEW SALI Pricing**

*Applicable to Electronic orders only, excluding fax, from credit account
 customers.

*Carriage rates exclude Seme Trade Supplies.



Tel: 01664 484000
 Fax: 01664 563976
 email: sales@seme.co.uk

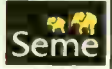

Widescreen TVs



DVD Hi-fi's

Electronicworld

TV AND VIDEO LTD

The very Latest Style in Home Entertainment
HITACHI JVC SONY SANYO TOSHIBA

**TOP QUALITY STOCK
 ALL GRADED**

- Sony 32DX40 Widescreen £400
- Toshiba 32" 100Hz Picture Frame £400
- JVC AV32/R25 Widescreen £375
- Philips 32" Pixel Plus £400
- Sony 28DX40 Widescreen £300

**THIS IS JUST A SMALL
 SELECTION OF
 OUR HUGE STOCK**

All prices are Exclusive of VAT
BIRMINGHAM
 208 Bromford Lane, Erdington, Birmingham
 B24 8DL
 Tel: 0121 327 3273 Fax: 0121 322 2011
LONDON
 221 Kenton Road, Middlesex HA3 0HD
 Tel: 020 8907 9387
PRESTON
 Unit 434 Ranglet Road, Walton Summit,
 Preston PR5 8AR
 Tel: 01772 316066

Camcorders
 Working from £40 (Viewcam From £80)
 Non-Working from £20 (Viewcam From £40)
 All without accessories



**Mixed 'B' Grade Stock -
 Export Enquiries Welcome!**



WEB SERVICE

To reserve your web site space telephone
Tel: 020 8722 6028 Fax: 020 8722 6096
E-MAILS r.gurunlian@highburybiz.com



Alltrade Aerials & Satellite Ltd

<http://www.alltrade.co.uk>

Phone 01273 413798 Fax 01273 425700
Full e-commerce site with over 1500 products with in-stock quantities!! We supply everything associated with Digital/Analogue Terrestrial & DTH/Motorised Satellite reception. All Antennas. All Brackets. All Cables. All Connectors. All Amplifiers. We provide a free MATV/SMATV planning service as well.

Cricklewood Electronics

<http://www.cricklewoodelectronics.co.uk>

Cricklewood Electronics stock one of the widest ranges of components, especially semiconductors including ICs, transistors, capacitors, resistors. all at competitive prices.

Charles Hyde & Son Ltd

<http://www.charleshhyde.co.uk>

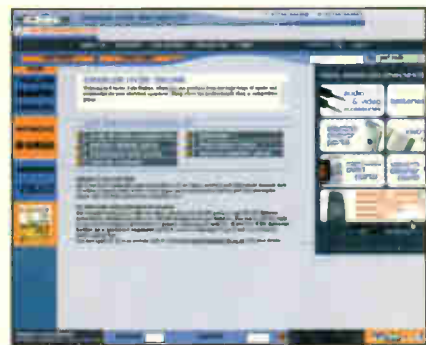

Search for both original and copy spare parts in our extensive database covering Akai, Alba, Bush, Ferguson, Goldstar, Hitachi, LG, Matsui, Nokia, Saisho, Sanyo, Sony, Sharp, Thomson, Panasonic, Philips, Samsung, Tascam, Teac, Toshiba, Yamaha and many more. In addition huge ranges of Lasers, Lopts, Remote controls and Semiconductors may be accessed.

Dönberg Electronics

<http://www.donberg.ie>

<http://www.donberg-electronics.com>

<http://www.electronic-spare-parts.com>

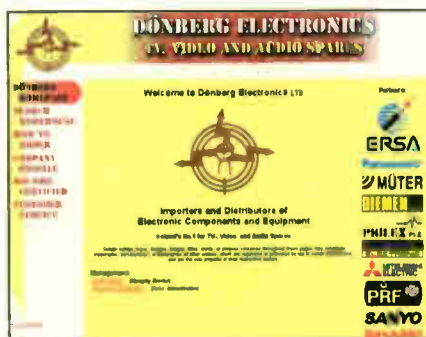

As the leading distributor for the TV, Video and Audio trade in Ireland, we supply over 2000 shops & service dept with Audio-Video and TV spares, Semiconductors, Test Equipment, Service Manuals, Remote Controls etc. At present we stock over 35,000 different lines. We hold agencies for: Panasonic, Sharp, Mitsubishi, Sanyo, Beko, Ersa, Müter, Diemen HR, Philex, PRF, König-electronics. We specialise in parts for all continental sets and obsolete semiconductors.

EURAS International Ltd

<http://www.euras.co.uk/>

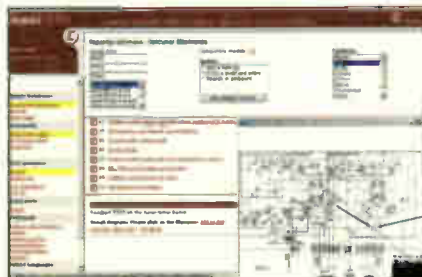

This website offers more than 900.000 tested repair tips for entertainment and communication electronics as well as security technology. Thousands of new repair information each months. Discussion Forum, Tech-Chat and a valuable Pinboard System. Visit the site and apply for a free 30 day trial (no deposit required).

JJ Components

<http://www.jjcomponents.co.uk>

<http://www.jjcomponents.com>

As distributors for the last 13 years for major brands of tv's and video's we supply semiconductors, aerial accessories, audio spares, cd laser pick ups, fuses, leads, posisters, remotes, resistors, soldering accessories, lopts, tv switches, etc. You can place your order via the web, which is still under development and more pages will be added this year. Distributors for classic remotes, lopts, cd laser pick ups and tv-video parts. See our advert on new ventures with the web sites, for short term office space.

J W Hardy Communications

<http://www.jwhardy.co.uk>



R.F. Network Specialist. Shop online - for R.F.network components. We supply a full range of TV, radio reception equipment to receive analogue/digital signals from both terrestrial and satellite sources. We provide a free planning service for your R.F. networks, MATV and SMATV etc

Holderness Solutions Ltd

<http://www.digisatsolutions.com>

Suppliers of over 3000 lines of equipment to the aerial and satellite trade. All major brands stocked from coax plug to 1.8mtr + dishes.

M.C.E.S.

<http://www.mces.coo.uk>

The MCES site gives details of our range of service including Tuners, Video Heads, RF & IF Modules plus latest prices offers.



MMWafercards

<http://www.mmwafercards.com>

Smartcards and programmers for all access-controlled applications. Incorporating www.satstore.co.uk The Enthusiasts Satellite Store. Tel 01386 48731 Fax 01386 765875

Switch-it-on

<http://www.switch-it-on.co.uk>

We sell multi-region dvd players to trade



and public, also tv, videos, hifi and playstation 2. We design our own upgrades on dvd and we sell all spare parts. All makes and most models stocked.

Swires Research

<http://www.swires.com>



Swires Research produce high quality instruments for the television industry, including portable signal level meters and spectrum analysers for digital and analogue RF signal measurements.

Televés

<http://www.televés.com>

Televés website was launched as an easier way to keep in contact with our



World-wide Network of Subsidiaries and Clients. This site is constantly updated with useful information/news plus you can download info on our range: TV Aerials & accessories, Domestic and Distribution amplifiers, Systems Equipment for DTT and Analogue TV, Meters and much more.

To reserve your web site space
 phone Reuben Gurnlian
 Tel: 020 8722 6028
 Fax: 020 8722 6096

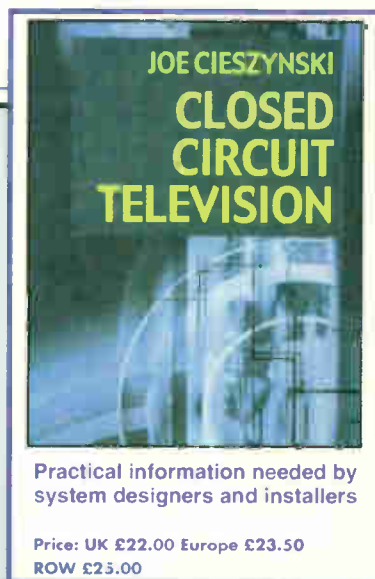

Practical information needed by system designers and installers

Price: UK £22.00 Europe £23.50 ROW £25.00

How to order (Closed circuit television)

I enclose a cheque/bank draft for £ _____ (payable to Television)

Please charge my credit/charge card

Mastercard American Express Visa Diners Club

Credit Card No: _____ Expiry Date: _____

Signature of Cardholder _____

Cardholder's statement address: (please use capitals)

Name _____

Address _____

Post Code _____ Tel: _____

Closed circuit television

Closed Circuit Television (CCTV) surveillance is one of the fastest growing areas in the security industry. This book is an essential guide for all security professionals and CCTV installers. However, unlike most existing books on CCTV, this is not just a discussion of security issues, but a thorough guide to the technical side – installation, maintenance, video recording, cameras and monitors, etc.

This book provides the underpinning knowledge required for the level 3 NVQs from SITO / City & Guilds. The concise, accessible text makes it an ideal coursebook, and this accessibility also makes it ideal for hard-pressed practitioners.

Contents: The CCTV industry; Video signal transmission; Light and lenses; Television fundamentals; The camera; Monitors; Video recording; Switchers; Telemetry; Motion detection; Commissioning and maintenance.

Post your order to:- Jackie Lowe, Highbury Business Communications, Anne Boleyn House, 9-13 Ewell Road, Cheam, Surrey SM3 8BZ

AUDIO FAULTS

Reports from
Geoff Darby
C. Bowers
Eugene Trundle
and
Dave Gough

We welcome fault reports from readers – payment for each fault is made after publication. See page 300 for details of where and how to send reports.

Sony MZ-N707

This personal MD recorder didn't produce any audio output, though it appeared to play discs all right. When I removed the bottom cover and pressed the PCB in the vicinity of headphone amplifier chip IC302, audio from one or both channels could be made to return. It depended on the angle at which I pressed.

I've had this problem before with other MZ-XXXX models. When I examined the PCB at IC302's location I could see that the IC's pins were covered with what can only be described as Araldite. I've found this substance there before: it's definitely not flux, as it is quite tough.

In order to sort the problem out you need two free hands and a powerful magnifier. I use an excellent headband type that's available from Farnell Components, order no. 724-5830. It comes in three different magnification powers – 724-5830 is the strongest. The first step is to get the epoxy-type material off the pins (you can't solder through it). I find that this is best done with a small scalpel. The one I use is a retractable type from X-Acto. It's like a click-click ballpoint pen and is available from good craft shops. Once the epoxy has been removed, I clean down with a toothbrush and alcohol.

When I inspected the pins closely several of them looked as if they had never taken solder in the flow process. It's exactly the same situation I've found on previous occasions. Once everything is clean and dry it's not too difficult to add some solder to the IC pins. But, be warned, you'll need a very fine iron. I use an Antex iron with a needle tip. In addition you need very fine-gauge solder and a very good eye (even with the benefit of the magnifier). For success, an extremely steady hand is also required. If you don't feel confident to carry out this type of work, it's probably best to leave it to someone who is. It is very easy to get into a mess and make things worse than they were before. Remember that this is a £200 unit.

Once the resoldering had been carried out and the board had been thoroughly defluxed and cleaned the audio was back, and solid! G.D.

Sony STR-DE475

The customer's odd complaint about this AV amplifier was "plays very silently only"! We do get 'em in this trade, don't we? What he actually meant was no audio. I quickly established that this was not caused by trouble in the output stages. When the amplifier is set to the 5.1 mode there's little apart from IC201, an 80-pin flatpack IC, between the rear-panel input

sockets and the input circuitry of the power amplifiers. IC201 is referred to as the analogue sound processor on the circuit diagram. After establishing that the muting transistors Q361-6 were not in operation I ordered a replacement IC. Once it had been fitted all functions operated normally and good sound was present from all channels. G.D.

Pioneer XR-P470C with S-P470V speakers

There were two complaints about this equipment, one to do with playing CDs and the other about a crackling sound from the speakers. The CD problem was a minor one and was quickly resolved. Attention was then turned to the complaint about crackling.

Up to this point the unit had been run with the workshop test speakers and had shown no signs of audio trouble. Unusually, the customer had had the foresight to bring the speakers along, so these were next connected. The sound from both was fine at a 'normal' listening level, but when the volume setting was increased a little above this the output from one of the speakers suddenly started to sound very distorted, and the speaker protection relay in the hi-fi unit began to pulse with the bass. The offending speaker sounded fine once the volume setting was reduced.

I popped the decorative front off the speaker cabinet and felt the cone movement. It was smooth, with no feeling of drag at all. In desperation I checked the resistance of the coil, but this was exactly the same as that of the good speaker. I started the system playing again with the front off and turned the volume up until the problem appeared. At this point the cone was moving probably $\pm 5\text{mm}$ on bass notes. I don't know why, but I decided to advance the volume setting further. The strange result was that the symptom improved then went away completely! After that the speaker worked correctly at all volume settings.

Now I've never known a speaker to get better spontaneously, and I was burning with curiosity as to what could have been causing this odd behaviour. So I removed the bass driver from the enclosure and, after a brief inspection, the cause of the problem became apparent.

The voice-coil wires are brought out on to the rear of the cone and then soldered and glued to super-flexible 'tails'. These isolate the moving cone from the stationary connection tags. The tails are made from many strands of very fine wire, woven together a bit like Litz wire. On this partic-



ular speaker the tails were very long, probably 5-6cm, and at high volume settings cone movement was very large. As a result metal fatigue had, over the years, occurred and a few strands had broken free. As these strands were so long, they could easily reach across the gap to the other tail.

So at high volume the vibration caused them to touch and bounce on the other tail, producing the initial distortion and crackle, followed by momentary opening of the protection relay. By turning the volume up high I had 'blasted' them far enough away to relieve the problem, but I'm sure that this would have been only a temporary 'cure'. Giving the offending strands a quick 'haircut' ensured a permanent cure. G.D.

Sony SA-WMS7

There was no sound from this unit though the power light was green. When I took the back off and checked inside I found that the 800mA fuse F1 had blown. There didn't seem to be any reason for this so, before fitting a replacement, I checked with Sony in case there had been an upgrade. I was told that to avoid a recurrence the fuse should be upgraded to 1AT (part no. 1-532-078-00). C.B.

Toshiba SJ3429

There was no power to the amplifier and tuner, though the tape deck appeared to be OK. So I took the top cover off and inspected the protection resistors. Meter checks showed that R905 and R913 had both gone high in value: instead of being in the low-ohms range they were in the high kilohms range. Replacements restored normal operation. C.B.

Sony HCD-M70

There was sound skipping when CDs were played. Voltage checks at the optical pick-up and spindle motor showed that everything appeared to be within specification, so I consulted Sony Technical to see if any light could be shed on the problem. I was told that in a limited number of KSM mechanisms gear A is of incorrect diameter. This can cause various problems, e.g. sound skipping, no reading of discs or no switching to the next track. The units affected have numbers between 12522P and 28122P. The solution is simple: to ensure correct operation of the CD section,

replaced gear A with the improved type, part no. 2-625-188-02. C.B.

Schneider 2290 Midi

The problems with this somewhat ancient but solidly-built outfit were that it wouldn't play CDs and that the disc drawer sometimes failed to retract fully. I was alarmed to find that the lens of the optical unit was actually hitting the disc! The cause of the trouble was that the little turntable had moved down the shaft of the spindle motor. Once the correct height had been carefully established, the turntable was refixed with cyanoacrylate glue. This and a new tray-drive belt completed the repair. E.T.

Sony TA818M

Intermittent sound dropout was the complaint with this unit. The cause was the protection relay RY801, which had dry-soldered joints and tarnished internal contacts. I guess it could have been cleaned and resoldered, but a new one seemed to be the better solution. E.T.

Aiwa RX-N5K

This middle-aged tuner-amplifier worked all right apart from lack of its fluorescent display. Replacement of the electrolytic capacitors C107 (100µF, 25V) and C108 (47µF, 50V) brought the display back to life. E.T.

Sony HCD-A190

The complaint with this unit, one of Sony's vast range of audio centres, was "no sound output". In fact the sound from both channels came up after a period of operation that varied from five seconds to forty minutes or more. The culprit was the big TA8221AH audio power amplifier chip IC1201, whose internal mute section had failed in some way. E.T.

Sony HCD-RXD3

The problem with this unit was confined to the CD player section, whose sound would trip out every few seconds. I noticed that the sled 'jumped' at each break in the sound, and thought that I had cured the fault with a clean, polish and lubrication of the slide shaft. But the fault returned. It took a new laser unit to cure this fault completely. E.T.

Marantz CP230

These professional portable cassette

decks were much favoured by outside broadcast/recording people. They are still held in high esteem and, because of their build quality, provide good quality results and excellent service. But this one produced a very nasty screeching sound when it was operated. After stripping the deck down I removed the main motor and powered it via the bench power supply. This confirmed my suspicions: there was a loud squeal. Some careful lubrication, followed by an overnight soak test, proved that the motor and the unit were now in full working order. D.G.

Sony TC158SD

This nice little professional portable cassette deck worked all right with a DC/battery supply but not with an AC supply. Cold checks inside revealed the culprit, Q512 (2SC1173), which was open-circuit. As I didn't have this type in stock I pressed a 2SD1138 into service. It worked fine. D.G.

Musical Fidelity B1 integrated amplifier

I must confess that I like servicing good-quality hi-fi gear. This amplifier was no exception to the rule: good build and sound. It was in a bad way however. No audio output, only the dreaded hum! In fact after ten seconds or so you could fry an egg with the heat from the right-channel transistors. So the repair was as follows.

Replace all eight 2N3055 (same as BU208) output transistors. Use plenty of heatsink compound and take time and care over fitting. Double check your work – it always pays with unforgiving amplifiers to get it right first time. Next check all the 0-47Ω, 2W wirewound bias resistors. If in doubt, replace them all. A slight resistance change in these items can cause problems with this amplifier.

Finally, centre the four 100kΩ bias control potentiometers and power up. If all's well, set the bias for an optimum 15mV. Leave the amplifier to run quietly for a few hours, then recheck this. D.G.

Sony RX77S

The complaint with this hi-fi stack was no display/functions. Checks on the PCB mounted close to the power transformer showed that R13/14, which are both 2.2Ω, were open-circuit. Replacements restored full operation. D.G. ■

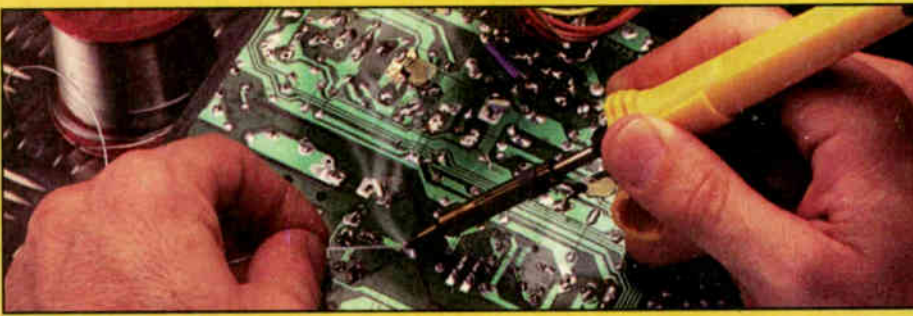

Bench Notes

Adrian Gardiner

**starts a new series on
PC servicing**

PC Servicing - 1

This month I'm starting a series of articles on PCs. They will cover both hardware and software, the aim being to demystify that machine in the corner to which we are so often a slave. I hope to provide something for everyone, regardless of your current ability.

PCs are everywhere - most homes now have one. Despite their versatility, remember that they consist of electronic circuitry that does nothing more than carry out calculations. They are our tool and work for us, not the other way round! You shouldn't be frightened of them or the consequences of your actions. If you want to know "what happens if I do this", try it and see. Trial and error is an excellent way of learning about computers. And once you have a bit of experience of them, PCs can be a useful source of extra income.

I shall have to make a few assumptions, as follows: that you are familiar with the basics of operating a PC, including the usual applications, and that you can use a mouse and understand basic terminology. As it is still the most common PC operating system in use, the series will be based on Windows 98 - though much of the information provided is applicable to other systems.

Backing up

One of the most important computer tasks is to keep regular back-ups. Although people rely on their PCs for many different things, few safeguard their work. There are several different forms of back-up device, one of the cheapest being a CD writer. These are usually supplied with a program, which is straightforward to use, to 'burn' (record on) CDs. You need to back up your documents, folders, accounts information and other such data. If you use email for your contacts, particularly the Windows address book, this should also be backed up regularly. You can do this by choosing 'export' from the file menu of the address book, then selecting a name and a location where it is to be saved. Other similar programs, such as diaries, can be backed up in the same way.

A more comprehensive back-up can be

carried out with specialist software that manages the task for you. Microsoft includes a program within Windows to do this. Access to it is either via the start menu, or by 'right clicking' over the hard drive that you want to back up then selecting the option from the menu presented. The initial back-up you carry out will protect your entire PC and, in the process, produce a large file: it could also take some time to do. Subsequent back-ups, done on a regular basis (weekly for most small businesses), will save only the files that have been altered since the original back-up. This is much quicker and takes up little room. Then, should a disaster occur, you will be able to recover your entire PC system with little effort.

With advances in the technology there have never before been so many choices between inexpensive data storage systems, so there is no excuse for not carrying out the exercise. I have recently bought one of the new solid-state USB storage devices for my own back-ups, and find it very useful and easy to use.

PC hardware

Every PC contains the same essential items: a CPU (Central Processing Unit) or processor; RAM (random-access memory); ROM (read-only memory) or more often EPROM (electrically programmable ROM); and an IO (input/output) controller. In addition a backing store, usually a hard disk, is required to store the programs and data. Even the relatively simple microcontroller ICs used in many modern appliances, including TV sets, require the basic CPU, RAM, ROM and IO controller.

In a PC the IO controller is connected to several buses that move data to and from the various parts of the PC. There are usually a PCI and ISA bus, which allows a variety of expansion cards (PCBs) to be added; an AGP bus to connect a graphics card to drive the monitor; and an IDE bus to interface with the system's disk drives (floppy, hard, and/or Zip and CD). Common extras are a modem and a sound card - these are usually plugged into the PCI bus. Cheaper systems often have the graphics, modem and sound card hardware integrated on

the motherboard. They are accessed in the same way however.

Memory

PC users often misunderstand and are confused about the amount of memory and hard-disk space they have in their PCs. RAM is used by the operating system for temporary storage while a program's instructions are being carried out. The hard disk is used to retain your programs and data. As Windows requires a lot of memory however it uses a section of the hard disk as a 'virtual' memory. The exact amount it uses varies, but increases when the PC has only a small amount of RAM fitted. As hard drives are slower than memory chips, machines with more RAM perform better and faster. Windows 98 PCs work best with 256MB of RAM, while PCs with XP installed happily gobble up 512MB. Incidentally Windows 98 has a memory limitation of 256MB, so there's no point in fitting any more as it will not be used by the system.

PC software

The software arrangement in a PC should be considered in terms of layers. A typical structure is: (1) BIOS; (2) operating system; (3) program; (4) data. The BIOS (Basic Input Output System) is the first program the processor acts on when it receives a hard reset instruction, for example when the PC is first switched on. Stored in the EPROM, the BIOS sets up the PC's hardware arrangements and gives instructions for loading the operating system, e.g. Windows 98. Settings specific to a particular PC are loaded at this stage, from a small battery backed-up CMOS memory chip. The operating system, which gives the PC the look and feel you are used to, is then loaded, followed by whatever program you are using, e.g. Microsoft Word. The final layer is your actual use of the machine, i.e. data.

To follow

Over the next few issues I hope to unravel the mysteries of these various layers. Once you understand what they do and how they do it, you are in a good position to be able to solve errors and problems. So, next month, an in-depth look at the BIOS. ■

TELEVISION

AND HOME ELECTRONICS REPAIR

Television & Home Electronics Repair magazine is the only magazine for technicians who deal with consumer electronic products, in particular TV, Video, Satellite and Audio equipment.



- Keep up to date with the latest information and changes affecting this industry
- Tips & guides on repairing television and electronic equipment including satellite receivers, PCs, monitors, VCRs, DVD players, audio equipment and much, much more.....
- Essential reference and in-depth features covered monthly
- Launched in 1935 - is the longest established consumer electronics magazine
- Highly respected journal with a high grade of editorial news

Make sure you receive your regular monthly copy by subscribing today.....

Complete and fax the coupon to: +44 (0) 1353 654400

HIGHBURY
Business Communications
A DIVISION OF Highbury Media Communications PLC

I wish to subscribe for one year to Television:

Price UK £33.80 Europe £48.00
 Rest of World £63.50 US\$99.00
 Euro 100.96

I wish to subscribe for two years to Television:

Price UK £53.00 Europe £77.00
 Rest of World £99.00 US\$154.00
 Euro 157.41

Please tick preferred method of payment

I enclose a cheque payable to Highbury
Business Communications Ltd

Please invoice me Purchase No _____
(NB Purchase order must be included to validate invoice)

Please charge my: Master Card/Visa/Amex/Diners
Club/Switch/Delta (please circle)

Card No _____

Expiry Date _____

(Switch/Delta Only) Valid form / Issue Number

Signature _____

Date _____

Name _____

Job Title _____

Company _____

Address _____

Postcode/Zip _____

Country _____

Telephone / Fax _____

E-mail _____

Please tick here if you do not wish to be contacted by
other businesses either by

mail telephone fax email

Please return to: Highbury Subscription Services,
Link House, 8 Bartholomew's Walk, Ely,
Cambridgeshire CB7 4ZD, UK.

Email: wss@wyverncrest.co.uk

(Quote ref: TV1)

WHAT A LIFE!



A field call in the countryside involved some navigational difficulties. Problems with a jammed VCR and some more widescreen TV sets. Donald Bullock's servicing commentary

It was a lovely day, balmy and still. The sun smiled down from its blue sky, the chaffinches were singing of their love of life, the grasshoppers chirped and passers-by beamed contentedly as they went about their business.

"Lovely day" observed Steven. "Why don't you and mum go for a nice drive in the countryside? She'd love that. You could meander along the riverbank towards Meadowgold. Perhaps have a nice meal at the Kingfisher Arms. They do a lovely mixed grill on Wednesdays.

I eyed him carefully.

"Two points" I said, "I don't know the road to Meadowgold, and today isn't Wednesday, it's Thursday!"

"Oh, ah" he replied, "but it's even better on Thursdays. They do steak and chips. Really nice. And mum knows the way – she went there with me last week."

"So why did you go there last week?" I asked.

"I'd a call to Paradise Cottage, by the weir" Steven replied, "to look at old Mrs Goodhew's Sharp telly. Had to come back to order some spares. I see they've just arrived in the post."

"And now you want me to go there and fix her set!" I said, my razor-sharp mind catching on instantly.

"Got it in one" he commented, "but there's the nice drive, the meal – and I've put the spares and toolkit in your car for you . . ."

"You're so kind" I remarked.

An hour later, when Greeneyes had put her face on and poured herself into her lime-green trouser suit, we sped off into the countryside.

The journey

Before long the houses thinned out and became the occasional country cottage. I was soon singing of shady nooks and babbling brooks and winding lanes. Just like a youthful Bing Crosby (I thought). Between lines I whistled the music too. A pretty good parody of Bix Beiderbecke's accompanying horn (I reckoned).

Then we saw a whitewashed, creeper-clad cottage ahead, and the road forked to each side of it.

"Left or right dear? Boo de boo boo" I sang at Greeneyes. "Which way do I go, boo lah de dum boo?"

"Straight on" she replied.

I looked at her, saw that the cottage was fast approaching, and looked in the rear mirror. There were two cars close behind. I forgot about Bing and Bix. "Which road do I take?" I bawled urgently.

"I told you, straight on" she replied, "why do I have to say everything twice?"

The cottage was in front of us, and I hurriedly braked. The car behind stopped in time, but the one behind it didn't. There was a nasty crunching noise.

The chap in the back car sprang out and started shouting at the driver behind us, who waved his arms at us and started to bang his forehead with his palm.

"Go left" said Greeneyes.

I smacked the car into gear and shot off, expertly negotiating a series of bends.

"Turn right" Greeneyes said.

I did, into a leafy lane with a duck pond and a village pump nestling beside an ancient church.

Meanwhile two cars sped past the

lane, and we heard some angry shouting . . .

The repair

When we arrived at Paradise Cottage I found that Mrs Goodhew's set was a giant Sharp Model 56FW-53H, with 56cm screen.

"I'll make a pot of tea and fetch some slices of my apple cake" the good lady said as she bustled off towards the kitchen.

The set was dead, as Steven had mentioned, with its BUH515 line output transistor short-circuit. The soldering in the line output stage wasn't all that good – one of the joints to R613 in the line scan circuit had been arcing. R623 (1Ω, 2W) in the HT feed had also suffered. I replaced them both, then moved to the power supply where the BZW04-145 avalanche diode D753 and the optocoupler IC705 had to be replaced. They are mounted on the copper side of the board. Then I remade some poor joints.

When I'd finished I switched on and was grateful to find that the set sprang to life. It produced an excellent picture.

As Greeneyes finished her second slice of apple cake I noticed that my tea had gone cold. After thanking Mrs Goodhew for her hospitality we set off back home.

"Let's go back on the Ashlehurst Road" said Greeneyes, "it's even more rural and so straightforward that even someone of your age and mental state can't go wrong."

I smiled happily at her consideration. All went well until we rounded a bend and came to

another pretty cottage complete with fork roads. I looked in the rear mirror and saw a lorry load of straw bales fast gaining on me.

"Which fork road?" I cried urgently.

"Straight on, like before" she said as I squealed the car into the left fork.

"No, not left. Straight on I said. Straight on!!"

Then a lecture began. "I said straight on and you turned left. Now I'm having to say everything three times!"

More trouble

As we arrived back at the workshop we ran into Mrs Bronson and her posse of kids. She was carrying a smallish TV set. The eldest offspring eyed me coldly.

"That man's got a red face mam" he said, "is that 'cos he drinks too much whiskey, like Grampy?"

"Shullup" Mrs Bronson bawled, as her other son ran across and kicked the battery stand over. Then she placed the set on the counter. It was a Samsung CI5079 (SCT11D chassis).

"Ain't got no sound, duck" she said, "I spex it's the loudspeaker thing, or the knob that turns it up."

I took her details, then the family departed. Paul decided to have a go at the set.

"Speaker's OK" he said, "I'd better check the audio output chip."

In this model it's a TDA7056A (IC601). Instead of the expected 12V supply at pin 2 there was only 1V. The feed is via two 0.47 Ω , 2W resistors, R812 and R813. When they were checked one of them was found to be almost open-circuit. A replacement restored the 12V supply, but there was still no sound. As there was no obvious cause Paul replaced the IC. This made no difference either.

Scope checks around the separate sound SAW filter (SF101) and IF chip (ICK01, type TDA4445B) suggested that everything was OK here. What else was there? There's a muting arrangement that involves two transistors, Q903 (KSC815Y) and Q907 (KSR1012). The later was short-circuit base-to-emitter. A replacement restored the sound. So there had been two causes of the no-sound problem.

"Good job you're so clever" Steven said.

"Sure am" Paul replied.

The banter came to a quick end when Mr Kenton arrived. He was carrying a Panasonic NVHD90 VCR.

VCR trouble

"Joo know, this machine'll be the death of me" he complained, "it will, you know. Mark my words."

"Is there someone in there with a gun?" I asked.

"It's not funny" he retorted. "This is the second time it's gone wrong, and it isn't that old. The first time was the winter before last."

"Terrible" I replied, "what's up with it this time?"

"How should I know?" he said, "it's you whose supposed to know about these things."

I leant forward. "What are the symptoms then" I asked quietly.

His face became a picture of misery. "It's jammed, with my best tape in it. Now that can't be right, can it? In all fairness, that shouldn't happen."

I said we would investigate and, when he'd departed, set about extracting the tape from the machine. It was well jammed in all right, but I managed to get it out undamaged. After that I cleaned the mechanism, fitted a new idler and roller, then reset the timing.

But it ran intermittently while on soak test. I had to fit a replacement clutch to get it right.

When Mr Kenton came back for it and saw the bill he started to complain again.

"Three separate things wrong? This is the end, it really is. I can't take any more of this. I'm gonna have to get some stronger pills from the doctor."

Widescreen TVs

Paul had pulled a widescreen Bush Model WS6674 on to his bench. The complaint was 'dead'. Before he took the back off he looked out a 1M Ω , 1W resistor.

"You psychic?" I asked.

"No, just had a number of these sets in" he replied, "when they are dead it's usually because RP05 in the power supply has failed. A half-watt resistor is fitted but doesn't seem up to it, so I fit a 1W type."

He was quite right about the cause of the failure. The replacement resistor restored normal operation, and an outstanding picture.

Meanwhile Mr Hubbard had struggled in with his 28in. widescreen Panasonic set, Model W28R4DP (Euro-4 chassis). "Has the repair kit you ordered come in?" he asked.

"Yup!" said Steven, "we'll give you a call when it's done."

The problem is that the original type of line output transistor fitted, a BU2508AXLB in position Q551,

tends to fail prematurely. The kit contains two transistors, the one you fit depending on the tube type. In this case the correct type was 2SD1577LB. You also have to replace the resistor, R507, in the feed to the line driver stage. Again, this depends on tube type, either 100 Ω or 270 Ω (1W, 5%).

There were no problems once these items had been replaced. The kit costs just £5.00 plus VAT. It's worth buying from Panasonic. The 2SD1577LB is hard to obtain elsewhere and can cost as much as £9.00 plus VAT.

Make sure of your copy of *Television*

It can be difficult finding a copy of *Television* at local newsagents. The number of magazines being published keeps increasing, which means that newsagents have less shelf space for the display of individual titles. Specialist magazines in particular get crowded out.

There's a solution to the problem. Most newsagents provide "shop-save" and/or home-delivery services. There's no charge for a shop save. You simply ask your newsagent to order a copy for you: it will be kept on one side each month ready for you to collect. Home-delivered copies are ordered in the same way, but generally incur a delivery charge.

A newsagent can order any magazine for you, whether or not the shop normally stocks it.

If you buy your copies of *Television* from a newsagent and want to make sure you get every issue, just ask at the counter.

tips, guides, and reports for people repairing televisions and electronic equipment

TELEVISION

AND HOME ELECTRONICS REPAIR
MARCH 2003 £3.20

PC-camcorder interconnections

Introduction to PC servicing

The coherer revisited

Test report
Evoke-1 DAB radio



Satellite, Audio, Monitor, TV, VCR and DVD faults



DVD

**Fault reports from
Geoff Darby
Matt Marrs
and
C. Bowers**

We welcome fault reports from readers – payment for each fault is made after publication. See page 300 for details of where and how to send reports.

Sharp DV740H

I'm not at my best first thing in the morning, especially at the beginning of the week. So I was feeling grumpy and in need of a quick repair to cheer me up. This was first item I picked up, and was a player I'd not come across before. The fault symptom was no analogue sound. Needless to say I didn't have a service manual.

There was nothing obviously amiss when I took a quick look inside after removing the cover so, with heavy heart, I took a closer look and did some general prodding around inside. Close to J1 I spotted a couple of blue diodes that looked suspiciously like zeners. This suspicion was reinforced by the fact that the pins of J1 were marked on the board as being supply rails. When I carried out voltage checks across these diodes, D5 and D6, there was a reading across D6 but nothing across D5. Cold checks revealed a short-circuit across D5 but, when one end was lifted, the diode was proved to be blameless. Cold checks across the nearby electrolytics proved that C58 (470µF, 16V) was the culprit.

There was voltage across D5 when a replacement capacitor had been fitted, and when the analogue sound was switched back on via the set-up menu there was good quality audio from all the relevant outputs. With spirits thus lifted, I moved on to the next one . . . G.D.

Kenwood DVR7000

This curiously-designed home-cinema unit has two power supplies. The first is of the chopper type with a whole raft of outputs including the standby 5V supply. The second is a linear type with a large transformer. It seems to power the six output stages and is turned on by a relay that's driven from the system-control processor.

The unit was dead because the chopper power supply was inactive. I soon found that the 110kΩ start-up resistor R3 was open-circuit. It showed no signs of distress and, as the unit was only a couple of months old, I felt that the reason for its failure was more likely to be working-voltage distress than the more usual change of value because of ageing. In view of this I decided to replace it with two 56kΩ, high-voltage resistors connected in series, doubling the working-voltage rating while getting very close to the original, somewhat unusual, resistance value. Once the power supply had been refitted the unit worked normally. G.D.

Pioneer DV454S

This beautifully-styled slimline DVD player was dead. The usual 380V or so was present across the mains bridge rectifier's reservoir capacitor however. The power supply doesn't use a chopper control chip and, as I didn't have the circuit diagram, I had to start following the print around. R71, which is connected to the 380V supply, feeds the cathode of D75. This is marked on the board silk-screening as a zener diode. Its anode is not returned directly to chassis however. Instead, it's connected to another zener diode, D71, via a tiny 3.3MΩ resistor, R74. The anode of this second zener diode is returned to chassis.

There was full HT at both ends of R71, at both ends of D75 and at one end of R74. There was no voltage at the other end, across D71. Cold checks proved that this zener diode was OK, which left only R74 as suspect. When it was removed from the board it proved to be open-circuit. A replacement, of slightly larger proportions, restored normal operation. G.D.

Sharp DV740

If there's no audio output check whether D5 or C58 on the main board is short-circuit. These items provide a -12V supply. M.M.

Sony DAV-S400 or HCD-S400

When a disc was inserted it would be rotated but there were no control functions and no display. A quick inspection within the unit revealed the cause: the ribbon connector that connects the power-supply board to the main DVD PCB was improperly seated in the surface-mounted connector CN008. A push down on the connector ribbon restored normal operation. C.B.

Sony HCD-S800

There was no operation in the DVD mode and the unit would intermittently display a "C-81" error code. The cause was traced to a defective surface-mounted transistor, Q002, on side B of the DVD board. A call to Sony Technical revealed that a small modification may be needed when this fault is experienced. C.B. ■

Solution to Test Case 483

— page 280 —

The key to diagnosis of the puzzling problem with the JVC HRD910 VCR lay with the basic timing reference for capstan and drum motor speed control. In machines of this vintage the colour subcarrier crystal provides the reference: it's a very accurate and stable frequency source, and ensures that the video signals from the machine during playback are of close to broadcast standards.

In the HRD910 the subcarrier reference signal should be present at pin 42 of the servo-control chip. It comes, via CN6, from the crystal oscillator in IC1 (JCP0016-2) away on video board 05, which is a daughter of the main PCB. There was no oscillation here, in fact there was no activity of any sort at this video-processing chip, for the very good reason that it had no operating voltage — the SWD 5V line was at zero here. It was present and correct at the power supply regulator output however, i.e. at the collector of stabiliser transistor Q803.

The circuit diagram in the service manual showed these two points linked directly, but Sage found an ICP-N15 circuit protector (CP803) on the board — it's also mentioned as an addition in a JVC service bulletin. It had gone open-circuit, apparently for its own internal reasons, as the current through the replacement was normal and stable at about 300mA. So, in the end, the repair was simple. How many other older machines could be repaired economically, with a little time and trouble, instead of being consigned to the skip?

NEXT MONTH IN TELEVISION

The Las Vegas CES

The annual CES exhibition held in Las Vegas is the world's leading presentation of all that's new in consumer electronics. George Cole reports on the latest technology to reach the marketplace.

Servicing the Toshiba C5SS chassis

John Coombes presents a servicing guide for the Toshiba C5SS chassis, which is used in Models 2557DB, 2857DB and 3357DB.

Line timebase operation

The line timebase is at the heart of a TV set, generating the EHT and other supplies as well as the line deflection. Its operation became rather more complex when the EW diode modulator technique was added. Keith Cummins explains it all and provides an historical perspective.

Distributing analogue and digital signals

The presence of analogue and digital signals side-by-side in a distribution system can cause reception problems. J. LeJeune explains the situation and describes some solutions.

PLUS ALL THE REGULAR FEATURES

TELEVISION INDEX & DIRECTORY 2003

Plus hard-copy index and reprints service

Here's the essential repair information you need! The Television Index & Directory 2003, in CD-ROM form, contains the text of nearly 15,000 high quality fault reports on TVs, VCRs, Camcorders, DVD players, Monitors, Satellite TV units, Audio equipment and CD players, searchable by make and model, plus the text of 180 Test Cases and over 200 major servicing articles, from fifteen years of Television magazine. It also contains a full fifteen year index of Television, a Spares Guide, a directory of Trade and Professional Organisations, an International TV Standards guide, a satellite TV Channel Finder, a TV transmitter list and a compendium of internet resources for service engineers. The software is quick and easy to use, and runs on any PC with Windows 95, 98, ME, NT, XP or 2000.

Television Index & Directory 2003 CD-ROM, £199

Television Index & Directory 2003 CD-ROM upgrade, £46 (to qualify for this upgrade you need to have purchased a previous version of the Television Index on floppy disk or on CD-ROM)

A six-month update of the index and fault reports will be available in May 2003. If you wish to take advantage of this, £10 should be added to your order.

Television Index only, 1988—2002, £36

Television Index only upgrade from previous versions, £16

Hard-copy indexes of Television magazine are available for Volumes 38 (1988) to 52 (2002) at £3.50 per volume.

Reprints of articles from Television back to 1988 are also available, at the flat rate of £3.50 per article — you can order through our web site, or write to the address below.

The above prices include UK postage and VAT where applicable. Add an extra £1 postage for non-UK EC orders, or £5 for non-EC overseas orders, although Channel Island residents do not need to add any extra postage. Cheques should be made payable to SoftCopy Ltd. Access, Visa or MasterCard Credit Cards are accepted. Allow up to 28 days for delivery (UK).

SoftCopy Limited, 1 Vineries Close, Cheltenham, GL53 0NU, UK

**Telephone 01242 241 455, Fax 01242 241 468
e-mail: sales@softcopy.co.uk web site:
http://www.softcopy.co.uk**

Published on the third Wednesday of each month by Highbury Business Communications, Anne Boleyn House, 9-13 Ewell Road, Cheam, Surrey SM3 8BZ. **Highbury Business Communications** is a division of **Highbury Communications PLC**. **Filmsetting** by G&E A1 Parkway, Southgate Way, Orton Southgate, Peterborough PE2 6YN. **Printed** in England by Polestar (Colchester) Ltd., Newcomen Way, Severalls Industrial Park, Colchester, Essex CO4 4TG. **Distributed** by Comag, Tavistock Road, West Drayton, Middlesex UB7 7GE (tel. 01895 444 055). **Sole Agents** for Australia and New Zealand, Gordon and Gotch (Asia) Ltd., South Africa, Central News Agency Ltd. **Television** is sold subject to the following conditions, namely that it shall not, without the written consent of the Publishers first having been given, be lent, resold, hired out or otherwise disposed of by way of Trade at more than the recommended selling price shown on the cover, excluding Eire where the selling price is subject to currency exchange fluctuations and VAT, and that it shall not be lent, resold, hired or otherwise disposed of in a mutilated condition or in any unauthorised cover by way of Trade or affixed to or as part of any publication or advertising, literary or pictorial matter whatsoever.

Economic Devices

PO Box 73, Oaken Gates TF2 8WR Tel ++44 (0)1952 273130 Fax ++44 (0)1952 405478

Remote Controls from £5.95 each

Stock held for over 53000 different models

SEMICONDUCTORS

Over 34,000 types of transistors, IC's, diodes etc. or equivalents stocked

We take your hassle Some suppliers just won't help. We will work really hard to find those difficult parts - just ask and let our 'no holds barred' enquiry hound work for you.!!!

...and look at the special offers.....

BUT11A @ 29p each BUT11AF @ 41p each
BU508A @ 75p each Fully wired scart lead 89p

a slight inconvenience....

...you must buy more than one.

BU208A X 5 75p ea	TEA2018A X 5 99p ea
BU508A X 5 79p ea	UC3842 X 5 59p ea
BU508AF X 5 85p ea	CNX62A X 5 29p ea
BU508D X 5 89p ea	S2000AF X 5 84p ea
BUT11A X 5 29p ea	TDA3653B X 5 55p ea
BUT11AF X 5 47p ea	TDA3654 X 5 82p ea
Phillips type 1.2 volt Back up battery	X 5 59p ea
Phillips type 2.4 volt Back up battery	X 5 120p ea
Scart - Scart lead 1.5m Fully wired	X 2 89p ea
Positor PT37, TH98009 (White)	X 5 69p ea
Thom TX100 Chassis 110 DGR LOPTX	each £11.24
Phillips GP90 Chassis LOPTX	each £11.63

...and now ask about our value for money full price list. Remember £1.50 post & handling

All major credit cards accepted

www.telepart.co.uk

The web page where you can look up the parts and order all things TV, VCR and Satellite. Web search by model for video parts, remote controls, LOPTX etc. overseas enquiries particularly welcome

New CCTV catalogue out NOW

cameras, monitors, switches quads, multiplexers, the lot.

PERIFELEC

MC 30 A Spectrum Analyser



- Synthesized satellite cable and TV field strength meter with panoramic reception on 14 cm (5.5") screen and digital carriers measurement
- Complete microprocessor and lsi/lsi logic control.
- Continuous frequencies from 46 to 860 MHz and from 920 to 2150 MHz on 4 bands.
- Selectable 4, 1 and 0.2 MHz spectrum band-width, picture measurement 1 MHz.
- Display of picture of selected synthesized channel.
- FM (Radio) L/L, B/G, 1, D/K/K', M/N TV standards and Ku and C satellite standards.
- Possibility of 32 programs memorized per frequency band.
- Display (2 Lines of 16 characters).
- Range of measurement of signal strength from 20 to 120 dBµV, manual or automatic attenuator.
- Battery life about 1 hour 20 minutes, weight 5,8 Kg.

- Display of full-band and 4 possible expanded spectrums.
- Channels and frequency plans of cable and TV standards memorized.
- Frequency, signal strength in dBµV or bargraph, displayed on a digital display (2 lines of 16 characters).
- Voltage of remote power supply in 14v or 18v and 22 KHz in satellite → DiSeq C™ v1.2 switching.

The panoramic field strength meter MC30A combines in one instrument all the functions necessary for installing and checking TV or satellite reception, both analogue and digital. The visualization of the spectrum and the picture allows the carrying out of all the necessary adjustments with this one instrument. The high technology used in the MC30A allows a range of possibilities unheard of in an instrument in this price category.

Lacuna Digital Satellite Meter

A custom designed, small lightweight ABS case, created with the installer in mind



- Signal strength and BER will be displayed together
- Identifies the chosen satellite
- Signal strength and BER settings calibrated locally for realisation by distributor
- Removable F connector
- LNB short circuit protection and LNB power supply
- Compatible with all satellite transmission: Ku and C band, DVB and DSS

NEW Lacuna Terrestrial Digital Meter

Small, lightweight custom designed for terrestrial digital installations

- Identifies transmitter
- Measures signal strength, carrier/noise and BER
 - UHF / VHF
- Analogue and digital measurement
- Removable F connector
- 4 line LCD with backlight
- Weight including batteries 600g
- 12v line power facility



Full catalogue of meters available, please phone for details.

COASTAL AERIAL SUPPLIES

Unit X2, Rudford Industrial Estate, Ford, Arundel BN18 0BD
Telephone: 0870 2641990 Fax: 0870 264 1991

Perifelec
Sole Import
Distributors

TRIAX

DVB 2000T



TRIAX DVB 2000T
Part No.: 300055

Free-to-View Digital Terrestrial Receiver

- One off payment - No contract.
- Quick installation.
- Easy tuning with diagnostic feedback.
- Fully DVB compliant.
- Works with low signal levels.
- RF Modulator (Ch 21-69) with UHF bypass.
- DTG tested.
- Future proofing: auto scans for new channels, upgradeable over air software and services.
- Complete with Scart, RF lead, remote control and batteries.



T: 0845 601 0578
F: 0845 601 1023
sales@triaux.co.uk
www.triaux.co.uk



Televés

World Leading Manufacturer
of Satellite & Distribution Equipment



Systems Equipment for Analogue & Digital TV



Televés UK Ltd t 01633-875821 f 01 633-866311 e televés.uk@televés.com www.televés.com

**WATCH SLIDES ON TV
MAKE VIDEOS OF
YOUR SLIDES
DIGITISE YOUR
SLIDES**
(using a video capture card)



Liesgang diatv automatic slide viewer with built in high quality colour TV camera. It has a composite video output to a phono plug (SCART & BNC adaptors are available). They are in very good condition with few signs of use. For further details see www.diatv.co.uk
.....£91.91+ vat = £108.00

Board cameras all with 512x582 pixels 8.5mm 1/3 inch sensor and composite video out. All need to be housed in your own enclosure and have fragile exposed surface mount parts. They all require a power supply of between 10 and 12v DC 150mA.

47MIR size 60x36x27mm with 6 infra red LEDs (gives the same illumination as a small torch but is not visible to the human eye).....£37.00 + vat = £43.48

30MP size 32x32x14mm spy camera with a fixed focus pin hole lens for hiding behind a very small hole.....£35.00 + vat = £41.13

40MC size 39x38x27mm camera for 'C' mount lens these give a much sharper image than with the smaller lenses.....£32.00 + vat = £37.60

Economy C mount lenses all fixed focus & fixed iris

VSL1220F 12mm F1.6 12x15 degrees viewing angle.....£15.97 + vat = £18.76

VSL4022F 4mm F1.22 63x47 degrees viewing angle.....£17.65 + vat = £20.74

VSL6022F 6mm F1.22 42x32 degrees viewing angle.....£19.05 + vat = £22.38

VSL8020F 8mm F1.22 32x24 degrees viewing angle.....£19.90 + vat = £23.38

Better quality C Mount lenses

VSL1614F 16mm F1.6 30x24 degrees viewing angle.....£26.43 + vat = £31.06

VWL813M 8mm F1.3 with iris 56x42 degrees viewing angle.....£77.45 + vat = £91.00

1206 surface mount resistors E12 values 10 ohm to 1M ohm 100 of 1 value £1.00 + vat 1000 of 1 value £5.00 + vat

866 battery pack originally intended to be used with an orbitel mobile telephone it contains 10 1.6Ah sub C batteries (42x22dia the size usually used in cordless screwdrivers etc.) the pack is new and unused and can be broken open quite easily.....£7.46+vat = £8.77



Please add 1.66 + vat = £1.95 postage & packing per order

JPG ELECTRONICS

Shaws Row, Old Road, Chesterfield, S40 2RB

Tel 01246 211202 Fax 01246 550959 Mastercard/Visa/Switch

Callers welcome 9:30 a.m. to 5:30 p.m. Monday to Saturday

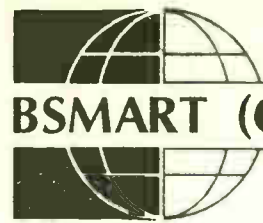

BSMART (CRAWLEY) LTD

**Largest selection
of**

MAJOR MANUFACTURERS

NEW "B"

GRADE PRODUCTS

T.V. VIDEO AUDIO

MICROWAVE OVENS

Contact Paul Bean

BSMART (CRAWLEY) LTD.

10/11 LLOYDS COURT, MANOR ROYAL,
CRAWLEY, SUSSEX RH10 2QX

Tel: (01293) 618000

Fax: (01293) 400133

**F4 Service Management
Users**

Following the success of the highly acclaimed F4 Service Management in the early 1990's the new powerful software Nunar allows you to use your existing F4 customer records to create a new database for organising service calls and processing customer orders.

Nunar provides five different search methods to instantly locate existing F4 customers. All details are then automatically transferred to Nunar. Customers are located by either of these F4 fields:

F4 Owner ID Postcode Address Name Telephone

The postcode and telephone searches for example locate and transfer all customer details from F4 to Nunar, this avoids duplicating details when booking new instructions. A professional image is portrayed when customers are located from their telephone number, especially when caller ID is displayed. This allows you to have customer details on screen before answering the telephone.

Like F4, Nunar is extremely easy to use with the familiar drop down windows. She boasts an infinite user entry when used on a network. Please contact us for more information.

Logik Business Solutions

17 Marsworth, Stafford

Tel: 01785 211888

Mob: 07748916526

TUBES

Widescreen:-

28" Thomson	W66EGV
28" Panasonic	W66EHK
28" LG	W66QBD
28" Thomson	W66EJU
28" Philips	W66ESF/ECK
32" Thomson	W76EDX
32" Thomson	W76EGV
32" Philips	W76ESF

Standard:-

25" Samsung	59KPR
26" Panasonic	66ECF
26" Thomson	66ECY, 66EHJ
29" Philips	68ESF

Ring Irene for prices

We also de-scratch tubes

EXPRESS TV

The Mill, Mill Lane,

Rugeley, Staffs WS15 2JW

Tel: 01889 577600 Fax: 01889 575600

J J COMPONENTS ARE STRIKING AGAIN

New Classic LOPTS and REMOTES, CD PICK UPS available from us - subject to stock availability. Use original part numbers to order your lopts - prices given on the phone.

NEW LOPTS AVAILABLE NOW - CLASSIC			
BEKO	GOODMAN	PHILIPS	THOMPSON
1352.5036	50H0000205	140.10595	10452540
1352.5048	1182.1157	1372.0003/5	1372.0041
3311167	MAGNUM	1302.0007	1372.0042
1142.5117	1192.1007	1302.0012	40330.55
1362.5007	MATSUI	531.02229	TOSHIBA
DAEWOO	1352.5006	531.02233	40327.10
1142.5037	1352.5037	140.10639	40327.11
1142.5057	NOKIA	1362.0004	40327.12
1142.5077	1192.6002	140.10569	40327.15
1352.5008	1182.9018	1342.0005	SONY
1142.5090	1182.9009	140.10664	1.453.199.11
1342.0026	LOEWE	531.02431	1.453.186.11
1362.5018	1372.0007	531.980326	1.439.432.11
1362.5019	1372.8003/2	SAMSUNG	143.942.421
1352.5046	ORION	FCM20A015	1.439.432.6
50H0000096	1372.003	FCR25A005	SHARP
1352.5052	40337.48	FCR25A007	F2048BMZZ
CP375	PHILIPS	SANYO	F2049BMZZ
GRUNDIG	1352.5003	1302.0031	F2035BMZZ
2920165301	1392.5002	1332.0009	EXTRAS
P37-065	14010562	3441020	1142.5074
29201.0296	1392.5002	40337-50	1142.5086
29201.031.62	1392.0002	THOMPSON	1142.5083
GOODMAN	140.10563	1539.3000	
1372.0066			

CLASSIC FULL RANGE OF REMOTES AVAILABLE FOR MOST TV'S MAKES AND MODELS. CLASSIC WHERE QUALITY COUNTS.

NEW CD LASER PICK-UPS - CLASSIC		
JVC	SAMSUNG	SHARP
OPTIMA 610	SOH-90T4N	8136AFZZ
OPT.6S/150	SOH-A1	8147AFZZ
OPT.7B	SOH-AA	8151AFZZ
PANASONIC	SOH-AD3	8153AF01
RAE0113Z	SOH-AP/AP	8173AFZZ
RAE0150Z	SOH-DP1	8175AFZZ
RAE0152Z	SOH-DV1	8194AFZZ
SOAD70A	SOH-D21U	SONY
VED0378	SOH-DS2A	DAX-11A
VED0402	SANYO	KHM-220AAA
PHILIPS	SFP100	KHM-250AAA
CDM4.19	SF-90/91	KMS-260A
CDM12.4	SF-P101N	KSM-330A
CDM12.3	SHARP	KSM2101ADM
VAM2201	HPC-3LX	KSM2101BAM
VAM1202J	HPC-1LX/MX	KSM542AA
VAM1202-12	8112AFZZ	KSM620A

JAY'S NEW VENTURE - MORTGAGE AND REMORTGAGES FOR ANY PURPOSE

IN ASSOCIATION WITH EVERGREEN MORTGAGE SOLUTIONS LIMITED

BUY TO LET, FIRST TIME BUYER, RIGHT TO BUY, CCJ'S, POOR CREDIT RATINGS, MORTGAGE ARREARS.

NO PROOF OF INCOME, A FRIENDLY LENDING DECISION IN PRINCIPLE WITH JUST ONE CALL AND TALK TO JAY ON 07967 481467 or 020 8952 2371

YOUR HOME IS AT RISK IF YOU DO NOT KEEP UP REPAYMENTS ON A MORTGAGE OR OTHER LOAN SECURED ON IT.

ALSO VISIT WWW.JJOFFICES.CO.UK FOR SHORT/LONG TERM FURNISHED OFFICES IN LONDON, ON LICENCE BASIS

Please phone us for the types not listed, add £1/- and then add VAT 17.5% to the total. All items subject to availability. Major credit cards accepted/postal orders/cheques etc etc. J J COMPONENTS, 63 THE CHASE, EDGWARE, MIDDLESEX HA8 5DN 020 8952 2371. FAX: 020 8952 7982.

web: www.jjcomponents.co.uk. Email: jjcomponents@compuserve.com

PRODUCT WATCH

LACUNA SYSTEMS LTD

Specification of the new digital meter from Lacuna Systems

- A custom designed dual frequency ADS (designed with the customer in mind)
- The price starts from just £110
- Available with a 2 year full labour warranty
- 4 line display with back-light
- Signal strength and BER will be displayed together
- Includes the customer warranty
- Signal strength and BER wrong calibration tools for re-calibration in situations
- Removable TV connector
- Removable 9V battery
- USB port (optional)
- USB power supply
- Works to connect with car/fan
- Considerable cost savings by using the same TV and ADS
- Official installer

www.lacunasystems.co.uk

QUALITY EX-RENTAL STOCK AT LOW LOW PRICES

14" REMOTE £26	14" TEXT £31	20" REMOTE £26
20" TEXT £30	21" TEXT £36	21" NICAM £42
25" NICAM £59	MONO VCR £18	NICAM VCR £26

Free delivery to most of England

(Minimum order 25 units, discount for bulk orders)

All stock in good working order, fully guaranteed

01487 772335

Retail Warehouse, P.O Box 108, Huntingdon. PE28 2PP

Prices exclude V.A.T

Repair Centre Technician

Established in 1986, ICM Computer Group has grown both organically and through acquisition, with approximately 820 employees based at 20 operating locations throughout the UK.

Due to expansion we have a number of vacancies for technicians to work in our Birstall repair centre taking responsibility for the repair and maintenance of monitors, printers computer hardware and associated peripherals. Ideally you should possess an electronics qualification, be a good team player and have a flexible attitude. Applications from candidates who have experience of television/electronic repair would be considered.

Interested? Then send an up-to-date CV stating your current salary details to: The Personnel Department, ICM Computer Group Plc, ICM House, Oakwell Way, Oakwell Park, Birstall, WF17 9LU, or email us at staff@icm-computer.co.uk.

Visit our Web Site at www.icm-computer.co.uk

Service Link

PHONE 020-8722 6028
FAX 020-8770 2016

FOR SALE

TRADE SALES

TVs from £5
Working from £20

020 8771 2361
07956 544145

GENUINE OFFER OUTSTANDING VALUE

Tube W66EGV023X015 perfect £60.
Panasonic TX24DX1 widescreen complete working chassis £60.

10 Wide band aerials AHG48W (new)
5 Sky dish's & LNB (new)
6 Serviced TVs. Sony V8 camcorder, CCD-F330E, no video out.

Plus 1 Sanyo camcorder same condition.
THE LOT £420 - CASH CHECK IT OUT (INCLUSIVE)

NO TIME WASTERS

K.T.V. WAREHOUSE
Tuckingmill, Camborne,
Cornwall TR14 8NP
Phone/Fax 01209 - 718043
11am - 4pm

inStore TEL: 01274 665670
660196
ELECTRICS LIMITED FAX: 01274 665246
1043 LEEDS ROAD, BRADFORD BD3 7DB

MANUFACTURERS NEW UNDATED
STOCK, INHT IN ORIGINAL PACKING
EVERYTHING FULLY GUARANTEED

PHILIPS 28PW 9616 100Hz
WITH COROLESS SPEAKERS
INC STAND

4 FOR £1800 DELIVERED PRICE UK
FULL SELECTION OF FLAT SCREEN
TELEVISIONS, HI-FI
SYSTEMS, VCR AND DVD
PLEASE CALL FOR A LIST AND PRICES

SONY • PANASONIC • TOSHIBA • JVC
CREDIT CARDS WELCOME • 24 HR DELIVERY

LINEAGE

**CHEAPEST £3 UNIVERSAL REMOTE
HANDSETS**, plug-tops, crimps, tapes,
extension leads, time lapse video, printers,
cableties, fuses. **WANTED:** TV/VCR. Tel:
020 7232 2266. Fax: 020 7232 2288.

**PANASONIC, MITSUBISHI, SONY,
TOSHIBA, PHILIPS ETC.**,
fully refurbished TVs. Trade only.
Pearsons Television. Tel: 01484 863489

PHILIPS On Digiboxes and Sky Digiboxes.
For details call Barry McDonald on 01622
719313 or 07836 789528.

PROJECTOR SPARES

VIDIKRON

projector spare parts and
service information.

PROJECTSPARES
Tel: 01444 831769
Fax: 01444 831580
E-mail:
projectspares@btinternet.com

REPAIRS

Trade repairs to Sky digiboxes

Pace, Amstrad, Grundig, Panasonic,
(including Fluid Ingress).

All makes repaired at a fair fixed price.

Scan Digital Services

For details

Give Alan a ring on
Tel/Fax: 01633 25 40 50
E-Mail: alan@scansat.globalnet.co.uk

SKY DIGIBOX REPAIR CENTRE

Same day collection.
Large stocks of refurbished
boxes.

From £150 - call for details.

SERVICE & SALES DEPT
Satellite & Digital Services Ltd

The Digital Centre,
Howard Avenue, Barnstaple,
Devon, EX32 8QA
01271 325888

accent

TECHNIC ANALOGUE AND DIGITAL CAMCORDER REPAIRS

Collection anywhere in
the UK.

All makes, ultra fast
service.

Phone: 01905 771025
www.accent-technic.co.uk

SERVICE DATA

Service Information **Fryerns** Circuit Diagrams

TV's, VCR's, SATELLITE
CAMCORDERS, AUDIO &
HI-FI's

Prices are from £5.50 + £2.75 P&P
add a further £5.50 per item
in the same order

note: some items priced individually
we now supply universal
tv/video remotes at competitive
prices

Payment by credit card, PO or cheque
Tel: Fax 01206 211570
e-mail: colin@fryerns.fsbusiness.co.uk



2 The Lodge
Easthorpe Green
Marks Tey, Colchester
CO6 1HA

OPEN 6 DAYS
TV/VCR CIRCUITS
(WE DO NOT STOCK
AUDIO OR MONITOR
INFORMATION)

TEL A.T.V. on
0114 285 4254

CTV Circuits from £5.00
VCR Circuits from £7.00
CTV Manuals from £10.50
VCR Manuals from £14.50
User instructions also available
(P/P add £2.50 to each order)

**419 LANGSETT ROAD
SHEFFIELD S6 2LL**

MANUAL COLLECTIONS PURCHASED,
(POST 1995)

NEED HELP NOW?

Then ring the

★ ELECTRON TECHNICAL HELPLINE ★

Genuine help available to all repairers
of
T.V. - V.C.R. - SAT - AUDIO (Inc Valves)
- MICROWAVE - MONITOR AND
MOST ELECTRONIC EQUIP

Over 30 years experience and vast data
base

0906 470 1706
Calls cost 60p per minute

Hours of Business Mon to Fri
9.00 am-12.30 pm : 2.15 pm-5.30 pm
Sat Morn 9 am-12 noon
ELECTRON G.T.
9 CHAPEL ST. DONISTHORPE,
SWADLINCOTE. DERBYSHIRE DE12 7PS

SERVICE MANUALS

Have you ever turned away work
for want of a Service Manual?
Have you ever bought a Service
Manual and never used it more
than once?

Then why not join ...

THE MANUALS LIBRARY

For details and membership
application form write,
phone or fax:

HARVEY ELECTRONICS
43 Loop Road, Beachley, Chepstow,
Mons, NP16 7HE

Tel: 01291 623086 Fax: 01291 628786

Visa: Mastercard accepted

SITUATIONS VACANT

ELECTRONICS BENCH ENGINEER

We are looking for an electronic
Engineer with a proven track
record in repairing TV/Video
Equipment to component level.
We can offer full or part time (may
suit semi - retired person). We offer
training, career development and
competitive salary.

We are a well-established CCTV
company based in London.
Please send your CV to:

SVTS
Unit 317, Stratford Workshops,
Burford Road, London E15 2SP

For a **FREE** consultation
on how best to market
your products/services
to a professional
audience
contact **REUBEN**
on **020 8722 6028**

SITUATIONS WANTED

MATURE ENGINEER.

26yrs. TLO with leading manufacturer.
Seeks any interesting or challenging
position or assignment, possibly in
training or admin.

Full, Part-time or Contractual.

For CV, background and discussion
call 020 8661 7590

WANTED

BEST CASH PRICES PAID

For **ALL** valves
especially KT88, PX4
and other audio
types.

Tel: 01403 784961

Billington Export Ltd
Sussex RH14 9EZ
Fax 01403 783519
Email: sales@bel-tubes.co.uk
Visitors by appointment

CLASSIFIED TEL: 020 8722 6028

New Product

Atlas LCR Passive Component Analyser (Model LCR40)

"No other LCR is as easy as this!"

Just clip on the test leads and press test. The Atlas LCR will automatically identify the type of component, apply the appropriate test level and frequency, display the component's value and more!

Probes are detachable too, so you can use the optional SMT tweezers for your tiny unmarked passives - **fantastic**.

Inductance range: 1 μ H to 10H
 Capacitance range: 1pF to 10,000 μ F
 Resistance range: 1 Ω to 2M Ω
 Basic accuracy: 1%
 Test signals: 1V, 3mA max



£79

fully inclusive UK price



Lots of accessories available soon!

- Automatic component identification (Inductor, Capacitor or Resistor).
- Component value measurement.
- Automatic test frequency selection (DC, 1kHz, 15kHz or 200kHz).
- Inductor DC resistance measurement.
- Non-volatile probe compensation memory.
- Detachable probes allowing use of optional test prods, SMT tweezers, etc...
- Hands free mode with value hold.

atlas

semiconductor analyser

Check and identify your semi's

£60

fully inclusive UK price



NEW MEASURES TRANSISTOR LEAKAGE!

enclosure colours may vary

- Automatic component identification
- Pinout identification
- Transistor gain measurement
- MOSFET gate threshold measurement
- PN junction characteristics measurement
- Shorted Junction identification
- Transistor leakage measurement
- Just connect the part anyway round and press the button!
- Auto power on/off

Supports:

- Bipolar transistors,
- Darlington transistors,
- Diode protected transistors,
- Resistor shunted transistors,
- Enhancement mode MOSFETs,
- Depletion mode MOSFETs,
- Junction FETs,
- Low power triacs and thyristors,
- Diodes and diode networks,
- LEDs (+bicolours)

NPN bipolar Darlington

Diode protection between C-E

Resistor shunt between B-E

Current gain Hfe=126

Enhancement mode N-Ch MOSFET

Gate Threshold Vgs=3.4V

BLUE Col Emit

0.77V

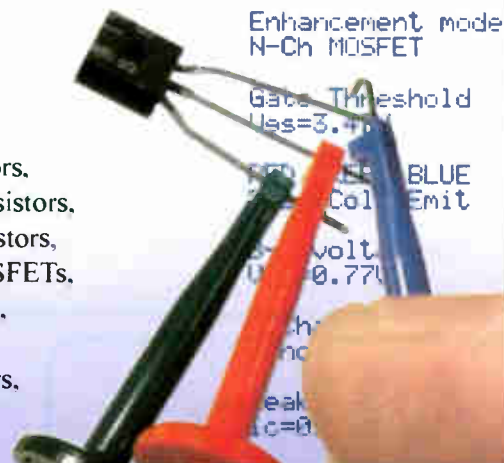

Visit www.peakelec.co.uk to download the data sheets, user guides and copies of independent reviews. You can pay using a cheque, postal order, credit or debit card and even pay securely online. Please contact us for your volume requirements.

Also available from: (prices vary)



PEAK
 electronic design ltd

Atlas House, Kiln Lane
 Harpur Ind. Est., Buxton
 Derbyshire, SK17 9JL, UK

Tel. 01298 70012

www.peakelec.co.uk
sales@peakelec.co.uk

Fax. 01298 70046





TELEVISION TEST PATTERN GENERATORS

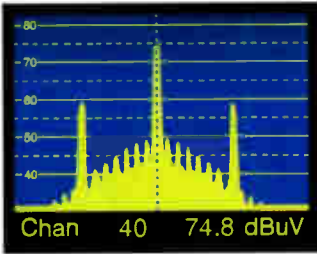

The new pattern generators **GV 798** and **GV 898** offer advanced features at realistic prices. They produce 16:9 and 4:3 formats, output level set in 1dB steps, multistandard, VITS, WSS, VPS, PDC, Teletext and much more. GV 898 uses vestigial side band modulation.

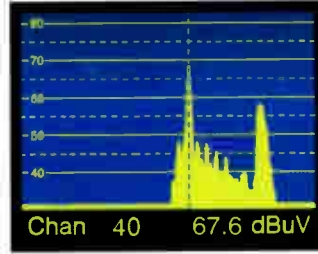

PROMAX GV SERIES

- ◆ Choice of 12 instruments
- ◆ NICAM and Teletext
- ◆ 4:3 and 16:9 Formats
- ◆ Full field and VITS
- ◆ Computer Controlled
- ◆ Front panel memories
- ◆ Multi Standard, PAL, NTSC, SECAM
- ◆ Own Company Logo
- ◆ Computer Monitor testers
- ◆ Hand Held Models
- ◆ High Quality Construction
- ◆ Attractive Price Levels
- ◆ Full After Sales Service
- ◆ Available from Stock



FOR TELEVISION PATTERN GENERATORS, THERE'S NO WIDER CHOICE THAN WITH PROMAX



SELECTED ITEMS FROM THE PROMAX RANGE OF TEST EQUIPMENT



MS 250

Analogue and Digital Satellite Detector.



PRODIG 1

Satellite Dish Installer's Meter
Does more than just BSKyB



PRODIG 2

Analogue & Digital Aerial Meter
Measures digital channel power and C/N



MC 377+

Analogue & Digital, Satellite & Terrestrial
Measures channel power and C/N



PROLINK 3 + 4 SERIES

Satellite & Terrestrial, Analogue & Digital,
Spectrum Analyser with BER (optional on P3)

Alban

ALBAN ELECTRONICS LIMITED

THE PROMAX SERVICE CENTRE

6 Caxton Centre, Porters Wood,
St. Albans, Hertfordshire, AL3 6XT.

TEL: 01727 832266 FAX: 01727 810546

WEB: www.albanelectronics.co.uk

EMAIL: info@albanelectronics.co.uk

SALES + SERVICE + CALIBRATION



TELECOMMUNICATIONS
TEST EQUIPMENT
AE 767 Spectrum Analyser



NEW!
THE NEW
ALBAN WEB SITE ...
www.albanelectronics.co.uk
FOR ALL THE LATEST NEWS
AND INFORMATION
FROM ALBAN
NEW!