

Tips, guides and reports for people repairing televisions and electronic equipment

TELEVISION

AND HOME ELECTRONICS REPAIR

DECEMBER 2003 £3.20

Maintaining PA amplifiers



Mobile phones and their repair

Tackling the Vestel 11AK33 chassis

Putting the triac to work



Satellite, Audio, Monitor, TV, VCR and DVD faults



Seasons Greetings and Best Wishes for 2004

It's been another exciting year for Classic. Through constant research and by listening to you our customers, we have expanded our range, developed more new products and provided even more cost effective solutions for the service industry.

2004 will bring even more exciting news, but for now we would like to thank all of our customers and distributors for supporting us and wish you all a

*Merry Christmas
and a
Happy New Year*

For more information on the entire Classic range or details of a distributor near you, call 01635 278678, visit us online; www.classic-electronics.co.uk or email us at sales@classic-electronics.co.uk



Technical helpline 01635 278678

CONTENTS

December 2003

Vol. 54, No. 2

67 Comment

Sony stumbles

68 Teletopics

Digital TV broadcasting developments. DVD update. TV phones. Sharp's latest LCD technology includes 3D. Industry news.

70 Mobile phones and their repair

Mobile phones are part of everyday life for most people nowadays. Chris Archer outlines their



history, how they operate, then dismantling and repair procedures for some common models.

74 Putting the triac to work

The triac is a useful semiconductor device that's not as well-known as it should be. J. LeJeune describes its mode of operation and how to make use of it.

76 Service notes on the Vestel 11AK33 chassis

The 11AK33 chassis is used in various models from Hitachi, Wharfedale and other sources. Alan Dent summarises his experiences to date with this generally well-engineered product.

80 A flexible CCTV system

In this concluding instalment Ian Rees considers cameras, proximity detectors, system expansion and construction and installation.

89 Repairing PA amplifiers

Geoff Darby has been involved with this for some time and explains the type of problems you can get and how to tackle them. Also how to get such work.

90 Servicing the Sharp DA100 (50Hz) and DA50W chassis

Part 4 of this series, by Alex Towers, deals with the audio circuitry including the separate Dolby Pro-Logic board used in most models.

92 Book review

DVD players and drives, by K.F. Ibrahim.

94 Books to buy

96 Letters

Aerials galore. Polarity protection. DVD chopper device. Schneider spares. That tuning knob.

97 Help wanted

98 DX and Satellite Reception

Latest on the Coship CDVB3188 digital satellite receiver. The prospects for digital DXing, both TV and DAB. Roger Bunney reports.

102 Audio faults

104 Monitors

Guidance on repairing monitors and related equipment.

106 Bench notes

In Part 8 of his series on PC servicing Adrian Gardiner provides advice on how to improve the performance of a PC that uses the Windows 98 operating system.

108 VCR clinic

109 Test Case 492

110 TV fault finding

113 DVD faults

114 Web service

Useful websites for TV professionals, technicians and enthusiasts.

116 Service casebook

Michael Maurice selects faults from his notebook.

118 Satellite notebook

A poor signal problem. Digital channel update. BBC1 Scotland via satellite. Hellas Sat 2 at 39°E.



121 Next month in Television

122 What a life!

Sets and couples and their demands. A TV/DVD combi unit fault. Donald Bullock's commentary.

Editor

John A. Reddihough

Deputy Editor

Tessa Winford

Advertisement Sales

Mark Gardner

01322 611 289

Fax 01322 616 376

Editorial Assistant

Caroline Fisher

01322 611 274

Publishing Director

Tony Greville

Note that we are unable to answer technical queries over the telephone and cannot provide information on spares other than that given in our Spares Guide.

Disclaimer

We work hard to ensure that the information presented in *Television* is accurate. However, *Television's* publisher - Highbury Business Communications - will not take responsibility for any injury or loss of earnings that may result from applying information presented in the magazine. It is your responsibility to familiarise yourself with the laws relating to dealing with your customers and suppliers, and with safety practices relating to working with electrical/electronic circuitry - particularly as regards electric shock, fire hazards and explosions.

Next issue, dated
January, on sale
December 17



Colour CCTV camera, 8mm lens, 12V d.c. 200mA 582x628 Resolution 380 lines Automatic aperture lens Mirror function PAL Back Light Compensation MLR, 100x40x40mm. Ref EE2 E69

Built-in Audio .15lux CCD camera 12V d.c. 200mA 480 lines s/n ratio >48db 1V P-P output 110mm x 60mm x 50mm. Ref EE1 E99



Metal CCTV camera housings for internal or external use. Made from aluminium and plastic they are suitable for mounting body cameras in. Available in two sizes 1 - 100 x 70 x 170mm and 2 - 100 x 70 x 280mm. Ref EE6 E22 EE7 E26 multi-position brackets. Ref EE8 E8

Excellent quality multi-purpose TV/TFT screen, works as just a LCD colour monitor with any of our CCTV cameras or as a conventional TV. Ideal for use in boats and caravans 49-7MHz-91-75MHz VHF channels 1-5, 168-25MHz-222.75MHz VHF channels 6-12, 471.25MHz-869-75MHz, Cable channels 112-325MHz-166-75MHz Z1-Z7, Cable channels 224-25MHz-446-75MHz Z8-Z35 5" colour screen. Audio output 150mW. Connections, external aerial, earphone jack, audio/video input, 12V d.c. or mains. Accessories supplied Power supply, Remote control, Cigar lead power supply, Headphone Stand/bracket. 5" model £139 Ref EE9, 6" model £149. Ref EE10



Self-cocking pistol picr002 crossbow with metal body. Self-cocking for precise string alignment Aluminium alloy construction High tec fibre glass limbs Automatic safety catch Supplied with three bolts Track style for greater accuracy. Adjustable rear sight 50lb drawweight 150ft sec velocity Break action 17" string 30m range £21.65 Ref PLCR002

Fully cased IR light source suitable for CCTV applications. The unit measures 10 x 10 x 150mm, is 12V d.c. operated and contains 54 infra-red LEDs. Designed to mount on a standard CCTV camera bracket. The unit also contains a daylight sensor that will only activate the infra-red lamp when the light level drops below a preset level. The infra-red lamp is suitable for indoor or exterior use, typical useage would be to provide additional IR illumination for CCTV cameras. £49. Ref EE11

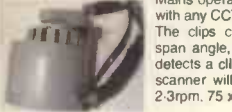

Mains operated and designed to be used with any CCTV camera causing it to scan. The clips can be moved to adjust the span angle, the motor reversing when it detects a clip. With the clips removed the scanner will rotate constantly at approx 2.3rpm. 75 x 75 x 80mm £23. Ref EE12

Colour CCTV Camera measures 60x45mm and has a built-in light level detector and 12 IR LEDs 0.2 lux 12 IR LEDs 12V d.c. Bracket Easy connect leads £69. Ref EE15



A high quality external colour CCTV camera with built-in infra-red LEDs measuring 60 x 60 x 60mm Easy connect leads colour Waterproof PAL 1/4in. CCD 542 x 588 pixels 420 lines 0.05 lux 3.66m F2 78 deg lens 12V d.c. 400mA Built-in light level sensor. £99. Ref EE13



Colour pinhole CCTV camera module with audio. Compact, just 20x20x20mm, built-in audio and easy connect leads PAL CMOS sensor 6-9V d.c. Effective Pixels 628x582 Illumination 2 lux Definition >240 Signal/noise ratio >40db Power consumption 200mW £35. Ref EE21



A small colour CCTV camera measuring just 35 x 28 x 30mm. Supplied complete with bracket, microphone and easy connect leads. Built-in audio. Colour 380 line resolution PAL 0.2 lux +18db sensitivity. Effective pixels 628 x 582 Power source 6-12V d.c. Power consumption 200mW £36. Ref EE16

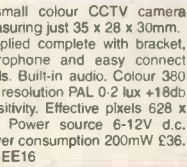

Complete wireless CCTV system with video. Kit comprises pinhole colour camera with simple battery connection and a receiver with video output. 380 lines colour 2.4GHz 3 lux 6-12V d.c. manual tuning Available in two versions, pinhole and standard. £79 (pinhole) Ref EE17, £79 (standard). Ref EE18



Small transmitter designed to transmit audio and video signals on 2.4GHz. Unit measures 45 x 35 x 10mm. Ideal for assembly into covert CCTV systems Easy connect leads Audio and video input 12V d.c. Complete with aerial Selectable channel switch £30. Ref EE19

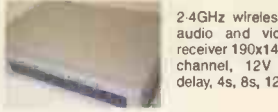

2.4GHz wireless receiver Fully cased audio and video 2.4GHz wireless receiver 190x140x30mm, metal case, 4 channel, 12V d.c. Adjustable time delay, 4s, 8s, 12s, 16s. £45. Ref EE20

The smallest PMR446 radios currently available (54x87x37mm). These tiny handheld PMR radios not only look great, but they are user friendly & packed with features including VOX, Scan & Dual Watch. Priced at £59.99 PER PAIR they are excellent value for money. Our new favourite PMR radios! Standby - 35 hours Includes: - 2 x Radios, 2 x Belt Clips & 2 x Carry Strap £59.95 Ref ALAN1 Or supplied with 2 sets of rechargeable batteries and two mains chargers £84.99. Ref Alan2



Beltronics BEL550 Euro radar and GATSO detector Claimed Detection Range: GATSO up to 400m. Radar & Laser guns up to 3 miles. Detects GATSO speed cameras at least 200 metres away, plenty of time to adjust your speed £319. Ref BEL550

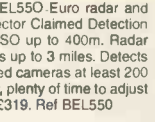

TheTENS mini Microprocessors offer six types of automatic programme for shoulder pain, back/neck pain, aching joints, Rheumatic pain, migraines headaches, sports injuries, period pain. In fact all over body treatment. Will not interfere with existing medication. Not suitable for anyone with a heart pacemaker. Batteries supplied. £19.95 Ref TEN327 Spare pack of electrodes £5.99. Ref TEN327X



Dummy CCTV cameras These motorised cameras will work either on 2 AA batteries or with a standard DC adapter (not supplied) They have a built-in movement detector that will activate the camera if movement is detected causing the camera to 'pan' Good deterrent. Camera measures 20cm high, supplied with fixing screws. Camera also has a flashing red l.e.d. built in. £9.95. Ref CAMERAB

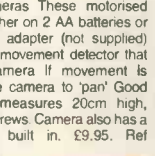

INFRA-RED FILM 6" square piece of flexible infra-red film that will only allow IR light through. Perfect for converting ordinary torches, lights, headlights etc to infra-red output only using standard light bulbs Easily cut to shape. 6" square £15. Ref IRF2 or a 12" sq for £29 IRF2A

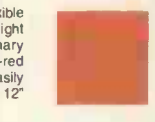

GASTON SEALED LEAD-ACID BATTERIES



1.3AH 12V @ £5 REF GT1213
3.4AH 12V @ £8 REF GT1234
7AH 12V @ £8 REF FT127
17AH 12V @ £18 REF GT1217

All new and boxed, bargain prices. Good quality sealed lead-acid batteries

SOLAR PANEL 10 watt silicon solar panel, at least 10 year life, 365 x 26mm, waterproof, ideal for fixing to caravans, boat, motorhomes etc. Nicely made unit with fixing holes for secure fittings. Complete with leads and connectors. Anodised frame. Supplied with two leads, one 3M lead is used for the op with two croc clips, the other lead is used to connect extra panels. Panels do NOT require a blocking diode, they can be left connected at all times without discharging the battery. £84.99. REF PAN



8A solar regulator 12V, 96 watt, 150mm x 100mm x 25mm. £28. REF SOLREG2



High-power modules (80W+) using 125mm square multi-crystal silicon solar cells with bypass diode. Anti-reflection coating and BSF structure to improve cell conversion efficiency. 14%. Using white tempered glass, EVA resin, and a weatherproof film along with an aluminium frame for extended outdoor use, system Lead wire with waterproof connector. Four sizes, 80W 12V dc, 1200 x 530 x 35mm, £287. REF NE80, 123W 12V d.c., 1499 x 662 x 46mm, £439. REF NDL3, 125W 24V, 1190 x 792 x 46mm, £439. REF NEL5 and 165W 24V, 157 x 826 x 46mm, £593.

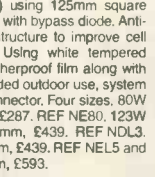

THE TIDE CLOCK. These clocks indicate the state of the tide. Most areas in the world have two high tides and two low tides a day, so the tide clock has been specially designed to rotate twice each lunar day (every 12 hours and 25 minutes) giving you a quick and easy indication of high and low water. The Quartz tide clock will always stay calibrated to the moon. £21 REF TIDECL



LINEAR ACTUATORS 12-36V D.C. BUILT-IN ADJUSTABLE LIMIT SWITCHES. POWER COATED 18in. THROW UP TO 1,000lb. THRUST (400lb. RECOMMENDED LOAD). SUPPLIED WITH MOUNTING BRACKETS DESIGNED FOR OUTDOOR USE. These brackets originally made for moving very large satellite dishes are possibly more suitable for closing gates, mechanical machinery, robot wars etc. Our first sale was to a company building solar panels that track the sun! Two sizes available, 12in. and 18in. throw. £29.95. REF ACT12, £34.95 REF ACT18.



POWERSAFE DEEP CYCLE BATTERIES
12V 51AH. NOW ONLY £29.95 EACH
YUASA 6V 100AH NOW ONLY £19 EACH



BRAND NEW MILITARY ISSUE DOSE METERS (radiation detectors). Current NATO issue. Standard emergency services unit. Used by most of the world's military personnel. New and boxed. £69. REF SIEM69

NIGHT VISION SYSTEM. Superb hunting rifle sight to fit most rifles, grooved for a telescopic sight. Complete with infra-red illuminator. Magnification 2-7x. Complete with rubber eye shield and case. Opens up a whole new world! Russian made. Can be used as a hand held or mounted on a rifle. £99. REF PN1



These Samarium magnets measure 57mm x 20mm and have a threaded hole (5/16th UNF) in the centre and magnetic strength of 2.2 gauss. We have tested these on a steel beam running through the offices and found that they will take more than 170lb. (77kg) in weight before being pulled off. With keeper. £19.95. REF MAG77.

Peltier Effect heat pump. Semiconductor thermo-electric device which works on the Peltier effect. When supplied with a suitable electric current, can either cool or heat. Also when subject to an externally applied temperature gradient can produce an electric current. Ideal for cooling or controlling the temperature of sub assemblies. Each module is supplied with a comprehensive 18-page Peltier design manual featuring circuit designs, design information etc. etc. The Peltier manual is also available separately. Maximum watts 56.2 40 x 40mm Imax, 5.5A Vmax, 16.7 Tmax (c-dry N2). 72. £29.95 (inc. manual. REF PELT1. Just manual £4 REF PELT2.

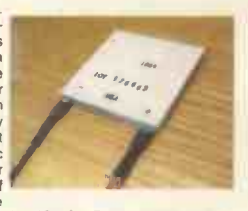

New transmitter, receiver and camera kit. £69. Kit contains four channel switchable camera with built-in audio, six IR l.e.d.s and transmitter, four channel switchable receiver, 2 power supplies, cables connectors and mounting bracket. £69. Wireless Transmitter. Black and white camera (75 x 50 x 55mm). Built-in 4 channel transmitter (switchable). Audio built-in 6 IR l.e.d.s. Bracket/stand. Power supply 30m range Wireless Receiver 4 channel (switchable). Audio/video leads and scart adapter. Power supply and manual, £69. REF COP24.



This miniature Stirling Cycle Engine measures 7in. x 4in. and comes complete with built-in alcohol burner. Red flywheels and chassis mounted on a green base, these all-metal beauties silently running at speeds in excess of 1,000 r.p.m. attract attention and create awe wherever displayed. This model comes completely assembled and ready to run. £97. REF SOL1

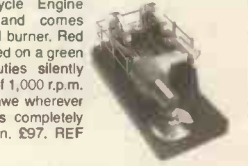

BULL GROUP LTD
UNIT D, HENFIELD BUSINESS PARK,
HENFIELD, SUSSEX BN5 9SL
TERMS: CASH, PO, CHEQUE PRICES + VAT
WITH ORDER PLUS £5.50 P&P (UK) PLUS VAT.
24 HOUR SERVICE £7.50 (UK) PLUS VAT.
OVERSEAS ORDERS AT COST PLUS £3.50
Tel: 0870 7707520 Fax 01273 491813
Sales@bullnet.co.uk
www.bullnet.co.uk

SHOP ONLINE
WWW.BULLNET.CO.UK



world of Sony

movies, music, TV, games, electronics

Sony stumbles

Sony has never ceased to amaze since it was started in post-war Tokyo in 1946. It has undoubtedly become the best known consumer electronics brand worldwide, its success being based on a long series of innovative products that have met consumer aspirations. Obvious examples are the Trinitron TV system, the CD disc system (developed with Philips), the Walkman and, in more recent times, the PlayStation games system. But it hasn't always succeeded (an example being the Betamax VCR system); it can misjudge markets (it failed to foresee the rapid advance of flat-panel TV, and missed out on the mobile phone market); and it is as subject to the intense competition in the worldwide consumer electronics market as any of the other major companies in this field.

There has always been something strange about the Sony way of doing things. Why reinvent the shadowmask tube in the form of the Trinitron? Maybe to get round patent problems, though at a cost. The Trinitron has certain advantages, but overall they have been negligible from the practical viewpoint with continued development of the basic shadowmask tube. The success of the Trinitron, with Sony going its own way, undoubtedly led to the Betamax failure. Sony was late in licensing its technology, which was probably superior, and failed to appreciate that cassette rental companies would want to stock only one type of cassette, the market leader (VHS). And the Sony going-its-own-way approach has extended to all sorts of minor bits and pieces. What was the point of the gate-controlled switch line output device, when a standard line output transistor worked better? Just, it seems, to be different. There are countless examples of this sort of thing in Sony products.

All this can have a highly adverse effect in difficult market conditions. And there has never been a more trying time in the worldwide consumer electronics industry than the present, with intense competition particularly from low-cost producers such as China. Sony has been going through a bad patch. It shocked the industry and the financial markets when it announced a \$1bn loss in the last quarter of its financial year to the end of March. Sony shares dropped 25 per cent in two days. More recently Sony has announced poor results for the quarter of the 2003-4 financial year to the end of September, with a 25 per cent fall in profit compared to the previous year – this at a time when Matsushita announced a 32 per cent profit

increase for the latest half year, while Sharp has forecast record profits. Sony's revenue was just slightly ahead, by 0.4 per cent. A fall in PlayStation 2 games console sales and a series of Hollywood box-office flops were blamed for this. But Sony's main problems relate to its electronics businesses, and action was clearly required.

Hence Sony's announcement of a three-year plan, aimed at increasing operating profit margins from 2.5 to ten per cent and reducing fixed costs by \$3bn, while investing heavily in new product development – in particular a new games system microprocessor chip that could appear in other products, including TV sets. The cost of the plan is put at some \$2.7bn.

How is it to be achieved? For a start Sony intends to reduce its workforce by 13 per cent, meaning some 20,000 job losses. It seems that the main loss, about 7,000, will be in Japan – Sony has been slow to move production to low-cost countries. The 4,500 Sony jobs in the UK seem to be relatively safe. There is to be outsourced manufacture of mature products, in particular CRT TV set production will be moved from Japan. And there is to be a huge effort to tackle

the parts problem. The aim is to reduce the number of separate items used by nearly 90 per cent, from 840,000 to 100,000, by 2005. About time, some might say, but it will be hard on Sony's suppliers, which are expected to be reduced from 4,700 or so to 1,000. Standardisation is the key here. Sony is without LCD technology, hence the planned joint venture with Samsung (see Teletopics). And Sony intends to target the huge Chinese market for consumer electronics, aiming at a five per cent share. This doesn't sound a lot, but would make a big difference. Sony also intends to play a major part in the development of consumer product networking – linking everything together for maximum convenience and effectiveness – which is clearly the direction in which the industry is going.

The next couple of years are likely to be difficult for Sony. For too long the technical brilliance of its products and their appeal to consumers have hidden manufacturing inefficiency. One wishes the company well in its efforts to get back on track to a profitable future. The company deserves success after contributing so much to public pleasure and convenience worldwide. ■

COPYRIGHT

© Highbury Business Communications, 2003. All rights reserved. No part of this publication may be reproduced, stored or transmitted in any form or by any means without the written permission of the publishers.

All reasonable precautions are taken by *Television* to ensure that the advice and data published are reliable. We cannot however guarantee it and we cannot accept legal responsibility for it.

CORRESPONDENCE

All correspondence regarding advertisements should be addressed to the Advertisement Manager, *Television*, Highbury Business Communications, Nexus House, Azalea Drive, Swanley, Kent, BR8 8HU. Editorial correspondence should be addressed to *Television*, Editorial Department, Highbury Business Communications, Nexus House, Azalea Drive, Swanley, Kent, BR8 8HU.

INDEXES AND BINDERS

Indexes for Vols. 38 to 52 are available at £3.50 each from SoftCopy Ltd., who can also supply an fifteen-year consolidated index on computer disc. For further details see page 697.

Binders that hold twelve issues of *Television* are available for £6.50 each from Modern Bookbinders, Pringle Street, Blackburn, BB1 1SA. Telephone: 01254 59 371. Make cheques payable to "Television Binders".

Newstrade Enquires

Distributed by COMAG

Telephone: 01895 444055

ISSN 0032-647X

SUBSCRIPTIONS

Highbury Subscription Services, Link House, 8 Bartholomew's Walk, Ely, Cambridge CB7 4ZD. Telephone 01353 654 431 Fax 01353 654 400 Email hbc.subs@highbury-wyvern.co.uk Please notify change of address.

Subscription rates:

UK 1 year £33.80, 2 years £54.00, 3 years £71.00.
Republic of Ireland 1 year £38.95, 2 years £62.00, 3 years £81.85.
Mainland Europe 1 year £49.00, 2 years £78.40, 3 years £102.90.
Rest of World 1 year £63.50, 2 years £101.00, 3 years £133.00.
Cheques should be made payable to *Television*.

BACK NUMBERS

If available issues are £4.00 each.



HIGHBURY
Business Communications

A SUBSIDIARY OF HIGHBURY HOUSE COMMUNICATIONS PLC

TELETOPICS

Digital TV broadcasting developments

BT and Freeview have signed a joint marketing agreement that provides BT customers with the thirty Freeview digital TV and radio channels and the BT Openworld internet service via a digital adaptor for viewing on their TV sets. The move is part of BT plans to broaden the appeal of its broadband operations by adding premium services. The full range of such services has yet to be decided, but is likely to include time-shifted TV to enable viewers to select their own viewing times and a catalogue of additional content that would be available for downloading, from films to past TV programmes.

It's understood that some upgrading of the BT broadband network may be required for full implementation of the service. The interactive adaptor required will cost about £130 and will be available direct from BT, whose customers will get the Freeview services for a one-off payment of about

£90. BT already has a marketing agreement with BSkyB.

Ex-BSkyB executives David Chance and Ian West are reported to be interested in offering a £10 a month service using Freeview's spare channel capacity.

BSkyB has launched Sky Scape, an internet website that enables PC users with a broadband connection to receive Sky video clips, short films and football action.

There's a new pricing deal for Sky+: a free subscription for customers who subscribe to more than one of Sky's premium sports or movie channels. The basic Sky+ subscription remains at £10 per month, with the Sky+ box costing £199 plus £50 for a standard installation. Sky's Extra Subscription, which gives customers independent viewing of Sky channels in another room, now costs £10 a month when taken with Sky+. BSkyB is to impose a price increase of five per cent or more for

its programme packages from next month.

Humax is to launch a DTT personal video recorder early next year, with a twin tuner and a 20GB hard disk that can be upgraded by the user to 80GB. Humax is in discussions to include the GuidePlus EPG.

A US appeals court has upheld a ruling that requires American TV set manufacturers to include a digital tuner in all new large-screen sets from next year. The FCC had issued an order to this effect in 2002, as part of a programme to convert US TV from analogue to digital. The US Consumers Electronics Association had argued that the FCC had no authority to make such an order.

EU commissioner Erkki Liikinen has written to all EU member states requesting that they publish the dates by which they plan to switch from analogue to digital TV broadcasting. He has also issued guidelines for the reuse of the analogue TV spectrum.

More BBC DAB transmitters

During August and September the BBC added ten new transmitters to its DAB network, bringing an extra 2.4m people within the coverage and improving the signal for nearly two million more. The new transmitters are at Heathfield (East Sussex), Idle (Bradford), Piccadilly Plaza (Manchester), Naish Hill (Chippenham), Manningtree (Ipswich), Rowridge (Isle of Wight/Southampton), Dover, Bromsgrove (Worcester), Salisbury and Bath. The latest information is available at www.bbc.co.uk/digitalradio

TV Lifting Aid

Advanced Handling has introduced the Liftmate, a two-wheel trolley designed for delivering TV sets and moving them around. It has a single mast with winch and uses either a fork-lift or a pair of suction cups to support the set. For further details phone 01778 345 365 or check the website at www.advancehandling.co.uk

Industry news

Samsung and Sony have signed a 'memorandum of understanding' with the aim of establishing a joint venture for the manufacture of amorphous TFT LCD panels. The joint venture will involve an investment of some \$2bn (about £1.3bn). It's expected to start production in early 2004, producing seventh-generation panels (1,870 x 2,200mm substrates) at a plant to be built by Samsung in Korea. The target is to produce tens of thousands of substrate sheets per month by the summer of 2005.

TCL International, which is China's largest manufacturer of TV sets, and French manufacturer Thomson plan to merge their TV and DVD-player manufacturing operations. The Chinese company would own 67 per cent of the joint venture, to be called TCL-Thomson, which would become the world's largest TV manufacturer with sales of over \$3.5bn a year, some 20,000 employees and production of 18m or so units a year. The deal is subject to final agreement and regulatory approval, which are expected in the first half of 2004. TCL has been seeking a way of enhancing its position in the global market, and has also been in talks with Philips. Last year it bought the bankrupt German TV manufacturer Schneider Electronics.

Sharp expects to increase its net profits for the current half year to a record ¥27bn (\$243m), 19 per cent more than for the equivalent period in the previous year. The company attributes this to success with its flat-panel TV sets and camera-phones.



The world's largest LG Electronics 76-Inch PDP

LG unveiled the world's largest plasma-panel TV set, with a 76in. screen, at the recent Korea Electronics Show in Seoul. The display panel is just 83mm thick. A 70in. version was introduced in July. The new 76in. display has 2.07 million pixels, providing a resolution of 1,920 x 1,080 pixels. A one-unit type filter is attached to the PDP module itself.

DVD update

Pioneer plans to launch two DVD players with an HDMI (High-Definition Multimedia Interface) connection. This is an industry-supported standard for the transmission of uncompressed digital audio and video via a single cable. It's designed to provide an interface between AV sources such as a set-top box, DVD player, AV receiver and a digital TV set. Models DV688AV and DV868AV are designed for use with Pioneer's plasma display products, which also have an HDMI port.

Toshiba has launched a dual-format DVD recorder, Model D-R1, which can record on DVD-RAM, DVD-RW (video mode only) and DVD-R discs. Other features include an IEEE 1394 interface for digital camcorders, an RGB-compatible scart socket and a PAL progressive scan output. Cost is about £400. Toshiba has also developed a gallium-nitride based blue-violet laser for use with the next generation of DVD players/recorders. The new laser has a wavelength of 409nm and an optical output of about 200mW.

JVC has launched a home cinema system, Model QP-ES8AL, that includes the DR-M1 multi-format DVD recorder, which has also now been launched in the UK. The DR-M1 can record on and play back DVD-RAM, DVD-RW and DVD-R discs. It can also play back DVD-Video, CD, CD-R/RW and Video-CD discs, also WMA and MP3 audio files and JPEG still photos stored on a CD-R or CD-RW disc.

Sony has launched the PSX combined PlayStation 2, hard-disk recorder and DVD recorder in Japan. There are two models, the DESR-5000 which has a 250GB hard disk capable of recording up to 325 hours of video material, and the DESR-7000 which has a 160GB hard disk

capable of recording up to 204 hours of video material. No UK launch dates have been announced.

The DVD Forum has rejected a proposed disc that consists of half-thickness DVD and CD discs glued back-to-back and should thus be playable by any CD or DVD machine. The samples submitted were too thick and could jam in a slot-loading CD player. There could also be legal problems with linking the CD and DVD Forum specifications. The Forum had previously rejected a disc with CD and DVD layers because of unpredictable performance when played by DVD machines.

Pioneer and Panasonic plan to launch combined DVD-R and hard-disk recorders that can copy VHS recordings at up to 24 times normal speed. The hard-disk section has an analogue input and converts this to MPEG-2 video. As VHS picture quality is relatively poor, recording on the hard disk can be done at a low data rate of about 1.7Mbits/sec, one sixth that used for high-quality DVD recordings. During the recording process the hard disk section automatically creates a menu index, using thumbnail images. The user then decides what is to be transferred to a blank DVD-R disk. As the VHS-quality pictures have been recorded at a sixth of the normal DVD rate, they can be copied to the DVD-R disc at 24 times normal speed (the fastest DVD-R blanks work at up to four times the normal speed).

Philips is working on a combined DVD+R and hard-disk recorder that can carry out similar copying at 48 times normal speed, so that an hour of video can be copied in little more than a minute – DVD+R blanks can work at up eight times normal speed.

JVC's new MiniDV camcorder, Model GR-D200, incorporates a whole load of technology in its compact, stylish case. The 1/4in., 1.33 Megapixel image sensor, together with the super high-band processor, achieve a horizontal resolution of 540 lines. The USB interface and software CD-ROM incorporated make a variety of video creativity and communication functions possible.

The USB interface can send streaming video (MPEG-1) to a PC for various purposes such as recording on a CD-R disc. The software provided enables the MPEG-1 data to be converted to MPEG-4 for emailing. Digital stills can be captured and in addition a built-in digital still camera enables HG digital stills to be shot, with four selectable size settings, and stored on the 8MB SD memory card provided. The memory card can also be used with an MPEG-4 email video clip recording function. All stored data can be quickly transferred via the USB interface, with on-screen icon access. The memory card can be ejected and inserted into an optional floppy disk or PC card adaptor for transfer to a PC.

The DV input/output terminal (i.Link and IEEE 1394 compliant) provides fast data transfer to/from a computer equipped with a DV board and dubbing to/from another MiniDV unit. An

analogue input enables analogue video from an external source to be dubbed to the MiniDV format.

The camcorder comes with a set of software for convenient image handling and modification. It's equipped with a 2.5in. LCD monitor that can be freely tilted for accurate, creative shooting, and has a 200x super digital zoom. The digital image stabiliser eliminates hand shake.



TV-phones

Nokia is to launch a mobile phone with a built-in TV tuner which will enable users of 3G phone networks to receive TV broadcasts that use the DVB-H (Digital Video Broadcasting for Handsets) standard. Model 7700 will also include a video camera and an FM radio. No launch date has been announced.

NEC demonstrated a working prototype mobile phone with built-in TV tuner in June (see Teletopics last month). Sanyo demonstrated a TV-phone at the recent CEATEC exhibition in Tokyo.

Sharp's latest LCD technology includes 3D

A 3D LCD screen that requires no special glasses to see 3D images has been introduced by Sharp in a notebook PC, Model PC-RD3D. The display can be switched between plane (2D) and solid (3D) modes. Sharp uses a technique known as the parallax barrier to control the path of light so that slightly different images reach the left and right eyes. The 3D screen combines a conventional TFT LCD with a switching LCD that provides the optical parallax barrier, making it possible to separate the display images into right and left. By displaying the images as a stereographic pair, each eye sees only the image intended for it: the brain combines these images to perceive a 3D image. The switching LCD makes the parallax barrier transparent to provide 2D displays. No UK launch date has been suggested.

Sharp has also developed what it calls Advanced Super View LCD technology, a new LCD module that provides an ultra-wide viewing angle. The modules, with screen sizes from 1.5 to 6in., are designed for use in portable devices such as mobile phones, PDAs and digital still cameras. Commercial production is to start in 2004.



Mobile phones are part of everyday life for most people nowadays. Chris Archer outlines their history, how they operate, then dismantling and repair procedures for some common models. The aim is to provide enough basic information to enable faulty phones to be repaired rather than consigned to the bin

Mobile phones and their repair

The aim of this article is to demystify mobile phones by providing a bit of background history, an introduction to their operation, then dismantling and repair procedures for some common models. This should give you enough confidence to attempt repairs rather than just consigning faulty units to the bin.

Fig. 1: Aerial removal, Nokia Model 3210.

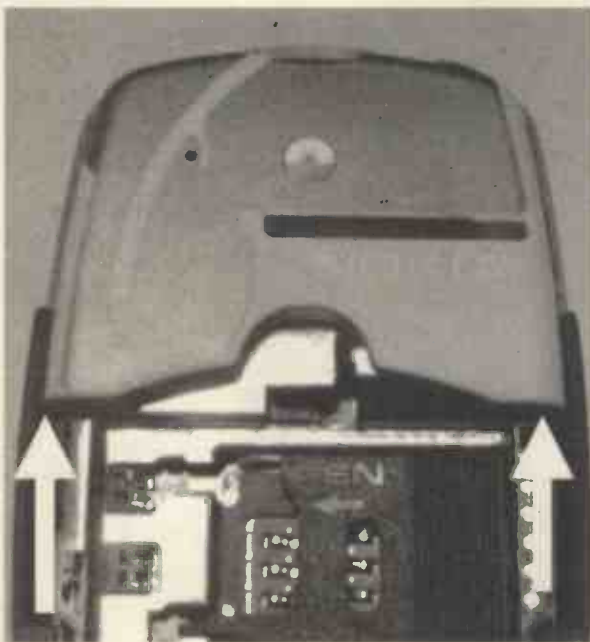

Historical note

Mobile phones first appeared in the UK in 1985. First-generation (1G) phones used analogue voice channels that were susceptible to interference and fading. They were also inefficient in their use of bandwidth, and a simple scanning radio could be used to eavesdrop on conversations. It proved to be a very successful operation however, with a peak of nearly two million subscribers in the UK before the current second-generation (2G) digital system began to take hold in the early nineties.

The 2G system used in the UK and most of the rest of the world, with the notable exception of the US, Canada and Japan, is known as GSM (Global System for Mobile Communications). In recent months the third-generation (3G) system has started to operate in the UK. It provides much greater channel bandwidth, and thus makes possible bandwidth-hungry applications such as video messaging.

Basic operation

The basic idea behind all three generations of mobile phones is that of 'cells'. The base station for each cell uses one or more specific frequencies. Mobile phones in the

vicinity of the base station use these frequencies. If a phone moves, for example when it's used in a car, the signal from the initial base station will decrease while that from a different base station will increase. At some point the network will decide to hand the phone over to the new base station, and it will be told to change channels.

The size of these cells varies with population density. In a rural area a base station may cover many tens of square miles, while an urban base station may operate at low power and cover only a few hundred square metres, thus allowing greater reuse of frequencies.

Two mobile-phone bands are used in the UK, the 900MHz band which provides a total of 124 frequencies and the 1.8GHz band that provides 374 frequencies. These frequencies are sub-divided by using time-division multiplexing: each frequency is divided into frames on a time basis, with each phone being allowed one third of the time, so three phones can share the same frequency.

In the US the two main systems are TDMA, which is similar to that just described, and the newer CDMA (Code Division Multiplexing) system. CDMA is

slightly more complex because, instead of a particular frequency and time-slot being assigned to a call, each piece of data sent by a phone or the base station is assigned to a different frequency and a different time slot. The selection of frequencies and time slots follows specified patterns, so that each end of the system knows where to look for the next piece of data being sent. The advantage of this system is that it overcomes interference problems with individual frequencies. A GSM phone using a frequency that's subject to interference could find communication impossible – until the system decides to change it to a new frequency. A CDMA phone in the same situation would simply lose some data, which can be tolerated. This spread-spectrum technique is also used for military communications, because of its reduced susceptibility to interference (harder to jam) and because it is harder to intercept if you don't know the algorithm for where and when each piece of information is being sent.

The new 3G phones use a system called UMTS (Universal Mobile Telephone Service). This is basically the CDMA system just described, but with a wider bandwidth capability and split-frequency bands – one for the base stations and one for the phones.

The phones themselves can vary their power output in accordance with the strength of the signal received from the base station. Typically, the power can vary from about 1mW to 2W (20W with some of the old analogue phones). This helps reduce interference with closely-spaced cells, and prolongs battery life. Note that some devices sold by accessory shops to minimise phone radiation reduce the received signal strength, with the result that the phone increases its power output, thus negating the effect of the shield.

Single- and multi-band phones

As mentioned earlier the 2G mobile-phone networks in the UK use two bands. Vodafone and O2 share the 900MHz band while Orange and T-Mobile share the 1.8GHz band. As the 900MHz band has fewer channels, Vodafone and O2 also have some 1.8GHz base stations in densely-populated areas. Other 'virtual' operators, such as Virgin and BT, use the facilities of one of the main operators to provide their services.

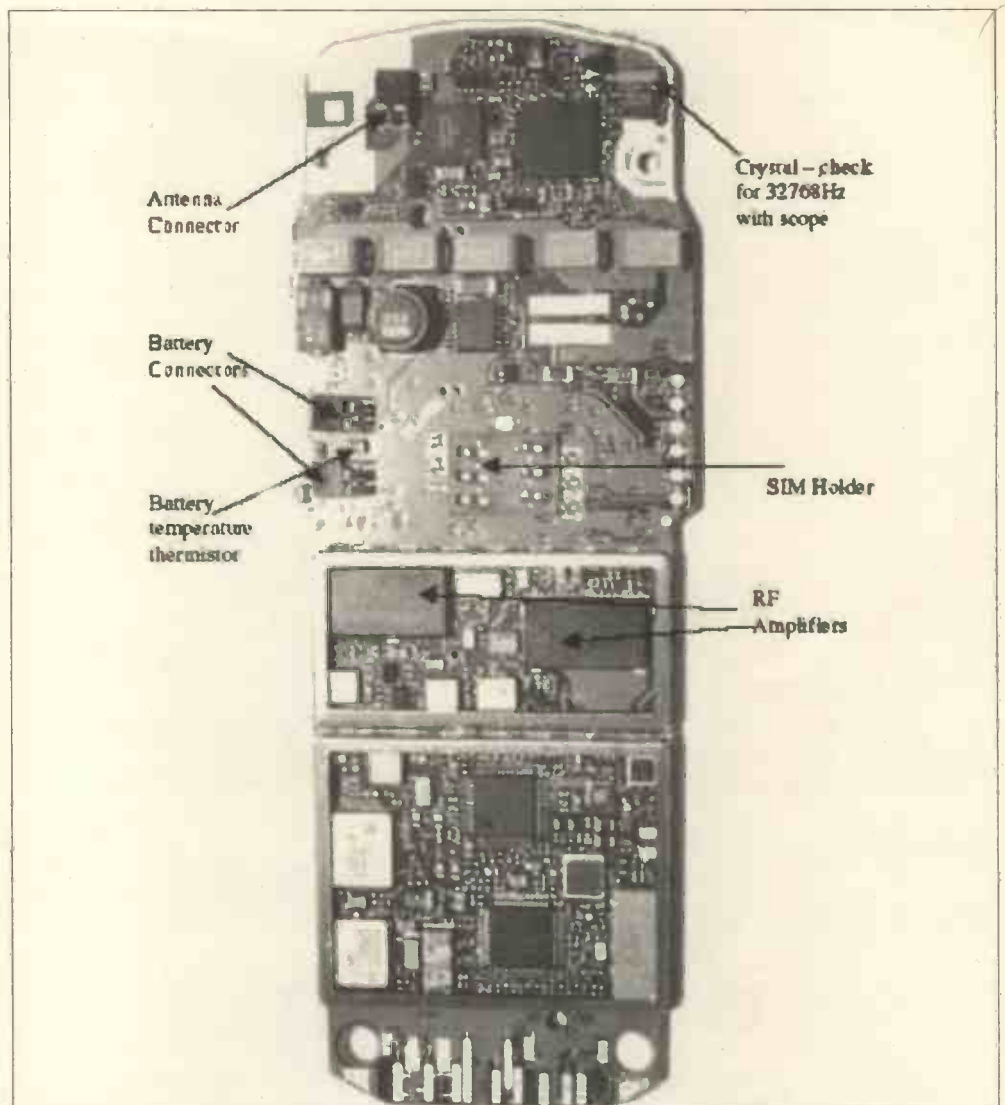

Early 2G phones were of the single-band type. Current 2G phones are of either the dual-band (900MHz/1.8GHz) or triple-band type – the latter enables them to be used in the US, where there is a limited but rapidly growing GSM service that uses the 1.9GHz band. Sadly, the move to 3G does not simplify the situation. In Europe 3G uses frequencies in the 1.9 and 2.1GHz bands. These frequencies are assigned to other uses in the US, where other bands will have to be selected. In addition, current 3G phones also have 2G capability so that they can operate outside the 3G coverage area. This again wouldn't work in the US.

Phone repair precautions

Before we move on to dismantling phones, a word about safety. The phones run at low voltage and the RF output is also relatively low, so they are safe to handle when opened up on the test bench. Phones contain many devices that could be sensitive to static however so, for

the sake of the phone, normal precautions such as anti-static mats and wrist straps should be used.

Also note that the normal working voltages of many components are very low, so the use of a typical ohmmeter for fault-finding may present a voltage that's higher than allowable and thus cause damage.

Unlocking and unblocking

There is often confusion about these terms and the legal situation.

First, unlocking. A service provider typically locks phones so that they will work only with a SIM card from that provider. Where the service provider gives away or heavily subsidises phones, it will want to ensure that it gets a return on their use: locking is a good way of achieving this. Once a phone is out of contract, it is permissible to unlock the phone so that it will work with any SIM card. Service providers will give you a code to unlock a phone, but will charge handsomely for the privilege.

The alternative is to unlock the

Fig. 2: The Nokia Model 3210 PCB, battery side.

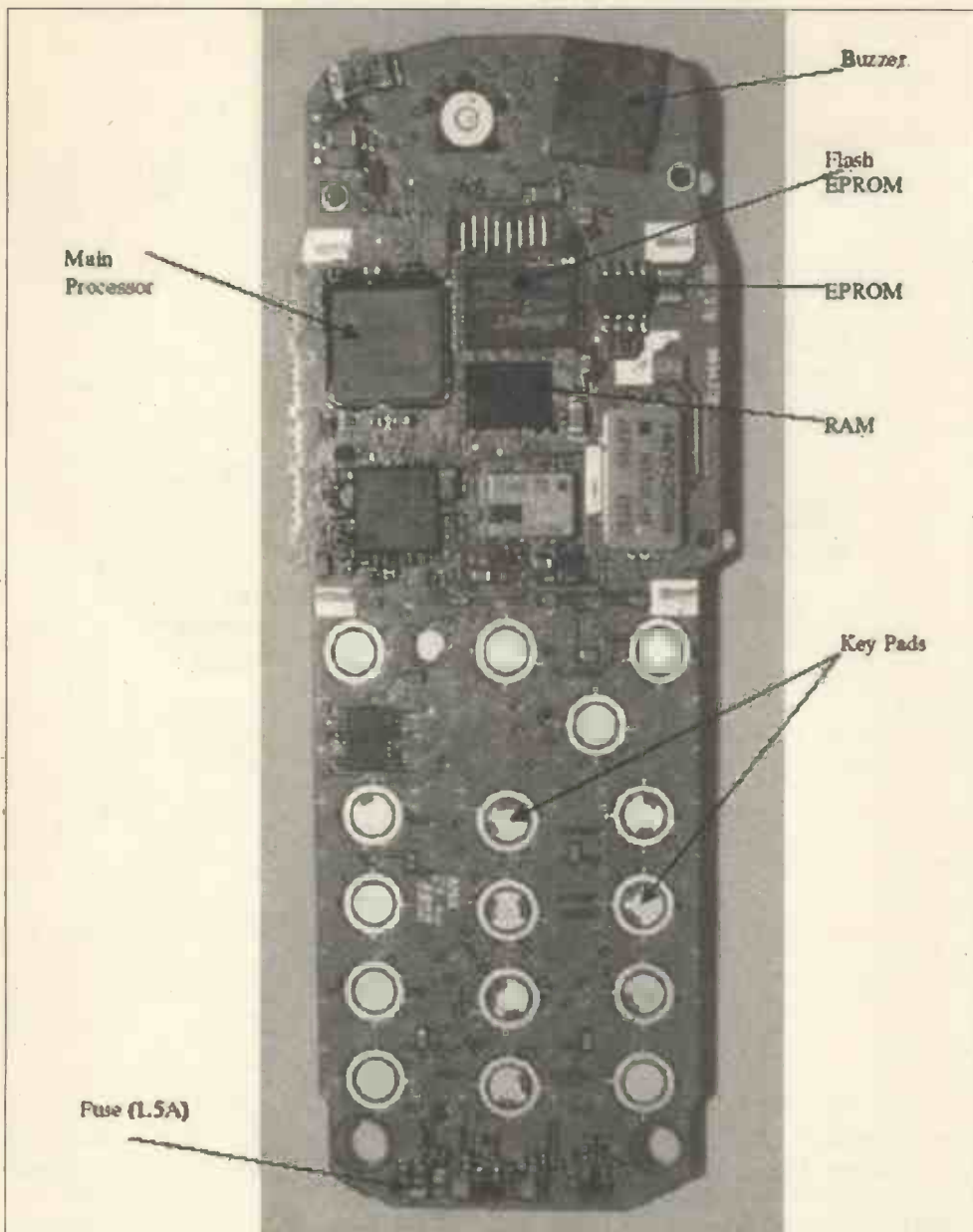

Fig. 3: The Nokia Model 3210 PCB, keyboard side.

phone yourself. Provided the phone is legally owned by the person who wants it to be unlocked, there is no problem about this. If you plan to carry out this operation regularly, it's worth investing in an unlocking tool rather than paying others to do the job. The price of these tools runs from a few tens of pounds to several hundred, depending on the range of models covered. A visit to a website such as www.activemobiles.com will give you some idea of what's available.

Secondly, unlocking. This is illegal, as is the supply or ownership of any equipment intended to unblock a phone. You can be jailed if convicted of such an offence. A phone becomes blocked when the owner reports that it has been lost or stolen. The phone will then not work with any network and thus becomes useless. Blocking is

based on the 15-digit IMEI number programmed into the phone. Unblocking involves changing this number so that it appears to be a different phone and works again.

With a second-hand phone it's always worth checking that the IMEI number printed on the case, usually under the battery, matches the number displayed on screen when you type in *#06#. If they differ, the phone could have been stolen and unblocked.

Common faults

Mobile phones are subjected to more abuse than most other electronic equipment. They are dropped, get left in hot cars, and have coffee spilt on them. This leads to faults such as failure to charge, screen fade and buttons not working. In many cases these faults can be put right with a minimum of

equipment. Other faults however, such as loss of signal, usually mean terminal failure, as repair is possible only with specialised equipment.

Of all the mobile phone brands on the market, Nokia models are by far the most common. So I'll concentrate on this brand. Much of what is said is applicable to other brands however.

The Nokia models you are likely to see for repair are the older 5110 and 5146 single-band phones and more recent 3210, 7110, 8210 and 3310. The most recent models with cameras etc. built in will generally be in guarantee and will therefore be returned to the supplier for repair rather than taken to an independent repairer. Interestingly, the models I've listed above all contain basically the same circuitry. Nokia has updated them from time to time and reduced the component size and count, but the basic design remained the same.

I will run through dismantling and typical faults. Model 3210 will be covered in detail, after which I will look at some of the other phones and their typical faults.

Model 3210

To dismantle the Nokia 3210, remove the back panel and the battery then slide the blade of a thin, flat-bladed screwdriver between the case and the aerial (see the arrows in Fig. 1) and lift the aerial slightly. Repeat the process on the other side of the aerial and lift it off. Next remove the four Torx T6 screws visible. Maplin sells a good-quality T6 screwdriver, part no. MC41U. The metal backplate can then be levered out, revealing the PCB. The plastic connector block at the bottom of the phone can now be lifted out, followed by the PCB itself. The phone contains a single PCB with components on both sides, see Figs. 2 and 3 where the major items are identified.

Typical faults and their remedies are as follows.

Failure to charge: Check the contacts between the connector block and the PCB. Check for a dry-joint at the battery connectors on the PCB: if one of the contacts is loose, the phone will work but not charge. Check whether the thermistor has become detached. I've found this item to be loose or missing in a number of phones. The phone then thinks that the battery temperature is too high and

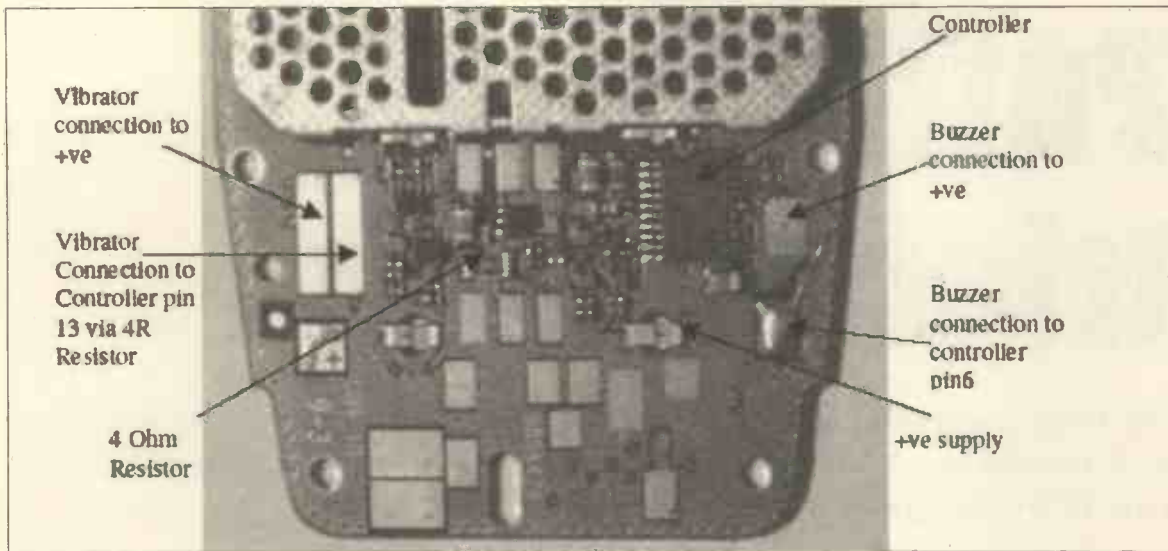

Fig. 4: PCB in the Nokia Model 3310, showing the vibrator connections.

refuses to charge. Check the voltage across the battery connectors – this fluctuates at about 3V with no battery present. **Failure to power on:** Leave the phone on charge for at least five minutes. If the battery is really flat, there will be no sign of life from the phone until there is enough charge in the battery to start up the internal circuitry. Check the charge state of the battery. Note that the phone will not work with mains charging and the battery removed. Check the battery connectors (see failure to charge). Check that there's a 32kHz sinewave at the crystal.

Faulty buttons: This problem is usually caused by liquid spilt on the keyboard. It can usually be cured by cleaning the PCB in the area of the keys and the plastic/metal film that provides the button contacts. When three or four buttons appear to be faulty this usually means failure of one of the major components associated with the keyboard matrix.

Models 5110, 5146, 5130 and 402

These phones are basically similar – some operate at 900MHz and some at 1.8GHz. To dismantle them, remove the battery and clip-on cover then the four T6 screws in the battery compartment. Turn the phone over. The grey plastic cover will now come off, revealing two more screws at the top of the case. Remove these to release the upper PCB, with the screen. A single screw in the centre of the board holds the lower PCB.

These phones are robust and, despite their age, very reliable. The most common fault is a cracked

case where the aerial emerges or a snapped aerial. A broken aerial can be removed by using a pair of pliers to squeeze its base, inside the case, to compress the retaining lug then pushing the aerial upwards. Make sure that the replacement is of the correct type – the 900MHz and 1.8GHz versions look the same but are different internally.

These phones often suffer from screen fade or a completely blank screen. This can usually be cured as follows. Remove the screen from the PCB by prizing out the four metal lugs on the screen surround. The elastomer, which connects the LCD to the PCB, can then be removed with a screwdriver and cleaned with a degreasing agent. Bend the four lugs in slightly before clipping the LCD back on to the PCB: this will hold the LCD to the PCB more tightly and reduce the chance of a recurrence of the problem.

Charging problems are usually caused by one of two factors. The small surface-mounted 1.5A fuse mounted at the bottom left, on the opposite side of the PCB to the SIM holder, may have blown; or the centre pin of the power connector may have become loose as a result of movement and may need to be resoldered to the PCB.

Models 3310 and 3330

Model 3310 and its WAP cousin the 3300 are dismantled by removing the clip-on covers then undoing the six T6 screws in the case. Next, insert a small, flat screwdriver between the case and the screen to free the screen from the clips. The screen can then be lifted free, followed by the PCB. Everything is on a single PCB in this model, with the connectors and

ancillary components fitted into the moulded case.

Failure of the on/off switch is common. It's mounted on the PCB at 90° to the rubber button at the top of the phone and seems to rely on a certain amount of sideways pressure for operation. When this fails, users tend press harder or use a pen which breaks the switch or makes it come apart. The top of the switch clips on the base, which is soldered to the PCB. It is sometimes possible to repair the switch by removing the top then reassembling it correctly.

A recurring problem with these phones is failure to ring or vibrate. Before you start fault-finding, a quick check on the menus is always worthwhile. It may just be that the phone has been set to silent or vibrate has been disabled. If this fails to produce the solution, check the vibrator-motor connectors. These are long, thin metal strips that make contact by pressure on the PCB. If a phone has been dropped, the contactor may have bent so that it no longer makes contact. If this proves to be OK, check the vibrator momentarily with a DC source of about 3V. Finally, check the continuity between the positive supply and the ringer/vibrator, also the connections to the controller IC. I've come across many cases where these PCB connections have failed – I can only assume that this is related to the track thickness and the current required to drive these devices. If these connections are faulty, a thin wire such as a Verewire pen will be needed to bridge the gap. In Fig. 4 I have added a wire from the ringer pad to pin 6 of the controller IC to overcome this problem. ■

Putting the triac to work

The triac is a useful semiconductor device that's not as well-known as it should be. J. LeJeune describes its mode of operation and how to make use of it

The triac is in effect two thyristors that are inverse-parallel connected and are fabricated as a single device, with three terminals. It deserves more attention than it's normally given. The name is a combination of 'triode' and AC, denoting that it's a three-terminal device for use with alternating current. It was developed by General Electric, which took out patent no. 3,275,909 for it, and differs from a thyristor in that it can conduct in both directions, controlled by a positive- or negative-going trigger pulse at its gate. The device has been notably successful as a means of controlling AC power.

Basic operation

The basic npnp + pnpn structure of the device is illustrated in Fig. 1. Terminals T1 and T2 are connected to both a p and an n region, with the result that between each terminal there's an npnp structure in parallel with a pnpn structure. The gate is also connected to both p and n regions, so that either positive- or negative-going trigger pulses can

be used. The modes of operation are as follows:

- (1) Terminal T2 positive with respect to terminal T1, positive-going trigger pulse.
- (2) Terminal T2 positive with respect to terminal T1, negative-going trigger pulse.
- (3) Terminal T2 negative with respect to terminal T1, positive-going trigger pulse.
- (4) Terminal T2 negative with respect to terminal T1, negative-going trigger pulse.

The device is triggered during either the first or the third quadrant of the applied AC waveform depending on the mode of operation.

Because a triac can conduct in either direction it cannot turn off in the same manner as a thyristor. It switches off only when the applied AC crosses the zero point. For this reason it cannot be used for HF applications. Use at 50Hz allows correct operation however.

Switching with an inductive load is unreliable unless a CR network is connected across terminals T1 and T2 to limit the change of voltage with time (dv/dt) to about $1V/\mu\text{sec}$. Suitable values are $0.1\mu\text{F}$ and 100Ω . In addition the device must have a switching capability of better than $2V/\mu\text{sec}$.

Use

The use of triacs has advantages over mechanical devices in static switching circuits. A heavy current can be controlled by a

small gate signal, there's no contact bounce and, as switch-off occurs at the zero crossover, there are no voltage transients with an inductive load. An added bonus is a very low component count. The disadvantage of a triac compared with a relay or contactor is that one cannot readily isolate the control circuit from the power source.

A well-known Korean-made vacuum cleaner used variable triggering of a triac for motor-speed adjustment, with the control potentiometer sited in the handle of the suction pipe. An optocoupler was used for isolation, but a small mains transformer had to be used to provide the low-voltage supply for the control circuit. A pair of wires was embedded in the suction pipe, with a connector at the bag end. This system was prone to breakdown and was not used in subsequent models.

A triac responds well to variable triggering where isolation is unimportant, but extra components need to be added to the basic circuit to achieve smooth operation, see Fig. 2. D3 is a diac, or bi-directional diode, which is used to trigger the triac. The charging circuit RV1/C1 controls the point at which D3 switches on. Other triggering devices can be used, with varying levels of efficiency. The diac is favoured in America, possibly because of the lower mains voltage used there. A neon lamp without its series resistor works fairly well with a 230V supply. A silicon bilateral switch is another possibility, while for more sensitive applications the

Fig. 1: Basic structure of a triac.

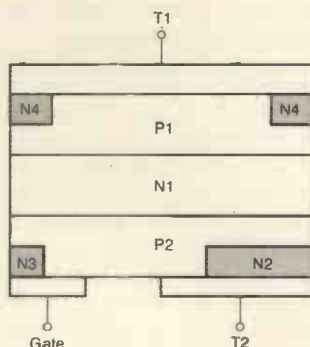

unijunction transistor provides a neat solution.

A simple charging circuit for control can cause abrupt triggering when attempting to raise the power in the load from zero to a chosen level, with smooth adjustment over the range thereafter. To counter this effect and provide smoother operation, R1, D1 and D2 are added to the basic circuit. The diodes reset the charge on the capacitor at the end of each positive-going half cycle. During the positive half-cycle both diodes are reverse biased and C1 charges via RV1. At some point the diac triggers the triac. As the supply voltage falls during the second quadrant of the AC cycle, a point will be reached where the voltage at the cathode of D2 falls below that across C1. D2 will then conduct, discharging C1 via R1. When the mains supply crosses the zero point and becomes negative, D1 conducts and C1 charges to a negative voltage. No reset occurs at the end of the negative half-cycle. A reduction of the 'snap-on' effect can also be obtained by connecting the 'hot' end of RV1 to the supply side of the load, though this may not be convenient when controlling remote items such as lighting.

The diac, which is probably the best trigger device for a triac, normally has a switch-on voltage of 28-36V and a maximum switch-on current of 250 μ A. Above that current the diac has a negative-resistance characteristic.

Triggering is in effect by means of a synchronised relaxation oscillator. A unijunction transistor, for example the tried and trusted 2N2646, can be used to provide a more sensitive triggering circuit. Fig. 3 shows a full-wave trigger arrangement based on a unijunction transistor (Tr1). Note that the DC supply for the transistor is not smoothed but is clipped at 20V by the zener diode. This arrangement provides synchronism at 100Hz. The transistor is transformer-coupled to the gate of the triac. RV1 could be replaced by a pnp transistor with a DC control signal applied between its base and emitter: this would allow the use of a light-dependent resistor or a thermistor as the control element.

Very short switching times give rise to RF interference, so

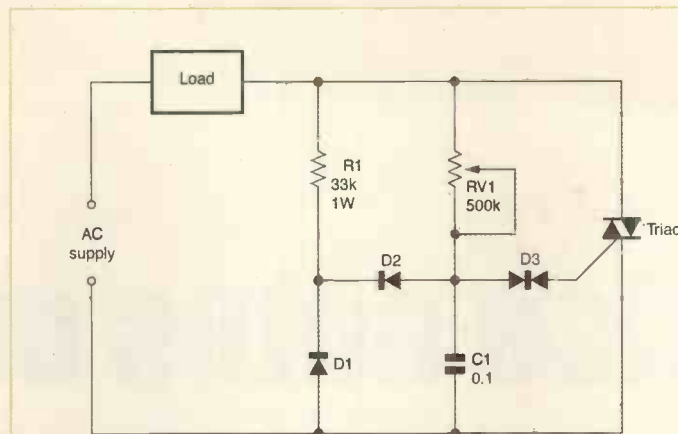

Fig. 2: Typical triac AC-control circuit, with components added (D1, D2 and R1) to reduce the 'snap-on' effect and give smooth control up to full power. D1 and D2 are type 1N4004.

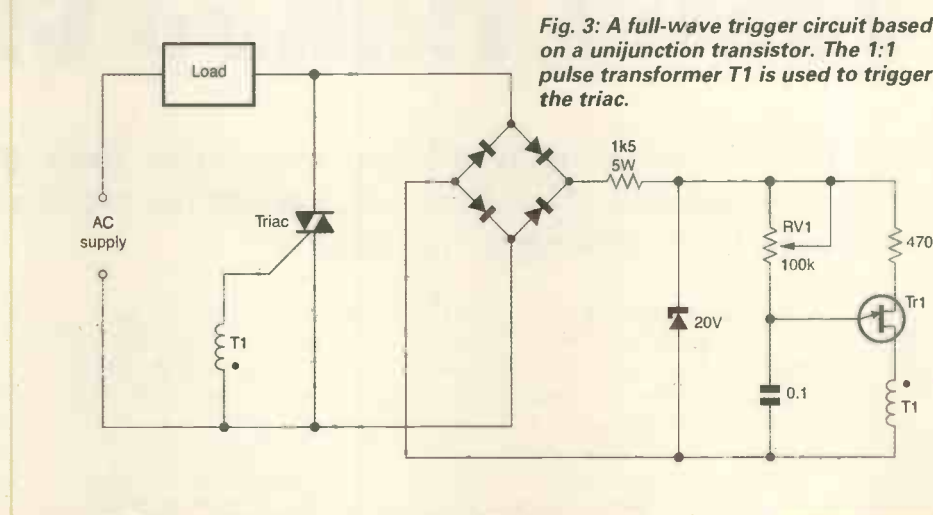

Fig. 3: A full-wave trigger circuit based on a unijunction transistor. The 1:1 pulse transformer T1 is used to trigger the triac.

suppression should be used to prevent transients reaching the mains supply. Suppression chokes are often sufficient: they should be used at both sides of the supply, as close as possible to the triac.

Heatsinking

Like all power semiconductor devices, triacs require an adequate means of heat dissipation. The size of the heatsink used obviously depends on the power handled, and can be quite small in comparison with that required by a device operating in linear class A conditions. This is because the triac is either fully on or totally off, and it is only resistive losses within the device that cause heating. An 0.5mm thick steel plate measuring 4 x 5cm, painted matt black, is adequate for a 6A triac controlling a 1kW motor. Triac overheating will change its characteristics and may lead to permanent damage – the customary short-circuit!

Applications

Triac lamp-dimming circuits should not be used with fluorescent lamps and energy-saving bulbs. Present-day applications for triacs include adjustable motor-speed control for electric drills, food mixers, vacuum cleaners and washing machines. Commutator-type motors are more easily controlled, but induction motors can also be controlled using more sophisticated circuitry, with tachometer feedback to maintain stable speed regulation and a minimum speed setting just above the start switch cutout point.

The triac has been around for a long time, about forty years, quietly getting on with the job and hidden away in a vast variety of housings. It is the silent servant in many an application, very reliable and rugged, yet offering low-cost solutions for various power-control needs. ■

Service notes on the Vestel 11AK33 chassis

The 11AK33 chassis is used in various models from Hitachi, Wharfedale and other sources. Alan Dent summarises his experiences to date with this generally well-engineered product

I have recently had for repair a number of Hitachi sets, Model C28W440N, which are fitted with the Vestel 11AK33 chassis. This chassis is also used in the Wharfedale flat-screen Models 28PF1 and 32PF1. But there are different versions of the chassis, which affects servicing procedures. The Hitachi model is fitted with version 11AK33J4 (software AK33J024) while the Wharfedale models are fitted with version 11AK33J3 (software AK33B023). With the Hitachi version a 'fault condition trip' is written into the software. Under a lot of conditions this doesn't allow 'hot' repairs. The software trip is not present with the Wharfedale models, but nevertheless some of the faults mentioned below are very relevant to them.

The main PCB in this chassis is made of high-quality material – composite fibreglass rather than the usual paper phenolic material. Thus physical breakage is rare. The board may nevertheless be damaged should a component overheat and burn its solder pads. This particularly applies to D601 (BA159) which provides the 60V flyback supply for the STV9379FA field output chip IC600. The supply is derived from pin 11 of the LOPT, and is also the source of the tuning voltage.

Types of tripping

If pin 30, blanking input, of the 64-pin TDA8885 jungle (IF/colour decoder/timebase generator) chip IC200 doesn't receive the correct waveform the chip sends a shutdown signal via the

I²C bus to the microcontroller chip IC500, which in turn switches the power supply to standby. At the same time IC200 ceases to produce the line-drive output at pin 56.

There are several possible reasons why this might occur. In most fault conditions the set reverts to standby after five seconds. Under some fault conditions however the set reverts to standby after approximately two seconds. These are separate conditions and require different approaches.

Two-second trip

In this condition there is almost certainly a fault in the power supply. What happens is that as soon as the line-drive pulses appear and the line output stage draws current (200mA) the power supply reverts to standby. To enable fault-finding to be carried out in this condition the following steps should be taken.

(1) Connect a 60W lamp as a dummy load across the HT (150V/160V) reservoir capacitor C127.

(2) Disconnect link J290 and fit a flexi jumper from the pad of J288 in series with J290 to L504 (+3.3V) near the microcontroller chip. Also disconnect a link that supplies HT to the line output stage – there are four to choose from.

The standby command is now disabled and the power supply can be 'hot tested'. Various items can be disconnected to isolate sections of the power-supply

control – the collector of Q105, the collector of Q103 and any two pins of thyristor Q107. Once these items have been disconnected only the HT-monitoring circuit and the optocoupler IC100 will be in use. If, after this, the power supply still fails to give full output, check R128 (130k Ω) in the HT-monitoring circuit. If its value changes by ten per cent it will prevent the power supply from providing full output.

Alternatively you can make up a module from scrap components, see Fig. 1, to replace the control circuit and optocoupler. Remove the optocoupler (IC100) from the PCB and connect the module in its place.

It is not unusual for items on the primary side of the power supply to fail. IC106 (MC44608) and the optocoupler IC100 (TCET110G) can both be responsible for low output.

Resolder all disconnected items once the fault has been cleared.

Five-second trip

This is the more difficult situation, as many conditions can cause the set to revert to standby after five seconds. As previously mentioned, the jungle chip IC200 will tell the microcontroller chip IC500 to switch the power supply to standby if the blanking waveform at pin 30 is missing – it will also cease to produce the line drive pulses. The blanking waveform is made up of elements from the field and line output stages. Thus a problem in the line or field timebase or a missing power supply will produce the revert to standby after five seconds

condition. To establish the cause, I recommend the following checks.

If a spare control panel is available, connect it to PL509. If not, it may save time to remove the panel from the set to make switch-on easier – so that you don't have to try to switch on from the front every time.

(1) Check for line drive at the base of the BU2508AF line output transistor Q602 or some other convenient place. Note that the line drive does not appear immediately – the jungle chip has a delay timer. If there is no line drive after three seconds, check back via the line driver transistor Q600 to pin 56 of IC200. If there is no line drive here, check that the 12MHz crystal X200, connected to pins 51 and 52, is oscillating. IC200 may be faulty, or the 8V supply at pin 23 or 53 may be missing.

(2) If the line output stage is able to operate and produce EHT, check the supplies to the STV9379FA field out-

put chip IC600. There are three supplies, +60V at pin 3, -11V at pin 4 and +11V at pin 2. It's best to check these supplies at the IC's pins, as they are all fed via fusible resistors. If any voltage is missing, check the relevant fusible resistor. If it's burnt, replace the IC. You may find that the voltages are present and that there are field-drive ramps at pins 1 and 7 yet there's no output. In this case IC600 is probably faulty.

(3) If there are no ramp drives at pins 1 and 7 of IC600, check for oscillation at pin 4 of IC200 – this is the field-ramp generator. Also check at pins 64 and 63 for field drive and inverted field drive respectively.

(4) If the EHT comes up then the set goes to standby the EHT overvoltage trip in IC200 may be operating. IC200 monitors the EHT and HT voltages at pin 3 and the beam current at pin 34. The nominal voltage at pin 3 is approximately 1.8V DC. If this voltage

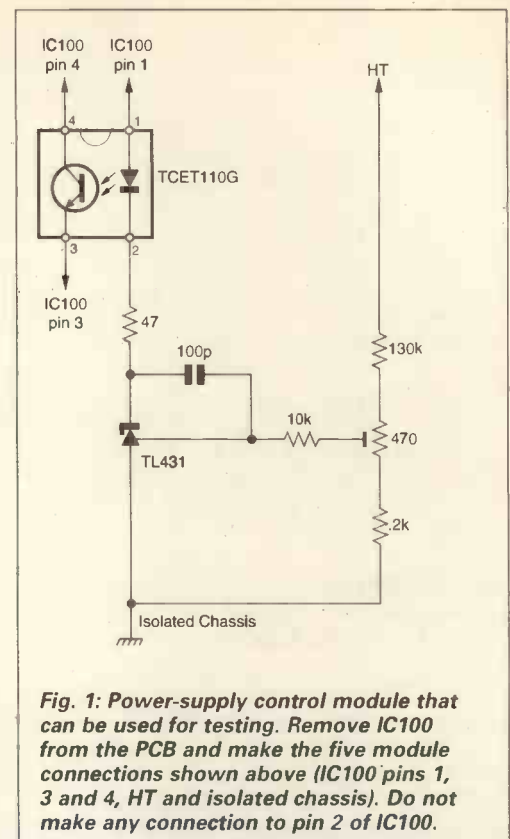

Fig. 1: Power-supply control module that can be used for testing. Remove IC100 from the PCB and make the five module connections shown above (IC100 pins 1, 3 and 4, HT and isolated chassis). Do not make any connection to pin 2 of IC100.

Table 1: Voltages/waveforms at the pins of IC200 (TDA8885)

Pin	Voltage/waveform	Pin	Voltage/waveform
1	IF input. 2V DC	33	R drive output, 2V p-p
2	IF input. 2V DC	34	BCL input. 2.8V
3	EHT monitoring, normally 1.8V DC	35	Red OSD input. 3.5V DC
4	3V p-p field ramp on 2V pedestal	36	Green OSD input. 3.5V DC
5	4V DC	37	Blue OSD input. 3.5V DC
6	Chassis	38	1V p-p OSD blanking on 3.5V pedestal
7	AGC. 2.8V DC with normal signal	39	1V p-p luminance on 3V pedestal
8	Sound IF input. 2V DC	40	1V p-p luminance on 3V pedestal
9	Sound IF input. 2V DC	41	Scart R in. 0V DC
10	SIF AGC. 2.5V DC	42	Scart G in. 0V DC
11	0.5V p-p sound on 2.5V pedestal	43	Scart B in. 0V DC
12	n/c	44	Scart blanking in. 0V DC
13	7.4V DC	45	0V
14	Chassis	46	2.6V DC
15	IF PLL. 2.5V DC	47	2.6V DC
16	2V p-p comp video on 2V pedestal	48	2.6V DC
17	SCL. 5V p-p	49	4V pedestal with 0.4V p-p RF on top
18	SDA. 5V p-p	50	5V DC
19	3.5V DC	51	Xtal RF, 2V p-p on 0.5V pedestal
20	1.5V DC	52	Xtal RF, 2.5V p-p on 0.5V pedestal
21	S video in. 3.5V DC	53	8V DC
22	0V	54	2V p-p comp video on 2V pedestal
23	8V DC	55	4V DC
24	1V p-p comp video on 3.2V pedestal	56	3.8V p-p line drive on 2V pedestal
25	Chassis	57	6V p-p sandcastle pulses on -0.5V pedestal
26	2V DC	58	PLL. 3V DC with slight RF on top
27	n/c	59	PLL. 4V DC
28	2.3V DC	60	-
29	1V p-p comp video on 3.2V pedestal	61	Chassis
30	3V p-p blanking on 3V pedestal	62	0.3V parabola on 2.6V pedestal (EW drive)
31	Blue drive output, 2V p-p	63	2.5V p-p inverted field drive on 1.5V pedestal
32	Green drive output, 2V p-p	64	2.5V p-p field drive on 1.5V pedestal

ONLINE SHOPPING CHEAPER AND EASIER

www.elclondon.co.uk

TV, VIDEO SPARES AND ELECTRICAL ITEMS



ELC EAST LONDON COMPONENTS
63 PLASHET GROVE, LONDON E6 1AD.
 TWO MINUTES WALK FROM UPTON PARK TUBE STATION
 TEL: 020 8472 4871 FAX: 020 8503 5926
 E-mail: sales@elclondon.co.uk

SPARES & REPAIRS

**SPECIALISTS IN ALL MAKES AND
 MODELS OF SATELLITE EQUIPMENT**
 ECHOSTAR / TECHNOMATE / HUMAX / MANHATTAN
 GRUNDIG / PANASONIC / PACE / AMSTRAD

**SAME DAY COLLECTION FROM MAINLAND
 UK ADDRESSES - BOOK BEFORE 1PM**

**LARGE SELECTION OF REFURB BOXES COMPLETE
 WITH 12 MONTHS WARRANTY AND
 NEW ACCESSORIES**

**SPARE PARTS FOR DIGIBOXES - NEW AND USED -
 POWER SUPPLY UNITS, TUNERS, MODEMS,
 RF SOCKETS, BGA'S AND CHIPS**

WE ALSO STOCK COSMETICS FOR ALL DIGIBOXES

**EXCLUSIVE
 TO SDS!**



SILVER PACE 2200 DIGIBOXES

DISCOUNTS ON QUANTITIES

SDS
 Satellite &
 Digital Services Ltd.

**1 HOWARD AVENUE
 BARNSTAPLE
 DEVON
 EX32 8QA
 TEL: 01271 325888
 FAX: 01271 329163
chrissds@hotmail.com**



Electronicworld TV AND VIDEO LTD

Our **HUGE** product-range has **HUNDREDS** of models,
 most of which are **NEARLY NEW**.
 You'll find **EXCELLENT QUALITY** with the very latest
 style in **HOME ENTERTAINMENT** and the ultimate
 range of **PREMIUM BRANDS**.
 Our prices, we believe **CAN'T BE BEATEN**.



TVRUS Electrical Goods at **UNBEATABLE Prices...** vsp SECURITY

Wholesale Customers
 for more information
 click here >>

See our new awesome web site. Just click
 on the wholesale link to view just a small
 sample of our stock.

<http://www.tvrus.co.uk>

All prices are Exclusive of VAT
BIRMINGHAM
 208 Bromford Lane, Erdington, Birmingham
 B24 8DL
 Tel: 0121 327 3273 Fax: 0121 322 2011
LONDON
 221 Kenton Road, Middlesex HA3 0HD
 Tel: 020 8907 9387
PRESTON
 Unit 434 Ranglet Road, Walton Summit,
 Preston PR5 8AR
 Tel: 01772 316066



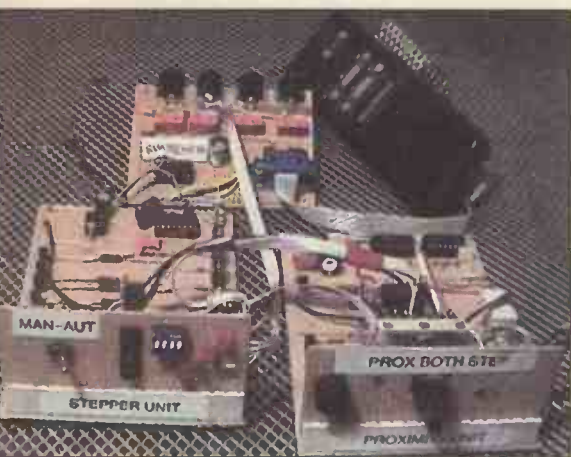

A flexible CCTV system

In this concluding instalment Ian Rees considers cameras, proximity detectors, system expansion and construction and installation

Part 1 last month described the overall system and dealt with the basic circuit modules used. To start with this month we'll consider camera requirements.

Cameras

Any type of CCD camera can be used with these circuits. Select them to suit the particular site and lighting conditions. Thieves go to great lengths to steal expensive, professional cameras mounted in what look like inaccessible positions. For this reason I often find it preferable to use miniature PCB CCD types which can be fitted in covert, unconventional cases that draw less attention. Dummy decoy cameras can be installed to act as a deterrent. The financial loss is relatively little should they be stolen.

Waterproof enclosures for standard cameras are expensive. The PCB CCD type can be built into a small weatherproof plastic box with a transparent lid and mounted outside without a separate enclosure. Use of a smoky-tinted lid reduces the visibility of the contents without spoiling the optical functions of the camera. Any free space available in the box can be used for control and supply circuitry. The small amount of heat generated by the internal circuitry helps prevent condensation in cold, damp weather. Cable entry is via waterproof glands.

When sub-miniature bare PCB CCD cameras first became available their price and performance did not match that of the cheaper fully-cased types. So they had no advantages apart from small size. Now that the price has fallen to about £10 they are much more attractive for a multitude of applications. Colour and monochrome

imaging is reasonably good and improving. Pinhole, wide- and narrow-angle lenses are available. Without iris or automatic focusing, these cameras are so far limited to applications where the light level remains reasonably constant and the depth of focus doesn't change.

At this end of the market camera specifications, if available, are usually not very helpful, so comparing like with like is difficult. Paying more will sometimes buy you less. The scrap of paper that passes as instruction/specification often gives just the colour code for the wiring and the supply voltage. Catalogues may include some sort of optimistic specifications but often contain a clause such as "the unit supplied may vary from the one illustrated, depending on availability". It is best to adopt a "buyer beware" policy and check every purchase immediately to ensure that camera(s) are satisfactory for your requirements.

Not all specifications state the country the cameras are designed to work in. In the UK the video output must conform to the European CCIR TV and UK PAL colour standards. Cameras bought from UK suppliers are likely to be OK, but beware when purchasing via the internet.

The following are the most commonly quoted items in published specifications:

CCD 'screen': Most of the PCB cameras available have a 1/3in. CCD (charge-coupled device) imaging area on which the image is focused. The size is measured diagonally across this light-sensitive area, in the same way as with CRTs. The actual size is 3.6 x 4.8mm. There are in excess of 300,000 pixels in this area.

Horizontal resolution: Horizontal line resolution determines the detail that can be resolved in an image focused on the CCD. Specifications usually quote figures between 200-600 lines. PCB cameras with good resolution start at around 350 lines.

Minimum illumination: The minimum light level required for the camera to work lies between 0.1-10 lux. Monochrome cameras are more sensitive. Expect figures for an average PCB camera to be less than 1 lux mono and less than 5 lux colour.

Many are able to achieve 0.1 and 1 lux respectively. 1 lux is approximately equivalent to twilight.

Shutter speed: This is an automatic function similar to that with an optical photographic camera. The CCD imager is switched on and off, which simulates the shutter effect. The faster the speed the lower the sensitivity: conversely the lower the speed the higher the sensitivity. Shutter speed is controlled by the amount of light that falls on the CCD, and is therefore a compromise between image flaring and blurring. Specifications usually quote speeds as being between a fiftieth and 1/100,000th of a second.

High light levels will white or blackout the image in part or total. Provided the camera is not pointed directly at the sun, a CCD will recover when the light level drops back within its control range.

The shutter is sometimes confusingly referred to as an electronic iris.

Lens: Unlike standard, cased cameras, which are usually supplied without a lens, PCB units have a fitted lens assembly that cannot normally be substituted. The only adjustment possible is focus. There's a small grub screw on the lens screw housing. When this is loosened, the assembly can be rotated to achieve focus. A series of crosshatch lines drawn on a piece of A4 paper and viewed at an appropriate distance forms a suitable target.

The majority of PCB cameras are fitted with a 3.6mm lens that provides a 70-90° viewing angle. Pinhole cameras used in hidden positions provide a reduced angle of 60-80°. A degree of fisheye distortion is normal near the edges of the image.

If you need to dismantle a lens assembly for any reason, do so with caution. You will find as many as three or more lenses inside, all with their own small ring spacers. Should they fall out unexpectedly it can be a problem, if you have not noted their correct positions and orientation, to put them back correctly.

Video output: The video output can be fed directly to a standard scart or composite video socket without a problem. The unbalanced video signal amplitude is 1V

peak-to-peak at 75Ω, with a noise ratio better than 40dB.

Audio output: Many PCB cameras are fitted with a small electret microphone. There is no standard: the output can be in the range 50-500mV, at 600Ω to 1kΩ. Some include a preamplifier, but not all. Preamplification may be required for a feed to a scart socket.

Supply: The nominal supply voltage is 12V DC, but many cameras will operate at down to 10V DC. Consumption can be expected to lie between 20-250mA, the majority consuming about 50-100mA. Colour cameras have the highest consumption.

PCB cameras are terminated with short, unscreened colour-coded flyleads that may be connected to the board via sockets. Standard colour conventions are red positive connection, black negative/common ground and yellow video output. When a microphone is incorporated the audio output is white or green. As with many Far Eastern products, some makers fail to observe this convention. So be very careful about getting the connections right. These cameras are unforgiving. Reversing the positive/negative connections or connecting the positive supply to the video output will normally destroy the camera instantly.

Proximity detectors

Infra-red: Passive IR detectors are cheap but very prone to producing false alarms if not carefully sited and installed. Security alarm systems use them almost exclusively indoors. They do not work well outdoors in varying sunlight or windy conditions, where changing air temperature or gusts can trigger them. Because of their simple installation and wide coverage, I use the multi-knock type that reduces false triggering. False alarms are not acceptable with security systems but less serious with CCTV trigger systems. Break-beam active systems are far less prone to false triggering but a lot more expensive.

Once power has been connected to a PIR unit a normally-closed circuit will go open-circuit when triggered. When power is turned on it takes several seconds for the PIRs in the system to reach the operating set position.

A useful way of using a PIR incorporated in a floodlight is to fit a mains-operated relay to the auxiliary mains output of the floodlight. When the floodlight is triggered by the PIR, the relay signals the proximity unit. The CCTV camera can then take advantage of the floodlight that illuminates the scene. If it's acceptable for the floodlight to operate in daylight, it can be set to 'walk test' mode. Light-on time should be short.

Switches: Standard security-encapsulated magnetic-reed switches fitted to gates and doors are reliable proximity detectors.

Security systems tend to use them in the normally-closed mode, with the magnet close to the reed. I prefer to use a momentary-closed switching arrangement, see Fig. 10, with the reed mounted on the inside of the doorframe or gatepost and the magnet on the outside of the door or gate. With the door or gate closed, the magnet is too far away to close the reed switch. As the door is opened, the magnet passes and operates the reed switch. It does the same when the door closes. This momentarily-closed reed switch operation can be detected by a normally-open proximity unit input.

Alternatively the same effect can be obtained with a small arm above the door to hold the reed switch and the passing magnet below attached to the door. For correct operation the door or gate needs to have a closing mechanism.

Microswitches can be used but are usually not waterproof and don't have the same service reliability.

Pressure mats are normally open-circuit devices. Two layers of metal foil within a strong plastic wallet are separated by a layer of thin insulating foam that has large circular holes cut in it. Anyone who treads on the mat shorts the two layers of foil together, through the holes. The mat is connected to the normally-open proximity unit inputs. Pressure mats are reasonably reliable. Different sizes for placing under mats or stair treads and in doorways can be obtained. Staff aware of their position can step over them to prevent false triggering.

Garages often use an air hose connected to a pressure switch to indicate the arrival of a vehicle on the forecourt. This arrangement could also be used to trigger the proximity unit.

VOX operation

A baby alarm is an application where a voice-operated switch is an advantage. Fig. 11 shows a circuit designed for this application. The electret microphone M picks up sounds that are amplified by Tr1. RV1 adjusts its output, which is fed to Tr2.

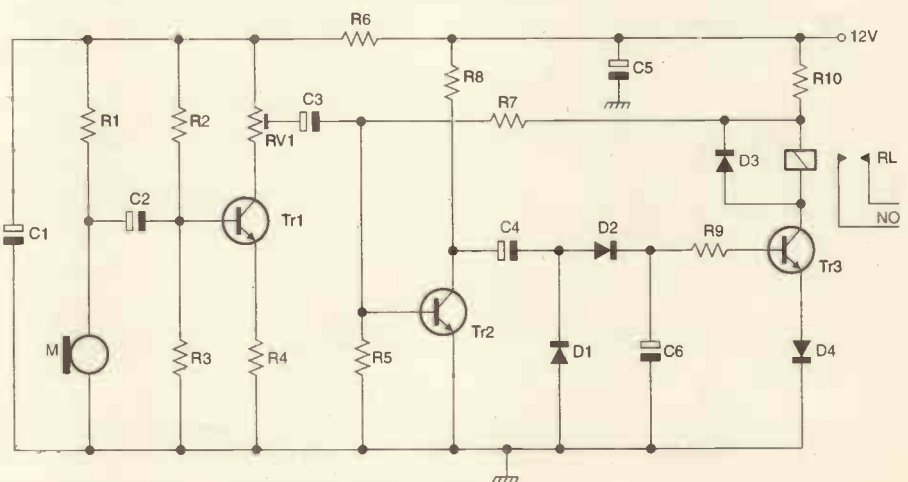

Fig. 11: A voice-operated proximity switch circuit.

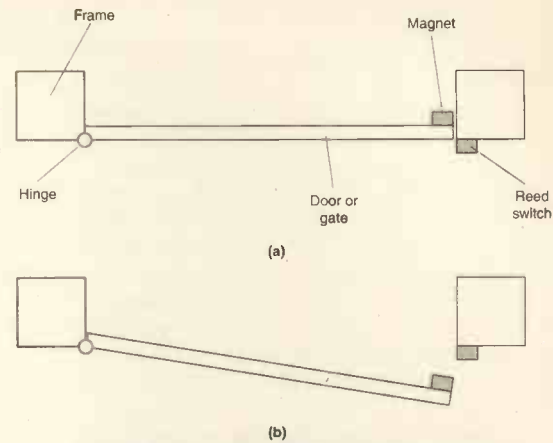

Fig. 10: Momentary-closed operation of a reed switch for proximity detection. (a) Door closed, reed switch open. (b) The reed switch momentarily closes as the door is opened (and closed).

This transistor boosts the amplification and feeds rectifier diodes D1 and D2 via C4. The output from these diodes is smoothed by C6 and applied to the base of the relay driver transistor Tr3. When the voltage at the base of Tr3 rises sufficiently relay RL closes.

Since only a momentary closure of the relay contacts is required, Tr2's base-bias resistor R7 is fed via R10. When Tr3 conducts, the voltage at the junction of R10/R7 falls, reducing the bias applied to Tr2. The effect is to reduce Tr2's gain. As a result Tr3 switches off, opening the relay contacts. The brief closure of the relay contacts can be used to trigger a normally-open proximity unit input.

The sensitivity of the circuit is adequate for most purposes. If more gain is required, add a 47μF, 16V electrolytic capacitor across R4. If a longer delay is required before operation, increase the value of C6.

System expansion

What the customer thinks he wants at the start of an installation is seldom what's installed at the end! With this in mind, I always try to leave plans sufficiently

adaptable to cope with expansion as required.

When a system employs more than six cameras without proximity detection the time taken to cycle through all the cameras and back again is far too slow. Extra switching relays can easily be used to expand the system. RL1-4 in Fig. 4 can be replaced with two or three separate 5V relays with their coils connected in series. This will enable up to thirty cameras to be switched simultaneously in three banks of ten to feed three monitors. Or, more practically, twelve cameras could be switched in three banks of four and viewed via three individual monitors. Proximity detection can still be used, taking care that the three individual cameras have appropriate views of the site. Cycle times for twelve cameras used in this way are the same as for four. No changes are required to the circuit, apart from adding the additional relays.

Other combinations are obviously possible. In addition to splitting cameras between monitors to reduce the cycle time, they can be daisy-chained to obtain multiple images at different locations. Monitors usually have pass-through connectors for this purpose. Otherwise line amplifiers may be required to drive extra monitors.

Maintaining the 75Ω line impedance is important for picture quality. A monitor's own internal 75Ω switched load should be the only one required, but in the real world it seldom is. The system described here may result in line problems that need to be corrected. Every termination and switch introduces impedance errors. PCB CCD cameras themselves have non-standard terminations, and may not match to the line well. A cure is to employ a line amplifier at strategic positions.

Line amplifier circuit

Fig. 12 shows a general-purpose line amplifier circuit. Resistor RA holds the input impedance at 75Ω. In some cases however the value of RA may need to be adjusted, or it may need to be dispensed

with should it cause problems—especially when connected directly to a CCD camera. RV1 is used to adjust the output. It's normally set at about 75Ω. Where more than one line amplifier is cascaded along the signal line its output may require extra attenuation. This is best achieved by adding resistor RB. A good starting point is about 100Ω.

Construction and installation

Many constructional points have been mentioned where relevant. In general nothing is super critical. I have built different combinations of the circuits described using several layouts and have taken technical liberties without many problems arising.

All logic circuitry requires the liberal use of decoupling to prevent problems caused by supply spikes. Unexpected camera selection problems or resets during operation are usually caused by this. In all such cases the addition of extra decoupling near IC supply pins will cure the problem. If you feel like getting technical, an oscilloscope can be used to sort it out. But simply bridging the supply pins (7 and 14 etc.) of relevant ICs with a 100nF ceramic capacitor will reveal where the decoupling is required. For similar reasons any unused gates or logic should, if not used, be disabled. If an output is not used, this is achieved by grounding the input.

In some locations proximity inputs can pick up RF or mains interference. Simple filtering by adding a 100nF ceramic capacitor across the input will usually provide a cure, but in extreme cases a screened lead may be required. Another solution would be to use a reed relay at the proximity unit, with its contacts connected to the input and the coil fed from the proximity device, giving total isolation.

I have used Vero, Matrix and my own etched boards for mounting the components, with equal success.

The original prototype on which this article is based (see photograph last month) has been kept to test new variants of the system, saving a lot of time rebuilding basic circuits.

The flexibility provided by building your own equipment gives a considerable cost advantage in comparison with the purchase of professional modular equipment. My last installation had a number of cameras clustered in one area and the rest widely scattered around a three-acre site. With the same basic circuitry described here, the cluster was daisy-chained and remotely controlled while the rest had individual feeds that were selected locally. The site uses proximity recording during darkness, controlled and triggered by PIR floodlighting only. Multiplexed cameras and switching coupled to slow-scan recorders would have been prohibitively costly.

Covert camera systems installed to catch thieves, vandals and graffiti artists can be hilarious, with enough cloak-and-dagger to fill a Bond movie! ■

Component list

VOX/proximity switch

R1	39kΩ
R2, 7	390kΩ
R3, 5	68kΩ
R4	3.3kΩ
R6, 9	1kΩ
R8	2.2kΩ
R10	270Ω (see text) All 0.25W, 5%
RV1	2.2kΩ miniature preset
C1, 5	100μF, 16V electrolytic
C2	4.7μF, 10V electrolytic
C3, 4	10μF, 16V electrolytic
C6	22μF, 10V electrolytic
Tr1-3	BC547B
D1-4	1N4148*
RL	SP NO contact, 5V coil (150Ω)
M	Electret microphone

*D3 may be built into the relay

Line amplifier

R1	22kΩ
R2	6.8kΩ
R3	1kΩ
R4	330Ω
R5, 6	270Ω
R7	470Ω
RA, B	75Ω (see text) All 0.25W, 5%
RV1	1kΩ linear preset
C1, 2	0.1μF 100V ceramic
C3, 4	100μF, 16V electrolytic
C5	0.1μF 100V ceramic
C6	330μF, 10V electrolytic
Tr1, 3	BC547B
Tr2	BC557B

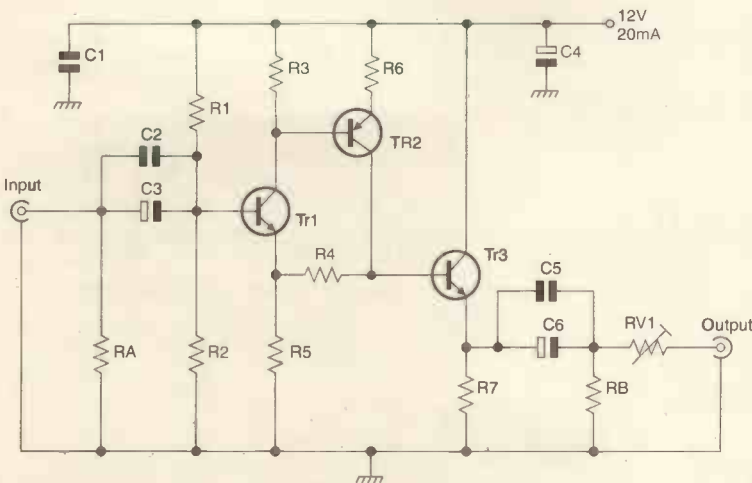

Fig. 12: General-purpose line amplifier circuit.

Grandata Ltd

distributor of electronic components

Specials Offers and New Arrivals !!

High Quality Fully Shielded Foil Wrapped Scart Lead

Length : 1.5m Width : 12mm

Box of 25

Price : £ 30.00 + vat

Box of 50

Price : £ 50.00 + vat

Order Code : PLG26



Fully Shielded 21 Pin Connected Scart Lead

Length : 1.5m Width : 8mm

Box of 50

Price : £ 30.00 + vat

Box of 100

Price : £ 55.00 + vat

Order Code : PLG23



New Arrival !!

Jaeger 2003 / 2004 Semiconductor Comparison Book

This A5 sized book contains vital information on 41,400 types of components.

Transistors , Diodes , Thyristors , IC's all covered with details of :
Design

Brief data / description

Construction type...etc

Order Code : BOOK04
Price : £ 23.00 - No VAT
(plus £ 2.00 + vat for Postage)

Coax Fly Lead Plug to Socket

Length : 2m

Box of 50

Price : £ 15.00 + vat

Box of 100

Price : £ 25.00 + vat

Order Code : COXCABLE



2 Phono to 2 Phono Cable

Length : 1.2m

Box of 25

Price : £ 12.50 + vat

Box of 50

Price : £ 20.00 + vat

Order Code : PLG33



Scart Plug to Scart Sockets 5 way splitter

Length : 0.4m

Box of 10

Price : £ 20.00 + vat

Order Code : PLG44



Switched Scart to 3 Phono and S-Video Sockets

Box of 10

Price : £ 10.00 + vat

Box of 20

Price : £ 17.00 + vat

Order Code : PLG85

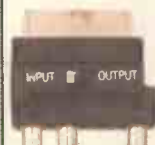

Aerial Installation Accessories

SLx Aerial Amplifiers

Now with built in Digital ByPass Operates with Sky™ DigiEye

Class leading noise figure of 4dB or less

6dB signal amplification on all models



Description

Order Code

Price

2 Way - No Bypass	SLX2	£ 8.00 + vat
2 Way - With Bypass	SLX2B	£ 9.25 + vat
4 Way - No Bypass	SLX4	£ 13.00 + vat
4 Way - With Bypass	SLX4B	£ 14.00 + vat
6 Way - No Bypass	SLX6	£ 18.00 + vat
6 Way - With Bypass	SLX6B	£ 19.00 + vat
8 Way - No Bypass	SLX8	£ 18.50 + vat
8 Way - With Bypass	SLX8B	£ 20.00 + vat

SLx Masthead Amplifiers

UHF TV antenna pre amplifier designed for the professional aerial installer

15dB gain masthead amplifier ideal for majority of domestic installations

26dB gain masthead amplifier for longer cable runs (loss of more than 3dB) or if connected to passive splitters

Requires 12V DC power supply via download either via dedicated power supply unit or from a distribution amplifier with line powering

15dB Amp Order Code : 27830R
Price : £ 4.30 + vat

26dB Amp Order Code : 27831R
Price : £ 4.50 + vat

SLx Masthead Amp PSU
Order Code : 27832R
Price : £ 5.00 + vat

Postage for 2+ £ 5.00 + vat



Coax Plug Aluminium



Order Code : PLG51

Bag of 10

Price : £ 1.25 + vat

Bag of 100

Price : £ 9.00 + vat

Screw Type Coax Plugs



Order Code : PLG62

Bag of 10

Price : £ 1.60 + vat

Bag of 100

Price : £ 12.50 + vat

Twist On F Connectors



Order Code : PLG101

Bag of 10

Price : £ 1.00 + vat

Bag of 100

Price : £ 6.00 + vat

Coax Coupler Socket to Socket



Order Code

PLG54

Bag of 10

Price : £1.50 + vat

Coax Coupler Plug to Plug



Order Code

PLG55

Bag of 10

Price : £1.50 + vat

Y Splitter Inductive 3 way



Order Code

YSPLITTER

Price : 40p + vat

Bag of 10

Price : £ 3.00 + vat

K.P. House , Unit 15 , Pop In Commercial Centre , Southway , Wembley , Middlesex . HA9 0HB England

Tel : (020) 8900 2329

Fax : (020) 8903 6126

Email : sales@grandata.co.uk

Grandata Ltd

distributor of electronic components

Digital Satellite Accessories

Sky™ Digital Remote & TV Link Eye Combination

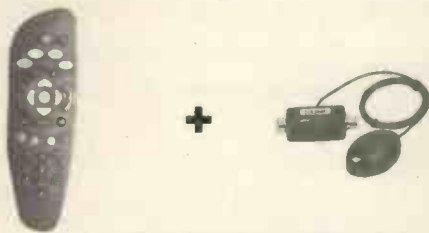

Order Code : SKYPACK1

Price : £ 16.00 + vat each

5 +

£ 14.50 + vat each

Sky™ Digital Remote Controls



Order Code : RCSKY

1 +

£ 7.95 + vat each

5 +

£ 7.45 + vat each

10 +

£ 6.95 + vat each

Sky™ Digital Remote & SLx Link Eye Combination

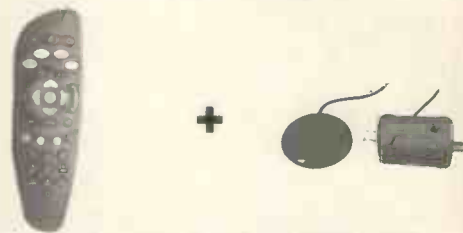

Order Code : SKYPACK2

Price : £ 13.00 + vat each

5 +

£ 11.50 + vat each

SLx Link Eye

Allows control of Sky™ Digibox via the signal feed for second TV

Order Code : 27833R

1 - 9

£ 6.50 + vat each

10 - 24

£ 5.50 + vat each

Sky™ Digital TV Link Eye

Order Code : TVLINKEYE

Price

£ 10.75 + vat

5 +

£ 7.99 + vat each

10+

£ 6.99 + vat each

SLx Amp By Pass Kit

For use with aerial amplifiers and Sky™ Digibox

Allows for operation of Link Eye in conjunction with a distribution amplifier

Order Code : 27829R

Price : £ 5.00 + vat

Satellite Repair / Mod Kits

Amstrad DRX100

Tuner Repair Kit

Order Code
SATKIT35

Price
£ 1.40 + vat

Amstrad DRX100

Power Supply Reliability Kit

Order Code
SATKIT36

Price
£ 12.00 + vat

Amstrad DRX100

Power Supply Repair Kit

Order Code
SATKIT37

Price
£ 13.50 + vat

Grundig GDS200

Digital Satellite Receiver Repair Kit

Early psu
MODEL : DSO - 0385 REV C

Order Code: SATKIT34A
Price : £ 10.00 + vat

Grundig GDS200/300

Digital Satellite Receiver Repair Kit

LATER psu TYPE REV 03
DSO - 0375 REV A
DSO - 0385 REV 5

Order Code: SATKIT34B
Price : £ 10.00 + vat

Digital Satellite Receivers Fan Kit

Suitable for

Amstrad DRX100 , DRX200
Grundig GDR200 , GDS200
Pace Digibox

plus many more analogue makes and models

Order Code : FANKIT1

Price : £ 10.00 + vat

Panasonic Digital Satellite Receiver Fan Kit

Suitable for Panasonic TU-DSB20/30 , TU-DSB31/35

Order Code : FANKIT2

Price : £ 15.00 + vat

Grundig Digital Satellite Receivers Reliability Kit

These kits contain capacitors that are generally of higher specification than those fitted by the manufacturers.

New Arrivals !!

GDS200

Early PSU
DSO0385 Rev C

Kit Contains 9 capacitors

Code : RELKIT34A

Price: £ 4.00 + vat

GDS200 / GDS300

Later PSU
DSO0375 Rev A
DSO0385 Rev F

Kit Contains 11 capacitors

Code : RELKIT34B

Price: £ 4.00 + vat

GDS200 / GDS300

Later PSU
Rev 03

Kit Contains 13 capacitors

Code : RELKIT34C

Price: £ 4.00 + vat

GDS200 / GDS300

Samsung PSU
PSSH370601B

Kit Contains 12 capacitors

Code : RELKIT34D Price: £ 4.00 + vat

GDS300

Samsung PSU
PSSH370603B

Kit Contains 13 capacitors

Code : RELKIT34E Price: £ 4.00 + vat

Grandata Ltd

distributor of electronic components

Television Repair / Mod Kits

MAKE & MODEL	KIT TYPE	CODE	MAKE & MODEL	KIT TYPE	CODE	MAKE & MODEL	KIT TYPE	CODE	MAKE & MODEL	KIT TYPE	CODE
ALBA			GOODMANS..Continued			MITSUBISHI..Continued			PHILIPS..Continued		
1452T.....PSU.....ONWAKIT			2029T.....PSU.....ONWAKIT			CT21AV1BS.....PSU.....MITSKIT3			310.32262.....PHILKIT8		
1427T.....PSU.....ONWAKIT			2029TA.....PSU.....ONWAKIT			CT25A2STX.....TDA 8178S.....MITSKIT1			310.62264.....PHILKIT1		
1402.....PSU.....ONWAKIT			F16 CHASSIS.....FRAME.....GOODKIT1			CT25A3STX.....TDA 8178S.....MITSKIT1			ANUBIS A.....SOPS.....PHILKIT2		
1455T.....PSU.....ONWAKIT			F16 CHASSIS.....LINE.....GOODKIT1			CT25A4STX.....TDA 8178S.....MITSKIT1			CP110 CHASSIS.....SOPS.....PHILKIT8		
1456T.....PSU.....ONWAKIT			F16.....PSU.....GOODKIT1			CT25A6STX.....TDA 8178S.....MITSKIT1			G90A CHASSIS.....SOPS.....PHILKIT10		
1458T.....PSU.....ONWAKIT			F16.....VIDEO.....GOODKIT1			CT25AV1B.....PSU.....MITSKIT3			G90B CHASSIS.....SOPS.....PHILKIT10		
1459T.....PSU.....ONWAKIT			GRUNDIG			CT25AV1BS.....PSU.....MITSKIT3			G110 CHASSIS.....SOPS.....PHILKIT3		
1499Y.....STANDBY.....MODKIT37			CUC 7350.....GRUNDIGKIT1			CT25AV1BD.....PSU.....MITSKIT3			GR2.1 CHASSIS.....SOPS.....PHILKIT1		
2002.....PSU.....ONWAKIT			CUC 7301/3			CT25AV1BDS.....PSU.....MITSKIT3			GR2.2 CHASSIS.....SOPS.....PHILKIT1		
2009B.....PSU.....ONWAKIT			(BUZ90).....PSU.....GRUNDIGKIT2			CT28AV1B.....PSU.....MITSKIT3			D-16 CHASSIS.....SOPS.....PHILKIT6		
2052T.....PSU.....ONWAKIT			CUC 7301/3			CT28AX1BD.....PSU.....MITSKIT3			HSM VIDEO.....SOPS.....PHILKIT5		
2152T.....PSU.....ONWAKIT			(MJF18004).....PSU.....GRUNDIGKIT3			CT28AV1BDS.....PSU.....MITSKIT3			JSM VIDEO.....SOPS.....PHILKIT4		
2099TX.....STANDBY.....MODKIT37			HINARI			CT29AS1.....TDA 8178S.....MITSKIT2			KSM VIDEO.....SOPS.....PHILKIT9		
BTV17.....STANDBY.....MODKIT37			HIT14RC.....PSU.....ONWAKIT			CT29A4.....TDA 8178S.....MITSKIT2			LSM VIDEO.....SOPS.....PHILKIT7		
CTV501.....PSU.....ONWAKIT			JVC			CT29A6.....TDA 8178S.....MITSKIT2			SAMSUNG		
CTV701.....PSU.....ONWAKIT			AV29SX1EK.....FIELD O/P.....JVCKIT1			CT29B2.....TDA 8178S.....MITSKIT2			Ci5944.....FRAME.....SAMKIT2		
CTV840.....PSU.....ONWAKIT			AV29SX1EN.....FIELD O/P.....JVCKIT1			MAKE & MODEL	KIT TYPE	CODE	Ci6844.....FRAME.....SAMKIT2		
CTV841.....PSU.....ONWAKIT			AV29SX1PF.....FIELD O/P.....JVCKIT1			CT29B3.....TDA 8178S.....MITSKIT2			Vik310.....PSU.....SAMSUNGKIT		
CTV485.....PSU.....ONWAKIT			AV29TSIE1.....FIELD O/P.....JVCKIT1			CT29B6.....TDA 8178S.....MITSKIT2			Vik320.....PSU.....SAMSUNGKIT		
AKAI			C14E1EK.....PSU.....ONWAKIT			CT33B3.....TDA 8178S.....MITSKIT2			Vik350.....PSU.....SAMSUNGKIT		
CT1417.....PSU.....ONWAKIT			C14T1EK.....PSU.....ONWAKIT			M5 SERIES.....PSU.....MITSKIT3			Vi375.....PSU.....SAMSUNGKIT		
CT2159U.....PSU.....ONWAKIT			C21ET1EK.....PSU.....ONWAKIT			NEI/NIKKAI			V395.....PSU.....SAMSUNGKIT		
CT2162UNT.....PSU.....ONWAKIT			CS21M3EK.....PSU.....ONWAKIT			CE25 CHASSIS.....PSU.....NIKKAIKIT1			WINNER 1.....PSU.....SAMSUNGKIT		
CT2863UNT.....PSU.....ONWAKIT			MATSUI			C289FTXN.....PSU.....NIKKAIKIT1			SHARP		
DECCA/TATUNG			1455.....PSU.....ONWAKIT			C28F41FXN.....PSU.....NIKKAIKIT1			51CS03H.....PSU.....SHARPKIT1		
TVC563.....STANDBY.....MODKIT37			1498.....PSU.....ONWAKIT			PANASONIC			51CS05H.....PSU.....SHARPKIT1		
GOLDSTAR			2086.....PSU.....ONWAKIT			IC561.....TDA 8175.....PANKIT1			59CS03H.....PSU.....SHARPKIT2		
CF25A50F.....FRAME.....MODKIT36			2098.....PSU.....ONWAKIT			TX25XD60.....VERT OUTPUT.....PANKIT2			59CS05H.....PSU.....SHARPKIT2		
CF25C22C.....FRAME.....MODKIT35			21V1N (BUZ90).....PSU.....GRUNDIGKIT2			TC28XD60.....VERT OUTPUT.....PANKIT2			59CSD8H.....PSU.....SHARPKIT2		
CF28A50F.....FRAME.....MODKIT36			21V1T(MJF18004) PSU.....GRUNDIGKIT3			TX28XD70.....VERT OUTPUT.....PANKIT2			59DS03H.....PSU.....SHARPKIT3		
CF28C22F.....FRAME.....MODKIT35			TVR180RT/2080 STANDBY.....MODKIT37			TX29XD70.....VERT OUTPUT.....PANKIT2			66CS03H.....PSU.....SHARPKIT2		
CF28C28F.....FRAME.....MODKIT36			MITSUBISHI			TX-W26D3.....VERT OUTPUT.....PANKIT2			66CS05H.....PSU.....SHARPKIT2		
CF29C42F.....FRAME.....MODKIT35			AV1 SERIES.....PSU.....MITSKIT3			PHILIPS			66CSD8H.....PSU.....SHARPKIT2		
GOODMANS			CT1M5B.....PSU.....MITSKIT3			310.10708.....PHILKIT3			THOMSON		
147TT.....PSU.....ONWAKIT			CT21M5BT.....PSU.....MITSKIT3			310.20491.....PHILKIT2			35029400.....THOMKIT2		
149T.....PSU.....ONWAKIT			CT25M5BT.....PSU.....MITSKIT3			310.20496.....PHILKIT10			35065920.....THORNKIT1		
1430RA.....PSU.....ONWAKIT			CT21A2STX.....TDA 8178S.....MITSKIT1			310.31994.....PHILKIT6			FV70.....PSU.....THORNKIT1		
1430RS.....PSU.....ONWAKIT			CT21AX1B.....PSU.....MITSKIT3			310.32252.....PHILKIT5			IC7 CHASSIS..TDA 8178FS.....THOMKIT1		
1430RW.....PSU.....ONWAKIT			CT21A3STX.....TDA 8178S.....MITSKIT1			310.32253.....PHILKIT4			IC7 CHASSIS.....FRAME.....THOMKIT3		
1450T.....PSU.....ONWAKIT			MITSUBISHI			310.32254.....PHILKIT9			IC8 CHASSIS..TDA 8178FS.....THOMKIT1		
1455TS.....PSU.....ONWAKIT			AV1 SERIES.....PSU.....MITSKIT3			310.32255.....PHILKIT7			ICC8 CHASSIS.....FRAME.....THOMKIT3		
2019R.....PSU.....ONWAKIT			CT1M5B.....PSU.....MITSKIT3			PHILIPS			ICC9 CHASSIS..EAST/WEST.....THOMKIT4		
ORDER CODE			PRICE	ORDER CODE	PRICE	ORDER CODE	PRICE	ORDER CODE	PRICE	ORDER CODE	PRICE
GRUNDIGKIT1.....£ 10.50		MITSKIT3.....£ 6.00		PANKIT2.....£ 9.00		PHILKIT6.....£ 5.50		SHARPKIT2.....£ 11.00		THOMKIT1.....£ 7.00	
GRUNDIGKIT2.....£ 10.50		MODKIT35.....£ 9.50		PHILKIT1.....£ 7.60		PHILKIT7.....£ 7.60		SHARPKIT3.....£ 9.00		THOMKIT2.....£ 12.00	
GRUNDIGKIT3.....£ 10.50		MODKIT36.....£ 5.00		PHILKIT10.....£ 8.50		PHILKIT8.....£ 4.25		THOMKIT3.....£ 9.00		THOMKIT4.....£ 4.00	
GOODKIT1.....£ 11.00		MODKIT37.....£ 6.50		PHILKIT2.....£ 2.50		PHILKIT9.....£ 7.50		THORNKIT1.....£ 12.75			
JVCKIT1.....£ 11.00		NIKKAIKIT1.....£ 12.00		PHILKIT3.....£ 4.00		SAMKIT2.....£ 8.00					
MITSKIT1.....£ 3.00		ONWAKIT.....£ 12.00		PHILKIT4.....£ 4.25		SAMSUNGKIT.....£ 16.00					
MITSKIT2.....£ 15.00		PANKIT1.....£ 15.00		PHILKIT5.....£ 5.75		SHARPKIT1.....£ 11.00					

Repair Kits - New Arrivals!!

<p>Matsui</p> <p>1496R/T and 2096R/T Repair Kit for Power Supply using a BUZ90</p> <p>Order Code MODKIT43</p> <p>Price £ 7.00 + vat</p>	<p>Matsui</p> <p>1496R/T and 2096R/T Repair Kit for Power Supply using a H3N90</p> <p>Order Code MODKIT44</p> <p>Price £ 7.00 + vat</p>	<p>Sharp</p> <p>56FW53H,66FW53H, 66FW54H,76FW53H, 76FW54H PSU & Dolby Upgrade</p> <p>Order Code MODKIT45</p> <p>Price £ 4.00 + vat</p>	<p>Sony VCR</p> <p>SLV715HB SLV777UB Repair Kit for Power Supply</p> <p>Order Code MODKIT40</p> <p>Price £ 6.00 + vat</p>	<p>Thomson</p> <p>ICC17 Power Supply Repair Kit</p> <p>Order Code MODKIT41</p> <p>Price £ 6.00 + vat</p>
--	--	---	--	---

Grandata Ltd

distributor of electronic components

Konig Remote Controls

KONIG
ELECTRONIC

KONIG
ELECTRONIC

Part No.	Code	Part No.	Code	Part No.	Code	Part No.	Code	Part No.	Code	Part No.	Code
AKAI		FERGUSON .continued		HITACHI .continued		NOKIA		PHILIPS .continued		SHARP .continued	
CT2582E	IR9700	68LS2	IR9639	C24W511T	IR9983	3125	IR9157	RC9020	IR9434	RRMCG0662PESA	IR9487
CT2585	IR9700	A10R	IR9258	C2514	IR9476	3126F	IR9157	RC9030	IR9434	RRMCG0779BMSA	IR9711
CT2885	IR9700	A14R	IR9259	C2546	IR9677	C1	IR9157	RC9050	IR9556	RRMCG1048BMSA	IR9788
CT2885E	IR9700	A36R	IR9259	C2546TN	IR9677	C2	IR9157	RC9057	IR9710	RRMCG0898CESA	IR9487
IR16	IR9700	B51F	IR9639	C2547TN	IR9677	C3	IR9161	RC9060	IR9556	RRMCG1014BMSA	IR9711
RC556	IR9397	B51NX	IR9639	C2556TN	IR9983	CM1	IR9161	RC9070	IR9434	RRMCG1023BMSA	IR9711
RC85	IR9700	B59F	IR9639	C2566TN	IR9677	D1	IR9569	RC9133	IR9710	RRMCG1031BMSA	IR9788
AMSTRAD		B59N	IR9639	C2567TN	IR9983	D2	IR9161	SAMSUNG		RRMCG1036BMSA	IR9711
SRD550	IR9386	B59NX	IR9639	C2567TN2	IR9983	E1	IR9161	CX5312W	IR9432	RRMCG1046BMSA	IR9788
SRX510	IR9386	B68F	IR9639	C2586TN	IR9983	E2	IR9161	CX5325W	IR9432	RRMCG1048BMSA	IR9788
AE6001	IR9352	B68NX	IR9639	C2595H	IR9142	EM2	IR9700	CX534WT	IR9432	RRMCG1050BMSA	IR9788
B & O		C59NX	IR9639	C2660	IR9142	ES5	IR9701	RM104	IR9432	RRMCG2799CESA	IR9487
Beolink 100	IR9843	C88NX	IR9639	C2661	IR9142	FS10	IR9573	RM109	IR9546	SV2044G	IR9487
BEKO		D51ND	IR9639	C2846TN	IR9677	FS11	IR9506	SV2145G	IR9487	SV2044S	IR9487
RC51321	IR9398	D59N	IR9639	C2847TN	IR9677	FS4/1	IR9573	SV2145S	IR9487	SV2277S1	IR9487
RC51331	IR9398	D59N	IR9639	C2856TN	IR9677	FS4/2	IR9573	SV2277S1	IR9487	SV2877S1	IR9487
RC61331	IR9398	D78N	IR9639	C2861TN	IR9677	FS9/1	IR9573	SV2877S1	IR9487	SV2877S1	IR9487
BLAUPUNKT		E51N	IR9639	C2867TN	IR9677	FS9	IR9506	SV2877S1	IR9487	SV2877S1	IR9487
9669493	IR9188	E59R8	IR9639	C28W410TN	IR9983	FS9	IR9506	SV2877S1	IR9487	SV2877S1	IR9487
1532	IR9503	RCU1734	IR9584	C28W510TN	IR9983	IR1	IR9157	SV2877S1	IR9487	SV2877S1	IR9487
1570-46	IR9516	RCU1785	IR9584	CBP1476R	IR9142	IR2	IR9157	SV2877S1	IR9487	SV2877S1	IR9487
9627 105 463	IR9188	RCU1789	IR9584	CBP1646R	IR9142	IR3	IR9157	SV2877S1	IR9487	SV2877S1	IR9487
9668813000	IR9516	RH880	IR9584	CBP2067	IR9142	IR4	IR9157	SV2877S1	IR9487	SV2877S1	IR9487
1555-46	IR9516	RH885	IR9325	CBP2216	IR9142	IR5	IR9157	SV2877S1	IR9487	SV2877S1	IR9487
1563-46	IR9516	RHT01	IR9259	CBP2222	IR9142	IR6	IR9157	SV2877S1	IR9487	SV2877S1	IR9487
IB16	IR9504	RHT10	IR9639	CBP226	IR9142	IR7	IR9157	SV2877S1	IR9487	SV2877S1	IR9487
C16	IR9504	RHT30	IR9259	CBP260	IR9142	IR8	IR9157	SV2877S1	IR9487	SV2877S1	IR9487
D32	IR9503	T49F	IR9639	CL2156TAN	IR9983	IR9	IR9157	SV2877S1	IR9487	SV2877S1	IR9487
L32	IR9503	T49N	IR9639	CL24W1TAN	IR9983	IR10	IR9157	SV2877S1	IR9487	SV2877S1	IR9487
M32	IR9503	T59	IR9639	CL2556TAN	IR9983	IR11	IR9157	SV2877S1	IR9487	SV2877S1	IR9487
M55-16	IR9516	T59N	IR9639	CL2586TAN	IR9983	IR12	IR9157	SV2877S1	IR9487	SV2877S1	IR9487
M63-16	IR9516	T68N	IR9639	CL2586TAN	IR9983	IR13	IR9157	SV2877S1	IR9487	SV2877S1	IR9487
IM70-16	IR9516	T742	IR9584	CL2886TAN	IR9983	IR14	IR9157	SV2877S1	IR9487	SV2877S1	IR9487
IP32	IR9503	T752	IR9584	CL2886TAN	IR9983	IR15	IR9157	SV2877S1	IR9487	SV2877S1	IR9487
Q16	IR9504	T758	IR9584	CL28W1TAN	IR9983	IR16	IR9157	SV2877S1	IR9487	SV2877S1	IR9487
IR32	IR9504	T789	IR9584	CL28W2TAN	IR9983	IR17	IR9157	SV2877S1	IR9487	SV2877S1	IR9487
TC106	IR9406	T789	IR9584	CL32WD2TAN	IR9983	IR18	IR9157	SV2877S1	IR9487	SV2877S1	IR9487
TC110 PIP	IR9248	T789	IR9584	CLE871A	IR9602	IR19	IR9157	SV2877S1	IR9487	SV2877S1	IR9487
TC143	IR9406	T789	IR9584	CLE871B	IR9602	IR20	IR9157	SV2877S1	IR9487	SV2877S1	IR9487
TC144	IR9406	T789	IR9584	CLE874A	IR9602	IR21	IR9157	SV2877S1	IR9487	SV2877S1	IR9487
TC190	IR9529	T789	IR9584	CLE874B	IR9602	IR22	IR9157	SV2877S1	IR9487	SV2877S1	IR9487
TC192	IR9529	T789	IR9584	CLE876	IR9476	IR23	IR9157	SV2877S1	IR9487	SV2877S1	IR9487
TC194	IR9529	T789	IR9584	CLE876C	IR9477	IR24	IR9157	SV2877S1	IR9487	SV2877S1	IR9487
CROWN		T789	IR9584	CLE876G	IR9477	IR25	IR9157	SV2877S1	IR9487	SV2877S1	IR9487
RC51331	IR9398	105-088	IR9403	CLE876G	IR9477	IR26	IR9157	SV2877S1	IR9487	SV2877S1	IR9487
RC61331	IR9398	105-209B	IR9862	CLE902A	IR9677	IR27	IR9157	SV2877S1	IR9487	SV2877S1	IR9487
21907	IR9397	105-210A	IR9862	CLE902B	IR9677	IR28	IR9157	SV2877S1	IR9487	SV2877S1	IR9487
DAEWOO		105-219J	IR9862	CLE903A	IR9677	IR29	IR9157	SV2877S1	IR9487	SV2877S1	IR9487
DMQ1414	IR9397	105-224V	IR9862	CLE921A	IR9983	IR30	IR9157	SV2877S1	IR9487	SV2877S1	IR9487
DMQ14A 1	IR9840	105-229H	IR9862	CLE921B	IR9983	IR31	IR9157	SV2877S1	IR9487	SV2877S1	IR9487
DMQ20A 1	IR9840	105-230C	IR9862	CLE922A	IR9983	IR32	IR9157	SV2877S1	IR9487	SV2877S1	IR9487
DMQ2195	IR9840	3B1	IR9862	CLE922B	IR9983	IR33	IR9157	SV2877S1	IR9487	SV2877S1	IR9487
DMQ2585	IR9840	CB20E40X	IR9862	CLR876E	IR9477	IR34	IR9157	SV2877S1	IR9487	SV2877S1	IR9487
DMQ2895	IR9840	CBT2190E	IR9403	CP2146TA	IR9677	IR35	IR9157	SV2877S1	IR9487	SV2877S1	IR9487
FERGUSON		CBT4902	IR9403	CP2546	IR9677	IR36	IR9157	SV2877S1	IR9487	SV2877S1	IR9487
20H3	IR9594	CBT4902E	IR9403	CP2546TA	IR9677	IR37	IR9157	SV2877S1	IR9487	SV2877S1	IR9487
22B5	IR9584	CBT9905	IR9403	CP2566TAN	IR9983	IR38	IR9157	SV2877S1	IR9487	SV2877S1	IR9487
22H3	IR9584	VS088K	IR9862	CP2856TAN	IR9983	IR39	IR9157	SV2877S1	IR9487	SV2877S1	IR9487
2415	IR9584	GRUNDIG		CP2856TAN	IR9983	IR40	IR9157	SV2877S1	IR9487	SV2877S1	IR9487
2422	IR9584	CUC503	IR9614	CP2856TAN	IR9983	IR41	IR9157	SV2877S1	IR9487	SV2877S1	IR9487
2423	IR9584	CUC5200	IR9614	CP2856TAN	IR9983	IR42	IR9157	SV2877S1	IR9487	SV2877S1	IR9487
2433	IR9584	CUC5301	IR9529	CP2856TAN	IR9983	IR43	IR9157	SV2877S1	IR9487	SV2877S1	IR9487
2445	IR9584	CUC5302	IR9529	CP2856TAN	IR9983	IR44	IR9157	SV2877S1	IR9487	SV2877S1	IR9487
2452	IR9584	CUC5310	IR9614	CP2856TAN	IR9983	IR45	IR9157	SV2877S1	IR9487	SV2877S1	IR9487
2463	IR9584	RC212	IR9614	CP2856TAN	IR9983	IR46	IR9157	SV2877S1	IR9487	SV2877S1	IR9487
2475	IR9584	RC300	IR9614	CP2856TAN	IR9983	IR47	IR9157	SV2877S1	IR9487	SV2877S1	IR9487
26H3	IR9584	TP500VT	IR9500	CP2856TAN	IR9983	IR48	IR9157	SV2877S1	IR9487	SV2877S1	IR9487
29132	IR9584	TP590VT	IR9509	CP2856TAN	IR9983	IR49	IR9157	SV2877S1	IR9487	SV2877S1	IR9487
36K2	IR9584	TP600VT	IR9509	CP2856TAN	IR9983	IR50	IR9157	SV2877S1	IR9487	SV2877S1	IR9487
41H3	IR9584	TP610	IR9509	CP2856TAN	IR9983	IR51	IR9157	SV2877S1	IR9487	SV2877S1	IR9487
4233	IR9584	TP621	IR9509	CP2856TAN	IR9983	IR52	IR9157	SV2877S1	IR9487	SV2877S1	IR9487
4414	IR9584	TP630	IR9509	CP2856TAN	IR9983	IR53	IR9157	SV2877S1	IR9487	SV2877S1	IR9487
4415	IR9584	TP650	IR9509	CP2856TAN	IR9983	IR54	IR9157	SV2877S1	IR9487	SV2877S1	IR9487
4423	IR9584	TP661	IR9509	CP2856TAN	IR9983	IR55	IR9157	SV2877S1	IR9487	SV2877S1	IR9487
4433	IR9584	TP661 TOP	IR9615	CP2856TAN	IR9983	IR56	IR9157	SV2877S1	IR9487	SV2877S1	IR9487
51A0	IR9584	TP663	IR9614	CP2856TAN	IR9983	IR57	IR9157	SV2877S1	IR9487	SV2877S1	IR9487
51A2	IR9584	TP663	IR9614	CP2856TAN	IR9983	IR58	IR9157	SV2877S1	IR9487	SV2877S1	IR9487
51A3	IR9584	TP663	IR9614	CP2856TAN	IR9983	IR59	IR9157	SV2877S1	IR9487	SV2877S1	IR9487
51A4	IR9584	TP663	IR9614	CP2856TAN	IR9983	IR60	IR9157	SV2877S1	IR9487	SV2877S1	IR9487
51A5	IR9584	TP663	IR9614	CP2856TAN	IR9983	IR61	IR9157	SV2877S1	IR9487	SV2877S1	IR9487
51G2	IR9584	TP663	IR9614	CP2856TAN	IR9983	IR62	IR9157	SV2877S1	IR9487	SV2877S1	IR9487
51G3	IR9584	TP663	IR9614	CP2856TAN	IR9983	IR63	IR9157	SV2877S1	IR9487	SV2877S1	IR9487
51H3	IR9584	TP663	IR9614	CP2856TAN	IR9983	IR64	IR9157	SV2877S1	IR9487	SV2877S1	IR9487
51H4	IR9584	TP663	IR9614	CP2856TAN	IR9983	IR65	IR9157	SV2877S1	IR9487	SV2877S1	IR9487
51J7	IR9584	TP663	IR9614	CP2856TAN	IR9983	IR66	IR9157	SV2877S1	IR9487	SV2877S1	IR9487
51K3	IR9584	TP663	IR961								

Grandata Ltd

distributor of electronic components

Transistors / Linear IC's

Part No.	Price	Part No.	Price	Part No.	Price	Part No.	Price	Part No.	Price	Part No.	Price						
BU208A	£0.75	IRF5450	£5.00	MJE350	£0.80	STK4191	£9.00	STK5464	£3.00	STR371	£4.00	TDA2450-3	£10.00	TDA4865	£2.50	TDA8138	£2.00
BU2506DF	£0.90	IRF5740	£3.00	MJF		STK4191 X	£14.00	STK5466	£5.00	STR380	£3.50	TDA2460-2	£0.70	TDA4670	£4.75	TDA8138A	£1.30
BU2506DX	£1.00	IRF5840	£3.00	MJF16206	£4.50	STK419-130	£15.00	STK5467	£4.00	STR381	£3.90	TDA2501	£3.00	TDA4671	£5.00	TDA8138B	£2.00
BU2508A	£1.00	IRF610	£0.80	MJF18004	£1.75	STK4197-140	£16.00	STK5468	£4.00	STR383	£4.10	TDA2506T	£8.00	TDA4680	£3.50	TDA8139	£2.00
BU2508AF	£1.10	IRF611	£1.20	MJF18006	£2.00	STK4197 II	£9.50	STK5471	£9.00	STR384	£3.50	TDA2507	£4.50	TDA4681	£4.50	TDA8140	£2.00
BU2508AX	£1.30	IRF620	£1.00	MJF18008	£1.75	STK4198 II	£10.50	STK5472	£3.75	STR40090	£3.50	TDA2510	£4.50	TDA4685	£2.75	TDA8143	£1.60
BU2508D	£1.30	IRF630	£0.75	MJF18204	£2.50	STK4199 II	£10.50	STK5473	£4.80	STR40115	£6.00	TDA2514A	£5.00	TDA4686	£5.00	TDA8145	£1.20
BU2508DF	£1.20	IRF634	£1.25	STK0025	£4.20	STK4200	£4.00	STK5474	£5.00	STR4080A	£6.50	TDA2515	£4.50	TDA4687	£5.00	TDA8146	£2.00
BU2508DX	£1.50	IRF640	£1.50	STK0039	£6.00	STK4204 II	£10.50	STK5475	£3.50	STR4142	£4.50	TDA2520-1	£9.00	TDA4700A	£7.50	TDA8153	£10.00
BU2520AF	£1.70	IRF640F	£2.00	STK086	£10.00	STK4204 II	£10.50	STK5476	£4.50	STR4211	£3.15	TDA2521	£8.00	TDA4710H	£7.00	TDA8170	£1.70
BU2520AX	£1.40	IRF630S	£2.00	STK1039	£4.60	STK4204 II	£10.50	STK5477	£2.50	STR4211 II	£3.15	TDA2522	£12.00	TDA4714C	£3.50	TDA8171	£2.30
BU2520DF	£2.25	IRF642	£2.00	STK1040	£6.40	STK4211 II	£10.00	STK5478	£3.00	STR4311	£9.50	TDA2523	£8.50	TDA4716C	£4.50	TDA8172	£2.00
BU2520DX	£2.00	IRF644	£2.00	STK1049	£7.00	STK4211 V	£8.00	STK5481	£4.70	STR4400	£8.00	TDA2525	£4.50	TDA4720	£6.60	TDA8173	£2.00
BU2520AX	£1.50	IRF650	£2.00	STK2025	£6.50	STK4221 II	£12.00	STK5482	£2.85	STR441	£9.50	TDA2530	£3.00	TDA4725	£7.50	TDA8174	£2.00
BU2525A	£3.25	IRF710	£1.50	STK1060	£7.00	STK4231 II	£10.50	STK5483	£4.40	STR44115	£4.75	TDA2546	£2.00	TDA4780	£3.00	TDA8175	£7.00
BU2525AF	£2.20	IRF720	£0.85	STK2025	£6.20	STK4231 V	£14.00	STK5486	£4.50	STR442	£16.00	TDA2549	£3.00	TDA4800	£6.00	TDA8177	£3.00
BU2525AX	£1.90	IRF730	£1.25	STK2028	£5.00	STK4241	£10.50	STK5487	£5.25	STR450A	£7.00	TDA2558	£4.00	TDA4810	£5.00	TDA8177F	£3.50
BU2525D	£2.40	IRF740	£0.90	STK2029	£6.00	STK4241 V	£12.50	STK5488	£8.80	STR451	£8.00	TDA2560Q	£7.00	TDA4850	£4.75	TDA8179S	£7.50
BU2525DF	£1.75	IRF740F	£3.00	STK2030	£10.00	STK4272	£5.00	STK5490	£4.50	STR4511	£5.50	TDA2560-3	£14.00	TDA4851	£3.25	TDA8180	£12.50
BU2527AF	£4.00	IRF820	£0.90	STK2038	£7.00	STK4273	£5.50	STK561	£4.00	STR4512	£4.00	TDA2574V	£3.50	TDA4852	£3.25	TDA8205	£12.50
BU2527AX	£2.50	IRF830	£0.85	STK2048	£9.50	STK4274	£5.00	STK563	£4.15	STR452	£4.75	TDA2576A	£9.00	TDA4854	£5.00	TDA8212	£3.50
BU2527DF	£2.00	IRF830F	£1.60	STK2058 IV	£16.00	STK4274	£5.00	STK5637	£3.00	STR453	£5.00	TDA2577A	£2.00	TDA4855	£6.00	TDA8214B	£10.50
BU2527DX	£2.00	IRF840	£0.85	STK2101	£10.50	STK4300	£5.00	STK5720	£4.00	STR454	£13.00	TDA2578A	£7.00	TDA4856	£5.00	TDA8215H	£3.00
BU2532AL	£3.25	IRF840F	£1.75	STK2110	£5.50	STK4301	£5.00	STK5725	£3.50	STR455	£2.10	TDA2579A	£2.10	TDA4858	£3.50	TDA8217	£2.25
BU2708AF	£2.00	IRF9140	£10.00	STK2139	£6.75	STK4311	£6.50	STK5730	£3.00	STR456	£4.70	TDA2579B	£3.25	TDA4860	£2.00	TDA8303	£2.50
BU2708AX	£2.00	IRF9230	£4.00	STK2155	£9.00	STK433	£4.00	STK5733	£4.00	STR457	£6.00	TDA2652	£48.00	TDA4861	£3.50	TDA8304	£4.00
BU2708DF	£2.00	IRF9510	£1.50	STK2230	£4.70	STK4332	£3.65	STK5733	£4.00	STR470	£3.00	TDA2653A	£4.50	TDA4866	£2.75	TDA8305	£5.00
BU2708DX	£2.00	IRF9511	£1.50	STK3102 II	£5.30	STK435	£3.75	STK6324B	£5.00	STR50020	£3.50	TDA2710-1	£4.00	TDA4880	£4.50	TDA8305A	£5.00
BU2720AX	£2.00	IRF9520	£1.50	STK3106	£25.00	STK4352	£5.00	STK6327	£12.00	STR50092	£5.50	TDA2820M	£1.00	TDA4918A	£17.00	TDA8310	£6.00
BU2720DF	£2.00	IRF9520F	£1.25	STK3122 III	£7.25	STK4356	£4.30	STK6328A	£4.00	STR5103A	£2.60	TDA2822M	£0.60	TDA4930	£5.00	TDA8350Q	£2.75
BU2720DX	£2.00	IRF9531	£2.00	STK3152 II	£9.00	STK4362	£4.50	STK6341	£6.00	STR51012A	£6.50	TDA3190	£2.00	TDA4935	£3.00	TDA8351	£2.00
BU2722AF	£3.30	IRF9540	£1.75	STK3156	£5.00	STK437	£6.00	STK6607	£4.00	STR51113	£5.00	TDA3301B	£16.00	TDA4940	£2.00	TDA8354Q	£2.75
BU2725AF	£2.00	IRF9541	£2.00	STK350-030	£7.00	STK4372	£4.90	STK6712BIV	£5.50	STR51015	£6.00	TDA3303	£7.00	TDA4941	£2.00	TDA8356	£2.00
BU2725DF	£2.00	IRF9510	£0.95	STK392-040	£12.00	STK439	£5.00	STK6722	£6.50	STR50213	£4.00	TDA3501	£3.00	TDA4942	£2.80	TDA8360N3	£8.00
BU2725DF	£2.00	IRF9620	£0.85	STK401-050	£8.00	STK4392	£5.00	STK6732	£10.00	STR50330	£4.75	TDA3502	£3.60	TDA4950	£1.00	TDA8361AN3	£8.00
BU2727AF	£2.00	IRF9622	£2.00	STK401-080	£9.00	STK441	£6.80	STK6821	£7.50	STR51041	£5.00	TDA3504	£3.00	TDA4951	£4.50	TDA8361N3	£9.00
BU2727AX	£2.00	IRF9630	£1.30	STK401-120	£10.00	STK442	£4.50	STK6875	£6.50	STR51213	£5.00	TDA3507	£4.50	TDA5010	£3.00	TDA8362AN	£12.00
BU2727DF	£2.00	IRF9640	£2.30	STK401-140	£12.00	STK443	£7.00	STK6892	£10.00	STR51424	£7.00	TDA3521	£7.50	TDA5040	£6.00	TDA8362AN3	£7.50
BU2727DX	£1.00	IRF8C20	£1.10	STK4017	£4.00	STK4432	£6.00	STK6893	£4.50	STR53041	£4.00	TDA3560	£6.00	TDA5050	£9.00	TDA8362BN3	£8.50
BU2727AF	£0.60	IRF8C30	£1.20	STK4019	£4.80	STK457	£4.70	STK6962	£2.75	STR54041	£3.20	TDA3561	£3.00	TDA5600	£4.00	TDA8362N3	£12.00
BU2727AX	£0.60	IRF8C40	£2.10	STK402-040	£7.00	STK459	£5.80	STK6972	£3.00	STR5412	£2.80	TDA3561A	£3.00	TDA5610-2	£7.50	TDA8362NA	£9.00
BU2727DF	£0.90	IRF8E30	£2.25	STK402-070	£7.00	STK460	£6.60	STK6981B	£5.00	STR55041	£4.50	TDA3562A	£2.60	TDA5620	£4.50	TDA8362N5	£12.00
BU2727DX	£0.75	IRF9D120	£1.00	STK402-070	£7.00	STK461	£6.00	STK6982	£6.00	STR56041	£5.50	TDA3563	£3.50	TDA5702	£13.00	TDA8366N2	£15.00
BU2727DF	£0.85	IRF9D120	£1.20	STK402-071	£7.00	STK463	£9.50	STK6982H	£6.00	STR58041	£2.50	TDA3563A	£4.00	TDA5830-2	£11.00	TDA8366N3	£11.50
BU2727DX	£1.30	IRF9D220	£1.00	STK402-090	£8.00	STK465	£9.00	STK7216	£4.20	STR59041	£3.00	TDA3564	£3.25	TDA6100Q	£1.50	TDA8370	£1.50
BUH1015	£4.25	IRF1210	£3.00	STK4021	£3.80	STK473	£8.20	STK7127	£2.50	STR60001	£6.25	TDA3565	£2.20	TDA6101Q	£1.20	TDA8372A	£16.50
BUH1215	£4.50	IRF1210	£3.00	STK402-100	£9.00	STK4793	£8.00	STK7225	£5.00	STR6008X	£5.75	TDA3566	£2.80	TDA6103Q	£2.25	TDA8374	£10.00
BUH515	£2.00	IRF1210	£3.00	STK402-100	£9.00	STK4803	£10.00	STK7226	£17.00	STR6020	£2.70	TDA3566A	£3.00	TDA6106Q	£1.25	TDA8375A	£12.50
BUH515D	£2.50	IRF1210	£3.00	STK402-120	£9.00	STK4813	£8.00	STK7231	£7.00	STR61001	£4.75	TDA3567	£3.50	TDA6107Q	£3.00	TDA8376	£15.00
BUH517	£2.75	IRF1210	£3.00	STK402 II	£5.50	STK4833	£8.50	STK7253	£5.00	STR7001	£6.00	TDA3569	£3.00	TDA6108JF	£3.00	TDA8380	£2.00
BUH517D	£1.75	IRF1210	£3.00	STK4025	£5.30	STK4843	£7.20	STK7253	£6.50	STR80145	£4.75	TDA3570	£3.75	TDA6111Q	£2.25	TDA8424	£4.00
BUH715	£4.25	IRF150	£2.40	STK4026	£4.80	STK4853	£17.00	STK730-060	£6.50	STR81145	£3.75	TDA3576B	£7.00	TDA6120Q	£5.50	TDA8425	£5.00
BU310	£1.25	IRF240	£3.00	STK4026H	£4.80	STK4863	£7.00	STK730-080	£6.00	STR81159	£4.00	TDA3576	£6.75	TDA6160-2S	£4.75	TDA8432	£5.50
BU381	£1.50	IRF250	£2.80	STK4028V	£5.00	STK4873	£11.00	STK7308	£7.00	STR8124	£10.00	TDA3581	£2.00	TDA6160-2X	£2.50	TDA8433	£6.00
BU381D	£1.25	IRF340	£2.50	STK4028	£5.50	STK488-010	£8.00	STK7309	£4.00	STR83145	£5.00	TDA3581A	£3.50	TDA7052	£1.20	TDA8440	£3.00
BUH11A	£0.35	IRF350	£3.25	STK4032 II	£5.10	STK488-050	£8.00	STK7310	£3.20	STR83159	£7.00	TDA3582	£5.00	TDA7056	£2.00	TDA8443	£3.50
BUH11AF	£0.35	IRF360	£8.00	STK4034 X	£9.25	STK4893	£10.00	STK73405 II	£5.50	TDA1420	£8.00	TDA3582A	£8.00	TDA7262	£3.25	TDA8451	£3.25
BUH11AX	£0.30	IRF450	£2.70	STK4036	£4.70	STK4913	£9.00	STK73410	£3.50	TDA1470	£12.00	TDA3583B	£2.00	TDA7263	£3.50	TDA8453	£3.50
BUH12	£0.80	IRF460	£4.00	STK4036V	£8.00	STK501	£5.50	STK73410 II	£5.00	TDA1514A	£3.25	TDA3583C	£0.85	TDA7263M	£4.00	TDA8461	£9.50
BUH12A	£0.80	IRF9P140	£14.50	STK4038	£6.80	STK50322	£3.50	STK7348	£4.00	TDA1514A	£3.25	TDA3584	£0.80	TDA7264	£5.00	TDA8501	£3.75
BUH12AF	£0.90	IRF9P240	£3.00	STK4040 II	£6.50	STK5314	£4.75	STK7356	£4.25	TDA1541	£5.00	TDA3584A	£0.85	TDA7265	£5.00	TDA8505	£11.00
BUH18	£0.80	IRFPC40	£3.00	STK4042 II	£8.00	STK5315	£5.00	STK7358	£4.40	TDA1541A	£4.00	TDA3584A	£3.00	TDA7266	£4.25	TDA8560Q	£4.25
BUH18A	£0.80	IRFPC50	£4.50	STK4046	£9.50	STK5323	£6.00	STK7359	£4.25	TDA1546T	£10.50	TDA3585	£3.00	TDA7269	£5		

Grandata Ltd

distributor of electronic components

Line Output Transformers

Part No	Code	Price	Part No	Code	Price	Part No	Code	Price	Part No	Code	Price	Part No	Code	Price
ALBA			HITACHI..continued			PANASONIC..continued			PHILIPS..continued			THOMSON..continued		
3714002	LOT02	£12.00	2433453	LOT82	£12.50	TLF 14568 F	LOT40	£15.00	AT 2079 / 21	LOT395	£12.00	10588080.P2	LOT1505	£19.00
043714002J	LOT02	£12.00	2433751	LOT01	£13.00	TLF 14584 F	LOT41	£17.00	AT 2079 / 24	LOT392	£15.00	151128140	LOT1505	£19.00
43700000	LOT02	£12.00	2433752	LOT01	£13.00	TLF 14586 F	LOT42	£17.00	AT 2079 / 40	LOT773	£11.50	1512814	LOT1505	£19.00
AMSTRAD			2433891	LOT23	£12.50	PHILIPS			AT 2079 / 99	LOT276	£14.00	15128140	LOT1505	£19.00
1810951	LOT55	£14.00	2433892	LOT84	£14.50	3119 108 31260	LOT90	£12.50	AT 2079/30 01	LOT106	£12.50	153144.6	LOT1505	£19.00
3714002	LOT02	£12.00	2433893	LOT23	£12.50	3119 108 31290	LOT73	£11.50	AT 2079/30102	LOT106	£12.50	15314460	LOT1505	£19.00
043714002J	LOT02	£12.00	2433952	LOT33	£10.00	3119 108 31440	LOT433	£16.00	SAISHO			1531447 A	LOT1505	£19.00
43700000	LOT02	£12.00	2434002	LOT226	£14.50	3119 108 31441	LOT433	£16.00	3714002	LOT02	£12.00	1532873 A	LOT1505	£19.00
AM152591	LOT55	£14.00	2434141	LOT33	£10.00	3119 108 31442	LOT433	£16.00	043714002J	LOT02	£12.00	3233500	LOT244	£14.50
FERGUSON			2434274	LOT44	£10.50	3119 198 62930	LOT57	£11.00	43700000	LOT02	£12.00	3233900	LOT244	£14.50
00 D-3-508-002	LOT381	£15.50	2434393	LOT405	£22.50	3122 108 10246	LOT111	£15.00	7140021	LOT02	£12.00	40011200	LOT244	£14.50
06 D-3-083-001	LOT82	£12.50	2434593	LOT44	£10.50	3122 138 36070	LOT111	£15.00	SHARP			40148300	LOT244	£14.50
06 D-3-083-002	LOT82	£12.50	2435006	LOT401	£17.00	3122 138 36072	LOT111	£15.00	RTRNF 1220 CEZZLOT39	£18.50	TOSHIBA			
06 D-3-084-001	LOT23	£12.50	2435131	LOT251	£14.50	3122 138 36920	LOT57	£11.00	RTRNF 2001 CEZZLOT338	£17.50	1810951	LOT55	£14.00	
06 D-3-087-001	LOT23	£12.50	2436201	LOT90	£12.50	3122 138 36922	LOT57	£11.00	RTRNF 2006 CEZZLOT308	£13.50	2433751	LOT01	£13.00	
06 D-3-088-001	LOT84	£14.50	23236465	LOT392	£15.00	3122 138 37050	LOT132	£15.00	RTRNF 2023 CEZZLOT310	£15.00	23236098	LOT288	£14.00	
06 D-3-093-001	LOT204	£16.00	2433891H	LOT23	£12.50	3122 138 37050	LOT132	£15.00	SONY			23236198	LOT288	£14.00
06 D-3-508-003	LOT276	£14.00	45150504	LOT362	£16.00	3122 138 37620	LOT90	£12.50	1-439-286-00	LOT46	£13.00	23236201	LOT395	£12.00
06 D-3-512-001	LOT204	£16.00	MATSUI			3122 138 37771	LOT129	£14.00	1-439-286-11	LOT46	£13.00	23236245	LOT395	£12.00
29201-022-01	LOT63	£17.00	20070	LOT438	£16.00	3122 138 37992	LOT1116	£19.00	1-439-332-41	LOT100	£15.00	23236255	LOT289	£15.00
473197	LOT304	£15.50	20071	LOT438	£16.00	3122 138 38040	LOT73	£11.50	1-439-332-42	LOT101	£14.50	23236425	LOT288	£14.00
D 059 / 37	LOT200	£14.00	20072	LOT438	£16.00	3122 138 38123	LOT395	£12.00	1-439-286-12	LOT46	£13.00	23236427	LOT395	£12.00
GOODMANS			20073	LOT438	£16.00	3128 138 20200	LOT433	£16.00	1-439-286-13	LOT46	£13.00	23236428	LOT289	£15.00
1142.5057	LOT1164	£15.00	20074	LOT438	£16.00	3128 138 20201	LOT433	£16.00	1-439-286-21	LOT46	£13.00	23236424	LOT129	£14.00
1142.5077	LOT1164	£15.00	20075	LOT438	£16.00	3128 138 20202	LOT433	£16.00	1-439-332-41	LOT100	£15.00	TFB 4090 AD	LOT395	£12.00
1142.5079	LOT1164	£15.00	3714002	LOT02	£12.00	3138 108 30100	LOT106	£12.50	1-439-332-42	LOT101	£14.50	TFB 4124 AE	LOT392	£15.00
1142.5081	LOT1184	£15.00	3221008	LOT438	£16.00	3138 108 30101	LOT106	£12.50	1-439-332-52	LOT100	£15.00	TFB 4124 AP	LOT392	£15.00
1152-5016	LOT1934	£19.00	043714002J	LOT02	£12.00	3138 108 30103	LOT106	£12.50	1-439-363-11	LOT268	£14.00	We are stockist of both		
1179.0387	LOT1147	£16.00	043221088P	LOT438	£16.00	3139 128 30400	LOT90	£12.50	1-439-363-21	LOT268	£14.00	Konig		
1192.0527	LOT1147	£16.00	43700000	LOT02	£12.00	40348-08	LOT1577	£18.00	1-439-387-11	LOT311	£14.50	and		
1352.5008	LOT1167	£15.00	7140021	LOT02	£12.00	40348A-09	LOT1577	£18.00	1-439-387-21	LOT311	£14.50	HR Diemen		
1352.5008E	LOT1167	£16.00	MITSUBISHI			4812 140 10246	LOT111	£15.00	1-439-416-11	LOT255	£16.00	LOPT's		
1352.5016	LOT1934	£19.00	731003	LOT51	£15.50	4812 140 10349	LOT106	£12.50	1-439-416-12	LOT255	£16.00	This is just a selection		
1352.5027	LOT1270	£16.00	334 P 18506	LOT51	£15.50	4812 140 10369	LOT90	£12.50	1-439-416-23	LOT255	£16.00	of the LOPT's that we		
1352.5033	LOT1270	£16.00	OREGA			4812 140 10421	LOT90	£12.50	1-439-416-41	LOT255	£16.00	stock....Please call on		
HINARI			40153201	LOT349	£17.50	4822 140 10246	LOT111	£15.00	1-439-416-51	LOT255	£16.00	020 8900 2329 for copy		
3714002	LOT02	£12.00	ORION			4822 140 10274	LOT123	£14.50	THOMSON			of our LOPT catalogue		
043714002J	LOT02	£12.00	3714002	LOT02	£12.00	4822 140 10306	LOT57	£11.00	105009.8	LOT1505	£19.00			
43700000	LOT02	£12.00	043714002J	LOT02	£12.00	4822 140 10349	LOT106	£12.50	10500980	LOT1505	£19.00			
CF 124 B	LOT67	£14.50	43700000	LOT02	£12.00	4822 140 10384	LOT127	£15.50	10500980.P1	LOT1505	£19.00			
CF 124 E	LOT67	£14.50	PANASONIC			4822 140 10406	LOT73	£11.50	10531460	LOT1505	£19.00			
HITACHI			TLF 14512 F	LOT39	£18.50	4822 140 10544	LOT433	£16.00	105660.6	LOT1505	£19.00			
2424593	LOT44	£10.50	TLF 14520 F	LOT40	£15.00	4822 140 10566	LOT433	£16.00	10566060	LOT1505	£19.00			
2432461	LOT169	£15.00	TLF 14521 F	LOT39	£18.50	AT 2076 / 10	LOT57	£11.00	10566060.P2	LOT1505	£19.00			
2432761	LOT169	£15.00	TLF 14567 F	LOT39	£18.50	AT 2077 / 81	LOT121	£15.00	105880.8	LOT1505	£19.00			
						AT 2078 / 21	LOT395	£12.00	10588080	LOT1505	£19.00			
						AT 2079 / 15	LOT129	£14.00						

We are stockist of both
Konig
and
HR Diemen
LOPT's
This is just a selection
of the LOPT's that we
stock....Please call on
020 8900 2329 for copy
of our LOPT catalogue

CD Pick Ups and Mechanisms

Part No	Price	Part No	Price	Part No	Price
CDM12.1 Mechanism	£14.00	KSS 213 B	£8.75	OPTIMA 6 S	£11.50
KHM220AAA		KSS 213 C	£9.50	OPTIMA 5	£11.50
DVD Laser	£ 40.00	KSS 213 D	£16.00	RCTRTH8151	£20.00
KSS 210A Original	£11.00	KSS 213 F	£12.00	RCTRTH8112	£14.00
KSS 210A Replacement	£9.50	KSS 240 A	£30.00	RCTRTH8147 Mech	£ 10.00
KSS 210 B	£15.00	NKS 240 A			
		Replacment for KSS240A	£20.00		

Check out our Online Catalogue at
www.grandata.co.uk

This advertisement is just a selection of our stock.
Please contact us if you cannot find the part you are looking for.

* Please add £1 p+p and VAT to all orders (Unless Otherwise stated) * All components are brand new
* We accept payment by Access , Switch , Visa , Cheque and Postal Order
* All prices quoted are subject to availability and may be changed without prior notice

E & OE

K.P. House , Unit 15 , Pop In Commercial Centre , Southway , Wembley , Middlesex HA9 0HB England
Tel : (020) 8900 2329 Email : sales@grandata.co.uk
Fax : (020) 8903 6126 Website : http://www.grandata.co.uk



Here's a useful sideline, looking after the amplifiers used by local musicians. Geoff Darby has been involved in this work for some time and explains the type of problems you can get and how to tackle them. Also how to get such work

Repairing PA amplifiers

For some years now I have looked after PA amplifiers for several local bands. In general they are well-built units that are usually quite easy to repair. They don't suffer from output stage failure nearly as often as you might expect and, even when you do get defective output transistors or FETs, it's unusual for a multiple-device cascade failure or burn up to occur.

The most common problems are physical damage to sockets and adjustment potentiometers, and bad joints. An area where dry-joints are particularly prone to occur is in the circuitry used to produce the low-voltage positive and negative rails for the preamplifier stages. Such supplies are often very simply derived and regulated – by 'zenering-down' from the high-voltage supplies for the output stages. You will typically find 5W wirewound resistors and 2-3W zener diodes used for the purpose. These devices run very hot of course. Also look out for associated decoupling capacitors.

The equipment is usually expensive to buy and replace and you generally find that the owner expects to pay a fair price for any repairs required. These are often 'urgent', for a gig that's to be played in a couple of days' time. As temporary equipment hire is expensive, the owner may well be prepared to pay a premium for a fast turnaround. In my experience engineers who are prepared to look at this sort of equipment are thin on the ground and, once you've got a customer, he'll stick with you for life – provided you look after him/her. Be prepared to get your phone number passed around: you are likely to get calls that start "you don't know me but . . ."

If there's a band playing in your local pub when you go in, it's well worth handing your card to the members, particularly the person at the mixing desk, if they have one. This is usually the person who's responsible for looking after the equipment. If you have a local shop that sells musical instruments and/or amplification equipment it's worth making yourself known there. Even if they have someone on call, they will

probably be interested in you for holiday, emergency or illness cover.

Here are a couple of faults I have had recently, to give you an indication of the type of problems you are likely to face and how to go about getting to the bottom of them.

An Ampeg combo

The first item was an Ampeg combo (that's a speaker cabinet with built-in amplifier), Model B15T. It's slightly unusual in that when the unit is being transported the amplifier lives upside down in the top of the cabinet. To use it, you undo clips at each side, lift off the entire wooden top of the cabinet, turn it the other way up and replace it on top of the cabinet. The amplifier is of chassis-type construction, fixed to the wooden cabinet top. The cabinet's internal speaker plugs into a socket at the rear of the chassis.

The owner's complaint was that it had suddenly gone very quiet halfway through only the second song of the evening. Oh dear!! Scope checks showed that there was a good level of undistorted audio at the master volume control, which is at the end of the preamplifier chain, but a very low level where the signal left the preamplifier board as drive for the output stage. There are two 1.5kΩ resistors in series between these two points, with a FET connected between their junction and ground. This device, an n-channel junction FET type J122, proved to be short-circuit drain-to-source. None of the components on the preamplifier board have reference numbers. The FET is located between the master volume control and line output level potentiometers. I'm not sure about its function – the block diagram silk-screened on the amplifier's top cover would suggest that it's part of a muting arrangement – but a replacement cured the fault.

While on the subject of block diagrams, it's worth mentioning that these amplifiers often have quite an elaborate one on the case top. They are there to impress of

course, by looking very technical, but once you learn to ignore all the 'technical terms' on the diagram can be a very useful guide to the general arrangement of the equipment and how it's supposed to work.

A mixing and effects desk

The second item, which came in a day later, was a Studiomaster Model Power House 8-2. It's a superior-quality 8-channel mixing and effects desk with built-in 250W RMS stereo power amplifiers. The complaint was that input channel 5 had originally failed and now they had all failed. It turned out that the second problem was a red herring – the owner had set a mixdown routeing switch wrongly, with the result that the mixer desk was effectively no longer directly connected to the power amplifiers. Once this had been corrected, the unit was back to its original complaint, a dead channel 5.

The eight input channels each have their own separate preamplifier board. They are all identical, so it's easy to compare waveforms and voltages. The preamplifier and tone amplifier in each channel are based on TL072 low-noise bi-FET operational amplifiers. In a good channel there was a large signal present at pin 7 (output b) of IC2 and the average voltage was zero. At the same pin of the corresponding chip in the bad channel there was no signal and a slight negative voltage. A replacement IC put the channel right.

In conclusion

I hope this shows you that such equipment contains nothing to worry about. Problems can usually be solved by employing straightforward fault-finding techniques, of which we should all be capable. The advantage is that you can get much-needed additional business that tends to be long-term. And, because of the nice build quality, you get a lot more job satisfaction than with the average piece of domestic equipment. We could all do with more of that! ■

Servicing

the Sharp DA100 (50Hz) and DA50W chassis

Part 4 of this series, by **Alex Towers**, deals with the audio circuitry including the separate Dolby Pro-Logic board used in most models

As mentioned last month the audio output stages operate in the class D (switching) mode and use a TDA7480 IC. Fig. 38 shows the left-channel audio output circuit. At switch on C362 is discharged and the voltage at pin 12 of IC301 is thus low. This prevents any output from the IC until the supplies have been established. Once the supplies are present and the voltage at pin 12 is in excess of 2.7V the IC will begin to switch, producing at pin 4 a pulse-width modulated output whose frequency and mark-space ratio depend on the input at pin 11. L352 and C361

form a low-pass filter that converts the PWM output to an analogue signal to drive the loudspeaker. A proportion of this output is fed via R358 to an averaging circuit as a protection signal: if the average of the signal at the junction of L352 and R358 is not zero, the control software will switch the set to standby.

Q305 is switched on during system reset or when the microcontroller chip IC1001 produces an HOUT (Horizontal Mute) output at pin 57. IC301 is thus muted as pin 12 is at

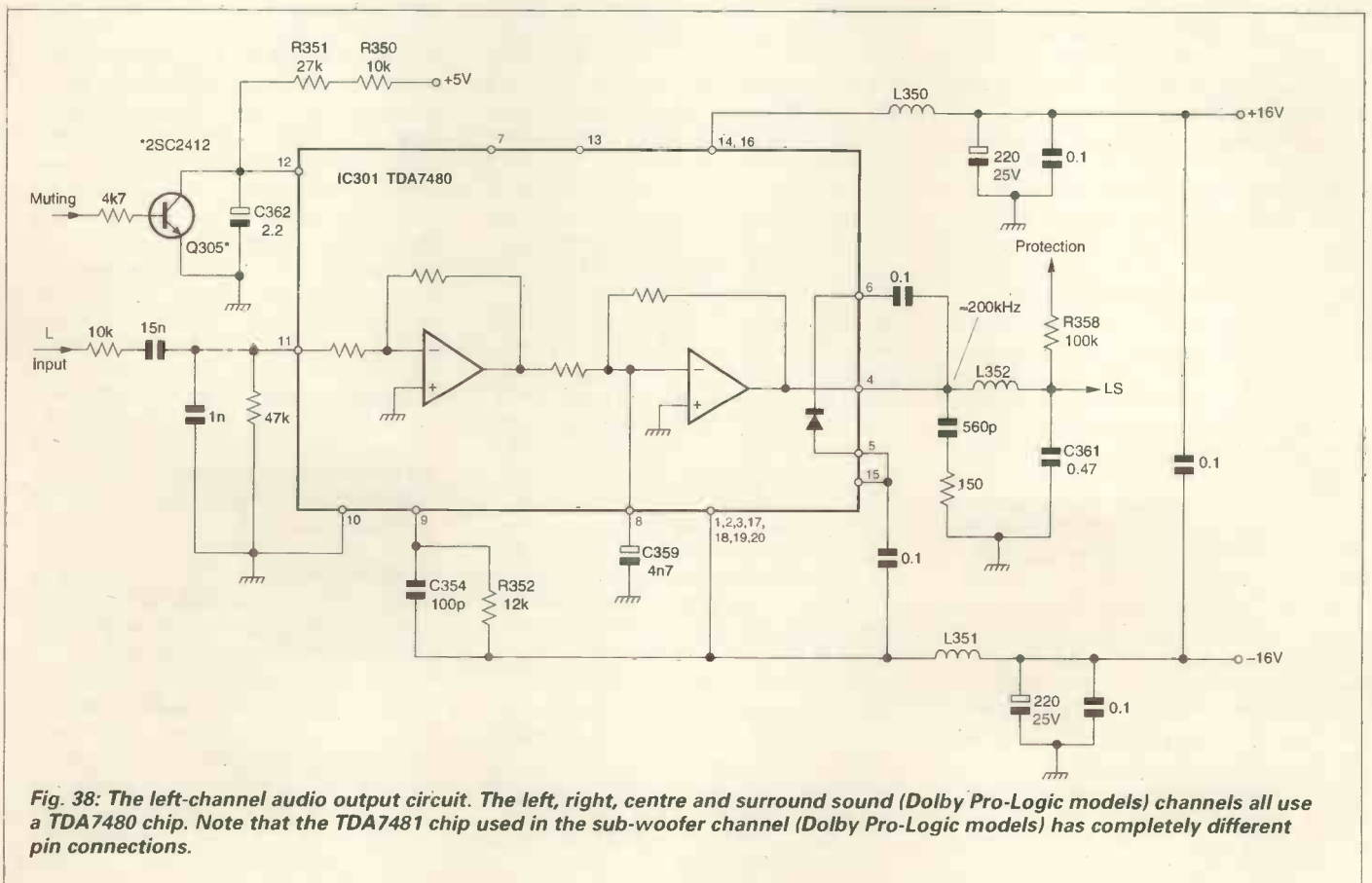
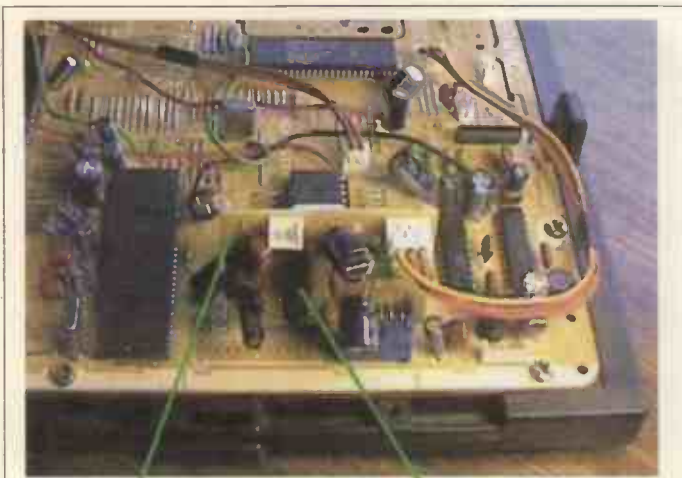

Fig. 38: The left-channel audio output circuit. The left, right, centre and surround sound (Dolby Pro-Logic models) channels all use a TDA7480 chip. Note that the TDA7481 chip used in the sub-woofer channel (Dolby Pro-Logic models) has completely different pin connections.



Centre speaker PWB IC1302 - IC1300 is an SMD device mounted on the print side of the PWB

Fig. 39: Location of the centre-speaker PCB.

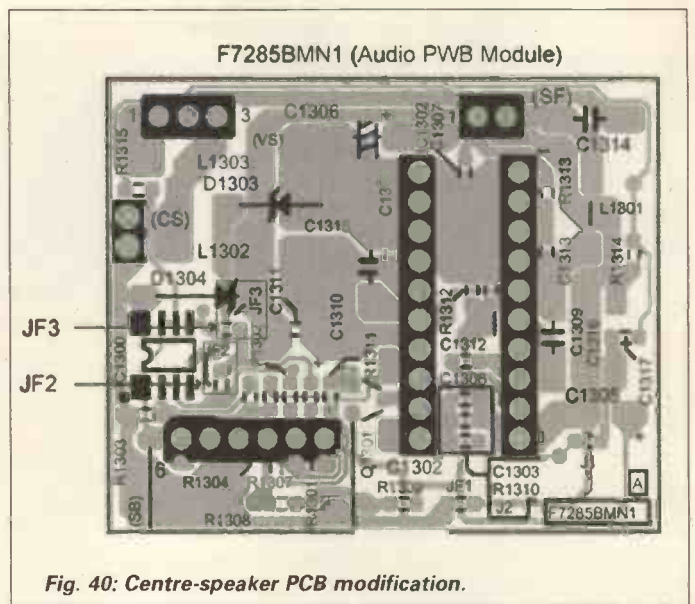

Fig. 40: Centre-speaker PCB modification.

chassis potential.

All models except for the 56FW53H are fitted with a centre-speaker PCB which uses a similar circuit. IC1302 is the centre-channel output chip, which is again type TDA7480. Fig. 39 shows the location of the centre-speaker PCB. Note that this has gone through a number of revisions, not all of which are compatible. Be sure to use the correct circuit diagram when servicing.

In Models 66GF64H and 76GH64H the centre speaker is located in the rear cabinet.

Audio fault-finding

Audio output stage faults are usually caused by high HT (see Part 2, October, page 726 for more on this fault condition). When the HT is excessive one or both of the audio output ICs (IC301, IC302) may fail. Usually the supply feed coils (L350 and L351 for IC301, L315 and L316 for IC302) will go open-circuit as the IC draws excessive current. The part no. for these coils is VP-CD3R3K0000. Check IC1302 on the centre-speaker PCB as well, as this also fails. The feed coils here are L1302 and L1303 (same part no.).

If a whistling is heard from the centre speaker it could be that the centre signal is beating with the left or right signal. To cure this reduce the value of R1312 from 12kΩ to 8.2kΩ (Sharp part no. VRS-TV1JD822J). This will change IC1302's operating frequency and stop the beat.

It's possible for the protection circuit to operate when the speakers (left, right and centre) are left disconnected. This can be particularly frustrating when carrying out repairs. As the leads that connect the speakers to the PCB are fairly long they can be left connected, even when the chassis is tilted to provide easy access.

IC1300, an op-amp IC that's mounted on the print side of the centre-speaker PCB, can run hot and result in a dead set (short-circuit across the +16V or -16V rail). To reduce IC1300's operating temperature add jumper wires JF2 and JF3 as shown in Fig. 40. Check for dry-joints at C1306 (2.2μF) and resolder if necessary. Also check the condition of IC1300 and replace if necessary. If the track is cut below IC1300 and jumper link JL1 is fitted, as shown in Fig. 41, it is not necessary to carry out the modification shown in Fig. 40. If the set is dead with IC1300 short-circuit, it can be run by completely disconnecting the centre-speaker PCB. The part no. for JF2 and JF3 is VRS-TV1JD000J; the part no. for IC1300 is VHIBA4558F/-1.

Dolby Pro-Logic circuitry

Models whose numbers end in a 4, e.g. Model 66GF64H, incorporate Dolby Pro-Logic circuitry. This is on a separate PCB, see Fig. 42, which includes its own mains-isolated chopper power

supply. There are four output ICs, IC1302/3/4 (all type TDA7480) and IC1305 (type TDA7481). The other ICs on the board are the Dolby Pro-Logic processor IC1301 (type DPL3519) and the feedback optocoupler IC1703 (type MOC8106) in the power supply. The PCBs used in different models are virtually identical except that in GF models the input for the sub-woofer output chip IC1305 (pin 9) is obtained from pin 31 of the MSP3410D processor chip IC305 on the main PCB instead of pin 21 of IC1301. Because of this the matching circuit, which consists of Q1304 (2SC2412) and the associated components, differs. In addition a different output from IC1301 is used to drive the surround-sound output chip IC1304. The DPL PCBs in FW and GF models are therefore not interchangeable. There are also software differences between the models. The GF models have the sub-woofer speaker in the rear cover.

The chopper power supply operates in the same way as that on the main chassis but generates only four outputs, +17V and -17V for the output chips, +8V for the DPL processor and +5V for the muting circuits. The chopper chip is Q1701 (type 2SK2605). Its heatsink gets very hot - sometimes it is too hot to touch. This is normal. During standby the power supply is turned off by IC702 on the main chassis in the same way as with the main power supply.

The board receives a stereo signal input, derived from either an off-air Nicam signal or an external AV source, from the MSP

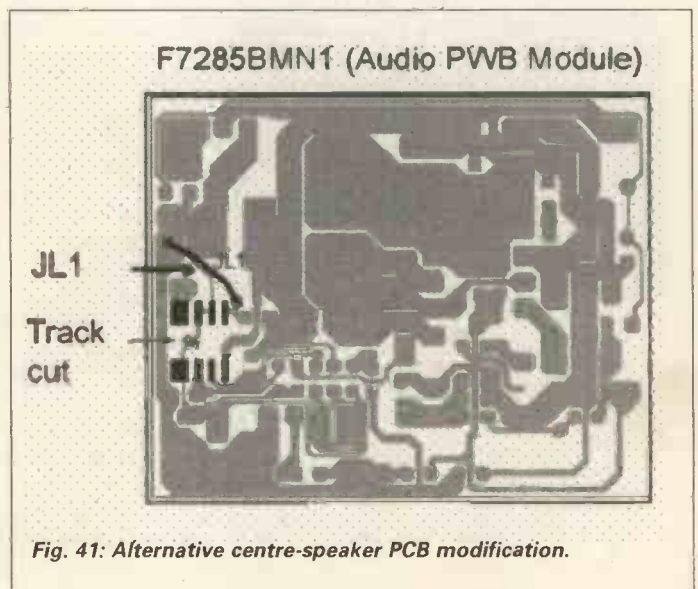

Fig. 41: Alternative centre-speaker PCB modification.

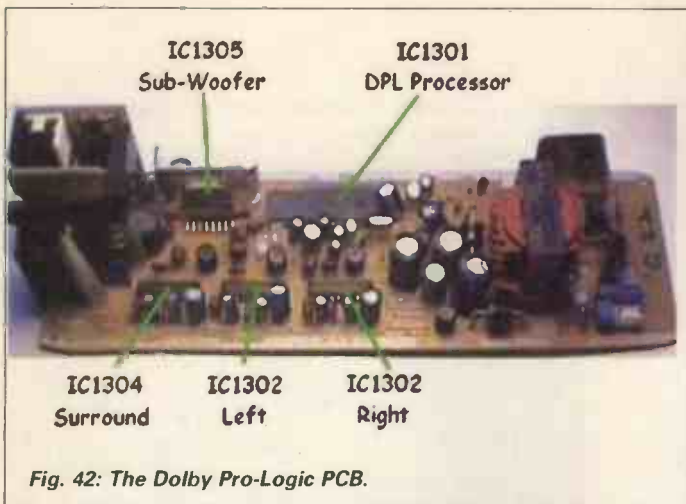

Fig. 42: The Dolby Pro-Logic PCB.

sound processor chip IC305 on the main PCB. IC1301 converts this to Dolby Pro-Logic outputs.

IC1302 (left) and IC1303 (right) drive 8Ω loudspeakers. IC1305 (sub-woofer) drives a 4Ω base-reflex speaker. IC1304 (surround sound) drives two 16Ω speakers which are connected in parallel but in anti-phase. If the front speakers are connected to the rear speaker output IC1304 will eventually fail. Invariably the customer will complain that the rear speakers didn't produce enough volume before the IC failed.

Faults in the Dolby Pro-Logic circuit

With an incorrectly operating or dead set the Dolby Pro-Logic PCB can be ruled out as a possible cause simply by disconnecting it from the main PCB. This is easily done by disconnecting the large multi-way cable from the main PCB, see Fig. 43. The set should then start up normally, but there will be no sound if the

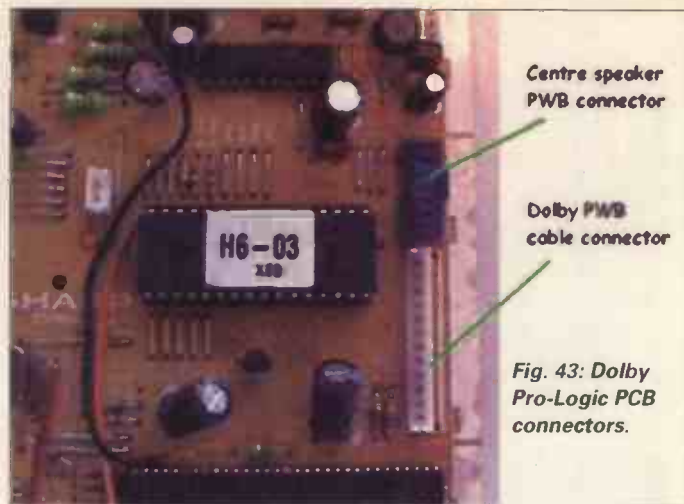

Fig. 43: Dolby Pro-Logic PCB connectors.

receiver is set for external speakers.

A set may sometimes appear to be dead because of failure of the Dolby Pro-Logic power supply. The usual situation is that the chopper transistor Q1701 has failed along with the ±17V rectifiers D1708 and D1710 (type MR826) and some or all of the output chips IC1302/3/4/5.

Some problems are customer-generated, especially when they relate to user settings. Amongst the more common are that the set is not configured for external speakers (no sound from the external speakers) or that the set has not been set up for Dolby Pro-Logic (no Dolby Pro-Logic operation). Refer to the user operation manual for more information on this.

Next month

In Part 5 next month we'll tackle the control system and the video/sync processor chip.

Book review

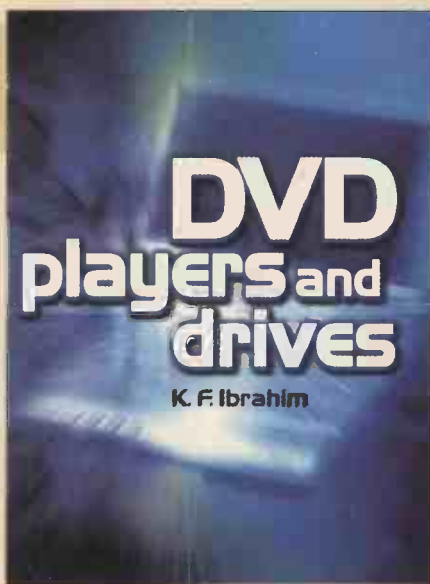

DVD players and drives by K.F. Ibrahim, published by Newnes, Linacre House, Jordan Hill, Oxford, OX2 8DP at £24.99. Approximately 320 pages 234 x 156mm. ISBN 0 7506 5736 7.

The DVD has turned out to be one of the most successful electronic products ever introduced. This meaty book tells you all you could possibly need to know about the technology. It does so in a clear, down-to-earth manner, with copious use of illustrations and tables. You will find it not only an excellent introduction to the subject but also a very useful reference source subsequently.

The opening chapter deals with the various types of DVD, including one I'd not heard of before, the DVD-PROM. It describes the technical features of the discs, followed by an introduction to encoding and playback. If you are at all rusty on the basics of digital electronics and microprocessors, the following chapter makes all this clear, including AD and DA conversion and the error-control techniques used. The following chapters cover in detail video signals, encoding, framing and forward error correction, the optical pickup, signal processing and control, and decoding, followed by power supply and user interface arrangements.

Servicing is dealt with in chapter 10, which describes logical fault finding with key waveforms. The common symptoms and their causes are listed.

There follow chapters on basic DVD data streams, including search, cell structure and video management, and DVD production. The latter is enlightening, describing the new skills required in allocating resources and in menu and navigation design.

We then come to drives. This chapter describes basic PC operation, the fault-finding utilities provided by Windows and how to install a DVD drive.

The book is rounded off with an excellent glossary and various appendices.

One or two minor blemishes were noted. The Fig. 2.3 referred to on page 17 is actually Fig. A1.3 in an appendix, and there are several spelling errors in diagrams. These shouldn't cause the reader any trouble however. Otherwise an excellent and detailed coverage of all aspects of the subject.

J.A.R.

FRUSTRATED!

Looking for ICs TRANSISTORS?

A phone call to us could get a result. We offer an extensive range and with a World-wide database at our fingertips, we are able to source even more. We specialise in devices with the following prefix (to name but a few).



2N 2SA 2SB 2SC 2SD 2P 2SJ 2SK 3N 3SK 4N 6N 17 40 AD
 ADC AN AM AY BA BC BD BDT BDV BDW BDX BF
 BFR BFS BFT BFW BFX BFY BLY BLX BS BR BRX BRY BS
 BSS BSV BSW BSX BT BTA BTB BRW BU BUK BUT BUV
 BUW BUX BUY BUZ CA CD DX CXA DAC DG DM DS
 DTA DTC GL GM HA HCF HD HEF ICL ICM IRF J KA
 KIA L LA LB LC LD LF LM M M5M MA MAB MAX MB
 MC MDA J MJE MJF MM MN MPS MP5A MP5H MP5U
 MRF NJM NE OM OP PA PAL PIC PN RC S SAA SAB
 SAD SAJ SAS SDA SG SI SL SN SO STA STK STR STRD
 STRM STRS SVI T TA TAA TAG TBA TC TCA TDA TDB
 TEA TIC TIP TIPL TEA TL TLC TMP TMS TPU U UA
 UAA UC UDN ULN UM UPA UPC UPD VN X XR Z ZN
 ZTX + many others

We can also offer equivalents (at customers' risk).
 A LARGE RANGE OF ELECTRONIC COMPONENTS ON
 OUR CD ROM - LIST AVAILABLE ON REQUEST
 Mail, phone, Fax, Credit Card orders & callers welcome.



Cricklewood Electronics Ltd

40-42 Cricklewood Broadway, London NW2 3ET
 Tel: 020 8452 0161 Fax: 020 8208 1441
 www.cricklewoodelectronics.co.uk
 E-mail: sales@cricklewoodelectronics.com

inStore

ELECTRICS LIMITED

171 HAREHILLS LANE, LEEDS LS8 3QE
 Tel: 0113 240 1114. Tel/Fax: 0113 240 7275.
 Mobile: 07976 403134
 Email: sales@instoreleeds.freemove.co.uk

MANUFACTURES GRADED PRODUCTS ALL PRICES PLUS VAT: ALL PRODUCTS FULLY GUARANTEED

- *
 PHILIPS 32PW6506 32" WIDESCREEN REAL FLAT,
 FM RADIO, 50HZ **£349.00**
- *
 PHILIPS 32PW9527 32" WIDESCREEN REAL FLAT,
 DOLBY, 100HZ, PIXEL PLUS **£449.00**
- *
 PHILIPS LX3000 DVD PLAYER 5.1 SURROUND
 SOUND SYSTEM, 75W RMS **£139.00**
- *
 PHILIPS 14" TV/VCR COMBI FROM **£84.00**
 PHILIPS 14" PORTABLES FROM **£59.00**
- *
 PHILIPS VCR'S FROM **£39.00**
 PHILIPS AUDIO SYSTEMS FROM **£44.00**
- *
**FURTHER OFFERS AVAILABLE
 PLEASE CALL FOR A PRICE LIST
 CREDIT CARDS WELCOME: NEXT DAY DELIVERY**



NIKKO ELECTRONICS

ELECTRONIC COMPONENTS DISTRIBUTORS

LOPT'S

• LOPT'S FOR MONITORS
 OVER 500 DIFFERENT
 TYPES IN STOCK

• LOPT'S FOR TV'S
 FROM £6.00

1352.5037	£9.00
NIK-7503	£6.00
NIK-8336	£9.00
NIK-7927	£8.50
NIK-7880	£8.25
NIK-8007	£8.25
NIK-8320	£9.00

and more, Pls enq!

• REMOTE CONTROL
 FOR TV/VIDEO
 FROM £5.00

DVD/CD LASER PICKUPS + MECHANISM

REPLACEMENT

KSS-210A	£8.50	KSS-213D	£9.50
KSS-213B	£8.50	KSS-213E	£8.75
KSS-213C	£8.50	KSS-220F	£13.00
KSS-240A	£17.50	KSS-710A	£15.50
KSS-210B	£8.50	KSS-720A	£25.00

ORIGINAL ALSO AVAILABLE FOR KENWOOD, PIONEER, SONY

KHM 220 AAA orig	£57.00
CDM 12.1	£13.00
12.3	£14.75
12.4	£23.00

AND A LOT MORE, PLEASE ENQUIRE!

AN-5277	£2.35	TA-8268	£15.00
AN-7125	£2.49	TA-8273	£11.50
BA-4900	£5.50	TA-8277	£11.95
BA-4901A	£8.50	TA-8427K	£0.89
BA-4905	£5.99	TDA-7384	£4.90
BA-4908	£6.50	TDA-7385	£5.75
BA-4911	£8.50	TDA-7386	£6.99
HA-13158	£5.50	TDA-7560	£13.00
HA-13159	£13.50	TDA-8568Q	£5.75
TA-8260	£8.50	TDA-16833	£1.35
TA-8262	£10.75	TDA-16846	£1.48
TA-8263	£9.25	STK-5332	£1.30

STK-401-020	STK-407-070	STK-490-310
STK-401-030	STK-407-090	STK-495-020
STK-401-040	STK-407-100	STK-496-030
STK-402-030	STK-407-120	STR-F6523
STK-402-040	STK-407-710	STR-F6524
STK-402-070	STK-411-220	STR-F6535
STK-402-071	STK-411-240	STR-F6552
STK-402-090	STK-411-290	STR-F6653
STK-402-100	STK-412-010	STR-F6654
STK-402-120	STK-412-020	STR-F6655
STK-402-240	STK-419-120	STR-F6656
STK-405-030	STK-419-130	STR-F6668
STK-405-050	STK-419-150	STR-F6676
STK-405-070	STK-442-130	STR-F6707
STK-405-090	STK-443-050	PAL-006A
STK-405-120	STK-489-010	PAL-007A
STK-407-040	STK-490-040	
STK-407-050	STK-490-110	

- Sony tactile switch 4 pin MOQ 10pcs £0.28
- Sony tactile switch 2pin MOQ 10pcs £0.25
- Wire ended lamps for car stereo 6,9,12V
 MOQ 50pcs £0.15 each

● SPECIAL MOQ 10PCS

S-2000N/CH	£0.65	BUT-11A	£0.35
BU-2508AF/CH	£0.65	SAP15P	£3.25
BU-508AF/CH	£0.49	SAP15N	£3.25
STR-50103A	£1.75	UC-3842A	£0.45
STR-54041	£1.49	TDA-8361/N3	£2.75

● PRICES QUOTED EXCLUDING VAT AND SUBJECT
 TO CHANGE W/O PRIOR NOTICE.

NIKKO ELECTRONICS
 358 Kingston Road, Ewell, Epsom Surrey KT19 0DT
 Tel: 020 8393 7774
 Email: dalbani@nikko-electronics.co.uk
 Website: www.dalbani.co.uk

IT'S EASY
 TO ORDER

PHONE
 020 8393 7774
 OR FAX
 020 8393 7395

CLICK/ORDER
 ONLINE
 VIEW OUR CAT ON
 www.dalbani.co.uk



TELEVISION BOOKS

AND HOME ELECTRONICS REPAIR

The Television Book Service offers access to our team of specialist publishing experts. We can order any book or CD-ROM currently in print from *War And Peace* to the *Newnes Guide to Television and Video Technology*. All books are delivered free of charge within the UK unless otherwise stated. Contact us at the numbers below:

Telephone: **01737 812727** or **01737 812676**

Fax: 01737 813526 Email: salesteam@boffinbooks.demon.co.uk

If you are ordering by credit card, need further information, or would like to use our search facilities call

01737 812727 Fax 01737 813526

The order/helpline is open from 9am to 5pm, or leave your order on our out of hours answerline or email us at

salesteam@boffinbooks.demon.co.uk

When placing orders please quote * Name * Address (home & delivery) * Daytime telephone number * Debit/Credit card number * Expiry date * Details of order. Please note that prices may change, but are correct at time of going to press.

Boffin Books Ltd., 24 Walton Street, Walton-on-the-Hill, Tadworth, Surrey KT20 7RT

VCR FAULT FINDING GUIDE

Edit. Peter Marlow

A distillation of the most-used fault reports from 11 years of *Television* magazine. Arranged by make and model, it features over 2000 reports on over 200 models of VCR, including diagnosis and repair advice.



Mar 2000 447 pages PB

Code: BUT0-7506-4634-9

£23.50

VIDEO AND CAMCORDER SERVICING AND TECHNOLOGY

Steve Beeching 5th ed

A comprehensive guide to domestic VCR technology and repair techniques. This edition brings the information fully-up-to-date, with expanded coverage of camcorders, sections on DVD equipment and the latest VCR technology.

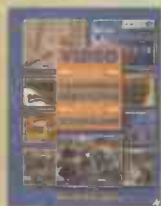

Apr 2001 323 pages PB

Code: BUT0-7506-5039-7

£23.50

SERVICING TV, SATELLITE AND VIDEO EQUIPMENT

Eugene Trundle. Rev. 2nd Edition

A practical hands-on guide for service engineers, installation technicians and servicing students, this text emphasizes the practical business of fault diagnosis and repair of TV, satellite and video equipment.



Nov 2001 336 pages PB

Code: BUT0-7506-5507-0

£24.50

NEWNES GUIDE TO TELEVISION AND VIDEO TECHNOLOGY

Eugene Trundle. 3rd ed

An exploration of television and video technology. It covers the fundamentals of digital television (satellite, cable and terrestrial) and digital video, as well as providing a grounding in analogue systems.



Feb 2001 432 pages PB

Code: BUT0-7506-4810-4

£17.99

NEWNES GUIDE TO DIGITAL TELEVISION

Richard Brice. 2nd ed

Covering all aspects of digital television, this text encompasses the electronics of the equipment, data compression, television production, servicing and the different transition methods - terrestrial, satellite and cable. The text has been updated with developments since the 2000 edition.



Sep 2002 304 pages HB

Code BUT0-7506-5721-9

£24.99

TV FAULT FINDING GUIDE

Edited by Peter Marlow

A distillation of the most-used fault reports from 11 years of *Television* magazine. Arranged by make and model, it features over 200 reports on over 300 models of television, including diagnosis and repair advice.



Mar 2000 387 pages PB

Code: BUT0-7506-4633-0

£23.50

DIGITAL SATELLITE TV HANDBOOK

Mark E. Long

A handbook and CD-ROM pack on digital satellite television. It provides an overview of all the digital TV platforms in use world-wide. It includes satellite coverage maps and transmission parameters that readers will need to receive digital TV services from any location in the world.



Sept 1999 207 pages PB CD-ROM

Code: BUT0-7506-7171-8

£41.99

DICTIONARY OF VIDEO AND TELEVISION TECHNOLOGY

Jack Tsatsoulis

This work provides comprehensive and contemporary information on the essential concepts and terms in video and television, including coverage of test and measurement procedures. The CD accompanying the text includes an electronic version of the book.



Dec 2002 365 pages CD-ROM

Code: BUT1-878707-99-X

£29.99

VIDEO DEMYSTIFIED

Keith Jack. 3rd ed

This edition has been updated to include information on digital television, datacasting, interactive video, digital camcorders and VCRs, and video interfacing. Coverage is international, including European, Asian, and North/South American video standards, methods, and techniques.



Jul 2001 784 pages PB CD-ROM

Code: BUT1-878707-56-6

£50.00

NEWNES TELEVISION AND VIDEO ENGINEER'S POCKET BOOK

Eugene Trundle. 3rd ed

This updated text provides a pocket tool for service engineers. It presents a range of essential information in a compact form, covering television reception, satellite and cable television, video recorders, colour camera technology, teletext and fault-finding.



Oct 1999 512 pages HB

Code: BUT0-7506-4194-0

£17.99

TELEVISION: AN INTERNATIONAL HISTORY OF THE FORMATIVE YEARS

R.W. Burns

This concise history of television from its conception to the 1940s considers the factors - technical, social and financial - that influenced and led to the establishment of many of the world's high-definition broadcasting services.



656 pages HB

Code: IEE 0-85296-914-7

£39.00

FUNDAMENTALS OF DIGITAL TELEVISION TRANSMISSION

Gerald W. Collins

The switch from analogue to digital broadcast systems is a hot topic in broadcast engineering as the technology rapidly evolves. This text discusses both American ATSC and European DVT-T systems, and collates the latest research previously scattered throughout various journals.



Dec 2000 288 pages HB

Code: WIL0-471-39199-9

£54.50

STANDARD HANDBOOK OF VIDEO AND TELEVISION ENGINEERING

Jerry Whitaker; Blair Benson

As the television engineering field is rocked by digital technologies and FCC mandates, this handbook has been revised and updated. It features 70 per cent new material, including a section on digital television, and comes with a CD-ROM containing standards, archived texts and software.



140 pages HB & CD-ROM

Code: MCG0-07-069627-6

£91.99

TELEVISION ORDER FORM Tel: 01737 812727 Fax: 01737 813526

Please order following:	Qty	Name	Daytime Tel
BUT0750646349 VCR Fault Finding Guide £23.50	<input type="checkbox"/>	Address	
BUT0750650397 Video & Camcorder Servicing Technology £23.50	<input type="checkbox"/>	Postcode	
BUT0750655070 Servicing TV, Satellite & Video Equip £24.50	<input type="checkbox"/>	Delivery address (if different)	
BUT0750648104 Newnes Guide to TV & Video Technology £17.99	<input type="checkbox"/>	Postcode	
BUT0750657219 Newnes Guide to Digital Television £24.99	<input type="checkbox"/>	POSTAGE & PACKING FREE IN THE UK*	
BUT0750646330 TV Fault Finding Guide £23.50	<input type="checkbox"/>	I enclose a cheque/postal order value £ _____ payable to 'Boffin Books Ltd'	
BUT0750671718 Digital Satellite TV Handbook £41.99	<input type="checkbox"/>	Please debit my Access/Visa/Switch/Delta card Issue number (Switch only) _____	
BUT187870799x Dictionary of Video & TV Technology £29.99	<input type="checkbox"/>	Card Number _____	Expiry Date _____
BUT1878707566 Video Demystified Guide £50.00	<input type="checkbox"/>	Signed _____ email:salesteam@boffinbooks.demon.co.uk	
BUT0750641940 Newnes TV & Video Engineer's Pocket Book £17.99	<input type="checkbox"/>	*Postage charges outside the UK available upon request or email to salesteam@boffinbooks.demon.co.uk	
IE00852969147 TV: An Int History of the Formative Years £39.00	<input type="checkbox"/>	Post to: Boffin Books Ltd., 24 Walton Street, Walton-on-the-Hill, Tadworth, Surrey KT20 7RT, UK	
WIL0471391999 Digital Television £54.50	<input type="checkbox"/>		
MCG0070696276 Standard Handbk of Video and TV Engineering £91.99	<input type="checkbox"/>		

LETTERS

Send letters to "Television", Highbury Business Communications, Nexus House, Azalea Drive, Swanley, Kent, BR8 8HU or e-mail t.winford@highburybiz.com using subject heading 'Television Letters'.

Please send plain text messages. Do NOT send attachments. Be sure to type your full name, address, postcode, telephone and e-mail address (if any). Your address and telephone number will not be published but your e-mail address will unless you state otherwise. Please send ONLY text intended for the letters page. Correspondence relating to subscriptions and other matters must be sent to the office address given above.



Polarity protection

I have been following the recent correspondence about providing battery polarity protection and would like to add the following comments. The use of a bridge rectifier, suggested by David Mawtus, to allow the input to be of either polarity is elegantly simple but may not be satisfactory in every case. Whichever way round the input, there are always two diodes in series with the supply. A normal silicon bridge rectifier will therefore drop $2 \times 0.7V = 1.4V$, which leaves 10.6V available from a 12V battery supply. A fully-charged battery will provide over 12V but, if the equipment being supplied is for example a TV set with a regulated 11V internal supply line, there will be no headroom to allow the regulator to operate correctly as the battery discharges. When the voltage drop along the connecting leads is added, regulation may prove to be impossible even with a fully-charged battery. Use of high-current Schottky diodes may help, but this could be expensive and remains a less than ideal solution.

Jim Littler's original design, using a relay, eliminates the above problem. I used a similar circuit in my design of the Television Monochrome Portable, see October 1977 issue. May I now suggest the simplified arrangement shown in Fig. 1? A dual-colour LED shows green or red depending on whether the supply polarity is correct or reversed. D1 allows the relay to be energised only when the polarity is correct. Fuse F1 is included to prevent cable burning or welding of the relay contacts should a short-circuit occur downstream from the unit, especially if direct connection to a car battery is used – don't forget how hazardous a car battery can be!

*Keith Cummins,
Chale Green, Isle of Wight.*

With reference to the suggested use of a bridge rectifier to provide battery polarity protection (Letters, November), this would not be suitable with a PMR (or CB) transceiver. You need the very low impedance of the battery to reduce noise etc. in the receive mode, and maximum voltage for the power amplifier in the transmit mode. The voltage drop across the bridge would affect the latter, while the forward resistance of the diodes would result in poor reception. PMR and CB transceivers use a heavy-current reverse diode in parallel to provide protection

but, as my original letter pointed out, damage can still occur, hence the suggested protection circuit.

There was an error in the circuit as shown (Fig. 1, page 733, October). The buzzer should be connected across both the red LED and the $1.5k\Omega$ resistor to provide sufficient voltage to operate.

*Jim Littler,
Wigan, Lancs.*

Schneider spares

In the October issue TV Fault Finding section Glyn Dickinson reported a problem with a Schneider TV Model STV2802T – he couldn't obtain the VDP3108B IC he required. Wizard Distributors, a long-established distributor for Schneider spares, can supply all currently available parts provided we have the model and ident number for the set concerned. This includes the VDP3108B IC. Details of Schneider and other spares available from us can be found at our website at

www.wizard-distributors.co.uk
*Ron Blyth, Wizard Distributors,
Empress Mill, Empress Street,
Manchester, M16 9EN.
Phone 0161 872 5438, fax 0161 873 7365.
E.mail sales@wizard-distributors.co.uk*

That tuning knob

With reference to the article on the Bush Model VTR103 AM/FM radio receiver in the October issue, I repaired many of these sets at the time and always dreaded having to prise off the tuning knob in case it broke. But one day I was given this tip. Take a length of 'figure-of-eight' flex about 12-15in. long and separate the two halves in the middle with a razor blade to form a loop. Feed one half of the loop under the tuning knob so that it runs from side to side more or less across the centre of the knob. Feed the other half under the tuning knob on the other side, so that the still joined halves of the flex are opposite each other on either side of the knob. Tie the two free ends together then pull on the knot. This leaves one hand free to restrain the radio cabinet. It should be

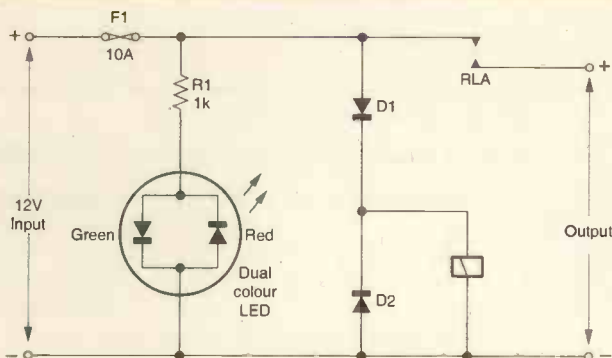

Fig. 1: Simple way of providing battery polarity protection with a relay. D1 and D2 are type 1N4001.

easy to extract the knob without any damage – no broken knob or finger nails, and no screwdriver scratches.

The modern 'figure-of-eight' flex usually has an outer covering. Remove this in the middle of a short length to gain access to the two conductors. This will do just as well.

Mike Harris,
Cheadle Hulme, Cheshire.

DVD fault

My thanks to the three readers who phoned me to help with my query (Help Wanted, October) regarding a blown chip in the Proline DVD player Model DVD2500. The chopper device U801 is type TOP223P. I was also told that it's available from Wiltsgrove in Birmingham and subsequently bought some. The player is now working. Interesting that in the same issue J.S. Ogilvie reported a similar fault with an Oritron DVD600 player and was also having difficulty in obtaining the chopper device.

Derek Castle,
Leeds, West Yorkshire.



Photo 1: Large skeleton dishes used on the Laois/Kilkenny border in Southern Ireland to receive BBC and ITV transmissions from Wales.

Aerials galore

On a recent visit to Southern Ireland I took the two photos shown alongside, Photos 1 and 2. They were taken on the

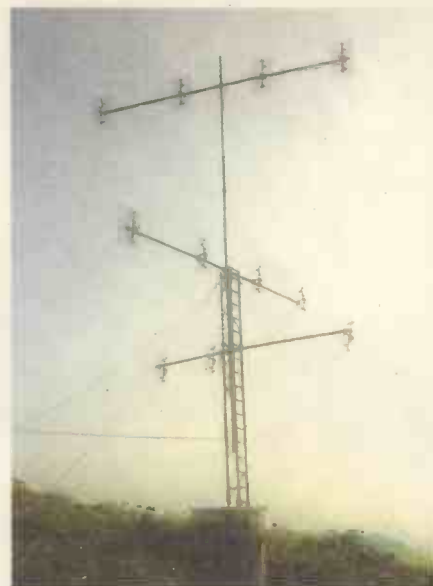

Photo 2: Stacked bow-tie aerial systems used to retransmit the signals to local residents.

Laois/Kilkenny border. Photo 1 shows large skeleton dishes that are used to pick up BBC and ITV transmissions from Wales. Photo 2 shows the stacked bow-tie aerial systems used to retransmit the signals to local residents, who rent converter boxes to receive the signals. Bill MacDonald, G8PUJ, London.

Correction

We regret that because of a production/computer error the uncorrected text of the IFA Berlin Show report appeared in last month's issue. The errors were mainly small misspellings that we hope didn't cause too much confusion. The normal MPEG-4 mode with the Panasonic D-snap range of camcorders runs at 300kbits/sec. Funkausstellung has two Is not one.

HELP WANTED

The help wanted column is intended to assist readers who require a part, circuit etc. that's not generally available. Requests are published at the discretion of the editor. Send them to the editorial department or email to t.winford@highburybiz.com

Wanted: New/as-new wide-neck CRT type A56-540X to complete a restoration project. Denis Everingham, 20 Green Lane, Acomb, York, YO24 3DL. Phone 01904 798 572.

Wanted: A circuit diagram for the Heathkit SW717 short-wave receiver. Also help with an east-west bowing fault with the Wharfedale Model 550SM-R. I have replaced the TDA8145 IC, the 30V zener diode and the BY228 and BYV95C diodes. The two controls on the sub-panel have little or no effect. H.S. Downing, 16 Mayfield Crescent, Lower Stondon, Henlow, Bedfordshire, SG16 6LF. Phone

01462 850 244.

Wanted: For spares, Quad 303 and 405 power amplifiers; 33, 34 and 44 control units; and FM3 tuners. Working or non-working. Also panels and modules for these units. Phone Mike on 01758 613 790.

Wanted: Service manual for the NordMende VCR Model V8005U. Raymond Myers, 64 East Road, Langford, Biggleswade, Bedfordshire, SG18 9QN. Phone 01462 851 515 ext. 4882 daytime or 01462 700 256 evenings.

Wanted: Old half-inch diameter ferrite rods. Must be six inches or more long. Will pay very good money for them. Peter Tankard, 16A Birkendale Road, Sheffield, S6 3NL. Phone 07931 463 823 (mobile).

Wanted: Help with a PC problem. A friend of mine bought a last on the shelf Patriot Model PBK 450/1 PC (serial no. P9CB5804226) from PC World, with no driver software supplied. The graphics card is type VIA PC100 (Integrated Graphics). After a relatively short time he purchased a digital camera which, when installed, made the system crash. I have managed to rebuild the system to a usable state, but cannot find a driver for the on-board graphics card. PC World's help line refers me to their web site to download the correct driver, but neither they nor I know which driver to download. In the

meantime the PC is set at 16 colours (640 x 480) with the device manager set for a standard PCI graphics adapter. If anyone out there knows which driver to download, you'd make an old boy very happy. Please email any suggestions to Colin Squires at colin.squires@larfarge-ukaggregates.larfarge.com

For disposal: Sony reel-to-reel video recorder Model CV2100ACE in working order. Phone for details. I also have a Pye CT205 hybrid CTV receiver, working, which is free to collect. Phone 0161 684 1214.

Wanted: Remote control unit for the Crown TV Model CRV37 (11AK08 chassis). Roy Bailey, 22 Grebe Close, Waterlooville, Hants, PO8 9UT.

Wanted: A scrap Sony C5 or C7 Betamax VCR or the CX186 and CX143N servo ICs. All costs covered. Phone 01483 720 022.

For disposal: Free to collect, various Seventies to modern TV sets, VCRs and electrical items, e.g. JVC 'magic eye', Quinrix and Trinitron tubes, Grundig TVs/portables, USSR valve oscilloscope, Cossor signal generator, audio, hi-fi, DEC/JPM coin-op PSUs etc. Please send requirements to S. Sharpe, 29 Limes Avenue, Nether Langwith, Mansfield, Notts, NG20 9ET.



DX and Satellite Reception

Terrestrial DX and satellite TV reception reports. Broadcast and satellite TV news. Latest on the Coship CDVB3188 digital satellite receiver. The prospects for digital DXing, both TV and DAB. Roger Bunney reports



Televisao de Mocambique (Maputo) received via Telecom 2D (8°W).

Conditions were generally flat for terrestrial DX-TV reception during September. But the period from the 12th through to the 19th, which coincided with an almost static high-pressure system and another heatwave, gave improved tropospheric reception. Here in Romsey, Hants most clear UHF channels carried French TV and there was severe interference on the local channels. Peter Schubert (Rainham, Essex) was away at Mersea Island on the coast at the time, where he reports that Band III and UHF stations in France and the Benelux countries were 'banging in' like the locals.

During this period Cyril Willis (King's Lynn) spent more time with Band III DAB than TV, though only UK DAB stations such as GWR + SAGA (Swindon), BBC Solent and Shropshire and Switch + CE (London) were heard. Interesting that Cyril received Spanish commercial TV stations – Classica Spain, R. Galega and E4EO – as well as TVE. His reception included Danish and French FM stations in Band II, and Band III TV stations from TVE ch. E5 to DR (Denmark) ch. E10.

It was thus a relatively quiet time for terrestrial signals. Fortunately, as usual, satellite activity saved the day!

Satellite sightings

Several readers observed the Euro 1,080-line HDTV tests via Astra 1 (19.2°E) at 12.168GHz V (SR 27,500, FEC 3/4) carried out during the IBC. Hugh Cocks (Algarve, Portugal) found that a PC running at 24Mbits/sec minimum was required to lock the excellent pictures. Edmund Spicer (Littlehampton) mentions that the tests featured mainly classical music concerts. His Manhattan DigiPlaza receiver decoded the audio channels with breakups but, with the signal just below threshold, the screen showed "barely moving pixellations".

Astra 1A has moved to an inclined-orbit graveyard at 5.2°E. It continues to transmit the new Austrian erotic channel TV6 at 11.389GHz V (2,894, 3/4), but with an 80cm dish there's pixellation. The RTL-9 channel next door at 11.370GHz V (3,260, 5/6) produces 100 per cent signal-strength FTA pictures. This suggests that TV6 is running at a much lower EIRP level. RTL-9 is also available, encrypted, at 13° and 19.2°E. In the interests of accuracy, I understand that TV6 comes through pixel-free using a 1.2m dish and that the best times to watch are 10 p.m. BST and 12 p.m. to 1 a.m.

The Pope was on his European tour during September and touched down in Poland on the 11th. There were live pictures of the massive welcoming crowds via Eutelsat W2 (16°E) at 12.703GHz H (5,632, 3/4). The following day brought news of the assassination of the Swedish foreign minister Anna Lindh in Stockholm. Sky News Stockholm very quickly set up transmissions for live reports, from 1745 hours, via Eutelsat 2F3 (21.5°E) at 11.684GHz H (5,632, 3/4), using the UKI-818 SIS 44 truck.

Early in the month there was a conference of French-speaking African states in Paris. Alan Richards (Nottingham) reported a hive of 'African' activity via Telecom 2D (8°W). When I checked I found some really exotic TV channels. The GlobeCast NE ch. 2 multiplex at 12.547GHz H (6,109, 3/4) carried RTG Niger, MBI Mozambique and RTG Conakry Guinea. Another multiplex at 12.553GHz V (same SR and FEC) carried Service 1 TV Sat Telediffusions Gabonaise, Service 2 TV Sat Libreville Gabon, Service 3 TV Sat Doula Cameroon and Service 4 which consisted of a radio channel, language unknown. An old friend, RTNC (Radio-Television Nationale Congolaise) Kinshasa, was present at 12.746GHz V. I last saw this via NSS-7 in August 2002. These transmissions provided a fascinating glimpse of the local African TV scene and were still present at the end of the month. Transmission quality was generally good, though on one evening the Gabon channels were of quality resembling a multi-generation VHS tape, with field rolling, tearing, the lot – the PM5544 test pattern that followed programme closedown reached a frequency response of just 1.5MHz.

Reports from a Spanish-language conference were seen via Atlantic Bird-1 (12.5°W) later in the month, at 11.104GHz H

(20,145, 3/4). The first indication of this came from a satellite receiver tuning menu at 11-0575GHz V (6,111-3, 3/4), when GlobeCast was uplinking the incoming downlink circuit details. Eventually GlobeCast Spain Coral Gables, FL, alternating with Calhoun TES-1 colour bar tests, appeared. After that there were news pictures of the conference delegates arriving, followed by live conference 'action'. The following night produced further reports of action and speeches. Atlantic Bird-1 has also been carrying 'Gay TV by Fortress' on Friday nights at 11-155GHz H (2,894, 3/4). This is an Italian-language programme that's transmitted from 2300 hours to past 0130 hours at least. There are interviews, phone-ins and pop videos. The VPID is 4194, the APID 4195, the PCR 4194 and the TextPID 4197.

The Labour Party conference at Bournemouth produced a flurry of live satellite feeds, via Telecom 2D for UK regional offerings and Hot Bird for national ones, using several downlinks clustered around 12.5-12.6GHz H (5,632, 3/4), including Sky News at 12-525GHz.

Russian exiles or those studying the language will find several Russian TV channels via Telstar-11 (37-5°W). At the time of writing the following are available as FTA MPEG signals: ORT International at 12-513GHz H, RTR Planeta at 12-519GHz H and Moskva-Otkrytyj Mir at 12-523GHz H (all 3,617, 3/4). The latter is also available at 12-529GHz H (3,254, 3/4). Information from Stefan Hagendorn via the internet.

The problems in the Middle East get steadily worse. Live footage of a meeting with Yasser Arafat at his HQ, with massive crowds in attendance, was seen via Eutelsat W2 (16°E) in early September. The frequency was 12-556GHz H (5,632, 3/4), the coverage being for CBS-Tel Aviv with NTSC colour. Curiously, Reuters Jerusalem appeared via NSS-7 (21-5°W) at 11-659GHz H (4,000, 5/6) during the evening of the 22nd, again with Yasser Arafat, this time at a meeting with UK officials. The Sky News London crew often download via W2 at 12-525GHz H (5,632, 3/4): during the Hutton enquiry their UKI-511 truck was very busy with live reports from its parked location on a London pavement!

HellasSat-1 (30°E) has really come to life in recent weeks, with two major multiplexes in operation at 12-524GHz V (27,500, 3/4) and 12-566GHz V (30,000, 7/8). The former carries four channels from the Eastern Mediterranean area, RTS-SAT, MK-TV SAT, Cyprus-SAT and ERT-SAT. The latter carries sixteen TV channels, most being from Italy – six RAI variations, the Italian Senate proceedings and various minor channels. News feeds have been seen at 11-007 and 11-015GHz V (5,632, 3/4).

The dramatic Hurricane Isabel hit the US eastern seaboard towards the end of the month. Live reports from local stations were fed into the network and the NSS Newsource circuit to Europe via NSS-7 at 11-563GHz H (6,109, 3/4). Alan Richards saw a feed via Hispasat (30°W) from 'Rep Dominicana', showing the effects of the hurricane in that part of the Caribbean: the audio was a mixture of Mexican, Italian and Portuguese, though two-way communication with Madrid produced correct answers to questions! This feed was at 12-096GHz H (5,632, 3/4) in MPEG 4:2:2 format.

Broadcast news

US: The FCC's deadline for parallel analogue/digital terrestrial TV transmissions from the main high-powered stations passed earlier this year with only about forty per cent of the 360 transmitters equipped for digital operation. Raising funds for digital equipment has been a problem for some stations, but Congress is to provide additional funding for the change and the FCC has extended its deadlines. Digital cable TV take-up has been small to date and coverage is patchy. Here's one for the record books: the first PBS (public broadcast service) station in the US opened on 25 May 1953, in Houston, Texas.

India: National broadcaster Doordarshan opened its 24-hour terrestrial news channel on November 1, with Hindi and English audio. It is entering a market that's already saturated, though most of the news broadcasters use satellite downlinks with cable



Radio-Television Nationale Congolaise (Kinshasa) received via Telecom 2D.

distribution. The new channel marks Doordarshan's 44th anniversary.

Bahrain: A very large UHF-TV and FM radio station is under construction for the terrestrial services of MBC-Saravision. For TV six 60kW transmitters will operate within the ch. E38-57 spectrum. The FM system will consist of at least ten 10kW transmitters.

DXer's SPECIAL 14" TV



- Direct channel entry/readout
- Direct frequency entry 40-860MHz
- Multistandard
- Low noise tuner
- 12v DC and mains operation
- Remote control
- Scart connection
- Auto scanning of RF channels
- Auto scanning of frequencies 40-860MHz
- Cable tuner
- Video squelch (removed in tuning mode)
- Six teletexts
- Covers systems BG/LL/DKK PAL and SECAM, NTC via the scart

£299.00
Overnight delivery by insured courier £12.00

FREE BBC VIEWING IN EUROPE

Perfect reception only with the latest THOMSON digi box

- The correct digi box + the correct dish + the correct LNB = perfect reception anywhere
- Watch the BBC wherever you like, in Europe etc
- Digital satellite systems from only £399.00
- All dish systems are supplied with LNB, cable and plugs
- You can receive FREE viewing of BBC1, 2, 3, 4, children's BBC, BBC24 hour news and all the BBC radio stations plus many more
- ITV1, Channels 4 and 5 available by subscription arranged by ourselves
- Increase your dish size with our new enhanced imported LNBs



Tripods £49.95

Digital system with 88cm dish — £438.95
with 1.1m dish — £478.95
ALL PRICES INC VAT

Overnight delivery in the UK for all items by insured courier £12.00

FULLY COMPREHENSIVE 35 PAGE CATALOGUE AVAILABLE BY RETURN OF POST FOR £1.50

AERIAL TECHNIQUES LTD Tel: 01202-423555 Fax: 01202-425055
59 Watcombe Road, Southbourne, Bournemouth, Dorset BH6 3LX, UK
E-mail: atech@dircon.co.uk www.aerial-techniques.com
Est 1979 Callers by Appointment please





A CNN NewsSource caption received via NSS-7 (21.5°W).

Croatia: The third TV channel franchise has been awarded to RTL, which will pay some US\$45k annually for the ten-year commercial franchise and a further US\$15k to the regulatory authorities. RTL will have to raise millions of dollars to set up production and transmission facilities. No on-air date has been announced.

Kenya: KBC has once again accepted help from CCTV (Chinese TV) for a modernisation and upgrading of its radio and TV broadcasting system, both production and transmission, throughout the country.

Satellite news

Paris-based Eutelsat reports that its downlinks are running at 74 per cent capacity. Takeover attempts from Intelsat and PanAmSat have been fought off. Hot Bird 6's four-transponder Ka-band capacity with on-board 'Skyplexing' is being promoted as suitable for DTH applications across Europe. Uplinks can be via a small (1m) dish. Eutelsat has designed a prototype 11/20GHz (Ku/Ka) twin-LNB dual-band receiver. It considers that Ka band could be used for home shopping or even local TV stations.

Chai TV, a Jewish satellite TV channel, plans to start using Hot Bird 6 from next March. The Paris-based production centre will include a newsroom with over forty staff, with an additional twenty staff in Jerusalem. Most news will be sourced from Israel but editorial decisions will be taken in Paris.

From early next year Intelsat 907 (27.5°W) is to provide fast broadband internet, email, data and video entertainment services via a Ku-band spot beam for Lufthansa and BA transatlantic aircraft. Successful tests were conducted earlier this year. Users within aircraft will be able to connect laptop PCs to LANs and Ethernet jacks. Intelsat opened its new Hagerstown, Maryland mountainside teleport at the end of September.

Philips has started to supply STBs for Bulgaria's first digital DTH service, which will use CryptoWorks encryption. The company was signed up as prime STB supplier for the interactive service, which is due to start operations about now.

Qatar-based TV channel al-Jazeera is to open a new Arab-language sports channel that will specialise in European football. Transmissions will be beamed FTA across the Middle/Far East, SE Asia and N Africa, initially for twelve hours daily, expanding to 24 hours in 2006 for the Asian Games in Qatar.

The Coship CDVB3188C satellite receiver

The enhanced version of this remarkable digital satellite receiver

that was promised (see review in the September issue) has failed to materialise, but production of the initial model continues in China, with delivery to the Southern hemisphere though not Europe. However a New Zealand company, Satlink, can supply it to the UK at US\$190 plus US\$20 freight. The receivers carry EMC approval (EN55013, EN55020) but do not have a CE label. Receivers are unpacked, the two-pin American plug is cut off, then the receivers are repacked. They are therefore delivered as "non-working, requiring modification for UK operation". This is relevant should a customs query arise.

A system B/G modulator (5.5MHz sound/vision spacing) is fitted, but I'm not sure whether this is VHF or UHF. I have asked about retuning for system I (6MHz sound/vision spacing), but baseband video/audio outputs are available for direct use or feeding to an outboard modulator.

Several enthusiasts have obtained receivers via this round-the-world route, so the company seems to be reliable – I have myself just ordered a second unit. You can email the company at satlinknz.co.nz or check at

www.satlinknz.co.uk

Alternatively you can fax 00 64 098 149 447 or phone 00 64 025 937 025 (they are +12 hours ahead of GMT, so phone late in the evening!). The address is Satlink, Box 60428, Titirangi, Auckland, North Island, New Zealand.

Digital DXing prospects

I discussed the prospects for digital TV DXing in a previous column. There has been a certain amount of success with this in the US, but the digital transmitter power levels there are similar to the analogue ones. In Europe the digital TV power levels are much lower. To take Rowridge, Isle of Wight as an example, the analogue transmitters run at 500kW ERP while the digital ones run at 20kW or less. In addition, instead of having the channels in group A the multiplexes are dotted across the UHF spectrum. So there are two disadvantages for digital TV DXing, the lower field strengths and the need to use a wideband aerial, which has inherently less gain. Further, unlike analogue transmission where a weak signal produces a poor picture with noise (snow), a digital transmission produces either a good-quality picture, with a threshold margin of about 0.5-1dB that gives rise to pixellation, or nothing at all.

This suggests that for digital DXTV reception a strong signal, above the pixellation level, will be required. The DTT DXTV signal count is therefore likely to be considerably below what we have experienced with analogue signals. How to go about it? You could concentrate on a known frequency and wait, or engage in frequency hopping. There have been only a few reports of DTT DXTV in the UK so far, and these have mainly consisted of reception of a neighbouring region's multiplexes. Only time will tell however.

Greater success has been achieved with DAB-DX reception. I would strongly advise those interested to check out the web site at

www.skywaves.net

which provides information on the theory and practice of DAB. It describes the basics concisely and the potential for reception.

At present the upper end of Band III is used for DAB in the UK, 218-230MHz. This is from slightly above the old ch. B13 upwards. Aerials will look remarkably similar, though we won't get into the double-elevens that graced the rooftops in many a fringe area in the 405-line days. The microwave band L has been used for French test transmissions – this will be available in the UK in four-five years' time.

Several DAB receivers are available, from about £99 (Goodmans) upwards. The Evoke models have created much interest. Tuners with a more traditional look are becoming available from Sony, Arcam, JVC etc., and are perhaps better suited to DAB-DXing.

The high quality possible with DAB has received much

publicity, but some DAB multiplexes seem to pack in too many signals, with reduced bit rates etc. – hi-fi buffs have commented that the quality can be inferior to analogue FM. Perhaps a trade reader might like to comment on the topic of quality v. bit rate etc.

Will Band III DAB-DX work? Several members of the British FM and TV Circle had some limited success during the tropospheric openings in August. A DXer in the Hull area apparently received German DAB, while our old friend Cyril Willis (King's Lynn) received DAB multiplexes from South Wales, the SW, the London area and the Benelux countries, using his discone aerial – a vertically-polarised wideband system much favoured by 'scanoraks'. His farthest reception was from the VRT Studio in Brussels. He uses an Acoustic Solutions receiver, and found that "the signal is either there or not but in borderline cases it keeps breaking up and distorting". In comparison, during this period he received FM-DX from Scandinavia, Germany, Denmark and deep into France, using an eight-element Triax 88-108MHz aerial with a gain of 9.5dBd. The discone aerial has a 'gain' of below 0dBd. Better DAB-DX results would probably have been achieved using a correct, high-gain, vertically-polarised array. There have been no reports of SpE digital DX to date!

Several manufacturers are producing Band III DAB aerials. Maxview aerials are on sale at Maplins outlets. Antiference has two aerials available, a single dipole (DAB2301) and a four-element array (DAB2304) – the latter has a gain of 4dBd and a front-to-back ratio of 19dB. For further details check with the web site at

www.antiference.co.uk/outdoor.htm

Fig. 1 shows a simple vertically-polarised two-element aerial that covers 217-230MHz. It provides a gain of about 2.2dBd, a

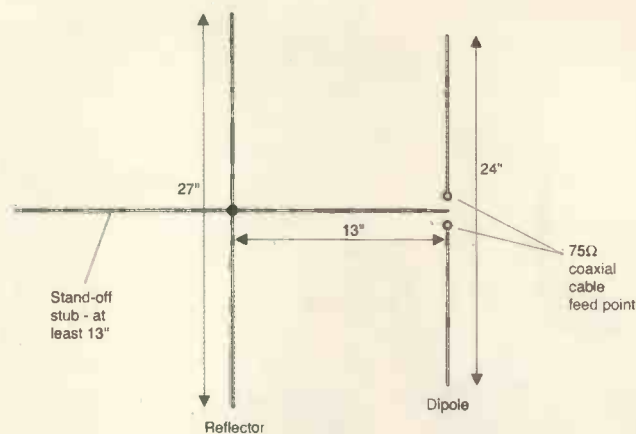

Fig. 1: A simple DAB-band aerial that covers 217-230MHz. Mount the aerial vertically. The output impedance is approximately 60Ω. Use materials as available – an FM aerial is ideal. 1in. outside-diameter aluminium tube is suggested for the boom, 0.5in. OD aluminium tube for the elements.

front-to-back ratio of 12dB and matching to a 75Ω feeder cable. Note that the proximity of a vertical metal support mast has, unlike a horizontally-polarised aerial, a direct effect with a vertically-polarised aerial. It affects both the polar response and the matching between the aerial and the feeder cable, particularly when a single dipole is used. I would suggest that to minimise interaction, cable mismatching etc. a single half-wave dipole is mounted a full wavelength from the metal support mast.

DAB-DX is very new in the UK. Any observations from readers on the subject would be welcome. Write c/o the magazine's address, which you'll find on page 67.

REMOTES DIRECT

All makes and models

Replacement and Originals remote controls available.

!!!!!!At a fraction of the cost!!!!!!

Please contact for instant quote

ROB or MARK

Tel: 01257 793527

E-mail: infrared@btconnect.com

Or check out our website and order on-line

Website:

www.remotesdirect.co.uk

Also available a wide range of satellite equipment

And various other electronics!!!!!!!

Sky Digital Satellite Tuner Repairs

We also repair Power Supplies, Complete Set Top Box's
UHF Tuners and Modulators

For more information and latest prices
See our web site

www.mces.co.uk
MCES Digital

15 Lostock Road Davyhulme Manchester M41 0ES

E-mail: sales@mces.co.uk

Phone: 0161 746 8037

Fax: 0161 746 8136



AUDIO FAULTS

Reports from
Geoff Darby
Chris Bowers
Chris Avis
Eugene Trundle
David Kerrod
and
John Coombes

We welcome fault reports from readers – payment for each fault is made after publication.

Reports can be sent by post to:

Television Magazine Fault Reports,
Highbury Business Communications
Nexus House,
Azalea Drive, Swanley, Kent BR8 8HU

or e-mailed to:
t.winford@highburybiz.com

Sony HCD-LX9AV

This monster one-piece hi-fi unit, with DJ Mix, Guitar, Mic and goodness knows what else by way of inputs and modes, had a fault that was designed to separate the men from the boys. There was no audio from the front (main) channels, though the surround sound channels were OK.

To start with, the audio/power PCB is impossible to work on. You can't measure the voltages at the STK device without risk of electrocution from the exposed mains terminals on the power transformer. You can't remove the PCB on its leads, as at one edge it has two connectors that mate directly with a pair of matching connectors on the large, vertical main PCB. Extender leads are not available.

As an initial guess, I decided to go for the STK device itself. This brought another problem to light. According to the service manuals, both the paper one and the Sony Assist one, the LX9 version of the hi-fi should be fitted with an STK442-020, and only the LX10 version should be fitted with an STK412-040. Yet my LX9 was fitted with the latter type! A call to Sony didn't help much. It was their feeling that if the IC appeared to be the original one it probably was, and I shouldn't be too concerned. So I ordered an STK412-040.

When it arrived I removed the board. First take out the entire rear panel (about 100 screws), then the screws that secure the board, the heatsink and the side main PCB. A number of connectors and ribbon cables also have to be released. After that I replaced the IC, then reassembled the unit – sufficiently to enable it to be tested. The fault was still present of course. To be honest, I hadn't expected the unit to work, but you have to hope.

About the only way that I could see of being able to check voltages was to remove the surround-sound amplifier sub-PCB, which sits at the top of the heatsink, above the STK. Once it was out I was just about able, in conjunction with the removed back panel, to get in with scope and meter probes. The first thing I found wrong was that the +VL and +ZD supplies, at pins 2 and 3, were both at the same voltage. According to the circuit diagram they should be at 60.9V and 24.2V respectively. This is impossible however, as there is a 15V zener diode connected between the pins. There's a similar arrangement on the negative side, but the voltages here are helpfully marked –24.3V and '*'. By following the +VL supply around the board I was able to find that it's actually the B+ rail, which should be at 31.5V. This seemed to correspond with what was present at the pin, so I expected the +ZD

pin to be at 15V less. Checking at the negative side, I found that there was –30V and –15V at the two corresponding pins.

A cold check at pins 2 and 3 revealed a dead short between them, so the board came out again. The most likely bet was the zener diode, D852. When I unsoldered this item it fell in half. In went a replacement, back went the board, on went the power – and still nothing.

Further voltage checks along the STK's pins showed that the –60V supply (–VCC) at pin 12 was missing. It comes from the standby switching transistor Q834 via a 100Ω safety resistor, R857. There was nothing at this resistor or the collector of Q834, but plenty at its emitter. Q834 was cut off because its base and emitter were at exactly the same voltage. Q843's drive comes, via D805, from the junction of two series-connected resistors in Q803's collector circuit. Cold checks here showed that D805 was OK but that one of the two resistors, R821, was open-circuit. It's a minuscule 33kΩ type. A replacement, followed once again by a unit rebuild, restored normal operation.

Was the original STK device faulty? Had it led to the demise of the zener diode? I didn't put it back to find out! It's now in the junk box labelled 'possibly OK'. I will have to wait until I have something easier to work on before I try it out elsewhere.
G.D.

Denon UDM30

The complaints with this hi-fi unit were that it wouldn't play CDs and that there was a 'smoky' smell from inside. Both were true. In fact the smell was so metallic and pungent I suspected that the owner's cat had been there before me. There were no obvious signs of PCB or chassis corrosion however, nor of anything burnt or starting to burn when power was applied. So I turned my attention to why the CD section wasn't working.

When I examined the laser I found that the inside of the lens was completely 'smoked'. So presumably either the laser diode or the pickup chip inside the optical block had virtually caught fire, coating the inside of the lens with residue and producing the pungent smell. It was a good job that the unit was under warranty as the cost of the replacement laser, which comes as a deck assembly, is horrendous. It did cure the problems however.
G.D.

JVC UXP7R

The owner's complaint with this elegant little unit was as follows: "went bang, has power but no sound, CD drawer not

opening". On test I found that there was indeed no sound and no response from the CD drawer, but the disc that was trapped inside did spin up and did 'play' when asked. There was also no LCD backlighting, and the standby LED went from red to nothing instead of turning green.

These symptoms suggested power-supply problems, so I decided that the best approach would be to tackle the failure of the drawer to open. I soon found that the supply to the loading-motor driver IC was missing at pins 11 and 12 of CN652. It's called SW10 at this point, though elsewhere it's called SW9V. It took me a little time to trace the source back to IC910, using the circuit diagram. This IC is referred to as a 'multiregulator'. It's on the main PCB, at the back, bolted to the same heatsink as the audio output IC. You can't really see its pins until you remove the plastic cover attached to the rear panel.

Once this had been done, gaining access, it was immediately apparent that almost every pin was either completely dry-jointed or showed signs that it was about to part company with the PCB. A clean up and application of fresh solder restored the supply to the CD section and the other functions. **G.D.**

Sony MZ-N707

This personal MiniDisc unit wouldn't play discs. Apart from the initial sled-motor activity there was no feeling of vibration or disc movement, even though the display indicated that the disc was being spun up. With the door open and the disc removed I was able to insert the tip of a cotton bud to check the turntable rotation. It was able to turn quite freely, but was ever so slightly stiff in comparison with normal operation.

These motors are tiny, and have just enough 'oomph' to turn themselves and the disc. Any slight stiffness in the bearings is enough to prevent them being able to spin up a disc. The diagnosis was confirmed by fitting a new motor, which restored normal operation. **G.D.**

Sharp MD-MX10H

The right channel audio was low with all functions. A simple cause for a change. Coupling capacitor CS08 (1 μ F, 50V) was open-circuit. A replacement restored correct audio. **G.D.**

JVC XVS302SL

The front panel display showed only a few random dots that varied depending on what the unit was doing at the time.

When the main PCB was removed the cause was immediately visible. Of the 41 connections to the display panel only three showed no signs of distress. The other 38 were all dry-jointed at best and cracked right round at worst. Application of a little liquid flux and fresh solder restored a solid and correct display once the unit had been reassembled. **G.D.**

Sony CDP-CE375

This five-disc CD changer unit seemed to be totally dead. Cold checks inside with a multimeter soon revealed the cause of the trouble: the main power transformer T601 was open-circuit on the primary side. A replacement transformer, part no. 1-435-343-11 restored normal operation. **C.B.**

Sony TC-K611S

This single-tape stereo cassette deck made a clicking noise when the power was turned on. A look inside, around the tape deck mechanism, revealed the cause: a loose shaft on the R-FWD flywheel assembly, part no. X-3356-642-1. The tape-deck motor and flywheel continue to run when they are not in use. A replacement restored normal click-free operation. **C.B.**

Sony TA-VE170

This AV amplifier went into the protection mode less than a minute after being switched on. The fan came to a screeching halt at the same time. The cause of the trouble was the 12V DC fan motor on the main board. A replacement fan, part no. 1-763-561-22, restored normal fan operation and unlocked the protection mode. **C.B.**

Sony CDP-X229ES

This CD unit produced the no-disc message when a disc had been loaded. A look inside revealed the cause of the trouble: there was a kink in the middle of the flexiprint lead, part no. 1-575-001-11, that connects the KSS240A laser unit to board BD. A replacement flexiprint lead restored correct operation. **C.B.**

Sony STR-DB940

This unit would go into the protection mode at high volume levels. Voltage and capacitance checks on the main board revealed the cause, which was C590 (4.7 μ F, 6.3V). A replacement capacitor restored normal operation. **C.B.**

Panasonic SAHD52

A new laser was fitted, after which this unit test played through several discs

faultlessly and was returned to its owner. Two days later it came back, with the complaint that it kept stopping while playing a disc. When I inserted my vintage rock'n'roll test disc it refused to return this – a real emergency!

Tests revealed that the output from the 8V supply regulator was very low. This crazy circuit sits on the bottom left-hand side of the CD PCB and is readily accessible. It consists mainly of two parallel-connected 2SD2037 transistors which are mounted straight on the board with no heatsinks. The heat generated by this suicidal arrangement had resulted in a charred board and failure of one of the transistors in the pair. I cleaned up and repaired the board then fitted two new 2SD2037 transistors, complete with homemade clip-on heatsinks. A long test proved that all was now well – but those heatsinks were working hard! **C.A.**

Technics RSB755

This is an old cassette deck but a very high-quality one with a direct-drive capstan and 'beltless' operation. It came to me with two problems. The fluorescent display was intermittent because of dry-jointed heater pins on the display panel. And there was no tape-reel drive because the reel-motor pinion was loose on its shaft. This is item 130 in the exploded view of the deck. **E.T.**

Panasonic SAHE200

The fault with this AV amplifier was no sound with the error code F70 displayed. This indicates communication failure between the main microcontroller chip and other components. The cause of the fault was no +5V supply on the digital PCB because F5 (1-25A) was open-circuit. It's on the transformer sub-PCB. **D.K.**

Panasonic SAGX550

If the loudspeaker and headphone outputs from this amplifier cut out when the volume level is increased above 8 on the scale, check for noise on the supply to the cooling fan. The usual cause of such noise is that the contacts between the fan and the main PCB are dirty or tarnished. Alternatively the legs of the contacts may be dry-jointed to the PCB. If these points are OK, check the protection transistor Q604 (2SC3311) by replacement. **J.C.**

Technics A900

When this amplifier was warm its output was low and distorted. The cause was found to be dry-joints at the pins of Q752 (2SB941) and Q751 (2SD1265). **J.C.** ■



MONITORS

Fault reports from
Gerry Mumford
and
Ian Field

We welcome fault reports from readers – payment for each fault is made after publication.

Reports can be sent by post to:

Television Magazine Fault Reports,
Highbury Business Communications
Nexus House,
Azalea Drive, Swanley, Kent BR8 8HU

or e-mailed to:
t.winford@highburybiz.com

Proview PK770M

This monitor powered up but produced only the lower half of the display with a bright horizontal line just above. The cause of this partial frame collapse was big dry-joints at the frame output chip IC301.

While I had the monitor dismantled I replaced C635 (22 μ F, 250V) as this capacitor has a reputation for unreliability, causing the demise of the B+ regulator FET Q630. The rectifier diodes on the secondary side of the power supply were also resoldered, as they tend to become dry-jointed. G.M.

Viglen AX1595

This monitor powered up with green LED illumination but no display. Unusually, the 2SC5048 line output transistor Q105 read open-circuit. But the scorched print gave the game away: the transistor had virtually disintegrated, and turned to white ash when it was removed. The reason for its demise was a dry-joint at the tuning capacitor C106. Q105 normally goes short-circuit when this fault occurs, the result being the usual dead with clicking (tripping) symptom. G.M.

Apricot XJ49905

This monitor is a Trinitron version of the AST LR14. The complaint was no display. I started by checking D314 (RGP02-14, 200mA 1.4kV) as this can cause trouble, but it turned out to be OK. Subsequent checks revealed that one of the two 68k Ω resistors across R335 was open-circuit. It was also encrusted with brown residue from white glue. This 'brown glue' starts off white, the deterioration occurring as a result of heat and/or dielectric stress. The decomposition product is very corrosive and can eat through component leads and, evidently, resistors.

During a routine inspection I noticed that the 4N35 optocoupler PM1 in the power-supply regulation path had not been inserted properly: the pins on the optotransistor side only just made contact with the solder. C322 (5.6nF, 1.6kV) was of the square, blue type. Whatever else you do, this component must be replaced with a resin-dipped type. This particular customer likes to have over-scan capability without pincushion distortion. The value of C322 in the various versions of this AST-produced chassis can be anywhere between 5.1nF and 8.2nF. Upgrading to 6.8nF seemed to be about right, but the nearest I had available was 7nF. In fact this produced the best compromise I've come across between increased width and rise in the line output transistor's temperature.

It always seems to be hard work to get the grey-scale right with these Trinitron monitors. Initially the green background seemed to be excessive, but once this had

been corrected the red gain was so far short that reducing the green and blue gain to minimum would not provide compensation. I repeated the procedure with the 0.56 Ω resistor from pin 21 of the LM1203 chip shorted. This time the blue gain was inadequate. It also turned out that with the blue preset (VR421, 100 Ω) shorted the blue screen setting was excessive. I was eventually able to balance the three background presets with VR421 shorted and a 1k Ω preset added in parallel with R446.

This situation was clearly not acceptable. The cure was to clean the red and green cathodes. The best result that could be obtained was when the red and green cathodes were producing twice their previous emission but still less than the blue cathode's emission. Fortunately I was then able to achieve satisfactory gain/background balance without any modification to the circuitry. I.F.

Sony CPD15SF2

The complaint with this monitor was intermittent colours and sometimes shuts down and won't restart. An initial inspection showed that the soldering was up to Sony's usual standard – looks perfect but resoldering every joint will cure a number of mysterious faults! The cause of the intermittent colours was the signal cable, which had faulty red and blue signal leads.

A continuity checker had given the all clear on the 14 pins that are used (there's no connection to pin 9) but didn't leave a hand free to wiggle the cable. I use a signal-cable checker that consists of a 15-pin sub-D connector with its pins connected together and wired via an H4 headlamp bulb with both filaments in parallel (about 8A) to a 10 x D-cell NiCd pack (12V), the other end being connected to a test probe to check each wire at the monitor end of the cable (once it has been disconnected of course). Wiggling the cable when checked in this way proved the point.

The soldering on the main PCB looked perfect in that it was consistent, with no 'blobbed' joints or any that were barely covered. If resoldering every joint on the board doesn't cure intermittent shutdown, check whether R602 and R620 between the chopper heatsink and the main electrolytic reservoir capacitor are touching together. Sometimes you find that there's a blob of silicone sealant to keep these resistors apart, sometimes not.

Another of these monitors had a mysterious excessive width problem. The cause turned out to be faulty scan coils – when I stripped the unit I saw that there had been arcing at the scan plug.

These monitors have excellent resolution. I.F. ■



TELEVISION reader offer:
x1, x10 switchable
oscilloscope probes,
only £21.74 a pair,
fully inclusive*

*Additional pairs as part of the same order, only £19.24 each pair.

Seen on sale for £20 each, these high-quality oscilloscope probe sets comprise:

- two x1, x10 switchable probe bodies
- two insulating tips
- two IC tips and two sprung hooks
- trimming tools

There's also two BNC adaptors for using the cables as 1.5m-long BNC-to-BNC links. Each probe has its own storage wallet.

To order your pair of probes, send the coupon together with £21.74 UK/Europe to **Probe Offer, Jackie Lowe, Highbury Business Communications, Anne Boleyn House, 9-13 Ewell Road, Cheam, Surrey, SM3 8BZ**

Readers outside Europe, please add £2.50 to your order.

Please supply the following:

Probes

Total _____

Name _____

Address _____

Postcode _____ Telephone _____

Method of payment (please circle)

Cheques should be made payable to TELEVISION

Access/Mastercard/Visa/Cheque/PO

Credit card no. _____

Card expiry date _____ Signed _____

Please allow up to 28 days for delivery

Specifications

Switch position 1

Bandwidth	DC to 10MHz
Input resistance	1MΩ - i.e. oscilloscope i/p
Input capacitance	40pF+oscilloscope capacitance
Working voltage	600V DC or pk-pk AC

Switch position 2

Bandwidth	DC to 150MHz
Rise time	2.4ns
Input resistance	10MΩ ±1% if oscilloscope i/p is 1MΩ
Input capacitance	12pF if oscilloscope i/p is 20pF
Compensation range	10-60pF
Working voltage	600V DC or pk-pk AC

Switch position 'Ref'

Probe tip grounded via 9MΩ, scope i/p grounded



Bench Notes

In Part 8 of his series on PC servicing **Adrian Gardiner** continues with advice on how to improve the performance of a PC that uses the Windows 98 operating system

If you followed the instructions in my last article your Windows 98 installation should be running much faster than before. You will feel as if you have upgraded to a more powerful model! By continuing with the enhancements suggested this month your PC will run faster than ever, and in addition your Windows system will be more reliable and stable.

Network trick!

To start with we're going to tell Windows that your PC is a network server. This makes no difference to the operation of the machine from the user's viewpoint, but affects the way in which the PC handles background tasks, optimising it for maximum throughput.

Start by calling up the control panel – click on the start menu then select 'settings, control panel'. Click on 'system'. When the new window opens, click on the 'performance' tab. Next click on 'file system' in the advanced settings section. A window will appear with further choices.

The first screen on this advanced properties box enables you to 'specify the typical role of the computer'. From the available drop-down list, choose 'network server'. Then click on OK. Click on OK a

second time, after which the PC will have to be restarted.

Cache improvement

The next improvement is to the way in which Windows handles caching of the hard drive(s). Caching is the technique of storing information temporarily to provide faster access to it. Although this is usually beneficial, it can increase the time required to access the hard-disk drive(s) because it 'caches' the read information. The purpose of a hard drive is to store a lot of information, and with most systems a speed improvement can be achieved by disabling the cache facility.

Once again call up the control panel and click on 'system'. Click on the 'performance' tab, then 'file system' in the advanced settings section. Click on the 'troubleshooting' tab in the window that appears, then place a tick in the box labelled 'disable write-behind caching for all drives'. Once again click on OK twice, then restart the machine.

Manual swapping!

Windows requires a large amount of memory (RAM) to function properly. But, as mentioned last month, the optimum amount with Windows 98 (and in fact the maximum it can address) is 256MB. Windows uses more memory than this however, by using what's called a 'swap' file. This is a section of the hard-drive space that's used as extra memory. With most Windows installations the size of the swap file varies in accordance with what the operating system is currently doing. The purpose of this is to ensure that the size of the file is big enough for Windows but small enough not to have a major impact on your hard-drive space. Because of this size variation, and other hard-drive activity that's carried out, the swap file has

to move around from time to time. It usually ends up being split between two or more separate areas of the hard-drive space. This is not only cumbersome but slows down access to the swap file.

What we are going to do is to override the swap-file settings manually. Microsoft advises against doing this, as misuse of the swap file can make Windows crash. If you follow the instructions below however you should not encounter any problems. By setting the size of the swap-file manually you reserve a fixed portion of the hard drive for it. This can give considerable speed advantages.

The first and foremost requirement is that you should set up the swap file manually only when the physical memory (RAM) can be divided into 64 exactly, i.e. if you have 128MB of RAM this can be divided by two to give 64. So you should set up the swap file manually only when your PC has 64, 128, 192 or 256MB of RAM.

Once again start by calling up the control panel and clicking on 'system'. The window that opens shows you the amount of RAM fitted in your PC. Check that it meets the requirement laid down above.

If so click on the 'performance' tab then, in the advanced settings, click on 'virtual memory'. The window that opens will look like the one shown in Photo 1. Click on the option to 'specify my own virtual memory settings'. Normally the drive selected would be your main drive C. If your machine has multiple drives however you can select an alternative. Enter twice the amount of RAM you have in the 'minimum' and 'maximum' boxes, i.e. if you have 128MB of RAM, enter 256 in both boxes. Click OK twice, then restart the machine.

Note that during the process of changing the virtual memory settings Windows will warn you that this is an advanced operation. But you knew that anyway!

Summary

And that's it! By now you should have a fully functioning and very fast PC. Next month we'll continue the series with a look at problem solving. ■



Photo 1: Windows virtual memory settings.

MERRY XMAS AND A HAPPY NEW YEAR

14" CTV R/C
FROM



£29.99

Pictures for Illustration Purpose Only

20" CTV R/C
FROM



£37.99

Pictures for Illustration Purpose Only

28" WIDESCREEN
R/C TEXT FROM



£99.99

Pictures for Illustration Purpose Only

32" WIDESCREEN
R/C FROM



£199.99

Pictures for Illustration Purpose Only

TECHNIKA
MULTIREGION
DVD FROM



£24.99

Pictures for Illustration Purpose Only

VCR'S FROM



SPECIAL!!

£16.99

Pictures for Illustration Purpose Only

DVD'S FROM



MULTIREGION

£24.99

Pictures for Illustration Purpose Only

KE 14P2B



14" Tv/Vcr Combi
From

£54.99

Panasonic
KXFP155



Plain Paper Fax

£59.99

INFLATABLE
Speakers From



Brand New!!

£12.50

Hitachi Radio
Alarm Clock



£39.99

SONY DAV-S888

NEW!!



*Sony Dvd Home Cinema
*Dvd/Cd/Cdr/Cdrw/Mp3 Playback
*6 Speaker System
*Total 600W: 100W x 5 100W RMS
(10% THD), 12 Months Warranty!

£497.99

TECHNICS SCHDV560



SPECIAL!!

*Technics Compact Component
Stack System
*CD, Tape, Tuner
*Input select
*Silver w/Brown Side Panels

£199.99

DANSAI
MULTIREGION
DVD FROM



£29.99

Pictures for Illustration Purpose Only

OMICRON HALOGEN HEATER



Halogen Technology
Instant Heat
Variable Heat Settings
Low, Medium & High
Thermal Safety Cut Out
Stability Safety Grills
Double Safety Grills
Low Running Costs
Oscillating Feature

Brand New!! **Only £15.99**

INTERCOM SECURITY SYSTEM



*Bell camera and full Accessories included
*Additional camera sold separate
*Infra Red Camera for Night vision
*Built in Mic for sound
*optional electric door latch activation
*Switch Between camera with A/B switch
*Two Way speech
*250 metre cable
*Audio/visual output

£34.99

MORPHY RICHARDS
2 SLICE TOASTER



£7.49

PHILIPS FWC115 MICRO HIFI
MICRO HIFI SYSTEM



£39.99

POP IDOL KARAOKE MACHINE



£84.99

FIRST AUSTRIA MCD-1050
MINI HIFI



£44.99

FIRST AUSTRIA MCD1010
MICRO HIFI SYSTEM



£29.99

TECHNICS SP-96

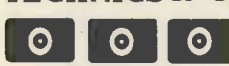

BRAND NEW!!

3x SURROUND SPEAKERS
SILVER!!

£13.99

Naiko Dishwasher
NDW080



£49.99

Panasonic
NVGS10B



£269.99

HITACHI
Cv800/810



£16.99

HITACHI
HTDK150EUK



£119.99

WWW.TRADEELECTRONIX.CO.UK INFO@TRADEELECTRONIX.CO.UK

MUCH MORE TV'S VCR'S DVD'S HIFI'S ETC IN STOCK!!

All Goods are Graded unless otherwise stated ,Goods are subject to Vat, carriage & availability Prices subject to change without prior notice

Trade
ElectroniX

30/34 River street Digbeth B'ham B5 5SA
Tel:0121 773 3300 Fax 0121 773 2300



VCR CLINIC

Reports from
Eugene Trundle
Martin McCluskey
Mike Adye
Michael Dranfield
Steve Hague
John Coombes
Colin McCormick and
Dean Ratcliffe

We welcome fault reports from readers – payment for each fault is made after publication.

Reports can be sent by post to:

Television Magazine Fault Reports,
Highbury Business Communications
Nexus House,
Azalea Drive, Swanley, Kent BR8 8HU

or e-mailed to:
t.winford@highburybiz.com

JVC HRJ690

A complete lack of everything was the symptom with this machine, but the mains fuse was intact and a very quiet, very brief squawk could be heard from the chopper transformer when power was applied. We discovered that a 15V protection zener diode, D5301, was short-circuit. It must have failed for reasons of its own, because no external cause could be found. **E.T.**

Tatung TVR934

This old-timer's deck and display functions worked normally but there were no E-E signals and there was no output from the RF modulator. The cause was an open-circuit regulator chip, IC502. Three-leg 10V regulators are rare, but we found one in a similar machine on the scrap pile. **E.T.**

Toshiba V727B

This V3 series machine had a very dim fluorescent display. As is usually the case, the cause was low heater current in the display tube. The culprit was CP041 (220 μ F, 10V) in the power supply. **E.T.**

JVC HRJ610EK

There was no spool drive when the tape was being unlaced. As a result a loop of tape would be caught in the deck during eject. The cause was a faulty idler gear unit, whose friction clutch had lost its grip. The part no. is PU60618-1-3. **E.T.**

Amstrad UF30

After tape rewind or fast forward this machine would shut down with 'tape prob' shown in the display. The cause of the trouble was in the auto-stop circuit. The cure was to replace the infra-red LED D6001. **M.McC.**

Panasonic NVHD600

There was no clock display. Otherwise this VCR was OK. Unusually for a modern machine, the filament supply for the display is obtained from a DC-DC converter on the front panel. I found that Q1701 (a BC639 is a suitable replacement) was short-circuit. But there was still no display when the replacement had been fitted. Further checks revealed that a tiny coil, L7, on the top panel was open-circuit. It's in the supply to the circuitry on the front panel. Normal operation was restored by fitting a similar coil from a scrap machine. **M.McC.**

Toshiba V720

This machine wouldn't take up tape in the play and eject modes. There was also a clicking noise from the deck. The problem was to do with the centre clutch/gear assembly – because of a tiny crack in the plastic, the upper pair of cogs had separated from each other.

As the owner didn't want to spend much

on having the machine repaired, a familiar story these days, I decided to try supergluing the cogs together. This cured the fault and, several months later, we have not seen the machine back in the workshop. **M.McC.**

Daewoo DVF522P

This machine would accept a tape but there was no drum rotation. When the loading arms had tried to thread the tape around the stationary drum the VCR would shut down. Normal operation was restored by cleaning and lubricating the mode switch. **M.McC.**

Panasonic NVSD230B (Z mechanism)

This machine's deck mechanism was jammed solid and there was a cassette stuck inside. The cause of the problem was clear once the deck fixing screws had been removed – I had to drill two holes in the trapped cassette to get at the front ones. The 'arm loading take up' plastic cog had been chewed up by the teeth in the metal rack. This cog's part no. is VXL2670. Everything worked normally once a replacement had been fitted.

The build quality of these decks is nowhere as good as that of the earlier K mechanism. **M.McC.**

JVC HRD540/660/770

The display panel was unreadable because C131 (47 μ F, 16V) and C238 (10 μ F, 16V) had both failed with high ESR readings. If there's a tracking bar at the top of the picture, check the loading-arm ferrules beneath the deck and replace the 3.3 μ F, 50V surface-mounted capacitor on the drum motor. **M.A.**

Goodmans TVC14VP

Tuning drift was the problem with this TV/VCR combi unit. So we took the back off, put it to one side and monitored the tuning voltage (VT) at the tuner. Result: no tuning drift at all! Once we had the manual we checked the tuning-voltage regulator IV05. It was a μ PC547J that drifted. Correct operation was restored by fitting a TAA550B as a replacement and a 105 $^{\circ}$ C capacitor in position C837 (47 μ F, 50V). **M.A.**

Sony SLVX9G

It's not very often that I repair VCRs now that the average price of a basic machine is £49, or less if you watch out for special offers at Safeway – about five months ago they were selling two-head LG machines at £34.99. But this was a top-of-the-range VCR, and the customer agreed to a minimum repair cost of £35. The machine was dead with a fully laced-up tape in it.

Fortunately the cause was a simple power-supply fault. R156 (2.2M Ω) was open-circuit and the resistor in series with it, R157 (also 2.2M Ω), had gone high in value. Replacement with 0.75W, 350V metal-film

resistors ensured a lasting cure. **M.D.**

Samsung SV651B

The symptoms with this machine were no display and no deck functions. There was HT at the primary side of the chopper circuit but no switching action. It's a refreshingly simple power supply. Cold checks showed that transistor Q15R02, type 2SC3203, was leaky base-to-emitter. A replacement restored normal operation – a BC639 does the job. **S.H.**

Goodmans VN9000

E-E operation was affected by a hum bar though playback via the scart socket was OK. The cause was traced to two capacitors in the power supply. C26 (22 μ F, 50V) had fallen in value to 17.2 μ F while C23 (1,000 μ F, 10V) was low at 151.1 μ F. **J.C.**

Panasonic K mechanism

Failure of the drum servo to lock is usually caused by high tape tension across the video head, because the brake (part no. VXZ0313) is broken.

A line twitch on the picture, often very intermittent, is caused by a faulty impedance roller (part no. VXP1402).

If the tape edge is being damaged, check whether arm P5 (part no. VXL2306) is bent/ distorted. This arm

can also be the cause of the mechanism jamming intermittently when loading.

If the tape jams intermittently with the error code F06 shown in the display, the main shaft unit (part no. VXP1339-1L) is damaged/bent/distorted. **J.C.**

JVC HRJ625

Failure to eject the tape can be caused by several things, such as a faulty cassette housing or a broken guide pole that causes a mechanical obstruction. In this case however the lug on the change-arm assembly (item 74) was broken. It holds the spring and provides the correct tension on the main slider bar. **J.C.**

Mitsubishi HS641V

This machine was dead with no display. The cause was traced to C910 (4.7 μ F, 50V) in the power supply. It was open-circuit. **J.C.**

Portland DV-K2AOP (Daewoo)

This quite new machine is used as a video security recorder in a local memorial park. It came to us because it was dead. I found that there was 330V at the mains bridge rectifier's reservoir capacitor but no other life. Worryingly, the 330V remained long after the source of power was removed. Investigation inside

the power supply can revealed a very fine gap in the tracks between the 300V supply. This had arced as a result of damp conditions, blowing some of the tracks off the board. I cut away the remainder of the very close supply tracks, patched out with wiring and sealed the PCB with lacquer. **C.McC.**

Hitachi VT150E

There was slow fast forward/rewind. The cause was found to be paint that was peeling off the supply reel, interfering with the reel pulses. The cure was to replace the supply reel, part no. 6416631, also the take-up reel, part no. 6416651. **D.R.**

Toshiba V710UK

There was no clock display, just a flashing red LED. The cause was the D1SS31 diode on the secondary side of the power supply. It could of course have been any of the rectifier diodes here. **D.R.**

Philips VR6761

This machine was dead. I found that the thermal cutout in the power supply, next to Q7001, was faulty. **D.R.**

Mitsubishi HS651V

This machine reverted to standby after a few seconds. Q903 was faulty. **D.R.**

Test Case 492

Many of you will remember that, as mentioned in Test Case 484 (April), our company has taken over another local firm, Satellite Sam's. As a result the workshop's digital TV business has increased. Much of the service work arising from this takeover is carried out by our new man Todd, helped out by Cathode Ray when it comes to climbing ladders and bolting up ironmongery. Though it's not possible to repair some of the faults that occur with satellite receivers, there is plenty to keep these young men busy. Join Todd in the big white Toyota van on this cold and wet morning and see how many of his puzzles you can solve . . .

Mr Searle called us to see to a fault with his rented VCR. When that had been fixed, he led Todd to his Sky+ receiver/recorder box and explained that, even with the 20-30 hour capability of its 40GB hard disk, he was running out of space. He was increasingly faced with the problem of choosing what to add to the bulging files of *Coronation Street*, *Eastenders*, *Emmerdale* and others, mostly clocked up by Mrs Searle and remaining unwatched. Was there a solution, he asked? Todd knew of a little gadget that enables a VCR to record automatically from satellite TV (Phantom PVR). But that would provide only another eight hours which was not, it seemed, enough for the Searle family. In addition, the quality provided was poor – VHS-LP. Was there a better solution? Todd promised to consult Sage on the matter.

First however a call had to be made to Henry Bowden. His dish had fallen off the wall two days previously, and Cathode Ray had found that the rendering and pointing were crumbling

to the extent that it was not possible to get an adequate fix for the replacement dish – the old one had been substantially damaged when it hit the ground. Henry Bowden also has a Sky+ digibox and sought to console himself, in his enforced abstinence from live satellite TV viewing, with recordings he had stashed away in his Sky box – the builder's lead time is longer than ours. But to his horror he found that he couldn't play them back. Hence his latest call. In fact Todd was unable to help here. Why? You can play back videotapes at any time and any place. Why not the recordings you've paid to capture on a hard disk in a satellite recording box?

The last call for Todd that afternoon, and the last question for you, was out on the arterial road, which is lined with bungalows. Mr Holden resides there, and was very frustrated with his reception of Freeview broadcasting. The signal on the Poxhamfield Road is relatively weak and the heavy traffic, stationary at busy times, generates enough ignition and other interference to make DTV viewing a misery – a mystery even at times, because the pictures are obliterated by mosaics of squares and jagged, frozen streaks. Two types of Freeview adapter had already been tried at the location, with different but poor results. We cannot pretend that Todd was able to provide a magic-wand solution to this one – indeed there were none that day. But a solution was found. The Holdens now watch breakfast and teatime TV in spite of the roaring engines and thrashing windscreen wipers of the vehicles outside their front window. How was this achieved, along with a 'safety margin' for bad-reception days? Colin Doc, Sage and Cathode Ray were all involved in this one.

For the solutions, turn to page 121.

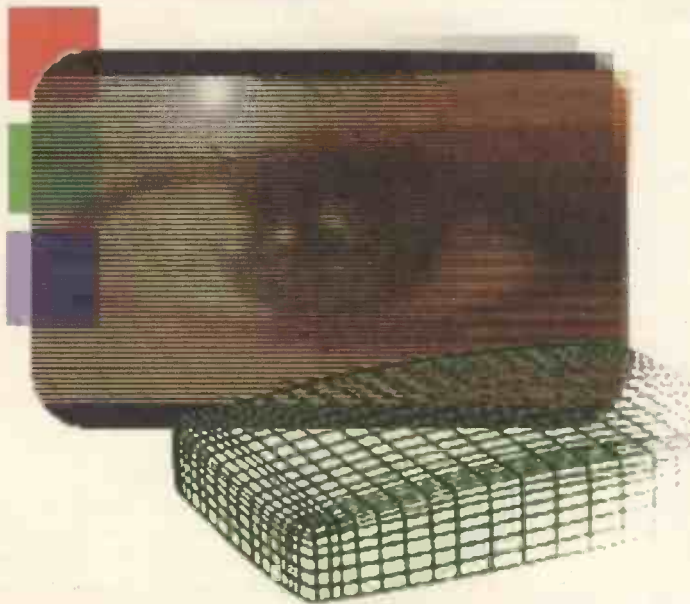

TV FAULT FINDING

Reports from

Philip Salkeld

Martyn S. Davis

Dominic Barrett

Jim Littler

Chris Avis

Uel Harte

Bob Flynn

Arthur Jackson

Paul Godfrey

David Packham

and

Eugene Trundle

We welcome fault reports from readers – payment for each fault is made after publication.

Reports can be sent by post to:

Television Magazine Fault Reports,
Highbury Business Communications
Nexus House,
Azalea Drive, Swanley, Kent BR8 8HU

or e-mailed to:

t.winford@highburybiz.com

Sony KV32FQ75 (AE5A chassis)

The symptoms were lack of width and EW curving. There are two transistors in the line output stage in this chassis, Q8603 and Q8604. When Q8604 goes short-circuit you get the tripping problem. When Q8603 goes short-circuit you get the symptoms listed above. A replacement, part no. 8-729-046-18, restored normal operation. P.S.

Hitachi C24W430N-311

When one of these sets comes in dead the cause is very often dry-joints at one of the two voltage regulators on the long heatsink. If not, reach for the service manual: you've no chance without it! The first step is to disconnect the HT supply to the line output stage and connect a dummy load instead. Then feed 5V from an external power supply to R957, which is in the power-good line to pin 60 of the micro-controller chip IC001. This will prevent the power supply closing down, and is a great help in determining whether the fault is field collapse or something else.

In this case the set was still dead, which suggested that the cause of the fault was in the power supply. I noticed that C905 (220µF, 400V) was fully charged even when the set was switched off. In fact the power supply was not drawing any current, which normally means a fault on the primary side of the circuit. I didn't mess about, instead replacing Q902 (part

no. J2315921R), Q905 (part no. T633133), Q906 (part no. J2315891R), IC900 (part no. T900452) and IC901 (part no. T548013), also Q907 and Q908 which have the same part nos. as above.

Once these components had been replaced the set came to life with a slight lack of width. All that was needed, after removing the dummy load, was to adjust VR950 gradually for 150V across C958.

Bring back the Philips G11 chassis, all is forgiven! P.S.

Panasonic TX29A3 (Euro-1 chassis)

Lack of height with field foldover is a straightforward fault – the field output IC needs to be replaced. Unfortunately the TDA8175 is now obsolete. You have to fit a TDA8177 which comes as a kit, part no. TZS9EK026-1, with a number of other parts. P.S.

JVC AV32R25EKS (JK chassis)

This set had been subjected to water damage. The only way to get it to work was to replace the main PCB assembly. Nowadays with fairly new sets obtaining the correct part number can be a problem. If the serial number with one of these sets ends in an A the part no. is SJL-1108A-U2.

When the new board arrived I fitted it and found that there were two problems: no sound and funny colours – it looked like an ident fault. I came to the conclusion that the set was probably working on the wrong system and, after a lot of thought, decided to take the EPROM (IC702) from the faulty panel and fit in the new one. This proved to be a good idea, as it restored correct operation. In luck again! P.S.

Daewoo DTE28A7GB

The picture width twitched, but not all the time. I phoned Daewoo technical and was given the following advice: look for dry-joints, particularly at D405 (BY288), R399 (12Ω, 2W) and C499 (6.8nF). Before I resoldered them I gave them a good bash, but nothing happened on the screen. Being someone who always does as he is told, I then resoldered them. A long soak test proved that this had fixed the fault. P.S.

Beko NR28128NX

This was another dead set. If you find that R101 (4.7Ω, 0.5W) has burnt out the line output transformer has been arcing. Guess how I found out! Beko spares can be obtained from SEME. P.S.

Panasonic TX33AK10 (Euro-5 chassis)

This set produced a good picture and

sound when switched on, but after a few minutes the picture darkened and became very yellow. When teletext was selected however the display was correct, with all three colours present, though a little dark. The fault had become gradually worse over a month.

The cure was to replace three capacitors on the tube base panel, C395 (part no. ECQM1H104J), C386 (part no. ECVK3D392J) and C397 (part no. ECKC3D222JB). My thanks to Panasonic technical for help with this. The fault can also be caused by a dry-joint at pin 39 of IC601 on the main signal board. Fortunately replacing the three capacitors in the customer's house restored correct operation. **M.S.D.**

Hitachi C32W510SN (A7 chassis)

In the May 2003 issue (page 431) I reported an unusual fault with a 32in. Hitachi set fitted with this chassis. The EHT was tripping on and off because of a short-circuit in the Philips CRT, with evidence in the form of burnt-out resistors on the tube base panel. Apparently there had been a batch of faulty tubes and the symptoms are now well known. The point however is that because of the way in which the set switches on it can be very difficult to diagnose whether or not the tube is the cause.

This set was dead (stuck in standby) but was fitted with an LG tube. At switch-on the microcontroller chip performs an auto grey-scale check on the tube. If it is unable to carry out this check for any reason, the set is locked out and stuck in standby. So far there doesn't seem to be a way to get round this situation in order to prove whether or not the tube is faulty. The set didn't have burnt-out resistors on the CRT base panel, but I was lucky because I had another working C32W510 in the workshop. It had had the usual dry-joints at IC951. The set worked when these were resoldered – but it was fitted with a Philips tube!

After consultation with Hitachi I connected the faulty set's chassis (the one with the LG tube) to the Philips tube and switched on. I was rewarded with an EHT rustle and a raster. This suggested that the LG tube was faulty, and indeed all that was required was a replacement. The tube costs over £680 plus VAT however. Fortunately the cost was covered by Hitachi, as the failure had occurred within the first twelve months.

At the moment it seems that the only way of diagnosing whether the fault is in the line output stage/power supply or the tube is by tube substitution. The newer Model C32WF810, which is fitted with

the A/D8 chassis, operates in a similar manner and can cause quite big headaches should the tube fail. It's as well to be aware of this. Hopefully our good friends at Hitachi will come up with a way of bypassing the various feedback lines to the microcontroller chip so that we can isolate or show a faulty tube. **M.S.D.**

Toshiba 28N03

We've recently had two of these sets that came in dead. In both the cause was ZP82, a soldered-in 2.5A fuse. Replacement and a soak test was all that was required. **M.S.D.**

Hitachi C28W430N (A7 chassis)

At switch on the audio came up with horrendous crackling. This could be instigated to some extent by wiggling the aerial lead. There were also odd pips and squeaks. I resoldered the usual dry-joints at the voltage regulators then found that the cause of the trouble was dry-joints around the audio chip, in particular at R4005. A soak test after resoldering these joints proved that the fault had been cured. **M.S.D.**

Toshiba 2101TB

For about the first twenty minutes after this set was switched on from cold the power supply tripped. Thereafter the set behaved itself. Hairdryer and freezer tests showed that C830 (100µF, 50V), the reservoir capacitor for the TDA4601 chopper control chip's LT supply, was faulty. Its location, between a heatsink and a high-wattage resistor, probably contributed to the failure. **D.B.**

Bush DVD142 (11AK46 chassis)

The fault symptoms with this TV/DVD combi unit were a white screen (uncontrollable brightness with flyback lines), sound OK. The cause was R642 (10Ω, 0.25W) which had gone open-circuit. I think this is a fault that others are likely to come across. **J.L.**

Goodmans Compact 210

These Comet cheapies are better than some but do suffer from a few bugs. Attention to these will clear most reported symptoms and improve reliability. The base of the 39Ω resistor RS06 in the power supply snubber network is spattered with the dreaded brown glue, which can cause a flashover with consequent component damage and must be removed – hopefully before Armageddon! Also check for and clean off any signs of glue in the power supply area under the board.

The three 470µF capacitors in the power supply should all be replaced, par-

ticularly CP28 which is mounted near a hot regulator with predictable results. CO82 (1,000µF, 35V) under the tube bowl is also worth an ESR check. Finally check and resolder, as necessary the blue capacitor adjacent to the line-scan coil socket. **C.A.**

Grundig MW82-2101 (CUC2058 chassis)

This set was dead with the HT fuse open-circuit because the chopper FET T6006 was short-circuit. Its part no. is GR83028-050-50. I also found that the TDA4605-3 chopper control chip IC60010, part no. GR8305-354-605, had failed. The cause of all this trouble was that R60001 (270kΩ) was open-circuit. Replacement of these items cured the fault.

I have had a few problems with the heatsink foil on T6006 blowing the HT fuse intermittently. Its part no. is GR29303-156-1801. **U.H.**

LG RI28CZ10RX (14.2 chassis)

This set was dead with the power supply tripping. Initial checks on the primary side of the power supply revealed nothing amiss. When I disconnected the supply to the line output stage the set came on in standby. Checks on the line output transformer revealed a short-circuit between the primary and secondary windings. Thankfully a replacement, part no. 057834-EL2, cured the fault. **U.H.**

Daewoo DWX28W5GB (CP775 chassis)

This set had just a flashing LED. Checks in the line output stage revealed that the BY288 diode in the EW modulator section was short-circuit. A replacement brought the set back to life, but when the aerial was connected I found that there was an EW problem. A check for drive modulation at pin 8 of the TDA8358J chip IC301 showed that this was missing. The repair was completed by fitting a replacement. **U.H.**

LG CI14B501F (11.1 chassis)

The complaint with this set was no scart input. A scope check at pin 19 of the scart socket showed that there was a video output. The scart input is fed to pin 15 of the TDA8361 chip IC1, but there was no video at this point. When I traced back to the scart socket I came to a 47nF surface-mounted capacitor, C39, which had never been fitted. Adding this component cured the fault. **U.H.**

Daewoo GB2898T (CP775)

If you find that the 2SD1880 line output transistor is short-circuit the cause will be

breakdown of the insulation in the transformer. This is becoming a stock fault. The part numbers are TSD2578 for the transistor and 50H0000181 for the transformer. U.H.

Sharp 37AM-12H (5BSA chassis)

The cause of intermittent loss of signals or going off tune was traced to the 47nF surface-mounted capacitor C211, which is connected to the tuner's VT pin. It was intermittent. B.F.

Panasonic TX24A1 (Alpha 2 chassis)

The picture width would decrease, especially with bright scenes. Eventually the set would shut down. The cause was the STR54041M chopper chip. Replace it with a Panasonic IC – other chips will not last. While you are there it's a good idea to replace C808 (10µF, 50V). B.F.

Toshiba 2101TB

The cause of field collapse was a short between pins 1 and 2 of the AN5515 field output IC. As a result R327 (6-8Ω, 1W fusible) had failed. In addition to these items I replaced C313 (100µF, 35V) and D305 (BYD33J) in the flyback boost network. B.F.

Goodmans W288NS

The chassis in this widescreen model is similar to the F11. There was no sign of life apart from a noise from the power supply. As with the F11 chassis, the cause was a poor connection at C134 (11nF, 1-6kV). Rather than resoldering it I fitted a replacement. This condition normally damages the S2055N line output transistor and the TDA4950 pincushion correction chip. They seemed to be OK but, to be on the safe side, I fitted replacements. B.F.

Toshiba 2527DB (C2D chassis)

There was reduced picture height when the set was cold. As it warmed up the height gradually increased. This condition can normally be cured by replacing C322 (2.2µF, 50V) and C317 (220µF, 16V). In fact this action did improve matters, but not enough. I then replaced IC302 (TA8859P), which again produced some improvement and the fault took less time to clear. But the complete cure was to remove the components in this area and clean both sides of the PCB. C317 had leaked electrolyte, a little of which had passed through a small hole to the print side. B.F.

Philips 25PT532B (GR2.4 chassis)

The customer said there had been line collapse followed by nothing except the green LED flashing. The plug/socket on the scan coils needed rewiring, but the set

was the same after doing this. Further checks showed that the line output transistor was OK but the 315mA Wickman fuse F1534 was open-circuit. A replacement didn't change the situation. I eventually found that D6561 (BZX79C68) was leaky. There was normal operation once this item had been replaced. B.F.

Goodmans 2185T

Sometimes the power supply wouldn't start up. This fault can be caused by any of the two 150kΩ or 270kΩ resistors, but in this case the cause was the STR54041 power IC itself. B.F.

Grundig ST70-775/9 (CUC6460 chassis)

A dead set with the chopper transistor T644 short-circuit and the Wickman fuse S1624 open-circuit can be caused by a far from obvious dry-joint at C648. B.F.

Sanyo C28WN1B (WB2B chassis)

The fault with this widescreen set was field collapse. Access for servicing is difficult, as the EHT lead is quite short. This limits chassis positions for voltage checks. The set is fitted with a TDA8361 video/chroma/deflection processor chip (IC101) and an LA7833 field output chip (IC501) but, unusually, a TA8859AP 'deflection correction' chip (IC531) is included in the field drive path between IC101 and IC501. It carries out vertical and horizontal geometry correction under the control of the I²C bus, which is connected to pins 9 and 10. There was a vertical trigger input at pin 13 but no field drive output at pin 8. A replacement cured the fault but took several weeks to obtain. The picture was then excellent. A.J.

Ferguson W70201S (ICC17 chassis)

The top half of the picture was blanked out and the bottom half displayed the part of the picture that should have appeared at the top. The TDA8351 field output chip IF01 requires separate + and - drive inputs at pins 1 and 2, and the symptoms suggested that one of these inputs was missing. Scope checks showed that the + drive waveform at pin 1 was barely visible, the cause being a very leaky surface-mounted capacitor, CF01 (1nF), between this pin and chassis. A replacement restored normal operation. A.J.

Thomson 44RW67US (ICC21 chassis)

At switch on this 44in. rear-projection set produced an uncontrollable screeching and vibration from the speakers. A picture appeared, but I quickly switched the set off. Cold checks revealed that the TDA7269 audio amplifier chip IA002 was short-circuit, and in fact had split apart physically. This IC drives the centre

speakers. No other component fault was found. I did however find that no heatsink compound had been used. This may well have led to the IC's failure. A.J.

Samsung CI3373Z (SCT13B chassis)

We sold large numbers of these 14in. sets and now see quite a few of them with the dead set symptom, apart from a slowly flashing red LED. The fault can be intermittent. The cause every time has been dry-joints at the rivet connections to the line output transistor Q401. A.J.

Sharp C3706H (14B chassis)

This set switched itself to standby after five seconds. I found that the protection circuit, which consists of Q603, Q608 etc., was being activated. As no shorts could be detected and the HT voltage was normal I decided to bypass the trip by removing Q608. This enabled fault-finding to be continued. There are several inputs to the protection circuit, and in this case the problem was found to be with the beam-limiter input. R623 (1.2MΩ) was totally open-circuit. It's connected to the HT supply as part of a potential-divider network. A.J.

Philips 25PT4103 (L6.2 chassis)

This set appeared to be dead, with no sound or picture via the tuner or scart socket. When the setting of the first anode control was increased a red line appeared. The cause of the fault was traced to R3438 (3.3Ω) which was open-circuit. A replacement restored all functions. P.G.

Samsung CF25A64DF

The report said that this set was dead. In fact it was tripping, because the TDA8350Q field/EW output IC was faulty. A replacement brought the set back to life, but with distorted verticals and flyback lines. The cause was traced to FR359 (10Ω, 0.5W fusible) in the 45V supply to the chip. D.P.

Daewoo T514 (CP365 chassis)

We've had two cases of intermittent failure to start up with this model. In one case the set would also intermittently revert to standby of its own accord. In both sets the cure was to replace the following capacitors in the TDA4601-type power supply: C811, C813 and C817 (all 100µF, 50V) and C812 (1µF, 50V). E.T.

Panasonic TX29AD1 (Euro-2 chassis)

Intermittent field collapse was the problem with this set. The fault would come and go at the slightest touch on the chassis or even the cabinet. This one was easily dealt with using fresh solder, flux and a hot iron – virtually every pin of the TDA8175 field output chip I591 was dry-jointed. E.T.



DVD

**Fault reports from
Geoff Darby
and
Chris Bowers**

We welcome fault reports from readers – payment for each fault is made after publication.

Reports can be sent by post to:

Television Magazine Fault Reports,
Highbury Business Communications
Nexus House,
Azalea Drive, Swanley,
Kent BR8 8HU

or e-mailed to:
t.winford@highburybiz.com

Ferguson DVD400FE

The only sign of life from this budget DVD player was a glowing standby LED. Scope checks showed that the power supply was running, but there were large pulses at the cathode of D807, which runs hot. The associated reservoir capacitor C807 (1,000µF, 10V) sits right alongside. It's blue sleeve looked decidedly tired and discoloured, and an ESR check showed that it was away with the fairies.

I decided to fit a replacement rated at 16V and, in an effort to reduce its running temperature and thus improve long-term reliability, left its leadouts slightly longer than normal so that it could be bent over away from the diode. When the power supply was refitted and the unit was powered it worked normally. **G.D.**

Technics SL-DV280

This unit is part of a four-piece DVD/hi-fi system. According to the job card the fault was "won't read discs after cleaning". I have warned against the use of DIY cleaning discs in the past. This was another reason why. I assume that one of those cleaning discs that have brush hairs sticking out of it had been used. These hairs cause problems. Hair had obviously got caught in the tiny piece of plastic that surrounds the immediate area of the lens. Because of the high torque and rotational speed of the DVD spindle motor, the little cover had been torn off and become jammed between the lens and the main laser cover.

Once the little cover had been removed the lens was free to move again and the unit was able to read discs normally. I was not able to refit the displaced piece, as its mounting clips had been badly distorted. But it certainly doesn't affect the basic operation of the optical block. About the only possible purpose I can see for it is to

provide a little more dust protection for the internal optics than that provided by the basic laser cover. **G.D.**

Sony SLV-D900G

This combined DVD player/VCR failed to read discs after a few seconds. Voltage and scope checks revealed that the cause of the fault was the optical block, which didn't focus properly. A replacement, part no. 1-796-620-11, and auto-adjustment set-up via the service menu restored normal DVD operation. **C.B.**

Sony HCD-S800

This unit would power off after a few seconds when it tried to read a disc. The cause was suggested by Sony technical: the 29MHz crystal oscillator X102 on the DVD board can cease to operate because of a fault with the optical block. A new KHM-240AAA optical block, part no. 8-820-144-06, restored normal operation. **C.B.**

Sony DVP-NS305

This unit failed to power up. Some checks showed that the cause was the switching chip IC101. An improved type, part no. 9-885-030-35, should be fitted unless the board part nos. are 1-468-648-12 or 1-468-651-13, which in this case they weren't. The new chip restored normal operation. **C.B.**

Sony DVP-S735D

Digitised square blocks appeared in the DVD picture and also the various menu screens. Checks on board MB-86 showed that the cause was the 16MB SDRAM chip IC504. A replacement, part no. 8-759-463-47, restored normal pictures and displays. **C.B.**

Sony DVP-S535D

This unit produced no video through the RGB (only), Y/C or composite video outputs. All the mechanical functions worked correctly. Checks inside, on board MB86, revealed that the 3V regulator IC503 was faulty. A replacement, part no. 8-759-486-55, restored the video output. **C.B.**

Sony DVP-S9000ES

Sometimes this DVD unit's tray would not be loaded completely. Investigation inside revealed that the cause was the loading assembly (item 104) and the tray assembly (item 101). There are improved replacements for these two assemblies, part nos. A-6062-471-F and X-3950-950-6. Once they had been obtained and fitted there was normal tray loading. If the number printed on the MD cover contains the letter F or later, the new loading assembly is already fitted. **C.B.**

WEB SERVICE

To reserve your web site space telephone
Tel: 01322 611292 Fax: 01322 616376
E-MAILS r.gurunlian@highburybiz.com



Alban Electronics

<http://www.albanelectronics.co.uk>

Alban stocks, supplies and provides technical support for a range of terrestrial/cable/satellite and analogue/digital TV equipment. PROMAX (manufacturers electronic test equipment including signal level meters, spectrum analysers, BER/CSI/MER analysers for QPSK, QAM & COFDM, optical fibre light sources and power meters, 16:9 test pattern generators), ALCAD (manufacturers of R.F. wide band and adjacent channel amplifiers, aerials for MATV, SMATV & IRS systems) and ANTARES (cascadeable multi-switches). ALBAN has a complete after sales repair and calibration service that is fully supported by the manufacturers, in addition provides a free system design service using only reliable high quality components.

Alltrade Aerials & Satellite Ltd

<http://www.alltrade.co.uk>
Leading distributor to the trade



Full e-commerce site with over 1500 products with in-stock quantities!! We supply everything associated with Digital/Analogue Terrestrial & DTH/Motorised Satellite reception. All Antennas. All Brackets. All Cables. All Connectors. All Amplifiers. We provide a free MATV/SMATV planning service as well.
Phone 0845 075 0751 Fax 01273 425700

Cricklewood Electronics

<http://www.cricklewoodelectronics.co.uk>

Cricklewood Electronics stock one of the widest ranges of components, especially semiconductors including ICs, transistors, capacitors, resistors. all at competitive prices.

Charles Hyde & Son Ltd

<http://www.charleshhyde.co.uk>

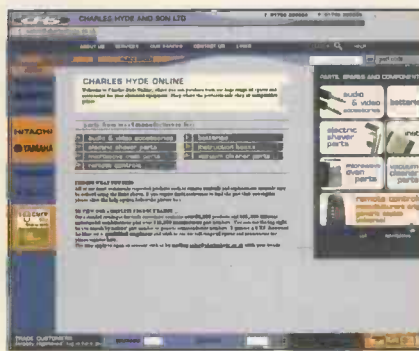

Search for both original and copy spare parts in our extensive database covering Akai, Alba, Bush, Ferguson, Goldstar, Hitachi, LG, Matsui, Nokia, Saisho, Sanyo, Sony, Sharp, Thomson, Panasonic, Philips, Samsung, Tascam, Teac, Toshiba, Yamaha and many more. In addition huge ranges of Lasers, Lopt, Remote controls and Semiconductors may be accessed.

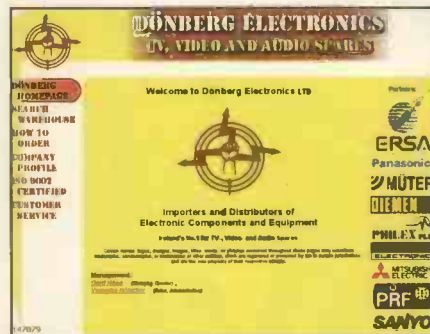

Donberg Electronics

<http://www.donberg.ie>

<http://www.donberg-electronics.com>

<http://www.electronic-spare-parts.com>

As the leading distributor for the TV, Video and Audio trade in Ireland, we supply over 2000 shops & service dept with Audio-Video and TV spares, Semiconductors, Test Equipment, Service Manuals, Remote Controls etc. At present we stock over 35,000 different lines. We hold agencies for: Panasonic, Sharp, Mitsubishi, Sanyo, Beko, Ersa, Müter, Diemen HR, Philex, PRF, König-electronics. We specialise in parts for all continental sets and obsolete semiconductors.

J W Hardy Communications

<http://www.jwhardy.co.uk>

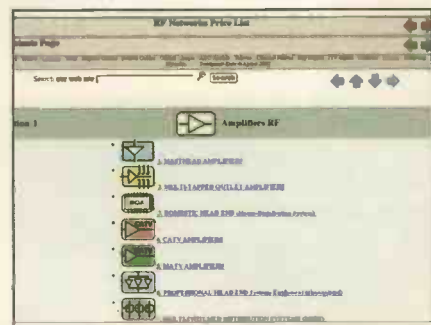

R.F. Network Specialist.
Shop online - for R.F.network components. We supply a full range of TV, radio reception equipment to receive analogue/digital signals from both

terrestrial and satellite sources. We provide a free planning service for your R.F. networks, MATV and SMATV etc

Irwin Electronics

<http://www.irwinelectronics.co.uk>

As Classic Distributors we complement our existing mail and trade counter business with our website. You can order parts on-line quickly and easily. We intend to explore alternative ways of assisting engineers to run their business successfully.

MMWafercards

<http://www.mmwafercards.com>



Smartcards and programmers for all access-controlled applications. Incorporating www.satstore.co.uk The Enthusiasts Satellite Store. Tel 01386 48731 Fax 01386 765875

M.C.E.S.

<http://www.mces.co.uk>

The MCES site gives details of our range of service including Tuners, Video Heads, RF & IF Modules plus latest prices offers.



Swires Research

<http://www.swires.com>

Swires Research produce high quality instruments for the television industry, including portable signal level meters and spectrum analysers for digital and analogue RF signal measurements.

Televés

<http://www.televés.com>

Televés website was launched as an easier way to keep in contact with our World-wide Network of Subsidiaries

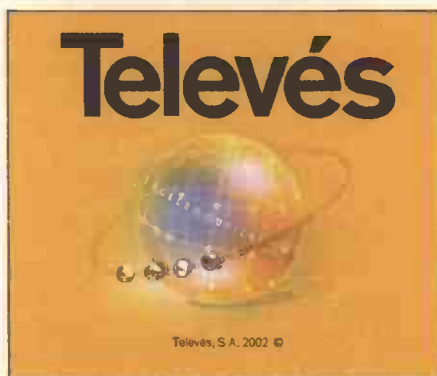

and Clients. This site is constantly updated with useful information/news plus you can download info on our range: TV Aerials & accessories, Domestic and Distribution amplifiers, Systems Equipment for DTT and Analogue TV, Meters and much more.

Wiltsgrove

<http://www.wiltsgrove.co.uk>



WILTSGROVE LTD founded in 1984, is renowned as a leading supplier of Audio, Video, TV, Spare parts and Accessories.

We are now pleased to announce the launch of our ONLINE CATALOGUE:

<http://www.wiltsgrove.co.uk>

Our easy to use search engine will allow you to find the products you require via:

- Make / Model.
- Product Category.
- Key Word search.
- Manufacturers part number.
- Our Order Code.

All orders before 5pm will be dispatched the same day.

Tel: (0121) 772 2733

Fax: (0121) 766 6100

Email: sales@wiltsgrove.co.uk

Make sure of your copy of **Television**

It can be difficult finding a copy of *Television* at local newsagents. The number of magazines being published keeps increasing, which means that newsagents have less shelf space for the display of individual titles. Specialist magazines in particular get crowded out.

There's a solution to the problem. Most newsagents provide "shop-save" and/or home-delivery services. There's no charge for a shop save. You simply ask your newsagent to order a copy for you: it will be kept on one side each month ready for you to collect. Home-delivered copies are ordered in the same way, but generally incur a delivery charge.

A newsagent can order any magazine for you, whether or not the shop normally stocks it.

If you buy your copies of *Television* from a newsagent and want to make sure you get every issue, just ask at the counter.



Service Casebook

Michael Maurice

Sony KV2217UB (YE2 chassis)

This set's picture had a pinkish tinge. The customer said that the fault had occurred suddenly, which ruled out a worn CRT. The cause was the RGB preset controls RV701-5. They had become noisy, so I replaced all five then reset the grey-scale. The result was an excellent picture.

Mitsubishi CT2965STX (Euro 8F chassis)

When this set was switched on from cold all the analogue settings went to maximum. The cause was the reservoir capacitor for the -30V supply. I replaced C906, C964, C709 and C710, all of which were leaking.

Sony KV29F1U (BE3D chassis)

This was a somewhat elusive fault. When the set was switched on from cold the picture would be noisy and start coming in at the sides. The cause was the line driver transistor Q803 (2SC2688L), which was dry-jointed.

JVC AV25F1EK (JX chassis)

This set was dead because the line output transformer had failed. When this happens the power supply trips out immediately. One way of checking for LOPT failure is to disconnect the power supply's HT plug and see if the set powers up. If it does, reconnect the HT plug, disconnect the other plugs and again see if the set powers up. If it doesn't the LOPT is almost certainly faulty.

Toshiba 261T4B

There was a bright band down the right-hand side of the picture. The cause was C449, the reservoir capacitor for the supply to the RGB output stages. Once a replacement had been fitted, also a new power switch, the set was OK.

Philips 24CE3588 (CP110 chassis)

The picture produced by this set had lines across it and the bottom half was missing. Resoldering the field output transistors cleared these symptoms.

Sony KVX2542U (AE1C chassis)

There was a horizontal white line across the screen, but this time the field output stage was not the cause. Its 27V supply is also used by the TEA2031A EW-correction chip IC1501, which is on board J1. The cause of the trouble was in the EW correction circuit: the loading coil L806 had shorted turns and was burnt. I had to replace both the coil and the TEA2031A chip.

B&O 3382

Because of a short-circuit in the line output

stage there was no picture or sound. In this case the cause was not the line output transistor but the small output transformer, T11, which was short-circuit primary-to-secondary. In these sets the EHT, focus and A1 supplies are derived from the chopper transformer, in a similar arrangement to that in the Ferguson TX10 chassis. T11 looks like a linearity or EW loading coil.

Philips 21GR2752 (G90B chassis)

The complaint with this set was that the picture was poor for about twenty minutes after it was switched on. I found three electrolytics in poor condition, as follows: C2660 (680µF), the reservoir capacitor for the 8-6V output from the chopper transformer; C2551 (1µF) in the line scan circuit; and C2570 (22µF), the reservoir capacitor for the 200V supply used by the TDA8153 RGB output IC. Replacements restored good pictures from switch on.

Decca DBS9892C

This set was dead apart from a squeal that came from the power supply. The line output transistor was short-circuit and, as the connector to the line scan coils was dry-jointed and burnt, this was replaced as well. The set then worked. Next morning the customer phoned to say that it had gone again. This time I replaced the line output transistor and the tuning capacitors. But the repair lasted for only thirty seconds. All was well once the BY228 and BY399 diodes in the EW modulator circuit had been replaced.

Grundig T70-540 (CUC5310 chassis)

There were two faults with this set. One was that the bottom of the picture was bouncing up and down, the other that the remote-control unit didn't work. The first was cured by resoldering dry-joints around the TDA8214A timebase generator/field output chip IC520. The second fault was caused by a faulty infra-red receiver. A replacement restored normal operation.

Philips 21AA3350/05B (Anubis A chassis)

This set was dead, so I fitted the Philips power-supply kit. The set then worked but, as I moved the chassis, there was a crackle and it died. To cut a long story short, there was a crack in the print going to the secondary side of the optocoupler. This was repaired but the set then wouldn't go to standby. The cause was failure of thyristor Thy6570 (SFOR5D43) and diode D6569 (LL4148) in the standby-control circuit on the secondary side of the chopper transformer. ■

Top ten regulators

Look at these prices.

STR 51424M	£6.95
STR 54041	£2.95
STRS 5707	£3.95
STRS 6545	£5.95
STRS 6707	£4.95
STRS 6708	£5.95
STRS 6709	£5.95
STRF 6653	£4.95
STRF 6654	£6.95
STR 56041	£4.95

+vat

Free or low £1.00 p&p on orders means:

**YOU CAN EASILY AFFORD TO ORDER
MORE THAN ONCE A DAY!!!**

0114 273 9622



IrwinElectronics

"The television engineer's wholesaler"

Unit 200, JC Albyn Complex, Burton Rd., SHEFFIELD S3 8BX

Order online at www.IrwinElectronics.co.uk

WATCH SLIDES ON TV MAKE VIDEOS OF YOUR SLIDES DIGITISE YOUR SLIDES

(using a video capture card)



"Liesgang diatv" automatic slide viewer with built in high quality colour TV camera. It has a composite video output to a phono plug (SCART & BNC adaptors are available). They are in very good condition with few signs of use. For further details see www.diatv.co.uk

£91.91 + vat = £108.00

Board cameras all with 512x582 pixels 8.5mm 1/3 inch sensor and composite video out. All need to be housed in your own enclosure and have fragile exposed surface mount parts. They all require a power supply of between 10 and 12v DC 150mA.

47MIR size 60x36x27mm with 6 infra red LEDs (gives the same illumination as a small torch but is not visible to the human eye).....£37.00 + vat = £43.48

30MP size 32x32x14mm spy camera with a fixed focus pin hole lens for hiding behind a very small hole.....£35.00 + vat = £41.13

40MC size 39x38x27mm camera for 'C' mount lens these give a much sharper image than with the smaller lenses.....£32.00 + vat = £37.60

Economy C mount lenses all fixed focus & fixed iris

VSL1220F 12mm F1.6 12x15 degrees viewing angle.....£15.97 + vat = £18.76

VSL4022F 4mm F1.22 63x47 degrees viewing angle.....£17.65 + vat = £20.74

VSL6022F 6mm F1.22 42x32 degrees viewing angle.....£19.05 + vat = £22.38

VSL8020F 8mm F1.22 32x24 degrees viewing angle.....£19.90 + vat = £23.38

Better quality C Mount lenses

VSL1614F 16mm F1.6 30x24 degrees viewing angle.....£26.43 + vat = £31.06

VWL813M 8mm F1.3 with iris 56x42 degrees viewing angle.....£77.45 + vat = £91.00

1206 surface mount resistors E12 values 10 ohm to 1M ohm 100 of 1 value £1.00 + vat 1000 of 1 value £5.00 + vat

866 battery pack originally intended to be used with an orbital mobile telephone it contains 10 1.6Ah sub C batteries (42x22dia the size usually used in cordless screwdrivers etc.) the pack is new and unused and can be broken open quite easily.....£7.46 + vat = £8.77



Please add 1.66 + vat = £1.95 postage & packing per order

JPG ELECTRONICS

Shaws Row, Old Road, Chesterfield, S40 2RB

Tel 01246 211202 Fax 01246 550959 Mastercard/Visa/Switch

Callers welcome 9:30 a.m. to 5:30 p.m. Monday to Saturday

SPARES DIRECT



Why go anywhere else for Panasonic spares?

From phones to cameras, home cinema systems to DVD players, Panasonic brings ideas to life. If you service or repair any of our products, we can make your life easier too, thanks to the new Panasonic Spares Direct website.

Specially developed for smaller companies who only need parts or advice occasionally but still want genuine discounts on guaranteed spare parts, it's now open for business.

Register on the subscription-based site now and for just £24 for a year's access you'll find the most competitive prices, online technical information and repair manuals, special offers and immediate part number identification.

It's fast, it's easy, it's trouble-free and it's the only place you need to visit when you need to service or repair any Panasonic product.

So why call us for spares when you can now visit us 24 hours a day?

Visit www.panasonic-spares-direct.co.uk for more information.

Panasonic

Panasonic CS UK

Willoughby Road, Bracknell, Berkshire, RG12 8FP

www.panasonic-spares-direct.co.uk

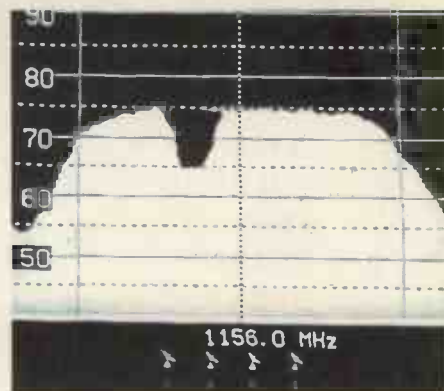

Photo 1: Spectrum-analyser display showing a distinct dip in the transponder 54 frequency response.



Photo 2: Record TV International, Brazil, via Astra at 28.2°E.

SATELLITE NOTEBOOK

**Reports from
Christopher Holland
Hugh Cocks
John Coombes and
Michael Dranfield**

Poor signal

Mr McGregor is an expatriate Scot who lives in southern England. He enjoys watching the local Scottish TV news since we added this using his digibox's extra-channels menu. It's available via transponder 54 (10.906GHz V, SR 22,000, FEC 5/6). But over the past few weeks the signal had started to break up when it rained, even when the rain was light, whereas his local ITV (West Country, EPG no. 103) via transponder 49 (10.831GHz H) was fine.

When I connected a spectrum analyser to the IF input to his receiver from the

LNB I saw that there was a distinct dip (see Photo 1) in transponder 54's frequency response, which is centred at 1,156MHz. The response should of course be relatively flat, as was the case with the neighbouring ITV transponders with opposite polarisation. As I expected, changing the LNB made no difference. But running a temporary cable down from the roof produced a flat spectrum-analyser display, so we replaced the cable. Mr McGregor's old cable dated from the early days of analogue Sky transmissions and had presumably been damaged in some way, causing the dip in the IF response. The damage didn't affect reception when the signal was strong but, when the signal was attenuated by rain, the result was picture break up.

I noticed that with the new cable installed the signal quality displayed by the digibox at the default frequency (11.778GHz V) increased slightly. Despite being at high band, the IF is nearby at 1,178MHz. C.H.

Digital channel update

The latest channel additions at 28.2°E are listed in Table 1. Where allocated, the



Photo 3: Record TV International caption.



Photo 4: Record TV Brazil celebrating 50 years on air.



Photo 5: Caption showing non-availability of a BBC1 Scotland digital satellite programme.



Photo 6: RAI's pulse-and-bar pattern used prior to a feed via Eutelsat W3 at 11-170GHz H.

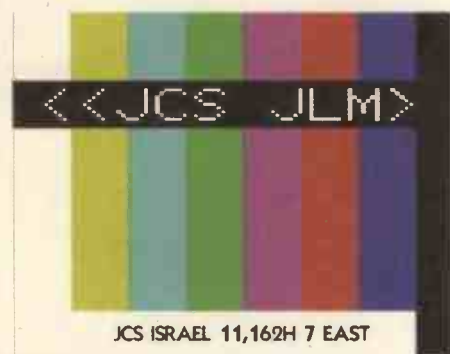

Photo 7: The Jerusalem Capital Studios ident, received via Eutelsat W3 at 11-162GHz H.



Photo 8: EBU New York ident via Eutelsat W3. The service does not have a fixed slot. On this occasion the signal was at 11-014GHz V.

Table 1: Latest digital channel changes at 28-2°E

Channel and EPG no.	Sat	TP	Frequency/pol
Golf TV (429)	EB	C5	11-390GHz/H
Music channels*	EB	C6	11-426GHz/H
Record TV International (830)	EB	C5	11-390GHz/H
SAB/MATV (829)	EB	C5	11-390GHz/H
Vectone Bangla	EB	C10	11-642GHz/H
Vectone Tamil	EB	C10	11-642GHz/H

*High Energy, Low Energy, Wellbeing, Classic, Groove.

TP = transponder. EB = Eurobird

EPG number is shown in brackets after the channel name.

Record TV originates from Brazil, and is the second network there after TV Globo. The international service is free of commercials. Overnight it carries religious programmes, during the day and in the evenings the output is typical South American TV. I'm not sure whether the transmissions will remain FTA or require a subscription. At the end of September the station was celebrating fifty years on air. See Photos 2, 3 and 4.

The music audio services at 11-426GHz H have 'Astra 2D' signal characteristics, with a symbol rate of 22,000 and 5/6 FEC rather than the normal Eurobird/Astra 2A/B 27,500 and 2/3. They don't seem to be part of the Sky package. C.H.

BBC1 Scotland via satellite

Since the BBC1 regional programmes all became available via satellite I've noticed that at times, particularly on Sunday afternoons, BBC1 Scotland (EPG no. 941 for non-Scottish viewers, no. 101 when a Scottish card is used) says that the programme is not available via digital satellite transmission (see Photo 5). The problem seems to be that the transmission rights outside Scotland for some Scottish football games are not held by the BBC. Digital satellite transmission would make them viewable in the rest of the UK and (heaven forbid!) parts of Europe.

The caption tells you that the programme can be watched via Freeview or analogue services but, in a number of remote locations in Scotland, good-quality off-air reception simply isn't possible – because of the terrain and the fact that the UHF relay stations don't transmit the Freeview services.

Before encryption ceased, satellite access to these football games was not blocked because BBC1 Scotland couldn't be received unless the card was registered with an address that had a Scottish post code. C.H.

Hellas Sat 2 at 39°E

Hellas Sat 2 is a powerful, Greek-owned

satellite that was launched in May. It transmits only a few channels at present, see Table 2, but is expected to become busier next year during the Olympic Games in Greece.

The satellite has four different footprints. Beams F1 and F2 are fixed over Europe, F1 using 12-5-12-75GHz and F2 10-95-11-2GHz and 11-45-11-7GHz. Beams S1 and S2 can be steered over southern Africa and the Middle East, with S1 using 12-5-12-75GHz and S2 10-95-11-2GHz and 11-45-11-7GHz. H.C.

Unusual test cards

More unusual test cards and captions. Photo 6 shows the Italian broadcaster RAI's pulse-and-bar pattern that's used prior to transmission of a feed via Eutelsat W3 (7°E) at 11-170GHz H. ITA78 indicates the satellite uplink used. RAI uses a slot between about 11-170GHz and 11-190GHz in which it can transmit several feeds at once via this satellite. Just below RAI you find, at 11-162GHz H, the permanent frequency used by Jerusalem Capital Studios, Israel. It's normally on-air with either this identification (see Photo 7) or news material.

Photo 8 shows the EBU New York caption seen via W3 at 11-014GHz V – this service doesn't have a permanent frequency slot. The signal is a 625-line transmission that's sent across the Atlantic prior to being uplinked for Eurovision members. Transmissions are more common in the late afternoon and early evening, or when there is important news. The caption may be transmitted for some time before and after a newsfeed takes place. H.C.

Correction

An editorial error occurred in the Pace 2200 digibox fault report in last month's issue (page 56). The 22kHz tone is generated by a pulse-width modulator in the main microcontroller chip, which is U300 (ST20): it's switched on and off by the housekeeping microcontroller chip, which is U600.

Table 2: Channels currently available via Hellas Sat 2

Frequency/pol	SR and FEC	Channel name
10.957GHz V	2,966 3/4	Antenna 1 Pacific. Also Antenna 1 Radio
10.957GHz V	2,966 3/4	Studio Alpha (see Photo 11)
12.524GHz V	27,500 3/4	ERT Satellite, Cyprus Sat, MKTV Sat (see Photo 9) and RTV Serbia Sat (see Photo 10)
12.524GHz H	29,000 3/4	Scrambled package



Photo 9: MKTV Sat via Hellas Sat 2 at 12.524GHz V.



Photo 10: RTV (Serbia) via Hellas Sat 2 at 12.524GHz V.



Photo 11: Studio Alpha via Hellas Sat 2 at 10.957 GHz V.

Amstrad DRX100

When you get the 'no-signal' condition, the first thing to do is to check capacitors C105, C110, C112, C113, C115, C122, C124 and C352. They are all 47µF, 35V, 105°C. If they prove to be OK, check whether Q101 (TIP42C) is open-circuit base-to-collector before, if necessary, replacing the tuner. J.C.

Grundig GD5310/02

Lockout/freeze frame was the problem with this digibox. The cause was traced to C12 (1,000µF, 16V) which had gone open-circuit. J.C.

Amstrad DRX100

This digibox was stuck in standby with 18V at the LNB socket, indicating that it was not going to come on. I noticed that the 56.448MHz clock signal at pin 24 of the decoder G729 was missing, but this turned out to be a red herring as it reappeared at power up then died again.

To force a reset I shorted pin 2 of IC U3 (DS1233) to chassis a few times with the digibox still connected to the mains supply. This produced a result: the digibox came out of standby with use of the remote-control unit. The banner at the bottom of the screen was OK but the picture was broken up, a bit like a Grundig digibox with a dud power supply.

Now that I could see the fault I replaced the two AV SRAM chips U601 and U602 (type KM416S1120DT-G10). This cured the fault: the digibox would now boot up correctly when first powered. M.D.

Amstrad DRX100

This digibox produced the "no satellite signal received" message. I plugged in my satellite polarisation checker and found that the red LED came on, indicating that the LNB voltage was in excess of 22V.

The culprit was the vertical/horizontal polarisation switching regulator U101 (type KA317), which was short-circuit. A replacement cured the fault but, while checking the operation of the digibox, I found that the LNB voltage couldn't be turned off using the installation menu. The LNB switch-off transistor Q101 (2SA928) was also short-circuit. All was well once this transistor had been replaced. M.D.

Grundig GDS3000

The problem with this new digibox model was no picture via either the RF or scart output, though the sound was OK. Scart/RF video routing is carried out by IC U15 (type ML6429CS). Checks here showed that there was a video input at pin 2 but no output at pin 3. A new ML6429CS chip cured the fault. M.D.

Amstrad DRX100

If one of these digiboxes is stuck in standby with no LNB voltage, check for a 27MHz clock signal at pin 2 of the buffer chip U2. Although the IC could be faulty, the more likely culprit is the 27MHz crystal X1. M.D.

Amstrad DRX100

This digibox produced the "no satellite signal received" message. The tuner wasn't the cause this time as I had repaired it only three months previously. Another common problem with this model is failure of the QPSK chip U100 (type BCM4200). As it's easy to replace I fitted a new one. But the fault remained.

The LNB was being powered. The 28V tuning supply was present at pin 10 of the tuner, and there was 5V at pin 6. The next step was to check the serial data to the tuner, at pin 2 of IC U103A. I compared the data here with that in a working digibox and found it to be the same.

The Q and I signals at pin 55 of U100 and TP113 were correct (200mV peak-to-peak) without an LNB connected, but when the LNB was connected they rose to over 4V p-p instead of the expected 400mV p-p, and the AGC output at pin 41 of U100 was up and down all over the place.

The problem was clearly signal-related, so I decided to swap the tuner. This made no difference. More careful checks in the Q+, Q- and I+, I- input circuit showed that there were low-amplitude signals at pins 49 and 54 of U100. These come from a divider that consists of R126, R127 and C119, which is where the problem lay. When C119 was removed from the board and checked I found that it was leaky - the reading was approximately 400Ω. Replacing this a pin-head size surface-mounted 1µF ceramic capacitor cured the fault which, as far as the customer was concerned, was the same as before. M.D.

Solution to Test Case 492—

see page 108—

The technology, and customers' expectations, were very different in the days when Sage drove a white van around! Even so it was Sage who provided the solution to Mr Searle's problem. He whipped out the Sky+ box's existing 40GB hard drive and, for a hefty fee, replaced it with a 120GB unit of the same make and type. After a full-system reset the outfit had three times the original recording capability, and Mr Searle was well pleased. Anyone want to buy a 40GB Maxtor D540X HDD for their PC?

Henry Bowden was a victim of BSkyB's rather questionable policy of 'replay control'. The software in the Sky+ box allows playback of recordings only when the dish is present and correct, signals are flowing, and the Sky+ subscription has been paid. How would you feel if the BBC and the ITV companies had such a grip on your VCR?

Finally, the problems experienced by the Holdens on the Poxhamfield Road. The first part of the solution was to provide a good-quality, high-gain grouped aerial. It was mounted on a 3m pole fixed to the chimney, then carefully aligned. Its output was routed via CT100-type satellite cable straight to the aerial socket of a new Philips DTV adapter, Model DTR1500. This unit incorporates a pulse-suppression chip to combat impulsive interference. Problem solved!

NEXT MONTH IN TELEVISION

Introduction to computer networking

Work patterns for electronics installers and service personnel are changing. A major area of expansion today is computer networking – LANs and WANs (local and wide area networks). Networking allows information to be exchanged and resources such as printers, and files on the hard disk and CD-ROMs of one PC, to be shared by others. Fawzi Ibrahim starts a new series that explains what is involved.

How important is coaxial cable quality?

Well, it's often vital to ensure good reception. Bill Wright has had a lot of experience of the effects of inferior cable being used in various types of installation, but decided that he needed a measure of the performance of different cables. So he carried out some simple tests to find out how much the performance of various types of cable differs. The results are presented in this article.

New CRTs from LG.Philips

The Cybertube+ SuperSlim range has been introduced to compete with flat-panel displays. P.J. Haddock describes its advantages and the new technology involved.

PLUS ALL THE REGULAR FEATURES

TELEVISION INDEX & DIRECTORY 2003

Plus hard-copy index and reprints service

Here's the essential repair information you need! The Television Index & Directory 2003, in CD-ROM form, contains the text of nearly 15,000 high quality fault reports on TVs, VCRs, Camcorders, DVD players, Monitors, Satellite TV units, Audio equipment and CD players, searchable by make and model, plus the text of 180 Test Cases and over 200 major servicing articles, from fifteen years of Television magazine. It also contains a full fifteen year index of Television, a Spares Guide, a directory of Trade and Professional Organisations, an International TV Standards guide, a satellite TV Channel Finder, a TV transmitter list and a compendium of internet resources for service engineers. The software is quick and easy to use, and runs on any PC with Windows 95, 98, ME, NT, XP or 2000.

Television Index & Directory 2003 CD-ROM, £199

Television Index & Directory 2003 CD-ROM upgrade, £46 (to qualify for this upgrade you need to have purchased a previous version of the Television Index on floppy disk or on CD-ROM)

A six-month update of the index and fault reports will be available in May 2003. If you wish to take advantage of this, £10 should be added to your order.

Television Index only, 1988—2002, £36

Television Index only upgrade from previous versions, £16

Hard-copy indexes of Television magazine are available for Volumes 38 (1988) to 52 (2002) at £3.50 per volume.

Reprints of articles from Television back to 1988 are also available, at the flat rate of £3.50 per article — you can order through our web site, or write to the address below.

The above prices include UK postage and VAT where applicable. Add an extra £1 postage for non-UK EC orders, or £5 for non-EC overseas orders, although Channel Island residents do not need to add any extra postage. Cheques should be made payable to SoftCopy Ltd. Access, Visa or MasterCard Credit Cards are accepted. Allow up to 28 days for delivery (UK).

SoftCopy Limited, 1 Vineries Close, Cheltenham, GL53 ONU, UK

Telephone 01242 241 455, Fax 01242 241 468

e-mail: sales@softcopy.co.uk web site:

http://www.softcopy.co.uk

Published on the third Wednesday of each month by Highbury Business Communications, Nexus House, Azalea Drive, Swanley, Kent, BR8 8HU. Highbury Business Communications is a division of Highbury Communications PLC. Filmsetting by Impress, Unit 2, Parkway, Southgate Way, Orton Southgate, Peterborough PE2 6YN. Printed in England by Polestar (Colchester) Ltd., Newcomen Way, Severalls Industrial Park, Colchester, Essex CO4 4TG. Distributed by Comag, Tavistock Road, West Drayton, Middlesex UB7 7GE (tel. 01895 444 055). Sole Agents for Australia and New Zealand, Gordon and Gotch (Asia) Ltd.; South Africa, Central News Agency Ltd. *Television* is sold subject to the following conditions, namely that it shall not, without the written consent of the Publishers first having been given, be lent, resold, hired out or otherwise disposed of by way of Trade at more than the recommended selling price shown on the cover, excluding Eire where the selling price is subject to currency exchange fluctuations and VAT, and that it shall not be lent, resold, hired or otherwise disposed of in a mutilated condition or in any unauthorised cover by way of Trade or affixed to or as part of any publication or advertising, literary or pictorial matter whatsoever.



WHAT A LIFE!

Trouble with prats of one type or another – including ITV News! Sets and couples and their demands. Some TV and a TV/DVD combi unit fault. Donald Bullock’s servicing commentary

As regular readers will know, I seem to receive the attention of an excessive number of prats. I’ve often wondered whether every one of them in the locality makes a beeline for me, or whether others get a share. It might help me to decide about this if other readers who regard themselves as prat-prone would drop me an email to tell be about their experiences. I’ll give you the address at the end of this piece. If enough emails on the subject arrive, I’ll include some of the details in a future column. To give you the idea, I’ll recount some recent prat experiences in a moment. Meanwhile I have to say that the ITV News channel qualifies for membership of the league of prats.

ITV News

When it isn’t running advertisements by the yard, ITV News provides a series of written news items at the bottom of the screen. The problem with this lies in the presentation. Take first the awkward style. Imagine a report on a current football occurrence. An average grown-up might write “Basher Punk, the footballer, was found guilty today and mildly reprimanded for attacking ten other players during last Saturday’s match and also hitting the referee. He denies the charges and says the others were simply accident-prone”.

Not ITV News however! You get a horrible, disjointed presentation of the story via bottom-of-the-screen headlines, in this sort of style: “Basher Punk has been charged. Basher Bunk has been mildly reprimanded. Basher Punk found guilty of attacking ten other players.

Basher Punk is a footballer. Basher Punk also hit the referee. Basher Punk denies the charges. Basher Punk says men were all accident-prone.”

One’s mind reels when confronted with this repetitive nonsense. Then there’s the all too common illiteracy. Take the news item about a parachutist who died when his parachutes failed to open. We were able to read, all day, that the parachutes’ “chords” had been cut. Chords relate to music of course. They meant cords.

If you think I’m being a bit too sensitive about this, bear in mind that it’s a British news programme that goes out all over the world from the ITV stable, the country’s second largest broadcasting outfit. When exposed to such incompetence, viewers must wonder how accurately the actual news presentation is handled. When I was at school such abysmal standards would have produced instant reprimands. My old schoolmaster Mr Cryer would have a very busy time if he could be brought back and let loose amongst today’s TV broadcasters!

Most intelligent viewers would turn the channel off as soon as they had heard the news headlines – or tried to hear them above the pulsating, stabbing and bubbling electronic noise that ITV insists on using to drown its announcers’ words.

The Russell-Burrows

Back to customers however. Have you noticed that when you encounter a decent, agreeable chap his wife is all too often a battleaxe? It works the other way as well: decent lady,

disagreeable chap. It has been said that it takes a couple to produce two complete individuals. Trouble is they don’t make equal contributions, certainly when it comes to the decency or the prat scale. Take the case of the Russell-Burrows, old customers of ours.

They came in the other day with their Bush Model WS6671 TV set, which is fitted with the Vestel 11AK19P4 chassis. “Hello Mr Bullock” he greeted us cheerfully as he entered backwards, holding one end of the set. “It’s dead like. You’ve done work for us before, a long time back. It was the sound that time.”

“Wojamean a long time back” cut in his wife, “it wasn’t that long ago at all. You’m goin’ the right way to us getting a great big bill again!”

Greeneyes quickly checked and handed a sheet to me. “March 1999” it said, “no sound, dry-joints, £7.50.” I showed it to Jack Russell-Burrows.

“See dear, it wasn’t that much” he said. “And they got it done it an hour or two.”

His wife Enid scowled. “Seems a lot to me” she said, “just for a loose wire ...”

Fortunately he steered her out at this point, and Paul soon dismantled the set. There wasn’t much left of D822 (MR856), which is in series between the mains bridge rectifier and the chopper circuit. Paul fitted a replacement then started to carry out cold checks on the components downstream. The MTP6N60E chopper transistor Q802 was short-circuit, also D823 (1N4148) which is connected between the gate and source of Q802, and D824 (BA159).

“Don’t think old Burrows’ wife is going to like this one bit” he commented. Further tests showed that three more BA159 diodes were short-circuit, D825, D826 and D827. Having fitted replacements he surveyed the chassis and carried out one or two spot checks. Then he looked around the power supply for dry-joints, resoldering a couple that

were suspect. The next step was to spray the new diode in the D822 position with freezer and keep an eye on it when he applied power. The frost disappeared at once. Paul pulled the plug then felt D822 with his finger. It was hot.

"Oh dear" he said, "the MC44604P chopper control chip IC802 must have failed." Paul fitted a replacement and went through the D822 spraying procedure again. This time the set performed perfectly when he switched it on.

"Eight new components and a couple of hours for labour – assuming the set survives its soak test" he concluded, "the lady ain't going to like it at all!"

The Horrobins

Mr Horrobin then barged in, accompanied by his quiet and cheerful wife. On the decency scale I'd say she contributes 96 per cent to Mr Horrobin's four per cent. They chalk up the same score on the noise scale.

"Your bloody front door's stiff to open" he barked, "anyway, 'im's in the car. Can't manage 'im on me own. You two beller bring 'im in. Then if 'e gets dropped it's your fault not mine."

"Eustace!" his wife said, "not so loud dear."

"You shullup" he replied, "I wants tuh talk to these people."

She smiled at us by way of apology, and Paul and I went out to collect the set. It was a monster, a 28in. NEI Model C28F1FXN.

"What's the trouble with it?" I asked Mr Horrobin.

"That's for you to find out, ennit?" he replied, "atter all, you'm supposed to be the telly experts, ain't you? I dresses tripe, and can talk tripe for hours."

Steven plugged the set in and switched it on. It remained in standby. So he prepared to write out a card.

"What's 'im going to cost, and when can we have 'im back?" Mr Horrobin said. "Couple of 'ours, shallus say? Not as we watches 'im much, mind."

"We'll phone you as soon as we know" Steven replied.

When the Horrobins had gone Steven started to check the set, concentrating on the line output

stage. He found the BU508AF line output transistor TR128 short-circuit base-to-collector. When this happens the BY299 diode (D110) in the EW diode modulator circuit often fails as well. Sure enough it was short-circuit. Steven fitted replacements and, not finding anything else wrong, switched the set on again. All he got for his trouble was a loud click – the set remained in standby. When he freeze-sprayed the replacement components the frost disappeared immediately. They were both short-circuit. "They didn't have a very long life!" he commented.

Steven fitted fresh replacements then spent some time checking about in the chassis. But he couldn't find any other faulty components. After a while he suggested that one of the replacement components might have been faulty. As they were new, he hadn't checked them.

I thought about it then shook my head. "There must be a short somewhere" I concluded, "or an intermittent joint arcing and drawing a lot of current."

Steven returned to his checking and finally removed the scan-coil plug. This was the cause of the trouble: it was badly carbonised, and had been arcing. When he'd fitted a replacement he hesitated before trying the set again. He needn't have worried. The set worked well, and Steven heaved a huge sigh of relief.

A TV/DVD combi unit

While he'd been doing this Horace Price called in with a Grundig TV/DVD combi unit. I saw him coming and slipped off to the back of the shop. Not to be away from Horace particularly, but to be away from the combi unit he was carrying. They frighten me! Paul stepped forward to greet him.

"Hi, Horace, what's new?" he asked.

"Toothache, a lousy cold, won 200 salami sandwiches in a Crubbs Foodstore competition and" he hesitated, then brightened up, "oh yes, the missus left me and went to live with that tall, thin chap who runs Snoddies! It's heaven now. I go shopping on my own and if I want a pie I have a pie. And another if I want it. If I want to cross over the road for a pint at the Trafalgar Arms, over I go. I feel twenty years younger!"

I came out when Paul had booked the unit in and Horace had gone on his way, maybe to the Trafalgar Arms. "There goes a happy man" I commented. On a decency scale for the couple, Horace had contributed the lot. "I'm glad she settled on the tall, thin chap from Snoddies" I added.

The combi unit was a Model TVDVD1450, about a year old. Paul plugged it in and found that it produced an unmodulated raster with no sound. After carrying out a lot of voltage checks and clearing everything else, he concluded that the cause had to be the tuner. He packed it up and sent it off to MCES in Manchester. We rely on them when we get tuner problems. They provide a first-class service and we never have to worry about the results. The service is fast and the charges very reasonable.

A widescreen Panasonic

Shortly afterwards Tom Murphy called in with his wife. He was having trouble with his 32in. widescreen Panasonic TV, Model TX32DK2.

"It blubbers and bejabbers" he commented, "but it's mighty heavy like. I've got it in the car outside. I want you boys to help me get it out."

"Do you think you could?" added his wife. "He doesn't like bothering people, but he's not as young as he was..."

So we all went out to pull and coax the monster out of the car and into the shop.

When Steven tried it the set produced a blue screen. It didn't take him long to discover the cause of the trouble, which was the tube – type W76ESF031X13. There was a short in the blue gun.

After getting Murphy's acceptance of the quote we ordered a replacement from D'Lec Components at Cobham in Kent. It arrived a couple of days later. When we'd fitted it the set worked exceptionally well.

"Nice couple, the Murphys" I said to Steven. "Both decent, too. I'd say they're about 50/50 on the decency scale!"

Oh yes, the email address. You can write to me at donald@wheatleypress.com I look forward to hearing from you!

TELEVISION

AND HOME ELECTRONICS REPAIR

Television & Home Electronics Repair magazine is the only magazine for technicians who deal with consumer electronic products, in particular TV, Video, Satellite and Audio equipment.

- Keep up to date with the latest information and changes affecting this industry
- Tips & guides on repairing television and electronic equipment including satellite receivers, PCs, monitors, VCRs, DVD players, audio equipment and much, much more.....
- Essential reference and in-depth features covered monthly
- Launched in 1935 - is the longest established consumer electronics magazine
- Highly respected journal with a high grade of editorial news



Make sure you receive your regular monthly copy by subscribing today.....

Complete and fax the coupon to: +44 (0) 1353 654400

HIGHBURY
Business Communications
A SUBSIDIARY OF HIGHBURY HOUSE COMMUNICATIONS PLC

I wish to subscribe for one year to Television:

Price UK £33.80 Europe £48.00
 Rest of World £63.50 US\$99.00
 Euro 100.96

I wish to subscribe for two years to Television:

Price UK £53.00 Europe £77.00
 Rest of World £99.00 US\$154.00
 Euro 157.41

Please tick preferred method of payment

- I enclose a cheque payable to Highbury Business Communications Ltd
- Please invoice me Purchase No _____
(NB Purchase order must be included to validate invoice)
- Please charge my: Master Card/Visa/Amex/Diners Club/Switch/Delta (please circle)

Card No _____

Expiry Date _____

(Switch/Delta Only) Valid form / Issue Number

Signature _____

Date _____

Name _____

Job Title _____

Company _____

Address _____

Postcode/Zip _____

Country _____

Telephone / Fax _____

E-mail _____

Please tick here if you do not wish to be contacted by other businesses either by

mail telephone fax email

Please return to: Highbury Subscription Services,
Link House, 8 Bartholomew's Walk, Ely,
Cambridgeshire CB7 4ZD, UK.

Email: wss@wyverncrest.co.uk

(Quote ref: TV1)

TUBES

14" Philips/Orion	34EAC, 34AGT, 34JLL	£30
24" Philips widescreen	W56ECK, W56ESF	£160
24" Thomson widescreen	W56EGV	£160
26" Philips standard	66EAK	£75
26" Thomson standard	66ECY, 66EHJ	£65
28" Thomson widescreen	W66EGV, W66EJU	£85
28" LG widescreen	W66QBD	£85
28" Philips widescreen	W66ECK, W66ESF	£160
29" Philips standard	68ESF	£145
32" Thomson widescreen	W76EDX	£120
32" Philips widescreen	W76ESF	£245

All prices include carriage but are subject to VAT

We also de-scratch tubes

EXPRESS TV SUPPLIES LTD

The Mill, Mill Lane,

Rugeley, Staffs WS15 2JW

Tel: 01889 577600 Fax: 01889 575600

JOHN RADIO ELECTRONIC TEST AND COMMUNICATION EQPT.

MASSIVE RETIREMENT CLEARANCE SALE

30.00SQ FT OF TEKTRONIX-HP-AGILENT-MARCONI-PHILIPS-RACAL ETC.,

Over the rest of this year at our bulk Smithies Mill site sales by auction-Tender-Offer-all welcome private or trade-single or bulk items. Equipment sale floor 6000sq ft +25.000sq ft of adjoining buildings plus 9000sq ft will be slowly added from our Whitehall Works headquarter site.

Open weekdays 9am-5pm and Saturday mornings to 1:00pm
Closed dinner 1- 2pm

ALWAYS PHONE FOR APPOINTMENT FIRST.

Item lists-photos-site map-on
website www.johnsradio-electronics.com
website www.johnsradio-uk.com www.johnsradio.com
email: johnsradio@btconnect.com

Location M62 Junction 27, A62 to Huddersfield, 1 mile Birstall Smithies Lights (6 roads) look to your left, site under factory chimney with aerials on top, road second left, Smithies Moor Lane, 100yds second entrance on left.

Johns Radio, Smithies Mill, Birstall Smithies Lights, 883-885 Bradford Rd, Batley, West Yorks WF17 8NN-8NS.

Phone - 01924 442905 - Fax - 01924 448170

Our normal sales, workshop, repairs and calibration will continue until clearance of all items.

Contact Patricia at Whitehall Works-84 Whitehall Rd East, Birkenshaw, Bradford BD11 2ER.

Phone - 01274 684007 - Fax 01274 651160

www.tech-asset.co.uk



VIDEO DISPLAY (EUROPE) LIMITED

Video Display (Europe) Ltd, Unit 5, Old Forge Trading Est
Dudley Road, Lye, Stourbridge, West Midlands DY9 8EL
United Kingdom
Tel 44 (0) 1384 894777. Fax: 44 (0) 1384 895788
adriang@vdceuro.com

Data & Display Components

PERIFELEC

MC 30 A Spectrum Analyser



- Synthesized satellite cable and TV field strength meter with panoramic reception on 14 cm (5,5") screen and digital carriers measurement.
- Complete microprocessor and lpsl51 logic control.
- Continuous frequencies from 46 to 860 MHz and from 920 to 2150 MHz on 4 bands.
- Selectable 4, 1 and 0,2 MHz spectrum band-width, picture measurement 1 MHz.
- Display of picture of selected synthesized channel.
- FM (Radio) L/L, B/G, I, D/K/K', M/N TV standards and Ku and C satellite standards.
- Possibility of 32 programs memorized per frequency band.
- Display (2 Lines of 16 characters).
- Range of measurement of signal strength from 20 to 120 dBµV, manual or automatic attenuator.
- Battery life about 1 hour 20 minutes, weight 5,8 Kg.

- Display of full-band and 4 possible expanded spectrums.
- Channels and frequency plans of cable and TV standards memorized.
- Frequency, signal strength in dBµV or bargraph, displayed on a digital display (2 lines of 16 characters).
- Voltage of remote power supply in 14v or 18v and 22 KHz in satellite + DiSEC C™ v1.2 switching.

The panoramic field strength meter MC30A combines in one instrument all the functions necessary for installing and checking TV or satellite reception, both analogue and digital. The visualization of the spectrum and the picture allows the carrying out of all the necessary adjustments with this one instrument. The high technology used in the MC30A allows a range of possibilities unheard of in a instrument in this price category.

Lacuna Digital Satellite Meter

A custom designed, small lightweight ABS case, created with the installer in mind

- Signal strength and BER will be displayed together
- Identifies the chosen satellite
- Signal strengths and BER settings calibrated facility for recalibration by distributor
- Removable 'F' connector
- LNB short circuit protection and LNB power supply
- Compatible with all satellite transmissions ie. Ku and C band, DVB and DSS

NEW Lacuna Terrestrial Digital Meter

Small, lightweight custom designed for terrestrial digital installations

- Identifies transmitter
- Measures signal strength, carrier/noise and BER
 - UHF / VHF
- Analogue and digital measurement
- Removable 'F' connector
- 4 line LCD with backlight
- Weight including batteries 600g
 - 12v line power facility

Full catalogue of meters available. please phone for details.

COASTAL AERIAL SUPPLIES

Unit X2, Rudford Industrial Estate, Ford, Arundel BN18 0BD
Telephone: 0870 2641990 Fax: 0870 264 1991

Perifelec
Sole Import
Distributors



www.colourtrade.com



- Wholesale made easier online
- Sign up now for wholesale prices
- All orders dispatched same day
- Huge range of Christmas stock now in
- Full range of factory graded and new TV DVD/VCR's, HiFi, I.C.E Systems, small and large domestic goods.
- Export department for brown and white goods.

Merry Christmas from Colourtrade

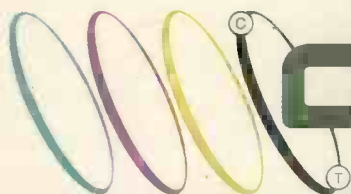

COLOUR TRADE

**POSSIBLY
LARGEST & OLDEST
EST. IN
THE UK EST FOR
30 YEARS**

Wholesaler Distributors & Expert Agents of
Domestic Electronics & Appliances

**FULL RANGE OF FACTORY
GRADED TV's DVD / VIDEOS
HI-FI SMALL & LARGE
DOMESTIC GOODS**

TECHNICAL SUPPORT

Now Available

TV's, DVD's, VCR & AUDIO

Over 40 years of genuine experience

Experts on:-

Thomson • Sanyo • Beko • LG • Tatung • Ferguson
Bush • Funai • Pacific • Dansai • Samsung & more

0907 076 70 80

Call cost 60p min

MAIN DEALER

- Thompson
- Sanyo
- Beko



Tel: 0121 359 7020 Fax: 0121 359 6344

Phoenix House, 190 Bridge St. West, Newtown, Birmingham B19 2YT

Email: inquiries@colourtrade.com

ADVERTISERS INDEX

Alban Electronics	OBC	JPG Electronics	117
Bull Group Ltd	66	Kudos Marketing	117
Campion Electronics	127	M.C.E.S.	101
Coastal Aerial Supplies	125	Nikko Electronics	93
Colourtrade	126	Peak Electronic Design	IBC
Cricklewood Electronics Ltd ..	93	Remotes Direct	101
East London Components	79	Satellite & Digital Services ..	79
Economic Devices	127	Steward of Reading	78
Electronic World T.V & Vico ..	79	Trade Electronics	107
Express T.V.	125	TW Electronics	IFC
Grandata Ltd	83 - 88	Urwin	117
Instore Electrics	93	Video Display Europe Ltd ...	125
Johns Radio	125		

Campion Electronics Ltd.

**SUPPLIERS OF QUALITY
EX-RENTAL TV'S**

and video equipment to independent
retailers across the UK and EIRE.

FREE DELIVERY SERVICE
to most areas of UK

WORLDWIDE EXPORT SERVICE
Large stock of TVs suitable for export
Experts in UHF/VHF conversion

Visit our large warehouse at:

Units 1 & 2 Tenat Works,
Worcester Rd, Kidderminster,
Worc, DY10 1JR

Tel: **(01562) 746000** (2 Lines)

Just 20 miles from Birmingham City Centre

Economic Devices

PO Box 73, Oakengates TF2 9WR

Tel ++ 44 (0)1952 273130

Fax ++44 (0)1952 405478

Remote Controls from **£5.95** each

Stock held for over **53000** different models

SEMICONDUCTORS
over **34,000** types of
transistors, IC's, diodes etc. or equivalents stocked

We take your hassle Some suppliers just won't help. We will
work really hard to find those difficult
parts - just ask and let our 'no holds barred' enquiry hound work for you.!!!

...and look at the **special offers.....**

BUT11A @ **29p** each BUT11AF @ **41p** each
BU508A @ **45p** each Fully wired scart lead **39p**

a slight inconvenience....
...you must buy more than one.

BU208A	X 5	75p ea	TEA2018A	X 5	99p ea
BU508A	X 5	79p ea	UC3842	X 5	59p ea
BU508AF	X 5	85p ea	CNX62A	X 5	29p ea
BU508D	X 5	89p ea	S2000AF	X 5	84p ea
BUT11A	X 5	29p ea	TDA3653B	X 5	55p ea
BUT11AF	X 5	47p ea	TDA3654	X 5	82p ea
Phillips type 1.2 volt Back up battery				X 5	59p ea
Phillips type 2.4 volt Back up battery				X 5	120p ea
Scart - Scart lead 1.5m Fully wired				X 2	89p ea
Positor PT37, TH98009 (White)				X 5	59p ea
Thorn TX100 Chassis 110 DGR LOPTX				each	£11.24
Phillips CP90 Chassis LOPTX				each	£11.63

...and now ask about our
value for money full price list.
Remember £1.50 post & handling
All major credit cards accepted

www.telepart.co.uk

The web page here you can look up the price and order all things TV, VCR and Satellite. Web search by model for video part, remote controls, LOPTX etc.
overseas enquiries particularly welcome

New CCTV catalogue out NOW
cameras, monitors, switches,
quads, multiplexers, the lot.

Service Link

TELEPHONE 01322 611289

FAX 01322 616376

FOR SALE

ICC17 LOPTX Kit

Widescreen Special

Ferguson W7023U etc.

Thomson 24WK23U etc

Pt no. 10608670P1

ONLY £24.95!

IrwinElectronics

Telephone 0114 273 9622

MISCELLANEOUS

LOOKING FOR AN EXTRA SOURCE OF INCOME?

Why not sell Broadband services to your customers? Top rated ISP, serious income possibilities.

More info:

www.dothebusiness.co.uk

Tel: 0845 166 4811

PHOTOGRAPHIC SERVICES

BENCH ENGINEER REQUIRED

TO REPAIR ANALOG AND DIGITAL CAMCORDERS ETC

- Minimum experience 5 years
- Able to work to component level
- Location Kent
- Performance pay 20-35k + healthcare

Contact Trevor on Tel: 01732 761270
E-mail address: trev4dnh@aol.com

PROJECTOR SPARES

VIDIKRON

projector spare parts and service information.

PROJECTSPARES

Tel: 01444 831769

Fax: 01444 831580

E-mail:

projectspares@btinternet.com

LINEAGE

CHEAPEST: CABLE TIES, FUSES, plug-tops, crimps, tapes, tv/video, handsets, extension leads, fax, printers, baskets, ladies trousers. Tel: 020 7232 2266. Fax: 020 7232 2288.

REPAIRS

Trade repairs to Sky digiboxes

Pace, Amstrad, Grundig, Panasonic, (including Fluid Ingress). All makes repaired at a fair fixed price.

Scan Digital Services

For details

Give Alan a ring on

Tel/Fax: 01633 25 40 50

E-Mail: alan@scansat.globalnet.co.uk

SERVICE DATA

NEED HELP NOW?

Then ring the

★ ELECTRON TECHNICAL HELPLINE ★

Genuine help available to all repairers of

T.V. - V.C.R - SAT - AUDIO (Inc Valves)

Over 30 years experience and vast data base

0906 470 1706

Calls cost 60p per minute

Hours of Business Mon to Fri
9.00 am - 12.30pm : 2.15pm - 5.30pm
Sat. Morn 9am - 12.30pm

OPEN 6 DAYS
TV/VCR CIRCUITS (WE DO NOT STOCK AUDIO OR MONITOR INFORMATION)

TEL A.T.V. on
0114 285 4254

CTV Circuits..... from £5.00
VCR Circuits..... from £7.00
CTV Manuals..... from £10.50
VCR Manuals..... from £14.50
User instructions also available (P/P add £2.50 to each order)

419 LANGSETT ROAD
SHEFFIELD S6 2LL

MANUAL COLLECTIONS PURCHASED, (POST 1995)



SERVICE DATA

SERVICE MANUALS

Have you ever turned away work for want of a Service Manual?

Have you ever bought a Service Manual and never used it more than once?

Then why not join ...

THE MANUALS LIBRARY

For details and membership application form write, phone or fax:

HARVEY ELECTRONICS
43 Loop Road, Beachley, Chepstow, Mons, NP16 7HE

Tel: 01291 623086 Fax: 01291 628786

Visa: Mastercard accepted

SERVICE DATA

Service Information **FES** Circuit Diagrams

TV's, VCR's, SATELLITE CAMCORDERS, AUDIO & HI-FI's

Prices are from £5.50 + £2.75 P&P add a further £5.50 per item in the same order

note: some items priced individually we now supply universal tv/video remotes at competitive prices

Payment by credit card, PO or cheque

Tel: Fax 01206 211570

e-mail: colin@fryerns.fsbusiness.co.uk



2 The Lodge
Easthorpe Green
Marks Tey, Colchester
CO6 1HA

WANTED

BEST CASH PRICES PAID

FOR VALVES KT88, PX4 AND MOST AUDIO/OTHER TYPES.

Tel: 01403 784961

Billington Export Ltd
Sussex RH14 9EZ
Fax 01403 783519
Email: sales@bel-tubes.co.uk
Visitors by appointment

SERVICE INFO

TV - VIDEO - AUDIO

Prices- any make/model

CTV	s/man	10.00
VCR	s/man	15.00
CTV	circs	5.00
VCR	circs	7.00

Other items POA

All prices include p/p.
Do not add any VAT

AMTel

Huna,
Caithness KW1 4YL
01955 611313

www.amtel.org.uk

For a **FREE** consultation on how best to market your products/services to a professional audience contact **MARK** on **01322 611289**

Service Link

TELEPHONE 01322 611289 FAX 01322 616376

atlas LCR

Passive Component Analyser
(Model LCR40)

£79

fully inclusive UK price

Just clip on the test leads and press test. The Atlas LCR will automatically identify the type of component, apply the appropriate test level and frequency, display the component's value and more!
Probes are detachable too, so you can use the optional SMD tweezers for your tiny unmarked passives - fantastic.

- Automatic component identification (Inductor, Capacitor or Resistor)
- Component value measurement
- Auto frequency (DC, 1kHz, 15kHz, 200kHz)
- Inductor DC resistance measurement
- Non-volatile probe compensation memory
- Detachable probes allowing use of optional test prods, SMD tweezers, etc...
- Hands free mode with value hold

Inductance range: 1 μ H to 10H
Capacitance range: 1pF to 10,000 μ F
Resistance range: 1 Ω to 2M Ω
Basic accuracy: 1%
Test signals: 1V, 3mA max

"Astonishingly, this little unit seems to pack most of the punch of a large and very expensive automated LCR bridge into its tiny case."

Andy Flind - EPE Magazine March 2003

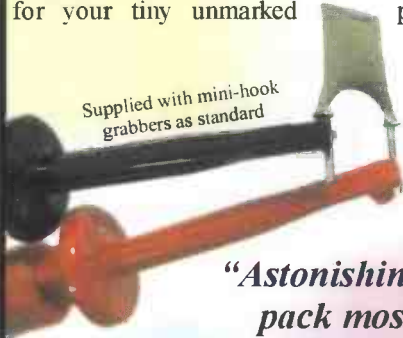

atlas DCA

Semiconductor Analyser
(Model DCA55)

£60

fully inclusive UK price

NOW MEASURES
TRANSISTOR
LEAKAGE!

Check and
identify
your semi's

- Automatic component identification
- Pinout identification
- Transistor gain measurement
- MOSFET gate threshold measurement
- PN junction characteristics measurement
- Shorted Junction identification
- Transistor leakage measurement
- Just connect the part anyway round and press the button!
- Auto power on/off

NPN bipolar
Darlington
Diode protection
between C-E
Resistor shunt
between B-E
Current gain
Hfe=126
Enhancement mode
N-Ch MOSFET

Bipolar transistors,
Darlington transistors,
Diode protected transistors,
Resistor shunted transistors,
Enhancement mode MOSFETs,
Depletion mode MOSFETs,
Junction FETs,
Low power triacs and thyristors,
Diodes and diode networks,
LEDs (+bicolours)

"It's the kind of instrument that should be on every engineers and enthusiasts bench."

EPE Magazine
March 2000



atlas PACK £129!

LCR40 and DCA55 Pack

fully inclusive UK price

Why not order both analysers at the same time and take advantage of our special offer, saving you £10!



Visit www.peakelec.co.uk to download the data sheets, user guides and copies of independent reviews. You can pay using a cheque, postal order, credit or debit card and even pay securely online. Please contact us for your volume requirements.

Also available from Farnell, Maplin, Rapid and CPC (prices vary)

PEAK
electronic design ltd

Atlas House, Kiln Lane
Harpur Ind. Est., Buxton
Derbyshire, SK17 9JL, UK

www.peakelec.co.uk
sales@peakelec.co.uk

Tel. 01298 70012 Fax. 01298 70046



TELEVISION TEST PATTERN GENERATORS

The new **GV 998** is a digital pattern generator offering more advanced features at again a realistic price. Those features include :

- ◆ MPEG-2 format Transport Stream generation
- ◆ Video and audio included in the TS
- ◆ Video and audio inputs
- ◆ Generation of a variable frequency sound carrier for decoding verification
- ◆ Multistandard and multisystem analogue TV signal generation
- ◆ Possibility to edit different fields of the TS database to present the name of the service provider
- ◆ Remote control via a personal computer
- ◆ Moving video patterns to check MPEG-2 decoders

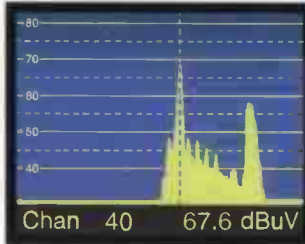
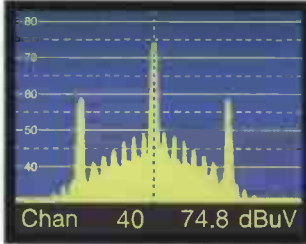

PROMAX GV SERIES

- ◆ Choice of 12 instruments
- ◆ NICAM and Teletext
- ◆ 4:3 and 16:9 Formats
- ◆ Full field and VITS
- ◆ Computer Controlled
- ◆ Front panel memories
- ◆ Own Company Logo
- ◆ Computer Monitor testers
- ◆ Hand Held Models
- ◆ Multi Standard, PAL, NTSC, SECAM
- ◆ High Quality Construction
- ◆ Attractive Price Levels
- ◆ Full After Sales Service
- ◆ Available from Stock

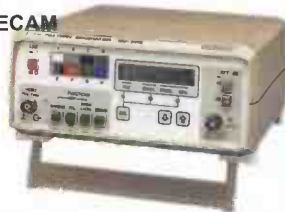
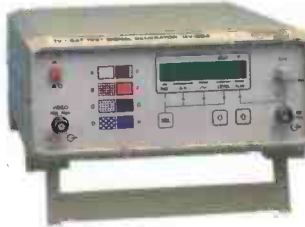

FOR TELEVISION PATTERN GENERATORS, THERE'S NO WIDER CHOICE THAN WITH PROMAX



SELECTED ITEMS FROM THE PROMAX RANGE OF TEST EQUIPMENT



MS 250

Analogue and Digital Satellite Detector.



PRODIG 1

Satellite Dish Installer's Meter Does more than just BSKyB



PRODIG 2

Analogue & Digital Aerial Meter Measures digital channel power and C/N

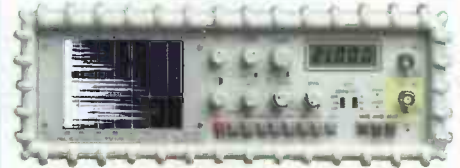

MC 377+

Analogue & Digital, Satellite & Terrestrial Measures channel power and C/N



PROLINK 3 + 4 SERIES

Satellite & Terrestrial, Analogue & Digital, Spectrum Analyser with BER (optional on P3)

Alban

ALBAN ELECTRONICS LIMITED

THE PROMAX SERVICE CENTRE

6 Caxton Centre, Porters Wood, St. Albans, Hertfordshire, AL3 6XT.

TEL: 01727 832266 FAX: 01727 810546

WEB : www.albanelectronics.co.uk

EMAIL : info@albanelectronics.co.uk

SALES + SERVICE + CALIBRATION



TELECOMMUNICATIONS TEST EQUIPMENT
AE 767 Spectrum Analyser



NEW!
THE NEW ALBAN WEB SITE ...
www.albanelectronics.co.uk
FOR ALL THE LATEST NEWS AND INFORMATION FROM ALBAN
NEW!