

Tips, guides and reports for people repairing televisions and electronic equipment

# TELEVISION

**AND HOME ELECTRONICS REPAIR**

**JANUARY 2004 £3.20**



**New super-slim CRTs**

**Introduction to Networking**

**Using the correct  
coaxial cable**



**Satellite, Audio, Monitor, TV, VCR and DVD faults**



## We're getting ready for a special New Years celebration...

Classic Electronics, Europe's most innovative supplier to the Service industry is about to enter a new and exciting phase of our continuous product development philosophy. Make sure you see next months issue to see what is revealed when we **'Pop the Cork'**.

For more information on the entire Classic range of products or details of a distributor near you, call 01635 278678, visit us on the web; [www.classic-electronics.co.uk](http://www.classic-electronics.co.uk) or email us at [sales@classic-electronics.co.uk](mailto:sales@classic-electronics.co.uk)



Technical helpline 01635 278678

# CONTENTS

January 2004

Vol. 54, No. 3

## 131 Comment

Looking ahead

## 132 Teletopics

Broadband satellite internet service launched. Microsoft's Media Centre PC system launched. DAB update. Sat TV tuner with terrestrial modulator. Japanese go for UHDTV.

## 134 New CRTs from LG.Philips

The Cybertube+ SuperSlim range is being launched to compete with flat-panel displays. P.J.



Haddock describes its advantages and the new technology involved.

## 136 Introduction to computer networking

Work patterns for electronics installers and service personnel are changing. A major area of expansion today is computer networking – LANs and WANs (local- and wide-area networks). Fawzi Ibrahim starts a new series that explains what is involved.

## 142 Coaxial cable quality

How important is coaxial cable quality? Bill Wright has had a lot of experience of the effects of inferior cable being used in various types of installation, but decided that he needed a measure of the performance of different cables. The results and his conclusions are presented in this article.

## 146 IBC 2003

The International Broadcasting Convention is where the future unfolds. This year's event was held at the RAI centre, Amsterdam in mid-September. J. LeJeune reports.

## 148 Service casebook

Michael Maurice selects faults from his notebook.

## 155 Servicing the Sharp DA100 (50Hz) and DA50W chassis

Part 5 of this series, by Alex Towers, deals with the control system and the video/deflection processor chip.

## 160 Letters

TETRA problems. The Panasonic Z deck. Mobile phone warning. Germanium signal transistors.

## 161 Help wanted

## 162 DX and Satellite Reception

Terrestrial DX and satellite TV reception reports. Broadcast and satellite TV news. Auto-searching satellite receivers. Notch filtering for Band I. Roger Bunney reports.

## 166 Audio faults

Hints and tips on repairing professional and consumer equipment.

## 168 Monitors

Guidance on repairing monitors and related equipment.

## 169 Test Case 493

## 170 Bench notes

In this concluding instalment in his current series Adrian Gardiner describes basic software faults and the action required to deal with them.

## 172 VCR clinic

## 174 TV fault finding

## 177 DVD faults

## 178 Web service

## 180 What a life!

Unusual customer requests. Steven and Paul scarper off. The TV clinic. Donald Bullock's servicing commentary.

## 182 Satellite notebook

A Nokia 9800 problem. Digital channel update.



BBC Radio via Eutelsat W2. PAS-1R at 45°W. Unusual test cards. Digibox fault reports.

## 185 Next month in Television

## 186 Books to buy

## Editor

John A. Reddihough

## Deputy Editor

Tessa Winford

## Advertisement Sales

Luke Baldock

01322 611 289

Fax 01322 616 376

## Editorial Assistant

Caroline Fisher

01322 611 274

## Managing Editor

Bill Evett

## Publishing Director

Tony Greville

Note that we are unable to answer technical queries over the telephone and cannot provide information on spares other than that given in our Spares Guide.

## Disclaimer

We work hard to ensure that the information presented in *Television* is accurate. However, *Television's* publisher – Highbury Business Communications – will not take responsibility for any injury or loss of earnings that may result from applying information presented in the magazine. It is your responsibility to familiarise yourself with the laws relating to dealing with your customers and suppliers, and with safety practices relating to working with electrical/electronic circuitry – particularly as regards electric shock, fire hazards and explosions.

Next issue, dated  
February, on sale  
January 21

# WILTSGROVE LTD

35/38 River Street, Digbeth, Birmingham B5 5BS

TEL: 0121 772 2733 - FAX: 0121 766 6100

Wishing all our customers a

## HAPPY NEW YEAR!!



e-mail: [sales@wiltsgrove.co.uk](mailto:sales@wiltsgrove.co.uk)  
<http://www.wiltsgrove.co.uk>

Opening Times: 9:00am - 6:00pm (Monday to Saturday)

**VALID UNTIL THE END OF JANUARY 2004**

### FREE TO AIR DIGITAL INSTALLATION KIT



#### KIT CONTAINS

- **2 WAY AMPLIFIER.** Improves the quality of signal reception to your aerial.
- **25m HIGH QUALITY DIGITAL SATELLITE CABLE.** Provides your digital receiver with a high quality signal.
- **1.2m SCREENED FLYLEAD.** Supply your TV with an interference-free signal.
- **HIGH QUALITY COAX CONNECTOR.** Gives your receiver a quality connection.

Order code: **AE-11000** £11.85

- High Quality Digital Coax Cable to get the best signal from your Digital Aerial.
- Digital Ready Aerial Amplifier boosts the TV signal in poor reception areas.
- Screened flylead minimises interference and gives better sound & picture quality.

### AUDIO/VIDEO SELECTOR



- Program the selector with your existing Remote Control - up to 15ft range.
- Connects up to FOUR Audio/Video devices to TWO output sources such as TV or VCR.
- Converts Between Composite video & S-VHS.
- Lets you switch quickly between components.

1 £18.75

Order code: **AV-7015** 5+ £17.95

### GAME AV SELECTOR DELUX



Works with: VCR, TV Games, Cable TV, AV selector, V8 & VCD/DVD/ILD.

1 £4.95

Order code: **AV-7025** 5+ £4.45

### AUDIO/VIDEO SENDER



• Wireless Audio/Video Transmitter with IR Remote Control Extender.

• Built In Infrared Remote Control Extender allows you to increase your existing remote control operating range from ANY room in the house.

RF Signals **2.4 GHZ** 1 £39.95

Order code: **AV-7030** 5+ £37.95

### UNIVERSAL REMOTE CONTROL



**8 in 1** VCR SAT CD CTV AUX

- Pre-programmed for most brands of equipment.
- Perfect replacement for lost or broken remotes.
- Replaces 8 remotes, TVs, VCRs, SATs, CDs & CTVs.
- With Teletext & Fastext function.

1 £6.75

Order code: **URM-380** 10+ £5.95

### SKY NAVIGATOR - KEYBOARD REMOTE



- Compatible with Sky Digibox & Sky plus.
- Flip-flop design. • Batteries & Instructions incl.

Order code: **IR-330G** £16.95

### GENUINE SKY REMOTE CONTROL



QUANTITY DISCOUNT AVAILABLE!!

£7.95

Order code: **IR-1086G**

### SKYPLUS REMOTE CONTROL



1 £13.25

5+ £13.10

10+ £12.95

Order code: **IR-2274G**

### EYE LINK - suitable for SKY Digital

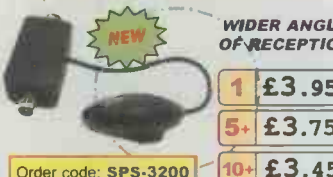

WIDER ANGLE OF RECEPTION

1 £3.95

5+ £3.75

10+ £3.45

### UNIVERSAL REMOTE CONTROL



**3 in 1 ONE FOR ALL**

- Ready to operate all brands of TV, video recorder and satellite receiver/cable box.
- Guaranteed to work.

1 £4.45

Order code: **URC-6530** 10+ £3.95

### DIGITAL SATELLITE RECEIVER



- High quality Video & Audio.
- Favourite Channels list.
- Compatible DISEQC 1.2 / USALS.
- Channel control via 'move', 'lock', 'favourites', 'delete' & 'add'.
- Teletext function.
- Software upgrade function.
- Scans for recently added transponders.
- Automatic support system PAL/NTSC.
- Auto saving of previous channel and auto-return.

Order code: **AE-7296** £99.95

### AAA BRITE POWER BATTERIES

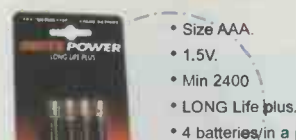

- Size AAA.
- 1.5V.
- Min 2400
- LONG Life plus.
- 4 batteries in a pack.

PACK OF 10+ £0.40 each

Order code: **BAT-3005** 50+ £0.32 each

### AA BRITE POWER BATTERIES



- Size AA.
- 1.5V.
- LONG Life plus.
- 4 batteries in a pack.

PACK OF 10+ £0.40 each

Order code: **BAT-3010** 50+ £0.32 each

### SCART BOX 3 IN 1 OUT SWITCHED



1 £2.95

10+ £2.75

Order code: **AVS-1077**

### SCART PLUG TO 5 SCART SOCKET



1 £1.95

10+ £1.75

Order code: **AVS-1080**

### MAINS ADAPTOR

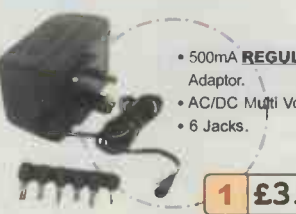

- 500mA **REGULATED** Adaptor.
- AC/DC Multi Voltage.
- 6 Jacks.

1 £3.95

Order code: **SER-1092** 10+ £3.45

### DIGITAL SATELLITE RECEIVER KIT

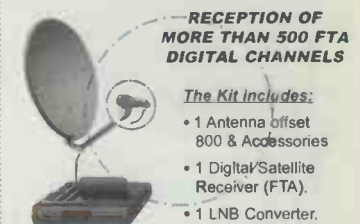

RECEPTION OF MORE THAN 500 FTA DIGITAL CHANNELS

The Kit includes:

- 1 Antenna offset 800 & Accessories
- 1 Digital/Satellite Receiver (FTA)
- 1 LNB Converter.

Order code: **AE-7524** £115.95

### IRODA PRO 120 SOLDER TROUCH



- Self igniting.
- Portable.
- Multi functional heat tool.
- Simple & Safe to operate under any condition.
- Tip can reach 1300°C (2500°F) = to 120W iron.

Order code: **SER-4900** £16.75

### IRODA PRO 120 SOLDERING IRON



- **30W-125W** Power Range
- Butane Powered.
- Bold Ergonomic Design.
- Portable Multi-functions.

APPLICATIONS:

- Automotive & truck repairs.
- Electrical Components.
- Field Repairs.
- Jewellery Repair.
- Repairs TV sets, meters, switch boards.
- Weld Plastics.

£24.50

Order code: **SER-4911**

### TRANSFORMERS - IN STOCK

OEM NO.	PRICE (£)
M12-96	10.95
1352-5033	11.45
1352-5058	11.45
40348A-01	11.45
1352.5008	11.95
1352.5006	12.95
40330-16	12.95
40348A-03	12.95
11425083	13.25
11425086	13.25
11425111	13.25
30002048	13.25
30002051	13.25
40337-16	13.25
003311124	13.95
HR8317	14.25
003311153	14.76
1352-5036	14.76
40348A-06	14.76
11425057	14.90
11425077	14.90
11425079	14.90
11425081	14.90
FSA28013M	14.90
FSA36012M	14.90
1362.5002	15.75
13720052	15.75
1372.0066A	15.75
1382.0052	15.75
003311166	15.87
1352.5048	15.87
M12-137	15.87

\* PRICES SUBJECT TO AVAILABILITY, VAT & CARRIAGE.  
 \*\* PRICES MAYBE CHANGED WITHOUT PRIOR NOTICE.

**\*\*TRADE ONLY\*\***

Freefax Orderline: **0500 55 05 05**

# Looking ahead

**F**orecasters often get it right, but sometimes get it spectacularly wrong. How can you be reasonably sure of getting it right? When it comes to technology, it depends on your vantage point during the progress of an R&D programme. If a lot of money and research are going into something, there is clearly a likelihood of success. And it helps if the technology concerned is not, like say nanotubes, completely new. Take microprocessor chips for example. Their capabilities have doubled time and time again over the years, as more circuitry has been squeezed into less space. Is there much farther to go? Obviously a physical constraint must occur at some point. But improved performance is on the way, and there's more than one way of going about it.

You can go on increasing the clock speed, or you can get the processor to do more than one thing at a time (or, of course, you could do both!). Microprocessors already operate at faster speeds than the associated chips, memory devices in particular. So it helps if they can do several things at a time instead of hanging around waiting. One way of achieving this is by time-slicing: the microprocessor spends a few microseconds on one activity then moves to another and so on to keep it busy. A further advance is to use what's called simultaneous multi-threading (SMT). Instead of the processor moving from one task to another on a strict time-schedule basis (time-slicing), it is able to decide for itself what is most urgent for it to do next – which 'thread' to work on. The hardware technology to make this possible has been available for about eight years, and is already in limited use. The problem is that a computer's application and operating system software may have to change in order to make best use of this approach. That takes time, and can lead to compatibility problems.

The SMT approach should, with present technology, produce processors that provide between two and four times the performance of single-thread processors. Intel's Xeon chips for servers and Pentium IV chips for PCs are capable of two-thread operation. IBM's PowerPC processors can switch between single-threaded and multi-threaded operation as required.

Where does this fit into the field of consumer electronics? The main relevance at present is for games consoles, which require massive computing power to be able to handle the action-packed, '3D' programs people want. A major battle is

looming here, in particular between Sony and Microsoft. Sony has for some time been pouring huge resources into a new microprocessor chip to power its next-generation games console – and to serve other purposes as well. Microsoft has decided to use IBM's PowerPC processor chips in its next-generation Xbox console. Both Sony and Microsoft see such consoles as being the core for future domestic electronic systems. IBM hopes that its PowerPC technology will enable it to gain a major position in the consumer electronics field. For Microsoft, compatibility with older Xbox software could be provided by the emulation-technology it acquired from Connectix, whose Virtual PC enables Intel-based software to be used with PowerPC chips.

It brings one down to earth to reflect that all this high technology could succeed or fail depending on the time taken to get products to market and the ability to back them with must-have software. It's similar to the VHS-Beta battle, but with technology advanced by several generations.

There are more prosaic matters in the consumer electronics field. The move to flat-panel TV seems to be taking off faster than many of us expected. Price is of course

crucial here. Networking is the current buzzword, and of course home entertainment centres as opposed to the traditional bits and pieces we are used to switching between – separate audio, video and so on. Again it all depends on price, and convenience. Do you want to throw everything out and start afresh with a networked entertainment centre? Some will, but this doesn't so far have the look of a mass market about it. Not while China churns out traditional consumer electronics products at give-away prices!

Nevertheless a recent report from the US suggests that the traditional hi-fi market is fast being overtaken by the home theatre approach, with multiple surround sound. The major factor here is the success of DVD, which provides high-quality audio and video combined. Hi-fi separates are apparently fast disappearing from US retailers' shelves.

Will it end up with those powerful microprocessor chips driving all before them, with Intel, IBM and Microsoft taking over the consumer electronics industry? Sony at any rate is, as usual, going about things in its own way, having seen the direction in which consumer electronics is going.

## COPYRIGHT

© Highbury Business Communications, 2004. All rights reserved. No part of this publication may be reproduced, stored or transmitted in any form or by any means without the written permission of the publishers.

All reasonable precautions are taken by *Television* to ensure that the advice and data published are reliable. We cannot however guarantee it and we cannot accept legal responsibility for it.

## CORRESPONDENCE

All correspondence regarding advertisements should be addressed to the Advertisement Manager, *Television*, Highbury Business Communications, Nexus House, Azalea Drive, Swanley, Kent, BR8 8HU. Editorial correspondence should be addressed to *Television*, Editorial Department, Highbury Business Communications, Nexus House, Azalea Drive, Swanley, Kent, BR8 8HU.

## INDEXES AND BINDERS

Indexes for Vols. 38 to 53 are available at £3.50 each from SoftCopy Ltd., who can also supply an fifteen-year consolidated index on computer disc. For further details see page 185.

Binders that hold twelve issues of *Television* are available for £6.50 each from Modern Bookbinders, Pringle Street, Blackburn, BB1 1SA. Telephone: 01254 59 371. Make cheques payable to "Television Binders".

## Newstrade Enquires

Distributed by COMAG

Telephone: 01895 444055

ISSN 0032-647X

## SUBSCRIPTIONS

Highbury Subscription Services, Link House, 8 Bartholomew's Walk, Ely, Cambridge CB7 4ZD. Telephone 01353 654 431 Fax 01353 654 400 Email [hbc.subs@highbury-wyvern.co.uk](mailto:hbc.subs@highbury-wyvern.co.uk) Please notify change of address.

## Subscription rates:

UK 1 year £33.80, 2 years £54.00, 3 years £71.00.  
Republic of Ireland 1 year £38.95, 2 years £62.00, 3 years £81.85.  
Mainland Europe 1 year £49.00, 2 years £78.40, 3 years £102.90.  
Rest of World 1 year £63.50, 2 years £101.00, 3 years £133.00.  
Cheques should be made payable to *Television*.

## BACK NUMBERS

If available issues are £4.00 each.



**HIGHBURY**  
Business Communications

A SUBSIDIARY OF HIGHBURY HOUSE COMMUNICATIONS PLC

# TELETOPICS

## Broadband satellite internet service launched

Satellite operator SES Astra and AVC Broadband, a network and communications company, have launched the UK's first nationwide consumer broadband internet via satellite service. The download speed is in excess of 512kbits/sec, ten times that provided by a standard 56kbits/sec phone-line modem, and the service provides unlimited internet access. It's intended primarily for the 29 per cent of households in the UK that don't have access to terrestrial broadband services.

There will be an initial installation and set-up charge of about £250 to cover the provision of a dish, cabling and the USB satellite modem, though the service can make use of an existing Astra digital satellite TV mini-dish. AVC Broadband uses the existing phone line and modem for the return path, so customers can retain their existing ISP and email addresses. The subscription charge is expected to be about £35 a month.

In addition to internet access, services

will include on-line gambling, video and music on demand, video and music streaming and others. AVC Broadband will be available directly from AVC, from independent electrical and PC retailers and satellite installers. Those who carry out installations have to be accredited, which means they will have completed a course run by the CAI (Confederation of Aerial Industries). The work includes testing the PC used and checking that the digital satellite TV installation is functioning correctly.

### Japanese go for UHDV

The Japan Broadcasting Corporation has demonstrated a UHDV (Ultra High Definition Video) system with some 4,000 lines and sixteen times the equivalent pixel count of the current 1,000-line HDTV system.

This sort of resolution should not be too great a problem in the AV sphere, but spectrum space for broadcasting could be another matter. JVC plans to introduce Direct-drive Image Light Amplifier (D-ILA) projectors in Japan in the second half of 2004, for large-screen entertainment. The pixel count would be 3,840 x 2,048. JVC will be supplying this technology to other major AV manufacturers.

## Microsoft's Media Center system launched

The Microsoft Media Center PC system has been launched in the UK. It enables a PC to be converted for use as a TV set, personal video recorder and DVD recorder, but is not available as an upgrade option. Windows Media Centre is a super-set of the Windows XP Professional operating system, and comes preloaded on a PC.

Microsoft says that the basic specification for a Media Center PC includes a mid- to high-end processor, more than enough memory to cater for computing and entertainment needs, high-capacity hard disks, CD-ROM/DVD drives, advanced graphics and audio capabilities, and networking connectivity. An advanced

graphics card is required to display TV pictures on a computer monitor screen. Optional features include a hardware encoder that enables TV material from cable, satellite or terrestrial sources to be recorded on the PC's hard disk, an output that enables Media Center content to be displayed by an external TV set, a digital audio output for linking to a home entertainment system, and a Media Center compatible remote-control unit that can be used to communicate with the PC and a cable or satellite TV STB.

Packard Bell has launched a range of Media Centre PCs at prices ranging from £1,199 to £1,499.

## DAB update

During October the BBC switched on three more DAB transmitters as part of its plan to increase the BBC's national digital radio coverage to 85 per cent of the UK by the middle of 2004. BBC coverage now extends to 70 per cent of the population. The three new transmitters are Angus (Dundee), Blunston (Swindon) and Churchdown Hill (Cheltenham/Gloucester).

Goodmans has released a DAB radio, Model GSR80DAB, at £90 – it's described as a portable stereo kitchen radio, maybe because it includes a cooking timer and a

clock. It also incorporates an FM tuner, and can store up to twenty stations.

Digital radio software specialist firm Radioscape has introduced a new version of its RS200 DAB/FM/RDS receiver module. Radioscape worked in conjunction with Texas Instruments to develop the ICs in this module, which is used by Morphy Richards, Roberts Radio and other manufacturers. The new version, RS200L, adds an L-band tuner (Band L is used in Germany and Canada for DAB broadcasting). It also incorporates a memory that provides up to ten minutes of audio live pause or rewind.

## Digital TV forecasts

Two recent surveys indicate uncertainty about the UK's move to digital TV only. BARB (the Broadcasters' Audience Research Board) reports that at the beginning of November 2003 about 50.4 per cent of viewers had access to digital TV services of one sort or another, with Sky One having the largest audience. A report by Informa Media suggests that the government may find it impossible to reach the target of 95 per cent digital TV households by 2006-2010, the time at which the analogue switch-off is planned to take place.

Informa Media forecasts that Freeview will have added 1.3m homes during 2003, bringing the total to 2.4m. It expects the take-up of Freeview to decline over the next few years, with 678,000 homes added in 2004 and some 357,000 in 2005, falling to about 250,000 a year thereafter. If these forecasts are correct, Freeview would be received by about twenty per cent of households by 2010, a total of 4.7m. Informa Media forecasts that by this time 49 per cent of households will be receiving satellite and cable digital TV services. This suggests that only 69 per cent of households would be equipped to receive digital TV.



Tatung has launched this 30in. LCD TV, Model TLT3001S. Features include Nicam stereo, a multi-standard tuning system, 250-page teletext, picture-in-picture, picture-and-picture and a comprehensive range of connectors, including four video. There is a PC interface with VGA and audio inputs. The Tatung range also includes a 42in. plasma-screen model.

## Semiconductors

Micronas has introduced a range of single-chip analogue TV processors, the VCT49XYL series, that integrate the functions of IF, audio, video and deflection processing and control. Designed to be suitable for use with a wide range of TV standards, the software- and pin-compatible chips can be used in anything from low-cost mono sets to high-end ones with 16:9 flat screens and surround sound. The chips can also process FM radio transmissions and the radio data services RDS/RBDS without the need for any additional components. For further information go to the website at [www.micronas.com](http://www.micronas.com)

Maxim has introduced an unusual IC, type MAX9890, that's called a de-thumper. It's for connection between an audio amplifier and headphones to cut out switch-on transients. The IC operates at 2.7-5.5V, 20µA and provides 23dB of suppression. Third harmonic distortion is 0.006 per cent with a 32W load. Shutdown current is 1nA. The only other component required is an 0.1µF capacitor.

Xicor has launched a range of 'front-end' chips for converting RGB or component video signals from a PC, DVD player or STB to drive a high-resolution flat-panel monitor, LCD projector or

HDTV set. The ICs in the range operate at 140, 170, 210, 240 or 275Msamples/sec to provide different resolution displays. Each has three independent 8-bit channels that feature low-noise signal processing, a low-jitter digital PLL for high resolution and a wide input bandwidth to ensure ultra-sharp images. Additional peaking can be applied to restore sharpness when long cable lengths are used. An automatic black-level compensation circuit eliminates offset errors caused by mismatch and drift. The chips in the range are as follows: X98027 QXGA resolution; X98024 WUXGA resolution; X98021 UXGA resolution; X98017 WSXGA resolution; and X98014 SXGA and lower resolutions.

Researchers at Virginia Tech in the US have developed a fast, snubberless high-power switching device called an ETO (emitter turn-off) thyristor. It combines GTO (gate turn-off) thyristor and IGBT (insulated-gate bipolar transistor) technology. Current GTOs require a snubber capacitor for protection during turn-off, but this wastes power, slows the turn off and increases the complexity of the energy-recovery circuits. The device can handle 1.5kA, with surges to 10kA.

Sharp and Toshiba. China last year produced some 19m TV sets, making it the world's largest manufacturer. China's Electronics Exporters Association has pledged to work with US officials to prove that allegations of dumping are unfounded.

Dell is implementing its plans to enter the consumer electronics market. It has introduced a range of LCD TV sets in the US, and has now launched a 17in. LCD TV model in Japan. Dell is also selling MP3 music players. Hewlett-Packard plans to start selling large-screen flat-panel TV sets in the US during the first quarter of 2004.

combines a digital satellite tuner with a modulator which provides a PAL, NTSC or Secam analogue TV output at either UHF or VHF. There is also a loop-through circuit to enable a terrestrial TV aerial or a hybrid fibre coaxial cable outlet to be connected.



JVC has launched a range of three 'natural flat' widescreen CRT TV sets with 36, 32 and 28in. screens – Models HV-36P38, HV-32P37 and HV-28P37 respectively. Features include new-generation DIST (Digital Image Scaling Technology) plus contour and colour enhancement, motion compensation, a digital comb filter and auto video-noise reduction. Model HV-36P38 has an impressive loudspeaker array – four 3 x 10cm speakers, two tweeters and a 13cm sub-woofer.

JVC is also about to launch a range of LCD models and a 42in. widescreen plasma-panel TV. More details next month.

## Memory Stick developments

Philips has licensed Memory Stick technology from Sony for use with its Nexperia range of programmable chips for multimedia applications. Samsung has also reached agreement with Sony to manufacture products that incorporate Memory Stick technology – under a previous agreement signed in 2001 Sony worked with Samsung to add Memory Stick compatibility to a range of Samsung products, including DVD players, mobile phones, PCs and TV sets. The new licence allows in-house manufacture of Memory Stick products by Samsung.

Sony has recently doubled the capacity of the Memory Stick Duo, which is a third the size and half the weight of standard Memory Sticks and is designed for use in portable products such as mobile phones and digital cameras. The Memory Stick Duo can now store 128MB of data. Sony has also developed a Memory Stick Pro Duo, which can store 256MB or 512MB of data.

Panasonic has developed a 1GB version of its SD memory card. The data transfer rate is 20Mbits/sec, which is twice as fast as the 512MB version. The card can store up to 16 CDs (64MB per disc), 385 JPEG images of 5-megapixel quality, 24 minutes of MPEG-2 material in DVD quality, or nine hours of MPEG-4 material (384kbits/sec).

## Around the world

The Commerce Department has ruled that China is selling TV sets at below cost in the US. This could result in the imposition of import duties between 28-46 per cent on some of the most popular brands, including Apex, Emerson and Sansui. The duties are being imposed provisionally and will not be finalised until a ruling by the International Trade Commission, expected in May. Few TV sets are nowadays assembled in the US, though some 5,000 employees continue to produce sets for Philips, Samsung, Sanyo,

## Latest TV indexes

The 2004 Television Index and Directory is now available on CD-ROM at £199. It covers sixteen years of Television magazine issues from 1988-2003, with the text of all TV, VCR, camcorder, DVD player, audio equipment, monitor and satellite receiver/decoder fault reports in full, searchable by make and model; the text of over 250 major servicing articles; a spares guide; a directory of trade and professional organisations; a TV transmitter list; an international TV standards guide; a satellite TV channel finder; and a compendium of internet resources for service engineers. A full upgrade for those with a previous index CD-ROM is available at £46.

A Television index only, covering 1988-2003, is available at £36 – or an upgrade costs £18. For further information see page 185.

## Sat TV tuner with terrestrial modulator

Philips Electronics has introduced a satellite TV tuner that incorporates an analogue terrestrial TV modulator. The SDM1700



# New CRTs from LG.Philips

**The Cybertube+ SuperSlim range is being launched to compete with flat-panel displays. P.J. Haddock describes its advantages and the new technology involved**

TV tube development continues despite the increasing effort being put into liquid-crystal and plasma displays. LG.Philips Displays, the world's largest manufacturer of TV and monitor tubes, has recently announced a new range of CRTs, the Cybertube+ SuperSlim. They will enable setmakers to produce stylish new sets that appear to be little deeper than flat-panel types, while benefiting from the performance, cost and life-expectancy advantages of a CRT. Performance benefits include superior colour rendition and contrast ratio, and freedom from motion artifacts (blurring).

production at the LG.Philips Displays plant in Durham. The improved design has resulted in a tube that's actually more robust during manufacture and in use than previous 21in. tubes. Successful pre-production prototypes of the 32in. tube have been made and volume manufacture does not appear to present any problems. Photo 3 shows the ultra-slim profile of the 32in. widescreen tube.

These two tubes are the first in the planned range.

## The technology

LG.Philips Displays emphasises that the new tubes can be manufactured with standard CRT production technology and used in standard TV chassis. The improved design has been achieved by treating the tube as a single entity, with each component element (electron gun, deflection yoke, shadowmask and screen) optimised in relation to overall system performance. Some parameters depend on two or three factors. Compensation for the deformation that occurs as the beams pass through the deflection field has for

## Initial tubes

The first two CRTs to be announced are a 21in. 4:3 aspect ratio real-flat screen tube with 110° deflection (90° is normal with 21in. tubes) and a 32in. real-flat widescreen tube with 125° deflection. These wide deflection angles enable the front-to-back depth of the tubes to be reduced to 35cm. Photos 1 and 2 show the reduction in TV set depth that can be achieved with them.

The 21in. tube is entering volume

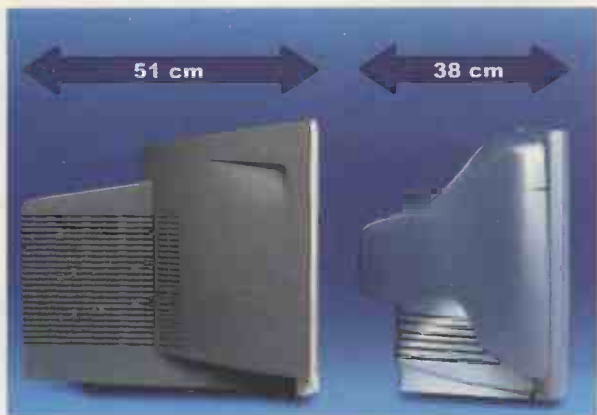

**Photo 1:** Use of the new LG.Philips 21in. Cybertube+ SuperSlim tube enables the depth of a typical 21in. real-flat 4:3 format TV set to be reduced by 13cm, to about 38cm.



602 8921

(16)

example been provided by the inclusion of beam-forming plates in the electron gun.

This integrated approach is crucial in obtaining the required spot performance (size and homogeneity) with the increased deflection angles. Excellent spot performance over the entire screen area has been achieved without the need for a DAF (Dynamic Astigmatism and Focus) gun. This not only reduces the complexity of the gun but means that the 21in. tube can be used in a standard 25in. TV chassis, which will provide the required deflection. In fact because of the zero-DAF gun and highly-efficient yoke both tubes can be used in standard TV chassis with minimum modification. The gun used in these tubes has conventional oxide cathodes while achieving the spot performance usually associated with more expensive impregnated cathodes. This adds to the overall performance and price competitiveness.

Advances in the design of the gun, such as reduction in gun pitch from 6.5 to 5.5mm and the incorporation of special beam-forming electrodes, have been achieved by using advanced computer-aided simulation techniques that model the behaviour of the electron optics accurately. As a result the gun out-performs previous non-DAF guns used in the company's 21in. tube range and equals the performance of the DAF gun used in its existing 32in. Cybertubes.

Another example of the fine-tuning made possible by computer-aided design relates to the deflection yoke. The geometry of the windings in the rectangular-coil yoke (see Photo 4) has been adjusted for optimum deflection sensitivity, colour convergence and picture geometry. As a result, even the 125° 32in. tube has a deflection sensitivity of just below 50mJ, convergence errors less than 1.5mm and geometric distortion less than 2mm.

The use of a 125° deflection angle with the 32in. tube means that the beam strikes the shadowmask at a very shallow angle close to the edges of the screen. Compensation has been provided by optimising the mask curvature and by careful design of the mask-suspension system. As a result the ambient and local doming performance match that

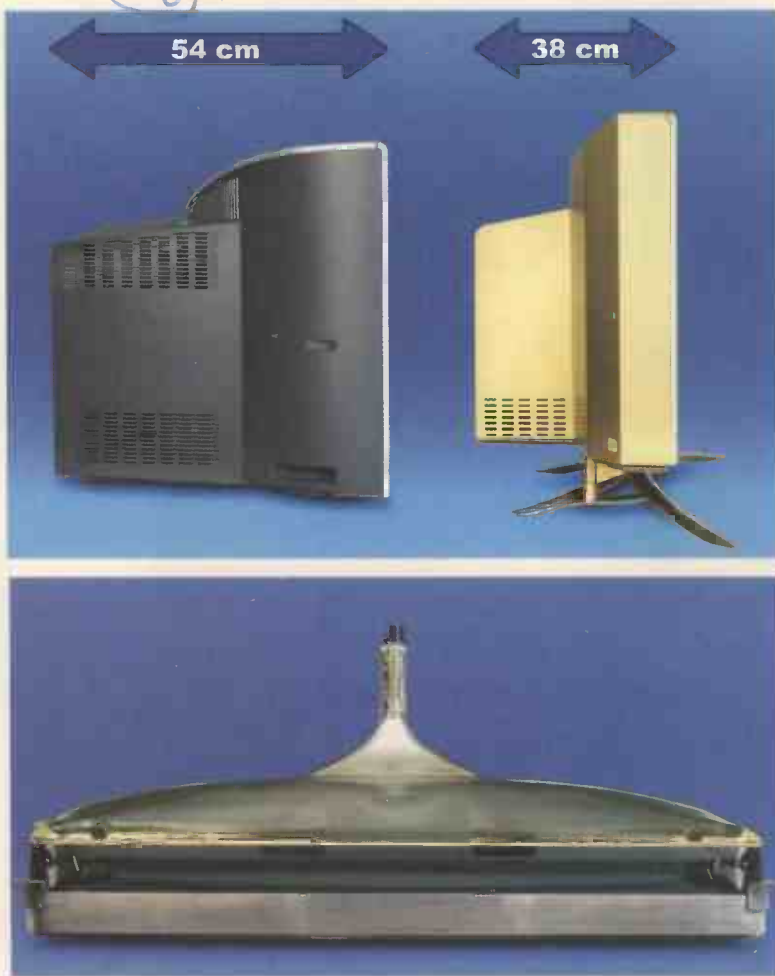

Photo 2: The LG.Philips 32in. widescreen Cybertube+ SuperSlim tube also enables the depth of a set to be reduced to 38cm, giving it a clearly slim-line appearance.



Photo 3: The ultra-slim profile of the LG.Philips 32in. Cybertube+ SuperSlim tube.

of a conventional 32in. tube.

Because of their shallow profile the tubes use less glass than conventional ones and therefore weigh less. Reduction in depth and weight offers setmakers significant savings with factors such as packaging and transport costs. In comparison with conventional 21in. TV sets for example about fifty per cent more slim-line sets can be packed into a standard transport container, and each set requires less packaging around it.

#### In conclusion

CRTs continue to provide superior performance and cost less than equivalent flat-panel displays, and have a longer life. The TV set footprint with these CRTs is in fact little more than that with a flat-panel display, because to achieve stability the stand required for the latter is often considerably deeper than the set itself. And, despite the publicity photos, not all users find it convenient to hang a flat-panel display on the wall.

The Cybertube+ SlimLine tubes described here were demonstrated at a show held by LG.Philips Displays to coincide with the

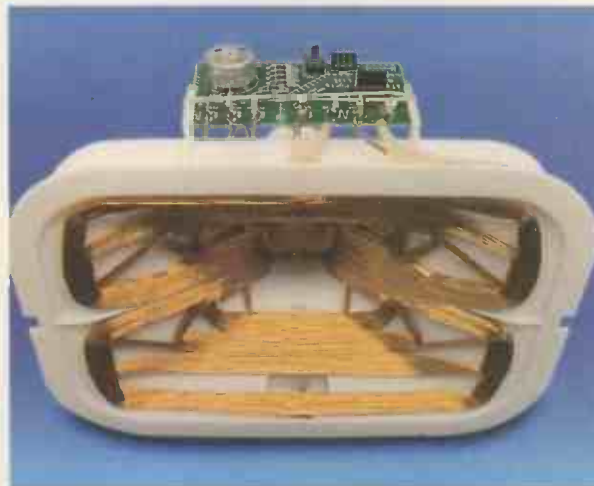

Photo 4: The double-mussel rectangular-coil deflection yoke assembly developed for the 32in. widescreen Cybertube+ SuperSlim CRT.

recent IFA at Berlin (see the November issue, pages 12-15). Other picture tubes on show included the company's new 36in. widescreen real-flat high-definition CRT and tubes that use tinted glass to achieve exceptional contrast and white uniformity without the need for vulnerable colour-tint screen coatings. ■

# Introduction to computer networking

Work patterns for electronics installers and service personnel are changing. A major area of expansion today is computer networking – LANs and WANs (local- and wide-area networks). Networking enables information to be exchanged between computers, and resources to be shared. Fawzi Ibrahim starts a new series that explains what is involved

**A** network is a number of computers linked together in a way that enables information to be exchanged between them. It also enables resources such as printers, and files on the hard disk or CD-ROMs of one computer, to be shared by others in the network.

A network can be as small as two computers or as large as the internet. A small network,

consisting of a few computers at a single location such as an office, a building or a campus, is known as a local-area network (LAN). A larger network, involving a number of LANs at different locations, is called a wide-area network (WAN). High-speed connections, possibly involving satellites, are normally used to link the various parts of a WAN. The internet is a world-wide network (web) that

incorporates WANs in different countries. A private part of the internet, within a single company, is known as an intranet.

## Network types

The computers in a LAN may be linked in either of two ways, peer-to-peer or server-client (see Figs. 1 and 2). In a peer-to-peer (P-P) network the computers all have the same status and each one has direct access to every other one in the network. Microsoft refers to a P-P network as a workgroup environment. In a server-client network, which is more centralised, one (or more) computers have a different role from the others. These are the server computer(s). Networks of this type are administered centrally and provide more secure, centralised resources for sharing by a number of client PCs/workstations. Because servers hold an organisation's most valuable data, they are normally located in secure rooms or closets to prevent unauthorised access.

## Topologies

The way in which the computers are linked to each other is called topology. The most widely used topologies are bus, star and ring.

With bus topology, see Fig. 3, each computer is connected to a single cable by means of a T

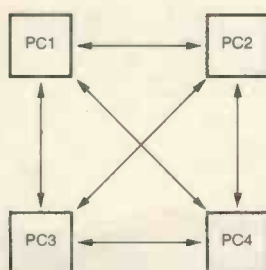

Fig. 1: Peer-to-peer networking.

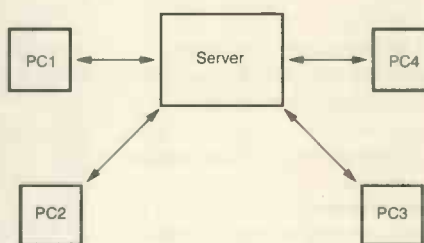

Fig. 2: Server-client networking.

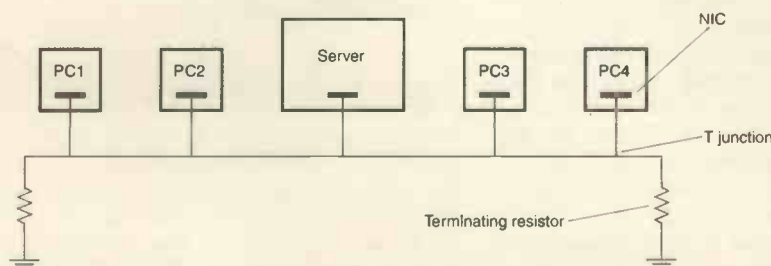
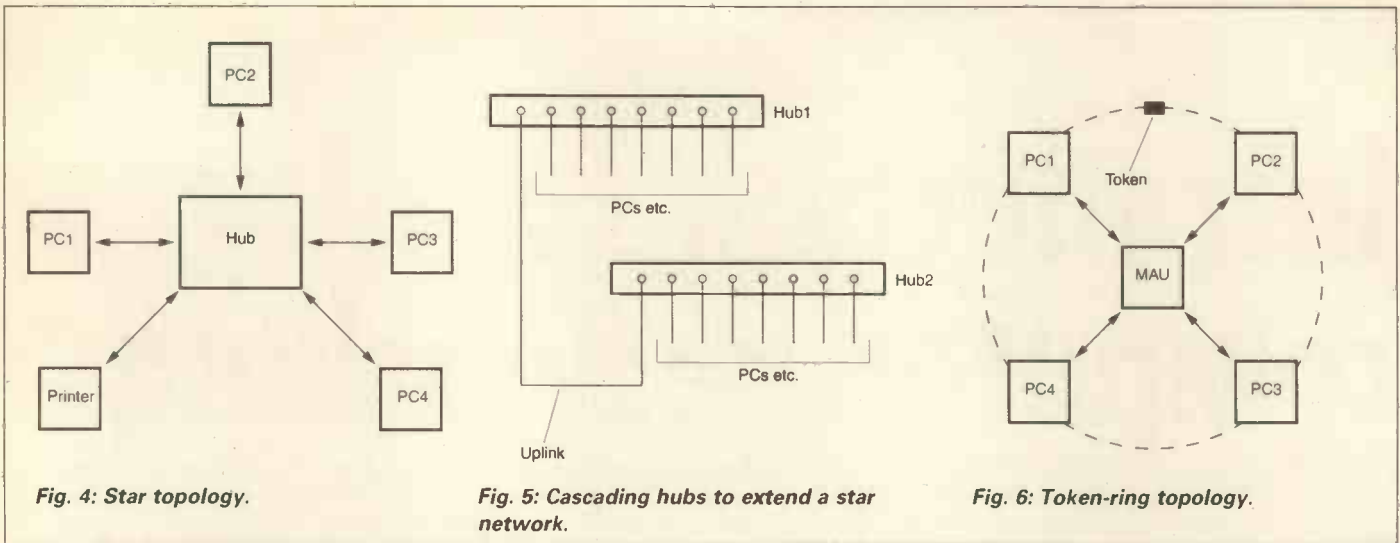

Fig. 3: Bus topology, with four workstations and a server computer.



junction. A terminating resistor whose value is equal to the cable's characteristic resistance, e.g. 50Ω for a thinnet-type coaxial cable, is fitted at each end of the cable to prevent data reflection, which would cause interference. With bus topology the failure of one PC/workstation does not cause network failure, but a break in the cable would do so.

The advantages of bus topology are easy cable connection, inexpensive cable and connectors can be used, and the fact that failure of a single workstation doesn't affect the rest of the LAN. Disadvantages are limited cable length and number of computers, the fact that heavy traffic can cause sudden performance degradation, difficulty in isolating network errors, and the fact that a break in the cable affects the whole network.

Star topology, see Fig. 4, is a type of bus arrangement except that each computer or resource (e.g. printer) is linked to a central unit, known as the hub, which provides a common interconnection for the devices to communicate with each other. The hub has a number of ports (eight, sixteen etc.) to which the devices can be connected via category 5 cable.

Signals from any device connected to the network are passed in this way to the others. It's easy to add or disconnect PCs, printers etc. To expand the network, other hubs can be connected in cascade – see Fig. 5. An advantage of star topology is that failure of one device or the cable connected to it does not affect the remaining parts of the network. The star arrangement provides central monitoring and control, since all the connections

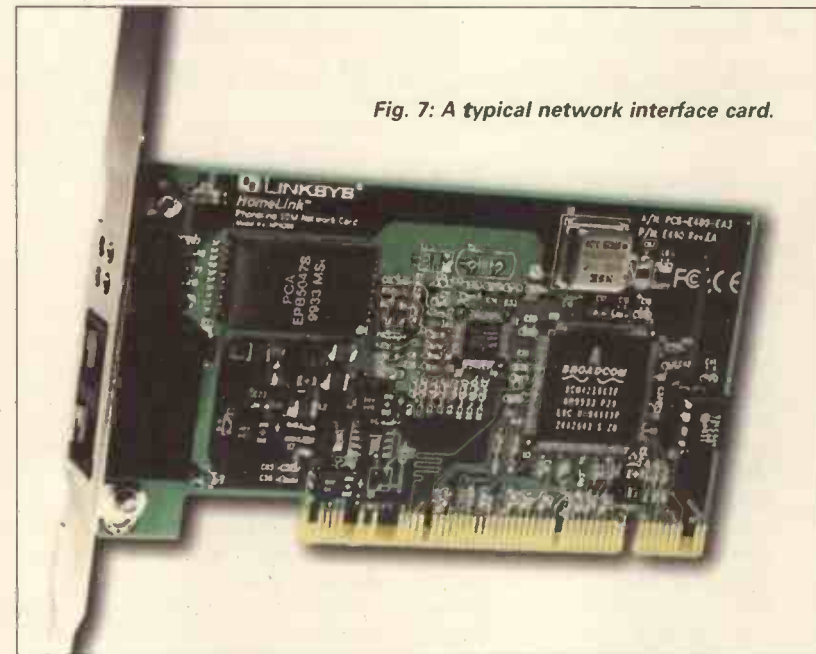

Fig. 7: A typical network interface card.

are made at one point, the hub. Failure of the hub will cripple all the workstations connected to it however.

With the token-ring arrangement, see Fig. 6, each PC is connected to the next with the last connected to the first to complete the ring. But the ring is not a physical one: instead, a central hub known as a media-access unit (MAU) or multi-station access unit (MSAU) is used. Signals from one PC travel to the MAU and are sent out to the next one, returning to the hub and continuing in this way until they arrive back at the PC from which they originated. Thus although the arrangement looks like a star the signal path is a ring. The arrangement is, for this reason, also known as a "logical ring".

Computers use a token to transmit data, and must wait for a free token before they can start to

send a message. The token contains the source and destination addresses. When the recipient device receives the message it

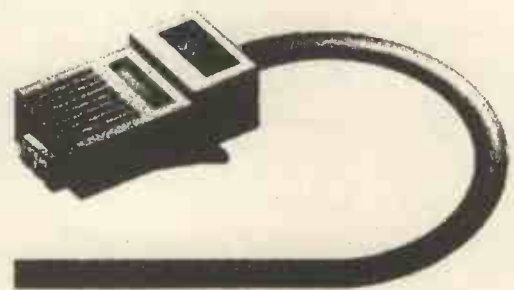

Fig. 8: The RJ-45 connector for UTP cabling.

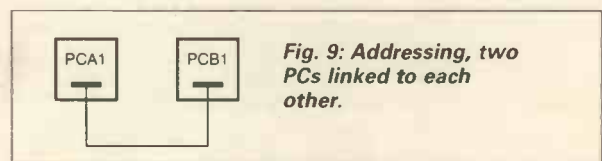
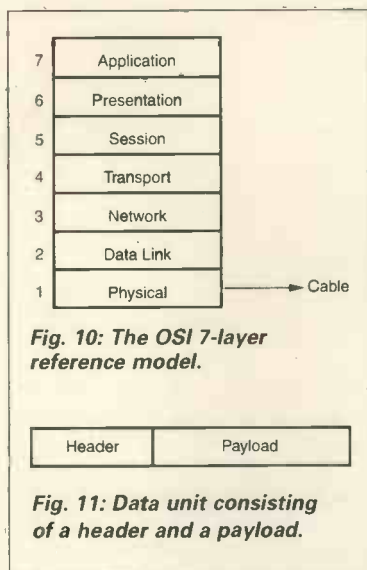

Fig. 9: Addressing, two PCs linked to each other.



**Fig. 10: The OSI 7-layer reference model.**

**Fig. 11: Data unit consisting of a header and a payload.**

returns the token to the originating computer to verify that the message has been received. The token is then handed on to the next computer in the ring and so on.

In comparison with bus topology, wiring a token-ring is complex and expensive. It provides centralised monitoring and control however, by means of the MAU. When there's a malfunctioning computer or cable, the MAU can effectively remove the offending computer from the ring, enabling the rest of the network to function normally.

### Hardware and software

Hardware includes the computer, a network interface, connecting cables and associated connectors, hubs, switches, repeaters, routers and bridges. Software includes the computer's operating system and the various protocol and application programs.

A network computer's requirements, in terms of processor speed, system RAM, hard-disk capacity and peripheral devices, depend on its role in the network (workstation or server) and the type of network operating system in use. Several operating systems can provide networking. Some, such as Windows 3.x, 95, 98 and ME, provide only peer-to-peer operation. Novell 3.11 upwards provides server-client operation only, while Windows NT and 2000 can be used for both peer-to-peer and server-client operation.

In most computers interfacing takes the form of a network interface card (NIC) which is fitted in a PCI, ISA or EISA slot on the motherboard. See Fig. 7. Some computers incorporate the network-adaptor function on to the motherboard itself.

Installing a network card with non-plug-and-play operating systems such as Windows NT and Novell 3.x onwards involves setting its IRQ (interrupt request) and port address, such as 5 and 320 respectively, and loading the appropriate NIC driver. With plug-and-play operating systems such as Windows 2000 an IRQ and a port address are allocated by the system itself. Drivers are normally provided by the manufacturer of the NIC, on a floppy disc or more recently a CD-ROM. But network operating systems provide drivers for most commonly used network cards: these can be selected manually or searched for by the operating system – this is the case with Windows 95 onwards.

Network cards normally provide one or two connections for different types of cable. The most common connectors are BNC for coaxial cable (known as thinnet coaxial) and RJ-45 for a twisted pair. In addition a 15-pin DB-15 connector may be provided for thick coaxial cable, known as thicknet.

The purpose of the NIC is to transform the information packets generated by the relevant computer protocols into a series of digital bit stream ones and zeros that can be sent along a communication cable.

### The MAC address

Every NIC has a unique identification number or address, which is known as the MAC (Media Access Control) address or physical address. It's a 48-bit code written as a 12-digit hex number, such as 00 08 0D 5E 8F 0A. The address is divided into two equal parts of 24 bits each. The first, 00 08 0D in our example, is the manufacturer's code: the second, 5E 8F 0A here, is a number that's generated at random during the manufacturing process. The possibility that two network address cards would have the same MAC address is virtually nil. Every adaptor card, including adaptors that are built-in on the motherboard, has a unique, recognisable number for communications use.

### Cables

Two main types of cable are used in networks, coaxial and twisted pair. The former comes in two varieties, thinnet (RG-58) for distances up to 185m and thicknet for longer distances. The most common type of connector for

coaxial cables is the Bayonet-Neill-Concelman (BNC). There are two main types of twisted-pair cable, the unshielded twisted pair (UTP) and the shielded twisted pair (STP). There are several categories of UTP, with different properties in terms of bandwidth, speed and use. Table 1 summarises these. The standard connector for UTP cabling is the RJ-45, see Fig. 8. It's a plastic connector that looks like a large telephone-type connector. A slot allows the connector to be inserted one way only. RJ stands for Registered Jack. The standard designates which wire goes with which pin inside the connector.

Another type of cable that's becoming popular is the fibre-optic type, which consists of a centre glass core surrounded by several layers of protective material. Light rather than electrical signals are transmitted, eliminating the problem of electrical interference. This has also made it standard for connecting networks between buildings.

Fibre-optic cable can transmit signals over much greater distances than coaxial and twisted-pair cable, at extremely fast speed and much wider bandwidth. It is therefore useful for transmitting bandwidth-hungry services such as videoconferencing and interactive systems. The cost of fibre-optic cable is comparable to that of copper, but it's more difficult to install and modify.

### Open-system interconnection

Devices such as a hub or router operate at different stages of the communication chain. Before we consider these devices and their properties, we should take a look at the communication process. Network communication is based on the OSI (Open-System Interconnection) reference model, which consists of seven stages that are known as layers (see later). For this reason the OSI model is also known as the 7-layer reference model.

Consider the simple case of sending a message from A to B. A arranges for a courier to pick up a letter and deliver it to B. Since the transfer is between two clients only, there is no need to include an address with the letter. But if A wants to send letters to more than one person – B1, B2, B3, etc. – destination addresses must be included with the messages. If the

system is extended so that several people, A1, A2, A3 etc., can communicate with B1, B2, B3 etc., letter delivery will involve a number of stages: the collection of letters, sorting them according to their destination addresses, transporting the letters and delivering them to the individual addresses. Network communication is based on the same principles.

Fig. 9 shows two computers, PCA1 and PCB1, connected to each other directly via a communication medium such as a cable. Each is fitted with an NIC. Using an application program such as Word or Notepad, a text message can be written at PCA1 and sent to PCB1. PCA1's NIC will translate the text into serial data that can be sent via the cable. Since the two PCs are the only ones in the network, there is no need for a destination address to be included with the message. If a further PC is added to the network however a destination address will have to be included to indicate which PC the message is to be sent to.

The obvious addresses to use are those incorporated in each PC's NIC, namely the MAC addresses. For this reason the final message data frames created by the sender PC's NIC contain the destination MAC address and, normally, the source MAC address as well. These addresses have no relation to a PC's position in a network however. It would be like every home in the UK being identified by a unique name, such as Sea View, Ashcroft etc., with no reference to street name, town or district. MAC addresses are adequate for communication between computers on the same network, but when it comes to communication between networks in a WAN, such as the internet, a logical system of addressing computers, capable of routing messages between networks, is required.

### The OSI 7-layer reference model

Initially networks were built using different hardware and software specifications. As a result they were incompatible and it was difficult for networks to communicate with one another. There was thus the need for a standard network communication model, which was met by the International Organisation for

**Table 1: UTP cable categories**

Category	Use
1	Voice only (telephone wire)
2	Data to 4Mbits/sec (local talk)
3	Data to 10Mbits/sec (Ethernet)
4	Data to 20Mbits/sec
5	Data to 100Mbits/sec

Standardisation (ISO) when, in 1984, it approved a network model to help manufacturers create interoperable networks. This was the Open System Interconnection (OSI) model. It describes how information or data makes its way from an application program such as a spreadsheet or video clip through a network medium such as a cable to another application program at a remote network location.

The process is divided into seven stages, called layers, see Fig. 10. There are seven layers, with each layer providing a particular function. The top three layers, 7, 6 and 5, relate to the application in use. The lower four are concerned with the flow of data through the network.

The information generated at the Application layer is divided into blocks of data, which are also known as data units (DU). Each data unit consists of a header and a payload, see Fig. 11. The header contains identification, synchronisation and control information. This layer is closest to the user, providing services for the user's application which may be word processing, a spreadsheet program etc.

The next layer down, Presentation, receives the data units and formats them so that the data can be understood and read by subsequent layers. It then adds its own header to form a new data unit, a process known as encapsulation. Encryption and compression of data may take place in this layer. Examples of presentation-layer programs are JPEG, MPEG, ASCII and HTML.

The data is then passed to the next layer, Session, which carries out programming to define the start and end of a communication across the network, known as a communication session or conversation. It includes the control and management of bi-directional messages, and the synchronisation and management

of data exchange, adding its own header. Examples of Session programs are SQL and ASP.

The following four layers ensure that the remote location is identified, that bi-directional communication takes place, and that data is sent in a form that can be deciphered at the receiving end. Layer 4, Transport, establishes direct end-to-end communication between the source and the remote device. It generally provides at least two services, a 'reliable' connection-orientated service and an 'unreliable' connectionless service. The first ensures that a connection is made and an acknowledgement is received before data is exchanged. With the unreliable service a network connection is not necessary prior to sending a message and no acknowledgement is required. With this service there is no guarantee that messages sent out are actually received at the intended destination. The transport layer adds its own header to the data units it receives from the session layer, and produces its own data units which are known as segments for the reliable service and datagrams for the unreliable service.

Layer 3, Network, encapsulates the data units into packets by adding a header to each one. These packets are passed to layer 2, Data Link, which encapsulates them as frames, adding its own header. The Network layer functions at the network address level, by including the source and destination network addresses in its headers. The Data Link layer is responsible for the transmission of data, hence its name. The data frames it produces usually have three parts: a header which contains control/information, a data payload which is the packet from the previous layer, and a trailer which usually contains a checksum for error correction. The final Physical Layer 1 converts the data frames into a series of bits for

*Perm Client  
Lounge &  
Video x  
TV all snow  
01562 730896*

transmission and determines the transmission characteristics – type of modulation, error-correction and speed. These depend on the type of LAN. The most common are Ethernet, LocalTalk, Token Ring, FDDI (Fibre Distributed Data Interface) and ATM (Asynchronous Transfer Mode). LocalTalk is a protocol developed by Apple Computers for Macs. It's also known as AppleTalk. FDDI is primarily used to interconnect two or more LANs, often over large distances. ATM transmits data as small packets of fixed size instead of variable-length packets. It's used at speeds of 155-2,488Mbits/sec.

At the receiving end the process is reversed, the data units being de-encapsulated as they move from one layer to the next. Each layer removes the header from the previous layer to unwrap the data block within.

### The Data Link layer

The IEEE Standards divide the data-link layer into two sub-layers, LLC (Logical Link Control) and MAC (Media Access Control). The LLC sub-layer provides a path to and from the Network layer regardless of the type of network protocol used. Operating under the IEEE 802.2 specification (normally referred to as Ethernet 802.2) it is compatible with the different types of MAC standard. The MAC sub-layer generates frames that are appropriate for the physical layer standards used.

There are two main MAC control techniques. CSMA/CD, Carrier Sense Multiple Access with Collision Detection (IEEE 802.3), is for use with bus network topology. Token control is for use with either token bus (IEEE 802.4) or token ring (IEEE 802.5) topology.

In bus topology, where all the computers are connected to the cable via which data is transmitted, the cable is said to be in a multiple-access mode. Frames that incorporate the destination address of a remote computer are transmitted via the cable to all the other computers on the network. When a computer matches the destination address, it reads the data contained in the frames and responds accordingly. The source address is included as part of the frame header so that the receiving computer can direct its response to the computer that's sending the data.

It's possible, with this type of communication, for two computers to attempt to transmit a frame at the

same time, which would corrupt data from both sources. To reduce this possibility the source computer, before it transmits a frame, 'listens' to the cable to check whether another frame is currently being transmitted. If a carrier signal is detected, the computer defers transmission until the passing frame has been completed, then attempts to transmit its own frame.

There remains the possibility that two computers wish to transmit a frame simultaneously. They simultaneously listen for activity on the cable and, having sensed none, commence to transmit frames. A 'collision' is then said to have occurred, since the contents of both frames collide and are corrupted. To avoid this, a transmitting computer continues to monitor cable activity after transmission of a frame: if the signals are different, a collision is assumed to have taken place. When collision detect (CD) is found by one computer, it first enforces collision by sending a random bit pattern for a short time. The computers involved then wait for a further short random period before attempting retransmission. Collisions produce delays and create extra traffic. But as transmission of a frame is initiated only when there is no activity on the cable the possibility of a collision is very low.

The Apple Computer LocalTalk protocol uses CSMA/CA (Carrier Sense Multiple Access with Collision Avoidance) which is very similar to CSMA/CD. But with CSMA/CA the computer signals its intent to transmit before it actually does so. The Macintosh operating system enables peer-to-peer networks to be established without the need for additional software. With the addition of the server version of AppleShare software a client-server network can be established. A disadvantage of LocalTalk is its relatively slow speed, 230kbits/sec.

The other method of controlling access to the network is token control. The token is passed from one computer to another in accordance with a defined set of rules. A computer can transmit a frame only when it is in possession of the token. When it has finished transmitting a frame, it must pass the token on for use by another computer. If a computer with a token has nothing to transmit, it passes the token on. In this way only one computer at a time has access to the network.

### Network devices

**Hubs:** A hub connects a number of computers or other network devices together to form a network segment. All computers in this segment can communicate with each other directly. Ethernet hubs are the most common type, but there are hubs for other types of network, such as USB (Universal Serial Bus). Hubs operate at layer 1 of the OSI model.

A hub has a series of ports that accept network cable. Smaller hubs have four or sometimes five (the fifth being reserved for 'uplink' connections to another hub or similar device) while larger ones have eight, twelve, 16 or even 24 ports.

Passive hubs retransmit data but don't regenerate it. Active hubs regenerate the data before retransmitting it.

**Repeaters:** Network repeaters are used to regenerate data to ensure that its amplitude and shape is maintained. With a system like Ethernet, data can travel only a limited distance before degradation starts to occur. Repeaters try to preserve data integrity, extending the distance over which it can safely travel. Repeaters are normally integrated within hubs (see above). They operate at layer 1 of the OSI model.

**Bridges:** A bridge enables two separate segments to be linked together to extend the network's distance span. It doesn't modify packets or messages. Bridges operate at layer 2 (Data Link) of the OSI model.

**Routers:** These enable two or more LANs to be connected. They do this by unpacking each incoming frame to extract the IP destination address, thereby determining where to send each information packet. Operation is at layer 3 of the OSI model.

**Gateways:** A gateway enables systems that use different protocols to communicate with one another. Gateways use software that's able to translate data from one format to another. Gateways operate at layer 4 and above of the OSI model.

### Next month

In Part 2 next month we'll describe the practical implementation of the network protocols.

# MERRY XMAS AND A HAPPY NEW YEAR

14" CTV R/C  
FROM



£29.99

20" CTV R/C  
FROM



£37.99

28" WIDESCREEN  
R/C TEXT FROM



£99.99

32" WIDESCREEN  
R/C FROM



£199.99

TECHNIKA  
MULTIREGION  
DVD FROM



£24.99

VCR'S FROM



SPECIAL!!

£16.99

DVD'S FROM



MULTIREGION

£24.99

KE14P2B



14"Tv/Vcr Combi  
From

£54.99

Panasonic  
KXFP155



NEW!!

Plain Paper Fax

£59.99

INFLATABLE  
Speakers From



Brand New!!

£12.50

Hitachi Radio  
Alarm Clock



£39.99

SONY DAV-S888

NEW!!



\*Sony Dvd Home Cinema  
\*Dvd/Cd/Cdr/CdRw/Mp3 Playback  
\*6 Speaker System  
\*Total 600W: 100W x 5 100W RMS  
(10% THD), 12 Months Warranty!

£497.99

TECHNICS SCHDV560



SPECIAL!!

\*Technics Compact Component  
Stack System  
\*CD, Tape, Tuner  
\*Input select  
\*Silver w/Brown Side Panels

£199.99

DANSAI  
MULTIREGION  
DVD FROM

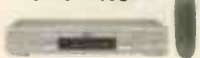

£29.99

OMICRON HALOGEN HEATER



Halogen Technology  
Instant Heat  
Variable Heat Settings  
Low, Medium & High  
Thermal Safety Cut Out  
Stability Safety Cut Out  
Double Safety Grills  
Low Running Costs  
Oscillating Feature

Brand New!! Only £15.99

INTERCOM SECURITY SYSTEM



\*Bell camera and full Accessories included  
\*Additional camera sold separate  
\*Infra Red Camera for Night vision  
\*Built in Mic for sound  
\*optional electric door latch activation  
\*Switch Between camera with A/B switch  
\*Two Way speech  
\*250 metre cable  
\*Audio/visual output

£34.99

MORPHY RICHARDS  
2 SLICE TOASTER



£7.49

PHILIPS FWC115 MICRO HIFI  
MICRO HIFI SYSTEM



£39.99

POP IDOL KARAOKE MACHINE



£84.99

FIRST AUSTRIA MCD-1050  
MINI HIFI



£44.99

FIRST AUSTRIA MCD1010  
MICRO HIFI SYSTEM



£29.99

TECHNICS SP-96



BRAND NEW!!

3x SURROUND SPEAKERS  
SILVER!!

£13.99

Naiko Dishwasher  
NDW080



£49.99

Panasonic  
NVGS10B



£269.99

HITACHI  
Cv800/810



£16.99

HITACHI  
HTDK150EUK



£119.99

WWW.TRADEELECTRONIX.CO.UK INFO@TRADEELECTRONIX.CO.UK

MUCH MORE TV'S VCR'S DVD'S HIFI'S ETC IN STOCK!!

All Goods are Graded unless otherwise stated, Goods are subject to Vat, carriage & availability Prices subject to change without prior notice

Trade  
ElectroniX

30/34 River street Digbeth B'ham B5 5SA  
Tel:0121 773 3300 Fax 0121 773 2300

# Coaxial cable quality

How important is coaxial cable quality? **Bill Wright** has had a lot of experience of the effects of inferior cable being used in various types of installation, but decided that he needed a measure of the performance of different cables. So he carried out some simple tests to find out how much the performance of various types of cable differs. The results and his conclusions are presented in this article

**Fig. 1: Different types of coaxial cable for TV use. From top to bottom: type A, with semi-airspaced dielectric, copper tape and copper braid; type B, with foam dielectric, copper tape and copper braid; type C, with semi-airspaced dielectric that has 'silver-paper' wrap and copper braid; type D, with semi-airspaced dielectric and copper braid.**

**S**ome months ago in these pages I raised the subject of the use of low-grade aerial and satellite download cables, and gave some examples of the sort of reception problems they can cause.

Awareness of these problems made me wish that I had a valid way of comparing the various types of cable in common use.

The effects of the use of inferior cable can be bad enough with a small domestic installation but are much worse, and more expensive to correct, with a distribution system that serves say a dozen flats. Quite often the TV system will, with a building contract such as a block of flats, be part of the electrical contractor's work. He in turn will pass on the specialist part of the work to a local TV shop or aerial installer. The electrician will supply and install the TV cables from the head-end or repeater positions down to the outlets. The aerial contractor's job is to come in near the end and install the aerial, dish, amplifiers, trunk cables and everything else that's necessary to make the system work.

I always specify the type of cable needed, and make it plain that if the electricians use poor-quality stuff I can't be held responsible for any problems that might

arise. In the world of competitive tendering however the temptation to cut corners is strong, and quite often my insistence on the use of good-quality coaxial cable is ignored. On many occasions I'm not even asked of course, because I'm not invited on to the job until it's too late – after the walls have been plastered and decorated. Now I'm never in any doubt about making a fuss over this, the only question being how much fuss? One might have a vague feeling that the signal levels at the outlets farthest from the head end are likely to be a 'bit low', but this sort of vagueness isn't enough when you are threatening to withdraw all relevant warranties.

Some time ago I realised that I needed a quantitative measure of the performance of different types of cable. Since the manufacturers of 'budget' cables don't publish figures, I decided to carry out a few simple tests to find out the extent to which the performance of various types of cables differs. Even if you never install anything more complicated than an aerial feeding one set, I think the results will be of interest to you.

## Types of cable

I've divided the various commonly-available cables into four groups, types A, B, C and D. They are all 75Ω download cables with an outside diameter between 6.6 and 7mm. From top to bottom, see Fig. 1, they are as follows

**Type A, semi-airspaced dielectric with copper tape and copper braid:** Commonly known as 'copper-on-copper', the best-known example of this type is Raydex CT100. Other makes are Cavell QC100 and Hycomm HYC100. The designation CT100 is often used in a general sense, no doubt to the great annoyance of Raydex. Be aware that some cables sold as 'CT100-type' are nothing like the genuine thing.

The expression semi-airspaced refers to the construction of the white dielectric, and means that it has 'cells' (holes) that run through it longitudinally. All semi-airspaced cables seem to have five 'cells', see Fig. 2. Copper prices rise and fall but, at the time of writing, this type of cable should cost no more than £18 + VAT per 100m. Confusingly, this type of cable is sometimes incorrectly called "double screened".

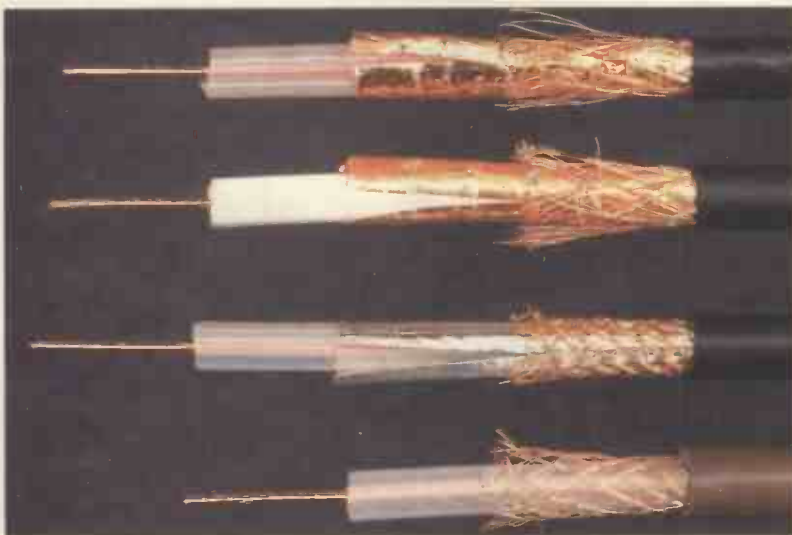



**Type B, foam dielectric with copper tape and copper braid:** These cables are identical to type A products except that they have a foam instead of a semi-airspaced dielectric. Semi-airspaced cables can deform quite easily when mishandled and for this reason foam cables, which are more robust when bent or crushed, are making a comeback. It's very difficult to fit semi-airspaced cable into a backbox without it kinking, so the reintroduction of foam cables seems to be a good idea. The foam cables of yesteryear absorbed atmospheric and other moisture rather readily, resulting in severe performance degradation, but the manufacturers assure us that the modern products are free from this defect. This type of cable is similar in price to type A, or perhaps slightly cheaper. The many different products available include Webro WF100 and Cavel QF100.

**Type C, semi-airspaced dielectric with 'silver-paper' wrap and copper braid:** This cable is sold as 'satellite download' but Sky forbids its use. The screen consists of a transparent plastic wrap with a microscopically thin layer of silver-coloured material bonded to it and very low-density copper braid. One peculiarity of this type of cable is that the dielectric will slide along very easily inside the screen. If the cable has been stretched slightly during installation, the inner core and dielectric can retract out of the F plug shortly afterwards, causing severe installer confusion! These cables sell for about £8.50 + VAT per 100m.

**Type D, semi-airspaced dielectric with copper braid:** This cable has no foil wrap. It's commonly called 'low-loss', a designation that originated in the early days of UHF transmission to distinguish it from the smaller-diameter, solid-dielectric cables used for VHF. It usually has a brown outer sheath, though the DIY sheds stock it in white. Over the years the braid density of 'low-loss' has mysteriously decreased. In 1969 it was quite a job to unravel the braid when fitting a coaxial plug; now there's hardly anything to unravel! Some manufacturers still produce this type of cable, with braid coverage as high as 60 per cent, but these products are rarely used. Much more common are the cheap versions with braid coverage as little as 20 per cent.

No manufacturer has ever pretended that this type of cable is suitable for satellite use, but this fact is persistently ignored by builders, and by Bodgitt & Scarper Aerials and others of that ilk. What the motive is I don't know, because these cables are generally no cheaper than the C type ones.

This cable is the site electrician's favourite. Left to their own devices, this is what some of them will use for everything – UHF, satellite, surveillance cameras, dog leads, the lot. It's almost universally used for built-in downloads in new housing, where individual aerials will be fitted.

### Signal loss

I tested types A and B first, and was relieved to find that my results corresponded pretty closely with the various manufacturers' figures. This suggested that my experimental method is valid. It is, in fact, very simple. I laid out exactly 50m of each cable, making sure that there were no kinks or sharp bends. As a UHF signal source I used a vision modulator from Satellite Solutions: Sky digital transponders were used as the satellite IF source. I checked both these sources at regular intervals during the tests, to make sure that there was no variation. The measuring instruments at

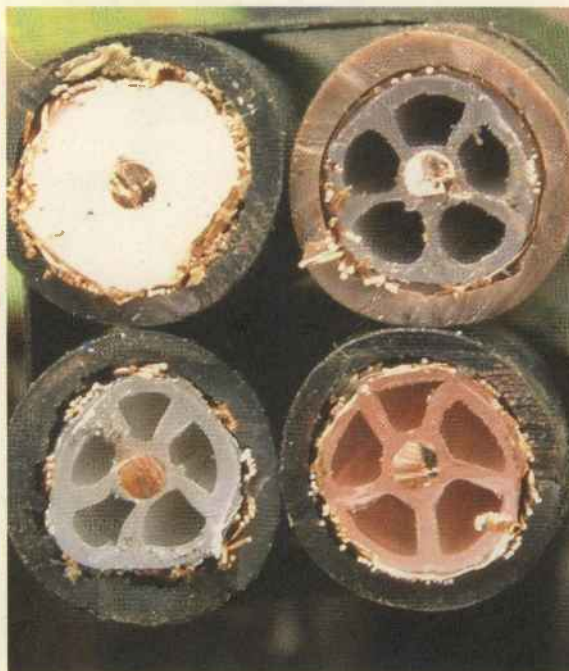

**Fig. 2: Different types of dielectric.** Top left, foam dielectric used in type B cable; top right, semi-airspaced used in type D cable; bottom left semi-airspaced used in type C cable; bottom right semi-airspaced used in type A cable.

the other end of the cables were recently-calibrated spectrum analysers. Fig. 3 shows the results.

Cable types A and B performed almost identically, so the results are shown as a single line. Losses climb to 18dB per 100m at the top of the UHF band, and 33dB at the top of the satellite IF band. Cable type C is significantly more lossy at 24.5dB and 44.5dB respectively.

There are many different D-type cables and, frankly, you only have to look at some of them to see that they are about as much use as wet string. For the tests I used one of the better products. Even so type D contributes a loss of 32.5dB at the top of the UHF band and a massive 66dB, *double* the figure for types A and B, at the top of the satellite IF band.

### Practical significance

What do these figures mean in practice? If we leave aside cable deterioration with age (of which more later), probably not all that much where cable runs are short. The problems arise where cable runs are longer

**Fig. 3: Comparison of signal attenuation per unit length with different types of cable.**

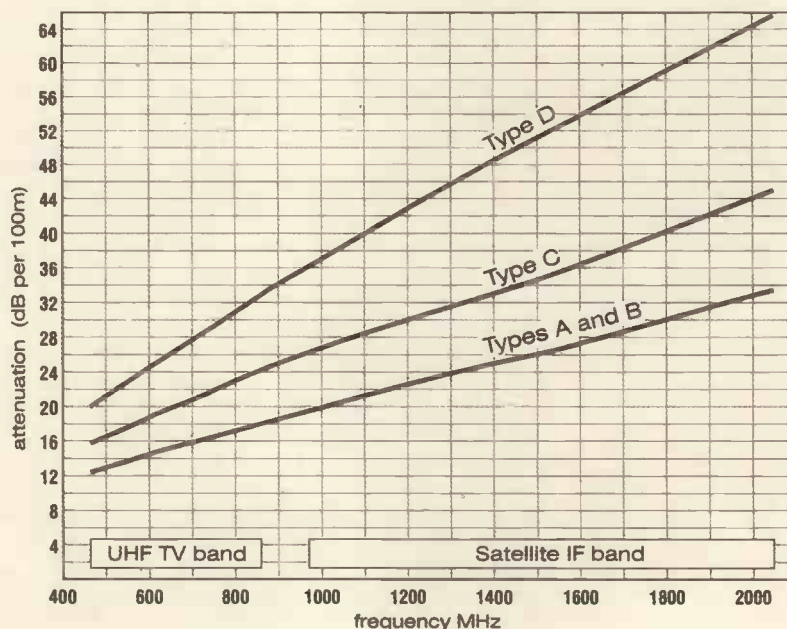

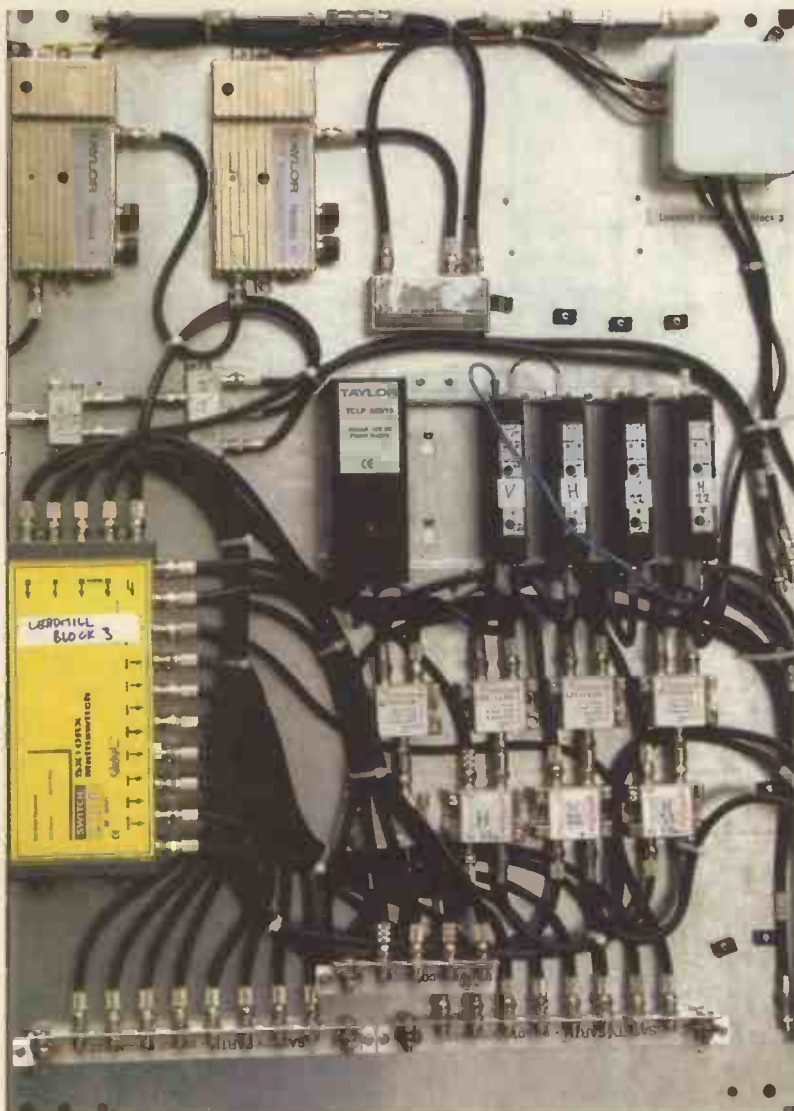

**Fig. 4: A distribution system head-end, ready for installation. The earth rails at the bottom are the connections for twenty downloads, some of which will be 30m long. The connections on the right are the feeds to the repeaters.**

than average, and where signal levels or carrier-to-noise ratios are marginal to start with. Take the following situation for example.

A wideband UHF aerial feeds a simple domestic distribution amplifier via 10m of cable, and one or more of the downloads from the amplifier to the outlets is 25m long. The signals carried include analogue ch. 21, transmitted at 500kW, and a 'must-have' digital multiplex on ch. 67, transmitted at 10kW. Sounds familiar? If type A or B cable is used the overall loss on ch. 67 will be 6.3dB. If type D cable is used, the overall loss increases to 11.4dB, and the ch. 67 signals will be attenuated 2.5dB more than the ch. 21 signal. This will add to an already very unsatisfactory signal-level imbalance and could increase the chances of digital signal dropout. Where cable runs are 30m or longer, type D cables are quite inadequate for UHF and of course absolutely hopeless for satellite IF.

Although type C cable performs significantly better than type D, in my opinion it is so far behind types A and B that it should not be used for good-quality UHF or satellite installations. For budget domestic installations, maybe. Cables of this type are sold as 'satellite' cable, and the unwary could quite reasonably suppose from this that their performance is good enough for even the more demanding installations.

Incidentally, distribution systems that carry satellite IF signals have each download going back to a

polarisation switch and, since the switches are normally located together in large groups (see Fig. 4), the downloads are likely to be long. In the case of the block of twelve flats mentioned earlier, all the downloads will lead to one amplifier and switch unit, so some of the cables might easily be 40m in length. Where satellite cable runs exceed 30m I prefer to use CT125 cable. This is a larger-diameter version of CT100.

### Screening

Inadequately-screened cables will both radiate and receive signals. This is a difficult thing to measure properly unless you have an electronics laboratory, but I was able to carry out a simple experiment that gave comparative, though not absolute, figures.

I laid out 50m of each of the cables under test, along with an additional length of type D cable. The latter, used as a 'transmit' cable, was connected to a high-level signal source. The other cables were tested for their ability to receive from it – or, perhaps I should say, their inability not to receive from it! All five cables were bundled together very loosely, with cable ties at 1m intervals, to simulate the sort of proximity that would be present if the cables had been installed in a wall cavity, across a loft, or whatever. The far ends of the cables were all terminated at 75Ω. The test was done at one frequency only, 727MHz. Table 1 shows the crosstalk figures, which are simply the differences between the signal fed to the transmit cable and those obtained from the receive cables.

Although the signal source and the measuring instruments were 5m apart, I think that the results for cable types A and B were compromised slightly by direct transmission from source to instrument. This is likely to happen with a ratio of 80dB. Slight movement of the connectors caused a fluctuation of a few dB. So, for this reason, the figures for cable types A and B are probably slightly worse than they would be in practice. The crosstalk with cable types C and D was much more 'solid'.

I repeated the experiment, this time with all the cables reduced to 20m. The results were virtually unaltered. I also attempted an experiment using type A cable for transmission, but could get no meaningful results from cable types A, B or C.

This strongly suggests that if the cables in an installation are all of type A or B crosstalk will be unmeasurably small. Cable type C's performance is perfectly adequate. But look at type D, returning -29dB! Remember that analogue video needs a signal-to-noise ratio of at least 46dB.

This simple test confirmed what a lot of installers have always suspected. Many and varied are the interference problems that can be cured by replacing cheap coax or flyleads with CT100 cable. Satellite IF leaking into a UHF feeder, computer noise entering the flylead of an adjacent TV set, maintained lighting chargers putting white lines across all the TV screens in the building – the list is endless. Downloads inevitably pass alongside or at least near mains cables so, given digital terrestrial TV's susceptibility to impulse interference, type D cable is simply not suitable.

### Cable deterioration

Coaxial cables deteriorate with age, mainly because of the gradual ingress of moisture. Visible evidence is presented by a yellowing of the dielectric and dark discoloration of the copper. Even when these signs are not present, the performance of a cable may fall off severely over a period of years. Type D cables seem to

suffer most, probably because the outer sheath is more permeable and there's no foil screen to act as a moisture barrier. TV distribution systems often share ducts and voids with district heating schemes and other plumbing: in such a humid, damp environment type D cables will become astronomically lossy after a few years. The signal losses are much worse at higher frequencies so, if you are quoting for the conversion of a system from Group A analogue to wideband digital, beware!

In my opinion type D cable should not be installed behind the plaster in a new building. I suspect that it picks up moisture as the building dries out, because deterioration seems to set in very quickly. This can become a serious problem early in the life of a building. The way technology changes nowadays, it seems very short-sighted to use anything less than CT100 cable. The cost difference is, after all, at most only a few pounds, and who knows what signals and frequencies these cables will be expected to carry during their lifetime?

### Kinks and bends

The characteristic impedance of coaxial cable depends partly on the ratio between the diameter of the inner conductor and that of the screen. When a cable is forced into a tight bend this ratio changes and an impedance 'bump' is created. This isn't the place to go into cable impedance, standing waves and what have you but, take my word for it, impedance bumps are a Bad Thing! The minimum acceptable bend radius is usually regarded as being about ten times the cable diameter, whatever the cable type.

The performance of coaxial cable will suffer if it has been ill-treated during installation – by kinking, being forced into small bends, or crushing. I suppose I should have set up some sort of comparative test in which the different types of cable were (a) subjected to a pretty violent installation by disgruntled electricians on piece rates and (b) installed by placid electricians keen on transcendental meditation. But I didn't. Take it as read: if coaxial cable is squashed, kinked, twisted, scorched or stretched, its performance will suffer.

What happens if a cable is bent repeatedly? This can occur during a difficult installation, or during normal use over a long period. Type C cable, with its transparent plastic wrap and thin layer of conductive material, suffers badly. Tiny radial cracks appear in the conductive coating and, since the braid is very skimpy, impedance 'bumps' are likely. But I must stress that repeated flexing of any coaxial cable will cause damage. The copper foil in type A and B cable can crack and, of course, the inner core of all cables will eventually snap. Special flexible coaxial cables are available, with seven-strand inners, solid dielectric and a dense braid of fine wire. But they are expensive and 'lossy', and are thus only really suitable for short interconnecting leads.

### Crushing and trapping

Cable clips should be of the correct size, and cable ties should not be over-tightened. Cables can be trapped and squashed accidentally, especially on a building site. When planning cable routes, try to anticipate the actions of 'other trades'. Cables in lofts should not run where, for example, they may fall victim to plumbers' size-twelve boots. Clip them to the side of timber that will be walked on, not the top. If it seems likely that a cable run will be mistreated in this way, use type B: foam-dielectric cables are physically tougher than any of the semi-airspaced ones.

Table 1: Screening efficiency test results

Cable type	Crosstalk from transmit cable (typeD)
A	-80.4dB
B	-81.4dB
C	-66.6dB
D	-29.0dB

### Cables to avoid

The list is many and varied. One such cable has no braid, just a few strands of wire that run longitudinally, and some sort of shiny (and allegedly conductive) coating that's attached to the inside of the outer sheath. Apart from the obvious screening deficiency, it's difficult to make a convincing connection to this type cable, which is very susceptible to kinking and crushing.

Sometimes electricians will use oddments of coaxial cable left over from previous jobs. This is where you are likely to encounter cable that's intended for baseband video use. Such cable is easy to spot, because it has a solid dielectric. It's very lossy at UHF, and utterly hopeless for satellite use. Remember that to the average electrician coax is coax, and if he has half a reel left over from a surveillance-camera installation he will use it for TV downloads. Similarly you may encounter 50Ω and 93Ω coaxial cable, which is useless for TV purposes. Any cable with an overall diameter of less than 6.5mm is highly suspect. Some cables have a type number printed at intervals along their length. Amongst the hundreds of different types of unsuitable coaxial cable that are available the following, in my experience, are commonly found on building sites masquerading as TV downloads: URM43, URM70, URM76, RG58, RG59 and RG62.

If you come across an unfamiliar cable, I suggest that you take a sample away and test it. Even a short length, say 10m, of unsuitable cable will show excessive signal loss if compared directly with the same length of CT100 cable. Carry out the test with high UHF channels or satellite IF. Thin braid cover is a sure sign of inadequate screening.

### Summary

For distribution systems and good-quality domestic work use copper-on-copper cable with either semi-airspaced or foam dielectric. If the cable will, unavoidably, have to be forced into tight bends, or might be crushed, use a foam type.

For long runs, especially with satellite signals, consider the use of a larger-diameter cable such as Raydex CT125 or Cavel QC125.

For budget domestic work, type C cable is probably the best choice. Since this type of cable costs about the same as the 'low-loss' type D, there seems to be no point in using the latter. But bear this in mind: the cost difference between the best cable and the worst is only about £1.50 for a standard domestic aerial job. I have to say that the only cables you will find in the back of my van are types A and B.

Most installers know that good cable is essential for satellite use, but I hope that this article has clarified the differences between 'good', 'not so good' and 'bad' cable. The message hasn't quite got through to many however that UHF also requires good cable. I think our trade should recognise that cable quality is an important issue, particularly for digital reception. ■



**The International Broadcasting Convention is where the future unfolds. This year's event was held at the RAI centre, Amsterdam in mid-September. J. LeJeune reports on current developments**



# IBC 2003

**T**here were nearly a thousand exhibitors at this year's International Broadcasting Convention, which was held at the RAI centre in Amsterdam between 11-16 September. They occupied eleven halls plus a large part of the car park. Attendance increased by six per cent, but has still not reached the pre-September 11 2001 levels. There was not a lot by way of innovative products, but there were plenty of interesting developments of existing technology to grab the attention.

## Digital video encoding

Work on increased data compression continues apace, and some interesting low bit-rate encoders were demonstrated. There are two competing standards here, Windows Media 9 and H.264/MPEG-4/10. Both are capable of providing good results with 'standard' quality pictures at bit rates

between 1.5-2Mbits/sec. High-definition TV, about which more later, can be encoded at bit rates as low as 4-8Mbits/sec.

The Tandberg Television demonstration of Windows Media 9 encoding of some rapid-motion video at a bit rate of only 1.5Mbits/sec was most impressive. Windows Media 9 seems to be regarded as the better performer, but MPEG-4/10 is not far behind.

With all the attention being paid to new compression techniques, MPEG-2 may seem a bit passé. But some major manufacturers were showing MPEG-2 encoders that provide excellent performance with video encoded at only 2Mbits/sec. MPEG-2 obviously has some life in it yet, so there's no need for now to scrap relatively new equipment in favour of other forms of compression. HDTV encoders with bit rates as low as

4Mbits/sec were giving a good account of themselves.

## Video storage

Where to store the video data? Traditionally, tape has been used. One new option is the Sony Professional Optical Disc, which is a high-density recordable DVD disc that uses 405nm blue-laser technology. Several broadcasters intend to standardise on this for acquisition and subsequently as an archival system.

Thomson Broadcast and Media has been working with Panasonic on the use of SD memory cards in its cameras. The company says that its first products to make use of this form of storage would be its M-series iVDR video server and its Newsedit SC system. Several broadcasters expressed interest in this approach. But cost may be a disadvantage.

## Cable distribution

For the cable industry the latest buzz is Video over IP, that is using Internet Protocols for streaming video to viewers, either for general broadcasting or narrowcasting (transmission with a single destination, for example Video on Demand).

Big Band Networks showed a complete cable head-end in a small box able to handle 32 inputs and outputs with a variety of transmission standards, including VoIP. It can also provide QAM outputs for standard cable TV networks.

## STBs and PVRs

The set-top box manufacturers were present in force with a wide variety of features, technologies and styles. The appearance of STBs at under £50 is imminent: they will



*Motorola's two-tier stand. Everything from phones to fibre optics.*

have fewer buttons and dials, and thus be easier to operate and understand.

Personal video recorders were also present in large numbers. A new approach, using an STB with a large data-storage capacity and feeding it overnight with a requested programme at a low bit rate from a server somewhere in the system is finding a market, challenging Video on Demand as the way to provide such services.

### Conference sessions

Away from the exhibition halls, with their dazzling array of production facilities, satellite uplinks, digital editing suites and OB vehicles, the conference sessions created a great deal of interest. There was a definite focus on VoIP, which seems to be the flavour of the year. Every manufacturer had something that would connect to an IP network. There were numerous papers on subjects ranging from maintaining quality of service to the control of a studio TV camera from one's armchair.

Networking in the home, using Bluetooth wireless and power-line technology, was being discussed. There were sessions dealing with the use of 5GHz as a broadcast band, and the congestion being experienced in the 2-4GHz band. Less well-known but a powerful contender for future home networking is the IEEE 802.15.x ultra wideband approach.

Apple Computers demonstrated 'Rendezvous', a true plug-and-play network technology that required no setting up of devices that comply with the standard. Bridgeco showed its wireless products for the entertainment market. They are fairly straightforward, but a look at the company's website at [www.bridgeco.net](http://www.bridgeco.net) could be worthwhile.

Ashley Highfield of the BBC gave a keynote speech that described a number of systems the Corporation has been trying out in the Hull area, including Super Electronic Programme Guides, but with no clue as to when they will be introduced. The BBC is also committed to Very Local Community TV as a means of providing highly localised news, and has a desire to improve the quality of eTV (enhanced TV). This is TV with additional features in the data stream to make it pseudo-interactive, but with no return path so no two-way operation. A good example is Sky News' eight screens that can be selected by the remote-control unit's red button. The BBC feels that interest in features such as a voting facility is likely to reach a plateau then wane as the innovative appeal wears off – especially as much viewing is done when people are otherwise engaged, for example eating. The BBC also predicts, nor surprisingly, that sales of PVRs will increase exponentially as their price falls.

The session on making money from interactive TV placed increased emphasis on betting – UK legislation on this is due to be relaxed. Research is being carried out on what can and cannot pay off with iTV and eTV. One paper took a step backwards

from technical innovation and called for greater understanding of consumer wishes when devising interactive services.

Concern about possible infringement of programme owners legal rights as a result of the BBC's move to unencrypted digital satellite TV broadcasting was expressed at a panel session on the legal aspects of digital TV.

### Metadata

Returning to technical matters, the subject of metadata was prominent. There were mentions of it at the previous show, and standards were being promoted. This year there were several demonstrations and even real implementations, suggesting that it has now arrived. Metadata is additional information about picture content, carried alongside the basic video and audio data. The information is partially about range and position, also about movement. It can be used for various purposes.

A Spanish presentation demonstrated an experimental system that uses synchronised MPEG-7 metadata with a terrestrial digital TV network and an MHP (multimedia home platform) domestic gateway. The demonstration was of a film clip with metadata that described the content, in real time: think of it as being like a commentary with dialogue in the form of subtitles. The technique is likely to be used mainly with PVRs, to enable users to find any part of a recording using simple descriptions. In the studio, metadata has applications for news programming, to replace current workflow systems. The BBC has stated its commitment to the use of metadata as a programme-making tool. Sony described a system using 'face metadata for content navigation': a video item is analysed for face recognition, metadata is generated from the analysis and is then used to search for other clips that contain the same face.

### Technical sessions

There was a report on the provision of more elaborate electronic programme guides for the visually impaired – a research project is being funded by BSkyB and the ITC. A paper from Japan described an Ultra High Definition TV system using 4,000 lines.

Discussions were held on the restoration of old optical film soundtracks, virtual-reality studio sets and mixed-reality productions.

On the audio side there was much discussion about lack of audio-level uniformity from programme to programme and channel to channel. A Belgian paper outlined the problems faced by those who seek greater sound-level uniformity, while a paper from Dolby highlighted a different approach, based on consumer reaction. This assessed speech content rather than more general sound-level measurement. A Finnish paper took the debate further, discussing LF enhancement with multi-channel systems and the difficulty in getting correct balance. This suggests a move towards the provision of multi-channel sound with broadcasting, to complement the growing sales of home-cinema surround-sound systems. Further confirmation of such a move came from a US paper on broadcast centre monitoring of multi-channel sound for both TV and radio transmissions, something that's already being implemented there.

Finally, there was a paper on an EU project which is investigating the convergence of digital broadcasting and mobile telecommunications. This coincides with the publication of DVB.2.0 and subsection DVB-H, the H denoting hand-held devices such as cellphones, PDAs and laptop computers.

### In conclusion

IBC is where the future unfolds. What we see there has developed beyond the crystal-ball stage, becoming either a specification or a working prototype that will be a here-and-now product the following year.

For the consumer, HDTV and multi-channel audio, for both TV and radio, are now on the horizon. The ability to watch TV and access the internet with your cellphone is around the corner. Improved transmission standards, better reception conditions and TV channel consolidation are also on the cards. Many of the medium-quality TV channels will disappear and there is likely to be a number of new, very low-cost channels principally for commercial use. In brief, the good may get better and the poor worse. ■

Microsoft's stand, demonstrating Windows Media 9.

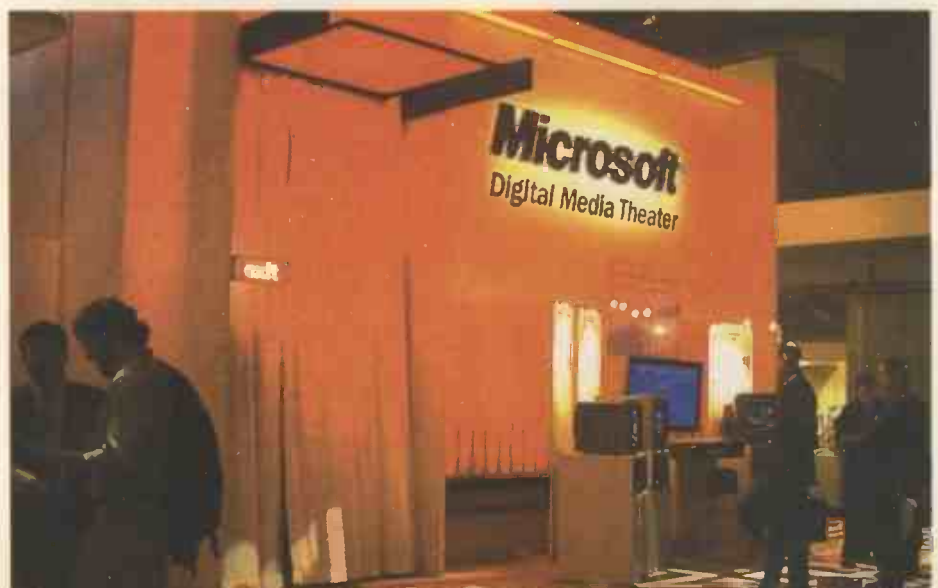



## Michael Maurice

### Sony KVA2122U (AEIC chassis)

This set led me a merry dance. The reported faults were doesn't come on straight away, intermittent no picture with the channel number showing, and intermittent crackling from the loudspeakers. Whenever I'm called to one of these receivers I carry out a general service, which means replacing the four electrolytic capacitors on the primary side of the power supply, also C532 and C531 (uprate to 50V) in the field output stage, and resoldering IC251, IC252, IC604, IC608 and the dry-joints in the IF module. It pays to take a good look around for other dry-joints.

Having done all this, in the customer's house, I reassembled the set, switched it on and got nothing, except a pumping noise from the power supply! Back in the workshop I disabled the line output stage, connected a bulb across the 135V supply and tried again. The bulb lit, but when the set was tried with the supply to the line output stage reconnected it tripped. When I heated the power supply the set started and ran. Various things were tried before I finally discovered that the 5V regulator IC604 was thermally sensitive. A replacement cured the trouble.

# Service Casebook

### Bush 2866SM2

I was told that you couldn't change channels once the set had warmed up: the channel number would change, but not the channel. When the overview was called up there was gibberish in the channel information. The set was naturally working fine when I visited the customer. I took a chance and replaced the EEPROM. The set then worked, and there haven't been any complaints since.

### Nokia FS91E1 (FS chassis)

This set had a very narrow picture. The culprit was in the EW diode modulator circuit, where Ck24 was open-circuit. Its value varies with tube type – 5.6nF or 6.8nF.

### Philips 28ML8800 (FL1.6 chassis)

This should have been an easy fault: the set went into the protection mode after a few minutes. Unfortunately the set had been used in this state for some time, and there was now dark text and no sound except from the scart socket. The first fault was easy to cure. There were dry-joints at the EW loading coil. The other problems were caused by EEPROM corruption, as a result of interference from the dry-joint condition. But I didn't have a service manual or the option codes – and neither did EURAS. Fortunately the internet proved to be a great help. I went into Google and put in FL1.6. It didn't take long before I found a site that provided some option codes. A complete cure was achieved by going into the service mode and inserting these codes. What did we do before the internet!

### Vintage equipment

Every so often someone asks me to repair a piece of vintage equipment. The customer who phoned me on this occasion had a late Sixties radiogram in which the turntable wouldn't rotate. When the customer confirmed that it played 78s I assured him that the cause wasn't a belt but most likely that the turntable had seized through lack of use.

The radiogram was a Decca model fitted with a BSR autochanger, the tuner and amplifier being fully transistorised.

I removed the turntable unit and began to strip it. The turntable had seized, also the large cam gear. The later was the hardest to remove. Moderate force was required, together with some WD40. Once I had removed the cam I had to scrape off the old grease before I could clean the surfaces with solvent cleaner. The turntable worked beautifully when all the old grease had been cleaned off both the cam and the turntable bearing, new grease had been applied then the items had been reassembled. The customer was very pleased, and it was a job that for once I really enjoyed doing.

### Philips 28ML8760 (FL1.0 chassis)

The reported fault was intermittent loss of picture, the sound being OK. When I checked the set I found that there was still a faint raster when the fault occurred. This suggested a blanking fault. Examination with a magnifier revealed that C4404 in the field output stage was dry-jointed. All I had to do was to resolder it.

### Sony KVA2922U (AEIC chassis)

I thought I knew all the faults that this chassis could throw at me. But this was a new one. The customer complained that he couldn't tune in to his cable box, which was linked via a scart lead. But if you connect the two via a scart lead you don't need to tune in! The fault was that you couldn't get a picture via the scart lead or the tuner.

I resoldered suspect joints all over the main board, the A board and even the J1 board. There was no change, so I had to take this back-breaker to the workshop for attention. After tracing the video signal across the various boards I discovered that the cause of the fault was loss of the 7V supply, because L604 was open-circuit. A replacement restored normal operation. ■

# Grandata Ltd

distributor of electronic components

## Specials Offers and New Arrivals !!

### High Quality Fully Shielded Foil Wrapped Scart Lead

Length : 1.5m Width : 12mm

Box of 25

Price : £ 30.00 + vat

Box of 50

Price : £ 50.00 + vat

**Order Code : PLG26**



### Fully Shielded 21 Pin Connected Scart Lead

Length : 1.5m Width : 8mm

Box of 50

Price : £ 30.00 + vat

Box of 100

Price : £ 55.00 + vat

**Order Code : PLG23**



### New Arrival !!

#### Jaeger 2003 / 2004 Semiconductor Comparison Book

This A5 sized book contains vital information on 41,400 types of components.

Transistors , Diodes , Thyristors , IC's all covered with details of : Design

Brief data / description  
Construction type...etc

**Order Code : BOOK04**

**Price : £ 23.00 - No VAT**  
(plus £ 2.00 + vat for Postage)

### Coax Fly Lead Plug to Socket

Length : 2m

Box of 50

Price : £ 15.00 + vat

Box of 100

Price : £ 25.00 + vat

**Order Code : COXCABLE**



### 2 Phono to 2 Phono Cable

Length : 1.2m

Box of 25

Price : £ 12.50 + vat

Box of 50

Price : £ 20.00 + vat

**Order Code : PLG33**



### Scart Plug to Scart Sockets 5 way splitter

Length : 0.4m

Box of 10

Price : £ 20.00 + vat

**Order Code : PLG44**



### Switched Scart to 3 Phono and S-Video Sockets

Box of 10

Price : £ 10.00 + vat

Box of 20

Price : £ 17.00 + vat

**Order Code : PLG85**

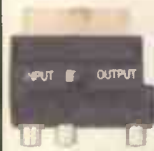

## Aerial Installation Accessories

### SLx Aerial Amplifiers

Now with built in Digital ByPass Operates with Sky™ DigiEye

Class leading noise figure of 4dB or less

6dB signal amplification on all models



Integrated  
Digital  
By Pass

#### Description

#### Order Code

#### Price

2 Way - No Bypass	SLX2	£ 8.00 + vat
2 Way - With Bypass	SLX2B	£ 9.25 + vat
4 Way - No Bypass	SLX4	£ 13.00 + vat
4 Way - With Bypass	SLX4B	£ 14.00 + vat
6 Way - No Bypass	SLX6	£ 18.00 + vat
6 Way - With Bypass	SLX6B	£ 19.00 + vat
8 Way - No Bypass	SLX8	£ 18.50 + vat
8 Way - With Bypass	SLX8B	£ 20.00 + vat

### SLx Masthead Amplifiers

UHF TV antenna pre amplifier designed for the professional aerial installer

15dB gain masthead amplifier ideal for majority of domestic installations

26dB gain masthead amplifier for longer cable runs (loss of more than 3dB) or if connected to passive splitters



Requires 12V DC power supply via download either via dedicated power supply unit or from a distribution amplifier with line powering

15dB Amp Order Code : 27830R  
Price : £ 4.30 + vat

26dB Amp Order Code : 27831R  
Price : £ 4.50 + vat

SLx Masthead Amp PSU  
Order Code : 27832R  
Price : £ 5.00 + vat

Postage for 2+ £ 5.00 + vat

### Coax Plug Aluminium

Order Code : PLG51  
Bag of 10  
Price : £ 1.25 + vat  
Bag of 100  
Price : £ 9.00 + vat



### Screw Type Coax Plugs

Order Code : PLG62  
Bag of 10  
Price : £ 1.60 + vat  
Bag of 100  
Price : £ 12.50 + vat



### Twist On F Connectors

Order Code : PLG101  
Bag of 10  
Price : £ 1.00 + vat  
Bag of 100  
Price : £ 6.00 + vat



### Coax Coupler Socket to Socket

Order Code  
PLG54  
Bag of 10  
Price : £ 1.50 + vat



### Coax Coupler Plug to Plug

Order Code  
PLG55  
Bag of 10  
Price : £ 1.50 + vat



### Y Splitter Inductive 3 way

Order Code  
YSPLITTER  
Price : 40p + vat  
Bag of 10  
Price : £ 3.00 + vat



K.P. House , Unit 15 , Pop In Commercial Centre , Southway , Wembley , Middlesex . HA9 0HB England

Tel : (020) 8900 2329

Fax : (020) 8903 6126

Email : sales@grandata.co.uk

# Grandata Ltd

distributor of electronic components

## Digital Satellite Accessories

### Sky™ Digital Remote & TV Link Eye Combination

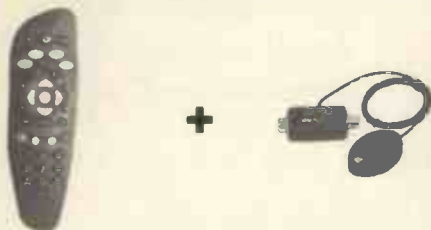

Order Code : SKYPACK1

Price : £ 16.00 + vat each

5 +

£ 14.50 + vat each

### Sky™ Digital Remote Controls



Order Code : RCSKY

1 +

£ 7.95 + vat each

5 +

£ 7.45 + vat each

10 +

£ 6.95 + vat each

### Sky™ Digital Remote & SLx Link Eye Combination



Order Code : SKYPACK2

Price : £ 13.00 + vat each

5 +

£ 11.50 + vat each

### SLx Link Eye

Allows control of Sky™ Digibox via the signal feed for second TV

Order Code : 27833R

1 - 9

£ 6.50 + vat each

10 - 24

£ 5.50 + vat each



### Sky™ Digital TV Link Eye

Order Code : TVLINKEYE

Price

£ 10.75 + vat

5 +

£ 7.99 + vat each

10+

£ 6.99 + vat each



### SLx Amp By Pass Kit

For use with aerial amplifiers and Sky™ Digibox

Allows for operation of Link Eye in conjunction with a distribution amplifier



Order Code : 27829R

Price : £ 5.00 + vat

## Satellite Repair / Mod Kits

### Amstrad DRX100

Tuner Repair Kit

Order Code  
SATKIT35

Price  
£ 1.40 + vat

### Amstrad DRX100

Power Supply  
Reliability Kit

Order Code  
SATKIT36

Price  
£ 12.00 + vat

### Amstrad DRX100

Power Supply  
Repair Kit

Order Code  
SATKIT37

Price  
£ 13.50 + vat

### Grundig GDS200

Digital Satellite Receiver  
Repair Kit

Early psu  
MODEL : DSO - 0385 REV C

Order Code: SATKIT34A  
Price : £ 10.00 + vat

### Grundig GDS200/300

Digital Satellite Receiver  
Repair Kit

LATER psu TYPE REV 03  
DSO - 0375 REV A  
DSO - 0385 REV 5

Order Code: SATKIT34B  
Price : £ 10.00 + vat

### Digital Satellite Receivers Fan Kit

Suitable for

Amstrad DRX100 , DRX200  
Grundig GDR200 , GDS200  
Pace Digibox

plus many more analogue makes and models

Order Code : FANKIT1

Price : £ 10.00 + vat

### Panasonic Digital Satellite Receiver Fan Kit

Suitable for Panasonic TU-DSB20/30 , TU-DSB31/35

Order Code : FANKIT2

Price : £ 15.00 + vat

### Grundig Digital Satellite Receivers Reliability Kit

These kits contain capacitors that are generally of higher specification than those fitted by the manufacturers.

**New Arrivals !!**

#### GDS200

Early PSU  
DSO0385 Rev C

Kit Contains 9 capacitors

Code : RELKIT34A

Price: £ 4.00 + vat

#### GDS200 / GDS300

Later PSU  
DSO0375 Rev A  
DSO0385 Rev F

Kit Contains 11 capacitors

Code : RELKIT34B

Price: £ 4.00 + vat

#### GDS200 / GDS300

Later PSU  
Rev 03

Kit Contains 13 capacitors

Code : RELKIT34C

Price: £ 4.00 + vat

#### GDS200 / GDS300

Samsung PSU  
PSSH370601B

Kit Contains 12 capacitors

Code : RELKIT34D Price: £ 4.00 + vat

#### GDS300

Samsung PSU  
PSSH370603B

Kit Contains 13 capacitors

Code : RELKIT34E Price: £ 4.00 + vat





# Grandata Ltd

distributor of electronic components

## Television Repair / Mod Kits

MAKE & MODEL	KIT TYPE	CODE	MAKE & MODEL	KIT TYPE	CODE	MAKE & MODEL	KIT TYPE	CODE	MAKE & MODEL	KIT TYPE	CODE
<b>ALBA</b>			<b>GOODMANS..Continued</b>			<b>mitsubishi..Continued</b>			<b>PHILIPS..Continued</b>		
1452T	PSU	ONWAKIT	2029T	PSU	ONWAKIT	CT21AV1BS	PSU	MITSKIT3	310.32262		PHILKIT8
1427T	PSU	ONWAKIT	2029TA	PSU	ONWAKIT	CT25A2STX	TDA 8178S	MITSKIT1	310.62264		PHILKIT1
1402	PSU	ONWAKIT	F16 CHASSIS	FRAME	GOODKIT1	CT25A3STX	TDA 8178S	MITSKIT1	ANUBIS A	SOPS	PHILKIT2
1455T	PSU	ONWAKIT	F16 CHASSIS	LINE	GOODKIT1	CT25A4STX	TDA 8178S	MITSKIT1	CP110 CHASSIS	SOPS	PHILKIT8
1456T	PSU	ONWAKIT	F16	PSU	GOODKIT1	CT25A6STX	TDA 8178S	MITSKIT1	G90A CHASSIS	SOPS	PHILKIT10
1458T	PSU	ONWAKIT	F16	VIDEO	GOODKIT1	CT25AV1B	PSU	MITSKIT3	G90B CHASSIS	SOPS	PHILKIT10
1459T	PSU	ONWAKIT	<b>GRUNDIG</b>			CT25AV1BS	PSU	MITSKIT3	G110 CHASSIS	SOPS	PHILKIT3
1499Y	STANDBY	MODKIT37	CUC 7350		GRUNDIGKIT1	CT25AV1BD	PSU	MITSKIT3	GR2.1 CHASSIS	SOPS	PHILKIT1
2002	PSU	ONWAKIT	CUC 7301/3			CT25AV1BDS	PSU	MITSKIT3	GR2.2 CHASSIS	SOPS	PHILKIT1
2009B	PSU	ONWAKIT	(BUZ90)	PSU	GRUNDIGKIT2	CT28AV1B	PSU	MITSKIT3	D-16 CHASSIS	SOPS	PHILKIT6
2052T	PSU	ONWAKIT	CUC 7301/3			CT28AX1BD	PSU	MITSKIT3	HSM VIDEO	SOPS	PHILKIT5
2152T	PSU	ONWAKIT	(MJF18004)	PSU	GRUNDIGKIT3	CT28AV1BDS	PSU	MITSKIT3	GR2 VIDEO	SOPS	PHILKIT4
2099TX	STANDBY	MODKIT37	<b>HINARI</b>			CT29AS1	TDA 8178S	MITSKIT2	KSM VIDEO	SOPS	PHILKIT9
BTV17	STANDBY	MODKIT37	HIT14RC	PSU	ONWAKIT	CT29A4	TDA 8178S	MITSKIT2	LSM VIDEO	SOPS	PHILKIT7
CTV501	PSU	ONWAKIT	<b>JVC</b>			CT29A6	TDA 8178S	MITSKIT2	<b>SAMSUNG</b>		
CTV701	PSU	ONWAKIT	AV29SX1EK	FIELD O/P	JVCKIT1	CT29B2	TDA 8178S	MITSKIT2	CI5944	FRAME	SAMKIT2
CTV840	PSU	ONWAKIT	AV29SX1EN	FIELD O/P	JVCKIT1	<b>MAKE &amp; MODEL</b>	<b>KIT TYPE</b>	<b>CODE</b>	CI6844	FRAME	SAMKIT2
CTV841	PSU	ONWAKIT	AV29SX1PF	FIELD O/P	JVCKIT1	CT29B3	TDA 8178S	MITSKIT2	VIK310	PSU	SAMSUNGKIT
CTV485	PSU	ONWAKIT	AV29TSIE1	FIELD O/P	JVCKIT1	CT29B6	TDA 8178S	MITSKIT2	VIK320	PSU	SAMSUNGKIT
<b>AKAI</b>			C14E1EK	PSU	ONWAKIT	CT33B3	TDA 8178S	MITSKIT2	VJK350	PSU	SAMSUNGKIT
CT1417	PSU	ONWAKIT	C14T1EK	PSU	ONWAKIT	M5 SERIES	PSU	MITSKIT3	V1375	PSU	SAMSUNGKIT
CT2159U	PSU	ONWAKIT	C21ET1EK	PSU	ONWAKIT	<b>NEI/NIKKAI</b>			V1395	PSU	SAMSUNGKIT
CT2162UNT	PSU	ONWAKIT	CS21M3EK	PSU	ONWAKIT	CE25 CHASSIS	PSU	NIKKAIKIT1	WINNER 1	PSU	SAMSUNGKIT
CT2863UNT	PSU	ONWAKIT	<b>MATSUI</b>			C289FTXN	PSU	NIKKAIKIT1	<b>SHARP</b>		
<b>DECCA/TATUNG</b>			1455	PSU	ONWAKIT	C28F41FXN	PSU	NIKKAIKIT1	51CS03H	PSU	SHARPKIT1
TVC563	STANDBY	MODKIT37	1498	PSU	ONWAKIT	<b>PANASONIC</b>			51CS05H	PSU	SHARPKIT1
<b>GOLDSTAR</b>			2086	PSU	ONWAKIT	IC561	TDA 8175	PANKIT1	59CS03H	PSU	SHARPKIT2
CF25A50F	FRAME	MODKIT36	2098	PSU	ONWAKIT	TX25XD060	VERT OUTPUT	PANKIT2	59CS05H	PSU	SHARPKIT2
CF25C22C	FRAME	MODKIT35	21V1N (BUZ90)	PSU	GRUNDIGKIT2	TC28XD00	VERT OUTPUT	PANKIT2	59CSD8H	PSU	SHARPKIT2
CF28A50F	FRAME	MODKIT36	21V1T (MJF18004)	PSU	GRUNDIGKIT3	TX28XD70	VERT OUTPUT	PANKIT2	59DS03H	PSU	SHARPKIT3
CF28C22F	FRAME	MODKIT35	TVR180R/T/2080	STANDBY	MODKIT37	TX29XD70	VERT OUTPUT	PANKIT2	66CS03H	PSU	SHARPKIT2
CF28C28F	FRAME	MODKIT36	<b>MITSUBISHI</b>			TX-W26D3	VERT OUTPUT	PANKIT2	66CS05H	PSU	SHARPKIT2
CF29C42F	FRAME	MODKIT35	AV1 SERIES	PSU	MITSKIT3	<b>PHILIPS</b>			66CSD8H	PSU	SHARPKIT2
<b>GOODMANS</b>			CT1M5B	PSU	MITSKIT3	310.10708		PHILKIT3	<b>THOMSON</b>		
147TT	PSU	ONWAKIT	CT21M5BT	PSU	MITSKIT3	310.20491		PHILKIT2	35029400		THOMKIT2
149T	PSU	ONWAKIT	CT25M5BT	PSU	MITSKIT3	310.20496		PHILKIT10	35065920		THORNKIT1
1430RA	PSU	ONWAKIT	CT21A2STX	TDA 8178S	MITSKIT1	310.31994		PHILKIT6	FV70	PSU	THORNKIT1
1430RS	PSU	ONWAKIT	CT21AX1B	PSU	MITSKIT3	310.32252		PHILKIT5	ICC7 CHASSIS	TDA 8178FS	THOMKIT1
1430RW	PSU	ONWAKIT	CT21A3STX	TDA 8178S	MITSKIT1	310.32253		PHILKIT4	ICC7 CHASSIS	FRAME	THOMKIT3
1450T	PSU	ONWAKIT	<b>MITSUBISHI</b>			310.32254		PHILKIT9	ICC8 CHASSIS	TDA 8178FS	THOMKIT1
1455TS	PSU	ONWAKIT	AV1 SERIES	PSU	MITSKIT3	310.32255		PHILKIT7	ICC8 CHASSIS	FRAME	THOMKIT3
2019R	PSU	ONWAKIT	CT1M5B	PSU	MITSKIT3	<b>PHILIPS</b>			ICC9 CHASSIS	EAST/WEST	THOMKIT4
			CT21M5BT	PSU	MITSKIT3	310.10708		PHILKIT3	R3000	PSU	THOMKIT2
			CT25M5BT	PSU	MITSKIT3	310.20491		PHILKIT2	R4000	PSU	THOMKIT2
			CT21A2STX	TDA 8178S	MITSKIT1	310.20496		PHILKIT10	TX92F CHASSIS	EAST/WEST	THOMKIT4
			CT21AX1B	PSU	MITSKIT3	310.31994		PHILKIT6			
			CT21A3STX	TDA 8178S	MITSKIT1	310.32252		PHILKIT5			
						310.32253		PHILKIT4			
						310.32254		PHILKIT9			
						310.32255		PHILKIT7			

ORDER CODE	PRICE	ORDER CODE	PRICE	ORDER CODE	PRICE	ORDER CODE	PRICE	ORDER CODE	PRICE
GRUNDIGKIT1	£ 10.50	MITSKIT3	£ 6.00	PANKIT2	£ 9.00	PHILKIT6	£ 5.50	SHARPKIT2	£ 11.00
GRUNDIGKIT2	£ 10.50	MODKIT35	£ 9.50	PHILKIT1	£ 7.60	PHILKIT7	£ 7.60	SHARPKIT3	£ 9.00
GRUNDIGKIT3	£ 10.50	MODKIT36	£ 5.00	PHILKIT10	£ 8.50	PHILKIT8	£ 4.25	THOMKIT1	£ 7.00
GOODKIT1	£ 11.00	MODKIT37	£ 6.50	PHILKIT2	£ 2.50	PHILKIT9	£ 7.50	THOMKIT2	£ 12.00
JVCKIT1	£ 11.00	NIKKAIKIT1	£ 12.00	PHILKIT3	£ 4.00	SAMKIT2	£ 8.00	THOMKIT3	£ 9.00
MITSKIT1	£ 3.00	ONWAKIT	£ 12.00	PHILKIT4	£ 4.25	SAMSUNGKIT	£ 16.00	THOMKIT4	£ 4.00
MITSKIT2	£ 15.00	PANKIT1	£ 15.00	PHILKIT5	£ 5.75	SHARPKIT1	£ 11.00	THORNKIT1	£ 12.75

## Repair Kits - New Arrivals!!

Matsui	Matsui	Sharp	Sony VCR	Thomson
1496R/T and 2096R/T Repair Kit for Power Supply using a BUZ90	1496R/T and 2096R/T Repair Kit for Power Supply using a H3N90	56FW53H,66FW53H, 66FW54H,76FW53H, 76FW54H PSU & Dolby Upgrade	SLV715HB SLV777UB Repair Kit for Power Supply	ICC17 Power Supply Repair Kit
<b>Order Code</b> MODKIT43	<b>Order Code</b> MODKIT44	<b>Order Code</b> MODKIT45	<b>Order Code</b> MODKIT40	<b>Order Code</b> MODKIT41
<b>Price</b> £ 7.00 + vat	<b>Price</b> £ 7.00 + vat	<b>Price</b> £ 4.00 + vat	<b>Price</b> £ 6.00 + vat	<b>Price</b> £ 6.00 + vat



# Grandata Ltd

distributor of electronic components

## Transistors / Linear IC's

Part No.	Price	Part No.	Price	Part No.	Price	Part No.	Price	Part No.	Price	Part No.	Price	Part No.	Price	Part No.	Price		
BU208A	£0.75	IRF5450	£5.00	MJE350	£0.80	STK4191	£9.00	STK5464	£3.00	STR371	£4.00	TDA2450-3	£10.00	TDA4665	£2.50	TDA8138	£2.00
BU2506DF	£0.90	IRF5740	£3.00	MJF		STK4191 X	£14.00	STK5466	£5.00	STR380	£3.50	TDA2460-2	£0.70	TDA4670	£4.75	TDA8138A	£1.30
BU2506DX	£1.00	IRF5840	£3.00	MJF16206	£4.50	STK419-130	£15.00	STK5467	£4.00	STR381	£3.90	TDA2501	£3.00	TDA4671	£5.00	TDA8138B	£2.00
BU2508A	£1.00	IRF610	£0.80	MJF18004	£1.75	STK419-140	£16.00	STK5468	£3.00	STR383	£4.10	TDA2506T	£8.00	TDA4680	£3.50	TDA8139	£2.00
BU2508AF	£1.10	IRF611	£1.20	MJF18006	£2.00	STK4192	£7.00	STK5471	£9.00	STR384	£3.50	TDA2507	£4.50	TDA4681	£4.50	TDA8140	£2.00
BU2508AX	£1.30	IRF620	£1.00	MJF18008	£1.75	STK4197 II	£9.50	STK5472	£3.75	STR40090	£3.50	TDA2510	£4.50	TDA4685	£2.75	TDA8143	£1.60
BU2508D	£1.30	IRF630	£0.75	MJF18204	£2.50	STK4199 II	£10.50	STK5473	£4.80	STR40115	£6.00	TDA2514A	£5.00	TDA4686	£5.00	TDA8145	£1.20
BU2508DF	£1.20	IRF634	£1.25	STK0025	£4.20	STK4200	£4.00	STK5474	£5.00	STR4090A	£6.50	TDA2515	£4.50	TDA4687	£5.00	TDA8146	£2.00
BU2508DX	£1.50	IRF640	£1.50	STK0039	£6.00	STK4204 II	£10.50	STK5476	£3.50	STR4190	£3.30	TDA2520-1	£9.00	TDA4700A	£7.50	TDA8153	£1.00
BU2520AF	£1.70	IRF640F	£2.00	STK086	£10.00	STK4204 II	£10.50	STK5477	£4.50	STR4142	£4.50	TDA2521	£8.00	TDA4710H	£7.00	TDA8170	£1.70
BU2520AX	£1.40	IRF630S	£2.00	STK1039	£4.60	STK4204II	£10.50	STK5478	£2.50	STR4211	£3.15	TDA2522	£12.00	TDA4714C	£3.50	TDA8171	£2.30
BU2520DF	£2.25	IRF642	£2.00	STK1040	£6.40	STK4211 II	£10.00	STK5479	£3.00	STR4311	£9.50	TDA2523	£8.50	TDA4716C	£4.50	TDA8172	£2.00
BU2520DX	£2.00	IRF644	£2.00	STK1049	£7.00	STK4211 V	£8.00	STK5481	£4.70	STR440	£8.00	TDA2525	£4.50	TDA4720	£6.60	TDA8173	£1.75
BU2522AX	£1.50	IRF655	£2.00	STK1050	£6.50	STK4221 II	£12.00	STK5482	£2.85	STR441	£9.50	TDA2530	£3.00	TDA4725	£7.50	TDA8174	£2.00
BU2525A	£3.25	IRF710	£1.50	STK1060	£7.00	STK4231 II	£10.50	STK5483	£4.40	STR4415	£4.75	TDA2548	£2.00	TDA4780	£6.00	TDA8175	£7.00
BU2525AF	£2.20	IRF720	£0.85	STK2025	£6.20	STK2025	£6.20	STK5486	£4.50	STR442	£16.00	TDA2549	£3.00	TDA4800	£3.00	TDA8177	£3.00
BU2525AX	£1.90	IRF730	£1.25	STK2028	£5.00	STK4241	£10.50	STK5487	£5.25	STR450A	£7.00	TDA2558	£4.00	TDA4810	£5.00	TDA8177F	£3.50
BU2525DF	£2.40	IRF740	£0.90	STK2029	£6.00	STK4241 V	£12.50	STK5488	£4.80	STR451	£8.00	TDA2560Q	£7.00	TDA4850	£4.75	TDA8179S	£7.50
BU2525DX	£2.60	IRF740F	£3.00	STK2030	£10.00	STK4272	£5.00	STK5490	£4.50	STR4511	£5.50	TDA2560-3	£14.00	TDA4851	£3.25	TDA8180	£12.50
BU2527AF	£4.00	IRF820	£0.90	STK2038	£7.00	STK4273	£5.50	STK5491	£4.00	STR4512	£4.00	TDA2574V	£3.50	TDA4852	£3.25	TDA8205	£12.50
BU2527AX	£2.50	IRF830	£0.85	STK2048	£9.50	STK4274	£5.00	STK5492	£4.15	STR452	£4.75	TDA2576A	£9.00	TDA4854	£5.00	TDA8212	£3.50
BU2527DF	£2.00	IRF830F	£1.60	STK2058 IV	£16.00	STK4274	£5.00	STK5632	£3.00	STR453	£5.00	TDA2577A	£2.00	TDA4855	£6.00	TDA8214B	£10.50
BU2527DX	£2.00	IRF840	£0.85	STK2101	£10.50	STK430	£5.00	STK5720	£4.00	STR454	£13.00	TDA2578A	£7.00	TDA4856	£5.00	TDA8215H	£3.00
BU2528AL	£3.25	IRF840F	£1.75	STK2110	£5.50	STK4301	£5.00	STK5725	£3.50	STR455	£5.50	TDA2579A	£2.10	TDA4858	£3.50	TDA8217	£2.25
BU2708AF	£2.00	IRF9140	£10.00	STK2139	£6.75	STK4311	£6.50	STK5730	£3.00	STR456	£4.70	TDA2579B	£3.25	TDA4860	£2.00	TDA8303	£2.50
BU2708AX	£2.00	IRF9230	£4.00	STK2155	£9.00	STK433	£4.00	STK583	£4.00	STR457	£6.00	TDA2652	£48.00	TDA4861	£3.50	TDA8304	£4.00
BU2708DF	£2.00	IRF9510	£1.50	STK2230	£4.70	STK4332	£3.85	STK6316	£3.00	STR470	£3.00	TDA2653A	£4.50	TDA4866	£2.75	TDA8305	£5.00
BU2708DX	£2.00	IRF9511	£1.50	STK3102 II	£5.30	STK435	£3.75	STK6324B	£5.00	STR50020	£3.50	TDA2710-1	£4.00	TDA4880	£4.50	TDA8305A	£5.00
BU2720AX	£2.00	IRF9520	£1.50	STK3106	£25.00	STK4352	£5.00	STK6327	£12.00	STR50092	£5.50	TDA2820M	£1.00	TDA4918A	£17.00	TDA8310	£6.00
BU2720DF	£2.00	IRF9530	£1.25	STK3122 III	£7.25	STK436	£4.30	STK6328A	£4.00	STR50103A	£2.60	TDA2822M	£0.60	TDA4930	£5.00	TDA8350Q	£2.75
BU2720DX	£2.00	IRF9531	£2.00	STK3152 II	£9.00	STK4362	£4.50	STK6431	£6.00	STR50112A	£6.50	TDA3190	£2.00	TDA4935	£3.00	TDA8351	£2.00
BU2722AF	£3.30	IRF9540	£1.75	STK3156	£5.00	STK437	£6.00	STK6607	£4.00	STR50113	£5.00	TDA3301B	£16.00	TDA4950	£2.00	TDA8354C	£2.75
BU2725AF	£2.00	IRF9541	£2.00	STK350-030	£7.00	STK4372	£4.90	STK6712BIV	£5.50	STR50115	£5.00	TDA3303	£7.00	TDA4941	£2.80	TDA8356	£2.00
BU2725DF	£2.00	IRF9610	£0.95	STK392-040	£12.00	STK439	£5.00	STK6722	£6.50	STR50213	£4.00	TDA3501	£3.00	TDA4942	£2.00	TDA8360N3	£8.00
BU2725DX	£2.00	IRF9620	£0.85	STK401-050	£8.00	STK4392	£5.00	STK6732	£10.00	STR50330	£4.75	TDA3502	£3.60	TDA4950	£1.00	TDA8361AN3	£8.00
BU2727AF	£2.00	IRF9622	£2.00	STK401-080	£9.00	STK441	£6.80	STK6822	£7.50	STR51041	£5.00	TDA3504	£3.00	TDA4951	£4.50	TDA8361N3	£9.00
BU2727AX	£2.00	IRF9630	£1.30	STK401-120	£10.00	STK4412	£4.50	STK6875	£6.50	STR51213	£5.00	TDA3507	£4.50	TDA5010	£3.00	TDA8362AN	£7.00
BU2727DF	£2.00	IRF9640	£2.30	STK401-140	£12.00	STK443	£7.00	STK6922	£10.00	STR51424	£7.00	TDA3521	£7.50	TDA5021	£6.00	TDA8362AN3	£12.50
BU2727DX	£2.00	IRF9640	£2.30	STK401-180	£14.00	STK4432	£4.00	STK6932	£4.50	STR53041	£4.00	TDA3560	£6.00	TDA5500	£9.00	TDA8362BN3	£8.50
BU5060DF	£1.00	IRFBC20	£1.10	STK4019	£4.80	STK457	£8.00	STK6962	£2.75	STR54041	£3.20	TDA3561	£3.00	TDA5501	£4.50	TDA8362N3	£12.00
BU508AF	£0.60	IRFBC30	£1.20	STK402-040	£7.00	STK457	£8.00	STK6962	£2.75	STR5412	£2.80	TDA3561A	£3.00	TDA5600	£4.00	TDA8362N5	£12.00
BU508APH	£0.60	IRFBC30	£1.20	STK402-070	£7.00	STK459	£5.60	STK6982	£3.00	STR5414	£2.80	TDA3562A	£2.60	TDA5610	£7.50	TDA8362N7	£9.00
BU508AX	£0.90	IRFBC30	£1.20	STK402-070	£7.00	STK460	£6.60	STK6981B	£5.00	STR5414	£2.80	TDA3562A	£2.60	TDA5610	£7.50	TDA8362N7	£9.00
BU508D	£0.75	IRFBC30	£1.20	STK402-070	£7.00	STK461	£6.00	STK6982	£6.00	STR5414	£2.80	TDA3563A	£3.00	TDA5610	£7.50	TDA8362N7	£9.00
BU508DF	£0.85	IRFBC30	£1.20	STK402-071	£7.00	STK463	£9.50	STK6982H	£6.00	STR5804	£2.50	TDA3563A	£3.00	TDA5610	£7.50	TDA8362N7	£9.00
BU508DF	£1.30	IRF9220	£1.00	STK402-090	£8.00	STK465	£9.00	STK7216	£2.20	STR59041	£3.00	TDA3564	£3.25	TDA5610	£7.50	TDA8370	£11.50
BUH1015	£4.25	IRF1120	£3.00	STK4021	£3.80	STK4773	£8.00	STK7217	£4.50	STR6001	£5.25	TDA3565	£2.20	TDA5610	£7.50	TDA8372A	£16.50
BUH1215	£4.50	IRFBC40	£1.00	STK402-100	£9.00	STK4793	£8.00	STK7225	£5.00	STR6008X	£5.75	TDA3566	£2.80	TDA5610	£7.50	TDA8374	£10.00
BUH1515	£2.50	IRFBC40G	£2.00	STK402-100	£9.00	STK4803	£10.00	STK7226	£17.00	STR6020	£2.70	TDA3566A	£3.00	TDA5610	£7.50	TDA8375A	£12.50
BUH1515D	£2.00	IRF1210	£2.00	STK402-120	£9.00	STK4813	£8.00	STK7233	£7.00	STR61001	£4.75	TDA3567	£3.50	TDA6107C	£3.00	TDA8376	£15.00
BUH1517	£2.75	IRFP054	£4.00	STK402120	£9.00	STK4833	£8.50	STK7251	£5.00	STR7001	£6.00	TDA3567	£3.50	TDA6110JF	£3.00	TDA8380	£2.00
BUH1517	£2.75	IRFP064	£5.00	STK402150	£9.00	STK4843	£7.50	STK7253	£6.50	STR700145	£4.75	TDA3569	£3.00	TDA6111C	£2.25	TDA8424	£4.00
BUH1517	£2.75	IRFP140	£2.50	STK40225	£5.30	STK4853	£17.00	STK7300-060	£6.50	STR81145	£3.75	TDA3570	£3.75	TDA6120Q	£5.50	TDA8425	£5.00
BUH1715	£4.25	IRFP150	£2.40	STK40268	£4.80	STK4863	£6.00	STK7300-080	£6.00	STR81159	£4.00	TDA3576B	£7.00	TDA6160-2S	£4.75	TDA8432	£5.50
BUH310	£1.25	IRFP240	£3.00	STK40268	£4.80	STK4873	£11.00	STK7300	£7.00	STR8124	£10.00	TDA3650	£6.75	TDA6160-2X	£2.50	TDA8433	£6.00
BUH381D	£1.25	IRFP340	£2.80	STK40268	£4.80	STK4873	£11.00	STK7309	£7.00	STR83145	£5.00	TDA3651A	£2.00	TDA7052	£1.20	TDA8440	£3.00
BUT11A	£0.35	IRFP350	£3.25	STK4028	£5.50	STK488-010	£8.00	STK7310	£3.20	STR8325	£7.00	TDA3652					

# Grandata Ltd

distributor of electronic components

## Line Output Transformers

Part No	Code	Price	Part No	Code	Price	Part No	Code	Price	Part No	Code	Price	
<b>ALBA</b>			<b>HITACHI..continued</b>			<b>PANASONIC..continued</b>			<b>PHILIPS..continued</b>			
3714002	LOT02	£12.00	2433453	LOT82	£12.50	TLF 14568 F	LOT40	£15.00	AT 2079 / 21	LOT395	£12.00	
043714002J	LOT02	£12.00	2433751	LOT01	£13.00	TLF 14584 F	LOT41	£17.00	AT 2079 / 24	LOT392	£15.00	
43700000	LOT02	£12.00	2433752	LOT01	£13.00	TLF 14586 F	LOT42	£17.00	AT 2079 / 40	LOT73	£11.50	
<b>AMSTRAD</b>			2433891	LOT23	£12.50	<b>PHILIPS</b>			AT 2079 / 99	LOT276	£14.00	
1810951	LOT55	£14.00	2433892	LOT84	£14.50	3119 108 31260	LOT90	£12.50	AT 2079/30 01	LOT106	£12.50	
3714002	LOT02	£12.00	2433893	LOT23	£12.50	3119 108 31290	LOT73	£11.50	AT 2079/30102	LOT106	£12.50	
043714002J	LOT02	£12.00	2433952	LOT33	£10.00	3119 108 31440	LOT433	£16.00	<b>SAISHO</b>			
43700000	LOT02	£12.00	2434002	LOT226	£14.50	3119 108 31441	LOT433	£16.00	3714002	LOT02	£12.00	
AM152591	LOT55	£14.00	2434141	LOT33	£10.00	3119 108 31442	LOT433	£16.00	043714002J	LOT02	£12.00	
<b>FERGUSON</b>			2434274	LOT44	£10.50	3119 198 62930	LOT57	£11.00	43700000	LOT02	£12.00	
00 D-3-508-002	LOT381	£15.50	2434393	LOT405	£22.50	3122 138 10246	LOT111	£15.00	7140021	LOT02	£12.00	
06 D-3-083-001	LOT82	£12.50	2434593	LOT401	£17.00	3122 138 36070	LOT111	£15.00	<b>SHARP</b>			
06 D-3-083-002	LOT82	£12.50	2435006	LOT251	£14.50	3122 138 36072	LOT111	£15.00	RTRNF 1220 CEZZLOT39	£18.50	<b>TOSHIBA</b>	
06 D-3-084-001	LOT23	£12.50	2436201	LOT90	£12.50	3122 138 36920	LOT57	£11.00	RTRNF 2001 CEZZLOT338	£17.50		
06 D-3-087-001	LOT23	£12.50	23236465	LOT392	£15.00	3122 138 36922	LOT57	£11.00	RTRNF 2006 CEZZLOT308	£13.50		
06 D-3-088-001	LOT84	£14.50	2433891H	LOT23	£12.50	3122 138 37050	LOT132	£15.00	RTRNF 2023 CEZZLOT310	£15.00		
06 D-3-093-001	LOT204	£16.00	45150504	LOT362	£16.00	3122 138 37620	LOT90	£12.50	1810951	LOT55		£14.00
06 D-3-508-003	LOT276	£14.00	<b>MATSUI</b>			3122 138 37771	LOT129	£14.00	2433751	LOT01		£13.00
06 D-3-512-001	LOT204	£16.00	20070	LOT438	£16.00	3122 138 37992	LOT1116	£19.00	23236098	LOT288		£14.00
29201-022-01	LOT63	£17.00	20071	LOT438	£16.00	3122 138 38040	LOT73	£11.50	23236198	LOT288		£14.00
473197	LOT304	£15.50	20072	LOT438	£16.00	3122 138 38123	LOT395	£12.00	23236201	LOT244		£14.50
D 059 / 37	LOT200	£14.00	20073	LOT438	£16.00	3128 138 20200	LOT433	£16.00	23236201	LOT395		£12.00
<b>GOODMANS</b>			20074	LOT438	£16.00	3128 138 20201	LOT433	£16.00	23236245	LOT395	£12.00	
1142.5057	LOT1164	£15.00	20075	LOT438	£16.00	3128 138 20202	LOT433	£16.00	23236255	LOT289	£15.00	
1142.5077	LOT1164	£15.00	3714002	LOT02	£12.00	3138 108 30100	LOT106	£12.50	23236425	LOT288	£14.00	
1142.5079	LOT1164	£15.00	3221008	LOT438	£16.00	3138 108 30101	LOT106	£12.50	23236427	LOT395	£12.00	
1142.5081	LOT1164	£15.00	043714002J	LOT02	£12.00	3138 108 30103	LOT106	£12.50	23236428	LOT289	£15.00	
1152-5016	LOT1934	£19.00	043221088P	LOT438	£16.00	3139 128 30400	LOT90	£12.50	23236424	LOT129	£14.00	
1179-0387	LOT1147	£16.00	43700000	LOT02	£12.00	40348-08	LOT1577	£18.00	TFB 4090 AD	LOT395	£12.00	
1192.0527	LOT1147	£16.00	7140021	LOT02	£12.00	40348A-08	LOT1577	£18.00	TFB 4124 AE	LOT392	£15.00	
1352.5008	LOT1167	£15.00	<b>MITSUBISHI</b>			40348A-09	LOT1577	£18.00	TFB 4124 AP	LOT392	£15.00	
1352.5008E	LOT1167	£16.00	731003	LOT51	£15.50	4812 140 10246	LOT111	£15.00	<div style="border: 1px solid black; padding: 5px;"><p>We are stockist of both</p><h2 style="text-align: center;">Konig and HR Diemen</h2><p style="text-align: center;">LOPT's</p><p>This is just a selection of the LOPT's that we stock....Please call on 020 8900 2329 for copy of our LOPT catalogue</p></div>			
1352.5016	LOR1934	£19.00	334 P 18506	LOT51	£15.50	4812 140 10349	LOT106	£12.50				
1352.5027	LOT1270	£16.00	<b>OREGA</b>			4812 140 10369	LOT90	£12.50				
1352.5033	LOT1270	£16.00	40153201	LOT349	£17.50	4812 140 10421	LOT90	£12.50				
<b>HINARI</b>			<b>ORION</b>			4822 140 10246	LOT111	£15.00				
3714002	LOT02	£12.00	3714002	LOT02	£12.00	4822 140 10274	LOT123	£14.50				
043714002J	LOT02	£12.00	043714002J	LOT02	£12.00	4822 140 10306	LOT57	£11.00				
43700000	LOT02	£12.00	43700000	LOT02	£12.00	4822 140 10349	LOT106	£12.50				
CF 124 B	LOT67	£14.50	<b>PANASONIC</b>			4822 140 10381	LOT128	£13.00				
CF 124 E	LOT67	£14.50	TLF 14512 F	LOT39	£18.50	4822 140 10384	LOT127	£15.50				
<b>HITACHI</b>			TLF 14520 F	LOT40	£15.00	4822 140 10406	LOT73	£11.50				
2424593	LOT44	£10.50	TLF 14521 F	LOT39	£18.50	4822 140 10544	LOT433	£16.00				
2432461	LOT169	£15.00	TLF 14567 F	LOT39	£18.50	4822 140 10566	LOT433	£16.00				
2432761	LOT169	£15.00	<b>PANASONIC..continued</b>			AT 2076 / 10	LOT57	£11.00				
<b>THOMSON..continued</b>			TLF 14512 F	LOT39	£18.50	AT 2077 / 81	LOT121	£15.00				
10588080.P2	LOT1505	£19.00	TLF 14567 F	LOT39	£18.50	AT 2078 / 21	LOT395	£12.00				
151128140	LOT1505	£19.00	<b>PHILIPS..continued</b>			AT 2079 / 15	LOT129	£14.00				
151281.4	LOT1505	£19.00	3119 108 31260	LOT90	£12.50	<b>PHILIPS..continued</b>						
15128140	LOT1505	£19.00	3119 108 31290	LOT73	£11.50	AT 2079 / 21	LOT395	£12.00				
153144.6	LOT1505	£19.00	3119 108 31440	LOT433	£16.00	AT 2079 / 24	LOT392	£15.00				
15314460	LOT1505	£19.00	3119 108 31441	LOT433	£16.00	AT 2079 / 40	LOT73	£11.50				
1531447 A	LOT1505	£19.00	3119 108 31442	LOT433	£16.00	AT 2079 / 99	LOT276	£14.00				
1532873 A	LOT1505	£19.00	3119 198 62930	LOT57	£11.00	AT 2079/30 01	LOT106	£12.50				
3233500	LOT244	£14.50	3122 138 10246	LOT111	£15.00	AT 2079/30102	LOT106	£12.50				
3233900	LOT244	£14.50	3122 138 36070	LOT111	£15.00	<b>SAISHO</b>						
40011200	LOT244	£14.50	3122 138 36072	LOT111	£15.00	3714002	LOT02	£12.00				
40148300	LOT244	£14.50	3122 138 36920	LOT57	£11.00	043714002J	LOT02	£12.00				
<b>TOSHIBA</b>			3122 138 36922	LOT57	£11.00	43700000	LOT02	£12.00				
1810951	LOT55	£14.00	3122 138 37050	LOT132	£15.00	7140021	LOT02	£12.00				
2433751	LOT01	£13.00	3122 138 37620	LOT90	£12.50	<b>SHARP</b>						
23236098	LOT288	£14.00	3122 138 37771	LOT129	£14.00	RTRNF 1220 CEZZLOT39	£18.50					
23236198	LOT288	£14.00	3122 138 37992	LOT1116	£19.00	RTRNF 2001 CEZZLOT338	£17.50					
23236201	LOT244	£14.50	3122 138 38040	LOT73	£11.50	RTRNF 2006 CEZZLOT308	£13.50					
23236245	LOT395	£12.00	3122 138 38123	LOT395	£12.00	RTRNF 2023 CEZZLOT310	£15.00					
23236255	LOT289	£15.00	3128 138 20200	LOT433	£16.00	<b>SONY</b>						
23236425	LOT288	£14.00	3128 138 20201	LOT433	£16.00	1-439-286-00	LOT46	£13.00				
23236427	LOT395	£12.00	3128 138 20202	LOT433	£16.00	1-439-286-11	LOT46	£13.00				
23236428	LOT289	£15.00	3138 108 30100	LOT106	£12.50	1-439-286-12	LOT46	£13.00				
23236424	LOT129	£14.00	3138 108 30101	LOT106	£12.50	1-439-286-13	LOT46	£13.00				
TFB 4090 AD	LOT395	£12.00	3138 108 30103	LOT106	£12.50	1-439-286-21	LOT46	£13.00				
TFB 4124 AE	LOT392	£15.00	3139 128 30400	LOT90	£12.50	1-439-332-41	LOT100	£15.00				
TFB 4124 AP	LOT392	£15.00	40348-08	LOT1577	£18.00	1-439-332-42	LOT101	£14.50				
			40348A-08	LOT1577	£18.00	1-439-332-52	LOT100	£15.00				
			4812 140 10246	LOT111	£15.00	1-439-363-11	LOT268	£14.00				
			4812 140 10349	LOT106	£12.50	1-439-363-21	LOT268	£14.00				
			4812 140 10369	LOT90	£12.50	1-439-387-11	LOT311	£14.50				
			4812 140 10421	LOT90	£12.50	1-439-387-21	LOT311	£14.50				
			4822 140 10246	LOT111	£15.00	1-439-416-11	LOT255	£16.00				
			4822 140 10274	LOT123	£14.50	1-439-416-12	LOT255	£16.00				
			4822 140 10306	LOT57	£11.00	1-439-416-21	LOT255	£16.00				
			4822 140 10349	LOT106	£12.50	1-439-416-23	LOT255	£16.00				
			4822 140 10381	LOT128	£13.00	1-439-416-41	LOT255	£16.00				
			4822 140 10384	LOT127	£15.50	1-439-416-51	LOT255	£16.00				
			4822 140 10406	LOT73	£11.50	<b>THOMSON</b>						
			4822 140 10544	LOT433	£16.00	105009.8	LOT1505	£19.00				
			4822 140 10566	LOT433	£16.00	10500980	LOT1505	£19.00				
			AT 2076 / 10	LOT57	£11.00	10500980.P1	LOT1505	£19.00				
			AT 2077 / 81	LOT121	£15.00	10531460	LOT1505	£19.00				
			AT 2078 / 21	LOT395	£12.00	105660.6	LOT1505	£19.00				
			AT 2079 / 15	LOT129	£14.00	105660060	LOT1505	£19.00				
			<b>PHILIPS..continued</b>			10566060	LOT1505	£19.00				
			3119 108 31260	LOT90	£12.50	10566060.P2	LOT1505	£19.00				
			3119 108 31290	LOT73	£11.50	105880.8	LOT1505	£19.00				
			3119 108 31440	LOT433	£16.00	10588080	LOT1505	£19.00				
			3119 108 31441	LOT433	£16.00							

## CD Pick Ups and Mechanisms

Part No	Price	Part No	Price	Part No	Price
CDM12.1 Mechanism	£14.00	KSS 213 B	£8.75	OPTIMA 6 S	£11.50
KHM220AAA		KSS 213 C	£9.50	OPTIMA 5	£11.50
DVD Laser	£ 40.00	KSS 213 D	£16.00	RCTRTH8151	

Part 5 of this series, by Alex Towers, deals with the control system and the video/deflection processor chip



## Servicing

# the Sharp DA100 (50Hz) and DA50W chassis

As with all recent Sharp TV chassis, the main microcontroller chip (CPU) IC1001 is responsible for control of the set. It communicates with other areas of the chassis via various data buses but, as with similar chassis, it doesn't operate during standby. There is therefore a need for some form of control on the primary side of the power

supply. A slave processor (IC702), which is connected to the main microcontroller chip via two optocouplers (in/out), is used for this purpose. The slave processor has a volatile memory, thus each time power is applied to a set the chopper circuit has to start up so that the slave processor's program can be downloaded from the EPROM/OTP/MTP (depending on

model) chip IC1002 via IC1001. The set can then switch to standby. The remote-control receiver is connected to the slave processor chip. Fig. 44 shows the control system in block diagram form.

IC1001 is connected to other parts of the chassis via several types of bus. A parallel bus links IC1001 to the EPROM/OTP/MTP

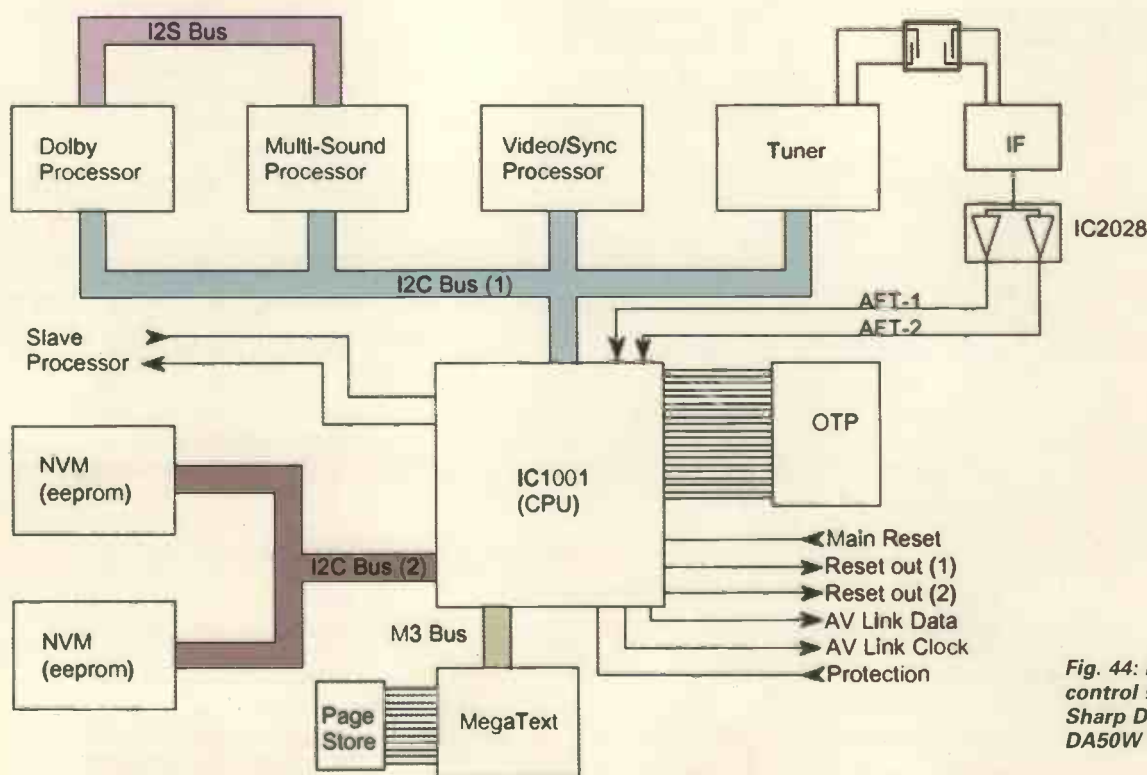

Fig. 44: Block diagram of the control system used in the Sharp DA100 (50Hz) and DA50W chassis.

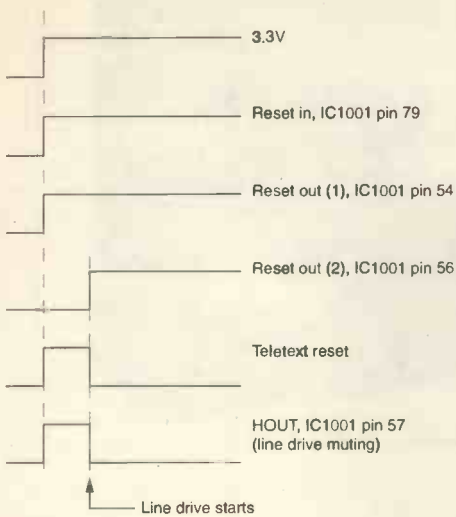

Fig. 45: Reset timing diagram.

chip IC1002, which contains the operating system. There are two I<sup>2</sup>C buses. I<sup>2</sup>C(2) is used for the links to the EEPROMs (NVMs) – some models have two of them. These memory chips contain data relating to all adjustments – end user, service or an automatic setting carried out by the CPU. I<sup>2</sup>C(1) provides serial data communications between the CPU and the tuner, the video/deflection processor chip IC801, the multi-sound processor chip IC305 and the Dolby processor chip IC1301 (where fitted). The M3 bus provides communication between the CPU and the Megatext processor IC.

Two data lines provide communication between IC1001 and the slave processor chip

IC702 on the primary side of the power supply, via optocouplers IC703 for the feed to IC702 from IC1001 and IC704 for the feed from IC702 to IC1001.

### Resets

There are three reset lines associated with IC1001. The main system reset is generated by IC1005 and operates each time the chopper power supply starts up. It's a change of state from low to high. Reset out (1) is generated by IC1001 and is fed to the video/deflection processor chip IC801. If IC801 is not reset, the line generator will not function. Reset out (1) occurs only after a main reset in. Reset out (2) resets all other relevant sections of the set and occurs only after a reset

out (1). Note that the reset for the teletext IC is inverted.

Fig. 45 shows the reset timing. Resets are a change of state, from low to high or high to low. The order of events is as shown: establishing the 3.3V supply; reset in at pin 79 of IC1001; reset out (1) at pin 54; reset out (2), pin 56. The line generator starts when reset out (1) has occurred, but line drive will not be present until the mute (HOUT) from pin 57 of IC1001 has been released (0V).

### Protection

Pin 95 of IC1001 provides safety monitoring for various conditions in the chassis. Fig. 46 shows the audio output and beam-current monitoring circuitry. The outputs from all the audio output stages are fed to the bases of Q303 and Q304 via R360, which with C377 forms an averaging circuit. As the output voltage fed to the speakers should have an average DC level of 0V over a period of time, the DC voltage at the bases of Q303 and Q304 should be zero. If the voltage moves in a positive direction, Q303 will switch on, removing the 5V bias at pin 95 of IC1001. The set will then switch to standby. Similarly if the DC voltage moves in a negative direction Q304 and Q302 will switch on, with the same result.

If the beam current is excessive, sensed at pin 8 of the line output transformer T601, zener diode D622 will conduct and Q606 will switch on. As with the audio-output fault condition, the set will switch to standby.

Fig. 47 shows the main reset and line-drive mute circuitry. During the boot-up sequence the line drive to the line driver and output

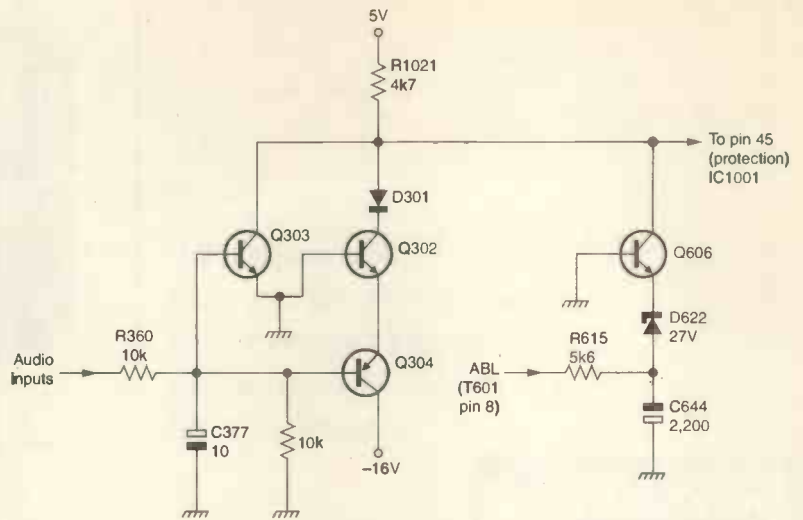

Fig. 46: The audio-output and beam-current monitoring circuitry.

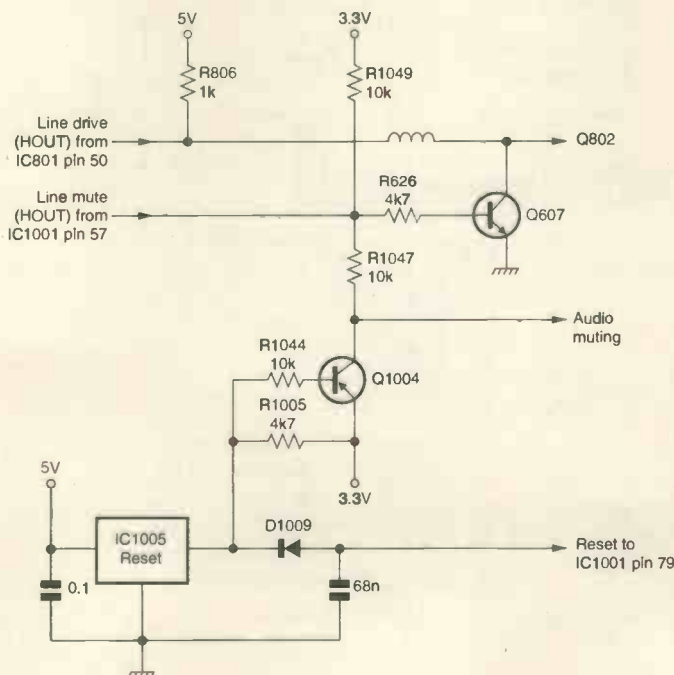

Fig. 47: The main reset and line-drive mute circuitry.

stages is muted by switching Q607 on, thus shorting out the line drive. A word of explanation is required at this point, as there are two HOUT lines. HOUT from pin 50 of IC801 is the actual line drive, which is fed to the line driver stage via Q802. HOUT from pin 57 of IC1001 is the line muting signal, which switches Q607 on and off. Muting is also applied to the audio circuits, to prevent any sound from the speakers during start-up or shut-down. HOUT from IC1001 also occurs when the microcontroller chip fails to communicate with the various devices connected to the I<sup>2</sup>C buses.

### AV link

The chassis can control a VCR directly via the scart socket, or the VCR can control the TV set. In either case the VCR must be compatible with the AV link system used. And, during installation of the TV set and VCR, it will be necessary to decide which device has overall control.

Fig. 48 shows the control circuitry. Commands from the TV set to the VCR appear at pin 16 of IC1001 and are fed via Q1005 to pin 10 of the AV-1 and RGB scart sockets. Instructions from the VCR come via the same scart connections then pass via D1003 to pin 92 of IC1001. Zener diode D411 provides protection against excess voltage being applied to the scart sockets.

### Microcontroller faults

Faults associated with the microcontroller chip IC1001 normally result in failure of the set to function, i.e. turn on or operate correctly. A check on the ALE (all logic enable) output at pin 36 will show whether the internal system is carrying out instruction cycles. This pin changes state with each instruction cycle that the chip carries out, so it's a good indicator of whether the IC is working. The normal frequency of this squarewave signal is 8.77MHz.

### The EPROM and EEPROMs

For it to work the microcontroller chip IC1001 requires an operating program, which is held in IC1002. Three different types of device have been used in this position – EPROM, OTP or MTP. An EPROM has a small transparent window in the top so that UV

light can be used to erase the stored data: OTPs and MTPs don't have this window. OTPs (one-time program) are devices that can be programmed only once. They are cheaper than an EPROM, but less flexible. MTPs (multi-time program) are similar to OTPs but can be programmed many times. Note that all these devices are static-sensitive, so anti-static precautions must be adhered to when handling them.

EEPROMs, alternatively called NVMs, are used to store various values that can be adjusted in the service mode and any changes made by the user while setting up the receiver. They are also used to store various transient data values generated by the microcontroller chip during its operation.

If a blank EEPROM is fitted, a set of default data values stored in the EPROM will be downloaded to it via the microcontroller chip during the boot-up procedure. This takes about a minute to complete and takes place only at initial switch-on after replacing the EEPROM. It's important that this process is not interrupted, as this could corrupt the data. If a set switches on within ten seconds after fitting a new EEPROM this writing procedure has not been completed and there may be a problem elsewhere in the set.

When an EEPROM has been changed it's possible that, when the set is switched on, there may be picture problems such as poor geometry, incorrect audio and picture settings etc. This is because the default data needs to be modified to take account of CRT and component tolerances and any customer preference data that will have been lost.

Before blanking or changing the EEPROM, it's advisable to check that the correct EPROM version is fitted. Refer to Part 1 in this series, last September, for more information on the type of chip

used in the IC1002 position in particular chassis.

### EEPROM blanking

The data stored in the EEPROM is vital for the set's correct operation. When a fault occurs, it can be difficult to decide whether the cause is a hardware or a software (data corruption) failure. In such a case it's helpful to check that the EEPROM contains correct data. If the EEPROM is loaded with a working set of default data values, the set will then either work (if data corruption was the problem) or remain faulty (if the cause of the problem is a hardware defect).

The problems that can be caused by faulty software are many and varied. Some of the worst memory corruption faults can lead to premature failure of the line and/or field output stages. Most such problems are permanent however, such as no sound, a blank raster, blanking faults (half a picture, missing parts of the picture, etc.), OSD and teletext faults. The list of possible faults is quite extensive.

Without access to an EEPROM programmer or blanking jig, you have little option but to replace the EEPROM, switch the set on and wait. With all FW, HW and GS models it takes about a minute for default data to be downloaded from the EPROM after fitting a blank EEPROM. Corruption can occur if the process is interrupted, then the whole process has to be repeated.

Two types of blanking jigs are available for these chassis, one for the FW/GF models and the other for HW models. They come in the form of an EPROM/OTP/MTP, the Sharp part numbers being:

FW/GF blanking jig FW-SERV-JIG01

HW blanking jig HW-SERV-JIG01.

Note that the HW blanking jig

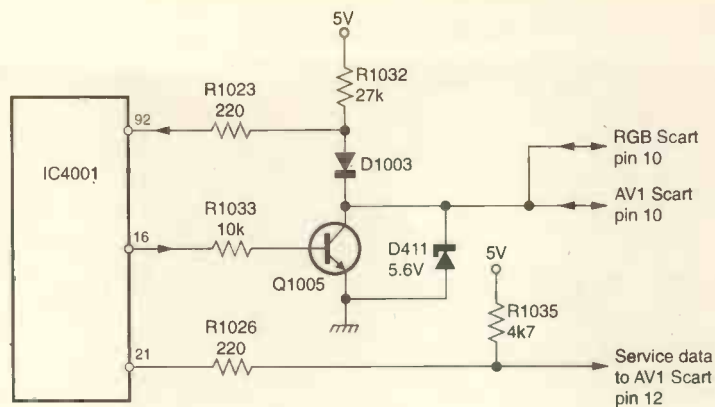

Fig. 48: The AV link control circuitry.

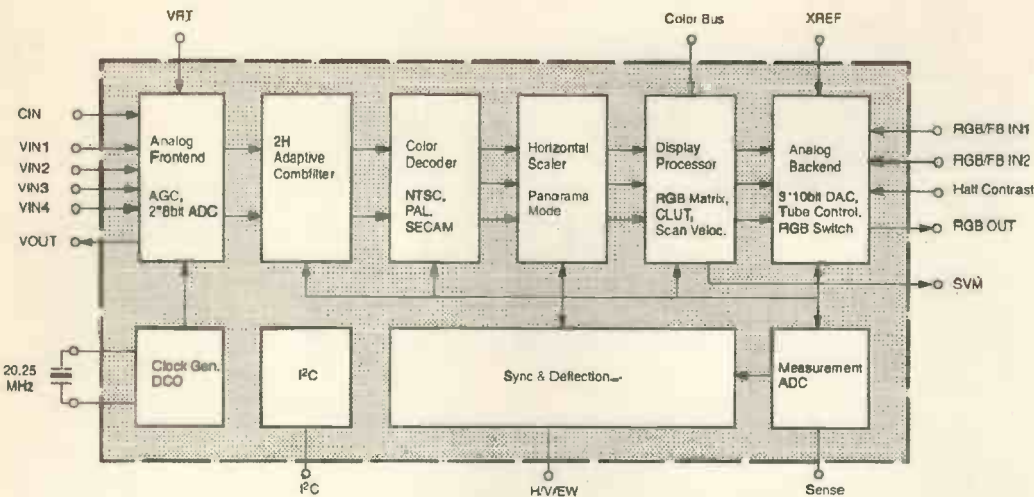

Fig. 49: Block diagram of the VDP3120 video/deflection processor chip IC801.

works at the lower supply voltage (3.3V). Although it won't be damaged if used with a 5V set, the EEPROM will not be blanked. The reverse is also the case – when an FW/GF blanking jig is used with a 3.3V supply.

Use of the jig is simple. Just follow the instructions below:

- (1) Turn off the TV set at the mains.
- (2) Remove IC1002.
- (3) Replace IC1002 with the correct blanking jig.
- (4) For sets with two EEPROMs, disconnect pin 5 of IC1004.
- (5) Turn the set on (out of standby).
- (6) Wait for one minute.
- (7) Turn the set off at the mains.
- (8) Remove the blanking jig from the IC1002 socket.
- (9) Replace the original IC1002.
- (10) Turn the set on (out of standby).
- (11) The set will take about a minute to come on.

### EEPROM programming jig

To make fault-finding a lot easier Sharp has issued details of a handy little jig that enables these ICs to be programmed quickly and easily. In most cases the EEPROM doesn't have to be removed from the PCB. Default data is available for account holders from the Sharp Technical website. For non-account holders a disk is available from the Sharp parts centre, with payment by

credit card. Alternatively the kit can be purchased from Willow Vale Electronics. The part no. for the jig is NVM-PROG-JIG1, Sharp price code BC. The part no. for the disk is NVM-DATADISK1, Sharp price code AL.

Once the jig has been made and the software installed on a PC, it's possible to program an EEPROM, view the data, and even take data from a good EEPROM. Version 1.17 of the Ponyprog software is recommended for use with this jig – other versions have been known to cause various communication failures and thus crashed data.

Further details of the jig were given in the February 2003 issue of *Television*.

### The video/deflection processor IC

The video/deflection processor chip IC801 is a member of the Micronas VDP31xxB family. These high-quality processors provide economic integration of various functions in all classes of TV sets. They are based on functional blocks in two previous Micronas chips, the VPC3200A video processor and DDP3300A display and deflection processor. Fig. 49 shows a block diagram for the device, which contains all the video, display and deflection processing required for 4:3 and 16:9 TV sets operating at 50Hz or 60Hz. The functions incorporated are as follows: a 2H adaptive comb filter; a scan-velocity modulator; a 1H comb filter; colour-transient improvement; RGB insertion; CRT control; a programmable RGB matrix; four composite inputs (one for S-VHS); a composite video and sync output; horizontal scaling (0.25 to 4); panorama vision; a black-level expander; dynamic peaking; a soft-limiter (gamma

correction); high-performance line and field deflection generators; a separate ADC for CRT measurements; EHT compensation; an embedded RISC controller (80 MIPS); an I<sup>2</sup>C interface. There's just one crystal (20.25MHz) for all systems, and few external components are needed. A single 5V supply is required.

The analogue front-end provides analogue interfaces for all the video inputs and mainly carries out analogue-to-digital conversion for the following digital video processing. Most of the functional blocks in the front-end are digitally controlled (clamping, AGC and clock oscillator): the control loops are closed by the fast processor embedded in the decoder.

Up to five analogue inputs can be connected, four for composite video or S-VHS luminance. These four inputs are AC-coupled, clamped to the sync back porch and amplified by variable-gain amplifiers. The other input is for an S-VHS chroma signal, which is internally biased and has a fixed-gain amplifier. There are two analogue-to-digital converters that run at 20.25MHz and have 8-bit resolution. The input to the luminance ADC is available at the analogue video output pin, and must be buffered by a source-follower.

The average beam-current limiter (BCL) in the chip uses the beam-current sensing input. A filter with a bandwidth of approximately 2kHz is used to average the beam-current value during the active picture period. The limiter has an automatic offset adjustment which is active two lines before the first beam cut-off measurement line and allows threshold-current setting. If the beam current is above the threshold, the excess current value is low-pass filtered and used to attenuate the RGB outputs, by adjusting the white-drive multipliers for the internal, digital RGB signals, and the analogue contrast multipliers for the analogue RGB inputs to the chip.

The lower limit of the attenuation is programmable, so a minimum contrast can always be set. The ABL attenuation is switched off during the CRT current measurement. This is why some faults are 'masked' in the service mode. After the white-drive current measurement line, it takes three lines to switch back to BCL-limited drives and



brightness.

Pin 34 provides an analogue output to drive the scan-velocity modulator circuit (see next month). The DAC involved is a current sink, like the RGB DACs. At zero signal level the output current is 50 per cent of maximum.

### Protection arrangements

The chip contains protection inputs at pins 11 and 12, see Fig. 50. These provide CRT and drive stage protection. Pin 11 monitors the operation of the field output stage. Its input, a 50Hz, 5V peak pulse, is taken from the field flyback generator circuit (Q502 and Q503). If the negative edge of this signal is not detected the RGB drives are blanked. This feature can be selected by software.

Pin 13 is the usual line-flyback pulse feedback pin. The pulses are also rectified by D615 and C617 as a way of monitoring the EHT voltage. The voltage thus obtained, less than 1V under normal conditions, is fed to pin 12, with D617 to provide limiting. There are two threshold levels. Between zero and the lower

threshold level normal operation continues. Between the lower and higher threshold levels the RGB drives are blanked. If the DC voltage continues to rise and passes the higher threshold level the line drive output is also cut off.

### Fault notes

Two different types of VDP chip are used in the IC801 position, VDP3120 and VDP3130, depending on chassis version – see Note 4 on page 670 in Part 1

of this series (September 2003 issue). These two types are not compatible.

A slightly different version of the VDP3120 chip is used in later versions of the chassis. The basic type number is the same, but the revision number differs. Should patterning be experienced after replacing a VDP3120 chip, remove C824 if fitted. This 10nF capacitor is connected between pin 33 and chassis, in parallel with R801 (10kΩ). Poor dressing of the cables can also cause patterning.

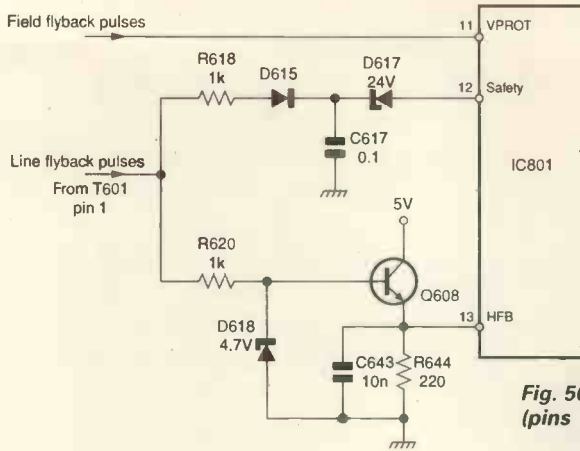

Fig. 50: The protection inputs to IC801 (pins 11 and 12).

## WATCH SLIDES ON TV MAKE VIDEOS OF YOUR SLIDES DIGITISE YOUR SLIDES

(using a video capture card)



"Liesgang diatv" automatic slide viewer with built in high quality colour TV camera. It has a composite video output to a phono plug (SCART & BNC adaptors are available). They are in very good condition with few signs of use. For further details see [www.diatv.co.uk](http://www.diatv.co.uk)

Board cameras all with 512x582 pixels 8.5mm 1/3 inch sensor and composite video out. All need to be housed in your own enclosure and have fragile exposed-surface mount parts. They all require a power supply of between 10 and 12v DC 150mA.

47MIR size 60x36x27mm with 6 infra red LEDs (gives the same illumination as a small torch but is not visible to the human eye).....£37.00 + vat = £43.48

30MP size 32x32x14mm spy camera with a fixed focus pin-hole lens for hiding behind a very small hole.....£35.00 + vat = £41.13

40MC size 39x38x27mm camera for 'C' mount lens these give a much sharper image than with the smaller lenses.....£32.00 + vat = £37.60

Economy C mount lenses all fixed focus & fixed iris

VSL1220F 12mm F1.6 12x15 degrees viewing angle.....£15.97 + vat = £18.76

VSL4022F 4mm F1.22 63x47 degrees viewing angle.....£17.65 + vat = £20.74

VSL6022F 6mm F1.22 42x32 degrees viewing angle.....£19.05 + vat = £22.38

VSL8020F 8mm F1.22 32x24 degrees viewing angle.....£19.90 + vat = £23.38

Better quality C Mount lenses

VSL1614F 16mm F1.8 30x24 degrees viewing angle.....£26.43 + vat = £31.06

VWL813M 8mm F1.3 with iris 56x42 degrees viewing angle.....£77.45 + vat = £91.00

1206 surface mount resistors E12 values 10 ohm to 1M ohm 100 of 1 value £1.00 + vat 1000 of 1 value £5.00 + vat

866 battery pack originally intended to be used with an orbital mobile telephone it contains 10 1.6Ah sub C batteries (42x22dia the size usually used in cordless screwdrivers etc.) the pack is new and unused and can be broken open quite easily.....£7.46+vat = £8.77



Please add 1.66 + vat = £1.95 postage & packing per order

### JPG ELECTRONICS

Shaws Row, Old Road, Chesterfield, S40 2RB

Tel 01246 211202 Fax 01246 550959 Mastercard/Visa/Switch

Callers welcome 9:30 a.m. to 5:30 p.m. Monday to Saturday

# Campion Electronics Ltd.

SUPPLIERS OF QUALITY  
EX-RENTAL TV'S

and video equipment to independent  
retailers across the UK and EIRE.

FREE DELIVERY SERVICE  
to most areas of UK

WORLDWIDE EXPORT SERVICE  
Large stock of TVs suitable for export  
Experts in UHF/VHF conversion

Visit our large warehouse at:

Units 1 & 2 Tenat Works,  
Worcester Rd, Kidderminster,  
Worc, DY10 1JR

Tel: (01562) 746000 (2 Lines)

Just 20 miles from Birmingham City Centre

# LETTERS

Send letters to "Television", Highbury Business Communications, Nexus House, Azalea Drive, Swanley, Kent, BR8 8HU or e-mail [t.winford@highburybiz.com](mailto:t.winford@highburybiz.com) using subject heading 'Television Letters'.

Please send plain text messages. Do NOT send attachments. Be sure to type your full name, address, postcode, telephone and e-mail address (if any).

Your address and telephone number will not be published but your e-mail address will unless you state otherwise.

Please send ONLY text intended for the letters page. Correspondence relating to subscriptions and other matters must be sent to the office address given above.



## TETRA problems

I was interested in Bill Wright's article on TETRA TV interference in the November issue. A recent letter in my local newspaper claims that TETRA transmissions are also causing interference to radio broadcasts, a problem which the writer claims can be solved in his area only by purchasing a digital (DAB) radio.

There is also a contentious health issue. I've read that TETRA transmissions contain a modulation component at 17.6Hz, which is believed by some to be a hazard since it is close to a human brain rhythm at about 16Hz. Some people who live close to TETRA masts believe that the transmissions make them feel disturbed and ill. The evidence to support this is at present sparse and circumstantial but, if there's a real problem, it is likely to show up statistically – in the same way that smoking and lung cancer were found to be statistically linked before the physical process came to be understood. Time alone will tell if the health fears are justified.

*Keith Cummins,  
Chale Green, Isle of Wight.*

## The Panasonic Z deck

In the December VCR Clinic feature Martin McCluskey mentioned difficulty in replacing the take-up loading gear (VXL2760) in the Panasonic Z deck when there's a cassette stuck inside the machine. I've replaced a number of these loading gears and have found a simpler solution to the problem of removing a stuck cassette.

Remove the loading block by releasing the three lock tabs. Place a screwdriver blade between the rack teeth and the

raised part of the chassis, then force the rack to the unloaded position. This occurs when the two holes in the rack line up with corresponding holes in the chassis. Once this position has been reached, turn the main gear to eject the cassette.

I have also been told that it is possible to force the take-up gear down its shaft by pushing hard and breaking the clip that retains the gear on the shaft.

*Paul Hardy,  
Chinnor, Oxon.*

## Mobile phone warning

If you receive a text message on your mobile from the number 15477, indicating that you have won a two-night stay in the Druid's Marriott in Wicklow and saying that you must reply with the text "#90" or "#09", you should delete the text immediately and not reply. This is a fraud operation whereby, once you press #90 or #09 and reply text, your SIM card can be accessed and calls made at your expense.

Forward this information to as many people as you can to stop the fraud.

The basic action applies to any text you receive when you do not know who the sender is – never reply with a code.

*Craig Packer,  
[craig.packer@soongroup.co.uk](mailto:craig.packer@soongroup.co.uk)*

## PA amplifiers

I would like to add a few points to those made by Geoff Darby in his excellent article on PA amplifiers in the December issue. Many modern PA amplifiers and group amplification systems use valves or Darlington transistors in the output stage, or a mixture of both. I was recently asked to repair a 36-year old 100W Marshall PA amplifier because the mains transformer had burnt out. After a quick call to Marshall in Milton Keynes a replacement was on its way, along with a free copy of the circuit diagram. Marshall amplifiers are extremely well built and a pleasure to work on. I would encourage TV engineers to diversify and take on this type of work. PA amplifiers are nearly always worth repair, and no 'special tools' or test

equipment are required.

Some younger-generation engineers seem to be put off when valve circuitry is involved. But there are no real problems: get the voltages right and your problems will be solved. I have never experienced any difficulty in obtaining spares or technical advice for this type of equipment. Three companies in particular, Marshall, Peavy and Carlsford, have excellent spares services and technical departments that will provide free advice over the phone.

Replacement valves are obviously required from time to time and can be expensive when obtained from the original equipment manufacturers. As a source I recommend Watford Valves in St. Albans. The company can supply high-quality replacement valves at very competitive prices, also matched pairs, fully tested. It's open seven days a week, up to 9 p.m.!

*Steve Roberts,  
Roberts Electronics,  
Mallaig, Inverness.*

## Germanium signal transistors

With reference to the article on vintage transistor radio repair (October issue, page 734) and the mention of AF117-series germanium transistors, when these transistors develop an internal collector-to-screen short-circuit you can avoid the bother and cost of replacement by cutting the screen lead. They all seem to work OK after doing this.

I have an Eddystone EC10 short-wave receiver that's full of these AF117/OC170 transistors and works fine. It must be thirty years old. I also have a Dansette radio in which the AF117s are contained in a small tinplate module made by Mullard. Roberts Radio often used these modules. AF117s and OC170s were also used in Pye radio-telephones. I once had a Pye Cambridge that was converted to 144MHz. The RF amplifier used to go short-circuit: I wonder if static picked up by the aerial caused the damage?

*Mark Garton,  
Bromsgrove, Worcestershire.*

# HELP WANTED

The help wanted column is intended to assist readers who require a part, circuit etc. that's not generally available. Requests are published at the discretion of the editor. Send them to the editorial department or email to [t.winford@highburybiz.com](mailto:t.winford@highburybiz.com)

- Wanted:** Does anyone have for sale an Escort Model 1025 autoranging multimeter, supplied by CPC in the 90s? It features a rotary selection switch, capacitance checks and a frequency test. Good price paid. Phone John on 01384 864 058 (Brierley Hill, West Midlands).
- Wanted:** Service manual for the Philips VR2022 VCR. Phone P. Wright on 01237 470 425.
- Wanted:** Audio/hi-fi PCB for the JVC HR-S4700 or Ferguson FV59S S-VHS recorder; a capstan motor and servo con-

- trol board for the Akai VS-A77 VCR; and a complete mechanical deck for the Sony CCD-TRV35E camcorder, or one from another Sony model that has the same type of deck. If you can help with any of these items, phone Dave on 01843 231 512 or email [hedgehog@turbo48.fsnet.co.uk](mailto:hedgehog@turbo48.fsnet.co.uk)
- Wanted:** TV trolley with suction pads to grip the CRT. Any condition. Phone Tony Roberts TV on 01903 782 141.
- Wanted:** Circuit diagram (photocopy OK) for the Yamaha NS series A-500 amplifier. Phone Colin Chandler on 01922 638 718 or email [c\\_chandler70@hotmail.com](mailto:c_chandler70@hotmail.com)
- Wanted:** A DC-DC converter unit for the Sony SLC9UB Betamax VCR or a scrap machine with a good power supply and D board. Phone Andy on 01902 880 063.
- Wanted:** Early (pre-1975) colour and black-and-white sets, equipment, picture monitors, spare parts, home-built equipment, catalogues etc. Phone Keith Parker on 020 8422 5049.
- Wanted:** Old half-inch diameter ferrite rods. Must be six inches or more long. Will pay very good money for them. Peter Tankard, 16A Birkendale Road, Sheffield, S6 3NL. Phone 07931 463 823 (mobile).
- Wanted:** The top PCB for a Ferguson mid hi-fi Model HFD06. It contains tuning, audio etc. and eight function push-buttons. This is an old unit dating from 1988. Can someone out there help? E. James, 8 Bryn-y-Derwydd, Trefin,

- Haverfordwest, Pembrokeshire, SA62 5AY. Phone (mobile) 07814 176 641.
- For disposal:** *Television* magazines dated from January 1992 to February 2003, a total of 134 issues covering eight years, in binders. Also U-View TV circuits 1987-1996, five volumes, in good condition. Offers invited as I've now retired from the trade. Phone John Langley on 01536 723 411 (Kettering, Northants).
- Wanted:** Loudspeaker for the Panasonic radio-cassette player Model RX-CW55L. Phone G. McDonald on 01903 743 557 (Storrington, West Sussex).
- Wanted:** Naiko/Bush 28in. widescreen sets, working or non-working. Must be silver with remote-control units. Good prices paid. Carl Hales, 115 Tamworth Road, Long Eaton, Nottingham, NG10 1BG. Phone 0115 973 4382.
- Wanted:** CRT type A51EAF00X01, used in the ITT Digi 3 chassis and many 21in. ITT models dating from the 1986-90 period. Also a Panasonic tube base, part no. TMP107238, used in the Alpha 1 chassis. Phone Bruce on 01708 558 792.
- Wanted:** Mains transformer for the Mullard high-speed valve tester. Alternatively, is anyone interested in cards and adaptors for this valve tester? Phone Len on 01277 205 882, or mobile 07732 563 946, or email [starburst051246@aol.com](mailto:starburst051246@aol.com)
- Wanted:** Desperately, circuit diagram for the Beam Echo Avantic Tuner BM611. Phone Gary Riley on 01484 328 296.

Complete and fax the coupon to: +44 (0) 1353 654400



## TELEVISION AND HOME ELECTRONICS REPAIR

Television & Home Electronics Repair magazine is the only magazine for technicians who deal with consumer electronic products, in particular TV, Video, Satellite and Audio equipment.

Keep up to date with the latest information and changes affecting this industry including tips & guides on repairing television and electronic equipment including satellite receivers, PCs, monitors, VCRs, DVD players, audio equipment and much more.....



Make sure you receive your regular monthly copy by subscribing today.....

I wish to subscribe for one year to *Television*:  
 Price  UK £33.80  Europe £48.00  
 Rest of World £63.50  US\$99.00  Euro 100.96

I wish to subscribe for two years to *Television*:  
 Price  UK £53.00  Europe £77.00  
 Rest of World £99.00  US\$154.00  Euro 157.41

Please tick preferred method of payment  
 I enclose a cheque payable to Highbury Business Communications Ltd  
 Please invoice me  Purchase No  
 (NB Purchase order must be included to validate invoice)

Please charge my: Master Card/Visa/Amex/Diners  
 Club/Switch/Delta (please circle)

Card No \_\_\_\_\_  
 Expiry Date \_\_\_\_\_  
 (Switch/Delta Only) Valid from  /  /  Issue Number

Signature \_\_\_\_\_  
 Date \_\_\_\_\_  
 Name \_\_\_\_\_  
 Job Title \_\_\_\_\_  
 Company \_\_\_\_\_  
 Address \_\_\_\_\_  
 \_\_\_\_\_  
 Postcode/Zip \_\_\_\_\_  
 Country \_\_\_\_\_  
 Telephone/Fax \_\_\_\_\_  
 E-mail \_\_\_\_\_

Please tick here if you do not wish to be contacted by other businesses either by  
 Mail  Telephone  Fax  E-mail

Please return to: Highbury Subscription Services, Link House,  
 8 Bartholomew's Walk, Ely, Cambridgeshire CB7 4ZD, UK.  
 Email: [wss@wyverncrest.co.uk](mailto:wss@wyverncrest.co.uk) (Quote ref: TV1)



# DX and Satellite Reception

**Terrestrial DX and satellite TV reception reports. Broadcast and satellite TV news. Auto-searching satellite receivers. Notch filtering for Band I. Roger Bunney reports**

October was an unusual month for reception, with some Sporadic E, aurora-enhanced reflections, meteor-shower and tropospheric activity. Towards the end of the month large sunspots produced flares and solar storms that upset the Earth's ionosphere sufficiently to create aurora activity to the north.

Unfortunately aurora displays are rarely seen in the southern UK, but vigilant DXers in the north should have seen the magnetic storms as colourful displays across the northern skies. Iain Menzies (Aberdeen) reported very strong activity in Band I at about midnight on the 22nd, identified as NRK (Norway). Cyril Willis (King's Lynn) noted NRK on chs. E2-4 and YLE (Finland) chs. E3 and 4. I found that the fluttery late-night signals across all Band I channels towards the end of the month resembled meteor-scatter rather than aurora reception: this was of course the Orionids meteor-shower period.

Here's the log for SpE activity during October, to the 28th:

- 7/10/03 MTV (Hungary) ch. R1; RTL+ (Hungary) R2; HRT (Croatia) E4; ORF (Austria) E2a, 4; ARD (Germany) E2, 3. The MUF rose into Band II (FM).
- 8/10/03 SVT (Sweden) E2.
- 19/10/03 RAI (Italy) IA, IB; Tele A (Italy) E2-.
- 21/10/03 TVE (Spain) E2. Also NRK and YLE late night, see above.
- 26/10/03 TVE E2, 3; RAI IA.

Stable high-pressure conditions produced enhanced tropospheric activity across Bands II and III and at UHF from about the 7th. French, Benelux, German, Danish and Norwegian signals were received at very high levels across the above bands, including DAB at the top of Band III. Distances achieved with DAB reception are now approaching 300 miles – the distance from Cyril's location to Scotland and the Benelux countries. I feel that October was a rewarding month.

Congratulations to Canadian radio amateur VE6JW (Namao, Alberta) who on July 24 made two-way contact with three amateurs in Ireland, Scotland and England in the 6m (50MHz) band. A remarkable distance.

On a personal note, I was laid low for two weeks during the month by the flu virus that swept the south. A forced move from Word Perfect to Microsoft Word hasn't helped!

## Satellite sightings

An interesting four-channel TV multiplex appeared during



*Manhattan ferry boat following the dockside collision. Reception via NSS-7.*

October via NSS-7 (21.5°W) at 12.734GHz H (symbol rate 16,635, FEC 3/4), with service ident 'Boucha Oui'. It consists of Arabic programming on channels TDA-1 (corner logo '3'); TDA-2 Algere; TDA-3 with colour bars and a superimposed caption 'videolock error TDA-3'; and TDA-4 which is blank. There are also radio channels across the band with various Arabic contents. Alan Richards (Nottingham) suggests that this is an Algerian multiplex feeder for French Foreign Legion troops in either Afghanistan, Kenya or Ethiopia.

Signs of approaching winter, with snow and skiing championships, once frequently seen via Eutelsat W3 (7°E) EBU circuits but now lost to most of us with the advent of MPEG 4:2:2. The analogue transmissions in earlier days usually had SIS (sound in syncs): a sync inserter was required for video stability, and a late receiver offered audio out as well. Life was simple then! On the afternoon of October 26 the Media Center Tirol was feeding Austrian championship skiing via Eutelsat W1 (10°E) at 11.090GHz V (6,109, 3/4). Pretty pictures of snow and mountain slopes. At 1616 hours GMT there was an abrupt end to the transmission, with no terminating test card and ident. The crew obviously rushed home for tea!

During the period under review satellite ENEX (European News EXchange, based in Luxembourg) via W1 at 12.510 and 12.516GHz H (5,632, 3/4) proved to be interesting. There are several daily news exchanges, with the transmissions well timetabled along with information on the up and down frequencies. Service idents are similar to ENEXII LUX-LXB-1. With my RSD receiver the scan AFC confused itself because of its wide acceptance characteristic, whereas the Coship receiver with tighter AFC span produced an ENEX screen at 12.510GHz and a totally blank screen at 12.516GHz. Further up, at 12.732GHz V (same SR and FEC), you find APTN London, with colour bars and tone and the occasional newsfeed.

Bizarre corporate proceedings viewings were seen on the 21st via the Atlantic Bird-1 (12.5°W) GlobeCast multiplex, at 11.104GHz H (20,145, 3/4). While Channel 1 carried a Microsoft Office effort (updated 2003 version, presented in a theatre), Channel 2 featured a NASA-TV fashion show, with models showing the space suits, protective clothing etc. that the well-dressed Shuttle crew member must wear. This originated from GlobeCast LA – I wondered whether it was an upmarket charity event.

There was much concern about the Pope's health during the middle of the month. CNN Newsource fed extensive footage of Paul Paul's life one evening via NSS-7. Eutelsat W2 (16°E) featured live pictures of the Vatican on the 18th, when a large number of new cardinals were appointed: UK + Fox News Rome carried NTSC and PAL reports at 11.110GHz V, Up Stream ITA for Italian TV was at 11.090GHz V, and TES61 Sky ITA was at 11.081GHz V (all 5,632, 3/4). The following evening produced yet more TV from Rome. A service carried by APTN Rome Path 1 (10.967GHz V, 4,167, 5/6) was followed with the blessing of the people in St. Peter's Square and then a massive firework display.

Interest in Intelsat 801 (31.5°W) waned when the GranadaMedia SNG trucks moved to Telecom 2D (8°W). The French regionals continue to use both satellites however. A check on 801 in the middle of the month revealed, at 11.028GHz V (5,632, 3/4), Oest Info Nantes with a video package about a rusty barge, followed by a cut to Oest Info Brest with drama up a town centre steeple and a man being lowered in a stretcher, watched by a tense crowd.

Goodbye Concorde. On the 24th Sky News carried live pictures of the final service landing and disembarkation, with statements from the pilot and crew. This was seen via the usual Eutelsat W2 slot at 12.525GHz H (5,632, 3/4) from Heathrow. The BT5 feeder was also active at 11.169GHz H (5,632, 3/4), with cockpit and control tower pictures of the talk down as the Concorde landed. Impressive yet sad.

On the 19th PAS-6 (43°W) carried a Fox News feed at 12.578GHz H (19,850, 3/4) and test pattern, but with the ident from 'Buenos Aires/5411-4349-4883/Torneos & Competencias'. Alan Richards kept viewing till well past midnight UK but there were no signs of any tournaments and competitions. Colour bars remained, and he retired to bed!

A busy period across the Clarke belt.

### Broadcast news

**Germany:** Following the end of analogue TV transmissions in the Berlin Brandenburg region, the government is now moving to the second stage in the conversion from analogue to digital TV. This summer (2004) will see the start of DTT in the five northern regions. Hamburg expects to be on air with about 24 FTA channels by April, with the main towns in the other four regions – Niedersachsen, Schleswig/Holstein, Bremen and Mecklenburg – following later. More details next month.

The German news channel NTV is still running at a loss. It has been told by holding company RTL to improve performance and be out of the red over the next two years.

**DTT:** The Spanish government is encouraging the TV industry to



Regional French VTR clock. Received via Intelsat 801.

move to DTT. Over the past twelve months several broadcasters have conducted trial DTT transmissions, including RTVE, Canal Plus Espagne, Antena 3 and Tele-5. The question of which DTT standard to adopt has yet to be decided.

The French authorities have given the go-ahead to four TV groups, including TF1, M6 and Canal Plus, to start DTT multiplexes though no on-air dates have been scheduled.

RTM Malaysia intends to start digital TV and radio test

## DXer's SPECIAL 14" TV



- Direct channel entry/readout
- Direct frequency entry 40-860MHz
- Multistandard
- Low noise tuner
- 12v DC and mains operation
- Remote control
- Scart connection
- Auto scanning of RF channels
- Auto scanning of frequencies 40-860MHz
- Cable tuner
- Video squelch (removed in tuning mode)
- Six teletexts
- Covers systems BG/LL/DKK PAL and SECAM, NTC via the scart

£299.00

Overnight delivery by insured courier £12.00

---

## FREE BBC VIEWING IN EUROPE

Perfect reception only with the latest THOMSON digi box

- The correct digi box + the correct dish + the correct LNB = perfect reception anywhere
- Watch the BBC wherever you like, in Europe etc
- Digital satellite systems from only £399.00
- All dish systems are supplied with LNB, cable and plugs
- You can receive FREE viewing of BBC1,2,3,4, children's BBC, BBC24 hour news and all the BBC radio stations plus many more
- ITV1, Channels 4 and 5 available by subscription arranged by ourselves
- Increase your dish size with our new enhanced Imported LNBs



Tripods £49.95

Digital system with 88cm dish — £438.95

with 1.1m dish — £478.95

ALL PRICES INC VAT

Overnight delivery in the UK for all items by insured courier £12.00

FULLY COMPREHENSIVE 35 PAGE CATALOGUE AVAILABLE BY RETURN OF POST FOR £1.50

AERIAL TECHNIQUES LTD Tel: 01202-423555 Fax: 01202-425055  
59 Watcombe Road, Southbourne, Bournemouth, Dorset BH6 3LX, UK  
E-mail: atech@dircon.co.uk www.aerial-techniques.com  
Est 1979 Callers by Appointment please



Advise on Bahrain TV changes. Reception via Arabsat (26°E).

transmissions in Kuala Lumpur this summer. RTM estimates that it would take ten years to extend coverage nationwide.

**Iceland:** The Northern Lights TV network, which was featured on TV downlinks for a short time, has merged with MGM Networks to create a new pay-TV service in Reykjavik. The Northern Lights Communications (NLC) operation began on November 1.

**Eastern Europe:** The AXN pay-TV service has been launched in Poland, Hungary, Bulgaria, Slovakia and the Czech Republic with an activity and action format.

**Iraq:** Garry Smith (TRN) reports that a three-channel TV service of sorts, called New Iraqi Television (NITV), is now on air. Channel 1 is an Arabic service that reaches about three-quarters of the population. TV Iraq is an English-language service that will eventually include regional opt-outs and input from external TV services, e.g. DW-TV. Baghdad TV is currently testing in the capital and should be in operation by the time this note is published.

### Satellite news

The EBU has renewed its contract for C-band feeds via AsiaSat-2 (105°E), which carries regular and occasional news feeds and exchanges between the Far East, SE Asia, Australasia and Europe. Pan-European distribution is normally in Ku band via Eutelsat W3 (7°E). AsiaSat-2 also brings many sporting events to Europe. Broadcasters increasingly use low-elevation satellites, for example Europe\*Star-1 (45°E) and PAS-7 (68.5°E), for Asian and NW Australian direct Ku-band feeds to Europe, for example news of the Bali bombing. High-quality pictures of the latter were seen using dishes down to 1.2m in diameter.

The NY Bankruptcy Court has agreed to the sale of Loran satellite assets to Intelsat. Telstar 5 (97°W), 6 (93°W), 7 (129°W) and 13 (121°W) have been transferred to Intelsat's fleet. Telstar 8, which is being built, is also being transferred. It will slot in at 89°W in mid-2004. The deal also includes goodwill, contracts, teleports and fibre connections.

PanAmSat has signed a contract with Space Systems/Loral to design and construct a replacement satellite – the final orbital slot has still to be decided. A second contract, to produce an in-orbit spare, has been agreed in principle.

The Israeli satellite/cable regulatory authority has suggested that foreign-originated programming should contain no more than 15 per cent advertising – the NTV and ORT channels that target Russian-speaking Israelis often contain 25 per cent advertising.

### Auto-searching satellite receivers

Roy Carmen suggests that there is some confusion about what is meant by auto search and blind search with satellite receivers, and which receivers have what facilities.

With blind search the user selects a bandwidth to be searched, enters the low frequency then the high frequency, also the polarisation (depending on DiSEqC options available) and, where relevant, wide or narrow search within the scan. The receiver then scans upwards in frequency and logs the signals present, noting the frequency, SR (symbol rate), FEC (forward error correction) and PIDs (packet identifiers), until the scan has been completed. The user can then see the channels found in a tabular listing and view, save or delete channels. The symbol rate (Mega symbols per second) will lie between a low of about 1,500 and 45,000.

With auto search the receiver checks for transponders whose parameters (SR/FEC/PIDs) are known, though the user may be able to load new data.

With auto SR the user enters a frequency and selects the polarisation. The receiver should then find and lock the required signal, with the correct SR, FEC and PIDs.

Now to the receivers that have some of these features. The RSD ODM-300 (999-channel memory) and RSD ODM-302 (3,000-channel memory) are no longer manufactured but are still available. They can search for symbol rate and FEC – you just enter the relevant frequency. The ODM-302 reappeared as the New Wave 9000, manufactured by a Korean company and housed in a shiny case. It has similar search facilities but uses a more advanced circuit. Distributed by Stirling and available from Satellite Superstore, Newcastle, UK.

The Coship CDVB3188C provides auto search and locks in SR, FEC and PIDs in the blind-search mode, and covers both the C and Ku bands. It's available in SE Asia and can be bought from New Zealand as a personal import, see last month's column. It doesn't carry the CE logo, and is therefore not distributed in Europe.

The Satwork 3618, and 3688 with upgraded memory, have blind-search capability and are basically similar to the Coship receiver. They are available from US satellite dealers. There have been various software upgrades, so check for an up-to-date status.

The newly-released Innovia IDS3088 also provides blind search.

On the second-hand market the Nokia 9200, 9500 and 9600 have auto SR/FEC and adjustable bandwidth search – provided the auto SR processor is fitted. Check this when buying a receiver, also that the appropriate software has been fitted. These receivers tend to be expensive.

### Band I interference

I make no apology about returning to the topic of RF interference, which is perhaps the main difficulty when attempting weak-signal reception. For those TV-DXing in Band I, the main problem is certainly the 49MHz band and its legal occupants, the free-wheeling, unstable baby alarms, walkie-talkies, a few cordless phones and maybe a smattering of pagers. Very few TV-DXers can avoid this menace, even in the wilds of Scotland. For those who live in a modern residential housing estate the difficulties are considerable.

Narrow-band IF operation can help, certainly with 49MHz interference in ch. E2 (48.25MHz vision carrier). I've also had some success with aerial phasers. The Timewave ANC4 was in use here recently and the results were encouraging. But with the rapidly changing phase, signal strength and polarisation of an incoming ch. R1 signal during an SpE opening you can spend more time twiddling the phase and noise level adjustments than the DX dials!

Notch filters can help when they provide a very deep, sharp notch. But we are concerned with one, two or more narrow-band interference signals between say 49-85MHz and 50MHz while checking ch. R1 for DX video, a tall order.

At my home, typical scanner (R7000) signal-strength

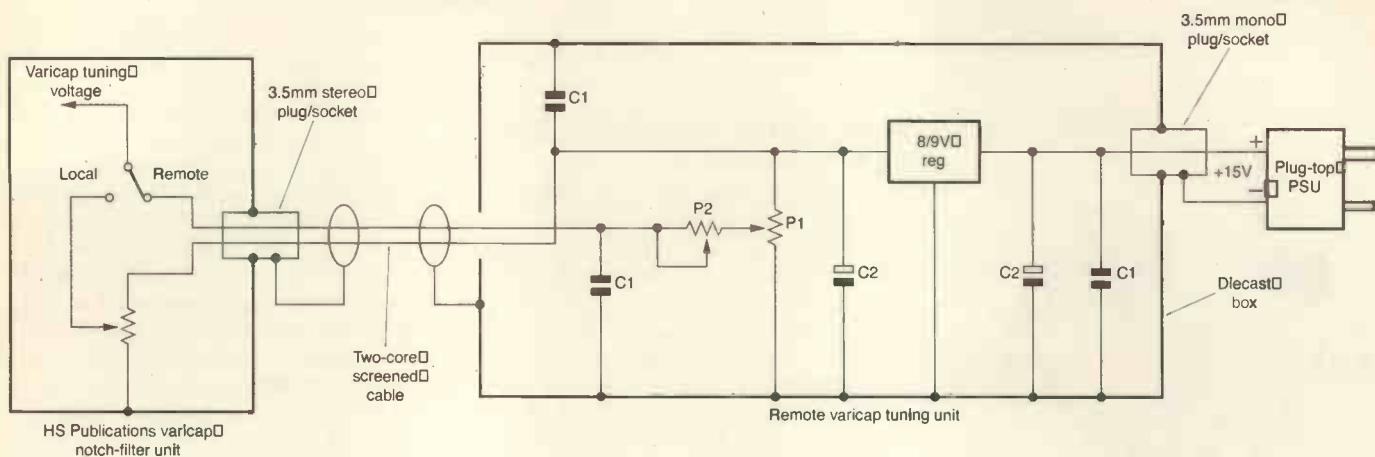

**Fig. 1: Remote-control option for use with the HS Publications varicap-tuned notch filter. Reg 7808 or 7809, 1A. C1 0.01 $\mu$ F, 50V. C2 47 $\mu$ F, 25V. P1 4.7k $\Omega$  lin. P2 2k $\Omega$  lin.**

measurements can read up to S9 + 30dB. This is very strong, and there are numerous of these baby alarms in the vicinity. With several potentially-active, closely-spaced frequencies, use of a traditionally tuned (preset capacitor) filter isn't practical. A steeply-sided notch filter centred within the 49MHz band made it possible to resolve ch. R1 signals. The answer seemed to be a filter whose notch could be tuned across the several 49MHz channels. This led to the HS Publications varicap-tuned notch filter.

Last summer I discussed with Garry Smith (HS Publications) the possibility of a high-performance, low-VHF varicap-tuned filter whose notch could be moved remotely from the DXing position. In this context low VHF means the polluted 48-52MHz segment of the band. The result of this discussion was a notch filter in a small diecast box, varicap tuned and with the facility to switch between use of either a control atop the unit or a separate remote-control arrangement, see Fig. 1.

The accompanying photographs show the prototype varicap notch-filter unit – the final version, which may differ slightly in appearance, will be available from HS Publications early in 2004. It's a very compact filter with standard in/out Belling Lee sockets. A two-way sub-miniature toggle switch adjacent to the 270° notch tuning potentiometer enables either local or remote tuning to be selected. The tuning voltage supply is fed in via the 3.5mm stereo socket on the forward-facing side of the filter.

A clever touch is the use of 3.5mm audio plugs. A 3.5mm mono plug can be used to power the notch filter, with the + feed via the inner (tip) and earth return via the body. For remote tuning, a 3.5mm stereo plug is used with the + feed via the inner (tip), the tuning voltage via the ring and the earth return via the body. A varicap-tuning supply of 1.5V-8V covers from ch. E2 to E4.

The remote-tuning unit I built is powered by an unregulated DC power supply (Connect-it Model ES96UK from Europasonic (UK) Ltd.) that provides a switched output up to 12V. Select 12V and the polarity settings and superglue in position. The power supply can be obtained from Hypervalue, Wilkinson, Greenwelds etc. at £3 or less. I cut off the multiway DC connector and replaced it with a single plug. The supply gives 15V off load, which is sufficient to drive a 1A 7808 or 7809 regulator inside the remote-tuning unit. I used another diecast box for strength and optimum earthing continuity. The box contains a main 4.7k $\Omega$  tuning potentiometer (P1) and a 2k $\Omega$  series fine tuning potentiometer (P2), the slider being connected to the ring of the 3.5mm input plug on the varicap notch-filter unit.

Setting up the notch filter is simplicity itself – but careful tuning is necessary to avoid missing the notch. A 'depth' preset potentiometer is present between the Belling Lee sockets. Set it mid way, locate an unwanted signal, and centre the notch to minimise this. Then adjust the depth preset to maximise and

sharpen the notch. A notch depth approaching 55-60dB is attainable.

The price of the varicap Band I notch filter has still to be worked out. It will be available from HS Publications, 7 Epping Close, Derby, DE22 4HR (phone 01332 381 699). For latest information you can check the website at [www.test-cards@fsnet.co.uk](http://www.test-cards@fsnet.co.uk)

I'll report in this column when the unit is available. Any postal enquires, please include a stamped, addressed envelope. ■



**External view of the prototype HS Publications varicap-tuned notch filter for Band I.**



**Internal view of the prototype HS Publications varicap-tuned notch filter for Band I.**

# AUDIO FAULTS

Reports from  
**Nick Arnold**  
**Geoff Darby**  
**Philip Rosbottom**  
**Eugene Trundle**  
**Chris Bowers and**  
**Chris Avis**

We welcome fault reports from readers – payment for each fault is made after publication.

Reports can be sent by post to:

Television Magazine Fault Reports,  
Highbury Business Communications,  
Nexus House,  
Azalea Drive, Swanley, Kent BR8 8HU

or e-mailed to:  
t.winford@highburybiz.com

## Sony TC-V10 cassette deck and TA-V10 amplifier

This cassette deck is part of the V10 stacking system and was therefore considered to be worth repairing despite its advanced age. The symptoms were that playback sound was fine momentarily then faded to nothing, with the VU display indicating full output continuously. It transpired that the bias/erase oscillator was running continuously, wiping the tape as it was played – except for the inch or so between the heads at the start of playback.

I had no manual, but eventually found that Q307 (type 603 3YG) in the oscillator's switching circuitry was faulty. A general-purpose npn transistor restored normal operation before too many of my tapes had been destroyed. You also get this type of fault with certain VCRs.

The partnering TA-V10 amplifier came in for repair shortly afterwards, the complaint being intermittently distorted sound in either channel, usually at low volume levels. It sounded like a sticking voice coil, but the speakers were blameless. My suspicions about the obsolescent STK-series hybrid output chip were also unfounded, the cause of the trouble being dirty contacts on the speaker protection relay. I cleaned the contacts with very fine wet-and-dry paper soaked in Servisol. N.A.

## Sony HCD-CP505

When this unit was powered it came on briefly then the standby relay dropped back out and it became completely dead – apart from the red standby light. The unit took no notice of its on/standby button. At no time, even during the brief period when the standby relay was on, was there anything other than a completely blank display.

I turned my attention first to the power supply board, where every joint appeared to be bad. This was because of the use of the new lead-free solder. I remain unconvinced about the ability of this material to make long-term chemically-stable joints – or indeed about the detrimental effects of 'real' solder. After all, not long since we all drank water delivered to our houses in lead pipes.

Anyway the clue to the cause of the problem was the lack of any display. The system controller chip is not mounted on the front control PCB, as you might expect. Instead it's on a PCB called the 'digital board', which is located under the MiniDisc unit. Once it had been exposed by removing the MiniDisc chassis, it was easy to check the IC's 16MHz clock resonator X402 with a scope probe. There was no waveform here until pressure was

applied with the probe. When the clock signal was restored, four dashes appeared in the display.

After removing the board I inspected the resonator's three joints. They all looked grey and dry – but so did every other joint on the board. Undeterred, I unsoldered and removed the resonator, turned it round to face the opposite way on the board – this sometimes helps with crystals and resonators that are reluctant to resonate – then resoldered it with conventional solder.

Once the unit had been reassembled it performed faultlessly, and continued to do so throughout many power ups and downs over an extended soak-test period. G.D.

## Sharp CD-DP2500H

This was a straightforward job – apart from the need to download the service manual from the internet then wrestle with the Adobe Acrobat program to get it to print the pages required in the size required. Initially the unit wouldn't read discs. The cause was nothing more than a faulty HPC-1LX laser unit. So why did I need a service manual?

Well, after replacing the laser unit there was no audio output with any function. Wet-finger tests quickly established that there was a fault in the low-level circuitry on the side PCB rather than the output circuitry on the main PCB. Healthy hum could be induced on all channels back to the audio processor chip IC401.

By referring to the circuit diagram I quickly established that the supply voltage was missing at pin 23 of this IC. The B+ supply should be present here. It's produced on the main PCB as 'analogue 10V' by a monolithic regulator, IC802. All three pins of this chip were dry-jointed, and several other devices nearby had poor joints at their pins. A blanket reflow in the area, with new solder as required, put matters right. G.D.

## Sony ZS-D50

If you have the misfortune to find one of these design nightmares, or indeed one of its close relatives in the ZS series, on your bench with tales of CD woe written on the job ticket, be sure that your quote is high enough to cover the extra time it is surely going to take you.

The models concerned are easy to recognise. The CD unit is vertical in the normal, closed condition, and hides behind a very 'cassette-looking' door. When you press 'open' the door rolls up into the unit and the CD deck slides out, down a curving track, until it is presented horizontally to take a disc. At this point the optical block looks as though it's easy to get at. But don't be fooled – it's not!



To start with the back of the unit is secured by no fewer than 18 screws. Once you've removed these and got inside you'll find a homogenous 'lump'. This is the CD mechanism, and a PCB with the audio heatsink is attached to it. The 'lump' can be removed from the front panel by undoing a further four screws, plus another one that secures the headphone socket. After doing this you will have to disconnect many ribbons and harnesses, all of which are too tight to allow movement without disconnection. Take note of exactly how these cables are dressed, as they pass through slots in the unit's internal walls. If they are not positioned correctly when you reassemble the unit, the back won't fit to the front properly.

Once you've obtained proper access to the front of the CD unit, you will be tempted to dismantle it to get the deck out from the slide-in/out mechanism. My advice, unless you are a masochist, is don't! There are gears and tracks and shafts involved, the timing of which is critical to the tooth if you ever want to see that deck slide back home again. The alternative technique that I've developed might be regarded by some as a bodge but, if you've ever had a go at one, you'll understand.

If you remove the two black screws at the front underside of the CD tray, the top and bottom halves can be separated by a couple of centimetres by gently bending the plastic – it's quite pliable, doesn't break if you don't go mad with it, and goes back exactly as it started off. With a suitably-sized gap opened up in this way, you can insert a pair of long-nosed pliers and pull out the laser flexiprint from its connector at the rear of the compartment. The deck can then be eased off the pins over which its suspension rubbers sit, and swung out of the gap. The motor leads remain connected, but are long enough to allow this. You can then easily replace the laser and refit the deck. Getting the laser's flexiprint back into its connector is a bit fiddly but, believe me, not half as fiddly as putting all those gears back and reassembling the whole unit, only to find that the deck sticks at the last moment . . .

Reassembly is a straight reversal of the dismantling procedure outlined above but, as mentioned earlier, take note of the cable dressing – and check all functions before replacing those 18 back screws. **G.D.**

### **Pioneer SX-D5000**

This large digital receiver dating from

about 1980 seemed to be dead, but the heatsink was at gas mark 6. Resoldering the +18V and -18V regulators on the power supply board brought it back to life, and resetting the quiescent current at 60mA instead of 200mA stopped the overheating. This was a transition model from the analogue ones of the Seventies to the all-digital ones of the Eighties. **P.R.**

### **Yamaha TC800GL**

This classic cassette deck's belt had turned into a gooey mess. It dates from 1978, but belts are still available from Yamaha dealers. Clean away all residue from the old belt, remove the PCB and, with a bit of fiddling, the new one can be dropped in. **P.R.**

### **Pioneer SA-9500**

This power amplifier dates from 1975. There was no output because one channel was holding the speaker relay off. The output, driver and voltage-amplifier transistors all had to be replaced, also the positive regulated supply transistor on the power-supply board. Fitting decent heatsinks to the power-supply transistors will ensure that they work for another thirty years. **P.R.**

### **Technics RS-B305**

No sound was the fault with this unit. It was cured by resoldering the large IC at the front, right-hand side of the main PCB. **P.R.**

### **Roxan Xerxes T/T**

This unit uses two LM1875 audio output power amplifiers to supply the motor's two windings, with the waveforms 90° out-of-phase. The ICs had failed, with signs of heat stress, because they had not been fitted on the heatsink properly. The two regulators on the same heatsink can fail for the same reason. **P.R.**

### **Aiwa CX-ZM2600K**

If either of the deck-drive belts in this audio centre slips, the system-control section will shut down the motor drive until the unit is powered down and then switched on again. This can be very misleading during fault diagnosis, as it may lead you to suspect non-existent faults in the motor or the driver, syscon or power-supply sections. **E.T.**

### **Sony TA-SP55**

There was no sound from the main speakers and only one output from the stereo headphone jack. Voltage checks revealed that the cause of the fault was the LM4766T power amplifier chip IC211, which is on the heatsink in the

middle of the unit. A replacement, part no. 8-759-681-35, restored normal output from both main speakers and correct outputs from the headphone socket. **C.B.**

### **Sony HCD-H551**

There was no display and no sound from the tuner. Ohmmeter checks on the main board revealed that R1601 and R1604 (both 1Ω, 5%, 0.25W) were open-circuit. All was well once replacements had been fitted. **C.B.**

### **Sony STR-DB1080**

About five minutes after this unit was switched on a buzzing sound (instability) came from the speakers. I checked around the power regulator ICs on the main board with a voltmeter, a heat gun and a can of freezer. This proved that IC802 was faulty. Replacement of this IC, part no. 8-759-245-87, and a new heatsink, part no. 4-248-611-01, cured the fault. **C.B.**

### **Sony HCD-N355 (with D570)**

There was no output from either channel. Trying to be quick and clever (a delusion at my age!) I needlessly replaced the STK4172 chip. I then checked at mute pin 1 of connector CN1204 to the output board. The voltage here was well below the correct 5V (not 7.5V as shown on the PCB and the circuit diagram), but rose when pin 1 was isolated. This meant that the cause of the fault was on the main PCB. C1220 (330μF, 10V) on this board indirectly decouples the mute line. When I checked it with the ESR meter it produced a reading of 0.32Ω, but my old and trusty analogue meter revealed a 7Ω leak. **C.A.**

### **Kenwood KAF3030R**

This amplifier's primary fuse blew violently at switch on. It didn't happen when the connector to the transformer's secondary windings was unplugged from the power amplifier board, where two bridge rectifiers reside. Easy, I thought – a short-circuit on the main board. But I couldn't find one. A closer look at the circuit diagram revealed that one of the secondary windings has two separate sections, with the common centre tap and connection to chassis completed at the main board via the connector lead. C660 (0.1μF) on the transformer board is a tiny disc ceramic capacitor that's connected across the outer ends of these two windings. This underrated component, a false economy, had gone short-circuit, but the short didn't show up until the windings were joined. **C.A.**



# MONITORS

Fault reports from  
**Gerry Mumford**  
**Bob Bradley**  
and  
**Ian Field**

We welcome fault reports from readers – payment for each fault is made after publication.

Reports can be sent by post to:

Television Magazine Fault Reports,  
Highbury Business Communications  
Nexus House,  
Azalea Drive, Swanley,  
Kent BR8 8HU

or e-mailed to:  
t.winford@highburybiz.com

## LG Studioworks 560N (Model CB560BN)

This monitor was obviously tripping – when it was switched on it made a repeated, loud clicking sound while the amber LED blinked. As no short-circuits could be detected anywhere I decided to concentrate on the power supply. The output voltages marked on the board made it clear that there was a regulation problem – they were all 50 per cent too high. Use of an ESR meter led me to the cause, which was C911 (4.7 $\mu$ F, 50V). It's on the primary side of the power supply, part of the voltage-sensing network, and was virtually open-circuit. G.M.

## Proview EM-171 (KX-772NS) 786N

This monitor had several model numbers on the rear sticker, as listed above. It powered up with the green LED illuminated but there was no display. Visual inspection inside revealed a burn mark on ferrite bead L703A, where it had become dry-jointed and arced over. As a result the 2SC5449 line output transistor Q703 had gone short-circuit and the feed resistor R703A (2.2 $\Omega$ , 1W) had burnt up and gone open-circuit. Replacement of these two components, along with repair of the ferrite bead and the associated PCB track, restored a perfect display. G.M.

## Dell E770P

The report said that this 17in. monitor was dead, but when I switched it on in the workshop the green power LED lit and I could hear the EHT rustle up. There was no display however. I removed the back cover to measure the EHT voltage, to check that it was not dying away. It was good and steady. So attention was turned to the CRT base panel. I removed the metal shield to gain access to the PCB in order to check the heater, G1 and G2/A1 supplies and the RGB drives, and found that the G2/A1 supply was missing. It comes from the flyback transformer on the main chassis. When I checked here I found that one of the G2/A1 decoupling capacitors, C2624 (10nF, 1kV), had gone short-circuit with evidence of burning. A replacement capacitor restored normal operation. B.B.

## XIOD CXK15E

This 15in. monitor seemed to be OK when it was switched on, but after a few minutes a ripple started to appear at the edges of the display. It became worse the longer the monitor was left on and was more prominent on vertical lines – similar

to poor mains smoothing.

In view of the symptoms I checked the power supply first, but couldn't find anything amiss here. When I turned attention to the B+ regulator I found that its reservoir capacitor C128 (47 $\mu$ F, 250V) had leaked and was low in value. A suitable replacement cured the fault. B.B.

## Tatung TM1401

The field engineer's report on this 14in. monitor said that the display was flooding blue intermittently. As luck would have it, the fault was present when the monitor appeared on the bench for repair.

I removed the metal screen plate from the rear of the CRT base PCB to enable me to make some measurements and check for possible dry-joints. With an ageing monitor like this I always rework the solder joints around the CRT socket as a matter of course. This was not the cause of the trouble however. I then found that the supply to the blue output stage was missing. It should be at about 75V. Tracing back from the CRT's blue pin towards the supply rail I found that L261 was open-circuit. It must have been failing intermittently, hence the fault report. A replacement inductor from a scrap monitor proved to be of the correct value and cured the fault.

While the monitor was being soaked tested it failed with line collapse. The cause was dry-joints at the plug and socket for the scan coils. Reworking these joints, on the main board, cured the problem and proved the value of soak testing. B.B.

## Compaq 473E series

This monitor's mains fuse had blown. Cold checks on the usual causes failed to reveal anything amiss. Visual examination then showed that C827 (1 $\mu$ F, 450V) had vented, though the damage was not conspicuous. It smooths the start-up supply. This is obtained from the AC input via D813 (1N4006), which was short-circuit. Once these two items and the fuse had been replaced the monitor fired up, but there was no blue in the display. It was so bad that I checked whether all three CRT heaters were lit! Checks on the emission of the three cathodes confirmed that the blue one had low-emission – but not by that much.

No faulty components were found in the blue video path, but a look at the output stage circuitry showed what the problem was. Fig. 1 shows the red driver and output stages – the three channels are virtually identical. What struck me about the design is that the background preset R910 is connected to the centre point of

between the three outputs, however slight, will eventually damage the tube. Use of this technique with a computer monitor, which may run for hours at a time with predominantly one or two primary colours displayed, seems to me to be most unwise.

The only way to get any blue drive was to connect the feed end of the potentiometer to the 75V rail instead of the output stage's centre point. This had to be done in all three stages. As the DC voltage applied to the three cathodes no longer varies with the signal when this is done, the 100Ω resistors connected in series with the wipers of the presets (R908 etc.) need to be replaced with clamp diodes (cathode to the slider of the preset control).

If the damage to the CRT is less severe than in this particular case, the zener diodes connected in parallel with the presets can be left in place. It depends on whether the three guns can be balanced with the zener diodes limiting the adjustment range. If the zener diodes are left in place, ensure that the series-connected 10kΩ, 1W resistors are not overheating.

This arrangement, which is very similar to that used in earlier Compaq models, is quite difficult to set up for a perfect grey-scale. But with patience even a very old CRT can be set up to produce an acceptable display. I.F. ■

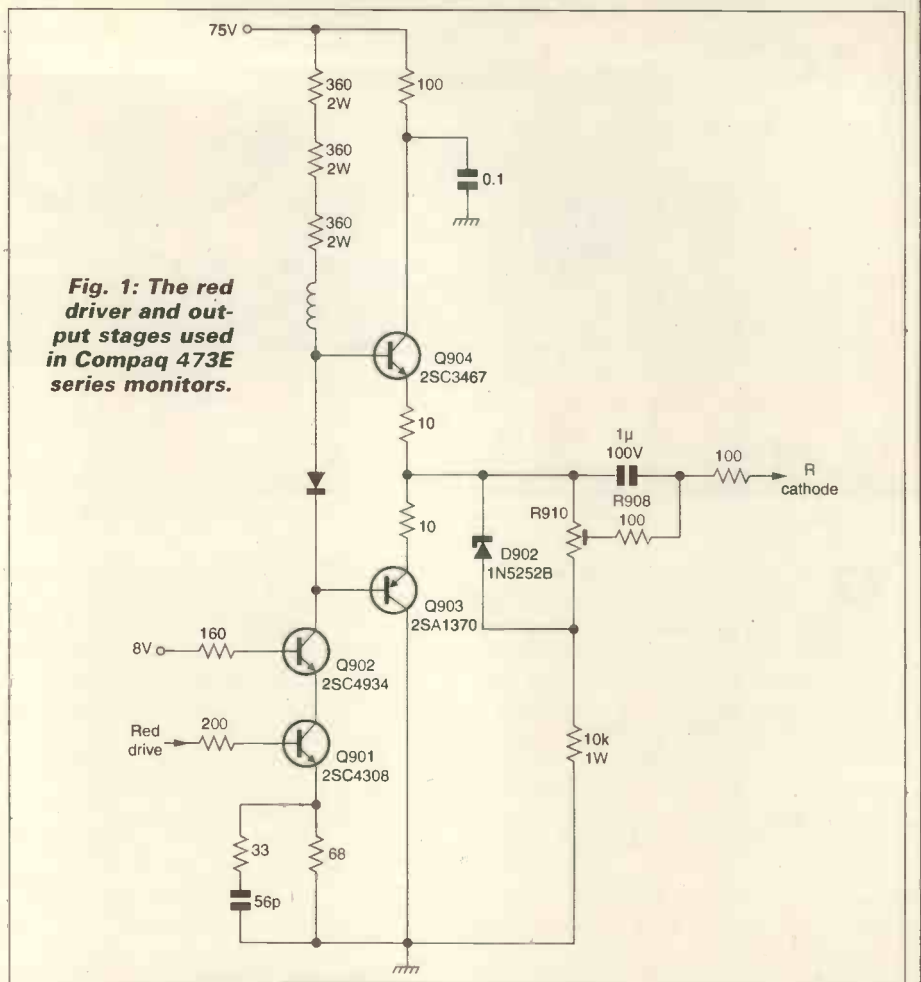

Fig. 1: The red driver and output stages used in Compaq 473E series monitors.

## Test Case 493

Charles Dickens was very good at story telling, especially at Christmas. Let's try the same thing, with our own true tale of Christmas past.

It was December 1968, just 35 years ago. Sage, barely out of his teens, was Chief TV Engineer (in fact the only engineer!) at the Wakeness-on-Sea branch of the Co-op, which in those days did a roaring trade in TV sets, primarily its own Defiant brand. These sets were a little cheaper than those of the main brands of the time, when a typical black-and-white set cost £60-£70. This represented many weeks' average wage. So repairs were well worthwhile in those days!

The set on the bench that day was not a Defiant one, though the word would certainly be applicable, as we shall see. It was, even at that time, getting on a bit, and in fact the make and type is not important. The problems could have occurred with almost any brand. In fact the sets in those far-off days had much in common, at least in the sections that concern us here.

The problem was no picture. At switch on, and after the normal warm-up period, some parts of the set became

rather too warm. Accompanied by clicks that sounded alarming, a red glow spread across the anode of the PL81 line output valve, then that of the PY81 boost diode. The set was hastily switched off, as the PY82 mains rectifier's anode also began to get uncomfortably hot. Sage carried out some resistance checks with his trusty Avo meter, but could detect no short-circuits in the line output stage. Maybe there were shorted turns in the line output transformer or the scan coils. But there were less expensive possibilities. What was the problem here? Sage found out without the need to use a soldering iron.

With this problem solved everything ran cool (or at least as cool as those throbbing-valve sets ever did!), but there was still no picture. Arcs to a screwdriver could be drawn from all three valve caps in the line output stage, beefy ones at the PL81 and PY81, and a thinner, longer one at the top of the EY51 EHT rectifier valve. This second problem was an easy one to diagnose, calling for only careful observation with all the workshop lights out in the afternoon of that gloomy day. A soldering iron was needed to fix this one. Just three joints, care-

fully made, were required to change a component that generally didn't require soldering for its replacement and fitting. What was it? A clue: its cost was about eleven shillings.

Having carried out these two repairs young Sage (though he hadn't acquired the nickname at the time) confidently expected to see a picture on the screen when he switched the set on again. But he didn't, though the sound was OK. There was EHT at the tube, whose A1 and focus voltages were also present and correct. Its other electrodes were also at the correct potentials, which Sage had checked carefully. And its heater was alright. So what ailed the blasted thing?

Sage switched off the lights again, and turned the brightness control setting to maximum. There was no light on the screen. The electrode voltages were checked once more, and the presence of the EHT was confirmed – by drawing a spark, something that didn't trouble those rugged old sets. Could the picture tube have been faulty? In fact it was OK. All that was required was an adjustment – to a component with no electrical connections at all! What was it? For the solution, turn to page 185

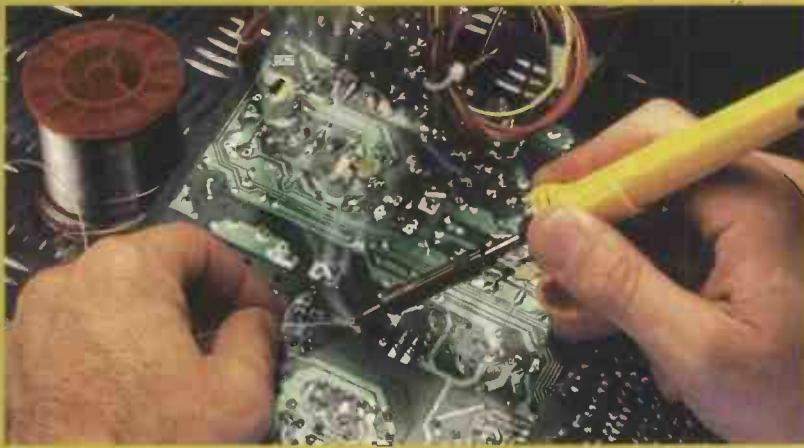

In this concluding instalment in his current series **Adrian Gardiner** describes basic software faults and the action required to deal with them

## Bench Notes

Over the past few months this series of articles has dealt with installing and configuring Windows 98, including tweaks and adjustments to optimise its performance. If you have followed the advice you should have a working PC that's fast and efficient. To conclude this series I'm going to take a look at trouble-shooting with Windows installations – in order to reduce reinstalls and improve productivity. The ability to offer your customers a 'repair' option rather than just a reinstallation can be very profitable, and will soon gain you a good reputation amongst PC users.

### Random faults

You will often encounter a PC that produces totally random errors, with no consistency about what or when. The cause is usually either corruption of the Windows registry or one or more corrupt system files. The simplest way to correct this is to reinstall Windows *over the top of the existing installation*. This will repair the registry, and replace the defective files, without changing any of the main settings or causing any problems with installed software.

If there are still random faults when you have taken this action, the next step is to try replacing the PC's RAM. RAM is used as a temporary store during all processing while the PC is in operation. Thus problems here can cause all sorts of faults.

If you still have problems after replacing the RAM, the only option left is to attempt a clean reinstallation of the operating system.

### Random restart

I have on many occasions come across a PC that appears to operate normally then, for no apparent reason, restarts. The cause has almost always been the CPU chip overheating – it's a problem with AMD processors in particular. To fix this fault, remove the heatsink and fan assembly from the chip. Clean the

surface of the IC with isopropyl alcohol, then apply fresh thermal grease – the old grease often solidifies and becomes inefficient. You will then need to replace the fan. Usually the cheapest way to do this is to use a complete replacement heatsink/fan assembly.

If this action fails to cure the fault, it's likely that the processor chip has been damaged and will need replacement. If you don't have a suitable spare IC to hand however it may be worth eliminating software causes first – by a fresh installation of Windows.

### Shutdown freeze

Another common complaint is Windows locking up when attempting to shut down. This is a known problem with Windows 98, affecting about 20 per cent of hardware configurations. A patch is available from Microsoft's website to deal with this problem.

### Specific application crashes

Many specific application crashes can be solved by reinstalling the program that causes the fault, but more often a corrupt Windows system file is the cause. To locate and repair this, load the Windows 'System Configuration Utility' (see Part 7) and, from the 'System Tools' menu, choose 'System File Checker'. From the window that opens, select 'Scan for altered files'. Windows will then check the integrity of its system files and warn you of any that do not match its database. If it finds any altered files it will offer you the chance to replace them with the originals, which you should allow it to do.

By following the above steps you will hopefully have corrected the problem. As an unfortunate side effect however you may now have another application that fails to work correctly, as it may need an updated system file that you have downgraded. If this should occur, reinstall the particular program and all should be well.

### Start-up issues

As Windows starts up it loads a large number of device drivers. If it cannot find a required driver for any reason it will stop loading and display an error message. In almost all circumstances it's possible to continue loading Windows after 'pressing any key'. Most such errors are the result of network drivers, caused by failed network installations.

To repair the fault, open the 'Windows Registry Editor' by clicking on 'Start > Run' and typing 'Regedit'. Once loaded, select 'find' from the edit menu and type in the driver that was indicated in the error message. Press 'enter' and Windows will search for the registry entry that contains this driver. Once it has been found, regedit will highlight the entry, which you should delete. Repeat these steps until you get the message 'Finished searching the registry'. Close the program and restart the PC, which should now start OK. Finally, if necessary, reinstall the element of Windows, network etc. that caused the problem.

### Blue screen of Death!

The famous "blue screen of death" style errors are usually caused by 'illegal' operations, that is Windows has tried to do something that it can't, such as overwriting an element of code in memory. To attempt repair of such faults, carry out the following procedure.

Reinstall the application that causes the error > check for/replace altered system file > reinstall Windows over the top of the existing installation > reinstall Windows fresh.

### Over to you

Those who have followed this series may encounter problems that haven't so far been raised. It's not possible to deal with them on an individual basis but, if you care to write in to the magazine or email us (t.winford@highburybiz.com), I will try to provide general guidance in subsequent issues of the magazine.

JOHN RADIO ELECTRONIC TEST AND COMMUNICATION EQPT.

# MASSIVE RETIREMENT CLEARANCE SALE

30.00SQ FT OF TEKTRONIX-HP-AGILENT-MARCONI-PHILIPS-RACAL ETC.,

Over the rest of this year at our bulk Smithies Mill site sales by auction-Tender-Offer-all welcome private or trade-single or bulk items. Equipment sale floor 6000sq ft +25.000sq ft of adjoining buildings plus 9000sq ft will be slowly added from our Whitehall Works headquarter site.

Open weekdays 9am-5pm and Saturday mornings to 1:00pm  
Closed dinner 1- 2pm

ALWAYS PHONE FOR APPOINTMENT FIRST.

Item lists-photos-site map-on

website [www.johnsradio-electronics.com](http://www.johnsradio-electronics.com)

website [www.johnsradio-uk.com](http://www.johnsradio-uk.com) [www.johnsradio.com](http://www.johnsradio.com)  
email: [johnsradio@btconnect.com](mailto:johnsradio@btconnect.com)

Location M62 Junction 27, A62 to Huddersfield, 1 mile Birstall Smithies Lights (6 roads) look to your left, site under factory chimney with aerials on top, road second left, Smithies Moor Lane, 100yds second entrance on left.

Johns Radio, Smithies Mill, Birstall Smithies Lights,  
883-885 Bradford Rd, Batley, West Yorks WF17 8NN-8NS.

Phone - 01924 442905 - Fax - 01924 448170

Our normal sales, workshop, repairs and calibration will continue until clearance of all items.

Contact Patricia at Whitehall Works-84 Whitehall Rd East,  
Birkenshaw, Bradford BD11 2ER.

Phone - 01274 684007 - Fax 01274 651160

[www.tech-asset.co.uk](http://www.tech-asset.co.uk)

# Congratulations You've survived 2003

For TV engineers

The longest driest summer  
for 50 years was tough

Happy new year

## We're here to help you in 2004

To get your Pocket sized catalogue  
Ring Mike today on

# 0114 273 9622



- ✓ Run by T.V. engineers for T.V. Engineers.
- ✓ You speak to experienced engineers with in-depth knowledge of TV/Video trade.
- ✓ CLASSIC® distributors and trade counter.
- ✓ We stock parts that engineers advise us to stock, with regular updates.
- ✓ Free or low £1.00 p&p on orders means:  
**YOU CAN EASILY AFFORD TO ORDER  
MORE THAN ONCE A DAY!!!**



## IrwinElectronics

"The television engineer's wholesaler"

Online you can order at [www.IrwinElectronics.co.uk](http://www.IrwinElectronics.co.uk)

# TUBES

## NEW and GRADED Philips CRTs

### 28" WIDESCREEN

from ..... ONLY £130

### 32" WIDESCREEN

from ..... ONLY £195

Prices include carriage  
but are subject to VAT

Quantity reductions

Other makes and sizes of  
CRT available

De-scratching service

### EXPRESS TV SUPPLIES LTD

The Mill, Mill Lane,

Rugeley, Staffs WS15 2JW

Tel: 01889 577600 Fax: 01889 575600

## [www.sdstrade.co.uk](http://www.sdstrade.co.uk)

# sky Freeview OR sky FREEVIEW

### SPECIALISTS IN ALL MAKES AND MODELS OF SATELLITE EQUIPMENT

ALL ORDERS WELCOME - LARGE OR SMALL

REPAIRS FROM ONLY £35 + VAT

SKY & SKY+ SPARES - MOST MAKES AND MODELS

### NEW MODEL SKY PLUS - INCLUDING DELIVERY AND INSTALLATION KIT ONLY £199

HUNDREDS OF REFURBS AND NEW BOXES  
CALL FOR PRICES OR VISIT OUR WEB SITE

## EXCLUSIVE TO SDS!



### SILVER PACE 2200 DIGIBOXES

CALL FOR TRADE PRICES



1 HOWARD AVENUE  
BARNSTAPLE  
DEVON  
EX32 8QA  
TEL: 01271 325888  
FAX: 01271 329163



## VCR CLINIC

Reports from  
**Eugene Trundle**  
**Bob Dewis**  
**Bob Flynn**  
 and  
**Chris Avis**

We welcome fault reports from readers – payment for each fault is made after publication.

Reports can be sent by post to:

Television Magazine Fault Reports,  
 Highbury Business Communications,  
 Nexus House,  
 Azalea Drive, Swanley, Kent BR8 8HU

or e-mailed to:  
[t.winford@highburybiz.com](mailto:t.winford@highburybiz.com)

### Samsung SV213B

Intermittent failure to eject, or leaving a tape loop at eject, is not uncommon with this model. I've found that replacement of the mode switch S601 (part no. AC34-22001E) and the reel idler (part no. AC66-10010A) cures the fault. These are not expensive items. **E.T.**

### Philips VR530/07

The problem with this VCR was intermittent failure to accept or eject a cassette, with the deck getting out of phase mechanically. I found that the tiny FL drive rack was bent out of alignment and that the rotary mode switch needed cleaning. **E.T.**

### Samsung SV613B

A roaring noise came from within this machine and when the cassette was ejected the tape was looped. The cure was to replace the broken reel-drive belt and clean and lubricate the capstan motor's bearings. **E.T.**

### JVC HRJ435

The deck mechanism in this machine was jammed, with a cassette trapped inside. Inspection revealed that the back-tension regulator arm had collided with the retracting tape-entry guide. The cause was not the usual take-up lever assembly but tension-arm lever no. 3 in the exploded diagram, part no. PQ35012-1-3. A plastic spigot had broken off it. **E.T.**

### Sony SLV625UB

As soon as the tape had laced around the drum this machine would unlace and shut down. The cause was lack of FG feedback from the head drum motor, which rotated properly. A replacement stator assembly from a scrap machine cured the problem, despite the fact that there was no discernible fault with the FG coil or its connections to the discarded motor part. **E.T.**

### Sony SLV-SE720G

Manufacturers who won't talk to non-account holders can give their products a bad name. At times repairs may have to be sent miles away to the nearest repair centre. Here's a typical example. We had given up with this machine, then a second one came in with the same fault.

The symptoms were no clock display, no E-E sound, no playback picture and the front buttons doing weird things. Not being Sony repair agents we were unable to phone for advice. But, while having a pint with a friend, I was given an account number. As a result I was able to phone Sony technical and spoke to a nice chap who told me to check whether C701 was fitted the right way round, then change the value of R668

and R669 to 4·k7Ω and reset the EEPROM – he kindly faxed me the option data settings. As a result we had two working machines and two happy customers. The nearest Sony agent is 23 miles away.

I would not normally look for capacitors fitted the wrong way round, or change resistor values. **B.D.**

### Bush VCR924NVPSIL

Weird mechanical behaviour, with ERR showing in the display, was as usual cured by dismantling the mode switch and cleaning the inside. The mode switch is mounted on the main PCB, under the deck, which is the same as that used in the Thomson Model VTH6210U, though I suspect that it's a new type of Daewoo manufacture. SEME can supply the mode switch for the Thomson model at 27 pence, part no. 35155800 – this won't last! **B.F.**

### GoldStar P131 (D27 mechanism)

The cassette wouldn't eject – it would make a feeble attempt then the machine would switch off. Normal operation was restored by replacing CP22 (47μF, 25V) in the power supply. It could also be the cause of sluggish mechanical movement. **B.F.**

### Hitachi VTM530E (Philips Turbo deck)

The tape wouldn't eject because the mechanics stopped when unloading towards the eject position. The reason for this was that the left loading arm was one tooth out of phase with the loading gear (item 27). This cannot be seen, because the back-tension arm is in the way. The cause of the trouble was that the plastic shaft on which the loading gear rotates had come adrift from the chassis. The only remedy is to glue the shaft back to the chassis securely and leave overnight. Replacing the loading gear and both tape arms completed the repair. **B.F.**

### Sharp VC-MH54HM

After one and a half to two hours this machine would stop and unlace, while playing or recording. If started again it would do so, but only for a while. As I could see no mechanical reason for this I made a guess and replaced both reel sensors, D854 and D855. The machine then ran for days with no problems. **B.F.**

### Panasonic TX14-GV1 (Daewoo CP421 chassis)

This combi unit produced very warbly sound when playing tapes, particularly in the LP mode. Control pulses were present but were not very clean. I found that disturbing the board would clear the fault intermittently. The cause of the trouble was a dry-joint at the decoupling capacitor CN34 in the control circuit. **C.A.**

# D-GEN A breakthrough in low cost pattern generators, 14 display outputs at 512\*288 resolution, including three full testcards of 4:3 and 16:9 ratios.

A micro and a 4 Meg flash memory are the base for this new design, 8 bits of data per pixel enabling 32 levels of Colour. Composite, S Video, and RGB SCART output sockets. A DC/DC converter power supply enables just 2 AA cells to power the unit. There is also a DC adapter socket for mains operation that also acts as a charger. Audio 1khz tone sinewave output is available via front Phono socket or SCART connector. The kit comes with a high quality double sided PCB, ready programmed micro and flash memory. All components including case, self adhesive overlay, drill template and full construction manual are supplied in the kit. Only soldering of components to PCB and drilling, filling of plastic end panels is required to construct D-GEN. The unit can be built in three to five hours.

Note: ROM & Micro are socketed and fully software upgradable

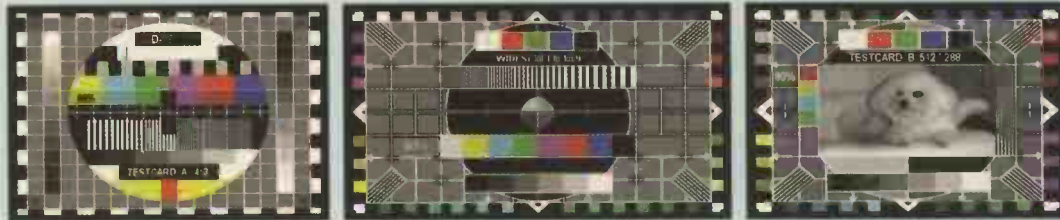

Full parts kit to build the D-GEN, £75.



## S.V.G.A II. MONITOR TESTER : MULTIGEN VIDEO GENERATOR

Kit price of only £29.50.

Kit price for Multigen, £58.

Please add £2 postage to all orders, £3 for overseas orders.  
Send cheque, Postal Orders or International Money Orders to:  
J Harding, 43 Jonathan road, Trentham, Stoke-on-Trent, Staffs, ST4-8LP England.  
For more information on all these kits, send S.A.E or.

Visit our website "http://www.videocorner.co.uk" or Email us at "roy@videocorner.co.uk"

### SPECIAL OFFERS

- TEKTRONIX 2445A 4 Ch 150MHz Delay, Cursors etc. Supplied with 2 Tektronix probes **ONLY £425**
- TEKTRONIX 2232 Digital Storage Scope. Dual Trace 100 MHz, 100m/s with probes. £255
- H.P. 54501A Digitizing Oscilloscope 100MHz, 4Ch £245
- CIRRUS CRL254 Sound Level Meter with Calibrator, 80-120dB, LEQ. £95
- BECKMAN HD110 Handheld 3 1/2 digit DMM, 28 ranges with battery, leads and carrying case. £30
- WAYNE KERR B424 Component Bridge. £50
- RACAL 9300 True RMS Voltmeter 5Hz-20MHz usable. £50
- RACAL 9300B as above. £75

- H.P. 3312A Function Gen 0.1Hz-13MHz AM/FM Sweep/Tri/Gate/Burst etc. £300
- FARNELL ANM255 Automatic Mod Meter 1.5MHz-2GHz Unused. £300
- FARNELL DSG1 Low Frequency Syn Sig Gen 0.01Hz to 99.99kHz, Low Distortion TTL/Square/Pulse Outputs etc. £95
- FLUKE 8060A Handheld True RMS DMM 4 1/2 digit As new £150. Used £95
- H.P. 3310A Function Gen 0.005Hz-5MHz Sine/Sq/Tri/Ramp/Pulse. £125
- FARNELL FLM4 Sine/Sq Oscillator 10Hz-1MHz distortion, TTL Output, Amplitude Meter. £200
- H.P. 545A Logic Probe with 5474 Current Tracer. £200
- FLUKE 77 Multimeter 3 1/2 digit. £60
- FLUKE 77 SERIES II. £70
- HEME 1000 LCD Clamp Meter 1000A In Carrying Case. £60

- BLACK STAR ORION PAL/TV VIDEO Colour Pattern Generator from £125
- THURLBY/THANDAR TG210 Full Function Generator 0.002Hz-2MHz TTL etc. £95
- THURLBY/THANDAR PSU 0-3V 0-2A Twice (Late colours). £200
- Racal 9008 Automatic Modulation Meter AM/FM 1.5MHz-2GHz **ONLY £95**
- Datron 1061A High Quality 6 1/2 digit Bench Multimeter True RMS/4 wire/Current Converter **ONLY £225**

### STEWART OF READING

110 WYKEHAM ROAD, READING, BERKS RG6 1PL  
Telephone: (0118) 9268041 Fax: (0118) 9351696  
www.stewart-of-reading.co.uk



Callers welcome 9am-5.30pm Monday to Friday (other times by arrangement)

### JUST IN

- H.P. 8640A SIGNAL GENERATOR AM/FM £250
- 500KHZ-512MHZ
- KENWOOD CS4025 Oscilloscope Dual Trace 20MHz £125
- LEADER LB0523 Oscilloscope Dual Trace 35MHz £140
- GOULD OS300 Oscilloscope Dual Trace 20MHz £95
- NATIONAL PANASONIC VP7705A Distortion Analyser £125
- KENWOOD VT176 Millivoltmeter 2Channel £50
- KENWOOD FL140 Wow & Flutter Meter £50
- KENWOOD FL180A Wow & Flutter Meter £50
- BIRD 43 Watt Meter £75
- Elements for the above. £25

- MARCONI 893C AF Power Meter, Sinad Measurement. Unused £100 Used £60
- MARCONI 893B - No Sinad. £30
- MARCONI 2610 True RMS Voltmeter Autoranging 5Hz-25MHz £195
- GOULD J3B Sine/Sq Osc. 10Hz-100kHz. Low distortion £125
- AVO 8 Mk6 in Ever Ready Case, with leads £80
- Others Avos £150
- GOODWILL GVT427 Dual Ch AM/FM Modulator in 12 Ranges Freq 10Hz-1MHz £100-£125
- SOLARTRON 7150 DMM True RMS - IEEE £95-£60
- SOLARTRON 750 PLUS £95

- QUALITY RACAL COU... £50
- Counter, 50MHz £50
- 916 Counter, 10Hz-520MHz. £75
- 18 Counter, 10Hz-560MHz. £50
- AIM 9343M, LCD. £200
- Automeasurements £100
- HUNTRON £25
- MARCONI £25
- Automeasurements £100
- FARNELL AP60/150 3MHz Auto-ranging £2000
- FARNELL AP100/90 3MHz Auto-ranging £2000
- H.P. 6012B DC PSU 0-100V 0-1000mA £1000
- FARNELL AP60/50 3MHz Auto-ranging £1000
- FARNELL H60-150 0-60V 0-50A £2750
- FARNELL H60/25 0-60V, 0-25A £400
- Power Supply HPS3010 0-30V, 0-10A £140
- FARNELL Dual PSU XA35-2T 0-35V 0-2A Twice QMD LCD Display £180
- FARNELL L30-2 0-30V; 0-2A £80
- FARNELL L30-1 0-30V; 0-1A £60
- Many other Power Supplies available.
- Isolating Transformer 240V In/Out 500VA £40

### Farnell DTV 12-14 OSCILLOSCOPE

Dual Trace 12 MHz TV. Coupling..ONLY £75

### FARNELL LFI Sine/Sq OSCILLATOR

10HZ- 1MHZ ..... ONLY £75

### OSCILLOSCOPES

- TEKTRONIX TDS350 Dual Trace 200MHz 16/5 unused £150
- TEKTRONIX TDS300 Dual Trace 100MHz 50/50 £100
- TEKTRONIX TDS320 Dual Trace 100MHz 50/50 £90
- TEKTRONIX TDS310 Dual Trace 50MHz 20/20 £80
- ECROY 9400A Dual Trace 175MHz SG/S £325
- HITACHI VC6523 Dual Trace £300
- Philips PM3092 2+20 200MHz £350
- Philips PM3082 2+20 200MHz £350
- Philips PM3082 2+20 200MHz £350
- TEKTRONIX TDS350 Dual Trace 200MHz 16/5 unused £150
- TEKTRONIX TDS300 Dual Trace 100MHz 50/50 £100
- TEKTRONIX TDS320 Dual Trace 100MHz 50/50 £90
- TEKTRONIX TDS310 Dual Trace 50MHz 20/20 £80
- ECROY 9400A Dual Trace 175MHz SG/S £325
- HITACHI VC6523 Dual Trace £300
- Philips PM3092 2+20 200MHz £350
- Philips PM3082 2+20 200MHz £350
- Philips PM3082 2+20 200MHz £350
- TEKTRONIX TDS350 Dual Trace 200MHz 16/5 unused £150
- TEKTRONIX TDS300 Dual Trace 100MHz 50/50 £100
- TEKTRONIX TDS320 Dual Trace 100MHz 50/50 £90
- TEKTRONIX TDS310 Dual Trace 50MHz 20/20 £80
- ECROY 9400A Dual Trace 175MHz SG/S £325
- HITACHI VC6523 Dual Trace £300
- Philips PM3092 2+20 200MHz £350
- Philips PM3082 2+20 200MHz £350
- Philips PM3082 2+20 200MHz £350

### OSCILLOSCOPES AVAILABLE

- H.P. 8657A Syn 100kHz - 1040MHz Sig Gen £2000
- H.P. 8656B Syn 100kHz - 890MHz Sig Gen £1350
- H.P. 8656A Syn 100kHz - 990 MHz Sig Gen £395
- R&B APN62 Syn 1Hz - 260kHz Sig Gen £425
- FARNELL 2440 Output LCD Display 200MHz. £550
- REGAL Counter IEEE £250
- FREQC 9081 Syn AM/FM Sig Gen 5MHz - 520MHz £600
- H.P. 3325A Syn Function Gen 21MHz £1500
- MARCONI 6500 Amplitude Analyser £1500
- H.P. 4192A Impedance Analyser £5000
- H.P. 4275A LCR Meter 10kHz - 10MHz £2750
- H.P. 8903A Distortion Analyser £1000
- WAYNE KERR Inductance Analyser 3245 £1200
- H.P. 8112A Pulse Generator 50MHz £1250
- MARCONI 2440 Freq Counter 20GHz £1000
- H.P. 5350B Freq Counter 20GHz £2000
- H.P. 5342A 10Hz - 18GHz Freq Counter £800
- H.P. 1650B Logic Analyser 80 Channel £1000
- MARCONI 2305 Mod Meter 500kHz - 2GHz £750

### H.P. 6063B DC Electronic Load 3-240V/0-10A 250W

- P.O.A.
- H.P. 66312A PSU 0 - 20V/0-2A. £400
- H.P. 66311B PSU 0 - 15V/0-3A. £400
- H.P. 66309D PSU Dual 0 - 15V 0-3A/0-12V 0-1.5A. £750
- H.P. 6632B PSU 0 - 20V/0-5A. £500
- H.P. 6628A PSU Triple Output ranging from 0-7V 0-5A to 0-20V 0-4A £850
- Agilent 34401A DMM 6 1/2 digit £400/£450
- Agilent 1778A DMM 5 1/2 digit £275
- Agilent 45 DMM Dual Display £400
- KEITHLEY 2015 DMM 7 1/2 digit £950
- KEITHLEY 616B Programmable Electrometer £1250
- H.P. 4338B Bench Meter £1500
- RACAL 9300 2.99 2.6 GHz £500
- RACAL 9300B 2.99 2.6 GHz £850
- Agilent 33120A Function Gen/ARB £900/£1000
- Agilent 33120B Function Gen/ARB £700 As New £850
- TEKTRONIX AF320 Arbitrary Function Gen £1250
- H.P. 8904A Syn Function Gen DC - 600kHz £1000/£1250
- BLACK STAR JUPITOR 2010 Function Gen 0.2Hz - 2MHz with Frequency Counter £140
- H.P. 8116A Pulse Generator 1mH-50MHz. £1950
- H.P. 8657B Syn Signal Gen 0.1-2080MHz. £2500
- CO-AXIAL SWITCH 1.5GHz £140
- IEEE CABLES. £80

### SPECTRUM ANALYSERS

- H.P. 8720C Microwave Network Analyser 50Hz - 20GHz £12500
- H.P. 8561B 50Hz - 6.5GHz £5000
- H.P. 8560A 50Hz - 2.9GHz Synthesised. £5000
- H.P. 8594E 9kHz - 2.9GHz £4500
- H.P. 8591E 1MHz - 1.8GHz 75 ohm £2750
- H.P. 853A with 8559A 100kHz - 21GHz £1750
- H.P. 8558B with Main Frame 100kHz - 1500MHz £750
- H.P. 3585A 20Hz - 40MHz £2500
- H.P. 3580A 5Hz - 50kHz £600
- ADVANTECH R4131B 10kHz - 3.5GHz £2750
- EATON/Aitech 757 0.001 - 22GHz £750
- MARCONI 2382 100Hz - 400MHz High Res. £2000
- MARCONI 2370 30Hz - 110MHz £500
- H.P. 182 with 8557 10kHz - 350MHz £500
- H.P. 141T Systems £500
- 8553 1kHz - 110MHz £750
- 8554 500kHz - 1250MHz £1500
- 8555 10MHz - 18GHz £2100
- H.P. 8443 Tracking Gen/Counter 110MHz. £650
- H.P. 8444 Opt 059. £750
- B & K 2033R Signal Analyser £2150
- H.P. 8754A Network Analyser 4MHz - 1300MHz £1250
- H.P. 3577A Network Analyser 5Hz - 200MHz £3000
- H.P. 53310A Modulation Corrnal Analyser Opt 001/003. £5000
- ONO SOKKI Portable FFT Analyser £1500

### RADIO COMMUNICATIONS TEST SETS

- MARCONI 2955/2955R £1000
- Rohde & Schwarz GMT 0.1 - 100MHz £1500
- Schlumberger 4040 £750

USED EQUIPMENT - GUARANTEED. Manuals supplied.  
This is a VERY SMALL SAMPLE OF STOCK. SAE or telephone for lists. Please check availability before ordering. CARRIAGE all units £16. VAT to be added to total of goods and carriage.

C81N. 0121 476  
WEST HEATH 873%  
131 COFTON B31

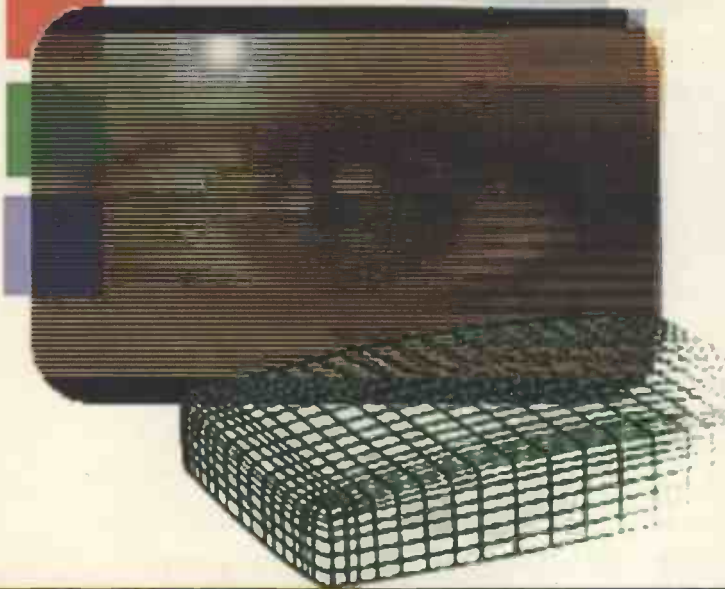

fault had to be on the primary side of the circuit. Many items were checked, and some changed, before I came to the cause of the trouble. There was slight reverse leakage in diode D6515. It's marked T4148, but a 1N4148 worked all right. M.D.

### Grundig CUC6330 chassis

This set wouldn't come out of standby. The cause of the problem was simple enough: there was no serial clock or data on the I<sup>2</sup>C bus between the microcontroller chip and a handful of other chips, not even a blip at switch on. To cut a very long story short, after much wasted time the cause of the fault was traced to the infra-red remote-control receiver, a three-pin device as used in many chassis.

Disconnecting this item restored activity on the I<sup>2</sup>C bus and the set sprang to life.

I have never had a fault like this before. In most sets a faulty sensor only results in no remote-control operation. M.D.

### Toshiba 2181TB

This set was dead with a faulty STR58041 chopper chip and the 4.7Ω surge-limiter resistor R872 open-circuit. The cause of the failure however was C821 (470pF, 2kV), which is in the chopper circuit's snubber network. It had a pinhole in the side. M.D.

### Bush 2871NTX (11AK19 chassis)

This set would trip back to standby, with low EHT voltage. The cause seemed to be a dry-joint at C630 (0.47μF, 250V) in the line output stage. Always remove this capacitor and check its value, as the dry-joint can lead to internal heating with the result that its value falls.

This was attended to but the fault was still present. Further checks revealed that coil L602 had shorted turns. The service manual gives its value as 1mH, but it read 30μH. A replacement brought the set back to life – with EW distortion. All that was required was to replace the 2.7Ω safety resistor R629 in the EW drive circuit. M.D.

### Sharp 28HW53H (DA50W chassis)

We've had a number of these sets with the same fault: the brightness steps up and down at will. It can be a difficult fault to deal with. One of the causes can be the RGB output chip IC1801 on the tube's base panel. There are two different types. If a replacement doesn't cure the fault replace Q912 (BC337-40) which is also on the CRT base panel. The part no. is TX0218BMZZ. With the last two sets however the cause has been corrupt data in the EEPROM chip IC1003. The only

## TV FAULT FINDING

Reports from  
Michael Dranfield  
Philip Salkeld  
Eugene Trundle  
Dave Husband  
Jerry Fedorak  
Mike Leach  
James Grant and  
Garry Laidler

We welcome fault reports from readers – payment for each fault is made after publication.

Reports can be sent by post to:

Television Magazine Fault Reports,  
Highbury Business Communications  
Nexus House,  
Azalea Drive, Swanley, Kent BR8 8HU

or e-mailed to:  
t.winford@highburybiz.com

### Thomson 28KV24U (ICC17 chassis)

There was an intermittent fault with this set: it would trip off after a couple of hours' use. I found that the fault could be brought on in minutes by using a hairdryer, so it seemed that tracing the cause would be quite simple. Not so, as the chassis has components on both sides of the PCB. I thought I had narrowed down the fault area to the electronic trip circuit, which is centred on transistor TL71. But grounding the collector of this transistor failed to cure the fault, so the cause was elsewhere.

I eventually came to the power-fail transistor TP86 (BC856B): heating it tripped the set. But a replacement failed to cure the fault. While checking the voltages around TP86 I found that it was on the edge of conduction. Heating it had simply tipped the balance. Its emitter was sitting at 7V instead of 5V. The penny then dropped.

The HT voltage was too high – in fact all the outputs from the power supply were too high. The cause of the mischief was RP63 in the voltage-error sensing circuit. Its value should be 432kΩ, but it had risen to 527kΩ. M.D.

### Schneider STV1405T

This set, which is fitted with the Philips CTN-BB chassis, was tripping. The power supply wouldn't work with a bulb as the load, so it seemed that the cause of the



answer is to replace this eight-pin, surface-mounted IC, part no. RH-IX1603BMZZ. Before you do so, go into the service mode and make a note of all the settings. Please don't forget! P.S.

### **Tatung T14RF71 (F series chassis)**

This small portable was brought in because it had an intermittent revert to standby problem. On test it did just so after a period of time, with the standby light continuously blinking. Replacement of the usual 180k $\Omega$  resistors R909, R913 and R922 on the CRT base panel didn't improve matters. To cut a long story short, the cause of the trouble was incorrect setting of the first-anode preset on the line output transformer. What a life! P.S.

### **Beko NR20242-8R**

The fault symptom with this almost new set was intermittent black horizontal lines across the picture. They came and went when the board was flexed. After intense resoldering followed by exhaustion I decided to phone Beko Technical, who knew about the problem. I was advised to replace the surface-mounted 1nF capacitor C410. When you unsolder it one leg will drop off. I must add that there were also no graphics when the lines appeared. The capacitor can be ordered from CPC, part no. CA00639. This seemed to be the easiest course. P.S.

### **Bush WS6674**

This set was tripping. I went straight to the line output transistor but found that it was OK. Further checks brought me to DD07 (BY228), which was short-circuit. When this happens you usually find that RV38 (2.2 $\Omega$ , 1W) has burnt out. The set worked once replacements had been fitted, but there was excessive width. I rechecked DD07 and found that there was a short-circuit reading across it, though the diode itself was all right. Further checks in the EW circuitry brought me to transistor TV01 (BD680A), which was the cause of the short-circuit reading. All was well once this item had been replaced. P.S.

### **JVC AV21TS4EK (JH chassis)**

This set was dead. Faults with these excellent sets are usually straightforward, and this was no exception. The on/off switch was jammed. A replacement can be ordered from JVC spares – part no. QSW0750-001. P.S.

### **Goodmans GTV66W1 (11AK19 chassis)**

The complaint with this set was no picture. When the setting of the first

anode control was advanced a picture with lack of contrast appeared. This suggested a fault in the beam-current limiter circuit, which is connected to the earthy end of the line output transformer's EHT section. While checking the components involved I discovered that C604 (47nF, 63V) was short-circuit. A replacement cured the fault. P.S.

### **Bush WS6674**

Use of glue in the line output stage is causing some problems with these sets. The glue can eat the solder around CD21, with the result that the S2000N line output transistor TD02 blows. The same problem affects a coil that's connected to the plug for the line-scan coils, but in this case the fault symptom is line collapse. P.S.

### **Daewoo T514**

The picture would gradually fade out at random times, leaving the sound normal and EHT present to bristle my arm hairs near the screen. The trouble of course was the tube's heaters going out. There was a hairline crack in the solder at one of the line output transformer's heater-supply pins. E.T.

### **Panasonic TX21GV1**

This TV-VCR combi unit was as dead as a doornail following a lightning surge. There were flashover deposits on the PCB near the standby chopper transformer's primary side leadouts (T802). An external 9V supply proved that the rest of the set was working. The problem was cured by fitting a new TOP210 standby chopper chip I807 (expensive) and replacing C840. E.T.

### **Sony KVM21TU**

More dry-joints, though this set had lasted well – it first saw the light of day in 1989. The symptom was intermittent sound, the cause being dry-joints at the pins of IC201 on audio board KM. E.T.

### **Tatung V14RDDO**

A bright vertical line down the screen showed that there was an open-circuit in the line scan path. The badly burnt joint between pin 1 of the yoke connection plug 401 and the PCB land could have had serious consequences had it not been found and repaired. E.T.

### **Sharp 76FW53H (DA100 chassis)**

I thought this big, widescreen set's CRT was faulty – the picture was dark and smeary. But when the back was removed I was surprised to find not a Philips but a Thomson tube! A closer look at the screen showed that there was slight horizontal

shading. Memories of twentieth century Philips and GEC chassis came flooding back, where a similar problem would occur when the supply to the RGB output stages was low. So I checked this voltage at plug H on the CRT base panel. It was low at 150V instead of 175V. The reservoir capacitor for this supply, C1811 (10 $\mu$ F), is also on the CRT base panel. A replacement capacitor cured the fault. D.H.

### **Watson FA7040**

The only results this 28in. colour set produced were a flashing green LED and a ticking noise. I started to work with my trusty Avo meter and soon discovered that D612 (BY228) was short-circuit and R629 (2.7 $\Omega$ ) open-circuit. The results were good once replacements had been fitted. Note that the value of R629 in this chassis depends on tube size. J.F.

### **Philips 14GR1221/05W (GR1-AX chassis)**

There was a smoothing problem with this set, the symptoms being ripple on the right-hand side of the display and hum on sound. Checks in the power supply area revealed that C2606 (68 $\mu$ F, 400V), the mains bridge rectifier's reservoir capacitor, was faulty. A replacement cleared the faults. J.F.

### **Bush 2514T**

Sometimes the standby LED would come on, but mostly the set remained dead. Checks in the power supply area revealed that R605 (5.6k $\Omega$ ) was dry-jointed. Resoldering it restored normal operation with good results. J.F.

### **Goodmans GTV76W2SIL**

The complaint with this monster 32in. set was a small picture. Actually it had an EW fault. Once we got it on the bench I was able to carry out some checks in the line output stage area and found that the value of R629 (54 $\Omega$ ) had fallen (it's value depends on tube size). A replacement brought up a full-sized picture. To prevent failure of this resistor, check the capacitors in the line output stage for dry-joints. Make sure you soak test the set before returning it. J.F.

### **Alba CTV601 (Onwa chassis)**

There was no sound or picture. I found that the 12V zener diode ZD402 was short-circuit and as a result R422 (5.2 $\Omega$ ) had gone open-circuit. The set worked fine once these items had been replaced. J.F.

### **Daewoo DVT1482P**

This TV/VCR combi set was dead. Visual

checks showed that someone had replaced Q801, using a transistor with a Panasonic number. Reference to the circuit diagram showed that it was the wrong type. I obtained the correct 2SD2499 from SEME and fitted it. The set then worked correctly. J.F.

### **Philips 24PW6322/05 (MD1.2E chassis)**

This set was tripping and produced a burning smell. When I took the back off and switched the set on smoke came from the area of the line output transformer. Checks showed that C2420, a ceramic disc capacitor that's connected in parallel with the two line output transistors, was scorched. A replacement restored the excellent picture. Its value depends on tube size and type, 1.5nF in this case. J.F.

### **Sony KV28FX65U (AE5 chassis)**

This set worked all right for the first five minutes or so, after which the remote- and local-control functions would lock up. If the set was switched off at the mains then switched back on again it would often work normally, but only for a further five minutes, often less. These sets suffer from what I would call high-resistance connections, rather than dry-joints, on board M1, which contains the microcontroller and teletext decoder. It's in a metal can at the right-hand side of the chassis. Great care is required when resoldering on this board, as the chips are very small.

Resoldering the memory chip IC9107 will often cure intermittent problems, but in this case the microcontroller chip IC9105 had to be replaced. M.L.

### **Hitachi C28W440N (11AK33 chassis)**

At switch on this brand new set would shut down to standby before any sort of raster appeared. The cause of the trouble was obvious once the chassis had been removed. There were three big dry-joints at the STV9379FA field output chip IC600 and others in the line output stage. Once these had been attended to the set produced a good quality picture. M.L.

### **Samsung SP403J**

This lamp-driven rear-projection set had suffered badly and required a lot of work to the optics section. Because the LCD unit was faulty, a large area of the screen in the centre wasn't lit. The LCD unit alone cost over £300 trade! In addition the lamp had exceeded its recommended 6,000 hours' use, and the flashing red light at the front of the set indicated that lamp replacement was due. Also one of the

lenses attached to the old LCD unit had deteriorated so badly that a dark-brown patch had formed in the centre. But our problems started after the optical replacements had been installed, and I have to thank Samsung service for the answer. Basically the set wouldn't enter the service mode. To do this you put the set in standby then press the following buttons on the remote-control unit, one after another: display; picture standard; mute; power. But when this was done the picture would flash on and off with the service mode graphics showing on screen for only about two seconds at a time.

With these sets you have to reset the lamp-hours parameter in the service mode to stop the lamp replacement indicator at the front of the set flashing – this can be annoying for the customer. But if the 6,000 hours has been exceeded a software bug can stop you being able to select sections of the service mode because they flash on and off the screen. There's an answer, but you have to be quick – very quick! Observe the service mode flashing on and off then press the following buttons on the remote-control unit, in this order: programme up three times, volume up once, cancel once. If you can do this in two seconds you will have reset the lamp hours to zero and stopped the red light at the front of the set flashing. It took me ten-twelve goes, but it really does work. Thank you, Samsung! M.L.

### **Bush 1473T (11AK20 chassis)**

There was no tuning with this 14in. portable. All it produced was a snowy raster, though the tuning indicator moved all right. Lack of a circuit diagram meant that I had to work out that the tuning voltage is fed to pin 2 of the tuner (counting from the aerial socket) then trace back to the collector of Q505, which was OK, then back to the area beside the line output transformer, where I found that R822 (15k $\Omega$ ) was open-circuit. It feeds the 33V tuning supply, which is derived from the 112V supply. After replacing this resistor the tuning worked and the set produced an excellent picture.

During my fault-finding I also discovered that Q202 was short-circuit. But this is the Band III switching transistor and wouldn't have had any effect here. J.G.

### **Black Diamond BDS29S (11AK19 chassis)**

This 28in. set ticked very quietly. I wasted time looking for line output stage problems, which are common with these sets, then noticed that D807 (BA159) in the power supply looked visibly distressed. It was short-circuit. A long

soak test after fitting a replacement proved that everything was now OK. G.L.

### **Matsui 2107NS Mk 2**

This set came in dead with the surge-limiter resistor R503 (5.6 $\Omega$ , 7W) open-circuit and the chopper FET Q501 (2SK2651) short-circuit. The damage had been done by R528 (470k $\Omega$ ) going open-circuit. To ensure a reliable repair I also replaced R529 (1M $\Omega$ ), IC501 (TDA16846) and C503 (100 $\mu$ F). G.L.

### **Nikkai Baby 10**

I get a few of these sets in when the caravan season draws to a close. This set's picture had corrugated verticals for ten minutes from cold. A new-type regulator had been fitted, and this is where the fault lay. C481 (100 $\mu$ F) and C483 (2,200 $\mu$ F) inside the regulator had dried up and were very low in value. Replacements cured the fault. I have a feeling that I will see more of this fault, because of the number of these regulators I've fitted. G.L.

### **Matsui 28WV2N (CUC2059 chassis)**

I had repaired this large set some months previously because of a power supply fault. Now the customer complained that the picture kept twitching, with the OSD coming on. I didn't relish having to pick it up, so I had a look at it in situ. Fortunately all that was wrong was an almost invisible dry-joint at C53009, which is to the left of the line output transistor. G.L.

### **Sony KVM2141U (BE2 chassis)**

Field collapse was the complaint with this set, and a quick check showed that the supply to the field output IC was missing. Tracing back from this item I came to R819 (1.2 $\Omega$ ) which was open-circuit. No reason for its failure could be found, and a long soak test after fitting a replacement proved that all was now well.

A fault that's quite common with these sets is intermittent loss of colour, the cause being trimmer CT332. I checked the capacitance of a working trimmer and found that it's about 15pF. So whenever I get one of these sets I fit a fixed 15pF capacitor in place of CT332. I've done quite a few and had no problems. Suitable capacitors are available from CPC under order code CA01795. G.L.

### **Samsung CI5030AN**

The problem with this set was severe patterning on the screen. Fortunately the state of C831 (470 $\mu$ F, 25V) gave the game away. It's the reservoir capacitor for the 16V supply, on the secondary side of the chopper transformer. All was well once a replacement had been fitted. G.L.



# DVD

**Fault reports from  
Andrew Duggan  
Geoff Darby  
George Cooper  
Roy Blaber  
and  
David Kerrod**

We welcome fault reports from readers – payment for each fault is made after publication.

Reports can be sent by post to:

Television Magazine Fault Reports,  
Highbury Business Communications,  
Nexus House,  
Azalea Drive, Swanley,  
Kent BR8 8HU

or e-mailed to:  
t.winford@highburybiz.com

## Thomson DTH220U

This player appeared to be dead, with no display etc. Checks showed that the primary side of the power supply was intact, but there was a short-circuit across one of the outputs on the secondary side. D809 was the cause. My thanks to Thomson technical and RS Components for their help in obtaining a suitable replacement. A.D.

## Pioneer DV454S

This elegant slim-line player was dead. As the mains fuse was intact and no flames or smoke issued from any of the other components in the chopper power supply, I thought it safe to assume that the cause was probably an open-circuit start-up resistor or similar fault on the primary side of the supply. There's no controller chip, which made it a little more difficult to locate likely candidates, but a few voltage checks led me to R74. It's connected to the base of Q71, and had full HT at one end and nothing at the other.

Its last stripe was green, so the value was definitely something in the megohms range. But it was impossible to determine whether this minuscule resistor's first two stripes were red/red or orange/orange. I tried all the usual tricks – trying to compare the colour of the stripes to those on a good known-value resistor elsewhere on the board – to no avail. So I put in a call to Pioneer technical, who are always very helpful.

It transpired that there are two versions of the power supply fitted in these machines. The circuit diagram for one of them has the component values marked on it. The other one doesn't. Guess which power supply was fitted in this machine . . .

After some discussion it was agreed that the way to go about it would be to fit

a 3.3M $\Omega$  resistor and see if the supply started up. It did, and the whole machine came back to life and played discs without any problems. A long soak test proved that it was OK. When the unit is working normally, the voltage at the Q71 end of this resistor is about 8.5V.

I always believe in returning help from companies that still maintain proper technical help lines with qualified people at the other end of the phone, and Pioneer always does its level best to point you in the right direction. So, to finish the job off, I rang the nice man back to confirm that the player had been fixed and that he could write 3M3 next to R74 on his circuit diagram. G.D.

## Smartmedia DVD4032

These DVD players are popular with enthusiasts as they will play any type of disc, with no macrovision. This one came in dead. There was no display and there were no functions. The first thing I noticed when I removed the top casing was that two capacitors on the power supply board, on the secondary side, were bulging at the top. This was not a good sign, as I have had other makes with similar problems and it usually means that the power supply voltages have gone high, often with catastrophic results on the video board. Undaunted, I removed the power supply board and replaced the two bulging capacitors, C7 (1,000 $\mu$ F, 16V) and C12 (470 $\mu$ F, 16V). I then tested the 1N5822 rectifier diode in this supply and found that it was quite leaky. So a replacement was fitted. To be on the safe side I also replaced the single capacitor on the primary side of the power supply, C21 (22 $\mu$ F, 50V). The player was then powered and tested. It worked perfectly. G.C.

## Thomson DTH210

This was a new machine to me. The job ticket said it was dead. I found that the mains fuse was OK and couldn't find any shorts on the primary side of the power supply. So I started to carry out checks on the secondary side, and soon found that D809 (SR160) was short-circuit. A replacement restored normal operation. R.B.

## Panasonic NVVHD1

This DVD/VCR combi unit had no video or DVD display and no mechanical operation. A check on the outputs from the power supply showed that the voltages were all correct. But voltage checks on the video PCB showed that the 12V supply was missing. This also feeds some of the 5V lines. Q1007 (2SC1959Y) was open-circuit base-to-emitter. D.K. ■

# WEB SERVICE

To reserve your web site space telephone  
 Tel: 01322 611292 Fax: 01322 616376  
 E-MAILS [r.gurunlian@highburybiz.com](mailto:r.gurunlian@highburybiz.com)



## Alban Electronics

<http://www.albanelectronics.co.uk>

Alban stocks, supplies and provides technical support for a range of terrestrial/cable/satellite and analogue/digital TV equipment. PROMAX (manufacturers electronic test equipment including signal level meters, spectrum analysers, BER/CSI/MER analysers for QPSK, QAM & COFDM, optical fibre light sources and power meters, 16:9 test pattern generators), ALCAD (manufacturers of R.F. wide band and adjacent channel amplifiers, aerials for MATV, SMATV & IRS systems) and ANTARES (cascadeable multi-switches). ALBAN has a complete after sales repair and calibration service that is fully supported by the manufacturers, in addition provides a free system design service using only reliable high quality components.

## Alltrade Aerials & Satellite Ltd

<http://www.alltrade.co.uk>  
 Leading distributor to the trade



Full e-commerce site with over 1500 products with in-stock quantities!! We supply everything associated with Digital/Analogue Terrestrial & DTH/Motorised Satellite reception. All Antennas. All Brackets. All Cables. All Connectors. All Amplifiers. We provide a free MATV/SMATV planning service as well.  
 Phone 0845 075 0751 Fax 01273 425700

## Cricklewood Electronics

<http://www.cricklewoodelectronics.co.uk>

Cricklewood Electronics stock one of the widest ranges of components, especially semiconductors including ICs, transistors, capacitors, resistors. all at competitive prices.

## Charles Hyde & Son Ltd

<http://www.charleshyde.co.uk>

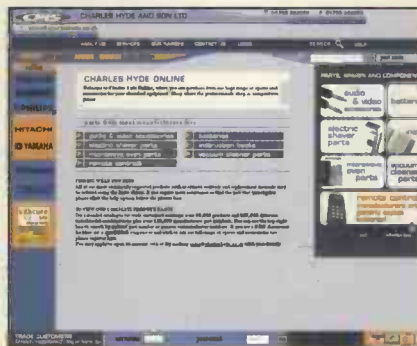

Search for both original and copy spare parts in our extensive database covering Akai, Alba, Bush, Ferguson, Goldstar, Hitachi, LG, Matsui, Nokia, Saisho, Sanyo, Sony, Sharp, Thomson, Panasonic, Philips, Samsung, Tascam, Teac, Toshiba, Yamaha and many more. In addition huge ranges of Lasers, Lopts, Remote controls and Semiconductors may be accessed.

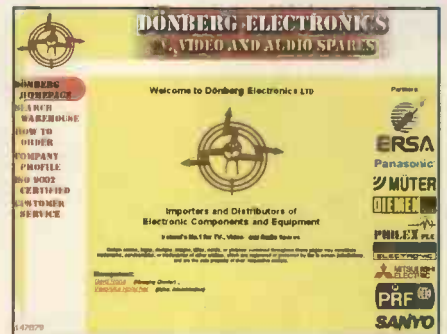

## Dönberg Electronics

<http://www.donberg.ie>

<http://www.donberg-electronics.com>

<http://www.electronic-spare-parts.com>

As the leading distributor for the TV, Video and Audio trade in Ireland, we supply over 2000 shops & service dept with Audio-Video and TV spares, Semiconductors, Test Equipment, Service Manuals, Remote Controls etc. At present we stock over 35,000 different lines. We hold agencies for: Panasonic, Sharp, Mitsubishi, Sanyo, Beko, Ersa, Müter, Diemen HR, Philex, PRF, König-electronics. We specialise in parts for all continental sets and obsolete semiconductors.

## J W Hardy Communications

<http://www.jwhardy.co.uk>

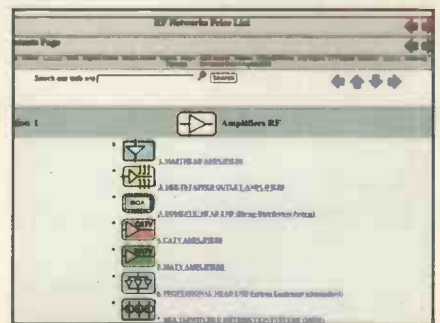

R.F. Network Specialist.  
 Shop online - for R.F.network components. We supply a full range of TV, radio reception equipment to receive analogue/digital signals from both

terrestrial and satellite sources. We provide a free planning service for your R.F. networks, MATV and SMATV etc

### Irwin Electronics

<http://www.irwinelectronics.co.uk>

As Classic Distributors we complement our existing mail and trade counter business with our website. You can order parts on-line quickly and easily. We intend to explore alternative ways of assisting engineers to run their business successfully.

### MMWafercards

<http://www.mmwafercards.com>



Smartcards and programmers for all access-controlled applications. Incorporating [www.satstore.co.uk](http://www.satstore.co.uk) The Enthusiasts Satellite Store. Tel 01386 48731 Fax 01386 765875

### M.C.E.S.

<http://www.mces.co.uk>

The MCES site gives details of our range of service including Tuners, Video Heads, RF & IF Modules plus latest prices offers.



### Swires Research

<http://www.swires.com>

Swires Research produce high quality instruments for the television industry, including portable signal level meters and spectrum analysers for digital and analogue RF signal measurements.

### Televés

<http://www.televés.com>

Televés website was launched as an easier way to keep in contact with our World-wide Network of Subsidiaries

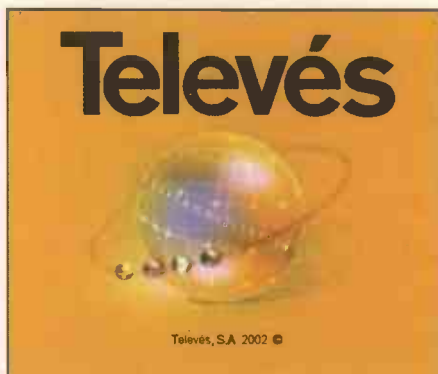

and Clients. This site is constantly updated with useful information/news plus you can download info on our range: TV Aerials & accessories, Domestic and Distribution amplifiers, Systems Equipment for DTT and Analogue TV, Meters and much more.

### Wiltsgrove

<http://www.wiltsgrove.co.uk>



**WILTSGROVE LTD** founded in 1984, is renowned as a leading supplier of Audio, Video, TV, Spare parts and Accessories.

We are now pleased to announce the launch of our ONLINE CATALOGUE:

<http://www.wiltsgrove.co.uk>

Our easy to use search engine will allow you to find the products you require via:

- Make / Model.
- Product Category.
- Key Word search.
- Manufacturers part number.
- Our Order Code.

All orders before 5pm will be dispatched the same day.

**Tel:** (0121) 772 2733  
**Fax:** (0121) 766 6100  
**Email:** [sales@wiltsgrove.co.uk](mailto:sales@wiltsgrove.co.uk)

# Make sure of your copy of **Television**

It can be difficult finding a copy of *Television* at local newsagents. The number of magazines being published keeps increasing, which means that newsagents have less shelf space for the display of individual titles. Specialist magazines in particular get crowded out.

There's a solution to the problem. Most newsagents provide "shop-save" and/or home-delivery services. There's no charge for a shop save. You simply ask your newsagent to order a copy for you: it will be kept on one side each month ready for you to collect. Home-delivered copies are ordered in the same way, but generally incur a delivery charge.

A newsagent can order any magazine for you, whether or not the shop normally stocks it.

If you buy your copies of *Television* from a newsagent and want to make sure you get every issue, just ask at the counter.



# WHAT A LIFE!

## Unusual customer requests. Component-level testing. Odd fault with a Panasonic set. Steven and Paul scarper off. The TV clinic. Donald Bullock's servicing commentary

**T**here was a very welcome letter at the top of my postbag today. Another from Ron Bravery, telling me about strange customers he's had over the years. First a rather forceful lady.

"I want a BBC test card, please, young man" she declared.

Ron swallowed, straightened his tie and did his best. "Er, you can't actually buy them, I'm afraid" he managed.

"Can't buy them? Well perhaps you can give me one. Right away, if you could. I've a lot to do, and I'm in a hurry" she replied.

"Er, I can't do that either" Ron replied, "you see, they belong to the BBC, which transmits them over the air."

"Don't try to fool me" the lady replied, "my neighbour's got one. I've seen it a number of times."

Ron doesn't tell us what he did next. He obviously managed to extricate himself from the situation somehow. Space helps, if you can manage it quickly!

The other odd customer was an old boy who breezed in and asked for "a box of medium waves and a tube of Q paste to help with selectivity improvement".

You don't see Q referred to much nowadays. It was the measure of the goodness of a tuned circuit. The higher the Q factor, the more sensitive the radio receiver.

Stick at your post, Ron, I say. There are better times around the corner. Hopefully.

### Aerial work

David Porter's email addresses me as Mr Billhook. Says he's taking on some of the characteristics of his odder customers. Welcome to the club, Dave! He goes on to mention a colleague of his, Bill Wright, who doesn't collect

characters but photographs some of the odd things they do. In fact he's compiled a sort of rogues' gallery of excellently photographed blunders and outrageous workmanship. If you want to take a look, go to

[www.wrightsairials.tv/roguesgalleryview.html](http://www.wrightsairials.tv/roguesgalleryview.html)

I've had a look. Some of it would be unbelievable were it not for the extremely clear photographs. Well worth a visit!

### Component-level testing

Alan Velden tells me he moved from TV servicing to computer repairs some while ago. Reckons he's past the age of retirement. But I think he's one of the newer fellahs in disguise. Says he thinks *Television* started out with this title when he was a youngster. That gives the game away. In its earlier days it was known as *Practical Television* and was edited by F.J. Camm, who also edited *Practical Wireless* – amongst other Newnes publications. This wasn't an entirely accurate description of his role however. He was certainly clever, and was able to master the technology of the day fast enough. He seemed to like to have his name on magazines and books and Newnes backed him, making him a sort of celebrity at the time. Others, rudely, would refer to his magazines as Camm's comics. But they sold well, so FJC obviously knew his market. The chap who did the day-to-day work of editing *Practical Wireless* and *Practical Television* up to the late Fifties was Bill Delaney. But he never got his name on them!

Alan says he is surprised that there are still engineers who routinely diagnose and repair equipment down to component level. I suppose he bases this on the cost of time compared to the low cost nowadays of mass-produced panels.

But there are other aspects. For a start engineers aren't always paid an appropriate rate for their time and skills. Never were in this trade. And where power circuits are involved it will always be worthwhile looking for and repairing faults. Even at the present unbelievably low cost of much domestic electronic equipment it remains cheaper to deal with the dry-joint that's giving the no results symptom than to buy new.

"I've enjoyed your column for so long" writes Alan "that I can't recall when it started." Nor can I, for that matter! But I do recall that it coincided with my ever-increasing family – we ended up with five boys and a girl – and my developing taste for malt whisky. "Please tell us how it all started, and of all the changes over the years" he concludes. Well, Al, it would take me a long, long time, and fill a very long book!

### Odd TV set behaviour

Gerry Meek, another long-standing reader, mentions an odd fault he has with a Panasonic TX32PK2 32in. widescreen colour set (Euro-4 chassis) that he bought as recently as 2001. He describes the symptoms as follows:

"At switch on a yellow background with fuzzy white lines appears, the sound being OK. Then the set switches to standby. If I try again after a few minutes, the same thing happens but the picture gradually becomes sharp, only to fade to white after which the set cuts out again. When a further try is made a few minutes later the set gradually settles to produce an acceptable picture."

Now I'm not clued up about this chassis. Steven has dealt with a number of these sets however, so I asked him for his comments.

There's a 120kΩ resistor, R558, in the line output stage that tends to go high in value or open-circuit. It's worth checking this. The CRT's pins and the sockets on the base PCB should be carefully cleaned. The EEPROM chip is a frequent casualty in this set but fails completely: since the fault isn't consistent, this possibility is ruled out.

Otherwise, it could well be that the tube's emission is low. Regardless of what the tube label says, it will be of

Philips manufacture. They do seem to bite the dust as early as this. We've never come across one priced at less than about £300.

So there you are. As one who has taken many batterings from fairly new Sony tubes ("dull red picture, Mr Bullock") I'm sorry to have to suggest this sad prospect.

### A stint at the shop

Just before we returned to Spain after our last visit to the UK Steven and Paul tackled me in the shop, pointing out in a well-rehearsed manner that they had both been working so hard recently that they were faded and jaded.

"We need a day or two away from the shop" Steven said.

I must say he did look a bit fatigued, so he had my sympathy. Then Paul cut in.

"I'm not as young as I was" he commented, "and I heard on the news the other day that someone's sons and daughters are nowadays unlikely to live as long as their father".

"I heard that too" I replied. "And did you hear why? Because, instead of getting up early and getting cracking and eating proper food and living active lives, you lot loll about in front of TV sets stuffing fatty rubbish and watching the antics of other fat bores who are even duffer than yourselves. Why, when I was your age..."

"Never mind that" Paul said, "I've had a headache for days. Strain and overwork I'd say. A chap needs a day off now and again - to recharge his batteries, so to speak."

"I see that the weather out there is vile" I pointed out. "Cold, cutting wind, puddles everywhere, dark skies full of rain. It couldn't be the time for the Cheltenham races, could it? The weather certainly suggests so."

"Why I do believe it is the Cheltenham races today" said Paul.

"And all weekend" added Steven.

"And I daresay you've raided the petty cash and looked up where the Guinness tent is?" I asked, then pointed to the pile of sets on the shop floor. "Fill me in" I said.

"That's old Scrubber Hopton's Sobell" Steven said. "Tube, line output transformer, paper capacitors oozing - not worth repair."

"Sobell!" I exclaimed, "I thought they went out with the Major!"

"And the rest are all done, with the bills attached" Steven concluded.

And with that the two of them skipped off, like a pair of sprightly yearlings.

They passed a grim-looking old dear at the door. It was Mrs Hopton. She

headed for me and eyed me suspiciously.

"You used to be that Mr Bullock, didn't you?" she asked.

"Well, if you put it that way" I replied. "Now this set of yours, very old now you realise. Too old to be worth repair in fact, even if we could get the parts."

"You're trying to sell me a new one, ain't you?" she said, "that tall thin chap at Snoddies warned me that's ussactly what you'd say!"

"Wouldn't he mend it either?" I asked.

"E'd just lost 'is screwdriver, otherwise he would have done. A real genulman, not like you lot!"

"You tell 'im Mam" commented a dapper little chap who was struggling in with a widescreen Akura TV set. It was Sid Tredwell, and his set turned out to be a Model APTPV028WSS.

"Too much width, and the picture's sorta shaped like an hourglass" he explained.

### Dr Bullock's TV clinic

"EW trouble" I pronounced, then opened up the set and pounced on RV38, a 2.2Ω safety resistor that had failed. I fitted a replacement then switched the set on. The new resistor immediately went open-circuit. This time I replaced CD21 (680nF) as well as the resistor. That did the trick.

"Next!" I bawled.

A thin, spare chap came in, looking as though he had just been wound up.

"I'm Mr Leaky, hasn't it?" he sang, "and my set is in my car's boot, Mr Burley. You can bring it in for me, if you will, 'cos I'm getting old like."

He looked about fifteen years younger than me, but I walked out for him, leaving Greeneyes to mind the shop. His car was about a hundred yards up the road and the set was an ancient 21in. Pye Model 52KE1585 (CP90 chassis). I hadn't seen one for ages.

"Long time no see!" I said as I brought it in, trying to be bright.

He looked at me, puzzled. "No sea, Mr Burcock? No, that's true. But there never was here in the midlands, wasn't there?"

I smiled benignly, having decided to get back at him via his pocket. "What's the trouble with it?" I asked.

He looked surprised. "Well I suppose it's because the land is too high" he added.

I tapped the set hard. "The set" I said firmly, "what's wrong with it?"

"Oh" he exclaimed, "plenty of sownd like, only no peecture."

My first instinct was to look for the 165V supply to the RGB output stages,

but it was all right. Then I advanced the setting of the first anode control. This made no difference, in fact the A1 supply was missing. That meant a new line output transformer, which we happened to have in stock. It must have been waiting for ages for a suitable set to turn up. I fitted it while Mr Leaky waited. The result was an excellent picture. He was well pleased.

Then I quickly did the bill and presented it to him. His smile faded.

"Oh, thirty powends is it, Mr Bursome" he commented, "didn't take long to tot itself up to thirty powends, did it?"

But, as he peeled some loot from the nest of notes he had in his wallet, his smile returned. "Oh well, these transformer things don't grow on trees, do 'un?" he observed, "but it's sort of funny how one moment you've got thirty powends in your pocket and the next it's in someone else's!"

Another caller had arrived however, with a Sony KV25K5. He put it on the bench and started to explain.

"It's giving me serious trouble" Mr Wu said. "When I switch it on all I get is two flashes from the standby light."

"Not much of a show" I sympathised, then went straight to the line output transistor which was dead short. In this chassis (FE1) it's a 2SD2539, and nothing else will do. Fortunately we had one in stock, so I fitted it then checked for dry-joints in the line driver stage. There they were, in all their wickedness, waiting to punish the new transistor. But I resoldered them carefully, then switched on. Another excellent picture, and one more satisfied customer.

The final customer that morning was a charming young lady who brought in a 14in. Matsui portable, Model 14TR50. She's actually Elijah Spry's fifth wife. A remarkable man!

"It's causing us a lot of worry. When we switch it on it goes for only five seconds, then this little light flashes" she said, pointing to the standby LED.

"They do these things" I replied, glancing at my watch. I must have had about a thousand of these sets on the bench, all with the same trouble. I took three 180kΩ, 0.5W resistors from the drawer and tinned them. Then I quickly dismantled the set and fitted the resistors in place of the open-circuit ones on the tube base panel. After that the set worked perfectly.

Lotus Rose was pleased and paid the modest fee happily. It was time to hang up the 'gone to lunch' notice.

Oh, and don't forget, keep those emails rolling in. You can write to me at [donald@wheatleypress.com](mailto:donald@wheatleypress.com)



# SATELLITE NOTEBOOK

Reports from  
**Christopher Holland**  
**Hugh Cocks and**  
**Michael Dranfield**

## Nokia 9800

This Nokia receiver was about three years old and had given its owner good service during that time. He has been using it mainly for the free-to-air German channels via Astra 1 at 19°E. Recently however reception of some of the stations has produced a blank screen, though plenty of signal is present.

I decided to go to the Nokia website ([www.nokia.com](http://www.nokia.com)) to try and find information on the latest software used in this model. The section on the 9800 Mediamaster is very helpful, and explained that the current version is MA2.0. The version in use in this 9800 was much older – the software version

installed in a 9800 can be found by going to the main menu and pressing option 7, see Photo 1.

To download the latest version the receiver has to be tuned to the German news channel NTV, which is transmitted via Astra 1 (19°E) at 12.607GHz vertical, with SR 22,000 and FEC 5/6. You then have to enter the system configuration menu and select option 6, receiver upgrade (see Photo 2). Note that the system configuration menu is protected by a PIN, which is normally 1234. If no upgrade is available, a message will be seen (see Photo 3). If one is available advice is given on screen. Upgrading takes about twenty minutes, during which time the mains power and satellite signal should not be interrupted. During the download period the front display shows a series of flashing numbers.

Once the upgrade had been carried out, reception of the previously unavailable channels was restored. The receiver was then put on a long soak test.

I noticed that a lot of the German channels now display an on-screen red button briefly when they are selected, see



Photo 1: Nokia 9800 receiver software version display.

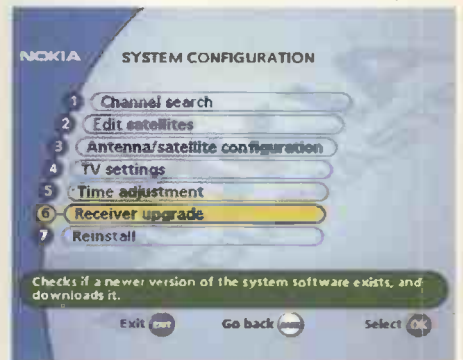

Photo 2: System configuration menu, Nokia Model 9800.

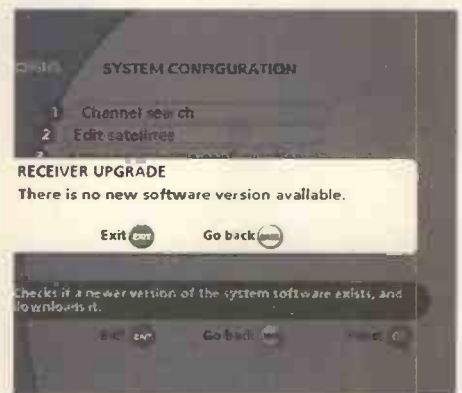

Photo 3: Nokia upgrade message received via the German news channel NTV.



Photo 4: When selected many German channels now briefly display a red button to call up an EPG.





Photo 5: Typical German EPG.



Photo 6: CCTV (China) channel 4 via PAS-1R at 45°W.

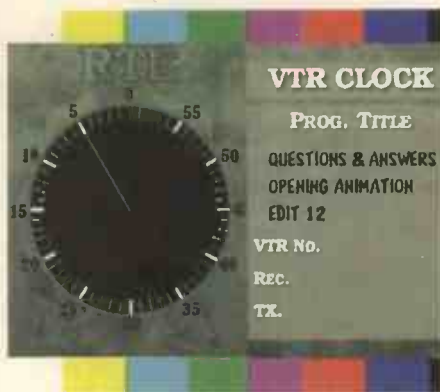

Photo 7: An RTE OB link received via Intelsat 903.



Photo 8: A Eurovision transmission from the Dutch MCR, Hilversum, via Eutelsat W3.

Table 1: Latest digital channel changes at 28.2°E

Channel and EPG no.	Sat	TP	Frequency/pol
Deutsche Welle TV (834)	2D	43	10-733GHz/H
Game in TV	EB	C5	11-391GHz/H
I Sports TV	EB	D7S	11-548GHz/H
Mobile Crazy TV (691)	2B	33	12-344GHz/H
Nation (277)	EB	C6	11-426GHz/V
OBE (280)	EB	D12S	11-681GHz/H
Television X2 (971)	EB	D7S	11-585GHz/H
Television X3 (974)	EB	D7S	11-585GHz/H
TVE International (835)	2D	43	10-733GHz/H
UK TV tests (see text)	2A	15	11-992GHz/H
Vectone Hindi (831)	EB	D10S	11-642GHz/H

TP = transponder. EB = Eurobird. 2A, 2B, 2D = Astra 2A/B/D.

Photo 4. Pressing the red button on the remote-control unit brings up an electronic programme guide, see Photo 5. As before, with channels that don't display the red dot pressing the I button on the remote-control unit gives programme information.

Various other improvements have been introduced with this software upgrade. They include an increase in the number of stored channels to 5,000, being able to view the channel selected in the 'channel-edit' mode, and placing any data channels found in a separate data-channel list. The later avoids cluttering up the main TV channel list and is a very useful feature. C.H.

### Digital channel update

The latest channel additions at 28.2°E are listed in Table 1. Where allocated, the EPG number is shown in brackets after the channel name.

Channel 5 (EPG no. 105) has moved to transponder 31 (12-303GHz H). Sky One Ireland has moved to transponder 27 (12-226GHz V): Sky One UK remains at transponder 30. The Sci-Fi channel (EPG no. 130) has moved to transponder 23 (12-148GHz H). At the time of writing, UK Style + 1, UK Gold + 1 and UK Food + 1 are testing via transponder 15 (11-992GHz H).

Vectone Tamil and Vectone Bangla, listed last month, have been given EPG nos. 832 and 833 respectively. C.H.

### BBC Radio via Eutelsat W2

BBC Radio 1-4 have mysteriously appeared via Eutelsat W2 (16°E) in recent weeks. They can be found at both 11-634 and 11-659GHz V, with SR 17,577 and FEC 5/6. To obtain reception the audio PIDs (packet identifiers) have to be entered manually: they are 6210, 6226, 6242 and 6258 respectively for Radio 1-4. Some digital receivers won't produce any sound but, when entering the audio information in the 'advanced search menu'

which is available with most receivers, enter the PID as 8191 and the PCR PID the same as the audio PID for the station concerned.

The BBC transmissions appear to be part of two streams used by NTL to link to some digital terrestrial transmitters. Other channels in these multiplexes are scrambled however. C.H.

### PAS-1R (45°W) Ku-band transmissions

PanAmSat-1 at 45°W, launched in 1988, was the first of the privately-owned satellites to be used by broadcasters for transatlantic links. I remember receiving early analogue test transmissions that consisted of local New York city TV stations received off air, complete with ghosting, and channel-changing at the US uplink site! After many years' service PAS-1 was replaced with the higher-powered PAS-1R, which provides fewer Ku-band TV transmissions today than in years gone by. The satellite also has 4GHz capacity, and 11GHz beams that are aimed at Europe and North Africa, plus separate ones for the Americas.

Occasional feeds can be found between 11-450-11-700GHz, with either horizontal or vertical polarisation, but the only main fixed TV signal at present is CCTV (China) channel 4, see Photo 6. This is at 11-670GHz H, with SR 26,691 and FEC 5/6. China Radio International is transmitted along with this signal. H.C.

### Unusual test cards

Three shots this month. Photo 7 shows an outside broadcast link for Irish broadcaster RTE via Intelsat 903 (34.5°W). The frequency was 11-130GHz V, with SR 4,700 and FEC 3/4. Photo 8 shows a transmission from the Dutch Master Control Room (MCR) at Hilversum, received via Eutelsat W3 (7°E). Photo 9, also via W3, is from the Belgrade (Serbia) MCR. The second two shots are



Photo 9: A Eurovision transmission from the Serbian MCR, Belgrade, via Eutelsat W3.



Photo 10: An unusual BBC caption received at the end of October via Astra 2D.

Eurovision transmissions. All three used the MPEG 4:2:2 format. H.C.

### BBC test film

Photo 10 shows an unusual BBC caption that was being transmitted at the end of October via Astra 2D transponder 50 (10.847GHz V) – the interactive stream 2 – prior to a fifteen-minute test-film loop. It could be viewed only with a non-digibox satellite receiver. The film consisted of sweeping views from various countryside locations, with the film's time-elapsed shown on-screen. H.C.

### Pace 2200

Stuck in standby with the LNB voltage pulsing to 13V every three seconds is a common problem with this model, but can be very intermittent. The first time I came across it the box came on while I was scoping waveforms and the fault didn't reappear until three weeks later. The cause of the trouble is an intermittent 29.49120MHz modem clock crystal. You can check it at pins 66-67 of the DSP1675 modem chip U700. M.D.

### Grundig GDS200/1

This digibox didn't produce any sound. I decided to check the signals at the

AK4317VF analogue-to-digital converter chip U31. Pin 5 had the 12.35MHz clock signal; pin 7 was at 3.07MHz, approximately 64 times the audio sampling rate; pin 9, the right-left clock, was running at 48kHz; and the 18-bit PCM data input from the STi3520 AV decoder chip was present at pin 8. But there were no analogue audio outputs at pins 17 and 18. There should be 100-200mV peak-to-peak signals here. The analogue and digital power supplies were both present, so it seemed that the chip was faulty. Wrong!

I had forgotten to check the mute input at pin 12. This comes from pin 168 of the ST20TP3 microprocessor chip. A replacement ST20TP3 chip cured the fault. M.D.

### Amstrad DRX100

A problem I've come across a few times with this digibox is that L106 has burnt up. It's a 10µH surface-mounted inductor that feeds the 28V tuning supply to the tuner. I am not sure of the cause of this fault, as a new inductor provides a cure and I've never found a measurable short-circuit. But to be on the safe side I replace the surface-mounted decoupling capacitor C103 (0.1µF) and the tuner. M.D.

## ONLINE SHOPPING CHEAPER AND EASIER

[www.elclondon.co.uk](http://www.elclondon.co.uk)

TV, VIDEO SPARES AND ELECTRICAL ITEMS



**ELC EAST LONDON COMPONENTS**  
63 PLASHET GROVE, LONDON E6 1AD.  
TWO MINUTES WALK FROM UPTON PARK TUBE STATION  
TEL: 020 8472 4871 FAX: 020 8503 5926  
E-mail: [sales@elclondon.co.uk](mailto:sales@elclondon.co.uk)

# REMOTES DIRECT

All makes and models  
Replacement and Originals remote  
controls available.

!!!!!!At a fraction of the cost!!!!!!

Please contact for instant quote

**ROB or MARK**

**Tel: 01257 793527**

**E-mail: [infrared@btconnect.com](mailto:infrared@btconnect.com)**

Or check out our website and  
order on-line

**Website:**

**[www.remotesdirect.co.uk](http://www.remotesdirect.co.uk)**

Also available a wide range of  
satellite equipment

And various other electronics!!!!!!!

## Solution to Test Case 493-

see page 169 -

Well, we did say that it was an old TV set, even for the time we're writing about! Unlike a transistor, a line output valve gets hot and bothered in the absence of a drive waveform. The cause of the first fault was simply that the ECL80 line oscillator valve had failed. A replacement restored the line drive but not the picture, because of the second fault. The cause of problem number two was that the heater in the wired-in EY51 EHT rectifier valve was open-circuit. With no cathode emission, there was no conduction and hence no EHT voltage.

The cause of the final fault was interesting: technicians who weren't around at the time would probably never guess what it was. Some of those early picture tubes had no aluminium layer behind the phosphor coating on the screen. The result was a somewhat dull picture, and in addition the phosphor coating was vulnerable to ion burn. To prevent this the electron gun was not aimed directly at the screen, but instead at the wall of the tube's neck. The electron beam, but not the harmful ion radiation, was deflected back towards the screen by an ion-trap magnet, which was strapped to the neck of the tube over the gun assembly. Its positioning was critical, and this one had been moved - perhaps during transportation, perhaps by a dabbler, or maybe by the customer? Once it had been correctly positioned a picture was finally obtained.

Merry Christmas to you all!

## NEXT MONTH IN TELEVISION

### Test report: the D-GEN pattern generator

The current situation, with widescreen TV sets, software pre-settings and a complete lack of broadcast test cards, has brought with it the need for a comprehensive test-pattern generator in portable form. Precise setting up and adjustment is often needed when a critical component has been replaced, particularly an EEPROM. Eugene Trundle has assembled, tested and assessed a new type of pattern generator that has only recently become available.

### Sky digibox RF2 checker

There is a saying that the simplest ideas are best. This project couldn't be simpler - there are just five components plus a case and coaxial socket. But it's a great help when servicing digiboxes. Designed by Michael Dranfield.

### A low-cost CCTV recording system

Burglary and vandalism are all too common nowadays. Deterrence can be provided by using a CCTV camera, sensor and dedicated VCR. Most people don't want to go to the expense of an elaborate system, so Mike Rutherford has devised this low-cost system that can be easily built and installed.

## TELEVISION INDEX & DIRECTORY 2004

Plus hard-copy index and reprints service

Here's the essential repair information you need! The Television Index & Directory 2004, in CD-ROM form, contains the text of over 15,000 high quality fault reports on TVs, VCRs, Camcorders, DVD players, Monitors, Satellite TV units, Audio equipment and CD players, searchable by make and model, plus the text of 200 Test Cases and over 250 major servicing articles, from sixteen years of Television magazine. It also contains a full sixteen-year index of Television, a Spares Guide, a directory of Trade and Professional Organisations, an International TV Standards guide, a satellite TV Channel Finder, a TV transmitter list and a compendium of internet resources for service engineers. The software is quick and easy to use, and runs on any PC with Windows 95, 98, ME, NT, XP or 2000.

### Television Index & Directory 2004 CD-ROM, £199

Television Index & Directory 2004 CD-ROM upgrade, £46 (to qualify for this upgrade you need to have purchased a previous version of the Television Index on floppy disk or on CD-ROM)

A six-month update of the index and fault reports will be available in May 2004. If you wish to take advantage of this, £10 should be added to your order.

Television Index only, 1988-2003, £36

Television Index only upgrade from previous versions, £18

**Hard-copy indexes** of Television magazine are available for Volumes 38 (1988) to 53 (2003) at £3.50 per volume.

**Reprints of articles** from Television back to 1988 are also available, at the flat rate of £4.00 per article - you can order through our web site, or write to the address below.

The above prices include UK postage and VAT where applicable. Add an extra £1 postage for non-UK EC orders, or £5 for non-EC overseas orders, although Channel Island residents do not need to add any extra postage. Cheques should be made payable to SoftCopy Ltd. All major credit and debit cards are accepted. Please use our new secure website for your orders, details below. Allow up to 28 days for delivery (UK).

**SoftCopy Limited, 1 Vineries Close, Cheltenham, GL53 ONU, UK**

Telephone 01242 241 455 Fax 01242 241 468

e-mail: [sales@softcopy.co.uk](mailto:sales@softcopy.co.uk)  
web site: <http://www.televisionmag.co.uk>

Published on the third Wednesday of each month by Highbury Business Communications, Nexus House, Azalea Drive, Swanley, Kent, BR8 8HU. **Highbury Business Communications** is a division of **Highbury Communications PLC**. **Filmsetting** by Impress, Unit 2, Parkway, Southgate Way, Orton Southgate, Peterborough PE2 6YN. **Printed** in England by Polestar (Colchester) Ltd., Newcomen Way, Severalls Industrial Park, Colchester, Essex CO4 4TG. **Distributed** by Comag, Tavistock Road, West Drayton, Middlesex UB7 7GE (tel. 01895 444 055). **Sole Agents** for Australia and New Zealand, Gordon and Gotch (Asia) Ltd.; South Africa, Central News Agency Ltd. *Television* is sold subject to the following conditions, namely that it shall not, without the written consent of the Publishers first having been given, be lent, resold, hired out or otherwise disposed of by way of Trade at more than the recommended selling price shown on the cover, excluding Eire where the selling price is subject to currency exchange fluctuations and VAT, and that it shall not be lent, resold, hired or otherwise disposed of in a mutilated condition or in any unauthorised cover by way of Trade or affixed to or as part of any publication or advertising, literary or pictorial matter whatsoever.

# TELEVISION BOOKS

AND HOME ELECTRONICS REPAIR

The Television Book Service offers access to our team of specialist publishing experts. We can order any book or CD-ROM currently in print from *War And Peace* to the *Newnes Guide to Television and Video Technology*. All books are delivered free of charge within the UK unless otherwise stated. Contact us at the numbers below:

Telephone: **01737 812727** or **01737 812676**

Fax: 01737 813526 Email: [salesteam@boffinbooks.demon.co.uk](mailto:salesteam@boffinbooks.demon.co.uk)

If you are ordering by credit card, need further information, or would like to use our search facilities call

**01737 812727 Fax 01737 813526**

The order/helpline is open from 9am to 5pm, or leave your order on our out of hours answerline or email us at [salesteam@boffinbooks.demon.co.uk](mailto:salesteam@boffinbooks.demon.co.uk).

When placing orders please quote \* Name \* Address (home & delivery) \* Daytime telephone number \* Debit/Credit card number \* Expiry date \* Details of order. Please note that prices may change, but are correct at time of going to press.

Boffin Books Ltd., 24 Walton Street, Walton-on-the-Hill, Tadworth, Surrey KT20 7RT

## VCR FAULT FINDING GUIDE

Edit. Peter Marlow

A distillation of the most-used fault reports from 11 years of *Television* magazine. Arranged by make and model, it features over 2000 reports on over 200 models of VCR, including diagnosis and repair advice.



Mar 2000 447 pages PB

Code: BUTO-7506-4634-9

**£23.50**

## VIDEO AND CAMCORDER SERVICING AND TECHNOLOGY

Steve Beeching 5th ed

A comprehensive guide to domestic VCR technology and repair techniques. This edition brings the information fully-up-to-date, with expanded coverage of camcorders, sections on DVD equipment and the latest VCR technology.



Apr 2001 323 pages PB

Code: BUTO-7506-5039-7

**£23.50**

## SERVICING TV, SATELLITE AND VIDEO EQUIPMENT

Eugene Trundle. Rev. 2nd Edition

A practical hands-on guide for service engineers, installation technicians and servicing students, this text emphasizes the practical business of fault diagnosis and repair of TV, satellite and video equipment.



Nov 2001 336 pages PB

Code: BUTO-7506-5507-0

**£24.50**

## NEWNES GUIDE TO TELEVISION AND VIDEO TECHNOLOGY

Eugene Trundle. 3rd ed

An exploration of television and video technology. It covers the fundamentals of digital television (satellite, cable and terrestrial) and digital video, as well as providing a grounding in analogue systems.



Feb 2001 432 pages PB

Code: BUTO-7506-4810-4

**£17.99**

## NEWNES GUIDE TO DIGITAL TELEVISION

Richard Brice. 2nd ed

Covering all aspects of digital television, this text encompasses the electronics of the equipment, data compression, television production, servicing and the different transition methods - terrestrial, satellite and cable. The text has been updated with developments since the 2000 edition.



Sep 2002 304 pages HB

Code BUTO-7506-5721-9

**£24.99**

## TV FAULT FINDING GUIDE

Edited by Peter Marlow

A distillation of the most-used fault reports from 11 years of *Television* magazine. Arranged by make and model, it features over 200 reports on over 300 models of television, including diagnosis and repair advice.



Mar 2000 387 pages PB

Code: BUTO-7506-4633-0

**£23.50**

## DIGITAL SATELLITE TV HANDBOOK

Mark E. Long

A handbook and CD-ROM pack on digital satellite television. It provides an overview of all the digital TV platforms in use world-wide. It includes satellite coverage maps and transmission parameters that readers will need to receive digital TV services from any location in the world.

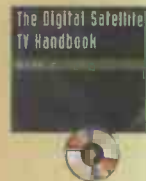

Sept 1999 207 pages PB CD-ROM

Code: BUTO-7506-7171-8

**£41.99**

## DICTIONARY OF VIDEO AND TELEVISION TECHNOLOGY

Jack Tsatsoulin

This work provides comprehensive and contemporary information on the essential concepts and terms in video and television, including coverage of test and measurement procedures. The CD accompanying the text includes an electronic version of the book.



Dec 2002 365 pages CD-ROM

Code: BUT1-878707-99-X

£29.99

## VIDEO DEMYSTIFIED

Keith Jack. 3rd ed

This edition has been updated to include information on digital television, datacasting, interactive video, digital camcorders and VCRs, and video interfacing. Coverage is international, including European, Asian, and North/South American video standards, methods, and techniques.



Jul 2001 784 pages PB CD-ROM

Code: BUT1-878707-56-6

£50.00

## NEWNES TELEVISION AND VIDEO ENGINEER'S POCKET BOOK

Eugene Trundle. 3rd ed

This updated text provides a pocket tool for service engineers. It presents a range of essential information in a compact form, covering television reception, satellite and cable television, video recorders, colour camera technology, teletext and fault-finding.

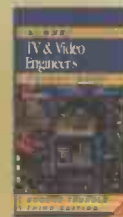

Oct 1999 512 pages HB

Code: BUT0-7506-4194-0

£17.99

## TELEVISION: AN INTERNATIONAL HISTORY OF THE FORMATIVE YEARS

R.W. Burns

This concise history of television from its conception to the 1940s considers the factors - technical, social and financial - that influenced and led to the establishment of many of the world's high-definition broadcasting services.



656 pages HB

Code: IEE 0-85296-914-7

£39.00

## FUNDAMENTALS OF DIGITAL TELEVISION TRANSMISSION

Gerald W. Collins

The switch from analogue to digital broadcast systems is a hot topic in broadcast engineering as the technology rapidly evolves. This text discusses both American ATSC and European DVB-T systems, and collates the latest research previously scattered throughout various journals.



Dec 2000 288 pages HB

Code: WIL0-471-39199-9

£54.50

## STANDARD HANDBOOK OF VIDEO AND TELEVISION ENGINEERING

Jerry Whitaker; Blair Benson

As the television engineering field is rocked by digital technologies and FCC mandates, this handbook has been revised and updated. It features 70 per cent new material, including a section on digital television, and comes with a CD-ROM containing standards, archived texts and software.



140 pages HB & CD-ROM

Code: MCG0-07-069627-6

£91.99

### TELEVISION ORDER FORM Tel: 01737 812727 Fax: 01737 813526

Please order following:	Qty	Name	Daytime Tel
BUTO750646349 VCR Fault Finding Guide £23.50	<input type="checkbox"/> ___	Address	
BUTO750650397 Video & Camcorder Servicing Technology £23.50	<input type="checkbox"/> ___	Postcode	
BUTO750655070 Servicing TV, Satellite & Video Equip £24.50	<input type="checkbox"/> ___	Delivery address (if different)	
BUTO750648104 Newnes Guide to TV & Video Technology £17.99	<input type="checkbox"/> ___	Postcode	
BUTO750657219 Newnes Guide to Digital Television £24.99	<input type="checkbox"/> ___	POSTAGE & PACKING FREE IN THE UK*	
BUTO750646330 TV Fault Finding Guide £23.50	<input type="checkbox"/> ___	I enclose a cheque/postal order value £ _____ payable to 'Boffin Books Ltd'	
BUTO750671718 Digital Satellite TV Handbook £41.99	<input type="checkbox"/> ___	Please debit my Access/Visa/Switch/Delta card Issue number (Switch only) _____	
BUT187870799x Dictionary of Video & TV Technology £29.99	<input type="checkbox"/> ___	Card Number _____ Expiry Date _____	
BUT1878707566 Video Demystified Guide £50.00	<input type="checkbox"/> ___	Signed _____ email:salesteam@boffinbooks.demon.co.uk	
BUTO750641940 Newnes TV & Video Engineer's Pocket Book £17.99	<input type="checkbox"/> ___	*Postage charges outside the UK available upon request or email to salesteam@boffinbooks.demon.co.uk	
IEO0852969147 TV: An Int History of the Formative Years £39.00	<input type="checkbox"/> ___	Post to: <b>Boffin Books Ltd., 24 Walton Street, Walton-on-the-Hill,</b>	
WIL0471391999 Digital Television £54.50	<input type="checkbox"/> ___	<b>Tadworth, Surrey KT20 7RT, UK</b>	
MCG0070696276 Standard Handbk of Video and TV Engineering £91.99	<input type="checkbox"/> ___		



**TELEVISION reader offer:**  
**x1, x10 switchable**  
**oscilloscope probes,**  
**only £21.74 a pair,**  
**fully inclusive\***

\*Additional pairs as part of the same order, only £19.24 each pair.

Seen on sale for £20 each, these high-quality oscilloscope probe sets comprise:

- two x1, x10 switchable probe bodies
- two insulating tips
- two IC tips and two sprung hooks
- trimming tools

There's also two BNC adaptors for using the cables as 1.5m-long BNC-to-BNC links. Each probe has its own storage wallet.

To order your pair of probes, send the coupon together with £21.74 UK/Europe to **Probe Offer, Jackie Lowe, Highbury Business Communications, Anne Boleyn House, 9-13 Ewell Road, Cheam, Surrey, SM3 8BZ**

Readers outside Europe, please add £2.50 to your order.

Please supply the following:

**Probes**

Total \_\_\_\_\_

Name \_\_\_\_\_

Address \_\_\_\_\_

\_\_\_\_\_

\_\_\_\_\_

Postcode \_\_\_\_\_

Telephone \_\_\_\_\_

Method of payment (please circle)

**Cheques should be made payable to TELEVISION**

Access/Mastercard/Visa/Cheque/PO

Credit card no \_\_\_\_\_

Card expiry date \_\_\_\_\_

Signed \_\_\_\_\_

**Please allow up to 28 days for delivery**

**Specifications**

**Switch position 1**

Bandwidth	DC to 10MHz
Input resistance	1MΩ – i.e. oscilloscope i/p
Input capacitance	40pF+oscilloscope capacitance
Working voltage	600V DC or pk-pk AC

**Switch position 2**

Bandwidth	DC to 150MHz
Rise time	2.4ns
Input resistance	10MΩ ±1% if oscilloscope i/p is 1MΩ
Input capacitance	12pF if oscilloscope i/p is 20pF
Compensation range	10-60pF
Working voltage	600V DC or pk-pk AC

**Switch position 'Ref'**

Probe tip grounded via 9MΩ, scope i/p grounded



# What a Lovely Pair!



## HORIZON DIGITAL TERRESTRIAL METER

### HDTM

- Signal Strength and BER displayed together
- Pre and post BER displayed on sub menu
- 10 pre programmed transmitters (via website) or all channel step through
- Audible tune-in, with back light
- 7 or 8 MHz channels
- 2K and 8K mode
- Automatic Transmission and constellation
- VHF (band3) and UHF bands
- RF input range 167-862 MHz
- Input dynamic range -72dBm~-20dBm
- Input connector BNC. Input imp75 ohms. Loop through
- External power for mast amplifiers, etc.
- Built in universal charger 80-250 V Ac. Intelligent charger (CE approved) with delta V delta T detection. Fast charge, then Trickle
- Run time with full charge: Minimum 5 hours from 2.5 Ah battery
- Figure of 8 mains input connector. 2.1 mm Female PSU plug for external charge via supplied car charger
- Computer interface: Serial port (Com 1-4) for upgradeable software on transmitters.

## HORIZON DIGITAL SATELLITE METER

### HDSMV2

- Signal Strength and BER displayed together
- 32 Transponders or 16 satellites, horizontal & vertical
- Audible tune-in, with back light
- DVB, C&Ku band, Mpeg, V Sat compatible
- Input dynamic range -65dBm~-25dBm
- Input connector F-female. Input imp 75 ohms
- Symbol Frequency rate from 1 Msps~45Msps
- Universal charger 80 V ~ 250 V Ac. Intelligent Charger (CE approved) with delta V delta T detection Fast charge, then Trickle
- Run time with full charge (single LNB): Minimum 3 hours from 2.4Ah battery
- Figure of 8 mains input connector. 2.1 mm Female PSU plug for external charge via car charger
- LNB short circuit protection 500 mA automatic limiter
- RF input range 950- 2150 MHz
- Computer interface: Serial Port (COM 1,2,3 or 4) for upgradeable software on satellite settings.

[www.horizonhge.com](http://www.horizonhge.com)

Speed up your installations call NOW on +44 (0)20 8281 3777  
or email [sales@horizonhge.com](mailto:sales@horizonhge.com) for a reliable solution



# COLOUR TRADE

**POSSIBLY  
LARGEST & OLDEST  
EST. IN  
THE UK EST FOR  
30 YEARS**

Wholesaler Distributors & Expert Agents of  
Domestic Electronics & Appliances

**FULL RANGE OF FACTORY  
GRADED TV's DVD / VIDEOS  
HI-FI SMALL & LARGE  
DOMESTIC GOODS**

**WHOLESALE MADE EASY ON LINE, SIGN UP  
NOW FOR OUR WHOLESALE PRICES.  
ALL ORDERS DISPATCHED ON THE SAME DAY.**

*Now Available*

**TV's, DVD's, VCR & AUDIO**

*Over 40 years of genuine experience*

**Experts on:-**

Thomson • Sanyo • Beko • LG • Tatung • Ferguson  
Bush • Funai • Pacific • Dansai • Samsung & more

**TECHNICAL SUPPORT  
0907 076 70 80**

Call cost 60p min

## MAIN DEALER

- Thompson
- Sanyo
- Beko



**Tel: 0121 359 7020 Fax: 0121 359 6344**

**Phoenix House, 190 Bridge St. West, Newtown, Birmingham B19 2YT**

Email: [inquiries@colourtrade.com](mailto:inquiries@colourtrade.com)

# FRUSTRATED!

Looking for ICs TRANSISTORS?

A phone call to us could get a result. We offer an extensive range and with a World-wide database at our fingertips, we are able to source even more. We specialise in devices with the following prefix (to name but a few).



2N 2SA 2SB 2SC 2SD 2P 2SJ 2SK 3N 3SK 4N 6N 17 40 AD  
 ADC AN AM AY BA BC BD BDT BDV BDW BDX BF  
 BFR BFS BFT BFW BFX BFY BLY BLX BS BR BRX BRY BS  
 BSS BSV BSW BSX BT BTA BTB BRW BU BUK BUT BUY  
 BUW BUX BUY BUZ CA CD DX CXA DAC DG DM DS  
 DTA DTC GL GM HA HCF HD HEF ICL ICM IRF J KA  
 KIA L LA LB LC LD LF LM M MSM MA MAB MAX MB  
 MC MDA J MJE MJF MM MN MPS MPSA MPSH MPSU  
 MRF NJM NE OM OP PA PAL PIC PN RC S SAA SAB  
 SAD SAJ SAS SDA SG SI SL SN SO STA STK STR STRD  
 STRM STRS SV1 T TA TAA TAG TBA TC TCA TDA TDB  
 TEA TIC TIP TIPL TEA TL TLC TMP TMS TPU U UA  
 UAA UC UDN ULN UM UPA UPC UPD VN X XR Z ZN  
 ZTX + many others

We can also offer equivalents (at customers' risk).

A LARGE RANGE OF ELECTRONIC COMPONENTS ON  
 OUR CD ROM - LIST AVAILABLE ON REQUEST  
 Mail, phone, Fax, Credit Card orders & callers welcome.



## Cricklewood Electronics Ltd

40-42 Cricklewood Broadway, London NW2 3ET  
 Tel: 020 8452 0161 Fax: 020 8208 1441  
 www.cricklewoodelectronics.co.uk  
 E-mail: sales@cricklewoodelectronics.com

## inStore

ELECTRICS LIMITED

171 HAREHILLS LANE, LEEDS LS8 3QE  
 Tel: 0113 240 1114. Tel/Fax: 0113 240 7275.  
 Mobile: 07976 403134  
 Email: sales@instoreleeds.freeserve.co.uk

### MANUFACTURES GRADED PRODUCTS ALL PRICES PLUS VAT: ALL PRODUCTS FULLY GUARANTEED

\*  
 PHILIPS 32PW6506 32" WIDESCREEN REAL FLAT,  
 FM RADIO, 50HZ **£349.00**

\*  
 PHILIPS 32PW9527 32" WIDESCREEN REAL FLAT,  
 DOLBY, 100HZ, PIXEL PLUS **£449.00**

\*  
 PHILIPS LX3000 DVD PLAYER 5.1 SURROUND  
 SOUND SYSTEM, 75W RMS **£139.00**

\*  
 PHILIPS 14" TV/VCR COMBI FROM **£84.00**  
 PHILIPS 14" PORTABLES FROM **£59.00**

\*  
 PHILIPS VCR'S FROM **£39.00**  
 PHILIPS AUDIO SYSTEMS FROM **£44.00**

\*  
**FURTHER OFFERS AVAILABLE  
 PLEASE CALL FOR A PRICE LIST  
 CREDIT CARDS WELCOME: NEXT DAY DELIVERY**

## SPARES DIRECT



## Why go any- where else for Panasonic spares?

From phones to cameras, home cinema systems to DVD players, Panasonic brings ideas to life. If you service or repair any of our products, we can make your life easier too, thanks to the new Panasonic Spares Direct website.

Specially developed for smaller companies who only need parts or advice occasionally but still want genuine discounts on guaranteed spare parts, it's now open for business.

Register on the subscription-based site now and for just £24 for a year's access you'll find the most competitive prices, online technical information and repair manuals, special offers and immediate part number identification.

It's fast, it's easy, it's trouble-free and it's the only place you need to visit when you need to service or repair any Panasonic product.

So why call us for spares when you can now visit us 24 hours a day?

Visit [www.panasonic-spares-direct.co.uk](http://www.panasonic-spares-direct.co.uk) for more information.

## Panasonic

Panasonic CS UK  
 Willoughby Road, Bracknell, Berkshire, RG12 8FP

[www.panasonic-spares-direct.co.uk](http://www.panasonic-spares-direct.co.uk)



# ADVERTISERS INDEX

AERIAL TECHNIQUES .....	163
ALBAN ELECTRONICS .....	OBC
B SMART .....	191
CAMPION ELECTRONICS .....	159
COLOURTRADE .....	189
CRH ELECTRICAL DESIGN .....	173
CRICKLEWOOD ELECTRONICS LTD .....	190
DIGI REPAIRS .....	191
EAST LONDON COMPONENTS .....	184
EXPRESS TV .....	171
GRANDATA .....	149-154
HORIZON GLOBAL ELECTRONICS .....	189
INSTORE ELECTRICS .....	190
IRWIN ELECTRONICS .....	171
JOHNS RADIO .....	171
JPG ELECTRONICS .....	159
KUDOS MARKETING .....	190
M.C.E.S. ....	191
PEAK ELECTRICAL DESIGN .....	IBC
REMOTES DIRECT .....	184
SATELLITE AND DIGITAL SERVICES .....	171
STEWART OF READING .....	173
TRADE ELECTRONICS .....	141
TW ELECTRONICS .....	IFC
WILTSGROVE .....	130

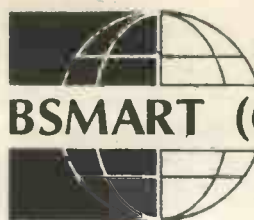

**BSMART (CRAWLEY) LTD**

**Largest selection  
of**

**MAJOR MANUFACTURERS  
NEW "B"  
GRADE PRODUCTS**

**T.V. VIDEO AUDIO  
MICROWAVE OVENS**

**Contact Paul Bean**

BSMART (CRAWLEY) LTD.  
10/11 LLOYDS COURT, MANOR ROYAL,  
CRAWLEY, SUSSEX RH10 2QX

Tel: (01293) 618000  
Fax: (01293) 400133

# Sky Digital Satellite Tuner Repairs

We also repair Power Supplies, Complete Set Top Box's  
UHF Tuners and Modulators

For more information and latest prices  
See our web site

***www.mces.co.uk***

# MCES Digital

15 Lostock Road Davyhulme Manchester M41 0ES

E-mail: [sales@mces.co.uk](mailto:sales@mces.co.uk)

Phone: 0161 746 8037

Fax: 0161 746 8136



## SKY DIGIBOX TRADE REPAIR SERVICE FOR THE UK & EIRE

Are you looking for a reliable company to repair your sky digiboxes?  
We offer **FREE SAMEDAY** Collection when you send more than  
one box for repair!

### ● PRICES

#### For 1 box

Pace, Grundig, Amstrad ... Fixed price £38 + VAT Includes return delivery  
Panasonic, Sony ..... Fixed price £55 + VAT includes return delivery

#### For more than 1 box

e.g 2 X Pace ..... £76 + VAT includes Collection & return delivery

- PRICES INCLUDE ALL FAULTS MICRO PROCESSOR, MODEM, SOFTWARE CORRUPTION AND BGA REPLACEMENT .
- SPECIALISTS IN THE REPAIR OF PANASONIC TU DSB 30 (modification for BBC and ITV low band problem)
- REFURBISHED DIGIBOXES FOR SALE. IDEAL FOR USE WITH NEXT GENERATION CARD WITH NO SUBSCRIPTION TO PAY (BBC, ITV, CHANNELS 4 & 5) (6 months warranty + new remote and accessories)
- FAST TURNAROUND TIME
- ALL REPAIRS GUARANTEED
- COLLECTION ARRANGED FROM ANYWHERE IN THE UNITED KINGDOM AND EIRE
- AUTHORISED SKY DIGITAL REPAIR CENTRE.

Receive our latest Satellite and technical newsletter **FREE** through email. Just send us an email with Newsletter in the Subject title to:  
[info@digirepairs.co.uk](mailto:info@digirepairs.co.uk)

### Contact:

**DIGI REPAIRS (UK & Ireland)**  
UNIT 25, ENNISKILLEN BUSINESS CENTRE  
TEMPO ROAD, ENNISKILLEN BT74 4RL  
TEL NO: 02866327293 (NATIONAL RATE)  
0845 6441628 (LOCAL RATE)  
FROM R.O.I. 0486 632 7293  
Email: [info@digirepairs.co.uk](mailto:info@digirepairs.co.uk)

# Service Link

TELEPHONE 01322 611289

FAX 01322 616376

## FOR SALE

### ICC17 LOPTX Kit

Widescreen Special

Ferguson W7023U etc.

Thomson 24WK23U etc

Pt no. 10608670P1

**ONLY £24.95!**

**IrwinElectronics**

Telephone 0114 273 9622

## MISCELLANEOUS

### LOOKING FOR AN EXTRA SOURCE OF INCOME?

Why not sell Broadband services to your customers? Top rated ISP, serious income possibilities.

More info:

[www.dothebusiness.co.uk](http://www.dothebusiness.co.uk)

Tel: 0845 166 4811

## PHOTOGRAPHIC SERVICES

### BENCH ENGINEER REQUIRED

TO REPAIR ANALOG AND DIGITAL CAMCORDERS ETC

- Minimum experience 5 years
- Able to work to component level
- Location Kent
- Performance pay 20-35k + healthcare

Contact Trevor on Tel: 01732 761270

E-mail address: [trev4dnh@aol.com](mailto:trev4dnh@aol.com)

## PROJECTOR SPARES

### VIDIKRON

projector spare parts and service information.

PROJECTSPARES

Tel: 01444 831769

Fax: 01444 831580

E-mail:

[projectspares@btinternet.com](mailto:projectspares@btinternet.com)

## LINEAGE

**CHEAPEST: CABLE TIES, FUSES,** plug-tops, crimps, tapes, tv/video, handsets, extension leads, fax, printers, baskets, ladies trousers. Tel: 020 7232 2266. Fax: 020 7232 2288.

## REPAIRS

### Trade repairs to Sky digiboxes

Pace, Amstrad, Grundig, Panasonic, (Including Fluid Ingress).

All makes repaired at a fair fixed price.

### Scan Digital Services

For details

Give Alan a ring on

Tel/Fax: 01633 25 40 50

E-Mail: [alan@scansat.globalnet.co.uk](mailto:alan@scansat.globalnet.co.uk)

## SERVICE DATA

### NEED HELP NOW?

Then ring the

### ★ ELECTRON TECHNICAL HELPLINE ★

Genuine help available to all repairers of

T.V. - V.C.R. - SAT - AUDIO  
(Inc Valves)

Over 30 years experience and vast data base

**0906 470 1706**

Calls cost 60p per minute

Hours of Business Mon to Fri

9.00 am - 12.30pm : 2.15pm - 5.30pm

Sat. Morn 9am - 12.30pm

**OPEN 6 DAYS**

TV/VCR CIRCUITS  
(WE DO NOT STOCK  
AUDIO OR MONITOR  
INFORMATION)

TEL A.T.V. on

**0114 285 4254**

CTV Circuits ..... from £5.00

VCR Circuits ..... from £7.00

CTV Manuals ..... from £10.50

VCR Manuals ..... from £14.50

User instructions also available  
(P/P add £2.50 to each order)

**419 LANGSETT ROAD  
SHEFFIELD S6 2LL**

MANUAL COLLECTIONS PURCHASED,  
VISA (POST 1995)

## SERVICE DATA

### SERVICE MANUALS

Have you ever turned away work for want of a Service Manual? Have you ever brought a Service Manual and never used it more than once? Then why not join ...

### THE MANUALS LIBRARY

For details and membership application form write, phone or fax:

### HARVEY ELECTRONICS

43 Loop Road, Beachley,  
Chepstow, Mons, NP16 7HE

Tel/Fax No: 01291 623086

Visa: Mastercard accepted

### SERVICE INFO

TV - VIDEO - AUDIO

Prices- any make/model

CTV s/man 10.00

VCR s/man 15.00

CTV circs 5.00

VCR circs 7.00

Other items POA

All prices include p/p.

Do not add any VAT

**AMTel**

Huna,

Caithness KW1 4YL

**01955 611313**

[www.amtel.org.uk](http://www.amtel.org.uk)

## WANTED

### BEST CASH PRICES PAID

FOR VALVES KT88,  
PX4 AND MOST  
AUDIO/OTHER  
TYPES.

Tel: 01403 784961

Billington Export Ltd

Sussex RH14 9EZ

Fax 01403 783519

Email: [sales@bel-tubes.co.uk](mailto:sales@bel-tubes.co.uk)

Visitors by appointment

For a

# FREE

consultation  
on how best

to market

your

products/  
services

to a

professional

audience

contact

# MARK

on

# 01322

# 611289

## Service Link

TELEPHONE 01322 611289

FAX 01322 616376

CLASSIFIED TEL: 01322 611289

# atlas LCR

# £79

Passive Component Analyser  
(Model LCR40)

fully inclusive UK price

Just clip on the test leads and press test. The Atlas LCR will automatically identify the type of component, apply the appropriate test level and frequency, display the component's value and more!  
Probes are detachable too, so you can use the optional SMD tweezers for your tiny unmarked passives - fantastic.

- Automatic component identification (Inductor, Capacitor or Resistor)
- Component value measurement
- Auto frequency (DC, 1kHz, 15kHz, 200kHz)
- Inductor DC resistance measurement
- Non-volatile probe compensation memory
- Detachable probes allowing use of optional test prods, SMD tweezers, etc...
- Hands free mode with value hold



Inductance range: 1 $\mu$ H to 10H  
Capacitance range: 1pF to 10,000 $\mu$ F  
Resistance range: 1 $\Omega$  to 2M $\Omega$   
Basic accuracy: 1%  
Test signals: 1V, 3mA max



See the full review on our website!

*"Astonishingly, this little unit seems to pack most of the punch of a large and very expensive automated LCR bridge into its tiny case."*

Andy Flind - EPE Magazine March 2003

Accessories:  
Carry case  
Tweezer Probes  
Crocodile Probe Set  
Large Grabber Probes  
(more available soon)

# atlas DCA

# £60

Semiconductor Analyser  
(Model DCA55)

fully inclusive UK price

NOW MEASURES TRANSISTOR LEAKAGE!

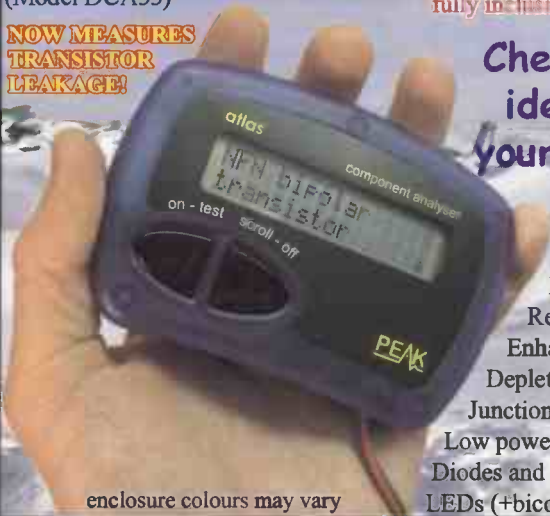

Check and identify your semi's

- Automatic component identification
- Pinout identification
- Transistor gain measurement
- MOSFET gate threshold measurement
- PN junction characteristics measurement
- Shorted Junction identification
- Transistor leakage measurement
- Just connect the part anyway round and press the button!
- Auto power on/off

NPN bipolar Darlington  
Diode Protection between C-E  
Resistor shunt between B-E  
Current gain H<sub>FE</sub>=126  
Enhancement mode N-Ch MOSFET

Bipolar transistors,  
Darlington transistors,  
Diode protected transistors,  
Resistor shunted transistors,  
Enhancement mode MOSFETs,  
Depletion mode MOSFETs,  
Junction FETs,  
Low power triacs and thyristors,  
Diodes and diode networks,  
LEDs (+bicolours)

*"It's the kind of instrument that should be on every engineers and enthusiasts bench."*

EPE Magazine March 2000

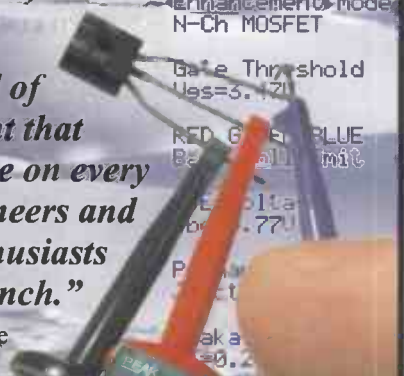

# atlas PACK £129!

LCR40 and DCA55 Pack

fully inclusive UK price

Why not order both analysers at the same time and take advantage of our special offer, saving you £10!



Visit [www.peakelec.co.uk](http://www.peakelec.co.uk) to download the data sheets, user guides and copies of independent reviews. You can pay using a cheque, postal order, credit or debit card and even pay securely online. Please contact us for your volume requirements.

Also available from Farnell, Maplin, Rapid and CPC (prices vary)

**PEAK**  
electronic design ltd

Atlas House, Kiln Lane  
Harpur Ind. Est., Buxton  
Derbyshire, SK17 9JL, UK

[www.peakelec.co.uk](http://www.peakelec.co.uk)  
[sales@peakelec.co.uk](mailto:sales@peakelec.co.uk)

Tel. 01298 70012 Fax. 01298 70046



# TELEVISION TEST PATTERN GENERATORS

The new **GV 998** is a digital pattern generator offering more advanced features at again a realistic price. Those features include :

- ◆ MPEG-2 format Transport Stream generation
- ◆ Video and audio included in the TS
- ◆ Video and audio inputs
- ◆ Generation of a variable frequency sound carrier for decoding verification
- ◆ Multistandard and multisystem analogue TV signal generation
- ◆ Possibility to edit different fields of the TS database to present the name of the service provider
- ◆ Remote control via a personal computer
- ◆ Moving video patterns to check MPEG-2 decoders

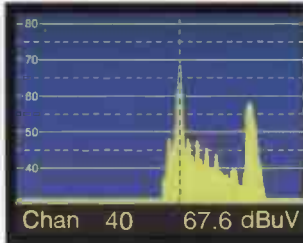
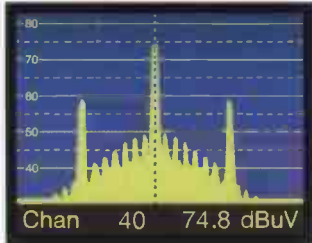

## PROMAX GV SERIES

- ◆ Choice of 12 instruments
- ◆ NICAM and Teletext
- ◆ 4:3 and 16:9 Formats
- ◆ Full field and VITS
- ◆ Computer Controlled
- ◆ Front panel memories
- ◆ Own Company Logo
- ◆ Computer Monitor testers
- ◆ Hand Held Models
- ◆ Multi Standard, PAL, NTSC, SECAM
- ◆ High Quality Construction
- ◆ Attractive Price Levels
- ◆ Full After Sales Service
- ◆ Available from Stock

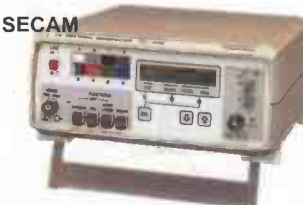
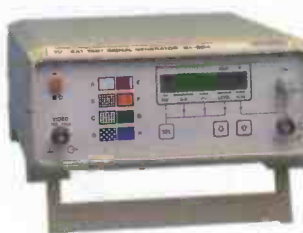
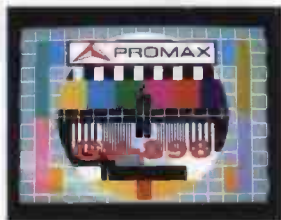
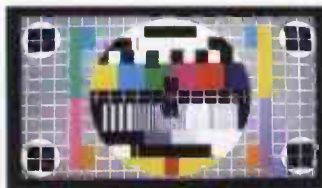

FOR TELEVISION PATTERN GENERATORS, THERE'S NO WIDER CHOICE THAN WITH PROMAX



## SELECTED ITEMS FROM THE PROMAX RANGE OF TEST EQUIPMENT



**MS 250**

Analogue and Digital Satellite Detector.



**PRODIG 1**

Satellite Dish Installer's Meter Does more than just BSkyB



**PRODIG 2**

Analogue & Digital Aerial Meter Measures digital channel power and C/N

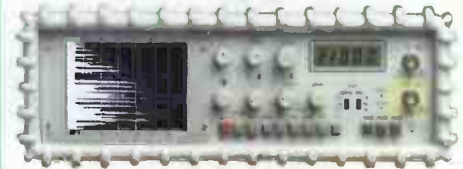

**MC 377+**

Analogue & Digital, Satellite & Terrestrial Measures channel power and C/N



**PROLINK 3 + 4 SERIES**

Satellite & Terrestrial, Analogue & Digital, Spectrum Analyser with BER (optional on P3)

# Alban

ALBAN ELECTRONICS LIMITED

THE PROMAX SERVICE CENTRE

6 Caxton Centre, Porters Wood, St. Albans, Hertfordshire, AL3 6XT.

TEL: 01727 832266 FAX: 01727 810546

WEB : [www.albanelectronics.co.uk](http://www.albanelectronics.co.uk)

EMAIL : [info@albanelectronics.co.uk](mailto:info@albanelectronics.co.uk)

SALES + SERVICE + CALIBRATION



TELECOMMUNICATIONS TEST EQUIPMENT  
AE 767 Spectrum Analyser



**NEW!**  
THE NEW  
ALBAN WEB SITE ...  
[www.albanelectronics.co.uk](http://www.albanelectronics.co.uk)  
FOR ALL THE LATEST NEWS  
AND INFORMATION  
FROM ALBAN  
**NEW!**