

Tips, guides and reports for people repairing televisions and electronic equipment

# TELEVISION

AND HOME ELECTRONICS REPAIR

MARCH 2004 £3.20

## Workshop equipment guide



**Servicing the  
Philips L01 chassis**

**Simple volume  
compressor circuit**



**Satellite, Audio, Monitor, TV, VCR and DVD faults**



The celebrations continue...

With the launch of 57  
brand new handsets in our  
new 2004 case designs.

These 57 handsets which are additions to our existing range, cover over 1,100 of the latest TV/VCR/DVD models from the JK's major brand names and are all available now.

For your free look up card listing all these new additions, visit the Classic website, [www.classic-electronics.co.uk](http://www.classic-electronics.co.uk) and click on 'NEWS', contact your usual Classic distributor, phone us on 01635 278678 or email us at [sales@classic-electronics.co.uk](mailto:sales@classic-electronics.co.uk)



**classic**

Technical helpline 01635 278678

# CONTENTS

March 2004

Vol. 54, No. 5

## 259 Comment

Thoughts on CES.

## 260 Teletopics

Alba bids for Grundig. Philips develops rollable video displays. New MiniDisc format. D-VHS development from JVC. Recycling consortium set up.

## 262 Simple volume-compressor circuit

Keith Cummins discovered that the car mobile-phone hands-free kit he bought was very loud and prone to howl-back. To overcome the problem he devised this simple volume-compressor circuit.

## 263 Workshop equipment guide 2004 – Part One



Eugene Trundle takes a look at what's good and what's new in the world of test gear and aids for bench and field servicing. There's nowadays a huge armoury of equipment for testing, fault diagnosis, repair and setting up the digital and analogue circuitry and systems we have to deal with. Part 1 kicks off with traditional analogue test equipment.

## 272 Servicing the Philips L01 chassis

The Philips L01 chassis can drive 14 to 32in. tubes with 4:3 or 16:9 aspect ratio. It's based on the Philips Ultimate One Chip (UOC), an 80-pin IC that acts as the microcontroller and signal processor. Brian Storm describes the circuitry used, the service modes and lists some known faults.

## 277 Introduction to computer networking

In Part 3 of his latest series Fawzi Ibrahim describes the action of routers in local-area and wide-area networks.

## 280 Service casebook

Michael Maurice selects faults from his notebook.

## 287 College of NW London

The College of NW London has been expanding the range courses and services on digital technology it offers to firms of all types and sizes.

## 288 A day in the life of . . .

Peter Dolman reflects on a day in the workshop and the huge efforts that were required to set it up in an old farm outbuilding.



## 290 DX and Satellite Reception

Terrestrial DX and satellite TV reception reports. Broadcast, satellite and digital TV news. Could Bluetooth be an interference problem? The early days of ITV. Roger Bunney reports.

## 294 Audio faults

## 295 Test Case 495

## 296 Extended fault reports

Reports on tricky or complex TV fault conditions. We've put a few of them together in this extended fault report feature.

## 298 TV fault finding

## 301 VCR clinic

## 302 DVD faults

## 304 Letters

Picture quality. TV downloads.

## 304 Help wanted

## 305 Monitors

Guidance on repairing monitors and related equipment.

## 306 Web service

## 308 Books to buy

## 310 What a life!

A mixed batch of customers and faulty equipment. Donald Bullock's servicing commentary.

## 312 Satellite notebook

The European HDTV channel. Digital channel update. Reception from Eutelsat 2F3. Digibox fault report.

### Editor

John A. Reddihough

### Deputy Editor

Tessa Winford

### Production Editor

Jane Massey

### Advertisement Sales

Luke Baldock

01322 611 289

Fax 01322 616 376

### Editorial Assistant

Caroline Fisher

01322 611 274

### Managing Editor

Bill Evett

### Publishing Director

Tony Greville

Note that we are unable to answer technical queries over the telephone and cannot provide information on spares other than that given in our Spares Guide.

### Disclaimer

We work hard to ensure that the information presented in *Television* is accurate. However, *Television's* publisher - Highbury Business Communications - will not take responsibility for any injury or loss of earnings that may result from applying information presented in the magazine. It is your responsibility to familiarise yourself with the laws relating to dealing with your customers and suppliers, and with safety practices relating to working with electrical/electronic circuitry - particularly as regards electric shock, fire hazards and explosions.

# WILTSGROVE LTD

35/38 River Street, Digbeth, Birmingham B5 5SB

TEL: 0121 772 2733 - FAX: 0121 766 6100



e-mail: [sales@wiltsgrove.co.uk](mailto:sales@wiltsgrove.co.uk)  
<http://www.wiltsgrove.co.uk>

Opening Times: 9:00am - 6:00pm (Monday to Saturday)

**VALID UNTIL THE END OF MARCH 2004**

WILTSGROVE LTD sole distributor of ...

## ruwido

Ruwido is the forerunner in technology and know-how and one of the world's leading companies specialised in innovative infrared applications.

Ruwido replacement remote controls (**RIR Series**) for most makes and models at **£5.95 IN-STOCK!**



### TRANSFORMERS - IN STOCK

OEM NO.	PRICE (£)	OEM NO.	PRICE (£)	OEM NO.	PRICE (£)
003071002	5.95	FUV20A002B	10.95	13525006	12.95
2436892	9.95	13525033	11.45	13525016	12.98
F2015BM	10.90	11425057	11.95	10500980P1	14.25
10542971	10.95	13525048	11.95	1352.5036	14.45
13420006	10.95	10270640	12.45	3214029	14.75
13525008	10.95	1355037	12.95	10516050	14.98

### 4CH REAL TIME STAND ALONE DVR



Order code  
**AV-6075**

**£345.00**

#### FEATURES

- Built-in Quad,
- Various recording speed
- Individual camera set up
- Manual / alarm / schedule recording mode
- Real time display
- Buzzer alarm when video loss
- Looping output
- Alarm Input x 4

#### SPECIFICATION

Image System	NTSC	PAL
Resolution Display	720 x 480	720 x 576
Video Input	BNC x 4	
Video Looping output	BNC x 4	
Video Output	BNC x 1	
Display Frame	4 x 30 fields/sec	4 x 25 fields/sec
Rec Frame Rate (QUAD)	Max 30 fps	Max 25 fps
Rec Frame Rate (MUX)	Max 30 / 4 fps	Max 25 / 4 fps
Storage Media Max	2 IDE Hard Disks	
Image Format	MJPEG	
Compress	Low: 12K bytes/frame	High: 20K bytes/frame
	Rate Medium: 15K bytes/frame	
Recording Mode	Manual / Alarm / Schedule	
Playback Speed	Fast Forward x 2 x 4 x 6 / Fast Reverse x 6	
	Frame by Frame Forward Playback	
On Screen Display & Setup	Time / Date / Setup Menu	
Relay Output	NO or NC Programmable Contact x 1	
Password Control	One for HDD format	
Buzzer	Yes	
Video loss	Yes	
Power Input	AC 90-260 V Input 60/50Hz)	
Dimensions (WxHxD)	432 x 44 x 28 mm	
Weight	4 (Kgs)	

\* PRICES SUBJECT TO AVAILABILITY, VAT & CARRIAGE.  
 \* PRICES MAYBE CHANGED WITHOUT PRIOR NOTICE.

**\*\*TRADE ONLY\*\***

### MAINS SWITCH



REPLACEMENT

Order code  
**SW-02R**

1 **£1.95**  
 10+ **£1.75**

### MAINS SWITCH



MAKE/MODEL No.

**FERGUSON**  
 A10R B49F  
 A14R C39F  
 B14C C49F  
 B14R D14R  
 B39F T10R

Order code  
**SW-1046**

1 **£2.55**  
 10+ **£1.95**

### MAINS SWITCH



REPLACEMENT

Order code  
**SW-1007R**

1 **£1.20**  
 10+ **£1.08**

### MAINS SWITCH

REMOTE CONTACTS

MAKE/MODEL No.  
**BUSH**  
 WS6668S11

Order code  
**SW-1047R**

REPLACEMENT

1 **£1.95**  
 10+ **£1.75**

### MAINS SWITCH



Order code  
**SW-1009**

1 **£1.25**  
 10+ **£1.12**

### MAINS SWITCH

NO REMOTE CONTACTS

MAKE/MODEL No.  
**DAEWOO**  
 DWP28W2GB

Order code  
**SW-1054R**

REPLACEMENT

1 **£1.95**  
 10+ **£1.75**

### MAINS SWITCH



Order code  
**SW-1014R**

REPLACEMENT  
 1 **£1.20**  
 10+ **£1.08**

### MAINS SWITCH



MAKE/MODEL No.

**SANYO**  
 CBP2151 CBP2180  
 CBP2152 CBP2551  
 CBP2162 CBP2552  
 CBP2168

Order code  
**SW-144R**

REPLACEMENT

1 **£1.25**  
 10+ **£1.12**

### MAINS SWITCH

MAKE/MODEL No.

**PHILIPS**  
 14PV284  
 14PV330/07  
 21PT1664  
 21PT4475  
 24PW6005  
 25PT4475  
 28PW6005/05  
 28PW6515/05  
 32PW6305  
 32PW6515

Order code  
**SW-1042R**

REPLACEMENT  
 1 **£1.95**  
 10+ **£1.75**

### MAINS SWITCH

MAKE/MODEL No.

**SONY**  
 KVD2512U  
 KVE2922U  
 KVM14TU  
 KVM1420U  
 KVM19TU  
 KVM2131  
 KVM2151  
 KVM2121U  
 KVM2131U  
 KVM2132U

Order code  
**SW-148R**

REPLACEMENT

1 **£1.25**  
 10+ **£1.12**

Freefax Orderline: **0500 55 05 05**

# Thoughts on CES

The Las Vegas Consumer Electronics Show, held in early February, is probably as good an indication of the state of the consumer electronics industry as any, reflecting as it does conditions in the world's largest CE market, the US. According to estimates released by the US Consumer Electronics Association, which runs the CES, volume sales last year are expected to have increased by between 5-25 per cent, depending on sector, while sales by value increased by just two per cent, to some \$96.3bn (£52.2bn). So there you have it in a nutshell – pressure on profitability. Nowhere is this more marked than with DVD players, which just two years ago were providing good profits as something new but have since become a commodity, selling at about \$30 apiece in the US.

Nevertheless this year's CES was an important event: to maintain their position and profitability, manufacturers are concentrating on innovation and adding value – all those extras that are packed into today's leading products – while the show marked a noticeable increase in the IT industry's interest in consumer electronics. For example Microsoft used the show as an opportunity to unveil a range of products and services designed to establish the PC as the centre of home entertainment. Hewlett-Packard highlighted market convergence by announcing a range of CE products to complement its IT portfolio: plasma and LCD TV sets, home-cinema projectors, and a Home Entertainment Hub to provide a central domestic storage and access device for audio and video material. Gateway has already become one of the leading sellers of flat-screen TV sets in the US.

High-definition TV was a major feature of the Show. How might we get it here? Digital transmission and satellite bandwidth are both keys to this, but it seems more likely that a move to higher definition will driven by the AV market. Once you have HD AV material and displays, broadcasting will eventually follow. But HDTV is probably more important in the US, which still suffers from its traditional, relatively low-definition 525-line broadcasting system. Really good 625-line displays are good enough for most purposes, unless you are viewing a massive screen. HD video based on blue-light laser technology could help drive the AV market: it depends on how the technology comes to be marketed – whether it goes the same way as basic DVD, or can be exploited to give manufacturers and retailers alike greater benefit.

Plasma and LCD panels are well suited to HD video, since you can pack those pixels in. Samsung showed an 80in. plasma screen

## Technological innovation is vital for today's leaders in the CE and IT markets to stay ahead. It won't be easy for them.

and a 57in. LCD screen, both the largest so far of their types. All very well, but hardly the thing for the average living room, certainly in the UK.

What manufacturers seem to want us to have are media centres that serve AV outlets around the home. The hard-disk drive is steadily overtaking other forms of media storage for all applications, with suitable software of course. This is the way in which the likes of Microsoft and H-P are beginning to participate in the world of CE. The hard disk is readily compatible with other digital AV media: digital technology should be able to handle data in different formats, though it doesn't always seem so in practice!

The IT companies can benefit from having proprietary software. Apple Computer for example has had marked success with its iPod and iTunes technology,

### COPYRIGHT

© Highbury Business Communications, 2004. All rights reserved. No part of this publication may be reproduced, stored or transmitted in any form or by any means without the written permission of the publishers.

All reasonable precautions are taken by *Television* to ensure that the advice and data published are reliable. We cannot however guarantee it and we cannot accept legal responsibility for it.

### CORRESPONDENCE

All correspondence regarding advertisements should be addressed to the Advertisement Manager, *Television*, Highbury Business Communications, Nexus House, Azalea Drive, Swanley, Kent, BR8 8HU. Editorial correspondence should be addressed to *Television*, Editorial Department, Highbury Business Communications, Nexus House, Azalea Drive, Swanley, Kent, BR8 8HU.

### INDEXES AND BINDERS

Indexes for Vols. 38 to 53 are available at £3.50 each from SoftCopy Ltd., who can also supply an fifteen-year consolidated index on computer disc. For further details see page 315.

Binders that hold twelve issues of *Television* are available for £6.50 each from Modern Bookbinders, Pringle Street, Blackburn, BB1 1SA. Telephone: 01254 59 371. Make cheques payable to "Television Binders".

### Newstrade Enquires

Distributed by COMAG

Telephone: 01895 444055

ISSN 0032-647X

which H-P has licensed as part of its entry into the CE market.

There is also something new in broadband cable distribution: plastic rather than glass fibre-optic cable. Sejong Network Technologies, a South Korean company, demonstrated what it described as the first "gigabit to the home" system using plastic fibre cable. The company is a member of POFTO (the Plastic Optical Fibre Trade Organisation), along with Mitsubishi Rayon and others. Sejong's Gigabox is the centre of its home distribution network.

Innovation and value-added features can be used to drive markets but, one can't help wondering, will the products all end up being mass-produced by OEM businesses in China, with little profit for anyone? Technological innovation is vital for today's leaders in the CE and IT markets to stay ahead. It won't be easy for them.

Next month we will include a more detailed review of what was to be seen at CES 2004.

### Cover photo

Our thanks to Swires Research who provided the main cover photograph this month.

### SUBSCRIPTIONS

Highbury Subscription Services, Link House, 8 Bartholomew's Walk, Ely, Cambridge CB7 4ZD. Telephone 01353 654 431 Fax 01353 654 400 Email hbc.subs@highbury-wyvern.co.uk Please notify change of address.

### Subscription rates:

UK 1 year £33.80, 2 years £54.00, 3 years £71.00.  
Republic of Ireland 1 year £38.95, 2 years £62.00, 3 years £81.85.  
Mainland Europe 1 year £49.00, 2 years £78.40, 3 years £102.90.  
Rest of World 1 year £63.50, 2 years £101.00, 3 years £133.00.  
Cheques should be made payable to *Television*.

### BACK NUMBERS

If available issues are £4.00 each.



**HIGHBURY**  
Business Communications

A SUBSIDIARY OF HIGHBURY HOUSE COMMUNICATIONS PLC

# TELETOPICS

## Alba bids for Grundig

Alba and Turkish manufacturer Beko Elektronik have, in a 50-50 partnership, made an offer worth up to £80m for the Home Intermedia Systems (TV, video) division of Grundig, which was placed in administration early last year (see Teletopics June 2003) after several loss-making years. Alba's present range of

brands includes Bush, Goodmans and Roadstar. Up to now the company's sales have been 85 per cent in the UK. The expectation is that within three years 50 per cent of Alba's sales could be outside the UK, mainly in Europe. Alba's shares advanced strongly on the prospect of substantially increased business after acquir-

ing the well-established Grundig brand.

The administrator has been able to keep Grundig going, and in fact it had a strong presence at last year's IFA in Berlin. Staff levels have, in administration, been cut from 2,700 to about 350. Grundig was expected to return to profitability in the year to April 2005.

## Rollable video displays

Philips has developed a new, lightweight video display screen that's unbreakable and can be rolled up into a small-sized housing when not in active use. The company says it is particularly attractive for mobile applications, including portable TV sets and games consoles, and adds that large-area displays could ultimately become feasible. At present the largest screen produced has a diameter of 5in., cost rather than production difficulty is likely to determine size limit.

Flexibility is such that the screens could be integrated into an everyday object such as a pen. Philips considers that the availability of such displays will greatly stimulate the development of electronic books,

newspapers and magazines, and new services offered by 3G mobile-network operators. Having proved the feasibility of manufacturing such displays, Philips plans to move rapidly towards development of volume-production technology. An internal venture called Polymer Vision has been established for the purpose within the Philips Technology Incubator.

Polymer Vision is involved in the fabrication of large arrays of polymer-based thin-film transistors (TFTs) and the design of circuitry that exploits the characteristics of organic electronics. The 5in. rollable organics-based screen has QVGA resolution (320 x 240 pixels at 85 d.p.i.) and a bending radius of 2cm. The display com-

bines a 25-micron thick active-matrix backplane that contains the pixel-drive electronics with a 200-micron thick front plane of reflective 'electronic ink' developed by E Ink Corporation. The latter contains capsules of coloured particles that react to an electric charge. Electronic-ink based displays are thin and flexible because they don't require cell gap control. Displays made using this technology can be used for reading-intensive applications.

Power consumption is extremely low. The prototype screens have almost 80,000 TFTs, providing the largest organics-based display to date with the smallest pixel pitch. Polymer Vision is developing a pilot production line.



A prototype Sony Hi-MD Walkman.

## New MiniDisc format

Sony has developed a new MiniDisc format, Hi-MD, with a storage capacity of 1GB, i.e. more than five times the amount of sound, video or computer data that can be stored on a standard MiniDisc.

The key to this is a new technique called Domain Wall Displacement Detection (DWDD). The new MiniDisc has three magnetic layers instead of one. The data is recorded on the bottom layer but is too small to be read by an MD laser, so the laser power is increased to alter the characteristics of the middle layer and produce brief expanded spots that can be read in the top layer. Heating and cooling is fast enough for DVD-quality video and surround sound audio to be recorded and played back. ATRAC3 plus compression is used for sound and a FAT (File Allocation Table) system for data files such as video and text.

Hi-MD Walkman products are scheduled for launch in Europe in early summer. They will be compatible with the standard MiniDisc format.

## D-VHS development

JVC has developed a system for authoring DTS surround-sound with its Data-VHS (D-VHS) D-Theatre high-definition prerecorded video software format, as an option in the North American market. D-VHS is a high-definition version of VHS, using digital instead of analogue recording. D-Theatre incorporates proprietary encryption to prevent unauthorised copying. The DTS system was added as an option to D-Theatre software, which

includes Dolby Digital and MPEG Audio (MPEG-1, Layer 2) as mandatory audio components.

JVC announced the D-VHS D-Theatre format in 2002: the encryption enables film companies to release high-definition content on D-VHS tape. It's currently the only format in the world that enables consumers to view high-definition that's better than HD broadcast standards. Since D-Theatre was launched, high-definition

film content has been released by major studios such as Artisan Home Entertainment, DreamWorks SKG, Twentieth Century Fox and Universal Studios. There are now more than fifty titles. Dolby Digital sound is encoded at 576kbits/sec with D-VHS. This is faster than DVD's Dolby Digital data rate, and surpasses that of DVD Video. D-Theatre DTS surround-sound is encoded at its full rate of 1.5Mbits/sec.

## Smallest camcorder from Sanyo

Sanyo has launched the Xacti Model VPC-C1 camcorder which, weighing only 155g, is claimed to be the world's smallest digital video recorder. Several other world firsts are claimed, including the first to use a 3.2 megapixel sensor for movies and stills simultaneously, the first to use MPEG-4 video compression with VGA picture quality, and the first to use AAC stereo sound recording. Data storage is on an SD memory card, giving about 40 minutes of S-VHS quality video with a 256MB card. Why Xacti? Well, it's a combination of 'exact' and 'active', the idea being optimum 'lifestyle appeal'. The unit has a large-diameter 24mm objective lens and a 5.8x optical zoom.

Recording quality is adjustable between five levels, from low-resolution web video to DVD quality. A 1GB SD card will hold over an hour of HQ-video or over five

hours of web-quality video. A flip-out display enables recording to be monitored: the LCD panel is trans-reflective, enabling sunlight to enhance viewing in bright conditions. A super macro mode can focus on objects only 20mm away from the objective lens. Shots can be edited in-camera to save downloading time. A multiplay facility strings shots together to provide a slide show. The built-in stereo microphone gives 16-bit two-channel sound that's compressed as MPEG-4 audio. A voice recorder function enables over four hours of audio to be recorded on a 256MB SD card.

Other features include creative image modes, auto-focus, video image stabilisation, portrait and landscape modes, zoom-and-crop recording and dual menus to assist the user interface.

A docking station is provided to ensure that the VPC-C1 remains charged and can

be easily connected to PC and TV devices via USB and AV cables. The CPC-C1 is expected to sell for under £500. For further details check at [www.sanyo.co.uk](http://www.sanyo.co.uk)

## Recycling consortium set up

A number of manufacturers of electrical and electronic equipment have set up a joint company to manage the recycling of their products in the UK under the Waste Electrical and Electronic Equipment (WEEE) Directive, which will come into effect in August 2005. The new company has the provisional title Recycling Electrical Producers Industry Consortium (REPIC); members include Alba, Beko,

B&W Loudspeakers, BSH Home Appliances, Candy, Glen Dimplex, Hoover, Kohler, Merloni, Numatic, Philips and Smeg. Other companies are expected to join or set up alternative consortia. The company will enter into contracts with recycling businesses to take large volumes of discarded products, from TV sets to light bulbs, and expects to recycle some 1.2m tonnes of products a year.

## Dell enters TV market

Dell, the world's largest PC company, has launched its first TV set. At present it is on sale only in the US, at about \$700. Model W1700 has a widescreen LCD panel and, naturally, can also be used as a PC monitor – it enables two web pages or word docu-

ments to be viewed side by side. There's remote control, and the audio from built-in surround-sound speakers can be adjusted for different types of material. The connection cables are easy to identify and hide behind a cover.

## Sharp's triple-tuner video recorder

Sharp has launched in Japan a DVD/VCR combination recorder, Model DV-RW200, that's equipped with three tuners. There are a VHF/UHF tuner and an analogue BS (Broadcast Satellite) tuner for recording on DVD, and an additional VHF/UHF tuner for recording on VHS tape. The arrangement makes it possible to tune in and record different TV channels, one on tape and the other on DVD.

The unit also features 'easy DVD video dubbing', i.e. material can be transferred from videotape to a DVD-RW/R disc or from a DVD-RW/R disc to tape. Sharp says that the basic recording medium is shifting from tape to disc: the DV-RW200 is a versatile alternative that enables users to make use of either. No UK launch details have been released.

LG has launched a multi-standard DVD recorder, Model DR4810, in the UK. It can record on DVD+R/RW and DVD-R/RW discs and has DTS, Dolby Digital 5.1, PCM and 3D surround sound options. The DR4810 can read DVD (PAL or NTSC), Audio-CD, CD-R/RW, DVD+R/RW, DVD-R/RW, V-CD, SVCD and MP3-encoded CD discs. It will also work with the WMA system, giving playback of compressed downloaded material, and the Kodak Picture CD system, and has a JPEG

viewer. There are five record-quality settings. With a 4.7GB disc the recording time is two hours in the standard-quality mode and four hours in the lower-quality mode.

There are comprehensive file management and editing facilities. Thumbnail previews for title, chapter and programme, and a delete option, make access to material fast and simple. Recordings can be moved and chapters ordered and titled. The picture-in-picture facility enables two images to be viewed simultaneously, such as a movie and a TV channel. The protected disc option ensures that recordings cannot be accidentally erased or over-recorded. There's a DV input for camcorders, and a memory-card slot for SD and multi-media cards.

For further details check at [www.lge.co.uk](http://www.lge.co.uk)



LG's multi-standard DVD recorder

# Simple volume-compressor circuit

**Keith Cummins discovered that the car mobile-phone hands-free kit he bought was very loud and prone to howl-back. To overcome the problem he devised this simple volume-compressor circuit**

I recently bought a hands-free kit to use with my mobile phone in the car. Having connected it as instructed, I found that it was very loud and prone to howl-back – despite the claim that proper duplex operation was provided.

As a simple initial expedient I muffled the speaker by wrapping it in an old pullover. This solved the basic problem, so I knew that I needed to reduce the volume from the speaker. I opened the unit, hoping to find a volume adjustment, but there wasn't one. Having no circuit details I decided to adopt the most elementary approach, adding a resistor in series with the speaker. This worked, but I found that there was a noticeable volume variation between calls. Presumably the designer had set the volume level to cater for the worst-case communications situation in the noisiest vehicle, with the result that the average volume was excessive.

**Figure 1: Test circuit for determining the lamp's characteristics. See Table 1.**

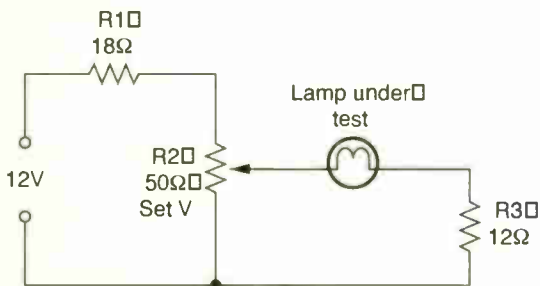
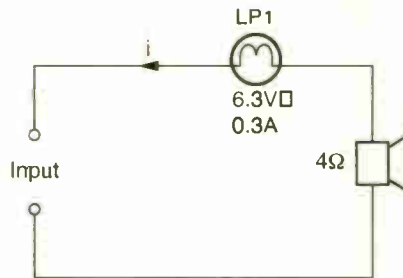

**Table 1: Lamp characteristics**

Lamp V	V across R3	Lamp I (mA)	Lamp R (Ω)
0.25	0.85	71	3.52
0.5	1.09	91	5.49
1	1.47	122	8.19
1.5	1.8	150	10
2	2.1	175	11.42
2.5	2.36	197	12.7
3	2.62	218	13.76
3.5	2.85	237	14.77

**Table 2: Attenuation provided by the circuit**

Current (i, mA)	Lamp V	Speaker V	Total V	Attenuation ratio	Attenuation dB
71	0.25	0.28	0.53	0.53	5.5
91	0.5	0.36	0.86	0.42	7.5
122	1	0.49	1.49	0.33	9.6
150	1.5	0.6	2.1	0.29	10.75
175	2	0.7	2.7	0.26	11.7
197	2.5	0.79	3.29	0.24	12.4
218	3	0.87	3.87	0.22	13.15
237	3.5	0.95	4.45	0.21	13.55



**Figure 2: The lamp and speaker connected in series to provide volume compression. See Table 2.**

## Solution

A degree of volume compression appeared to be needed. The simplest approach would be to add a resistive device with a positive temperature-coefficiency characteristic in series with the speaker. A small bulb meets this requirement. Its filament has a low thermal capacity and hence a quick response time to signals of ranging amplitude.

Some experimentation proved that a 6.3V, 0.3A bulb worked well when connected in series with the 4Ω speaker. I wanted to evaluate the performance more precisely however and obtain some meaningful numbers. So I set up the test circuit shown in Figure 1. This enabled the characteristics of the lamp to be measured, see Table 1.

The lamp current can be determined by measuring the voltage across the series resistor R3 and applying Ohm's Law. The voltage across the lamp can be measured

directly. Knowing the voltage and the current, we can calculate the lamp's resistance at different applied voltages. This is shown in the final column in Table 1.

Figure 2 shows the lamp and speaker connected in series. Since we know the current/voltage characteristic of the lamp, we can calculate the voltage across the speaker for a given overall input voltage – the same current flows through them both. This will be an RMS calculation only, but gives a good idea of the overall performance. By comparing the speaker voltage with the overall voltage applied to the lamp-speaker combination, see Table 2, it's possible to calculate the attenuation in dB at different input voltages. The final column in Table 2 shows the results, which range from 5.5 to 13.55dB. This seems to be a sensible range and works well in practice, at the same time curing the howl-back problem.



# WORKSHOP EQUIPMENT GUIDE

Eugene Trundle takes a look at what's good and what's new in the world of test gear and aids for bench and field servicing. There's nowadays a huge armoury of equipment for testing, fault diagnosis, repair and setting up the digital and analogue circuitry and systems we have to deal with. Part one kicks off with traditional analogue test equipment.

2004  
PART 1

The transition from analogue to digital technology is taking place at a rapid pace all around us. Sound and vision transmission systems, signal processing and storage, even picture display devices are going digital. We need test and diagnostic equipment to be able to cope with all this new technology. Some of what's described in this survey is PC-based, some contains digital processors and some is concerned with fault finding within PCs.

But much of the technology that continues to play a leading role in the new millennium is still firmly rooted in the analogue sphere. Switch-mode power supplies, CRTs and the associated scanning circuitry are examples. Since they use considerable power, these are the most fault-prone sections of equipment – and thus the ones most likely to require attention from the service technician. In fact trouble is far more likely to arise from a dried-up electrolytic capaci-

tor or a poor soldered joint than from failure of a complex digital-processing chip.

A considerable armoury of equipment is available for testing, fault diagnosis, repair and setting up the huge diversity of consumer electronics now in people's homes. It's used on the roof, in the customer's home and of course in the relative haven of the workshop. We'll start this guide with a look at traditional analogue equipment – the sort that's still the most used in everyday servicing.

## OSCILLOSCOPES

The analogue scope is one of the mainstays of the TV and video repair bench.

Traditional types in single-channel form with a bandwidth of 10MHz are available from Caltek at less than £100 and from Grundig and Tecstar in the £120-150 range. Another £200 will buy a dual-trace scope with a bandwidth of 35MHz: Hameg and Instek have excellent 6in.-screen models in this category, both with TV sync facilities. The Hameg model has a better Y sensitivity (2mV/div) and includes a component-test facility.

Moving up the scale we find the Hameg Model HM 507, a 50MHz-bandwidth scope with a traditional look and CRT display but incorporating a digital storage facility based on a 2k x 8-bit per channel memory backed up by a 2k x 8-bit EEPROM for storage and reference. The real-time sampling rate is 100Msamples/sec (maximum) using an 8-bit flash AD converter. A separate horizontal-deflection generator comes into play in the digital mode, with the scanning rate variable from 100sec-50nsec/division. This scope is priced at a very reasonable £760.

Amongst a large inventory of test equipment Vann Draper Electronics can supply the Grundig Digimess range of oscilloscopes. The company is currently offering readers of *Television* a 20 per cent discount across this product range so that, for example, the price of Model M060, a dual-trace, 60MHz-bandwidth scope with TV triggering, becomes less than £650.

Digital LCD scopes start at around the £750 mark, with the Tecstar 80MHz bandwidth model that has a 5.7in., 320 x 240 pixel back-lit display and the Tektronix TDS1000 range with a bandwidth of 60MHz upwards. Both have familiar analogue-style controls, but the physical depth is less than with a CRT-based instrument – just 125mm (5in.) with the Tektronix instruments. They are also lighter to carry of course. The Tektronix TDS2000 range starts at less than £1,000. Their colour LCD screens have many advantages. Y bandwidths range from 60-200MHz with 2Gsamples/sec, 8-bit vertical resolution and 2mV sensitivity. The digital realm includes an increasing number of PC-based scopes, some of which we will look at later in this guide – they don't have knobs or buttons!

Hand-held scopes necessarily use an LCD screen. Some combine the scope function with those of a digital multimeter and a frequency counter. Their bandwidth is generally not as great as with a bench-type scope, but for certain applications in the field they score because of their lightness and portability. The simplest and cheapest are available from Velleman, with 2MHz and 12MHz bandwidths at about £100 and £200 respectively. For £140 there's the Metex 5MHz instrument that incorporates a 3<sup>1</sup>/<sub>2</sub>-digit multimeter. At £225 you can buy the Tenma 2MHz type that also incorporates a 3<sup>1</sup>/<sub>2</sub>-digit multimeter and in addition a 5-digit, 10MHz frequency counter. Way beyond these, in terms of price and features, comes the Fluke Model 123. This hand-held scope/recorder/DMM, a pocket laboratory, costs about £800.



The Hameg HM1507 150MHz digital storage oscilloscope which is priced at £1250.



The Grundig Model M060 from Vann Draper.



Tektronix TDS1000 and (below) TDS2000 series solid-state oscilloscopes.

## OSCILLOSCOPES

CONT'D...



The Velleman HPS40 hand-held scope

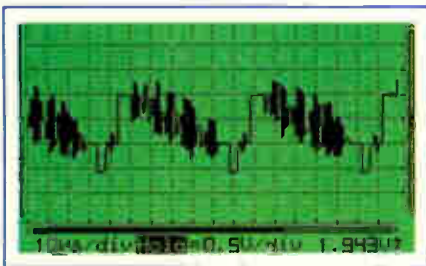

Colour-bar waveform displayed by a hand-held LCD scope

Centre – Multimeters: DMM and accessories from Grundig

Right – Component testers: a Peak component tester.

## MULTIMETERS

For various good reasons some technicians still prefer analogue multimeters. The Avo 8 is still going, now in Mk 7 form, at no less than £580. My own Avo 8 is a treasured possession that's still in daily use. At the other end of the scale, basic analogue multimeters can be bought for less than £5. These come into the 'disposable' category. They are used by field/installation technicians for simple general-purpose work, by those who install aerials and home-cinema systems and, by those who check batteries and appliances at the shop counter.



Digital DMMs are the most common of course: there are probably more models and types on offer than with any other class of test gear. Once again they start at incredibly low prices, less than a tenner: auto-ranging types can be bought for less than twice that. There are now many specialist types for specific applications: for use with electrical and electromechanical gear or for automotive work; probe- and pen-types; ruggedised ones and so on. For the GP service technician the hand-held manual/auto-ranging Fluke 111 at about £100 is well worth considering, with its bar-graph indication; capacitance, frequency and 10A current reading capabilities; a buzz continuity test and 40M $\Omega$  resistance range. In addition to a digital LCD readout some DMMs have an analogue bar-graph for quick assimilation of the result. Maplin's new Model M9704 at £34 (catalogue no. N26AJ) goes further, with a dual display panel that has an LCD readout and a moving-coil meter. It can measure capacitance and frequency as well as voltage, current and resistance, and can check out semiconductor devices.

Tecstar has, at less than £500, an excellent new high-resolution bench DMM with a 5 $\frac{1}{2}$ -digit fluorescent display and, best, 0.012 per cent accuracy: Kenwood had a hand in this. Digital frequency meters are akin to DMMs: a new hand-held type from Thurlby-Thandar, Model PFM1300, provides frequency coverage from 5Hz to 1.3GHz despite a two-figure price tag.

## COMPONENT TESTERS

Both oscilloscopes and DMMs can incorporate component testers of various types. Specialist component testers generally provide more comprehensive checks and are more accurate. A couple of automatic analysers are available from Peak: one, at about £70, for passive (*R*, *C* and *L*) components, and one at about £50 for two and three-leg semiconductor devices.

Both have a digital readout and a clever auto-identification feature that enables you to connect any component under test any way round, press one key and get a readout of what the component is and what state it is in. These two models, the LCR40 and DCA55, can be bought together at just under £110 for the pair.



Hameg markets an analogue component tester, Model HZ65 at about £50, for use with any scope that has X-Y inputs. It works in a similar fashion to those built into the company's own oscilloscopes, providing an on-screen 'signature' for various component types and combinations of them. With experience in use it works well.

There's a whole raft of hand-held component testers, looking like DMMs but generally higher in price, with facilities for testing *L*, *C* and *R* components. Amongst the best – and more expensive at about £200 – is the Megger push-button Model B131. It has best accuracy of 0.5 per cent with its 4-digit counter and has dissipation and a *Q*-factor readout. ABI makes auto-testers for linear and digital ICs. They fit into DIL sockets, 16-pin and 40-pin respectively, and have in-built libraries for automatic device recognition, indication and testing. Prices are £380 and £330 respectively. I feel that the DIL-package limitation is a serious one these days.

Personally I find that the most useful component tester, one that's used on average several times a day in my workshop, is an ESR meter for testing electrolytic capacitors in situ. Two well-established instruments of this type are the Electronic Design Specialists' model with micro-processor control and a 20-segment LED readout, at £175, and the Capacitor Wizard from SEME at £146. Both are effective and very useful. The EDS model automatically dumps any charge in the capacitor before testing it: if a charged capacitor blows up the Capacitor Wizard you can buy a £10 repair kit. It's not necessary to spend lots of money on an ESR tester: see the DIY kit section in Part 2 next month.

# Soldering and desoldering station



The Erska SMT 60 Soldering and De-soldering Station from Blundell makes easy work of hand soldering or repairing printed circuit boards.

A wide variety of interchangeable Tips can be operated, all of which can be held by the SMD 8012 Tip Holder so you can quickly choose the Tip which best suits the application.

The Handsets heat up in a matter of seconds, with Tips taking only a few seconds to change.

The Hot Tweezers enable you to get into tight spaces making fast work of De-soldering and removing faulty components.

Also included is a cleverly designed Drag Soldering Tip which makes easy work of replacing large J-Leaded components.

# BLUNDELL

PRODUCTION EQUIPMENT



SMD 8012  
Tip Holder

203 Torrington Avenue, Coventry CV4 9UT, England.

Tel: 02476 473 003 Fax: 02476 694 155

Email: sales@blundell.co.uk • www.blundell.co.uk

## RECEPTION TESTING



*The Swires Research Digi-Sat 2001 reception tester*



*The Promax Prolink 4C provides this constellation display*



*The Prodig 1 digital Satellite Hunter from Promax*



*The Televés on-screen indicating Model MTD50.*

*Right: A simple, inexpensive satellite signal strength meter from Televés*



While the need for convergence-adjustment crosshatch generators has fallen off, it is quite the reverse with reception testers. The terrestrial and satellite bands have become busier and more crowded with transmissions, digital and analogue, and optimising reception is now an exacting business. This is especially true of terrestrial digital broadcasting, where the early (pre-broadcast) promises of rugged transmission and reliable reception have proved to be false and concepts like 'graceful degradation', in which picture quality is related to bit-error rates, have been discarded. Hence the need for instruments that show not only the signal strength but also identify the programme source and indicate quantitatively its received goodness – in terms of bit-error rate and carrier-to-noise ratio. There are now several of these precise and complex instruments to choose from, but not at the price of the old "wow: stop now" meters. We'll consider first those designed for terrestrial DTV use: in the UK this currently means Freeview reception.

While there are some cheap 'n' cheerful 'basic' meters for checking satellite signals the same doesn't seem to be the case with terrestrial testers, where the start point is at about £260 with the Lacuna type TM2 from Coastal Aerial Supplies. It is small and light with facilities for testing analogue and digital signals, in the latter case identifying the transmitter (UHF or VHF) and giving strength, carrier-to-noise ratio and BER (Bit Error Rate) readouts via a backlit 4-line LCD display. It works from 12V line power or internal, rechargeable batteries. The Horizon HDTM is similar in nature and function though larger and thus not easily hand-held. This one has its own mains charger and costs about £320.

Another £60 or so will buy you the similar-looking IN01360 type from CPC. This one has a 2-line LCD readout with backlight and also incorporates a built-in demodulator and speaker for TV sound identification together with sophisticated 'package flatness' and channel-interference indications. The IM Digi-T 203 from Swires Research, at £269, also comes into this category. This hand-held instrument with six control keys and a 2-line LCD indicator measures analogue and digital signals in the VHF and UHF TV bands and gives BER and C/N ratio readouts. A new hand-held terrestrial analogue and digital tester from CPC at £343, type IN04114, has span and spectrum displays plus BER and C/N ratio indications from its LCD display. It can also cope with the high-QAM modulation system used with cable networks.

There are still very simple satellite signal testers, though these are confined to non-quantitative strength measurement. The LevelMeter costs £30 and does its stuff with a row of LEDs and an audible level indicator. The Digsat types are similar, but with LCD indicators, while Televés and Promax have pointer-and-scale types at £45-£50. Something better is required for serious work however. At the lower end

of the price scale rivals Horizon and Lacuna have, as with terrestrial meters, similar models at about £250 apiece, neck-hung in one case and hand-held (the 'yellow bone') in the other. Both provide 2-line LCD readout of signal strength, BER and C/N ratio, and both are pre-programmed with data per existing satellite. Here too Swires Research has a similar product, the hand-held Digi-Sat 2001, which gives three-hours operation with batteries and reads out via a 2-line LCD screen signal strength, BER and C/N ratio for 19 pre-programmed satellites. Price is £240. The Prodig 1 from Promax is more sophisticated than these and of course more expensive. This 3-key, 3-step Satellite Hunter costs £375.

From these LCD-readout types we move up to ones that provide, on a monochrome or colour screen, actual satellite TV pictures and, more important, a spectrum display of the SHF band. In the Promax range they start at about £800 and, with increasing features, benefits, bells and whistles, end up with the Prolink 4C, which has a colour LCD picture/display panel, at £2,250. It's ideal for watching GMTV as you sip your coffee astride the ridge tiles, and also has terrestrial signal-testing facilities. The Perifelec Model MC30 at £1,100 is also in this 'dual-standard' category. It has monochrome-tube and alphanumeric displays, internal channel/frequency memory and 4-band coverage.

Unless you confine yourself to either terrestrial or satellite work, which is rare except perhaps for Sky contractors and specialist satellite traders, a dual-standard meter might be the best option. It can cost less than the alternative two separate instruments with similar specifications. I've already mentioned the top-end dual-standard Promax Prolink 4 and the Perifelec Model MC30, which both have panoramic monitor screens. There are more contenders in this sector of the market. The Televés Model MTD50 has a 4½ in. monochrome CRT display for picture and spectrum, a 5-digit LCD frequency readout and the ability to measure analogue signal strength, digital channel power and C/N ratio, covering 48-856MHz and 950-2,050MHz. It costs over £1,000. If you want the same type of instrument in terms of screen size/type and frequency coverage, plus the ability to measure and indicate BER with QPSK modulation, the new IN04115 signal analyser from CPC does the job at about £1,200. This and the Televés model both have an audio tone indication of signal strength to facilitate eyes-off antenna alignment, and both are neck-hung with internal rechargeable batteries.

The Promax MC377+, a long-standing and popular type at £800, is similar to the Televés MTD50. The Promax range also includes the Prolink 2+ with QPSK BER measurement for satellite TV at £1,200, and the Prolink 3+ with on-screen rather than LCD readout of all measurements and BER indication for COFDM, QAM and QPSK modulation at £1,800.

**FROM HAMEG...**

**SPECIAL OFFER** Call our number below and quote "TELEVISION" magazine

**Analogue & Analogue/Digital Oscilloscopes  
from 35MHz to 200MHz, 2GS/s...**

**Signal Generators & Measurement Systems  
from DC to 1.2GHz...**

**Spectrum Analysers & Trackers  
from 1GHz to 3.3GHz...**

All With Two Year Warranty.



**HAMEG UK LIMITED** 78 SINGER WAY. KEMPSTON. BEDS. MK42 7PU  
Tel: 01234 856345 Fax: 01234 856100 e-mail [hameguk@btopenworld.com](mailto:hameguk@btopenworld.com)

**leaders**  
reliability practicability professionalism



**Multimeter FSM** Indispensable Installer's TOOL

THE ULTIMATE RANGE FIELD STRENGTH METERS (FSM)

- 3 or 5" TFT screen
- High resolution 0.1dB
- High accuracy  $\pm 1$ dB MATV &  $\pm 2$ SAT
- C/N measurement (analogue and digital measurements)
- Up to 4hours battery
- Shock protection (rubber)
- Quick menu keys
- RS232 & Scart sockets
- Easy and friendly to use

Televés U.K. LTD  
T. 01633-875821  
F. 01633- 866311  
[televés.uk@televés.com](mailto:televés.uk@televés.com)



**Televés**  
[www.televés.com](http://www.televés.com)



**Almost everything you  
need for your business  
under one mouse**

CPC have over 100,000 top quality products online, ranging from spares and components to computing, audio, video, cables, connectors, electrical, security components, tools, in the work place and test equipment all available in just two clicks.

[www.cpc.co.uk](http://www.cpc.co.uk)



## PATTERN GENERATORS



**Top: The Promax GV998 MPEG-2 DTV pattern generator.**

**Centre: Twins – the Hameg triple low-voltage PSU and programmable DMM.**

**Bottom: Grungig bench-type variable PSU from Vann Draper.**

There was a time when a pattern generator was an essential part of a field technician's kit. We've still got Labgear ones stashed away here, used for setting up delta-gun tube beam registration thirty-odd years ago!

There's less need for convergence and purity setting now, but a pattern generator is still very useful, especially after replacement of data-memory chips and components in CRT-scanning circuitry.

The ultimate pattern generators in our sphere are perhaps the Promax GV series

ones. There's a whole range of these instruments, culminating in the analogue Model GV898 with a widescreen (16:9) test card and vestigial-sideband RF operation. It has options for 14:9 aspect ratio, teletext and Nicam functions and multi-standard operation. Prices range from £433 to over £2,500 depending on the class of instrument and the options required.

Alban has beaten everyone else I know to the market with a multi-standard MPEG-2 digital TV pattern generator: Model GV998 simulates DTV transmissions. In the analogue hand-held range Promax offers Models VG90 and GC981, the latter with a circle in its repertoire of patterns, at £210 each.

Competition in this portable realm is provided by the well-established Ozan Teletest 2 and Teletest Pro instruments, at £170 and £240 respectively. Neither can generate on-screen circles or comprehensive broadcast-style test cards however. That's left to the small, rugged Burosch Model TPG-1 at £190, the cheapest ready-made instrument that I know of with this capability. But you don't have to spend three-figure sums to get broadcast-type test cards now!

See the DIY kit section in Part 2 for further details.

## POWER SUPPLIES



A bench-based DC power supply unit is virtually indispensable. Ideally it should have variable

voltage and current-limit controls and a readout of voltage and current.

A maximum voltage of 15 or 20V with say 4A capability covers most everyday requirements, with myriad uses – driving little motors, testing zener diodes, powering amplifiers and valve heaters, operating portable audio and video gear, substituting for dead sections of equipment power supplies and so on. Such units have long been around and there's a lot of competition between manufacturers and retailers.

For many years I have been served well by a 0-15V 4A unit with dual LED indicators for voltage and current and rotary control knobs for each. If you are prepared to settle for analogue meters some very good value-for-money units are available.

For example the CPC IN00702 provides a variable 3-15V regulated output with 6A

capability (but no current-limiting control) for as little as £50; a similar job that runs to 30A costs £114. £60 will buy you a variable 0-30V, 2.5A regulated supply with adjustable current control, CPC code IN00701.

Tenma has a wide choice of excellent bench PSUs. They range up to 30V at 10A, in single- and triple-output versions, with a choice of digital or analogue voltage and current readouts.

GW Instek offers 30V, 3A bench PSUs with coarse and fine voltage and current controls: with analogue meters they cost £150 while with LED numicators the price is £200.

You sometimes need to simulate a 12V lead-acid battery and, especially when servicing in-car equipment, draw a lot of current.

There are 13.8V units in the Maplin Palstar RP range: the RP07H (4A) at £21, RP08J (6A) at £30 and RP09K (15A) at £68. They have foldback current protection.

The 4A and 6A units have a cigar-lighter style output socket alongside their 4mm output sockets.



## APPLIANCE & SAFETY CHECKS

Safety testing of consumer electrical and electronic equipment is an important aspect of our service industry.

Where people's lives are at stake there is no room for compromise or guesswork, and the law comes down very heavily on anyone who is responsible for accidents.

The primary requirements are:

- to ensure, in the case of anything that has exposed metal of any sort, that there is good insulation between this and the mains connections;
- that anything with a third (earth) connection to its mains lead has a low impedance path between exposed metal and earth;
- and, in the case of microwave ovens, that energy radiation leakage is not excessive.

Appliance testers can be expensive, though again there's a cost-effective DIY solution, see Part 2. Prices of commercially available instruments start at about £200 for Seaward's long-

established PAC500 and PAC500+ models, which have single push-button operation and simple pass/fail indication. For insulation, the test potential is 500V DC with a 2M $\Omega$  pass threshold, while the earth-bond test is made at up to 25A with pass levels of 250m $\Omega$  or 300m $\Omega$ .

Seaward's products range up from there, with increasing features and benefits. Model 500H at £320 has quantitative readouts and IT-equipment 'friendliness'. The Europa PAC looks a bit like a DMM but has a higher price tag at £560. Flagship Model Supernova Plus at just over £1,000, with matching software packages available for an additional £450-£500, has a full graphics display, a qwerty keyboard, non-volatile flash memory, provides every sort of safety test and has PC connectivity.

Megger also specialises in PAT testing. Model PAT32, with quantitative LCD-panel readout and an IT-equipment compatible (100mA constant-current) earth-continuity test, is available at

£580. The all-singing, all-dancing Model PAT4DVF, with flash test, costs a little over £1,000. Robin is the third main contender in the PAT market, with a range of instruments that reaches its peak with the SmartPAT 5000. Its specification is similar to the top-end models from Seaward and Megger and, you guessed it, the cost is just over £1,000. You can even get, from Farnell, a gadget to test your appliance tester! It costs £10.23 and can be obtained under order code 428-3442. I haven't seen any means of testing this item but, if there was such a thing, its cost in proportion would be just under 11p. How would you know if it had broken down?

Returning to reality, and to microwave oven testers, you find that two types are generally available, with calibration traceable to national standards and readout in mW/cm<sup>2</sup>. The Caltek A100, with power-measurement capability, costs about £160; the CPC IN00096 confines itself to leakage testing and costs a more modest £116.

## VCR FAULT FINDING

Most VCR fault diagnosis and repair can be carried out with the equipment described elsewhere in this guide. The exception to this – and about the only place where there are still any adjustments to be made – is of course the mechanical deck. SEME's MB-SWISS 4 test tape at £23 provides wide-ranging test facilities: it can check tape back-tension, head-switch gap point, video head tracking, ACE head X and Y alignment, and video head wear. The only feature it lacks is a 6kHz audio tone for ACE head tilt adjustment. This can be found, along with the other facilities mentioned above, on the Burosch OSD-AT test tape which sells for £24. Burosch also produces a test-pattern service tape, type VST-30, at £14; and a Video-8 version with five test patterns and stereo sound at £30.

Skeleton cassettes in VHS and 8mm form, for sight and access to deck mechanisms and components, can be obtained from CPC at £9 apiece. They are also useful for investigating the causes of tape-chewing.

## TV TESTING

Much of what is described in this guide is applicable to TV servicing of course.

Test gear that's dedicated to TV applications is all, in one way or another, related to the CRT and its attendant circuits. For measuring the very high accelerating voltages that CRTs use there's a choice of stand-alone instruments like the Tenma one that reads up to 40kV, at £50; and attenuating probes, for example the Tenma and Fluke 40kV types, at £35 and £120 respectively, for use with an ordinary DMM. Just thirty three years ago in the February 1971 issue of *Television* I described how to build an EHT meter on the cheap. I've still got it, and it still works!

These days the EHT potential is developed by voltage multiplication within the line output transformer, a component whose failure is common but not always easy to diagnose.

The HR LOPT tester, at about £80, comes to the rescue here. It tests LOPTs dynamically, in situ if necessary, with an LCD panel EHT voltage readout and

waveform indication by using a separate scope. A version for testing PC monitor LOPTs, which run at higher frequencies, is available at about the same price.

The CRT itself is generally reliable but can of course fail or lose emission. When there's an internal failure, for example inter-electrode leakage or a short-circuit, the highly-nervous overload trip and/or auto grey-scale arrangements in modern TV sets can thoroughly confuse the issue. Hence the need for a tube tester.

The main players here are Promax, with the RT901 single-meter tester/rejuvenator at £260; and BMR, with Model 2005, a four-meter job that provides simultaneous readouts for the R, G and B guns and rejuvenation, at about £550.

The famed B&K tube tester is no longer available, but tube base sockets can still be got for it – at a price.

Mains-operated degaussing wands are available from SEME (TEST 619 at £34) and CPC (IN00705 at £38).



Above: PCB testing with a conductive brush and probe.

Right: the BMR Model 2005 CRT tester.

PCBs are becoming smaller, along with the components on them. Apart from soldering and rework equipment, which we will consider next month, there's a range of test gear for tracing faults in and associated with PCBs. A short-circuit on a board or in a component connected to many others that share a track, for example a 5V line, can be difficult and time-consuming to locate. A very low-resistance reading instrument with a test-tone indication is required here.

Two types are available from CPC. The IN02003 has a stainless steel brush and needle probe, with a 500mV test potential at a maximum current of 100µA. This hand-held device is priced at £35.

Type IN01793 is similar but with two needle probes. The audible tone, from an internal sounder and at a 3.5mm headphone socket, falls in frequency as the trouble-spot is approached, working with track resistances from zero to 250mΩ. This one costs £52.



An alternative to these specialised instruments is perhaps to use aukka milliohm meter that can read down to 0.1mΩ. But at a cost of £200+ it would be

difficult to justify buying such a unit for

this purpose alone.

To penetrate the lacquer on very narrow PC tracks you need really slim and sharp needle-pointed probes. I have yet to find these in any catalogue (does anyone know of such items?) and make my own either using real sewing needles or taking commercially-available probes to the grindstone.

CONTINUED NEXT MONTH

### SPECIAL OFFERS

**ONLY £425**

TEKTRONIX 2445A 4 Ch 150MHz Delay, Cursors etc Supplied with 2 Tektronix probes

TEKTRONIX 2232 Digital Storage Scope. Dual Trace 100 MHz/100m/s with probes £525  
 H.P. 54501A Digitizing Oscilloscope 100MHz, 4Ch £425  
 CIRRUS CRL254 Sound Level Meter with Calibrator, 80-120dB, LED £95  
 BECKMAN HD110 Handheld 3 1/2 digit DMM, 28 ranges with battery, leads and carrying case £30  
 WAYNE KERR B424 Component Bridge £50  
 RACAL 9300 True RMS Voltmeter 5Hz-20MHz usable to 60MHz 10v-316v RACAL 9300B as above £75

H.P. 3312A Function Gen 0.1Hz-13MHz AM/FM Sweep/Tri/Gate/Burst etc £300  
 FARNELL AMM255 Automatic Mod Meter 1 5MHz-2GHz Unused £300  
 FARNELL DSG1 Low Frequency Syn Sig Gen 0.001Hz to 99.99kHz, Low Distortion TTL/Square/Pulse Outputs etc £95  
 FLUKE 8060A Handheld True RMS DMM 4 1/2 digit As new £150, Used £95  
 H.P. 3310A Function Gen 0.005Hz-5MHz Sine/Sq/Tri Ramp/Pulse £125  
 FARNELL FLM4 Sine/Sq Oscillator 10Hz-1MHz distortion TTL Output, Amplitude Mod £95  
 H.P. 545A Logic Probe with 547A Current Tracer £60  
 FLUKE 77 SERIES II Multimeter 3 1/2 digit £70  
 HEME 1000 LCD Clamp Meter 1000A In Carrying Case £60

BLACK STAR ORION PAL/TV VIDE Colour Pattern Generator from £125  
 THURLBY/THANDAR TG218 Function Generator 0.002Hz-2MHz TTL etc £95  
 THURLBY THANDAR PSU 200W 0-20V 0-2A Twice (Late colours) £200

Recal 900B Automatic Modulation Meter AM/FM 1.5MHz-2GHz **£95**

Oatron 1061A High Quality 6 1/2 digit Bench Multimeter True RMS/4 wire/Current Converter **£225**

### JUST IN

H.P. 8640A SIGNAL GENERATOR AM/FM £250  
 500KHz-512MHz  
 KENWOOD CS4025 Oscilloscope Dual Trace 20MHz £125  
 LEADER LB0523 Oscilloscope Dual Trace 35MHz £140  
 GOULD DS300 Oscilloscope Dual Trace 20MHz £80  
 NATIONAL PANASONIC VP7705A Distortion Analyser £125  
 KENWOOD VT176 Millivoltmeter 2Channel £50  
 KENWOOD FL140 Wow & Flutter Meter £50  
 KENWOOD FL180A Wow & Flutter Meter £50  
 BIRD 43 Watt Meter £75  
 Elements for the above £25

MARCONI 893C AF Power Meter, Sinad Measurement. Unused £100 Used £60  
 MARCONI 893B No Sinad £30  
 MARCONI 2610 True RMS Voltmeter Autorangin 5Hz-25MHz £195  
 GOULD J38 Sine/Sq Osc. 10Hz-100kHz, Low distortion £125  
 AVO 8 Mk6 in Ever Ready Case, with leads £80  
 Others Avos £50  
 GODDWILL GVT427 Dual Ch AC/DC Voltmeter in 12 Ranges Freq 10Hz-1MHz £1,100-£125  
 SCLARTRON 7150 DMM True RMS - IEEE £95-£125

SOLA 50 PLUS QUALITY RACAL Counter, 50MHz £150  
 916 Counter 0Hz-520MHz £75  
 18 Counter 10Hz-560MHz £50  
 AIM 9343M, LCR Meter £200

Automeasurements HUNTRON HEM 1000 MARCONI 1000 gen, 10-520MHz £140

Power Supply HPS3010 0-30V, 0-10A £40  
 FARNELL Dual PSU XA35-2T 0-35V 0-2A Twice QMD LCD Display £180  
 FARNELL L30-2 0-30V, 0-2A £80  
 FARNELL L30-1 0-30V, 0-1A £20

Many other Power Supplies available.  
 Isolating Transformer 240V In/Out 500VA £40

### Farnell DTV 12-14 OSCILLOSCOPE

Dual Trace 12 MHz TV, Coupling... ONLY £75

### FARNELL LFI Sine/Sq OSCILLATOR

10Hz-1MHz... ONLY £75

### OSCILLOSCOPES

TEKTRONIX TOS350 Dual Trace 200MHz 16/5 unused £500  
 TEKTRONIX TDS320 Dual Trace 100MHz 5 1/2 digit £300  
 TEKTRONIX TDS310 Dual Trace 50MHz 20MHz 5 1/2 digit £250  
 LECROY 9400A Dual Trace 175MHz 5G/5 £300  
 HITACHI VC8523 Dual Trace £300  
 PHILIPS PM3092 2-Ch 200MHz 5 1/2 digit New £950  
 PHILIPS PM3082 2-Ch 200MHz 5 1/2 digit £700 As New

TEKTRONIX 485 Dual Trace 100MHz Delay Sweep £350  
 TEKTRONIX 475 Dual Trace 100MHz Delay Sweep £350  
 TEKTRONIX 465 Dual Trace 100MHz Delay Sweep £350  
 TEKTRONIX 455 Dual Trace 100MHz Delay Sweep £350  
 PHILIPS PM3092 2-Ch 200MHz 5 1/2 digit New £950  
 PHILIPS PM3082 2-Ch 200MHz 5 1/2 digit £700 As New

H.P. 6063B DC Electronic Load 3-240V/0-10A 250W P.D.A. £400  
 H.P. 66312A PSU 0-20V/0-2A £400  
 H.P. 66311B PSU 0-15V/0-3A £400  
 H.P. 66309D PSU Dual 0-15V 0-3A/0-12V 0-1.5A £750  
 H.P. 6632B PSU 0-20V/0-5A £500  
 H.P. 6623A PSU Triple Output ranging from 0-7V 0-5A to 0-20V 0-4A £850  
 H.P. 34401A DMM 6 1/2 digit £400/£450  
 H.P. 875A DMM 5 1/2 digit £275  
 H.P. 45 DMM Dual Display £400  
 KEITHLEY 2015 6 1/2 digit £395  
 KEITHLEY 5115 Programmable Electrometer £1250  
 H.P. 4338B 100MHz 100V 3GHz £500  
 H.P. 4338A 100MHz 100V 3GHz £500  
 H.P. 4338C 100MHz 100V 3GHz £850  
 H.P. 4338D 100MHz 100V 3GHz £1000

TEKTRONIX AFG320 Arbitrary Function Gen. £1250  
 H.P. 8904A Syn Function Gen DC - 600KHz £1000/£1250  
 BLACK STAR JUPITOR 2010 Function Gen 0.2Hz - 2MHz, with Frequency Counter £140  
 H.P. 8116A Pulse Generator 1mH-50MHz £1950  
 H.P. 8657B Syn Signal Gen 0.1-2080MHz £2500  
 CO-AXIAL SWITCH 1.5GHz £40  
 IEEE CABLES... £10

### SPECTRUM ANALYSERS

H.P. 8720C Microwave Network Analyser 50Hz - 20GHz £12500  
 H.P. 8561B 50Hz - 6.5GHz £2500  
 H.P. 8560A 50Hz - 2.9GHz Synthesised £5000  
 H.P. 8594E 9KHz - 2.9GHz £4500  
 H.P. 8591E 1MHz - 1.8GHz 75 ohm £2750  
 H.P. 8534 with 8559A 100KHz - 21GHz £1750  
 H.P. 8558B with Main Frame 100KHz - 1500MHz £2500  
 H.P. 3585A 20Hz - 40MHz £2500  
 H.P. 3580A 5Hz - 50KHz £800  
 ADVANTECH R4131B 10KHz - 3.5GHz £2750  
 EATON/Alitech 757 0.001 - 22GHz £2000  
 MARCONI 2382 100Hz - 400MHz High Res £2000  
 MARCONI 2370 30Hz - 110MHz £500  
 H.P. 182 with 8557 10KHz - 350MHz £2500  
 H.P. 141T Systems £500  
 8553 1KHz - 110MHz £750  
 8554 500KHz - 1250MHz £250  
 8555 10MHz - 18GHz £100  
 H.P. 8443 Tracking Gen/Counter 110MHz £250  
 H.P. 8444 Opt 059 £650  
 B & K 2033R Signal Analyser £2750  
 H.P. 8754A Network Analyser 4MHz - 1300MHz £1250  
 H.P. 3577A Network Analyser 5Hz - 200MHz £3000  
 H.P. 53310A Modulation Domain Analyser Opt 001/003 £5000  
 DNO SOKKI Portable FFT Analyser £1500

### RADIO COMMUNICATIONS TEST SETS

MARCONI 2955/2955R £1000  
 Rohde & Schwarz CMT 0.1 - 100MHz £1500  
 Schlumberger 4040 £750

Check our website for latest prices and equipment

**STEWART OF READING**  
 110 WYKEHAM ROAD, READING, BERKS RG6 1PL  
 Telephone: (0118) 9268041 Fax: (0118) 9351696  
 www.stewart-of-reading.co.uk  
 Callers welcome 9am-5.30pm Monday to Friday (other times by arrangement)

USED EQUIPMENT - GUARANTEED. Manuals supplied.  
 This is a VERY SMALL SAMPLE OF STOCK. SAE or telephone for lists. Please check availability before ordering. CARRIAGE all units £16. VAT to be added to total of goods and carriage.

270

March 2004 TELEVISION



14" CTV R/C  
FROM



£29.99

20" CTV R/C  
FROM



£37.99

28" WIDESCREEN  
R/C TEXT FROM



£99.99

32" WIDESCREEN  
R/C FROM



£199.99

TECHNIKA  
MULTIREGION  
DVD FROM



£24.99

VCR'S FROM



SPECIAL!!

£16.99

DVD'S FROM



MULTIREGION

£24.99

KE14P2B



14" Tv/Vcr Combi  
From

£54.99

Panasonic  
KXFP155



NEW!!

Plain Paper Fax

£59.99

INFLATABLE  
Speakers From



Brand New!!

£12.50

Hitachi Radio  
Alarm Clock



£39.99

SONY DAV-S888

NEW!!



\*Sony Dvd Home Cinema  
\*Dvd/Cd/Cdr/Cdrw/Mp3 Playback  
\*6 Speaker System  
\*Total 600W: 100W x 5 100W RMS  
(10% THD), 12 Months Warranty!

£497.99

TECHNICS SCHDV560



SPECIAL!!

\*Technics Compact Component  
Stack System  
\*CD, Tape, Tuner  
\*Input select  
\*Silver w/Brown Side Panels

£199.99

DANSAI  
MULTIREGION  
DVD FROM



£29.99

OMICRON HALOGEN HEATER



Halogen Technology  
Instant Heat  
Variable Heat Settings  
Low, Medium & High  
Thermal Safety Cut Out  
Stability Safety Cut Out  
Double Safety Grills  
Low Running Costs  
Oscillating Feature

Brand New!! Only £15.99

INTERCOM SECURITY SYSTEM



\*Bell camera and full Accessories included  
\*Additional camera sold separate  
\*Intra Red Camera for Night vision  
\*Built in Mic for sound  
\*optional electric door latch activation  
\*Switch Between camera with A/B switch  
\*Two Way speech  
\*250 metre cable  
\*Audio/visual output

£34.99

MORPHY RICHARDS  
2 SLICE TOASTER



£7.49

PHILIPS FWC115 MICRO HIFI  
MICRO HIFI SYSTEM



£39.99

POP IDOL KARAOKE MACHINE



£84.99

FIRST AUSTRIA MCD-1050  
MINI HIFI



£44.99

FIRST AUSTRIA MCD1010  
MICRO HIFI SYSTEM



£29.99

TECHNICS SP-96



BRAND NEW!!

2x SURROUND SPEAKERS  
SILVER!!

£13.99

Naliko Dishwasher  
NDW080



£49.99

Panasonic  
NVGS10B



£269.99

HITACHI  
Cv800/810



£16.99

HITACHI  
HTDK150EUK



£119.99

WWW.TRADEELECTRONIX.CO.UK INFO@TRADEELECTRONIX.CO.UK

MUCH MORE TV'S VCR'S DVD'S HIFI'S ETC IN STOCK!!

All Goods are Graded unless otherwise stated, Goods are subject to Vat, carriage & availability Prices subject to change without prior notice

Trade  
ElectroniX

30/34 River street Digbeth B'ham B5 5SA  
Tel:0121 773 3300 Fax 0121 773 2300

# Servicing

## the Philips L01 chassis

The Philips L01 chassis can drive 14 to 32in. tubes with 4:3 or 16:9 aspect ratio displays. It's based on the Philips Ultimate One Chip (UOC), an 80-pin IC that acts as the microcontroller and signal processor. Brian Storm describes the circuitry used, the service modes, and lists some known faults

The Philips L01 was designed as a global 50Hz chassis able to drive 14 to 32in. tubes with either 4:3 or 16:9 aspect ratio. There are 100 UHF channel presets and 40 FM radio channel presets – the aerial cable for the latter plugs into a small three-pin socket beneath the UHF aerial input. The version of the chassis used in smaller sets (14-21in.) is designated L01.2, the version for larger-screen sets (up to 32in.) being designated L01.1

The chassis is based on the Philips Ultimate One Chip (UOC) IC that acts as the microcontroller and signal processor (sound, video and deflection). The chip was mentioned in a previous article in these pages on the Panasonic Z8 chassis. This time the QFP80 quad flat-package version is used. The 80-pin, surface-mounted chip is fitted on the underside of the main PCB. Its part number varies with model and thus the features required. It's important to appreciate this, as changing an 80-pin, surface-mounted device two or three times is no laughing matter. Stereo sets are fitted with an MSP3415G multi-processor.

The UOC IC requires a 3.3V supply for the microcontroller section and an 8V supply for the signal processing stages. It provides the following functions and processing: main microcontroller; on-screen display generator; teletext processor; RGB processor; video processor; video input switching; sound input switching (mono sets); sound demodulator (mono sets); video demodulator; colour decoder (multi-standard); line timebase generator; field scan driver; EW driver.

### Power supply circuitry

The chopper power supply, see Figs. 1 and 2, is based on the popular TEA1507 control chip (IC7520), a so-called second-generation green chip. This 8-pin dual in-line IC is designed to maximise power efficiency in all operating modes. A special feature, called the burst mode, can be used for low-power standby operation. In this mode the chip produces controlled bursts of switching signals to operate the chopper power supply in a low-power condition, producing just enough power to maintain the 3.3V supply for the UOC device.

IC7520 receives a start-up supply at pin 8 via R3532. This is obtained from the mains rectifier and, via an internal current source, charges C2521. During the start-up sequence C2522 provides a soft-start action. Pin 1 of IC7520 can be taken low to activate the burst mode, though it's not done in this way in the L01 chassis. Once the start-up sequence has been completed IC7520 is supplied from winding 8-9 on the chopper transformer T5520 via rectifier diode D6520, with C2521 as the reservoir capacitor.

To achieve a high operating efficiency the chassis uses a variable-frequency, quasi-resonant flyback-converter chopper arrangement. Pin 4 (demag) of the IC7520 monitors the transformer's feedback winding (pins 8-9) pulse by pulse for control and protection purposes. Variations in the load on the supply are fed back to pin 3 of IC7520 via the optocoupler IC7515. Monitoring is based on the circuitry around transistor Tr7540 and zener diode D6540 on the secondary side of the circuit. This monitors the 140V HT feed to

the line output stage. An increase in the HT voltage increases the current through the optocoupler.

Transistors Tr7541 and Tr7542 are used for standby switching. When a standby command is received the UOC activates this circuit. IC7520 detects the condition, which it interprets as a drastic overload, switching to the burst mode for safe operation.

Transistor Tr7522 on the primary side of the circuit is used to protect the chopper FET Tr7521. If there is an overload on the transformer, shorted turns or mains input spiking Tr7522 switches on temporarily, removing the drive to Tr7521. Primary side excess current is monitored by resistors R3526 and R3527. The voltage developed across them is fed to pin 5 (sense) of IC7520. Should the voltage exceed a pre-set level, current limiting is activated.

In the standby mode the main 12V supply on the secondary side of the circuit provides enough power for the 3.3V regulator IC7560 to maintain the supply for the UOC.

The degaussing control circuit is powered by the auxiliary 13V supply derived from the line output stage, so degaussing is activated when leaving the standby mode. The degaussing relay driver transistor Tr7580 switches on initially, closing the relay. A timing circuit, consisting of R3580 and C2580, is connected to its base. When C2580 has charged (4 seconds) Tr7580 switches off, releasing the relay. The 13V line supplements the 3.3V supply via R3565 and D6565 when the UOC is active and thus drawing more current.



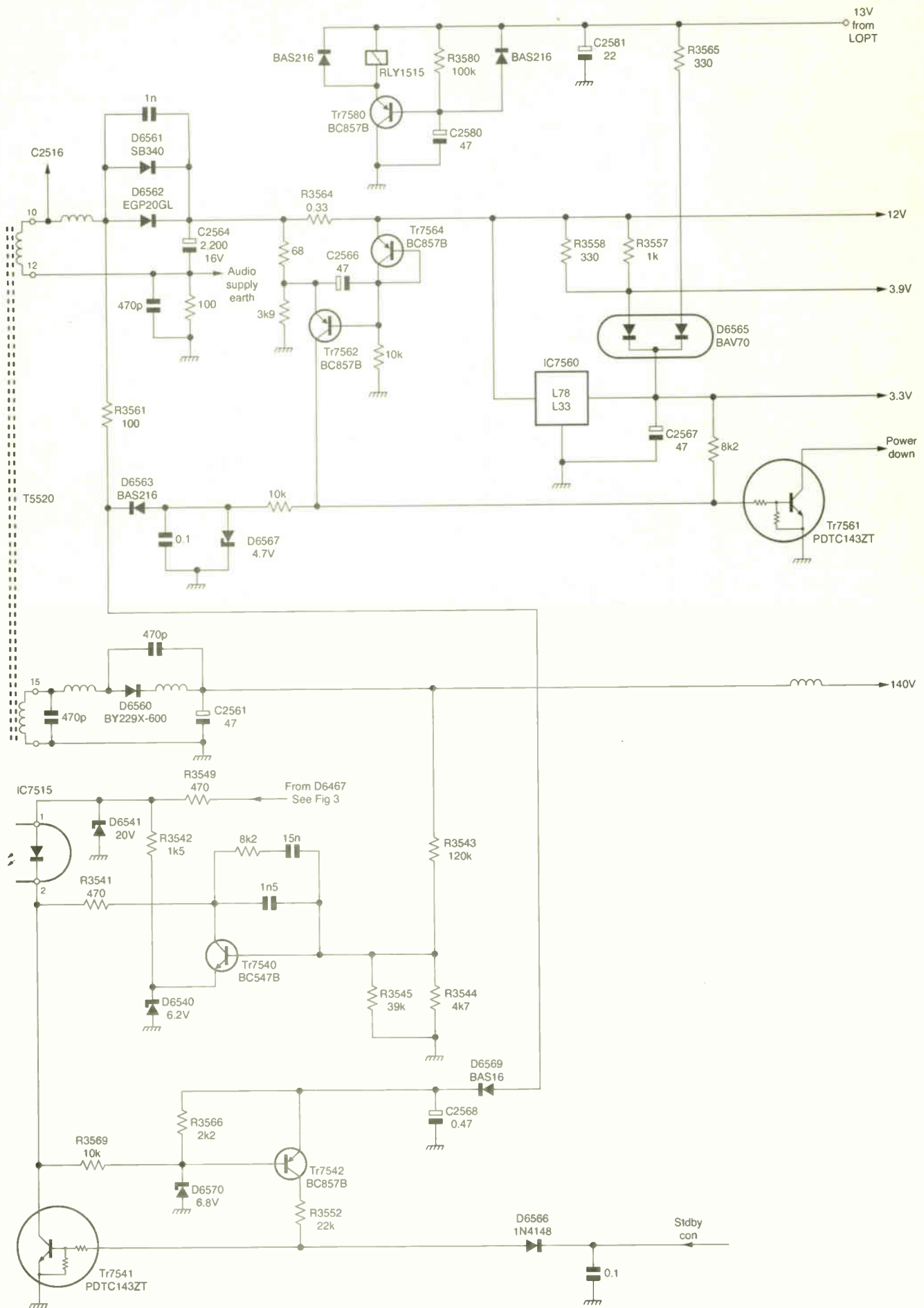

in some extra capacitors with carefully-selected values. The result is to give a non-linear stretch to the 4:3 image.

Pin 7 of the line output transformer feeds the CRT heaters. This pin is also connected to rectifier diode D6447 which feeds two pnp transistors, Tr7441 and Tr7443. Tr7441 is for black current monitoring and protection. Should the rectified heater supply fall, Tr7441 switches on. The black-current line then rises above the limits expected by the running software. After a pause the set reverts to standby. Tr7443 is included to detect a rise in the rectified heater supply. In this event it conducts and the EHT0 line voltage rises sharply. This is detected at pin 34 of the UOC as a sharp rise in the EHT and again the set reverts to standby.

An added complexity is that the field guard waveform is connected to the black-current line (Tr7441's collector) so that the running software can monitor this as well as the black current.

With this chassis too little or too much beam current will initiate protection, so be very careful when setting the AI control on the line output transformer.

### Fault codes

To help with fault finding the set's software produces and stores in memory fault-code information, see Table 1.

### Customer service mode

A customer service mode is included in the software to help with fault diagnosis on outside calls. To activate this, press and hold the remote-control unit's mute key and at the same time press and hold any local key for four seconds. It's easiest to use the set's volume-down key. This produces on screen a read-only display that shows the software version, fault codes, software options, tuning standards and the user-control settings. In addition any

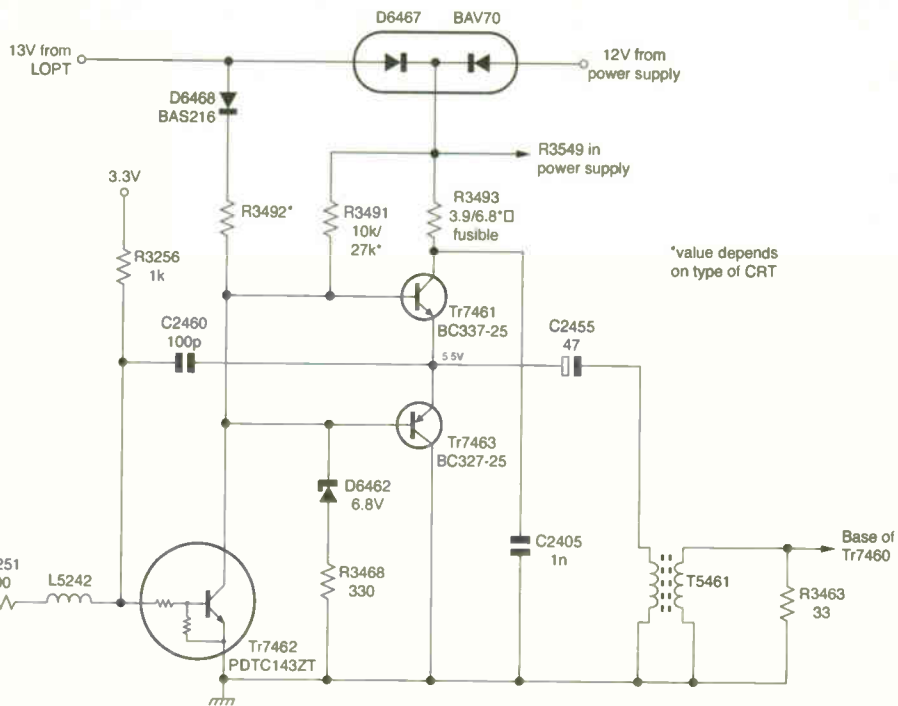

Fig. 3: The line drive circuitry.

sound muting is deactivated, along with child locks, parental controls and timer on/off settings.

To cancel the customer service display simply press any key.

### Default service mode

If a set is faulty, getting an error code displayed could be impossible without removing certain connections to the UOC. This is not easy with a surface-mounted component. To overcome the problem a default service mode is available using a remote-control unit key sequence: 062596 and menu. If it's not possible to produce an on-screen display the red LED will blink sequentially to indicate the fault code.

A more drastic method of entering the

default service mode is to short together two internal service links, 9641 and 9631 (see Fig. 4), before switching on. If this method is used, check the LT lines quickly as the 8V line protection is overridden. If a faulty EEPROM is suspected, the service links can be used to check whether the UOC works when the EEPROM has been removed. But the raster will be small, noisy and distorted.

### Service alignment mode

To enter the main service alignment mode, use the remote-control unit key sequence 062596 followed by screen info. This gives direct access to the model options, geometry settings, grey-scale settings etc. The software options can be checked with a list of codes on a white label that's usually on the back of the CRT.

After carrying out a repair, don't forget to clear the error code buffer from this service mode.

To exit the service alignment mode, switch the set to standby – simply switching it off will bring it back on in the service alignment mode.

### Known faults

Transistor Tr7441 (BC857B) in the line output stage protection circuitry can be the cause of several different faults depending on whether it's leaky or short-circuit. The set may lapse into standby after briefly showing a coloured or bright raster. It may show a black raster then go off. Sometimes the set just stays in standby but

Table 1: Fault codes for the L01 chassis

Code Fault condition

0	No fault
1	X-ray protection (USA only)
2	Line timebase protection/high beam current
3	Field protection/missing or distorted field guard waveform
4	Multi-sound processor not responding to the data bus
5	Power-off reset/3.3V or 8V supply failure
6	Clock or data bus line problem
7	Excess 12V supply current
8	EW protection activated
9	EEPROM not responding to the data bus
10	Tuner not responding to the data bus
11	Black-current loop outside specification
12	PIP generator not responding to data bus (not Europe)

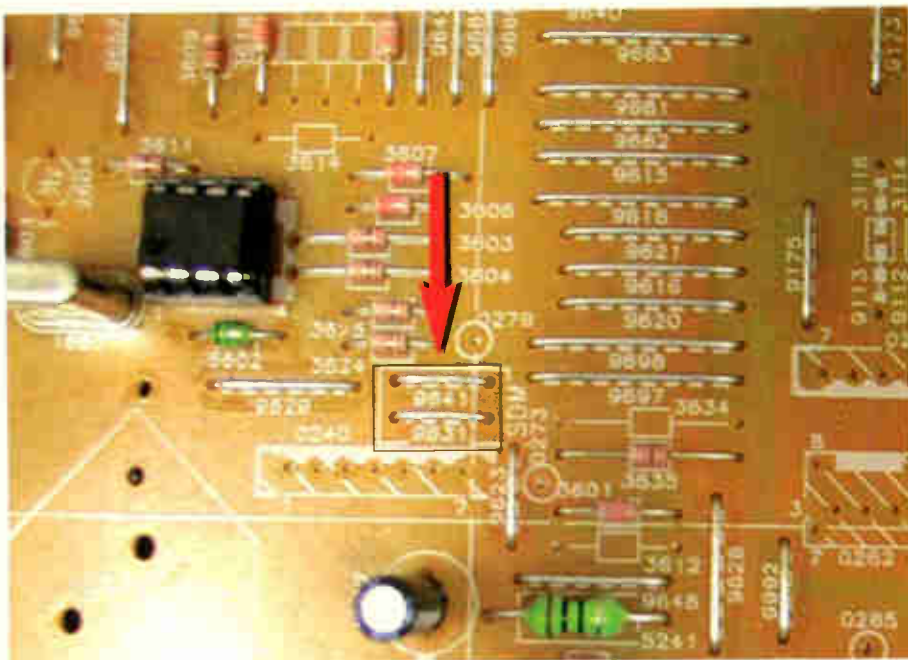

Fig. 4: Short these service links to enter the default service mode.

the LED flashes eleven times repeatedly. The 3.3V regulator IC7560 (L78L33) can fail. If it goes short-circuit, the UOC will almost certainly fail as well. Make sure that you double check the UOC part number for the set, as a number of different versions are used in the L01.1/L01.2 range.

The line output transformer T5445 can fail. The power supply then goes into the current-limiting mode.

The tuner can fail, but always check that the option byte data is correct before you condemn it, as the on-board software enables several different tuners to be used. Low gain can simply mean that the wrong tuner type has been selected.

This is not really a fault: if the local keypad doesn't work, someone has activated the child-lock mode. To release, use the remote-control unit and the user menus.



# COLOUR TRADE

**POSSIBLY  
LARGEST & OLDEST  
EST. IN  
THE UK EST FOR  
30 YEARS**

Wholesaler Distributors & Expert Agents of  
Domestic Electronics & Appliances

**FULL RANGE OF FACTORY  
GRADED TV's DVD / VIDEOS  
HI-FI SMALL & LARGE  
DOMESTIC GOODS**

[www.colourtrade.com](http://www.colourtrade.com)

**WHOLESALE MADE EASY ON LINE, SIGN UP  
NOW FOR OUR WHOLESALE PRICES.  
ALL ORDERS DISPATCHED ON THE SAME DAY.**

**Now Available  
TV's, DVD's, VCR & AUDIO**

*Over 40 years of genuine experience*

Experts on:-

Thomson • Sanyo • Beko • LG • Tatung • Ferguson  
Bush • Funai • Pacific • Dansal • Samsung & more

**TECHNICAL SUPPORT  
0907 076 70 80**

Call cost 60p min

**MAIN DEALER**

- Thompson
- Sanyo
- Beko



**Tel: 0121 359 7020 Fax: 0121 359 6344**

Phoenix House, 190 Bridge St. West, Newtown, Birmingham B19 2YT

Email: [inquiries@colourtrade.com](mailto:inquiries@colourtrade.com)

# Introduction to computer networking

## In Part 3 of his current series Fawzi Ibrahim\* describes the action of routers in local-area and wide-area networks

As mentioned in the previous instalments in this series, communication between hosts (PCs, workstations) on different networks requires a router to direct messages from one network to another. A router may be a dedicated computer or it may be a PC, for example a Windows 2000 server, configured for routing messages between networks.

A router has two or more network interface cards, usually known simply as interfaces, see Fig. 1. Each interface (IF) is connected to a network that has a different network address. Routing information, in the form of network addresses, their subnet masks and the route to the network, is held in a routing table. In Fig. 1 interface IF1 is connected to network 195.123.10.0/24 (subnet mask 255.255.255.0) while interface IF2 is connected to network 130.55.0.1 (subnet mask 255.255.0.0). By default, the router will know of the existence of the two networks and will enter them in its routing table, as shown in Table 1.

The first entry in the table states that for network 130.55.0.0, subnet mask 255.255.0.0, the router (normally known as the gateway) has an IP address of 130.55.0.1, i.e. IF2. The second entry states that for network 195.123.10.0, subnet mask 255.255.255.0, the gateway has an address of 195.123.10.1, i.e. IF1. Thus messages, in the form of frames, arriving at IF1 destined for network 130.55.0.0 are directed to IF2; conversely messages arriving at

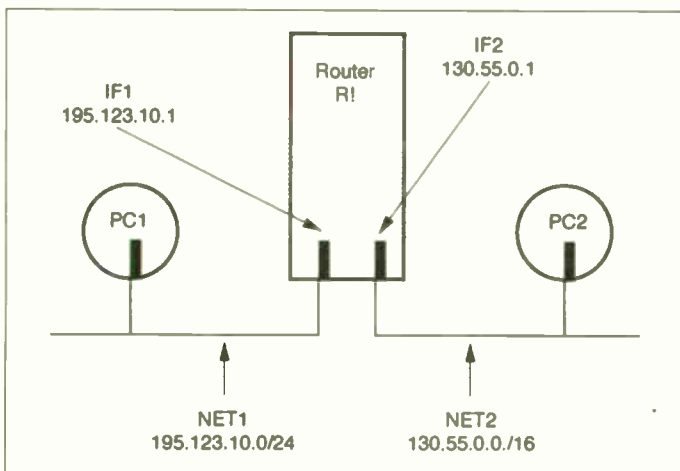

Fig. 1: A router with two interfaces connected to two networks.

IF2 destined for network 195.123.10.0 are directed to IF1.

Routers can direct messages to their various interfaces only when the destination network address is listed in the routing table. If not, a message to the effect that the network is 'unreachable' will be sent back to the source address.

### Default gateway

When you configure the TCP/IP of a host PC you are, in addition to setting the IP address and the subnet mask, invited to enter the IP address of a gateway. This is the IP address of a router to which messages destined for hosts on remote networks will be directed. It's known as the default gateway.

For host PC1 in the network shown in Fig. 2 the default gateway is the router interface that's connected to it, namely 100.0.0.1. For PC3 the default gateway is 200.0.0.1. For PC2 there are two possible gateways, 150.0.0.1 and 150.0.0.3.

In the routing table the default gateway is entered as network 0.0.0.0, subnet 0.0.0.0, i.e. any network with any subnet mask. For example the routing table for PC1 would, at the top, have the following entries for the default gateway:

```
0.0.0.0 0.0.0.0 100.0.0.1 100.0.0.2
```

The first two entries indicate any network, the third the gateway IP address and the fourth the PC's own IP address. A typical routing table, showing all default entries, is shown in Fig. 3. Table 2 explains the meaning of each field and each entry.

Routers function at the network layer of the 7-layer model. When a frame arrives, the router de-encapsulates it up to the network layer. It then checks the network layer packet's header to retrieve the destination IP address and its subnet mask, from which the network address is obtained. The router will then look up the network address in its routing table. If the address is listed, the router adds its own header and re-encapsulates the packet, which is sent to the data link layer where it is encapsulated and sent to the physical layer for final encapsulation into a frame.

Where more than one router is involved, as is usually the case with a WAN (wide area network), entries for remote networks must be made in the routing tables. These entries may be static or dynamic.

\*Fawzi Ibrahim is senior lecturer at the College of North West London and is the author of several books, including *PC Operation and Repair*.

```

C:\WINNT\System32\CMD.exe
Microsoft Windows 2000 [Version 5.00.2195]
(C) Copyright 1985-2000 Microsoft Corp.

C:\>route print

Interface List
-----
Mx1 ..... MS TCP Loopback interface
0x1000003 ..... 00 10 dc d9 2c b4 ..... Intel(R) PRO Adapter

Active Routes:
Network Destination        Netmask          Gateway          Interface        Metric
-----
0.0.0.0                    0.0.0.0          200.200.200.245 200.200.200.1   1
127.0.0.0                  255.0.0.0        127.0.0.1        127.0.0.1       1
200.200.200.0              255.255.255.0    200.200.200.1    200.200.200.1   1
200.200.200.1              255.255.255.0    127.0.0.1        127.0.0.1       1
200.200.200.255           255.255.255.0    200.200.200.1    200.200.200.1   1
224.0.0.0                  224.0.0.0        200.200.200.1    200.200.200.1   1
255.255.255.255           255.255.255.0    200.200.200.1    200.200.200.1   1
Default Gateway:          200.200.200.245

Persistent Routes:
None

C:\>

```

- Address of default gateway
- Local loopback
- Local subnet address
- Network card address
- Subnet broadcast address
- Multicast broadcast address
- Internet broadcast address

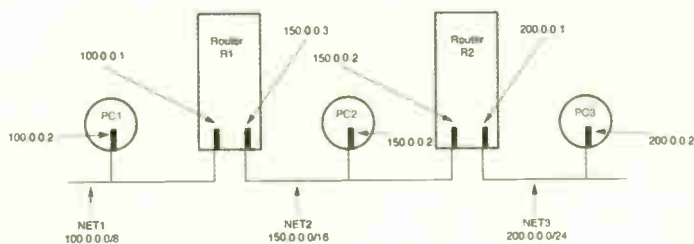

Fig. 2: Computer network with two routers, R1 and R2

Consider the network shown in Fig. 2. In this case router R1 has knowledge of NET1 and NET2 but not NET3. Its routing table will contain entries for network 100.0.0.0, subnet mask 255.0.0.0, and network 150.0.0.0, subnet mask 255.255.0.0. Thus frames from hosts on NET1 destined for NET3 would not be delivered. Similarly, router R2 has knowledge of network 150.0.0.0, subnet mask 255.255.0.0, and network 200.0.0.0, subnet mask 255.255.255.0, but no knowledge of NET1. Frames from hosts on NET3 destined for NET1 will thus not be delivered.

### Full communication

There are two ways of overcoming this limitation to allow full communication between all the hosts involved. The first is to set a default gateway for each router, namely 150.0.0.1 for router R1 and 150.0.0.3 for router R2. The second is to add an additional entry in each router's routing table.

While the first method rectifies the problem, what is called 'looping' between the two routers may occur, creating unnecessary traffic in the network. Looping occurs when a host, say PC1, attempts to send a message to a remote host on a network other than NET1, NET2 or NET3. The message will be sent to router R1. As it is for a remote network R1 will send it to the next gateway, router R2. This router receives it, notes that it is for a remote network, and sends it to gateway R1. R1 sends it back to R2, and so on. This will be terminated after a period of time known as

Table 1: Routing table for R1, Fig. 1

Network	Netmask	Gateway	Interface
130.55.0.0	255.255.0.0	130.55.0.1	130.55.0.1
195.123.10.0	255.255.255.0	195.123.10.1	195.123.10.1

TTL (Time To Live). For this reason, routers are not configured with a default gateway.

The recommended method is to add a static route for NET3 in router R1 and a static route for NET1 in router R2. These entries may be made statically, i.e. manually, or dynamically, i.e. automatically.

Static entry involves carrying out a route-add command at the relevant router. In this case at router R1 add a route for NET1 from the command line prompt as follows:

```
ROUTE ADD 200.0.0.0 MASK 255.255.255.0 150.0.0.1
(150.0.0.1 is the gateway IP address, i.e. the interface to which frames destined for NET3 should be directed.)
```

At router R2 add a route for NET3 from the command line prompt as follows:

```
ROUTE ADD 100.0.0.0 MASK 255.0.0.0 150.0.0.3
(150.0.0.3 is the gateway IP address, i.e. the interface to which frames destined for NET1 should be directed.)
```

Static entries are stored in the computer's system memory and will thus be lost if the router is rebooted. To avoid this, a permanent route entry can be made using switch -p (p for persistent) with the command, i.e. ROUTE ADD -P.

With Windows 2000 a static route entry can be added using the more convenient Routing and Remote Access utility. This method of adding static routes suffers from the disadvantage that it doesn't identify faults in the entry, compared with the command-line entry that refuses to add an entry if an incorrect mask or interface is included.

### DHCP default gateway configuration

The Options utility of a DHCP server can be used for default gateway configuration. A DHCP server has a number of settings listed under two sets of options: scope options, which apply to all workstations in that particular scope; and server options, which apply to all workstations regardless of the scope where there are two or more DHCP scopes.

To set the gateway of a DHCP host, set the Router option number 06 to the IP address of the appropriate router interface.

### Next Month

In Part 4 next month we will deal with DNS (Domain Numbering Service), which enables host computers belonging to on company/organisation but located at a number of cities, countries or continents to be grouped together into a single-name domain known as an FQDN (Fully Qualified Domain Name).



**Table 2: Routeing table field and entry meanings**

<i>Routeing table field</i>	<i>Function</i>
<b>Network address</b>	For network address identification. Can be the address of a host, subnet, network or the default gateway.
<b>Netmask</b>	Determines how much of a packet's destination address must match the network address in the routeing table before the route can be used to deliver the packet.
<b>Gateway address</b>	Identifies where a packet has to be sent. Can be either a PC's IP address or the default gateway address.
<b>Interface</b>	Identifies, depending on the routeing entry, either a PC's IP address or the loopback address (127.0.0.1).
<b>Metric</b>	Identifies the number of hops between a PC and the destination network address. The local network is always one hop. Each router thereafter adds another hop. A PC uses the hop count to determine the fastest route for a packet.
<i>Entry</i>	<i>Description</i>
<b>0.0.0.0</b>	This entry identifies the address of the default gateway. IP uses this address to route a packet in the event that the routeing table doesn't contain a route to the packet's destination network address. The value for the network address is 0.0.0.0; the subnet mask is also 0.0.0.0; the gateway address is your default gateway address; and the interface is your IP address. You will not see this entry unless you have configured a default gateway address for your computer.
<b>Local loopback 127.0.0.0</b>	This entry provides the route for testing the IP configuration of your computer, using the address 127.0.0.1. The network address is 127.0.0.0; the subnet mask is 255.0.0.0; the gateway address is 127.0.0.1; and the interface is 127.0.0.1.
<b>Local subnet address</b>	For example 200.200.200.0. This entry identifies the route to the local network. The network address is the local subnet address (using the classroom network, 200.200.200.0); the netmask is the subnet mask you are using (255.255.255.0 in the classroom); the gateway and interface addresses are your IP address (200.200.200.# in the classroom).
<b>Network card address</b>	For example 200.200.200.12. This entry identifies the route to your IP address. The network address is your IP address; the subnet mask is always 255.255.255.255; the gateway and interfaces are 127.0.0.1. Because the gateway and interface addresses are the same, if you send a packet with the destination address set to your IP address the packet will stay in your computer and not be transmitted on the network.
<b>Subnet broadcast address</b>	For example 200.200.200.255. This entry identifies the route for broadcasts on your local TCP/IP network. The network address is the portion of your IP address according to its class (A, B or C), and host addresses are set to all 255s. For example, with a class C classroom network address the subnet broadcast address is 200.200.200.255; the netmask for this routeing entry is 255.255.255.255; and the gateway and interface addresses are your IP address.
<b>Multicast broadcast address 224.0.0.0</b>	This entry defines the route for sending multicasts, enabling you to send messages to multiple hosts simultaneously. The network address is 224.0.0.0; the netmask is 224.0.0.0; the gateway and interface addresses are your IP address.
<b>Internetwork broadcast address 255.255.255.255</b>	This entry identifies the route for sending broadcasts to the entire TCP/IP network, including all network addresses. The network address and netmask are both 255.255.255.255; the gateway and interface addresses are your IP address



# Service Casebook

Michael Maurice

**One of the problems you get when running a servicing business is sets that fail again soon after repair, often exhibiting the same symptoms but with a totally different cause. Here are six examples I've had recently.**

### **Philips 29PT6973**

The original fault had been the dead-set symptom because the on/off switch had burnt out. Less than two months later I was called back because the set was again dead. This time the cause was one of the 220nF disc capacitors in the power supply. The customer understood the situation and paid, but was clearly not happy.

### **Grundig M70-2701**

Again the original fault had been a dead set. Repair of the power supply had involved replacement of the 68k $\Omega$  and 270k $\Omega$  resistors along with the IRFPC50 chopper FET and the TDA4605-3 chopper control chip. Within a month it had failed again, the symptom this time being a bright white screen. The green video output IC was short-circuit, and as a result the 10 $\Omega$  resistor in the 200V supply had gone open-circuit.

### **Panasonic TX25MD1 (Euro-2L chassis)**

Tuner drift had been the original fault with this set. It had been easily solved in the customer's home by replacing the tuner. Within three weeks I was called back when the degaussing resistor failed, blowing the mains fuse.

### **Philips K40 chassis**

The original fault with this elderly set had been intermittent loss of the picture, the cause as usual being dry-joints around the line output transformer. Within five weeks the set was back, this time dead with just a flash from the standby light. I found that the line output transistor was short-circuit. When I fitted a replacement the set came on with a horrible squealing sound and a smell of burning. The line output transformer had also failed. The customer agreed to the repair because it was cheaper than a new set – and the picture is incredibly good.

### **Panasonic TX25MS1 (Euro-2L chassis)**

When this set was first switched on there was a bright raster with flyback lines, also an EW fault. The sound was OK until the set tripped. If you tried a few times the fault would go away. The first thing I did

was to resolder a number of suspect joints in the line output stage, and fit new capacitors in some places where the local cowboy had fitted unsuitable ones. As the set then behaved itself, I returned it to the customer.

Two weeks later the set was back again, this time with a short-circuit line output transistor. I fitted a replacement, then looked for a possible cause of the original transistor's failure. While doing this I found that several pins of the VDU IC were dry-jointed. Resoldering them seemed to cure the fault. Had they been the cause? Probably, as the set hasn't been back.

### **Sharp 66CS03H**

I was originally called to this set because it took a long time to come on. Replacement of the usual crop of capacitors in the power supply cured that problem. But a few weeks later I was called back because there was no sound. R643 was open-circuit.

### **Panasonic NVHD675**

This relatively new VCR didn't respond to remote-control commands. The cause was obvious once it had been stripped down: the infra-red remote sensor was dry-jointed.

### **JVC AV25F1EK (JX chassis)**

The customer said that the picture had taken longer and longer to appear. There was now a very dim picture, as though the CRT had failed. A check with my CRT tester proved that this wasn't the case however. After some thought I decided to replace the TDA4580 RGB video controller chip IC351. Much to my relief, this cured the fault.

### **Orion 32F44**

Field collapse was the fault with this widescreen set. It wasn't easy trying to find the faulty parts in a badly-lit room, but this made more sense than taking the monster down three flights of stairs. I had to replace the TDA8350Q chip ICF1, also RF8, RF9, RF10 and RF16.

### **Goodmans 1760SW**

I don't normally service Goodmans audio systems, but the owner was adamant that she wanted this one repaired. The problem was that after about thirty seconds the light on the CD player would flicker and it would turn itself off, saying "no disc". After dismantling the system, which is a nightmare, I found the 8V regulator that powers the CD section. It consists basically of a couple of transistors and a 9.1V zener diode. A replacement zener diode and series power transistor restored the supply and got the CD player going again. I was concerned that the transistor ran very hot, because its heatsink was woefully inadequate, but a soak test over several days confirmed that it was working satisfactorily.

# Grandata Ltd

distributor of electronic components

## Television Repair / Mod Kits

MAKE & MODEL	KIT TYPE	CODE
<b>ALBA</b>		
1452T	PSU	ONWAKIT
1427T	PSU	ONWAKIT
1402	PSU	ONWAKIT
1455T	PSU	ONWAKIT
1456T	PSU	ONWAKIT
1458T	PSU	ONWAKIT
1459T	PSU	ONWAKIT
1499Y	STANDBY	MODKIT37
14SLTX	STANDBY	MODKIT37
1799Y	STANDBY	MODKIT37
2002	PSU	ONWAKIT
2009B	PSU	ONWAKIT
2052T	PSU	ONWAKIT
2152T	PSU	ONWAKIT
2099TX	STANDBY	MODKIT37
BTV17	STANDBY	MODKIT37
CTV501	PSU	ONWAKIT
CTV701	PSU	ONWAKIT
CTV840	PSU	ONWAKIT
CTV841	PSU	ONWAKIT
CTV485	PSU	ONWAKIT
<b>AKAI</b>		
CT1417	PSU	ONWAKIT
CT2159U	PSU	ONWAKIT
CT2162UNT	PSU	ONWAKIT
CT2863UNT	PSU	ONWAKIT
<b>DECCATATUNG</b>		
F SERIES	PSU	MODKIT30
TVC563	STANDBY	MODKIT37
<b>GOLDSTAR</b>		
CF25A50F	FRAME	MODKIT36
CF25C22C	FRAME	MODKIT35
CF28A50F	FRAME	MODKIT36
CF28C22F	FRAME	MODKIT35
CF28C28F	FRAME	MODKIT36
CF29C42F	FRAME	MODKIT35
<b>GOODMANS</b>		
147TT	PSU	ONWAKIT
149T	PSU	ONWAKIT
1430RA	PSU	ONWAKIT
1430RS	PSU	ONWAKIT
1430RW	PSU	ONWAKIT
1450T	PSU	ONWAKIT
1455TS	PSU	ONWAKIT
2019R	PSU	ONWAKIT
2029T	PSU	ONWAKIT
2029TA	PSU	ONWAKIT
COMPACT 11	PSU	MODKIT47
F16 CHASSIS	FRAME	GOODKIT1
F16 CHASSIS	LINE	GOODKIT1

MAKE & MODEL	KIT TYPE	CODE
<b>GOODMANS..continued</b>		
F16	PSU	GOODKIT1
F16	VIDEO	GOODKIT1
<b>GRUNDIG</b>		
CUC 2050	PSU	MODKIT48
CUC 2051	PSU	MODKIT48
CUC 2058	PSU	MODKIT48
CUC 2059	PSU	MODKIT48
CUC 2080	PSU	MODKIT48
CUC 7350		GRUNDIGKIT1
CUC 7301/3		
(BUZ90)	PSU	GRUNDIGKIT2
CUC 7301/3		
(MJF18004)	PSU	GRUNDIGKIT3
<b>HINARI</b>		
HIT14RC	PSU	ONWAKIT
<b>JVC</b>		
AV29SX1EK	FIELD O/P	JVCKIT1
AV29SX1EN	FIELD O/P	JVCKIT1
AV29SX1EN1	FIELD O/P	JVCKIT1
AV29SX1PF	FIELD O/P	JVCKIT1
AV29TSIE1	FIELD O/P	JVCKIT1
C14E1EK	PSU	ONWAKIT
C14T1EK	PSU	ONWAKIT
C21ET1EK	PSU	ONWAKIT
CS21M3EK	PSU	ONWAKIT
<b>MATSUI</b>		
1455	PSU	ONWAKIT
1496R/T (H3N90)	PSU	MODKIT43
1496R/T (BUZ90)	PSU	MODKIT44
1498	PSU	ONWAKIT
2086	PSU	ONWAKIT
2096R/T (H3N90)	PSU	MODKIT43
2096R/T (BUZ90)	PSU	MODKIT44
2098	PSU	ONWAKIT
21V1N (BUZ90)	PSU	GRUNDIGKIT2
21V1T (MJF18004)	PSU	GRUNDIGKIT3
TVR180R/208	STANDBY	MODKIT37
TVR185T	STANDBY	MODKIT39
<b>mitsubishi</b>		
AV1 SERIES	PSU	MITSKIT3
CT1M5B	PSU	MITSKIT3
CT21M5BT	PSU	MITSKIT3
CT25M5BT	PSU	MITSKIT3
CT21A2STX	TDA 8178S	MITSKIT1
CT21AX1B	PSU	MITSKIT3
CT21A3STX	TDA 8178S	MITSKIT1
CT21AV1BS	PSU	MITSKIT3
CT25A2STX	TDA 8178S	MITSKIT1
CT25A3STX	TDA 8178S	MITSKIT1

MAKE & MODEL	KIT TYPE	CODE
<b>mitsubishi..continued</b>		
CT25A4STX	TDA 8178S	MITSKIT1
CT25A6STX	TDA 8178S	MITSKIT1
CT25AV1B	PSU	MITSKIT3
CT25AV1BS	PSU	MITSKIT3
CT25AV1BD	PSU	MITSKIT3
CT25AV1BDS	PSU	MITSKIT3
CT28AV1B	PSU	MITSKIT3
CT28AX1BD	PSU	MITSKIT3
CT28AV1BDS	PSU	MITSKIT3
CT29AS1	TDA 8178S	MITSKIT2
CT29A4	TDA 8178S	MITSKIT2
CT29A6	TDA 8178S	MITSKIT2
CT29B2	TDA 8178S	MITSKIT2
CT29B3	TDA 8178S	MITSKIT2
CT29B6	TDA 8178S	MITSKIT2
CT33B3	TDA 8178S	MITSKIT2
M5 SERIES	PSU	MITSKIT3
<b>NEI/NIKKAI</b>		
CE25 CHASSIS	PSU	NIKKAIKIT1
C289FTXN	PSU	NIKKAIKIT1
C28F41FXN	PSU	NIKKAIKIT1
<b>PANASONIC</b>		
IC561	TDA 8175	PANKIT1
TX25XD60	VERT OUTPUT	PANKIT2
TC28XD60	VERT OUTPUT	PANKIT2
TX28XD70	VERT OUTPUT	PANKIT2
TX29XD70	VERT OUTPUT	PANKIT2
TX-W26D3	VERT OUTPUT	PANKIT2
<b>PHILIPS</b>		
310.10708		PHILKIT3
310.20491		PHILKIT2
310.20496		PHILKIT10
310.31994		PHILKIT6
310.32252		PHILKIT5
310.32253		PHILKIT4
310.32254		PHILKIT9
310.32255		PHILKIT7
310.32262		PHILKIT8
310.62264		PHILKIT1
ANUBIS A	SOPS	PHILKIT2
CP110 CHASSIS	SOPS	PHILKIT8
G90A CHASSIS	SOPS	PHILKIT10
G90B CHASSIS	SOPS	PHILKIT10
G110 CHASSIS	SOPS	PHILKIT3
GR2.1 CHASSIS	SOPS	PHILKIT1
GR2.2 CHASSIS	SOPS	PHILKIT1
D-16 CHASSIS	SOPS	PHILKIT6
HSM VIDEO	SOPS	PHILKIT5
JSM VIDEO	SOPS	PHILKIT4
KSM VIDEO	SOPS	PHILKIT9
LSM VIDEO	SOPS	PHILKIT7

MAKE & MODEL	KIT TYPE	CODE
<b>SAMSUNG</b>		
CI5944	FRAME	SAMKIT2
CI6844	FRAME	SAMKIT2
VIK310	PSU	SAMUNGKIT
VIK320	PSU	SAMUNGKIT
VIK350	PSU	SAMUNGKIT
VI375	PSU	SAMUNGKIT
VI395	PSU	SAMUNGKIT
WINNER 1	PSU	SAMUNGKIT
<b>SHARP</b>		
51CS03H	PSU	SHARPKIT1
51CS05H	PSU	SHARPKIT1
56FW53H	PSU & DOLBY	MODKIT45
59CS03H	PSU	SHARPKIT2
59CS05H	PSU	SHARPKIT2
59CS08H	PSU	SHARPKIT2
59DS03H	PSU	SHARPKIT3
59FW53H	PSU & EW	MODKIT49
66CS03H	PSU	SHARPKIT2
66CS05H	PSU	SHARPKIT2
66CS08H	PSU	SHARPKIT2
66FW53H	PSU & DOLBY	MODKIT45
66FW53H	PSU & EW	MODKIT49
66FW54H	PSU & DOLBY	MODKIT45
66FW54H	PSU & EW	MODKIT49
66FW54H	PSU & DOLBY	MODKIT45
66FW54H	PSU & EW	MODKIT49
DA-100 CHASSIS	PSU & EW	MODKIT49
<b>SONY</b>		
SLV715HB	VCR - PSU	MODKIT40
SLV777UB	VCR - PSU	MODKIT40
<b>THOMSON</b>		
35029400		THOMKIT2
35065920		THORNKIT1
FV70	PSU	THORNKIT1
ICC7 CHASSIS	TDA 8178FS	THOMKIT1
ICC7 CHASSIS	FRAME	THOMKIT3
ICC8 CHASSIS	TDA 8178FS	THOMKIT1
ICC8 CHASSIS	FRAME	THOMKIT3
ICC9 CHASSIS	EAST/WEST	THOMKIT4
ICC17 CHASSIS	PSU	MODKIT41
ISS20 (TV-DVD)	PSU	MODKIT46
R3000	PSU	THOMKIT2
R4000	PSU	THOMKIT2
TX92F CHASSIS	EAST/WEST	THOMKIT4

ORDER CODE	PRICE
GOODKIT1	£ 11.00
GRUNDIGKIT1	£ 10.50
GRUNDIGKIT2	£ 10.50
GRUNDIGKIT3	£ 10.50
JVCKIT1	£ 11.00
MITSKIT1	£ 3.00
MITSKIT2	£ 15.00
MITSKIT3	£ 6.00
MODKIT30	£ 10.00

ORDER CODE	PRICE
MODKIT35	£ 9.50
MODKIT36	£ 5.00
MODKIT37	£ 6.50
MODKIT39	£ 8.50
MODKIT40	£ 6.00
MODKIT41	£ 6.00
MODKIT43	£ 7.00
MODKIT44	£ 7.00
MODKIT45	£ 4.00

ORDER CODE	PRICE
MODKIT46	£ 12.00
MODKIT47	£ 15.50
MODKIT48	£ 8.00
MODKIT49	£ 13.00
NIKKAIKIT1	£ 12.00
ONWAKIT1	£ 12.00
PANKIT1	£ 15.00
PANKIT2	£ 9.00
PHILKIT1	£ 10.00

ORDER CODE	PRICE
PHILKIT2	£ 2.50
PHILKIT3	£ 4.00
PHILKIT4	£ 4.25
PHILKIT5	£ 5.75
PHILKIT6	£ 5.50
PHILKIT7	£ 7.60
PHILKIT8	£ 4.25
PHILKIT9	£ 7.50
PHILKIT10	£ 8.50

ORDER CODE	PRICE
SAMKIT2	£ 8.00
SAMUNGKIT	£ 16.00
SHARPKIT1	£ 11.00
SHARPKIT2	£ 11.00
SHARPKIT3	£ 9.00
THOMKIT1	£ 7.00
THOMKIT2	£ 12.00
THOMKIT3	£ 9.00
THOMKIT4	£ 4.00

### New Arrival !!

#### Philips L01.1E Chassis PSU Repair Kit

Fits the following models :

28PT4457/05 , 28PW5407/05 , 28PW6006/05

Order Code : MODKIT50

Price : £ 18.00 + vat

### New Arrival !!

#### Vestel 11AK31 Chassis PSU Repair Kit

Fits the following brands :

Bush , Goodman , Hitachi , Toshiba  
Models BD2851S , BD2951S , BD2581S , BD3251S

Order Code : MODKIT51

Price : £ 10.00 + vat

K.P. House , Unit 15 , Pop In Commercial Centre , Southway , Wembley , Middlesex , HA9 0HB England

Tel: (020) 8900 2329

Fax : (020) 8903 6126

Email : sales@grandata.co.uk

# Grandata Ltd

distributor of electronic components

## Digital Satellite Accessories

### Sky™ Digital Remote & TV Link Eye Combination



**Order Code : SKYPACK1**

**Price : £ 16.00 + vat each**

**5 +**

**£ 14.50 + vat each**

**Carriage Charged at £ 5.00 + vat**

### Sky™ Digital Remote Controls



**Order Code : RCSKY**

**Price £ 7.95 + vat**

**5 or more £ 7.45 + vat each**

**10 + £ 6.95 + vat each**

**Carriage Charged at £ 5.00 + vat**

### Sky™ Digital Remote & SLx Link Eye Combination



**Order Code : SKYPACK2**

**Price £ 13.00 + vat each**

**5 + £ 11.50 + vat each**

**Carriage Charged at £ 5.00 + vat**

### SLx Link Eye

Allows control of Sky™ Digibox via the signal feed for second TV



**Order Code**

**27833R**

**£ 5.80 + vat each**

**10 or more**

**£ 4.80 + vat each**

### Sky™ Digital TV Link Eye

**Order Code : TVLINKEYE**

**Price £ 10.00 + vat**

**5 +**

**£ 7.99 + vat each**



### SLx Amp By Pass Kit

For use with aerial amplifiers and Sky™ Digibox

Allows for operation of Link Eye in conjunction with a distribution amplifier



**Order Code 27829R**

**Price: £ 5.00 + vat**

## Satellite Repair / Mod Kits

### Amstrad DRX100

Tuner Repair Kit

**Order Code SATKIT35**

**Price £ 1.40 + vat**

### Amstrad DRX100

PSU Reliability Kit

**Order Code SATKIT36**

**Price £ 12.00 + vat**

### Amstrad DRX100

PSU Repair Kit

**Order Code SATKIT37**

**Price £ 13.50 + vat**

### Grundig GDS200

Digital Satellite Receiver Repair Kit

Early psu  
MODEL DSO - 0385 REV C

**Order Code SATKIT34A**

**Price : £ 10.00 + vat**

### Grundig GDS200 / GDS300

Digital Satellite Receiver Repair Kit

LATER psu TYPE REV 03  
DSO - 0375 REV A DSO - 0385 REV 5

**Order Code SATKIT34B**

**Price : £ 10.00 + vat**

### Digital Satellite Receivers Fan Kit

Suitable for

Amstrad DRX100 , DRX200  
Grundig GDR200 , GDS200  
Pace Digibox

plus many more analogue makes and models

**Order Code : FANKIT1**

**Price : £ 10.00 + vat**

### Panasonic Digital Satellite Receiver Fan Kit

Suitable for Panasonic TU-DSB20/30 , TU-DSB31/35

**Order Code : FANKIT2**

**Price : £ 15.00 + vat**

## Grundig Digital Satellite Receivers Reliability Kit

These kits contain capacitors that are generally of higher specification than those fitted by the manufacturers.

### GDS200

Early PSU  
DSO0385 Rev C

Kit Contains 9 capacitors

**Code : RELKIT34A**

**Price: £ 4.00 + vat**

### GDS200 / GDS300

Later PSU  
DSO0375 Rev A  
DSO0385 Rev F

Kit Contains 11 capacitors

**Code : RELKIT34B**

**Price: £ 4.00 + vat**

### GDS200 / GDS300

Later PSU  
Rev 03

Kit Contains 13 capacitors

**Code : RELKIT34C**

**Price: £ 4.00 + vat**

### GDS200 / GDS300

Samsung PSU  
PSSH370601B

Kit Contains 12 capacitors

**Code : RELKIT34D Price: £ 4.00 + vat**

### GDS300

Samsung PSU  
PSSH370603B

Kit Contains 13 capacitors

**Code : RELKIT34E Price: £ 4.00 + vat**

# Grandata Ltd

distributor of electronic components

## 105°C Electrolytic Capacitors

VALUE	CODE	PRICE PER	PACK	VALUE	CODE	PRICE PER	PACK	VALUE	CODE	PRICE PER	PACK	VALUE	CODE	PRICE PER	PACK	VALUE	CODE	PRICE PER	PACK
<b>6.3 Volts</b>				<b>25 Volts...continued</b>				<b>50 Volts...continued</b>				<b>100 Volts...continued</b>				<b>250 Volts...continued</b>			
220uF	CAP163	£0.70	10	1000uF	CAP46	£3.65	10	100uF	CAP66	£0.85	10	2.2uF	CAP94	£0.50	5	33uF	CAP206	£1.75	5
470uF	CAP164	£0.80	10	1500uF	CAP47	£3.90	5	220uF	CAP67	£1.75	10	3.3uF	CAP95	£0.50	5	47uF	CAP106	£4.35	10
<b>10 Volts</b>				<b>35 Volts</b>				<b>63 Volts</b>				<b>100 Volts...continued</b>				<b>350 Volts</b>			
100uF	CAP118	£0.45	10	1uF	CAP130	£0.40	10	0.22uF	CAP145	£0.45	10	22uF	CAP102	£6.00	5	1uF	CAP156	£0.70	10
220uF	CAP165	£1.00	10	3.3uF	CAP131	£0.40	10	0.33uF	CAP178	£0.35	10	330uF	CAP189	£3.00	2	3.3uF	CAP157	£1.50	10
470uF	CAP29	£1.20	10	4.7uF	CAP132	£0.45	10	0.47uF	CAP73	£0.35	10	470uF	CAP103	£6.00	5	4.7uF	CAP158	£2.25	10
680uF	CAP166	£1.20	10	10uF	CAP52	£0.50	10	1uF	CAP74	£0.35	10	680uF	CAP190	£3.00	2	10uF	CAP159	£3.40	10
1000uF	CAP119	£1.50	10	100uF	CAP53	£0.45	10	1.5uF	CAP75	£0.35	10	1000uF	CAP191	£3.00	1	33uF	CAP209	£2.60	5
2200uF	CAP120	£2.10	10	330uF	CAP54	£0.50	5	2.2uF	CAP76	£0.50	10	100uF	CAP192	£0.45	10	47uF	CAP210	£1.50	2
3300uF	CAP167	£1.60	5	47uF	CAP55	£0.85	10	3.3uF	CAP77	£0.35	10	1uF	CAP193	£0.45	10	100uF	CAP211	£3.00	2
<b>16 Volts</b>				<b>40 Volts</b>				<b>100 Volts</b>				<b>300 Volts</b>				<b>400 Volts</b>			
22uF	CAP121	£0.35	10	2200uF	CAP61	£2.45	2	6.8uF	CAP180	£0.50	10	0.47uF	CAP194	£0.45	10	0.47uF	CAP213	£0.60	10
33uF	CAP122	£0.35	10	2200uF	CAP62	£10.00	5	10uF	CAP181	£1.10	10	1uF	CAP195	£1.00	10	1uF	CAP214	£2.15	5
47uF	CAP123	£0.35	10	4700uF	CAP63	£6.50	5	15uF	CAP79	£0.95	5	4.7uF	CAP196	£2.20	5	2.2uF	CAP108	£2.25	5
100uF	CAP124	£0.60	10	1000uF	CAP64	£4.35	10	22uF	CAP80	£0.75	10	10uF	CAP197	£1.40	10	3.3uF	CAP215	£2.25	5
150uF	CAP168	£0.65	5	1500uF	CAP65	£4.00	5	33uF	CAP81	£0.85	10	22uF	CAP198	£1.80	10	4.7uF	CAP109	£3.15	5
220uF	CAP125	£0.80	10	2200uF	CAP66	£2.45	2	47uF	CAP82	£0.95	10	33uF	CAP199	£2.30	10	10uF	CAP110	£4.00	5
330uF	CAP30	£1.75	10	3300uF	CAP67	£10.00	5	56uF	CAP83	£1.30	5	47uF	CAP200	£2.50	1	22uF	CAP111	£2.50	2
470uF	CAP31	£1.75	10	4700uF	CAP68	£3.50	2	68uF	CAP84	£1.20	5	100uF	CAP201	£2.50	1	33uF	CAP215	£2.50	2
680uF	CAP32	£2.10	5	2200uF	CAP174	£1.80	2	100uF	CAP85	£2.80	5	220uF	CAP202	£0.60	10	47uF	CAP112	£3.50	2
1000uF	CAP33	£2.10	10	2200uF	CAP175	£2.00	1	150uF	CAP86	£2.80	10	100uF	CAP203	£1.30	10	68uF	CAP216	£3.50	2
1200uF	CAP169	£1.50	5	2200uF	CAP176	£0.35	10	330uF	CAP87	£4.00	10	2.2uF	CAP204	£2.00	10	100uF	CAP113	£2.50	2
1500uF	CAP170	£1.50	5	0.47uF	CAP177	£0.45	10	470uF	CAP88	£5.25	10	100uF	CAP205	£1.75	10	33uF	CAP216	£4.15	2
2200uF	CAP34	£5.25	10	1uF	CAP137	£0.35	10	680uF	CAP89	£5.00	10	220uF	CAP206	£2.00	10	47uF	CAP217	£3.20	1
3300uF	CAP35	£5.00	5	2.2uF	CAP138	£0.35	10	1000uF	CAP90	£5.40	5	100uF	CAP207	£2.50	1	150uF	CAP161	£7.00	2
4700uF	CAP36	£6.10	10	3.3uF	CAP139	£0.35	10	2200uF	CAP182	£2.20	1	330uF	CAP208	£2.50	1	560uF	CAP162	£4.00	1
6800uF	CAP171	£4.50	5	4.7uF	CAP140	£0.35	10	4700uF	CAP183	£4.00	1	<b>250 Volts</b>				<b>450 Volts</b>			
<b>25 Volts</b>				<b>50 Volts</b>				<b>100 Volts</b>				<b>250 Volts</b>				<b>450 Volts</b>			
10uF	CAP37	£0.45	10	0.47uF	CAP176	£0.35	10	0.1uF	CAP184	£0.80	10	0.47uF	CAP209	£0.60	10	1uF	CAP113	£2.80	5
15uF	CAP172	£0.45	10	1uF	CAP137	£0.35	10	0.22uF	CAP185	£0.80	10	1uF	CAP210	£0.60	10	2.2uF	CAP114	£3.20	5
22uF	CAP38	£0.45	10	2.2uF	CAP138	£0.35	10	0.33uF	CAP186	£0.80	10	2.2uF	CAP211	£1.30	10	3.3uF	CAP218	£3.20	5
33uF	CAP126	£0.40	10	3.3uF	CAP139	£0.35	10	0.47uF	CAP91	£0.50	5	3.3uF	CAP212	£1.75	10	4.7uF	CAP219	£4.95	5
47uF	CAP39	£0.48	5	4.7uF	CAP140	£0.35	10	1uF	CAP92	£0.85	10	4.7uF	CAP213	£2.00	10	10uF	CAP220	£5.50	5
68uF	CAP127	£0.55	10	6.8uF	CAP141	£0.35	10	100uF	CAP93	£0.70	10	10uF	CAP214	£2.60	10	22uF	CAP116	£4.15	2
100uF	CAP40	£0.70	10	10uF	CAP63	£0.50	10	1.5uF	CAP93	£0.70	10	22uF	CAP215	£2.30	10	33uF	CAP219	£3.00	2
120uF	CAP128	£0.85	10	22uF	CAP64	£0.70	10	2200uF	CAP182	£2.20	1	33uF	CAP216	£2.00	10	47uF	CAP220	£2.00	1
150uF	CAP41	£0.95	5	33uF	CAP141	£0.85	10	4700uF	CAP183	£4.00	1	47uF	CAP217	£3.00	2	100uF	CAP221	£3.00	1
220uF	CAP42	£1.20	10	47uF	CAP65	£0.85	10	68uF	CAP142	£0.90	10	100uF	CAP218	£2.00	10				
330uF	CAP43	£1.40	5	68uF	CAP142	£0.90	10												
470uF	CAP44	£1.90	10																
680uF	CAP45	£3.15	5																

## Aerial & Satellite Installation Accessories

### SLx Aerial Amplifiers

Now with built in Digital ByPass Operates with Sky™ DigiEye

Class leading noise figure of 4dB or less

6dB signal amplification on all models



Integrated Digital By Pass

Description	Order Code	Price
<b>2 Way - No Bypass</b>	<b>SLX2</b>	<b>£ 8.00 + vat</b>
<b>2 Way - With Bypass</b>	<b>SLX2B</b>	<b>£ 9.25 + vat</b>
<b>4 Way - No Bypass</b>	<b>SLX4</b>	<b>£ 13.00 + vat</b>
<b>4 Way - With Bypass</b>	<b>SLX4B</b>	<b>£ 14.00 + vat</b>
<b>6 Way - No Bypass</b>	<b>SLX6</b>	<b>£ 18.00 + vat</b>
<b>6 Way - With Bypass</b>	<b>SLX6B</b>	<b>£ 19.00 + vat</b>
<b>8 Way - No Bypass</b>	<b>SLX8</b>	<b>£ 18.50 + vat</b>
<b>8 Way - With Bypass</b>	<b>SLX8B</b>	<b>£ 20.00 + vat</b>

### SLx Masthead Amplifiers

UHF TV antenna pre amplifier designed for the professional aerial installer

15dB gain masthead amplifier ideal for majority of domestic installations

26dB gain masthead amplifier for longer cable runs (loss of more than 3dB) or if connected to passive splitters

Requires 12V DC power supply via download either via dedicated power supply unit or from a distribution amplifier with line powering

**15dB Amp Order Code : 27830R**  
**Price : £ 4.30 + vat**

**26dB Amp Order Code : 27831R**  
**Price : £ 4.50 + vat**

**SLx Masthead Amp PSU**  
**Order Code : 27832R**  
**Price : £ 5.00 + vat**

**Postage for 2+ £ 5.00 + vat**

### Coax Plug Aluminium



**Order Code : PLG51**  
**Bag of 10**  
**Price : £ 1.25 + vat**

**Bag of 100**  
**Price : £ 9.00 + vat**

### Screw Type Coax Plugs



**Order Code : PLG62**  
**Bag of 10**  
**Price : £ 1.60 + vat**

**Bag of 100**  
**Price: £12.50 + vat**

### Twist On F Connectors



**Order Code : PLG101**  
**Bag of 10**  
**Price : £ 1.00 + vat**

**Bag of 100**  
**Price : £ 6.00 + vat**

### SLx Satellite Finder

Allows the user to find the best azimuth / elevation settings for a satellite dish, resulting in the best signal reception / picture and sound quality

- Compact design
- Backlit meter scale
- Audible signal strength reading
- Adjustable level control
- Adjustable sensitivity adjustment
- Frequency Range : 950 - 2250Mhz



**Order Code : 27860R Price : £ 10.00 + vat**

# Grandata Ltd

distributor of electronic components

## Konig Replacement Remote Controls

Part No.	Code	Part No.	Code	Part No.	Code	Part No.	Code	Part No.	Code	Part No.	Code
<b>AKAI</b>		<b>FERGUSON .continued</b>		<b>HITACHI .continued</b>		<b>NOKIA</b>		<b>PHILIPS .continued</b>		<b>SHARP .continued</b>	
CT2582E	IR9700	68LS2	IR9639	C24W5511T	IR9983	3126	IR9157	RC9020	IR9434	RRMCG0662PESA	IR9487
CT2585	IR9700	A10R	IR9259	C2514	IR9476	3126F	IR9157	RC9030	IR9434	RRMCG0739BMSA	IR9711
CT2885	IR9700	A14R	IR9259	C2546	IR9259	C1	IR9161	RC9050	IR9556	RRMCG0777PESA	IR9487
CT2885E	IR9700	A36R	IR9259	C2546TN	IR9277	C2	IR9161	RC9057	IR9710	RRMCG0803PESA	IR9487
IR16	IR9700	B51F	IR9639	C2547TN	IR9677	C3	IR9161	RC9060	IR9556	RRMCG1014BMSA	IR9711
RC556	IR9397	B51NX	IR9399	C2556TN	IR9983	C4	IR9161	RC9070	IR9434	RRMCG1023BMSA	IR9711
RC85	IR9700	B59F	IR9639	C2566TN	IR9677	CM1	IR9569	RC9133	IR9710	RRMCG1036BMSA	IR9711
<b>AMSTRAD</b>		B59N	IR9639	C2567TN	IR9983	D1	IR9161	<b>SAMSUNG</b>		RRMCG1046BMSA	IR9788
SRD550	IR9386	B59NX	IR9639	C2567TN2	IR9983	D2	IR9161	CX5312W	IR9432	RRMCG1068BMSA	IR9711
SRX510	IR9386	B68F	IR9519	C2568TN	IR9983	E1	IR9161	CX5325W	IR9432	RRMCG1048BMSA	IR9788
AE6001	IR9352	B68NX	IR9639	C2659H	IR9142	E2	IR9161	CX532WT	IR9432	RRMCG1050BMSA	IR9788
<b>B &amp; O</b>		C59NX	IR9639	C2660	IR9142	EM2	IR9700	CX534WT	IR9432	RRMCG2799CESA	IR9487
Beclink 100	IR9443	C68NX	IR9639	C2661	IR9142	ES5	IR9701	RM104	IR9432	SV2044S	IR9487
<b>BEKO</b>		D51ND	IR9639	C2846TN	IR9677	FS10	IR9573	RM109	IR9546	SV2145G	IR9487
RC51321	IR9398	D59F	IR9639	C2847TN	IR9677	FS11	IR9506	<b>SANYO</b>		SV2145S	IR9487
RC51331	IR9398	D59N	IR9639	C2856TN	IR9983	FS41	IR9573	4AA4U10092	IR9459	SV2145S	IR9487
RC61331	IR9398	D68N	IR9639	C2866TN	IR9677	FS42	IR9573	JXA	IR9457	SV2145S	IR9487
<b>BLAUPUNKT</b>		D78N	IR9639	C2896TN	IR9983	FS5	IR9506	JXBA	IR9457	SV2145S	IR9487
8669493	IR9188	E51N	IR9639	C2896TN	IR9983	FS51	IR9573	JXCL	IR9530	SV27751	IR9487
1532	IR9503	E59R8	IR9639	C28W410TN	IR9983	FS9	IR9506	JXCR	IR9530	SV2877S1	IR9487
1570-46	IR9516	RCU1734	IR9584	C28W510TN	IR9983	FS9	IR9506	JXFF	IR9457		
8627 105 463	IR9188	RCU1742	IR9584	CP1476R	IR9142	IRC1	IR9157	JXGA	IR9139		
8668813000	IR9516	RCU1785	IR9584	CP1646R	IR9142	IRC2	IR9157	JXGT	IR9139		
1555-46	IR9516	RCU1789	IR9584	CP2067	IR9142	IRC2	IR9157	JXGW	IR9460		
1563-46	IR9516	RH880	IR9584	CP2216	IR9142	IR1	IR9535	JXGY	IR9460		
IB16	IR9504	RH885	IR9325	CP222	IR9142	IR2	IR9535	JXLB	IR9460		
IC16	IR9504	RHT01	IR9259	CP260	IR9142	IR3	IR9535	JXLG	IR9460		
ID32	IR9503	RHT10	IR9325	CP260	IR9142	IR3	IR9535	JXLB	IR9460		
IL32	IR9503	RHT30	IR9639	CL2156TAN	IR9983	RCN610	IR9752	RC238	IR9974		
IM32	IR9503	T49F	IR9639	CL24W1TAN	IR9983	RCN620	IR9751	RC254	IR9974		
IM55-16	IR9516	T49N	IR9639	CL256TAN	IR9983	RCN624	IR9757	RC258	IR9974		
IM63-16	IR9516	T51F	IR9639	CL256TAN	IR9983	SM1	IR9491	RC305	IR9974		
IM70-16	IR9516	T51N	IR9639	CL286TAN	IR9983	SM2	IR9491	RC307	IR9974		
IP32	IR9503	T59F	IR9639	CL286TAN	IR9983			RC308	IR9457		
IQ16	IR9504	T59N	IR9639	CL28W1TAN	IR9983	<b>PANASONIC</b>		RC317	IR9457		
IR32	IR9504	T68N	IR9639	CL29W2TAN	IR9983	02280227	IR9835	RC318	IR9457		
TC106	IR9406	T742	IR9584	CL32W2TAN	IR9983	01059216	IR9835	RC318	IR9457		
TC110 PIP	IR9248	IT52	IR9584	CLE871B	IR9602	EUR50100	IR9826	RC318	IR9457		
TC143	IR9406	T758	IR9584	CLE874A	IR9602	EUR51921	IR9835	RC321	IR9457		
TC144	IR9406	T789	IR9584	CLE874B	IR9602	IR3592	IR9826	RC625	IR9457		
TC190	IR9529	T78DPL	IR9639	CLE876	IR9476	TC1485DR	IR9826	RC628	IR9457		
TC192	IR9529	<b>GOLDSTAR</b>		CLE876C	IR9477	TC1451R	IR9834	RC642	IR9530		
TC194	IR9529	105-068	IR9403	CLE876D	IR9477	TC150E	IR9562	RC645	IR9974		
<b>CROWN</b>		105209B	IR9862	CLE902A	IR9677	TC1656PFR	IR9826	RC685	IR9457		
RC51331	IR9398	105210A	IR9862	CLE902B	IR9677	TC1785DRS	IR9826	RC700	IR9139		
RC61331	IR9398	105-219J	IR9864	CLE903A	IR9677	TC1785UR	IR9826	RC702	IR9139		
2190T	IR9397	105-224V	IR9864	CLE921A	IR9677	TC2185DRS	IR9826	RC710	IR9139		
<b>DAEWOO</b>		105-229H	IR9864	CLE921B	IR9677	TC2185UR	IR9826	RC711	IR9460		
DMQ1414	IR9397	105230A	IR9862	CLE922A	IR9677	TC21R1C	IR9826	RC901	IR9139		
DMQ14A 1	IR9840	105-230C	IR9864	CLE922B	IR9677	TC21R1U	IR9826	S02	IR9460		
DMQ20A 1	IR9840	38T1	IR9854	CLR876E	IR9477	TC21S1R	IR9834	S03	IR9460		
DMQ2195	IR9840	CB20E40X	IR9854	CP2146TA	IR9677	TCC23PFR	IR9826	<b>SHARP</b>			
DMQ2595	IR9840	CBT2190E	IR9403	CP2546	IR9677	TNQ1410	IR9826	37AM12S	IR9788		
DMQ2895	IR9840	CBT4902	IR9403	CP2546TA	IR9677	TNQ8E0421	IR9826	51AM12S	IR9788		
<b>FERGUSON</b>		CBT4902E	IR9403	CP2566TAN	IR9983	TNQ8E0422	IR9826	51AT 15S	IR9788		
20H3	IR9594	CBT9905	IR9403	CP2841TA	IR9677	TNQ8E0428	IR9826	54AM12S	IR9788		
22B5	IR9584	V5068K	IR9862	CP2856TA	IR9983	TNQ8E0430	IR9826	54AT 15S	IR9788		
22H3	IR9594	<b>GRUNDIG</b>		CP2866TAN	IR9983	TNQ8E0432	IR9826	54CS05SN	IR9711		
2415	IR9584	CUC50	IR9614	CP29W2TAN	IR9983	TNQ8E0435	IR9836	SV2044	IR9487		
2422	IR9584	CUC5030	IR9529	CP29W2TAN	IR9983	TNQ8E0436	IR9836	SV2145S	IR9487		
2423	IR9584	CUC5310	IR9529	CPT155E	IR9576	TNQ8E0441	IR9826	70C503S	IR9711		
2433	IR9584	RC212	IR9614	CPT155F	IR9576	TNQ8E0461	IR9834	72C503S	IR9711		
2445	IR9584	RC300	IR9614	CPT1560	IR9576	TX1451T	IR9834	72C505SN	IR9711		
2452	IR9584	RC212	IR9614	CPT1561	IR9576	TX21S1RC	IR9834	C1421	IR9487		
2453	IR9584	RC300	IR9614	CPT1561	IR9576	TX21S1T	IR9834	C2021	IR9487		
2463	IR9584	TP500VT	IR9500	CPT2155	IR9575	TX21S1TC	IR9834	CV2121	IR9487		
26H3	IR9594	TP590VT	IR9509	CPT2164	IR9575	TX21T1C	IR9826	CV3707	IR9487		
29132	IR9584	TP600VT	IR9509	CPT2558	IR9575	TX25A2C	IR9836	CV3709	IR9487		
36K2	IR9594	TP610	IR9509	CPT2564	IR9575	TX25A2CI	IR9836	CV3710	IR9487		
41H3	IR9594	TP621	IR9509	CPT2566	IR9575	TX25W2	IR9836	CV3720	IR9487		
4233	IR9584	TP630	IR9509	CPT2669	IR9575	TX25W2C	IR9836	DV1416SN	IR9487		
4414	IR9584	TP650	IR9509	CP272795	IR9576	TX25W2CI	IR9836	DV1506SN	IR9487		
4415	IR9584	TP661	IR9509	CP272870	IR9576	TX28A1D	IR9826	DV1706SN	IR9487		
4423	IR9584	TP661 TOP	IR9615	CST11430	IR9576	TX28A2C	IR9836	DV21081S	IR9711		
51A0	IR9584	TP710	IR9614	CST11435	IR9576	TX28A2CI	IR9836	DV2130EX	IR9487		
51A2	IR9584	TP711	IR9614	CST11560	IR9576	TX28W2	IR9836	DV25071S	IR9711		
51A3	IR9584	TP712	IR9614	CST11600	IR9576	TX28W2C	IR9836	DV25073S	IR9711		
51A4	IR9584	TP715	IR9749	CTR200M	IR9542	TX28XDP1C	IR9835	DV25081S	IR9711		
51A5	IR9584	TP720	IR9614	<b>JVC</b>		TX29AD1D	IR9835	DV25083S	IR9711		
51G2	IR9594	TP720	IR9614	AV21TS1EN	IR9698	TX29W2CI	IR9836	DV28037S	IR9711		
51G3	IR9594	TP720	IR9614	AV25TS1EN	IR9698	TX33A2C	IR9836	DV28071S	IR9711		
51H3	IR9594	TP720	IR9614	AV25VM1EN	IR9698	TX33A2CI	IR9836	DV28081S	IR9711		
51H4	IR9594	TP720	IR9614	AV25VM1EN	IR9698	PHILIPS	IR9836	DV28083S	IR9711		
51K3	IR9594	TP720	IR9614	AV28X11EN	IR9698	RC5002	IR9510	DV3750S	IR9788		
5980	IR9584	TP720	IR9614	AV29TS1EN	IR9698	RC5140	IR9510	DV3780S	IR9788		
5982	IR9584	TP720	IR9614	AV32WZ2EN	IR9698	RC5154	IR9510	DV5160S	IR9788		
5983	IR9584	TRC 1	IR9715	RC8072	IR9698	RC5240	IR9510	DV5403S	IR9711		
5984	IR9584	TRC 2	IR9715	RC8073	IR9698	RC5250	IR9510	DV5432S	IR9711		
5985	IR9584	TRC 2	IR9715	RC8074	IR9698	RC5260	IR9510	DV5465S	IR9711		
59D2	IR9584	2970491	IR9479	RMC530	IR9698	RC5300	IR9510	DV5470S	IR9711		
59D3	IR9584	A518780	IR9142	RMC682	IR9698	RC5350	IR9510	DV5935H	IR9711		
59G3	IR9594	C1405	IR9476	RMC7611E	IR9698	RC5410	IR9553	DV6301S	IR9711		
59H4	IR9594	C1414	IR9476	RMC770	IR9698	RC5420	IR9553	DV6303S	IR9711		
59H5	IR9594	C2057H	IR9142	RMC771E	IR9698	RC5540	IR9510	DV6311S	IR9711		
59B2	IR9584	C2067H	IR9142	RMC7931E	IR9698	RC5701	IR9634	DV6313S			

# Grandata Ltd

distributor of electronic components

## Transistors / Linear IC's

Part No.	Price	Part No.	Price	Part No.	Price	Part No.	Price	Part No.	Price	Part No.	Price	Part No.	Price	Part No.	Price		
BU208A	£0.75	IRF5450	£5.00	MJE350	£0.80	STK4191	£9.00	STK5464	£3.00	STR371	£4.00	TDA2450-3	£10.00	TDA4665	£2.50	TDA8138	£2.00
BU2508DF	£1.00	IRF5740	£3.50	MJE350	£0.80	STK4191 X	£14.00	STK5466	£5.00	STR380	£3.50	TDA2460-2	£0.70	TDA4670	£4.75	TDA8138A	£1.30
BU2508DX	£1.00	IRF5840	£3.80	MJE350	£0.80	STK4191-130	£15.00	STK5467	£3.00	STR381	£3.90	TDA2501	£3.00	TDA4671	£5.00	TDA8138B	£2.00
BU2508FA	£1.10	IRF610	£0.80	MJE350	£0.80	STK4191-140	£16.00	STK5468	£3.00	STR383	£4.10	TDA2506T	£8.00	TDA4680	£3.50	TDA8139	£2.00
BU2508AX	£1.30	IRF620	£1.00	MJE350	£0.80	STK4192	£7.00	STK5471	£9.00	STR384	£3.50	TDA2507	£4.50	TDA4681	£4.50	TDA8140	£2.00
BU2508D	£1.30	IRF630	£0.75	MJE350	£0.80	STK4192 II	£9.50	STK5472	£3.75	STR4090	£3.50	TDA2510	£4.50	TDA4685	£2.75	TDA8143	£1.60
BU2508DF	£1.20	IRF634	£1.25	MJE350	£0.80	STK4192 II	£9.50	STK5473	£4.80	STR4090A	£6.50	TDA2514A	£5.00	TDA4686	£5.00	TDA8145	£1.20
BU2508DX	£1.50	IRF640	£1.50	MJE350	£0.80	STK4192 III	£10.50	STK5474	£5.00	STR41090	£3.30	TDA2515	£4.50	TDA4687	£5.00	TDA8146	£2.00
BU2520AF	£1.70	IRF640F	£2.00	MJE350	£0.80	STK4200 II	£10.50	STK5477	£4.50	STR4142	£4.50	TDA2520-1	£9.00	TDA4700A	£7.50	TDA8153	£10.00
BU2520AX	£1.40	IRF630S	£2.00	MJE350	£0.80	STK4204 II	£10.50	STK5478	£2.50	STR4211	£1.15	TDA2522	£12.00	TDA4710H	£7.00	TDA8170	£1.70
BU2520DF	£2.25	IRF642	£2.00	MJE350	£0.80	STK4211 II	£10.00	STK5479	£3.00	STR4311	£9.40	TDA2523	£8.50	TDA4714C	£3.50	TDA8171	£2.30
BU2520DX	£2.00	IRF644	£2.00	MJE350	£0.80	STK4211 V	£8.00	STK5481	£4.70	STR440	£8.00	TDA2525	£4.50	TDA4716C	£4.50	TDA8172	£2.00
BU2522AX	£1.50	IRF650	£2.00	MJE350	£0.80	STK4221 II	£12.00	STK5482	£2.85	STR441	£9.50	TDA2530	£3.00	TDA4720	£6.60	TDA8173	£1.75
BU2525A	£3.25	IRF710	£1.50	MJE350	£0.80	STK4231 II	£10.50	STK5483	£4.40	STR4415	£4.75	TDA2548	£2.00	TDA4725	£7.50	TDA8174	£2.00
BU2525AF	£2.20	IRF720	£0.85	MJE350	£0.80	STK4231 V	£14.00	STK5486	£4.50	STR442	£16.00	TDA2549	£3.00	TDA4770	£6.00	TDA8175	£7.00
BU2525AX	£1.90	IRF730	£1.25	MJE350	£0.80	STK4241	£10.50	STK5487	£5.25	STR450A	£7.00	TDA2558	£4.00	TDA4800	£3.00	TDA8177	£3.00
BU2525D	£2.40	IRF740	£0.90	MJE350	£0.80	STK4241 V	£12.50	STK5488	£4.80	STR451	£8.00	TDA2560	£7.00	TDA4810	£5.00	TDA8179	£3.50
BU2525DF	£1.75	IRF740F	£3.00	MJE350	£0.80	STK4272	£5.00	STK5490	£4.50	STR4511	£5.50	TDA2560-3	£14.00	TDA4851	£3.25	TDA8179S	£7.50
BU2527AF	£4.00	IRF820	£0.90	MJE350	£0.80	STK4273	£5.50	STK5491	£6.00	STR4512	£4.00	TDA2574V	£3.50	TDA4852	£3.25	TDA8180	£12.50
BU2527AX	£2.50	IRF830	£0.85	MJE350	£0.80	STK4274	£5.00	STK563	£4.15	STR452	£4.75	TDA2576A	£9.00	TDA4853	£5.00	TDA8205	£12.50
BU2527DF	£2.00	IRF830F	£1.60	MJE350	£0.80	STK4274	£5.00	STK5632	£3.00	STR453	£5.00	TDA2577A	£2.00	TDA4854	£6.00	TDA8212	£3.50
BU2527DX	£2.00	IRF840	£0.85	MJE350	£0.80	STK4300	£5.00	STK5720	£4.00	STR454	£13.00	TDA2578A	£7.00	TDA4855	£6.00	TDA8214B	£10.50
BU2532AL	£3.25	IRF840F	£1.75	MJE350	£0.80	STK4301	£5.00	STK5725	£3.50	STR455	£5.50	TDA2579A	£2.10	TDA4856	£5.00	TDA8215H	£3.50
BU2708AF	£2.00	IRF9140	£10.00	MJE350	£0.80	STK4311	£6.50	STK5730	£3.00	STR456	£4.70	TDA2579B	£2.35	TDA4858	£3.50	TDA8217	£2.25
BU2708AX	£2.00	IRF9230	£4.00	MJE350	£0.80	STK4331	£4.00	STK5733	£4.00	STR457	£6.00	TDA2652	£48.00	TDA4860	£2.00	TDA8303	£2.50
BU2708DF	£2.00	IRF9510	£1.50	MJE350	£0.80	STK4332	£3.65	STK5734	£3.00	STR458	£3.00	TDA2653A	£4.50	TDA4861	£3.50	TDA8304	£4.00
BU2708DX	£2.00	IRF9511	£1.50	MJE350	£0.80	STK4333	£3.75	STK6324B	£5.00	STR459	£3.50	TDA2710-1	£4.00	TDA4866	£2.75	TDA8305	£5.00
BU2720AF	£2.00	IRF9520	£1.50	MJE350	£0.80	STK4336	£5.00	STK6327	£12.00	STR5002	£3.50	TDA2820M	£1.00	TDA4880	£4.50	TDA8305A	£5.00
BU2720DF	£2.00	IRF9530	£1.25	MJE350	£0.80	STK4362	£4.50	STK6328A	£4.00	STR5009	£5.50	TDA2822M	£3.60	TDA4918A	£17.00	TDA8310	£6.00
BU2720DX	£2.00	IRF9531	£2.00	MJE350	£0.80	STK4362	£4.50	STK6431	£6.00	STR5103A	£2.60	TDA2822M	£3.60	TDA4930	£5.00	TDA8350O	£2.75
BU2722AF	£3.30	IRF9540	£1.75	MJE350	£0.80	STK4372	£6.00	STK6607	£4.00	STR510113	£5.00	TDA3190	£2.00	TDA4935	£3.00	TDA8351	£2.00
BU2725AF	£2.00	IRF9541	£2.00	MJE350	£0.80	STK4372	£6.00	STK6712	£10.00	STR510113	£5.00	TDA3301B	£16.00	TDA4940	£2.00	TDA8354	£2.75
BU2725DF	£2.00	IRF9610	£0.85	MJE350	£0.80	STK4379	£5.00	STK6722	£6.50	STR510115	£5.00	TDA3303	£7.00	TDA4941	£2.80	TDA8356	£2.00
BU2725DX	£2.00	IRF9620	£0.85	MJE350	£0.80	STK4392	£5.00	STK6732	£10.00	STR510213	£4.00	TDA3501	£3.70	TDA4942	£2.00	TDA8360N3	£8.00
BU2727AF	£2.00	IRF9622	£2.00	MJE350	£0.80	STK441	£6.80	STK6822	£7.50	STR50330	£4.75	TDA3502	£3.60	TDA4950	£1.00	TDA8361AN3	£8.00
BU2727AX	£2.00	IRF9630	£1.30	MJE350	£0.80	STK4412	£4.50	STK6875	£6.50	STR5041	£5.00	TDA3504	£3.00	TDA4951	£4.50	TDA8361IN3	£9.00
BU2727DF	£2.00	IRF9640	£2.30	MJE350	£0.80	STK4413	£7.00	STK6922	£10.00	STR51213	£5.00	TDA3507	£4.50	TDA4952	£1.00	TDA8362AN	£12.00
BU2727DX	£2.00	IRFBC20	£1.10	MJE350	£0.80	STK4432	£6.00	STK6922	£10.00	STR5142A	£7.00	TDA3521	£7.00	TDA4953	£1.00	TDA8362AN3	£7.50
BU508AF	£0.80	IRFBC30	£1.20	MJE350	£0.80	STK4457	£4.70	STK6922	£10.00	STR53041	£4.00	TDA3560	£6.00	TDA4954	£1.00	TDA8362BN3	£8.50
BU508AX	£0.60	IRFBC40	£2.10	MJE350	£0.80	STK450	£5.60	STK6927	£2.75	STR54041	£3.20	TDA3561	£3.00	TDA4955	£2.00	TDA8362N3	£12.00
BU508DH	£0.75	IRFBC30	£2.25	MJE350	£0.80	STK4502-070	£7.00	STK6927	£2.75	STR55041	£4.50	TDA3561A	£3.00	TDA4956	£1.00	TDA8362N4	£9.00
BU508DF	£0.85	IRFD120	£1.00	MJE350	£0.80	STK4502-070	£7.00	STK6927B	£6.00	STR56041	£5.50	TDA3562A	£2.80	TDA4957	£1.00	TDA8362N5	£12.00
BU508DR	£1.20	IRFD9220	£1.00	MJE350	£0.80	STK4502-071	£7.00	STK6928	£6.00	STR56041	£5.50	TDA3563	£3.60	TDA5702	£13.00	TDA8362N6	£15.00
BUH1015	£4.30	IRFH120	£3.00	MJE350	£0.80	STK4502-090	£7.00	STK7216	£4.20	STR58041	£2.50	TDA3563A	£4.00	TDA5830-2	£11.00	TDA8362N7	£11.50
BUH1215	£4.50	IRFH240	£1.00	MJE350	£0.80	STK4502-100	£9.00	STK7217	£2.50	STR59041	£3.00	TDA3564	£3.25	TDA6100Q	£1.20	TDA8372A	£16.50
BUH515	£2.00	IRFBC40G	£2.00	MJE350	£0.80	STK4502-120	£9.00	STK7225	£5.00	STR60001	£5.25	TDA3566	£2.80	TDA6103Q	£2.25	TDA8374	£10.00
BUH515D	£2.50	IRFP054	£4.00	MJE350	£0.80	STK4502-120	£9.00	STK7233	£17.00	STR60011	£5.75	TDA3566A	£3.20	TDA6106Q	£1.25	TDA8375A	£12.50
BUH517	£2.75	IRFP064	£5.00	MJE350	£0.80	STK4502-120	£9.00	STK7253	£6.50	STR60021	£2.70	TDA3567	£3.50	TDA6107Q	£3.00	TDA8376	£15.00
BUH517D	£1.75	IRFP140	£2.50	MJE350	£0.80	STK4502-120	£9.00	STK7251	£5.00	STR7001	£6.00	TDA3567A	£3.00	TDA6108JF	£2.25	TDA8380	£2.00
BUH715	£4.25	IRFP150	£2.40	MJE350	£0.80	STK4502-120	£9.00	STK7253	£6.50	STR80145	£4.75	TDA3569	£3.75	TDA6111Q	£3.00	TDA8424	£4.00
BUL10	£1.25	IRFP240	£3.00	MJE350	£0.80	STK4502-120	£9.00	STK7300-060	£6.50	STR81145	£3.75	TDA3570	£3.75	TDA6112Q	£5.50	TDA8425	£5.00
BUL31	£1.50	IRFP250	£2.80	MJE350	£0.80	STK4502-120	£9.00	STK7300-080	£6.00	STR81159	£4.00	TDA3572	£3.75	TDA6120S	£5.00	TDA8432	£5.50
BUL38	£1.25	IRFP340	£2.50	MJE350	£0.80	STK4502-120	£9.00	STK7309	£7.00	STR8124	£1.00	TDA3575	£3.75	TDA6160-2X	£2.50	TDA8433	£6.00
BUL38D	£1.25	IRFP350	£3.25	MJE350	£0.80	STK4502-120	£9.00	STK7309	£7.00	STR8145	£5.00	TDA3576	£3.50	TDA7052	£1.20	TDA8440	£3.00
BUT11A	£0.35	IRFP360	£9.00	MJE350	£0.80	STK4502-120	£9.00	STK7309	£7.00	STR8159	£7.00	TDA3577	£3.75	TDA7056	£3.25	TDA8443	£3.50
BUT11AF	£0.35	IRFP450	£8.00	MJE350	£0.80	STK4502-120	£9.00	STK7310	£3.20	STR8159	£7.00	TDA3578	£3.75	TDA7262	£3.00	TDA8451	£3.25
BUT11AX	£0.80	IRFP460	£4.00	MJE350	£0.80	STK4502-120	£9.00	STK7310 II	£3.20	TDA1420	£8.00	TDA3579	£3.75	TDA7263	£3.50	TDA8453	£3.50
BUT12	£0.80	IRFP480	£4.00	MJE350	£0												

# Grandata Ltd

distributor of electronic components

## Line Output Transformers

Part No	Code	Price	Part No	Code	Price	Part No	Code	Price	Part No	Code	Price			
<b>ALBA</b>			<b>HITACHI...continued</b>			<b>PANASONIC...continued</b>			<b>PHILIPS...continued</b>			<b>THOMSON...continued</b>		
3714002	LOT02	£12.00	2433453	LOT82	£12.50	TLF 14568 F	LOT40	£15.00	AT 2079 / 21	LOT395	£12.00	10588080.P2	LOT1505	£19.00
043714002J	LOT02	£12.00	2433751	LOT01	£13.00	TLF 14584 F	LOT41	£17.00	AT 2079 / 24	LOT392	£15.00	151128140	LOT1505	£19.00
43700000	LOT02	£12.00	2433752	LOT01	£13.00	TLF 14586 F	LOT42	£17.00	AT 2079 / 40	LOT73	£11.50	1512814	LOT1505	£19.00
<b>AMSTRAD</b>			2433891	LOT23	£12.50				AT 2079 / 99	LOT276	£14.00	15128140	LOT1505	£19.00
1810951	LOT55	£14.00	2433892	LOT84	£14.50				AT 2079/30 01	LOT106	£12.50	153144.6	LOT1505	£19.00
3714002	LOT02	£12.00	2433893	LOT23	£12.50				AT 2079/30102	LOT106	£12.50	1531447 A	LOT1505	£19.00
043714002J	LOT02	£12.00	2433952	LOT33	£10.00				<b>SATSHO</b>			1532873 A	LOT1505	£19.00
43700000	LOT02	£12.00	2434002	LOT226	£14.50				3714002	LOT02	£12.00	3233500	LOT244	£14.50
AM152591	LOT55	£14.00	2434141	LOT33	£10.00				043714002J	LOT02	£12.00	3233900	LOT244	£14.50
<b>FERGUSON</b>			2434274	LOT44	£10.50				43700000	LOT02	£12.00	40011200	LOT244	£14.50
00 D-3-508-002	LOT381	£15.50	2434393	LOT405	£22.50				7140021	LOT02	£12.00	40148300	LOT244	£14.50
06 D-3-083-001	LOT82	£12.50	2434593	LOT44	£10.50				<b>SHARP</b>			<b>TOSHIBA</b>		
06 D-3-083-002	LOT82	£12.50	2435006	LOT401	£17.00				RTRNF 1220 CEZZLOT39	£18.50	1810951	LOT55	£14.00	
06 D-3-084-001	LOT23	£12.50	2435131	LOT251	£14.50				RTRNF 2001 CEZZLOT338	£17.50	2433751	LOT01	£13.00	
06 D-3-087-001	LOT23	£12.00	2436201	LOT90	£12.50				RTRNF 2006 CEZZLOT308	£13.50	23236098	LOT288	£14.00	
06 D-3-088-001	LOT84	£14.50	23236465	LOT392	£15.00				RTRNF 2023 CEZZLOT310	£15.00	23236198	LOT288	£14.00	
06 D-3-093-001	LOT204	£16.00	2433891H	LOT23	£12.50				<b>SONY</b>			23236201	LOT395	£15.00
06 D-3-508-003	LOT276	£14.00	45150504	LOT362	£16.00				1-439-286-00	LOT46	£13.00	23236245	LOT395	£12.00
06 D-3-512-001	LOT204	£16.00	<b>MATSUI</b>						1-439-286-11	LOT46	£13.00	23236255	LOT289	£15.00
29201-022-01	LOT63	£17.00	20070	LOT438	£16.00				1-439-286-12	LOT46	£13.00	23236427	LOT395	£12.00
473197	LOT304	£15.50	20071	LOT438	£16.00				1-439-286-13	LOT46	£13.00	23236428	LOT289	£15.00
D 059 / 37	LOT200	£14.00	20072	LOT438	£16.00				1-439-286-21	LOT46	£13.00	23236424	LOT129	£14.00
<b>GOODMANS</b>			20073	LOT438	£16.00				1-439-332-41	LOT100	£15.00	TFB 4090 AD	LOT395	£12.00
1142.5057	LOT1164	£15.00	20074	LOT438	£16.00				1-439-332-42	LOT101	£14.50	TFB 4124 AE	LOT392	£15.00
1142.5079	LOT1164	£15.00	20075	LOT438	£16.00				1-439-332-52	LOT100	£15.00	TFB 4124 AP	LOT392	£15.00
1142.5081	LOT1164	£15.00	3714002	LOT02	£12.00				1-439-363-11	LOT268	£14.00	<b>We are stockist of both</b>		
1152.5016	LOT1934	£19.00	3221008	LOT438	£16.00				1-439-363-21	LOT268	£14.00	<b>Konig</b>		
1179.0387	LOT1147	£16.00	043714002J	LOT02	£12.00				1-439-387-11	LOT311	£14.50	<b>and</b>		
1192.0527	LOT1147	£16.00	043221088P	LOT438	£16.00				1-439-387-21	LOT311	£14.50	<b>HR Diemen</b>		
1352.5008	LOT1167	£15.00	43700000	LOT02	£12.00				1-439-416-11	LOT255	£16.00	<b>LOPT's</b>		
1352.5008E	LOT1167	£16.00	7140021	LOT02	£12.00				1-439-416-12	LOT255	£16.00	<b>This is just a selection</b>		
1352.5016	LOR1934	£19.00	<b>mitsubishi</b>						1-439-416-21	LOT255	£16.00	<b>of the LOPT's that we</b>		
1352.5027	LOT1270	£16.00	731003	LOT51	£15.50				1-439-416-23	LOT255	£16.00	<b>stock....Please call on</b>		
1352.5033	LOT1270	£16.00	334 P 18506	LOT51	£15.50				1-439-416-41	LOT255	£16.00	<b>020 8900 2329 for copy</b>		
<b>HINARI</b>			<b>OREGA</b>						1-439-416-51	LOT255	£16.00	<b>of our LOPT catalogue</b>		
3714002	LOT02	£12.00	40153201	LOT349	£17.50				<b>THOMSON</b>					
043714002J	LOT02	£12.00	<b>ORION</b>						105009.8	LOT1505	£19.00			
43700000	LOT02	£12.00	3714002	LOT02	£12.00				10500980	LOT1505	£19.00			
CF 124 B	LOT67	£14.50	043714002J	LOT02	£12.00				10500980.P1	LOT1505	£19.00			
CF 124 E	LOT67	£14.50	43700000	LOT02	£12.00				10531460	LOT1505	£19.00			
<b>HITACHI</b>			<b>PANASONIC</b>						105660.6	LOT1505	£19.00			
2424593	LOT44	£10.50	TLF 14512 F	LOT39	£18.50				105660060	LOT1505	£19.00			
2432461	LOT169	£15.00	TLF 14520 F	LOT40	£15.00				105660600	LOT1505	£19.00			
2432761	LOT169	£15.00	TLF 14521 F	LOT39	£18.50				10566060.P2	LOT1505	£19.00			
			TLF 14567 F	LOT39	£18.50				105880.8	LOT1505	£19.00			
									10588080	LOT1505	£19.00			

We are stockist of both  
**Konig**  
 and  
**HR Diemen**  
 LOPT's  
 This is just a selection  
 of the LOPT's that we  
 stock....Please call on  
 020 8900 2329 for copy  
 of our LOPT catalogue

## CD Pick Ups and Mechanisms

Part No	Price	Part No	Price	Part No	Price
CDM12.1 Mechanism	£14.00	KSS 213 B	£8.75	OPTIMA 6 S	£11.50
KHM220AAA		KSS 213 C	£9.50	OPTIMA 5	£11.50
DVD Laser	£ 40.00	KSS 213 D	£16.00	RCTRTH8151	£20.00
KSS 210A Original	£11.00	KSS 213 F	£12.00	RCTRTH8112	£14.00
KSS 210A Replacement	£9.50	KSS 240 A	£30.00	RCTRTH8147 Mech	£ 10.00
KSS 210 B	£15.00	NKS 240 A			
		Replacement for KSS240A	£20.00		

Check out our Online Catalogue at  
[www.grandata.co.uk](http://www.grandata.co.uk)

This advertisement is just a selection of our stock.  
 Please contact us if you cannot find the part you are looking for.

\* Please add £1 p+p and VAT to all orders (Unless Otherwise stated) \* All components are brand new  
 \* We accept payment by Access , Switch , Visa , Cheque and Postal Order  
 \* All prices quoted are subject to availability and may be changed without prior notice

E & OE

K.P. House , Unit 15 , Pop In Commercial Centre , Southway , Wembley , Middlesex . HA9 0HB England

Tel : (020) 8900 2329  
 Fax : (020) 8903 6126

Email : sales@grandata.co.uk  
 Website : www.grandata.co.uk



# College of NW London serves business



The College of NW London has been expanding the range courses and services on digital technology it offers to firms of all types and sizes.



The Digital Village, launched two years ago at the College of North West London, is extending its range of services to provide short courses for small- and medium-sized businesses. So far over 700 businesses in West London have benefited from the two-year project, which has provided free advice and support, including seminars and workshops, on all aspects of digital technology. The college now has three Centres of Vocational Excellence (CoVE), all in the Faculty of Technology. This is an unprecedented achievement, reflecting the status of the college as a centre of technology in the UK. Digital Village activities are being expanded to include free analysis of training needs for businesses and an extensive range of low-cost, short courses designed to provide essential skills in a variety of digital fields.

The Digital Village is managed by senior lecturer Fawzi Ibrahim, who is the author of several books on electronics, television and

computers. He comments: "We have found that businesses require more than just advice. They need the know-how to enable them to make full use of the new digital technology. It isn't so much qualifications that are needed, rather knowledge of the basic and essential skills that enable full use to be made of digital technology. We have state-of-the-art facilities and equipment that we are keen to make available to engineers and businesses to exploit."

The Digital Village now offers a vast range of short courses in digital technology. The aim is to provide businesses with short, compact courses of one, two or three days' duration, covering the essential skills in a particular field – skills that can then be immediately employed in the job. All participants get a Digital Village certificate. If they wish to gain a City and Guilds

qualification or sit a trade examination they can do so through the college's extensive list of courses.

The courses on offer range from digital audio and video broadcasting and reception to computer repair and Windows 2000 network administration and infrastructure. One course covers aerial installation for digital TV and audio transmissions. As the analogue switch-off approaches, aerial installers will be as much in demand as plumbers are today. Furthermore many people will want video distribution of some

sort in their homes, in order to make full use of second and third TV sets. For this reason a one-day course on IF distribution is available. Another course that should be of interest to network, aerial and electrical installers

covers network cabling using both copper and fibre optics. On the IT side, courses include network administration (three days), e-commerce (three days), wireless networks (one day), broadband (one day), PC configuration and troubleshooting (three days) and network routing (CISCO) systems.

All courses involve a unique combination of theory and hands-on practical tasks carried out with industry-standard equipment.

The college offers flexibility in terms of dates, place and course contents to suit the requirements of businesses.

For full details of dates, duration and fees, phone 020 8830 3483 or email:

FI@DigitalVillage@cnwl.ac.uk  
www.DigitalVillage.cnwl.ac.uk

# A day in the life of...



*The premises of Dolman Electronics, converted from a milking parlour*

## **Peter Dolman reflects on a day in the workshop and the huge efforts required to set it up in an old farm outbuilding**

I never did like Mondays much. Don't misunderstand me, I love this job. Honestly! It's just that as I get older I seem to enjoy other things too, like dawdling over breakfast and gazing at the birds in the garden. But on days such as this one, when I might be guilty of arriving at the workshop a couple of minutes late, you can bet I will be caught out by an early bird of the human type.

### **A Kenwood CD player**

In this case it was the demure Miss Crisp, who was waiting with her brother Everard. She batted her eyelids and spoke to him in a minus 90dB whisper, while edging a Kenwood DP7030 CD player into my arms. "It's that CD" Everard bellowed on her behalf. "he's gone crackerdisc or summat. Phone 'er when 'er's done." Then they were gone.

Once peace had returned I decided that, as fortune favours the brave, I might just take a look at it. When I removed the cover I found an audiophile product of superb build quality. I inserted a disc, which immediately spun anticlockwise at great speed. After watching and wondering, I decided that a check on the balanced supply rails would be a logical starting point. So, in the absence of a service manual, I began to check the DC conditions at the many regulator transistors present. There are two large PCBs, one at each side

of the mechanism. As I probed the one on the right-hand side the problem disappeared, never to return!

Undaunted, I removed the PCB and studied its underside. Link W27, near the front end of a long copper bus bar, appeared to be dry-jointed. So, to prove the point, I unsoldered it and powered the unit. To my immense pleasure the symptom had reappeared, and could be made to come and go by unmaking and making the link.

I finished off the repair by cleaning the pick-up lens, and put on a nostalgia test CD. As comforting sounds emanated from the workshop audio system, I took in my surroundings and recalled a time, several years ago, when things weren't looking anything like as rosy for us...

### **Flashback**

My heart sank as I walked through the building that was to become our new workshop. It wasn't quite as I remembered it nine months previously when, filled with naive enthusiasm, I had first visualised it as a state of the art service department with my name outside.

I had for some years been trying to find a new home with potentially useful outbuildings. Then, in the early spring of 1990, this little farm came on the market. It was situated within a few miles of the workshop I rented at the time, which meant that I would be able to preserve links with my established customer base. Once we had seen the place we had fallen for it and had felt as if it was, somehow, our destiny to live and work there. Maybe, if we sold everything we possessed and mortgaged ourselves to the hilt, we might be able to buy it.

Now, still reeling from the combined effects of juggling bridging loans, solicitors,

banks and estate agents, with the need to continue running a business from the current workshop, I found myself standing in a cheerless milking parlour, taking in the reality of its uneven flooring, frameless doorways and unglazed windows, which complemented the scene by introducing an icy chill. The rubber-clad mains wiring looped across the woodworm-infested roof timbers was damper than I recalled during my swift springtime evaluation.

To have the building renovated professionally was out of the question. The well-meant guesstimates provided by enthusiastic friends and customers in pre-ownership days turned out to be hopelessly optimistic. While I grimly contemplated the unplanned expense of retaining my old workshop and the impossibility of the new situation, my thoughts turned to taking counsel with Señor Mick, who worked 'on the building' as they say...

### **Back to the present**

The sound of a car door slamming jerked me back to the present. A large gent in a chalky-looking boiler suit was making a grand entrance complete with an incredibly dusty Toshiba 2505DB. On setting it down he stared intently at Dear Heart then down at himself.

"Look at the state of me" he exclaimed, giving the set a sideways glance. He proceeded to slap himself vigorously, until the plaster dust that had come from his hallway covered the contents of the workshop and its occupants. Then he turned his attention to the fault. "Dunno what it is" he explained, shaking his head sadly. "He's got a short picture on BBC but he's all liney on the ITV, like. I dunno what it is..."

As he continued his detailed appraisal, I

found my mind once more beginning to drift back to the memory of times past, to my workshop renovation problems and the man we got to know as Señor Mick...

### Señor Mick

After much tea drinking and tooth sucking Señor Mick had made his proposal. "You'll just have to do it yourself" he concluded with a grin. Despite my protestations that I wouldn't be handy with anything heavier than a soldering iron, he devised a plan of action for us. Each weekend he would visit us and issue instructions for the coming week's activities. We had to obey them to the letter.

Each weekday I would have to work on AV repairs, then in the evening toil on the conversion of my ice chamber until exhaustion took over. Come the following weekend Señor Mick would reappear, appraise my efforts and issue fresh commands.

Eventually, if I stuck at it, all would be ready for a weekend transfer of the stock and repairs between the workshops. Inspired by the prospect, I set up accounts with builders' merchants, who perplexed me by querying everything that Señor Mick had specified, and electrical suppliers who didn't.

I hired a pneumatic drill, and invested in heaps of gravel whenever directed, even buying a handsome cement mixer to coerce him to sort out the damp, uneven floors. He in turn produced metal-clad security doors which I fitted upside down. After observing my feeble attempts at puttying, he suggested employing a glazier to make the place bearable to work in. Best of all, I somehow managed to persuade my wonderful brother-in-law Richard and his son Robert to sacrifice six months' worth of weekend leisure and instead spend them on the delights of endless timber sawing, worm-proofing, plasterboarding and painting, rewarding them with nothing more than tea and Chinese takeaways.

Gradually the place had taken shape. As summer approached, it neared completion. Fully rewired, the benches built, night-storage heating installed, doors fitted correctly, secure and lockable. The great moving weekend arrived...

### The Toe-sheba problem

I started as Dear Heart sweetly brought me back to reality – by digging me savagely in the ribs. Her way of reminding me of our precious productivity, which was going out of the window while I was taking my trip down memory lane.

The man in the boiler suit was still in full swing. "So when can I pick up the Toe-sheba then? It can't be much. Nothing in 'em nowadays, and my missus says she saw down at Tesco..."

Glancing at the clock, I decided to bring his spiel to a close by promising to attend to the repair the moment he left.

Seconds later I was vacuuming out his set, then took a look at the conditions



A corner of the workshop

inside. These sets commonly suffer from field scan problems. This one was no exception. Full scanning was restored by replacing C372 (2.2 $\mu$ F) and C317 (1 $\mu$ F). But further tests revealed the presence of field foldover when the set was first switched on, provided the received transmission at the time was in 4:3 format. If a letterbox programme happened to be selected, there was no sign of the foldover! The culprit was C313 (220 $\mu$ F) in the flyback boost circuit.

### An Aiwa audio centre

The next job that required attention was an Aiwa MX3300M 3-disc CD player and twin cassette plus receiver, housed in twin enclosures. None of the front buttons functioned, and there was no display. Fortunately I'd come across this before. In many Aiwa models a voltage-doubling arrangement is used to provide a -32V supply to bias the filament of the fluorescent display. It employs two electrolytic capacitors that tend to dry up, extinguishing the display. In this particular model the supply also feeds pin 71, which is marked VFDP, of the display control IC. Without this supply the front buttons also become inoperative!

Having sorted that out I passed the equipment to technician Dear Heart for a CD changer mechanism clean and general TLC overhaul. Brewing us a nice cuppa, I continued to reflect on the days that saw the last lap of our workshop relocation.

### The relocation

You might think that it would be quite a challenge to clear and transfer the contents of a workshop when you've been in it for over ten years. In fact I hadn't really

thought about that side of the relocation. Surely it would be easy compared with what we had already achieved? But, in addition to over a hundred repairs, there were stock sets, test gear, benches and so on to shift. Although we kept on removing vanloads of the stuff our old workshop, seemingly miffed at no longer being at the centre of our working lives, stubbornly refused to look any emptier – until two full days of effort on our part had drawn to an end.

We finally took down the aerial array and set off with it sticking up out of the sun roof of the company Cavalier Estate, young Robert in the passenger seat being in sole charge of gripping and twirling it. This was much to the amusement of the whole village, who had turned up for the annual fete and thought we were part of the entertainment!

So far as our customers were concerned we had simply closed one workshop on a Friday and opened a new one on the following Monday. Even our telephone number hadn't changed, so it must have appeared quite seamless.

The new workshop took some getting used to, and is still being improved and upgraded. Like all of us trying to make a living in this trade, Dear Heart and myself have seen the products we work on evolve while their owners' attitudes have also changed. One policy that has helped has been to set up a professional relationship with various manufacturers as their authorised service centre.

In conclusion we would like to thank *Television* for being such a mainstay for this trade, and hope to be able to invite you to join us for more days in the life of our workshop. ●



# DX and Satellite Reception

**Terrestrial DX and satellite TV reception reports. Broadcast, satellite and digital TV news. Could Bluetooth be an interference problem? The early days of ITV. Roger Bunney reports**



**Test card from a local UHF station received by Hugh Cocks in the Algarve.**

December 2003 was a poor month for DX reception. The only reports of mid-winter Sporadic E activity were of reception from TVE (Spain) on the 11th – Madrid ch. E2. Izana (Canary Is) ch. E3 and an unidentified ch. E4 station. There was a tropospheric lift on the 4/5th, reported by Cyril Willis (King's Lynn), with Band III reception from ARD (Germany) in chs. E6, 7, 9 and 11, RTL (Luxembourg) ch. E7 and Canal Plus (France) in chs. L5, 6 and 9. TE (transequatorial skip) reception has now fizzled out in the Algarve, where Hugh Cocks reports that many new UHF transmitters are opening in Morocco, particularly for the RTM-2 network.

It's time to review briefly the year that has just drawn to an end. Noteworthy were the excellent SpE activity during the summer, and the incredible record that was established with Band II FM reception in Ireland and Northern England from stations along the US Eastern seaboard. The distances involved suggest either extreme double-hop or even triple-hop SpE. There were also many instances of Band I reception from the Middle East in the UK. After a relatively good year, let's keep our fingers crossed for an even better 2004.

There's still a question over the closure of the Spanish VHF TV network. A listing (see news section) suggests that this occurred at the end of October, but Hugh Cocks in Portugal reports that Madrid ch. E2 and Izana ch. E3 were still on air just prior to Christmas. RTP (Portugal) also continued to transmit in ch. E3.

## Satellite sightings

On Christmas Eve the CNN Newsource feed via NSS-7 (21.5°W) at 11.563GHz H (SR 6.117, FEC 3/4) carried for some hours a 'locked-off' camera shot of downtown Los Angeles, courtesy of KTLA-TV. The significance of this is not known: possibly either a follow-on from the Californian earthquake a few days previously or the prevented terrorist hijacking of an Air France plane bound for LA. There was happier news from Iraq earlier, during the afternoon of Christmas Eve, when talk-show host David Letterman appeared at a GI base in Baghdad. At the end of the news item (NTSC) the reporter gave several dozen outwards, each with a different TV station or network: these end voiceovers would then be edited on to the main item for the relevant TV station. This was via Eutelsat W2 (16°E) at 12.540GHz H (5.632, 3/4), with an unusual service identification – 523209.

Christmas Day produced many of the traditional OB offerings, including the Pope at the Vatican and many regional services. For example ZDF DSNG-2 ZU uplinked a morning carol concert via Eutelsat W1 (10°E) at 11.063GHz V (6.109, 3/4). The Tellytrack, a South African horse-racing service via Europe\*Star-1 (45°E), has moved slightly to 11.497GHz V (3.253, 7/8): on Christmas afternoon it was running videotaped documentaries on racing folk and promoting holiday race meetings, including many UK ones on Boxing Day. When I checked on Boxing Day I found that Tellytrack featured a single South African race meeting plus live UK meets at Wincanton, Wetherby and Wolverhampton. I recall working on Boxing Day OBs at Wincanton years ago, and still shudder at the many weather variations in just a few hours on that bleak hillside!

But bad news was seldom far away during 2003. On Christmas Day the US military HQ in Iraq was hit by missiles: CBS ran two NTSC uplinks from Baghdad via Eutelsat W2 to provide latest news for those back home. CBS is based at the Rimal Hotel in central Baghdad, the outward uplinks being at 12.548 and 12.566GHz H (5.632, 3/4). The first hop is to London, then New York: the incoming reverse programme sound (IFB) from NY also passes via London, as became evident when the Baghdad crew tried to speak to NY.

On the late afternoon of Christmas Day a suicide bomber struck in Tel Aviv, bringing fresh carnage. UP4 (APTN) fed initial live pictures via Eutelsat W1 at 10.973GHz V (4.167, 5/6), with a second feed via W2 at 12.533GHz H (5.632, 3/4). The pictures via both satellites were sourced from RR Satellite, an Israeli-

based satellite-linking facility. The bomber had blown himself up at a bus stop, killing three Israelis. The aftermath pictures were graphic and tragic. Hardly the season of peace and goodwill to all men.

While checking W1 on the afternoon of December 20 I found fuzzy black-and-white pictures from a helicopter/aircraft tracking an Arab dhow. Figures could be seen throwing sacks into the sea: those aboard were aware of impending arrest and shortly afterwards armed marines boarded the dhow and took over. It subsequently transpired that the boat had been involved in drug running in the North Arabian Gulf and carried a large quantity of heroin. Sections of this footage were later shown by Sky News. The original feed from the Gulf via a news provider, possibly APTN, was at 10.967GHz V (4,167, 5/6).

Earlier that day the same frequency had carried an unusual two-channel multiplex, VIA 1 and VIA 2, which consisted of Spanish-language reports transmitted simultaneously from a military location, possibly in Baghdad, with the reporters only feet from each other. I've no idea of the source or destination. The only clue (?) I obtained was a 'NET 1' ident in the RSD receiver's 'information' analysis menu.

In mid-December the Old Bailey jury brought in its guilty verdict after the long Sohan murder trial. Not unexpectedly there was considerable media interest. Sky News fed reports from the pavement outside the court via Eutelsat W2 at 12.525GHz H (5,632, 3/4). Anglia TV used the TES-42 satellite truck to provide a live insert from its reporter, based outside Sohan Church, for the evening news magazine programme at 1800 hours. At the house, still fenced and boarded up, where the murder had occurred another TV crew operated a Jimmy-jib to give the camera a view. Throughout the original searches, then the arrests, the same Anglia reporter had been on site. TES-42 downlinks via Telecom 2D (8°W) at 12.601GHz H (5,632, 3/4).

Edmund Spencer bade farewell to the TV7 Tunisia analogue downlink via Eutelsat W2 at 11.596GHz V. He reports that a new Albanian TV multiplex has appeared via this satellite, at 11.449GHz H (14,000, 3/4). In early December the multiplex was FTA but subsequently adopted Irdeto encryption for all but a promotional channel. Interesting that on December 8 the latter carried Premiership football (Leeds v. Chelsea) with an Albanian-language commentary.

Finally Alan Richards (Nottingham) noted that on December 14 the Clarke Belt was full of Saddam capture reports. Broadcasters from 1°W to 16°E carried the news. Clear MPEG-2 returned to Eutelsat W3 (7°E), with EBU Baghdad on two paths plus Poland POL 25 IRAK. There were at least five reports via W1 at one time with a further three via W2.

### Broadcast news

**Spain:** Information received from the Benelux BDXC suggests that the Spanish (TVE) VHF transmitters were due to close down on October 31, with Navacerrada (Madrid) ch. E2 moving to ch. E26, Aitana (Alicante) ch. E3 moving to ch. E63, Izana (Canary Is) ch. E3 moving to ch. E42, Santiago (Coruna) ch. E4 moving to ch. E53, Guadalcanal (Seville) ch. E4 moving to ch. E43 and Sollube (Bilbao) ch. E4 moving to ch. E26. But Hugh Cocks (Algrave) says that Madrid ch. E2 and Izana ch. E3 at any rate were still on air on December 23.

**UK:** The Isle of Wight RSL station Solent TV (ch. 54 H) has installed a new transmitter at Rowridge and now uses the full allocated 2kW ERP. There has been a noticeable improvement in the received picture quality – here at Romsey, Hants it is noise-free. The previous franchisee TV 12 apparently used a lower ERP. A year into the new franchise and Solent TV has made remarkable progress, with local programming and internet content. Check at the Solent TV website. The station is run on a non-profit, community-orientated basis, unlike most other RSLs.

Southampton TV on chs. 29 and 55 is getting increased adver-

tising support but has suggested in the local press that it would consider offers for its Portsmouth and Southampton stations.

**Iraq:** The Iraqi Media Network, which provides TV and radio services, is to be rebuilt. Contracts are currently on offer. The services have proved to be unpopular with Iraqis.

**Canada:** CTV is now producing CTV-East, an HDTV channel for cable distribution nationally. CTV-East programming is also transmitted by CFTO-TV (Toronto), with either true HD content or material upconverted to a compatible HD format.

**Zimbabwe:** On December 1 ZBC started a new national channel, National TV (NTV), transmitting from Bulawayo in various local ethnic languages. The main national channel ZBC-1 transmits from the Harare studio with mainly English-language programming.

### Digital TV news

French DTT transmissions are expected to start by the end of March next year with a minimum of fifteen national and regional FTA channels plus fifteen pay-TV channels. S. Korea has still not decided whether to adopt the DVB or ATSC DTT standard. The Maltese government is keen to adopt DTT and is waiting for the telecom authority to confirm suitable frequencies.

About 25 DTT licences have been issued to local stations in eastern and central Japan – the official start of DTT was on December 1. National broadcasters NHK and Fuji are transmitting DTT but take-up is slow and coverage across Japan is expected to take some years to complete. The government hopes to end analogue transmissions by 2011. A 600m broadcasting

## DXer's SPECIAL 14" TV



~~£299.00~~  
**SPECIAL OFFER**  
**NOW ONLY**  
~~£249.00~~

Overnight delivery by insured courier £12.00

- Direct channel entry/readout
- Direct frequency entry
- 40-860MHz
- Multistandard
- Low noise tuner
- 12v DC and mains operation
- Remote control
- Scart connection
- Auto scanning of RF channels
- Auto scanning of frequencies 40-860MHz
- Cable tuner
- Video squelch (removed in tuning mode)
- Six teletexts
- Covers systems BG/LL/DKK PAL and SECAM, NTSC via the scart

## FREE BBC VIEWING IN EUROPE

Perfect reception only with  
the latest THOMSON digi box  
12 volt SKY MINIBOX Now Available

- The correct digi box + the correct dish + the correct LNB = perfect reception anywhere
- Watch the BBC wherever you like, in Europe etc
- Digital satellite systems from only £399.00
- All dish systems are supplied with LNB, cable and plugs
- You can receive FREE viewing of BBC1,2,3,4 children's BBC, BBC24 hour news and all the BBC radio stations plus many more
- ITV1 Channels 4 and 5 available for a one off payment arranged by ourselves
- Increase your dish size with our new enhanced imported LNBs



**Tripods £49.95**

**Digital system with  
88cm dish — £438.95  
with 1.1m dish — £478.95**  
ALL PRICES INC VAT

Overnight delivery in the UK for all items by insured courier £12.00

FULLY COMPREHENSIVE 35 PAGE CATALOGUE AVAILABLE BY RETURN OF POST FOR £1.50

**AERIAL TECHNIQUES LTD** Tel: 01202-423555 Fax: 01202-425055  
59 Watcombe Road, Southbourne, Bournemouth, Dorset BH6 3LX, UK  
E-mail: atech@dircon.co.uk www.aerial-techniques.com  
Est 1979 Callers by Appointment please



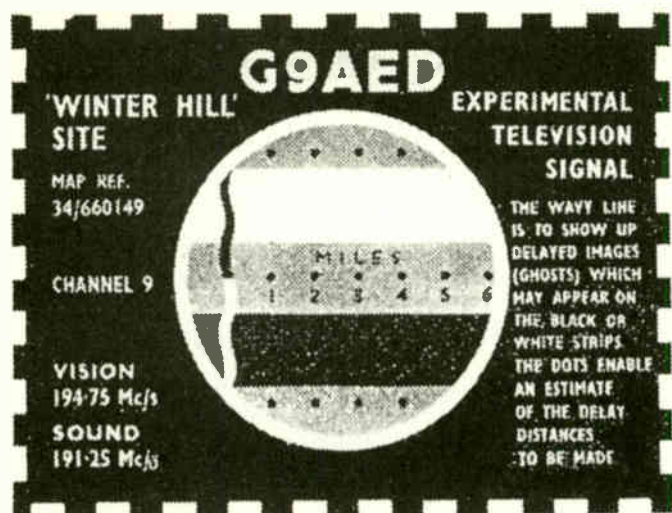

The Belling Lee G9AED experimental test card transmitted at Winter Hill in early 1956.

tower is to be constructed in Tokyo, carrying six TV networks plus radio services.

Taiwan hopes to start DTT transmissions prior to 2008, because mainland China aims to start DTT transmissions in time for the 2008 Olympic Games. The Taiwan government has decreed that cable systems must be fully digital by 2006. Cable networks are concerned about the cost of set-top boxes and the fact that the government has still not decided whether to use the DVB or the ATSC standard.

### Satellite news

Eutelsat 2F3 (21.5°E) has in recent months entered an extreme inclined orbit. Even ITN OB links are having problems maintaining signal lock back to the studio. Lyngsat has ceased listing OB/news feeds via this satellite at its website.

A multitude of satellite news channels are operational or planned for the Middle East. Saudi Arabia was due to open a news channel in February, carrying Arabic and international news. Saudi TV opened a sports channel last autumn.

The Al-Arabiya TV offices in Iraq have been searched by US forces and a transmission ban has been imposed. But an offshoot, Middle East News, continues to operate from premises in Dubai. The Middle East Broadcasting Centre offices in Dubai have also been searched.

CBC/Radio Canada is to start a satellite national radio service covering the whole country, financed by subscriptions. French- and English-language services will be transmitted. Inevitably the footprint will cover much of the US.

### Bluetooth

A reader asks whether Bluetooth could interfere with satellite reception. This seems unlikely: Bluetooth operates at 2.4-2.48GHz with low powers. It's a short-range radio link for voice or data communication, operating at 1mW for up to 10m though a 'medium-range' option increases the range to 100m. I found a great deal of information on the system at the Ericsson website. The problem seems to be more with interference to Bluetooth: because of this it uses various techniques to provide high-level protection from interference and also data security. The system can be used on a master-slave basis to form 'piconets'. It is also possible for piconets to be linked in a network called a scatternet.

Bluetooth is a form of radio LAN (Local Area Network) whose main aim is to link equipment without the need for extensive cabling. Go to the Ericsson website for further information.

### The early days of ITV

*Television*, previously *Practical Television* (the change occurred between the September/October 1970 issues), has chronicled the advances in TV reception, receiver design and broadcasting since 1950. Last summer Bill Wright of Wright's Aerials got in touch

with me to ask if I had any old catalogues etc. relating to the early days of ITV, particularly Band III aerials and ITV converters, for inclusion in his website:

<http://www.wrights-aerials.tv/albertsatticgallery.htm>

It's well worth a look! Fortunately I have retained all my copies of the magazine back to 1959, and have obtained previous copies going back to 1955 at jumble sales and when readers have kindly offered them when moving etc. So Bill's Band III requirements were soon sorted out. But I continued to muse over 405 lines and times past!

ITA Croydon ch. 9 opened on September 22 1955, using a 200ft mast (a new 500ft mast was erected in 1962). It was followed by the Litchfield (Midlands) ch. 8 transmitter on February 17 1956. As the ITA network spread during the late Fifties, aerial manufacturer Belling Lee usually appeared at future transmitter sites with its temporary test transmitter G9AED, operating at 1kW peak white with a four folded-dipole aerial atop an 85ft lattice mast, to enable early trade test assessments to be carried out. G9AED certainly appeared at the Croydon, Lichfield, Winter Hill and Chillerton Down sites and possibly others. I'm not certain when the exercise ended.

The spread of the ITA network closely followed the earlier route of BBC TV. The January 1950 issue of *Practical Wireless/Television* described the London-Birmingham TV link to Sutton Coldfield (ch. 4). The Post Office contracted out the multi-hop circuit to GEC in May 1947, following six months of research. The north-bound FM TV links operated at 870 and 890Mc/s, with simultaneous south-bound feed capacity at 917 and 937Mc/s (Mc/s in those days!). From the Museum Telephone Exchange at Howland Street, London, the BBC hopped four times to reach the Newhill Street phone exchange in Birmingham. Compare this with the "new Southern Television link" described in the November 1958 issue of *Practical Television*, with just two 4GHz hops from Museum to Golden Pot (Alton) and a further hop to Chillerton Down, a total of 83 miles. This was followed by a 2GHz link to the Southampton PO (18 miles) and a coaxial feed down to the Plaza, Northam. All links worked two-way simultaneously.

In those days the pages of *Practical Television* were full of advertisements for Band III aerials and ITV converters, both fully built and DIY kits. Turret tuners were produced by Brayhead and Cyldon amongst others. Companies that have long gone included Spencer West and Fringevision. Others, who included Labgear which then produced preamplifiers and TV interference filters, are still with us today. These filters were necessary because many ITV converters simply provided an output on one of the Band I channels, so a filter was required to prevent breakthrough of the local BBC channel on to the new ITV programme.

In November 1958 there was an article in *Practical Television* on BBC widescreen TV tests, using an aspect ratio of 7:4 (very similar to the 16:9 45 years later).

Back in 1955 B.L. Morley wrote a TV DX series in *Practical Television*. Interesting transmitter listings included Paris operating with 441 and 819 lines, Eindhoven (Holland) ch. E1A with the video at 47.75Mc/s and the audio at 53.75Mc/s, and Lopik ch. E4. Karel Kiesel (Belgium) wrote in the January 1950 issue of *Practical Wireless* that Eindhoven is really perfect using an indoor half-wave dipole without a reflector! He was awaiting a government decision whether to adopt 405 or 625 lines. Things have changed in the DXing world!

Finally, has anyone any information on C Aerials of Croydon, whose Band III aerials resembled a fish skeleton, and Dale Aerials which made the Band III Dale Parabolic reflector aerial (eight reflectors on a curved boom with a single dipole at the focal point) – a later Mark 2 version used a corner-reflector? The Dale aerials were around in the early Sixties and were popular with aerial riggers in very hilly locations where signal scattering was experienced. An intact C aerial is still present at a house near St. Lukes, Guildford.

# Campion Electronics Ltd.

**SUPPLIERS OF QUALITY  
EX-RENTAL TV'S**

and video equipment to independent  
retailers across the UK and EIRE.

**FREE DELIVERY SERVICE**  
to most areas of UK

**WORLDWIDE EXPORT SERVICE**

Large stock of TVs suitable for export  
Experts in UHF/VHF conversion

Visit our large warehouse at:

Units 1 & 2 Tenat Works,  
Worcester Rd, Kidderminster,  
Worc, DY10 1JR

Tel: **(01562) 746000** (2 Lines)

Just 20 miles from Birmingham City Centre

**www.sdstrade.co.uk**

**sky Freeview** OR **sky FREEVIEW**

**SPECIALISTS IN ALL MAKES AND  
MODELS OF SATELLITE EQUIPMENT**

**ALL ORDERS WELCOME - LARGE OR SMALL**

**REPAIRS FROM ONLY £35 + VAT**

**SKY & SKY+ SPARES - MOST MAKES AND MODELS**

**sky+** **NEW MODEL SKY+  
INCLUDING DELIVERY AND  
INSTALLATION KIT - £199**

**HUNDREDS OF REFURBS AND NEW BOXES  
CALL FOR PRICES OR VISIT OUR WEB SITE**

**EXCLUSIVE  
TO SDS!**



**SILVER PACE 2200 DIGIBOXES  
CALL FOR TRADE PRICES**

**SDS**  
Satellite &  
Digital Services Ltd

1 HOWARD AVENUE  
BARNSTAPLE  
DEVON  
EX32 8QA  
TEL: 01271 325888  
FAX: 01271 329163

SPARES DIRECT



**WWWhy go any-  
where else for  
Panasonic  
spares?**



From phones to cameras, home cinema systems to DVD players, Panasonic brings ideas to life. If you service or repair any of our products, we can make your life easier too, thanks to the new Panasonic Spares Direct website.

Specially developed for smaller companies who only need parts or advice occasionally but still want genuine discounts on guaranteed spare parts, it's now open for business.

Register on the subscription-based site now and for just £24 for a year's access you'll find the most competitive prices, online technical information and repair manuals, special offers and immediate part number identification.

It's fast, it's easy, it's trouble-free and it's the only place you need to visit when you need to service or repair any Panasonic product.

So why call us for spares when you can now visit us 24 hours a day?

Visit [www.panasonic-spares-direct.co.uk](http://www.panasonic-spares-direct.co.uk) for more information.

**Panasonic**

Panasonic CS UK  
Willoughby Road, Bracknell, Berkshire, RG12 8FP

[www.panasonic-spares-direct.co.uk](http://www.panasonic-spares-direct.co.uk)



# AUDIO FAULTS

Reports from  
**Chris Bowers**  
**Dave Gough**  
**Mike Leach**  
**Geoff Darby**  
and  
**Philip Rosbottom**

We welcome fault reports from readers – payment for each fault is made after publication.

Reports can be sent by post to:

Television Magazine Fault Reports,  
Highbury Business Communications,  
Nexus House,  
Azalea Drive, Swanley, Kent BR8 8HU

or e-mailed to:  
t.winford@highburybiz.com

## Sony STR-DB840

This unit didn't power up. A look round inside showed that the power transformer's connector CNP805 on board DC (2) required attention – the unit came to life when it was moved. A quick clean up restored normal operation. **C.B.**

## Sony CDP101

This old-timer was a first-generation player, released in the early Eighties and at the time very expensive. It's powerful, with a brilliant transport system and Aston-Martin build quality, also remote control. The years take their toll however and things can go wrong, though not a lot. A common fault is failure of the drawer to open on command: the unit goes through the motions but that's all.

Remove the lid and observe the drawer slides/guides. On close inspection you will see a small silver lever at the right side rear of the drawer's right-side rail. It should move back to allow the drawer to release, and reverse to lock the drawer in when closed. To gain access to the lever for service you have to remove the player's bottom cover. The lever will seem to be almost seized. Remove the circlip, detach the pull-back spring and spray a small amount of release agent on the pole, then pull the lever off gently. Twenty years of use and heat will have hardened the grease to a cement-like substance. A good clean and regrease solves the problem.

All grease points in a machine of this age will probably need similar attention. But it's great to work on such class gear, and owners don't mind paying. **D.G.**

## Yamaha A09

This amplifier was brought in because it was dead. After removing the cover I found that fuse F1 (1.6A) was black. Meter checks then confirmed suspicions that bridge rectifier diodes D601/2 (1N5402) were short-circuit. Once replacements had been fitted and further checks had been carried out all was found to be well and the unit powered up and worked correctly. **D.G.**

## Sony CDP-CX235

The reported fault was failure to play CDs: the unit would load a disc but not play it. I found that a disc wouldn't spin because there was no focus or sled movement. So I tried one of my usual tests in this situation: I moved the laser manually to the outside of the disc and switched on again to see if the laser returned to the beginning. It didn't.

Heating board BD produced some results. Application of freezer stopped operation again. Inspection of the board revealed some very poor looking soldering to the CXD2587Q digital signal processor

chip. A reflow of the solder around this chip restored normal operation without need for IC replacement. The machine was returned to the customer after several days on soak test and never came back. **M.L.**

## Kenwood DPR28

The owner's complaint with this carousel-type five-CD player was that "when five discs are on the turntable they stop short of the position where they are picked up to be played". This seemed to be a very precise description and, as the owner is a police officer, one I was inclined to believe – though a part of me was sceptical. In fact the unit always played correctly with one or two disks loaded, but the carousel positioning became unreliable with three discs loaded. With four discs it became iffy, and with five downright erratic. As more weight went on the carousel the motor seemed to labour, which suggested that there might be a power-supply problem. The unit is part of a stacking system and is fed with low-voltage AC from the amplifier unit via the bus cable. It contains rectifiers, smoothing capacitors and regulators. I soon discovered that the problem corrected itself when the PCB was pressed in the vicinity of these devices.

To get the PCB out to examine its underside is no mean feat. The tray has to be removed from the changer assembly to gain access to two of its securing screws. Many connectors have to be unhitched, including more than enough of those dreadful stiff-wire 'snatch' types. Once the board had been removed I was able to home straight in on C501, where there was a whopping cracked-all-round dry-joint at the positive leg. While the board was out I decided to give it a good examination, using my headband magnifier. An alarming number of iffy joints were to be seen, many of which were fully cracked. A few years ago I would have spotted them at a hundred paces with the naked eye!

A blanket resolder, followed by refitting the board and tray, provided a complete cure. **G.D.**

## Sony HCD-H1600

This old-timer led me a merry dance. When it was powered a loud hum, unaffected by the setting of the volume control, came from the speakers. Scope checks in the power supply showed that there was huge ripple on the +12V rail and a lesser amount on the -12V rail. My ESR meter quickly proved that all was not well with C285 (4.700 $\mu$ F, 16V), the reservoir capacitor for the +12V supply. C286 (2.200 $\mu$ F, 25V), the reservoir capacitor for the -12V supply, read OK even though the scope had shown that there was considerable ripple at its negative terminal.



There was a sizzling sound when I applied my soldering iron to C285's joints, and my nose was assaulted by the immediately-recognisable smell of fuming electrolyte. When the capacitor had been removed I saw that it had indeed leaked. Several tracks pass under the capacitor, and there are through-plated holes nearby. The tracks had been stripped of their solder resist and looked very dull. There were no signs of distress in the vicinity of C286 when it had been removed, but I decided to fit a replacement before reassembling the unit.

I cleaned the leaked electrolyte from the tracks carefully, and spent some time with a strong light, magnifier and an Avometer set to the ohms range to see how much damage had been done. It was clear that the negative terminal of C285 and the positive terminal of C286 were no longer connected together or to chassis. I reinstated these connections using fine, insulated etch-revision wire. As there didn't seem to be any other problems I fitted new capacitors and, confidently, switched on. I was rewarded with a loud hum!

Out came the board again, then the two new capacitors. After a lot more Avo checks I found a through-plated hole that links an area of earth print on the top of the board to an area underneath. The reading between these two earth areas was about  $1k\Omega$ . Bridging the hole restored good bonding between the two earth

areas, so the new capacitors went back in and the board was refitted. Guess what? When I switched on I was greeted with a gentle hum, which this time was affected by the setting of the volume control. Further scope checks showed that there was now no excessive ripple on any of the supplies, so I began to look at what I had done during the course of the repair.

When I had restored the connection between the two capacitors and from there to chassis I had picked a point, which was conveniently marked 'Gnd', at one of the board's connectors to terminate my rework wire. This point had read perfectly to chassis, and had clearly restored a good earth connection to the capacitors, because the ripple across them had disappeared. In view of the fact that since fitting this wire I had found another problem, in the form of the bad through-plated hole that had now been bridged, I decided to disconnect my added wire and see if the capacitors still had good connections to chassis. They did! So I removed the wire completely, then switched on. This time there was silence!

A final check on all functions showed that the unit now worked correctly in every respect. **G.D.**

#### **Luxman L309**

There was no output from this 75W amplifier, another classic from the Seventies. Each power amplifier plugs into the main

board – great idea! I found that the driver and output transistors were all short-circuit. The driver transistors are TO66 types that are not available, so I replaced them with TO220 transistors obtained from RS. Cut down (to TO220) heatsinks were fitted to the transistors as without a heatsink they run hot. The output transistors were replaced using MJ15015/16 pairs. **P.R.**

#### **Technics RS630T**

This cassette deck was running the tape at high speed. It seemed that either the capstan motor's speed regulation had been lost or the take-up reel was pulling the tape too fast. I found that the spring had come off the pinch wheel. Refitting it cured the fault – after a struggle to keep the spring in position while slipping the wheel over the pivot! **P.R.**

#### **Sony TA-E77ES**

This high-end preamplifier's phono socket outer connections were being lost – they were working loose as a result of plugging/unplugging. The top row of the sockets can be held by soldering a length of braiding along the line of the spigots at the back of the sockets. As the unit also produced spurious howling/oscillations, the braid was continued to earth points on the chassis. The case of the volume control was also earthed. The chassis is made of polymer resin, which could account for these problems. **P.R.**

## Test Case 495

The Test Case workshop covers a large geographical area that includes coastal, urban and rural locations. There are many differences between them, not so much with respect to customers' equipment of course but the customers themselves, the signal-reception conditions – and the reliability of the mains supply! In country districts power is often supplied via overhead lines and, especially in winter, can be subject to cuts, brown-outs and surges. Something of the sort had occurred in the region of Northfield, because phone calls and duff equipment were coming in from that neck of the woods.

Amongst the sets there was a Sony TV Model KVX2928U (BE3B chassis). It was totally dead, with its mains fuse blown and the big STR-S6708 chopper chip IC600 short-circuit between pins 1 and 2. Real Technician ordered a replacement, also a new current-sampling resistor (R605,  $0.27\Omega$ ) as the one in the set looked somewhat stressed. When they arrived and were fitted the set showed some signs of life – the standby LED glowed for example – but there was another problem of some sort. When the set was brought out of standby there was a quick burst of energy, complete with the rustle of EHT, after which the set reverted to standby. How often have you cleared one fault only to be confronted with another one? What does it do for your estimate or quote and your morale?!

Real Technician connected his oscilloscope across the HT (135V) reservoir capacitor on the secondary side of the chopper circuit. When he switched the set on again he saw that the volt-

age rose to almost 140V in the split-second before it shut down. The over-voltage protection circuit must be coming into operation he decided. Now optocouplers, especially when they are used for voltage-regulation feedback in a power supply, can be unreliable devices. There is one here, IC600, and RT found that there was a new one in the stores. In it went but, naturally, it made no difference to the fault symptom! RT's beady eye next alighted on the regulation circuitry associated with IC601. He saw a three-legged device, IC602, that was labelled 'error amplifier'. Maybe it was one of those so-called variable zener diode thingys, which can also give trouble. There wasn't one in the stores, so an order went off to Sony pronto. The set then sat on the shelf for a couple of days before the device arrived and was fitted. How did you guess? It made no difference!

RT, becoming a little desperate, turned his attention to the primary side of the power supply. He found a transistor here, Q601, that was marked '7V regulator' on the circuit diagram but 'soft-start' in the service manual's block diagram. Maybe the telly wasn't starting softly enough? In went a replacement and, for good measure, the 6.8V zener diode (D603) in its base circuit was also replaced. In for a penny, in for a pound, thought RT as he fitted replacement electrolytic capacitors in the nearby positions C604 and C605. But the set continued to revert to standby immediately after switch-on. Had RT started off on the wrong foot? Was the fault in the power supply at all? For the solution, turn to page 315.

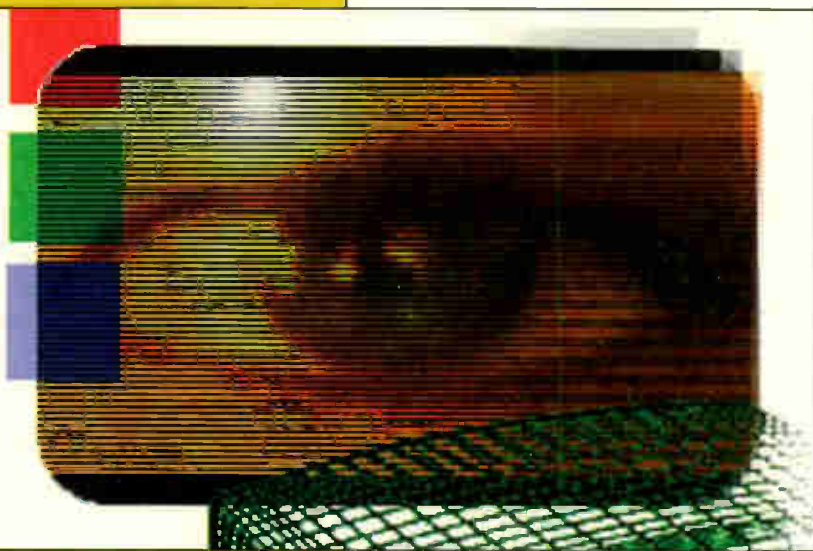

# Extended fault reports

Reports on complex or tricky TV fault conditions are sometimes too long for inclusion in our regular fault-finding section. We've put a few of them together in this extended fault report feature

Reports from  
Mike Leach and  
Denis Foley

## Sony KV32LS35U (FE2 chassis)

This monster Sony set was another head-banger that came my way recently. The symptoms were very unusual. When the set was switched on it produced a plain white raster, with no sound or scart switching and no sign of snow via the tuner. It would not respond to remote-control commands, though the LED flashed when a remote-control button was pressed. It obviously knew that something was happening but was unable to process this.

The workshop was very busy at the time so, after a quick assessment, an EEPROM chip was ordered. This seemed to be a logical first step. When the new chip arrived I fitted it and found that the symptoms hadn't changed but the picture settings had. Obviously the new EEPROM was blank. This affected the picture size, so it was clear that the control system was at least partially working and that the EEPROM's settings were being processed. I blew the dust off the oscilloscope and set about trying to find out what was going on.

Clock and data pulses were present at the microcontroller chip and looked OK – as far as one can reasonably tell. Nevertheless I decided to disconnect the clock and data lines at the various controlled devices in the chassis to see if any corruption was taking place. The tuner was disconnected first, then the multisound processor chip. There was no difference in either case and not much left to check, so I went back to the microcontroller chip. Further checks in the control area led me to believe that this chip had to be faulty. A replacement was ordered and subsequently fitted. Lo and behold, no difference!

I had already spoken to Sony technical to discuss the fact that in some of these sets the microcontroller chip has no reset, the reset IC being absent. I don't know if one had ever been fitted in this case, but was told that some earlier sets do have a reset IC and later ones don't. In this set the reset pin (64) appeared to be connected to

chassis. This had confused me – I had spent some time looking for a short-circuit that wasn't there!

A second call to Sony produced the answer. After some ten minutes' discussion, making scope checks at the same time, it was suggested that I try pressing the TV button on the remote-control unit – the one that takes you out of the teletext mode and is highlighted as a square box. I pressed it and the graphics came up. There was picture snow and all the remote-control functions worked. When I picked myself up off the workshop floor and retrieved the swinging telephone handset, before it came back and hit me on the head, the very nice chap at Sony told me that the set must somehow have entered the ageing mode. This is entered by keying TT07 in the service mode, and produces the very symptoms I had thought to be a fault. Pressing the TV button exits this mode, returning the set to normal.

As the original EEPROM had all the customer's settings stored in it I refitted it. The 'fault' symptoms were then back. The EEPROM had remembered the ageing mode, and the TV button had to be pressed again to produce a picture. After that everything was OK.

I wondered whether the original microcontroller chip had caused all this to happen, as both EEPROMs produced the effect. They had both been connected to the original microcontroller chip before a replacement had been fitted. Maybe, maybe not! I also keep thinking to myself that of all the remote-control buttons I had pressed during diagnosis and testing I had never once pressed the TV button. If I had done so I might have cured the 'fault' without knowing why! Many thanks to Sony technical. M.L.

## Sanyo CE28FWN3-B (EB6-C28 chassis)

This set was in and out of the workshop several times before the cause of the fault was discovered. It would come in with drastically reduced height and very poor trapezium settings. A new EEPROM had been fitted and the receiver had been set up, but it still came back with the same problem. Not having a Sanyo agency, we didn't appreciate how badly the trapezium adjustment can be affected when there's a field fault in this chassis. Several other engineers (thank you Graham at PVS) advised me to look for a field fault rather than concentrate on the memory/control section.

The set sat on the rack for several days before being switched on. When powered it produced a good picture, but the height decreased very slowly over a period of about six hours. The following morning it was only slightly better, and no external heat or freezing had any effect. Basically, once it had gone into the fault condition it

would take several days to right itself if it wasn't switched on. Don't you just love 'em!

I left the set for a week then hooked a scope to the field output chip's drive pin and switched it on. After about four-five hours the waveform was slowly becoming smaller. The drive waveform comes from pin 26 of the jungle chip IC201, which is type TB1251CN – obviously a Sanyo special. I got the same results with the scope connected to this pin – low drive. There was a scrap chassis in the workshop, so I took its jungle chip and fitted this in the present patient. A full field then filled the screen, topping up my confidence no end. Anyone else had trouble with this chip? M.L.

### Sony KV29LS30U

This 29in. set's line output transistor was short-circuit. I ordered and fitted the transistor kit (part no. 994801441) and the new transistor failed at switch on. This is not uncommon: it usually means that the line output transformer (part no. 145330831) has failed. So I fitted a replacement and was rewarded with a blank raster.

I moved a little uneasily on my ageing bench stool, as I knew I was in for a lengthy repair and had assured the customer that his set would be ready later that day. Sound was present, also the on-screen graphics, but there was no picture. Teletext worked, except that the red was missing. The LED at the front of the set flashed several times. I can't remember how many – my mind was concentrated on replacing the microcontroller etc. chip, which in this chassis is an 'ultimate one chip' device (or UOC). It does just about everything known to man, but the replacement didn't cure my problem! Well it did, slightly: it cured the no red in the teletext mode, that was all.

I turned my attention to the beam-limiting (ABL) circuit, which is connected to the UOC chip, and found a total of three surface-mounted diodes that were all either leaky or short-circuit: D021, D505 and D507. Replacement of these finally restored normal operation, some ten days after the initial promise . . .

These UOC chips are actually quite reliable, though they do tend to fail big time when there has been a major failure in the line output stage. When ordering a replacement, always check the IC's mask version. There have been several updates,

**Figure 1: The protection circuit in the Philips G110 chassis acts on the chopper power supply via the feedback optocoupler IC7614. Various sensing circuits are connected to the transistor latch Tr7655/6**

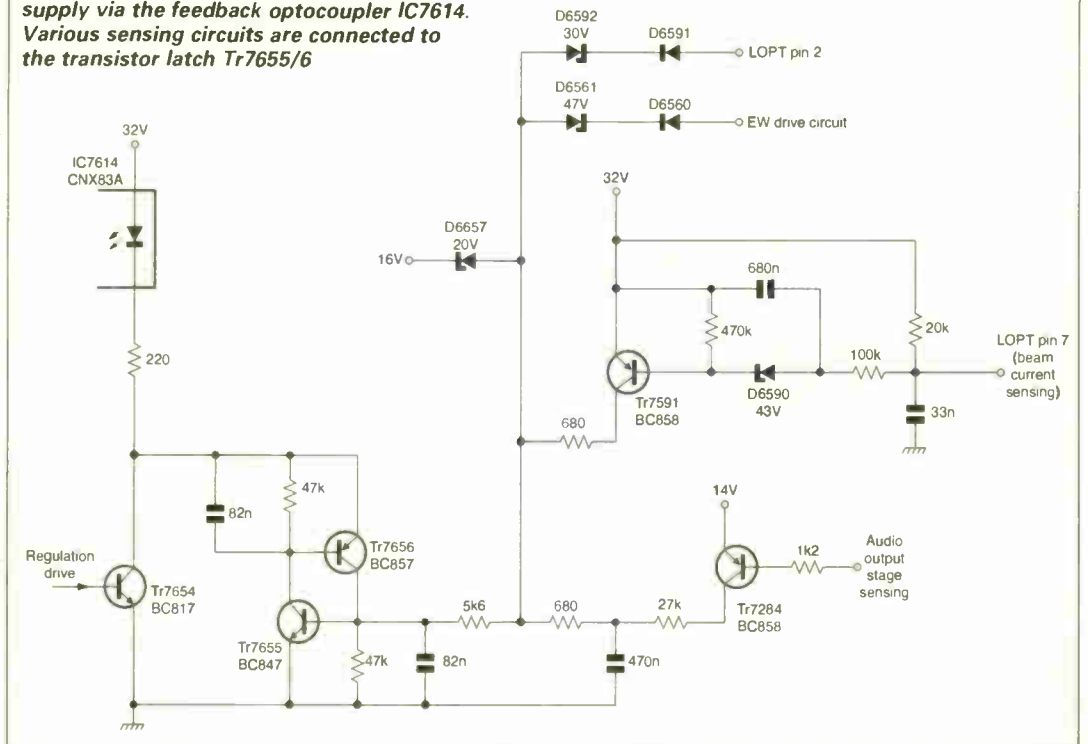

and the correct version must be used as the replacement – be warned! M.L.

### Philips G110 chassis with Nicam

The initial fault with this set was a short-circuit BU508AF line output transistor (Tr7545). When I fitted a replacement the set worked for about five seconds after which there were two loud cracks because of excessive EHT. This was enough to destroy the line output transistor again. Examination of C2548 (8.2nF, 3kV) in the diode modulator circuit showed that it had a bulge in its side.

So C2548 was replaced and another BU508AF was fitted. I then had a totally dead set with no LED illumination. When I disconnected the supply to the line output stage and connected a dummy load in its place the HT was correct at about 148V. So the power supply hadn't been damaged. Fortunately I had a line output transformer in stock, but installing it got me no farther forward.

I've had problems previously when trying to find the cause of faults in the protection circuitry see **Figure 1** in these sets. It wasn't going to be easy this time either! The Wickman fuse F1534 in the EW drive circuit was OK. So were zener diodes D6561, D6590 and D6592, which are used to sense various conditions. Eventually I got round to checking transistor Tr7591 (BC858) in the beam-current sensing circuit. It was leaky emitter-to-collector. Once a replacement had been fitted the power supply started to work, as did the line output stage. There was sound, but where was the picture?

When I advanced the setting of the A1 control on the line output transformer

there was a dim raster, but no luminance or colour. While I was trying to find the cause of this latest condition the set, after about twenty minutes, again went into the protection mode.

Further checks on the items I had already replaced got me nowhere. This time I had to look farther afield, to the Nicam stereo section. This circuitry is shown in diagram E in the service manual: the previous components had all been in diagram B, power supply and deflection. There's a further protection circuit for the audio output section, with another BC858 transistor, Tr7284. It was also leaky emitter-to-collector. A replacement restored normal power-supply operation.

I now had a set that would remain on long enough to trace the cause of the final fault (no picture). When I connected a scart lead to my monitor it produced a normal picture. There were video inputs at pins 21, 22 and 25 of the TDA8390 luminance/chroma processor chip IC7350, but no RGB outputs at pins 13, 17 and 15. Voltage checks around this IC revealed a high at pin 9, about 5V if my memory is correct, instead of a low of 0V. This pin controls the switching between external RGB inputs to the IC and decoded off-air signals. Temporarily shorting pin 9 to chassis produced the 0V that was required for normal off-air reception. I now had normal reception, and decided to leave it at that!

"Why go to so much trouble with an old set?" I hear you ask. Well, I have provided an annual service contract with this set since it was new. It seemed only fair to the customer that I should try my best to get her set working when it had given so little trouble over the years. D.F.

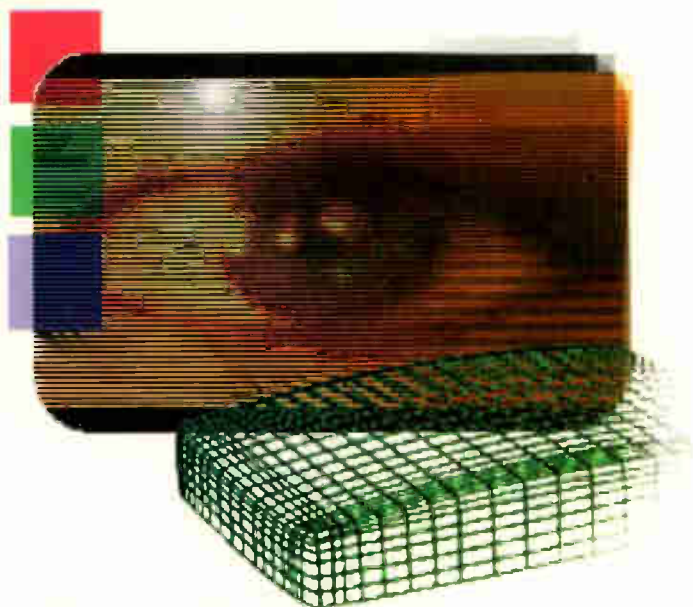

## TV FAULT FINDING

Reports from  
**Michael Dranfield**  
**Philip Salkeld**  
**Uel Harte**  
**Arthur Jackson**  
**Jerry Fedorak**  
**L. Gare**  
**John Evans and**  
**Philip Laws**

We welcome fault reports from readers – payment for each fault is made after publication.

Reports can be sent by post to:

Television Magazine Fault Reports,  
 Highbury Business Communications,  
 Nexus House,  
 Azalea Drive, Swanley, Kent BR8 8HU

or e-mailed to:  
[t.winford@highburybiz.com](mailto:t.winford@highburybiz.com)

### Goodmans GTV34R3

Stuck in standby, with the power supply running but no line drive, is a problem I've come across on several occasions with various different sets that use this chassis. The cause is always an invisible dry-joint at the little blue resonator between C20 and C24 near the STV2102B jungle chip. There's no circuit reference number for the resonator on the PCB. M.D.

### Tatung T14TK70L (L series chassis)

This newish set produced a bright white raster with flyback lines. I carried out some checks on the CRT base panel and found that safety resistor R24 (22Ω) was open-circuit. The associated electrolytic capacitor C6 (22μF, 250V) had a bulging top. So I replaced these items and switched on again. R24 immediately blew, though there was no short-circuit at its output side. I then noticed that D607 (BYT42G) on the main board was charred, while capacitor C621 (10μF, 250V) had burst its top open. Replacements (R24, D607 and C621) restored normal operation. It would appear that D607 had been the basic cause of the fault. M.D.

### Ferguson TX807 chassis

The dealer who brought this set in said that the 24V zener diode DP27 went short-circuit at switch-on. As DP27 is connected in series with the start-up resistors I found this difficult to believe. But he was right. I couldn't find any faults on the primary side of the power supply but noticed that DP90

(RGP10D) on the secondary side had been replaced. A BY133 had been used, and the board beneath it was discoloured.

I replaced DP90 with the correct type, also DP27, and confidently switched the set on. Once again DP27 went short-circuit. Now DP90 is the rectifier for the supply to the audio output stage. I figured that if this had been the original cause of the problem the safety resistor RP90 (0.22Ω) may have been damaged. In fact it was open-circuit. I concluded that the power supply will not run correctly unless fully loaded. M.D.

### Daewoo IR14A5

This 14in. set had a big burn up in the power supply. R806 (100Ω) and R807 (2.4kΩ) were both burnt to a crisp. R804 (0.56Ω) was open-circuit, and the snubber capacitor C806 (470pF, 2kV) was split down the centre. I suspect that this capacitor had failed initially, leading to all the other damage. If so the STRS5707 chopper chip 1801 would also have been damaged. I replaced this item as well and, when I switched the set on again, it fired up first time. M.D.

### Philips 21PT1664/05S (SL9.2E chassis)

Sound but no picture was the complaint with this set, i.e. there was no raster. When I removed the back I saw that the CRT's heaters were alight. So I adjusted the A1 supply control on the line output transformer, fully expecting to see the field-collapse symptom. But there was no change. A check on the A1 supply at the tube produced a reading of about 20V. The control was open-circuit. Replacement of the line output transformer, part no. 4822 1401 0669, was the answer. I seem to recall that the same problem used to occur with an older Philips chassis. P.S.

### Tatung T14RF71 (F series chassis)

This set appeared to be in standby, but the HT output from the power supply was pulsing between 50V and 105V. Disconnecting the power supply outputs made no difference to the symptoms, so I started to carry out component checks in the power supply. This led me to C809 (100μF, 250V) which was open-circuit. A replacement restored the set to full operation. P.S.

### Bush WS6674

This widescreen set was stuck in standby. With this type of fault I generally check the HT supply at the collector of the line output transistor first. It read 100V and was decaying, which was strange to say the least. The power supply produces an HT output of 145V, which is fed to pin 2 of the line output transformer. It was pres-

ent and correct. Pin 1 of the transformer feeds the line output transistor. A piece of glue was stuck on pin 1, making it high-resistance. All that was needed to put matters right was to resolder pin 1. P.S.

### **Toshiba 3387DB (C8SS chassis)**

This set's green LED was flashing. When I noticed that the CRT was a Philips one I figured that it was the cause of the fault. A tap on the neck of the tube verified this. When the replacement came it was a Thomson type, which is fitted with different scan coils. A phone call to Toshiba spares revealed that a kit, part no. 23013117, is required.

The replacement was straightforward but, when the set was switched on, there was trapezium distortion. I read the instructions again and found that the two leads in the two-pin plug that goes from the CRT base panel to the scan coils have to be interchanged. Doing this cured the problem. All this work because the original Philips tube is no longer available! P.S.

### **Sony KV28LS35U (FE2 chassis)**

This set was dead. A good place to start is the BU2515DX-127 line output transistor Q533, which was short-circuit. The part no. is 872904908. When I fitted a replacement the set was still dead, with the front LED flashing twice. According to the manual this means that there is an excess-current problem.

I dived into the excess-current network and eventually came to R618 (270k $\Omega$ , 0.5W) which had gone high in value. A replacement restored normal operation. I have to say that Sony sets are not the best to work on. P.S.

### **Hitachi C2556TN**

This set belongs to a neighbour, who knocked on my door and said that it kept stopping and starting. When I walked into the room and saw the model my immediate thoughts were of dry-joints at the usual LT regulators, especially when I tried tapping the set. But this wasn't the cause. The offending dry-joint was revealed only when I removed the plastic frame from the PCB. The HT preset VR950 was the culprit.

Two weeks after that I had another set in which VR950 was dry-jointed. P.S.

### **Akai TV2111TGB**

The fault symptoms with this set were cramped field scanning and inability to tune in channels. I wondered whether the two faults were related – a supply rail problem perhaps? As I didn't have a service manual I phoned my friend Tom in Cookstown NI. He suggested a check on the 33V zener diode D14 and the 47 $\mu$ F,

25V capacitor C26. Both turned out to be leaky. U.H.

### **Daewoo DWX28W5GB (CP885 chassis)**

I had two of these sets, both new stock, that reverted to standby intermittently. The cause of the problem was the connection between the line output transistor and the transformer. Close inspection revealed a high-resistance here. U.H.

### **Dansai 9313A**

The initial fault was failure to revert to standby correctly. This set led me a merry dance. I found that transistor Q506 (2N5401) was leaky, and a replacement seemed to cure the fault. A day later Q506 failed again. A check on the HT output from the power supply then revealed that it was high at 127V instead of 108V. Adjusting the preset made no difference. The cause of the problem turned out to be C809 on the primary side of the power supply. U.H.

### **Daewoo GB20HIT**

The complaint with this set was sound distortion when warm. I ran the set for two hours before the fault put in an appearance. Then, by using freezer spray, I found that the cause was C620 (100 $\mu$ F, 25V). It was leaky. U.H.

### **Grundig ST55-734 (CUC2121 chassis)**

The problem with this set was very intermittent field collapse. It was not a difficult fault: coil L53021 next to the field output IC was dry-jointed. U.H.

### **Philips 32PW6332 (MD1.2E chassis)**

This chassis is used in several 25, 28 and 32in. models. We've had a problem several times with them, the symptoms being a dead set with the mains fuse blown and two or more of diodes D6510-6513 in the mains bridge rectifier network short-circuit. Cold checks usually fail to reveal any other shorts. In this case the thing to do is to remove C2544 (2.2nF, 2kV) in the snubber network, inspect it and check for leakage. A burnt pinhole is often evident, together with a slight leak. If this item is not checked a replacement fuse and diodes will usually blow instantly at switch on. The part no. for the capacitor is 4822 126 13451. A.J.

### **Grundig GT1402 (G1000 chassis)**

There was no sound from this 14in. set. Checks around the audio output chip IC550 showed that the 9V supply at pin 2

was missing. The cause was simply that the series resistor R560 (4.7 $\Omega$  safety) was open-circuit. There were no other component faults, but the soldering was poor in all areas and the speaker leads had not been trimmed and appeared to touch where they came through the PCB. I replaced R560, resoldered as necessary and trimmed the speaker wires. A.J.

### **Sharp 51DT25H (CA1 chassis)**

The fault report said that the sound pulsed on and off and the picture took ten minutes to appear. This was a useful and accurate description. Checks showed that there was excessive ripple on the +10V rail, because C712 (220 $\mu$ F, 16V) was virtually open-circuit. All the other capacitors in this area were perfect. A.J.

### **Philips 25PT4523 (MD1.2E chassis)**

This set's power supply was tripping rapidly. Initial checks showed that the outputs at all the rectifier diodes on the secondary side of the power supply were low. A lot of time was spent checking out the high-power stages, but the cause of the problem turned out to be a short across the +5V standby rail. When attention was turned to the small-signal panel I found that the Aquadag wire and spring were jammed across it, because the plastic clip on the tube had snapped. The microcontroller chip IC7600 and the EEPROM chip IC7685 had both been damaged. I had to repair the Aquadag cable and replace both chips. A.J.

### **Hitachi C28WD2TN**

This set would run for a few minutes then produce a loud plop from the speakers and go dead. The cause was very poor joints at the 5V regulator IC951 (L7805CP). It's becoming a common problem with this range of Hitachi sets. A.J.

### **Philips 28PW6305 (A10E chassis)**

No remote-control operation with this chassis is commonly caused by the microcontroller chip IC7064. We have had two cases recently however where the cause was the infra-red receiver IC6009, which seems to go open-circuit. The part no. is 9322 127 54667. A.J.

### **Matsui 1496T**

This set was tripping (ticking noise). On inspection I found that C576 was dry-jointed. I decided to check the BUH515D line output transistor Q580 and found that it was leaky. Resoldering and a new line output transistor restored the set to life, with a good picture. J.F.

### **Philips 28PW6332/05 (MD1.2E chassis)**

When this 28in. set was switched on it produced a vertical line straight down the centre of the screen for a second. Line collapse followed by switch off presumably. There's a ribbon cable that goes from the line output stage to a PCB above the scan coils. On inspection I found a dry-joint here. To be on the safe side I resoldered all the connections. This time there was a good picture when the set was switched on. J.F.

### **Zanusi 26ZA374GB (Telaid BS665 chassis)**

When the customer phoned and said her Zanussi had gone off I thought she must be referring to a washing machine. But no, when I called round there was a Zanussi TV set. When I switched it on there was a line whistle. Cold checks showed that the BU2508AX line output transistor was leaky. All was well once a replacement had been fitted. J.F.

### **Beko 1222ONX**

The customer said there was a crackle with Nicam sound when the set had warmed up. The 17.472MHz crystal Q4 on the Nicam board was faulty. L.G.

### **Alba 4859 (11AK19 chassis)**

The picture would go but came back when the panel was flexed. I found that there were poor connections between B701 and pin 22 (beam-current limiting) of the jungle chip IC401. L.G.

### **B&O 3119 MX2000**

RL25 (10k $\Omega$ ), which is connected to pin 5 of the line output transformer, was burnt. When I fitted a replacement transformer and resistor there was a weak/dim picture. CL24 was then found to be short-circuit. L.G.

### **Philips 24PW6322/05 (MD1.2E AA chassis)**

This set was dead (no results) with the red LED flashing. Cold checks in the power supply showed that the STH8NA60FI chopper FET was short-circuit.

I replaced it, also the MC44603P control chip IC7520, but when I switched on there was a tripping noise and smoke came from the 1nF, 2kV blue disc capacitor C2433 in the line output stage. It's connected between the collectors of the two parallel line output transistors and chassis. I fitted a replacement capacitor and checked other components in the line output stage. All appeared to be well here and when I switched on there was a good picture. J.E.

### **Bush 7690D**

This monster integrated-digital widescreen set is fitted with the 11AK19 chassis. The reported fault was no picture, just lines. What this meant was a blank raster with flyback lines – the sound was OK. Checks on the CRT base panel revealed that R914 (47 $\Omega$  fusible) was open-circuit, because the TDA6108JF RGB output chip IC901 was faulty. A normal picture was displayed once these two items had been replaced. R914 is quite well hidden between IC901's heatsink and the white-coloured connector next to it. J.E.

### **Schneider STV2802T**

The customer said there was no picture and a cracking noise. When I removed the back and switched on, violent arcing was seen at the top of the line output transformer. I would advise against fitting an HR8320 as a replacement as adjustment to the adjacent heatsink will be required for access to the focus control. In this situation you will often find that the S2055N line output transistor has blown. Even if it seems to be OK I recommend fitting a replacement. While you are at it, check IC401 for dry-joints. It's mounted against the rear of the heatsink mentioned above.

The original line output transformer is available from CPC under order code TFFBT40680. J.E.

### **Matsui 20TN (Tatung D4N chassis)**

There was no audio and no OSD, just black panels with no text. This fault is caused by the XL24CO4P EEPROM chip. When you have fitted a replacement it will be necessary to retune the set, reset the user controls and adjust the picture height and linearity. To do this enter the service mode by shorting out PL701, which is next to the microcontroller chip. Use the remote-control unit's P+ and P- buttons to step through the program and the vol+ and vol- buttons to alter settings. Store new settings by pressing the Clear button (stored will show at the top of the screen). To leave the service mode remove the shorting link. J.E.

### **Panasonic TX32PK3 (Euro-4 chassis)**

This set would come on for about six seconds then revert to standby. During its on time the EHT rustle could be heard and, if the A1 control was advanced, a faint blank raster could be seen.

I checked the various protection lines and found that the voltage at pin 71 (Vprot) of the main microcontroller chip IC1101 was low. This led me to the VDP

chip IC601, where the field flyback pulse was missing at pin 11. As full scanning was possible, I traced back along the pulse path and came to chip capacitor C454 (220nF) which was open-circuit. P.L.

### **Philips 25PT482 (GR2.2 AA chassis)**

The fault report said "goes off". Once the usual dry-joints around the line output transformer had been attended to the set remained on. While it was being soaked tested however the picture occasionally faded to snow. The tuner wasn't sensitive to tapping, but I managed to make some voltage measurements with the set in the fault condition. These showed that the tuner's AGC voltage had fallen from a nominal 6V to zero. I traced the source back to the large IF module, where it was the only voltage that varied. Inspection here, with a magnifier, revealed a cracked joint at R3013, which supplies bias to pin 10 of the IF chip. Resoldering this joint provided a lasting cure.

I subsequently had another Philips set that was fitted with a similar IF module and had the same fault. P.L.

### **Panasonic TX14S1T (Z5 chassis)**

The symptoms with this set were dead with a twittering power supply. Voltage checks showed that all outputs from the power supply were low. I decided to disconnect the HT feed to the line output stage and fit a dummy load instead – a 60W bulb. The power supply would then sometimes run normally. There was nothing obviously wrong with the line output stage, so I reconnected its supply. To my surprise the set then sprang to life, with the bulb I had forgotten to disconnect glowing merrily! How could this be?

After disconnecting/connecting the bulb a few times and discounting thoughts of under-load protection I turned my attention to the primary side of the power supply, where R821 (330k $\Omega$ ) was open-circuit. P.L.

### **Bush 1441 (Grundig G1000 chassis)**

The picture's height was reduced, it was shifted to the left and was very weak with a poor grey scale. All that was necessary was to set up the RGB outputs and the picture geometry, using the service menu. To do this, switch the set on while holding the prog + and - buttons on the set. Then select the item to be adjusted with the remote-control unit's menu button and adjust it with the handset's prog + and - buttons. When finished, press the TV button to store the new settings. P.L.



## VCR CLINIC

Reports from  
**Bob Flynn**  
**Gary Laidler**  
**Peter Tennant**  
**George Cooper**  
and  
**Dean Ratcliffe**

We welcome fault reports from readers – payment for each fault is made after publication.

Reports can be sent by post to:

Television Magazine Fault Reports,  
Highbury Business Communications,  
Nexus House,  
Azalea Drive, Swanley, Kent BR8 8HU

or e-mailed to:  
t.winford@highburybiz.com

### **Panasonic NVF70 (G deck)**

Although this machine played perfectly there was an annoying clunk every few seconds. When I looked at the underneath of the deck while it was playing I saw that the clutch disc (item 116) was vibrating in coincidence with the noise. It shouldn't move at all in the play mode. The cause was revealed when I removed the centre pulley unit (item 137): its lowest small gear had come adrift as a result of a crack in the main body. A new centre pulley unit cured the fault. **B.F.**

### **Bush VCR840VP (Aiwa TN6500 mechanism)**

When a tape was played the sound was OK but the TV picture remained on! The only possible clue to the cause of this weird fault was that there would be slight interference on the E-to-E picture when a tape was inserted. As getting to the power circuit is a lengthy process I decided to replace all nine capacitors on the secondary side. This cured the fault. When I checked them afterwards it seemed that C821 (1,000 $\mu$ F, 16V) had probably been the cause. **B.F.**

### **Panasonic NVF70 (G deck)**

The E-to-E picture had severe patterning. The playback picture also had severe patterning but in addition was in black and white. Replacing C22 (680 $\mu$ F, 10V) inside the power supply cured the fault. It's a problem I have not had before. **B.F.**

### **Bush VCR906SIL-T5**

When a tape was inserted this machine went into a sluggish fast-forward. After about five seconds it would power down with ERR in the clock display. Puzzling symptoms, but the cure was simple: give the mode switch a good clean. It's mounted on the bottom panel. **G.L.**

### **Toshiba V703**

The problem with this VCR was tape chewing, the cause being the rotor. Once this had been dealt with the picture had a flicker and was mistracking. I decided to scope the outputs from the power supply and, sure enough, ripple was present. The culprits were the 15 $\mu$ F and 47 $\mu$ F electrolytics on the stand-up subpanel. **G.L.**

### **Panasonic NVSD200**

This VCR wouldn't accept a tape and a chattering noise came from the loading motor area. It was not the loading coupling or the main lever this time but the gear worm wheel, part no. VDC7466, which was a bit toothless. It's available from SEME at 55p. **G.L.**

### **Proline VR515**

This fairly new VCR suffered from intermittent loss of tracking and would speed

up from time to time. The cause of the fault was easily traced to connector PJ201, which connects the CTL head to the main board. The poor joints looked as though they had been present from new. **G.L.**

### **JVC HRD455**

If you get one of these old machines that won't accept tapes, replace both cassette switches to cure the problem. **P.T.**

### **Sanyo VHR899**

This VCR was dead with the fuse in the plug open-circuit. I thought it was going to be an easy job, but not so. When I tested the machine I found that it was very slow at loading tapes. It turned out that the loading motor was the cause. All was well after fitting a replacement followed by a general clean and test. **P.T.**

### **Hitachi VTM930E**

This machine was completely dead. I discovered that R851 (1 $\Omega$ , 0.5W fusible) in the power supply was open-circuit. It's not shown on my circuit diagram. **G.C.**

### **Sanyo VHR244E**

The complaint with this machine was that it would cut off seconds after going into the record mode. Playback was OK. PR512 again I thought, but couldn't have been more wrong: when I removed the top cover I found that it's an earlier model that does not have PR512. As I powered up the machine to take voltage readings I detected a horrid smell that came from the power supply section. You have to remove the main PCB and take off a large metal screening can just to be able to see the power supply. A quick visual inspection revealed that C5107 (47 $\mu$ F, 25V) had leaked badly. It was the source of the smell and had corroded the following adjacent components: C5106 (47 $\mu$ F, 50V), C1501 1,000 $\mu$ F, 16V) and D5114 (1SS244). I removed the damaged components, cleaned the board and fitted replacements. After that the machine worked flawlessly. **G.C.**

### **Toshiba V825B**

This machine was dead with no signs of life. The cause was C835 (820 $\mu$ F, 16V) in the power supply. **G.C.**

### **Panasonic NVSD220**

There were no functions with this machine, a tape was stuck in it and there was no E-E operation. The cause was loss of the 5V supply at Q1003. A 2SD1330 or 2SD1996 is used in this position. **D.R.**

### **JVC HRD960**

If the display is dim, check or replace C28 and C29. **D.R.**



# DVD

**Fault reports from  
Chris Bowers  
Geoff Darby  
and  
Mike Leach**

We welcome fault reports from readers – payment for each fault is made after publication.

Reports can be sent by post to:

Television Magazine Fault Reports,  
Highbury Business Communications,  
Nexus House,  
Azalea Drive, Swanley,  
Kent BR8 8HU

or e-mailed to:  
t.winford@highburybiz.com

## **Sony DVP-CX860**

The fault with this unit was intermittent no power-on. Checks inside revealed that C301 (680 $\mu$ F) was faulty. To cure the intermittent failure the replacement should be 1.500 $\mu$ F, part no. 1-137-921-11. C.B.

## **Sony DAV-S880/HCD-S880**

When this unit was tuned to a station broadcasting RDS information the registered station's name would disappear. The cause of the problem was microprocessor IC901 on the DVD board. A replacement, type  $\mu$ PD703033BYGF-M31-3BA, part no. 6-803-244-01, restored the missing station names with RDS. C.B.

## **Sony DAV-S550/HCD-S550**

There was no operation with this DVD unit – it was stuck in the protection mode after a mains power blackout. I'd had this fault before with an HCD-S880. All that was required was to check on the power board, where the cause was confirmed as being C921 (2.200 $\mu$ F, 35V). A replacement restored normal operation. C.B.

## **Sony DVP-NS330**

The complaint with this DVD player was "makes a background noise with all discs". There didn't seem to be a problem at first, so I left it running for a while then removed the top cover to have a probe around. There was an odd rustle from the sound when the MPEG board was pressed, and the stereo 'spatial' feel changed. At first I thought that this was going to be a real nasty, such as a bad through-plated hole or a poor joint at one of the several 100+ pin ICs.

More careful prodding led me to connector CN601 however. It connects the MPEG board to the main board, and is an uninsulated open-wire affair – those with children will understand the description that it looks like the teeth of a metal nit

comb set in a plastic frame. The 'teeth' had been subjected to a knock at some time. This had put a dent in them, drawing several of the conductors very close together at that point. So close in fact that two were just about touching. You could instigate the noise by literally blowing on the connector.

After disconnecting power from the player I was able to straighten the conductors easily by slipping a scalpel blade down between them and twisting it until separation was restored. This action provided a complete cure. G.D.

## **Sony PlayStation 2**

We have two of these at home. They've never given any trouble, so I have not previously had cause to look inside one. This unit had arrived in a bundle of other items from an engineer who specialises in TV and video – he tends to leave his HiFi and DVD repairs to me. The owners had been using the machine for normal DVD playback as well as for games. According to them it ceased to read discs after they had had some particularly dusty building work done.

The unit proved to be very easy to take apart: remove six screws from underneath, four covered with clip-in plastic blinds and two with rubber feet. The DVD deck has its own plastic cover, which is secured by four very small Phillips screws. Once the cover has been removed the whole deck is in plain view, including the laser, as the disc clamp is part of the cover.

The deck, and the laser lens in particular, was very dusty. So I set about carrying out a full clean and relubrication. The laser unit is of a type I had not seen before, so I had no experience as to whether a clean was going to be enough. Once the unit had been reassembled however both game-play and regular DVDs were read faultlessly. A long soak test proved that this reading was reliable. G.D.

## **Hitachi DV-P325E**

This machine was completely dead, with nothing alight in the display. Checks on the secondary side of the power supply showed that there was a short across the 9V output, between the cathode of D1030 and chassis. The diode and its reservoir capacitor C1035 were both OK, the culprit being D1048, which is a zener diode.

Replacement of the diode is not easy: you have to remove the front of the machine to gain access to the PCB to unsolder it. Now maybe I missed something here, but getting the front off with the disc tray loaded is almost impossible. You end up with numerous removed screws and a pile of bits they wouldn't be able to piece back together on the Krypton Factor in two hours, let alone two minutes! Things got better however when, after replacing the diode, the machine powered up in its stripped-down state. All was then well. M.L.





# What a Lovely Pair!



## HORIZON DIGITAL TERRESTRIAL METER

### HDTM

- Signal Strength and BER displayed together
- Pre and post BER displayed on sub menu
- 10 pre programmed transmitters (via website) or all channel step through
- Audible tune-in, with back light
- 7 or 8 MHz channels
- 2K and 8K mode
- Automatic Transmission and constellation
- VHF (band3) and UHF bands
- RF input range 167-862 MHz
- Input dynamic range -72dBm~-20dBm
- Input connector BNC. Input imp75 ohms. Loop through
- External power for mast amplifiers, etc.
- Built in universal charger 80-250 V Ac. Intelligent charger (CE approved) with delta V delta T detection. Fast charge, then Trickle
- Run time with full charge: Minimum 5 hours from 2.5 Ah battery
- Figure of 8 mains input connector. 2.1 mm Female PSU plug for external charge via supplied car charger
- Computer interface: Serial port (Com 1-4) for upgradeable software on transmitters.

## HORIZON DIGITAL SATELLITE METER

### HDSMV2

- Signal Strength and BER displayed together
- 32 Transponders or 16 satellites, horizontal & vertical
- Audible tune-in, with back light
- DVB, C&Ku band, Mpeg, V Sat compatible
- Input dynamic range -65dBm~-25dBm
- Input connector F-female. Input imp 75 ohms
- Symbol Frequency rate from 1 Msps~45Msps
- Universal charger 80 V ~ 250 V Ac. Intelligent Charger (CE approved) with delta V delta T detection Fast charge, then Trickle
- Run time with full charge (single LNB): Minimum 3 hours from 2.4Ah battery
- Figure of 8 mains input connector. 2.1 mm Female PSU plug for external charge via car charger
- LNB short circuit protection 500 mA automatic limiter
- RF input range 950- 2150 MHz
- Computer interface: Serial Port (COM 1,2,3 or 4) for upgradeable software on satellite settings.

[www.horizonhge.com](http://www.horizonhge.com)

Speed up your installations call NOW on +44 (0)20 8281 3777  
or email [sales@horizonhge.com](mailto:sales@horizonhge.com) for a reliable solution



## SKY DIGIBOX TRADE REPAIR SERVICE FOR THE UK & EIRE

Are you looking for a reliable company to repair your sky digiboxes? We offer **FREE SAMEDAY** Collection when you send more than one box for repair!

### ● PRICES

#### For 1 box

Pace, Grundig, Amstrad ... Fixed price £38 + VAT includes return delivery  
Panasonic, Sony ... Fixed price £55 + VAT includes return delivery

#### For more than 1 box

e.g 2 X Pace ... £76 + VAT includes Collection & return delivery

- PRICES INCLUDE ALL FAULTS MICRO PROCESSOR, MODEM, SOFTWARE CORRUPTION AND BGA REPLACEMENT .
- SPECIALISTS IN THE REPAIR OF PANASONIC TU DSB 30 ( modification for BBC and ITV low band problem )
- REFURBISHED DIGIBOXES FOR SALE. IDEAL FOR USE WITH NEXT GENERATION CARD WITH NO SUBSCRIPTION TO PAY (BBC, ITV, CHANNELS 4 & 5) (6 months warranty + new remote and accessories)
- FAST TURNAROUND TIME
- ALL REPAIRS GUARANTEED
- COLLECTION ARRANGED FROM ANYWHERE IN THE UNITED KINGDOM AND EIRE
- AUTHORISED SKY DIGITAL REPAIR CENTRE.

Receive our latest Satellite and technical newsletter **FREE** through email. Just send us an email with Newsletter in the Subject title to: [info@digirepairs.co.uk](mailto:info@digirepairs.co.uk)

### Contact:

**DIGI REPAIRS (UK & Ireland)**  
UNIT 25, ENNISKILLEN BUSINESS CENTRE  
TEMPO ROAD, ENNISKILLEN BT74 4RL  
TEL NO: 02866327293 (NATIONAL RATE)  
0845 6441628 (LOCAL RATE)  
FROM R.O.I. 0486 632 7293  
Email: [info@digirepairs.co.uk](mailto:info@digirepairs.co.uk)

## Grandata Ltd

distributor of electronic components

### Mobile Phone Wireless Handsfree Solution



Works in any car

Works with any mobile phone

NO cigarette lighter needed

NO Wires

NO Installation

Clip the wireless speakerphone to your sunvisor

Clip the wireless transmitter to your phone

Then your ready to drive with both hands on the steering wheel

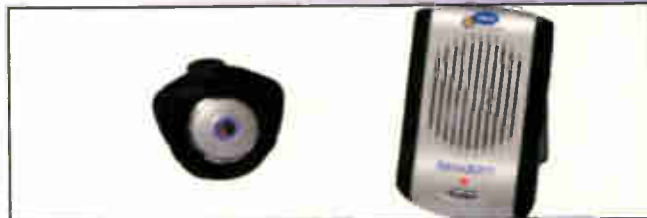

**Order Code : FREEDOMTALK**

**Price : £ 25.50 + vat**

See our 6 page advert for more Special Offers

K.P. House , Unit 15 , Pop In Commercial Centre , Southway ,  
Wembley , Middlesex . HA9 0HB England

Tel: (020) 8900 2329 Fax : (020) 8903 6126

Email : [sales@grandata.co.uk](mailto:sales@grandata.co.uk)

# LETTERS



## Picture quality

Back in 1996 you published a letter from me commenting on the poor picture quality with many TV programmes because of standards conversion from 525-line NTSC sources. Have things improved now that we are in the 21st century? Apparently not.

Digital TV produces unnatural-looking, low-definition pictures with clearly visible pixellation effects where there is movement. Films and other material that starts off on 35mm film is now electronically processed, the end result looking like a long-play VHS recording minus the noise.

Thirty years ago I worked for a national rental company, installing TV sets fitted with the then new Philips G8 chassis.

Given a good signal, the pictures these sets produced were superb. Today's digital picture quality would have meant an instant service call from most viewers in 1974!

DVD players sounded promising at first, but the ones I've seen all give poor-

Send letters to "Television", Highbury Business Communications, Nexus House, Azalea Drive, Swanley, Kent, BR8 8HU or e-mail [t.winford@highburybiz.com](mailto:t.winford@highburybiz.com)

using subject heading 'Television Letters'.

Please send plain text messages. Do NOT send attachments. Be sure to type your full name, address, postcode, telephone and e-mail address (if any).

Your address and telephone number will not be published but your e-mail address will unless you state otherwise.

quality, low-definition pictures, presumably because of bandwidth limitations.

Once the present analogue transmissions have been switched off, will there be any way in which we can view good-quality TV pictures in our own homes?

*Martin McCluskey,  
Bishop Auckland, Co. Durham.*

## TV downloads

I must congratulate Bill Wright for his excellent article on television downloads in the January issue. For many years 'Wizzo' aerial installers have been reluctant to use high-quality downloads with TV aerials to save costs. I well remember the days of cracked aerial insulators, caused by ice during cold weather: one would get the odd Snoddies customer phoning to report "water coming out of the back of the telly". The cause was mainly failure to prevent water ingress by say a little mastic around the open feeder. Water could also trickle down in the space between the sheath and the screen. As a result the copper braid would turn green and eventually disintegrate. This produced severe mismatching and a poor signal at the TV input. Happy days!

*Ron Bravery,  
Sent by email.*

After reading Bill Wright's article (January) on coaxial cable quality I was motivated to replace some of my cable runs - I live in a fringe area where the signal levels are very low. In my experience the effect of corrosion, particularly with the coaxial braiding, can be very detrimental to signal levels.

As most braiding is copper, and most connections are to steel or aluminium, there is inevitably electrolytic action between the metals in the presence of moisture. I found that one or two cable runs had a DC loop resistance of 50Ω over 10m! Cleaning all connections and smearing them with WD40 reduced the readings to less than 2Ω, greatly improving reception. The same applies to the aerial connections, and the connections to any other devices installed externally, but access can be a problem. Fortunately mine are all in the loft, so I was able to overhaul everything. Loft installation carries the penalty of reduced signal strength and other difficulties, but there is no wind damage and corrosion is greatly reduced. So if loft installation is possible the equipment will be virtually everlasting.

*D.K. Yeomans,  
Angmering, West Sussex.*

## HELP WANTED

The help wanted column is intended to assist readers who require a part, circuit etc not generally available. Requests are published at the discretion of the editor.

Send them to the editorial department or email to [t.winford@highburybiz.com](mailto:t.winford@highburybiz.com)

**Wanted:** Mode switch for the Hitachi VCR Model VT130E. Laurie Jones, 56 Southridge Rise, Crowborough, East Sussex, TN6 1LQ. Phone 01892 654 867

**Wanted:** A number of encoder/decoder chips type 4M3750. Peter Ward, Petgra, Forest Corner, Ringwood, Hants, BH24 3JW. Phone 01425 475 445

**Wanted/for sale:** Require a power supply panel for the Tandberg Model CTV2-6-133, new if possible or from an existing set. This 26in. model with remote control was top of the CTV2 range. Have for sale a Tandberg Model CTV1 and a new A56-540X tube. S. Mann, 12 Levens Way, Silverdale, Carnforth, Lancashire, LA5

0TG. Phone/fax 01542 701 431

**Wanted:** A diagram (photocopy OK) to enable me to index the cams and gears in a Sony VCR Model SLV-F900UX. Also require a TMP47C410AN controller chip for a Toshiba microwave oven. Rod Proctor, 8A Maliston Road, Great Sankey, Warrington, WA5 1JR. Phone 01925 635 582 or 07931 913 726

**Wanted/for disposal:** Require a service manual for the Canon Model FAX-B200S-BHT04063 fax/copier machine. Have for disposal free to a good home RF output valves type TT22 (7738Z) for a Sailor marine transmitter/receiver. Steve Roberts, Fasgadh, Marine Place, Mallaig, Inverness-shire, PH41 4RD. Phone/fax 01687 462 189

**For disposal:** Copies of *Television* from 1975-2003, U-View circuit books, manuals, spare parts and test equipment. Phone David Miles on 0151 932 1419

**Wanted:** Scan D assembly (PCB) for a Pioneer 50in. plasma screen. Other markings

are AWZ6229 and ANP1892-B. Or alternatively a scan-drive IC type SN755862PJA. Phone Jeff on 0113 268 6412 or email [jeff@evaservices.freemove.co.uk](mailto:jeff@evaservices.freemove.co.uk)

**For disposal:** TVs of yesteryear, free to collector. National Model TC85; Bush colour sets, one fitted with the T20 chassis and the other with the Z718 chassis; Sony Model KV1820; and a Ferguson monochrome portable fitted with the 1690 chassis. Michael Dranfield, 6 Calesdale Close, Buxton, Derbyshire, SK17 9RH. Phone (daytime) 01298 73 989 or email [mdranfield@smartone.co.uk](mailto:mdranfield@smartone.co.uk)

**Wanted:** A graphics driver for a Patriot PC Model PBC X 366/1. The graphics is an on-board type (integrated graphics) via PC100. The machine crashed and I have no driver software for it. The device manager has set it for 16 colours (640 x 480). Can anyone tell me which driver to download and where to download it from? Please email any information or suggestions, however small, to [jnrbutts@onetel.net.uk](mailto:jnrbutts@onetel.net.uk)

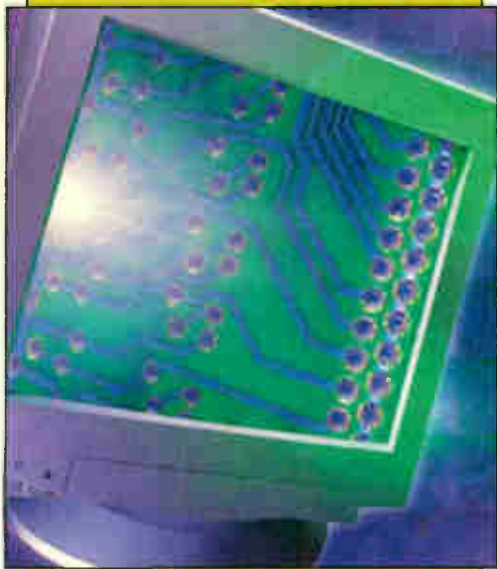

# MONITORS

Fault reports from  
**Gerry Mumford**  
**George Cooper**  
**Bob Bradley**  
and  
**Ian Field**

We welcome fault reports from readers – payment for each fault is made after publication.

Reports can be sent by post to:

Television Magazine Fault Reports,  
Highbury Business Communications,  
Nexus House,  
Azalea Drive, Swanley, Kent BR8 8HU

or e-mailed to:  
t.winford@highburybiz.com

## Dynamode

Apart from the name Dynamode at the front there was no indication of the origin of this LCD-based flat-screen monitor, though there was an obvious slight indentation at the rear where a sticker should have been but had fallen off. The unit, which was completely dead, incorporates a mains power supply in its base. Only the base had to be stripped down to repair it, which was very convenient.

The power supply uses quite an unusual circuit that's based on the IMO280R chopper IC. Tests showed that the start-up voltage was very low, because the decoupling capacitor C6 (100nF, 63V) was leaky. Once a replacement had been fitted the unit powered up and produced a first-class display. **G.M.**

## NEC MultiSync EP1370

This very large, natural-flat CRT monitor powered up, but with just an amber LED and a quiet, rhythmic buzzing sound from within. A fairly major strip-down was required to gain access to the panels. Checks then showed that the 2SC5453 line output transistor Q561 was very leaky while the 2SJ569 B+ regulator FET Q5G1 was short-circuit. Replacement of these two devices restored normal operation, with a superb-quality display. **G.M.**

## Proview 772M

The customer complained that this monitor would switch off intermittently. When I tried it on the bench it came on and stayed on. Twisting the PCB made it cut off however. There were quite a few dry-looking joints, but resoldering didn't help. I eventually found that the 10k $\Omega$  HT preset VR501 was faulty – the merest touch on the slider made the power die. A replacement followed by a long soak test with much twisting of the PCB proved that all was now well. **G.C.**

## Compaq V570

The customer said that the fault with this 15in. monitor was excessive brightness. The symptom was present when I powered the monitor, so I set about stripping it down. I've not had the problem before with this model.

The fault had also affected the spot-suppression circuit, as there was a small, faint phosphor burn at the centre of the screen, caused by an excessively bright spot at switch-off. I noticed, without having a circuit diagram to work with, a row of high-value resistors to the rear of the line output transformer. So I checked these and found that R521 (330k $\Omega$ ) was open-circuit. It's in series with D504, to which reverse bias from a line output transformer pin is applied. D504 provides a high negative

voltage for the brightness circuit.

Replacement of the 330k $\Omega$  resistor cured the fault, but the customer was not too happy when the phosphor burn was pointed out to him. The damage had of course been done before the monitor arrived in the workshop. **B.B.**

## Elonex MN024

There were a couple of these Acer-made monitors (F6Y version) on the scrap pile, the complaint in both cases being an out-of-focus display. All the monitors on the scrap pile were fitted with Panasonic CRTs, so I was not able to compare the performance when a CRT of another make was fitted. Two different LOPTs were tried in an attempt to check whether this item was the cause of the problem, but there didn't seem to be much difference with either of them fitted. So I pushed the main PCB into the front plastic moulding that contained the least-bad CRT!

In recent times I've had focus problems with CRTs from various manufacturers. My guess is that because of commercial pressure inadequate time is given to ensuring good evacuation. There could be contaminants in the vacuum, or possibly getter residues could accumulate between the focus and first-anode electrodes, their effect varying with temperature. A cure that sometimes works is to fit a flylead to the focus cavity on the CRT base and 'flash' this between chassis and the original focus lead a few times to produce an internal flashover and, hopefully, dislodge any particles that have accumulated on the electrodes. With some CRTs I've encountered this technique has been only partially effective or not at all. On one or two occasions I've resorted to drawing a spark from the anode cavity, which is a risky business. It was common practice in the days when TV CRTs needed their electrodes cleaning, but can be more tricky with monitors – especially as most won't run without a signal source being connected. The safest way to do this seems to be to use a scrap CRT base socket with a secure earth strap from the first anode pin to chassis or the Aquadag braid and a flylead from the focus cavity to the final anode cavity.

As far as the monitor's chassis was concerned, the usual crop of electrolytic capacitors between the cable-mounting bracket and the line output stage heatsink needed attention. The two 250V electrolytics (1 $\mu$ F and 4.7 $\mu$ F) had off-the-scale ESR readings. Working across the board to the '3842 chopper control chip, I found that every 10 $\mu$ F, 50V electrolytic I encountered had an unacceptable ESR reading. But the large electrolytic capacitors on the secondary side of the power supply all had very low ESR readings, despite the fact that some of them run quite hot in operation. **I.F.**

# WEB SERVICE

To reserve your web site space telephone  
 Tel: 01322 611289 Fax: 01322 616339  
 E-MAILS [L.Baldock@highburybiz.com](mailto:L.Baldock@highburybiz.com)



## Alban Electronics

<http://www.albanelectronics.co.uk>

Alban stocks, supplies and provides technical support for a range of terrestrial/cable/satellite and analogue/digital TV equipment. PROMAX (manufacturers electronic test equipment including signal level meters, spectrum analysers, BER/CSI/MER analysers for QPSK, QAM & COFDM, optical fibre light sources and power meters, 16:9 test pattern generators), ALCAD (manufacturers of R.F. wide band and adjacent channel amplifiers, aerials for MATV, SMATV & IRS systems) and ANTARES (cascadeable multi-switches). ALBAN has a complete after sales repair and calibration service that is fully supported by the manufacturers, in addition provides a free system design service using only reliable high quality components.

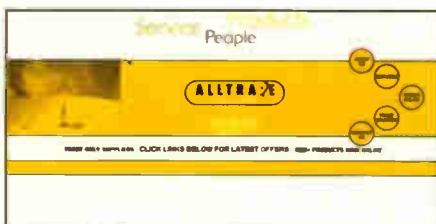

## Alltrade Aerials & Satellite Ltd

<http://www.alltrade.co.uk>

Leading distributor to the trade Full e-commerce site with over 1500 products with in-stock quantities!! We supply everything associated with Digital/Analogue Terrestrial & DTH/Motorised Satellite reception. All Antennas. All Brackets. All Cables. All Connectors. All Amplifiers. We provide a free MATV/SMATV planning service as well. Phone 0845 075 0751 Fax 01273 425700

## Charles Hyde & Son Ltd

<http://www.charleshyde.co.uk>

Search for both original and copy spare parts in our extensive database covering Akai, Alba, Bush, Ferguson, Goldstar, Hitachi, LG, Matsui, Nokia, Saisho, Sanyo, Sony, Sharp, Thomson, Panasonic, Philips, Samsung, Tascam, Teac, Toshiba, Yamaha and many more. In addition huge ranges of Lasers, Lopts, Remote controls and Semiconductors may be accessed.

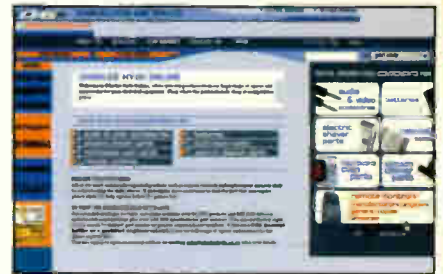

## Repairhelper's - Storefinder UK

<http://www.storefinder.repairhelper.co.uk>



your own optimized pre-built web page with a built-in online contact form and complete listings within the Repairhelper Network of sites.

We specialise in promoting electronic repair services throughout the Internet. It's a well known fact that the Internet is the fastest growing advertising medium today but the majority of repair companies and repair engineers are not making use of the Internet to gain more custom.

Repairhelper's Storefinder is a UK Search Engine dedicated to the electronic repair trade (i.e. TV, VCR, DVD repair etc). Sign up with Repairhelper's Storefinder - you get



## Swires Research

<http://www.swires.com>

Swires Research produce high quality instruments for the television industry, including portable signal level meters and spectrum analysers for digital and analogue RF signal measurements.



## Wiltsgrove

<http://www.wiltsgrove.co.uk>

**WILTSGROVE LTD** founded in 1984, is renowned as a leading supplier of Audio, Video, TV, Spare parts and Accessories.

We are now pleased to announce the launch of our ONLINE CATALOGUE:

Our easy to use search engine will allow you to find the products you require via:

- Make/Model. • Product Category.
- Key Word search. • Manufacturers part number. • Our Order Code.

All orders before 5pm will be dispatched the same day.

Tel: (0121) 772 2733 Fax: (0121) 766 6100  
 Email: [sales@wiltsgrove.co.uk](mailto:sales@wiltsgrove.co.uk)

# swires research



## IMDIGITAL T

- Analogue/Digital Terrestrial Signal level meter.
- UHF channels 21-68 pre-programmed into instrument.
- Strong fibreglass reinforced polycarbonate case.
- Long battery life – over 5 hours.
- Gives signal level and signal to noise (SNR) readings.

## DIGISAT 2001

- Easy to use Digital Satellite meter. 13 preset satellites pre-programmed. Optional Software available to add more.
- NiMh batteries give over 4 hours continuous operation.
- Signal quality: Good, Marginal or Fail. Also gives BER and SNR figures.



40 Hornsby Square, Southfields Ind. Park, Laidon, Essex SS15 6SD. Tel: 01268 417584. Fax: 01268 419083

Visit our website at:- [www.swires.com](http://www.swires.com)

# WOLSEY

## Wolsey Installer Meters

Designed with the installer in mind!



- Customised lightweight ABS Shock Absorbent housings
- Purpose designed functional outer case with neck strap
- Ergonomically angled screen for maximum visibility
- Simple to operate with one hand
- 4 line display with backlight, shows signal strength and quality
- Pre-programmed for major European Satellites or UK Transmitters and Multiplexes
- Weighs less than 1Kg
- Mains and car chargers

SAT 2 Meter (304051)  
TERR 2 Meter (304050)

For details of distributors:  
T: 0845 601 0578  
[sales@triax.co.uk](mailto:sales@triax.co.uk)

Complete and fax the coupon to: +44 (0) 1353 654400

I wish to subscribe for one year to Television:

Price  UK £33.80  Europe £48.00  
 Rest of World £63.50  US\$99.00  Euro 100.96

I wish to subscribe for two years to Television:

Price  UK £53.00  Europe £77.00  
 Rest of World £99.00  US\$154.00  Euro 157.41

Please tick preferred method of payment

I enclose a cheque payable to Highbury Business Communications Ltd  
 Please Invoice me  Purchase No

(NB Purchase order must be included to validate Invoice)

Please charge my: Master Card/Visa/Amex/Diners  
Club/Switch/Delta (please circle)

Card No

Expiry Date

(Switch/Delta Only) Valid from  /  /  Issue Number

Signature

Date

Name

Job Title

Company

Address

Postcode/Zip

Country

Telephone/Fax

E-mail

Please tick here if you do not wish to be contacted by other businesses either by  
Mail  Telephone  Fax  E-mail

Please return to: Highbury Subscription Services, Link House,  
8 Bartholomew's Walk, Ely, Cambridgeshire CB7 4ZD, UK.

Email: [wss@wyverncrest.co.uk](mailto:wss@wyverncrest.co.uk)

(Quote ref: TV1)

  
HIGHBURY  
Business Communications

# TELEVISION

AND HOME ELECTRONICS REPAIR

Television & Home Electronics Repair magazine is the only magazine for technicians who deal with consumer electronic products, in particular TV, Video, Satellite and Audio equipment.

Keep up to date with the latest information and changes affecting this industry including tips & guides on repairing television and electronic equipment including satellite receivers, PCs, monitors, VCRs, DVD players, audio equipment and much more.....



Make sure you receive your regular monthly copy by subscribing today.....

# TELEVISION BOOKS

AND HOME ELECTRONICS REPAIR

The Television Book Service offers access to our team of specialist publishing experts. We can order any book or CD-ROM currently in print from *War And Peace* to the *Newnes Guide to Television and Video Technology*. All books are delivered free of charge within the UK unless otherwise stated. Contact us at the numbers below:

Telephone: **01737 812727** or **01737 812676**

Fax: 01737 813526

Email: [salesteam@boffinbooks.demon.co.uk](mailto:salesteam@boffinbooks.demon.co.uk)

## DVD PLAYERS AND DRIVES

**K F Ibrahim**  
(College of North West London)

This text is based on hands-on experience and acts as a guide to DVD technology and its application, with a special focus on design issues. The principles of the subject are introduced from the basics, and DVD applications are illustrated by genuine technical information.



Aug 2003 ▲ 256 pages ▲ Glossary ▲ Index  
PB ▲ Published in UK

Code 0 7506 5736 7

£24.99

## ELECTRONIC CLASSICS: COLLECTING, RESTORATION AND REPAIR

**Andrew Emmerson**

This text encompasses all aspects of buying, collecting, restoring, repairing, sourcing parts, professional services, clubs and societies. The first part covers technical aspects of restoration and details where components can be found; the second presents useful information for collectors.



Aug 1998 ▲ 256 pages ▲ Index  
10 halftones ▲ 50 line illustrations ▲ PB  
Published in UK

Code 0 7506 3788 7

£21.99

## CLOSED CIRCUIT TELEVISION: CCTV INSTALLATION, MAINTENANCE AND OPERATION

**Joe Cieszynski**

CCTV surveillance is one of the fastest growing areas in the security industry, and this is a thorough guide to the technical side of CCTV – including installation, maintenance, video recording, cameras and monitors. The second edition is fully dual-standard for PAL and NTSC systems.



2nd edition ▲ Sept 2003 ▲ 256 pages  
Glossary ▲ Index ▲ PB ▲ Published in UK

Code 0 7506 5728 5

£24.99

## DICTIONARY OF VIDEO AND TELEVISION TECHNOLOGY

**Jack Tsatsoulis**

This work provides comprehensive and contemporary information on the essential concepts and terms in video and television, including coverage of test and measurement procedures. The CD accompanying the text includes an electronic version of the book.



Sept 2002 ▲ 365 pages & CD-Rom  
Published in UK

Code 1 878787 99 1

£29.99

## NEWNES GUIDE TO TELEVISION & VIDEO TECHNOLOGY

**Eugene Trundle**

An exploration of television and video technology. It covers the fundamentals of digital television (satellite, cable and terrestrial) and digital video, as well as providing a grounding in analogue systems.



3rd edition ▲ Feb 2001 ▲ 432 pages ▲ Index  
PB ▲ Published in UK

Code 0 7506 4810 4

£17.99

## NEWNES GUIDE TO DIGITAL TV

**Richard Brice**

Covering all aspects of digital television, this text encompasses the electronics of the equipment, data compression, television production, servicing and the different transition methods - terrestrial, satellite and cable. The text has been updated with developments since the 2000 edition.



2nd edition ▲ Dec 2002 ▲ 304 pages ▲ Index  
45 illustrations ▲ 15 photographs ▲ HB  
Published in UK

Code 0 7506 5721 9

£24.99

## INTRODUCTION TO DIGITAL SYSTEMS

**John Crisp**

This self-study text introduces digital electronics from first principles, before going on to cover all the main areas of knowledge and expertise. It covers the practicalities of designing and building circuits, including fault-finding and the use of test equipment.



Feb 2000 ▲ 302 pages ▲ Glossary ▲ Index  
PB ▲ Published in UK

Code 0 7506 4583 8

£18.99

## NEWNES DICTIONARY OF ELECTRONICS

**S W Amos; R S Amos**

Aimed at engineers, technicians and students working in the field of electronics, this dictionary provides clear and concise definitions, including TV, radio and computing terms, with illustrations and circuit diagrams.



4th edition ▲ Mar 2002 ▲ 394 pages  
100 illustrations ▲ PB ▲ Published in UK

Code 0 7506 5642 5

£12.99

## PRACTICAL ELECTRONIC FAULT FINDING AND TROUBLESHOOTING

**Robin Pain (Design Engineer, Cotag International Ltd)**

A text using simple circuit examples to illustrate principles and concepts fundamental to the process of analog and digital fault finding. It aims to help the reader tackle any job, from fixing a TV to improving the sound of a hi-fi. A digital multimeter and oscilloscope are needed for these jobs.



Apr 1996 ▲ 284 pages ▲ Index  
50 line illustrations ▲ PB ▲ Published in UK

Code 0 7506 2461 2

£21.99

## PRACTICAL ELECTRONICS HANDBOOK

**Ian Sinclair**

A collection of all the key data, facts, practical guidance and circuit design basics needed by a spectrum of students, electronics enthusiasts, technicians and circuit designers. It provides explanations and practical guidance, and includes new sections on SHF techniques and intruder alarms.



5th edition ▲ Feb 2000 ▲ 571 pages  
Illustrations ▲ PB ▲ Published in UK

Code 0 7506 4585 7

£16.99

## RSGB RADIO & ELECTRONICS COOKBOOK

**Radio Society of Great Britain**

Only a basic knowledge of electronics is assumed for this collection of electronics projects, and it is ideal for all electronics and DIY enthusiasts and experimenters. Designed by the RSGB, the UK radio amateurs federation, the projects are clearly explained step by step.



Nov 2000 ▲ 336 pages ▲ PB ▲ Illustrations  
Published in UK

Code 0 7506 5214 4

£17.99

## REFERENCE DATA FOR ENGINEERS: RADIO, ELECTRONICS, COMPUTERS AND COMMUNICATIONS

**Mac E Van Valkenburg; Edited by Wendy Middleton**

Written by professionals for professionals, this is a complete reference for engineers. As well as addressing radio technology data, it covers digital electronics, computers and communications.



9th edition ▲ Aug 2001  
1568 pages & CD-Rom ▲ 1385 line illustrations  
HB ▲ Published in UK

Code 0 7506 7291 9

£90.00

## SERVICE ENGINEER'S POCKET BOOK

**Lewis & Sinclair**

This title aims to provide the service engineer with all the necessary information to carry out work on domestic electronics equipment. The coverage ranges from satellite reception to NICAM. Both analogue and digital equipment are covered, and there are chapters on common problems.



Jan 1998 ▲ 238 pages ▲ HB

Code 0 7506 3448 0

£14.99

## SERVICING TV, SATELLITE & VIDEO EQUIPMENT

**Eugene Trundle**

A practical hands-on guide for service engineers, installation technicians and servicing students, this text emphasises the practical business of fault diagnosis and repair of TV, satellite and video equipment.



Revised 2nd edition ▲ Nov 2001 ▲ 336 pages  
Symptom index ▲ PB ▲ Published in UK

Code 0 7506 5507 0

£21.99

## TELEVISION MICROPROCESSOR IC DATA FILES

J Edwards

Microprocessor ICs are the most complicated part of TV equipment and present special problems to the engineer. This text covers the most popular microprocessor ICs. Each device is presented graphically with the relevant data information given against each pin.

Mar 1997 ▲ 240 pages ▲ 200 line drawings

PB ▲ Published in UK

Code 0-7506-3235-7

£19.99



## TELEVISION IC DATA FILES

J Edwards

A compendium of data on all the most common integrated circuits used in televisions. Each device is illustrated with a pin-out diagram, and all the measurements and signal data in the book were taken under actual working conditions. This second edition contains over 70 new ICs.

2nd edition ▲ Jan 2000 ▲ 245 pages

PB ▲ Published in UK

Code 0-7506-4581-4

£18.99



## TV FAULT-FINDING GUIDE

Edited by Peter Marlow

A distillation of the most-used fault reports from 11 years of *Television* magazine. Arranged by make and model, it features over 200 reports on over 300 models of television, including diagnosis and repair advice.

Mar 2000 ▲ 387 pages ▲ Illustrations

PB ▲ Published in UK

Code 0-7506-4633-0

£20.99



## VALVE AMPLIFIERS

Morgan Jones

The author's straightforward approach, using as little maths as possible, should be of use to those with only a limited knowledge of the field as well as being the standard reference for experts in valve audio. Design principles and construction techniques are also provided.

3rd edition ▲ Aug 2003 ▲ 624 pages ▲ Index

PB ▲ Published in UK

Code 0-7506-5694-8

£29.99



## VCR FAULT-FINDING GUIDE

Edited by Peter Marlow

A distillation of the most-used fault reports from 11 years of *Television* magazine. Arranged by make and model, it features over 2000 reports on over 200 models of VCR, including diagnosis and repair advice.

Mar 2000 ▲ 447 pages ▲ Illustrations ▲ PB

Published in UK

Code 0-7506-4634-9

£20.99



## VCR IC DATA FILES

J Edwards

This text aims to provide the workshop technician and the field engineer with a convenient method of fault-finding without the need to consult workshop manuals. The most popular ICs used in video recorders are covered. Each device is presented graphically with data given against each pin.

Jul 1998 ▲ 448 pages ▲ 200 line illustrations

PB ▲ Published in UK

Code 0-7506-3893-0

£20.99



## VIDEO AND CAMCORDER SERVICING AND TECHNOLOGY

Steve Beeching

A comprehensive guide to domestic VCR technology and repair techniques. This edition brings the information fully-up-to-date, with expanded coverage of camcorders, sections on DVD equipment and the latest VCR technology.

5th edition ▲ Apr 2001 ▲ 323 pages

Illustrations ▲ PB ▲ Published in UK

Code 0-7506-5029-7

£20.99



## VIDEO DEMYSTIFIED

Keith Jack

This edition has been updated to include information on digital television, datacasting, interactive video, digital camcorders and VCRs, and video interfacing. Coverage is international, including European, Asian and North/South American video standards, methods and techniques.

3rd edition ▲ Jul 2001 ▲ 784 pages & CD-Rom

References ▲ Glossary ▲ Index ▲ PB

Published in UK

Code 0-7506-5694-8

£50.00



## THE DIGITAL SATELLITE TV HANDBOOK

Mark E Long

A handbook and CD-ROM pack on digital satellite television. It provides an overview of all the digital TV platforms in use world-wide. It includes satellite coverage maps and transmission parameters that readers will need to receive digital TV services from any location in the world.

Sept 1999 ▲ 207 pages & CD-Rom ▲ PB

Code 0-7506-7771-0

£41.99



## NEWNES GUIDE TO RADIO AND COMMUNICATIONS TECHNOLOGY

Ian Poole

This is a guide to the technology and applications of modern radio and communications equipment. The author's approach provides a useful foundation for college students and technicians seeking an update on the latest technology.

Jul 2003 ▲ 352 pages ▲ Index ▲ PB

Published in UK

Code 0-7506-5412-0

£16.99



## VALVE RADIO & AUDIO REPAIR HANDBOOK

Charles Miller

A practical manual for collectors, dealers and service engineers of valve audio and radio equipment. This edition includes new material on restoration and valve amplifiers.

2nd edition ▲ Apr 2000 ▲ 280 pages

▲ 10 halftones ▲ 50 line illustrations ▲ PB

Published in UK

Code 0-7506-3995-4

£20.99



## NEWNES TV & VIDEO ENGINEER'S POCKET BOOK

Eugene Trundle

This updated text provides a pocket tool for service engineers. It presents a range of essential information in a compact form, covering television reception, satellite and cable television, video recorders, colour camera technology, teletext and fault-finding.

3rd edition ▲ Oct 1999 ▲ 512 pages ▲ HB

Code 0-7506-4194-0

£17.99



## TELEVISION ORDER FORM

Please order or search the following:

Code	Description	Qty	Price

POSTAGE & PACKING FREE IN THE UK\*

TOTAL

Name Daytime Tel

Address

Postcode

I enclose a cheque/postal order value £ payable to 'Boffin Books Ltd'

Please debit my Access/Visa/Switch/Delta card Issue number (Switch only)

Card Number Expiry Date

Signed

\* Postage charges outside the UK available upon request or email: [salesteam@boffinbooks.demon.co.uk](mailto:salesteam@boffinbooks.demon.co.uk)

Post to: Boffin Books Ltd, 24 Walton Street, Walton-on-the-Hill, Tadworth, Surrey KT20 7RT, UK

If you are ordering by credit card, need further information, or would like to use our search facilities, call

01737 812727 Fax 01737 813526

The order/helpline is open from 9am to 5pm, or leave your order on our out-of-hours answerline or email us at

[salesteam@boffinbooks.demon.co.uk](mailto:salesteam@boffinbooks.demon.co.uk)

When placing orders please quote ● Name ● Address (home & delivery) ● Daytime telephone number ● Debit/Credit card number ● Expiry date ● Details of order. Please note that prices may change, but are correct at time of going to press.



# WHAT A LIFE!

**A mixed batch of faulty equipment.  
An even more mixed batch of customers.  
Donald Bullock's servicing commentary**

I'm not too good at remembering faces. Never was, and it has caused me more than a few problems over the years. This can be particularly so when I sell TV sets or whatever, especially those bought in at 'special' prices, where the profit margin might make the job almost worthwhile.

## **A displeased customer**

When dealing with customers I can get really friendly and personable. Almost nice to know.

It happened again last week. Paul had diagnosed a faulty smoothing block in Mr Hoighty's TV set – a monster with the largest screen I've ever seen and all the latest technical extras. It was capable of everything short of doing the washing up.

But Mr Hoighty had become displeased with it, because this was the second time it had given him trouble during its first eighteen months. When we told him that this time we wanted £25 to repair it he became even more displeased. His eyes turned to slits, and he slammed his upper lip down like the top of a roller-top desk.

"I gave it a chance last year" he hissed, "and let you repair it. I would have let you repair it this time if it had been under guarantee, like then. But nothing and nobody plays me up twice, see? I'm cute when it comes to paying out. You can keep the bloody set!"

He signed our bit of paper with a flourish and strutted out, beaming like a victorious gladiator.

Paul, who had witnessed it all, scratched the top of his head like a puzzled Stan Laurel. So I tried to ease his evident discomfort. Olly style.

"What's the matter Stanley?" I asked. "Now it's ours. We can mend it and sell it for a mighty good price. Just think, Mr Hoighty hasn't been bad to us at all!"

---

*When dealing with customers I can get really friendly and personable – almost nice to know...*

---

"He hasn't?" said Paul.

"Not at all" I said, "in fact he's done us nothing short of one great big favour." I began to hum a tune. Paul looked at me, pursed his lips and smiled with his mouth, though not his eyes.

It wasn't long before the set sat gleaming in the middle of our shop display. When it caught the eye of Bertie Bunyan, happiness started to well up within me. The keener Bertie became, the happier I got. Within two minutes we were on the most jovial of first-name terms. Two minutes after that, as the set became his very own, he made me and our till croon. Our lifelong friendship had got off to a flying start.

A day or two later, in the Red Lion, some chap started waving and grinning at me from across the room. I looked at him stonily. "Who's that lunatic over

---

*His eyes turned to slits, and he slammed his upper lip down like the top of a roller-top desk*

---

there?" I asked Steven.

"The chap you sold that monster TV set to" he replied.

I turned round to wave and return his grin, but by now he seemed to be deep in thought, studying the carpet.

"Funny chap" I said. "Didn't really take to him. Bit dishevelled. Thought he might work for some oil-stained backstreet dump that tinkers with bangers..."

"But don't you remember his face?" Steven continued.

"Well, not really..."

## **Video trouble**

Just then a heavy little fellow sloped up to us, nursing a pint.

"Be you the Mr Bullock that mends tellys?" he asked.

I gave him a watery grin and pointed at Steven.

Pausing only to give me a withering look, Steven smiled at him and bent down to align his ear with the chap's mouth.

"I don't wanna talk shop when you're 'aving a drink after a day's work, but I got a video, see?" he continued. "And he's gone dead like. 'Ow much would that cost now? Could you do 'im quick? Couldn't be much wrong like. Oney they've got brand new 'uns up town fer £35.50..."

At that I caught sight of somebody I knew over the other side of the room and sloped off, leaving Steven to deal with the fella's questions.

Next morning the chap waddled in with his recorder. It turned out to be a Samsung SV230B. He saw me there.

"Joo work here?" he asked. Then he saw Steven. "I brought the recorder in, Mr Er..aww..ahh" he said. "I knows it can't cost much. Only the missus 'as this in-grown toe-nail like, an' 'er sister ent none too good..."

When he'd departed Paul took the machine to the bench and opened it up.



It was dead all right. But nothing difficult. The two start-up resistors on the primary side of the power supply, R15D12 and R15D15, were open-circuit. Once he'd replaced them

the machine seemed to be OK. He started to write out the job card.

"Don't forget his wife's toe nail" I said, "and the state of her sister ..."

Then we noticed a personable and, I suppose, good looking chap in a leather jerkin thing. He was heading for the shop door and was carrying a VCR.

"Can't be coming in here, can he?" I commented. "He looks too normal."

He did come in, smiling pleasantly, and the VCR was an Akai VSG745.

"Morning Mr Bullock" he said, closing the door quietly behind him. "Is there any chance you could repair this for me, please?"

As Steven booked it in I could see that he was impressed. "Nice to encounter a normal fella for once" he commented.

This VCR was also dead, for the same reason. Paul, who handles the videos, soon found that R209 (270k $\Omega$ ) was open-circuit. The repair took a matter of minutes.

The chap came back later that day, and was happy with the price. He opened his jerkin and pulled out a frilly pink handbag.

I turned to Steven when he'd gone. "As you said, he was a bit different" I commented.

### A camcorder

Our next caller opened the door and popped his head in.

"Hello Mr Burford" he exclaimed. "I'm Tom Western and I'm coming in!" Then he ran away.

We exchanged glances, but not for long. Within a minute or two he was back, clutching a camcorder. It was a Samsung VPL500.

"He works, Mr Boodle, but he don't work" Tom explained helpfully. "You puts a tape in, and he don't play it, then you takes it out and he do." Steven gulped a bit.

"Any chance of me picking it up tonight?"

"We'll try" said Steven, "call in about five."

"That's good of you. See you tomorrow."

Steven looked at this one. He found

---

*"It blew up, Mr Bullock" he trumpeted.  
"Just as my wife was about to  
watch her favourite programme!  
Have you met my wife?" ...*

---

that the carriage drawer would close without a cassette in, but with a cassette in it wouldn't. When he dismantled it he found that the capstan motor was sluggish. It didn't respond to cleaning and lubrication, so a replacement was ordered. It arrived first thing next morning. Once it had been fitted the camcorder worked normally.

Later that day Mr Western popped his head around the door, said he was coming in, then dashed off again. But he soon returned, and was happy that we'd been able to cure the trouble with his Samsung.

"Glad you were able to fix it by today" he said, "only I needed it last night to see that *Cheaters* programme. Really good, innit?"

### A blown up Sharp

Mr Christianiou hales from Greece. He's tall and well padded, and sports a big black moustache. The set he struggled in with was a Sharp 51CS05H, one that's fitted with the CS chassis.

"It blew up, Mr Bullock" he trumpeted. "Just as my wife was about to watch her favourite programme! Have you met my wife?"

I shook my head. "Don't think I've had the pleasure" I commented.

He rolled his eyes and brought his hands up as though to conduct an unseen orchestra, swaying to its silent music. "Oh Mr Bullock" he continued, "my wife ..., my wife ..." He smiled happily at the thought of her.

"Er, yes. Well, right" I said. "We'll have a look at the set and give you a ring."

"Oh thank you, Mr Bullock" he continued, "my wife will be pleased." Then he closed his eyes and started swaying again.

When he'd departed Steven pulled the set on to the bench. We've had a lot of dealings with these sets. They can blow the line output transistor weekly unless you get to the root of the trouble, which is a couple of capacitors, C604 (330 $\mu$ F, 10V) and

C714 (1.000 $\mu$ F, 10V). C604 is in the line output stage and forms part of the unusual feedback drive arrangement. C714 is the reservoir capacitor, on the secondary side of

the chopper circuit, for the 7V supply that feeds the 5V regulators.

Steven replaced them and the line output transistor, after which the set worked happily enough.

### Help wanted

The phone rang. Steven answered it, but I could hear the raucous voice from the other side of the room. It could only have been Stan Idler.

"If you comes outa your shop door and looks to your right, you'll see me by my red car" he bellowed. "I'm wearing a brown trench coat and a big cap like."

Steven frowned and put the phone down. He went out, huddling his shoulders against the rain, paused, looked right then ran off up the road.

He was away for fifteen minutes.

When he returned, puffing and blowing, he was soaking wet and was carrying a large 21in. Matsui set, Model 2107R.

"Thanks for 'elping me, Mr Bullock" Idler said. "I'd have carried 'im meself, except I've this bad back like."

Steven opened his mouth to reply, but no words came out.

"Give us a ring like" said Idler as he made off.

"Where did you get to?" I asked when Steven had recovered his breath.

"He was parked over a hundred yards up the road" he replied. "He could have pulled on to the front ..."

By now Paul had powered the set and found that it was dead. The trouble was in the start-up circuit, where a 1M $\Omega$ , 0.5W resistor was open-circuit.

"Experience has taught me to suspect any resistors that are over 68k $\Omega$ " I commented, "the higher the value, the more likely it is that you'll find them open-circuit."

A replacement got the set working again.

### Keep it up!

Many thanks to all of you who have sent me emails recently. I'll include some comments next time. Keep it up – you can reach me at [donald@wheatleypress.com](mailto:donald@wheatleypress.com)

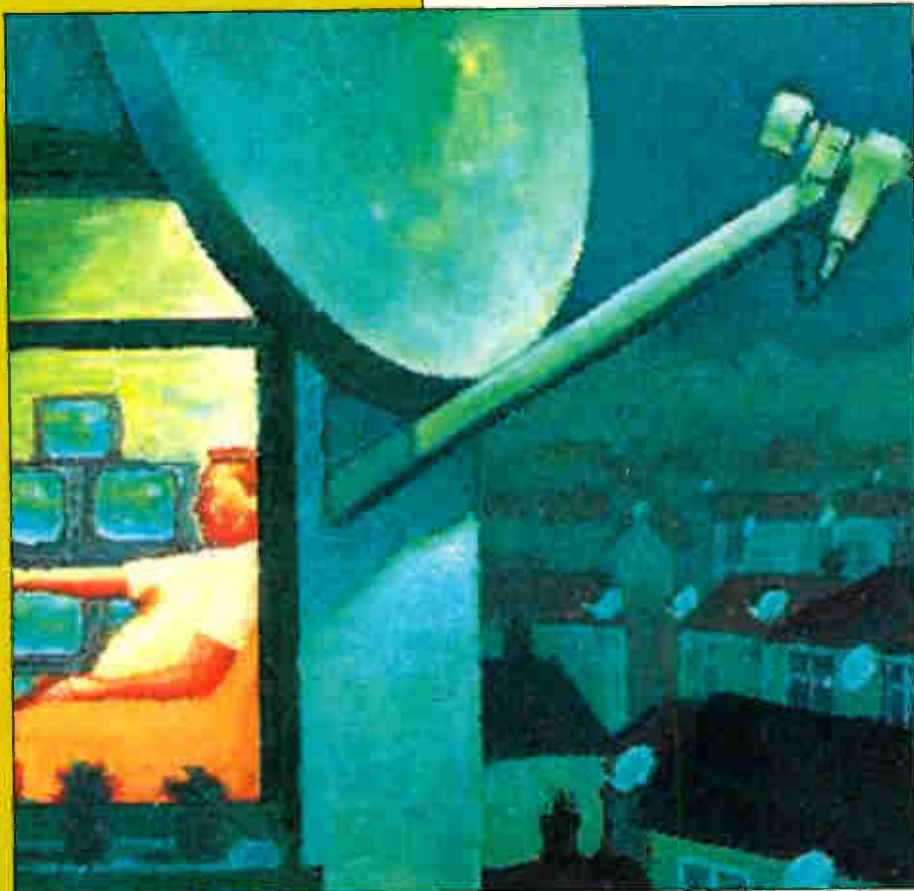

# SATELLITE NOTEBOOK

Reports from  
**Christopher Holland**  
**Hugh Cocks and**  
**Michael Dranfield**

## HDTV

The European high-definition TV channel via Astra at 19.2°E, mentioned in this column last November, started some regular transmissions at the beginning of January – see Photo 1. At the moment however the number of programmes is rather small. HDTV receiver boxes are still very thin on the ground, but a PC-based receiver can be used to receive the transmissions. The channel frequency is 12.168GHz, with vertical polarisation, a symbol rate of 27,500 and 3/4 FEC. C.H.

## Digital channel update

The latest channel additions at 28.2°E are listed in Table 1. Where allocated, the EPG number is shown in brackets after the channel name. The old film channel TCM via transponder 18 (12.051GHz V, Astra 2A) and the channel with EPG no. 327, which were free-to-air, are now encrypted. Radio channels Kiss FM, Kerrang and

Smash Hits, mentioned last month, have ceased testing on transponder 32 (Astra 2B) and have moved their tests to transponder D9S (Eurobird). C.H.

## Eutelsat 2F3

This month we'll take a look at the signals available via Eutelsat 2F3 at 21.5°E. The satellite is very busy, mainly with feeds for broadcasters, but there's a complication with reception. At the time of writing the satellite is in an inclined orbit of about 3° (this could increase as time goes on). This is sufficient variation in its location to require some adjustment of the receiving dish's direction to maintain reception during the course of a day.

Geostationary satellites normally hold their position to within a tenth of a degree or so, enabling fixed receiving dishes to pick up the transmissions. To maintain this station-keeping accuracy most satellites have on-board gas-powered thrusters that are fired every so often. In general a geostationary satellite's life depends more on the amount of stabilising-thruster gas left than the on-board electronics. Towards the end of a satellite's useful life the stabilisers may be fired less frequently, the result being an inclined orbit. Eutelsat 2F3 was launched in 1991, probably with a predicted life of 10-12 years.

Many of the old Soviet Gorizont satellites had an inclined orbit from the start of



Photo 1: Some regular European high-definition TV channel transmissions via Astra at 19.2°E started in early January.



Photo 2: Dish actuator used by Hugh Cocks with his 2m dish's polar mount for satellite tracking.



Photo 3: An ITN feed via Eutelsat 2F3.



Photo 4: An ITN feed via Eutelsat 2F3.

their lives, partly because of the relatively northern latitude of the launch site used to place them in orbit. They were intended for links to terrestrial rebroadcast transmitters that had specialised receiving dishes. Broadcasters that use Eutelsat 2F3 will have dishes with tracking facilities, at both the transmit and receive end. Part of the attraction of using this satellite is the lower charge made by Eutelsat in comparison with use of a 'conventional' geostationary satellite. A satellite news-gathering truck will have motors that enable the dish on its roof to locate satellites, so slight adjustment during an uplink period shouldn't be much of a problem for the operator inside.

To track the satellite I use a standard dish actuator with my 2m dish's polar mount. It replaces the normal fixed adjuster, enabling the dish to move up and down. See Photo 2. The elevation actuator is coupled to an old positioner which is independent of the conventional polar mount actuator that drives the dish from east to west in the normal way. A fixed dish could be used for reception from the satellite, but some manual azimuth and elevation adjustment would be required. This would no doubt become tedious!

The satellite wanders across the conventional geostationary-arc position twice a day, at about 1000 and 2200 GMT. If a normal polar mount is used to steer the receiving dish, these are good times at which to locate the satellite initially. As the satellite feeds tend to come and go, it's very convenient that several Italian channels use the satellite to link with Hotbird at 13°E and are always on air, see Table 2. The satellite is just over 2° to the east of the massive signals from the Astra 1 slot (19.2°E), so a dish with good side-lobe rejection is a help.

Two very strong non-TV carriers are always present via the satellite's low band, at approximately 11.065GHz and 11.570GHz with vertical polarisation. They provide a convenient and easy way of finding the wandering bird with a spectrum analyser.

An ITN feed channel is nearly always on air at 11.097GHz H, see Photos 3 and 4. The symbol rate is 5.632 and the FEC value 3/4. But the MPEG 4:2:2 format is used, whereas the Italian channels use MPEG 4:2:0 and can thus be picked up by any digital satellite receiver. MPEG 4:2:2 signals are most easily picked up using a

**Table 1: Latest digital channel changes at 28.2°E**

Channel and EPG no.	Sat	TP	Frequency/pol
FX UK (289)	2B	21	12.110GHz/H
Radio channels*	EB	D9S	11.623GHz/H
VH2 (446)	2A	10	11.895GHz/V

\*Heat, Kerrang, Kiss 100, Magic 105.4FM, Mojo, Q, Smash Hits and The Hits.  
TP = transponder. EB = Eurobird. 2A, 2B = Astra 2A/B.

PC-based satellite receiving system, as described in the August and September 2003 issues.

The satellite's lowest elevation occurs at about 1600 GMT, the highest twelve hours later at about 0400 GMT. With a 2m dish some adjustment is needed every half an hour or so to maintain maximum signal. The movement of the satellite in the sky is actually an elongated figure of eight rather than just up and down, so some fine adjustment of the EW actuator is required as well.

Living in southern Portugal, which is near the bottom west of Eutelsat 2F3's footprint, I found that even before the satellite's orbit became inclined there was some variation (3dB or so) in signal strength, particularly in the 12GHz band, as the whole footprint of a satellite moves up and down. The effect shouldn't be as noticeable in the UK, which is away from the edge of the satellite's beam. During transmission of a feed I've noticed that, depending on its length, the signal strength can become gradually weaker – this occurs as the satellite moves away from the uplink signal – then suddenly strengthens as the uplink dish is realigned with the satellite.

Feed frequencies occasionally used are as follows. Unless otherwise indicated, all have a symbol rate of 5.632 with 3/4 FEC and are horizontally polarised.

**Miscellaneous feeds:** 11.023 and 12.694GHz. The latter uses vertical polarisation, has an SR of 4.094 and 1/2 FEC.

**Sky feeds:** 11.041, 11.049, 11.685 and 11.693GHz. See Photos 5 and 6.

**ITN feeds:** 11.065, 11.073, 11.081, 11.089 and 11.097GHz (the latter is almost always on-air).

**France 2 feeds:** 11.655GHz (see Photos 7 and 8).

**SIS feeds:** 11.057GHz and between

**Table 2: Italian channels via Eutelsat 2F3**

Frequency/pol	Symbol rate	FEC	Channel name
12.701GHz/V	2,195	2/3	Sardegna Uno Sat
12.717GHz/V	2,500	2/3	Count Down TV
12.722GHz/V	2,170	3/4	Mediatel



Photo 5: A Sky feed via Eutelsat 2F3.



Photo 6: A Sky feed via Eutelsat 2F3.



Photo 7: A France 2 feed via Eutelsat 2F3.



Photo 8: A France 2 feed via Eutelsat 2F3.

11-580-11-680GHz (see Photo 9). Very occasionally SIS feeds at 11-642; 11-662 or 11-682GHz use an SR of 10.850 and 3/4 FEC.

**BBC feeds:** I've found BBC feeds at 10-961, 10-969, 10-978, 11-014, 12-548, 12-557, 12-568 and 12-571GHz with the standard characteristics. Feeds at 12-507, 12-512, 12-518, 12-526, 12-531 and 12-537GHz however mainly use an SR of 4.224 with 7/8 FEC, though the last two frequencies occasionally use an SR of 5.632 with 3/4 FEC. Very occasional feeds at 10-964, 10-982, 12-553 and 12-573 use an SR of 12.600 with 3/4 FEC. See Photos 10 and 11. There are two marker beacons at about 12-522 and 12-563GHz that may be present to help the BBC uplink trucks find the satellite. **H.C.**

### **Pace 250053**

The customer complained that some channels were missing. On test I test found that the digibox was stuck on vertical polarisation. When I selected a channel with horizontal polarisation, EPG no. 235, the LNB-polarisation change FET Q100 didn't apply 20V to the cathode of D100.



*Photo 9: An SIS feed via Eutelsat 2F3.*

Q100 was not the cause of the fault however. There was only 15V at its input instead of 20V. In fact the 20V output from the power supply was missing – the 15V was coming via the FET's internal protection diode.

When I examined the power supply panel I found a burnt-up, surface-mounted decoupling capacitor, C2532, on the underside. The track beneath it had also been damaged. No value for this capacitor is given in the manual, so I removed one from a scrap PCB and found that it's 47nF. A replacement capacitor and some track repair cured the fault. **M.D.**



*Photo 10: A BBC feed via Eutelsat 2F3.*



*Photo 11: A BBC feed via Eutelsat 2F3.*

## Solution to Test Case 495

- see page 295 -

Real Technician, after correct diagnosis and repair of the initial dead-set fault with the Sony TV Model KVX2928U (BE3B chassis), spent a long time jumping to conclusions, all wrong ones. It stemmed from his too-hasty check on the 135V HT line once primary power had been restored. In fact the voltage (there is no preset adjustment for it) was about right, and was certainly not triggering over-voltage protection as RT had supposed. Nor was there any problem in the line output stage: scan current and the CRT's beam-accelerating voltages were being generated normally during the short burst of activity each time the set was brought out of the standby mode.

In fact the cause of the problem was to do with the EEPROM chip IC002. It was not faulty but the data within it was incorrect. The data had probably been corrupted by the same mains-voltage surge that had destroyed the fuse and the chopper chip. IC002 needed to be reprogrammed, but the set first had to be made to stay on long enough for this to be done! The trick is to earth the 'prot' line at pin 9 of connector CN001 on board A. You then enter a specific eleven- or eight-key sequence to reinitialise the memory chip. Once the mains supply has been switched off then on again the software will be reset and normal operation restored. Wow!

## NEXT MONTH IN TELEVISION

### CES Las Vegas 2004

This year's Consumer Electronics Show at Las Vegas was a great success, a show-piece for an industry that sold over \$96bn worth of goods in the US last year. Price competition is fierce, so the emphasis is on innovation and value-added to achieve profitability. George Cole reports on the highlights of the Show.

### Replacing the Painter chip

Philips refers to the main microcontroller IC in the A10E chassis as the Painter. It's a small, surface-mounted 100-pin device that can be the cause of many symptoms. Particular care is required when replacing it. Martin Cole explains how to go about the operation.

### Vintage radio repairs

Pete Roberts provides further guidance on how to tackle vintage equipment. This time some faults with the Radford FMT1 hybrid FM tuner and the Motorola 124 car radio.

### Wireless broadband links

Steve Beeching on the advantages of having a wireless broadband link for internet connection.

**PLUS ALL THE REGULAR FEATURES**

## TELEVISION INDEX & DIRECTORY 2004

Plus hard-copy index and reprints service

Here's the essential repair information you need! The Television Index & Directory 2004, in CD-ROM form, contains the text of over 15,000 high quality fault reports on TVs, VCRs, Camcorders, DVD players, Monitors, Satellite TV units, Audio equipment and CD players, searchable by make and model, plus the text of 200 Test Cases and over 250 major servicing articles, from sixteen years of Television magazine. It also contains a full sixteen-year index of Television, a Spares Guide, a directory of Trade and Professional Organisations, an International TV Standards guide, a satellite TV Channel Finder, a TV transmitter list and a compendium of internet resources for service engineers. The software is quick and easy to use, and runs on any PC with Windows 95, 98, ME, NT, XP or 2000.

### Television Index & Directory 2004 CD-ROM, £199

Television Index & Directory 2004 CD-ROM upgrade, £46 (to qualify for this upgrade you need to have purchased a previous version of the Television Index on floppy disk or on CD-ROM)

A six-month update of the index and fault reports will be available in May 2004. If you wish to take advantage of this, £10 should be added to your order.

Television Index only, 1988—2003, £36

Television Index only upgrade from previous versions, £18

**Hard-copy indexes** of Television magazine are available for Volumes 38 (1988) to 53 (2003) at £3.50 per volume.

**Reprints of articles** from Television back to 1988 are also available, at the flat rate of £4.00 per article — you can order through our web site, or write to the address below.

The above prices include UK postage and VAT where applicable. Add an extra £1 postage for non-UK EC orders, or £5 for non-EC overseas orders, although Channel Island residents do not need to add any extra postage. Cheques should be made payable to SoftCopy Ltd. All major credit and debit cards are accepted. Please use our new secure website for your orders, details below.

Allow up to 28 days for delivery (UK).

**SoftCopy Limited, 1 Vineries Close, Cheltenham, GL53 ONU, UK**

Telephone 01242 241 455 Fax 01242 241 468

e-mail: [sales@softcopy.co.uk](mailto:sales@softcopy.co.uk)

web site: <http://www.televisionmag.co.uk>

Published on the third Wednesday of each month by Highbury Business Communications, Nexus House, Azalea Drive, Swanley, Kent. BR8 8HU. **Highbury Business Communications** is a division of **Highbury Communications PLC**. **Filmsetting** by Impress, Unit 2, Parkway, Southgate Way, Orton Southgate, Peterborough PE2 6YN. **Printed** in England by Polestar (Colchester) Ltd., Newcomen Way, Severalls Industrial Park, Colchester, Essex CO4 4TG. **Distributed** by Comag, Tavistock Road, West Drayton, Middlesex UB7 7GE (tel. 01895 444 055). **Sole Agents** for Australia and New Zealand, Gordon and Gotch (Asia) Ltd.; South Africa, Central News Agency Ltd. **Television** is sold subject to the following conditions, namely that it shall not, without the written consent of the Publishers first having been given, be lent, resold, hired out or otherwise disposed of by way of Trade at more than the recommended selling price shown on the cover, excluding Eire where the selling price is subject to currency exchange fluctuations and VAT, and that it shall not be lent, resold, hired or otherwise disposed of in a mutilated condition or in any unauthorised cover by way of Trade or affixed to or as part of any publication or advertising, literary or pictorial matter whatsoever.

## PERIFELEC

### MC 30 A Spectrum Analyser



- Synthesized satellite cable and TV field strength meter with panoramic reception on 14 cm (5.5") screen and digital carriers measurement.
- Complete microprocessor and IspLSI logic control.
- Continuous frequencies from 46 to 860 MHz and from 920 to 2150 MHz on 4 bands.
- Selectable 4, 1 and 0.2 MHz spectrum band-width, picture measurement 1 MHz.
- Display of picture of selected synthesized channel.
- FM (Radio) LA, BAG, I, D/K/K', MN TV standards and Ku and C satellite standards.
- Possibility of 32 programs memorized per frequency band.
- Display (2 Lines of 16 characters).
- Range of measurement of signal strength from 20 to 120 dBµV, manual or automatic attenuator.
- Battery life about 1 hour 20 minutes, weight 5,8 Kg.

- Display of full-band and 4 possible expanded spectrums.
- Channels and frequency plans of cable and TV standards memorized.
- Frequency, signal strength in dBµV or bargraph, displayed on a digital display (2 lines of 16 characters).
- Voltage of remote power supply in 14v or 18v and 22 KHz in satellite + DiSEq C™ v1.2 switching.

The panoramic field strength meter MC30A combines in one instrument all the functions necessary for installing and checking TV or satellite reception, both analogue and digital. The visualization of the spectrum and the picture allows the carrying out of all the necessary adjustments with this one instrument. The high technology used in the MC30A allows a range of possibilities unheard of in a instrument in this price category.

### Lacuna Digital Satellite Meter

A custom designed, small lightweight ABS case, created with the installer in mind



- Signal strength and BER will be displayed together
- Indicates the chosen satellite
- Signal strength and BER settings calibrated factory for resellers by distributor
- Removable F connector
- LNB short circuit protection and LNB power supply
- Compatible with all satellite transmissions Ku and C band, DVB and DSS

### NEW Lacuna Terrestrial Digital Meter

Small, lightweight custom designed for terrestrial digital installations

- Identifies transmitter
- Measures signal strength, carrier/noise and BER
  - UHF / VHF
- Analogue and digital measurement
- Removable F connector
  - 4 line LCD with backlight
- Weight including batteries 600g
- 12v line power facility



Full catalogue of meters available, please phone for details.

### COASTAL AERIAL SUPPLIES

Unit X2, Rudford Industrial Estate, Ford, Arundel BN18 0BD  
Telephone: 0870 2641990 Fax: 0870 264 1991

Perifelec  
Sole Import  
Distributors

## Economic Devices

PO Box 71, Oakenegates TF2 8WR

Tel ++ 44 (0)1952 273130

Fax ++44 (0)1952 405478

# Remote Controls from £5.95 each

Stock held for over 53000 different models

## SEMICONDUCTORS

Over 34,000 types of transistors, IC's, diodes etc. or equivalents stocked

We take your hassle Some suppliers just won't help. We will work really hard to find those difficult parts - just ask and let our 'no holds barred' enquiry hound work for you.!!!

...and look at the special offers.....

BUT11A @ 29p each BUT11AF @ 41p each  
BU508A @ 45p each Fully wired scart lead 39p

a slight inconvenience...

...you must buy more than one.

BU208A	X 5	75p ea	TEA2018A	X 5	99p ea
BU508A	X 5	79p ea	UC3842	X 5	59p ea
BU508AF	X 5	85p ea	CNX62A	X 5	29p ea
BU508D	X 5	89p ea	S2000AF	X 5	84p ea
BUT11A	X 5	29p ea	TDA3653B	X 5	55p ea
BUT11AF	X 5	47p ea	TDA3654	X 5	82p ea
Philips type 1.2 volt	Back up battery	X 5			59p ea
Philips type 2.4 volt	Back up battery	X 5			120p ea
Scart - Scart lead 1.5m	Fully wired	X 2			89p ea
Positor PT37, TH98009 (White)		X 5			59p ea
Thorn TX100 Chassis	110 DGR LOPTX	each			£11.24
Philips CP90 Chassis	LOPTX	each			£11.63

...and now ask about our value for money full price list. Remember £1.50 post & handling

All major credit cards accepted

[www.telepart.co.uk](http://www.telepart.co.uk)

The web page here you can look up the price and order all things TV, VCR and Satellite. Web search by model for video parts, remote controls, LOPT's etc. evercase enquiries particularly welcome

## New CCTV catalogue out NOW

cameras, monitors, switches quads, multiplexers, the lot.

# REMOTES DIRECT

All makes and models Replacement and Originals remote controls available.

!!!!!!At a fraction of the cost!!!!!!

Please contact for instant quote

ROB or MARK

Tel: 01257 793527

E-mail: [infrared@btconnect.com](mailto:infrared@btconnect.com)

Or check out our website and order on-line

Website:

[www.remotesdirect.co.uk](http://www.remotesdirect.co.uk)

Also available a wide range of satellite equipment

And various other electronics!!!!!!!

## Tuner Repairs

+

## IC Fitting Service

+

## Digital set top box repairs

For more information and latest prices

See our web site

[www.mces.co.uk](http://www.mces.co.uk)

## MCES Digital

15 Lostock Road Davyhulme Manchester M41 0ES

E-mail: [sales@mces.co.uk](mailto:sales@mces.co.uk)

Phone: 0161 746 8037

Fax: 0161 746 8136

**NEW!** **TV Test Patterns Generator** **DVD VIDEO**  
SET-UP AND DIAGNOSTIC TOOL



**£29.00**  
inc p&p  
Includes Free  
BBC Test Card  
F!

Designed as an alternative to expensive pattern generators this comprehensive Service DVD gives you exceptional picture quality and portability of all your trusted favourites.  
All Test Patterns include a 1 KHz test tone. This is an exceptional tool for any service dept or field service engineer at a very affordable price.  
Enquiries: [ahmet.h@btconnect.com](mailto:ahmet.h@btconnect.com)

**Order Form:** Enclose cheque for £29.00 made payable to A. Huseyin

Name (Block Caps): \_\_\_\_\_  
Address: \_\_\_\_\_  
Post Code: \_\_\_\_\_  
Phone: \_\_\_\_\_ Email: \_\_\_\_\_

Send this form with your payment to:  
A. Huseyin, Unit 1b Foxholes Ave, Hertford, Herts SG13 7JG

**NEW TUBE DISPOSAL.**  
**W76LPF / M90AHL**  
**W76EGX / A80EJA**  
**A59TMZ / A41EAM**  
Other types also in stock.  
All at £20.00 each  
*(Sending to Eastern Europe in 30 days time so be quick)*

New tubes urgently required, also TV sets with good tubes especially Widescreen.

**Tel 01474 361276/ 327677**  
**Fax 01474 335228**  
**E-mail: [sales@dlec.co.uk](mailto:sales@dlec.co.uk)**

**D'Lec Components Ltd**  
**3 Manor Court, Sole Street,**  
**Cobham Kent DA13 9BU**  
**England**

**Visit [www.dlec.co.uk](http://www.dlec.co.uk)**

**Profilo Telra**  
Brand New PT92  
Complete Working PCB's  
(Widescreen Version)

As used in the following makes of TV  
Bush, Fidelity, Wharfedale, Akura, JMB,  
Naiko & Watson

**BUY ONE GET ONE FREE**  
Buy one carton of Perfect PCB's and get one  
carton of damaged PCB's FREE for spares  
Only £10 + VAT each in lots 9  
Next day Carriage £9.95  
Most major credit cards accepted  
Good Stocks of Virgin Returns  
in Televisions and DVD's  
For more information contact  
Contact Ian Botterill

**Key Electronics Ltd**  
**01388 819525**

**This Magazine reaches over**  
**10,000**  
**potential customers**  
**To advertise in this space**  
**call Luke on**  
**01322 611289**

**WEB SITE [WWW.JOHNSRADIO-UK.COM](http://WWW.JOHNSRADIO-UK.COM) [WWW.JOHNSRADIO.COM](http://WWW.JOHNSRADIO.COM)**  
**JOHN SRADIO ELECTRONICS TEST AND COMMUNICATION EQPT**  
**MASSIVE 10,000 SQ FT**  
**WAREHOUSE CLEARANCE SALE**  
DC-MICROWAVE TO 300 GHZ - OPTICAL - LIGHT - EQPT - PARTS  
**TEKTRONIX - HP - AGILENT - MARCONI**  
**PHILIPS - RACAL - B&K - R&S - W&G - ETC**  
Sales Warehouse, Johnsradio, Smithies Mill, Birstal Smithies Lights, 883-885 Bradford Rd,  
Batley, West Yorkshire, WF17 8NN.  
Tel: 01924 442905 Fax: 01924 448170 E-mail: [johnsradio@btconnect.com](mailto:johnsradio@btconnect.com)  
Directions M62 Junction 27, A62 to Huddersfield, 1 mile to Birstal Smithies Lights, (6 roads)  
left under factory chimney aerial, Smithies Moor Lane 50 YDS second left red gate.  
**HOURS M-F 9AM - 1PM AND 2PM - 5PM, SAT 9AM - 1PM**  
Phone for appointment or to request item lists, photos, site map.  
All welcome, Private or trade, for sales, workshop repairs or calibration.  
**PLEASE CONTACT PATRICIA AT WHITEHALL WORKS, 84 WHITEHALL ROAD,**  
**EAST BIRKENSRAW, BRADFORD, WEST YORKSHIRE, BD11 2ER**  
Tel: 01274 684007 Fax: 01274 651160  
**WEB SITE [WWW.JOHNSRADIO-UK.COM](http://WWW.JOHNSRADIO-UK.COM) [WWW.JOHNSRADIO.COM](http://WWW.JOHNSRADIO.COM)**

# FRUSTRATED!

Looking for ICs TRANSISTORS?

A phone call to us could get a result. We offer an extensive range and with a World-wide database at our fingertips, we are able to source even more. We specialise in devices with the following prefix (to name but a few).



2N 2SA 2SB 2SC 2SD 2P 2SJ 2SK 3N 3SK 4N 6N 17 40 AD  
 ADC AN AM AY BA BC BD BDT BDV BDW BDX BF  
 BFR BFS BFT BFW BFX BFY BLY BLX BS BR BRX BRY BS  
 BSS BSV BSW BSX BT BTA BTB BRW BU BUK BUT BUY  
 BUW BUX BUY BUZ CA CD DX CXA DAC DG DM DS  
 DTA DTC GL GM HA HCF HD HEF ICL ICM IRF J KA  
 KIA L LA LB LC LD LF LM M M5M MA MAB MAX MB  
 MC MDA J MJE MJF MM MN MPS MPSA MPSH MPSU  
 MRF NJM NE OM OP PA PAL PIC PN RC S SAA SAB  
 SAD SAJ SAS SDA SG SI SL SN SO STA STK STR STRD  
 STRM STRS SVI T TA TAA TAG TBA TC TCA TDA TDB  
 TEA TIC TIP TIPL TEA TL TLC TMP TMS TPU U UA  
 UAA UC UDN ULN UM UPA UPC UPD VN X XR Z ZN  
 ZTX + many others

We can also offer equivalents (at customers' risk).  
**A LARGE RANGE OF ELECTRONIC COMPONENTS ON  
 OUR CD ROM - LIST AVAILABLE ON REQUEST**  
 Mail. phone. Fax. Credit Card orders & callers welcome.



## Cricklewood Electronics Ltd

40-42 Cricklewood Broadway, London NW2 3ET  
 Tel: 020 8452 0161 Fax: 020 8208 1441  
 www.cricklewoodelectronics.co.uk  
 E-mail: sales@cricklewoodelectronics.com

## WATCH SLIDES ON TV MAKE VIDEOS OF YOUR SLIDES DIGITISE YOUR SLIDES (using a video capture card)



"Liesgang diatv" automatic slide viewer with built in high quality colour TV camera. It has a composite video output to a phono plug (SCART & BNC adaptors are available). They are in very good condition with few signs of use. For further details see www.diatv.co.uk  
 £91.91+ vat = £108.00

Board cameras all with 512x582 pixels 8.5mm 1/3 inch sensor and composite video out. All need to be housed in your own enclosure and have fragile exposed surface mount parts. They all require a power supply of between 10 and 12v DC 150mA.

47MIR size 60x36x27mm with 6 Infra red LEDs (gives the same illumination as a small torch but is not visible to the human eye).....£37.00 + vat = £43.48

30MP size 32x32x14mm spy camera with a fixed focus pin hole lens for hiding behind a very small hole.....£35.00 + vat = £41.13

40MC size 39x38x27mm camera for 'C' mount lens these give a much sharper image than with the smaller lenses.....£32.00 + vat = £37.60

Economy C mount lenses all fixed focus & fixed iris

VSL1220F 12mm F1.6 12x15 degrees viewing angle.....£15.97 + vat = £18.76

VSL4022F 4mm F1.22 63x47 degrees viewing angle.....£17.65 + vat = £20.74

VSL6022F 6mm F1.22 42x32 degrees viewing angle.....£19.05 + vat = £22.38

VSL8020F 8mm F1.22 32x24 degrees viewing angle.....£19.90 + vat = £23.38

Better quality C Mount lenses

VSL1614F 16mm F1.6 30x24 degrees viewing angle.....£26.43 + vat = £31.06

VWL813M 8mm F1.3 with Iris 56x42 degrees viewing angle.....£77.45 + vat = £91.00

1206 surface mount resistors E12 values 10 ohm to 1M ohm 100 of 1 value £1.00 + vat

1000 of 1 value £5.00 + vat

866 battery pack originally intended to be used with an orbital mobile telephone it contains 10 1.6Ah sub C batteries (42x22dia the size usually used in cordless screwdrivers etc.)

the pack is new and unused and can be broken open quite easily.....£7.46+vat = £8.77



Please add 1.66 + vat = £1.95 postage & packing per order

### JPG ELECTRONICS

Shaws Row, Old Road, Chesterfield, S40 2RB  
 Tel 01246 211202 Fax 01246 550959 Mastercard/Visa/Switch  
 Callers welcome 9:30 a.m. to 5:30 p.m. Monday to Saturday

## inStore

ELECTRICS LIMITED

171 HAREHILLS LANE, LEEDS LS8 3QE  
 Tel: 0113 240 1114. Tel/Fax: 0113 240 7275.  
 Mobile: 07976 403134  
 Email: sales@instoreleeds.freereserve.co.uk

## MANUFACTURES GRADED PRODUCTS ALL PRICES PLUS VAT: ALL PRODUCTS FULLY GUARANTEED

\*  
 PHILIPS 32PW6506 32" WIDESCREEN REAL FLAT,  
 FM RADIO, 50HZ **£329.00**

\*  
 PHILIPS 32PW9527 32" WIDESCREEN REAL FLAT,  
 DOLBY, 100HZ, PIXEL PLUS **£469.00**

\*  
 PHILIPS LX3000 DVD PLAYER 5.1 SURROUND  
 SOUND SYSTEM, 75W RMS **£139.00**

\*  
 PHILIPS 14" TV/VCR COMBI FROM **£84.00**  
 PHILIPS 14" PORTABLES FROM **£59.00**

\*  
 PHILIPS VCR'S FROM **£39.00**  
 PHILIPS AUDIO SYSTEMS FROM **£44.00**

\*  
**FURTHER OFFERS AVAILABLE  
 PLEASE CALL FOR A PRICE LIST  
 CREDIT CARDS WELCOME: NEXT DAY DELIVERY**

# TUBES

## NEW and GRADED Philips CRTs

28" WIDESCREEN  
 from .....ONLY £130

32" WIDESCREEN  
 from .....ONLY £195

Prices include carriage  
 but are subject to VAT

Quantity reductions

Other makes and sizes of  
 CRT available

De-scratching service

## EXPRESS TV SUPPLIES LTD

The Mill, Mill Lane,  
 Rugeley, Staffs WS15 2JW  
 Tel: 01889 577600 Fax: 01889 575600



# Technical Liaison Officer

*Linn Products Ltd manufactures a wide range of products for music, home cinema, sound distribution and home automation applications. From its distribution centre LinnSight Ltd, in Prestwick, Ayrshire, Linn distributes premium brand Loewe televisions, DVDs, VCRs and audio solutions to the UK and Eire. These high quality products are technically advanced to meet the needs of the most discerning customers.*

We require a Technical Liaison Officer to develop and provide expert technical support for the Linnsight business and our customers. This is a field based position and will involve extensive travel within Scotland, Northern England and Ireland. The main responsibility of the role is to create and implement initiatives to:

- Continually improve the expertise and service offered to our customers by the technical support network.
- Develop the network by identifying and targeting new sectors within the market.
- Ensure the application and maintenance of agreed technical support standards and policies.
- Reduce the number of complaints and returns by providing support and advice for the retail network.

Applicants must have an HND in electronics, an understanding of current and future display technologies – CRT, LCD and Plasma, and be able to demonstrate a sound technical background. The successful candidate will be a pro-active individual with problem solving skills and the ability to interact with people at all levels, whilst projecting a professional image at all times.

If you think can meet the challenge of this role please e-mail your CV to [recruitment@linn.co.uk](mailto:recruitment@linn.co.uk) or mail it to the Recruitment Team, Linn Products Ltd, Floors Road, Waterfoot, Glasgow G76 0EP. To find out more about Linn please visit the website at [www.linn.co.uk](http://www.linn.co.uk)

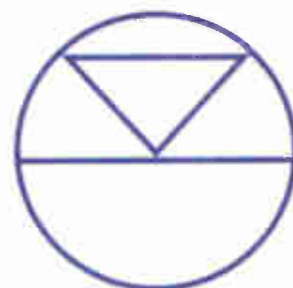

**LINN**

# Service Link

TELEPHONE 01322 611289

FAX 01322 616376

## FOR SALE

### ? STOP

LOPT'S. REMOTES  
ALL TV COMPONENTS

TIDMAN MAIL ORDER LTD  
236 SANDYCOMBE RD  
KEW RICHMOND  
SURREY TW9 2EQ  
(1/2 MILE FROM KEW BRIDGE)  
PHONE: 020-8948-3702

**EX RENTAL  
TVs, VCRs,  
PORTABLES**

For stock list call

**Barry McDonald**  
01622 719313  
or 07836 789528

## PROJECTOR SPARES

### VIDIKRON

projector spare parts and  
service information.

PROJECTSPARES  
Tel: 01444 831769  
Fax: 01444 831580  
E-mail:  
projectspares@btinternet.com

## REPAIRS

Trade repairs to  
**Sky digiboxes**

Pace, Amstrad, Grundig, Panasonic,  
(including Fluid Ingress).  
All makes repaired at a fair fixed price.

**Scan Digital Services**  
For details  
Give Alan a ring on  
Tel/Fax: 01633 25 40 50  
E-Mail: alan@scansat.globalnet.co.uk

## SERVICE DATA

### NEED HELP NOW?

Then ring the

#### ★ ELECTRON TECHNICAL HELPLINE ★

Genuine help available to all  
repairers of

T.V. - V.C.R - SAT - AUDIO  
(Inc Valves)

Over 30 years experience and  
vast data base

**0906 470 1706**

Calls cost 60p per minute

Hours of Business Mon to Fri  
9.00 am - 12.30pm : 2.15pm - 5.30pm  
Sat. Morn 9am - 12.30pm

## SERVICE DATA

### SERVICE MANUALS

Have you ever turned away  
work for want of a Service  
Manual? Have you ever brought  
a Service Manual and never  
used it more than once?  
Then why not join ...

#### THE MANUALS LIBRARY

For details and membership  
application form write,  
phone or fax:

#### HARVEY ELECTRONICS

43 Loop Road, Beachley,  
Chepstow, Mons, NP16 7HE

Tel/Fax No: 01291 623086

Visa: Mastercard accepted

**OPEN  
6 DAYS**

TV/VCR CIRCUITS  
(WE DO NOT STOCK  
AUDIO OR MONITOR  
INFORMATION)

TEL A.T.V. on  
**0114 285 4254**

CTV Circuits ..... from £5.00  
VCR Circuits ..... from £7.00  
CTV Manuals ..... from £10.50  
VCR Manuals ..... from £14.50

User instructions also available  
(P/P add £2.50 to each order)

**419 LANGSETT ROAD  
SHEFFIELD S6 2LL**

MANUAL COLLECTIONS PURCHASED.  
(POST 1995)

## SERVICE INFO

TV - VIDEO - AUDIO

Prices- any make/model

CTV	s/man	9.50
VCR	s/man	13.50
CTV	circs	4.50
VCR	circs	6.00

Other items POA

All prices include p/p.  
Do not add any VAT

**AMTel**

Huna,  
Caithness KW1 4YL  
01955 611313  
www.amtel.co.uk

## WANTED

### BEST CASH PRICES PAID

FOR VALVES KT88,  
PX4 AND MOST  
AUDIO/OTHER  
TYPES.

Tel: 01403 784961

Billington Export Ltd  
Sussex RH14 9EZ  
Fax 01403 783519  
Email: sales@bel-tubes.co.uk  
Visitors by appointment

## LINEAGE

**CHEAPEST: CABLE TIES, FUSES,**  
plug-tops, crimps, tapes, tv/video, handsets,  
extension leads, fax, printers, baskets, ladies  
trousers. Tel: 020 7232 2266. Fax: 020 7232  
2288.

**ENGINEERS PLEASE CHECK OUT:**  
[www.madecontrollers.co.uk](http://www.madecontrollers.co.uk) for a device,  
which will save time/money & change the  
way you repair equipment forever.

**TELEVISION MAGAZINES:-** March  
1973 - present, complete set. To be collected  
or will be disposed of. North Lincolnshire -  
01724 346355. Free of charge.

For a

# FREE

consultation  
on how best  
to market  
your  
products/  
services  
to a  
professional  
audience  
contact

## LUKE

on

## 01322

## 611289

# Service Link

TELEPHONE 01322 611289 FAX 01322 616376

CLASSIFIED TEL: 01322 611289

# atlas LCR

# £79

## Passive Component Analyser (Model LCR40)

fully inclusive UK price

Just clip on the test leads and press test. The Atlas LCR will automatically identify the type of component, apply the appropriate test level and frequency, display the component's value and more!

Probes are detachable too, so you can use the optional SMD tweezers for your tiny unmarked passives - fantastic.

- Automatic component identification (Inductor, Capacitor or Resistor)
- Component value measurement
- Auto frequency (DC, 1kHz, 15kHz, 200kHz)
- Inductor DC resistance measurement
- Non-volatile probe compensation memory
- Detachable probes allowing use of optional test prods, SMD tweezers, etc...
- Hands free mode with value hold

Supplied with mini-hook grabbers as standard

Inductance range: 1 $\mu$ H to 10H  
 Capacitance range: 1pF to 10,000 $\mu$ F  
 Resistance range: 1 $\Omega$  to 2M $\Omega$   
 Basic accuracy: 1%  
 Test signals: 1V, 3mA max

*"Astonishingly, this little unit seems to pack most of the punch of a large and very expensive automated LCR bridge into its tiny case."*

See the full review on our website!

Andy Flind - EPE Magazine March 2003



### Accessories:

- Carry case
  - Tweezer Probes
  - Crocodile Probe Set
  - Large Grabber Probes
- (more available soon)

# atlas DCA

# £60

## Semiconductor Analyser (Model DCA55)

fully inclusive UK price

**NOW MEASURES TRANSISTOR LEAKAGE**

Check and identify your semi's

- Automatic component identification
- Pinout identification
- Transistor gain measurement
- MOSFET gate threshold measurement
- PN junction characteristics measurement
- Shorted Junction identification
- Transistor leakage measurement
- Just connect the part anyway round and press the button!
- Auto power on/off

NPN bipolar  
Darlington

Diode protection  
between C-E

Resistor shunt  
between B-E

Current gain  
Hfe=126

Enhancement mode  
N-Ch MOSFET

Gate Threshold  
Vgs=3.42V

Blue  
B-E  
limit

177V

0.4

Bipolar transistors,  
 Darlington transistors,  
 Diode protected transistors,  
 Resistor shunted transistors,  
 Enhancement mode MOSFETs,  
 Depletion mode MOSFETs,  
 Junction FETs,  
 Low power triacs and thyristors,  
 Diodes and diode networks,  
 LEDs (+bicolours)

*"It's the kind of instrument that should be on every engineers and enthusiasts bench."*

EPE Magazine  
March 2000



enclosure colours may vary



# atlas PACK £129!

## LCR40 and DCA55 Pack

fully inclusive UK price

Why not order both analysers at the same time and take advantage of our special offer, saving you £10!

Visit [www.peakelec.co.uk](http://www.peakelec.co.uk) to download the data sheets, user guides and copies of independent reviews. You can pay using a cheque, postal order, credit or debit card and even pay securely online. Please contact us for your volume requirements.

Also available from Farnell, Maplin, Rapid and CPC (prices vary)

**PEAK**  
electronic design ltd

Atlas House, Kiln Lane  
 Harpur Ind. Est., Buxton  
 Derbyshire, SK17 9JL, UK

[www.peakelec.co.uk](http://www.peakelec.co.uk)  
[sales@peakelec.co.uk](mailto:sales@peakelec.co.uk)

Tel. 01298 70012 Fax. 01298 70046



# TELEVISION TEST PATTERN GENERATORS

The new **GV 998** is a digital pattern generator offering more advanced features at again a realistic price. Those features include :

- ◆ MPEG-2 format Transport Stream generation
- ◆ Video and audio included in the TS
- ◆ Video and audio inputs
- ◆ Generation of a variable frequency sound carrier for decoding verification
- ◆ Multistandard and multisystem analogue TV signal generation
- ◆ Possibility to edit different fields of the TS database to present the name of the service provider
- ◆ Remote control via a personal computer
- ◆ Moving video patterns to check MPEG-2 decoders

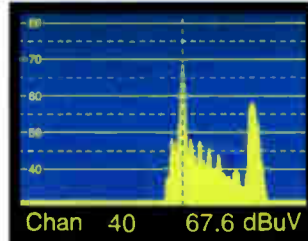
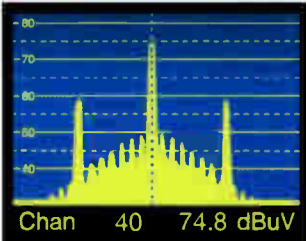

## PROMAX GV SERIES

- ◆ Choice of 12 instruments
- ◆ NICAM and Teletext
- ◆ 4:3 and 16:9 Formats
- ◆ Full field and VITS
- ◆ Computer Controlled
- ◆ Front panel memories
- ◆ Own Company Logo
- ◆ Computer Monitor testers
- ◆ Hand Held Models
- ◆ Multi Standard, PAL, NTSC, SECAM
- ◆ High Quality Construction
- ◆ Attractive Price Levels
- ◆ Full After Sales Service
- ◆ Available from Stock



FOR TELEVISION PATTERN GENERATORS, THERE'S NO WIDER CHOICE THAN WITH PROMAX



SELECTED ITEMS FROM THE PROMAX RANGE OF TEST EQUIPMENT

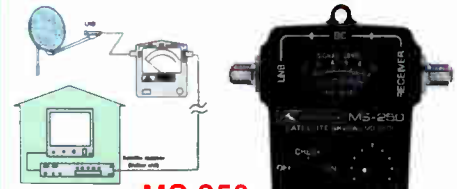

**MS 250**

Analogue and Digital Satellite Detector.



**PRODIG 1**

Satellite Dish Installer's Meter Does more than just BskyB



**PRODIG 2**

Analogue & Digital Aerial Meter Measures digital channel power and C/N



**MC 377+**

Analogue & Digital, Satellite & Terrestrial Measures channel power and C/N



**PROLINK 3 + 4 SERIES**

Satellite & Terrestrial, Analogue & Digital, Spectrum Analyser with BER (optional on P3)

# Alban



TELECOMMUNICATIONS TEST EQUIPMENT  
AE 767 Spectrum Analyser

ALBAN ELECTRONICS LIMITED  
THE PROMAX SERVICE CENTRE

6 Caxton Centre, Porters Wood,  
St. Albans, Hertfordshire, AL3 6XT.  
TEL: 01727 832266 FAX: 01727 810546  
WEB: [www.albanelectronics.co.uk](http://www.albanelectronics.co.uk)  
EMAIL: [info@albanelectronics.co.uk](mailto:info@albanelectronics.co.uk)  
SALES + SERVICE + CALIBRATION



**NEW!**  
THE NEW  
ALBAN WEB SITE ...  
[www.albanelectronics.co.uk](http://www.albanelectronics.co.uk)  
FOR ALL THE LATEST NEWS  
AND INFORMATION  
FROM ALBAN  
**NEW!**