

NEWS AND TECHNOLOGY ■ INSTALLATION ■ SERVICING ■ DEVELOPMENTS

# TELEVISION

AND CONSUMER ELECTRONICS

JUNE 2004 £3.20

## Test report:

Horizon digital  
signal-strength  
meters



The Sale of  
Goods Act  
*explained*

Servicing the  
Hitachi A7 chassis



FAULT FINDING FOR TV ■ AUDIO ■ SATELLITE ■ VIDEO ■ IT



# It takes a big catalogue to give you all the remote controls you need!

We didn't mean for it to be so big, it's just that when we asked you what was needed by the industry the answer was – the most definitive remote control cross reference available in the European market.

We listened to you and the result is our latest 2004/2005 remote control catalogue. It is big! 456 pages listing over 15,000 models, 22,000 part numbers, handset numbers and 4,400 original handset illustrations. It is the most complete guide to remote controls ever produced.

As new models are being added to our range every day even a catalogue such as this will not contain the new additions to our range since printing. No problem! Simply check for the model you require on our website [www.classic-electronics.co.uk](http://www.classic-electronics.co.uk)

Over the next two months your Classic distributor will be sending you your very own copy of the catalogue. If you do not receive your copy or you need an additional copy contact your usual Classic distributor, phone us on 01635 278678 or email us at [sales@classic-electronics.co.uk](mailto:sales@classic-electronics.co.uk).



Technical helpline 01635 278678

# CONTENTS

June 2004

Vol. 54, No. 8

## 451 Comment

Public-service broadcasting. High-street gloom. Sony's loss of focus.

## 452 News

Ofcom on the digital transition. Dixons to close stores. TV via your mobile. Video news. Pay-per-view TV from BT.

## 454 Test report: Horizon digital signal meters

Eugene Trundle checks out a pair of digital-TV reception testers for satellite and DTT work.

## 458 The Sale of Goods Act

The Sale of Goods Act, which originally came into effect in 1979 and was supplemented by Regulations introduced in 2003, affects everyone who has commercial dealings with the public. You can get into difficulties that could involve expense and wasted time if you are not familiar with its requirements. Michael Maurice provides a guide to how it affects our trade.

## 462 Servicing the Hitachi A7 chassis

Glyn Dickinson provides a repair guide for this chassis, which was introduced in 1998 and remained in production for several years. It was used in a wide range of models, both 4:3 aspect ratio and widescreen.

## 468 A holiday at Murphys

Ron Bourne recalls training back in the Fifties, when he attended a course on TV at the Murphy Radio factory in Welwyn Garden City.



## 475 Bench notes

Engineers are occasionally tempted to tackle a repair that's obviously going to be uneconomic. Adrian Gardiner describes such a job, with a Panasonic home cinema system.



## 476 The digital home

The government has set up a Digital Action Plan with the aim of moving TV broadcasting to an all-digital basis by the year 2010. Various issues still have to be resolved however before homes can be converted to the all-digital dream. These involve aerial standards, signal distribution within the home, video recording and set-top boxes. J. LeJeune reports on the current situation.

## 480 Letters

Days of DC. Digital picture quality. Naiko spares. Sharp probes. An unusual aerial rotator.

## 481 Help wanted

## 482 DX and Satellite Reception

Terrestrial DX and satellite TV reception reports. Broadcast and satellite TV news. VHF TV aerial construction and mysteries. Roger Bunney reports.

## 486 Audio faults

## 488 DVD and home cinema fault reports

## 489 Test Case 498

## 490 VCR clinic

## 492 TV fault finding

## 496 Books to buy

The Television book service, with details of some of the titles you can order.

## 498 Satellite notebook

Recording satellite radio on CD. Digital channel update. TV from Express AM22 at 53°E. Digibox fault reports.

## 502 Service casebook

Michael Maurice on problems he's encountered in the field and the workshop.

## 503 Web service

## 504 What a Life!

From a pool-side idyll to a surprise interview, all in a day's work. Donald Bullock's servicing commentary.

## 506 Monitor faults

## 507 Next month in Television

### Editor

John A. Reddihough  
TVeditor@highburybiz.com

### Deputy Editor

Tessa Winford

### Production Editor

Jane Massey

### Production Executive

Dean Turner  
01322 611206  
d.turner@highburybiz.com

### Advertisement Sales

Luke Baldock  
01322 611 289  
Fax 01322 616 376

### Editorial Assistant

Caroline Fisher  
01322 611 274

### Managing Editor

Bill Evett

### Publishing Director

Tony Greville

Note that we are unable to answer technical queries over the telephone and cannot provide information on spares other than that given in our Spares Guide.

#### Disclaimer

We work hard to ensure that the information presented in *Television* is accurate. However, *Television's* publisher - Highbury Business - will not take responsibility for any injury or loss of earnings that may result from applying information presented in the magazine. It is your responsibility to familiarise yourself with the laws relating to dealing with your customers and suppliers, and with safety practices relating to working with electrical/electronic circuitry - particularly as regards electric shock, fire hazards and explosions.

Next issue, dated  
July, on sale June 16

# RDS 80 SOLDERING STATION

## NOT JUST ANY OLD IRON

Excerpt of 832/842 soldering tip series

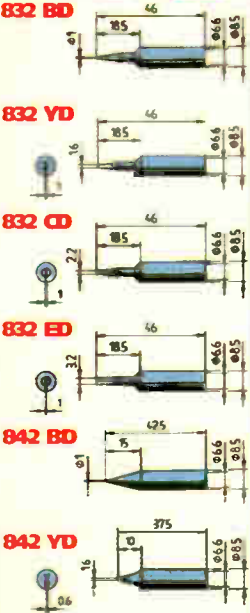

**LEAD FREE**  
Compatible

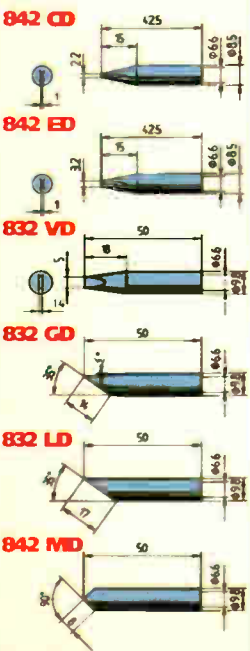

- DIGITAL DISPLAY
- LEAD FREE COMPATIBLE
- 290 WATT HEAT-UP RATE
- VAST LOW COST TIP SELECTION
- VARIABLE TEMPERATURE SOLDERING
- ALL TIPS ARE LONG LIFE ● CLOSED LOOP SYSTEM

**£99.00\***  
FREE DELIVERY  
\*Price excludes VAT

**MAKE THE CHANGE • CHANGE THE MAKE**

# BLUNDELL

PRODUCTION EQUIPMENT

203 Torrington Avenue, Coventry CV4 9UT, England  
 Telephone: 024 7647 3003 • Fax: 024 7669 4155  
 email: sales@blundell.co.uk • www.blundell.co.uk

## COPYRIGHT

© Highbury Business, 2004. All rights reserved. No part of this publication may be reproduced, stored or transmitted in any form or by any means without the written permission of the publishers.

All reasonable precautions are taken by *Television* to ensure that the advice and data published are reliable. We cannot however guarantee it and we cannot accept legal responsibility for it.

## CORRESPONDENCE

All correspondence regarding advertisements should be addressed to the Advertisement Manager, Television, Highbury Business, Media House, Azalea Drive, Swanley, Kent, BR8 8HU. Editorial correspondence should be addressed to Television, Editorial Department, Highbury Business, Media House, Azalea Drive, Swanley, Kent, BR8 8HU.

## INDEXES AND BINDERS

Indexes for Vols. 38 to 53 are available at £3.50 each from SoftCopy Ltd., who can also supply an fifteen-year consolidated index on computer disc. For further details see page 507. Binders that hold twelve issues of *Television* are available for £6.50 each from Modern Bookbinders, Pringle Street, Blackburn, BB1 1SA. Telephone: 01254 59 371. Make cheques payable to "Television Binders".

## Newstrade Enquiries

Seymour Distribution Ltd.

ISSN 0032-647X

## SUBSCRIPTIONS

Highbury Fulfilment Services, Link House, 8 Bartholomew's Walk, Ely, Cambridge CB7 4ZD.  
Telephone 01353 654 431  
Fax 01353 654 400  
Email hbc.subs@highbury-wyvern.co.uk  
Please notify change of address.

### Subscription rates:

UK 1 year £33.80  
2 years £54.00  
3 years £71.00  
Republic of Ireland 1 year £38.95  
2 years £62.00  
3 years £81.85  
Mainland Europe 1 year £49.00  
2 years £78.40  
3 years £102.90  
Rest of World 1 year £63.50  
2 years £101.00  
3 years £133.00

Cheques should be made payable to Television.

## BACK NUMBERS

If available issues are £4.00 each



# Public-service broadcasting

The new regulator Ofcom seems to be operating in overdrive. In one month we have had its report on the digital transition (see over page) and, subsequently, its initial views on the future of public-service broadcasting. The latter have, understandably, caused a bit of a stir. They nevertheless serve to highlight the changes that are taking place in the world of TV, and the role that public-service broadcasting should play in this new world.

The situation that's developing is not all that healthy. Lots more channels should mean lots more choice. In practice it can mean more and more rubbish. Channels cost money to run, but available finance is limited. Thus many channels can mean that resources are spread too thinly. The public, for its part, has made its preferences clear. The main interests seem to be soap, reality TV and of course sport. It is disheartening that there has been a 47 per cent increase in soap broadcasting over the past five years.

Most people are content to pay the TV licence fee and appreciate the value of news and current-affairs programmes, even if they

don't pay much attention to them. In fact in a democracy it is vital that the public has access to impartial and accurate information. The licence fee can provide the means for this, and is thus essential. But a significant question Ofcom has raised is whether the fee should be used exclusively to fund the BBC, or be used by several broadcasters. It's an interesting point and a bit of a conundrum. There is clearly a danger that if the funding is spread around too widely it will lose its effectiveness. A strong, independent public-service broadcaster is essential, and the BBC has traditionally fulfilled this role. Does it matter that it also provides entertainment and seeks a mass audience? To remain a force in the TV world, it has to be more than a glorified newsdesk and purveyor of culture.

There's a danger that Ofcom, concentrating more on change than the need to preserve essential services, could cause a lot of damage. One has only to think of the chaos that has been caused to the railway system by ill-considered meddling. Ofcom should realise that it has very heavy responsibilities. It doesn't give the impression of being mindful of this.

## Sony's loss of focus

Sony, which is rightly renowned for its video and audio technology, seems to have lost its way in recent times. In the last financial year Sony's profits fell by almost a quarter. In comparison, Sharp and Sanyo have been doing very well. At Sony the talk is about cost-cutting, restructuring and investment to regain profitability. The company seemed to lose its ability to focus on the latest electronic opportunities when, some fifteen years ago, it bought Columbia Pictures, the idea being to be able to back its video products with programme material. But the worlds of consumer

electronics and Hollywood have little in common. Sony found it difficult to work with Columbia, and the joint company has never operated smoothly. So the news that it is considering a bid worth some \$5bn for Metro-Goldwyn-Mayer, albeit in conjunction with two private-equity investors, comes as something of a surprise. It could only distract Sony's management from the task of increasing its profit margin from the present dismal 1.9 per cent. Getting involved with MGM seems to be about the last thing that Sony should be contemplating.

## High-street gloom

What's gone wrong with the traditional shopping high street? Stalwarts such as Boots and WH Smith have been doing poorly, and Marks & Spencer has its problems. Now Dixons has announced store closures and plans to pull out altogether over the next ten years. The basic facts are that retailing has become intensely competitive while high-street costs are high. Outlets are small in comparison with the

supermarkets, so shoppers are offered less choice at higher prices. The way things are going, the high street will soon consist of mainly coffee shops and estate agents, which is hardly an enticing prospect. The main problem is that rents are far too high, the result of ever-upwards rent revisions. Something will have to be done about this if we are not to lose the convenience of high-street shopping.

## Ofcom on the digital transition

In early April the new media regulator Ofcom issued a report on the transition from analogue to digital TV, with recommendations on how the analogue switch-off might be implemented. The report states that over half of UK households already have digital TV reception facilities and that the government's target of an analogue switch-off by 2010 is possible if certain conditions are met. It recommends switchover on a region-by-region basis in order to limit the scale of viewer disruption. Ofcom suggests that a rolling programme of regional switchovers would be practical, taking about four years to complete after two years of initial preparation. The regional approach would enable technical preparations to be undertaken area by area, spreading the costs and avoiding the risks inherent in a national switchover. If the switchover were to take place between 2007 and the end of 2010, a decision would be required in early 2005.

On the basis of the switchover in Berlin, Ofcom suggests that it would be helpful for some analogue channels to be switched off before others. One or more analogue channels could be switched off six months ahead of the others, enabling digital terrestrial signals to be boosted to full strength. Switching off one or two analogue channels would enable areas currently without any DTT signals to begin receiving them. It would also bring home to viewers the imminence of the switchover and the need to purchase appropriate receiving equipment. Remaining analogue transmissions would be switched off at the date set for each region.

with provision of information and assistance continuing for some months after completion of the switchover.

Policy recommendations include giving viewers advance notice of the switchover date so that they can make plans about buying digital reception equipment without uncertainty about the switchover date. But Ofcom recognises that this could reinforce viewer resistance to the switchover before it is generally recognised as being a technological necessity. It adds however that with most households already having access to digital TV the foundations for announcement of a timetable have already been laid. Ofcom believes that the announcement would significantly increase digital TV reception and would help enable the final switchover to be completed by the end of 2010. Research conducted by the DTI indicates that many analogue viewers would be prepared to buy digital equipment once they knew that a digital switchover was imminent.

No mention is made of the possible supply of free set-top converters for those unwilling to buy digital receiving equipment. The government would understandably be reluctant to contemplate such a step. What could cause problems is the realisation by viewers that new, expensive aerials will also be required in many areas for reliable reception.

Ofcom suggests the possibility of imposing spectrum pricing as an incentive to promote the switchover. Channel 3 licensees and Channel Five already pay for their licences to broadcast: with spectrum pricing introduced,

charges could for the first time be applied to the BBC. Channel 4 and S4C, from say 2006. Ofcom recommends that as part of the BBC's Royal Charter review the government should insist on obligations to roll-out digital transmissions nationwide, ensure that viewers can continue to receive its channels via the current free-to-view satellite services, and provide information on and promote the switchover.

Ofcom wants improved DTT coverage, and suggests that satellite transmissions could play an important role in increasing digital take-up by those who don't want pay TV. It points out that FTV access to some public service broadcasters is currently not available via digital satellite transmission, and considers that this might have to be remedied by regulatory intervention, the cost falling on the broadcasters. Ofcom recommends that the government should continue its efforts to overcome impediments to other forms of digital reception, for example planning restrictions on satellite dishes. It adds that DTT signals can be boosted once the switchover is under way, but recognises that international agreements to avoid interference will impose limitations in some areas. It seems possible that to achieve maximum DTT coverage it will be necessary to operate some multiplexes at a lower transmission capacity. Ofcom notes the difficult trade-off between coverage and efficiency and whether to use 16QAM or 64QAM modulation.

Ofcom adds that the switchover will not be possible unless viewers are convinced of its benefits, and recommends a mass national advertising campaign to bring home the advantages, followed by the provision of information to each household on the switchover timetable in the area. It also recommends a labelling scheme to warn consumers that unconverted analogue equipment would not be usable after a set date. This

would require the co-operation of manufacturers and retailers.

Ofcom recommends that a body should be set up to co-ordinate the switchover. It could be called SwitchCo and would highlight the benefits of the switchover, inform about and promote the timetable, advise about the practicalities, ensure clear labelling and description of relevant consumer products, and provide liaison between the government, Ofcom, the transmission companies and the broadcasters. It could work to maximise the range of digital options available to viewers.

What's going to happen to all those analogue VCRs? Ofcom simply says that people will "either have to convert their video recorders or purchase new recording devices with integrated digital tuners". A great help!

### Pay-per-view TV from BT

BT has announced plans to offer pay-per-view video via a broadband connection. It has set up BT Rich Media, which will provide end-to-end production facilities for small companies and organisations. This will enable them to provide audio and video content online. Next year BT plans to offer customers a number of media services via the internet, including live video, having developed a new broadband technology that guarantees high download speeds: BT's 'flexible-bandwidth' technology provides downloading at 2Mbits/sec, which equates to almost DVD quality video. This should lead to a pay-per-view TV service starting next year. BT has been working with Netgem and SetPal to develop set-top boxes for interfacing TV sets with a broadband internet connection.

### Institutions remain separate

Talks on merging the Institution of Electrical Engineers (IEE), the Institution of Mechanical Engineers (IMechE) and the Institution of Incorporated Engineers (IIE) to form a combined Institute of Engineering with a membership of some 250,000 have been called off. It seems that differences in ways of working and structures have made the effort and cost involved too great. For the time being the Institutions will remain separate.

# New Hitachi DVD camcorders

Hitachi has launched two 'fourth-generation' DVD camcorders, Models DZ-MV550E and DZ-MV580E (see photo above). Model DZ-580E provides higher resolution with a 1Megapixel CCD image sensor. It has a 10x optical zoom and 240x digital zoom. Model DZ-MV550E has lower resolution but the powerful 18x optical zoom lens offers greater flexibility for everyday use. The camcorders have a simplified,

quick-menu option for easy operation. Simple disc navigation gives instant access to clips: you simply select the thumbnail that represents the beginning of the required scene then play it back.

The camcorders have a high-speed USB2.0 interface for fast uploading to and downloading from a PC, and an SD-type flash-memory



card slot for easy capture and transfer of still photographs. The high-resolution (120kpixel) 2.5in. colour LCD screen makes filming and on-camera editing simple. An extensive range of PC software is supplied for quick and easy video editing. When recording on a DVD-RAM disc the advanced menu features can be used for editing.

For further information go to: [www.hitachi.co.uk](http://www.hitachi.co.uk)

## Dixons to close stores

Dixons has announced that 106 of its 320 high-street stores are to be closed within a matter of weeks, affecting some 1,000 staff. It intends to move to larger, new-format stores, referred to as xL, that will be at least five times larger than the current typical high-street store – Dixons at present has five xL stores. All the stores to be closed have been trading at a loss, the result of escalating costs (rents etc.) and savage price competition. It is hoped that many of

the staff affected will be deployed to other retail outlets within the group (Currys, PC World, the Link).

John Clare, Dixons Group chief executive, envisages that the remaining 214 high-street Dixons stores will be closed over the next ten years, with a move to some 130 xL stores at edge of town centre or out-of-town retail park locations where space is less expensive. The immediate closures amount to just two per cent of the company's trading space.

## Video news

Following the news that dual-layer DVD+R discs with increased storage capacity (see News last month) are to be launched this year, there has been an announcement that dual-layer DVD-R discs will become available in late 2004 or early 2005.

Sanyo has launched its first DVD recorder, Model DVR-500. It records on DVD+RW and DVD+R discs and can also read DVD-R, Super Video CD, Video CD, CD and CD-R discs with MP3, WMA or JPEG files.

Philips has released a 17in. widescreen LCD monitor with built-in tuner, Model 170T4. It has multiple video inputs, including S-video and composite, to provide displays with a PC, TV set, DVD player or VCR. There is also a VGA input. Philips claims that the monitor is future-proof, being compatible with 1,080-line interlaced and 720-line progressive signals as well as current 576p and 480p sources. There's an autostore with 100 preset channels. Price is about £500.

## TV via your mobile

Mobile phone users could before long be able to watch DTT via their handsets. During the past eighteen months trials of the technology have been taking place in a number of countries, including Korea, Japan, Finland and Germany. Mobile network

operators, handset makers and broadcasters have been involved. Trials in the UK may be held later this year, with DTT chipsets incorporated in mobile phones.

Nokia's first TV compatible phone, Model 7700, is due to be released later this year. It

has a large screen and battery: future TV-compatible handsets are expected to be smaller.

Welcoming the prospect David Chance, chairman of Top-Up TV, hoped that phones would incorporate a conditional-access chipset. Well he would, wouldn't he?!

## New digital-ready aerials from Philex

Philex has launched a new range of indoor and outdoor wideband, digital-ready aerials. There are three indoor and two outdoor models. The Orbit is an indoor aerial with built-in amplifier for set-top or wall mounting. Frequency range is 470-680MHz with a gain of 22dB

(maximum) and a noise figure of 6dB. It can be adjusted through 360° laterally and 90° vertically for optimum reception, and has adjustable gain. Powering can be 230V AC or 12V DC – a blue LED power indicator is included. The Kobra is similar but without an amplifier, the indoor

range being completed with an entry-level five-element model.

For outdoor use there are two log-periodic aerials, Models LPw30 and LPw40. These provide a gain of 10.5 and 12.5dB respectively. Model LPw40 carries the CAI benchmark for digital TV.



### Sanyo's upmarket LCD TVs

Sanyo is to launch a new range of upmarket LCD TV sets, Models 30LD3, 27LC3, 20LC3 and 15LC3 – the first two figures indicate screen size. Model 30LC3 is expected to sell for about £2,000. It has a built-in Freeview tuner, a viewing angle of 170° and active 3D surround, which gives a cinematic surround-sound effect. There is also an Eco mode for reduced power consumption, child lock and a sleep timer.

## TEST REPORT:

# Horizon digital signal meters

Eugene Trundle checks out a pair of digital-TV reception testers

Long gone are the days when an analogue signal-strength meter sufficed when aligning TV aerials and dishes. Signal-strength meters have now gone digital, like the signals they receive and the boxes these signals feed. There are several classes of instrument in this market, each with a fairly well-defined price point.

At the bottom there are the simplest types that merely provide an overall-strength reading based on all the signals that come from a transmitter or satellite. These cost about £30-£60 and are just

adequate, perhaps, for the most basic installations – and caravanners. The next class consists of hand-held or neck-slung meters that can identify the transmitter/satellite from which a signal comes and gives a readout of signal- or carrier-to-noise ratio and the received bit-error ratio (BER). These cost about £300. Beyond this, ranging in price from £800 to about £1,200, there are instruments, still portable but heavier and more complex, with a screen on which the transmitted picture or, much more significant, a band spectrum can be displayed. The lat-

ter is especially important as the terrestrial broadcast bands and satellite slots become ever more crowded. Some top-end instruments can operate on two or more systems – satellite, terrestrial and cable. The most sophisticated can range in price up to £2,500, with a colour display and every possible bell, whistle and hooter.

What you choose will depend on the type of work you do, which of the three transmission modes you normally work with, and where in the installation market you pitch yourself. If you confine your-





self to contract work with Sky dishes, you won't need the top-end Promax Prolink 4. At the other extreme, if you undertake SMATV installations a £40 SatMax WonderWave will not do for you! The instruments I'm reviewing here are in the middle category: hand-held or neck-slung alignment/installation meters with a digital readout, non-volatile software programming for relevant signal sources, and a rechargeable battery power supply. These Horizon meters use Ni-MH batteries and are priced at £250 + VAT for the satellite version and £299 + VAT for the terrestrial (Freeview) type.

## Description

The two meters have much in common but are readily identifiable by their colour – yellow for the satellite version, red for the terrestrial one. They come with a lined, 'Velcroed' and reasonably weatherproof leather-look case that has a neck strap and a viewing window, and contain a 2.4Ah Ni-MH battery pack that gives over six hours' use with the terrestrial version and, because of the current drain taken by the LNB, about half that with the satellite version. An 'intelligent' mains charger is built in, arranged for a four-hour charging cycle and trickle-charging thereafter. There's a car cigar-lighter cord for charging on the move, and the battery condition is shown in the front panel readout throughout its charge and discharge cycles. The meters have an RF loop-through facility and a simple to understand operating system that's based on four membrane-type keys and a four-line backlit LCD panel. The accompanying picture shows the front face of the terrestrial version, Model HDTM.

Both units are software programmed, in flash memory via an RS232 serial data port, for the transmitters/transponders of interest – up to 32 of them, each with up to 16 multiplexes for the Freeview Model HDTM, or from 16 selected satellites for Model HDSM. They can, on request, be custom-programmed before delivery (and even personalised with your name!).

Alternatively you can carry out programming by downloading from Horizon's website via the PC lead supplied: the system is compatible with Windows 98 to XP and requires Winzip software to run – this is easily downloaded from the Web if required.

The menu-key-led data readouts give indication of four basic parameters: signal source; signal strength in bar-graph and quantitative ( $\text{dB}\mu\text{V}$ ) form; pre-BER with 'pass' and 'fail' measurements; and post-BER. The latter two indicate the bit-error ratio before and after internal error correction of the type that takes place inside a set-top box or IDTV. For TV aerial/dish alignment the pre-BER is the most important factor.

## Up the ladder

I started with the satellite meter which, at switch on, defaults to the UK's most-used satellite slot, Astra at 28.2°E – whence come all those highbrow Sky programmes. I found that Turksat, Hispasat, Telecom 2A and 2C, Thor, Sirius, Eutelsat W1/2/3, Hot Bird, Astra at 19.2°E and Arabsat were also preprogrammed. This is more than enough for most installers, without need to go to Horizon's database. During my tests I confined myself to the two Astra slots and Hot Bird. For alignment you of course need a start point: a compass and an inclinometer of some sort, or great familiarity with the local topography relative to the satellite you are seeking.

With each satellite setting the meter scans the vertically- then the horizontally-polarised transponders, stopping at each match with its internal database and switching to a strength reading (S) to enable you to peak the alignment of the dish. The 'searching' caption is soon replaced by a 'found' one, and a second (Q) bar-graph that represents the inverse of the bit-error ratio. At the point where these readings peak, usually together I found, the dish can be tightened up, leaving you to see how you (and the dish/LNB) have done in terms of the C/N (carrier-to-noise) ratio, indicated in dB, and V, which represents the corrected Viterbi BER, given as a percentage.

In practice I found that this works smoothly and well. The S and Q readouts, with quick response, are the main ones at the dish. In the living room the S, Q and

V readouts enable you to check on cable loss. This is more laborious than with a spectrum-analyser instrument, because of the need to check on strength and quality at two or three points in the first IF band, i.e. low, medium and high.

In the wind and rain while I was evaluating this meter I found that the neck-strap suspension is convenient and the weather-proofing at least as good as my own! If the instrument was mine I would keep a little extension lead permanently connected to the F-type input socket, to prevent wear on the socket and permit 'flap-down' operation in wet weather. I certainly had no doubt when a dish was correctly aligned using this meter: with a little experience one soon gets to know what to expect in terms of signal strength and quality. I also found that the instrument provides about fifty per cent longer running time per battery charge than its otherwise similar competitor, the Lacuna Sat Meter 2, along with a physically easier fitting for the F connector.

The bright red terrestrial meter, Model HDTM, is much more likely to need a download feed of your local Freeview DTV transmitters, because of their greater number and the fast rate at which they are coming on stream. Armed with the downloaded programs for my local transmitters, I first climbed to the roof of Trundle Towers. I found that my aerial, which had been installed many years ago, presumably with the aid of a simple analogue meter, was off-beam by a few degrees. The before and after alignment carrier strengths and BER readings differed considerably: my DTV reception, good before, was better for the

**Table 1: Horizon digital signal meter specifications**

### Model HDTM

RF input range	-72dBmV to +20dBmV
Frequency coverage	167-862MHz
Memory capacity	32 transmitters, 16 multiplexes each
RF booster supply	12V, 200mA
Battery life	Over six hours

### Model HDSM

RF input range	-65dBmV to +25dBmV
Memory capacity	16 satellites, 32 transponders
LNB supply	13V V, 18V H
LNB short-circuit protection	Automatic at 500mA
Battery life	Over three hours

### General

Dimensions	170 x 123 x 58mm (w/d/h)
Weight	900g with batteries
Power source	Internal 2.4Ah Ni-MH battery, internal mains charger
Supplied accessories	Mains lead, car cord, PC lead
PC interface	Serial via RS232
Battery discharge time (idle)	24 days
Warranty	One year

directional tweak of the aerial. In this and several subsequent installation and alignment jobs, I found that the six-hour battery charge got me through a lot of work.

As with the satellite version, at switch on the HDTM defaults to the top of the stored transmitter list, which can then be stepped through sequentially by scrolling down. Aerial siting and alignment are carried out in terms of RF level readouts per multiplex: the difference in multiplex signal strengths at some sites was very noticeable. Analogue transmissions are also catered for, in terms of signal strength, but there are obviously no BER readings with these. The preloaded data knows the channels used for digital transmission at each programmed site, but there is also a step-through-channels facility. This is useful when you don't have data loaded for the transmissions you are seek-

ing, and for checking adjacent analogue transmissions.

With Freeview signals the pass/fail indication is again given in the pre-BER mode. This takes about twenty seconds to appear. The post-BER ('VIT') reading has a rather longer sampling time, about one minute, and is not available in the step-through-channel mode.

This meter's RF terminals are of the BNC type, no doubt in preference to the less secure and more wear-prone Belling-Lee type. So I again made a short extender/adaptor lead for each. This also permits flap-down operation where necessary, and solves the problem of the undersized hole in the flap.

#### Conclusion

These meters both worked well for me, and appear to be rugged as long as they

are kept in their protective cases. They are more than adequate for their purpose, and compare well with other instruments in the same class and price range.

I found a reasonable, but not exact, correspondence between the meter's fail indication and signal shutdown with satellite receivers. There's more variation with Freeview boxes, certain more recent models being much better at coping with a poor and noisy signal. Take a bow, Philips and Nokia . . .

In choosing what to buy however it's important to appreciate the other types of instrument that are available in this field. It could, for example, be that a dual (satellite/terrestrial) instrument would be more convenient than a system-dedicated one, or that a spectrum-display type would better suit your needs – horses for courses, but these options both come at a premium. ■

#### AVAILABILITY

The meters are available from Horizon Global Electronics Ltd., 27 Pennant Terrace, Walthamstow, London, E17 5BD.

Phone 020 8281 3777. You can order by email from [sales@horizonhge.com](mailto:sales@horizonhge.com)  
There's a website at [www.horizonhge.com](http://www.horizonhge.com)

# EXPORT ENQUIRY'S WELCOME!!

## WE SELL TV'S, DVD'S, VCR'S, HI-FI AUDIO

## SMALL APPLIANCES AND WHITE GOODS

### HITACHI SONY BEKO PANASONIC BUSH LG PHILIPS

### SVA TRADEX TXL DAEWOO MORPHY RICHARDS AKURA

### LUKER AND MANY MORE TOP NAME BRANDS!!

#### 14" CTV R/C



From

**£29.99**

#### BASIC MICROWAVE



From

**£14.99**

#### BASIC MULTIREGION



DVD

From

**£17.99**

**Trade**  
Electronix

30/34 River street Digbeth B'ham B5 5SA

Tel: 0121 773 3300 Fax 0121 773 2300

[WWW.TRADEELECTRONIX.CO.UK](http://WWW.TRADEELECTRONIX.CO.UK) [INFO@TRADEELECTRONIX.CO.UK](mailto:INFO@TRADEELECTRONIX.CO.UK)





# The Sale of Goods Act

**The Sale of Goods Act, which originally came into effect in 1979 and was supplemented by Regulations introduced in 2003, affects everyone who has commercial dealings with the public. You can get into difficulties that could involve expense and wasted time if you are not familiar with its requirements. Michael Maurice provides a guide to how it affects our trade**

**T**he aim of the Sale of Goods Act, which originally came into effect in 1979, is to give the consumer greater protection against faulty goods and rogue traders. On 31 March 2003 the Sale & Supply of Goods to Consumers Regulations 2002 were introduced to supplement the Act. They set a minimum standard throughout Europe, and give the consumer greater rights when buying across borders. To put it another way, the new regulations and laws effectively set in stone the existing laws and rights of the consumer. Much of what is contained in the following article is available in a document called *A Trader's Guide*, published by the DTI (Department of Trade and Industry). This is available from the DTI and local Trading Standard Offices.

The Act and the new Regulations are quite complex. I will try to explain the various parts as clearly as I can, especially those that relate to our trade, but must point out that I am not a lawyer and don't have any legal training. The information in this article has been obtained primarily by refer-

ring to the *Trader's Guide*. It is supplemented by information I've gathered in the course of business. Some points consist of my carefully considered opinion. I must emphasise that this is a general guide and that neither I nor the publishers can be held responsible for any inaccuracies.

## Rights

According to the Act a product should be of satisfactory quality and fit for the purpose for which it is bought. Thus if the customer tells the retailer that the product he requires must be capable of doing X, Y and Z, should he subsequently find that it doesn't do what he wants he is entitled to return the goods and receive a full refund. If, however, the customer does not tell the salesperson his requirements and then, having made the purchase, finds that the product does not meet his expectations, the retailer is under no obligation to accept the goods back.

Certain provisions of the Act do not apply to businesses, traders and people who use goods in connection with their business: these are implied rights as to fitness and quality and are covered by the contract between the two parties. Thus a customer who finds that a product he has bought from you is repeatedly faulty may be entitled to a refund or a replacement, but the retailer may not have the right to demand the same from his supplier. Another example is someone who buys a car for business use, say as a mini cab. And it could be argued that we, as engineers, are not end

users and are therefore not covered by the Act. A consumer is considered to be someone who has bought goods for his or her personal use, i.e. not for use in connection with a business.

When a consumer buys a product from a trader/retailer he invokes a contract between himself and the retailer. In law, the consumer's legal comeback is with the retailer, not the manufacturer.

If a manufacturer or supplier states that a product will do X, Y and Z and it is subsequently found that the product doesn't, it is still the retailer's responsibility to ensure that the description of the product is accurate. The retailer might be able to argue that he was unaware that a manufacturer's claims were false: but the customer's rights are always with the retailer.

Consumers are entitled to receive products of satisfactory quality, taking into account purchase price and other relevant factors. If an item has a fault that was present at the time of purchase, sometimes called a 'latent' or 'inherent' defect, the customer can complain when this is discovered.

## What's reasonable?

The word 'reasonable' crops up in many parts of this article and the legislation. But there is no statutory definition of what is reasonable and what isn't. Dictionaries provide a number of definitions. 'Fair and sensible' and 'fairly good but not especially good' are most likely to be relevant here. There is however case law as to what 'reasonable' means.

---

**The retailer should either exchange the product, repair it or arrange for the manufacturer's service department to repair it.**

---

## Legal remedies

When a product is faulty, the first course of action on the part of the customer is to return it to the retailer or, if it's a large item like a TV set, call the service department. If the product is virtually new, i.e. under 14-28 days old, a replacement can be requested as it should be obvious that there was an inherent fault from new.

The retailer should either exchange the product, repair it or arrange for the manufacturer's service department to repair it.

There are circumstances under which a consumer cannot expect legal redress. These are as follows.

First, fair wear and tear. In days gone by for example a manufacturer would exclude bulbs and styli from a guarantee or, in the case of a car, wear to brake linings. These are considered to be service items.

Secondly misuse or accidental damage, for example if a customer drops the product or spills water into it. In such circumstances the customer cannot expect the product to be rectified as though there was a defect. If you are unfortunate enough to be involved in an accident while driving a new car, you cannot expect the dealer or the manufacturer's agent to repair it under the terms of the warranty, the exception being if you could show that a mechanical defect, e.g. complete brake failure, was the cause of the accident.

Thirdly, when the purchaser simply decides that he no longer wants the product. The retailer is under no obligation to accept a product back simply because the purchaser, having got it home, decides he doesn't want it after all or it doesn't fit – assuming that any dimensions quoted are accurate. Indeed if the retailer does accept a product back it can no longer be considered as new for the purpose of a future sale. An exception to this is goods bought by mail order or over the internet.

Neither can a consumer expect legal redress if an item had a defect that was pointed out at the time of sale, or has a defect that should have been evident on reasonable inspection. If you buy a product that was on display and later find that it's scratched, the retailer is under no obligation to accept it back. Or, if the product has a part missing and this was pointed out at the time of sale, there is again no obligation to accept the product back.

When a product is found to have been faulty at the time of sale

the purchaser, on returning it to the retailer, is legally entitled to: (a) a full refund if this is within a reasonable time of the sale (a reasonable time is not defined by law, but is usually quite short); or (b) a reasonable amount of compensation (or damages) at up to six years (five in Scotland) from the date of the sale.

The Act does not mean or imply that all products have to last for six years or shouldn't go wrong within six years: it's the limit for making a claim against the retailer in respect of a fault that was present at the time of sale. It is not the equivalent of a guarantee. There are a number of implications to this, which I will be discussing later.

Most electrical and mechanical goods are covered by a manufacturer's warranty. This often says that the goods are guaranteed to be free of defects for a stated period, usually one year. What usually happens is that if a product fails within a short time after purchase, usually 14-28 days, the retailer will exchange it, or will send someone to repair it, or will have an agreement with the manufacturer or a specialist service agent to carry out the repair.

Under the Regulations the consumer can, when a fault is discovered, choose to request a replacement, especially if the fault develops within a short period of time; a repair; or a full or partial refund.

## Proving the fault

Consumers generally have to prove that the product was faulty at the time of sale. This is especially so when the consumer requests a refund or compensation. There is an exception to this. When the customer returns a product to the retailer within six months of the date of sale, the law assumes that the fault was present at the time, the onus being on the retailer to prove otherwise. This is usually quite obvious: either the product works correctly or it doesn't! The exception here is when the fault is intermittent, showing up only on rare occasions.

## Servicing and repairs

The Supply of Goods and Services Act 1982 requires a service to be carried out with reasonable care and skill within a reasonable time and, where no price is agreed, the charge should be reasonable. This does not apply in Scotland, where common law prevails. Again that word reasonable keeps cropping up, but has no legal definition.

## Conforming to contract

When a customer buys a product he enters into a contract with the seller. The contract usually consists of a sales or till receipt. Should the customer subsequently complain that the product is faulty, what he means in legal terms is that it does not conform to contract, though members of the public would rarely put it that way. Products do not conform to contract when they are defective at the time of sale or they fail to work later, even after a number of years, because of an inherent fault, i.e. one that could be said to exist at the time of sale. Products do not conform to contract if they do not comply with any description given by the retailer prior to the sale.

The Sale of Goods Act 1979 determines whether there is lack of conformity with the contract. It lays down the following requirements. The product should match any description given to it. It should be of satisfactory quality, i.e. it should meet what any reasonable person would regard as being satisfactory, taking into account any description provided, the price paid and all relevant circumstances. For example, you wouldn't expect a £25 radio to provide high-fidelity performance but, if the description said the frequency response was 20Hz to 20kHz, then it should conform to this specification. Even without such a description, a certain clarity of sound would be expected. And the product should be reasonably fit for the purpose made known to the retailer at the time of sale (unless the retailer disputed the appropriateness for the purpose at the time of sale).

If a customer says, or it should be obvious to the retailer, that a product is wanted for a particular purpose, even if this is not the purpose for which the product is normally supplied, and the retailer agrees that the product is suitable for this purpose, the product must be relatively fit for this purpose. If the retailer is unsure that the product will meet this requirement he should make it clear to the customer, preferably in writing (perhaps on the sales receipt), to protect himself against future claims. Similarly I would suggest to a customer that if he wants the product for a particular purpose this should be put on paper which the retailer should sign before the transaction is completed. In this way there can be no argument about whether or not the product is suitable for the intended purpose. Here are some examples.

A customer of mine went to a well-known national retailer to buy a camera and told the salesperson that he wanted to use it to photograph sporting events, so it should be able to react and operate extremely quickly. He subsequently found that the camera he bought didn't operate fast enough: by the time it had zoomed and focused, the event was over. When he took the camera back to the shop he was, after a lengthy discussion with the manager, sold another one that performed equally poorly. On returning this one the retailer was not interested and would not return the purchaser's money. Under the Act however the customer was entitled to a refund, as the camera didn't meet the requirements made known to the retailer. Had the customer got the retailer to sign to the effect that he knew the customer's requirements, the customer could have expected to have won his case if taken to the Small Claims Court.

If a customer buys some software to load on to an Apple Mac PC and makes it known that the PC is of this type, he has the legal right to return the software if it's not compatible with an Apple Mac – because the software does not conform to contract. If however the customer does not mention that the PC is an Apple Mac, and the retailer had no reason to suspect this, the retailer could dispute the unsuitability of the product for the purpose. Furthermore most software packages state on the box the operating system(s) they

are compatible with, the onus being on the consumer to check for suitability.

A customer buys a VCR for the sole purpose of recording the output from a CCTV system. He doesn't say this, only that he wants a cheap VCR. If, after nine months, the heads fail because of the amount of use, the retailer can hardly be held responsible for what would be considered fair wear and tear in the circumstances. If however the customer had asked for a VCR to be used specifically for this purpose, it would be up to the retailer to ensure that the VCR he sold would stand up to this use.

### Fair wear and tear

The law does not state nor assume that products are expected to work fault-free. Indeed it allows for the fact that products can and will break down at some time during normal use. Consumers cannot hold the seller responsible for failure as a result of fair wear and tear: there needs to be a fault that was present at the time of sale. If for example a customer uses his VCR for an excessive number of hours and the result is what might be considered premature head wear, he has no legal redress with the retailer. If however the customer could prove that the back tension was set at the factory at a higher level than specified by the manufacturer, then he would have a legal right against the retailer.

Sometimes a sales contract excludes items that are considered

'able', there is no precise definition in law. It is somewhat subjective, but can be taken into account when trying to determine whether goods conform to contract. Price is a relevant factor here, so is suitability for the use intended. Grounds for arguing about durability include price; inappropriate use; and construction and the suitability of the materials used. An expensive product that uses inferior parts may well fail the durability test, for example a top-of-the-range VCR that uses the same mechanism as a basic model, or an expensive TV set that uses a common, inferior component.

### Remedies

There are several remedies that a consumer can use where a product is considered to have failed to conform to contract, two long-established legal remedies and four additional requirements introduced in March 2003. These are as follows.

(1) Rejection of goods. This long-standing remedy enables a customer to reject a product and ask for his money back provided the complaint is made within a reasonable time. The Sale of Goods Act does not provide a definition of what is a reasonable time, but it's quite short. A court would, after taking all relevant factors into account, determine what a reasonable time should be.

To implement this course of action, the consumer must advise the retailer of his intention to reject

---

## Consumers cannot hold the seller responsible for failure as a result of fair wear and tear: there needs to be a fault that was present at the time of sale.

---

'service items'. A car manufacturer for example cannot give a warranty as to how long the brake linings or the clutch plate will last, as this will vary with the driver and the way in which the car is driven. If the brake calliper or cylinder leaked fluid on to the brake linings however the customer could expect to have the linings replaced under the terms of the warranty.

Many items are not expected to last for six or more years. A £60 VCR cannot be expected to have the same life expectancy, build quality and durability as one that costs £200.

But durability can be a difficult matter. As with the word 'reason-

the product. The consumer is not obliged to return it, but must make it available for collection by the retailer. The customer would usually return a product, but this may be difficult where the item is bulky or heavy.

(2) The other long-standing remedy is a claim for compensation, otherwise known as damages. This can be used where the customer is not entitled to reject the product or chooses to do otherwise. Compensation is designed to compensate for losses that arise from a defective product. The customer may also seek consequential losses. For example

*A set that obviously doesn't conform to contract.*



the customer may seek to have the cost of any postage and packing he incurs reimbursed by the seller or may, having had a repair carried out by a third party, seek reimbursement for this repair. If the customer does the latter however it may make it difficult for him to prove that the fault was present at the time of sale, while the retailer could argue that he should have been given the opportunity to rectify the fault himself and that, by going to a third party, the customer is not mitigating his losses.

**(3) Repair and replacement.** Retailers and manufacturers have for many years voluntarily provided a guarantee for goods sold. This normally takes the form of agreement to repair or, when the product cannot be quickly and easily repaired, the offer of a replacement. This now has legal status, and consumers can quote the Regulations in force since 31 March 2003 to demand repair or replacement where the product does not conform to contract.

**(4) Reasonable time and significant inconvenience.** The Sale of Goods Act states that repairs should be carried out within a reasonable time and without significant inconvenience to the customer. Once again these requirements are vague and would be assessed in law on a case-by-case basis. A reasonable time could be about five working days, but this could vary and circumstances such as the availability of spare parts would have to be taken into account. But the retailer is obliged to minimise the amount of inconvenience to the customer. He may do this by attempting to speed up the repair or by the loan of a similar product. If the supplier is made aware that the product is required for use on a certain day, he should ensure that it is ready for use on that day. To give an obvious example, if a customer bought a wedding dress and found a fault with it a week prior to her wedding, it would be of little use if the supplier said he would have it ready two days after the big day!

**(5) Disproportionate cost.** It would be unreasonable to demand that a retailer pays for repairs that would exceed the cost of the product. For example the cost of new heads for a budget VCR costing £70 could, along with the cost of labour for fitting them, cost say £90. In this case the retailer could opt to replace



---

### **The Sale of Goods Act states that repairs should be carried out within a reasonable time and without significant inconvenience to the customer.**

---

the VCR. Conversely where a 5p fuse in a £1,000 TV set has failed it would be unreasonable for the customer to demand a new set.

**(6) Partial or full refund.** If neither repair nor replacement is practical, the Regulations provide alternative remedies in the form of either a full or a partial refund. To determine whether a full or a partial refund is appropriate or, in the latter case, what proportion is to be given, the retailer takes into account the benefit the customer has had from the product. If, for example, the product has a normal life span of say eight years, and breaks down after five years because of an inherent fault for which there is no remedy, the customer cannot expect a full refund as he has had the benefit of the product for five years. Thus a reasonable refund would be three eighths of the original price.

#### **Supply of spare parts**

There is also a legal obligation on suppliers, retailers and manufacturers to make spare parts available for at least seven years from the time of selling a product to the consumer. If a manufacturer is unable to supply a spare part without which a product is unusable, the consumer has a legal right against the dealer who supplied it for the remaining time during which he could have expected it to last.

This depends to a certain extent on the original cost of the product. It might be argued that a £25 radio-

cassette recorder wouldn't necessarily be expected to last for eight years, while a 32in. widescreen TV set should be usable for eight years or so though not necessarily without failures. If, after a couple of years, a spare part is no longer available, the consumer can claim damages against the retailer for the remaining part of what might be considered the normal lifespan of the set. It is no defence for the retailer to suggest that the product should last for only say three years. If that is proposed, I suggest the retailer makes this clear at the time of sale – though I doubt whether he would sell many products on that basis!

#### **Sales receipts**

When a consumer complains that a product is faulty and seeks a remedy, the retailer is entitled to satisfy himself that the consumer did purchase the product from him on the date claimed. The best way for a customer to provide this proof is to produce the sales receipt that should have been obtained when the product was bought. In the absence of such proof, the onus is on the customer to prove that the product was bought from the retailer on the date claimed. A detailed credit-card statement is often acceptable as proof.

If the consumer can offer no proof that he bought the product from the retailer on the date claimed, he would be unlikely to be able to pursue a legal remedy. ■

**Continued next month**

## SERVICING

# the Hitachi A7 chassis

Glyn Dickinson provides a repair guide for this chassis, which was introduced in 1998 and remained in production for several years. It was used in a wide range of models, both 4:3 aspect ratio and widescreen

The Hitachi A7 chassis was introduced in 1998 and was the company's first one for widescreen models. A pared-down version was used in Hitachi's last UK-produced (pre-Vestel) large-screen 4:3 aspect-ratio sets, Hitachi's smaller-screen models being supplied by Daewoo then Tatung. The A7 chassis is well-designed, most problems arising because of assembly problems or poor components. Picture quality is reasonably good – provided the digital noise-reduction circuit is switched off and the sharpness control is set at less than fifty per cent. Breathing is quite noticeable with 14:9 and 4:3 pictures: most people seem to use the panoramic 'Michelin-man' ratio however and so don't complain about this.

Hitachi has a department whose job it is to provide confusing model numbers. They certainly got to work with the A7 chassis. Models C2X56TN, C2567TN (Nicam), C2X86TN (Dolby), C2966 and C2986 are 4:3 aspect-ratio sets. The department was then given a W to play with, so we got the widescreen Models C24W1TN, C28W1TN, C28W2TN and C32WD2TN. These were superseded by the similar TN2 models, which had the VGA panel deleted and became the C2X/32W410/430TN (Nicam) and C2X/32W510/530TN (Dolby Pro-Logic). An S in the model number simply means a silver cabinet. As many CRT variations were used and the chassis was in production for four years' there were numerous circuit additions and deletions. This article concentrates on the 28in. widescreen Nicam set.

The sets came with a stand or an optional video cabinet on to which the set is located with two pegs and is secured (hopefully!) by two

screws. These can be found by reaching above the video shelf. A chubby screwdriver is handy here!

### Switch-on sequence

In common with most modern sets, the set carries out a check at switch on run by the microcontroller chip. First the power supply comes on and voltages develop. The standby light is then illuminated dimly for a second, after which it becomes bright. On early models it should then dim and the degaussing relay will click. Software checks are in progress at this time. Once these have been completed (about ten seconds, though it seems much longer) another relay clicks (early models again) and, hopefully, the on-screen display will appear, followed by the sound and then a picture. It's important to remember that the set will return to standby if any of the checks fail. Something as simple as an over-advanced A1 control will cause this. There can, as a result, be all sorts of difficulties with fault diagnosis.

### Tube troubles

Before any work is carried out I recommend one thing. If the set is fitted with the dreaded Philips tube with the middle letters ESF, inspect the CRT base. If any components here are burnt the CRT has an internal short and, unless the customer is a bank manager, repair will be uneconomic. This might just save you some time.

GoldStar tubes fitted in larger-screen sets have their own quirk: they can suffer from the 'purple-neck syndrome', which will trip the set. It seems to be an inherent weakness with the CRT. Here's a warning from a tube man. Even though a purple neck usually means air in the CRT, this tube can still

implode spectacularly. So take care over the replacement.

If a Panasonic CRT is fitted you can usually heave a sigh of relief!

### Dismantling

Even though the 32in. sets are a bit awkward to handle, I don't recommend trying to service them in the customer's house. The cabinet front can become alarmingly floppy, especially if the stand's screws haven't been fitted!

For virtually all repairs it's necessary to remove the plastic chassis frame. To do this, remove the back and one black screw by the phono sockets, the extension speaker socket panel (two screws) if fitted, the VGA interface panel if fitted, and the white plastic rivet by the line output transformer. If this rivet puts up a fight, cut it off rather than risk a crack in the PCB. Be careful of the electrolytic mounted beside the rivet. Remove the CRT base and the two purse clips that secure the speaker wires. On later models there may be a sub-power PCB – remove this.

Remove the tape that holds a blue wire away from the high-wattage resistors (don't forget to replace it when reassembling), turn the chassis over, and cut the transit cable tie by the chopper transformer if this hasn't already been done. Inspect the chassis for 'after-thought' components, and check that they won't be fouled by the chassis – if they come off, you won't ever find out where they came from! Mark the position of the A1 control, then slide the chassis a couple of inches to the front. Disengage the left-hand side and remove the frame.

### Power supply operation

The Hitachi designers work on an



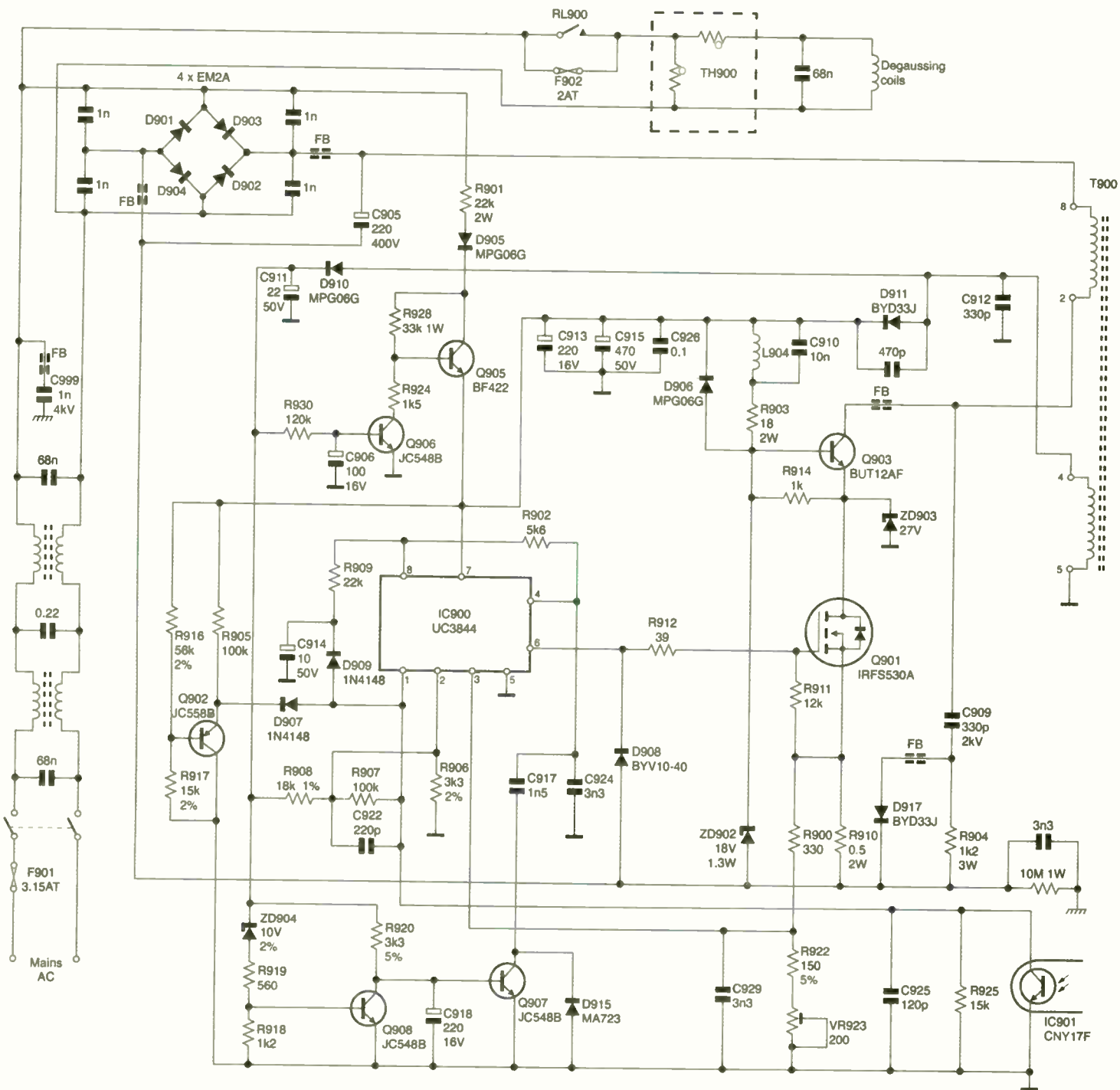

**Fig. 1: The power supply circuitry, primary side. Circuit and component-value variations will be found in different versions/models. and F902 are not fitted when RL900 is used.**

'if it ain't broke' basis, so the power supply will be vaguely familiar to those who remember the CPT2198 series. Thermistors aside, this was a good basic design that was refined during the Nineties, the result being a very reliable circuit. I'm not sure whether the Vestel chassis Hitachi is now using will continue this tradition . . .

Two factors that are typical of Hitachi design are low power consumption and lots of protection circuits. Much additional circuitry is

used to this end. Once this has been stripped away (not literally!) you will see that the power-supply design is fairly conventional. Figs. 1 and 2 show the circuitry on the primary and secondary sides of the chopper transformer T900 respectively.

In early models the degaussing circuit uses a relay to isolate the coils completely once they have been activated. The main power supply uses an optocoupler, IC901, for regulation. Bridge rectifier

D901-4 rectifies the mains supply, and pin 7 of the UC3844 chopper control chip IC900 receives a start-up supply, about 16V, via R901, D905 and Q905. IC900 produces a squarewave drive output at pin 6. This is fed to the gate of the BUK452-60A FET Q901, which is connected in series with a BUT12AF bipolar transistor, Q903. Thus Q901 drives Q903 at its emitter. The purpose of Q903 is to provide a cleaner and more rapid switch-off than the FET on its own

can, and seems to help increase its life. Once the power supply is running the start-up feed is disabled by Q906 switching off Q905. This reduces consumption.

The current that passes through the primary winding of T900 is monitored by R910 (0.5Ω, 2W), the voltage developed across this resistor being fed to pin 3 of IC900. If the voltage is excessive, IC900 shuts down. Q907 and Q908 alter the operating frequency in the standby mode. Q902 protects IC900 when there's an under-voltage condition.

The secondary side of the power supply is quite complicated, mainly because of the protection circuitry (see Fig. 3). IC950 is a quad comparator that monitors various voltages and shuts down the power supply, via the microcontroller chip, should a fault develop. Comparator 1 monitors the 26V audio supply at pin 6; comparator 3 monitors the conditions in the line output stage at pin 8, i.e. current through the line output transistor Q751; while comparator 4 monitors the 200V supply produced from a tap on the line output transformer, and hence the EHT, at pin 10. LT protection relies on reverse-biased diodes: D962 (18V supply); D963 (8V supply), D969 (5V supply); and D972 (5V standby supply).

Comparator 2 is used as a 'power-good' detector. Should a brief mains supply interruption that could lock-up the microcontroller chip occur, this comparator will shut down then restart the power supply to initialise the set. Bear this in mind when investigating difficult intermittent trip faults.

The HT is set by VR950, which forms part of a potential divider with R950 and R953. Error sensing is carried out by Q954, whose emitter is held at 6.2V by ZD950. Don't be fooled by this. Despite its circuit reference number, ZD950 is a voltage-reference diode, not a zener diode, and measures open-circuit. It must be replaced by the correct type (BZV10). A 6.2V zener diode will shut down the power supply, or make it behave erratically. Q954 drives the LED in IC901.

In standby the LT supplies are switched off by a high from pin 24 of the microcontroller chip.

The LT voltage regulators are conventional: IC951 is the 5V regulator, IC952 the 5V standby regulator while Q957 regulates the 8V supply.

Traditionalists will applaud the inclusion of a good old-fashioned avalanche diode, ZD970 (PGKE180), across the HT supply.

### Dead set, fuse blown

This is an unusual fault but, if the mains fuse has failed, you will probably find that Q903 is short-circuit. Replace the following items – use genuine Hitachi parts: Q903 (BUT12AF), Q901 (BUK452-60A), IC900 (UC3844), R910 (0.5Ω), R950 (68kΩ metal film) and ZD903 (27V). Check all the other diodes in this area.

### Set trips intermittently

By far the most common complaint is the set reverting to standby, or tripping out then reverting to channel 1. Although the cause is usually dry-joints, to avoid recalls it is worth carrying out the following procedure.

Resolder the HT preset VR950. Resolder the line driver transistor Q701 and the transformer and capacitors in the line output stage. Trim any leads in this area – the shears didn't always cut these during manufacture – and check the soldering here.

Next to the middle of the PCB. Resolder IC951, IC952, IC602, Q601, Q957, Q951 and R986 – dry-joints here are the most common causes of tripping.

Now turn the chassis over and inspect the area between the audio heatsink and the front switches. There are several through-board links here: resolder them. There are also three between the field output IC and the LOPT, and two around the jungle IC.

A couple of other things should be checked. If R950 (68kΩ, near the HT preset) is a carbon resistor, replace it with a metal-film type (part no. 0113795). If it's not present, fit modification kit J3333961. Don't get too alarmed – it's a spring! Fit the longer end to the core of the line output transformer, then push the other end through nearest hole in the line output transistor's heatsink and secure it on the adjoining tag. Although this is not specifically advised, I think it is good practice to thread the spring through a piece of sleeving in case it becomes detached. The purpose of the spring is to prevent static build-up that can cause spurious tripping.

Hopefully the set will, once reassembled, run. Adjust the HT

preset for the voltage shown in Table 1. The voltage is critical to within 0.2V, so an accurate digital meter should be used – no AVOs here, please! Adjust the voltage with the set cold, displaying an average picture, then recheck half an hour later. If a test pattern is not available, I find that a text page is next best. With widescreen models the voltage will decrease *slightly* as the set warms up.

Hopefully the set will now no longer trip. If it still does, there are various possibilities. A noisy IR preamplifier (metal type) may cause noise spikes. An over-advanced A1 can also cause this – check the black level with text. If a GoldStar CRT is fitted, a very slight reduction may be needed. If the trip operates at high volume and contrast levels, it's permissible to reduce the sensitivity slightly by turning VR923 anticlockwise.

If the set still trips, panic. Recheck for dry-joints and monitor the HT to try to isolate the fault. We've had a faulty HT preset and a loose core in the chopper transformer cause this, also the CRT – the trip is so quick that we didn't see the red flash at first, but flicking in and out of text provoked it. A new CRT was the cure, though I was far from convinced that it would work! Check the degaussing circuit: in the quest for low power a relay was used in early models, but later ones use a conventional circuit, so check for an intermittent posistor.

If the set trips only in the customer's house, check for energy-saving light bulbs that can cause random IR interference. Also make sure that the mains socket is good and secure: a drop-out will not necessarily affect the picture but will activate the power-good comparator which will deliberately trip the set. Block-type mains adaptors should not be used, and check any dubious multiplugs.

### Set trips permanently

In this case the set remains dead or tries to start then immediately shuts down. This points to an over-voltage or, more usually, excess-current condition. Check and resolder the possible dry-joints listed above – you will need to anyway! – and check that R950 is up to standard (if in doubt, replace it). But the most common cause is a short in the line output stage, either the x line output transistor Q751 (BU2508AF, Hitachi specification)

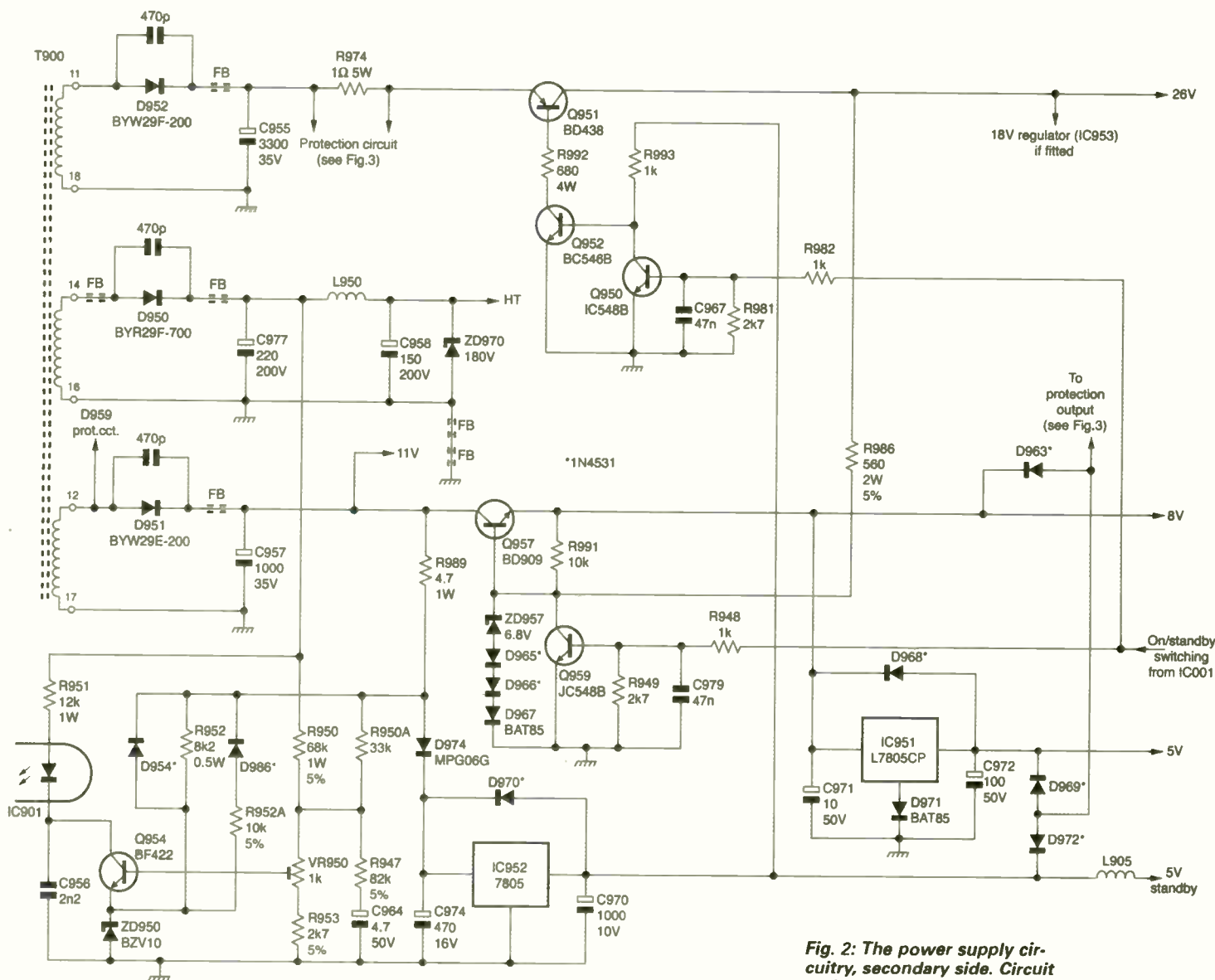

**Fig. 2: The power supply circuit, secondary side. Circuit and component-value variations will be found in different versions/models.**

or a disc-ceramic tuning capacitor (values vary, but the offender will usually put its hands up!). When replacing the transistor, check very carefully for dry-joints in the line driver area and replace the line driver transistor if you are unsure about it. Very often the customer will complain about a shifted picture before the failure. Check and resolder the through-board links by the jungle chip as well to avoid a recall: there is also a hidden one next to IC950.

If the line output stage is blameless, the next favourite is the audio output stage, which is based on IC4000. Not surprisingly, damage here is usually caused by someone adding extension speakers. Failure can take out part of the 26V rail, Q951 often being damaged.

If the set works when brought into the workshop, suspect that someone has put an audio phono lead in the 18V supply for the IR speaker extender. This can result in R975 (22Ω, 2W) overheating slightly – the supply regulator IC953 usually survives. A knock-on effect is that the audio item connected doesn't take too kindly to 18V in a signal path, the result being another repair!

The next suspect in line is the field output IC – very often repeatedly switching the set on will reveal field collapse or half a raster.

If the set is still tripping, it's time to check the protection circuitry. The circuits themselves are quite reliable, so they are generally responding to a fault – don't be tempted disconnect them and look for where the smoke

comes from! The 26V line carries quite a current, and if the relevant trip is disconnected there can be a minor explosion. The value of R766 (emitter of Q751) is critical (1Ω, 10W, 5%).

As previously described, the trip circuitry is based on IC950. To isolate all the trips (beware!!!) desolder pin 12 (earth) of the IC. A better course is to remove each diode in turn – remembering that the last one to be disconnected will be the faulty one...

### Hum bar

A hum bar on the screen can be caused by the degaussing circuit in later sets without the relay. A modification sheet is available to reinstate the relay if necessary – the idea is to prevent any current what-

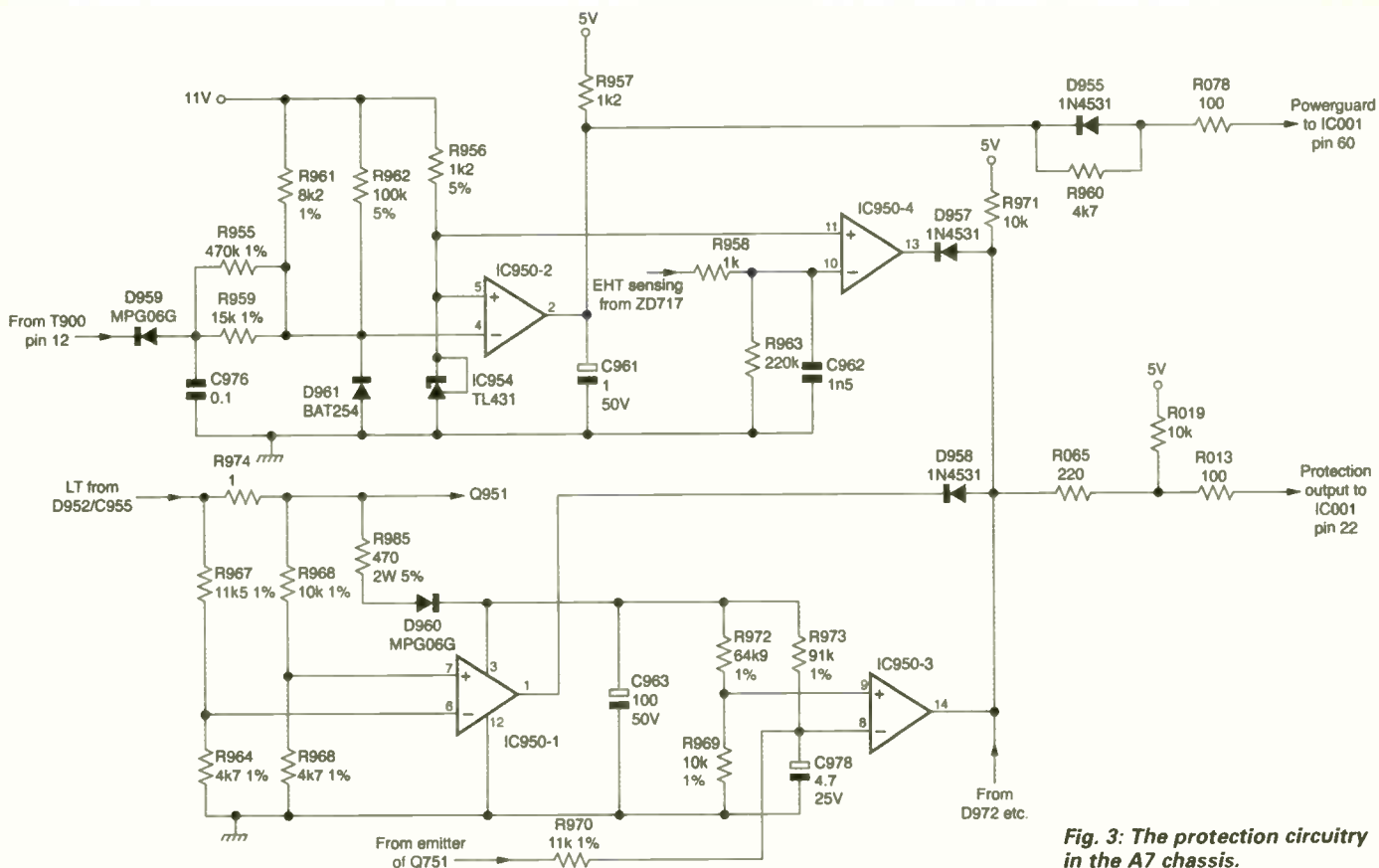

Fig. 3: The protection circuitry in the A7 chassis.

soever flowing via the coils once degaussing has been achieved. It also has the advantage that degaussing is controlled by the 5V line, so a set left in standby will be degaussed at switch on. It's a fairly involved modification, so make sure that this is the cause of the fault – by temporarily disconnecting the coils first.

### Field and EW circuits

In the large-screen models the field/EW chip IC601 is a conventional TDA8350Q. It's fed by the 27V supply, which is derived from pin 5 of the LOPT, with flyback boost derived from the 200V supply. This IC is more reliable than in other chassis because, in most models, a separate EW MOSFET

driver (Q601) is used – the designers felt that IC601 ran too hot when its internal EW amplifier is used.

The smaller-screen models may not have Q601 fitted, instead using IC601's amplifier pins 11 and 12.

Most faults here are confined to the IC, dry-joints and dried-out capacitors. One 'fault' that can be misleading is when the lower half of the picture is blanked out because someone has switched on the blanking in the vertical adjustment menu! This is always handy as a test for some know-all who isn't familiar with the chassis...

### Audio stages

Basic versions of the chassis use IC4000 (TDA7263M). As previously mentioned, it can short internally. Remove it to check if it's the cause of tripping – often there's a hole in the side! An intermittent crackle can be caused by a through-board connection by the IC. Check the connections to R4005 – it can be missed, as it's hidden between two capacitors – and R4009.

Switching and stereo processing is carried out by IC400 (TDA9875). Fortunately it doesn't seem to cause much trouble, as the switching circuits are a nightmare – especially as shown in the manual!

The only fault I've had here was distortion with one AV input. It was caused by the IC.

If fitted, the Dolby circuit uses a Yamaha YSS241 chip in conjunction with IC400. It's virtually trouble-free. Any odd buzzes are usually caused by incorrect cable routing. External amplifier-speakers are used, so the outputs are via four phono plugs. Understandably, not much happens when a customer connects conventional speakers to these outputs!

The original Dolby sets came with IR wireless speakers. The advantages were dubious – a power lead to each speaker was still required. More seriously, there were pops, crackles, drop-outs and hisses, especially with non-Dolby broadcasts. Conventional amplifier-speakers were supplied with later sets.

### The signals circuitry

As with most modern sets, this area is relatively trouble-free. On the odd occasion the tuner fails, with predictable symptoms. The scart sockets can be changed to AV, RGB or S-Video via the menus. Scart-I doesn't always switch when presented with an AV signal, or chooses RGB which is incompatible with

Table 1: HT voltages for different models

Model	HT
2156/2186	110V
2156/2186 (later version)	109V
2556/2586/2856/2886	152V
24/28W	152V
24/28W (Panasonic CRT)	142V
32W	150V*
2966/2986	150V
2556 (Toshiba CRT)	115.5V
*originally 149V	

some Sky boxes. It is usually best to use Scart-2 for satellite reception and force AV mode through the "More . . ." menu.

The processor used varies. Early models were fitted with a TDA8375, which was subsequently changed to a TDA8843 then a TDA8841. These ICs are not interchangeable, and care must be taken that a replacement has the correct suffix – there are six possibilities.

Unstable text and on-screen displays are usually caused by a dried-out capacitor in the deflection circuit – C601 (220 $\mu$ F, 35V).

Poor picture is a complaint you get occasionally, usually described as being over-bright or with loss of detail. The picture is usually fine at switch on, but the contrast gradually increases until the controls won't go low enough, with corresponding overshoot. Much time can be wasted looking for a heat-related fault. The cause of the problem is our old friends the earthing points on the PCB. The problem areas are around IC501 and between the LOPT and the field output IC. All the through-holes here must be reworked carefully – on both sides of the PCB, as a resistance of only a couple of ohms can wreak havoc with the picture. Any apparent beam-limiter faults are also usually caused by problems in this area, though tapping the PCB will rarely cause the symptom, suggesting that there's a component fault.

### The brain

The microcontroller chip IC001 is an 80-pin surface-mounted device, type SAA5296/7. The difference between them is the location of the program code, which is internal with the SAA5297 but external, in EPROM IC002, with the SAA5296, an interface chip (IC003) being required. Remember that this is not the same as the settings EEPROM which, in both cases, is IC005 (type ST24W16). IC004 is an analogue switch that's used to route the I<sup>2</sup>C bus.

As in most chassis the microcontroller chip is very reliable: replacement is usually unnecessary and can cause all sorts of other problems. If there is a problem, start with the EEPROM and then look for a load on the I<sup>2</sup>C bus caused by another part of the circuitry. Check for oscillation at pins 57 and 58 (12MHz crystal) of IC001.

Random channel changes and/or volume changes can be caused by a

noisy 5V rail, dry-joints, a faulty IR receiver or the front-panel switches (check by replacement in both cases). Make sure that the set isn't tripping and resetting the micro. Carry out a very careful inspection of the PCB around the customer controls – spillage here can cause all sorts of trouble.

Remember that the LED should glow bright, then dim as the set comes out of standby. To bring it out, press and hold the P+ button: if the light doesn't dim, investigation in the microcontroller area will have to be carried out. More often it dims then reverts to bright: this is a trip condition, and investigation should take place elsewhere as previously outlined.

For those not familiar with Hitachi tuning systems, to tune the set press and hold the menu button. An additional line (install) will appear, enabling the tuning function. A quick method of temporarily tuning a channel is to use the CH button on the remote-control unit and type in its number.

### The service menu

Access to the service menu is similar to earlier models. Select menu then press vol+ and vol- on the front panel simultaneously for about five seconds until another three lines appear: install, service and exit service. This may take a few tries, as it can be a bit fiddly. I am extremely reluctant to adjust anything in the service mode – unless I know that someone else hasn't been so cautious! Adjustment of the geometry and so on is fairly straightforward, but do remember to check all resolution modes after any changes. As always, it makes sense to make a note of the settings – some software uses bargraphs, some numbers. Cathode level is best set at 77V with a test pattern, though the manual originally suggested 84V or 91V – GoldStar CRTs can overrun and trip the set at this level.

The details of the set can be found under options. The size of the screen is important here, though usually the Model number is W2D/TN instead of -410 and -510.

Under options you will see two extra lines that might be unfamiliar – shipping mode and factory mode. Shipping mode does what it says – returns the settings to default. This is useful if the memory is hopelessly corrupted. Factory mode, like formatting a hard disk, falls into the "don't even think about it" cat-

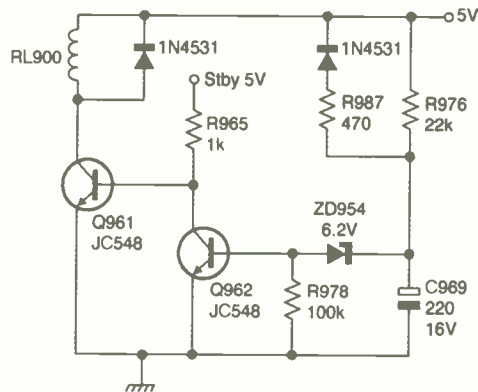

Fig. 4: The degaussing relay drive circuit used in earlier production sets.

egory. The set will not know what it is. If you are determined to do it, make a shadow copy of the data first. It's usually best to obtain a replacement EEPROM and tweak it as required. When adjustments have been completed, remember to go to 'exit service menu' to memorise and return the set to standby.

Odd complaints with early sets, such as inaccessible text pages, inability to tune in higher channels or problems with Sky remote compatibility, can be resolved by changing the EEPROM to one with software version 3.0. Press menu repeatedly in the service mode to see which version is running. Problems are usually confined to versions lower than 2.0.

### In conclusion

Once the dry-joints have been dealt with and modifications have been carried out this is a very reliable chassis. The A8 and A20 that followed it are similar, but use switching regulators in the LT circuits. This solves the dry-joint problem here, though the through-board links are still a problem, especially on the digital processing panel.

Following these chassis, Hitachi pulled out of European CRT-based TV set production to concentrate on plasma displays. Current large-screen Hitachi sets use the ubiquitous Vestel 11AK19 and 11AK33 chassis, with minor modifications to the trip circuits and software. ■

*My thanks to Dave Evans, Hitachi TLO supremo, and Hitachi's computer brain dump for assistance with this article.*

# A holiday at Murphys

**Ron Bourne** recalls training back in the Fifties, when he attended a course at the Murphy Radio factory in Welwyn Garden City

**D**uring the early Fifties I was invited to go on a course on television at Murphy Radio Ltd., Welwyn Garden City. This was a major event in my life. Nowadays we travel all over the world without a thought. In those days London was a distant city. There were not many cars on the roads – only bosses had them! So the journey was to London on the LMS then, via the underground, to Kings Cross to join the local LNER service to Welwyn Garden City. During this latter part of the journey I had my first glimpse of the TV transmitting aerial at Alexandra Palace, the only one in the country at the time.

## Our landlady

I can't remember the name of our landlady – there were about six of us engineers. She was a formidable lady whose husband had been ordered to sleep in the garden shed to make room for us! Her view seemed to be that everyone who hailed from north of Watford lived in a cave. I was bottom of the pile when she discovered that I was from Stoke-on-Trent. So I ended up in the attic bedroom with an engineer from Rugeley.

At breakfast she told us the rules of the house. In before 10.30 p.m., no keys. She then enquired if anyone played whist?

Everyone decided that they were not familiar with cards. Obviously she would have had to win!

## At the factory

The next day about twelve of us assembled in a small class room at the factory. We were, in this unfamiliar environment, going to learn about the mysteries of TV circuitry. There were two tutors. I remember spend-

ing much of the first morning on the principles of the blocking oscillator, which was widely used as a TV timebase generator. We were then introduced to the complex TV signal waveform, interlacing, sync separation, the thyatron and other matters.

After lunch in the works canteen we were shown the workbenches where we would do our practical work. They would be condemned outright today. The benches were made of Dexion angle with a chipboard surface, and along the front there were power sockets coupled by conduit we were told we mustn't touch while looking at the test sets as they were earthed! Some of the sets had chassis that were at half mains potential, so there would be no way of escaping an electric shock. We were told to keep our left hand in our pocket. No isolating transformers in those days!

The main Murphy TV product at the time was Model V114, a heavy beast with a huge power transformer on the bottom chassis. It produced a killer mains-derived 6kV supply for the set's

12in. CRT. A UU\* full-wave rectifier valve was used to produce the HT supply. Even the vision IF detector was a small, clip-in thermionic valve – there were no semiconductor devices in those days!

After dinner at our lodging – there was still food rationing at the time – some of us went to the factory canteen where, in a darkened corner, there were some chairs

around the god we were going to worship in our future years – a large 12in. console TV. At that time programmes ran from 8 to 10 p.m., not counting breakdowns during which an interlude was shown. We saw a plough going up and down a field. Don't forget that in those days all programmes were live. Even so, it all seemed to be a miracle. We couldn't foresee what the future would hold.

Our training lasted for six more days. It included an introduction to the new idea of deriving the EHT supply from the flyback pulses in the line timebase. We thought this wouldn't catch on, because of poor regulation. There was nothing like a sharp scanning line with good regulation, provided by a lethal mains-derived supply!

## The sets

The construction of the sets in the early Fifties would not be believed today. Their heavy metal, sprayed chassis would nowadays satisfy a car body shop inspection. The cabinets were made of highly-polished wood. De luxe sets had folding doors. Genuine, lovely pieces of furniture – no plastic then!

Later, one de luxe Murphy set had a 15in. CRT that was operated at 15kV derived from the mains. The EHT generator circuit was at the base of the large cabinet. It used two EHT valve rectifiers in a voltage-doubling arrangement. This was a real killer – I've seen a one-and-a-half inch arc-over. You had to make sure that the large smoothing capacitors were discharged when an earth lead. If you discharged them with a screwdriver its tip would be blown off!

## Return

We returned to our workshops to await our turn in the evolution of television – the opening of the Sutton Coldfield transmitter. ■

*Model V114C which had a nine inch screen and was manufactured in 1949.*



*A 1953 Murphy twelve inch model V210C.*

# Grandata Ltd

distributor of electronic components

## Television Repair / Mod Kits

MAKE & MODEL	KIT TYPE	CODE
<b>ALBA</b>		
1452T	PSU	ONWAKIT
1427T	PSU	ONWAKIT
1402	PSU	ONWAKIT
1455T	PSU	ONWAKIT
1456T	PSU	ONWAKIT
1458T	PSU	ONWAKIT
1459T	PSU	ONWAKIT
1499Y	STANDBY	MODKIT37
14SLTX	STANDBY	MODKIT37
1799Y	STANDBY	MODKIT37
2002	PSU	ONWAKIT
2009B	PSU	ONWAKIT
2052T	PSU	ONWAKIT
2152T	PSU	ONWAKIT
2099TX	STANDBY	MODKIT37
BTV17	STANDBY	MODKIT37
CTV501	PSU	ONWAKIT
CTV701	PSU	ONWAKIT
CTV840	PSU	ONWAKIT
CTV841	PSU	ONWAKIT
CTV485	PSU	ONWAKIT
<b>AKAI</b>		
CT1417	PSU	ONWAKIT
CT2159U	PSU	ONWAKIT
CT2162UNT	PSU	ONWAKIT
CT2863UNT	PSU	ONWAKIT
<b>DECCA/TATUNG</b>		
F SERIES	PSU	MODKIT30
TVC563	STANDBY	MODKIT37
<b>GOLDSTAR</b>		
CF25A50F	FRAME	MODKIT36
CF25C22C	FRAME	MODKIT35
CF28A50F	FRAME	MODKIT36
CF28C22F	FRAME	MODKIT35
CF28C28F	FRAME	MODKIT36
CF29C42F	FRAME	MODKIT35
<b>GOODMANS</b>		
147TT	PSU	ONWAKIT
149T	PSU	ONWAKIT
1430RA	PSU	ONWAKIT
1430RS	PSU	ONWAKIT
1430RW	PSU	ONWAKIT
1450T	PSU	ONWAKIT
1455TS	PSU	ONWAKIT
2019R	PSU	ONWAKIT
2029T	PSU	ONWAKIT
2029TA	PSU	ONWAKIT
COMPACT 11	PSU	MODKIT47
F16 CHASSIS	FRAME	GOODKIT1
F16 CHASSIS	LINE	GOODKIT1

MAKE & MODEL	KIT TYPE	CODE
<b>GOODMANS..continued</b>		
F16	PSU	GOODKIT1
F16	VIDEO	GOODKIT1
<b>GRUNDIG</b>		
CUC 2050	PSU	MODKIT48
CUC 2051	PSU	MODKIT48
CUC 2058	PSU	MODKIT48
CUC 2059	PSU	MODKIT48
CUC 2080	PSU	MODKIT48
CUC 7350		GRUNDIGKIT1
CUC 7301/3		(BUZ90) PSU GRUNDIGKIT2
CUC 7301/3		(MJF18004) PSU GRUNDIGKIT3
<b>HINARI</b>		
HIT14RC	PSU	ONWAKIT
<b>JVC</b>		
AV29SX1EK	FIELD O/P	JVCKIT1
AV29SX1EN	FIELD O/P	JVCKIT1
AV29SX1EN1	FIELD O/P	JVCKIT1
AV29SX1PF	FIELD O/P	JVCKIT1
AV29TSIE1	FIELD O/P	JVCKIT1
C14E1EK	PSU	ONWAKIT
C14T1EK	PSU	ONWAKIT
C21ET1EK	PSU	ONWAKIT
CS21M3EK	PSU	ONWAKIT
<b>MATSUI</b>		
1455	PSU	ONWAKIT
1496RT (H3N90)	PSU	MODKIT43
1496RT (BUZ90)	PSU	MODKIT44
1498	PSU	ONWAKIT
2086	PSU	ONWAKIT
2096RT (H3N90)	PSU	MODKIT43
2096RT (BUZ90)	PSU	MODKIT44
2098	PSU	ONWAKIT
21V1N (BUZ90)	PSU	GRUNDIGKIT2
21V1T (MJF18004)	PSU	GRUNDIGKIT3
TVR180R/208	STANDBY	MODKIT37
TVR185T	STANDBY	MODKIT39
<b>mitsubishi</b>		
AV1 SERIES	PSU	MITSKIT3
CT1M5B	PSU	MITSKIT3
CT21M5BT	PSU	MITSKIT3
CT25M5BT	PSU	MITSKIT3
CT21A2STX	TDA 8178S	MITSKIT1
CT21AX1B	PSU	MITSKIT3
CT21A3STX	TDA 8178S	MITSKIT1
CT21AV1BS	PSU	MITSKIT3
CT25A2STX	TDA 8178S	MITSKIT1
CT25A3STX	TDA 8178S	MITSKIT1

MAKE & MODEL	KIT TYPE	CODE
<b>mitsubishi..continued</b>		
CT25A4STX	TDA 8178S	MITSKIT1
CT25A6STX	TDA 8178S	MITSKIT1
CT25AV1B	PSU	MITSKIT3
CT25AV1BS	PSU	MITSKIT3
CT25AV1BD	PSU	MITSKIT3
CT25AV1BDS	PSU	MITSKIT3
CT28AV1B	PSU	MITSKIT3
CT28AX1BD	PSU	MITSKIT3
CT28AV1BDS	PSU	MITSKIT3
CT29AS1	TDA 8178S	MITSKIT2
CT29A4	TDA 8178S	MITSKIT2
CT29A6	TDA 8178S	MITSKIT2
CT29B2	TDA 8178S	MITSKIT2
CT29B3	TDA 8178S	MITSKIT2
CT29B6	TDA 8178S	MITSKIT2
CT33B3	TDA 8178S	MITSKIT2
M5 SERIES	PSU	MITSKIT3
<b>NEI/NIKKAI</b>		
CE25 CHASSIS	PSU	NIKKAIKIT1
C289FTXN	PSU	NIKKAIKIT1
C28F41FXN	PSU	NIKKAIKIT1
<b>PANASONIC</b>		
IC561	TDA 8175	PANKIT1
TX25XD60	VERT OUTPUT	PANKIT2
TC28XD60	VERT OUTPUT	PANKIT2
TX28XD70	VERT OUTPUT	PANKIT2
TX29XD70	VERT OUTPUT	PANKIT2
TX-W26D3	VERT OUTPUT	PANKIT2
<b>PHILIPS</b>		
310.10708		PHILKIT3
310.20491		PHILKIT2
310.20496		PHILKIT10
310.31994		PHILKIT6
310.32252		PHILKIT5
310.32253		PHILKIT4
310.32254		PHILKIT9
310.32255		PHILKIT7
310.32262		PHILKIT8
310.62264		PHILKIT1
ANUBIS A	SOPS	PHILKIT2
CP110 CHASSIS	SOPS	PHILKIT8
G90A CHASSIS	SOPS	PHILKIT10
G90B CHASSIS	SOPS	PHILKIT10
G110 CHASSIS	SOPS	PHILKIT3
GR2.1 CHASSIS	SOPS	PHILKIT1
GR2.2 CHASSIS	SOPS	PHILKIT1
D-16 CHASSIS	SOPS	PHILKIT6
HSM VIDEO	SOPS	PHILKIT5
JSM VIDEO	SOPS	PHILKIT4
KSM VIDEO	SOPS	PHILKIT9
LSM VIDEO	SOPS	PHILKIT7

MAKE & MODEL	KIT TYPE	CODE
<b>SAMSUNG</b>		
CI5944	FRAME	SAMKIT2
CI6844	FRAME	SAMKIT2
VIK310	PSU	SAMUNGKIT
VIK320	PSU	SAMUNGKIT
VIK350	PSU	SAMUNGKIT
VI375	PSU	SAMUNGKIT
VI395	PSU	SAMUNGKIT
WINNER 1	PSU	SAMUNGKIT
<b>SHARP</b>		
51CS03H	PSU	SHARPKIT1
51CS05H	PSU	SHARPKIT1
56FW53H	PSU & DOLBY	MODKIT45
59CS03H	PSU	SHARPKIT2
59CS05H	PSU	SHARPKIT2
59CSD8H	PSU	SHARPKIT2
59DS03H	PSU	SHARPKIT3
59FW53H	PSU & EW	MODKIT49
66CS03H	PSU	SHARPKIT2
66CS05H	PSU	SHARPKIT2
66CSD8H	PSU	SHARPKIT2
66FW53H	PSU & DOLBY	MODKIT45
66FW53H	PSU & EW	MODKIT49
66FW54H	PSU & DOLBY	MODKIT45
66FW54H	PSU & EW	MODKIT49
76FW53H	PSU & DOLBY	MODKIT45
76FW53H	PSU & EW	MODKIT49
76FW54H	PSU & DOLBY	MODKIT45
76FW54H	PSU & EW	MODKIT49
DA-100 CHASSIS	PSU & EW	MODKIT49
<b>SONY</b>		
SLV715HB	VCR - PSU	MODKIT40
SLV777UB	VCR - PSU	MODKIT40
<b>THOMSON</b>		
35029400		THOMKIT2
35065920		THORNKIT1
FV70	PSU	THORNKIT1
ICC7 CHASSIS	TDA 8178FS	THOMKIT1
ICC7 CHASSIS	FRAME	THOMKIT3
ICC8 CHASSIS	TDA 8178FS	THOMKIT1
ICC8 CHASSIS	FRAME	THOMKIT3
ICC9 CHASSIS	EASTWEST	THOMKIT4
ICC17 CHASSIS	PSU	MODKIT41
ISS20 (TV-DVD)	PSU	MODKIT46
R3000	PSU	THOMKIT2
R4000	PSU	THOMKIT2
TX92F CHASSIS	EASTWEST	THOMKIT4

ORDER CODE	PRICE
GOODKIT1	£ 11.00
GRUNDIGKIT1	£ 10.50
GRUNDIGKIT2	£ 10.50
GRUNDIGKIT3	£ 10.50
JVCKIT1	£ 11.00
MITSKIT1	£ 3.00
MITSKIT2	£ 15.00
MITSKIT3	£ 6.00
MODKIT30	£ 10.00

ORDER CODE	PRICE
MODKIT35	£ 9.50
MODKIT36	£ 5.00
MODKIT37	£ 6.50
MODKIT39	£ 8.50
MODKIT40	£ 6.00
MODKIT41	£ 6.00
MODKIT43	£ 7.00
MODKIT44	£ 7.00
MODKIT45	£ 4.00

ORDER CODE	PRICE
MODKIT46	£ 12.00
MODKIT47	£ 15.50
MODKIT48	£ 8.00
MODKIT49	£ 13.00
NIKKAIKIT1	£ 12.00
ONWAKIT	£ 12.00
PANKIT1	£ 15.00
PANKIT2	£ 9.00
PHILKIT1	£ 10.00

ORDER CODE	PRICE
PHILKIT2	£ 2.50
PHILKIT3	£ 4.00
PHILKIT4	£ 4.25
PHILKIT5	£ 5.75
PHILKIT6	£ 5.50
PHILKIT7	£ 7.60
PHILKIT8	£ 4.25
PHILKIT9	£ 7.50
PHILKIT10	£ 8.50

ORDER CODE	PRICE
SAMKIT2	£ 8.00
SAMUNGKIT	£ 16.00
SHARPKIT1	£ 11.00
SHARPKIT2	£ 11.00
SHARPKIT3	£ 9.00
THOMKIT1	£ 7.00
THOMKIT2	£ 12.00
THOMKIT3	£ 9.00
THOMKIT4	£ 4.00

**New Arrival !!**

**Philips L01.1E Chassis PSU Repair Kit**

Fits the following models :

28PT4457/05 , 28PW5407/05 , 28PW6006/05

**Order Code : MODKIT50**  
**Price : £ 18.00 + vat**

**New Arrival !!**

**Vestel 11AK31 Chassis PSU Repair Kit**

Fits the following brands :

Bush , Goodman , Hitachi , Toshiba  
Models BD2851S , BD2951S , BD2581S , BD3251S

**Order Code : MODKIT51**  
**Price : £ 10.00 + vat**

# Grandata Ltd

distributor of electronic components

## Digital Satellite Accessories

### Sky™ Digital Remote & TV Link Eye Combination



**Order Code : SKYPACK1**

**Price : £ 16.00 + vat each**

**5 +**

**£ 14.50 + vat each**

**Carriage Charged at £ 5.00 + vat**

### Sky™ Digital Remote Controls



**Order Code : RCSKY**

**Price £ 7.95 + vat**

**5 or more £ 7.45 + vat each**

**10 + £ 6.95 + vat each**

**Carriage Charged at £ 5.00 + vat**

### Sky™ Digital Remote & SLx Link Eye Combination



**Order Code : SKYPACK2**

**Price £ 13.00 + vat each**

**5 + £ 11.50 + vat each**

**Carriage Charged at £ 5.00 + vat**

### SLx Link Eye

Allows control of Sky™ Digibox via the signal feed for second TV



**Order Code**

**27833R**

**£ 5.80 + vat each**

**10 or more**

**£ 4.80 + vat each**

### Sky™ Digital TV Link Eye

**Order Code : TVLINKEYE**

**Price**

**£ 10.00 + vat**

**5 +**

**£ 7.99 + vat**

**each**



### SLx Amp By Pass Kit

For use with aerial amplifiers and Sky™ Digibox

Allows for operation of Link Eye in conjunction with a distribution amplifier



**Order Code 27829R**

**Price: £ 5.00 + vat**

## Satellite Repair / Mod Kits

### Amstrad DRX100

Tuner Repair Kit

**Order Code SATKIT35**

**Price**

**£ 1.40 + vat**

### Amstrad DRX100

PSU Reliability Kit

**Order Code SATKIT36**

**Price**

**£ 12.00 + vat**

### Amstrad DRX100

PSU Repair Kit

**Order Code SATKIT37**

**Price**

**£ 13.50 + vat**

### Grundig GDS200

Digital Satellite Receiver Repair Kit

Early psu  
MODEL DSO - 0385 REV C

**Order Code SATKIT34A**

**Price : £ 10.00 + vat**

### Grundig GDS200 / GDS300

Digital Satellite Receiver Repair Kit

LATER psu TYPE REV 03  
DSO - 0375 REV A DSO - 0385 REV 5

**Order Code SATKIT34B**

**Price : £ 10.00 + vat**

### Digital Satellite Receivers Fan Kit

Suitable for

Amstrad DRX100 , DRX200  
Grundig GDR200 , GDS200  
Pace Digibox

plus many more analogue makes and models

**Order Code : FANKIT1**

**Price : £ 10.00 + vat**

### Panasonic Digital Satellite Receiver Fan Kit

Suitable for Panasonic TU-DSB20/30 , TU-DSB31/35

**Order Code : FANKIT2**

**Price : £ 15.00 + vat**

### Grundig Digital Satellite Receivers Reliability Kit

These kits contain capacitors that are generally of higher specification than those fitted by the manufacturers.

#### GDS200

Early PSU  
DSO0385 Rev C

Kit Contains 9 capacitors

**Code : RELKIT34A**

**Price: £ 4.00 + vat**

#### GDS200 / GDS300

Later PSU  
DSO0375 Rev A  
DSO0385 Rev F

Kit Contains 11 capacitors

**Code : RELKIT34B**

**Price: £ 4.00 + vat**

#### GDS200 / GDS300

Later PSU  
Rev 03

Kit Contains 13 capacitors

**Code : RELKIT34C**

**Price: £ 4.00 + vat**

#### GDS200 / GDS300

Samsung PSU  
PSSH370601B

Kit Contains 12 capacitors

**Code : RELKIT34D Price: £ 4.00 + vat**

#### GDS300

Samsung PSU  
PSSH370603B

Kit Contains 13 capacitors

**Code : RELKIT34E Price: £ 4.00 + vat**



# Grandata Ltd

distributor of electronic components

## 105°C Electrolytic Capacitors

VALUE CODE PRICE PER PACK	VALUE CODE PRICE PER PACK	VALUE CODE PRICE PER PACK	VALUE CODE PRICE PER PACK	VALUE CODE PRICE PER PACK
<b>6.3 Volts</b>				
220uF ...CAP163 ...£0.70.....10				
470uF ...CAP164 ...£0.80.....10				
<b>10 Volts</b>				
100uF ...CAP118 ...£0.45.....10				
220uF ...CAP165 ...£1.00.....10				
470uF ...CAP29 ...£1.20.....10				
680uF ...CAP166 ...£1.20.....10				
1000uF ...CAP119 ...£1.50.....10				
2200uF ...CAP120 ...£2.10.....10				
3300uF ...CAP167 ...£1.60.....5				
<b>16 Volts</b>				
22uF ...CAP121 ...£0.35.....10				
33uF ...CAP122 ...£0.35.....10				
47uF ...CAP123 ...£0.35.....10				
100uF ...CAP124 ...£0.60.....10				
150uF ...CAP168 ...£0.65.....5				
220uF ...CAP125 ...£0.80.....10				
330uF ...CAP30 ...£1.75.....10				
470uF ...CAP31 ...£1.75.....10				
680uF ...CAP32 ...£2.10.....5				
1000uF ...CAP33 ...£2.10.....10				
1200uF ...CAP169 ...£1.50.....5				
1500uF ...CAP170 ...£1.50.....5				
2200uF ...CAP34 ...£5.25.....10				
3300uF ...CAP35 ...£5.00.....5				
4700uF ...CAP36 ...£6.10.....10				
6800uF ...CAP171 ...£4.50.....5				
<b>25 Volts</b>				
10uF ...CAP37 ...£0.45.....10				
15uF ...CAP172 ...£0.45.....10				
22uF ...CAP38 ...£0.45.....10				
33uF ...CAP126 ...£0.40.....10				
47uF ...CAP39 ...£0.48.....5				
68uF ...CAP127 ...£0.55.....10				
100uF ...CAP40 ...£0.70.....10				
120uF ...CAP128 ...£0.85.....10				
150uF ...CAP41 ...£0.95.....5				
220uF ...CAP42 ...£1.20.....10				
330uF ...CAP43 ...£1.40.....5				
470uF ...CAP44 ...£1.90.....10				
680uF ...CAP45 ...£3.15.....5				
<b>25 Volts...continued</b>				
1000uF ...CAP46 ...£3.65.....10				
1500uF ...CAP47 ...£3.90.....5				
2200uF ...CAP48 ...£2.00.....2				
3300uF ...CAP49 ...£2.20.....2				
4700uF ...CAP50 ...£3.65.....2				
6800uF ...CAP51 ...£3.90.....2				
<b>35 Volts</b>				
1uF ...CAP130 ...£0.40.....10				
3.3uF ...CAP131 ...£0.40.....10				
4.7uF ...CAP132 ...£0.45.....10				
10uF ...CAP52 ...£0.50.....10				
22uF ...CAP53 ...£0.45.....10				
33uF ...CAP54 ...£0.50.....5				
47uF ...CAP55 ...£0.85.....10				
68uF ...CAP133 ...£0.55.....10				
100uF ...CAP56 ...£0.85.....10				
150uF ...CAP57 ...£0.95.....5				
220uF ...CAP58 ...£1.45.....5				
330uF ...CAP134 ...£1.60.....10				
470uF ...CAP135 ...£1.75.....10				
680uF ...CAP59 ...£6.50.....10				
1000uF ...CAP60 ...£4.35.....10				
1500uF ...CAP173 ...£4.00.....5				
2200uF ...CAP61 ...£2.45.....2				
3300uF ...CAP62 ...£10.00.....5				
4700uF ...CAP136 ...£3.50.....2				
<b>40 Volts</b>				
2200uF ...CAP174 ...£1.80.....2				
2200uF ...CAP175 ...£2.00.....1				
<b>50 Volts</b>				
0.47uF ...CAP176 ...£0.35.....10				
1uF ...CAP137 ...£0.35.....10				
2.2uF ...CAP138 ...£0.35.....10				
3.3uF ...CAP139 ...£0.35.....10				
4.7uF ...CAP140 ...£0.35.....10				
6.8uF ...CAP177 ...£0.45.....10				
10uF ...CAP63 ...£0.50.....10				
22uF ...CAP64 ...£0.70.....10				
33uF ...CAP141 ...£0.85.....10				
47uF ...CAP65 ...£0.85.....10				
68uF ...CAP142 ...£0.90.....10				
<b>50 Volts...continued</b>				
100uF ...CAP66 ...£0.85.....10				
220uF ...CAP67 ...£1.75.....10				
330uF ...CAP68 ...£2.45.....10				
470uF ...CAP69 ...£4.35.....10				
680uF ...CAP70 ...£4.90.....5				
1000uF ...CAP71 ...£5.25.....10				
1500uF ...CAP143 ...£4.50.....5				
2200uF ...CAP72 ...£3.25.....2				
3300uF ...CAP144 ...£3.25.....2				
<b>63 Volts</b>				
0.22uF ...CAP145 ...£0.45.....10				
0.33uF ...CAP178 ...£0.35.....10				
0.47uF ...CAP73 ...£0.35.....10				
1uF ...CAP74 ...£0.35.....10				
1.5uF ...CAP179 ...£0.35.....10				
2.2uF ...CAP75 ...£0.35.....10				
3.3uF ...CAP76 ...£0.50.....10				
4.7uF ...CAP77 ...£0.35.....10				
6.8uF ...CAP180 ...£0.50.....10				
10uF ...CAP78 ...£0.50.....10				
15uF ...CAP79 ...£0.95.....5				
22uF ...CAP80 ...£0.75.....10				
33uF ...CAP81 ...£0.85.....10				
47uF ...CAP82 ...£0.95.....10				
56uF ...CAP181 ...£1.10.....10				
68uF ...CAP83 ...£1.30.....5				
100uF ...CAP84 ...£1.20.....10				
150uF ...CAP85 ...£2.80.....5				
220uF ...CAP86 ...£2.80.....10				
330uF ...CAP87 ...£4.00.....10				
470uF ...CAP88 ...£5.25.....10				
680uF ...CAP89 ...£5.00.....10				
1000uF ...CAP90 ...£5.40.....5				
2200uF ...CAP182 ...£2.20.....1				
4700uF ...CAP183 ...£4.00.....1				
<b>100 Volts</b>				
0.1uF ...CAP184 ...£0.80.....10				
0.22uF ...CAP185 ...£0.80.....10				
0.33uF ...CAP186 ...£0.80.....10				
0.47uF ...CAP91 ...£0.50.....5				
1uF ...CAP92 ...£0.85.....10				
1.5uF ...CAP93 ...£0.70.....5				
<b>100 Volts...continued</b>				
2.2uF ...CAP94 ...£0.50.....5				
3.3uF ...CAP95 ...£0.50.....5				
4.7uF ...CAP96 ...£0.50.....5				
6.8uF ...CAP187 ...£0.80.....10				
10uF ...CAP97 ...£0.95.....10				
22uF ...CAP98 ...£1.05.....10				
33uF ...CAP99 ...£1.55.....5				
47uF ...CAP100 ...£1.75.....10				
68uF ...CAP188 ...£1.30.....5				
100uF ...CAP101 ...£2.10.....10				
220uF ...CAP102 ...£6.00.....5				
330uF ...CAP189 ...£3.00.....2				
470uF ...CAP103 ...£6.00.....5				
680uF ...CAP190 ...£3.00.....2				
1000uF ...CAP191 ...£3.00.....1				
<b>150 Volts</b>				
0.47uF ...CAP192 ...£0.45.....10				
1uF ...CAP193 ...£0.45.....10				
2.2uF ...CAP194 ...£0.45.....10				
3.3uF ...CAP194 ...£1.00.....10				
4.7uF ...CAP195 ...£1.00.....10				
10uF ...CAP147 ...£1.40.....10				
22uF ...CAP148 ...£1.80.....10				
33uF ...CAP149 ...£2.30.....10				
47uF ...CAP196 ...£2.20.....5				
100uF ...CAP150 ...£3.25.....5				
220uF ...CAP197 ...£3.00.....2				
470uF ...CAP198 ...£3.25.....1				
<b>200 Volts</b>				
22uF ...CAP199 ...£1.60.....5				
100uF ...CAP151 ...£3.25.....5				
220uF ...CAP200 ...£2.50.....1				
330uF ...CAP201 ...£2.50.....1				
<b>250 Volts</b>				
0.47uF ...CAP202 ...£0.60.....10				
1uF ...CAP152 ...£0.60.....10				
2.2uF ...CAP203 ...£1.30.....10				
3.3uF ...CAP104 ...£1.75.....10				
4.7uF ...CAP204 ...£2.00.....10				
10uF ...CAP105 ...£2.60.....10				
22uF ...CAP153 ...£2.30.....10				
<b>250 Volts...continued</b>				
33uF ...CAP206 ...£1.75.....5				
47uF ...CAP106 ...£4.35.....10				
100uF ...CAP154 ...£4.50.....5				
220uF ...CAP155 ...£2.00.....2				
330uF ...CAP206 ...£2.50.....1				
<b>350 Volts</b>				
1uF ...CAP156 ...£0.70.....10				
2.2uF ...CAP207 ...£1.20.....10				
3.3uF ...CAP157 ...£1.50.....10				
4.7uF ...CAP208 ...£1.10.....5				
10uF ...CAP158 ...£2.25.....10				
22uF ...CAP159 ...£3.40.....10				
33uF ...CAP209 ...£2.60.....5				
47uF ...CAP210 ...£1.50.....2				
100uF ...CAP211 ...£3.00.....2				
330uF ...CAP212 ...£5.00.....1				
<b>400 Volts</b>				
0.47uF ...CAP213 ...£0.60.....10				
1uF ...CAP107 ...£2.15.....5				
2.2uF ...CAP108 ...£2.25.....5				
3.3uF ...CAP214 ...£2.25.....5				
4.7uF ...CAP109 ...£3.15.....5				
10uF ...CAP110 ...£4.00.....5				
22uF ...CAP111 ...£2.50.....2				
33uF ...CAP215 ...£2.50.....2				
47uF ...CAP112 ...£3.50.....2				
68uF ...CAP216 ...£3.50.....2				
100uF ...CAP160 ...£4.00.....2				
150uF ...CAP113 ...£3.20.....1				
220uF ...CAP161 ...£7.00.....2				
560uF ...CAP162 ...£4.00.....1				
<b>450 Volts</b>				
1uF ...CAP217 ...£2.80.....5				
2.2uF ...CAP114 ...£3.20.....5				
3.3uF ...CAP218 ...£3.20.....5				
4.7uF ...CAP115 ...£4.95.....5				
10uF ...CAP116 ...£5.50.....5				
22uF ...CAP217 ...£4.15.....2				
33uF ...CAP219 ...£3.00.....2				
47uF ...CAP220 ...£2.00.....1				
100uF ...CAP221 ...£3.00.....1				

## Aerial & Satellite Installation Accessories

### SLx Aerial Amplifiers

Now with built in Digital ByPass Operates with Sky™ DigiEye

Class leading noise figure of 4dB or less

6dB signal amplification on all models

Description	Order Code	Price
<b>2 Way - No Bypass</b>	<b>SLX2</b>	<b>£ 8.00 + vat</b>
<b>2 Way - With Bypass</b>	<b>SLX2B</b>	<b>£ 9.25 + vat</b>
<b>4 Way - No Bypass</b>	<b>SLX4</b>	<b>£ 13.00 + vat</b>
<b>4 Way - With Bypass</b>	<b>SLX4B</b>	<b>£ 14.00 + vat</b>
<b>6 Way - No Bypass</b>	<b>SLX6</b>	<b>£ 18.00 + vat</b>
<b>6 Way - With Bypass</b>	<b>SLX6B</b>	<b>£ 19.00 + vat</b>
<b>8 Way - No Bypass</b>	<b>SLX8</b>	<b>£ 18.50 + vat</b>
<b>8 Way - With Bypass</b>	<b>SLX8B</b>	<b>£ 20.00 + vat</b>



Integrated Digital By Pass

### SLx Masthead Amplifiers

UHF TV antenna pre amplifier designed for the professional aerial installer

15dB gain masthead amplifier ideal for majority of domestic installations

26dB gain masthead amplifier for longer cable runs (loss of more than 3dB) or if connected to passive splitters

Requires 12V DC power supply via download either via dedicated power supply unit or from a distribution amplifier with line powering

**15dB Amp Order Code : 27830R**  
**Price : £ 4.30 + vat**

**26dB Amp Order Code : 27831R**  
**Price : £ 4.50 + vat**

**SLx Masthead Amp PSU**  
**Order Code : 27832R**  
**Price : £ 5.00 + vat**

**Postage for 2+ £ 5.00 + vat**



### Coax Plug Aluminium



**Order Code : PLG51**  
**Bag of 10**  
**Price : £ 1.25 + vat**

**Bag of 100**  
**Price : £ 9.00 + vat**

### Screw Type Coax Plugs



**Order Code : PLG62**  
**Bag of 10**  
**Price : £ 1.60 + vat**

**Bag of 100**  
**Price: £12.50 + vat**



# Grandata Ltd

distributor of electronic components

## Transistors / Linear IC's

Part No.	Price	Part No.	Price	Part No.	Price	Part No.	Price	Part No.	Price	Part No.	Price	Part No.	Price	Part No.	Price		
BU208A	£0 75	IRF5450	£5 00	MJE350	£0 80	STK4191	£9 00	STK5464	£3 00	STR371	£4 00	TDA2450-3	£10 00	TDA4665	£2 50	TDA8136	£2 00
BU2506DF	£0 90	IRF5740	£3 00	MJF		STK4191 X	£14 00	STK5466	£5 00	STR380	£3 50	TDA2460-2	£0 70	TDA4670	£4 75	TDA8138A	£1 30
BU2506DX	£1 00	IRF5840	£3 00	MJF 182006	£4 50	STK419-130	£15 00	STK5467	£4 00	STR381	£3 90	TDA2501	£3 00	TDA4671	£5 00	TDA8138B	£2 00
BU2508A	£1 00	IRF610	£0 80	MJF 18004	£1 75	STK419-140	£16 00	STK5468	£3 00	STR383	£4 10	TDA2506T	£8 00	TDA4680	£3 50	TDA8139	£2 00
BU2508AF	£1 10	IRF611	£1 20	MJF 18006	£2 00	STK4192	£7 00	STK5471	£9 00	STR384	£3 50	TDA2507	£4 50	TDA4681	£4 50	TDA8140	£2 00
BU2508AX	£1 30	IRF620	£1 00	MJF 18008	£1 75	STK4197 II	£9 50	STK5472	£3 75	STR40090	£3 50	TDA2510	£4 50	TDA4685	£2 75	TDA8143	£1 60
BU2508D	£1 30	IRF630	£0 75	MJF 18204	£2 50	STK4199 II	£10 50	STK5473	£4 80	STR40115	£6 00	TDA2514A	£5 00	TDA4686	£5 00	TDA8145	£1 20
BU2508DF	£1 20	IRF634	£1 25	STK0025	£4 20	STK4199II	£10 50	STK5474	£5 00	STR4090A	£6 50	TDA2514A	£5 00	TDA4687	£5 00	TDA8146	£2 00
BU2508DX	£1 50	IRF640	£1 50	STK0039	£6 00	STK4200	£4 00	STK5476	£3 50	STR41090	£3 30	TDA2521	£8 00	TDA4700A	£7 50	TDA8153	£10 00
BU2520AF	£1 70	IRF640F	£2 00	STK086	£10 00	STK4204 II	£10 50	STK5477	£4 50	STR4142	£4 50	TDA2520-1	£9 00	TDA4710H	£7 00	TDA8170	£1 70
BU2520AX	£1 40	IRF630S	£2 00	STK1039	£4 60	STK4204II	£10 50	STK5478	£2 50	STR4211	£3 15	TDA2522	£12 00	TDA4714C	£3 50	TDA8171	£2 30
BU2520DF	£2 25	IRF642	£2 00	STK1040	£6 40	STK4211 II	£10 00	STK5479	£3 00	STR4311	£9 50	TDA2523	£8 50	TDA4716C	£4 50	TDA8172	£2 00
BU2520DX	£2 00	IRF644	£2 00	STK1049	£7 00	STK4211 V	£8 00	STK5481	£4 70	STR440	£8 00	TDA2525	£4 50	TDA4720	£6 60	TDA8173	£1 75
BU2522AX	£1 50	IRF652	£2 00	STK1050	£6 50	STK4221 II	£12 00	STK5482	£2 85	STR441	£9 50	TDA2530	£3 00	TDA4725	£7 50	TDA8174	£2 00
BU2525A	£3 25	IRF710	£1 50	STK1060	£7 00	STK4231 II	£10 50	STK5483	£4 40	STR44115	£4 75	TDA2548	£2 00	TDA4780	£6 00	TDA8175	£7 00
BU2525AF	£2 20	IRF720	£0 85	STK2025	£6 20	STK4231 V	£14 00	STK5486	£4 50	STR442	£16 00	TDA2549	£3 00	TDA4800	£3 00	TDA8177	£3 00
BU2525AX	£1 90	IRF730	£1 25	STK2028	£5 00	STK4241 V	£12 50	STK5487	£5 25	STR450A	£7 00	TDA2558	£4 00	TDA4810	£5 00	TDA8177F	£3 50
BU2525DF	£1 75	IRF740F	£3 00	STK2039	£6 00	STK4241 V	£12 50	STK5488	£4 80	STR451	£8 00	TDA2560Q	£7 00	TDA4850	£4 75	TDA8179S	£7 50
BU2527AF	£4 00	IRF820	£0 90	STK2038	£7 00	STK4272	£5 00	STK5490	£4 50	STR4511	£5 50	TDA2560-3	£14 00	TDA4851	£3 25	TDA8180	£12 50
BU2527AX	£2 50	IRF830	£0 85	STK2048	£9 50	STK4273	£5 50	STK561	£4 00	STR4512	£4 00	TDA2574V	£3 50	TDA4852	£3 25	TDA8205	£12 50
BU2527DF	£2 00	IRF830F	£0 85	STK2048 IV	£16 00	STK4274	£5 00	STK563	£4 15	STR452	£4 75	TDA2577A	£9 00	TDA4854	£5 00	TDA8212	£3 50
BU2527DX	£2 00	IRF840	£0 85	STK2101	£10 50	STK430	£5 00	STK5632	£3 00	STR453	£5 00	TDA2577A	£2 00	TDA4855	£6 00	TDA8214B	£10 50
BU2532AL	£3 25	IRF840F	£1 75	STK2139	£6 75	STK4301	£5 00	STK5720	£4 00	STR454	£13 00	TDA2578A	£7 00	TDA4856	£5 00	TDA8215H	£3 00
BU2708AF	£2 00	IRF9140	£10 00	STK2155	£9 00	STK4301	£5 00	STK5725	£3 50	STR455	£5 50	TDA2579A	£2 10	TDA4858	£3 50	TDA8217	£2 50
BU2708AX	£2 40	IRF9230	£4 00	STK2202	£4 70	STK4332	£3 85	STK5730	£3 00	STR456	£4 70	TDA2579B	£3 25	TDA4860	£2 00	TDA8303	£2 25
BU2708DF	£2 00	IRF9510	£1 50	STK3102 II	£5 30	STK4332	£3 85	STK583	£4 00	STR457	£6 00	TDA2652	£48 00	TDA4861	£3 50	TDA8304	£4 00
BU2708DX	£2 00	IRF9511	£1 50	STK3106	£25 00	STK4332	£3 85	STK6316	£3 00	STR470	£3 00	TDA2653A	£4 50	TDA4866	£2 75	TDA8305	£5 00
BU2720AF	£2 00	IRF9520	£1 50	STK3122 III	£7 25	STK4352	£5 00	STK6324B	£5 00	STR50020	£3 50	TDA2710-1	£4 00	TDA4880	£4 50	TDA8305A	£5 00
BU2720DF	£2 00	IRF9530	£1 25	STK3152 II	£9 00	STK4352	£5 00	STK6327	£12 00	STR50092	£5 00	TDA2820M	£1 00	TDA4918A	£17 00	TDA8310	£6 00
BU2720DX	£2 00	IRF9531	£2 00	STK3156	£5 00	STK4362	£4 30	STK6328A	£4 00	STR50103A	£2 60	TDA2822M	£0 60	TDA4930	£5 00	TDA83500	£2 75
BU2722AF	£3 30	IRF9540	£1 75	STK350-030	£7 00	STK4362	£4 30	STK6431	£6 00	STR50112A	£6 50	TDA3190	£2 00	TDA4935	£3 00	TDA8351	£2 00
BU2725AF	£2 00	IRF9541	£2 00	STK392-040	£12 00	STK437	£6 00	STK6607	£4 50	STR50113	£5 00	TDA3301B	£16 00	TDA4940	£2 00	TDA83540	£2 75
BU2725DF	£2 00	IRF9610	£0 85	STK401-050	£8 00	STK4372	£4 90	STK6712BIV	£5 00	STR50115	£5 00	TDA3303	£7 00	TDA4941	£2 80	TDA8356	£2 00
BU2725DX	£2 00	IRF9622	£2 00	STK401-080	£9 00	STK439	£5 00	STK6722	£6 50	STR50213	£4 00	TDA3501	£3 00	TDA4942	£2 00	TDA8360N3	£8 00
BU2727AF	£2 00	IRF9632	£1 30	STK401-120	£10 00	STK4392	£5 00	STK6732	£10 00	STR50230	£4 75	TDA3502	£3 60	TDA4950	£1 00	TDA8361A/N3	£8 00
BU2727DF	£2 00	IRF9640	£2 30	STK401-140	£12 00	STK441	£6 80	STK6822	£7 50	STR51041	£5 00	TDA3503	£3 00	TDA4951	£4 50	TDA8361N	£9 00
BU2727AX	£2 00	IRF9640F	£2 30	STK4017	£4 00	STK4412	£4 50	STK6875	£6 50	STR51213	£5 00	TDA3507	£4 50	TDA5010	£3 00	TDA8362AN	£12 00
BU506DF	£1 00	IRFBC20	£1 10	STK4019	£4 80	STK443	£7 00	STK6922	£10 00	STR51424	£7 00	TDA3521	£7 50	TDA5400	£6 00	TDA8362AN3	£7 50
BU508AF	£0 60	IRFBC30	£1 20	STK402-040	£7 00	STK4432	£6 00	STK6932	£4 50	STR5304A1	£4 00	TDA3560	£6 00	TDA5500	£9 00	TDA8362BN3	£8 50
BU508APH	£0 80	IRFBC40	£1 20	STK402-070	£7 00	STK457	£4 70	STK6962	£2 75	STR54041	£3 20	TDA3561	£3 00	TDA5600	£4 50	TDA8362N3	£12 00
BU508AXI	£0 90	IRFBE30	£2 25	STK402-070	£7 00	STK459	£5 60	STK6972	£3 00	STR5412	£2 80	TDA3561A	£3 00	TDA5610-2	£7 50	TDA8362N4	£9 00
BU508D	£0 75	IRFD120	£1 00	STK402-070	£7 00	STK460	£6 60	STK6981B	£5 00	STR55041	£4 50	TDA3562A	£2 60	TDA5620	£4 50	TDA8362N5	£12 00
BU508DF	£0 85	IRFD9120	£1 20	STK402-071	£7 00	STK461	£6 00	STK6982H	£6 00	STR56041	£5 50	TDA3563	£3 00	TDA5702	£13 00	TDA8362N2	£15 00
BU508DR	£1 30	IRFD9220	£1 00	STK402-090	£8 00	STK465	£9 50	STK7216	£4 20	STR58041	£2 50	TDA3563A	£4 00	TDA5830-2	£11 00	TDA8366N3	£11 50
BUH1015	£4 25	IRFF120	£1 00	STK4021	£3 80	STK465	£9 00	STK7217	£2 50	STR59041	£3 00	TDA3564	£3 25	TDA61000	£1 50	TDA8370	£11 50
BUH1215	£4 50	IRFFBC40	£1 00	STK402-100	£9 00	STK4773	£8 20	STK7225	£5 00	STR60001	£5 25	TDA3565	£2 20	TDA61010	£1 20	TDA8372A	£16 50
BUH515	£2 00	IRFFP054	£2 00	STK402-120	£9 00	STK4793	£8 00	STK7226	£17 00	STR6008X	£5 75	TDA3566	£2 80	TDA61030	£2 25	TDA8374	£10 00
BUH517D	£2 75	IRFFP064	£2 50	STK40212 II	£5 50	STK4803	£10 00	STK7233	£7 00	STR6201	£5 25	TDA3567	£3 00	TDA61060	£1 25	TDA8375A	£12 50
BUH715	£4 25	IRFFP150	£2 40	STK4025	£5 30	STK4813	£8 00	STK7251	£5 00	STR81001	£4 75	TDA3567	£3 50	TDA61070	£3 00	TDA8376	£15 00
BUL310	£1 25	IRFFP240	£3 00	STK4026	£4 80	STK4833	£8 50	STK7253	£6 50	STR80145	£4 75	TDA3569	£3 00	TDA6110F	£3 00	TDA8380	£2 00
BUL381	£1 50	IRFFP250	£2 80	STK4026II	£4 80	STK4853	£17 00	STK730-060	£6 50	STR81145	£3 75	TDA3570	£3 75	TDA6111J	£2 25	TDA8424	£4 00
BUL381D	£1 25	IRFFP340	£2 50	STK4026V	£5 00	STK4863	£7 00	STK730-080	£6 00	STR81159	£4 00	TDA3576B	£7 00	TDA61200	£5 50	TDA8425	£5 00
BUL11A	£0 35	IRFFP350	£3 25	STK4032 II	£5 10	STK4873	£11 00	STK7308	£7 00	STR8124	£10 00	TDA3576F	£7 00	TDA61200-2K	£2 50	TDA8433	£6 00
BUL11AF	£0 35	IRFFP360	£8 00	STK4034 X	£9 25	STK4888-010	£8 00	STK7309	£4 00	STR83145	£5 00	TDA3576G	£7 00	TDA61260	£4 75	TDA8432	£5 50
BUL11AX	£0 50	IRFFP450	£2 70	STK4036	£4 70	STK4888-050	£8 00	STK7310	£3 20	STR83159	£7 00	TDA3581	£2 00	TDA61260	£2 50	TDA8440	£3 00
BUL12	£0 80	IRFFP460	£4 00	STK4036V	£8 00	STK4993	£10 00	STK7310S II	£5 50	STR84120	£8 00	TDA3652	£5 00	TDA7056	£1 20	TDA8443	£3 50
BUL12AF	£0 80	IRFFP9140	£14 50	STK4040 II	£6 50	STK5013	£8 00	STK73410 II	£5 00	TDA1470	£12 00	TDA3652TX10	£8 00	TDA7262	£3 25	TDA8451	£3 25
BUL18A	£0 80	IRFFP450	£4 50	STK4040 II	£6 50	STK5032	£3 50	STK7348	£4 00	TDA1514A	£3 25	TDA3653	£0 80	TDA7283	£3 50	TDA8453	£3 50
BUL18AF	£0 65	IRFFP60	£6 00	STK4042 II	£8 00	STK5034	£4 75	STK7356	£4 25	TDA1541	£5 00	TDA3653C	£0 85	TDA7263M	£4 00	TDA8461	£9 50
BUL18A	£0 65	IRFFP60	£6 00	STK4050 II	£16 00	STK5315	£5 00	STK7358	£4 40	TDA1541A	£4 00	TDA3654	£0 80	TDA7284	£5 00	TDA8501	£3 75
BUL275A	£0 65	IRFFP60	£6 00	STK4050-030	£7 00	STK5323	£6 00	STK7359	£4 25	TDA1546T	£10 50	TDA3654	£0 85	TDA7285	£5 00	TDA8505	£11 00
BUL275AF	£2 00	IRFFP60	£6 00	STK405-050A	£12 00	STK5325	£3 70	STK7365	£3 75	TDA1547	£10 00	TDA3655	£5 00	TDA7286	£5 00	TDA8560Q	£4 25
BUL275A	£0 75	IRFFP60	£6 00	STK405-070A	£8 00	STK5326	£7 50	STK73907	£7 00	TDA1552Q	£3 50	TDA3656	£4 00	TDA7			

# Grandata Ltd

distributor of electronic components

## Line Output Transformers

Part No	Code	Price	Part No	Code	Price	Part No	Code	Price	Part No	Code	Price	Part No	Code	Price
<b>ALBA</b>			<b>HITACHI..continued</b>			<b>PANASONIC..continued</b>			<b>PHILIPS..continued</b>			<b>THOMSON..continued</b>		
3714002	LOT02	£12.00	2433453	LOT82	£12.50	TLF 14568 F	LOT40	£15.00	AT 2079 / 21	LOT395	£12.00	10588080.P2	LOT1505	£19.00
043714002J	LOT02	£12.00	2433751	LOT01	£13.00	TLF 14584 F	LOT41	£17.00	AT 2079 / 24	LOT392	£15.00	151128140	LOT1505	£19.00
43700000	LOT02	£12.00	2433752	LOT01	£13.00	TLF 14586 F	LOT42	£17.00	AT 2079 / 40	LOT73	£11.50	1512814	LOT1505	£19.00
<b>AMSTRAD</b>			2433891	LOT23	£12.50	<b>PHILIPS</b>			AT 2079 / 99	LOT276	£14.00	15128140	LOT1505	£19.00
1810951	LOT55	£14.00	2433892	LOT84	£14.50	3119 108 31260	LOT90	£12.50	AT 2079/30 01	LOT106	£12.50	153144.6	LOT1505	£19.00
3714002	LOT02	£12.00	2433893	LOT23	£12.50	3119 108 31290	LOT73	£11.50	AT 2079/30102	LOT106	£12.50	15314460	LOT1505	£19.00
043714002J	LOT02	£12.00	2433952	LOT33	£10.50	3119 108 31440	LOT433	£16.00	<b>SAISHO</b>			1531447 A	LOT1505	£19.00
43700000	LOT02	£12.00	2434002	LOT226	£14.50	3119 108 31444	LOT433	£16.00	3714002	LOT02	£12.00	1532873 A	LOT1505	£19.00
AM152591	LOT55	£14.00	2434141	LOT33	£10.00	3119 108 31442	LOT433	£16.00	043714002J	LOT02	£12.00	3233900	LOT244	£14.50
<b>FERGUSON</b>			2434274	LOT44	£10.50	3119 198 62930	LOT57	£11.00	43700000	LOT02	£12.00	40011200	LOT244	£14.50
00 D-3-508-002	LOT381	£15.50	2434393	LOT405	£22.50	3122 108 10246	LOT111	£15.00	7140021	LOT02	£12.00	40148300	LOT244	£14.50
06 D-3-083-001	LOT82	£12.50	2435006	LOT401	£17.00	3122 138 36070	LOT111	£15.00	<b>SHARP</b>			<b>TOSHIBA</b>		
06 D-3-083-002	LOT82	£12.50	2435131	LOT251	£14.50	3122 138 36072	LOT111	£15.00	RTRNF 1220 CEZZLOT39	£18.50	1810951	LOT55	£14.00	
06 D-3-084-001	LOT23	£12.50	2436201	LOT90	£12.50	3122 138 36920	LOT57	£11.00	RTRNF 2001 CEZZLOT338	£17.50	2433751	LOT01	£13.00	
06 D-3-087-001	LOT23	£12.50	23236465	LOT392	£15.00	3122 138 36923	LOT57	£11.00	RTRNF 2006 CEZZLOT308	£13.50	23236098	LOT288	£14.00	
06 D-3-088-001	LOT84	£14.50	2433891H	LOT323	£12.50	3122 138 37050	LOT132	£15.00	RTRNF 2023 CEZZLOT310	£15.00	23236198	LOT288	£14.00	
06 D-3-093-001	LOT204	£16.00	45150504	LOT362	£16.00	3122 138 37620	LOT90	£12.50	<b>SONY</b>			23236201	LOT395	£12.00
06 D-3-508-003	LOT276	£14.00	<b>MATSUI</b>			3122 138 37771	LOT129	£14.00	1-439-286-00	LOT46	£13.00	23236245	LOT395	£12.00
06 D-3-512-001	LOT204	£16.00	20070	LOT438	£16.00	3122 138 37992	LOT116	£19.00	1-439-286-11	LOT46	£13.00	23236255	LOT289	£15.00
29201-022-01	LOT63	£17.00	20071	LOT438	£16.00	3122 138 38040	LOT73	£11.50	1-439-286-12	LOT46	£13.00	23236425	LOT288	£14.00
473197	LOT304	£15.50	20072	LOT438	£16.00	3122 138 38123	LOT395	£12.00	1-439-286-13	LOT46	£13.00	23236427	LOT395	£12.00
D 059 / 37	LOT200	£14.00	20073	LOT438	£16.00	3128 138 20200	LOT433	£16.00	1-439-286-21	LOT46	£13.00	23236428	LOT289	£15.00
<b>GOODMANS</b>			20074	LOT438	£16.00	3128 138 20201	LOT433	£16.00	1-439-332-41	LOT100	£15.00	23236424	LOT129	£14.00
1142.5057	LOT1164	£15.00	20075	LOT438	£16.00	3128 138 20202	LOT433	£16.00	1-439-332-42	LOT101	£14.50	TFB 4090 AD	LOT395	£12.00
1142.5077	LOT1164	£15.00	3714002	LOT02	£12.00	3138 108 30100	LOT106	£12.50	1-439-332-52	LOT100	£15.00	TFB 4124 AE	LOT392	£15.00
1142.5079	LOT1164	£15.00	3221008	LOT438	£16.00	3138 108 30101	LOT106	£12.50	1-439-363-11	LOT268	£14.00	TFB 4124 AP	LOT392	£15.00
1142.5081	LOT1164	£15.00	043714002J	LOT02	£12.00	3138 108 30103	LOT106	£12.50	1-439-363-21	LOT268	£14.00	<b>We are stockist of both</b>		
1152-5016	LOT1934	£19.00	043221088P	LOT438	£16.00	3139 128 30400	LOT90	£12.50	1-439-387-11	LOT311	£14.50	<b>Konig</b>		
1179.0387	LOT1147	£16.00	43700000	LOT02	£12.00	40348-08	LOT1577	£18.00	1-439-387-21	LOT311	£14.50	<b>and</b>		
1192.0527	LOT1147	£16.00	7140021	LOT02	£12.00	40348A-08	LOT1577	£18.00	1-439-416-11	LOT255	£16.00	<b>HR Diemen</b>		
1352.5008	LOT1167	£15.00	<b>MITSUBISHI</b>			4812 140 10246	LOT111	£15.00	1-439-416-12	LOT255	£16.00	<b>LOPT's</b>		
1352.5008E	LOT1167	£16.00	731003	LOT51	£15.50	40348A-09	LOT1577	£18.00	1-439-416-21	LOT255	£16.00	<b>This is just a selection</b>		
1352.5016	LOR1934	£19.00	334 P 18506	LOT51	£15.50	4812 140 10349	LOT106	£12.50	1-439-416-23	LOT255	£16.00	<b>of the LOPT s that we</b>		
1352.5027	LOT1270	£16.00	<b>OREGA</b>			4812 140 10369	LOT90	£12.50	1-439-416-51	LOT255	£16.00	<b>stock....Please call on</b>		
1352.5033	LOT1270	£16.00	40153201	LOT349	£17.50	4812 140 10421	LOT90	£12.50	<b>THOMSON</b>			<b>020 8900 2329 for copy</b>		
<b>HINARI</b>			<b>ORION</b>			4822 140 10246	LOT111	£15.00	105009.8	LOT1505	£19.00	<b>of our LOPT catalogue</b>		
3714002	LOT02	£12.00	3714002	LOT02	£12.00	4822 140 10274	LOT123	£14.50	10500980	LOT1505	£19.00			
043714002J	LOT02	£12.00	043714002J	LOT02	£12.00	4822 140 10306	LOT57	£11.00	10500980.P1	LOT1505	£19.00			
43700000	LOT02	£12.00	43700000	LOT02	£12.00	4822 140 10349	LOT106	£12.50	10531460	LOT1505	£19.00			
CF 124 B	LOT67	£14.50	<b>PANASONIC</b>			4822 140 10406	LOT73	£11.50	105660.6	LOT1505	£19.00			
CF 124 E	LOT67	£14.50	TLF 14512 F	LOT39	£18.50	4822 140 10544	LOT433	£16.00	10566060	LOT1505	£19.00			
<b>HITACHI</b>			TLF 14520 F	LOT40	£15.00	4822 140 10566	LOT433	£16.00	10566060.P2	LOT1505	£19.00			
2424593	LOT44	£10.50	TLF 14521 F	LOT39	£18.50	AT 2076 / 10	LOT57	£11.00	105880.8	LOT1505	£19.00			
2432461	LOT169	£15.00	TLF 14567 F	LOT39	£18.50	AT 2077 / 81	LOT121	£15.00	10588080	LOT1505	£19.00			
2432761	LOT169	£15.00				AT 2078 / 21	LOT395	£12.00	10588080	LOT1505	£19.00			
						AT 2079 / 15	LOT129	£14.00						

We are stockist of both  
**Konig**  
and  
**HR Diemen**  
LOPT's  
This is just a selection  
of the LOPT s that we  
stock....Please call on  
020 8900 2329 for copy  
of our LOPT catalogue

## CD Pick Ups and Mechanisms

Part No	Price	Part No	Price	Part No	Price
CDM12.1 Mechanism	£14.00	KSS 213 B	£8.75	OPTIMA 6 S	£11.50
KHM220AAA		KSS 213 C	£9.50	OPTIMA 5	£11.50
DVD Laser	£ 40.00	KSS 213 D	£16.00	RCTRTH8151	£20.00
KSS 210A Original	£11.00	KSS 213 F	£12.00	RCTRTH8112	£14.00
KSS 210A Replacement	£9.50	KSS 240 A	£30.00	RCTRTH8147 Mech	£ 10.00
KSS 210 B	£15.00	NKS 240 A			
		Replacment for KSS240A	£20.00		

Check out our Online Catalogue at

[www.grandata.co.uk](http://www.grandata.co.uk)

This advertisement is just a selection of our stock.

Please contact us if you cannot find the part you are looking for.

\* Please add £1 p+p and VAT to all orders (Unless Otherwise stated) \* All components are brand new

\* We accept payment by Access , Switch , Visa , Cheque and Postal Order

\* All prices quoted are subject to availability and may be changed without prior notice

E & OE

K.R. House , Unit 15 , Pop In Commercial Centre , Southway , Wembley , Middlesex . HA9 0HB England

Tel : (020) 8900 2329

Email : [sales@grandata.co.uk](mailto:sales@grandata.co.uk)

Fax : (020) 8903 6126

Website : [www.grandata.co.uk](http://www.grandata.co.uk)



## Bench Notes

**Engineers are occasionally tempted to tackle a repair that's obviously going to be uneconomic, maybe out of interest or for their own/family use.**

**Adrian Gardiner describes such a job, with a Panasonic home cinema system**

### Engineering madness

I know few people in this trade who, at some point, haven't suffered from a moment of madness. You know the sort of thing – that totally scrap unit sitting on your bench, fit only for the skip, but somehow you feel tempted to repair it. One such item adorned my bench recently, a Panasonic SAHT70 DVD home cinema system with a five-DVD auto-changer mechanism. The unit had been struck by lightning, and the customer's insurance company had paid for a replacement. I had acquired the scrap unit and decided, during a brief lapse from normal business sense, that it would look rather nice in my living room. So I set about removing the lid in order to investigate further.

### The power supply

The unit was completely dead, and a quick inspection of the power PCB revealed a scorch mark and several vaporised printed tracks. As with other models in this series, power is derived from a large transformer. It has multiple wires and is brought into circuit by a relay that's operated by the microcontroller chip. A separate transformer, T502, provides a standby supply via a 5V regulator circuit that's based around Q592. It was in this area of the circuitry that the vaporisation had occurred: Q592 itself had gone short-circuit.

I replaced Q592 and remade the missing tracks. But when I tested the unit it was still dead. A quick check at the output of the regulator produced a voltage reading of only 1.5V. So it was obviously severely overloaded and, as it supplies power directly to the microcontroller chip IC601 and its associated circuitry, I came to the conclusion that this IC had suffered during the lightning strike and was in need of replacement. It's a 100-pin flat-pack device which is mounted on the front PCB. To gain access to this when the unit is dead you first have to open the tray. A special hex tool is required for this purpose. You insert the tool underneath the unit and turn it clockwise to open the drawer.

The 5V standby supply was normal

once a new microcontroller chip had been obtained and fitted, and the standby LED on the front panel lit up. Pressing the power switch had no effect however. Checks around IC601 revealed that its reset pin 18 was being held low permanently. Reset is provided by the digital transistor Q601, which was short-circuit collector-to-emitter. After fitting a replacement I found that the power switch, when pressed, now operated the relay to activate the main power supply.

I was greeted with the Panasonic welcome message in the display. This was followed by immediate shutdown of the system, which reverted to standby. Clearly some kind of protection mode was in operation, but testing was going to be difficult as there was an on period of only two seconds.

A multi-regulator chip, IC502 (type STK470-050A), provides the main supplies in this model. Cold checks around it revealed a faulty PCB-mounted fuse, FP549. Hoping that I would be lucky, I replaced this fuse and reapplied power. Naturally the fuse immediately failed. So an order for a new STK470-050A regulator went off to Panasonic.

The regulator is mounted on the main PCB and, to gain access, a complete strip-down is required. The replacement duly arrived and was fitted. At last the power supply ran normally and the unit remained on. It accepted and read a DVD disc, but several faults remained. There was no audio from any of the outputs, including the auxiliary sockets; the remote-control system didn't function; and the five-disc auto-changer didn't work correctly. Returning to the front panel, I found that the remote-control problem was easy to solve – by replacing the IR sensor Z601.

### The mechanical problem

I decided to tackle the mechanical problem next. The unit would load a disc correctly. But when it was asked to change to another disc it 'parked' the first disc successfully then jammed. The cause of this was the disc-change solenoid, which failed to operate. Checks in the solenoid's drive circuit

revealed a short-circuit transistor. A replacement sorted out the mechanical problem, but not the missing audio one.

### Loss of audio

The audio output from the DVD module is fed to the digital signal-processor (DSP) board. Here the analogue audio switch chip IC802 selects an input from either the DVD mechanism or the tuner pack. Checks showed that there was no output from this IC. Once a replacement had been fitted there was normal audio at the auxiliary output sockets, but elsewhere there was still no audio.

The unit uses a number of M5228 surface-mounted operational-amplifier ICs. These are common in Panasonic and Technics equipment and are prone to failure. I found that one such device, IC803 on the DSP board, was faulty. After its replacement there was normal audio from the front left-hand channel but from nowhere else. Turning my attention to the main panel I found another defective M5228 chip, IC402. Replacement of this restored normal audio to the front speakers, but the surround-sound, sub-woofer and centre channels remained dead.

Extensive checks in the audio circuitry failed to reveal anything amiss. The only other clue was that the volume control behaved erratically. So I came to the conclusion that the digital signal processor chip IC801 on the DSP board was defective. A replacement was ordered and subsequently fitted, after which I was delighted to find that the sub-woofer and centre channels were now OK and that there was normal volume-control operation. But there was still a problem with the surround-sound rear channels.

There's a small input board, which contains the scart socket etc., on the rear panel. Checks here showed where the surround sound was being lost. It passes through another M5228 op-amp, IC103. So a replacement was fitted.

### Success at last!

The DVD home cinema system was at last fully operational. My sanity was also restored – until the next time! ■

# The digital home

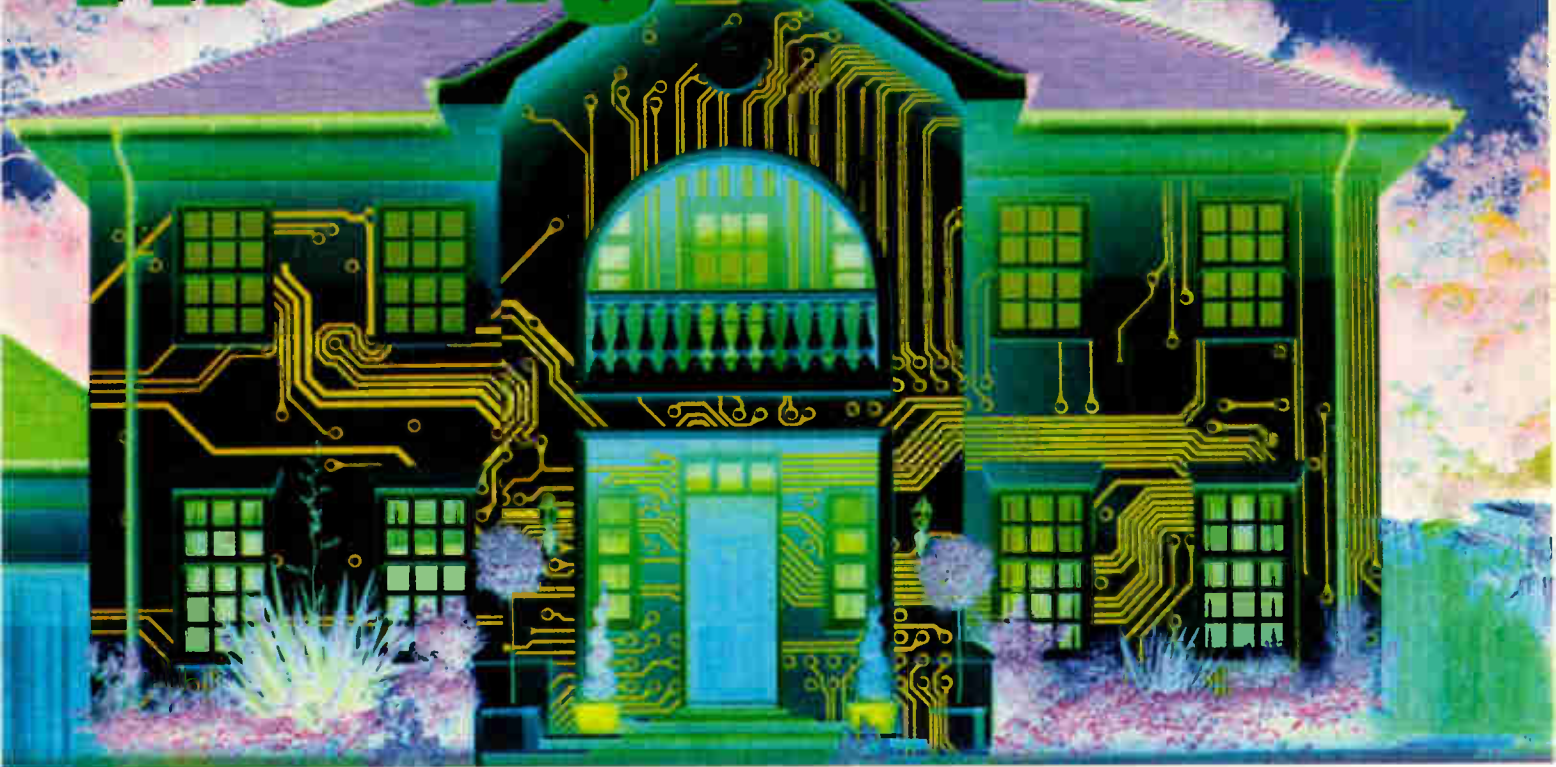

The government has set up a Digital Action Plan with the aim of moving TV broadcasting to an all-digital basis by the year 2010. Various issues still have to be resolved however before homes can be converted to the all-digital dream. These involve aerial standards, signal distribution within the home, video recording and set-top boxes. J. LeJeune reports on the current situation

The government has shown some determination to move TV broadcasting to an all-digital basis by the year 2010 and is fairly confident that this target can be met. A number of technical issues remain to be resolved however before homes can be converted to the all-digital dream. These relate to the design and installation

of suitable aerials, signal distribution within homes, video recording, and the design, development and supply of set-top boxes. To achieve the goal of an all-digital future post-2010, the government has set up a Digital Action Plan. Figure 1 shows its structure.

The Action Plan lays down the need for trials to ensure that householders will be able to replace all existing analogue TV equipment in their homes with corresponding digital devices. In fact the Go Digital project has already taken place, and highlighted the need to convert the whole house, not just the TV set in the living room, and a number of other issues.

## Signal delivery

While some people think that the current use of UHF for terrestrial signal delivery is outdated and advocate satellite delivery instead, it has been shown that digital terres-

trial delivery at UHF works well, exemplified by the success of Freeview with the public. This is offset to some extent by the still limited coverage provided by DTT, amounting to 75 per cent of the population, though the use of 16QAM (16 quadrature amplitude modulation) instead of 64QAM with four of the available multiplexes has greatly extended coverage.

There is also the problem of reception with portable TV sets, for which analogue remains more usable than digital reception. At present over 70 per cent of multi-channel reception is via sets situated in the living room. The extension of this facility to other, smaller sets around the home is considered by many to be rather too expensive an undertaking and possibly unnecessary. An increase in the field strength of the digital signals, as a result of a corresponding increase in the power output from transmitters, would help equate digital reception using portable sets with current analogue reception.

There are numerous alternatives to a power increase. The most viable are the provision of numerous repeaters, diversity reception, the use of active deflectors, wireless distribution in the home at 5.8GHz, cable or Wi-Fi digital home networks and wired RF distribution systems. Each has its merits. These could be adopted individ-

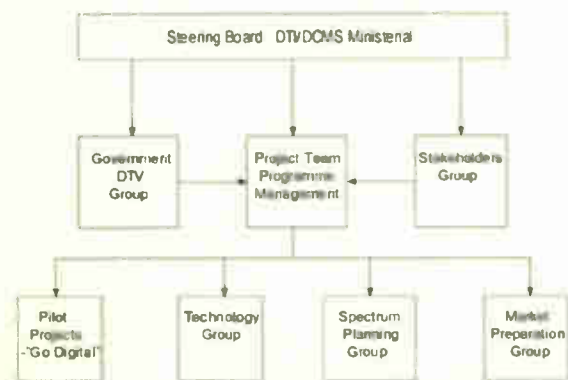

Figure 1: Structure of the government's Digital Action Plan.

ually or in combination to provide the best answer to particular problems.

Reflected signals that result in multi-path reception are a problem with analogue reception, and because of this aerial positioning is sometimes tricky. DTT can cope with multi-path signals but, eventually, this distortion of the received signal adds so much unwanted rubbish that decoding ceases and reception abruptly ends. Diversity reception has much in its favour but is costly. Even without it, digital reception is more costly than analogue. There is also the problem that impulsive noise can mar the quality of reception in marginal-signal areas. We have already learnt a lot about this.

### Quality counts

For successful digital reception quality counts: from the aerial to the outlet socket, quality of construction coupled with good performance are of huge importance. The addition of DTT signals was a disaster initially with a twenty year old analogue distribution system that had previously provided acceptable performance. Only when the cabling had been checked and some sections replaced, screened splitters and multi-taps had been fitted, and all outlet plates had been changed to take a combination of F connectors, could the digital performance be regarded as satisfactory.

The outlet plates were removed and blank plates drilled with a hole to take an F barrel connector were installed. The incoming cables were terminated with a right-angled F plug because many of the patress boxes were only the depth of the plaster. Flyleads to receivers or set-top boxes were replaced with ones of quality similar to distribution cabling, and appropriate plugs were fitted properly. Crimped F connectors were found to perform less well than the threaded type or the later 'snap 'n' seal' connectors, possibly because of cable deformation at the crimp. This does not solve the problems of reception with portable sets however: at the present time this remains a trial-and-error business.

DTT reception seems to be particularly vulnerable to the presence of impulsive noise, with momentary freezing of images and unpleasantly loud plops on sound. Several chipset manufacturers are working on spike-cancellation techniques, but these are specific to

certain types of impulse spike and the problem remains largely unsolved.

### Home-entertainment centres and signal distribution

The living room has already become the centre of a cluster of home-entertainment items, a trend that's expected to continue. An audio system, audio recorder, DVD player or recorder, VCR, satellite and/or DTT set-top box, maybe a dish positioner, a computer or games machine, a broadband internet modem and a cable set-top box could be present in any combination. It's likely that there will be a requirement for material from different sources to be played or displayed in different rooms in a house. The advent of HDTV will probably make analogue PAL UHF distribution unsuitable. The requirement for RGB distribution is a strong possibility. The feasibility of multi-channel home distribution at 5.8GHz is being studied, this frequency providing an alternative to the 2.4GHz slot that's rapidly becoming unusable because of signal congestion. The Wi-Fi 802.11 standard could be pressed into service for video-signal distribution though it remains relatively untested for this purpose.

Wired distribution systems are found in many homes. They provide the nearest thing to the concept of the all-digital home but are mainly used for the multi-point

delivery of analogue TV and radio signals. Many of these simple distribution systems could be up-graded to carry digital signals. In many cases additions to the wiring will have to be more visible than that installed when the dwelling was built. External cabling is never pretty: foresight by home designers and builders may be the answer to this problem, with cable for current and possible future use installed at the time of construction. CAT5E and coaxial cables plus several copper pairs wired from a central point to all rooms would be a boon to future installers, provided a standard that permits easy location and identification is adopted and adhered to.

An alternative is the use of domestic mains wiring to send signals from one room to another. This method of distribution is under development and several large schemes are being evaluated in the UK, Germany and Switzerland. Germany has a strict standard for such equipment.

### Recording video

The advent of the personal video recorder (PVR) has made TV programmes much more readily accessible to the viewer. In addition to the time-shift facility, a programme can be recorded from the point where viewing is interrupted for some reason, enabling viewing to be resumed subsequently while, simultaneously, the remainder of

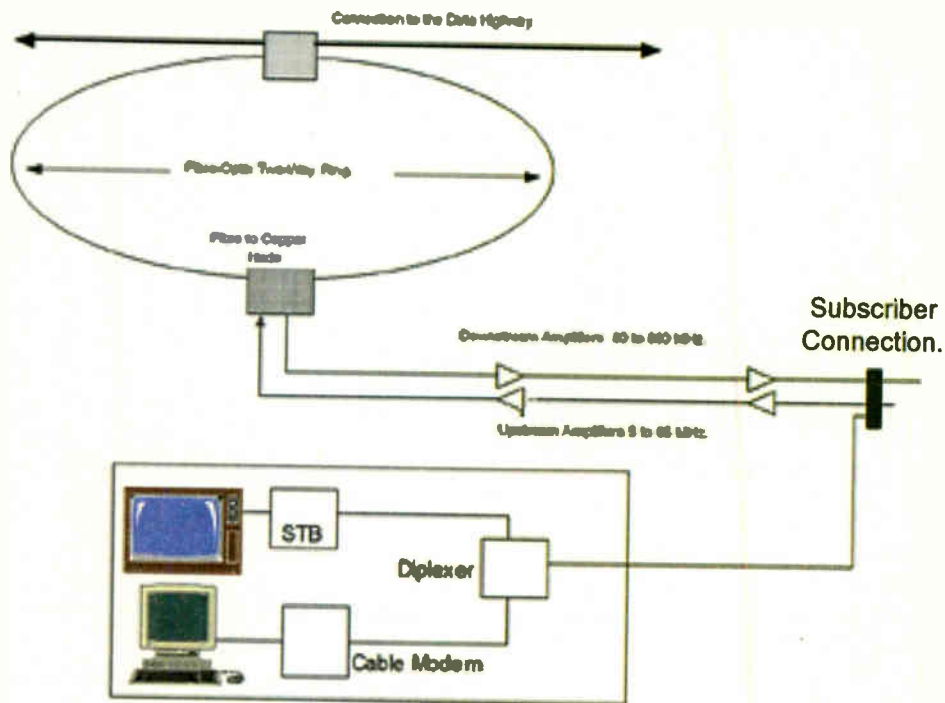

Figure 2: A typical digital cable network arrangement.

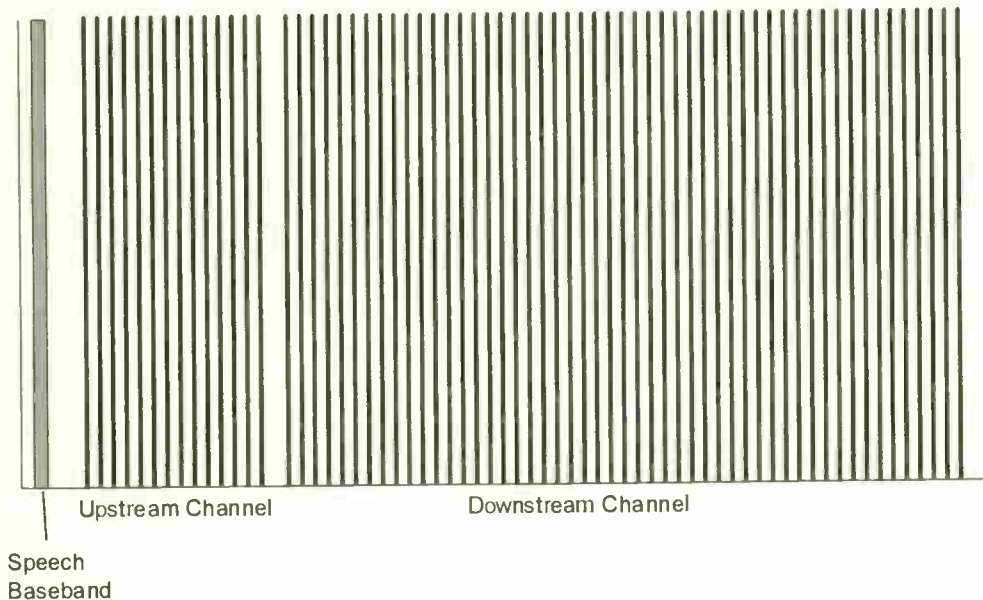

Figure 3: The ADSL signal spectrum, with equally-spaced OFDM (orthogonal frequency-division multiplex) carriers.

the programme is being recorded. The development of several clever means of accessing recorded material directly via a graphical display of the contents of the disk drive will make the use of PVRs increasingly appealing.

The fact that over thirty million analogue VCRs are installed in the UK alone makes changeover to a digital-only system a major problem, given the amount of pre-recorded analogue material and archive tapes that viewers will continue to want to use. Thus although digital technology may supplant analogue for all main home-entertainment and information purposes, there will still have to be a place for analogue in future digital homes.

Some manufacturers may make provision for analogue devices in their set-top boxes and PVRs. For a period there will be a niche market of this type, with recording on to hard disks, or DVD-R/RW drives. The transition to all digital will be blurred by continuing use of 'legacy' analogue equipment, both VCRs and receivers. All-digital receivers are more expensive, and many users of analogue receivers still in good condition will prefer to go digital by using a set-top box.

In late 2002 the TVAnytime Industry group agreed a standard for a hard-disk recorder with advanced features. It includes simple functions like programmed recording as well as advanced features and a degree of future-proofing.

In the period before the full ETSI standards are met, many

manufacturers would use the digital equivalent of PDC (programme delivery control) to enable recording to be timed by the metadata included in the SI (service information) layer of the data stream. Inevitably these would be 'half-way' products, preceding the advent of more sophisticated devices that meet the ETSI standards. Solution of the EPG problem has become an urgent matter, as the EIT (event information tables) are inefficient. At some stage receivers and recorders will both be capable of assembling a full programme database of schedules to ease timer programming.

#### Set-top boxes

The set-top box market for DTT is at present an open one, and consumers are confused about the different 'features' offered by the manufacturers. Work is continuing on a basic standard that provides customers with a range of facilities regarded as appropriate for a versatile yet reasonably-priced product. Naturally some manufacturers will want to introduce models that fall below such a standard while others will want to offer more. To avoid confusion, a 'star' rating system is under consideration.

#### Interactive and enhanced TV

Interactive and enhanced TV cause a degree of confusion for digital customers. Enhanced TV is in common use, providing supplementary data streams that can be selected via the remote-control keypad. The Sky News facility is a good example: this becomes inter-

active only when the viewer chooses to vote on a topic. Interactive TV requires a return path to the broadcaster of course. In the Sky case satellite viewers communicate back to Sky via a telephone link. Other means are provided by the mobile phone SMS service, while cable network subscribers are provided with a return path via the operator's network to the data highway.

#### Cable TV

For cable TV subscribers additional services such as Video on Demand (VoD), a pay-TV service that delivers a film or feature to one customer only; information services such as time, weather, stock-exchange prices and football results; and a fast broadband connection to the internet make full use of the network's return path. With most modern networks the upstream paths use a band of frequencies from 5-65MHz. Speed of data communication is ensured by the bandwidth of the coaxial and fibre-optic cabling used. Figure 2 shows a typical digital cable network arrangement.

#### Data via telephone lines

Telephone companies all over the world use ADSL and its derivative VDSL. The technology makes use of the existing copper-wire pairs that carry the telephone service, adding RF carriers in the range 200kHz to 2.2MHz modulated with digital data. Although the technology works well, the reach of the RF signals is restricted by line conditions. The length of the local loop cannot, at present, extend much more than 3km with new lines.

VDSL (very high-speed digital subscriber line) technology is more difficult to implement, though many telephone companies are proposing such services. Despite their limitations, the xDSL services have the advantage that nearly everyone has a telephone connection.

Figure 3 shows the ADSL signal spectrum.

#### In conclusion

The all-digital home will provide unparalleled versatility for obtaining entertainment, information and assistance. Electronic retailers should start to educate their customers about the offerings that will be available in the near future. But forget the silly applications – the intelligent dustbin, refrigerator and possibly vacuum cleaner. These will surely be gimmicks. ■



NEWS AND TECHNOLOGY ■ INSTALLATION ■ SERVICING ■ DEVELOPMENTS

# TELEVISION

## AND CONSUMER ELECTRONICS

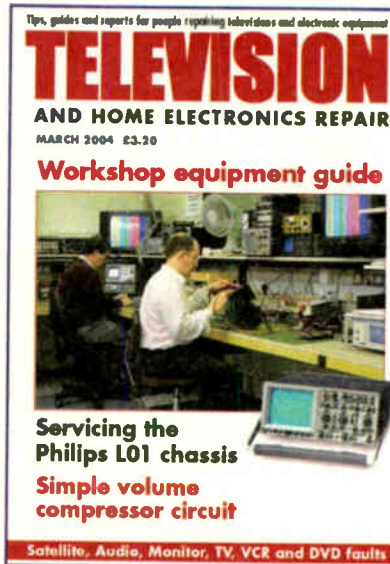
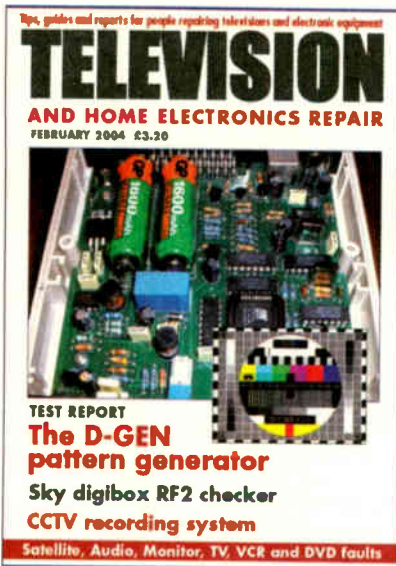

Television and Consumer Electronics magazine is the only magazine for technicians who deal with consumer electronic products, in particular TV, video, satellite and audio equipment.

- Launched in 1935 this respected journal is the longest established consumer electronics magazine
- Tips and guides on repairing television and electronic equipment including satellite receivers, PCs, monitors, VCRs, DVD, audio equipment and much more
- Keep up to date with the latest information and changes affecting the industry
- Essential reference and in-depth features covered monthly
- Essential reference and in-depth features covered monthly

## Make sure of your copy now...

### Subscription rates for 1 year:

UK £33.80 ● Europe £49.00 or €92  
USA \$104 ● Rest of the World £63.50

### Subscription rates for 2 years

UK £53 ● Europe £78.40 or €146  
USA \$166.65 ● Rest of the World £101

### Contact

Highbury Fulfilment Services,  
Link House, 8 Bartholomew's Walk, Ely, Cambridge CB7 4ZD.

Telephone 01353 654 431

Fax 01353 654 400

Email [hbc.subs@highbury-wyvern.co.uk](mailto:hbc.subs@highbury-wyvern.co.uk)



HIGHBURY  
BUSINESS  
A HIGBURY HOUSE CONSULTING PLC COMPANY

# LETTERS

Send letters to "Television", Highbury Business, Media House, Azalea Drive, Swanley, Kent, BR8 8HU or e-mail [t.winford@highburybiz.com](mailto:t.winford@highburybiz.com) using subject heading 'Television Letters'.

Please send plain text messages. Do NOT send attachments. Be sure to type your full name, address, postcode, telephone and e-mail address (if any). Your address and telephone number will not be published but your e-mail address will unless you state otherwise.



## Days of DC

I showed Keith Cummins' article Days of DC (May) to my dad. The subsequent reminiscences occupied the rest of the evening! There was the occasion when the local electricity supply, which came from the colliery power station, had a fault that caused smoke to come from just about every TV set and radio in the pit village. Then there was the customer who used TV coax for his electric fire and wondered why the lead got hotter than the fire!

Mention of the old Wylex plugs took us back. When some new houses were built in the village in the early Sixties the local electrician got the job of wiring them and fitted Wylex sockets throughout. People who subsequently moved in found that his was the only shop for miles around that sold the plugs, which were twice the price of ordinary ones! Weren't there two types, 13A and 5A? I seem to remember that you could plug in a 13A plug then push in a 5A plug at the back, piggyback style. No, that's too bizarre – I must have dreamt it!

When I tired of using a brace and bit to drill holes for aerial leads in customers' window frames I bought an elec-



Photo 1: Part of Bill Wright's collection of extension leads, including front and rear views of a Wylex plug.

tric drill. Very modern and labour saving, but the problem was plugging it in – because of all the different sockets then in use. Some houses didn't have sockets at all, so you had to remove the living room light bulb and make your connection to the holder! Incidentally in those days a common DIY method of making the hole through the window frame was to repeatedly heat a poker and burn your way through!

I solved my connection problems by making up five short extension leads. Each had a different plug at one end and a 13A socket at the other. Because I am constitutionally unable to throw anything away, I still have this kit. A section of it is shown in the accompanying photograph (Photo 1). The strange object at the bottom, in the middle, is a Wylex plug, and there's a rear view of one just below top right.

I still have to wire up fiddly little 2A plugs from time to time because, in the Sixties, they were often fitted to power a TV distribution amplifier from the lighting circuit.

*Bill Wright,  
Micklebring, Rotherham.*

I enjoyed Keith Cummins' article on DC mains supplies, and knew that car batteries could be charged from such a supply via a series load: I thought one used a light bulb of suitable power, but it was a long time ago!

Mains regulation remained a problem much later, with the power cuts about forty years ago. A local dealer I knew received hundreds of service calls for adjustments and explanations about what was happening. While lack of width was easy to explain to customers, I recollect that Bush TV sets could respond to a low mains supply by producing a picture with no sound! Most calls required just 'twiddling' and explanation during the day when the voltage was nearer normal.

In those days people dreaded tube failure, hence the popularity of TV rental. But I have several colour sets in use that still produce fine pictures despite being over twenty years old!

*Philip H. Bearman,  
New Barnet, Herts.*

Keith Cummins' account of his grandfather charging a car battery from a DC mains supply, using an electric fire in series, reminded me of a design for a DIY light dimmer I once saw in an electronics book that dated from the Fifties. The dimmer, intended for theatrical use, consisted of a vertically mounted section of drainpipe that was sealed at the bottom with bitumen and filled with a salt-water solution. Connections were made to an electrode at the bottom of the pipe and to another one mounted on a plunger that could be moved up and down inside, thus providing a variable resistance to dim the mains-powered lighting.

Health and safety at work? No chance!

*Martin McCluskey,  
Bishop Auckland, Co. Durham.*

## Digital picture quality

I have to disagree with Gerald Gutteridge who maintains (letters, May) that digital transmissions provide a better picture than analogue ones. The point is, you can't get more out than you put in. Where there's no significant scene change from frame to frame the digital picture is indeed very good – because the system is not being stretched. When there's a bit of lateral movement however, or a few quick scene changes, the picture looks a lot less good: there are lots of motion artefacts (pixellation), depending on the bandwidth (bit rate) allocated to the particular channel. An example is the heavenly halos that surround football and rugby players with digital TV. Analogue viewers shouldn't feel left out here, as most OBs are digital from end to end – so you can preview digital artefacts on your analogue set now. The last few rugby matches from Twickenham demonstrate this perfectly. I've seen the future and it stinks – pixellates if you like!

The minimum bit rate for decent digital TV is apparently about 4Mbits/sec. This is for an average programme. What are the broadcasters using? I know for a fact that for some rugby games OBs have used as low a rate as 2Mbits/sec. The result is horrendous – sub-VHS quality. A complete multiplex has (used to have?)

26Mbits/sec. But there may be eight or more channels. It seems that the system is built to a cost, not a specification!

*Geoff Thomas,  
Merthyr Tudful.*

### Naiko spares

In the May editorial you asked about spares for Naiko equipment. These are available from Naiko UK Ltd., Naiko House, Spear Fir, Bardsey, Leeds, LS17 9EA. The phone number is 0193 757 9888.

*Dave Packham,  
Leeds.*

### Sharp probes

In his recent workshop equipment feature (March/April) Eugene Trundle mentioned that he didn't know of any very sharp probes. We used to manufacture a set of 'ultra-sharp' meter probes that can easily penetrate solder resist, flux and even PVC cable. They received a favourable review in the January 1991 issue of *Television*. Unfortunately, because of the high cost of manufacture, we are no longer able to

produce these probes. A limited number of sets are available however, priced at £12 per set plus £1.50 post and packing. Please send cheques to LMB Electronics, 301 Mawney Road, Romford, Essex, RM7 8DR. Our phone number is 01708 748 836.

*Michael Bennett,  
LMB Electronics.*

### An unusual aerial rotator

I recently came across the accompanying picture (see Photo 2) which I took when in the Czech Republic two or three years ago. A unique aerial rotator, don't you think?

*Fernley J. Heath, C.E.,  
Newton Abbot, Devon.*

### Clever baby

About a year ago a neighbour asked me to look at his set, a Proline Model 2811. The line output transformer had to be replaced because it was arcing. Recently the set was passed on to me as my neighbour had decided to update.

The only fault I could see was lack of



**Photo 2: Bicycle-wheel aerial rotator, spotted in the Czech Republic a couple of years ago.**

height and width. Easy I thought, low HT. I found a few dry-joints and thought that was it, but not so. Then I asked whether the remote-control unit was available. "Oh" came the reply. "the baby plays with it all the time." The penny then dropped. I entered the code and reset everything.

The question is, how can a year-old baby find the code, let alone upset all the settings?!

*Jim Lesurf,  
Dagenham, Essex.*

# HELP WANTED

**Wanted:** Reel-to-reel stereo tape recorder to borrow, buy or rent, possibly even a salvage unit. Equipment is required to transfer old family recordings. Phone Armando Guselli on 01923 896 941.

**Wanted:** I have several Philips/Marantz DCC recorders, Models 900/DD82, that date from the 1990s. They work fine but produce no audio output. If anyone has any ideas or can help, I would be grateful. I suspect the DA or AD or the digital boards, the two plug-in boards in the middle of the main PCB. Philip Rosbottom. Please email [phillip@mottob777.fsnet.co.uk](mailto:phillip@mottob777.fsnet.co.uk)

**Wanted:** Back-tension gauge for modern VCRs, e.g. Matsui. Tape-splicing kit for VHS tapes. Loading gear for the Philips Turbo deck as used in Models VR242/VR7229/VR7239 etc., part no. 4822 310 10657. TMP47C433AN38-42 processor chip and socket. Mains lead, telescopic FM aerial and battery cover for the Vega Selena transistor radio dating from 1980/1, or a set for spares. Have for disposal a large-screen colour TV set fitted

with the Thorn 8800 chassis. R. Bailey, 22 Grebe Close, Waterlooville, Hants, PO8 9UT. Phone 023 9278 3811.

**Wanted:** Old half-inch diameter ferrite rods. Must be six inches or more long. Will pay very good money for them. Peter Tankard, 16A Birkendale Road, Sheffield, S6 3NL. Phone 07931 463 823 (mobile) 9 a.m. to 10 p.m.

**Wanted:** Does anyone know of a source of spares for a Minato portable TV set? There are power supply problems. D.W. Davies, Emlyn Electronics, 119 Emlyn Avenue, Ebbw Vale, Gwent, NP23 5TZ. Phone 01495 307 256.

**Wanted:** Early (pre-1975) black-and-white and colour sets, equipment, picture monitors, spare parts, home-built equipment, manuals, catalogues etc. Please phone Keith Parker on 020 8422 5049 (Harrow, London).

**For sale:** Marconi TF868B LCR bridge in GWO with manual, £25. Manor Supplies Mk IV colour-bar etc. generator in GWO with manual £15. Samsung 13in. Syncmaster 3 colour monitor Model CVM4967T, works but colour drifts, £5. Box of assorted items with the following and more. £10: Thorn Model VR172L VCR (has tracking fault) with manual and remote-control unit; AEI transistor test set R2446; Panasonic KX-T2406DBE UK answer-phone; Eclipse 36 chisel/plane honing guide with instructions; ultrasonic distance-measuring tool with user guide. All proceeds go to charity. Buyer collects (Bishop's Stortford, Herts). Phone David Martin on 01279 506 212 or email [dandjmartin@ntlworld.com](mailto:dandjmartin@ntlworld.com)

**Wanted:** For spares, Quad 33, 34 or 44 pre-amplifiers and 303 or 405 power amplifiers,

also modules and boards for these models, preferably non-workers. Phone Mike on 01758 613 790.

**Wanted:** I would like to be able to vary the playing speed with a radio-CD player – quite a few very low-priced and attractive units are available at present. The problem is that dance music is not always recorded on CDs at the correct speed, while it is desirable to be able to vary the speed for teaching or practice purposes. Presumably the frequency of the drive to the motor would have to be made adjustable. Equipment with a variable-speed feature is available commercially, but the price is prohibitive and features that are not strictly necessary are included. I would appreciate guidance from anyone who might know how to carry out this modification. D.N. Wellings, FIIIE, Nordheide, Shurton, Stogursey, Bridgwater, TA5 1QE. Phone 01278 732 099.

**Wanted:** Chopper transformer for the Panasonic TX-25W3 etc. (Euro 1 chassis). Part no: 5451708900, cct ref: T639. Rod Tyler, Tyler TV. Phone: 01798 342210 e-mail [r@rt Tyler60.fsnet.co.uk](mailto:r@rt Tyler60.fsnet.co.uk)

**Wanted:** Circuit diagram for the removable front panel in a Sony Car Radio Model XR-U301RDS – alternatively an old/replacement front panel would be much appreciated. Phone Graham on 01905 371504 (evenings) or e-mail [graham.seward@lineone.net](mailto:graham.seward@lineone.net)

**Wanted:** One supply brake assembly item 148 part no. 641C529010 for the Mitsubishi VCR Model HS-B20/30, or just the rubber tube. Phone Graham Bond on 0117 965 6667 or email: [GRAHAMBOND\\_GBVS@msn.com](mailto:GRAHAMBOND_GBVS@msn.com)



# DX and Satellite Reception

**Terrestrial DX and satellite TV reception reports. Broadcast and satellite TV news. VHF TV aerial construction and mysteries. Injuries, part 2. Roger Bunney reports**



*Terrorists strike in Madrid. Scene outside the Puerta de Atocha station. Seen via Eutelsat W2 (16°E).*

**W**inter conditions continued during March and there was very little terrestrial DXTV reception to report. A minor Sporadic E opening occurred on the 6th, with reception of RAI (Italy) ch. 1A from 9.20 p.m. onwards. On the 21st Peter Schubert (Rainham) received unidentified SpE programming in ch. E3. Cyril Willis (King's Lynn) has nothing to report other than meteor-shower pings.

Conditions are better down under, where Robert Copeman (Melbourne) reports that the SpE season was good. Nothing exotic, but the usual stations were received. Autumn is approaching there, and the signals are fading away. Unlike the situation here in Europe, there has been no closedown of Low Band (Band I) transmitters – VHF is still a main spectrum for TV transmission, and DTT is a long way off! Satellite transmissions are on the increase, especially for far-flung island groups where a single downlink can give coverage over a wide area. Fiji Television for example has invested heavily to bring Fiji 1 and six pay-TV channels to the island group. The main problem there could be the reliability of electricity supplies in remote areas.

It seems that in New Zealand people who sign up for Sky Network NZ often find that the dish installer hasn't reconnected the terrestrial TV aerial. Thus viewers are deprived of their local UHF transmissions. This appears to be a specific installation instruction.

## Satellite sightings

March was marked by much violence. There were the train bombings in Madrid on the 11th, with over 190 rush-hour commuters being killed. The sombre mood was captured by the Newlink feeder via Eutelsat W2 (16°E) that afternoon, uplinking from outside the Puerto de Atocha railway station. Several live reports were transmitted, including English, but the haunting background image was that of a long row of parked black hearses waiting as the rails were cleared. Newlink ran news reports for several hours, at 12.562GHz H (SR 2,816, FEC 3/4). Many other satellite trucks were uplinking news about the Madrid terrorist tragedy, for example via Eutelsat W1 (10°E) at 10.967GHz (4,167, 5/6) and 11.099GHz (5,632, 3/4). The following day brought more news uplinks and it became known that the bombings had been carried out by al-Qaeda rather than the ETA. Anti-war crowds demonstrated on the streets, and Eutelsat W2 became a major carrier of the news, with the following active: E16 at 12.548GHz H; Enex-B at 12.563GHz H; Atlas-Enex GlobeStar Espana at 12.510GHz H; RTL Xng D22 at 12.518GHz H; Sky News at 12.533GHz H with a church service; and Esretet 3 at 10.998GHz H – this is an EBU frequency.

Two days later there was a general election in Spain and a new government was elected. Once more there were news feeds everywhere. But it was also election time in Russia where, not unexpectedly, President Putin was overwhelmingly re-elected. With the events in Spain, there was very little coverage from Moscow. I checked at 10°E and found that UKI 298 Moscow was using the APTN slot at 10.967GHz (4,167, 5/6), with a studio shot of a reporter and an inlay of the Kremlin Square as a backdrop. He appeared to be totally unaware of the mass of smoke and flames in the background, because a massive building called the Manezh was alight from end to end. When I moved to 16°E I found that dramatic live pictures were being provided by a Russian satellite truck as the huge building burnt, with the Moscow fire brigade helpless. This was an NTV RUS-6 news feed at 12.563GHz H (5,632, 3/4). This major incident seemed to produce little coverage in the UK press.

Iraq was rarely out of the headlines. A major attack on the US Military HQ in central Baghdad produced reports from APTN Baghdad and CBS Baghdad via Eutelsat W1 at 10.972GHz V and 12.533GHz H respectively (5,632, 3/4). There was graphic footage of the damage to the buildings. Subsequently Dan Rather, the veteran CBS TV news reporter, arrived in Baghdad to give nightly on-the-spot reports. He is exemplary in his politeness and friendliness to the crews who work with him, as can be

seen from non-edited VTR footage. On the 9th he interviewed the American ambassador in one of Saddam's palaces. Dan had previously interviewed Saddam himself prior to the start of the war. We saw Dan and the ambassador walking along the marble corridors of the massive palace. The local newsroom for CBS is at the Baghdad Mansour Hotel. When it's in operation, you find reports via Eutelsat W2 (16°E) at between 12.533GHz and 12.560GHz H.

March 9 saw the return of UK prisoners captured in Afghanistan from the prison camp in Cuba. On the 10th Sky News UKI-15 was camped outside Paddington Green Police Station, where the prisoners were taken, uplinking via W2 at 12.525GHz H (5,632, 3/4). Was something happening in Afghanistan on the 23rd? At 1900 hours a Kabul News (screen ident, on colour bars) transmission from APTN Afghanistan (service ident) appeared via W2 at 10.967GHz V (4,167, 5/6). A reporter stood for ten minutes, obviously cold, but there's no report – only colour bars, then the transmission was terminated!

Eutelsat 2F3 wanders around at 21.5°E, shuffling within a 3.5° inclined orbit. I gather that it's on boresight for standard-tracking dishes, i.e. non-inclined-orbit tracking, during the late afternoon. So at 1600 hours I carried out a scan across the upper part of the Ku band, including the Telecom section, and found a number of signals, with no side-lobe problems from the Astra 1 powerhouse at 19.2°E. Sislink 20 UK was present at 11.659GHz (Tramore horse racing), Basic 8MHz S1 at 11.664GHz (Ascot horse racing), Sis 18 Path 2 at 11.675GHz and UKI 784 C1 4.2 at 11.696GHz, the latter two with anti-war meetings in London. These transmissions were all with horizontal polarisation, running at 5,632, 3/4. Another four transmissions were present in the Telecom band: BBC UKI-777P at 12.507GHz H, Baghdad 216 at 12.538GHz H (both running at 4,226, 7/8), Solo at 12.544GHz H and UKI-534 DSNG at 12.574GHz H (both running at 12,593, 3/4). On the 23rd APTN Jerusalem was present at 12.538GHz H (4,226, 5/6) with the service ident Digit Video. So, despite the widely-inclined orbit, it's possible to find many live OB and news downlinks from the unstable 2F3!

Alan Richards has now moved from the Nottingham area to Horncastle in Lincolnshire. Sadly he had to leave behind his ex-SIS bookies 1.5m prime-focus dish, and is for the present using an 80cm Sky (analogue) dish. With slight modifications to the dish mounting he can cover from Express at 53°E to his old favourite PAS-9 at 58°W. Express produced SGU-1 and -2 (previously on Sesat, 36°E) at 10.974GHz H (8,888, 3/4). SGU-1 had a "pan pipe and piano accompaniment" against pictures of snowy suburbs and city footage, while SGU-2 carried a blue screen with the ident cry TB2. Colour bars with the ident Satvision UK were present at 11.645GHz V (2,170, 3/4) via Europe\*Star (45°E). Alan says that the Sirius slot (5°E) can be an active spot. He reports Latvia-TV5 testing at 11.840GHz H (27,500, 3/4) with lots of adverts, a fashion programme and a nice multi-coloured petal logo in the top right-hand corner. Oltenia TV has recently appeared nearby at 12.625GHz V (3,400, 3/4) with material of the classic B movie type, football from Craiova etc. and a nice selection of national music rendered on harpsichord and zither, all FTA!

Finally Edmund Spicer (Littlehampton) reports a few changes at Turksat 1C (42°E). TRT1 and 2 and the TRT3 and TRT4 + 8 radio stations are now carried FTA in a multiplex at 11.096GHz V (27,500, 3/4). When there are major football games, e.g. Turkey v. UK, TRT1 usually carries the event with very few adverts – combine the picture with commentary on BBC Radio 5 Live and you'd think you were in the Ankara stadium!

### Broadcast news

**Germany:** The closure of analogue TV services and the move to DTT across Germany continues. The Rhineland Palatinate and Baden-Wuerttemberg regions are to have eight state and commercial DVB-T TV channels that will open on October 4 and a further sixteen that will open on December 6, when the analogue



*Election night in Moscow, when the Manezh art museum behind Kremlin Square caught fire. Reception via the APTN feed from Eutelsat W1 (10°E).*

services will close. Digital TV fill-in relays will be progressively opened in the above and the Hesse regions next year.

**Sweden:** Channels TV3 and ZTV are now available again terrestrially, via the Teracom DTT multiplex. Channel TV8 should also be available terrestrially by the time this is read.

**US:** The FCC is considering ways to encourage viewers to move to DTT as the deadline for 85 per cent population coverage by 2006 nears, though there's no hope of that being achieved. Dual analogue/digital transmissions have failed to produce the DTT take-up expected, possibly because of equipment costs.

**Taiwan:** CNS-TV, which opened a DTT service last June, has to date attracted only some 10,000 subscribers.

**Russia:** Despite the fact that there is no official analogue-to-digital switchover date, the head of Russian State TV is planning for a large subscriber take-up of a basic digital TV service across the Moscow region over the next year. The company promoting the service, Skylar, will provide a free set-top box for the \$5 a month service provided the receiver is 'digital capable'.

**Ireland:** The government, in conjunction with RTE, is about to announce a digital TV project covering the Dublin area. Up to a million potential viewers would need to buy a set-top box. The FTA multiplex will be transmitted from the Three Rocks site and will include RTE-1, Network 2, TV3, TG4 and up to six UK channels.

**Switzerland:** The German-language U1 channel that uses the former TV3 facility, offering sport, general entertainment and documentary material, has been offered a ten-year franchise. The potential number of viewers should reach 1.8m by January 2005.

**Hungary:** The new chairman of MTV has suggested that it should open additional TV channels, including ones for sport, news, culture and 'nostalgia'.

**Luxembourg:** RTL has further increased its empire with the acquisition of full voting rights in the French channel M6. Gosta van der Linden reports that the 100kW ch. E7 RTL Dudelange transmitter closed down at the end of March, perhaps as part of the move to DTT.

**San Marino:** The RTV studio base at the small republic, near Rimini, has been completely re-equipped. Sony Italia provided a



A NASA TV publicity transmission – the start of a Mars exploration update. Via Atlantic Bird 1 (12.5°W).

consultancy service for RTV, which now has six ENG units and a six-camera OB van. The whole system is being upgraded for digital operation.

**RSL-TV:** Southampton Television, which transmits on chs. 29 and 55, went into administration in early March but continues to be on air. Latest news, in mid-March, is that the RSL-TV Oxford Channel has taken over the ailing Southampton station.

### Satellite news

The new Eutelsat satellite W3A was launched on March 15, to slot in at 7°E. It has 58 transponders in all, mostly Ku-band but with some Ka-band capacity. Coverage, widebeam or spot-beam, reaches across Europe, the Middle East and North Africa, extending south to Somalia and Ethiopia. Operations include VSAT, DTH, broadband, one/two-way video linking and news feed services.

At the April NAB show in Las Vegas SISlink launched its new self-contained automatic satellite uplink equipment,  $\mu$ POD. The compact package can be carried in most vehicles and will provide performance similar to that obtained with a standard SNG truck.

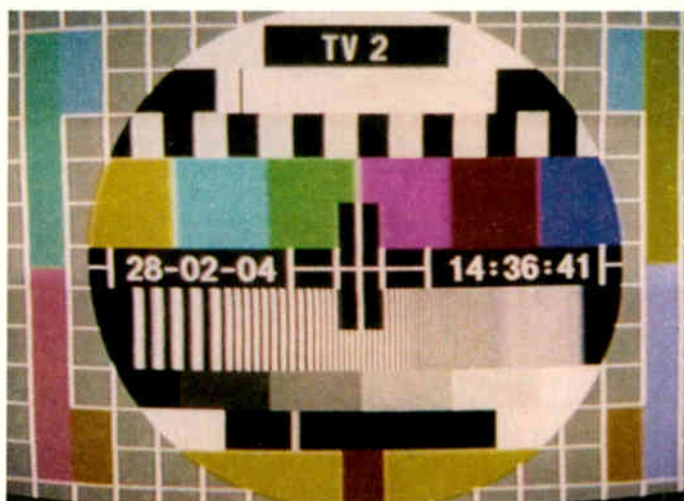

TV2 Norway test pattern, received via Eutelsat W2 (16°E). The vertical white bar in the black rectangle at the bottom cycles right to left continuously.

Once fitted to its host vehicle the equipment can be used by a single operator, via a laptop computer, and provides automatic alignment with both synchronous and inclined-orbit satellites. It can be 'broken' down into small, user-friendly packages for flyaway operation.

Turkmenistan is to have a fourth TV channel, following an agreement with InSpace Communication which will install and operate the new equipment. Transmissions should start this summer.

The Corse Mediterranee channel is to open shortly, transmitting French-language programming from Corsica across much of North and Western Europe and North Africa. It will be operated by the France 3 mainland network.

Jordan has announced the go-ahead for the Al Khalijiya (Gulf One) satellite TV channel, which will provide Arabic programming for the Gulf and Middle East.

A new Tunisian commercial channel, NASR TV, is to download from the Hot Bird slot at 13°E.

The French pay-TV channel TPS has signed an agreement to screen UK Premier league football matches for three seasons from August 1st. Matches, live or recorded, will be broadcast across France, Monaco, the Comoro Is, Guadeloupe, Mauritius and Mayotte.

The Thai army has for years transmitted radio and TV programming. The army's satellite division has opened a new TV channel, One Tambon, to advertise Thai products, downlinking to Japan. It will also be distributed via Tokyo cable systems.

And finally the new Danish-based channel TV2 Charlie is intended for the over fifty year olds. This subscription channel will be broadcast via cable and satellite capacity at 1°W, and will make some fifty per cent of its programming.

### VHF TV aerials

Steve Bell's mention of an 'aerial mystery' on the letters page in the April issue produced an interesting response last month. This cleared up the basic mystery. It reminded me of the time when I used to build a range of Band I aerials that were sold by South West Aerials, which subsequently became Aerial Techniques. Aerial hum or element self-resonance was a common problem with certain types of Band I aerials, and could be overcome quite cheaply. It was common to see a large Band I aerial with element sections missing, or indeed a whole element. Curious perhaps that the end 12in. or so would fall off a vertically-polarised aerial – this couldn't be blamed on roosting pigeons!

During one very warm summer evening in the Seventies I heard, when in back garden, an odd buzzing noise. Looking up at the DX-TV mast, I saw that the four-element, horizontally-mounted wideband Band I array appeared to be in distress, with the reflector part clearly 'vibrating' – despite the fact that there was no wind. I climbed the mast and found that two distinct parts of each reflector rod were vibrating, sufficiently to look 'fuzzy'. These were a section perhaps a foot from the main boom fixing clips and another about a foot from the end. Both the elements that comprised the reflector were suffering similarly. In effect it seemed to be a sort of mechanical standing wave! To touch the vibrating part of the element was painful, but to grasp the element elsewhere instantly stopped the buzzing. I was at 52ft. above ground, hanging on to the lattice mast. This was not the best place for extensive testing!

The Band I aerials I made all used hard-drawn half-inch seamless alloy rather than the seamed alloy tubing most aerial manufacturers used. I recalled an old Telerection aerial whose Band I elements were full of sawdust, obviously to damp out physical oscillation. Experimentation with lengths of sash cord inserted in the reflector stopped the buzzing. Thereafter my Band I aerials all included an 18in. length of waxed washing line in each reflector element and the problem never recurred. Seamed alloy didn't suffer from the problem to the same extent.

The resonance always occurred on a warm, still day. Why, I have no idea. But clearly if the situation had been allowed to con-

tinue there would eventually be metal fatigue and the element would fracture at one of the nodal points.

I am intrigued by an elderly Band I/III aerial that is still in position in Totton centre. It's a memorial to TV of old, and the days of the Chillerton Down ch. 11 and Rowridge ch. 3 transmitters. The aerial, see Fig. 1, is a simple type that would be used in areas close to local transmitters. It has three Band III elements at the front and a single Band I dipole at the back: between them there's a further element, which is presumably a full-wave Band III dipole. This latter element, which is mounted with its own dipole insulator, has phasing elements that are connected to the larger Band I dipole. These are screw-fitted on to the dipole insulators. So far so good, but the curiosity is that the phasing elements have a connecting section that loops round at the rear of the Band I dipole and appears to short it out. Obviously it doesn't, but can any reader comment on this rear loop and how Band I performance was maintained?

### Injuries, part 2

In the April column I mentioned my fall from a 4ft high domestic stepladder over Christmas and the injuries I sustained. Pains in my arm continued into March, and I eventually consulted a local osteopath. He discovered torn muscles that "were repairable without hospital treatment", and I subsequently endured several sessions of paid torture. He seems to know his stuff, and there has been a 75 per cent improvement. I am promised a full recovery over the next few weeks.

Fortunately I am not a self-employed aerial rigger, nor do I have to carry large TV sets. Had that been my work, funds could have been at a very low level by now. The moral is, take care and assess risks before you start on a task.

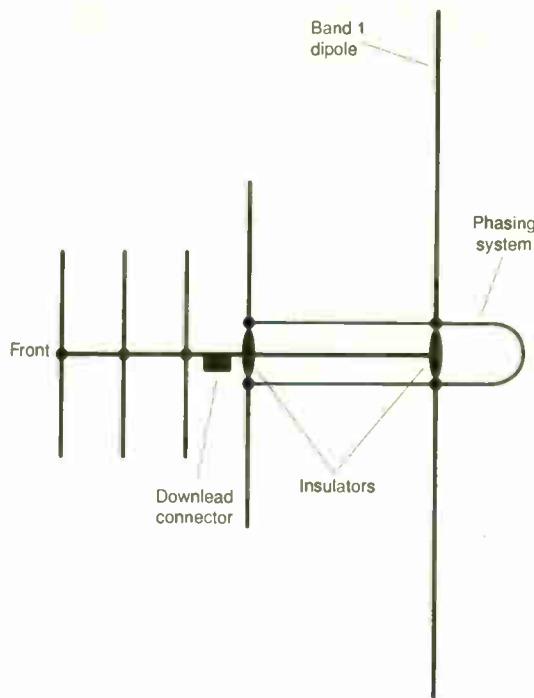

Fig. 1: Combined Band I/III local-reception aerial dating from the 1970-80 period. The Band I dipole seems to be shorted out! Any ideas about this?



# NIKKO ELECTRONICS

## ELECTRONIC COMPONENTS DISTRIBUTORS

### LOPT'S

• LOPT'S FOR MONITORS  
OVER 500 DIFFERENT  
TYPES IN STOCK

• LOPT'S FOR TV'S  
FROM £6.00

• ORIGINAL ELDOR  
LOPT'S

• HR DIEMEN AND

• LOW COST NIKKO  
LOPT'S

and more, Pls enq!

• REMOTE CONTROL  
FOR TV/VIDEO  
FROM £5.00

### DVD/CD LASER PICKUPS + MECHANISM

#### REPLACEMENT

KSS-210A ...	£7.95	KSS-213D ...	£8.50
KSS-213B ...	£7.95	KSS-213E ...	£8.75
KSS-213C ...	£7.50	KSS-220F ...	£13.00
KSS-240A ...	£17.50	KSS-710A ...	£15.50
KSS-210B ...	£8.50		

#### ORIGINAL ALSO AVAILABLE FOR KENWOOD, PIONEER, SONY

KHM 220 AAA orig	£57.00
CDM 12.1	£13.00
12.3	£14.75
12.4	£23.00

#### AND A LOT MORE, PLEASE ENQUIRE!

AN-5277	£2.35	TA-8273	£11.50
AN-7125	£2.49	TA-8276	
BA-4900	£5.50	TA-8277	£11.95
BA-4901A	£8.50	TA-8427K	£0.89
BA-4905	£5.99	TDA-7384	£4.90
BA-4908	£6.50	TDA-7385	£5.75
BA-4911	£8.50	TDA-7386	£6.99
HA-13158	£5.50	TDA-7490	
HA-13159	£13.50	TDA-7560	£13.00
TA-8260	£8.50	TDA-8568Q	£5.75
TA-8262	£10.75	TDA-8588BJ	
TA-8263	£9.25	TDA-16833	£1.35
TA-8268	£15.00	TDA-16846	£1.48
TA-8272		STK-5332	£1.30

STK-401-020	STK-407-070	STK-490-310
STK-401-030	STK-407-090	STK-495-020
STK-401-040	STK-407-100	STK-496-030
STK-402-030	STK-407-120	STR-F6523
STK-402-040	STK-407-710	STR-F6524
STK-402-070	STK-411-220	STR-F6535
STK-402-071	STK-411-240	STR-F6552
STK-402-090	STK-411-290	STR-F6653
STK-402-100	STK-412-010	STR-F6654
STK-402-120	STK-412-020	STR-F6655
STK-402-240	STK-419-120	STR-F6656
STK-405-030	STK-419-130	STR-F6668
STK-405-050	STK-419-150	STR-F6676
STK-405-070	STK-442-130	STR-F6707
STK-405-090	STK-443-050	PAL-006A
STK-405-120	STK-489-010	PAL-007A
STK-407-040	STK-490-040	
STK-407-050	STK-490-110	

- Sony tactile switch 4 pin MOQ 10pcs ... £0.28
- Sony tactile switch 2pin MOQ 10pcs ... £0.25
- Wire ended lamps for car stereo 6,9,12V  
MOQ 50pcs ... £0.15 each

#### • SPECIAL MOQ 10PCS

S-2000N/CH	£0.65	BUT-11A	£0.35
S-2055N	£0.65	SAP15P	£3.25
BU-2508AF/CH	£0.65	SAP15N	£3.25
BU-508AF/CH	£0.49	UC-3842A	£0.45
STR-50103A	£1.75	TDA-8361/N3	£2.75
STR-54041	£1.49		

• PRICES QUOTED EXCLUDING VAT AND  
SUBJECT TO CHANGE W/O PRIOR NOTICE.

NIKKO ELECTRONICS  
358 Kingston Road, Ewell, Epsom Surrey KT19 0DT  
Tel: 020 8393 7774  
Email: dalbani@nikko-electronics.co.uk  
Website: www.dalbani.co.uk

IT'S EASY  
TO ORDER

PHONE  
020 8393 7774  
OR FAX  
020 8393 7395

CLICK/ORDER  
ONLINE  
VIEW OUR CAT ON  
www.dalbani.co.uk





# AUDIO FAULTS

Reports from  
**Geoff Darby**  
**Eugene Trundle**  
**James Grant**  
**J.S. Ogilvie**  
**Martyn S. Davis**  
**Chris Bowers and**  
**Philip Rosbottom**

We welcome fault reports from readers – payment for each fault is made after publication.

Reports can be sent by post to:

Television Magazine Fault Reports,  
Highbury Business,  
Media House,  
Azalea Drive, Swanley,  
Kent BR8 8HU

or e-mailed to:  
t.winford@highburybiz.com

## Phoenix Gold ZX450

This large car power amplifier was basically dead, which is often the case when one of them is brought in for repair. I've found that there is a general lack of understanding amongst engineers of the principles involved with these units: this tends to put them off wanting to take a look. At a first glance they do tend to look very complex inside. They are rather less daunting when you realise that two thirds of the transistors or FETs bolted to the heatsink are part of the switch-mode power supply.

The reason why a switch-mode power supply is required is that the output powers quoted by the manufacturer, and desired by owners, from the huge speaker system simply cannot be achieved with a nominal 12V supply. Assume that 4Ω speakers are used. With a 12V supply the maximum current that could be driven through the speaker coils would be  $12/4 = 3A$ . This would equate with a maximum theoretical power of 36W, which is nothing like the hundreds of watts often claimed. The switch-mode power supply boosts the 12V input to typically  $\pm 20V$ . The theoretical power then becomes 400W (current through the speaker coils 10A). Allowing for system inefficiencies, 100W RMS can easily be attained.

You don't get "owt for nowt" of course in this world. For the switch-mode section to deliver the sort of power required by the amplifier proper, the DC input power requirement is huge. This is the reason why these amplifiers have input fuses that the Electricity Board would be proud of, and power terminals to which you could connect welding cable (the owners often do... ). It's also the reason why you may find up to ten switching transistors connected in parallel, and why the majority of faults occur in this area rather than the output stages, which are quite reliable.

You will often find that there's a blown fuse and one or more of the switching transistors is short-circuit. These are usually FETs, and are readily available from your normal general component supplier. When checking them, don't get carried away looking for the same readings across them all. If you look a little closer you may well find that some of the TO220 packages are actually double diodes – the secondary side rectifiers. If you find short-circuit FETs, check for burnt-out print tracks and open-circuit current-sharing resistors.

The cause of the vast majority of faults is easily found by checking as above. On occasion however you may find that the chopper control chip has failed. This can lead to the demise of the switching devices so, once you've replaced any faulty ones, you should attempt to trace the drive to them and disconnect it. Repower, remem-

bering to bridge the 'remote' terminal to +12V, and check that drive pulses are present.

The fuse in this particular Phoenix amplifier was intact. The switch-mode control circuit was on a separate board, and a scope check showed that it wasn't producing drive pulses though the 12V input was present. Further checks on this board revealed a distinct lack of volts anywhere, other than at the input pin. While following the print round I came to a ZTX490 transistor that's controlled from the 'remote' input terminal. This transistor was short-circuit base-to-collector. A replacement restored normal operation.

It transpired that the owner had been attempting to fit a fancier fan, with rotating blue LEDs on it. Such things are available as accessories. He had been trying to connect it to the remote-control circuitry when the failure had occurred... G.D.

## Technics SU-X990D

The owner's complaint with this heavy hi-fi amplifier was "powers up but no output: crackling before, but was working". A fair amount of dismantling is required to get the main PCB out to examine its underside. Once I had reached this point and turned the PCB over I came across one of the worst cases of heat-stressed joints I've ever seen. Just about every semiconductor device on the board, both power and small-signal devices though, curiously, not the output hybrid, had cracked or crystallised joints on all legs. The worst were at the devices mounted on heatsinks. There was also similar trouble at the legs of more than a few passive components.

A lengthy blanket resoldering operation, followed by a close inspection using a strong magnifying glass, restored the amplifier to its former glory. G.D.

## Grundig M5C

What's that then? It's a smart-looking music centre and it worked well, except CD music playout stopped after one-two hours. The fault was in the laser unit, type KSS-213C. We replaced it with a bargain from CPC: order code AS00201 brings you the complete CD deck, with two motors and the laser assembly, for £13.50 (at the time of writing) net. E.T.

## Sony HCDH1600

This CD player attempted to spin up and read a disc but didn't, eventually saying "no disc". When I tried to open the drawer to get the disc out and see if the lens was dirty it wouldn't open, and a hum came from the speakers. There was also a smell, like electrolyte, from somewhere around the regulator circuits.



A close visual inspection failed to reveal anything amiss, and scope checks on the supply lines for any excessive ripple also drew a blank. Time to dig deeper. There's a row of electrolytics beneath the regulator heatsink. C280 and C282 (both 100µF, 35V) were leaking electrolyte and had damaged the print running through beneath their legs. Everything worked again once I had repaired the missing print and replaced the two electrolytics. J.G.

### Sony ZS-D50

This is a portable radio-cassette-CD player unit. The problem was that the tape jammed in the loaded position. This happens when the capstan belt, part no. 3-029-598-01, slips off. As a precaution, fit a complete set of belts. J.S.O.

### Kenwood SE-A551S

This three-year old AV control centre came in because its volume control was dicky. It's the first time I've had one of these in for repair, and I was very glad that the volume potentiometer was easy

to get at. It lives on a little sub-board that can be removed without disturbing anything else. The part no. is T99-0559-05. M.S.D.

### Sony STR-DB930

This unit failed to power up. Checks inside with a voltmeter showed that the cause was the display controller IC102, part no. 8-759-641-15. There was normal operation once a replacement had been fitted. C.B.

### Sony HCD-CP300

Cassette playback was slower with deck A than deck B. The cause was the cassette mechanism itself, part no. 1-796-078-11. A replacement restored normal playback. C.B.

### Sony STR-DE475

There was no sound from this stereo FM/AM receiver's left and right surround-sound speakers. Checks on the main board, on the B side, revealed dry-joints at RY550 and RY601. All was well once these two relays had been resoldered. C.B.

### Sony PMC-303L

This personal component system made a skipping sound and wouldn't play CDs. The cause was the KSS-213B optical pickup unit, part no. 8-848-379-31. A replacement restored normal operation. C.B.

### Sony HCD-CP333

There were missing segments in the characters displayed by the LCD panel. Checks on the main board, using a voltmeter, revealed that the cause was the system control chip IC601, not the display control chip IC602. A replacement, part no. 6-800-361-01, restored correct operation. C.B.

### Technics SL-QX200

This direct-drive turntable's arm lift didn't work. The actuator had come out of the lever/slot under the arm mounting. P.R.

### Technics RS-M253X

The mechanism didn't do anything, because the large square belt that drives the gear assembly for the functions was stretched. A replacement from CPC, 2mm by 51mm, restored normal operation. P.R.



## What a Lovely Pair!



### HORIZON DIGITAL TERRESTRIAL METER

#### HDTM

- Signal Strength and BER displayed together
- Pre and post BER displayed on sub menu
- 10 pre programmed transmitters (via website) or all channel step through
- Audible tune-in, with back light
- 7 or 8 MHz channels
- 2K and 8K mode
- Automatic Transmission and constellation
- VHF (band3) and UHF bands
- RF input range 167-862 MHz
- Input dynamic range -72dBm~-20dBm
- Input connector BNC. Input imp75 ohms. Loop through
- External power for mast amplifiers, etc.
- Built in universal charger 80-250 V Ac. Intelligent charger (CE approved) with delta V delta T detection. Fast charge, then Trickle
- Run time with full charge: Minimum 5 hours from 2.5 Ah battery
- Figure of 8 mains input connector. 2.1 mm Female PSU plug for external charge via supplied car charger
- Computer interface: Serial port (Com 1-4) for upgradeable software on transmitters.

### HORIZON DIGITAL SATELLITE METER

#### HDSMV2

- Signal Strength and BER displayed together
- 32 Transponders or 16 satellites, horizontal & vertical
- Audible tune-in, with back light
- DVB, C&Ku band, Mpeg, V Sat compatible
- Input dynamic range -65dBm~-25dBm
- Input connector F-female. Input imp 75 ohms
- Symbol Frequency rate from 1 Msps~45Msps
- Universal charger 80 V ~ 250 V Ac. Intelligent Charger (CE approved) with delta V delta T detection Fast charge, then Trickle
- Run time with full charge (single LNB): Minimum 3 hours from 2.4Ah battery
- Figure of 8 mains input connector. 2.1 mm Female PSU plug for external charge via car charger
- LNB short circuit protection 500 mA automatic limiter
- RF input range 950- 2150 MHz
- Computer interface: Serial Port (COM 1,2,3 or 4) for upgradeable software on satellite settings.

[www.horizonhge.com](http://www.horizonhge.com)

Speed up your installations call NOW on +44 (0)20 8281 3777  
or email [sales@horizonhge.com](mailto:sales@horizonhge.com) for a reliable solution

**HORIZON**  
For a reliable solution!



# DVD

**Fault reports from  
Geoff Darby  
and  
Chris Bowers**

**We welcome fault reports from  
readers – payment for each fault is  
made after publication.**

**Reports can be sent by post to:**

**Television Magazine Fault Reports,  
Highbury Business,  
Media House,  
Azalea Drive, Swanley,  
Kent BR8 8HU**

**or e-mailed to:  
t.winford@highburybiz.com**

## **Aiwa HT-DV90K**

A lot of engineers I know don't seem to like Aiwa equipment. But in general I've had no problems with overall build quality, performance or design. It's rare to get a fault that can't be fixed, or to find that a problem is difficult to work on because of poor mechanical design. This item was particularly noteworthy. The problem was simple enough, a defective laser, but it's got to be the easiest one in the world to change, bar none!

Once the unit's case has been removed the top of the deck is completely exposed. To remove the laser you take out a single screw at the end of the slide rod and disconnect the ribbon cable. The replacement is just as easy to fit, after swapping the plastic rack from the old one. Remember to unsolder the two very easy to get at shorting points at either side of its PCB after plugging the ribbon cable back in.

Aiwa parts are now supplied via Sony. The laser was very reasonably priced, making the repair economic – something that's becoming increasingly rare with DVD players. **G.D.**

## **Technics SL-HDV600**

This four-piece DVD/hi-fi system refused to read any discs, DVD or CD, and displayed error code H02. This indicates spindle motor trouble. The motor did in fact feel rough and stiff and in need of replacement. It's not supplied as a separate unit, coming pre-fitted to the plastic deck chassis (item 307 in the exploded view) with the turntable already fitted. A number of items have to be swapped from the old chassis to the new one. These include the optical block, its slide rods, clips, bias springs and screws, two gears and the suspension rubber. Several other gears are pre-fitted, also the optical block

tilt-adjustment screws.

I changed all these items over and refitted the deck. Then I tried it, only to have exactly the same problem. This is not uncommon, the usual cause being that the surface-mounted driver chip IC2501 (BA5823FM) on the board under the deck has been damaged by the faulty motor. Be careful when you order the replacement, as the other chip on the board is designated IC5201. If you want to be reasonably certain that the IC is faulty before you order a replacement you can check with a scope, set to DC, connected to TP5210. This is pin 17 of the flexiprint connector on the PCB. The signal here is called 'Spdin', and is the control signal to IC2501 to start the spindle motor. Once focus has been achieved, this line will shift level. If it does, and the spindle motor doesn't start, there's a good chance that the IC is faulty.

Once I'd fitted the replacement the unit read and played all discs correctly. One final task remained – to set the optical block tilt. This adjustment must be carried out whenever major mechanical work has been done on the deck, such as in this case where the slide rods had been swapped over and sat on arbitrarily adjusted screws. Fortunately it's easy to do.

Insert a DVD disc and allow it to be read. Then stop the unit and press the front-panel 'stop' and remote-control button '5' simultaneously. This will bring up the jitter display. Press 'play' and confirm normal playback. The first three figures in the display represent the jitter percentage, for example 092 indicates 9.2 per cent.

Once the disc is playing, move a few chapters in and confirm that a reasonably steady jitter figure is displayed. Next gently insert a 2mm hex wrench (Allen key) into one of the three holes in the chassis pan, immediately under the deck. The machine can be stood on four upturned coffee mugs to facilitate this. I usually start with the hole at the front. 'Feel' the wrench around gently until it engages with the head of the adjustment screw. Try to avoid pushing on or disturbing the deck. Wait until any disturbance has evened out to a steady display again, then adjust the screw gently one turn clockwise. Wait again for the display to settle. Note the figure, then turn the screw two turns anti-clockwise. Choose which direction produced the biggest reduction in the jitter figure, then continue adjusting in that direction until there is no further improvement. Repeat this procedure for the other two adjustment screws, which are accessible through the other two holes in the chassis pan. Finally go round all three again and tweak for the lowest jitter figure.

With this unit I was able to get a very respectable 6.5 per cent (065 indicated).

Treat anything below 8 or 9 as acceptable. This adjustment should also be carried out when the laser is replaced.

One final note. If, after working on the deck, one of these units seems to struggle to read a disc, either DVD or CD, and you get very high jitter figure readings, check the lens carefully for smudges or fingerprints. These units are extremely intolerant of this – I've been caught out on more than one occasion. G.D.

### **Sony HCD-S500**

There was no eject or operation in the DVD mode. Multimeter checks on the DVD board revealed that Q002, on side B of the board, was faulty. A modification is required when you get this fault. Remove Q002 and replace it with 'house assembly' part no. X-4954-896-1. The three wires must be connected as follows: with the B side of the board face up and Q001 upside down in front of you, connect the blue wire to the collector (top), the white wire to the base (bottom left), and the red wire to the emitter (bottom right-hand side) next to the Q002 print. Also replace chip resistor R011 (1k $\Omega$ ) with a 470 $\Omega$  chip resistor, part no. 1-218-949-1. This is the chip resistor just

below the white (base) wire.

When you replace the board in the unit, screw the 'Q002' house assembly to the amp board, using the screw next to the flexible connectors. Don't touch any part of the DVD or power board when doing this. Normal DVD operation should be restored once these two components have been replaced. C.B.

### **Sony HCD-S300**

There was no power supply operation. The cause was found to be optocoupler PC901 on the power board. Normal operation was restored once a replacement had been fitted. The part no. is 8-749-019-04. C.B.

### **Sony DVP-NS405**

There was no display and the disc spun at high speed. A check on board IF89, side B, using a magnifying glass revealed the cause of the fault, a dry-joint at Q404. Once this had been resoldered there was a normal display and the disc rotated at the correct speed. C.B.

### **Sony HCD-C770**

The pictures produced by this DVD player were all right for about an hour, after

which they started to jump and freeze. A look inside revealed that the optical pickup assembly was working correctly. Then, checking with a heat-gun and a can of freezer, I found that the cause of the fault was C702 on the DVD board. A small modification involving a couple of components was required to restore normal DVD playback. C.B.

### **Sony SLV-D950GI**

This DVD player/VCR wouldn't play DVD discs. I tried a quick play with a normal CD disc, which played back all right. So it seemed that the cause of the trouble was the optical pickup H211, part no. 9-885-037-37. A replacement restored full normal operation. C.B.

### **Sony DVP-F21**

The problem was that the disc dropped at eject. A call to Sony technical provided the solution. The push switch, part no. 1-762-594-64, on board MD91 needs to be attached at the centre of the fixing. Fit a replacement, then check while holding the unit vertically so that the disc slot is face down: insert and eject a disc three times to ensure that it doesn't drop. C.B.

## Test Case 498

One of the nastiest things that can occur when servicing consumer electronics products is the 'instant blow-up'. This sort of thing usually arises with the power supply in an audio output amplifier or a TV set. You look for and replace damaged components, then find that the replacements are destroyed as soon as power is applied. The puff of smoke or the blue flash from the fuse is very demoralising, especially when it happens for the second or third time! The advent of single-chip circuits has eased the situation in TV field output stages and most audio amplifiers. But TV switch-mode power supplies seem to be ever more diverse, and some of them are prone to repeated self-destruction on the repair bench.

The problem we had on this occasion was with a Philips Model 21PT5322 (MD1.2E chassis). The set looked innocent enough when it came into the workshop, the fault report consisting of just one word, 'dead'. As Television Ted was away on holiday, it would have to be tackled by Cathode Ray – between his washing-machine repair jobs and satellite call-outs, such is life in the workshop at present. Ray took the back off and the main PCB out, and soon found that the 2.5AT internal mains fuse F1501 was open-circuit, having blown violently (its glass was black inside). This could be an easy one, Ray thought. He checked the mains bridge rectifier diodes, which were all OK. The associated filter capacitors, on the AC and DC side of the bridge, were also OK. But the chopper transistor Tr7540 was short-circuit between all three pins. It was a MOSFET device, of a type that Ray had never come across before – an STP4NA60F. Needless to say there was no such thing in the stores. None of the other power-

supply components that Ray checked showed any signs of being faulty, so he ordered a replacement MOSFET and also, to be on the safe side, a new MC44603P control chip (IC7520). It could have been the initial cause of the fault, or it may have received a dose of 300V at pin 3 when Tr7540 failed. Reasonably confident that he had solved the problem, Ray returned to his Hoover washing machine. It needed motor brushes and a drum-drive belt. Variety is the spice of life!

The spare parts for the Philips TV set were not long in coming, and Ray quickly fitted them – he was under pressure from the customer, as is usual these days. When he connected the set to the bench mains socket and switched it on there was a momentary buzz followed by a bright flash from the mains fuse. Back to square one!

Ray studied the circuit diagram in the service manual. There were so many possibilities! Maybe something funny with the optocoupler, or shorted turns in the chopper transformer. Perhaps some heavy loading on the secondary side of the circuit, not detectable by cold resistance checks. Possibly something on the primary side of the circuit breaking down under load or applied voltage...

Ray found a helpful section in the service manual, headed 'fault finding in the power supply'. It called for the use of a DC power supply, so Ray approached Sage for the loan of his one. This worthy, acquainted with the situation, took one look at the set and made a suggestion that resulted in a complete cure. What was it? Should Ray have known more?

*The answers will be found on page 507.*



## VCR CLINIC

Reports from  
**Eugene Trundle**  
**Peter Tennant**  
**Chris Bowers**  
**Bob Longhurst**  
**L. Gare**  
**Dave Gough**  
and  
**Martin McCluskey**

We welcome fault reports from readers – payment for each fault is made after publication.

Reports can be sent by post to:

Television Magazine Fault Reports,  
Highbury Business,  
Media House,  
Azalea Drive, Swanley, Kent BR8 8HU

or e-mailed to:  
t.winford@highburybiz.com

### Panasonic NV-SD220B

A cassette was trapped inside this machine, while the front panel displayed the caption H02. It didn't take long to discover that the capstan wasn't turning. It took rather longer to establish that the BA6187S capstan-drive chip IC2501 was the cause. E.T.

### Philips VR437

This VCR produced no signs of life, but the mains fuse was intact and there was 320V at the chopper transformer's primary winding. My trusty ESR meter showed – after discharging the mains bridge rectifier's reservoir capacitor! – that C2114 and C2201 had both dried out. C2114 (47 $\mu$ F, 25V) is on the primary side of the power supply, while C2201 (47 $\mu$ F, 50V) is on the secondary side. E.T.

### Daewoo V235

This VCR was dead. After a lot of searching in the power supply I found that R52 (390k $\Omega$ ) was open-circuit. I also replaced R51, which has the same value, though this one produced the correct resistance reading. In addition it's best to check the electrolytics in the power supply. A couple of them were low in value. P.T.

### Sanyo VHR899

This VCR was dead with the fuse in the plug open-circuit. I thought it was going to be an easy job, but not so. When I tested the machine I found that it was very slow at loading tapes. It turned out that the loading motor had to be replaced. All was well after a general clean and test. P.T.

### JVC HRD455

If one of these good old machines won't accept tapes, replace both cassette switches to cure the problem. P.T.

### Aiwa HV-GX35

A very dim display is a common fault with this model. The cause is usually CP25 (1,000 $\mu$ F, 10V) in the power supply but, if you are unlucky, it can be fluorescent display itself. P.T.

### Sony SLV750HF

This VCR produced snowy playback pictures, though the sound was OK. As a first step I checked the drum for possible dirty or bad heads, but everything was OK in this respect. I then checked the head amplifier assembly and found that IC801 was the cause. A new IC restored clean pictures. C.B.

### Sony SLV825

The display disappeared when the PAL/NTSC switch was in the PAL position but was OK in the NTSC position. Capacitance meter checks on board MF167

revealed that C604 was the cause of the fault. This double-layer 0.22 $\mu$ F memory capacitor had started to leak on to the board. A quick board clean up and a replacement capacitor restored normal operation. C.B.

### Aiwa VX-G143K

This VCR was dead. I found that the STRF6707 chip IC501 in the power supply was faulty. Nothing else had failed. B.L.

### Akai VS105

Failure of the brakes to release in fast forward/rewind was cured by cleaning the mode switch. The fault with another of these machines was no RF or video output and no supply to the tuner. FR3 (0.3 $\Omega$ ) in the 18V supply was high in value. L.G.

### Amstrad UF30

This VCR wouldn't store channels. The cause was the X24C02P EEPROM IC6004. L.G.

### Alba VCR7300

According to its frustrated owner this budget VCR did all sorts of strange things. As usual, removal of the mode switch and a check inside showed what was wrong. Once it had been cleaned and retensioned, then refitted, the machine behaved normally. D.G.

### GoldStar T2631

This VCR was dead with no display. I removed the power supply can and checked the ESR of the electrolytics. True to form, they were all faulty. Once all eight had been replaced the machine sprang to life. To avoid comebacks, it's good workshop policy to replace every electrolytic capacitor in this power supply. D.G.

### Panasonic NVSD40

The complaint with this VCR was that it produced bad pictures. This was confirmed when I connected it to my monitor on the bench. Head cleaning proved fruitless, but I had in stock a replacement drum unit. Once this had been fitted the machine produced stunning pictures. D.G.

### Sanyo VHRH790E

This VCR remained dead after a power cut and no amount of blasting with a hairdryer produced any signs of life. When I removed the deck and PCB I found that one of the start-up resistors in the power supply, R60001 (270k $\Omega$ ), was open-circuit. A replacement brought the machine back to life. Beware of a fully-charged mains-rectifier reservoir capacitor. The other series-connected start-up resistor, R60007 (68k $\Omega$ ), is less likely to cause problems. M.McC.

**inStore**  
ELECTRICS LIMITED

171 HAREHILLS LANE, LEEDS LS8 3QE  
Tel: 0113 240 1114. Tel/Fax: 0113 240 7275.  
Mobile: 07976 403134  
Email: sales@instoreleeds.freeserve.co.uk

**PHILIPS**

14" PORTABLE FROM **£39.00**

\*

14" COMBI TV/VCR **£69.00**

\*

24" W/S TV FROM **£149.00**

\*

28" W/S TV FROM **£169.00**

\*

32" W/S TV FROM **£269.00**

\*

DVD PLAYERS FROM **£34.00**

\*

VCRS FROM **£34.00**

\*

AUDIO FROM **£34.00**

**PLEASE CALL FOR A STOCK LIST  
MANUFACTURERS GRADED PRODUCTS**

**Grandata Ltd**

distributor of electronic components

**Mobile Phone Wireless Handsfree Solution**



*Works in any car*

*Works with any mobile phone*

*NO cigarette lighter needed*

*NO Wires*

*NO Installation*

*Clip the wireless speakerphone to your sunvisor*

*Clip the wireless transmitter to your phone*

*Then your ready to drive with both hands on the steering wheel*

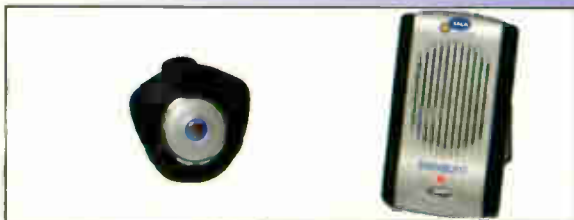

**Order Code : FONEFREE**

**Price : £ 16.00 + vat**

*See our 6 page advert for more Special Offers*

K.P. House , Unit 15 , Pop In Commercial Centre , Southway ,  
Wembley , Middlesex . HA9 0HB England  
Tel: (020) 8900 2320 Fax : (020) 8908 0120  
Email : sales@grandata.co.uk

**SPARES DIRECT**



**WWWhy go any-  
where else for  
Panasonic  
spares?**

From phones to cameras, home cinema systems to DVD players, Panasonic brings ideas to life. If you service or repair any of our products, we can make your life easier too, thanks to the new Panasonic Spares Direct website.

Specially developed for smaller companies who only need parts or advice occasionally but still want genuine discounts on guaranteed spare parts, it's now open for business

Register on the site now and you'll find the most competitive prices, on-line technical information and repair manuals, special offers and immediate part number identification.

It's fast, it's easy, it's trouble-free and it's the only place you need to visit when you need to service or repair any Panasonic product.

So why call us for spares when you can now visit us 24 hours a day?

Visit [www.panasonic-spares-direct.co.uk](http://www.panasonic-spares-direct.co.uk) for more information.

**Panasonic**

Panasonic CS UK  
Willoughby Road, Bracknell, Berkshire, RG12 8FP

[www.panasonic-spares-direct.co.uk](http://www.panasonic-spares-direct.co.uk)

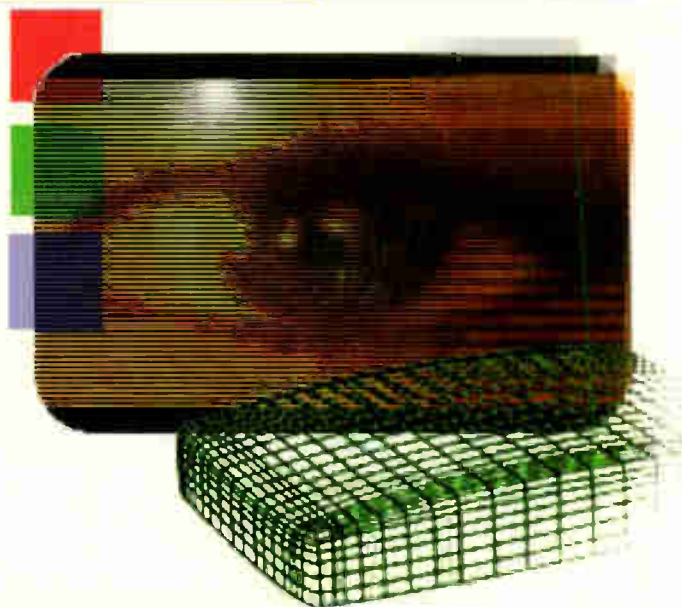

## TV FAULT FINDING

Reports from  
**Michael Dranfield**  
**Philip Salkeld**  
**Mike Leach**  
**Eugene Trundle**  
**Uel Harte**  
**M. Richardson**  
**Jerry Fedorak**  
**Bill Bolem and**  
**Gary Laidler**

We welcome fault reports from readers – payment for each fault is made after publication.

Reports can be sent by post to:

Television Magazine Fault Reports,  
 Highbury Business,  
 Media House,  
 Azalea Drive, Swanley,  
 Kent BR8 8HU

or e-mailed to:  
[t.winford@highburybiz.com](mailto:t.winford@highburybiz.com)

### Matsui 2107T

This set's power supply was tripping audibly. A check on the 2SC5250 line output transistor showed that it was slightly leaky. The cause wasn't obvious until I brought my x10 eyeglass into play: I could then see a ring around one leg of the line driver transformer. Resoldering plus a replacement transistor restored normal operation. M.D.

### LG KE14P2GX

This is a 14in. TV/VCR combi unit. If the fuse in the plug or the internal mains fuse blows every couple of weeks, replace the degaussing resistor TH801. It has a tendency to intermittent internal flashover. I've had this fault a few times now. M.D.

### Ferguson M51131 (TX807C chassis)

This set seemed to be dead, but voltage checks showed that there was 35V at the collector of the line output transistor. Cold checks revealed a dead-short rectifier, DP092 (MUR120), on the secondary side of the power supply. A replacement brought this eighteen-month old set back to life. M.D.

### Bush WS6674 (11AK37 chassis)

This set was dead with no LED display. The mains bridge rectifier's reservoir capacitor held its 330V charge when the set was switched off, a clear indication

that the fault was in the power supply. I noticed a couple of high-value resistors around the chopper IC, and when these were checked I found that RP06 (3.9M $\Omega$ , 0.5W) was open-circuit. A replacement brought the set back to life. It seems to be a popular model. P.S.

### Philips 28PW9536/05R (SMG7.1E chassis)

The complaint with this set was distorted sound from the right-hand channel. Interchanging the speakers made no difference. On the assumption that it was not an output stage fault, and having found that there was activity around the MSP3410D multiple sound processor chip IC7751, I decided to order a replacement. This 68-pin surface-mounted IC is a horror to change. Thankfully the replacement put matters right. P.S.

### Mitsubishi CT25AV1B (EE3 chassis)

The customer complained that the picture was too wide. On inspection I saw that there was an EW problem. Checks revealed a short-circuit reading across one of the EW modulator diodes, D506, but the diode itself was OK. Time to disconnect pins 4 and 5 of the TEA2031A EW correction chip IC551, where a short-circuit was found to be present. A replacement IC restored the scanning to its correct width. P.S.

### Toshiba 3339DB

The standby light was on but there were no other signs of life. A check at the HT fuse produced a reading of 60V, which indicates that the set is stuck in standby. This is a known fault, the cause being shorted turns in the line output transformer. In the past the cost of this item has been prohibitive, but I've noticed that Toshiba now stocks an equivalent, part no. 23236641, at a very reasonable price. It makes repair of this oldish set a sensible proposition. P.S.

### Philips 28PW6615/05 (MG1.1E chassis)

The customer said that the picture would flash red then went completely red. No surprise to find that the W66ESF002X14 tube was faulty. Fortunately it was insured. After fitting a replacement I was rewarded with sound and a raster. A check on the CRT base board showed that the TDA6108JF RGB output chip was running cold. Further checks revealed that the BAV21 diodes D6305, D6306 and D6307 (part no. 4822 1303080842) were all leaky, also the BAS216 diode D6310 (part no. 4822 13083757). To be on the safe side I also replaced the TDA6108JF chip,

part no. 9352 56140112. CRT flashovers can cause quite a lot of destruction. P.S.

#### **Bush WS6674 (PT92 chassis)**

Apparently the picture had become narrow then the set had shut down in standby. I found that the BY228 EW modulator diode DD07 and the BD680A driver transistor DV01 were short-circuit, while RV38 (2.2Ω) was burnt out. When I replaced these items and switched the set on it was back in the narrow-picture condition. After a few seconds RV38 started to overheat. When you get this situation, check CD08 and CD21 (both 680nF, 250V) with a capacitance meter. Replacement of one of these capacitors normally clears the fault. On this occasion however there was glue at the two legs of CD21. It effectively made CD21 open-circuit. All was well once this clear glue had been removed and the capacitor had been resoldered. P.S.

#### **Panasonic TX28PL4**

There was sound but no picture from the AV3 output. Otherwise the set worked perfectly. My first step was to carry out a self-check on the set, in case the micro-controller chip had been corrupted. The situation remained the same after doing this however. A look at the block diagram showed that the AV3 socket is fed from the video processor chip IC601. A replacement, part no. VDP3120BPPC2, put matters right. This IC has been a problem with many Panasonic models. P.S.

#### **Philips 25PT4103/05 (L6.2 chassis)**

This set was very slow to start up. It would come on only when it had been switched on for about five minutes. While it was thinking about rousing itself a loud hum came from the speaker, and I found that most of the voltages on the secondary side of the power supply were low. A drop of freezer and my trusty hairdryer helped with the diagnosis. The cause of the trouble turned out to be transistor Tr7501 (BF487) in the power supply. M.L.

#### **Hitachi C32WD2TN2 (A7 chassis)**

This large-screen set's power supply was constantly pumping. As there were no obvious shorts in the line output stage I disconnected D952 to remove the 26V supply to the audio output stage. The pumping then stopped, and inspection of the TDA7263 audio output chip IC4000 revealed a crack at the centre of the chip. I fitted a replacement, which went bang shortly after switch on. This time the set continued to run but there was no sound

from the right-hand channel. Two zener diodes in the audio output circuit were found to be faulty. ZD4002 (36V) and ZD4000 (12V). A couple of new diodes and another output chip restored the sound. M.L.

#### **Philips 14PT3685/05 (L9.3 chassis)**

It's great when you can relate what you learnt at technical college all those years ago to a fault with a modern-day receiver! The symptom with this set was a bent and rather curvy field collapse. I remember being told that the cause would usually turn out to be open-circuit field scan coils. Well, not quite. In this case it wasn't the coils themselves but an open-circuit connection in the scan-coil plug, which plugs into the main PCB. The crimping was poor and was easy to put right, providing a cheap cure. M.L.

#### **Sharp 37AM23H (5BSA chassis)**

Only snow was present on the screen, and I soon found that there was no voltage at the tuner's supply pin. A circuit diagram was required to follow the path of the supply to the tuner. In the process I found a leaky 3.3V zener diode, D211. A replacement restored life to the tuner and all was then well. M.L.

#### **Daewoo DTL25G7GB**

This set had poor and intermittent remote-control functions. It would sometimes be OK, and on others wouldn't appear to come out of standby. The LED would turn green however, but no line drive would be produced. When the set decided to work correctly a very loud buzzing and vibration came from the area of the chopper transformer. Prodding and poking in this area with an insulated, blunt instrument made no difference to the tone of the buzz. Bells started to ring in my empty, Monday-morning head, so I measured the voltage across the mains bridge rectifier's reservoir capacitor. The meter produced a reading of only 221V! A replacement 180μF, 400V electrolytic cured the evils mentioned above, and Monday suddenly didn't seem so bad after all! M.L.

#### **Daewoo T514 (CP365 chassis)**

If the complaint is intermittent picture fading or no picture from a cold switch on, check for bad solder joints in the tube's heater circuit – at pin 10 of the line output transformer and the motherboard plug pin it feeds. E.T.

#### **Sony KV36FS76U**

This is certainly a heavy set – it took four

of us to carry it into the workshop! The complaint was a rattling/whistling sound that came from within and whose loudness increased with the picture-tube's beam current. The line output transformer was the cause, the set running silently once a replacement had been fitted. E.T.

#### **Hitachi CPT2578 (G8Q chassis)**

How old does a TV set have to be before it gets kicked out of this column? This one clocks in at some fourteen years. The complaint was about an intermittent burping from the loudspeaker in the standby mode, with the two green LED bars flashing. The cure was to replace C908 (470μF, 25V) in the power supply. E.T.

#### **Tatung T20TD51 (D series chassis)**

We rent out a lot of Tatung TV sets that use this chassis and have got to know them very well. But it was the first time we'd had this fault. The 115V rectifier D809 was dry-jointed at both legs, the result being spasmodic shutdown. I also found that the soldering of crystal XL301 was suspect. This is a common complaint with the chassis. E.T.

#### **Philips 14PV320**

This TV/VCR combi unit produced the no-go symptom, though a subdued pumping noise came from the chopper transformer as a result of the operation of its excess-current trip. Checks showed that D6391 (BYW98-200) was short-circuit, though its series-wired fuse F1391 remained intact. E.T.

#### **Tatung T21TD50 (D series chassis)**

The picture had disappeared, though the sound remained. I found that resistor R427 (22Ω) was burnt and open-circuit, because the line driver transistor TR402 was leaky. It's advisable to fit a 2SD677C type in this position, in place of the original BC337, even though the lead-out configuration is different. E.T.

#### **Grundig P37-070 (CUC7301 chassis)**

This set seemed to be dead, but the power supply was tripping slowly. Checks on the primary side revealed that R667 (1Ω) had risen in value to 3.1Ω. As a precaution I also replaced R666, which is in parallel with R667. Note that the values can vary with different chassis. U.H.

#### **Bush DVD142TV (11AK46 chassis)**

This TV/DVD combi set had been purchased from a local supermarket less than

three months ago. But the owner had lost his receipt, and therefore wanted us to repair it. The red light would come on then, when the unit was switched on from standby, the green light appeared. But shortly afterwards the set reverted to standby. A check on the BU808DFI line output transistor Q602 revealed that it was leaky. So a replacement was fitted and all the associated circuitry was checked. The unit was then left to run for the rest of the day, with no problems.

The next day the original fault symptoms returned, but this time the line output transistor was OK. The cause of the problem was the MC44608P40 chip IC800 in the power supply – found by heating and freezing it.

To go into the service menu, first press menu on the remote-control unit then scroll down to install. Don't enter it; instead, press 4, 7, 2 and 5 on the remote-control unit. M.R.

#### **LG R128CZ10RX**

The first anode voltage was fluctuating, producing a very bright raster with fly-back lines. Checks on the tube base panel showed that R709 (220Ω) was open-circuit and C703 (10μF, 250V) leaky. M.R.

#### **Samsung WS28V53N**

This set was brought in because of lack of green in the picture. Both IC501 and IC502 (the red and green drive chips) on the CRT base panel had short-circuit pins, but the fault was still present when replacements had been fitted. Further checks showed that R508 (82kΩ, 0.25W) was open-circuit. M.R.

#### **Sony KV16WT1U**

The symptom with this new set was field collapse. In the past I've found dry-joint problems in the field output stage in Sony sets. Not this time however. So out with my trusty Avo to check the voltages at the line output transformer, where the 24V supply was missing. The dry-joint was at wire link L807, which was almost dropping out. Resoldering cured the fault.

I also found poor soldering at the rear scart socket. After dealing with this I gave the set a soak test to ensure that everything was OK. J.F.

#### **Sharp DV5940H (4BS-C chassis)**

This set was tripping, so checks were carried out in the line output stage where the 2SD1546 output transistor was found to be leaky. After fitting a replacement I checked the connections at the scan-coil

plug's socket, as this chassis suffers from problems here. After resoldering the socket I switched the set on and obtained a perfect picture. J.F.

#### **Philips 28PW6615/05**

When I tried this 28in. widescreen set the standby LED was flashing. Cold checks in the power supply revealed that the relay, circuit reference 1002, was intermittent. It's available from CPC as part no. PS280-10375. J.F.

#### **Fidelity CTV3128NF**

All this large set produced was a ticking noise. Tests showed that the BU2525AF line output transistor Q602 was leaky. There were also dry-joints at the tuning capacitors. Everything was OK once these problems had been attended to. J.F.

#### **Goodmans Compact 110**

There was no picture or sound, only the front red LED was on. When I checked the 12V supply to the line output stage I found that coil LH01 was open-circuit. It's located near the TDA3653A field output IC. A blob of glue on the track side of the PCB had hidden an open-circuit solder joint at the coil. Once it had been cleaned and resoldered the set worked normally. B.B.

#### **Philips 14PT1532/05 (L6.1 AA chassis)**

There was lack of height and foldover, and R3405 was burning. The cause of the fault was the surface-mounted capacitor C2404 which was leaky. Once I'd replaced these two components the set worked correctly. B.B.

#### **Black Diamond BD14T (11AK20S chassis)**

This set was dead with the mains fuse blown. On initial investigation I couldn't see anything else wrong – the MOSFET chopper transistor and its control chip were both OK. By chance I then noticed that the blue disc-type capacitor C808 was split open. A replacement plus a new fuse restored normal operation. U.H.

#### **Philips 14PT2002/05 (L01.2E chassis)**

There was no sound. I initially thought that the set might be in the wrong sound standard, but checks on the menu and option codes proved fruitless. Close inspection of the surface-mounted jungle chip IC7200 showed that several of its pins were poorly soldered. A complete solder reflow cured the fault. U.H.

#### **Sharp 51DT25H**

Strange noises came from the line output stage in this set. A quick check showed that L604 had been overheating. The cause of the trouble was D604, which was short-circuit. U.H.

#### **Daewoo GB20C5NTS (CP185 chassis)**

This set became a bit of a nightmare to repair. The fault was stuck in standby, with the standby LED flicking slowly between green and amber. My initial suspicion was a fault in the line output stage, but there was nothing obviously wrong here and a new output transformer, also a new field output IC, made no difference.

Attention was then turned to the microcontroller chip. Clock and data pulses were present, and the supply voltage was correct. A scope check at reset pin 60 showed that it didn't toggle at switch on. When I disconnected pin 60 the set came back to life. A replacement microcontroller chip cleared the fault. Note that the new version 2 should be fitted, and that the EPROM should be replaced at the same time. Remember to adjust the tuner option codes after fitting the replacements. U.H.

#### **Technosonic Q7 text**

The fault report with this Amstrad-based portable said "small picture". A check on the HT voltage at the cathode of D511 produced a reading of only 85V instead of 110V. The usual culprits in this situation are C508 and C509 on the primary side of the power supply. This time they were OK, but I fitted replacements to be on the safe side. The actual cause of the fault was the 330μF, 160V HT smoothing capacitor C517. A replacement cleared the fault. U.H.

#### **Schneider STV2802T**

I am used to line output transformer failure with these sets. The problem with this one however was bad EW distortion. Once the back had been removed the cause was obvious from the state of C313 (12μF, 100V – strange value). A replacement restored correct scanning. G.L.

#### **Goodmans 286NS (Philips L6.2 chassis)**

The only sign of life with this set was a faint whistle from the line output stage. An ohmmeter check across the output transistor produced a dead short reading, which is what you usually find with these sets. But the transistor itself was OK, the cause of the fault being C2912 (2.2nF, 2kV) which was short-circuit. G.L.



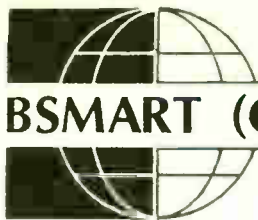

**BSMART (CRAWLEY) LTD**

**Largest selection  
of**

**MAJOR MANUFACTURERS  
NEW "B"  
GRADE PRODUCTS**

**T.V. VIDEO AUDIO  
MICROWAVE OVENS**

**Contact Paul Bean**

BSMART (CRAWLEY) LTD.  
10/11 LLOYDS COURT, MANOR ROYAL,  
CRAWLEY, SUSSEX RH10 2QX

Tel: (01293) 618000  
Fax: (01293) 400133

# Campion Electronics Ltd.

**SUPPLIERS OF QUALITY  
EX-RENTAL TV'S**

and video equipment to independent  
retailers across the UK and EIRE.

**FREE DELIVERY SERVICE**  
to most areas of UK

**WORLDWIDE EXPORT SERVICE**  
Large stock of TVs suitable for export  
Experts in UHF/VHF conversion

Visit our large warehouse at:

**Units 1 & 2 Tenat Works,  
Worcester Rd, Kidderminster,  
Worc, DY10 1JR**

**Tel: (01562) 746000 (2 Lines)**

**Just 20 miles from Birmingham City Centre**

## PERIFELEC

MC 30 A Spectrum Analyser



- Synthesized satellite cable and TV field strength meter with panoramic reception on 14 cm (5.5") screen and digital carriers measurement
- Complete microprocessor and ispLSI logic control.
- Continuous frequencies from 46 to 860 MHz and from 920 to 2150 MHz on 4 bands.
- Selectable 1, 1 and 0.2 MHz spectrum band-width, picture measurement 1 MHz.
- Display of picture of selected synthesized channel.
- FM (Radio) L/L, B/G, I, D/K/K, M/N TV standards and Ku and C satellite standards.
- Possibility of 32 programs memorized per frequency band.
- Display (2 lines of 16 characters).
- Range of measurement of signal strength from 20 to 120 dBµV, manual or automatic attenuator.
- Battery life about 1 hour 20 minutes, weight 5,8 Kg

- Display of full-band and 4 possible expanded spectrums.
- Channels and frequency plans of cable and TV standards memorized.
- Frequency, signal strength in dBµV or bargraph, displayed on a digital display (2 lines of 16 characters).
- Voltage of remote power supply in 14v or 18v and 22 KHz in satellite → DiSeq C™ v1.2 switching.

The panoramic field strength meter MC30A combines in one instrument all the functions necessary for installing and checking TV or satellite reception, both analogue and digital. The visualization of the spectrum and the picture allows the carrying out of all the necessary adjustments with this one instrument. The high technology used in the MC30A allows a range of possibilities unheard of in a instrument in this price category.

### Lacuna Digital Satellite Meter

A custom designed, small  
lightweight ABS case,  
created with the  
installer in mind



- Signal strength and BER will be displayed together
- Identifies the chosen satellite
- Signal strengths and BER settings calibrated facility for mic calibration by distributor
- Removable 'F' connector
- USB short circuit protection and LNB power supply
- Compatible with all satellite transmissions in Ku and C band, DVB and DSS

### NEW Lacuna Terrestrial Digital Meter

Small, lightweight custom designed for  
terrestrial digital installations

- Identifies transmitter
- Measures signal strength, carrier/noise and BER
  - UHF / VHF
- Analogue and digital measurement
- Removable 'F' connector
- 4 line LCD with backlight
- Weight including batteries 600g
- 12v line power facility



Full catalogue of  
meters available,  
please phone for  
details.

## COASTAL AERIAL SUPPLIES

Unit X2, Rudford Industrial Estate, Ford, Arundel BN18 0BD  
Telephone: 0870 2641990 Fax: 0870 264 1991

Perifelec  
Sole Import  
Distributors

## FRUSTRATED!

Looking for ICs TRANSISTORS?

A phone call to us could get a  
result. We offer an extensive  
range and with a World-wide  
database at our fingertips, we are able  
to source even more. We specialise in  
devices with the following prefix  
(to name but a few).



2N 2SA 2SB 2SC 2SD 2P 2SJ 2SK 3N 3SK 4N 6N 17 40 AD  
ADC AN AM AY BA BC BD BDT BDV BDW BDX BF  
BFR BFS BFT BFW BFX BFY BLY BLX BS BR BRX BRY BS  
BSS BSV BSW BSX BT BTA BTB BRW BU BUK BUT BUY  
BUW BUX BUY BUZ CA CD DX CXA DAC DG DM DS  
DTA DTC GL GM HA HCF HD HEF ICL ICM IRF J KA  
KIA L LA LB LC LD LF LM M M5M MA MAB MAX MB  
MC MDA J MJE MJF MM MN MPS MPSA MPSH MPSU  
MRF NJM NE OM OP PA PAL PIC PN RC S SAA SAB  
SAD SAJ SAS SDA SG SI SL SN SO STA STK STR STRD  
STRM STRS SVI T TA TAA TAG TBA TC TCA TDA TDB  
TEA TIC TIP TIPL TEA TL TLC TMP TMS TPU U UA  
UAA UC UDN ULN UM UPA UPC UPD VN X XR Z ZN  
ZTX + many others

We can also offer equivalents (at customers' risk).  
A LARGE RANGE OF ELECTRONIC COMPONENTS ON  
OUR CD ROM - LIST AVAILABLE ON REQUEST  
Mail, phone, Fax, Credit Card orders & callers welcome.



## Cricklewood Electronics Ltd

40-42 Cricklewood Broadway, London NW2 3ET

Tel: 020 8452 0161 Fax: 020 8208 1441

www.cricklewoodelectronics.co.uk

E-mail: sales@cricklewoodelectronics.com

# TELEVISION BOOKS

AND HOME ELECTRONICS REPAIR

The Television Book Service offers access to our team of specialist publishing experts. We can order any book or CD-ROM currently in print from *War And Peace* to the *Newnes Guide to Television and Video Technology*. All books are delivered free of charge within the UK unless otherwise stated. Contact us at the numbers below:

Telephone: **01737 812727** or **01737 812676**

Fax: 01737 813526

Email: [salesteam@boffinbooks.demon.co.uk](mailto:salesteam@boffinbooks.demon.co.uk)

## DVD PLAYERS AND DRIVES

**K F Ibrahim**  
(College of North West London)

This text is based on hands-on experience and acts as a guide to DVD technology and its application, with a special focus on design issues. The principles of the subject are introduced from the basics, and DVD applications are illustrated by genuine technical information.

Aug 2003 ▲ 256 pages ▲ Glossary ▲ Index  
PB ▲ Published in UK

Code 0-7506-5736-7

£24.99



## ELECTRONIC CLASSICS: COLLECTING, RESTORATION AND REPAIR

**Andrew Emmerson**

This text encompasses all aspects of buying, collecting, restoring, repairing, sourcing parts, professional services, clubs and societies. The first part covers technical aspects of restoration and details where components can be found; the second presents useful information for collectors.

Aug 1998 ▲ 256 pages ▲ Index  
10 half-tones ▲ 50 line illustrations ▲ PB  
Published in UK

Code 0-7506-3788-9

£21.99



## CLOSED CIRCUIT TELEVISION: CCTV INSTALLATION, MAINTENANCE AND OPERATION

**Joe Cieszynski**

CCTV surveillance is one of the fastest growing areas in the security industry, and this is a thorough guide to the technical side of CCTV – including installation, maintenance, video recording, cameras and monitors. The second edition is fully dual-standard for PAL and NTSC systems.

2nd edition ▲ Sept 2003 ▲ 256 pages  
Glossary ▲ Index ▲ PB ▲ Published in UK

Code 0-7506-5728-6

£24.99



## DICTIONARY OF VIDEO AND TELEVISION TECHNOLOGY

**Jack Tsatsoulis**

This work provides comprehensive and contemporary information on the essential concepts and terms in video and television, including coverage of test and measurement procedures. The CD accompanying the text includes an electronic version of the book.

Sept 2002 ▲ 365 pages & CD-Rom  
Published in UK

Code 1-878707-99-X

£29.99



## INTRODUCTION TO DIGITAL SYSTEMS

**John Crisp**

This self-study text introduces digital electronics from first principles, before going on to cover all the main areas of knowledge and expertise. It covers the practicalities of designing and building circuits, including fault-finding and the use of test equipment.

Feb 2000 ▲ 302 pages ▲ Glossary ▲ Index  
PB ▲ Published in UK

Code 0-7506-4583-0

£18.99



## NEWNES DICTIONARY OF ELECTRONICS

**S W Amos; R S Amos**

Aimed at engineers, technicians and students working in the field of electronics, this dictionary provides clear and concise definitions, including TV, radio and computing terms, with illustrations and circuit diagrams.

4th edition ▲ Mar 2002 ▲ 394 pages  
100 illustrations ▲ PB ▲ Published in UK

Code 0-7506-5642-5

£12.99



## NEWNES GUIDE TO TELEVISION & VIDEO TECHNOLOGY

**Eugene Trundle**

An exploration of television and video technology. It covers the fundamentals of digital television (satellite, cable and terrestrial) and digital video, as well as providing a grounding in analogue systems.

3rd edition ▲ Feb 2001 ▲ 432 pages ▲ Index  
PB ▲ Published in UK

Code 0-7506-4810-4

£17.99



## NEWNES GUIDE TO DIGITAL TV

**Richard Brice**

Covering all aspects of digital television, this text encompasses the electronics of the equipment, data compression, television production, servicing and the different transmission methods - terrestrial, satellite and cable. The text has been updated with developments since the 2000 edition.

2nd edition ▲ Oct 2002 ▲ 304 pages ▲ Index  
45 illustrations ▲ 15 photographs ▲ HB  
Published in UK

Code 0-7506-5721-9

£24.99



## PRACTICAL ELECTRONIC FAULT FINDING AND TROUBLESHOOTING

**Robin Pain (Design Engineer, Cotag International Ltd)**

A text using simple circuit examples to illustrate principles and concepts fundamental to the process of analog and digital fault finding. It aims to help the reader tackle any job, from fixing a TV to improving the sound of a hi-fi. A digital multimeter and oscilloscope are needed for these jobs.

Apr 1996 ▲ 284 pages ▲ Index  
50 line illustrations ▲ PB ▲ Published in UK

Code 0-7506-2461-2

£21.99



## PRACTICAL ELECTRONICS HANDBOOK

**Ian Sinclair**

A collection of all the key data, facts, practical guidance and circuit design basics needed by a spectrum of students, electronics enthusiasts, technicians and circuit designers. It provides explanations and practical guidance, and includes new sections on SHF techniques and intruder alarms.

5th edition ▲ Feb 2000 ▲ 571 pages  
Illustrations ▲ PB ▲ Published in UK

Code 0-7506-4585-7

£16.99



## RSGB RADIO & ELECTRONICS COOKBOOK

**Radio Society of Great Britain**

Only a basic knowledge of electronics is assumed for this collection of electronics projects, and it is ideal for all electronics and DIY enthusiasts and experimenters. Designed by the RSGB, the UK radio amateurs federation, the projects are clearly explained step by step.

Nov 2000 ▲ 336 pages ▲ PB ▲ Illustrations  
Published in UK

Code 0-7506-5214-4

£17.99



## REFERENCE DATA FOR ENGINEERS: RADIO, ELECTRONICS, COMPUTERS AND COMMUNICATIONS

**Max E Van Valkenburg; Edited by Wendy Middleton**

Written by professionals for professionals, this is a complete reference for engineers. As well as addressing radio technology data, it covers digital electronics, computers and communications.

9th edition ▲ Aug 2001  
1568 pages & CD-Rom ▲ 1385 line illustrations  
HB ▲ Published in UK

Code 0-7506-7291-9

£90.00



## SERVICE ENGINEER'S POCKET BOOK

**Lewis & Sinclair**

This title aims to provide the service engineer with all the necessary information to carry out work on domestic electronics equipment. The coverage ranges from satellite reception to NICAM. Both analogue and digital equipment are covered, and there are chapters on common problems.

Jan 1998 ▲ 238 pages ▲ HB

Code BUTO-7506-3448-0

£14.99



## SERVICING TV, SATELLITE & VIDEO EQUIPMENT

**Eugene Trundle**

A practical hands-on guide for service engineers, installation technicians and servicing students, this text emphasises the practical business of fault diagnosis and repair of TV, satellite and video equipment.

Revised 2nd edition ▲ Nov 2001 ▲ 336 pages  
Symptom index ▲ PB ▲ Published in UK

Code 0-7506-5507-0

£21.99







# SATELLITE NOTEBOOK

Reports from  
**Christopher Holland**  
**Hugh Cocks and**  
**Michael Dranfield**

**Recording satellite radio on CD**  
 I like to record radio programmes on a CD from time to time, in particular for listening to in the car. It's handy if the CD player accepts rewriteable audio CDs (not all

of them do), as these can be recorded over and treated in much the same way as tape. Recording can be done using the PC-based satellite receiver I've mentioned several times over the past few months, though a couple of intermediate steps are required before a recorded file can be transferred on to a CD.

When the satellite radio programme is stored on the hard disk it will be in MPEG-1 Layer 2 format (MP2), with sampling at 48kHz. This has to be converted to a Wave file with sampling at 44.1kHz before it can be accepted by a CD recording program such as Nero 6.

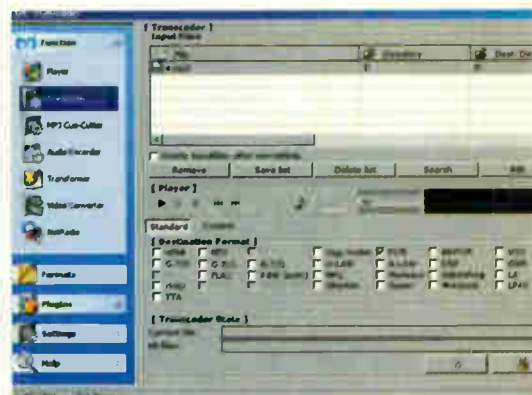

Photo 2: The GX::Transcoder program.



Photo 3: The Cool Edit Pro program.



Photo 4: The BT Tower caption.



<http://www.germanixsoft.de>

Lade Einstellungen ... / Loading defaults ... ... check cli encoders

Photo 1: The GX::Transcoder program.



Photo 5: The facility line caption.

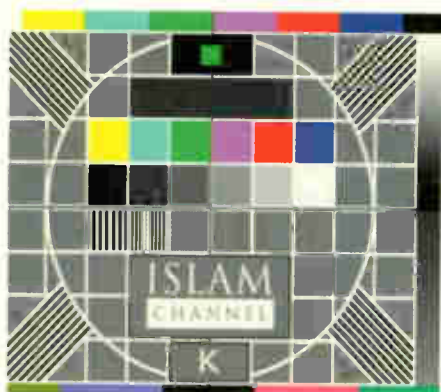

Photo 6: The Islam TV test pattern.

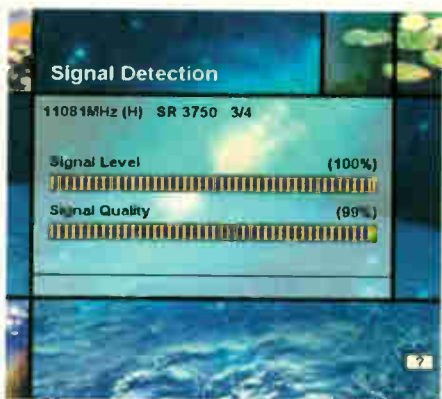

Photo 7: Exatel test signal from Express AM22.



Photo 8: Test KRT signal from Express AM22.



Photo 9: Ukraina I Mir from Express AM22.

Table 1: Latest digital channel changes at 28-2°E

Channel and EPG no.	Sat	TP	Frequency/pol
Bollywood TV (844)	EB	D7S	11-588GHz/H
BT Tower caption*. See Photo 4	2A	14	11-973GHz/V
Facility line*. See Photo 5	2A	14	11-973GHz/V
Golf TV Pro Shop	2B	36	12-402GHz/V
Islam TV (836). See Photo 6	EB	D11S	11-662GHz/H
Liberty Radio (936)	2B	36	12-402GHz/V
Yarr Radio (937)	2B	32	12-324GHz/V

\*Receivable only with non-digibox receivers at the time of writing.

TP = transponder. EB = Eurobird. 2A/B = Astra 2A and 2B.

While Nero is happy converting the more familiar MP3 type file into a Wave file it can't cope with an MP2 file. A useful free program called GX::Transcoder that will convert MP2 files to Wave format is available from [www.germanixsoft.de](http://www.germanixsoft.de) (see Photos 1 and 2). It will also convert MP2 files to MP3, which is useful for portable audio players that may not play MP2 files, though I have no experience of this. The program is unfortunately a large download, at about 17MB.

If the satellite receiver program has saved the recorded programme as an MPA file, alter it to an MP2 file as the audio transcoder doesn't know what an MPA file is! This is easily done by right-clicking on the mouse once the file icon has been selected, then going to the rename option and changing the A to a 2. Ignore the Windows warning message that the file may become unstable if you proceed with the change. When the file has been converted to Wave format it will still be with 48kHz sampling but, once you've transferred the file to the Nero recording program, it will be changed to 44.1kHz sampling. That's helpful!

Another program that will do all the conversion is Cool Edit Pro, see Photo 3 – it was mentioned recently in the letters pages. The company that made this program has been taken over by Adobe, and the program is now known as Adobe Audition. Cool Edit doesn't mind whether the stored file is MP2 or MPA, but the option of extracting the audio from a video file has to be selected rather than opening the file in the conventional manner.

Cool Edit is also useful for enhancing the sound track of stored off-air TV programmes prior to recording them on to a DVD, as described last month. After adjusting the audio characteristics, save the file as an MP2 type which can then be transferred to the DVD Lab authoring program. It's most important not to alter the length of the file, as it would be out-of-

sync with the MPV file.

If you wish to save anything in MP2 format using Cool Edit Pro, a DLL file has to be added to the program. It's available free and was part of a much older version of Cool Edit, being discontinued in the up-to-date versions of the program. You can find the DLL add-in, as I did, by doing an internet search with Google or a similar search engine: type in Cool Edit MP2. You are immediately directed to the right place, with directions of how to install it as well.

Another way of making an audio CD is to use the Cool Edit Pro program to store directly on the hard disk any audio that's coming from the sound card. Prior to storage, a new file has to be created: remember, when prompted by the program, to set the audio sampling rate at 44.1kHz. Once you've stored the material and carried out any editing, save it as a Wave file. It can then be transferred to the CD recording program. H.C.

### Digital channel update

The latest channel additions at 28-2°E are listed in Table 1. Where allocated, the EPG number is shown in brackets after the channel name.

Towards the end of March a lot of the channels in the EPG range 100-200 were renumbered. Table 2 shows the revised listing. C.H.

### Express AM22 (53°E)

This month we'll take a look at the transponder activity aboard the recently launched Russian Express AM22 satellite at 53°E. Though the satellite has a relatively low elevation angle, it provides very strong Ku-band signals in Western Europe. Eutelsat recently announced that it would be leasing some transponder space on the satellite, which is so far relatively little used. At present only two transponders are being used for TV, though this should increase somewhat in the near future.

In early April there were tests labelled

**Table 2: Revised EPG channel numbers**

136	Men and Motors	181	Avago
139	Sky Travel	184	BEN
140	Sky Travel Extra	187	Reality TV
142	UKTV Style	190	Hallmark (no change)
143	UKTV Style Plus	193	E! Entertainment
144	UKTV Food	196	UKTV Bright Ideas
145	UKTV Food + 1	199	FTN
146	UKTV Drama	202	Performance Channel
148	Travel Channel	205	Rapture TV
149	Travel 2	208	Friendly TV
151	Ch. 4 Wales/S4C Digital*	211	ACTV
154	Discovery Health	214	Live TV
157	Arts World	217	Game Nation
160	Life TV	220	Fashion TV (no change)
164	E4 + 1	223	OBE
166	Overload	226	Game In TV
169	BBC1 (Ireland)**	229	Biography Channel
170	BBC2 (Ireland)**	232	Hollywood TV
172	Game Network	247	Classics TV (no change)
175	ITV2	289	FX (no change)
178	You TV	295	Sky Vegas Live (no change)

\*With viewing cards registered at a Welsh address Channel 4 is now on EPG no. 151 and S4C on EPG no. 104.

\*\*In Ireland BBC1 and BBC2 Northern Ireland are on EGP nos. 169 and 170 respectively.

**Table 3: Signals received from Express AM22 at 53°E**

Frequency/pol	SR	FEC	Service
10.978GHz/H	8,888	3/4	SGU TV1 and TV2. See Photos 10, 11
11.081GHz/V	3,750	3/4	Exatel tests, Ukraina I Mir



Photo 10: SGU TV1 from Express AM22.



Photo 11: SGU TV2 from Express AM22.

Exatel at 11-081GHz V. Strangely, the main on-screen picture consisted of a tuning menu from a Humax satellite receiver, see Photo 7. It showed the signal strength of the downlinked signal, though the polarisation was given as horizontal instead of the correct vertical! After a period the transmission changed to a Russian channel called KRT, see Photo 8, complete with hum bars and with no sound. After a few hours the tests stopped, but several days later a channel called Ukraina I Mir started to be transmitted, with the same signal characteristics. See Photo 9. Table 3 shows the signals received to date. H.C.

### Panasonic TU-DSB31

The customer complained about picture break up. When I ran his digibox in the workshop for a couple of days it was OK, but the picture break up started again as soon as it was returned. In view of this I advised him to get the LNB checked. He did so, and in fact had the LNB and cable run replaced. But the fault remained. So the digibox came back to the workshop, where again it worked correctly. I suggested sending the digibox back to Panasonic, which runs an exchange scheme – you never get the same box back, which is handy if there's a nasty intermittent fault.

I eventually managed to get a replace-

ment and tested it in the shop for a day. It was fine. But ten minutes after the customer collected it he phoned to say that the picture was still breaking up. So the aerial installer was asked back to recheck the dish and LNB, which he said were fine. After more messing about I obtained another digibox from Panasonic, but the fault was still present. Yet another digibox was obtained from Panasonic. Each one worked all right at the shop, but not at the customer's house.

I then lent the customer two stock Panasonic digiboxes, a TU-DSB30 and a TU-DSB35. The former worked perfectly at the customer's house but the DSB35, which looks the same as the DSB31, produced break up.

The customer decided to phone Sky for advice, and was told to switch the output from RGB to PAL. Much to my and his amazement, this cured the break-up problem. But he had just bought an expensive 32in. set, and wanted the better picture quality that RGB output provides.

By now I could see that this was a factory problem, and that no matter how many new DSB31 or DSB35 digiboxes were tried the problem would remain. I managed to speak to the Panasonic service manager in the workshop. He confirmed that there was a design fault, and said that there was nothing Panasonic or I could do. He suggested replacing the DSB31 with the later DSB50 model, to which I agreed, but later came back to say that his boss had vetoed this and all he could do was to refund the money I had paid for the exchange.

By now the customer was getting really

angry. So I gave him the Panasonic service manager's phone number to see if he could sort the problem out. When the customer reported back to me the bottom line was that Panasonic knew about the problem but was not prepared to provide a newer replacement model. At least the customer knew that it wasn't my fault!

I then spoke to John Glenton at MCES about the problem. He said they had come up with a modification to cure it, and that if I sent him the tuner he would carry out the modification. I couldn't for the life of me see how a modification to the tuner would cure picture break up in the RGB mode but, clutching at any straw, I decided to give it a go. When the tuner came back I fitted it and let the customer try the box. A couple of days later, to my amazement, he said that the fault had been cured.

According to John Glenton the current drawn by the RGB output can affect the tuner, causing intermittent picture break up. I can only assume that the video output chip and the tuner are fed from the same supply line, and that this is how the faults are related. Anyway the customer went away happy, more so because I had repaired his digibox when Panasonic had told him that nothing could be done. But the credit has to go to John Glenton at MCES, without whose help repair would not have been possible. You can contact

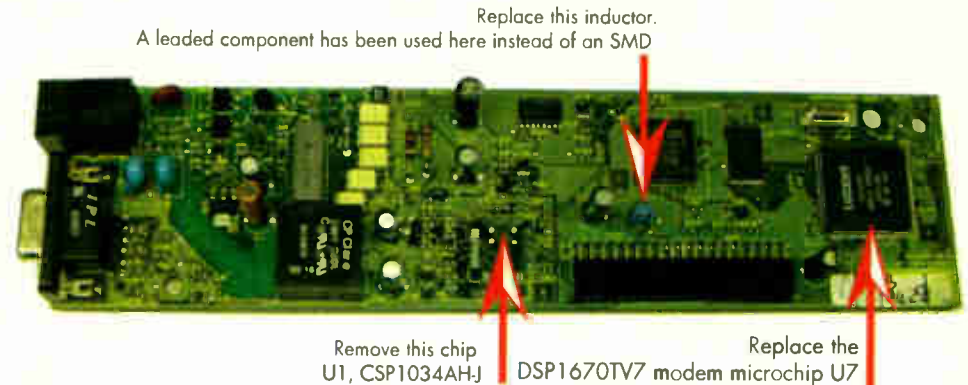

Fig. 1: Work required on a lightning-damaged Grundig GDS series modem PCB to restore digibox operation without the interactive facility.

MCES on 0161 746 8037, or alternatively email sales@mc.es.co.uk M.D.

### Grundig GDS series modem board

When the modem in one of these digiboxes has been affected by a lightning strike the box will be stuck in standby with the red LED flashing. As the microcontroller chip has to communicate with the modem before the box will come on, leaving the modem board out won't help. In my experience so much damage is caused to the line side that the modem board cannot be repaired economically.

All may not be lost however. Many customers don't use the interactive services and, if these are not required, it's possible to

get the modem board up and running so that the box will work though the modem side is dead. First replace the DSP1670TV7 modem microcontroller chip U7. Then check the 100µH surface-mounted inductor L5. If it's open-circuit, the CSP1034AH-J line interface driver chip U1 is faulty. As this will no longer be required, remove it from the PCB. Replace L5 with virtually any RF choke that has a DC resistance of about 1Ω or less. Fig. 1 shows the work required.

In 99 per cent of cases this action will restore communication between the modem board and the main microcontroller chip, and the result will be a working digibox without interactive services. M.D.

## Grandata Ltd

distributor of electronic equipment

### Universal Remote Control with Menu



Operate upto 8 devices

Comes with a menu function

Operates ON Digital, Sky™ Digital and most of all major brands

Available as a Box of 10

**Order Code : RC81**

**Price : £ 35.00 + vat**

(£ 3.50 + vat each)

Carriage charged at £ 5.00 + vat

### 2 Stroke 850W Electricity Generator

Ideal for powering Small Power Tools, Lighting ...etc

Small, Compact & Lightweight

Quiet Running (65dB at 7 metres)

Overload Circuit Breaker

5.8 Hours Running Time

Anti - Vibration Feet

4 Litre Fuel Tank

BS Output Socket

Carrying Handle

Recall Starter



**Order Code : G850**

**Price : £ 100.00 + vat**

Carriage charged at £ 5.00 + vat

K.P. House, Unit 15, Pop In Commercial Centre, Southway, Wembley, Middlesex. HA9 0HE England

Tel: (020) 8900 2329

Fax: (020) 8903 6126

Email: sales@grandata.co.uk



**Almost everything you need for your business under one mouse**

CPC have over 100,000 top quality products online, ranging from spares and components to computing, audio, video, cables, connectors, electrical, security components, tools, in the work place and test equipment all available in just two clicks.

[www.cpc.co.uk](http://www.cpc.co.uk)



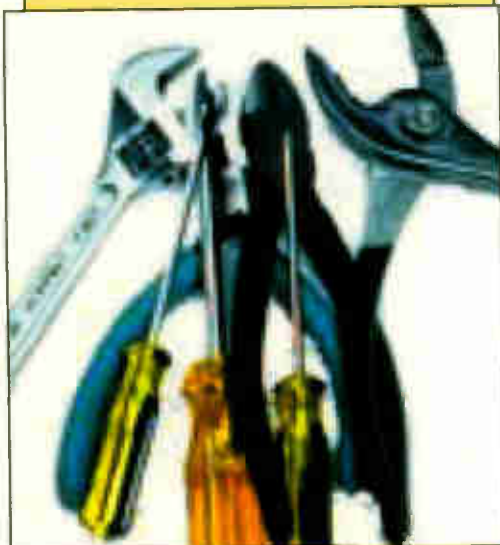

## Service Casebook

Michael Maurice

### Sony KV29LS30U

All that happened when this set was switched on was that the standby LED started to flash. These sets are heavy beasts, and I didn't relish the thought of having to take it back to the workshop. Checks showed that the HT supply came up when the set was brought out of standby, but was low at about 90V instead of 135V. I carry an oscilloscope in the car, and by checking at the collector of the line output transistor I could see that all was not well. The most likely suspect was the line output transformer. I returned next day with a replacement and fitted it. The set produced a good picture once the focus had been adjusted.

### Mitsubishi CT2125TX

The complaint with this set was poor text reception, especially BBC2 Ceefax. Whenever I get one of these sets in I replace all the electrolytic capacitors in the power supply. Most of them were leaking. Once replacements had been fitted the set worked very well – including BBC2 Ceefax.

### Matsui 32WN01

This set was actually badged Philips. So, when the customer phoned me up and told me that it was dead apart from a flashing red light, I had an idea that the cause could be one of those little blue disc capacitors. Unfortunately on test I found that the line output transistor and transformer had both failed. I managed to obtain replacements next day and, once they had been fitted, I was rewarded with a good picture.

### Toshiba 2939DB

This set had no sync. The cause turned out to be the clock crystal associated with the text module, ZT01. A replacement cured the fault.

### Hitachi C1709T

The picture was very, very green. In fact there was simply no red or blue. The usual cause of loss of one or more colours is failure of the relevant BF459 RGB output transistors on the CRT base PCB. Not this time however. After carrying out further checks, in the workshop, I came to the conclusion that the cause of the fault lay in the TA8690AN jungle chip. A replacement confirmed this diagnosis.

### Toshiba 2505DB

I was told that there was intermittent loss of colour and found that there was a black-and-white picture. The set had received attention from a local cowboy, who had told the customer that there was a bad connection, probably broken print, and that tracing it would be impossible. He had carried out a makeshift repair by wedging the

PCB with the scart sockets against another module. This had worked – for about twenty minutes – then failed, leaving the customer £35 worse off and still with no colour.

I took the set back to the workshop and checked with the circuit diagram. Chroma and luminance separation, also input switching, are carried out on the scart PCB. I removed this PCB and looked for dry-joints. There were several at the connectors that plug into the main PCB, especially the one for chroma out. Resoldering provided a complete cure. Shame on that cowboy!

Incidentally our local main library has all the U-View circuit books – it's where I found the circuit diagram for this set.

### Philips 20CT4636

This elderly set appeared to be dead except for a flash from the standby light. The cause turned out to be the TDA3576B timebase generator chip. I managed to obtain a replacement, which restored normal operation.

### Finlandia C66HZ6 (Salora M chassis)

This set was totally dead, with the mains fuse blown and the chopper transistor short-circuit. I found that the plastic holders which retain the degaussing coils and the Aquadag earthing braid had cracked. As a result the braid had come off and shorted out the heatsinks.

I decided to take this set back to the workshop, partly because it needed a service and also because I feared that it might be a complicated repair. To start with I replaced the chopper transistor and the 15V zener diode that's connected between its base and emitter. The replacements went short-circuit at switch on. I had to hunt round for someone who had an LF0070D hybrid chopper drive IC, but eventually found one. I also replaced the small electrolytic capacitors on the primary side of the power supply, and many on the secondary side. Fortunately the set then worked.

The pictures produced by these sets have always been excellent. I wonder how many of today's sets will be working reliably with good CRTs in 13 years' time?

### Panasonic TX25MD1 (Euro 2 chassis)

The customer complained that she couldn't receive the 'cable channel', though she could with her portable TV set. It was an old analogue cable system, with the output from the terminal on ch. 52. The problem was that the set's tuner was failing. As I carry these in stock it didn't take long to fit a replacement. A check with the customer next day proved that all was well.



# WEB SERVICE

To reserve your web site space telephone  
 Tel: 01322 611289 Fax: 01322 616339  
 E-MAILS [L.Baldock@highburybiz.com](mailto:L.Baldock@highburybiz.com)



## Alban Electronics

<http://www.albanelectronics.co.uk>

Alban stocks, supplies and provides technical support for a range of terrestrial/cable/satellite and analogue/digital TV equipment. PROMAX (manufacturers electronic test equipment including signal level meters, spectrum analysers, BER/CSI/MER analysers for QPSK, QAM & COFDM, optical fibre light sources and power meters, 16:9 test pattern generators), ALCAD (manufacturers of R.F. wide band and adjacent channel amplifiers, aerials for MATV, SMATV & IRS systems) and ANTARES (cascadeable multi-switches). ALBAN has a complete after sales repair and calibration service that is fully supported by the manufacturers, in addition provides a free system design service using only reliable high quality components.



## Alltrade Aerial & Satellite Ltd

<http://www.alltrade.co.uk>

Leading distributor to the trade Full e-commerce site with over 1500 products with in-stock quantities!! We supply everything associated with Digital/Analogue Terrestrial & DTH/Motorised Satellite reception. All Antennas. All Brackets. All Cables. All Connectors. All Amplifiers. We provide a free MATV/SMATV planning service as well. Phone 0845 075 0751 Fax 0870 770 9151

## Charles Hyde & Son Ltd

<http://www.charleshyde.co.uk>

Search for both original and copy spare parts in our extensive database covering Akai, Alba, Bush, Ferguson, Goldstar, Hitachi, LG, Matsui, Nokia, Saisho, Sanyo, Sony, Sharp, Thomson, Panasonic, Philips, Samsung, Tascam, Teac, Toshiba, Yamaha and many more. In addition huge ranges of Lasers, Lopts, Remote controls and Semiconductors may be accessed.

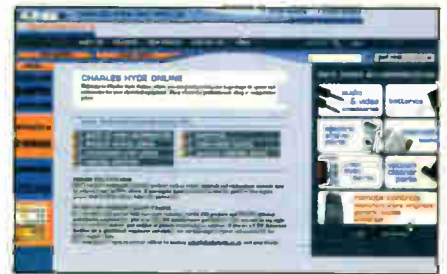

## Repairhelper's - Storefinder UK

[www.storefinder.repairhelper.co.uk](http://www.storefinder.repairhelper.co.uk)

We specialise in promoting electronic repair services throughout the Internet. It's a well known fact that the Internet is the fastest growing advertising medium today but the majority of repair companies and repair engineers are not making use of the Internet to gain more custom. Repairhelper's Storefinder is a UK Search Engine dedicated to the electronic repair trade (i.e. TV, VCR, DVD repair etc). Sign up with Repairhelper's Storefinder - you get your own optimized pre-built web page with a built-in online contact form and complete listings within the Repairhelper Network of sites.

## Irwin Electronics

<http://www.irwinelectronics.co.uk>

As Classic Distributors we complement our existing mail and trade counter business with our website. You can order parts on-line quickly and easily. We intend to explore alternative ways of assisting engineers to run their business successfully.



## Swires Research

<http://www.swires.com>

Swires Research produce high quality instruments for the television industry, including portable signal level meters and spectrum analysers for digital and analogue RF signal measurements.



## Wiltsgrove

<http://www.wiltsgrove.co.uk>

**WILTSGROVE LTD** founded in 1984, is renowned as a leading supplier of Audio, Video, TV, Spare parts and Accessories. We are now pleased to announce the launch of our ONLINE CATALOGUE:

Our easy to use search engine will allow you

to find the products you require via: • Make/Model. • Product Category. • Key Word search. • Manufacturers part number. • Our Order Code.

All orders before 5pm will be dispatched the same day.

Tel: (0121) 772 2733 • Fax: (0121) 766 610 • Email: [sales@wiltsgrove.co.uk](mailto:sales@wiltsgrove.co.uk)



# WHAT a LIFE!

From a pool-side idyll to a surprise interview, all in a day's work.  
Donald Bullock's servicing commentary

It was good of the boys to pressure me into having a day off. Since it looked promising, I decided to follow the quiet country lanes to the Haven Pool to prepare my favourite tench swim for the start of fishing next month. It's a magical spot. There were a few overhanging willows to trim back, one or two water-lily roots to drag out and, to make room for my rod, a few bank-side bulrush reeds to tether. To make it all enjoyable, the scent of wild roses filled the air.

## Summer idyll

It promised to be a day of bliss. The sun smiled contentedly, and a gentle mist shrouded and softened the water. A pair of blue-powdered doves fluttered and cooed in a nearby beech tree, a flock of amorous coots twittered and dived at the far end of the pool, crickets chirped in the long grass and dragon-flies hovered and darted over the lilies. I plopped a handful of bread-paste nuggets into the water where my float would soon be. What heaven, I thought, what total tranquillity! There was never anything like the peace and solitude of the waterside to banish all thoughts of television – and the bores who pester those who carry its cross.

## An interruption

Then I heard the sound of feet tramping on the overgrown path. They drew nearer. It was old Moggy Morgan, who farms nearby.

"Ah, Donald" he wheezed, "just the chap! That set you fixed the other month. Still playing up, you know. My missus reckons that the picture slips from corner to corner, and the sound sort of races. But 'er's been under the old Quack, like. Keeps on complaining though. Pop over to the house for me, will you?"

I screwed my face up and pre-

pared to go along. Then Gaffer Unwin appeared. Another local.

"Ha! Just phoned the shop" he exclaimed. "The boys said you were in the country, and I thought 'yes, and I know where he gets. He won't mind a visit to the cottage for a minute or two. Ready?'"

I stared at them both. "Look, I'm off duty" I said, "why not take your sets to the shop?"

The air seemed different when they'd departed. No more magic. The soft mist had gone, also the scent of wild roses. And the doves, the coots and the dragon-flies. I decided to return to work in the hope of being able to go out again next day.

## Back at the shop

Moggy Morgan and Gaffer Unwin got there at the same time as I did. Both had brought along enormous TV sets. I let them go in first. Inside the shop the boys were talking to an extremely scruffy-looking chap with a flash camera. He turned round and looked at us as we came in.

"Donald Bullock?" he asked Moggy.

"Not me" Moggy answered.

"Donald Bullock?" he asked Gaffer.

"You'm a joking" Gaffer replied.

I followed them in and hastily went through to the workshop, leaving Steven to book in their sets. Moggy Morgan's was a 28in. widescreen Sharp set, Model 66GF63H (DA100 chassis). "Crackle on the sound and no picture" he said. Paul immediately put it on the bench.

Gaffer Unwin's set was a 32in. widescreen Matsui model, fitted with the Grundig CUC2058 chassis. "Just before it died" he said, "it displayed a bowed picture".

## The Western Gazette

The scruffy chap, taking it all in, wanted to get on. He addressed himself to Moggy Morgan. "Who are you then, boy-oh?" he asked.

Moggy told him.

He then turned to Gaffer Unwin. "You sure you're not old Mr Bullock?" he asked.

"Quite certain" said Gaffer.

At that Steven called me out to introduce me to our scruffy caller.

"This is Scoop Spinner from the *Western Gazette*" he said, "he



wants to interview you on your lifetime in the television trade."

"Ello, Mr Bullock!" said Scoop, "that's it, we're doing a series featuring old-established local businesses. Do you know that yours is by far the oldest-established local TV firm?"

### A hectic time

As he spoke the Reverend Goode came in with his curate, who was carrying an Awai XR-MDS7EZ hi-fi unit.

"Greetings, Donald" the Reverend boomed. "Do be the angel you are and have a look at my verger's gramophone thing, will you? His wife is suffering from severe toothache."

Greeneyes then brought in the tea, and Paul announced his findings after dealing with Moggy's Sharp set. On test the set had displayed a faint blank raster with flyback lines, and there had been a crackle with the sound. The cause of the former fault had been Q912, a BC337-40 transistor on the tube base panel. Its base-emitter junction was open-circuit and, as a result, the TEA5101A RGB output chip had no 12V supply at pin 2. The crackle had been from the front centre speaker. Replacement of the TDA7480 centre audio output chip IC1302, the BA4558F driver chip IC1300 and three associated electrolytics on the centre-speaker PCB had cleared the crackle. Some resoldering was also required. After that the set worked well.

Scoop Spinner, who was paying attention to everything, was beginning to look bewildered.

Mrs Catmore, accompanied by her unruly kids, then came in to buy a battery. The eldest had a sticky toffee-apple which he waved about, the youngest pulled the telephone off the counter while the other one spun the battery carousel around so that it collapsed and scattered batteries all over the floor.

"Was a marrer with you lot?" Mrs Catmore shouted. "I can't take yous nowhere, can I?"

### A Lecron

A further visitor, Roger

Dodgeworth, then arrived with a 28in. widescreen set. "It's a Lecron. Mr Bullock" he said.

"A what-ron?" I asked.

"A Lecron" he replied. "Model CTV900W it says on the back. It's dead. Belongs to my cousin. Mrs Woodward, who got it from Debenhams with the insurance she received after she put her husband away. Did you know him?"

I shook my head.

Oh, a real beast he was" continued Roger, "a real beast. Why he ..."

"Look Roger" I interrupted, "it's a bit hectic here at present. Can we talk about the set?"

"One day she refused him a Woodbine" Roger continued, "and he walked out. Bought a toffee 'ammer, went home and gave her an 'ammering!"

Steven was looking at the Reverend's Awai hi-fi unit while Paul was attending to Gaffer Unwin's Matsui TV, so I decided to take a look at the Lecron. We'd no data on it, and I couldn't identify the chassis, but checks in the power supply revealed a blown fuse, a short-circuit BUZ90A MOSFET, designated T602, and a similarly shorted TDA4605-2 chopper control chip. I fitted replacements, then checked for any other shorts. Not finding any, I switched the set on. The fuse blew at once. Further investigation revealed that the degaussing resistor was virtually short-circuit when cold. Once I'd replaced this item the set worked normally. The picture was OK, and the sound particularly good.

### Progress

As I was boxing the set up Steven mentioned that he'd found the cause of the trouble with the Awai hi-fi unit. There had been an open-circuit fusible link, PR001, in the supply to the display. It worked correctly when this had been replaced.

Then George the postman came in with our mail. "Nothing too worryin'" he commented, "a packet from SEME, your water rates, a letter from the telephone people, a few bills and a nice let-

ter with a lady's handwriting. Smells nice and scenty ..."

By the time he had gone on his way Paul had got Gaffer Unwin's Matsui back in working order. The cause of the dead-set symptom was similar to that with the Lecron. The 1.6A fuse Si60001 had blown, the IRFPC50 chopper MOSFET T60006 was short-circuit, also the TDA4605-3 control chip. In addition resistor R60001 had risen in value from 270k $\Omega$  to over 550k $\Omega$ .

Once these items had been replaced he investigated the EW fault. There was a short-circuit modulator diode, D53072, and the 4.7 $\Omega$  safety feed resistor R55006 was open-circuit. After fitting replacements he'd tested the set. To his relief it crackled to life and produced excellent results.

### The interview

Scoop, who was getting impatient and was a bit confused about what was going on, gnawed at his pencil and darted his eyes about. He decided to settle on the Reverend.

"Paul" he said, "was there ITV when ..."

"That's Paul there" the Reverend said.

Scoop turned on his feet and saw Greeneyes. "Er, Mrs Catmore ..." he began. Greeneyes sighed loudly and left the room.

At that Steven decided to intervene. "Look Scoop" he said as he pointed to everyone in turn, "this is Paul, I'm Steven, the gentlemen with the white collars are the Reverend Goode and his curate, George the postman brought the letters, and Moggie Morgan, Gaffer Unwin and Roger Dodgeworth brought their sets in for attention. And this is my father Donald, who you came to see. Mrs Catmore left with her little ones after buying a battery, and you're Scoop Spinner of the *Western Gazette*."

"Oh right, Donald" Scoop replied, "tell you what. Things can be a bit hectic here, can't they? I'll go back to the office and we'll finish the interview on the phone, if that's OK." ■



# MONITORS

**Fault reports from  
Gerry Mumford  
and  
Ian Field**

We welcome fault reports from readers – payment for each fault is made after publication.

Reports can be sent by post to:

Television Magazine Fault Reports,  
Highbury Business,  
Media House,  
Azalea Drive, Swanley,  
Kent BR8 8HU

or e-mailed to:  
t.winford@highburybiz.com

## Taxan 7D16 (Model EV735TC099)

This 17in. monitor powered up with the green LED lit but there was no display at all. Checks showed that the EHT was correct but the A1/G2 voltage was only 1.4V. This model uses electrical adjustment of the A1/G2 voltage rather than the usual control on the LOPT. Checks in the relevant circuitry showed that R255 and R256 (both 470k $\Omega$ , 0.5W) were open-circuit. They form a potential divider for the 1.1kV supply developed by the LOPT for the A1/G2 feed. G.M.

## Elonex MN034P

The complaint with this monitor was instability as the width was adjusted. It seemed to be caused by a glitch in the B+ PWM regulator's voltage feedback loop from the line output transformer. The effect was like a step on the width of the raster. With width adjustment this step would diminish to a single slightly longer line that stuck out at each side of the raster. The effect would disappear altogether when the width control was rotated farther.

As no cause could be found, I had to assume that a servo-loop glitch had produced a visible effect because of component-value drift. The solution seemed to be to increase the width by means other than the front control. As various combinations of adjustment seemed to be able to increase the width without moving the point of instability, I decided to try increasing the value of the flyback tuning capacitor. The original value was 4.3nF (1.6kV). The maximum limit seems to be 6.8nF with this chassis. If the value is increased too far the flyback slows down, the result being foldover at the left-hand edge, with the line output transistor showing no sign of distress.

With other monitors a more likely result would be line output transistor overheating and, in extreme cases, distortion of the forward-scan linear ramp. In such a case the top of the linear ramp begins to flatten, producing a cramped right-hand edge of the display. It seems that the 2SC5148 transistor used in this chassis has enough spare capacity to provide increased collector current! I.F.

## Dell Ultrascan P1428E

These monitors usually contain a Samsung chassis, which is what I was expecting. The Samsung version seldom gives trouble but suffers from dry-joints, often with fairly alarming symptoms. So repair always begins with removal of the chassis and a check on the soldering. When I got to this point I realised that the chassis was probably the similar-looking Hyundai one. There was a Toshiba instead of the usual Samsung CRT, and only two of the ICs on

the main PCB were Samsung branded.

The soldering was absolutely appalling! Apart from the loose signal connector at the back of the board, almost every in-line set of three or more pins had at least the first signs of fracture rings forming around the solder fillets. Some of the ones in which the solder still had some malleability were beginning to pull through. Inspection was hindered by residues of whatever had been used to deflux the PCB, and this seemed to be resistant to most types of solvent. The only thing I could find that would clean it off was a steel wire brush!

A further problem was the remnants of pre-cropped leads that were hidden in the solder fillets. The component leads had evidently been cropped prior to flow-soldering and many of the shorter leads, such as those of ICs, had incompletely cropped bits hanging by a sliver as they went into the soldering dip. These incompletely severed clippings hide in the solder, waiting to cause shorts when the soldering is reworked. Careful cleaning and inspection with a magnifier is essential. Even when the PCB has been scrubbed with a steel wire brush flux residues survive in small clumps between close-spaced pins. This adds to the difficulty in spotting stray clippings. The best approach is to have a scalpel at the ready while the PCB is under the magnifier so that any remaining contaminants can be dug out.

After doing all this I found that the monitor still failed to power up when reassembled. To cut a long story short, there was no voltage at pin 7 (supply) of the KA3842 chopper control chip. Cutting pin 7 restored the supply, which proved that the IC was faulty rather than the start-up resistors or the circuitry that cuts them off when the power supply gets going. Once a replacement had been fitted the monitor powered up – and produced erratic, flickering colours! When I removed the CRT base screen I found that the soldering here was every bit as bad as on the main PCB. All three power transistors had at least one leg detached, with signs of arcing.

Although I remain uncertain about the identification of this particular chassis, it's one I've seen from time to time and I should point out that this example was the worst I've ever come across. Normally the cause of the reported fault consists of a moderate number of dry-joints and/or one or two faulty electrolytics. But this one had been "run into the ground" before its owner decided to have it serviced. Judging by the burn marks around the video output transistors, the monitor must have remained in use for a considerable time after it had become obvious that faults were developing, and had been taken out of service only when it refused to work at all! I.F.

## Solution to Test Case 498

- see page 489 -

Cathode Ray had done most of the right things in trying to diagnose the cause of the fault with this kamikaze Philips TV set. Maybe he would have eventually got to the bottom of the trouble had he worked through the suggestions in the Philips service manual. The guide it provides is commendable, and is something that very few other manufacturers take the trouble to include, though the credit is somewhat dimmed by the tendency of this switch-mode power-supply design to self-destruct in the manner described.

Anyway Sage knew, and perhaps Ray should have known or found out, that the fault is by no means unknown with this and similar chassis in the MD1 series, and that a kit of parts is available from Philips to cure it. Its name is ES7056, the part number being 4822 310 32259, and the cost is about £14. It contains no fewer than fourteen components, not all of which will be required for the particular version of the chassis.

In Philips' own words, "mutual influences caused by the failure of one part are possible". Ray had another way of putting it, but nevertheless fitting all the relevant bits in the repair kit, including the items Ray had already replaced, did the trick. It was a bit of an anticlimax for the entire staff of the service department, who had gathered around the bench at switch on, when the EHT rustled up followed by the sight and sound of the lovely Lorraine Kelley, the apple of Sage's eye.

## NEXT MONTH IN TELEVISION

### A microcontroller-based CCTV switching system

John Young describes a microcontroller-based video switching system which is used with four CCTV security cameras. These monitor activity in and around a garage that's sixty yards from the house, so a method of transmitting video signals is required. The microcontroller switches from camera to camera every three seconds - the PIR sensors are not triggered.

### Freeview tryout

Ray Porter's installation of a Freeview box was not without its problems, especially as the local signal conditions are not ideal. After some experimentation satisfactory reception of most multiplexes was obtained.

### An aerial for DAB reception

DAB reception via a receiver's vertical whip aerial turned out to be very unsatisfactory, so K. Rutherford set about making a properly-proportioned dipole that was mounted in the loft and coupled to the receiver via the domestic signal-distribution system. The result was good, error-free reception in all rooms.

PLUS ALL THE REGULAR FEATURES

## TELEVISION INDEX & DIRECTORY 2004

### Plus hard-copy index and reprints service

Here's the essential repair information you need! The Television Index & Directory 2004, in CD-ROM form, contains the text of over 15,000 high quality fault reports on TVs, VCRs, Camcorders, DVD players, Monitors, Satellite TV units, Audio equipment and CD players, searchable by make and model, plus the text of 200 Test Cases and over 250 major servicing articles, from sixteen years of Television magazine. It also contains a full sixteen-year index of Television, a Spares Guide, a directory of Trade and Professional Organisations, an International TV Standards guide, a satellite TV Channel Finder, a TV transmitter list and a compendium of internet resources for service engineers. The software is quick and easy to use, and runs on any PC with Windows 95, 98, ME, NT, XP or 2000.

### Television Index & Directory 2004 CD-ROM, £199

Television Index & Directory 2004 CD-ROM upgrade, £46 (to qualify for this upgrade you need to have purchased a previous version of the Television Index on floppy disk or on CD-ROM)

A six-month update of the index and fault reports will be available in May 2004. If you wish to take advantage of this, £10 should be added to your order.

Television Index only, 1988—2003, £36

Television Index only upgrade from previous versions, £18

**Hard-copy indexes** of Television magazine are available for Volumes 38 (1988) to 53 (2003) at £3.50 per volume.

**Reprints of articles** from Television back to 1988 are also available, at the flat rate of £4.00 per article — you can order through our web site, or write to the address below.

The above prices include UK postage and VAT where applicable. Add an extra £1 postage for non-UK EC orders, or £5 for non-EC overseas orders, although Channel Island residents do not need to add any extra postage. Cheques should be made payable to SoftCopy Ltd. All major credit and debit cards are accepted. Please use our new secure website for your orders, details below. Allow up to 28 days for delivery (UK).

**SoftCopy Limited, 1 Vineries Close, Cheltenham, GL53 ONU, UK**

**Telephone 01242 241 455 Fax 01242 241 468**

**e-mail: [sales@softcopy.co.uk](mailto:sales@softcopy.co.uk)**

**web site: <http://www.televisionmag.co.uk>**

Published on the third Wednesday of each month by Highbury Business, Media House, Azalea Drive, Swanley, Kent, BR8 8HU. Highbury Business is a division of Highbury House Communications PLC. Filmsetting by Impress, Unit 2, Parkway, Southgate Way, Orton Southgate, Peterborough PE2 6YN. Printed in England by Polestar (Colchester) Ltd., Newcomen Way, Severalls Industrial Park, Colchester, Essex CO4 4TG. Distributed by Seymour Distribution Ltd, 86 Newman St, London, W1T 3EX. Sole Agents for Australia and New Zealand, Gordon and Gotch (Asia) Ltd.; South Africa, Central News Agency Ltd. Television is sold subject to the following conditions, namely that it shall not, without the written consent of the Publishers first having been given, be lent, resold, hired out or otherwise disposed of by way of Trade at more than the recommended selling price shown on the cover, excluding Eire where the selling price is subject to currency exchange fluctuations and VAT, and that it shall not be lent, resold, hired or otherwise disposed of in a mutilated condition or in any unauthorised cover by way of Trade or affixed to or as part of any publication or advertising, literary or pictorial matter whatsoever.

# TUBES FOR SANYO SETS

414 010 7100

W66ESF

NEW £125.00

*Are you paying more?*

LOADS MORE TYPES IN STOCK

## CONTACT

D'Lec Components Ltd  
3 Manor Court, Sole Street,  
Cobham, Kent DA13 9BU

Tel 01474 361276

Fax 01474 335228

E-mail: [sales@dlec.co.uk](mailto:sales@dlec.co.uk)

Visit [www.dlec.co.uk](http://www.dlec.co.uk)

# Tuner Repairs

+

# IC Fitting Service

+

# Digital set top box repairs

For more information and latest prices

See our web site

[www.mces.co.uk](http://www.mces.co.uk)

# MCES Digital

15 Lostock Road Davyhulme Manchester M41 0ES

E-mail: [sales@mces.co.uk](mailto:sales@mces.co.uk)

Phone: 0161 746 8037

Fax: 0161 746 8136



Are you looking for a reliable company to repair your sky digiboxes?  
We offer **FREE SAMEDAY** Collection when you send more than  
one box for repair!

#### ● FIXED PRICES

Pace, Grundig, Amstrad . . . . . Fixed price £38 + VAT Includes return delivery

Panasonic, Sony . . . . . Fixed price £55 + VAT Includes return delivery

Sky + (Standard repair) . . . . . Fixed price £45 + VAT Includes return delivery

(Hard Drive replacement) Fixed price £75 + VAT Includes return delivery

● Prices include all faults Micro processor, Modem, Software corruption and  
BGA replacement. *Send more than one box at a time we collect for FREE.*

● Specialists in the repair of Amstrad & Sony digiboxes.

● Refurbished digiboxes for sale.

● Fast Turnaround Time.

● All repairs fully guaranteed.

● Collection arranged from anywhere in the United Kingdom and Eire.

● Authorised Sky Digital Repair Centre.

Receive our latest Satellite and technical newsletter **FREE** through

email. Just send us an email with Newsletter in the Subject title to:

[Info@digirepairs.co.uk](mailto:Info@digirepairs.co.uk)

#### Contact:

**DIGI REPAIRS (UK & Ireland)**

**UNIT 25, ENNISKILLEN BUSINESS CENTRE**

**TEMPO ROAD, ENNISKILLEN BT74 4RL**

**TEL: 02866327293 (NATIONAL RATE)**

**0845 6441628 (LOCAL RATE)**

**Email: [info@digirepairs.co.uk](mailto:info@digirepairs.co.uk)**

## ONLINE SHOPPING CHEAPER AND EASIER

[www.elclondon.co.uk](http://www.elclondon.co.uk)

TV, VIDEO SPARES AND ELECTRICAL ITEMS



**ELC EAST LONDON COMPONENTS**

**63 PLASHET GROVE, LONDON E6 1AD.**

**TWO MINUTES WALK FROM UPTON PARK TUBE STATION**

**TEL: 020 8472 4871 FAX: 020 8503 5926**

**E-mail: [sales@elclondon.co.uk](mailto:sales@elclondon.co.uk)**

**WHETHER ELECTRONICS IS YOUR HOBBY  
OR YOUR LIVELIHOOD . . .  
YOU NEED THE **MODERN ELECTRONICS MANUAL**  
and the **ELECTRONICS SERVICE MANUAL****

**THE MODERN ELECTRONICS MANUAL (CD-ROM VERSION ONLY)**

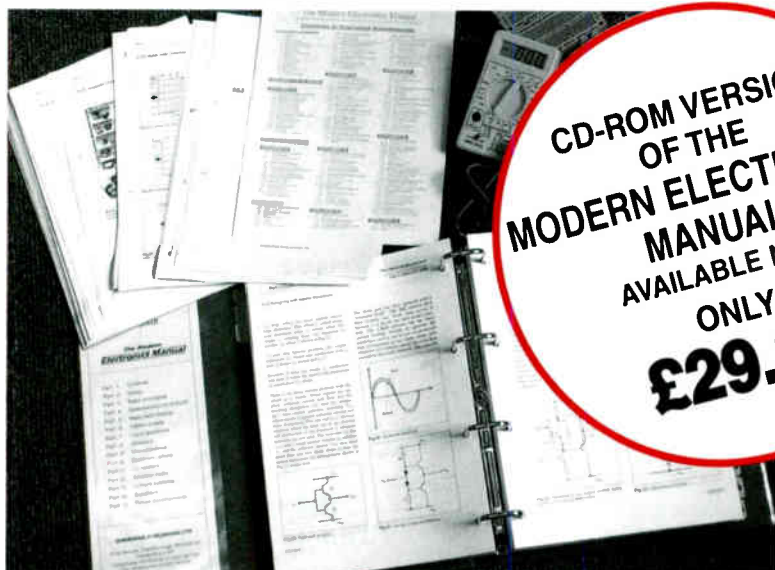

*The essential reference work for everyone studying electronics*

- Over 800 pages
- In-depth theory
- Projects to build
- Detailed assembly instructions
- Full components checklists
- Extensive data tables
- Manufacturers' web links
- Easy-to-use Adobe Acrobat format
- Clear and simple layout
- Comprehensive subject range
- Professionally written
- Supplements

**EVERYTHING YOU NEED TO GET STARTED AND GO FURTHER IN ELECTRONICS!**

The revised CD-ROM edition of the Modern Electronics Base Manual (MEM) contains practical, easy-to-follow information on the following subjects:

**BASIC PRINCIPLES:** Electronic Components and their Characteristics (16 sections from Resistors and Potentiometers to Crystals, Crystal Modules and Resonators); Circuits Using Passive Components (10 sections); Power Supplies; The Amateur Electronics Workshop; The Uses of Semiconductors; Digital Electronics (6 sections); Operational Amplifiers; Introduction to Physics, including practical experiments; Semiconductors (5 sections) and Digital Instruments (3 sections).

**CIRCUITS TO BUILD:** There's nothing to beat the satisfaction of creating your own projects. From basic principles, like soldering and making printed circuit boards, to the tools needed for circuit-building, the Modern Electronics Manual and its Supplements describe clearly, with appropriate diagrams, how to assemble a radio, loudspeaker circuits, amplifiers, car projects,

a computer interface, measuring instruments, workshop equipment, security systems, medical and musical circuits, etc. The Base Manual describes 12 projects including a Theremin and a Simple TENS Unit.

**ESSENTIAL DATA:** Extensive tables on diodes, transistors, thyristors and triacs, digital and linear i.c.s.

**EXTENSIVE GLOSSARY:** Should you come across a technical word, phrase or abbreviation you're not familiar with, simply look up the glossary included in the Manual and you'll find a comprehensive definition in plain English.

The Manual also covers **Safety** and provides web links to component and equipment **Manufacturers and Suppliers**. The most comprehensive reference work ever produced at a price you can afford, the CD-ROM edition of **THE MODERN ELECTRONICS MANUAL** provides you with all the **essential** information you need.

**THE MODERN ELECTRONICS MANUAL (MEM – CD-ROM version only)**

**Revised CD-ROM Edition of Basic Work:** Contains over 800 pages of information in Adobe Acrobat format. Edited by John Becker.

**Supplements:** Additional CD-ROMs each containing approximately 500 pages of additional information on specific areas of electronics are available for £19.95 each. Information on the availability and content of each Supplement CD-ROM will be sent to you.

**Presentation:** CD-ROM suitable for any modern PC. Requires Adobe Acrobat Reader which is included on the MEM CD-ROM.

**Price of the Basic Work: £29.95 POST FREE.**

**ORDER BOTH MANUALS TOGETHER AND SAVE £10**

*A mass of well-organised and clearly explained information is brought to you by expert editorial teams whose combined experience ensures the widest coverage  
Supplements to these unique publications, keep you abreast of the latest technology and techniques if required*

# ELECTRONICS SERVICE MANUAL

(CD-ROM VERSION ONLY)

## EVERYTHING YOU NEED TO KNOW TO GET STARTED IN REPAIRING AND SERVICING ELECTRONIC EQUIPMENT

**SAFETY:** Be knowledgeable about Safety Regulations, Electrical Safety and First Aid.

**UNDERPINNING KNOWLEDGE:** Specific sections enable you to Understand Electrical and Electronic Principles, Active and Passive Components, Circuit Diagrams, Circuit Measurements, Radio, Computers, Valves and Manufacturers' Data, etc.

**PRACTICAL SKILLS:** Learn how to identify Electronic Components, Avoid Static Hazards, Carry Out Soldering and Wiring, Remove and Replace Components.

**TEST EQUIPMENT:** How to Choose and Use Test Equipment, Assemble a Toolkit, Set Up a Workshop, and Get the Most from Your Multimeter and Oscilloscope, etc.

**SERVICING TECHNIQUES:** The Manual includes vital guidelines on how to Service Audio Amplifiers. The Supplements include similar guidelines for Radio Receivers, TV Receivers, Cassette Recorders, Video Recorders, Personal Computers, etc.

**TECHNICAL NOTES:** Commencing with the IBM PC, this section and the Supplements deal with a very wide range of specific types of equipment – radios, TVs, cassette recorders, amplifiers, video recorders etc..

**REFERENCE DATA:** Detailing vital parameters for Diodes, Small-Signal Transistors, Power Transistors, Thyristors, Triacs and Field Effect Transistors. Supplements include Operational Amplifiers, Logic Circuits, Optoelectronic Devices, etc.

## The essential work for servicing and repairing electronic equipment

- Around 900 pages
- Fundamental principles
- Troubleshooting techniques
- Servicing techniques
- Choosing and using test equipment
- Reference data
- Manufacturers' web links
- Easy-to-use Adobe Acrobat format
- Clear and simple layout
- Vital safety precautions
- Professionally written
- Supplements

## ELECTRONICS SERVICE MANUAL (ESM – CD-ROM version only)

**Basic Work:** Contains around 900 pages of information. Edited by Mike Tooley BA

**Supplements:** Additional CD-ROMs each containing approximately 500 pages of additional information on specific areas of electronics are available for £19.95 each. Information on the availability and content of each Supplement CD-ROM will be sent to you.

**Presentation:** CD-ROM suitable for any modern PC. Requires Adobe Acrobat Reader which is included on the ESM CD-ROM.

**Price of the Basic Work: £29.95 POST FREE**



## SPECIAL OFFER

**£10 OFF** Buy both Manuals together and save £10.

**PLUS FREE POSTAGE TO ANYWHERE IN THE WORLD**  
(We use the VAT portion of the price to pay for overseas AIRMAIL postage)

Wimborne Publishing Ltd., Dept D6, 408 Wimborne Road East, Ferndown, Dorset BH22 9ND. Tel: 01202 873872. Fax: 01202 874562.  
Online shop: [www.epemag.wimborne.co.uk/shopdoor.htm](http://www.epemag.wimborne.co.uk/shopdoor.htm)

**PLEASE** send me



THE MODERN ELECTRONICS MANUAL (CD-ROM version only)

ELECTRONICS SERVICE MANUAL (CD-ROM version only)

I enclose payment of £29.95 (for one Manual) or £49.90 for both Manuals (saving £10 by ordering both together).

FULL NAME .....  
(PLEASE PRINT)

ADDRESS .....

.....POSTCODE .....

SIGNATURE .....

I enclose cheque/PO in UK pounds payable to Wimborne Publishing Ltd.

Please charge my Visa/Mastercard/Amex/Diners Club/Switch Switch Issue No .....

Card No .....

Valid From ..... Expiry Date .....

Card Security Code ..... (The last 3 digits on or just under the signature strip)

### ORDER FORM

Simply complete and return the order form with your payment to the following address:

Wimborne Publishing Ltd,  
Dept. D6,  
408 Wimborne Road East,  
Ferndown,  
Dorset BH22 9ND

Your CD-ROM(s) will be posted to you by first class mail or airmail within four working days of receipt of your order



# Economic Devices

PO Box 73, Oakengates TF1 8WR

Tel ++44 (0)1952 273130 Fax ++44 (0)1952 405478

**Remote Controls** from **£5.95 each**

Stock held for over **53000** different models

**SEMICONDUCTORS**

over **34,000** types of transistors, IC's, diodes etc. or equivalents stocked

We take your hassle Some suppliers just won't help. We will work really hard to find those difficult parts - just ask and let our 'no holds barred' enquiry hound work for you!!!

...and look at the **special offers**.....

BUT11A @ **29p** each BUT11AF @ **41p** each  
BU508A @ **43p** each Fully wired scart lead **39p**

a slight inconvenience.....

....you must buy more than one.

BU208A X 5	75p ea	TEA2018A X 5	99p ea
BU508A X 5	79p ea	UC3842 X 5	59p ea
BU508AF X 5	85p ea	CNX62A X 5	29p ea
BU508D X 5	89p ea	S2000AF X 5	84p ea
BUT11A X 5	29p ea	TDA3653B X 5	55p ea
BUT11AF X 5	47p ea	TDA3654 X 5	82p ea
Philips type 1.2 volt	Back up battery	X 5	59p ea
Philips type 2.4 volt	Back up battery	X 5	120p ea
Scart - Scart lead 1.5m	Fully wired	X 2	89p ea
Positor PT37, TH98009 (White)		X 6	69p ea
Thorn TX100 Chassis 110 DGR	LOPTX	each	£11.24
Philips CP90 Chassis	LOPTX	each	£11.63

...and now ask about our value for money full price list. Remember £1.50 post & handling

All major credit cards accepted

**www.telepart.co.uk**

The web page where you can look up the price and order all items TV, VCR and Satellite. Web search by model for video parts, remote controls, LOPTX etc. overseas enquiries particularly welcome

**New CCTV catalogue out NOW**  
cameras, monitors, switches  
quads, multiplexers, the lot.

# TUBES

**NEW and GRADED CRTs**

W66ESF002X .....	From £100
W66ECK001X .....	From £100
W66EGV023X .....	From £70
W76ESF031X .....	From £180
W76EGV023X .....	From £150
66EAK071X .....	From £50

Quantity reductions

Other makes and sizes available

De-scratching service

Prices plus carriage and VAT

**EXPRESS TV SUPPLIES LTD**

The Mill, Mill Lane,

Rugeley, Staffs WS15 2JW

Tel: 01889 577600 Fax: 01889 575600



## Electronicworld

TV AND VIDEO LTD

**SPECIAL OFFER - FOR ONE MONTH ONLY!**

Just to name a few, for example:

14" TV/DVD Combi	£40
14" Portable TV	£25
Widescreen TV from only	£70
Working box VCR	£15

Minimum quantity 5 items  
Our prices are unbeatable try us!





**Electrical Goods at UNBEATABLE Prices...**





See our new awesome web site. Just click on the wholesale link to view just a small sample of our stock.

**http://www.tvrus.co.uk**

All prices are Exclusive of VAT

**BIRMINGHAM**  
208 Bromford Lane, Erdington, Birmingham B24 8DL  
Tel: 0121 327 3273 Fax: 0121 322 2011

**LONDON**  
221 Kenton Road, Middlesex HA3 0HD  
Tel: 020 8907 9387

**PRESTON**  
Unit 434 Rangleat Road, Walton Summit, Preston PR5 8AR  
Tel: 01772 316066







**WATCH SLIDES ON TV  
MAKE VIDEOS OF  
YOUR SLIDES  
DIGITISE YOUR  
SLIDES  
(using a video capture card)**



"Liesgang diatv" automatic slide viewer with built in high quality colour TV camera. It has a composite video output to a phono plug (SCART & BNC adaptors are available). They are in very good condition with few signs of use. For further details see [www.diatv.co.uk](http://www.diatv.co.uk)

Board cameras all with 512x582 pixels 8.5mm 1/3 inch sensor and composite video out. All need to be housed in your own enclosure and have fragile exposed surface mount parts. They all require a power supply of between 10 and 12v DC 150mA.

47MIR size 60x36x27mm with 6 infra red LEDs (gives the same illumination as a small torch but is not visible to the human eye).....£37.00 + vat = £43.48

30MP size 32x32x14mm spy camera with a fixed focus pin hole lens for hiding behind a very small hole.....£35.00 + vat = £41.13

40MC size 39x38x27mm camera for 'C' mount lens these give a much sharper image than with the smaller lenses.....£32.00 + vat = £37.60

Economy C mount lenses all fixed focus & fixed iris

VSL1220F 12mm F1.6 12x15 degrees viewing angle.....£15.97 + vat = £18.76

VSL4022F 4mm F1.22 63x47 degrees viewing angle.....£17.65 + vat = £20.74

VSL6022F 6mm F1.22 42x32 degrees viewing angle.....£19.05 + vat = £22.38

VSL8020F 8mm F1.22 32x24 degrees viewing angle.....£19.90 + vat = £23.38

Better quality C Mount lenses

VSL1614F 16mm F1.6 30x24 degrees viewing angle.....£26.43 + vat = £31.06

VWL813M 8mm F1.3 with iris 56x42 degrees viewing angle.....£77.45 + vat = £91.00

1206 surface mount resistors E12 values 10 ohm to 1M ohm 100 of 1 value £1.00 + vat

1000 of 1 value £5.00 + vat

866 battery pack originally intended to be used with an orbital mobile telephone it contains 10 1.6Ah sub C batteries (42x22dia the size usually used in cordless screwdrivers etc.) the pack is new and unused and can be broken open quite easily.....£7.46+vat = £8.77



Please add 1.66 + vat = £1.95 postage & packing per order

**JPG ELECTRONICS**

Shaws Row, Old Road, Chesterfield, S40 2RB

Tel 01246 211202 Fax 01246 550959 Mastercard/Visa/Switch

Callers welcome 9:30 a.m. to 5:30 p.m. Monday to Saturday

WEB SITE [WWW.JOHNSRADIO-UK.COM](http://WWW.JOHNSRADIO-UK.COM) [WWW.JOHNSRADIO.COM](http://WWW.JOHNSRADIO.COM)

JOHNSRADIO ELECTRONICS TEST AND COMMUNICATION EQPT

**MASSIVE 10,000 SQ FT  
WAREHOUSE CLEARANCE SALE**

DC-MICROWAVE TO 300 GHZ - OPTICAL - LIGHT - EQPT - PARTS  
TEKTRONIX - HP - AGILENT - MARCONI  
PHILIPS - RACAL - B&K - R&S - W&G - ETC  
Sales Warehouse, Johnsradio, Smithies Mill, Birstal Smithies Lights, 883-885 Bradford Rd, Batley, West Yorkshire, WF17 8NN.

Tel: 01924 442905 Fax: 01924 448170 E-mail: [johnsradio@btconnect.com](mailto:johnsradio@btconnect.com)

Directions M62 Junction 27, A62 to Huddersfield, 1 mile to Birstal Smithies Lights, (6 roads) left under factory chimney aerial, Smithies Moor Lane 50 YDS second left red gate.

HOURS M-F 9AM - 1PM AND 2PM - 5PM, SAT 9AM - 1PM

Phone for appointment or to request item lists, photos, site map.

All welcome, Private or trade, for sales, workshop repairs or calibration.

PLEASE CONTACT PATRICIA AT WHITEHALL WORKS, 84 WHITEHALL ROAD, EAST BIRKENSHAW, BRADFORD, WEST YORKSHIRE, BD11 2ER

Tel: 01274 684007 Fax: 01274 651160

WEB SITE [WWW.JOHNSRADIO-UK.COM](http://WWW.JOHNSRADIO-UK.COM) [WWW.JOHNSRADIO.COM](http://WWW.JOHNSRADIO.COM)

This Magazine reaches over

**10,000**  
potential customers

To advertise in this space  
call/tel on

**01322 611289**

[www.sdstrade.co.uk](http://www.sdstrade.co.uk)

sky Freeview OR sky FREEVIEW

**SPECIALISTS IN ALL MAKES AND  
MODELS OF SATELLITE EQUIPMENT**

**ALL ORDERS WELCOME - LARGE OR SMALL**

**REPAIRS FROM ONLY £35 + VAT**

**SKY & SKY+ SPARES - MOST MAKES AND MODELS**

sky+ NEW MODEL SKY+  
INCLUDING DELIVERY AND  
INSTALLATION KIT - £199

**HUNDREDS OF REFURBS AND NEW BOXES  
CALL FOR PRICES OR VISIT OUR WEB SITE**

**EXCLUSIVE  
TO SDS!**



**SILVER PACE 2200 DIGIBOXES  
CALL FOR TRADE PRICES**

**SDS**  
Satellite &  
Digital Services Ltd

1 HOWARD AVENUE  
BARNSTAPLE  
DEVON  
EX32 8QA  
TEL: 01271 325888  
FAX: 01271 329163

**leaders**

reliability practicability professionalism



**Multimeter FSM** Indispensable  
Installer's TOOL

THE ULTIMATE RANGE FIELD STRENGTH METERS (FSM)

- 3 or 5" TFT screen
- High resolution 0.1dB
- High accuracy +/-1dB MATV & +-2SAT
- C/N measurement (analogue and digital measurements)
- Up to 4 hours battery
- Shock protection (rubber)
- Quick menu keys
- RS232 & Scart sockets
- Easy and friendly to use

Televés U.K. LTD  
T. 01633-375821  
F. 01633-886311  
[televés.uk@televés.com](mailto:televés.uk@televés.com)



**Televés**  
[www.televés.com](http://www.televés.com)



**TELEVISION reader offer:**  
**x1, x10 switchable**  
**oscilloscope probes,**  
**only £21.74 a pair,**  
**fully inclusive\***

\*Additional pairs as part of the same order, only £19.24 each pair.

Please supply the following:

**Probes**

Total \_\_\_\_\_

Name \_\_\_\_\_

Address \_\_\_\_\_

\_\_\_\_\_

Postcode \_\_\_\_\_ Telephone \_\_\_\_\_

Method of payment (please circle)

**Cheques should be made payable to TELEVISION**

Access/Mastercard/Visa/Cheque/PO

Credit card no \_\_\_\_\_

Card expiry date

Signed

**Please allow up to 28 days for delivery**

Seen on sale for £20 each, these high-quality oscilloscope probe sets comprise:

- two x1, x10 switchable probe bodies
- two insulating tips
- two IC tips and two sprung hooks
- trimming tools

There's also two BNC adaptors for using the cables as 1.5m-long BNC-to-BNC links. Each probe has its own storage wallet.

To order your pair of probes, send the coupon together with £21.74 UK/Europe to **Probe Offer, Jackie Lowe, Highbury Boleyn House, 9-13 Ewell Road, Cheam, Surrey, SM3 8BZ**

Readers outside Europe, please add £2.50 to your order.

**Specifications**

**Switch position 1**

Bandwidth	DC to 10MHz
Input resistance	1MΩ – i.e. oscilloscope i/p
Input capacitance	40pF+oscilloscope capacitance
Working voltage	600V DC or pk-pk AC

**Switch position 2**

Bandwidth	DC to 150MHz
Rise time	2.4ns
Input resistance	10MΩ ±1% if oscilloscope i/p is 1MΩ
Input capacitance	12pF if oscilloscope i/p is 20pF
Compensation range	10-60pF
Working voltage	600V DC or pk-pk AC

**Switch position 'Ref'**

Probe tip grounded via 9MΩ, scope i/p grounded

# Service Link

**TELEPHONE 01322 611289**  
**FAX 01322 616376**

## FOR SALE

**inStore**  
ELECTRICS LIMITED  
171 HAREHILLS LANE,  
LEEDS LS8 3QE  
Tel: 0113 240 1114

Tatung LCD 15" .....£239  
Philips LCD 15" .....£299  
Philips LCD 17" .....£299

Other models available.  
CALL FOR FULL PRICE LIST

## PROJECTOR SPARES

Spare parts and service information for  
**VIDIKRON**  
video projectors from  
**PROJECTSPARES**  
Tel: 01444 831769  
Fax: 01444 831580  
E-mail:  
projectspares@btinternet.com

## RECRUITMENT

**BENCH/FIELD ENGINEER REQUIRED**

Small family business, based near Stanford-Le-Hope requires a qualified TV/VCR/Audio Bench/Field Engineer.

Minimum of 3 years experience. Salary negotiable, dependent on experience and qualifications.

Reply by phone: 01375 640800

## SERVICE DATA

**NEED HELP NOW?**

Then ring the  
★ **ELECTRON TECHNICAL HELPLINE** ★

Genuine help available to all repairers of  
T.V. - V.C.R. - SAT - AUDIO  
(Inc Valves)

Over 30 years experience and vast data base

**0906 470 1706**  
Calls cost 60p per minute

## SERVICE DATA

**Fryerns**  
Service Information **FES** Circuit Diagrams

TV's, VCR's, SATELLITE CAMCORDERS, AUDIO & HI-FI's

Prices are from £5.50 + £2.75 P&P add a further £5.50 per item in the same order

note: some items priced individually  
we now supply universal tv/video remotes at competitive prices

Payment by credit card, PO or cheque  
Tel/Fax 01206 211570  
e-mail: colin@fryerns.fsbusiness.co.uk

2 The Lodge  
Easthorpe Green  
Marks Tey, Colchester  
CO6 1HA



## SERVICE DATA

**SERVICE MANUALS**

Have you ever turned away work for want of a Service Manual? Have you ever brought a Service Manual and never used it more than once? Then why not join ...

**THE MANUALS LIBRARY**

For details and membership application form write, phone or fax:

**HARVEY ELECTRONICS**  
43 Loop Road, Beachley,  
Chepstow, Mons, NP16 7HE  
Tel/Fax No: 01291 623086  
Visa: Mastercard accepted

## WANTED

**BEST CASH PRICES PAID**

FOR VALVES KT88, PX4 AND MOST AUDIO/OTHER TYPES.

Tel: 01403 784961

Billington Export Ltd  
Sussex RH14 9EZ  
Fax 01403 783519  
Email: sales@bel-tubes.co.uk  
Visitors by appointment

## Service Link

**OPEN 6 DAYS** TV/VCR CIRCUITS (WE DO NOT STOCK AUDIO OR MONITOR INFORMATION)

**TEL A.T.V. on 0114 285 4254**

CTV Circuits ..... from £5.00  
VCR Circuits ..... from £7.00  
CTV Manuals ..... from £10.50  
VCR Manuals ..... from £14.50  
User instructions also available (P/P add £2.50 to each order)

**419 LANGSETT ROAD SHEFFIELD S6 2LL**

MANUAL COLLECTIONS PURCHASED, (POST 1995)



**SERVICE MANUALS**  
and Service Sheets for  
TV - VIDEO - AUDIO

Prices start at

CTV	s/sheet	5.00
VCR	s/sheet	7.00
CTV	s/man	10.00
VCR	s/man	13.00

No p/p or VAT  
- Other items POA -

**AMTEL**  
Huna,  
Caithness KW1 4YL  
01955 611313  
www.amtel.co.uk

For a **FREE** consultation on how best to market your products/services to a professional audience contact **LUKE** on **01322 611289**

# IS THIS THE END OF "BAD BACKS"?

[www.advancedhandling.co.uk/tvlifting.htm](http://www.advancedhandling.co.uk/tvlifting.htm)



"The LIFTM8™ has revolutionized the way that I do business. I can now tackle jobs where I would have had to take a second man, saving me money every time I use it! It even gives me a stable working platform for repairing TV's in customers homes."

Mr Dobson - Shop Owner - North West



CALL NOW

**01778 345365**

#### LIGHTWEIGHT

The LIFTM8 weighs less than 20KG's, is simple to move and transport, removable legs complete the package.

#### ROTATING SUCTION CUPS

Simply rotate TV's through 90 degrees to fit through doorways with ease.

#### WINCH OPERATION

Raise and lower the set using the marine quality winch fitted with a "memory free" Kevlar rope.

#### MOBILE WORKBENCH

Lay down the LIFTM8 and it becomes a mobile workbench.

**advanced handling**  
Intelligent Handling Solutions

Northfields Industrial Estate, Market Deeping, Peterborough, PE6 8LD  
Tel. 01778 345365 - Fax. 01778 341654 - [sales@advancedhandling.co.uk](mailto:sales@advancedhandling.co.uk)

Advanced Handling Limited has been manufacturing materials handling equipment in the UK for the last 27 years. The LIFTM8 is the latest in a long line of intelligent handling solutions to be supplied to the UK electrical retail industry.

# TELEVISION TEST PATTERN GENERATORS

The new **GV 998** is a digital pattern generator offering more advanced features at again a realistic price. Those features include :

- ◆ MPEG-2 format Transport Stream generation
- ◆ Video and audio included in the TS
- ◆ Video and audio inputs
- ◆ Generation of a variable frequency sound carrier for decoding verification
- ◆ Multistandard and multisystem analogue TV signal generation
- ◆ Possibility to edit different fields of the TS database to present the name of the service provider
- ◆ Remote control via a personal computer
- ◆ Moving video patterns to check MPEG-2 decoders

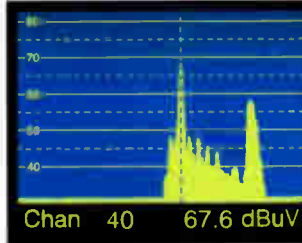
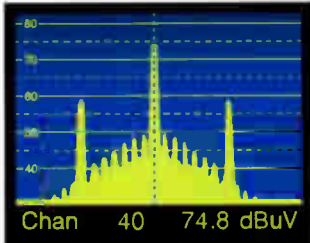

## PROMAX GV SERIES

- ◆ Choice of 12 instruments
- ◆ NICAM and Teletext
- ◆ 4:3 and 16:9 Formats
- ◆ Full field and VITS
- ◆ Computer Controlled
- ◆ Front panel memories
- ◆ Own Company Logo
- ◆ Computer Monitor testers
- ◆ Hand Held Models
- ◆ Multi Standard, PAL, NTSC, SECAM
- ◆ High Quality Construction
- ◆ Attractive Price Levels
- ◆ Full After Sales Service
- ◆ Available from Stock



FOR TELEVISION PATTERN GENERATORS, THERE'S NO WIDER CHOICE THAN WITH PROMAX



SELECTED ITEMS FROM THE PROMAX RANGE OF TEST EQUIPMENT



**MS 250**

Analogue and Digital Satellite Detector.



**PRODIG 1**

Satellite Dish Installer's Meter Does more than just BSkyB



**PRODIG 2**

Analogue & Digital Aerial Meter Measures digital channel power and C/N



**MC 377+**

Analogue & Digital, Satellite & Terrestrial Measures channel power and C/N

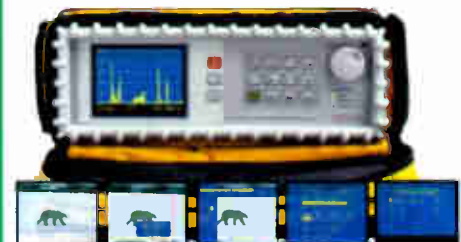

**PROLINK 3 + 4 SERIES**

Satellite & Terrestrial, Analogue & Digital, Spectrum Analyser with BER (optional on P3)

# Alban

ALBAN ELECTRONICS LIMITED

THE PROMAX SERVICE CENTRE

6 Caxton Centre, Porters Wood, St. Albans, Hertfordshire, AL3 6XT.

TEL: 01727 832266 FAX: 01727 810546

WEB : [www.albanelectronics.co.uk](http://www.albanelectronics.co.uk)

EMAIL : [info@albanelectronics.co.uk](mailto:info@albanelectronics.co.uk)

SALES + SERVICE + CALIBRATION



TELECOMMUNICATIONS TEST EQUIPMENT  
AE 767 Spectrum Analyser



**NEW!**

THE NEW  
ALBAN WEB SITE...  
[www.albanelectronics.co.uk](http://www.albanelectronics.co.uk)  
FOR ALL THE LATEST NEWS  
AND INFORMATION  
FROM ALBAN

**NEW!**