

NEWS AND TECHNOLOGY ■ INSTALLATION ■ SERVICING ■ DEVELOPMENTS

TELEVISION

TELEVISION

PLQ, JPE
4.P1

AND

classement : PLQ

ELECTRONICS

JUNE 2005

£3.20

Plasma display technology



VINTAGE REPAIR:
Ferguson
352U radio



TEST REPORT:
Peak Atlas
ESR meter

Servicing the
B&O Unity TV chassis



FAULT FINDING FOR TV ■ AUDIO ■ SATELLITE ■ VIDEO ■ IT

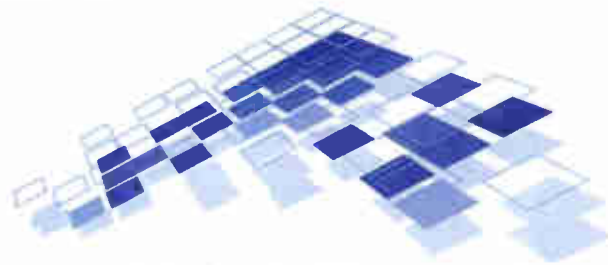

Digi Repairs
U K & I r e l a n d



sky+ TRADE REPAIR SERVICE FOR THE UK & EIRE

Are you looking for a reliable company to repair your sky digiboxes?
We offer **FREE SAMEDAY** Collection when you send more than
one box for repair!

● **FIXED PRICES**

Pace, Grundig, Amstrad **Fixed price £38 + VAT includes return delivery**
Panasonic, Sony

Sky + (Standard repair) Fixed price £45 + VAT includes return delivery
(Hard Drive replacement) Fixed price £75 + VAT includes return delivery

- Prices include all faults Micro processor, Modem, Software corruption and BGA replacement. *Send more than one box at a time we collect for FREE.*
- Specialists in the repair of Amstrad & Sony digiboxes.
- Refurbished digiboxes for sale (subject to availability).
- Fast Turnaround Time.
- All repairs fully guaranteed (6 months).
- Collection arranged from anywhere in the United Kingdom and Eire.
- Authorised Sky Digital Repair Centre.

*Receive our latest Satellite and technical newsletter **FREE** through
email. Just send us an email with Newsletter in the Subject title to:
info@digirepairs.co.uk*

Contact:

DIGI REPAIRS (UK & Ireland)
UNIT 25, ENNISKILLEN BUSINESS CENTRE
TEMPO ROAD, ENNISKILLEN BT74 4RL
TEL: 02866327293 (NATIONAL RATE)
0845 6441628 (LOCAL RATE)
Email: info@digirepairs.co.uk

CONTENTS

June 2005

Vol. 55 No. 8

451 Comment

Tough conditions.

452 News

Talks on a common blue-laser DVD format. Dixons expands overseas. FDP production. New battery technology. UK launch for Warner Mini DVDs. JVC develops a dual-layer DVD-RW disc.

454 Plasma display technology

Fawzi Ibrahim starts a new series that will provide an in-depth account of the operation and control of plasma display panels. Part 1 describes the construction and basic operation of a plasma display panel and the drive requirements and techniques used.

458 Test Case 510

460 Test report: The Peak Atlas ESR tester

Electrolytic capacitor ESR testing has done a lot to help and to speed up CE equipment servicing in recent years. Peak has recently introduced a new



tester, Model ESR60, with several interesting features. Eugene Trundle has given one an extended test.

462 Vintage restoration: the Ferguson Model 352U

Malcolm Burrell describes the steps he took to make an otherwise worthless set usable and presentable.

465 Service Casebook

Michael Maurice describes recent servicing problems.

466 Servicing the B&O Unity TV chassis

The Unity TV chassis has some novel features that could cause confusion. Paul Coles explains the basic operation of the sets then describes fault conditions that can be encountered, the steps to take to establish the cause and the appropriate repair process.

474 Developments from JVC

JVC recently announced a number of new products and technological developments in the TV, home recording and camcorder fields. George Cole reports.

478 Take care of your pennies

Elaine Everest provides advice for the self-employed TV engineer on dealing with banks.

480 Letters

Wavefront tilt. Who invented the AVO 8? A good start. Faulty LOPTs. Matters historical.

482 Help wanted

483 VCR clinic

484 DX and Satellite Reception

Terrestrial DX and satellite TV reception reports. DTT DX. Blind-search digital satellite receivers. The Quali-TV HD-TV satellite receiver. Roger Bunney reports.

488 Audio faults

490 Bench notes

Adrian Gardiner on the need to go lead-free to meet the latest requirements from the authorities and set-makers. And some notes on interesting websites.

492 TV fault finding

495 DVD and home cinema fault reports

496 Books to buy

498 Extended fault reports

A few longer reports on complex or tricky fault conditions.

500 What a Life!

A session at the shop, with some audio and TV repairs. Email summary. A warning about the prospects for LCD TV repair. Donald Bullock's servicing commentary.

502 Satellite notebook

Problems with Sky remote-control units. Digital channel update (28.2°E). WNBC New York. Atlantic Bird 3 (5°W). End of an era. Fault reports.

506 Monitor faults

507 Next month in Television

Editor

John A. Reddihough
TVeditor@highburybiz.com

Deputy Editor

Tessa Winford

Production Editor

Jane Massey

Production Executive

Deam Turner
01322 611206

Group Advertisement

Sales Executive

Bethany Treleaven
01322 611 289
Fax 01322 616 376

Editorial Assistant

Katie Butler
01322 616 147

Publishing Director

Tony Greville

Note that we are unable to answer technical queries over the telephone and cannot provide information on spares other than that given in our Spares Guide.

Disclaimer

We work hard to ensure that the information presented in *Television* is accurate. However, *Television's* publisher - Highbury Business - will not take responsibility for any injury or loss of earnings that may result from applying information presented in the magazine. It is your responsibility to familiarise yourself with the laws relating to dealing with your customers and suppliers, and with safety practices relating to working with electrical/electronic circuitry - particularly as regards electric shock, fire hazards and explosions.

Next issue, dated
July, on sale June 15

GV 198



PROMAX



NEW!

TELEVISION TEST PATTERN GENERATOR

FEATURES INCLUDE :

- ◆ Suitable for Televisions, projectors and flat screens
- ◆ Covers 4:3 and 16:9 formats
- ◆ Tunable RF modulator between 37MHz and 865MHz
- ◆ Tunable by channel (CCIR, OIRT or FCC) or frequency
- ◆ PAL / SECAM / NTSC Colour Systems
- ◆ B / G / D / K / L / I / M / N Standards
- ◆ Composite Video and Sync outputs
- ◆ High Quality Construction
- ◆ 10 Front panel memories
- ◆ EUROCONNECTOR interface
- ◆ Electronic Attenuator
- ◆ Compact and Strong
- ◆ User friendly
- ◆ Attractive Price
- ◆ Clear LCD Display
- ◆ Available from Stock
- ◆ Full After Sales Service

WIDE SCREENS



PROJECTORS

FLAT SCREENS



PROMAX

FOR ELECTRONIC TEST EQUIPMENT, THERE IS NO WIDER CHOICE THAN WITH PROMAX

Alban

ALBAN ELECTRONICS LIMITED

THE PROMAX SERVICE CENTRE

6 Caxton Centre, Porters Wood, St. Albans, Hertfordshire, AL3 6XT.

TEL: 01727 832266

FAX: 01727 810546

WEB: www.albanelectronics.co.uk

EMAIL: info@albanelectronics.co.uk

SALES + SERVICE + CALIBRATION



GV 241

COMPUTER MONITOR PATTERN GENERATOR

In the world of computer monitors, unlike those for televisions, there is a multiplicity of different systems involved. To satisfy this incredible demand, PROMAX has designed the GV-241, a universal generator for the testing of computer monitors, which greatly facilitates their adjustment, control and repair.

- ◆ Test Patterns : Colour Bars; Red; Green; Blue; Scale of Greys; Cross hatch; Multiburst and White
- ◆ Outputs : R; B; G; CVS; HS; VS; CS; C1, C2, and C3

AA 930 AUDIO ANALYSER



The AA-930 has been designed to facilitate the repair, tuning and analysis of audio frequency equipment in general. Hence, why the six indispensable measurement instruments from an audio service workshop have been combined into this one piece of test equipment. The AA-930 is equipped with RCA 600 Ω and DIN 47 kΩ connectors for the inputs and outputs. In addition, two BNC connectors on the front panel and two RCA connectors on the rear panel allow the user to view all of the signals measured by the instruments.

- ◆ Low Frequency Generator
- ◆ Wow and Flutter Measurement
- ◆ Distortion Meter
- ◆ Stereo Watt Meter
- ◆ Millivolt Meter
- ◆ Azimut



TA 903B CRT REJUVENATOR

The TA-903B has been designed to analyse and rejuvenate the cathode ray tubes (CRT) of colour and black and white televisions and monitors. The user can detect and depending upon circumstances repair the leakage or short circuits, simultaneously measure the current of the RGB cathodes in the cut off point, trace the voltage / current characteristics and rejuvenate each of the three cathodes independently.

COPYRIGHT

© Nexus Media Communications 2005. All rights reserved. No part of this publication may be reproduced, stored or transmitted in any form or by any means without the written permission of the publishers.

All reasonable precautions are taken by *Television* to ensure that the advice and data published are reliable. We cannot however guarantee it and we cannot accept legal responsibility for it.

CORRESPONDENCE

All correspondence regarding advertisements should be addressed to the Advertisement Manager, Television, Nexus Media Communications, Media House, Azalea Drive, Swanley, Kent, BR8 8HU. Editorial correspondence should be addressed to Television, Editorial Department, Nexus Media Communications, Media House, Azalea Drive, Swanley, Kent, BR8 8HU.

INDEXES AND BINDERS

Indexes for Vols. 38 to 53 are available at £3.50 each from SoftCopy Ltd., who can also supply an fifteen-year consolidated index on computer disc. For further details see page 507.

Binders that hold twelve issues of *Television* are available for £6.50 each from Modern Bookbinders, Pringle Street, Blackburn, BB1 1SA. Telephone: 01254 59 371.

Make cheques payable to "Television Binders".

Newstrade Enquires

by Seymour Distribution Ltd.,
86 Newman St, London, W1T 3EX.

ISSN 0032-647X**Newstrade Hotline**

If you are experiencing problems getting copies through your newsagent, please call Debbie Jenner on 01322 611210.

SUBSCRIPTIONS

Customer Interface Ltd.,

Cary Court,

Somerton,

TA11 7BR.

Telephone 0870 4287950

Fax 01458 271146

Subscription rates:

UK 1 year £33.80

2 years £61.00

3 years £81.00

Republic of Ireland 1 year £38.95

2 years £70.00

3 years £94.00

Mainland Europe 1 year £49.00

2 years £88.00

3 years £118.00

Rest of World 1 year £63.50

2 years £114.00

3 years £152.00

Cheques should be made payable to Television.

BACK NUMBERS

If available issues are £4.00 each.

Tough Conditions

The fact that so many of the major manufacturers in our field report on their trading results at much the same time, in late March/April, enables us to gain a pretty clear idea of the overall trading situation. The year 2004-5 has provided mainly gloomy news. It's not that sales have been poor, simply that over production and intense competition in some areas made it difficult to achieve profitability. With lots of new technology to offer a worldwide public that showed no reluctance to buy, it should have been a time of booming revenues. The digital age is rapidly taking over from the analogue era, with the added bonus of all those flat screens. But flat rather sums it up. Firms that have announced results recently include Sony, Sharp, Samsung, Matsushita (Panasonic), Philips and the Chinese company TCL Multimedia, the world's largest TV manufacturer. The cause of the trouble is relentless pressure on prices. DVD recorder prices fell by some 40 per cent during the year, while the price of flat-screen TV sets fell by 20-30 per cent.

There have been exceptions to the general gloom, notably Sharp which reported record sales and profits and predicted further success in the year ahead. It expects a shortage of large LCD panels to have a stabilising effect on prices. The company decided some time back to drop CRT set manufacture and concentrate on LCD TV, and has become the world's largest manufacturer of such sets. The move seems to have paid off. By getting in at an early stage and investing heavily in the technology, Sharp has succeeded where those who took a more leisurely approach to change have done poorly. It expects worldwide sales of LCD sets to rise to 15m this year, with an increase of 30 per cent in its own sales. The company benefited from a shift to larger-size LCD TV sets, which are more profitable. In other product areas however Sharp had less success, reflecting the situation with other companies. Nevertheless sales were a record Y2,540bn and profits a record Y151bn.

Matsushita was the other success story last year, with group sales up 16 per cent and consolidated profits up 58 per cent at Y308bn. But it predicted flat sales for the year ahead, with severe trading conditions and ever intensifying price decreases. Last year the company had success with strong sales of plasma TV sets and DVD recorders – and a washing machine. Matsushita is building the world's largest plasma TV plant, and anticipates an increase in plasma TV set sales of over 60 per cent.

Sony's problems were discussed here last

month. Its electronics side made an operating loss of Y34.4bn last year, following a loss of Y6.8bn the previous year. The electronics business is expected to make a loss again this year – the entertainment side seems to be keeping it going. It is difficult to assess Sony's current overall profitability, partly because of changes to its pension fund obligations.

Samsung, the world's largest maker of plasma display panels, reported a drop in first quarter net profit of over 50 per cent. The company is also the world's second largest manufacturer of semiconductor devices and a major producer of mobile phones and LCD panels. Operating profit from its LCD division fell by 97 per cent. In addition to weak pricing power the company blames an unfavourable exchange rate with respect to the dollar – over four-fifths of its output is exported – and problems with its credit card affiliate. The company expects conditions to remain difficult, but is optimistic about trading in the longer term. It continues to invest heavily in R&D and manufacturing capacity, which are both essential for its long-term health.

During the first quarter of the present trading year Philips' five in-house divisions were all profitable. Its US consumer electronics unit, which had faced closure, increased sales by 29 per cent. But there was a substantial fall in overall consolidated profits, partly as a result of losses by its jointly owned display company LG.Philips, which is a major manufacturer of LCD screens. Philips is considering withdrawal from this display joint venture.

Chinese TV manufacturer TCL Multimedia suffered a profit decline of 51 per cent last year despite a sales increase of 69 per cent, a clear indication of the pressure on margins. The company has had problems with restructuring overseas acquisitions – it bought Thomson's TV and DVD player operation in 2004 and in 2002 acquired German manufacturer Schneider Electronics. Chairman Li Dongsheng commented that business conditions are particularly tough in North America and Europe, presumably because of the buying power of mass retailers.

It's not only the AV field that's affected by these conditions. Exports of digital cameras from Japan declined for the first time in February, by 0.9 per cent on a year-by-year basis but, more significantly, by 11 per cent in value. Japanese manufacturers account for about 80 per cent of worldwide digital camera production.

Talks on a common blue-laser DVD format

Sony and Toshiba have confirmed that they are holding talks with a view to adopting a common format for the next generation of DVD discs with enhanced storage capacity, instead of pursuing their two rival systems – the Blu-ray disc and HD-DVD respectively. Some reports have suggested that Philips has also been involved in the negotiations. The Blu-ray system is supported by Sony, Philips, Pioneer, Apple, Dell and others while HD-DVD's advocates include Toshiba, Sanyo and NEC. Some electronics manufacturers have been hedging their bets by giving support to both. Hollywood studios have also been supporting both formats to some degree. The discussions come at a time when computer, con-

sumer electronics and consumer groups say that to launch two rival formats could harm the prospects for both of them.

The talks are aimed at developing a hybrid format, in the same way that DVD includes features from Toshiba's SD format and the Sony/Philips MMCD. They both have some features in common, including the use of a blue-light laser to increase the data density, the use of Microsoft's VC-1 video compression technology and the AAC copyright protection system, but there are many technical hurdles to overcome. Both proposed formats use 12cm discs of 1.2mm thickness. The Blu-ray disc has a 1mm recording layer at the top however, while HD-DVD uses a conventional DVD structure with two

0.6mm discs bonded together. Blu-ray has the advantage of greater storage capacity, 50GB in comparison with 30GB, but HD-DVD can be produced using current DVD manufacturing technology. Sony has apparently proposed using the Blu-ray disc structure with HD-DVD software technology as the basis for a new format, while Toshiba has proposed using the basic HD-DVD disc structure and Sony's multilayer disc-recording technology.

The main advantage of the new systems is their ability to store HD material. This is important for the film companies, which are increasingly dependent on revenue from selling recorded material. Figures compiled by the Digital Entertainment Group

show that US consumers spent \$21.2bn on buying and renting DVDs in 2004, an increase of 33 per cent on 2003. In comparison box-office revenues grew only modestly. Only 40 per cent of films ever recoup their production and marketing costs.

Sony, Toshiba and any others involved will have to move fast if their negotiations are to be successful, because launch dates are approaching. There are plans to launch the first HD-DVD players and discs in Japan and the US later this year while Sony intends to incorporate Blu-ray technology in its next-generation games console PlayStation 3, which is scheduled for launch next year. Any new hybrid format is unlikely to appear this year.

Dixons expands overseas

Dixons, which is facing reduced consumer spending in the UK and increasing competition from the supermarkets, has decided to enter the Russian market. The company has taken an option to buy the Eldorado Group for \$1.9bn (£1bn) by 2011. It will acquire a ten per cent stake for \$190m by the end of 2007, then has the right to buy the rest of the business for a further \$1.71bn by 2011. Dixons chief executive John Clare feels that in an unknown market it's better to acquire an established business rather than go in from scratch. The company at present operates in thirteen different countries, includ-

ing Italy and Greece, and has made six acquisitions in the past.

Eldorado is Russian's largest non-food retailer. It was founded in Yekaterinburg in the Urals in 1995, and moved into the Ukraine in 1999. Eldorado at present has some 610 stores, just over half of which are franchised, in 420 towns and cities. Turnover last year was £1.3bn, an increase of more than 80 per cent on 2003.

Dixons expects to be selling more product overseas than in the UK by the end of the decade. It at present has some 416 stores on the Continent, compared with 976 in the UK.

Handheld PAT from Seaward

Seaward's new PrimeTest 300 lightweight, handheld portable appliance tester has been designed to boost productivity by making tests faster and easier. It incorporates all required Class I and Class II electrical safety tests in a compact, user-friendly design. The long-life battery eliminates reliance on a mains supply, making the instrument suitable for use anywhere, and reduces downtime between tests. New Bluetooth technology provides wireless connection of bar-code scanners, label printers and other accessories, providing cable-free testing without the need to plug and unplug leads and cords. There are manual and automatic test modes, and the large internal memory stores test results for safety audit and traceability purposes. Wireless connection enables stored data to be transferred immediately to PC-based record-keeping systems.

The new tester is an addition to Seaward's comprehensive range of PAT equipment, software and accessories.

Seaward Electronic Ltd. can be contacted at 0191 586 3511. There's a website at www.seaward.co.uk or you can email sales@seaward.co.uk



UK launch for Warner Mini DVDs

Warner Bros is to launch its Mini DVD format in the UK. The discs have a diameter of 8 instead of 12cm, making it possible to develop miniature DVD players. They store up to an hour of DVD-quality sound and video. The format is aimed at younger users – launch titles include Batman, The Flintstones and Scooby Doo. Cyberhome and Samsung have released mini DVD players in the US. The Cyberhome CH-MDP-2500 has a 2.5in. 4:3 LCD screen and weighs 273g.

New battery technology

Sony has developed what is claimed to be the industry's first hybrid lithium-ion rechargeable battery, known as Nexelion. The new battery has a tin-based amorphous anode instead of one that uses graphite-based materials. This increases the lithium-ion storage capacity per volume ratio by 50 per cent and the overall battery capacity by 30 per cent. Initial use will be as a battery pack for Sony's Handycam products.

The tin-based amorphous anode consists of a number of elements including tin, cobalt

and carbon, which are mixed at nanometre level. Conventional batteries use carbon-based materials such as soft and hard carbons as well as graphite. By adding several elements to the tin-based compound, Sony has been able to minimise the change in particle shape during charge and discharge. This solves the problem of cycling characteristics. The result is a 50 per cent higher unit per volume ratio of lithium-ion density compared with a conventional graphite anode. Some 90 per cent of a Nexelion battery's

fully-charged capacity can discharge at 0°C to room temperature (25°C), giving improved video shooting time in cold-weather conditions.

Toshiba has announced a new lithium-ion battery that can be recharged to 80 per cent of its energy capacity in just one minute, some sixty times faster than a typical current lithium-ion battery. According to Toshiba the new battery combines advances in nano-material technology with cumulative experience in the manufacture of lithium-ion battery cells.

Kameleon RC from One For All

The latest addition to the One For All range of universal remote-control units is the Kameleon 10, which provides control of ten domestic entertainment devices. It has a blue touch-screen electro-luminescent display and comes with rechargeable batteries and a new charging cradle. Multi-room operation is provided by the use of RF transmission.



According to the manufacturer the unit will operate all entertainment devices while its built-in modem, allowing upgrades for the latest codes, keeps it future-proof. As with the existing Kameleon range, users can navigate between ten screens, each of which shows only the keys required for the item being controlled. The price is about £99.95.

For further information check at www.oneforall-int.com

JVC develops dual-layer DVD-RW disc

JVC has developed what is claimed to be the world's first single-sided, dual-layer DVD-RW disc, with a storage capacity of 8.5GB. This provides a video recording time of up to ten hours, 50 minutes in a DVD recorder's EP mode or up to three and a half hours in the SP mode. Until now single-sided, dual-layer discs have been limited to write-once capability. JVC says that the breakthrough has been made possible by the development of a high-sensitivity recording film, a new recording method (N-Strategy) that enhances erasability, and a proprietary precision

thin-film forming technology. JVC has also developed a facing-film bonding method that makes possible mass production of the new discs using conventional manufacturing equipment.

The new disc provides 1.8 times the storage capacity of a conventional single-sided, single-layer DVD-RW disc. It is expected to be widely used for video recording and for mobile and desktop PCs. JVC plans to put forward a proposal to the DVD Forum in an effort to promote the adoption of single-sided, dual-layer DVD-RW disc technology.

Advanced Freeview box launched

Technology company iPlayer has launched what it describes as a combined Freeview box, communications and multimedia adapter. The iPlayer+ is a DTT receiver that includes a seven-day EPG, Top Up TV compatibility, interactive services and multiple AV outputs, with the additional functionality of a home-entertainment system and communications centre. Users can watch the Freeview channels, listen to a digital radio channel, use email, access the internet, send and receive SMS text messages via a TV set, or stream MP3 files and JPEG images from a PC located in a different part of the house. Other features include WiFi compatibility and a USB port. There's an optional keyboard. Price is about £90.

FDP production

The S-LCD Corporation, a joint venture that was formed by Samsung and Sony in April 2004, has started to supply generation 7 amorphous TFT LCD screens to its parent companies.

One generation 7 glass substrate (1,870 x 2,200mm) provides a number of screens depending on size – 18 26in. panels, 12 32in. panels, 8 40in. panels or 6 46in. panels.

Pioneer has announced that it is to close about a quarter of its global manufacturing facilities because of over supply and falling prices. The company says that plasma display panel prices in particular have fallen by some 40 per cent recently. Nevertheless Pioneer sees future growth in the PDP market, from about 2.4m in the current year (to the end of March) to 11m by March 2009.

Matsushita (Panasonic) is at present building the world's largest plasma display panel plant in anticipation of an expected increase of over sixty per cent in sales of plasma TV sets.

LG Electronics and Matsushita Electric have settled a dispute over plasma display technology. The companies filed lawsuits against each other last year claiming infringement of patents: as a result, imports of LG panels to Japan and Matsushita panels to Korea were suspended. Under the agreement between the companies the import suspensions will end and the companies will cross-licence their PDP, PC and DVD patents.

The companies are to set up a Business Collaboration Committee to explore areas of potential collaboration.

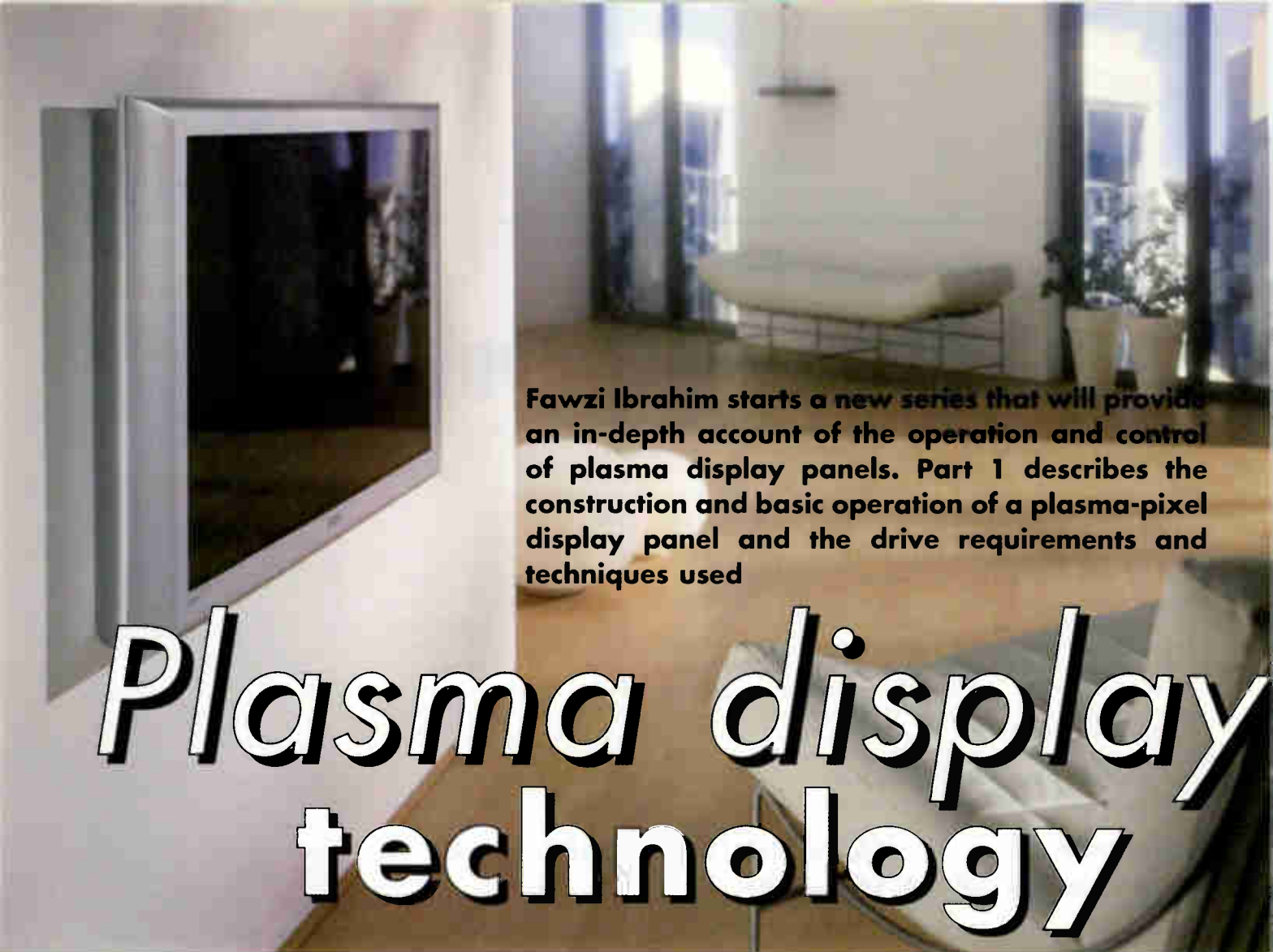
A photograph of a plasma display panel mounted on a wall in a modern living room. The room features a white sofa, a coffee table, and large windows with a view of a city skyline. The plasma display panel is the central focus, showing a dark image.

Fawzi Ibrahim starts a new series that will provide an in-depth account of the operation and control of plasma display panels. Part 1 describes the construction and basic operation of a plasma-pixel display panel and the drive requirements and techniques used

Plasma display technology

For many decades the CRT had a monopoly as the display device for TV, computer and other applications. This situation has now changed, with the CRT being challenged by flat-panel displays (FPDs) of various types. The two main types are the liquid-crystal display (LCD) and the plasma-display panel (PDP). CRTs remain the most common type of display in use for consumer TV applications, and continue to provide very good pictures at low cost. But their weight and bulk become prohibitive with screen sizes above about 36in. LCDs, which are used for laptop and now desk-top PCs and many recent TV models, are normally used for small to medium size screens. Plasma technology is favoured for larger flat screens, for example TV displays over 36in.

PDP technology is based on the light output created by high-voltage glow discharges whose dimensions are in the $100\mu\text{m}$ range. These provide the picture elements (pixels) in the display. Visible light is emitted for a monochrome display, but with a colour display the ultraviolet (UV) photons emitted by the discharges are converted to visible photons by red, green and blue phosphors. So the gas mixture used to produce the discharges must be efficient at creating UV photons: xenon is generally used, in a mixture with another rare gas such as neon or helium.

The concept of the plasma display panel is actually quite old, but it has become a serious competitor to CRTs and other technologies for large screens in only the last few years – as a result of improvements in luminous efficiency, contrast ratio, life time and the electronic drivers required. This article will cover the construction and operation of a plasma panel and the drive requirements and techniques.

The plasma pixels

Each plasma pixel is based on three discharge cells that provide

red, green and/or blue outputs as required. The operating principle of a plasma cell is closely related to that of the simple neon light source. It has long been known that certain mixtures of gasses, such as neon, helium and xenon, break down to become plasma when they are subjected to a sufficiently high voltage. This is known as a plasma discharge. In addition to electrical conduction, a plasma discharge converts part of the electrical energy involved into electromagnetic radiation, including UV and visible light. See Fig. 1. This effect is used in a matrix of cells that are controlled by arrays of row and column electrodes and are mounted between two glass plates, at the front and back.

The major drawback of a simple plasma-discharge cell is the fact that the light emitted is the familiar orange glow of a neon sign. To overcome this, and produce a range of colours, the insides of the plasma cells are coated with phosphors that emit red, green and blue light when activated. See Fig. 2.

Modifications have been introduced to simplify construction, reduce cost and increase the brightness. The result is the co-planar cell in which two electrodes, called sustain and scan, are placed in the same plane instead of facing each other. See Fig. 3. A third electrode, known as the data or address electrode, controls the direction of the main discharge – perpendicular to the parallel electrodes. This electrode is also used to apply video data to the cell, hence its name.

The three electrodes are mounted on the front and rear glass plates. The data electrode is on the rear glass plate while the scan and sustain electrodes are on the front plate. Being at the front, the scan and sustain electrodes are made of transparent material. The division between the cells consists of a barrier rib: this prevents adjacent cells from activating each other.

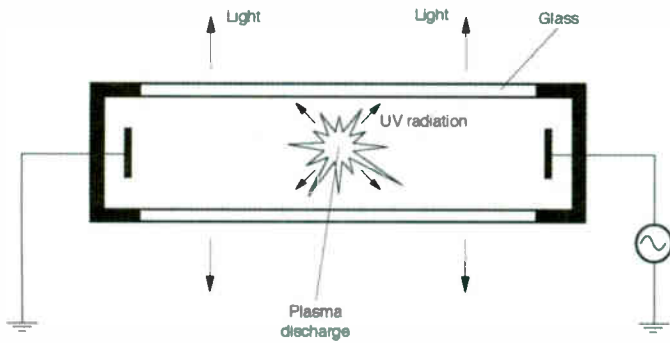

Fig. 1: The basic plasma discharge.

Driving a plasma cell

There are three stages to driving a plasma cell, see Fig. 4: (1) set or initialise (also known as erase); (2) address or write; and (3) discharge or sustain (also known as display).

The cell is initialised by removing any residual charge that may remain from a previous drive cycle. This is accomplished by applying an initialise/set pulse between the sustain and the scan electrodes. See Fig. 5. The result is a start discharge, the gas in the cell becoming ionised. This start discharge is not a fully-fledged discharge, and very little emission occurs.

Once the cell has been cleared and set, the next stage is to determine whether it is to be turned on to produce a light output. This depends on the picture content. To select a cell for discharge, a positive-going pulse is applied to the data electrode and a negative-going pulse to the scan electrode. This is the write stage. Ions and free electrons are created, charging the dielectric around the electrodes. The charge is known as a 'wall charge': it primes the cell for a fully-fledged plasma discharge at the following step.

The next stage is to produce the full discharge and thus light emission. This is accomplished by applying a sustain pulse between the scan and the sustain electrodes. The pulse is of polarity (negative-going) such that it adds to the existing wall charge. As a result a plasma discharge occurs and, with it, emission of the relevant colour output. The pulses are at a high frequency, in the region of 200kHz.

This plasma discharge reverses the polarity of the wall charge. Next, by applying a positive-going sustain pulse between the scan and sustain electrodes, a second plasma discharge occurs, reversing the wall charge. This process continues, with discharges occurring at the negative and positive peaks of each sustain pulse, see Fig. 6. Pixel brightness is determined by the number of sustain pulses applied to the electrodes.

If the cell is not selected for emission during the write phase there will be no wall charge and a cell discharge will not be sustained, even when the sustain pulses are applied.

The process is then repeated, starting with initialisation.

The plasma panel

A plasma panel consists of a matrix of cells arranged in rows (lines) and columns. Each row of cells has a sustain and a scan electrode bus while each column of cells is underlined by a data/address bus. The electrodes are protected from UV bombardment, which would limit their working life, by an insulating dielectric that acts as a protective coat. This creates a capacitive reactance in series with the cell. Apart from acting as a current limiter, the reactance is crucial to formation of the wall charge, acting as a temporary memory to store one-bit video data.

The plasma panel is built by first mounting the data electrodes on the rear glass. A protective dielectric coating is then applied. Ribs are created as colour area dividers, and colour phosphors are added to the cells thus formed. Transparent scan and sustain electrodes are mounted on the front glass, with a

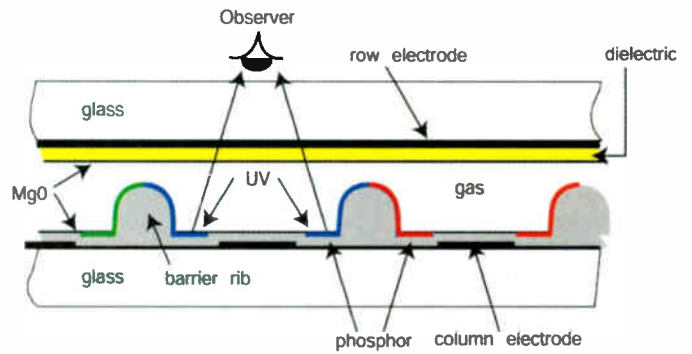

Fig. 2: Obtaining a coloured light output by UV activation of phosphors.

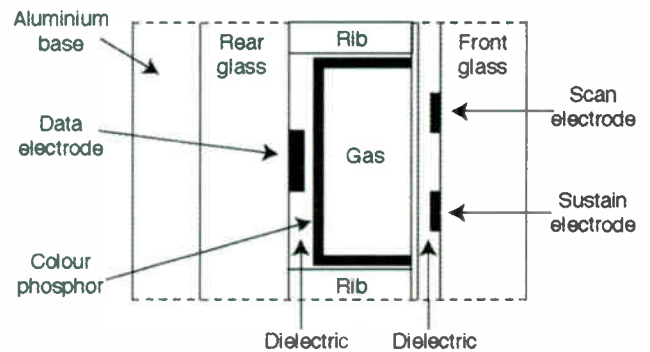

Fig. 3: Basic pixel cell structure (one colour).

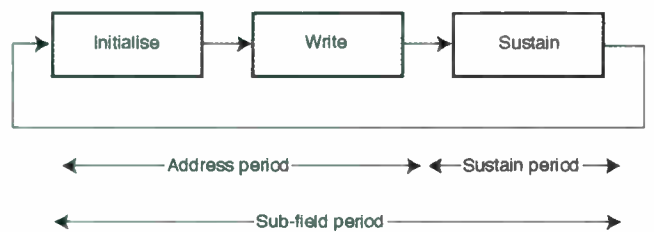

Fig. 4: The three-phase pixel cell drive cycle.

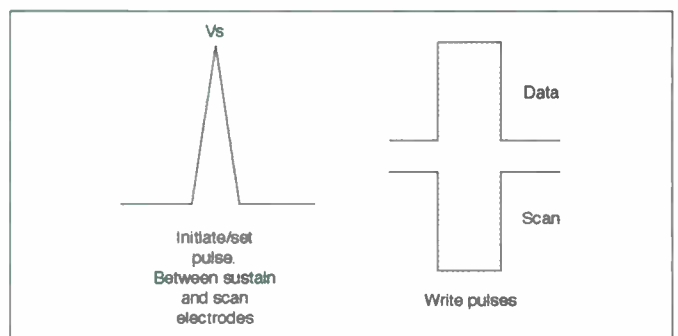

Fig. 5: Basic pixel drive pulses.

protective dielectric coating as before. Finally a magnesium-oxide overcoat is applied over the front glass dielectric to protect the electrodes from discharge.

The cells are of different sizes depending on the phosphor colour, with the blue cells wider and the red cells narrower than the green cells. The reason for this asymmetry is to cater for the different efficiencies of the phosphors. This asymmetric arrangement has the disadvantages of increasing manufacturing

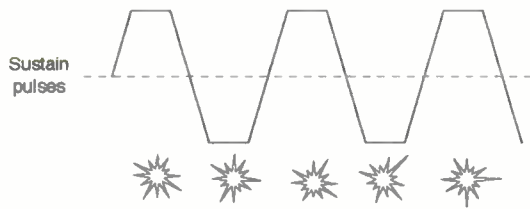

Fig. 6: Discharges occur at the positive and negative peaks of the sustain pulses.

cost and reducing life time however. Box-shaped cells are used to provide a larger effective phosphor surface.

Driving a PDP

As described earlier, driving a plasma cell involves a three-stage cycle: initialise, write and discharge. When applied to a PDP, the technique is called Address Display Separated (ADS). Cells are addressed individually line-by-line then, in a separate stage, they are discharged simultaneously.

The initialise pulse is first applied to all the cells simultaneously. The cells are then addressed one line at a time. Each line is selected in turn, and the cells along it are addressed individually by the digital video data fed into the data electrode bus. If a cell is selected, the dielectric on its wall is charged (wall charge).

Once the plasma cells in one line have been addressed and the appropriate cells have been turned on, the next line is selected and so on. When all the lines have been scanned and the cells have been addressed, the sustain/display phase is implemented by applying a series of sustain pulses to all the cells simultaneously. The scan waveform thus has the distinctive shape shown in Fig. 7.

Set (initialise) voltage pulse V_s is applied to all the scan electrodes simultaneously to clear and set all the plasma cells. This is followed by the address/write period, during which each line of pixels is selected in turn and the cells in the selected line are addressed individually by the digital video data fed down the relevant data electrode bus one bit at a time – hence the

name 'one-bit plane technique'. A one video data bit selects the cell for emission, and a wall charge is created. A zero video data bit will not select a cell and no wall charge will be formed.

Once a line has been addressed, its scan electrode voltage is kept at a negative level known as the base-write voltage, V_{bw} , for the remaining duration of the address period. This is necessary to avoid premature discharge of the cells, known as a self-erasing discharge, which would remove the wall charge. The sustain bus is kept at a small negative voltage known as the sub-write voltage, V_{sw} , during the address period.

At the end of the address period out-of-phase $5\mu\text{sec}$ pulses are fed to all the sustain and scan electrodes for the simultaneous discharge/display of all the selected cells.

Scanning

With a CRT line scanning and light emission take place simultaneously. With a plasma panel however scanning, in the form of addressing the pixel cells, takes place sequentially line by line, a process that's separate from the actual emission of light. The latter takes place during the sustain period, when all the selected pixels are discharged simultaneously. For this reason the flicker associated with interlaced CRT scanning is completely avoided.

The ADS plasma panel addressing technique is sequential, while TV broadcasting involves interlaced pictures. It's therefore necessary for interlace-to-progressive (I-P) conversion to take place before the video data are fed to the data electrode buses.

Table 1 compares CRT and PDP characteristics.

Sub-field coding

A PDP's brightness level depends on the number of sustain pulses and therefore the duration of the sustain period. A long sustain period produces more plasma cell discharges and therefore a higher brightness level and vice versa.

A single drive cycle of initialise, write and discharge (sustain) produces one level of brightness. To produce different levels of brightness at different plasma cells, in other words to produce a grey scale, we need more than one drive cycle per picture frame. And since each drive cycle requires one bit of video, the number of times the initialise, write and discharge cycle can

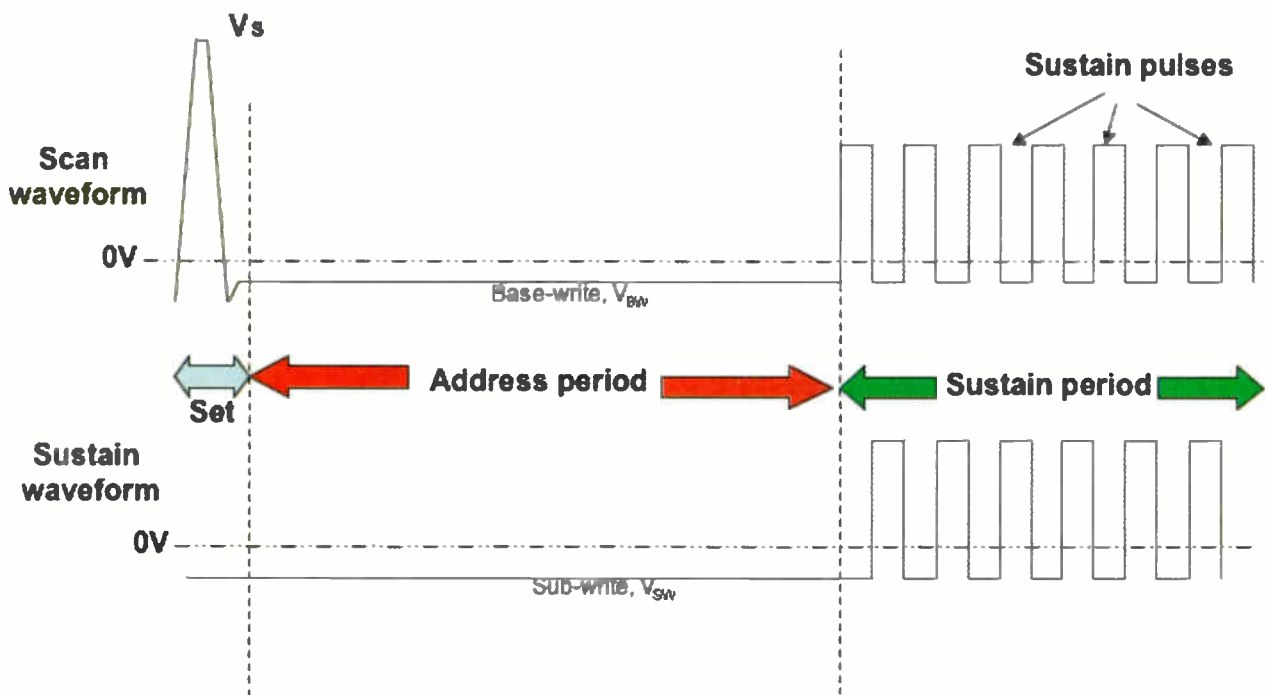

Fig. 7: Scan and sustain drive waveforms.

be repeated is limited by the number of bits used in the data words that determine the brightness levels of the pixels.

Thus if eight bits are used to determine the brightness level produced by a plasma cell, the discharge cycle will be repeated eight times for each complete picture. Each such cycle is known as a sub-field. With 8-bit video, eight sub-fields are used for each picture and two to the power of eight different levels of brightness can be created, giving 256 grey-scale levels. Similarly 10-bit video with ten discharge cycles gives 1,024 grey-scale levels while 7-bit video gives 128 grey-scale levels.

Each sub-field (SF) is given a brightness weighting that's determined by the length of the sustain period. A sub-field with a short discharge period results in low brightness and vice versa. Table 2 shows a simple binary weighting. The total brightness of each plasma cell is the summation of the brightness contributed by each sub-field. Fig. 9 shows the sustain periods for each sub-field.

The complete set of sub-fields has to take place during the duration of one complete TV picture frame, which with the UK 625-line system is 20ms and the US 525-line system is 16.7ms.

Notice that while the discharge time increases progressively in binary steps, the address period is constant throughout, with a typical value of 1.7ms. During this relatively short period of time, all the lines have to be addressed line by line. For a VGA screen with 480 lines, the address cycle time is in the region of $1.7/480 = 3.5\mu\text{sec}$ per line, resulting in an address frequency of $1/3.5 = 285\text{kHz}$.

In order to increase the time available for the addressing period, to suit high-resolution panels where the number of lines can exceed 1,000, 'dual scanning' is used. The screen is divided into two halves, upper and lower, the two halves being scanned simultaneously, see Fig. 9. This doubles the time available for addressing each line. Simultaneous scanning requires two independent panel drive systems however, thus increasing the cost.

The number of colours available also depends on the number of sub-fields, and thus the number of video bits. For 8-bit video, each colour cell has 256 levels. Thus a pixel that consists of three colour cells can produce 2^{24} (or $256 \times 256 \times 256$) = 16.778 million colours. 10-bit video would give 1.07bn colours and so on.

Video processing

From all this it's obvious that the ADS drive method requires a video processing system that's quite different from that used by a conventional CRT receiver. Fig. 10 shows a basic block dia-

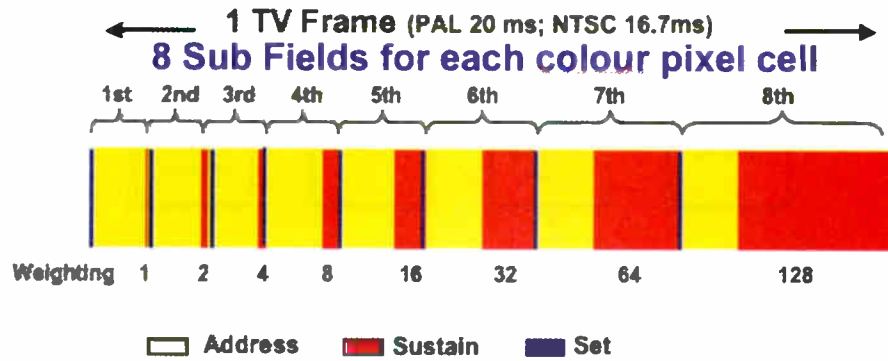

Fig. 8: The sub-field drive system.

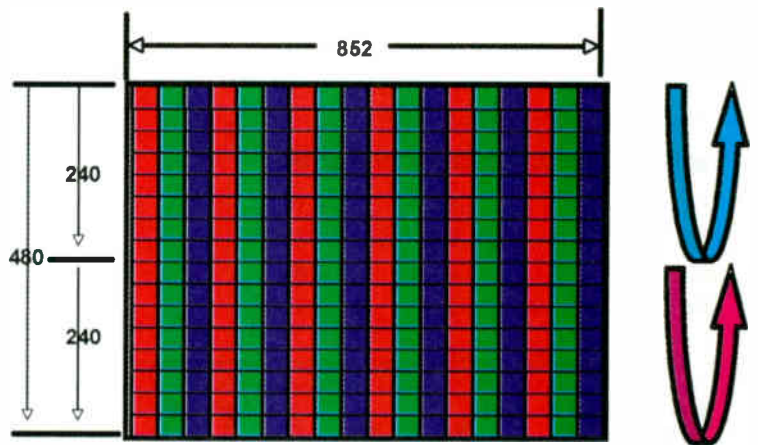

Fig. 9: Simultaneous scanning of the upper and lower parts of a PDP.

gram for a PDP video processing system.

Analogue video (PAL, NTSC or SECAM) in composite, RGB or component video form is first fed to an analogue-to-digital converter, then to an interlace-to-progressive converter that combines the two interlaced fields to form a single picture frame. If the input source is already in digital form, this can be fed straight to the I-P converter.

Unlike a CRT, the relationship between the input signal and the luminance output is linear with a PDP. Gamma-correction is introduced at the broadcasting stage to compensate for a CRT's non-linear input/output characteristic, so with a PDP de-gamma-correction is necessary.

The dither and error diffusion circuitry is used to overcome the tendency to grey-scale loss as a result of a combination of moving pictures and the limited number of sub-fields.

Table 1: CRT-PDP comparison

Characteristic	CRT	PDP
Scanning	Dot sequence, interlaced	Line sequence, progressive
Emission	Dot sequence	Simultaneous
Phosphor excitation	By electron beam	By UV radiation
Brightness control	By beam current	By discharge (sustain) period
Power consumption	100-150W	350-500W

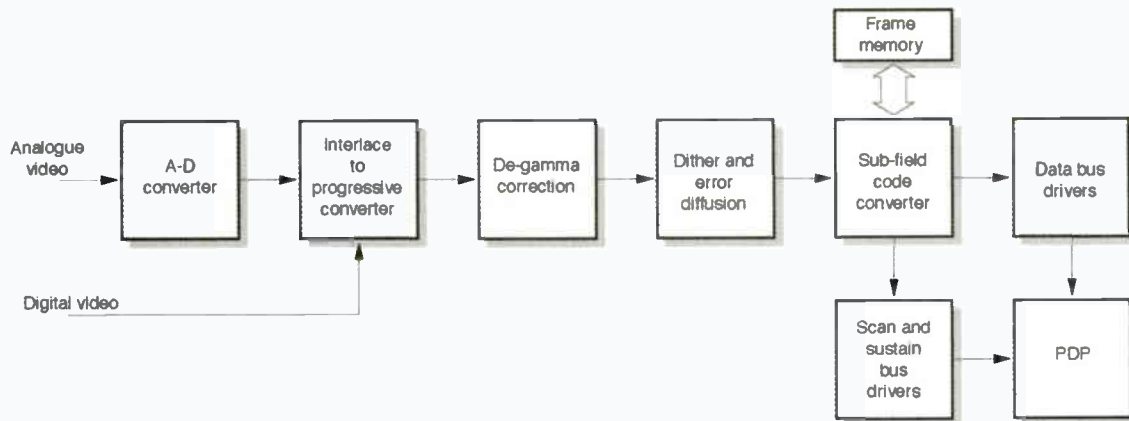

Fig. 10: Basic elements of a PDP video processing system.

The video data is then fed to a sub-field code converter, to convert each picture frame into a number of sub-fields, and is finally passed to the PDP data bus drivers. These are responsible for feeding the video data bits to the data electrode buses. The sub-field code converter is also responsible for synchronising the scan and sustain bus drivers.

Table 2: Simple binary weighting

SF1	$2^0 = 1$	SF5	$2^4 = 16$
SF2	$2^1 = 2$	SF6	$2^5 = 32$
SF3	$2^2 = 4$	SF7	$2^6 = 64$
SF4	$2^3 = 8$	SF8	$2^7 = 128$

Next month

In Part 2 next month we'll be taking a look at various techniques that have been devised to improve the performance of PDPs.

Fawzi Ibrahim is currently engaged in developing and running training courses on plasma and TFT/LCD at the College of North West London. He may be contacted by email at Fawzi.Ibrahim@cnwl.ac.uk or by phone on 07976 350724.

Test Case 510

Service technicians increasingly find themselves trying to repair equipment without the benefit of a service manual or even a circuit diagram. And, increasingly, the viability of carrying out a repair to cheap equipment is doubtful as service costs rise while the shop-shelf (supermarket-shelf!) price of new gear falls. Both these factors were relevant to the job to be described this month, but it was still successful!

The patient that managed to pull through was a Wharfedale DVD player, Model M3. It was manufactured in China and imported, we understand, by the dealer buying/selling group CIH/Euronics. The label that came with it said "erratic operation", and never was a description more appropriate! When a disc was inserted it would sometimes fail to be recognised at all, with the spindle motor whirring and roaring. If the disc did start to play, the picture it produced frequently froze, as did the controls themselves. More often than not there was no response to the remote-control zapper's keys or the front-panel controls. In this condition the only way to change things was to switch the machine off. Sometimes the

tray open-close key switched off the front-panel display. The soundtrack was often replaced by a steady bleep tone or a tinkling-bell effect. What a diverse collection of symptoms!

So diverse in fact that they suggested a system-control, reset or data-corruption problem. Real Technician, the lucky man assigned to this repair, looked at the huge chips on the control/processor board. His heart sank. Are these things really intended to be repaired? DVD players now sell for less than £40 in some places. As he contemplated condemning this one, RT's eye fell on the power-supply panel. It contained lots of familiar components, and the output plug CN503 was clearly marked with the voltages to be expected. RT reasoned that the symptoms produced by this machine could stem from incorrect supply-line voltages. So out came his digital multimeter and he found the following readings at the power supply plug: the +3.6V line was at 3.42V, the +5V line at 4.91V, the +12V line at +12.08V and the -12V line at -13.83V. These seemed to be reasonably close to correct, RT thought. Not far enough out, he guessed, to cause such chaos to the

machine's operation.

RT half-heartedly examined the plug/socket connections throughout the machine, and peered through his big illuminated magnifying glass at the soldering of the hundreds of legs on the surface-mounted chips on the right-hand PCB. As nothing amiss could be seen, RT started the machine up again. The panel display showed, sequentially, 'hello' then 'load', after which it extinguished itself. The spindle motor whirred up and down, while the optical-unit's lens clicked and oscillated a few times before settling down.

The machine remained in limbo while RT pressed and flexed (gently!) the PCBs then, with a plastic knitting needle, the rows of leadouts on the LSI chips. A bright idea took RT to the workshop PC to visit a couple of repair-tip websites, but there was no mention of this fault . . .

Only good for the dustbin then, it seemed. Coffee-time discussion with the other workshop worthies cast doubt on RT's testing techniques however. Could sloppy working have prevented him from making a diagnosis? What do you know that RT didn't? See page 507.

Horizon Digital Satellite Meter

HDSM

- Signal Strength and BER displayed together
- 32 Transponders or 16 satellites, horizontal & vertical
- Audible tune-in, with back light
- DVB, C&Ku band, Mpeg, V Sat compatible
- Figure 8 mains input connector. 2.1 mm Female PSU plug

HORIZON

For a reliable solution!

www.horizonhge.com

For a threesome to remember choose Horizon Satellite Meters

Horizon Digital Terrestrial Meter

DTM

- Displays Signal Strength (R.F level) and Pre and Post BER together (via website) or all channel step through
- Audible tune-in, with back light
- Automatic constellation
- RF input range 167-862 MHz
- Input dynamic range -72dBm ~ -20dBm



MiniSAT

- Cost effective
- Small and Compact
- Measures two sets at same time
- Self powered via rechargeable NiMH batteries
- Powered via built in batteries, charger or receiver



Also available from the following distributors

Eurosat Midlands 01922 639299 www.eurosatmidlands.com

Eurosat North 01924 423602 www.eurosatmidlands.com

Grax Nottingham 0115 927 9993 www.grax.co.uk

Grax Manchester 0161 747 2007 www.grax.co.uk

Grax Leeds 0113 26 33 500 www.grax.co.uk

Solutions Group 08456 444 000 www.solutionsgroup-plc.com

Or contact Horizon direct for your local supplier

on +44 (0)20 8344 8230

or email sales@horizonhge.com



COLOUR TRADE

**POSSIBLY
LARGEST & OLDEST
EST. IN
THE UK EST FOR
30 YEARS**

Wholesaler Distributors & Expert Agents of
Domestic Electronics & Appliances

**FULL RANGE OF FACTORY
GRADED TV's DVD / VIDEOS
HI-FI SMALL & LARGE
DOMESTIC GOODS**

www.colourtrade.com

**WHOLESALE MADE EASY ON LINE, SIGN UP
NOW FOR OUR WHOLESALE PRICES.
ALL ORDERS DISPATCHED ON THE SAME DAY.**

Now Available
TV's, DVD's, VCR & AUDIO

Over 40 years of genuine experience

Experts on:-

Thomson • Sanyo • Beko • LG • Tatung • Ferguson
Bush • Funai • Pacific • Dansai • Samsung & more

**TECHNICAL SUPPORT
0907 076 70 80**

Call cost 60p min

MAIN DEALER

- Thompson
- Sanyo
- Beko



Tel: 0121 359 7020 Fax: 0121 359 6344

Phoenix House, 190 Bridge St. West, Newtown, Birmingham B19 2YT

Email: inquiries@colourtrade.com

Test report:

The Peak Atlas ESR tester

Electrolytic capacitor ESR testing has done a lot to help and to speed up CE equipment servicing in recent years. Peak has recently introduced a new tester, Model ESR60, with several interesting features. Eugene Trundle has given one an extended test

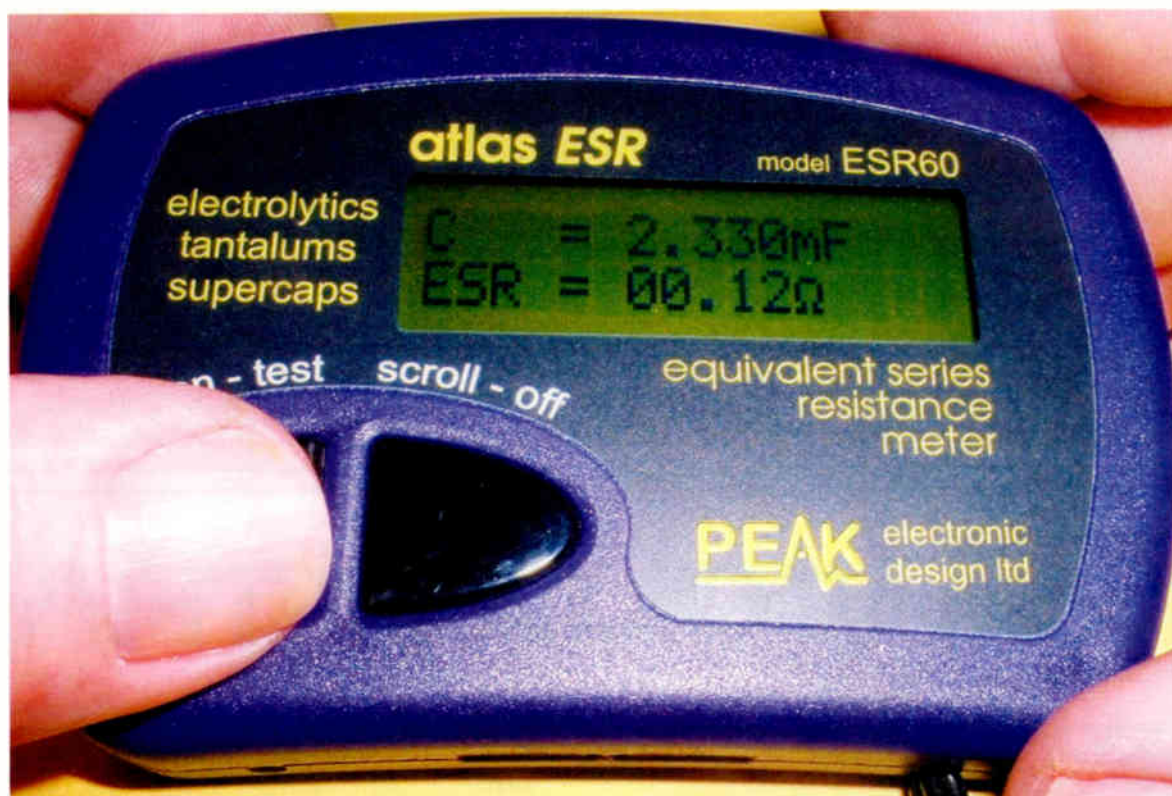

The Peak Atlas ESR tester Model ESR60.

In the past few years electrolytic capacitor ESR (Effective Series Resistance) testing has become a common topic in this magazine. There have been articles and constructional projects, amongst which there was an excellent practical design by Alan Willcox in last December's issue. This is the one I have been using in my workshop lately, with great success.

In practice the ESR of an electrolytic capacitor is much more significant than its actual capacitance value, especially in the signal-coupling and supply-decoupling roles such capacitors perform in the sort of equipment we handle. Once you've got used to working with an ESR tester you would never want to be without one. A testimony to the usefulness of an ESR tester is that I and others in our workshop are often able to short-circuit (!) the business

of conventional fault diagnosis by testing all, or most, relevant electrolytic capacitors in a piece of equipment and replacing any that produce an excessive resistance reading. Very often this will cure a fault that could be producing very strange symptoms – ones that, especially in digital equipment, you might not readily attribute to a faulty electrolytic capacitor. Typical examples might be DVD players and satellite set-top boxes for which we have no service manual or circuit diagram.

Electrolytic capacitor failure is becoming one of the most common causes of breakdown in consumer electronic equipment as plugs, sockets, switches and similar connectors are designed out, as mechanics are simplified, as ICs and their jointing become more reliable and as competition and price-cutting demand ever

more cost-effective designs. But equipment designers seem to have a blind spot when it comes to the physical design, component specification and layout of chopper power supplies. The combination of a relatively cheap capacitor, a high ripple current and the close proximity of hot components will often lead to failure sooner or later, despite the fact that the equipment gets out of the factory door OK and usually survives through the one-year warranty period! Experienced technicians have learnt what type of capacitor, in which place (usually the power-supply section), to go for first in carrying out a general test with an ESR meter.

Apart from the DIY designs that have appeared in this magazine, I know of two sorts which are available commercially: the analogue-meter reading Capacitor Wizard that

costs about £145, and the Electronic Design Specialist type, with a 20-segment LED readout, that costs about £175. Both are effective, though with the former, care is required to discharge the capacitors before connecting them for test. I don't know of any that have a digital readout or a facility for measuring the capacitance of the component being tested.

Description

Peak Electronic Design has been making small test equipment items for some years, in hand-held form. They come in curvy little cases, size 10 x 7cm, with a digital-readout panel. A colour-coding system is used for different functions, generally red for cable testing, yellow for LCR checking, orange for triacs and blue for semiconductor devices. This one, as the accompanying picture shows, is purple. It's powered by an internal 12V alkaline battery, of the sort used in car-security fobs.

There is only one control, an on key that initialises the instrument. After that it takes a few seconds to go through a test cycle. Any DC charge (within reason, see the specification table) is first removed, after which the meter takes about eight seconds to calculate the electrolytic's ESR and capacitance values, which are then shown simultaneously in the two-line LCD panel. The instrument shuts down automatically after a further twenty seconds – there's no need for an off switch! ESR from 0-10Ω can be read, with a resolution of 0.01Ω below 1Ω and 0.1Ω above 1Ω. The capacitance measuring range is 1-22,000μF, with an accuracy of about ±4%. The test frequency is 100kHz, current 20mA (short-circuit) and voltage 2.5V (open-circuit).

The test leads supplied are 450mm long, and each has two conductors, one to apply the test waveform and one to measure the result. This Kelvin arrangement increases the accuracy by removing the effect of lead inductance. Inside the unit I found a rugged construction on a fibreglass PCB, with half a dozen ICs, a precision crystal, the LCD panel and a handful of other items. The only internal parts that appear to have a finite life-span are, ironically, a couple of surface-mounted, 100μF, 16V electrolytic capacitors! They would be easy to replace should this ever be necessary.

The instrument can be connected to the capacitor under test either way round, and will test capacitors in or out of circuit for ESR. Capacitance

measurement is more likely to be accurate with the component isolated. For further details, see Table 1.

On test

This little gizmo kept me company on the bench and in the field for several weeks. At the end of the assessment I took a bunch of good and duff electrolytic capacitors home and played with the meter at length. I found it satisfactory in every way, once I had made some needle-pointed test probes to connect to the mini-crocodile clips provided – these probes facilitated easier connection to capacitors in situ. The long test leads supplied were appreciated in use with, for example, a large-screen TV set, especially in the field where the instrument needs to be out in the light for easy reading. For situations like this an 'eyes-off' indication of low ESR, in the form of a bleep, would have been useful, cutting in at say resistance values below 1Ω or 0.5Ω. It would also have been good to have had ESR readings of up to 20Ω, to take into account low-value, high-voltage capacitors such as the 1μF and 2.2μF, 100-400V types typically found in the 'kick-start' circuit in a chopper power supply – they often fail. These are minor points however.

The meter performed very well in all respects. I have no reason to doubt the accuracy of either the ESR or the capacitance readings, and the simplicity of operation is a great benefit. The analyser's ability to read capacitance as well as ESR showed clearly that an electrolytic capacitor's value in μF can remain correct though its internal resistance is excessively high. But I found a few capacitors, mainly old ones, whose value had decreased as their series

resistance had increased.

When I came to check the tester's vulnerability to damage from a charged capacitor, I used a bench power supply to charge an out-of-circuit capacitor to just the specified 'abuse' level. I then connected it, with some trepidation, to the tester. No harm came from this, but it's obviously best to ensure that the capacitor being tested has been discharged. The internal discharge should, I feel, be regarded as emergency protection rather than being relied on for each test, especially as there's a limit of 40V with capacitors of value higher than 10μF. Better safe than sorry!

Verdict

The introduction of the Peak Atlas ESR60 will, I believe, force a rethink amongst makers and sellers of ESR testers that cost twice as much or more. This one is smaller, lighter, has more features and is more useful. I never thought that anything would prise me away from my trusty analogue ESR tester, but this one has done it!

Excellent indeed, and designed and priced for the service technician – unlike some pieces of test equipment that have come to my notice lately.

Availability

The Peak Atlas ESR tester Model ESR60 costs, with delivery, £67.23 plus VAT, a total of £79. A one-year guarantee is included. It's available from Peak Electronic Design Ltd., Buxton, Derbyshire. The phone number is 01298 70 012 and the email address sales@peakelec.co.uk

There's a website at www.peakelec.co.uk

Table 1: Peak Atlas ESR60 specification

ESR measuring range	0-10Ω
Resolution	<1Ω, 0.01Ω; >1Ω, 0.1Ω
Accuracy	<1Ω, ±2%, ±0.02Ω; >1Ω, ±2%, ±0.2Ω
Capacitance range	1-22,000μF
Accuracy	±4%, ±0.2μF
Peak test current into s/c	20mA
Peak test voltage across o/c	2.5V
Operating frequency	100kHz
Abuse voltage	<10μF, ±400V; >10μF, 40V
Battery	GP23A 12V alkaline
Battery voltage range	12-8.5V, with low-battery warning at 8.5V
Inactivity time-out	10 seconds
Dimensions	103 x 70 x 20mm (w x h x d)
Operating temperature range	10-40°C
Accessories supplied	Battery, leads and instruction book with ESR value table

Vintage repair: the Ferguson

Model 352U



Appearance of the Ferguson Model 352U table radio receiver, with its distinctive cabinet and tuning knob.

At first glance I didn't think this little radio set, which dates from about 1955, would be worthy of restoration. So it haunted the workshop for three or four years, gathering further layers of dirt and barely escaping the dustbin. One control knob and the trim from the tuning knob were missing; there were no rear or bottom covers; and the audio was exceedingly indistinct. As my interest in vintage radio sets grew however, it became increasingly clear that it would be necessary to be able to make parts that were missing. The 352U seemed an ideal test bed for the purpose – but by this time its loudspeaker had been consigned to another set!

I recalled from early sales literature that the exterior design of the set was distinctive (see heading photo), particularly the tuning knob in the centre with its domed gold trim. The other two controls would have been recessed into the sides of the plastic cabinet, volume/on-off to the right and the wavechange switch to the left, but the latter was missing.

Little service data is available. No *Trader* sheet seems to have been issued, but the circuit diagram (see Fig. 1) is in the 1956-7 volume of *Radio and Television Servicing*. Most *Trader* sheets provided a photograph to show the model covered. I would like to express appreciation

Malcolm Burrell describes the steps he took to make an otherwise worthless set usable and presentable

of those who managed to cram complex circuit and layout diagrams, technical descriptions and voltage and alignment information into the extremely limited space of the *Trader* service sheets.

Description

Basically, the Ferguson Model 352U is housed in a mauve plastic cabinet with a beige loudspeaker grill, uses three valves, covers the long and medium wavebands and has a 3 Ω , 6 x 4in. loudspeaker. A Westinghouse metal rectifier is used in the HT supply. Each valve in the economical AC/DC design has a dual function, so it's equivalent to a set with six valves. AGC is applied via R6 to the IF amplifier stage and also via R2 to the frequency changer stage.

The wavechange knob

The first task was to try to construct a replacement wavechange knob. If this was not possible, the project would be at an end. But experience gained in making a replica would help with other vintage radio and TV set restorations. As the wavechange switch had a similar 1/4in. (8mm) shaft to the volume control, I assumed that the shape, size and design of the surviving knob would provide a pattern for moulding a replacement.

When a wavechange switch is operated considerable stress is often applied to the stem of the control knob. So this is a common point where damage occurs. Modern fibreglass and polyester materials are durable but cannot always duplicate the strength of the material they might be used to replace. Some plastics are extremely hard but retain a little flexibility. Polyester tends to crack or crumble

instead of flexing. It's often better therefore to find a disused knob and slice the shaft from it for use with a new creation. Provide as large a cross-sectional area as possible to bond with the stem of the replacement, in order to distribute the operating stress.

Making the mould

Several materials could be useful for creating the mould required. No doubt a good craft shop would be able to offer some advice on this. The material should inflict minimum damage on the original, but modelling clay and putty were dismissed because they never harden fully. That would cause warp and result in distortion. As I had decided to use polyester filler for the final product (the knob), it seemed unwise to use this to create the mould – in case it became fused with the cast.

I eventually decided to try standard, water-based multipurpose filler of the type used for household decoration, e.g. Polyfilla. This proved to be surprisingly successful. Water-based 'wood filler' would no doubt prove to be an acceptable substitute. The mould would be a 'negative' form of the original knob, with the cavities standing proud. I decided make it in two halves, the circular rear portion and the front section with its indentations.

A barrier of petroleum jelly was smeared over the entire surface of the knob to be reproduced. A secondary barrier of thin, absorbent tissue paper (e.g. toilet paper) was then pressed on to the surface. After that the filler paste was inserted into the front of the knob and the crevices. It was important to place a control shaft into the

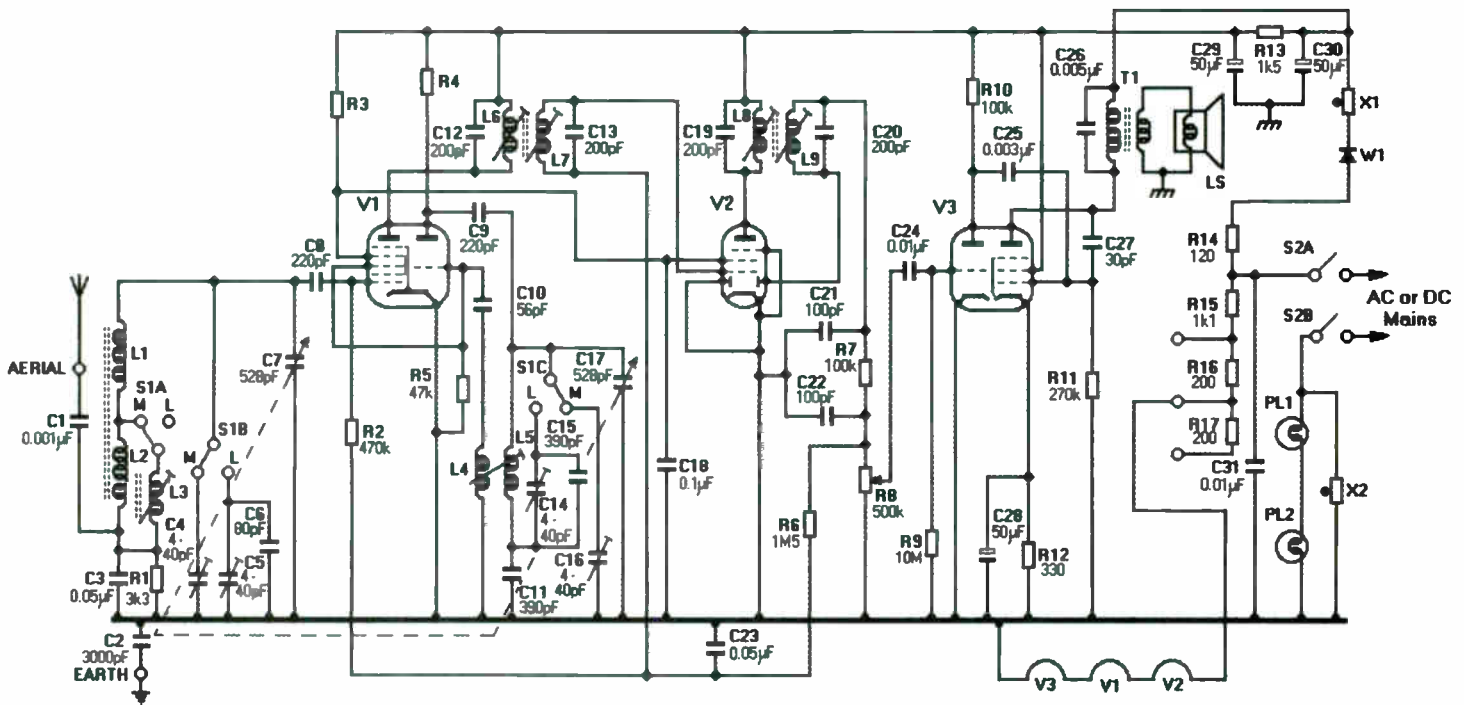

Fig. 1: Circuit diagram of the Ferguson Model 352U. V1 UCH81, V2 UBF80, V3 UCL83. W1 is a Westinghouse contact-cooled metal rectifier. L4/5 should be shown with a ferrite core.

mould to ensure that a suitable aperture would remain, see Photo 1. Finally, loops of wire were inserted at convenient points to facilitate easy withdrawal.

Once it had hardened, the mould for the front of the knob was separated and fragments of tissue paper were removed. I then found it necessary to allow some hours for it to dry fully before attempting further work. Meanwhile the back of the knob was coated with barriers of petroleum jelly and tissue paper, and a layer of water-based filler was built around it in the same way as before.

Photo 2 shows the original Ferguson 352U volume/on-off control knob and the moulds made from it. The quality of the cast (the new knob) depends on that of the mould. Some additional filling, correction and smoothing were needed.

Making the cast

Once an acceptable mould had been created, both halves were coated with petroleum jelly. This time, tissue paper was not used. I then mixed some polyester filler and impacted it into each half – firmly, to avoid air pockets. The two halves were then brought together until the filler hardened, whereupon a tag on the loops of wire separated them (there was some risk of the moulds being fractured). I now had a knob that was a reasonable facsimile of the original

one, see Photo 3.

But there were imperfections – minute holes and jagged edges. These were made good using fine wet-and-dry paper, filling where necessary. I strongly advise that you make this a gradual process, viewing the cast at different times under various lighting conditions. Like writing, painting and sculpture, today's success might come to be seen as tomorrow's failure! The attempt to achieve perfection is exceedingly tedious. Compromise is, with patience, a little more easily achieved!

As previously mentioned, I considered it better to slice the shaft from another control knob rather than replicate the original. If the control spindle is to pass into the body of the new knob, it should be smeared with petroleum jelly, inserted through the new shaft then into the knob, to ensure correct positioning – particularly when the spindle has a 'flat'. A disused potentiometer is suitable for this purpose.

A thin layer of polyester was used to attach the new shaft to the new knob. Once the filler had hardened, the spindle was retrieved and the entire assembly was inspected prior to being painted – with a modelling enamel of the correct hue, in this case mauve mixed with dark brown. The enamel tended to flow over most of the remaining imperfections, giving a smooth,



Photo 1: Shaft attached to the moulding for the new wavechange switch knob.

glossy finish. See Photos 4 and 5.

Tuning control trim

The trim at the centre of the tuning knob was clearly essential to the appearance of the set. It was specially shaped into a shallow, conical 'dome' in bright bronze or gold. I decided to experiment with polyester filler to provide a substitute.

A sheet of paper was laid across the surface of the inner tuning knob and scored to indicate the ridge that defines the circumference of the trim. When the paper was removed the ridge was outlined in ink then cut out. Filler was used to form a tough dome on the paper. This was contoured, using sandpaper, prior to being sprayed with bronze paint. The result was smoothed with fine

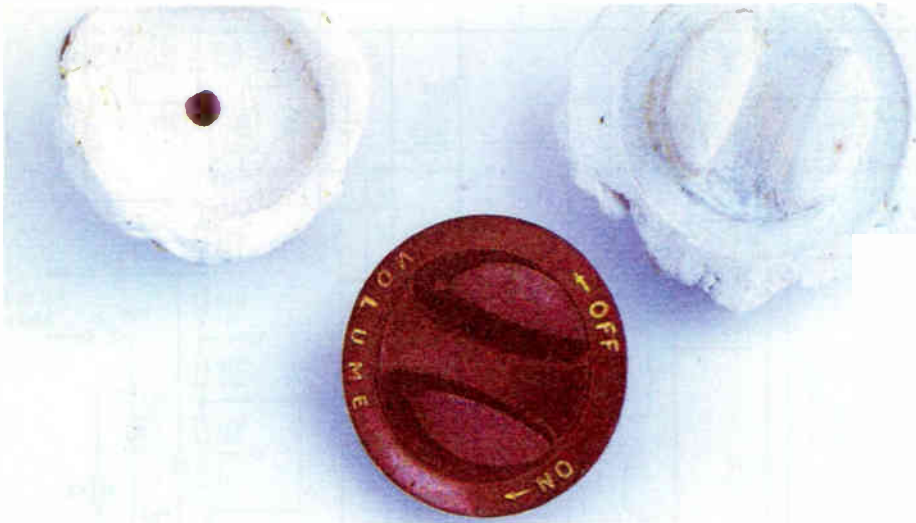

Photo 2: The original Ferguson 352U volume/on-off control knob and the moulds taken from it.



Photo 4: The new wavechange switch knob when painted.

Photo 5: The new knob fitted to the radio.



wet-and-dry paper. Although the finish was not the original mirror one, it provided an acceptable addition to the tuning knob.

Back and bottom covers

Back and bottom covers were considered obligatory, to protect the receiver as well as for the safety of potential users. The originals would undoubtedly have been made of dark brown fibreboard, embossed with the Ferguson logo in silver. A reasonable substitute would have been a form of drilled hardboard known as peg-board. This now seems to be impossible to obtain however. So there was little alternative to shaping a sheet of standard hardboard to fit the cabinet, then drilling holes to facilitate free air circulation.

Surprisingly, the new covers seemed neither superfluous nor ugly. A dedicated restorer would have scoured the world for the correct type, but the set seemed happy with what had been made for it.

The electronics

Operation of the circuit is fairly simple. V1 (UCH81) is a triode-heptode that's used as oscillator, mixer and first IF stage. The following UBF80 (V2) is the second IF amplifier and detector while V3 (UCL83) is the audio amplifier and output valve.

One of the dial lamps was open-circuit and the other one blackened. The HT supply at the cathode of the contact-cooled rectifier W1 seemed to be about right at some 185V. But when I switched to LW reception there were simply rather poor MW signals!

After much investigation I concluded that the front-end alignment must have been disturbed. MW needed adjustment – in particular



Photo 3: The cast for the new knob.

L3 needed to be carefully reset for optimum results. Once this was achieved, C5 and C14 were adjusted for optimum reception of BBC Radio 4 at 198kHz (1,500m).

The components, including the electrolytic capacitors, all seemed to be in order, but replacement of the audio coupler C24 produced some improvement. Presumably the original capacitor had fallen in value. Coupler C25 was also replaced, as any leakage would destroy the output valve.

Replacement dial lamps produced a substantial improvement in the performance – they provide the mains neutral connection to chassis, in parallel with thermistor X2. A new UCH81 valve further enhanced the sensitivity.

In conclusion

The measures outlined above made an otherwise worthless piece of equipment usable and presentable. Similar moulding techniques could be used for the replication of other items – no doubt small knobs for TV receiver preset controls could be created simply from a clay impression, provided allowance is made for the control spindle. Some presentation parts might also be made in this way.

Replacement of the dial lamps in the 352U also produced a pleasant surprise when the chassis was refitted in the cabinet. Because of their position on the chassis, I had assumed that they were simply intended to provide stray light through the outer tuning scale. In fact they also light the white, translucent rim of the tuning knob, producing a very attractive glow. The set had certainly come to life!

There is a problem with involvement in a restoration project such as this – one becomes attached to the set. It's extremely unlikely that this one will be consigned anywhere other than the shelf used to exhibit and demonstrate my vintage receivers! ■

Service Casebook

Michael Maurice



Hitachi C36WF830TN

This monster was stuck in standby. The cause was dry-joints on the line oscillator board, which plugs into the main board just in front of the scart sockets. You have to remove the power supply, which is to the rear of the chassis, to get at this board. The problem was with the wire links at the earth points. Remove the old solder, clean the links with a fibre-tip pen, then resolder on both sides. This action cured the fault.

Grundig GTV2150

This TV/VCR combi unit, which appears to be based on an Orion chassis, was dead. Checks showed that the line output transistor was short-circuit. Whenever I get this situation, I look for the cause. In this case the line driver transformer was dry-jointed. The cure was to replace the transistor and resolder the transformer.

JVC RX-MXG9B

When this hi-fi system was powered up the CD drawer flew open and there was a clicking noise as the sled went back to the centre and hit the end stop. The voltages in the power supply were all present and correct, and I was about to give up when I came across wire link W984, one end of which had never been soldered. The system had worked all those years through mechanical connection between the link and the PCB's solder pad! Soldering it provided a complete cure.

Sharp VCMH60

VCRs are nowadays considered to be throwaway items, but the owner of this one wanted it repaired. It appeared to be dead, though the drum was spinning. When I'd unplugged and checked various items the machine just ticked! It was soon apparent that there was a power supply fault. Replacing the main smoothing capacitors on the secondary side of the power supply restored normal operation.

Hitachi C2846TN

The complaint with this set was no colour. In addition you couldn't bring up the menus to check the picture and sound settings. Checks around the microcontroller chip showed that the line-frequency pulses here were of low amplitude. The cause was the micro chip itself.

Once a new microcontroller chip had been fitted the menus could be brought up. The colour setting was at approximately 50 per cent, so there should have been colour. A replacement TDA8361N5 jungle chip restored the colour.

Ferguson 51J8 (TX99 chassis)

Most of these sets were probably consigned to the skip years ago. But not this one, which is still going and its sprightly 104-year old

owner doesn't want to get rid of it. The complaint was loss of memory on certain channels, the cause being a faulty M494B1 microcontroller/EEPROM IC. A replacement, obtained from SEME, cured the fault. The customer was very pleased, and so was I. Somehow I can't see her getting used to the latest widescreen sets with their complicated menu-driven remote controls!

Italian Sky Digital

An old customer had brought back an Italian Sky Digital receiver. He could get Italian pictures and sound on his TV set, using the scart socket, but he couldn't get the signals to go round the rest of the house. This wasn't surprising, as the Italian Sky box didn't have RF facilities.

I was about to give up when I spotted an old, redundant Grundig analogue receiver. These receivers have a facility to connect a decoder via a third scart socket. So I connected the VCR output from the Italian Sky Digital receiver to the Grundig receiver's decoder input and set up the receiver so that its programmes went through the 'decoder'. Bingo, it worked.

All I still had to do was to tune in the DVD/VCR recorder and get that going round the house as well.

Hitachi C2566TN

This set was now stuck in standby. Before that it had been going off intermittently. A quick check revealed that regulators IC951 and IC952 had been resoldered on a previous occasion. But they were in fact the cause of the trouble. The cure was to remove them both, clean their pins thoroughly and then resolder them.

Toshiba 55PJ6DB

There were two problems with this huge projection set. First the convergence was way out, and secondly for the first ten minutes the picture was distorted with field roll. I cured the first fault by replacing the two STK392-110 convergence output chips. To cure the second fault I had to remove the IF module and replace all the electrolytic capacitors. There are no diagrams for this module – Toshiba expects it to be replaced as a complete unit but, at nearly £200, it's very expensive. The set produced excellent results when the above work had been carried out.

Sanyo CBP2180

The problem with this set was field collapse. It was cured initially by resoldering the dry-joints around the field output IC. A couple of months later however the customer called to say that the fault was back, though it was now intermittent. This time the cause was the coil in the supply to the field output IC. It was going open-circuit intermittently.

Servicing the B&O Unity TV chassis

The Unity TV chassis has some novel features that could cause confusion. Paul Coles explains the basic operation of the sets then describes fault conditions that could be encountered, the steps to take to establish the cause and the remedial action required

The B&O Unity chassis was introduced in the early Nineties and was used in several chassis types/Models as follows: chassis type 39XX, Models L4500, LX4500, LS500 and LX5500; types 316X and 326X in Models MX3500 and MX5500; and type 36XX in Models LS3500 and LS5500. An X in the model number indicates that teletext is included, while Model numbers that start with an M have monitor styling. The first digit in the model number indicates the tube size, e.g. 4 25in. and 5 28in. The tubes are of the flat square type, while the audio section can provide 2 x 40W of hi-fi sound – there's a built-in Nicam decoder, and bass, treble and loudness controls are provided.

The sets were supplied with Beolink 1000 remote control. They can be turned on in the audio mode (AV-Radio). Stereo audio can be fed in at the audio socket from a set-top box for listening to Sky Radio etc., or a B&O CD player can be plugged in (AV-CD). TV station identification is carried out via teletext station naming. Some sets have motorised stands or bases: the set can be rotated via remote control by selecting picture then using the < or > buttons depending on which direction is required. All B&O VCRs connected to these sets can be operated via the Beolink remote-control unit.

Signal circuits

Module 1 contains the tuner unit, IF and detector circuits. Band selection and the tuning voltage are controlled by the computer interface chip 11C4 (SAB3037) in communication with the microcontroller chip via the I²C bus. The tuner's oscillator frequency + 256 is fed back to pin 20 of 11C4. The IF output from the tuner is routed to SAWF1 and SAWF2 to obtain the sound and video IF signals for 11C6 (TDA8120). Demodulated video leaves this IC at pin 8 and is

passed to module 5 (AV/scart). Divided down sound IF – 6MHz (mono FM), 6.552MHz (Nicam) – leaves at pin 5. The 6MHz FM sound is fed to the FM demodulator chip 11C2 (TDA2557) while the 6.552MHz signal is sent to Nicam module 8.

Colour decoder module 2 receives video from AV/scart module 5. It goes via switching chip 21C2 (TA7348P) to pin 25 of the decoder chip 21C3 (TEA5640C). The demodulated R – Y and B – Y signals are then fed to pins 17 and 18 of the matrixing/control/blanking chip 21C4 (TDA3506). The Y signal from the delay line enters this IC at pin 15. R, G and B outputs are produced at pins 1, 2 and 3. Both these ICs have sandcastle pulse inputs. Note that 21C3 does not have a 4.433MHz crystal connected to it: the reference frequencies required for detection are generated internally from data stored in an internal ROM and a 62.5kHz signal that's fed to pin 15 from 21C6 (HEF4060). All adjustments to the video processor 21C4 are carried out via remote control in the service mode. 21C4 also carries out CRT gun cut-off and balancing (auto grey-scale) during the field blanking period. The clamping capacitors are C20, C21 and C29 (each 47nF) for RGB emission and C30 (22µF) for CRT leakage current.

Nicam decoding is fairly conventional. The module receives a 15V input at pin 5 of plug P804: 10V and 5V supplies are derived from this. If either of these supplies is missing the set will not come out of standby. For fault-finding, demultiplexer mute can be disabled by disconnecting pin 20 of 81C2 (CF70123) and applying logic 1 to this pin.

Deflection circuitry

PCB10 is the deflection module. There are three main ICs on this module, the sync processor and line drive generator 101C2

(TDA2579A); the geometry processor 101C5 (TDA8432) which produces the field and EW drives; and the TDA2170 field output chip 101C1. There is also a small still-display module that ensures stable on-screen displays under no-signal or noisy-signal conditions. The idea is to prevent noise disturbing the line oscillator.

Pin 16 of 101C2 should be at 9.5V for the line oscillator to start up. In the audio mode (no EHT and deflection) the voltage at this pin is low. The line drive output is at pin 11 of this IC. Pin 3 is the field sync output, which is fed to pin 2 of the processor chip 101C5 via the non-interlace flip-flop 101C6 (4013). The chassis can be switched to the non-interlaced mode (shift 7) for computer use, games etc. 101C5 is I²C bus controlled and, with 101C2, generates and monitors all deflection signals, drives etc. Geometry adjustments are carried out via remote control in the service mode and are applied to 101C5 via the I²C bus. Pin 24 monitors the CRT beam current (LOPT pin 4) to keep the field geometry and line scanning stable with EHT variation.

There are two versions of this module. Type 8007379 (later) has a FET line driver with transformer. The earlier version uses four transistors (10TR4/5/6/7) and no transformer in the line driver stage. This has slow-start built in to protect the line output stage and power supply. The idea is to allow the CRT's capacitance to charge slowly when switching from the audio mode, providing correct conditions for the line output transistor to switch off rapidly (if it turns off slowly heat is generated and the transistor can fail).

The power supply

The chopper power supply (see Figs. 1 and 2) is capable of producing an output of about 200W and operates at twice the line frequency (32kHz), locked to the line frequency in the TV mode to avoid

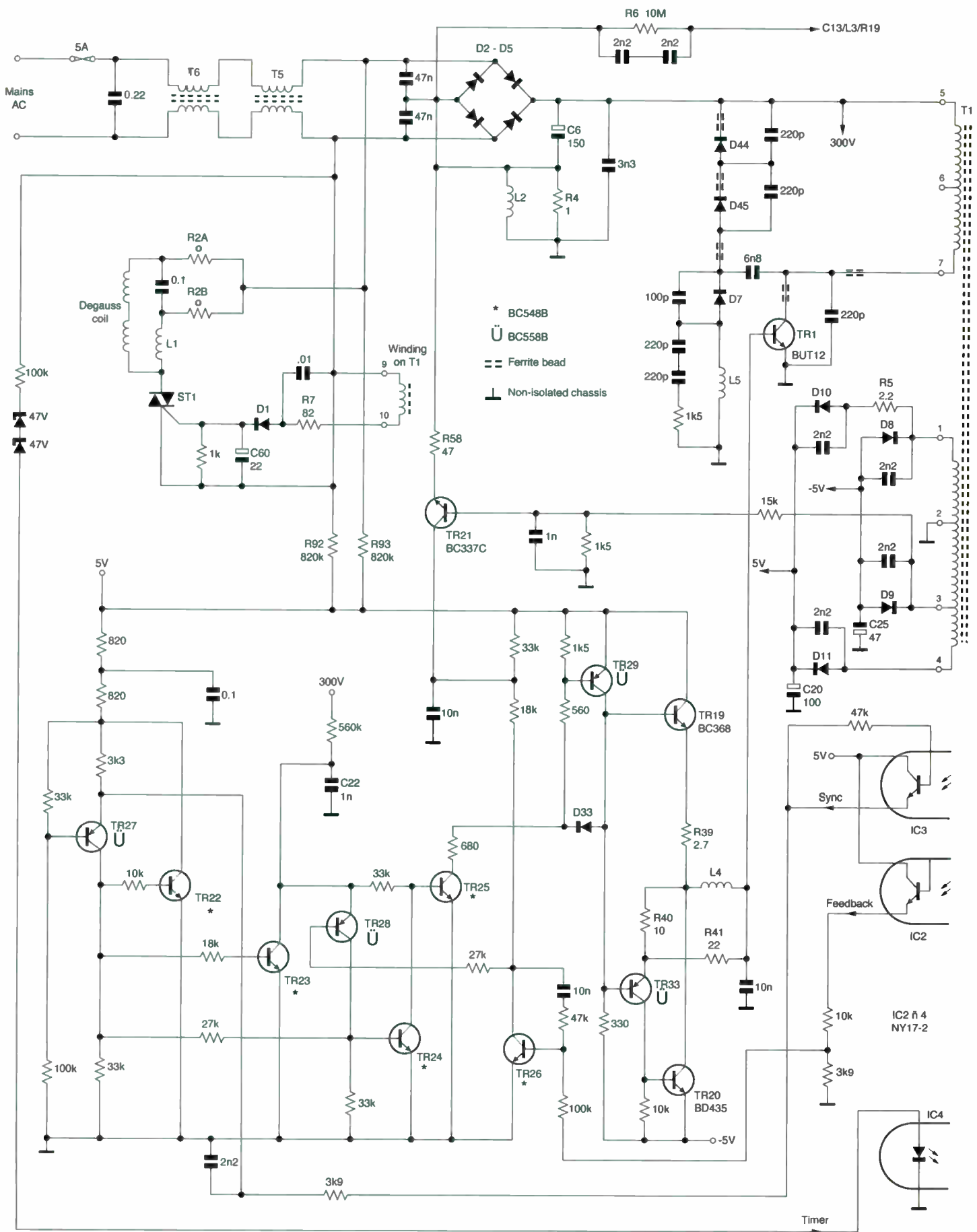

Fig. 1: Circuitry on the primary side of the chopper power supply.

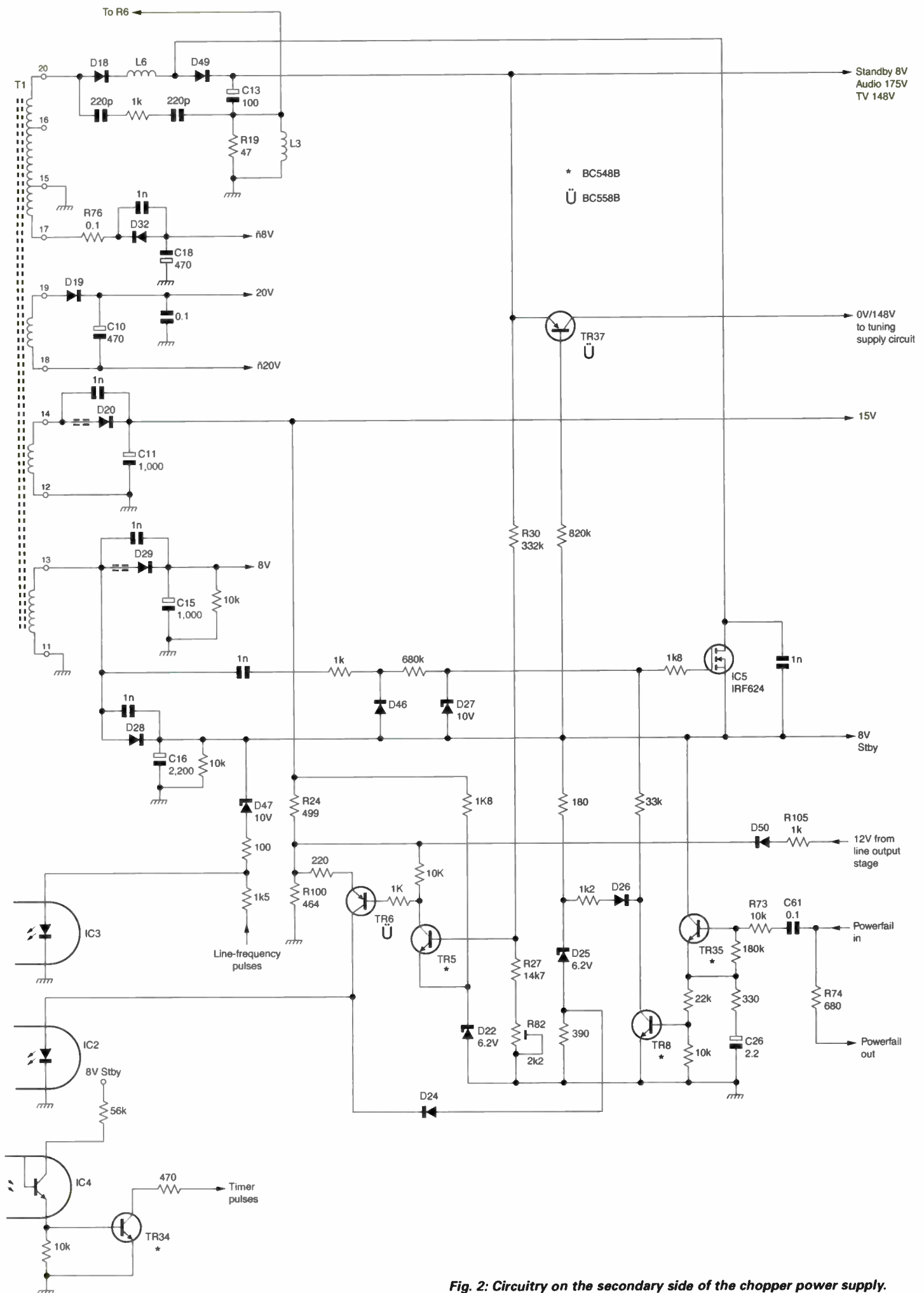

Fig. 2: Circuitry on the secondary side of the chopper power supply.

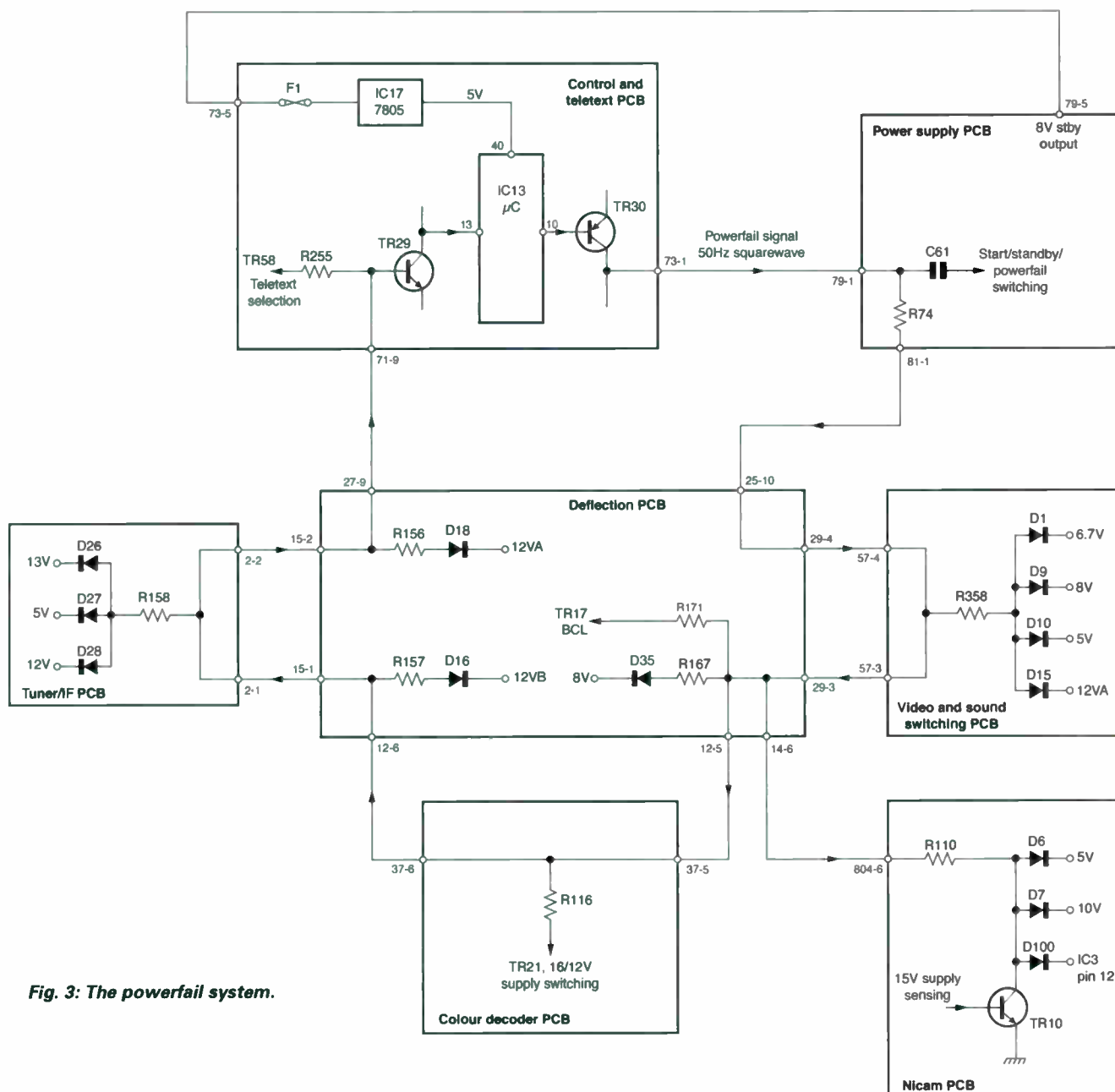

Fig. 3: The powerfail system.

picture disturbances. The start-up supply for the oscillator and driver stages is via R92 and R93. Oscillator transistors 4TR27 and 4TR22 control the ramp-generator transistor 4TR23. The ramp generated across 4C22 is fed to the pulse-width modulator that consists of transistors 4TR28 and 4TR24, with feedback via 4TR26. 4TR25 is a buffer stage, which is followed by the chopper driver stage using transistors 4TR29/33/19/20 in a push-pull arrangement. In the standby mode the chopper transistor 4TR1 is driven by narrow pulses. The width of the drive pulses is controlled via optocoupler 4IC2. 4TR21 provides protection during start up, when the electrolytics are discharged, by monitoring the load on the power supply and reducing

the chopper on time until all the outputs have been established.

To switch on from standby the microcontroller chip 6IC13, which is on the teletext/control module, produces a 5V squarewave output (powerfail) at pin 10. This is fed via the powerfail bus to 4TR35 which switches on, charging 4C26. 4TR8 then switches on and as a result FET 4IC5 switches off. The 8V standby voltage falls and the regulation feedback increases the width of the chopper drive pulses to compensate. When the power supply starts to produce normal outputs, regulation is controlled by the potential divider network 4R30, 4R27, 4R82.

To switch to standby, the microcontroller chip removes the drive to 4TR35. 4TR8 switches off and FET

4IC5 switches on, connecting the HT line to the 8V standby supply. All outputs fall to approximately a fifteenth of their normal operating levels, with the HT output at 8V instead of 148V.

Powerfail system

The powerfail system, see Fig. 3, monitors various conditions throughout the chassis. It's based on the 5V squarewave output produced at pin 10 of the microcontroller chip 6IC13. This is ring-coupled through all the modules except for the Nicam one (spur only here), returning to pin 13 of 6IC13 if there are no faults. When an overload or a missing or excessive voltage is detected the powerfail signal ceases, there's no drive to 4TR35 and the set reverts to standby.



Service Kit 6276331 for checking the boards.

Fault conditions

No standby LED illumination, set appears to be dead: 4C20 (100 μ F) and 4C25 (47 μ F) have dried up. The replacements should be 105° types.

Set totally dead with the BUT12 chopper transistor 4TR1 short-circuit: Check and repair damaged print then replace 4TR20 (BD435), 4TR19 (BC368), 4TR29 and 4TR33 (both BC558B). Replace 4TR1 (BUT12) but note that it is very important to use a very good-quality branded transistor or a specially-selected one from B&O. Under no circumstances use a cheap device, e.g. one with the type number ground off and BUT12 MEV painted on. This will fail, causing considerable print damage with other transistors blown.

Stuck in standby occasionally/permanently, sometimes switches to standby when on: Usual cause is a powerfail error being fed to the microcontroller chip 6IC13. As a result, power is lost. Resolder all the diodes on the secondary side of the power supply, module 4, and resolder the transformers and semiconductor devices on the deflection panel. This will usually cure the

trouble. Then go into the service mode (short P48 on module 5, at the bottom right-hand corner) while the set is on and clear the powerfail error code. To leave the service mode, press off on the remote-control unit.

Set won't come out of standby:

Try turning on in the service mode (short P48). If the set doesn't switch on, press reset on the TV then unplug the Nicam module and press TV on the remote-control unit. If the set then works, the 10V supply on the Nicam module is missing, usually because the surface-mounted transistor 8TR8 (BC808-25) is open-circuit. Replace if necessary and refit the module.

If still no go, the BU508A (BU2508 in some sets) line output transistor 10TR8 is probably short-circuit. Fit a replacement then, before switching on, check the line driver stage. In early versions, replace the drive coupling capacitor 10C9 (220 μ F, 25V) which will have leaked. In later versions fitted with a line driver transformer replace C12.

The set could be stuck in standby because the IR receiver is turned off. Try picture 1 store picture 5 store then try again.

The set may come on with field collapse or no sound when P48 is shorted. Check the field output stage and sound output stages as necessary.

If necessary check the I²C clock and data lines with a scope. No data usually means that 6L11 or 6L12 (10 μ H) on the teletext/microcontroller board has failed. Replace as necessary.

If the set fails to come on with the Nicam module removed, use service kit 6276331 (see photo), fitting the leads one by one and pressing standby then TV until the set comes on. The board thus identified as faulty can be run, with caution, and checked conventionally, looking for missing or loaded supplies. Note that the powerfail bus monitors all the supply lines in the set,

the beam current and all PCBs except the Nicam module.

Sides of the picture curved: Don't run the set in this condition for long – the transformers and coils get very hot! If 10TR1 (BD135) and 10R5 (1k Ω) are burnt and overheating, replace the EW loading coil 10L4. Note that transformer 10T2 may also have been damaged (if a new one is difficult to obtain, use T5 from a scrap 2800 board).

AV board: Module 6 is trouble-free apart from dry-joints, which can cause intermittent audio loss on one channel etc.

Picture dim, almost negative, with trace of colour – may be intermittent: Check for 2V peak-to-peak video at the scart socket. If excessively low, locate and replace the video gain preset 1R108 (4.7k Ω , 2.2k Ω on some sets). It's on the tuner/IF module. Adjust the replacement for 1V peak-to-peak video at the emitter of 1TR1 or 2V p-p at the scart socket.

Weak picture with dark lines across: Remove the colour decoder, module 2, and resolder the main ICs. Locate the D-A converter chip 2IC5 (TDA8444) and resolder the surface-mounted resistors 2R60/1/2/3/4/5/6/7 around it. If the fault becomes permanent because of this problem, pin 19 of 2IC5 (contrast input) will be at 0V instead of about 3.5V.

Loud crackles, intermittent loss of sound: Locate the QPSK demodulator chip 8IC1 (TA8662N) on the Nicam module and carefully replace it. Then connect a scope in the XY mode, X to 8L2 and Y to 8L1, and adjust 8C34 (VCO) for a stable waveform – it looks like an X with a circle round it (the X should not be tilted).

The alternative is to remove and return the module to B&O for exchange/repair. ■

Table 1: I²C bus error codes

Code	Faulty item
22	6IC8, teletext generator
40	8IC1, Nicam port expander
42	2IC5, DAC for CRT grey scale/cut-off
80	5IC1, sound control
84	1IC7, stereo decoder
8C	10IC5, geometry processor*
C0	1IC4, CITAC IC (tuning etc.)
44	12IC10, PIP switch IC
2E	12IC9, PIP IC

*Or all communication blocked. Set started in service mode displays field collapse (horizontal line).

Table 2: Part numbers

Item	Part no.
BUT12 kit, power supply	8320850
Line output transistor (BU508A)	8320857
EW loading coil (L4)	8024046
EW transformer (10T2)	8014074
8TR8 on Nicam board	8320609
6L11 and 6L12 (μ C board)	8020552

Grandata Ltd

distributor of electronic components

48 Element Digital Compatible Aerial

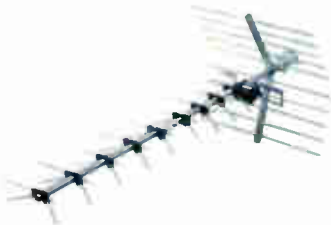

Receives both digital and analogue signals
For poor to weak strength signal areas
Robust design for low wind loading - 2 peices boom with aluminium wire rod elements
Supplied with F connector and clamp for horizontal and vertical (fits up to 57mm masts)
Ideal for areas with bad picture ghosting
Supplied part assembled - no tools required

Order Code : 27884R Price : £ 20.00 + vat
Carriage charged at £ 6.00 + vat

SLx Masthead Amplifiers

UHF TV and FM radio antenna preamplifiers designed for professional aerial installers.

1 way amplifiers come with screw terminals

2 and 4 way amplifiers come with F connectors

Requires 12V DC power supply connected via a download

Description

1 way UHF TV Masthead Amplifier - 15dB Gain
Order Code : 27830R Price : £ 4.30 + vat

1 way UHF TV Masthead Amplifier - 26dB Gain
Order Code : 27831R Price : £ 4.50 + vat

2 way UHF TV Masthead Amplifier - 10dB Gain
Order Code : 27837R Price : £ 9.00 + vat

4 way UHF TV Masthead Amplifier - 10dB Gain
Order Code : 27838R Price : £ 9.50 + vat

4 way UHF TV & FM Masthead Amp - 10dB Gain
Order Code : 27839R Price : £ 10.00 + vat

Masthead Amplifier Power Supply
Order Code : 27832R Price : £ 5.00 + vat

Carriage charged at £ 2.00 + vat or £ 6.00 + vat for 2 or more



SLx Distribution Amplifiers



A range of Aerial amplifiers designed to allow distribution of TV , Satellite and FM signal without the loss of picture and sound quality.

Available with intergrated Digital bypass - to allow the use of SKY™ digieye (B).

Main Operated , comes with full instructions

Description	Gain	Order Code	Price
2 way	18dB	SLX2	£ 8.00 + vat
2 way with Bypass	6dB	SLX2B	£ 9.25 + vat
4 way	12dB	SLX4	£ 13.00 + vat
4 way with Bypass	6dB	SLX4B	£ 14.00 + vat
6 way	12dB	SLX6	£ 18.00 + vat
6 way with Bypass	6dB	SLX6B	£ 19.00 + vat
8 way	12dB	SLX8	£ 18.50 + vat
8 way with Bypass	6dB	SLX8B	£ 20.00 + vat

Carriage charged at £ 2.00 + vat or £ 6.00 + vat for 2 or more

Satellite Finder



Compact design - Backlit meter scale
Audible signal strength reading
Adjustable level control
Adjustable sensitivity adjustment
Frequency Range : 950 - 2250Mhz

Order Code : 27860R
Price : £ 10.00 + vat

Coax Plug Aluminium



Order Code : PLG51
Bag of 10
Price : £ 1.25 + vat
Bag of 100
Price : £ 9.00 + vat

Screw Type Coax Plugs



Order Code : PLG62
Bag of 10
Price : £ 1.60 + vat
Bag of 100
Price : £ 12.50 + vat

Twist on F Connectors



Order Code : PLG101
Bag of 10
Price : £ 1.00 + vat
Bag of 100
Price : £ 6.00 + vat

Sky™ Remote Controls



Order Code : RCSKY
Price : £ 8.50 + vat

5 or more
£ 7.99 + vat each

10 or more
£ 7.50 + vat each

20 or more
£ 6.75 + vat each

Carriage charged at £ 6.00 + vat

Sky™ Remote Controls & SLx Link Eye



Order Code : SKYPACK2

Price : £ 13.00 + vat

5 or more
£ 11.50 + vat each

10 or more
£ 10.50 + vat each

Carriage charged at £ 6.00 + vat



Check out our Online Catalogue at
www.grandata.co.uk

This advertisement is just a selection of our stock.

Please contact us if you cannot find the part you are looking for.

* Please add £1 p+p and VAT to all orders (Unless Otherwise stated) * All components are brand new

* We accept payment by Access , Switch , Visa , Cheque and Postal Order

* All prices quoted are subject to availability and may be changed without prior notice

E & OE

Developments from JVC

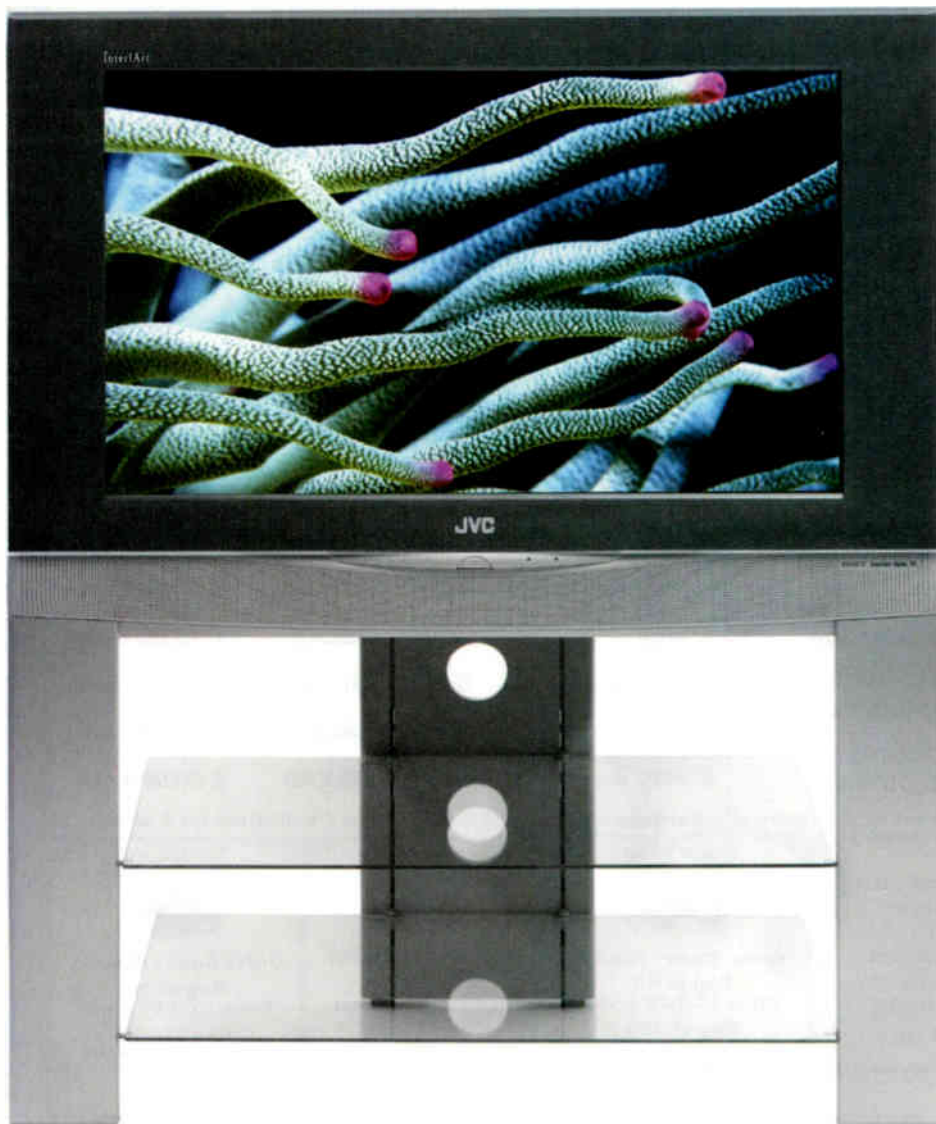

JVC recently announced a number of new products and technological developments in the TV, home recording and camcorder fields

Above: Model HV-32D40, a 32in. widescreen IDTV set that's fitted with a DynaPix CRT and uses JVC's DIST system.

Earlier this year JVC, ever a leader in the AV field, revealed its latest product line-up and thinking at the annual dealer conference, held this year in Prague. In the TV sector JVC points out that the CRT set market is still healthy, despite the massive growth in sales of flat display panel sets, with new technology coming through. Some older technologies are disappearing however, such as JVC's 3D-Phonic and the Dolby Pro-Logic audio formats.

Television

A prototype slim-line set based on what JVC calls a short-neck CRT was shown. The tube has 100° deflection which enables the gun to be closer to the screen, enabling the depth of the set to be reduced by 30 per cent in comparison with use of a standard CRT. The set was certainly impressive but Andy Northwood, JVC's sales resources manager, said that the company is still undecided on how to go about marketing short-neck CRT technol-

ogy. Nevertheless JVC will be launching Model AV-32EL5 later this year, a 32in. widescreen set with 100Hz scanning, DigiPure Pro technology, a seven-day EPG and two scart sockets. No price details have been released.

Could the short-neck technology have just missed its window of opportunity, now that cheaper LCD and plasma sets have arrived and further developments are being introduced in these fields? It will be difficult to market short-neck CRT sets unless the price gap in comparison with standard CRT sets is small. It will be interesting to see how JVC tackles this conundrum.

JVC has launched a range of natural-flat widescreen CRT IDTV sets that are equipped with a DTT tuner. There's also a DTT set-top box, Model TU-DB1, whose features include 200-channel storage capacity, fully automatic set-up, a user-friendly graphics interface, a 7-day EPG and comprehensive outputs.

Models HV-28D40 and HV-32D40 are fitted with DynaPix CRTs and feature JVC's high-resolution picture technology DIST (Digital Image Scaling Technology). Core to this is a high-precision input converter and formatter with smart frame-rate conversion, supported by Super DigiPure and Colour DigiPure digital processing with a wide-range CRT driver. Other features of these models include single-tuner PAP (picture and picture), picture and text dual screen, 1,500-page teletext (level 2.5) with improved sub-page text, 3D Cinema Sound and comprehensive input/output connectors.

Models AV-28EX5 and AV-32EX5 use JVC's 100Hz DigiPure Pro high-resolution picture technology which includes motion compensation, movie theatre, a digital comb filter and automatic digital video noise reduction. As with the above models, features include 1,500-page teletext, picture and text dual screen and 3D Cinema Sound.

There are also two entry-level sets, Models AV-28E50 and AV-32E50.

Naturally JVC is also launching a wide range of flat-screen panel models, LCD and plasma, many of which include an HDMI (High



Left: JVC plasma set with stand.

Definition Multimedia Interface). There are eleven LCD models, ranging from the LT-15B60 to the LT-40DF7, the middle number indicating the screen size. Model LT-15B60 has a 15in. VGA screen and both scart and PC input sockets. The aim is clearly to persuade those who might buy a 14in. CRT set for the spare room or bedroom to move up to an LCD product. The larger-screen models (17, 23, 26, 32, 37 and 40in.) have WXGA screens (1,920 x 1,080 pixels) and varying features, adding a DTT tuner, a slot for Top Up TV and HDMI as the specification improves.

Andy Northwood says that as far as JVC is concerned 40in. is at present the cut-off point for LCD, any model with a larger screen using plasma technology. He conceded that if LCD panels continue to increase in size and become more cost competitive plasma could ultimately disappear, though this is considered to be unlikely to happen in the immediate future. So the flat-screen panel range is rounded off with three 42in. plasma sets, Models PD-42V60, PD-42DX6 and PD-42B50. The differences relate to IDTV, DIST and HDMI.

Of particular interest was a JVC development, fast-response LCD drive, which increases the response time to 7msec. This significantly

reduces the smearing sometimes seen with fast-moving objects. A comparison between the fast-response system and a standard display showed a clear improvement in picture quality and performance. But a quick look at the back of the display revealed lots of equipment – we are clearly some way off seeing this technology incorporated in a single chipset!

Home storage

This might sound like cupboards and fridges, but is the name JVC has adopted for its domestic recording technologies – VCR, DVD, hard drive and memory card. Andy Northwood pointed out that there is still a considerable market for VHS: even the high-street retailer which said it would stop selling VCRs stocks combi models that combine VCR technology with DVD and/or hard drive recording. There are several new VCRs in this year's line up. Model HR-V615 is a hi-fi stereo model with SQPB (S-VHS Quasi Playback), NTSC playback and two scart sockets. Model HR-V616 is a black version of the silver V615. Model HR-S5975 is the latest S-VHS machine. Model HR-XV28 is

a combined DVD player and VCR.

New DVD recorders include Model DR-M80 which can record on DVD-RAM and DVD-R/RW discs and Model DR-M100 which adds a DV input socket for recording DV camcorder footage on a blank DVD disc. Models DR-MV1 and DR-MV5 are combined DVD recorder and VHS machines that include a progressive-scan output. JVC announced that it is adding DVD +R/RW playback capability to its range of DVD recorders.

Model DR-MH50 includes a 250GB hard-disk drive and can play back DVD-Video, WMA, MP3, JPEG and CD discs and material. Other features include a PAL progressive-scan output (625P) that, using a motion-active system, generates a progressive-scan signal from an interlaced source such as a TV programme recorded on a DVD. With movie discs this enables the DR-MH50 to provide PAL progressive pictures without interlacing the original material.

Model DR-MH50 can also memorise data from up to 2,000 programmes and tell the user which disc to load when he is looking for a particular show. Once a disc has been loaded, or the list of hard-disk recorded programmes is displayed, animated thumbnails are shown for fast access. The programme starts when a thumbnail has been selected. It is also possible to record and play back TV programmes simultaneously with a DVD-RAM disc. The hard-disk drive can store up to 473 hours of video and offers a range of recording modes, ranging from XP which records at 10Mbits/sec and provides up to 53 hours of recording to FR which records at 1.2Mbits/sec and provides the maximum recording time.

The DR-MH50 uses a system called Intelligent Dual-Pass Encode Dubbing to copy

Home theatre Model TH-R1 includes a DVD-RAM/-R/-RW recorder.



Model DR-DX7 combines a DVD recorder, a 250GB hard-disk drive and a MiniDV tape deck.



from the hard drive to a DVD disc. It works by analysing the entire video content when this is recorded on the hard disk then, on transferring it to a DVD, adjusts the bit rate according to the complexity of each scene. This ensures clear pictures with the best possible resolution and minimum MPEG noise, even with complex scenes that include many moving objects. Images can also be transferred from the hard-disk drive to a DVD at up to 32 times normal speed, making it possible to transfer a one-hour programme to DVD in just under two minutes.

The DR-MH50 offers a PAL Progressive (625P) output from any DVD and also has a system called 'temporary-loop recording'. This works in the same way as a Sky+ box's instant rewind feature, i.e. the hard disk records TV programmes up to a specified number of minutes/hours in a continuous loop. Temporary-loop recording is activated automatically whenever the unit is turned on, enabling the user to rewind real-time broadcasts for playback or recording from the beginning without loading a disc or setting a timer. Retro-active recording means that it's possible, even when midway through a real-time programme, to rewind and record from the beginning. Relief recording is useful when someone has set

the recording timer but omitted to load a disc, or when the loaded disc has insufficient space for the programme to be recorded. The DR-MH50 automatically detects the absence of a disc or lack of space and records the programme on the hard-disk drive.

Other combined hard-disk drive and DVD recorders include Models DR-MH20 (80GB hard drive), DR-MH30, DR-



Camcorder Model GR-DF470 is a MiniDV type that includes Bi-Phonic sound recording.

MH300 (both 160GB hard drive) and DR-MH600 (250GB hard drive).

Combi products include Model DR-MX1, which has a DVD recorder, a VHS deck and a 160GB hard-disk drive and provides six-way, high-speed dubbing. Model DR-DX7 combines a DVD recorder, a 250GB hard-disk drive and a MiniDV tape deck.

Other DVD products include Model UX-GD7, a five-disc DVD changer that's compatible with the DVD-RAM, DVD-Audio and DivX formats and has a PC link. Model TH-R1 is a home theatre system that includes a DVD-RAM/R/-RW recorder. Model RD-XV10 is a neat looking DVD/MiniDisc portable that also plays DVD-Audio discs.

Blu-ray

JVC showed a Blu-ray disc recorder and discs, though there are no plans to launch such products in the UK this year. The company has developed a triple-layer disc that consists of a Blu-ray recording layer and a DVD-9 dual-layer. Again, there is no indication as to when such discs might reach the market.

Camcorders

It's no surprise that JVC, which developed the VHS-C format, is still supporting analogue recording. There are two new VHS camcorders, Models GR-FX17 and GR-FXM41, which both have a 25x optical zoom. Model GR-DF470 is a MiniDV camcorder that includes Bi-Phonic sound recording. This is a type of stereo system that uses two separate sound channels. A 3D sound effect is created when these are played back via headphones. I first heard Bi-Phonic sound being demonstrated by JVC back in the 1980s. As far as I know this is only the second JVC product to feature it (it was also used with a sound system launched outside the UK), which suggests that it was quite a task to incorporate the technology into a camcorder!

JVC highlighted a new technology called Live Slow. Camcorders with this feature can record live events in real-time and play them back at slow speed with normal sound. The system works by feeding twenty frames into a memory with each frame written four times, i.e. eighty frames. This enables the scene to be played back at a quarter of the normal speed. Recordings made at normal speed can also be converted for Live Slow playback. JVC says the feature is useful for playing back short scenes of fast-moving action, such as someone throwing an object or kicking a football.

JVC was also highlighting its new Everio digital media camera, Model GZ-MC500. This uses a removable 4GB micro hard-disk drive that can store a mixture of sound, still images and moving video. It has three CCD image sensors, a 1.8in. LCD screen, can record 5 Megapixel still pictures and store up to an hour of video.

Model GR-X5 is a semi-professional MiniDV camcorder with three 1.33 Megapixel CCD image sensors, providing a horizontal resolution of 540 lines. It has a 10x optical zoom and includes DV, S-video and USB 2.0 connectors. ■

WEB SERVICE

To reserve your web site space telephone
 Tel: 01322 611292 Fax: 01322 616339
 E-MAILS b.treleaven@highburybiz.com



Alltrade Aerial & Satellite Ltd

www.alltrade.co.uk

Leading distributor to the trade.

Full e-commerce site with over 1500 products with in-stock quantities!! We supply everything associated with Digital/Analogue Terrestrial & DTH/Motorised Satellite reception. All Antennas. All Brackets. All Cables. All Connectors. All Amplifiers. We provide a free MATV/SMATV planning service as well.

Trade Counters @ Brighton, Cardiff, Dartford and Watford

Phone 0845 075 0751

Fax 0870 770 9151



Charles Hyde & Son Ltd

www.charleshhyde.co.uk

Search for both original and copy spare parts in our extensive database covering Akai, Alba, Bush, Ferguson, Goldstar, Hitachi, LG, Matsui, Nokia, Saisho, Sanyo, Sony, Sharp, Thomson, Panasonic, Philips, Samsung, Tascam, Teac, Toshiba, Yamaha and many more. In addition huge ranges of Lasers, Lopts, Remote controls and Semiconductors may be accessed.



Amtel Electronics

www.amtel.co.uk

Amtel Electronics provide service manuals and service sheets for most major brands of TV, video, Satellite, Audio equipment etc. OEM service information is available for most European, USA and Far Eastern makes and models.

Amtel electronics is one of the leading service information suppliers. Please contact us with your requirements via our contact page or telephone 01955 611313.



Horizon

www.horizonhge.com

Horizon is a UK company specialising in the design and manufacture of test equipment for the digital satellite and terrestrial market. The meters are used for the easy alignment of satellite dishes and antenna during installation. At around 1kg they are light and easy to use, packed with features normally found on expensive and heavier spectrum analysers. Manufactured in the UK we have meters used in over 21 countries.

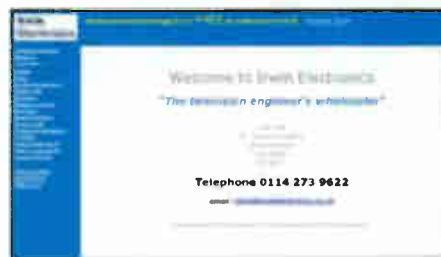

IRWIN ELECTRONICS

www.irwinelectronics.co.uk

As classic distributors we compliment our existing mail and trade counter business with our website. You can order parts on-line quickly and easily. We intend to explore alternative ways of assisting engineers to run their business successfully.



Swires Research

www.swires.com

Swires Research produce high quality instruments for the television industry, including portable signal level meters and spectrum analysers for digital and analogue RF signal measurements.



Wizard Distributors

www.wizard-distributors.co.uk

Main distributor for major brands. Search by make/model for LOPTX; switches; remotes etc. Find ICs; semicons; service kits; lasers; capacitors; resistors and a huge range of service aids, tools and other products.



Take care of your pennies\$

Elaine Everest provides advice for the self-employed TV engineer on dealing with banks

Banks! To many self-employed people it's a swear word. Do you show signs of fear when the dreaded business bank statement comes through your letterbox? Does the energy sap from you when you see the words 'bank charges'?

More to the point, do you file away the statement in the cardboard box you call a filing system and promptly forget it? You'd be surprised how many people do just that. It's what the country's financial institutions hope for – someone not looking after their money.

Think of this. Every bank you walk into has wall-to-wall carpets. There are matching desks and chairs throughout each branch, and the latest computerised equipment sits at every workstation. Your own home certainly isn't as well furnished and equipped. Who paid for this? You did, and everyone else who doesn't spare a few minutes each month to check the entries in their statement and query the excessive charges.

What to do

Make a cup of coffee and sit down, pen and notebook to hand.

This won't hurt – honest! Compare each cheque entry against the stubs in your chequebook. Tick them off if they are right, make a note on your pad if they are wrong. Do the same with your paying-in book. You'd be surprised how many mistakes are made here, not always yours. Banks never used to make mistakes, but that was in the days when cashiers didn't wear false scarlet nails and chew gum!

Now you've checked the entries, check their charges. Amongst the correspondence you've never read there will be notification of their fees. Banks have to advise you of their fees before they are allowed to take money from your account. If you don't have a copy of their fees, phone the bank and ask for one. It's your right.

There will be a list of charges that are taken from your account at the end of each quarter. You are charged for how many cheques you write, how many cheques you deposit, how much cash you withdraw and how much cash you pay in. You are also charged a fee each time you make a payment into the bank.

How to reduce charges

First, check that the bank has added the number of cheques correctly. If you don't agree, make a note of it. Now consider: did you have to write out so many cheques? Have you got into the habit of using your business bank account for personal items? This could be costing you nearly a pound each time you pick up the chequebook. Pay your suppliers once a month, not every time you need something. Take out a regular wage at a set time each month and pay it into a personal account for domestic use only. Personal banking is free. Draw your wage from the cash point – this is nearly fifty pence cheaper than using a cheque at the bank counter.

Next, check the standing orders and direct debits. Are they correct? Have any been taken twice, or not at all? If you find an error, again make a note of it.

Bounced cheques – God forbid, but it happens to everyone these days. Chances are you assumed that you had cleared funds when in fact there was another day to go before the cash was available. This can bounce many cheques and direct debits, each at £35 a time. Ouch! So be wary and try not to make this mistake. There will be times when you had almost enough in cleared funds but the bank bounced your cheques for the sake of several pounds that weren't available until the following day. Notify them and make your distress clear. They are not completely devoid of feelings, and may rectify the error in your favour.

Do you pay your takings into the bank every day? This is another mistake. You are charged each time for this. By paying in only once a week you will make a further saving.

Do you need a business account?

By this time you should need to refill your coffee mug, so ponder this point while you wait for the kettle to boil.

Do you actually need a business bank account? Yes, I know it looks flash when you post off a payment to a supplier, but in all honesty big companies don't care who sends



them a cheque as long as the account is paid in time.

If you are a self-employed person without premises or staff, why not run a personal account instead? With free banking, cheque card and on-line banking, it would save a lot of headaches and money each month.

If it's essential that you have a business bank account, shop around. There's no such thing as loyalty these days. Move your bank account to the people that can offer you the best deal. Most major banks offer free business banking for the first year or eighteen months after setting up a business. Why not ask if they will extend this? After all they need your business. Another big bank, which used to be a building society, is currently offering free business banking forever. But beware, there may be a catch. Ask questions and compare quotes – pretend that you are buying a new car and get the best price! Go shopping on the internet. Most major banking institutions have websites with special offers attached.

Your personal banking advisor

By now you will have finished your mug of coffee and will have a good few entries in your notebook. Pick up the telephone and ring your personal banking advisor – a posh name for what was your bank manager once upon a time. After working your way through a telephone minefield of push-buttons and electronic voices, you will reach what sounds like a young child so far as work experience is concerned. This is the person in charge of your finances. Frightening, isn't it? But don't be dissuaded. He will want to know the name of your grandmother and about six other security procedures before he considers it safe to talk to you about your own money. Well, that could be to your advantage. But at this point he normally cannot find you on the system, or has lost your paperwork. Persevere. Do not lose your rag – yet!

Explain to him the errors in your statement, item by item. He will try to say that it's your fault. Stand firm and insist that it is the bank's error. He will eventually capitulate. Personal contact when making these enquiries is better than writing a letter – the bank can lose a letter, or choose to ignore your comments.

Once all errors have been agreed, negotiate a reimbursement. After all the bank has caused you a great deal of distress. You are a busy person, and time costs money. Cry a little if it helps. It's your money that you are fighting for!

Recompense

Nine out of ten times you will be given a free recompense for the bank's poor performance. You will of course be told that that this can be done only once, and please don't tell anyone. Promise by all means. Even call the young lad 'sir'. Until next month, that is, when you can repeat the whole performance once again.

LETTERS



Wavefront tilt

In his column in the April issue Roger Bunney asks about wavefront tilt (page 358). If my memory is correct, going back to the days when I was doing my amateur radio theory, the wavefront-tilt effect with a vertically-polarised signal is caused in part by diffraction at the wave/ground interface. The effect depends greatly on the frequency of the wave and the permittivity of the ground over which it is passing. The difference in dielectric constant between the air and ground produces an effect called 'gradient bending', which is analogous to light bending in a lens. I seem to recall that increasing air density closer to the ground also plays a part at lower frequencies and, as such, the effect is much more pronounced at frequencies in the HF rather than the VHF range. But I suppose that the Band 1 signals used in the early days of TV transmission in the UK and elsewhere, and still used in some countries, fall only just into the VHF range.

I think the maths of why the effect occurs is quite complex, and has to do with the radius of curvature of the wavefront being less than that of the earth. But, basically, the diffraction at the ground results in energy being absorbed by the ground. This imposes a 'drag' on the bottom of the wavefront, slowing it and causing it to bend forwards slightly. The effect is cumulative, so the farther you are away from the transmitter the greater the tilt on the arriving wavefront, hence the reason why the type of aerial described by Roger would be recommended for optimum reception in fringe areas.

On a slightly different subject, there's an amateur TV repeater in our town. It operates at just over 1.200MHz, in the 24cm amateur band. A couple of years ago it was located at the top of a fairly steep hill, which was good for most of the ATV operators in the area. The operator

Send letters to "Television", Media House, Azalea Drive, Swanley, Kent, BR8 8HU or e-mail t.winford@highburybiz.com using subject heading 'Television Letters'.

Please send plain text messages. Do NOT send attachments. Be sure to type your full name, address, postcode, telephone and e-mail address (if any). Your address and telephone number will not be published but your e-mail address will unless you state otherwise.

of one station however, only about three-quarters of a mile from the repeater, had great difficulty in either getting a signal to the repeater or receiving one from it, despite his best efforts. The solution ultimately adopted was simple. All that was required was to tilt his transmit and receive aerial pair up by a few degrees. So it just goes to show – even at these elevated frequencies, 'flat to the ground' is not necessarily the best orientation for an aerial.

*Geoff Darby,
Earls Barton, Northampton.*

Who invented the AVO 8?

Thomas Edison, Bill Gates, Clive Sinclair, Trevor Bayliss, James Dyson – all names of great inventors. But who created the AVO 8? It can only be described as a classic, iconic meter. Built like a tank yet performs like a Spitfire. No Far East DMM will outlast it. I'm the proud owner of an AVO 8 Mk V, bought for £12 in mint condition at a car boot sale. It would be interesting to know something of the history. Why 8, although we know there was a 7; where was the factory; is there anyone alive who worked there; and are they still made today somewhere? Perhaps someone could provide more background information.

*D. Lee,
Claughton, Wirral.*

A good start

Having become interested in electronics at the age of six, I've always been a big reader of technical publications. I started taking *Practical Wireless* in 1974, at the age of ten, and not long after added *Everyday Electronics*, *Television* and *Electronics Today International*. In the years that followed, my hobby turned into a job. I started from home, advertising a repair service in the local paper. Then I started to offer reconditioned ex-rental colour TV sets. I bought them by the van load, faulty, from Mantles in Manchester, who advertised regularly in *Television* at the time.

My favourite sets, for ease of repair, were the GEC C2114 series, with a plastic cabinet. I used to buy them for £25 each. Business was good, considering that the average price of a new 20in. set was

then something like £350. Even so, getting a new business off the ground and competing with established repair shops was not easy. So, in addition to investing in a brand new Hameg 20MHz oscilloscope, I constructed all my own test equipment, usually from projects in *Television*.

In the early days a lot of the delta-gun CRTs found in sets fitted with chassis such as the Philips G8 and G9 and the Thorn 8500 and 3500, also the tubes in my favourite monochrome TV chassis, the Thorn 1500, suffered from low emission. Reactivation would usually extend the life of a set usefully, so I decided that it would be a good idea to have a CRT tester/reactivator. I had seen various designs in *Television*, and decided on one that was published in about 1981. After collecting all the bits, etching two PCBs and making some modifications to the original circuit, I set about building it on August 21, 1984 – my twenty first birthday! Construction was completed a week later and, despite the complexity of the wiring to the rotary switches, it worked first time. The accompanying photographs show the unit, which gave many years good service. At the time some ex-rental dealers would let you remove the backs of TV sets to test the CRT before purchase. They always commented on the professional-looking construction of my home-made tester.

In the years that followed I went on to open a shop and eventually splashed out on a Leader LCT910A professional CRT tester. I still have this but rarely use it now as new TV sets are so cheap and, when the CRT fails, it's usually because of a heater-cathode short that cannot be removed anyway.

At the age of forty I've seen a lot of changes. Most of the fun has disappeared from the job, because people are so reluctant to have anything repaired. But I have my memories, a thirty-year collection of magazines – and a whole host of redundant home-made test equipment!

*Michael Dranfield,
Buxton, Derbyshire.*

Faulty LOPTs

Two sets with very similar problems arrived one after the other. The first was a

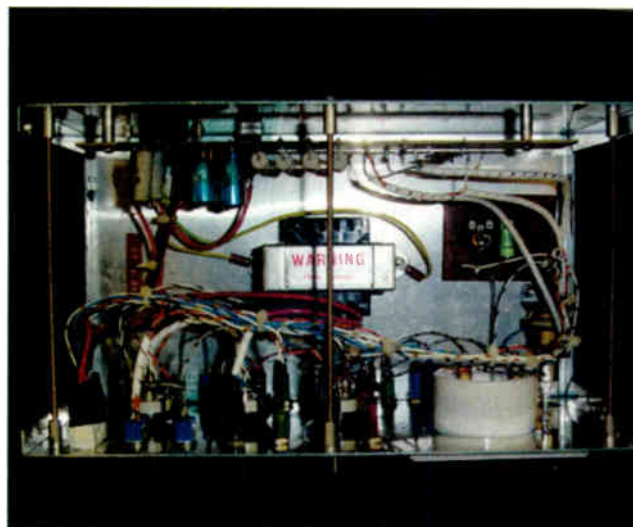

Front and internal views of the CRT tester/reactivator built by Michael Dranfield in 1984.

Schneider Model STV2104T, the second a Sony Model KV28FX20U (BE2E chassis). With both the fault symptom was no EHT, with the line output transistor short-circuit all ways. My in-circuit LOPT tester said that both transformers were OK. But when they had been removed, after much work looking for an alternative cause of the failure, and tested with a dynamic checker the boost voltage produced was way below what is expected. Needless to say new transformers cured both sets. Both testers were projects featured in previous issues of *Television*.

Claude Jackson,
St Austell, Cornwall.

Matters historical

It's not often that I find myself in disagreement with you but I must object to your remark (Comment, February) that "in 1922 [the BBC] had a staff of four and provided a primitive radio service in the London area". In fact the old British Broadcasting Company came on air simultaneously in London, Birmingham and Manchester on November 15 of that year and a fourth station, in Newcastle, commenced broadcasting on Christmas Eve. I suggest that it would have required rather more than four people to handle all those transmitters, unless they were provided with exceptionally fast personal transport!

Interestingly, these four 'main' stations were opened before the BBC's licence to broadcast was received, in January 1923. Early in that year two more main stations were opened at Cardiff and Glasgow, and were followed a few months later by two more at Aberdeen and Bournemouth plus a low-power relay station at Sheffield. By June 1924 further relays had opened at Plymouth, Edinburgh and Liverpool, and in the next three months four more followed at Leeds, Bradford, Hull and

Nottingham. By Christmas of that year relays were in operation at Stoke, Dundee and Swansea, with the experimental high-power station at Chelmsford contributing to the coverage. This brought just over seventy per cent of the UK's population into what was officially called the "uninterrupted range of a station", more familiarly known as "crystal range", i.e. where a simple crystal set would provide good reception. In fact if you bought a valve radio set reception was possible over much greater distances with, according to what I hear, a great deal more certainty of success than purchasers of today's digital receivers have.

I was lucky enough to learn a little about the Stoke-on-Trent station 2ST at first hand a couple of years ago. I used to do a phone-in programme for the modern BBC Stoke Radio, with a very lovely and talented young lady called Barbara Adams, in which we took calls from listeners regarding vintage radio receivers and other items. One day, after I had mentioned the old Stoke station, we had a call from a very elderly gentleman who had been what we now call a disc jockey for 2ST. The studio had been above the Midland Bank Chambers in Stoke, and the transmitting aerial was strung between two tall chimneys at a nearby pottery. We had a very entertaining chat about the early days of the BBC, and I felt privileged to have had the opportunity of talking to a genuine pioneer.

Tearing myself, reluctantly, from Radio Fun, I must say that I enjoyed Eugene Trundle's paean to the AVO 8. Since Eugene said everything that there is to say on the advantages of the AVO 8, including parking screws on the dial glass, I'll content myself with mentioning that a few years ago I supplied several of these fine meters to certain BBC engineers whose officially-issued digital

things just wouldn't do what they wanted, especially in the field of 'tuning for maximum deflection'.

Eugene's quoted price of £585 plus VAT for a current AVO 8 is certainly staggering at first glance, but is put in perspective when you remember that fifty-odd years ago it cost £20, at a time when a service engineer was lucky to earn about £8 a week. So it took two and a half weeks to earn enough to buy one then and, if we believe that to earn £400 a week is considered to be on the breadline nowadays (concerted ironical laughter from self-employed engineers and journalists), the present price is actually cheaper. But, to be more realistic, AVO 8s appear regularly at *Radiophile* auctions from about £10 upwards, so prospective owners are invited to apply to this writer. We also handle other test gear of all descriptions, including oscilloscopes, signal generators and valve testers.

The piece on the CAI brought back memories of Rediffusion and TUDK and all that jazz. Back in the Fifties I did contract work for our local Rediffusion branch, fitting converters to customers' ordinary sets to enable them to receive the BBC and ITV 'by wire'. In those days the two channels (four and eight in our area) were converted down to what we then called short waves at about 6-8MHz and 'phantomed' via the existing audio cable network. The receiver converter consisted of a small metal chassis on which a couple of PCF80s were mounted, along with the necessary tuning coils, a changeover switch and a few more bits and pieces including a mains dropper resistor. Conversion consisted of chopping out the entire 'front-end' of the set, including the video detector and output stages and the sound output stage and loudspeaker: the converter provided drive for the CRT and sync separator, with TV

sound coming via the cable to a standard Rediffusion loudspeaker. The converter's dropper resistor compensated for the valves removed in the set's heater chain. We bought the converters from Rediffusion for £4.4s, and the regulated price to the customer was £6.6s. So there was a modest profit, and we were allowed to keep all the bits we had removed from the sets. Inevitably, the workshop ended up awash with EF80s and loudspeakers. Despite optimistic ideas about being able to sell these on, I found few buyers. Still, it provided a steady little income while it lasted.

News of the impending analogue TV switch off reminds me yet again that fifty odd years ago we in the trade were waiting impatiently for the new ITV stations to come on air. Only those of us who were around then can possibly envisage the enormous interest aroused by the challenge to the BBC's monopoly, and the thrill of seeing for the first time the Associated Rediffusion, ATV and ABC logos on the screen. All three programme contractors have now gone, and ITV as originally intended has disappeared along with them, to be replaced by – well, you tell me, as my description could be regarded as libellous.

I view the abandonment of analogue TV with complete indifference, as my wife and I have long been disenchanted by what purports to be entertainment today, and will be content to watch the stockpile of good, decent films we have built up on tape and DVD. From what I read, including letters in *Television*, it appears that the lot of the TV engineer is not going to be a happy one when only digital TV and radio are available – the

vagaries of reception seem to be far worse than anything I ever encountered in the days of Bands I, II and III. And it's pathetic that after all these years buying a new radio set does not automatically mean, if it happens to be a digital device, that you will have good reception. What on earth is supposed to be the advantage over conventional AM and FM, apart from the possibility of cramming more stations into the available air space? Those of us who regret the passing of 'proper' BBC know very well that these new stations will simply pump out more and more thump, thump, screech, thump non-music, despite whatever grandiose promises may be made by the Radio Authority.

Finally, in the 'if only' category, the letter from Philip Bearman regarding a 1936 combined radio/TV that he refused to take away as a gift. A number of pre-war TV receivers have made up to £3,500 at *Radiophile* auctions, and I would estimate that the one Philip missed would have easily reached or even exceeded this figure. Oh well, Philip, if you or anyone else should encounter another old set, please let me know – I may be able to do you a bit of good. Incidentally post-war sets into the Fifties are now attracting very worthwhile prices, so keep your eyes open!

*Chas E. Miller,
Editor, The Radiophile,
Larkhill, Newport Road,
Woodseaves, Stafford, ST20 0NP.
Phonelfax (office hours) 01785 284 696.*

Editorial comment: We don't know what sort of transport was provided (!), but the figure of four BBC staff in 1922 was

taken from an official BBC publication. Furthermore the date at which this was applicable is given as December 31. At the time there were 35,774 radio receiving licences. By the end of 1923 the figures are given as 177 staff and 595,496 licences.

Scotch tapes and carriage costs

I was interested to read about problems caused by Scotch videotapes (Test Case 509, May), having had to scrap about twenty of them. They had all been affected in various degrees by a white mould, and were unusable. I had stored a large number of videotapes in the same location, but only the Scotch ones had been affected. One Scotch tape didn't appear to have been affected but left a thick coating of oxide on the heads, necessitating a thorough clean. It was also binned.

Regarding the letter about postage charges, I am becoming increasingly dismayed by companies that send out even the smallest item by carrier. Have they never heard of recorded delivery? I was looking for some Weller soldering-iron tips and found a firm in Leicestershire that could supply them, by carrier only, at 6GBP. So I didn't bother. A catalogue from Jaycar Electronics in Australia lists carriage charges to the UK at 5GBP for goods up to the value of 49.99GBP. Apparently it's cheaper to send goods from Australia than from Leicestershire. I can't help noticing how quickly the cost of goods becomes poor value once carriage charges are added.

Incidentally the Jaycar website is worth a look.

*Marc O'Polo,
sent by email.*

HELP WANTED HELP WANTED HELP WANTED HELP WANTED

Wanted: Service manual and/or user manual for the Philips PM5334 TV sweep generator (wobbulator). All costs reimbursed. Phone Dave Hazell on 01793 765 390.

Wanted: An on/off volume control for the Roberts Radio Model R606MB, which dates back to the early 1980s. Alternatively a scrap set would do. E. James, 8 Bryn-y-Derwydd, Trefin, Haverfordwest, Pembrokeshire, SA62 5AY. Phone 07814 176 641.

For sale: *Television* magazines from 1987 to 1992. Total 62 copies (a few missing, mainly 1992). Phone Mike on 01758 613 790.

Wanted/for sale: Require Denco coils for transistor use. Blue aerial coils 3T, 4T and 5T; red oscillator coils 3T, 4T and 5T; IF transformers IF18 (465kHz) and IFT14 (470kHz). Have for sale a Scopex oscilloscope Model 4010A, in box with instructions and probe. Offers please. H.S. Downing, 16 Mayfield Crescent, Lower Stondon, Henlow, Bedfordshire, SG16 6LF. Phone 01462 850 244.

For disposal: Lots of service manuals collected 4-16 years ago, also some service equipment and seventeen volumes of *Radio and Television Servicing*. Offers or ideas please. G. Johnson, West Hawke, Gangers Hill, Woldingham, Surrey, CR3 7AD.

Wanted: Circuit diagram, including control board, for the Philco washer/dryer Model WD2002S. Also a maintenance manual for the Olivetti photocopier Model 8515 or information on where details can be found, i.e. websites etc. Email Tony Rigby at 113670.225@compuserve.com

Wanted: Old half-inch diameter ferrite rods. Must be six inches or more long. Will pay very good money for them. Peter Tankard, 16A Birkendale Road, Sheffield, S6 3NL. Phone 0114 231 6321 between 9 a.m. and 10.30 p.m.

Wanted: Does anyone know the location of a stockist of Steadfast screwdrivers in southern England? Please email johnanderson_500@hotmail.com

Wanted: Circuit diagrams for the Onwa 3-

--3221 tuner, cassette and CD combination and for the Volvo CR---530 car radio, cassette and stacker CD. Please email Ian McPherson on ian-ann@xtra.co.nz

For disposal: A number of eproms, some empty, some requiring UV erasure, as follows: 2516 (two); 2716 (13); 2764 (43); 27128 (19); 27256 (four). Any reasonable offer accepted. Phone Ian Thompson on 01274 689 488 (Bradford, West Yorkshire) or email ian@g4lug.fsnet.co.uk

For exchange/disposal: Have for exchange two 32in. CRTs, types W76EWS001X11 and W76ESF031X13, for one 28in. CRT type W66ECK001X13. Also, for disposal, a Leak Stereo 30 amplifier and a Stereofetic tuner. Both working but need service. E.A. Crathorne, 2 Harden Close, Walsall, WS3 1BU. Phone 01922 401 130. **Wanted:** Quad 33, 34 or 44 preamplifiers, 405 power amplifiers and FM3 tuners for spares. Also boards and modules for these. Contact Mike on 01758 613 790.



VCR CLINIC

Reports from
Eugene Trundle
Nick Beer
Martin McCluskey
Chris Bowers
Bob Flynn
Roy Blaber
and
Alan Stubbins

We welcome fault reports from readers – payment for each fault is made after publication.

Reports can be sent by post to:

Television Magazine Fault Reports,
Nexus Media Communications,
Media House,
Azalea Drive, Swanley, Kent BR8 8HU

or e-mailed to:
t.winford@highburybiz.com

JVC HRJ670

There was a horrific set of symptoms with this machine: intermittent operation; erratic deck functions; the display spasmodically flashing and producing random indications; vertical white lines superimposed on the output picture; and so on. The cause of the trouble was in the power supply, where the mains bridge rectifier's reservoir capacitor C5006 (68 μ F, 400V) was open-circuit. **E.T.**

B&O VX4500

The customer said that this machine "wouldn't record". In fact there was no real E-E video – there was clearly no sync, so the vision looked negative. The fault was obviously thermal, so I decided to check the electrolytic capacitors in the tuner-video path. When I scoped the output at pin 16 of the IF unit I could see that there was trouble here. By now the symptom had changed to weak field sync.

The cause of the trouble was C14 (1 μ F, 50V), which is inside the IF pack. I replaced all the electrolytics in the pack to make a reliable job of it. Normally the IF pack is considered to be a replacement item. **N.B.**

Philips 14VP162

If the audio output from one of these TV/VCR combi units cannot be turned above a certain level it's probably in the hotel mode. Select ch. 38 then press 'stop' on the front panel and on the remote-control unit simultaneously. This toggles the hotel mode on and off. H+ on the screen in on, H- is off. **M.McC.**

Goodmans TVC142C/Daewoo DVT14F6P

This TV/VCR combi unit was dead apart from a clicking from one of the relays on the separate power/line output panel. I had no circuit diagram, but found that the Ever 6V supply was present and correct at one of the power board's plug connectors. As the standby LED was out, investigation turned to the main VCR board. A piece of print near the microcontroller chip was labelled E5-3V, but a meter check here produced a 0V reading. When I followed the track back I came to a small diode that's marked on the print as a link, J155. It reduces the Ever 6V supply to E5-3V, and was open-circuit. A replacement (1N4148) restored normal operation. **M.McC.**

Sony SLV-SE820G

The symptoms with this machine were no fluorescent display, erratic operation of the panel buttons, no sound, and a just suggestion of pictures. The cure was as follows. Replace the 100-pin servo/system control chip IC601 and the EEPROM chip IC605, then carry out option settings for the EEPROM. To do this, obtain the adjustment

mode by pressing and holding for five seconds the record button on the VCR and the menu button on the remote-control unit. Numbers 1-72 appear.

Select each number for this model, using the remote-control unit's FF, REW, pause and stop buttons. Turn the required numbers black with the RC unit's select button. The numbers to select, with the SE820G, are 3-15 inclusive, 19, 23, 27, 29, 32, 33, 34, 35, 40, 41, 45, 47, 48, 49, 50, 60, 61, 63, 64, 69 and 72. When the numbers have been selected, press the RC unit's menu button. The VCR's RF output switches to ch. 21, then OK.

Also set the tracking, using the RC unit's test and 5 buttons; and the head switching, using the RC unit's test and SP/LP buttons.

Sony SLV-SE730G

A tape, which was the wrong way round, was stuck in this unit's flap. When I checked inside I found that a slight press on the carriage mechanism's lower bar would release the tape. It could then be pushed back through the front, allowing normal operation of the machine. **C.B.**

JVC HRJ670 (1998 deck)

Heavier tapes, i.e. three- and four-hour ones, would go in crooked, with the right-hand side not going down properly. The cause was not the cassette holder but its metal drive arm (item 211 in the manual). **B.F.**

Panasonic NVFJ625

There was no rewind/fast forward and the tape looped out of the cassette when ejected. I tried cleaning the mode switch, which didn't help, then suspected the capstan motor. When I inspected its PCB closely I found several dry-joints. Once these had been dealt with and the machine had been reassembled it worked fine. **R.B.**

Sony SL-C30 etc

The customer said this Betamax machine had shut down after being in operation for about an hour. There was a repeat performance the following day, with the tape snagging on eject.

When I had the machine on the bench I noticed that there was tape bunching between the capstan and the take-up spool, indicating inadequate take-up torque. The cause of this fault is the temperature-compensation thermistor TH304 on servo board SS16, beneath the modulator. Unfortunately this item is no longer available. Stable and reliable operation can however be achieved by replacing it with a 5-1k Ω metal-film resistor and resetting the torque control RV309 for optimum results.

I've also had this fault with Models SL-C20, SL-C40, SL-HF100 and SL-HF950, but not with Models SLF30 and SLF60 in which the thermistor is omitted. **A.S.**



DX and Satellite Reception

Terrestrial DX and satellite TV reception reports. DTT DX. Blind-search digital satellite receivers. Broadcast and satellite TV news. French TV power reductions. The Quali-TV HD-TV satellite receiver. Roger Bunney reports

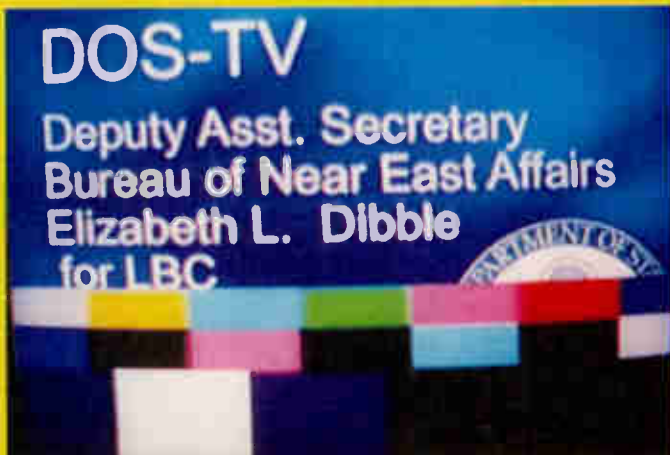

DOS-TV, Department of State Washington, received via Atlantic Bird 1 (12.5°W).

It's fortunate that interesting satellite signals are always present. During the early months of the year they provide compensation for the lack of terrestrial DX signals. If the annual Sporadic E season is to be a good one, April will normally give us a hint of what we can expect come the summer months. In a good year there would traditionally be one or two SpE openings during April, followed by a lull for a few weeks before the season started in mid to late May. Unfortunately the omens are not too good this time. More Band I transmitters have closed, including those in mainland Spain, and we're at the low part of the current sunspot cycle. But there will be openings. For the last two years at least there has been some transatlantic Band II (FM) reception, and TE signals from Africa and from South and Central America have been received in Portugal recently. It just means being very alert and patient.

The only reported SpE during March was a short opening on the 20th, with unidentified programming in Ch. E3. There was a slight tropospheric lift on the 19th, with band I/III/UHF reception from the Benelux countries in Eastern England.

DTT DX

Our DX colleagues in North America have had success with both SpE (low-band VHF) and tropospheric (VHF/UHF) DTT DX – for recent examples check the WTFDA website. Certainly DAB DX works. In the April issue I raised the question of the availability in the UK of equipment with VHF DTT capability. Subsequently Gareth Foster reported that Thomson Freeview STBs have Band III capability and a letter arrived from Stephen Nelson (Truro) who has one of them, Model DT12300, which is Top Up TV ready. It covers the European Band III, 177.5-218.7MHz, and the UK UHF bands, 474-858MHz. He writes as follows about the unit.

"I bought mine from Comet, but have seen them for sale elsewhere. It has a useful tuning feature: you can set to Automatic and scan all the frequencies, locking in stations as the scan progresses, or select Manual and scan a particular frequency or a few frequencies of your choice. The latter is very useful where I live, as I can receive signals from several transmitters but want to lock in only the correct ones from Redruth – leaving all the others in can confuse the situation!"

Microwave TV links

I was recently asked whether it's possible to receive cross-country microwave TV links. They must be in decline by now, with the spread of optical fibre, but you would need to live on the same axis as the microwave link and have facilities for reception in the 6-8GHz band. I recall that when Hugh Cocks lived in East Sussex he was able to receive terrestrial cross-channel 4GHz links, probably from enhanced side-lobe radiation, when conditions were suitable. Today all content will be digital of course.

Things were different fifty five years ago. The London to Birmingham TV link operated at 870-890MHz northbound, with a reverse feed at 917-937MHz. A repeater would receive at 870MHz and retransmit at 890MHz, the next one receiving at 890MHz and retransmitting at 870MHz and so on. The parabolic reflectors used on the repeater site towers were 14ft high and 10ft wide. The link started at London Museum and ended at Birmingham exchange, with repeaters at Harrow Weald, Dunstable, Blackdown Hill and Turner's Hill. There was an additional connection between the BBC's Birmingham studio and the ch. B4 transmitter site at Sutton Coldfield, and the Alexandra Palace ch. B1 output was received off-air at Wembley and could be inserted into the north-bound feed to Birmingham.

Satellite sightings

In recent Satellite Notebook columns Chris Holland has mentioned the various news and OB feeds via Intelsat 603 at

20°W. As noted the satellite is in an inclined orbit at over 2°, which means that you must either pick the right time of day for access or use a dish with an additional actuator arm for inclined-orbit tracking. It's much easier to point your dish at the Atlantic Bird 1 slot (12.5°W) and check the 11-11.2GHz spectrum, particularly from 1730 hours UK time when the regional BBC TV studios are preparing for their evening magazine programme inserts.

For example on the evening of March 24 horizontal polarisation produced UKI-6590 Elstree live from Luton Airport at 11-185GHz and UKI-705 BBC S?? at 11-167GHz, while vertical polarisation produced Giga TEL UKI-7?? at 11-045GHz, UKI-827 Newcastle at 11-050GHz, BBC Leeds UKI-??? at 11-055GHz, UKI-845 Manchester at 11-061GHz, Scopus NET TE at 11-067GHz and TXP B4 CH F at 11-072GHz, all transmitted with the usual BBC digital parameters (symbol rate 4,226, FEC 7/8). Unfortunately full service identifications were not always visible, because of the inability of my receivers to show lengthy text idents. MPEG-2 and the 4:2:2 version were both in use. Other BBC uplink trucks noted have been UKI-301, -398, -705, -888PI, -903 and -1091PI.

On the same date channel 1 of the GlobeCast multiplex via Atlantic Bird 1 (11-106GHz H, SR 20,145, FEC 3/4) produced a DOS-TV Q & A presentation at 1900 hours – DOS-TV is the US Department of State feeder from the Foreign Press Center. Questions were phoned in and carried on Audio 1 stereo and Audio 1 mono L, the answers from the DOS being on Audio 1 mono R.

PGA golf tournaments are a regular feature via the GlobeCast multiplex during the UK evenings. In mid March channel 3 transmitted the PGA Honda Classic from the Mirasol Country Club, Palm Beach Gardens, Florida – rather warmer there than here!

On the evening of March 19 GlobeCast Africa carried a remarkable pop concert entitled 46664. The Johannesburg concert, in support of Aids fund raising, ran for several hours and the main guest was Nelson Mandela – his 'people number' during his years of imprisonment was 46664. The transmission appeared via Europe*Star 1 (45°E) at 11-607GHz V (5,632, 3/4). Meanwhile the original blind scan had also rung up 11-525GHz V, GlobeCast Afr-TV, a favoured GlobeCast frequency. But when I checked after saving it in memory it had closed down, as had GCA1 at 11-516GHz V (GCA1 = GlobeCast Africa 1).

While feed hunting during the late afternoon on the 19th I had checked a couple of satellites that I rarely visit, Intelsat 801 (31.5°W) and 903 (34.5°W). 801 had a day of football, courtesy of BT TES 32, with pitch coverage at 11-020GHz V and the commentator at 11-011GHz V (both 5,632, 3/4). 903 was more interesting with RTE LON HBR at 11-137GHz V, RTE SMUZ LBR at 11-153GHz V (SR 4,699, ?FEC) and Gigatel UKI-7?? at 11-144GHz V. Unless otherwise indicated, these all had a 5,632 symbol rate and 3/4 FEC – and all were encrypted! Care is required when scanning 801 because of the proximity of the powerhouse Hispasat (30°W). I had adjacent-slot 'bleed-over' from a Spanish feed, TV Prog, an interview in a football dressing room, at 11-625GHz V (5,632, 3/4).

The satellite that's easy to find for breaking news feeds is Eutelsat W1 (10°E). It produced news of several dramatic events during March. On March 3 The Global Flyer landed at Kansas City Airport. There were live pictures as news helicopters followed the fragile craft to a perfect touchdown. On March 8 there were live pictures of a police chase, from a news helicopter "somewhere in the USA". A getaway car was being pursued by upwards of a dozen police cars. When it eventually slowed, pulled over and came to a stop it was immediately surrounded by armed police. Windows were broken and the occupants were dragged out and jumped on then taken into custody. Just like in TV films! Further drama on the 11th when Brian Nichols, on trial in an Atlanta courtroom, grabbed a policeman's gun then



The Atlanta courtroom shootout, a live report from UPA Atlanta ch. 2 via Eutelsat W1 (10°E).

shot him, the judge and another court official. He made off in a stolen car, having pistol-whipped the owner. Nichols was caught next day – there were live reports from outside a courthouse. On the 17th Fidel Castro was wheeled out to make a very long speech, lasting some hours, in Havana. APTN kept dipping in and out of his speech throughout the evening.

On the 21st there was another school massacre. Student and Nazi/Hitler enthusiast Jeff Weise had snatched his ex-policeman grandfather's gun belt, then shot him and his partner. Thus armed, he drove a pickup truck to Red Lake School where he shot a security guard, a teacher and five teenage pupils. When the police arrived there was an exchange of fire before Weise turned the gun on himself. The Minnesota school is on the Chippewa reservation, an isolated region near the Canadian border. On the 22nd the FBI conducted an on-site press conference and shooting-sequence update. Later press calls were at the FBI's Minnesota HQ in St. Paul. A final dramatic sighting was presented on the 23rd, with live pictures from an explosion-racked oil refinery at Houston, Texas, as firemen fought to subdue the resulting blaze. At least fourteen refinery workers had been killed. Air pictures were fed live to the local TV station, to network affiliates and worldwide feeds.

The best frequencies to check with Eutelsat W1 are 10-967 and 10-972GHz V (4,167, 5/6), but some content is encrypted.

Blind-search digital satellite receivers

The introduction of blind-search has perhaps been the most important advance in digital receiver design during the last couple of years. It enables a satellite enthusiast/feed-hunter to scan a satellite's frequency spectrum with the receiver itself locating signals and confirming their frequency and parameters, enabling them to be stored for investigation later. A check via the 'information' option should then display the service identification, programme name, the various PIDs, the frequency and symbol rate (SR). Few if any such sets divulge the FEC, but knowing this is less important as most non blind-search receivers will lock to a signal with only the frequency and the SR entered for search. This point was mentioned in Nick Harrold's review of the Fortec blind-search receiver range in the April issue. Several blind-search receivers are now available, including the Manhattan range that's distributed by Eurosat. Check the advertisements in *What Satellite and Digital TV* for sources and, for equipment information, the Feedhunters website.

I've used two versions of the Coship Model CDVB3188C over the last couple of years, and would recommend it as possi-



Pactv, Hollywood Oscars feed via Eutelsat W1 (10°E).



An improvised Russian test pattern. Seen during an NTV feed via Eutelsat W2 (16°E).

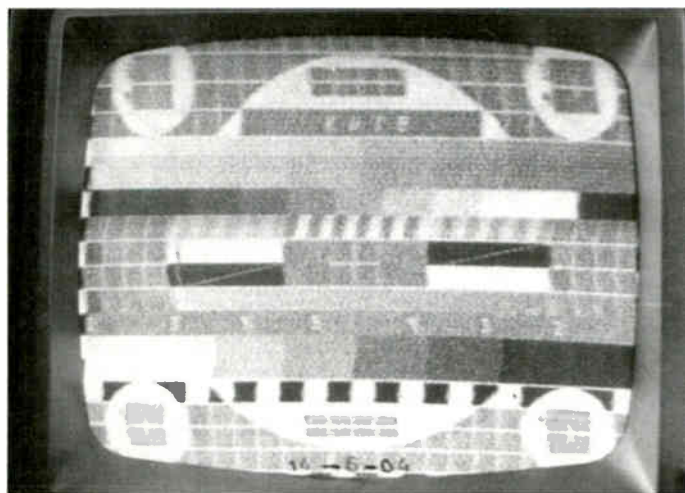

Sporadic E reception by Ryn Muntjewerff (The Netherlands) from Kiev (Knib), Ukraine, ch. R1 — the 1+1 test pattern.

ably the nearest to the ideal blind-search unit at present. The reason for this is as follows. The downlink spectrum of telecommunications satellites is often divided into two sections, broadcast TV programming and feeders. For example with Eutelsat W1 (10°E) news and OB feeds are found between about 10·950-11·180GHz. So I would want to search that spectrum only. With Eutelsat W2 (16°E) I would want to check 10·950-11·160GHz and 12·5-12·560GHz for news feeds. So I need to be able to enter an in (start) and an out (finish) frequency to be blind-searched.

It's therefore important that for satellite 'DXing' it should be possible to programme the receiver to search what you want, not the whole 10·7-12·75GHz spectrum in one massive chunk. By the time the receiver has arrived at 12·75GHz that rare news feed from Nepal at 10·975GHz may have closed down, the sat crew having their lunch! So check that this facility is available before you buy.

Broadcast news

UK: A local TV news service is to open in central UK this autumn, providing coverage of the following areas: Shropshire, Coventry/Warwickshire, Stoke/Staffordshire, Herefordshire/Worcestershire and Birmingham. Each local TV area will shadow the BBC local radio service. This experimental TV service will be accessed by using the red button on a remote-control unit, and will provide up to ten minutes of continually updated news. If the pilot service is successful, a further sixty local TV news services will be introduced gradually across the BBC regions.

US: Politicians are pressing for an analogue close down at the end of 2006, the time originally set for broadcasters to complete their move to digital transmission. At present most broadcasters transmit both analogue and digital signals, and setmakers intend to provide digital receivers by mid 2007. Although most households receive their TV via satellite or cable, some twenty million rely on terrestrial TV transmissions.

Sweden: DTT expansion continues and the low-power Joestrom SVT-1 analogue transmitter (ch. E4) has already closed down. It appears that the present plan is to close all the analogue TV transmitters by February 2008. Some will have been on air for 54 years!

DAB is at present on only ch.12B (225·648MHz) in Sweden. Current transmitters are Goteborg, Malmo (both 2kW ERP), Stockholm/Enkoping (2·6kW), Stockholm/Nacka (2·5kW), Uppsala (1·5kW), Sodertalje (2·3kW) and only one in the far north, at Alvsbyen (3·8kW).

Germany: The Flensburg ch. 4 transmitter closed on February 28th, also ch. E10 from the same site. Many other analogue UHF transmitters well-known to DXers, such as Dusseldorf, Dortmund, Kleve, Wesel, Schleswig, Hamburg, Kiel, Lubeck, Eutin and Buderich/Wesel were due to close by April 4. They will be missed . . .

Botswana: The Ministry of Communications has announced that new transmitting equipment is being installed for Botswana TV and Radio Botswana at the site near Phikwe, including a new mast to carry the aerials. When complete, Radio Botswana FM channels RB1 and RB2 will be transmitted along with the Botswana TV service.

Satellite news

US satellite TV broadcaster DirecTV was due to launch Spaceway 1, the first of four new satellites, in late April. It's described as the "most complex commercial satellite system" ever constructed, with a heavy transponder loading and a unique steerable aerial for downlinking — it can be adjusted in-situ to alter the footprint. The satellite will be able to provide over

Table 1: French UHF transmitter power changes

Site	New ERP	Old ERP	Site	New ERP	Old ERP
Abbeville	80kW	380kW	Limoges*	260kW	485kW
Alencon	40kW	12kW	Metz	180kW	590kW
Amiens	120kW	165kW	Mezieres	4.5kW	200kW
Argenton	18kW	41kW	Mulhouse*	83kW	780kW
Auxerre	45kW	215kW	Nancy*	30kW	180kW
Bar-le-Duc	70kW	80kW	Nantes	50kW	665kW
Bourges*	211kW	410kW	Paris (Tour Eiffel)	100kW	215kW
Brest*	230kW	703kW	Parthenay	30kW	60kW
Caen*	198kW	500kW	Reims*	80kW	400kW
Chartres	50kW	160kW	Rennes*	500kW	370kW
Clermont-Ferrand*	200kW	330kW	Rouen*	65kW	173kW
Laval	20kW	60kW	Strasbourg	542kW	233kW
Le Havre*	20kW	90kW**	Tours	95kW	390kW
Le Mans	150kW	320kW	Troyes	250kW	640kW
Lille	9.5kW	450kW	Vannes	75kW	70kW

* Band III transmitters at these sites are subject to ERP alterations.

** Also 2.1kW from 90kW (two transmitters).

1,500 high-quality TV channels by mid 2007. Spaceway 2 will be launched later in the year, operating in the Ka band, the next to be exploited for DTH broadcasting.

The Dutch authorities ordered the New Skies Satellite group to stop transmitting the Lebanese TV channel al Manar via its satellites, claiming that the controversial channel hadn't been granted a licence. Al Manar has now gone black. Eutelsat was previously under pressure to drop al Manar from its multiplexes.

A new US satellite, AMC-12, is now in orbit at 37.5°W, offering high-power C-band capacity between Africa, Europe and the Americas. SES Americom, which owns the satellite, is offering 33 transponders for downlinking to Africa branded as Astra 4A.

Worldspace is encrypting more WRN radio services – listeners wishing to continue with them have to pay a monthly subscription. RTE (Ireland) is being encrypted though it wanted to remain an FTA service. Other broadcasters that use WRN capacity include Radio Nederland.

French TV power reductions

In preparation for the introduction of DTT the radiated power of most French UHF transmitters is being reduced. These power reductions are considerable and will affect UK South Coast viewers who currently receive cross-channel French TV. The Benelux DX Club has provided a detailed listing of the changes, and Table 1 summarises those at the larger transmitters in the northern and central parts of France. Lower-power transmitter changes are not shown. Note that there are also some transmitter power increases.

DTT coverage will be gradually expanded across France. The first seventeen sites, covering 35 per cent of the population, have been in operation since March, the transmitters being as follows: Bordeaux Est, Bordeaux Cauderan, Brest, Lille, Lyon, Nantes, Marseille Masif de l'Etoile, Marseille Pomegues, Niort, Paris Eiffel, Paris Est, Paris Nord, Paris Sud, Rennes, Rouen, Toulouse and Vannes. The full DTT expansion plan can be seen at www.tvnt.net/couverture/htm

The ch. L30 TMC Monaco site (Mont Angel) continues to transmit at 1,000kW ERP, the only transmitter remaining in France with this high power.

The Quali-TV HD-TV satellite receiver

The following is not intended as a review but merely as a report on my experiences with the Quali-TV satellite receiver Model QS10801RCI, which can decode MPEG 4:2:2 as well as MPEG-

2 signals and provide HDTV outputs. I bought one a few weeks ago from satellite dealer Smallworld in Birmingham.

MPEG 4:2:2 is being increasingly used by news operators and outside broadcasters as a way of providing higher-quality video. Until recently it could be decoded only by using an expensive professional receiver or by fitting a SkyStar or similar card in your PC, which would need to have adequate processing capacity. An earlier version of the Quali-TV HD receiver would decode MPEG 4:2:2 but imperfections were apparent in the pictures. New software has overcome the problem, and HD-TV and MPEG 4:2:2 transmissions can now be received with excellent video and audio quality.

At the time of writing I've been using the receiver for about four weeks, but lack of time has prevented a detailed knowledge of the operation of the unit. The receiver can store 3,000 channels and comes preloaded for many satellites and multiplexes. Smallwood suggested that in view of my interest in single-frequency feed hunting I delete any that aren't needed, so I deleted several hundred. There's no blind-search, so I use my Coship receiver for this purpose. It identifies signals by frequency and SR, displaying all MPEG-2 content. The non MPEG-2 signals received may be data, encrypted or 4:2:2. These can be entered using the Quali-TV's home-search option. If successful, a picture will appear on the screen and the channel will be stored in the tuning memory.

First the down points. I've found that the Quali-TV occasionally refuses to display a signal. At times the remote-control unit seems to be reluctant to act, or the Quali-TV is very slow to respond. There's no RF modulator. And the operating manual consists of mainly small, off-screen photographs with flow charts. The images are small and indistinct. More descriptive text would help – even important points such as how to delete are not covered. I found the delete button in a menu photograph in a flow chart (it appears as a dot on the 'set channel' menu, as 'del'). I would have welcomed more simple explanations.

The up points are that it displays HD and MPEG 4:2:2 material with excellent quality and there are lots of rear-chassis options for feeding monitors, recorders etc. When it's good it's very good.

Smallwood has been very helpful in supplying the receiver and providing advice. My receiver cost about £400 in early February. Smallwood is at 3 Wood End Road, Erdington, Birmingham, B24 8AA. The phone number is 0121 373 8016. There's a website at www.smallwood.uk.com or you can email support@smallwood.uk.com



AUDIO FAULTS

Reports from
Geoff Darby
Roy Blaber
Chris Bowers
Philip Rosbottom

We welcome fault reports from readers – payment for each fault is made after publication.

Reports can be sent by post to:

Television Magazine Fault Reports,
Nexus Media Communications,
Media House,
Azalea Drive, Swanley,
Kent BR8 8HU

or e-mailed to:
t.winford@highburybiz.com

Technics SL-PJ44 CD player

This old-timer was reluctant to get a disc to spin. Sometimes it would just 'bump' the disc a couple of times. At others it would lazily roll the disc backwards. Occasionally it would spin the disc in the right direction sluggishly and, if left long enough, might just get up enough revolutions to read the TOC.

As the spindle motor is a direct-drive type, similar to the capstan motors used in many VCRs, I initially suspected a power-supply fault rather than something motor-related. A closer look however revealed, under the metal lower bearing plate, a PCB with electrolytics on it. This plate is easy to remove after taking out two screws. The PCB that's then accessible has the three motor stator coils, the drive IC, three normal electrolytics and two surface-mounted ones on it. One of these, with a value of $33\mu\text{F}$ and rated at 25V, had leaked.

I cleaned up the PCB and fitted a replacement capacitor. This restored the fast spin-up and TOC read normal with Technics players. G.D.

Sharp XL1500H

Fuse blowing was the complaint with this unit. Initial checks revealed a dead short across the main smoothing capacitor C131 ($2,200\mu\text{F}$). A print track lead from it to the output IC, which was my first suspect as being the cause of the problem. With its pins unsoldered however the short was still present. Second favourite was C115 ($10\mu\text{F}$), a decoupler that's right up close to the IC. Again this proved to be blameless.

The culprit finally turned out to be C116 (22nF), a ceramic disc HF bypass capacitor for C115. Once it had been removed the short disappeared. With a replacement fitted the unit performed normally, with no signs of fuse blowing. G.D.

Behringer Eurodesk MX3282A

The note that came with this monster 32-channel professional mixing desk simply said "went bang". It has a separate rack-mount power supply that delivers $\pm 18\text{V}$, $+12\text{V}$, $+5\text{V}$ and $+48\text{V}$ for phantom feeding. The bang certainly hadn't come from this unit, as the outputs were all correct. A quick look inside showed that it used a simple linear design and that there were no signs of any distress.

Before going further I decided that a bit more knowledge about the failure circumstances would be helpful. The owner said he had been listening with headphones that had gone bang. After that the deck had ceased all operation.

Armed with this information I removed the covers and powered up. The only signs

of activity were that the power LED lit up, also the 48V phantom-feed LED when this facility was enabled using the rear-panel switch. My next move was to check for voltages on the three PCBs. Some large multiway cables run between them, also a six-way with quite chunky wires. -18V was present at two of these wires, but little else. As they were the middle two pins, and a quick glance at the contents of the boards revealed a lot of op-amps, it seemed reasonable to assume that $+18\text{V}$ should have been present at two more pins.

I switched off and checked the resistance to chassis at all pins. The two that I thought should probably carry $+18\text{V}$ read dead short. It was easy, next, to unplug the boards from one another and recheck. The board at the right-hand side, top, with the front towards you, contains the final mix-down stage, headphone amplifiers, LED bargraph, line-out drivers and eight of the 32 input channels. The connections from the external power supply arrive at this board first. The other two boards are identical 12-channel input/tone/fader modules. I was able to establish quickly that the suspected $+18\text{V}$ pins read OK on the mix-down board and one of the 12-channel boards but dead short on the remaining one.

This is where the problems started. The PCB is secured to the main body of the unit by about 16 screws, and there are a number of connectors to uncouple. To remove the board however 156 – yes, that's correct – twiddle knobs and slider knobs have to be removed.

Once the board was out I checked for any obvious problems such as bulged or exploded electrolytic capacitors, but none were apparent. I then spent some time metering all the electrolytics. Once again, this failed to reveal anything amiss. So there was no option other than to fault-find on it the hard way. The rail with the short on it went as a print run from the connector right over to the other side of the board, with twelve through-plated holes on it, one above each of the twelve channels. When you tried to see where these went to on the component side of the board you were lost, as the entire upper surface of the board is covered with potentiometers that obscure all the print runs.

Although I am always loath to do it, there seemed little option other than to employ the 'half-split' short-location method. This involves making small print cuts at carefully worked out places on the print 'tree' to isolate the short to a single branch, then unsolder each component on that branch in turn to find the faulty one.

Using this method, I was able first to isolate the fault to a single channel out of the

twelve and then to the vicinity of two NMJ-series SIL op-amp ICs. I managed to isolate the positive supply pin of each of these devices, but the short remained. This left only C283, an 0.1 μ F ceramic capacitor that's connected directly to the supply pin of IC55. It was of the blue type you used to see sprinkled liberally around logic boards a few years ago, as supply decouplers. When this item was removed it was proved to be the cause of the elusive short.

After bridging all the print cuts I'd made during the fault-location process, and replacing the faulty capacitor, the tedious job of rebuilding the unit had to be undertaken. The knobs are all colour-coded, so they had to be selected from the tub in which they had been stored during the repair. Just refitting them all took the better part of an hour.

When the unit was reassembled and switched on it lit up like a Christmas tree, and I was rewarded with a fully-working piece of equipment. It may seem that a lot of effort was required to carry out the repair – but it seemed worthwhile when I wrote out the bill . . . G.D.

Grundig UMS12

The ticket with this one said "sound from headphones only". I never got as far as checking that because, when the unit was powered with speakers connected, a very violent buzz came from them.

The cause was obvious once the covers had been removed. A nice easy one for a change. The main smoothing capacitor (3,300 μ F, 35V) was bulging at the top and bottom. A replacement restored normal audio from the speakers and headphones. G.D.

Denon UDM30

The complaint was no sound output. Checks in the output stage revealed that it was working but was muted. This led me to the DTA114EK transistor T211, which was open-circuit. R.B.

Sony HCD-CP555

This audio system's five-disc interchanger was faulty. A look inside revealed that a disc had become stuck between the top bracket, ref. #163, and the stacker. A new bracket, part no. X-2022-668-1, was required to restore normal CD operation. C.B.

Sony STR-LV500

All the segments of this FM/AM stereo radio receiver's display were lit up. Checks on the display board revealed that the fluorescent indicator tube FL801, part no. 1-518-903-11, was faulty. It had

become shorted, because the customer had spilt a small amount of liquid on the front of the unit. I checked around the front display PCB for any further liquid damage then fitted a replacement tube. After that everything worked normally. C.B.

NAD 514

This compact disc player wouldn't play a disc when it was inserted. When I examined the CD mechanism I found the cause of the fault: the loading pulley had become stretched and was unable to raise the CD mechanism when the tray closed. A replacement belt restored normal loading and playing. C.B.

Sony HCD-SD1

This unit failed to operate. Checks inside, on the sub-tran PCB, revealed that relay RY901 was faulty. A new relay restored normal operation. C.B.

Sony SA-WMSP501

This active sub-woofer made a rattling noise with bass notes. The front silver panel can be levered off slowly at the bottom, using a flat screwdriver. When I did this I saw the cause of the trouble: a loose circular cushion pad, near the top of the unit between the front silver panel and the case, was vibrating. All that was needed to restore normal rattle-free sound output was to glue or tack the circular pad in its right position – then replace the front. C.B.

Sony HCD-HP7

There was no sound in the tuner mode. Checks on the main board revealed that

diode D102 was defective. A small modification is required when this fault occurs. Replace the diode with a zero-ohms resistor chip, part no. 1-216-864-91, then fit a 10ED40-TA1B2 diode, part no. 6-500-522-11, in place of the tinned wire JW415, with its anode and cathode the same way round as D102 had been. C.B.

Technics SU8080

Intermittent sound was the complaint with this amplifier, which dates from 1978. The cause turned out to be the speaker connections. These are in the form of a collet arrangement that tightens the wires. Where the wires fit inside it there were small bits of plastic that had broken off something and prevented tightening against the wires. To repair, the connector assembly had to be removed from the chassis and dismantled. I removed the back panel but even so it was a fiddly business to get the connectors off.

This was one of Technics better amplifiers, producing 72W RMS per channel. It doesn't like a low speaker impedance – below 4 Ω . The over-current circuit will limit the maximum current.

I've had to deal with many of these amplifiers that have had no component failures, only noisy potentiometers and switches.

A common complaint is no sound from any input. Check that the preamplifier-main amplifier links are present! There's a bunch of fuses under a plate to the right of the transformers (see photo). These may be missed if you don't know they are there. P.R.



Inside the Technics SU8080 amplifier.



Adrian Gardiner on the need to go lead-free to meet the latest requirements from the authorities and setmakers. Also some notes on interesting websites

Bench Notes

My business development series continues this month with a look at soldering practice in the modern service workshop. Efficient soldering is obviously important for business success. Then, for something different, I'll provide some notes on websites that you might find of interest.

Go lead-free!

Your soldering iron is by far the most important piece of equipment in any electronic workshop. Yet many engineers skimp on this vital tool, often making do with a very basic unit. I've found that the most popular still seems to be the basic Weller Magnastat soldering station. It's a bit dated for today's workshops however, and you should be investing in newer temperature-controlled equipment.

Use of lead-free solder will become compulsory throughout the European Union from 1 July 2006, in line with global efforts to reduce environmental pollution. Several manufacturers have already gone lead-free, including Sony and Panasonic. Authorised service agents are now required to meet this standard in repairs and reworking. In anticipation of this, several new lead-free alloys have been developed. They include tin-copper, tin-silver and silver-copper. But the removal of lead from solder has introduced a number of complications. The main one is an increase in the melting point, which can result in quality and stability problems. Lead-free solder also reduces processability, because of lower wetting and changes in flow behaviour.

The new lead-free alloys are more temperature-sensitive than conventional solder. It's important therefore to avoid increasing the process temperature, as the longer cooling time can cause microcracks. In addition, higher soldering temperatures can result in black layers on the soldering tip. This makes it unwettable, causing early fallout (charred flux, oxidised tin, tin-copper-iron fusion).

The higher melting points of the new lead-free alloys make specific demands on

hand-operated soldering tools. Soldering irons must have higher power, optimised temperature control and better thermal conductivity to reduce heat loss at the soldering tip. The higher melting points mean that more thermal energy is required to melt the alloy – increasing the temperature by 40°C increases the thermal energy needed by two to three times. One way to achieve this is simply to increase the iron's temperature, but the problem with this is that at higher temperatures the flux burns off immediately and cannot work effectively. Flux is essential to the soldering process, as it deoxidises the metal surfaces and facilitates diffusion of the metals into each other. The way to overcome this is to be able to transfer increased amounts of thermal energy rapidly, at lower temperatures. And this calls for hand-held soldering tools that are more efficient technically.

It's also essential to optimise selection of the soldering tip. A soldering tip has two main tasks, to transfer thermal energy as efficiently as possible, and to carry solder to the joint in combination with flux. The higher tin content of lead-free solder reduces tip lifetime however, because of iron leaching at higher temperatures. In practice shorter, thicker tips are more efficient for lead-free soldering as they transfer the heat needed into the solder joint without increasing the process temperature. This reduces thermal stress on components and PCBs, and minimises damage to the solder tip.



The Weller WSD81 soldering station used by Adrian Gardiner.

What to buy

So what should you buy? You need a soldering station that's fully temperature-controlled, with a fast heat up and thermal recovery. You should also be able to interchange a wide range of tips to suit the current task, without having to wait for the tip to cool down. All the leading manufacturers, including Weller, Antex and Pace, have suitable systems.

My own station is a Weller WSD81 unit, see the accompanying photograph. It has a digital base unit that provides control of the temperature to within one degree over the range 50-450°C. Heating up from switch on takes only fifteen seconds, and the iron is of a comfortable pencil-type design fitted with a highly-flexible silicone cable. There's a wide range of 'hot-changeable' tips: their compact design provides fast thermal transfer, which is ideal for working with lead-free solder.

I use a standard 2.4mm screwdriver tip for most work, fitting smaller tips for very fine work. For most work I use a temperature of 350°C, increasing this to 370°C for lead-free solder. When working with higher-mass areas, such as ground planes and eyelets on LOPTs etc., I increase the temperature to 400-425°C. A lower temperature of 325°C works well for flat-pack work, reducing the possibility of PCB damage.

Surface-mount reworking

Work with BGA (ball grid array) devices calls for very specialised equipment. Our company is still investigating this. Regular surface-mount repairs are fairly straightforward however, given a high-quality soldering iron. I am surprised by the number of engineers who shy away from replacing flat-pack ICs. Buy yourself a decent iron and get busy! If it's new to you, practice on some old boards first.

There are a number of different approaches to replacing a flat-pack device, from 'unpicking' the old one to the use of specialist vacuum hot-air equipment. Personally I favour the use of rework alloy and the 'drag' soldering technique. The alloy in question has been reviewed in a

previous issue of *Television*. Apply it to all the pins of the IC to be replaced, retaining the heat long enough to remove it. The trick to being successful is to use plenty of flux. Use a high enough temperature to ensure that the solder melts quickly: 325°C should be enough for a small flat-pack device, increasing to 350°C for a larger one. Increase these temperatures by 20°C when lead-free solder has been used.

After removal of the component the area should be cleaned properly. Good-quality braid is ideal for this, followed by a good clean up with PCB cleaner. A fresh layer of flux should then be applied, prior to lining up the new IC.

The principle of drag soldering is very simple. First 'tack' a couple of the IC's corner pins in order to keep it aligned. Check carefully under a good magnifier. Also make sure that plenty of flux has been applied, to ensure that the solder flows correctly. Next fit a GW (gull wing) type bit to the iron, clean the tip and apply solder. Then simply drag it nicely and gently along each row of pins. The flux will pull the solder into the joint naturally, producing a very clean finish. Give your work a final careful inspection under a magnifier.

Next month I'll continue with a look at the other equipment required.

The wacky worldwide web!

No doubt most of you have internet access. In addition to its use in the course of your everyday work however it can provide constantly changing entertainment. I've put together the following collection of slightly unusual websites that I hope you will find of interest.

www.ebay.co.uk No article about websites would be complete about a mention of eBay, so we'll start off with it! eBay has become the largest online shopping centre in the world. I'm sure that all of you have heard about it if not used it. Worth mention here are a few of the categories of interest to those in our trade. First, there are specialist categories for test equipment and components. At present they are buried in the 'business' section of

the site, but they may well be moved around as time goes on. Type 'oscilloscope' or, indeed, any piece of equipment into the search bar and you'll be surprised by the number of units listed.

Of far more interest is the 'Vintage and Collectables' section of eBay. There are separate sub-categories here for a number of types of old electronic equipment, including everything from vintage computers and calculators to very old and unusual TV sets. Whether you are a serious collector or just looking for a restoration project, you are bound to find something worth a bid.

www.old-computers.com I love this site, which is a must for any computer enthusiast or anyone who wants a trip down memory lane. Well maintained and regularly updated, it features a museum, a history of computing, magazine and discussion forum plus much more. The museum currently contains 891 vintage computers dating from 1951 to 1995. Searchable by model, make or year of release, there are technical specifications for each computer and pictures of most of them. If you are not sure where to start, the site offers a 'random model' search that chooses a computer for you! There's also a 'just for fun' section. The site attracts over 8,000 visitors a day. Well worth a look

www.torchreviews.net This site begs the question 'why?' It's also regularly updated and maintained. It features reviews and articles on a wide range of torches! Perfect before you pop out to replace your old flashlight. Quite why anyone wants to spend large amounts of time writing about torches is open to question, but it nevertheless makes for an unusual website when you are bored. And it goes to show that, search far enough on the net, you will find someone who has written about a subject!

www.amug.org/~jthomas/clockpage.html Remember the nixie tube? These cold-cathode neon display devices were widely used in the Sixties. But since their

production was discontinued, years ago now, a new, popular use for the remaining ones has sprung up, making them very collectable: many people have made digital clocks that use them for the display. The site is a wealth of information, with examples of such projects – most show off the tubes in their full glory. It's run by an enthusiast and is full of links to other similar sites. A great read for a rainy afternoon.

www.cathodecorner.com Nixie tubes not enough for you? Cathode corner is another site that brings vintage displays to a collectable clock. Not only nixie clocks this time however. The site's owner, David Forbes, has designed a clock that displays the time on an old oscilloscope CRT. This design surely takes clockmaking to its extreme form, but the site is certainly worth a visit.

www.20q.com and www.20q.net Here's a seriously addictive game, 20 Questions. Based on the classic guessing game, this hi-tech version will blow your mind. Originally set up in 1988 as an experiment in artificial intelligence, this clever software program has been learning just about everything there is to know.

You think of something then, through a process of simple questions, mainly with yes or no answers, the game guesses what you were thinking about. It's scary how accurate it is, usually guessing the item within the first twenty questions. Often the questions will seem to be totally unrelated to your thought then, all of a sudden, the game guesses it correctly. This amazing puzzle will leave you bewildered as to how it does this, and addicted to trying it again.

20q.com is the main site for the puzzle, with information about it and its history. 20q.net is the actual game itself. Have fun!

I hope you enjoy trawling through the suggestions above. If any of you have other wacky or unusual sites to suggest, please let me know through the magazine so that I can include some in a future article. ■

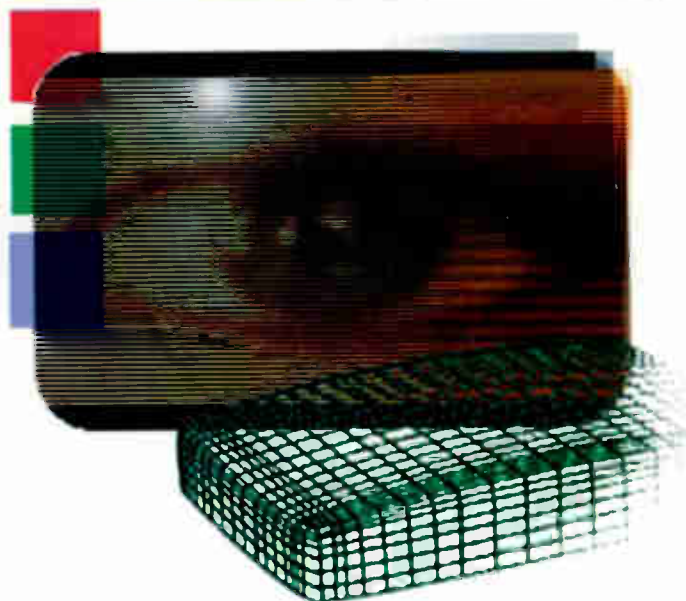

TV FAULT FINDING

Reports from
Philip Salkeld
Gary Laidler
Charles Ritchie
Chris Bowers
Chris Avis
Uel Harte
 and
Glyn Dickinson

We welcome fault reports from readers – payment for each fault is made after publication.

Reports can be sent by post to:

Television Magazine Fault Reports,
 Nexus Media Communications,
 Media House,
 Azalea Drive, Swanley,
 Kent BR8 8HU

or e-mailed to:
t.winford@highburybiz.com

Sony KV28FX66U (AE6B chassis)

The symptoms with this set were no results with the LED flashing twice. Normally a faulty line output transformer is the cause of this situation, but there was no sign of line drive and the 135V HT feed was missing. A check at pin 1 of CN6005 on board G (power supply) showed that the HT was not being produced. Extensive cold checks on this board eventually revealed that R6019 (390kΩ, 0.5W) was open-circuit. All was well once a replacement had been fitted. There are no easy faults with Sony sets unfortunately. P.S.

Panasonic TX32LXD1

The fault with this LCD set was that at switch on the display momentarily lit up then the set reverted to standby. My thanks to Panasonic technical who told me the cause before the set actually came in for repair. The cure is to replace the 1.5A circuit protector R916 with an updated 2.5A version. P.S.

JVC AV28GT1SJF (11AK45 chassis)

This set was dead with the 5A fuse in the mains plug open-circuit. The 3.15A fuse in the set was OK, and a general check around the power supply failed to reveal any short-circuits. So I was left with no alternative to replacing the mains-plug fuse and switching on. There was immedi-

ate flashing around the P6NK60ZF chopper transistor Q102. On removal it was like charcoal. I cleaned around the print, fitted a replacement and switched on again. Although the set was still dead there was no arcing. Replacement of the MC44608 chopper control IC restored normal working order.

This Vestel chassis is also used in the more common Sharp Model 28LW92H. P.S.

Grundig ST84-796/9 TOP/LOG (CUC6380 chassis)

There was sound but no picture. When the setting of the first anode preset on the line output transformer was advanced the fault was seen to be field collapse. Checks around the TDA8350Q field/EW output chip IC430 showed that the 45V supply was present at pin 8 but the 16V supply at pin 4 was missing. This supply is derived from the line output transformer, where I found that R525 (1Ω, 2W) was badly burnt and open-circuit. Replacement of R525 and IC430 restored this huge, heavy set to working order. P.S.

Toshiba 40WH08B

This projection set was stuck in standby. Unless you are familiar with these sets the problem is knowing where to start. I began with cold checks in the power supply and found that R821, a 4.7Ω wire-wound resistor, was open-circuit. This led me to the bridge rectifier D802 which turned out to be short-circuit.

I decided to check with the Toshiba website, which has been helpful in the past, and found a bulletin on this fault. There's a repair kit, part no. 40WHPOW-ER. Fitting this prevents a recurrence of the fault. P.S.

Panasonic TX32DK1

Lack of contrast was the fault with this set. Most video problems with this chassis are caused by the video processor chip IC601. I was fairly confident that a replacement would cure the fault, but my face sank when it didn't. The next step was to get out the manual so that the beam-current limiter circuit could be checked. This network starts at pin 3 of the line output transformer, where I found that R558 (120kΩ, 0.5W) was open-circuit. At least I have a spare IC601. P.S.

Sony KD28DX40U (FE2D chassis)

This analogue-digital set would come on for a few seconds then revert to line collapse with the red LED flashing twice, which indicates that it's in the excess-current mode. The fact that it happened every time the set was switched on cleared the

possibility of a fault in the line output stage. So the next step was to check components in the excess-current circuitry. This can take time. When, eventually, I checked R618 (270k Ω , 0.5W) it read 470k Ω . A replacement restored normal operation. P.S.

Samsung CI5013T

This old-timer had suffered from the usual failure of the line output transistor and capacitors in the power supply. When replacements had been fitted the set worked but there was tuning drift when it was cold. To cure this fault I had to replace C111 (3.3 μ F), C113 (100 μ F), C604 (47 μ F) and C608 (1 μ F). G.L.

Wharfedale M8 (PT92 chassis)

This set was dead with the BU508AF line output transistor TD02 short-circuit because of a dry-joint at the scan-coil plug. Once I had attended to these points the set produced a very narrow picture. I was surprised to find that the capacitors in the line output stage were all innocent. The culprit was diode DD07 (BY228) in the EW modulator circuit. It was leaky and, as a result, RV38 (22 Ω , 1W) in the drive circuit had failed. G.L.

JVC AV29TS2EK

The fault with this set was field cramping and foldover at the bottom of the screen. FR553 (1 Ω , 1W) in the -14V supply to the LA7845N field output chip IC401 had risen in value to 18 Ω . Once I'd fitted a replacement and resoldered the IC's pins the scanning was back to normal. C.R.

Panasonic TX14B4TL (Z185 chassis)

This set had me fooled. The complaint was lack of height. As there was no field distortion I went to the service menu and adjusted the height. But even at the maximum setting there was still lack of height. I checked the field output stage, but everything seemed to be in order.

A colleague suggested that the set might be in the 16:9 mode. This seemed to be unlikely, as it's a portable model, but I've seen this feature with some larger 4:3 sets. He was right of course. The problem was solved by going into the user menu and resetting to 4:3, then going into the service menu and restoring the height to its original setting. C.R.

Panasonic TC1785 (Z3 chassis)

Two of these sets came in on the same day with the same fault – an intermittent dark flashing picture. In both cases resoldering the connections to the TDA3566 colour decoder chip IC601 on board B cured the fault.

As the sets appeared to have received little attention over the years I decided to do a blanket resoldering job on them, paying particular attention to the connections to the TDA4505M IF/sync chip IC101, the TDA3653B field output chip IC451 and the line driver transformer T531. C.R.

Mitsubishi CT2534TX (Euro 4 chassis)

There was intermittent height variation and field foldover in the centre of the screen. The 25V supply to the field output stage is derived from the line output stage. When I monitored this I found that it was varying in unison with the fault symptom. I also noticed that the HT supply was varying between 135V and 155V. The cure was to replace IC901 (STR59041), Q901 (2SC2236Y), Q954 (2SD965R) and Q955 (JC501Q) in the power supply and resolder numerous dry-joints. This stabilised the HT supply. Interesting that the width didn't vary when the fault was present. C.R.

Philips 20PV220

When this combi unit was switched on it produced a white raster with flyback lines. A few seconds later it would trip. Prior to the tripping I noticed that the 170V supply to the CRT base panel was missing. It comes from the power/deflection PCB, where D6532 (BYD33J) was short-circuit and R3532 (4.7 Ω) open-circuit. There was a normal picture once these components had been replaced. C.R.

Panasonic TX21S3T (Z7 chassis)

When this set was switched on it reverted to standby after a few seconds. But I could hear the EHT rustle up before it went to standby. When the back was removed the set worked perfectly.

Suspecting a dry-joint somewhere, I decided to try tapping the PCB gently with the handle of a screwdriver. When I tapped in the vicinity of the LA7840 field output chip IC451 there was field collapse followed by a switch to standby. The solution was to resolder IC451's pins. While I was about it I also resoldered the connections to the line driver transformer. C.R.

Sony KD32DX100U (AE6D chassis)

There was no power and the LED flashed twice. Multimeter checks revealed that R6019 (330k Ω) on board G was defective. A replacement, part no. 1-247-891-00, restored normal power-on operation.

Another of these sets had colour patch-

es on the left- and right-hand sides of the screen. When I carried out a visual inspection inside the set I saw that the clamp which secures the deflection yoke had not been tightened during manufacture. Over a period of time it had slipped back on the tube neck, causing horrendous purity errors. All was well once the yoke had been pushed forward and the clamp tightened. C.B.

Schneider 28G011

This set had a blank raster and no sound. A look inside revealed what appeared to be a Philips chassis. During a visual inspection I saw that an L7809CV 9V regulator had overheated and its legs had started to disintegrate. A replacement restored the picture and sound. C.B.

Sony KD32DX150U (AE6D chassis)

This set produced an unstable picture, both horizontally and vertically. Voltage and capacitance checks revealed the cause of the fault, which was a ceramic chip capacitor, C6827 (0.01 μ F, 25V), on board D2. A replacement restored picture stability. The part no. is 1-162-970-11. C.B.

Philips 20PV164

This combi unit appeared to be dead. It didn't take long to find that the supply to the field output IC was missing, because R3511 was open-circuit. Once a replacement had been fitted the unit worked normally. C.B.

Panasonic TX21AD2M (Euro-2M chassis)

There was sound but no display. I discovered that the 27V supply protector F851 had blown because of a direct short between the primary and secondary windings of the line driver transformer T501. It was the first time I've experienced failure of this component in the Euro-2 chassis. Fortunately a similar scrap chassis provided the correct replacement. C.A.

Mitsubishi CT25A2STX (Euro 12 chassis)

There was sound from both channels, but with a loud buzz on the left-hand side. This familiar symptom with the Euro 12 chassis suggested problems with the 0.47 μ F electrolytics in the IF module. Many of them were in poor condition, but replacing them made no difference. Scope checks on the AF outputs from the Nicam board showed no superimposed interference, but checks at the inputs to the audio amplifier IC361 did. When the ESRs of the 1 μ F, 50V input coupling capacitors

C361/2 were checked they were both found to be open-circuit!

Replacements cured the buzz and, not surprisingly, increased the overall sound level. C.A.

Toshiba 1400RB

This old faithful had died and its devoted owner wondered whether it could be revived. My past experience with these sets prompted me to give an optimistic prognosis. Later, on the operating table, I found that the 5V supply was missing. There was no 9V supply at the collector of QA03. This is derived from the mains AC input via a hefty 3.9k Ω resistor, RA60, which had no voltage at its output end. After an initially misleading ESR test on the associated 470 μ F, 16V reservoir capacitor CA45 I carried out a DC resistance check and found that this capacitor was short-circuit. The patient responded well to the corrective surgery, producing a healthy picture and sound to match. C.A.

Panasonic TX14GV1 (CP421 chassis)

This combi unit with the usual Daewoo power board produced regular clicks from RLY1 but nothing else. There was almost no 9V output from the TOP210-based standby supply, where I found that C840 (47 μ F, 25V) had an ESR of 5.2 Ω . A replacement brought the unit back to life, but I had to resist the temptation to watch I Rotor which was in the video compartment! C.A.

Samsung CI14Y2TS (KS1A chassis)

This set refused to come out of standby. I won't tell you how many hours I spent on it! In the fault condition the power supply was running correctly and the HT to the line output stage was correct. The clue was corrupted line drive. Check the 12MHz crystal X901, which is beside IC201. It was running at the wrong frequency. The part no. is 2801-001476. U.H.

Akura ATPTV028WSS (PT92-110 chassis)

This set, with its long-winded model number, was tripping. A resistance check first from the collector of the line output transistor to chassis is often productive with this fault condition, and in this case showed a leak of 200 Ω between the collector of TD02 and chassis. But it took longer than it should have done to track down the cause, which was the yellow ceramic flyback tuning capacitor CD27

(2.2nF, 2kV). This item had a telltale hairline crack at the rear side but was obscured behind CD18 (that's my excuse). I replaced it with an uprated 3kV type. If the defective capacitor had been coloured blue I would have found it much quicker! C.A.

Grundig Elegance MW82-2101

This was an unusual fault: every few weeks the HT fuse would blow. Investigation eventually revealed a small pinhole in the insulator foil for transistor T6006. The part no. is GR26303-1561-801. U.H.

Toshiba 2500TB

The complaint with this set was that it took ten minutes to come on. I found that at switch on the HT was low, at only 33V. When I started to carry out checks on the primary side of the power supply I discovered that C831 (100 μ F, 50V) was leaky. A replacement cured the problem. U.H.

Goodmans GTV69W5SIL (11AK37 chassis)

The fault symptom with this set was that the standby light was pulsing slowly. Checks on the primary side of the power supply showed that the 22k Ω surface-mounted chip resistor R803 was open-circuit. When I switched on after fitting a replacement the HT was fluctuating. This was cured by replacing the optocoupler IC801. U.H.

Grundig MW70-3699 (CUC2059 chassis)

The set's standby light was pulsing slowly. I first isolated the line output stage by disconnecting the scan-coil plug. This proved that the power supply was OK. Further checks showed that the line output transistor and the EW circuit were also both OK. From experience, line output transformer failure is rare with this chassis. But my tester showed that the primary winding had shorted turns. The part no. is GR20221-029-63. It's still available from CPC. U.H.

Daewoo GB20C5NTS (CP185 chassis)

The fault symptom was severe line tearing at the top, extending the full width of the screen. While observing this I recalled a similar fault with a Beko set a few months before. Scope checks on the inputs to the field output chip showed that they were OK, but there was a lot of distortion at the output side. A replacement IC made no difference, so checks on

the components in the output circuit had to be carried out. This eventually led me to R305 (330 Ω), which was open-circuit. It's connected in parallel with the scan coils and is located at the back, beside the scan-coil plug on the chassis. A replacement removed the disturbance. U.H.

Panasonic TXW28R4

We don't see many Panasonic sets in this part of the country. The problem with this one was that it reverted to standby after a few minutes. After leaving the set on test for a short while I noticed it going into the field collapse condition. The cure was to resolder dry-joints at the field output chip IC451. U.H.

Thomson 32VK29UW

The trouble with this set was that it would revert to standby, with no particular fault pattern. The cure was to replace the CRT socket, part no. 8029880. It's available from SEME at modest cost under part no. TPAR2560. U.H.

Grundig T55-440 (CUC4400 chassis)

The customer complained that it took twenty minutes from switch on for the picture and sound to appear. As there were no outputs on the secondary side of the power supply in the fault condition I suspected capacitor trouble on the primary side. The culprit turned out to be C633 (100 μ F, 25V). U.H.

Matsui 20TN/Decca D21NDF5 (D4N chassis)

Two of these sets had the same fault, no sound and no on-screen display. I decided to replace the microcontroller chip, which didn't help. But replacing the EEPROM cured both faults.

To set up the height, short the service pins and scroll down to option 09. To store, press either 'TV' or 'clear' on the remote-control unit. Charles Hyde stock the EEPROM under code 25003AH. G.D.

Philips 28PT4523 (MD1.2 chassis)

Bang then dead are not the happiest symptoms with a Philips set! In this case the mains-plug fuse had blown and the bridge rectifier was short-circuit. Everything else seemed to be fine. I replaced these two items and powered the set via a variac. As I increased the input a picture appeared, then there was a flash and a bang. Fortunately it was only C2543 (2.2nF, 1kV) in the chopper-circuit snubber network exploding, though another bridge rectifier was required. G.D.



DVD

**Fault reports from
Chris Bowers
Geoff Darby
and
Steve Roberts**

We welcome fault reports from readers – payment for each fault is made after publication.

Reports can be sent by post to:

**Television Magazine Fault Reports,
Nexus Media Communications,
Media House,
Azalea Drive, Swanley,
Kent BR8 8HU**

**or e-mailed to:
t.winford@highburybiz.com**

Sony HCD-SB300

This new SACD/DVD/receiver produced no output from the speakers but showed a headphone sign in the display – with no headphones plugged in. As soon as the top was removed the speakers worked. Investigation inside, on the H/P board that's mounted off the front panel, revealed the cause. The back of the connector that connects the H/P board to the amplifier board was shorted to the chassis base. All that was needed to restore normal output from the speakers was to stick a small piece of insulation tape on the edge of the rise chassis base, just under the connector on the H/P board. **C.B.**

Sony PlayStation 2

This was yet another 'must-do' item, this time to win my daughter's boyfriend some Brownie points at his new job. The unit belonged to one of his colleagues, the complaint being that it wouldn't play discs and made a funny grating noise.

Once I had the case off I was able to remove the deck cover, which supports the disc clamp. So, when I loaded a disc, I had to quickly pop an old clamp magnet down on top of it to hold it down on the turntable. The machine spun the disc OK and made all the right servo noises. The laser zipped backwards and forwards busily across the disc, and the 'loading' message appeared on the monitor. But this was all that happened.

The laser light on a DVD deck is so intense that the beam can be clearly seen through the disc. When I watched carefully the beam, despite all the sled activity, never moved farther than about half way out to the edge of the disc. So my next move was to examine the sled's mechanical operation in detail.

With the tray open the sled drive is all clearly visible and easily accessible. It's a simple arrangement, with the laser running on two slide rods, driven by a long worm-drive extension to the sled motor shaft. The interface between the laser and the

worm is a plastic 'flap'. This has two ridges moulded in its underside, pitched to engage with the coarse 'thread' of the worm shaft.

The shaft is easy to rotate by stroking a finger across it. When this was tried the laser moved smoothly for the first half of its travel. It then became tight however, and the result of further rotation of the shaft was that the plastic pawl slipped rather than moving the laser assembly. This was the cause of the reported grating noise.

The laser is easy to remove. Undo a single screw that retains the slide rod on the worm-drive side of the deck. The laser can then be lifted clear of the deck and the other slide rod, after disconnecting the flexiprint. Once I had done this I was able to feel, clearly, that the laser was generally stiff on the slide rod still fitted to it, particularly so from about half way along. The bearing holes on the laser are lined with Oilite phosphor-bronze type material. I gave them a good clean, and also cleaned and polished the rod. After that I added a couple of drops of very light machine oil to each bearing sleeve and left it to soak in.

When the slide rod was reinserted there was so little friction that you could have blown the laser along it. Once the deck had all been reassembled I repeated the finger-roll test on the drive worm. This time the laser moved easily from one end of its track to the other.

The whole machine was then reassembled and tried. It now read any type of disc put in it – PS2 game, DVD or audio – without incident. The Brownie points were won and, much more importantly, my reputation as a worker of magic was preserved! **G.D.**

Toshiba SD125E

The customer complained that the DVD drawer wouldn't open, using either the front-panel button or the remote-control unit. It took me a while to locate the cause of the problem, which turned out to be dry-joints on the PCB where the power supply is connected to the front panel. A grey ribbon cable (four-core) is soldered through the board. It's directly behind the drawer-open button on the front panel.

I can only assume that continual button pushing eventually made matters worse. The track leading from the ribbon cable is extremely thin, and could easily fracture. I gave the four connections a good blanket of solder, which seemed to cure the problem. If the track had been damaged as well as being dry-jointed, I guess that repair would not have been possible, thus sending another DVD player to that great scrapyard in the sky!

Other engineers will probably have experienced the problem with this machine. If not, they soon will do. **S.R.**

TELEVISION BOOKS

AND HOME ELECTRONICS REPAIR

The Television Book Service offers access to our team of specialist publishing experts. We can order any book or CD-ROM currently in print from *War And Peace* to the *Newnes Guide to Television and Video Technology*. All books are delivered free of charge within the UK unless otherwise stated. Contact us at the numbers below:

Telephone: **01737 812727** or **01737 812676**

Fax: 01737 813526

Email: salesteam@boffinbooks.demon.co.uk

DVD PLAYERS AND DRIVES

K F Ibrahim
(College of North West London)

This text is based on hands-on experience and acts as a guide to DVD technology and its application, with a special focus on design issues. The principles of the subject are introduced from the basics, and DVD applications are illustrated by genuine technical information.

Aug 2003 ▲ 256 pages ▲ Glossary ▲ Index
PB ▲ Published in UK

Code 0 7506 5736 7

£24.99



ELECTRONIC CLASSICS: COLLECTING, RESTORATION AND REPAIR

Andrew Emmerson

This text encompasses all aspects of buying, collecting, restoring, repairing, sourcing parts, professional services, clubs and societies. The first part covers technical aspects of restoration and details where components can be found; the second presents useful information for collectors.

Aug 1998 ▲ 256 pages ▲ Index
10 halftones ▲ 50 line illustrations ▲ PB
Published in UK

Code 0 7506 3788 9

£21.99



CLOSED CIRCUIT TELEVISION: CCTV INSTALLATION, MAINTENANCE AND OPERATION

Joe Cieszynski

CCTV surveillance is one of the fastest growing areas in the security industry, and this is a thorough guide to the technical side of CCTV – including installation, maintenance, video recording, cameras and monitors. The second edition is fully dual-standard for PAL and NTSC systems.

2nd edition ▲ Sept 2003 ▲ 256 pages
Glossary ▲ Index ▲ PB ▲ Published in UK

Code 0 7506 5778 4

£24.99



DICTIONARY OF VIDEO AND TELEVISION TECHNOLOGY

Jack Tsatsoulin

This work provides comprehensive and contemporary information on the essential concepts and terms in video and television, including coverage of test and measurement procedures. The CD accompanying the text includes an electronic version of the book.

Sept 2002 ▲ 365 pages & CD-Rom
Published in UK

Code 1 871707 99 3

£29.99



INTRODUCTION TO DIGITAL SYSTEMS

John Crisp

This self-study text introduces digital electronics from first principles, before going on to cover all the main areas of knowledge and expertise. It covers the practicalities of designing and building circuits, including fault-finding and the use of test equipment.

Feb 2000 ▲ 392 pages ▲ Glossary ▲ Index
PB ▲ Published in UK

Code 0 7506 4581 0

£18.99



NEWNES DICTIONARY OF ELECTRONICS

S W Amos; R S Amos

Aimed at engineers, technicians and students working in the field of electronics, this dictionary provides clear and concise definitions, including TV, radio and computing terms, with illustrations and circuit diagrams.

4th edition ▲ Mar 2002 ▲ 394 pages
100 illustrations ▲ PB ▲ Published in UK

Code 0 7506 5842 5

£12.99



NEWNES GUIDE TO TELEVISION & VIDEO TECHNOLOGY

Eugene Trundle

An exploration of television and video technology. It covers the fundamentals of digital television (satellite, cable and terrestrial) and digital video, as well as providing a grounding in analogue systems.

3rd edition ▲ Feb 2001 ▲ 432 pages ▲ Index
PB ▲ Published in UK

Code 0 7506 4818 4

£17.99



NEWNES GUIDE TO DIGITAL TV

Richard Brice

Covering all aspects of digital television, this text encompasses the electronics of the equipment, data compression, television production, servicing and the different transmission methods – terrestrial, satellite and cable. The text has been updated with developments since the 2000 edition.

2nd edition ▲ Oct 2002 ▲ 304 pages ▲ Index
45 illustrations ▲ 15 photographs ▲ HB
Published in UK

Code 0 7506 5771 9

£24.99



PRACTICAL ELECTRONIC FAULT FINDING AND TROUBLESHOOTING

Robin Pain (Design Engineer, Cotag International Ltd)

A text using simple circuit examples to illustrate principles and concepts fundamental to the process of analog and digital fault finding. It aims to help the reader tackle any job, from fixing a TV to improving the sound of a hi-fi. A digital multimeter and oscilloscope are needed for these jobs.

Apr 1996 ▲ 284 pages ▲ Index
50 line illustrations ▲ PB ▲ Published in UK

Code 0 7506 7441 7

£21.99



PRACTICAL ELECTRONICS HANDBOOK

Ian Sinclair

A collection of all the key data, facts, practical guidance and circuit design basics needed by a spectrum of students, electronics enthusiasts, technicians and circuit designers. It provides explanations and practical guidance, and includes new sections on SHF techniques and intruder alarms.

5th edition ▲ Feb 2000 ▲ 571 pages
Illustrations ▲ PB ▲ Published in UK

Code 0 7506 4585 7

£16.99



RSGB RADIO & ELECTRONICS COOKBOOK

Radio Society of Great Britain

Only a basic knowledge of electronics is assumed for this collection of electronics projects, and it is ideal for all electronics and DIY enthusiasts and experimenters. Designed by the RSGB, the UK radio amateurs federation, the projects are clearly explained step by step.

Nov 2000 ▲ 336 pages ▲ PB ▲ Illustrations
Published in UK

Code 0 7506 5714 4

£17.99



REFERENCE DATA FOR ENGINEERS: RADIO, ELECTRONICS, COMPUTERS AND COMMUNICATIONS

Max E Van Valkenburg; Edited by Wendy Middleton

Written by professionals for professionals, this is a complete reference for engineers. As well as addressing radio technology data, it covers digital electronics, computers and communications.

9th edition ▲ Aug 2001
1568 pages & CD-Rom ▲ 1385 line illustrations
HB ▲ Published in UK

Code 0 7506 7791 9

£90.00



SERVICE ENGINEER'S POCKET BOOK

Lewis & Sinclair

This title aims to provide the service engineer with all the necessary information to carry out work on domestic electronics equipment. The coverage ranges from satellite reception to NICAM. Both analogue and digital equipment are covered, and there are chapters on common problems.

Jan 1998 ▲ 238 pages ▲ HB

Code 0 7506 3448 0

£14.99



SERVICING TV, SATELLITE & VIDEO EQUIPMENT

Eugene Trundle

A practical hands-on guide for service engineers, installation technicians and servicing students, this text emphasises the practical business of fault diagnosis and repair of TV, satellite and video equipment.

Revised 2nd edition ▲ Nov 2001 ▲ 336 pages
Symptom index ▲ PB ▲ Published in UK

Code 0 7506 3587 0

£21.99



TELEVISION MICROPROCESSOR IC DATA FILES

J Edwards

Microprocessor ICs are the most complicated part of TV equipment and present special problems to the engineer. This text covers the most popular microprocessor ICs. Each device is presented graphically with the relevant data information given against each pin.



Mar 1997 ▲ 240 pages ▲ 200 line drawings

PB ▲ Published in UK

Code 0-7506-3335-2

£19.99

TELEVISION IC DATA FILES

J Edwards

A compendium of data on all the most common integrated circuits used in televisions. Each device is illustrated with a pin-out diagram, and all the measurements and signal data in the book were taken under actual working conditions. This second edition contains over 70 new ICs.



2nd edition ▲ Jan 2000 ▲ 245 pages

PB ▲ Published in UK

Code 0-7506-4581-4

£18.99

TV FAULT-FINDING GUIDE

Edited by Peter Marlow

A distillation of the most-used fault reports from 11 years of *Television* magazine. Arranged by make and model, it features over 200 reports on over 300 models of television, including diagnosis and repair advice.



Mar 2000 ▲ 387 pages ▲ Illustrations

PB ▲ Published in UK

Code 0-7506-4633-0

£20.99

VALVE AMPLIFIERS

Morgan Jones

The author's straightforward approach, using as little maths as possible, should be of use to those with only a limited knowledge of the field as well as being the standard reference for experts in valve audio. Design principles and construction techniques are also provided.



3rd edition ▲ Aug 2003 ▲ 624 pages ▲ Index

PB ▲ Published in UK

Code 0-7506-5894-8

£29.99

VCR FAULT-FINDING GUIDE

Edited by Peter Marlow

A distillation of the most-used fault reports from 11 years of *Television* magazine. Arranged by make and model, it features over 2000 reports on over 200 models of VCR, including diagnosis and repair advice.



Mar 2000 ▲ 447 pages ▲ Illustrations ▲ PB

Published in UK

Code 0-7506-4634-9

£20.99

VCR IC DATA FILES

J Edwards

This text aims to provide the workshop technician and the field engineer with a convenient method of fault-finding without the need to consult workshop manuals. The most popular ICs used in video recorders are covered. Each device is presented graphically with data given against each pin.



Jul 1998 ▲ 448 pages ▲ 200 line illustrations

PB ▲ Published in UK

Code 0-7506-3993-6

£20.99

VIDEO AND CAMCORDER SERVICING AND TECHNOLOGY

Steve Beeching

A comprehensive guide to domestic VCR technology and repair techniques. This edition brings the information fully-up-to-date, with expanded coverage of camcorders, sections on DVD equipment and the latest VCR technology.



5th edition ▲ Apr 2001 ▲ 323 pages

Illustrations ▲ PB ▲ Published in UK

Code 0-7506-5829-7

£20.99

VIDEO DEMYSTIFIED

Keith Jack

This edition has been updated to include information on digital television, datacasting, interactive video, digital camcorders and VCRs, and video interfacing. Coverage is international, including European, Asian and North/South American video standards, methods and techniques.



3rd edition ▲ Jul 2001 ▲ 784 pages & CD-Rom

References ▲ Glossary ▲ Index ▲ PB

Published in UK

Code 0-7506-5648-6

£50.00

THE DIGITAL SATELLITE TV HANDBOOK

Mark E Long

A handbook and CD-ROM pack on digital satellite television. It provides an overview of all the digital TV platforms in use world-wide. It includes satellite coverage maps and transmission parameters that readers will need to receive digital TV services from any location in the world.



Sept 1999 ▲ 207 pages & CD-Rom ▲ PB

Code 0-7506-7171-0

£41.99

NEWNES GUIDE TO RADIO AND COMMUNICATIONS TECHNOLOGY

Ian Poole

This is a guide to the technology and applications of modern radio and communications equipment. The author's approach provides a useful foundation for college students and technicians seeking an update on the latest technology.



Jul 2003 ▲ 352 pages ▲ Index ▲ PB

Published in UK

Code 0-7506-5615-3

£16.99

VALVE RADIO & AUDIO REPAIR HANDBOOK

Charles Miller

A practical manual for collectors, dealers and service engineers of valve audio and radio equipment. This edition includes new material on restoration and valve amplifiers.



2nd edition ▲ Apr 2000 ▲ 280 pages

▲ 10 half-tones ▲ 50 line illustrations ▲ PB

Published in UK

Code 0-7506-3995-4

£20.99

NEWNES TV & VIDEO ENGINEER'S POCKET BOOK

Eugene Trundle

This updated text provides a pocket tool for service engineers. It presents a range of essential information in a compact form, covering television reception, satellite and cable television, video recorders, colour camera technology, teletext and fault-finding.



3rd edition ▲ Oct 1999 ▲ 512 pages ▲ HB

Code 0-7506-4194-0

£17.99

TELEVISION ORDER FORM

Please order or search the following:

Code	Description	Qty	Price

POSTAGE & PACKING **FREE** IN THE UK* **TOTAL**

Name Daytime Tel

Address

Postcode

I enclose a cheque/postal order value £ payable to 'Boffin Books Ltd'

Please debit my Access/Visa/Switch/Delta card Issue number (Switch only)

Card Number Expiry Date

Signed

*Postage charges outside the UK available upon request or email: salesteam@boffinbooks.demon.co.uk

Post to: **Boffin Books Ltd, 24 Walton Street, Walton-on-the-Hill, Tadworth, Surrey KT20 7RT, UK**

If you are ordering by credit card, need further information, or would like to use our search facilities, call

01737 812727 Fax 01737 813526

The order/telephone is open from 9am to 5pm, or leave your order on our out-of-hours answerphone or email us at

boffinbooks.demon.co.uk

When placing orders please quote: Home Address (home & delivery) Daytime telephone number Debit/Credit card number Expiry date Details of order. Please note that prices may change, but are correct at time of going to press.

Extended Fault Reports

Reports on complex or tricky TV fault conditions are sometimes too long for inclusion in our basic fault-finding section. We've put a few of them together in this extended fault report feature

Reports from
Martin McCluskey
Arthur Jackson and
Martin J. Abbott

We welcome fault reports from readers – payment for each fault is made after publication.

Reports can be sent by post to:

Television Magazine Fault Reports,
Nexus Media Communications,
Media House,
Azalea Drive, Swanley,
Kent BR8 8HU

or e-mailed to:
t.winford@highburybiz.com

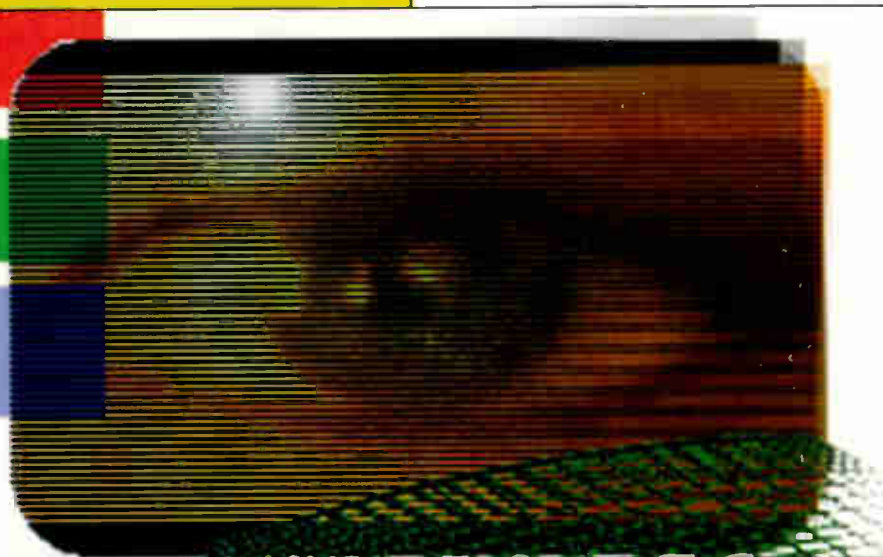

Ferguson B59F (ICC7 chassis)

At switch on there was a brief squawk from the power supply while the red LED lit for one second. There were no measurable shorts across the outputs from the secondary side of the chopper power supply but I noticed that CP22 (470 μ F, 16V), which is near the TEA2261 chopper control chip IP01, was leaking electrolyte on to the PCB. A board clean up and a replacement capacitor failed to cure the fault however.

Much time was wasted checking for overloads. I then noticed that CL14 (1,000 μ F, 16V), which is the reservoir capacitor for the 13V UL3 supply, looked a bit shrivelled up. This supply is derived from the line output transformer. It's used in various sections of the receiver and also provides a feed to the regulation circuit in the power supply. A replacement capacitor restored normal operation.

The ICC7 chassis has been around for almost fifteen years but I've still not found a way to fault-find with it logically. M.McC.

Samsung CI21S20BT (S15A chassis)

There were intermittent field problems with this 21in. mono-sound set. As it warmed up, the picture would start to close in from the top and bottom until it eventually collapsed completely. When I checked I found that the PCB was sensitive almost anywhere and that the symptoms would vary from field collapse to gross over-scanning.

At one time during field collapse however I was able to establish that the supplies to pins 3 and 6 of the field output chip IC301 were present while the output waveform at pin 7 was missing. So attention was turned to the drive source. The Vout 1 and 2 drive waveforms come from

pins 46 and 47 of the multifunction chip IC201, which Samsung calls 'the one chip'. The cause of the trouble was obvious on close inspection: the IC had not been fully inserted into the board along one side, leaving pins 29 to 56 just touching the solder. I cleaned off the remaining solder, resealed the IC then resoldered it. This provided a reliable repair. A.J.

Fidelity CTV3221NF

The chassis in this 21in. Nicam set looked familiar to those used in several other brands, and from the description the fault didn't seem to be too serious. The customer said there was a short picture with the top section stretched and the lower section compressed, so a fault in the field output stage was suspected. But when the set arrived the picture was also found to be lacking in width, by about two inches at each side.

Checks showed that the HT line was at 85V, which seemed to be very low. So I switched off and carried out some cold checks on the primary side of the power supply. This revealed that C11 (47 μ F, 25V), which decouples pin 6 of the TDA4605-3 chopper control chip, had a very high ESR – 18 Ω . A replacement was confidently fitted, but there was no improvement when the set was switched on again. Further checks, on the secondary side of the power supply, revealed that C25 (47 μ F, 160V) was completely open-circuit. When a replacement had been fitted the HT rose to 125V and there was a perfect picture with correct geometry. A.J.

Samsung SP42W4HBX (type J54A42U4)

This 42in. rear-projection set would switch on in the standby mode but when start-up was attempted there was a loud screeching and the standby LED remained red. Cold checks revealed that the line output transistor, type J6920, was short-circuit. I removed it and connected a bulb across the HT supply so that I could check the HT and drive conditions in the line output stage. These were both fine.

A replacement transistor was therefore temporarily fitted, on the underside of the PCB, to monitor the conditions at switch on. When this was tried the LED briefly went green but, within seconds, there was screeching and fizzing from the line output stage. The new transistor quickly failed, and the original conditions returned. As there were no obvious shorts or burn marks and all the capacitors in the line output stage checked out OK, suspicion fell on the output transformer.

Before ordering a replacement I decided to check with Samsung technical. A very helpful man confirmed my suspicion but

said that a complete PCB containing the LOPT is normally supplied, as other components may have been damaged, and that the price of the assembly is quite reasonable. So we ordered the board, known as the SUB PCB ASSY, part no. BP94-00044A, as suggested and fitted it carefully. I say carefully because there are a large number of plugs/sockets and it's possible to put some of these in the wrong places. This restored a good picture and sound.

The only adjustments required were slight corrections to the convergence, carried out via the customer menus. The complete SUB PCB ASSY cost £98 plus VAT trade. A.J.

Philips 29PT828 (GFL2.20E chassis)

In our opinion this excellent quality 29in. 4 x 3 model has been very reliable. In fact up to now we've had only two in for repair, the problem in both cases being intermittent field scanning caused by dry-joints at the field output chip IC7260. So when this one came in with complaints about intermittent closing to a horizontal line and switching off at random a similar cause was suspected.

But the trouble this time was quite different. After varying periods of time the picture would start to close in vertically and equally from the top and bottom, leaving about 4in. of scanning. The picture would then open out fully and close down fully about once a second until the set went into the protection mode and shut down. The cause of the fault was traced to the drive source, which is on a geometry panel called DDP. Checks in this area revealed that a 22V reference voltage, at pin 2 of J13, dropped to about 9V in the fault condition. The faulty component was the 22V zener diode D6306, type BZX79C22V, which is on the main PCB. When tested it was found to be very leaky. A.J.

Toshiba 36ZP18Q (COOS chassis)

The owner of this 36in. set provided a good description of some unusual picture faults that were very intermittent and would sometimes show from cold or after the set had been running for a short time. He said that parts of the picture would freeze or go into lines while other parts remained normal. When the set was put on test the picture remained perfect until the third morning. The trouble then showed up from cold. The picture was perfect in the centre third of the screen but the top and bottom sections consisted of stationary horizontal lines, just as if the line frequency was slightly off. Over the

next few minutes the horizontal lines cleared and the top and bottom sections went into a digital still mode, a normal picture remaining in the centre of the screen.

This was clearly a digital processing fault of some sort, so I checked with Toshiba technical to find out whether any such symptoms were known. They confirmed that there had been a few reports of unusual digital ill effects, and that in all cases the problem had been in the DFS module. This is a non-serviceable board, part no. 23785888, but is very reasonably priced at £52.87 + VAT. Replacement of this board cleared the fault. A.J.

Samsung 28W8VDE (KS3A-P chassis)

The complaint with this widescreen set was no blue, though some blue did bleed through in patches on certain scenes. The RGB output stages are on the CRT base panel, where three TDA6101Q ICs are used to drive the three guns. IC503 is the one that provides the blue drive. Checks here proved that there was a problem, and cleared the tube of blame.

Pin 3 of IC503 is the blue drive input. The voltage here was at 2V, while the voltages at the other two chips, IC501 and IC502, were at 3.8V. When I checked with the circuit diagram I found that there's a 100kΩ resistor, R513, between pins 9 and 3 to provide feedback. It was open-circuit. A replacement restored normal colours.

The equivalent resistors in the other channels are R503 (red) and R508 (green). A.J.

Toshiba 21S23B2

No power was the complaint with this fairly new 21in. set. When it was tested however a slight whining noise could be heard. This suggested trouble in the line output stage, and I found that the 2SD2499 output transistor Q401 was short-circuit, probably because the driver transformer T401 was badly dry-jointed. When T401 had been resoldered and a new transistor had been fitted the set worked perfectly, but I decided to check at the Toshiba technical website to see if any other problems were known.

The report on this fault recommended that for a reliable repair T401 should be removed from the board to scrape and re-tin its legs. Be careful how you go about this. When I unsoldered T401 with braid and tried to lift it out it was still held solid to the board. So I gave it a gentle rock and, to my horror, the upper part snapped and tore away two of the winding leadouts, leaving the bottom part firmly fixed with a red glue. I eventually

managed to remove and repair it, but watch out – I've since seen a few more of these sets with the same fault. A.J.

Bush ITV2100 Internet TV (Beko 7SZ chassis)

I was called out to this set to replace the mains fuse, which needed upgrading to 3.15AT.

The customer was hard of hearing and complained about poor speech intelligibility – the sound reproduction was indeed poor.

This set is equipped with a graphic equaliser that can be set up manually to flatten the frequency response and provide a smooth presence rise. The equaliser has an adjustment range of ±12dB in 2dB steps. One block showing in the bar graph indicates –12dB.

I found that the following set up worked well: 100Hz –2dB; 300Hz –6dB; 1kHz –2dB; 3.3kHz +2dB; 10kHz –4dB. This corresponds with the following number of blocks in the bar graph: 6, 4, 6, 8, 5. M.J.A.

Sony KVX21TU (AE1 chassis)

This set would rustle up then shut down. The mains supply had to be left switched off for several minutes before trying again. On examination I found that R822 which protects the line driver stage and R802 which protects the field output stage were visibly distressed. This suggested that the set had been running in an over-voltage condition for some time.

R522 (100kΩ) in the feed to the HT (+B) preset RV501 checked out OK but sputtered when it was resoldered, suggesting that there had been electrolyte leakage from C517. When checked C517 was found to have an ESR of 75Ω. Before fitting a replacement I cleaned the area with a wodge of paper tissue soaked in rework flux.

RV501 had gone high-resistance and was replaced, along with C518 (0.47μF, 50V) which couples the input to the base of the line driver transistor. C518 had also gone high ESR. Finally I found that the line output transformer had shorted turns. A Konig replacement from CPC, stock no. TFFBT40089, was very reasonably priced so I decided to fit one – the customer didn't want to pay much, a common frustration for service engineers. The inductance of the primary winding was 3.483mH and the Q 17.5 at 1kHz.

Note that there is also a standby HT preset, RV601. They both need to be set up – for 135V at TP91.

I normally fit HR LOPTs as I have come to trust them over the years. They are available at a reasonable price from Wilts Grove. M.J.A.

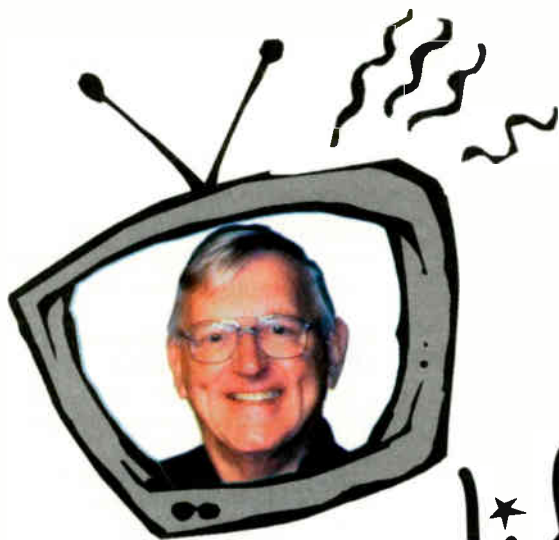

What a life!

Donald Bullock's servicing commentary

▶▶ A session at the shop with some audio and TV repairs ▶▶ Email summary
▶▶ And a warning about the prospects for LCD TV repair ▶▶

Ossie Onions didn't look too pleased as he elbowed the shop door open. "I'm giving that little swine one more chance" he growled.

I looked through the glass door anxiously to see who he was talking about, but there was no one that close. "What's eating you?" Ossie, I asked.

He twitched his mouth towards his right ear and switched on the sweetest smile. "The wife's Sony. On the back seat he be. Fetch 'im in, will you? You're younger than I, and I got a terrible bad foot." He twitched his mouth again and switched off his smile. As he's fifty odd and reckons I look younger, I decided he was OK.

Meanwhile Paul had popped out to his car to collect the offending item, which turned out to be a Sony mini hi-fi Model HCD-CP101.

"What's up with it?" I asked him.

"Stubbed it against our step" he replied.

"The set, Ossie" I said gently.

He moved his mouth again and switched on the smile. "You could possibly just about hear it if you was an ant what crawled into the speaker thing" he said.

I made a note and busied myself at the battery stand until he departed.

Paul decided to tackle the unit. Ossie had been right. If you listened at full volume you could just about hear some sound.

"We've had it before with this model" Paul commented. "If I recall correctly the cause was a transistor in the muting circuit. I must have made a note of it somewhere."

He had. The transistor was Q330 and, in addition to fitting a replacement, you have to replace wire link JW370 with a 470Ω resistor. Once this had been done the unit produced normal sound.

A Sharp GA10

Shortly afterwards Steven humped in a Sharp TV set from Ed Bigg's car. Ed is a window cleaner. Drives the largest BMW I've ever seen.

"Look at the state of your windows" he commented, "you could have 'em sparkling clean all the time for just twenty quid a week. I'm sure you could afford that rather than have 'em dirty!"

Paul looked at the windows. "No need for that Ed" he com-

mented, "they're sparkling clean as it is. Did 'em myself only yesterday – for nowt!"

"You ought to see the state of the baker's windows up the road" I said, jerking my thumb over my shoulder. "Talk about needing a clean . . ."

His eyes narrowed. "Gotta go" he said as he flew out.

"There's no baker up the road" Paul commented. "The one who was there closed ten or more years ago. Shop was demolished to make way for the roundabout."

"Quite so" I said.

The set, Model 66GS62H (GA10 chassis), was stuck in standby. A check on the BUH515D line output transistor showed that it was short-circuit. We've had the fault before. Q602 (2SK2843) goes short-circuit as well. It's best to fit a hefty heatsink, with plenty of compound, and you'll find a dry-joint at C619. This is the basic cause of the trouble.

Once we'd followed this procedure the set worked all right. We put it aside to wait for Ed's return.

A phone call

Just then the phone rang. "Is that Bulger's Television?" a female voice drawled.

"More or less" Paul replied.

"Well look hyah. Our set's quait dead. It's big and hevai, a good wan. Loewe Xelos. Onlah pretty flashing lights. Ohh, and a ticking noise. Need somewaan to collect it. Can you come now?"

"That was Lady Lloyd-Cranbrooke" Paul told us, "only person in these parts who talks like that. Local magistrate. Certainly puts yobs in their place."

"Better watch out then when you call" Steven commented.

"Loewe Xelos, it'll weigh a ton. We'd better both go."

Ages later they returned with the giant set, and it took all three of us to get it on to the bench. It was Model 5381ZW, the one that costs a bomb.

There was no start up, with the red and green LEDs on and a tripping noise every ten seconds. We decided to isolate the line output stage and try again. This made no difference, so we started to carry out checks in the power supply. Or at least Paul did. After checking quite a few things he found that R622 (820kΩ) was open-circuit. It's on the primary side. Once a replacement had

been fitted the set worked normally, with a very good picture indeed. He couldn't find anything else amiss.

"She'll be pleased" said Steven, "even though you look like a criminal. Probably let you off with a caution and a couple of cop-pers for the poor box."

"Never mind the funnies" Paul replied, "let's get it in the van in one go, shall we?"

And off they struggled with it.

Emails

I've had a hefty wad of emails this month – thanks!

K. Knopov of Samsung has a story with a moral to tell. A man was driving up a steep and narrow mountain road when an attractive woman came driving towards him in an open-topped car. As they passed, she leaned towards him and shouted "pig". "Bitch" he shouted back and, as he rounded the bend, crashed into an enormous pig in the middle of the road. If only men would listen, K comments.

A while back I mentioned to the editor the enormous kindness and helpfulness of readers of our magazine. "It's like belonging to a friendly club" I added. He agreed, and said it was part of the pleasure of his job. I wonder how many readers appreciate that John and Tessa alone organise the editorial contents and maintain friendly liaison with the many regular contributors? It doesn't happen by chance!

To return once again to my ancient Sony PS-LX50 turntable, I had become convinced that there was no such thing as a manual. Sony in Ireland declared no knowledge of it to a supplier there who tried to help. Then, all at once, several readers responded with advice, technical help and servicing data. I am especially indebted to Alan Bray, Mike Wall and Ray Smith and, thanks to them, have been able to listen to my vinyl records again as well as the CDs. I am beginning to sympathise with those who maintain that vinyl has the edge on CDs when it comes to bringing the sound to life. As a buff once said to me, "natural sound isn't digital, it's continuous, not sliced up segments at different frequencies".

I don't wish to get involved in yet another controversial subject just now. However I'm by no means convinced that the headlong rush to digital TV is a good thing. I much prefer analogue UHF transmissions and, if that means fewer channels, it would be all to the good. My view is that there's enough talent to keep only one part-time programme going.

Incidentally Ray Smith runs his own repair shop at Pedmore and has promised me some customer stories. Let's have 'em, Ray! Others who have provided help include David Smith of Leigh in Lancashire and James Horsley of Horsley Electronics. Emails are always welcome. You can reach me at donald@wheatleypress.com

Help requests

Tony Agar has a problem with a Bush Model 2037T (11AK30 chassis) which is dead. When powered up the LED glows red, then green when the channel buttons are touched. He's also been unable to locate a remote-control unit for it. Can anyone help?

M. Joshi complains about a patterned, disturbed picture, worse on some channels, with a 14in. Grundig set (CUC7303 chassis) when operated with an indoor aerial. With an outdoor aerial the picture is perfect. Bridging the electrolytics in the IF strip and in the LT supplies made no difference. This looks like normal performance to me. The set is working at full gain with a poor signal so everything gets amplified, noise and all. M. Joshi doesn't give his first name or locality. I prefer to know – because I'm nosy!

Friends

I've had another letter from an old friend, Peter Nutkins, who has

visited us in Spain. "Christmas time used to be the busiest of the year" he writes, "but this last one brought only a couple of calls. A friend who is also in the trade found the reason when he visited the local recycling centre. There was a skip overflowing with used sets. Previously he'd done good business reconditioning large and widescreen sets he had found at the tip. Now, because new sets are so cheap, people are dumping working sets and buying new ones."

I've also had a welcome email from my old friend Steve Beeching. What he doesn't know about servicing camcorders and video cameras could, as they say, be written on the side of a red-current. In his latest email he mentions an ancient Revox audio tape recorder he decided to tackle after reading my recent reference to a Grundig TK830.

"It uses 10in. reels of tape" he says, "and still works well. I tried to change a chip in it but couldn't get through the hot glass thing. It unplugged however, so I put another one in. These old things don't have enough legs on them for my taste, and there are too many high voltages flying around them."

I'd never known much about Revox tape recorders, and couldn't figure out what the "hot glass thing" was. "Here's a clue" Steve replied, "they work by thermionic emission, and some people remember them as valves!"

You've been warned!

He then told me about his attempts to repair a 26in. LCD TV set with a red level instead of the correct black level. "The LCD is driven by four differential-drive pairs as well as a clock pair. I wondered why there were four pairs for three drives (red, green and blue) and asked the manufacturer's Technical Department. They said they had no idea, because the factory 'doesn't tell them', but that the cause of the fault was 'most certainly' on the digital processing board. So, after replacing a couple of suspect ICs to no avail, I sent the board to them for testing. I subsequently ordered a replacement board at over £200, but it made no difference. They wouldn't accept it back for credit because they said I had used it!"

"Meanwhile I had found the cause of the trouble, and am still waiting for the original board to be returned."

"So" Steve concludes, "you can tell any other service technicians who may be contemplating LCD or plasma TV repairs to beware. Spares are going to be very, very expensive. New LCD screens come complete with peripheral units – power supplies, backlights, drive boards etc., and the cost ranges from about £800 to £1,200. You've been warned!"

CORRECTIONS

Two errors in the May issue have come to our attention.

The readings in Table 1 on page 437 were given as being in W instead of Ω . This error can occur when there's a last-minute change of typeface.

In the constructional notes on the flock applicator, page 408, we said use 'heatsink' instead of 'heatshrink' sleeving to secure the diode tube to the output lead.

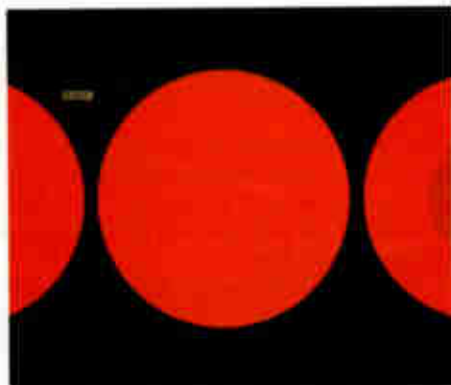
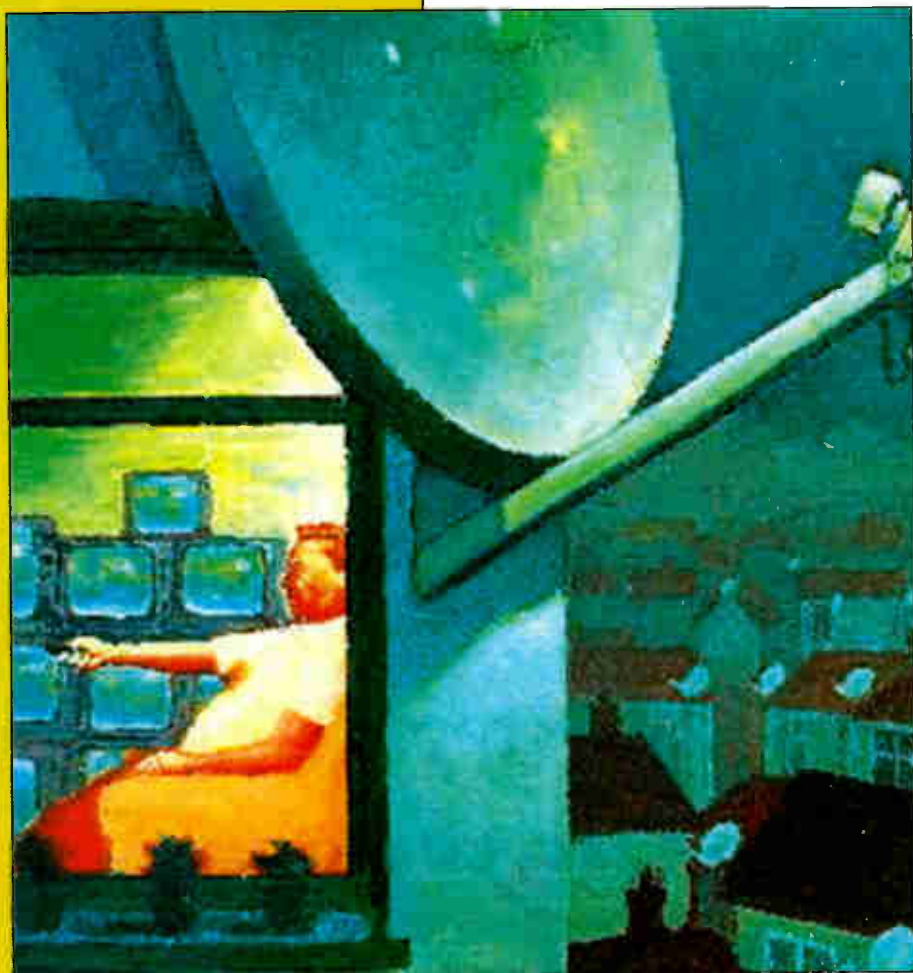

Photo 1: Moving red circles received from the BBC's interactive transponder 38 a few minutes prior to an interactive transmission.

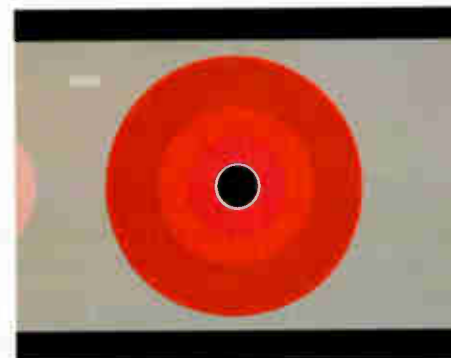

Photo 2: Moving red circles received from the BBC's interactive transponder 38 a few minutes prior to an interactive transmission.

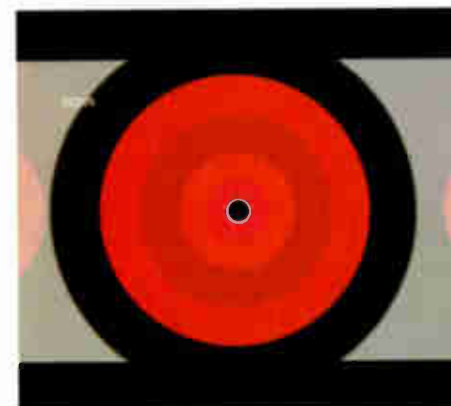

Photo 3: Moving red circles received from the BBC's interactive transponder 38 a few minutes prior to an interactive transmission.

SATELLITE NOTEBOOK

Reports from
Christopher Holland
Pete Haylor
 and
Michael Dranfield

Sky digibox remote controls

Sky digibox remote-control units have proved to be fairly reliable over the years, and replacement units are readily available. In view of the low replacement cost, it's not worth doing much work on a faulty unit. Occasionally however a quick investigation can be worthwhile. The lettering on the buttons is in general very hard wearing: it's easy to spot a unit that's had a hard life, as the numbers start to fade – particularly buttons 1 and 0 if the user enters channel numbers directly instead of finding the channels via the EPG system. Not long since I came across a unit with an unusual fault however.

Pressing any button would light the visible red LED above the Sky button as normal. This usually indicates that there's life inside the unit. But there was no response

at all from the digibox, and replacing the batteries made no difference, suggesting a digibox fault condition. A check with another remote-control unit produced normal channel changing however. When I opened the remote-control unit I found that the IR LED was open-circuit. A replacement restored normal operation.

A fairly common complaint is no results, the visible LED doesn't light up and new batteries make no difference – customers often phone us in a panic about this! The cause is usually the edge of one button being trapped under the unit's plastic moulding. As a result the button is in permanent contact with the PCB. The unit becomes totally inactive a few seconds after the permanent contact is made.

Strange effects can occur when rechargeable batteries are used, because of their lower voltage. They should be avoided at all costs!

The units respond well to internal cleaning of the PCB and the two rubber button pads when the complaint is that extra pressure is needed to make some of the buttons work. Extra pressure may be required initially to get most of the buttons to work when an old unit hasn't been used for a while, but after a few presses of each



Photo 4: WNBC received via Telstar 12 (15°W) at 11:531GHz/H.



Photo 5: WNBC received via Telstar 12 (15°W) at 11.531GHz/H.



Photo 6: WNBC received via Telstar 12 (15°W) at 11.531GHz/H.



Photo 7: Italian feed received from Atlantic Bird 3 (5°W) at 11.466GHz/V.



Photo 8: GlobeCast feed via Atlantic Bird 3 at 12.543GHz/H.

Table 1: Latest digital channel changes at 28.2°E

Channel and EPG no.	Sat	TP	Frequency/pol
Geo TV (838)	EB	C6	11.390GHz/V
Inspiration Network International (678)	EB	D11S	11.662GHz/H
Movies 333* (333)	EB	C6	11.426GHz/V
Poker TV (265)	EB	D4S	11.527GHz/V
Sit Up TV	EB	C4	11.307GHz/V
Tests	EB	C4	11.343GHz/V
Tests	2A**	1	11.720GHz/H
UKTV Style Gardens (144)	2A	6	11.817GHz/V
Zee Gujarati (839)	2B	14	11.973GHz/V

* FTA channel that transmits between 2-5 a.m.

** One of the old BBC transponders that was in use up to July 2003 and had been switched off since then.

2A = Astra 2A 2B = Astra 2B EB = Eurobird

button normal results should be obtained.

Getting inside the unit is easy when you are familiar with the procedure. Take off the battery cover and remove either a small Phillips or Allen screw above the battery compartment area. Once this has been done, prise off the top plastic assembly that covers the LEDs. This is most easily done by inserting a medium-sized screwdriver at the end of the moulding nearest the battery compartment, then forcing the assembly forwards rather than up. Another small screw hole will then be exposed at the rear of the unit, and a screw may or may not be fitted here. The main assembly can now be opened up. I find this easiest to do by starting to prise it apart from the battery-compartment end towards the front of the unit.

Reassembly is straightforward, but be sure to insert the red LED in the hole in the upper plastic moulding, otherwise it may be bent over and not be seen in operation. Also remember to slot the battery springs through their two holes, or they will be hidden inside the unit which certainly won't work.

Once the unit works correctly the code for the set it controls will have to be re-entered. If not, the unit won't operate the set's volume control or switch it on and off. The unit defaults to control Sony TVs if the battery is out for any length of time. C.H.

Digital channel update (28.2°E)

The latest channel additions at 28.2°E are listed in Table 1. Where allocated, the EPG number is shown in brackets after the channel name.

Men and Motors (EPG no. 139) is now being transmitted via ITV's transponder 53 (Astra 2D, 10.891GHz/H) and will probably leave its old home at transponder 27 (Astra 2A) shortly.

I've seen a sequence of moving red circles (see Photos 1, 2 and 3) from the BBC's interactive transponder 38 (Astra 2B, 12.442GHz/V) a few minutes prior to an interactive transmission. They can't be seen with a digibox, only with an FTA

satellite receiver tuned directly to the transponder.

Radio London, mentioned last month, has been allocated EPG no. 940. Music Choice has moved to EPG nos. 498 and 499 (previously 480 and 481). The Irish channels RTE 1, RTE 2 and TG4 are now available, with N. Ireland viewing cards only, at EPG nos. 267, 268 and 269.

TWC Reloaded (EPG no. 428) is no longer being transmitted. C.H.

WNBC TV New York

The NBC New York City channel WNBC has recently become available, together with the MSNBC financial news channel, via Telstar 12 (15°W) at 11.531GHz/H (SR 3,260, FEC 7/8). See Photos 4, 5 and 6. Telstar 12 can be found just to the right of Atlantic Bird 1, which carries the BBC's satellite feeds mentioned here recently. Unfortunately the 525-line, 60Hz pictures suffer from some pixellation effects when there's rapid movement on the screen.

The history of WNBC goes back to the beginning of 525-line TV broadcasting in the US in 1941 – it was then WNBT. C.H.

Atlantic Bird 3 (5°W)

We looked at this satellite's C-band (4GHz) output a while ago but never covered its Ku-band (11-12GHz) offerings.

Several French analogue channels are still available, see Table 2. They were transferred from a previous French Telecom satellite that was at the same orbital slot. One can't help wondering how much longer they will continue to be transmitted in this form.

The digital channels available are listed in Table 3. The channels transmitted at 11.590GHz/V are rebroadcast by the recently started French DTT service.

I've seen satellite feeds between 10.95-11.2GHz and 11.45-11.7GHz using both polarisations.

Italian feeds have been seen at 10.987GHz/H, 11.466GHz/V and 11.497GHz/V, all with SR 6,111 and FEC



Photo 9: GlobeCast feed via Atlantic Bird 3 at 12:543GHz/H.



Photo 10: Europe by Satellite (European Union) via Atlantic Bird 3 at 12:585GHz/H.

Table 2: Analogue Ku-band transmissions from Atlantic Bird 3

Frequency	Service(s)
12:522GHz	M6 plus Mood Music radio at 7.75MHz mono
12:565GHz	France 2 plus Berbere Radio at 7.75MHz mono
12:605GHz	France 5, Arte
12:649GHz	Canal Plus*. Sound is at 6.6MHz mono, 7.02/7.2MHz stereo
12:691GHz	TF1
12:731GHz	France 3

*Canal Plus transmits scrambled films using a line-shuffle system, though there are some periods during the day without scrambling. All channels are vertically polarised and use Secam colour, and all except Canal Plus (see above) transmit mono TV sound on a subcarrier at 5.8MHz.

Table 3: Digital Ku-band transmissions from Atlantic Bird 3

Frequency/pol	SR/FEC	Services
11:590GHz/V	19,635 2/3	France 2, 3, 4, 5, Arte, Parliamentary channel
12:543GHz/H	27,500 3/4	GlobeCast feeds, MCM (scrambled), various radio stations. See Photos 8 and 9
12:585GHz/H	30,000 7/8	Europe by Satellite. See Photo 10
12:615GHz/H	8,790 7/8	Pink TV (Serbia, scrambled)
12:635GHz/H	2,235 5/6	La 9, Italia Channel
12:642GHz/H	3,092 5/6	Serbian TV and Radio
12:711GHz/H	30,000 1/2	ABS, CBN. Scrambled

3/4. Photo 7 shows a feed received at 11:466GHz/V.

10:975, 10:984 and 11:541GHz/V have been active with feeds with SR 5,632 and FEC 3/4. Polish broadcaster TVP has been seen using 11:537GHz/H using the same characteristics.

Feeds have been seen at 11:516 and 11:680GHz/V with the unusual SR of 21,000 and FEC 3/4.

Unfortunately quite a high proportion of the feeds seen so far have been encrypted. C.H.

End of an era!

It has been announced that from the end

of April the Italian RAI 1, 2 and 3 channels from Hot Bird (13°E) will be available in digital form only. Back in 1984 RAI 1 was one of the first occupants of the new ECS (later Eutelsat) F1 satellite at 13°E. RAI 2 and 3 followed some years later, after ECS F1 had been replaced.

When material was transmitted and RAI didn't have the European broadcasting rights the signal would be scrambled, using a line-shuffle system similar to that used by the French Canal Plus terrestrial analogue network. Decoders were available to residents who, within Italy, couldn't receive a decent off-air terrestrial signal.

There is a similar situation with RAI's digital transmissions, viewing cards being available within Italy though they aren't required for viewing most of the time. C.H.

Sky callout

I was called to a Sky installation because the "no satellite signal being received" message was displayed. The initial fault was caused by contractors who had been working on the roof: they had knocked the dish slightly out of alignment. This was easily corrected but, when the receiver was tried, the same message appeared on the screen.

I removed the F connector from the receiver and found evidence of water penetration. In addition the centre connection was missing. This was because the customer, in attempting to try a replacement receiver, had pushed the centre core back up the cable. Cutting the cable back to clean copper and refitting the F connector cured that. But, though I checked the cable, I couldn't find the cause of the water penetration. The customer decided to leave it and see if the problem recurs.

Being an avid football fan, with his team playing next day, he had contacted Sky to transfer the card to his replacement receiver. As the system was faulty however it didn't work with the new box. Trying the card in the old box also produced an error message. So the long drawn-out business of reinstating the card with the original box had to be undertaken. P.H.

Installation botch

The complaint with an installation that consisted of an 80cm dish with two LNBS set to Astra and Hot Bird was that most of the Astra signal strength had been lost. A visit to the dish revealed that the 'fitter' had cable tied the Astra LNB to the Hot Bird one and, over time, this had slipped down. After fitting the correct multi-arm holder and setting the LNBS the signals were as they should have been. P.H.

Grundig GDS3000

This digibox was stuck in standby. Repeated pressing of the front standby button would bring it on, but with no audio or video from either the scart or RF output. The cause of the trouble was simple enough, the AV RAM chip U6 (type K4S641632F). M.D.

Grundig GDS3000

I've come across quite a few of these digiboxes that suffer from poor soldered joints at the various surface-mounted ICs. Once you've narrowed the cause of the fault to a particular chip, don't immediately replace it. Try a reflow first. You might find that you don't need to replace the IC after all. M.D.

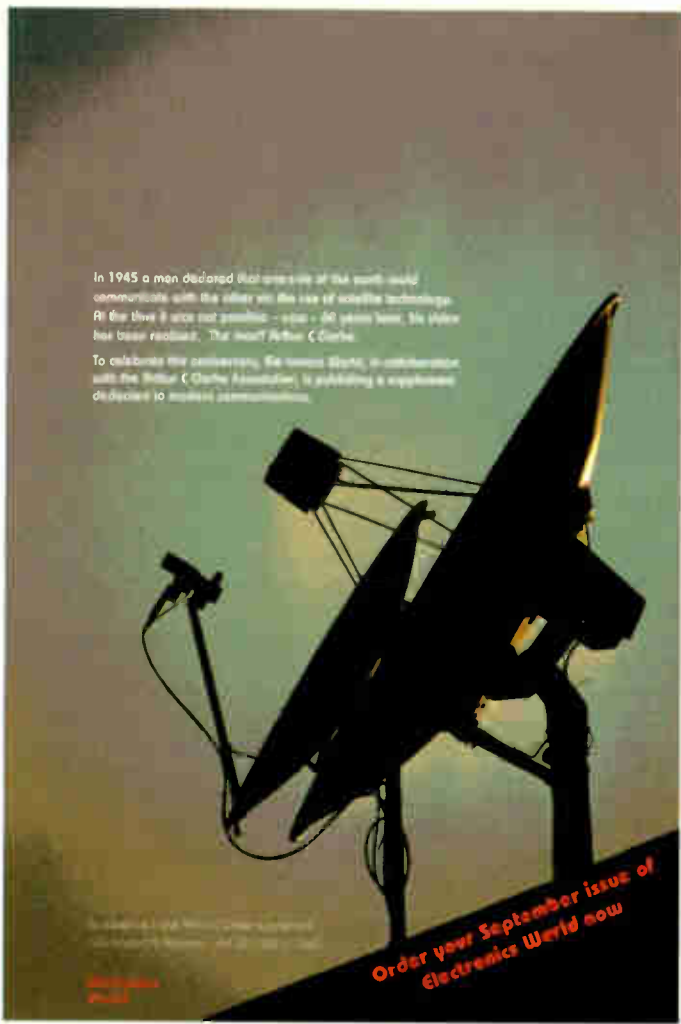

In 1945 a man declared that one of the world's most important communications will be the ability to use of satellite technology. At the time it was not possible - even 60 years later, the vision has been realised. The world's first IC Chips.

To celebrate this anniversary, we have joined in celebration with the Royal C. Clarke Association, in publishing a magazine devoted to modern communications.

Order your September issue of Electronics World now

FRUSTRATED!

Looking for ICs TRANSISTORS?

A phone call to us could get a result. We offer an extensive range and with a World-wide database at our fingertips, we are able to source even more. We specialise in devices with the following prefix (to name but a few).



2N 2SA 2SB 2SC 2SD 2P 2SJ 2SK 3N 3SK 4N 6N 17 40 AD
 ADC AN AM AY BA BC BD BDT BDV BDW BDX BF
 BFR BFS BFT BFW BFX BFY BLY BLX BS BR BRX BRY BS
 BSS BSV BSW BSX BT BTA BTB BRW BU BUK BUT BUY
 BUW BUJ BUY BUZ CA CD DX CXA DAC DG DM DS
 DTA DTC GL GM HA HCF HD HEF ICL ICM IRF J KA
 KIA L LA LB LC LD LF LM M M5M MA MAB MAX MB
 MC MDA J MJE MJF MM MN MPS MPSA MPSP MPSPU
 MRF NJM NE OM OP PA PAL PIC PN RC S SAA SAB
 SAD SAJ SAS SDA SG SI SL SN SO STA STK STR STRD
 STRM STRS SV1 T TA TAA TAG TBA TC TCA TDA TDB
 TEA TIC TIP TIPL TEA TL TLC TMP TMS TPU U UA
 UAA UC UDN ULN UM UPA UPC UPD VN X XR Z ZN
 ZTX + many others

Please visit our website at
www.cricklewoodelectronics.com
 17 thousand components in stock

Mail, phone, Fax, Credit Card orders & callers welcome.



Cricklewood Electronics Ltd

40-42 Cricklewood Broadway, London NW2 3ET

Tel: 020 8452 0161 Fax: 020 8208 1441

Visit our new www.cricklewoodelectronics.com
 Email: sales@cricklewoodelectronics.com

Do you want a deeper knowledge of circuits & electronic systems?

Then take out a subscription to Electronics World

Every month you will receive details on what's new in electronic circuits and associated equipment. We will keep you up-to-date with the latest research, technology, applications, products and theory in areas such as audio, RF, components, CAD design, simulation software, PC and micro-based products.

Your subscription includes:

- 12 magazines a year sent to your office or home
- Money saving offers on components and equipment

Each issue is packed with:

- Electronic design solutions
- Electronic applications
- Circuit diagrams
- Industry comment

Risk-free offer

As a subscriber we offer you a money-back guarantee. So you may cancel at any time and receive a full refund on all unmailed magazines.

SUBSCRIBE NOW!

COMPLETE AND RETURN THE FORM OPPOSITE



Subscription Order Form

Yes - I would like to subscribe to Electronics World for:

- 1 year at: £38.95 (UK) €95 (Europe) US\$125 (Worldwide)
- 2 years at: £70 (UK) €170 (Europe) US\$225 (Worldwide) save 10%
- 3 years at: £94 (UK) €225 (Europe) US\$295 (Worldwide) save 20%

Three Ways to Pay:

- Invoice my company
- I enclose a cheque payable to Electronics World

Charge my: Visa Mastercard Amex Switch Delta

Issue No. (Switch/Delta) Expiry date /

Name:

Company name:

Address:

.....Postcode:

Telephone Number:

Fax Number

Email:

Please tick here if you are happy for us to contact you by email

Post to: Debbie Jenner, Freepost SEA 11435, Electronics World, Media House, Swanley, Kent BR8 8BR (no stamp required) UK only
 OVERSEAS SUBSCRIBERS please send to: Debbie Jenner, Electronics World, Media House, Swanley, Kent BR8 8BR, UK.

If you prefer not to receive promotional mailings from other companies, please tick box

Ref: 125

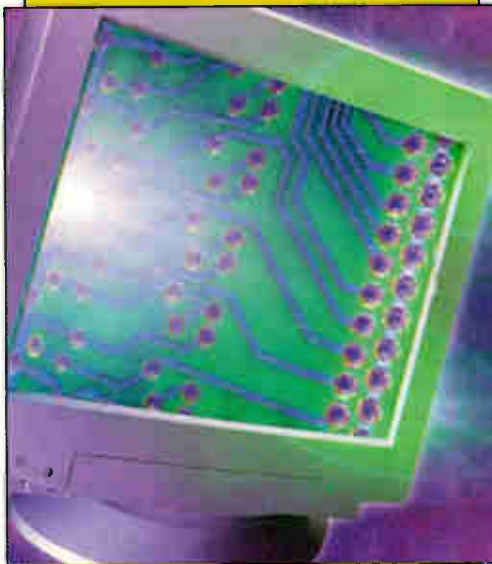

MONITORS

**Fault reports from
Alun Rawson-Williams
and
Bob Bradley**

We welcome fault reports from readers – payment for each fault is made after publication.

Reports can be sent by post to:

Television Magazine Fault Reports,
Highbury Business,
Media House,
Azalea Drive, Swanley,
Kent BR8 8HU

or e-mailed to:
t.winford@highburybiz.com

AOC Spectrum 5ELr

This monitor came on all right from cold for twenty seconds or so then started to trip. The front LEDs all flashed together, and the line scanning repeatedly collapsed. The tripping and line-scan collapses became more rapid the longer the monitor was left on. Eventually the power supply shut down.

The IRF634A B+ regulator transistor Q911 was running rather hot and was found to be leaky. There were two other faulty components. D925 (STPR320) was short-circuit. It's an ultra-fast recovery rectifier diode with If 3A, V_{rrm} 200V and trr 30nsec. I couldn't find a supplier, so I used a BYW95-200 as a replacement – it has similar characteristics. Secondly L906 had shorted turns. I obtained a replacement from a scrap chassis. The three components are mounted quite close to one another at the centre of the PCB.

When the monitor is working correctly the B+ voltage at TP901 should be 85V in the low-resolution mode and Q911 should run reasonably cool. **A.R.-W.**

Royal CX1469

We are quite often asked to carry out emergency repairs to monitors and computers we never expected to see again, to help someone carry on until the start of the next financial year. This ten-year old 800 x 600 monitor had been in daily use since new as a bill/invoice producer at a builder's supply outlet. It was dead except for a one-second burst of light from the front LED at switch on. An hour and a half later, after replacing the 2SD2125 line output transistor Q405 and slight adjustments to the RGB settings etc., it was back on its counter, with a remarkably clear display considering its age.

It was still going strong three weeks later when we were called out to attend to a printer at the same office. Although this sort of job upsets the workshop routine, it's appreciated and the customer always comes back. **A.R.-W.**

Acer V551

Three of these monitors came in at the same time, from the same customer. They were all completely dead – there was no front LED display and no degaussing action could be heard. I at first thought that the monitor was of Philips manufacture, as the CRT, ICs, capacitors and even the LOPT were all Philips types. But when I eventually gained access to the print side of the PCB it was clearly marked Acer.

To gain access, first disconnect the scan-coil plug, the degaussing plug and the two black CRT earthing leads to each side of the bottom screening plate. This

provides just enough clearance for the chassis assembly to be removed, later. The CRT base is glued to the glass with what can only be described as thick Superglue. Remove the single PK screw at the back of the chassis, by the signal-input lead – it holds the PCB to the bottom screening plate. Release, on either side at the front, the plastic retainers that hold the chassis assembly to the front escutcheon. Then slide the whole assembly backwards and clear of the plastic runners. Finally slide the metal bottom forwards and clear.

In all three cases the fault that stared me in the eye after this dismantling operation was that the back soldered connections to the mains on/off switch were dry-jointed. While the PCB was out I gave it a visual inspection and saw that the soldered connections to the chopper and line output transformers were on the thin side. I remade these, just in case and to prevent call-backs. **A.R.-W.**

AOC Spectrum 5ELr

The customer complained that this monitor displayed numerous intermittent fault symptoms – horizontal black lines on the screen, field collapse, line collapse and twitching, varying width. They could all be cured temporarily by a sharp tap on the side of the cabinet or by switching the monitor off for a few minutes.

A general resolder in the area around the line output transformer T402 and the field output chip IC601 provided a permanent cure. **A.R.-W.**

Proview 1766

This 17in. monitor seems to suffer from a number of dry-joints that produce different symptoms, either intermittent loss of line sync or EW and width problems when the monitor is moved.

The intermittent line sync fault is usually caused by a dry-joint at capacitor C905, which is mounted in close proximity to IC901.

Dry-joints at transistor Q307 and inductor L607 are the cause of the width and EW correction intermittently jumping in and out. These components are in the centre of the main board, near the heatsink. **B.B.**

Proview PV1455A

A fault you can get with this 14in. monitor is the display breaking up, the cause being dry-joints at the EW modulator diode D601.

Another fault is excessive width with no EW control. If you get this trouble check the TIF122 EW modulator driver transistor Q301, which will probably be short-circuit. **B.B.**

Solution to Test Case 510

- see page 458 -

The situation described this month is now very common with all types of equipment: no circuit diagram, few clues, a high-tech but low-value product – and a feeling of impotence on the part of the engineer! In this case RT was quite right to suspect a power-supply problem, but he was a bit cursory in just checking the supply-line voltages. While he was taking the readings his DMM's display was jumping about somewhat, which should have alerted him to the likelihood of ripple or hash being present. Subsequent checks with an oscilloscope revealed that the +3.6V and +5V supplies had 100Hz pulses of 1.2V and 1V peak-to-peak respectively superimposed on them. The ±12V supplies contained no ripple of that sort, but close examination revealed bursts of hash at 100Hz.

Turning to the primary side of the power supply, RT found that the voltage across the mains bridge rectifier's reservoir capacitor C502, measured with the meter, was just 215V, while an oscilloscope check showed that a huge ripple waveform was present, in the form of a positive-going mains half-cycle. In fact C502 was completely open-circuit! A replacement capacitor (68µF, 400V) restored normal operation of this DVD player in every respect.

The chopper device (U501) used in this player is a little-fingernail sized TEA1523P, without a heatsink. It did very well to survive this level of electrical abuse.

NEXT MONTH IN TELEVISION

Wireless technologies in CE products

Graham Maynard starts a new series on the use of wireless technologies in consumer electronics and electrical products. Many systems have been devised in recent years, and more are on the horizon. The articles will describe how they work and how they compare.

A precision milliohm meter

Alan Willcox presents a short-location adaptor that has a resolution of 1mΩ when used in conjunction with a digital voltmeter set to the 200mV range. It's ideal for locating shorts on bus lines.

More on plasma

Fawzi Ibrahim takes a look at various techniques that have been devised to improve the performance of plasma display panels. Charles Arundel describes various fault conditions and repairs with Daewoo PDPs.

Latest Philips CE technology

Philips recently provided a presentation on TV and DVD developments and wireless internet entertainment around the home. George Cole reports.

PLUS ALL THE REGULAR FEATURES

TELEVISION INDEX & DIRECTORY 2005

Plus hard-copy index and reprints service

Here's the essential repair information you need! The Television Index & Directory 2005, in CD-ROM form, contains the text of over 16,000 high quality fault reports on TVs, VCRs, Camcorders, DVD players, Monitors, Satellite TV units, Audio equipment and CD players, searchable by make and model, plus the text of 200 Test Cases and over 300 major servicing articles, from seventeen years of Television magazine. It also contains a full seventeen-year index of Television, a Spares Guide, a directory of Trade and Professional Organisations, an International TV Standards guide, a satellite TV Channel Finder, a TV transmitter list and a compendium of internet resources for service engineers. The software is quick and easy to use, and runs on any PC with Windows 95, 98, ME, NT, XP or 2000.

Television Index & Directory 2005 CD-ROM, £199

Television Index & Directory 2005 CD-ROM upgrade, £47 (to qualify for this upgrade you need to have purchased a previous version of the Television Index on floppy disk or on CD-ROM)

A six-month update of the index and fault reports will be available in May 2005. If you wish to take advantage of this, £10 should be added to your order.

Television Index only, 1988–2004, £36

Television Index only upgrade from previous versions, £20

Hard-copy indexes of Television magazine are available for Volumes 38 (1988) to 54 (2004) at £3.50 per volume.

Reprints of articles from Television back to 1988 are also available, at the flat rate of £4.00 per article — you can order through our web site, or write to the address below.

The above prices include UK postage and VAT where applicable. Add an extra £1 postage for non-UK EC orders, or £5 for non-EC overseas orders, although Channel Island residents do not need to add any extra postage. Cheques should be made payable to SoftCopy Ltd. All major credit and debit cards are accepted. Please use our new secure website for your orders, details below. Allow up to 28 days for delivery (UK).

SoftCopy Limited, 1 Vineries Close, Cheltenham, GL53 0NU, UK

**Telephone 01242 241 455 Fax 01242 241 468
e-mail: sales@softcopy.co.uk**

web site: <http://www.televisionmag.co.uk>

Published on the third Wednesday of each month by Nexus Media Communications, Media House, Azalea Drive, Swanley, Kent, BR8 8HU. Nexus Media Communications is a trading name of Highbury Business Communications Ltd., a subsidiary of Nexus Holdings Ltd. Registered in the UK, number 5346404. Registered office Hanover House, Hanover Square, London W1S 1HP. **Filmsetting** by Impress, Unit 2, Parkway, Southgate Way, Orton Southgate, Peterborough PE2 6YN. **Printed** in England by William Gibbons Ltd, 26 Planetary Road, Willenhall, West Midlands, WV13 3XT **Distributed** by Seymour Distribution Ltd, 86 Newman St, London, W1T 3EX. **Sole Agents** for Australia and New Zealand, Gordon and Gotch (Asia) Ltd.; South Africa, Central News Agency Ltd. *Television* is sold subject to the following conditions, namely that it shall not, without the written consent of the Publishers first having been given, be lent, resold, hired out or otherwise disposed by way of Trade at more than the recommended selling price shown on the cover, excluding Eire where the selling price is subject to currency exchange fluctuations and VAT, and that it shall not be lent, resold, hired or otherwise disposed of in a mutilated condition or in any unauthorised cover by way of Trade or affixed to or as part of any publication or advertising, literary or pictorial matter whatsoever.



NIKKO ELECTRONICS

Est.1983

...Suppliers to the www.world

HYUNDAI IMAGEQUEST LCD & Plasma TVs

Excl. VAT



17" / 12ms / s-video / composite / antenna / PC input	£237.60
19" / 25ms / s-video / composite / antenna / PC input / teletext	£364.63
20" / 4.3 / 16ms / 170 viewing angle / 1* SCART / composite video / s-video / PC analog input / integrated tuner / contrast 700:1	£410.32
26" / 16ms / 170 viewing angle / 2*SCART / composite video / s-video / 252 page teletext / PC input / integrated tuner / contrast 600:1	£693.62
32" / 16ms / 170 viewing angle / 2* SCART / composite video / s-video / 252 page teletext / PC input / integrated tuner / contrast 1000:1	£912.95
42" / 852*480 / contrast 3200:1 / 2*SCART / composite video / s-video / DVI / PC input / 2*PAL integrated tuner / 252 pages teletext. PLASMA TV	£1,251.07
42" / 1024*768 / contrast ratio 3500:1 / 2*SCART / composite video / s-video / DVI / 252 page teletext / PC input / 2*PAL integrated tuner. PLASMA TV	£1,552.65
50" / 1366*768 / contrast ratio 3000:1 / 2*SCART / composite video / s-video / DVI / 252 page teletext / PC input / 2*PAL integrated tuner. PLASMA TV	£2,557.89

CALL NOW Phone: 020.8393.7774 Fax: 020.8393.7395
www.dalbani.co.uk



leaders

reliability practicability professionalism

Multimeter FSM Indispensable Installer's TOOL

THE ULTIMATE RANGE FIELD STRENGTH METERS (FSM)

- 3 or 5" TFT screen
- High resolution 0.1dB
- High accuracy $\pm 1dB$ MATV & $\pm 2SAT$
- C/N measurement (analogue and digital measurements)
- Up to 4hours battery
- Shock protection (rubber)
- Quick menu keys
- RS232 & Scart sockets
- Easy and friendly to use

Televés U.K.LTD
 T. 01633-875821
 F. 01633- 866311
televés.uk@televés.com



Televés
www.televés.com

Economic Devices

PO Box 73, Oakengates TF2 8WR Tel ++44 (0)1952 273130 Fax ++44 (0)1952 405478

Remote Controls from **£5.95** each

Stock held for over 53000 different models

SEMICONDUCTORS
 over **34,000** types of
 transistors, IC's, diodes etc. or equivalents stocked

We take your hassle Some suppliers just won't help. We will work really hard to find those difficult parts - just ask and let our 'no holds barred' enquiry hound work for you!!!

...and look at the special offers.....

BUT11A @ ~~49p~~ each BUT11AF @ ~~41p~~ each
 BU508A @ ~~15p~~ each Fully wired scart lead ~~69p~~

a slight inconvenience....
you must buy more than one.

BU208A X 5	75p ea	TEA2018A X 5	99p ea
BU508A X 5	79p ea	UC3842 X 5	59p ea
BU508AF X 5	85p ea	CNX62A X 5	29p ea
BU508D X 5	89p ea	S2000AF X 5	84p ea
BUT11A X 5	29p ea	TDA3653B X 5	55p ea
BUT11AF X 5	47p ea	TDA3654 X 5	82p ea
Philips type 1.2 volt	Back up battery	X 5	59p ea
Philips type 2.4 volt	Back up battery	X 5	120p ea
Scart - Scart lead	1.5m Fully wired	X 2	89p ea
Positor PT37, TH98009 (White)		X 5	59p ea
Thorn TX100 Chassis	110 DGR LOPTX	each	£11.24
Philips CP90 Chassis	LOPTX	each	£11.63

...and now ask about our value for money full price list. Remember £1.50 post & handling All major credit cards accepted

www.telepart.co.uk

The web page here you can look up the price and order all things TV VCR and Satelite. Web search by model for video parts, remote control, LOPTX etc. overseas enquiries particularly welcome

New CCTV catalogue out NOW
 cameras, monitors, switches
 quads, multiplexers, the lot.

BARGAIN CENTRE

RING 01257 477040 OR VISIT US AT
**BARGAIN CENTRE. 217 SPENDMORE LANE COPPULL
PR7 5BY**

Fantastic Saving on State of the Art Satellite Equipment, full range of cards and programmers in stock. Also full range of Computer Inks from only £4.99. VCR from only £39.99. Motorized Satellite System from only £349.00 on the first 10 orders
6-channel Adult card completely free

Adult, French, Albanian, Arabic, Spanish, German, Dutch.
Continental Sports and Films.

Also Sky Plus receivers opening offer only £149.00

Limited Availability!

State of the Art Manhattan Plaza Range in stock featuring Blind



We also stock At Mega card, Opos cards full range of cams and Infinity programmers



REDLIGHT TELEVISION



JUST SOME OF THE CHANNELS AVAILABLE FROM ACROSS EUROPE



NIKKO ELECTRONICS

Est.1983

...Suppliers to the www.world

	USB / Firewire Cables		iPod Accessories		New TVs LCD / Plasma 20" - 50"
	DVD/CD Drives		Power Adaptors		MP3 / MP4 Players
	Remote Controls		Audio / Video Adaptors		Audio / Video Adaptors
	Memory Cards		Computer Accessories		Batteries
	Hard Disk Caddy		SIM Card Backup		USB Memory Sticks

CALL NOW Phone: 020.8393.7774 Fax: 020.8393.7395
www.dalbani.co.uk



C.R.H Electronics Design

Specialists in Video test-equipment Kits

D-GEN A breakthrough in low cost pattern generators now has 15 display outputs and W.S.S, wide screen signalling. Release V1.6 software has improved timing and test patterns.

A Ubicom micro and a 4 Meg flash memory are the base for this new design, 8 bits of data per pixel enabling 32 levels of Colour. Composite, S Video, and RGB SCART output sockets. A DC/DC converter power supply enables just 2 AA cells to power the unit. There is also a DC adapter socket for mains operation that also acts as a charger. Audio 1khz tone sine wave output is available via front Phono socket or SCART connector. The test patterns are interlaced and include crosshatch, dot, centering, colourbars, grayscale, pulse&bar, red, green, blue, black, white and flash with red border. The kit comes with a high quality double sided PCB, ready programmed micro and flash memory. All components including case, self adhesive overlay, drill template and full construction manual are supplied in the kit to build the unit pictured. Only soldering of components to PCB and drilling, filling of plastic end panels is required to construct D-GEN.

The unit can be built in three to five hours.
Note: ROM & Micro are socketed and fully software upgradeable.
All Kits normally supplied with Bone case but Black available if requested.

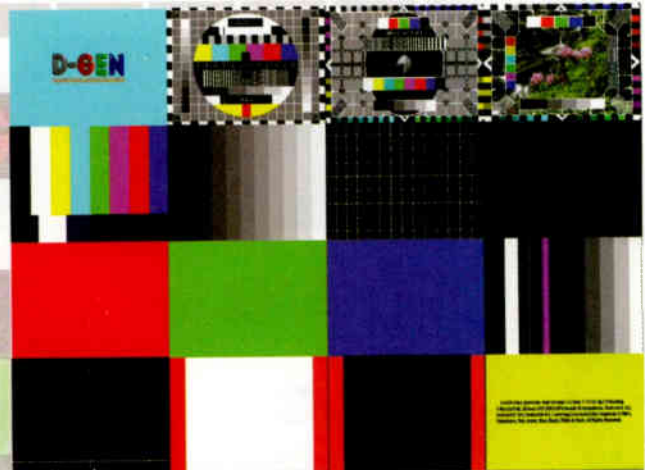

The DGEN video generator was reviewed in February 2004 Edition of this Magazine by Martin Trudell.



D-GEN PAL VIDEO TESTCARD GENERATOR £75.00



SVGA III MONITOR TESTER £45.00 (Available soon)



MULTIGEN VGA, NTSC & PAL £49.00 (New reduced price)

PLEASE NOTE NEW ADDRESS

Please add £2 postage per kit UK & Northern Ireland. £3 for Europe, £4 Overseas orders.
Send cheque, Postal Orders or International Money Orders made payable to **J Harding To:**
J Harding, 12 Herm Close, Seabridge, Newcastle-under-Lyme, Staffs, ST5-3LL, England.

For more information on all these kits, send S.A.E or.

Visit our website "<http://www.videocorner.co.uk>" or Email us at "roy@videocorner.co.uk"

ECU Trans Ltd

Large Quantity of Ex-rental
TV's Videos Hi-Fi & DVD

Worldwide Export, also UK
Wholesale/Retails

Over 2000 items per week go
through our warehouses

Call now on!

Tel: 01753 543 244 or 572 444
Fax: 01753 543 224 or 572 333
e.mail: ecutrans@aol.com

Unit 11.

Middlegreen Trading Estate
Middlegreen Road, Langley
Berks, SL3 6DF

5 mins from M4 - Junction 5

D'LEC COMPONENTS LIMITED

Stockists of Colour Picture Tubes

ATTN SANYO AND PANASONIC DEALERS

NEW COLOUR PICTURE TUBES AT LOW PRICES,
ALL NEW WITH A ONE-YEAR WARRANTY!

W66EHK PANASONIC £115.00 DELIVERED

W66ESF 414 010 7100 £125.00 DELIVERED

ALL TUBES FOR SANYO SETS IN STOCK

CALL

D'LEC COMPONENTS LTD
3 MANOR COURT, SOLE STREET,
COBHAM, KENT DA13 9BU

TEL 01474 361276

WWW.DLEC.CO.UK

Tel 01474 361276/327677 Fax 335228

Email sales@dlec.co.uk

Visit www.dlec.co.uk



inStore
ELECTRICS LIMITED

1043 LEEDS ROAD,
BRADFORD BD3 7DB

Tel: 01274 665670

01274 660196

01274 665246

Email: instoreelectrics@btconnect.com

PHILIPS

AWARD WINNING PLASMA & LCD TV

AT COMPETITIVE PRICES RING FOR STOCK & PRICE

- * REAL FLAT TV'S From **£215**
- * INTEGRATED DIGITAL From **£239**
- * 14" COMBI From **£65**
- * DVD From **£34**
- * VCR From **£39**
- * MICRO SYSTEMS From **£27**
- * DVD / VCR COMBI **£79**
- * DVD SURROUND SYSTEMS FROM **£96**

* Always a full selection of current models with slight
marks at knock down prices

* **FAX your letter heading for bulk trade price list**

AS NEW MANUFACTURERS GRADED PRODUCT

NO MARKS • ORIGINAL PACKING • FULLY GUARANTEED

NEXT DAY DELIVERY • CREDIT CARDS WELCOME

This Magazine reaches over

10,000

potential customers

To advertise in this space
call Beth on

01322 611292

WEB SITE WWW.JOHNSRADIO-UK.COM WWW.JOHN RADIO.COM
JOHN SRADIO ELECTRONICS TEST AND COMMUNICATION EQPT

LARGE QUANTITY SALE EX M.O.D.

MARCONI TF2019A Synthesized Signal Generators - 80Khz to 1040Mc/s
AM - FM - High Class with many functions - £285 each.

TEKTRONIX 2445 A OSCILLOSCOPE 150Mc/s Four Channel £300.

HP COMMUNICATION TEST SET 8922M - 10 - 1000Mc/s + GMS 83220E

Converter 1710 - 1900Mc/s - DCS - PCS - MS £500

HP COMMUNICATION TEST SET 8922M OPT 010(Dual) etc, £750.

ALL UNITS AND PRICED EX WORKS WITH INSTRUCTIONS - TESTED BASIC
WORKING. CARR + PACKING IF REQUIRED EXTRA.

Phone for appointment or to request item lists, photos, site map.

All welcome, Private or Trade, sales, workshop repairs or calibration

PLEASE CONTACT PATRICIA AT WHITEHALL WORKS, 84 WHITEHALL ROAD
EAST, BIRKENS SHAW, BRADFORD, WEST YORKSHIRE, BD11 2ER.

Tel: 01274 684007 Fax: 01274 651160

WEB SITE WWW.JOHN SRADIO-UK.COM WWW.JOHN RADIO.COM

Service Link

TELEPHONE 01322 611292 FAX 01322 616376

FOR SALE

"The television engineer's
wholesaler"

ICC17 LOPTX Kit
Ferguson W7023U etc.
Thomson 24WK23U etc
Pt no. 10608670P1 £24.95

GRUNDIG EHT TRAY
BG1899022644 £18.95

www.lrwinElectronics.co.uk
Telephone 0114 273 9622

SERVICE DATA

TV/VCR CIRCUITS
OPEN 6 DAYS (WE DO NOT STOCK
AUDIO OR MONITOR
INFORMATION)

TEL A.T.V. on
0114 285 4254

CTV Circuits from £5.00
VCR Circuits from £7.00
CTV Manuals from £10.50
VCR Manuals from £14.50
(P/P add £2.50 to each order)

**419 LANGSETT ROAD
SHEFFIELD S6 2LL**

www.atvcircuitsandservicemanuals.co.uk
MANUAL COLLECTIONS PURCHASED,
(POST 1995)

Ex Rental TVs

Sony, Philips,
Hitachi

32 and 28 Widescreens
Portables, Combis

For stock and price
Telephone

Barry McDonald

07836 789528

SERVICE DATA

NEED HELP NOW?

Then ring the
★ **ELECTRON TECHNICAL
HELPLINE** ★

Genuine help available to all
repairers of
T.V. - V.C.R. - SAT - AUDIO
(Inc Valves)
Over 30 years experience and vast
data base

9 Chapel Street, Donisthorpe,
Derbyshire DE12 7PS

0906 470 1706

Calls cost 60p per minute

SERVICE MANUALS

and Service Sheets for
TV - VIDEO - AUDIO

Prices start at

CTV	s/sheet	5.00
VCR	s/sheet	7.00
CTV	s/man	10.00
VCR	s/man	13.00

No p/p or VAT
- Other items POA -

AMTEL

Huna,
Caitness KW1 4YL
01955 611313

www.amtel.co.uk

SERVICE MANUALS

Have you ever turned away
work for want of a Service
Manual? Have you ever brought
a Service Manual and never
used it more than once?
Then why not join ...

THE MANUALS LIBRARY

For details and membership
application form write,
phone or fax:

HARVEY ELECTRONICS

43 Loop Road, Beachley,
Chepstow, Mons, NP16 7HE
Tel/Fax No: 01291 623086

Visa: Mastercard accepted

Fryerns

Service Information **FES** Circuit Diagrams

TV's, VCR's, SATELLITE
CAMCORDERS, AUDIO &
HI-FI's

Prices are from £5.50 + £2.75 P&P
add a further £5.50 per item
in the same order

note: some items priced individually
we now supply universal
tv/video remotes at competitive
prices

Payment by credit card, PO or cheque

Tel: Fax 01206 211570

e-mail: colin@fryerns.fsbusiness.co.uk



2 The Lodge
Easthorpe Green
Marks Tey, Colchester
CO6 1HA

LINEAGE

PRIVATE RETAILER has excellent part
exchange colour televisions and videos to
clear. Tel: 01494 814317.

PROJECTOR SPARES

Spare parts and service
information for

VIDIKRON

video projectors from
PROJECTSPARES

Tel: 01444 831769

Fax: 01444 831580

E-mail:

projectspares@btinternet.com

RECRUITMENT

BENCH ENGINEER REQUIRED

TO REPAIR: •VCR's •Monitors •Cameras
Part Time

Senior, Experienced Person need apply
(with City and Guilds 224)

GOOD RATE OF PAY

5 Mins from Stratford Station

Phone Basil
0208 519-0044

RECRUITMENT

CLEARVISION

TV & Video Sales & Repairs

In Stanford Le Hope, Essex

Require

P/T FIELD ENGINEER/INSTALLER

Must be experienced in this field. Needs to be fit.
Good communication skills and enthusiastic manner
towards customers.

Working hours and pay to be negotiated.

Phone Paul or Michael on 01375 640800

TECHNICAL ADVICE

www.service-link.co.uk

Service Manuals - Technical Bulletins Circuit Diagrams - Fault Finding

We have a huge service manuals database with over 7,000 manuals
covering the past 40 years.

Visit our website for full details or email us with make, model and
fault description. We will email you by return with details of our
service options available to you.

enquiries@service-link.co.uk

Like you, we are tv engineers and have found it hard to obtain
service info quickly and at a good price.

We have invested heavily to be able to help you 7 days a week.

www.service-link.co.uk 01582 672134

WANTED

WANTED Surplus or Obsolete Electronic Components

Turn your excess stock into instant cash!

SEND OR FAX YOUR LIST IN STRICTEST CONFIDENCE

Will collect anywhere in the UK



Mushroom
COMPONENTS

28 College Street, Kempston, Bedfordshire, MK42 8LU

Tel: 01234 363611 Fax: 01234 326611

E-mail: sales@mushroom.co.uk

Internet: www.mushroom.co.uk

BEST CASH PRICES PAID

FOR VALVES KT88,
PX4 AND MOST
AUDIO/OTHER
TYPES.

Tel: 01403 784961

Billington Export Ltd
Sussex RH14 9EZ
Fax 01403 783519

Email: sales@bel-tubes.co.uk
Visitors by appointment

For a **FREE**

consultation on how best
to market your
products/services to a
professional audience
contact

**BETH on
01322
611292**

CLASSIFIED TEL: 01322 611254

NEW HANDSETS AND
MODELS ADDED DAILY.
CHECK OUT
www.classic-serviceparts.com
FOR THE LATEST INFORMATION.



The good news is, we can replace it..!

Ah, Man's best friend... A loving, loyal companion but not averse to taking a fancy to those fun looking chewy things sat near the television set. And, when the fun's over, the chances of the handset being able to function are, if you excuse the pun, pretty remote to say the least. Fortunately, Classic supply a vast range of remote controls for TV, VCR, Satellite, Freeview set top boxes etc. Designed to be user friendly and covering all the functions of the original handset, the Classic range provides a cost effective solution to your remote control requirements.

Classic remote controls are available from our nationwide network of distributors.

For up to date cross-reference information or for more information on the whole Classic range of service products, visit our website www.classic-serviceparts.com, phone us on 01635 278678 or email us at uksales@classic-serviceparts.com.



**classic**

Technical helpline 01635 278678

TELEVISION TEST PATTERN GENERATORS

The new **GV 998** is a digital pattern generator offering more advanced features at again a realistic price. Those features include :

- ◆ MPEG-2 format Transport Stream generation
- ◆ Video and audio included in the TS
- ◆ Video and audio inputs
- ◆ Generation of a variable frequency sound carrier for decoding verification
- ◆ Multistandard and multisystem analogue TV signal generation
- ◆ Possibility to edit different fields of the TS database to present the name of the service provider
- ◆ Remote control via a personal computer
- ◆ Moving video patterns to check MPEG-2 decoders

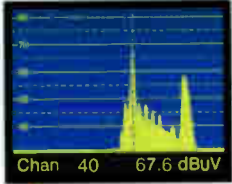
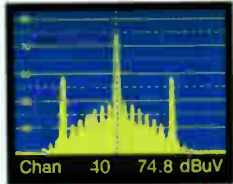

**IDEAL FOR
PLASMA
DISPLAYS**

**IDEAL FOR
WIDE SCREEN**



PROMAX GV SERIES

- ◆ Choice of 12 instruments
- ◆ NICAM and Teletext
- ◆ 4:3 and 16:9 Formats
- ◆ Full field and VITS
- ◆ Computer Controlled
- ◆ Front panel memories
- ◆ Own Company Logo
- ◆ Computer Monitor testers
- ◆ Hand Held Models
- ◆ Multi Standard, PAL, NTSC, SECAM
- ◆ High Quality Construction
- ◆ Attractive Price Levels
- ◆ Full After Sales Service
- ◆ Available from Stock



**FOR TELEVISION PATTERN GENERATORS,
THERE'S NO WIDER CHOICE THAN WITH PROMAX**



SELECTED ITEMS FROM THE PROMAX RANGE OF TEST EQUIPMENT



MS 250

Analogue and Digital Satellite Detector.



PRODIG 1+

Satellite Dish Installer's Meter
Does more than just BSkyB



PRODIG 2

Analogue & Digital Aerial Meter
Measures digital channel power and C/N



MC 577

Analogue & Digital, Satellite & Terrestrial
Measures channel power and C/N



PROLINK 3 + 4 PREMIUM

Satellite & Terrestrial, Analogue & Digital,
Spectrum Analyser with BER (optional on P3)



**AA 930
AUDIO ANALYSER**

**TA 903B
CRT
REJUVENATOR**



Alban

ALBAN ELECTRONICS LIMITED

THE PROMAX SERVICE CENTRE

6 Caxton Centre, Porters Wood,
St. Albans, Hertfordshire, AL3 6XT.

TEL: 01727 832266 FAX: 01727 810546

WEB : www.albanelectronics.co.uk

EMAIL : info@albanelectronics.co.uk

SALES + SERVICE + CALIBRATION