

25p

The **SHORT WAVE** *Magazine*

VOL. XXX

MAY, 1972

NUMBER 3

for
the
radio
amateur
and
amateur
radio

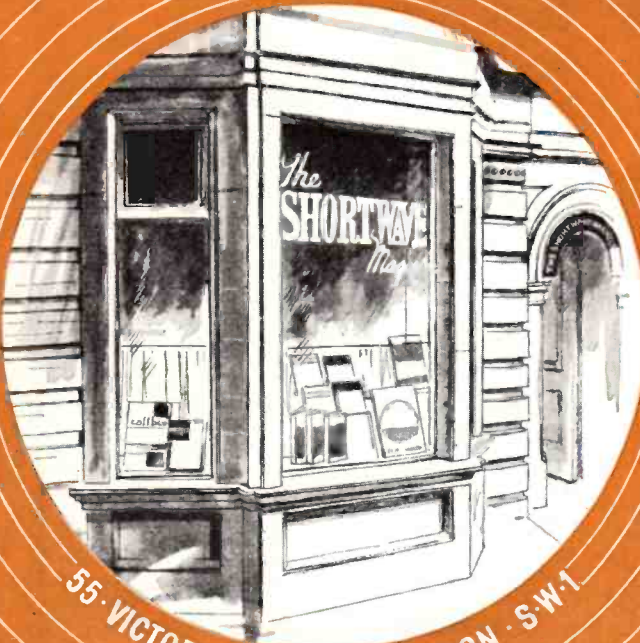

55 · VICTORIA STREET · LONDON · S.W.1

Technical Books and Manuals

(ENGLISH AND AMERICAN)

AERIAL INFORMATION

ABC of Antennas	90p
Aerials (By D. Sjobbema)	88p
Aerial Handbook (Briggs)	87p
Amateur Radio Antennas (Hooton)	£1-87
Antenna Handbook, Volume 1	£1-77
Antenna Round-Up, Volume 1	£1-47
Antenna Round-Up, Volume 2	£1-77
Antenna Handbook, 12th Edition	£1-40
Beam Antenna Handbook	£2-10
Ham Antenna Construction Projects	£1-47
Quad Antennae	£1-80
S9 Signals	87p
73 Vertical, Beam and Triangle Antennas (by E. M. Noll)	£2-40
73 Dipole and Long-Wire Antennas (by E. M. Noll)	£2-20
SWL Antenna Construction Projects	£1-38

BOOKS FOR THE BEGINNER

Amateur Radio (Rayer)	£1-60
Beginners Guide to Radio (7th Edition)	£1-12
Beginners Guide to Electronics (N.E.)	£1-10
Beginners Guide to Transistors	£1-12
Beginners Guide to Colour TV	82p
Better Short Wave Reception	£1-80
Course in Radio Fundamentals	62p
Foundations of Wireless and Electronics	£2-02
Guide to Amateur Radio	50p
How to Become a Radio Amateur	59p
Morse Code for the Radio Amateur	15p
Learning the RT Code	27p
Radio, by D. Gibson	85p
Radio Amateur Examination Manual	45p
Short Wave Listener's Guide (N.E.)	O/P
Simple Short Wave Receivers (Data)	89p
Understanding A Amateur Radio	£1-37

GENERAL

Easibinder	O/S
Guide to Broadcasting Stations (16th Edition)	60p
How to Listen to the World 1971—Edition	£1-37
RCA Receiving Tubes Manual	£1-77
RCA Transistor Manual (N.E.)	£1-75
RCA Transmitting Tubes	£1-35
Shop and Shack Shortcuts	£1-75
Television Explained Vol. I	£1-35
Television Explained Vol. II	£1-37
Telecommunications Pocket Book (T. L. Squires)	£1-32
World Radio and TV Handbook 1972 Edition	£2-80
ABC of Electronics (by Farl J. Waters)	£1-20
ABC of FET's	£1-35
ABC's of Short Wave Listening	£1-02
Building Your Amateur Radio Novice Station (by W7OE)	£1-57
FET Circuits (by Rufus P. Turner)	£1-52
FET Principles, Experiments and Projects	£2-15
Having Fun with Transistors	£1-59
Know Your Oscilloscope (by Paul C. Smith)	£1-80
110 Integrated Circuit Projects for the Home Constructor	£1-22
49 Easy Transistor Projects	£1-01
Practical Ham Radio Projects (by W6NJV)	£1-15
Practical Transistor Theory	£1-10
Practical Wireless Circuits	£1-34
Single Sideband: Theory & Practice (by H. D. Hooton)	£3-47

ARRL Calculator, Type A	92p
ARRL Calculator, Type B	72p
Easibinder (to hold 12 copies of Short Wave Magazine together)	90p
Practical Integrated Circuits (Newnes-Butterworth)	£1-01
110 Semi-Conductors Projects for the Home Constructor (Iliffe)	£1-37

HANDBOOKS AND MANUALS

Amateur Radio DX Handbook	£2-17
Electronic Circuit Handbook, Vol. 1	£1-42
Electronic Circuit Handbook, Vol. 2	£1-42
Mobile Handbook, CQ	£1-40
Mobile Manual, ARRL	£1-40
New RTTY Handbook	£1-80
Radio Amateur Handbook 1972 (ARRL)	£2-85
Radio Amateur Handbook 1972 (ARRL) (Hard Cover)	£3-62
Radio Amateur Operators Handbook, 12th Edition	53p
Radio Communication Handbook (RSGB)	£3-50
Rtty A-Z (CQ Tech. Series)	£2-25
Surplus Conversion Handbook	£1-37
Transistor Substitution Handbook No. 10	£1-12

USEFUL REFERENCE BOOKS

Amateur Radio SSB Guide	£1-59
Amateur Radio Techniques (N/E)	O/S
Amateur Radio Construction Projects	O/S
Amateur Radio Circuit Book	70p
Guide to Amateur Radio	50p
Engineers' Pocket Book—6th Edition	£1-48
'G' Call Book 1972	60p
Hams' Interpreter	63p
Hints and Kinks, Vol. 8 (ARRL)	62p
Radio Amateur Examination Manual	45p
Operating an Amateur Radio Stat.	25p
Radio Data Reference Book (3rd Edition)	£1-00
Radio, Valve and Transistor Data (Iliffe), 9th Edition	89p
Service Valve and Semiconductors Equivalents	35p
Single Sideband for the Radio Amateur (ARRL), 5th Edition	£1-67
Single Sideband (Theory & Practice) by H. D. Hooton	£3-47
Sun, Earth and Radio by J. A. Ratcliffe	91p
Surplus Schematics (CQ)	£1-22
Transistor Pocket Book	£1-57
Q & A on Audio	54p

TRANSISTOR MANUALS

ABC of Transistors	£1-33
Handbook of Transistor Circuits	£2-35
Transistor Fundamentals: Basic Semi-Conductor and Circuit Principles, Vol. 1	£1-92
Transistor Fundamentals: Basic Transistor Circuits, Vol. 2	£1-92
Transistor Fundamentals: Electrical Equipment. Circuits, Vol. 3	£1-92
Transistor Fundamentals: Student's Workbook	£1-92
Transistor Substitution Handbook, No. 10	£1-12
Using 'Scopes in Transistor Circuits	£1-77

VHF PUBLICATIONS

VHF Handbook, Wm. I. Orr	£1-79
VHF Manual (ARRL)	£1-37
VHF/UHF Manual (RSGB) N/E	£1-80

The above prices include postage and packing.

Many of these Titles are American in origin.

Available from **SHORT WAVE MAGAZINE**
 Publication Dept., 55 Victoria St., London SW1H 0HF 01-222 5341
 (Counter Service. 9.30-5.15. Mon. to Fri.) (Nearest Station: St. James's Park)

(GIRO A/C. No. 547 6151)

MULTI-METERS



MODEL 500 30,000 O.P.V. with overload protection mirror scale 0/5/2/5/10 / 25 / 100 / 250 / 500 / 1,000v. D.C. 0 / 2.5 / 10 / 100 / 250 / 500 / 1,000v. A.C. 0 / 50µA / 5 / 50 / 500mA. 12 amp. D.C. 0/60/K/6 Meg/600 Meg. £, £8-87½ Post paid.

SKYWOOD SW-500



50K Ω/Volt. Mirror scale D.C. Volts 0-6/3/12/30/300/600. D.C. Current 20uA/6/600mA Resistance 10K/100K/1 Meg/10 Meg. Decibels -20 to +57 dB., £7-50. P. & P. 15p.



MODEL 5025 57 Ranges. Giant 3½in. Meter, Polar Reverse Switch. Sensitivity : 50K/Volt D.C. 5K/Volt A.C. D.C. Volts : +125, 25, 12.5, 5, 10, 25, 50, 125, 250, 500, 1,000v. A.C. 25, 50, 100, 250, 500, 1,000v. D.C. Current : 25, 50LA, 2-5, 5, 25, 50, 250, 500mA, 5, 10 amp. Resistance : 2K, 10K, 100K, 1Meg. 10 Meg. Decibels : -20 to +85 dB., £12-50. P. & P. 17½p.



MODEL S-100TR Multimeter/Transistor Tester 100,000 O.P.V. Mirror Scale/Overload Protection. 0/12 / 6 / 3 / 12 / 30 / 120 / 600v. D.C. 0/6/30 / 120 / 600v. A.C. 0 / 12 / 600µA / 12 / 100 Meg -20 to +50 dB. 0-01-2 MFD. Transistor tester measures Alpha, Beta and Ico. Complete with batteries, instructions and leads, £13-50. P. & P. 25p.

POWER SUPPLY UNITS



RP 214 Regulated Power Supply. Solid state. Variable output 0-24v.D.C. up to 1 amp. Dual scale meter to monitor voltage and current. Input 220/240v. A.C. Size : 185 x 85 x 105mm., £8-97. P. & P. 25p.

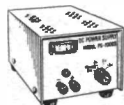

PS.1000B Regulated Power Supply. Solid state. Output 6, 9 or 12 volt D.C. up to 3 amps. Meter to monitor current. Input 220/240v. A.C. Size : 4" x 3½" x 6½", £11-97. P. & P. 25p.

CRYSTAL CALIBRATOR No. 10



Small portable crystal controlled wavemeter. Size 7" x 7½ x 4". Frequency range 500 Kc/s.-10 Mc/s. (up to 30 Mc/s. on harmonics). Calibrated dial. Power requirements complete with instructions. 300v. D.C. 15mA and 12v. D.C. 0-3A. Excellent condition, £4-47½. Carr. 37½p.

LAFAYETTE HA.800 SOLID STATE AMATEUR COMMUNICATION RECEIVER SIX BANDS 3-5-4, 7-7-3, 14-14-35, 21-45, 28-29-7, 50-54 Mc/s.

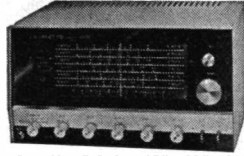

Dual conversion on all bands. 2 x 455 Kc/s. mechanical filters. Product detector Variable B.F.O. 100 Kc/s. crystal calibrator. "S" meter Huge slide rule dial. Operation 230v. AC or 12v. DC. Size 15" x 9½" x 8½". Complete with instruction manual, £57-50. Carr. paid (100 Kc/s. Crystal £1-97½ extra).



UNR-30. 4 BAND COMMUNICATION RECEIVER

Covering 550 Kc/s.-30 Mc/s. Incorporates variable FOB for CW/SSB reception. Built-in speaker and phone jack. Metal cabinet. Operation 220/240v. A.C. supplied brand new, guaranteed with instructions, £15-75. Carr. 37½p.

SKYWOOD CX203 COMMUNICATION RECEIVER

Solid state. Coverage on 5 bands 200-420 kHz and .55 to 30 MHz. Illuminated slide rule dial. Bandspread. Aerial tuning. BFO. AVC. ANL. "S" meter. AM/CW/SSB. Integrated speaker and phone socket. Operation 220/240v. A.C. or 12v. D.C. Size : 325 x 266 x 150 mm. Complete with instructions and circuit. £28-50 Carr. 50p

LAFAYETTE SOLID STATE HA600 RECEIVER

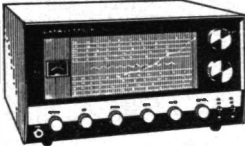

5 Band AM/CW/SSB amateur and short wave 50 Kc/s.-400 Kc/s. and 550 Kc/s.-30 Mc/s. F.E.T. front end. 2 Mechanical filters. Huge Dial. Product detector. Variable BFO. Noise limiter, S Meter. 24½" Bandspread. 230v. A.C./12v. D.C. Neg. earth operation, RF gain control. Size : 15" x 9½" x 8½". Wt. 1B lbs. Exceptional value, £50. Carr. 50p.

TRIO JR-500E AMATEUR RECEIVER

7 separate ranges between 3-5 and 29-7 Mc/s. 7 valves, 2 transistors and 5 diodes plus 8 crystals ; output B and 500 ohm and 5000 ohm phone jack. Crystal controlled oscillator. Variable BFO - VFO - AVC - ANL - S meter - SSB-CW - Stand-by switch - special double gear dial drive socket for connection to a transmitter. 115/250v. A.C. Mains. Size : 7" x 13" x 10" with instruction manual and service data, £65-00, Carriage paid. Package deal : JR500E with SP5D speaker and HS4 headphones, £69-50.



TRIO TS 510 AMATEUR TRANSCEIVER with speaker and mains P.S.U., £180.

TRIO JR310 AMATEUR BAND 10-80 Metre Receiver, £77-50.

B.C.221 FREQUENCY METERS Latest release 125 kHz-20 MHz. Excellent condition. Fully tested and checked and complete with calibrator charts, £27-50 each. Carr., 50p.

CLEAR PLASTIC PANEL METERS

First grade quality, Moving Coil panel meters, available ex-stock. Quantity discounts. Type MR.38P. 1 21/32in. square fronts.



50µA	£2-10	1 amp	£1-60	150v DC	£1-60
50-0-50µA	£1-90	2 amp	£1-60	300v DC	£1-60
100µA	£1-90	5 amp	£1-60	500v DC	£1-60
100-0-100µA	£1-75	20mA	£1-60	750v DC	£1-60
200µA	£1-75	50mA	£1-60	15v AC	£1-60
500µA	£1-65	100mA	£1-60	50v AC	£1-60
500-0-500µA		150mA	£1-60	150v AC	£1-60
		200mA	£1-60	300v AC	£1-60
		300mA	£1-60	500v AC	£1-60
1mA	£1-60	500mA	£1-60	S meter 1 mA	£1-70
1-0-1mA	£1-60	3v DC	£1-60	VU meter	£2-10
2mA	£1-60	10v DC	£1-60		
5mA	£1-60	20v DC	£1-60		
10mA	£1-60	100v DC	£1-60		
750mA	£1-60				

FULL RANGE OF OTHER SIZES IN STOCK, SEND S.A.E. FOR LEAFLET.

URIA SOLID STATE COMMUNICATION RECEIVER



4 bands covering 550 Kc/s.-30 Mc/s. continuous. Special features are use of FET transistors, S Meter, built-in speaker, variable BFO for SSB reception, noise limiter, bandspread control, sensitivity control. Output for low impedance headphones. Operation 220-240v. A.C. or 12v. D.C. Size : 12¾" x 4¾" x 7". Excellent value. Only £25-00. Carr. 37½p.

TEIS TRANSISTORISED GRID DIP METERS



Six ranges. 440 Kc/s.-280 Mc/s. Operates on 9v. battery. Full instructions £12-50. P.P. 17½p.

HANSEN SWR-3 BRIDGE

Impedance 52 ohms. Also operates as field strength indicator, complete with telescopic aerial, £4-25 each. P.P. 17½p. PL259 plugs to suit 37½p each.

HAMGEAR PRESELECTORS

PMIIA £9-20 & PMIIB £8-25. P.P. 20p.

Latest Catalogue

Our New 6th edition gives full details of a comprehensive range of HI-FI EQUIPMENT COMPONENTS, TEST EQUIPMENT and COMMUNICATIONS EQUIPMENT, FREE DISCOUNT COUPONS VALUE 50p. 272 pages, fully illustrated and detailing thousands of items at bargain prices.

SEND NOW! STILL ONLY 37½p P. & P. 10p.



G.W.SMITH & CO. (RADIO) LTD

10 TOTTENHAM CT. RD. LONDON, W1 Tel: 01-637 2232
 27 TOTTENHAM CT. RD. LONDON, W1 Tel: 01-636 3715
 3 LISLE STREET, LONDON, W.C.2 Tel: 01-437 8204
 34 LISLE STREET, LONDON, W.C.2 Tel: 01-437 9155
 311 EDGWARE ROAD, LONDON, W.2 Tel: 01-262 0387

CALLERS WELCOME MONDAY TO SATURDAY 9AM-6PM

All Mail Orders to - 11-12, Paddington Green, London, W.2 Tel: 01-262 6562

CALL BOOKS

INTERNATIONAL: RADIO AMATEUR CALL BOOK	
"DX Listings"	£3.10
"U.S. Listings"	£4.10
The two together, covering the World	£6.80
"G's" only 1972	60p

MAPS

AMATEUR RADIO MAP OF WORLD Mercator Projection — Much DX Information — in colour. Second Edition	65p
DX ZONE MAP (GREAT CIRCLE) In colour with Country/Prefix Supplement Revised to Dec. 1970	85p
RADIO AMATEUR MAP OF THE U.S.A. AND NORTH AMERICA State boundaries and prefixes, size 24" by 30", paper	60p
RADIO AMATEUR'S WORLD ATLAS In booklet form, Mercator projec- tion, for desk use. Gives Zones and Prefixes	85p

LOG BOOKS

Standard Log (New Glossy Cover)	55p
Log and VHF Contest Log	40p
Receiving Station Log	45p

(The above prices include postage and packing).

MORSE COURSES

G3HSC Rhythm Method of Morse Tuition	
*Complete Course with three 3 speed L.P. records with books	£4.50
*Beginner's Course with two 3 speed L.P. records with book	£3.30
Single 12" L.P. Beginner's with book	£2.75
Single, 12" L.P. Advanced with book	£2.75
Three speed simulated GPO test. 7" d.s. E.P. record	85p
Ex.Gov. Heavy Duty Morse Keys Fully Shrouded	95p

Prices include postage, packing and insurance
in U.K. only *Overseas orders + £1.00.

Available from

SHORT WAVE MAGAZINE

Publications Dept., 55 Victoria Street,
London, SW1H 0HF 01-222 5341

(Counter Service, 9.30-5.15, Mon. to Fri.)

(Nearest Station: St. James's Park)

(GIRO A/C No. 547 6151)

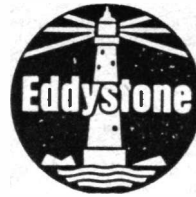

"LISTEN TO THE WORLD WITH EDDYSTONE"

Your local Eddystone dealer
is:

CHESHIRE

The Transistor Centre
(Wilmslow) Ltd.
Green Lane
Wilmslow 24766

CORNWALL

R. V. Heming Ltd.
(Peter Heming G3WBW)
Cliff Road, Newquay
Newquay 2191

S.S.B. Products
(Norman Birkett G3EKX)
7 Little Castle Street
Truro
Devoran 862575

DEVON

Graham Newbery
(Reg. Ward G2BSW) Axminster
Axminster 3163

ESSEX

F. E. Smith
184 Moulsham Street
Chelmsford
Chelmsford 54594

HAMPSHIRE

Southern Marine Radio
(Southampton) Ltd
Solent House, Town Quay
Town Quay 22721

Wireless Supplies Unlimited
264-266 Old Christchurch Road
Bournemouth
Bournemouth 24567

IRELAND

John F. MacMahon
10, Church Street, Enniskillen
Co. Fermanagh, N. Ireland
Enniskillen 2955

ISLE OF WIGHT

Sherratt & Son
81-82-83 High Street, Newport
Newport 3358-9

KENT

G. T. & R. Wilson
12-14-16 Queen Street
Gravesend
Gravesend 63527/8

LANCASHIRE

Holdings Photo Audio Centre
Mincing Lane - Darwen Street,
Blackburn BB2 2AF
Tele. 59595

Stephen-James Ltd
70 Priory Road, Anfield
Liverpool L4 2RZ
051-263 7829

North West Electrics
769 Stockport Road
Levenshulme, Manchester 19
061-224 4911

Croffilm Ltd
46 Friargate
Preston PR1-2AT
Preston 55244

LEICESTERSHIRE

A. K. Davey Ltd
New Street, Hinckley
Hinckley 2173 and 4288

LONDON

Imhofs (Retail) Ltd
112-116 New Oxford Street
W.C.1
01-636 7878

R. T. & I. Electronics Ltd
Ashville Old Hall
Ashville Road
Leytonstone, E.11
01-539 4986

Radio Shack Ltd
182 Broadhurst Gardens
London, N.W.6
01-624 7174

NORFOLK

The Record Shop
157 King Street
Great Yarmouth

NORTHUMBERLAND

Aitken Bros & Company
35 High Bridge
Newcastle upon Tyne NE1 1EW
Newcastle upon Tyne 26729

SCOTLAND

L. Hardie
542 George Street
Aberdeen
Aberdeen 20113

WALES

Holt High Fidelity
Picton Arcade, Swansea
Swansea 53254

Holt High Fidelity
8 Portland Street, Swansea
Swansea 41032

WARWICKSHIRE

Chas. H. Young Ltd
170/172 Corporation Street
Birmingham 4
021-236 1635

How to measure very high frequencies at very low cost:

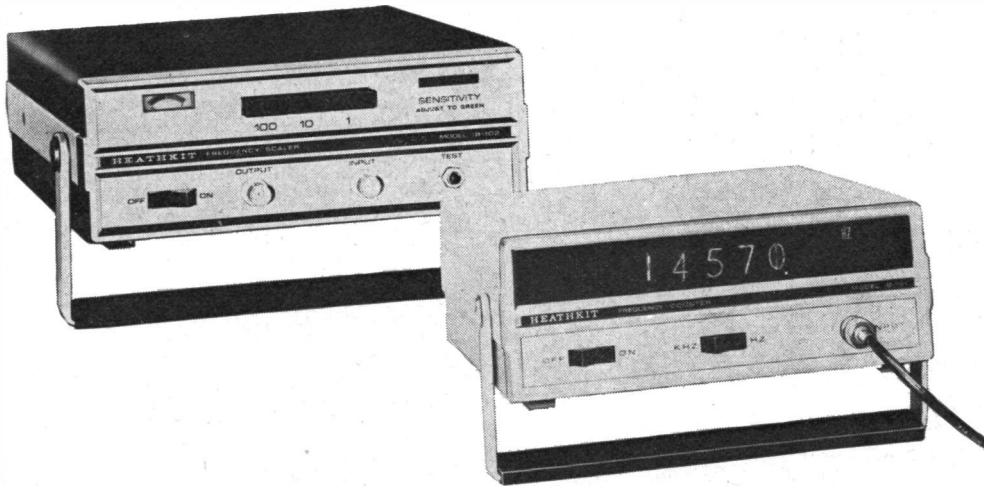

Combine the new Heathkit IB-102 Scaler and IB-101 Counter and get 75 MHz capability for less than **£150!**

The Heathkit IB-101 : 15 MHz for just £95. An accurate, low cost counter for dozens of applications. Delivers instant, reliable counting from 1 Hz to over 15 MHz with 5-digit cold-cathode readout tubes. Computer-type integrated circuitry eliminates blinking readout . . . provides a rock-stable divider chain that never needs adjustment. Hz/kHz switch and overrange indicator give the IB-101's 5-digit readout the same capability as an 8-digit counter. Set the range switch to kHz and read out to the nearest kHz . . . push the switch to the Hz position and read down to the last Hz. Overage and Hz/kHz indicators light up to give correct range and error-free measurement . . . make an 8-digit measurement to over 15 MHz in seconds. The exclusive Heath-designed dual gate, diode-protected MOSFET input circuit provides proper triggering over a wide range of input levels . . . without adjustment or input attenuators. Input Z is 1 megohm shunted by less than 20 pF to minimize loading. A special low drift, temperature compensated 1 MHz crystal oscillator provides a highly stable time base. Other features include all solid-state circuitry using 26 ICs, 8 transistors and 6 diodes . . . combination carrying handle/tilt stand . . . BNC input with cable supplied . . . easy 6 hour assembly. Shipping weight : 7 lbs.

Extend the range of virtually any frequency counter to 175 MHz for only £40*. The new Heathkit IB-102, in combination with the IB-101 or virtually any other existing counter, gives you fast, accurate, reliable measurement capability into the VHF region for less than £150. The IB-102 will divide input frequencies from 2 MHz to 175 MHz with the scaled output fed to any compatible counter with a 1 megohm input. Front panel switch-selection of 10 : 1 or 100 : 1 scaling ratios . . . resolution down to 10 Hz with a counter

having 1 second time base. For use with frequencies within the range of the counter being used, a 1 : 1 switch position provides straight-through counting without scaling. The exclusive Heath input circuit triggers at extremely low signal levels, increasing versatility greatly. At 100 MHz, for example, only 50 mV maximum is needed to trigger. The front panel Test switch gives a quick, easy method of checking input level. Other features include all solid-state IC/transistor design . . . handy tilt stand-carrying handle and easy 5 hour design. Get into VHF measurement the easy, inexpensive Heath way . . . with the new IB-102. Shipping weight : 7 lbs.

- Please send Specification Sheets
- Please send FREE Heathkit Catalogue.

Name

Address

Prices and specifications subject to change without notice.
*Mail order prices ; ex factory. SWM 05/72

KIT MODEL IB-101 £95.00 plus 40p post. KIT MODEL IB-102 £40.00 plus 40p post.

Please address all enquiries & correspondence:

HEATH (Gloucester) LTD. GLOUCESTER GL2 . 6EE TEL. 29451



A Schlumberger Company

**GREAT NEWS FROM RADIO SHACK
LOOK AT OUR NEW LOW PRICES FOR DRAKE EQUIPMENT**

**DRAKE'S TR-4
SIDE BAND
TRANSCIEVER
from
RADIO SHACK
£265.00**

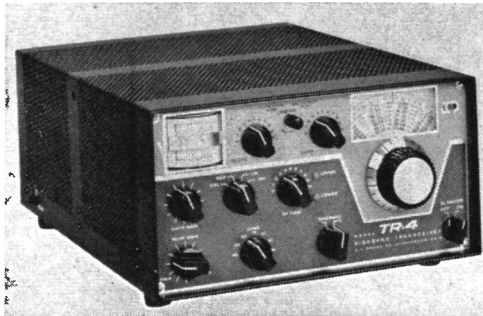

RECEIVERS AND ACCESSORIES

2-C	Receiver—SSB, AM, CV, RTTY	£112.50
2-AC	Crystal Calibrator for 2-C	£8.95
2-CS	Matching Speaker for 2-C	£9.95
2-CQ	Q-Multiplier Speaker for 2-C	£17.95
2-NB	Noise Blanker for 2-C	£11.95
R-4B	Receiver—SSB, AM, SW, RTTY	£212.50
MS-4	Matching Speaker for R-4B, TR-4, SW-4A	£9.95
SW-4A	Receiver—AM, International, SW	£145.00
AL-4	Loop Antenna for SW-4A	£9.50
SPR-4	Receiver—General Purpose	£219.50
	Amateur Band Crystal Kit for SPR-4	£11.95
5NB	Noise Blanker for SPR-4	£29.00
SCC-4	Calibrator—100 kHz for SPR-4	£8.95
Adapter	Transceiver for SPR-4, T-4XB	£7.00
DC	Power Cord for SPR-4	£2.50
DSR-1	Digital Receiver	£975.00

TRANSCIEVERS AND ACCESSORIES

TR-4	SSB Transceiver	£265.00
4-NB	Plug-in Noise Blanker for TR-4	£44.50
AC-4	115/240v. Power Supply for TR-4, T-4XB	£46.95
DC-4	12v. Power Supply for TR-4, T-4XB and Receiver	£55.00
MMK-3	Mobile Mounting Kit for TR-4	£3.50
RV-4	Remote VFO for TR-4	£49.50
FF-1	Crystal Control for TR-4	£11.95
MC-4	Mobile Console	£31.50

COPAL DIGITAL CLOCKS

101	£9.95
222	£7.25
601	£15.00

TRANSMITTERS AND ACCESSORIES

T-4XB	SSB Transmitter (see AC-4 opposite)	£219.50
L-4B	Linear Amplifier (includes Power Supply)	£375.00
MN-4	Antenna Match Network for T-4XB, TR-4	£43.75
MN-2000	Antenna Match Network. 2000 Watts	£85.95
W-4	RF Wattmeter 2—30 MHz	£27.50
WV-4	RF Wattmeter 20—200 MHz	£32.50
C-4	Station Control Console	£135.00
729SRD	Cardioid Microphone	£7.95

CONVERTERS AND ACCESSORIES

TC-2	2m. Transmitter Converter	£135.00
SC-2	2m. Converter	£33.50
SC-6	6m. Converter	£31.50
CPS-1	Power Supply for SC-2 and SC-6, 115v.	£9.50
SCC-1	VHF Crystal Calibrator	£12.50
CC-1	Converter Console	£12.95
TV-1000LP	Low Pass Filter	£8.95

ACCESSORY CRYSTALS AND INSTRUCTION MANUALS

	Operating Manuals	£1.00
	Crystals for 2-C, R-4B, SW-4A, T-4XB	£2.50
	Fixed Frequency Crystals	£3.50
CA-1	Stacking Cabinet Adapter for T-4XB, R-4B	£7.50

Carriage extra on all items

COLLINS S LINE

New from stock at realistic prices including KWM-2 transceiver

YAESU MUSEN Full range in stock

New HEATHKITS stocked as well as some ready assembled units

KW — HALLICRAFTERS — SHURE — TRIO — EDDYSTONE — TEN-TEC — OMEGA-T — JOHNSON — WIGHTRAPS — etc. S.A.E. for details.
HY-GAIN PRODUCTS FROM RADIO SHACK

VERTICAL ANTENNAS AND ACCESSORIES

18HT	6 thru 80 metre Vertical "Hy-Tower"	£96.00
12 AVQ	10 thru 20 metre Vertical Trapped Antenna	£15.50
14 AVQ/WB	10 thru 40 metre Vertical Trapped Antenna	£18.50
18 AVT/WB	10 thru 80 metre Vertical Trapped Antenna	£32.50
18 V	10 thru 80 metre Vertical Antenna	£9.75
12 RMQ	Roof Mounting Kit for 12 AVQ	£8.50
14 RMQ	Roof Mounting Kit for 14 AVQ/WB	£9.75
LC 80Q	80 metre Loading Coil for 14 AVQ/WB	£6.50

TRI-BAND BEAMS AND QUADS

TH6DXX	Super Thunderbird 6 Element 10-15-20m. Beam	£84.00
TH3MK3	Thunderbird 3 Element 10-15-20m. Beam	£67.50
TH3JR	3 Element 10-15-20m. Beam. 600W PEP rating	£46.50
TH2MK3	Thunderbird 2 Element 10-15-20m. Beam	£48.00
HY-QUAD	3 Band 2 Element Cubical Quad. Sgl. Feed Line	£61.00
DB10-15A	10 and 15 metre Duo-Band Beam	£50.00

Carriage extra on all items

CDR ROTATORS

HAM-M	£70.00
TR-44	£40.00

Rotator cable available.

NOW OPEN 6 DAYS 9 till 5 closed for lunch between 1 and 2

HIGH PERFORMANCE MONO-BAND BEAMS

204BA	4 Element 20 metre Beam	£68.50
203BA	3 Element 20 metre Beam	£66.50
153BA	3 Element 15 metre Beam	£32.00
103BA	3 Element 10 metre Beam	£23.00

HAMCAT MOBILE ANTENNAS

257	Mobile Mast with foldover hinge and swivel base	£8.50
252	80 metre Coil and Tip Rod	£9.75
256	40 metre Coil and Tip Rod	£8.75
255	20 metre Coil and Tip Rod	£8.00
254	15 metre Coil and Tip Rod	£6.50
253	10 metre Coil and Tip Rod	£5.50
492	Coil and Tip Rod Spring	£1.50
499	Flush Body Mount	£4.75

AR22R	£25.00
AR-20	£20.00

RADIO SHACK LTD.

Just around the corner from West Hampstead Underground Station

**182 BROADHURST GARDENS
LONDON NW6 3AY
Telephone: 01-624 7174
Giro Account No. 588 7151**

NORTH WEST ELECTRICS

769, STOCKPORT ROAD, LEVENSHULME,
MANCHESTER, 19.

Phone: 061-224 4911

G3MAX

**EDDYSTONE AND TRIO RECEIVERS. DIECAST BOXES.
JACKSON CAPACITORS AND DRIVES. DENCO COILS.
"RADIOSPARES" TRANSFORMERS AND COMPONENTS.
"Q" MAX CUTTERS.**

INTEGRATED CIRCUITS AND COMPONENTS FOR FREQUENCY COUNTERS AND CLOCKS
7490N 86p, 7400N 22½p, 7473N 55p, 74141N £1.12, 72710N 46p NEW TEXAS

HOLDERS for 14 way and 16 way 15p each
DECADE COUNTER BOARD 12 way 15 uses 7490 and 74141N 37½p
DECADE COUNTER BOARD with fitting for Quad latch, 16 way 160p
NUMICATORS FOR DIGITAL READOUT. £1.50 each. GN4 with base. End viewing 1" dia. GNP 7AH side viewing 1½" high, ¾" dia. Miniature type A7001. 1½" high, ½" dia. POST 5p on any item. Excess will be refunded

POT CORE. .666 dia. With bobbin on ½" Aladdin former. Type 10D, 14p, post 5p.

POLYPROPYLENE ROPE. 500lb. strain. 100 yd. reel, £1, post 15p.

BARGAIN OFFER. 100 yard drum 75 ohm high power coaxial cable. Attenuation per 100ft. 2.8 dB 200 MHz, 4 dB 600 MHz, 5.3 dB 800 MHz, £6.75, carriage £1.

DENCO COILS. All ranges in stock. 32p each, post 5p each coil. Please state valve or transistor type when ordering.

COAX LINK LEAD. 8' 6" cable with 2 Burndept/Londex coax plugs, 35p each, post 15p (50Ω impedance).

5" DESYN INDICATOR, 75p, post 25p.

3" DESYN INDICATOR. 62p, post 20p. Compass degrees and corrector on 5" Desyn only.

VIBRATORS. 12 volt synchronous. Type No. 12SR7, 50p each. Special offer 3 for £1, postage 15p.

CONVERTER CHASSIS. New spares for transistorised UHF tuner. Contains 4 gang min. var. cap. 4 tube trimmers, in screened sections, 25p, post 15p.

PRINTED CIRCUIT BOARD for Digital Clock. Printed Circuit Board for 4 Digit Readout. Size of boards 4" x 3". £1.50 each. Stamped Addressed envelope for details.

JACKSONS 6/36 slow motion dial and drive, £1.55, post 15p.

WE WOULD BE PLEASED TO RECEIVE QSL CARD FOR DISPLAY

TUNER UNIT. 2-Roller coils, 1½" dia. 5¼" long. 3-Miniature D.C. motors. 3-Sangamo relays 200-0-200 micro amp movements. 6-700 ohm sealed relays. 3-170 ohm sealed relays. 1-500 uA meter, £3.00, post 65p.

IF STRIP. Ex R3673 Rx. 7.5 MHz with circuit. Less valves. 8 B7G PTFE holders. Sealed relay twin 500 ohm coil. 12-pin plug and socket, 50p, post 20p.

CONVERTER 20 to 90 MHz. 7.5 MHz IF. Ex 3673 Rx. 2/EF91's. 1-616 Osc., £1.25, post 20p. Some less valves, 75p, post 20p.

TRANSFORMER. Specially wound for Digital instruments. 200 volt 40 mA HT. 6 volt 1A. Two windings LT. Will supply 6v. 2A. or 12v. 1A. CT 2½" x 2" x 2½", £1.50, post 25p.

CV416 (6F17) VALVE, 30p each, post 5p, or 4 for £1.20, post paid.

SPECTRUM ANALYSER, MARCONI OA1094. Frequency range 0-10 kHz. 200-800 kHz. 3-1 to 30 MHz. Complete on trolley. 1 only, £250. with Handbook.

ALI. MINI BOXES. With fitted lid. Post 5p per box.
3" x 2" x 1", 33p 5½" x 4" x 1½", 43p
4" x 2½" x 1½", 38p 4" x 2½" x 2", 38p
4" x 4" x 1½", 38p 5" x 2½" x 1½", 38p

INSTRUMENT CONTROL KNOBS. Black with bright Ali. centre, ½" brass insert with grub screw. 1", 1½" and 1¾" dia. 15p each, post 5p each. Any excess refunded.

Business Hours : Tues.-Fri., 9.30 a.m. to 6.30 p.m.
SATURDAY : 9 a.m.-5 p.m. OPEN ALL DAY.
CLOSED ALL DAY MONDAY.

WE WELCOME ALL ENQUIRIES HOWEVER SMALL
Stamped addressed envelope please for special offer list

LOWE ELECTRONICS

119 Cavendish Road, Matlock, Derbyshire. DE4 3HE

Tel: Matlock 2817 or 2430 9 a.m. - 9 p.m.

Bill: G3UBO

Alan: G3MME

MAIN DISTRIBUTOR FOR YAESU MUSEN EQUIPMENT

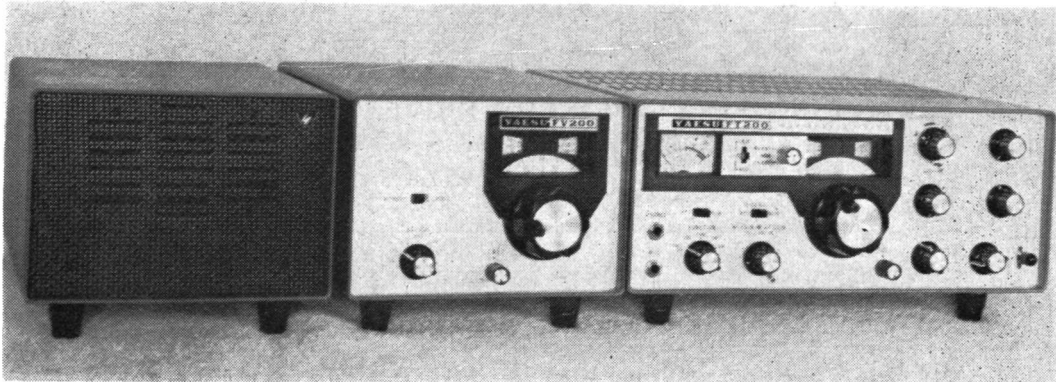

There are several reasons why we feel the Yaesu FT200 is such a good buy. No attempt has been made to permit a CW filter to be fitted. The designer has not allowed any switching around the filter and thereby achieves maximum isolation between filter input and output. This accounts for the incredibly good skirt selectivity of the FT200. Skirt selectivity which, in our estimation is, for SSB, the best of the Yaesu range. We also like the pre-mixed oscillator chain which gives the superior signal handling and low noise capabilities of a single superhet while at the same time retaining a 9MHz I.F. with its superb image rejection. Lots of other things add up to an unmistakable best buy. Stable, accurate, gear-driven solid state VFO, VOX, break-in CW, CW sidetone monitor, RIT, 100 kHz marker, 300W SSB speech peaks, half microvolt sensitivity, etc. etc. All in all, at £250 it would still be a good buy. At £134 (plus A.C. psu £38) it's INCREDIBLE.

FT101 Transceiver	£240-00
FT101 fitted 160m.	£255-00
FT101 fitted 160m. and new PA coil	£255-00
SP101 matching speaker	£10-00
FV101 remote VFO	£38-00
FT101 mobile mount	£5-00
FL2100 Linear	£135-00
FRdx400 super de luxe Receiver	£160-00
SP400 speaker	£10-00
FLdx400 transmitter	£140-00
FL2000B Linear	£135-00
FT-2F 2m. FM	£84-00
FT-2 Auto	£129-00

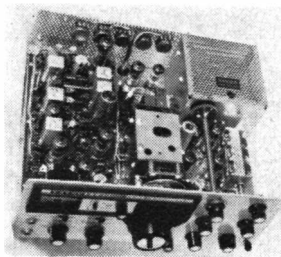

FT200 Transceiver	£134-00
FP200 AC p.s.u./speaker	£38-00
FV200 remote VFO	£38-00
DC200 mobile p.s.u.	£45-00
FTdx401 Transceiver	£215-00
FV401 remote VFO	£38-00
SP401 speaker	£10-00
YC305 counter	£79-50
FT75	£80-00
FP75	£20-00
DC75	£20-00
FR-50B receiver	£52-00

The above equipment is ex-stock and apart from sundry spares which go first-class mail, we send all equipment by Securicor, who almost invariably deliver within 24 hours and, more important, treat the gear gently. There is no extra charge for this service, nor for the fact that all equipment is thoroughly checked before despatch. Plus of course our unbeatable 12-month guarantee and our money-back guarantee.

Other new equipment: (post paid)

Plain morse keys, ball-bearing pivots, £1, Katsumi EK-9X electronic keyers £8-20, Asahi twin meter SWR meters £6-80.

Dummy Load/Wattmeters: please do not confuse these with the cheap and cheerful so-called power meters which are frequency conscious, impedance conscious and of dubious accuracy. These are Wattmeters (a horse of somewhat different colour!), they are neat and compact (approximately 5" x 5" x 10" deep), but MORE important are accurate and MOST important present a substantially constant 50 ohms impedance over the frequency range of 3 MHz to 500 MHz. They are switched to read F.S. 20 or 120W and give useful readings as low as 1/4W. The SWR is better than 1 : 1.2 over the entire range and no serious VHF operator should be without one, particularly at this price, £32.

Valves: Postage Extra: 6AH6 80p, 6 AQ5 75p, 6BZ6 42p, 6U8A 80p, 6CL6 50p, 6AN3 74p, 6EW6 75p, 6EH7 45p, 6BMS 50p, 6AW8A £1-75, 7360 £2-10, 12 BY7A 70p, EF183 45p, 6GK6 92p, 6JS6A/B/C £1-75, 6 KD6 £1-75, 6146B £2-60, 61M6A £1-25, 6LQ6 £2-25, 572B £8-00.

Special Brand-new Surplus 6AK5 special quality 10p.

Please include lots for postage on valves—we'll refund any excess.

Antennae:

Asahi AS-33-3-element trap beam for 20, 15 and 10m. Beautifully made, low SWR (better than 1.5 : 1), handling 2kW p.e.p., with an 8 dB gain. Anyone knowing our QTH knows how exposed it is—our AS-33 has withstood severe gales without any trouble. It flops not, neither doth it droop. Its price puts it out of the cheap and cheerful class, but it is our opinion that quality and performance are worth paying for. £60, carriage paid.

Asahi Echo-8G.40 to 10m. trap vertical. Self-supporting, handles 1kW p.e.p. SWR better than 1.5 : 1. This vertical can be mounted on a post at ground level, in which case radials are not necessary, although they are always beneficial, or it can be mounted up aloft, in which case it can be treated as a ground plane with radials as per instruction sheet. £17-50, carriage paid.

Digital Clocks:

Copal 222 £7-50, Digiator £5-50.

Mikes, filters, mobile whips, connectors, coax, rotators, etc. etc. Everything for the complete station.

Second-hand Equipment. All mint, fully checked, serviced where necessary and complete with manual. Each one carries our comprehensive guarantee. Please note that carriage by Securicor is £1.75 extra on all second-hand gear.

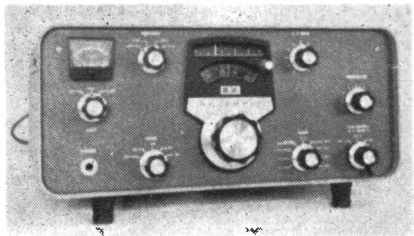

Heathkit SB301 (illustrated), mint condition with extra AM filter and 2m^r converter, £95.00.

Lafayette HA350 (illustrated), another specimen. Still, in our opinion, a best buy in its price class. The true Kokusai mechanical filter gives the required selectivity for SSB and sensitivity and stability are unequalled at the price, £50.

Sommerkamp FRdx500 (illustrated). Very, very few ever appear on the second-hand market. Here's a good one at £95.

- Sommerkamp FR100B, excellent £75.00
- KW201 £75.00
- Inoue, IC700R £60.00
- Hammarlund HQ170A £70.00

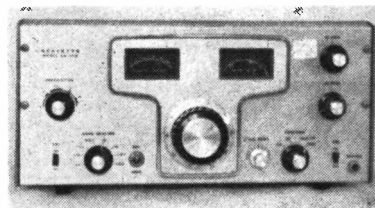

Transmitters: Sommerkamp FL200B £80, Yaesu Musen FL100B £65, Vespa Mk. I £70, Hammarlund Hx50 £80, G and D Linear 600W £35.

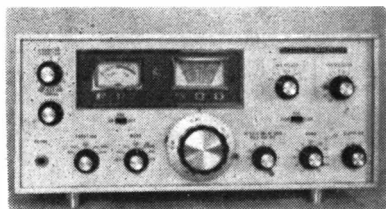

Transceivers. All complete with power supplies, all checked, serviced and guaranteed.

- National NCX-5 ... £175.00
- National NC200... .. £95.00
- National NCX-3 ... £85.00
- KW2000 £120.00
- KW2000A £150.00
- Codar AT5 T28 mobile p.s.u. and remote switch £25.00
- Swan 500 £175.00
- SB101, C.W. filter, mint £155.00
- Trio TS510 £125.00
- KW Atlanta £140.00
- Inoue IC700 £100.00

V.H.F. enthusiasts . . . Do you live in Birmingham, Liverpool, Manchester, Leeds or similar big city? Read on! As you know, in London and the South 2m. FM has caught on well and truly—we are selling FT-2F's like hot cakes. Initially, though, we had an awful job to sell them—nobody wanted to know! Same in the North—nobody wants to know. In order to stimulate northern sales and get a foot in the door as it were, we make the following offer. The first ten members of a club in a large city who join together to form a 2m. FM net get FT-2F's for £50 each. This offer is necessarily limited both in time and scope because we make a very handsome loss on each sale, so don't leave it too long, it's a chance that you'll never get again. Mind you, we're not so daft, because once the first ten are in use in the area, they start to sell fast!

Low Electronics

119 Cavendish Road, Matlock, Derbyshire. DE4 3HE.

Tel. Matlock 2817 or 2430 (9 a.m. - 9 p.m.)

Bill G3UBO, Alan G3MME. Hours: Tuesday to Saturday 9-5.30 (closed for lunch 1-2 and all day Monday).

SERVICE AND SALES (evenings and weekends only): John G3JYG, 16 Harvard Road, Ringmer, Lewes, Sussex. Tel: Ringmer 812071. Sim, 19 Ellismuir Road, Baillieston, Nr. Glasgow. Tel. 041-771 0364.

Sim and John will be Happy to Demonstrate New Yaesu Gear by appointment. They also have a pretty good selection of Second Hand Trade-ins at the right price.

SERVICE ONLY (evenings and weekends): Dave Dryden, G3BKQ, 205 Main Street, Thornton, Leics. Alan Bartlett, GW3YSA, 35 Pen-y-Waun, Efail Isaf, Nr. Pontypridd, Glam. Peter Ward, G3XWX, 47 Radstock Avenue, Ward End, Birmingham, B36 8HD.

SOME RECOMMENDED TITLES BRIEFLY DESCRIBED

BEGINNER'S GUIDE TO RADIO

For many years "Beginner's Guide to Radio" has been extremely popular as an introduction to the subject of radio-and-how-it-works. The many advances made in recent times have rendered a new edition necessary.

This seventh edition has been completely rewritten and brought up-to-date to take account of the latest techniques and methods, and covers every aspect of the modern radio scene, while including the important basic information necessary for the newcomer to the subject.

The reader is guided from the first principles of electricity and magnetism, through radio waves, modulation and radio components, including valves and transistors, taking in radio transmitters and stereo broadcasting, and ending with hi-fi reproduction.

The book will be of interest to all who wish to understand the how-and-why of radio, whether it be for a hobby or a profession.

Seventh Edition

£1.12 post free

49 EASY TRANSISTOR PROJECTS

This book is for the electronic hobbyist who is interested in developing projects that can be fun as well as useful. Most projects can be constructed in one evening using only a few inexpensive parts. Many of the parts can be salvaged from old radio and television chassis.

Each project is presented in an easy-to-understand way, with a parts list and a schematic diagram. Many value substitutions can be made in resistors and capacitors without affecting the end result, providing that the proper transistors, coils, and transformers are used.

Projects in this book, which include an AM radio, an FM receiver, light relay controls, audio amplifiers, code practice oscillators and test equipment—each designed with only two transistor types.

£1.01 post free

110 INTEGRATED CIRCUIT PROJECTS FOR THE HOME CONSTRUCTOR

Integrated circuits are the most important new semiconductor devices to have been developed within the past decade. They are compact, easy to use and less expensive than their discrete transistor-resistor equivalents. This volume gives an entirely practical introduction to these devices by describing one hundred and ten constructional projects in which they can be used.

The projects range from simple low-level amplifiers to complex test equipment and include a number of hi-fi circuits and logic circuits. The integrated circuits used are internationally available types and all the projects have been designed, built and fully evaluated. The book should prove to be of practical interest to the professional engineer, the student and the amateur.

£1.22 post free

110 SEMICONDUCTOR PROJECTS

Due to the rapid advances in semiconductor technology, many engineers and certainly most amateurs have found it impossible to keep track of the new devices that become available because of lack of readable information. This book introduces the reader to such outstandingly useful new devices as the field-effect transistor, unijunction transistors, silicon controlled-rectifiers, silicon planar transistors and integrated circuits, giving their properties and methods of operation, with full constructional details of many exceptionally useful circuits.

Of particular interest to the amateur are simple amplifiers, lamp and relay driving circuits, electronic switches—operated by light, sound or contact with water—and delay circuits ranging from a fraction of a second to 35 minutes. Among the many circuits which will be of interest to the practising engineer are amplifiers with input impedances as high as 500 megohms, voltage and current regulators, waveform generators, analogue-to-digital converters and logic circuits. All circuits are designed around internationally available semiconductor devices.

124 pages, including 110 illustrations

£1.37 post free

RADIO AMATEUR OPERATOR'S HANDBOOK

The opportunity has been taken of bringing this edition—the twelfth—right up-to-date and of incorporating extensive revisions. The book covers in detail the Post Office regulations governing the issue of transmitting licences.

The purpose of this Handbook is to provide all the information which the operator of a radio station may need about such matters as Country Prefixes, Call Sign Areas, Frequency Allocations, Standard Frequency Transmissions, Time Factors, Distance Tables, and so on. For the newcomer, this manual enables him to find the basic answers and to obtain the maximum pleasure from his hobby.

53p post free

HAMS INTERPRETER

This valuable book written by DLICU contains a collection of phrases and expressions designed to assist those amateurs who wish to enlarge their knowledge of various languages for use on amateur radio—it is a must for every DX'er.

63p post free

PRACTICAL INTEGRATED CIRCUITS

This is the first British book to be published on micro-electronics for the amateur experimenter. With circuit diagrams, layouts and easy instructions, it shows how to construct ten practical radio and electronic devices using integrated circuits (IC's) which are now available at low cost from many component stores. Micro-electronics—the big development in electronics since the transistor—involve complex circuits in the form of the integrated circuit (IC) opens up a fascinating new field for the electronics student, constructor and experimenter. This book shows how to get started and produce some really interesting and worthwhile equipment.

£1.01 post free

HANDBOOK OF TRANSISTOR CIRCUITS

By Allan Lytel

Here is a collection of more than 200 practical transistorised circuits for use in counters, power controls, timers, indicators, photoelectric devices, power regulators, amplifiers, power supplies, oscillators, power converters, and other applications. Schematic diagrams, parts lists and descriptions of operation are included for each circuit.

Planned as a supplement and companion volume to author Lytel's previous book, *Transistor Circuit Manual*, many of the circuits employ such specialised semi-conductor devices as silicon-controlled rectifiers, photocells, zener diodes, and tunnel diodes, in addition to standard diodes and transistors.

This book is a handy source of information on the design, operation, and application of a wide variety of transistorised circuits. Engineers, technicians, students, and hobbyists will all find the circuits of interest and the material of value in research, development, experiment, and general studies of circuitry.

£2.35 post free

PRACTICAL WIRELESS CIRCUITS

There are more than 50 different circuits detailed in this book. Transistor receivers, 22 in all, range from an ultra-simple crystal diode circuit to a very sophisticated 10-transistor communications Rx. Valve receivers cover MW, SW and FM. Transistor and valve amplifiers include pre-amplifier, P.A. and Stereo.

There is a chapter on transmitters and transceivers, and another on transmitter and receiver circuits for Model Control. Circuits for an extensive range of Test Gear cover everything from a simple Transistor Tester to a Comprehensive Multimeter, including a Pocket Signal Tracer (RF, AF and IF), also FM, Square-Wave and Noise Generators.

Among the special circuits are a recording level meter for tape recorders, an electronic photographic timer and a solar cell receiver.

The first few simple circuits are accompanied by step-by-step instructions to enable the absolute beginner to gain enough experience with circuitry building to tackle the more complicated work.

£1.34 post free

Some of the Books described here are American in origin

The above prices include postage & packing.

Delivery is from stock.

Available from

Publications Dept., 55 Victoria St., London S.W.1

(Counter Service, 9.30-5.15, Mon. to Fri.)

SHORT WAVE MAGAZINE

01-222 5341

(Nearest Station: St. James's Park)

(GIRO A/C. No. 547 6151)

THE SENATOR CRYSTAL BANK

G3UGY

Phone: 01-769 1639

CRYSTALS FROM STOCK AT KEEN PRICES

SENATOR CRYSTALS: the first place to contact when you need good crystals quickly.

Here are just a few of the popular frequencies actually in STOCK now :

kHz	Price	MHz	Price
100 in HC13/U ...	£2.50	28-045 in HC25/U ...	£1.60
455 in HC6/U ...	£1.75	28-500 in HC25/U ...	£1.60
500 in HC6/U ...	£1.75	30-000 in HC6/U ...	£1.60
		32-500 in HC18/U* ...	£1.60
1-000 in HC6/U ...	£1.75	34-000 in HC18/U* ...	£1.60
2-000 in HC6/U ...	£1.60	34-500 in HC18/U* ...	£1.60
3-500 in HC6/U ...	£1.75	35-000 in HC18/U* ...	£1.75
5-000 in HC25/U* ...	£1.60	35-500 in HC18/U* ...	£1.75
7-000 in HC6/U ...	£1.50	38-666 in HC18/U* ...	£1.35
7-520 in HC25/U ...	£1.80	40-000 in HC18/U* ...	£1.60
7-755 in HC6/U ...	£1.80	42-000 in HC18/U* ...	£1.60
9-000 in HC6/U ...	£1.50	70-000 in HC18/U* ...	£2.00
10-000 in HC6/U ...	£1.50	71-000 in HC18/U* ...	£2.00
10-245 in HC25/U ...	£1.60	72-050 in HC18/U* ...	£1.75
11-000 in HC6/U ...	£1.50	72-425 in HC18/U* ...	£1.75
19-500 in HC6/U ...	£1.60	72-500 in HC25/U* ...	£1.75
24-500 in HC18/U* ...	£1.60	72-525 in HC18/U* ...	£1.75
25-000 in HC6/U ...	£1.60	96-000 in HC6/U ...	£2.00
26-500 in HC18/U* ...	£1.60	116-000 in HC18/U ...	£2.80

* = Also in HC6/U

TWO more stock frequencies : 454 kHz and 456 kHz in HC /U, useful for side-band filters etc. at £1.75 each.

And here's our STOCK range of BRAND NEW HC6/U 8 MHz for 2M :

8-002 8-007 8-012 8-018 8-021 8-0266 8-032 8-041 8-043 8-047 8-048 8-0555 8-058 8-061 8-070 8-081 8-092 8-100 8-104 8-107

All at £1.25 each, post free. These crystals pull well when VXO'd

Here are some popular frequencies for VHF, home station, mobile channels and R.A.E.N. ALL IN STOCK :

8-0555 MHz in HC6/U for TX × 18 =	145-000 MHz 2M Mobile	£1.25
44-7666 MHz in HC6/U for RX × 3 +	10.7 MHz	
	= 145-000 MHz 2M Mobile	£1.80
8-100 MHz in HC6/U for TX × 18 =	145-800 MHz for RAEN	£1.25
45-0333 MHz in HC6/U for RX × 3 +	10.7 MHz	
	= 145-800 MHz for RAEN	£1.80
12-975 MHz in HC6/U for RX × 12 =	10.7 MHz	
	= 145-000 MHz 2M Mobile	£1.60
11-1916 MHz in HC6/U for RX × 12 +	10.7 MHz	
	= 145-000 MHz 2M Mobile	£1.60
12-0833 MHz in HC6/U for TX × 12 =	145-000 MHz 2M Mobile	£1.60

Mail Order SENATOR CRYSTALS Dept. S.W., 36 Valleyfield Road, SW16 2HR

8-7825 MHz in HC6/U for TX × 8 =	70-260 MHz 4M Mobile	£1.60
29-780 MHz in HC6/U for RX × 2 +	10.7 MHz	
	= 70-260 MHz 4M Mobile	£1.65
6-74666 MHz in HC6/U for RX × 12 =	10.7 MHz	
	= 70-260 MHz 4M Mobile	£1.60
11-710 MHz in HC6/U for TX × 6 =	70-260 MHz 4M Mobile	£1.60

You'll find the above frequencies may be suitable for your PYE Cambridge, Ranger, Vanguard and other makes of ex-commercial R/T gear for the well-used mobile call channels. Check up with crystal multiplication data and crystal spec. in equipment manuals for suitability.

116-000 MHz in HC18/U NOW IN STOCK at £2.80. Ideal for 2M converter for I.F. 28-30 MHz, thus dispensing with need for osc. multiplication.

160m. modification on the FT-101. See February 1972 Radio Communication, page 84 using 7-520 MHz in HC25/U. In stock at £1.80.

PYE Cambridge 2nd oscillator crystal-change. See January 1972 Radio Communication, page 10 using 10-245 MHz in HC25/U. In stock at £1.60.

160m. modification on the JR-310. See December 1971 Short Wave Magazine, page 601 using 7-755 MHz in HC6/U. In stock at £1.80.

70cm. Converter—See December 1971 Short Wave Magazine, page 611 using 96-000 MHz. In stock at £2.00.

"TWO MORE STOCK FREQUENCIES. 1-6184 MHz and 1-6202 MHz (1.8 kHz apart) in HC6/U useful for side-band filters etc. at £1.80 each."

New facility at SENATOR enables us to REDUCE PRICES on many made to order units, as follows :

50—	149.9 kHz in HC13/U	£4.60
150—	499 kHz in HC6/U	£3.85
450—	500 kHz in HC6/U	£3.50
501—	999 kHz in HC1/U	£4.50
1-000—	1.39 MHz in HC6/U	£3.20
1-40 —	.00 MHz in HC6/U (18/U & 25/U over 5 MHz)	£2.00**
20-00 —	9.99 MHz in HC6/U ; HC18/U ; HC25/U	£2.25**
60-00 —	9.99 MHz in HC6/U ; HC18/U ; HC25/U	£2.50**
80-00 —	114.00 MHz in HC6/U ; HC18/U ; HC25/U	£3.00**
114-00 —	140.99 MHz in HC6/U ; HC18/U ; HC25/U	£7.00
141-00 —	175.99 MHz in HC6/U ; HC18/U ; HC25/U	£8.75
176-00 —	200.00 MHz in HC6/U ; HC18/U ; HC25/U	£12.00

Under 1 MHz to -01% tolerance. 1 MHz upwards to -005% tolerance. Closer tolerances by quotation.

THE AMATEUR RADIO SHOP G4MH

13 CHAPEL HILL, HUDDERSFIELD.

Telephone: 20774

(Member of Amateur Radio Retailers Association)

Agents for : KW, Eddystone, Yaesu Musen, Codar, Trio, J-Beams, Tavasus Mobile AE's.

K.W. Atlanta	£210	Trio TS510 ...	£180	FT101 ...	£240
2000B	...	JR 599 ...	£199	FT 401 ...	£215
204 TX	...	JR 310 ...	£83.50	FT 200 ...	£134
202 RX	...	9R59DS ...	£57.50	AC PSU ...	£38
107 ATU	...	£40	MIC's SWR ind. etc.	FRDX 400 ...	£160

The 4MH 2 mtr. Tx, £11.50. Matching Modulator, £11.50 (the pair for £22). Morse Practice Osc., 90p. S.S.M. Converters, R5GB Publications etc., 2 mtr. xtals.

Large selection of S/hand gear too fast moving to advertise, due to rallies, etc. (s.a.e. for lists). All guaranteed. More wanted for cash. C.U. at : Belle Vue, Northern Mobile Rally, Leeds and Hull. If you require special items, ring and we will bring them along.

H.P., Full Service, Car Park, Closed Tuesday.
Translation Service (S.A.E. details)

To become a Direct Subscriber costs you (first-class posting) £3.00 for a year of twelve issues, starting any time now. Orders to Circulation Dept., Short Wave Magazine, Ltd., 55 Victoria Street, London, SW1H-0HF



OUR AESU MUSEN DISTRIBUTOR

When you buy YAESU from their U.K. main distributor you get the best engineering standards in the world and superb performance too. All items carry the YAESU 12 months guarantee. We also do free labour on warranty claims, and carry an excellent stock of spares. Remember, we were FIRST to offer YAESU on the UK market and FIRST to give you SECURICOR 24-hour delivery; a standard of service which cannot be surpassed.



THE SUPERB FT-101 (Ex-Stock) (with 160m., £15 extra).



Deposit £24 followed by monthly payments as follows:
 3 at £21, 9 at £20
 or 5 at £15, 13 at £14 or 6 at £12, 18 at £11
 or 14 at £10, 16 at £9 or 9 at £9, 27 at £8

The FT-101 is a 260w. p.e.p. SSB/AM/CW transceiver with an amazingly sensitive receiver. You'll hear signals which are inaudible on many other equipments. It comes complete with speaker and microphone, AC and DC P.S.U.s built-in. There's nothing to touch it for value!

MATCHING FL-2100 LINEAR (Ex-Stock).



The FL-2100 is designed to match the FT-101 and runs 1200w. p.e.p. If it's a linear you require for some other exciter, compare the FL-2100 with 2 fans, AC and HV safety interlock and fully screened input circuitry. You'll not find better value!

YD844 FV200 (Ex Stock) £38-00 FT200 (Ex Stock) £132-00 FP200 (Ex Stock) £38-00

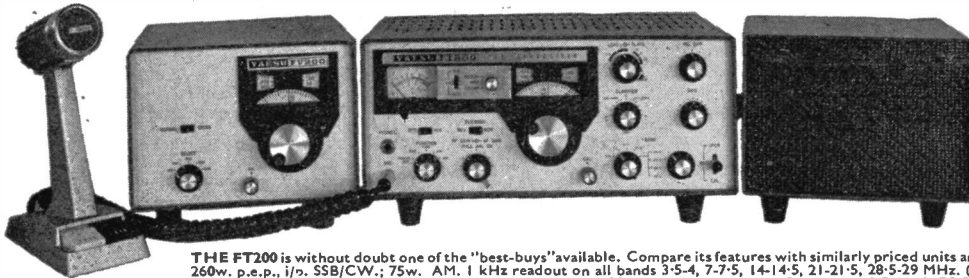

★ WE GUARANTEE ALL ITEMS MARKED EX-STOCK ARE AVAILABLE FOR IMMEDIATE DELIVERY

THE FT200 is without doubt one of the "best-buys" available. Compare its features with similarly priced units and kits. SPECIFICATION: 260w. p.e.p. i/p. SSB/CW.; 75w. AM. 1 kHz readout on all bands 3-5.4, 7-7.5, 14-14.5, 21-21.5, 28-5-29 MHz. (3 optional crystals available for 28-28.5, 29-29.5 and 29.5-30 MHz. Stability: 100Hz 30 mins. after warm-up. Sensitivity: 0.5µV 10dB/S+N. Selectivity: 2.3 kHz (6dB), 4kHz (60dB). Solid state FET VFO with excellent linearity (like all YAESU VFO's). 25/100 Calibrator. VOX/PTT. Separate DC supply available for mobile use. Clarifier ±5 kHz. Break-in CW keying.

FLDX400 (Ex Stock). TRANSMITTER

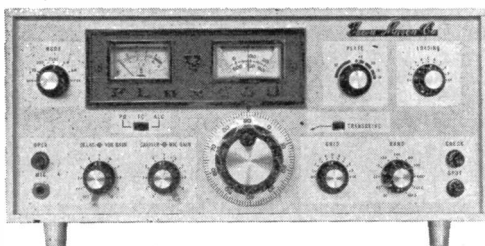

The FL400 SSB/CW/AM transmitter covers 80-10m. and is designed to operate separately or transceive with the FR400 receiver. At 240w. p.e.p. input this makes an ideal station transmitter.

Transceives with

★
NEW
FR400SDX
 fitted 4m
 + 160-2m!
 (Ex-Stock).

FRSDX 400 (Ex-Stock)

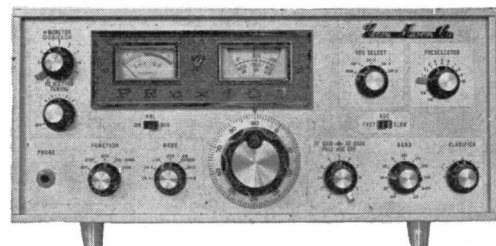

Made especially for WESTERN ELECTRONICS, the FR400SDX is the only receiver in the UK covering 160m.-10m. + 4m. + 2m. It is fitted with 4 mechanical filters, rejection tuning and a host of other features for FM/AM/CW and SSB reception.

YAESU PRICE LIST FREE DELIVERY NORMALLY 24 HOURS MANUFACTURERS GUARANTEE

FT101 fitted 160m. ...	£255-00	FR400DX receiver ...	£120-00	AM filter FR400 ...	£7-50	YC-305 Frequency counter ...	£79-50
FT101 transceiver ...	£240-00	FR400S DX Receiver, 160-2m. ...	£160-00	FTS60 Transceiver ...	£195-00	FT2F 2m. transceiver ...	£84-00
FV101 Remote VFO ...	£38-00	FL400 Transmitter ...	£140-00	FV400S remote VFO ...	£38-00	FP2AC Ac PSU for FT2F ...	£25-00
FL2100 Linear Amplifier ...	£135-00	SP400 speaker ...	£10-00	FT401 Transceiver ...	£215-00	FP2AC/B AC supply with batteries ...	£34-00
SPI01 Speaker for FT101 ...	£10-00	FL2000B Linear amplifier ...	£135-00	FV401 Remote VFO ...	£38-00	Crystals for FT2F ...	£1-60
Fan FT101 ...	£8-00	FM Unit for FR400 ...	£7-50	SP401 Speaker ...	£10-00	FP50DX Low pass filter ...	£6-60
FT200 Transceiver ...	£134-00	FC2 2m. converter ...	£12-00	FL2500 Linear amplifier ...	£118-00	Mobile mount FT101 ...	£5-00
FP200 AC supply for FT200 ...	£38-00	FC6 6m. converter ...	£12-00	YD846 Hand microphone ...	£5-00	CW filter FT101, FT401, FT560 ...	£15-00
DC200 PSU for FT200 ...	£48-00	CW filter FR400 ...	£12-50	YD844 table microphone ...	£12-00		
FV200 Remote VFO for FT200 ...	£38-00						

MIDLANDS AGENT. Contact Andy Martin, G3UDR, on Shipston-on-Stour 61839 who has most YAESU items available for immediate collection.
 Hours of Business: 9-5.30 p.m. Mon.-Fri., Sat. 9-12.30 p.m.

WESTERN ELECTRONICS (U.K.) LTD.,
 Tel.: TOTTON 4930 and 2785.

OSBORNE RD., TOTTON, SO4 4DN, HANTS.
 Cables: "AERIAL", SOUTHAMPTON.

GREAT NEWS! NEW RANGES OF ANTENNAS!

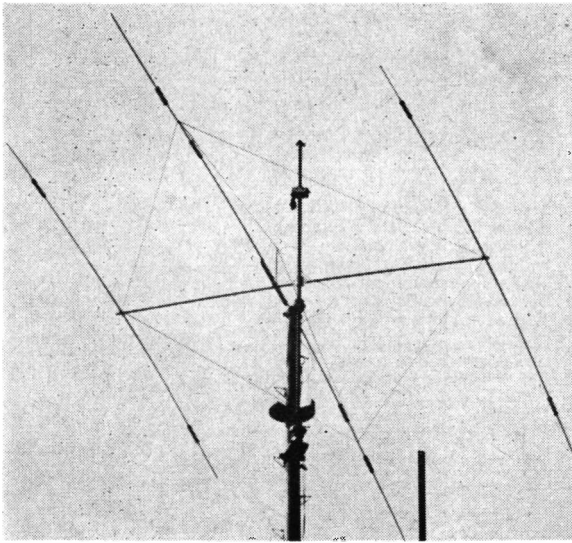

THE FINEST FROM JAPAN

ASAHI

THE AS-3340 10-40m. BEAM
(illustrated left) ONLY £76-50 (carriage paid)

FORWARD GAIN: UP TO 8dB. FRONT/BACK RATIO; 20dB. POWER HANDLING; 2 kW p.e.p.

AS-3340 10-40m. 3 ele.	£76-50
AS-33 10-20m. 3 ele.	£62-25
AS-23 10-15m. 3 ele.	£58-50
AS-21 15m. 3 ele.	£31-50
AS-203W 20m. 3 ele.	£56-70
AS-154 15m. 4 ele.	£40-50
AS-153W 15m. 3 ele.	£32-70
AS-104 10m. 4 ele.	£33-90
AS-103 10m. 3 ele.	£29-95
Echo-8G 10-40m. Vertical	£17-25
AS-2HG 2m. 3-4dB gain G.P.	£7-50
AS-303A 10-80m. Mobile... ..	£33-00

SWR 1 POWER METERS	
ME-11B	£7-20
ME-11N	£13-00

THE FINEST FROM CANADA

GEM-QUAD

NOTE THESE STAR FEATURES

£65-00 (carriage paid)

- ★ Weighs only 21 lbs. (half the weight of other goods).
- ★ Withstands 100 m.p.h. winds.
- ★ Can be converted to a 3 ele. or 4 ele. quad.
- ★ Fibreglass tri-dectic spreaders for low wind loading.
- ★ Single 52 ohm feed. ★ Balun included.
- ★ Low angle radiation. ★ Completely weather resistant.

18AVT
(Illustrated Right)

HY-GAIN (carriage paid)
HY-GAIN 18AVT/WB THE GREAT NEW WIDE BAND
VERTICAL SELF SUPPORTING FOR, 10-80m. (ex-stock) £33-00.

Take the wide band, omnidirectional performance of Hy-Gains famous 14AVQ/WB add 80 mtrs. plus extra heavy duty construction and you have the new 18AVT/WB ★ True $\frac{1}{2}$ -wave resonance on all bands ★ 52 Ω I/P ★ SWR of 2: 1 or less at band edges ★ 1 kW (AM) ★ Radiation pattern has an outstandingly low angle ★ Roof or ground mounting.

Hy-tower, 10-80m.	£99-50	TH6DXX, 10-20m. 6 ele. beam	£88-00	203BA, 20m. 3 ele. beam	£67-50
18V, 10-80m. vertical	£10-90	TH3MK3, 10-20m. 3 ele. 2 kW	£69-50	153BA, 15m. 3 ele. beam	£33-00
12AVQ, 10-20m. vertical	£16-50	TH3 Jnr., 10-20m. 3 ele. 600w.	£48-00	103BA, 10m. 3 ele. beam	£26-50
14AVQ, 10-40m. vertical	£18-50	Hy-Quad, 10-20m. 2 ele.	£62-50	18TD, Reettape portable dipole	£41-00
18AVT, 10-80m. vertical	£33-00	DB10-15, 10-15m. 3 ele.	£51-00	LA1 Lightning arrestor	£14-50
LC80Q, 80m. coil for 14AVQ	£6-70	204BA, 20m. 4 ele. beam	£80-00	LA2 Lightning arrestor	£2-50

MOSLEY ANTENNAS (ex-stock, carriage paid)			
Mustang, 10-20m. 3 ele.	£39-50	TA33 Jnr. "E", 10-20m., fits 2" mast	£35-00
TA33 Jnr., 10-20m. 3 ele.	£34-50	TA32 Jnr., 10-20m. 2 ele.	£24-50
		TA32 Jnr. E, 10-20m. 2 ele.... ..	£25-00
		Atlas Vert., 10-40m.... ..	£20-50

J BEAM ANTENNAS (ex-stock, carriage paid)			
10/4Y, 10m. 4 ele. array	£21-90	2/XD, Crossed dipole	£4-20
4/3Y, 4m. 3 ele. folded dipole	£3-85	2/10XY, Cross polarised 10 ele. yagi, 12" boom	£11-00
4/4Y, 4m. 4 ele. folded dipole	£5-10	2/0V, Omni or bi-directional	£6-50
PM4/2, Coax harness to match 2 x 4m.	£4-10	2/8, 2m. Double 4 slot fed	£4-60
2/4Y, 2m. 4 ele. folded dipole	£2-65	2/12, 2m. Double 6 slot fed	£6-15
2/6Y, 2m. 6 ele. folded dipole	£3-20	2/16, 2m. Double 8 slot fed	£7-65
2/8Y, 2m. 8 ele. folded dipole	£3-80	2/HO, 2m. Halo mobile aerial	£1-30
2/10Y, 2m. 10 ele. folded dipole	£8-20	2/HM, 2m. Halo with $\frac{1}{2}$ " mast	£1-60
2/14Y, 2m. 14 element yagi	£10-50	PM2/2, Coax harness to match 2 x 2m.	£2-60
2/14P, 2m. 14 ele. "Parabeam"	£13-00		

BANTEX FIBREGLASS MOBILE (ex-stock, carriage 50p). 2m. $\frac{1}{2}$ wave £2-75, 2m. $\frac{1}{4}$ wave £6-15, 2m. $\frac{1}{2}$ wave £4-35, 4m. $\frac{1}{4}$ wave £3-00, magnetic mount £4-95.

ROTATORS (carriage): AR20 £20-00 (40p), AR22 £25-00 (65p), TR44 £40-00 (75p), HAM-M £70 (80p).

NEW/USED EQUIPMENT (3 months guarantee over £45-00)

New Trio 9R59DS	£57-50	KW 2000, good	£120-00	Lafayette HA500, very good	£35-00	Sommerkamp FR100B, v.g.	£85-00
New Digital 500	£225-00	KW 2000A, very good	£160-00	Lafayette HA600, very good	£35-00	Sommerkamp FL200B, v.g.	£85-00
New KW Atlanta	£210-00	KW Atlanta, excellent	£160-00	Trio JR500SE, excellent	£50-00	Yaesu FL2000B, very good	£110-00
		Swan 270, excellent	£170-00	Trio 9R59DS, new	£57-50	Hammarlund SP600, good	£75-00

YOUR "ONE-STOP" SINGLE SOURCE OF TOWERS, ANTENNAS, ROTATORS, CABLES.

WESTERN ELECTRONICS (U.K.) LTD.,

OSBORNE RD., TOTTON, SO4 4DN, HANTS.

TEL. TOTTON 4930 or 2785

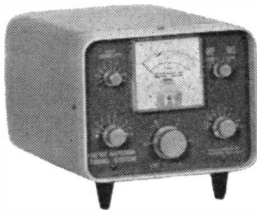

KW 107 ANTENNA
Tuning SYSTEM

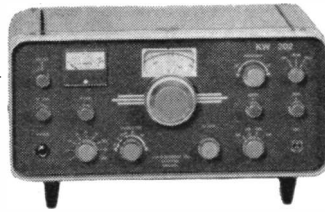

KW 202 RECEIVER, 10-160 metres
SSB/AM/CW, with Mechanical
Filter, built-in 'Q' Multiplier (Peak &
Null), 500 kHz VFO covering all Bands.



KW 204 TRANSMITTER. 10-160
metres SSB/AM/CW. Successor to
the famous KW "Vespa"—Perfectly
matches the KW202 Receiver and is
similar in appearance. 180 watts p.e.p. from trustworthy 6146's.
Built-in Power Supply. Provides "side tone" CW monitoring.
A beautiful compact efficient unit. Price £145 carriage extra.



KW 202
SPEAKER

Two Speed VFO Drive. Excellent Sig./Noise and sensitivity performance. Very attractive (similar in appearance to KW2000B). 100 kHz Crystal Calibrator price £140 carriage extra.

2 Great Transceivers
DELIVERY IMMEDIATELY, FROM STOCK

KW2000B 10-160 metres SSB
TRANSCIVER: 180 watts PEP
10-160 metres, complete with A.C.
p.s.u., VOX P.T.T., I.R.T./I.T.T.

£240 carriage extra.

KW ATLANTA
10-80 metres.
KW Atlanta and A.C.
p.s.u.

£210 carriage extra.

or separate units

Matching **KW1000 LINEAR AMPLIFIER**
for KW 204 and KW 2000B—also available.
1200 watt pep max. Pair T160L/572B tubes
including 2.5kv Power Unit built-in to
KW2000B style cabinet £135 carriage extra.
KW 101 Standing-Wave-Ratio meter, £9.25.
KW 103 SWR/Power meter 0-100 & 0-1000
watts £12.50*. KW103 with Dummy Load
and Coax Lead, £20.50*. KW 107 Antenna
Tuning System including E-Z Match, SWR Ind.,
Dummy Load, Antenna Switch, 5 position,
£40.00*. Also KW Trap Dipole with twin
feeder and 4 other types (only the original
Trap from KW is good enough for you). KW
E-Z Match ATV, KW Low Pass Filters, KW &
H2P Baluns, etc. *Carriage extra.



All Equipment Available
through accredited agents

TRADE-IN EQUIPMENT AND MANY IMPORTED ITEMS AVAILABLE WRITE FOR DETAILS TODAY

K. W. ELECTRONICS LIMITED: 1 HEATH STREET, DARTFORD, KENT
Tel.: Dartford 25574 Cables: Kaydublew Dartford

EASY TERMS ON EQUIPMENT AVAILABLE OVER 12, 18 OR 24 MONTHS



WE ARE THE ANTENNA PEOPLE

WHY BUY IMPORTED EXPENSIVE TYPES—

**BACK BRITAIN—BUY ANTENNA'S
MANUFACTURED 100% IN ENGLAND**

GET FULL VALUE FOR YOUR
MONEY

MUSTANG

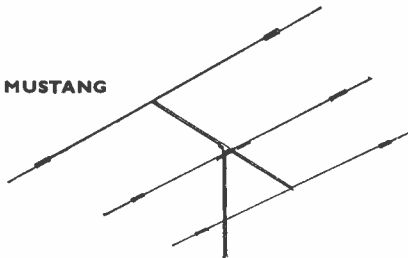

MUSTANG

ELAN	SWL-7	Imported Antenna's	
TA-33 Jr.	RD-5	Classic-33	
TA-32 Jr.	A-315	A-203-C	
TA-31 Jr.	A-215	TA-36	A-92-S
V-3 Jr.	A-310	TA-33 Snr.	TD-2
VTD-3 Jr.	A-210	TA-32 Snr.	DI-10
TD-3 Jr.	TW-3X	RV-4	DI-2

Rotators, Towers, Polythene cord and rope, Coax cable,
Control cable, Twin feeder, SWR indicators and many more
Antenna accessories.

Send for **HANDBOOK/CATALOGUE** containing full details and prices
of Antennae and technical information, 35 pages 15p refundable on
purchase of an Antenna.



V-3 Jr.

ADMINISTRATIVE ADDRESS ONLY

Mosley Electronics Ltd. 40, Valley Road, New Costessey, Norwich, Norfolk Nor. 26K

ADVERTISERS
INDEX

	PAGE
Aero & General Supplies ...	180
Amateur Electronics (G3FIK) ...	183
John R. R. Baker ...	191
Belding & Bennett (Morse) ...	180
J. Birkett	185
"BoomMike" <i>inside back cover</i>	
B.I.E.T.	192
C.D. Telecomms	191
Colomor Electronics, Ltd. ...	181
Derwent Radio <i>inside back cover</i>	
E. & E. Services	180
Echelford Communications ...	187
Eddystone Agents	130
Eley Electronics	192
General Merchandise Credit, Ltd.	188
G.W.M. Radio	182
Hamgear Electronics	182
Heath (Gloucester) Ltd. ...	131
Holdings Photo-Audio Centre (Trio)	191
Home Radio (Components) Ltd.	189
Imhofs	182
John's Radio <i>inside back cover</i>	
K.W. Electronics	140
Lewis Radio	181
Lowe Electronics	134, 135
May (Leicester) Ltd.	180
Markham Electronics	188
Marktyme	181
Mosley Electronics	140
Newbery, Graham	186
North West Electrics	133
P. & P. Developments <i>back cover</i>	
Partridge Electronics, Ltd. ...	185
Radio Shack, Ltd.	132
R. T. and I. Electronics, Ltd. ...	183
Senator Crystals	137, 191
Small Advertisements	185-191
Smith, G. W. (Radio)	129
Solid State Modules	142
Sontronics	<i>inside back cover</i>
Spacemark, Ltd.	182
SSB Products	186
Stephens-James	142
Strumech Engineering	187
S.W.M. Publications <i>inside front cover, back cover, 130, 136, 184, 190, 192</i>	
Taurus Electrical Services ...	180
The Amateur Radio Shop ...	137
The Radio Shop (Bristol) ...	180
The Trading Post	191
J. & A. Tweedy (Electronic Supplies) Ltd.	190
Western Electronics, Ltd. ...	138, 139
Yukan	192

SHORT WAVE MAGAZINE

(GB3SWM)

Vol. XXX

MAY, 1972

No. 343

CONTENTS

	Page
Editorial—Reflection	143
Communication and DX News , by E. P. Essery, G3KFE	144
Items of Interest	150
The Mobile Scene	151
Self-Protecting Stabilised Power Supply Unit , by A. R. Tungate	152
Specially on The Air	153
FM Detector and Limiter , by C. P. Howard, G8ANU	154
Notes on Mobile Noise Suppression , by M. K. Dunn, G3KTL	156
Low Pass Filter for Audio , by J. B. Hodgson, B.Sc., G3YKB	158
Practical Electronic Keyer , by G. Denby, G3FCW	159
"SWL"—Listener Feature , by Justin Cooper	163
VHF Bands , by A. H. Dormer, G3DAH	169
The Month with The Clubs—From Reports	174
New QTH'S	179

Managing Editor: AUSTIN FORSYTH, o.B.E. (G6FO/G3SWM)

Advertising: Maria Greenwood

Published at 55 Victoria Street, London, SW1H-0HF, on the last Friday of the month, dated the month following. Telephone: 01-222 5341 & 5342

Annual Subscription: Home: £2.75 (£3.00 first class) post paid
Overseas: £2.75 \$(7.00 U.S.), post free surface mail

Editorial Address: Short Wave Magazine, BUCKINGHAM, England

AUTHORS' MSS

Articles submitted for Editorial consideration must be typed double-spaced with wide margins on one side only of quarto or foolscap sheets. Photographs should be lightly identified in pencil on the back with details on a separate sheet. All drawings and diagrams should also be shown separately, and tables of values prepared in accordance with our normal setting convention—see any issue. Payment is made for all material used, and it is a condition of acceptance that full copyright passes to the Short Wave Magazine, Ltd., on publication.

© Short Wave Magazine Ltd.

SOLID STATE MODULES

Telephone: HUDDERSFIELD 23991

63 WOODHEAD ROAD, SOLID, LOCKWOOD, HUDDERSFIELD, HD4 6ER

MANUFACTURERS AND SUPPLIERS OF COMMUNICATIONS EQUIPMENT

Call in any time and inspect our own manufacture gear, also our range of Yaesu Mussen and second-hand gear. All the gear should be in stock, but you can always ring for confirmation.

NEW—THE SENTINEL X DUAL GATE MOSFET CONVERTER

This new 2-metre converter is a de luxe version of our well-established Sentinel converter. It has the same basic specification but may be used with an internal mains P.S.U. and with battery supplies. It features an RF gain control to reduce cross modulation and overload of the main receiver and may be switched between mains and battery. Size is 5" x 1 1/2" front 4" deep. I.F.s from stock 28-30 MHz and 4-6 MHz at the moment. Price £16.50 less mains P.S.U. £19.50 including P.S.U. The Power Supply unit may be added easily in future.

THE SENTINEL DUAL GATE MOSFET 2-METRE CONVERTER

The Sentinel X described above is not replacing this standard converter which is still frequently described to us as "the best one around."

- ★ Low noise figure 2dB.
- ★ Gain 30dB.
- ★ Dual gate MOSFETs in the RF amplifiers and mixer for excellent overload and cross modulation characteristics.
- ★ Size only 2 1/4" x 3" x 1 1/4" aluminium case—silver hammer finish with black trim.
- ★ Stock I.F.s: 2-4 MHz, 4-6 MHz, 9-11 MHz, 14-16 MHz, 18-20 MHz, 23-25 MHz, 24-26 MHz, 27-29-7 MHz, 28-30 MHz. Price £13.75.

THE SENTINEL DUAL GATE MOSFET 4-METRE CONVERTER

- ★ Specification as for the 2-metre unit.
- ★ I.F. outputs 4-4.7 MHz, 25-25.7 MHz, 28-28.7 MHz for 70-70.7 MHz input.
- ★ Price £13.75.

THE SENTINEL LOW NOISE FET 2-METRE PRE-AMPLIFIER

- ★ Low noise figure 1dB.
- ★ Gain 18dB.
- ★ A most useful device if your present 2-metre set-up is not quite up to scratch! Price £6.50.

SM70 70cms. CONVERTER

- ★ Low noise figure 4.5dB.
- ★ IF output 144-146 MHz. By using the 70cm. converter with a 2-metre converter you can have a high-performance 70cm. unit at a low price—£13.75.

THE SPITFIRE 2-METRE A.M. TRANSMITTER

- ★ 5 watts input. At least 2 watts output.
- ★ 12 volts operation.
- ★ Modulation wave shaping gives good, clean 100% audio.
- ★ Audio monitoring point for headphones.
- ★ Size 4 1/2" x 2 1/4" x 5 1/2" deep.
- ★ Front panel meter indicates R.F. output and modulation. Price £22.00.

THE SPITFIRE MODULATOR

- ★ Same size and appearance as the transmitter.
- ★ 100% modulates our transmitter.
- ★ Price £10.00.

SOLID STATE 9 MHz SSB GENERATOR

- ★ Selectable USB, LSB, and CW.
- ★ 0.2 volts into 80 Ohms output.
- ★ Sideband suppression 45dB. Carrier suppression 50dB.
- ★ A sound basis for your SSB transmitter.
- ★ Price £11.00 less filter and carrier crystals.
- ★ XF-9A filter £11.00. Carrier crystal £1.50 each.

NOW YAESU MUSEN GEAR FROM STOCK

FT101. This is modified by us to reduce dramatically the cross modulation and intermodulation. These alterations and the top band one carry our normal guarantee. Price £240. Including top band £250. FT200 Transceiver £134, AC supply £38. FT401 Transceiver £215. FT560 Transceiver £195. FR400 Super de Luxe receiver £160. Loudspeaker unit £10. This we offer with service facilities at our premises—often carried out while you wait, as we do with our own equipment.

KVG 9 MHz CRYSTAL FILTERS

XF-9A SSB transmission 2.5 KHz £11.00. XF-9B SSB receivers and transceivers 2.4 KHz £15.00. XF-9C AM 3.7 KHz £15.00. XF-9D AM 5 KHz £15.00. XF-9M CW 0.5 KHz £11.50. Carrier crystals £1.50 each. Plessey SL600 series ICs: SL610, 11, 12 £1.80. SL620, 21 £2.50. SL630 £1.70. NEW—SL623 £8.00. SL640, 41 £3.30. National LM373 £3.20. TAD100 £1.88. LP1175 £1.40. Erie discoidal feed throughs 55p per doz., 6p each. 1000pF discs 5p each, 50p per doz. Mullard tubular ceramic trimmers 6pF 12p each, £1.20 per doz. 18pF 17.5p each, £1.75 per doz.

SECOND-HAND GEAR

KW2000A £150. FL200B £80. HA350s £50-£55. SX117 £80. The ORIGINAL G2DAF MKII as published by Dick £55. LG50 as new £27.50. Come and try all this gear at G3MXG.

STEPHENS - JAMES LTD.

70 PRIORY ROAD, LIVERPOOL, L4 2RZ

Tel: 051-263 7829

G3LRB
G3MCN

The Widest Range of
Equipment in the North

Yaesu-Musen			
FT101 Transceiver	£240	Hy-Gain Antenna Range	
FT2F 2m Transceiver	£84	12AVQ 10-15-20m. Vertical	£15.50
FT200 Transceiver	£172	14VQ/VVB 10-15-20-40m.	
FR500 Transmitter	£140	Vertical	£18.50
FR500 Receiver	£120/£160	18AVQ/VVB 10 through	£33.00
Remote VFO's	£38	80m.	£84.00
SP400 Loudspeaker	£10.00	TH6DX Tribander Beam	£67.50
FL2000B Linear	£135	TH3MK3 Tribander Beam	£46.50
YDB44 Table Microphone	£12	TH3JNR Tribander Beam	£48.00
YDB46 Hand Microphone	£5.00	TH2 MK3 Two Element	£6.75
FT401 Transceiver	£215	LC80Q Loading Coil	£7.75
KW Electronics		BNR6 Balun	£7.75
KW202 Receiver	£140	203BA 20m. 3 Element	£68.50
KW204 Transmitter	£145		
KW2000B Transceiver	£240	G-Whip Antenna Range	
KW2000B Remote VFO	£39.50	160m. Ranger	£7.50
KW Atlanta Transceiver	£210	160/80m. Duobander	£9.00
KW Atlanta VFO	£37.00	10-15-20m. Tribander	£11.50
KW107 Antenna Matching Unit	£40.00	Coils for LF Bands	each £4.00
KW E-Z Match	£15.00	Base mounts	each £1.45
KW103 SWR/Power Meter	£12.50	2 metre S/Bth Vertical	£4.20
KW Trap Dipole	£12.50	Multimobile	£12.50
KW Traps per pair	£4.50		
KW Dummy Load 50 ohms	£7.00	Lafayette	
KW Balun	£1.95	HA6000A Receiver	£45.00
KW105 Matching Unit	£37.00		
Trio		Test Equipment	
JR599 Receiver	£199	Tech 15 G.D.O.	£12.50
9R59DS Receiver	£57.50	OSKER/SWR/Power meter	£18.00
JR310 Receiver	£83.50	Sansei SWR Bridge	£4.00
SP5D Loudspeaker	£4.50	TTC1069 Multimeter	£14.50
Eddystone		TNK TW50 K Multimeter	£8.50
EC10 Mk. 2 Receiver	£79.00	TMLPL436 Multimeter	£7.00
A.C. Power Unit	£7.75	C1000 Pocket Multimeter	£3.25
898 S. M. Drive	£8.92	Omega Noise Bridge TE701	£13.50
EB37 Receiver	£98.00	Omega Noise Bridge TE702	£19.50
Asahi Antenna Range		TE16A Transistor Sig. Gen.	£7.95
3 Band 3 Element Beam	£60.00	Tech to 2 Oscilloscope	£22.50
40 to 10m. Trapped Vertical	£16.50	Medco High Pass Filters	£2.40
		TE 22D Sig-Gen.	£15.00

Microphones	
Shure 210	£5.75
Shure 444	£14.00
Sentinel 2m. Converters	£13.75
Sentinel 4m. Converters	£13.75
Sentinel 70cm. Converter	£13.75
J Beam	
We are now stocking the full range of J Beam antennae, at current prices. Lashing kits, masts etc.	
Copal	
Copal 222 24 Hour	£7.50
Copal 601 24 hour Calendar	£17.00
24 hour Battery Clock.	
Large	£22.00
Antenna Rotators	
£20, £25, £40, £70	
Semi Automatic Bug Keys	£4.50
H2P Balun I	£3.00
Wight Balun	£3.25
Wight Traps	£2.50
Dipole T Pieces	per pair
Egg Insulators	13p
300 Ohm Twin Feeder	3p
50 Ohm coaxial cable	per yd.
75 Ohm twin feeder	per yd.
Tunable RF meters	£4.00
PL259 Plugs	30p
Sockets	30p
Cable reducers	10p
Line connectors	90p
QVO-3-20A	£1.75
QVO-3-10	75p
Codar	
AT5 A.C. P.s.u.	£11.50
AT5 Mk. 2 Transmitter	£22.50
PR40 Preselector	£8.50

Secondhand Equipment	
National NCX5 Mk. 2	£175.00
Codar PR30X Preselector	£6.00
Heathkit DX100 Tx.	£30.00
Heathkit DX60 Tx.	£25.00
Collins 755-1 Rx.	£165.00
Inoue Tx and Rx.	£130.00
KW201 Receiver	£85.00
Eddystone 680X Rx.	£70.00
Codar PR30 Preselector	£5.00
Heathkit HR10 Rx.	£35.00
Hammarlund HX50 Tx.	£85.00
KW Vespa Mk. 2	£90.00
Radiovision Preselector	£5.00
Trio TS510 with A.C. P.s.u.	£130.00
Trio TS510 with A.C. P.s.u. 2 VFO	£140.00
Trio JR500 Rx.	£50.00
Heathkit HW30 2m Transceiver	£22.00
KW E-Z Match	£12.50
Panda Cub Tx.	£22.00
Heathkit SB300 Rx.	£90.00
Osker SWR Bridge	£15.00
Lafayette KT320 Rx.	£20.00
Full range of Eddystone die-cast boxes, Stella cabinets, Ali panels and chassis. Panel meters, plugs, valves. Full information on all products sent on receipt of LARGE S.A.E. Return mail order service on all stocked items. Orders under 25p respectfully declined.	
Carriage/postage extra, all items.	
All RSGB Publications stocked at current prices.	
Full demonstration facilities.	

HP terms arranged on all orders over £25. Minimum deposit 10% on new equipment, 20% on secondhand.

MEMBER OF THE AMATEUR
RADIO RETAILERS ASSOCIATION

Part exchanges welcomed. Equipment bought for cash. After Sales Service. Shop hours 9.30 to 1 p.m. 2.15 to 6 p.m. Half day is Wednesday

FOR THE RADIO AMATEUR AND AMATEUR RADIO

The SHORT-WAVE *Magazine*

E D I T O R I A L

Reflection

For the third month running, we have to use this space to explain why—because of circumstances quite outside our control—the distribution of this issue may be delayed.

This time it is the Trouble on The Railways. It is astonishing how few people realise that the Post Office clears the bulk of the mail mainly by ordinary train, and that between the big centres of population these trains run from about midnight till the early morning.

At the time of writing, all this movement has become gummed up. It means not only that ordinary mail delivery is slowed but also that parcels can be held up almost indefinitely.

Our normal distribution is through Post Office channels—whether the single copy to a subscriber in Belfast or Bournemouth, or the bulk order by parcel to retailers in Newcastle or Newport, Mon.

Unless the mail stoppage became unblocked by about April 25, there is no knowing when this issue will reach readers.

These months since Christmas have presented us with a series of sickening and infuriating practical production problems, none of which were within our control and all costing a great deal in terms of time, money and effort in the attempt to overcome them.

In all his 30 years' experience, the writer of this piece has never had to contend with such frustrations as during the last few months.

*Austin Smith,
G6FO.*

WORLD-WIDE COMMUNICATION

COMMUNICATION and DX NEWS

E. P. Essery, G3KFE

WHEN the band conditions are too flat or too noisy to be enjoyed it is the time of year gardens become a pleasure to sit in—but can someone explain how it happens that XYL's demand lawn-mowing or other equally taxing forms of exercise the very instant the band of interest shows signs of opening-up? Conversely, why is it that when one is willing to cut the grass because static levels are too high, a cloud-burst develops at the precise moment one sallies forth with the mower!

But enough: To our mutttons. By and large one could say the bands have lived up to their reputations at this season, with the proviso that already they seem to be showing signs of dropping into the summer doldrums. Let us see what the keen types all have to say of things.

Top Band

The "season" is more or less over at the time of writing, although during June there will be the South American tests to keep the faithful entertained. We have a note on this from PY1DVG. Tests will be run each night during June, starting at midnight GMT. For the first five minutes the stations North of the Equator call, and every alternate five minutes, the Southerners having their call during 0005-0010, and every alternate five minutes. As for frequencies, the Northerners should be in the 1825-1835 kHz area, those South of the Equator using 1800-1807 kHz. As this series is primarily for the non-VE/W stations, they are asked to avoid using the "DX-window" frequencies, but if they must try, to operate as low as 1824 kHz. Of the countries known or expected to be on down South, there are PY, ZP, ZD9, VP8, LU and CX.

G3ZYY has been sculling around Hong Kong and Singapore, although by the time this is in print he will be back in the U.K. Though he was not able to get a ticket for the DX places he touched, he did manage to obtain from source a FT-101 (with

the Top Band modification fitted) and received his /M permission, so Trev will no doubt be turning up on Top Band or Eighty ere long.

The Top Band activity of G2HKU (Sheppey) is slightly greater than lately, and Ted managed to make SSB contacts with GM3HLQ, PA0PN, OL1API, and GW3VLX/P, while the CW made short work of GM3ANO and HB0XIX.

G3TKN is science master at a school in the Isle of Wight, where he is operational with a Codar AT5 and B-40 receiver, worked into a half-wave at 45 feet. The interesting thing about this is that their main operating times are lunch and late afternoon; at these sort of times, the AM gets into the London area quite well, but most of the signals have some QSB on them—a situation which strongly suggests there is at least some sky-wave propagation in daylight.

Because of the early posting of this piece last month, the letter from G4ABQ advising his exercise on Ailsa Craig was too late to cover—they were to have been mainly 160 and 80 metres over the weekend of April 15/16.

G4ALG (Reading) is on Top Band at the moment, but has an HF transmitter in the offing, which will make him keen to clear his TVI so he can go on the DX bands in TV hours.

Reverting to the international aspect, we have a nice letter from HB9NL with his pickings over the season just over. Frank offers no less than *eight* HB "Firsts"—for his contacts with VP2A, ZD8AY, 8P6DR, PY1DVG, VK6NK, 5Z4MO, ZD9BM and VK5KO; in addition there were some repeat-QSO's—notably with VK's, W1, W2, W3, W4, W8 and W9 call areas. For a little bit of late extra, your scribe heard, on April 10, HB9NL working VK3CZ at about 2040z, the report to the VK being 469—the VK was all of RST-229 in the G3KFE receiver, but nonetheless provided one a big thrill! On a different tack,

HB9NL wants to know the QSL address of HZ1KE, worked on Top Band but not to date confirmed. The only suggestion we can offer is to try sending a card to HZ3TYQ, Victor Crawford, P.O. Box 1721, Aramco, Dhahran, Saudi Arabia.

The absence of G3DCS (Ipswich) from the piece of late is all explained—Enver has been somewhat QRL but March brought some improvement in the situation, with, on Top Band CW, OK1MAC, OL1APC and OL5ANJ, as well as the odd QSO on other bands, as reported elsewhere.

Eighty

An opportunity now, for your old scribe to relate a Sad Story with a Moral, in true Victorian fashion. It must be said that G3KFE is not exactly an addict of Eighty; but it occurred to him that his new aerial for Top Band could well be loaded-up on Eighty. Now, KFE has an all-band, match anything-to-anything, box of tricks which connects the rig to whatever aerial he wants to use, or can dream up. But this time, after two days of fiddling, the aerial still just did not want to know. Surprise, surprise—when the penny dropped, he found he had accidentally cut the Top Band wire to be *exactly* $\frac{3}{4}$ -wave on the frequency the Tx was trying to push power out on—and the one thing that ATU couldn't cope with was a resonant length.

However, to more happy thoughts: G4AMJ (St. Ives) finds he now stands at 138/23 worked/confirmed—no doubt the bureaux will swell the second total in due course. As for Eighty, his SSB came up with VP9GE while CW accounted for VP2AAA, VE2NV and VP2MU.

Quite a long letter from G4AMT (Penzance)—one day your conductor will post to G4AMJ his letter from G4AMT and *vice-versa*, which ought to start a riot in Cornwall! However, Terry found 80m. plagued with QRN, and when conditions seemed good, little DX was in evidence. The highlight was working 6D4J in

Benito Jaunez Is., in great demand but not seeming to make many contacts. Other SSB exchanges, between 0600 and 0900z, included EA6BN, VE1MC, VE1ADV, VE1FO, K1OME, YV4YC, 3A0GA, ZL4KE and ZL4GA.

A long list and a short letter from G3JFF (Cowplain) who did mention his requirement for a pair of "Mk. I ears" for DX. However, even without this valuable aid, CW accounted for HB0XJJ, VP2AAA, VP2MU, VE1 and VE2.

From W6AM (Long Beach) come two letters, the first due to post delays. Don seems to have spent quite a while on 80 metres working 6W8DY, on SSB, plus CW with 8P6DR, G4ALE and 9Y4OV.

As in all things, a little of what you fancy does you good—so G2HKU spent a bit of time on each band, on 3.5 MHz hooking up with VE1FO, HK1NR, HK4DF, HK6BRK and 8P6AY, all with Sideband.

G3NOF (Yeovil) mentions 3.5 MHz as an afterthought this time. Don raised nothing exciting, although GB2MT, UA1WAF, UP2ER, UV3CO, UW3NG, UK1ABB, VE1OC, VE1QM, VO1BV, VO1NP and VP2LAT were all interesting in the SSB mode.

For a while, we gather, this is the last report from GM30OK (Irvine), as he is going to MP4-land to work on an off-shore drilling rig, one week ashore and two aboard—so we should hear some activity from him as soon as things are set up. However, it is understood the local QRM on the Rig is pretty tough—it goes on for twenty-four hours daily! As to the home catch on Eighty, GM30OK offers CW with EQ2BQ, FC0VQ, PJ7VL (a new country) TA3GZ, UA0AAK, UF6FAG, UH8CS, UI8BI, UI8IF, UL7CH and 9H3B.

For G3DCS the crying need of the moment is an audio filter at 600 Hz to back up the transceiver for CW—every time Enver hears of one in the Small Advs. he gets there too late, and there is not enough time to build one when aerial experiments are the main interest. Even without the filter CW saw off ZB2CI, W3BY and W3GM.

G2DC (Ringwood) notes that the sunspot count has been very erratic—with 119 recorded for 23-24 March,

but as low as 25 on March 28. On Eighty conditions to North America and the Caribbean area have been pretty good between 0300 and 0630z, albeit the commercial and European QRM makes working all-round DX rather tricky. However, CW produced VO1AW, VP2AAA, VP2LY, VP2MU, VP9BX, W1-5, W7-0, VE1-7, and 8P6DR—which at least proves the keying hand is still working!

Forty Metres

That picture last time, on p.83, of FI8QQ triggered off a note from G3EKN (Acocks Green) who was a

SWL in those far-off days, and in fact had a QSL for his listener report on FI8QQ's signals on the old 42-metre band, which he was good enough to let us see—alas, it would not have reproduced clearly enough to have been used as illustration. It is interesting to note that it was heard on a 0-V-1 receiver hooked to a hundred feet of aerial.

It was all CW on Forty for G4AMJ, it seems—he tackled and landed VE2NV, VE3KZ, VE2AY, VE3XK, W1-6, W8-0, including K5ABV, K6AN, W6HOC, K9CUY, W9LKJ, W0WPL and WA0EMS. G4AMT has a Theory. He



F. R. Blake, G3YLR, 13 Raymond Road, Bicester, Oxon, OX6-8DQ, first became interested in Amateur Radio in 1943. He travelled widely—to South America, the African countries, Canada and the U.S.A.—taking the R.A.E. in 1968. Now operational on all bands Top to Two, he runs a K.W. Vespa Mk. II with an inverted-Vee trap dipole for HF, main station Rx being a Lafayette HA-500 with converters for 2m./160m. Though most of the equipment is commercial, all ancillaries are home-constructed. As the photograph shows, G3YLR holds a number of operating certificates (including our VHFCC). An electrical engineer by profession, he is also a member of the Thames Valley Special Constabulary.

reckons that the method of finding a "clear channel" on Forty, used by the EU chaps, is to spin the VFO and call CQ DX when it stops—Murphy's Law means that *all* such attempts land on top of G4AMT's QSO's! Not deterred by such tactics Terry spent a few early-mornings key-bashing to book in VP2AAA, VE7VC, W7JLU, W7SFA and WA7OTT/7. Oddly enough, during the recent *ARRL Test*, all W call areas *other* than W7 were raised. SSB was not to be neglected, it being used to exchange reports with KZ5JT, TI2J, VP7NH, YV1PW, ZP5AL, VK7GK, and ZL2BT—again all in the 0600-0900z time-bracket.

Just one 40m. contact worth mentioning from G3JFF, who worked VP2AAA. That went for your conductor, too, whose only short spell on Forty yielded lots of funny noises and UK9ABA busily calling CQ Contest at S9-plus-a-lot, with no takers to speak of (other than G3KFE).

Forty CW from the key of W6AM accounted for EA5FO, JX6CP, YO4AAW, GC2LU, UK1ZAC, PAØZEZ, YO2BB and OK1TA. All, of course, QRM in U.K., but DX in W6-land—strange how one's

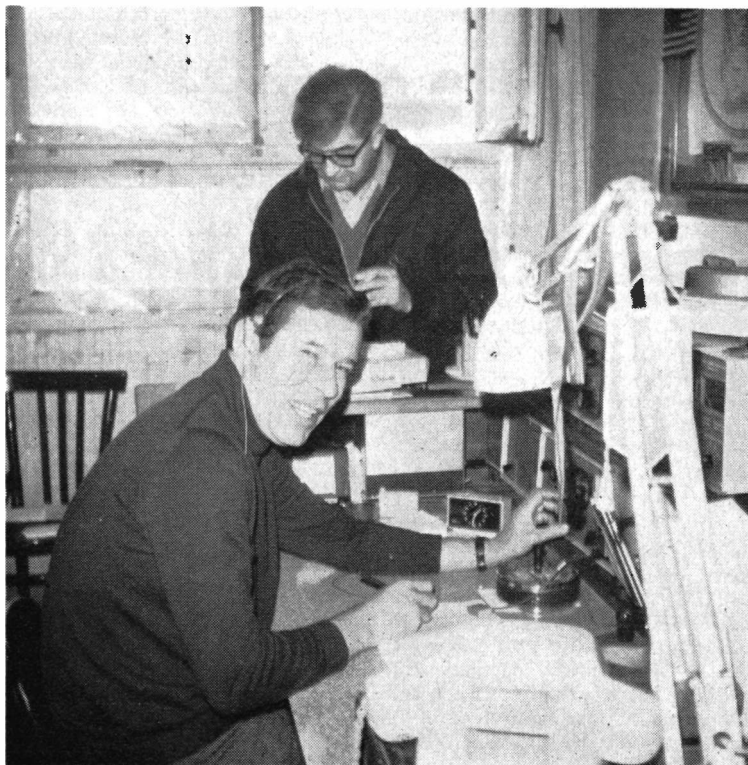

In December last, DL1CU and DL9PF made a DX-trip to Castelgandolfo to activate a new prefix, HV2—which is hoped will be accepted as a "new country" because HV2 is extra-territorial in the Vatican City (HV3) context. These DL's made three thousand QSO's in five days, with the co-operation of HV3SJ (background), seen here with DL9PF (operating)

BRIEF DX DATA

Call	Details
JTØAE	New prefix; Pavel hopes to be on 1.8 MHz from June. QSL via OK1AQW.
KC6-KX6	KH6AG making a run to KX6MA, last week in April; first week of May to Ponape KC6; second week to KC6, Truk; third week to Yap; fourth week to Koror.
UPØL-19	On Twenty in the mornings. Soviet Ice station in Arctic, QSL's to UW3HY.
WG3-WP6	New prefixes: WG3SFC, Goddard Space Centre; WP6JPL from Jet Propulsion Labs. Hq; both active during the <i>Apollo 16</i> mission.
5U7AK	14230 kHz, SSB, 2151z, QSL to David Kepple, P.O. Box 4, Tillaberi.
CR8	CR8AG, CR8AK, both on Fifteen, 21200 or 21250 kHz around lunchtime—starts about 1200 for an hour. QSL to P.O. Box 123, Dili, Portuguese Timor.

location will colour one's ideas of DX!

The band for G2HKU came up with VE1ASJ on Sideband, with CW to OHØNI, PJØJR and UK9AAN. Not to be outdone, GM3OOK keyed with EA6BD, PY7VKZ, UD6DEX, UH8AE, UJ8JAS, VE7VC, VE7HP, VP9BK, W7IR and W7SF. However, to Jake's chagrin, he has not managed to connect closer than a QRZ GM3? to anyone in Nevada to complete his WAS, even though a W7 in Oregon obligingly QSY'd to the local eighty-metre net to try and rustle one up for him. All good fun...

Again it was all CW for G3DCS, who confined himself to working W1-2-3.

G5PR (Petersfield) uses a KW-2000A, mostly on CW, and can work anything he can hear on the rig, using a good old all-band Windom, with 99-foot top, tapped at 22 feet from one end with a single-wire

feeder of 33 feet. Ten is not much used, because of TVI, but Clive is clear on the other bands, using this aerial fed through an L-network against a (doubtless very good) earth. Most of his DX, on whatever band, is worked between 1800 and 2100 clock. G5PR, like us, is too lazy to get up and play with his wireless set before having breakfast or going to work!

Not so G2DC—Jack found conditions pretty fair between 2300 and 0730z, with a few days when the band was very good between 0630 and 0830, WAC being twice made around this time. CW contacts were logged with HC1KP, KS4BA (on Swan Is. for a new one), PY2EXD, PY5OS, LU3CD, VE7IG/8, VK2EO, VK2YT, VK3FC, VK3NR, VK3AZY, VK3CZ, VK7GK, VP2AAA, VP2LY, VP2MU, VP2VA, VP8HT, VP9BK, all W call areas, VE1-7, 3AØGA, 9L1MN and 8P6DR.

Reporting the HF Bands

This and That

Quite a lot of people seem to be getting involved in the Marconi 75th Anniversary celebrations. GB3RN will be the Royal Navy station, on all through May; they recall also Captain Jackson, R.N., who was experimenting along the same lines at the same time as Marconi—a model of his original transmitter is on show at H.M.S. *Mercury*, where GB3RN is at home.

The 26 members of the Barry College Club can certainly feel proud of the amount of publicity they have got themselves about this event. As well as the exhibition in the National Museum of Wales, a BBC (sound) documentary is scheduled for May 18, visiting the Lavernock station, and a "do" on May 20 at Lavernock Point Holiday camp—to which there is an open invitation. There is an award—detailed information from GW3VBP, *QTHR*. Commemorative stations will be on from 4S7RS, GB3MKT, GB3BCT, G2WS/P, GB2SM, GB3RN, GB3RCS (a station at Poldhu under the Cornish club *aegis*), II4FGM, WM2GK, PA9IARU, LA5KO/L, LA5QK/L, 6Y5GB, 6Y5RS, 6Y5LA and 6Y5NY—with confirmation awaited of stations being set up at Signal Hill, Newfoundland, and Ballybunion, Co. Kerry.

Marconi's Apprentice Association did their bit (in the BBC context) during February 12-15, with GB2MT on from Writtle, at the site of the original broadcasting transmitter in this country. Among the OT's worked were G3REO (a relative of Eckersley) G5LC (who knew him) G2DX (who was moved to come and visit them at Writtle) and K4RF, who could recall hearing 2LO (London) 2MT, 5NW (Newcastle) and 6XX (Davenport).

For Contests and such things, the source for information is W1WY. Frank had himself a ball in the *CQ 160* contest, making 200 QSO's

in 13 countries with 24 DX contacts, a new one being KH6HCM—and without sitting up all night!

The CW leg of the Bermuda contest is over May 6-7, 0001z Saturday to 0200z Sunday, with the U.K. a permanent element in the competition. The same weekend sees the *OZ-CCA CW Contest*, which is a world-wide type affair. Then a week later there is the *USSR CW DX Contest*, this one running from 2100z Saturday to 2100z Sunday, May 13-14.

Now, a complete change of scene. G3KPO, recently moved from I.o.W. to Lincolnshire, remarks that we amateurs get a bit of fun denied to other viewers watching the "box." A recent "cops and robbers" scene saw the Law bursting into the crook hideout, where the policeman looked puzzled at what he saw—well he might, for what the FBI man said was a "very high-powered

marine transmitter" was nothing more or less than a typical low-power amateur rig of the fifties with, as centre-piece, a DX-40!

Down to Ten

Nice work if you can get it, is about the size of it; when one takes into consideration the way the sunspot number has been falling, it is really quite surprising how well the band has been standing up.

G3SXR/M (Fowey) uses a KW-2000 at 90 watts p.e.p., to his own "Super-improved magic wand" of a mobile whip. Steve spent quite a little time on Ten, and managed to contact W2-3-4-7-8-9, VO1, VP8MM, ZS6, JA, CR6's, 4X4, PY's 1-2-7, LU, OX3, VS6, 9K2, CP1, YV's, SV0, ZC4, 5B4 and 5N2.

As usual, W6AM found a little something of interest on all the bands; this time round, Ten has accounted for CW QSO's with UK0FAA, LZ2WC, 7Q7AA, PJ9JT, CP1AP, CR6AT, OE5OES, 9H1CH, HG5ES, YV4VAS and 9H3C. (Remember, some of these may be local to us, but they are DX out on the West Coast.)

Nice to hear again from G3ZAY (Petts Wood) who had a short spell

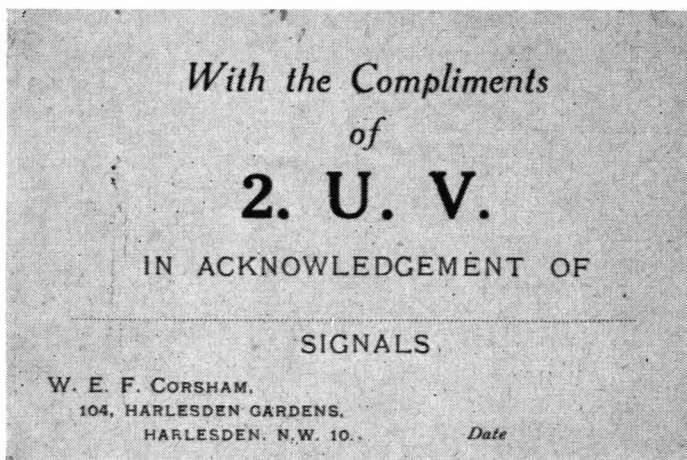

The very first QSL ever conceived—this is the paste-board (exact size) sent out nearly 50 years ago by 2UV, as he was in those days, to acknowledge QSO's and listener reports. G2UV himself (*QTHR*) is happily still with us and as active as ever. His original idea has built up into a world-wide traffic in QSL's—probably numbering not less than ten million cards a year.

This must represent a huge cost in printing, postage and time spent in filling them in. Like us, he probably wonders whether his idea was worth it—though for him in those early days it was a convenient way to acknowledge reports and contacts. It was because everybody else thought the same that the QSL situation is as we have it today!

home from Cambridge, and managed in that time to pump 60 watts into his Quad (which on Ten shows about 4 : 1 VSWR on the feeder!) But they accounted for 3B8CG, ZD8RR, VE8RCS, CR6NF, VU2JM, ET3GK, CR7FR, JA6BSM, HS5AFJ, 9U5AC, VK6CT, KG6SL, 5H3LV and WA2VU/3D6.

At G3NOF, the normally rather pessimistic tone of Don's report is changed to guarded optimism, as far as Ten goes, with very strong signals there to be heard; in the mornings it has been VK, 9M2, VU, and so on, with W's taking over from lunchtime to as late as 2115z some days, while on others the W's have faded out and been replaced by South Americans. G3NOF figured in the logs of CR6MK, CR6MQ, HC2GG/1, K0MXA, SV0WOO, VU2AAA, VP8MM, all the W call areas, ZS1KZ, ZS5RW, ZS5ZM.

In spite of the predictions the band has held up quite well, says G2DC, although Jack admits things have not been so rosy since the end of March. His CW raised VP2AAA, VP2MU, VP8HJ, VK6HD, VK6WO, VO1AW, ZE3JO, all W call areas, VE1-7, 7Q7BC, 8P6DR and 9J2GE.

Quite a bit of his limited operating time was used on Ten by G3DCS, both CW and SSB. The latter mode netted him G3XPM/P/W1, and most W call areas, while CW accounted for OA4ZP, CP1AP, ZC4CB, XE1IJ and some W's and VE's.

Ten for GM300K was rather overshadowed by Twenty, but that did not stop Jake from landing EL2Y, OX3AB, OX3DL, UA0AAD, UA0BX, VP9BK, W6's and ZS3AW at the CW end of the band.

Fifteen and Twenty

By far the largest clip is the one covering these two bands. G3NOF heard little on Fifteen, other than YA1KY and W7QD in Arizona. However, Twenty offered a fine selection, much improved, with from 0800 the VK's and ZL's, the North Americans riding through from noon to after midnight, while the Africans have appeared in the evenings.

Another one who seems to have collected more plums on 20m. than Fifteen is GM300K—Jake offers, on 15 CW, JD1ACH (Bonin), KR8BY, TG4SR, VS6CH, WA1CBH/6Y5A, XE2BG, ZE1JL and 9Q5HE. This contrasts with



Station of VE3RE, Phil Wharton, 3287 Lawrence Avenue East, Scarborough, Ontario, who is an ex-Canadian Merchant Ship operator (callsigns VDFX, VDTP and VDDV) and is now a member of the staff of BC station KELK. His Amateur Radio interest is chasing the DX on 20m.

the twenty-metre collection of JA's, CN8CG, JW7FD, KA9AG, VK2APK, VK2XJ, VK3ZT, all W call areas, XE1FE, VK1OK, ZB2CG, YV5AQD, ZL2AFZ, ZL2ON, ZL4GR, 5U7AW and 9M2AV.

For G3DCS, CW was the mode on 21 MHz, by way of QSO's with VP2MU, VP8HJ, most W call areas, and some of the VE's—this sort of thing on *Twenty* also, meaning PY7PU, VO1CA, VO1HI, PY6HL, SV1HA, VP2MU, W's and VE's on the key—with lots of W's on the microphone.

It is interesting that although G2DC has somewhat neglected *Fifteen*, he has spies who tell him the Central Pacific has been good on some mornings when he has been elsewhere. His arisings have been, all CW, with PY1CPC, VK2GW, VK6HA, VP2AAA, VP2LY, VP2MU, VP8HJ, VP9BX, VE1-7, VE7IG/8, all W call areas, ZL1DS/2, ZL1AIZ, ZL2CD, 3D6AX, 3B8RS, 5H3LV, 5Z4KL and 7Q7BC.

G4AMJ has a bumper bundle on both bands and modes. Taking 21

MHz first, we find his CW tackling ZC4CB, 5Z4KL, 9H1CH, JA and UL7PA, as against SSB with JA, SV0WOO, FL0QQ, 5H3LV, K6UMT/KL7, HD1RF, 5Z4MO and ET3ZU.

What a sad fate to befall anyone! G3DNF (Leeds) has been driven, with whips and scorpions, to the paint-brush, the paste-bucket, and other such nauseous activities, poor fellow. However, although he was too exhausted to try his luck much on Ten or Fifteen, he did look at *Twenty CW* for KG6JAR, 7Q7AE, UG6AB, 3A0GA, CR5AJ, 9N2AB, VP2LY, VK3BED, UW3HY/0, 9V1OK, and a "ZA1ZA," who sounds to be more ornamental than useful.

What G4AMT calls the "assorted rubbish" worked on *Fifteen* aggregated to a string of JA's, JH1GGG, JH2JAE, JE1CZC, JR1DRG, all W call areas apart from W7 (but including four Sixes) VE6, VE7, VE8, KR6UZ, HM4GF, M1B, ZB2CG, 7Q7BC, HS2AGP, XE2WH, MP4MBB, VS6CY, KL7HEF, 5H3LV, 9K2BQ, YA1RG, W4IZ/KV4, VQ9NEW,

9J2RA and VU2JM, all the foregoing being SSB contacts. CW was used twice, 5Z4KL and ZC4CB.

G8DI (Liverpool) spent Easter in GW—without a receiver. However, 3B8RS, TG9NJ, TG4SR, VP2MU, VP2AAA, VP8HJ, 5Z4KL, 9J2GE, PJ8AR, 9L1VW and the U5Ø-type calls as they have appeared were all booked in on *Fifteen* during the month.

On to G3JFF, who did for CR5AJ, UF5ØA, UF5ØE, UL5ØD, UH8AE, UH8CJ, VE4MP, VE4XJ, VE5XC, VE5RA, VE7UZ, VP2AAA, VP2LY, VP9AF, VK3MR, WAØMLE (in N. Dakota), 5Z4KL, KH6IJ, KH6FF, G3RSP /MM (off Ceylon) and ZL4PM, all on *Twenty*. Incidentally the only try on SSB was for VR6TC who was missed, while the VP2LY contact, for DXCC Number 199, took 4½ hours to get to the top of the queue! (You've really got to try, these days!) As for *Fifteen*, all CW, we find EP2CC, OX3VJ, UB5OE, UCSO, UF5Ø, UKØFAA, VP2AAA, VP2MU, VP8HJ, VP9BK, 3B8RS and VP2VAS for the magic 200th country.

At W6AM, although the main interest has clearly been elsewhere for the moment, Don did not fail at least to look at 15m./20m. One notes, on *Twenty*, for instance, ST2SA, SSB, plus OD5LX, SV1AE, JY8JK and 9H3C all taken on the key.

Although G2HKU has not been so active lately, he seems still able to snaffle the odd new one which may appear. 14 MHz SSB gave KJ6CW, not to mention other DX of the shape of HK4CKT, HC2LL, KL7HAQ, KL7HFA, JA1NAW, VK3AMT, VK7GK, PY7BDX, W4IZ/KV4, ZL1VN and ZL3SE on Sideband; VK3LV and W7IR were both on CW. *Fifteen* showed up with 3B8RS and ZC4CB, on the key.

G3ZAY has the benefit of a Quad on *Fifteen* with a better SWR, so that he can load full power into it, plus a dipole for *Twenty*—Martin wishes he had a Quad on *Twenty* also, because of the gotaways! *Twenty* SSB gave a string of KH6's, KC4USV, KL7's, a brace of KS6's, XE1IJ, FK8CD, FK8AU, YJ8BL, KJ6CW, FB8ZZ, 6D4EB, CR5XX, VR1AC, DU1ZAC, 9M2DW, and VQ9NEW—but failed when

presented with VR6TC, ZK1CD, KB6CU, FWØAB and some KM6's. The Quad on 21 MHz helped along with FL8DA, CR5XX, VS6CY, HS1AFP, FM7AI, TT8AC, VP2EEE, 6D4FFC, KG6JBO, UL5OE, VS9MZ, FR7ZU/E, XE1IJ and 5VZJS.

From G3ZPF (Dudley) comes a message on behalf of VS9MZ, otherwise G3UKN, who comes up on 21·306 plus or minus 10 kHz, at 1700z looking only for U.K. stations—meaning the rest of the world can go to blazes at that period!—and similarly but more rarely surfaces on 14140 kHz plus or minus QRM at 1600z, with the same idea in mind. Colin claims he hardly ever hears a G! G3ZPF goes on to discuss his QRM from exams, and states that he "struck a blow for freedom" by working ZS6ABN, 6W8AT, AP2KV, FY7AG, UD6BD, ZB2GG and 5H3LZ, which hiked him up to 123 countries, along with such lesser fry as PY2UR, JY1/B, PZ1CI, 9K2CA, DFØMOD, VO1BT, VO1CU, UB5ØA, UC5ØA, JY6ABS, U2BEZ, ZS5JG, ZB2CK, DU1ZAC, VS9MZ and "sundries." A nice turn of phrase, has David! Incidentally, for those who might be interested, a dipole

at 15 feet, cut for 14 MHz, and an FT-DX560 were used to do the work.

G5PR comes in again here, stressing the point that an omnidirectional aerial such as his Windom, by saying how, when he failed to raise 9V1QK, W6EBG heard and called G5PR so a very pleasant 569 QSO resulted from a missed DX contact. Clive uses pretty well all CW, which yielded him VE7BZC, ZS2EM, VE4NXX, CR7EY, CR7AD, JA3GZN, JA8AUD, UK9SAY, 4X4PW, TG4SR (a corking great signal), and PY7VHB. G5PR is yet another who finds his transceiver SSB selectivity quite adequate for normal conditions if one has a keen ear, his audio filter being seldom pressed into service.

G2NJ (Peterborough) is still collecting the /MM stations as his personal variation on the DX theme, and this time his catches were SM5BNK/MM (100 miles West of Haifa) and OX3XS/MM, both on 14 MHz, plus a "landed" /MM in the shape of G3TZL, home on leave in Hampshire for the moment.

And That's It

And that again wraps up our



SM1CNS, Thomas Karlsson, P.O. Box 336, Visby 62103, is one of Sweden's keenest DX operators, working from Gotland. He has a modern rig, is an active amateur in the best sense, and is always willing to handle cards for any SM1, SK1 or SL1 station.

story for the month. We should be back of course again by next month, and for that the deadline will be first post arrival on **May 8**, addressed: CDXN, SHORT WAVE MAGAZINE,

BUCKINGHAM. Closing dates for months following are: **June 12, July 10 and August 7**. Please don't be late—we just haven't the time to catch up on late reports or requests

for special notice (e.g. if you are going to Andorra on August 5, we've got to know about it, with all the details, by July 10 at the very latest!).

ITEMS OF INTEREST

The Post Office recently announced that during last year 116 successful prosecutions were initiated for "illegal radio transmission". Of these, 78 were for "broadcasting", meaning presumably the playing of record-music on wavelengths within the tuning range of the ordinary domestic receiver.

* * *

For last year's J-O-T-A, in October, the final accounting shows that there were 250 U.K. amateur-band stations on the air for the event. Between them, they worked 399 different Scout stations in 53 countries—a most gratifying result for the U.K. organiser, L. R. Mitchell, G3BHK, and a surprising increase on the previous year in Scout stations worked (254).

* * *

The British Amateur Radio Teleprinter Group (B.A.R.T.G.) will be holding their first convention on Saturday, May 20, in Meopham Village Hall, Kent (NGR TQ 644655), with sign-posting from the A.2, London to Rochester, and the A.20, London-Maidstone, Meopham being on the A.227 between these two trunk roads. Meopham itself is on the Southern line from Victoria. The convention is to be open from 11.0 a.m. till 7.0 p.m., entrance charge 15p. Activities will include a live RTTY station signing G4ATG on the HF bands; trade stands; bring-and-buy stall in the T/P context (no use taking along old TV chassis!); a raffle; lectures on RTTY topics, and demonstrations on radio T/P equipment. Information, and arrangements for RTTY skeds: J. D. Heck, G3WGM, 5 Hartsbourne Avenue, Bushey Heath, Herts.

* * *

According to a recent issue of the American *Radio-Electronics*, a trade war has developed between R.C.A. and CBS on the matter of quadrasonic record standards—these being discs providing the new concept of "four-channel sound". The differences lie in the way in which the sound is recorded and taken off the disc. In the R.C.A.'s CD-4 method a modulated 30 kHz carrier is impressed on two channels, the reproducer thus requiring a detector unit ("demodulator") to give off the recording (said to be of unsurpassable quality). On the other hand,

the CBS-Sony SQ-System is a four-channel matrix disc, said not to give such good quality as in the CD-4 system. Needless to say, the Japanese manufacturers are also in on this, some adopting the simpler approach and others the CD-4, with its carrier system. Surely, the modern hi-fi man, striving always for the ultimate, must these days have a lot of very sophisticated audio equipment to get his results.

* * *

"The usable radio spectrum is a limited natural resource and there is intense competition for frequencies. The I.T.U. system provides what may be fairly described as standards for the allocation and use of frequencies, weaker than strict rules but stronger than recommendations"—thus *New Scientist* of March 30 last. The Master International Frequency Register (MIFR) lists nearly 400,000 definite frequency assignments. The I.T.U. Radio Regulations—by which, in effect, all radio operation throughout the world is governed—require I.T.U. member-countries to notify the Frequency Registration Board of frequencies allocated within their jurisdiction, covering also their ships, aircraft—and spacecraft. Certain practical and foreseeable difficulties have arisen in connection with the Intelstat communications systems, i.e., frequency and power, positioning of geo-stationary orbits and the obvious need to avoid mutual interference. Thus is posed a new problem for the I.T.U.

* * *

Present membership of the F.O.C. (First-Class CW Operators' Club) totals 512, of whom 197 are U.K. AT-stations; 168 amateurs in U.S.; and the remainder under some 40 other prefixes—making the Club truly international in character. It has been decided to hold the membership at around the 500-mark, this being about the limit that can reasonably be handled by one individual acting as hon. secretary (at present, Capt. W. H. Windle, G8VG, 121 Laburnum Avenue, Dartford, Kent). The financial statement for the year shows a small loss on the Annual Dinner but a substantial balance to carry forward of £715—so that's all right. Membership of the F.O.C. is by selective invitation only and a system of sponsoring by active members. Seniority in the Club is determined by membership number.

*To keep in touch with the world of Amateur Radio, read "Short Wave Magazine" regularly—
Independent, Unsubsidised and now in its 30th volume.*

THE MOBILE SCENE

As we write two Mobile Rallies—the White Rose at Leeds and the North Midlands at Drayton Park, Staffs.—will already have happened. With four more events scheduled (Verulam, St. Albans; South Shields, Co. Durham; the Cornish at Truro; and Scarborough, Yorks.) it makes a total for the Season of no less than 18 Rallies of which we have had notification—and no doubt there are some others still to come.

However, organisers of Rallies yet to be fixed and notified should note that the “available Sundays” have already been pretty well booked. The only way to avoid a clash is by distinct geographical separation—while the keen types will think nothing of a round-trip of 300 miles or more, the family man /M must look for an event which is comfortably within mid-morning and the children’s bed-time travelling range—there is no pleasure in getting home late with the XYL hot and cross and the harmonics giving it air in the back of the car!

And nowadays, when visitors get to a Rally they hope (and expect!) to find that, if they are mobiles, they can get shot of the family for an hour or two while they go round to meet other /M’s and find out what’s going on.

RALLY CALENDAR

- May 7:** Spalding Tulip-Time Rally at Surfleet, Lincs., 4 miles north of Spalding on the A.16 Spalding to Boston. The tulip fields should be in full bloom, and are a magnificent sight. Pleasant riverside venue, offering overnight camping and caravan facilities, attractions to include trade stands, raffle and bring-and-buy stall. Free admission, and refreshments available on site. Talk-in by G3VPR/P on 1980 kHz, G3MMS/P on 70.26 MHz and G3XBS/P on 145.80 MHz. Maps of the Tulip Fields and further information from: R. Harrison, G3VPR, *QTHR*.
- May 21:** Annual Northern Mobile Rally, at Moor Grange School, Parkstone Avenue, off Ring Road, West Park, Leeds, with all the usual attractions, including trade stands, sale of surplus equipment (bring yours for the stall) and prize draw. Refreshments will be available. Contact for details: D. Binns, G3MGI, *QTHR*.
- May 28:** Chiltern Amateur Radio Club Rally at West Wycombe, Bucks., at the Dashwood home near High Wycombe, on the Oxford road just outside the town. This event will coincide with the Steam Rally and the Model World shows. Details from: P. Perkins, G3OUV, Loakes House, Loakes Park, High Wycombe, Bucks.
- May 28:** Hull & District Amateur Radio Society’s first Mobile Rally, in the grounds of the East Riding College of Education, Bishops Burton, on the A.1079, York-Beverley. A great effort is being put into this event. The site is ideal and the programme is to provide entertainments and attractions for the whole family. There will be Trade stands, a bring-and-buy stall, raffles and a junk sale, ending with a “barbecue tea round a camp fire”. Talk-in will be given on Top Band (G3AMW, 1980 kHz) and on two metres, 145.00 MHz dead, by G8EAH. Information: L. D. Colley, G3AGX, *QTHR*.
- June 17 (Saturday):** Verulam Amateur Radio Club Mobile Rally at Salisbury Hall, London Colney, near St. Albans on the A.6. Contact: H. Young, G3YHY, 93 Leaford Crescent, Watford, WD2-5JQ, Herts. (*Further details later.*)
- June 18:** Anglian Mobile Rally, at the Suffolk Show Ground, Ipswich. The form as in previous years, with overnight caravan stands and entertainment on the ground for all comers. GB3AMR will be in operation on all bands, either to give talk-in on 80/160m. or 2m./4m. or, separately, to work DX on the HF bands (quite a commitment!). Information from: D. W. Thomas, G3ZLN, *QTHR*, or ring Ipswich 55200.
- June 25:** West of England Mobile Rally, at Longleat House, near Warminster, as in previous years. Contact: D. Iles, G3COP, *QTHR*. (*Further details later.*)
- July 2:** South Shields annual Mobile Rally, this year at Redwell County Secondary School. Details from: D. Forster, G3DDI, *QTHR*.
- July 9:** Cornish Radio Amateur Club Rally at Truro Rugby Football Ground. Details: M. Locke, G3NKE, *QTHR* (Tel: Camborne 2419).
- July 16:** Rally laid on by Scarborough Amateur Radio Society at Burniston Road Barracks, as last year. Information: J. Cutter, G3VAN, *QTHR*.
- July 16:** Upton-on-Severn Mobile Rally organised by the Worcester & District Amateur Radio Club. Information: B. Jones, G8ASO, *QTHR*.
- August 13:** Torbay Amateur Radio Society Mobile Rally at Newton Abbot Rugby Ground.
- August 13:** Annual Derby Mobile Rally at Rykneld Schools, as in previous years. Details from T. Darn, G3FGY, *QTHR*.
- August 20:** Saltash & District Amateur Radio Club Rally at Saltash Grammar School, with all the usual side-shows and activities, most of which can be under cover. Ample free parking on site. Details from: I. Aldridge, G4AJU, 302 St. Peter’s Road, Manadon, Plymouth, Devon PL5 3DU.
- August 26-27:** Stratford-on-Avon Radio Club Mobile Rally at the National Agricultural Centre, Kenilworth, Warwickshire, Hq. of the Royal Agricultural Society of England. Contact: M. J. W. Webb, G3OOQ, *QTHR*, or ring Stratford-on-Avon 5973. (*Further details later.*)
- September 24:** Harlow & District Amateur Radio Society annual Rally at Magdalen Laver Village Hall, as in previous years. For details: V. Heard, 106 Vicarage Wood, Harlow, Essex.

So that we can report their events in this space, Rally organisers are reminded that we would be glad to have, as soon as possible after the Rally takes place, brief summaries of how it went off with, in particular, the totals of the mobiles worked or talked in on each band. We would also like to see good black-and-white photographs taken at Rallies—whether of talk-in station with their operators (giving equipment details), general crowd scenes or groups of individuals identified by call sign. Such pictures as we can use are paid for immediately on publication. All such material should be addressed: “Mobile Scene,” SHORT WAVE MAGAZINE, BUCKINGHAM.

SELF-PROTECTING STABILISED POWER SUPPLY UNIT

GIVING NINE VOLTS AT
UP TO TWO AMPS

A. R. TUNGATE

FROM time to time the writer has experimented with transistorised circuitry and invariably the power requirements have been procured from dry batteries appropriately connected to meet the desired voltage and current demands. On each occasion, after looking over the unwieldy mass and the resultant "bird's nest" your contributor promised himself a mains operated stabilised power supply, capable of giving voltages in the range most frequently encountered when using solid-state equipments, namely 6 to 18 volts, at a current rating of some 1.5 amperes.

The promise eventually reached fruition, and the diagram Fig. 1 showing the circuit finally evolved. The only component purchased was the bridge rectifier at a cost of 52p, the remainder of the gear being extricated from the usual hoard of junk found in the shed, shack, cellar or what-have-you, so there was no complaint over the final cost of this piece of equipment.

The origin of T1, the mains transformer, is not known, but suffice to say it bore a label marked "Songster" and gave secondary voltages of 6, 12, 15 and 18v. The 15-volt winding is applied to the bridge, which in this case comprises two selenium bridge rectifiers connected in parallel. (One rectifier by itself tends to run warm on full load.) With a 2000 μ F capacitor (C1) across the bridge, a mean DC level of 19 volts appears at the input of the stabiliser.

Action of The Circuit

Tr1, the power regulator, uses a NKT304. An AU103 can also be used in this position. Indeed, the latter was in the original power version but was changed after it developed an internal fault. The characteristics of an OC28 show that this too could be used in this position without circuit changes.

Tr2 is connected to function as a feedback amplifier, whilst Tr3 operates as a differential control amplifier.

The zener diode provides a reference potential of 9 volts constant at the emitter of the differential amplifier, and in operation, this part of the circuit compares a portion of the stabilised output voltage on its base with the reference voltage on its emitter. When the terminal voltage of the stabiliser is reduced by load currents increasing, part of the reduction occurs at the base of the control amplifier, whilst the entire change occurs at the emitter because the voltage across the zener is held constant at 9 volts. The overall effect is that more current is supplied to the feedback amplifier and the

Table of Values

Self-Protecting Stabilised PSU

C1, C3 = 2,000 μ F, 25v.	Z1 = 9v. Zener,
C2 = .005 μ F	BZY88 or ZF9-1
R1 = One ohm, 5w.	T1 = Standard pri.,
R2 = 10 ohms, $\frac{1}{2}$ w.	0-6-12-15-18v.
R3 = 100 ohms, 2w.	on secondary
R4 = 220 ohms, 2w.	S1 = DPST toggle
R5 = 12 ohms, 10w.	FS1 = 150 mA cartridge
R6 = 270 ohms, $\frac{1}{2}$ w.	FS2 = 2 amp. cartridge
R7 = 220 ohms, $\frac{1}{2}$ w.	Tr1 = NKT304 (or
R8 = 120 ohms, $\frac{1}{2}$ w.	AU103,
R9 = 1,200 ohms, $\frac{1}{2}$ w.	NKT452,
R10 = 470 ohms, $\frac{1}{2}$ w.	AD149)
RV1 = 500-ohm wire-	Tr2 = NKT212 (or
wound	AC154, AC128,
pot'meter, $\frac{1}{2}$ w.	AC155, 2N270)
MR1,	Tr3 = NKT713 (or
MR2 = S.T.C. selenium	ZT80, AC168,
bridge, 20v.	2N647, 2N649)
2 amp.	

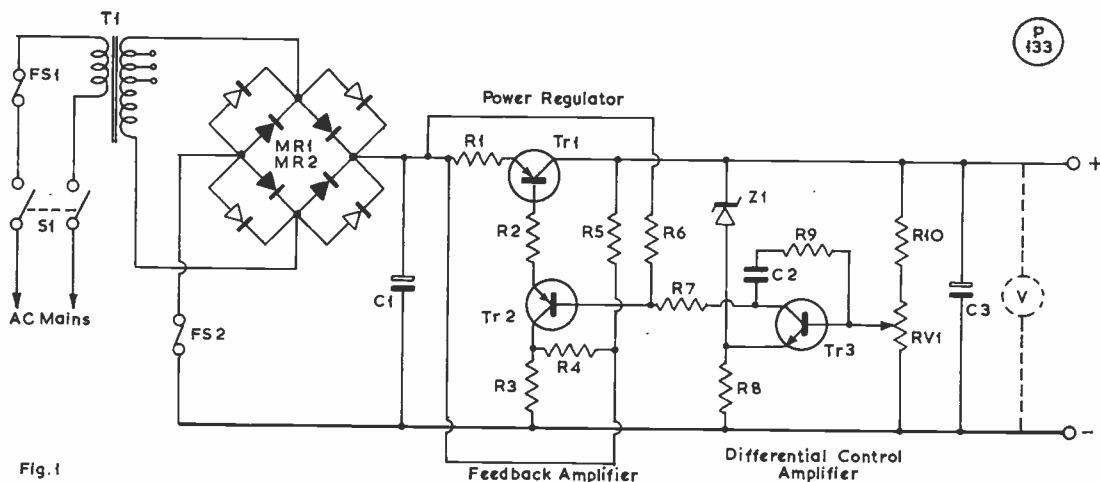

Fig. 1

Fig. 1. Circuit diagram of the self-protecting stabilised PSU.

forward bias to the power regulator increases, thus restoring the output voltage to its original set value.

RV1 permits setting the voltage on the base of Tr3, which in turn controls the output voltage and allows the voltage to be set within the limits of 6 to 18v.

Whilst Tr3 is shown as being a NKT713, other types of transistors were tried in this position, these being a ZT80, AC168, 2N647 and 2N649. The latter two allowed the power supply to function but this particular stage showed traces of instability when this type of transistor was used. The instability took the form of HF oscillations, but a cure was effected by reducing the gain of the stage, using R9 and C2 in series from the base to the collector. The NKT713 functions with or without R9 and C2, but these components have been left in as a safety measure.

Short-Circuit Protection

If the load current is increased beyond 2 amps. by reason of, say, a short circuit on the external apparatus, the output voltage drops very sharply. In consequence, the current through the zener falls at the same rate. At the same time, the voltage on the base of Tr3, derived from the potential divider across the supply, also falls. The net effect is that Tr3 is cut off; this in turn cuts off Tr2, the feedback amplifier, and Tr1, being current driven, loses its drive and therefore this too cuts off. Thus, as implied in the title of this article, the stabiliser is self protecting, the limit being approximately 2 amps.

The entire unit was constructed on a $5\frac{1}{2} \times 3\frac{1}{2} \times 2$ inch chassis, and the layout was not critical. Fig. 2 shows the layout adopted. Tr1 requires a heat-sink, and in this instance, the chassis itself was used. Components, other than the mains transformer, the bridge, C1 and C3, were mounted on *Veroboard*, fixed underneath the chassis.

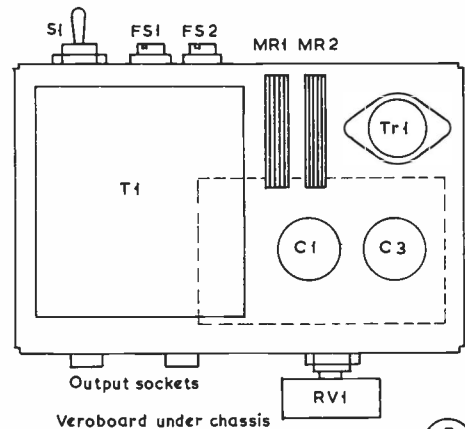

Fig. 2

Fig. 2. Practical layout arrangement for the PSU.

RV1 was set on the front flange of the chassis together with two insulated sockets for the output voltage. Two further insulated sockets were wired in parallel with the output sockets to accept an external voltmeter. Mains switch and fuses were mounted on the rear flange.

The unit, so far, has met the power requirements of all solid-state hook-ups; supplied an IC stereo system; and last but not least has functioned as a trickle charger for the car battery!

SPECIALLY ON THE AIR

The season has now arrived when we start publishing details relative to amateur-band stations which are to be on the air for some occasion at which the public is to be present, e.g., fêtes, country shows, D-I-Y exhibitions and such. The information we need for publication—in good time please—is callsign, date, occasion, sponsoring group, bands to be worked and the callsign/address of the contact man for enquiries and QSL's—all on a *separate* piece of paper addressed to: "Specially on the Air", SHORT WAVE MAGAZINE, BUCKINGHAM. Following are those notified at the time of writing:

EI0DMF, May 12-21: By the Dundalk Amateur Radio Society, in conjunction with the Dundalk May Festival, operating all bands 10-80m. CW/SSB as conditions permit, and round the clock at weekends.—W. Scully, EI2I, 48 Woodland Drive, Ard Easmuinn, Dundalk, Co. Louth, Eire.

GB3LEC, May 20-21: Set up by the Amateur Radio Club of Nottingham for the Long Eaton Carnival, West Park, Long Eaton, Notts., operating mainly during day-time on 10-160m. and two metres, AM/SSB.—G. Dover, G4AFJ, 21 Greenwood Avenue, Nottingham.

GB3HCF, June 4: Put on for the Hereford Cider Festival, The Racecourse, Hereford, by the local Amateur

Radio Society, running SSB on 10-15-20-80m. and AM/RTTY on two metres.—S. Jesson, 181 King's Acre Road, Hereford.

GB3FK, June 23-24: As part of the Festival of Kidderminster, two stations to be on the air, HF bands and two metres, also demonstration of CC/TV. Location Brintors Park, Kidderminster, at which visitors will be very welcome.—D. Hicks, G8EPR, 10 Birmingham Road, Kidderminster, Worcs.

Notices should be set out in the form shown here and sent in as soon as possible. For such events, the Ministry will always issue "for duration only" callsigns specially for the occasion, subject to the station being under the responsible control of a fully-licensed local amateur.

CORRECTION NOTE—"888A RECEIVER"

Further to this article in our April issue, the 10-metre coverage should have been given as 28-30 MHz (p.90), and the o/p valve a 6AQ5 (p.91). The third line down under "Panel Controls" (p.91) should read AF Gain. These were misprints, not noticed in the final check. (We can always be shot down on something, by somebody, somewhere! The "greatest living expert" on *any* topic discussed in the MAGAZINE is always the quiet man sitting right at the back of the class!)

FM DETECTOR AND LIMITER

PRACTICAL CIRCUIT FOR RECEIVER ADDITION— USING N5111A IC PIECE AS BASIS

C. P. HOWARD (G8ANU)

THE use of NBFM as a method of modulation for amateur transmitters on 2m. and 70 cm. is becoming increasingly popular. There are, no doubt, a number of reasons for this but probably the important ones are the reduction in TVI often achieved by changing from AM to FM, the simplicity and cheapness of an NBFM modulator (150 watts can be modulated with exactly the same modulator as used for 1.5 watts!) and finally the fact that commercial FM gear is now appearing on the market, both new and in the "ex-business R/T" form.

FM has much to recommend it as a form of modulation but most of its potential for effective, noise-free communication is lost because of the usual amateur practice of receiving NBFM on an AM receiver by the "slope method" of detection—in which the frequency

change on the signal is converted into an amplitude change by tuning the centre of the signal to the sloping side of the receiver IF selectivity curve. This is unsatisfactory because (a) Of the distortion introduced by the shape of the curve, (b) There is no limiting to reject AM interference, and (c) The available receiver selectivity and gain are not fully used.

Circuit

In Fig. 2 is shown the circuit of an effective limiter and demodulator for FM using a *Signetics* N5111A integrated circuit. This device comprises a three-stage limiter and a balanced product detector and is specifically intended for use in FM receivers, the basic circuit being given in Fig. 1. A special feature is that only a single untapped tuned circuit is required and adjustment is extremely simple. The N5111A is claimed to be effective over a frequency range of 5 kHz to 50 MHz and so can be fitted for any commonly-used IF channel.

The version of the circuit shown here was fitted to a "Heathkit" HW-17A two-metre transceiver with a second IF of 2 MHz. For use at different IF's no change need be made other than to the tuned circuit and possibly to the value of C1 (input coupling capacitor). The tuned circuit used was a *Denco* transistor IF transformer type IFT-17, which is intended for a 1.6 MHz IF but which tunes 2 MHz with the top of the slug flush with the top

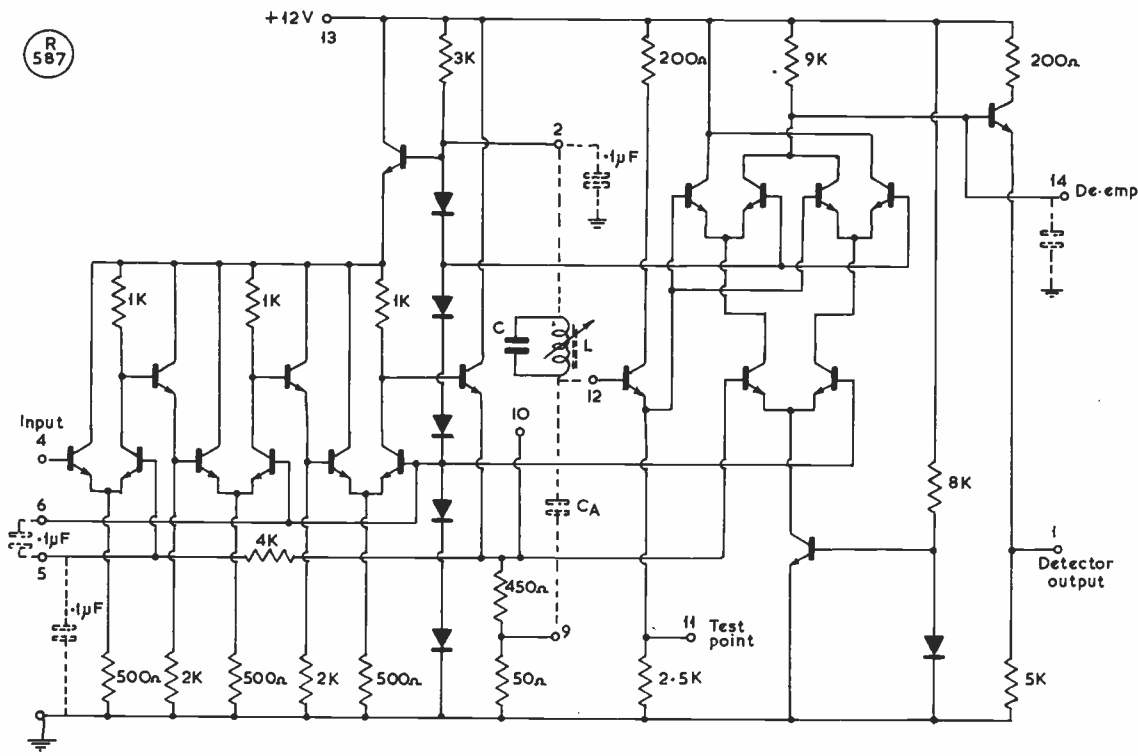

Fig. 1

Fig. 1. Diagram complete of the "Signetics" N5111A integrated circuit round which the FM/Detector Limiter unit described by G8ANU is constructed.

The HW-17A two-metre transceiver with the FM/AM switch added between the Rx audio gain control and main tuning knob. The box at the right-hand end of the case contains the RF pre-amplifier and coax relay, as described in the article on the HW-17A in our April issue.



of the can. The main tuned winding was used and the coupling winding removed. For a 10.7 MHz IF the IFT-15 and for 465 kHz the IFT-14 transformers should be suitable.

Construction

The unit was constructed on a 2in. by 3in. piece of 40 thou. thick unclad epoxy-glass board by drilling 14 suitable holes for the pins of the IC and also holes for mounting the transformer. Strips of *Cir-kit* were applied to the board on the underside to provide an earth rail on both sides of the IC and 15v. input and output rails. Terminal pins were fitted at one end of the board for all external leads. Connections were soldered directly to the IC pins and the leads of all 0.1 μ F ceramic decoupling capacitors were cut to the absolute minimum length. The only other precaution was to keep connec-

tions at pin 4 (input) as far as possible away from pins 9, 10 and 12.

The layout is shown in Fig. 3 and the photographs and should not be critical (possibilities are 0.1in. Matrix

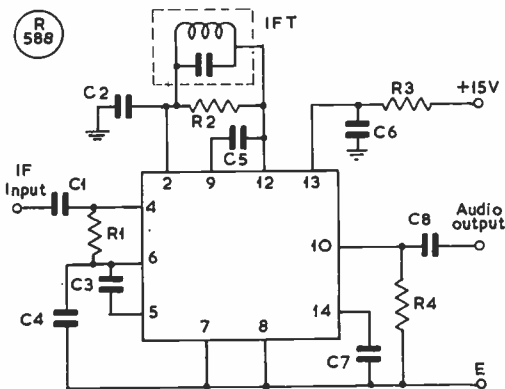
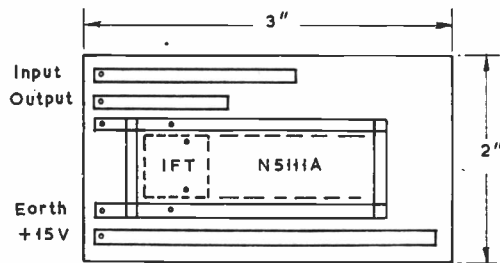
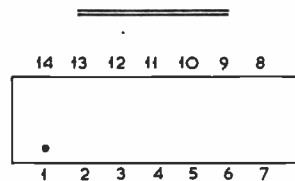

Fig. 2

Fig. 2. The FM unit incorporating the N5111A module of Fig. 1. Values here are: C1, 30 pF, and see text; C2, C3, C4, C6, 0.1 μ F; C5, 5 pF; C7, .01 μ F; C8, 50 μ F; R1, R3, 100 ohms; R2, 20K; R4, 1K; IFT, Denco IFT-17, and see text.



Layout of underside of board



Pin connections of N5111A

Fig. 3

Fig. 3. Layout of circuit board and pin connections for Signetics N5111A IC module.

- (1) Audio output (marked by "Signetics" symbol).
- (2) Detector input reference.
- (3) Not connected.
- (4) Input.
- (5) Decoupling.
- (6) Amplifier input reference.
- (7) Earth.
- (8) Main earth.
- (9) Amplifier low output.
- (10) Amplifier high output.
- (11) Test point.
- (12) Detector input.
- (13) Positive supply (15 volts max.)
- (14) De-emphasis.

board, one-tenth matrix *Veroboard* or a printed circuit board). The RF input to the unit should be taken from a suitable IF stage (in the HW-17A from the connection between T4 output and D201 with a short rigid wire routed clear of earthy points). Some slight retuning of the IF stage involved may be required—in the case of the HW-17A just a touch on the slug of T4. No AM/FM change-over switching is required at this point and AM sensitivity is not affected. The DC pos. input should be of the order of 12 to 15 volts and consumption is about 20 mA. (In the HW-17A the supply can be taken from the end of C325.) A connection is also made to a nearby earth point. A screened lead should be taken to somewhere near the volume control of the receiver from the "audio out" pin of the module, and an SPDT switch used to connect the audio output of either the FM detector or the AM detector to the top end of the audio gain control and the front panel, and finally labelled. For the HW-17A a switch was fitted between the volume control and the receiver tuning control and the front panel was labelled with black *Data* panel signs.

Alignment

The only alignment required is to tune in a fairly weak FM signal, switch to "FM" and adjust the core of the IFT on the unit for maximum audio output and then fix it in position—that's all!

Results Obtained

No suitable test equipment being available precise measurements could not be made but in practical terms

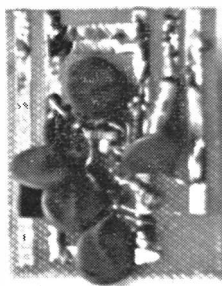

Underside of the Unit showing "Cir-kit" strips — see text.

the performance is satisfactory. The limiter is sufficiently effective to clip-off most of the audio from an AM signal and when a weak, apparently unmodulated, signal is tuned in on "AM" and the switch then flicked to "FM" it frequently turns out to be a perfectly readable NBFM signal which otherwise would have been missed as it could not have been resolved satisfactorily by "slope detection".

Assuming all components had to be bought and not obtained from the junk box, the total cost of construction should not exceed about £2.50.

NOTE ON MOBILE NOISE SUPPRESSION

CURING VOLTAGE-STABILISER SIZZLE

M. K. DUNN (G3KTL)

THERE are many sources of electrical interference which prove exasperating to the car radio listener, especially if his radio is only a transistor portable with a ferrite aerial and not one specially designed for use in a car.

The greatest sufferers of noise are, of course, mobile operators who are often listening to signals of relatively low strength. One of the sources of interference which (though not fitted on all cars is often overlooked even where it does exist) is the instrument voltage stabiliser. This is a device to give more accurate readings on such instruments as temperature gauges (not capillary) and petrol gauges. To achieve this the voltage is not taken from the full supply, which will be subject to change depending on charge/discharge, but fed *via* a regulator device which for cheapness is of the *bi-metallic* strip variety. Herein lies our noise problem.

The basic idea is that the regulator contacts open and close in such a way that the damped gauges iron out the difference as if it were a constant but lower voltage.

These contacts also vibrate with the motion of the car and produce a sort of "frying sizzle". If you are not sure if this applies to your car, carry out the following checks. (1) Switch on and observe the fuel gauge. If it swings instantly to its reading the problem is not there. (2) If the fuel gauge rises slowly, taking perhaps 5 or 10 seconds to reach its proper reading, wait until it settles and then tap the panel near the instruments. With your radio tuned to a weak signal you will probably hear the characteristic sizzle which ceases when the vibration stops. This sizzle is caused by the stabiliser, and whereas a 1 μ F capacitor to earth from the input side of the stabiliser may help, it is unlikely to be a complete cure.

But for a little constructional effort you can make a transistorised stabiliser which will do the job far better than the original. To take a particular example: The author's car is a Cortina, and Ford gauges require 5.0 volts at a maximum of 250 mA per gauge, full scale. To cope with this a single transistor and zener diode arrangement is adequate.

The transistor chosen was a BFY50 to work on negative earth, though a larger power type would give a wider choice of n.p.n. or p.n.p. for either car earth polarity.

Circuitry

The circuit is very simple and so is the construction—see drawings opposite. The BFY50 was fixed in place on the metal body of the unit by a light smear of *Araldite* which not only holds it but conducts heat quite

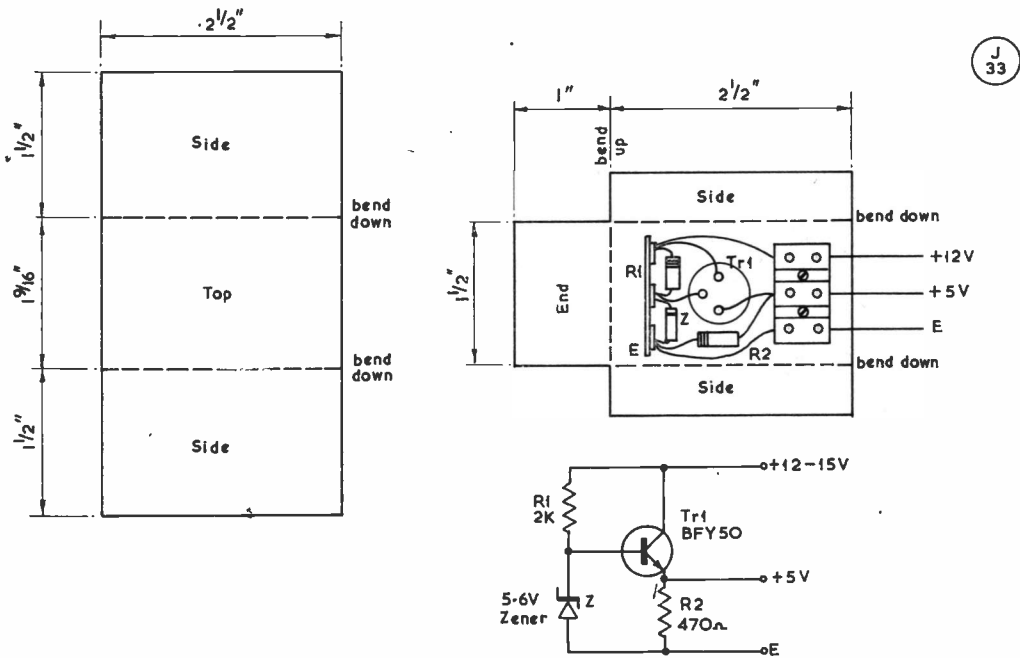

Construction, layout and circuitry of the Sizzle Suppressor.

adequately. Lucas connectors can be fixed either on flying leads or straight to the terminal block for easy wiring to the existing connectors. Mounting is as shown.

A brief check with only the 12v. supply connected should show an output of 5 volts and if so it is ready for the meters to be connected and a full test to be carried out.

The sizzle should now have gone completely and the unit can therefore be tied out of sight behind the dash (provided it is not placed where the car heater can cause it to overheat). It should be noted that the instruments will take appreciably longer than before to rise to their proper readings. This is simply because they are now at a constant 5 volts and not, as before, at an initial boost of 12 volts until the stabiliser actuated—but this is in no way a detriment to the operation of the car or the device.

N.R.S.A. ANNUAL CONVENTION

The Northern Radio Societies Association will be holding their convention for this year on Sunday, May 7, at the Belle Vue Zoological Gardens on the A.57, two miles east of Manchester. This has become a well-established annual event, for which a number of societies local to the North-East collaborate, aiming to put on a good show well worth a visit. Opening for visitors at 11.0 a.m.—they should take the Longsight entrance as being the most convenient for Belle Vue—there will be talk-in on 2-4-160m. from 10.0 a.m. by GB2BVC, and a demonstration station on the HF bands. All contacts

will be QSL'd by special card.—P. Taylor, G8BCG, 2 Columbia Avenue, Gorton, Manchester, 18.

CORRECTION NOTE—"TTx for Top Band"

Reference the Table of Values accompanying Fig. 1 on p.93 of the April issue, R5 should have been included and shown as 15,000 ohms. C29, C30, are 820 μF (p.99, Fig. 8).

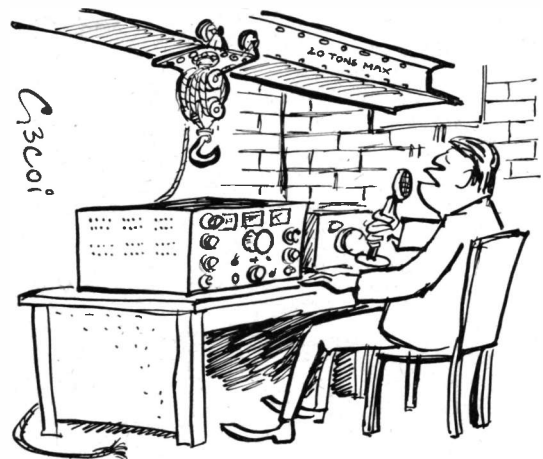

"... No trouble here in moving the old AR88 around ..."

LOW PASS FILTER FOR AUDIO

DEEP NOTCH USING A TOROID

J. B. HODGSON, B.Sc. (G3YKB)

ALTHOUGH this filter was originally designed to clean up the output of an audio frequency shift oscillator for VHF RTTY, it may well be possible to employ it in other transmitter or receiver audio circuits, e.g., as a post-clipping filter in an FM transmitter. Basically the design is a three-pole elliptic filter (Fig. 1) with the following characteristics:

- Passband ripple 1 dB
- 1 dB cut-off frequency 3.0 kHz
- Notch frequency 6.375 kHz
- Source and load impedances (R_s, R_L) 2,000 ohms

Applying these figures to the formulae given by Skwirzynski results in component values of:

- $C_1 = C_3 = 0.05 \mu F$
- $C_2 = 0.007 \mu F$
- $L = 88 \text{ mH}$

A test filter was constructed using miniature paper capacitors ($C_2 = 0.005 \mu F + 0.002 \mu F$) and a 88 mH

Table I

CORE TYPE	DIAM. (mm)	TURNS	SWG	ADJ.
FX2238	18	208	34	
FX2240	25	144	30	
LA1113 LA1220 LA2300 LA2334	25	420	35	✓
LA1226 LA2500	18	515	39	✓

Data for Toroid Construction—see text.

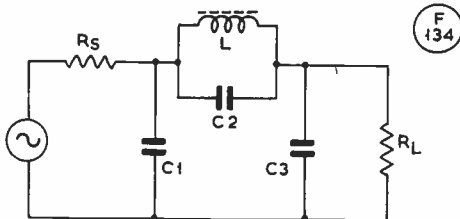

Fig. 1

Fig. 1. Circuit of the Filter.

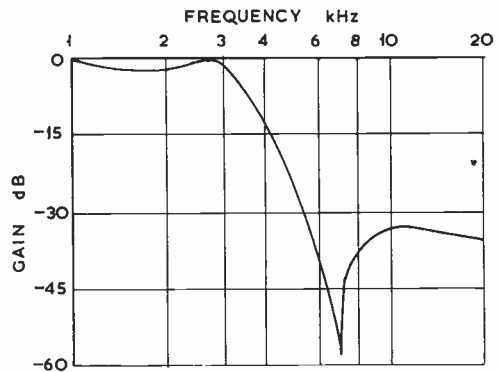

Fig. 2

F 135

Fig. 2. Showing frequency notch obtained.

telephone-line loading toroid (obtainable from *Space-mark, Ltd.*), the frequency response of which is shown in Fig. 2. It was later found that the toroid was actually 83 mH, hence the notch occurred at 6.6 kHz rather than at 6.375 kHz.

As an alternative to the 88 mH toroid, one of the more common types of pot-core could be used, for which some winding details are given in Table I. However, it should be noted that if the pot cores have to be purchased brand new, they will probably cost more than the ready wound 88 mH toroid. Nevertheless, the Vinkor adjustable cores (LA series) do give the constructor the advantage of being able to adjust the response a little, after the circuit has been made up.

As a final test, the filter output was examined using 2125 Hz and 2975 Hz (RTTY tones) square-wave TTL signals as input (Fig. 3). The resultant waveforms were sinusoidal with 0.8 per cent distortion at 2125 Hz and 0.7 per cent distortion at 2975 Hz, i.e., much lower levels than the average AM modulator produces. The output amplitude was approximately 700 mV r.m.s.

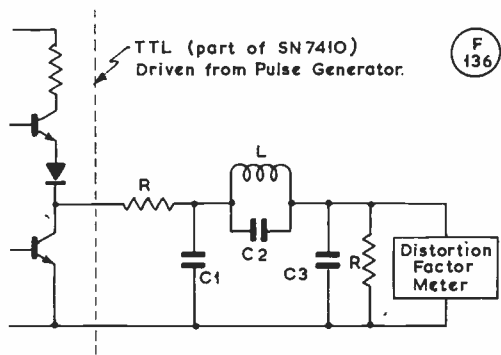

Fig. 3

F 136

Fig. 3. Circuit discussed in the text, for which values are: $C_1, C_3, .05 \mu F$; $C_2, .007 \mu F$; $R = R = 2K$; and inductance $L, 88 \text{ mH}$ (see text).

PRACTICAL ELECTRONIC KEYER

TRUE AND CONSTANT DOT-DASH
RATIO — DC/AC OPERATION —
WITH MONITORING
INCORPORATED

G. DENBY (G3FCW)

WHY an electronic keyer anyway? Why not the traditional straight or the bug key? Nothing is wrong with either, and if carefully used they are both capable of sending good Morse—but the electronic bug has two major advantages: It is less tiring to use than the other two but, primarily, it is capable of sending perfect Morse—that is, code as G.F.B. Morse intended it should sound, meaning dashes just three times the length of a dot, and dot-length spacing between dots and dashes. Not nearly, but exactly so.

Regular listening on any CW band—commercial as well as amateur—will enable a particular operator to be identified, not only by his callsign but by the kind of Morse he sends. His sending, over the years perhaps, has acquired a swing, embodying characteristics that make

his “fist” his alone. It may be a “personalised signal” he transmits, but it is unnecessarily difficult to read.

Conversely, listen to some of the tape transmissions sent by the news agencies, and hear how precision Morse really should sound. The keyer described is capable of similar results, and only inter-letter and inter-word spacings are left to the operator. The rest it does for you perfectly, electronically.

The Circuit

Many electronic keyer circuits include a weight control which varies the mark/space ratio. This is because in these designs this ratio alters at different sending speeds and is usually correct over a limited speed range only. Instances of incorrectly set weight can all too often be heard on the bands—the dots come out much too fast for the dashes!

In the keyer here described the weight is set, correctly, by flip-flop operation, throughout the speed range.

The circuit is an adaptation from both the keyer described in the 1970 *ARRL Handbook* and the design by G3KPT in the March 1971 issue of *SHORT WAVE MAGAZINE*. The additions are a monitor, and a PSU permitting operation from either 240v. AC or 12v. DC. In addition to discrete components, two IC's are used, a 7473 dual JK flip-flop and a 7402 quadruple NOR gate. Three of these gates are wired for use as inverters, only one operating as a NOR gate proper. (over)

*The Keyer as constructed
by the author.*



Tr1 and Tr2 comprise a pulse generator switched by the keying paddle via Tr3. At the same time as the generator is triggered the dot flip-flop is opened, via an inverter, to accept the pulses. VR1 varies the charging time of C1 and acts as a speed control. This potentiometer is without switch and thus can be left pre-set at any particular sending speed.

On dots the flip-flop output passes through the NOR gate and an inverter to drive the output transistor Tr4.

On dashes, the pulse generator and dot flip-flop are still operated via D3, but in addition the dash flip-flop is opened by an inverter, and is driven by the dot flip-flop. The outputs of both flip-flops are then added in the NOR gate to form dashes.

Once initiated, characters are self-completing by diodes D1 and D2, which become forward-biased by the NOR gate output, and parallel the key lever contacts

Table of Values

Circuit of the G3FCW Keyer Unit

C1 = 8 μ F 15v.	D4 = On relay
C2 = 1 μ F 15v.	D5, D6 = 1N4001
C3 = .01 μ F	D7 = BZY88
C4 = 0.1 μ F	IC1 = SN7473
C5 = 25 μ F 6.4v.	IC2 = SN7402
C6 = 2,000 μ F 25v.	TR1 = BCY70
R1 = 27,000 ohms	TR2,
R2 = 47,000 ohms	TR3,
R3, R4 = 100 ohms	TR4,
R5, R6,	TR5 = BC107
R7, R8 = 1,000 ohms	TR6 = 2N3053
R9 = 270,000 ohms	N1 = 240v. neon
R10 = 270 ohms	SW1 = 1-pole, 4-way,
VR1 = 100,000 ohms	3-bank
VR2 = 500 ohms preset	LS = 3-ohm speaker
T1 = Miniature push-	RL = G.W.M. Radio,
pull output type	Type T37358A
T2 = 240v. AC, 0-12v.,	Knobs =
0-12v. @ 150 mA	Keying
D1, D2,	Lever = Bauer from
D3 = OA91	Spacemark, Ltd.

(cont'd. p.162)

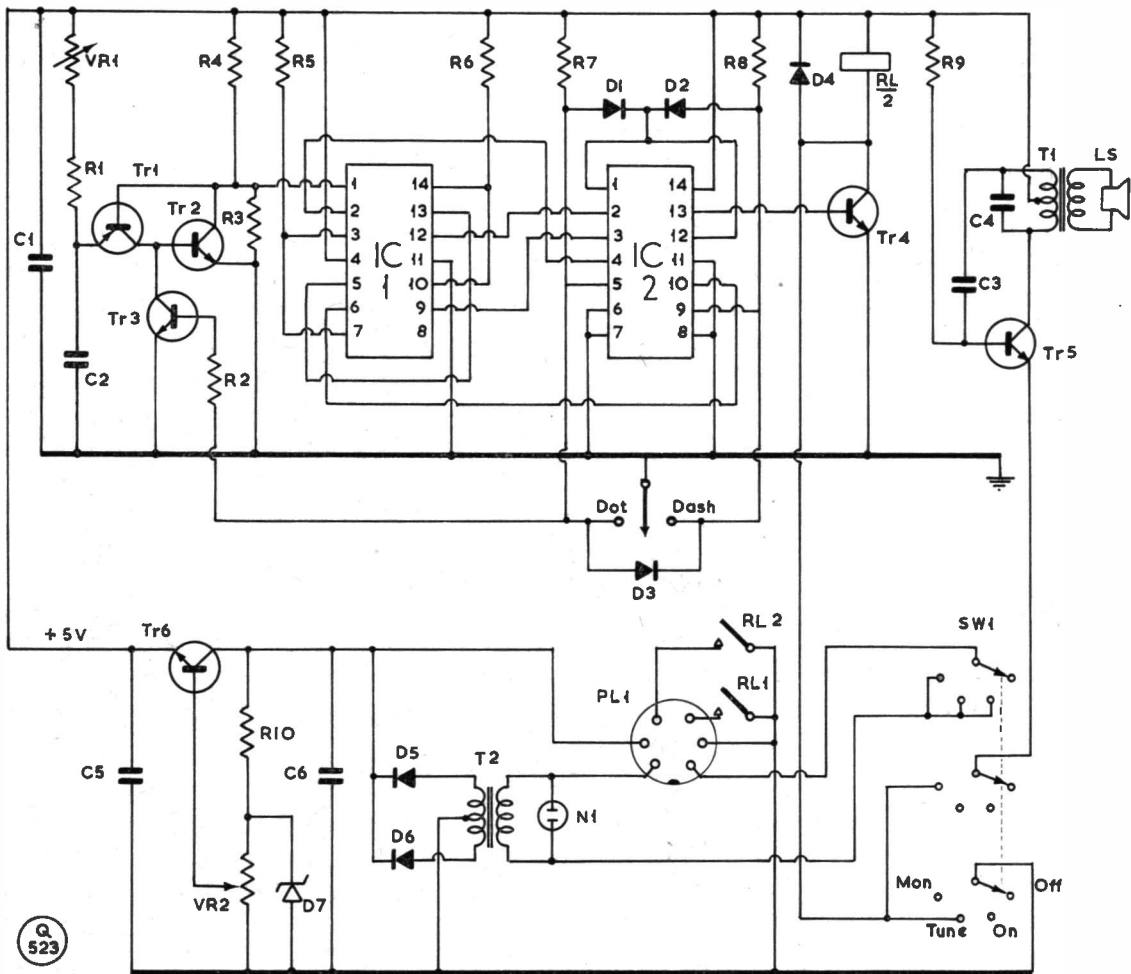

Circuit complete of the G3FCW Electronic Keyer.

Q 523

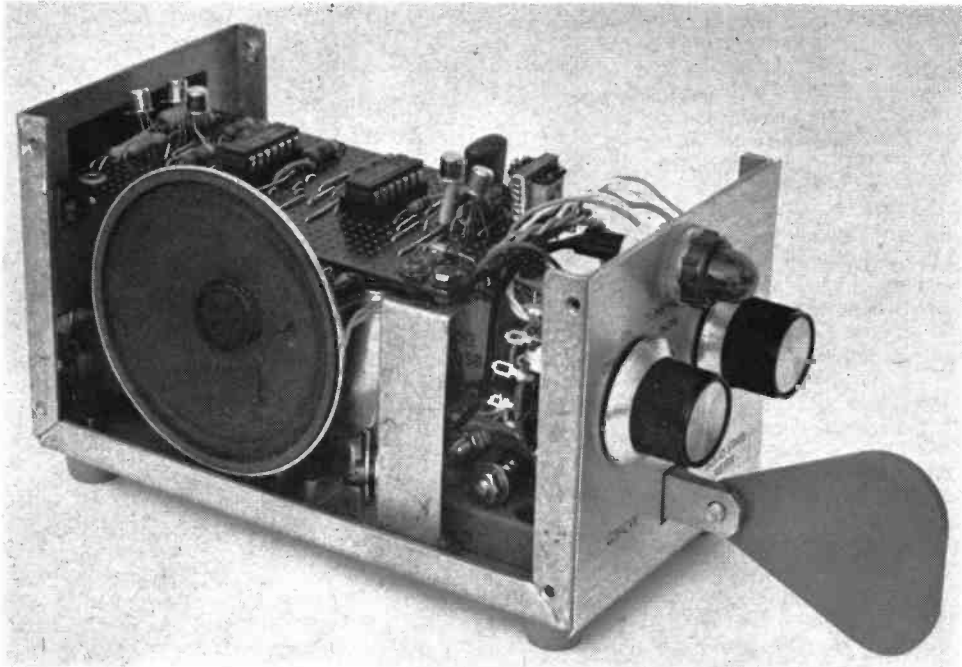

Completed G3FCW Electronic Keyer with top cover removed.

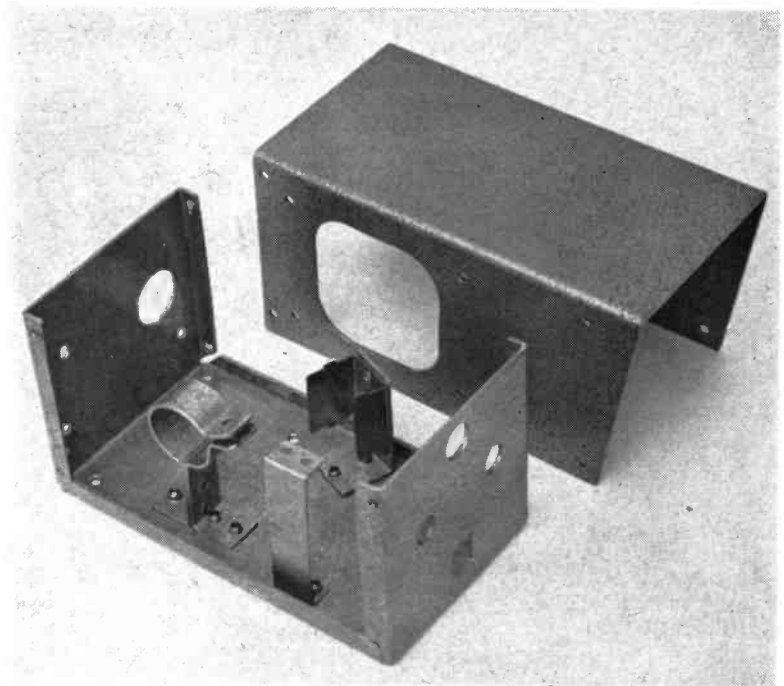

Chassis and cover bent up from 16g. aluminium, with brackets pop-riveted to chassis.

*Speaker and main
Veroboard mounting.*

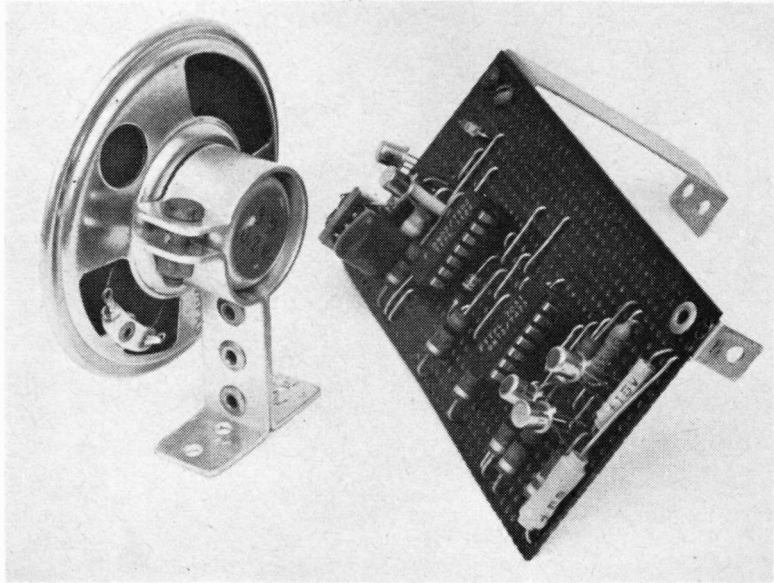

until the end of the character.

There was some difficulty in finding a reed relay which would operate at 5v. A suitable item was obtained from *G.W.M. Radio Ltd., Worthing*, and is their type T37358A. This has four normally-open reeds within the coil, and two of these are wired to the multiplug for transmitter keying. The relay comes with a silicon diode wired across two tags and this is used as D4 for reverse voltage suppression which could otherwise damage Tr4. Tr5 is used in a Hartley oscillator and gives sufficient sidetone volume for normal usage.

The function switch is wired so that transmitter "Tune" is only one position away from either the "On" or "Monitor" positions. The "On" position allows keying without internal monitor when some other sidetone is used to follow keying.

Getting The Power

Initially, battery operation was tried but life seemed limited using three HP7 cells. After a few minutes' operation voltage fell to 4 only and this was felt to be unacceptable. Although manganese batteries were a possibility not tried, it was decided a mains/12v. DC PSU would be more practical. The PSU uses a 2N3053 as a series regulator with a BZY88C6V2 6.2v. zener diode as reference. The 500-ohm skeleton potentiometer allows the output to be set to precisely 5v. on load.

DC before the regulator is about 15v. and this allows 12v. DC to be applied *via* the appropriate contacts on the multiplug, without switching from 240v. AC, by using two plugs each wired for the appropriate supply. The nominal 12v. DC, as in portable/mobile operation, approaches 15v. in a charging condition on the car.

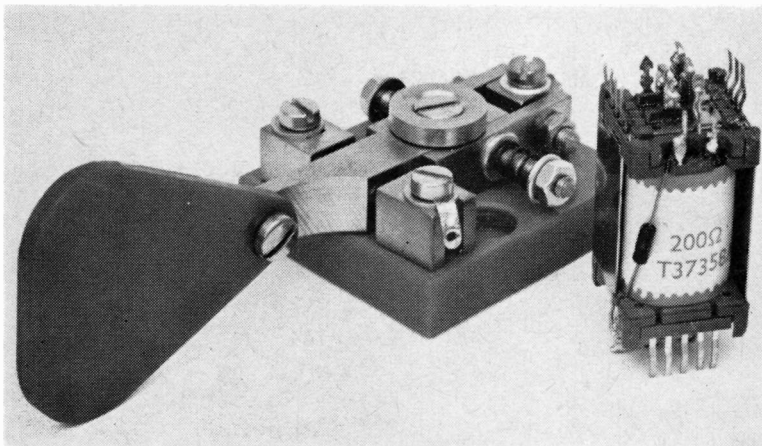

*Bauer keying lever
(Spacemark) and relay
(G.W.M. Radio).*

The neon pilot of course only operates on an AC input to the keyer.

Construction

The chassis and cover were bent up from 16g. aluminium and finished with silver hammer enamel. The panel is 3in. square and the chassis 5½in. long. The cover at the top is 6in. long to give a half-inch overhang. Four small p.v.c. feet are fitted to the chassis corners, and as the completed keyer weighs just over 2 lbs., in use it remains firmly in position. Three simple brackets were made from aluminium scraps to hold the speaker, relay and main *Veroboard*, and the general construction can be seen from the photographs.

Wiring was done on 0.1 *Veroboard*, with sockets for the IC's. The PSU was made up as a sub-assembly

by supporting a piece of *Veroboard* carrying the components on the connection from the mains transformer. This formed a rigid assembly and is mounted horizontally from the back panel. The 2N3053 regulator is fitted with a type 5F half-inch heatclip to help dissipation.

The front panel was cut out of an anodised aluminium wall tile from the D-I-Y section of the local supermarket, keeping one bevelled end as the lower edge of the panel. The square hole for the arm of the keying paddle was simply made in the thin metal by careful use of a small file. When drilling was completed, panel lettering was added by *Blick* dry-print lettering using Gill Medium 10 pt. caps for the callsign and 8 pt. caps for the rest. The panel then received a spraying with *Letraset 101* protective coating from an aerosol. Knobs are *Eagle* type F.13 instrument pointer knobs.



SHORT WAVE LISTENER FEATURE

By Justin Cooper

LISTENING AND IDENTIFICATION— GETTING THAT QSL CARD—NOTES ON ANTENNAE—NEWS, VIEWS AND COMMENT FROM ANOTHER BIG MAIL

PERHAPS the most important part of the game, for the brain, is the listening to and correct *identification* of stations heard; and it is in just this area that the novices are weakest, as our regular scrutiny of the HPX entries tells only too clearly. The interesting point is that in the majority of cases this is quite certainly a misreading of a legitimate call, in some others a call belonging to an organisation with whom we share an allocation, or a pirate—but the SWL copies down in his log a collection of letters and numbers which often bear no resemblance to the real thing, and which could have been put right for certain had the SWL taken a little thought. For instance, one knows that a callsign of the older sort will consist of one or two letters, a number and one, two or three letters. Later ones look like American valve types, e.g., 5Z4LW, and the most recent manifestation is of the form “C31EF,” with *two* numbers between the letters.

Knowing the form a callsign should take is part of the battle; the other one is the ability to identify the country of origin. The common ones most of us know by heart, the less common appear in the main body of the *Prefix List*. All these should be easy enough to deal with. But what about the “new one” that crops up with a “special” prefix commemorating this-or-that?

This is where a knowledge of the unusual allocated country prefixes comes in handy—one is printed in the back page of our *Prefix List*. If, for instance a “4C2AA” were to pop up, in a contest, not giving location details, and dishing out QSO's at a great rate, the SWL with

savvy turns to the back page, scans the list and says “Ah, this is a special for Mexico!” On the other hand, he could equally well confirm the country of origin of, say, a “4J2AA” to be Russia, and so forth, from the same reference. What it boils down to is that a *Prefix List* is a vital accessory at any station where DX is the interest—indeed J.C. has no less than three of them, one stapled in the back of the log, one pinned to the wall above the receivers within easy-reference reach, and the third kept in the QSL file.

And, you know, there really is no reason why a wrong logging should ever disfigure your HPX List or log-book, if only because, after eliminating the “dead wood” by checking with the *Prefix List*, all the rest must have been *heard*; and all a poor and unselective receiver can do is to mean that you *don't hear at all*, under the QRM, that which the guy with the super box can copy easily.

The Mail

A. I. Williams (*Stockport*) sends in a first entry for HPX; he uses a Trio 9R-59DE and an end-fed 132-footer. However, keen though he may be, exams. and the need for some sleep reduce his listening-time drastically. Alan reckons his next task as an SWL will be to learn Morse—good!

For J. Gravell (*Burry Port*) the receiver is an Eddy-stone S.640, the aerial a forty-metre dipole at fifteen feet and the location sea level, although doubtless the fact that there is a sea-water take-off through a half-circle East—South—West, must help the score along a lot.

Like Father, like Son is the saying—but we have lists from Bruce Thomas and his father L. Thomas, just to prove the reverse also to hold good. Young Bruce has married since last he wrote and as a result moved away from home. However, he left Dad with an NC-155 receiver, which the latter has turned to good account

when coupled to a TV aerial on the top of a 32-foot pole! Bruce now runs a KW-201, coupled to a KW E-Zee Match and Joystick, and this has raised for him a few queries, which we can perhaps resolve most quickly by saying just that he has got the right answer to them all.

C. K. A. *Verstage (Olá Basing)* runs a Yaesu FR-DX 400SDX and Trio JR-500SE as his main receivers, to which he can couple a Joystick, a Mosley TA-32, a tri-band beam and a two-metre 14-element Parabeam—very nice, too! Measurement of frequency is by means of a BC-221, and the “shack” is in fact the inner end of the garage.

Now to A. K. *Milner (Grantham)*, who used our Small Advertisement columns to dispose of both his *Trio* 9R-59DS and *Ecdystone* 840A, which have departed in favour of an *Eddystone* 888A all amateur-band Rx, used in conjunction with a “piece of wire” in the false roof and a Hamgear PM.II as ATU.

The last of our list of “new comrades” is M. *Brooke (Cleckheaton)* who runs a 19 Set, which he hopes to be able to replace when he is started at work, to happen in a few weeks’ time. The DX on Eighty seems to be the favourite area for listening, with such as CT1, EA8, W/K, KP4AN, OX3JW, VO1FG, VO1BT, VE1, VP2VIM, VP2LAT, TF and 6W8AL all entered in the log.

The mystery of the station variously reported as “JYADO/AM” and “JY8ADO/AM” is solved by H. *Stephenson*, who hails from *Newcastle-on-Tyne*. Howard encloses with his letter a photostat of the QSL he received, showing that the call is indeed *JYADO/AM* (the aircraft’s-own call) and the operator the captain, A. Hussein. Quite as a sideline, it is of interest to note that the old rule about making a listener report interesting is borne out here—Captain Hussein has added a little handwritten comment thanking Howard for the information given in the report—even though he is not legit in the strictly Amateur Radio context! (Ship or aircraft call signs should *not* be used on the amateur bands or outside their allocated channels).

B. *Stone (Penzance)* is all involved in R.A.E. and O-Level’s but is thinking of putting up a wire-beam for Twenty, along lines already adopted by G4AMJ and G3DLH.

Another who is bogged down in both O-Levels and the R.A.E. is W. *Edwards (Tadworth)*—and this is as good a time as any to remark that if there is any sort of a struggle between these two conflicting aims, those O-Level papers are far more important—eventually, they bring in the “gravy” to pay for all those nice bits of gear you dream of and see other chaps buying. Oddly enough, W.E. has been SWL’ing for quite a while without ever hearing VK, until a quick look round between studies yielded VK3MO at well over the S9—could be a lucky omen for him!

Congratulations to S. *Cole (Newport, Mon.)* on the receipt of his call, GW8FTQ. Stephen is “on” with an HW-30 and Yaesu receiver to a five-element beam, but is not neglecting to continue his Morse work—indeed, he says that when finding Two dead and flipping the bandswitch to loads of DX on Twenty is about the best incentive to persevere there can be!

HPX LADDER

(All-Time post war)

SWL	PREFIXES	SWL	PREFIXES
PHONE ONLY		PHONE ONLY	
S. Foster (Lincoln)	1257	N. Askew (Coventry)	643
R. Shilvoek (Lye)	1150	D. A. Shepherd	
J. Singleton (Hull)	1120		(Brierley Hill) 615
A. W. Nielson (Glasgow)	1102	A. Judge (Sheffield)	612
J. Fitzgerald		Mrs. S. Singleton (Hull)	600
	(Gt. Missenden) 1001	R. Pepper (Bradford)	562
T. Rootsey (Ilford)	964	J. R. Cowan (Rochford)	559
G. S. Taylor (Rugeley)	929	J. Woods (Woodbridge)	559
I. Brown (Newtonabbey)	916	K. C. Webb (Reading)	553
K. Kyezor (Perivale)	896	J. Iredale (Llandudno)	545
R. Carter (Blackburn)	868	P. Bence (Cardiff)	538
M. T. Hyder (Hythe)	848	P. Harris (Surbiton)	537
M. J. Quintin		J. Dunnett (Luton)	536
	(Wotton-u-Edge) 823	D. J. Browning	
B. Hughes (Worcester)	822		(Bishops Stortford) 533
A. Mercer (Wigan)	820	W. B. Taunton (Meopham)	530
D. Rodgers (Bolton)	815	B. Thomas (Pontefract)	514
N. Henbrey (Northiam)	806	J. W. Jarvis	
J. G. Ayton (Sunderland)	802		(Rickmansworth) 506
M. Fisher (Bradford, 9)	773	CW ONLY	
H. Alford (Burnham-on-Sea)	770	A. Glass (Plymouth)	796
S. Proud (Letterston)	762	J. Dunnett (Luton)	676
J. P. Scragg (Stockport)	760	G. Proud (Letterston)	602
K. Plumridge (Southampton)	751	H. Wright (Pontefract)	495
T. W. Hyder (Southampton)	715	W. B. Taunton (Meopham)	466
M. Williams (Sleaford)	704	J. Halden	
A. R. Holland (Malvern)	702		(Newcastle, Staffs.) 445
H. M. Graham (Harefield)	702	A. Rowland (BFPO 53)	328
G. W. Raven		R. Mortimore (Cardiff)	306
	(London, S.E.13) 701	D. Rodgers (Harwood)	261
E. Parker (Hove)	680	T. Thornton (Wargrave)	238
E. W. Robinson		D. Lockwood	
	(Bury St. Edmunds) 670		(Sharlston Common) 212
P. L. King (Ryde)	662		
J. H. Sparkes (Trowbridge)	651		

Starting score 500 for Phone, 200 for CW. Listings include only recent claims. Rules for HPX as given in the November issue. DX Zone Map, and latest Prefix List, 85p post free, from Publications Dept., Short Wave Magazine, 55 Victoria Street, London SW1H-0HF.

Problem of Getting the QSL

How long do QSL cards take to come through from the Bureau, asks J. *Cowan (Rochford)*, to which the only answer we can give is “it all depends”! The point is that, given you have a supply of envelopes at the Bureau, stamped with the correct amount—lots of the envelopes are not properly franked!—then one is down to two main factors, of which by far the most important is that the station to whom you QSL has an envelope at his Bureau, and the second that he does ensure his QSL’s go off promptly even when he is relatively inactive—thirdly, of course, he must feel inclined to QSL *you!* It is a great temptation, to which many amateurs succumb during periods of low activity, to hold their Bureau outgoing envelope until they have enough cards to fill it to the right weight—but if that takes six months, then the guy who had the QSO leading to the first card going in the envelope has been waiting six months for the card before even it starts on its journey. Then again, if you are not very active yourself, the Bureau manager will wait till he has a “full house” of cards for your envelope—after all, if he doesn’t he is wasting *your* money! To obviate this difficulty, it is easy to put an instruction such as “wait three” to tell the Bureau manager what you want him to do.

Editorial Note: The whole business of “cards via Bureaux” depends on so many factors: Whether you and

the man you are QSL'ing have envelopes lodged for the purpose of exchange at the Bureau you both happen to use or, in the case of overseas stations, if the bureaux involved are in exchange relations—whether your target is interested in SWL reports (most are not)—how long it takes him, after getting your card, to fill in one of his own for you—the speed of action of the bureau manager himself—and the fact that international exchanges of cards in bulk must be by surface mail to save what would otherwise be enormous postage charges. These factors can all add up to delays which in practice vary from months to *years!* In other words, when sending off cards by bureaux, just hope for the best!

The alternative, which is what we always recommend, is to QSL selectivity and *direct*, either with an s.a.e. if you are a G/SWL reporting to a U.K. station, or enclosing an IRC if you are after a DX operator's card—but be warned that neither s.a.e.'s nor IRC's will *guarantee* a reply-card! The only real advantage of QSL'ing direct lies in the probability that if you are going to get a card back at all, it will arrive much sooner than "QSL'ing via Bureau".

This is, of course, all in the SWL context (the Tx-to-Tx aspect is somewhat different) and one is sorry to be so discouraging but these are the facts where the generality of listener QSL'ing is concerned. Of course, we are well aware that there are quite a few SWL's who can say that they get returns round 60%-70% without undue delay—but this is usually where they have QSL'd direct with what the recipient regarded as a useful and interesting report that he was glad to get.

The thing to remember is that no amateur-operated station is compelled to respond to all QSL's that he receives, even if s.a.e./IRC are sent. Clever and experienced SWL's who can show a high QSL percentage return rate (and anything over 60% is high) know all about what is being said here and send out their reports accordingly.

Those listeners starting on the amateur bands after a spell of BC station reporting are often misled by the fact that most SW/BC stations will automatically send back a card for all or any reports received—they

are only too pleased to—for they have a staff to attend to such matters and *expect* to receive 100's of listener reports. The amateur station operator, on the other hand, is on his own, with perhaps only his XYL or girlfriend to help him cope with the QSL chore. Dealing with unwanted QSL's is, in effect, a waste of air time. So it is not surprising that they pick out for reply-action only the cards they consider worth attention—and in the nature of things, these would be mainly those from AT-stations worked.

* * *

Nice to hear again from *S. Foster (Lincoln)*; Stew will be married by the time this comes to be read, and already the domestic QRM is beginning, with a trip to Athens, followed by most of the remainder of the month dealing with the garden. No doubt about it, weeds



SWL W. L. Barnes-Ricker, 11 Inchbrook Road, Kenilworth, Warks., started in 1922 and experienced all the early Rx developments—crystals sets, hard and soft valves, home-built receivers (and components!) as well as QSL cards from famous stations like KDKA and W2XAF. Now, as we see from this picture, he runs much more sophisticated equipment and is as keen as ever on radio—indeed, at the age of 65, he is taking the May R.A.E. All readers will wish him luck!

grow faster than new prefixes this time of year!

It is always a good thing to join a club if it is possible; *M. Williams (Sleaford)* has now got in with the Spalding crowd, finding the atmosphere relaxed and friendly, which means Maurice should be able to learn a lot.

M. Fisher (Bradford) has traded his Trio receiver in for an AR88D, and thinks that, despite the extra size, the old '88 was worth it. Could be, at that; it certainly enjoyed a longer production run in years than most of the others put together, mainly because the Services, who never waste money on junk, kept on buying until at least the early 1960's.

Sad to relate, *A. Judge (Bishops Stortford)* is still not far along the way to his VHF converter project; and with warm weather coming on, there are urgent matters to be dealt with in the aerial line—You'll just have to make an effort, Tony!

K. Webb (Earley) has been putting in much time on his accountancy examinations, but had a tune round to find the bands quite nicely open. Keith heard a couple of odd prefixes in UC50C and UB50C, which were commemoration stations celebrating 50 years of the Russian Republic. They are coming on from each of the "countries" comprising the USSR for a week at a time, with snappy contacts to give everyone a chance—there is a contest for which the prime requirement is to work them at each stop. On a different tack, the stations from Italy and Scandinavia, using weird call-signs on 27 MHz, are probably the European versions of the Citizens' Band, which some countries allow.

For *N. Gerdes (Basingstoke)* activity has been low in one direction due to operation on the Cadet Force network in a sort of contest, running over several weeks. So far the best DX worked with the four watts of AM into a three-quarter wave end-fed has been another Cadet unit three hundred miles away.

R. Holland (Malvern) reckons the recent openings on Ten to have been the best since the 1958 sunspot peak, with stations coming in from all over the world—aided by the Trio JR-500 and 9R-59 receivers now in use. Indeed, Roy thinks the JR-500 the best receiver he ever owned.

Perhaps the most interesting part of *J. Fitzgerald's* note from *Great Missenden*, was the bit where WA6GLD, in his letter to John in reply to a report, discussed the sort of gear the W6's run: There is W6AM and his aerial farm of rhombics; and W6RR, who has 2 kW p.e.p. into an eight-element for Ten, a six-element for Fifteen, five elements on Twenty, and a full-size three-element monster for Forty! And this lot is all at eighty-five feet, to make sure it radiates!

From *R. Shilvock (Lye)* come three points; one, the "JYADO/AM", we have already dealt with. Then there is the question of the status of YU2VF/Y, on an island off Yugoslavia—anyone know anything? Thirdly, there was a BY0AC, heard with a Spanish accent on 14306 kHz at 1900z on February 22. This one we would view with grave suspicion, as, after all, one would not expect a Chinese to speak English with a *Spanish* accent. On the other hand, there is always the possibility he might be real—after all, there have been one or two genuine ones of late, albeit only, so far as the writer is aware, on CW.

NEW HPX LADDER

(Starting January 1, 1972)

SWL	PREFIXES	SWL	PREFIXES
PHONE ONLY		PHONE ONLY	
M. Winberg (Penzance)	437	M. Kitchener (Hitchin)	295
J. V. Parker (Newcastle-on-Tyne)	424	Z. Parmigniani (Stockport)	275
C. K. Verstage (Old Basing)	413	G. Ridgway (Basildon)	268
N. Gerdes (Basingstoke)	398	P. Newman (Thame)	265
H. Stephenson (Newcastle-on-Tyne)	397	R. Impey (Brentwood)	252
O. L. Cross (Bexleyheath)	386	J. Gravell (Burry Port)	244
A. I. Williams (Stockport)	377	W. and J. Bingham (Carrickfergus)	230
M. Marsden (Ilford)	364	A. K. Milner (Grantham)	230
Mrs. R. Smith (Nuneaton)	351	K. Rogers (Ullesthorpe)	229
R. Philpot (Shenfield)	350	B. Stone (Penzance)	223
A. West (Herne Hill)	333	R. Jones (Caerphilly)	216
L. Thomas (Castleford)	328	S. Clark (Charterhouse)	211
K. A. Hastie (Jedburgh)	303	R. C. Jones (Reigate)	210

Listings include only recent claims. Starting score 200.
Rules as for HPX—see p.560, November 1971 issue.

P. L. Newman (Thame) is in a bit of a pickle with his converter to the design of L. Case, published a few years back. The oscillator goes OK, but by the sound of things the mixer proper is not hitting the band. Anyone who has any knowledge of this circuit, or, maybe, even L. Case himself (who was a reader of this piece at one time) please get in touch with SWL Newman direct; he is at 58 Park Street, Thame, Oxon.

Of late, *E. Parker (Hove)* has not been listening all that much, mainly because he has been rehashing his hi-fi; but, as he says, the pleasure of listening to Beethoven's Fifth Symphony has made the effort well worth while. And one could comment in addition that, quite apart from the Amateur Radio association of its *di-di-di-dah* theme, most of the older readers will recall that wonderful music, telling the whole world Hitler couldn't beat the G's.

A. Mercer (Wigan) is very apologetic about missing the last "SWL," because of those exams, but the improvement in conditions of late has enabled him to pick up his new prefixes as though nothing had happened, as the table will show. And the bonus is that, if the exams don't kick up too much QRM, Alan may be able to sit R.A.E. next December.

* * *

As always there is much of interest in the letter from *H. M. Graham (Harefield)*. This time, Maurice seems to have tackled all bands, including an early-morning session on Eighty when he just couldn't write fast enough to log all the W's heard between 0530 and 6040! On a different line, Maurice wonders just where VP8MM is located—answered by looking in the J.C. QSL file, which gives him as Stanley, Falkland Is.—and very prompt with the QSL cards he is, too.

Shelagh and John Singleton (Hull) now have to share the use of the receiver, by tackling it in half-hour stints apiece—but as John says, the snag is that this scheme falls down if skip conditions change suddenly!

For *A. West (Herne Hill)* things have not been too bad, with signals heard on Ten, first loggings of W on Eighty, and a few prefixes picked up on Two. However,

Robin Philpot, 58 Hutton Drive, Hutton, Shenfield, Essex, has a fine array of equipment with which to pursue his main interest, DX. Also working for an R.A.E. pass, he hopes soon to be on the air. Robin asks us to say that he would be glad if any local SWL's would get in touch with him.

Albert has no less than four prefix question-marks, alongside which your conductor has put his red pencil mark which denotes "Ungood."

One of the things about Amateur Radio which gives *K. Kyezor (Perivale)* pleasure is the satisfaction gained from winking out a station buried under QRM by using skill in receiver operation—how very true! Oddly enough, this is a pleasure which few operators get, if only because the Tx type usually has a fair idea of the stations which he would be wasting his time calling.

The month or so reviewed by *O. Cross (Bexleyheath)* included, as it did for most of us, a spell of odd hours, occasioned by the presence or absence of electric power; and Owen made the best of his opportunities to listen at times when he would normally have been at work.

Talking of power, *K. Rogers (Ullesthorpe)* was able to keep going by means of a candle to light the log, and a T.28 receiver normally run off batteries. Ken also has a Mosfet converter, which unfortunately needs the main receiver, an RA-1, to act as the tunable IF, which meant no two-metre operation during power cuts. The aerials: For Two a Halo, and for the other bands an end-fed wire of 100 feet, starting at 25 feet high, and ending ten feet lower; and this is fed through an ATU. R.A.E. is high on the list, and, indeed, by the time this gets into print all the R.A.E. candidates will be entering on the last lap of their preparation. Let us hope that every one who has made the needed effort will pass!

Normally, *B. Hughes (Worcester)* is one of the chaps who content themselves just with sending in a list; but this time we hear he has had three weeks laid up—the opportunity was eagerly snatched to bring the logs bang up-to-date. Bernard often listens to contests, and always does his loggings for these in rough at the time, so that what goes in to the log is a "fair copy" and not a scruffy original.

A. Glass (Plymouth) offers "PX3BA" for our inspection, but, alas for Bert, we have to say No. A look at the prefix list shows a variety of P-type callsigns, but not PX, which at one time was the prefix for Andorra but is now, to the best of your conductor's knowledge, disused.

R. Carter (Blackburn) has a fine crop of weirdies; apart from his "HF's", which are almost certainly mis-readings of HS calls, the rest are all phoney except for a perfectly good RL7PA on Ten, who would, of course be signing UL7 were he on any lower-frequency band.

From his new address, *K. Plumridge (Southampton)*



writes to put his claim firmly into the All-Time, with a score of 751. At the new place there is a dipole for Twenty up in the loft, but other aerials must wait until the R.A.E. has been taken—studying for it is keeping him away from the rig, even.

The Trap Dipole

Recently we explained how a trap dipole could be made up; now *D. A. Shepherd (Kingswinford)* wants to know how such a trap dipole works. The principle is that if one wants to operate a dipole on two bands not in odd harmonic relationship—say, Twenty and Eighty, for example, one cuts a dipole for Twenty, and terminates it on a parallel-tuned circuit trimmed to reject 14 MHz RF, thus taking the place of an insulator, at each end. This done, one takes more wire, and adds it on the other end of the traps, cutting it by experiment until it shows resonance at the desired frequency on Eighty; the end-to-end length will be less than a normal 3.5 MHz dipole due to the loading-coil effect of the 14 MHz traps at this lower frequency. This is the basis for the trap aerials, often using more than one pair of traps in each element, but there is an interesting variation, with which a *single* trap can be made to go on several bands. This uses a 108-foot span (for the phone bands) with a trap resonant at 7.2 MHz with 100 pF. The traps are fitted, one in each leg, at 31ft. 4in. from the centre, cover six inches in themselves, and have twenty-two feet in each end section. This assembly is resonant as a slightly loaded 3.5 MHz dipole. On Forty, the traps make the inner spans look like a forty-metre dipole, which also will

work nicely on Fifteen, its third harmonic. On Ten, it also comes near to seven half-waves, and so we can get a low SWR on the 80, 40, 15, 10 metre bands. The compromise comes on 20m. and here the SWR is somewhat high, although mitigated to some extent by the damping effect of the feeder resistance, so that many amateurs use them with transceivers happily enough.

* * *

Last time out, *J. Iredale (Llandudno)* forgot to mention his tackle. He uses a Trio JR-500SE for 80-10m., with a converter for Top Band, and a two-metre device, the latter still being in the "brewing" phase. Julian has a word of thanks to record—he has received much help from GW3RUA and her OM, GW3GWX, for which he is very grateful. On his aerials front there is an end-fed Top Band half-wave used on all bands, and a dipole cut for 21 MHz.

R. A. Jones (Caerphilly) has harsh things to say of the QRM generators on Eighty's DX, and even harsher things to say of the practical joker who cut down his aerial wire! The things that happen!

Now to *A. Rowland (BFPO 53)* who has aerial and earth problems; he lives on a first floor flat with no access to ground directly, and a roof-top above which is usually cluttered with the washing-line. This is, as always, a very tricky one to answer without actually seeing the place. Perhaps one way would be the traditional "piece of wire round the picture-rail," or even hidden under the carpet, coupled against the mains earth through an ATU if you can trust the local mains supply, and are prepared to make "pulling the big switch" a matter of taking the power-plug right out so that there is no chance of nasty things happening in the event of a power breakdown. However, you will have to resign yourself to a certain amount of noise pick-up. Another way is to hang up a dipole as long as possible, and feed it at the centre with 300-ohm ribbon type feeder if you can get it, or even the twin flat lighting flex sold in the multiple stores, with an ATU to bring the resulting impedance to resonance and match.

Still with SWL Rowland, Alan also wants to know how to obtain one of the Zone Maps—write to Publications Dept., SHORT WAVE MAGAZINE, 55 Victoria Street, London, SW1H-0HF. Incidentally, this Great Circle projection map is centred on London, but would be tolerably accurate for most of Europe, and certainly for the U.K. If one is further away, say in Africa, one should be prepared to use a Mercator Projection map showing Zones and Prefixes; and if one is using a beam aerial, then perhaps the easy way of getting a table of short-path beam headings would be to invest in a copy of the *Amateur Radio DX Handbook* by Don Miller, W9WNV, which contains a large number of sets of beam-headings covering just about anywhere in the world to anywhere, not to mention lots of other useful information. (See pp.66-67, April issue, for prices and details.)

N. Askew (Coventry) has one of the Marconi HR-110 receivers, and wonders if anyone else has one for SWL use—he has never heard of it for sale other than at the time and place where he got his. Whichever way, if SWL Askew is pleased with it, that's the main thing!

Oh, dear! We slipped! *J. H. Sparkes (Trowbridge)* wasn't credited with all the prefixes he claimed, last

time out, so he sent a duplicate list asking for his deletions—sorry, OM, the fingers and toes just don't seem to have been up to counting that many—there's nothing wrong with the prefixes, and we hope this time the Table is correct.

Sad to say, *Mrs. R. Smith (Nuneaton)* is being kept off the air by her son—he has his nose to the study grindstone, for his A-Level exams., in the room where the receiver is! Our only suggestion is to pinch the receiver, and take it to somewhere more convenient, on the grounds of "removing temptation!"

To Those Taking The R.A.E.

Our good wishes to every candidate, reading these lines, who is in for the Exam. now upon us. If he has been properly instructed within the syllabus and has done his reading conscientiously, he ought to pass, no trouble at all.

When you go in, take it easy. Study the Question Paper carefully and pick out those that you feel you thoroughly understand and can deal with easily. Remember that you *must* answer both questions in Part I. It is in Part II that the choice lies. If you are weak in maths or with formulae, take first the questions you know you can do. Keep your answers short and to the point—never use seven words where four would be enough. Then work back towards what, for you, seem to be more difficult questions. Take no notice of what anyone else in the room is doing—the problem is between you, the Question Paper before you, and eventually the Examiner. Write carefully and legibly—remember that an unreadable scribble, even if it does contain the right answer, amounts in effect to being rude to the Examiner. He will always warm to a clean and tidy presentation and will be inclined to pass over minor inaccuracies if he thinks that really you do understand what the question means.

So, good luck, and let us know in due course whether you collected that Pass slip, and the grading you got.

For the Next Time

Once again we have reached the bottom of the pile; we acknowledge entries for the HPX Ladder in addition from *J. Woods, Woodbridge*; *W. B. Taunton, Meopham*; *G. W. Raven, London, S.E.13*; *E. W. Robinson, Bury St. Edmunds*; *H. Alford, Burnham-on-Sea*; *R. Philpot, Shenfield*; *A. W. Nielson, Glasgow*; *R. Bence, Cardiff* and *N. Henbrey, Northiam*.

As for the next time, the deadline will be May 30, addressed as always to "SWL," SHORT WAVE MAGAZINE, BUCKINGHAM. 73.

BIG I.E.A. EXHIBITION—MAY

This year's International Instruments, Electronics and Automation Exhibition will be held at Olympia, London, during May 8-12, when the theme will be "Getting Back to Prosperity", it now being admitted that the electronics industry has been in the doldrums for the last four years or so. All the firms showing—and there will be no less than 56 concerns sponsored by the U.S. Dept. of Commerce, as well as companies from other countries overseas—will be interested only in the "hard sell". Let us hope that the U.K. will be adequately represented in the face of such competition.

ONCE again, conditions on the VHF bands have been very patchy, mostly down on average, with just the occasional lift. March 17-18 produced some reasonable DX on 70 cm. and 2m. and the 19-20 saw Continentals coming in from F and DL. At the end of March and the beginning of April, both N-S and E-W paths were open for 200-mile contacts on 2m. and 4m. Propagation was slightly better in the Midlands and the North than in the South, on occasions. G3NHE (Sheffield) records with pleasure his discovery of 70 cm. stations beyond the 50-mile mark, and had good QSO's into Northumberland and Surrey on the morning of March 18; on March 21 he found both GW3NNF (Anglesey) and EI4AL near Athlone good signals on CW. He was luckier than G8AGL, who reckons that conditions this year have hit a new low. Incidentally, those who worked John at Wolverhampton airport may like to know that he is now Chief Flying Instructor at Hull airport.

Still no aurora to report at the time of writing and still no obvious signs of a break in either the weather or the poorish propagation conditions.

Contests

The "local" Region I VHF Contest will be run again this year under the auspices of the Ainsdale Radio Club. The date is June 25, the time from 0900-1800z, and the bands 4m., 2m. and 70 cm. This contest is also open to operators outside Region I, and a special prize will again be awarded to such an operator who scores the greatest number of points in contacts with stations in the Region. Logs should be sent to G2CUZ, *QTHR*, from whom further particulars may be obtained. Incidentally, the Ainsdale Club are doing their bit to promote greater activity on 70 cm. by offering a bonus multiplier of 6 for contacts on that band.

Times for the mid-Severn Valley Teleprinter Group RTTY contest on May 14 are now stated to be 0900-1500z. The frequency of the auto-printer watch is 144.486 MHz. Other details as for last month.

The 4m. contest on April 8 did not produce anything very startling in the way of DX. Propagation was

VHF BANDS

A. H. DORMER, G3DAH

fairly good at the start, dropped off during the late morning and early afternoon, and then revived slightly towards the end. Surprisingly, perhaps, there was not a great deal of CW about, and activity generally seemed on the low side, although GM was worked on the key from the Midlands during the afternoon, and G3OHH (Mow Cop, Staffs.) had successive QSO's with GD2HDZ and G3KSU in I.o.W.

Forthcoming events are the 432 MHz contest over May 6-7, and the 144 MHz affair on May 21.

Wrinkles

G4ALN comes up with a scheme for resolving phase modulation in the absence of an appropriate demodulator and de-emphasis network: Try using the BFO and tuning to the centre of the carrier. You may be surprised to find that you can resolve the signal far better than you can using slope detection. (This will not, of course, apply to those receivers with narrow band filters.)

G3VJF has an elegant method for measuring his own, and external, frequency deviation on NBFM: Connect the DC input of a 'scope to the output of the discriminator in the station Rx and tune in your own unmodulated NBFM signal. The horizontal trace should now be at the centre of the screen; detune the Rx up and down from centre frequency by 1, 2 and then 3 kHz; the trace will move vertically as this is done, and the positions it occupies at the various settings can be noted—a graticule is advantageous here.

Now modulate the signal and adjust the audio gain controls until speech peaks just reach the 3 kHz limits. Alternatively, use an audio signal generator set at 3 kHz, at the same output level as the normal microphone output, and use this for calibration. This procedure does more than just give an indication of the deviation. It shows up drift and/or inaccurate netting when several NBFM stations are supposedly on the same channel. And, by golly, does it show up the over-deviation so prevalent on 2m.!! As a guide, on the Sommerkamp FR-DX500, plus or minus 3 kHz is equivalent to a voltage shift of plus or minus 2 volts at the discriminator output.

VHFCC Awards

Two "Firsts" in this month's list of new members of the VHF Century Club. Jim James, GW3KZT (Newport, Mon.) becomes the first operator with a GW prefix to gain this distinction, and Nigel Hadley, G8FAG (Aylesbury) is the first G8F/3 to receive the Award.

GW3KZT operates on two metres and earns Certificate No. 145 for his results on that band. He had been away from Amateur Radio for some 11 years while in VK, and it was not until he returned to this country that the bug got him again, and so he re-sat the R.A.E. and Morse Test and at the beginning of the 70's was on VHF. He runs a modified Pye base-station with a QQV06-40A in the final, the Trio JR-500S with FET pre-amp. and converter, and a 6/6 slot at 25ft. The take-off from the 500ft. a.s.l. site is pretty good in most directions, but the Brecon Beacons are very much of a barrier to the West and North. He is a late-night bird, so you will often find him on about 144.35 MHz after midnight.

G8FAG, Award No. 144 for 2m., made the necessary number of contacts, and, more importantly, got the 100 QSL cards in, since he started up on the band in August, 1972. He runs an HW-30 with 5 watts input, a Trio JR-500S with FET converter, and an 8-ele. Yagi at 35ft. from the 260ft. a.s.l. site. As can be seen from the Annual VHF Tables, he claims 41 counties and 4 countries worked with this QRP set-up—a very creditable performance indeed.

Award No. 140 goes to G3GBH

(Bridlington) who operates on 2m. from the *sea-front* at a height of 30ft. only. While this is OK for Continental working, the Pennines and the Yorkshire Wolds make contacts pretty difficult in other directions. He also runs a modified Pye base-station with a QQV06-40A PA but has replaced the original 6V6 modulators with EL34's. The beam is a 7-ele. Yagi at 30ft. The Rx is interesting at it is a home-made, solid state, double superhet, with an FET converter, the IF's being 7.9 MHz and 455 kHz. Harry finds that the Continentals are much more reliable than U.K. stations as far as QSL cards are concerned—he estimates the return-rate from them to be in the region of 70% against the 25% from G's. One cannot help wondering why the U.K. rate is so consistently low—it used not to be! Future plans include operations on 70 cm., and VFO control of the Tx to replace the existing xtal channels.

From Camberley in Surrey, G8ECO gains two-metre Award No. 141. He opened up in 1970 with a QQV03-10 PA and a nuvistor converter feeding a Trio 9R-59DE, but the Tx is now an Emsac TX2 and the 8-ele. beam is up at 32ft. He should be QRV on 70 cm. again shortly.

G3PTO (Horfield, Bristol) gets Award No. 142 for two-metre work from his old QTH in Wolverhampton. Although he first came on the band in 1962, operations ceased in 1967 when some local hooligans set fire to the shack! During that period, the gear consisted of a QQV07-50 PA and a pair of stacked 10-ele. beams at 40ft., and the converters were nuvistor with the occasional addition of a parametric pre-amp. He is now mobile on 144.43 MHz most evenings, from a good site near the home QTH, at 350ft. a.s.l. with a halo and a TW "Communicator."

Finally, G8EFR of Whittington, Staffs., who receives Certificate No. 143 for 2m. He started up in 1970 with a QRP rig, but now has an SCR-522 on A3 and F3. The Rx is a BC-348Q with FET converter and the beam a 6-ele. Yagi at 28ft. The QTH is at 200ft. or so a.s.l. with a good take-off pretty well all round. Once again, his QSL return rate is only about 50%, and even

that is better than what appears to be the national average of around 30%! He is now working for the G4 ticket.

Congratulations to them all, and one awaits with interest their entries for the VHF Annual Tables.

Beacons and Repeaters

Details were given last month of the new Swiss beacon on two metres. Reception of this beacon has now been reported by G8BGQ (Rickmansworth) and by G8BMD up in Shropshire, and this in spite of some pretty poor tropo. conditions. For those who missed the earlier announcement, and to add some further details, parameters are as follows:—Callsign, *HB9HB*; Location, *Chasseral*, QRA Locator *DH66f*; QRG, *145.985 MHz*; output, *10 watts*; Antenna, *Yagi beaming North*; Keying, *continuous c/s FSK*. This is going to be a most useful indicator of propagation conditions to the South-East during the summer months if reception is possible at this time of the year and under the prevailing circumstances.

GM8FWY gives a warning to those who rely on beacons for frequency checking purposes. They are not always spot-on, and quotes the Angus beacon as being high in frequency on March 19, although checks since have shown it to be very close to the correct figure. Details of the frequency variation in the Wrotham 2m. beacon are published from time to time and it is reasonable to suppose that some small deviation from the correct figure will be observed on *all* beacons, but the error is usually quite negligible—being in the order of *cycles*, and therefore well within the tolerance of any usual amateur Rx. If absolute accuracy is required, some much more sophisticated method of measurement is necessary.

Four-metre beacons in the U.K. are back in service again. Subject to correction, it is believed that this is only the second time that GB3SU has been off the air since installation; a very fine record. GB3SX was reported in the Midlands as being down in strength after its return to service, but this may have been due to propagation conditions, and recent checks have shown it to be at usual level.

From G8AWR comes some depressing news about the effect of

the introduction of FM repeaters in Germany, whence he has recently returned. It seems that normal tuning and transmitting procedures for DX working have gone by the board. The repeater frequencies are under heavy QRM from masses of FM mobile and fixed stations, with the result that, unless one is equipped with NBFM and xtals for the appropriate channels, the chances of getting a DX contact are fairly remote. The multiplicity of repeaters in that country has brought about this situation, and one can but hope that the smaller number of such installations planned for the U.K. will not give rise to a similar situation here. When 500-mile contacts *via* repeaters on 2m. become the norm, much of the fun will have gone out of DX operating as we now know it.

It looks as if someone is quickly off the mark with a repeater! An installation in the North-West is responding to 70.26 MHz signals in the Midlands and Manchester areas and replying on 145.8 MHz. Beam headings suggest North Wales as a possible location. Why the mystery!

The Scottish Scene

The mammoth 2m. DX-expedition organised by the Watson's College chaps has now been finalised as follows: May 13, *Wigtown*; 14th, *Kirkcudbright*; 15th, *Dumfries*; 16th, *Lanark*; 17th, *Peebles*; 18th, *Selkirk*; 19th, *Roxburgh*; 20th, *Cumberland*; 21st, *nil*; 22nd, *Westmorland*; 23rd, *Flin*; 24th, *Denbigh*; 25th, *Caernarvon*; 26th, *Merioneth*; 27th, *Montgomery*; 28th, *Cardigan*; 29th, *Stafford*; 30th, *Yorkshire*; 31st, *Northumberland*; June 1, *Berwick*; and June 2 in *East Lothian*. You can't complain about lack of variety there, and this trip (which looks to us just about impossible in terms of the ground to be covered) may enable some operators, both North and South of the Border, to knock off a few of the difficult counties. The programme, between 1800-2200z each evening, is to run SSB for the first 15 minutes in each hour listening on channel; AM for the next 30 minutes and tuning over the band; then CW for the last 15 minutes of each hour, listening in the CW section. QRG as follows: SSB, 145.4 MHz; AM, 145.5 MHz; and CW, 145.5

MHz. Skeds may be arranged with Roger Manners, GM3ZVL, QTHR. Best of luck, chaps—by heavens, they'll need it! (They'll do well if they get operational from 12 or so of those twenty counties within the period!)

Mention has been made in the Column from time to time of the father/son combinations to be heard on the VHF air. Here is a new one, though: Father GM4ABH and sons GM3ZXE and GM8FUS are all operating 2m. portable from a site near the Angus beacon. They should be able to put in a good signal in the South as they are already well received in the Lothians.

GM3BQO has at last been persuaded by his neighbour GM6XI to come on two metres—"Britain's Queerest Object" as he still styles himself, has a good QTH in Edinburgh and a great deal of "know-how". Also up on 2m. is GM8EKF, operating *pro tem* from a flat in Edinburgh. He is particularly well placed for contacts to the North, for which the Aberdeen boys may be thankful. Although not a newcomer to the band, GM3UBJ has been mobile on two metres recently, and a long way from his Banffshire home to boot! Jimmy McCaig, GM3BQA of North Berwick, is putting out a fine NBFM signal on 2m. and no prize is offered for guessing correctly the antenna he uses—a Quad, of course! He plans to be on SSB shortly.

George Burt, GM3OXX, continues to play it the hard way! Good Friday saw him at the top of the Cheviots at 2636ft. a.s.l. in appalling conditions. He stuck it out in his tent on the peat bog until Saturday evening when the gear became u/s because of the wet. He still managed to make over 70 contacts on 2m. with his QRP 500 mW Tx, and over half of these were with English stations. He also had QSO's with Newcastle-upon-Tyne and Duns (Berwickshire) on 70 cm., which is pretty good going considering the poor propagation over the holiday. He has now worked GM3VBB over a distance of 16 miles on 23 cm., which must have pleased them both. Incidentally, GM3VBB also holds the call GM6ADU/T, and would doubtless be glad to hear from interested parties.

It is reported that there is a grow-

ing interest in two metres in the Kingdom of Fife, which will interest the county chasers. Reported also is the imminent return to his homeland of GM3IVZ who has been exiled in UA3 for some time.

The Manchester University Club are planning an expedition to Islay and Jura in late June. With the call GM3YOK, held by their president, they could hardly do less! Details next month.

Bill Jarvis, GM8APX, will be QRV portable from several mountain tops in Perthshire on May 13/14 or 20/21. He is in charge of Physics at Rannoch School and will be taking a party of his youngsters out to attack the Perthshire "Munroes" as part of a charity programme. He

will have NBFM on 144.46, 144.6, 145.0, 145.6 and 145.8 MHz and will be calling both North and South.

As noted in "VHF Bands" in the March issue, GM8FFX and GM3ZBE were operating from Cairn o' Mounth in Kincardineshire for the March 4-5 contest. Their best DX was with OZ9SW on 70 cm. at 5 & 9 both ways. They also worked OZ5HA on that band. SK6AB, who can listen on 432 MHz but not, at present, transmit, gave them 5 & 7 over the two-metre channel, which is very nice going. GM8BDX (Duns, Berwickshire) and G3YRH (Newcastle) were also contacted at 5 & 9 both ways as was GM3OXX/P, who was only running 150 mW at the time!

(over)

THREE BAND ANNUAL VHF TABLE

January to December, 1972

Station	FOUR METRES		TWO METRES		70 CENTIMETRES		TOTAL pts.
	Counties	Countries	Counties	Countries	Counties	Countries	
G5DF	19	2	37	5	19	1	83
G3DAH	10	1	29	3	17	1	61
G3MHE	—	—	40	4	11	1	56
G8BXX	—	—	32	2	18	1	53
G3OHH	19	2	16	2	10	2	51
G8FAG	—	—	41	4	—	—	45
G8CIW	—	—	36	6	—	—	42
G4ALN	—	—	23	4	13	1	41
GD2HDZ	—	—	23	3	8	2	36
G8CBU	—	—	23	2	4	1	30
G8EMS	—	—	26	2	—	—	28
G3FIJ	5	1	14	2	4	1	27
GM8BDX	—	—	20	3	2	2	27
G8AGL	—	—	25	1	—	—	26
G8BKR	—	—	16	2	5	2	25
G8ERM	—	—	21	2	—	—	23
G4AJE	—	—	21	1	—	—	22
G8COG	—	—	19	2	—	—	21
GW3CBY	—	—	10	2	1	1	14
F6BQH	—	—	7	3	—	—	10
G3EKP	—	—	4	2	1	1	10
G8DBX	—	—	6	2	—	—	8
G4AVX	—	—	5	1	—	—	6
G8FSO	—	—	4	2	—	—	6

These Tables go through to December 31, 1972. The Three-Band Annual Tables show claims to date for the year commencing January 1, 1972. Claims should be sent to:—"VHF Bands," SHORT WAVE MAGAZINE, BUCKINGHAM, as scores accrue.

This enterprising GM pair will have some 400 watts of SSB available for portable operation on 2m. and are making a start on SSB for 70 cm. They will be on from the Isle of Man during the period August 17-27, a date which includes the SSB contest. They have acquired a dish for 1296 MHz which should make them a very attractive target if they can get it out portable!

News from Abroad

John Attlee, G8DOS/SM7FZD, is now permanently resident in Malmö, and has his two-metre gear with him (75 watts of NBFM and an 8/8 slot at 120ft.); he is looking for British contacts. Skeds can be arranged with him at Strandgatan 50B, 216 12 Malmö, Sweden, against the time when conditions improve. (He has not got CW at present, so will not be available during an aurora!) As far as frequencies are concerned, he suggests that the top 500 kHz of the band should be avoided since over there that segment is filled with modified, ex-taxi rigs with 25 kHz deviation. He gets out well from the QTH and has already made contact with OZ3TQ (whom readers may recall is ex-G3TPL). Auroral openings in those latitudes are far more common than they are in England, of course, and John says that they have already had three good ones this year; the strength of some of the LA, OH and Northern SM signals has to be heard to be believed. Preparations are in hand to come on 70 cm. with a 46-ele. beam, and SSB is also a prospect.

Much sought after during an aurora, and under extended tropo. conditions come to that, is SK6AB, situated in the Chalmers University of Technology in Gothenburg, Sweden. Some measure of their activity may be gained from the fact that, apart from all the Continental stations they have worked, they had QSO's with 110 different British stations during 1971. They use a German transceiver, the 2G70B, which gives them SSB/CW/AM/NBFM on all bands with VFO facilities, and for 2m. they mix the output of this Tx and apply it to a pair of 4CX250B's running a cool 500 watts. This is then fed to a pair of 14-ele. beams. They can receive on 70 cm. at present and will have a 5-watt Tx going shortly which

will feed four 46-ele. beams—have already been heard from GM3ZBE and GM8FFX. Best openings during 1971 were on March 3, when they worked 36 U.K. stations, of whom 27 were on SSB and nine on CW; and September 7, when they contacted 51 U.K. stations and EI6AS. They always try to be on the band then there is an aurora around, but have to limit their operations before 2000z since, prior to that time, they are apt to cause a bit of havoc to some of the laboratory work going on!

They pass on some useful gen. about operating practices. Most SM's in the North, and the OH's, do not work on the usual 2m. SSB channel as they do not have xtals for this frequency, so they tend to use sideband near 144.2 MHz, although SM6 and SM7 do operate the international channel. CW activity is high at the low end of the band, particularly on the first Tuesday of each month, when there is a Scandinavian Activity Contest during 1800-2300z.

Home News

Many readers will have heard the chit-chat going around on two metres about the contact between an Essex station and an "I3 in Venice" on the night of April 4. Great has been the speculation about the propagation medium which would account for such a QSO, the most commonly mooted being the Sporadic-E theory—in spite of the time of year and day, or night, which made such a hypothesis unlikely. But—*Eureka!*, the mystery has been solved. The I3 and his wife, who also holds an Eyetic ticket, were operating from a London hotel during a short visit here and had brought a low-power rig with them. Naughty, naughty—hadn't they heard about reciprocal licensing? (This is the sort of thing that needs to be stamped on heavily with both feet.)

G3XIM will be /P in the Lleyn area, Caernarvon, during the period May 29 to June 3. He will have gear for 2m. and 4m. and can receive all modes, although he will be transmitting AM and NBFM only on 145.0 MHz with 10 watts to a beam and has three other frequencies available as required. Activity will be mainly during the evenings, but if the licence comes through

on time there should be some mobile operations during the daytime.

GW8FTA plans a trip to Monmouthshire and a 1,883ft. a.s.l. mountain during the period May 6-July 6. Frequency will be 144-338 MHz, and he would particularly welcome reports from SWL's at over 50 km. from the site. All reports, which should be sent to M. P. Austin, 26 CWRT Glas, Croesyceiliog, Cwmbran, Mon. or via the Bureau, will receive a QSL card. He has already tested out the site and has made contacts with Kent, Surrey, Hampshire and London in the South, and also worked into Cardigan, Derby, Warwick and Staffs, so it looks a good bet for those wanting Monmouth. If you are interested, skeds can be arranged. Times of operation 0900-1700z weekends only.

The Kentish Beacon (G2JF) is now back after his trip to South Africa.

Mention was made last month to the welcome appearance, on the 2m. SSB channel, of G3BW in Whitehaven, Cumberland. Readers may like to know that Bill is active most evenings with a QQV06-40A linear fed from a QQV03-10 mixer. The beam is a 10-ele. at 42ft. and the prime mover an FT-101 tuning 28-30 MHz. G3BW is one of the well-known GDX operators of early two-metre days.

Another mention last month was of the activity from GB2MT, the special station set up at Writtle, Essex, by the Marconi Apprentices' Radio Club in connection with the 50th Anniversary of the start of regular broadcasting service in this country. They made some 740 contacts in all, of which about 100 were on 2m. using 50 watts output and a fixed 8-ele. Yagi at 100ft. Unfortunately, conditions on Two were pretty poor and no super-DX contacts were recorded. QSL cards should be on the way, but queries can be passed to the club. Operators included G3OZF, G3ZLQ, G3VDB, G3WSN, G8CUT, G8CUQ, G8EQM, G8DJG and G8BFV, to whom thanks for this information.

G8CIW, of Tooting in London, is one of the newcomers to 2m. SSB who has been putting in a good signal over most of the country. He appeared to be the only station

in the South audible in the Midlands during the slight lift on March 18. He is looking for skeds with stations in the South West—including GC. Write him *QTHR*. G8FSO is now active on 2m. from Wakefield, Yorks. and hopes to have 70 cm. available soon. He has only 2 watts of NBFM at the moment to a 6 ele. Yagi, and asks for skeds outside the West Riding! G8BKR comes up with the news that GW3DFF in Swansea is now QRV on 70 cm.; if you can't find him immediately on that band, try 144.51 MHz for a QSY . . . GW3TKH (Cardiff) has video and is looking for contacts . . . G8ATV of Malmesbury, Wilts, is off to Hong Kong for 18 months in August . . .

G3NHE (Sheffield) is now up on 70 cm. with 20 watts from a QV03-20A; he is another who believes in having-a-go when the bands sound dead; even if no QSO results, it may brighten the life of an SWL. He also pleads for more activity on 70 cm., and supports the idea of a multiplier for that band during contests; he quotes the example of the last 144/432 MHz event in which, although he made 113 contacts on 2m. and 16 on 70 cm. his neighbour, G3NEO, with a handful of 2m. contacts but 31 on 70 cm., scored 150 points more than he did. He also advocates more CW on 70 cm. and suggests that if an "Activity Night" is too much to hope for, then what about an "Activity Hour". Readers views would be welcome.

Norman Horrocks, G2CUZ, the secretary of the Ainsdale Radio Club, says that there is a large body of opinion in the Lancashire area which holds that the GI and GM operators are not getting a fair crack of the whip on two metres since the Band Plan was amended to combine the Zones in the North and North-West of the U.K., as the Lancashire QRM is a bit fierce for them at times. Perhaps one may be forgiven, therefore, for pointing out yet again, that the Plan has been amended to create a "window" between 145.85 MHz and 145.95 MHz for the GI's and GM's operators, and that it would be of advantage to most of us if that spot were left clear for them. One must give the amendment time to take effect, and it may be advisable to review the plan again in, say, a year's time.

G8COG in Birmingham is only

on Two at the present time, but is collecting the bits and pieces for 70 cm. He complains, and don't we all, about the RF welding and heating equipment which causes so much S9+ QRN on 2m. particularly, with the noise 100 kHz wide and drifting 500 kHz in 20 seconds! He suggests that it might be a good idea if those operators who are able to work during the day, when activity is generally low, were to call CQ exactly on the hour, as is becoming the practice on the SSB channels during the evenings. This is fine, and would almost certainly result in more QSO's. The trick is to get it started, and get people used to the idea.

The next meeting of the South-East UHF/VHF Group will be at Wye College, near Ashford, Kent, on May 5, when the speaker will be G2DCG, talking about some of his experiences on the HF and VHF bands in Australia, where he recently spent a protracted holiday.

It is with regret that we must record the sudden death of Peter Bradley, G8KZ of Faversham, Kent. He will be remembered by many as the owner of *Hamrad*, a business which in earlier days supplied so many amateurs with components for home construction.

23 Centimetres

G8BYV (Dereham, Norfolk) has been getting some very nice results on 23 cm. Over March 16-18, he worked G8ACN, near Saffron Walden, Essex (40m.), G8ARM, London (82m.), G3SXX, Cambridge (35m.), G8AZM, Sidcup (80+m.), G3ZEZ, Clacton (60m.) and G3PQR, Frinton (50m.). On the 21st, he had contacts with PAØDBQ (150m.), PAØWFO (160m.), and had reception report from PAØWTE of 5 & 3 at 250 miles, all on 23 cm. He also had nine PAØ QSO's on 70 cm. the same day. Subsequently,

he worked G8BAV in Derby (90m.) at 5 & 4. *Very* good going, on which he is to be congratulated. He now has a VFO working on 1296 MHz, and is getting good reports on the stability.

VHF Annual Tables

The response continues to rise, although it falls a long way short of the totals which were coming in ten years ago! It is regretted that some claims were omitted from last month's Tables, but copy had to be in early, and so last-minute entries just had to wait over until this month. In spite of the poor conditions, G5DF in Reading has increased his total by 12 and, thanks to the 144/432 MHz and 70 MHz contests, your scribe has managed to get his up a bit also. G8FSO, appearing in the Tables for the first time this month, has the right idea; although he only works the one band, and therefore cannot hope fully to compete with those who work all three, he says that his score may be of interest to others in his area, and that if nobody comes last, who can come first? Please get claims in as early as possible after you receive your copy of the *Magazine*. It will all even out at the end of the year when ample time will be allowed to get the final scores in.

Deadline

Deadline for the next issue is **May 6**. The address for news, views, claims and comment is:—"VHF Bands", SHORT WAVE MAGAZINE, BUCKINGHAM. Closing dates for the next few months are: June 10, July 8, August 5 and September 9. Please note that these are *hard* dates, by when your material must be in. Anything received later cannot be covered till the following month. Cheers for now and *vy* 73 *de* G3DAH.

TV LICENCE RECORDS ON COMPUTER

The Ministry of Posts & Telecommunications, Waterloo Bridge House, Waterloo Road, London, SE1-8UA, inform us that henceforth all TV licence data are being kept by computer. This is going to mean filling up a new sort of TV licence application form in order to get the machinery ticking—and one can foresee a vast complication developing as the anti-form-fillers get into their stride!

THE MONTH WITH THE CLUBS

By "Club Secretary"

(Deadline for June issue: May 5)

(Please address all reports for this feature to "Club Secretary," SHORT WAVE MAGAZINE, Buckingham.)

WE have, in one of these preambles some time ago, talked about the need for the Club to welcome a potential new member as such, and not leave him out in the cold, feeling unwelcome. However, there is another side to this coin (as there is with any other) which was rather vividly brought to light in a conversation at a recent meeting. The point was put in the form of a question, namely, how much time are you supposed to spend trying to talk to the new chap if he, for some reason, will only answer in monosyllables?

Putting the matter into simple terms, what he was saying was simply that if the chap makes no attempt to react to the existing members in a friendly way, they should take it as read that he really wants to be left alone to enjoy himself in solitude.

Where *does* the responsibility fall in such a case, if the chap says he didn't join "because no one would talk to him."?

Southern England

Echelford have the top spot in this pile; they had their AGM at the March meeting, and G6JP was booked to take the rostrum at the meeting in April, but as yet we have not been advised of the May doings at the Hall, St. Martins Court, Kingston Crescent, Ashford, Middx. Thus we have to refer you to G3VWJ, address as in Panel, p.176.

"To be arranged" says the *Mid Sussex Newsletter* of their meetings on May 4 and 18, although dates in April and June are both firm bookings—so there is a reasonable certainty that if you go along to Marle Place, Leylands Road, Burgess Hill on the dates noted there will be *something* of Amateur Radio interest going on.

North Kent seem to have changed their Secretary, and this is reflected in the Panel; on May 11 there is the AGM, and on the 25th a combined meeting with the Cray Valley group to discuss NFD arrangements. All meetings are at the Congregational Church Hall, Bexleyheath.

At **Shefford** they prefer it weekly, at the Church Hall, Amphill Road, with Thursday the favoured day. Hence May 4 is a talk on First Aid, May 11 a Morse Quiz, May 18 a visit to Sandy Heath BBC, and on the 25th there will be a D/F hunt, organised by G2AUA.

Over to **Bishops Stortford**, where, for their sins, they are to have a talk, by G3KFE, to be inflicted upon them—the subject at the time of writing is quite unknown and will probably remain so until the start of the talking. Then he will probably go off at a tangent! This one is

on May 15, at the British Legion Club, at the top of Windhill.

Bedford have their corporate being in the Dolphin, The Broadway, Bedford. Here there is May 4 for NFD Planning, and D/F; May 11 for a demonstration of the FT-DX560; May 14 a D/F Hunt; May 18 a talk about Fiji by G3HZG; and on May 21 there is a VHF contest. Then there is a session of "Small Projects for the Novice" by G3XDU to fill in May 25, leaving May 28 when the Spring Holiday Net meeting on 3650 kHz is down for 1000 clock. And that should be enough for the keenest!

The fortnightly session is preferred at **Horsham**, where May 2 is devoted to Wavemeters and Licensing Conditions, followed on May 16 by an informal. As the Hq. is not mentioned, we must refer you to the hon. Secretary, at the address in the Panel on p.176.

Pressing on, there is **Acton, Brentford and Chiswick** to take in—here the subject is Aerial Matching and the Standing Wave Ratio, in the form of a discussion on May 16 at the Chiswick Trades and Social Club, 66 High Road, Chiswick.

It looks like the first and third Wednesdays at **Cray Valley**. With the AGM only just passed, we can hardly expect a fully finalised programme yet, but we are to understand there will be a Junk Sale at the mid-monthly May evening. As always, "home" is the Eltham Congregational Church Hall.

Chews House, 77 High Street, South, Dunstable, is the place where the **Dunstable Downs** group get together on Friday evenings. As for the lectures, there is G3RPE, who is coming along to talk about 3 cm, on May 5, and on May 19, the lecture is on Integrated Circuits in solid-state communications equipment. The "between weeks" are given over to informals, R.A.E. and Morse.

Edgware now, where on May 8, G3GC and G3SJE will talk about "Contest Operating," with May 22 given over to an NFD briefing. Both are timed for 8.0 p.m. at St. George's Hall, 51 Flower Lane, Mill Hill.

Lots of new members is the story from **Crystal Palace**, where G3FZL seems to have been hon. Secretary ever since your conductor first started doing this piece; and since the programme for May 20 at Emmanuel Church Hall is "open", we can also remark this is the first month to be open for as far back as we can recall—not a bad record!

Lots of things for **Chiltern** to do this month, what between the informal on May 9; the demo. station at Borlase School Fete at Marlow; G3DAH of "VHF Bands" giving a talk, and the Chiltern Mobile Rally on

“What is it, for heaven’s sake?” After the recent highly successful Racal Club Surplus Sale, for which attendance was up about 50% on their previous sale in 1971. A fine range of excellent equipment—mainly the firm’s own surplus—was disposed of at very attractive prices.



May 28.

For May in Verulam, G3VUQ and G3OHX will be appearing together to present a lecture entitled “Diagnosis of TVI”—a subject of consuming interest in an area of Channel ITV, which puts paid to most amateur operation above 7 MHz. Note, all members, visitors and others interested in this lecture, that the date is *May 24* and not the normal “third Wednesday” date.

Crawley have had a narrow escape—we nearly made the mistake of putting them in the Midlands clip! However, they are remaining in Sussex for the time being, at Trinity Congregational Church Hall, Ifield, Crawley. They will have a rather interesting evening on May 24, as G3KAX will be giving a slide show and talk about VP8-land.

Preparations for NFD are going on apace, at the Thames Valley Club. On the first Wednesday in May, G3KTU will be giving a talk on the “Useful Things which can be Done with a Simple Oscilloscope”—one hopes that this will encourage more attention to what must be the least used of all the test gear in the average amateur station—at the same time as it is the most used in a professional lab! Looking forward to June, we see that G3JIP will be discussing TVI and “other forms of interference.” As for the venue, that is the Three Pigeons, Portsmouth Road, Long Ditton, Surrey.

Nationals

First, the Royal Navy A.R.S. which is well worth joining if you are eligible—and this is if you are, or have been, in the Navy, or the Merchant Navy, or in another country’s Navy. Apart from the Nets, they have all sorts of things organised, such as QSL’s at a special rate, the *Newsletter*, the QRQ runs for those who like CW and certificates-on-the-wall, and other interests.

R.A.I.B.C. always has something of interest in their *Newsletter*. As always, this month they report new members, both blind and invalid, as well as some

supporters—but one can be sure they can use more help, both practically and financially, in their very much appreciated work.

B.A.R.T.G. have their Convention on May 20, at Meopham Village Hall, on the A.227, between Wrotham and Gravesend. There will be sales stands, talk-in on Four, a working station exhibit, lectorettes, snacks in the Hall—meals can be obtained in the village—and a shuttle service from the station for those not coming by road. As for the *Newsletter*, this issue carries a most informative note on the decoding of the weather transmissions—those five-figure groups one often hears on the radio and uses for Morse number practice.

It is not very often they report in, but whenever they do, your scribe is in a quandary as to whether they should be put in this clip or treated as a normal group which would put them in the “Southern England” slot. We are referring, of course, to the Scout station and group at Baden-Powell House, Queens Gate, South Kensington; the next meeting is down as May 18, and the programme to be announced—not surprising as they have just had their AGM.

Now we have A.R.M.S. catering for the mobile types, whatever band or mode they favour. Perhaps the most important facility this Club offers to members is the Information Service, covering such matters as reciprocal licensing, interference suppression of the car, and so on—and the *Mobile News* each month must run a close second, with interesting articles of mobile interest.

Scotland and North

Top of the pile here is Hull, who have their place at 592 Hessle Road, where they can be found on Friday evenings. Thus, for May, we see they have, on the 5th, a session of preparation for Field Day, and on the 12th, G3WWD will be talking about Mobile Gear. May 19 is the date for G3PQY to air the vital subject of Aerials. A Quiz is down for May 26, and on May 28, “all hands

to the pumps" will be the cry for the Mobile Rally, at the East Riding College of Agriculture, Bishop Burton.

Wirral Newsletter covers the period up to that under review, so we cannot tell you what is going for your entertainment; however, we can say that they foregather on the first and third Wednesdays, at the Sports Centre—ex-Drill Hall—Grange Road West, in Birkenhead, the starting time being 7.45 p.m.

If you are in the Bury area, **Bury and Rossendale** are the chaps for you. Look for the George Hotel in Market Street, on the evening of May 9. G3FLR is going to talk about the conversion of transistor portables to Top Band, with a view to their use for D/F operation—interesting and practical. As for June 13, G3AKX, the manager of Jodrell Bank, is booked for what should be a very interesting evening.

Thornton Cleveleys come next, their place being at the St. John Ambulance Brigade Hq., Fleetwood Road North, Thornton. May 3 is the allotted date, for a showing of the W1BB tape-and-slide lecture, and on May 17 the topic will be radio-activity and Lasers.

Up in York they are a taciturn lot—they just tell us

they can be found on any Thursday evening in the British Legion, 61 Micklegate, York.

At **Wakefield** they are still happily occupying their Hq., in Wakefield Youth Centre, Ings Road. Here they assemble on alternate Tuesdays, the activities including both on-the-air sessions and R.A.E. tuition. For further information, we have to refer you to the secretary, G3XVU, address as in the Panel below.

The home of the **Otley** club is their own, and is at 14 Court House Street, Otley, where they can be contacted on Tuesdays. A popular attraction on May 9 at Hq. will be the talk by Dr. A. R. Bailey, of Amplifier fame.

The hon. Secretary of the **West of Scotland** club, GM3VTB, makes a point when he says he finds it very difficult to get lecturers to commit themselves too far ahead, as is needed for his letter each month to contain advance news. They must be canny types in GM-land. However, as some indication of the sort of thing that attracts a *regular* turnout of *fifty* or more, we notice that in March, they had GM3ITN on the 3rd talking about certificate hunting; on the 10th GM6MD discussed model-engineering, and showed some trains and boats,

Names and Addresses of Club Secretaries Reporting in this issue:

ACTON, BRENTFORD & CHISWICK: W. G. Dyer, G3GEH, 188 Gunnersbury Avenue, London, W.3.
 A.R.M.S.: N. A. S. Fitch, G3FPK, 40 Eskdale Gardens, Purley, Surrey CR2-1EZ.
 BADEN-POWELL HOUSE: A. Watts, G3FXC, 312 Tudor Drive, Kingston, Surrey.
 BEDFORD: J. Bennett, G3FWA, 47 Ibbett Close, Kempston (2427), Bedford.
 BISHOPS STORTFORD: E. P. Essery, G3KFE, 17 Ascot Close, Parsonage Lane, Bishops Stortford (2501), Herts.
 BORDER: C. H. Crook, G3YOG, 19 Hatters Lane, Berwick-on-Tweed.
 B.A.R.T.G.: G. Shirville, G3VZV, 2 Bradford Way, Toddington (2740), Dunstable, Beds.
 BURY & ROSSENDALE: F. S. Burnett, G3RSM, 13 Rhiwlas Drive, Bury, (061-764 7554).
 CHILTERN: P. J. Perkins, G3OUV, Loakes House, Loakes Park, High Wycombe, Bucks. (High Wycombe 0494 21612).
 CORNISH: J. Farrar, G3UCQ, Elm Cottage, Ventonleague, Hayle.
 COVENTRY: C. Jaynes, 20 Belgrave Road, Wyken, Coventry.
 CRAWLEY: G. Bowden, G3YVR, 51 Leighlands Road, Pound Hill (3253), Crawley, Sussex.
 CRAY VALLEY: P. F. Vella, G3WVP, 78 Hurst Road, Sidcup, Kent.
 CRYSTAL PALACE: G. M. C. Stone, G3FZL, 11 Liphook Crescent, London SE23-3BN. (01-699 6940).
 DERBY: F. C. Ward, G2CVV, 5 Uplands Avenue, Littleover, Derby (2193), DE3-7GE.
 DUNSTABLE DOWNS: C. G. Powell, G8BPK, 1 Wenwell Close, Bucklands Wharf, Aston Clinton (600), Aylesbury.
 ECHELFORD: V. W. Higgs, G3VWJ, 205 Commercial Road, Staines, Middx., TW18-2QT.
 EDGWARE: A. J. Masson, G3PSP, 62 Coldharbour Lane, Bushey, Herts., WD2-3NY.
 EXETER: A. W. Bawden, 232 Exwick Road, Exeter, EX4-2BA.
 GLENROTHES: E. H. Ross, GM3LWS, 24 Ettrick Way, Glenrothes, Fife.
 HEREFORD: S. Jesson, 181 Kings Road, Hereford (3237).
 HORSHAM: R. J. Polley, G3PYC, 81 Beech Road, Horsham, Sussex.
 HULL: Mrs. M. Longson, 4 Chester Road, Wold Road, Hull, HU5-5QE.
 MANSFIELD: F. Clarke, G3XWZ, 149 Somersall Street, Mansfield, Notts.
 MIDLAND: N. Gutteridge, G8BHE, 68 Max Road, Quinton, Birmingham 32. (021-022 9787).
 MID-SUSSEX: E. J. Letts, G3RXJ, 87 Meadow Lane, Burgess Hill (3552), Sussex.
 NORTH KENT: M. Lee, G4BAL, 46 Harman Drive, Sidcup, DA15-8LY.

NOTTINGHAM: G. Dover, G4AFJ, 21 Greenwood Avenue, Nottingham NG3-7FX.
 OTLEY: H. S. Johnstone, 12 Rurple Croft, Newall Carr, Otley, Yorks., LS21-2RE.
 PEMBROKE: J. Hogg, GW4AKO, 2 Pembroke Road, Pembroke Docks., Pems.
 PLYMOUTH: S. E. Martin, 32 East Park Avenue, Mutley, Plymouth, PL4-6PF.
 R.A.I.B.C.: Mrs. F. Woolley, G3LWY, Woodclose, Penselwood, Wincanton, Somerset.
 READING: D. King, 34 Crawshey Drive, Emmer Green, Reading, RG4-8SY.
 ROYAL NAVY: CRS A. G. Walker, R.N.A.R.S., H.M.S. *Mercury*, Leydene, Patersfield, Hants.
 SHEFFORD: A. Sullivan, G2DGF, 12 Glebe Road, Letchworth, Herts.
 SLADE: J. E. Drakeley, 186 Conway Road, Chelmsley Wood, Birmingham, 37.
 SOLIHULL: A. W. Bagley, G3XPY, 266 Warwick Road, Olton, Solihull. (021-706 3688).
 SOUTH BIRMINGHAM: R. J. Thompson, 23 Fox Hill, Selly Oak, Birmingham 29.
 SOUTHGATE: J. Batchelor, G3XMV, 22 Faversham Avenue, Bush Hill Park, Enfield, Middx. (01-360 6537).
 SOUTH MANCHESTER: D. Holland, G3WFT, 7 Alcester Road, Sale, Cheshire, M33-3GW.
 SOUTHPORT: D. J. Worsick, 9 Elmdale Close, Formby, Lancs.
 STOURBRIDGE: B. Powell, 17 Mill Road, Cradley Heath, Warley, Worcs.
 SURREY: S. A. Morley, G3FWR, 22 Old Farleigh Road, Selsdon, South Croydon, CR2-8PB. (01-657 3258).
 THAMES VALLEY: C. Seaman, G3ATF, 40 Park Road, Ashford, Middx.
 THORNTON CLEVELEYS: R. Bellerby, G3ZYE, 4 The Cop, Fleetwood, Lancs. (Cleveleys 6826).
 TORBAY: Mrs. G. L. Western, G3NQD, 10 Truro Avenue, Here, Torquay.
 VERULAM: H. Young, G3YHY, 93 Leaford Crescent, Watford, Herts., WD2-5JQ.
 WAKEFIELD: M. E. Garner, G3XVU, 13 Kingsland Avenue, Drighlington, Bradford, BD11-1EY.
 WEST OF SCOTLAND: V. T. Budas, GM3VTB, 28 Kelvinside Gardens, Glasgow, G20-6BB.
 WIRRAL: A. Fisher, G3WSD, 34 Glenmore Road, Oxton, Birkenhead, Cheshire.
 WIRRAL (DX Assn.): M. Davidson, G3YSM, 43 Stuart Avenue, Moreton, Wirral, L45-9PE.
 WOLVERHAMPTON: J. P. H. Burden, 28 Coalway Road, Wolverhampton, WV3 7LX.
 YORK: J. A. Rainbow, G8BOK, 14 Temple Road, Bishopthorpe, York, YO2-1QN.

followed by a couple of films. Then there was GM3YUO on March 17, his theme being headphone amplifiers and CW audio filters for selectivity; again the evening ended with films. On March 24, GM3CSM talked about DX'ing, and on the 31st, when the effects of the proposed Value-Added Tax in the Amateur Radio context were discussed by GM3EDZ. If they can keep that sort of thing up, they *must* be worth getting to know!

Westerlies

This part of the world shows a thin picking this month, although there are more to be found in the Short Notices box.

Torbay have their Annual General Meeting on April 29, at their Headquarters in Bath Lane—so May 27 is the date for the following session, which will be to discuss Field Day and have what is described as a "Fifty-Fifty Sale". The Club Hq. is open to visitors on Tuesday evenings and the last Friday in the month.

May for **Cornish** means the 4th at SWEB's Clubroom, Pool, Camborne, when it is hoped to be able to give a talk on Long-Distance Telephone links.

Hereford, who have become much more active over the last year or so, report a healthy increase in membership, now standing at 33. The programme is slanted towards helping unlicensed members to get through R.A.E. and the Morse Test. They also propose to take the Monmouth Cheshire Home under their wing. Next regular meetings are on May 5, 19 and 26, then on June 2 and 4—this latter will be the Hereford Cider Festival, featuring the Club's GB3HCF station on the air.

Going much further West, the **Pembroke** group will be holding their annual "bucket-and-spade party" at the Regency Hall, Saundersfoot, Pembs. (as in previous years) on June 25, with talk-in on 1875 kHz and 144.35 MHz, also ZD9BE showing films of his activities on Tristan da Cunha. All details from the secretary, GW4AKO, as Panel opposite. Those proposing to attend the Saundersfoot get-together are specially asked to signify.

Midlands

Twice weekly the **South Manchester** chaps foregather. On Mondays the VHF wallahs can be found in the shack at Greeba, Shady Lane, Manchester 23, from 8.0 p.m. onwards, while Friday nights sees the whole crowd getting together at Sale Moor Community Centre, Norris Road. For the latter, May 5 has G3SMT talking about VHF/UHF receiving techniques, while on May 12, they will be hearing about the winner of the home-construction contest. May 19 is most important, being the AGM, this being followed by G8EXF reviewing Integrated Circuits.

South Birmingham meet at Hampstead House, Fairfax Road, West Heath. Here there is an Extraordinary General Meeting, followed by a natter, the date being May 3, and the starting time 8.0 p.m.

On the other side of the City, we find **Slade**, who have Hq. at Church House, High Street, Erdington. On May 5, G3JZF will be talking about closed-circuit TV principles, while on May 19, they have an informal "digest" entitled QRU?

Still near Birmingham we have **Coventry**. There the scheme is weekly meetings at the Wheatley Room,

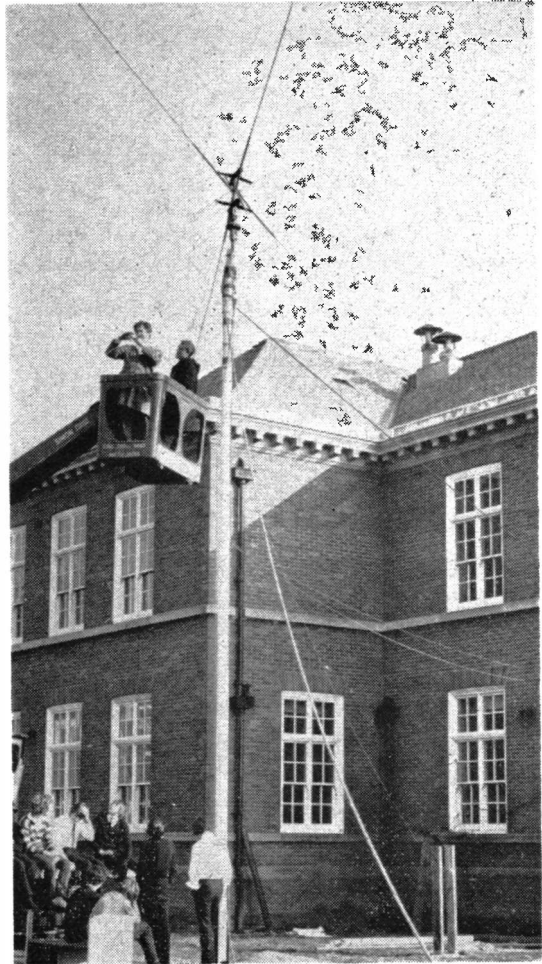

When the Rossall Amateur Radio Society had need to rebuild their Cubical Quad they had the valuable assistance of a hydraulic platform loaned by Fleetwood Corporation for tackling the airborne side of the job. Forward planning envisages a 60ft. Versatower on which to mount the beam.

City of Coventry Scout Hq., St. Nicholas Street, Radford Road. There are Nights-on-the-Air booked for May 12 and 26th; on May 5 they have G3BA, the maestro himself, talking about the Art of VHF Operating. May 19 is down for the president's Radio Car Rally, and on June 2, all is work, for NFD will be upon them.

Solihull have an informal in the Malt Shovel, High Street, starting at nine in the evening of May 2. This is followed on May 16 by the "proper" Club session on "Getting Going on Top Band and Two," a discussion led by G3PYR.

And so we can leave the centre of England, and we head for **Nottingham** where there is a Forum on May 4, and a discussion of arrangements for the special-activity station for Long Eaton Carnival, not to mention Field Day as well. Hq. is at Sherwood Community Centre, Mansfield Road.

(over)

SHORT CLUB NOTICES

CLUB NAME	HEADQUARTERS LOCATION	MEETING DAY MONTHLY
Border	Tweed View Hotel, Berwick-on-Tweed	April 30, at 1500
Derby	Room 4, 119 Green Lane, Derby.	Wednesdays
Exeter	Community Centre, St. Davids Hill	Tuesdays
Glenrothes	Old Nursery Building, Leslie, Fife	1st Sunday
Mansfield	New Inn, Westgate	1st Friday
Midland	Midland Institute, Margaret Street, Birmingham	May 16
Plymouth	Virginia House, Bretonside	May 2 (AGM), 16
Reading	Ashmead School, Northumberland Avenue	May 9, 23
Southgate	Civil Defence Hut, opp. Arnos Grove Tube	May 11
Southport	c/o 9 Elmdale Close, Formby	Wednesday:
Stourbridge	Longlands School, Brook Street	May 15
Surrey	Swan and Sugarloaf, South Croydon	May 16
Wirral DX	at G2SB, QTHR	May 25

N.B.—In each case, Secretary's name and address appears in Panel, p.176.

Wolverhampton have dates booked weekly on Mondays through May, from the 1st to the 22nd, the one after being on June 5. However, the big night is Friday, May 19, when the dinner to celebrate this society's 50th anniversary will be held—in the Tattersall Suite, The Racecourse, Wolverhampton, tickets being priced at £2. Full details of all events from the secretary, as in Panel.

Round-Off

Back to normality for next time, so the deadline for sending in your *June* programme details will be to arrive by first post on May 5, addressed to "Club Secretary," SHORT WAVE MAGAZINE, BUCKINGHAM.

Will all scribes and secretaries please note the following closing dates: **June 9, July 7 and August 4**. These are all *Fridays*, and the feature is written up over the ensuing weekend. That means we must have reports on time—so post 1st class by the Wednesday before the Friday date given and use the correct (Buckingham) address. Though editorial mail sent to our London office will always reach us in the end, it can mean that material posted on a Thursday is not delivered there till Saturday (when the Office is shut) and so is not seen until Monday—too late to be taken into "Month with The Clubs". So, as we like to cover everything and everybody, please help us by getting it right! 73, and keep the ball rolling.

PROPOSED NEW AMATEUR ASSOCIATION

We are informed that it is planned to launch a body to be called the "Engineers & Scientists Amateur Radio Association." If you are interested, and feel that you should qualify, the contact-man is F. Houghton, G3VZM, QTHR, for all details. However, perhaps we ought to say that membership is associated with the C.H.C. (Certificate Hunters' Club)—which seems to make it rather an odd proposition. The C.H.C. itself holds its 1972 convention on April 29, at the Shaftesbury Hotel, Liverpool. Information either from GB3CHC, over the air, or from J. A. Share, G3OKA, QTHR.

MPT ADVISORY COMMITTEE ON NOISE QRM

The Ministry has appointed a committee to "advise on new regulations to protect radio and TV services from interference caused by the ignition systems of petrol engines"—the object is to standardise the suppression requirements for motor vehicles. With due respect to the 10 members appointed, it seems to us that only four are qualified to advise even within the narrow terms of their brief (and here we do *not* include the lady representing the National Federation of Women's Institutes, eminent as she would be in many other fields). With the pollution of the ether—by noise interference of every sort—assuming the proportions with which all radio services have to contend, we would be more enthusiastic about a qualified body sitting on the problem as a full-time job.



" . . . Yes, it's all ex-Army gear at this station . . . "

NEW QTH's

This space is available for the publication of the addresses of all holders of new U.K. callsigns, as issued, or changes of address of transmitters already licensed. All addresses published here will be reprinted in the U.K. section of the "RADIO AMATEUR CALL BOOK" in preparation. QTH's are inserted as they are received, up to the limit of the space allowance each month. Please write clearly and address on a separate slip to QTH Section.

G4AJU, I. Aldridge, 302 St. Peter's Road, Manadon, Plymouth, Devon, PL5 3DU.
G4ATJ, Amateur Radio Society, Science Dept., Henry Compton School, Kingswood Road, Fulham, London, S.W.6.
G4AWE, Western Electronics (U.K.) Limited, Osborne Road, Totton, Southampton, SO4 4DN. (Tel. Totton 4930, or 2785.)
G4AYO, M. J. Hewitt, 22 Broad Walk, Orpington, Kent, BR6 7RZ. (Tel. Orpington 36742.)
G4AYR, T. R. R. H. C. Greenwood, 21 Buchan Close, Cowley, Middlesex.
G4AYS, A. E. Crook, 153 Hawthorn Cottages, Shortheath, Moira, Burton-on-Trent, Staffs.
G4AYT, C. H. Ashby, 4 Hill-rest Close, Kennington, Ashford, Kent.
G4AYX, N. E. Achurch, 20-A North Fen Road, Glinton, Peterborough, PE6 7JL.
G4AYZ, D. F. Watton, 353 Billing Road East, Northampton, Northants. (Tel. 0604 33834.)
G4AZN, B. M. Crook, 41 Radley Road, Abingdon, Berks.
G4BAL, M. Lee (ex-G8EJH), 46 Harman Drive, Sidcup, Kent, NA15 8LY.
G4BAU, R. T. Russell (ex-G8ELI), 59 Campbell Road, Gravesend, Kent, DA11 0JZ. (Tel. Gravesend 3428.)
G18FLQ, R. D. Moore, 5 Beechgrove Rise, Belfast, BT6 0NH.
G8FRL, M. A. Wallace, 7 River Court, Ferry Lane, Cambridge.
G8FSB, W. Kitchen, 12 Clonard Way, Pinner, Middlesex, HA5 4BU. (Tel. 01-428 3005.)
G8FSK, G. K. Day, 38 Woodstock Road, Begbroke, Oxford, OX5 1RG. (Tel. Kidlington 2215.)
G8FSW, D. J. Old, 7 Trelawney Road, Camborne, Cornwall.
G8FSX, J. C. Old, 7 Trelawney Road, Camborne, Cornwall.
G8FTH, J. Anderson, 30 Liscombe Road, Dunstable, Beds. (Tel. Dunstable 65277.)
G8FUD, E. W. Law, 6 Blossom Hill, Erdington, Birmingham, 24.

G8FUI, W. O. Raybould, 16 Brookbank Road, Gornal Wood, Dudley, Worcs., DY3 2RX.
GM8FVX, M. Muirden, 29 Gairn Crescent, Aberdeen, AB1 6BE.
G8FVY, R. T. Pill, 125 Worcester Road, Bootle, 20, Lancs., L20 9AB.
G8FWO, S. B. Sawyer, 34 Sandringham Road, Dalston, London, E.8.
GW8FXR, R. I. Thomas, 13 Northways, Porthcawl, Glam.
GM8FYA, Amateur Radio Society, Science Department, Peebles High School, Peebles.
G8FYD, H. R. Goodwin, 102 Foley Road West, Streetly, Sutton Coldfield, Warks.
G18FZC, E. L. Warner, 44 Thorndale Avenue, Larne, Co. Antrim.
G8FZM, K. I. Haggard, 415 Dover Road, Walmer, Deal, Kent. (Tel. Deal 5363.)
G8FZO, A. Cox, Lower Park, The Walls, Mistley, Essex. (Tel. Manningtree 2621.)

CHANGE OF ADDRESS

G3BLP, G. W. J. Haydon, 29 Tring Road, Dunstable, Beds. (Tel. Dunstable 602137.)
G3PFJ, A. A. Littlewood, Hempstone Park Farm, Littlehempston, Totnes, Devon. (Tel. Totnes 3789.)
G3GYH, E. R. Boothroyd, The Laurels, Dunford Bridge, Penistone, Sheffield, Yorkshire.
GC3HLS, A. Woolven (ex-G3HLS), Villa Capri, Castle Green, Gorey, St. Martin, Jersey. (Tel. East 242.)
G3KPO, D. Byrne, Alverstone House, Quadring, Spalding, Lincs. (Tel. Gosberton 485.)
G3OJZ, B. R. Todd-White, 3 Alexandra Road, Capel-le-Ferne, Folkestone, Kent.
G3PMR, A. H. Jubb, 8 Pembroke Green, Lea, Malmesbury, Wilts.
G3PXW, Z. L. Williams, Llandaf, 2 Belle Orchard, Tenbury Wells, Worcs.
G3SVK, F. L. Curtis, 5 Campus Road, Walthamstow, London, E.17.
GM3SZP, R. Paton, B.Sc. (ex-G3SZP), 67 Lambie Crescent, Newton Mearns, Glasgow, G77 6JU.

G3SZZ, A. R. Clarke, 8 Vicarage Close, Heath, Chesterfield, Derbyshire, S44 5RY.
G3UGF, R. J. Constantine, Victoria Farm Cottage, Clifford, Boston Spa, Yorkshire.
G3UOL, W. F. M. Hahn, 91 The Chesils, Styvechale, Coventry, Warks., CV3 5BE.
G3UTF, R. Clarke, 8 Vicarage Close, Heath, Chesterfield, Derbyshire, S44 5RY.
G3VFI, J. A. Rampton, 58 Kiln Road, Fareham, Hants.
G3VTR, A. W. Davis, 93 Herons Wood, Harlow, Essex. (Tel. Harlow 33084.)
G3ZDR, C. Stampton, 125 Gravesham Court, Gravesend, Kent.
GW4AEC, S. W. Davies, Moelwyn Dairy, 70 New Street, Portmadoc, Caerns.
G5ZN, P. Nicoll, 68 Princes Avenue, Withernsea, East Yorkshire.
G8BAA, D. Earnshaw, 15 Firtree Place, Anchorsholme, Blackpool, Lancs., FY5 3DP
G8CFN, H. B. F. Powell, Lime Trees, Park Lane, Ashted, Surrey.
G8DOT, B. Llewellyn, 14 Fennell Close, Tiptree, Colchester, Essex, CO5 0TF.
G8EAF, M. E. T. Lisle, 1 Heath Villas, Free School Lane, Halifax, Yorkshire, HX3 0BB. (Tel. Halifax 66644.)

AMENDMENT

G3SHC, F. W. Wood, 9 Albury Avenue, Bexleyheath, Kent, DA7 4SJ (postal code).
GW3VXP, R. J. Williams, Petherton, 120 Wordsworth Avenue, Penarth, Glam., CF6 1RQ (postal code).
GM3XFC, H. R. S. Canale, 18 Seaton Road, Arbroath, Angus. (Tel. Arbroath 4862) (new Tel. No. only.)
G4ADQ, Amateur Radio Club, Farnell Instruments Ltd., Sandbeck Way, Wetherby, Yorkshire, LS22 4DH. (Tel. 0937 3541.)

SENSATIONAL NEWS

FROM YOUR DIGITAL CLOCK SPECIALISTS
 A FANTASTIC NEW LOW PRICE DEAL FOR
 RADIO AMATEURS AND SHORT WAVE
 LISTENERS*

AND

FIRST AS ALWAYS — WE PRESENT COPALS
 LATEST — THE '227'



THE SUPERB NEW '227.' Slightly larger than the 222 and with a chunky new look. In four colours—Elack, White, Red and Yellow. Not only tells you the time for long keeping, but the alarm will wake you for that important sked, or remind you (if it must) that the XYL wants you to put the dinner on!! £8.25

OUR AMBITION IS TO SEE A DIGITAL CLOCK IN EVERY AMATEUR & SWL'S SHACK (preferably supplied by us of course). These new prices should help to make this a possibility:

COPAL/CASION '222'	£6.65
24 HOUR CLOCKS. '601'	£13.75
'401'	£11.75

FREE: POSTAGE, PACKING AND INSURANCE ON ALL CLOCKS

All Copal Clocks are mains operated with synchronous motors giving incredible accuracy and have built-in illumination. All our clocks have been carefully checked and tested and carry a 12-MONTH GUARANTEE. S.A.E. will bring full details of the range. Be sure to indicate that you require the Radio Amateurs' and S.W. Listeners' price list though.

* For those who are interested these new prices are possible as a result of a small decrease in import duty and Purchase Tax, lower prices from Copal and a special discount to Radio Amateurs and S.W. Listeners from us. We won't get too far, but you will get a lovely clock for a most reasonable price.

DON'T DELAY—SEND TODAY. ALL ORDERS AND ENQUIRIES RECEIVE IMMEDIATE ATTENTION. PLEASE NOTE: Our Annual Holidays are from 9th May to 23rd May inclusive. Any mail received during this period will be dealt with on 24th May certain.

AERO & GENERAL SUPPLIES

NANAIMO HOUSE, 2-Ringwood Avenue,
 Leeds, LS14 1AJ.

Tel: Leeds 658568

THE RADIO SHOP

Dept. SWM. 16 Cherry Lane,
 Bristol, BSI 3NG.
 Tel.: Bristol 421196. STD Code 0272

Your West Country shop for electronic components and solid state devices
2 METRE CONVERTER KIT. 9V Neg. each feeding 28-30 MHz. Consisting of: RF BF180, Fet. mixer, crystal osc. BF180, and multiplier BF180. Complete with all components, instructions and aluminium box. *Not for beginners.*
 Price £4.75 P. & P. 18p. Catalogue 5p post free

LOW NOISE 2 METRE CONVERTERS.
 £10.50 each.

2 METRE PRE-AMPS. £4.50 each.

E & E SERVICES
 (Formerly G. R. GRIGG)

72 ELMSTONE ROAD, RAINHAM, KENT.

Member of Amateur Radio Retailers Association

TAURUS ELECTRICAL SERVICES

(Prop.: G3TED)

All prices include carriage

SPECIAL OFFER. Ferric Chloride Powder for printed circuit etching. Full instructions. 1 lb. bag, 40p; 3 bags, £1

CIRCUIT BREAKERS. Small 5α or 10α	50p
SMALL RECTIFIER BRIDGES. 60PIV 2α	25p
FIELD TELEPHONES. Tele "F" each £4; pair £7.50	
DC MULTIPLIER UNITS for CT54, V-Voltmeter	30p
SMALL CONTROL BOXES with Lamp, etc. Bargain	25p
TRANSISTORS ACT20. New 25p or 5 for £1.00	
U.H.F. DUMMY LOAD 7715 with Cavity Capacitance Unit and position indicator. Few at	£5.00
RF INDICATOR 7150. Complete with 1 amp RF Meter with Loading Resistors. 50 watt with coax connections. New and good. Few at	£5.00
CARBON DUMMY LOADS (165Ω). 2 in parallel, OK for 200 watt	£1.00

RTTY

ALL CREED EQUIPMENT AND PAPER ADVERTISED PREVIOUSLY STILL AVAILABLE	
AMERICAN VALVE TERMINAL UNITS, TA182/U. 110v. A.C. Drawing-in-lid, neat	£9.00
TELETYPE KLEINSCHMIDT TT98B/FG. Good condition Teleprinters, neat looking. 115/230v. AC 50 or 60Ω. 184 watts max.	£27.00
12ft. FOLDING AERIALS, NEW	75p
SMALL 4ft. FOLDING AERIALS	50p
AIRCRAFT MACH METERS, NEW	80p
AIRCRAFT AIRSPEED SWITCHES, NEW	70p
MIXED XTALS. Our assortment, 10 for	£1.00
ROLLER INDUCTORS, New	75p
NEW VARIABLE CONDENSERS (BOXEC). Spindle both ends, two types:	
74PF + 74PF. 750v. D.C. (Polar type 015)	75p
102PF Single (Polar type 012)	50p
MINIATURE ROTARY TRANSFORMERS. 28v. D.C. in 250v. D.C. at .06 out. Will run off 12v, giving approx. 150v. out.	75p
MIN. DIODE EQUIV. IN4007. 1,000 PIV at 1 1/2 amps. 18p each or £2.00 doz.	
EPICYCLIC SLOW MOTION DRIVES. 8-1 ratio std. spindle	20p
MAINS SMALL MOTORS. 1 REV/HR. Power full	50p
SPECIAL OFFER of QV003-10's. Tested	55p
New 6CL6's. Tested	55p
6L6's. Rugged and New	80p
TELEPHONE HANDSETS each	40p
E180CC valves	25p
METERS	
2 1/2" round 50-0-50 Microamp Meters	80p
SPEAKERS—New. 1 1/2" 40Ω	35p
BY100's. Tested	15p ea. £1.50 doz.
144 Kc/S. TRANSCIEVERS. Less valves	£3.00
With valves (15)	£5.00
TRANS. CALL UNITS (mains intercoms.) Complete	£2.20
MARGIN DISTORTION TEST SETS. In new condition with handbook. Delivered	£7.50

26/28 NOTTINGHAM ROAD, LOUGHBOROUGH

Telephone 5131

G3ACQ Offers:— Trio 9R59DS. Trio JR310. Trio Hi Fi Amps. **RANGE OF 18 TESTMETERS** in stock - £3 to £20. **XTALS** - still large stocks. Please enquire '65p each. Digital clocks - GDO's - S.W. Bridges. Nordmende and Koyo professional receivers in stock (both good transistor radios with BFO's).

S. MAY (Leicester) LTD.

12/14 CHURCHGATE, CITY CENTRE,
 LEICESTER LE1 4AJ

Telephone: 28662

MORSE MADE !!!

FACT NOT FICTION. If you start RIGHT you will be reading amateur and commercial Morse within a month. (Normal progress to be expected.)
 Using scientifically prepared 3-speed records you automatically learn to recognise the code RHYTHM without translating. You can't help it, it's as easy as learning a tune. 18-V.P.M. in 4 weeks guaranteed. For Complete Course 3 Records & Books send £4.50 (overseas £1 Extra).
 For Further details of course Ring 01-660 2896/01-668 3255 or send 4p stamp for explanatory booklet to—
G3HSC (Box 14) 45 GREEN LANE, PURLEY, SURREY.

SOUND BARGAINS

BEST OF ALL WORLDS
GIANT POWER MULTI-WAVEBAND COMMUNICATIONS RECEIVER
 WITH 3 in 1 AC/DC POWER SUPPLY SYSTEM
 MAINS/BATTERY plus BUILT-IN BATTERY BOOSTER



VHF, FM, AM, A.F.C. AIR BAND, PUBLIC SERVICE AND WEATHER BANDS
OUR PRICE £10.50
 + 40p P. & P.

THIS NEW 1972 RADIO.
 No less than 3 VHF BANDS. Picks up Aircraft Transmissions, Pop Pirates, Taxis, Ambulances, Local Radio, Continentals and all BBC, VHF Stations plus fascinating Public Service Transmissions we are not allowed to mention! Even TV sound in certain areas.

PLUS A SPECIAL WEATHER-BAND
 Frequency ranges : MW540-1600 kHz. FM88-108 MHz. Airband 108-145 MHz. VHF 145-175 MHz, 23 semi-conductors, 12 transistors, 11 diodes and thermistors. Automatic frequency control. 31" telescopic aerial. Runs off mains AC 230-250 volts or off 4 U2 batteries, or use re-chargeable nickel alkali cell. Finished in strong leather grained case with carrying handle. Approx. size 10½" x 6½" x 3½". Written guarantee. Special magnetic ear-piece for personal listening, dry batteries FREE. **HURRY!** Limited quantity only from Marktyme. Money back guarantee.

Tune into the world with this amazing communications receiver. A truly exceptional unit in performance and looks—leatherette with stainless steel trim. Looks good anywhere. Use either as a portable with standard batteries or plug it directly into 220-240 volt domestic mains supply. 14 Transistors; 9 diodes; 1 thermister. Internal ferrite rod antenna plus telescopic aerial. Separate tone, volume and tuning controls with push-button selectors for the 8 WAVEBANDS. Complete with Hi-Fi earphone for personal listening.

Frequency ranges : Long wave 150-350 Kcs. Medium 353-1605 Kcs. Marine 1-6-4.5 Mcs. Short Wave 12-24 Mcs. FM/VHF 88-108 Mcs. Aircraft 108-135 Mcs. **PUBLIC SERVICE BANDS** 135-174 Mcs. Fully guaranteed.

OUR PRICE £28.95
 + 50p P. & P.

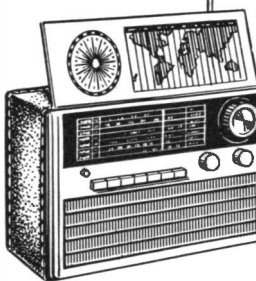

8 WAVEBANDS AND WORLD MAP & TIME ZONE DIAL

SAVE NEARLY £14
 on this DELUXE CASSETTE

TAPE RECORDER and PLAYER



OUR SLASHED PRICE £13.95
 PLUS 30p P&P
MADE TO SELL AT RECOMMENDED LIST PRICE OF £26.97

COMPLETE WITH REMOTE CONTROL MICROPHONE
MAINS/BATTERY
 It's true! Less than half the recommended price. Accepts 30, 60 and 90 minute Philips Cassette Tapes. Separate volume control, rapid re-wind and input socket for remote control microphone. Only £13.95 + 30p P. & P. Send £14.25. C60 Cassette and battery 45p extra. Now available Battery Cassette Recorder, £12.99 + 30p P. & P.

N.B. The Ministry of Post & Telecommunications has pointed out that a licence (not generally available to the public) is required for reception of transmissions by Fire Brigade, Aircraft, Shipping, etc.

MARKTYME

(Dept. SW1), 372 EDGWARE ROAD, LONDON, W.2. Tel. 01-723 0094
 Callers welcome Monday to Saturday 9 a.m. - 6 p.m.

Portable AM/FM World-Wide Communications Receiver

Another Scoop!
TELETON TF 182 8 WAVEBAND RECEIVER
 List Price £69.75
OUR PRICE £49.95
ONLY £5* DOWN!



The very latest technical improvements in Audio radio reception makes this sensitive world-wide portable 8 waveband AM/FM radio receiver unique. Its sensitivity and exceptional quality performance must be heard to be believed. Listen to the world in the comfort of your home and at a price which makes it a real bargain not to be missed.

JUST LOOK AT THESE SPECIFICATIONS!

8 Wavebands FM/MW/LW, SW1 to 5 World Zone map, World Time Dial, Tuning and fine tuning controls and Tuning Indicator Meter, Tape/Record playback switch, Two built-in Ferrite aerials for LW MW and SW1 and 5ft. Telescopic aerial for other bands. Mains or Battery operation. Earphone and mains lead. Facilities for feeding in via the DIN sockets into an Audio Amplifier or Tape Recorder.
 List Price £69.75p **OUR PRICE £49.95p*** Terms deposit £5.00 followed by 12 payments of £5.00. Total £65.00 P & P 50p.
 Limited quantity only - Don't wait **SEND £5.50 TODAY.**

CALLERS WELCOME

Please send me free details of your range.

Name

Address..... SWM 5/72

LEWIS radio 100, Chase Side London N.14
 Tel: 01-886 3733/9666

MI-19467-A MASTER OSCILLATORS

These R.C.A. units which are used in the ET 4336 transmitter and which were supplied as a separate item, each in its own slide-in metal case, are ideal as the heart of any high-power transmitter, unmodified as a low-power (approx. 20w.) transmitter, or as a basis for modification to suit individual requirements. They incorporate a 6-position oscillator switch (covering 1 to 5 MHz); a 3-position Multiplier switch (covering 2 to 10 MHz); a D.C. current meter, and oscillator and multiplier coils with "turns counting" mechanisms for precise tuning. Power requirements are H.T. and L.T. for the 807 valve used in the unit, and are brought in by an 8-pin Jones plug on the rear of the chassis. The basic frequency coverage of the oscillator is 1 to 10 MHz, which can be extended to 20 MHz when used as the oscillator section of a higher power transmitter or when used on its own. All these and many more details are covered in full in the extremely comprehensive instruction/service manual (supplied with each unit) containing wiring and circuit diagrams, adjustments, photographs, etc. **BRAND NEW.** Price per unit is £8.50 including 2, 807 valves. Carriage 75p.

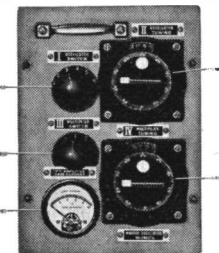

COLOMOR ELECTRONICS LTD.
 01-743 0899 01-748 8006
 170 GOLDHAWK ROAD,
 LONDON, W.12.

G. W. M. RADIO LTD.

MURPHY MARINE SHIP TRANSMITTERS. 1.5 to 16 Mc/s. VFO or crystal. 40 watts RT or CW. Valves P.A. 3 5B/254M in parallel, modulation pair 5B/254M. Two panel meters. Size 13" x 13" x 14". Complete and clean but not tested. Less power supplies, £11 carriage paid. A few similar Pye units with same line up but 13" x 15" x 14" have calibrated VFO, same price.

AERIAL VARIOMETER TUNERS. Made for 19 set Mk III. New condition, £1.30, post paid.

REED RELAY inserts, 1.85" long (body length 1.1"). Diameter .14" to switch up to 500ma at up to 250v. D.C. Gold clad contacts, 63p per doz., £3.75 per 100. £27.50 per 1000, post paid.

100 kc/s. crystals, glass envelope on octal base, £1.25, post paid. 2 meter transmitter sub-units. Contain 2 x 6516, 2 x 6064, QV04-7 and TT15 valves, £2, post paid. Pocket Dosimeters, 15p, post paid. Meters 1½ dia. 500 microamps calibrated 0-10, 75p, post paid.

PORTABLE AERIAL MASTS. Fine quality 48ft. mast by Coubro & Scutton. 2" dia. aluminium sections, complete with 16 guys, pickets and all fittings. Unused and in "as new" condition in green canvas carrying bag, £21, carriage paid. Also available Erection Derrick kit containing 3 additional mast sections, ropes and pulleys, etc. to enable mast to be erected by fewer personnel, £5, carriage paid.

HYGROMETERS. Wet and dry bulb type, new, £1.25, post paid.

TRANSFORMERS. Used "C" core, 200-250v. to 230-0-230v. 260ma. 6.3v. 0.6a., 6.3. 6.0a., £2, post paid. Chokes "C" core 10h. 75 ma., 50p, post paid or 6 for £1.65, post paid. Unused Radiospares "Heavy Duty" 205-245v. to 350-0-350v. 150ma, 6.3v. 2.5a., 6.3 3a., 6.3v. 2a (tapped at 5v. 3.5a), £2, post paid. "Midget Output" 50p post. New Gardner potted 200-250v. to 12.7v. 2.5a., £1, post paid.

Used. 0 - 250v. to 800 - 700 - 300 - 200 - 0 - 200 - 300 - 700 - 800v. 800 and 700 at 200ma, 300 at 100ma, 200 at 50ma when used simultaneously. 5v. 2a, 4v. 7a, 6.4v. 7a, 6.4v. 1a. £4 carriage paid.

CAPACITORS, paper, 8uf 400v., 30p, post paid or 6 for £1.05, post paid.

BC221 complete with charts, £16.75, carriage paid. SCR552 Transmitter units, £3 and receiver units £2, post paid.

All Receivers and Test Equipment are in working order at time of dispatch. Carriage charges quoted are for England and Wales only.

Telephone 34897

Terms: Cash with order

Early closing Wednesday

40-42 PORTLAND ROAD, WORTHING, SUSSEX

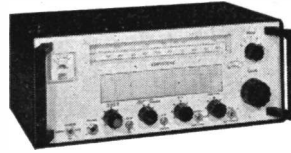

new from eddystone

Model 1000 Communications Receiver

Introducing the very latest communications receiver from the Eddystone stable. The model 1000 covers C.W., M.C.W., A.M. and S.S.B. having a frequency range of 30 MHz to 550KHz. Powered by integral battery pack (rechargeable) or A.C. mains (110-250v 50-60 Hz). Other features include single conversion using I.C., F.E. and bi-polar transistors, desensitising facilities, carrier level meter and separate fine tuning control. Variable selectivity is achieved by incorporating high grade ceramic ladder filters. A pre-production model of this remarkable new receiver can be heard and inspected in the Eddystone showroom at Imhofs.

Other outstanding winners

Eddystone EC10 Mk. 2. Still 'Top of the Pops' in the modest price range of communication receivers. Embodies features usually only found in the more expensive designs. £79.00.

Eddystone EB37. A high performance transistorised receiver with long, medium and three short wave bands. Powered by batteries or A.C. supply. £102.90 (including £18.90 tax).

Eddystone 830/7. Wide range communications receiver. A high grade HF/MF receiver covering 300 KHz - 30 MHz in nine ranges with crystal control facilities. Many satisfied users acclaim it as 'the best ever'. £389.00.

Write for comprehensive leaflets on any of the above.

IMHOFS

MAIN EDDYSTONE
DISTRIBUTORS



Dept: 11/5

112-116 New Oxford Street, London, WC1A 1HJ.

Tel: 01-636 7878
R67

Samson's Latest Models!

● ETM-2b Keyer

● ETM-3b Squeeze - Keyer

both with watchmaker-assembled keying movement, silent reed relay, speed control, sidetone.

ETM-2b—Successor to the well-known ETM-2, used by coast stations and big ships the world over. ● Glass-fibre printed circuit, 11 transistors, 6 diodes. ● Ratio control. ● Mercury or penlite battery supply. £22.45 (£23.80 with mercury batteries).

ETM-3b—In its latest form it now has 4 IC's, 9 transistors, 3 diodes. ● Use either as foolproof iambic-mode squeeze-keyer (characters made with fewer paddle movements—cuts effort) or as a normal twin-paddle electronic keyer. ● Constant 3:1 dash-dot ratio. ● AC power supply, 110/240V. £25.95.

ALSO: ETM-2bS and ETM-3bS (change-over relays) and ETM-2Z and ETM-3Z (heavy-duty relays). SAMSON STA Speaker/Amplifier for all ETM Keyers, £2.75.

JUNKER precision hand key, £8.95. **BAUER** keying lever/paddle unit, £2.75. **RTTY CONVERTER-KEYER**, Model TTU, £115. **88mH TOROIDS**, 75p/pair. **PRINTSET** Basi-kits. **SSB 90° AUDIO** Phase Shift Networks.

All goods post-paid UK. Send stamp for Catalogue SP5.

PLEASE NOTE OUR NEW ADDRESS:

SPACEMARK LTD.

THORNFIELD HOUSE, DELAMERE ROAD,
ALTRINCHAM, CHESHIRE.

(Tel.: 061-928 8458)

HAMGEAR ELECTRONICS

PRESELECTORS

P.M. IIA This is a preselector covering from 1.8 to 32 Mc/s. in six overlapping ranges. Having a built-in antenna coupler to tune the antenna followed by a pentode to boost the signal up to 25 dB., before it reaches the Rx. With internal power supply, mains On/Off, indicator lamp and primary fuse. Price £9.20.

P.M. IIB This is a preselector with the same spec. as above, 1.8 to 32 Mc/s. and antenna coupler except it is solid state with an F.E.T. plus Bipolar. Price £8.25.

CALIBRATORS

Get acquainted with our calibrators:

P.M. IV 1 Mc/s. with 1,000 c/s modulation.

P.M. V 1 Mc/s. and 100 kc/s. with 1,000 c/s. modulation.

P.M. VIII 1 Mc/s., 100 kc/s. and 10 kc/s. with 1,000 c/s. modulation. This one has the ability to be tuned zero beat to a frequency standard transmission such as M.S.F.

Both P.M. V and P.M. VIII have integrated decade counters, nothing to go out of adjustment.

All the units are battery powered and as such are quite portable.

All give beats up to at least 30 Mc/s.

Priced at £4.50, £6.50 and £10.75 respectively.

Postage and packing, 25p.

2½p stamp for illustrated leaflets

29 CARLYLE ROAD, NORWICH

R. T. & I. ELECTRONICS LTD.

where equipment is fully overhauled

EDDYSTONE EC10 Mk. I	£45.00	(£1.00)
HALLICRAFTERS SX 117	£115.00	(£1.50)
HAMMARLUND HQ 170	£150.00	(£1.50)
LAFAYETTE HA-600	£36.00	(£1.00)
LAFAYETTE HE-80	£48.00	(£1.50)
LAFAYETTE HE-30	£25.00	(£1.25)
HEATHKIT MOHICAN	£35.00	(£1.25)
NATIONAL NCX-500 Transceiver c/w a.c. p.s.u.	£230.00	(£3.00)
HAMMARLUND HQ-145-X	£135.00	(£2.00)
RCA AR88D	£70.00	(£2.00)
LAFAYETTE HA-63	£22.00	(£1.00)
HAMMARLUND HQ180	£150.00	(£2.00)
HEATHKIT GR64	£25.00	(£1.00)
EDDYSTONE 840A	£35.00	(£1.50)
KW 201	£90.00	(£1.50)
KW VESPA II c/w p.s.u.	£105.00	(£2.00)
KW 77	£70.00 & £80.00	(£1.50)
HALLICRAFTERS S 240 as new	£35.00	(£1.00)
EDDYSTONE 940, as new	£135.00	(£1.50)

WE CAN ALSO SUPPLY ANY MAKE OF NEW EQUIPMENT—and have pleasure in giving a few examples which are normally in stock:—

ANGLIA, 2 metre converters (state I.F. required), £15.00 (30p).
 AVOMETERS, Model 7, Mk. 2, £37.60; Model 8, Mk. 4, £40.90; Model 9, Mk. 4, £40.90; Model 40, Mk. 2, £37.60; Multiminor, Mk. 4, £13.50; Standard leather carrying case (Models 7, 8, 9, 40), £6.50; Every-Ready ditto, £7.40; Multiminor leather case, £3.30; 10KV D.C. Multiplier for Model 8 or 9, £6.10; 30KV D.C. ditto, £9.90; Pair of Long Reach Safety Clips, £1.50; Model EA113 Electronic Avo, £82.00. All above post free in U.K. Trade and Educational enquiries invited.

S. G. BROWN'S HEADPHONES, Type "F" 120 ohms, 2,000 ohms, 4,000 ohms, £4.95 (25p); Rubber earpads for same, 45p per pair (3p). Type 3C110 Noise excluding (with superb fitting), high quality, electrodynamic, £7.35 (25p). Standard Jack Plug, 24p (4p).

EDDYSTONE EQUIPMENT, Receivers, 830/7, £372.75; EA12 £205.00; EC10/2, £79.00; EC10/1, £64.50; 924 A.C. mains p.s.u., £7.75 (50p); Doublet Aerial, 731/1, £5.28 (50p); Plinth Speaker, 906, £6.20 (50p); General Purpose Speaker, 935, £5.55 (40p); Edometer, 902 Mk. 2, £29.50 (50p); Telescopic Aerial, LP.3126, £2.50 (25p); Diecast Boxes from 45p (10p). Brochure on request.

CODAR EQUIPMENT, AT5 Mk. II, £22.50 (50p); PR 40, £8.50 (30p); 250/5, £11.00 (65p); CR70A, £22.50 (65p); T2, £17.50 (25p); PR30, £7.50 (25p); PR30X, £9.50 (25p); I2M/5, £11.50 (40p); I2/RC, £2.50 (15p); RQ10X, £9.00 (35p). Leaflets on request.

Our latest list of over 50 receivers, and many other interesting items sent free upon receipt of your s.a.e. Carriage for England, Scotland and Wales shown in brackets. Terms: C.W.O., Approved Monthly Accounts, Hire Purchase and Part Exchange. Special facilities for export. Enquiries invited.

- At R.T. & I.
- ★ We have full H.P. facilities
- ★ Part exchanges are a pleasure
- ★ We purchase for cash
- ★ We offer a first-class overhaul service for your electronic equipment, whether you are an amateur or professional user
- ★ We have EASY Parking facilities
- ★ We welcome your enquiries for specific items which, although not advertised, may very well be in stock.

PARTRIDGE "JOYSTICKS," "New Lightweight VFA" £12.99 (30p). "JOYMATCH" III. Aerial Tuning Unit, £12.99 (30p). Literature on request.

TRIO EQUIPMENT, Transceiver, TS-S10 + PS-S10 a.c. p.s.u., £180.00 (£2.00); VFO-5D for above, £25.00 (50p); Receivers, JR-599, £185.00 (£1.00); JR-310, £77.50 (£1.00); JR-500-SE, £65.00 (£1.00); JR-59-DS, £47.50 (50p); SP-5D Loudspeaker, £4.37 (40p); Headphones, HS-4, £3.97 (20p); NEW TR-599 TRANSMITTER (to match JR-599), £185.00 (£2.00). Leaflets available.

SHURE MICROPHONES, 444T, £15.00 (40p); 444, £13.00 (40p); 401A, £6.50 (30p); 201, £5.40 (30p); 202, £6.00 (30p). Full details on request.

KEYNECTORS, piano key mains connector units, £2.75 (25p).

VALVES. Please state your requirements.

TMK METERS: TMK500, £8.25 (25p); TW20CB, £10.25 (25p); TP50SN, £5.75 (25p); 700, £16.50 (25p); also leather cases.

PHILIPS PM2403 ELECTRONIC MULTIMETER, £49 (25p).

We also supply PHILIPS and KORTING COLOUR TV TEST EQUIPMENT, including Colour Bar Generators, Convergators, etc.

KW EQUIPMENT, KW2000B + A.C. p.s.u., £240.00 (£2.00); D.C. p.s.u. for KW2000B, £44.00 (50p); KW 2000B only, £200.00 (£1.50); KW ATANTA + A.C. p.s.u., £200.00 (£2.00); Remote V.F.O. for Atlanta, £34.00 (50p); VOX unit for Atlanta, £7.50 (25p); Remote V.F.O. for 2000B, £36.00 (50p); KW1000 Linear amplifier, £135.00 (£1.50); KW202 Receiver with calibrator, £140.00 (£1.50); KW 702 Matching Spkr., £8.00 (80p); KW204 Transmitter, £142.00 (£2.00); KW105 combined E-Z Match; VSWR indicator, dummy load, and ant. switch (4 outlets) 52 or 75 ohms, £36.00 (80p); KW103 VSWR and power meter, 52 ohms, £12.50 (45p); KW101, VSWR meter, 52 or 75 ohms, £9.25 (30p); KW 107, £40.00 (50p); also E-Z match, dummy load, trap dipoles, etc., etc. Details on request.

R. T. & I. ELECTRONICS LTD.

Ashville Old Hall, Ashville Road, London, E.11 Tel: 01-539 4986

AMATEUR ELECTRONICS

BIRMINGHAM 021-327 1497 021-327 6313

MEMBER OF THE AMATEUR RADIO RETAILERS ASSOCIATION

At last we have secured our new premises, the address of which we give below and we shall be changing over during the course of the next few weeks. Will callers please note that the new place is located adjacently to the old address although we shall be located at both during the change-over period which will take several weeks. All mail, however, should be sent to the new address from now onwards. Our stock of new equipment and accessories is ever growing and we now have all major items in the HY-GAIN range together with excellent stocks of Rotators of various types, full details of which we show below.

PLEASE NOTE: We have full stocks of YAESU MUSEN, KW and TRIO equipment on which we offer excellent credit facilities and against which we welcome trade-ins. In view of the large turnover we enjoy in used gear we are only too pleased to accept your old rig provided, and this is a must to us, it is in top-notch physical and electrical condition. All prices shown below include carriage and postage unless otherwise stated.

NATIONAL NCX-5 TRANSCEIVER. Very nice Condition and fitted with Mk. II P.A. stage	£165.00
EDDYSTONE 940 RECEIVER. Excellent condition in all respects	£107.50
EDDYSTONE 940 RECEIVER. As above and with plinth speaker	£110.00
EDDYSTONE 940 RECEIVER. Another excellent specimen, late model	£112.50
EDDYSTONE 940 RECEIVER. As above, late model with plinth speaker	£115.00
EDDYSTONE EC10 RECEIVER. Unmarked and excellent	£49.50
HEATH SB-101 TRANSCEIVER with SB-600 SPEAKER. Unmarked	£162.50
GEC BR7 400E RECEIVER. Used, but very good condition	£62.50
TRIO 9R59DE RECEIVER. One only. Unmarked, excellent	£39.00
TRIO TS-S10 TRANSCEIVER. In exceptional condition	£150.00
LAFAYETTE HA-350 RECEIVER. Good condition. Electrically perfect	£62.50
HEATH MOHICAN RECEIVER. Factory built. With mains PSU. Mint	£42.50
HEATH MOHICAN RECEIVER. Excellent condition	£37.50
RACAL RA66B PANORAMIC ADAPTOR. Complete with manual. Used but good condition	£75.00
AR88D RECEIVER. One only, used condition but in full alignment and air-tested	£49.50
SOMMERKAMP FL-1000 LINEAR. Very good condition indeed	£75.00
EDDYSTONE 840A RECEIVER. Fair condition FB electrically	£35.00
TRIO JR-500SE RECEIVER. One only, mint condition	£55.00

The above is a selection of our ever-changing stock which includes the most advanced amateur equipment for the short wave listener or the licensed amateur. WE URGENTLY REQUIRE equipment of all types and for those readers in the general London area, Jeff Harris G3LWM, is able to collect personally from your QTH and similarly is equipped to give

home demonstrations of all new and used equipment in our range. Please contact Jeff Harris, J. H. Associates Ltd., Cricketfield Lane, Bishops Stortford, Herts, Tel: 0279 56347, Telex 81553.

HY-GAIN Antenna range:	
12AVQ Vertical	£16.50
14AVQ Vertical	£18.50
LC-80-Q80m. Loading coil	£6.70
18AVT/WB Vertical	£33.00
THDX 6 element beam	£88.00
TH3 Jnr 3 element beam	£48.00
TH3 Mk. 3 3 element beam	£69.50

J BEAM Antenna range Too numerous to detail but all in stock. Catalogue on receipt of your S.A.E.

ROTATORS	
AR20	Post paid £20.40
AR22	Post paid £25.65
TR44	Post paid £40.75
HAM-M	Post paid £70.80

WIGHTTRAPS per pair Post paid £1.65

TRAP DIPOLES. Several types in stock. Details on request.

UHF CONNECTORS. All types of UHF Connectors including the well-known PL259. Details as per last month.

TTC POWER METERS	
C3005	£7.40
C3042	£4.40

SHURE MICROPHONES	
Model 201	£5.75
Model 444	£13.25

COPAL CLOCKS All items in the existing Copal range, illustrated leaflet on receipt of your S.A.E.

MEDCO FILTERS Excellent stocks of all models. Post paid prices as per last month's ad.

OSKER BLOCK POWER METERS	
A MUST for the well equipped station	£18.00
RCA 6146B	each £3.05

G-WHIP ANTENNAE full range. Illustrated details on receipt of S.A.E. CREDIT TERMS: First class credit facilities with a 10% deposit only on most items and advantageous interest rates. On the spot transactions for the caller.

We are located three miles east of the city centre with our own parking facilities

ELECTRON HOUSE, 510-514 ALUM ROCK ROAD, BIRMINGHAM 8



AMERICAN TITLES FROM FOULSHAM-SAMS

ABC's of ANTENNAS

The introductory chapters cover the fundamentals of radio-wave propagation and basic antenna characteristics. The remainder of the book is then devoted to a discussion of the various types of antennas and their uses. Antennas for radio, television and two-way communications are included. Business radio, amateur, both mobile and fixed-station operation, are covered. The final chapter should be particularly appealing to those interested in microwave uses and radio-navigational systems. A perusal of this book will provide any student with an excellent foundation for more advanced study in antenna design

89p

ABC's OF SHORT-WAVE LISTENING

Have you ever listened to a radio and thought how enjoyable it would be to hear broadcasts from faraway places, such as Toronto, Berlin, and Tokyo, as well as signals from ships at sea and satellites in space. All these broadcasts can be at your fingertips, offering a fascinating hobby.

ABC's of Short-Wave Listening a non-technical guide, will help you get started, or give you added pointers if you are now engaged in this hobby. The mysteries of radio waves are revealed in a manner that anyone can understand, providing priceless knowledge about the ever-expanding world of short-wave radio.

£1.02

AMATEUR RADIO SSB GUIDE

Single-sideband receivers, transmitters, and transceivers are now available which have higher frequency stability and are much easier to tune than the early models. In this book, the author presents a guide to single-sideband and single-sideband equipment, which will be useful to any amateur considering or already operating SSB.

By W6TYH

£1.59

AMATEUR RADIO CONSTRUCTION PROJECTS

Amateur radio is a rewarding and enjoyable hobby. For many hams the greatest thrill comes from constructing and operating their own "home-brew" rigs. There is something about being able to lean back and say, "I built it myself," that isn't engendered by ownership of a commercial unit.

Amateur Radio Construction Projects is a book for every amateur, whether he wants to build all his equipment or just a unit or two to supplement what he already owns. Starting with many helpful construction hints (some of which will benefit the "old-timer"), the book progresses from simple projects to more complicated ones. Each chapter contains a complete circuit description, chassis layout, tuning procedure, and operating instructions, supplemented by schematic and pictorial diagrams and complete parts lists.

By W6NJV

O/P

BUILDING YOUR AMATEUR RADIO NOVICE STATION

This book is the first "completely detailed" construction manual for building an amateur novice radio station. Nothing is overlooked in building the station from scratch to the actual on-the-air operation. The transmitter and receiver are distinctly professional in performance quality and appearance.

The book is primarily directed to the novice radio ham, it contains many novel and valuable construction hints and tips for amateurs in any licence class. As a finished touch to the projects a complete "rollaway" ham shack for hams with limited space (apartment dwellers, etc.) is featured and fully described.

By W7OE

£1.57

HAM ANTENNA CONSTRUCTION PROJECTS

Besides full details on many useful and interesting types of aerials, Ham Antenna Construction Projects includes complete information on long-lasting construction methods, as well as how to position your antenna to achieve maximum distance with a given radiation pattern. In addition, much easy-to-understand technical information on tuning antennas and the use of test equipment is presented.

£1.47

PRACTICAL HAM RADIO PROJECTS

The projects described in this book include: all-band 500-watt linear amplifier . 2-metre SSB mixer and linear amplifier . all-band 500-watt antenna tuner . electronic automatic keyer . de luxe 6-metre mobile transmitter . universal transistor mobile modulator and power supply . transistor 2-metre superhet receiver . VFO for 6, 2, and 1.25 metres . transistor dip oscillator . 2-metre transceiver for mobile or fixed station . transistor 6-metre handie-talkie . monitor scope for SSB and AM. Just about all that is needed for a complete amateur station!

£1.15

SWL ANTENNA CONSTRUCTION PROJECTS

Two chapters cover the basic principles of antennae and the knowledge necessary for construction of the projects which are given in the following pages. The antenna projects themselves are divided into six classes. First are the dipole aerials such as segmented and inverted types. Following them are the vertical antennae, including array and beam types. Then horizontal beam systems (Yagis) are considered. Various low- and high-band and multiband triangle antennae are also discussed. The next section deals with long-wire antennae, such as vee beams and rhombics, for those SWL'ers with a sizeable plot of land available. For SWL'ers without land, indoor antennae, which are included in the final section, may be a solution. Three useful appendices are provided at the end of the book.

£1.40

TRANSISTOR FUNDAMENTALS Vol. 1

This book is a carefully planned programmed introduction to semi-conductors and the basic electrical circuits. It begins with a brief description of transistors and later devotes an entire chapter to an explanation of transistor principles. Sandwiched between these chapters are explanations of voltage, current, and resistance; and the all-important Ohm's Law and Kirchhoff's laws. The book also looks at the more complicated nature of inductance, capacitance, and resistance in AC circuits.

£1.92

TRANSISTOR FUNDAMENTALS Vol. 2

This volume describes transistors and how they are used in semi-conductor circuits. Simple circuits illustrate the basic principles involved, and the more complicated circuits found in amplifiers and oscillators help to show how the basic operations are applied. Later, some recent semi-conductor developments are discussed. Details descriptions of four new transistor devices are given and how they are being used.

£1.92

KNOW YOUR OSCILLOSCOPE

By Paul C. Smith

The oscilloscope provides you with a "third eye" which lets you see what is actually happening in electronic circuits. But you must know something of the nature of this valuable instrument, and how to use it, before it will serve you. This book presents complete information on the circuitry, functions, and applications of the oscilloscope in easy-to-understand language. Worthwhile reading for anyone who uses an oscilloscope . . . a "must" for service technicians and students.

£1.80

The Books described here are American in origin.

The above prices include postage & packing.

Delivery is from stock.

Available from

Publications Dept., 55 Victoria St., London S.W.1

(Counter Service, 9.30-5.15, Mon. to Fri.)

SHORT WAVE MAGAZINE

01-222 5341

(Nearest Station: St. James's Park)

(GIRO A/C. No. 547 6151)

SMALL ADVERTISEMENTS

("SITUATIONS" AND "TRADE")

5p per word, minimum charge £1.00. No series discount. All charges payable with order. Insertions of radio interest only accepted. Add 50% for Bold Face (Heavy Type). Box Numbers 12½p extra. No responsibility accepted for transcription errors. Replies to Box Numbers should be addressed to The Short Wave Magazine, 55 Victoria Street, London, SW1H 0HF.

TRADE

G3UTT, Tunbridge Wells now building up stocks of components for radio amateurs, including J-Beam Aerials, at Teleservice, 136 Camden Road, Tunbridge Wells, Kent.

STAY AT The Cornwall Ham-Radio Holiday Centre. Self-catering furnished accommodation. Six-element beam; 65ft. tower; 90 awards.—Full details from Bernard Broughton, G3XBR, St. Tudy, Boamin, Cornwall.

YORK Photo-Audio Centre for Yaesu Museu Transceivers: FT-101 with 160m. coverage, £255. FT-200 with PSU, £172. FT-401, £215. FT-2F, £84. Send 3p for complete lists and details of our Installment-Credit scheme with virtually no deposit and up to 24 months to pay. We are also stockists of Trio, Codar, Hamgear, etc., etc. and in our Hi-Fi Dept. we have B. & O., Trio, Sinclair Stereo-Sound, all on demonstration. Cameras and equipment considered in Part Exchange.—51 Fossgate, York, YO1-2TF, Tel: 56176 (or 25798 after hours).

QSL Cards. Two-colour. Attractive design, variable features, from £3.15 per 1,000 (inclusive). Send foolscap s.a.e. for samples.—A.R.A. Press, 46 Moad Avenue, Green Lane, Coventry.

QSL Cards for Tx and SWL. Send s.a.e. for samples stating which type required.—Beaumont, G5YV, 8 Ashfield Avenue, Morley, Leeds, LS27-0QD.

QSL Cards: for Tx, G8 or SWL. One to four-colour designs; large s.a.e. for samples; good selection.—Red Rose Publicity (Pennington), 34 Aqueduct Street, Preston, Lancs.

JUNE Issue: Due out May 26. Single-copy orders 25p, post free, to reach us by Wednesday, May 24, for posting on May 25.—Circulation Dept., Short Wave Magazine L'd., 16 Victoria Street, London, SW1H-0HF.

GOVERNMENT Surplus Wireless Equipment Handbook: Contains circuits, data, illustrations, valuable information on British/U.S.A. receivers, transmitters, transceivers. Includes modifications to sets and test equipment. Surplus/commercial cross-referenced valve and transistor guide. Price £2.85, post/packing 20p.—Gerald Myers (Dept. SW), 18 Shaftesbury Street, Leeds, LS12-3BT.

CERAMIC 455 kHz Resonators: Vernitron resonators for improved 455 kHz selectivity, as described by G3DNF for modifying the JR-310 (January/December, 1971). Kit of four TF-04 442, with seven close-tolerance poly. capacitors, for 2 kHz band-width, £1.85; other b/w's same price. 4-0, 5-7, 7-5, 10 and 12 kHz. Single TF-04 442, 40p, set of four, £1.50. **SSB Shaping Filters:** Three matched hi-Q resonators and two capacitors for ladder, with pass-band centred on 455 kHz and rejection slot at 453 kHz (TFN-3A, £1.50) or 457 kHz (TFN-3ADX, £1.50). Send stamp for short leaflet. Makers' data with orders. Mail order only. U.K. post 5p.—Amatronics, Ltd., 396 Selsdon Road, South Croydon, Surrey, CR2-0DE.

QSL CARDS and G.P.O. approved Logs (hard back), prompt delivery. Send 4p stamp for samples.—Atkinson Bros., Printers, Looe, Cornwall, PL13-1LA.

WHAT IS QRP?

50mW; 5w; 50w—?? LIKE "BEAUTY", IT'S IN THE EYE OF THE BEHOLDER!

"QRP" is used to describe rigs, shacks, signals, AERIALS—EARTH S-----WHOEVER HEARD OF A "QRP EARTH" (NO, NOT JUST A "SMALL WORLD"), BUT A

QRP ARTIFICIAL EARTH—
THAT REALLY WORKS!

—THE APARTMENT DWELLER'S DREAM—EVERYTHING IN THE SHACK—QRP RIG—7ft. 6in. JOYSTICK V.F.A. (THE QRP WORLD RECORD AWARD AERIAL) HIGH "Q" JOYMATCH A.T.U.—AND A

BANDSWITCHED JOYMATCH ARTIFICIAL EARTH—THAT'S REAL QRP—IT'S WHAT YOU DO WITH THAT SIGNAL, HOWEVER SMALL, THAT REALLY MATTERS—LET PARTRIDGE TELL YOU HOW!

AND PARTRIDGE HAVE NOT FORGOTTEN THE QRP MAN—OUR NEW EXPORT RANGE COMBINES ATTRACTIVE TREND SETTING PRESENTATION WITH THE ULTIMATE IN REAL EFFICIENCY IN PERFORMANCE.

FULL DETAILS—3p STAMP TO

Partridge Electronics Ltd.

BOX 3, BROADSTAIRS, KENT.

Phone: (Thanet) 0843 62535 (62839—7 to 8p.m.)

C.O.D. orders accepted.

SPECIAL OFFER OF UNMARKED TESTED
2N 3055 SILICON NPN POWER
TRANSISTORS.
30p each 4 for £1.

TESTED 2N 3054 SILICON POWER TRANSISTORS at 20p each, 3 for 50p.

SOLDER-IN FEED THRO's 500v.w. 2pf, 10pf, 15pf, 18pf, 22pf, 30pf, 1000pf. All at 15p per doz.

TRANSISTOR DISC CERAMICS. 1-8pf 50v.w., 3-3pf 50v.w., 4-7pf 100v.w., 10pf 50v.w., 68pf 50v.w., 100pf 100v.w., 500pf 100v.w., 1000pf 50v.w., 01uf 18v.w., 022uf 18v.w., 047uf 12v.w., 1uf 18v.w., 1uf 20v.w., 22uf 3v.w. All at 10 for 15p.

COMMUNICATION SERIES OF I.C.'s untested with Data 1xR.F., 3xI.F., 2xVOGAD, 2xAGC, 1xHeadphone Amp, 2xDouble Balanced Modulators, 1xMixer. The 12 I.C.'s for £2.75. Separate I.C.'s for 25p each.

RCA Low Noise 700 MHz NPN Transistors 2N 5181 at 15p.

RCA High Voltage TO66 NPN Power Transistor type 40546 at 30p each.

RCA 3N 140 FETs at 60p each, 3 for £1.50.

RCA NPN Power Transistor 40363 at 40p.

Transistor Package like RCA CA 3045 untested with details at 5 for 50p

100 PIV 5 amp SILICON BRIDGES sub-miniature at 50p.

1000 PIV 800mA SILICON RECTIFIERS at 10p each.

2 GHZ DUAL TRANSISTORS untested 4 for £1 with connections.

2N 3055 on Finned Heat Sink at 50p.

OC 36 on Finned Heat Sink at 50p.

3x200 PIV 12 amp SILICON DIODES on Finned Heat Sink at 50p.

LEADLESS DISC CERAMICS. 4-7pf or 200pf both at 15p per doz.

2K MULTI TURN TRIMPOTS at 10p each, 7 for 50p.

MULLARD FET BFW 10 25p each, 5 for £1.

300 MHz Divide by 2 Counters 60p each with details.

100 Assorted untested unmarked 400 mW, 1 watt, 2 watt Zeners Mixed at 50p.

BRANDED HIGH SPEED DUAL COMPARATORS in 14 Dual in Line Package with data at 30p each.

MOS MULTIPLEXERS 8 DIFFERENTIAL CHANNELS with SEQUENTIAL ACCESS untested in 40 Lead Flatpack, 3 for £1.

J. BIRKETT

Radio Component Suppliers,
25 THE STRAIT, LINCOLN.
Telephone: 20767

G3EKX S.S.B. PRODUCTS G3EKX

EDDYSTONE EC10 Mk. 2. Latest £79.00
 EDDYSTONE 1000 Price to be announced
 EDDYSTONE 935 speaker, £3.71 A.C. mains unit 924... £7.75

TRIO TS510/PS510. Latest transceiver. New £180.00
 TRIO JR310. Superb ham bands Rx. £79.50
 TRIO 9R59DS. Latest general coverage Rx. £57.50
 TRIO SP5D. Speaker £4.37

PAIR MATCHED 6HF5's R.C.A. (20p) £5.50
 PAIR MATCHED 6146 R.C.A. (20p) £5.00
 PAIR MATCHED 6146B R.C.A. (20p) £6.20

2 METRE 5 element wide spaced BEAM with 1-2½" masthead bracket. Only (80p) £2.50

NEW XTALS. All metal types. Mixed, not ex-govt. 80 kc/s. to 110 Mc/s. "State your requirements." S.A.E. essential (5p) ea. 50p

R.C.A. ROTARY RELAYS. 12v. 1/P.D.C. superb job. Ideal for aerial switching (15p) ea. 55p

E.H.T. TRANSFORMER. 600-0-600v. 1 amp. Impregnated 6" cube. New as used in pyramid linear (£1.50) £16.00

6HF5 FILAMENT TRANSFORMERS. 6v.-12 amp. (75p) £3.00

★ PYRAMID CHASSIS, and Manual, "FREE" with each pair of above Transformers.

HALLICRAFTERS SX100 with Manual (£1.50) £95.00
 VICEROY AND COLLINS Tx's. £65.00 and £15.00
 RI155 + pwr. unit and speaker (£1.50) £12.50

7 LITTLE CASTLE STREET, TRURO
 Tel. DEVORAN 862575 CORNWALL

GRAHAM NEWBERY

(REG WARD G2BSW)

WE ARE OFFICIALLY APPOINTED K.W. AGENTS FOR THE SOUTH WEST (Somerset, Dorset, Devon, Cornwall)

KW Atlanta with p.s.u. £210.00
 Remote VFO £37.00
 KW 2000B with p.s.u. £240.00
 Remote VFO £39.00
 KW 202 Receiver £140.00
 Matching Speaker £8.00
 KW 204 Transmitter £145.00
 KW 1000 Linear £135.00
 KW 101 VSWR Meter (52 or 75 ohm) £9.25
 KW103 VSWR Meter and Combined Power Meter £12.50
 KW E-Z Match. 10-80m. ATU £15.00
 KW 107 Combined E-Z Match, VSWR and R.F. Power Indicator, Dummy Load and Antenna Switch for 4 Outlets £40.00
 KW Trap Dipole 70' 75 ohm Twin Feeder £14.00
 KW Trap Dipole 97' Coaxial Feeder £15.00
 KW 3 way Antenna Switches (for coax) £3.75

EDDYSTONE RECEIVERS
 EC10 Mk. II £79.00
 EA12 £205.00
 830/7 £372.75

WE ARE THE DISTRIBUTORS OF EDDYSTONE PROFESSIONAL RECEIVERS FOR THE SOUTH WEST.

Trio Equipment Model 9R59DS £57.50
SECOND HAND EQUIPMENT in stock: Eddystone—940 General coverage Rx., £110; 680X, £65; 840, £30; KW Vespa Mk. II Transmitter and p.s.u., £95. Lafayette HA600 General Coverage Rx., £38. Heathkit Mohican (General coverage Rx., £25. Trio 9R59DS (1st new) £45.

SHURE MICROPHONES
 Model 444 £14.40
 Model 201 £6.00
 Model 202 £6.60

ANTENNAE Distributors for J/Beam and Joystick. Joymatch ATU's etc.

R.C.A. VALVES for KW and Heathkit equipment. 6146, 6146B, 6HF5, 6LQ6, 6GE5, 6EA8, 6GW8, 6GK6, 6CM6, 6CL6, 6CB6, 6BN8, 6H56, 6EW6, 12BA6, 12BE6, 12B26, etc. and many other types.

TRADE INS WITH PLEASURE. OUR STOCK OF GOOD SECOND HAND EQUIPMENT CHANGES DAILY - LET US KNOW YOUR REQUIREMENTS.

WE STOCK R.S.G.B. PUBLICATIONS, LOG BOOKS, Etc.

HP TERMS AVAILABLE

AXMINSTER — DEVON
 Telephone: 3163

COSSOR CC-15 high-band AM 15w. VHF transmitter/receivers, complete with control cables and speaker, suitable for conversion to 144 MHz, 10-watt transistorised PA on modulator, 12v. positive earth. Price £35.—Lincs Radio Systems Ltd., Cosalt Buildings, Fish Dock Road, Grimsby (57385), Lincs.

READERS ADVERTISEMENTS

2½p per word, minimum charge 50p payable with order. Add 25% for Bold Face (Heavy Type). Please write clearly, using full punctuation and recognised abbreviations. No responsibility accepted for transcription errors. Box Numbers 12½p extra. Replies to Box Numbers should be addressed to The Short Wave Magazine, 55 Victoria Street, London, SW1H 0HF.

READERS

WANTED: Faulty CR-100 or B.28 receiver. Any condition acceptable, even incomplete, please state price, anywhere.—Bentley, 27 De Vere Gardens, Ilford, Essex. (Tel: 01-554 6631 evenings).

WANTED: R.C.A. 8516L receiver, in mint condition. Price and details.—Chisholm, 141 Stanmore Road, Mount Florida, Glasgow, G42 9AN, Scotland.

SALE: Trio TS-510 transceiver with PSU and speaker, mint condition, £140. Trio JR-599 Rx. coverage 160 to 2 metres, with speaker, mint condition £140. Accept £260 for both.—Shaw, G3XFJ, QTHR, or ring 0904 78857 (York).

FOR SALE: Eddystone EC-10 Mk. I, excellent condition, £35.—Ring Oxshott 3449 (Surrey).

S-METERS suitable for R.C.A. AR88 D/LF receivers, 2½-in. diameter, 5 mA full-scale deflection, right-hand zero, complete with detailed fitting instructions, price £4.75 each, post paid. Also available, spares for AR88 D/LF receivers, send s.a.e. for list.—A. J. Reynolds, 5 Headland Way, Lingfield, Surrey.

SELLING: Drake 2B Rx, £50. KW-160 Tx, £10. Emsa 2m. converter, £5. Buyers collect, please.—Stampton, 125 Gravesham Court, Gravesend (63284), Kent.

WANTED: HRO, condition immaterial, with coils, manual etc.—de la Bertauche, G3RCO, QTHR or ring Seaton 21016.

RF AMMETERS: 500 mA, 1A, 75p; 2.5A, 3A, 3.5A, 4A, £1.25. Giant Marconi roller coils, £3 plus 50p post and packing. Giant ATU, useful parts, £2.50 plus 50p post and packing.—Dr. Nicholls, G3ZVZ, Ancoats Hospital, Manchester M46EB. (Tel: 061-205 2204.)

FOR SALE: Eddystone EB.35 with manual, case resprayed. Surplus to requirements. What offers?—Murgatroyd, G3PGX, QTHR.

SALE: Professionally built unused DX-100U, mint condition, with SB-10, £70 or near offer? Also Mosley V4/6, £7. Metrick 3-inch CRO, £4.—Sherley-Price, G8SP, QTHR, or ring Silchester 513 (Berks).

MANUALS: R.1155, T.1154, £1.50; R.206, 62T/R, 52, 88, 75p; R.216, R.210, SP.600, £2; B40, £1.75. Please add postage.—Brooks, 5 Farrant House, London, S.W.11.

SALE: Eddystone 840C and EC-10, both mint, £39 each. Hallicrafters S.20R, 550 kHz to 40 MHz, with bandspread, £9.50. Part EXCHANGE receivers welcome. **WANTED:** Eddystone 750.—Snowden, Swainsea Lane, Pickering, Yorkshire.

FOR SALE: UR1A solid-state communications receiver with Mosfet two-metre converter, ideal mobile receiver, 160 to 2 metres, £18 plus carriage.—Box No. 5085, Short Wave Magazine Ltd., 55 Victoria Street, London, SW1H 0HF.

SELLING: KW-600, £75. 12v. DC input inverters, output 240v. AC, 40 watts, £4. PSU, plus 600v., plus 300v., minus 70v. DC, £10. Valves 5B/255M, KW-2000A/B spares, etc. Two-metre and 4-metre crystals, meters, etc., s.a.e. list.—Wake, G5RP, QTHR, or ring East Hendred 384.

WANTED: Manual for GEC BRT-400E receiver. Buy or exchange.—Martin, 59 Macfarlane Street, Hamilton, New Zealand.

FOR SALE: B.40 communications receiver, 650 kHz to 30.5 MHz, good condition, unmodified, £20. Heath HW-30 two-metre transceiver, with auto-transformer for 240v. mains, crystal and microphone, in very good condition, £20 or offer? Mosfet two-metre converter, 1F 28-30 MHz, good condition, three months old, £10. R.23B receiver, coverage 2-30 MHz, fair condition, £10. All items carriage extra or buyers collect.—Ferguson, G8ELA, 223 London Road, Bedford, Beds. (Tel: Bedford 60549, weekends only.)

FOR SALE: Half-completed G2DAF Mk. II Tx, with Eddystone dial, Kokusai filter, Codar PA, coils, etc., with good components, £30 or near offer.—McLewee, G3OML, QTHR, or ring 01-540 2713 (Surrey.)

SELLING: Squeeze Keyer MSK4, mint, 230v. AC/6v. DC, £18.40. Heathkit Keyer HD-10, 117v. AC/45v. DC, £12.50.—Write Bridport, BM/G3KVV, London, W.C.1.

SALE: Lafayette FM receiver HA-52A, tuning 152-174 MHz, for 220-240 volts, in new condition, with manual, £20.—Cameron, Coombe Cottage, Pitchcombe, Stroud, Glos.

SELLING: Bendix wavemeter BC-221, brand new, £25. HRO dial, new in carton, £3—both carriage extra. **WANTED:** Hammarlund SP-600, Types JX6 to 20, preferably table-top cabinet model, must be in mint and original condition. Details and price.—Murray, 64 Moss Lane, Garstang, Lancs.

SALE: Pye Marine Rx 619-CAT with handbook, in excellent condition. PSU contains speaker and S-meter, built-in relay for Tx muting, gap-free coverage from 60 kHz to 31 MHz in 8 bands; dual conversion on HF ranges; half-lattice crystal filter; four selectivity positions. Price £38 or near offer. Prefer buyer collects.—Lindars, 52 Heathcote Drive, East Grinstead (23950), Sussex.

FOR SALE: Pye Vanguard radiotelephones, Type AM25BV, High Band and Low Band. These units are complete but less control box, cable, microphone and speaker, operate on 12-volt input, price £20, plus £1 post and packing.—Bamber, 20 Wellington Street, Littleport, Cambs.

SALE: Sommerkamp FT-DX100 transceiver, with built-in Vox, for AC/DC, and calibrator. Ideal for mobile, low battery drain, price £140.—Nicholls, G3NXX, QTHR, (Tel: Kidderminster 4842.)

FOR SALE: R.C.A. AR88D, coverage 540 kHz—32 MHz, with speaker, in good working order. Offers? Buyer collects, weekends only, or carriage extra.—Ring Morphey, Worcester 53311.

DISPOSING: Geloso HF converter, 4.6 MHz IF, crystal calibrator and PSU, £9. BC-221T frequency meter with PSU, £12. Post and packing extra.—Ledger, G3UBL, 7 Beamish Drive, Bushey Heath, Herts (or ring 01-950 3443.)

SALE: Hy-Gain 14-AVQ four-band vertical, £5. Joystick and Tuner 4, £5. Codar A.T.5 Tx and mains PSU, £15. Codar PR-30, £4.—Jones, G3ZZK, QTHR (or ring 01-476 4050.)

FOR SALE: G.E.C. RC.410 digital receiver, coverage 2-30 MHz, £300 or near offer.—Barden, 87 Barnett Road, Brighton, Sussex.

SELLING: Unica URA-1 solid-state communications receiver, mint, suitable for beginner, £20. Buyer collects.—Hanson, Hydon Hill, Clock Barn Lane, Hydon Heath, Godalming, Surrey.

INSIST ON VERSATOWER

Acclaimed as the World's leading telescopic tilttower in the field of radio communication
Models from 25' to 120'

Enquiries to

Western Electronics (UK) Ltd
Osborne Road, Totton, Southampton

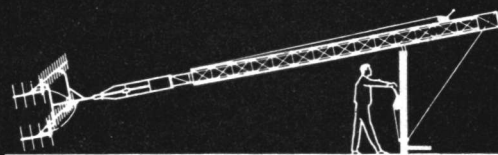

Look for the name

STRUMECH

Strumech Engineering Co Ltd
Coppice Side, Brownhills, Walsall, Staffs.

EHELDFORD COMMUNICATIONS

11 BROADWAY,
KINGSTON ROAD,
STAINES, MIDDX.

Telephone: Staines 54401

New items in stock include :

KW 2000B Transceiver and mains P.S.U.	£240.00
KW Ezee Match ATU	£15.00
KW Trap Dipole	£14.00
KW 52 ohm dummy load	£7.00
KW 103 SWR Meter	£12.50
Trio 9R59DS Receiver	£57.50
Trio SP5D Speaker	£4.50
Normende Globetrotter PRO portable Communications Receiver	£97.50
BSR Record Decks, Stereo Headphones, Speaker Systems, etc.	
Tavasu Mobile Whips and Coils :	
Whip and base with 6ft. 50 ohm coax ... (P/P 25p)	£2.88
Whip, base adaptor and 160m. coil ... (P/P 25p)	£5.95
J-Beam arrays—we are official London area stockist, full range in stock. R.S.G.B. Publications, including maps always available.	

Second-hand items at time of preparation include :

Codar AT5 TX	£18.00
Codar Mains P.S.U.	£8.00
	or £25 the pair
Class D Wavemeters, 6v. version	£6.75
Codar preselector, mains powered	£6.00
AR88 LF complete with speaker, handbook, etc. Immaculate condition (Carr. £2)	£50.00
Unica UR-1A solid-state general coverage RX	£24.00

**ALL ITEMS CARRIAGE EXTRA
LARGE S.A.E. FOR LISTS**

Hours of Opening :

Monday—Saturday 9 a.m.—6 p.m. Half Day Thursday (1 p.m.)
H.P. Terms available on all items over £25.

A. G. WHEELER, G3RHF M. STANSFIELD, G8DNM

MARKHAM ELECTRONICS

Technical
G3FPQ

YAESU TRANSCEIVERS

SALES
XYL

All ex-stock—delivery free—12 months' guarantee excluding valves and semi-conductors—unbeatable value—our prices and H.P. rates are the lowest available.

- FT101:** Ultra modern complete station—260w. P.E.P. input. Fully transistorised save for driver and P.A. Complete with microphone and built-in speaker £225
- FT200:** (Less P.S.U.), 260w. P.E.P. input. All usual operating facilities such as selectable USB/LSB, VOX, 100 kHz calibrator, clarifier ± 5 kHz are included. A modern transceiver with YAESU quality. £120
- FP200:** AC power supply and speaker unit for FT200 £35
- FTDX400:** 560w. P.E.P. input. Similar to FTDX560 but no W.W.V. band and no provision for CW filter. Limited number only £170
- FTDX560:** 560w. P.E.P. input. W.W.V. band and provision for installing C.W. filter, selectable USB/LSB, VOX, 25/100 kHz calibrator, clarifier ± 5 kHz, ANL and AC power supply all built-in £180
- FTDX401:** As FTDX560 plus built-in P.A. cooling fan, C.W. filter and sensational new noise blanker unit £205

FTDX400, FTDX560 and FTDX401 are all variations on the same basic design and represent unbeatable value for a high quality 560w. P.E.P. transceiver with built-in AC P.S.U.

**MARKHAM OAK, BUCKS HORN OAK,
FARNHAM, SURREY.**

Telephone Bentley (Hants) 3168 (evenings)

**Interested in Leasing
your equipment over
4/5 years and keeping
up to date?**

*Write or get your dealer to write
to:*

G8KA

**General Merchandise
Credit Ltd.,**

Cranbrook,

Kent.

Minimum package deal £200.

H.P. Terms over 3 years also.

FOR SALE: Telequipment double beam 'scope, Type D43, £45 or offer. Farnall power supply L30, 0-30v. at 500 mA with full overload protection. £30. Avo Model 8 Testmeter, £12-50. 375 unused resistors, various, plus 37 potentiometers, £5-50. 300 capacitors, various, unused, £7-50. Over 200 transistors, most new and unused, about 160 various diodes and IC's, £10 or offer.—Ring Ritchie, Moor End 284 (Northants.)

EXCHANGE or SELL: Two Advance Signal Generators Type C2, selection of 12 push-button preset frequencies between 30 kHz to 30 MHz. One Wavemeter Class-D. No. 2, mains/battery, with charts. One Pye Vanguard radiotelephone High-Band with controls; One ditto Low-Band. Four Murphy dash mounting radiotelephones, Low-Band Type TR.821/RAU, with transistor power supply. One 4ft. 6in. by 19in. by 18in. rack cabinet, complete with back and side opening doors. Two transmitters Type SCR-578, freq. 500 kHz MCW. One BC-342N receiver, partly rebuilt (not working). Six RF tuning units Type 28-LRU-420A; six IF ditto Type 28-LRU-421A. One Oscilloscope Type CD-568. Various mains transformers, meters, modulation transformers, 5B/254M valves and bases, many items too numerous to mention. **REQUIRED:** AR88D Rx, any Trio receiver or What-Have-You in the way of working HF receivers?—Davey, 49 Pebblemoor, Edlesborough, Dunstable. Beds. (Tel: Eaton-Bray 537, evenings or weekends.)

SALE: Sommerkamp FL-200B Tx, very little used. mint condition, £90 or offer.—Dudley, G3YRP, 31 Belle Vue Road, Ashbourne, Derbyshire.

WANTED: STC IF module, Model IFA/1-6/SSB Mk. II. Must be in good working order.—Box No. 5084, Short Wave Magazine, Ltd., 55 Victoria Street, London, SW1H-0HF.

SALE: Wight 14/21/28 MHz Cubical Quad system, £15.—Spencer, G3LW, QTHR. (Tel. 0543 481202).

SELLING: Naval UHF receiver tuning 250-700 MHz, plus loudspeaker/amplifier and special aerial system, £70. Carriage extra. Send s.a.e. with enquiries.—Hayward, Sunnyfields, Lighthouse Road, St. Margaret's Bay, Dover, Kent.

OFFERING: Eddystone 888 receiver, including Eddystone matching speaker, signal meter, and Codar PR-30 pre-amp. All in excellent order. £60 The Lot, or near offer.—Toothill, 9 Conal Avenue, Bradway, Sheffield. (Ring evenings, after 6 p.m., Sheffield 363085).

SELLING: Heathkit RF-1U signal generator (100 kHz-200 MHz). mint condition, £15. Carriage extra.—Seeds, G8DOH, 20 Elm Park Gardens, Dover, Kent.

FOR SALE: HA-350 Rx, immaculate condition, unmodified, with calibrator, £50.—Waters, 50 Trajan Walk, Heddon-On-The-Wall, Newcastle-upon-Tyne, Northumberland. (Tel. Wylam 2434).

SELLING: Eddystone Rx, 730/6, excellent condition, full coverage 500 kHz to 30 MHz. with xtal calibrator and manual, £70 or offer. National NC-183D Rx, in good condition, tuning 540 kHz to 55 MHz, with manual, £50 or offer. CR-100 Rx in working order, with manual, £5.—Bretherton, 9 Commercial Road, Chorley, Lancs., PR7 1EU.

EXCHANGE: Dulci VHF receiver, Batt./Mains model 88 to 175 MHz and 540 to 1600 kHz, valued £20, FOR Codar CR-70A, or similar receiver.—Forrest, 8/3 Calder Grove, Edinburgh 11.

SALE: Sommerkamp FL-DX500 and FR-DX500, coverage 160-2 metres, CW filter, FM unit, both excellent condition, £210. Would separate and consider EXCHANGE Drake R4-B and MS-4.—Box No. 5083, Short Wave Magazine, Ltd., 55 Victoria Street, London SW1H-0HF.

WANTED: Pre-1923 copies of "Wireless World" or any W/T books same period.—Hackney, 3A Clumber Crescent South, The Park, Nottingham (47081).

SELLING: KW-2000A complete with AC/PSU and full set of valves (spares), £155 or near offer. Also 40-watt 12v. DC alternator, complete with transistorised regulator, neg. earth, £10.50 or offer.—Sutherland, G3IES, QTHR, (or ring Bristol 622544).

FOR SALE: Armstrong stereo amplifier, mint, 25 watts per channel, £30. T.W. 144/28 MHz nuvistor converter, £8.—Ring Butler, day 01-633 4472, or eve./w'end 01-53 73906.

SELLING: Heathkit 10-20U 'scope, mint, £25. Variac PSU, 0-260v. AC, 0-240v. DC, at 7 amps, £15. Heath kit for HW-17A two-metre transceiver, new and tested, £30. E.M.I. 5-in. Lab 'Scope, £20. Much useful gear for sacrifice. Bring a sack and cash!—Butler, G3FMB, QTHR. (Tel. Medway 45975).

SALE: Mint Codar Tx, with AC Power Pack, also Eddystone 640 Rx with speaker, Class-D wavemeter and handbooks, £32. Buyer collects.—Woodward, Greenacres, Brookside, Arclid, Sandbach, Cheshire.

WANTED: Short wave receiver for teenager, full details please.—Hughes, 8 Kitling Greaves Lane, Burton-on-Trent, Staffs.

SALE: Heathkit SB-301, mint condition, unmarked and hardly used, all filters included. Offers?—Cliffe, The Willows, Kings Bromley, Burton-on-Trent, Staffs. (Tel. Yoxall 241).

FOR SALE: Sealed 10.7 MHz xtal filter, £3.50. Small 10.250 MHz xtal, £1. Miniature 450 kHz IF transformer in can, 20p; ditto 10.7 MHz, 20p. Marconi CT-44 AF output power meter, 200 micro-watt to 6 watts, various input impedances, £18. Marconi Deviation test set, 2.5 to 100 MHz, 0 to 75 kHz, deviation in 3 steps, £40. 0.005 mF 1000v. feed-throughs, 20p each. Circuit diagrams for most old and new test equipment, 50p each. Fused neon indicators, panel mounting, 15p each.—Ring Quirk, Yateley 83048 after 6 p.m.

FOR SALE: R.209 Mk. II Rx in new condition, with spares, size 8½ by 12 by 9in. deep, coverage 1 to 20 MHz, in three bands, takes AM/SSB/FM, requires 12v. DC, £10 or near offer.—Worthington, G3ZBM, QTHR, ring Crewe 68693.

MANUALS: Pye FM10, FM25, F30U, U10B, W15FM, R18FM, PTC8710, PTC8302, PTC 8306, HP1FM, W25FM, HP1AM, PTC2107, PTC2207, PTC2022, W15AM, PTC811Z, PTC114/115, PTC703/704Z, PTC300, RTC, PTC411, PTC455, PCI, PWRT, PTC145, SSB125, VHF/UHF-antennae, many others. **EXCHANGE:** High-Band AM10D Cambridge in very good condition, **FOR** good type-writer, electric or mechanical. QQV03-10, three for 55p. Swop Leak TL25 amp and pre-amp, W-H-Y?—Ring Morrison, 01-570 6181 (London).

SELLING: Heath HW-17A two-metre transceiver, handbook etc., one year old, £50. Six-over-six two-metre beam, £4. AR-10 Rotator and Control Box, £15.—Perry, G4ASX, 49A Gissbury Avenue, Peacehaven, Sussex. (Tel. Peacehaven 2325 after 6 p.m.).

SALE: K.W. Viceroy Mk. IIIA with extra filter, £70. Linear with PSU, £25.—Templer, G3RDX, Parsonage House, Woodbury (364), Exeter, Devon.

SELLING: Frequency meter 174/M, 20-250 MHz, looks like BC-221, £20. Frequency meter TS/127/U, 375-725 MHz, £15. 4X250B's, new, £1.50; bases, £2.50. Linear, uses 4X250B's, 225-400 MHz, £8.—Heathkit C/R bridge, £10.—Ring Liming, East Horsley (Surrey) 3982.

Would YOU pay 50 pence for a components catalogue?

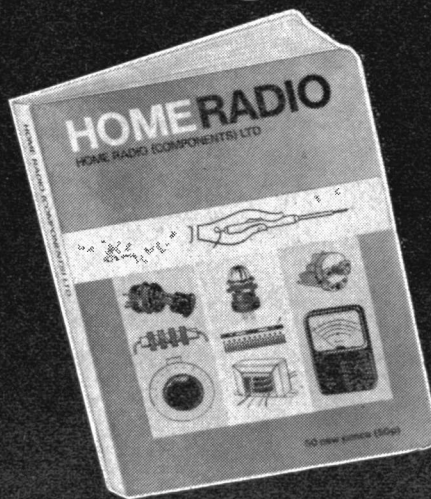

You'll be glad you did when you get THIS one!

A components catalogue is so vital to any keen constructor that it simply does not pay to make do with less than the best. True, the best may cost a little more . . . but it's the cheapest in the end. So invest in a Home Radio Components Catalogue, listing over 8,000 items, more than 1,500 of them illustrated. If you call at our shop the catalogue is yours for just 50 pence. If you order by post—70 pence, including postage and packing. You also get 10 Vouchers, each worth 5 pence when used as instructed—so you can get the cost of the catalogue back in any case!

Send Coupon today, with your cheque or P.O. for 70p

Please use block capitals	
Name	
Address	
HOME RADIO (Components) LTD. (01-648 8422) Dept. SW, 234-240 London Rd., Mitcham, CR43HD	

G2CTV **G3ZV**

J. & A. TWEEDY (Electronic Supplies) Ltd.

SPECIALISING IN AMATEUR RADIO EQUIPMENT

Full Range of KW, TRIO AND EDDYSTONE Equipment

YAESU :		YD844 Table mike ...	£12.00
FT101 Mobile/Fixed ...	£240.00	FT101 with top band ...	£255.00
FT401 Transceiver ...	£215.00	FT200 with psu ...	£172.00
FLDX400 Transmitter ...	£140.00	FRDX400 Receiver £120 to £160	
FL2000B Linear ...	£135.00	YD846 Hand mike ...	£5.00

EDDYSTONE RADIO EC10 Mk. II Receiver ... £79.00

MOSLEY AERIALS :

Atlas Vertical ...	£19.00
TA31JR ...	£13.25
TA32JR ...	£22.00
Ribbed Insulators ML5... ea.	5p

J BEAM AERIALS :

70/14Y 14 el. 70 cm. ...	£6.45
2HO Halo ...	£1.20
2HM Halo ...	£1.50
2/10Y 10 el. Yagi ...	£8.20
2/12 double six ...	£6.15
70/14Y 14 el. Parabeam ...	£3.80
2/14F 14 el. Parabeam ...	£13.00
70/16 double 8 70 cm. ...	£5.10
70/18P 18 el. Parabeam ...	£6.50

ROTATORS CDR20 ... £20.00 **CDR22** ... £25.00

TAVASU MOBILE WHIP WITH BASE AND CO-AX.

160 mtr. resonator ...	£2.75	80 mtr. resonator ...	£2.88
40 mtr. resonator ...	£2.47	20 mtr. resonator ...	£2.20
15 mtr. resonator ...	£2.20	C.P. adaptor ...	33p

Packaged deal consisting of one of each piece ... £13.75
Postage and packing 16p per item, 37p packaged deal

SE406 Saneil mini SWR Bridge ... £4.50

Medco Low Pass Filter FL50A, FL75A ... £5.70 ea.
Medco Low Pass Filter FL50B, FL75B ... £6.20 ea.

USED EQUIPMENT

Hammarlund HQ170A ...	£80.00	YAESU FTDX 400 ...	£155.00
Hallcrafters HT44 ...	£70.00	Codar AT5/DC psu/T28/	
Trio JR310, mint ...	£60.00	control unit ...	£28.00
Hy Gain 14AVQ ...	£19.00	Cannonball Topband +x	£18.50
		IBAVT/WB ...	£33.00

Please add for postage or carriage. Any excess sent will be refunded.
Postage on Halos 16p

OPEN TUESDAY TO SATURDAY, 9 a.m. to 5.30 p.m.
H.P. Terms available Part exchanges

64 Lordsmill Street, Chesterfield, Derbyshire
Tel. Chesterfield 4982 or 68005 Evenings

BERNARD BOOKS

COIL DESIGN AND CONSTRUCTION MANUAL 35p post paid

HANDBOOK OF TESTED TRANSISTOR CIRCUITS 45p post paid

HOW TO MAKE AERIALS FOR T.V. (Band 1 & 3) AND V.H.F. (Band 2) 23p post paid

HIGH FIDELITY LOUDSPEAKER ENCLOSURES 23p post paid

RADIO & ELECTRONIC COLOUR CODES & DATA CHART 21p post paid

RADIO TELEVISION AND ELECTRONICS DATA BOOK 23p post paid

TRANSISTOR CIRCUITS MANUAL No. 1 21p post paid

HANDBOOK OF TRANSISTOR EQUIVALENTS & SUBSTITUTES 45p post paid

HANDBOOK OF RADIO, T.V., & INDUSTRIAL TUBE & VALVE EQUIVALENTS 45p post paid

WORLD'S SHORT WAVE MEDIUM & LONG WAVE RADIO STATIONS & FM & TV LISTING 41p post paid

Available from

SHORT WAVE MAGAZINE

Publications Dept., 55 Victoria Street,
London, SW1H 0HF 01-222 5341/2

(Counter Service, 9.30-5.15, Mon. to Fri.)
(Nearest Station: St. James's Park)
(GIRO A/c. No. 547 6151)

FOR SALE: KW-2000A with AC/PSU and Shure 210 mic., little used, mint condition, original packing, £140.—Ring Bu. ler, 01-486 4376 after 7 p.m.

SELLING: Heath SW-717 receiver and manual, kit built, brand new, thoroughly instrument-aligned, with matching earphones, £25.—Cameron, 47 Moorway, Poulton-le-Fylde (6171), Lancs.

SALE: Mobile power pack for KW-2000A, 12v. neg. or pos., mint condition, with circuit, all cables, ready to use, £25.—Grist, G3GJX, QTHR, or ring Guildford 60163.

SALE: Sommerkamp FT-250 240-watt transceiver, excellent performance, deliver 100-mile radius, first reasonable offer. Jap Nuvistor GDO, £6.50.—Toby, G2CDN, 13 Wood Lane, Isleworth, Middlesex TW7EF.

DISPOSAL: Collins KWM-2 with mains, portable and mobile PSU, £600. Collins 75S-3 receiver, £200. Collins 312B-4 control unit, £55. Two-metre FM transceiver IC-2F, £70. Solid-state 2m. RF power amplifier, 100w. output, £70. Osker power meter, £12, Heathkit RF-1U signal generator, £18. GEC digital readout receiver RC-410, offers over £400?—Yu, 8 Basing Street, London, W11 (or ring 01-229 1229, office hours.)

SALE: Hamgear preselector PM2. Also books: "Transistor Projects," "Ham Antennas," and components, coils, transformers, etc., send s.a.e. for list. WANTED: Q-multiplier with PSU.—Hughes, 11 Henley Road, Ludlow, Salop SY8 1RA.

FOR SALE: One-MHz xtals. HC6/U mounting, 50p. Two-metre 8003 kHz, etc., CR1A type, 50p; others at 25p, FT-234, HC6/U, CR1A. Send s.a.e. please with inquiries. Also German wartime four-band Rx, 90 to 400 MHz, diode valve missing, £15 or offer, collect.—Cooper, 15 Drummond Avenue, Great Sutton, Cheshire.

SELLING: Eddystone EC-10 Mk. I, like new, £40. K.W. Valiant, coverage 10 to 160m, no PSU, £16. German-made 110v. motor, £1.50. Also (property of the late GW3MNF) K.W. Vanguard Mk. II, 10-160m. Tx, £25. Minimitter MR.37 receiver, £7. Buyers to collect.—Jones, GW3TMP, QTHR.

SALE: Eddystone EC-10 Mk. II, few hours' use only, £65. Cossor 339 'Scope, £10. Minimitter Mercury 150w. AM/CW/FM Tx, £30. Pye Ranger, with WBC outputs for 10 to 80m., £6.—Carter, G3ZW, 15 Goudhurst Road, Gillingham, Kent.

FOR SALE: Heathkit Mohican GC-1U receiver. £17.50. Eddystone S.640 Rx, £15.50. Also Beulah Electronics video camera, 405-line, tuned for Ch. II, believed OK but not tested, any offers?—Rabjohns, G3YBG, Exeter 74607.

SELLING: Trio 9R-59D fitted calibrator, various IF/AF mods., with SP5D speaker, £25. Hamgear PM.II fitted calibrator, £5. Codar A.T.5 Tx. with 250S PSU, £20. Or all together, £45.—Randall, G3OAZ, 9 Appledore Close, Eastbourne, Sussex.

SALE: Heathkit HW-12A, with PSU, microphone and speaker, professionally constructed and in excellent condition, £80. Also a Class-D wavemeter, £3.—Wilders, G3ZEO, QTHR, or ring Chelmsford 71754.

SELLING: Hallcrafters SX.62U receiver, 16 valves, coverage 550 kHz to 108 MHz, with extras, £80. Also Eddystone 840C, £45; Teletron TF-181, 150 kHz to 174 MHz, mains/battery operation, £45; Gnome Alpha enlarger, £10.—Ring Szmidi, 021-354 8689 (Birmingham) after 6.0 p.m.

SALE: Eddystone 940 receiver, three years old, in perfect condition, £100.—Goodfellow, Cherries, Stevens Lane, Claygate-Esher, Surrey (Tel: Esher 65263 or 65391.)

FOR SALE: Trio JR-310 SSB receiver, as new, standard price, £50, for cash.—Booth, 387 Hartington Walk, Balloon Wood, Wollaton, Nottingham (call after 6 p.m.)

SALE: National HRO receiver, unmodified, with complete set coil packs for 50 kHz to 30 MHz, including bandspread, two extra HF/GC coils. PSU and speaker, £20. Codar RQ-10X Q-multiplier, with PSU, £5. Codar PR-30X preselector, with PSU, £5. All items in FB condition.—Lawden, G3SS, 11 Tudor Walk, Framfield, Uckfield, Sussex (Tel: 082-582 623.)

OFFERING: Pye Vanguard radiotelephones, 25 kHz bandwidth, high-band type (tunes easily into two metres) complete with control box, cable, etc., £30 each, delivered 30 miles radius London.—Bennett, 43 The Mount, Clapton, London, E.5.

SELLING: Yaesu FT-200, with PSU/speaker and spare set valves, £125. Pair of selsyns, £1.50. Mobile PSU, transistorised, 300v., £3. Pye Ranger Rx/Tx on two metres, £6.—Quantrill, G3OPF, 10 Millford Avenue, Stony Stratford, Bucks.

SALE: Heath HW-32A, 20-metre SSB transceiver, with xtal calibrator, four months old and in perfect condition, with H/B mains PSU and built-in speaker, £55.—Ring Harrison, G4AGW, 01-476 7092 (London).

SELLING: Heathkit DX-100U Tx, AM/CW, £40. Beulah CC/TV camera, RF output, £40. Photopia camera tripod, £10. Telescope, 60 x 60, complete, £10. Pye PTC-723 4-metre base station, £20. Pye boot mounting Ranger, complete high-band, £10. Buyers to collect.—Smith, G3UGJ, QTHR.

SALE: Eddystone 840C receiver, excellent condition, buyer to collect, price £35.—White, Room 2, 7 De Crespigny Park, Denmark Hill, London, S.E.5. (Tel. 01-703 4534).

FOR SALE: Trio JR-500S receiver, in mint condition, £45 or 'near offer. K.W. Vanguard Tx, coverage 10 to 80m., £25 or offer. Buyer to inspect and collect, please.—Chisman, G4ADS, 5 Shirley Avenue, Ramsgate, Kent (Tel: 0843 (Thanet) 55317).

EXCHANGE or SELL: HA-55A aircraft Rx, mint; two/four metre Tx with PSU; 2m. Emsac converter, IF 28 to 30 MHz; 41-metre FET converter, 3.5 to 4.0 MHz IF; Cambridge Tx modified for /P on 4 metres, 12v. operation. WANTED: T.W. Communicator for 2m. or 4m.; R.220 Rx; R.216 with PSU; Type F27 AM base station, low band.—McGonigal, G1BZSC, QTHR.

JUNE issue SHORT WAVE MAGAZINE due out on Friday, May 26. Single copies at 25p post free can be supplied to orders reaching us by Wednesday 24th for despatch on Thursday 25th, the day before publication. Orders with remittance to: Circulation Dept., Short Wave Magazine, Ltd., 55 Victoria Street, London, SW1H-0HF.

Quartz Crystals

ANY frequency between : 24000 to 24333 MHz for 2m. Made to order to -005% tolerance at 95p each, post free.

Holder choice : HC6/U, HC18/U, HC25/U.

State frequency and holder style required.

SENATOR CRYSTALS

36 VALLEYFIELD ROAD,
LONDON, SW16 2HR

Sole agents for NKD Crystal Co.

THE TRADING POST 88FET
7 CASTLE ST., HASTINGS, T. H. RANSOM
SUSSEX. TEL. HAS 4

95p inc. P.P.	2 METRE XTALS	HC6/U
24-025 MHz = 144-150		24-172 MHz = 145-056
24-038 " = 144-228		24-182 " = 145-092
24-041 " = 144-246		24-198 " = 145-188
24-058 " = 144-348		24-205 " = 145-230
24-070 " = 144-420		24-212 " = 145-272
24-085 " = 144-510		24-220 " = 145-320
24-110 " = 144-660		24-232 " = 145-392
24-125 " = 144-750		24-245 " = 145-470
24-135 " = 144-810		24-258 " = 145-548
24-142 " = 144-852		24-268 " = 145-608
24-150 " = 144-900		24-278 " = 145-688
24-162 " = 144-972		24-288 " = 145-728
24-166 " = 144-996		

SPECIAL OFFER: 1 MHz HC6/U @ 75p
XTALS CUT TO ANY FREQ. IN HC6/U
—HC18/U—HC25/U
PRICES ON APPLICATION

C. D. TELECOMMS (L'pool)

44 IMPERIAL CHAMBERS,
62 DALE STREET, LIVERPOOL, L2 5SX

Radio Telephones. Mobile 10 watts A.M. All transistorised Rx. Valve Tx. PTT mic. 12v. DC. Lo-Band. Few only at ... £23.50 (carriage paid)

V.H.F. Rxs. This is a small self-contained Rx as used by Fire, Police, Ambulance. Double-superhet multi-channel Xtal-controlled. Built-in spkr. Ideal for conversion to 2m. Mains operated ... £25.00 (carriage paid)

U.H.F. Rxs. F.E.T. Front end. Available next month. Anticipated price... £40.45

Still Available. 15 watt R/T mobiles, as advertised April S.W.M.

Terms of Business: Cash with order. Cheques, etc. made payable to C.D. Telecomms. Callers by appointment.

TF on 70 mc/s!

Two way communication between 9/TF has resulted with our 6 ele. beam
4 metres ... 6 ele. £6.75 5 ele. £5.50 3 ele. £3.35
2 metres ... 9 ele. £3.65 8 ele. £3.30 5 ele. £2.60
70 cms. multigrad reflector 15 ele. £6.00 10 ele. £3.90 7 ele. £2.95
All 75 Ω. Clamps for 2" mast post paid. Low loss coax 60 yd. Ultra low
loss, 11p vd. 2" galvanised masts, 10' £2.20, 16' £3.30, 20' £4.40
couplers, 95p. Full range TV aerials in stock : UHF 8 ele. £1.90, 14 ele.
£2.35. All lashings, U bolts, etc. in stock.

JOHN R. R. BAKER
BONTNEWYDD CARDS, SY23-4JH

HOLDINGS



Swop your camera for
YAESU TRIO?

Transceivers and receivers on dem. Send large S.A.E. for R.S.G.B. test report on JR.310 with our top band, 144 MHz con. use cal. unit etc. Borrow a manual for 7 days. 12 month guarantee.

HOLDINGS PHOTO AUDIO CENTRE,
39/41 MINCING LANE, BLACKBURN, BB2 2AF.
Tel: 59595/6

FREE TO ENGINEERS



Whatever your age or experience you must read **New Opportunities**. It describes the easiest way to pass A.M.S.E., A.M.I.M.I., City & Guilds (all branches), Gen. Cert., etc., and gives details of courses in all branches of engineering Mechanics, Electrical, Civil, Auto, Aero, Radio, TV, Building, etc. You must read this book.

Send for your copy today—**FREE!**

B.I.E.T., B30, Aldermaston Court, Reading, RG7 4PF

Accredited by the Council for the
Accreditation of Correspondence Colleges

BRITISH INSTITUTE OF ENGINEERING TECHNOLOGY

MEMBER OF A.R.R.A.

H/D push button switches—panel or batten mounting—10p plus 5p carriage.

2-pin S.B.C. batten mounting lampholders—10p plus 5p carriage, £1 dozen carriage paid.

G.P.O.-type bulbholders—5p plus 5p carriage—60p dozen carriage paid, £4.00/100.

12-volt buzzers—open type—10p plus 8p carriage.

Fantastic I.C. offer—New Linear Amplifiers 709—not seconds—15p + 5p carr. Data Sheet available 5p extra.

13-amp switch sockets for mounting on panels—18p plus 5p carriage.

3½" AC ampeters—1-amp. or 5-amp. movements, various scales up to 3,000 amp.—45p plus 15p carriage.

Arrow rocker switches—S.P. make—10p plus 5p carriage—£1/dozen, carriage free.

8 MF 450-volt wire-ended tub. condensers—10p plus 5p carriage—£1/dozen, carriage free.

S/H ex-G.P.O. telephones with dial—85p plus 29p carriage.

ELEY ELECTRONICS

112, GROBY ROAD, GLENFIELD,
LEICESTER, LE3-8GL

£2.80

(The above price includes postage
and packing).

from:

SHORT WAVE MAGAZINE
55 Victoria Street, London, SW1H 0HF

YUKAN SO PROFESSIONAL THE
SELF-SPRAY YUKAN AEROSOL WAY—

Get these air drying **GREY HAMMER**
NOW! OR **BLACK WRINKLE**
(CRACKLE) finishes

Yukan Aerosol spraykit contains 453g. fine quality, durable easy instant spray. No stove baking required. Hammers available in grey and blue, 90p carr. pd. Modern Eggshell Black Wrinkle (Crackle) producing a 3D textured finish, 90p carr. pd., all at 85p per push-button self-spray can at our counter. Also durable, heat and water resistant Black Matt finish (350g. self-spray cans only) 75p carr. pd.

SPECIAL OFFER: One can plus optional transferable snap-on trigger handle (value 25p) for 95p carr. pd. Choice of 13 self-spray plain colours and primer (motor car quality) also available.

Please enclose cheque or crossed P.O. for total amount direct to:

DEPT: S → YUKAN, 307a EDGWARE ROAD, LONDON W2 1BN

We supply many Government Departments, Municipal Authorities, Institutes and Leading Industrial Organisations—We can supply you too. *Now British—even better*

Other Yukan Air Drying Aerosols, 453g. at 90p carr. pd. Includes: Zinc Chromate Clear Lacquer Metallics: Grey, Blue.



RADIO COMMUNICATION HANDBOOK

Fourth Edition of the
Original RSGB "Amateur Radio Handbook"

Price £3'15

(+ post and packing 35p.)

Available from stock

Order from

PUBLICATIONS DEPT.
SHORT WAVE MAGAZINE LTD.,
55 VICTORIA STREET, LONDON, SW1H 0HF

WORLD RADIO/TV HANDBOOK 1972

The World's only complete reference guide to International Radio & Television Broadcasting Stations. It includes: Frequencies, time schedules, announcements, personnel, slogans, interval signals and much more besides of value to the listener.

Lists all International short-wave stations, including frequencies, for each country; foreign broadcasts, long and medium wave stations (AM broadcast Band), TV stations and domestic programmes. Long recognised as the established authority by broadcasters and listeners. It is the only publication that enables you to identify BC stations quickly and easily. Enables you to fill more pages in your log book on the SW BC bands and helps you add more BC-station QSL cards to your collection.

£2.80

(The above price includes postage
and packing).

from:

SHORT WAVE MAGAZINE
55 Victoria Street, London, SW1H 0HF

"CALLBOOK"

With immediate effect—meaning the Winter editions of the U.S. and DX listings—the "Call Book" proper will be published only once a year, in December.

Supplements to both editions will appear at quarterly intervals, obtainable by prior order direct from the publishers.

We shall be able to supply the "Call Book" as an annual publication, as required at any time during the year, we shall not be handling the quarterly supplements. These will be available only direct from the publishers.

This comprehensive reference lists about 300,000 licensed radio amateurs in the United States Directory and 160,000 or more in the rest of the world (contained in the "DX Section"). In the U.S. Section, licence classifications are shown with revised listings of new licences, names and addresses. The CALLBOOK also includes much incidental DX information. Every amateur operator and SWL needs the CALLBOOK to get the most out of Amateur Radio.

DX Listings £3-10

US Listings £4-10

The two together, covering the World, £6-80

The above prices include postage and packing.

Your order to:

Publications Dept.,

SHORT WAVE MAGAZINE

55 Victoria Street, London, SW1H 0HF
01-222 5341

SCA 63982 **DERWENT RADIO** SCA 65996

SHOWROOM, 5 COLUMBUS RAVINE, SCARBOROUGH

KW Atlanta VFO	£32.00	Trio JR310	£77.00
Wightraps, pair	£2.50	Trio TS510 transceiver	£180.00
Wightraps hi power	£3.50	Trio SP5D speaker	£4.00
Hallcrafters SX 133	£145.00	G Whip 160/80	£9.00
Yaesu FT101	£240.00	G Whip Tribander	£9.00
Yaesu FT401	£215.00	G Whip basement	£1.50
Yaesu FL400	£140.00	Unica UR-1A rx.	£25.00
Yaesu FR400dx	£120.00	Halsion mobile whip	£7.50
Yaesu FR400S	£160.00	Unica UNR 30 rx.	£14.75
Yaesu FT200 and p.s.u.	£172.00	TE15 GDO	£12.50
SP 400 speaker	£10.00	Halsion extra coils	£4.40
Miniature transistor choke	5p	250 ohm carbon pot.	25p
Car radio tuner	15p	R5GB Logbook	45p
variable L	15p	R5GB C'book	50p
Panel mains neon	10p	Eddystone EC10 Mk. II	£74.00
Mains rocker sw with neon	20p	EC10 mains psu.	£7.75
Microswitch	5p	Silver mica, mixed bag	20p
m.e.s. bulbholder	1p	Ceramic capacitors mix	20p
2 pushbutton w/change switch	10p	Wirewound resistors, mix	50p
Trimmers 10-140pf	2p	Acacia Invader Iron	£1.70
Trimmers 4-40pf	3p	Sentinel 2m Conv.	£13.75
6v. a.c. relay, double c/o	30p	Sentinel 70 cm. Conv.	£13.75
4 digit impulse counter	40p	Codar 12/RC	£2.50
OC28 type heat sink 5 1/2"	5p	Lafayette 1A600	£45.00
OC71 type heat sink	2p	Lafayette HA800	£37.00
Mains slide switch	10p	Jackson 25 pfd variable	22p
10 crystals. Our selection	80p	TTC 5 band RF meter	£4.00
500 micro/a meter, round	60p	TTC s.w.r. bridge	£4.20
Small dc motor, 12v.	40p	TTC s.w.r. bridge	£7.20
5 mixed relays	50p	Amphenol PL259 ptfc	30p
6 ba. bolts, one type or mix. 18p per 100. £1 per 1,000		Amphenol SQ 238	25p
In-line fuse holders	2p	Amphenol reducers	5p
Resistor 3w.	20p	Amphenol SO239A ptfc	30p
Chokes 10H 50 m/a	20p	RCA 6LQ6	£2.60
Xtals 38-888	75p	RCA 6BK6	95p
Mosfets 3N140 3N141 (RCA)	85p	1 1/2" Beam 2m halo	£1.30
MFP 102 2N3819	40p	Shure 201	£5.50
OC170 AC187 AC188	25p	Shure 444	£14.00
BF190	37p	Acos Mic 45	£1.10
BC109 2N706	10p	Magazine binders	72p
Transistor equivalent manual	40p	Valve and Transistor Data	75p
Tested transistor ccts.	40p	Guide to B/cast Stations	50p
Transistor ccts. manual	15p	2ft telescopic aerial	35p
beginners	40p	All RCA publications in stock:	
Radio servicing for amateurs	20p	Tx valve manual	£1.00
Trio JR599	£185.00	Rx valve manual	£1.25
Trio Tx 599	£185.00	Transistor manual	£1.30
Trio 9R59DS	£47.00	Transistor servicing	£1.70
Trio JR500Se	£65.00	Hobby ccts. manual	£1.05

Wanted: We are always pleased to hear about your trade-in equipment and are looking for good KW, Eddystone, and TW items in particular. We can offer cash, or radio equipment in part exchange.

Trio JR500Se	£55.00	HRO gangs	£2.00
TS510 as new	£160.00	Eddystone 770R	£140.00
Trio JR 310 mint	£65.00	Eddystone 830/2	£200.00
Labgear LG300	£30.00	National NC109	£35.00
Central Electronics 100v. am/usb/fsk/IT	£150.00	AR89LF (Rough)	£20.00
Eddystone 840C	£45.00	BC221 freq. meter	£20.00
Vanguard hiband	£25.00	Heath Square wave gen	£9.00
Trio TS500 & p.s.u.	£125.00	100 resistors incl. histab	30p
Trio VFO-5	£18.00	100 assorted 6BA bolts	12p
Trio 9R59DS	£40.00	Dosimeter (new)	10p
Eddystone 840A	£35.00	Garx Popular Inverter	£4.50
1392 and p.s.u.	£15.00	kit	£8.00
TE15 GDO	£10.00	Murphy lowband cx/rx	£5.00
AR88 Mains cap.	£2.00		

LATEST: Plastic strip pockets to take 12 QSL cards for vertical wall display. One strip 3p, 10 strips 25p. Postage 6p.
Complete calibrator kit for Trio 9R59D. All parts including 1 MHz crystal and valve, £4. Please add extra for carriage. S.A.E. lists.

28 Hillcrest Avenue, Scarborough, Yorks.

GIEGER COUNTERS (For mains or portable battery use). Latest Home Office release and probably the last, of this well known Contamination Meter No. 1, this very useful instrument is used for the measurement of Radio-Activity. Indicated on an Internal Meter scaled 0-1 to 10 milli Rontgens/Hour, a socket is also provided for additional sound Monitoring on Headphones. This instrument is housed in a strong, light alloy case, placed in a carrying haversack with shoulder strap. Containing cable and hand held probe, Instruction card, plus the latest plug-in Vibrator Power Unit. Which uses current small transistor radio batteries (4 Mallory long life RM12 or 4 Ever Ready H.P.7 or equivalent makes). For Mobile use anywhere. (Cost Govt. approx. £70 each). Supplied brand new in carton only £5.50, carriage 50p. An additional plug-in Power Unit for Laboratory use, operating from 100-120 volts or 200-250 volts A.V. mains is available. Supplied brand new in carton at only £2.50, post 50p. Headphones (not necessary) if required £1.50. A few Gieger Counters as above new but not boxed in cardboard carton available at only £4.50 Carr. 50p.

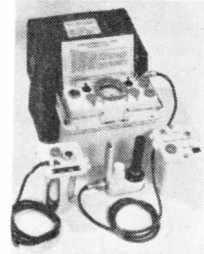

Meter Dose Rate Portable Trainer No. 1. This was used to train in the use of Gieger Counters. A very compact self-contained Gieger Counter, being very sensitive, radiation indicated on Internal Meter scales 0 to 3 Rontgens/Hour x 10-4, Unit contained in waterproof alloy case, which is handheld. Uses internal batteries (4 Ever Ready B105 and 1 U2 or equivalent makes). Not supplied. These have had little or practically no use, supplied as new in cartons. Few only, £3.50, carriage 50p.

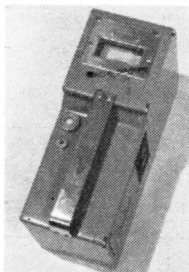

JOHNS RADIO
Dept. B, 424 BRADFORD ROAD,
BATLEY, YORKS.
Phone MORLEY 69696

TRANSCEIVERS. Due to warehouse clearance we have for disposal, few only Transceivers No. 62 Mk. 2, made by Pye for the Navy and Army. Using a total of 11 valves, 1 RF and 2 I.F. stages, A.V.C., BFO, covering 1.5 Mc/s. to 10 Mc/s. (approx. 200 to 30 metres) in two switched bands. Can be used on RT or CW, M.O. or Crystal. A very good internal ATU made of a rotating silver wire coil, tunable over the complete range, suitable for aerials 4ft. to 100ft., internal P.U. for 12 volt D.C. A meter is fitted for checking voltages A.V.C., etc. Housed in a metal waterproof case, approx. size 18" x 10 1/2" x 1 1/2". Supplied in very good used condition with headphones and mike, two spare valves, circuit, boxed. Few at £12.50, carriage £1. Airtested £1 extra. A few grade 2 sets £9.50, carriage £1. Airtested £1 extra. **CRYSTAL CALIBRATOR No. 10.** Range 500 kc/s. to 10 Mc/s., up to 30 Mc/s. on Harmonics. Size: 7" x 7 1/2" x 4". Power 300 volts HT, 12 volts LT. The Calibrator can plug into a Power Socket on the 62 Trans-Receiver which it was normally used with. Supplied in good used condition with circuit, £2.50, Post 50p or BRAND NEW IN CARTON with operating Manual and Circuit connectors to set £5, post 50p.

JOHNS RADIO
Dept. B, 424 Bradford Road, Batley, Yorks. Tel.: Morley 69696

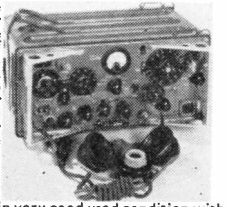

HEAD MICROPHONE UNITS
FOR MOBILE OR FIXED STATION

Puts the microphone where it's needed and leaves hands free

Model C-Ceramic Unit and heat resistant at £4.95 post paid.

Model X-Crystal Unit at £4.60 post paid.

All Fully Selected

'BOOMMIKE' P.O. Box 7, CHESTERFIELD, DERBYSHIRE

SONTRONICS' sensational BANDSCANNER, the 7 transistor monitor Rx. Covering a wider frequency range than any other unit on the amateur market. The front end comprises a high sensitivity, untuned, wide band cascade RF amplifier covering the entire RF spectrum from 50 kHz to 450 MHz. Uses UHF silicon planar transistors. Pocket sized and self-contained in a strong moulded, white plastic case, measuring 4 1/2" x 3" x 1 1/2"; complete with telescopic aerial and miniature loudspeaker. Sensitivity preset to receive a 5 watt Tx, whether on Top band or Two, at between 100 and 200 yards. Monitor local transmissions; remember, the strongest signal predominates.

The demand is growing, everyone has a use for the Bands scanner, the one and only "electronic ear." Send for the free data sheet—s.a.e. please! Only £8.80 each. P. and p. and insurance 20p. PP3 battery 14p extra.

Mail Order only. Official Orders Welcomed.

SONTRONICS
30 ASTBURY AVENUE,
POOLE, DORSET, BH12 5DT
Telephone: Bournemouth 58211

P. & P. DEVELOPMENTS

Havant 72657
Shop Hours

WE SPECIALISE IN VHF EQUIPMENT
FOR THE PROFESSIONAL AND AMATEUR!

Cosham 74695
Evenings, Weekends

VHF FM BASE STATIONS. High band complete with desk type, control unit and connecting lead. The control unit has a built-in microphone and LS, three switched channels, mute position, and switched volume level. These RT's are unused and complete. **£35 carr. paid**

GEC COURIERS. FM personal RT units. Modern design and appearance, up to 500 mw RF output, double superhet receiver. These units are unused and complete with mic, earpiece, and circuit diagram. **£25 each or £42 pair**

GEC LANCON'S. High band RT's FM not less than 250 mw rf output, double superhet receiver IuV sensitivity at 15 dB Sig./noise. Approx. size 20 x 11-1 x 3-7 cm. **£11 carr. paid**

HUDSON VHF FM BASE STATION. Complete low band TX/RX, ideal for converting to 4m. Good condition **£27 carr. paid**

GEC LOW BAND FM BASE STATION. QQV03-20 in final, complete TX/RX in unused condition **£40 carr. paid**

PYE HIGH BAND FM BASE STATION. QQV06-40A in final. 16 selected channels. Complete with remote control unit and hand set. Very clean, only **£45 carr. paid**

BCC BASE STATION. High band AM, runs QQV06-40A in final, complete with p.s.u. in one cabinet, only **£40 carr. paid**

HIGH BAND AM MOBILES. BCC mobile units TX/RX with vib p.s.u. and mic. 12 volt operation **£6 carr. paid**

GEC RC600. Mobile VHF/FM transmitter uses QQV03-10 and QQV03-20, transistor frequency multiplier chain, osc., and mic preamp boards. High output transistor inverter supply, 12v. pos. or neg. operation. This unit has been converted for use on 2m. **£17-50 carr. paid**

PYE BANTAM. High band complete with leather case in very good condition **£40 carr. paid**

B44 Mk. II. Ideal for converting to 4m. **£8 carr. paid**

LABGEAR L6-300. HF bands VFO/PA. Uses 813 as final with easily run 150 watts input. Good condition **£27 carr. paid**

DRAKE T-4X AND MS-4 PSU. Perfect order and in really good condition, including Top Band **£175 carr. paid**

EDDYSTONE 750. General coverage receiver, good working order. **£37-50 carr. paid**

AR88. In good condition **£26 carr. paid**

HALLICRAFTERS SX28. Average condition **£15 carr. paid**

TRIO JR500SE. Brand new **£57-50 carr. paid**

VHF FIBRE GLASS WHIP AERIALS. Ideal for cutting to $\frac{1}{4}$ wave on 2m. **£1 carr. paid**

MULLARD CERAMIC TRIMMERS. Type COOEA/6E, 0-6pf as used in many converters **each 13p**

UNMARKED CERAMIC TRIMMERS. 0-10 pf **each 5p**

EAGLE EQUIPMENT. S.A.E. for catalogue.

We can now supply Yaesu Musem and KW equipment. Trade-ins with pleasure. HP or personal loans easily arranged. S.A.E. for lists of other equipment in stock.

Terms of business: Mail Order only, CWO, min. order 25p. Carriage prices for delivery outside England and Wales will be extra. Viewing of equipment by appointment.

Agent: GBDOW, 20, Selhurst Way, Fair Oak, Eastleigh, Hants.
19 LONE VALLEY, WIDLEY, COSHAM, PORTSMOUTH, HANTS.

"DX ZONE MAP"

In four colours, on durable paper for wall mounting, 35in. wide by 25in. deep. Giving essential DX information—bearing and distance of all parts of the world relative to the U.K., the 40 Zone areas into which the world is divided for Amateur Radio purposes, with major prefixes listed separately. Distance scale in miles and kilometres. Time scale in GMT. Marking of Lat./Long. close enough for accurate plotting. Hundreds of place names, mainly the usual ones, and most of the rare islands.

With new revised Prefix List
Price 85p

including postage and special packing in
postal tube to avoid damage in transit.

Publications Dept.
Short Wave Magazine Ltd., 55 Victoria Street,
London, SW1H 0HF (01-222 5341/2.)

GUIDE TO BROADCASTING STATIONS

16th Edition

Hiffe & Son Ltd. 164 pages 60p (inclusive of p. & p.)

CONTENTS

Long- and Medium-Wave European Stations: Some L.W. and M.W. Stations outside Europe: Short-Wave Stations of the World: Stations outside Europe: Short-Wave Stations of the World: Map of Broadcasting Regions: European Standard Frequency Transmitters: Short Wave Broadcasting Bands: Wavelength and Frequency Conversion: European Television Stations: European VHF Sound Broadcasting Stations: Internationally Allocated Call Signs.

Available from stock:

PUBLICATIONS DEPT.
SHORT WAVE MAGAZINE
55 VICTORIA STREET, LONDON, SW1H 0HF

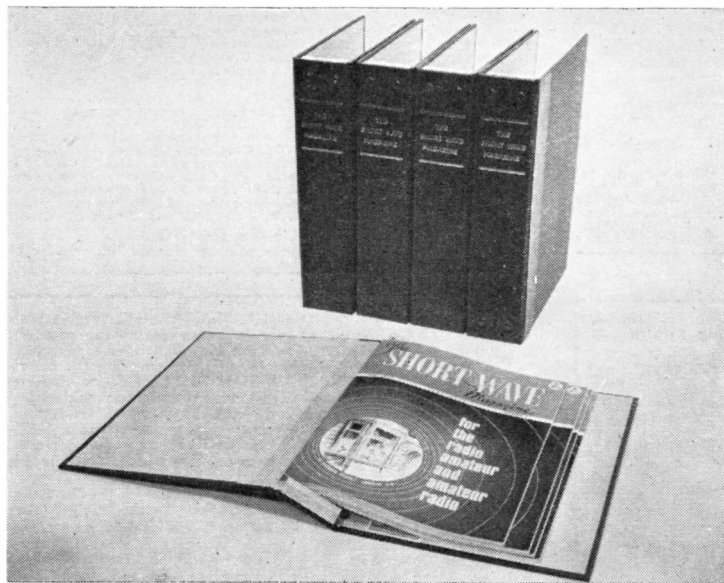

CREATE YOUR OWN REFERENCE LIBRARY

The "EASIBINDER" is designed to bind 12 copies of the Magazine as you receive them month by month, eventually providing a handsomely bound volume for the bookshelf.

No need to wait until twelve copies are assembled. As each copy is received, it is quickly and simply inserted into the binder. Whether partially or completely filled, the binder is equally effective, giving the appearance of a book, with each page opening flat.

Strongly made with stiff covers and attractively bound in maroon Leathercloth and Milskin, the binders have only the title gold blocked on the spine.

Price 88p post free.

PUBLICATIONS DEPARTMENT
SHORT WAVE MAGAZINE
55 VICTORIA STREET
LONDON, SW1H 0HF