

1.10.1 Ricambi per aratri

Spare parts for ploughs



Ricambi & accessori per macchine agricole

SPARE PARTS & ACCESSORIES FOR AGRICULTURAL MACHINE

Tutti gli articoli della presente sezione, prodotti da AMA SPA e/o da terzi per conto di AMA, sono adattabili ("non originali") alle marche indicate ai sensi di quanto previsto dal REG. CE n. 1400/2002. I diritti sui marchi citati appartengono ai legittimi proprietari ed il loro uso ha l'esclusiva finalità di consentire all'utilizzatore la comparazione dei diversi prodotti. All items of this section, manufactured by AMA SPA and/or any third party on behalf of AMA, are adaptable ("non-original") to the brands listed under the provisions of the REG. CE n. 1400/2002. The rights on the trademarks belong to their respective owners and their usage is only aimed to allow the user to compare different products.

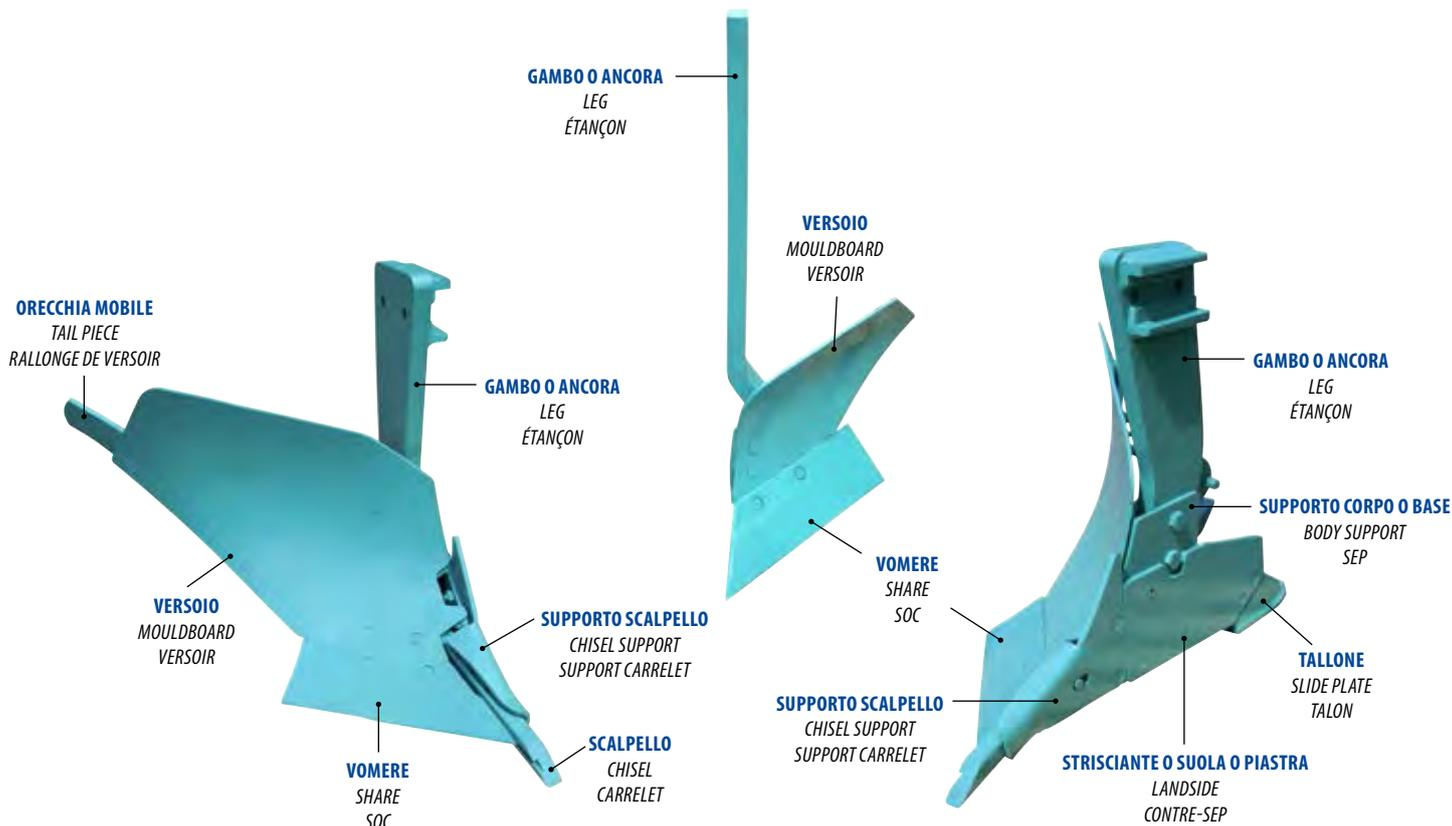
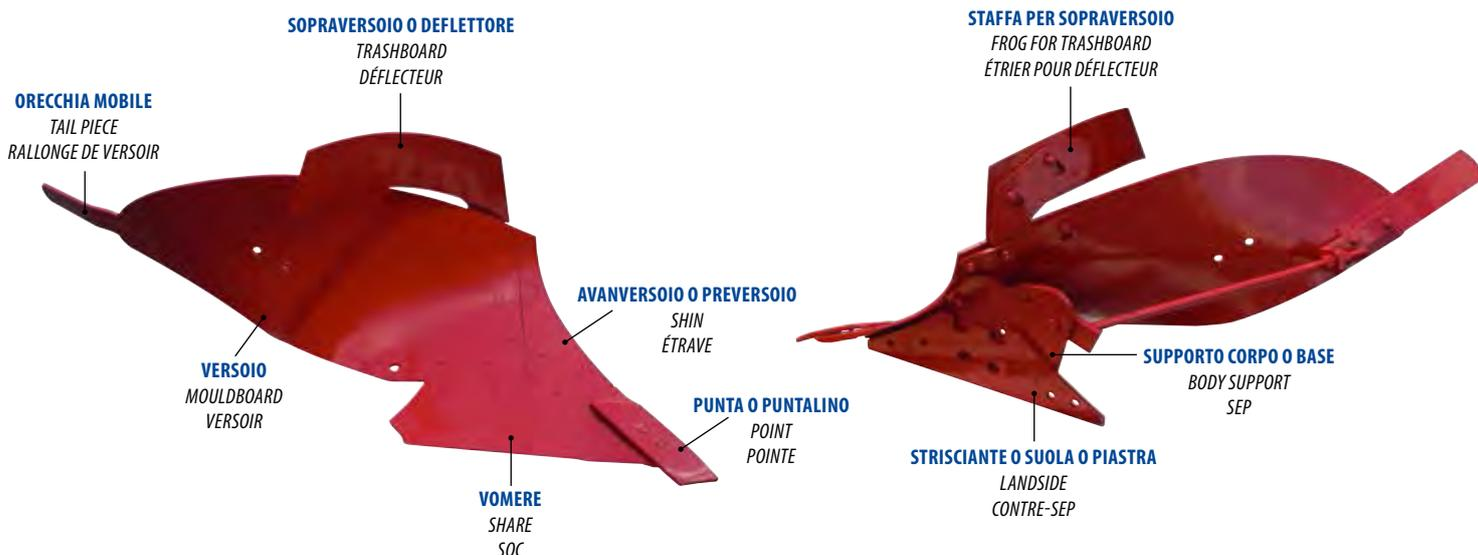
NOMENCLATURA PARTI DI RICAMBIO ARATRI • NOMENCLATURE OF SPARE PARTS FOR PLOUGHS

INDICE CAPITOLO 10.1 • INDEX SECTION 10.1
RICAMBI ARATRI

RICAMBI ADATTABILI DOWDESWELL	PAG. 1603
RICAMBI ADATTABILI ER.MO	PAG. 1605
RICAMBI ADATTABILI GHERARDI	PAG. 1615
RICAMBI ADATTABILI GREGOIRE - BESSON	PAG. 1616
RICAMBI ADATTABILI KUHN	PAG. 1618
RICAMBI ADATTABILI KVERNELAND	PAG. 1622
RICAMBI ADATTABILI LEMKEN	PAG. 1627
RICAMBI ADATTABILI NARDI	PAG. 1633
RICAMBI ADATTABILI MEC UN	PAG. 1656
RICAMBI ADATTABILI MEC CN	PAG. 1660

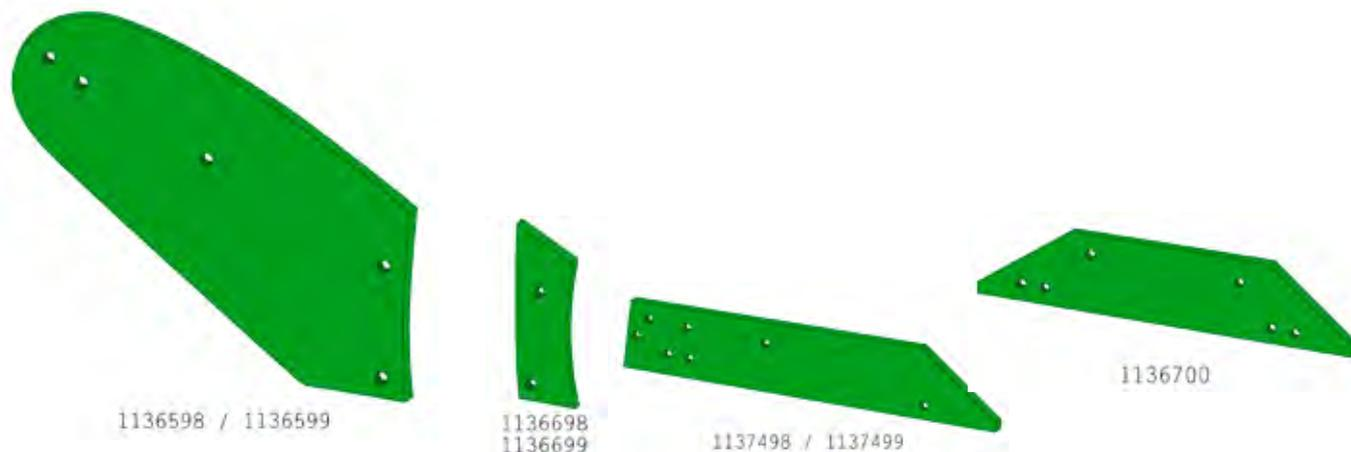
RICAMBI ADATTABILI OTMA	PAG. 1661
RICAMBI ADATTABILI OVERUM	PAG. 1666
RICAMBI ADATTABILI RABEWERK	PAG. 1670
RICAMBI ADATTABILI RANSOMES	PAG. 1672
RICAMBI ADATTABILI REGENT	PAG. 1673
RICAMBI ADATTABILI SOGEMA	PAG. 1675
RICAMBI ADATTABILI VIVIANI - MIPE	PAG. 1686
RICAMBI ADATTABILI MORO	PAG. 1632
RICAMBI ADATTABILI VIVIANI	PAG. 1685
RICAMBI ADATTABILI VOGEL&NOOT	PAG. 1687

VERSOI, STRISCIANTI PER CORPI ARANTI ADATTABILI ALLA PRODUZIONE DOWDESWELL DD
SOCS POUR CHARRUES ADAPTABLES DOWDESWELL DD
MOLDBOARDS, LANDSIDES FOR PLOUGH BODY SUIT TO DOWDESWELL DD PRODUCTION
STREICHBLECHE, STREIFEN FUER PFLUGKOEPPER PASSEND ZU DOWDESWELL DD
TEJA A TIRAS PARA CUERPO DE ARADO ADAPTABLE A LA PRODUCCION DOWDESWELL DD

Art./Ref.	Rif. Orig./Orig. Ref.	Titolo Prodotto/Titolo Prodotto	Spessore mm/Thickness mm	Brand
RC1563	1136598	VERSOIO DX	-	DOWDESWELL
RC1564	1136599	VERSOIO SX	-	DOWDESWELL
RC1517	1136698	AVANVERSOIO DX	-	DOWDESWELL
RC1518	1136699	AVANVERSOIO SX	-	DOWDESWELL
RC1524	1137498	STRISCIANTE DX	-	DOWDESWELL
RC1525	1137499	STRISCIANTE SX	-	DOWDESWELL
RC1514	1136700	STRISCIANTE REVERSIBILE DX-SX	12 mm	DOWDESWELL

VERSOI PER CORPI ARANTI ADATTABILI ALLA PRODUZIONE DOWDESWELL-RANSOME UCN
SOCS POUR CHARRUES ADAPTABLES DOWDESWELL-RANSOME UCN
MOLDBOARDS, LANDSIDES FOR PLOUGH BODY SUIT TO DOWDESWELL-RANSOME UCN PRODUCTION
STREICHBLECHE FUER PFLUGKOEPPER PASSEND ZU DOWDESWELL-RANSOME UCN
TEJA PARA CUERPO DE ARADO ADAPTABLE A LA PRODUCCION DOWDESWELL-RANSOME UCN

Art./Ref.	Rif. Orig./Orig. Ref.	Titolo Prodotto/Titolo Prodotto	Brand
RC1484	900643, PASC731	VERSOIO DX	DOWDESWELL - RANSOMES
RC1485	900644, PASC732	VERSOIO SX	DOWDESWELL - RANSOMES
RC1484A	900649, PASC733	AVANVERSOIO DX	DOWDESWELL - RANSOMES
RC1485A	900650, PASC734	AVANVERSOIO SX	DOWDESWELL - RANSOMES

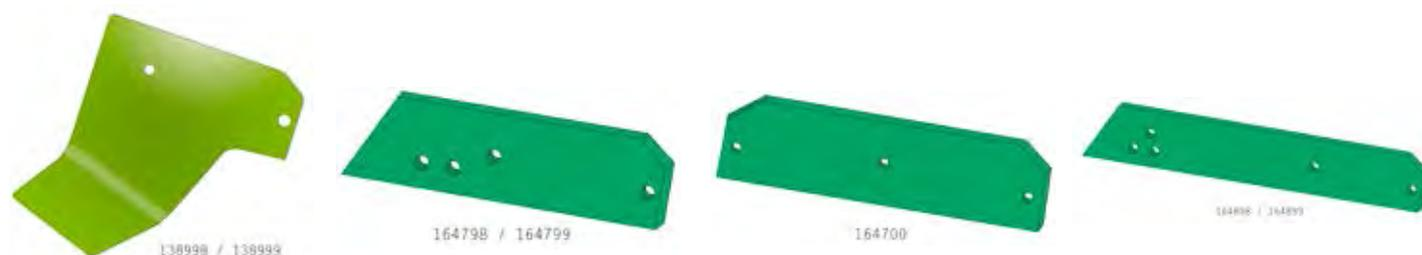
STRISCIANTI E COLTRI PER CORPI ARANTI ADATTABILI ALLA PRODUZIONE DOWDESWELL
FROTTANTS ET COUTRES POUR CHARRUES ADAPTABLES DOWDESWELL
LANDSIDES AND COULTERS FOR PLOUGH BODY SUIT TO DOWDESWELL PRODUCTION
ANLAGEN UND PFLUGEISEN FUER PFLUGKOERPER PASSEND ZU DOWDESWELL
ARRASTRANTES Y COBERTURAS PARA CUERPO DE ARADO ADAPTABLE A LA PRODUCCION DOWDESWELL

Art./Ref.	Rif. Orig./Orig. Ref.	Titolo Prodotto/Titolo Prodotto	Spessore mm/Thickness mm	Brand
RC1782	164798	STRISCIANTE DX	12 mm	DOWDESWELL
RC1783	164799	STRISCIANTE SX/	12 mm	DOWDESWELL
RC1784	164700	STRISCIANTE DX-SX	12 mm	DOWDESWELL
RC1785	164898	STRISCIANTE DX	12 mm	DOWDESWELL
RC1786	164899	STRISCIANTE SX	12 mm	DOWDESWELL
RC1780	138998	COLTRO DX	7 mm	DOWDESWELL
RC1781	138999	COLTRO SX	7 mm	DOWDESWELL
RC1780RP	138998	COLTRO CON RIPOORTO DI SALDATURA DX	7 mm	DOWDESWELL
RC1781RP	138999	COLTRO CON RIPOORTO DI SALDATURA SX	7 mm	DOWDESWELL

VOMERI, PUNTE E ACCESSORI PER CORPI ARANTI ADATTABILI ALLA PRODUZIONE DOWDESWELL
SOCs, POINTES ET ACCESSOIRS POUR CHARRUES ADAPTABLES DOWDESWELL
PLOWSHARES, DRILLS AND FITTING FOR PLOUGH BODY SUIT TO DOWDESWELL PRODUCTION
SCHARE, SPITZEN UND ZUBEHOER FUER PFLUGKOERPER PASSEND ZU DOWDESWELL
VOMERES, PUNTAS Y ACESORIOS PARA CUERPO DE ARADO ADAPTABLE A LA PRODUCCION DOWDESWELL

Art./Ref.	Rif. Orig./Orig. Ref.	Titolo Prodotto/Titolo Prodotto	Spessore mm/Thickness mm	Brand
RC1774	147898	VOMERINO DX	8 mm	DOWDESWELL
RC1775	147899	VOMERINO SX	8 mm	DOWDESWELL
RC1776	048098	VOMERINO DX	7 mm	DOWDESWELL
RC1777	048099	VOMERINO SX	7 mm	DOWDESWELL
RC1778	901953	PUNTA REVERSIBILE DX	15 mm	DOWDESWELL
RC1779	901954	PUNTA REVERSIBILE SX	15 mm	DOWDESWELL
RC1787	147298	PUNTA REVERSIBILE DX	12 mm	DOWDESWELL
RC1788	147299	PUNTA REVERSIBILE SX	12 mm	DOWDESWELL
RC1789	1176598	PUNTA REVERSIBILE DX	15 mm	DOWDESWELL
RC1790	1176599	PUNTA REVERSIBILE SX	15 mm	DOWDESWELL

RICAMBI PER CORPI ADATTABILI ALLA PRODUZIONE ER.MO TIPO 1E

RECHANGES CORPS LABOURANTS ADAPTABLES A LA PRODUCTION ER.MO MOD 1E

SPARE PARTS FOR PLOUGH BODIES SUITABLE TO ER.MO PRODUCTION TYPE 1E

ERSATZTEILE FUER PFLUGKORPER PASSEND ZU ER.MO TYP 1E

RECAMBIO CUERPOS ADAPTABLES A LA PRODUCCION ER.MO TIPO 1E

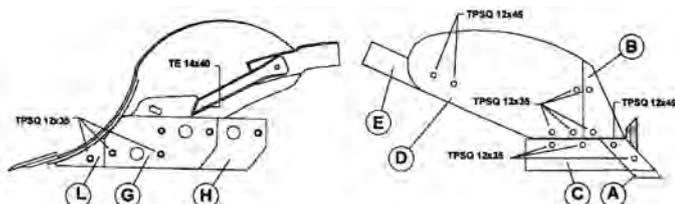

Art./Ref.	Rif. Orig./Orig. Ref.	Titolo Prodotto/Titolo Prodotto	Tipo/Type	Brand
RC1078	B58 D, CA002AD	LAMINO CON COLTRE DX	A	ER.MO
RC1079	B58 S, CA002AS	LAMINO CON COLTRE SX	A	ER.MO
RC1811	A31 D, SD001AD	PREVERSOIO DX	B	ER.MO
RC1812	A31 S, SD001AS	PREVERSOIO SX	B	ER.MO
RC1074	A22 D, CA093AD	VOMERE DX	C	ER.MO
RC1075	A22 S, CA093AS	VOMERE SX	C	ER.MO
RC1579	1E D, SD013AD	VERSOIO DX	D	ER.MO
RC1580	1E S, SD013AS	VERSOIO SX	D	ER.MO
RC1581	A13 D, CA046AD	ALETTONE DX	E	ER.MO
RC1582	A13 S, CA046AS	ALETTONE SX	E	ER.MO
RC1140	A36 D, CA071AD	FODERA ANTERIORE DX	G	ER.MO
RC1141	A36 S, CA071AS	FODERA ANTERIORE SX	G	ER.MO
RC1142	B63 D, CA072AD	FODERA POSTERIORE DX	H	ER.MO
RC1143	B63 S, CA072AS	FODERA POSTERIORE SX	H	ER.MO
RC1565	CA061AD, SQ2 D	SQUADRETTA LATERALE DX	L	ER.MO
RC1566	CA061AS, SQ2 S	SQUADRETTA LATERALE SX	L	ER.MO

RICAMBI PER CORPI ADATTABILI ALLA PRODUZIONE ER.MO TIPO 2E

RECHANGES CORPS LABOURANTS ADAPTABLES A LA PRODUCTION ER.MO MOD 2E

SPARE PARTS FOR PLOUGH BODIES SUITABLE TO ER.MO PRODUCTION TYPE 2E

ERSATZTEILE FUER PFLUGKORPER PASSEND ZU ER.MO TYP 2E

RECAMBIO CUERPOS ADAPTABLES A LA PRODUCCION ER.MO TIPO 2E

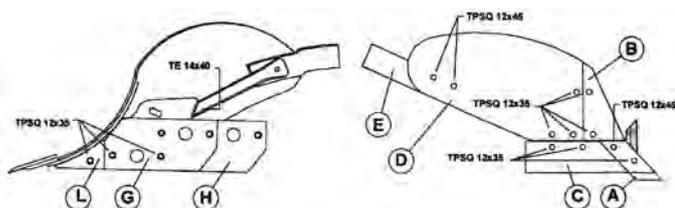

Art./Ref.	Rif. Orig./Orig. Ref.	Titolo Prodotto/Titolo Prodotto	Tipo/Type	Brand
RC1078	B58 D, CA002AD	LAMINO CON COLTRE DX	A	ER.MO
RC1079	B58 S, CA002AS	LAMINO CON COLTRE SX	A	ER.MO
RC1106	A32 D, SD002AD	PREVERSOIO DX	B	ER.MO
RC1107	A32 S, SD002AS	PREVERSOIO SX	B	ER.MO
RC1074	A22 D, CA093AD	VOMERE DX	C	ER.MO
RC1075	A22 S, CA093AS	VOMERE SX	C	ER.MO
RC1583	2E D, CA090AD	VERSOIO DX	D	ER.MO
RC1584	2E S, CA090AS	VERSOIO SX	D	ER.MO
RC1581	A13 D, CA046AD	ALETTONE DX	E	ER.MO
RC1582	A13 S, CA046AS	ALETTONE SX	E	ER.MO
RC1140	A36 D, CA071AD	FODERA ANTERIORE DX	G	ER.MO
RC1141	A36 S, CA071AS	FODERA ANTERIORE SX	G	ER.MO
RC1142	B63 D, CA072AD	FODERA POSTERIORE DX	H	ER.MO
RC1143	B63 S, CA072AS	FODERA POSTERIORE SX	H	ER.MO
RC1565	CA061AD, SQ2 D	SQUADRETTA LATERALE DX	L	ER.MO
RC1566	CA061AS, SQ2 S	SQUADRETTA LATERALE SX	L	ER.MO

RICAMBI PER CORPI ADATTABILI ALLA PRODUZIONE ER.MO TIPO 2ME

RECHANGES CORPS LABOURANTS ADAPTABLES A LA PRODUCTION ER.MO MOD 2ME

SPARE PARTS FOR PLOUGH BODIES SUITABLE TO ER.MO PRODUCTION TYPE 2ME

ERSATZTEILE FUER PFLUGKORPER PASSEND ZU ER.MO TYP 2ME

RECAMBIOS CUERPOS ADAPTABLES A LA PRODUCCION ER.MO TIPO 2ME

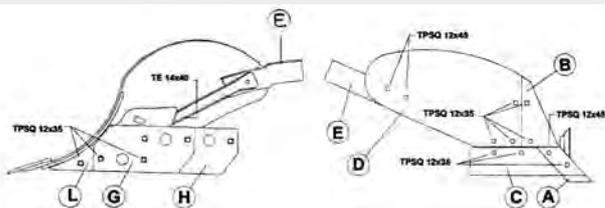

Art./Ref.	Rif. Orig./Orig. Ref.	Titolo Prodotto/Titolo Prodotto	Tipo/Type	Brand
RC1538	B57 D, CA001AD	LAMINO SENZA COLTRE DX	A	ER.MO
RC1539	B57 S, CA001AS	LAMINO SENZA COLTRE SX	A	ER.MO
RC1078	B58 D, CA002AD	LAMINO CON COLTRE DX	A	ER.MO
RC1079	B58 S, CA002AS	LAMINO CON COLTRE SX	A	ER.MO
RC1106	A32 D, SD002AD	PREVERSOIO DX	B	ER.MO
RC1107	A32 S, SD002AS	PREVERSOIO SX	B	ER.MO
RC1074	A22 D, CA093AD	VOMERE DX	C	ER.MO
RC1075	A22 S, CA093AS	VOMERE SX	C	ER.MO
RC1160	2M D - 2ME D, CA091AD	VERSOIO DX	D	ER.MO
RC1165	2M S - 2ME S, CA091AS	VERSOIO SX	D	ER.MO
RC1581	A13 D, CA046AD	ALETTONE DX	E	ER.MO
RC1582	A13 S, CA046AS	ALETTONE SX	E	ER.MO
RC1140	A36 D, CA071AD	FODERA ANTERIORE DX	G	ER.MO
RC1141	A36 S, CA071AS	FODERA ANTERIORE SX	G	ER.MO
RC1142	B63 D, CA072AD	FODERA POSTERIORE DX	H	ER.MO
RC1143	B63 S, CA072AS	FODERA POSTERIORE SX	H	ER.MO
RC1565	CA061AD, SQ2 D	SQUADRETTA LATERALE DX	L	ER.MO
RC1566	CA061AS, SQ2 S	SQUADRETTA LATERALE SX	L	ER.MO

RICAMBI PER CORPI ADATTABILI ALLA PRODUZIONE ER.MO TIPO 4SE

RECHANGES CORPS LABOURANTS ADAPTABLES A LA PRODUCTION ER.MO MOD 4SE

SPARE PARTS FOR PLOUGH BODIES SUITABLE TO ER.MO PRODUCTION TYPE 4SE

ERSATZTEILE FUER PFLUGKORPER PASSEND ZU ER.MO TYP 4SE

RECAMBIOS CUERPOS ADAPTABLES A LA PRODUCCION ER.MO TIPO 4SE

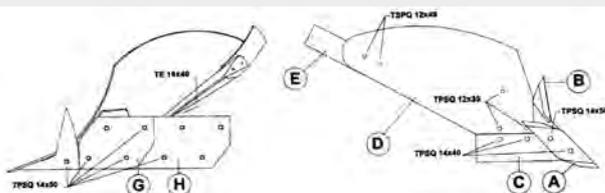

Art./Ref.	Rif. Orig./Orig. Ref.	Titolo Prodotto/Titolo Prodotto	Tipo/Type	Brand
RC1146A	B100D, CA005AD	LAMINO DX	A	ER.MO
RC1147A	B100S, CA005AS	LAMINO SX	A	ER.MO
RC1148	CA016AD, GS2 D	SUPPORTO DX	B	ER.MO
RC1149	CA016AS, GS2 S	SUPPORTO SX	B	ER.MO
RC1150	CA031AD, GS8 D	VOMERE DX	C	ER.MO
RC1151	CA031AS, GS8 S	VOMERE SX	C	ER.MO
RC1161	4SE D	VERSOIO DX	D	ER.MO
RC1166	4SE S	VERSOIO SX	D	ER.MO
RC1585	A16 D, CA048AD	ALETTONE DX	E	ER.MO
RC1586	A16 S, CA048AS	ALETTONE SX	E	ER.MO
RC1152	C10 D, CA073AD	FODERA ANTERIORE DX	G	ER.MO
RC1153	C10 S, CA073AS	FODERA ANTERIORE SX	G	ER.MO
RC1154	C10M D, CA074AD	FODERA ANTERIORE PER FUORISOLCO DX	G	ER.MO
RC1155	C10M S, CA074AS	FODERA ANTERIORE PER FUORISOLCO SX	G	ER.MO
RC1104	C11 D, CA075AD	FODERA POSTERIORE DX	H	ER.MO
RC1105	C11 S, CA075AS	FODERA POSTERIORE SX	H	ER.MO

RICAMBI PER CORPI ADATTABILI ALLA PRODUZIONE ER.MO TIPO L4S

RECHANGES CORPS LABOURANTS ADAPTABLES A LA PRODUCTION ER.MO MOD L4S

SPARE PARTS FOR PLOUGH BODIES SUITABLE TO ER.MO PRODUCTION TYPE L4S

ERSATZTEILE FUER PFLUGKORPER PASSEND ZU ER.MO TYP L4S

RECAMBIOS CUERPOS ADAPTABLES A LA PRODUCCION ER.MO TIPO L4S

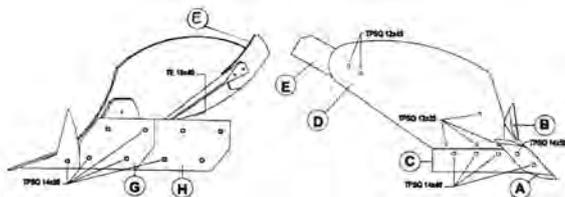

Art./Ref.	Rif. Orig./Orig. Ref.	Titolo Prodotto/Titolo Prodotto	Tipo/Type	Brand
RC1146A	B100D, CA005AD	LAMINO DX	A	ER.MO
RC1147A	B100S, CA005AS	LAMINO SX	A	ER.MO
RC1148	CA016AD, GS2 D	SUPPORTO DX	B	ER.MO
RC1149	CA016AS, GS2 S	SUPPORTO SX	B	ER.MO
RC1150B	CA032AD, GS8B D	VOMERE DX	C	ER.MO
RC1151B	CA032AS, GS8B S	VOMERE SX	C	ER.MO
RC1587	CA097AD, L4S D	VERSOIO DX	D	ER.MO
RC1588	CA097AS, L4S S	VERSOIO SX	D	ER.MO
RC1589	A16L D, CA049AD	ALETTONE DX	E	ER.MO
RC1590	A16L S, CA049AS	ALETTONE SX	E	ER.MO
RC1152	C10 D, CA073AD	FODERA ANTERIORE DX	G	ER.MO
RC1153	C10 S, CA073AS	FODERA ANTERIORE SX	G	ER.MO
RC1154	C10M D, CA074AD	FODERA ANTERIORE PER FUORISOLCO DX	G	ER.MO
RC1155	C10M S, CA074AS	FODERA ANTERIORE PER FUORISOLCO SX	G	ER.MO
RC1104	C11 D, CA075AD	FODERA POSTERIORE DX	H	ER.MO
RC1105	C11 S, CA075AS	FODERA POSTERIORE SX	H	ER.MO

RICAMBI PER CORPI ADATTABILI ALLA PRODUZIONE ER.MO TIPO 4ME-S4M

RECHANGES CORPS LABOURANTS ADAPTABLES A LA PRODUCTION ER.MO MOD 4ME-S4M

SPARE PARTS FOR PLOUGH BODIES SUITABLE TO ER.MO PRODUCTION TYPE 4ME-S4M

ERSATZTEILE FUER PFLUGKORPER PASSEND ZU ER.MO TYP 4ME-S4M

RECAMBIOS CUERPOS ADAPTABLES A LA PRODUCCION ER.MO TIPO 4ME-S4M

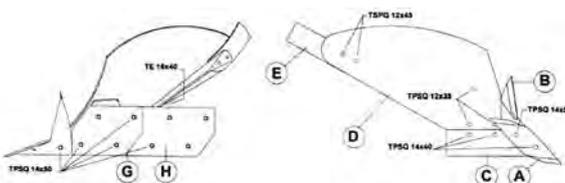

Art./Ref.	Rif. Orig./Orig. Ref.	Titolo Prodotto/Titolo Prodotto	Tipo/Type	Brand
RC1146A	B100D, CA005AD	LAMINO DX	A	ER.MO
RC1147A	B100S, CA005AS	LAMINO SX	A	ER.MO
RC1148	CA016AD, GS2 D	SUPPORTO DX	B	ER.MO
RC1149	CA016AS, GS2 S	SUPPORTO SX	B	ER.MO
RC1150	CA031AD, GS8 D	VOMERE DX	C	ER.MO
RC1151	CA031AS, GS8 S	VOMERE SX	C	ER.MO
RC1162	4ME D	VERSOIO DX	D	ER.MO
RC1167	4ME S	VERSOIO SX	D	ER.MO
RC1162A	CA096AD, S4M D	VERSOIO DX	D	ER.MO
RC1167A	CA096AS, S4M S	VERSOIO SX	D	ER.MO
RC1585	A16 D, CA048AD	ALETTONE DX	E	ER.MO
RC1586	A16 S, CA048AS	ALETTONE SX	E	ER.MO
RC1152	C10 D, CA073AD	FODERA ANTERIORE DX	G	ER.MO
RC1153	C10 S, CA073AS	FODERA ANTERIORE SX	G	ER.MO
RC1154	C10M D, CA074AD	FODERA ANTERIORE PER FUORISOLCO DX	G	ER.MO
RC1155	C10M S, CA074AS	FODERA ANTERIORE PER FUORISOLCO SX	G	ER.MO
RC1156	C12 D, CA076AD	FODERA POSTERIORE DX	H	ER.MO
RC1157	C12 S, CA076AS	FODERA POSTERIORE SX	H	ER.MO

RICAMBI PER CORPI ADATTABILI ALLA PRODUZIONE ER.MO TIPO 4S

RECHANGES CORPS LABOURANTS ADAPTABLES A LA PRODUCTION ER.MO MOD 4S

SPARE PARTS FOR PLOUGH BODIES SUITABLE TO ER.MO PRODUCTION TYPE 4S

ERSATZTEILE FUER PFLUGKORPER PASSEND ZU ER.MO TYP 4S

RECAMBIOS CUERPOS ADAPTABLES A LA PRODUCCION ER.MO TIPO 4S

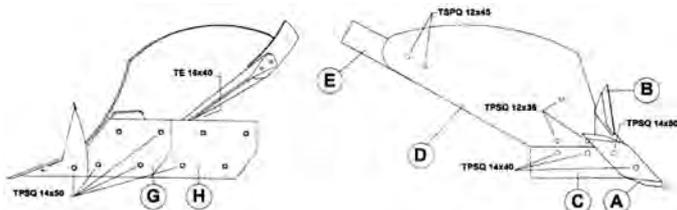

Art./Ref.	Rif. Orig./Orig. Ref.	Titolo Prodotto/Titolo Prodotto	Tipo/Type	Brand
RC1146A	B100D, CA005AD	LAMINO DX	A	ER.MO
RC1147A	B100S, CA005AS	LAMINO SX	A	ER.MO
RC1148	CA016AD, GS2 D	SUPPORTO DX	B	ER.MO
RC1149	CA016AS, GS2 S	SUPPORTO SX	B	ER.MO
RC1150	CA031AD, GS8 D	VOMERE DX	C	ER.MO
RC1151	CA031AS, GS8 S	VOMERE SX	C	ER.MO
RC1161A	4S D, CA095AD	VERSOIO DX	D	ER.MO
RC1166A	4S S, CA095AS	VERSOIO SX	D	ER.MO
RC1585	A16 D, CA048AD	ALETTONE DX	E	ER.MO
RC1586	A16 S, CA048AS	ALETTONE SX	E	ER.MO
RC1152	C10 D, CA073AD	FODERA ANTERIORE DX	G	ER.MO
RC1153	C10 S, CA073AS	FODERA ANTERIORE SX	G	ER.MO
RC1154	C10M D, CA074AD	FODERA ANTERIORE PER FUORISOLCO DX	G	ER.MO
RC1155	C10M S, CA074AS	FODERA ANTERIORE PER FUORISOLCO SX	G	ER.MO
RC1104	C11 D, CA075AD	FODERA POSTERIORE DX	H	ER.MO
RC1105	C11 S, CA075AS	FODERA POSTERIORE SX	H	ER.MO

RICAMBI PER CORPI ADATTABILI ALLA PRODUZIONE ER.MO TIPO 4M

RECHANGES CORPS LABOURANTS ADAPTABLES A LA PRODUCTION ER.MO MOD 4M

SPARE PARTS FOR PLOUGH BODIES SUITABLE TO ER.MO PRODUCTION TYPE 4M

ERSATZTEILE FUER PFLUGKORPER PASSEND ZU ER.MO TYP 4M

RECAMBIOS CUERPOS ADAPTABLES A LA PRODUCCION ER.MO TIPO 4M

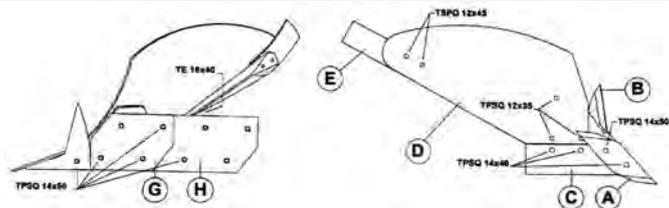

Art./Ref.	Rif. Orig./Orig. Ref.	Titolo Prodotto/Titolo Prodotto	Tipo/Type	Brand
RC1146A	B100D, CA005AD	LAMINO DX	A	ER.MO
RC1147A	B100S, CA005AS	LAMINO SX	A	ER.MO
RC1148	CA016AD, GS2 D	SUPPORTO DX	B	ER.MO
RC1149	CA016AS, GS2 S	SUPPORTO SX	B	ER.MO
RC1150	CA031AD, GS8 D	VOMERE DX	C	ER.MO
RC1151	CA031AS, GS8 S	VOMERE SX	C	ER.MO
RC1163A	4M D, CA098AD	VERSOIO DX	D	ER.MO
RC1168A	4M S, CA098AS	VERSOIO SX	D	ER.MO
RC1585	A16 D, CA048AD	ALETTONE DX	E	ER.MO
RC1586	A16 S, CA048AS	ALETTONE SX	E	ER.MO
RC1152	C10 D, CA073AD	FODERA ANTERIORE DX	G	ER.MO
RC1153	C10 S, CA073AS	FODERA ANTERIORE SX	G	ER.MO
RC1154	C10M D, CA074AD	FODERA ANTERIORE PER FUORISOLCO DX	G	ER.MO
RC1155	C10M S, CA074AS	FODERA ANTERIORE PER FUORISOLCO SX	G	ER.MO
RC1156	C12 D, CA076AD	FODERA POSTERIORE DX	H	ER.MO
RC1157	C12 S, CA076AS	FODERA POSTERIORE SX	H	ER.MO

RICAMBI PER CORPI ADATTABILI ALLA PRODUZIONE ER.MO TIPO 4ML

RECHANGES CORPS LABOURANTS ADAPTABLES A LA PRODUCTION ER.MO MOD 4ML

SPARE PARTS FOR PLOUGH BODIES SUITABLE TO ER.MO PRODUCTION TYPE 4ML

ERSATZTEILE FUER PFLUGKORPER PASSEND ZU ER.MO TYP 4ML

RECAMBIO CUERPOS ADAPTABLES A LA PRODUCCION ER.MO TIPO 4ML

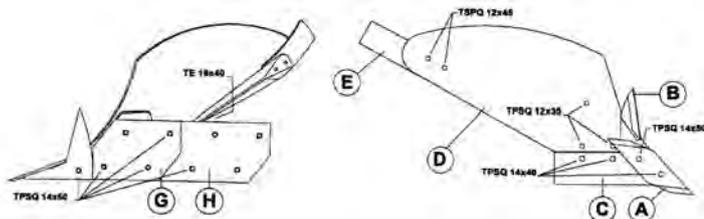

Art./Ref.	Rif. Orig./Orig. Ref.	Titolo Prodotto/Titolo Prodotto	Tipo/Type	Brand
RC1146A	B100D, CA005AD	LAMINO DX	A	ER.MO
RC1147A	B100S, CA005AS	LAMINO SX	A	ER.MO
RC1148	CA016AD, GS2 D	SUPPORTO DX	B	ER.MO
RC1149	CA016AS, GS2 S	SUPPORTO SX	B	ER.MO
RC1150	CA031AD, GS8 D	VOMERE DX	C	ER.MO
RC1151	CA031AS, GS8 S	VOMERE SX	C	ER.MO
RC1163	4ML D, CA099AD	VERSOIO DX	D	ER.MO
RC1168	4ML S, CA099AS	VERSOIO SX	D	ER.MO
RC1589	A16L D, CA049AD	ALETTONE DX	E	ER.MO
RC1590	A16L S, CA049AS	ALETTONE SX	E	ER.MO
RC1152	C10 D, CA073AD	FODERA ANTERIORE DX	G	ER.MO
RC1153	C10 S, CA073AS	FODERA ANTERIORE SX	G	ER.MO
RC1154	C10M D, CA074AD	FODERA ANTERIORE PER FUORISOLCO DX	G	ER.MO
RC1155	C10M S, CA074AS	FODERA ANTERIORE PER FUORISOLCO SX	G	ER.MO
RC1156	C12 D, CA076AD	FODERA POSTERIORE DX	H	ER.MO
RC1157	C12 S, CA076AS	FODERA POSTERIORE SX	H	ER.MO

RICAMBI PER CORPI ADATTABILI ALLA PRODUZIONE ER.MO TIPO L4M

RECHANGES CORPS LABOURANTS ADAPTABLES A LA PRODUCTION ER.MO MOD L4M

SPARE PARTS FOR PLOUGH BODIES SUITABLE TO ER.MO PRODUCTION TYPE L4M

ERSATZTEILE FUER PFLUGKORPER PASSEND ZU ER.MO TYP L4M

RECAMBIO CUERPOS ADAPTABLES A LA PRODUCCION ER.MO TIPO L4M

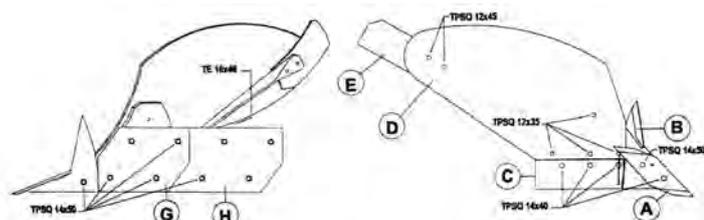

Art./Ref.	Rif. Orig./Orig. Ref.	Titolo Prodotto/Titolo Prodotto	Tipo/Type	Brand
RC1146A	B100D, CA005AD	LAMINO DX	A	ER.MO
RC1147A	B100S, CA005AS	LAMINO SX	A	ER.MO
RC1148	CA016AD, GS2 D	SUPPORTO DX	B	ER.MO
RC1149	CA016AS, GS2 S	SUPPORTO SX	B	ER.MO
RC1150B	CA032AD, GS8B D	VOMERE DX	C	ER.MO
RC1151B	CA032AS, GS8B S	VOMERE SX	C	ER.MO
RC1595	CA100AD, L4M D	VERSOIO DX	D	ER.MO
RC1596	CA100AS, L4M S	VERSOIO SX	D	ER.MO
RC1597	A16B D	ALETTONE DX	E	ER.MO
RC1598	A16B S	ALETTONE SX	E	ER.MO
RC1152	C10 D, CA073AD	FODERA ANTERIORE DX	G	ER.MO
RC1153	C10 S, CA073AS	FODERA ANTERIORE SX	G	ER.MO
RC1154	C10M D, CA074AD	FODERA ANTERIORE PER FUORISOLCO DX	G	ER.MO
RC1155	C10M S, CA074AS	FODERA ANTERIORE PER FUORISOLCO SX	G	ER.MO
RC1156	C12 D, CA076AD	FODERA POSTERIORE DX	H	ER.MO
RC1157	C12 S, CA076AS	FODERA POSTERIORE SX	H	ER.MO

RICAMBI PER CORPI ADATTABILI ALLA PRODUZIONE ER.MO TIPO L5B-L6B

RECHANGES CORPS LABOURANTS ADAPTABLES A LA PRODUCTION ER.MO MOD L5B-L6B

SPARE PARTS FOR PLOUGH BODIES SUITABLE TO ER.MO PRODUCTION TYPE L5B-L6B

ERSATZTEILE FUER PFLUGKORPER PASSEND ZU ER.MO TYP L5B-L6B

RECAMBIOS CUERPOS ADAPTABLES A LA PRODUCCION ER.MO TIPO L5B-L6B

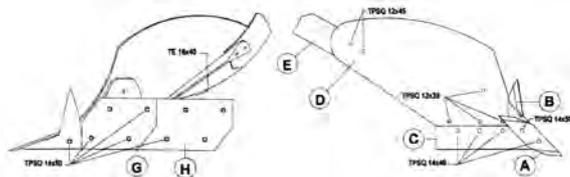

Art./Ref.	Rif. Orig./Orig. Ref.	Titolo Prodotto/Titolo Prodotto	Tipo/Type	Brand
RC1146A	B100D, CA005AD	LAMINO DX	A	ER.MO
RC1147A	B100S, CA005AS	LAMINO SX	A	ER.MO
RC1148	CA016AD, GS2 D	SUPPORTO DX	B	ER.MO
RC1149	CA016AS, GS2 S	SUPPORTO SX	B	ER.MO
RC1150B	CA032AD, GS8B D	VOMERE DX	C	ER.MO
RC1151B	CA032AS, GS8B S	VOMERE SX	C	ER.MO
RC1605	CA084AD, L5B D	VERSOIO DX	D	ER.MO
RC1606	CA084AS, L5B S	VERSOIO SX	D	ER.MO
RC1607	CA086AD, L6B D	VERSOIO DX	D	ER.MO
RC1608	CA086AS, L6B S	VERSOIO SX	D	ER.MO
RC1609	B84L D, SF078AD	ALETTONE DX	E	ER.MO
RC1610	B84L S, SF078AS	ALETTONE SX	E	ER.MO
RC1152	C10 D, CA073AD	FODERA ANTERIORE DX	G	ER.MO
RC1153	C10 S, CA073AS	FODERA ANTERIORE SX	G	ER.MO
RC1154	C10M D, CA074AD	FODERA ANTERIORE PER FUORISOLCO DX	G	ER.MO
RC1155	C10M S, CA074AS	FODERA ANTERIORE PER FUORISOLCO SX	G	ER.MO
RC1156	C12 D, CA076AD	FODERA POSTERIORE DX	H	ER.MO
RC1157	C12 S, CA076AS	FODERA POSTERIORE SX	H	ER.MO

RICAMBI PER CORPI ADATTABILI ALLA PRODUZIONE ER.MO TIPO 7E

RECHANGES CORPS LABOURANTS ADAPTABLES A LA PRODUCTION ER.MO MOD 7E

SPARE PARTS FOR PLOUGH BODIES SUITABLE TO ER.MO PRODUCTION TYPE 7E

ERSATZTEILE FUER PFLUGKORPER PASSEND ZU ER.MO TYP 7E

RECAMBIOS CUERPOS ADAPTABLES A LA PRODUCCION ER.MO TIPO 7E

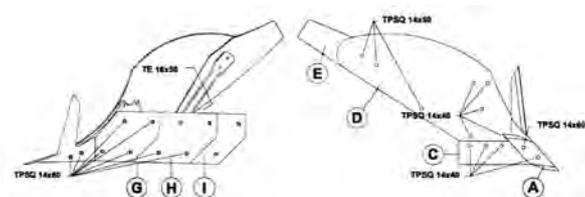

Art./Ref.	Rif. Orig./Orig. Ref.	Titolo Prodotto/Titolo Prodotto	Tipo/Type	Brand
RC1146	CA003AD, GS11 D	LAMINO REVERSIBILE DX	A	ER.MO
RC1147	CA003AS, GS11 S	LAMINO REVERSIBILE SX	A	ER.MO
RC1150A	CA033AD, GS9 D	VOMERE DX	C	ER.MO
RC1151A	CA033AS, GS9 S	VOMERE SX	C	ER.MO
RC1611	7E D, CA087AD	VERSOIO DX	D	ER.MO
RC1612	7E S, CA087AS	VERSOIO SX	D	ER.MO
RC1613	A17 D, SF069AD	ALETTONE DX	E	ER.MO
RC1614	A17 S, SF069AS	ALETTONE SX	E	ER.MO
RC1615	C86 D	FODERA ANTERIORE DX	G	ER.MO
RC1616	C86 S	FODERA ANTERIORE SX	G	ER.MO
RC1617	C86M D, SG065AD	FODERA ANTERIORE FUORISOLCO DX	G	ER.MO
RC1618	C86M S, SG065AS	FODERA ANTERIORE FUORISOLCO SX	G	ER.MO
RC1619	C88 D, SG066AD	FODERA POSTERIORE DX	H	ER.MO
RC1620	C88 S, SG066AS	FODERA POSTERIORE SX	H	ER.MO
RC1621	C89 D, SG067AD	FODERA POST. FUORISOLCO DX	I	ER.MO
RC1622	C89 S, SG067AS	FODERA POST. FUORISOLCO SX	I	ER.MO

RICAMBI PER CORPI ADATTABILI ALLA PRODUZIONE ER.MO TIPO 7BE

RECHANGES CORPS LABOURANTS ADAPTABLES A LA PRODUCTION ER.MO MOD 7BE

SPARE PARTS FOR PLOUGH BODIES SUITABLE TO ER.MO PRODUCTION TYPE 7BE

ERSATZTEILE FUER PFLUGKORPER PASSEND ZU ER.MO TYP 7BE

RECAMBIOS CUERPOS ADAPTABLES A LA PRODUCCION ER.MO TIPO 7BE

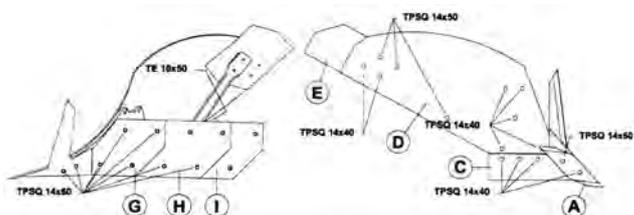

Art./Ref.	Rif. Orig./Orig. Ref.	Titolo Prodotto/Titolo Prodotto	Tipo/Type	Brand
RC1146	CA003AD, GS11 D	LAMINO REVERSIBILE DX	A	ER.MO
RC1147	CA003AS, GS11 S	LAMINO REVERSIBILE SX	A	ER.MO
RC1150A	CA033AD, GS9 D	VOMERE DX	C	ER.MO
RC1151A	CA033AS, GS9 S	VOMERE SX	C	ER.MO
RC1623	7BE D	VERSOIO DX	D	ER.MO
RC1624	7BE S	VERSOIO SX	D	ER.MO
RC1625	A7B D	ALETTONE DX	E	ER.MO
RC1626	A7B S	ALETTONE SX	E	ER.MO
RC1615	C86 D	FODERA ANTERIORE DX	G	ER.MO
RC1616	C86 S	FODERA ANTERIORE SX	G	ER.MO
RC1617	C86M D, SG065AD	FODERA ANTERIORE FUORISOLCO DX	G	ER.MO
RC1618	C86M S, SG065AS	FODERA ANTERIORE FUORISOLCO SX	G	ER.MO
RC1619	C88 D, SG066AD	FODERA POSTERIORE DX	H	ER.MO
RC1620	C88 S, SG066AS	FODERA POSTERIORE SX	H	ER.MO
RC1621	C89 D, SG067AD	FODERA POST. FUORISOLCO DX	I	ER.MO
RC1622	C89 S, SG067AS	FODERA POST. FUORISOLCO SX	I	ER.MO

RICAMBI PER CORPI ADATTABILI ALLA PRODUZIONE ER.MO TIPO 8E

RECHANGES CORPS LABOURANTS ADAPTABLES A LA PRODUCTION ER.MO MOD 8E

SPARE PARTS FOR PLOUGH BODIES SUITABLE TO ER.MO PRODUCTION TYPE 8E

ERSATZTEILE FUER PFLUGKORPER PASSEND ZU ER.MO TYP 8E

RECAMBIOS CUERPOS ADAPTABLES A LA PRODUCCION ER.MO TIPO 8E

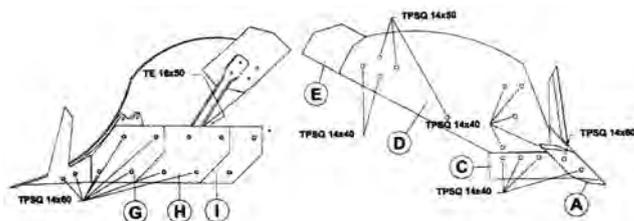

Art./Ref.	Rif. Orig./Orig. Ref.	Titolo Prodotto/Titolo Prodotto	Tipo/Type	Brand
RC1146	CA003AD, GS11 D	LAMINO REVERSIBILE DX	A	ER.MO
RC1147	CA003AS, GS11 S	LAMINO REVERSIBILE SX	A	ER.MO
RC1150A	CA033AD, GS9 D	VOMERE DX	C	ER.MO
RC1151A	CA033AS, GS9 S	VOMERE SX	C	ER.MO
RC1817	8E D, CA088AD	VERSOIO DX	D	ER.MO
RC1818	8E S, CA088AS	VERSOIO SX	D	ER.MO
RC1819	A18 D, SF070AD	ALETTONE DX	E	ER.MO
RC1820	A18 S, SF070AS	ALETTONE SX	E	ER.MO
RC1615	C86 D	FODERA ANTERIORE DX	G	ER.MO
RC1616	C86 S	FODERA ANTERIORE SX	G	ER.MO
RC1617	C86M D, SG065AD	FODERA ANTERIORE FUORISOLCO DX	G	ER.MO
RC1618	C86M S, SG065AS	FODERA ANTERIORE FUORISOLCO SX	G	ER.MO
RC1619	C88 D, SG066AD	FODERA POSTERIORE DX	H	ER.MO
RC1620	C88 S, SG066AS	FODERA POSTERIORE SX	H	ER.MO
RC1621	C89 D, SG067AD	FODERA POST. FUORISOLCO DX	I	ER.MO
RC1622	C89 S, SG067AS	FODERA POST. FUORISOLCO SX	I	ER.MO

RICAMBI PER CORPI ADATTABILI ALLA PRODUZIONE ER.MO TIPO 8BE

RECHANGES CORPS LABOURANTS ADAPTABLES A LA PRODUCTION ER.MO MOD 8BE

SPARE PARTS FOR PLOUGH BODIES SUITABLE TO ER.MO PRODUCTION TYPE 8BE

ERSATZTEILE FUER PFLUGKORPER PASSEND ZU ER.MO TYP 8BE

RECAMBIO CUERPOS ADAPTABLES A LA PRODUCCION ER.MO TIPO 8BE

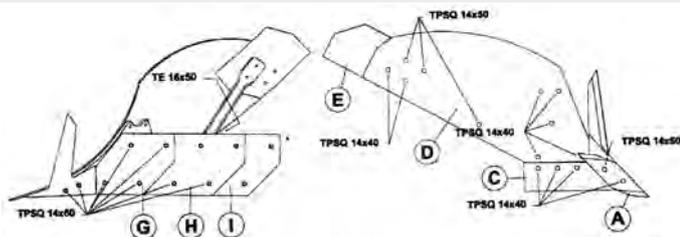

Art./Ref.	Rif. Orig./Orig. Ref.	Titolo Prodotto/Titolo Prodotto	Tipo/Type	Brand
RC1146	CA003AD, GS11 D	LAMINO REVERSIBILE DX	A	ER.MO
RC1147	CA003AS, GS11 S	LAMINO REVERSIBILE SX	A	ER.MO
RC1150A	CA033AD, GS9 D	VOMERE DX	C	ER.MO
RC1151A	CA033AS, GS9 S	VOMERE SX	C	ER.MO
RC1627	8BE D	VERSOIO DX	D	ER.MO
RC1628	8BE S	VERSOIO SX	D	ER.MO
RC1629	A8B D	ALETTONE DX	E	ER.MO
RC1630	A8B S	ALETTONE SX	E	ER.MO
RC1615	C86 D	FODERA ANTERIORE DX	G	ER.MO
RC1616	C86 S	FODERA ANTERIORE SX	G	ER.MO
RC1617	C86M D, SG065AD	FODERA ANTERIORE FUORISOLCO DX	G	ER.MO
RC1618	C86M S, SG065AS	FODERA ANTERIORE FUORISOLCO SX	G	ER.MO
RC1619	C88 D, SG066AD	FODERA POSTERIORE DX	H	ER.MO
RC1620	C88 S, SG066AS	FODERA POSTERIORE SX	H	ER.MO
RC1621	C89 D, SG067AD	FODERA POST. FUORISOLCO DX	I	ER.MO
RC1622	C89 S, SG067AS	FODERA POST. FUORISOLCO SX	I	ER.MO

RICAMBI PER CORPI ADATTABILI ALLA PRODUZIONE ER.MO TIPO 9E

RECHANGES CORPS LABOURANTS ADAPTABLES A LA PRODUCTION ER.MO MOD 9E

SPARE PARTS FOR PLOUGH BODIES SUITABLE TO ER.MO PRODUCTION TYPE 9E

ERSATZTEILE FUER PFLUGKORPER PASSEND ZU ER.MO TYP 9E

RECAMBIO CUERPOS ADAPTABLES A LA PRODUCCION ER.MO TIPO 9E

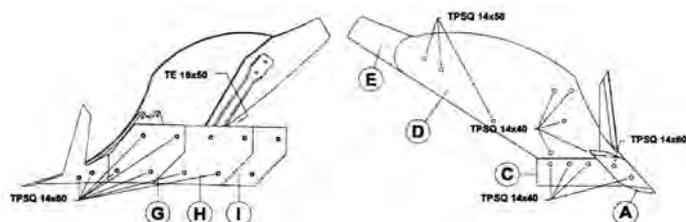

Art./Ref.	Rif. Orig./Orig. Ref.	Titolo Prodotto/Titolo Prodotto	Tipo/Type	Brand
RC1146	CA003AD, GS11 D	LAMINO REVERSIBILE DX	A	ER.MO
RC1147	CA003AS, GS11 S	LAMINO REVERSIBILE SX	A	ER.MO
RC1150A	CA033AD, GS9 D	VOMERE DX	C	ER.MO
RC1151A	CA033AS, GS9 S	VOMERE SX	C	ER.MO
RC1631	9E D, CA089AD	VERSOIO DX	D	ER.MO
RC1632	9E S, CA089AS	VERSOIO SX	D	ER.MO
RC1633	A19 D, SF071AD	ALETTONE DX	E	ER.MO
RC1634	A19 S, SF071AS	ALETTONE SX	E	ER.MO
RC1615	C86 D	FODERA ANTERIORE DX	G	ER.MO
RC1616	C86 S	FODERA ANTERIORE SX	G	ER.MO
RC1617	C86M D, SG065AD	FODERA ANTERIORE FUORISOLCO DX	G	ER.MO
RC1618	C86M S, SG065AS	FODERA ANTERIORE FUORISOLCO SX	G	ER.MO
RC1619	C88 D, SG066AD	FODERA POSTERIORE DX	H	ER.MO
RC1620	C88 S, SG066AS	FODERA POSTERIORE SX	H	ER.MO
RC1621	C89 D, SG067AD	FODERA POST. FUORISOLCO DX	I	ER.MO
RC1622	C89 S, SG067AS	FODERA POST. FUORISOLCO SX	I	ER.MO

RICAMBI PER CORPI ADATTABILI ALLA PRODUZIONE ER.MO TIPO 9BE

RECHANGES CORPS LABOURANTS ADAPTABLES A LA PRODUCTION ER.MO MOD 9BE

SPARE PARTS FOR PLOUGH BODIES SUITABLE TO ER.MO PRODUCTION TYPE 9BE

ERSATZTEILE FUER PFLUGKORPER PASSEND ZU ER.MO TYP 9BE

RECAMBIOS CUERPOS ADAPTABLES A LA PRODUCCION ER.MO TIPO 9BE

Art./Ref.	Rif. Orig./Orig. Ref.	Titolo Prodotto/Titolo Prodotto	Tipo/Type	Brand
RC1146	CA003AD, GS11 D	LAMINO REVERSIBILE DX	A	ER.MO
RC1147	CA003AS, GS11 S	LAMINO REVERSIBILE SX	A	ER.MO
RC1150A	CA033AD, GS9 D	VOMERE DX	C	ER.MO
RC1151A	CA033AS, GS9 S	VOMERE SX	C	ER.MO
RC1635	9BE D	VERSOIO DX	D	ER.MO
RC1636	9BE S	VERSOIO SX	D	ER.MO
RC1637	A9B D	ALETTONE DX	E	ER.MO
RC1638	A9B S	ALETTONE SX	E	ER.MO
RC1615	C86 D	FODERA ANTERIORE DX	G	ER.MO
RC1616	C86 S	FODERA ANTERIORE SX	G	ER.MO
RC1617	C86M D, SG065AD	FODERA ANTERIORE FUORISOLCO DX	G	ER.MO
RC1618	C86M S, SG065AS	FODERA ANTERIORE FUORISOLCO SX	G	ER.MO
RC1619	C88 D, SG066AD	FODERA POSTERIORE DX	H	ER.MO
RC1620	C88 S, SG066AS	FODERA POSTERIORE SX	H	ER.MO
RC1621	C89 D, SG067AD	FODERA POST. FUORISOLCO DX	I	ER.MO
RC1622	C89 S, SG067AS	FODERA POST. FUORISOLCO SX	I	ER.MO

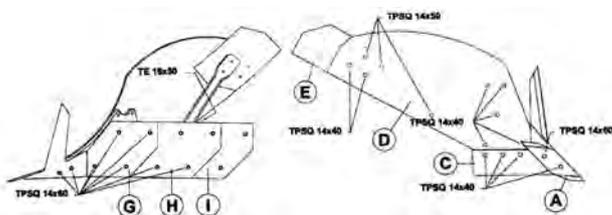
RICAMBI PER CORPI ADATTABILI ALLA PRODUZIONE ER.MO TIPO 10E-11E

RECHANGES CORPS LABOURANTS ADAPTABLES A LA PRODUCTION ER.MO MOD 10E-11E

SPARE PARTS FOR PLOUGH BODIES SUITABLE TO ER.MO PRODUCTION TYPE 10E-11E

ERSATZTEILE FUER PFLUGKORPER PASSEND ZU ER.MO TYP 10E-11E

RECAMBIOS CUERPOS ADAPTABLES A LA PRODUCCION ER.MO TIPO 10E-11E

Art./Ref.	Rif. Orig./Orig. Ref.	Titolo Prodotto/Titolo Prodotto	Tipo/Type	Brand
RC1146	CA003AD, GS11 D	LAMINO REVERSIBILE DX	A	ER.MO
RC1147	CA003AS, GS11 S	LAMINO REVERSIBILE SX	A	ER.MO
RC1150A	CA033AD, GS9 D	VOMERE DX	C	ER.MO
RC1151A	CA033AS, GS9 S	VOMERE SX	C	ER.MO
RC1639	10E D, SE051AD	VERSOIO DX	D	ER.MO
RC1640	10E S, SE051AS	VERSOIO SX	D	ER.MO
RC1641	11E D	VERSOIO DX	D	ER.MO
RC1642	11E S	VERSOIO SX	D	ER.MO
RC1643	A20 D	ALETTONE DX	E	ER.MO
RC1644	A20 S	ALETTONE SX	E	ER.MO
RC1645	A21 D	ALETTONE DX	E	ER.MO
RC1646	A21 S	ALETTONE SX	E	ER.MO
RC1647	A20C D, SF072AD	ALETTONE DX	E	ER.MO
RC1648	A20C S, SF072AS	ALETTONE SX	E	ER.MO
RC1649	A21C D	ALETTONE DX	E	ER.MO
RC1650	A21C S	ALETTONE SX	E	ER.MO
RC1615	C86 D	FODERA ANTERIORE DX	G	ER.MO
RC1616	C86 S	FODERA ANTERIORE SX	G	ER.MO
RC1617	C86M D, SG065AD	FODERA ANTERIORE FUORISOLCO DX	G	ER.MO
RC1618	C86M S, SG065AS	FODERA ANTERIORE FUORISOLCO SX	G	ER.MO
RC1619	C88 D, SG066AD	FODERA POSTERIORE DX	H	ER.MO
RC1620	C88 S, SG066AS	FODERA POSTERIORE SX	H	ER.MO
RC1621	C89 D, SG067AD	FODERA POST. FUORISOLCO DX	I	ER.MO
RC1622	C89 S, SG067AS	FODERA POST. FUORISOLCO SX	I	ER.MO

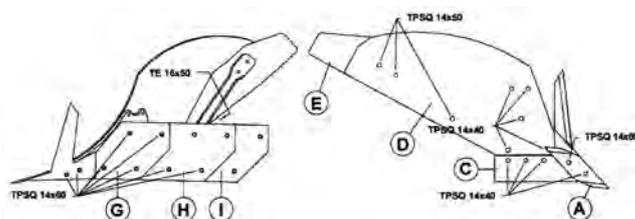

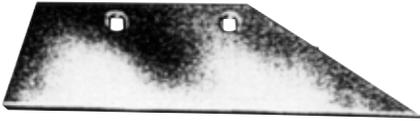
VOMERI PER CORPI ARANTI ADATTABILI ALLA PRODUZIONE GHERARDI
SOCES POUR CORPS LABOURANTS ADAPTABLES A LA PRODUCTION GHERARDI
SHARE FOR PLOUGH PARTS SUITABLE TO GHERARDI PRODUCTION
SCHARE FUER PFLUGKOERPER PASSEND ZU GHERARDI
SOPORTES ESCOPLA CUERPOS DE ARADO ADAPTABLES A LA PRODUCCION GHERARDI

Art./Ref.	Rif. Orig./Orig. Ref.	Titolo Prodotto/Titolo Prodotto	Brand	Applicazione/Application
RC0681	T 12	VOMERE DX	GHERARDI	AUTOMATICI - B40/T - 40B/H - 40/B - B40/A - B40/C - B40/D - T70/T - 41/B - Q50/T - CARRELLATI : 16M20/T - 36B3 - 36B10/T - 29B12 - 26B4 - 34B4/T - 32M16 - 27M16 - M5/20 - B29/20 - B28/2 - B26/4 - B34/4 - B36/10 - 22B18/T - B6/20 - 16M20 - 36B10 - 5M20 - 29B10 - 26B4/T - 6B20/T - 43B4 - 5M20/T - M16/20 - 6B10 - 22B18 - 6B12 - PORTATI : CM/552 - CMV/412/T - CMV/412 - CM/632 - CB/734 - CM/334/T - CM/434 - CB60 - CMV/306/T - CB/734/T - CBR/1052/T - CMV/412/TA - CM/334 - CM/534/T - CMV/552 - CMV/556 - CMV/554 - CM/434/T - CB/1032 - CB/720 - MP40 - M/556 - M/552/T - M/534 - CTR/1002/H - MP50 - M/408/T - M/308/T - CM50 - M/552 - CMV/604 - B/608 - BP70 - B/608/T - CB/1032/T - CB/610 - CB/562 - BP90
RC0684	T 22	VOMERE DX	GHERARDI	AUTOMATICI - Q60 - B56/T - T70/T - T60/B - B52/A - T60/A - B50/T - B52/B - B52/T - B50/B - 40/MH - 40/M - 42/B - 42/BH - CARRELLATI : 36M6 - 10B18 - 29M20 - B38/6 - 29M20/T - 11B16 - M34/4 - M29/20 - 29M12 - 11B18 - 7B14/T - 44B18 - 7MV6/T - 6M20/T - 44B16 - 6M20 - 6M12 - 7MV6 - 36M6/T - M6/20 - M36/8 - M26/4 - 10B16 - PORTATI : Q/1502/H - T/806 - CM/734 - CB/1334/FST - CB110 - CM/634 - B/706/T - CM60 - MP70 - B/1006/T - B/704/T - B/806 - M/606/T - BP110
RC0682	T 16	VOMERE DX	GHERARDI	AUTOMATICI - B70 - B72 - B60/T - B72/T - T35/Z - B48/D - T120 - T84 - M38 - M50/B - M48 - Q130/H - Q120/HT - B70/T - B18 - CARRELLATI : 7M8 - 13B18/T - 11M8 - 11M10 - 10M10 - 12B14/T - 44M10 - 7M8/T - 46B18 - 43B18/T - 47M10 - PORTATI : M/704/T - M/804 - CM/804

SUPPORTI SCALPELLO PER CORPI ARANTI ADATTABILI ALLA PRODUZIONE GHERARDI
SUPPORTS BURIN POUR CORPS LABOURANTS ADAPTABLES A LA PRODUCTION GHERARDI
CHISEL BEARINGS FOR PLOUGH PARTS SUITABLE TO GHERARDI PRODUCTION
MEISSELHALTER FUER PFLUGKOERPER PASSEND ZU GHERARDI
SOPORTES ESCOPLA CUERPOS DE ARADO ADAPTABLES A LA PRODUCCION GHERARDI

Art./Ref.	Rif. Orig./Orig. Ref.	Note/Note	Titolo Prodotto/Titolo Prodotto	Brand	Applicazione/Application
RC0680	101	Per scalpello 35x35	SUPPORTO SCALPELLO DX	GHERARDI	AUTOMATICI - B40/T - 40B/H - 40/B - B40/A - B40/C - B40/D - T70/T - 41/B - Q50/T - CARRELLATI : 16M20/T - 36B3 - 36B10/T - 29B12 - 26B4 - 34B4/T - 32M16 - 27M16 - M5/20 - B29/20 - B28/2 - B26/4 - B34/4 - B36/10 - 22B18/T - B6/20 - 16M20 - 36B10 - 5M20 - 29B10 - 26B4/T - 6B20/T - 43B4 - 5M20/T - M16/20 - 6B10 - 22B18 - 6B12 - PORTATI : CM/552 - CMV/412/T - CMV/412 - CM/632 - CB/734 - CM/334/T - CM/434 - CB60 - CMV/306/T - CB/734/T - CBR/1052/T - CMV/412/TA - CM/334 - CM/534/T - CMV/552 - CMV/556 - CMV/554 - CM/434/T - CB/1032 - CB/720 - MP40 - M/556 - M/552/T - M/534 - CTR/1002/H - MP50 - M/408/T - M/308/T - CM50 - M/552 - CMV/604 - B/608 - BP70 - B/608/T - CB/1032/T - CB/610 - CB/562 - BP90
RC0683	98	Per scalpello 40x40	SUPPORTO SCALPELLO DX	GHERARDI	AUTOMATICI - Q60 - B56/T - T70/T - T60/B - B52/A - T60/A - B50/T - B52/B - B52/T - B50/B - 40/MH - 40/M - 42/B - 42/BH - CARRELLATI : 36M6 - 10B18 - 29M20 - B38/6 - 29M20/T - 11B16 - M34/4 - M29/20 - 29M12 - 11B18 - 7B14/T - 44B18 - 7MV6/T - 6M20/T - 44B16 - 6M20 - 6M12 - 7MV6 - 36M6/T - M6/20 - M36/8 - M26/4 - 10B16 - PORTATI : Q/1502/H - T/806 - CM/734 - CB/1334/FST - CB110 - CM/634 - B/706/T - CM60 - MP70 - B/1006/T - B/704/T - B/806 - M/606/T - BP110
RC0681A	88	Per scalpello 50x50	SUPPORTO SCALPELLO DX	GHERARDI	AUTOMATICI - B70 - B72 - B60/T - B72/T - T35/Z - B48/D - T120 - T84 - M38 - M50/B - M48 - Q130/H - Q120/HT - B70/T - B18 - CARRELLATI : 7M8 - 13B18/T - 11M8 - 11M10 - 10M10 - 12B14/T - 44M10 - 7M8/T - 46B18 - 43B18/T - 47M10 - PORTATI : M/704/T - M/804 - CM/804

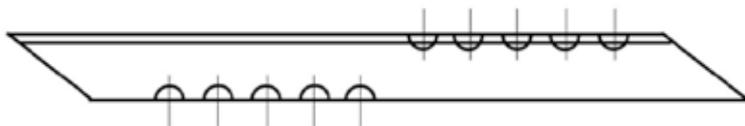
SCALPELLI PER CORPI ARANTI ADATTABILI ALLA PRODUZIONE GHERARDI
BURINS POUR CORPS LABORANTS ADAPTABLES A LA PRODUCTION GHERARDI
CHISELS FOR PLOUGH PARTS SUITABLE TO GHERARDI PRODUCTION
MEISSEL FUER PFLUGKOERPER PASSEND ZU GHERARDI
ESCOPLAS CUERPOS DE ARADO ADAPTABLES A LA PRODUCCION GHERARDI

Art./Ref.	Rif. Orig./Orig. Ref.	Titolo Prodotto/Titolo Prodotto	Brand
RC0685	35X35	SCALPELLO DX	GHERARDI
RC0686	40X40	SCALPELLO DX	GHERARDI
RC0687	50X50	SCALPELLO DX	GHERARDI

VERSOI E PREVERSOI PER CORPI ARANTI ADATTABILI ALLA PRODUZIONE GREGOIRE-BESSON
VERSOIRS POUR CHARRUES ADAPTABLES GREGOIRE-BESSON
MOLDBOARDS FOR PLOUGH BODY SUIT TO GREGOIRE-BESSON PRODUCTION
STREICHBLECHE FUER PFLUGKOERPER PASSEND ZU GREGOIRE-BESSON
OREJAS PARA CUERPO DE ARADO ADAPTABLE A LA PRODUCCION GREGOIRE-BESSON

Art./Ref.	Rif. Orig./Orig. Ref.	Titolo Prodotto/Titolo Prodotto	Spessore mm/Thickness mm	Brand
RC1174	173404, 173480	VERSOIO DX	-	GREGOIRE-BESSON
RC1175	173403, 173479	VERSOIO SX	-	GREGOIRE-BESSON
RC1200	173484	VERSOIO DX	-	GREGOIRE-BESSON
RC1201	173483	VERSOIO SX	-	GREGOIRE-BESSON
RC1910	173460	VERSOIO DX	8 mm	GREGOIRE-BESSON
RC1911	173459	VERSOIO SX	8 mm	GREGOIRE-BESSON
RC2273	177434	VERSOIO DX	8 mm	GREGOIRE-BESSON
RC2274	177433	VERSOIO SX	8 mm	GREGOIRE-BESSON
RC1176	173322	AVANVERSOIO DX	-	GREGOIRE-BESSON
RC1177	173321	AVANVERSOIO SX	-	GREGOIRE-BESSON
RC1178	173326	AVANVERSOIO DX	-	GREGOIRE-BESSON
RC1179	173325	AVANVERSOIO SX	-	GREGOIRE-BESSON
RC1480	173476	AVANVERSOIO DX	-	GREGOIRE-BESSON
RC1481	173475	AVANVERSOIO SX	-	GREGOIRE-BESSON
RC2275	173462	AVANVERSOIO DX	8 mm	GREGOIRE-BESSON
RC2276	173461	AVANVERSOIO SX	8 mm	GREGOIRE-BESSON

VOMERI, PUNTE E ACCESSORI PER CORPI ARANTI ADATTABILI ALLA PRODUZIONE GREGOIRE-BESSON

SOCS, POINTES ET ACCESSOIRES POUR CHARRUES ADAPTABLES GREGOIRE-BESSON

PLOWSHARES, DRILLS AND FITTING FOR PLOUGH BODY SUIT TO GREGOIRE-BESSON PRODUCTION

SCHARE, SPITZEN UND ZUBEHOER FUER PFLUGKOERPER PASSEND ZU GREGOIRE-BESSON

VOMERES, PUNTAS Y ACESORIOS PARA CUERPO DE ARADO ADAPTABLE A LA PRODUCCION GREGOIRE-BESSON



173424 - 173423



173614 - 173613

173332
173331

173324D - 173323G

Art./Ref.	Rif. Orig./Orig. Ref.	Titolo Prodotto/Titolo Prodotto	Brand
RC1180	173424	VOMERE 14" DX	GREGOIRE-BESSON
RC1181	173423	VOMERE 14" SX	GREGOIRE-BESSON
RC1182	173614	VOMERE 16" DX	GREGOIRE-BESSON
RC1183	173613	VOMERE 16" SX	GREGOIRE-BESSON
RC1184	173332	PUNTA REVERSIBILE DX	GREGOIRE-BESSON
RC1185	173331	PUNTA REVERSIBILE SX	GREGOIRE-BESSON
RC1186	173324D	COLTELLO PER VOMERE DX	GREGOIRE-BESSON
RC1187	173323G	COLTELLO PER VOMERE SX	GREGOIRE-BESSON

VOMERINI PER CORPI ARANTI ADATTABILI ALLA PRODUZIONE GREGOIRE-BESSON

PETITS SOCS POUR CORPS LABOURANTS ADAPTABLES A LA PRODUCT GREGOIRE BESSON

SMALL PLOWSHARES FOR PLOUGH PARTS SUITABLE TO GREGOIRE-BESSON PRODUCTION

SCHARE FUER PFLUGKOERPER PASSEND ZU GREGOIRE-BESSON

MINI-VOMERES CUERPOS DE ARADO ADAPTABLES A LA PRODUCCION GREGOIRE-BESSON

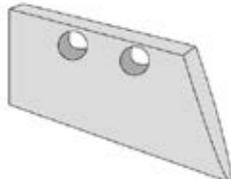

19114 / 19113

Art./Ref.	Rif. Orig./Orig. Ref.	Titolo Prodotto/Titolo Prodotto	Brand
RC1188	19114	VOMERINO DX	GREGOIRE-BESSON
RC1189	19113	VOMERINO SX	GREGOIRE-BESSON

STRISCIANTI PER CORPI ARANTI ADATTABILI ALLA PRODUZIONE GREGOIRE-BESSON

RAMPANTS POUR CORPS LABOURANTS ADAPTABLES A LA PRODUCT GREGOIRE BESSON

LANDSIDES FOR PLOUGH PARTS SUITABLE TO GREGOIRE-BESSON PRODUCTION

ANLAGEN FUER PFLUGKOERPER PASSEND ZU GREGOIRE-BESSON

FROTADORES CUERPOS DE ARADO ADAPTABLES A LA PRODUCCION GREGOIRE-BESSON



177312



173388



173338 / 173337

Art./Ref.	Rif. Orig./Orig. Ref.	Titolo Prodotto/Titolo Prodotto	Brand
RC1190	177312	STRISCIANTE DX-SX	GREGOIRE-BESSON
RC1191	173338	STRISCIANTE CORTO DX	GREGOIRE-BESSON
RC1192	173337	STRISCIANTE CORTO SX	GREGOIRE-BESSON
RC1193	173388	STRISCIANTE REVERSIBILE	GREGOIRE-BESSON

VOMERI, SCALPELLI E STRISCIANTI ADATTABILI ALLA PRODUZIONE GREGOIRE-BESSON
SOCs, CISEU ET FROTTANT ADAPTABLES A LA PRODUCT GREGOIRE-BESSON
PLOWSHARES, POINT AND LANDSIDES SUITABLE TO GREGOIRE-BESSON PRODUCTION
SCHARE, NEIFEL UND ANLAGEN PASSEND ZU GREGOIRE-BESSON
VOMERES, ESCOPOU Y ARRASTRANTES ADAPTABLES A LA PRODUCCION GREGOIRE-BESSON



Art./Ref.	Rif. Orig./Orig. Ref.	Titolo Prodotto/Titolo Prodotto	Brand
RC1196	172418	VOMERE DX	GREGOIRE-BESSON
RC1196S	172417	VOMERE SX	GREGOIRE-BESSON
RC1182A	172614	VOMERE DX	GREGOIRE-BESSON
RC1183A	172613	VOMERE SX	GREGOIRE-BESSON
RC1194	171207	SCALPELLO 30X30	GREGOIRE-BESSON
RC1195	172330	SCALPELLO 35X35	GREGOIRE-BESSON
RC1198	172380	STRISCIANTE REVERSIBILE DX-SX	GREGOIRE-BESSON

PUNTALINO PER CORPI ARANTI ADATTABILI ALLA PRODUZIONE KUHN
POINTE POUR CHARRUES ADAPTABLES KUHN
POINT FOR PLOUGH BODY SUIT TO KUHN PRODUCTION
SPITZEN FUER PFLUGKOERPER PASSEND ZU KUHN
PUNTA PARA CUERPO DE ARADO ADAPTABLE A LA PRODUCCION KUHN

Art./Ref.	Rif. Orig./Orig. Ref.	Titolo Prodotto/Titolo Prodotto	Spessore mm/Thickness mm	Peso Kg/Weight Kg	Note/Note	Brand
RC1532	622128	PUNTA REVERSIBILE DX	15 mm	2.5	Larghezza 75 mm . Lunghezza 283 mm. Fori bugnati.	KUHN
RC1533	622129	PUNTA REVERSIBILE SX	15 mm	2.5	Larghezza 75 mm . Lunghezza 283 mm. Fori bugnati.	KUHN
RC1532A	622174	PUNTA REVERSIBILE DX	15 mm	2.5	Larghezza 80 mm. Lunghezza 293 mm. Fori bugnati.	KUHN
RC1533A	622175	PUNTA REVERSIBILE SX	15 mm	2.5	Larghezza 80 mm. Lunghezza 293 mm. Fori bugnati.	KUHN
RC1532B	622180	PUNTA REVERSIBILE DX	12 mm	2	Larghezza 75 mm . Lunghezza 283 mm. Fori bugnati.	KUHN
RC1533B	622181	PUNTA REVERSIBILE SX	12 mm	2	Larghezza 75 mm. Lunghezza 283 mm. Fori bugnati.	KUHN

VERSOI, PREVERSOI E VOMERI PER CORPI ARANTI ADATTABILI ALLA PRODUZIONE KUHN
VERSOIRS ET SOCS POUR CHARRUES ADAPTABLES KUHN
MOULDBOARD AND PLOWSHARE FOR PLOUGH BODY SUIT TO KUHN PRODUCTION
MOLLBLECH UND SCHARE FUER PFLUGKOERPER PASSEND ZU KUHN
TEJA , REJA Y VOMERES PARA CUERPO DE ARADO ADAPTABLE A LA PRODUCCION KUHN

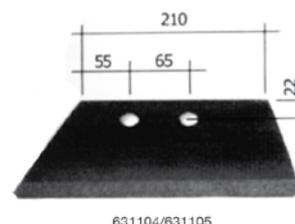

Art./Ref.	Rif. Orig./Orig. Ref.	Titolo Prodotto/Titolo Prodotto	Spessore mm/Thickness mm	Brand
RC1534	631104	VOMERINO AVANVOMERO DX	10 mm	KUHN
RC1535	631105	VOMERINO AVANVOMERO SX	10 mm	KUHN
RC2279	618104	VERSOIO DX	6 mm	KUHN
RC2280	618105	VERSOIO SX	6 mm	KUHN
RC2277	619120	AVANVERSOIO H4 DX	7 mm	KUHN
RC2278	619121	AVANVERSOIO H4 SX	7 mm	KUHN



631104/631105

VERSOI E PREVERSOI PER CORPI ARANTI ADATTABILI ALLA PRODUZIONE KUHN
SOCS ET AVANT-SOCS POUR CHARRUES ADAPTABLES KUHN
MOULDBOARD FOR PLOUGH BODY SUIT TO KUHN PRODUCTION
MOLLBLECH FUER PFLUGKOEPPER PASSEND ZU KUHN
TEJA Y REJA PARA CUERPO DE ARADO ADAPTABLE A LA PRODUCCION KUHN

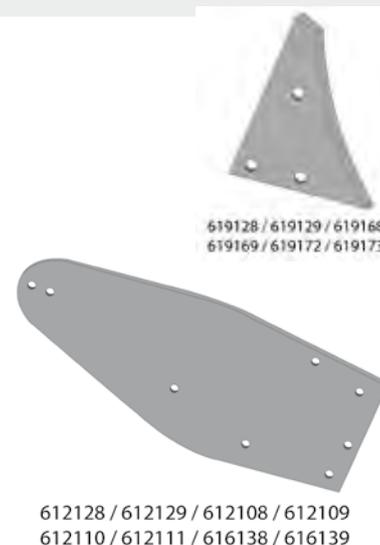
Art./Ref.	Rif. Orig./Orig. Ref.	Titolo Prodotto/Titolo Prodotto	Spessore mm/Thickness mm	Brand
RC1528	612128	VERSOIO DX	-	KUHN
RC1529	612129	VERSOIO SX	-	KUHN
RC1655	612108	VERSOIO DX	-	KUHN
RC1655S	612109	VERSOIO SX	-	KUHN
RC1655A	612110	VERSOIO DX	-	KUHN
RC1655AS	612111	VERSOIO SX	-	KUHN
RC1725	616138	VERSOIO DX	8 mm	KUHN
RC1726	616139	VERSOIO SX	8 mm	KUHN
RC1655B	619128	AVANVERSOIO DX	-	KUHN
RC1655BS	619129	AVANVERSOIO SX	-	KUHN
RC1526	619168	AVANVERSOIO DX	-	KUHN
RC1527	619169	AVANVERSOIO SX	-	KUHN
RC1530	619172	AVANVERSOIO DX	8 mm	KUHN
RC1531	619173	AVANVERSOIO SX	8 mm	KUHN

VERSOI E PREVERSOI PER CORPI ARANTI ADATTABILI ALLA PRODUZIONE KUHN
SOCS ET AVANT-SOCS POUR CHARRUES ADAPTABLES KUHN
MOULDBOARD FOR PLOUGH BODY SUIT TO KUHN PRODUCTION
MOLLBLECH FUER PFLUGKOEPPER PASSEND ZU KUHN
TEJA Y REJA PARA CUERPO DE ARADO ADAPTABLE A LA PRODUCCION KUHN

Art./Ref.	Rif. Orig./Orig. Ref.	Titolo Prodotto/Titolo Prodotto	Spessore mm/Thickness mm	Brand
RC1835	616190	VERSOIO DX	7 mm	KUHN
RC1836	616191	VERSOIO SX	7 mm	KUHN
RC1727	619200	AVANVERSOIO DX	7 mm	KUHN
RC1728	619201	AVANVERSOIO SX	7 mm	KUHN

VERSOI E PREVERSOI PER CORPI ARANTI ADATTABILI ALLA PRODUZIONE KUHN
SOCS ET AVANT-SOCS POUR CHARRUES ADAPTABLES KUHN
MOULDBOARD FOR PLOUGH BODY SUIT TO KUHN PRODUCTION
MOLLBLECH FUER PFLUGKOEPPER PASSEND ZU KUHN
TEJA Y REJA PARA CUERPO DE ARADO ADAPTABLE A LA PRODUCCION KUHN

Art./Ref.	Rif. Orig./Orig. Ref.	Titolo Prodotto/Titolo Prodotto	Spessore mm/Thickness mm	Brand
RC1831	616100	VERSOIO DX	7 mm	KUHN
RC1832	616101	VERSOIO SX	7 mm	KUHN
RC1833	619106	AVANVERSOIO DX	7 mm	KUHN
RC1834	619107	AVANVERSOIO SX	7 mm	KUHN

VOMERI PER CORPI ARANTI ADATTABILI ALLA PRODUZIONE KUHN
SOCS POUR CHARRUES ADAPTABLES KUHN
PLOWSHARE FOR PLOUGH BODY SUIT TO KUHN PRODUCTION
SCHARE FUER PFLUGKOERPER PASSEND ZU KUHN
VOMERES PARA CUERPO DE ARADO ADAPTABLE A LA PRODUCCION KUHN

631100 / 631101



631102 / 631103



631108 / 631109



631112

Art./Ref.	Rif. Orig./Orig. Ref.	Titolo Prodotto/Titolo Prodotto	Spessore mm/Thickness mm	Brand
RC1703	631100	VOMERINO DX	10 mm	KUHN
RC1704	631101	VOMERINO SX	10 mm	KUHN
RC1705	631102	VOMERINO DX	8 mm	KUHN
RC1706	631103	VOMERINO SX	8 mm	KUHN
RC1707	631108	VOMERINO DX	10 mm	KUHN
RC1708	631109	VOMERINO SX	10 mm	KUHN
RC1709	631112	VOMERINO REVERSIBILE DX-SX	10 mm	KUHN
RC1709A	631112	VOMERINO REVERSIBILE DX-SX	12 mm	KUHN

VOMERI PER CORPI ARANTI ADATTABILI ALLA PRODUZIONE KUHN
SOCS POUR CHARRUES ADAPTABLES KUHN
PLOWSHARE FOR PLOUGH BODY SUIT TO KUHN PRODUCTION
SCHARE FUER PFLUGKOERPER PASSEND ZU KUHN
VOMERES PARA CUERPO DE ARADO ADAPTABLE A LA PRODUCCION KUHN

622134 - 622135



622136 - 622137



622140 - 622141



622142 - 622143

Art./Ref.	Rif. Orig./Orig. Ref.	Titolo Prodotto/Titolo Prodotto	Brand
RC1680	622134	VOMERE DX	KUHN
RC1681	622135	VOMERE SX	KUHN
RC1682	622136	VOMERE DX	KUHN
RC1683	622137	VOMERE SX	KUHN
RC1684	622140	VOMERE DX	KUHN
RC1685	622141	VOMERE SX	KUHN
RC1686	622142	VOMERE DX	KUHN
RC1687	622143	VOMERE SX	KUHN
RC1688	622166	VOMERE DX	KUHN
RC1689	622167	VOMERE SX	KUHN
RC1690	622172	VOMERE DX	KUHN
RC1691	622173	VOMERE SX	KUHN



622166 - 622167



622172 - 622173

STRISCIANTI E COLTRI PER CORPI ARANTI ADATTABILI ALLA PRODUZIONE KUHN
FROTTANTS ET COUTRES POUR CHARRUES ADAPTABLES KUHN
LANDSIDES AND COULTERS FOR PLOUGH BODY SUIT TO KUHN PRODUCTION
ANLAGEN UND PFLUGEISEN FUER PFLUGKOERPER PASSEND ZU KUHN
ARRASTRANTES Y COBERTURAS PARA CUERPO DE ARADO ADAPTABLE A LA PRODUCCION KUHN

Art./Ref.	Rif. Orig./Orig. Ref.	Titolo Prodotto/Titolo Prodotto	Spessore mm/Thickness mm	Brand
RC1710	223192, 761108	STRISCIANTE DX-SX	10 mm	KUHN
RC1711	279140	STRISCIANTE DX-SX	10 mm	KUHN
RC1711A	279140	STRISCIANTE CON RIPOORTO DI SALDATURA DX-SX	10 mm	KUHN
RC1712	279114	STRISCIANTE DX	10 mm	KUHN
RC1713	279115	STRISCIANTE SX	10 mm	KUHN
RC1714	279130	STRISCIANTE DX	10 mm	KUHN
RC1715	279131	STRISCIANTE SX	10 mm	KUHN
RC1716	200645	STRISCIANTE DX-SX	10 mm	KUHN
RC1717	278076	STRISCIANTE DX	10 mm	KUHN
RC1718	278077	STRISCIANTE SX	10 mm	KUHN
RC1719	278074	STRISCIANTE DX	10 mm	KUHN
RC1721	279138	STRISCIANTE DX	10 mm	KUHN
RC1722	279139	STRISCIANTE SX	10 mm	KUHN
RC1723	761110	STRISCIANTE DX	10 mm	KUHN
RC1724	761111	STRISCIANTE SX	10 mm	KUHN
RC1729	270060	COLTRO	10 mm	KUHN

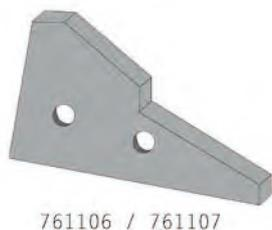
STRISCIANTE PER CORPI ARANTI ADATTABILI ALLA PRODUZIONE KUHN
FROTTANT POUR CHARRUES ADAPTABLES KUHN
LANDSIDE FOR PLOUGH BODY SUIT TO KUHN PRODUCTION
ANLAGE FUER PFLUGKOERPER PASSEND ZU KUHN
ARRASTRANTE PARA CUERPO DE ARADO ADAPTABLE A LA PRODUCCION KUHN

Art./Ref.	Rif. Orig./Orig. Ref.	Titolo Prodotto/Titolo Prodotto	Brand
RC1489	761106	STRISCIANTE ADATTABILE HB DX	KUHN
RC1490	761107	STRISCIANTE ADATTABILE HB SX	KUHN

RICAMBI PER CORPI ARANTI ADATTABILI ALLA PRODUZIONE N. 1-2-3-4-5 KVERNELAND

RECHANGES POUR CORPS CHARRUES ADAPTABLES N. 1-2-3-4-5 KVERNELAND

SPARE PARTS FOR PLOUGH-BODY SUIT TO N. 1-2-3-4-5 KVERNELAND PRODUCTION

ERSATZTEILE FÜR PFLUGKÖRPER PASSEND ZU N. 1-2-3-4-5 KVERNELAND

RECAMBIOS PARA CUERPOS DE ARADO ADAPTABLE A LA PRODUCCION N. 1-2-3-4-5 KVERNELAND

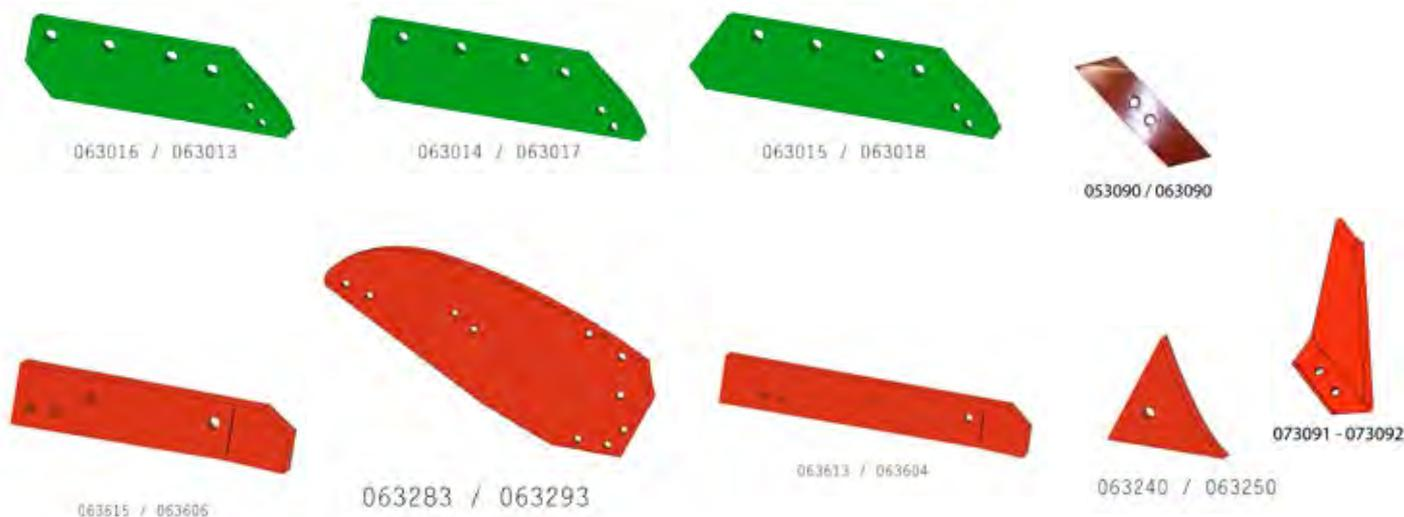

Art./Ref.	Rif. Orig./Orig. Ref.	Titolo Prodotto/Titolo Prodotto	Spessore mm/Thickness mm	Note/Note	Brand
RC0980	063013	VOMERE DX	-	-	KVERNELAND
RC0980S	063016	VOMERE SX	-	-	KVERNELAND
RC0981	063014	VOMERE 14" DX	-	-	KVERNELAND
RC0981S	063017	VOMERE 14" SX	-	-	KVERNELAND
RC0982	063015	VOMERE 16" DX	-	-	KVERNELAND
RC0982S	063018	VOMERE 16" SX	-	-	KVERNELAND
RC0983	053090	PUNTA REVERSIBILE DX	12 mm	Sabbiata e verniciata	KVERNELAND
RC0983NV	053090	PUNTA REVERSIBILE DX	12 mm	Sabbiata e non verniciata	KVERNELAND
RC0983S	063090	PUNTA REVERSIBILE SX	12 mm	Sabbiata e verniciata.	KVERNELAND
RC0983SNV	063090	PUNTA REVERSIBILE SX	12 mm	Sabbiata e non verniciata	KVERNELAND
RC0983RP	053090	PUNTA REVERSIBILE DX	12 mm	Con riporto di saldatura, sabbiata e verniciata	KVERNELAND
RC0983SRP	063090	PUNTA REVERSIBILE SX	12 mm	Con riporto di saldatura, sabbiata e verniciata	KVERNELAND
RC0983SP15	053090	PUNTA REVERSIBILE DX	15 mm	-	KVERNELAND
RC0983SSP15	063090	PUNTA REVERSIBILE SX	15 mm	-	KVERNELAND
RC0984	073091	COLTELLO PER VOMERE DX	-	-	KVERNELAND
RC0984S	073092	COLTELLO PER VOMERE SX	-	-	KVERNELAND
RC0985	063603, 063613	STRISCIANTE DX	-	-	KVERNELAND
RC0985S	063604	STRISCIANTE SX	-	-	KVERNELAND
RC0986	063605, 063615	STRISCIANTE CORTO DX	-	-	KVERNELAND
RC0986S	063606	STRISCIANTE CORTO SX	-	-	KVERNELAND
RC0989	063283	VERSOIO 14"/16" DX	-	-	KVERNELAND
RC0989S	063293	VERSOIO 14"/16" SX	-	-	KVERNELAND
RC0990	063240	AVANVERSOIO DX	-	-	KVERNELAND
RC0990S	063250	AVANVERSOIO SX	-	-	KVERNELAND

VERSOI, ALETTONE E ACCESSORI PER CORPI ARANTI ADATTABILI ALLA PRODUZIONE N. 6-7-8-9-20-28-30 KVERNELAND
VERSOIRS, AILETTES ET ACCESSOIRS POUR CORPS CHARRUES ADAPTABLES N.6-7-8-9-20-28-30 KVERNELAND
MOLDBOARDS, AILERONS AND FITTINGS FOR PLOUGH-BODY SUIT TO N. 6-7-8-9-20-28-30 KVERNELAND PRODUCTION
STREICHBLECHE, MOLLBLECHLANTE UND ZUBEHOER FÜR PFLUGKÖRPER PASSEND ZU N.6-7-8-9-20-28-30 KVERNELAND
OREJAS, ALERON Y ACESORIOS PARA CUERPOS DE ARADO ADAPTABLE A LA PRODUCCION N. 6-7-8-9-20-28-30 KVERNELAND

073300 / 073301



073310 / 073311



053387 / 063388



073290 / 073291



073286 / 073287

073260 / 073261
073280 / 073281

083228 / 083229



073256 / 073257



073250 / 073251



073411 / 073412

Art./Ref.	Rif. Orig./Orig. Ref.	Titolo Prodotto/Titolo Prodotto	Brand
RC1005	073300	SOPRAVERSOIO DX	KVERNELAND
RC1005S	073301	SOPRAVERSOIO SX	KVERNELAND
RC1006	073310	STAFFA SOPRAVERSOIO DX	KVERNELAND
RC1006S	073311	STAFFA SOPRAVERSOIO SX	KVERNELAND
RC1016	053387	ORECCHIA MOBILE DX	KVERNELAND
RC1016S	063388	ORECCHIA MOBILE SX	KVERNELAND
RC1013	073290	VERSOIO 14"/20" DX	KVERNELAND
RC1013S	073291	VERSOIO 14"/20" SX	KVERNELAND
RC1012	073286	VERSOIO 12"/18" DX	KVERNELAND
RC1012S	073287	VERSOIO 12"/18" SX	KVERNELAND
RC1009	073260	VERSOIO 12"/16" DX	KVERNELAND
RC1009S	073261	VERSOIO 12"/16" SX	KVERNELAND
RC1011	073280	VERSOIO 12" DX	KVERNELAND
RC1011S	073281	VERSOIO 12" SX	KVERNELAND
RC1049	083228	VERSOIO DX	KVERNELAND
RC1049S	083229	VERSOIO SX	KVERNELAND
RC1015	073256	AVANVERSOIO DX	KVERNELAND
RC1015S	073257	AVANVERSOIO SX	KVERNELAND
RC1014	073250	AVANVERSOIO DX	KVERNELAND
RC1014S	073251	AVANVERSOIO SX	KVERNELAND
RC1039	073411	BASE DX	KVERNELAND
RC1039S	073412	BASE SX	KVERNELAND

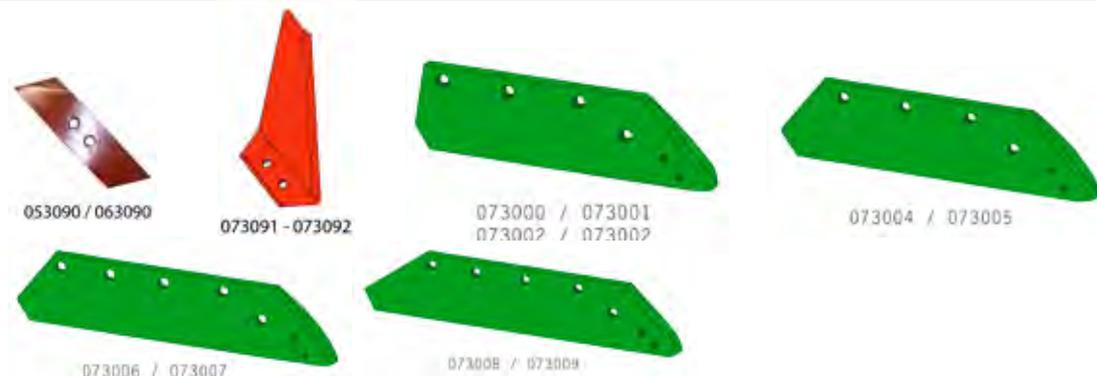
VOMERI, PUNTE E ACCESSORI PER CORPI ARANTI ADATTABILI ALLA PRODUZIONE N. 6-7-8-9-28 KVERNELAND
SOCs, POINTES ET ACCESSOIRS POUR CORPS CHARRUES ADAPTABLES N.6-7-8-9-28 KVERNELAND
PLOWSHARES, DRILLS AND FITTINGS FOR PLOUGH-BODY SUIT TO N. 6-7-8-9-28 KVERNELAND PRODUCTION
SCHARE, SPITZEN UND ZUBEHOER FÜR PFLUGKÖRPER PASSEND ZU N. 6-7-8-9-28 KVERNELAND
VOMERES, PUNTAS Y ACESORIOS PARA CUERPOS DE ARADO ADAPTABLE A LA PRODUCCION N. 6-7-8-9-28 KVERNELAND

Art./Ref.	Rif. Orig./Orig. Ref.	Titolo Prodotto/Titolo Prodotto	Spessore mm/Thickness mm	Note/Note	Brand
RC1000	073000	VOMERE 12" DX	-	-	KVERNELAND
RC1000S	073001	VOMERE 12" SX	-	-	KVERNELAND
RC1001	073002	VOMERE 14" DX	-	-	KVERNELAND
RC1001S	073003	VOMERE 14" SX	-	-	KVERNELAND
RC1002	073004	VOMERE 16" DX	-	-	KVERNELAND
RC1002S	073005	VOMERE 16" SX	-	-	KVERNELAND
RC1003	073006	VOMERE 18" DX	-	-	KVERNELAND
RC1003S	073007	VOMERE 18" SX	-	-	KVERNELAND
RC1004	073008	VOMERE 20" DX	-	-	KVERNELAND
RC1004S	073009	VOMERE 20" SX	-	-	KVERNELAND
RC0984	073091	COLTELLO PER VOMERE DX	-	-	KVERNELAND
RC0984S	073092	COLTELLO PER VOMERE SX	-	-	KVERNELAND
RC0983	053090	PUNTA REVERSIBILE DX	12 mm	Sabbiata e verniciata	KVERNELAND
RC0983NV	053090	PUNTA REVERSIBILE DX	12 mm	Sabbiata e non verniciata	KVERNELAND
RC0983S	063090	PUNTA REVERSIBILE SX	12 mm	Sabbiata e verniciata.	KVERNELAND
RC0983SNV	063090	PUNTA REVERSIBILE SX	12 mm	Sabbiata e non verniciata	KVERNELAND
RC0983RP	053090	PUNTA REVERSIBILE DX	12 mm	con riporto di saldatura, Sabbiata e verniciata.	KVERNELAND
RC0983SRP	063090	PUNTA REVERSIBILE SX	12 mm	con riporto di saldatura, Sabbiata e verniciata.	KVERNELAND
RC0983SP15	053090	PUNTA REVERSIBILE DX	15 mm	-	KVERNELAND
RC0983SSP15	063090	PUNTA REVERSIBILE SX	15 mm	-	KVERNELAND

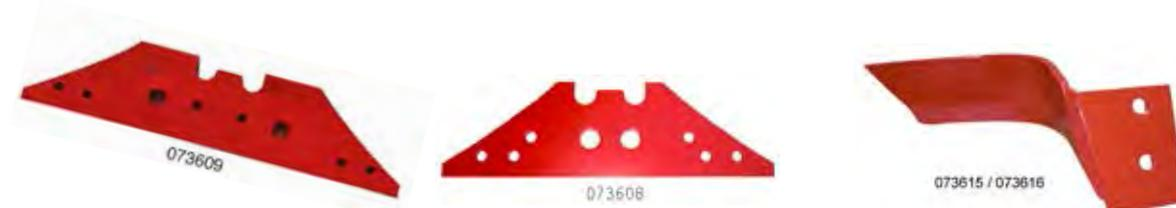
STRISCIANTI E ACCESSORI PER CORPI ARANTI ADATTABILI ALLA PRODUZIONE N. 6-7-8-9-12-19-20-28-30 KVERNELAND
FROTANT ET ACCESSOIRS POUR CORPS CHARRUES ADAPTABLES N.6-7-8-9-12-19-20-28-30 KVERNELAND
LANDSIDES AND FITTINGS FOR PLOUGH-BODY SUIT TO N. 6-7-8-9-12-19-20-28-30 KVERNELAND PRODUCTION
ANLAGEN FÜR PFLUGKÖRPER UND ZUBEHOER PASSEND ZU N. 6-7-8-9-12-19-20-28-30 KVERNELAND
ARRASTRANTES Y ACESORIOS PARA CUERPOS DE ARADO ADAPTABLE A LA PRODUCCION N. 6-7-8-9-12-19-20-28-30 KVERNELAND

Art./Ref.	Rif. Orig./Orig. Ref.	Titolo Prodotto/Titolo Prodotto	Spessore mm/Thickness mm	Brand
RC1007	073608	STRISCIANTE DX-SX	10 mm	KVERNELAND
RC1007I	073608	STRISCIANTE DX-SX	15 mm	KVERNELAND
RC1008	073609	STRISCIANTE DX-SX	10 mm	KVERNELAND
RC1008I	073609	STRISCIANTE DX-SX	15 mm	KVERNELAND
RC2271	073615	ORECCHIA DX	10 mm	KVERNELAND
RC2272	073616	ORECCHIA SX	10 mm	KVERNELAND

COLTELLO PER CORPI ARANTI ADATTABILI ALLA PRODUZIONE N. 6-7-8-9-28 KVERNELAND

COUTEAUX POUR CORPS CHARRUES ADAPTABLES N.6-7-8-9-28 KVERNELAND

KNIFE FOR PLOUGH-BODY SUIT TO N. 6-7-8-9-28 KVERNELAND PRODUCTION

MESSER FÜR PFLUGKÖRPER PASSEND ZU N. 6-7-8-9-28 KVERNELAND

CUCHILLA PARA CUERPOS DE ARADO ADAPTABLE A LA PRODUCCION N. 6-7-8-9-28 KVERNELAND



084320/084321

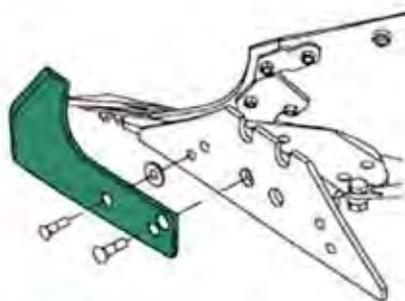

Art./Ref.	Rif. Orig./Orig. Ref.	Titolo Prodotto/Titolo Prodotto	Spessore mm/Thickness mm	Brand
RC1856	084320	COLTELLO DX	10 mm	KVERNELAND
RC1857	084321	COLTELLO SX	10 mm	KVERNELAND

VERSOI, ALETTONE E ACCESSORI PER CORPI ARANTI ADATTABILI ALLA PRODUZIONE N. 12 - 19 KVERNELAND

VERSOIRS, AILLETES ET ACCESSOIRS POUR CORPS CHARRUES ADAPTABLES N.12-19 KVERNELAND

MOLDBOARDS, AILERONS AND FITTINGS FOR PLOUGH-BODY SUIT TO N.12-19 KVERNELAND PRODUCTION

STREICHBLECHE, MOLLBLECHKANTE UND ZUBEHOER FÜR PFLUGKÖRPER PASSEND ZU N. 12-19 KVERNELAND

OREJAS, ALERON Y ACESORIOS PARA CUERPOS DE ARADO ADAPTABLE A LA PRODUCCION N. 12-19 KVERNELAND



073290 / 073291



073230 / 073231



053387 / 063388



073300 / 073301



073310 / 073311

Art./Ref.	Rif. Orig./Orig. Ref.	Titolo Prodotto/Titolo Prodotto	Spessore mm/Thickness mm	Brand
RC1029	073230	AVANVERSOIO DX	8 mm	KVERNELAND
RC1029S	073231	AVANVERSOIO SX	8 mm	KVERNELAND
RC1029I	073230	AVANVERSOIO DX	10 mm	KVERNELAND
RC1029IS	073231	AVANVERSOIO SX	10 mm	KVERNELAND
RC1006	073310	STAFFA SOPRAVERSOIO DX	-	KVERNELAND
RC1006S	073311	STAFFA SOPRAVERSOIO SX	-	KVERNELAND
RC1016	053387	ORECCHIA MOBILE DX	-	KVERNELAND
RC1016S	063388	ORECCHIA MOBILE SX	-	KVERNELAND
RC1013	073290	VERSOIO 14"/20" DX	-	KVERNELAND
RC1013S	073291	VERSOIO 14"/20" SX	-	KVERNELAND
RC1005	073300	SOPRAVERSOIO DX	-	KVERNELAND
RC1005S	073301	SOPRAVERSOIO SX	-	KVERNELAND

VOMERI, PUNTE E ACCESSORI PER CORPI ARANTI ADATTABILI ALLA PRODUZIONE N. 12-19-20-30 KVERNELAND
SOCs, POINTES ET ACCESSOIRS POUR CORPS CHARRUES ADAPTABLES N.12-19-20-30 KVERNELAND
PLOWSHARES, DRILLS AND FITTINGS FOR PLOUGH-BODY SUIT TO N.12-19-20-30 KVERNELAND PRODUCTION
SCHARE, SPITZEN UND ZUBEHOER FÜR PFLUGKÖRPER PASSEND ZU N.12-19-20-30 KVERNELAND
VOMERES, PUNTAS Y ACESORIOS PARA CUERPOS DE ARADO ADAPTABLE A LA PRODUCCION N.12-19-20-30 KVERNELAND

Art./Ref.	Rif. Orig./Orig. Ref.	Titolo Prodotto/Titolo Prodotto	Spessore mm/Thickness mm	Note/Note	Brand
RC1022	073056	VOMERE DX	-	-	KVERNELAND
RC1022S	073057	VOMERE SX	-	-	KVERNELAND
RC1023	073080	VOMERE DX	-	-	KVERNELAND
RC1023S	073081	VOMERE SX	-	-	KVERNELAND
RC0984	073091	COLTELLO PER VOMERE DX	-	-	KVERNELAND
RC0984S	073092	COLTELLO PER VOMERE SX	-	-	KVERNELAND
RC0983	053090	PUNTA REVERSIBILE DX	12 mm	Sabbiata e verniciata	KVERNELAND
RC0983NV	053090	PUNTA REVERSIBILE DX	12 mm	Sabbiata e non verniciata	KVERNELAND
RC0983S	063090	PUNTA REVERSIBILE SX	12 mm	Sabbiata e verniciata	KVERNELAND
RC0983SNV	063090	PUNTA REVERSIBILE SX	12 mm	Sabbiata e non verniciata	KVERNELAND
RC0983RP	053090	PUNTA REVERSIBILE DX	12 mm	con riporto di saldatura, Sabbiata e verniciata	KVERNELAND
RC0983SRP	063090	PUNTA REVERSIBILE SX	12 mm	con riporto di saldatura Sabbiata e verniciata	KVERNELAND
RC0983SP15	053090	PUNTA REVERSIBILE DX	15 mm	Sabbiata e verniciata	KVERNELAND
RC0983SP15	063090	PUNTA REVERSIBILE SX	15 mm	Sabbiata e verniciata	KVERNELAND

TALLONE PER CORPI ARANTI ADATTABILI ALLA PRODUZIONE KVERNELAND
TALON POUR CORPS CHARRUES ADAPTABLES KVERNELAND
SLIDE PLATE FOR PLOUGH-BODY SUIT TO KVERNELAND PRODUCTION
GLEITPLATTE FÜR PFLUGKÖRPER PASSEND ZU FÜR KVERNELAND
TALÓN PARA CUERPOS DE ARADO ADAPTABLE A LA PRODUCCION KVERNELAND

Art./Ref.	Rif. Orig./Orig. Ref.	Titolo Prodotto/Titolo Prodotto	Spessore mm/Thickness mm	Brand
RC1675	073614	TALLONE DX-SX	13 mm	KVERNELAND

STRISCIANTI PER CORPI ARANTI ADATTABILI ALLA PRODUZIONE KVERNELAND
FROTTANT POUR CORPS CHARRUES ADAPTABLES KVERNELAND
LANDSIDES FOR PLOUGH-BODY SUIT TO KVERNELAND PRODUCTION
ANLAGEN FÜR PFLUGKÖRPER PASSEND ZU KVERNELAND
ARRASTRANTES PARA CUERPOS DE ARADO ADAPTABLE A LA PRODUCCION KVERNELAND

Art./Ref.	Rif. Orig./Orig. Ref.	Titolo Prodotto/Titolo Prodotto	Spessore mm/Thickness mm	Brand
RC1730	063600	STRISCIANTE DX-SX	12 mm	KVERNELAND
RC1731	063601A	STRISCIANTE DX-SX	12 mm	KVERNELAND

VOMERINI E VERSOI PER CORPI ARANTI ADATTABILI ALLA PRODUZIONE KVERNELAND

SOCs ET AILETTES POUR CORPS CHARRUES ADAPTABLES KVERNELAND

SMALL PLOWSHARES AND MOLDBOARDS FOR PLOUGH-BODY SUIT TO KVERNELAND PRODUCTION

SCHARE UND STREICHBLECHE FÜR PFLUGKÖRPER PASSEND ZU KVERNELAND

VOMERES Y ALETAS PARA CUERPOS DE ARADO ADAPTABLE A LA PRODUCCION KVERNELAND



066880 / 066881



066868 / 066869



066878 / 066879

Art./Ref.	Rif. Orig./Orig. Ref.	Titolo Prodotto/Titolo Prodotto	Brand
RC1044	066868	VOMERINO CORTO DX	KVERNELAND
RC1044S	066869	VOMERINO CORTO SX	KVERNELAND
RC1045	066880	VERSOIO DX	KVERNELAND
RC1045S	066881	VERSOIO SX	KVERNELAND
RC1654	066878	VERSOIO DX	KVERNELAND
RC1654S	066879	VERSOIO SX	KVERNELAND

VERSOI ALETTONE E ACCESSORI PER CORPI ARANTI ADATTABILI ALLA PRODUZIONE B LEMKEN

VERSOIR AILERON ET ACCESSOIRS POUR CORPS CHARRUES ADAPTABLES B LEMKEN

B MOLDBOARD, AILERONS AND FITTINGS FOR PLOUGH-BODY SUIT TO LEMKEN PRODUCTION

STREICHBLECHE, MOLLBLECHKANTE UND ZUBEHÖR FÜR PFLUGKÖRPER PASSEND ZU B LEMKEN

OREJAS ALERON Y ACESORIOS PARA CUERPOS DE ARADO ADAPTABLE A LA PRODUCCION B LEMKEN



3441034 / 3441035



3441040 / 3441041



3451000 / 3451001



3451002 / 3451003



3476000 / 3476001

Art./Ref.	Rif. Orig./Orig. Ref.	Titolo Prodotto/Titolo Prodotto	Brand
RC1333	3476000	ALETTONE DX	LEMKEN
RC1334	3476001	ALETTONE SX	LEMKEN
RC1335	3441034	VERSOIO DX	LEMKEN
RC1336	3441035	VERSOIO SX	LEMKEN
RC1337	3441040	VERSOIO DX	LEMKEN
RC1338	3441041	VERSOIO SX	LEMKEN
RC1339	3451000	PREVERSOIO DX	LEMKEN
RC1340	3451001	PREVERSOIO SX	LEMKEN
RC1341	3451002	PREVERSOIO DX 10 mm	LEMKEN
RC1342	3451003	PREVERSOIO SX 10 mm	LEMKEN

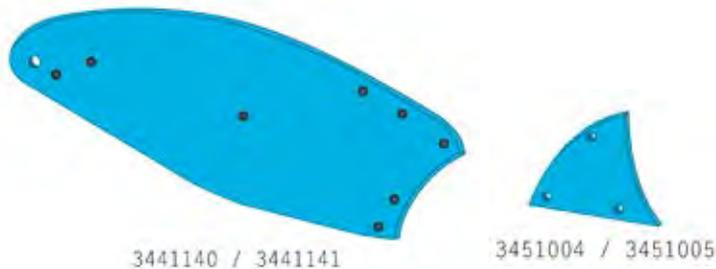
VERSOI E ACCESSORI PER CORPI ARANTI ADATTABILI ALLA PRODUZIONE C40 LEMKEN
VERSOIRS ET ACCESSOIRS POUR CORPS CHARRUES ADAPTABLES C40 LEMKEN
MOLDBOARDS AND FITTINGS FOR PLOUGH-BODY SUIT TO C40 LEMKEN PRODUCTION
STREICHBLECHE UND ZUBEHOER FÜR PFLUGKÖRPER PASSEND ZU C40 LEMKEN
OREJAS Y ACESORIOS PARA CUERPOS DE ARADO ADAPTABLE A LA PRODUCCION C40 LEMKEN

Art./Ref.	Rif. Orig./Orig. Ref.	Titolo Prodotto/Titolo Prodotto	Brand
CP5978	3441140	VERSOIO DX	LEMKEN
CP5979	3441141	VERSOIO SX	LEMKEN
CP5980	3451004	PREVERSOIO DX	LEMKEN
CP5981	3451005	PREVERSOIO SX	LEMKEN

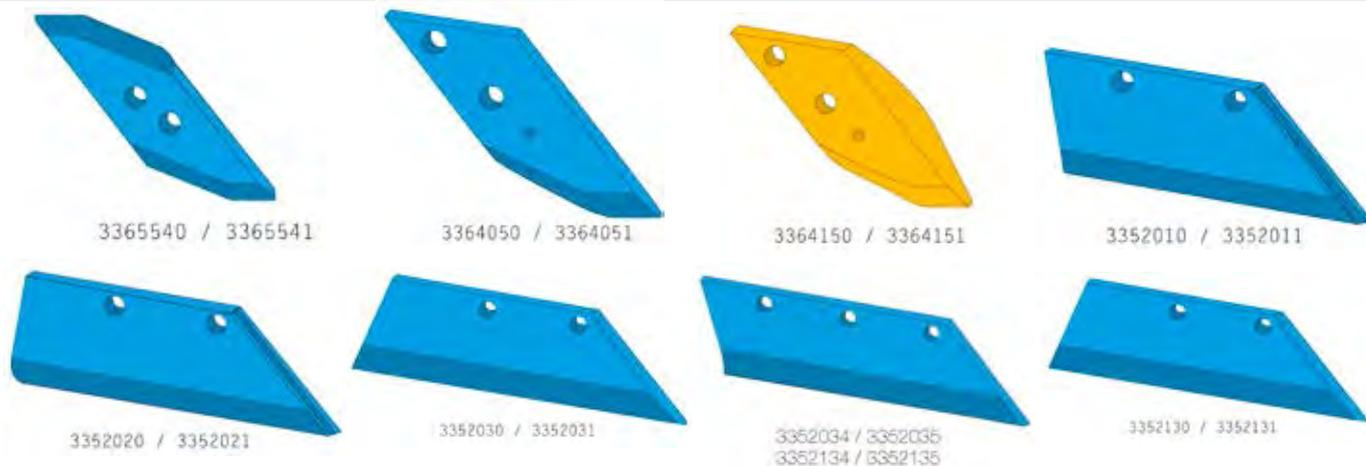
VOMERI E PUNTE PER CORPI ARANTI ADATTABILI ALLA PRODUZIONE B-BS40-BS42-C-US35-US40 LEMKEN
SOCES ET POINTES POUR CORPS CHARRUES ADAPTABLES B-BS40-BS42-C-US35-US40 LEMKEN
B-BS40-BS42-C-US35-US40 SHARES AND DRILLS FOR PLOUGH-BODY SUIT TO LEMKEN PRODUCTION
SCHARE UND SPITZEN FÜR PFLUGKÖRPER PASSEND ZU B-BS40-BS42-C-US35-US40 LEMKEN
VOMERES Y PUNTAS PARA CUERPOS DE ARADO ADAPTABLE A LA PRODUCCION B-BS40-BS42-C-US35-US40 LEMKEN
ЛЕМЕХА И НАКОНЕЧНИКИ ДЛЯ КОРПУСОВ ПЛУГА, АДАПТИРОВАННЫЕ К ПРОИЗВОДСТВУ B-BS40-BS42-C-US35-US40 LEMKEN

Art./Ref.	Rif. Orig./Orig. Ref.	Titolo Prodotto/Titolo Prodotto	Spessore mm/Thickness mm	Note/Note	Brand
RC1347	3365540	PUNTA REVERSIBILE DX	-	-	LEMKEN
RC1348	3365541	PUNTA REVERSIBILE SX	-	-	LEMKEN
RC1349	3364050	PUNTA DX	12 mm	-	LEMKEN
RC1350	3364051	PUNTA SX	12 mm	-	LEMKEN
RC1351	3364150	PUNTA CON RIPORTO DI SALDATURA DX	12 mm	Con riporto di saldatura	LEMKEN
RC1352	3364151	PUNTA CON RIPORTO DI SALDATURA SX	12 mm	Con riporto di saldatura	LEMKEN
RC1353	3352010	VOMERE 14" DX	-	-	LEMKEN
RC1354	3352011	VOMERE 14" SX	-	-	LEMKEN
RC1355	3352020	VOMERE 16" DX	-	-	LEMKEN
RC1356	3352021	VOMERE 16" SX	-	-	LEMKEN
RC1357	3352030	VOMERE 18" DX	-	-	LEMKEN
RC1358	3352031	VOMERE 18" SX	-	-	LEMKEN
RC1361	3352130	VOMERE 18" DX 11 mm	11 mm	-	LEMKEN
RC1362	3352131	VOMERE 18" SX 11 mm	11 mm	-	LEMKEN
RC1359	3352034	VOMERE 20" DX	-	-	LEMKEN
RC1360	3352035	VOMERE 20" SX	-	-	LEMKEN
RC1363	3352134	VOMERE 20" DX 11 mm	11 mm	-	LEMKEN
RC1364	3352135	VOMERE 20" SX 11 mm	11 mm	-	LEMKEN

STRISCIANTI E COLTRI PER CORPI ARANTI ADATTABILI ALLA PRODUZIONE **B-BS40-BS42-C-US35-US40 LEMKEN**

FROTTANT ET COUTRES POUR CORPS CHARRUES ADAPTABLES B-BS40-BS42-C-US35-US40 LEMKEN

B-BS40-BS42-C-US35-US40 LANDSIDES AND COULTERS FOR PLOUGH-BODY SUIT TO LEMKEN PRODUCTION

ANLAGEN UND PFLUGEISEN FÜR PFLUGKÖRPER PASSEND ZU B-BS40-BS42-C-US35-US40 LEMKEN

ARRASTRANTES Y COBERTORES PARA CUERPOS DE ARADO ADAPTABLE A LA PRODUCCION B-BS40-BS42-C-US35-US40 LEMKEN

3401900AK10
3401901AK10

3411500



3411504



3411508

Art./Ref.	Rif. Orig./Orig. Ref.	Titolo Prodotto/Titolo Prodotto	Brand
RC1387	3401900AK10	STRISCIANTE DX	LEMKEN
RC1388	3401901AK10	STRISCIANTE SX	LEMKEN
RC1389	3411500	STRISCIANTE DX-SX	LEMKEN
RC1390	3411504	STRISCIANTE DX-SX	LEMKEN
RC1391	3411508	STRISCIANTE DX-SX	LEMKEN
RC1393	3492890	COLTRE DX	LEMKEN
RC1394	3492891	COLTRE SX	LEMKEN

3492890
3492891VERSOI, ALETTONE E ACCESSORI PER CORPI ARANTI ADATTABILI ALLA PRODUZIONE **BS 42 LEMKEN**

VERSOIR AILERON ET ACCESSOIRS POUR CORPS CHARRUES ADAPTABLES BS42 LEMKEN

BS 42 MOLDBOARDS, AILERONS AND FITTINGS FOR PLOUGH-BODY SUIT TO LEMKEN PRODUCTION

STREICHBLECHE, MOLLBLECHKANTE UND ZUBEHÖR FÜR PFLUGKÖRPER PASSEND ZU BS 42 LEMKEN

OREJAS, ALERON Y ACESORIOS PARA CUERPOS DE ARADO ADAPTABLE A LA PRODUCCION BS 42 LEMKEN

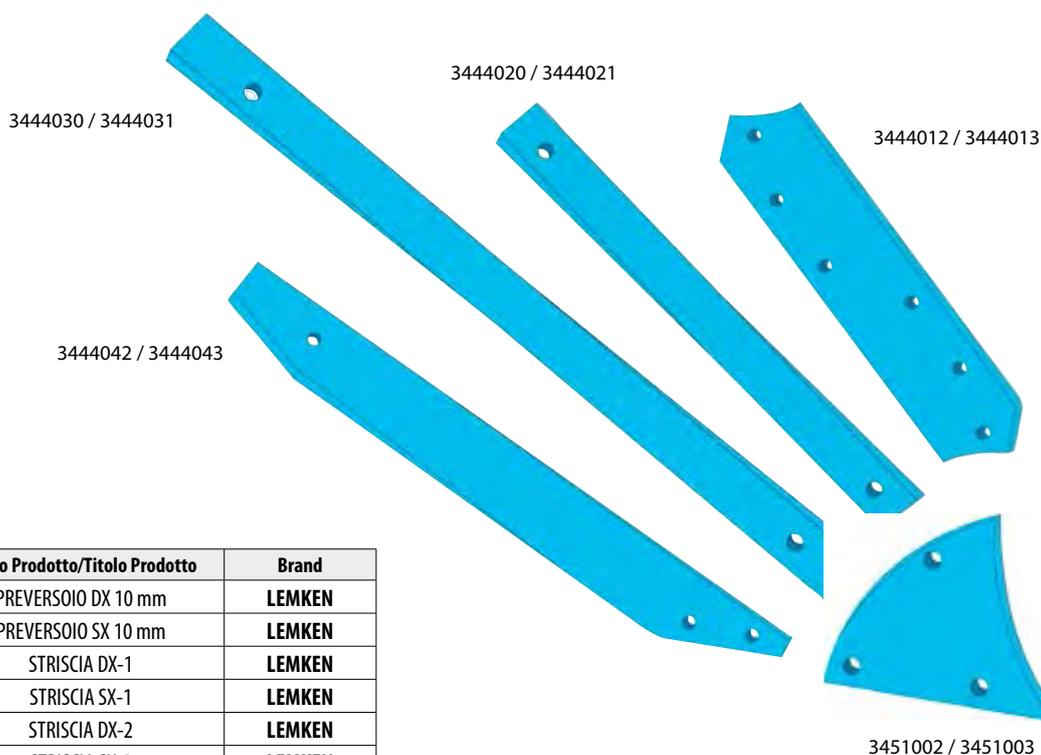

3444030 / 3444031

3444020 / 3444021

3444012 / 3444013

3444042 / 3444043

3451002 / 3451003

Art./Ref.	Rif. Orig./Orig. Ref.	Titolo Prodotto/Titolo Prodotto	Brand
RC1341	3451002	PREVERSOIO DX 10 mm	LEMKEN
RC1342	3451003	PREVERSOIO SX 10 mm	LEMKEN
RC1375A	3444012	STRISCIA DX-1	LEMKEN
RC1376A	3444013	STRISCIA SX-1	LEMKEN
RC1367	3444020	STRISCIA DX-2	LEMKEN
RC1368	3444021	STRISCIA SX-2	LEMKEN
RC1369	3444030	STRISCIA DX-3	LEMKEN
RC1370	3444031	STRISCIA SX-3	LEMKEN
RC1373	3444042	STRISCIA DX-4	LEMKEN
RC1374	3444043	STRISCIA SX-4	LEMKEN

SUPPORTO CORPO ADATTABILE ALLA PRODUZIONE LEMKEN

SEP ADAPTABLE À LA PRODUCTION LEMKEN
 FROG ADAPTABLE TO LEMKEN PRODUCTION
 PFLUGKÖRPER-HALTER PASSEND ZU LEMKEN
 SOPORTA ADAPTABLE LEMKEN



4671010 / 4671011

Art./Ref.	Rif. Orig./Orig. Ref.	Titolo Prodotto/Titolo Prodotto	Note/Note	Brand	Applicazione/Application
RC1886	4671010	SUPPORTO CORPO DX	Modello BK 13 R	LEMKEN	B35-B25-B25H, B40-B30-B20, BS42-BS40-BS20, D50, US40-US35
RC1886S	4671011	SUPPORTO CORPO SX	Modello BK 13 L	LEMKEN	B35-B25-B25H, B40-B30-B20, BS42-BS40-BS20, D50, US40-US35

VOMERI E PUNTE PER CORPI ARANTI ADATTABILI ALLA PRODUZIONE BS 42 LEMKEN

SOCES ET POINTES POUR CORPS CHARRUES ADAPTABLES BS42 LEMKEN
 BS 42 PLOWSHARES AND DRILLS FOR PLOUGH-BODY SUIT TO LEMKEN PRODUCTION
 SCHARE UND SPITZEN FÜR PFLUGKÖRPER PASSEND ZU BS 42 LEMKEN
 VOMERES Y PUNTAS PARA CUERPOS DE ARADO ADAPTABLE A LA PRODUCCION BS 42 LEMKEN

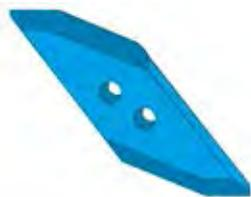

3365540 / 3365541



3364050 / 3364051



3352030 / 3352031

 3352034 / 3352035
 3352134 / 3352135

Art./Ref.	Rif. Orig./Orig. Ref.	Titolo Prodotto/Titolo Prodotto	Spessore mm/Thickness mm	Brand
RC1359	3352034	VOMERE 20" DX	-	LEMKEN
RC1360	3352035	VOMERE 20" SX	-	LEMKEN
RC1357	3352030	VOMERE 18" DX	-	LEMKEN
RC1358	3352031	VOMERE 18" SX	-	LEMKEN
RC1349	3364050	PUNTA DX	12 mm	LEMKEN
RC1350	3364051	PUNTA SX	12 mm	LEMKEN
RC1347	3365540	PUNTA REVERSIBILE DX	-	LEMKEN
RC1348	3365541	PUNTA REVERSIBILE SX	-	LEMKEN

VERSOI, VOMERI ED ACCESSORI PER CORPI ARANTI ADATTABILI ALLA PRODUZIONE LEMKEN
VERSOIRS, SOC ET ACCESSOIRS POUR CORPS CHARRUES ADAPTABLES LEMKEN
MOLDBOARDS, SHARE AND FITTINGS FOR PLOUGH-BODY SUIT TO LEMKEN PRODUCTION
TREICHBLECHE, SCHAR UND ZUBEHOER FÜR PFLUGKÖRPER PASSEND ZU LEMKEN
OREJAS, REJA Y ACESORIOS PARA CUERPOS DE ARADO ADAPTABLE A LA PRODUCCION LEMKEN

3363724



3470600 / 3470601



4570840 / 4570841



3363710 / 3363711



3470650 / 3470651

Art./Ref.	Rif. Orig./Orig. Ref.	Titolo Prodotto/Titolo Prodotto	Brand
RC1883	4570840	SUPPORTO AVANVOMERE A VERSOIO DX	LEMKEN
RC1884	4570841	SUPPORTO AVANVOMERE A VERSOIO SX	LEMKEN
RC1414	3470600	ALETTA DX	LEMKEN
RC1415	3470601	ALETTA SX	LEMKEN
RC1413	3363724	VOMERE REVERSIBILE DX-SX	LEMKEN
RC1881	3363710	VOMERE DX	LEMKEN
RC1882	3363711	VOMERE SX	LEMKEN
RC1879	3470650	VERSOIO DX	LEMKEN
RC1880	3470651	VERSOIO SX	LEMKEN

VOMERI PER CORPI ARANTI ADATTABILI ALLA PRODUZIONE MORO

SOCS POUR CORPS CHARRUES ADAPTABLES MORO

PLOWSHARES FOR PLOUGH-BODY SUIT TO MORO PRODUCTION

SCHARE FÜR PFLUGKÖRPER PASSEND ZU MORO

VOMERES PARA CUERPOS DE ARADO ADAPTABLE A LA PRODUCCION MORO

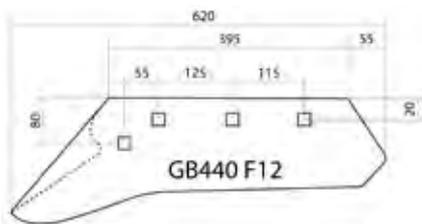
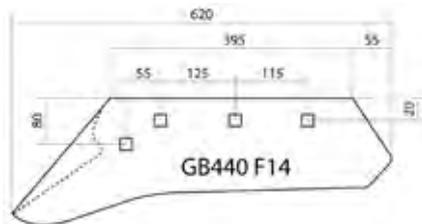
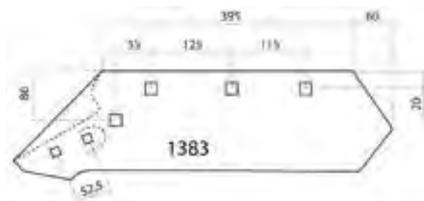
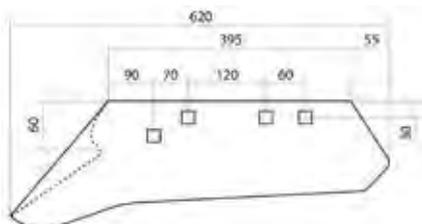
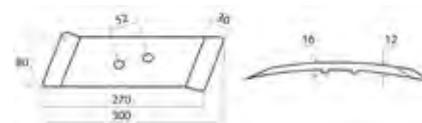
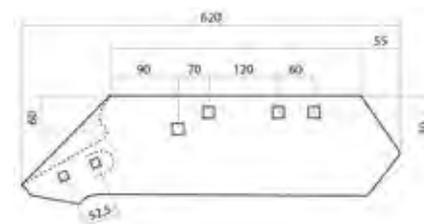
1

2

3

4

5

6

Art./Ref.	Rif. Orig./Orig. Ref.	Titolo Prodotto/Titolo Prodotto	Tipo/Type	Note/Note	Brand
CP4718	GB440 F12	VOMERE DX	1	fori da 12 mm	MORO
CP4719	GB440 F12	VOMERE SX	1	fori da 12 mm	MORO
CP4707	GB440 F14	VOMERE DX	2	fori da 14 mm	MORO
CP4707S	GB440 F14	VOMERE SX	2	fori da 14 mm	MORO
CP4740	1362.3R.D-A7	VOMERE DX	4	fori da 14 mm	MORO
CP4741	1362.3R.I-A7	VOMERE SX	4	fori da 14 mm	MORO
CP4802	26040 - 1383.14.D-A7	VOMERE DX	3	fori da 14 mm	MORO
CP4803	26041 - 1383.14.I-A7	VOMERE SX	3	fori da 14 mm	MORO
CP4740A	-	VOMERE DX	6	fori da 14 mm	-
CP4741A	-	VOMERE SX	6	fori da 14 mm	-
CP4813	26060	PUNTA MORO-KUHN CON FORI DX	5	Applicabile al CP4802 e CP4740A	MORO
CP4814	26061	PUNTA MORO-KUHN CON FORI SX	5	Applicabile al CP4803 e CP4741A	MORO

VOMERI PER CORPI A SCALPELLO ADATTABILI ALLA PRODUZIONE NARDI

SOCS ADAPTABLE TYPE NARDI

PLOUGHSHARE FOR NARDI LINE

PLUGSCHARE PASSEND FÜR NARDI

REJAS PARA PRODUCCIÓN NARDI



Art./Ref.	Rif. Orig./Orig. Ref.	Titolo Prodotto/Titolo Prodotto	Brand	Applicazione/Application
RC0300B	0C42	VOMERE DX	NARDI	ATTREZZATURE DA VIGNETO: HRR 30-31-32-33
RC0301A	0CS42	VOMERE SX	NARDI	ATTREZZATURE DA VIGNETO: HRR 30-31-32-33
RC0300	1C43	VOMERE DX	NARDI	ATTREZZATURE DA VIGNETO: 2 VR 32 CF - 3 AS 50 - 5-7 HRR 32-33 - PRR 30-31 - 5-7 HR 32-33 - QR 20-21-30-31 - QM 30 - TRR 30-31 - PR 20-21-30-31 - VRR 32-33 - QRR 30-31 - VR 20-21-32-33 - VM 30 - TR 20-21-30-31 - AVANVOMERI: NVR 70X40 - MOTOCOLTIVATORI: 3 VR 15 - M 7 - Z 7 - BR 13 - BPH 17 - TR 15 - BP 13 - A 20 - VR 13 - TR 13 - PORTATI: PRRP 48 - QL 38 F - VECCHIA PRODUZIONE: BR 10 - QC 30-31 - BPH 16 - PRRP 40 - QA - QR 40-41 - TR 40-41 - BLP 20-30 - VR 15 - VA - VRR - ZIL 7 - VR 10 - VRIF - VR 38 - ZIL 10 - 1 ETR - 0 PER - 1-2 AL 40 - PA - E 7 - ML 10 - ML 7 - HRR 30-31 - 2 DPE - ZL 10
RC0301	1CS43	VOMERE SX	NARDI	ATTREZZATURE DA VIGNETO: 5-7 HR 32-33 - 5-7 HRR 32-33 - 3 AS 50 - PR 20-21-30-31 - 2 VR 32 CF - VRR 32-33 - PRR 30-31 - QR 20-21-30-31 - QM 30 - VM 30 - VR 20-21-32-33 - TRR 30-31 - TR 20-21-30-31 - QRR 30-31 - AVANVOMERI: NVR 70X40 - MOTOCOLTIVATORI: M 7 - TR 15 - BP 13 - TR 13 - BR 13 - BPH 17 - A 20 - 3 VR 15 - Z 7 - VR 13 - PORTATI: PRRP 48 - QL 38 F - VECCHIA PRODUZIONE: VRR - VR 15 - TR 40-41 - QR 40-41 - ZIL 7 - ZIL 10 - ML 10 - QC 30-31 - ZL 10 - QA - VA - PRRP 40 - PA - HRR 30-31 - E 7 - 1-2 AL 40 - VR 38 - 0 PER - ML 7 - 1 ETR - 2 DPE - BR 10 - VRIF - BLP 20-30 - BPH 16 - VR 10
RC0302	9C53	VOMERE DX	NARDI	CARRELLATI: 35 MRCUSA - 130 BTRRCO - 35 MRCUA - 0 MRCAUG - 70 BRCU - 75 BRRCO - 60-65 BRCUA - 55 BRCUA - 45-50 MRCU - 45-50 ZRCUI - 1 BRCAUGF - 50 BRRCUA - 45-50 MRCUS - 2 BRAUGF - PORTATI: 60 MZE - 115 BDF - 120-121-130-131 BZD - MRCP 48 H - 125 BZF - BTRP 110 A - 1-2 BTG - 95-100 BRPSA - 80-90 MZSA - 80-81-90-91 MZC - 1-2 TQRF - 110 BZS - BRCP 68-70 H - BCP 70 H - 50-55-65 MRPS - MCP 48 H - 135 BDF - BRCPL 80 - 130 BZS - 130 TZE - MPSC 60-70 - MRCP 47 - MRCPL 48 - BRP 110 A - 100 BZE - 180 QTZE - BTRP 100 A - 1-2 TQRFI - 180-181 BTZA - BTRP 160 A - 1-2 BTGI - 60 MZS - VECCHIA PRODUZIONE: BRP 70 - BCP 705 F - BCP 705 D - BRCP 70 D - BRP 100 - BRCP 90 A - BRCP 70 F - MRCP 48 F - 0 MRAUG - 1 TQR - 0 MAUG - 1 BRCAUG - 1-2 BTA - 1 1/2 MRRAUS - 1 MDAU - BP 70 D - 1 DZM - 1 MAU - 1-1 1/2 ZRAU - MRPL 42-47-48-49 - MRPS 48-58 - 1-2 BTD - 1-2 BTC - 1-2 BTE - 1-2 BTF - 1-2 DBTB - 100-120-121-130-131 BZ - 0-1 MRAUS - 0-1 MRAU - 1-2 BTB - 1-2 ZDAU - 1-2 DBTA - 3 BAU - 180 QTZ - 180 QTZA - 130 TZ - 130 TZD - 2 TQRCI - 2 BAUG - 2 BDAU - 130 BRPSA - 60-80-81-90-91 MZ - 2 BRAU - 180-181 BTZ - 2 ZMB - 2 1/2 BLRAU - 2 QPR - 2 RDTQ - 2 TQRB - 2 TQRA - 2 DTQ - BRCP 68 - 2 1/2 BRCAU - 2-3 DTQP - 2 1/2 ZRAU - 2 TQRC - 55-60-65 BRCU - 2 BRCAUG - MRCP 48 D - MPSC 48 - MP 48 D - MP 40 - DAP 60 - MPS 58 - MPL 42-45-47 - 70 BRRCOB - BRCP 100 E - BRCP 100 D - MPP 40-60 - MCP 48 D - BTRP 100-110-160 - 3 QRP - 3 DQPR - 3 TAUG - MCP 48 F - 95-100 BRPS - 3 BRRAU - 35 MRCU - 50 BRRCU - MP 35 - 3 BDAU - MCPSC 48
RC0303	9CS53	VOMERE SX	NARDI	CARRELLATI: 50 BRRCUA - 70 BRCU - 35 MRCUSA - 45-50 MRCU - 130 BTRRCO - 35 MRCUA - 45-50 MRCUS - 45-50 ZRCUI - 75 BRRCO - 2 BRAUGF - 1 BRCAUGF - 55 BRCUA - 0 MRCAUG - 60-65 BRCUA - PORTATI: MPSC 60-70 - MRCP 47 - BTRP 160 A - MCP 48 H - 50-55-65 MRPS - 80-90 MZSA - 120-121-130-131 BZD - 115 BDF - 110 BZS - 1-2 TQRF - 100 BZE - 1-2 TQRFI - 95-100 BRPSA - 1-2 BTGI - BCP 70 H - MRCPL 48 - BTRP 100 A - 125 BZF - BRCP 68-70 H - BRP 110 A - BRCPL 80 - 1-2 BTG - MRCP 48 H - BTRP 110 A - 180-181 BTZA - 180 QTZE - 130 TZE - 135 BDF - 60 MZS - 130 BZS - 80-81-90-91 MZC - 60 MZE - VECCHIA PRODUZIONE: 2 1/2 BRCAU - 1-2 DBTB - 1-2 BTD - 1-2 BTC - 2-3 DTQP - 2 1/2 ZRAU - 2 DTQ - 100-120-121-130-131 BZ - 2 1/2 BLRAU - 2 TQRCI - 1-2 BTF - 95-100 BRPS - 130 TZD - BRCP 90 A - MPL 42-45-47 - 2 TQRC - 2 BRCAUG - 1-2 DBTA - 2 ZMB - BRP 100 - 1-2 ZDAU - 2 TQRA - 1-1 1/2 ZRAU - 1 TQR - MRPS 48-58 - 1 MDAU - 1 1/2 MRRAUS - 130 BRPSA - 1 DZM - 1 MAU - 1 BRCAUG - 1-2 BTA - 2 QPR - 2 TQRB - 1-2 BTB - 0-1 MRAU - 0-1 MRAUS - MRPL 42-47-48-49 - 0 MAUG - 0 MRAUG - 3 TAUG - 130 TZ - MCPSC 48 - 2 RDTQ - 1-2 BTE - 3 BDAU - MP 35 - MCP 48 F - DAP 60 - 2 BDAU - MCP 48 D - 180-181 BTZ - 2 BRAU - 3 DQPR - 3 QRP - 35 MRCU - 3 BRRAU - 60-80-81-90-91 MZ - 55-60-65 BRCU - 50 BRRCU - 70 BRRCOB - BRP 70 - MP 40 - BRCP 100 D - 3 BAU - MP 48 D - BP 70 D - BCP 705 F - BRCP 70 F - BRCP 70 D - BCP 705 D - BRCP 100 E - BRCP 68 - BTRP 100-110-160 - MRCP 48 D - 2 BAUG - 180 QTZA - MRCP 48 F - MPSC 48 - MPS 58 - 180 QTZ - MPP 40-60

Art./Ref.	Rif. Orig./Orig. Ref.	Titolo Prodotto/Titolo Prodotto	Brand	Applicazione/Application
RC0304	13C53	VOMERE DX	NARDI	CARRELLATI: 60 MRCUA - 55 MRCU - 1 MCAUGF - PORTATI: 110 MZS - 135 BRPSA - 100 MZC - 115 MDF - 140 BZD - 125 MZD - MRCP 58-70 H - BTSG 150 - MCP 58-70 H - 180 BZA - MRPL 80 - 70 MRPS - BTS 120 - 95 MPSA - 120 MZD - VECCHIA PRODUZIONE: MRP 70 D - MPP 60 - MRPL 50-55-56-61 - 2 1/2 DBTA - 4 DTQR - 1 MCAUG - 1 MAUG - MCP 58-70 F - ZPL 80 - 100-120 MZ - 135 BRPS - 95 MPS - 3 DBTA - 4 DTQP - 140-180 BZ - 2 MRAU - MCP 58-70 D - 2 DZM - 60 MRCU - 2 MDAU - MP 58-70 D - MRP 2L 50 - MP 50 D - MRCP 58-70 F - MRP 55 - 5 QPR - MPL 50 - MRCP 58-70 D
RC0305	13CS53	VOMERE SX	NARDI	CARRELLATI: 60 MRCUA - 1 MCAUGF - 55 MRCU - PORTATI: 125 MZD - BTSG 150 - 135 BRPSA - BTS 120 - MCP 58-70 H - 140 BZD - 110 MZS - MRCP 58-70 H - 115 MDF - 100 MZC - 120 MZD - 70 MRPS - MRPL 80 - 95 MPSA - 180 BZA - VECCHIA PRODUZIONE: MRP 70 D - MP 50 D - MPL 50 - 1 MCAUG - MP 58-70 D - 135 BRPS - MRPL 50-55-56-61 - ZPL 80 - 100-120 MZ - 1 MAUG - 2 MDAU - 95 MPS - 140-180 BZ - 2 DZM - 2 1/2 DBTA - MPP 60 - 3 DBTA - 4 DTQP - 60 MRCU - 2 MRAU - MCP 58-70 F - MRCP 58-70 F - 5 QPR - MRP 2L 50 - MRCP 58-70 D - MCP 58-70 D - MRP 55 - 4 DTQR
RC0306	16C53	VOMERE DX	NARDI	CARRELLATI: 3 DMRAUG - 80-90-100 MRRCOB - PORTATI: MRP 100-130 K - 150 MRPSA - MRP 160 A - TRAINATI: 6 BTRBI - 70-80 DMR - 4-5 BTRG - 4-5 BTRGI - 4-5 BTRFI - 4-5 BTRF - 70-80 DMRI - VECCHIA PRODUZIONE: MRP 100 G - 000 DMRB - 000 DMRA - 00 DMR 21 - 00 DMRFI - 0 DMR 2 - 00 DMRF - MRP 160 - 00 DMRE - 000 DMR 21 - 00 DMRB - 000 DMRRB - 00 DMRA - 000 DMR 2 - 000 DMRR - 000 DMRR - 0 DMR 21 - 00 DMRC - 000 DMREI - 00 DMRD - 000 DMRE - 0 DMRA - 3 MAUG - 3-4 DMIGA - 80-90-100 MRRCO - 000 DMRR2E - 150 MRPS - 4 MRAU - 000 DMREI - 4 BTRBI - 4 RMA - 3-4 DMIGB - 5 MAUG - 4 BTRB - 0 DMRF - MRP 130 H - 0 DMRB - 5 DBR - 0 DMRE - 0 DMREI - MRP 100 F - MRP 100 H - 0 DMRC - 0 DMRD
RC0020	1C54	VOMERE DX	NARDI	ATTREZZATURE DA VIGNETO: TR 50-51 - BC 61 - VR 50-51 - TC 50-51-60-61-66 - QC 50-51-60-61 - QR 50-51-66 - MOTOCOLTIVATORI: BPK 35/A - BPS 20/A - PORTATI: BTRP 22/A - BTRP 22 - BRCP 18
RC2020	1CS54	VOMERE SX	NARDI	ATTREZZATURE DA VIGNETO: VR 50-51 - BC 61 - QC 50-51-60-61 - TC 50-51-60-61-66 - TR 50-51 - QR 50-51-66 - MOTOCOLTIVATORI: BPS 20/A - BPK 35/A - PORTATI: BTRP 22/A - BRCP 18 - BTRP 22
RC0308	5C54	VOMERE DX	NARDI	CARRELLATI: 35 BTRCUA - PORTATI: 40 BZE - BRCPL 28 A - BP 28 H - BRCP 28 H - DAP 18 A - 35 BRPSA - TQPT 60 C - BRP 26 V - TQRCP 48 H - BTP 28 G - 60 BTZE - BPSC 28-30 A - TQRT 60 L - BTRCP 28 H - BTRCPL 38-48 A - VECCHIA PRODUZIONE: BRCP 28 B - BPSC 28-30 - BRCPL 28 - BRPS 28 - BTRCP 28 F - BTRCP 28 D - QPRP 48 - DAP 18 - BTRCP 28-38 D - BTRCP 38-48 - TQPT - ZBAP 39 - 40 BZ - TQRCP 48 D - 35 BRPS - TQRCP 48 F - BP 28 D - 0 BTCAU - 00-0 BTRCAU - 60 BTZ - 00-0 BTRCAUS - BRCP 28 G - BP 28 F - 35 TRCU - BRCP 28 F - BRCP 28 A - BRCP 28 D - BRCP 28 C - BRCP 28 E
RC0309	5CS54	VOMERE SX	NARDI	CARRELLATI: 35 BTRCUA - PORTATI: BPSC 28-30 A - 35 BRPSA - BRCP 28 H - BP 28 H - BTP 28 G - BTRCP 28 H - BRP 26 V - BTRCPL 38-48 A - TQPT 60 C - BRCPL 28 A - DAP 18 A - TQRCP 48 H - 60 BTZE - TQRT 60 L - 40 BZE - VECCHIA PRODUZIONE: TQPT - BTRCP 28-38 D - BTRCP 38-48 - 35 BRPS - TQRCP 48 F - DAP 18 - ZBAP 39 - 0 BTCAU - 00-0 BTRCAU - 40 BZ - BRPS 28 - BTRCP 28 F - BTRCP 28 D - 00-0 BTRCAUS - QPRP 48 - 60 BTZ - BP 28 D - BRCPL 28 - BPSC 28-30 - BRCP 28 C - 35 TRCU - TQRCP 48 D - BRCP 28 A - BP 28 F - BRCP 28 E - BRCP 28 D - BRCP 28 B - BRCP 28 G - BRCP 28 F
RC0310	6C54	VOMERE DX	NARDI	CARRELLATI: 45-50 BTRCUA - 0 BTCUAG - 35 BRCUSA - 35 BRCUA - 1 BTCUAGF - PORTATI: MPSC 28 A - MCP 18 A - ZAP 35 - BP 38 H - BPG 50 - TQRCP 70 H - BP 38 G - BRCPL 38 A - BRCP 39 H - BPSC 50 - BRCP 38 H - MCPL 15 - BTRCP 48 H - DAP 28 A - MCP2L 18 - 40 BRPSA - ZCPL 28 - TRAINATI: 00 BTFI - 00 BTGI - 00 BTG - 00 BTF - VECCHIA PRODUZIONE: DAP 28 - BCRP 38-39 G - BRP 35 - BCRP 38-39 F - BP 38 F - BP 38 D - BTRCP 48 F - BRPL 35 - BRPL 32-42 - TQRCP 70 D - BRPL 47 - BRPS 38 - MPSC 28 - MPL 14 - BTRCP 48 E - MCP 18 - MC 14 - BTRCP 48 D - M 14 - 40 BRPS - 00 BT - 45-50 BTRCU - 1 BTCAU - 35 BRCU - 0 BCUA - ZPL 32-42 - 00-0 BRCAUSP - BCRP 38-39 A - 00-0 BRCAU - ZPL 25-30-35 - 1 BTCAUG - 1 BTRCAUS - 00-0 BRCAUS - BRCPL 38 - BRP 37 - BCRP 38-39 D - 1 BTRCAU - BCRP 38-39 B - BPSC 38 - BCRP 38-39 C - BRCP 27 - 1 1/2 BTRCAU - 1 TRAU - 1 1/2 BTRCAUS - 00 BRAU - BRCP 28-36
RC0311	6CS54	VOMERE SX	NARDI	CARRELLATI: 35 BRCUSA - 1 BTCUAGF - 0 BTCUAG - 45-50 BTRCUA - 35 BRCUA - PORTATI: MCP2L 18 - 40 BRPSA - DAP 28 A - ZAP 35 - BRCPL 38 A - MPSC 28 A - BTRCP 48 H - BPSC 50 - MCP 18 A - MCPL 15 - BRCP 39 H - TQRCP 70 H - BRCP 38 H - BPG 50 - ZCPL 28 - BP 38 H - BP 38 G - TRAINATI: 00 BTG - 00 BTGI - 00 BTF - 00 BTFI - VECCHIA PRODUZIONE: BCRP 38-39 G - BRP 35 - BP 38 D - BCRP 38-39 F - BP 38 F - BRPL 47 - BCRP 38-39 D - BRPS 38 - BTRCP 48 F - BTRCP 48 E - DAP 28 - BRPL 35 - BTRCP 48 D - MPL 14 - MC 14 - MPSC 28 - BRPL 32-42 - TQRCP 70 D - MCP 18 - BCRP 38-39 B - 00 BT - 00 BRAU - 40 BRPS - 45-50 BTRCU - 35 BRCU - 0 BCUA - ZPL 25-30-35 - 00-0 BRCAU - BCRP 38-39 A - 00-0 BRCAUS - ZPL 32-42 - 1 BTCAU - 1 BTRCAU - 00-0 BRCAUSP - BPSC 38 - 1 BTRCAUS - BRP 37 - BCRP 38-39 C - BRCPL 38 - BRCP 28-36 - BRCP 27 - M 14 - 1 1/2 BTRCAUS - 1 TRAU - 1 BTCAUG - 1 1/2 BTRCAU

Art./Ref.	Rif. Orig./Orig. Ref.	Titolo Prodotto/Titolo Prodotto	Brand	Applicazione/Application
RC0312	7C54	VOMERE DX	NARDI	<p>CARRELLATI: 30 MRCUSA - 30 ZRCU - 0 BCAUGA - 30-45-50 BRCUSA - 0 BRAUGA - 0 BTCUAG - 30 MRCUA - 2 BTCAUGF - 35 ZRACUI - 30-45-50 BRCUA - 35 ZRACU - PORTATI: MCP 38 H - MPG 50 - 90 BTZE - BTP 60 SI - 80-90 BZSA - BTRCP 52-70-80 H - 120 TZE - 120-130 QTZE - BTRCPL 80 - DAP 38-48 A - EEP 130 FS - TQS 150 - ZAP 45-60 - TQRT 90 C - MPSC 30 A - MRCP 28-38 H - MRCPL 28-38 A - PERT 130 C - PES 140 UA - PESS 150 - ZCPL 38-48 - TQRT 80-150 C - BTP 38 G - BP 48-58 H - BPSC 50-60 - BRCPL 48 A - BRCP 48-58 H - QPRT 130-140-150 C - TQP 80-90 SI - QPS 140 UA - BPSC 70 A - MP 46 H - 50-60-80-90 BZE - 100 BTZ - 110 BTZS - 40 MZE - 35-40 MRPSA - 50-70 BRPSA - 60 BZS - TRAINATI: 0 BTGI - 0 TQRFI - 0 BTRFI - 0 BTRG - 0 TQRF - 0 BTRGI - 0 BTF - 0 BTFI - 0 BTG - 0 BTRF - VECCHIA PRODUZIONE: QPRT 130-140-150 A - TQRT 80-90-150 - ZBAP 50-60-80 - 1-1 1/2 BRCAUS - ZF 32 - 0 PQ/A - QPS 140 U - 00 ZLAU - BRCPL 48 - BP 48-58 D - 00 MRCAUA/S - BRPL 47 - MPPC 27 - BPSC 48 - 1-1 1/2 BRCAU - TBP 80 C - QTP 80 C - 00 TQ/C - QPRT - 0 QT/A - MRPL 22-32 - 00 MCAU - MRCP 28-36 - MRPC 27 - 0 ZRAU - PERT 130 - MRPO 28-38 - PER 140 U - MRPS 28-38-48 - PERT 130 A - MPU 30 - MPSC 30-38 - PQP 80 C - 0 TB/A - ZPL 37-42 - TQRT 80-90-150 A - 0 BRAUG - 00 MRCAU - MRCP 28-38 D - MRCP 28-38 F - MRCPL 28-38 - MRCP 35 - 1 BAU - QPRT 130-140-150 - 35-40 MRPS - 30 MRCU - 30-45-50 BRCU - 2-2 1/2-3 TRAU - 2-2 1/2 BTRCAU - 120 TZD - 1-1 1/2 BCUA - BTRCP 70-80 F - DAP 49 - 0 BTR - DAP 38-48 - 120-130 QTZ - 50-60-80-90 BZ - 80-90 BZC - BRPS 48-58 - 90 BTZC - ZPU 40 - 35 ZRCUI - 35 ZRCU - 120-130 QTZD - 2 TAUG - 40 MZ - 2 BTCAUG - BTRCP 70-80 D - 90 BTZ - BRCP 40 - BPP 40 - 0 BCAUG - ZQPT 801 - BRCP 48-58 D - ZPU 30 - BP 48-58 F - 0 BTA - BRCP 48-58 F - BRCP 48-58 G - 120 TZ - BTRCP 52 D - MP 46 F - MPFS 30-40 - MCP 38 D - BTRCP 52 F - MP 46 D - MCP 38 F - BTRCP 52 E - MCPL 28 - 0 BTB - BRPL 55</p>
RC0313	7C54	VOMERE SX	NARDI	<p>CARRELLATI: 30 ZRCU - 30 MRCUA - 0 BTCUAG - 0 BRAUGA - 30-45-50 BRCUSA - 30 MRCUSA - 30-45-50 BRCUA - 35 ZRACU - 35 ZRACUI - 2 BTCAUGF - 0 BCAUGA - PORTATI: BTP 60 SI - MCP 38 H - MPG 50 - MP 46 H - BTRCP 52-70-80 H - 120-130 QTZE - 80-90 BZSA - BTRCPL 80 - DAP 38-48 A - EEP 130 FS - ZCPL 38-48 - MRCPL 28-38 A - TQRT 80-150 C - TQS 150 - TQRT 90 C - PESS 150 - MRCP 28-38 H - 90 BTZE - PES 140 UA - PERT 130 C - ZAP 45-60 - MPSC 30 A - BP 48-58 H - BPSC 70 A - BPSC 50-60 - BRCPL 48 A - BRCP 48-58 H - QPRT 130-140-150 C - TQP 80-90 SI - QPS 140 UA - BTP 38 G - 120 TZE - 50-60-80-90 BZE - 40 MZE - 60 BZS - 100 BTZ - 35-40 MRPSA - 110 BTZS - 50-70 BRPSA - TRAINATI: 0 BTRGI - 0 BTG - 0 TQRF - 0 BTRFI - 0 BTF - 0 BTRF - 0 BTFI - 0 BTGI - 0 BTRG - 0 TQRFI - VECCHIA PRODUZIONE: 1 BAU - QPRT 130-140-150 A - ZF 32 - ZPL 37-42 - TQRT 80-90-150 - 0 PQ/A - QPRT 130-140-150 - 1-1 1/2 BRCAU - QTP 80 C - DAP 49 - BP 48-58 D - MPPC 27 - BP 48-58 F - TBP 80 C - BRCPL 48 - QPRT - QPS 140 U - 1-1 1/2 BRCAUS - 00 ZLAU - 0 QT/A - PERT 130 - PER 140 U - 00 MRCAU - MRPC 27 - PERT 130 A - 00 MCAU - MRPL 22-32 - MRPO 28-38 - 0 ZRAU - MRPS 28-38-48 - MPU 30 - MPSC 30-38 - PQP 80 C - BRPS 48-58 - TQRT 80-90-150 A - 1-1 1/2 BCUA - 00 MRCAUA/S - MRCP 28-38 F - MRCP 28-36 - MRCP 28-38 D - 0 TB/A - MRCPL 28-38 - ZBAP 50-60-80 - MRCP 35 - 35 ZRCUI - 30-45-50 BRCU - 2-2 1/2-3 TRAU - 2-2 1/2 BTRCAU - 30 MRCU - 120 TZD - DAP 38-48 - 0 BTR - BTRCP 70-80 F - ZQPT 801 - 120-130 QTZ - 50-60-80-90 BZ - 80-90 BZC - 90 BTZ - 90 BTZC - ZPU 40 - 35-40 MRPS - 35 ZRCU - 120-130 QTZD - 2 TAUG - 40 MZ - 2 BTCAUG - BTRCP 70-80 D - BTRCP 52 D - BRCP 40 - 0 BTA - BPSC 48 - 0 BTB - BRCP 48-58 G - BRCP 48-58 F - BRPL 47 - 00 TQ/C - BPP 40 - BRCP 48-58 D - ZPU 30 - 0 BRAUG - MPFS 30-40 - MCP 38 D - BTRCP 52 F - BTRCP 52 E - MP 46 F - MP 46 D - 120 TZ - MCPL 28 - 0 BCAUG - BRPL 55 - MCP 38 F</p>
RC0314	12C54	VOMERE DX	NARDI	<p>CARRELLATI: 3 BRRAUG/A - 80-90-100 BRRCO/B - 2 MRAUG/F - 65 MRCUA - 70 MRRCO/B - 70 MRCU - PORTATI: MS 120 - BRP 160 A - BRP 120 K - MPR 90 H - 150 BRPS/B - TRAINATI: 3 BTRFI - 3 BTRF - 2 1/2-3-4 BTGI - 3 BTRG - 2 1/2-3-4 BTF - 2 1/2-3-4 BTG - 2 1/2-3-4 BTFI - 4 BTP - 4 BTPI - 3-4-4 1/2 TQRFI - 3-4-4 1/2 TQRF - 3 BTRGI - VECCHIA PRODUZIONE: BRP 160 - 2 BTRB - MRP 90 G - 2 MRAUG - 3 BRAUG - 2 1/2-3 BTE - 2 1/2-3 BTB - 2 1/2-3 BTA - 2 1/2-3 BTC - 2 1/2-3 BT/EI - 2 1/2-3 BTD - 2 1/2-3 MRAU - 3 BRRAUG - BRP 120 D - 4 BTSPI - 4 BTA - 80-90-100 BRRCO - 70 MRRCO - 3-4 BRAU - BRP 120 G - 4 BTSP - 4 BTSPFI - 4 BTB - 4 BTSPF - 4 TQRB - 4 BT/BI - 2 MAU - 150 BRPS - BRP 120 H - 5 QPR - 2 DMIGA - 2 DMIGB - 4 TQRA - 2 BTRA - 65 MRCU - 2 BTRC</p>

SCALPELLI ADATTABILI ALLA PRODUZIONE NARDI

CISEU ADAPTABLE TYPE NARDI

POINT FOR NARDI LINE

NEIFEL PASSEND FÜR NARDI

ESCOPOU PARA PRODUCCIÓN NARDI



Art./Ref.	Rif. Orig./ Orig. Ref.	Titolo Prodotto/ Titolo Prodotto	Brand	Applicazione/Application
RC0334	5C63	SCALPELLO 30x30 DX	NARDI	CARRELLATI: 30 BRCUS/A - 35 BTRCU/A - 30 BRCU/A - PORTATI: BRCPL 28 A - BPSC 30 A - BRP 26 V - BRCP 28/H - BP 28/H - 120 QTZ/E - BPSC 28 A - BTP 60 SI - BTP 38 G - BTRCP 28/H - BTRCPL 38 A - PER 130/C - BTP 28 G - BTRCPL 48 A - DAP 18/A - 35 BRPS/A - EEP 130 FS - TQPR 60/C - TQRT 80/C - TQRC 48/H - TQP 80 SI - 40-50 BZ/E - 60-90 BTZ/E - QPRT 130/C - TQRT 60L - VECCHIA PRODUZIONE: BP 28 D - DAP 18 - TQRC 48 F - TQRT 80 A - BTRCPL 38-48 - BTRCP 28 D - BTRCP 28 F - QPRT 130 - TQRT 80 B - 0 BTAU - BPSC 28-30 - 00-0 BTRCAU - PERT 130 A - BP 28 F - 120 QTZA - 40-50 BZ - BRCP 28 G - 35 BRPS - 60-90 BTZ - 30 BRCU - QPRT 130 A - BRCP 28 F - 120 QTZD - TQPR 60 - 35 BTRCU - BRCP 28 D - TQRC 48 D - BRCPL 28 - 00-0 BTRCAUS - BPFS 30
RC0335	5CS63	SCALPELLO 30X30 SX	NARDI	CARRELLATI: 30 BRCU/A - 35 BTRCU/A - 30 BRCUS/A - PORTATI: BTP 28 G - 35 BRPS/A - 60-90 BTZ/E - DAP 18/A - BTRCPL 48 A - BRP 26 V - BRCPL 28 A - BPSC 30 A - BRCP 28/H - BP 28/H - BPSC 28 A - EEP 130 FS - 40-50 BZ/E - TQRC 48/H - PER 130/C - QPRT 130/C - TQRT 60L - BTP 60 SI - BTRCP 28/H - TQRT 80/C - BTRCPL 38 A - TQP 80 SI - TQPR 60/C - BTP 38 G - 120 QTZ/E - VECCHIA PRODUZIONE: PERT 130 A - QPRT 130 - BP 28 F - BTRCP 28 F - BTRCP 28 D - BP 28 D - DAP 18 - BPFS 30 - BTRCPL 38-48 - 00-0 BTRCAUS - TQRC 48 F - TQRC 48 D - 120 QTZA - 40-50 BZ - BPSC 28-30 - 00-0 BTRCAU - TQRT 80 B - TQRT 80 A - 0 BTAU - 60-90 BTZ - TQPR 60 - BRCP 28 D - BRCP 28 G - 35 BTRCU - BRCP 28 F - BRCPL 28 - 120 QTZD - 35 BRPS - QPRT 130 A - 30 BRCU
RC0344	6C64	SCALPELLO 35X35 DX	NARDI	CARRELLATI: 35-45 BRCUS/A - 45-50 BTRCU/A - 50 BRCU/A - 1-2 BTCUAG/F - 0 BCAUG/A - 30 MRCUS/A - 30 MRCU/A - 35 ZRACUI - 0 BRAUG/A - 50 BRCUS/A - 30 ZRCU - 35 ZRACY - 0 BTCUAG - 35-45 BRCU/A - PORTATI: MPG 50 - 60 BZS - MRCP 28-38/H - BPSC 70/A - MP 46/H - BP 38-48-58/H - TQRC 7/H - PES 140 U/A - TQR 90 SI - 40-50-70 BRPS/A - QPS 140 U/A - 35-40 MRPS/A - 40 MZ/E - PESS 150 - QPRT 150/C - BTRCP 48-52-70-80/A - 80-90 BZS/A - QPRT 140/C - BPG 50 - MRCPL 28-38/A - BRCP 38/A - BTRCPL 80 - BRCPL 38-48/A - 110 BTZS - MPSC 28-30/A - BTRCPL 80/A - BRCP 38-39-48-58/H - 60-80-90 BZ/E - 120 TZ/E - 130 QTZ/E - DAP 28-38-48/A - MPSC 50 - ZAP 34-45-60 - BP 38 G - MCP 38/H - TQRT 90/C - TQS 150 - MCPL 15 - BPSC 50-60 - 100 BTZ - MCP 18/A - MRCPL 38-48/A - TQRT 150/C - MCPL2L 18 - TRAINATI: 0 BTRF - 0 BTRFI - 00-0 BTGI - 00-0 BTFI - 0 BTRG - 0 BTRGI - 0 TQRF - 0 TQRFI - 00-0 BTF - 00-0 BTG - VECCHIA PRODUZIONE: BRCP 38-39-48-58 D - BP 38-48-58 F - BRCP 58 - BRCP 38-39-48-58 F - BRP 37-47 - BRCP 38-39-48-58 G - BRCP 40-48 - BRCPL 49 - BRCPL 38-48 - BP 48 - BP 40 - MCP 38 D - BP 38-48-58 D - BPP 40 - MPL 28 - MP2L 18 - MRCP 27-35 - MPL 14 - MCPL 28 - MP 46 D - MCPC 21 - MRCP 28-38 - MRCP 28-38 D - TQRT 150 - BRP 40 - MPSC 28-30-38 - MPL 38 - MP2L 14 - MPFS 30-40 - MP 46 F - MRP 27 - MRCP 36 - PES 140 U - MRPS 28-38 - MRPL 27-35-37 - MRPO 28-38 - MRCP 28 - MRCPL 38-48 - QPRT 150 A - MRCP 28-38 F - QPRT 140 - QPS 140 U - TQRC 70 D - MCP 38 F - BPSC 38-48 - 0 BTA - 0 BTB - 0 BCAUG - 0 BRAUG - ZPL 27-35-37 - TRCP2L 55 - ZP 40 - ZPL 45-47 - ZQTP 801 - 35-40 MRPS - 40-50-70 BRPS - 60-80-90 BZ - 40 MZ - 35-45-50 BRCU - 0 BTAU - 00-0-1-1 1/2 BRCU/S - TQRT 90 A - ZAPL 38-48 - 00 MRAU - 00 MRAUI - 00-0-1-1 1/2 BRAU - 0 BTR - 00 BT - DAP 28-38-48 - 0 ZRAU - 00-0-1-1 1/2 BRCU - 00 MRCU/S - ZF 32 - ZF 45 - ZCPL 28-38-48 - ZBAP 60-80-90 - 00 ZLAU - 0 BTC - TQRT 150 A - 30 MRCU - BRPS 28-38-48-58 - 45-50 BTRCU - BRCP 27-35 - BTRCP 52 D - BTCP 48-70-80 F - 00 MRCU - BTCP 48-70-80 D - BRPC 28-36 - BRPL 45-47 - MC 14 - MCP 18 - DAP 35-40 - M 14 - BTRCP 52 F - BRPL 55 - BTRCP 52 E - 1 BTAU - BRPO 38 - 1 1/2 BAU - 1 1/2 BRRAU - 1 1/2 BRRAU/S - 1 BTAU - 1-1 1/2 -2-3 TRAU - 1-2 BTAUG - 130 QTZA - 120 TZC - 1-1 1/2 BTRCAU - 130 QTZD - 130 QTZC - 2 BTRCAU - 3 BTRCAU - 120 TZD - 2 TAUG - 2-2 1/2 BTRCAU
RC0345	6CS64	SCALPELLO 35X35 SX	NARDI	CARRELLATI: 30 ZRCU - 30 MRCUS/A - 35-45 BRCU/A - 0 BCAUG/A - 35 ZRACUI - 35-45 BRCUS/A - 50 BRCU/A - 1-2 BTCUAG/F - 0 BRAUG/A - 30 MRCU/A - 45-50 BTRCU/A - 50 BRCUS/A - 35 ZRACY - 0 BTCUAG - PORTATI: QPS 140 U/A - MRCPL 28-38/A - MRCPL 38-48/A - 110 BTZS - PES 140 U/A - QPRT 140/C - 130 QTZ/E - BRCP 38-39-48-58/H - QPRT 150/C - 120 TZ/E - 100 BTZ - 35-40 MRPS/A - TQR 90 SI - 60 BZS - MPSC 28-30/A - 60-80-90 BZ/E - 40 MZ/E - 40-50-70 BRPS/A - TQRC 7/H - TQRT 150/C - MPSC 50 - PESS 150 - BRCP 38/A - MCPL2L 18 - BP 38 G - MCPL 15 - BP 38-48-58/H - BPSC 50-60 - MCP 18/A - BPG 50 - BTRCPL 80/A - BTRCPL 80 - DAP 28-38-48/A - 80-90 BZS/A - MCP 38/H - BTRCP 48-52-70-80/A - MPG 50 - BRCPL 38-48/A - MP 46/H - MRCP 28-38/H - TQS 150 - ZAP 34-45-60 - BPSC 70/A - TQRT 90/C - TRAINATI: 0 TQRFI - 0 TQRF - 0 BTRGI - 0 BTRG - 00-0 BTGI - 0 BTRFI - 00-0 BTG - 00-0 BTF - 00-0 BTFI - 0 BTRF - VECCHIA PRODUZIONE: BRCP 38-39-48-58 D - MCPL 28 - MCPC 21 - BRCP 58 - MP 46 D - BRCP 40-48 - BRCPL 49 - MPFS 30-40 - BP 38-48-58 F - BRCPL 38-48 - MPL 14 - MRCP 27-35 - BPP 40 - MRCP 28-38 - MRCP 28-38 D - BPSC 38-48 - BRP 37-47 - BP 40 - MP2L 18 - BP 48 - BP 38-48-58 D - BRCP 38-39-48-58 F - TQRT 150 - MRCP 28-38 F - MRCPL 38-48 - MRP 27 - TQRC 70 D - MP2L 14 - MPL 38 - MCP 38 F - MPSC 28-30-38 - MRCP 36 - MRPL 27-35-37 - QPS 140 U - MCP 38 D - MRCP 28 - BRCP 38-39-48-58 G - QPRT 140 - BTRCP 52 E - MRPO 28-38 - QPRT 150 A - PES 140 U - MRPS 28-38 - MP 46 F - 30 MRCU - 0 BTA - BRP 40 - 0 BCAUG - 0 BRAUG - ZPL 27-35-37 - TRCP2L 55 - ZP 40 - ZPL 45-47 - ZQTP 801 - 40 MZ - 35-40 MRPS - 40-50-70 BRPS - 35-45-50 BRCU - 1 BTAU - 0 BTAU - 00-0-1-1 1/2 BRCU/S - TQRT 90 A - ZAPL 38-48 - 00 MRAUI - 00-0-1-1 1/2 BRAU - 00-0-1-1 1/2 BRCU - 0 BTR - 00 MRAU - 0 ZRAU - 00 BT - 00 MRCU - 00 MRCU/S - ZF 32 - ZF 45 - ZCPL 28-38-48 - ZBAP 60-80-90 - 00 ZLAU - 0 BTC - 60-80-90 BZ - 0 BTB - BRPO 38 - BRCP 27-35 - BRCP 28-36 - BRPS 28-38-48-58 - BTRCP 52 D - BTCP 48-70-80 D - BTCP 48-70-80 F - BRPL 45-47 - BRPL 55 - MCP 18 - DAP 35-40 - DAP 28-38-48 - MC 14 - 45-50 BTRCU - TQRT 150 A - BTRCP 52 F - MPL 28 - M 14 - 1 1/2 BAU - 1 1/2 BRRAU - 1 1/2 BRRAU/S - 1 BTAU - 1-1 1/2 -2-3 TRAU - 130 QTZA - 1-1 1/2 BTRCAU - 120 TZC - 1-2 BTRCAU - 130 QTZD - 120 TZD - 3 BTRCAU - 2 TAUG - 2-2 1/2 BTRCAU

Art./Ref.	Rif. Orig./ Orig. Ref.	Titolo Prodotto/ Titolo Prodotto	Brand	Applicazione/Application
RC0336	9C63	SCALPELLO 40X40 DX	NARDI	CARRELLATI: 45-50 ZRCU - 35 MRCU/A - 45-50 ZRCUI - 50 BRRCO/A - 0 MRCAUG - 60-65 BRCAU - 1 BRCUAG/F - 35 MRCUS/A - 45-50 MRCU - 45-50 MRCUS - 55 BRCAU/A - PORTATI: BRCP 68-70/H - 180 QTZ/E - 95-100 BRPS/A - 60 MZ/E - MRCP 47 - 180 BTZ/A - 125 BZ/F - 80-90 MZS/A - BTS 100 - 120-130 BZ/D - 130 BZS - BTRP 100/A - BTRP 110/A - BRCL 80 - 135 BDF - 50-55-65 MRPS - 60 MZS - BRCP 90/A - BCP 70/H - MRCL 48 - 130 TZ/E - 110 BZS - MRCP 48/H - MCP 48/H - MPSC 60-70 - 115 BDF - 100 BZ/E - TRAINATI: 1 BTF - 1 BTG - 1 TQRF - 1 TQRFI - 1 BTFI - 1 BTGI - VECCHIA PRODUZIONE: BRPL 80 - BRCP 100 E - 0-1-1 1/2 MAU - BRCP 70 F - BRCP 68 - BRCP 100 F - MPP 40 - BRCP 70 D - BRCP 100 D - 1 BTC - 0 MAUG - MP2L 42-45-47 - MRCP 48 D - MRCP 48 F - MPSC 48 - MRPL 47-49 - MRP 47 - MRPS 48-58 - 180 QTZ - 1 BTB - 130 TZ - 0-1 MRAU - 0-1 MRAUS - 0-1 MDAU - 1 BTA - BCP 70 D - 1 BTD - MPS 58 - 1 BRCUAG - 0 MRAUG - 70 BRRCOB - 70 BRRCO - 60-80-90 MZ - 80-90 MZ/C - 95-100 BRPS - 2-3 ZB - 2 BAU - 50-55-60-65 BRCAU - 1-2 DBTA - 100-120-130 BZ - 1-1 1/2 ZRAU - 180 BTZ - BCP 70 F - 1 TQR - 2 QPR - 1 1/2 MRRAUS - 1 1/2 MRRAU - 1 DZM - 3 DQPR - 1-2 DBTB - MP 48/D - MP 35 - DAP 60 - MCPSC 48 - MCP 48 D - BP 70/D - 2-3 DTQP - BRCP 90 - BTRP 100-110 - BS 100 - 35 MRCU - 2-2 1/2 ZRAU - 2-3 BDAU - 2 BRAU - 2 DTQR - MCP 48 F - 130 BRPS - 2 TAUG
RC0337	9CS63	SCALPELLO 40X40 SX	NARDI	CARRELLATI: 1 BRCUAG/F - 50 BRRCU/A - 55 BRCAU/A - 45-50 MRCU - 0 MRCAUG - 60-65 BRCAU - 45-50 ZRCUI - 45-50 ZRCU - 35 MRCUS/A - 35 MRCU/A - 45-50 MRCUS - PORTATI: 60 MZS - 100 BZ/E - 115 BDF - 60 MZ/E - 50-55-65 MRPS - BTRP 110/A - BTS 100 - 80-90 MZS/A - BRCP 68-70/H - 95-100 BRPS/A - BTRP 100/A - 180 QTZ/E - MRCP 48/H - 130 BZS - 120-130 BZ/D - MRCL 48 - 110 BZS - MCP 48/H - BRCL 80 - MPSC 60-70 - 130 TZ/E - BCP 70/H - 135 BDF - MRCP 47 - 125 BZ/F - BRCP 90/A - 180 BTZ/A - TRAINATI: 1 BTGI - 1 TQRF - 1 BTG - 1 TQRFI - 1 BTFI - VECCHIA PRODUZIONE: BRCP 100 D - BRCP 70 F - BRCP 100 E - BRCP 68 - MPP 40 - BCP 70 D - BRCP 100 F - BCP 70 F - BRCP 90 - MPSC 48 - MRCP 48 D - 0 MRAUG - MP2L 42-45-47 - MRP 47 - MRPS 48-58 - BP 70/D - MRPL 47-49 - 0 MAUG - 1 BTA - 1 BTC - 0-1 MRAUS - 1 BRCUAG - 0-1-1 1/2 MAU - 0-1 MRAU - 0-1 MDAU - 1 BTD - MPS 58 - 1 BTB - BRCP 70 D - 1-2 DBTB - 100-120-130 BZ - 1 1/2 MRRAUS - 1 1/2 MRRAU - 130 TZ - 1-2 DBTA - 70 BRRCOB - 70 BRRCO - 60-80-90 MZ - 2 QPR - 1 DZM - 2 DTQR - 130 BRPS - MCP 48 F - 2 BRAU - 2 BAU - 1-1 1/2 ZRAU - 180 BTZ - 180 QTZ - 95-100 BRPS - 1 TQR - BS 100 - BRPL 80 - BTRP 100-110 - DAP 60 - MP 35 - MCPSC 48 - 80-90 MZ/C - MP 48/D - MRCP 48 F - MCP 48 D - 2-3 DTQP - 3 DQPR - 50-55-60-65 BRCAU - 2-3 BDAU - 2-3 ZB - 2 TAUG - 35 MRCU - 2-2 1/2 ZRAU
RC0338	11C63	SCALPELLO 45X45 DX	NARDI	CARRELLATI: 75 BRRCO - 55 MRCU - 70 BRCAU - 130 BTRCO - 60 MRCUA - 2 BRAUG/F - 1 MCAUG/F - PORTATI: 181 BTZ/A - BRP 110/A - 70 MRPS - 95 MPS/A - MRCP 58-70/H - 110 MZS - 135 BRPS/A - 115 MDF - MRPL 80 - 180 BZ/A - 120 MZ/D - BTS 120 - MCP 58-70/H - 121-131-140 BZ/D - BTRP 160/A - 125 MZ/D - 81-91-100 MZ/C - TRAINATI: 2 BTF - 2 BTG - 2 BTGI - 2 TQRF - 2 BTFI - 2 TQRFI - VECCHIA PRODUZIONE: 2 NTE - 121-131-140-180-181 BZ - 2 1/2 - 3 DBTA - 2 BRAUG - DAP 80 - 2 NTD - MRP 55 - 2 BAUG/F - 2 ZM - MRPL 56-61 - 1 MCAUG - 2 NTB - 95 MPS - 2 NTA - MRPL 50 - BTRP 160 - MRP 70/D - 2 MDAU - 2 NTC - 135 BRPS - ZPL 80 - 3 BRRAU - 3 DTQR - 3-4-5 DTQP - 3-4 DTQR - 2 1/2 BRAU - 3 BRAU - BRP 110 - 2 BAUG - 81-91-100-120 MZ - 60 MRCU - 2 1/2 - 3 DBTB - MRCP 58-70/F - MRCP 58-70/D - 2 DZM - MCP 58-70/D - MP2L 50 - MCP 58-70/F - MP 50 - MPP 60 - MPL 50 - MP 58-70/D
RC0339	11CS63	SCALPELLO 45X45 SX	NARDI	CARRELLATI: 75 BRRCO - 55 MRCU - 60 MRCUA - 2 BRAUG/F - 70 BRCAU - 1 MCAUG/F - 130 BTRCO - PORTATI: 125 MZ/D - 135 BRPS/A - 180 BZ/A - 81-91-100 MZ/C - 70 MRPS - MRCP 58-70/H - BRP 110/A - 110 MZS - 95 MPS/A - MCP 58-70/H - 181 BTZ/A - MRPL 80 - 120 MZ/D - 115 MDF - BTS 120 - BTRP 160/A - 121-131-140 BZ/D - TRAINATI: 2 BTF - 2 BTGI - 2 TQRF - 2 TQRFI - 2 BTFI - 2 BTG - VECCHIA PRODUZIONE: ZPL 80 - BRP 110 - MCP 58-70/F - MRCP 58-70/D - MRP 70/D - BTRP 160 - 1 MCAUG - DAP 80 - 121-131-140-180-181 BZ - 135 BRPS - MCP 58-70/D - MRP 55 - MRPL 50 - MRPL 56-61 - 81-91-100-120 MZ - 2 BRAUG - 2 BAUG/F - 2 1/2 - 3 DBTB - 2 DZM - 2 BAUG - 2 MDAU - 2 1/2 - 3 DBTA - 2 NTA - 2 NTC - 2 NTD - MRCP 58-70/F - 2 NTE - 2 ZM - 95 MPS - 2 NTB - MP 58-70/D - MPL 50 - MP 50 - MP2L 50 - 60 MRCU - 2 1/2 BRAU - MPP 60 - 3 BRRAU - 3-4-5 DTQP - 2-3 DBTR - 3 BRAU - 3 DTQR - 3-4 DTQR
RC0340	12C63	SCALPELLO 50X50 DX	NARDI	CARRELLATI: 80-90-100 BRRCO/B - 70 MRRCO/B - 2 MRAUG/F - 3 BRRAUG/A - 70 MRCU - 65 MRCUA - PORTATI: MRP 130/K - MRP 90/H - 150 BRPS/B - 150 MRPS/A - MRP 100/K - BRP 160/A - MS 120 - BRP 120/K - TRAINATI: 70 DMR - 2 1/2 - 3-4 BTF - 2 1/2 - 3-4 BTG - 2 1/2 - 3-4 BTGI - 2 1/2 - 3-4 BTFI - 4 BTRF - 4 BTRFI - 4 BTRG - 4 BTRGI - 3 BTRF - 3 BTRG - 3 BTRGI - 4 BTPI - 3-4-4 1/2 TQRF - 3-4-4 1/2 TQRFI - 70 DMR/I - 4 BTP - 3 BTRFI - VECCHIA PRODUZIONE: 2 DMIG - 2 MRAUG - 4 BTR/C - BRP 160 - 2-3 MAU - MRP 100 D - MRP 130 H - 00 DMRB - 00 DMRA - 4 BT/B - 2 1/2 - 3 BT/E - 000 DMR/I-21 - 000 DMRB - 1 DMRA - 4 BNRAU - 150 BRPS - 150 MRPS - 00 DMRC - 000 DMR/E - BRP 120 D - 2 1/2 - 3 MRAU - 4 BAU - 2-3 BTRFI - 000 DMRA - 2-3 BTRF - 4 BT/BI - 5 DTR - 5 QPR - 4 BTSP - 4 BTSP/I - 5 DBR - 4 DMIG/B - 3 MAUG - 80-90-100 BRRCO - 65 MRCU - 80-90 MRRCO - 3 BT/EI - BRP 120 G - 3 DMZ - 3 BRRAUG - 4 QPR - 70 MRRCO - 0 DMRA - 0 DMRB - 4 BT/D - MRP 100 H - 4 MRAU - MRP 100 G - 3 ZM - BRP 120 H - MRP 90 D - MRP 90 G - 3 MDAU - 4 BTR/CI - MRP 130 G - MRP 130
RC0341	12CS63	SCALPELLO 50X50 SX	NARDI	CARRELLATI: 3 BRRAUG/A - 70 MRRCO/B - 65 MRCUA - 2 MRAUG/F - 70 MRCU - 80-90-100 BRRCO/B - PORTATI: MRP 130/K - 150 BRPS/B - MRP 90/H - MRP 100/K - 150 MRPS/A - BRP 160/A - BRP 120/K - MS 120 - TRAINATI: 70 DMR - 4 BTRGI - 2 1/2 - 3-4 BTG - 2 1/2 - 3-4 BTGI - 70 DMR/I - 2 1/2 - 3-4 BTF - 4 BTRF - 4 BTRFI - 4 BTRG - 2 1/2 - 3-4 BTFI - 3 BTRFI - 3 BTRG - 3-4-4 1/2 TQRFI - 3-4-4 1/2 TQRF - 4 BTPI - 3 BTRGI - 4 BTP - 3 BTRF - VECCHIA PRODUZIONE: 2 MRAUG - 3 ZM - 4 BTR/C - 2-3 BTRFI - MRP 100 H - MRP 130 H - MRP 100 G - MRP 100 D - 4 BT/B - 00 DMRB - 2 1/2 - 3 BT/E - 150 MRPS - 1 DMRA - 150 BRPS - BRP 120 D - 3 MDAU - 4 BNRAU - 000 DMRB - 000 DMRC - BRP 120 G - 2 1/2 - 3 MRAU - 2 DMIG - 000 DMRA - 000 DMR/E - 000 DMR/I-21 - 2-3 BTRF - 4 BAU - 4 BTSP - 4 BTSP/I - 4 BTR/CI - 4 DMIG/B - 5 DTR - 4 MRAU - 5 QPR - 65 MRCU - 70 MRRCO - 3 DMZ - BRP 120 H - 2-3 MAU - 80-90 MRRCO - 3 MAUG - 5 DBR - 80-90-100 BRRCO - 4 QPR - 00 DMRA - MRP 130 - 0 DMRB - 0 DMRA - 4 BT/BI - BRP 160 - 3 BT/EI - 3 BRRAUG - 4 BT/D - MRP 90 G - MRP 90 D - MRP 130 G
RC0346	17C63	SCALPELLO 55X55 DX	NARDI	CARRELLATI: 80-90 MRRCO/B - 3 MRAUG - PORTATI: MRP 130/K - 150 MRPS/A - TRAINATI: 70 DMR - 70 DMR/I - 4 BTR/F-G - 4 BTR/FI-GI - VECCHIA PRODUZIONE: 000 DMR/E - MRP 130 G-H - 000 DMR/I-21 - 1 DMR/A - 3 MAUG - 150 MRPS - 4 BTR/CI - 5 DBR - 4 MRAU - 4 DMIG/B - 80-90 MRRCO - 4 BTR/C - 000 DMR/A-B - MRP 130 - 00 DMR/A-B-C

SCALPELLI ADATTABILI ALLA PRODUZIONE NARDI
CISEU ADAPTABLE TYPE NARDI
POINT FOR NARDI LINE
NEIFEL PASSEND FÜR NARDI
ESCOPUO PARA PRODUCCIÓN NARDI

Art./Ref.	Rif. Orig./Orig. Ref.	Titolo Prodotto/Titolo Prodotto	Brand	Applicazione/Application
RC0330	1C62	SCALPELLO 40X20 DX	NARDI	ATTREZZATURE DA VIGNETO: PR 20-21 - VR 20-21 - TR 20-21 - 3 AR 18 - QR 20-21 VECCHIA PRODUZIONE: TR 18-19 - QR 18-19 - VR 18-19 - PR 18-19
RC0331	1CS62	SCALPELLO 40X20 SX	NARDI	ATTREZZATURE DA VIGNETO: TR 20-21 - PR 20-21 - QR 20-21 - 3 AR 18 - VR 20-21 VECCHIA PRODUZIONE: PR 18-19 - TR 18-19 - QR 18-19 - VR 18-19
RC0332	2C62	SCALPELLO 40X25 DX	NARDI	ATTREZZATURE DA VIGNETO: PRR 30-31 - 3 AR 30 - TR 30-31 - QR 30-31 - PR 30-31 - QM 30 - 5-7 HRR 32 - VM 30 - VR 32-33 - 5-7 HRR 33 - TRR 30-31 - 2 VR 32 CF - QRR 30-31 - CARRELLATI: 30 BTRCU PORTATI: PRRP 48 - BVCPL 15 - QL 38 F - BRVP 18 - BTRCPL 28 - BRVP2L 18 - BRP 21 - BTRCP 18-28
RC0333	2CS62	SCALPELLO 40X25 SX	NARDI	ATTREZZATURE DA VIGNETO: PR 30-31 - PRR 30-31 - QRR 30-31 - TR 30-31 - QM 30 - QR 30-31 - 5-7 HRR 32 - 3 AR 30 - VR 32-33 - TRR 30-31 - 2 VR 32 CF - 5-7 HRR 33 - VM 30 CARRELLATI: 30 BTRCU - PORTATI: QL 38 F - PRRP 48 - BVCPL 15 - BTRCP 18-28 - BTRCPL 28 - BRVP2L 18 - BRVP 18 - BRP 21
RC0332A	2C61	SCALPELLO 40X25	NARDI	ATTREZZATURE DA VIGNETO: VRR 30-31-32-33 - HRR 30-31-32-33

SUPPORTI SCALPELLO ADATTABILI ALLA PRODUZIONE NARDI
SUPPORT CISEAU ADAPTABLE TYPE NARDI
SUPPORT POINT FOR NARDI LINE
NEIBELSTÜTZE PASSEND FÜR NARDI
SOPORTE ESCOPLA PARA PRODUCCIÓN NARDI

Art./Ref.	Rif. Orig./Orig. Ref.	Titolo Prodotto/Titolo Prodotto	Brand	Applicazione/Application
RC0500	5C83	SUPPORTO SCALPELLO DX	NARDI	CARRELLATI: 35 BTRCU/A - 30 BRCUS/A - 30 BRCU/A - PORTATI: BTP 28-38 G - BRP 26/V - 35 BRPS/A - 60-90 BTZ/E - BTP 60 SI - TQP 80 SI - QPRT 130/C - EEP 130 FS - DAP 18/A - PERT 130/C - BTRCP 28/H - BPSC 28-30/A - BRCP 28/H - BRCPL 28/A - BP 28/H - TQRT 80/C - TQRCPL 60/C - TQRT 60L - 120 QTZ/E - TQRCPL 48/H - 40-50 BZ/E - VECCHIA PRODUZIONE: BTRCP 28/D-F - TBP 80/C - QPRT 130/A - 60-90 BTZ - 00-0 BTRCAU - Z 14 - PERT 130/A - 120 QTZ - OTP 80/C - 0 PQ/A - ZBAP 39-48-50 - BP 28/D-F - 0 BT/A - DAP 18 - BTRCPL 38-48/A - BRCP 28/D-F-G - BTRCP 38 - BLCPC 28 - PERT 130 - PQP 80/C - 35 BRPS - TQPRT 60 - 00-0 BTRCAU/S - TQRT 80 - 3 PFS 30 - 35 BTRCU - 30 BRCU - BRPO 28 - 120 QTZ/A-D - 40-50 BZ - BPSC 28-30 - TQRT 80/A-B - BRCPL 28 - TQRCPL 48/D-F - BRPS 28 - BTRCP 28-38/D - 0 QT/A
RC0501	5CS83	SUPPORTO SCALPELLO SX	NARDI	CARRELLATI: 30 BRCUS/A - 30 BRCU/A - 35 BTRCU/A - PORTATI: BTP 60 SI - BRP 26/V - 60-90 BTZ/E - BRCPL 28/A - 35 BRPS/A - BPSC 28-30/A - TQP 80 SI - DAP 18/A - EEP 130 FS - QPRT 130/C - PERT 130/C - BRCP 28/H - BTRCP 28/H - BP 28/H - BTP 28-38 G - TQRT 60L - TQRCPL 48/H - TQRCPL 60/C - 120 QTZ/E - 40-50 BZ/E - TQRT 80/C - VECCHIA PRODUZIONE: QPRT 130/A - 120 QTZ - 00-0 BTRCAU - PQP 80/C - BTRCP 28/D-F - ZBAP 39-48-50 - TQPRT 60 - 00-0 BTRCAU/S - PERT 130/A - 0 BT/A - BP 28/D-F - 0 PQ/A - 60-90 BTZ - OTP 80/C - 0 QT/A - BTRCPL 38-48/A - BTRCP 38 - DAP 18 - BRCP 28/D-F-G - PERT 130 - TQRT 80/A-B - 35 BRPS - TQRCPL 48/D-F - 120 QTZ/A-D - 3 PFS 30 - 40-50 BZ - Z 14 - 35 BTRCU - TBP 80/C - 30 BRCU - TQRT 80 - BPSC 28-30 - BLCPC 28 - BTRCP 28-38/D - BRCPL 28 - BRPO 28 - BRPS 28

Art./Ref.	Rif. Orig./ Orig. Ref.	Titolo Prodotto/ Titolo Prodotto	Brand	Applicazione/Application
RC0502	6C83	SUPPORTO SCALPELLO DX	NARDI	CARRELLATI: 45-50 BTRCU/A - 30 ZRCU - 1 BTCAUG/F - 35-45 BRCUS/A - 35-45 BRCU/A - 0 BCAUG/A - PORTATI: MRCP 28/H - 60-80 BZ/E - 35 MRPS/A - 40 MZ/E - MCP 18/A - MRCPL 28/A - 40-50 BRPS/A - TQP 90 SI - BPG 50 - BPSC 50-60 - QPS 140 U/A - BRCPL 48/A - BTRCP 48-52-70/H - DAP 28-38/A - BP 38/G - BRCPL 38-48/A - BRCP 38-39-48/H - 100 BTZ - 130 QTZ/E - BRCPL 38/A - BP 38-48/H - MCPL 15 - TQRT 90/C - TQRCP 70/H - MCP2L 18 - ZAP 35-45 - QPRT 140/C - ZCPL 28-38 - MPSC 28-30/A - PES 140 U/A - TRAINATI: 0 TQR/F-FI - 00-0 BT/F-G - 00 BT/FI-GI - VECCHIA PRODUZIONE: MP2L 18-20 - BRCPL 38-48 - MCPL 28 - BRCP 38-39-48/D-F-G - BTRCP 48-70/D-F - MPSC 28-30 - BPP 40 - MRCP 28-38 - MPO 20-21 - BRP 37-47 - BPSC 38-48 - BTRCP 52/D-E-F - MPL 14 - MCP 18 - MRPL 22 - MRPS 28 - MP 14 - PES 140 U - QPS 140 U - QPRT 140 - BP 38-48/D-F - MP 18 - BRCPL 28 - MCP 20-21 - BRCP 40 - MRP 28 - MRPO 28 - MRCP 28/D-F - MRP 27 - MPFS 30 - BRCP 28-36 - 0 BCUAG - TQRCP 70/D - ZBAP 60-80 - TQRT 90/A - ZQTP 80/I - ZPL 27-35 - 35-45 BRCU - 40 MZ - 40-50 BRPS - 1 BTCUAG - TRP2L 45 - ZAPL 28 - 00 BT - 0-1-1 1/2 BCAU - 00 MCAU/I - 00 ZLAU - 00-0 BRAU - 00-0 BRAU/SP - 0 BT/A-B-C - 00-0 BRCAU - 00-0 BRCAU/S - 00-0 TQ/C - 45-50 BTRCU - 80 BZ/C - BRPO 28 - BRPL 49 - 00 ZAU/N - 0 BTCAUG - BRPL 37-47 - BRPL 32-42 - DAP 28-38 - BRPS 38-48 - BRPC 27-35 - BRP 38-48 - 1 DQP - 130 QTZ - 1-1 1/2 BRCAU/S - 1-1 1/2 BRCAU - 35 MRPS - 60-80 BZ - 1-1 1/2 BRAU/SP - 1-1 1/2 BRAU - 130 QTZ/D - 2 1/2-3 BTRCAU - 1-1 1/2 BTRCAU - 1 TAUG - DAP 27-35
RC0503	6CS83	SUPPORTO SCALPELLO SX	NARDI	CARRELLATI: 0 BCAUG/A - 35-45 BRCUS/A - 35-45 BRCU/A - 1 BTCAUG/F - 30 ZRCU - 45-50 BTRCU/A - PORTATI: 130 QTZ/E - 40-50 BRPS/A - 35 MRPS/A - BRCP 38-39-48/H - QPRT 140/C - ZCPL 28-38 - 40 MZ/E - QPS 140 U/A - MRCP 28/H - 60-80 BZ/E - MRCPL 28/A - PES 140 U/A - TQP 90 SI - 100 BTZ - BRCPL 38-48/A - BPSC 50-60 - BPG 50 - BP 38/G - DAP 28-38/A - MPSC 28-30/A - BRCPL 38/A - BTRCP 48-52-70/H - BRCPL 48/A - TQRCP 70/H - MRCPL 18/A - MCP2L 18 - TQRT 90/C - BP 38-48/H - ZAP 35-45 - MCPL 15 - TRAINATI: 00-0 BT/F-G - 00 BT/FI-GI - 0 TQR/F-FI - VECCHIA PRODUZIONE: BRCP 38-39-48/D-F-G - BRCP 28-36 - BTRCP 48-70/D-F - BRCPL 38-48 - BP 38-48/D-F - BPSC 38-48 - BPP 40 - MP 18 - MCPL 28 - BTRCP 52/D-E-F - MRCP 28-38 - MCP 20-21 - MP2L 18-20 - MPO 20-21 - MPFS 30 - MPL 14 - MPSC 28-30 - MP 14 - PES 140 U - MRCPL 28 - MRP 27 - MRPO 28 - MRPL 22 - MRPS 28 - MCP 18 - MRCP 28/D-F - QPRT 140 - QPS 140 U - BRCP 40 - BRPL 49 - 0 BCUAG - ZQTP 80/I - ZBAP 60-80 - ZAPL 28 - TRP2L 45 - ZPL 27-35 - 0 BT/A-B-C - TQRCP 70/D - 45-50 BTRCU - 40 MZ - 40-50 BRPS - 00 ZLAU - 00-0 BRCAU - 00 ZAU/N - 00 BT - 00 MCAU/I - DAP 28-38 - 0-1-1 1/2 BCAU - 00-0 BRAU/SP - 00-0 BRAU - 00-0 BRCAU/S - 0 BTCAUG - 00-0 TQ/C - 80 BZ/C - TQRT 90/A - BRPL 37-47 - MRP 28 - 1 BTCUAG - 130 QTZ - BRPL 32-42 - BRPC 27-35 - BRPS 38-48 - BRPO 28 - BRP 38-48 - BRP 37-47 - 130 QTZ/D - 2 1/2-3 BTRCAU - 1-1 1/2 BRCAU/S - 1-1 1/2 BRCAU - 35 MRPS - 35-45 BRCU - 1-1 1/2 BRAU/SP - 1-1 1/2 BRAU - DAP 27-35 - 1-1 1/2 BTRCAU - 1 TAUG - 1 DQP - 60-80 BZ
RC0504	8C83	SUPPORTO SCALPELLO DX	NARDI	CARRELLATI: 30 MRCU/A - 30 MRCUS/A - 2 BTCAUG/F - 50 BRCUS/A - 50 BRCU/A - 35 ZRACU - 0 BRAUG/A - 35 ZRACU - PORTATI: 40 MRPS/A - PESS 150 - MCP 38/H - TQS 150 - BP 58/H - 90 BZ/E - BPSC 70/A - MP 46/H - ZAP 60 - 70 BRPS/A - BTRCPL 80 - BTRCP 80/H - DAP 48/A - BRCP 58/H - BRCPL 38/H - ZCPL 48 - 120 TZ/E - BPSC 50 - MRCPL 38/A - TQRT 150/C - QPRT 150/C - MPG 50 - TRAINATI: 0 BTR/FI-GI - 0 BTR/F-G - VECCHIA PRODUZIONE: MRP 38 - BRPL 55 - MRCP 35-36-37 - BPSC 70 - MRCPL 38 - MRCP 38/D-F - MPFS 40 - TQRT 150/A-B - BP 58/D-F - QPRT 150 - MRPS 38 - MRPL 61 - TQRT 150 - MRPL 32-37-38 - QPRT 150/A-B - MPSC 38 - BRCP 58/D-F-G - MPL 38 - ZBAP 90/A - ZF 45 - 2 BTAUG - ZPL 47 - 0 BRAUG - 00 MRCAU - 120 TZ/D - 00 MRAU - BRPS 58 - 0 ZRAU - 00 MRAU/SP - 120 TZ - 0 BTR - 0 MRCAU/S - DAP 40 - DAP 48 - MCP 38/D-F - 90 BZ - MP 46/D-F - 2 BTCAUG - 2 TAUG - 70 BRPS - 50 BRCU - 90 BZ/C - 40 MRPS - 30 MRCU - BTRCP 80/D-F
RC0505	8CS83	SUPPORTO SCALPELLO SX	NARDI	CARRELLATI: 30 MRCUS/A - 30 MRCU/A - 2 BTCAUG/F - 50 BRCU/A - 0 BRAUG/A - 35 ZRACU - 35 ZRACUI - 50 BRCUS/A - PORTATI: 40 MRPS/A - 90 BZ/E - QPRT 150/C - PESS 150 - BRCP 58/H - BPSC 50 - BP 58/H - ZAP 60 - MCP 38/H - MP 46/H - BTRCPL 80 - BTRCP 80/H - DAP 48/A - BPSC 70/A - ZCPL 48 - MRCP 38/H - MRCPL 38/A - 120 TZ/E - TQS 150 - MPG 50 - 70 BRPS/A - TQRT 150/C - TRAINATI: 0 BTR/FI-GI - 0 BTR/F-G - VECCHIA PRODUZIONE: BRCP 58/D-F-G - MPL 38 - MRP 38 - MRCPL 38 - BPSC 70 - MPSC 38 - MRCP 35-36-37 - MPFS 40 - MRPL 61 - MRPS 38 - TQRT 150/A-B - QPRT 150/A-B - QPRT 150 - BRPS 58 - TQRT 150 - MRCP 38/D-F - MRPL 32-37-38 - 0 BRAUG - ZPL 47 - 120 TZ - 2 BTCAUG - ZBAP 90/A - 0 BTR - ZF 45 - 0 MRCAU/S - 2 BTAUG - 00 MRAU - 00 MRAU/SP - BP 58/D-F - 00 MRCAU - 120 TZ/D - 70 BRPS - 0 ZRAU - MCP 38/D-F - DAP 40 - BTRCP 80/D-F - BRPL 55 - 90 BZ - DAP 48 - MP 46/D-F - 50 BRCU - 90 BZ/C - 30 MRCU - 2 TAUG - 40 MRPS
RC0506	9C83	SUPPORTO SCALPELLO DX	NARDI	CARRELLATI: 45-50 MRCUS - 50 BRRCU/A - 45-50 ZRCUI - 55 BRCU/A - 45-50 ZRCU - 35 MRCUS/A - 35 MRCU/A - 45-50 MRCU - 1 BRCAUG/F - 60-65 BRCUA - 0 MRCAUG - PORTATI: 50-55-65 MRPS - MRCP 47 - MRCPL 48 - 95-100 BRPS/A - BTRP 100-110/A - MRCPL 48/H - MPSC 60-70 - BCP 70/H - BRCPL 80 - BRCP 90/A - BRCP 68-70/H - MCP 48/H - 60 MZ/E - 120-130 BZ/D - 180 BTZ/A - 100 BZ/E - 130 TZ/E - 125 BZ/F - 180 QTZ/E - TRAINATI: 1 BT/F-G - 1 TQR/F-FI - 1 BT/FI-GI - VECCHIA PRODUZIONE: 0-1-1 1/2 MRAU - 0-1-1 1/2 MRAU/S - 2-3 BAU - 0 MRAUG - BRCP 68 - 0-1-1 1/2 MAU - MPSC 58 - 2 1/2 ZUA - BRP 100 - BRCP 90 - BRCP 70/D-F - BCP 70/D-F - 0-1-1 1/2 MRAU/SP - BRP 100/D-F - 180 QTZ - 180 QTZ/A - 2 QPR - MRP 47 - MRPL 47 - 2 BRAU - MRPS 48-58 - 95-100 BRPS - MRPL 42-45 - 2 1/2 ZRAU - MPSC 48 - 0 MAUG - 1 BT/A-B-C-D-E - MRCP 48/D-F - MRCP 48/D - 1 BRAUG - MP2L 42-45 - 2-3 BDAU - 100 BZ/C - 3 TAUG - 1 1/2 MRRAU/S - 50 BRRCU - 100 BZ - 1-2 DBT/A-B - 35 MRCU - 130 TZ - 55-60-65 BRCU - 60 MZ - BP 70/D - 70 BRRCO/B - 80-90 MZ - 120-130 BZ - 130 TZ/D - 2-3 ZB - 80-90 MZ/C - BRPL 80 - MP 48/D - MPL 47 - BRP 70/D - 1 TQR - 2 1/2 BLRAU - DAP 60 - MPP 40 - MPC 47 - BTRP 100-110 - 1-1 1/2 ZRAU - MCP 48/D-F - BS 100 - 2 ZMB - MCPSC 48 - MP 35-40
RC0507	9CS83	SUPPORTO SCALPELLO SX	NARDI	CARRELLATI: 0 MRCAUG - 45-50 ZRCU - 55 BRCU/A - 1 BRCAUG/F - 60-65 BRCUA - 45-50 MRCU - 50 BRRCU/A - 45-50 ZRCUI - 45-50 MRCUS - 35 MRCU/A - 35 MRCUS/A - PORTATI: 125 BZ/F - BRCPL 80 - 130 TZ/E - 60 MZ/E - 95-100 BRPS/A - BTRP 100-110/A - 50-55-65 MRPS - BRCP 90/A - 180 QTZ/E - BCP 70/H - 120-130 BZ/D - MRCP 47 - 180 BTZ/A - MCP 48/H - BRCP 68-70/H - MRCPL 48 - 100 BZ/E - MRCP 48/H - MPSC 60-70 - TRAINATI: 1 TQR/F-FI - 1 BT/F-G - 1 BT/FI-GI - VECCHIA PRODUZIONE: MP 48/D - BP 70/D - BRP 100 - BRCP 68 - BRCP 70/D-F - BRCP 90 - BCP 70/D-F - MPSC 58 - MRPL 42-45 - MP2L 42-45 - MRCP 48/D - 0-1-1 1/2 MRAU - MRCP 48/D-F - MRPL 47 - MRPS 48-58 - MRP 47 - 0 MAUG - 1 BT/A-B-C-D-E - 0 MRAUG - 0-1-1 1/2 MAU - 0-1-1 1/2 MRAU/S - 0-1-1 1/2 MRAU/SP - 1 BRAUG - BRP 100/D-F - 1 TQR - MPSC 48 - 120-130 BZ - 1-1 1/2 ZRAU - 2-3 BDAU - 100 BZ - 100 BZ/C - 130 TZ/D - 60 MZ - 70 BRRCO/B - 130 TZ - 2 QPR - 2 1/2 BLRAU - 180 QTZ - 180 QTZ/A - BRP 70/D - 2 BRAU - 2 ZMB - 2 1/2 ZRAU - 2-3 BAU - 2 1/2 ZUA - 80-90 MZ - 1-2 DBT/A-B - BRPL 80 - BS 100 - BTRP 100-110 - MCP 48/D-F - MPP 40 - MP 35-40 - 80-90 MZ/C - MPL 47 - DAP 60 - MPC 47 - 55-60-65 BRCU - 95-100 BRPS - MCPSC 48 - 35 MRCU - 1 1/2 MRRAU/S - 3 TAUG - 2-3 ZB - 50 BRRCU

Art./Ref.	Rif. Orig./Orig. Ref.	Titolo Prodotto/ Titolo Prodotto	Brand	Applicazione/Application
RC0508	11C83	SUPPORTO SCALPELLO DX	NARDI	CARRELLATI: 70 BRCU - 2 BRAUG/F - 75 BRRCO - PORTATI: BRP 110/A - BTRP 160/A - 121-131 BZ/D - 181 BTZ/A - TRAINATI: 2 TQR/F-FI - 2 BT/F-G - 2 BT/FI-GI - VECCHIA PRODUZIONE: 2 BT/A-B-C-D-E - 121-131 BZ - 2 BAUG - 2 BAUG/F - BRP 110 - 181 BTZ - 3 BRRAU - 3 DTQR - 2 1/2-3 BRAU - 3 QPR - BTRP 160 - 2 BRAUG - 81-91 MZ
RC0510	12C83	SUPPORTO SCALPELLO DX	NARDI	CARRELLATI: 1 MCAUG/F - 55 MRCU - 60 MRCUA - PORTATI: MRPL 80 - MRCP 58-70/H - 135 BRPS/A - BTS 120 - MCP 58-70/H - 120 MZ/D - 95 MPS/A - 100 MZ/C - 180 BZ/A - 125 MZ/D - 140 BZ/D - 70 MRPS - VECCHIA PRODUZIONE: 1 MCAUG - 135 BRPS - 100-120 MZ - MP 58-70/D - ZPL 80 - 2 1/2 DBT/A-B - 60 MRCU - 95 MPS - 140-180 BZ - MCP 58-70/D-F - MRCP 58-70/D-F - 3 DBT/AB
RC0511	12CS83	SUPPORTO SCALPELLO SX	NARDI	CARRELLATI: 1 MCAUG/F - 55 MRCU - 60 MRCUA - PORTATI: BTS 120 - MCP 58-70/H - 125 MZ/D - MRCP 58-70/H - 140 BZ/D - MRPL 80 - 135 BRPS/A - 70 MRPS - 120 MZ/D - 180 BZ/A - 95 MPS/A - 100 MZ/C - VECCHIA PRODUZIONE: 1 MCAUG - 135 BRPS - 100-120 MZ - 3 DBT/AB - 140-180 BZ - 2 1/2 DBT/A-B - MRCP 58-70/D-F - 95 MPS - 60 MRCU - MCP 58-70/D-F - ZPL 80 - MP 58-70/D
RC0512	13C83	SUPPORTO SCALPELLO DX	NARDI	CARRELLATI: 80-90-100 BRRCO/B - 75 BRRCO - 130 BTRRCO - 70 MRRCO/B - 70 MRCU - 65 MRCUA - 3 BRRAUG/A - 2 MRAUG/F - PORTATI: MS 120 - MRP 100/K - BRP 160/A - BRP 120/K - 150 BRPS/B - TRAINATI: 3-4-4 1/2 TQR/F-FI - 2 1/2 -3-4 BT/F-G - 4 BTP - 3 BTR/FI-GI - 3 BTR/F-G - 4 BTP/I - 2 1/2 -3-4 BT/FI-GI - VECCHIA PRODUZIONE: 2 DMIG/A-B - 2 1/2 -3 MRAU - 2 1/2-3 MDAU - 2 MAUG - 2 1/2 BT/A-B-C-D-E - 2 MRAUG - 2 1/2 -3 MAU - 3 BAUG - 2 1/2 BT/A-B-C-D-E - MRP 100/D-F-G-H - 80-90-100 BRRCO - 70 MRRCO - 4-5 QPR - 3 ZM - 3 BT/E - 65 MRCU - 4 BT/A-B - BRP 160 - MRP 90 - 3 BRRAUG - 150 BRPS - MRP 90/G - BRP 120/D-E-F-H
RC0514	17C83	SUPPORTO SCALPELLO DX	NARDI	CARRELLATI: 3 MRAUG - 90 MRRCO/B - 80 MRRCO/B - PORTATI: 150 MRPS/A - MRP 130/K - TRAINATI: 4 BTR/H - 5 BTR/GI 1 - 4 BTR/BI 1 - 5 BTR/G - 5 BTR/F - 4 BTR/BI 2 - 4 BTR/BI 3 - 5 BTR/FI - 4 BTR/F - 70 DMR/I 1 - 5 BTR/GI 3 - 70 DMR/I 2 - 5 BTR/GI 2 - 4 BTR/G - 4 BTR/GI - 4 BTR/FI - 70 DMR

SUPPORTI SCALPELLO CON COLTRI DAL BASSO ADATTABILI ALLA PRODUZIONE NARDI

SUPPORT CISEAU AVEC COUTRES ADAPTABLE TYPE NARDI
 SUPPORT W/LANDSIDE COULTER POINT FOR NARDI LINE
 NEIBELSTÜTZE MIT ANLAGENSECH PASSEND FÜR NARDI
 SOPORTE ESCOPLLO PARA PRODUCCIÓN NARDI



Art./Ref.	Rif. Orig./Orig. Ref.	Titolo Prodotto/Titolo Prodotto	Brand	Applicazione/Application
RC0896	5C86	SUPPORTO CON COLTRE DX	NARDI	CARRELLATI: 35 BTRCU/A - 30 BRCU/A - 30 BRCUS/A - PORTATI: PERT 130/C - 60-90 BTZ/E - BP 28/H - 35 BRPS/A - BRCP 28/H - BTP 60 SI - BRCP 28/A - BTP 28-38 G - BRP 26/V - BPSC 28-30/A - 120 QTZ/E - 40-50 BZ/E - BTRCP 28/H - EEP 130 FS - DAP 18/A - TQP 80 SI - TQRCP 60/C - TQRCP 48/H - TQRT 80/C - QPRT 130/C - TQRT 60/L - VECCHIA PRODUZIONE: DAP 18 - BPSC 28-30 - BP 28/D-F - BTRCPL 38-48/A - PQP 80/C - BRCP 28/D-F-G - BLCPC 28 - OTP 80/C - TBP 80/C - BTRCP 38 - PERT 130/A - BTRCP 28/D-F - PERT 130 - QPRT 130/A - TQRT 80/A-B - 0 QT/A - TQRCP 48/D-F - 120 QTZ/A-D - TQRT 80 - Z 14 - 00-0 BTRCAU/S - BRCP 28 - 0 BT/A - ZBAP 39-48-50 - 0 PQ/A - 40-50 BZ - 00-0 BTRCAU - TQPRT 60 - 120 QTZ - BRPS 28 - BTRCP 28-38/D - 35 BRPS - BRPO 28 - 3 PFS 30 - 30 BRCU - 60-90 BTZ - 35 BTRCU
RC0897	5CS86	SUPPORTO CON COLTRE SX	NARDI	CARRELLATI: 35 BTRCU/A - 30 BRCU/A - 30 BRCUS/A - PORTATI: BPSC 28-30/A - 40-50 BZ/E - 60-90 BTZ/E - 35 BRPS/A - 120 QTZ/E - BTP 28-38 G - BRCP 28/H - TQP 80 SI - BTP 60 SI - BP 28/H - BRP 26/V - BRCP 28/A - QPRT 130/C - TQRT 80/C - EEP 130 FS - PERT 130/C - TQRCP 48/H - BTRCP 28/H - DAP 18/A - TQRT 60/L - TQRCP 60/C - VECCHIA PRODUZIONE: BTRCPL 38-48/A - BPSC 28-30 - DAP 18 - PERT 130 - BLCPC 28 - BTRCP 28/D-F - PQP 80/C - BTRCP 38 - BP 28/D-F - BTRCP 28-38/D - QPRT 130/A - PERT 130/A - TBP 80/C - BRCP 28/D-F-G - OTP 80/C - 120 QTZ - 00-0 BTRCAU/S - 00-0 BTRCAU - Z 14 - TQRCP 48/D-F - 0 QT/A - 0 PQ/A - BRCP 28 - 0 BT/A - ZBAP 39-48-50 - TQRT 80 - TQRT 80/A-B - 30 BRCU - TQPRT 60 - BRPO 28 - BRPS 28 - 3 PFS 30 - 35 BRPS - 120 QTZ/A-D - 35 BTRCU - 40-50 BZ - 60-90 BTZ

Art./Ref.	Rif. Orig./Orig. Ref.	Titolo Prodotto/Titolo Prodotto	Brand	Applicazione/Application
RC0898	6C86	SUPPORTO CON COLTRE DX	NARDI	<p>CARRELLATI: 0 BCAUG/A - 30 ZRCU - 35-45 BRCU/A - 35-45 BRCUS/A - 45-50 BTRCU/A - 1 BTCAUG/F - PORTATI: 35 MRPS/A - MCP2L 18 - 100 BTZ - PES 140 U/A - 130 QTZ/E - 60-80 BZ/E - TQP 90 SI - 40 MZ/E - QPS 140 U/A - MPSC 28-30/A - MCPL 15 - BTRCP 48-52-70/H - BRCPL 48/A - BRCP 38-39-48/H - MCP 18/A - MRCPL 28/A - MRCP 28/H - BRCPL 38-48/A - BP 38/G - BRCPL 38/A - BPSC 50-60 - BPG 50 - BP 38-48/H - QPRT 140/C - DAP 28-38/A - TQRT 90/C - TQRCP 70/H - ZCPL 28-38 - ZAP 35-45 - 40-50 BRPS/A - TRAINATI: 00-0 BT/FI-GI - 00-0 BT/F-G - 0 TQR/F-FI - VECCHIA PRODUZIONE: 00-0 BRCU/S - MCP 18 - BRCP 38-39-48/D-F-G - MRP 28 - MRPL 22 - MRCP 28-38 - MPO 20-21 - MRP 27 - 00-0 BRCU - BRCP 40 - BRCP 27-35 - 00-0 TQ/C - ZAP 28 - 00 MCAU/I - BRCP 28-36 - 00-0 BRAU/SP - BRCPL 38-48 - MRCPL 28 - MRPO 28 - 0-1-1 1/2 BCAU - MP 18 - MP 14 - MCPL 28 - MCP 20-21 - MPL 14 - 00 BT - BP 38-48/D-F - MRCP 28/D-F - QPS 140 U - MPSC 28-30 - MRPS 28 - 00 ZLAU - QPRT 140 - PES 140 U - 00-0 BRAU - MP2L 18-20 - MPFS 30 - 1-1 1/2 BRAU/SP - 1-1 1/2 BRCU/S - 1-1 1/2 BRCU - 35 MRPS - 1-1 1/2 BRAU - 1 TAUG - 2 1/2 - 3 BTCAU - ZBAP 60-80 - 1-1 1/2 BTRCAU - 60-80 BZ - ZQTP 80/I - 40-50 BRPS - BPP 40 - 40 MZ - 35-45 BRCU - 45-50 BTRCU - 80 BZ/C - ZPL 27-35 - 0 BT/A-B-C - TQRCP 70/D - 0 BCAUG - BTRCP 52/D-E-F - 00 ZAU/N - DAP 28-38 - 1 BTCUAG - BTRCP 48-70/D-F - TQRT 90/A - BPSC 38-48 - TRP2L 45 - 130 QTZ/D - BRPS 38-48 - DAP 27-35 - BRPO 28 - BRPL 49 - 1 DQP - 130 QTZ - BRPL 37-47 - 0 BTCAUG - BRP 37-47 - BRPL 32-42 - BRP 38-48</p>
RC0899	6CS86	SUPPORTO CON COLTRE SX	NARDI	<p>CARRELLATI: 1 BTCAUG/F - 0 BCAUG/A - 35-45 BRCU/A - 35-45 BRCUS/A - 45-50 BTRCU/A - 30 ZRCU - PORTATI: QPRT 140/C - TQP 90 SI - BPSC 50-60 - 100 BTZ - ZCPL 28-38 - BRCP 38-39-48/H - MRCPL 28/A - QPS 140 U/A - PES 140 U/A - 130 QTZ/E - MRCP 28/H - 35 MRPS/A - 40-50 BRPS/A - 60-80 BZ/E - 40 MZ/E - BRCPL 38-48/A - DAP 28-38/A - BRCPL 38/A - BP 38-48/H - BTRCP 48-52-70/H - BRCPL 48/A - MCPL 15 - BPG 50 - MCP 18/A - BP 38/G - MPSC 28-30/A - TQRCP 70/H - MCP2L 18 - TQRT 90/C - ZAP 35-45 - TRAINATI: 0 TQR/F-FI - 00-0 BT/FI-GI - 00-0 BT/F-G - VECCHIA PRODUZIONE: BTRCP 48-70/D-F - BRCP 28-36 - BRCP 27-35 - BP 38-48/D-F - BPSC 38-48 - BRCP 40 - BPP 40 - BRCPL 38-48 - MCP 20-21 - MP 18 - MP 14 - MP2L 18-20 - MCPL 28 - MPSC 28-30 - MPO 20-21 - BTRCP 52/D-E-F - MPFS 30 - MPL 14 - PES 140 U - MRCP 28-38 - MRCP 28/D-F - MRCPL 28 - MRPL 22 - MRP 28 - MRPO 28 - MRPS 28 - QPRT 140 - MCP 18 - QPS 140 U - BRCPL 38-39-48/D-F-G - 00-0 TQ/C - ZBAP 60-80 - ZAPL 28 - TQRCP 70/D - TQRT 90/A - ZQTP 80/I - 0 BCAUG - 40-50 BRPS - 35-45 BRCU - 40 MZ - ZPL 27-35 - TRP2L 45 - DAP 28-38 - 0-1-1 1/2 BCAU - 00 BT - 00 ZAU/N - 00 MCAU/I - 0 BTCAUG - 00 ZLAU - 00-0 BRAU/SP - 00-0 BRCU - 00-0 BRCU/S - 00-0 BRAU - 80 BZ/C - 0 BT/A-B-C - BRPL 49 - BRPL 37-47 - MRP 27 - 130 QTZ - BRPL 32-42 - BRP 37-47 - 60-80 BZ - DAP 27-35 - BRPS 38-48 - BRPO 28 - 130 QTZ/D - BRP 38-48 - 1-1 1/2 BRCU - 1-1 1/2 BRAU/SP - 35 MRPS - 2 1/2 - 3 BTCAU - 1-1 1/2 BRAU - 45-50 BTRCU - 1-1 1/2 BRCU/S - 1 DQP - 1 BTCUAG - 1 TAUG - 1-1 1/2 BTRCAU</p>
RC0900	8C86	SUPPORTO CON COLTRE DX	NARDI	<p>CARRELLATI: 30 MRCU/A - 35 ZRACUI - 0 BRAUG/A - 50 BRCU/A - 35 ZRACU - 2 BTCAUG/F - 50 BRCU/A - 30 MRCU/A - PORTATI: BTRCPL 80 - TQS 150 - BTRCP 80/H - 40 MRPS/A - MRCP 38/H - 90 BZ/E - MP 46/H - QPRT 150/C - MPG 50 - MRCPL 38/A - BRCP 58/H - BPSC 70/A - MCP 38/H - BPSC 50 - BP 58/H - TQRT 150/C - DAP 48/A - PESS 150 - ZAP 60 - ZCPL 48 - 70 BRPS/A - 120 TZ/E - TRAINATI: 0 BTR/FI-GI - 0 BTR/F-G - VECCHIA PRODUZIONE: QPRT 150/A-B - 120 TZ/D - MPFS 40 - BRCP 58/D-F-G - QPRT 150 - 0 ZRAU - BP 58/D-F - MRPL 61 - MRPS 38 - MRP 38 - MRCPL 38 - 00 MRAU/SP - TQRT 150/A-B - 90 BZ/C - 0 MRCU/S - MRCP 38/D-F - MPSC 38 - MPL 38 - 00 MRAU - MRCP 35-36-37 - MRPL 32-37-38 - TQRT 150 - 0 BTR - 0 BRAUG - 2 BTCAUG - DAP 40 - ZPL 47 - 50 BRCU - 70 BRPS - BRPL 55 - 40 MRPS - 30 MRCU - 2 TAUG - ZF 45 - 90 BZ - ZBAP 90/A - 00 MRCU - BPSC 70 - DAP 48 - BRPS 58 - 120 TZ - 2 BTAUG - MP 46/D-F - MCP 38/D-F - BTRCP 80/D-F</p>
RC0901	8CS86	SUPPORTO CON COLTRE SX	NARDI	<p>CARRELLATI: 35 ZRACU - 50 BRCU/A - 35 ZRACUI - 2 BTCAUG/F - 30 MRCU/A - 0 BRAUG/A - 50 BRCU/A - 30 MRCU/A - PORTATI: BTRCP 80/H - BTRCPL 80 - 90 BZ/E - 40 MRPS/A - BRCP 58/H - QPRT 150/C - PESS 150 - MPG 50 - MRCPL 38/A - BRCPL 38/A - BPSC 70/A - BPSC 50 - MP 46/H - MCP 38/H - BP 58/H - TQRT 150/C - DAP 48/A - TQS 150 - ZCPL 48 - ZAP 60 - 70 BRPS/A - 120 TZ/E - TRAINATI: 0 BTR/FI-GI - 0 BTR/F-G - VECCHIA PRODUZIONE: QPRT 150 - TQRT 150/A-B - 00 MRCU - MRPL 61 - MRPS 38 - MPFS 40 - BRPS 58 - 2 BTAUG - BRCP 58/D-F - TQRT 150 - MRP 38 - MRCPL 38/D-F - 00 MRAU - MRCPL 38 - 00 MRAU/SP - 0 ZRAU - MPL 38 - MRPL 32-37-38 - QPRT 150/A-B - MRCP 35-36-37 - MPSC 38 - 120 TZ/D - 120 TZ - 40 MRPS - 2 BTCAUG - 0 BTR - ZF 45 - 70 BRPS - 2 TAUG - BPSC 70 - 90 BZ/C - 90 BZ - 30 MRCU - DAP 48 - 50 BRCU - BRPL 55 - BP 58/D-F - 0 MRCU/S - DAP 40 - BTRCP 80/D-F - ZPL 47 - 0 BRAUG - MP 46/D-F - MCP 38/D-F - ZBAP 90/A</p>
RC0902	9C86	SUPPORTO CON COLTRE DX	NARDI	<p>CARRELLATI: 35 MRCU/A - 50 BRRCU/A - 35 MRCUS/A - 45-50 MRCU - 45-50 ZRCU - 45-50 MRCUS - 55 BRCU/A - 60-65 BRCU/A - 45-50 ZRCUI - 1 BRCAUG/F - 0 MRCAUG - PORTATI: 50-55-65 MRPS - 95-100 BRPS/A - BRCP 90/A - MPSC 60-70 - MRCPL 48 - 60 MZ/E - MRCP 47 - BRCPL 80 - MCP 48/H - BRCP 68-70/H - BCP 70/H - BTRP 100-110/A - MRCPL 48/H - 180 QTZ/E - 120-130 BZ/D - 125 BZ/F - 100 BZ/E - 130 TZ/E - 180 BTZ/A - TRAINATI: 1 TQR/F-FI - 1 BT/FI-GI - 1 BT/F-G - VECCHIA PRODUZIONE: MPS 58 - MPP 40 - 0-1-1 1/2 MAU - 0-1-1 1/2 MRAU - 0 MRAUG - 180 QTZ - 2 1/2 BLRAU - 130 TZ/D - 2 1/2 ZRAU - BP 70/D - BRCP 70/D-F - BRCP 90 - BRP 100 - BRP 100/D-F - 0 MAUG - 0-1-1 1/2 MRAU/S - 2 BRAU - MRPS 48-58 - MP2L 42-45 - 180 QTZ/A - MPSC 48 - 80-90 MZ/C - MRPL 42-45 - 1 BRAUG - MRP 47 - 0-1-1 1/2 MRAU/SP - 1 BT/A-B-C-D-E - BRCP 68 - MRPL 47 - MRCP 48/D-F - MRCP 48/D - 3 TAUG - 35 MRCU - 100 BZ - 2-3 ZB - 2-3 BAU - 1 1/2 MRRAU/S - 50 BRRCU - 100 BZ/C - 95-100 BRPS - 60 MZ - 2 1/2 ZUA - 130 TZ - 55-60-65 BRCU - 70 BRRCO/B - 1 TQR - 80-90 MZ - 1-2 DBT/A-B - 120-130 BZ - MPC 47 - MPL 47 - MCPSC 48 - MP 48/D - BRP 70/D - BRPL 80 - 1-1 1/2 ZRAU - 2 ZMB - MP 35-40 - MCP 48/D-F - DAP 60 - 2-3 BDAU - 2 QPR - BTRP 100-110 - BS 100 - BCP 70/D-F</p>

Art./Ref.	Rif. Orig./Orig. Ref.	Titolo Prodotto/Titolo Prodotto	Brand	Applicazione/Application
RC0903	9CS86	SUPPORTO CON COLTRE SX	NARDI	CARRELLATI: 0 MRCAUG - 35 MRCUS/A - 60-65 BRCUA - 50 BRRCO/A - 45-50 MRCU - 35 MRCU/A - 45-50 ZRCU - 55 BRCU/A - 45-50 ZRCUI - 45-50 MRCUS - 1 BRCAUG/F - PORTATI: 95-100 BRPS/A - 60 MZ/E - BRCP 68-70/H - 100 BZ/E - BCP 70/H - MCP 48/H - BTRP 100-110/A - BRCP 90/A - BRCLP 80 - 50-55-65 MRPS - MRCP 47 - MPSC 60-70 - 180 BTZ/A - 180 QTZ/E - MRCP 48/H - 130 TZ/E - 125 BZ/F - 120-130 BZ/D - MRCPL 48 - TRAINATI: 1 BT/FI-GI - 1 TQR/F-FI - 1 BT/F-G - VECCHIA PRODUZIONE: MRP 47 - BRCP 90 - BRP 100/D-F - BCP 70/D-F - BRP 70/D - BRPL 80 - BP 70/D - MP 35-40 - MRPS 48-58 - BRP 100 - MRCP 48/D-F - 1 BRAUG - 0-1-1 1/2 MRAU - 0 MRAUG - 0 MAUG - 0-1-1 1/2 MRAU/SP - 1 BT/A-B-C-D-E - MRP2L 42-45 - BRCP 70/D-F - MPS 58 - MPSC 48 - MPP 40 - MP2L 42-45 - 0-1-1 1/2 MRAU/S - MRCP 48/D - MRPL 47 - 0-1-1 1/2 MAU - 1-1 1/2 ZRAU - 1-2 DBT/A-B - 130 TZ - 1 1/2 MRRAU/S - 100 BZ - 2-3 BDAU - 2-3 BAU - 120-130 BZ - 130 TZ/D - 2 ZMB - 180 QTZ - 180 QTZ/A - MP 48/D - 2 BRAU - 2 QPR - 2 1/2 BLRAU - 2 1/2 ZRAU - 2 1/2 ZUA - 60 MZ - 100 BZ/C - 55-60-65 BRCU - DAP 60 - BRCP 68 - BTRP 100-110 - BS 100 - MPC 47 - MPL 47 - MCPSC 48 - 50 BRRCO - MCP 48/D-F - 95-100 BRPS - 70 BRRCO/B - 80-90 MZ - 1 TQR - 80-90 MZ/C - 3 TAUG - 35 MRCU - 2-3 ZB
RC0904	11C86	SUPPORTO CON COLTRE DX	NARDI	CARRELLATI: 75 BRRCO - 70 BRCU - 2 BRAUG/F - PORTATI: BTRP 160/A - BRP 110/A - 181 BTZ/A - 121-131 BZ/D - TRAINATI: 2 TQR/F-FI - 2 BT/FI-GI - 2 BT/F-G - VECCHIA PRODUZIONE: 2 1/2-3 BRAU - 2 BAUG/F - 2 BAUG - 81-91 MZ - 3 BRRAU - 121-131 BZ - 2 BRAUG - 3 DTQR - BRP 110 - 181 BTZ - 3 QPR - 2 BT/A-B-C-D-E - BTRP 160
RC0906	12C86	SUPPORTO CON COLTRE DX	NARDI	CARRELLATI: 55 MRCU - 60 MRCUA - 1 MCAUG/F - PORTATI: 100 MZ/C - MRPL 80 - MCP 58-70/H - MRCP 58-70/H - 70 MRPS - 120 MZ/D - 125 MZ/D - 135 BRPS/A - 95 MPS/A - 140 BZ/D - BTS 120 - 180 BZ/A - VECCHIA PRODUZIONE: 1 MCAUG - 100-120 MZ - ZPL 80 - MCP 58-70/D-F - 3 DBT/AB - 140-180 BZ - 2 1/2 DBT/A-B - 135 BRPS - MRCP 58-70/D-F - 95 MPS - MP 58-70/D - 60 MRCU
RC0907	12CS86	SUPPORTO CON COLTRE SX	NARDI	CARRELLATI: 55 MRCU - 1 MCAUG/F - 60 MRCUA - PORTATI: MRPL 80 - MCP 58-70/H - 125 MZ/D - MRCP 58-70/H - BTS 120 - 120 MZ/D - 100 MZ/C - 140 BZ/D - 180 BZ/A - 135 BRPS/A - 95 MPS/A - 70 MRPS - VECCHIA PRODUZIONE: 100-120 MZ - 1 MCAUG - 2 1/2 DBT/A-B - ZPL 80 - 140-180 BZ - 3 DBT/AB - MP 58-70/D - MCP 58-70/D-F - 95 MPS - MRCP 58-70/D-F - 60 MRCU - 135 BRPS
RC0908	13C86	SUPPORTO CON COLTRE DX	NARDI	CARRELLATI: 2 RAUG/F - 3 BRRAUG/A - 75 BRRCO - 70 MRRCO/B - 65 MRCUA - 70 MRCU - 130 BTRCO - 80-90-100 BRRCO/B - PORTATI: MS 120 - BRP 120/K - BRP 160/A - MRP 100/K - 150 BRPS/B - TRAINATI: 2 1/2 - 3-4 BT/F-G - 2 1/2 - 3-4 BT/FI-GI - 3 BTR/F-G - 3-4-4 1/2 TQR/F-FI - 3 BTR/FI-GI - 4 BTP - 4 BTP/I - VECCHIA PRODUZIONE: 150 BRPS - BRP 120/D-E-F-H - 2 MAUG - 2 1/2 - 3 MDAU - 2 DMIG/A-B - 2 1/2 - 3 MAU - 2 1/2 - 3 MRAU - 2 MRAUG - 4 BT/A-B - 4-5 QPR - 80-90-100 BRRCO - 3 BT/E - 3 BRRAUG - 3 ZM - 70 MRRCO - 65 MRCU - MRP 90/G - MRP 100/D-F-G-H - MRP 90 - 2 1/2 BT/A-B-C-D-E - 3 BAUG - BRP 160

VERSOI ADATTABILI ALLA PRODUZIONE NARDI

VERSOIRS ADAPTABLE TYPE NARDI

MOULD BOARD FOR NARDI LINE

STREICHBLECHE PASSEND FÜR NARDI

OREJAS PARA PRODUCCIÓN NARDI

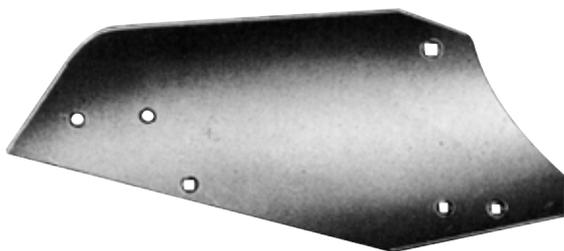

Art./Ref.	Rif. Orig./Orig. Ref.	Titolo Prodotto/Titolo Prodotto	Brand	Applicazione/Application
RC0430	1C173	VERSOIO DX	NARDI	ATTREZZATURE DA VIGNETO: VR 20 - PR 20 - QR 20 - TR 20 - MOTOCOLTIVATORI: BR 13 - TR 13 - TR 15 - VR 13 - 3 VR 15 - VECCHIA PRODUZIONE: VR 1 - QR 18 - VR 10 - PR 18 - VR 18 - HR 20 - TR 18
RC0431	1CS173	VERSOIO SX	NARDI	ATTREZZATURE DA VIGNETO: VR 20 - TR 20 - PR 20 - QR 20 - MOTOCOLTIVATORI: BR 13 - 3 VR 15 - TR 15 - VR 13 - TR 13 - VECCHIA PRODUZIONE: HR 20 - TR 18 - QR 18 - PR 18 - VR 10 - VR 1 - VR 18
RC0432	2C173	VERSOIO DX	NARDI	ATTREZZATURE DA VIGNETO: PR 21-3 - TR 21-30 - VR 21 - PRR 30 - TRR 30 - QR 21-30 - QM 30 - QRR 30 - VM 30 - PORTATI: QL 38/F - PRRP 48 - VECCHIA PRODUZIONE: VR 30 - VR 40 - HR 3 - VR 10-16 - VC 30 - PRP 48 - 1 ETR - TR 40 - HRR 30 - 0 PER - VRR 30
RC0433	2CS173	VERSOIO SX	NARDI	ATTREZZATURE DA VIGNETO: QRR 30 - PR 21-3 - QR 21-30 - PRR 30 - VR 21 - TR 21-30 - QM 30 - TRR 30 - VM 30 - PORTATI: QL 38/F - PRRP 48 - VECCHIA PRODUZIONE: 1 ETR - VR 40 - VC 30 - TR 40 - VR 10-16 - VR 30 - 0 PER - VRR 30 - PRP 48 - HRR 30 - HR 3

Art./Ref.	Rif. Orig./Orig. Ref.	Titolo Prodotto/ Titolo Prodotto	Brand	Applicazione/Application
RC0433A	3C173	VERSOIO DX	NARDI	ATTREZZATURE DA VIGNETO: TR 31 - 5 HRR 33 - QRR 31 - PRR 31 - 7 HRR 31 - QR 31 - PR 31 - VRR 31 - VR 33 - 7 HRR 33 - TRR 31 - 5 HRR 31 - VRR 33 - VR 31 - MOTOCOLTIVATORI: M 7 - A 25 - BPH 17 - A 30/A - BP 13 - A 40 - PORTATI: PRRP 48
RC0433B	3CS173	VERSOIO SX	NARDI	ATTREZZATURE DA VIGNETO: QRR 31 - 5 HRR 33 - QR 31 - TRR 31 - 7 HRR 31 - PR 31 - PRR 31 - 5 HRR 31 - VR 33 - VRR 31 - 7 HRR 33 - VR 31 - TR 31 - VRR 33 - MOTOCOLTIVATORI: A 40 - BPH 17 - A 30/A - A 25 - BP 13 - M 7 - PORTATI: PRRP 48
RC0433C	3C173A	VERSOIO DX	NARDI	ATTREZZATURE DA VIGNETO: QC 51 - QR 51 - MC 61 - TC 61 - QC 61 - TR 51 - VR 51 - BC 61 - TC 51
RC0433D	3CS173A	VERSOIO SX	NARDI	ATTREZZATURE DA VIGNETO: BC 61 - MC 61 - QC 51 - QC 61 - VR 51 - TC 61 - TR 51 - QR 51 - TC 51
RC0428B	6C161B	VERSOIO DX	NARDI	CARRELLATI: 30 BRCU/A - 44 BTRCU - 30 BRCUS/A - PORTATI: 123 TQZS/A - TQRT 80/C - 103 BTZS/A - TQRAT 80 - TQRT 70/B - 103 BTZS/A - 120 QTZ/E - SC5,5 - SC5 - BTP 60 SI/A - QPRT 130/C - BP 36 G - BTRCP 39/A - 50 BZ/E - 68 BZS/A - 90 BTZ/E - TQRAT 70/A
RC0429B	6CS161B	VERSOIO SX	NARDI	CARRELLATI: 44 BTRCU - 30 BRCU/A - 30 BRCUS/A - PORTATI: 90 BTZ/E - SC5,5 - TQRAT 70/A - SC5 - 68 BZS/A - 50 BZ/E - BP 36 G - TQRT 70/B - 103 BTZS/A - BTP 60 SI/A - 103 BTZS/A - 120 QTZ/E - TQRT 80/C - 123 TQZS/A - QPRT 130/C - BTRCP 39/A - TQRAT 80
RC0434	7C162	VERSOIO DX	NARDI	CARRELLATI: 30 ZRCU - 45 BRCU/A - 0 BCUAG/A - 45 BRCUS/A - PORTATI: MPSC 30/A - 110 BTZS - 130 QTZ/E - DAP 38/A - QPS 140 U/A - QPRT 140/C - 100 BTZ - MRCP 28/H - BRCPL 48/A - BRCP 48/H - BTRCP 52-70/H - BPSC 60 - BP 48/H - 35 MRPS/A - MRCPL 28/A - ZCPL 38 - TQP 90 SI - 60-80 BZ/E - 40 MZ/E - 50 BRPS/A - TQRT 90/C - ZAP 45 - PES 140 U/A - 80 BZS/A - 60 BZS - TRAINATI: 0 BT/FI-GI - 0 BT/F-G - 0 TQR/F-FI - VECCHIA PRODUZIONE: TQRT 90 - 0 BCAUG - 0 BT/A-B-C-D - ZAPL 38 - ZBAP 60 - BRPS 48 - QPRT 140/A-B - QPS 140 - ZF 32 - PES 140 - 1-1 1/2 BRCU/S - 1-1 1/2 BRAU/SL - 1-1 1/2 BRCU - MRPS 28 - TQRT 90/A - 1-1 1/2 BAU - 1-1 1/2 BRAU - QPRT 140 - 0 BAUG - BPSC 48 - MPL 28 - MPFS 30 - 50 BRPS - MPSC 30 - MCPL 28 - DAP 38 - DAP 35 - 60-80 BZ - 130 QTZ/A-D - 40 MZ - BRCPL 48 - 2 TRAU - 45 BRCU - 2 1/2 - 3 TRAU - 2 1/2 - 3 BTRCAU - MRCP 27-28 - 80 BZ/C - BP 48/D-F - BRP 40-47 - BCPP 40 - 130 QTZ - BRPC 40-48 - BRCP 48/D-F-G - MRPL 27 - 35 MRPS - MRP 27 - MRPO 28 - BPP 40 - MRCPL 28 - MRCP 28/D-F - BTRCP 52/D-E-F - BTRCP 70/D-F
RC0435	7CS162	VERSOIO SX	NARDI	CARRELLATI: 30 ZRCU - 45 BRCUS/A - 45 BRCU/A - 0 BCUAG/A - PORTATI: PES 140 U/A - 60 BZS - 80 BZS/A - QPRT 140/C - ZCPL 38 - MPSC 30/A - 50 BRPS/A - BRCP 48/H - MRCP 28/H - TQP 90 SI - 100 BTZ - QPS 140 U/A - MRCPL 28/A - 110 BTZS - TQRT 90/C - 130 QTZ/E - 40 MZ/E - 35 MRPS/A - BTRCP 52-70/H - BP 48/H - 60-80 BZ/E - ZAP 45 - BPSC 60 - BRCPL 48/A - DAP 38/A - TRAINATI: 0 BT/F-G - 0 BT/FI-GI - 0 TQR/F-FI - VECCHIA PRODUZIONE: 60-80 BZ - 80 BZ/C - 45 BRCU - 1-1 1/2 BRAU - 1-1 1/2 BAU - ZF 32 - 130 QTZ/A-D - 1-1 1/2 BRCU - 0 BT/A-B-C-D - 1-1 1/2 BRAU/SL - 1-1 1/2 BRCU/S - TQRT 90/A - ZBAP 60 - 40 MZ - 0 BAUG - 0 BCAUG - ZAPL 38 - 50 BRPS - MRCP 27-28 - BPSC 48 - BRPC 40-48 - BRPS 48 - BPP 40 - BP 48/D-F - BRP 40-47 - BRCP 48/D-F-G - MCPL 28 - MPFS 30 - DAP 35 - 2 1/2 - 3 TRAU - BTRCP 70/D-F - BTRCP 52/D-E-F - 130 QTZ - DAP 38 - BRCPL 48 - MPL 28 - BCPP 40 - MRP 27 - MRPL 27 - 2 1/2 - 3 BTRCAU - 35 MRPS - MPSC 30 - 2 TRAU - MRCPL 28 - MRPO 28 - QPRT 140 - QPRT 140/A-B - TQRT 90 - QPS 140 - MRPS 28 - MRCP 28/D-F - PES 140
RC0434B	7C162B	VERSOIO DX	NARDI	CARRELLATI: 0 BCUAG/A - 45 BRCUS/A - 45 BRCU/A - 30 ZRCU - PORTATI: TQRT 90/C - 60 BZS - QPS 140 U/A - QPRT 140/C - ZCPL 38 - MPSC 30/A - TQP 90 SI - MRCP 28/H - 80 BZS/A - 35 MRPS/A - 130 QTZ/E - MRCPL 28/A - 40 MZ/E - 60-80 BZ/E - 50 BRPS/A - 110 BTZS - BRCP 48/H - 100 BTZ - DAP 38/A - PES 140 U/A - ZAP 45 - BP 48/H - BPSC 60 - BRCPL 48/A - BTRCP 52-70/H - TRAINATI: 0 BT/F-G - 0 TQR/F-FI - 0 BT/FI-GI - VECCHIA PRODUZIONE: 1-1 1/2 BRAU - TQRT 90/A - 2 1/2 - 3 BTRCAU - 1-1 1/2 BAU - 1-1 1/2 BRCU - 80 BZ/C - 50 BRPS - 0 BAUG - 0 BCAUG - 0 BT/A-B-C-D - ZF 32 - ZAPL 38 - 130 QTZ/A-D - 60-80 BZ - 130 QTZ - ZBAP 60 - 1-1 1/2 BRCU/S - 1-1 1/2 BRAU/SL - BRCP 48/D-F-G - BP 48/D-F - MCPL 28 - BRCPL 48 - BCPP 40 - QPRT 140 - QPRT 140/A-B - BPP 40 - DAP 38 - BTRCP 52/D-E-F - BRPC 40-48 - 2 TRAU - BRPS 48 - BTRCP 70/D-F - DAP 35 - BRP 40-47 - PES 140 - BPSC 48 - MPFS 30 - MRCPL 28 - MRP 27 - 45 BRCU - 35 MRPS - MRPS 28 - 40 MZ - MRCP 28/D-F - 2 1/2 - 3 TRAU - TQRT 90 - QPS 140 - MRPL 27 - MRPO 28 - MPSC 30 - MPL 28 - MRCP 27-28
RC0435B	7CS162B	VERSOIO SX	NARDI	CARRELLATI: 45 BRCU/A - 45 BRCUS/A - 0 BCUAG/A - 30 ZRCU - PORTATI: QPS 140 U/A - TQP 90 SI - 110 BTZS - MRCP 28/H - PES 140 U/A - MPSC 30/A - QPRT 140/C - MRCPL 28/A - BRCP 48/H - BTRCP 52-70/H - ZCPL 38 - TQRT 90/C - DAP 38/A - BRCPL 48/A - BP 48/H - 100 BTZ - ZAP 45 - BPSC 60 - 60 BZS - 50 BRPS/A - 60-80 BZ/E - 80 BZS/A - 40 MZ/E - 130 QTZ/E - 35 MRPS/A - TRAINATI: 0 TQR/F-FI - 0 BT/FI-GI - 0 BT/F-G - VECCHIA PRODUZIONE: BRPC 40-48 - 0 BCAUG - 130 QTZ/A-D - BTRCP 70/D-F - 0 BAUG - BRPS 48 - TQRT 90 - ZBAP 60 - MRPS 28 - ZF 32 - ZAPL 38 - 1-1 1/2 BAU - 1-1 1/2 BRAU - TQRT 90/A - 35 MRPS - MRCPL 28 - 1-1 1/2 BRAU/SL - 1-1 1/2 BRCU/S - 2 1/2 - 3 TRAU - DAP 38 - 0 BT/A-B-C-D - 1-1 1/2 BRCU - 2 TRAU - BTRCP 52/D-E-F - MRPO 28 - MRPL 27 - DAP 35 - QPS 140 - QPRT 140 - QPRT 140/A-B - 45 BRCU - MPSC 30 - MRP 27 - 80 BZ/C - MRCP 28/D-F - MRCP 27-28 - MPL 28 - 130 QTZ - 50 BRPS - 60-80 BZ - BCPP 40 - 2 1/2 - 3 BTRCAU - PES 140 - BRP 40-47 - BPP 40 - BP 48/D-F - BPSC 48 - MPFS 30 - 40 MZ - MCPL 28 - BRCP 48/D-F-G - BRCPL 48
RC0436	5C163	VERSOIO DX	NARDI	CARRELLATI: 35 BTCU/A - PORTATI: BTP 28 G - 35 BRPS/A - BRP 25/V - TQRT 60 L - BPSC 28-30/A - BRCP 28/H - BP 28/H - BRCPL 28/A - BTRCP 28/H - 40 BZE - TQRT 60/C - 60 BTZ/E - TQRCP 48/H - DAP 18/A - VECCHIA PRODUZIONE: BPFS 30 - BTRCPL 38-48 - BLCP 28 - BRCP 28/D-F-G - 60 TBZ - BP 28/D-F - BPSC 28-30 - BTRCPL 38-48/A - BRCPL 28 - 35 BTRCU - 40 BZ - 00 BTRCAU - 0 BTCAU - 00 BTRCAU/S - ZBAP 39 - DAP 18 - 35 BRPS - Z 14 - BTRCP 28/D-F - TQRT 60 - TQRCP 48/D-F - BRPS 28 - BTRCP 38-38/D
RC0437	5CS163	VERSOIO SX	NARDI	CARRELLATI: 35 BTCU/A - PORTATI: 35 BRPS/A - BRCPL 28/A - 40 BZE - BRCP 28/H - 60 BTZ/E - BPSC 28-30/A - BP 28/H - DAP 18/A - TQRT 60 L - TQRCP 48/H - BRP 25/V - BTP 28 G - TQRT 60/C - BTRCP 28/H - VECCHIA PRODUZIONE: BP 28/D-F - BTRCP 38-38/D - BLCP 28 - BTRCPL 38-48/A - BRPS 28 - BTRCPL 38-48 - BTRCP 28/D-F - BPFS 30 - BRCPL 28 - BPSC 28-30 - TQRT 60 - TQRCP 48/D-F - 0 BTCAU - ZBAP 39 - Z 14 - 00 BTRCAU - 00 BTRCAU/S - DAP 18 - BRCP 28/D-F-G - 35 BTRCU - 35 BRPS - 40 BZ - 60 TBZ

Art./Ref.	Rif. Orig./Orig. Ref.	Titolo Prodotto/ Titolo Prodotto	Brand	Applicazione/Application
RC0436B	5C163B	VERSOIO DX	NARDI	CARRELLATI: 35 BTCU/A - PORTATI: 35 BRPS/A - 60 BTZ/E - TQPRT 60/C - BRCPL 28/A - BPSC 28-30/A - BP 28/H - BRCP 28/H - BRP 25/V - BTP 28 G - TQRT 60 L - BTRCP 28/H - DAP 18/A - TQRCP 48/H - 40 BZE - VECCHIA PRODUZIONE: BTRCP 28/D-F - BLCPL 28 - BRPS 28 - TQPRT 60 - BTRCPL 38-48/A - DAP 18 - BTRCPL 38-48 - BTRCP 38-38/D - BPFS 30 - Z 14 - TQRCP 48/D-F - 35 BRPS - 00 BTRCAU - BPSC 28-30 - 00 BTRCAU/S - 60 TBZ - ZBAP 39 - BRCPL 28 - 40 BZ - BRCP 28/D-F-G - 0 BTCAU - 35 BTRCU - BP 28/D-F
RC0437B	5C5163B	VERSOIO SX	NARDI	CARRELLATI: 35 BTCU/A - PORTATI: BTP 28 G - TQRCP 48/H - 40 BZE - 60 BTZ/E - BPSC 28-30/A - TQPRT 60/C - TQRT 60 L - BRP 25/V - BTRCP 28/H - BP 28/H - BRCPL 28/A - BRCP 28/H - 35 BRPS/A - DAP 18/A - VECCHIA PRODUZIONE: BRCP 28/D-F-G - BTRCP 28/D-F - BTRCPL 38-48 - BTRCP 38-38/D - DAP 18 - BTRCPL 38-48/A - BRPS 28 - BPSC 28-30 - 00 BTRCAU/S - 0 BTCAU - 00 BTRCAU - ZBAP 39 - BLCPL 28 - BP 28/D-F - BPFS 30 - Z 14 - TQRCP 48/D-F - 35 BTRCU - TQPRT 60 - 40 BZ - 60 TBZ - 35 BRPS - BRCPL 28
RC0438	6C163	VERSOIO DX	NARDI	CARRELLATI: 1 BTCAUG/F - 45-50 BTRCU/A - 35 BRCU/A - 35 BRCUS/A - PORTATI: BPG 50 - BTRCP 48/H - BRCP 38-39/H - BP 38 G - BRCP 38/A - ZCPL 28 - BP 28/H - ZAP 35 - DAP 28/A - BPSC 50 - MPSC 28/A - MCP 18/A - 40 BRPS/A - MCP2L 18 - TQRCP 70/H - MCPL 15 - TRAINATI: 00 BT/F-G - 00 BT/FI-GI - VECCHIA PRODUZIONE: 40 BRPS - 1 BTCAUG - 00 MAU - 1 TAUG - 0 BCAU - 1 BTCUA - 00-0 BRAU - 0 BTAUG - 45-50 BTRCU - BP 38/D-F - BPSC 38 - ZAPL 38 - 1 TRAU - 1-1 1/2 BTRCAU - 0 BTCAUG - 35 BRCU - 00-0 BRCAU - MP2L 18 - TQRCP 70/D - MCP 18 - MP2L 14 - MC 14 - MPSC 28 - TRP2L55 - TRCP2L 55 - MCPC 21 - 00-0 BRAU/SL - MCP 18-20-21 - BRCP 28-36 - MPL 14 - BRP 37 - MP 18 - BTRCP 48/D-E-F - BRPS 38 - VPL 35 - 00-0 BRCAU/S - BRP 37 - M 14 - DAP 27 - BRCPL 38 - BRP 38-48 - DAP 28 - BRCP 38-39/A-D-F-G - BRPL 37-47 - BRPC 27-35
RC0439	6C5163	VERSOIO SX	NARDI	CARRELLATI: 1 BTCAUG/F - 45-50 BTRCU/A - 35 BRCU/A - 35 BRCUS/A - PORTATI: MCP 18/A - MCP2L 18 - BP 28/H - BPSC 50 - BPG 50 - ZAP 35 - BP 38 G - MPSC 28/A - MCPL 15 - DAP 28/A - ZCPL 28 - BRCP 38/A - BTRCP 48/H - 40 BRPS/A - TQRCP 70/H - BRCP 38-39/H - TRAINATI: 00 BT/FI-GI - 00 BT/F-G - VECCHIA PRODUZIONE: 0 BCAU - 0 BTAUG - 45-50 BTRCU - 00-0 BRAU/SL - 00-0 BRCAU - 1 TRAU - 1-1 1/2 BTRCAU - 0 BTCAUG - ZAPL 38 - TRCP2L 55 - VPL 35 - 00-0 BRAU - 00 MAU - MP2L 18 - 40 BRPS - TQRCP 70/D - 35 BRCU - TRP2L55 - BRP 37 - MPL 14 - MP 18 - MPSC 28 - MCPC 21 - BRPS 38 - MCP 18-20-21 - MCP 18 - MC 14 - M 14 - DAP 28 - DAP 27 - BTRCP 48/D-E-F - 00-0 BRCAU/S - BRPL 37-47 - MP2L 14 - BRCPL 38 - 1 BTCUA - 1 TAUG - 1 BTCAUG - BPSC 38 - BRP 37 - BRCP 28-36 - BP 38/D-F - BRCP 38-39/A-D-F-G - BRPC 27-35 - BRP 38-48
RC0438B	6C163B	VERSOIO DX	NARDI	CARRELLATI: 35 BRCU/A - 45-50 BTRCU/A - 35 BRCUS/A - 1 BTCAUG/F - PORTATI: TQRCP 70/H - BP 28/H - BPG 50 - BP 38 G - BRCP 38-39/H - 40 BRPS/A - ZAP 35 - MCP 18/A - MCP2L 18 - MPSC 28/A - DAP 28/A - BTRCP 48/H - ZCPL 28 - BRCP 38/A - MCPL 15 - BPSC 50 - TRAINATI: 00 BT/F-G - 00 BT/FI-GI - VECCHIA PRODUZIONE: 40 BRPS - ZAPL 38 - 45-50 BTRCU - 0 BTCAUG - 00-0 BRAU - 0 BTAUG - 1 BTCUA - 0 BCAU - 00 MAU - BRCP 38-39/A-D-F-G - 00-0 BRCAU - BP 38/D-F - BPSC 38 - BRCP 28-36 - 00-0 BRCAU/S - 1 BTCAUG - BRP 38-48 - BRP 37 - BRPL 37-47 - BRPC 27-35 - MPL 14 - BRPS 38 - BRCPL 38 - MCP 18 - 1 TAUG - DAP 27 - BTRCP 48/D-E-F - M 14 - BRP 37 - MC 14 - TRCP2L 55 - DAP 28 - 00-0 BRAU/SL - MCP 18-20-21 - 1 TRAU - TQRCP 70/D - 35 BRCU - MPSC 28 - 1-1 1/2 BTRCAU - MP2L 18 - VPL 35 - MP2L 14 - TRP2L55 - MCPC 21 - MP 18
RC0439B	6C5163B	VERSOIO SX	NARDI	CARRELLATI: 45-50 BTRCU/A - 1 BTCAUG/F - 35 BRCU/A - 35 BRCUS/A - PORTATI: MCP 18/A - MCPL 15 - ZCPL 28 - TQRCP 70/H - MPSC 28/A - DAP 28/A - ZAP 35 - MCP2L 18 - BPSC 50 - BRCP 38-39/H - BP 38 G - BPG 50 - BTRCP 48/H - BP 28/H - 40 BRPS/A - BRCP 38/A - TRAINATI: 00 BT/FI-GI - 00 BT/F-G - VECCHIA PRODUZIONE: BTRCP 48/D-E-F - BRCPL 38 - BRPS 38 - BP 38/D-F - 0 BTCAUG - ZAPL 38 - 00-0 BRAU - 00 MAU - 00-0 BRCAU/S - 00-0 BRCAU - 00-0 BRAU/SL - 0 BCAU - 0 BTAUG - BRPC 27-35 - BRPL 37-47 - BRP 37 - BRP 38-48 - DAP 27 - MP2L 14 - MCPC 21 - 40 BRPS - 1 BTCAUG - MP 18 - MCP 18-20-21 - 45-50 BTRCU - 1 TRAU - BPSC 38 - 1-1 1/2 BTRCAU - 1 TAUG - 1 BTCUA - M 14 - 35 BRCU - DAP 28 - TQRCP 70/D - BRCP 28-36 - BRCP 38-39/A-D-F-G - MC 14 - VPL 35 - MP2L 18 - MPL 14 - MPSC 28 - TRCP2L 55 - MCP 18 - TRP2L55
RC0440	8C163	VERSOIO DX	NARDI	CARRELLATI: 2 BTCAUG/F - 50 BRCU/A - 50 BRCUS/A - 0 BRAUG/A - 30 MRCUS/A - 35 ZRACUI - 35 ZRACU - 30 MRCU/A - PORTATI: BPSC 70/A - BP 58/H - PESS 150 - MRCPL 38/A - 120 TZ/E - TQR 150 - BRCP 58/H - QPRT 150/C - 70 BRPS/A - 90 BZS/A - 40 MRPS/A - ZAP 60 - 90 BZ/E - ZCPL 48 - TQRT 150/C - BTRCP 80/H - BTRCPL 80 - MCP 38/H - MPSC 50 - MRCP 38/H - DAP 48/A - MP 46/H - TRAINATI: 0 BTR/FI-GI - 0 BTR/F-G - VECCHIA PRODUZIONE: MRP 37 - 70 BRPS - DAP 48 - 2 BTAUG - 0 BTR - MRCPL 38 - MPSC 38 - MCPL 38 - 0 BRAUG - 35 ZRACU - BTRCP 80 - 40 MRPS - DAP 40 - 30 MRCU - 50 BRCU - 90 BZ/C - 90 BZ - 35 ZRACUI - BTRCP 80/D-F - ZBAP 90/A - MCP 38/D-F - MRCP 38/D-F - BRPS 58 - BRCPC 58 - MPFS 40 - BPSC 70 - BPFS 30 - BP 58/D-F - BRCP 58/D-F-G - TQRT 150 - MRPSC 35-36-38 - QPRT 150/A - MRPI 37-38 - MPL 38 - QPRT 150 - MRPS 38 - BRPL 55 - TQRT 150/A - 120 TZ/D - MP 46/D-F - 00 MRAU - 00 MCAU - MRPO 38 - ZF 45 - 1 1/2 BRRCAU/S - 120 TZ - 1 1/2 BRRCAU - 1 BCAU - 00 MRCU - 00 MRCU/S - 00 MRAU/S
RC0441	8C5163	VERSOIO SX	NARDI	CARRELLATI: 0 BRAUG/A - 30 MRCUS/A - 35 ZRACUI - 30 MRCU/A - 2 BTCAUG/F - 35 ZRACU - 50 BRCU/A - 50 BRCUS/A - PORTATI: MP 46/H - BRCP 58/H - BTRCP 80/H - MCP 38/H - DAP 48/A - 90 BZS/A - 120 TZ/E - BP 58/H - 70 BRPS/A - BPSC 70/A - MRCPL 38/A - MPSC 50 - 90 BZ/E - MRCP 38/H - BTRCPL 80 - 40 MRPS/A - PESS 150 - TQR 150 - ZCPL 48 - QPRT 150/C - TQRT 150/C - ZAP 60 - TRAINATI: 0 BTR/F-G - 0 BTR/FI-GI - VECCHIA PRODUZIONE: 50 BRCU - 90 BZ/C - 90 BZ - 1 BCAU - 00 MRCU/S - 1 1/2 BRRCAU/S - 120 TZ - 00 MRCU - 00 MRAU/S - 00 MRAU - 1 1/2 BRRCAU - 00 MCAU - 0 BTR - 35 ZRACUI - 0 BRAUG - ZF 45 - ZBAP 90/A - 120 TZ/D - 70 BRPS - TQRT 150/A - QPRT 150/A - TQRT 150 - MRPSC 35-36-38 - QPRT 150 - BRCP 58/D-F-G - 30 MRCU - MRPO 38 - MRPI 37-38 - MRP 37 - MRCPL 38 - MRCP 38/D-F - MPFS 40 - MPSC 38 - MPL 38 - BRCPC 58 - MP 46/D-F - BRPL 55 - BTRCP 80/D-F - MRPS 38 - 35 ZRACU - 2 BTAUG - 40 MRPS - DAP 48 - DAP 40 - BP 58/D-F - MCPL 38 - BPFS 30 - BPSC 70 - BRPS 58 - MCP 38/D-F - BTRCP 80

Art./Ref.	Rif. Orig./Orig. Ref.	Titolo Prodotto/ Titolo Prodotto	Brand	Applicazione/Application
RC0440B	8C163B	VERSOIO DX	NARDI	CARRELLATI: 35 ZRACU - 50 BRCU/A - 30 MRCU/A - 50 BRCUS/A - 35 ZRACUI - 2 BTAUG/F - 30 MRCUS/A - 0 BRAUG/A - PORTATI: MRCP 38/H - MP 46/H - MRCPL 38/A - MPSC 50 - QPRT 150/C - TQR 150 - PESS 150 - 40 MRPS/A - 70 BRPS/A - 90 BZ/E - ZCPL 48 - 120 TZ/E - ZAP 60 - 90 BZS/A - TQRT 150/C - BTRCPL 80 - BTRCP 80/H - BP 58/H - BRCP 58/H - BPSC 70/A - DAP 48/A - MCP 38/H - TRAINATI: 0 BTR/F-G - 0 BTR/FI-GI - VECCHIA PRODUZIONE: 0 BTR - 2 BTAUG - 30 MRCU - 90 BZ/C - 00 MCAU - 90 BZ - MCPL 38 - 70 BRPS - 0 BRAUG - 1 1/2 BRRCAU/S - 120 TZ/D - 00 MRCAU - 00 MRCAU/S - MRPSC 35-36-38 - 1 BCAU - 120 TZ - 00 MRAU/S - ZBAP 90/A - DAP 40 - BTRCP 80/D-F - ZF 45 - 00 MRAU - DAP 48 - 1 1/2 BRRCAU - MPSC 38 - MRPO 38 - MPL 38 - MPFS 40 - MP 46/D-F - MRPI 37-38 - TQRT 150 - MRPS 38 - MCP 38/D-F - QPRT 150/A - QPRT 150 - TQRT 150/A - MRCP 38/D-F - MRP 37 - 35 ZRCU - 50 BRCU - BPFS 30 - BRCPC 58 - BTRCP 80 - BP 58/D-F - BRCP 58/D-F-G - BPSC 70 - BRPS 58 - 35 ZRCUI - 40 MRPS - MRCPL 38 - BRPL 55
RC0441B	8CS163B	VERSOIO SX	NARDI	CARRELLATI: 35 ZRACU - 30 MRCU/A - 0 BRAUG/A - 50 BRCU/A - 50 BRCUS/A - 35 ZRACUI - 30 MRCU/A - 2 BTAUG/F - PORTATI: MRCPL 38/A - TQR 150 - MCP 38/H - PESS 150 - 120 TZ/E - DAP 48/A - MPSC 50 - BTRCP 80/H - BTRCPL 80 - BRCP 58/H - BP 58/H - MP 46/H - BPSC 70/A - MRCP 38/H - QPRT 150/C - 90 BZ/E - 70 BRPS/A - ZAP 60 - 90 BZS/A - ZCPL 48 - 40 MRPS/A - TQRT 150/C - TRAINATI: 0 BTR/FI-GI - 0 BTR/F-G - VECCHIA PRODUZIONE: 120 TZ - 00 MRAU - 00 MRCAU - 00 MRCAU/S - 40 MRPS - 120 TZ/D - MRPO 38 - 1 1/2 BRRCAU - QPRT 150/A - 00 MCAU - TQRT 150 - MRPSC 35-36-38 - QPRT 150 - 0 BTR - ZBAP 90/A - 00 MRCAU/S - MRPS 38 - 1 BCAU - TQRT 150/A - 0 BRAUG - 1 1/2 BRRCAU/S - MRCPL 38 - MP 46/D-F - ZF 45 - MPFS 40 - MCPL 38 - MPL 38 - MCP 38/D-F - 50 BRCU - 35 ZRCUI - 90 BZ - 30 MRCU - 35 ZRCU - 2 BTAUG - 90 BZ/C - MPSC 38 - 70 BRPS - BTRCP 80/D-F - BRCP 58 - BTRCP 80 - BRPL 55 - MRPI 37-38 - MRP 37 - BP 58/D-F - BRPS 58 - MRCP 38/D-F - DAP 48 - BRCP 58/D-F-G - DAP 40 - BPSC 70 - BPFS 30
RC0442	9C163	VERSOIO DX	NARDI	CARRELLATI: 50 BRRCU/A - 45 ZRCU - 45 ZRCUI - 60 BRCUA - 35 MRCU/A - 1 BRCUAG/F - 35 MRCUS/A - 55 BRCU/A - PORTATI: BCP 70/H - BTRP 100/A - BRCP 68-70/H - BRCPL 80 - 130 TZ/E - MPSC 60 - 100 BZ/E - 115 BDF - 180 QTZ/E - 110 BZS - MRPC 47 - 60 MZS - 50 MRPS - 60 MZ/E - TRAINATI: 1 BT/FI-GI - 1 BT/F-G - 1 TQR/F-FI - VECCHIA PRODUZIONE: 100 BZ/C - 50 BRRCU - 130 QTZ/D - 3 TAUG - 1 BT/A-B-C-D-E - 1 BAUG - 60 MZ - 55-60 BRCU - 1 DBT/A-B - 180 QTZ - 180 QTZ/A - 130 TZ/D - 130 TZ - 0 MRAU/SP - 130 QTZ - BRCP 70/D-F - MCPSC 48 - BTRP 100 - BCP 70/D-F - 1 TQR - 1 NRCAUG - MRPS 48 - MPP 40 - BRPL 80 - BRCP 68 - 2 RDTQ - 100 BZ - 2 BRAU - 35 MRCU - 2 QPR - 2 1/2 BLRAU - MPSC 48
RC0443	9CS163	VERSOIO SX	NARDI	CARRELLATI: 60 BRCUA - 35 MRCUS/A - 50 BRRCU/A - 35 MRCU/A - 45 ZRCUI - 45 ZRCU - 55 BRCU/A - 1 BRCUAG/F - PORTATI: MRPC 47 - MPSC 60 - 130 TZ/E - BCP 70/H - 115 BDF - 60 MZS - 50 MRPS - 60 MZ/E - BRCP 68-70/H - BTRP 100/A - 110 BZS - BRCP 80 - 180 QTZ/E - 100 BZ/E - TRAINATI: 1 BT/FI-GI - 1 TQR/F-FI - 1 BT/F-G - VECCHIA PRODUZIONE: 2 QPR - 2 BRAU - 60 MZ - 2 RDTQ - 35 MRCU - 2 1/2 BLRAU - 180 QTZ/A - 130 QTZ/D - 130 TZ/D - 180 QTZ - 130 TZ - 3 TAUG - 55-60 BRCU - 1 TQR - BCP 70/D-F - MRPS 48 - BRPL 80 - 100 BZ - 1 NRCAUG - 1 BT/A-B-C-D-E - 1 BAUG - 1 DBT/A-B - BRCP 70/D-F - 0 MRAU/SP - 100 BZ/C - 50 BRRCU - BRCP 68 - MCPSC 48 - 130 QTZ - BTRP 100 - MPSC 48 - MPP 40
RC0442B	9C163B	VERSOIO DX	NARDI	CARRELLATI: 1 BRCUAG/F - 60 BRCUA - 45 ZRCU - 50 BRRCU/A - 45 ZRCUI - 55 BRCU/A - 35 MRCUS/A - 35 MRCU/A - PORTATI: 110 BZS - 130 TZ/E - 115 BDF - 50 MRPS - BRCP 68-70/H - BCP 70/H - MRPC 47 - BRCP 80 - BTRP 100/A - MPSC 60 - 60 MZS - 60 MZ/E - 180 QTZ/E - 100 BZ/E - TRAINATI: 1 BT/F-G - 1 TQR/F-FI - 1 BT/FI-GI - VECCHIA PRODUZIONE: MCPSC 48 - MPP 40 - 100 BZ/C - 180 QTZ - BTRP 100 - MPSC 48 - BRCP 68 - 1 DBT/A-B - BRCP 70/D-F - 35 MRCU - BCP 70/D-F - BRPL 80 - 1 TQR - 1 NRCAUG - MRPS 48 - 100 BZ - 1 BAUG - 130 TZ/D - 2 QPR - 130 QTZ/D - 2 1/2 BLRAU - 2 RDTQ - 130 QTZ - 60 MZ - 130 TZ - 0 MRAU/SP - 3 TAUG - 55-60 BRCU - 1 BT/A-B-C-D-E - 50 BRRCU - 2 BRAU - 180 QTZ/A
RC0443B	9CS163B	VERSOIO SX	NARDI	CARRELLATI: 1 BRCUAG/F - 45 ZRCUI - 50 BRRCU/A - 35 MRCUS/A - 45 ZRCU - 35 MRCU/A - 55 BRCU/A - 60 BRCUA - PORTATI: BCP 70/H - 115 BDF - BRCP 68-70/H - BRCPL 80 - 180 QTZ/E - BTRP 100/A - MPSC 60 - 60 MZS - 110 BZS - 50 MRPS - 100 BZ/E - 60 MZ/E - 130 TZ/E - MRPC 47 - TRAINATI: 1 BT/F-G - 1 BT/FI-GI - 1 TQR/F-FI - VECCHIA PRODUZIONE: 60 MZ - 100 BZ/C - 50 BRRCU - 2 BRAU - 130 TZ - 180 QTZ - 130 QTZ - 130 QTZ/D - 180 QTZ/A - 130 TZ/D - 55-60 BRCU - 35 MRCU - 1 TQR - 1 NRCAUG - 1 DBT/A-B - MPSC 48 - 1 BT/A-B-C-D-E - 2 QPR - 3 TAUG - 1 BAUG - 0 MRAU/SP - BRCP 70/D-F - MRPS 48 - 100 BZ - 2 1/2 BLRAU - 2 RDTQ - BTRP 100 - MCPSC 48 - BCP 70/D-F - BRPL 80 - MPP 40 - BRCP 68
RC0444	10C163M	VERSOIO DX	NARDI	CARRELLATI: 2 BRAUG/F - 50 ZRCUI - 50 ZRCU - 45 MRCUS - 45 MRCU - 65 BRCUA - PORTATI: MRCP 48/H - MPSC 70 - MCP 48/H - BRCP 90/A - 80-81 MZ/C - 80 MZS/A - 55 MRPS - 95 BRPS/A - MRCPL 48 - 120-121 BZ/D - BTRP 110/A - TRAINATI: 2 TQR/F-FI - 2 BT/F-G - 2 BT/FI-GI - VECCHIA PRODUZIONE: MRPL 48-49 - MRPL 47 - 0 MAUG - 2 DBT/A-B - 2 BT/A-B-C-D-E - 3 QPR - 2 1/2 BRAU - 3 BRAU - MRP 47 - 2 DBTR - 80-81 MZ - MP 48/D - 2 BRAUG - MRCP 48/D-F - MCP 48/D-F - BRCP 90 - 65 BRCU - 120-121 BZ - BTRP 110 - 1-11/2 MRAU - 1-11/2 MRAU/S - 2 BAUG/F - 2 BAUG - 95 BRPS
RC0445	10CS163M	VERSOIO SX	NARDI	CARRELLATI: 65 BRCUA - 50 ZRCU - 45 MRCUS - 50 ZRCUI - 2 BRAUG/F - 45 MRCU - PORTATI: 55 MRPS - MPSC 70 - MRCP 48/H - 120-121 BZ/D - MRCPL 48 - 80 MZS/A - 95 BRPS/A - MCP 48/H - 80-81 MZ/C - BTRP 110/A - BRCP 90/A - TRAINATI: 2 TQR/F-FI - 2 BT/FI-GI - 2 BT/F-G - VECCHIA PRODUZIONE: 2 BT/A-B-C-D-E - 0 MAUG - MCP 48/D-F - 2 BAUG/F - 120-121 BZ - MP 48/D - 2 DBT/A-B - MRPL 48-49 - 2 DBTR - BRCP 90 - 2 1/2 BRAU - 2 BRAUG - 3 QPR - 65 BRCU - BTRP 110 - 80-81 MZ - 3 BRAU - MRCP 48/D-F - 1-11/2 MRAU - 95 BRPS - 1-11/2 MRAU/S - MRPL 47 - 2 BAUG - MRP 47
RC0444B	10C163B	VERSOIO DX	NARDI	CARRELLATI: 2 BRAUG/F - 50 ZRCU - 45 MRCUS - 45 MRCU - 65 BRCUA - 50 ZRCUI - PORTATI: 80 MZS/A - 55 MRPS - MCP 48/H - BTRP 110/A - MRCP 48/H - BRCP 90/A - MPSC 70 - MRCPL 48 - 120-121 BZ/D - 95 BRPS/A - 80-81 MZ/C - TRAINATI: 2 BT/FI-GI - 2 TQR/F-FI - 2 BT/F-G - VECCHIA PRODUZIONE: 0 MAUG - MRPL 48-49 - MRP 47 - BRCP 90 - MRPL 47 - 120-121 BZ - MCP 48/D-F - 2 BAUG/F - 2 BAUG - 1-11/2 MRAU/S - 1-11/2 MRAU - 2 DBTR - 2 1/2 BRAU - 3 QPR - 3 BRAU - BTRP 110 - 2 BT/A-B-C-D-E - 2 DBT/A-B - 65 BRCU - MP 48/D - 2 BRAUG - MRCP 48/D-F - 95 BRPS - 80-81 MZ

Art./Ref.	Rif. Orig./Orig. Ref.	Titolo Prodotto/ Titolo Prodotto	Brand	Applicazione/Application
RC0445B	10CS163B	VERSOIO SX	NARDI	CARRELLATI: 45 MRCU - 50 ZRCUI - 2 BRAUG/F - 65 BRUA - 50 ZRCU - 45 MRCUS - PORTATI: MPSC 70 - BRCP 90/A - MCP 48/H - 55 MRPS - 80-81 MZ/C - 95 BRPS/A - 80 MZS/A - MRCP 48/H - 120-121 BZ/D - MRCPL 48 - BTRP 110/A - TRAINATI: 2 BT/F-G - 2 TQR/F-FI - 2 BT/FI-GI - VECCHIA PRODUZIONE: MRPL 48-49 - 2 BT/A-B-C-D-E - 80-81 MZ - 0 MAUG - 2 DBTR - BTRP 110 - 2 1/2 BRAU - 3 QPR - MRPL 47 - 2 DBT/A-B - 3 BRAU - 120-121 BZ - BRCP 90 - MRCP 48/D-F - MCP 48/D-F - 95 BRPS - MP 48/D - 2 BRAUG - 1-11/2 MRAU - MRP 47 - 2 BAUG/F - 1-11/2 MRAU/S - 2 BAUG - 65 BRU
RC0446B	10C163MB	VERSOIO DX	NARDI	CARRELLATI: 50 MRCUS - 70 BRU - 130 BTRCO - 75 BRRCO - 0 MRCAUG - 50 MRCU - PORTATI: BTS 100 - 90-91 MZ/C - BTRP 160/A - 130 BZS - 90 MZS/A - 100 BRPS/A - 65 MRPS - 125 BZ/F - 180-181 BTZ/A - 130-131 BZ/D - BRP 110/A - 135 BDF - VECCHIA PRODUZIONE: 90-91 MZ - 3 BRRAU - 180-181 BTZ - 100 BRPS - 0 MRAUG - 70 BRRCO/B - 1 1/2 MRAU/S - BRP 110 - MPS 58 - 1 1/2 MRAU - 130-131 BZ - BTRP 160 - BS 100 - BRCP 100 - BRCP 100/D-E-F
RC0447B	10CS163MB	VERSOIO SX	NARDI	CARRELLATI: 50 MRCU - 130 BTRCO - 0 MRCAUG - 70 BRU - 50 MRCUS - 75 BRRCO - PORTATI: 100 BRPS/A - 125 BZ/F - 130 BZS - BTRP 160/A - 135 BDF - BTS 100 - 65 MRPS - BRP 110/A - 180-181 BTZ/A - 90-91 MZ/C - 90 MZS/A - 130-131 BZ/D - VECCHIA PRODUZIONE: 180-181 BTZ - 1 1/2 MRAU - MPS 58 - 3 BRRAU - 90-91 MZ - 100 BRPS - 0 MRAUG - 130-131 BZ - BRP 110 - BTRP 160 - BRCP 100 - BRCP 100/D-E-F - BS 100 - 70 BRRCO/B - 1 1/2 MRAU/S
RC0448	12C163	VERSOIO DX	NARDI	TRAINATI: 2 1/2 BT/FI-GI - 2 1/2 BT/F-G - VECCHIA PRODUZIONE: 3 BT/A-B-C - 2 1/2 BT/A-B-C-D-E - 2 BTR/A-B-C - 3 BAUG - 4 QPR - 3 TQR/A
RC0448B	12C163B	VERSOIO DX	NARDI	TRAINATI: 2 1/2 BT/H - 2 1/2 BT/BI - 2 1/2 BT/BI - 2 1/2 BT/FI - 2 1/2 BT/BI - 2 1/2 BT/G - 2 1/2 BT/FI - 2 1/2 BT/GI
RC0450	13C163	VERSOIO DX	NARDI	CARRELLATI: 1 MCAUG/F - 60 MRCUA - 55 MRCU - PORTATI: BTS 120 - 100 MZ/C - 115 MDF - 140 BZ/D - 110 MZS - 135 BRPS/A - MCP 58/H - MCRP 58/H - VECCHIA PRODUZIONE: MP 58/D - MRP 50 - 135 BRPS - MP2L 50 - ZPL 80 - 2 MRAU - 1 MAUG - MRPL 56-61 - 1 MCAUG - MPP 60 - MRC 58/D-F - 2 MAU - 140 BZ - 3 DBTR - 3 DBT/A-B - MCP 57/D-F - 4 DTQR - 2 MDAU - MPL 50 - 60 MRCU - MP 50 - 100 MZ - 5 QPR
RC0451	13CS163	VERSOIO SX	NARDI	CARRELLATI: 55 MRCU - 1 MCAUG/F - 60 MRCUA - PORTATI: 110 MZS - 100 MZ/C - 135 BRPS/A - 140 BZ/D - 115 MDF - MCP 58/H - MCRP 58/H - BTS 120 - VECCHIA PRODUZIONE: 140 BZ - 1 MCAUG - 100 MZ - 1 MAUG - MRP 50 - ZPL 80 - MRPL 56-61 - 3 DBT/A-B - 2 MAU - MPP 60 - MPL 50 - MP 50 - MCP 57/D-F - 135 BRPS - 2 MDAU - 3 DBTR - MP 58/D - 5 QPR - MP2L 50 - 4 DTQR - MRC 58/D-F - 60 MRCU - 2 MRAU
RC0450B	13C163B	VERSOIO DX	NARDI	CARRELLATI: 55 MRCU - 60 MRCUA - 1 MCAUG/F - PORTATI: 110 MZS - 135 BRPS/A - MCP 58/H - BTS 120 - 100 MZ/C - 140 BZ/D - 115 MDF - MCRP 58/H - VECCHIA PRODUZIONE: 135 BRPS - MCP 57/D-F - MRP 50 - 1 MCAUG - ZPL 80 - 1 MAUG - 100 MZ - MRPL 56-61 - MP 58/D - 3 DBTR - 2 MAU - 140 BZ - 3 DBT/A-B - MP 50 - 2 MRAU - 60 MRCU - 2 MDAU - MPP 60 - MP2L 50 - MRC 58/D-F - MPL 50 - 4 DTQR - 5 QPR
RC0451B	13CS163B	VERSOIO SX	NARDI	CARRELLATI: 55 MRCU - 1 MCAUG/F - 60 MRCUA - PORTATI: MCP 58/H - 140 BZ/D - MCRP 58/H - 115 MDF - 135 BRPS/A - 100 MZ/C - 110 MZS - BTS 120 - VECCHIA PRODUZIONE: MPP 60 - MP 50 - 60 MRCU - 3 DBT/A-B - 5 QPR - 4 DTQR - 2 MRAU - 3 DBTR - MP 58/D - MRC 58/D-F - MP2L 50 - MRP 50 - 100 MZ - MPL 50 - 135 BRPS - MRPL 56-61 - 140 BZ - ZPL 80 - MCP 57/D-F - 2 MAU - 2 MDAU - 1 MAUG - 1 MCAUG
RC0452	13C163L	VERSOIO DX	NARDI	PORTATI: 70 MRPS - MCP 70/H - 180 BZ/A - 120 MZ/D - MRCP 70/H - 95 MPS/A - 125 MZ/D - MRPL 80 - VECCHIA PRODUZIONE: 180 BZ - MRCP 70/D-F - MRP 70/D - MP 70 - MCP 70/D-F - 95 MPS - 120 MZ
RC0453B	14C163B	VERSOIO DX	NARDI	CARRELLATI: 100 BRRCO/B - 65 MRCUA - 2 MRAUG/F - PORTATI: BRP 160/A - TRAINATI: 4 BTP/I - 4-4 1/2 TQR/FI - 4 BTP - 4 BT/FI-GI - 3 BTR/F-G - 3 BTR/FI-GI - 4 BT/F-G - VECCHIA PRODUZIONE: 65 MRCU - BRP 160 - 100 BRRCO - 2 MRAUG - 4 BT/BI - 4 BT/A-B - 5 DQPR - 2 1/2 MRAU - 4 BTSP - 4 BTSP/FI - 4 TQR/A-B
RC0453	14C163	VERSOIO DX	NARDI	CARRELLATI: 65 MRCUA - 2 MRAUG/F - 100 BRRCO/B - PORTATI: BRP 160/A - TRAINATI: 3 BTR/F-G - 3 BTR/FI-GI - 4-4 1/2 TQR/FI - 4 BT/FI-GI - 4 BT/F-G - 4 BTP/I - 4 BTP - VECCHIA PRODUZIONE: 2 1/2 MRAU - 5 DQPR - 4 BTSP/FI - 2 MRAUG - BRP 160 - 4 TQR/A-B - 4 BTSP - 100 BRRCO - 4 BT/A-B - 65 MRCU - 4 BT/BI
RC0454B	13C164B	VERSOIO DX	NARDI	CARRELLATI: 3 BRRAU/A - 80-90 BRRCO/B - PORTATI: BRP 120/K - 150 BRPS/B - TRAINATI: 3 BT/F-G - 3 TQR/FI - 3 BT/FI-GI - VECCHIA PRODUZIONE: 3 BT/E - 3 TQR/A-B - BRP 120/D-F-G-H - 3 BRRAU - 2 BTR/C - 150 BRPS - 80-90 BRRCO - 3 BT/EI
RC0454	13C164	VERSOIO DX	NARDI	CARRELLATI: 80-90 BRRCO/B - 3 BRRAU/A - PORTATI: BRP 120/K - 150 BRPS/B - TRAINATI: 3 TQR/FI - 3 BT/FI-GI - 3 BT/F-G - VECCHIA PRODUZIONE: 3 TQR/A-B - 3 BT/EI - 3 BRRAU - 150 BRPS - 2 BTR/C - 80-90 BRRCO - BRP 120/D-F-G-H - 3 BT/E

SALVA VERSOI PER VERSOI A SCALPELLO ADATTABILI ALLA PRODUZIONE NARDI

PROTEGE VERSOIR ADAPTABLE TYPE NARDI

SHIN FOR POINT BODY FOR NARDI LINE

VESSHLEIBHANTE FÜR NEIBELSCHASTÜRPESS PASSEND FÜR NARDI

PARAOREJAS PARA OREJAS A ESCOPLA PARA PRODUCCIÓN NARDI

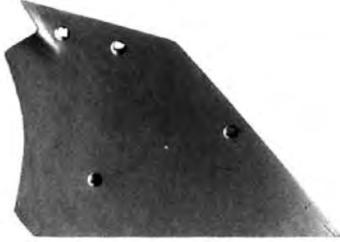
Note: Tutti i prodotti presenti in tabella vengono forniti non verniciati.

Notes: All products in the table are supplied unpainted.

Art./Ref.	Rif. Orig./ Orig. Ref.	Titolo Prodotto/ Titolo Prodotto	Brand	Applicazione/ Application
RC0910	7C162	SALVAVERSOIO DX	NARDI	CARRELLATI: 0 BCUAG/A - 45 BRCUS/A - 45 BRCU/A - 30 ZRCU - PORTATI: MRCPL 28/A - MPSC 30/A - BP 48/H - BRCP 48/H - ZCPL 38 - BPSC 60 - TQP 90 SI - QPS 140 U/A - TQRT 90/C - ZAP 45 - BRCPL 48/A - QPRT 140/C - MRCP 28/H - PES 140 U/A - DAP 38/A - 60-80 BZ/E - 100 BTZ - 130 QTZ/E - 110 BTZS - 60 BZS - 35 MRPS/A - BTRCP 52-70/H - 50 BRPS/A - 80 BZS/A - 40 MZ/E - TRAINATI: 0 TQR/F-FI - 0 BT/FI-GI - 0 BT/F-G - VECCHIA PRODUZIONE: MCPL 28
RC0911	7CS162	SALVAVERSOIO SX	NARDI	CARRELLATI: 0 BCUAG/A - 30 ZRCU - 45 BRCUS/A - 45 BRCU/A - PORTATI: 40 MZ/E - MRCPL 28/A - 35 MRPS/A - 50 BRPS/A - ZCPL 38 - 130 QTZ/E - 110 BTZS - 100 BTZ - 60-80 BZ/E - 60 BZS - 80 BZS/A - BRCP 48/H - TQRT 90/C - ZAP 45 - TQP 90 SI - QPRT 140/C - PES 140 U/A - MRCP 28/H - QPS 140 U/A - MPSC 30/A - BRCPL 48/A - DAP 38/A - BTRCP 52-70/H - BPSC 60 - BP 48/H - TRAINATI: 0 TQR/F-FI - 0 BT/FI-GI - 0 BT/F-G - VECCHIA PRODUZIONE: MCPL 28
RC0910B	7C162B	SALVAVERSOIO DX	NARDI	CARRELLATI: 45 BRCU/A - 0 BCUAG/A - 45 BRCUS/A - 30 ZRCU - PORTATI: MRCPL 28/A - 80 BZS/A - 60-80 BZ/E - 60 BZS - QPS 140 U/A - 35 MRPS/A - PES 140 U/A - ZCPL 38 - MPSC 30/A - 110 BTZS - 130 QTZ/E - 100 BTZ - TQRT 90/C - MRCP 28/H - TQP 90 SI - 50 BRPS/A - QPRT 140/C - ZAP 45 - BP 48/H - BPSC 60 - BRCP 48/H - 40 MZ/E - BRCP 48/A - BTRCP 52-70/H - DAP 38/A - TRAINATI: 0 BT/FI-GI - 0 BT/F-G - 0 TQR/F-FI - VECCHIA PRODUZIONE: MCPL 28
RC0911B	7CS162B	SALVAVERSOIO SX	NARDI	CARRELLATI: 0 BCUAG/A - 45 BRCU/A - 45 BRCUS/A - 30 ZRCU - PORTATI: BRCP 48/A - MPSC 30/A - BP 48/H - BPSC 60 - ZCPL 38 - QPS 140 U/A - MRCPL 28/A - QPRT 140/C - TQP 90 SI - ZAP 45 - TQRT 90/C - MRCP 28/H - BRCP 48/H - PES 140 U/A - 60 BZS - 80 BZS/A - 100 BTZ - 35 MRPS/A - 130 QTZ/E - 110 BTZS - 60-80 BZ/E - 50 BRPS/A - DAP 38/A - 40 MZ/E - BTRCP 52-70/H - TRAINATI: 0 BT/F-G - 0 TQR/F-FI - 0 BT/FI-GI - VECCHIA PRODUZIONE: MCPL 28
RC0912	8C163	SALVAVERSOIO DX	NARDI	CARRELLATI: 0 BRAUG/A - 35 ZRACU - 2 BTCAUG/F - 30 MRCU/A - 35 ZRACUI - 50 BRCU/A - 50 BRCUS/A - 30 MRCUS/A - PORTATI: BTRCPL 80 - 90 BZS/A - TQRT 150/C - QPRT 150/C - 70 BRPS/A - 40 MRPS/A - 90 BZ/E - ZAP 60 - 120 TZ/E - DAP 48/A - MCP 38/H - MRCP 38/H - MRCPL 38/A - BP 58/H - BPSC 70/A - BTRCP 80/H - ZCPL 48 - TQR 150 - BRCP 58/H - PESS 150 - MPSC 50 - MP 46/H - TRAINATI: 0 BTR/F-G - 0 BTR/FI-GI - VECCHIA PRODUZIONE: BPSC 70 - MPFS 40 - MRP 37 - MPSC 38 - MRCP 38/D-F - BP 58/D-F - BPFS 30 - MRCPL 38 - MPL 38 - MRPI 37-38 - MRPSC 35-36-38 - QPRT 150/A - QPRT 150 - MRPO 38 - TQRT 150 - BTRCP 80/D-F - BRPL 55 - BRCP 58/D-F-G - MP 46/D-F - MRPS 38 - BRCP 58 - ZBAP 90/A - 1 1/2 BRRCU/S - ZF 45 - 2 BTAUG - 0 BTR - 0 BRAUG - 1 1/2 BRRCU/S - 120 TZ/D - 00 MRCAU/S - BRPS 58 - 00 MRCAU - 00 MRAU/S - 120 TZ/D - 1 BCAU - 00 MCAU - 00 MRAU - TQRT 150/A - DAP 40 - BTRCP 80 - DAP 48 - 90 BZ - MCPL 38 - MCP 38/D-F - 35 ZRCU - 90 BZ/C - 70 BRPS - 50 BRCU - 30 MRCU - 35 ZRCUI - 40 MRPS
RC0913	8CS163	SALVAVERSOIO SX	NARDI	CARRELLATI: 30 MRCUS/A - 0 BRAUG/A - 35 ZRACUI - 30 MRCU/A - 35 ZRACU - 50 BRCU/A - 2 BTCAUG/F - 50 BRCUS/A - PORTATI: ZAP 60 - BRCP 58/H - BTRCP 80/H - BTRCPL 80 - MCP 38/H - BPSC 70/A - 90 BZS/A - BP 58/H - 120 TZ/E - DAP 48/A - MRCP 38/H - 40 MRPS/A - 90 BZ/E - MPSC 50 - MRCPL 38/A - TQRT 150/C - PESS 150 - QPRT 150/C - ZCPL 48 - 70 BRPS/A - TQR 150 - MP 46/H - TRAINATI: 0 BTR/FI-GI - 0 BTR/F-G - VECCHIA PRODUZIONE: 50 BRCU - 90 BZ/C - 90 BZ - 70 BRPS - BP 58/D-F - 1 1/2 BRRCU/S - 120 TZ/D - 00 MRAU/S - 00 MRCAU - 00 MRCAU/S - 120 TZ - 1 1/2 BRRCU/S - ZF 45 - 0 BRAUG - ZBAP 90/A - 00 MCAU - 00 MRAU - 0 BTR - 40 MRPS - QPRT 150 - QPRT 150/A - TQRT 150 - MRPS 38 - MRPSC 35-36-38 - MCPL 38 - MP 46/D-F - MRPO 38 - MRPI 37-38 - MRP 37 - MRCPL 38 - MRCP 38/D-F - MPFS 40 - MPSC 38 - MPL 38 - BRCP 58/D-F-G - BRCP 58 - TQRT 150/A - BTRCP 80/D-F - 35 ZRCU - 35 ZRCUI - 30 MRCU - 2 BTAUG - DAP 40 - DAP 48 - BPSC 70 - BRPL 55 - BPFS 30 - BRPS 58 - MCP 38/D-F - BTRCP 80 - 1 BCAU
RC0912B	8C163B	SALVAVERSOIO DX	NARDI	CARRELLATI: 0 BRAUG/A - 50 BRCUS/A - 2 BTCAUG/F - 30 MRCU/A - 30 MRCUS/A - 50 BRCU/A - 35 ZRACUI - 35 ZRACU - PORTATI: MCP 38/H - BRCP 58/H - BPSC 70/A - TQRT 150/C - 70 BRPS/A - BTRCPL 80 - 90 BZS/A - 40 MRPS/A - MP 46/H - 90 BZ/E - BTRCP 80/H - DAP 48/A - MPSC 50 - ZAP 60 - 120 TZ/E - QPRT 150/C - PESS 150 - ZCPL 48 - MRCP 38/H - BP 58/H - MRCPL 38/A - TQR 150 - TRAINATI: 0 BTR/FI-GI - 0 BTR/F-G - VECCHIA PRODUZIONE: BP 58/D-F - 1 1/2 BRRCU/S - 1 BCAU - 00 MRCAU/S - 00 MRAU/S - 00 MRCAU - 1 1/2 BRRCU/S - 120 TZ - ZF 45 - 0 BTR - 00 MCAU - 0 BRAUG - 90 BZ - 00 MRAU - 90 BZ/C - ZBAP 90/A - 70 BRPS - 120 TZ/D - 30 MRCU - MRPS 38 - QPRT 150 - QPRT 150/A - MRPSC 35-36-38 - MRPO 38 - BRPL 55 - BRCP 58 - TQRT 150 - MPSC 38 - MRCP 38/D-F - 35 ZRCU - MRP 37 - MPL 38 - MPFS 40 - MRPI 37-38 - BRPS 58 - TQRT 150/A - 2 BTAUG - DAP 40 - 35 ZRCUI - 40 MRPS - BRCP 58/D-F-G - 50 BRCU - MP 46/D-F - DAP 48 - BTRCP 80/D-F - BPSC 70 - BPFS 30 - MRCPL 38 - BTRCP 80 - MCP 38/D-F - MCPL 38
RC0913B	8CS163B	SALVAVERSOIO SX	NARDI	CARRELLATI: 0 BRAUG/A - 50 BRCUS/A - 30 MRCU/A - 35 ZRACU - 2 BTCAUG/F - 35 ZRACUI - 50 BRCU/A - 30 MRCUS/A - PORTATI: QPRT 150/C - 120 TZ/E - 70 BRPS/A - 40 MRPS/A - 90 BZ/E - 90 BZS/A - BTRCPL 80 - BTRCP 80/H - TQR 150 - BPSC 70/A - DAP 48/A - MCP 38/H - BRCP 58/H - MRCPL 38/A - MPSC 50 - BP 58/H - PESS 150 - MRCP 38/H - ZAP 60 - TQRT 150/C - ZCPL 48 - MP 46/H - TRAINATI: 0 BTR/FI-GI - 0 BTR/F-G - VECCHIA PRODUZIONE: TQRT 150/A - BPSC 70 - BP 58/D-F - BRPL 55 - BRCP 58 - BRCP 58/D-F-G - MP 46/D-F - QPRT 150/A - MPFS 40 - MPL 38 - MRCP 38/D-F - MPSC 38 - MRCPL 38 - MRP 37 - MRPI 37-38 - MRPS 38 - MRPO 38 - QPRT 150 - TQRT 150 - MRPSC 35-36-38 - 40 MRPS - 00 MCAU - 1 1/2 BRRCU/S - ZF 45 - 0 BRAUG - 2 BTAUG - 0 BTR - 120 TZ - 1 1/2 BRRCU/S - 00 MRCAU/S - BPFS 30 - 00 MRCAU - 00 MRAU/S - 1 BCAU - 00 MRAU - 70 BRPS - 120 TZ/D - DAP 48 - BTRCP 80/D-F - MCPL 38 - BTRCP 80 - BRPS 58 - 50 BRCU - DAP 40 - MCP 38/D-F - 90 BZ/C - 90 BZ - 35 ZRCUI - 30 MRCU - ZBAP 90/A - 35 ZRCU
RC0914	9C163B	SALVAVERSOIO DX	NARDI	CARRELLATI: 50 BRRCU/A - 45 ZRCUI - 35 MRCUS/A - 35 MRCU/A - 60 BRCU/A - 55 BRCU/A - 1 BRCUAG/F - 45 ZRCU - PORTATI: 50 MRPS - 115 BDF - BCP 70/H - 60 MZS - MPSC 60 - BRCP 68-70/H - BTRP 100/A - MRPC 47 - 180 QTZ/E - 130 TZ/E - 60 MZ/E - BRCP 80 - 100 BZ/E - 110 BZS - TRAINATI: 1 BT/FI-GI - 1 BT/F-G - 1 TQR/F-FI - VECCHIA PRODUZIONE: BRCP 68 - 1 BT/A-B-C-D-E - BCP 70/D-F - MRPS 48 - 1 BRCAUG - 0 MRAU/SP - 100 BZ - 1 TQR - 1 BAUG - BRCP 70/D-F - 100 BZ/C - MRCPC 48 - BRPL 80 - 130 TZ - 35 MRCU - 130 QTZ - 2 1/2 BLRAU - 2 RDQ - 2 BRAU - 3 TAUG - 2 QPR - 130 QTZ/D - 180 QTZ/A - BTRP 100 - MPP 40 - 130 TZ/D - 1 DBT/A-B - MPSC 48 - 180 QTZ - 60 MZ - 55-60 BRCU - 50 BRRCU

Art./Ref.	Rif. Orig./ Orig. Ref.	Titolo Prodotto/ Titolo Prodotto	Brand	Applicazione/ Application
RC0915	9CS163B	SALVAVERSOIO SX	NARDI	CARRELLATI: 55 BRCU/A - 60 BRCU/A - 35 MRCU/A - 45 ZRCU - 50 BRRCU/A - 35 MRCUS/A - 45 ZRCU - 1 BRCUAG/F - PORTATI: 60 MZS - BCP 70/H - 60 MZ/E - 50 MRPS - 110 BZS - 115 BDF - 180 QTZ/E - MPSC 60 - 100 BZ/E - BRCP 68-70/H - 130 TZ/E - BRCP 80 - BTRP 100/A - MRCP 47 - TRAINATI: 1 BT/F-G - 1 TQR/F-FI - 1 BT/FI-GI - VECCHIA PRODUZIONE: BRCP 70/D-F - MRPS 48 - BCP 70/D-F - 1 BRCAUG - 1 BAUG - 1 BT/A-B-C-D-E - 100 BZ/C - 1 DBT/A-B - 1 TQR - 100 BZ - 0 MRAU/SP - BRCP 68 - 130 QTZ/D - 180 QTZ/A - 180 QTZ - 130 QTZ - 2 1/2 BLRAU - 3 TAUG - BRPL 80 - 2 BRAU - 2 RDTQ - 130 TZ - 2 QPR - MPP 40 - MPSC 48 - 130 TZ/D - MCPSC 48 - BTRP 100 - 60 MZ - 55-60 BRCU - 35 MRCU - 50 BRRCU
RC0916	10C163	SALVAVERSOIO DX	NARDI	CARRELLATI: 50 ZRCU - 65 BRCU/A - 50 ZRCU - 45 MRCU - 45 MRCUS - 2 BRAUG/F - PORTATI: 120-121 BZ/D - 80 MZS/A - 55 MRPS - MPSC 70 - BRCP 90/A - MRCP 48 - MRCP 48/H - BTRP 110/A - MCP 48/H - 95 BRPS/A - 80-81 MZ/C - TRAINATI: 2 BT/FI-GI - 2 TQR/F-FI - 2 BT/F-G - VECCHIA PRODUZIONE: 2 BAUG - BRCP 90 - MRP 47 - 3 QPR - 120-121 BZ - MRPL 47 - 0 MAUG - MRPL 48-49 - 1-1 1/2 MRAU - 1-1 1/2 MRAU/S - 2 BAUG/F - 2 BT/A-B-C-D-E - 3 BRAU - MP 48/D - 2 DBTR - 95 BRPS - 65 BRCU - 2 DBT/A-B - MRCP 48/D-F - 80-81 MZ - 2 BRAUG - MCP 48/D-F - 2 1/2 BRAU - BTRP 110
RC0917	10CS163	SALVAVERSOIO SX	NARDI	CARRELLATI: 50 ZRCU - 45 MRCU - 50 ZRCU - 45 MRCUS - 2 BRAUG/F - 65 BRCU/A - PORTATI: MCP 48/H - MPSC 70 - BTRP 110/A - BRCP 90/A - 95 BRPS/A - 80 MZS/A - 80-81 MZ/C - 120-121 BZ/D - 55 MRPS - MRCP 48/H - MRCP 48 - TRAINATI: 2 TQR/F-FI - 2 BT/FI-GI - 2 BT/F-G - VECCHIA PRODUZIONE: 3 BRAU - 2 1/2 BRAU - 95 BRPS - 3 QPR - 2 BT/A-B-C-D-E - 80-81 MZ - 2 DBT/A-B - 2 DBTR - BRCP 90 - 1-1 1/2 MRAU/S - 2 BAUG - 1-1 1/2 MRAU - MRPL 47 - 65 BRCU - MRPL 48-49 - 120-121 BZ - 2 BAUG/F - MP 48/D - BTRP 110 - MRP 47 - MRCP 48/D-F - 2 BRAUG - MCP 48/D-F - 0 MAUG
RC0916B	10C163B	SALVAVERSOIO DX	NARDI	CARRELLATI: 45 MRCUS - 50 ZRCU - 50 ZRCU - 65 BRCU/A - 45 MRCU - 2 BRAUG/F - PORTATI: 80 MZS/A - BTRP 110/A - BRCP 90/A - MPSC 70 - 120-121 BZ/D - 95 BRPS/A - 80-81 MZ/C - 55 MRPS - MRCP 48/H - MRCP 48 - MCP 48/H - TRAINATI: 2 BT/FI-GI - 2 BT/FI-GI - 2 TQR/F-FI - VECCHIA PRODUZIONE: 95 BRPS - 2 DBT/A-B - 2 BT/A-B-C-D-E - MRP 47 - 3 BRAU - 3 QPR - 2 1/2 BRAU - 2 DBTR - 2 BRAUG - 2 BAUG - MRPL 48-49 - MRPL 47 - 80-81 MZ - 0 MAUG - 120-121 BZ - 1-1 1/2 MRAU - 1-1 1/2 MRAU/S - MP 48/D - 65 BRCU - MCP 48/D-F - MRCP 48/D-F - BTRP 110 - BRCP 90
RC0917B	10CS163B	SALVAVERSOIO SX	NARDI	CARRELLATI: 50 ZRCU - 45 MRCUS - 50 ZRCU - 2 BRAUG/F - 65 BRCU/A - 45 MRCU - PORTATI: MCP 48/H - 80 MZS/A - MRCP 48 - 55 MRPS - BTRP 110/A - 120-121 BZ/D - 95 BRPS/A - MPSC 70 - BRCP 90/A - 80-81 MZ/C - MRCP 48/H - TRAINATI: 2 BT/FI-GI - 2 TQR/F-FI - 2 BT/F-G - VECCHIA PRODUZIONE: 120-121 BZ - BTRP 110 - 2 BAUG - MRPL 48-49 - 0 MAUG - 1-1 1/2 MRAU - MRPL 47 - 1-1 1/2 MRAU/S - 2 BAUG/F - MRP 47 - 2 DBTR - 2 DBT/A-B - 3 QPR - 3 BRAU - BRCP 90 - 2 1/2 BRAU - 80-81 MZ - 2 BT/A-B-C-D-E - 95 BRPS - 2 BRAUG - MRCP 48/D-F - MCP 48/D-F - 65 BRCU - MP 48/D
RC0918	10C163MB	SALVAVERSOIO DX	NARDI	CARRELLATI: 75 BRRCO - 50 MRCUS - 70 BRCU - 50 MRCU - 0 MRCAUG - 130 BTRRCO - PORTATI: 180-181 BTZ/A - 65 MRPS - 100 BRPS/A - BTRP 160/A - 125 BZ/F - BRP 110/A - 90 MZS/A - BTS 100 - 130-131 BZ/D - 90-91 MZ/C - 130 BZS - 135 BDF - VECCHIA PRODUZIONE: MPS 58 - 100 BRPS - 0 MRAUG - 1 1/2 MRRAU - 1 1/2 MRRAU/S - 70 BRRCO/B - 130-131 BZ - 3 BRRAU - BRCP 100/D-E-F - 90-91 MZ - 180-181 BTZ - BRP 110 - BRCP 100 - BTRP 160 - BS 100
RC0919	10CS163MB	SALVAVERSOIO SX	NARDI	CARRELLATI: 50 MRCU - 50 MRCUS - 75 BRRCO - 70 BRCU - 0 MRCAUG - 130 BTRRCO - PORTATI: 65 MRPS - 100 BRPS/A - BTS 100 - 125 BZ/F - BRP 110/A - BTRP 160/A - 130 BZS - 180-181 BTZ/A - 130-131 BZ/D - 90 MZS/A - 135 BDF - 90-91 MZ/C - VECCHIA PRODUZIONE: 1 1/2 MRRAU/S - MPS 58 - 180-181 BTZ - 1 1/2 MRRAU - 0 MRAUG - 3 BRRAU - 100 BRPS - BRCP 100 - BS 100 - 90-91 MZ - BTRP 160 - 130-131 BZ - 70 BRRCO/B - BRP 110 - BRCP 100/D-E-F
RC0920	12C163	SALVAVERSOIO DX	NARDI	TRAINATI: 2 1/2 BT/F-G - 2 1/2 BT/FI-GI - VECCHIA PRODUZIONE: 3 BAUG - 4 QPR - 2 1/2 BT/A-B-C-D-E - 3 TQR/A - 3 BT/A-B-C - 2 BTR/A-B-C
RC0921	13C163	SALVAVERSOIO DX	NARDI	CARRELLATI: 60 MRCU/A - 1 MCUG/F - 55 MRCU - PORTATI: 110 MZS - 100 MZ/C - MRCP 58/H - MCP 58/H - BTS 120 - 140 BZ/D - 115 MDF - 135 BRPS/A - VECCHIA PRODUZIONE: MPL 50 - MRCP 58/D-F - 2 MDAU - 140 BZ - MCP 58/D-F - 1 MAUG - 60 MRCU - MRP 50 - MRPL 56-61 - 2 MAU - 1 MCAUG - ZPL 80 - 135 BRPS - 4 DTQR - 3 DBTR - 5 QPR - 2 MRAU - 3 DBT/A-B - MP 50 - 100 MZ - MP2L 50 - MPP 60 - MP 58/D
RC0922	13CS163	SALVAVERSOIO SX	NARDI	CARRELLATI: 55 MRCU - 60 MRCU/A - 1 MCUG/F - PORTATI: BTS 120 - MCP 58/H - 115 MDF - 140 BZ/D - MRCP 58/H - 110 MZS - 135 BRPS/A - 100 MZ/C - VECCHIA PRODUZIONE: 5 QPR - 4 DTQR - 2 MRAU - 60 MRCU - 2 MAU - 135 BRPS - 140 BZ - 2 MDAU - 3 DBT/A-B - 1 MCAUG - 3 DBTR - 1 MAUG - ZPL 80 - MRPL 56-61 - MRP 50 - MPL 50 - MP2L 50 - MCP 58/D-F - MRCP 58/D-F - MP 58/D - MPP 60 - MP 50 - 100 MZ
RC0921B	13C163B	SALVAVERSOIO DX	NARDI	CARRELLATI: 55 MRCU - 60 MRCU/A - 1 MCUG/F - PORTATI: 140 BZ/D - 100 MZ/C - MRCP 58/H - 135 BRPS/A - 110 MZS - 115 MDF - MCP 58/H - BTS 120 - VECCHIA PRODUZIONE: 60 MRCU - 3 DBTR - 2 MAU - 135 BRPS - 2 MDAU - 3 DBT/A-B - 140 BZ - MPP 60 - 1 MAUG - ZPL 80 - MRCP 58/D-F - MRP 50 - 4 DTQR - MRPL 56-61 - MCP 58/D-F - 1 MCAUG - MP2L 50 - 2 MRAU - MPL 50 - 5 QPR - MP 50 - MP 58/D - 100 MZ
RC0922B	13CS163B	SALVAVERSOIO SX	NARDI	CARRELLATI: 55 MRCU - 1 MCUG/F - 60 MRCU/A - PORTATI: 100 MZ/C - 110 MZS - BTS 120 - 135 BRPS/A - MCP 58/H - 140 BZ/D - MRCP 58/H - 115 MDF - VECCHIA PRODUZIONE: 1 MCAUG - MRP 50 - ZPL 80 - 1 MAUG - MCP 58/D-F - MP 58/D - MP 50 - MRCP 58/D-F - 100 MZ - MPP 60 - 60 MRCU - 140 BZ - 3 DBT/A-B - 2 MRAU - 135 BRPS - 2 MDAU - MRPL 56-61 - MPL 50 - MP2L 50 - 4 DTQR - 3 DBTR - 5 QPR
RC0923B	14C163B	SALVAVERSOIO DX	NARDI	CARRELLATI: 2 MRAUG/F - 65 MRCU/A - 100 BRRCO/B - PORTATI: BRP 160/A - TRAINATI: 4-4 1/2 TQR/F-FI - 4 BT/FI-GI - 4 BT/F-G - 4 BTP/I - 4 BTP - 3 BTR/FI-GI - 3 BTR/F-G - VECCHIA PRODUZIONE: 4 TQR/A-B - 65 MRCU - 4 BTSP - 4 BTSP/F-FI - 5 DQPR - 4 BT/A-B - 4 BT/BI - BRP 160 - 2 1/2 MRAU - 100 BRRCO - 2 MRAUG
RC0923	14C163	SALVAVERSOIO DX	NARDI	CARRELLATI: 2 MRAUG/F - 100 BRRCO/B - 65 MRCU/A - PORTATI: BRP 160/A - TRAINATI: 4 BTP/I - 4 BTP - 4 BT/FI-GI - 3 BTR/FI-GI - 4-4 1/2 TQR/F-FI - 3 BTR/F-G - 4 BT/F-G - VECCHIA PRODUZIONE: 4 BTSP - 100 BRRCO - 4 BTSP/F-FI - 4 BT/A-B - 65 MRCU - 2 MRAUG - 5 DQPR - 4 TQR/A-B - 4 BT/BI - 2 1/2 MRAU - BRP 160
RC0924B	13C164B	SALVAVERSOIO DX	NARDI	CARRELLATI: 80-90 BRRCO/B - 3 BRRAU/A - PORTATI: BRP 120/K - 150 BRPS/B - TRAINATI: 3 TQR/F-FI - 3 BT/F-G - 3 BT/FI-GI - VECCHIA PRODUZIONE: 3 TQR/A-B - 3 BRRAU - 150 BRPS - 2 BTR/C - BRP 120/D-F-G-H - 3 BT/E - 3 BT/EI - 80-90 BRRCO
RC0924	13C164	SALVAVERSOIO DX	NARDI	CARRELLATI: 3 BRRAU/A - 80-90 BRRCO/B - PORTATI: BRP 120/K - 150 BRPS/B - TRAINATI: 3 BT/F-G - 3 TQR/F-FI - 3 BT/FI-GI - VECCHIA PRODUZIONE: 3 BT/EI - 3 BT/E - 3 TQR/A-B - BRP 120/D-F-G-H - 2 BTR/C - 150 BRPS - 80-90 BRRCO - 3 BRRAU

ORECCHIE MOBILI ADATTABILI ALLA PRODUZIONE NARDI

OREILLES MOBILES ADAPTABLE TYPE NARDI

MOUL BOARDS EXTENSIONS FOR NARDI LINE

STREICHSCHTENE FÜR STREICHBLECH PASSEND FÜR NARDI

OREJAS MOVIBLES PARA PRODUCCIÓN NARDI



Art./Ref.	Rif. Orig./Orig. Ref.	Titolo Prodotto/Titolo Prodotto	Brand	Applicazione/Application
RC0462	5C182, 6C182	ORECCHIA MOBILE DX	NARDI	CARRELLATI: 30-35 BRCUS/A - 45 BTRCU/A - 30-35 BRCU/A - 1 BTCAUG/F - PORTATI: QPRT 130/C - PERT 130/C - ZAP 35 - DAP 28/A - 90 BTZ/E - 50 BZ/E - MVPL 15 - 40 BRPS/A - BRCP 38-39/H - MVP2L 18 - 120 QTZ/E - MCP 18/A - MCPL 15 - BTP 60 SI - EEP 130 FS - ZCPL 28 - MPSC 28/A - BTRCP 48/H - BRCPL 38/A - BRCPL 38-48/A - MCP2L 18 - BRNP 39 - BPG 50 - TQP 80 SI - BPSC 50 - TQRCP 70/H - BP 38/H - TQRT 80/C - TRAINATI: 00 BT/F-G - 00 BT/FI-GI - VECCHIA PRODUZIONE: BRCP 27-35 - BP 38/D-F - BRCP 38-39/D-F-G - BPL 35 - BRCPL 38-48 - BPSC 38 - BRCPC 28-36 - BRCPL 38 - QPRT 130/A - M 14 - MCP 18 - MCP 18-20-21 - MCPC 21 - MPSC 28 - TBP 60 - MP 12 - BCPP 40 - MP2L 14 - MP2L 18-20 - MVPL 28 - MVPL 28-48 - MVP2L - PER 130 - PERT 130/A - QPRT 130 - QTP 80/C - DAP 28 - ZVPL 27 - TRCP2L 55 - 1 BTAU - TQRT 80/A-B - TQRCP 70/D-F - TRP2L 55 - ZPL 27 - 90 BTZ - ZAPL 28 - ZBAP 38-48-50 - 00 MAU/I - ZVP2L 14-18 - 0 BCAU - 0 PQ - 00 BT - 0 QT - 0 BTCAUG - 00-0 BAU - 00-0 BRAU - 00-0 BRCAUS - BTRCP 48 - 50 BZ - 00-0 BRCAU - BRPS 38 - BRPO 38 - MPL 14 - 1 BTAU - BRPL 37-47 - BRP 37 - TBP 80/C - BTRCP 48/D-E-F - DAP 27 - BVP2L 35-47 - 3 MAU - BRP2L 55 - 45 BTRC - 1 1/2 BTRCAU - 1 TRAU - 30-35 BRCU - 1 TAUG - 40 BRPS - 1 BTCAUG - 120 QTZ/A-D - 1-1 1/2 BTRCAU/S - UN 7 - UN 9 - UN 6 - CN 9
RC0463	5CS182, 6CS182	ORECCHIA MOBILE SX	NARDI	CARRELLATI: 30-35 BRCU/A - 30-35 BRCUS/A - 1 BTCAUG/F - 45 BTRCU/A - PORTATI: BRNP 39 - BTP 60 SI - 120 QTZ/E - 90 BTZ/E - BTRCP 48/H - 40 BRPS/A - EEP 130 FS - PERT 130/C - DAP 28/A - MCP 18/A - MCPL 15 - MCP2L 18 - MPSC 28/A - QPRT 130/C - MVPL 15 - BP 38/H - BPG 50 - BPSC 50 - BRCP 38-39/H - MVP2L 18 - BRCPL 38-48/A - BRCPL 38/A - TQP 80 SI - TQRT 80/C - ZCPL 28 - TQRCP 70/H - ZAP 35 - 50 BZ/E - TRAINATI: 00 BT/FI-GI - 00 BT/F-G - VECCHIA PRODUZIONE: 00-0 BAU - PER 130 - MVPL 28-48 - 00-0 BRAU - MVPL 28 - DAP 28 - BRCPL 38-48 - BRCPL 38 - ZVP2L 14-18 - BRCPC 28-36 - BRCP 38-39/D-F-G - 00 MAU/I - PERT 130/A - BRCP 27-35 - MVP2L - QPRT 130 - 0 PQ - MCP 18-20-21 - 0 BTCAUG - MPL 14 - 00 BT - 45 BTRC - MP 12 - MPSC 28 - MP2L 14 - 0 BCAU - BPSC 38 - QPRT 130/A - 00-0 BRCAU - BCPP 40 - MCPC 21 - M 14 - MCP 18 - 00-0 BRCAUS - MP2L 18-20 - 1 BTCAUG - ZPL 27 - 1 TAUG - 1-1 1/2 BTRCAU/S - 120 QTZ/A-D - 3 MAU - 30-35 BRCU - TRP2L 55 - 1 1/2 BTRCAU - 40 BRPS - 90 BTZ - 50 BZ - QTP 80/C - 1 BTAU - ZBAP 38-48-50 - ZAPL 28 - TRCP2L 55 - 1 TRAU - BTRCP 48/D-E-F - TQRCP 70/D-F - DAP 27 - 0 QT - BPL 35 - BP 38/D-F - ZVPL 27 - TBP 60 - BVP2L 35-47 - BTRCP 48 - BRPS 38 - TQRT 80/A-B - BRPL 37-47 - BRPO 38 - TBP 80/C - BRP 37 - BRP2L 55 - UN 6 - UN 7 - UN 9 - CN 9
RC0464	7C183	ORECCHIA MOBILE DX	NARDI	CARRELLATI: 50 TRCU/A - 45 BRCU/A - 45 BRCUS/A - 0 BCUAG/A - 30 ZRCU - 30 ZRCUI - PORTATI: 35 MRPS/A - 80 BZS/A - 60-80 BZ/E - TQP 90 SI - QPS 140 U/A - BRCPL 48/A - BRCP 48/H - 60 BZS - BP 48/H - DAP 38/A - BTRCP 52/H - 40 MZ/E - BTRCP 70/H - MPSC 30/A - QPRT 140/C - MRCP 28/A - 100 BTZ - 50 BRPS/A - 130 QTZ/E - 110 BTZS - BPSC 60 - ZCPL 38 - MRCP 28/H - TQRT 90/C - PES 140 U/A - ZAP 45 - TRAINATI: 0 TQR/F-FI - 0 BT/F-G - 0 BT/FI-GI - VECCHIA PRODUZIONE: ZBAP 60-80 - MRPS 28 - BRCP 48/D-F-G - BP 48/D-F - BPSC 48 - MRPO 28 - BRCPL 48 - MRCP 28/D-F - TQRT 90/A - PES 140 U - MRCP 28-30 - MRCP 28 - QPS 140 U - PERT 140 - ZVCPL 38 - 2 1/2 - 3 BTRCAU - 0 BCUAG - 0 BT/D - 60-80 BZ - ZQPT 80/I - ZQPT 80/I - 1-1 1/2 BRCAU - 1-1 1/2 BRCAU/S - 00 ZLAU - 1-1 1/2 BCUAG - 130 QTZ/A-D - 50 BTRCU - ZBAP 80/I - MPSC 30 - DAP 38 - MPFS 30 - MCPL 28 - BTRCP 52/D-E-F - BTRCP 70/D-F - QPRT 140/A - 50 BRPS - 35 MRPS - 40 MZ - 45 BRCU - BRPS 48
RC0465	7CS183	ORECCHIA MOBILE SX	NARDI	CARRELLATI: 30 ZRCU - 0 BCUAG/A - 45 BRCU/A - 30 ZRCUI - 50 TRCU/A - 45 BRCUS/A - PORTATI: BTRCP 70/H - BTRCP 52/H - 60-80 BZ/E - DAP 38/A - 40 MZ/E - 35 MRPS/A - BP 48/H - ZAP 45 - TQP 90 SI - TQRT 90/C - PES 140 U/A - MRCP 28/H - 80 BZS/A - QPRT 140/C - BPSC 60 - BRCPL 48/A - MPSC 30/A - BRCP 48/H - MRCP 28/A - QPS 140 U/A - 110 BTZS - 130 QTZ/E - ZCPL 38 - 50 BRPS/A - 60 BZS - 100 BTZ - TRAINATI: 0 BT/FI-GI - 0 TQR/F-FI - 0 BT/F-G - VECCHIA PRODUZIONE: QPS 140 U - MRPS 28 - QPRT 140/A - MRPO 28 - PERT 140 - BRCPL 48 - 60-80 BZ - 130 QTZ/A-D - MRCP 28 - ZQPT 80/I - TQRT 90/A - 1-1 1/2 BCUAG - 00 ZLAU - 1-1 1/2 BRCAU/S - 1-1 1/2 BRCAU - MRCP 28/D-F - MRCP 28-30 - PES 140 U - 45 BRCU - ZBAP 80/I - BP 48/D-F - BTRCP 70/D-F - 0 BT/D - 2 1/2 - 3 BTRCAU - 50 BRPS - BRCP 48/D-F-G - 35 MRPS - 40 MZ - 0 BCUAG - 50 BTRCU - BRPS 48 - DAP 38 - ZBAP 60-80 - ZQPT 80/I - BTRCP 52/D-E-F - BPSC 48 - MPSC 30 - MCPL 28 - ZVCPL 38 - MPFS 30

Art./Ref.	Rif. Orig./Orig. Ref.	Titolo Prodotto/Titolo Prodotto	Brand	Applicazione/Application
RC0466	9C183	ORECCHIA MOBILE DX	NARDI	CARRELLATI: 35 ZRACUI - 30-35 MRCUS/A - 45 ZRCU - 35 ZRACU - 1 BRCAUG/F - 30-35 MRCU/A - 45 ZRCUI - 60 BRCUA - 0 BRAUG/A - 50 BRRCU/A - 2 BTCAUG/F - 50 BRCUS/A - 50-55 BRCU/A - PORTATI: TQS 150 - QPRT 150/C - 90 BZS/A - 90-100 BZ/E - BPSC 70/A - BCP 70/H - MCP 38/H - DAP 48/A - BRCLP 80 - 60 MZS - BP 58/H - BTRP 100/A - BTRCP 80/H - MP 46/H - 40-50 MRPS/A - BRCP 58-68-70/H - ZCPL 48 - BTRCPL 80 - BTRCPL 80/A - TQRT 150/C - 120-130 TZ/E - MRCP 38/H - ZAP 60 - MPSC 50-60 - MVPL 48 - MRCP 47/H - 180 QTZ/E - 110 BZS - 115 BDF - MRCLP 38/A - PESS 150 - MPG 50 - 60 MZ/E - TRAINATI: 1 TQR/F-FI - 1 BT/F-G - 0 BTR/FI-GI - 0 BTR/F-G - 1 BT/FI-GI - VECCHIA PRODUZIONE: BRCP 70/D-F - BRCLP 55 - QPER 150 - BPSC 70 - BP 58/D-F - MRCLP 38 - BCP 70/D-F - MRPO 38 - 0 BTR - BRCP 68 - MRCP 38/D-F - BP 70 - MRCP 36 - MPFS 40 - TQRT 150/A-B - ZBAP 90/A - MPSC 38 - TQRT 150 - MRPS 38-48 - BRCP 58/D-F-G - 0 BRAUG - MSPSC 48 - 40 MRPS - 0 MRAU/S - 00 MCAU - 0-1-1 1/2 ZRAU - 0 MRAU - 0 MAU - 1 BRCAUG - 1 BT/E - 00 MRCAU/S - 00 MRCAU - 120-130 TZ/A-D - 1 1/2 BRRCU/S - 1 1/2 BRRCU - 1 TQR - 1 DBT/A - 2 BTCAUG - 180 QTZ/A - 2 BAU - 2 BRAU - 1 BAUG - 50-55-60 BRCU - BRPS 58 - BTRP 100 - 2 DQP - BTRCP 80/D-F - DAP 48 - EP 58-70/D - MCP 38/D-F - MP 46/D-F - 35 ZRCU - 35 ZRCUI - 90-100 BZ - 60 ZM - 50 BRRCU - 70 BRPS - 30-35 MRCU - 2 ZM - 2 1/2 BLRAU - 3 TAUG - BRL 80
RC0467	9CS183	ORECCHIA MOBILE SX	NARDI	CARRELLATI: 45 ZRCU - 0 BRAUG/A - 60 BRCUA - 45 ZRCUI - 1 BRCAUG/F - 2 BTCAUG/F - 35 ZRACUI - 50-55 BRCU/A - 50 BRCUS/A - 35 ZRACU - 30-35 MRCUS/A - 30-35 MRCU/A - 50 BRRCU/A - PORTATI: BTRCPL 80 - BTRCP 80/H - BTRCPL 80/A - BTRP 100/A - 40-50 MRPS/A - DAP 48/A - MCP 38/H - MRCP 38/H - PESS 150 - ZCPL 48 - MPSC 50-60 - MRCP 47/H - MPG 50 - MRCLP 38/A - MVPL 48 - ZAP 60 - TQS 150 - BP 58/H - BRCLP 80 - 90 BZS/A - BCP 70/H - BPSC 70/A - QPRT 150/C - TQRT 150/C - MP 46/H - BRCP 58-68-70/H - 60 MZS - 110 BZS - 60 MZ/E - 115 BDF - 180 QTZ/E - 120-130 TZ/E - 90-100 BZ/E - TRAINATI: 1 BT/FI-GI - 1 TQR/F-FI - 0 BTR/FI-GI - 0 BTR/F-G - 1 BT/F-G - VECCHIA PRODUZIONE: TQRT 150 - 1 DBT/A - MRPS 38-48 - BCP 70/D-F - 2 BAU - QPER 150 - TQRT 150/A-B - BTRCP 80/D-F - BRCP 58/D-F-G - BRCP 68 - 120-130 TZ/A-D - MRPO 38 - MPFS 40 - 2 BRAU - 2 BTCAUG - 180 QTZ/A - MRCP 38/D-F - MRCP 36 - 1 1/2 BRRCU/S - MPSC 38 - MRCLP 38 - BRCLP 55 - 2 DQP - 0 BRAUG - MSPSC 48 - ZBAP 90/A - 70 BRPS - 1 1/2 BRRCU - 0 BTR - 0 MAU - 35 ZRCUI - 40 MRPS - 1 TQR - BTRP 100 - 1 BT/E - 1 BRCAUG - 2 ZM - 2 1/2 BLRAU - 90-100 BZ - BRCP 70/D-F - 50 BRRCU - 60 ZM - 30-35 MRCU - 35 ZRCU - 50-55-60 BRCU - BRPS 58 - 3 TAUG - BRP 70 - 0-1-1 1/2 ZRAU - 0 MRAU/S - 00 MRCAU - BPSC 70 - 00 MCAU - DAP 48 - BRL 80 - BP 58/D-F - MP 46/D-F - EP 58-70/D - 1 BAUG - 00 MRCAU/S - 0 MRAU - MCP 38/D-F
RC0468	10C184	ORECCHIA MOBILE DX	NARDI	CARRELLATI: 2 BRAUG/F - 50 ZRCUI - 65 BRUCA - 45 MRCUS - 45 MRCU - 50 ZRCU - PORTATI: 120-121 BZ/D - 80 MZS/A - MCP 48/H - 95 BRPS/A - 80-81 MZ/C - MRCLP 48 - 55 MRPS - BRCP 90/A - BTRP 110/A - MRCP 48/H - MPSC 70 - TRAINATI: 2 BT/FI-GI - 2 BT/F-G - 2 TQR/F-FI - VECCHIA PRODUZIONE: MP2L 50 - BS 100 - 1 MRAU - BTRP 110 - BRCP 90 - 120-121 BZ/A - MRCP 48/D-F - MRP 48/D - MRPL 48-49 - MVP 40 - 0 MAUG - 1 MRAU/S - 1 1/2 MRAU - 1-1 1/2 MAU - 1 BTR - 2 BAUG/F - 2 DBT/A-B - 2 BAUG - 2 BT/E - 3 BRAU - 3 QPR - DAP 60 - 2 1/2 ZRAU - 3 BAU - 3 ZB - 2 1/2 BRAU - MPL 45-47 - MPP 40 - MCP 48/D-F - MP 48/D - MP 40 - 95 BRPS - 65 BRCU - MP2L 42 - 80-81 MZ
RC0469	10CS184	ORECCHIA MOBILE SX	NARDI	CARRELLATI: 2 BRAUG/F - 50 ZRCU - 45 MRCU - 65 BRUCA - 45 MRCUS - 50 ZRCUI - PORTATI: 80-81 MZ/C - 80 MZS/A - MRCP 48/H - MRCLP 48 - BRCP 90/A - 95 BRPS/A - BTRP 110/A - MCP 48/H - 55 MRPS - MPSC 70 - 120-121 BZ/D - TRAINATI: 2 BT/F-G - 2 TQR/F-FI - 2 BT/FI-GI - VECCHIA PRODUZIONE: MRP 48/D - MP2L 50 - BTRP 110 - 1 MRAU - BRCP 90 - 1-1 1/2 MAU - MRPL 48-49 - BS 100 - MP2L 42 - 1 1/2 MRAU - MVP 40 - 1 MRAU/S - 0 MAUG - MRCP 48/D-F - 1 BTR - DAP 60 - 2 BAUG - 2 BAUG/F - 2 BT/E - 3 BAU - 2 1/2 ZRAU - MCP 48/D-F - 2 DBT/A-B - 2 1/2 BRAU - 3 QPR - 3 BRAU - MP 48/D - MPL 45-47 - 3 ZB - MP 40 - MPP 40 - 95 BRPS - 65 BRCU - 120-121 BZ/A - 80-81 MZ
RC0470	12C184	ORECCHIA MOBILE DX	NARDI	CARRELLATI: 130 BTRRCO - 75 BRRCO - 50 MRCUS - 50 MRCU - 70 BRCU - 0 MRCAUG - PORTATI: 90 MZS/A - 90-91 MZ/C - 130 BZS - 65 MRPS - 135 BDF - BRP 110/A - BTRP 160/A - BTS 100 - 100 BRPS/A - 180-181 BTZ/A - 130-131 BZ/D - 125 BZF - TRAINATI: 2 1/2 BT/F-G - 2 1/2 BT/FI-GI - VECCHIA PRODUZIONE: 1 1/2 MRRAU - BRP 110 - 1 1/2 MRRAU/S - 100 BRPS - 1 1/2 MRRCU - BRP 100 - 130-131 BZ - BRCP 100/E - 180-181 BTZ - 2 1/2 DBT/A-B - BRCP 100/F - 4 QPR - 4 BRAU - 3 BRRAU - 3 BAUG - 3 BRAUG - 2 1/2 BT/E - 2 BTR/A-B - MRPS 58 - 0 MRAUG - MPS 58 - 70 BRRCO/B - BTRP 160 - 90-91 MZ
RC0471	12CS184	ORECCHIA MOBILE SX	NARDI	CARRELLATI: 75 BRRCO - 50 MRCUS - 0 MRCAUG - 130 BTRRCO - 70 BRCU - 50 MRCU - PORTATI: 125 BZF - 130 BZS - 65 MRPS - 130-131 BZ/D - BTS 100 - 135 BDF - BTRP 160/A - BRP 110/A - 100 BRPS/A - 90 MZS/A - 90-91 MZ/C - 180-181 BTZ/A - TRAINATI: 2 1/2 BT/F-G - 2 1/2 BT/FI-GI - VECCHIA PRODUZIONE: BRP 110 - 3 BRRAU - 3 BAUG - 3 BRAUG - 2 BTR/A-B - 1 1/2 MRRCU - 100 BRPS - 1 1/2 MRRAU/S - 130-131 BZ - 1 1/2 MRRAU - BRCP 100/E - BRCP 100/F - 4 BRAU - 70 BRRCO/B - 90-91 MZ - 2 1/2 BT/E - 4 QPR - 180-181 BTZ - 2 1/2 DBT/A-B - BTRP 160 - 0 MRAUG - MRPS 58 - MPS 58 - BRP 100
RC0472	13C184	ORECCHIA MOBILE DX	NARDI	CARRELLATI: 3 BRRAUG/A - 2 MRAUG/F - 60-65 MRCUA - 55 MRCU - 80-90-100 BRRCO/B - 1 MCUAG/F - PORTATI: 150 BRPS/B - 180 BZ/A - 95 MPS/A - BTS 120 - 100 MZ/C - BRP 160/A - 125 MZD - 120 MZ/D - 115 MDF - 135 BRPS/A - 70 MRPS - 140 BZ/D - MRPL 80 - MRCP 58-70/H - MCP 70/H - 110 MZS - MCP 58/H - TRAINATI: 3-4 BT/F-G - 3-4 1/2 TQR/F-FI - 4 BTP/I - 4 BTP - 3-4 BT/FI-GI - 3 BTR/F-G - 3 BTR/FI-GI - VECCHIA PRODUZIONE: MCP 58/D-F - BRP 160 - BRP 120/D-E-G - 140-180 BZ - MRP2L 50 - ZPL 80 - 1 MCUAG - 100-120 MZ - BRP 120/H - MRPL 56-61 - 135-150 BRPS - MRP 70/D - 2 MRAUG - 2 1/2 MRAU - 2 ZM - 3 BRRAUG - 95 MPS - 2 MAU - 2 MRCAU - MRP 55 - 3 BT/EI - 3 BT/E - 3 DBT/A-B - 60-65 MRCU - 80-90-100 BRRCO - 4 BT/BI - MP 70/D - MP 50 - MPP 60 - MRCP 58-70/D-F - MCP 70/D-F - MP 58/D - 4 BT/B - 5 QPR - 4 BTSP - 4 BTSP/I
RC0473	13CS184	ORECCHIA MOBILE SX	NARDI	CARRELLATI: 60-65 MRCUA - 2 MRAUG/F - 1 MCUAG/F - 3 BRRAUG/A - 55 MRCU - 80-90-100 BRRCO/B - PORTATI: 125 MZD - 120 MZ/D - BTS 120 - BRP 160/A - MRCP 58-70/H - MCP 58/H - 115 MDF - 135 BRPS/A - 100 MZ/C - 150 BRPS/B - MRPL 80 - 110 MZS - 140 BZ/D - 95 MPS/A - MCP 70/H - 180 BZ/A - 70 MRPS - TRAINATI: 3-4 1/2 TQR/F-FI - 3-4 BT/F-G - 3 BTR/FI-GI - 4 BTP/I - 3-4 BT/FI-GI - 4 BTP - 3 BTR/F-G - VECCHIA PRODUZIONE: 1 MCUAG - 2 ZM - 2 MRAUG - MRPL 56-61 - 3 BRRAUG - MRP 55 - 2 1/2 MRAU - 135-150 BRPS - MRP2L 50 - 2 MAU - 100-120 MZ - MCP 58/D-F - 140-180 BZ - 2 MRCAU - ZPL 80 - BRP 120/D-E-G - 4 BTSP/I - 4 BTSP - 3 BT/EI - MRP 70/D - 4 BT/B - 4 BT/BI - 95 MPS - 3 BT/E - 5 QPR - MP 58/D - MP 50 - 60-65 MRCU - BRP 120/H - BRP 160 - MCP 70/D-F - MRCP 58-70/D-F - MP 70/D - MPP 60 - 80-90-100 BRRCO - 3 DBT/A-B

SUOLE ANTERIORI E POSTERIORI PER CORPI A SCALPELLO ADATTABILI ALLA PRODUZIONE NARDI

SEP AVANT ET ARRIERE POUR CORPS ADAPTABLE TYPE NARDI

LANDSIDE, FRONT AND BACK PART FOR POINT-BODY FOR NARDI LINE

GLEITPLATTE VORDETEIL UND HINTERTEIL FÜR NEIBELSCHASTÜRPESEN PASSEND FÜR NARDI

SUELAS ANTERIORES Y TRASERAS PARA CUERPOS A ESCOPLA PARA PRODUCCIÓN NARDI

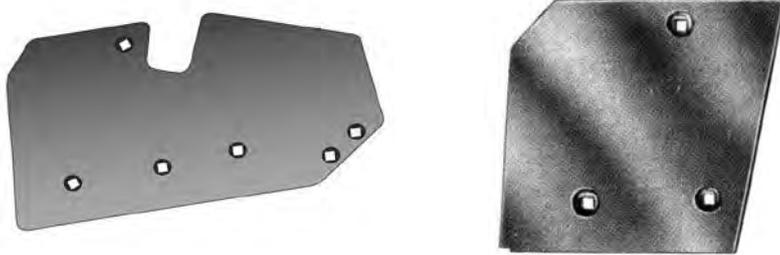

Art./Ref.	Rif. Orig./Orig. Ref.	Titolo Prodotto/Titolo Prodotto	Brand	Applicazione/Application
RC0370	5C115A	SUOLA ANTERIORE DX	NARDI	CARRELLATI: 35 TRCU/A - PORTATI: 60 BTZ/E - BP 28/H - 35 BRPS/A - BPT 28 G - BRCP 28/G - 40 BZ/E - BRP 26 V - BTRCP 28/H - TQRT 60 L - TQRCPL 48/H - TQPRT 60/C - BPSC 28-30/A - BRCPL 28/A - VECCHIA PRODUZIONE: BRCPC 28 - BPFS 30 - BTRCP 28/D-F - BLCPC 28 - BRPO 28 - BP 28/D-F - BTCP 28/D - BRCPL 28 - BRPS 28 - 00-0 BTRCAU - TQRCPL 48/D-F - TQPRT 60 - 0 BTCUA - BPSC 28-30 - TQRCPL 38-48 - 60 BTZ - BTRCPL 38-48/A - 40 BZ - BRCP 28/D-F-G - 35 BRPS - ZBAP 39 - BTRCPL 38-48
RC0371	5CS115A	SUOLA ANTERIORE SX	NARDI	CARRELLATI: 35 TRCU/A - PORTATI: 35 BRPS/A - 40 BZ/E - 60 BTZ/E - BP 28/H - BPT 28 G - BPSC 28-30/A - BTRCP 28/H - BRCP 28/G - TQRCPL 48/H - BRP 26 V - TQRT 60 L - TQPRT 60/C - BRCPL 28/A - VECCHIA PRODUZIONE: BLCPC 28 - BTRCPL 38-48 - BP 28/D-F - BRCPC 28 - BRPS 28 - BRPO 28 - BRCPL 28 - BTRCP 28/D-F - BTCP 28/D - TQRCPL 48/D-F - TQPRT 60 - 00-0 BTRCAU - 0 BTCUA - ZBAP 39 - BPFS 30 - 35 BRPS - TQRCPL 38-48 - 60 BTZ - BPSC 28-30 - BTRCPL 38-48/A - BRCP 28/D-F-G - 40 BZ
RC0372	5 1/2C115A	SUOLA ANTERIORE DX	NARDI	CARRELLATI: 30 BRCU/A - 30 BRCU/A - PORTATI: TQP 60 SI - 50 BZ/E - BTP 38 G - EEP 130 FS - TQRT 80/C - PER 130/C - 120 QTZ/E - 90 BTZ/E - BTP 60 SI - QPRT 130/C - VECCHIA PRODUZIONE: TQRT 80/A - QPT 80/A-B - TQRT 80 - TBP 80/A-D - QPRT 130/A - 90 BTZ - 120 QTZ/A-D - ZBAP 50 - 120 QTZ - PER 130 - 90 BTZ/C - 30 BRCU - PQP 80/A-D - QPRT 130 - 50 BZ - PER 130/A
RC0373	5 1/2CS115A	SUOLA ANTERIORE SX	NARDI	CARRELLATI: 30 BRCU/A - 30 BRCU/A - PORTATI: 50 BZ/E - PER 130/C - TQP 60 SI - EEP 130 FS - BTP 38 G - BTP 60 SI - QPRT 130/C - TQRT 80/C - 90 BTZ/E - 120 QTZ/E - VECCHIA PRODUZIONE: QPRT 130 - TBP 80/A-D - 30 BRCU - QPRT 130/A - 90 BTZ - 120 QTZ/A-D - QPT 80/A-B - PQP 80/A-D - TQRT 80/A - 90 BTZ/C - 50 BZ - ZBAP 50 - PER 130/A - 120 QTZ - TQRT 80 - PER 130
RC0374	6C115A	SUOLA ANTERIORE DX	NARDI	CARRELLATI: 45-50 BTRCU/A - 0 BCAUG/A - 1 BTCAUG/F - 35-45 BRCU/A - 35-45 BRCU/A - PORTATI: 60-80 BZ/E - BPG 50 - TQP 90 SI - QPRT 140 C - 80 BZS/A - 100 BTZ - BPSC 50-60 - QPS 140 U/A - 60 BZS - BRCPL 48/A - BP 38 G - BRCP 38-39-48/H - BP 38-48/H - TQRT 90 C - BRCPL 38-48/A - BRCPL 38/A - TQRCPL 70/H - BTRCP 48-52-70/H - PES 140 U/A - TRAINATI: 0 TQR/F-FI - 00-0 BT/F-G - 00-0 BT/FI-GI - VECCHIA PRODUZIONE: BRCP 38-39-48/D-F-G - BP 38-48/D-F - BPSC 38 - PES 140 U - BRPS 38-48 - BTRCP 48/D-F - BTRCP 52/D-E-F - BTRCP 70/D-F - QPRT 140 - TQRT 90 - BRPO 38 - QPS 140 U - TQRCPL 70/D-F - BRPL 49 - TRCP2L 55 - 1 BTCAUG - ZBAP 60-80 - 0 BCAUG - 0 BTCAUG - 0 TCAUG - ZQTP 801 - 0-1-1 1/2 BRCU - 0-1-1 1/2 BCU - BRCP 40 - 00 BT/C - 1 BTCAU - 00-0-1-1 1/2 BRCU/S - 40-50 BRPS - 0 BT/C - BRCPL 38-48 - 60-80 BZ - BCPP 40 - BRCPC 28-36 - BRCPL 48 - 35-45 BRUC - BRCPL 38 - 80 BZ/C - TQRT 90/A - 45-50 BTRCU - 2 1/2 BTRCAU - 3 BTRCAU
RC0375	6CS115A	SUOLA ANTERIORE SX	NARDI	CARRELLATI: 45-50 BTRCU/A - 0 BCAUG/A - 35-45 BRCU/A - 35-45 BRCU/A - 1 BTCAUG/F - PORTATI: BRCP 38-39-48/H - BP 38-48/H - BPG 50 - BRCPL 38/A - BRCPL 38-48/A - 100 BTZ - QPRT 140 C - TQRT 90 C - BRCPL 48/A - PES 140 U/A - BTRCP 48-52-70/H - TQRCPL 70/H - TQP 90 SI - BPSC 50-60 - QPS 140 U/A - 80 BZS/A - BP 38 G - 60 BZS - 60-80 BZ/E - TRAINATI: 0 TQR/F-FI - 00-0 BT/FI-GI - 00-0 BT/F-G - VECCHIA PRODUZIONE: QPS 140 U - ZBAP 60-80 - QPRT 140 - TQRT 90/A - 00-0-1-1 1/2 BRCU/S - 0 BCAUG - ZQTP 801 - BPSC 38 - BRPL 49 - BRPS 38-48 - BTRCP 70/D-F - BTRCP 52/D-E-F - BTRCP 48/D-F - 0 TCAUG - BRPO 38 - TQRT 90 - 0 BTCAUG - TQRCPL 70/D-F - PES 140 U - 0 BT/C - TRCP2L 55 - 2 1/2 BTRCAU - 3 BTRCAU - 0-1-1 1/2 BCU - 0-1-1 1/2 BRCU - 00 BT/C - 60-80 BZ - 80 BZ/C - 40-50 BRPS - 1 BTCAU - 45-50 BTRCU - 35-45 BRUC - BRCP 38-39-48/D-F-G - BP 38-48/D-F - BRCPL 38 - 1 BTCAUG - BCPP 40 - BRCPC 28-36 - BRCPL 48 - BRCP 40 - BRCPL 38-48
RC0376	8C115A	SUOLA ANTERIORE DX	NARDI	CARRELLATI: 0 BRAUG/A - 2 BTCAUG/F - 50 BRCU/A - 50 BRCU/A - PORTATI: BPSC 70/A - BTRCP 80/H - BP 58/H - QPRT 150/C - PESS 150 - 70 BRPS/A - TQS 150 - TQRT 150/A - BTRCPL 80/A - BTRCPL 80 - BRCP 58/H - 90 BZ/E - 120 TZ/E - 90 BZS/A - TRAINATI: 0 BTR/F-G - 0 BTR/FI-GI - VECCHIA PRODUZIONE: 2 BTCAUG - BP 58/D-F - 0 BTR - TQRT 150/A - 1 1/2 BRRCU/S - ZBAP 90/A - QPRT 150/A - QPRT 150 - 120 TZ/D - TQRT 150 - BPSC 70 - BRCPL 55 - 50 BRCU - 70 BRPS - 0 BRAUG - BRPS 58 - BTRCP 80/D-F - 90 BZ - 90 BZ/C - BRCP 58/D-F-G - 120 TZ - 1 1/2 BRRCU
RC0377	8CS115A	SUOLA ANTERIORE SX	NARDI	CARRELLATI: 50 BRCU/A - 2 BTCAUG/F - 0 BRAUG/A - 50 BRCU/A - PORTATI: BTRCP 80/H - BPSC 70/A - BP 58/H - 70 BRPS/A - BRCP 58/H - BTRCPL 80 - 90 BZ/E - 90 BZS/A - 120 TZ/E - QPRT 150/C - TQS 150 - PESS 150 - BTRCPL 80/A - TQRT 150/C - TRAINATI: 0 BTR/F-G - 0 BTR/FI-GI - VECCHIA PRODUZIONE: BP 58/D-F - ZBAP 90/A - TQRT 150 - TQRT 150/A - QPRT 150 - BPSC 70 - QPRT 150/A - 1 1/2 BRRCU/S - 50 BRCU - 2 BTCAUG - 120 TZ/D - BRCP 58/D-F-G - 120 TZ - 90 BZ/C - 1 1/2 BRRCU - BRCPL 55 - 90 BZ - BTRCP 80/D-F - 0 BTR - BRPS 58 - 70 BRPS - 0 BRAUG

Art./Ref.	Rif. Orig./Orig. Ref.	Titolo Prodotto/Titolo Prodotto	Brand	Applicazione/Application
RC0378	9C115AL	SUOLA ANTERIORE DX	NARDI	CARRELLATI: 75 BRRCO - 60-65 BRCUA - 2 BRAUG/F - 70 BRCU - 1 BRCUAG/F - 130 BTRRCO - 55 BRCU/A - 50 BRRCO/A - PORTATI: 130 BZS - 95-100 BRPS/A - 180-181 BTZ/A - BRCPL 80 - 110 BZS - BTRP 100 - 110-160/A - 115 BDF - 125 BZF - 120-121-130-131 BZ/D - BTS 100 - 135 BDF - 100 BZ/E - TRAINATI: 1-2 BT/F-G - 1-2 BT/FI-GI - 1-2 TQR/F-FI - VECCHIA PRODUZIONE: BRCP 68 - BRCP 100/E-F - 1 TQR - BP 70/D - 100 BZ/C - 100-120-121-130-131 BZ - 1 BRCAUG - BRCP 70/D-F - BS 100 - 130 TZ/D - 2 1/2 BRAU - 180 QTZ - 130 TZ - 180-181 BTZ - BCP 70/D-F - 2 BRAUG - 2 BT/E - 180 QTZ/A - 2 BAUG/F - BRCP 90 - BRP 110 - 70 BRRCO - 3 BRRAU - BTR 100-110-160 - 55-60-65 BRCU - 50 BRRCO - 95-100 BRPS
RC0379	9CS115AL	SUOLA ANTERIORE SX	NARDI	CARRELLATI: 50 BRRCO/A - 55 BRCU/A - 60-65 BRCUA - 75 BRRCO - 70 BRCU - 130 BTRRCO - 2 BRAUG/F - 1 BRCUAG/F - PORTATI: 115 BDF - 120-121-130-131 BZ/D - 110 BZS - 100 BZ/E - 95-100 BRPS/A - BTRP 100-110-160/A - BRCPL 80 - BTS 100 - 125 BZF - 180-181 BTZ/A - 135 BDF - 130 BZS - TRAINATI: 1-2 BT/F-G - 1-2 TQR/F-FI - 1-2 BT/FI-GI - VECCHIA PRODUZIONE: 180 QTZ/A - 2 BAUG/F - 1 BRCAUG - 50 BRRCO - 180-181 BTZ - 180 QTZ - 100-120-121-130-131 BZ - 95-100 BRPS - 55-60-65 BRCU - 1 TQR - BRCP 100/E-F - 100 BZ/C - BTR 100-110-160 - 3 BRRAU - BRP 110 - 2 BRAUG - 2 BT/E - 70 BRRCO - 2 1/2 BRAU - BS 100 - BRCP 90 - 130 TZ/D - BP 70/D - 130 TZ - BCP 70/D-F - BRCP 68 - BRCP 70/D-F
RC0380	13C115A	SUOLA ANTERIORE DX	NARDI	CARRELLATI: 80-90-100 BRRCO/B - PORTATI: 135 BRPS/A - BTS 120 - BRP 120 K - BRP 160/A - 180 BZ/A - 140 BZ/D - 150 BRPS/B - VECCHIA PRODUZIONE: 80-90-100 BRRCO - 140-180 BZ - BRP 160 - 135-150 BRPS - BRP 120/H
RC0381	13CS115A	SUOLA ANTERIORE SX	NARDI	CARRELLATI: 80-90-100 BRRCO/B - PORTATI: BRP 120 K - 135 BRPS/A - BRP 160/A - BTS 120 - 180 BZ/A - 140 BZ/D - 150 BRPS/B - VECCHIA PRODUZIONE: 140-180 BZ - BRP 120/H - 80-90-100 BRRCO - BRP 160 - 135-150 BRPS
RC0382	5C115	SUOLA POSTERIORE DX	NARDI	CARRELLATI: 35 BTRCU/A - PORTATI: 40 BZ/E - 35 BRPS/A - TQRT 60 L - BRCPL 28/A - BRCP 28/H - BP 28/H - BPSC 28-30/A - BTRCP 28/H - 60 BTZ/E - TQRT 60/C - BRP 26 V - DAP 18/A - TQRCP 48/H - BTP 28/G - VECCHIA PRODUZIONE: BP 28/D-F - BLCPC 28 - BTRCPL 48 - BRCPL 28 - BTRCP 28/D-F - BTRCPL 38-48/A - BRPS 28 - BRPO 28 - BPSC 28-30 - TQPRT 60 - TQRCP 48/D-F - 00-0 BTRCAU/S - 0 BTCAU - BPFS 30 - 40 BZ - DAP 18 - BRCP 28/D-F-G - Z 14 - 00-0 BTRCUA - 35 BRPS - 60 BTZ
RC0383	5CS115	SUOLA POSTERIORE SX	NARDI	CARRELLATI: 35 BTRCU/A - PORTATI: BPSC 28-30/A - 35 BRPS/A - BRCP 28/H - BTP 28/G - 60 BTZ/E - BRP 26 V - BTRCP 28/H - BP 28/H - BRCPL 28/A - TQRT 60/C - TQRT 60 L - DAP 18/A - 40 BZ/E - TQRCP 48/H - VECCHIA PRODUZIONE: BRCP 28/D-F-G - BRCPL 28 - 0 BTCAU - DAP 18 - BRPO 28 - 60 BTZ - BRPS 28 - BTRCP 28/D-F - BP 28/D-F - BTRCPL 38-48/A - BLCPC 28 - 00-0 BTRCAU/S - 35 BRPS - 00-0 BTRCUA - 40 BZ - Z 14 - TQRCP 48/D-F - BTRCPL 48 - TQPRT 60 - BPFS 30 - BPSC 28-30
RC0384	5 1/2C115	SUOLA POSTERIORE DX	NARDI	CARRELLATI: 30 BRCU/A - 30 BRCUS/A - VECCHIA PRODUZIONE: QPT 80/A-D - QTP 81 - 30 BRCU - PQP 81 - TBP 80/A-D - TBP 81 - ZBAP 50 - PQP 80/A-D
RC0385	5 1/2CS115	SUOLA POSTERIORE SX	NARDI	CARRELLATI: 30 BRCUS/A - 30 BRCU/A - VECCHIA PRODUZIONE: PQP 80/A-D - QPT 80/A-D - PQP 81 - QTP 81 - TBP 80/A-D - TBP 81 - 30 BRCU - ZBAP 50
RC0386	6C115	SUOLA POSTERIORE DX	NARDI	CARRELLATI: 35-45 BRCUS/A - 35-45 BRCU/A - 1 BTCUAG/F - 0 BTCUAG - VECCHIA PRODUZIONE: BRPO 38 - 0 TQR/A-B - 0-1-1 1/2 BRCAU - 00-0-1-1 1/2 BRCAU/S - 00 MCAU/I - 35-45 BRCU - 1-1 1/2 BTRCAU - 1 BTCAUG - 2-2 1/2 BTRCAU - 1 BTCAU - MPFS 30
RC0387	6CS115	SUOLA POSTERIORE SX	NARDI	CARRELLATI: 35-45 BRCU/A - 1 BTCUAG/F - 0 BTCUAG - 35-45 BRCUS/A - VECCHIA PRODUZIONE: 1 BTCAU - BRPO 38 - 00 MCAU/I - 0-1-1 1/2 BRCAU - 00-0-1-1 1/2 BRCAU/S - 1-1 1/2 BTRCAU - 2-2 1/2 BTRCAU - MPFS 30 - 35-45 BRCU - 1 BTCAUG - 0 TQR/A-B
RC0388	6C115L	SUOLA POSTERIORE DX	NARDI	CARRELLATI: 30 ZCRU - 45-50 BTRCU/A - 0 BCUAG/A - PORTATI: MCP 18/A - BRCP 38-39-48/H - DAP 28-38/A - 100 BTZ - 80 BZS/A - BP 38 G - BP 38/H - MCPL 15 - BTRCP 48-52-70/H - BPG 50 - BP 48/H - MCP2L 18 - MRCP 28/H - TQRCP 70/H - ZCPL 28-38 - 60 BZS - TQP 90 SI - 60-80 BZ/E - ZAP 35-45 - TRAINATI: 0 TQR/F-FI - 00-0 BT/FI-GI - 00-0 BT/F-G - VECCHIA PRODUZIONE: 0 BCAUG - ZAPL 28 - MRCP 28/D-F - MCPC 21 - MCP 18 - ZBAP 60-80 - MRCPC 28 - DAP 28-38 - BTRCP 52/D-E-F - BRPS 38-48 - BTRCP 48-70/D-F - ZF 32 - TRCPL 55 - 00 ZLAU - BRCPC 36 - MRPO 28 - 60-80 BZ - 45-60 BTRCU - BRPCP 28 - BRCPC 40 - BP 38-48/D-F - 80 BZ/C - BRCP 38-39-48/D-F-G - BRCP 40 - BRCPL 49 - TQECF 70/D
RC0389	6CS115L	SUOLA POSTERIORE SX	NARDI	CARRELLATI: 45-50 BTRCU/A - 30 ZCRU - 0 BCUAG/A - PORTATI: 100 BTZ - MCPL 15 - ZCPL 28-38 - 80 BZS/A - MCP 18/A - BPG 50 - BP 38/H - BP 48/H - BP 38 G - 60-80 BZ/E - BRCP 38-39-48/H - MRCP 28/H - MCP2L 18 - 60 BZS - BTRCP 48-52-70/H - ZAP 35-45 - DAP 28-38/A - TQRCP 70/H - TQP 90 SI - TRAINATI: 0 TQR/F-FI - 00-0 BT/F-G - 00-0 BT/FI-GI - VECCHIA PRODUZIONE: BTRCP 52/D-E-F - DAP 28-38 - BRPS 38-48 - BRCP 40 - MCP 18 - MRCP 28/D-F - BP 38-48/D-F - MCPC 21 - BTRCP 48-70/D-F - TRCPL 55 - MRCPC 28 - TQECF 70/D - 00 ZLAU - ZAPL 28 - 0 BCAUG - ZBAP 60-80 - ZF 32 - 60-80 BZ - MRPO 28 - BRCPL 49 - 80 BZ/C - BRCPC 40 - BRCP 38-39-48/D-F-G - 45-60 BTRCU - BRPCP 28 - BRCPC 36
RC0390	8C115	SUOLA POSTERIORE DX	NARDI	CARRELLATI: 50 BRCUS/A - 30 MRCU/A - 2 BTCAUG/F - 50 BRCU/A - 30 MRCUS/A - 0 BRAUG/A - PORTATI: BTRCP 80/H - MCP 38/H - 120 TZ/E - MPG 50 - BP 58/H - 90 BZS/A - MRCP 38/H - BRCP 58/H - MP 46/H - 90 BZ/E - TRAINATI: 0 BTR/F-G - 0 BTR/FI-GI - VECCHIA PRODUZIONE: BRCP 58/D-F-G - MPFS 40 - 0 BRAUG - ZBAP 90/A - MRCPC 36 - 00 MCAU - BP 58/D-F - MRCP 38/D-F - 0 BTR - MRPO 38 - 2 BTCAUG - BRCPL 55 - 0 ZRAU - 90 BZ - 120 TZ/D - 00 MRAU/SL - 90 BZ/C - 00 MRAU - 00 MRCAU - BRPS 58 - 1 1/2 BRRCAU - 00 MRCAU/S - 50 BRCU - MP 38-46 - MCP 38/F - 120 TZ - 1 1/2 BRRCAU/S - 30 MRCU - BTRCP 80/D-F

Art./Ref.	Rif. Orig./Orig. Ref.	Titolo Prodotto/Titolo Prodotto	Brand	Applicazione/Application
RC0391	8CS115	SUOLA POSTERIORE SX	NARDI	CARRELLATI: 2 BTCAUG/F - 50 BRUCU/A - 30 MRCUS/A - 0 BRAUG/A - 30 MRCU/A - 50 BRUCUS/A - PORTATI: BTRCP 80/H - MPG 50 - MRCP 38/H - MP 46/H - BP 58/H - BRCP 58/H - MCP 38/H - 90 BZS/A - 90 BZ/E - 120 TZ/E - TRAINATI: 0 BTR/F-G - 0 BTR/FI-GI - VECCHIA PRODUZIONE: MPFS 40 - 0 BTR - 1 1/2 BRRCU/S - BRCP 58/D-F-G - BRCP 55 - 0 BRAUG - 0 ZRAU - 120 TZ/D - 120 TZ - MRPO 38 - MRCP 36 - 00 MCAU - MRCP 38/D-F - ZBAP 90/A - 2 BTCAUG - 30 MRCU - 00 MRAU/SL - 1 1/2 BRRCU - 50 BRUCU - 90 BZ/C - BP 58/D-F - 00 MRCAU/S - 90 BZ - 00 MRAU - BRPS 58 - BTRCP 80/D-F - MP 38-46 - 00 MRCAU - MCP 38/F
RC0392	9C115	SUOLA POSTERIORE DX	NARDI	CARRELLATI: 35 MRCUS/A - 45-50 ZRCU - 35 MRCU/A - 45 MRCU - 60-65 BRUCU - 45 MRCUS - 70 BRUCU - 50 BRRCU/A - 55 BRUCU/A - 45-50 ZRCUI - 1 BRUCUAG/F - 0 MRCUAG - 2 BRAUG/F - PORTATI: MRCP 48/H - BRCP 68-70/H - BCP 70/F - BTRP 100-110/A - MRCP 47 - MCP 48/H - BRCP 90/A - 110 BZS - 130 TZ/E - 100 BZ/E - 180 QTZ/E - TRAINATI: 1-2 BT/FI-GI - 1-2 BT/F-G - 1-2 TQR/F-FI - VECCHIA PRODUZIONE: 1-2 BT/D-E - 1 1/2 MRAU - 1 1/2 MRAU/S - 2 BAUG - BRCP 68 - MRCP 48/D-F - 2-3 BRAU - 1 TQR - 1 BRCAUG - 1 BAUG - 100 BZ/C - 0-1 MRCAU/S - 0-1 MRAU - 2 1/2 BLRAU - 2 BRAUG - 0 MRAUG - BRCP 100/D - 100 BZ - 130 TZ/D - 3 BRRAU - BTRP 100-110 - 180 QTZ/A - 180 QTZ - 50 BRRCU - 55-60-65 BRUCU - 35 MRCU - BRP 70/D - BRP 100 - BRCP 70/F - 2 1/2 BRAU - BCP 70/D-F - BRCP 90 - 2 TQR/A-B-C - 3 BAU - MCP 48/D-F - 130 TZ - BP 70/D
RC0393	9CS115	SUOLA POSTERIORE SX	NARDI	CARRELLATI: 35 MRCUS/A - 45 MRCU - 45-50 ZRCU - 35 MRCU/A - 45-50 ZRCUI - 55 BRUCU/A - 60-65 BRUCU - 50 BRRCU/A - 45 MRCUS - 70 BRUCU - 1 BRUCUAG/F - 0 MRCUAG - 2 BRAUG/F - PORTATI: BRCP 90/A - BCP 70/F - MCP 48/H - MRCP 47 - BTRP 100-110/A - BRCP 68-70/H - 100 BZ/E - 130 TZ/E - 180 QTZ/E - MRCP 48/H - 110 BZS - TRAINATI: 1-2 TQR/F-FI - 1-2 BT/F-G - 1-2 BT/FI-GI - VECCHIA PRODUZIONE: BRCP 100/D - 0-1 MRCAU/S - 1 BAUG - 1 BRCAUG - 0 MRAUG - 100 BZ - MRCP 48/D-F - 1 1/2 MRAU - 1 1/2 MRAU/S - 1 TQR - 1-2 BT/D-E - BP 70/D - 0-1 MRCAU - BRCP 68 - 180 QTZ/A - 130 TZ - 130 TZ/D - 180 QTZ - 3 BAU - 2-3 BRAU - 2 1/2 BLRAU - BCP 70/D-F - 2 BRAUG - 2 BAUG - 2 TQR/A-B-C - 3 BRRAU - 2 1/2 BRAU - BTRP 100-110 - BRP 70/D - BRP 100 - MCP 48/D-F - BRCP 90 - BRCP 70/F - 55-60-65 BRUCU - 100 BZ/C - 35 MRCU - 50 BRRCU
RC0394	6C115LM	SUOLA POSTERIORE DX	NARDI	PORTATI: 40-50 BRPS/A - BRCP 38-48/A - BPSC 50-60 - 40 MZ/E - 35 MRPS/A - MPSC 28-30/A - MRCP 28/A - VECCHIA PRODUZIONE: BPSC 38-48 - MPSC 28-30 - MRCP 28 - MRPS 28 - BRCP 38-48 - 40 MZ - 35 MRPS - 40-50 BRPS - MCPL 28
RC0395	6CS115LM	SUOLA POSTERIORE SX	NARDI	PORTATI: 40-50 BRPS/A - MRCP 28/A - 40 MZ/E - 35 MRPS/A - BPSC 50-60 - MPSC 28-30/A - BRCP 38-48/A - VECCHIA PRODUZIONE: MPSC 28-30 - MCPL 28 - MRCP 28 - MRPS 28 - 35 MRPS - BRCP 38-48 - 40 MZ - 40-50 BRPS - BPSC 38-48
RC0396	8C115LR	SUOLA POSTERIORE DX	NARDI	CARRELLATI: 35 ZRACU - 35 ZRACUI - PORTATI: MPSC 50 - DAP 48/A - BTRCPL 80/A - BTRCPL 80 - 40 MRPS/A - 70 BRPS/A - ZAP 60 - MRCP 38/A - VECCHIA PRODUZIONE: BRPS 58 - MP 38/D - MP 46/D-F - MPSC 38 - MRCP 38 - 70 BRPS - 35 ZRCU - 35 ZRCUI - 40 MRPS - MRPS 38 - DAP 48 - MCP 38/D
RC0397	8CS115LR	SUOLA POSTERIORE SX	NARDI	CARRELLATI: 35 ZRACU - 35 ZRACUI - PORTATI: 40 MRPS/A - DAP 48/A - BTRCPL 80 - BTRCPL 80/A - ZAP 60 - MRCP 38/A - MPSC 50 - 70 BRPS/A - VECCHIA PRODUZIONE: MCP 38/D - MPSC 38 - MP 46/D-F - MRCP 38 - MP 38/D - 35 ZRCUI - 35 ZRCU - 40 MRPS - MRPS 38 - DAP 48 - 70 BRPS - BRPS 58
RC0398	9C115L	SUOLA POSTERIORE DX	NARDI	CARRELLATI: 50 MRCUS - 130 BTRRCO - 50 MRCU - 75 BTRRCO - PORTATI: 50-55-65 MRPS - 60 MZS - BRP 110/A - BRCP 80 - 60 MZ/E - BTRP 160/A - MPSC 60-70 - 80-90 MZS/A - MRCP 48 - 130 BZS - 180-181 BTZ/A - 120-121-130-131 BZ/D - 125 BZF - 80-81-90-91 MZ/C - VECCHIA PRODUZIONE: 1 1/2 MRRCU - 1 1/2 MRRCU/S - MRPL 48 - MRPS 58 - MRPS 48 - 120-121-130-131 BZ - MPSC 48 - BTRP 160 - 60-80-81-90-91 MZ - BRCP 100/F - MPS 58 - BRP 110
RC0399	9CS115L	SUOLA POSTERIORE SX	NARDI	CARRELLATI: 130 BTRRCO - 75 BTRRCO - 50 MRCUS - 50 MRCU - PORTATI: MPSC 60-70 - 60 MZS - 120-121-130-131 BZ/D - BTRP 160/A - BRCP 80 - MRCP 48 - BRP 110/A - 60 MZ/E - 125 BZF - 130 BZS - 180-181 BTZ/A - 80-81-90-91 MZ/C - 50-55-65 MRPS - 80-90 MZS/A - VECCHIA PRODUZIONE: MRPS 58 - MRPS 48 - BRCP 100/F - 1 1/2 MRRCU/S - MRPL 48 - BTRP 160 - 60-80-81-90-91 MZ - 1 1/2 MRRCU - MPS 58 - 120-121-130-131 BZ - MPSC 48 - BRP 110
RC0402	13C115	SUOLA POSTERIORE DX	NARDI	CARRELLATI: 55 MRCU - 80-90-100 BTRRCO/B - 70 MRRCO/B - 60 MRCUA - 70 MRCU - PORTATI: BRP 160/A - MCP 58-70/H - 110 MZS - MRP 90/H - 100 MZ/C - MRCP 58-70/H - BRP 120/K - 120-125 MZ/D - MRPL 80 - 150 BRPS/B - 180 BZ/A - 70 MRPS - 140 BZ/D - VECCHIA PRODUZIONE: 100-120 MZ - 2 MRCAU - MRP 70-90/D - 2 MRAU - BRP 120/E-G-H - MRP 90/G - 70 MRRCO - 140-180 BZ - MRCP 58-70/D-F - MCP 58-70/D-F - BRP 160 - 80-90-100 BTRRCO - 150 BRPS
RC0403	13CS115	SUOLA POSTERIORE SX	NARDI	CARRELLATI: 80-90-100 BTRRCO/B - 70 MRRCO/B - 55 MRCU - 60 MRCUA - 70 MRCU - PORTATI: BRP 120/K - 120-125 MZ/D - 100 MZ/C - BRP 160/A - MRCP 58-70/H - MCP 58-70/H - MRP 90/H - 180 BZ/A - 150 BRPS/B - 140 BZ/D - 110 MZS - MRPL 80 - 70 MRPS - VECCHIA PRODUZIONE: MRP 70-90/D - MRP 90/G - 100-120 MZ - BRP 120/E-G-H - 2 MRAU - 140-180 BZ - 2 MRCAU - 150 BRPS - 80-90-100 BTRRCO - MRCP 58-70/D-F - MCP 58-70/D-F - 70 MRRCO - BRP 160
RC0404	12C143	SUOLA DX	NARDI	CARRELLATI: 2 MRAUG/F - 3 BRRAUG/A - 65 MRCUA - TRAINATI: 3 TQR/F-FI - 2 1/2 - 3 BT/F-G - 2 1/2 - 3 BT/FI-GI - VECCHIA PRODUZIONE: 3 BRAUG - 2 1/2 LBT - 2 BTRZ/A-B-C - 2 MAUG - 3 BRRAUG - 2 MRAUG - 4 QPR - 3 TQR/A-B - 65 MRCU - 2 1/2 BT/A-B-C-D-E
RC0408	15C143	SUOLA DX	NARDI	TRAINATI: 3 BTR/GI - 4 BT/FI-GI - 3 BTR/G - 4 BT/F-G - 4 - 4 1/2 - 5 TQR/F-FI - 4 BTP/I - 4 BTP - VECCHIA PRODUZIONE: 4 BT/A-B - 4 BTSP - 3 MRAU - 3 BTR/A-B-F - 5 QPR

TALLONI ADATTABILI ALLA PRODUZIONE NARDI

TALON ADAPTABLE TYPE NARDI

SLIDE PLATE FOR NARDI LINE

GLEITPLATTE PASSEND FÜR NARDI

TALÓN PARA PRODUCCIÓN NARDI



Art./Ref.	Rif. Orig./Orig. Ref.	Titolo Prodotto/Titolo Prodotto	Brand	Applicazione/Application
RC0350	5C118	TALLONE DX	NARDI	CARRELLATI: 45-50 ZRCUI - 80-90-100 BRRCO/B - 70 MRRCO/B - 45-50 ZRCU - 45-50 MRCUS - 60 MRCUA - 50 BRRCU/A - 45-50-55-70 MRCU - 0 MRCUAG - 0 BCAUG/A - 30-35-45-50-55-70 BRCU/A - 30-35 ZRCU - 30-35-45-50 BRCUS/A - 0 BRUG/A - 35 ZRACUI - 35-45-50 BTRCU/A - 1 BRCAUG/F - 30-35 MRCU/A - 30-35 MRCUS/A - 2 BRAUG/F - 60-65 BRCUA - 1-2 BTCAUG/F - PORTATI: 150 BRPS/B - 40-60-80-90-100 BZ/E - BTP 28 G - 80-90 BZS/A - MCPL 15 - 120-180 QTZ/E - 130 BZS - MCPL2L 18 - DAP 18-28-38-48/A - 115 BDF - 100 BTZ - 120-121-130-131-140 BZ/D - 110 BZS - 135 BDF - MPSC 50-60-70 - MPSC 28-30/A - 120-130 TZ/E - ZAP 60 - 180-181 BTZ/A - 180 BZ/A - MRP 90/H - BPSC 50-60 - 60 BTZ/E - ZAP 35-45 - 60 BZS - TRAINATI: 0 BTR/F-G - 00-0-1-2 BT/FI-GI - 0 BTR/FI-GI - 0-1-2 TQR/F-FI - 00-0-1-2 BT/F-G - VECCHIA PRODUZIONE: BLCPC 27-28 - BRPC 28-36 - BPF 30 - MRCP 36 - BRCPL 28-38-48 - BPP 40 - 0-1 MAU - BCPC 28-36 - BRP 28-38-48 - QPT 80/C - BRPC 27-37 - BRPL 28-38-48 - BRPL 27-37-48-49 - BRP 70-100-120 - BRP 27-37 - BRCPC 28-40-48 - BP 48 - ZPL 80 - TRPL 45 - MRP2L 55 - TRP2L 55 - Z 14 - BPSC 28-30-38-48 - MRPS 28-38-48 - MRCPL 28-38-48 - MRP 70 - 0-1 BTCAUG - MRP 90 - MRPO 28-38 - MRP 90 G - 0 BTRAU - 0 MRAUG - 0 BCAU - ZBAP 39-50-60-80-90 - TBP 80/C - 0 BT/A-B - 0 BT - ZCPL 28-38-48 - MRCP 38 - 0 QT - 0 PQ - TQRCP 48 - 0 BTCAUG - PQP 80/C - 0 BTR - 00-0-1-1 1/2 BRAU/SP - 00-1-1 1/2 TRAU - 00-0-1-1 1/2 BRAU - 00 MRCAU - 00 MCAU - 00-0-1-1 1/2 BTRCAU - 00-0-1-1 1/2 BTRCAU/S - 95-100 BRPS - 70 BRPS - 95 MPS - 60-100 BTZ - 1 TQR - 00 MRCAU/S - 00 ZLAU - 1 1/2 MRRAU/S - 120-130 TZ - 1 1/2 MRRAU - BPSC 28-30 - 120-121-130-131-140 BZ - 150 BRPS - 120-180 QTZ - 00-0-1 BRCAU - 00-0-1 BRCAU/S - 00 ZLAU/N - 1 BT/E - 1 1/2 BRRCAU - 40-60-80-90-100 BZ - 1-1 1/2 ZRAU - MPSC 28-30-38 - 2-2 1/2 ZRAU - MCPL 28 - BS 100 - BRPS 28-38-48-58 - MPS 58 - MPFS 30-40 - BRPL 55 - BRPO 28-38 - MP 70 - MP 48-58 - MCPSC 48 - BRPO 40-47 - MPSC 48 - 0-1 MRAU - 2 BAUG - 2 BRCAU - 3 TRAU - 3 BRRAU - 2 BRAU - 35-40-50-55-65-70 MRPS - DAP 18-28-38-48-80 - 180 BZ - 180-181 BTZ - 35-40-50-70 BRPS - BTRPL 38-48
RC0351	5CS118	TALLONE SX	NARDI	CARRELLATI: 0 BCAUG/A - 50 BRRCU/A - 45-50 ZRCU - 45-50 ZRCUI - 30-35-45-50 BRCU/A - 1 BRCAUG/F - 30-35 ZRCU - 60 MRCUA - 30-35 MRCUS/A - 2 BRAUG/F - 0 MRCUAG - 80-90-100 BRRCO/B - 30-35 MRCU/A - 1-2 BTCAUG/F - 35 ZRACUI - 45-50 MRCUS - 0 BRUG/A - 70 MRRCO/B - 45-50-55-70 MRCU - 35-45-50 BTRCU/A - 30-35-45-50-55-70 BRCU/A - 60-65 BRCUA - PORTATI: DAP 18-28-38-48/A - 80-90 BZS/A - 60 BZS - MPSC 50-60-70 - BTP 28 G - 60 BTZ/E - 150 BRPS/B - MCPL2L 18 - 130 BZS - 120-180 QTZ/E - 120-130 TZ/E - 135 BDF - 180-181 BTZ/A - 110 BZS - 115 BDF - 100 BTZ - 120-121-130-131-140 BZ/D - ZAP 60 - BPSC 50-60 - MPSC 28-30/A - 40-60-80-90-100 BZ/E - 180 BZ/A - MRP 90/H - MCPL 15 - ZAP 35-45 - TRAINATI: 0 BTR/F-G - 0 BTR/FI-GI - 00-0-1-2 BT/FI-GI - 00-0-1-2 BT/F-G - 0-1-2 TQR/F-FI - VECCHIA PRODUZIONE: 0-1 MAU - BCPC 28-36 - BLCPC 27-28 - MPS 58 - BP 48 - BPSC 28-30-38-48 - BPF 30 - BRCPC 28-40-48 - BRPC 27-37 - BRP 28-38-48 - BRCPL 28-38-48 - BRP 70-100-120 - BRPL 27-37-48-49 - BRPC 28-36 - BRP 27-37 - MRPS 28-38-48 - TRPL 45 - Z 14 - MRP 90 - MRCPL 28-38-48 - MRP 70 - MRCP 38 - TRP2L 55 - TQRCP 48 - MRP2L 55 - BPSC 28-30 - QPT 80/C - PQP 80/C - TBP 80/C - MRPO 28-38 - MRP 90 G - ZCPL 28-38-48 - ZPL 80 - ZBAP 39-50-60-80-90 - MRCP 36 - 0 BT/A-B - 0 BTCAUG - 0 BTR - 0 BTRAU - 0 BCAU - 0-1 BTCAUG - 0 QT - 0 PQ - 0 BT - 0 MRAUG - 00-0-1-1 1/2 BTRCAU - 00-0-1-1 1/2 BTRCAU/S - 00 ZLAU - 00 MRCAU/S - 00 MRCAU - 1 BT/E - 1 TQR - 60-100 BTZ - 70 BRPS - 40-60-80-90-100 BZ - 00-1-1 1/2 TRAU - 1 1/2 BRRCAU - 00 ZLAU/N - 00-0-1 BRCAU - 1-1 1/2 ZRAU - 120-130 TZ - 1 1/2 MRRAU/S - 120-121-130-131-140 BZ - BPP 40 - 150 BRPS - 120-180 QTZ - 00-0-1-1 1/2 BRAU - 00-0-1-1 1/2 BRAU/SP - 00-0-1 BRCAU/S - 180 BZ - 1 1/2 MRRAU - 95-100 BRPS - 00 MCAU - MCPL 28 - MPSC 28-30-38 - 0-1 MRAU - BRPO 40-47 - BRPO 28-38 - MPSC 48 - MPFS 30-40 - BRPL 55 - BRPL 28-38-48 - MP 48-58 - MCPSC 48 - MP 70 - BS 100 - BRPS 28-38-48-58 - 2-2 1/2 ZRAU - 2 BRAU - DAP 18-28-38-48-80 - 2 BRCAU - 95 MPS - 180-181 BTZ - 3 BRRAU - 2 BAUG - BTRPL 38-48 - 35-40-50-55-65-70 MRPS - 35-40-50-70 BRPS - 3 TRAU
RC0352	9C113A	TALLONE DX	NARDI	VECCHIA PRODUZIONE: 1-2 BAUG - 2 TQR/CI - 1-2 BT/A-B-C - 2 TQR - 2 TQR/A-B-C - 2 BTR - BP 70/D - 1-2 DBT/A-B - 2 DTQ - 2-3 BAU - 2-3 BDAU - 2-3 ZB - 2-3 DTQP - 2 1/2-4 BRAU - 2-3 DZMB - 3 QPR - 3 TAUG
RC0354	12C113A	TALLONE DX	NARDI	CARRELLATI: 3 BRRAUG/A - TRAINATI: 4-4 1/2 TQR/F-FI - 2 1/2 - 3-4 BT/F-G - 3-4 BTR/FI-GI - 3-4 BTR/F-G - 2 1/2 - 3-4 BT/FI-GI - 4 BTR - 4 BTP/I - VECCHIA PRODUZIONE: 4 BT/BI - 4 1/2 TQR/C - 3 BRRAUG - 4 BTSP/I - 4 BTSP/F-FI - 5 TQR - 3 TQR/BI - 3-4 RDTQP - 3 BT/EI - 3 BT/A-B-C-D-E - 4-5 DTQP - 5 BAUG - 5 DQPR - 4 BTSP - 4 BT/B - 2 1/2 BT/EI - 2 1/2 BT/A-B-C-D-E - 3 BRAUG
RC0355	16C113	TALLONE DX	NARDI	CARRELLATI: 3 MRAUG

Art./Ref.	Rif. Orig./Orig. Ref.	Titolo Prodotto/Titolo Prodotto	Brand	Applicazione/Application
RC0356	9C113	TALLONE DX	NARDI	VECCHIA PRODUZIONE: 0-1 MDAU - 0-1-1 1/2 MRAU - MPL 48 - 0-1 MAU - MRPL 22-42 - ZPL 45 - 1 DMZ - 1-2 BT - 0 MAUG - 0-1-1 1/2 MRAU/SP - 1 1/2 BLRAU - 1-2 BAGU - 1-1 1/2 ZRAU - 2-3 BAU - 2 1/2 BLRAU - 2-3 BDAU - 2 QPR - 2-2 1/2 ZRAU - 2-2 1/2-3-4 BRAU - 2-3 DZMB - 1-2 DBT/A-B - 2-3 DTQP - 2-3 ZB - 3 TAUG - 3 TRAU - BP 70/D
RC0357	9CS113	TALLONE SX	NARDI	VECCHIA PRODUZIONE: 1-2 BAGU - BP 70/D - 0 MAUG - 0-1 MAU - MRPL 22-42 - MPL 48 - ZPL 45 - 0-1-1 1/2 MRAU/SP - 1 DMZ - 0-1 MDAU - 1 1/2 BLRAU - 0-1-1 1/2 MRAU - 1-1 1/2 ZRAU - 2 QPR - 1-2 DBT/A-B - 2 1/2 BLRAU - 2-2 1/2 ZRAU - 1-2 BT - 2-3 BAU - 2-2 1/2-3-4 BRAU - 2-3 DTQP - 2-3 BDAU - 2-3 ZB - 2-3 DZMB - 3 TAUG - 3 TRAU
RC0358	12C113	TALLONE DX	NARDI	CARRELLATI: 3 BRRAUG/A - VECCHIA PRODUZIONE: MPP 50-60 - MPL 50 - 1-2 MAUG - MRP2L 50 - MRPL 50 - MRP 55 - MP2 50 - 3 BRAUG - 2 MDAU - 2 DMIG/A-B - MP 50 - 2 BTR/A-B-C - 2-3 DZM - 2 MRAU - 2 RM/AI - 2 1/2 - 3 BT/A-B-C-D-E - 2 RM/A - 2 MAU - 3 BT/EI - 4 BTR/CI - 3 DBTR - 3 BTR/C - 3-5 BAUG - 4 BT/BI - 4 BTR/A-B-C - MRPL 50-61 - 3-4 TQR/A-B - 4 BT/A-B - 4 1/2 TR/A-B-C - 4 DTQP - 5 DTQP - 4 DTQR - 4 RDTQP - 5 TQR - 5 DQPR - 4-5 QPR
RC0360	12C113L	TALLONE DX	NARDI	CARRELLATI: 1 MCAUG/F - 2 MRCAUG/F - 65 MRCUA - PORTATI: MS 120 - TRAINATI: 3-4 BTR/F-G - 3-4 BTR/FI-GI - 2 1/2 - 3-4 BT/F-G - 3-4-4 1/2 TQR/F-FI - 4 BTP - 4 BTPI - 2 1/2 - 3-4 BT/FI-GI - VECCHIA PRODUZIONE: 2 1/2 MRAU - 2 MRAUG - 3-4 RM/I - 3-4 RM - 65 MRCU - 4 BTSP/F-FI - 1 MCAUG
RC0362	6C113	TALLONE DX	NARDI	PORTATI: 130 QTZ/E - QPRT 130 C - 50 BZ/E - QPRT 150 C - EEP 130 FS - BTP 60 SI - QPRT 140 C - 90 BTZ/E - BTS 100 - PES 140 U/A - TQP 80 SI - PESS 150 - QPS 140 U/A - TQRT 90 C - PERT 130 C - TQRT 80 C - TQPRIS 120 A - 110 BTZS - BPSC 70/A - TQRT 150 C - BTP 38 G - VECCHIA PRODUZIONE: QPRT 130-140-150/A - PERT 130/A - QPS 140 U - PES 140 U - QPRT 130-140-150 - 90 BTZ/C - 90 BTZ - TQRT 80-90-150 A - BPSC 70 - 50 BZ - TQRT 80-90-150 - PERT 130 - 130 QTZ/D - 130 QTZ
RC0363	6CS113	TALLONE SX	NARDI	PORTATI: TQP 80 SI - QPRT 140 C - EEP 130 FS - 130 QTZ/E - BPSC 70/A - 50 BZ/E - BTP 60 SI - BTP 38 G - BTS 100 - PERT 130 C - PESS 150 - TQRT 80 C - TQRT 150 C - TQRT 90 C - PES 140 U/A - QPRT 130 C - QPS 140 U/A - TQPRIS 120 A - QPRT 150 C - 110 BTZS - 90 BTZ/E - VECCHIA PRODUZIONE: PES 140 U - QPRT 130-140-150 - PERT 130/A - QPRT 130-140-150/A - BPSC 70 - QPS 140 U - TQRT 80-90-150 A - TQRT 80-90-150 - 90 BTZ - 130 QTZ - 90 BTZ/C - 130 QTZ/D - PERT 130 - 50 BZ
RC0364	16C113L	TALLONE DX	NARDI	CARRELLATI: 100 MRRCO/B - 80 MRRCO/B - 90 MRRCO/B - PORTATI: 150 MRPS/A - MRP 130 K - 150 MRSP/A - TRAINATI: 5 BTR/G - 5 BTR/FI - 5 BTR/GI 3 - 5 BTR/GI 2 - 6 BTR/BI 1 - 5 BTR/GI - 70 DMR/I 2 - 80 DMR/I 1 - 80 DMR/I 2 - 80 DMR - 70 DMR - 5 BTR/F - 70 DMR/I 1 - 6 BTR/BI 2

SUPPORTO CORPO A SCALPELLO ADATTABILE ALLA PRODUZIONE **NARDI**

SUPPORT A POINTE ADAPTABLES A LA PRODUCTION NARDI

CHISELED BEARING SUITABLE TO NARDI PRODUCTION

MEISSEL-HALTER PASSEND ZU NARDI

SOPORTES CUERPOS A ESCOPIO ADAPTABLES A LA PRODUCCION NARDI



Art./Ref.	Rif. Orig./Orig. Ref.	Titolo Prodotto/Titolo Prodotto	Note/Note	Brand	Applicazione/Application
RC0492	3C	SUPPORTO CORPO DX	Per versioio 3C173	NARDI	PORTATI: PRRP 48
RC0492S	3CS	SUPPORTO CORPO SX	Per versioio 3CS173	NARDI	PORTATI: PRRP 48
RC0493	5C231A	SUPPORTO CORPO DX	Per versioio 5C163-5C163B	NARDI	PORTATI: 40 BZ/E
RC0493S	5CS231A	SUPPORTO CORPO SX	Per versioio 5CS163-5CS163B	NARDI	PORTATI: 40 BZ/E
RC0493A	5 1/2C231A	SUPPORTO CORPO DX	Per versioio 6C161B	NARDI	PORTATI: 68 BZS/A
RC0317	6C231A	SUPPORTO CORPO DX	Per versioio 6C163-6C163B	NARDI	VECCHIA PRODUZIONE: 00 BT
RC0318	6CS231A	SUPPORTO CORPO SX	Per versioio 6CS163-6CS163B	NARDI	VECCHIA PRODUZIONE: 00 BT
RC0319	7C231A	SUPPORTO CORPO DX	Per versioio 7C162-7C162B	NARDI	TRAINATI: 0 BTF
RC0320	7CS231A	SUPPORTO CORPO SX	Per versioio 7CS162-7CS162B	NARDI	TRAINATI: 0 BTF
RC0321	8C231A	SUPPORTO CORPO DX	Per versioio 8C163-8C163B	NARDI	VECCHIA PRODUZIONE: 0 BTR
RC0322	8CS231A	SUPPORTO CORPO SX	Per versioio 8CS163-8CS163B	NARDI	VECCHIA PRODUZIONE: 0 BTR
RC0323	10C231	SUPPORTO CORPO ANTERIORE DX	Per versioio 9C163-9C163B	NARDI	TRAINATI: 1 BT
RC0324	10CS231	SUPPORTO CORPO ANTERIORE SX	Per versioio 9CS163-9CS163B	NARDI	TRAINATI: 1 BT
RC0325	10C231	SUPPORTO CORPO POSTERIORE DX	Per versioio 9C163-9C163B	NARDI	TRAINATI: 1 BT
RC0326	10CS231	SUPPORTO CORPO POSTERIORE SX	Per versioio 9CS163-9CS163B	NARDI	TRAINATI: 1 BT

ANCORE PER CORPI ARANTI ADATTABILI ALLA PRODUZIONE NARDI

ANCRE POUR CORPS LABOURANTS ADAPTABLES A LA PRODUCTION NARDI

SHORE ANCHOR FOR PLOUGH CORES SUITABLE NARDI PRODUCTION

BLATTFEDERZINKEN FUER PFLUGKOERPER PASSEND ZU NARDI

ANCLAS CUERPOS DE ARADO ADAPTABLES A LA PRODUCCION NARDI

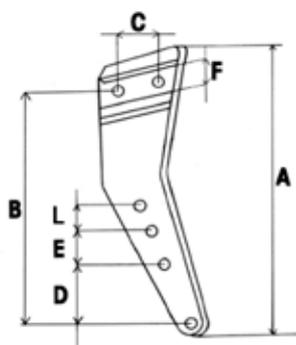

Art./Ref.	Titolo Prodotto/Titolo Prodotto	A mm	B mm	C mm	D mm	E mm	F mm	L mm	Spessore mm/ Thickness mm	Brand	Applicazione/ Application
RC0489	GAMBO PER CORPO DX	530	430	80 (2 FORI DA 21)	100	50	80	-	30	NARDI	3C DX
RC0489S	GAMBO PER CORPO SX	530	430	80 (2 FORI DA 21)	100	50	80	-	30	NARDI	3CS SX
CP1216	GAMBO PER CORPO DX	550	430	80 (2 FORI DA 21)	110	70	80	-	35	NARDI	5C DX
CP1216S	GAMBO PER CORPO SX	550	430	80 (2 FORI DA 21)	110	70	80	-	35	NARDI	5CS SX
CP1215	GAMBO PER CORPO DX	660	570	100 (2 FORI DA 23)	130	70	90	-	35	NARDI	00 BT DX
CP1215S	GAMBO PER CORPO SX	660	570	100 (2 FORI DA 23)	130	70	90	-	35	NARDI	00 BT SX
CP1497	GAMBO PER CORPO DX	595	480	100 (3 FORI DA 23)	50	80	100	70	40	NARDI	0 BTF DX
CP1498	GAMBO PER CORPO SX	595	480	100 (3 FORI DA 23)	50	80	100	70	40	NARDI	0 BTF SX
CP1490	GAMBO PER CORPO DX	620	470	120 (3 FORI DA 23)	50	80	100	70	40	NARDI	0 BTR DX
CP1491	GAMBO PER CORPO SX	620	470	120 (3 FORI DA 23)	50	80	100	70	40	NARDI	0 BTR SX
CP1129	GAMBO PER CORPO DX	660	525	120 (3 FORI DA 23)	50	80	100	70	45	NARDI	1 BT DX
CP1129S	GAMBO PER CORPO SX	660	525	120 (3 FORI DA 23)	50	80	100	70	45	NARDI	1 BT SX

RICAMBI PER CORPI ADATTABILI ALLA PRODUZIONE NARDI TIPO MEC UN 6

RECHANGES CORPS LABOURANTS ADAPTABLES A LA PRODUCTION NARDI MOD MEC UN 6

SPARE PARTS FOR PLOUGH BODIES SUITABLE TO NARDI PRODUCTION UN 6

ERSATZTEILE FUER PFLUGKOERPER PASSEND ZU NARDI TYP MEC UN 6

RECAMBIOS CUERPOS ADAPTABLES A LA PRODUCCION NARDI TIPO MEC UN 6

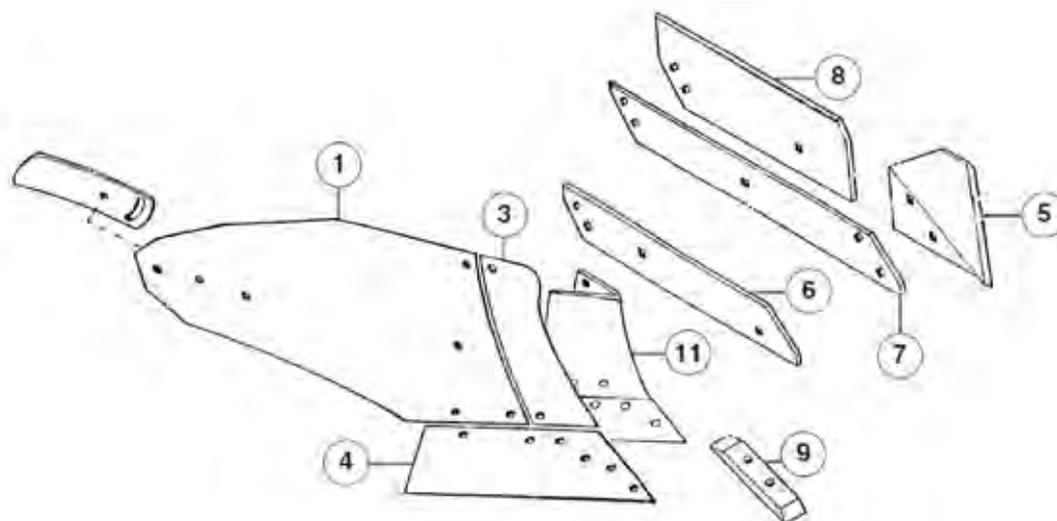

Art./Ref.	Rif. Orig./ Orig. Ref.	Titolo Prodotto/ Titolo Prodotto	Tipo/ Type	Note/ Note	Brand	Applicazione/Application
RC1050	6C175	VERSOIO DX	1.0		NARDI	EN 6, UN 6
RC1051	6CS175	VERSOIO SX	1.0		NARDI	EN 6, UN 6

Art./Ref.	Rif. Orig./ Orig. Ref.	Titolo Prodotto/ Titolo Prodotto	Tipo/ Type	Note/ Note	Brand	Applicazione/Application
RC0462	5C182, 6C182	ORECCHIA MOBILE DX	-	-	NARDI	CARRELLATI: 30-35 BRCUS/A - 45 BTRCU/A - 1 BTCAUG/F - 30-35 BRCU/A PORTATI: 120 QTZ/E - 90 BTZ/E - 50 BZ/E - MVP2L 18 - 40 BRPS/A - MCP2L 18 - EEP 130 FS - BPSC 50 - DAP 28/A - MCP 18/A - BTRCP 48/H - BTP 60 SI - MCPL 15 - BP 38/H - BRCP 38-39/H - QPRT 130/C - BRCPL 38-48/A - BRNP 39 - BRCPL 38/A - PERT 130/C - BPG 50 - MPSC 28/A - TQRT 80/C - TQRCP 70/H - TQP 80 SI - ZCPL 28 - ZAP 35 - MVPL 15 TRAINATI: 00 BT/F-G - 00 BT/FI-GI VECCHIA PRODUZIONE: BRCP 38-39/D-F-G - BRCP 27-35 - TQRT 80/A-B - ZAPL 28 - BP 38/D-F - ZBAP 38-48-50 - 0 BCAU - BRCPC 28-36 - BRCPL 38 - TRCP2L 55 - 0 PQ - BRCPL 38-48 - BRP 37 - 0 BTCAUG - BPL 35 - TQRCP 70/D-F - MCP 18-20-21 - BTRCP 48 - MCP 18 - DAP 27 - BVP2L 35-47 - 0 QT - BRP2L 55 - M 14 - DAP 28 - BCPP 40 - BRPL 37-47 - BPSC 38 - ZVP2L 14-18 - MCPC 21 - TRP2L 55 - BTRCP 48/D-E-F - BRPO 38 - BRPS 38 - MPSC 28 - 30-35 BRCU - 40 BRPS - MPL 14 - MP 12 - MVPL 28 - MP2L 14 - 90 BTZ - MVPL 28-48 - 50 BZ - PERT 130/A - QPRT 130/A - ZVPL 27 - QPRT 130 - PER 130 - MVP2L - 00 BT - TBP 60 - MP2L 18-20 - 45 BTRC - 1 BTCAU - 1 BTCAUG - QTP 80/C - 1 1/2 BTRCAU - 1-1 1/2 BTRCAU/S - 1 TAUG - 1 TRAU - 120 QTZ/A-D - 00 MAU/I - 1 BTAU - 3 MAU - TBP 80/C - 00-0 BAU - ZPL 27 - 00-0 BRCU - 00-0 BRAU - 00-0 BRCAUS CN 9 - UN 7 - UN 6 - UN 9
RC0463	5CS182, 6CS182	ORECCHIA MOBILE SX	-	-	NARDI	CARRELLATI: 1 BTCAUG/F - 30-35 BRCUS/A - 30-35 BRCU/A - 45 BTRCU/A PORTATI: BP 38/H - PERT 130/C - BPG 50 - MCP2L 18 - QPRT 130/C - 120 QTZ/E - MVP2L 18 - BPSC 50 - 90 BTZ/E - 50 BZ/E - 40 BRPS/A - BRCPL 38-48/A - BRNP 39 - BRCPL 38/A - BRCP 38-39/H - DAP 28/A - ZCPL 28 - MCPL 15 - MCP 18/A - ZAP 35 - TQP 80 SI - TQRT 80/C - BTRCP 48/H - TQRCP 70/H - MVPL 15 - BTP 60 SI - EEP 130 FS - MPSC 28/A TRAINATI: 00 BT/FI-GI - 00 BT/F-G VECCHIA PRODUZIONE: DAP 28 - BPL 35 - BTRCP 48/D-E-F - 40 BRPS - 45 BTRC - BRCP 27-35 - DAP 27 - MCP 18 - 30-35 BRCU - 3 MAU - BVP2L 35-47 - MCPC 21 - M 14 - BRP2L 55 - BRPL 37-47 - BTRCP 48 - MCP 18-20-21 - BCPP 40 - BRP 37 - BRPO 38 - BRCPC 28-36 - BP 38/D-F - BRCP 38-39/D-F-G - BPSC 38 - BRCPL 38-48 - BRCPL 38 - BRPS 38 - 1 1/2 BTRCAU - MVPL 28 - MP2L 18-20 - PER 130 - 0 BTCAUG - MP2L 14 - MPL 14 - MVP2L - MVPL 28-48 - MPSC 28 - 50 BZ - ZAPL 28 - TQRCP 70/D-F - TQRT 80/A-B - TRP2L 55 - TRCP2L 55 - 0 PQ - ZVPL 27 - ZPL 27 - 0 BCAU - ZVP2L 14-18 - QTP 80/C - ZBAP 38-48-50 - 00-0 BAU - MP 12 - 0 QT - 00 BT - 00 MAU/I - 1-1 1/2 BTRCAU/S - TBP 60 - 90 BTZ - 120 QTZ/A-D - 00-0 BRAU - 00-0 BRCU - TBP 80/C - PERT 130/A - QPRT 130 - QPRT 130/A - 1 BTCAU - 1 BTAU - 1 TAUG - 1 TRAU - 1 BTCAUG - 00-0 BRCAUS CN 9 - UN 6 - UN 9 - UN 7
RC1054	6C190	PROLUNGA VERSOIO DX	3.0	-	NARDI	UN 6
RC1055	6CS190	PROLUNGA VERSOIO SX	3.0	-	NARDI	UN 6
RC0938	6C191	PROLUNGA VERSOIO DX	3.0	-	NARDI	EN 6, UN 6
RC0939	6CS191	PROLUNGA VERSOIO SX	3.0	-	NARDI	EN 6, UN 6
RC1056	6C20	VOMERE DX	4.0	-	NARDI	CN 9, UN 6, UN 7, UN 9
RC1057	6CS20	VOMERE SX	4.0	-	NARDI	CN 9, UN 6, UN 7, UN 9
RC1058	6C275	COLTRE DAL BASSO DX	5.0	-	NARDI	CN 9, UN 6, UN 7, UN 9
RC1059	6CS275	COLTRE DAL BASSO SX	5.0	-	NARDI	CN 9, UN 6, UN 7, UN 9
RC1060	6C140A	SUOLA ANTERIORE DX	6.0	-	NARDI	CN 9, UN 6, UN 7, UN 9
RC1061	6CS140A	SUOLA ANTERIORE SX	6.0	-	NARDI	CN 9, UN 6, UN 7, UN 9
RC1062	6C140	SUOLA POSTERIORE DX	7.0	-	NARDI	CN 9, UN 6, UN 7, UN 9
RC1063	6CS140	SUOLA POSTERIORE SX	7.0	-	NARDI	CN 9, UN 6, UN 7, UN 9
RC1064	6C150	SALVA SUOLA DX	8.0	-	NARDI	UN 6, UN 7
RC1065	6CS150	SALVA SUOLA SX	8.0	-	NARDI	UN 6, UN 7
RC1066	6C60	SCALPELLO DX	9.0	2 fori	NARDI	CN 9, UN 6, UN 9
RC1067	6CS60	SCALPELLO SX	9.0	2 fori	NARDI	CN 9, UN 6, UN 9
RC1070	6C210	SUPPORTO CORPO DX	11.0	-	NARDI	UN 6, UN 7
RC1071	6CS210	SUPPORTO CORPO SX	11.0	-	NARDI	UN 6, UN 7

RICAMBI PER CORPI ADATTABILI ALLA PRODUZIONE NARDI TIPO MEC UN 7

RECHANGES CORPS LABOURANTS ADAPTABLES A LA PRODUCTION NARDI MOD MEC UN 7

SPARE PARTS FOR PLOUGH BODIES SUITABLE TO NARDI PRODUCTION UN 7

ERSATZTEILE FUER PFLUGKOERPER PASSEND ZU NARDI TYP MEC UN 7

RECAMBIOS CUERPOS ADAPTABLES A LA PRODUCCION NARDI TIPO MEC UN 7

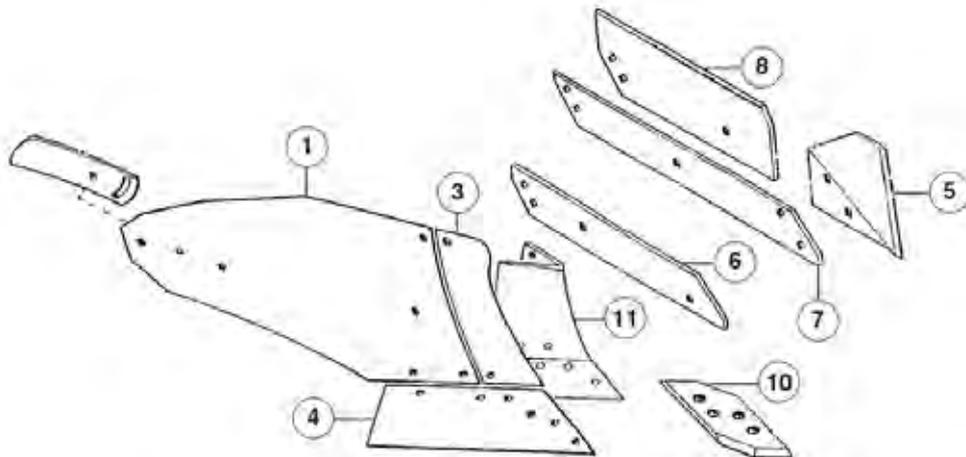

Art./Ref.	Rif. Orig./ Orig. Ref.	Titolo Prodotto/ Titolo Prodotto	Tipo/ Type	Note/ Note	Brand	Applicazione/ Application
RC1080	7C175	VERSOIO DX	1.0	-	NARDI	EN 7, UN 7
RC1081	7CS175	VERSOIO SX	1.0	-	NARDI	EN 7, UN 7
RC0462	5C182, 6C182	ORECCHIA MOBILE DX	-	-	NARDI	CARRELLATI: 30-35 BRCU/A - 45 BTRCU/A - 1 BTCAUG/F - 30-35 BRCU/A - PORTATI: BP 38/H - 120 QTZ/E - MCP2L 18 - MVP2L 18 - QPRT 130/C - PERT 130/C - 40 BRPS/A - BRCP 38-39/H - 50 BZ/E - BPSC 50 - BRCPL 38/A - 90 BTZ/E - BRNP 39 - BRCPL 38-48/A - BPG 50 - MVPL 15 - DAP 28/A - TQRC 70/H - ZCPL 28 - ZAP 35 - MCPL 15 - EEP 130 FS - TQP 80 SI - BTRCP 48/H - BTP 60 SI - TQRT 80/C - MPSC 28/A - MCP 18/A - TRAINATI: 00 BT/FI-GI - 00 BT/F-G - VECCHIA PRODUZIONE: BRPL 37-47 - BRCPL 38-48 - BVP2L 35-47 - 1 BTCAUG - 1 TAUG - 00 BT - QTP 80/C - BRCPL 38 - BTRCP 48/D-E-F - BRCPC 28-36 - MCP21 - 1 TRAU - BCPP 40 - MCP 18 - BRCP 27-35 - M 14 - BRPO 38 - BPSC 38 - MCP 18-20-21 - BRCP 38-39/D-F-G - DAP 27 - BTRCP 48 - BRP 37 - BP 38/D-F - BRPS 38 - DAP 28 - BRP2L 55 - BPL 35 - MP2L 18-20 - TBP 60 - TBP 80/C - ZVPL 27 - MVPL 28 - MP2L 14 - MVP2L - MVPL 28-48 - MPSC 28 - MPL 14 - ZVP2L 14-18 - 0 PQ - TQRC 70/D-F - TRP2L 55 - TRCP2L 55 - 120 QTZ/A-D - ZAPL 28 - TQRT 80/A-B - 0 BTCAUG - 0 BCAU - ZBAP 38-48-50 - QPRT 130 - ZPL 27 - 00-0 BAU - 00-0 BRCAUS - 00-0 BRCU - 00-0 BRAU - 00 MAU/I - 1 BTAU - 1-1 1/2 BTRCAU/S - 1 1/2 BTRCAU - QPRT 130/A - 1 BTCAU - 3 MAU - MP 12 - 45 BTRC - 0 QT - PER 130 - PERT 130/A - 50 BZ - 90 BTZ - 30-35 BRCU - 40 BRPS - UN 6 - UN 7 - CN 9 - UN 9
RC0463	5C5182, 6C5182	ORECCHIA MOBILE SX	-	-	NARDI	CARRELLATI: 30-35 BRCU/A - 45 BTRCU/A - 30-35 BRCU/A - 1 BTCAUG/F - PORTATI: MPSC 28/A - MVP2L 18 - QPRT 130/C - BPSC 50 - BRCPL 38-48/A - BRNP 39 - BRCPL 38/A - BRCP 38-39/H - BP 38/H - BPG 50 - PERT 130/C - 120 QTZ/E - TQRT 80/C - 90 BTZ/E - BTRCP 48/H - BTP 60 SI - 50 BZ/E - TQRC 70/H - ZAP 35 - TQP 80 SI - 40 BRPS/A - MCP2L 18 - MCP 18/A - EEP 130 FS - ZCPL 28 - MVPL 15 - DAP 28/A - MCPL 15 - TRAINATI: 00 BT/FI-GI - 00 BT/F-G - VECCHIA PRODUZIONE: BRCPL 38 - 45 BTRC - 50 BZ - 00 BT - BPL 35 - BRCPL 38-48 - BTRCP 48 - MCP21 - BRPS 38 - MCP 18-20-21 - M 14 - DAP 28 - BTRCP 48/D-E-F - DAP 27 - BVP2L 35-47 - BRP2L 55 - MCP 18 - BRCP 38-39/D-F-G - MP 12 - BRP 37 - BRPL 37-47 - BP 38/D-F - BCPP 40 - BRPO 38 - BRCP 27-35 - BPSC 38 - BRCPC 28-36 - 1 TAUG - MVPL 28-48 - MVPL 28 - PER 130 - ZBAP 38-48-50 - MP2L 18-20 - MP2L 14 - MVP2L - 0 QT - MPSC 28 - ZAPL 28 - ZVPL 27 - TQRC 70/D-F - TRCP2L 55 - TRP2L 55 - 40 BRPS - TQRT 80/A-B - ZPL 27 - 0 BTCAUG - 0 BCAU - ZVP2L 14-18 - QTP 80/C - 0 PQ - MPL 14 - 00-0 BRCAUS - 1 BTAU - 1 1/2 BTRCAU - 00 MAU/I - 00-0 BAU - 90 BTZ - TBP 60 - 00-0 BRAU - 00-0 BRCU - 1-1 1/2 BTRCAU/S - 30-35 BRCU - PERT 130/A - QPRT 130 - 120 QTZ/A-D - TBP 80/C - 3 MAU - QPRT 130/A - 1 BTCAU - 1 TRAU - 1 BTCAUG - UN 9 - UN 6 - UN 7 - CN 9
RC1084	7C190	PROLUNGA VERSOIO DX	3.0	-	NARDI	UN 7
RC1085	7CS190	PROLUNGA VERSOIO SX	3.0	-	NARDI	UN 7
RC1056	6C20	VOMERE DX	4.0	-	NARDI	CN 9, UN 6, UN 7, UN 9
RC1057	6CS20	VOMERE SX	4.0	-	NARDI	CN 9, UN 6, UN 7, UN 9
RC1058	6C275	COLTRE DAL BASSO DX	5.0	-	NARDI	CN 9, UN 6, UN 7, UN 9
RC1059	6CS275	COLTRE DAL BASSO SX	5.0	-	NARDI	CN 9, UN 6, UN 7, UN 9
RC1060	6C140A	SUOLA ANTERIORE DX	6.0	-	NARDI	CN 9, UN 6, UN 7, UN 9
RC1061	6CS140A	SUOLA ANTERIORE SX	6.0	-	NARDI	CN 9, UN 6, UN 7, UN 9
RC1062	6C140	SUOLA POSTERIORE DX	7.0	-	NARDI	CN 9, UN 6, UN 7, UN 9
RC1063	6CS140	SUOLA POSTERIORE SX	7.0	-	NARDI	CN 9, UN 6, UN 7, UN 9
RC1064	6C150	SALVASUOLA DX	8.0	-	NARDI	UN 6, UN 7
RC1065	6CS150	SALVASUOLA SX	8.0	-	NARDI	UN 6, UN 7
RC1068	7C60	SCALPELLO DX	10.0	4 fori	NARDI	UN 7
RC1069	7CS60	SCALPELLO SX	10.0	4 fori	NARDI	UN 7
RC1070	6C210	SUPPORTO CORPO DX	11.0	-	NARDI	UN 6, UN 7
RC1071	6CS210	SUPPORTO CORPO SX	11.0	-	NARDI	UN 6, UN 7

RICAMBI PER CORPI ADATTABILI ALLA PRODUZIONE NARDI TIPO MEC UN 9

RECHANGES CORPS LABOURANTS ADAPTABLES A LA PRODUCTION NARDI MOD MEC UN 9

SPARE PARTS FOR PLOUGH BODIES SUITABLE TO NARDI PRODUCTION TYPE MEC UN 9

ERSATZTEILE FUER PFLUGKORPER PASSEND ZU NARDI TYP MEC UN 9

RECAMBIOS CUERPOS ADAPTABLES A LA PRODUCCION NARDI TIPO MEC UN 9

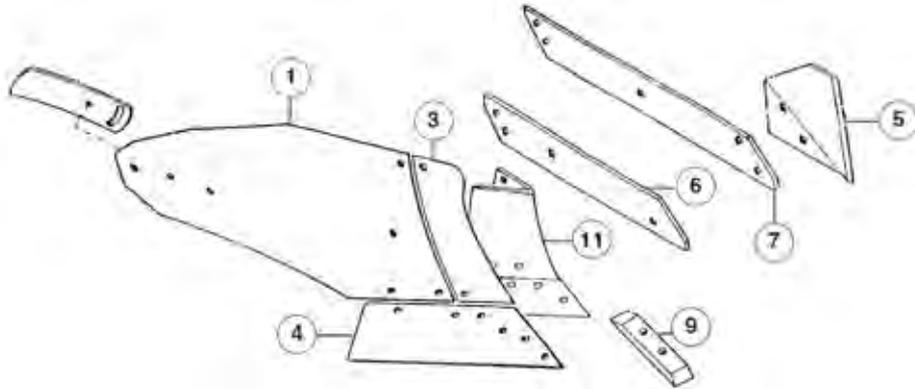

Art./Ref.	Rif. Orig./ Orig. Ref.	Titolo Prodotto/ Titolo Prodotto	Tipo/ Type	Note/ Note	Brand	Applicazione/ Application
RC1110	10C175	VERSOIO DX	1.0	-	NARDI	UN 9
RC1111	10CS175	VERSOIO SX	1.0	-	NARDI	UN 9
RC0462	5C182, 6C182	ORECCHIA MOBILE DX	-	-	NARDI	CARRELLATI: 1 BTCAUG/F - 45 BTRCU/A - 30-35 BRCU/A - 30-35 BRCUS/A - PORTATI: 50 BZ/E - 90 BTZ/E - 40 BRPS/A - 120 QTZ/E - BRNP 39 - BTP 60 SI - MCPL 15 - MCP2L 18 - BTRCP 48/H - DAP 28/A - EEP 130 FS - MCP 18/A - BPSC 50 - BRCP 38-39/H - QPRT 130/C - BP 38/H - MPSC 28/A - BPG 50 - BRCPL 38-48/A - BRCPL 38/A - TQRCP 70/H - MVPL 15 - MVP2L 18 - TQP 80 SI - ZCPL 28 - PERT 130/C - TQRT 80/C - ZAP 35 - TRAINATI: 00 BT/F-G - 00 BT/FI-GI - VECCHIA PRODUZIONE: QTP 80/C - 0 QT - BRCP 38-39/D-F-G - ZVPL 27 - BRCP 27-35 - BCPP 40 - BPSC 38 - BP 38/D-F - BRPO 38 - BRPS 38 - BRP 37 - BRPL 37-47 - BRCPC 28-36 - 00 BT - 0 BTCAUG - BRP2L 55 - MCPC 21 - ZAPL 28 - TRCP2L 55 - M 14 - TRP2L 55 - BTRCP 48/D-E-F - BTRCP 48 - ZBAP 38-48-50 - MPL 14 - DAP 28 - MCP 18 - MCP 18-20-21 - BVP2L 35-47 - 0 BCAU - DAP 27 - MPSC 28 - MP 12 - BPL 35 - 0 PQ - MVPL 28 - MP2L 18-20 - 90 BTZ - MVPL 28-48 - PER 130 - 3 MAU - 30-35 BRCU - MVP2L - PERT 130/A - 40 BRPS - 00 MAU/I - QPRT 130/A - QPRT 130 - BRCPL 38 - TBP 80/C - TBP 60 - 50 BZ - 00-0 BRCAUS - 45 BTRC - 1 TAUG - 1 1/2 BTRCAU - 1-1 1/2 BTRCAU/S - 1 TRAU - TQRCP 70/D-F - 1 BTAU - BRCPL 38-48 - ZVP2L 14-18 - TQRT 80/A-B - 00-0 BRAU - 120 QTZ/A-D - 1 BTCAU - MP2L 14 - 00-0 BRCAU - 00-0 BAU - 1 BTCAUG - ZPL 27 - UN 7 - CN 9 - UN 6 - UN 9
RC0463	5CS182, 6CS182	ORECCHIA MOBILE SX	-	-	NARDI	CARRELLATI: 30-35 BRCU/A - 30-35 BRCUS/A - 1 BTCAUG/F - 45 BTRCU/A - PORTATI: 90 BTZ/E - TQRCP 70/H - 40 BRPS/A - 50 BZ/E - MCP2L 18 - MCPL 15 - MPSC 28/A - BTRCP 48/H - EEP 130 FS - QPRT 130/C - DAP 28/A - MCP 18/A - BTP 60 SI - BRCPL 38-48/A - BRCPL 38/A - BP 38/H - BPG 50 - BRNP 39 - BPSC 50 - BRCP 38-39/H - 120 QTZ/E - MVPL 15 - PERT 130/C - ZCPL 28 - TQRT 80/C - ZAP 35 - TQP 80 SI - MVP2L 18 - TRAINATI: 00 BT/FI-GI - 00 BT/F-G - VECCHIA PRODUZIONE: BRCP 27-35 - BRP2L 55 - TQRT 80/A-B - BRPS 38 - BPSC 38 - BPL 35 - BRP 37 - BRPO 38 - BRCPC 28-36 - BRCP 38-39/D-F-G - 0 PQ - BRPL 37-47 - BCPP 40 - BP 38/D-F - 0 QT - MCPC 21 - DAP 27 - BTRCP 48 - TRP2L 55 - BTRCP 48/D-E-F - M 14 - ZAPL 28 - QPRT 130/A - ZBAP 38-48-50 - BVP2L 35-47 - TRCP2L 55 - 00 BT - MCP 18-20-21 - MP2L 14 - MP 12 - MPSC 28 - MCP 18 - MPL 14 - ZVP2L 14-18 - DAP 28 - 1 BTCAUG - 1-1 1/2 BTRCAU/S - 120 QTZ/A-D - 1 BTCAU - MP2L 18-20 - 1 1/2 BTRCAU - 1 TAUG - PERT 130/A - QPRT 130 - TBP 80/C - TBP 60 - QTP 80/C - BRCPL 38 - 40 BRPS - 30-35 BRCU - TQRCP 70/D-F - 3 MAU - 1 TRAU - 45 BTRC - ZPL 27 - MVP2L - PER 130 - 0 BCAU - ZVPL 27 - 50 BZ - 0 BTCAUG - 90 BTZ - BRCPL 38-48 - 00-0 BRCAU - 1 BTAU - 00-0 BRCAUS - 00 MAU/I - 00-0 BRAU - MVPL 28-48 - MVPL 28 - 00-0 BAU - UN 9 - CN 9 - UN 7 - UN 6
RC1114A	10C190	PROLUNGA VERSOIO DX	3.0	-	NARDI	UN 9
RC1115A	10CS190	PROLUNGA VERSOIO SX	3.0	-	NARDI	UN 9
RC1056	6C20	VOMERE DX	4.0	-	NARDI	CN 9, UN 6, UN 7, UN 9
RC1057	6CS20	VOMERE SX	4.0	-	NARDI	CN 9, UN 6, UN 7, UN 9
RC1058	6C275	COLTRE DAL BASSO DX	5.0	-	NARDI	CN 9, UN 6, UN 7, UN 9
RC1059	6CS275	COLTRE DAL BASSO SX	5.0	-	NARDI	CN 9, UN 6, UN 7, UN 9
RC1060	6C140A	SUOLA ANTERIORE DX	6.0	-	NARDI	CN 9, UN 6, UN 7, UN 9
RC1061	6CS140A	SUOLA ANTERIORE SX	6.0	-	NARDI	CN 9, UN 6, UN 7, UN 9
RC1062	6C140	SUOLA POSTERIORE DX	7.0	-	NARDI	CN 9, UN 6, UN 7, UN 9
RC1063	6CS140	SUOLA POSTERIORE SX	7.0	-	NARDI	CN 9, UN 6, UN 7, UN 9
RC1066	6C60	SCALPELLO DX	9.0	2 fori	NARDI	CN 9, UN 6, UN 9
RC1067	6CS60	SCALPELLO SX	9.0	2 fori	NARDI	CN 9, UN 6, UN 9
RC1130	8C210	SUPPORTO CORPO DX	11.0	-	NARDI	CN 9, UN 9
RC1131	8CS210	SUPPORTO CORPO SX	11.0	-	NARDI	CN 9, UN 9

RICAMBI PER CORPI ADATTABILI ALLA PRODUZIONE NARDI TIPO MEC CN-EN

RECHANGES CORPS LABOURANTS ADAPTABLES A LA PRODUCTION NARDI MOD MEC CN-EN

SPARE PARTS FOR PLOUGH BODIES SUITABLE TO NARDI PRODUCTION CN-EN

ERSATZTEILE FUER PFLUGKOERPER PASSEND ZU NARDI TYP MEC CN-EN

RECAMBIOS CUERPOS ADAPTABLES A LA PRODUCCION NARDI TIPO MEC CN-EN

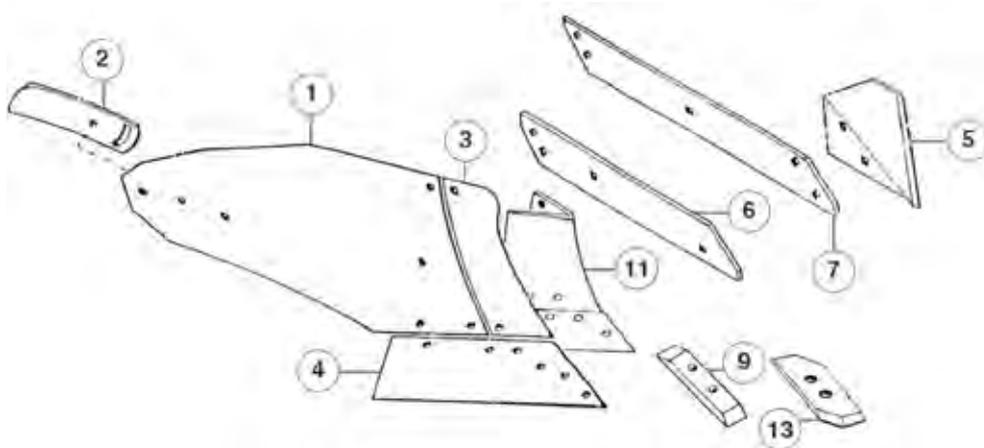

Art./Ref.	Rif. Orig./Orig. Ref.	Titolo Prodotto/Titolo Prodotto	Spessore mm/Thickness mm	Tipo/Type	Note/Note	Brand	Applicazione/Application
RC1868	5C205	VERSOIO DX	-	1.0	-	NARDI	CN 5
RC1869	5CS205	VERSOIO SX	-	1.0	-	NARDI	CN 5
RC1050	6C175	VERSOIO DX	-	1.0	-	NARDI	EN 6, UN 6
RC1051	6CS175	VERSOIO SX	-	1.0	-	NARDI	EN 6, UN 6
RC0940	6C205	VERSOIO DX	-	1.0	-	NARDI	CN 6
RC0941	6CS205	VERSOIO SX	-	1.0	-	NARDI	CN 6
RC1080	7C175	VERSOIO DX	-	1.0	-	NARDI	EN 7, UN 7
RC1081	7CS175	VERSOIO SX	-	1.0	-	NARDI	EN 7, UN 7
RC0226	7C205	VERSOIO DX	-	1.0	-	NARDI	CN 7
RC0227	7CS205	VERSOIO SX	-	1.0	-	NARDI	CN 7
RC1842	8C205	VERSOIO DX	-	1.0	-	NARDI	CN 8
RC1843	8CS205	VERSOIO SX	-	1.0	-	NARDI	CN 8
RC0228	9C205	VERSOIO DX	-	1.0	-	NARDI	CN 10
RC0229	9CS205	VERSOIO SX	-	1.0	-	NARDI	CN 10
RC0935	9C175	VERSOIO DX	-	1.0	-	NARDI	CN 9
RC0936	9CS175	VERSOIO SX	-	1.0	-	NARDI	CN 9
RC1052	5C181	ORECCHIA MOBILE DX	-	2.0	-	NARDI	CN 7
RC1053	5CS181	ORECCHIA MOBILE SX	-	2.0	-	NARDI	CN 7
RC1844	7C181	ORECCHIA MOBILE DX	-	2.0	-	NARDI	CN 8
RC1845	7CS181	ORECCHIA MOBILE SX	-	2.0	-	NARDI	CN 8
RC0938	6C191	PROLUNGA VERSOIO DX	-	3.0	-	NARDI	EN 6, UN 6
RC0939	6CS191	PROLUNGA VERSOIO SX	-	3.0	-	NARDI	EN 6, UN 6
RC1827	6C192	PROLUNGA VERSOIO DX	-	3.0	-	NARDI	CN 6
RC1828	6CS192	PROLUNGA VERSOIO SX	-	3.0	-	NARDI	CN 6
RC1542	7C192	PROLUNGA VERSOIO DX	-	3.0	-	NARDI	CN 7
RC1543	7CS192	PROLUNGA VERSOIO SX	-	3.0	-	NARDI	CN 7
RC1840	8C192	PROLUNGA VERSOIO DX	-	3.0	-	NARDI	CN 8
RC1841	8CS192	PROLUNGA VERSOIO SX	-	3.0	-	NARDI	CN 8
RC1114	9C190	PROLUNGA VERSOIO DX	-	3.0	-	NARDI	CN 9
RC1115	9CS190	PROLUNGA VERSOIO SX	-	3.0	-	NARDI	CN 9
RC0942	9C192	PROLUNGA VERSOIO DX	-	3.0	-	NARDI	CN 10
RC0943	9CS192	PROLUNGA VERSOIO SX	-	3.0	-	NARDI	CN 10
RC1056	6C20	VOMERE DX	-	4.0	-	NARDI	CN 9, UN 6, UN 7, UN 9
RC1057	6CS20	VOMERE SX	-	4.0	-	NARDI	CN 9, UN 6, UN 7, UN 9
RC0414	7C35	VOMERE DX	-	4.0	2 fori	NARDI	CN 6, CN 7, EN 6, EN 7
RC0415	7CS35	VOMERE SX	-	4.0	2 fori	NARDI	CN 6, CN 7, EN 6, EN 7
RC0412	8C35	VOMERE DX	-	4.0	2 fori	NARDI	CN 10, CN 8
RC0413	8CS35	VOMERE SX	-	4.0	2 fori	NARDI	CN 10, CN 8

Art./Ref.	Rif. Orig./Orig. Ref.	Titolo Prodotto/Titolo Prodotto	Spessore mm/Thickness mm	Tipo/Type	Note/Note	Brand	Applicazione/Application
RC0218	4C275	COLTRE DAL BASSO DX	-	5.0	-	NARDI	CN 6, CN 7, EN 6, EN 7
RC0219	4CS275	COLTRE DAL BASSO SX	-	5.0	-	NARDI	CN 6, CN 7, EN 6, EN 7
RC1058	6C275	COLTRE DAL BASSO DX	-	5.0	-	NARDI	CN 9, UN 6, UN 7, UN 9
RC1059	6CS275	COLTRE DAL BASSO SX	-	5.0	-	NARDI	CN 9, UN 6, UN 7, UN 9
RC1118	8C275	COLTRE DAL BASSO DX	-	5.0	-	NARDI	CN 10
RC1119	8CS275	COLTRE DAL BASSO SX	-	5.0	-	NARDI	CN 10
RC1060	6C140A	SUOLA ANTERIORE DX	-	6.0	-	NARDI	CN 9, UN 6, UN 7, UN 9
RC1061	6CS140A	SUOLA ANTERIORE SX	-	6.0	-	NARDI	CN 9, UN 6, UN 7, UN 9
RC0366	6C142A	SUOLA ANTERIORE DX	-	6.0	-	NARDI	CN 6, CN 7, EN 6, EN 7
RC0367	6CS142A	SUOLA ANTERIORE SX	-	6.0	-	NARDI	CN 6, CN 7, EN 6, EN 7
RC1656	8C142A	SUOLA ANTERIORE DX	-	6.0	-	NARDI	CN 8
RC1657	8CS142A	SUOLA ANTERIORE SX	-	6.0	-	NARDI	CN 8
RC1692	10C142A	SUOLA ANTERIORE DX	-	6.0	-	NARDI	CN 10
RC1693	10CS142A	SUOLA ANTERIORE SX	-	6.0	-	NARDI	CN 10
RC1823	10C142AFS	SUOLA ANTERIORE FUORI SOLCO DX	-	6.0	-	NARDI	CN 10
RC1824	10CS142AFS	SUOLA ANTERIORE FUORI SOLCO SX	-	6.0	-	NARDI	CN 10
RC1062	6C140	SUOLA POSTERIORE DX	-	7.0	-	NARDI	CN 9, UN 6, UN 7, UN 9
RC1063	6CS140	SUOLA POSTERIORE SX	-	7.0	-	NARDI	CN 9, UN 6, UN 7, UN 9
RC0361	6C142	SUOLA POSTERIORE DX	-	7.0	-	NARDI	CN 6, CN 7, EN 6, EN 7
RC0365	6CS142	SUOLA POSTERIORE SX	-	7.0	-	NARDI	CN 6, CN 7, EN 6, EN 7
RC1825	10C142FS	SUOLA POSTERIORE FUORI SOLCO DX	-	7.0	-	NARDI	CN 10
RC1826	10CS142FS	SUOLA POSTERIORE FUORI SOLCO SX	-	7.0	-	NARDI	CN 10
RC1694	10C142	SUOLA POSTERIORE DX	-	7.0	-	NARDI	CN 10
RC1695	10CS142	SUOLA POSTERIORE SX	-	7.0	-	NARDI	CN 10
RC1066	6C60	SCALPELLO DX	-	9.0	2 fori	NARDI	CN 9, UN 6, UN 9
RC1067	6CS60	SCALPELLO SX	-	9.0	2 fori	NARDI	CN 9, UN 6, UN 9
RC1130	8C210	SUPPORTO CORPO DX	-	11.0	-	NARDI	CN 9, UN 9
RC1131	8CS210	SUPPORTO CORPO SX	-	11.0	-	NARDI	CN 9, UN 9
RC1134	5C60	SCALPELLO DX	-	13.0	2 fori	NARDI	CN 6, CN 7, EN 6, EN 7
RC1135	5CS60	SCALPELLO SX	-	13.0	2 fori	NARDI	CN 6, CN 7, EN 6, EN 7
RC1172	8C60	SCALPELLO DX	15 mm	13.0	2 fori	NARDI	CN 8, CN 10
RC1173	8CS60	SCALPELLO SX	15 mm	13.0	2 fori	NARDI	CN 8, CN 10

VOMERI PER CORPI A SCALPELLO ADATTABILI ALLA PRODUZIONE OTMA

SOCES POUR CORPS ADAPTABLES OTMA

SHARES FOR CHISELED BODIES FOR OTMA PRODUCTION

SCHARE FUER MEISSELKÖRPER PASSEND ZU OTMA

REJAS DE CUERPOS A ESCOPLA ADAPTABLES A LA PRODUCCION OTMA



Art./Ref.	Rif. Orig./Orig. Ref.	Titolo Prodotto/Titolo Prodotto	Note/Note	Brand	Applicazione/Application
RC0600	V20	VOMERE DX	-	OTMA	141, 161
RC0600S	V20 SX	VOMERE SX	-	OTMA	141, 161
RC0601	V30	VOMERE DX	-	OTMA	181, 231
RC0601S	V30 SX	VOMERE SX	-	OTMA	181, 231
RC0602	V35	VOMERE DX	Vomere con tre fori di cui due in linea ed uno sfalsato rispetto agli altri	OTMA	271, 301, 321, 351
RC0602S	V35 SX	VOMERE SX	Vomere con tre fori di cui due in linea ed uno sfalsato rispetto agli altri	OTMA	271, 301, 321, 351
RC0603	V40	VOMERE DX	Vomere con tre fori di cui due in linea ed uno sfalsato rispetto agli altri	OTMA	381, 401
RC0603S	V40 SX	VOMERE SX	Vomere con tre fori di cui due in linea ed uno sfalsato rispetto agli altri	OTMA	381, 401
RC0604	V45	VOMERE DX	Vomere con tre fori di cui due in linea ed uno sfalsato rispetto agli altri	OTMA	441, 461, 501, 521, 551, 581
RC0604S	V45 SX	VOMERE SX	Vomere con tre fori di cui due in linea ed uno sfalsato rispetto agli altri	OTMA	441, 461, 501, 521, 551, 581

SCALPELLI PER CORPI ARANTI ADATTABILI ALLA PRODUZIONE OTMA
POINTES POUR CORPS CHARRUE ADAPTABLES OTMA
CHISELS FOR PLOUGH BODIES SUIT TO OTMA PRODUCTION
MEISSEL-FUER PFLUGKOERPER PASSEND ZU OTMA
POUNTEROS CUERPOS DE ARADO ADAPTABLES A LA PRODUCCION OTMA

Art./Ref.	Rif. Orig./Orig. Ref.	Titolo Prodotto/Titolo Prodotto	Brand	Applicazione/Application
RC0044	30X30, 30X30, 30X30 (H3)	SCALPELLO DX	SOGEMA - OTMA - VIVIANI	181, 231, 20 BP, 20 BT, 20 TB, 20 TP, 24 BPA, 25 BPA, 25 BTA, 25 MPA, 25 TBA, 25 TP, 28 BPA, 28 BTA, 28 MPA, 28 TBA, 28 TPA, 25B2, 25P1, 25P1G, 27B2, 30P1, 30P1G, 30P2G, 40P2, 40P2G, B30P2, B40P2, M30P1, N30P2, T40P3, T50P3
RC2044	30X30 SX, 30X30 SX	SCALPELLO SX	SOGEMA - OTMA	181, 231, 20 BP, 20 BT, 20 TB, 20 TP, 24 BPA, 25 BPA, 25 BTA, 25 MPA, 25 TBA, 25 TP, 28 BPA, 28 BTA, 28 MPA, 28 TBA, 28 TPA
RC0045	35X35, 35X35, 35X35 (H4)	SCALPELLO DX ADATTABILE SOGEMA	SOGEMA - OTMA - VIVIANI	321, 351, 30 BPA, 30 BTA, 30 D, 30 MPA, 30 TBA, 30 TPA, 32 BPA, 32 BTA, 32 TBA, 32 TPA, 34 BPA, 34 BTA, 35 BPA, 35 BTA, 35 MPA, 35 MTA, 35 TBA, 35 TPA, 25AA, 25B1, 27AA, 30AA, 30B2, 30BBR, 35AA, 35B2, 35BBR, 40B2, 40P1, 40P1G, 50P2, 50P2G, 60P2, 70P2, 70P2F, B50P2, B60P2, M40P1, T60P3, T80P3
RC2045	35X35 SX, 35X35 SX	SCALPELLO SX	SOGEMA - OTMA	271, 301, 321, 351, 30 BPA, 30 BTA, 30 D, 30 MPA, 30 TBA, 30 TPA, 32 BPA, 32 BTA, 32 TBA, 32 TPA, 34 BPA, 34 BTA, 35 BPA, 35 BTA, 35 MPA, 35 MTA, 35 TBA, 35 TPA
RC0046	40X40, 40X40, 40X40 (H6)	SCALPELLO DX ADATTABILE SOGEMA	SOGEMA - OTMA - VIVIANI	381, 401, 36 D, 38 BPA, 38 BTA, 38 D, 38 MPA, 38 MTA, 38 TBA, 38 TPA, 40 BPA, 40 D, 40 MPA, 40 MTA, 42 BPA, 42 BT Virg., 42 BTA, 42 D, 42 MPA, 42 TB, 43 BT Virg., 43 TB Virg., 44 BPA, 44 BTA, 44 D, 44 MPA, 44 MTA, 45 MTA, 46 BPA, 46 D, 46 MPA, 46 MTA, 49 BP, 49 MP, 100P2R, 30B1, 35B1, 40AA, 40B1, 40BBR, 45AA, 45B2, 50BBR, 50P1, 50P1G, 60P1, 70P1, 80P2, B100P2, B80P2, M50P1, M60P1, T100P3, T120P3
RC2046	40X40 SX, 40X40 SX	SCALPELLO SX	SOGEMA - OTMA	381, 401, 36 D, 38 BPA, 38 BTA, 38 D, 38 MPA, 38 MTA, 38 TBA, 38 TPA, 40 BPA, 40 D, 40 MPA, 40 MTA, 42 BPA, 42 BT Virg., 42 BTA, 42 D, 42 MPA, 42 TB, 43 BT Virg., 43 TB Virg., 44 BPA, 44 BTA, 44 D, 44 MPA, 44 MTA, 45 MTA, 46 BPA, 46 D, 46 MPA, 46 MTA, 49 BP, 49 MP
RC0047	45X45, 45X45, 45X45 (H7)	SCALPELLO DX	SOGEMA - OTMA - VIVIANI	441, 461, 501, 521, 47 BT, 47 BT Virg., 47 TB Virg., 49 BP-G, 49 BP-R, 50 BP, 50 BT, 50 M, 52 BP, 52 M, 52 M Leon., 52 MP, 53 MP, 54 M, 54 MP, 120P2R, 40BR, 45B1, 60BBR, 80P1R, 90A2, B120P2, M80P1
RC2047	45X45 SX, 45X45 SX	SCALPELLO SX	SOGEMA - OTMA	441, 461, 501, 521, 47 BT, 47 BT Virg., 47 TB Virg., 49 BP-G, 49 BP-R, 50 BP, 50 BT, 50 M, 52 BP, 52 M, 52 M Leon., 52 MP, 53 MP, 54 M, 54 MP
RC0048	50X50, 50X50	SCALPELLO DX	SOGEMA - OTMA	551, 581, 47 BTR, 47 TBR Virg., 50 D, 55 M, 57 MP, 65 M Leon., 65 M PFSI, 65 ML Leon.

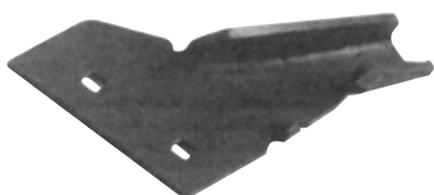
SUPPORTI SCALPELLO PER CORPI ARANTI ADATTABILI ALLA PRODUZIONE OTMA
SUPPORTS POUR CORPS CHARRUES ADAPTABLES OTMA
CHISELED BEARINGS FOR PLOUGH BODIES SUIT TO OTMA PRODUCTION
MEISSEL-HALTER FÜR PFLUGKOERPER PASSEND ZU OTMA
SOPORTES ESCOPLA PARA CUERPOS DE ARADO ADAPTABLES A LA PRODUCCION OTMA

Art./Ref.	Rif. Orig./Orig. Ref.	Titolo Prodotto/Titolo Prodotto	Brand	Applicazione/Application
RC0605	S/30	SUPPORTO SCALPELLO DX	OTMA	181, 231
RC0606	S/35	SUPPORTO SCALPELLO DX	OTMA	271, 301, 321, 351
RC0606S	S/35S	SUPPORTO SCALPELLO SX	OTMA	271/S, 301/S, 321/S, 351/S
RC0607	S/40	SUPPORTO SCALPELLO DX	OTMA	381, 401
RC0607S	S/40S	SUPPORTO SCALPELLO SX	OTMA	381/S, 401/S
RC0608	S/45	SUPPORTO SCALPELLO DX	OTMA	441, 461, 501, 521

SUPPORTI SCAPPELLO CON COLTRE VERTICALE PER CORPI ARANTI ADATTABILI ALLA PRODUZIONE OTMA

SUPPORTS AVEC COUTRE VERTICAL POUR CORPS ADAPTABLES OTMA

CHISELED BEARINGS WITH VERTICAL LAYER FOR PLOUGH BODIES OTMA PRODUCTION

MEISSEL-HALTER MIT VERTIKALEM PFLUGEISEN FUER PFLUGKOEPPER PASSEND ZU OTMA

SOPORTES ESCOPLA PARA CUERPOS DE ARADO ADAPTABLES A LA PRODUCCION OTMA

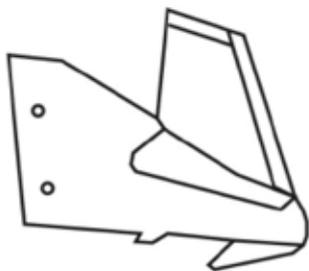

Art./Ref.	Rif. Orig./Orig. Ref.	Titolo Prodotto/Titolo Prodotto	Brand	Applicazione/Application
RC0605CB	SC/30	SUPPORTO CON COLTRE DX	OTMA	181, 231
RC0606CB	SC/35	SUPPORTO CON COLTRE DX	OTMA	271, 301, 321, 351
RC0606SCB	SC/35 S	SUPPORTO CON COLTRE SX	OTMA	271/S, 301/S, 321/S, 351/S
RC0607CB	SC/40	SUPPORTO CON COLTRE DX	OTMA	381, 401
RC0607SCB	SC/40 S	SUPPORTO CON COLTRE SX	OTMA	381/S, 401/S
RC0608CB	SC/45	SUPPORTO CON COLTRE DX	OTMA	441, 461, 501, 521

VERSOIR PER CORPI ARANTI ADATTABILI ALLA PRODUZIONE OTMA

VERSOIR POUR CORPS CHARRUE ADAPTABLES OTMA

MOULDBOARDS FOR PLOUGH BODIES SUIT TO OTMA PRODUCTION

STREICHBLECHE FUER PFLUGKOEPPER PASSEND ZU OTMA

OREJAS CUERPOS DE ARADO ADAPTABLES A LA PRODUCCION OTMA



Art./Ref.	Rif. Orig./Orig. Ref.	Titolo Prodotto/Titolo Prodotto	Brand	Applicazione/Application
RC0551	V/231	VERSOIO DX	OTMA	231
RC0551-S	V/231S	VERSOIO SX	OTMA	231S
RC0552	V/271	VERSOIO DX	OTMA	271
RC0552-S	V/271S	VERSOIO SX	OTMA	271S
RC0553	V/301	VERSOIO DX	OTMA	301
RC0553-S	V/301S	VERSOIO SX	OTMA	301S
RC0554	V/321	VERSOIO DX	OTMA	321
RC0554-S	V/321S	VERSOIO SX	OTMA	321S
RC0555	V/351	VERSOIO DX	OTMA	351
RC0555-S	V/351S	VERSOIO SX	OTMA	351S
RC0556	V/381	VERSOIO DX	OTMA	381
RC0556-S	V/381S	VERSOIO SX	OTMA	381S
RC0557	V/401	VERSOIO DX	OTMA	401
RC0557-S	V/401S	VERSOIO SX	OTMA	401S
RC0558	V/441	VERSOIO DX	OTMA	441
RC0558-S	V/441S	VERSOIO SX	OTMA	441S
RC0559	V/461	VERSOIO DX	OTMA	461
RC0559-S	V/461S	VERSOIO SX	OTMA	461S

RICAMBI PER CORPI ARANTI ADATTABILI ALLA PRODUZIONE OTMA U13

RECHANGES POUR CORPS LABOURANTS ADAPTÉS A LA PRODUCTION OTMA U13

SPARE PARTS FOR PLOUGH BODIES SUITABLE TO OTMA PRODUCTION U13

ERSATZTEILE FÜR PFLUGKÖRPER PASSEND ZU OTMA U13

RECAMBIOS CUERPOS DE ARADO ADAPTADOS A LA PRODUCCION OTMA U13

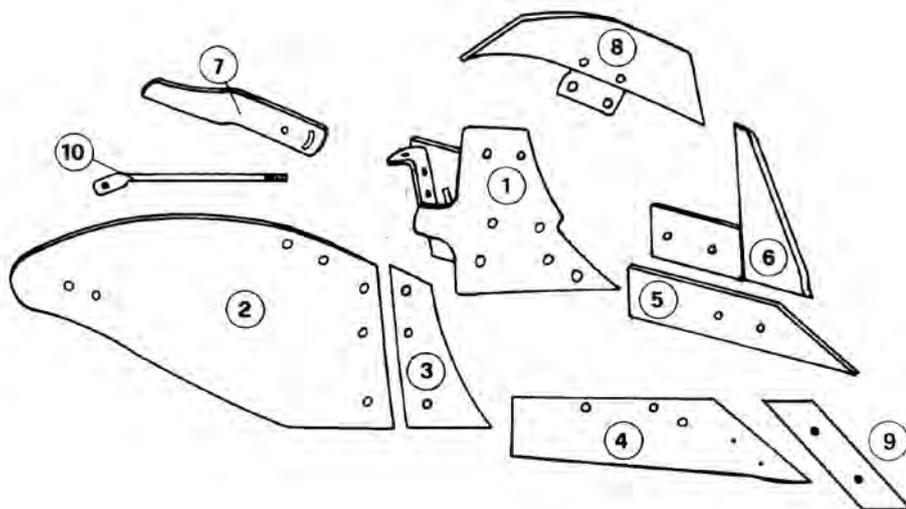

Art./Ref.	Rif. Orig./Orig. Ref.	Titolo Prodotto/Titolo Prodotto	Tipo/Type	Brand
RC0953	U 13	SUPPORTO CORPO DX	1.0	OTMA
RC0953 SX	U 13	SUPPORTO CORPO SX	1.0	OTMA
RC0954	HST1120	VERSOIO DX	2.0	OTMA
RC0954 SX	HST1130	VERSOIO SX	2.0	OTMA
RC0955	VST1120	AVANVERSOIO DX	3.0	OTMA
RC0955 SX	VST1130	AVANVERSOIO SX	3.0	OTMA
RC0956	MS1100	VOMERE PER PUNTALINO DX	4.0	OTMA
RC0956 SX	MS1110	VOMERE PER PUNTALINO SX	4.0	OTMA
RC0973AS	SS11465	VOMERE CON PUNTALINO STAMPATO SX	4.0	OTMA
RC0957	L1083	SUOLA POSTERIORE DX	5.0	OTMA
RC0957 SX	L1093	SUOLA POSTERIORE SX	5.0	OTMA
RC0974A	K1083	SUOLA ANTERIORE DX	5.0	OTMA
RC0974AS	K1093	SUOLA ANTERIORE SX	5.0	OTMA
RC0958	P290R	MEZZA SUOLA DX	6.0	OTMA
RC0958 SX	P290L	MEZZA SUOLA SX	6.0	OTMA
RC0959	SCHI1140	ORECCHIA MOBILE DX	7.0	OTMA
RC0959 SX	SCHI1150	ORECCHIA MOBILE SX	7.0	OTMA
RC0960	P261R	SOPRAVERSOIO DX	8.0	OTMA
RC0960 SX	P261L	SOPRAVERSOIO SX	8.0	OTMA
RC0961	M1000	PUNTA REVERSIBILE DX	9.0	OTMA
RC0961 SX	M1010	PUNTA REVERSIBILE SX	9.0	OTMA
RC0962	STU1640-STU1650	TIRANTE FILETTATO DX-SX	10.0	OTMA

RICAMBI PER CORPI ARANTI ADATTABILI ALLA PRODUZIONE OTMA U15

RECHANGES CORPS LABOURANTS ADAPTABLES A LA PRODUCTION OTMA U15

SPARE PARTS FOR PLOUGH BODIES SUITABLE TO OTMA PRODUCTION U15

ERSATZTEILE FUER PFLUGKOEPPER PASSEND ZU OTMA U15

RECAMBIOS CUERPOS DE ARADO ADAPTABLES A LA PRODUCCION NARDI TIPO OTMA U15

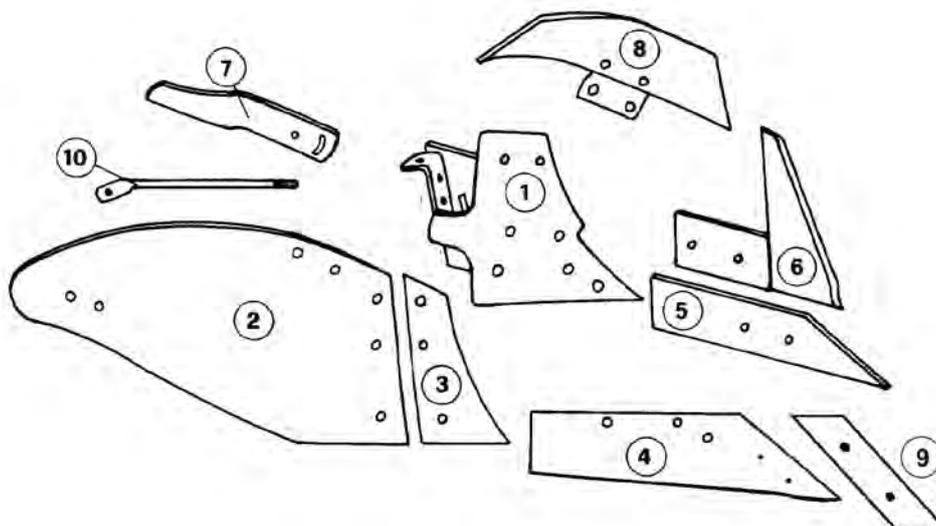

Art./Ref.	Rif. Orig./Orig. Ref.	Titolo Prodotto/Titolo Prodotto	Tipo/Type	Brand
RC0970	U 15	SUPPORTO CORPO DX	1.0	OTMA
RC0970S	U 15	SUPPORTO CORPO SX	1.0	OTMA
RC0971	HST1160	VERSOIO DX	2.0	OTMA
RC0971S	HST1170	VERSOIO SX	2.0	OTMA
RC0972	VST1160	AVANVERSOIO DX	3.0	OTMA
RC0972S	VST1170	AVANVERSOIO SX	3.0	OTMA
RC0956A	MS1140	VOMERE PER PUNTALINO DX	4.0	OTMA
RC0956AS	MS1150	VOMERE PER PUNTALINO SX	4.0	OTMA
RC0973	SS11466	VOMERE CON PUNTALINO STAMPATO DX	4.0	OTMA
RC0973S	SS11467	VOMERE CON PUNTALINO STAMPATO SX	4.0	OTMA
RC0957	L1083	SUOLA POSTERIORE DX	5.0	OTMA
RC0957 SX	L1093	SUOLA POSTERIORE SX	5.0	OTMA
RC0974A	K1083	SUOLA ANTERIORE DX	5.0	OTMA
RC0974AS	K1093	SUOLA ANTERIORE SX	5.0	OTMA
RC0958	P290R	MEZZA SUOLA DX	6.0	OTMA
RC0958 SX	P290L	MEZZA SUOLA SX	6.0	OTMA
RC0976	SCHI1280	ORECCHIA MOBILE DX	7.0	OTMA
RC0976S	SCHI1290	ORECCHIA MOBILE SX	7.0	OTMA
RC0960	P261R	SOPRAVERSOIO DX	8.0	OTMA
RC0960 SX	P261L	SOPRAVERSOIO SX	8.0	OTMA
RC0961	M1000	PUNTA REVERSIBILE DX	9.0	OTMA
RC0961 SX	M1010	PUNTA REVERSIBILE SX	9.0	OTMA

VERSOI, ALETTONE E ACCESSORI PER CORPI ARANTI ADATTABILI ALLA PRODUZIONE SR OVERUM

VERSOIRS, AILETTES ET ACCESSOIRS POUR CORPS CHARRUES ADAPTABLES SR OVERUM
 SR MOLDBOARDS, AILERONS AND FITTINGS FOR PLOUGH-BODY SUIT TO OVERUM PRODUCTION
 STREICHBLECHE, MOLLBLECHKANTE UND ZUBEHOER FÜR PFLUGKÖRPER PASSEND ZU SR OVERUM
 OREJAS, ALERON Y ACESORIOS PARA CUERPOS DE ARADO ADAPTABLE A LA PRODUCCION SR OVERUM



Art./Ref.	Rif. Orig./Orig. Ref.	Titolo Prodotto/Titolo Prodotto	Brand
RC1226	80604	VERSOIO DX	OVERUM
RC1227	80609	PREVERSOIO DX	OVERUM

VOMERI, PUNTE E ACCESSORI PER CORPI ARANTI ADATTABILI ALLA PRODUZIONE SR OVERUM

SOCS, POINTES ET ACCESSOIRS POUR CORPS CHARRUES ADAPTABLES SR OVERUM
 SR PLOWSHARES, DRILLS AND FITTINGS FOR PLOUGH-BODY SUIT TO OVERUM PRODUCTION
 SCHARE, SPITZEN UND ZUBEHOER FÜR PFLUGKÖRPER PASSEND ZU SR OVERUM
 VOMERES, PUNTAS Y ACESORIOS PARA CUERPOS DE ARADO ADAPTABLE A LA PRODUCCION SR OVERUM



Art./Ref.	Rif. Orig./Orig. Ref.	Titolo Prodotto/Titolo Prodotto	Brand
RC1220	74605	VOMERE 12" DX	OVERUM
RC1221	74606	VOMERE 14" DX	OVERUM
RC1222	74607	VOMERE 16" DX	OVERUM
RC1224	80605-92	VOMERE 14" DX	OVERUM
RC1225	80605-93	VOMERE 16" DX	OVERUM

VERSOI, ALETTONE E ACCESSORI PER CORPI ARANTI ADATTABILI ALLA PRODUZIONE UC OVERUM

VERSOIRS, AILETTES ET ACCESSOIRS POUR CORPS CHARRUES ADAPTABLES UC OVERUM
 UC MOLDBOARDS, AILERONS AND FITTINGS FOR PLOUGH-BODY SUIT TO OVERUM PRODUCTION
 STREICHBLECHE, MOLLBLECHKANTE UND ZUBEHOER FÜR PFLUGKÖRPER PASSEND ZU UC OVERUM
 OREJAS, ALERON Y ACESORIOS PARA CUERPOS DE ARADO ADAPTABLE A LA PRODUCCION UC OVERUM



Art./Ref.	Rif. Orig./Orig. Ref.	Titolo Prodotto/Titolo Prodotto	Brand
CP5105	84031	VERSOIO DX	OVERUM - MASSEY FERGUSON
CP5106	84087	VERSOIO SX	OVERUM - MASSEY FERGUSON
CP5107	84033	PREVERSOIO DX	OVERUM - MASSEY FERGUSON
CP5108	84082	PREVERSOIO SX	OVERUM - MASSEY FERGUSON

VOMERI, PUNTE E ACCESSORI PER CORPI ARANTI ADATTABILI ALLA PRODUZIONE UC OVERUM

SOCs, POINTES ET ACCESSOIRS POUR CORPS CHARRUES ADAPTABLES UC OVERUM
 UC PLOWSHARES, DRILLS AND FITTINGS FOR PLOUGH-BODY SUIT TO OVERUM PRODUCTION
 SCHARE, SPITZEN UND ZUBEHOER FÜR PFLUGKÖRPER PASSEND ZU UC OVERUM
 VOMERES, PUNTAS Y ACESORIOS PARA CUERPOS DE ARADO ADAPTABLE A LA PRODUCCION UC OVERUM

Art./Ref.	Rif. Orig./Orig. Ref.	Titolo Prodotto/Titolo Prodotto	Brand
CP5098	85004	VOMERE DX	OVERUM - MASSEY FERGUSON
CP5101	85194	VOMERE SX	OVERUM - MASSEY FERGUSON
CP5102	85039	VOMERE DX	OVERUM - MASSEY FERGUSON
CP5103	85195	VOMERE SX	OVERUM - MASSEY FERGUSON
CP5099	84987	PUNTE REVERSIBILE DX	OVERUM - MASSEY FERGUSON
CP5104	85206	PUNTE REVERSIBILE SX	OVERUM - MASSEY FERGUSON



STRISCIANTI E COLTRI PER CORPI ARANTI ADATTABILI ALLA PRODUZIONE UC-V OVERUM

FROTTANTS ET COUTRES POUR CORPS CHARRUES ADAPTABLES UC-V OVERUM
 UC-V LANDSIDES AND COULTERS FOR PLOUGH-BODY SUIT TO OVERUM PRODUCTION
 ANLAGEN UND PFLUGEISEN FÜR PFLUGKÖRPER PASSEND ZU UC-V OVERUM
 ARRASTRANTES Y COBERTORES PARA CUERPOS DE ARADO ADAPTABLE A LA PRODUCCION UC-V OVERUM

Art./Ref.	Rif. Orig./Orig. Ref.	Titolo Prodotto/Titolo Prodotto	Spessore mm/Thickness mm	Brand
RC1216	83981	STRISCIANTE CORTO DX	12 mm	OVERUM
RC1217	85196	STRISCIANTE CORTO SX	12 mm	OVERUM
CP5109	86291	STRISCIANTE CORTO DX	12 mm	OVERUM - MASSEY FERGUSON
CP5110	85578	STRISCIANTE CORTO SX	12 mm	OVERUM - MASSEY FERGUSON
RC1218	85118	STRISCIANTE LUNGO DX	12 mm	OVERUM
RC1219	85197	STRISCIANTE LUNGO SX	12 mm	OVERUM
CP5111	85202	STRISCIANTE LUNGO DX	12 mm	OVERUM - MASSEY FERGUSON
CP5112	85133	STRISCIANTE LUNGO SX	12 mm	OVERUM - MASSEY FERGUSON
RC1214	94622	COLTRE DX	6 mm	OVERUM
RC1215	94623	COLTRE SX	6 mm	OVERUM

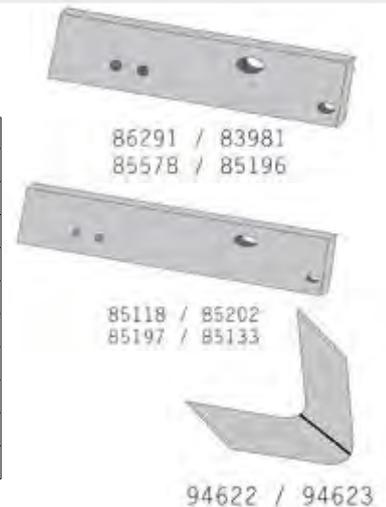

VERSOI, ALETTONE E ACCESSORI PER CORPI ARANTI ADATTABILI ALLA PRODUZIONE V OVERUM

VERSOIRS, AILETTES ET ACCESSOIRS POUR CORPS CHARRUES ADAPTABLES V OVERUM
 V MOLDBOARDS, AILERONS AND FITTINGS FOR PLOUGH-BODY SUIT TO OVERUM PRODUCTION
 STREICHBLECHE, MOLLBLECHKANTE UND ZUBEHOER FÜR PFLUGKÖRPER PASSEND ZU V OVERUM
 OREJAS, ALERON Y ACESORIOS PARA CUERPOS DE ARADO ADAPTABLE A LA PRODUCCION V OVERUM



Art./Ref.	Rif. Orig./Orig. Ref.	Titolo Prodotto/Titolo Prodotto	Brand
CP5105	84031	VERSOIO DX	OVERUM - MASSEY FERGUSON
CP5106	84087	VERSOIO SX	OVERUM - MASSEY FERGUSON
CP5107	84033	PREVERSOIO DX	OVERUM - MASSEY FERGUSON
CP5108	84082	PREVERSOIO SX	OVERUM - MASSEY FERGUSON
RC1210	85261	VERSOIO DX	OVERUM
RC1211	85262	VERSOIO SX	OVERUM
RC1212	83980	PREVERSOIO DX	OVERUM
RC1213	84083	PREVERSOIO SX	OVERUM



VOMERI, PUNTE E ACCESSORI PER CORPI ARANTI ADATTABILI ALLA PRODUZIONE V OVERUM
SOCs, POINTES ET ACCESSOIRS POUR CORPS CHARRUES ADAPTABLES V OVERUM
V PLOWSHARES, DRILLS AND FITTINGS FOR PLOUGH-BODY SUIT TO OVERUM PRODUCTION
SCHARE, SPITZEN UND ZUBEHOER FÜR PFLUGKÖRPER PASSEND ZU V OVERUM
VOMERES, PUNTAS Y ACESORIOS PARA CUERPOS DE ARADO ADAPTABLE A LA PRODUCCION V OVERUM

84060 / 85143



85383 / 85381



85384 / 85382

Art./Ref.	Rif. Orig./Orig. Ref.	Titolo Prodotto/Titolo Prodotto	Spessore mm/Thickness mm	Brand
RC1202	84060	PUNTA REVERSIBILE DX	10 mm	OVERUM
RC1203	85143	PUNTA REVERSIBILE SX	10 mm	OVERUM
RC1202C	84060	PUNTA REVERSIBILE CON RIPOSTO DI SALDATURA DX	12 mm	OVERUM
RC1203C	85143	PUNTA REVERSIBILE CON RIPOSTO DI SALDATURA SX	12 mm	OVERUM
RC1206	85383	VOMERE 14" DX	-	OVERUM
RC1207	85381	VOMERE 14" SX	-	OVERUM
RC1208	85384	VOMERE 16" DX	-	OVERUM
RC1209	85382	VOMERE 16" SX	-	OVERUM

VERSOI, ALETTONE E ACCESSORI PER CORPI ARANTI ADATTABILI ALLA PRODUZIONE XL OVERUM
VERSOIRS, AILETTES ET ACCESSOIRS POUR CORPS CHARRUES ADAPTABLES XL OVERUM
XL MOLDBOARDS, AILERONS AND FITTINGS FOR PLOUGH-BODY SUIT TO OVERUM PRODUCTION
STREICHBLECHE, MOLLBLECHKANTE UND ZUBEHOER FÜR PFLUGKÖRPER PASSEND ZU XL OVERUM
OREJAS, ALERON Y ACESORIOS PARA CUERPOS DE ARADO ADAPTABLE A LA PRODUCCION XL OVERUM

94594 / 94595



94596 / 94597

Art./Ref.	Rif. Orig./Orig. Ref.	Titolo Prodotto/Titolo Prodotto	Brand
RC1236	94594	VERSOIO DX	OVERUM
RC1237	94595	VERSOIO SX	OVERUM
RC1238	94596	PREVERSOIO DX	OVERUM
RC1239	94597	PREVERSOIO SX	OVERUM

VOMERI, PUNTE E ACCESSORI PER CORPI ARANTI ADATTABILI ALLA PRODUZIONE XL OVERUM
SOCs, POINTES ET ACCESSOIRS POUR CORPS CHARRUES ADAPTABLES XL OVERUM
XL PLOWSHARES, DRILLS AND FITTINGS FOR PLOUGH-BODY SUIT TO OVERUM PRODUCTION
SCHARE, SPITZEN UND ZUBEHOER FÜR PFLUGKÖRPER PASSEND ZU XL OVERUM
VOMERES, PUNTAS Y ACESORIOS PARA CUERPOS DE ARADO ADAPTABLE A LA PRODUCCION XL OVERUM

94608 / 94609



94598 / 94599



94600 / 94601



94602 / 94603

Art./Ref.	Rif. Orig./Orig. Ref.	Titolo Prodotto/Titolo Prodotto	Spessore mm/Thickness mm	Brand
RC1228	94608	PUNTA REVERSIBILE DX	10 mm	OVERUM
RC1229	94609	PUNTA REVERSIBILE SX	10 mm	OVERUM
RC1228C	94608	PUNTA REVERSIBILE DX	12 mm	OVERUM
RC1229C	94609	PUNTA REVERSIBILE SX	12 mm	OVERUM
RC1230	94598	VOMERE 14" DX	-	OVERUM
RC1231	94599	VOMERE 14" SX	-	OVERUM
RC1232	94600	VOMERE 16" DX	10 mm	OVERUM
RC1233	94601	VOMERE 16" SX	10 mm	OVERUM
RC1234	94602	VOMERE 18" DX	-	OVERUM
RC1235	94603	VOMERE 18" SX	-	OVERUM

STRISCIANTI E COLTRI PER CORPI ARANTI ADATTABILI ALLA PRODUZIONE XL OVERUM
FROTTANTS ET COUTRES POUR CORPS CHARRUES ADAPTABLES XL OVERUM
XL LANDSIDES AND COULTERS FOR PLOUGH-BODY SUIT TO OVERUM PRODUCTION
ANLAGEN UND PFLUGEISEN FÜR PFLUGKÖRPER PASSEND ZU XL OVERUM
ARRASTRANTES Y COBERTURAS PARA CUERPOS DE ARADO ADAPTABLE A LA PRODUCCION XL OVERUM

Art./Ref.	Rif. Orig./Orig. Ref.	Titolo Prodotto/Titolo Prodotto	Spessore mm/Thickness mm	Brand
RC1242	94604	STRISCIANTE DX	-	OVERUM
RC1243	94605	STRISCIANTE SX	-	OVERUM
RC1214	94622	COLTRE DX	6 mm	OVERUM
RC1215	94623	COLTRE SX	6 mm	OVERUM

STRISCIANTI PER CORPI ARANTI ADATTABILI ALLA PRODUZIONE OVERUM
FROTTANTS POUR CORPS CHARRUES ADAPTABLES OVERUM
LANDSIDES FOR PLOUGH-BODY SUIT TO OVERUM PRODUCTION
ANLAGEN FÜR PFLUGKÖRPER PASSEND ZU OVERUM
ARRASTRANTES PARA CUERPOS DE ARADO ADAPTABLE A LA PRODUCCION OVERUM

Art./Ref.	Rif. Orig./Orig. Ref.	Titolo Prodotto/Titolo Prodotto	Spessore mm/Thickness mm	Brand
RC1742	92230	STRISCIANTE DX	12 mm	OVERUM
RC1743	92229	STRISCIANTE SX	12 mm	OVERUM
RC1744	92232	STRISCIANTE DX	12 mm	OVERUM
RC1745	92231	STRISCIANTE SX	12 mm	OVERUM
RC1746	94289	STRISCIANTE DX-SX	12 mm	OVERUM

VOMERI PER CORPI ARANTI ADATTABILI ALLA PRODUZIONE OVERUM
SOCS POUR CORPS CHARRUES ADAPTABLES OVERUM
PLOWSHARES FOR PLOUGH-BODY SUIT TO OVERUM PRODUCTION
SCHARE FÜR PFLUGKÖRPER PASSEND ZU OVERUM
VOMERES PARA CUERPOS DE ARADO ADAPTABLE A LA PRODUCCION OVERUM

Art./Ref.	Rif. Orig./Orig. Ref.	Titolo Prodotto/Titolo Prodotto	Spessore mm/Thickness mm	Brand
RC1732	91801	VOMERINO DX	8 mm	OVERUM
RC1733	91802	VOMERINO SX	8 mm	OVERUM
RC1734	94610	VOMERINO DX	12 mm	OVERUM
RC1735	94611	VOMERINO SX	12 mm	OVERUM
RC1736	92199	VOMERINO DX	12 mm	OVERUM
RC1737	92200	VOMERINO SX	12 mm	OVERUM
RC1738	92218	VOMERINO DX	10 mm	OVERUM
RC1739	92216	VOMERINO SX	10 mm	OVERUM
RC1740	92219	VOMERINO DX	10 mm	OVERUM
RC1741	92217	VOMERINO SX	10 mm	OVERUM



VOMERI E PUNTE PER CORPI ARANTI ADATTABILI ALLA PRODUZIONE BP-321-322-323 PS/PSL - BP-2930 2940L RABEWERK
SOCs ET POINTES POUR CORPS CHARRUES ADAPTABLES BP-321-322-323 PS/PSL - BP-2930 2940L RABEWERK
BP-321-322-323 PS/PSL - BP-2930 2940L PLOWSHARES AND DRILLS FOR PLOUGH-BODY SUIT TO RABEWERK PRODUCTION
SCHARE UND SPITZEN FÜR PFLUGKÖRPER PASSEND ZU BP-321-322-323 PS/PSL - BP-2930 2940L RABEWERK
VOMERES Y PUNTAS PARA CUERPOS DE ARADO ADAPTABLE A LA PRODUCCION BP-321-322-323 PS/PSL - BP-2930 2940L RABEWERK

MP293 / MP293L



SSP2930SE / SSP2930SEL



SSP2940SE / SSP2940SEL

Art./Ref.	Rif. Orig./Orig. Ref.	Titolo Prodotto/Titolo Prodotto	Spessore mm/Thickness mm	Brand
CP1199A	MP293	PUNTALINO DX	12 mm	RABEWERK
CP1199AS	MP293L	PUNTALINO SX	12 mm	RABEWERK
CP1199	SSP2930SE	VOMERE DX	-	RABEWERK
CP1199S	SSP2930SEL	VOMERE SX	-	RABEWERK
RC1425	SSP2940SE	VOMERE DX	-	RABEWERK
RC1426	SSP2940SEL	VOMERE SX	-	RABEWERK

VOMERI, PUNTE E ACCESSORI PER CORPI ARANTI ADATTABILI ALLA PRODUZIONE RABEWERK
SOCs, POINTES ET ACCESSOIRS POUR CORPS CHARRUES ADAPTABLES RABEWERK
PLOWSHARES, DRILLS AND FITTING FOR PLOUGH-BODY SUIT TO RABEWERK PRODUCTION
SCHARE, SPITZEN UND ZUBEHOER FÜR PFLUGKÖRPER PASSEND ZU RABEWERK
VOMERES, PUNTAS Y ACESORIOS PARA CUERPOS DE ARADO ADAPTABLE A LA PRODUCCION RABEWERK

SDG14/16 - SDG14/16L



SDG181 - SDG181L



MP332 - MP332L



MP350 - MP350L



VRP350W - VRP350WL

Art./Ref.	Rif. Orig./Orig. Ref.	Titolo Prodotto/Titolo Prodotto	Spessore mm/Thickness mm	Brand
RC1747	SDG14/16	VOMERINO DX	8 mm	RABEWERK
RC1748	SDG14/16L	VOMERINO SX	8 mm	RABEWERK
RC1749	SDG181	VOMERINO DX	8 mm	RABEWERK
RC1750	SDG181L	VOMERINO SX	8 mm	RABEWERK
RC1760	MP332	PUNTA REVERSIBILE DX	12 mm	RABEWERK
RC1761	MP332L	PUNTA REVERSIBILE SX	12 mm	RABEWERK
RC1760RP	MP332	PUNTA REVERSIBILE CON RIPORTO DI SALDATURA DX	12 mm	RABEWERK
RC1761RP	MP332L	PUNTA REVERSIBILE CON RIPORTO DI SALDATURA SX	12 mm	RABEWERK
RC1762	MP350	PUNTA REVERSIBILE DX	12 mm	RABEWERK
RC1763	MP350L	PUNTA REVERSIBILE SX	12 mm	RABEWERK
RC1762RP	MP350	PUNTA REVERSIBILE CON RIPORTO DI SALDATURA DX	12 mm	RABEWERK
RC1763RP	MP350L	PUNTA REVERSIBILE CON RIPORTO DI SALDATURA SX	12 mm	RABEWERK
RC1751	VRP350W	PREVERSOIO SX	10 mm	RABEWERK
RC1752	VRP350WL	PREVERSOIO DX	10 mm	RABEWERK

STRISCIANTI E COLTRI PER CORPI ARANTI ADATTABILI ALLA PRODUZIONE BP-321-322-323 PS/PSL - BP-2930 2940L RABEWERK

FROTTANTS ET COUTRES POUR CORPS CHARRUES ADAPTABLES BP-321-322-323 PS/PSL - BP-2930 2940L RABEWERK

BP-321-322-323 PS/PSL - BP-2930 2940L LANDSIDES AND COULTERS FOR PLOUGH-BODY SUIT TO RABEWERK PRODUCTION

ANLAGEN UND PFLUGEISEN FÜR PFLUGKÖRPER PASSEND ZU BP-321-322-323 PS/PSL - BP-2930 2940L RABEWERK

ARRASTRANTES Y COBERTURAS PARA CUERPOS DE ARADO ADAPTABLE A LA PRODUCCION BP-321-322-323 PS/PSL - BP-2930 2940L RABEWERK



Art./Ref.	Rif. Orig./Orig. Ref.	Titolo Prodotto/Titolo Prodotto	Spessore mm/Thickness mm	Brand
RC1427	NG71	COLTELLO DX	-	RABEWERK
RC1428	NG71L	COLTELLO SX	-	RABEWERK
RC1429	VP2920	STRISCIANTE CORTO DX-SX	12 mm	RABEWERK
RC1430	WP2920	STRISCIANTE LUNGO DX-SX	12 mm	RABEWERK

VERSOIO, ALETTONE E ACCESSORI PER CORPI ARANTI ADATTABILI ALLA PRODUZIONE BP-2930 2940L RABEWERK

VERSOIRS, AILETTES ET ACCESSOIRS POUR CORPS CHARRUES ADAPTABLES BP-2930 2940L RABEWERK

BP-2930 2940L MOLDBOARDS, AILERONS AND FITTINGS FOR PLOUGH-BODY SUIT TO RABEWERK PRODUCTION

STREICHBLECH, MOLLBLECHKANTE UND ZUBEHÖR FÜR PFLUGKÖRPER PASSEND ZU BP-2930 2940L RABEWERK

OREJAS, ALERON Y ACESORIOS PARA CUERPOS DE ARADO ADAPTABLE A LA PRODUCCION BP-2930 2940L RABEWERK



Art./Ref.	Rif. Orig./Orig. Ref.	Titolo Prodotto/Titolo Prodotto	Brand
RC1417	PDG52	PROLUNGA DX	RABEWERK
RC1418	PDG52L	PROLUNGA SX	RABEWERK
RC1419	FP78	ALETTONE DX	RABEWERK
RC1420	FP78L	ALETTONE SX	RABEWERK
RC1421	HRP2960	VERSOIO DX	RABEWERK
RC1422	HRP2960L	VERSOIO SX	RABEWERK
RC1423	VRP292R	PREVERSOIO DX	RABEWERK
RC1424	VRP292L	PREVERSOIO SX	RABEWERK

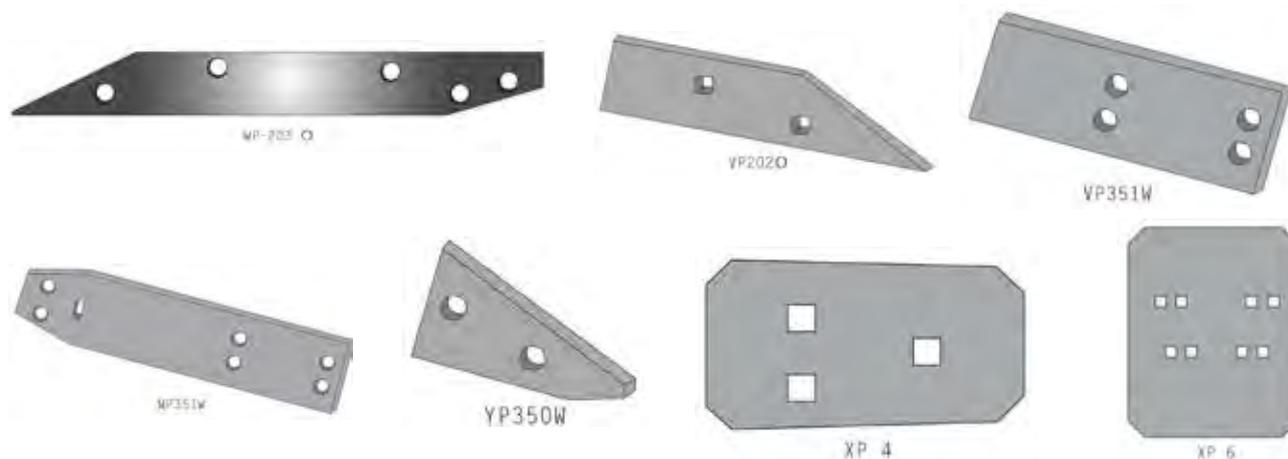

STRISCIANTI PER CORPI ARANTI ADATTABILI ALLA PRODUZIONE RABEWERK
FROTANTS POUR CORPS CHARRUES ADAPTABLES RABEWERK
LANDSIDES FOR PLOUGH-BODY SUIT TO RABEWERK PRODUCTION
ANLAGEN FÜR PFLUGKÖRPER PASSEND ZU RABEWERK
ARRASTRANTES PARA CUERPOS DE ARADO ADAPTABLE A LA PRODUCCION RABEWERK

Art./Ref.	Rif. Orig./Orig. Ref.	Titolo Prodotto/Titolo Prodotto	Spessore mm/Thickness mm	Brand
RC1753	WP2030	STRISCIANTE LUNGO DX-SX	12 mm	RABEWERK
RC1754	VP2020	STRISCIANTE CORTO DX-SX	12 mm	RABEWERK
RC1755	VP351W	STRISCIANTE DX-SX	12 mm	RABEWERK
RC1756	WP351W	STRISCIANTE DX-SX	12 mm	RABEWERK
RC1757	YP350W	STRISCIANTE DX-SX	12 mm	RABEWERK
RC1758	XP 4	STRISCIANTE DX-SX	8 mm	RABEWERK
RC1759	XP 6	STRISCIANTE DX-SX	7 mm	RABEWERK

VOMERI, PUNTE E ACCESSORI PER CORPI ARANTI ADATTABILI ALLA PRODUZIONE RANSOMES
SOCs, ET POINTES ET ACCESSOIRS POUR CORPS CHARRUES ADAPTABLES RANSOMES
PLOWSHARES, DRILLS AND FITTING FOR PLOUGH-BODY SUIT TO RANSOMES PRODUCTION
SCHARE, SPITZEN UND ZUBEHOER FÜR PFLUGKÖRPER PASSEND ZU RANSOMES
VOMERES, PUNTAS Y ACESORIOS PARA CUERPOS DE ARADO ADAPTABLE A LA PRODUCCION RANSOMES

Art./Ref.	Rif. Orig./Orig. Ref.	Titolo Prodotto/Titolo Prodotto	Spessore mm/Thickness mm	Brand
RC1764	PBA4127	VOMERINO DX	7 mm	RANSOMES
RC1765	PBA4126	VOMERINO SX	7 mm	RANSOMES
RC1766	PBA4177	VOMERINO DX	7 mm	RANSOMES
RC1767	PBA4178	VOMERINO SX	7 mm	RANSOMES
RC1772	PASC753	VOMERINO DX	8 mm	RANSOMES
RC1773	PASC754	VOMERINO SX	8 mm	RANSOMES
RC1770	PASC747	PUNTA REVERSIBILE DX	12 mm	RANSOMES
RC1771	PASC748	PUNTA REVERSIBILE SX	12 mm	RANSOMES
RC1768	PASC080	PREVERSOIO DX	8 mm	RANSOMES
RC1769	PASC081	PREVERSOIO SX	8 mm	RANSOMES

VOMERI PER CORPI ARANTI ADATTABILI ALLA PRODUZIONE REGENT

SOCS POUR CORPS CHARRUES ADAPTABLES REGENT

PLOWSHARES FOR PLOUGH-BODY SUIT TO REGENT PRODUCTION

SCHARE FÜR PFLUGKÖRPER PASSEND ZU REGENT

VOMERES PARA CUERPOS DE ARADO ADAPTABLE A LA PRODUCCION REGENT

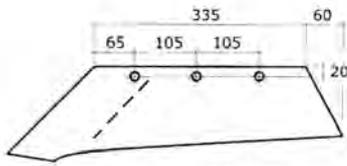

L45035151 / L45035152

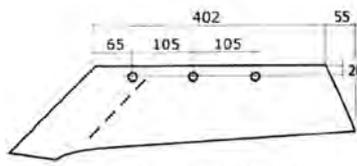

L45040151 / L45040152

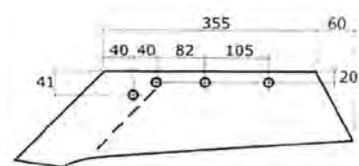

L45035211 / L45035212

Art./Ref.	Rif. Orig./Orig. Ref.	Titolo Prodotto/Titolo Prodotto	Brand
RC1443	L45035151	VOMERE DU35 DX	REGENT
RC1444	L45035152	VOMERE DU35 SX	REGENT
RC1445	L45040151	VOMERE DU40 DX	REGENT
RC1446	L45040152	VOMERE DU40 SX	REGENT
RC1447	L45035211	VOMERE DU435 DX	REGENT
RC1448	L45035212	VOMERE DU435 SX	REGENT

VOMERI PER CORPI ARANTI ADATTABILI ALLA PRODUZIONE REGENT

SOCS POUR CORPS CHARRUES ADAPTABLES REGENT

PLOWSHARES FOR PLOUGH-BODY SUIT TO REGENT PRODUCTION

SCHARE FÜR PFLUGKÖRPER PASSEND ZU REGENT

VOMERES PARA CUERPOS DE ARADO ADAPTABLE A LA PRODUCCION REGENT



51561171 / 51561172

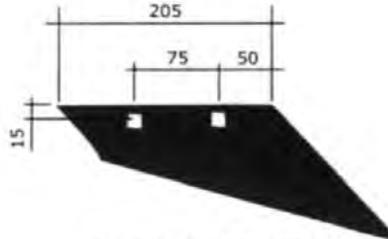

51101111 / 51101112

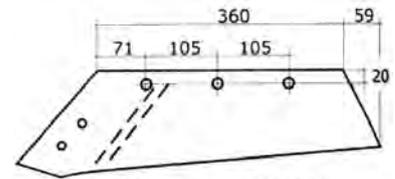

L45035171 / L45035172

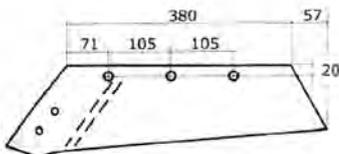

L45040241 / L45040242

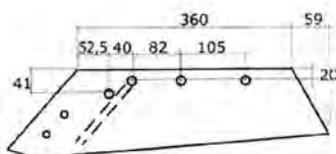

L45035221 / L45035222

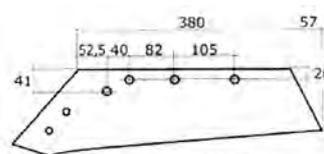

L45040271 / L45040272

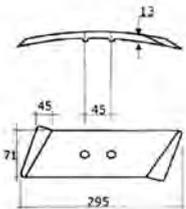

L45032172 / L45032171

Art./Ref.	Rif. Orig./Orig. Ref.	Titolo Prodotto/Titolo Prodotto	Spessore mm/Thickness mm	Brand
RC1451	L45035171	VOMERE DW35 DX	-	REGENT
RC1452	L45035172	VOMERE DW35 SX	-	REGENT
RC1453	L45040241	VOMERE DW40 DX	-	REGENT
RC1454	L45040242	VOMERE DW40 SX	-	REGENT
RC1455	L45035221	VOMERE DW435 DX	-	REGENT
RC1456	L45035222	VOMERE DW435 SX	-	REGENT
RC1457	L45040271	VOMERE DW440 DX	12	REGENT
RC1458	L45040272	VOMERE DW440 SX	12	REGENT
RC1459	L45032172	PUNTA DWS DX	-	REGENT
RC1460	L45032171	PUNTA DWS SX	-	REGENT
RC1461	51561171	ALETTA MAIS DX	-	REGENT
RC1462	51561171	ALETTA MAIS SX	-	REGENT
RC1465	51101111	VOMERINO DX	-	REGENT
RC1466	51101112	VOMERINO SX	-	REGENT

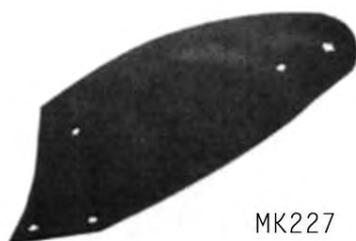
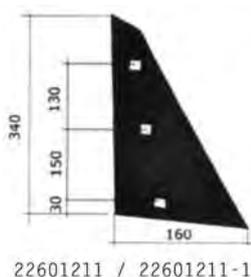
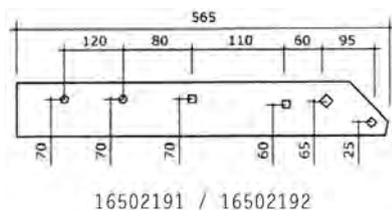
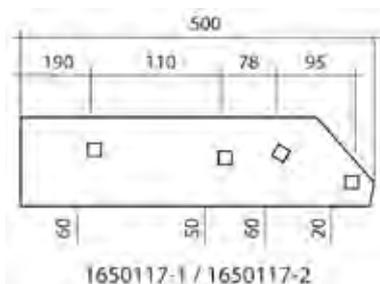
VARI PER CORPI ARANTI ADATTABILI ALLA PRODUZIONE REGENT
DIFFERENTS POUR CORPS CHARRUES ADAPTABLES REGENT
VARIOS FOR PLOUGH-BODY SUIT TO REGENT PRODUCTION
VERSCHIEDENE FÜR PFLUGKÖRPER PASSEND ZU REGENT
VARIOS PARA CUERPOS DE ARADO ADAPTABLE A LA PRODUCCION REGENT

MK227

Art./Ref.	Rif. Orig./Orig. Ref.	Titolo Prodotto/Titolo Prodotto	Brand
RC1467	1650117-1	STRISCIANTE ANTERIORE 100x12 DX	REGENT
RC1468	1650117-2	STRISCIANTE ANTERIORE 100x12 SX	REGENT
RC1469	16502191	STRISCIANTE POSTERIORE 100x12 DX	REGENT
RC1470	16502192	STRISCIANTE POSTERIORE 100x12 SX	REGENT
RC1472	22601211-1	PREVERSOIO DX	REGENT
RC1473	22601211-2	PREVERSOIO SX	REGENT
RC1474	MK227	VERSOIO DX	REGENT
RC1475	MK227	VERSOIO SX	REGENT

VOMERI PER CORPI A SCALPELLO ADATTABILI ALLA PRODUZIONE SOGEMA

SOCS POUR CORPS À CISEAU TYPE SOGEMA

PLOUGHSHARES FOR POINT-BODY FOR SOGEMA LINE

SCHARE FÜR PFLUGKÖRPER FÜR SOGEMA

VOMERES PARA CUERPOS A ESCOPLA PARA PRODUCCIÓN SOGEMA



Art./Ref.	Rif. Orig./Orig. Ref.	Titolo Prodotto/Titolo Prodotto	Brand	Applicazione/Application
RC0011	00 VS	VOMERE DX	SOGEMA	AN 1, AN 2, AN 3
RC2011	00 VS SX	VOMERE SX	SOGEMA	AN 1, AN 2, AN 3
RC0012	0 VS	VOMERE DX	SOGEMA	18 BP, 18 BT, 18 TB, 18 TP, 18 TPSR
RC2012	0 VS SX	VOMERE SX	SOGEMA	18 BP, 18 BT, 18 TB, 18 TP, 18 TPSR
RC0013	1/2 VS	VOMERE DX	SOGEMA	20 BP, 20 BT, 20 TP, 24 BP, 25 BPA, 25 BTA, 25 MPA, 25 TBA, 25 TP, 28 BPA, 28 BTA, 28 MPA, 28 TBA, 28 TPA
RC2013	1/2 VS SX	VOMERE SX	SOGEMA	20 BP, 20 BT, 20 TP, 24 BP, 25 BPA, 25 BTA, 25 MPA, 25 TBA, 25 TP, 28 BPA, 28 BTA, 28 MPA, 28 TBA, 28 TPA
RC0014	1 VS	VOMERE DX	SOGEMA	30 BPA, 30 BTA, 30 D, 30 MPA, 30 TBA, 30 TPA, 32 BPA, 32 BTA, 32 TBA, 32 TPA, 34 BPA, 34 BTA, 34 TBA, 35 BPA, 35 BTA, 35 MPA, 35 MTA, 35 TBA, 35 TPA
RC2014	1 VS SX	VOMERE SX	SOGEMA	30 BPA, 30 BTA, 30 D, 30 MPA, 30 TBA, 30 TPA, 32 BPA, 32 BTA, 32 TBA, 32 TPA, 34 BPA, 34 BTA, 34 TBA, 35 BPA, 35 BTA, 35 MPA, 35 MTA, 35 TBA, 35 TPA
RC0015	2 VS	VOMERE DX	SOGEMA	36 D, 36 MTA, 38 BPA, 38 D, 38 MPA, 38 TBA, 40 BPA, 40 MPA, 40 MTA
RC2015	2 VS SX	VOMERE SX	SOGEMA	36 D, 36 MTA, 38 BPA, 38 D, 38 MPA, 38 TBA, 40 BPA, 40 MPA, 40 MTA
RC0016	2 VS-L	VOMERE DX	SOGEMA	36 MTA, 42 BPA, 42 BT Virg., 42 BTA, 42 D, 42 MPA, 42 TB, 43 BT Virg., 43 TB Virg., 44 BPA, 44 D, 44 MPA, 44 MTA, 45 MTA, 46 BPA, 46 D, 46 MPA, 49 BP
RC2016	2 VS-L SX	VOMERE SX	SOGEMA	36 MTA, 42 BPA, 42 BT Virg., 42 BTA, 42 D, 42 MPA, 42 TB, 43 BT Virg., 43 TB Virg., 44 BPA, 44 D, 44 MPA, 44 MTA, 45 MTA, 46 BPA, 46 D, 46 MPA, 49 BP
RC0017	3 VS	VOMERE DX	SOGEMA	47 BT, 47 BT Virg., 47 BTR Virg., 47 TB Virg., 47 TBR Virg.
RC2017	3 VS SX	VOMERE SX	SOGEMA	47 BT, 47 BT Virg., 47 BTR Virg., 47 TB Virg., 47 TBR Virg.
RC0018	4 VS	VOMERE DX	SOGEMA	48 BP-G, 49 BP-R, 50 BP, 50 D, 50 M, 50 MP, 52 BP, 52 M, 52 M Leon., 52 MP, 53 MP, 54 M, 54 MP, 55 M, 65 M Leon., 65 M PFSI, 65 MD, 65 MDR, 65 ML Leon., 65 MR Leon.
RC2018	4 VS SX	VOMERE SX	SOGEMA	48 BP-G, 49 BP-R, 50 BP, 50 D, 50 M, 50 MP, 52 BP, 52 M, 52 M Leon., 52 MP, 53 MP, 54 M, 54 MP, 55 M, 65 M Leon., 65 M PFSI, 65 MD, 65 MDR, 65 ML Leon., 65 MR Leon.
RC0021	4 1/2 VS	VOMERE DX	SOGEMA	55/MP, 57/MP, 65/MD, 65/MDR
RC2021	4 1/2 VS SX	VOMERE SX	SOGEMA	55/MP, 57/MP, 65/MD, 65/MDR

SCALPELLI ADATTABILI ALLA PRODUZIONE SOGEMA

CISEAUX TYPE SOGEMA

POINTS FOR SOGEMA LINE

MEISSEL FÜR SOGEMA

ESCOPLAS PARA PRODUCCIÓN SOGEMA



Art./Ref.	Rif. Orig./Orig. Ref.	Titolo Prodotto/Titolo Prodotto	Brand	Applicazione/Application
RC0044	30X30, 30X30, 30X30 (H3)	SCALPELLO DX	SOGEMA - OTMA - VIVIANI	181, 231, 20 BP, 20 BT, 20 TB, 20 TP, 24 BPA, 25 BPA, 25 BTA, 25 MPA, 25 TBA, 25 TP, 28 BPA, 28 BTA, 28 MPA, 28 TBA, 28 TPA, 25B2, 25P1, 25P1G, 27B2, 30P1, 30P1G, 30P2G, 40P2, 40P2G, B30P2, B40P2, M30P1, N30P2, T40P3, T50P3
RC2044	30X30 SX, 30X30 SX	SCALPELLO SX	SOGEMA - OTMA	181, 231, 20 BP, 20 BT, 20 TB, 20 TP, 24 BPA, 25 BPA, 25 BTA, 25 MPA, 25 TBA, 25 TP, 28 BPA, 28 BTA, 28 MPA, 28 TBA, 28 TPA
RC0045	35X35, 35X35, 35X35 (H4)	SCALPELLO DX	SOGEMA - OTMA - VIVIANI	321, 351, 30 BPA, 30 BTA, 30 D, 30 MPA, 30 TBA, 30 TPA, 32 BPA, 32 BTA, 32 TBA, 32 TPA, 34 BPA, 34 BTA, 35 BPA, 35 BTA, 35 MPA, 35 MTA, 35 TBA, 35 TPA, 25AA, 25B1, 27AA, 30AA, 30B2, 30BBR, 35AA, 35B2, 35BBR, 40B2, 40P1, 40P1G, 50P2, 50P2G, 60P2, 70P2, 70P2F, B50P2, B60P2, M40P1, T60P3, T80P3

Art./Ref.	Rif. Orig./Orig. Ref.	Titolo Prodotto/Titolo Prodotto	Brand	Applicazione/Application
RC2045	35X35 SX, 35X35 SX	SCALPELLO SX	SOGEMA - OTMA	271, 301, 321, 351, 30 BPA, 30 BTA, 30 D, 30 MPA, 30 TBA, 30 TPA, 32 BPA, 32 BTA, 32 TBA, 32 TPA, 34 BPA, 34 BTA, 35 BPA, 35 BTA, 35 MPA, 35 MTA, 35 TBA, 35 TPA
RC0046	40X40, 40X40, 40X40 (H6)	SCALPELLO DX	SOGEMA - OTMA - VIVIANI	381, 401, 36 D, 38 BPA, 38 BTA, 38 D, 38 MPA, 38 MTA, 38 TBA, 38 TPA, 40 BPA, 40 D, 40 MPA, 40 MTA, 42 BPA, 42 BT Virg., 42 BTA, 42 D, 42 MPA, 42 TB, 43 BT Virg., 43 TB Virg., 44 BPA, 44 BTA, 44 D, 44 MPA, 44 MTA, 45 MTA, 46 BPA, 46 D, 46 MPA, 46 MTA, 49 BP, 49 MP, 100P2R, 30B1, 35B1, 40AA, 40B1, 40BBR, 45AA, 45B2, 50BBR, 50P1, 50P1G, 60P1, 70P1, 80P2, B100P2, B80P2, M50P1, M60P1, T100P3, T120P3
RC2046	40X40 SX, 40X40 SX	SCALPELLO SX	SOGEMA - OTMA	381, 401, 36 D, 38 BPA, 38 BTA, 38 D, 38 MPA, 38 MTA, 38 TBA, 38 TPA, 40 BPA, 40 D, 40 MPA, 40 MTA, 42 BPA, 42 BT Virg., 42 BTA, 42 D, 42 MPA, 42 TB, 43 BT Virg., 43 TB Virg., 44 BPA, 44 BTA, 44 D, 44 MPA, 44 MTA, 45 MTA, 46 BPA, 46 D, 46 MPA, 46 MTA, 49 BP, 49 MP
RC0047	45X45, 45X45, 45X45 (H7)	SCALPELLO DX	SOGEMA - OTMA - VIVIANI	441, 461, 501, 521, 47 BT, 47 BT Virg., 47 TB Virg., 49 BP-G, 49 BP-R, 50 BP, 50 BT, 50 M, 52 BP, 52 M, 52 M Leon., 52 MP, 53 MP, 54 M, 54 MP, 120P2R, 40BR, 45B1, 60BBR, 80P1R, 90A2, B120P2, M80P1
RC2047	45X45 SX, 45X45 SX	SCALPELLO SX	SOGEMA - OTMA	441, 461, 501, 521, 47 BT, 47 BT Virg., 47 TB Virg., 49 BP-G, 49 BP-R, 50 BP, 50 BT, 50 M, 52 BP, 52 M, 52 M Leon., 52 MP, 53 MP, 54 M, 54 MP
RC0048	50X50, 50X50	SCALPELLO DX	SOGEMA - OTMA	551, 581, 47 BTR, 47 TBR Virg., 50 D, 55 M, 57 MP, 65 M Leon., 65 M PFSI, 65 ML Leon.
RC2048	50X50 SX	SCALPELLO SX	SOGEMA	47 BTR, 47 TBR Virg., 50 D, 55 M, 57 MP, 65 M Leon., 65 M PFSI, 65 ML Leon.
RC0049	55X55	SCALPELLO DX	SOGEMA	65 MRA, 70 M, 70 M PFSI

SUPPORTI SCALPELLO ADATTABILI ALLA PRODUZIONE SOGEMA

SUPPORT CISEAU TYPE SOGEMA

SUPPORT POINT FOR SOGEMA LINE

MEISSEL-STÜTZE FÜR SOGEMA

SOPORTES ESCOPLO PARA PRODUCCIÓN SOGEMA

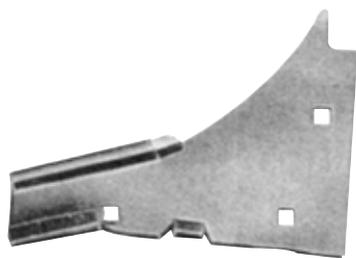

Art./Ref.	Rif. Orig./Orig. Ref.	Titolo Prodotto/Titolo Prodotto	Brand	Applicazione/Application
RC0170	00 SS	SUPPORTO SCALPELLO DX	SOGEMA	20 BP, 20 BT, 20 TB, 20 TP, 24 BPA, 24 TPA, 25 BPA, 25 BTA, 25 MPA, 25 TBA, 25 TPA, 28 BPA, 28 BTA, 28 MPA, 28 TBA, 28 TPA
RC2170	00 SS SX	SUPPORTO SCALPELLO SX	SOGEMA	20 BP, 20 TB, 20 TP, 24 BPA, 24 TPA, 25 BPA, 25 BTA, 25 MPA, 25 TBA, 25 TPA, 28 BPA, 28 BTA, 28 MPA, 28 TBA, 28 TPA
RC0171	0 SS	SUPPORTO SCALPELLO DX	SOGEMA	30 BPA, 30 BTA, 30 D, 30 MPA, 30 TBA, 30 TPA, 32 BPA, 32 BTA, 32 TBA, 32 TPA, 34 BTA, 35 BPA, 35 BTA, 35 MPA, 35 MTA, 35 TBA, 35 TPA
RC2171	0 SS SX	SUPPORTO SCALPELLO SX	SOGEMA	30 BPA, 30 BTA, 30 D, 30 MPA, 30 TBA, 30 TPA, 32 BPA, 32 BTA, 32 TBA, 32 TPA, 34 BTA, 35 BPA, 35 BTA, 35 MPA, 35 MTA, 35 TBA, 35 TPA
RC0172	1 SS Vecchia prod.	SUPPORTO SCALPELLO DX	SOGEMA	36 D, 38 BT, 38 D, 38 M, 38 MP, 40 M, 40 MP
RC0173	1 1/2 SS	SUPPORTO SCALPELLO DX	SOGEMA	36 D, 38 BPA, 38 BTA, 38 D, 38 MPA, 38 MTA, 38 TBA, 38 TPA, 40 BPA, 40 D, 40 MPA, 40 MTA
RC2173	1 1/2 SS SX	SUPPORTO SCALPELLO SX	SOGEMA	36 D, 38 BPA, 38 BTA, 38 D, 38 MPA, 38 MTA, 38 TBA, 38 TPA, 40 BPA, 40 D, 40 MPA, 40 MTA
RC0174	2 SS	SUPPORTO SCALPELLO DX	SOGEMA	42 BPA, 42 BT Virg., 42 BTA, 42 D, 42 MPA, 42 TB, 42 TB Virg., 43 BT Virg., 44 BPA, 44 BTA, 44 D, 44 MPA, 44 MTA, 45 MTA, 46 BPA, 46 D, 46 MPA, 46 MTA, 49 BP, 49 MP
RC2174	2 SS SX	SUPPORTO SCALPELLO SX	SOGEMA	42 BPA, 42 BT Virg., 42 BTA, 42 D, 42 MPA, 42 TB, 42 TB Virg., 43 BT Virg., 44 BPA, 44 BTA, 44 D, 44 MPA, 44 MTA, 45 MTA, 46 BPA, 46 D, 46 MPA, 46 MTA, 49 BP, 49 MP
RC0175	3 SS	SUPPORTO SCALPELLO DX	SOGEMA	47 BT, 47 BT Virg., 47 TB Virg., 49 BPG, 49 BPR, 50 BT, 50 M, 50 MP, 52 M, 52 M Leon., 52 MP, 54 M, 54 MP
RC2175	3 SS SX	SUPPORTO SCALPELLO SX	SOGEMA	47 BT, 47 BT Virg., 47 TB Virg., 49 BPG, 49 BPR, 50 BT, 50 M, 50 MP, 52 M, 52 M Leon., 52 MP, 54 M, 54 MP
RC0176	3 1/2 SS	SUPPORTO SCALPELLO DX	SOGEMA	47 BTR Virg., 47 TBR Virg., 50 D, 57 MP
RC0177	4 SS	SUPPORTO SCALPELLO DX	SOGEMA	55 M, 65 M Leon., 65 M PFSI, 65 MD, 65 MDR, 65 ML Leon.

SUPPORTI SCALPELLO CON COLTRI DAL BASSO ADATTABILI ALLA PRODUZIONE SOGEMA

SUPPORTS CISEAU AVEC COUTRES BAS TYPE SOGEMA

SUPPORT WITH LANDSIDE COULTER POINT FOR SOGEMA LINE

MEISSEL-STÜTZE MIT PFLUGEISEN FÜR SOGEMA

SOPORTES ESCOPLA CON COBERTURAS DESDE EL BAJO PARA PRODUCCIÓN SOGEMA



Art./Ref.	Rif. Orig./Orig. Ref.	Titolo Prodotto/Titolo Prodotto	Brand	Applicazione/Application
RC0178	00 SS-CB	SUPPORTO CON COLTRE DX	SOGEMA	DAL 20 AL 28
RC2178	00 SS-CB SX	SUPPORTO CON COLTRE SX	SOGEMA	DAL 20 AL 28 SX
RC0179	0 SS-CB	SUPPORTO CON COLTRE DX	SOGEMA	DAL 30 AL 35
RC2179	0 SS-CB SX	SUPPORTO CON COLTRE SX	SOGEMA	DAL 30 AL 35 SX
RC0180	1 SS-CB	SUPPORTO CON COLTRE DX	SOGEMA	DAL 38 AL 40
RC2180	1 SS-CB SX	SUPPORTO CON COLTRE SX	SOGEMA	DAL 38 AL 40 SX
RC0181	1 1/2 SS-CB	SUPPORTO CON COLTRE DX	SOGEMA	DAL 38 AL 40
RC2181	1 1/2 SS-CB SX	SUPPORTO CON COLTRE SX	SOGEMA	DAL 38 AL 40 SX
RC0182	2 SS-CB	SUPPORTO CON COLTRE DX	SOGEMA	DAL 42 AL 59
RC2182	2 SS-CB SX	SUPPORTO CON COLTRE SX	SOGEMA	DAL 42 AL 59 SX
RC0183	3 SS-CB	SUPPORTO CON COLTRE DX	SOGEMA	DAL 49 AL 54
RC2183	3 SS-CB SX	SUPPORTO CON COLTRE SX	SOGEMA	DAL 49 AL 54 SX
RC0184	4 SS-CB	SUPPORTO CON COLTRE DX	SOGEMA	DAL 55 AL 65

COLTRO DAL BASSO A SALDARE PER SUPPORTI A SCALPELLO ADATTABILI ALLA PRODUZIONE SOGEMA E NARDI

COUTRE BAS À SOUDER POUR SUPPORTS À CISEAU TYPE SOGEMA ET NARDI

WELD ON COULTER FOR SUPPORT POINT FOR SOGEMA AND NARDI LINE

PFLUGEISEN ZUM SCHWEISSEN FÜR MEISSEL-HALTER FÜR SOGEMA UND NARDI

COBERTURAS DESDE EL BAJO A SALDAR PARA SOPORTES A ESCOPLA PARA PRODUCCIÓN SOGEMA Y NARDI



Note: Tutti i prodotti presenti in tabella vengono forniti non verniciati.

Notes: All products in the table are supplied unpainted.

Art./Ref.	Titolo Prodotto/Titolo Prodotto	Brand	Applicazione/Application
RC0191	COLTRO DAL BASSO DX	NARDI - SOGEMA	Per supp. 11 C, Per supp. 5 C, Per supp. 6 C, Per supp. 8 C, Per supp. 9 C, Per supp. 0 SS, Per supp. 00 SS, Per supp. 1 1/2 SS, Per supp. 1 SS, Per supp. 2 SS
RC2191	COLTRO DAL BASSO SX	NARDI - SOGEMA	Per supp. 11 CS, Per supp. 5 CS, Per supp. 6 CS, Per supp. 8 CS, Per supp. 9 CS, Per supp. 0 SS SX, Per supp. 00 SS SX, Per supp. 1 1/2 SS SX, Per supp. 1 SS SX, Per supp. 2 SS SX
RC0192	COLTRO DAL BASSO DX	NARDI - SOGEMA	Per supp. 12 C, Per supp. 13 C, Per supp. 2 SS, Per supp. 3 SS
RC2192	COLTRO DAL BASSO SX	NARDI - SOGEMA	Per supp. 12 CS, Per supp. 13 CS, Per supp. 2 SS SX, Per supp. 3 SS SX

VERSOI PER CORPI A SCALPELLO ADATTABILI ALLA PRODUZIONE SOGEMA

VERSOIRS POUR CORPS À CISEAU TYPE SOGEMA

MOLDBOARDS FOR POINT-BODY FOR SOGEMA LINE

STREICHBLECHE FÜR MEISSEL-PFLUGKÖRPER FÜR SOGEMA

OREJAS PARA CUERPOS A ESCOPIO PARA PRODUCCIÓN SOGEMA

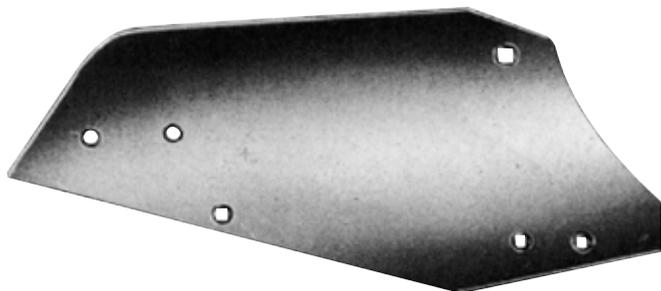

Art./Ref.	Rif. Orig./Orig. Ref.	Titolo Prodotto/Titolo Prodotto	Brand	Applicazione/Application
RC0060	18	VERSOIO DX	SOGEMA	18 BP, 18 BT, 18 TB, 18 TP
RC2060	18 SX	VERSOIO SX	SOGEMA	18 BP, 18 BT, 18 TB, 18 TP
RC0061	20	VERSOIO DX	SOGEMA	20 BP, 20 BT, 20 TB, 20 TP
RC2061	20 SX	VERSOIO SX	SOGEMA	20 BP, 20 BT, 20 TB, 20 TP
RC0062	24-25	VERSOIO DX	SOGEMA	24 BPA, 25 BPA, 25 BTA, 25 MPA, 25 TBA, 25 TP
RC2062	24-25 SX	VERSOIO SX	SOGEMA	24 BPA, 25 BPA, 25 BTA, 25 MPA, 25 TBA, 25 TP
RC0063	28	VERSOIO DX	SOGEMA	28 BPA, 28 BTA, 28 MPA, 28 TBA, 28 TPA
RC2063	28 SX	VERSOIO SX	SOGEMA	28 BPA, 28 BTA, 28 MPA, 28 TBA, 28 TPA
RC0064	30	VERSOIO DX	SOGEMA	30 BPA, 30 BTA, 30 D, 30 MPA, 30 TBA, 30 TPA
RC2064	30 SX	VERSOIO SX	SOGEMA	30 BPA, 30 BTA, 30 D, 30 MPA, 30 TBA, 30 TPA
RC0065	32	VERSOIO DX	SOGEMA	32 BPA, 32 BTA, 32 TBA, 32 TPA
RC2065	32 SX	VERSOIO SX	SOGEMA	32 BPA, 32 BTA, 32 TBA, 32 TPA
RC0066	35	VERSOIO DX	SOGEMA	35 BPA, 35 BTA, 35 MPA, 35 MTA, 35 TBA, 35 TPA
RC2066	35 SX	VERSOIO SX	SOGEMA	35 BPA, 35 BTA, 35 MPA, 35 MTA, 35 TBA, 35 TPA
RC0068	38	VERSOIO DX	SOGEMA	38 BPA, 38 BTA, 38 D, 38 MPA, 38 MTA, 38 TBA
RC2068	38 SX	VERSOIO SX	SOGEMA	38 BPA, 38 BTA, 38 D, 38 MPA, 38 MTA, 38 TBA
RC0069	40	VERSOIO DX	SOGEMA	40 BPA, 40 MPA, 40 MTA
RC2069	40 SX	VERSOIO SX	SOGEMA	40 BPA, 40 MPA, 40 MTA
RC0070	42	VERSOIO DX	SOGEMA	42 BT Virg., 42 BTA, 42 D, 42 TB, 43 BT Virg., 43 TB Virg.
RC2070	42 SX	VERSOIO SX	SOGEMA	42 BT Virg., 42 BTA, 42 D, 42 TB, 43 BT Virg., 43 TB Virg.
RC0071	44	VERSOIO DX	SOGEMA	44 BPA, 44 D, 44 MPA, 44 MTA
RC2071	44 SX	VERSOIO SX	SOGEMA	44 BPA, 44 D, 44 MPA, 44 MTA
RC0073	46	VERSOIO DX	SOGEMA	46 BPA, 46 D, 46 MPA, 46 MTA
RC2073	46 SX	VERSOIO SX	SOGEMA	46 BPA, 46 D, 46 MPA, 46 MTA
RC0077	47	VERSOIO DX	SOGEMA	47 BT, 47 BT Virg., 47 BTR Virg., 47 TB Virg.
RC0074	50	VERSOIO DX	SOGEMA	50 BT, 50 D, 50 M, 50 MP
RC2074	50 SX	VERSOIO SX	SOGEMA	50 BT, 50 D, 50 M, 50 MP
RC0075	52	VERSOIO DX	SOGEMA	52 Leon., 52 M, 52 MT
RC2075	52 SX	VERSOIO SX	SOGEMA	52 Leon., 52 M, 52 MT
RC0076	54	VERSOIO DX	SOGEMA	54 M, 54 MP
RC2076	54 SX	VERSOIO SX	SOGEMA	54 M, 54 MP

SALVAVERSOI PER ARATRO A SCALPELLO ADATTABILI ALLA PRODUZIONE SOGEMA
PROTEGE-VERSOIRS POUR CHARRUES À CISEAU TYPE SOGEMA
SHIN FOR POINT PLOUGH FOR SOGEMA LINE
STREICHBLECHE FÜR MEISSEL-PFLUGKÖRPER FÜR SOGEMA
SALVA-OREJAS PARA ARADO A ESCOPIO PARA PRODUCCIÓN SOGEMA

Note: Tutti i prodotti presenti in tabella vengono forniti non verniciati.

Notes: All products in the table are supplied unpainted.

Art./Ref.	Rif. Orig./Orig. Ref.	Titolo Prodotto/Titolo Prodotto	Brand	Applicazione/Application
RC0082	28	SALVAVERSOIO DX	SOGEMA	Versoio 28
RC2082	28 SX	SALVAVERSOIO SX	SOGEMA	Versoio 28 SX
RC0083	30	SALVAVERSOIO DX	SOGEMA	Versoio 30
RC2083	30 SX	SALVAVERSOIO SX	SOGEMA	Versoio 30 SX
RC0084	32	SALVAVERSOIO DX	SOGEMA	Versoio 32
RC2084	32 SX	SALVAVERSOIO SX	SOGEMA	Versoio 32 SX
RC0085	35	SALVAVERSOIO DX	SOGEMA	Versoio 35
RC2085	35 SX	SALVAVERSOIO SX	SOGEMA	Versoio 35 SX
RC0086	38	SALVAVERSOIO DX	SOGEMA	Versoio 38
RC2086	38 SX	SALVAVERSOIO SX	SOGEMA	Versoio 38 SX
RC0087	40	SALVAVERSOIO DX	SOGEMA	Versoio 40
RC2087	40 SX	SALVAVERSOIO SX	SOGEMA	Versoio 40 SX
RC0088	42	SALVAVERSOIO DX	SOGEMA	Versoio 42
RC2088	42 SX	SALVAVERSOIO SX	SOGEMA	Versoio 42 SX
RC0089	44	SALVAVERSOIO DX	SOGEMA	Versoio 44
RC2089	44 SX	SALVAVERSOIO SX	SOGEMA	Versoio 44 SX
RC0090	46	SALVAVERSOIO DX	SOGEMA	Versoio 46
RC2090	46 SX	SALVAVERSOIO SX	SOGEMA	Versoio 46 SX
RC0091	47	SALVAVERSOIO DX	SOGEMA	Versoio 47
RC2091	47 SX	SALVAVERSOIO SX	SOGEMA	Versoio 47 SX
RC0093	50	SALVAVERSOIO DX	SOGEMA	Versoio 50
RC2093	50 SX	SALVAVERSOIO SX	SOGEMA	Versoio 50 SX
RC0094	52	SALVAVERSOIO DX	SOGEMA	Versoio 52
RC2094	52 SX	SALVAVERSOIO SX	SOGEMA	Versoio 52 SX
RC0095	54	SALVAVERSOIO DX	SOGEMA	Versoio 54
RC2095	54 SX	SALVAVERSOIO SX	SOGEMA	Versoio 54 SX

ORECCHIE MOBILI ADATTABILI ALLA PRODUZIONE SOGEMA
OREILLES MEUBLES TYPE SOGEMA
MOUL BOARD EXTENSIONS FOR SOGEMA LINE
STREICHSCHIENE FÜR SOGEMA
OREJAS MOVILES PARA PRODUCCIÓN SOGEMA

Art./Ref.	Rif. Orig./Orig. Ref.	Titolo Prodotto/Titolo Prodotto	Note/Note	Brand	Applicazione/Application
RC0100	1 OM	ORECCHIA MOBILE DX	Per versoio dal 18 al 28	SOGEMA	VERSOIO DAL 18 AL 28
RC2100	1 OM SX	ORECCHIA MOBILE SX	Per versoio dal 18 al 28	SOGEMA	VERSOIO DAL 18 AL 28 SX
RC0101	2 OM	ORECCHIA MOBILE DX	Per versoio dal 30 al 32	SOGEMA	VERSOIO DAL 30 AL 32
RC2101	2 OM SX	ORECCHIA MOBILE SX	Per versoio dal 30 al 32	SOGEMA	VERSOIO DAL 30 AL 32 SX
RC0102	3 OM	ORECCHIA MOBILE DX	Per versoio dal 34 al 35	SOGEMA	VERSOIO DAL 34 AL 35
RC2102	3 OM SX	ORECCHIA MOBILE SX	Per versoio dal 34 al 35	SOGEMA	VERSOIO DAL 34 AL 35 SX
RC0103	4 OM	ORECCHIA MOBILE DX	Per versoio dal 36 al 38	SOGEMA	VERSOIO DAL 36 AL 38
RC2103	4 OM SX	ORECCHIA MOBILE SX	Per versoio dal 36 al 38	SOGEMA	VERSOIO DAL 36 AL 38 SX
RC0104	5 OM	ORECCHIA MOBILE DX	Per versoio dal 40 al 44	SOGEMA	VERSOIO DAL 40 AL 44
RC2104	5 OM SX	ORECCHIA MOBILE SX	Per versoio dal 40 al 44	SOGEMA	VERSOIO DAL 40 AL 44 SX
RC0105	6 OM	ORECCHIA MOBILE DX	Per versoio dal 45 al 49	SOGEMA	VERSOIO DAL 45 AL 49
RC2105	6 OM SX	ORECCHIA MOBILE SX	Per versoio dal 45 al 49	SOGEMA	VERSOIO DAL 45 AL 49 SX
RC0106	7 OM	ORECCHIA MOBILE DX	Per versoio dal 49/r - 49/g al 54	SOGEMA	VERSOIO DAL 49R-49G AL 54
RC2106	7 OM SX	ORECCHIA MOBILE SX	Per versoio dal 49/r - 49/g al 54	SOGEMA	VERSOIO DAL 49R-49G AL 54 SX

SUOLE ANTERIORI PER CORPI A SCALPELLO ADATTABILI ALLA PRODUZIONE SOGEMA
SEP AVANT POUR CORPS À CISEAU TYPE SOGEMA
LANDSIDE, FRONT PART FOR POINT-BODY FOR SOGEMA LINE
GLEITPLATTE/VORDETEIL FÜR MEISSEL-PFLUGKÖRPER FÜR SOGEMA
SUELAS ANTERIORES PARA CUERPOS A ESCOPIO PARA PRODUCCIÓN SOGEMA

Art./Ref.	Rif. Orig./Orig. Ref.	Titolo Prodotto/Titolo Prodotto	Brand	Applicazione/Application
RC0141	00 PAS	SUOLA ANTERIORE DX	SOGEMA	30 BPA, 30 BTA, 30 TBA, 30 TPA, 32 BPA, 32 BTA, 32 TPA, 34 BTA, 35 BPA, 35 BTA, 35 TBA, 35 TPA, 38 BPA, 38 BTA, 38 TBA, 38 TPA, 40 BPA, 42 TBA
RC2141	00 PAS SX	SUOLA ANTERIORE SX	SOGEMA	30 BPA, 30 BTA, 30 TBA, 30 TPA, 32 BPA, 32 BTA, 32 TPA, 34 BTA, 35 BPA, 35 BTA, 35 TBA, 35 TPA, 38 BPA, 38 BTA, 38 TBA, 38 TPA, 40 BPA, 42 TBA
RC0143	1/2 PAS	SUOLA ANTERIORE DX	SOGEMA	20 BP, 20 BT, 20 TB, 20 TP, 24 BPA, 24 TPA
RC2143	1/2 PAS SX	SUOLA ANTERIORE SX	SOGEMA	20 BP, 20 BT, 20 TB, 20 TP, 24 BPA, 24 TPA
RC0144	1 PAS	SUOLA ANTERIORE DX	SOGEMA	25 BPA, 25 BTA, 25 TBA, 25 TPA, 28 BPA, 28 BTA, 28 TBA, 28 TPA
RC2144	1 PAS SX	SUOLA ANTERIORE SX	SOGEMA	25 BPA, 25 BTA, 25 TBA, 25 TPA, 28 BPA, 28 BTA, 28 TBA, 28 TPA
RC0145	2 PAS	SUOLA ANTERIORE DX	SOGEMA	42 BPA, 42 BT Virg., 42 BTA, 42 TB, 42 TB Virg., 43 BT Virg., 43 TB Virg., 44 BPA, 44 BTA, 46 BPA, 49 BP
RC2145	2 PAS SX	SUOLA ANTERIORE SX	SOGEMA	42 BPA, 42 BT Virg., 42 BTA, 42 TB, 42 TB Virg., 43 BT Virg., 43 TB Virg., 44 BPA, 44 BTA, 46 BPA, 49 BP
RC0145A	2 1/2 PAS	SUOLA ANTERIORE DX	SOGEMA	42 BPA, 42 BT Virg., 42 BTA, 42 TB, 42 TB Virg., 43 BT Virg., 43 TB Virg., 44 BPA, 44 BTA, 46 BPA, 49 BP
RC2145A	2 1/2 PAS SX	SUOLA ANTERIORE SX	SOGEMA	42 BPA, 42 BT Virg., 42 BTA, 42 TB, 42 TB Virg., 43 BT Virg., 43 TB Virg., 44 BPA, 44 BTA, 46 BPA, 49 BP
RC0146	3 PAS	SUOLA ANTERIORE DX	SOGEMA	47 BT Virg., 47 BTA, 47 BTR Virg., 47 TB Virg., 47 TBR Virg., 49 BPG, 49 BPR, 50 BP, 52 BP
RC2146	3 PAS SX	SUOLA ANTERIORE SX	SOGEMA	47 BT Virg., 47 BTA, 47 BTR Virg., 47 TB Virg., 47 TBR Virg., 49 BPG, 49 BPR, 50 BP, 52 BP

SUOLE POSTERIORI PER CORPI A SCALPELLO E NORMALI ADATTABILI ALLA PRODUZIONE SOGEMA

SEP ARRIERE POUR CORPS À CISEAU ET NORMALS TYPE SOGEMA

LANDSIDE, BACK PART FOR POINT-BODY AND NORMAL-BODY FOR SOGEMA LINE

GLEITPLATTE/HINTERTEIL FÜR MEISSEL-PFLUGKÖRPER FÜR SOGEMA

SUELAS TRASERAS PARA CUERPOS A ESCOPIO Y NORMALES PARA PRODUCCIÓN SOGEMA

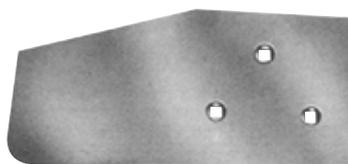

Art./Ref.	Rif. Orig./Orig. Ref.	Titolo Prodotto/Titolo Prodotto	Brand	Applicazione/Application
RC0151	0 1/2 PCP	SUOLA POSTERIORE DX	SOGEMA	20 BNP, 20 BP, 20 BT, 20 TB, 20 TNP, 20 TP
RC2151	0 1/2 PCP SX	SUOLA POSTERIORE SX	SOGEMA	20 BNP, 20 BP, 20 BT, 20 TB, 20 TNP, 20 TP
RC0152	1/2 PCP	SUOLA POSTERIORE DX	SOGEMA	24 BNPA, 24 BPA, 25 BNPA, 25 BPA, 25 BTA, 25 MNPA, 25 MPA, 25 TB, 25 TBA, 25 TNPA, 25 TPA, 28 BNPA, 28 BPA, 28 BTA, 28 BTB, 28 MNPA, 28 MPA, 28 TB, 28 TBA, 28 TNPA, 28 TPA
RC2152	1/2 PCP SX	SUOLA POSTERIORE SX	SOGEMA	24 BNPA, 24 BPA, 25 BNPA, 25 BPA, 25 BTA, 25 MNPA, 25 MPA, 25 TB, 25 TBA, 25 TNPA, 25 TPA, 28 BNPA, 28 BPA, 28 BTA, 28 BTB, 28 MNPA, 28 MPA, 28 TB, 28 TBA, 28 TNPA, 28 TPA
RC0123	1 PCP Vecchia prod.	SUOLA POSTERIORE DX	SOGEMA	30 BNPA, 30 BPA, 30 BTA, 30 MNPA, 30 MPA, 30 TBA, 32 BNPA, 32 BPA, 32 BTA, 32 TBA, 34 BT, 34 TBA, 35 BNPA, 35 BPA, 35 BTA, 35 MNPA, 35 MPA, 35 MTA, 35 TBA, 38 BTA, 38 MTA, 38 TBA, 40 MTA
RC2123	1 PCP Vecchia prod.SX	SUOLA POSTERIORE SX	SOGEMA	30 BNPA, 30 BPA, 30 BTA, 30 MNPA, 30 MPA, 30 TBA, 32 BNPA, 32 BPA, 32 BTA, 32 TBA, 34 BT, 34 TBA, 35 BNPA, 35 BPA, 35 BTA, 35 MNPA, 35 MPA, 35 MTA, 35 TBA, 38 BTA, 38 MTA, 38 TBA, 40 MTA
RC0153	1 PCP-L	SUOLA POSTERIORE DX	SOGEMA	20 BTA, 20 TB, 30 BNPA, 30 BNPB, 30 BPB, 30 BTA, 30 BTB, 30 DUPAO, 30 MNPA, 30 MPA, 30 TNPA, 30 TNPB, 30 TPA, 30 TPB, 32 BNPA, 32 BNPB, 32 BPB, 32 BTA, 32 BTB, 32 TB, 32 TNPA, 32 TNPB, 32 TPA, 34 BTA, 34 BTB, 34 TB, 35 BNPA, 35 BNPB, 35 BPB, 35 BTA, 35 BTB, 35 MNPA, 35 MPA, 35 MTA, 35 TB, 35 TNPA, 35 TNPB, 35 TPA, 38 BPA, 38 BPB, 38 BTA, 38 BTB, 38 DUPAO, 38 MPA, 38 MTA, 38 TB, 40 BPA, 40 BPB, 40 BTA, 40 BTB, 40 DUPAO, 40 MPA, 40 MTA, 40 TB, 40 TPA, 40 TPB
RC2153	1 PCP-L SX	SUOLA POSTERIORE SX	SOGEMA	20 BTA, 20 TB, 30 BNPA, 30 BNPB, 30 BPB, 30 BTA, 30 BTB, 30 DUPAO, 30 MNPA, 30 MPA, 30 TNPA, 30 TNPB, 30 TPA, 30 TPB, 32 BNPA, 32 BNPB, 32 BPB, 32 BTA, 32 BTB, 32 TB, 32 TNPA, 32 TNPB, 32 TPA, 34 BTA, 34 BTB, 34 TB, 35 BNPA, 35 BNPB, 35 BPB, 35 BTA, 35 BTB, 35 MNPA, 35 MPA, 35 MTA, 35 TB, 35 TNPA, 35 TNPB, 35 TPA, 38 BPA, 38 BPB, 38 BTA, 38 BTB, 38 DUPAO, 38 MPA, 38 MTA, 38 TB, 40 BPA, 40 BPB, 40 BTA, 40 BTB, 40 DUPAO, 40 MPA, 40 MTA, 40 TB, 40 TPA, 40 TPB
RC0154	1 1/2 PCP	SUOLA POSTERIORE DX	SOGEMA	38 BNPA, 38 BNPB, 38 BPA, 38 BPB, 38 DUPAO, 38 FD, 38 FS, 38 MNPA, 38 MNPB, 38 TNP, 38 TP, 40 BNPA, 40 BNPB, 40 BPA, 40 BPB, 40 DUPAO, 40 FD, 40 FS, 40 MNPA, 40 MNPB, 40 TNP, 40 TP
RC2154	1 1/2 PCP SX	SUOLA POSTERIORE SX	SOGEMA	38 BNPA, 38 BNPB, 38 BPA, 38 BPB, 38 DUPAO, 38 FD, 38 FS, 38 MNPA, 38 MNPB, 38 TNP, 38 TP, 40 BNPA, 40 BNPB, 40 BPA, 40 BPB, 40 DUPAO, 40 FD, 40 FS, 40 MNPA, 40 MNPB, 40 TNP, 40 TP
RC0124	2 PCP VECCHIA PRODUZIONE	SUOLA POSTERIORE DX	SOGEMA	42 BTA, 44 BTA, 44 MTA, 45 MTA, 46 MTA
RC2124	2 PCP VECCHIA PRODUZIONE SX	SUOLA POSTERIORE SX	SOGEMA	42 BTA, 44 BTA, 44 MTA, 45 MTA, 46 MTA
RC0163	2 PCP-L VECCHIA PRODUZIONE	SUOLA POSTERIORE DX	SOGEMA	44 BPA, 44 BPNA, 44 MNPA, 44 MPA, 46 BPA, 46 MPA
RC2163	2 PCP-L VECCHIA PRODUZIONE SX	SUOLA POSTERIORE SX	SOGEMA	44 BPA, 44 BPNA, 44 MNPA, 44 MPA, 46 BPA, 46 MPA
RC0159	2 PCP-LL	SUOLA POSTERIORE DX	SOGEMA	42 BNPA, 42 BNPB, 42 BPA, 42 BPB, 42 BTA, 42 BTB, 42 MNPA, 42 MNPB, 42 MPA, 42 MPB, 44 BNPA, 44 BNPB, 44 BPA, 44 BPB, 44 BTA, 44 BTB, 44 MNPA, 44 MNPB, 44 MPA, 44 MPB, 44 MTA, 45 MTA, 46 BNPA, 46 BPA, 46 DUPAO 100, 46 MNPA, 46 MNPB, 46 MPA, 46 MPB, 46 MTA
RC2159	2 PCP-LL SX	SUOLA POSTERIORE SX	SOGEMA	42 BNPA, 42 BNPB, 42 BPA, 42 BPB, 42 BTA, 42 BTB, 42 MNPA, 42 MNPB, 42 MPA, 42 MPB, 44 BNPA, 44 BNPB, 44 BPA, 44 BPB, 44 BTA, 44 BTB, 44 MNPA, 44 MNPB, 44 MPA, 44 MPB, 44 MTA, 45 MTA, 46 BNPA, 46 BPA, 46 DUPAO 100, 46 MNPA, 46 MNPB, 46 MPA, 46 MPB, 46 MTA
RC0160	2 1/2 PCP	SUOLA POSTERIORE DX	SOGEMA	46 BNPA, 46 BNPB, 46 BPA, 46 BPB, 49 BNPA, 49 BNPB, 49 BPA, 49 BPB, 49 BPG, 49 BPR, 49 MN, 49 MNP, 50 BNP, 50 BP, 50 MN, 50 MNP, 52 BNP, 52 BP, 52 MN, 52 MNP, 53 MN, 53 MNP, 54 MN, 54 MNP, 57 DUPAO, 57 MNP, 57 MP
RC2160	2 1/2 PCP SX	SUOLA POSTERIORE SX	SOGEMA	46 BNPA, 46 BNPB, 46 BPA, 46 BPB, 49 BNPA, 49 BNPB, 49 BPA, 49 BPB, 49 BPG, 49 BPR, 49 MN, 49 MNP, 50 BNP, 50 BP, 50 MN, 50 MNP, 52 BNP, 52 BP, 52 MN, 52 MNP, 53 MN, 53 MNP, 54 MN, 54 MNP, 57 DUPAO, 57 MNP, 57 MP
RC0158	2 1/2 PCP-LL	SUOLA POSTERIORE DX	SOGEMA	57/MP-MNP-FS VECCHIA PRODUZ.
RC2158	2 1/2 PCP-LL SX	SUOLA POSTERIORE SX	SOGEMA	57/MP-MNP-FS VECCHIA PRODUZ.
RC0161	3 PCP-L	SUOLA POSTERIORE DX	SOGEMA	50 M, 52 M
RC2161	3 PCP-L SX	SUOLA POSTERIORE SX	SOGEMA	50 M, 52 M
RC0162	3 1/2 PCP	SUOLA POSTERIORE DX	SOGEMA	47 BTA, 50 D, C 55
RC2162	3 1/2 PCP SX	SUOLA POSTERIORE SX	SOGEMA	47 BTA, 50 D, C 55

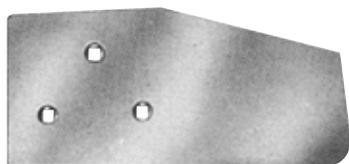
TALLONI POSTERIORI PER CORPI A SCALPELLO ADATTABILI ALLA PRODUZIONE SOGEMA
TALLON ARRIERE POUR CORPS À CISEAU TYPE SOGEMA
LANDSIDE, BACK PART FOR POINT-BODY FOR SOGEMA LINE
GLEITPLATTE/HINTERTEILE FÜR MEISSEL-PFLUGKÖRPER FÜR SOGEMA
TALON TRASERO PARA CUERPOS A ESCOPO PARA PRODUCCIÓN SOGEMA

Art./Ref.	Rif. Orig./Orig. Ref.	Titolo Prodotto/Titolo Prodotto	Brand	Applicazione/Application
RC0112	0 1/2 TP	TALLONE POSTERIORE DX	SOGEMA	20 BT, 20 TB
RC2112	0 1/2 TP SX	TALLONE POSTERIORE SX	SOGEMA	20 BT, 20 TB
RC0113	1/2 TP	TALLONE POSTERIORE DX	SOGEMA	25 BTA, 25 TBA, 28 BTA, 28 TBA
RC2113	1/2 TP SX	TALLONE POSTERIORE SX	SOGEMA	25 BTA, 25 TBA, 28 BTA, 28 TBA
RC0122	1 TP Vecchia prod.	TALLONE POSTERIORE DX	SOGEMA	30 BT, 30 BTA, 30 D, 30 TB, 30 TBA, 32 BT, 32 BTA, 32 TB, 32 TBA, 34 BT, 34 BTA, 35 BT, 35 BTA, 35 MTA, 35 TB, 35 TBA, 36 D, 38 BT, 38 BTA, 38 D, 38 MTA, 38 TB, 38 TBA, 40 D, 40 MTA
RC2122	1 TP Vecchia prod. SX	TALLONE POSTERIORE SX	SOGEMA	30 BT, 30 BTA, 30 D, 30 TB, 30 TBA, 32 BT, 32 BTA, 32 TB, 32 TBA, 34 BT, 34 BTA, 35 BT, 35 BTA, 35 MTA, 35 TB, 35 TBA, 36 D, 38 BT, 38 BTA, 38 D, 38 MTA, 38 TB, 38 TBA, 40 D, 40 MTA
RC0116	2 TP Vecchia prod.	TALLONE POSTERIORE DX	SOGEMA	42 BT, 42 BT Virg., 42 BTA, 42 D, 42 TB Virg., 43 BT Virg., 43 TB Virg., 44 BTA, 44 D, 44 MTA, 45 MTA, 46 D, 46 MTA
RC2116	2 TP Vecchia prod. SX	TALLONE POSTERIORE SX	SOGEMA	42 BT, 42 BT Virg., 42 BTA, 42 D, 42 TB Virg., 43 BT Virg., 43 TB Virg., 44 BTA, 44 D, 44 MTA, 45 MTA, 46 D, 46 MTA
RC0118	3 TP Vecchia prod.	TALLONE POSTERIORE DX	SOGEMA	47 BT Virg., 47 BTR Virg., 47 TB Virg., 50 M, 52 M, 52 M Leon.
RC2118	3 TP Vecchia prod. SX	TALLONE POSTERIORE SX	SOGEMA	47 BT Virg., 47 BTR Virg., 47 TB Virg., 50 M, 52 M, 52 M Leon.

TALLONI POSTERIORI PER CORPI A SCALPELLO ADATTABILI ALLA PRODUZIONE SOGEMA
TALLON ARRIERE POUR CORPS À CISEAU TYPE SOGEMA
LANDSIDES, BACK PART FOR POINT-BODY FOR SOGEMA LINE
GLEITPLATTE/HINTERTEILE FÜR MEISSEL-PFLUGKÖRPER FÜR SOGEMA
TALONES TRASEROS PARA CUERPOS A ESCOPO PARA PRODUCCIÓN SOGEMA

Art./Ref.	Rif. Orig./Orig. Ref.	Titolo Prodotto/Titolo Prodotto	Brand	Applicazione/Application
RC0125	1 TM	TALLONE POSTERIORE DX-SX	SOGEMA	32 BT, 34 BT, 35 BR, 35 MTA, 38 BT, 38 MTA, 40 BT, 40 MTA
RC0126	5 TM	TALLONE POSTERIORE DX-SX	SOGEMA	49 MD corpi dal 44 al 52, 49 MD per 100 CUZI, 49 MD per 140 CUZI, 65 MD, 65 MDR
RC0127	6 TM	TALLONE POSTERIORE DX-SX	SOGEMA	44 BD, 46 BD per 100 CUZI, 46 BD per 140 CUZI

SUPPORTO CORPO ANTERIORE A SCALPELLO ADATTABILE ALLA PRODUZIONE SOGEMA
COUTRE POUR CORPS À CISEAU ET NORMALS TYPE SOGEMA
COULTER FOR POINT AND NORMAL-BODY FOR SOGEMA LINE
PFLUGEISEN FÜR MEISSEL-PFLUGKÖRPER FÜR SOGEMA
COBERTURAS PARA CUERPOS A ESCOPIO Y NORMALES PARA PRODUCCIÓN SOGEMA

Art./Ref.	Rif. Orig./Orig. Ref.	Titolo Prodotto/Titolo Prodotto	Brand	Applicazione/Application
RC0241	20 A	SUPPORTO CORPO ANTERIORE DX	SOGEMA	20 BP, 20 BT, 20 TB, 20 TP
RC2241	20 A SX	SUPPORTO CORPO ANTERIORE SX	SOGEMA	20 BP, 20 BT, 20 TB, 20 TP
RC0242	25-28 A	SUPPORTO CORPO ANTERIORE DX	SOGEMA	25 BP, 25 BPA, 25 BT, 25 BTA, 25 TB, 25 TBA, 25 TP, 25 TPA, 28 BP, 28 BPA, 28 BT, 28 BTA, 28 TB, 28 TBA, 28 TP, 28 TPA
RC2242	25-28 A SX	SUPPORTO CORPO ANTERIORE SX	SOGEMA	25 BP, 25 BPA, 25 BT, 25 BTA, 25 TB, 25 TBA, 25 TP, 25 TPA, 28 BP, 28 BPA, 28 BT, 28 BTA, 28 TB, 28 TBA, 28 TP, 28 TPA
RC0243	30 A	SUPPORTO CORPO ANTERIORE DX	SOGEMA	30 BP, 30 BPA, 30 BT, 30 BTA, 30 TB, 30 TBA, 30 TP, 30 TPA
RC2243	30 A SX	SUPPORTO CORPO ANTERIORE SX	SOGEMA	30 BP, 30 BPA, 30 BT, 30 BTA, 30 TB, 30 TBA, 30 TP, 30 TPA
RC0244	32-34-35 A	SUPPORTO CORPO ANTERIORE DX	SOGEMA	32 BP, 32 BPA, 32 BT, 32 BTA, 32 TB, 32 TBA, 32 TP, 32 TPA, 34 BP, 34 BPA, 34 BT, 34 BTA, 34 TB, 34 TBA, 34 TP, 34 TPA, 35 BP, 35 BPA, 35 BT, 35 BTA, 35 TB, 35 TBA, 35 TP, 35 TPA
RC2244	32-34-35 A SX	SUPPORTO CORPO ANTERIORE SX	SOGEMA	32 BP, 32 BPA, 32 BT, 32 BTA, 32 TB, 32 TBA, 32 TP, 32 TPA, 34 BP, 34 BPA, 34 BT, 34 BTA, 34 TB, 34 TBA, 34 TP, 34 TPA, 35 BP, 35 BPA, 35 BT, 35 BTA, 35 TB, 35 TBA, 35 TP, 35 TPA
RC0245	38-40 A	SUPPORTO CORPO ANTERIORE DX	SOGEMA	38 BP, 38 BPA, 38 BT, 38 BTA, 38 TB, 38 TBA, 38 TP, 38 TPA, 40 BP, 40 BPA, 40 BT, 40 BTA, 40 TB, 40 TBA, 40 TP, 40 TPA
RC2245	38-40 A SX	SUPPORTO CORPO ANTERIORE SX	SOGEMA	38 BP, 38 BPA, 38 BT, 38 BTA, 38 TB, 38 TBA, 38 TP, 38 TPA, 40 BP, 40 BPA, 40 BT, 40 BTA, 40 TB, 40 TBA, 40 TP, 40 TPA
RC0246	42-44-46 A	SUPPORTO CORPO ANTERIORE DX	SOGEMA	42 AR, 42 BP, 42 BPA, 42 BT, 42 BTA, 42 TB, 42 TBA, 42 TP, 42 TPA, 44 AR, 44 BP, 44 BPA, 44 BT, 44 BTA, 44 TB, 44 TBA, 44 TP, 44 TPA, 46 AR, 46 BP, 46 BPA, 46 BT, 46 BTA, 46 TB, 46 TBA, 46 TP, 46 TPA
RC2246	42-44-46 A SX	SUPPORTO CORPO ANTERIORE SX	SOGEMA	42 AR, 42 BP, 42 BPA, 42 BT, 42 BTA, 42 TB, 42 TBA, 42 TP, 42 TPA, 44 AR, 44 BP, 44 BPA, 44 BT, 44 BTA, 44 TB, 44 TBA, 44 TP, 44 TPA, 46 AR, 46 BP, 46 BPA, 46 BT, 46 BTA, 46 TB, 46 TBA, 46 TP, 46 TPA
RC0247	49-50-52 A	SUPPORTO CORPO ANTERIORE DX	SOGEMA	49 G, 49 R, 50-52/BP
RC2247	49-50-52 A SX	SUPPORTO CORPO ANTERIORE SX	SOGEMA	49 G, 49 R, 50-52/BP

SUPPORTO CORPO POSTERIORE A SCALPELLO ADATTABILE ALLA PRODUZIONE SOGEMA
SUPPORT POUR CORP AVANT À CISEAU TYPE SOGEMA
FRONT POINT-BODY SUPPORT FOR SOGEMA LINE
PFLUGKÖRPER-HALTER/VORDERTEIL FÜR SOGEMA
SOPORTE CUERPO ANTERIOS A ESCOPIO PARA PRODUCCIÓN SOGEMA

Art./Ref.	Rif. Orig./Orig. Ref.	Titolo Prodotto/Titolo Prodotto	Brand	Applicazione/Application
RC0252	20 P	SUPPORTO CORPO POSTERIORE DX	SOGEMA	20 BP, 20 BT, 20 TB, 20 TP
RC2252	20 P SX	SUPPORTO CORPO POSTERIORE SX	SOGEMA	20 BP, 20 BT, 20 TB, 20 TP
RC0253	25-28 P	SUPPORTO CORPO POSTERIORE SX	SOGEMA	25 BP, 25 BPA, 25 BT, 25 BTA, 25 MP, 25 MPA, 25 TB, 25 TBA, 25 TP, 25 TPA, 28 BP, 28 BPA, 28 BT, 28 BTA, 28 MP, 28 MPA, 28 TB, 28 TBA, 28 TP, 28 TPA
RC2253	25-28 P SX	SUPPORTO CORPO POSTERIORE SX	SOGEMA	25 BP, 25 BPA, 25 BT, 25 BTA, 25 MP, 25 MPA, 25 TB, 25 TBA, 25 TP, 25 TPA, 28 BP, 28 BPA, 28 BT, 28 BTA, 28 MP, 28 MPA, 28 TB, 28 TBA, 28 TP, 28 TPA
RC0254	30 P	SUPPORTO CORPO POSTERIORE DX	SOGEMA	30 BP, 30 BPA, 30 BT, 30 BTA, 30 MP, 30 MPA, 30 TB, 30 TBA, 30 TP, 30 TPA
RC2254	30 P SX	SUPPORTO CORPO POSTERIORE SX	SOGEMA	30 BP, 30 BPA, 30 BT, 30 BTA, 30 MP, 30 MPA, 30 TB, 30 TBA, 30 TP, 30 TPA
RC0255	32-34-35 P	SUPPORTO CORPO POSTERIORE DX	SOGEMA	32 BP, 32 BPA, 32 BT, 32 BTA, 32 MDA, 32 MP, 32 MPA, 32 MTA, 32 TB, 32 TBA, 32 TP, 32 TPA, 324 MTA, 34 BP, 34 BPA, 34 BT, 34 BTA, 34 MDA, 34 MP, 34 MPA, 34 TB, 34 TBA, 34 TP, 34 TPA, 35 BP, 35 BPA, 35 BT, 35 BTA, 35 MDA, 35 MP, 35 MPA, 35 MTA, 35 TB, 35 TBA, 35 TP, 35 TPA

Art./Ref.	Rif. Orig./Orig. Ref.	Titolo Prodotto/Titolo Prodotto	Brand	Applicazione/Application
RC2255	32-34-35 P SX	SUPPORTO CORPO POSTERIORE SX	SOGEMA	32 BP, 32 BPA, 32 BT, 32 BTA, 32 MDA, 32 MP, 32 MPA, 32 MTA, 32 TB, 32 TBA, 32 TP, 32 TPA, 324 MTA, 34 BP, 34 BPA, 34 BT, 34 BTA, 34 MDA, 34 MP, 34 MPA, 34 TB, 34 TBA, 34 TP, 34 TPA, 35 BP, 35 BPA, 35 BT, 35 BTA, 35 MDA, 35 MP, 35 MPA, 35 MTA, 35 TB, 35 TBA, 35 TP, 35 TPA
RC0256	38-40 P	SUPPORTO CORPO POSTERIORE DX	SOGEMA	38 BP, 38 BPA, 38 BT, 38 BTA, 38 MDA, 38 MP, 38 MPA, 38 MTA, 38 TB, 38 TBA, 38 TP, 38 TPA, 40 BP, 40 BPA, 40 BT, 40 BTA, 40 MDA, 40 MP, 40 MPA, 40 MTA, 40 TB, 40 TBA, 40 TP, 40 TPA
RC2256	38-40 P SX	SUPPORTO CORPO POSTERIORE SX	SOGEMA	38 BP, 38 BPA, 38 BT, 38 BTA, 38 MDA, 38 MP, 38 MPA, 38 MTA, 38 TB, 38 TBA, 38 TP, 38 TPA, 40 BP, 40 BPA, 40 BT, 40 BTA, 40 MDA, 40 MP, 40 MPA, 40 MTA, 40 TB, 40 TBA, 40 TP, 40 TPA
RC0257	42-44-45-46 P	SUPPORTO CORPO POSTERIORE DX	SOGEMA	42 BP, 42 BPA, 42 BT, 42 BTA, 42 MDA, 42 MP, 42 MPA, 42 MTA, 42 TB, 42 TBA, 42 TP, 42 TPA, 44 BP, 44 BPA, 44 BT, 44 BTA, 44 MDA, 44 MP, 44 MPA, 44 MTA, 44 TB, 44 TBA, 44 TP, 44 TPA, 45 BP, 45 BPA, 45 BT, 45 BTA, 45 MDA, 45 MP, 45 MPA, 45 MTA, 45 TB, 45 TBA, 45 TP, 45 TPA, 46 BP, 46 BPA, 46 BT, 46 BTA, 46 MDA, 46 MP, 46 MPA, 46 MTA, 46 TB, 46 TBA, 46 TP, 46 TPA
RC2257	42-44-45-46 P SX	SUPPORTO CORPO POSTERIORE SX	SOGEMA	42 BP, 42 BPA, 42 BT, 42 BTA, 42 MDA, 42 MP, 42 MPA, 42 MTA, 42 TB, 42 TBA, 42 TP, 42 TPA, 44 BP, 44 BPA, 44 BT, 44 BTA, 44 MDA, 44 MP, 44 MPA, 44 MTA, 44 TB, 44 TBA, 44 TP, 44 TPA, 45 BP, 45 BPA, 45 BT, 45 BTA, 45 MDA, 45 MP, 45 MPA, 45 MTA, 45 TB, 45 TBA, 45 TP, 45 TPA, 46 BP, 46 BPA, 46 BT, 46 BTA, 46 MDA, 46 MP, 46 MPA, 46 MTA, 46 TB, 46 TBA, 46 TP, 46 TPA
RC0258	49-50-52 P	SUPPORTO CORPO POSTERIORE DX	SOGEMA	49 G, 49 R, 50-52/MP-BP-DT-MDA
RC2258	49-50-52 P SX	SUPPORTO CORPO POSTERIORE SX	SOGEMA	49 G, 49 R, 50-52/MP-BP-DT-MDA
RC0260	54 P	SUPPORTO CORPO POSTERIORE DX	SOGEMA	54 MP
RC2260	54 P SX	SUPPORTO CORPO POSTERIORE SX	SOGEMA	54 MP

ANCORE PER CORPI ARANTI ADATTABILI ALLA PRODUZIONE SOGEMA

ANCRES POUR CORPS LABOURANTS ADAPTABLES A LA PRODUCTION SOGEMA

SHORE ANCHOR FOR PLOUGH CORES SUITABLE TO SOGEMA PRODUCTION

BLATTFEDERZINKEN FUER PFLUGKOERPER PASSEND ZU SOGEMA

ANCLAS CUERPOS DE ARADO ADAPTABLES A LA PRODUCCION SOGEMA

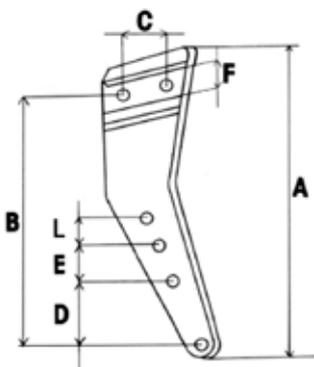

Art./Ref.	Titolo Prodotto/ Titolo Prodotto	A mm	B mm	C mm	D mm	E mm	F mm	L mm	Spessore mm/ Thickness mm	Tipo/Type	Brand	Applicazione/ Application
CP1120	GAMBO PER CORPO DX	550	460	80 (2 FORI DA 21)	120		80		35	NORMALE	SOGEMA	18-20 SCALPELLO ESTERNO
CP1121	GAMBO PER CORPO DX	620	520	100 (2 FORI DA 25)	130	70	90		35	BASSO ANT.	SOGEMA	20-25-28 SCALPELLO INTERNO
CP1121P	GAMBO PER CORPO DX	620	520	100 (2 FORI DA 21)	130	70	90		35	BASSO POST.	SOGEMA	20-25-28 SCALPELLO INTERNO
CP1122	GAMBO PER CORPO DX	650	570	100 (2 FORI DA 25)	130	70	90		35	MEDIO ANT.	SOGEMA	20-25-28-30 SCALPELLO INTERNO
CP1122P	GAMBO PER CORPO DX	650	570	100 (2 FORI DA 21)	130	70	90		35	MEDIO POST.	SOGEMA	20-25-28-30 SCALPELLO INTERNO
CP1123	GAMBO PER CORPO DX	700	610	100 (3 FORI DA 25)	130	70	100		35	NORMALE ANT.	SOGEMA	32-35 SCALPELLO INTERNO
CP1123P	GAMBO PER CORPO DX	700	610	100 (2 FORI DA 21)	130	70	100		35	NORMALE POST.	SOGEMA	32-35 SCALPELLO INTERNO
CP1124	GAMBO PER CORPO DX	700	605	120 (3 FORI DA 25)	130	70	100	70	40	BASSO ANT.	SOGEMA	38-40 SCALPELLO INTERNO
CP1124P	GAMBO PER CORPO DX	700	605	120 (2 FORI DA 23)	130	70	100	70	40	BASSO POST.	SOGEMA	38-40 SCALPELLO INTERNO
CP1125	GAMBO PER CORPO DX	770	680	120 (3 FORI DA 25)	130	70	100	70	40	ALTO ANT.	SOGEMA	38-40 SCALPELLO INTERNO
CP1125P	GAMBO PER CORPO DX	770	680	120 (2 FORI DA 23)	130	70	100	70	40	ALTO POST.	SOGEMA	38-40 SCALPELLO INTERNO
CP1126	GAMBO PER CORPO DX	730	610	150 (3 FORI DA 25)	50	80	110	70	50	BASSO	SOGEMA	42-44-46 SCALPELLO INTERNO
CP1127	GAMBO PER CORPO DX	770	650	150 (3 FORI DA 25)	50	80	110	70	50	ALTO	SOGEMA	42-44-46 SCALPELLO INTERNO

VOMERI PER CORPI ARANTI ADATTABILI ALLA PRODUZIONE VIVIANI

SOC POUR CORPS LABOURANT ADAPTABLES A LA PRODUCTION VIVIANI

SHARE FOR PLOUGH PARTS SUITABLE TO VIVIANI PRODUCTION

SCHARE FUER PFLUGKOERPER PASSEND ZU VIVIANI

REJA CUERPOS DE ARADO ADAPTABLES A LA PRODUCCION VIVIANI



Art./Ref.	Rif. Orig./Orig. Ref.	Titolo Prodotto/Titolo Prodotto	Brand	Applicazione/Application
RC0650	V12	VOMERE DX	VIVIANI	25B2, 25P1, 25P1G, 27B2, 30P2G, 40P2, 40P2G, B30P2, B40P2, N20P1, N30P2, T40P3, T50P3
RC0651	V14	VOMERE DX	VIVIANI	30 P1, 30 P1G, 30B2, 30BBR, 30BBRI, 35B2, 40 P1, 40 P1G, 50P2, 60P2, B50P2, B60P2, M30P1, M40P1, T60P3, T80P3
RC0652	V15	VOMERE DX	VIVIANI	25B1, 27B1, 35BBR, 35BBRI, 40B2, 70P2F
RC0653	V17	VOMERE DX	VIVIANI	100P2R, 30B1, 35B1, 40AA, 40B1, 40BBR, 40BBRI, 45AA, 45B2, 50BBR, 50BBRI, 50P1, 50P1G, 60P1, 70P1, 80P2, B100P2, B80P2, M50P1, M60P1, T100P3, T120P3
RC0654	V18	VOMERE DX	VIVIANI	100A2, 100P1R, 120P2R, 45B1, 60BBR, 80P1R, 90A2, B120P2, M100P1, M80P1, N60BBR, N60BBRI, N80P1
RC0655	V19	VOMERE DX	VIVIANI	120 A2

SCALPELLI PER CORPI ARANTI ADATTABILI ALLA PRODUZIONE VIVIANI

POINTES POUR CORPS CHARRUE ADAPTABLES VIVIANI

CHIESELS FOR PLOUGH BODY SUIT TO VIVIANI PRODUCTION

MEISSEL FUER PFLUGKOERPER PASSEND ZU VIVIANI

PUNTERO CUERPOS DE ARADO ADAPTABLES A LA PRODUCCION VIVIANI

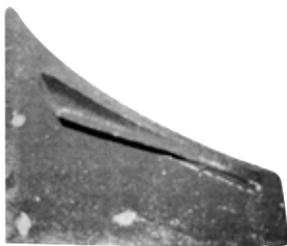

Art./Ref.	Rif. Orig./Orig. Ref.	Titolo Prodotto/Titolo Prodotto	Brand	Applicazione/Application
RC0044	30X30, 30X30, 30X30 (H3)	SCALPELLO DX	SOGEMA - OTMA - VIVIANI	181, 231, 20 BP, 20 BT, 20 TB, 20 TP, 24 BPA, 25 BPA, 25 BTA, 25 MPA, 25 TBA, 25 TP, 28 BPA, 28 BTA, 28 MPA, 28 TBA, 28 TPA, 25B2, 25P1, 25P1G, 27B2, 30P1, 30P1G, 30P2G, 40P2, 40P2G, B30P2, B40P2, M30P1, N30P2, T40P3, T50P3
RC0045	35X35, 35X35, 35X35 (H4)	SCALPELLO DX	SOGEMA - OTMA - VIVIANI	321, 351, 30 BPA, 30 BTA, 30 D, 30 MPA, 30 TBA, 30 TPA, 32 BPA, 32 BTA, 32 TBA, 32 TPA, 34 BPA, 34 BTA, 35 BPA, 35 BTA, 35 MPA, 35 MTA, 35 TBA, 35 TPA, 25AA, 25B1, 27AA, 30AA, 30B2, 30BBR, 35AA, 35B2, 35BBR, 40B2, 40P1, 40P1G, 50P2, 50P2G, 60P2, 70P2, 70P2F, B50P2, B60P2, M40P1, T60P3, T80P3
RC0046	40X40, 40X40, 40X40 (H6)	SCALPELLO DX	SOGEMA - OTMA - VIVIANI	381, 401, 36 D, 38 BPA, 38 BTA, 38 D, 38 MPA, 38 MTA, 38 TBA, 38 TPA, 40 BPA, 40 D, 40 MPA, 40 MTA, 42 BPA, 42 BT Virg., 42 BTA, 42 D, 42 MPA, 42 TB, 43 BT Virg., 43 TB Virg., 44 BPA, 44 BTA, 44 D, 44 MPA, 44 MTA, 45 MTA, 46 BPA, 46 D, 46 MPA, 46 MTA, 49 BP, 49 MP, 100P2R, 30B1, 35B1, 40AA, 40B1, 40BBR, 45AA, 45B2, 50BBR, 50P1, 50P1G, 60P1, 70P1, 80P2, B100P2, B80P2, M50P1, M60P1, T100P3, T120P3
RC0047	45X45, 45X45, 45X45 (H7)	SCALPELLO DX	SOGEMA - OTMA - VIVIANI	441, 461, 501, 521, 47 BT, 47 BT Virg., 47 TB Virg., 49 BP-G, 49 BP-R, 50 BP, 50 BT, 50 M, 52 BP, 52 M, 52 M Leon., 52 MP, 53 MP, 54 M, 54 MP, 120P2R, 40BR, 45B1, 60BBR, 80P1R, 90A2, B120P2, M80P1

SUPPORTI SCALPELLO PER CORPI ARANTI ADATTABILI ALLA PRODUZIONE VIVIANI
SUPPORTS BURIN POUR CORPS LABOURANTS ADAPTABLES A LA PRODUCTION VIVIANI
CHISEL BEARINGS FOR PLOUGH PARTS SUITABLE TO VIVIANI PRODUCTION
MEISSELHALTER FÜR PFLUGKÖRPER PASSEND ZU VIVIANI
SOPORTES ESCOPLA CUERPOS DE ARADO ADAPTABLES A LA PRODUCCION VIVIANI

Art./Ref.	Rif. Orig./Orig. Ref.	Titolo Prodotto/Titolo Prodotto	Note/Note	Brand	Applicazione/Application
RC0670	Z0	SUPPORTO SCALPELLO DX	Per scalpello 30x30	VIVIANI	25B2, 25P1, 25P1G, 27B2, 30P1, 30P1G, 30P2G, 40P2, 40P2G, B30P2, B40P2, M30P1, N30P2, T40P3, T50P3
RC0671	Z1	SUPPORTO SCALPELLO DX	Per scalpello 35x35	VIVIANI	25B1, 27B1, 30B2, 30BBR, 35B2, 35BBR, 40B2, 40P1, 40P1G, 50P2, 50P2G, 60P2, 70P2, 70P2F, B50P2, B60P2, M40P1, T80P3
RC0672	Z2	SUPPORTO SCALPELLO DX	Per scalpello 40x40	VIVIANI	100P2R, 30B1, 40B1, 40BBR, 45B2, 50BBR, 50P1, 50P1G, 5B1, 60P1, 70P1, 80P2, B100P2, B80P2, M50P1, M60P1, T100P3, T120P3
RC0673	Z3	SUPPORTO SCALPELLO DX	Per scalpello 45x45 e 50x50	VIVIANI	100A2, 100P1R, 120A2, 120P2R, 40BR, 45B1, 60BBR, 80P1R, 90A2, B120P2, M100P1, M80P1

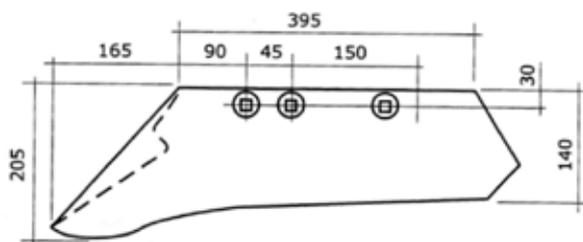
VOMERI PER CORPI ARANTI ADATTABILI ALLA PRODUZIONE VIVIANI-MIPE
SOCs POUR CORPS CHARRUES ADAPTABLES VIVIANI-MIPE
PLOWSHARES FOR PLOUGH-BODY SUIT TO VIVIANI-MIPE PRODUCTION
SCHARE FÜR PFLUGKÖRPER PASSEND ZU VIVIANI-MIPE
VOMERES PARA CUERPOS DE ARADO ADAPTABLE A LA PRODUCCION VIVIANI-MIPE

Art./Ref.	Rif. Orig./Orig. Ref.	Titolo Prodotto/Titolo Prodotto	Brand
CP4815	M2SV01	VOMERE DX	VIVIANI
CP4816	M2SV02	VOMERE SX	VIVIANI

RICAMBI PER CORPI ARANTI ADATTABILI ALLA PRODUZIONE WS VOGEL&NOOT

RECHANGES POUR CORPS CHARRUES ADAPTABLES A LA PRODUCTION WS VOGEL&NOOT

SPARE PARTS FOR WS PLOUGH PARTS SUITABLE TO VOGEL&NOOT PRODUCTION

ERSATZTEILE FUER PFLUGKOEPPER PASSEND ZU WS VOGEL&NOOT

RECAMBIOS PARA CUERPOS DE ARADO ADAPTABLES A LA PRODUCCION WS VOGEL&NOOT



Art./Ref.	Rif. Orig./Orig. Ref.	Titolo Prodotto/Titolo Prodotto	Tipo/Type	Spessore mm/Thickness mm	Note/Note	Brand
RC1248	PK8.011.01	PUNTA REVERSIBILE DX	1.0	15 mm	WS - UN	VOGEL&NOOT
RC1249	PK8.011.02	PUNTA REVERSIBILE SX	1.0	15 mm	WS - UN	VOGEL&NOOT
RC1256	PK0.011.01	PUNTA REVERSIBILE DX	2.0	-	WS - UN	VOGEL&NOOT
RC1257	PK0.011.02	PUNTA REVERSIBILE SX	2.0	-	WS - UN	VOGEL&NOOT
RC1264	PK0.000.03	VOMERE DX	3.0	-	WS350	VOGEL&NOOT
RC1265	PK0.000.04	VOMERE SX	3.0	-	WS350	VOGEL&NOOT
RC1266	PK0.000.05	VOMERE DX	3.0	-	WS400	VOGEL&NOOT
RC1267	PK0.000.06	VOMERE SX	3.0	-	WS400	VOGEL&NOOT
RC1268	PK0.000.07	VOMERE DX	3.0	-	WS430	VOGEL&NOOT
RC1269	PK0.000.08	VOMERE SX	3.0	-	WS430	VOGEL&NOOT
RC1272	PK6.013.01	VOMERE DX	4.0	-	WSM35	VOGEL&NOOT
RC1273	PK6.014.01	VOMERE SX	4.0	-	WSM35	VOGEL&NOOT
RC1274	PK7.013.01	VOMERE DX	4.0	-	WSM40	VOGEL&NOOT
RC1275	PK7.014.01	VOMERE SX	4.0	-	WSM40	VOGEL&NOOT
RC1276	PK8.013.01	VOMERE DX	4.0	-	WSM43	VOGEL&NOOT
RC1277	PK8.014.01	VOMERE SX	4.0	-	WSM43	VOGEL&NOOT
RC1280	PK0.010.03	VOMERE DX	5.0	-	WS350MWS350M	VOGEL&NOOT
RC1281	PK0.010.04	VOMERE SX	5.0	-	WS350MWS350M	VOGEL&NOOT
RC1284	PK0.010.07	VOMERE DX	5.0	-	WS430MWS430M	VOGEL&NOOT
RC1285	PK0.010.08	VOMERE SX	5.0	-	WS430MWS430M	VOGEL&NOOT
RC1286	PK8.001.09	VERSOIO DX	6.0	-	WY400AWY400A	VOGEL&NOOT
RC1287	PK8.002.09	VERSOIO SX	6.0	-	WY400AWY400A	VOGEL&NOOT
RC1288	PK8.005.01	AVANVERSOIO DX	7.0	-	WY400AWY400A	VOGEL&NOOT
RC1289	PK8.006.01	AVANVERSOIO SX	7.0	-	WY400AWY400A	VOGEL&NOOT
RC1323	PK8.034.01	PIASTRA ANTERIORE DX	8.0	-	WS - UN	VOGEL&NOOT
RC1324	PK8.035.01	PIASTRA ANTERIORE SX	8.0	-	WS - UN	VOGEL&NOOT
RC1290	P.89.034.01	PIASTRA CORTA DX	9.0	-	WS - UN	VOGEL&NOOT
RC1291	P.89.035.01	PIASTRA CORTA SX	9.0	-	WS - UN	VOGEL&NOOT
RC1292	P.89.036.01	PIASTRA LUNGA DX	9.0	-	WS - UN	VOGEL&NOOT
RC1293	P.89.037.01	PIASTRA LUNGA SX	9.0	-	WS - UN	VOGEL&NOOT
RC1294	P.58.011.01	TALLONE	10.0	-	WS - UN	VOGEL&NOOT

RICAMBI PER CORPI ARANTI ADATTABILI ALLA PRODUZIONE UN VOGEL&NOOT

RECHANGES POUR CORPS CHARRUES ADAPTABLES A LA PRODUCTION UN VOGEL&NOOT

SPARE PARTS FOR UN PLOUGH PARTS SUITABLE TO VOGEL&NOOT PRODUCTION

ERSATZTEILE FUER PFLUGKOERPER PASSEND ZU UN VOGEL&NOOT

RECAMBIOS PARA CUERPOS DE ARADO ADAPTABLES A LA PRODUCCION UN VOGEL&NOOT

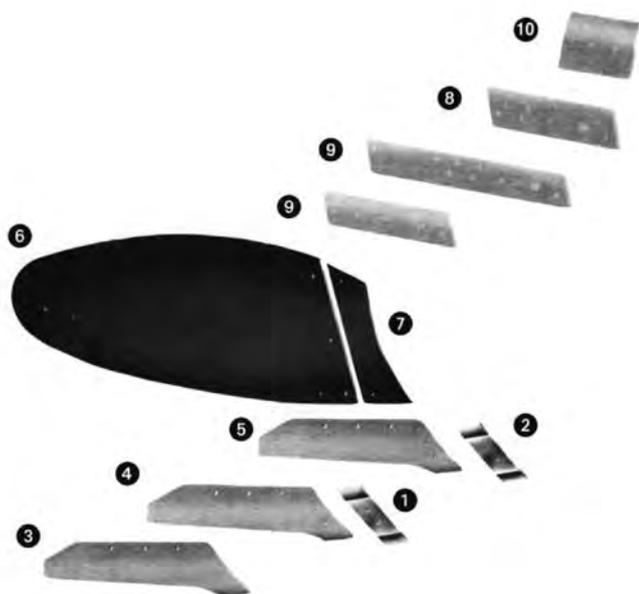

Art./Ref.	Rif. Orig./Orig. Ref.	Titolo Prodotto/Titolo Prodotto	Tipo/Type	Spessore mm/Thickness mm	Note/Note	Brand
RC1248	PK8.011.01	PUNTA REVERSIBILE DX	1.0	15 mm	WS - UN	VOGEL&NOOT
RC1249	PK8.011.02	PUNTA REVERSIBILE SX	1.0	15 mm	WS - UN	VOGEL&NOOT
RC1256	PK0.011.01	PUNTA REVERSIBILE DX	2.0	-	WS - UN	VOGEL&NOOT
RC1257	PK0.011.02	PUNTA REVERSIBILE SX	2.0	-	WS - UN	VOGEL&NOOT
RC1301	PK3.001.01	VOMERE DX	3.0	-	UN350	VOGEL&NOOT
RC1302	PK3.002.01	VOMERE SX	3.0	-	UN350	VOGEL&NOOT
RC1303	PK4.001.01	VOMERE DX	3.0	-	UN400	VOGEL&NOOT
RC1304	PK4.002.01	VOMERE SX	3.0	-	UN400	VOGEL&NOOT
RC1305	PK5.001.01	VOMERE DX	3.0	-	UN430	VOGEL&NOOT
RC1306	PK5.002.01	VOMERE SX	3.0	-	UN430	VOGEL&NOOT
RC1307	PK3.013.01	VOMERE DX	4.0	-	UNM35	VOGEL&NOOT
RC1308	PK3.014.01	VOMERE SX	4.0	-	UNM35	VOGEL&NOOT
RC1309	PK4.013.01	VOMERE DX	4.0	-	UNM40	VOGEL&NOOT
RC1310	PK4.014.01	VOMERE SX	4.0	-	UNM40	VOGEL&NOOT
RC1311	PK5.013.01	VOMERE DX	4.0	-	UNM43	VOGEL&NOOT
RC1312	PK5.014.01	VOMERE SX	4.0	-	UNM43	VOGEL&NOOT
RC1313	PK3.011.01	VOMERE DX	5.0	-	UN	VOGEL&NOOT
RC1314	PK3.012.01	VOMERE SX	5.0	-	UN	VOGEL&NOOT
RC1315	PK4.011.01	VOMERE DX	5.0	-	UN	VOGEL&NOOT
RC1316	PK4.012.01	VOMERE SX	5.0	-	UN	VOGEL&NOOT
RC1317	PK5.011.01	VOMERE DX	5.0	-	UN	VOGEL&NOOT
RC1318	PK5.012.01	VOMERE SX	5.0	-	UN	VOGEL&NOOT
RC1319	PK4.001.02	VERSOIO DX	6.0	-	UN400	VOGEL&NOOT
RC1320	PK4.002.02	VERSOIO SX	6.0	-	UN400	VOGEL&NOOT
RC1321	PK4.001.03	AVANVERSOIO DX	7.0	-	UN400	VOGEL&NOOT
RC1322	PK4.002.03	AVANVERSOIO SX	7.0	-	UN400	VOGEL&NOOT
RC1323	PK8.034.01	PIASTRA ANTERIORE DX	8.0	-	WS - UN	VOGEL&NOOT
RC1324	PK8.035.01	PIASTRA ANTERIORE SX	8.0	-	WS - UN	VOGEL&NOOT
RC1290	P.89.034.01	PIASTRA CORTA DX	9.0	-	WS - UN	VOGEL&NOOT
RC1291	P.89.035.01	PIASTRA CORTA SX	9.0	-	WS - UN	VOGEL&NOOT
RC1292	P.89.036.01	PIASTRA LUNGA DX	9.0	-	WS - UN	VOGEL&NOOT
RC1293	P.89.037.01	PIASTRA LUNGA SX	9.0	-	WS - UN	VOGEL&NOOT
RC1294	P.58.011.01	TALLONE	10.0	-	WS - UN	VOGEL&NOOT

VOMERI TIPO SACK NON FORATI

SOC MODELE SACK SANS TROU

PLOUGH SHARE TYPE SACK NOT PUNCHED

SCHAR TYP SACK NICHT GEBOHRT

REJAS TIPO SACK NO PINCHADAS

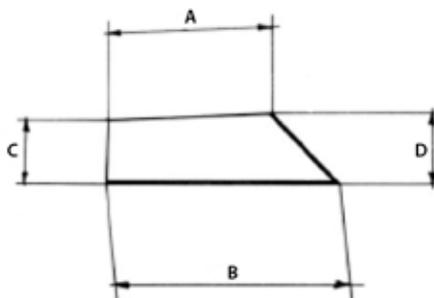

Note: Tutti i prodotti presenti in tabella vengono forniti non verniciati.

Notes: All products in the table are supplied unpainted.

Art./Ref.	Titolo Prodotto/Titolo Prodotto	A mm	B mm	C mm	D mm	Tipo/Type	Peso Kg/Weight Kg
CP1002N	VOMERE DX	220	300	110	120	NORMALE	2.4
CP1002NS	VOMERE SX	220	300	110	120	NORMALE	2.4
CP1003N	VOMERE DX	260	390	120	140	NORMALE	3.3
CP1003NS	VOMERE SX	260	390	120	140	NORMALE	3.3
CP1004N	VOMERE DX	280	410	120	140	NORMALE	3.4
CP1004NS	VOMERE SX	280	410	120	140	NORMALE	3.4
CP1005N	VOMERE DX	300	430	120	140	NORMALE	3.8
CP1005NS	VOMERE SX	300	430	120	140	NORMALE	3.8
CP1006N	VOMERE DX	320	450	120	140	NORMALE	4
CP1006NS	VOMERE SX	320	450	120	140	NORMALE	4
CP1007N	VOMERE DX	340	480	140	150	NORMALE	5.3
CP1007NS	VOMERE SX	340	480	140	150	NORMALE	5.3
CP1008N	VOMERE DX	380	500	140	150	NORMALE	6
CP1008NS	VOMERE SX	380	500	140	150	NORMALE	6
CP1875N	VOMERE DX	400	540	160	180	NORMALE	8
CP1876N	VOMERE DX	420	560	160	180	NORMALE	8.3
CP1877N	VOMERE DX	440	580	160	180	NORMALE	8.6
CP1878N	VOMERE DX	460	600	160	180	NORMALE	9
CP1879N	VOMERE DX	480	620	165	185	NORMALE	9.5
CP1880N	VOMERE DX	500	640	165	185	NORMALE	9.8
CP1881N	VOMERE DX	400	570	195	215	PESANTE	11.5
CP1882N	VOMERE DX	430	610	195	215	PESANTE	12
CP1883N	VOMERE DX	450	640	200	220	PESANTE	12.5
CP1884N	VOMERE DX	470	660	200	220	PESANTE	13.5
CP1884AN	VOMERE DX	500	690	185	215	PESANTE	14.5

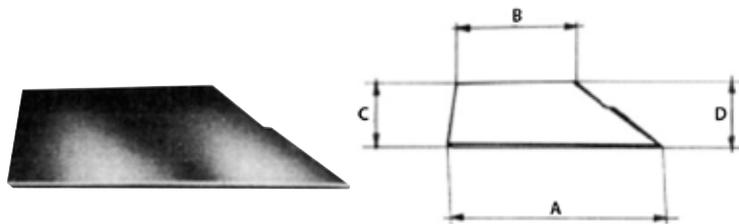
VOMERI A SCALPELLO NON FORATI
SOC A BURIN SANS TROU
CHISELED SHARE NOT PUNCHED
MEISSELSCHARE OHNE BOHRUNGEN
REJAS A ESCOPLLO NO PINCHADAS

Note: Tutti i prodotti presenti in tabella vengono forniti non verniciati.

Notes: All products in the table are supplied unpainted.

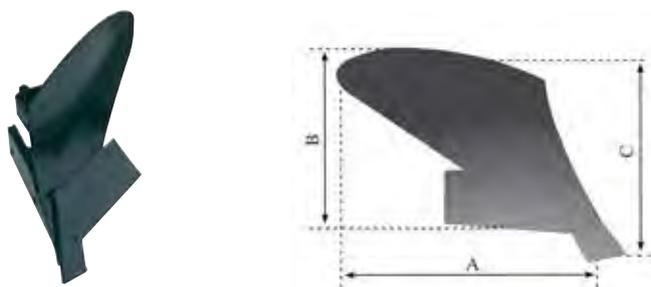
Art./Ref.	Titolo Prodotto/Titolo Prodotto	A mm	B mm	C mm	D mm	Spessore mm/Thickness mm	Tipo/Type	Peso Kg/Weight Kg
CP1009	VOMERE DX	350	250	100	110	9 mm	1C43	2.3
CP1009S	VOMERE SX	350	250	100	110	9 mm	1CS43 SX	2.3
CP1010	VOMERE DX	430	280	130	130	10 mm	5C54	3
CP1010S	VOMERE SX	430	280	130	130	10 mm	5CS54 SX	3
CP1011	VOMERE DX	470	290	140	140	10 mm	6C54	3.7
CP1011S	VOMERE SX	470	290	140	140	10 mm	6CS54 SX	3.7
CP1012	VOMERE DX	500	310	160	160	12 mm	7C54	5
CP1012S	VOMERE SX	500	310	160	160	12 mm	7CS54 SX	5
CP1013	VOMERE DX	550	340	165	165	12 mm	9C53	5.6
CP1013S	VOMERE SX	550	340	165	165	12 mm	9CS53 SX	5.6
CP1014	VOMERE DX	610	370	170	170	15 mm	13C53	7.8
CP1014S	VOMERE SX	610	370	170	170	15 mm	13CS53 SX	7.8
CP1015	VOMERE DX	550	370	180	180	15 mm	12C54	8
CP1016	VOMERE DX	420	230	130	140	10 mm	1/2 VS	3
CP1016S	VOMERE SX	420	230	130	140	10 mm	1/2 VS SX	3
CP1017	VOMERE DX	450	255	140	150	10 mm	1 VS	3.3
CP1017S	VOMERE SX	450	255	140	150	10 mm	1 VS SX	3.3
CP1018	VOMERE DX	500	300	150	165	12 mm	2 VS	5
CP1018S	VOMERE SX	500	300	150	165	12 mm	2 VS SX	5
CP1019	VOMERE DX	550	350	160	165	12 mm	2 VSL	5.5
CP1019S	VOMERE SX	550	350	160	165	12 mm	2 VSL SX	5.5
CP1020	VOMERE DX	530	300	170	180	15 mm	3 VS	6.5
CP1020S	VOMERE SX	530	300	170	180	15 mm	3 VS SX	6.5
CP1021	VOMERE DX	580	350	190	200	15 mm	4 VS	9
CP1021S	VOMERE SX	580	350	190	200	15 mm	4 VS SX	9

CORPO COMPLETO PER BRACCIO 40X40
CORPS COMPLET POUR BRAS 40X40
COMPLETE POLUGH BODY TO FIT 40X40 MOUNTING SHAFT
PFLUGKOERPER KOMPLETT FUER LENKER 40X40
CUERPO COMPLETO PARA BRAZO DE 40X40

Art./Ref.	Titolo Prodotto/Titolo Prodotto	A mm	B mm	C mm	Peso Kg/Weight Kg
CP5046	CORPO DX	600	300	250	17.6

VERSOIO

VERSOIR
MOULDBOARD
STREICHBLECHE
VERTEDERA

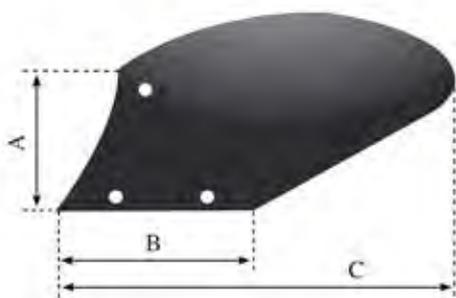

Art./Ref.	Titolo Prodotto/Titolo Prodotto	A mm	B mm	C mm	Spessore mm/Thickness mm	Peso Kg/Weight Kg
CP5047	VERSOIO DX	200	235	500	6 mm	4.3

VOMERE

SOC
PLOWSHARE
SCHARE
REJA

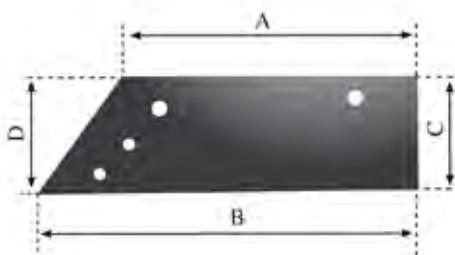

Art./Ref.	Titolo Prodotto/Titolo Prodotto	A mm	B mm	C mm	D mm	Spessore mm/Thickness mm	Peso Kg/Weight Kg
CP5048	VOMERE DX	275	340	110	120	10 mm	2.57

PUNTALINO

POINTE
DRILL
SPITZEN
PUNTA

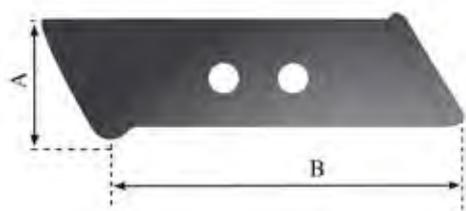

Art./Ref.	Titolo Prodotto/Titolo Prodotto	A mm	B mm	Spessore mm/Thickness mm	Peso Kg/Weight Kg
CP5049	PUNTALINO DX	60	190	12 mm	0.95

PIASTRA

CONTRE-SEP
LANDSIDE
ANLAGEN
COSTANERA

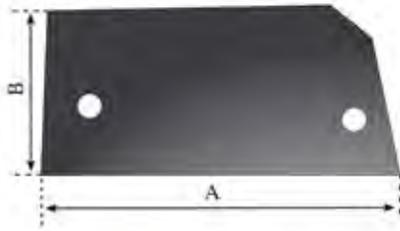

Art./Ref.	Titolo Prodotto/Titolo Prodotto	A mm	B mm	Spessore mm/Thickness mm	Peso Kg/Weight Kg
CP5050	PIASTRA	190	100	12 mm	1.6

CORPO COMPLETO VERSOIO A STRISCIE CORTO PER ANCORA

CORPS COMPLET VERSOIR A DENT COURT POUR LAME
COMPLETE PLOUGH BODY WITH SLAT MOULDBOARD SHORT PROFILE TO FIT TINE
PFLUGKOEPPER KOMPLETT MIT STREIFENSTREICHBLECH KURZ FUER ANKER
CUERPO COMPLETO TIRAS CORTAS PARA ANCORA

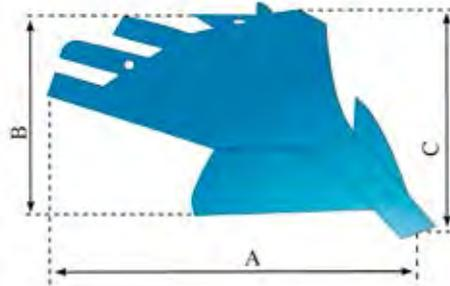

Art./Ref.	Titolo Prodotto/Titolo Prodotto	A mm	B mm	C mm	Peso Kg/Weight Kg
CP5448	CORPO DX	680	360	360	22

VERSOIO

VERSOIR
MOULDBOARD
STREICHBLECHE
VERTEDERA

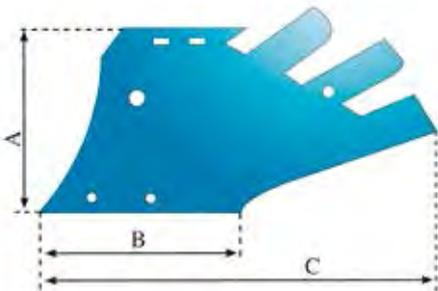

Art./Ref.	Titolo Prodotto/Titolo Prodotto	A mm	B mm	C mm	Spessore mm/Thickness mm	Peso Kg/Weight Kg
CP4735	VERSOIO DX	280	270	560	7 mm	6

VOMERE

SOC
 PLOWSHARE
 SCHARE
 REJA

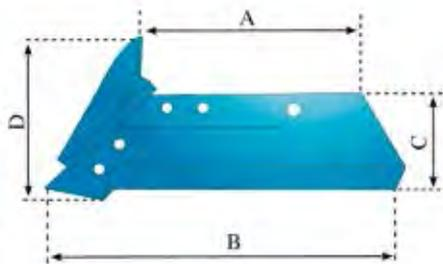

Art./Ref.	Titolo Prodotto/Titolo Prodotto	A mm	B mm	C mm	D mm	Spessore mm/Thickness mm	Peso Kg/Weight Kg
CP4733	VOMERE DX	290	410	110	110	10 mm	4.1

PUNTALINO

POINTE
 DRILL
 SPITZEN
 PUNTA



053090 / 063090

Art./Ref.	Rif. Orig./Orig. Ref.	Titolo Prodotto/Titolo Prodotto	Spessore mm/Thickness mm	Note/Note	Brand
RC0983	053090	PUNTA REVERSIBILE DX	12 mm	Sabbia e verniciata.	KVERNELAND

PIASTRA

CONTRE-SEP
 LANDSIDE
 ANLAGEN
 COSTANERA

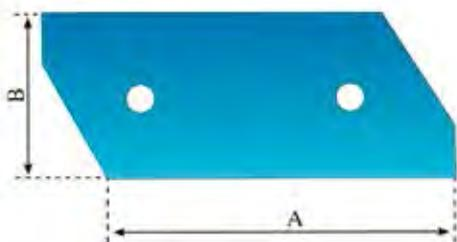

Art./Ref.	Titolo Prodotto/Titolo Prodotto	A mm	B mm	Spessore mm/Thickness mm	Peso Kg/Weight Kg
CP4734	PIASTRA	250	100	10 mm	1.7

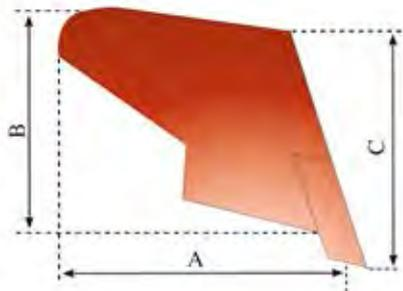
CORPO COMPLETO VERSOIO PIENO PER ANCORA
CORPS COMPLET PLEIN POUR LAME
COMPLETE PLOUGH BODY TO FIT TINET
PFLUGKOERPER KOMPLETT MIT STREICHBLECH FUER ANKER
CUERPO COMPLETO CERRADO PARA ANCORA

Art./Ref.	Titolo Prodotto/Titolo Prodotto	A mm	B mm	C mm	Peso Kg/Weight Kg
CP5446	CORPO DX	680	340	340	18.6

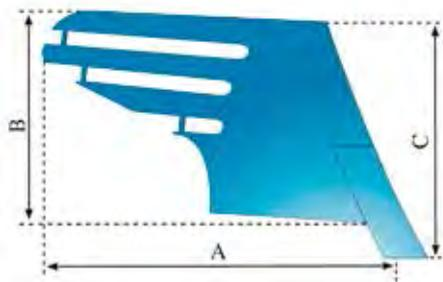
CORPO COMPLETO VERSOIO A STRISCIE PER ANCORA
CORPS COMPLET VERSOIR A DENT POUR LAME
COMPLETE PLOUGH BODY WITH SLAT MOULDBOARD TO FIT TINE
PFLUGKOERPER KOMPLETT MIT STREIFENSTREICHBLECH FUER ANKER
CUERPO COMPLETO A TIRAS PARA ANCORA

Art./Ref.	Titolo Prodotto/Titolo Prodotto	A mm	B mm	C mm	Peso Kg/Weight Kg
CP5447	CORPO DX	680	340	340	17.5

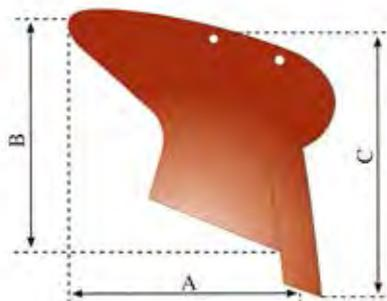
CORPO COMPLETO VERSOIO OVALE PER ANCORA
CORPS COMPLET VERSOIR OVALE POUR LAME
COMPLETE PLOUGH BODY WITH OVAL SHAPE MOULDBOARD TO FIT TINE
PFLUGKOERPER KOMPLETT MIT STREICHBLECH FUER ANKER
CUERPO COMPLETO PARA ANCORA VERTEDERA OVALADA

Art./Ref.	Titolo Prodotto/Titolo Prodotto	A mm	B mm	C mm	Peso Kg/Weight Kg
CP5422	CORPO DX	600	300	320	18.2

VERSOIO PIENO

VERSOIR PLEIN
MOULDBOARD
STREICHBLECH
VERTEDERA CERRADA

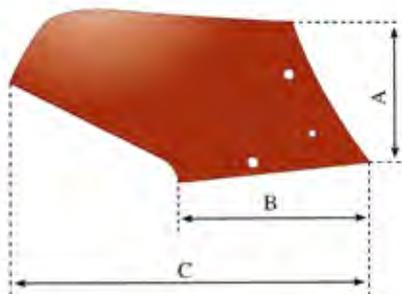

Art./Ref.	Titolo Prodotto/Titolo Prodotto	A mm	B mm	C mm	Spessore mm/Thickness mm	Peso Kg/Weight Kg
CP5430	VERSOIO DX	270	300	580	6 mm	6

VERSOIO A STRISCIE

VERSOIR A DENT
MOULDBOARD SLAT
STREIFENSTREICHBLECH
VERTEDERA A TIRAS

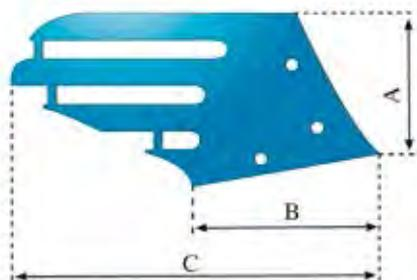

Art./Ref.	Titolo Prodotto/Titolo Prodotto	A mm	B mm	C mm	Spessore mm/Thickness mm	Peso Kg/Weight Kg
CP5432	VERSOIO DX	270	300	580	6 mm	5

VERSOIO OVALE

VERSOIR OVALE
OVAL SHAPE MOULDBOARD
STREICHBLECH OVAL
VERTEDERA OVALADA

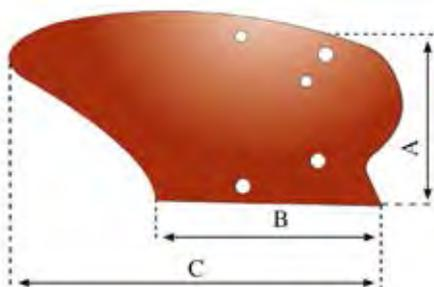

Art./Ref.	Titolo Prodotto/Titolo Prodotto	A mm	B mm	C mm	Spessore mm/Thickness mm	Peso Kg/Weight Kg
CP5413	VERSOIO DX	245	300	580	6 mm	5.4

VOMERE

SOC
 PLOWSHARE
 SCHARE
 REJA

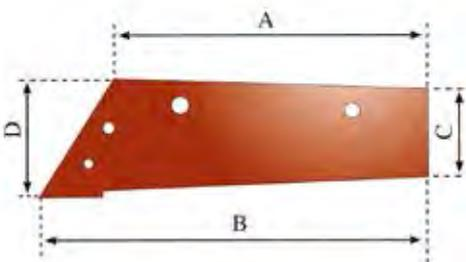

Art./Ref.	Titolo Prodotto/ Titolo Prodotto	A mm	B mm	C mm	D mm	Spessore mm/ Thickness mm	Peso Kg/ Weight Kg	Note/Note
CP5414	VERSOIO DX	300	360	85	120	10 mm	2.5	Applicabile al corpo CP5446-CP5447-CP5422

PUNTALINO

POINTE
 DRILL
 SPITZEN
 PUNTA

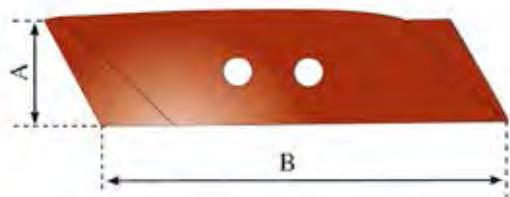

Art./Ref.	Titolo Prodotto/ Titolo Prodotto	A mm	B mm	Spessore mm/ Thickness mm	Peso Kg/ Weight Kg	Note/Note
CP5423	PUNTALINO DX	65	225	12 mm	1.24	Applicabile al corpo CP5446-CP5447-CP5422

PIASTRA

CONTRE-SEP
 LANDSIDE
 ANLAGEN
 COSTANERA

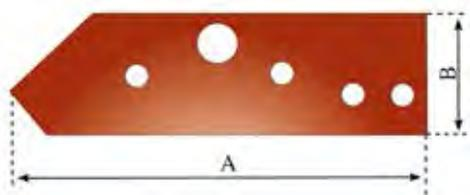

Art./Ref.	Titolo Prodotto/ Titolo Prodotto	A mm	B mm	Spessore mm/ Thickness mm	Peso Kg/ Weight Kg	Note/Note
CP5415	PIASTRA DX	335	100	12 mm	2.8	Applicabile al corpo CP5446-CP5447-CP5422

VITI FERMA SCALPELLO

VIS FERME BURINS

STOP CHISEL SCREWS

SCHRAUBEN MEISSEL-BLOCKIERUNG

TORNILLO BLOQUE ESCOPIO



Art./Ref.	Titolo Prodotto/Titolo Prodotto
RC0820	VITE FERMA SCALPELLO 20X50
RC0821	VITE FERMA SCALPELLO 22X60
RC0822	VITE FERMA SCALPELLO 24X60

BULLONI TESTA PIANA SVASATA CON ESAGONO INCASSATO

BOULONS TETE PLANE EVASE AVEC EXAGONE

FLAT-FLARING HEADED BOLTS WITH SET HEXAGON

SCHRAUBEN MIT SENKKOPF

PERNO CABEZA LLANA ABOCINADA CON HEXAGONO ENCAJADO



Art./Ref.	Titolo Prodotto/Titolo Prodotto
RC0818	BULLONE TSPEI 12X30
RC0824	BULLONE TSPEI 12X35
RC0825	BULLONE TSPEI 12X40
RC0828	BULLONE TSPEI 12X50
RC0829	BULLONE TSPEI 12X70
RC0832	BULLONE TSPEI 12X90
RC0815	BULLONE TSPEI 14X40
RC0839	BULLONE TSPEI 14X50
RC0816	BULLONE TSPEI 16X40
RC0836	BULLONE TSPEI 16X50

BULLONI TESTA ESAGONALE PER MONTAGGIO ZAPPE PER FRESE

BOULONS TETE EXAGONALE POUR MONTAGE PIOCHE POUR FRAISES

HEXAGONAL-HEADED BOLTS FOR CUTTER HOE ASSEMBLING

SCHRAUBEN MIT SECHSKANT-KOPF FUER FRAESMESSER

ESCOPIOS CUERPOS DE ARADO ADAPTABLES A LA PRODUCCION GHERARDI



Art./Ref.	Titolo Prodotto/Titolo Prodotto	Tipo/Type	Note/Note
RC0702	BULLONE TESTA ESAGONALE 8X30X1,25	ACCIAIO 8.8	LUNGHEZZA FILETTO MM 16
RC0708	BULLONE TESTA ESAGONALE 10X30X1,5	ACCIAIO 8.8	LUNGHEZZA FILETTO MM 15
RC0710	BULLONE TESTA ESAGONALE 10X30X1,25	ACCIAIO 8.8	LUNGHEZZA FILETTO MM 19
RC0712	BULLONE TESTA ESAGONALE 12X35X1,5	ACCIAIO 8.8/	LUNGHEZZA FILETTO MM 18
RC0716	BULLONE TESTA ESAGONALE 14X40X1,5	ACCIAIO 8.8	LUNGHEZZA FILETTO MM 20
RC0718	BULLONE TESTA ESAGONALE 7/16 HR L=40	ACCIAIO 8.8	LUNGHEZZA FILETTO MM 19,5
RC0720	BULLONE TESTA ESAGONALE 1/2 HR L=45	ACCIAIO 8.8	LUNGHEZZA FILETTO MM 21,5

BULLONI TESTA ESAGONALE PER STAFFE

BOULONS TETE HEXAGONALE POUR BRIDES
 HEXAGONAL BOLTS FOR CLAMPS
 SECHSKANTSCHRAUBE FÜR HALTERUNGEN
 ESCOPLoS CABEZA HEXAGONAL PARA ESTRIBOS

Note: Viti zincate con testa esagonale complete di dado per il fissaggio delle staffe.

Notes: Galvanized screws with exagonal head complete with nut to fix frames

Art./Ref.	Sezione/Section	A mm	Filettatura/Thread	Peso Kg/Weight Kg	Note/Note
RC0740	12 x 50	50	M 12	0.09	Bullone 8.8
RC0741	12 x 60	60	M 12	0.1	Bullone 8.8
RC0742	12 x 80	80	M 12	0.11	Bullone 8.8
RC0743	12 x 90	90	M 12	0.12	Bullone 8.8
RC0744	12 x 100	100	M 12	0.13	Bullone 8.8
RC0745	12 x 110	110	M 12	0.14	Bullone 8.8

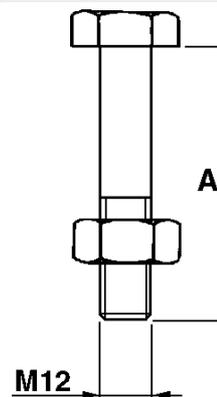

VITI TESTA OVALE PER VOMERINI

VIS TETE OVALE POUR SOCS
 OVAL HEAD SCREWS FOR SHARES
 OVALSCHRAUBEN FÜR SCHAREN
 TORNILLO CABEZA OVAL PARA REJAS

Note: Vite completa di dado con testa ovale e quadro sottotesta per il fissaggio dei vomerini alle molle tipo flex, gare e rompitraccia con foro per il fissaggio. Materiale 8.8

Notes: Oval head screws with square under-head complete with nut to fix tine on spring. Material 8.8

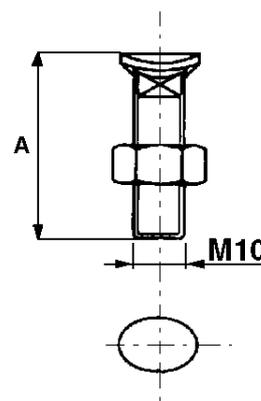
Art./Ref.	A mm	Filettatura/Thread	Peso Kg/Weight Kg	Note/Note
CP1358	38	M 10	0.03	Bullone testa ovale con quadro 10 mm.
CP1358A	45	M 10	0.05	Bullone testa ovale con quadro 10 mm.
CP1358B	60	M 10	0.06	Bullone testa ovale con quadro 10 mm.
CP1358E	55	M 10	0.06	Bullone testa ovale con quadro 10 mm.
CP1358F	30	M 10	0.04	Bullone testa ovale con quadro 10 mm.



BULLONI TESTA TONDA SVASATA PER VOMERINI

BOULONS TETE RONDE POUR SOCS
 FLAT-FLARING ROUND HEAD SREW FOR SHARES
 SENKSCHRAUBEN RUNDSCHRAUBE FÜR SCHAREN
 ESCOPLoS CABEZA REDONDA CÓNICA PARA REJAS

Note: Viti complete di dado con testa tonda svasata e quadro sottotesta per il fissaggio dei vomerini alle molle di qualsiasi modello e tipo.

Notes: Round head screws with square under-head complete with nut to fix tine on spring.

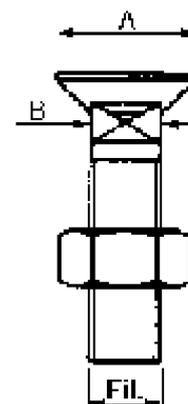
Art./Ref.	A mm	B mm	Filettatura/Thread
RC0760A	20	10	M 10 x 30
RC0759A	20	10	M 10 x 40
RC0757A	20	10	M 10 x 50
RC0755A	20	10	M 10 x 60
RC0754A	20	10	M 10 x 70
RC0763TG	24	12	M 12 x 35
RC0764TG	24	12	M 12 x 40
RC0766TG	24	12	M 12 x 50
RC0768TG	24	12	M 12 x 60
RC0770TG	24	12	M 12 x 70
RC0771TG	24	12	M 12 x 80



BULLONI CON TESTA SVASATA PIANA E QUADRO SOTTO TESTA 120° PER MONTAGGIO PARTI DI RICAMBIO PER CORPI ARANTI
BOULONS TETE EVASE PLANE ET CARRE SOUS TETE 120 POUR MONTAGE PARTS DE RECHANGE POUR CORPS LABOURANT
FLAT-FLARING HEADED BOLTS FOR PLOUGH PARTS
SENKSCRAUBEN FUER PFLUGKOERPER-ERSATZTEILE
ESCOPILOS CUERPOS DE ARADO ADAPTABLES A LA PRODUCCION GHERARDI

Art./Ref.	Titolo Prodotto/Titolo Prodotto	Note/Note
RC0762	BULLONE TSPQST M. 12X30 DX	Acciaio 8.8. Applicazioni: vomeri e versoi con foro quadrato e svasatura dei fori a 120°
RC0763	BULLONE TSPQST M. 12X35 DX	Acciaio 8.8. Applicazioni: vomeri, versoi, talloni e soles con foro quadrato e svasatura dei fori a 120°
RC0764	BULLONE TSPQST M. 12X40 DX	Acciaio 8.8. Applicazioni: soles e supporti scalpello con foro quadrato e svasatura dei fori a 120°
RC0765	BULLONE TSPQST M. 12X45 DX	Acciaio 8.8. Applicazioni: versoi, lamini e talloni con foro quadrato e svasatura dei fori a 120°
RC0766	BULLONE TSPQST M. 12X50 DX	Acciaio 8.8. Applicazioni: talloni, vomerine per ancore coltivatore, vomerine per ancore tiller e vomerine per ancore estirpatore con foro quadrato e svasatura dei fori a 120°
RC0768	BULLONE TSPQST M. 12X60 DX	Acciaio 8.8. Applicazioni: talloni, vomerine per ancore coltivatore, vomerine per ancore tiller e vomerine per ancore estirpatore con foro quadrato e svasatura dei fori a 120°
RC0770	BULLONE TSPQST M. 12X70 DX	Acciaio 8.8. Applicazioni: vomerine per ancore coltivatore, vomerine per ancore tiller e vomerine per ancore estirpatore con foro quadrato e svasatura dei fori a 120°
RC0771	BULLONE TSPQST M. 12X80 DX	Acciaio 8.8. Applicazioni: vomerine per ancore coltivatore, vomerine per ancore tiller e vomerine per ancore estirpatore con foro quadrato e svasatura dei fori a 120°
RC0773	BULLONE TSPQST M. 12X90 DX	Acciaio 8.8. Applicazioni: vomerine per ancore coltivatore, vomerine per ancore tiller e vomerine per ancore estirpatore con foro quadrato e svasatura dei fori a 120°
RC0774	BULLONE TSPQST M. 14X30 DX	Acciaio 8.8. Applicazioni: versoi e vomeri con foro quadrato e svasatura dei fori a 120°.
RC0775	BULLONE TSPQST M. 14X35 DX	Acciaio 8.8. Applicazioni: versoi e vomeri con foro quadrato e svasatura dei fori a 120°
RC0776	BULLONE TSPQST M. 14X40 DX	Acciaio 8.8. Applicazioni: versoi, vomeri, supporti scalpello, tiranti e soles con foro quadrato e svasatura dei fori a 120°
RC0777	BULLONE TSPQST M. 14X45 DX	Acciaio 8.8. Applicazioni: soles e talloni con foro quadrato e svasatura dei fori a 120°
RC0778	BULLONE TSPQST M. 14X50 DX	Acciaio 8.8. Applicazioni: versoi, lamini e fodere o soles con foro quadrato e svasatura dei fori a 120°
RC0780	BULLONE TSPQST M. 14X60 DX	Acciaio 8.8. Applicazioni: versoi ed orecchie mobili con foro quadrato e svasatura dei fori a 120°
RC0787	BULLONE TSPQST M. 16X35 DX	Acciaio 8.8. Applicazioni: vomeri con foro quadrato e svasatura dei fori a 120°
RC0788	BULLONE TSPQST M. 16X40 DX	Acciaio 8.8. Applicazioni: versoi, soles e supporti scalpello con foro quadrato e svasatura dei fori a 120°
RC0789	BULLONE TSPQST M. 16X45 DX	Acciaio 8.8. Applicazioni: versoi, soles e supporti scalpello con foro quadrato e svasatura dei fori a 120°
RC0790	BULLONE TSPQST M. 16X50 DX	Acciaio 8.8. Applicazioni: talloni con foro quadrato e svasatura dei fori a 120°
RC0792	BULLONE TSPQST M. 16X60 DX	Acciaio 8.8. Applicazioni: versoi ed orecchie mobili con foro quadrato e svasatura dei fori a 120°
RC0793	BULLONE TSPQST M. 16X70 DX	Acciaio 8.8. Applicazioni: versoi ed orecchie mobili con foro quadrato e svasatura dei fori a 120°
RC0800	BULLONE TSPQST M. 14X30 SX	Acciaio 8.8. Applicazioni: vomeri con foro quadrato e svasatura dei fori a 120°
RC0801	BULLONE TSPQST M. 14X35 SX	Acciaio 8.8. Applicazioni: vomeri con foro quadrato e svasatura dei fori a 120°
RC0802	BULLONE TSPQST M. 14X40 SX	Acciaio 8.8. Applicazioni: vomeri con foro quadrato e svasatura dei fori a 120°
RC0803	BULLONE TSPQST M. 14X50 SX	Acciaio 8.8. Applicazioni: vomeri con foro quadrato e svasatura dei fori a 120°
RC0804	BULLONE TSPQST M. 14X60 SX	Acciaio 8.8. Applicazioni: vomeri con foro quadrato e svasatura dei fori a 120°
RC0806	BULLONE TSPQST M. 16X40 SX	Acciaio 8.8. Applicazioni: vomeri con foro quadrato e svasatura dei fori a 120°.
RC0808	BULLONE TSPQST M. 16X50 SX	Acciaio 8.8. Applicazioni: vomeri con foro quadrato e svasatura dei fori a 120°

BULLONI PER MONTAGGIO PARTI DI RICAMBIO PER CORPI ARANTI ADATTABILI A KVERNELAND, GREGOIRE-BESSON, RABEWERK E OTMA U13-U15
BOULONS POUR MONTAGE PARTS DE RECHANGE POUR CORPS LABOURANTS ADAPTABLES A KVERNELAND, GREGOIRE-BESSON, RABEWERK ET OTMA U13-U15
BOLTS FOR SPARE PARTS PLOUGH BODIES ASSEMBLING SUITABLE TO KVERNELAND, GREGOIRE-BESSON, RABEWERK AND OTMA U13-U15
SCHRAUBEN FUER PFLUG-ERSATZTEILEN PASSEND ZU KVERNELAND, GREGOIRE-BESSON, RABEWERK UND OTMA U13-U15
PERNO MONTAJE RECAMBIOS CUERPOS DE ARADO ADAPTABLES A KVERNELAND, GREGOIRE-BESSON, RABEWERK Y OTMA U13-U15

Art./Ref.	Rif. Orig./Orig. Ref.	Titolo Prodotto/Titolo Prodotto	Note/Note	Brand
RC0827	013228	BULLONE 12X34 KVERNELAND-OTMA	Applicazioni: puntalino Kverneland-Otma	KVERNELAND
RC0847	013234	BULLONE 12X38 KVERNELAND	Applicazioni: puntalino Kverneland	KVERNELAND
RC0848	-	BULLONE 12X45 KVERNELAND	Applicazioni: puntalino Kverneland	-
RC0833	013332	BULLONE 14X34 KVERNELAND	Applicazioni: vomeri e striscianti Kverneland	KVERNELAND
RC0841	021483	BULLONE 16X80 KVERNELAND	Applicazioni: striscianti Kverneland	KVERNELAND
RC0849	1608236	BULLONE 12X35 RABEWERK	Applicazioni: puntalino Rabewerk	RABEWERK
RC0850	-	BULLONE 12X39 GREGOIRE-BESSON	Applicazioni: puntalino Gregoire-Besson	-

BULLONI PER MONTAGGIO PARTI DI RICAMBIO PER CORPI ARANTI ADATTABILI A KVERNELAND E OTMA U13-U15
BOULONS POUR MONTAGE PARTS DE RECHANGE POUR CORPS LABOURANTS ADAPTABLES A KVERNELAND ET OTMA U13-U15
BOLTS FOR SPARE PARTS PLOUGH BODIES ASSEMBLING SUITABLE TO KVERNELAND AND OTMA U13-U15
SCHRAUBEN FUER PFLUG-ERSATZTEILEN PASSEND ZU KVERNELAND UND OTMA U13-U15
PERNO MONTAJE RECAMBIOS CUERPOS DE ARADO ADAPTABLES A KVERNELAND Y OTMA U13-U15

Art./Ref.	Rif. Orig./Orig. Ref.	Titolo Prodotto/Titolo Prodotto	Note/Note	Brand
RC0750	-	BULLONE 10X30 CON NASELLO TESTA PICCOLA	Applicazioni: vomerini e versoi Kverneland (RC1044-RC1044S-RC1045-RC1045S). Diametro testa mm 16.	-
RC0840	033107	BULLONE 12X35 CON NASELLO TESTA PICCOLA	Applicazioni: versoi, avanversoi Kverneland e puntalini reversibili Overum . Diametro testa mm. 20	KVERNELAND
RC0838	-	BULLONE 12X35 CON NASELLO TESTA GRANDE	Applicazioni: vomeri, versoi e avanversoi Otma U13-U15. Diametro testa mm. 24	-

CORPI PER ARATRO MODELLO **SARA**

CORPS POUR CHARRUES MODELE SARA

PLOUGH CORES MODEL SARA

PFLUGKOEPPER MODELL SARA

CUERPOS DE ARADO MODELO SARA

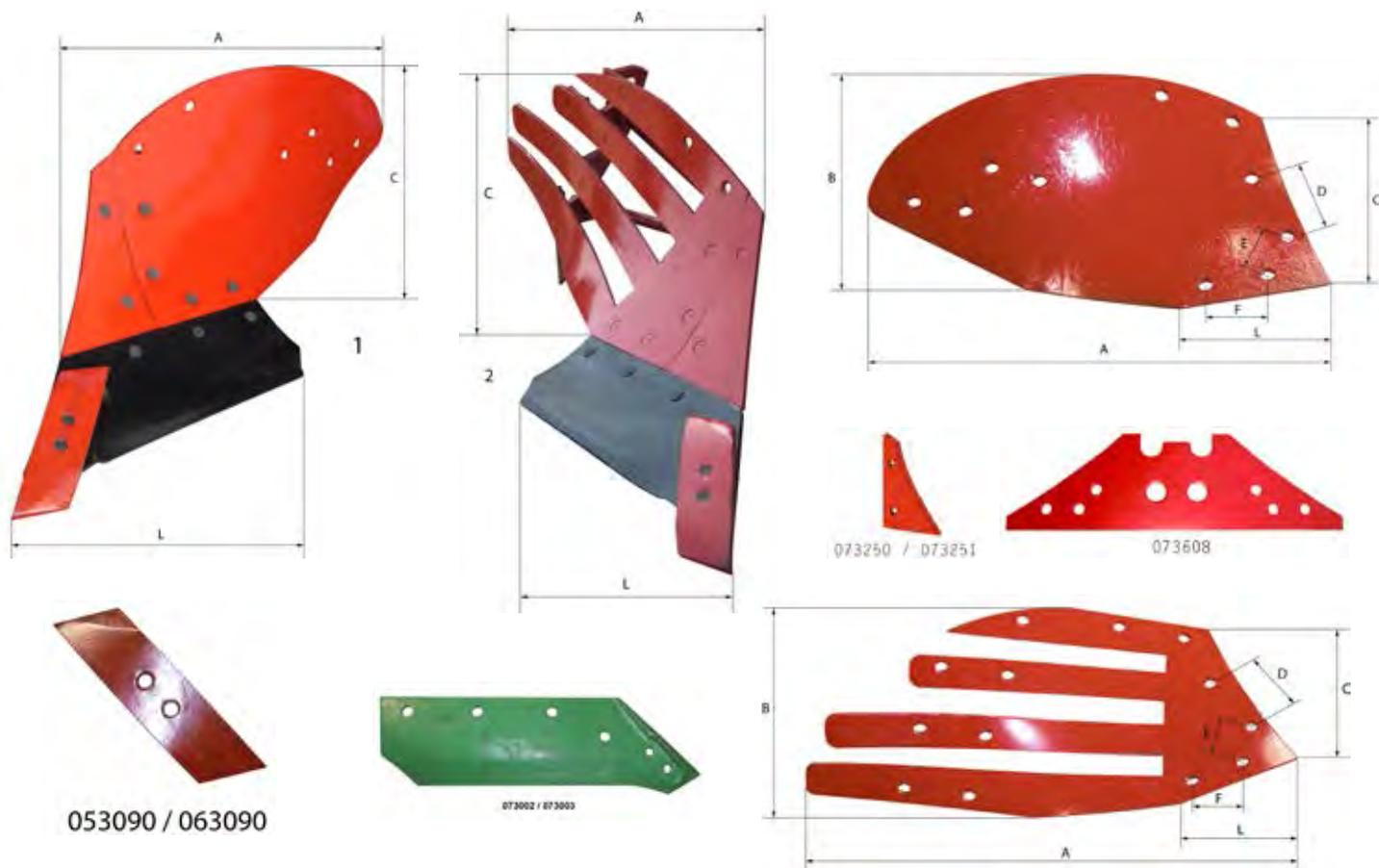
**Note:** Da utilizzare per lavorazioni superficiali**Notes:** To be used for surface processing

Art./Ref.	Rif. Orig./Orig. Ref.	Titolo Prodotto/Titolo Prodotto	A mm	C mm	L mm	B mm	D mm	E mm	F mm	Tipo/Type	Brand
RC1951	-	CORPO ANTERIORE VERSOIO PIENO PICCOLO DX	830	360	330	-	-	-	-	1	-
RC1951S	-	CORPO ANTERIORE VERSOIO PIENO PICCOLO SX	830	360	330	-	-	-	-	1	-
RC1953	-	CORPO ANTERIORE VERSOIO PIENO MEDIO DX	940	380	330	-	-	-	-	1	-
RC1953S	-	CORPO ANTERIORE VERSOIO PIENO MEDIO SX	940	380	330	-	-	-	-	1	-
RC2222	-	CORPO ANTERIORE VERSOIO A STRISCIE PICCOLO DX	830	360	330	-	-	-	-	2	-
RC2223	-	CORPO ANTERIORE VERSOIO A STRISCIE PICCOLO SX	830	360	330	-	-	-	-	2	-
RC2224	-	CORPO ANTERIORE VERSOIO A STRISCIE MEDIO DX	940	380	330	-	-	-	-	2	-
RC2225	-	CORPO ANTERIORE VERSOIO A STRISCIE MEDIO SX	940	380	330	-	-	-	-	2	-
CP6519	-	VERSOIO PIENO PER CORPO PICCOLO DX	695	270	210	320	103	71	90	-	-
CP6520	-	VERSOIO PIENO PER CORPO PICCOLO SX	695	270	210	320	103	71	90	-	-
CP6519ST	-	VERSOIO A STRISCIE PER CORPO PICCOLO DX	695	270	210	320	103	71	90	-	-
CP6520ST	-	VERSOIO A STRISCIE PER CORPO PICCOLO SX	695	270	210	320	103	71	90	-	-
CP6523	-	VERSOIO PIENO PER CORPO MEDIO DX	765	270	210	360	103	71	90	-	-
CP6524	-	VERSOIO PIENO PER CORPO MEDIO SX	765	270	210	360	103	71	90	-	-
CP6523ST	-	VERSOIO A STRISCIE PER CORPO MEDIO DX	765	270	210	360	103	71	90	-	-
CP6524ST	-	VERSOIO A STRISCIE PER CORPO MEDIO SX	765	270	210	360	103	71	90	-	-
RC1014	073250	AVANVERSOIO DX	-	-	-	-	-	-	-	-	KVERNELAND
RC1014S	073251	AVANVERSOIO SX	-	-	-	-	-	-	-	-	KVERNELAND
RC0983	053090	PUNTA REVERSIBILE DX	-	-	-	-	-	-	-	-	KVERNELAND
RC0983S	063090	PUNTA REVERSIBILE SX	-	-	-	-	-	-	-	-	KVERNELAND
RC1001	073002	VOMERE 14" DX	-	-	-	-	-	-	-	-	KVERNELAND
RC1001S	073003	VOMERE 14" SX	-	-	-	-	-	-	-	-	KVERNELAND
RC1007	073608	STRISCIANTE DX-SX	-	-	-	-	-	-	-	-	KVERNELAND

CORPI PER ARATRO ADATTABILI ALLA PRODUZIONE KVERNELAND

CORPS POUR CHARRUES ADAPTABLES A LA PRODUCTION KVERNELAND

PLOUGH CORES SUITABLE TO KVERNELAND

PFLUGKOEPPER PASSEND ZU KVERNELAND

CUERPOS DE ARADO ADAPTABLES A LA PRODUCCION KVERNELAND

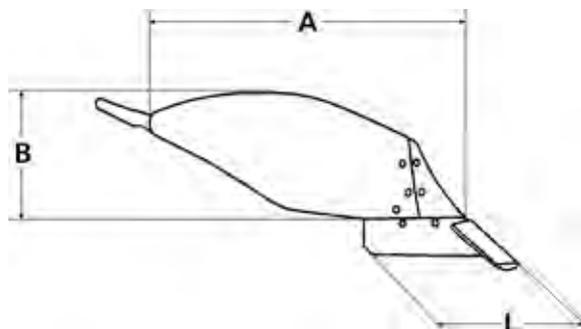

Art./Ref.	Titolo Prodotto/Titolo Prodotto	A mm	B mm	L mm	Note/Note
RC1030	CORPO ANTERIORE DX	1260	330	530	CORPO N.8
RC1031	CORPO ANTERIORE SX	1260	330	530	CORPO N.8
RC1030P	CORPO POSTERIORE DX	1260	330	530	CORPO N.8
RC1031P	CORPO POSTERIORE SX	1260	330	530	CORPO N.8
RC1995	CORPO ANTERIORE DX	1370	440	610	CORPO N.28
RC1996	CORPO ANTERIORE SX	1370	440	610	CORPO N.28
RC1995P	CORPO POSTERIORE DX	1370	440	610	CORPO N.28
RC1996P	CORPO POSTERIORE SX	1370	440	610	CORPO N.28

CORPI PER ARATRO ADATTABILI ALLA PRODUZIONE LEMKEN BS40

CORPS POUR CHARRUES ADAPTABLES A LA PRODUCTION LEMKEN BS40

PLOUGH CORES SUITABLE TO LEMKEN BS40

PFLUGKOEPPER PASSEND ZU LEMKEN BS40

CUERPOS DE ARADO ADAPTABLES A LA PRODUCCION LEMKEN BS40

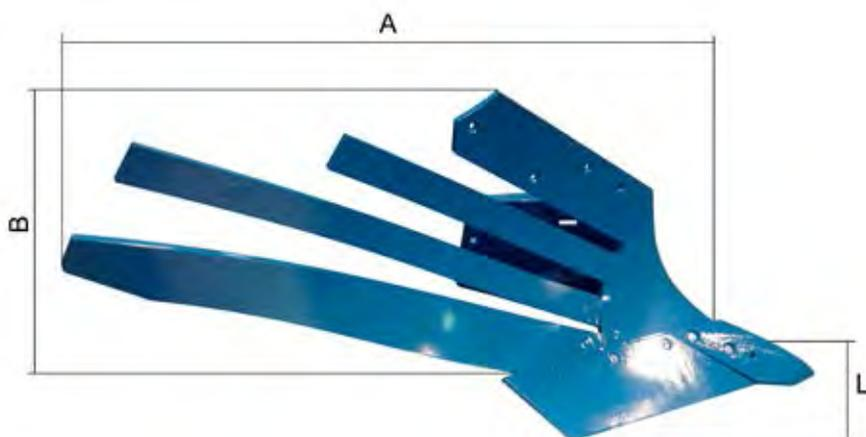

Art./Ref.	Titolo Prodotto/Titolo Prodotto	A mm	B mm	L mm
RC1924	CORPO DX	1260	460	430
RC1933	CORPO SX	1260	460	430

CORPI PER ARATRO ADATTABILI ALLA PRODUZIONE OTMA U13

CORPS POUR CHARRUES ADAPTABLES A LA PRODUCTION OTMA U13

PLOUGH CORES SUITABLE TO OTMA U13

PFLUGKOERPER PASSEND ZU OTMA U13

CUERPOS DE ARADO ADAPTABLES A LA PRODUCCION OTMA U13

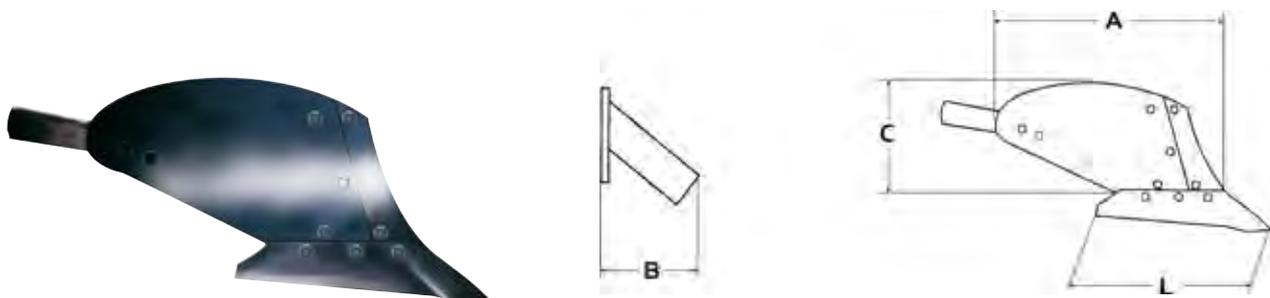

Art./Ref.	Titolo Prodotto/Titolo Prodotto	A mm	B mm	C mm	L mm
RC0967	CORPO ANTERIORE DX	850	380	350	560
RC0968	CORPO ANTERIORE SX	850	380	350	560
RC1040	CORPO POSTERIORE DX	850	380	350	560
RC1041	CORPO POSTERIORE SX	850	380	350	560

CORPI PER ARATRO ADATTABILI ALLA PRODUZIONE OTMA U15

CORPS POUR CHARRUES ADAPTABLES A LA PRODUCTION OTMA U15

PLOUGH CORES SUITABLE TO OTMA U15

PFLUGKOERPER PASSEND ZU OTMA U15

CUERPOS DE ARADO ADAPTABLES A LA PRODUCCION OTMA U15

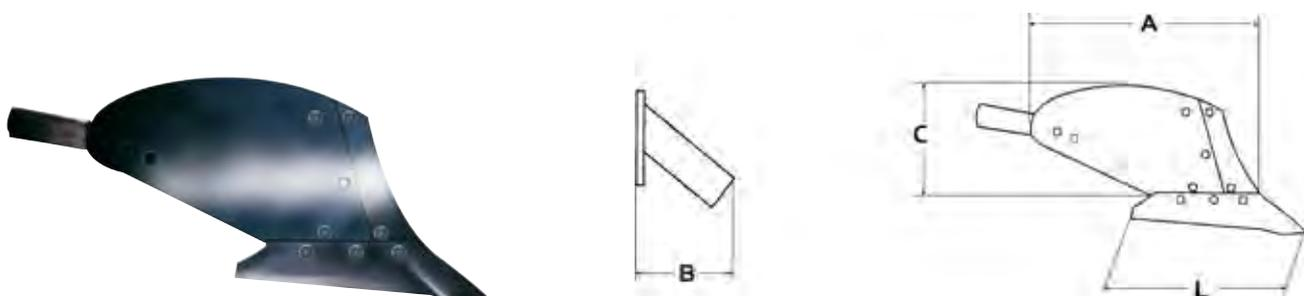

Art./Ref.	Titolo Prodotto/Titolo Prodotto	A mm	B mm	C mm	L mm
RC0965	CORPO ANTERIORE DX	890	400	380	600
RC0966	CORPO ANTERIORE SX	890	400	380	600
RC1042	CORPO POSTERIORE DX	890	400	380	600
RC1043	CORPO POSTERIORE SX	890	400	380	600

CORPI PER ARATRO ADATTABILI ALLA PRODUZIONE NARDI

CORPS POUR CHARRUE ADAPTABLES A LA PRODUCTION NARDI

PLOUGH CORES SUITABLE TO NARDI

PFLUGKOEPPER PASSEND ZU NARDI

CUERPOS DE ARADO ADAPTABLES A LA PRODUCCION NARDI

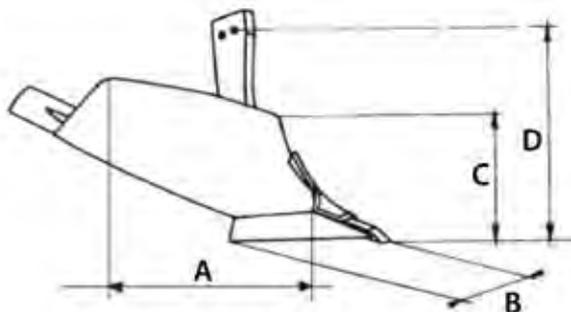

Art./Ref.	Rif. Orig./Orig. Ref.	Titolo Prodotto/Titolo Prodotto	A mm	B mm	C mm	D mm	Peso Kg/Weight Kg	Note/Note	Brand
CP3166A	3C ANT. DX	CORPO DX	500	445	290	475	35	CON GAMBO	NARDI
CP3170A	3C ANT. DX	CORPO DX	500	445	290	475	22	SENZA GAMBO	NARDI
CP3167A	3C POST. DX	CORPO DX	500	445	290	475	35	CON GAMBO	NARDI
CP3171A	3C POST. DX	CORPO DX	500	445	290	475	22	SENZA GAMBO	NARDI
CP3168A	3C ANT. SX	CORPO SX	500	445	290	475	35	CON GAMBO	NARDI
CP3172A	3C ANT. SX	CORPO SX	500	445	290	475	22	SENZA GAMBO	NARDI
CP3169A	3C POST. SX	CORPO SX	500	445	290	475	35	CON GAMBO	NARDI
CP3173A	3C POST. SX	CORPO SX	500	445	290	475	22	SENZA GAMBO	NARDI
CP3116A	5C ANT. DX	CORPO DX	650	475	335	610	59	CON GAMBO	NARDI
CP3120A	5C ANT. DX	CORPO DX	650	475	335	610	43	SENZA GAMBO	NARDI
CP3117A	5C POST. DX	CORPO DX	650	475	335	610	59	CON GAMBO	NARDI
CP3121A	5C POST. DX	CORPO DX	650	475	335	610	43	SENZA GAMBO	NARDI
CP3118A	5C ANT. SX	CORPO SX	650	475	335	610	59	CON GAMBO	NARDI
CP3122A	5C ANT. SX	CORPO SX	650	475	335	610	43	SENZA GAMBO	NARDI
CP3119A	5C POST. SX	CORPO SX	650	475	335	610	59	CON GAMBO	NARDI
CP3123A	5C POST. SX	CORPO SX	650	475	335	610	43	SENZA GAMBO	NARDI
CP1162A	00 BT ANT. DX	CORPO DX	790	500	350	600	79	CON GAMBO	NARDI
CP3100A	00 BT ANT. DX	CORPO DX	790	500	350	600	54	SENZA GAMBO	NARDI
CP1162ASX	00 BT ANT. SX	CORPO SX	790	500	350	600	79	CON GAMBO	NARDI
CP3101A	00 BT ANT. SX	CORPO SX.	790	500	350	600	54	SENZA GAMBO	NARDI
CP1162P	00 BT POST. DX	CORPO DX	790	500	350	600	83	CON GAMBO	NARDI
CP3102A	00 BT POST. DX	CORPO DX.	790	500	350	600	57	SENZA GAMBO	NARDI
CP1162PSX	00 BT POST. SX	CORPO SX	790	500	350	600	83	CON GAMBO	NARDI
CP3103A	00 BT POST. SX	CORPO SX	790	500	350	600	57	SENZA GAMBO	NARDI
CP1163A	0 BTF ANT. DX	CORPO DX	860	530	350	660	93	CON GAMBO	NARDI
CP3104A	0 BTF ANT. DX	CORPO DX	860	530	350	660	66	SENZA GAMBO	NARDI
CP1163ASX	0 BTF ANT. SX	CORPO SX	860	530	350	660	93	CON GAMBO	NARDI
CP3105A	0 BTF ANT. SX	CORPO SX	860	530	350	660	66	SENZA GAMBO	NARDI
CP1163P	0 BTF POST. DX	CORPO DX	860	530	350	660	96	CON GAMBO	NARDI
CP3106A	0 BTF POST. DX	CORPO DX	860	530	350	660	69	SENZA GAMBO	NARDI
CP1163PSX	0 BTF POST. SX	CORPO SX	860	530	350	660	96	CON GAMBO	NARDI
CP3107A	0 BTF POST. SX	CORPO SX	860	530	350	660	69	SENZA GAMBO	NARDI
CP1164A	0 BTR ANT. DX	CORPO DX	880	530	370	675	100	CON GAMBO	NARDI
CP3108A	0 BTR ANT. DX	CORPO DX	880	530	370	675	72	SENZA GAMBO	NARDI
CP1164ASX	0 BTR ANT. SX	CORPO SX	880	530	370	675	100	CON GAMBO	NARDI
CP3109A	0 BTR ANT. SX	CORPO SX	880	530	370	675	72	SENZA GAMBO	NARDI
CP1164P	0 BTR POST. DX	CORPO DX	880	530	370	675	104	CON GAMBO	NARDI
CP3110A	0 BTR POST. DX	CORPO DX	880	530	370	675	76	SENZA GAMBO	NARDI
CP1164PSX	0 BTR POST. SX	CORPO SX	880	530	370	675	104	CON GAMBO	NARDI
CP3111A	0 BTR POST. SX	CORPO SX	880	530	370	675	76	SENZA GAMBO	NARDI
CP1165A	1 BT ANT. DX	CORPO DX	1000	580	420	740	128	CON GAMBO	NARDI

Art./Ref.	Rif. Orig./Orig. Ref.	Titolo Prodotto/Titolo Prodotto	A mm	B mm	C mm	D mm	Peso Kg/Weight Kg	Note/Note	Brand
CP3112A	1 BT ANT. DX	CORPO DX	1000	580	420	740	90	SENZA GAMBO	NARDI
CP1165ASX	1 BT ANT. SX	CORPO SX	1000	580	420	740	128	CON GAMBO	NARDI
CP3113A	1 BT ANT. SX	CORPO SX	1000	580	420	740	90	SENZA GAMBO/	NARDI
CP1165P	1 BT POST. DX	CORPO DX	1000	580	420	740	133	CON GAMBO	NARDI
CP3114A	1 BT POST. DX	CORPO DX	1000	580	420	740	95	SENZA GAMBO	NARDI
CP1165PSX	1 BT POST. SX	CORPO SX	1000	580	420	740	133	CON GAMBO	NARDI
CP3115A	1 BT POST. SX	CORPO SX	1000	580	420	740	95	SENZA GAMBO	NARDI

CORPO CENTRALE PER VIGNETO ADATTABILE A NARDI HRR33

CORPS CENTRAL POUR VIGNERON ADAPTABLE A NARDI HRR33

VINEYARD MAIN BODY SUITABLE TO NARDI HRR33

ZENTRALKOERPER FUEER WEINGELAENDE PASSEND ZU NARDI HRR33

CUERPO CENTRAL DE VINEDO ADAPTABLE A NARDI HRR33



Art./Ref.	Titolo Prodotto/Titolo Prodotto	Note/Note
CP3154	ASSOLCATORE CENTRALE HRR33	Gambo 80x25. Apertura massima fra le due ali mm.545

CORPO LATERALE PER VIGNETO ADATTABILE A NARDI HRR33

CORPS LATERAL POUR VIGNERON ADAPTABLE A NARDI HRR33

VINEYARD SIDE BODY SUITABLE TO NARDI HRR33

SEITENKOERPER FUEER WEINGELAENDE PASSEND ZU NARDI HRR33

CUERPO LATERAL DE VINEDO ADAPTABLE A NARDI HRR33

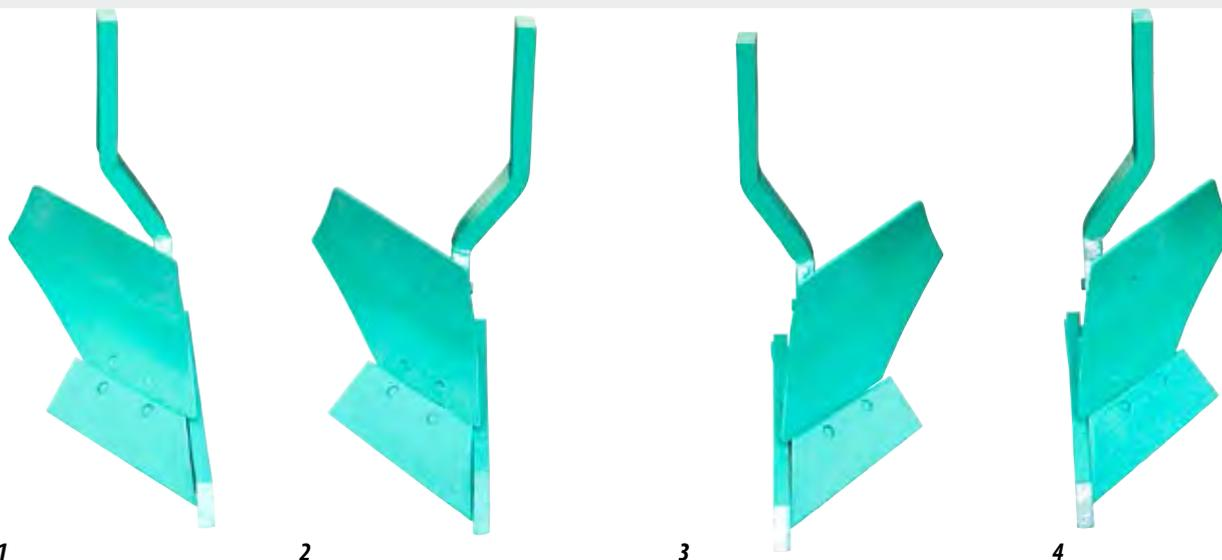

Art./Ref.	Titolo Prodotto/Titolo Prodotto	Tipo/Type	Note/Note
CP3152	CORPO LATERALE DX CON GAMBO DX HRR33	1	GAMBO 80x30
CP3152A	CORPO LATERALE DX CON GAMBO SX HRR33X	2	GAMBO 80x30
CP3153	CORPO LATERALE SX CON GAMBO DX HRR33	3	GAMBO 80x30
CP3153A	CORPO LATERALE SX CON GAMBO SX HRR33	4	GAMBO 80x30

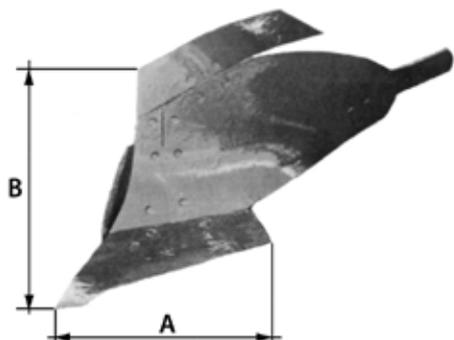
CORPI PER ARATRO ADATTABILI ALLA PRODUZIONE RABEWERK
CORPS POUR CHARRUES ADAPTABLES A LA PRODUCTION RABEWERK
PLOUGH CORES SUITABLE TO RABEWERK
PFLUGKOEPPER PASSEND ZU RABERWERK
CUERPOS DE ARADO ADAPTABLES A LA PRODUCCION RABEWERK

Art./Ref.	Rif. Orig./Orig. Ref.	Titolo Prodotto/Titolo Prodotto	A mm	B mm	Peso Kg/Weight Kg	Note/Note	Brand
CP1174	40/A DX	CORPO ANTERIORE DX	605	500	85	SENZA GAMBO	RABEWERK
CP1175	40/A SX	CORPO ANTERIORE SX	605	500	85	SENZA GAMBO	RABEWERK
CP1176	40/P DX	CORPO POSTERIORE DX	605	500	87	SENZA GAMBO	RABEWERK
CP1177	40/P SX	CORPO POSTERIORE SX	605	500	87	SENZA GAMBO	RABEWERK

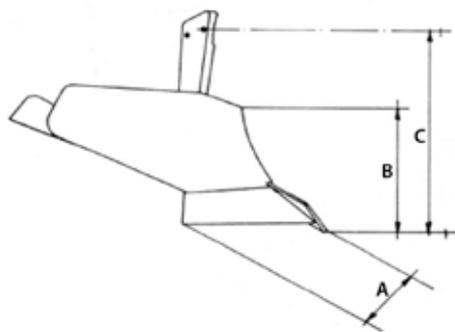
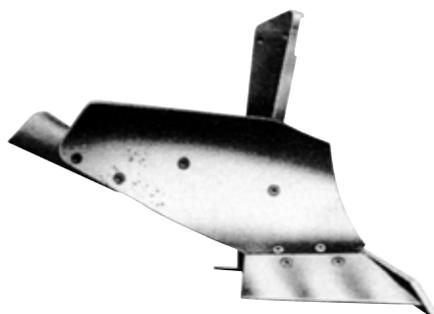
CORPI PER ARATRO ADATTABILI ALLA PRODUZIONE SOGEMA SCALPELLO ESTERNO
CORPS POUR CHARRUE ADAPTABLES A LA PRODUCTION SOGEMA TREPAN EXTERNE
PLOUGH CORE WITH EXTERNAL CHISEL SUITABLE TO SOGEMA
PFLUGKOEPPER PASSEND ZU SOGEMA AUSSEN MEISSEL
CUERPOS DE ARADO ADAPTABLES A LA PRODUCCION SOGEMA ESCOPLIO EXTERIOR

Art./Ref.	Rif. Orig./Orig. Ref.	Titolo Prodotto/Titolo Prodotto	A mm	B mm	C mm	Peso Kg/Weight Kg	Note/Note	Brand
CP1060	M 18/A DX	CORPO DX	200	200	450	39	CON GAMBO	SOGEMA
CP1060SG	M 18/A DX	CORPO DX	200	200	450	23	SENZA GAMBO	SOGEMA
CP1061	M 18/A SX	CORPO SX	200	200	450	39	CON GAMBO	SOGEMA
CP1061SG	M 18/A SX	CORPO SX	200	200	450	23	SENZA GAMBO	SOGEMA
CP1062	M 18/P DX	CORPO DX	200	200	450	40	CON GAMBO	SOGEMA
CP1062SG	M 18/P DX	CORPO DX	200	200	450	24	SENZA GAMBO	SOGEMA
CP1063	M 18/P SX	CORPO SX	200	200	450	40	CON GAMBO	SOGEMA
CP1063SG	M 18/P SX	CORPO SX	200	200	450	24	SENZA GAMBO	SOGEMA
CP1064	M 20/LA DX	CORPO DX	250	250	510	39.5	CON GAMBO	SOGEMA
CP1064SG	M 20/LA DX	CORPO DX	250	250	510	23.5	SENZA GAMBO	SOGEMA
CP1065	M 20/LA SX	CORPO SX	250	250	510	39.5	CON GAMBO	SOGEMA
CP1065SG	M 20/LA SX	CORPO SX	250	250	510	23.5	SENZA GAMBO	SOGEMA
CP1066	M 20/LP DX	CORPO DX	250	250	510	40.5	CON GAMBO	SOGEMA
CP1066SG	M 20/LP DX	CORPO DX	250	250	510	24.5	SENZA GAMBO	SOGEMA
CP1067	M 20/LP SX	CORPO SX	250	250	510	40.5	CON GAMBO	SOGEMA
CP1067SG	M 20/LP SX	CORPO SX	250	250	510	24.5	SENZA GAMBO	SOGEMA

CORPI PER ARATRO ADATTABILI ALLA PRODUZIONE SOGEMA SCALPELLO INTERNO

CORPS POUR CHARRUE ADAPTABLES A LA PRODUCTION SOGEMA TREPAN INTERNE

PLOUGH CORES WITH INTERNAL CHISEL SUITABLE TO SOGEMA

PFLUGKÖRPER PASSEND ZU SOGEMA INNEN MEISSEL

CUERPOS DE ARADO ADAPTABLES A LA PRODUCCION SOGEMA ESCOPLIO INTERIOR

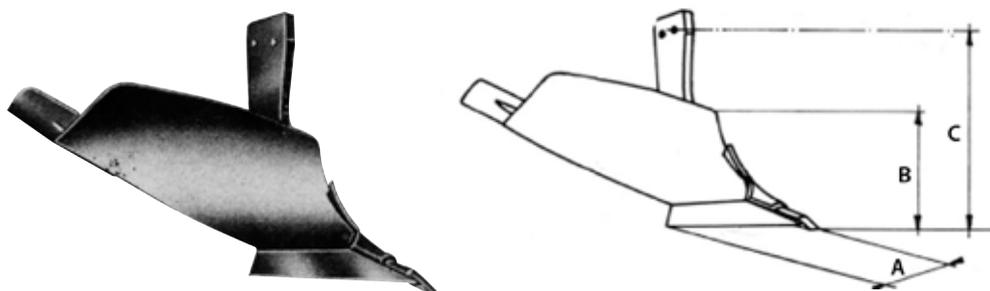

Art./Ref.	Rif. Orig./Orig. Ref.	Titolo Prodotto/Titolo Prodotto	A mm	B mm	C mm	Peso Kg/Weight Kg	Note/Note	Brand
CP1070	M 20/A	CORPO DX	250	250	540	56	CON GAMBO	SOGEMA
CP1070SG	M 20/A	CORPO DX	250	250	540	32.5	SENZA GAMBO	SOGEMA
CP1071	M 20/P	CORPO DX	250	250	540	59	CON GAMBO	SOGEMA
CP1071SG	M 20/P	CORPO DX	250	250	540	35.5	SENZA GAMBO	SOGEMA
CP1072	M 25/A	CORPO DX	280	280	540	60	CON GAMBO	SOGEMA
CP1072SG	M 25/A	CORPO DX	280	280	540	36.5	SENZA GAMBO	SOGEMA
CP1073	M 25/P	CORPO DX	280	280	540	61.5	CON GAMBO	SOGEMA
CP1073SG	M 25/P	CORPO DX	280	280	540	38	SENZA GAMBO	SOGEMA
CP1074	M 28/A	CORPO DX	300	300	560	59	CON GAMBO	SOGEMA
CP1074SG	M 28/A	CORPO DX	300	300	560	35.5	SENZA GAMBO	SOGEMA
CP1075	M 28/P	CORPO DX	300	300	560	62	CON GAMBO	SOGEMA
CP1075SG	M 28/P	CORPO DX	300	300	560	38.5	SENZA GAMBO	SOGEMA
CP1076	M 30/A DX	CORPO DX	330	330	600	70	CON GAMBO	SOGEMA
CP1076SG	M 30/A DX	CORPO DX	330	330	600	46.5	SENZA GAMBO	SOGEMA
CP1077	M 30/A SX	CORPO SX	330	330	600	70	CON GAMBO	SOGEMA
CP1077SG	M 30/A SX	CORPO SX	330	330	600	46.5	SENZA GAMBO	SOGEMA
CP1078	M 30/P DX	CORPO DX	330	330	600	75	CON GAMBO	SOGEMA
CP1078SG	M 30/P DX	CORPO DX	330	330	600	51.5	SENZA GAMBO	SOGEMA
CP1079	M 30/P SX	CORPO SX	330	330	600	75	CON GAMBO	SOGEMA
CP1079SG	M 30/P SX	CORPO SX	330	330	600	51.5	SENZA GAMBO	SOGEMA
CP1080	M 32/A DX	CORPO DX	350	350	625	78	CON GAMBO	SOGEMA
CP1080SG	M 32/A DX	CORPO DX	350	350	625	50	SENZA GAMBO	SOGEMA
CP1081	M 32/A SX	CORPO SX	350	350	625	78	CON GAMBO	SOGEMA
CP1081SG	M 32/A SX	CORPO SX	350	350	625	50	SENZA GAMBO	SOGEMA
CP1082	M 32/P DX	CORPO DX	350	350	625	83	CON GAMBO	SOGEMA
CP1082SG	M 32/P DX	CORPO DX	350	350	625	55	SENZA GAMBO	SOGEMA
CP1083	M 32/P SX	CORPO SX	350	350	625	83	CON GAMBO	SOGEMA
CP1083SG	M 32/P SX	CORPO SX	350	350	625	55	SENZA GAMBO	SOGEMA
CP1084	M 35/A DX	CORPO DX	380	380	650	83.5	CON GAMBO	SOGEMA
CP1084SG	M 35/A DX	CORPO DX	380	380	650	55.5	SENZA GAMBO	SOGEMA
CP1085	M 35/A SX	CORPO SX	380	380	650	83.5	CON GAMBO	SOGEMA
CP1085SG	M 35/A SX	CORPO SX	380	380	650	55.5	SENZA GAMBO	SOGEMA
CP1086	M 35/P DX	CORPO DX	380	380	650	85	CON GAMBO	SOGEMA
CP1086SG	M 35/P DX	CORPO DX	380	380	650	57	SENZA GAMBO	SOGEMA
CP1087	M 35/P SX	CORPO SX	380	380	650	85	CON GAMBO	SOGEMA
CP1087SG	M 35/P SX	CORPO SX	380	380	650	57	SENZA GAMBO	SOGEMA
CP1088	M 38/A DX	CORPO DX	400	410	660	103	CON GAMBO	SOGEMA
CP1088SG	M 38/A DX	CORPO DX	400	410	660	71	SENZA GAMBO	SOGEMA
CP1089	M 38/A SX	CORPO SX	400	410	660	103	CON GAMBO	SOGEMA
CP1089SG	M 38/A SX	CORPO SX	400	410	660	71	SENZA GAMBO	SOGEMA
CP1090	M 38/P DX	CORPO DX	400	410	660	110	CON GAMBO	SOGEMA
CP1090SG	M 38/P DX	CORPO DX	400	410	660	78	SENZA GAMBO	SOGEMA
CP1091	M 38/P SX	CORPO SX	400	410	660	110	CON GAMBO	SOGEMA
CP1091SG	M 38/P SX	CORPO SX	400	410	660	78	SENZA GAMBO	SOGEMA

Art./Ref.	Rif. Orig./Orig. Ref.	Titolo Prodotto/Titolo Prodotto	A mm	B mm	C mm	Peso Kg/Weight Kg	Note/Note	Brand
CP1092	M 40/A DX	CORPO DX	430	430	680	111	CON GAMBO	SOGEMA
CP1092SG	M 40/A DX	CORPO DX	430	430	680	76	SENZA GAMBO	SOGEMA
CP1093	M 40/A SX	CORPO SX	430	430	680	111	CON GAMBO	SOGEMA
CP1093SG	M 40/A SX	CORPO SX	430	430	680	76	SENZA GAMBO	SOGEMA
CP1094	M 40/P DX	CORPO DX	430	430	680	119	CON GAMBO	SOGEMA
CP1094SG	M 40/P DX	CORPO DX	430	430	680	84	SENZA GAMBO	SOGEMA
CP1095	M 40/P SX	CORPO SX	430	430	680	119	CON GAMBO	SOGEMA
CP1095SG	M 40/P SX	CORPO SX	430	430	680	84	SENZA GAMBO	SOGEMA
CP1096	M 42/A DX	CORPO DX	450	460	710	154	CON GAMBO	SOGEMA
CP1096SG	M 42/A DX	CORPO DX	450	460	710	102	SENZA GAMBO	SOGEMA
CP1097	M 42/A SX	CORPO SX	450	460	710	154	CON GAMBO	SOGEMA
CP1097SG	M 42/A SX	CORPO SX	450	460	710	102	SENZA GAMBO	SOGEMA
CP1098	M 42/P DX	CORPO DX	450	460	710	166	CON GAMBO	SOGEMA
CP1098SG	M 42/P DX	CORPO DX	450	460	710	114	SENZA GAMBO	SOGEMA
CP1099	M 42/P SX	CORPO SX	450	460	710	166	CON GAMBO	SOGEMA
CP1099SG	M 42/P SX	CORPO SX	450	460	710	114	SENZA GAMBO	SOGEMA
CP1100	M 44/A DX	CORPO DX	500	500	760	156	CON GAMBO	SOGEMA
CP1100SG	M 44/A DX	CORPO DX	500	500	760	104	SENZA GAMBO	SOGEMA
CP1101	M 44/A SX	CORPO SX	500	500	760	156	CON GAMBO	SOGEMA
CP1101SG	M 44/A SX	CORPO SX	500	500	760	104	SENZA GAMBO	SOGEMA
CP1102	M 44/P DX	CORPO DX	500	500	760	167	CON GAMBO	SOGEMA
CP1102SG	M 44/P DX	CORPO DX	500	500	760	115	SENZA GAMBO	SOGEMA
CP1103	M 44/P SX	CORPO SX	500	500	760	167	CON GAMBO	SOGEMA
CP1103SG	M 44/P SX	CORPO SX	500	500	760	115	SENZA GAMBO	SOGEMA
CP1104	M 46/A DX	CORPO DX	540	550	800	160.5	CON GAMBO	SOGEMA
CP1104SG	M 46/A DX	CORPO DX	540	550	800	108.5	SENZA GAMBO	SOGEMA
CP1105	M 46/A SX	CORPO SX	540	550	800	160.5	CON GAMBO	SOGEMA
CP1105SG	M 46/A SX	CORPO SX	540	550	800	108.5	SENZA GAMBO	SOGEMA
CP1106	M 46/P DX	CORPO DX	540	550	800	171	CON GAMBO	SOGEMA
CP1106SG	M 46/P DX	CORPO DX	540	550	800	119	SENZA GAMBO	SOGEMA
CP1107	M 46/P SX	CORPO SX	540	550	800	171	CON GAMBO	SOGEMA
CP1107SG	M 46/P SX	CORPO SX	540	550	800	119	SENZA GAMBO	SOGEMA
CP1108	M 50/A DX	CORPO DX	590	600	840	210	CON GAMBO	SOGEMA
CP1108SG	M 50/A DX	CORPO DX	590	600	840	142	SENZA GAMBO	SOGEMA
CP1109	M 50/A SX	CORPO SX	590	600	840	210	CON GAMBO	SOGEMA
CP1109SG	M 50/A SX	CORPO SX	590	600	840	142	SENZA GAMBO	SOGEMA
CP1110	M 50/P DX	CORPO DX	590	600	840	221	CON GAMBO	SOGEMA
CP1110SG	M 50/P DX	CORPO DX	590	600	840	153	SENZA GAMBO	SOGEMA
CP1111	M 50/P SX	CORPO SX	590	600	840	221	CON GAMBO	SOGEMA
CP1111SG	M 50/P SX	CORPO SX	590	600	840	153	SENZA GAMBO	SOGEMA
CP1112	M 52/A DX	CORPO DX	640	650	870	222	CON GAMBO	SOGEMA
CP1112SG	M 52/A DX	CORPO DX	640	650	870	154	SENZA GAMBO	SOGEMA
CP1113	M 52/A SX	CORPO SX	640	650	870	222	CON GAMBO	SOGEMA
CP1113SG	M 52/A SX	CORPO SX	640	650	870	154	SENZA GAMBO	SOGEMA
CP1114	M 52/P DX	CORPO DX	640	650	870	240.5	CON GAMBO	SOGEMA
CP1114SG	M 52/P DX	CORPO DX	640	650	870	172.5	SENZA GAMBO	SOGEMA
CP1115	M 52/P SX	CORPO SX	640	650	870	240.5	CON GAMBO	SOGEMA
CP1115SG	M 52/P SX	CORPO SX	640	650	870	172.5	SENZA GAMBO	SOGEMA
CP1116	M 54/A DX	CORPO DX	690	700	910	227	CON GAMBO	SOGEMA
CP1116SG	M 54/A DX	CORPO DX	690	700	910	159	SENZA GAMBO	SOGEMA
CP1117	M 54/A SX	CORPO SX	690	700	910	227	CON GAMBO	SOGEMA
CP1118	M 54/P DX	CORPO DX	690	700	910	245.5	CON GAMBO	SOGEMA
CP1119	M 54/P SX	CORPO SX	690	700	910	245.5	CON GAMBO	SOGEMA

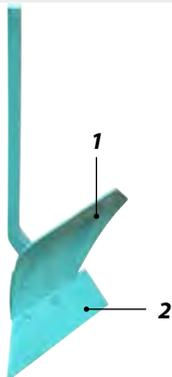
AVANVOMERE A VERSOIO E RICAMBI
RASETTE A VERSOIR ET RECHANGES
MOULBOARDED SKIM COULTER AND SPARE PARTS
STREICHBLECH SCHARVORDERTEIL UND ZUBEHOERTEILE
VERTEDERA A OREJA Y RECAMBIOS

Art./Ref.	Rif. Orig./Orig. Ref.	Titolo Prodotto/Titolo Prodotto	Tipo/Type	Brand
CP1556	-	AVANVOMERE A VERSOIO COMPLETO 50X25 DX	-	-
CP1557	-	AVANVOMERE A VERSOIO COMPLETO 50X25 SX	-	-
CP1558	-	AVANVOMERE A VERSOIO COMPLETO 60X30 DX	-	-
CP1559	-	AVANVOMERE A VERSOIO COMPLETO 60X30 SX	-	-
RC0300A	1C43A	VOMERE DX	2	NARDI
RC0301B	1CS43A	VOMERE SX	2	NARDI
RC0457	2C179	VERSOIO DX	1	NARDI
RC0457S	2CS179	VERSOIO SX	1	NARDI

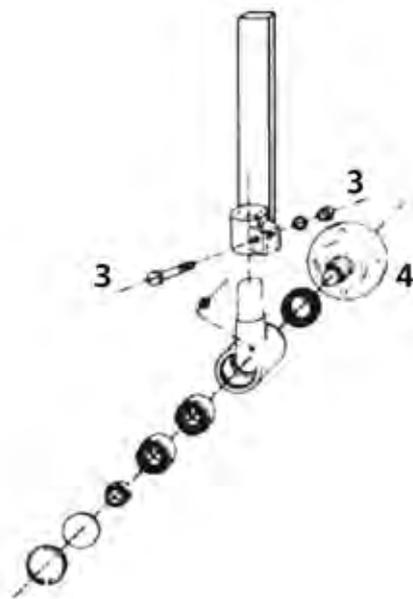
AVANVOMERI BOMBATI COMPLETI DI DISCO
RASETTE BOMBÉ À DISQUE
DISK SKIM COULTER
SCHEIBE MESSER
RASSETAS COMBADAS A PLATO

Art./Ref.	Titolo Prodotto/Titolo Prodotto	Peso Kg/Weight Kg	Tipo/Type
CP1030	AVANVOMERE COMPLETO CON DISCO @310 E BRACCIO 50X30	17	-
CP1031	AVANVOMERE COMPLETO CON DISCO @360 E BRACCIO 50X30	18	-
CP1031A	AVANVOMERE COMPLETO CON DISCO @360 E BRACCIO 60X30	19	-
CP1032	AVANVOMERE COMPLETO CON DISCO @410 E BRACCIO 60X30	20	-
SAR6181	BRACCIO PER AVANVOMERE 50X30	-	1
SAR6182	BRACCIO PER AVANVOMERE 60X30	-	1
SAR6180	MOZZO COMPLETO PER AVANVOMERE	-	2
RC0730	BULLONE T.E. 14X70X1.5	-	3
SAR6179	FLANGIA CON PERNO PER MOZZO AVANVOMERE	-	4

DISCHI PER AVANVOMERE A RICAMBIO
DISQUES POUR RASETTE
SKIM CULTER DISCS
SCHEIBEN FÜR VORPFLUG MESSER
PLATOS PARA RASETA

Art./Ref.	Titolo Prodotto/ Titolo Prodotto	Diametro mm/ Diameter mm	Spessore mm/ Thickness mm	Peso Kg/ Weight Kg	Note/Note
CP1540	DISCO AVANVOMERE	310	4.5	2.8	Concavità mm 23. Foro centrale mm 26. N.4 fori da 13 mm,interasse fori 115 mm.
CP1541	DISCO AVANVOMERE	360	4.5	3.7	Concavità mm 31. Foro centrale mm 26. N.4 fori da 13 mm,interasse fori 115 mm.
CP1542	DISCO AVANVOMERE	410	6	6.1	Concavità mm 39. Foro centrale mm 26. N.4 fori da 13 mm,interasse fori 115 mm.

AVANVOMERE DA MAIS
RASETTE POUR MAIS
MAIS SKIM COULTER
SCHAR VORDERTEIL
VERTEDERA PARA MAIZ

Art./Ref.	Titolo Prodotto/Titolo Prodotto
CP1162	AVANVOMERE COMPLETO MAIS 60X20 DX
CP1162S	AVANVOMERE COMPLETO MAIS 60X20 SX

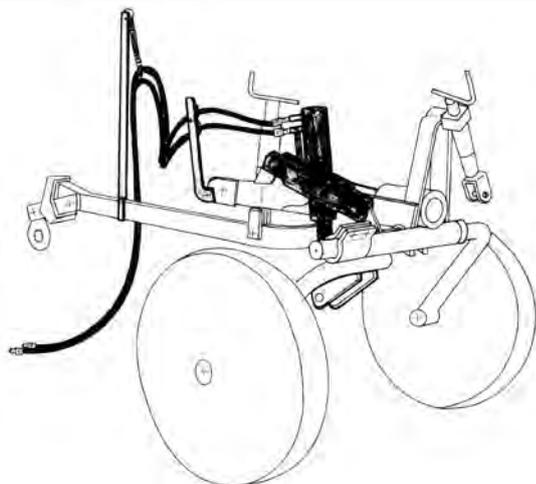
TRASFORMAZIONI DA MECCANICO A IDRAULICO PER ARATRI ADATTABILI A NARDI E SOGEMA
TRANSFORMATION DE MECHANIQUE A HIDRAULIQUE POUR CHARRUES ADAPTABLES A NARDI ET SOGEMA
MECHANICAL / HYDRAULIC TRANSFORMATIONS FOR PLOUGH SUITABLES TO NARDI AND SOGEMA
SATZ FUER HYDRULISCHE AUSRUESTUNG VON PFLUGKOERPER PASSEND ZU NARDI UND SOGEMA
TRANSFORMACION DE MECANICO A HIDRAULICO PARA ARADOS ADAPTABLES A NARDI Y SOGEMA

Note: Tutti i prodotti presenti in tabella vengono forniti non verniciati.

Notes: All products in the table are supplied unpainted.

Art./Ref.	Titolo Prodotto/Titolo Prodotto	Note/Note
CP1910	MODIFICA ARATRO C 28	ADATTABILE SOGEMA COMPLETA DI TUBI,PISTONE,PIASTRE E PERNO
CP1911	MODIFICA ARATRO C 32	ADATTABILE SOGEMA COMPLETA DI TUBI,PISTONE,PIASTRE E PERNO
CP1912	MODIFICA ARATRO C 35	ADATTABILE SOGEMA COMPLETA DI TUBI,PISTONE,PIASTRE E PERNO
CP1913	MODIFICA ARATRO CU 35-40	ADATTABILE SOGEMA COMPLETA DI TUBI,PISTONE,PIASTRE E PERNO
CP1914	MODIFICA ARATRO CU 45-50	ADATTABILE SOGEMA COMPLETA DI TUBI,PISTONE,PIASTRE E PERNO
CP1915	MODIFICA ARATRO 00BT-0BT	ADATTABILE SOGEMA COMPLETA DI TUBI,PISTONE,PIASTRE E PERNO
CP1916	MODIFICA ARATRO 1 BT- 1 1/2 BT	ADATTABILE SOGEMA COMPLETA DI TUBI,PISTONE,PIASTRE E PERNO
CP1917	MODIFICA ARATRO 00AUG-0AUG	ADATTABILE SOGEMA COMPLETA DI TUBI,PISTONE,PIASTRE E PERNO
CP1918	MODIFICA ARATRO 1AUG-1 1/2 AUG	ADATTABILE SOGEMA COMPLETA DI TUBI,PISTONE,PIASTRE E PERNO
CP1920	PISTONE PER MODIFICA 0BT-0AUG	-
CP1921	PISTONE MODIFICA 1-1/2 BT-1AUG	-
CP1922	PISTONE MODIFICA C28 CU 35-40-45-50	-
CP1922A	PISTONE PER MODIFICA C 32-35	-
CP1923	TUBO PER MODIFICA SOGEMA-NARDI	LUNGHEZZA MT 3,5

MOLLE PER STELO CILINDRO
RESSORTS POUR TIGE VERIN
SPRING FOR CYLINDER ROD
FEDER FUER ZYLINDER-KOLBENSTANGE
MUELLES PARA VASTAGO CILINDRO



Note: Tutti i prodotti presenti in tabella vengono forniti non verniciati.

Notes: All products in the table are supplied unpainted.

Art./Ref.	Titolo Prodotto/Titolo Prodotto
CP1924	MOLLA PER STELO PISTONE Ø 35
CP1925	MOLLA PER STELO PISTONE Ø 40
CP1926	MOLLA PER STELO PISTONE Ø 45

LIMITATORI DI CORSA PER PISTONI
LIMITATEURS DE COURSE POUR PITONS
STROKE LIMITING DEVICE
HUB-BEGRENZER FUER ZYLINDER
LIMITADOR DE CARRERA PARA PISTONES

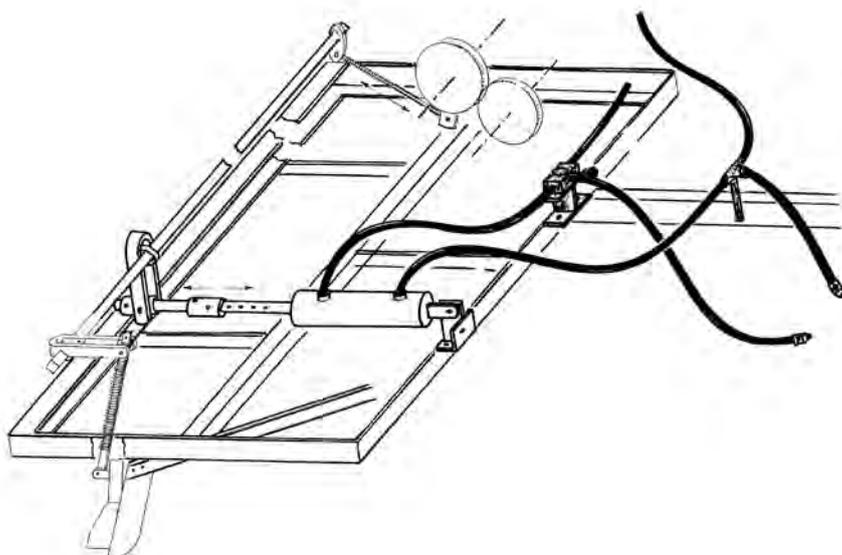
Art./Ref.	Titolo Prodotto/Titolo Prodotto	Spessore mm/Thickness mm
CP1900	DISTANZIALE STELO Ø 35 BASSO	17
CP1901	DISTANZIALE STELO Ø 35 ALTO	22
CP1902	DISTANZIALE STELO Ø 40 BASSO	19
CP1903	DISTANZIALE STELO Ø 40 ALTO	26
CP1904	DISTANZIALE STELO Ø 45 BASSO	18
CP1905	DISTANZIALE STELO Ø 45 ALTO	33

TRASFORMAZIONE DA MECCANICO AD IDRAULICO PER SEMINATRICE ADATTABILE A IMA LA ROCCA - SICMA - OMA ITALIA
TRANSFORMATION DE MECHANIQUE A HIDRAULIQUE POUR SEMOIRES ADAPTABLE A IMA LA ROCCA-SICMA ET OMA ITALIA
MECHANICAL / HYDRAULIC TRANSFORMATION FOR SOWING MACHINE SUITABLE TO IMA LA ROCCA-SICMA-OMA ITALIA
SATZ FUER HYDRULISCHE AUSRUESTUNG VON PFLUGKOERPER PASSEND ZU IMA LA ROCCA - SICMA - OMA ITALIA
TRANSFORMACION DE MECANICO A HIDRAULICO PARA ADAPTABLE A IMA LA ROCCA - SICMA - OMA ITALIA

Note: Tutti i prodotti presenti in tabella vengono forniti non verniciati.

Notes: All products in the table are supplied unpainted.

Art./Ref.	Titolo Prodotto/Titolo Prodotto	Note/Note
CP1930	MODIFICA IDRAULICA PER SEMINATRICE	COMPLETA DI DUE PISTONI CON BOCCOLE, TUBI IDRAULICI, DEVIATORE, STAFFA SUPPORTO TUBI, ATTACCO ANTERIORE E POSTERIORE PER PISTONI E BULLONERIA PER MONTAGGIO.

ALETTE, PUNTE E ACCESSORI PER CORPI ARANTI ADATTABILI ALLA PRODUZIONE LEMKEN
AILETTES, POINTES ET ACCESSOIRS POUR CORPS CHARRUES ADAPTABLES LEMKEN
TONGUES, DRILLS AND FITTINGS FOR PLOUGH-BODY SUIT TO LEMKEN PRODUCTION
MOLLBLECHVERLÄNGERUNG, SPITZEN UND ZUBEHÖR FÜR PFLUGKÖRPER PASSEND ZU LEMKEN
ALETAS, PUNTAS Y ACESORIOS PARA CUERPOS DE ARADO ADAPTABLE A LA PRODUCCION LEMKEN

4679105



3374398



3374395



3374394



3374399



3374412



3374413



3374416



3374417

 3374418
3374420

 3374419
3374421

3374424C



3374425C



3374388



3374392C



3374442

Art./Ref.	Rif. Orig./Orig. Ref.	Titolo Prodotto/Titolo Prodotto	Spessore mm/Thickness mm	Brand
RC1395	4679105	SUPPORTO	-	LEMKEN
RC1396	3374398	ALETTA DX	-	LEMKEN
RC1399	3374399	ALETTA SX	-	LEMKEN
RC1397	3374395	ALETTA	-	LEMKEN
RC1398	3374394	ALETTA	-	LEMKEN
RC1400	3374412	ALETTA DX	8 mm	LEMKEN
RC1401	3374413	ALETTA SX	8 mm	LEMKEN
RC1402	3374416	ALETTA DX	10 mm	LEMKEN
RC1403	3374417	ALETTA SX	10 mm	LEMKEN
RC1404	3374418	ALETTA DX	10 mm	LEMKEN
RC1405	3374419	ALETTA SX	10 mm	LEMKEN
RC1406	3374420	ALETTA DX	10 mm	LEMKEN
RC1407	3374421	ALETTA SX	10 mm	LEMKEN
RC1408	3374424C	ALETTA CON RIPORTO DI SALDATURA DX	8 mm	LEMKEN
RC1409	3374425C	ALETTA CON RIPORTO DI SALDATURA SX	8 mm	LEMKEN
RC1411	3374388	PUNTA	10 mm	LEMKEN
RC1411A	3374388	PUNTA	12 mm	LEMKEN
RC1412	3374392C	PUNTA CON RIPORTO DI SALDATURA	12 mm	LEMKEN
RC1969	3374442	PUNTA DI VOMERE MODELLO KARAT	10 mm	LEMKEN

PUNTA ADATTABILE ALLA PRODUZIONE LEMKEN

POINTE ADAPTABLE A LA PRODUCTION LEMKEN
 DRILL SUITABLE TO LEMKEN PRODUCTION
 SPITZE PASSEND ZU LEMKEN
 PUNTA ADAPTABELA A LA PRODUCCION LEMKEN



3374356

Art./Ref.	Rif. Orig./Orig. Ref.	Titolo Prodotto/Titolo Prodotto	Brand
RC1416	3374356	PUNTA	LEMKEN

ANCORA 60X25 ADATTABILE ALLA PRODUZIONE LEMKEN

ANCORE 60X25 ADAPTABLE A LA PRODUCTION LEMKEN
 TINE 60X25 SUITABLE TO LEMKEN PRODUCTION
 GRUBBERZINKE 60X25 PASSEND ZU LEMKEN
 BRAZO 60X25 ADAPTABLE A LA PRODUCCION LEMKEN

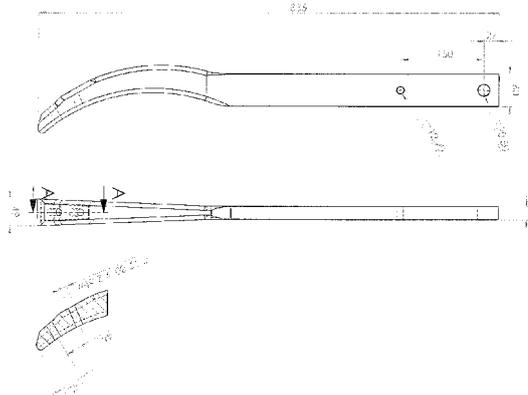

Art./Ref.	Titolo Prodotto/Titolo Prodotto	Note/Note
RC1519	ANCORA 60X25X835	N.2 fori per vomerina.

ANCORA 60X25 ADATTABILE ALLA PRODUZIONE LEMKEN

ANCORE 60X25 ADAPTABLE A LA PRODUCTION LEMKEN
 TINE 60X25 SUITABLE TO LEMKEN PRODUCTION
 GRUBBERZINKE 60X25 PASSEND ZU LEMKEN
 BRAZO 60X25 ADAPTABLE A LA PRODUCCION LEMKEN

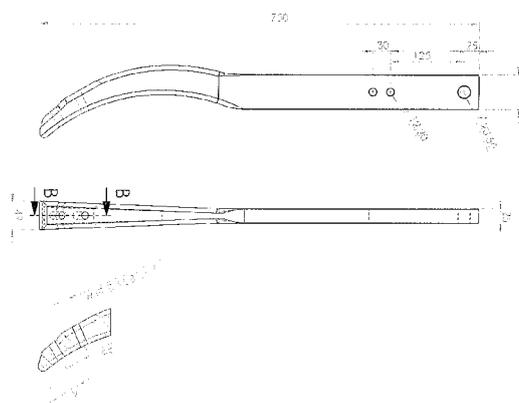

Art./Ref.	Titolo Prodotto/Titolo Prodotto	Note/Note
RC1519B	ANCORA 60X25X750	N.2 fori per vomerina.

ANCORA 40X16 ADATTABILE ALLA PRODUZIONE LEMKEN

ANCORE 40X16 ADAPTABLE A LA PRODUCTION LEMKEN

TINE 40X16 SUITABLE TO LEMKEN PRODUCTION

GRUBBERZINKE 40X16 PASSEND ZU LEMKEN

BRAZO 40X16 ADAPTABLE A LA PRODUCCION LEMKEN



Art./Ref.	Rif. Orig./Orig. Ref.	Titolo Prodotto/Titolo Prodotto	Note/Note	Brand
RC1519A	4653901	ANCORA 40X16X450	N.1 foro per vomerina.	LEMKEN

ANCORE 60X25 COMPLETE ADATTABILI ALLA PRODUZIONE LEMKEN

ANCORE 60X25 ADAPTABLE A LA PRODUCTION LEMKEN

TINE 60X25 SUITABLE TO LEMKEN PRODUCTION

GRUBBERZINKE 60X25 PASSEND ZU LEMKEN

BRAZO 60X25 ADAPTABLE A LA PRODUCCION LEMKEN



Art./Ref.	Titolo Prodotto/Titolo Prodotto
RC1855	ANCORA LEMKEN 60X25 COMPLETA 2 FORI

ANCORE 60X25 COMPLETE ADATTABILI ALLA PRODUZIONE LEMKEN

ANCORE 60X25 ADAPTABLE A LA PRODUCTION LEMKEN

TINE 60X25 SUITABLE TO LEMKEN PRODUCTION

GRUBBERZINKE 60X25 PASSEND ZU LEMKEN

BRAZO 60X25 ADAPTABLE A LA PRODUCCION LEMKEN



Art./Ref.	Titolo Prodotto/Titolo Prodotto
RC1855A	ANCORA LEMKEN 60X25 COMPLETA 3 FORI

ANCORA DECOMPATTATORE TIPO SARA MOD.1

DENT TYPE SARA MOD. 1

SUBSOIL LEG CURVED SARA STYLE N.1

DRILLSCHAR TYP SARA MOD. 1

ANCORA DECOMPACTADORA TIPO SARA MOD.1

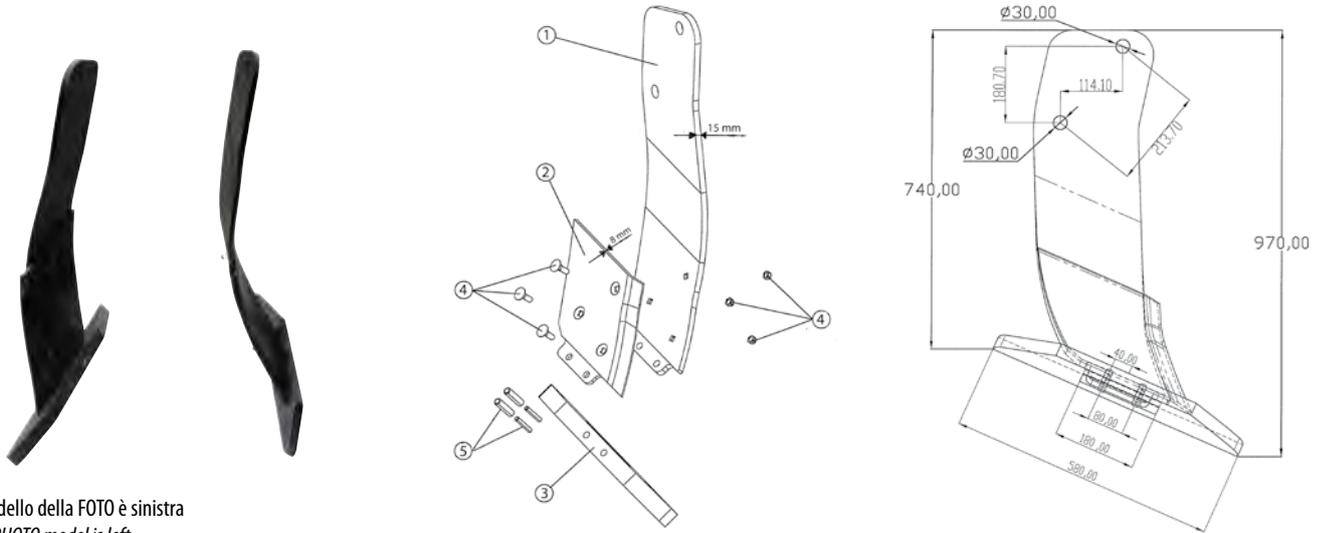

Note: Il modello della FOTO è sinistra
Notes: the PHOTO model is left

Art./Ref.	Titolo Prodotto/Titolo Prodotto	Spessore mm/Thickness mm	Tipo/Type
CP6024C	ANCORA DECOMPATTATORE COMPLETA SARA MOD.1 DX	-	-
CP6025C	ANCORA DECOMPATTATORE COMPLETA SARA MOD.1 SX	-	-
CP6024	ANCORA DECOMPATTATORE SARA DX	-	1
CP6025	ANCORA DECOMPATTATORE SARA SX	-	1
CP6026	COPRIANCORA PER CP6024C DX	-	2
CP6027	COPRIANCORA PER CP6025C SX	-	2
CP6028	SCALPELLO PER ANCORA CP6024C-CP6025C-CP6057C-CP6058C-CP6059C-CP6060C PANTOGRAFATO	60x40	3
CP6028S	SCALPELLO PER ANCORA CP6024C-CP6025C-CP6057C-CP6058C-CP6059C-CP6060C STAMPATO	60x40	3
RC0763A	BULLONE TSPQST 12X35 AUTOBLOCCANTE DX	-	4
CP2128	SPINA ELASTICA 16X60	-	5
CP2127	SPINA ELASTICA 10X60	-	5

SCALPELLO 50X50 ADATTABILE AD ANCORA DECOMPATTATORE SARA (CP6024-CP6025)

LAME 50X50 ADAPTABLE POUR DENT TYPE SARA (CP6024 - CP6025)

POINT 50X50 SUITABLE TO SUBSOIL LEG CURVED SARA STYLE (CP6024-CP6025)

MEISSEL 50X50 PASSEND ZU DRILLSCHAR SARA (CP6024-CP6025)

ESCOPLO 50X50 ADAPTABLE A ANCORA DECOMPACTADORA SARA (CP6024-CP6025)

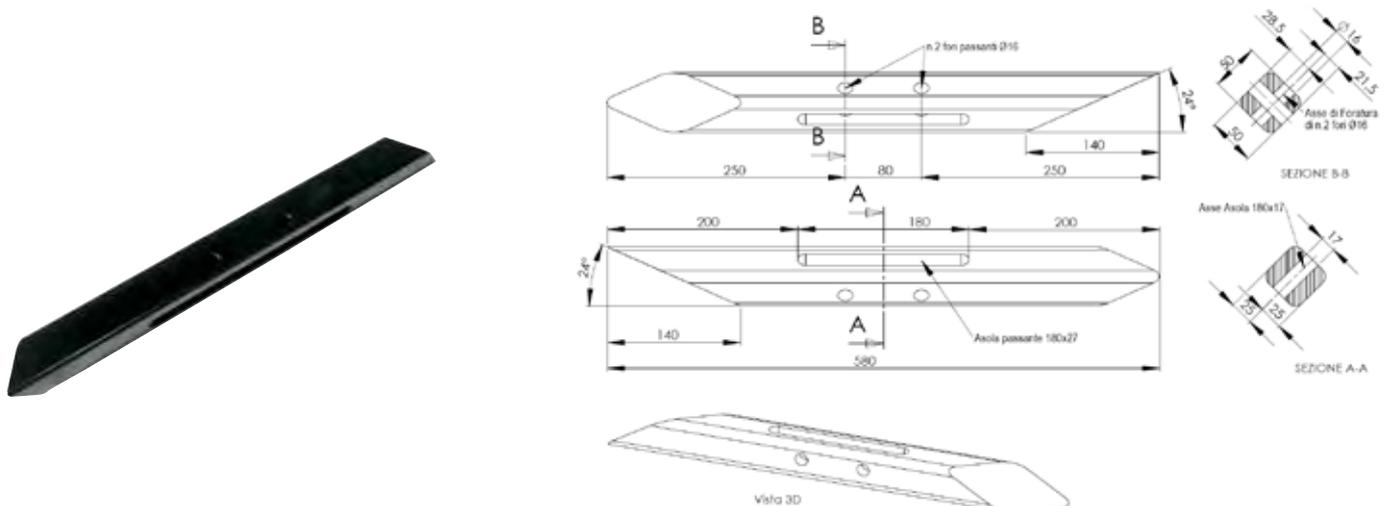

Art./Ref.	Titolo Prodotto/Titolo Prodotto	Note/Note
CP7003	SCALPELLO ANCORA DECOMPATTATORE 50X50 DX ASOLA 180X27	Modello in figura.
CP7004	SCALPELLO ANCORA DECOMPATTATORE 50X50 SX ASOLA 180X27	-

ANCORA DECOMPATTATORE TIPO SARA MOD.2

DENT TYPE SARA MOD.2

SUBSOIL LEG CURVED SARA STYLE N.2

DRILLSCHAR TYP SARA MOD. 2

ANCORA DECOMPACTADORA TIPO SARA MOD.2

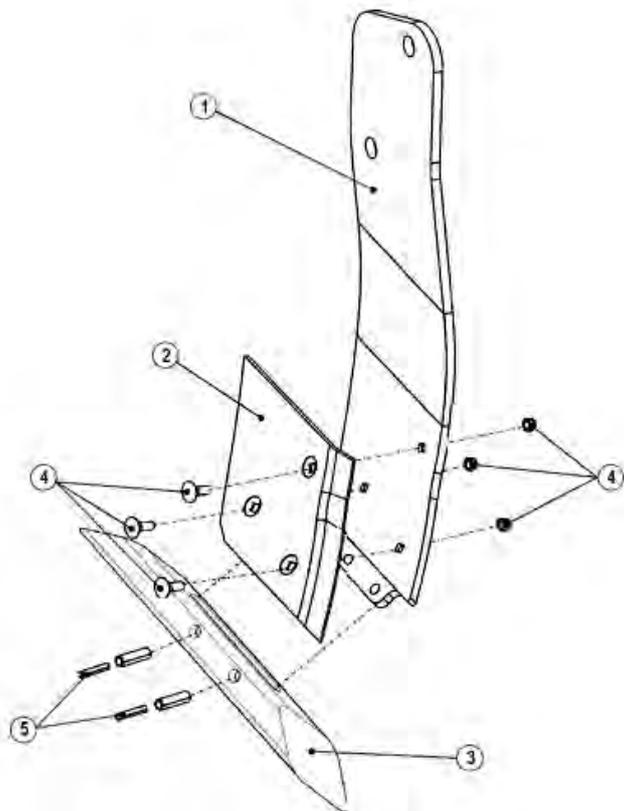
Note: Il modello della figura è destra

Notes: Il modello della figura è destra

Art./Ref.	Titolo Prodotto/Titolo Prodotto	Tipo/Type
CP7001	ANCORA DECOMPATTATORE COMPLETA SARA MOD.2 DX	-
CP7002	ANCORA DECOMPATTATORE COMPLETA SARA MOD.2 SX	-
CP6024	ANCORA DECOMPATTATORE SARA DX	1
CP6025	ANCORA DECOMPATTATORE SARA SX	1
CP6098	COPRIANCORA PER CP7001 DX	2
CP6099	COPRIANCORA PER CP7002 SX	2
CP6053	SCALPELLO ANCORA DECOMPATTATORE 50X50 DX	3
CP6054	SCALPELLO ANCORA DECOMPATTATORE 50X50 SX	3
RC0763A	BULLONE TSPQST 12X35 AUTOBLOCCANTE DX.	4
CP2128	SPINA ELASTICA 16X60	5
CP2127	SPINA ELASTICA 10X60	5

ANCORA RIPUNTATORE CURVA

ANCRE SOUS-SOLEUSE TOURNANTE

CURVED TINE

KRUMMER ANKER

ANCORA SUBSOLADORA CURVA

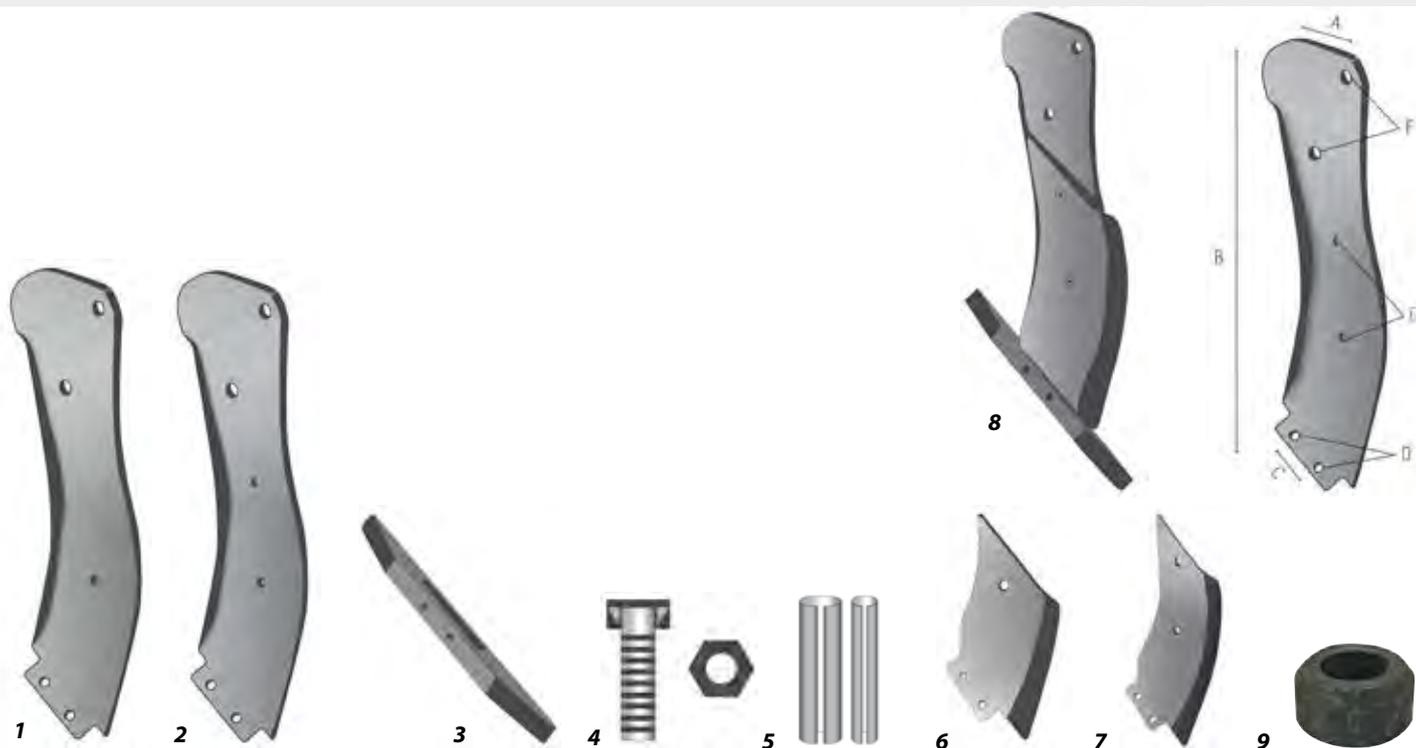

Note: Il modello della figura è destra. Vantaggi: Scava il terreno senza rigirarlo, lasciando uno strato vegetale praticamente intatto e scendendo a una profondità tra 25 a 45 cm. Caratteristiche: • Acciaio al boro. • Trattamento termico integrale, che garantisce una durezza di 49 +/- 2 HRC. Utilizzo: • Lavorare almeno 10 cm al di sotto dello strato da decompattare • Si raccomanda la lavorazione su terreno asciutto • La potenza consigliata per una profondità di 30 cm è 35-45 HP; per una profondità di 60 cm fino a 55-65 HP • La velocità di lavoro deve essere mantenuta tra 3 e 5 Km/h • Si consiglia di utilizzare un bullone di sicurezza M16 con resistenza 8.8

Notes: Benefits: Hollows the soil without disturbing it, leaving the vegetation practically intact and going in between 25 cm and 45 cm. Characteristics: • Boron steel. • Integral hardening, guaranteeing a 49 +/- 2 HRC hardness. Use: • Work 10 cm below the layer to be broken. • Working in dry soil is recommended. • The recommended power for 30 cm depth is 35.45 hp and up to 55- 65 hp for 60 cm. • Working speed should be kept between 3 and 5 km/h. • You should use a safety bolt M16, resistance 8.8.

Art./Ref.	Titolo Prodotto/Titolo Prodotto	A mm	B mm	C mm	D mm	E mm	F mm	Spessore mm/ Thickness mm	Tipo/ Type	Peso Kg/ Weight Kg
CP6057C	ANCORA RIPUNTATORE CURVA COMPLETA MOD.1 DX	-	-	-	-	-	-	-	8	-
CP6058C	ANCORA RIPUNTATORE CURVA COMPLETA MOD.1 SX	-	-	-	-	-	-	-	8	-
CP6059C	ANCORA RIPUNTATORE CURVA COMPLETA MOD.2 DX	-	-	-	-	-	-	-	8	-
CP6060C	ANCORA RIPUNTATORE CURVA COMPLETA MOD.2 SX	-	-	-	-	-	-	-	8	-
CP6057	ANCORA RIPUNTATORE CURVA MOD.1 DX	300	820	80	16	-	30	15 mm	1	23.2
CP6058	ANCORA RIPUNTATORE CURVA MOD.1 SX	300	820	80	16	-	30	15 mm	1	23.2
CP6059	ANCORA RIPUNTATORE CURVA MOD.2 DX	300	820	80	16	14	30	15 mm	2	23.2
CP6060	ANCORA RIPUNTATORE CURVA MOD.2 SX	300	820	80	16	14	30	15 mm	2	23.2
CP6061	COPRIANCORA PER CP6057 DX	-	-	-	-	-	-	8 mm	6	55
CP6062	COPRIANCORA PER CP6058 SX	-	-	-	-	-	-	8 mm	6	55
CP6063	COPRIANCORA PER CP6059 DX	-	-	-	-	-	-	8 mm	7	7.83
CP6064	COPRIANCORA PER CP6060 SX	-	-	-	-	-	-	8 mm	7	7.83
CP6028	SCALPELLO PER ANCORA CP6024C-CP6025C-CP6057C-CP6058C-CP6059C-CP6060C PANTOGRAFATO	-	-	-	-	-	-	60x40	3	-
CP6028S	SCALPELLO PER ANCORA CP6024C-CP6025C-CP6057C-CP6058C-CP6059C-CP6060C STAMPATO	-	-	-	-	-	-	60x40	3	-
RC0840A	BULLONE 14X40 CON NASELLO	-	-	-	-	-	-	-	4	-
CP2127	SPINA ELASTICA 10X60	-	-	-	-	-	-	-	5	-
CP2128	SPINA ELASTICA 16X60	-	-	-	-	-	-	-	5	-
RC0631	BOCCOLA PER ANCORA 16X30X15 MM	-	-	-	-	-	-	-	9	-

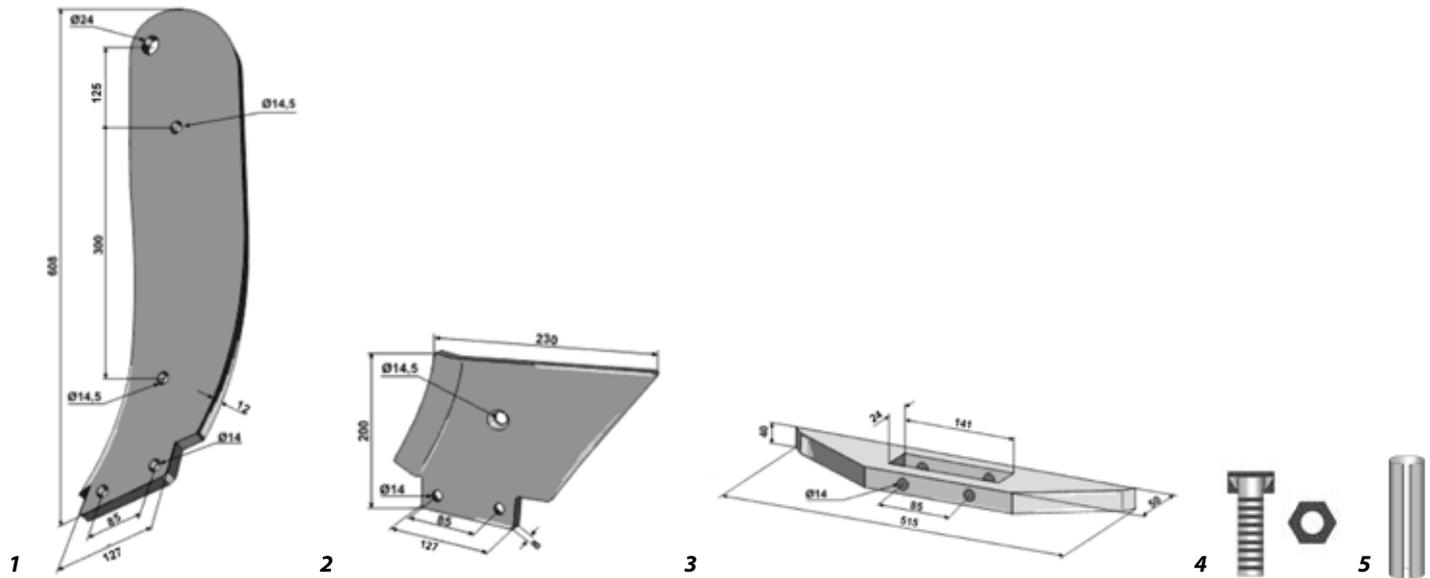
ANCORA RIPUNTATORE CURVA MODELLO PICCOLO
DENT COURBE MODELE PETIT
SUBSOIL LEG CURVED
TIEFENLOCHERER-ZINKEN GEBOGEN MODELL KLEIN
ANCORA SUBSOLADORA CURVA MODELO PEQUENO

Art./Ref.	Titolo Prodotto/Titolo Prodotto	Tipo/Type
CP6112C	ANCORA RIPUNTATORE COMPLETA MOD.PICCOLO DX	-
CP6113C	ANCORA RIPUNTATORE COMPLETA MOD.PICCOLO SX	-
CP6112	ANCORA RIPUNTATORE MOD.PICCOLO DX	1
CP6113	ANCORA RIPUNTATORE MOD.PICCOLO SX	1
CP6114	COPRIANCORA PER CP6112 DX	2
CP6115	COPRIANCORA PER CP6113 SX	2
CP6116	SCALPELLO PER ANCORA CP6112C-CP6113C	3
RC0815	BULLONE TSPEI 14X40/VITE TSPEI 14X40	4
CP2129	SPINA ELASTICA 14X50	5

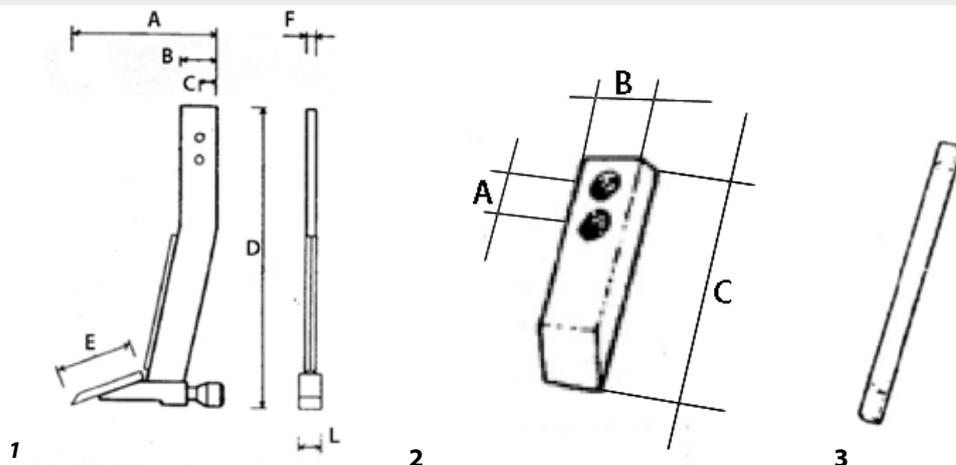
ANCORA PER RIPUNTATORE DRENATORE DA 130
DENT POUR SOUS-SOLEUSE POUR DRAINAGE EN 130
SHORE ANCHOR FOR DRAIN SUBSOILER WIDTH 130
ZINKE FUER DRAENIERUNGSMASCHINE VON 130
ANCLA ARADO DESFONDE / DRENADOR DE 130

Art./Ref.	Titolo Prodotto/Titolo Prodotto	A mm	B mm	C mm	D mm	E mm	F mm	L mm	Spessore mm/Thickness mm	Tipo/Type	Note/Note
CP2800	ANCORA PER RIPUNTATORE 130X30	490	130	60	1000	260	30	70	-	1	fori da mm 22 e diametro boccia mm 80.
CP2802	VOMERINO ANCORA CP2800-CP2806	60	80	260	-	-	-	-	20	2	fori da mm 17
CP2803	UTENSILE PER ANCORA CP2800	-	-	-	-	-	-	-	-	3	-

ANCORA PER RIPUNTATORE DRENATORE DA 160

DENT POUR SOUS-SOLEUSE POUR DRAINAGE EN 160

SHORE ANCHOR FOR DRAIN SUBSOILER WIDTH 160

ZINKE FUER DRAENIERUNGSMASCHINE VON 160

ANCLA ARADO DESFONDE / DRENADOR DE 160

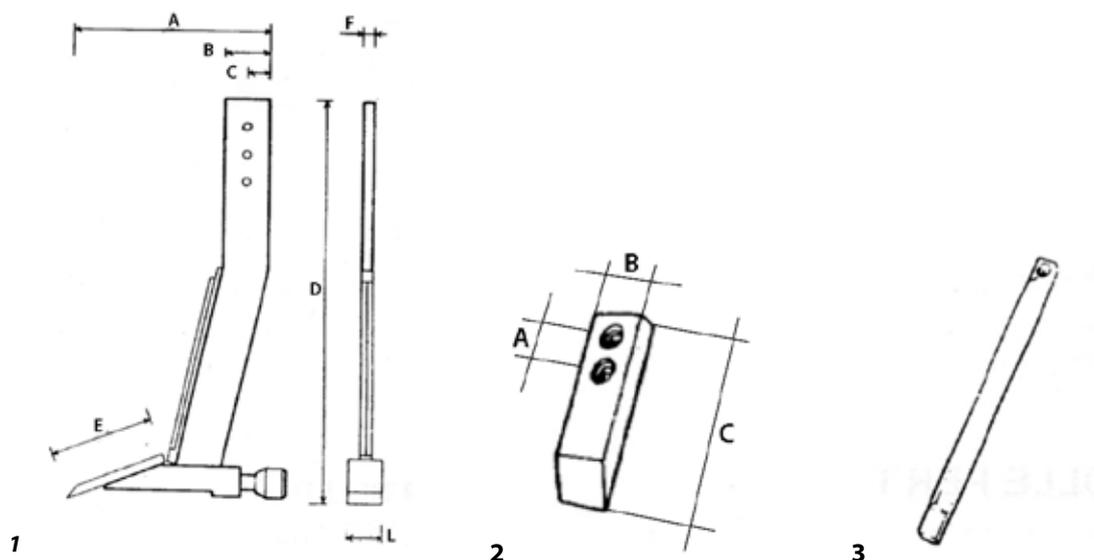

Art./Ref.	Titolo Prodotto/ Titolo Prodotto	A mm	B mm	C mm	D mm	E mm	F mm	L mm	Spessore mm/ Thickness mm	Tipo/ Type	Note/Note
CP2801	ANCORA PER RIPUNTATORE 160X35	720	160	80	1450	370	35	120	-	1	fori da mm 25 e diametro boccia mm 120
CP2804	VOMERINO PER ANCORA CP2801	80	120	360	-	-	-	-	25	2	fori da mm 17
CP2805	UTENSILE PER ANCORA CP2801	-	-	-	-	-	-	-	-	3	-

ANCORA PER DISSODATORE DA 130

DENT POUR DEFRICHAGE EN 130

SHORE ANCHOR FOR CHISEL WIDTH 130

ZINKE FUER RODUNGSMASCHINE VON 130

ANCLA RITURADOR DE 130

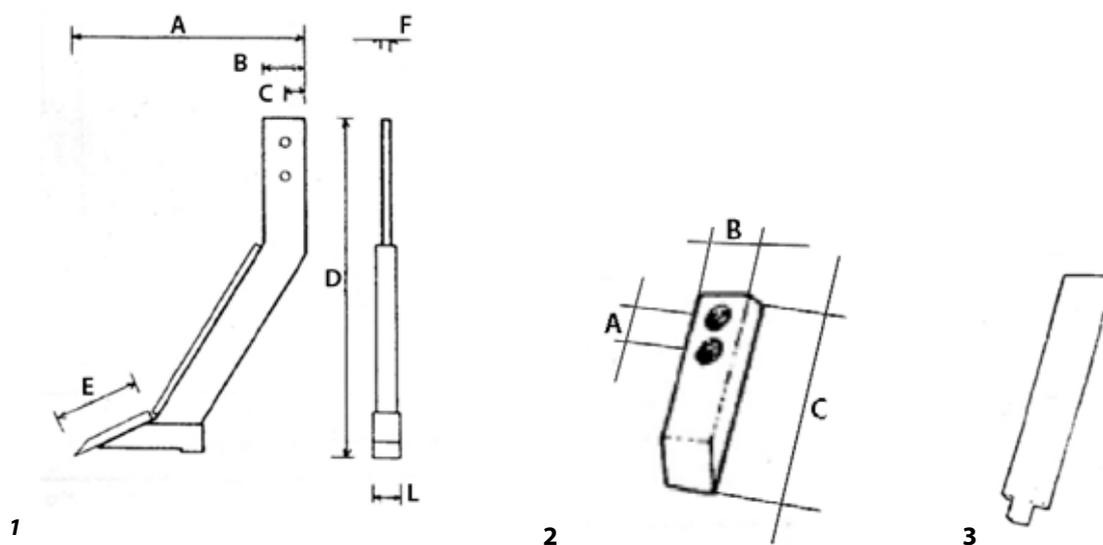

Art./Ref.	Titolo Prodotto/Titolo Prodotto	A mm	B mm	C mm	D mm	E mm	F mm	L mm	Spessore mm/Thickness mm	Tipo/Type	Note/Note
CP2806	ANCORA PER DISSODATORE 130X30	700	130	60	1000	260	30	80	-	1	fori da mm 22
CP2802	VOMERINO ANCORA CP2800-CP2806	60	80	260	-	-	-	-	20	2	fori da mm 17
CP2809	UTENSILE ESPULSORE ANCORA	-	-	-	-	-	-	-	-	3	-

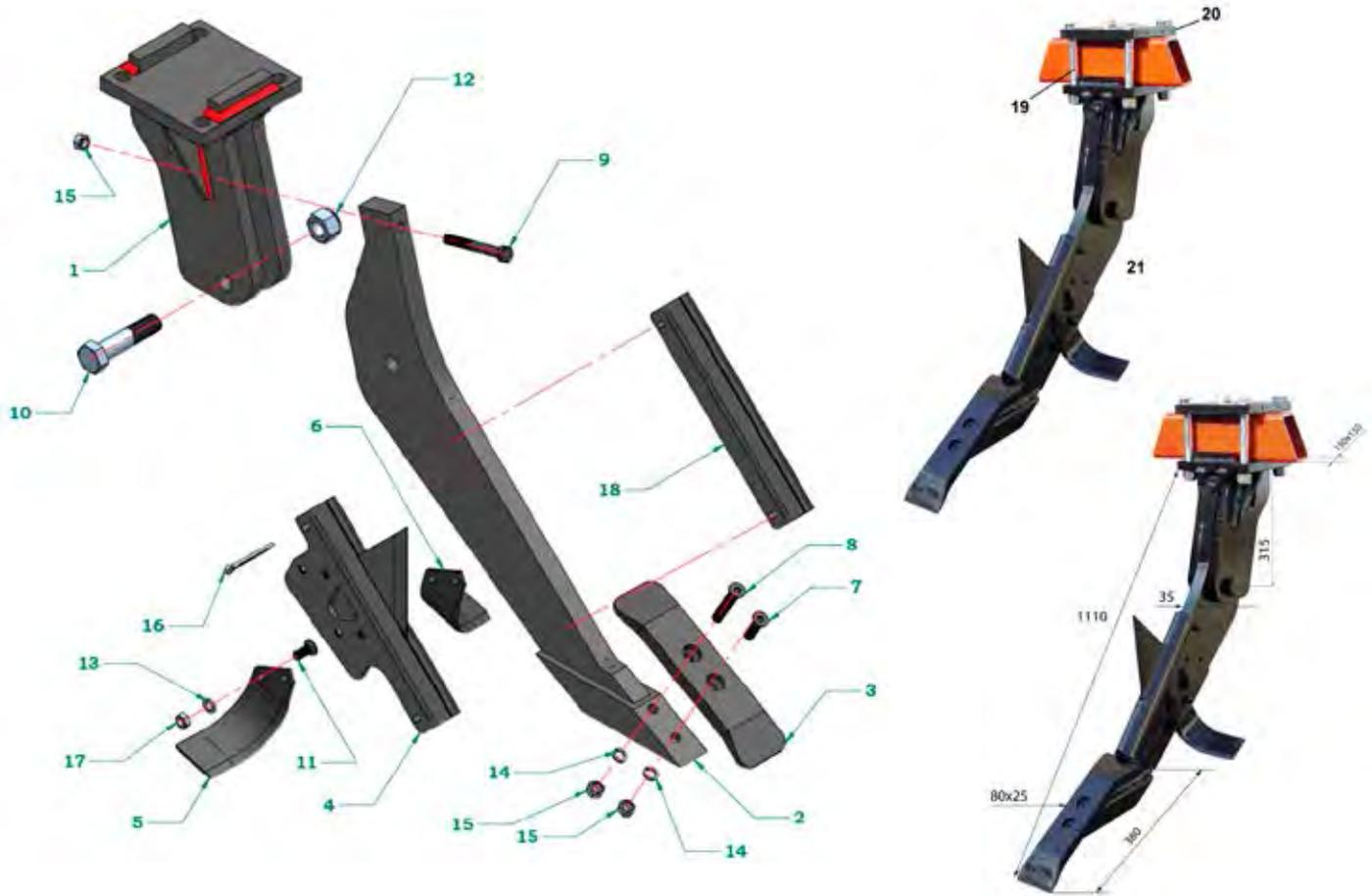
RICAMBI E ACCESSORI PER ANCORA RIPPER
PIECES ET ACCESSOIRES POUR DENT RIPPER
SPARE PARTS AND FITTINGS FOR RIPPER TINE
ERSATZTEILE UND ZUBEHOER FUER RIPPER - ZINKEN
REPUESTOS Y ACCESORIOS PARA BRAZO RIPPER

Note: Ancora adatta per sostituzione dell'aratura-Indicata per terreni compatti-Profondità di lavoro:50-60 cm.

Notes: Leg suited to substitute ploughing-Indicated for hard soils-Working depth:50-60cm.

Art./Ref.	Titolo Prodotto/Titolo Prodotto	Tipo/Type	Spessore mm/Thickness mm	Peso Kg/Weight Kg	Note/Note
CP6067C	ANCORA RIPUNTATORE COMPLETA	21	-	102	Con l'ancora completa vengono forniti anche la staffa superiore (SMI122251) ed i bulloni di fissaggio (RC0738) per telaio 150x150
SMI122251	STAFFA SUPERIORE ANCORA	20	-	-	-
RC0738	BULLONE 8.8 TESTA ESAGONALE 24X230	19	-	-	Per fissaggio staffa su trave
CP6066	STAFFA ANCORA	1	-	-	-
CP6067	ANCORA	2	35 mm	-	Materiale acciaio al boro temperato
CP6068	VOMERE	3	25 mm	-	Materiale acciaio al boro temperato
CP6069	ESPLORE PER ANCORA	4	-	-	Materiale acciaio al boro temperato
CP6070	ZAPPA ESPLORE DX	5	-	-	Materiale acciaio al boro temperato
CP6071	ZAPPA ESPLORE SX	6	-	-	Materiale acciaio al boro temperato
MCM527027	VITE UNI 5933 M 16X55	7	-	-	-
MCM527024	VITE UNI 5933 M 16X90	8	-	-	-
MCM520033	VITE 5737 T.E.16X130 12.9	9	-	-	-
MCM520127	VITE 5737 T.E.30X130 12.9	10	-	-	-
MCM527015	VITE UNI 5933 M 14X35	11	-	-	-
MCM520228	DADO UNI 7473 M30 AUTOBLOCCANTE	12	-	-	-
MCM540005	GROWER M 14	13	-	-	-
MCM540006	GROWER M 16	14	-	-	-
MCM523034	DADO UNI 5588 M16	15	-	-	-
SAR1873N	COPPIGLIA 10X70	16	-	-	-
MCM523023	DADO UNI 5588 M14	17	-	-	-
CP6072	PROTEZIONE ANCORA	18	-	-	Materiale acciaio al boro temperato

RICAMBI PER ANCORA TEDESCA ADATTABILE A GRUBER

PIECES RECHANGES POUR DENT ADAPTABLE A GRUBER

GERMAN ANCHOR SPARE PARTS SUITABLE TO GRUBER

ERSATZTEILE FUER DEUTSCHE ZINKE PASSEND ZU GRUBER

RECAMBIOS DE ANCLA ALEMANA ADAPTABLE A GRUBER

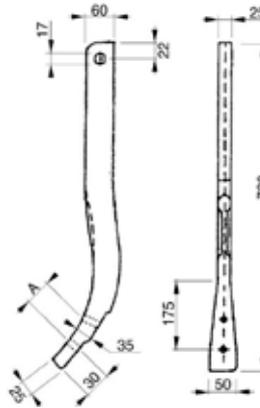
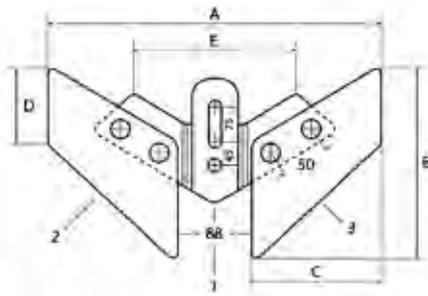

Note: Tutti i prodotti presenti in tabella vengono forniti non verniciati.

Notes: All products in the table are supplied unpainted.

Art./Ref.	Titolo Prodotto/Titolo Prodotto	Tipo/Type	A mm	B mm	C mm	D mm	E mm	Note/Note
CP3927	SOTTOVOMERE CURVATO STRETTO COMPLETO	1	360	-	-	-	135	-
CP3927B	ALETTA SOTTOVOMERE STRETTA DX	2	-	200	150	80	-	bulloni per montaggio aletta da 10x30 (RC0760A)/ bulloni per montaggio aletta da 10x30 (RC0760A)
CP3927C	ALETTA SOTTOVOMERE STRETTA SX	3	-	200	150	80	-	bulloni per montaggio aletta da 10x30 (RC0760A)
CP3927A	SOTTOVOMERE CURVATO LARGO COMPLETO	1	445	-	-	-	135	-
CP3927D	ALETTA SOTTOVOMERE LARGA DX	2	-	240	170	68	-	bulloni per montaggio aletta da 10x30 (RC0760A)
CP3927E	ALETTA SOTTOVOMERE LARGA SX	3	-	240	170	68	-	bulloni per montaggio aletta da 10x30 (RC0760A)
CP3927F	CORPO SOTTOVOMERE SENZA ALETTE	1	-	-	-	-	-	-
CP1457	ANCORA ESTIRPATORE ADATTABILE A GRUBER	4	70	-	-	-	-	I fori per il montaggio del sottovomere sono da mm 13
CP3929	ANCORA TEDESCA ADATTABILE A GRUBER	4	44.5	-	-	-	-	I fori per il montaggio del sottovomere sono da mm 13

VOMERE A ZAMPA D'OCA

SOC PATTE D'OIE

GOOSE CLAW SHARE

GÄNSEFUß-BREITSCHAR

REJA PATA DE OCA

Note: Tutti i prodotti presenti in tabella vengono forniti non verniciati.

Notes: All products in the table are supplied unpainted.

Art./Ref.	Spessore mm/Thickness mm	Note/Note
CP4974	10 mm	Interasse fori vomerina mm 45-75. Applicabile su ancora tipo Gruber - Art.CP1457-CP3929

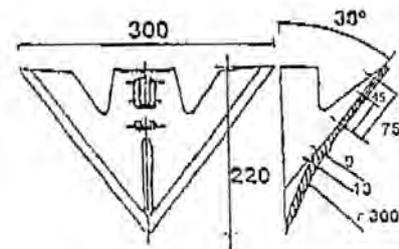

VOMERE TIPO BELGIO

SOC TYPE BELGIQUE

SHARE TYPE BELGIUM

SCHAR TYP BELGIEN

REJA TIPO BEGLIO

Note: Tutti i prodotti presenti in tabella vengono forniti non verniciati.

Notes: All products in the table are supplied unpainted.

Art./Ref.	Spessore mm/Thickness mm	Note/Note
CP4975	10 mm	Interasse fori vomerina mm 45-75. Applicabile su ancora tipo Gruber - Art.CP1457-CP3929.

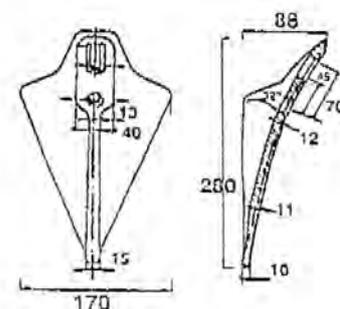

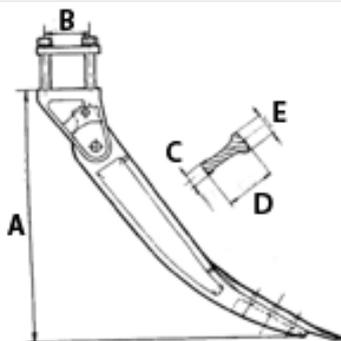
ANCORA PER RIPUNTATORE COMPLETA DI STAFFA E VOMERINA
DENT POUR SOUS-SOLEUSE COMPLET D'ETRIER ET SOC
ANCHOR COMPLETE WITH STIRRUP AND SHARE FOR SUBSOILER
GRUBBERZINKE KOMPLETT MIT HALTER UND SCHAR
ANCLA ARADO DE DESFONDE COMPLETA DE ESTRIBO Y REJA

Note: Tutti i prodotti presenti in tabella vengono forniti non verniciati.

Notes: All products in the table are supplied unpainted.

Art./Ref.	Titolo Prodotto/Titolo Prodotto	A mm	B mm	C mm	D mm	E mm	Note/Note
CP2164	ANCORA RIPUNTATORE COMPLETA DI STAFFA E VOMERINA	750	130	32	108	50	TELAIO 100X100

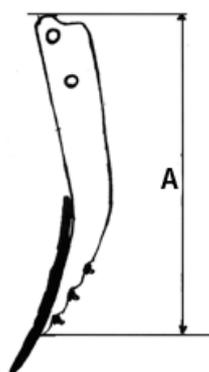
RICAMBI PER RIPUNTATORE TIPO SARA
RECHANGES POUR SOUS-SOLEUSE TYPE SARA
SUBSOILER SPARE PARTS TYPE SARA
ERSATZTEILE FUER GRUBBERZINKEN TYP SARA
RECAMBIOS DE ARADO DE DESFONDE TIPO SARA

Art./Ref.	Titolo Prodotto/Titolo Prodotto	A mm	Spessore mm/Thickness mm	Note/Note
CP2164A	ANCORA PER RIPPER TIPO SARA	775	30	Con vomerina e protezione salva ancora montate
CP2164C	STAFFA PER ANCORA TRAVE 120X80	-	-	-

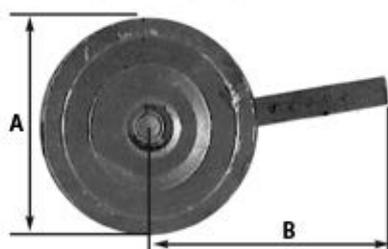
RUOTINO DI PROFONDITA' PER RIPUNTATORE
ROUE DE PROFONDITÀ POUR RIPONTEUR
DEPHT WHEEL FOR SUBSOILER
TIEFENRAD
RUEDECILLA DE PROFUNDIDAD PARA ARADO DE DESFONDE

Art./Ref.	Titolo Prodotto/Titolo Prodotto	A mm	B mm	Note/Note
SAR9015	RUOTINO DI PROFONDITA'/RUOTINO REGOLA PROFONDITA' FE.	400	520	BRACCIO 60X30

VOMERE PER RIPUNTATORE ADATTABILE A PEGORARO DOPPIA PUNTA

SOC POUR RIPOINTEUR ADAPTABLE A PEGORARO DOUBLE POINTE
 SHARE FOR DOUBLE POINT SUITABLE TO PEGORARO SUBSOILER
 SCHAR FUER GRUBBERZINKE PASSEND ZU PEGORARO DOPPELSPITZE
 REJA ARADO DE DESFONDE ADAPTABLE A PEGORARO PUNTA DOBLE

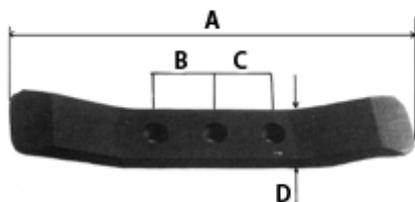

Art./Ref.	Titolo Prodotto/Titolo Prodotto	A mm	B mm	C mm	D mm	Spessore mm/Thickness mm
CP1989N	VOMERINA PER RIPUNTATORE DOPPIA PUNTA	435	66	66	70	20 mm
CP1989A	VOMERINA PER RIPUNTATORE DOPPIA PUNTA	435	66	66	70	18 mm
CP1989B	VOMERINA PER RIPUNTATORE DOPPIA PUNTA	435	66	66	100	15 mm

VOMERE PER RIPUNTATORE STAMPATA DOPPIA PUNTA

SOC POUR SOUS-SOLEUSE FORGEE DOUBLE POINTE
 SHARE FOR DOUBLE POINT PRINTOUT SUBSOILER
 ANSCHWEISS-SCHAR MIT DOPPEL-SPITZE
 REJA ARADO DE DESFONDE, ESTAMPADO, PUNTA DOBLE

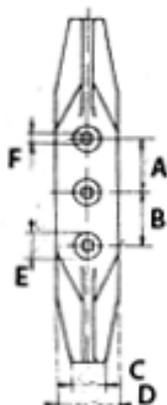

Note: Tutti i prodotti presenti in tabella vengono forniti non verniciati.

Notes: All products in the table are supplied unpainted.

Art./Ref.	Titolo Prodotto/Titolo Prodotto	A mm	B mm	C mm	D mm	E mm	F mm
CP2165	VOMERINA PER RIPUNTATORE DOPPIA PUNTA STAMPATA	66	66	42	76	30	13

VOMERE PER RIPUNTATORE AD UNA PUNTA

SOC POUR RIPOINTEUR AVEC UNE POINTE
 SHARE FOR ONE 1 POINT SUBSOILER
 SCHAR MIT EINER SPITZE
 REJA ARADO DE DESFONDE 1 PUNTA

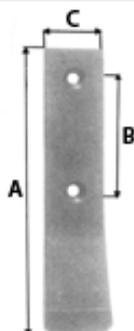

Art./Ref.	Titolo Prodotto/Titolo Prodotto	A mm	B mm	C mm	Spessore mm/Thickness mm	Peso Kg/Weight Kg	Note/Note
SAR6092	VOMERINA PER RIPUNTATORE AD UNA PUNTA	335	135	70	15	2.5	ACCIAIO SPECIALE BONIFICATO

VOMERE PER RIPUNTATORE DOPPIA PUNTA ADATTABILE AD AGRIM

SOC POUR SOUS-SOLEUSE DOUBLE POINTE ADAPTABLE A AGRIM

SHARE FOR DOUBLE POINT SUBSOILER SUITABLE TO AGRIM

PFLUGSCHAR MIT DOPPELTSPITZE PASSEND ZU AGRIM

REJA ARADO DESFONDE PUNTA DOBLE ADAPTABLE A AGRIM

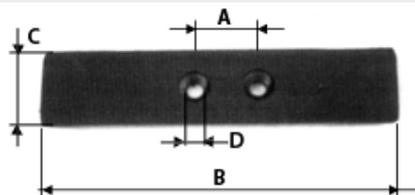

Art./Ref.	Titolo Prodotto/Titolo Prodotto	A mm	B mm	C mm	D mm	Spessore mm/Thickness mm	Note/Note
CP2166	VOMERINA PER RIPUNTATORE ADATTABILE AGRIM	55	310	70	14.5	20	FORI SVASATI DA ENTRAMBI I LATI

CORPI PER LA LAVORAZIONE DEL SUOLO ADATTABILI A VOLENTIERI

CORPS POUR LE TRAVAIL DU SOL ADAPTABLES A VOLENTIERI

SOIL EQUIPMENT CORES SUITABLES TO VOLENTIERI

PFLUGKOERPER FUER DIE BODENBEARBEITUNG PASSEND ZU VOLENTIERI

CUERPOS PARA LABOR SUELO ADAPTABLES A VOLENTIERI

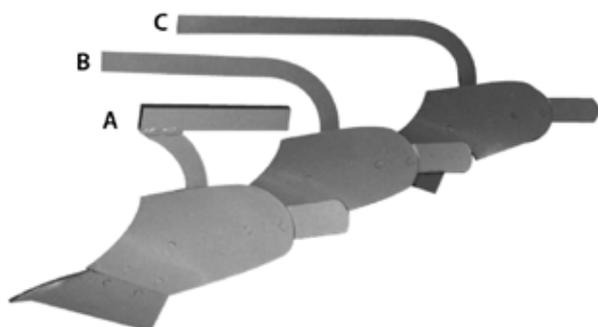

Art./Ref.	Titolo Prodotto/Titolo Prodotto	Tipo/Type
CP1166	CORPO VOLENTIERI CON ANCORA 60X30 MOD.N.2 DX	A
CP1166SX	CORPO VOLENTIERI CON ANCORA 60X30 MOD.N.2 SX	A
CP1167	CORPO VOLENTIERI CON ANCORA 60X30 MOD.N.4 DX	B
CP1167SX	CORPO VOLENTIERI CON ANCORA 60X30 MOD.N.4 SX	B
CP1168	CORPO VOLENTIERI CON ANCORA 60X30 MOD.N.5 DX	C
CP1168SX	CORPO VOLENTIERI CON ANCORA 60X30 MOD.N.5 SX	C
CP1033	CORPO VOLENTIERI CON ANCORA 70X35 MOD.N.2 DX	A
CP1033S	CORPO VOLENTIERI CON ANCORA 70X35 MOD.N.2 SX	A
CP1034	CORPO VOLENTIERI CON ANCORA 70X35 MOD.N.4 DX	B
CP1034S	CORPO VOLENTIERI CON ANCORA 70X35 MOD.N.4 SX	B
CP1035	CORPO VOLENTIERI CON ANCORA 70X35 MOD.N.5 DX	C
CP1035S	CORPO VOLENTIERI CON ANCORA 70X35 MOD.N.5 SX	C

SCALPELLO PER CORPI ARATRI DA VIGNETO ADATTABILE A VOLENTIERI

TREPAN POUR COPRPS CHARRUE POUR VIGNOBLE ADAPTABLE A VOLENTIERI

CHISEL FOR VINEYARD PLOUGH CORES SUITABLE TO VOLENTIERI

MEISSEL FUER PFLUGKOERPER PASSEND ZU VOLENTIERI

ESCOPIO CUERPOS ARADOS DE VINEDO ADAPTABLE A VOLENTIERI

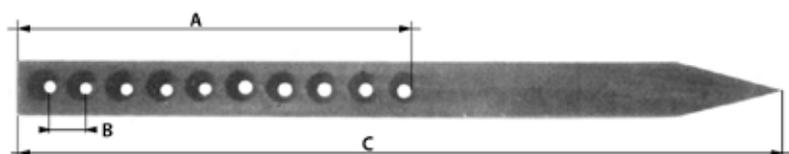

Art./Ref.	Titolo Prodotto/Titolo Prodotto	A mm	B mm/B mm	C mm/C mm	Note/Note
CP1163	SCALPELLO ADATTABILE A VOLENTIERI	300	30	600	ACCIAIO 45X20

VOMERI PER CORPI ARATRI DA VIGNETO ADATTABILI A VOLENTIERI
SOCs POUR CORPS LABOURANTS POUR VIGNOBLE ADAPTABLES A VOLENTIERI
SHARES FOR PLOUGH PARTS FOR VINEYARD SUITABLES TO VOLENTIERI
SCHAR FUER PFLUGKOERPER PASSEND ZU VOLENTIERI
REJAS CUERPOS ARADO DE VINEDO ADAPTABLES A VOLENTIERI

Art./Ref.	Titolo Prodotto/Titolo Prodotto
SAR6095	VOMERINO ADATTABILE A VOLENTIERI DX
SAR6095S	VOMERINO ADATTABILE A VOLENTIERI SX

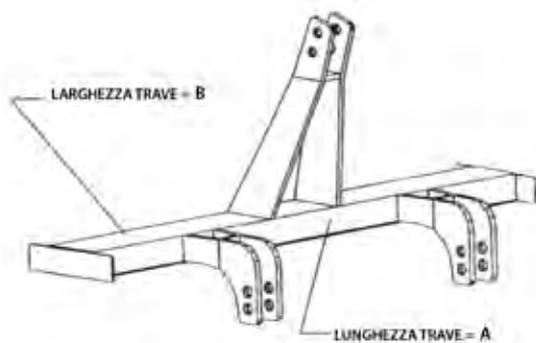
TELAIO PER ESTIRPATORI A TRE PUNTI
CHASSIS POUR ESTIRPATEURS A 3 POINTS
FRAME FOR 3 POINTS GRUBBERS
RAHMEN FUER 3 PUNKT GRUBBER
TELAR EXTIRPADOR TRES PUNTOS

Art./Ref.	Titolo Prodotto/Titolo Prodotto	A mm	B mm
SAR6126	TELAIO ESTIRPATORE	1200	100
SAR6127	TELAIO ESTIRPATORE	1400	100
SAR6123	TELAIO ESTIRPATORE	1400	120
SAR6128	TELAIO ESTIRPATORE	1600	120
SAR6120	TELAIO ESTIRPATORE	1400	140
SAR6121	TELAIO ESTIRPATORE	1600	140
SAR6122	TELAIO ESTIRPATORE	1800	140
SAR6124	TELAIO ESTIRPATORE	1600	160
SAR6125	TELAIO ESTIRPATORE	1800	160
SAR6129	TELAIO ESTIRPATORE	2100	160

SCIARPE PER ESTIRPATORI
ECHARPE POUR EXTIRPATEUR
SCARF FOR XTIRPATOR
HALTERUNG FUER GRUBBERZINKEN
BANDAS DE EXTIRPADORES

Note: Tutti i prodotti presenti in tabella vengono forniti non verniciati.

Notes: All products in the table are supplied unpainted.

Art./Ref.	Titolo Prodotto/Titolo Prodotto
CP1622	SCIARPA 50X20 FILETTO 20MA
CP1625	SCIARPA 60X30 FILETTO 22MA
CP1626	SCIARPA 60X30 FILETTO 24MA
CP1627	SCIARPA 70X35 FILETTO 27MA



STAFFA PER RUOTINO DI PROFONDITA'

BRIDE POUR ROUE DE PROFONDITÉ

BRACKET FOR DEPTH WHEEL

HALTER FUER TIEFENRAD

ESTRIBO PARA RUEDECILLA DE PROFUNDIDAD



Art./Ref.	Titolo Prodotto/Titolo Prodotto	Note/Note
SAR6248	STAFFA DOPPIA ATTACCO RUOTINO	PER ANCORIA 60X30

RUOTINO DI PROFONDITA'

ROUE DE PROFONDITA'

DEPTH WHEEL

RAD

RUEDECILLA DE PROFUNDIDAD

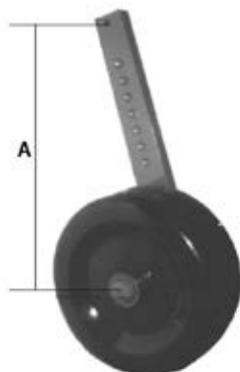
**Note:** Tutti i prodotti presenti in tabella vengono forniti non verniciati.**Notes:** All products in the table are supplied unpainted.

Art./Ref.	Titolo Prodotto/Titolo Prodotto	A mm/A mm	Note/Note
CP1633	RUOTINO DI PROFONDITA' CON RUOTA DA 250	380	BRACCIO 50X25
CP1634	RUOTINO DI PROFONDITA' CON RUOTA DA 300	380	BRACCIO 50X25

STAFFA PER TRAVE ESTIRPATORE

BRIDE POUR POUTRE ESTIRPATEUR

BRACKET FOR GRUBBER BEAM

HALTER FUER GRUBBER-BALKEN

ESTRIBO PARA VIGA EXTIRPADOR

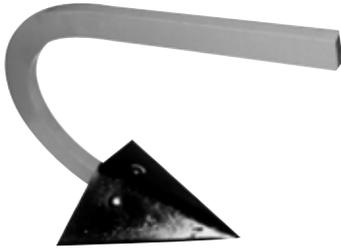

Art./Ref.	Titolo Prodotto/Titolo Prodotto
SAR6249	STAFFA PER TRAVE 100 FORO 22
SAR6246A	STAFFA PER TRAVE 100 FORO 24
SAR6245	STAFFA PER TRAVE 120 FORO 22
SAR6245A	STAFFA PER TRAVE 120 FORO 24
SAR6243	STAFFA PER TRAVE 140 FORO 22
SAR6243A	STAFFA PER TRAVE 140 FORO 24
SAR6244	STAFFA PER TRAVE 160 FORO 22
SAR6244A	STAFFA PER TRAVE 160 FORO 24

ANCORA ESTIRPATORE POSTERIORE ADATTABILE A **VOLENTIERI BONIFICATA CON VOMERINA MONTATA**
ANCRE ESTIRPATEURE POSTERIEURE ADAPTABLE A VOLENTIERI ASSIANI AVEC SON MONTE
BACK ANCHOR RIPPER SUITABLE TO VOLENTIERI RECLAIMED WITH SHARE ASSEMBLED
HINTER-GRUBBERZINKE VERGUETET PASSEND ZU VOLENTIERI MIT SCHAR
ANCLA POSTERIOR EXTIRPADOR ADAPTABLE A VOLENTIERI / SANEADA CON REJA MONTADA

Art./Ref.	Titolo Prodotto/Titolo Prodotto	Note/Note
SAR6237	ANCORA ESTIRPATORE VOLENTIERI POSTERIORE	ACCIAIO 50X25
CP1178	ANCORA ESTIRPATORE VOLENTIERI POSTERIORE	ACCIAIO 60X30
SAR6198	ANCORA ESTIRPATORE VOLENTIERI POSTERIORE	ACCIAIO 70X35

ANCORA ESTIRPATORE ANTERIORE ADATTABILE A **VOLENTIERI BONIFICATA CON VOMERINA MONTATA**
ANCRE ESTIRPATEURE ANTERIEURE ADAPTABLE A VOLENTIERI ASSIANI AVEC SON MONTE
FRONT ANCHOR RIPPER SUITABLE TO VOLENTIERI RECLAIMED WITH SHARE ASSEMBLED
VORDER-GRUBBERZINKE VERGUETET PASSEND ZU VOLENTIERI MIT SCHAR
ANCLA ANTERIOR EXTIRPADOR ADAPTABLE A VOLENTIERI / SANEADA CON REJA MONTADA

Art./Ref.	Titolo Prodotto/Titolo Prodotto	Note/Note
SAR6236	ANCORA ESTIRPATORE VOLENTIERI ANTERIORE	ACCIAIO 50X25
CP1169	ANCORA ESTIRPATORE VOLENTIERI ANTERIORE	ACCIAIO 60X30
SAR6197	ANCORA ESTIRPATORE VOLENTIERI ANTERIORE	ACCIAIO 70X35

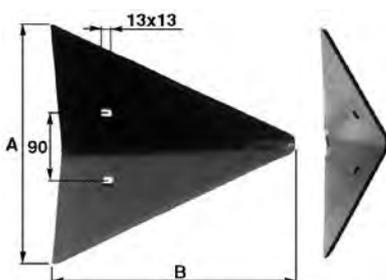
VOMERINA PER ANCORA ESTIRPATORE ADATTABILE A **VOLENTIERI**
SOC DENT D'EXTIRPATEUR ADAPTABLE A VOLENTIERI
SHARE FOR GRUBBER ANCHOR SUITABLE TO VOLENTIERI
SCHAR FUER GRUBBERZINKE PASSEND ZU VOLENTIERI
REJA DE ANCLA ARADO DE DESFONDE ADAPTABLE A VOLENTIERI

Art./Ref.	Titolo Prodotto/Titolo Prodotto	A mm	B mm	Spessore mm/Thickness mm
CP1980	VOMERINA PER ANCORA ADATTABILE A VOLENTIERI	320	320	6 mm

ANCORA SCARIFICATORE POSTERIORE ADATTABILE A **VOLENTIERI BONIFICATA**

ANCRE SCARIFICATEUR POSTERIEUR ADAPTABLE A VOLENTIERI BONIFICATA

REAR SCARIFIER ANCHOR SUITABLE TO VOLENTIERI

HINTER ZINKEN PASSEND ZU VOLENTIERI

ANCLA ESCARIDIFICADOR POSTERIOR ADAPTABLE A VOLENTIERI SANEADA



Art./Ref.	Titolo Prodotto/Titolo Prodotto	Note/Note
CP1180	ANCORA SCARIFICATORE POSTERIORE	ACCIAIO 60X30
SAR6233	ANCORA SCARIFICATORE POSTERIORE	ACCIAIO 70X35

ANCORA SCARIFICATORE ANTERIORE ADATTABILE A **VOLENTIERI BONIFICATA**

ANCRE SCARIFICATEUR ANTERIEUR ADAPTABLE A VOLENTIERI BONIFICATA

FRONT SCARIFIER ANCHOR SUITABLE TO VOLENTIERI

VORDER ZINKEN PASSEND ZU VOLENTIERI

ANCLA ESCARIDIFICADOR ANTERIOR ADAPTABLE A VOLENTIERI SANEADA



Art./Ref.	Titolo Prodotto/Titolo Prodotto	Note/Note
CP1179	ANCORA SCARIFICATORE ANTERIORE	ACCIAIO 60X30
SAR6232	ANCORA SCARIFICATORE ANTERIORE	ACCIAIO 70X35

PUNTA PER ANCORA SCARIFICATORE

PUNTE POUR ANCRE SCARIFIANT

POINT FOR ANCHOR RIPPER

ZINKEN-SPITZE

PUNTA DE ANCLA ESCARIFICADOR



Art./Ref.	Titolo Prodotto/Titolo Prodotto	Note/Note
SAR6231	PUNTA SCARIFICATORE	PER ANCORA 60X30
SAR6234	PUNTA SCARIFICATORE	PER ANCORA 70X35

ZAPPETTA PER RIPUNTATORE ADATTABILE A **PEGORARO**

LAME POUR DECHAUMEUR ADAPTABLE A PEGORARO

BLADE FOR TINE SUITABLE TO PEGORARO

SCHAR FUER GRUBBERZINKE PASSEND ZU PEGORARO

AZADA PARA SUBSOLADOR ADAPTABLE A PEGORARO



Art./Ref.	Titolo Prodotto/Titolo Prodotto	Note/Note
SAR6268	SCARPETTA PER RIPUNTATORE 70X18	PER ANCORA TIPO PEGORARO SPESSORE 35 MM

ANCORE PER ESTIRPATORI

ANGRES POUR EXTIRPATEURS

ANCHOR FOR GRUBBER

GRUBBERZINKEN

ANCLAS DE EXTIRPADOR

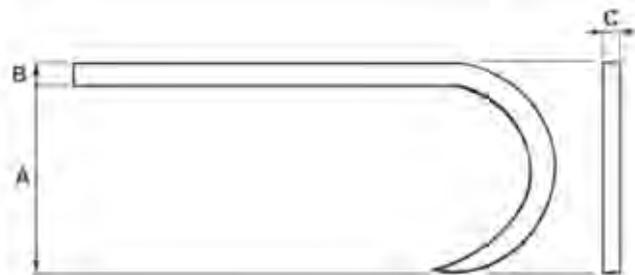
Note: Tutti i prodotti presenti in tabella vengono forniti non verniciati.

Notes: All products in the table are supplied unpainted.

Art./Ref.	Titolo Prodotto/Titolo Prodotto	A mm	B mm	C mm	Tipo/Type	Peso Kg/Weight Kg
CP1842N	ANCORA PER ESTIRPATORE	340	50	20	LUNGA	9.2
CP1843N	ANCORA PER ESTIRPATORE	340	50	20	CORTA	5.5
CP1844N	ANCORA PER ESTIRPATORE	400	50	25	LUNGA	12.5
CP1845N	ANCORA PER ESTIRPATORE	400	50	25	CORTA	8
CP1846N	ANCORA PER ESTIRPATORE	460	60	25	LUNGA	16.4
CP1847N	ANCORA PER ESTIRPATORE	460	60	25	CORTA	11
CP1848N	ANCORA PER ESTIRPATORE	460	60	30	LUNGA	20.5
CP1849N	ANCORA PER ESTIRPATORE	460	60	30	CORTA	13.7
CP1857AN	ANCORA PER ESTIRPATORE	460	70	25	LUNGA	20
CP1858AN	ANCORA PER ESTIRPATORE	460	70	25	CORTA	14.5
CP1850N	ANCORA PER ESTIRPATORE	460	70	30	LUNGA	24.5
CP1851N	ANCORA PER ESTIRPATORE	460	70	30	CORTA	16
CP1859N	ANCORA PER ESTIRPATORE	460	80	25	LUNGA	27.5
CP1860N	ANCORA PER ESTIRPATORE	460	80	25	CORTA	18.5
CP1852N	ANCORA PER ESTIRPATORE	460	80	30	LUNGA	32.5
CP1853N	ANCORA PER ESTIRPATORE	460	80	30	CORTA	21.5

STAFFE PER ANCORE ESTIRPATORE

CHASSIS POUR ANGRES EXTIRPATEUR

BRACKETS FOR EXTIRPATOR ANCHORS

HALTER FUER GRUBBERZINKEN

ESTRIBOS DE ANCLAS EXTIRPADORES

Note: Tutti i prodotti presenti in tabella vengono forniti non verniciati.

Notes: All products in the table are supplied unpainted.

Art./Ref.	Titolo Prodotto/Titolo Prodotto	Peso Kg/Weight Kg	Note/Note
CP1831N	STAFFA PER ANCORA ESTIRPATORE	2.3	PER ANCORA 50X20 E TRAVE DA 100
CP1832N	STAFFA PER ANCORA ESTIRPATORE	2.4	PER ANCORA 50X25 E TRAVE DA 100
CP1834N	STAFFA PER ANCORA ESTIRPATORE	4.4	PER ANCORA 60X25 E TRAVE DA 120
CP1835N	STAFFA PER ANCORA ESTIRPATORE	4.6	PER ANCORA 60X25 E TRAVE DA 140
CP1836N	STAFFA PER ANCORA ESTIRPATORE	4.2	PER ANCORA 60X30 E TRAVE DA 120
CP1837N	STAFFA PER ANCORA ESTIRPATORE	4.4	PER ANCORA 60X30 E TRAVE DA 140
CP1838N	STAFFA PER ANCORA ESTIRPATORE	4.4	PER ANCORA 70X30 E TRAVE DA 120
CP1839N	STAFFA PER ANCORA ESTIRPATORE	4.6	PER ANCORA 70X30 E TRAVE DA 140
CP1840N	STAFFA PER ANCORA ESTIRPATORE	5.6	PER ANCORA 70X30 E TRAVE DA 160
CP1841N	STAFFA PER ANCORA ESTIRPATORE	6.4	PER ANCORA 80X30 E TRAVE DA 160

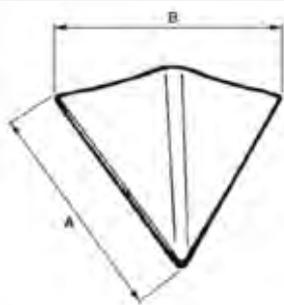
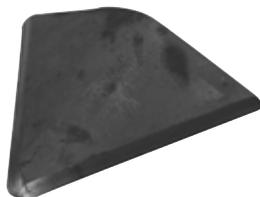
VOMERINE A SALDARE IN ACCIAIO STAMPATO
PETITS SOCS A SOUDER EN ACIER
HARDENED STEEL WELDED SHARE
SCHAR ZUM ANSCHWEISSEN AUS STAHL
REJAS EN ACERO IMPRESO

Note: Tutti i prodotti presenti in tabella vengono forniti non verniciati.

Notes: All products in the table are supplied unpainted.

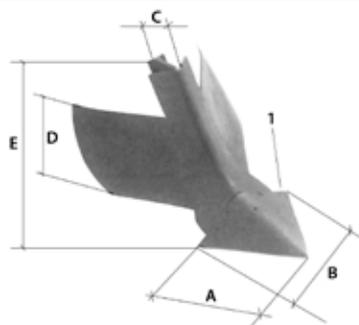
Art./Ref.	Titolo Prodotto/Titolo Prodotto	A mm	B mm	Spessore mm/Thickness mm	Peso Kg/Weight Kg
CP1854N	VOMERINA A SALDARE	230	200	8 mm	1.6
CP1855N	VOMERINA A SALDARE	270	220	8 mm	2
CP1856N	VOMERINA A SALDARE	285	240	8 mm	2.3
CP1857N	VOMERINA A SALDARE	310	270	9 mm	3.3
CP1858N	VOMERINA A SALDARE	340	290	9 mm	4

ASSOLCATORE AD ALI REGISTRABILI
BUTTOIR AILES REGLABLES
LISTER WITH REGISTRABLE FLANGES
FURCHENZIEHER MIT VERSTELLBAREN FLUEGELN
APORCADOR CON ALAS ASENTABLE

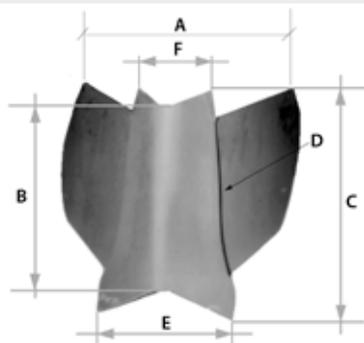
Art./Ref.	Titolo Prodotto/Titolo Prodotto	A mm	B mm	Tipo/Type	C mm	D mm	E mm	Note/Note
CP1960	ASSOLCATORE AD ALI REGISTRABILI	290	290	-	120	260	460	APERTURA MIN.160 MM - MAX.500 MM
CP1961	VOMERINA PER ASSOLCATORE CP1960	290	290	1	-	-	-	

ASSOLCATORE AD ALI REGISTRABILI PER ESTIRPATORE
RAYONNEUR AVEC AILES REGISTRABLES POUR ESTIRPATEUR
LISTER WITH REGISTRABLE FLANGES FOR GRUBBER
FURCHENZIEHER MIT VERSTELLBAREN FLUEGELN
APORCADOR CON ALAS ASENTABLES PARA EXTIRPADOR

Art./Ref.	Titolo Prodotto/Titolo Prodotto	A mm	B mm	C mm	D mm	E mm	F mm
SAR6079	ASSOLCATORE REGISTRABILE	MIN 300 - MAX 500	260	330	270	200	120

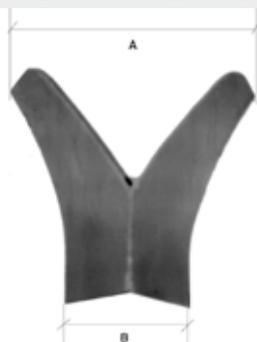
ASSOLCATORE ADA ALI FISSE PER ESTIRPATORE
RAYONNEUR AVEC AILES FIXÉES POUR ESTIRPATEUR
LISTER WITH FIXED FLANGES FOR GRUBBER
FURCHENZIEHER MIT FIXIERTEN FLUEGELN FUER GRUBBER
APORCADOR ALAS FIJAS PARA EXTIRPADOR

Art./Ref.	Titolo Prodotto/Titolo Prodotto	A mm	B mm
SAR6240	ASSOLCATORE FISSO	490	230
SAR6240P	ASSOLCATORE FISSO PICCOLO	420	230

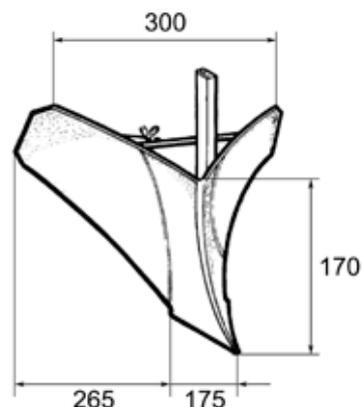
ASSOLCATORE PER MOTOZAPPA
RAYONNEUR POUR MOTOHOUE
LISTER FOR MOTORIZED HOE
FURCHENZIEHER FUER MOTORHACKE
APORCADOR PARA MOTO-AZADA

Art./Ref.	Titolo Prodotto/Titolo Prodotto	Note/Note
SAR6242	ASSOLCATORE PER MOTOZAPPA	Senza gambo e non verniciato
SAR6242A	ASSOLCATORE PER MOTOZAPPA	Con gambo 25X8
SAR6242B	ASSOLCATORE PER MOTOZAPPA	Con gambo 30X10
SAR6242C	ASSOLCATORE PER MOTOZAPPA	Con gambo 35X10
SAR6242D	ASSOLCATORE PER MOTOZAPPA	Con gambo 40X10

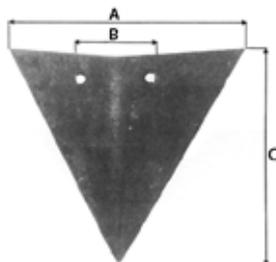
VOMERINA PER ESTIRPATORE A DUE FORI
SOC POUR DERACINEUR 2 TROUS
SHARE FOR 2 HOSES GRUBBER
SCHAR FUER 2-LOECHER-GRUBBERZINKEN
REJA PARA EXTIRPADOR 2 AGUJEROS

Note: Tutti i prodotti presenti in tabella vengono forniti non verniciati.

Notes: All products in the table are supplied unpainted.

Art./Ref.	A mm	B mm	C mm	Spessore mm/Thickness mm	Peso Kg/Weight Kg
CP1829N	315	85	275	7 mm	3.2

VOMERINA PER ESTIRPATORE A TRE FORI

SOC POUR DERACINEUR 3 TROUS

SHARE FOR 3 HOSES GRUBBER

SCHAR FUER GRUBBERZINKEN MIT 3 LOECHER

REJA EXTIRPADOR 3 AGUJEROS

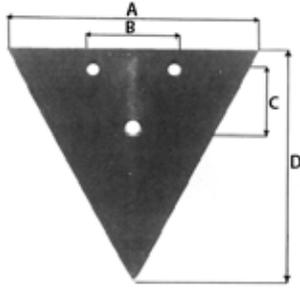

Note: Tutti i prodotti presenti in tabella vengono forniti non verniciati.

Notes: All products in the table are supplied unpainted.

Art./Ref.	A mm	B mm	C mm	D mm	Spessore mm/Thickness mm	Peso Kg/Weight Kg
CP1828N	350	100	70	300	7 mm	3.7

VOMERE ESTIRPATORE ADATTABILE SOGEMA

SOC DERACINEUR ADAPTABLE A SOGEMA

GRUBBER SHARE SUITABLE TO SOGEMA

SCHAR PASSEND ZU SOGEMA

REJA EXTIRPADOR ADAPTABLE A SOGEMA

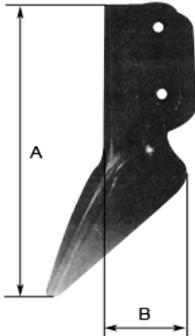

Art./Ref.	A mm	B mm	Note/Note
CP1279	290	150	Con fori laterali da mm 14 (interasse mm 64). Larghezza asola per ancora mm 28.

VOMERINA TIPO PUGLIA PICCOLA

SOC TYPE PUGLIA PETIT

LITTLE SHARE TYPE PUGLIA

SCHAR TYP „PUGLIA“ KLEIN

REJA TIPO PUGLIA PEQUENA

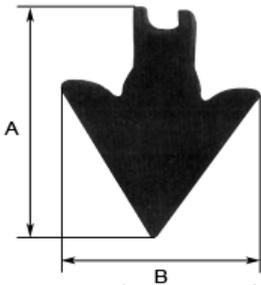

Note: Tutti i prodotti presenti in tabella vengono forniti non verniciati.

Notes: All products in the table are supplied unpainted.

Art./Ref.	A mm	B mm	Note/Note
CP1942	175	170	Senza fori laterali e non verniciata. Larghezza asola per ancora mm 28.

VOMERINA TIPO PUGLIA MEDIA

SOC TYPE PUGLIA MOYEN
 MEDIUM SHARE TYPE PUGLIA
 SCHAR TYP „PUGLIA“ MITTEL
 REJA TIPO PUGLIA MEDIA

Note: Tutti i prodotti presenti in tabella vengono forniti non verniciati.

Notes: All products in the table are supplied unpainted.

Art./Ref.	A mm	B mm	Note/Note
CP1941	210	185	Senza fori laterali e non verniciata. Larghezza asola per ancora mm 22.

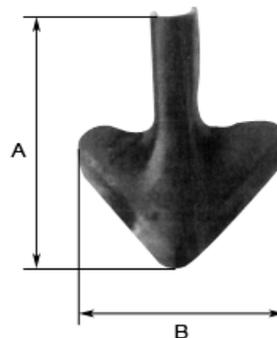
VOMERINA TIPO PUGLIA GRANDE

SOC TYPE PUGLIA GRAND
 LARGE SHARE TYPE PUGLIA
 SCHAR TYP „PUGLIA“ GROSS
 REJA TIPO PUGLIA GRANDE

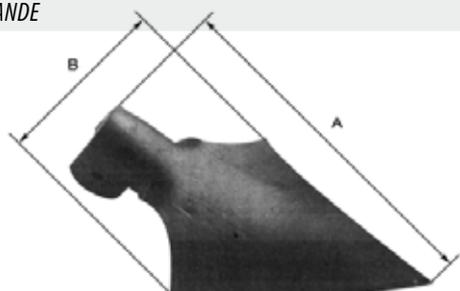

Art./Ref.	A mm	B mm	Note/Note
CP1940	170	310	Con fori laterali mm 13 e staffa saldata per alloggiamento ancora. Larghezza asola per ancora mm 33.

SUPPORTO MOLLEGGIATO PER ERPICE LEGGERO

SUPPORT SUSPENDU POUR HERSE LEGERE
 SPRUNG SUPPORT FOR LIGHT HARROW
 ZINKEN-HALTER GEFEDERT FUER LEICHTEN EGGEN
 SOPORTE AMORTIGUADOR PARA ERPICE LIGERO

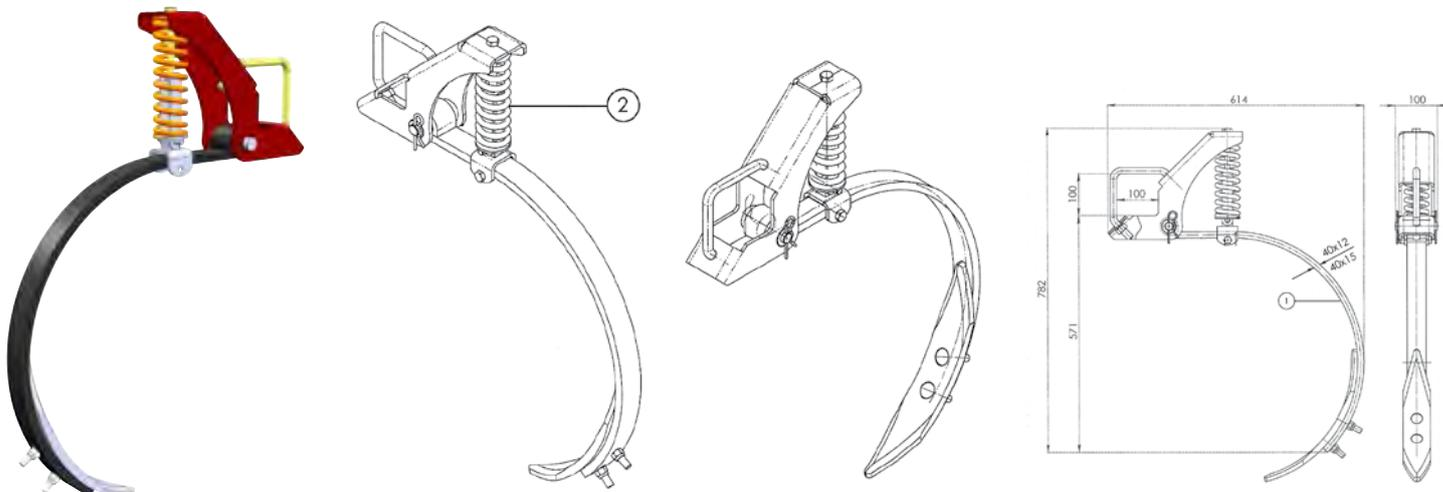

Art./Ref.	Titolo Prodotto/Titolo Prodotto	Tipo/Type	Note/Note
CP6132	SUPPORTO MOLLEGGIATO PER ERPICE LEGGERO CON ANCORA 40X15	-	Vomerina applicata art. CP1325A. In alternativa e possibile applicare art. SAR6212 o SAR6499 (vomerina triangolare).
CP6140	ANCORA 40X15 PER ERPICE CON MOLLA	1	Interasse fori per vomerina mm 45
CP6136	MOLLA PER SUPPORTO ERPICE LEGGERO	2	-

SUPPORTO MOLLEGGIATO PER ERPICE PESANTE

SUPPORT SUSPENDU POUR HERSE LOURDE
 SPRUNG SUPPORT FOR HEAVY HARROW
 ZINKEN-HALTER GEFEDERT FUER SCHWEREN EGGEN
 SOPORTE AMORTIGUADOR PARA ERPICE PESADO

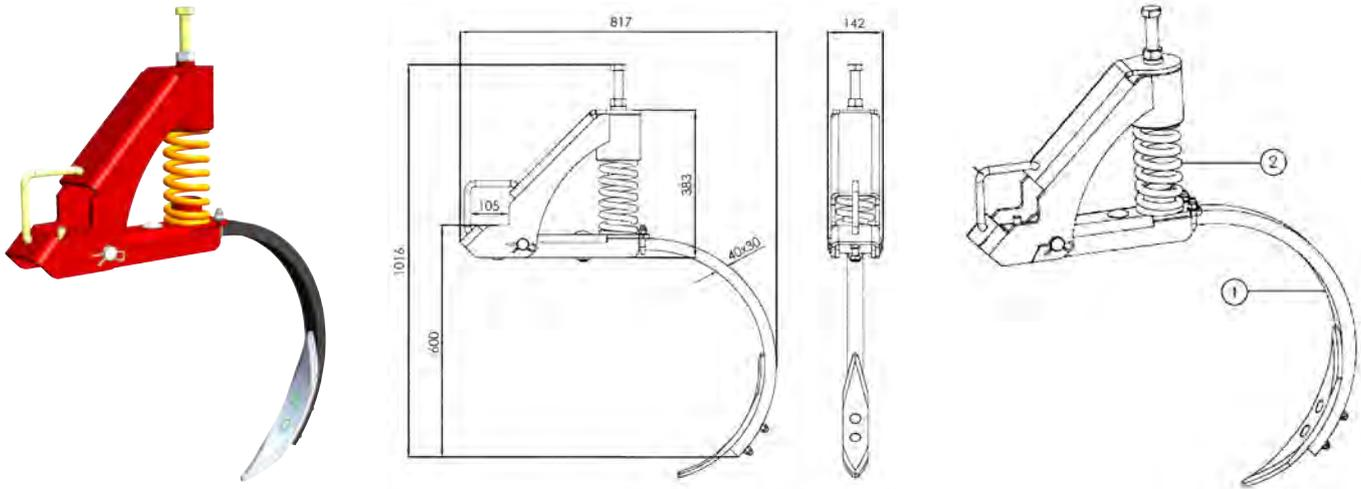

Art./Ref.	Titolo Prodotto/Titolo Prodotto	Tipo/Type	Note/Note
CP6133	SUPPORTO MOLLEGGIATO PER ERPICE PESANTE CON ANCORA 40X30	-	Vomerina applicata art.CP1325A. In alternativa e possibile applicare art.SAR6212 o SAR6499 (vomerina triangolare).
CP6135	ANCORA 40X30 PER ERPICE PESANTE	1	Interasse fori per vomerina mm 45
CP6137	MOLLA PER SUPPORTO ERPICE PESANTE	2	

ACCUMULATORI IDROPNEUMATICI A SACCA HTR

ACCUMULATEUR HYDROPNEUMATIQUE À VESSIE
 BLADDER TYPE HYDROPNEUMATIC ACCUMULATORS HTR
 HOCHDRUCKLUFTKRAFTSPEICHER MIT LUFTSACK, HTR SERIE
 ACCUMULADOR HIDROPNEUMATICO DE CAUCHO HTR



Note: RIPARABILE DALL'ALTO. Caratteristiche Tecniche: Pressione massima di lavoro (PS): 210/230 bar. Pressione di prova (PT): PS*1,43 bar. - Corpo: in acciaio al carbonio verniciato. - Temperatura d'impiego (TS): da -20°C a + 80°C. Sacca standard: adatta ad oli minerali e a fluidi non aggressivi. - Montaggio: da posizione verticale (valvola azoto verso l'alto) ad orizzontale. Rapporto di compressione: - consigliato: P2/P0 = 2.5 - massimo: P2/P0 = 4. Vita meccanica: il numero di cicli e' inversamente proporzionale all'aumento del rapporto di compressione. Disponibile: - connessione idraulica 1/2" BSP per modelli contrassegnati con (*) Conforme a: 97/23/CE - PED - 94/9/CE - ATEX Group II Cat 2 - ASME VIII Div. - GOST-R (Russia) - SELO (China). N.B.: L'articolo viene gestito a fabbisogno e i tempi di consegna sono di circa 20 gg dalla conferma dell'ordine. Al momento dell'ordine deve essere comunicata la pressione d'esercizio.

Notes: TOP REPARABLE. Technical Features: Maximum working pressure (PS): 250 / 210 / 150 bar. Test pressure (PT): PS x 1,43. Body: made in painted carbon steel. Working temperature (TS): from -20°C to +80°C. Standard bladder: can be used with mineral oils and non corrosive fluids. Installation position: from vertical (nitrogen valve upward) to horizontal position. Compression Ratio: - recommended: P2/P0 = 2.5 - maximum: P2/P0 = 4. Mechanical life: the number of cycles is inversely proportional to the increase of compression ratio. Available: - hydraulic connection 1/2" BSP for the models marked with (*). According to: - 97/23/CE - PED - 94/9/CE - ATEX Group II Cat 2 - ASME VIII Div. 1 - GOST-R (Russia) - SELO (China). N.B.: The article is handled in requirements and delivery times are approximately 20 days from the confirmation of order. At the time of order must be communicated to the operating pressure.

Art./Ref.	Titolo Prodotto/Titolo Prodotto	A mm	B mm	C mm	D mm	E mm	F mm	L mm	Diametro mm/Diameter mm	Spessore mm/Thickness mm	Tipo/Type	Peso Kg/Weight Kg
CP4834	ACCUMULATORE LT.1,5	210	25	15	115	1.5	150	280	M 18X1,5 *	40	1	5.3
CP4835	ACCUMULATORE LT.2,5	210	50	15	115	2.5	150	483	1" 1/4 BSP	110	2	11.5
CP4836	ACCUMULATORE LT.4,5	210	80	15	170	4.5	150	395	1" 1/4 BSP	400	2	15
CP4837A	ACCUMULATORE LT.6,5	210	60	20	170	6.5	150	520	1" 1/4 BSP	350	2	24
CP4838	ACCUMULATORE LT.10	210	80	15	170	10	150	760	1" 1/4 BSP	300	2	31

ELEMENTO COMPLETO PER TILLER

ELEMENT COMPLET POUR TILLER
 COMPLETE ELEMENT FOR TILLER
 PFLUG ELEMENT FUER TILLER
 ELEMENTO COMPLETO DE TILLER

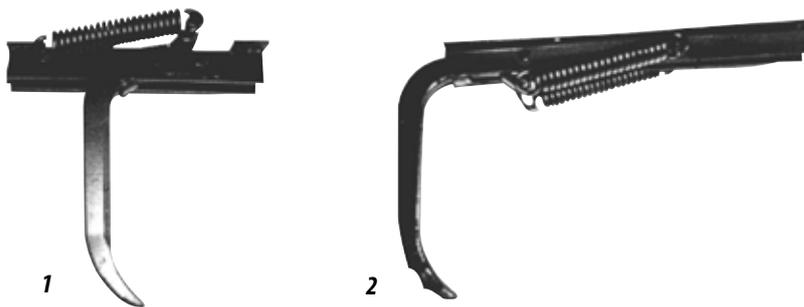

Note: Tutti i prodotti presenti in tabella vengono forniti non verniciati.

Notes: All products in the table are supplied unpainted.

Art./Ref.	Titolo Prodotto/Titolo Prodotto	Tipo/Type	Peso Kg/Weight Kg	Note/Note
CP1230	ELEMENTO PER TILLER	1 - CORTO NORMALE - ALTEZZA 470 MM	17.8	MOLLA APPLICATA ART.CP1247
CP1231	ELEMENTO PER TILLER	2 - LUNGO NORMALE - ALTEZZA 470 MM	19.1	MOLLA APPLICATA ART.CP1247
CP1232	ELEMENTO PER TILLER	1 - CORTO PESANTE - ALTEZZA 540 MM	27.4	MOLLA APPLICATA ART.CP1867
CP1233	ELEMENTO PER TILLER	2 - LUNGO PESANTE - ALTEZZA 540 MM	32.7	MOLLA APPLICATA ART.CP1867

TELAIETTO PER ANCORA TILLER

SUPPORT POUR TILLER
 FRAME FOR TILLER ANCHOR
 GESTELL FUER GRUBBERZINKEN
 TELAR DE ANCLA TILLER

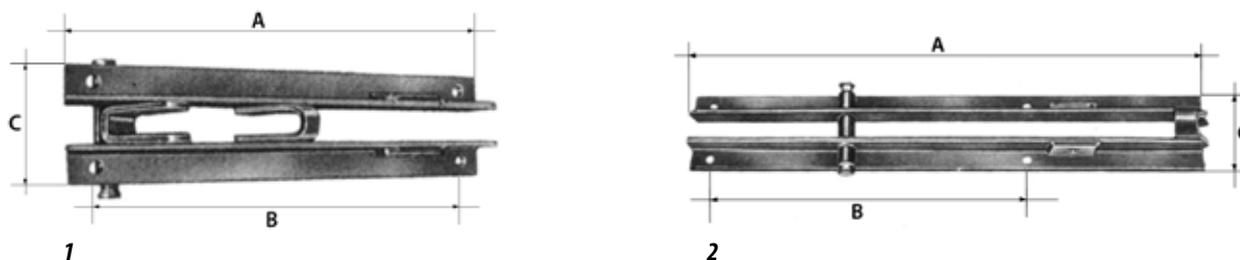

Note: Tutti i prodotti presenti in tabella vengono forniti non verniciati.

Notes: All products in the table are supplied unpainted.

Art./Ref.	Titolo Prodotto/Titolo Prodotto	A mm	B mm	C mm	Tipo/Type	Peso Kg/Weight Kg	Note/Note
RC0622	TELAIETTO PER ANCORA TILLER	540	490	120	1 - CORTO NORMALE	6.7	ACCIAIO 40X60X6
RC0624	TELAIETTO PER ANCORA TILLER	740	490	120	2 - LUNGO NORMALE	8.1	ACCIAIO 40X60X6
CP1238	TELAIETTO PER ANCORA TILLER	560	-	-	1 - CORTO PESANTE	10.8	ACCIAIO 80X12
CP1236	TELAIETTO PER ANCORA TILLER	1030	-	-	2 - LUNGO PESANTE	16.1	ACCIAIO 80X12

ANCORA FORATA PER TELAIETTO LUNGO COMPLETA DI NASELLO

ANCRES AVEC TROU POUR CADRE LONG COMPLETE DE MENTONNET
 PUNCHED SHORE ANCHOR WITH SNUG FOR LONG FRAME
 GEBOHRTE GRUBBERZINKE FUER GESTELL LANG KOMPLETT MIT ANKERUNG
 ANCLA HORADA PARA TELAR LARGO - COMPLETA DE DIENTE

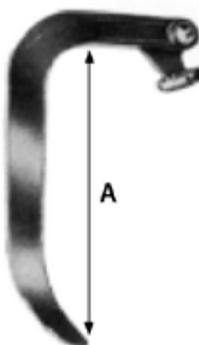

Note: Tutti i prodotti presenti in tabella vengono forniti non verniciati.

Notes: All products in the table are supplied unpainted.

Art./Ref.	Titolo Prodotto/Titolo Prodotto	A mm
RC0628	ANCORA PER TELAIETTO LUNGO	430

ANCORA FORATA PER TELAIETTO CORTO COMPLETA DI NASELLO

ANCRE AVEC TROU POUR CADRE COURT COMPLETE DE MENTONNET

PUNCHED SHORE ANCHOR WITH SNUG FOR SHORT FRAME

GEOHRTE GRUBBERZINKE FUER GESTELL KURZ KOMPLETT MIT ANKERUNG

ANCLA HORADA PARA TELAR CORTO- COMPLETA DE DIENTE

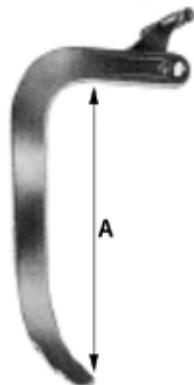
**Note:** Tutti i prodotti presenti in tabella vengono forniti non verniciati.**Notes:** All products in the table are supplied unpainted.

Art./Ref.	Titolo Prodotto/Titolo Prodotto	A mm
RC0626	ANCORA PER TELAIETTO CORTO	430

BOCCOLA PER ANCORA

BAGUE POUR ANCRE

BUSHING FOR SHORE ANCHOR

BUCHSEN FUER GRUBBERZINKEN

BUJE PARA ANCLA

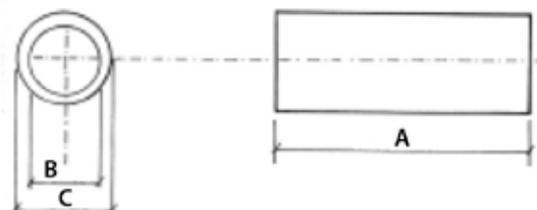
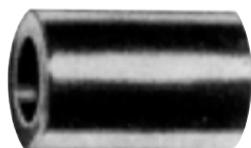
**Note:** Tutti i prodotti presenti in tabella vengono forniti non verniciati.**Notes:** All products in the table are supplied unpainted.

Art./Ref.	Titolo Prodotto/Titolo Prodotto	A mm	B mm	C mm
RC0630	BOCCOLA PER ANCORA TILLER	40	16	28
RC0630A	BOCCOLA PER ANCORA TILLER	50	20.5	32

NASELLO PER ANCORE TILLER

MENTONNET POUR ANGRES TILLER

SNUG FOR TILLER ANCHORS

HALTERUNG FUER GRUBBERZINKEN

DIENTE DE ENCLAS TILLER

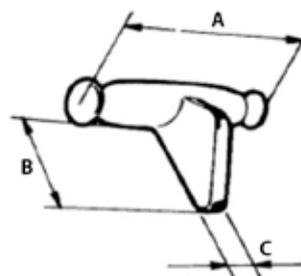
**Note:** Tutti i prodotti presenti in tabella vengono forniti non verniciati.**Notes:** All products in the table are supplied unpainted.

Art./Ref.	Titolo Prodotto/Titolo Prodotto	A mm	B mm	C mm	Tipo/Type
CP1242	NASELLO PER ANCORA TILLER	140	55	18	STAMPATO
CP1242A	NASELLO PER ANCORA TILLER	175	80	20	SALDATO PESANTE

ANCORE PER TILLER

ANCRE POUR TILLER
TILLER ANCHOR
GRUBBERZINKEN FUER TILLER
ANCLAS DE TILLER

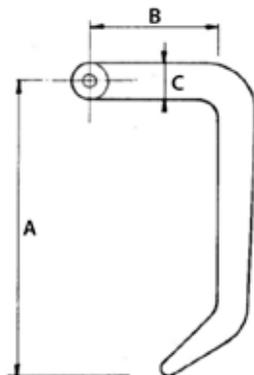

Note: Tutti i prodotti presenti in tabella vengono forniti non verniciati.

Notes: All products in the table are supplied unpainted.

Art./Ref.	Titolo Prodotto/Titolo Prodotto	A mm	B mm	C mm	Spessore mm/Thickness mm	Peso Kg/Weight Kg
CP1240	ANCORA TILLER MEDIA	470	210	50	20	5
CP1241	ANCORA TILLER PESANTE	540	210	60	25	7.5
CP1241A	ANCORA TILLER SUPER PESANTE	540	210	60	30	9.2

BARRA FORATA PER TELAI TILLER

BARRE AVEC TROU POUR CADRES TILLER
PUNCHED BAR FOR TILLER FRAME
GEMOHRTE STANGE FUER TILLER
BARRA PINCHADA DE TELAR TILLER



Note: Tutti i prodotti presenti in tabella vengono forniti non verniciati.

Notes: All products in the table are supplied unpainted.

Art./Ref.	Titolo Prodotto/Titolo Prodotto	A mm	Tipo/Type	Peso Kg/Weight Kg	Note/Note
CP1224	BARRA FORATA PER TILLER	1172	5 ANCORE	9.5	FERRO "L" 80X60X8
CP1225	BARRA FORATA PER TILLER	1676	7 ANCORE	13.7	FERRO "L" 80X60X8
CP1226	BARRA FORATA PER TILLER	2180	9 ANCORE	17.7	FERRO "L" 80X60X88
CP1227	BARRA FORATA PER TILLER	2404	11 ANCORE	19.7	FERRO "L" 80X60X8
CP1228	BARRA FORATA PER TILLER	2852	13 ANCORE	23	FERRO "L" 80X60X8
CP1229	BARRA FORATA PER TILLER	3300	15 ANCORE	27	FERRO "L" 80X60X8

MOLLE PER TILLER CON OCCHIO GIREVOLE

RESSORT POUR TILLER AVEC OEIL TOURNANT
RECOLVING EYE SPRINGS FOR TILLER
FEDER FUER GRUBBERZINKEN MIT DREHBAREN AUGEN
MUELLE DE TILLER CON OJO GIRATORIO

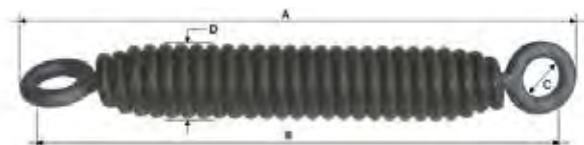

Note: Tutti i prodotti presenti in tabella vengono forniti non verniciati.

Notes: All products in the table are supplied unpainted.

Art./Ref.	Titolo Prodotto/Titolo Prodotto	A mm	B mm	C mm	D mm	Note/Note
CP1243	MOLLA PER TILLER CON OCCHIO GIREVOLE	355	335	32	52	filo 10 mm
CP1244	MOLLA PER TILLER CON OCCHIO GIREVOLE	357	335	32	52	filo 11 mm
CP1255	MOLLA PER TILLER CON OCCHIO GIREVOLE	440	420	32	60	filo 12 mm

MOLLE PER TILLER CON GANCIO APERTO

RESSORTS POUR TILLER AVEC CROCHET OUVERT

OPENED HOOK SPRING FOR TILLER

FEDER FUER GRUBBERZINKEN MIT OFFENEM HAKEN

MUELLE DE TILLER CON GANCHO ABIERTO

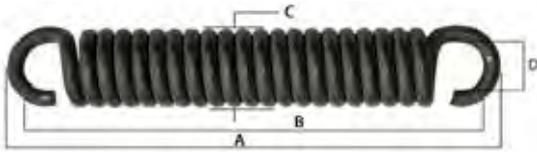
**Note:** Tutti i prodotti presenti in tabella vengono forniti non verniciati.**Notes:** All products in the table are supplied unpainted.

Art./Ref.	Titolo Prodotto/Titolo Prodotto	A mm	B mm	C mm	D mm	Tipo/Type	Note/Note
CP1246	MOLLA PER TILLER CON GANCIO APERTO	317	297	52	33	-	filo 10 mm
CP1248	MOLLA PER TILLER CON GANCIO APERTO	355	335	52	33	-	filo 10 mm
CP1933	MOLLA PER ESTIRPATORE CON GANCIO APERTO	345	325	55	35	-	filo 10 mm
CP1935	MOLLA PER ESTIRPATORE CON GANCIO APERTO	290	270	55	35	-	filo 10 mm
CP1247	MOLLA PER TILLER CON GANCIO APERTO	320	297	52	30	-	filo 11 mm
CP1249	MOLLA PER TILLER CON GANCIO APERTO	357	335	52	30	-	filo 11 mm
CP1867	MOLLA PER TILLER CON GANCIO APERTO	355	335	60	36	-	filo 12 mm
CP1934	MOLLA PER ESTIRPATORE CON GANCIO APERTO	375	351	70	45	-	filo 12 mm
RC0925	MOLLA PER TILLER CON GANCIO APERTO	335	315	51	34	NARDI	filo 9 mm
RC0926	MOLLA PER TILLER CON GANCIO APERTO	383	359	62	38	NARDI	filo 12 mm

MOLLA PER TILLER CON GANCIO A VITE

RESSORT POUR TILLER AVEC CROCHET A VIS

SPRING WITH SCREWED HOOK FOR TILLER

FEDER FUER GRUBBERZINKEN MIT ANSCHRAUB HAKEN

MUELLE DE TILLER CON GANCHO ROSCADO

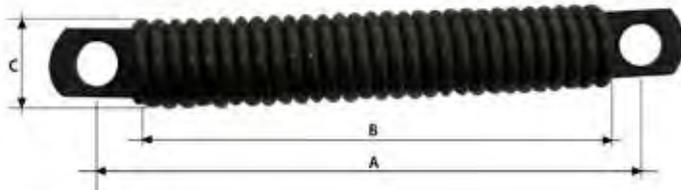
**Note:** Tutti i prodotti presenti in tabella vengono forniti non verniciati.**Notes:** All products in the table are supplied unpainted.

Art./Ref.	Titolo Prodotto/Titolo Prodotto	A mm	B mm	C mm	Tipo/Type	Note/Note
CP1254	MOLLA PER TILLER CON GANCIO A VITE	310	275	50	NARDI	filo 9 mm

GANCIO A VITE PER MOLLA TILLER

CROCHET A VIS POUR RESSORT TILLER

SCREWED HOOK FOR TILLER SPRING

ANSCHRAUB HAKEN FUER FEDER TILLER

GANCHO ROSCADO DE MUELLE TILLER

**Note:** Tutti i prodotti presenti in tabella vengono forniti non verniciati.**Notes:** All products in the table are supplied unpainted.

Art./Ref.	Titolo Prodotto/Titolo Prodotto	Tipo/Type	Note/Note
CP1258	GANCIO A VITE PER MOLLA TILLER	NARDI	diametro foro mm 23,5

VOMERINI A LANCIA PER ANCORA ESTIRPATORE

SOCS POUR DENT D'EXTIRPATEUR

SHARE FOR CULTIVATOR TINE

SCHAREN FÜR GRUBBERZINKEN

REJAS PARA ANCLA ESTIRPADOR

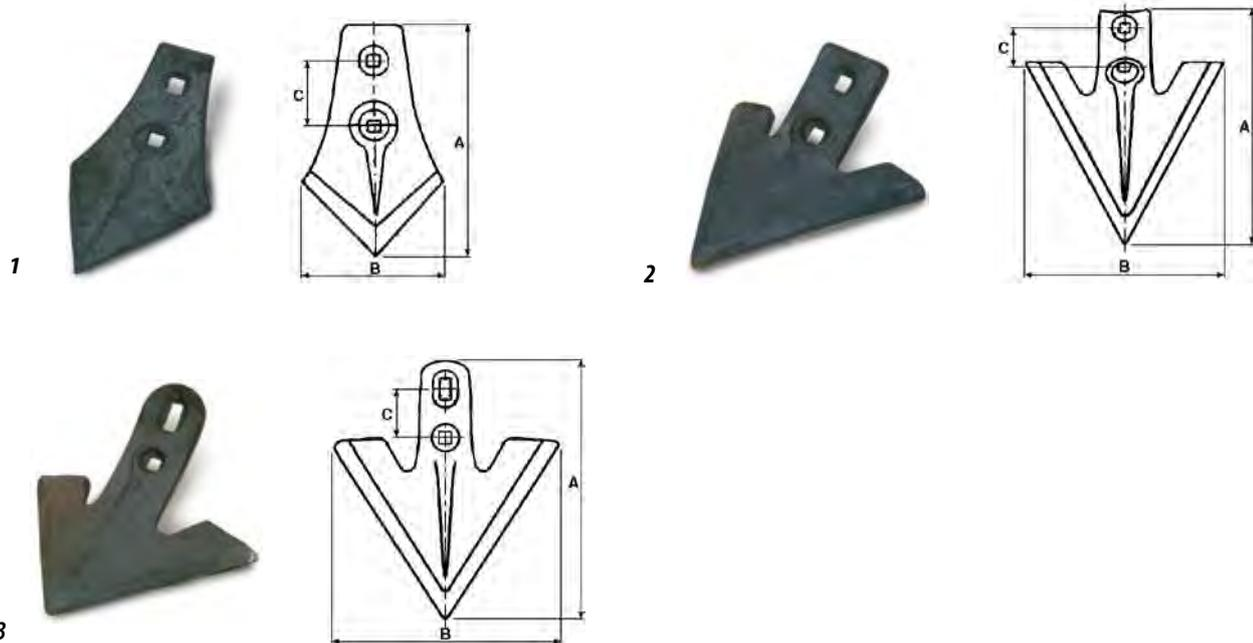

Note: Tutti i prodotti presenti in tabella vengono forniti non verniciati.

Notes: All products in the table are supplied unpainted.

Art./Ref.	Pos.	A mm	B mm	C mm	Spessore mm/Thickness mm	Peso Kg/Weight Kg
CP1251	1	235	125	45-50	10 mm	1.45
CP1252	2	240	190	45-50	10 mm	2.19
CP1253	3	280	240	45-60	10 mm	2.1

VOMERINE REVERSIBILI PER TILLER ADATTABILI NARDI

SOCS REVERSIBLES POUR TILLER ADAPTABLES A NARDI

REVERSIBLE SHARES FOR TILLER SUITABLES TO NARDI

WENDESHARE FUER TILLER PASSEND ZU NARDI

REJAS REVERSIBLES DE TILLER ADAPTABLES A NARDI

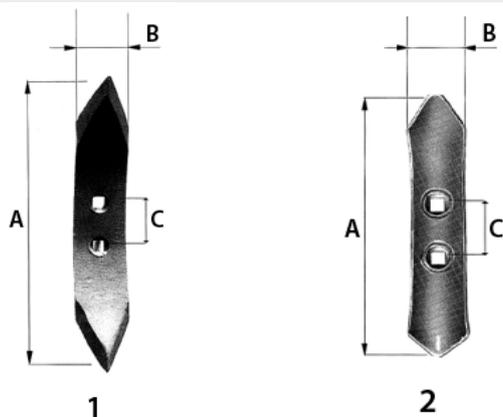

Art./Ref.	Rif. Orig./Orig. Ref.	A mm	B mm	C mm	Spessore mm/Thickness mm	Tipo/Type	Note/Note	Brand	Applicazione/Application
RC0519	6C426	350	70	55	15	1	N.2 fori svasati con quadro mm 15	NARDI	13-15-17-19-25 MV/3 T12, 5-7-9-11-13-15-MV/2, 7-9-11-13-15-17-19 MV/3
RC0521	2C425	250	50	50	13	2	N.2 fori svasati con quadro mm 13	NARDI	11-13 TM/A, 5 TM/GU, 5-7-9 CE 30, 5-7-9 CE 40, 5-7-9 TM, 5-7-9-11-13 CE 32, 5-7-9-11-13-15 M, 5/NGU, 7-11-13-15 TMR/A, 7-9 CE 50, 7-9-11-13 MR, 9 TMR, 9-11-13 ES

VOMERINE PER TILLER ADATTABILI NARDI

SOCs POUR TILLER ADAPTABLES A NARDI
 SHARE FOR TILLER SUITABLES TO NARDI
 SCHARE FUER TILLER PASSEND ZU NARDI
 REJAS DE TILLER ADAPTABLES A NARDI

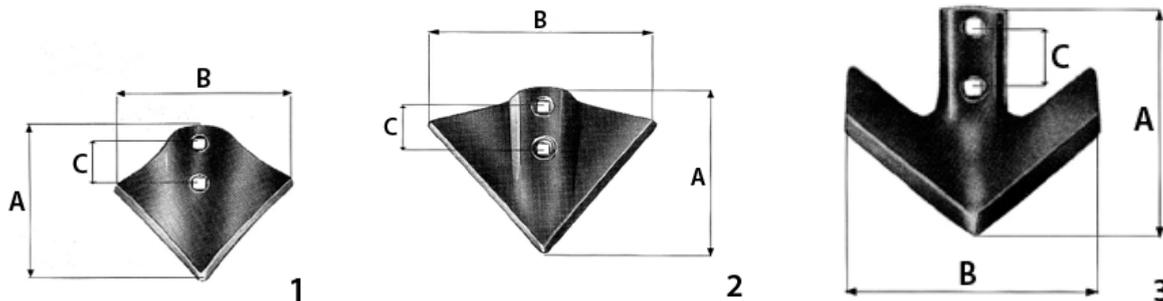

Art./Ref.	Rif. Orig./Orig. Ref.	A mm	B mm	C mm	Spessore mm/Thickness mm	Tipo/Type	Brand	Applicazione/Application
RC0523	2C430	200	205	50	7	1	NARDI	11-13 TM/A, 5 M/GU, 5 TM/GU, 5-7-9 TM, 5-7-9-11-13-15 M, 7-11-13-15 TMR/A, 7-9-11-13 MR, 9 TMR
RC0524	4C430	200	255	50	7	2	NARDI	11-13 TM/A, 5 TM/GU, 5-7-9 TM, 5-7-9-11-13-15 M, 5M/GU, 7-11-13-15 TMR/A, 7-9-11-13 MR, 9 TMR
RC0525	4C435	200	255	50	8	3	NARDI	11-13 TM/A, 5 M/GU, 5 TM/GU, 5-7-9 CE 30, 5-7-9 CE 40, 5-7-9 TM, 5-7-9-11-13 CE 32, 5-7-9-11-13-15 M, 7-11-13-15 TMR/A, 7-9 CE 50, 7-9-11-13 MR, 9 TMR, 9-11-13 ES

VOMERINA ADATTABILE SIDERMAN A SCALPELLO

SOC ADAPTABLE A 'SIDERMAN CHISEL'
 POINT SUITABLE TO SIDERMAN
 BEITEL-SCHAR PASSEND ZU SIDERMANN
 REJA ADAPTABLE A SIDERMAN DE FORMON

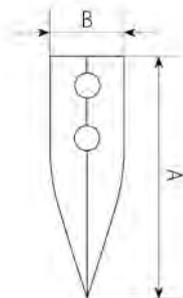

Art./Ref.	A mm	B mm	Spessore mm/Thickness mm	Peso Kg/Weight Kg	Note/Note
CP4424	260	75	10 mm	1.5	Fori da 14,5 mm, con interasse di 70 mm.

VOMERINA ADATTABILE SIDERMAN NORMALE

SOC ADAPTABLE A 'SIDERMAN STANDARD'
 POINT SUITABLE TO SIDERMAN REGULAR SIZE
 SCHAR PASSEND ZU SIDERMANN NORMAL
 REJA ADAPTABLE A SIDERMAN NORMAL

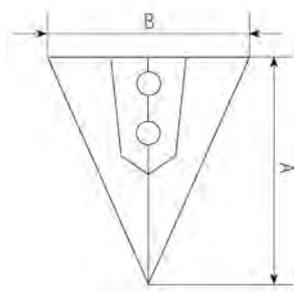

Art./Ref.	A mm	B mm	Spessore mm/Thickness mm	Peso Kg/Weight Kg	Note/Note
CP4425	250	200	8 mm	2	Fori da 14,5 mm, con interasse di 70 mm.

VOMERINA ADATTABILE SIDERMAN GRANDE

SOC ADAPTABLE A 'SIDERMAN GRAND'

POINT SUITABLE TO SIDERMAN BIG SIZE

SCHAR PASSEND ZU SIDERMANN GROSS

REJA ADAPTABLE A SIDERMAN GRANDE

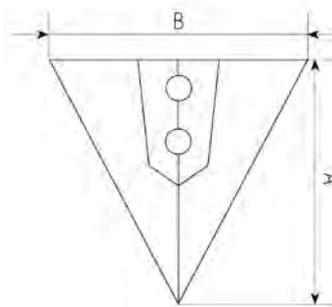

Art./Ref.	A mm	B mm	Spessore mm/Thickness mm	Peso Kg/Weight Kg	Note/Note
CP4426	260	240	8 mm	2.3	Fori da 14,5 mm, con interasse di 70 mm.

VOMERINA ADATTABILE SICILTILLER DUE FORI QUADRO-ASOLA A SCALPELLO

SOC ADAPTABLE A 'SICILTILLER 2 TROUS CARRE-ALLONGE' CHISEL'

POINT SUITABLE TO SICILTILLER 2 HOLES-SQUARED-NORMAL EYE

SCHAR PASSEND ZU SICILTILLER 2 LOECHER - MIT BEITELOESE

REJA ADAPTABLE A SEMICHISEL DOS TALADROS CUADRADO-CORREDERA DE FORMON

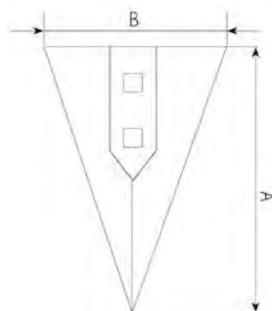

Art./Ref.	A mm	B mm	Spessore mm/Thickness mm	Peso Kg/Weight Kg	Note/Note
CP4427	260	70	8 mm	1.2	Fori da 13 mm di cui uno con asola. Interasse 40-50 mm.

VOMERINA ADATTABILE SICILTILLER DUE FORI QUADRO-ASOLA NORMALE

SOC ADAPTABLE A 'SICILTILLER 2 TROUS CARRE-ALLONGE' NORMAL'

POINT SUITABLE TO SICILTILLER 2 HOLES-SQUARED-NORMAL EYE

SCHAR PASSEND ZU SICILTILLER 2 LOECHER - MIT NORMALER OESE

REJA ADAPTABLE A SEMICHISEL DOS TALADROS CUADRADO-CORREDERA NORMAL

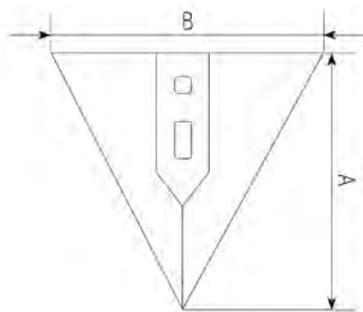

Art./Ref.	A mm	B mm	Spessore mm/Thickness mm	Peso Kg/Weight Kg	Note/Note
CP4428	240	220	8 mm	2	Fori da 13 mm di cui uno con asola. Interasse 40-50 mm.

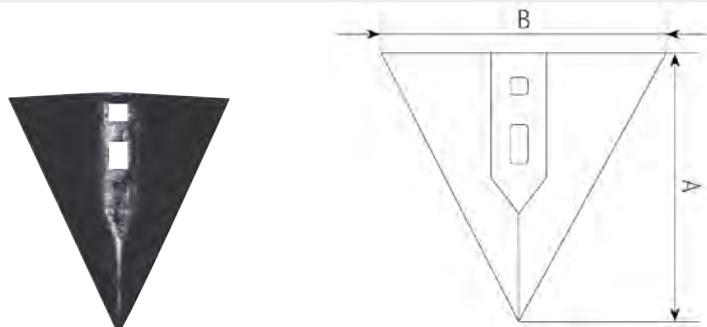
VOMERINA ADATTABILE SICILTILLER DUE FORI QUADRO-ASOLA LARGA
SOC ADAPTABLE A 'SICILTILLER 2 TROUS CARRE - ALLONGE' LARGE'
POINT SUITABLE TO SICILTILLER 2 HOLES-SQUARED-LARGE EYE
SCHAR PASSEND ZU SICILTILLER 2 LOECHER - MIT BREITER OESE
REJA ADAPTABLE A SEMICHISEL DOS TALADROS CUADRADO-CORREDERA GRANDE

Art./Ref.	A mm	B mm	Spessore mm/Thickness mm	Peso Kg/Weight Kg	Note/Note
CP4429	250	240	8 mm	2.2	Fori da 13 mm di cui uno con asola. Interasse 40-50 mm.

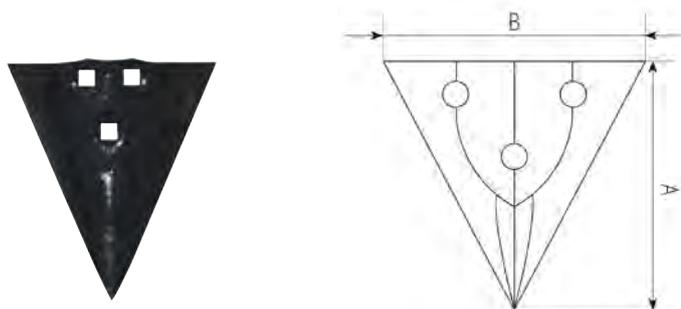
VOMERINA ADATTABILE SICILTILLER-DI RAIMONDO-RACITI TRE FORI
SOC ADAPTABLE A 'SICILTILLER-DI RAIMONDO-RACITI 3 TROUS'
POINT SUITABLE TO SICILTILLER-DI RAIMONDO-RACITI 3 HOLES
SCHAR PASSEND ZU SICILTILLER-DI RAIMONDO-RACITI 3 LOECHER
REJA ADAPTABLE A SICILTILLER-DI RAIMONDO-RACITI TRE TALADROS

Art./Ref.	A mm	B mm	Spessore mm/Thickness mm	Peso Kg/Weight Kg	Note/Note
CP4430	250	230	8 mm	2.2	Fori da 14,5 mm. Interasse fori lato B mm 46 e interasse fori lato A mm 58. Modello Sicltiller e Di Raimondo.
CP4432	250	230	8 mm	2.2	Fori da 14,5 mm. Interasse fori lato B mm 45 e interasse fori lato A mm 61. Modello Raciti.

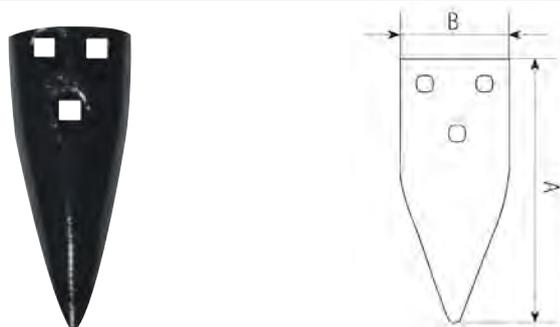
VOMERINA ADATTABILE SICILTILLER TRE FORI A SCALPELLO
SOC ADAPTABLE A 'SICILTILLER 3 TROUS CHISEL'
POINT SUITABLE TO SICILTILLER 3 HOLES
BEITEL-SCHAR PASSEND ZU SICILTILLER 3 LOECHER
REJA ADAPTABLE A SEMICHISEL TRES TALADROS DE FORMON

Art./Ref.	A mm	B mm	Spessore mm/Thickness mm	Peso Kg/Weight Kg	Note/Note
CP4431	270	110	10 mm	2.15	Fori da 14,5 mm. Interasse fori lato B mm 46 e interasse fori lato A mm 58.

VOMERINA TILLER MODELLO SPAGNA N.1

SOC MODELE 'SPAGNA NO.1'
 TILLER POINT SPANISH TYPE N.1
 TILLER SCHAR MOD. SPANIEN NR. 1
 REJA CHISEL MODELO ESPAÑA N.1

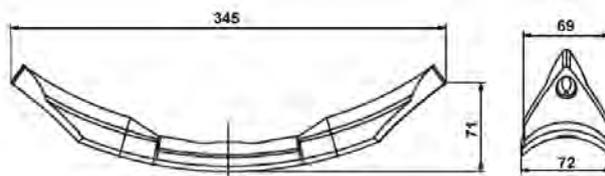
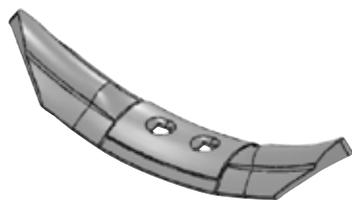

Art./Ref.	Spessore mm/Thickness mm	Note/Note
CP5903	9 mm	Fori da 13 mm. Interasse fori 45 mm

VOMERINA TILLER MODELLO SPAGNA N.2

SOC MODELE 'SPAGNA NO.2'
 TILLER POINT SPANISH TYPE N.2
 TILLER SCHAR MOD. SPANIEN NR. 2
 REJA CHISEL MODELO ESPAÑA N.2

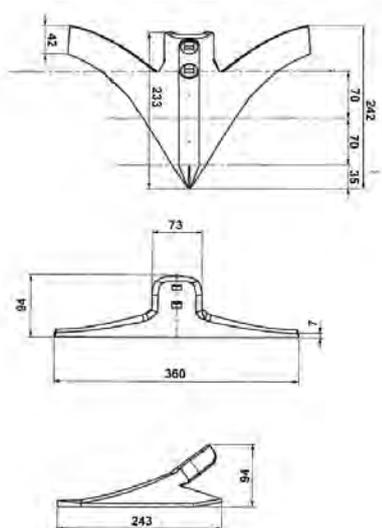

Art./Ref.	Spessore mm/Thickness mm	Note/Note
CP5924	9 mm	Fori da 13 mm. Interasse fori 45 mm

VOMERINA TILLER MODELLO SPAGNA N.3

SOC MODELE 'SPAGNA NO.3'
 TILLER POINT SPANISH TYPE N.3
 TILLER SCHAR MOD. SPANIEN NR. 3
 REJA CHISEL MODELO ESPAÑA N.3

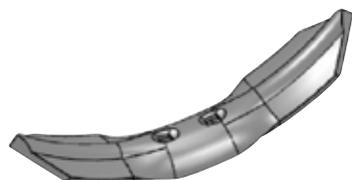

Art./Ref.	Spessore mm/Thickness mm	Note/Note
CP5905	8 mm	Fori da 13 mm. Interasse fori 45 mm

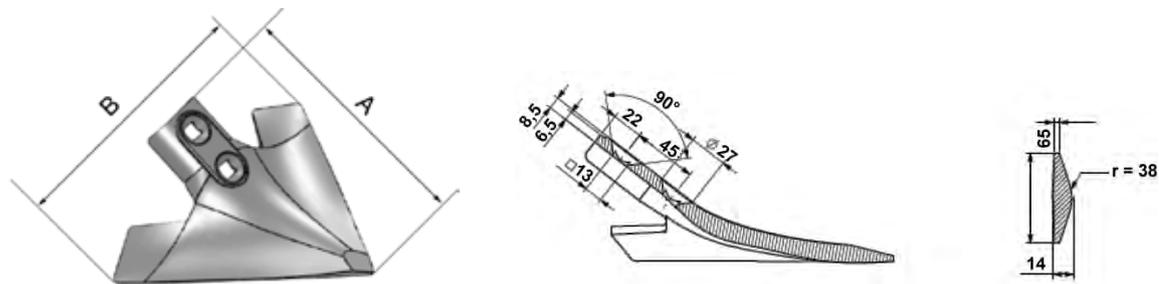
VOMERINA TILLER MODELLO SPAGNA N.4
SOC MODELE 'SPAGNA NO.4'
TILLER POINT SPANISH TYPE N.4
VOMERINA TILLER MODELLO SPAGNA N.4
REJA CHISEL MODELO ESPAÑA N.4

Art./Ref.	A mm	B mm	Spessore mm/Thickness mm	Note/Note
CP5922	225	266	9 mm	Fori da 13 mm. Interasse fori 45 mm.

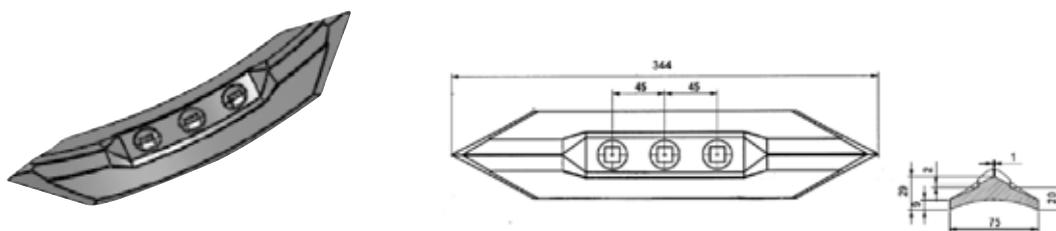
VOMERINA TILLER MODELLO SPAGNA N.5
SOC MODELE 'SPAGNA NO.5'
TILLER POINT SPANISH TYPE N.5
TILLER SCHAR MOD. SPANIEN NR. 5
REJA CHISEL MODELO ESPAÑA N.5

Art./Ref.	Spessore mm/Thickness mm	Note/Note
CP5906	9 mm	Fori da 13 mm. Interasse fori 45 mm

VOMERINA TILLER MODELLO SPAGNA N.6
SOC MODELE 'SPAGNA NO.6'
TILLER POINT SPANISH TYPE N.6
TILLER SCHAR MOD. SPANIEN NR. 6
REJA CHISEL MODELO ESPAÑA N.6

Art./Ref.	Spessore mm/Thickness mm	Note/Note
CP5909	12 mm	Fori da 13 mm. Interasse fori 45 mm

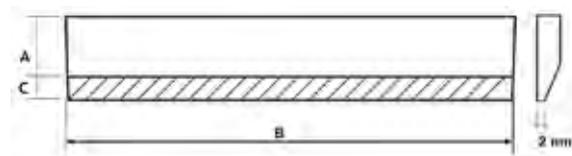
LAME FRESATE PER RUSPETTE IN ACCIAIO
LAMES FRAISÉE POUR PETITES DECAPEUSES EN ACIER
MILLED BLADES FOR STEEL SCRAPERS
FRAES-MESSER AUS STAHL
CUCHILLAS FRESADAS PARA EXCAVADORAS EN ACERO

Note: Tutti i prodotti presenti in tabella vengono forniti non verniciati.

Notes: All products in the table are supplied unpainted.

Art./Ref.	Titolo Prodotto/Titolo Prodotto	A mm	B mm	C mm	Spessore mm/Thickness mm
SAR7011	LAMA FRESATA	60	2000	35	12 mm
SAR7012	LAMA FRESATA	100	2000	35-40	12 mm
SAR7013	LAMA FRESATA	120	2000	35-40	12 mm
SAR7015	LAMA FRESATA	140	2000	35-40	12 mm
SAR7016	LAMA FRESATA	150	2000	35-40	12 mm
SAR7017	LAMA FRESATA	120	2000	35-40	15 mm
SAR7019	LAMA FRESATA	140	2000	35-40	15 mm
SAR7020	LAMA FRESATA	150	2000	35-40	15 mm

PIASTRE DENTATE PER RUSPE LIVELLATRICI
PLAQUE DENTEE POUR DECAPEUSES NIVELEUSES
TOOTHED PLATES FOR SCRAPERS
ZAHNPLATTEN FUER PLANIERSCHAUFELN
PLANCHAS DENTADAS DE EXCAVADORA NIVELADORA

Note: Tutti i prodotti presenti in tabella vengono forniti non verniciati.

Notes: All products in the table are supplied unpainted.

Art./Ref.	Titolo Prodotto/Titolo Prodotto	Diametro mm/Diameter mm	Note/Note
CP1276	PIASTRA DENTATA	186	SENZA FORO
CP1277	PIASTRA DENTATA	250	CON FORO DA 60 MM
CP1278	PIASTRA DENTATA	320	CON FORO DA 80 MM

1.10.2 Dischi frangizolle

Discs



Ricambi & accessori per macchine agricole

SPARE PARTS & ACCESSORIES FOR AGRICULTURAL MACHINE

Tutti gli articoli della presente sezione, prodotti da AMA SPA e/o da terzi per conto di AMA, sono adattabili ("non originali") alle marche indicate ai sensi di quanto previsto dal REG. CE n. 1400/2002. I diritti sui marchi citati appartengono ai legittimi proprietari ed il loro uso ha l'esclusiva finalità di consentire all'utilizzatore la comparazione dei diversi prodotti. All items of this section, manufactured by AMA SPA and/or any third party on behalf of AMA, are adaptable ("non-original") to the brands listed under the provisions of the REG. CE n. 1400/2002. The rights on the trademarks belong to their respective owners and their usage is only aimed to allow the user to compare different products.

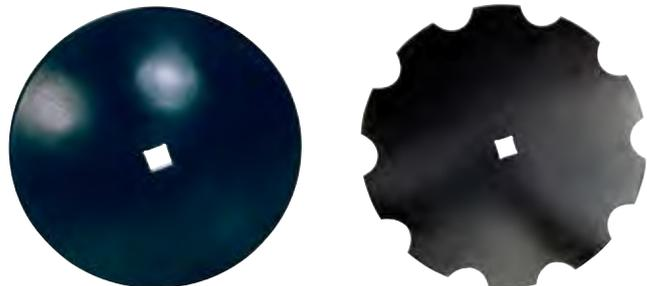
DISCHI FRANGIZOLLE CON FORO QUADRATO R600
DISQUES PULVERISEURS - TROU CARRÉ R600
DISCS - SQUARE HOLE R600
SCHEIBEN - VIERECKIGES LOCH R600
DISCOS DE GRADA - AGUJERO CUADRADO R600

Art./Ref.	Cod. Comp. NAF	Diam. Pollici/ Inch Diam.	Diametro mm/ Diameter mm	Spessore mm/ Thickness mm	Foro mm/ Hole mm	Concavità mm/ Concavity mm	Peso Kg/ Weight Kg	Note/Note
CPL18Q26	D410LQ26S3	16	410	3	26	37 (R600)	3.25	Liscio
CPD18Q26	D410DQ26S3	16	410	3	26	37 (R600)	2.75	Dentato
CPD19Q23	D460DQ23S3	18	460	3	23	46 (R600)	3.5	Dentato
CPL19Q26	D460LQ26S3	18	460	3	26	46 (R600)	4	Liscio
CPD19Q26	D460DQ26S3	18	460	3	26	46 (R600)	3.5	Dentato
CPL19Q31	D460LQ31S3	18	460	3	31	46 (R600)	4	Liscio
CPD19Q31	D460DQ31S3	18	460	3	31	46 (R600)	3.5	Dentato
CPD20Q23	D510DQ23S3S5	20	510	3.5	23	57 (R600)	5.2	Dentato
CPL20Q26	D510LQ26S3S5	20	510	3.5	26	57 (R600)	5.7	Liscio
CPD20Q26	D510DQ26S3S5	20	510	3.5	26	57 (R600)	5.2	Dentato
CPL20Q31	D510LQ31S3S5	20	510	3.5	31	57 (R600)	5.7	Liscio
CPD20Q31	D510DQ31S3S5	20	510	3.5	31	57 (R600)	5.2	Dentato
CPD20Q33	D510DQ33S3S5	20	510	3.5	33	57 (R600)	5.2	Dentato
CPL22Q26	D560LQ26S4S5	22	560	4.5	26	68 (R600)	9	Liscio
CPD22Q26	D560DQ26S4S5	22	560	4.5	26	68 (R600)	7.9	Dentato
CPL22Q29	D560LQ29S4S5	22	560	4.5	29	68 (R600)	9	Liscio
CPD22Q29	D560DQ29S4S5	22	560	4.5	26	68 (R600)	7.9	Dentato
CPL22Q31	D560LQ31S4S5	22	560	4.5	31	68 (R600)	9	Liscio
CPD22Q31	D560DQ31S4S5	22	560	4.5	31	68 (R600)	7.9	Dentato
CPL22Q33	D560LQ33S4S5	22	560	4.5	33	68 (R600)	9	Liscio
CPD22Q33	D560DQ33S4S5	22	560	4.5	33	68 (R600)	7.9	Dentato
CPL22Q41	D560LQ41S4S5	22	560	4.5	41	68 (R600)	9	Liscio
CPD22Q41	D560DQ41S4S5	22	560	4.5	41	68 (R600)	7.9	Dentato
CPL23Q31	D610LQ31S5	24	610	5	31	84 (R600)	12	Liscio
CPD23Q31	D610DQ31S5	24	610	5	31	84 (R600)	10.8	Dentato
CPL23Q33	D610LQ33S5	24	610	5	33	84 (R600)	12	Liscio
CPD23Q33	D610DQ33S5	24	610	5	33	84 (R600)	10.8	Dentato
CPL23Q41	D610LQ41S5	24	610	5	41	84 (R600)	12	Liscio
CPD23Q41	D610DQ41S5	24	610	5	41	84 (R600)	10.8	Dentato
CPL24Q31	D610LQ31S6	24	610	6	31	84 (R600)	14.1	Liscio
CPD24Q31	D610DQ31S6	24	610	6	31	84 (R600)	12.7	Dentato
CPL24Q33	D610LQ33S6	24	610	6	33	84 (R600)	14.1	Liscio
CPD24Q33	D610DQ33S6	24	610	6	33	84 (R600)	12.7	Dentato
CPL24Q41	D610LQ41S6	24	610	6	41	84 (R600)	14.1	Liscio
CPD24Q41	D610DQ41S6	24	610	6	41	84 (R600)	12.7	Dentato
CPL25Q33	D660LQ33S6	26	660	6	33	100 (R600)	17.2	Liscio
CPD25Q33	D660DQ33S6	26	660	6	33	100 (R600)	15.5	Dentato
CPL25Q41	D660LQ41S6	26	660	6	41	100 (R600)	17.2	Liscio
CPD25Q41	D660DQ41S6	26	660	6	41	100 (R600)	15.5	Dentato
CPL26Q41	D710LQ41S7	28	710	7	41	117 (R600)	27.2	Liscio
CPD26Q41	D710DQ41S7	28	710	7	41	117 (R600)	23.5	Dentato

DISCHI FRANGIZOLLE - FORO ESAGONALE R600

DISQUES PULVERISEURS - TROU HEXAGONAL R600

DISCS - HEXAGONAL HOLE R600

SCHEIBEN - SECHSECKIGES LOCH R600

DISCOS DE GRADA - AGUJERO EXAGONAL R600

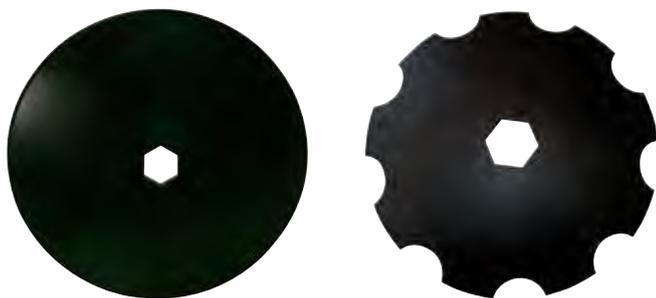

Art./Ref.	Cod. Comp. NAF	Diam. Pollici/ Inch Diam.	Diametro mm/ Diameter mm	Spessore mm/ Thickness mm	Foro mm/ Hole mm	Concavità mm/ Concavity mm	Peso Kg/ Weight Kg	Note/Note
CPL19E67	D460LE67S3	18	460	3	67	46 (R600)	4.2	Liscio
CPD19E67	D460DE67S3	18	460	3	67	46 (R600)	3.8	Dentato
CPL20E67	D510LE67S35	20	510	3.5	67	57 (R600)	4.2	Liscio
CPD20E67	D510DE67S35	20	510	3.5	67	57 (R600)	3.8	Dentato
CPL22E67	D560LE67S45	22	560	4.5	67	68 (R600)	9	Liscio
CPD22E67	D560DE67S45	22	560	4.5	67	68 (R600)	7.9	Dentato
CPL22E92	D560LE92S45	22	560	4.5	92	68 (R600)	9	Liscio
CPD22E92	D560DE92S45	22	560	4.5	92	68 (R600)	7.9	Dentato
CPL23E67	D610LE67S5	24	610	5	67	84 (R600)	12	Liscio
CPD23E67	D610DE67S5	24	610	5	67	84 (R600)	10.8	Dentato
CPL23E89	D610LE89S5	24	610	5	89	84 (R600)	12	Liscio
CPD23E89	D610DE89S5	24	610	5	89	84 (R600)	10.8	Dentato
CPL23E92	D610LE92S5	24	610	5	92	84 (R600)	12	Liscio
CPD23E92	D610DE92S5	24	610	5	92	84 (R600)	10.8	Dentato
CPL24E67	D610LE67S6	24	610	6	67	84 (R600)	12	Liscio
CPD24E67	D610DE67S6	24	610	6	67	84 (R600)	10.8	Dentato
CPL24E89	D610LE89S6	24	610	6	89	84 (R600)	12	Liscio
CPD24E89	D610DE89S6	24	610	6	89	84 (R600)	10.8	Dentato
CPL24E92	D610LE92S6	24	610	6	92	84 (R600)	12	Liscio
CPD24E92	D610DE92S6	24	610	6	92	84 (R600)	10.8	Dentato

DISCHI PER COLTIVATORE ADATTABILI VERDEGLIO

DISQUES POUR COLTIVATEUR ADAPTABLES VERDEGLIO

CULTIVATOR DISCS SUITABLES VERDEGLIO

EGGENSCHEIBEN PASSEND VERDEGLIO

DISCOS DE CULTIVADOR ADAPTABLES VERDEGLIO

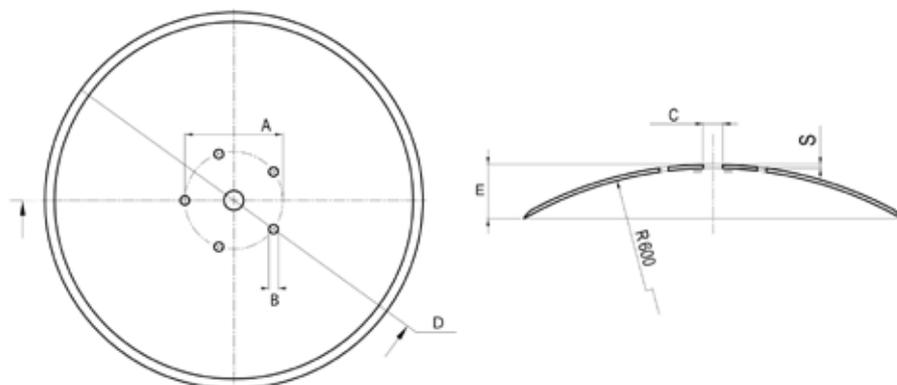

Art./Ref.	Cod. Comp. NAF	A mm	B mm	C mm	D mm	E mm	Spessore mm/Thickness mm	Note/Note
CP1440C	D560LT31F5S6	155	14.5	31	560	74	6	Fori cilindrici
CP1440CS	D560LT31F5S56	155	14.5	31	560	74	6	Fori svasati
CP1441C	D610LT31F5S6	155	14.5	31	610	90	6	Fori cilindrici
CP1441CS	D610LT31F5S56	155	14.5	31	610	90	6	Fori svasati

DISCHI PER ARATRO

DISQUES POUR CHARRUE
 PLOUGH DISCS
 PFLUGSCHEIBEN
 DISCOS DE ARADO

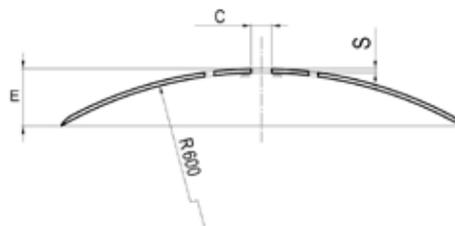
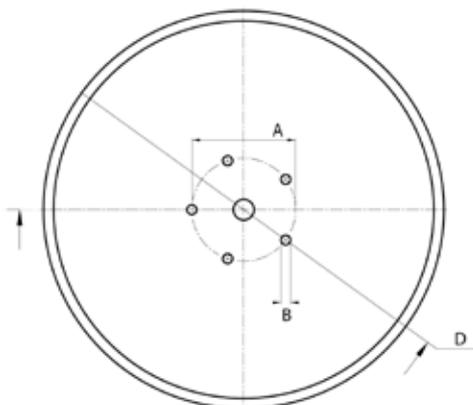

Art./Ref.	Cod. Comp. NAF	A mm	B mm	C mm	D mm	E mm	Spessore mm/Thickness mm	Note/Note
CP1440L	D560LT26FS5S6	210	13.5	26	560	74	6	Fori svasati
CP1441L	D610LT26FS5S6	210	14.5	26	610	90	6	Fori svasati
CP1442L	D660LT26FS5S6	260	16.5	26	660	106	6	Fori svasati
CP1443L	D710LT26FS5S6	260	16.5	26	710	123	6	Fori svasati

DISCHI PIANI

DISQUES PLANS
 SMOOTHED DISCS
 EGGENSCHIEBEN GLATT
 DISCOS LLANOS

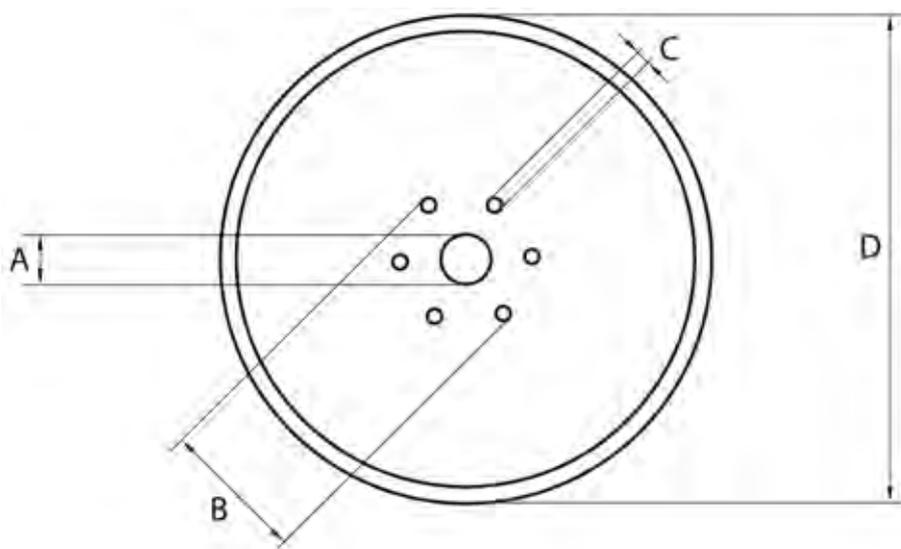

Art./Ref.	Cod. Comp. NAF	A mm	B mm	C mm	D mm	Spessore mm/Thickness mm	Peso Kg/Weight Kg	Note/Note
CP1527	D400LPF40F4S6	110	165	13	400	6 mm	5.7	Fori cilindrici
CP1528	D450LP7FS6	110	165	13	450	6 mm	6.8	Fori cilindrici
CP1529	D500LP7FS6	110	165	13	500	6 mm	8.6	Fori cilindrici

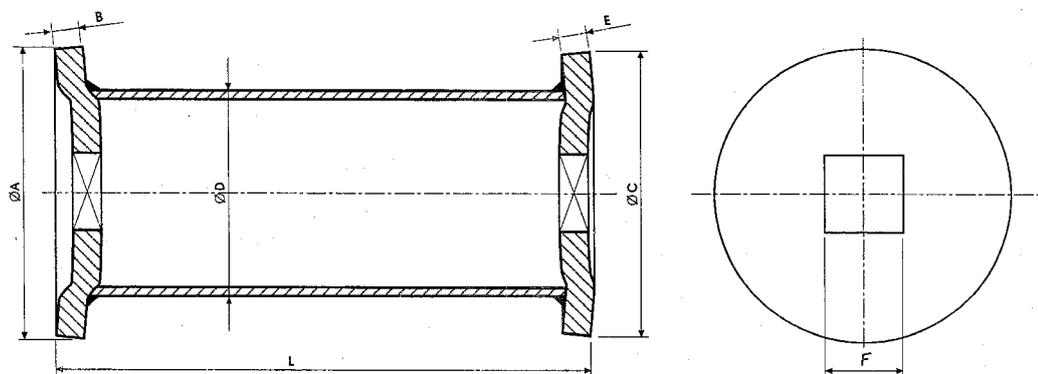
DISTANZIALI PER FRANGIZOLLE FLR
ECARTEUR POUR BRISE MOTTES FLR
SPACERS FOR FLR DISK HARROW
DISTANZSTUECK
RIOSTRAS DE ROTURADOR FLR

Note: Tutti i prodotti presenti in tabella vengono forniti non verniciati.

Notes: All products in the table are supplied unpainted.

Art./Ref.	Descrizione/Description	A mm	B mm	C mm	D mm	E mm	F mm	L mm
CP1885	DISTANZIALE EDLXP	100	5	100	70	5	26	174
CP1885A	DISTANZIALE 4C4012 Q 31	125	8	125	102	8	31	225.5

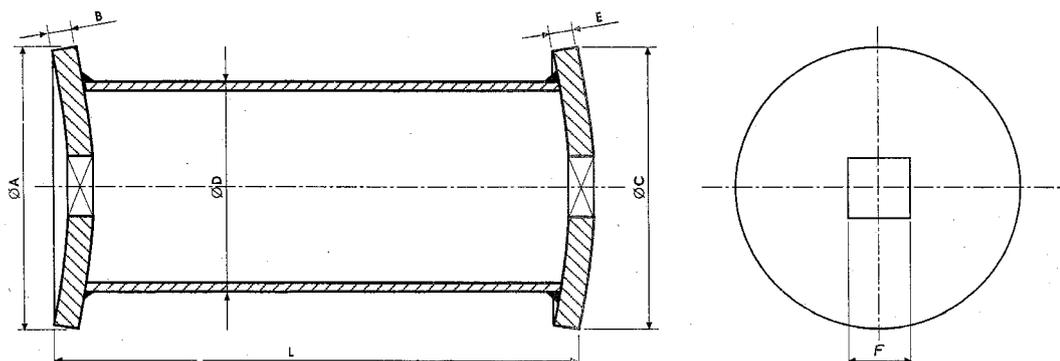
DISTANZIALI PER FRANGIZOLLE
ECARTEUR POUR BRISE MOTTES
SPACERS FOR DISK HARROW
DISTANZSTUECK
RIOSTRAS DE ROTURADOR

Art./Ref.	Descrizione/Description	A mm	B mm	C mm	D mm	E mm	F mm	L mm
CP1886	DISTANZIALE EVPT	125	6	125	89	6	26	221
CP1887	DISTANZIALE 4C4010	125	8	125	102	8	26	225.5
CP1888	DISTANZIALE 5C4012	145	10	145	114	10	31	225.5
CP1889	DISTANZIALE 6C4012	145	12	145	114	12	41	225.5
CP1890	DISTANZIALE 7C4012	145	12	145	127	12	41	225.5

SEMIDISTANZIALI PER FRANGIZOLLE

SEMI-ECARTEUR POUR BRISE MOTTES
 DEMI-SPACERS FOR DISK HARROW
 DISTANZSTUECK
 SEMI RIOSTRAS DE ROTURADOR

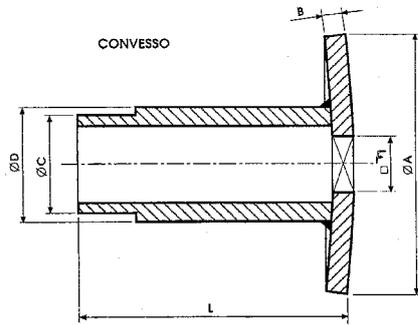
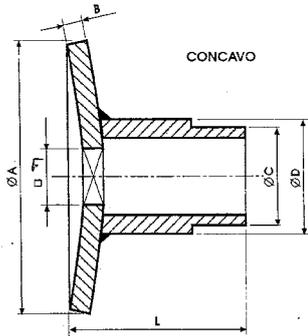

Note: Tutti i prodotti presenti in tabella vengono forniti non verniciati.

Notes: All products in the table are supplied unpainted.

Art./Ref.	Descrizione/Description	A mm	B mm	C mm	D mm	F mm	L mm	Tipo/Type
CP1892A	SEMIDISTANZIALE CORTO EDLXP/CC	100	8	45	54	26	62	CONCAVO
CP1892B	SEMIDISTANZIALE LUNGO EDLXP/CC	100	8	45	54	26	112	CONVESSO
CP1894A	SEMIDISTANZIALE CORTO 4C4022	135	10	45	54	26	80	CONCAVO
CP1894B	SEMIDISTANZIALE LUNGO 4C4032	115	10	45	54	26	136	CONVESSO
CP1894C	SEMIDISTANZIALE CORTO 4C4020	135	10	45	54	26	100	CONCAVO
CP1894D	SEMIDISTANZIALE LUNGO 4C4030	115	10	45	54	26	116	CONVESSO
CP1895A	SEMIDISTANZIALE CORTO 5C4022	145	12	55	63	31	82	CONCAVO
CP1895B	SEMIDISTANZIALE LUNGO 5C4032	145	12	55	63	31	139	CONVESSO
CP1896A	SEMIDISTANZIALE CORTO 6C4020	145	12	60	70	33	100	CONCAVO
CP1896B	SEMIDISTANZIALE LUNGO 6C4030	145	12	60	70	33	116.5	CONVESSO

SEMIDISTANZIALI PER FRANGIZOLLE A CANNOCCHIALE

SEMI-ECARTEUR POUR BRISE MOTTES A LONGUE-VUE
 DEMI-SPACERS FOR SPYGLASS DISK HARROW
 DISTANZSTUECK
 SEMI RIOSTRAS DE ROTURADOR CATALEJO

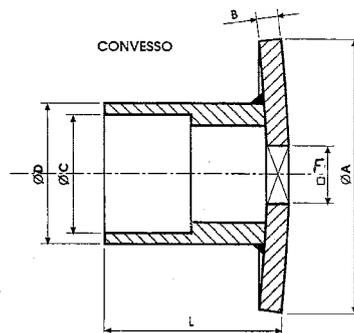
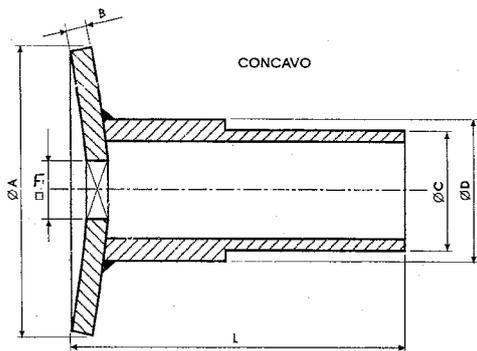

Note: Tutti i prodotti presenti in tabella vengono forniti non verniciati.

Notes: All products in the table are supplied unpainted.

Art./Ref.	Descrizione/Description	A mm	B mm	C mm	D mm	F mm	L mm	Tipo/Type
CP1887A	SEMIDISTANZIALE LUNGO EVPT	135	10	45	54	26	196	CONCAVO
CP1887B	SEMIDISTANZIALE CORTO EVPT/CV	115	10	45	57	26	98	CONVESSO
CP1888A	SEMIDISTANZIALE LUNGO 5C4023	155	12	55	63	31	150	CONCAVO
CP1888B	SEMIDISTANZIALE CORTO 5C4033	145	12	55	63	31	114	CONVESSO
CP1889D	SEMIDISTANZIALE LUNGO 6C4023	135	12	60	70	31	193	CONCAVO
CP1889E	SEMIDISTANZIALE CORTO 6C4033	135	12	60	70	31	94	CONVESSO
CP1889A	SEMIDISTANZIALE LUNGO 7C4023	155	12	70	82.5	41	137	CONCAVO
CP1889B	SEMIDISTANZIALE CORTO 7C4033	145	12	70	82.5	41	118.5	CONVESSO

ASSE PORTA DISCHI IN ACCIAIO PER FRANGIZOLLE COMPLETO DI DADO E FLANGE DI CHIUSURA

AXE PORTE DISQUES EN ACIER POUR BRISE-MOTTES COMPLET DE ECROU ET BRIDE DE FERMETURE

AXLE STEEL DISK HOLDER FOR DISK HARROW WITH GRIPPING NUT AND FLANGE

EGGENSCHEIBEN-ACHSE KOMPLETT MIT MUTTER UND FLANSCH

BARRA PORTADISCOS EN ACERO PARA ROTURAODOR / CON DADO Y ARANDELA DE CIERRE

Note: Tutti i prodotti presenti in tabella vengono forniti non verniciati.

Notes: All products in the table are supplied unpainted.

Art./Ref.	A mm	B mm	C mm	D mm	Note/Note
SAR6110A	1008	25	25	60	filetto M 24
SAR6110	1870	25	25	60	filetto M 24
SAR6111	2025	25	25	60	filetto M 24
SAR6111A	2370	25	25	60	filetto M 24
SAR6112	1008	30	30	60	filetto M 27
SAR6112A	1870	30	30	60	filetto M 27
SAR6113	2140	30	30	60	filetto M 27
SAR6114	2370	30	30	60	filetto M 27
SAR6113A	2450	30	30	60	filetto M 27
SAR6114E	2000	32	32	60	filetto M 27
SAR6114C	2000	40	40	60	filetto M 30

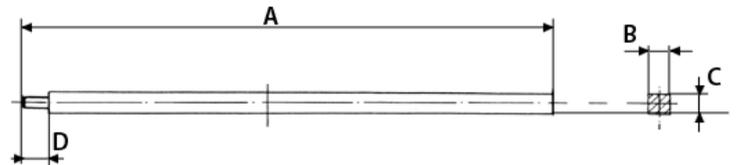

FLANGE DI CHIUSURA PER ASSI FRANGIZOLLE

BRIDE DE FERMETURE POUX AXES BRISE-MOTTES

GRIPPING FLANGE DOR DISK HARROW AXLES

VERSCHLUSS-FLANSCH FUER EGGENSCHIEBEN-ACHSE

ARANDELA DE CIERRRE PARA BARRAS ROTURADOR

Note: Tutti i prodotti presenti in tabella vengono forniti non verniciati.

Notes: All products in the table are supplied unpainted.

Art./Ref.	A mm	B mm	C mm	Note/Note
SAR6115	26	135	10	Concava
SAR6116	26	115	10	Convessa
SAR6117	31	145	12	Concava
SAR6118	31	145	10	Convessa
SAR6117B	41	145	15	Concava
SAR6118B	41	145	15	Convessa

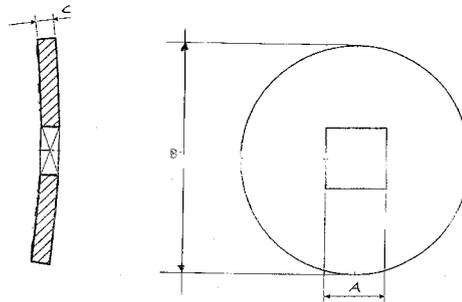

SUPPORTI CUSCINETTI PER FRANGIZOLLE

SUPPORTS PALIERS POUR BRISE-MOTTES

BEARING SUPPORTS FOR DISK HARROW

KUGELLAGER FUER EGGENSCHIEBEN

SOPORTES COJINETES PARA ROTURADOR

Art./Ref.	Foro mm/ Hole mm	Pos.	Note/Note
SAR6102	55	1	Supporto completo. Interasse fori 98 mm
SAR6106	-	3	Flangia per cuscinetto da 45 mm
SAR61061	-	2	Flangia per cuscinetto da 45 mm con ingrassatore
SAR6107	-	3	Flangia per cuscinetto da 55 mm
SAR61071	-	2	Flangia per cuscinetto da 55 mm con ingrassatore
SAR6104	-	4	Parapolvere per cuscinetto da 45 mm
SAR6105	-	4	Parapolvere per cuscinetto da 55 mm
SAR6103	-	5	Cuscinetto da 55 mm
SAR6100E	45	6	Assemblato e rivettato. Interasse fori 85 mm.
SAR6102E	55	6	Assemblato e rivettato. Interasse fori 98 mm.



MONTANTE PER SUPPORTO CUSCINETTO PER FRANGIZOLLE
MONTANT POUR SUPPORT POUR BRISE-MOTTES
MOUNTING FOR DISK HARROW BEARING
HALTER FUER EGGENSCHIEBEN-KUGELLAGER
MONTANTE PARA SOPORTE COJINETE DE ROTURADOR
Note: Tutti i prodotti presenti in tabella vengono forniti non verniciati.

Notes: All products in the table are supplied unpainted.

Art./Ref.	Descrizione/Description	Note/Note
SAR6108	MONTANTE X CUSCINETTO Ø 45	PER CUSCINETTO DA MM 45
SAR6109	MONTANTE X CUSCINETTO Ø 55	PER CUSCINETTO DA MM 55

RASCHIETTO PER FRANGIZOLLE
RACLETTE POUR BRISEURS
SCRAPER FOR DISK HARROW
SCHABEISEN FUER EGGENSCHIEBE
RASCADOR DE ROTURADOR
Note: Modello in figura DX. Tutti i prodotti presenti in tabella vengono forniti non verniciati.

Notes: Image model DX. All products in the table are supplied unpainted.

Art./Ref.	Descrizione/Description	Spessore mm/Thickness mm
CP1970	RASCHIETTO PER FRANGIZOLLE DX	6 mm
CP1970A	RASCHIETTO PER FRANGIZOLLE SX	6 mm

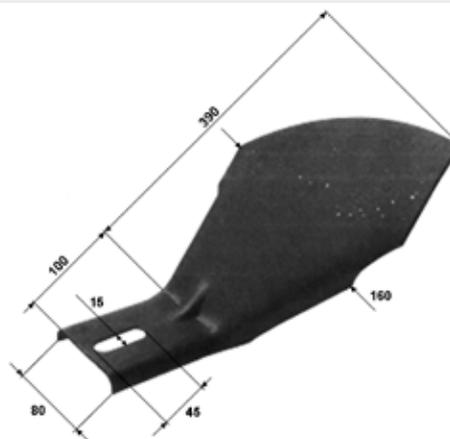
RASCHIETTO ADATTABILE A FRANGIZOLLE NARDI
RACLETTE ADAPTABLE POUR BRISEUR NARDI
SCRAPERER SUITABLE NARDI DISK HARROW
SCHABEISEN PASSEND ZU EGGENSCHIEBEN NARDI
RASCADOR ADAPTABLE DE ROTURADOR NARDI

Art./Ref.	Descrizione/Description	Note/Note
CP1971	RASCHIETTO TIPO NARDI	Adattabile Nardi

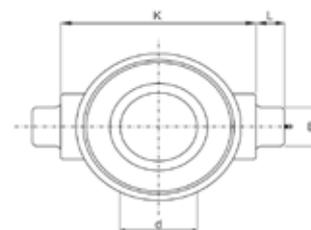

SUPPORTI CUSCINETTI ADATTABILI A FRANGIZOLLE NARDI
SUPPORTS PALIERS ADAPTABLES AUX BRISE-MOTTES NARDI
ADAPTABLE BEARING SUPPORTS FOR NARDI DISK HARROW
KUGELLAGER FUER EGGENSCHIEBEN NARDI
SOPORTES COJINETES ADAPTABLES PARA ROTURADOR NARDI

Art./Ref.	d mm	L mm	B mm	K mm	Peso Kg/Weight Kg	Foro mm/Hole mm	Note/Note
SAR6098	45	16,5	26	114	2	-	Cuscinetto completo
SAR6099	60	21	32	132	3,1	-	Cuscinetto completo
SAR6099B	70	21	40	150	4,5	-	Cuscinetto completo
SAR6084	-	-	-	-	-	45	Cuscinetto nudo
SAR6087	-	-	-	-	-	60	Cuscinetto nudo
SAR6088	-	-	-	-	-	45	Parapolvere
SAR6089	-	-	-	-	-	60	Parapolvere

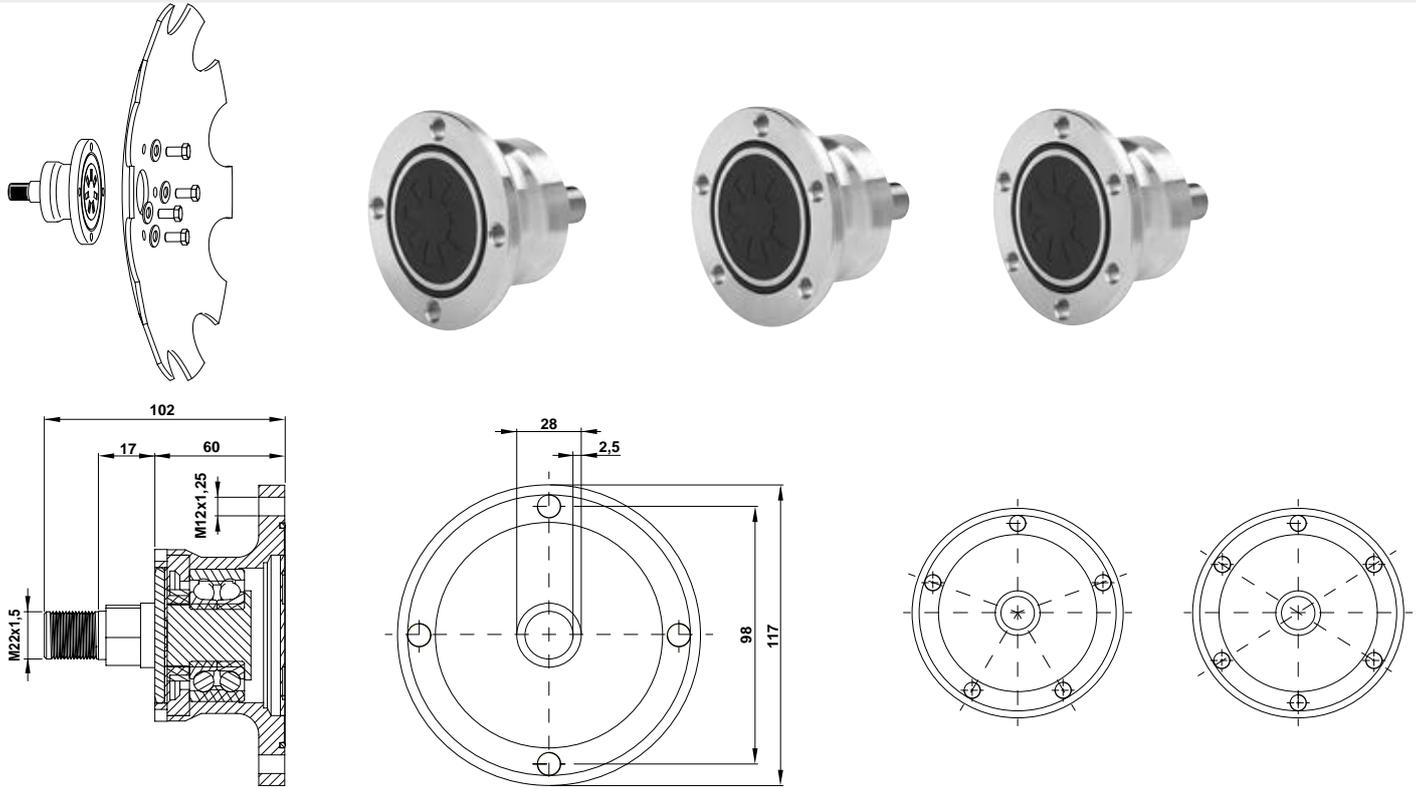

MOZZO SKF AGRI HUB CON FLANGIA A BASE PIANA PER ELEMENTI FRANGIZOLLE

MOYEU DE SKF AGRI HUB À BASE PLATE AVEC BRIDE POUR ÉLÉMENTS HERSES
 FLAT-BASED SKF AGRI HUB WITH FLANGE FOR HARROW ELEMENTS
 HALTERUNG SKF AGRI HUB MIT FLANSCH FÜR SCHEIBENEGGEN
 EJE SKF AGRI HUB CON BRIDA FONDO PLANO POR ELEMENTOS ROMPIPLACAS



Note: Il SKF Agri hub è un'unità cuscinetto completa, ingrassata e lubrificata a vita. Condizioni di applicazione tipiche: -Velocità trattore: 5-20 km/h -Diametro disco: 300-610 mm -Temperatura: da -20 a +50 °C. Condizioni di lavoro difficili: paglia, fibre vegetali, pietre, fertilizzanti, fango, polvere, acqua, neve.
Notes: The SKF Agri hub is a fully integrated hub bearing system, greased and sealed for the life of the unit. Typical application conditions: -Tractor Speed: 5-20 km/h -Disc Diameter: 300-610 mm - Temperature: -20 to +50 °C. -Harsch working conditions: straw, strings, stones, fertilizers, mud, dust, water, snow.

Art./Ref.	Descrizione/Description	Foro mm/Hole mm	Note/Note
CP6624	MOZZO FRANGIZZOLLE 4 FORI SKF	4xM12x1,25	Diametro perno di fissaggio mm 28
CP6625	MOZZO FRANGIZZOLLE 5 FORI SKF	5xM12x1,25	Diametro perno di fissaggio mm 28
CP6626	MOZZO FRANGIZZOLLE 6 FORI SKF	6xM12x1,25	Diametro perno di fissaggio mm 28

MOLLA DISCO 90X13 @ 30

DENT DISQUE 90X13 @ 30
 SPRING DISC 90X13 @ 30
 ZINKEN SCHEIBEN 90X13 @ 30
 MUELLE DISCOS 90X13 @ 30

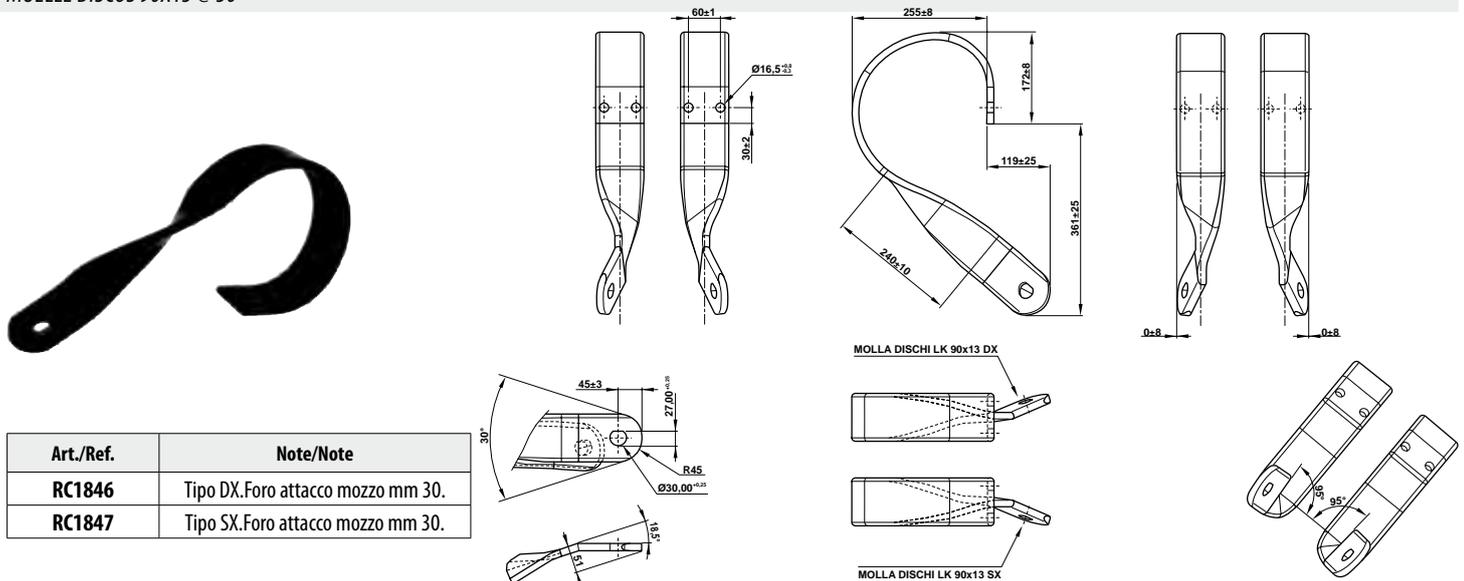

Art./Ref.	Note/Note
RC1846	Tipo DX. Foro attacco mozzo mm 30.
RC1847	Tipo SX. Foro attacco mozzo mm 30.

MOZZO CON PERNO DI FISSAGGIO DA 29,5 MM PER DISCO A BASE PIANA DA 460 E 510 DENTATO

MOYEU À BASE PLATE AVEC BOULON DE 29,5 MM POUR DISQUE DE 460 ET 510 DENTÉ

FLAT-BASED HUB WITH 29,5 MM BOLT FOR DISC WITH 460 AND 510 TEETH

HALTERUNG MIT WELLE DM=29,5 MM FUER GEZAHNTEN SCHEIBENEGGEN VON 460 BIS 510

EJE CON PERNO 29,5 MM POR DISCO FONDO PLANO 460 Y 510 CON DIENTES

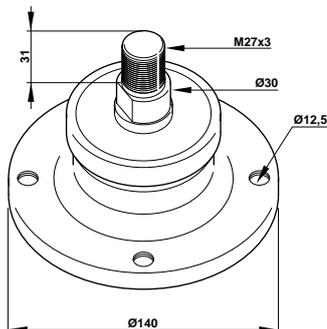

Art./Ref.	Descrizione/Description	Peso Kg/Weight Kg
CP6337A	Mozzo a 4 fori	3,45

MOZZO CON PERNO DI FISSAGGIO DA 29,5 MM PER DISCO A BASE PIANA DA 560 E 610 DENTATO

MOYEU À BASE PLATE AVEC BOULON DE 29,5 MM POUR DISQUE DE 560 ET 610 DENTÉ

FLAT-BASED HUB WITH 29,5 MM BOLT FOR DISC WITH 560 AND 610 TEETH

HALTERUNG MIT WELLE DM=29,5 MM FUER GEZAHNTEN SCHEIBENEGGEN VON 560 BIS 610

EJE CON PERNO 29,5 MM POR DISCO FONDO PLANO 560 Y 610 CON DIENTES

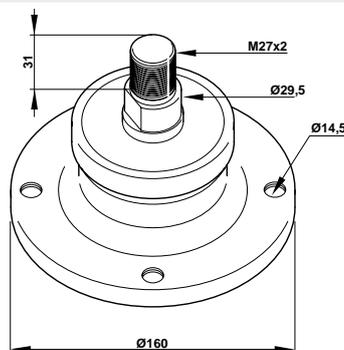

Art./Ref.	Descrizione/Description	Peso Kg/Weight Kg
CP6340A	Mozzo a 5 fori	4,9

GRUPPO MOZZO COMPLETO PER ERPICE A DISCHI INDIPENDENTI DA 460 E 510 TUBULARE 80X80

GRUPE MOYEU COMPLET POUR HERSE A DISQUES INDIPENDENTS DE 460 ET 510 TUBULAIRE 80 X 80

COMPLETE HUB SET FOR INDIPENDENT DISC HARROW OF 460 AND 510 TUBULAR 80X80

NABENGRUPPE KOMPLETT FUER EGGENSCHIEBEN VON 460 BIS 510 ROHR 80X80

GRUPO COMPLETO CORONA CENTRAL PARA GRADA CON DISCOS INDEPENDIENTES DE 460 Y 510 - TUBULAR 80X80

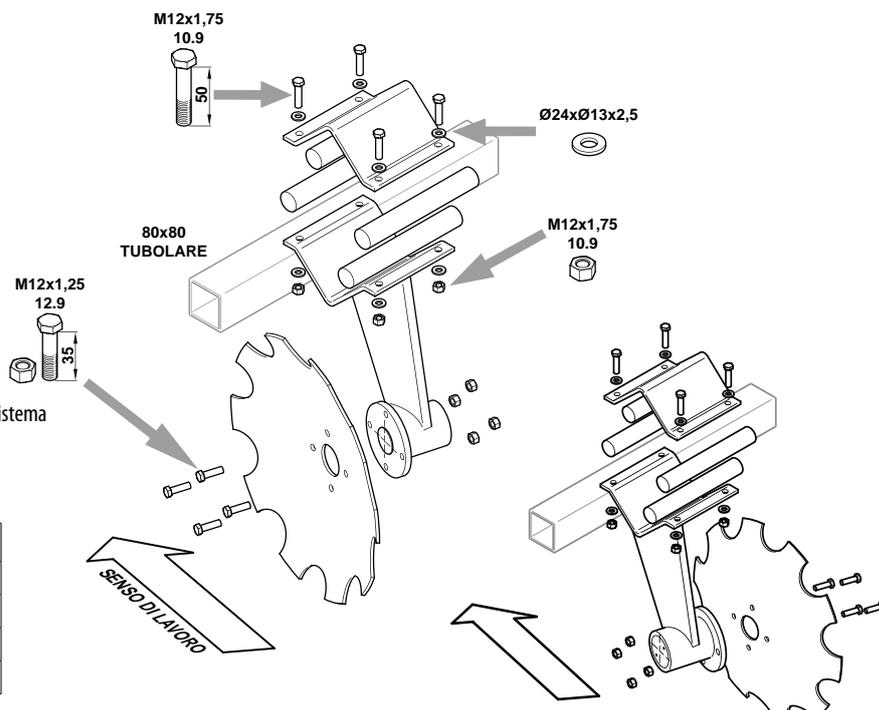

Note: Le varie bullonerie in figura sono presenti solo a scopo illustrativo del sistema di montaggio del supporto completo e non vengono forniti come ricambi.

Notes: nuts/ bolts and tubular in figure are only to illustrate the fitting system of the complete support and they are not supplied as spare parts.

Art./Ref.	Note/Note
CP5851	SUPPORTO ANTERIORE CON DISCO DA 460 DENTATO
CP5853	SUPPORTO POSTERIORE CON DISCO DA 460 DENTATO
CP5855	SUPPORTO ANTERIORE CON DISCO DA 510 DENTATO
CP5857	SUPPORTO POSTERIORE CON DISCO DA 510 DENTATO

GRUPPO MOZZO COMPLETO PER ERPICE A DISCHI INDIPENDENTI DA 460 E 510 TUBOLARE 80X80 SENZA DISCO

GROUPE MOYEU COMPLET POUR HERSE A DISQUES INDIPENDENTS DE 460 ET 510 TUBULAIRE 80 X 80 SANS DISQUE

COMPLETE HUB SET FOR INDIPENDENT DISC HARROW OF 460 AND 510 TUBULAR 80X80 WITHOUT DISC

NABENGRUPPE KOMPLETT FUER EGGENSCHIEBEN VON 460 BIS 510 ROHR 80X80 OHNE SCHEIBE

GRUPO COMPLETO CORONA CENTRAL PARA GRADA CON DISCOS INDEPENDIENTES DE 460 Y 510 - TUBOLAR 80X80 SIN DISCO

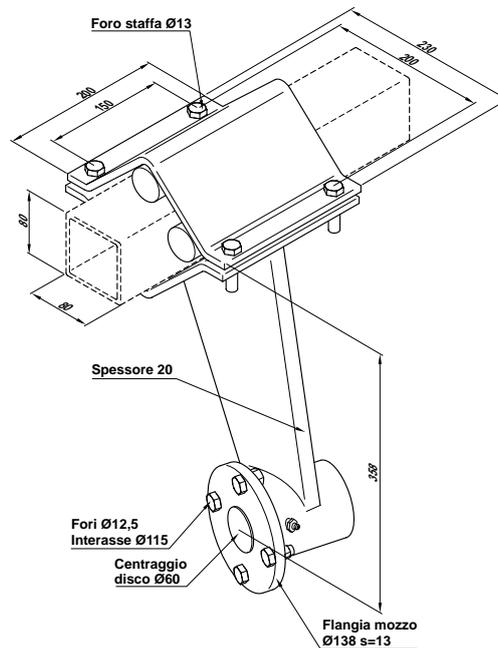

Art./Ref.	Note/Note
CP6049	SUPPORTO COMPLETO ANTERIORE SENZA DISCO 460-510
CP6050	SUPPORTO COMPLETO POSTERIORE SENZA DISCO 460-510

ELEMENTO FRANGIZOLE ANTERIORE E POSTERIORE PER DISCO DA 460 E 510

ELEMENT BRISE-MOTTES ANTERIEUR ET POSTERIEUR POUR DISQUE DE 460 ET 510

FRONT AND REAR DISK HARROW FOR DISK OF 460 AND 510

VORDER- UND HINTER-EGGENSCHEIBE FUER SCHEIBE AB 460 BIS 510

ELEMENTO ROTURADOR ANTERIOR Y POSTERIOR PARA DISCO DE 460 Y 510

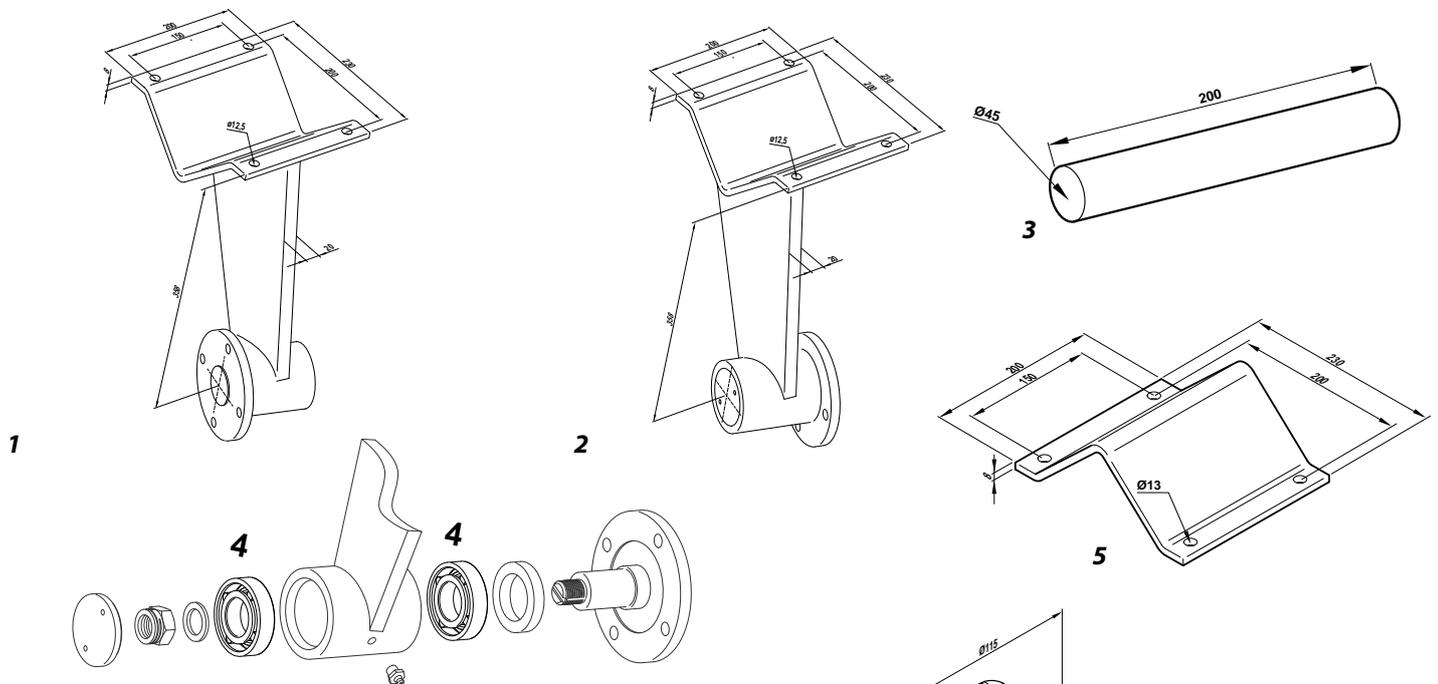

Art./Ref.	Peso Kg/Weight Kg	Pos.	Note/Note
CP5470	12.5	1	Supporto disco anteriore
CP5470S	12.5	2	Supporto disco posteriore
CP5653A	0.25	3	Sospensione elastica
SMI120848	4	5	Staffa superiore supporto
SMI121391	0.22	4	Cuscinetto a rulli
CP5509	2	6	Flangia mozzo per disco da 460 e 510

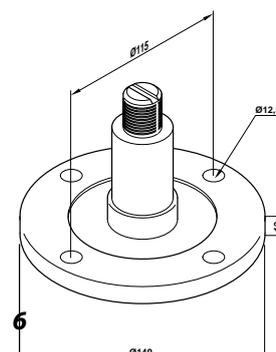

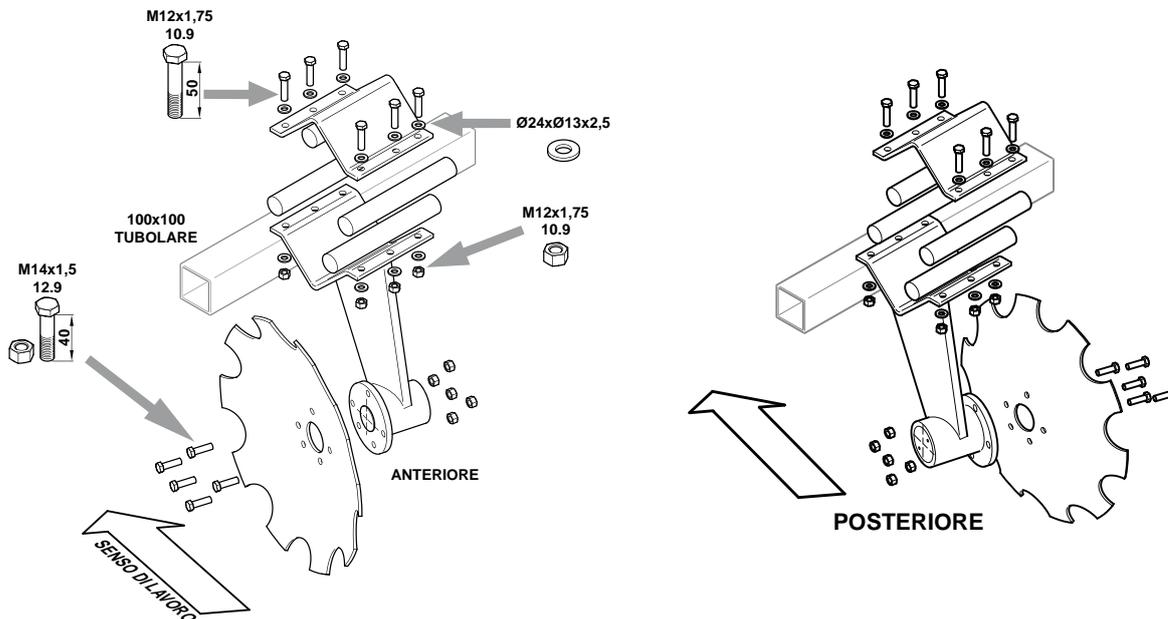
GRUPPO MOZZO COMPLETO PER ERPICE A DISCHI INDIPENDENTI DA 560 E 610 TUBOLARE 100X100
GROUPE MOYEU COMPLET POUR HERSE A DISQUES INDIPENDENTS DE 560 ET 610 TUBULAIRE 100 X 100
COMPLETE HUB SET FOR INDIPENDENT DISC HARROW OF 560 AND 610 TUBULAR 100X100
NABENGRUPPE KOMPLETT FUER EGGENSCHIEBEN VON 560 BIS 610 ROHR 100X100
GRUPO COMPLETO CORONA CENTRAL PARA GRADA CON DISCOS INDEPENDIENTES DE 560 Y 610 - TUBOLAR 100X100

Note: Le varie bullonerie in figura sono presenti solo a scopo illustrativo del sistema di montaggio del supporto completo e non vengono forniti come ricambi.

Notes: nuts/ bolts and tubular in figure are only to illustrate the fitting system of the complete support and they are not supplied as spare parts.

Art./Ref.	Note/Note
CP5859	Supporto anteriore con disco da 560 dentato
CP5861	Supporto posteriore con disco da 560 dentato
CP5863	Supporto anteriore con disco da 610 dentato
CP5865	Supporto posteriore con disco da 610 dentato

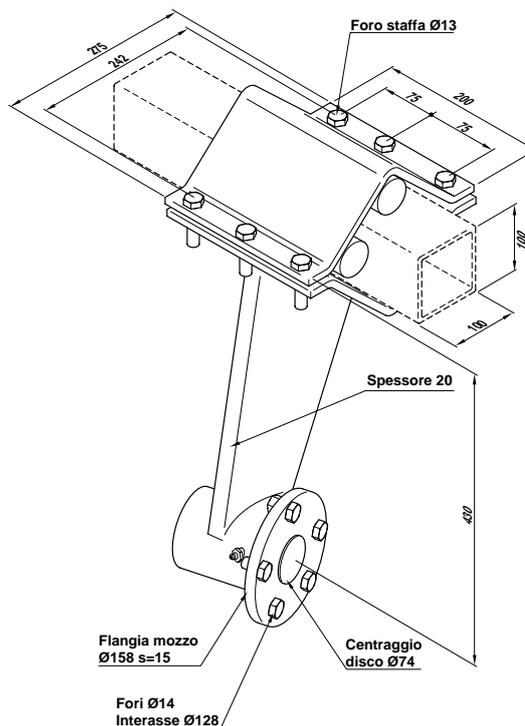
GRUPPO MOZZO COMPLETO PER ERPICE A DISCHI INDIPENDENTI DA 560 E 610 TUBOLARE 100X100 SENZA DISCO
GROUPE MOYEU COMPLET POUR HERSE A DISQUES INDIPENDENTS DE 560 ET 610 TUBULAIRE 100 X 100 SANS DISQUE
COMPLETE HUB SET FOR INDIPENDENT DISC HARROW OF 560 AND 610 TUBULAR 100X100 WITHOUT DISC
NABENGRUPPE KOMPLETT FUER EGGENSCHIEBEN VON 560 BIS 610 ROHR 100X100 OHNE SHEIBE
GRUPO COMPLETO CORONA CENTRAL PARA GRADA CON DISCOS INDEPENDIENTES DE 560 Y 610 - TUBOLAR 100X100 SIN DISCO

Art./Ref.	Note/Note
CP6074	SUPPORTO COMPLETO ANTERIORE SENZA DISCO 560-610
CP6075	SUPPORTO COMPLETO POSTERIORE SENZA DISCO 560-610

ELEMENTO FRANGIZOLE ANTERIORE E POSTERIORE PER DISCO DA 560 E 610

ELEMENT BRISE-MOTTES ANTERIEUR ET POSTERIEUR POUR DISQUE DE 560 ET 610

FRONT AND REAR DISK HARROW FOR DISC OF 560 AND 610

VORDER- UND HINTER-EGGENSCHEIBE FUER SCHEIBEN AB 560 UND 610

ELEMENTO ROTURADOR ANTERIOR Y POSTERIOR PARA DISCO DE 560 Y 610

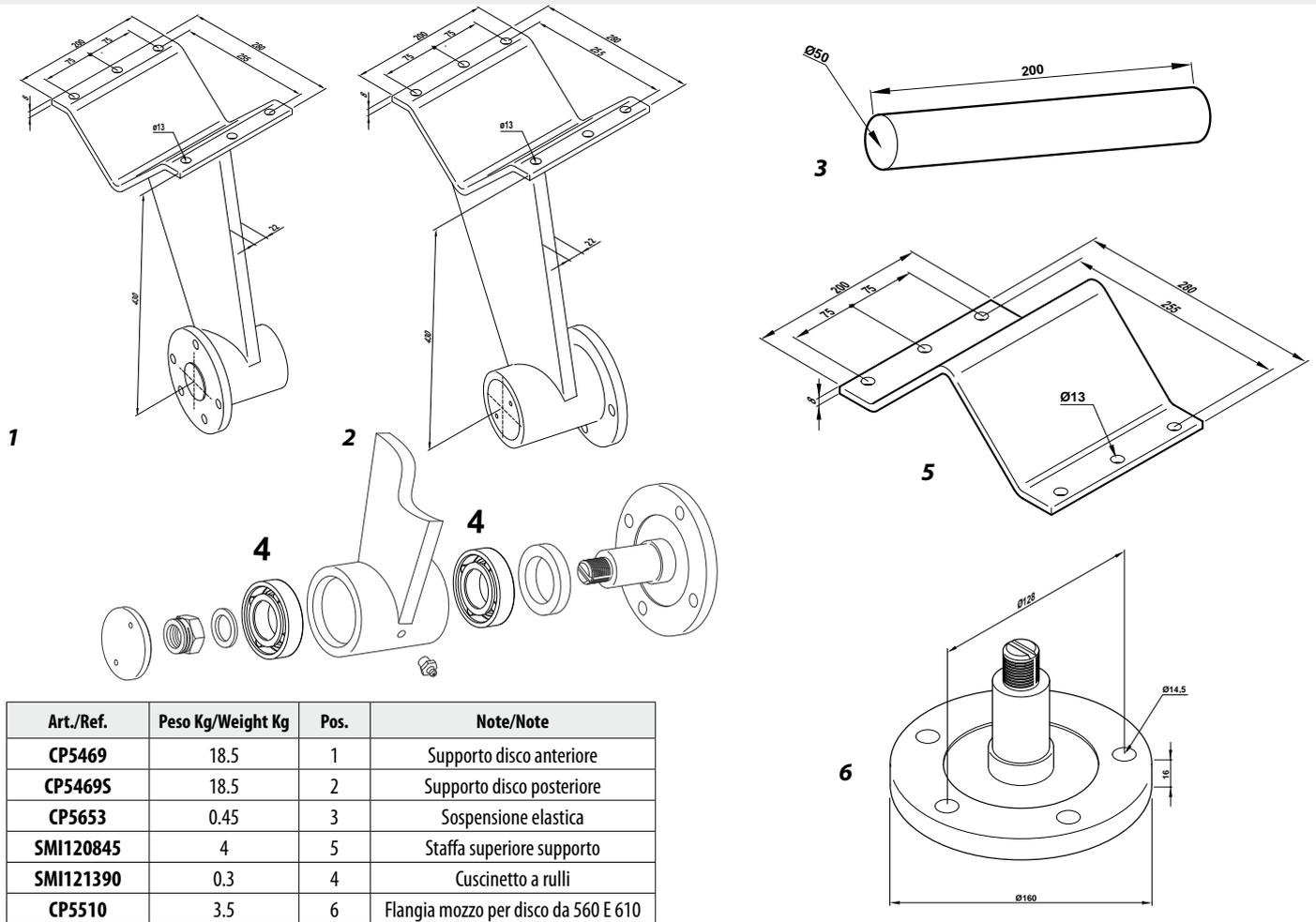

Art./Ref.	Peso Kg/Weight Kg	Pos.	Note/Note
CP5469	18.5	1	Supporto disco anteriore
CP5469S	18.5	2	Supporto disco posteriore
CP5653	0.45	3	Sospensione elastica
SMI120845	4	5	Staffa superiore supporto
SMI121390	0.3	4	Cuscinetto a rulli
CP5510	3.5	6	Flangia mozzo per disco da 560 E 610

GRUPPO MOZZO COMPLETO PER ERPICE A DISCHI INDIPENDENTI DA 460 E 510 TUBOLARE 80X80

GRUPE MOYEU COMPLET POUR HERSE A DISQUES INDIPENDENTS DE 460 ET 510 TUBULAIRE 80 X 80

COMPLETE HUB SET FOR INDIPENDENT DISK HARROW OF 460 AND 510 TUBULAR 80X80

NABENGRUPPE KOMPLETT FUER EGGENSCHIEBEN VON 460 BIS 510 ROHR 80X80

GRUPO COMPLETO CORONA CENTRAL PARA GRADA CON DISCOS INDEPENDIENTES DE 460 Y 510 - TUBOLAR 80X80

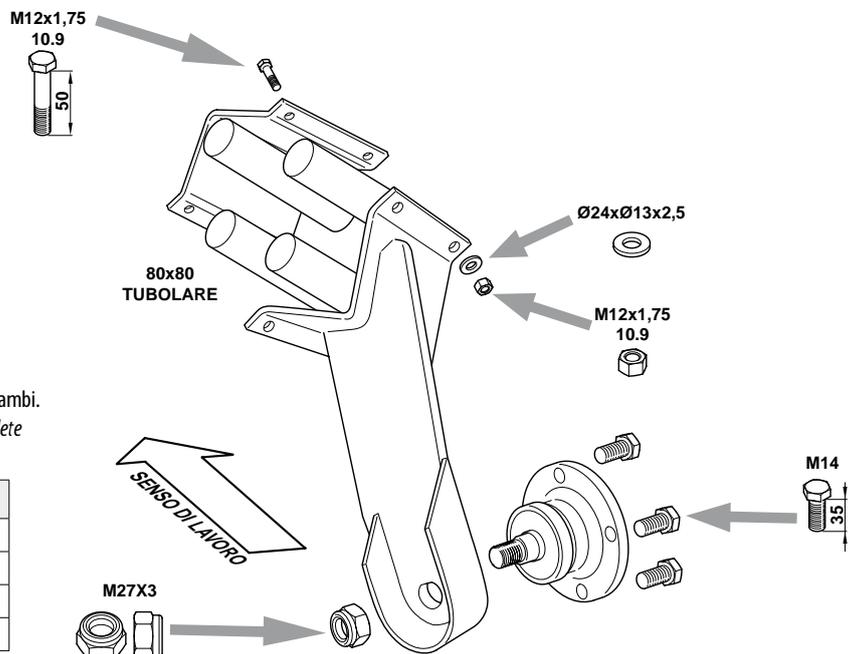

Note: Le varie bullonerie in figura sono presenti solo a scopo illustrativo del sistema di montaggio del supporto completo e non vengono forniti come ricambi.

Notes: Nuts/ bolts in figure are only to illustrate the fitting system of the complete support and they are not supplied as spare parts.

Art./Ref.	Note/Note
CP6341	SUPPORTO ANTERIORE CON DISCO DA 460 DENTATO
CP6342	SUPPORTO POSTERIORE CON DISCO DA 460 DENTATO
CP6343	SUPPORTO ANTERIORE CON DISCO DA 510 DENTATO
CP6344	SUPPORTO POSTERIORE CON DISCO DA 510 DENTATO

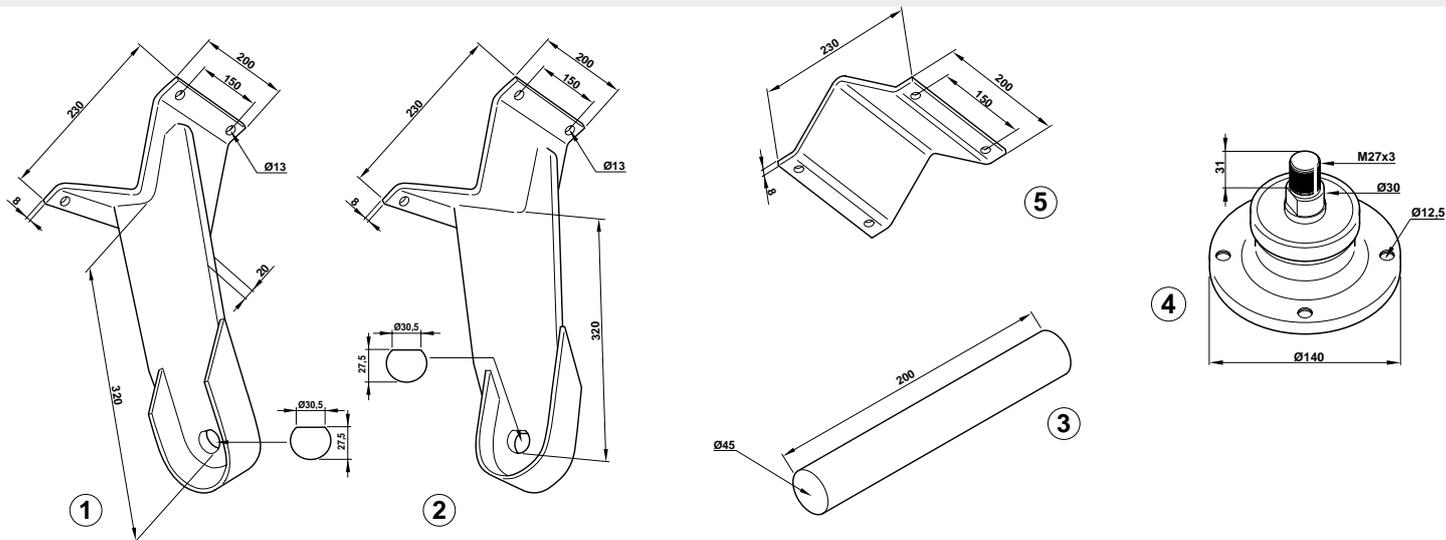
ELEMENTO FRANGIZZOLLE ANTERIORE E POSTERIORE PER DISCO DA 460 E 510
ELEMENT BRISE-MOTTES ANTERIEUR ET POSTERIEUR POUR DISQUE DE 460 ET 510
FRONT AND REAR DISK HARROW FOR DISK OF 460 AND 510
VORDER- UND HINTER-EGGENSCHEIBE FUER SCHEIBE AB 460 BIS 510
ELEMENTO ROTURADOR ANTERIOR Y POSTERIOR PARA DISCO DE 460 Y 510

Art./Ref.	Peso Kg/Weight Kg	Pos.	Note/Note
CP6335	12.5	1	Supporto disco anteriore
CP6336	12.5	2	Supporto disco posteriore
CP5653A	0.25	3	Sospensione elastica
CP6337	-	4	Mozzo per disco da 460 e 510.
SMI120848	4	5	Staffa superiore supporto

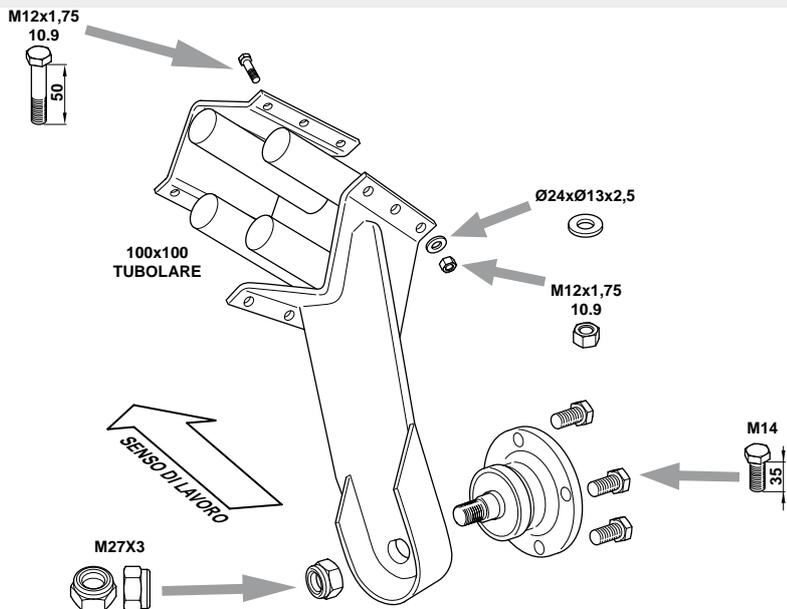
GRUPPO MOZZO COMPLETO PER ERPICE A DISCHI INDIPENDENTI DA 560 E 610 TUBOLARE 100X100
GRUPE MOYEU COMPLET POUR HERSE A DISQUES INDIPENDENTS DE 560 ET 610 TUBULAIRE 100 X 100
COMPLETE HUB SET FOR INDIPENDENT DISK HARROW OF 560 AND 610 TUBULAR 100X100
NABENGRUPPE KOMPLETT FUER EGGENSCHLEIBEN VON 560 BIS 610 ROHR 100X100
GRUPO COMPLETO CORONA CENTRAL PARA GRADA CON DISCOS INDEPENDIENTES DE 560 Y 610 - TUBOLAR 100X100

Note: Le varie bullonerie in figura sono presenti solo a scopo illustrativo del sistema di montaggio del supporto completo e non vengono forniti come ricambi.

Notes: Nuts/ bolts in figure are only to illustrate the fitting system of the complete support and they are not supplied as spare parts.

Art./Ref.	Note/Note
CP6345	SUPPORTO ANTERIORE CON DISCO DA 560 DENTATO
CP6346	SUPPORTO POSTERIORE CON DISCO DA 560 DENTATO
CP6347	SUPPORTO ANTERIORE CON DISCO DA 610 DENTATO
CP6348	SUPPORTO POSTERIORE CON DISCO DA 610 DENTATO

ELEMENTO FRANGIZZOLE ANTERIORE E POSTERIORE PER DISCO DA 560 E 610

ELEMENT BRISE-MOTTES ANTERIEUR ET POSTERIEUR POUR DISQUE DE 560 ET 610

FRONT AND REAR DISK HARROW FOR DISC OF 560 AND 610

VORDER- UND HINTER-EGGENSCHEIBE FUER SCHEIBEN AB 560 UND 610

ELEMENTO ROTURADOR ANTERIOR Y POSTERIOR PARA DISCO DE 560 Y 610

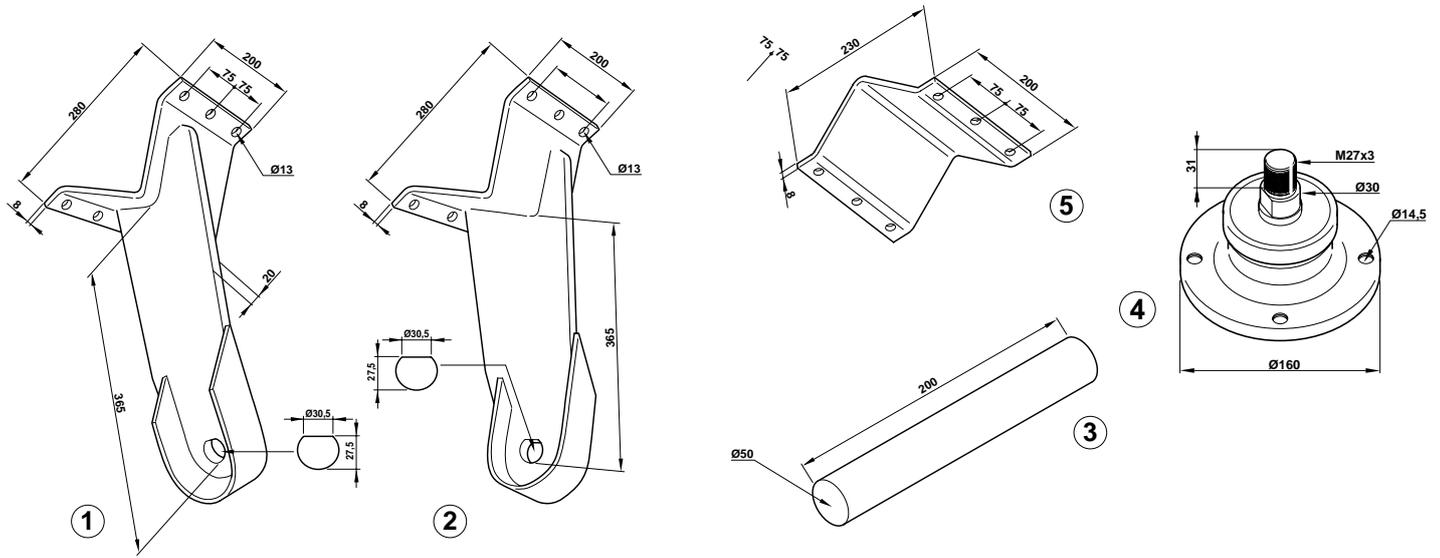

Art./Ref.	Peso Kg/Weight Kg	Pos.	Note/Note
CP6338	18.5	1	Supporto disco anteriore
CP6339	18.5	2	Supporto disco posteriore
CP5653	0.45	3	Sospensione elastica
CP6340	-	4	Mozzo per disco da 560 e 610.
SMI120845	4	5	Staffa superiore supporto

DISCHI CON BASE PIANA PER ELEMENTO FRANGIZZOLLE

DISQUES AVEC BASE PLATTE POUR ELEMENTS BRISE-MOTTES

SMOOTHED PLATE DISCS FOR DISK HARROW PART

EGGENSCHEIBEN GLATT

DISCOS CON BASE LLANA PARA ELEMENTO ROTURADOR

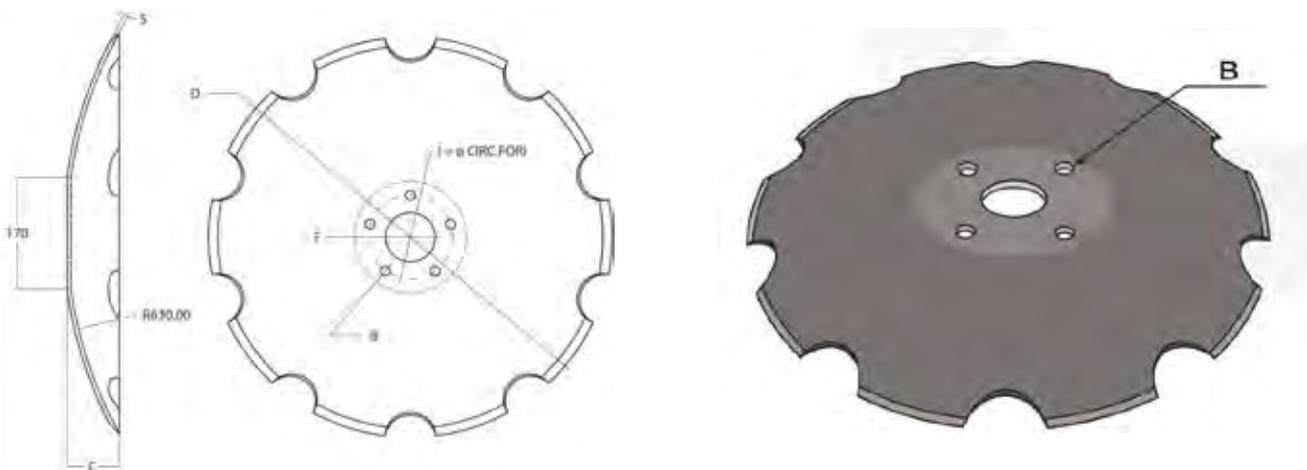

Art./Ref.	Cod. Comp. NAF	Diametro mm/ Diameter mm	Spessore mm/ Thickness mm	Foro mm/ Hole mm	Concavità mm/ Concavity mm	Note/Note
CP1512	D460D5FBP55	460	5	61	44	CIRCONFERENZA PASSANTE SUI 4 FORI MM 115 B=DIAMETRO MM 12,5
CP1511	D510D5FBP55	510	5	61	54.5	CIRCONFERENZA PASSANTE SUI 4 FORI MM 115 B=DIAMETRO MM 12,5
CP1513	D560D5FBP55	560	5	75	65	CIRCONFERENZA PASSANTE SUI 5 FORI MM 128 B=DIAMETRO MM 14,5
CP1510	D610D5FBP56	610	6	75	79	CIRCONFERENZA PASSANTE SUI 5 FORI MM 128 B=DIAMETRO MM 14,5

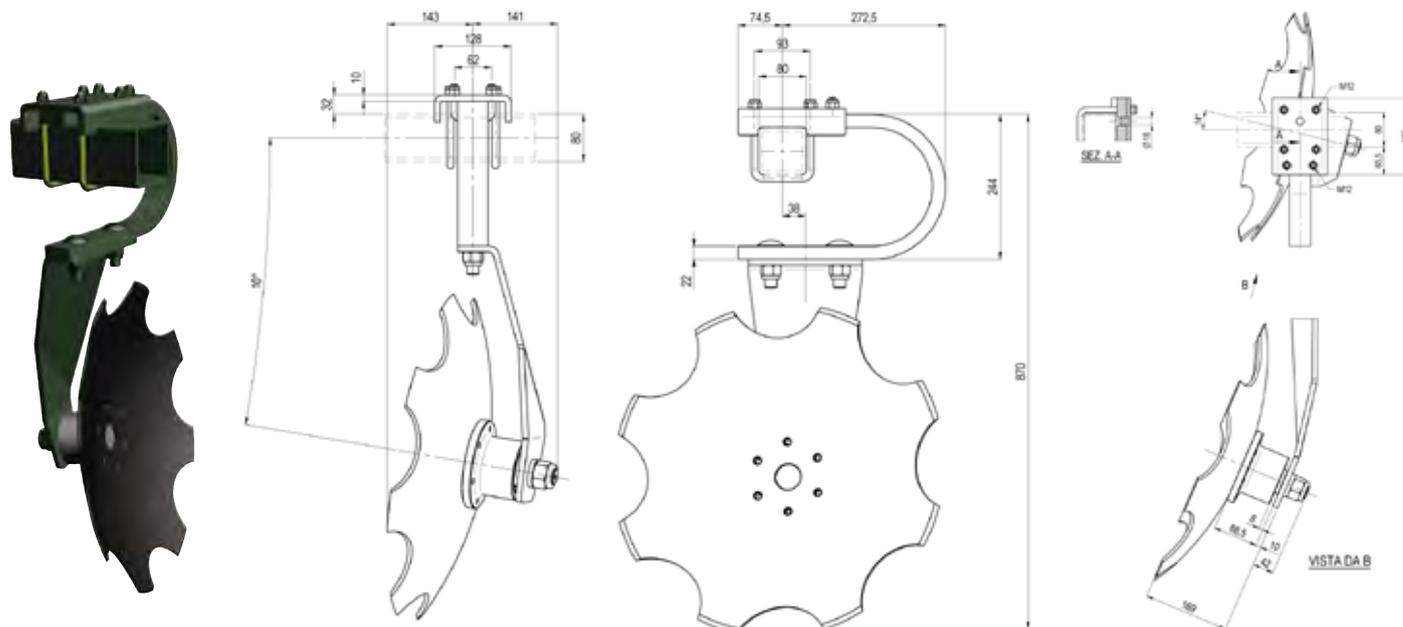
SUPPORTO MOLLEGGIATO PER ERPICE A DISCHI DA 560 TUBOLARE 80X80
SUPPORT SUSPENDU POUR HERSE DISQUE DE 560 TUBULAIRE 80 X 80
SPRUNG SUPPORT FOR HARROW DISC OF 560 TUBULAR 80X80
ZINKEN-HALTER GEFEDERT FUER LEICHTEN VON 560 ROHR 80X80
SOPORTE AMORTIGUADOR PARA ERPICE CON DISCOS DE 560 - TUBOLAR 80X80

Art./Ref.	Diametro mm/ Diameter mm	Spessore mm/ Thickness mm	Foro mm/ Hole mm	Concavità mm/ Concavity mm	Note/Note
CP6196	-	-	-	-	Supporto molleggiato completo di disco DX. Modello in figura.
CP6196S	-	-	-	-	Supporto molleggiato completo di disco SX.
CP6194	-	-	-	-	Mozzo portadisco.
CP6207A	560	5 mm	45	74	Disco con n.6 fori da 13,5 mm ,intereasse 120 mm. Bisello tipo A.

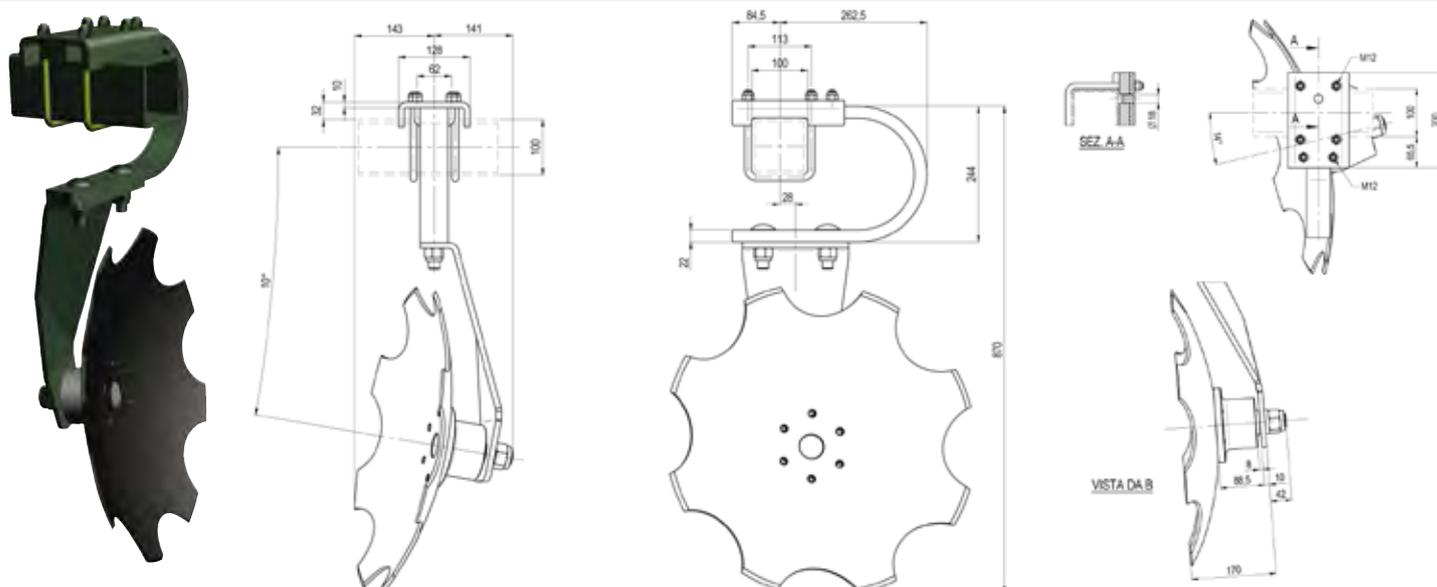
SUPPORTO MOLLEGGIATO PER ERPICE A DISCHI DA 560 TUBOLARE 100X100
SUPPORT SUSPENDU POUR HERSE DISQUE DE 560 TUBULAIRE 100 X 100
SPRUNG SUPPORT FOR HARROW DISC OF 560 TUBULAR 100X100
ZINKEN-HALTER GEFEDERT FUER LEICHTEN VON 560 ROHR 100X100
SOPORTE AMORTIGUADOR PARA ERPICE CON DISCOS DE 560 - TUBOLAR 100X100

Art./Ref.	Diametro mm/ Diameter mm	Spessore mm/ Thickness mm	Foro mm/ Hole mm	Concavità mm/ Concavity mm	Note/Note
CP6192	-	-	-	-	Supporto molleggiato completo di disco DX. Modello in figura.
CP6192S	-	-	-	-	Supporto molleggiato completo di disco SX.
CP6194	-	-	-	-	Mozzo portadisco
CP6207A	560	5 mm	45	74	Disco con n.6 fori da 13,5 mm ,intereasse 120 mm. Bisello tipo A.

DISCO ADATTABILE BDM AGRO CAMOMILLA

DISQUE ADAPTABLE BDM AGRO CAMOMILLA

DISC SUITABLE BDM AGRO CAMOMILLA MODEL

SCHEIBEN PASSEND ZU BDM AGRO CAMOMILLA

DISCOS ADAPTABLE BDM AGRO CAMOMILLA

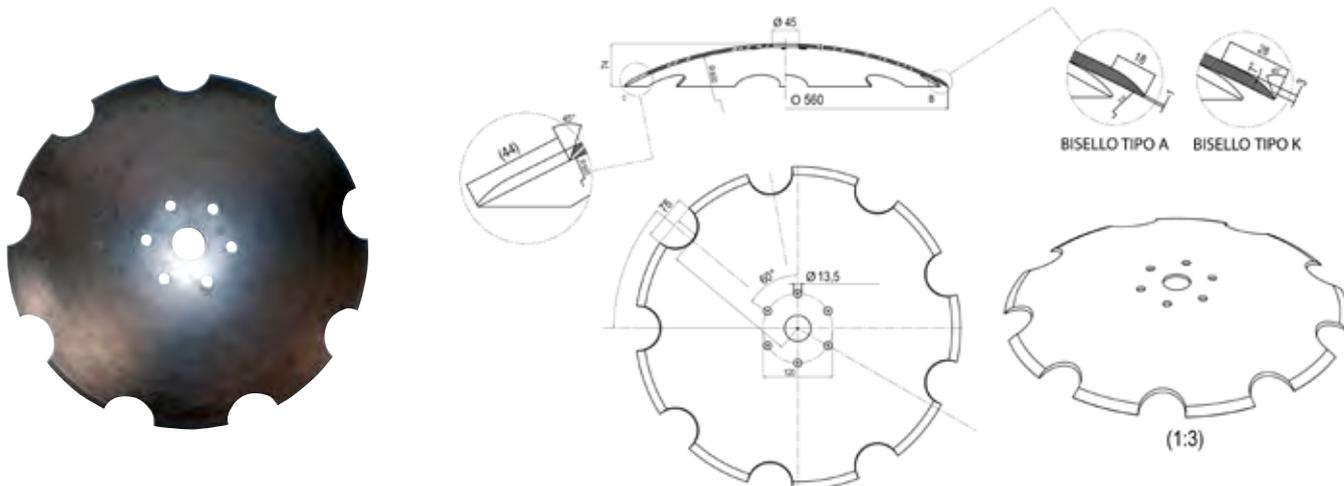
**Note:** Per quantita' consistenti possiamo realizzare dischi con diametri e forature come disegno del cliente.**Notes:** For high volumes, we are available to produce discs with customized diameter and holes.

Art./Ref.	Cod. Comp. NAF	Diametro mm/ Diameter mm	Spessore mm/ Thickness mm	Foro mm/ Hole mm	Concavità mm/ Concavity mm	Note/Note
CP6207A	D560DT45F135S5A	560	5 mm	45	74	Disco con n.6 fori da 13,5 mm ,interasse 120 mm. Bisello tipo A.
CP6214A	D560DT45F135S5K	560	5 mm	45	74	Disco con n.6 fori da 13,5 mm ,interasse 120 mm. Bisello tipo K.
CP6207	D560DT45F135S6A	560	6 mm	45	75	Disco con n.6 fori da 13,5 mm ,interasse 120 mm. Bisello tipo A.
CP6214	D560DT45F135S6K	560	6 mm	45	75	Disco con n.6 fori da 13,5 mm ,interasse 120 mm. Bisello tipo K.

DISCHI PER COLTIVATORE ADATTABILE KVERNELAND

DISQUES POUR COLTIVATEUR ADAPTABLE A KVERNELAND

CULTIVATOR DISCS SUITABLE TO KVERNELAND

EGGENSCHEIBEN PASSEND ZU KVERNELAND

DISCOS DE CULTIVADOR ADAPTABLE A KVERNELAND

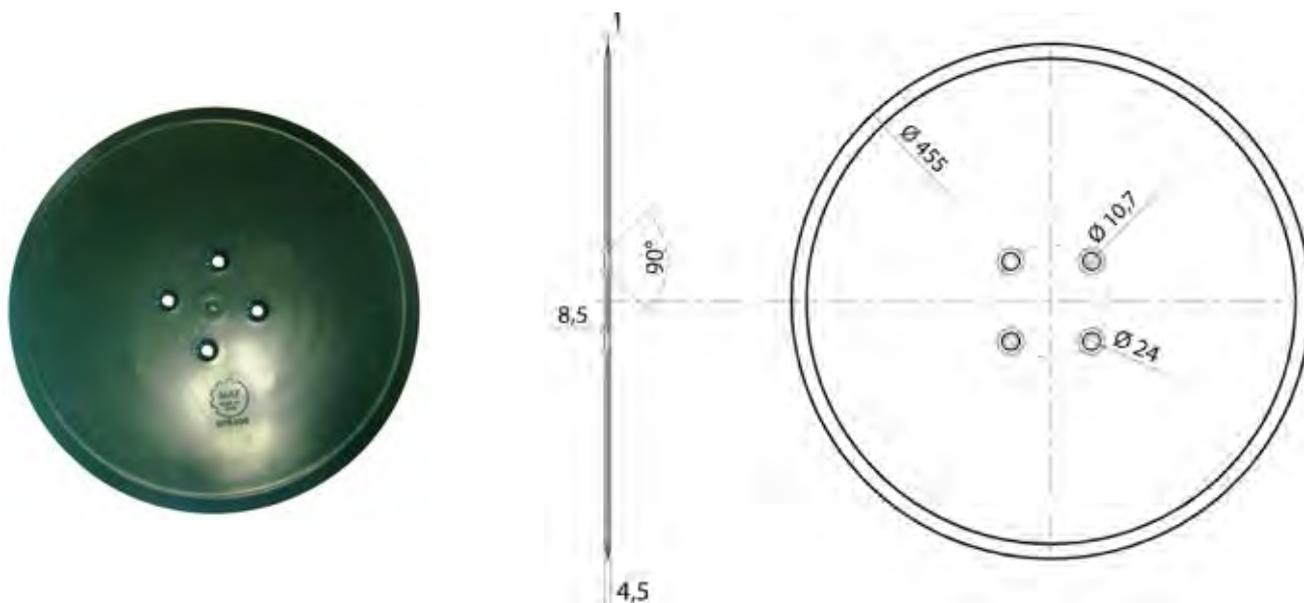

Art./Ref.	Cod. Comp. NAF	Diametro mm/ Diameter mm	Spessore mm/ Thickness mm	Foro mm/ Hole mm	Concavità mm/ Concavity mm	Note/Note	Brand	Rif. Orig./Orig. Ref.
RC1852	DKVN02	455	4.5	-	PIANO	n.4 fori da 10.7 bugnati	KVERNELAND	076406

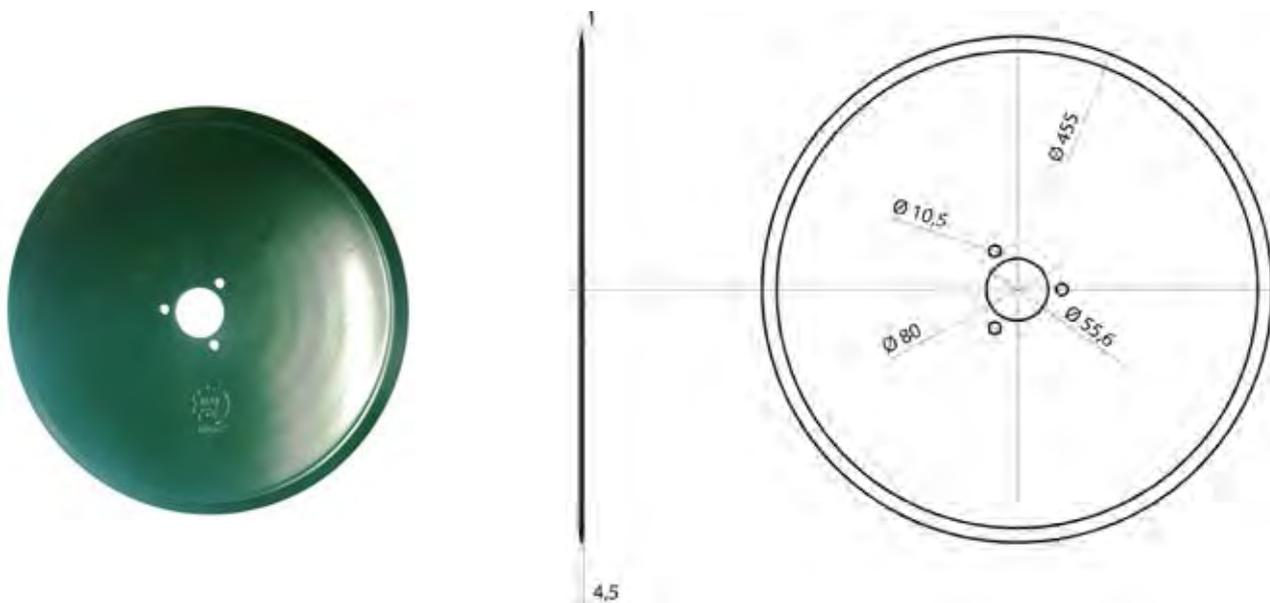
DISCHI PER COLTIVATORE ADATTABILE KVERNELAND
DISQUES POUR COLTIVATEUR ADAPTABLE A KVERNELAND
CULTIVATOR DISCS SUITABLE TO KVERNELAND
EGGENSCHEIBEN PASSEND ZU KVERNELAND
DISCOS DE CULTIVADOR ADAPTABLE A KVERNELAND

Art./Ref.	Cod. Comp. NAF	Diametro mm/ Diameter mm	Spessore mm/ Thickness mm	Foro mm/ Hole mm	Concavità mm/ Concavity mm	Note/Note	Brand	Rif. Orig./Orig. Ref.
RC1851	DKVN01	455	4.5 MM	55.6	PIANO	n.3 fori da 10.5 su circ. 80.	KVERNELAND	056112

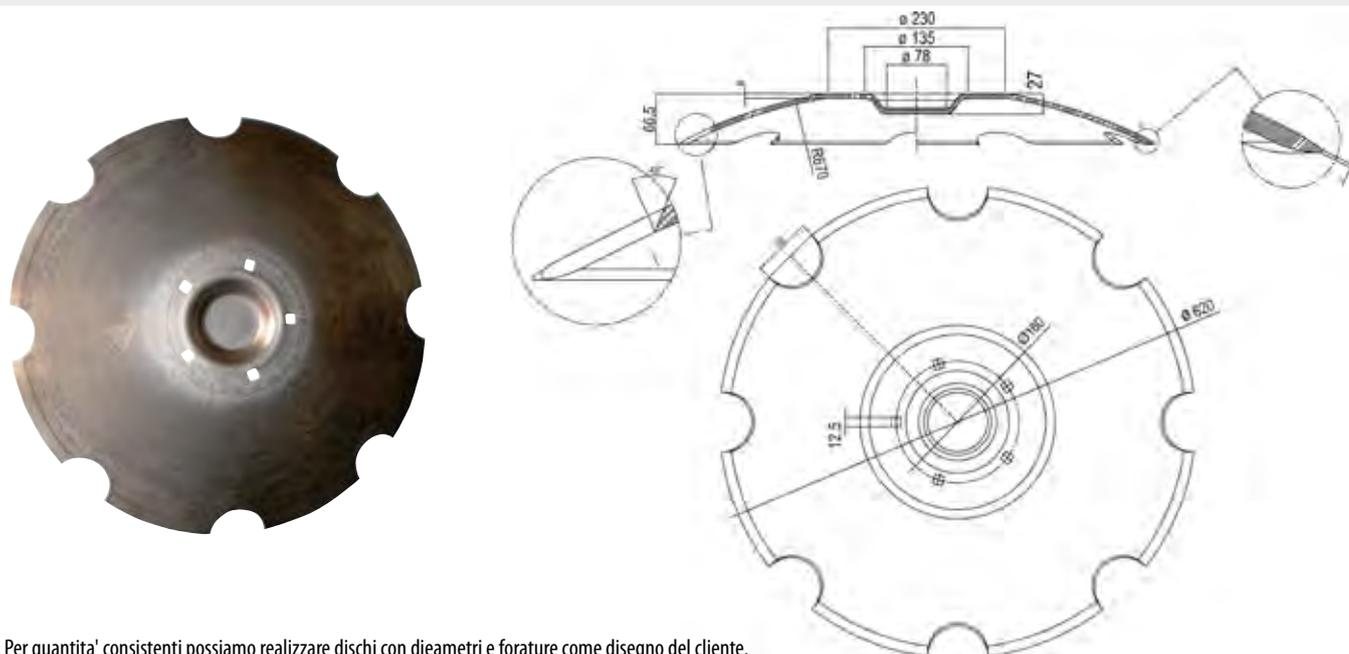
DISCO ADATTABILE LEMKEN 620 MM
DISQUE ADAPTABLE LEMKEN 620 MM
DISC SUITABLE TO LEMKEN 620 MM
SCHEIBEN PASSEND ZU LEMKEN 620 MM
DISCOS ADAPTABLE LEMKEN 620 MM

Note: Per quantità consistenti possiamo realizzare dischi con diametri e forature come disegno del cliente.

Notes: For high volumes, we are available to produce discs with customized diameter and holes.

Art./Ref.	Cod. Comp. NAF	Diametro mm/ Diameter mm	Spessore mm/ Thickness mm	Concavità mm/ Concavity mm	Note/Note	Brand	Rif. Orig./Orig. Ref.
CP6210	DUNI11	620	6 mm	60,5 mm	N.5 fori quadri da 12,6 mm ,interasse 160 mm	LEMKEN	3490467

1.10.3 Molle per vibrocoltivatori e socs reversibili

Vibrotiller springs & reversible socs



Ricambi & accessori per macchine agricole

SPARE PARTS & ACCESSORIES FOR AGRICULTURAL MACHINE

Tutti gli articoli della presente sezione, prodotti da AMA SPA e/o da terzi per conto di AMA, sono adattabili ("non originali") alle marche indicate ai sensi di quanto previsto dal REG. CE n. 1400/2002. I diritti sui marchi citati appartengono ai legittimi proprietari ed il loro uso ha l'esclusiva finalità di consentire all'utilizzatore la comparazione dei diversi prodotti. All items of this section, manufactured by AMA SPA and/or any third party on behalf of AMA, are adaptable ("non-original") to the brands listed under the provisions of the REG. CE n. 1400/2002. The rights on the trademarks belong to their respective owners and their usage is only aimed to allow the user to compare different products.

MOLLE FLEX PER VIBROCOLTIVATORI

DENT "FLEX" DE VIBROCOLTEUR
 VIBROTILLER SPRING TINE "FLEX"
 KULTIZINKE "FLEX" FÜR VIBRATIONSEGGE
 MUELLES TIPO "FLEX" PARA VIBROCOLTIVADORES

Standard - Alta

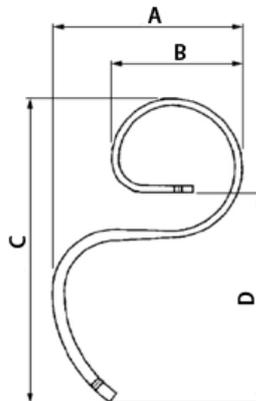
Scorrevole

Note: Le misure sono indicative e possono essere soggette a variazioni senza alcun obbligo di preavviso da parte nostra.

Notes: Indicated measures are approximate and can be changed without advise from our side.

Art./Ref.	Tipo/Type	Sezione/Section	A mm	B mm	C mm	D mm	Peso Kg/Weight Kg	Note/Note
CP1350	Standard	32 x 10	320	220	530	370	2.6	Senza vomere/Without tine
CP1350A	Standard	32 x 10	320	220	530	370	2.92	Con vomere/With tine - Art. CP1360D
CP1351	Standard	32 x 12	325	225	535	370	3	Senza vomere/Without tine
CP1351A	Standard	32 x 12	325	225	535	370	3.32	Con vomere/With tine - Art. CP1360D
CP1414	Alta	32 x 12	330	225	640	475	3.35	Senza vomere/Without tine
CP1349	Alta	45 x 12	345	260	665	515	4.95	Senza vomere/Without tine
CP1349A	Alta	45 x 12	345	260	665	515	5.61	Con vomere/With tine - Art. CP1360A
CP1410	Scorrevole	32 x 10	295	220	550	390	2.6	Senza vomere/Without tine
CP1410B	Scorrevole	32 x 10	295	220	550	390	2.92	Con vomere/With tine - Art. CP1823/

RINFORZI PER MOLLE FLEX

RENFORT DENTS FLEX
 FLEX AUXILIARY SPRINGS
 VERSTAERKUNG FÜR KULTIZINKE FLEX
 REFUERZO PARA MUELLES "FLEX"

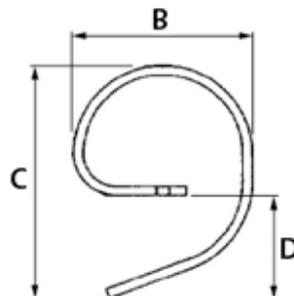

Standard

Con Occhio

Note: Le misure sono indicative e possono essere soggette a variazioni senza alcun obbligo di preavviso da parte nostra.

Notes: Indicated measures are approximate and can be changed without advise from our side.

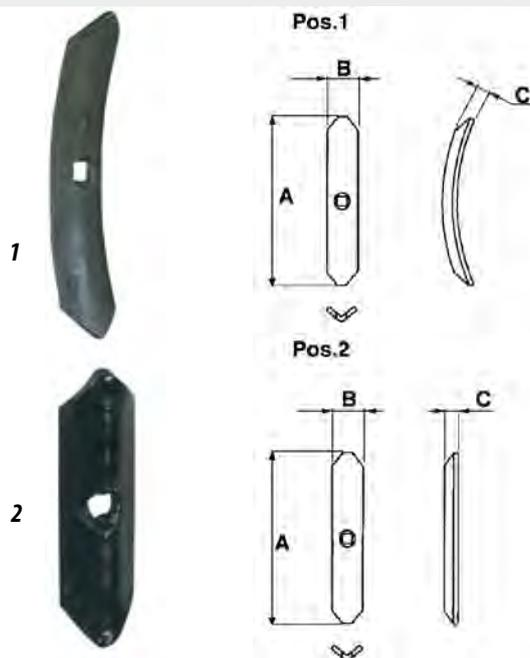
Art./Ref.	Tipo/Type	Sezione/Section	B mm	C mm	D mm	Peso Kg/Weight Kg
CP1353	Standard per flex 32x10 e 32x12	32 x 10	190	250	110	1.43
CP1354	Con occhio per flex 32x10 e 32x12	32 x 10	190	280	140	1.55
CP1352	Con occhio per flex 45x12	45 x 10	215	305	170	2.58

VOMERINI REVERSIBILI PER MOLLE FLEX
SOC POUR DENT CULTIVATEUR FLEX
SHARE FOR FLEX COLTIVATOR TINE
SCHAR FÜR BLATTFEDERZINKE FLEX
REJAS ABATIBLES PARA MUELLES FLEX

Note: Le misure sono indicative e possono essere soggette a variazioni senza alcun obbligo di preavviso da parte nostra.

Notes: Indicated measures are approximate and can be changed without advise from our side.

Art./Ref.	Pos.	A mm	B mm	C mm	Spessore mm/Thickness mm	Peso Kg/Weight Kg	Note/Note
CP1360D	1	190	40	16	5 mm	0.25	Per molle flex varie
CP1360	1	190	40	16	6 mm	0.3	Per molle flex varie e molle rompitraccia.
CP1822	1	210	40	16	8 mm	0.46	Per molle flex varie
CP1823	1	180	40	16	5 mm	0.25	Per molle flex scorrevoli
CP1825	2	195	40	16	5 mm	0.25	Per molle flex diritte 32x12
CP1360B	2	215	40	16	6 mm	0.37	Vomere reversibile dritto per molle flex 32x10 e 32x12
CP1472	2	135	40	16	5 mm	0.18	Vomere reversibile dritto per molle gare con foro e molle rompitraccia.
CP1826	2	135	40	16	6 mm	0.21	Per molle gare con foro
CP1360A	1	265	50	16	6 mm	0.63	Per molle flex 45x12

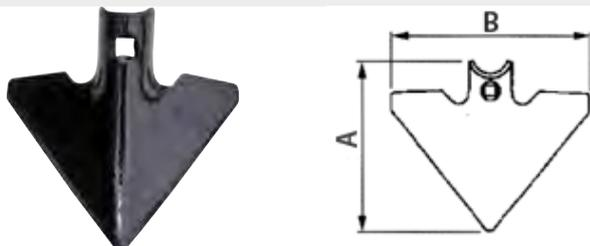
VOMERINI A LANCIA PER MOLLE FLEX
SOC COEUR POUR VIBROCOLTEUR
VIBROTILLER SHARE
GÄNSEFUSSCHAR FÜR KULTIZINKEN
REJAS A CORAZÓN PARA MUELLES FLEX

Note: Le misure sono indicative e possono essere soggette a variazioni senza alcun obbligo di preavviso da parte nostra.

Notes: Indicated measures are approximate and can be changed without advise from our side.

Art./Ref.	A mm	B mm	Spessore mm/Thickness mm	Peso Kg/Weight Kg
CP1362	125	105	4	0.22
CP1363	155	150	4	0.39
CP1364	155	175	4	0.44
CP1365	155	200	4	0.5

VOMERE A ZAMPA D'OCA

SOC PATTE D'OIE
DUCK FOOT POINT
GANSEFUSSCHAR
REJAS A PARA DE GANCO

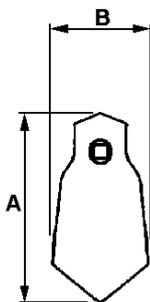

Note: Le misure sono indicative e possono essere soggette a variazioni senza alcun obbligo di preavviso da parte nostra.

Notes: Indicated measures are approximate and can be changed without advise from our side.

Art./Ref.	A mm	B mm	Spessore mm/Thickness mm	Peso Kg/Weight Kg
CP1361	145	70	4	0.23

VOMERE A SCALPELLO

SOC A' CISEAU
PLOUGHSHARES POINT
SCHARE MEISSEL
REJAS A ESCOPLLO



Art./Ref.	Sezione/Section	Peso Kg/Weight Kg
CP1489	40 X 5 e scalpello 25x8	0.24

VITI TESTA OVALE PER VOMERINI

VIS TETE OVALE POUR SOCS
OVAL HEAD SCREWS FOR SHARES
OVALSCHRAUBEN FÜR SCHAREN
TORNILLO CABEZA OVAL PARA REJAS

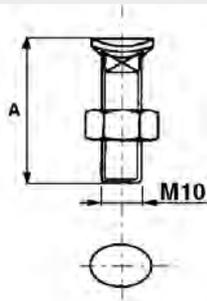

Note: Vite completa di dado con testa ovale e quadro sottotesta per il fissaggio dei vomerini alle molle tipo flex, gare e rompitraccia con foro per il fissaggio. Materiale 8.8

Notes: Oval head screws with square under-head complete with nut to fix tine on spring. Material 8.8

Art./Ref.	A mm	Filettatura/Thread	Peso Kg/Weight Kg	Note/Note
CP1358	38	M 10	0.03	Bullone testa ovale con quadro 10 mm.
CP1358A	45	M 10	0.05	Bullone testa ovale con quadro 10 mm.
CP1358B	60	M 10	0.06	Bullone testa ovale con quadro 10 mm.
CP1358E	55	M 10	0.06	Bullone testa ovale con quadro 10 mm.
CP1358F	30	M 10	0.04	Bullone testa ovale con quadro 10 mm.

STAFFE PER MOLLE FLEX

BRIDE POUR DENT VIBROCOLTEUR
VIBROTILLER TINE FRAME
HALTERUNG FÜR EINFACHE ZINKE
ESTRIBOS PARA MUELLES

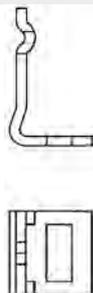

Art./Ref.	Sezione/Section	Telaio/Telaio	Note/Note
CP1356C	50 x 6	50 x 12	Staffa monolama per molla 32x10 H=22 - Single spring
CP1416	50 x 6	50 x 12	Staffa monolama per molla 32x12 H=24 - Single spring
CP1356	50 x 6	50 x 15	Staffa monolama per molla 32x10 - 32x12 H=27 - Single spring
CP1357B	50 x 6	50 x 15	Staffa bilama per molla 32x12 H=37 -Rinforzo 32x10 - Double spring

STAFFE PER MOLLE FLEX

BRIDE POUR DENT VIBROCOLTEUR
VIBROTILLER TINE FRAME
HALTERUNG FÜR EINFACHE ZINKE
ESTRIBOS PARA MUELLES

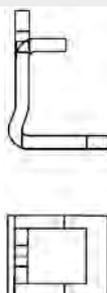

Art./Ref.	Sezione/Section	Telaio/Telaio	Note/Note
CP1356A	50 x 8	50 x 12	Staffa monolama per molla 32x12 H=24 - Single spring
CP1356B	50 x 8	50 x 15	Staffa monolama per molla 32x12 H=27 - Single spring/
CP1357A	50 x 8	50 x 12	Staffa bilama per molla 32x12 H=34 -Rinforzo 32x10 - Double spring
CP1357	50 x 8	50 x 15	Staffa bilama per molla 32x10 - 32x12 H=37 -Rinforzo 32x10 - Double spring

STAFFE PER MOLLE FLEX

BRIDE POUR DENT VIBROCOLTEUR
VIBROTILLER TINE FRAME
HALTERUNG FÜR EINFACHE ZINKE
ESTRIBOS PARA MUELLES

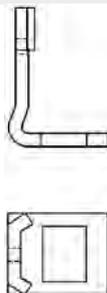

Art./Ref.	Sezione/Section	Telaio/Telaio	Note/Note
CP1359C	70 x 8	50 x 50	Staffa monolama per molla 45x12 H=61 - Single spring
CP1359	70 x 8	60 x 60	Staffa monolama per molla 45x12 H=71 - Single spring
CP1359A	70 x 8	60 x 60	Staffa bilama per molla 45x12 H=81 -Rinforzo 45x10 - Double spring

BULLONI TESTA ESAGONALE PER STAFFE

BOULONS TETE HEXAGONALE POUR BRIDES
 HEXAGONAL BOLTS FOR CLAMPS
 SECHSKANTSCHRAUBE FÜR HALTERUNGEN
 ESCOPLoS CABEZA HEXAGONAL PARA ESTRIBOS

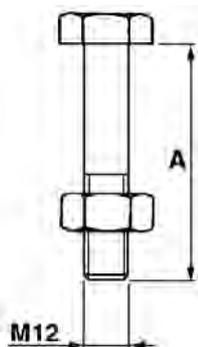

Note: Viti zincate con testa esagonale complete di dado per il fissaggio delle staffe.

Notes: Galvanized screws with exagonal head complete with nut to fix frames

Art./Ref.	Sezione/Section	A mm	Filettatura/Thread	Peso Kg/Weight Kg	Note/Note
RC0740	12 x 50	50	M 12	0.09	Bullone 8.8
RC0741	12 x 60	60	M 12	0.1	Bullone 8.8
RC0742	12 x 80	80	M 12	0.11	Bullone 8.8
RC0743	12 x 90	90	M 12	0.12	Bullone 8.8
RC0744	12 x 100	100	M 12	0.13	Bullone 8.8
RC0745	12 x 110	110	M 12	0.14	Bullone 8.8

MOLLE TIPO GARE POSTERIORI E ANTERIORI

DENTS GARE ARRIERE ET AVANT
 FRONT AND BACK SPRINGS GARE TYPE
 VORDER UND HINTERZINKEN TYP GARE
 MUELLES TIPO GARE/ANTERIOR Y POSTERIOR

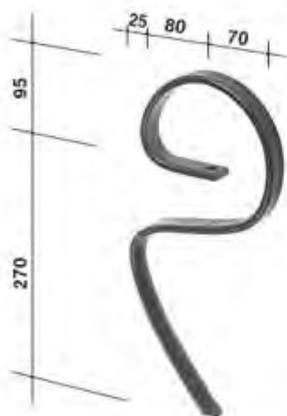

1

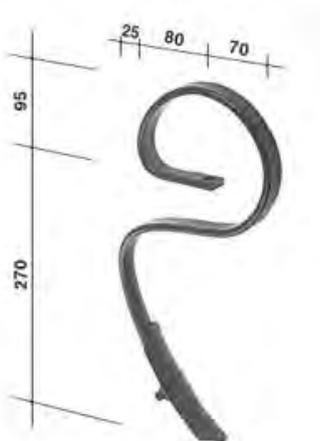

2

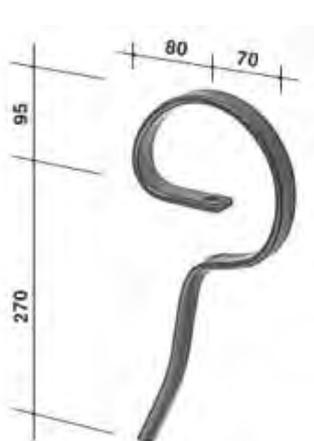

3

Note: Le misure sono indicative e possono essere soggette a variazioni senza alcun obbligo di preavviso da parte nostra.

Notes: Indicated measures are approximate and can be changed without advise from our side.

Art./Ref.	Pos.	Tipo/Type	Sezione/Section	Peso Kg/Weight Kg	Note/Note
CP1348	1	Bassa	25 x 8	1.07	Vomere mai applicabile/Without tine
CP1348C	2	Bassa	25 x 8	1.07	Senza vomere/Without tine
CP1348A	2	Bassa	25 x 8	1.2	Con vomere/With tine Art. CP1472C/Con vomere/With tine
CP1348B	3	Alta	25 x 8	0.91	Vomere mai applicabile/Without tine

STAFFE PER MOLLE TIPO GARE

BRIDES POUR DENTS GARE

CLAMPS FOR SPRINGS GARE TYPE

HALTERUNGEN FÜR ZINKEN TYP GARE

ESTRIBOS PARA MUELLES TIPO GARE

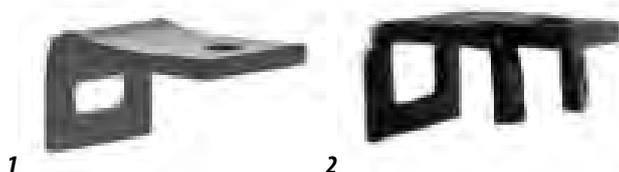

Art./Ref.	Pos.	Sezione/Section	Telaio/Telaio	Peso Kg/Weight Kg	Note/Note
CP1355	1	40 x 5	40 x 10	0.16	staffa per molla 25x8
CP1355A	2	40 x 6	40 x 10	0.17	staffa per molla 25x8

MOLLE FLEX PER VIBROCOLTIVATORI ADATTABILI A KONGSKILDE

DENT "FLEX" DE VIBROCOLTEUR ADAPTABLE A KONGSKILDE

VIBROTILLER SPRING TINE "FLEX" SUITABLE TO KONGSKILDE

KULTIZINKE "FLEX" FÜR VIBRATIONSEGGE PASSEND ZU KONGSKILDE

MUELLES TIPO "FLEX" PARA VIBROCOLTIVADORES ADAPTABLE A KONGSKYLDE

Note: Le misure sono indicative e possono essere soggette a variazioni senza alcun obbligo di preavviso da parte nostra.

Notes: Indicated measures are approximate and can be changed without advise from our side.

Art./Ref.	Sezione/Section	Peso Kg/Weight Kg	Note/Note
CP1412	32 x 10	1.67	Molla senza vomere / S-Tine without point
CP1412A	32 x 10	1.88	Molla con vomere CP1472 / S-Tine with point CP1472
CP1472	40 x 5	0.18	Vomere reversibile diritto per molle gare con foro e molle rompitraccia.
CP1358	10 x 38	0.03	Bullone testa ovale con quadro 10 mm.



MOLLE FLEX PER VIBROCOLTIVATORI ADATTABILI A KONGSKILDE

DENT "FLEX" DE VIBROCOLTEUR ADAPTABLE A KONGSKILDE

VIBROTILLER SPRING TINE "FLEX" SUITABLE TO KONGSKILDE

KULTIZINKE "FLEX" FÜR VIBRATIONSEGGE PASSEND ZU KONGSKILDE

MUELLES TIPO "FLEX" PARA VIBROCOLTIVADORES ADAPTABLE A KONGSKYLDE

Note: Le misure sono indicative e possono essere soggette a variazioni senza alcun obbligo di preavviso da parte nostra.

Notes: Indicated measures are approximate and can be changed without advise from our side.

Art./Ref.	Sezione/Section	Peso Kg/Weight Kg	Note/Note
CP1412C	32 x 10	2.15	Molla senza vomere / S-Tine without point
CP1412B	32 x 10	2.57	Molla con vomere CP1360B / S-Tine with point CP1360B
CP1413	32 x 12	2.54	Molla senza vomere / S-Tine without point
CP1413A	32 x 12	2.96	Molla con vomere CP1360B / S-Tine with point CP1360B
CP7404	32 x 12	2.72	Molla senza vomere / S-Tine without point. Tipo Jackpot.
CP7405	32 x 12	3.14	Molla con vomere CP1360B / S-Tine with point CP1360B. Tipo Jackpot. La quota 385* del disegno diventa *450 per questo articolo.
CP1360B	40 x 6	0.37	Vomere reversibile diritto per molle flex 32x10 e 32x12
CP1358	10 x 38	0.03	Bullone testa ovale con quadro 10 mm.

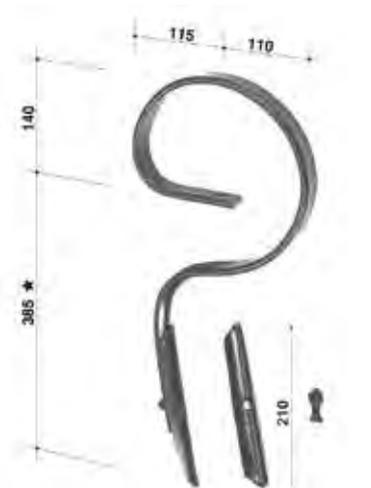

RINFORZI PER MOLLE FLEX ADATTABILE KONGSKILDE
RENFORT DENTS FLEX ADAPTABLE A KONGSKILDE
FLEX AUXILIARY SPRINGS SUITABLE TO KONGSKILDE
VERSTAERKUNG FÜR KULTIZINKE FLEX PASSEND ZU KONGSKILDE
REFUERZO PARA MUELLES "FLEX" ADAPTABLE A KONGSKYLDE

Note: Le misure sono indicative e possono essere soggette a variazioni senza alcun obbligo di preavviso da parte nostra.

Notes: Indicated measures are approximate and can be changed without advise from our side.

Art./Ref.	Sezione/Section	Peso Kg/Weight Kg	Note/Note
CP1353A	32 x 10	1.33	Rinforzo molla / Helper

MOLLE FLEX PER VIBROCOLTIVATORI ADATTABILE KONGSKILDE
DENT "FLEX" DE VIBROCOLTEUR ADAPTABLE A KONGSKILDE
VIBROTILLER SPRING TINE "FLEX" SUITABLE TO KONGSKILDE
KULTIZINKE "FLEX" FÜR VIBRATIONSEGGE PASSEND ZU KONGSKILDE
MUELLES TIPO "FLEX" PARA VIBROCOLTIVADORES ADAPTABLE A KONGSKYLDE

Note: Le misure sono indicative e possono essere soggette a variazioni senza alcun obbligo di preavviso da parte nostra.

Notes: Indicated measures are approximate and can be changed without advise from our side.

Art./Ref.	Sezione/Section	Peso Kg/Weight Kg	Note/Note
CP7406	45 x 12	3.9	Molla senza vomere / S-Tine without point.
CP7407	45 x 12	4.32	Molla con vomere CP1360B / S-Tine with point CP1360B.
CP1360B	40 x 6	0.37	Vomere reversibile diritto per molle flex 32x10 e 32x12
CP1358	10 x 38	0.03	Bullone testa ovale con quadro 10 mm.

MOLLE FLEX PER VIBROCOLTIVATORI ADATTABILI A EVA
DENT "FLEX" DE VIBROCOLTEUR ADAPTABLE EVA
VIBROTILLER SPRING TINE "FLEX" SUITABLE TO EVA
KULTIZINKE "FLEX" FÜR VIBRATIONSEGGE PASSEND ZU EVA
MUELLES TIPO "FLEX" PARA VIBROCOLTIVADORES ADAPTABLE EVA

Note: Le misure sono indicative e possono essere soggette a variazioni senza alcun obbligo di preavviso da parte nostra.

Notes: Indicated measures are approximate and can be changed without advise from our side.

Art./Ref.	Sezione/Section	Peso Kg/Weight Kg	Note/Note
CP7408	32 x 10	2.26	Molla senza vomere/S-Tine without point
CP7409	32 x 10	2.66	Molla con vomere CP7412 / S-Tine with point CP7412
CP7410	32 x 12	2.68	Molla senza vomere/S-Tine without point
CP7411	32 x 12	3.08	Molla con vomere CP7412 / S-Tine with point CP7412
CP7412	40 x 6	0.37	Vomere reversibile / Reversible point
CP1358	10 x 38	0.03	Bullone testa ovale con quadro 10 mm.

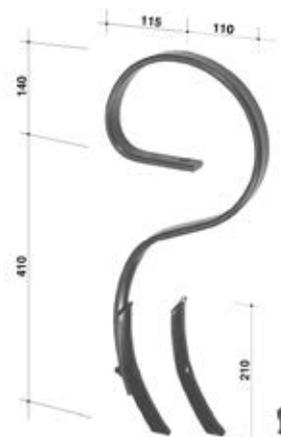

RINFORZI PER MOLLE FLEX ADATTABILE A EVA

RENFORT DENTS FLEX ADAPTABLE EVA

FLEX AUXILIARY SPRINGS SUITABLE TO EVA

VERSTAERKUNG FÜR KULTIZINKE FLEX PASSEND ZU EVA

REFUERZO PARA MUELLES "FLEX" ADAPTABLE EVA

Note: Le misure sono indicative e possono essere soggette a variazioni senza alcun obbligo di preavviso da parte nostra.

Notes: Indicated measures are approximate and can be changed without advise from our side.

Art./Ref.	Sezione/Section	Peso Kg/Weight Kg	Note/Note
CP1353A	32 x 10	1.33	Rinforzo molla / Helper

MOLLE FLEX PER VIBROCOLTIVATORI ADATTABILI A VADERSTAD

DENT "FLEX" DE VIBROCOLTEUR ADAPTABLE A VADERSTAD

VIBROTILLER SPRING TINE "FLEX" SUITABLE TO VADERSTAD

KULTIZINKE "FLEX" FÜR VIBRATIONSEGGE PASSEND ZU VADERSTAD

MUELLES TIPO "FLEX" PARA VIBROCOLTIVADORES ADAPTABLE A VADERSTAD

Note: Le misure sono indicative e possono essere soggette a variazioni senza alcun obbligo di preavviso da parte nostra.

Notes: Indicated measures are approximate and can be changed without advise from our side.

Art./Ref.	Sezione/Section	D mm	Peso Kg/Weight Kg	Note/Note
CP7413	45 x 10	165	3.68	Molla AN senza vomere/S-Tine without point
CP7414	45 x 10	165	4.08	Molla AN con vomere CP7412 / S-Tine with point CP7412
CP7415	45 x 10	105	3.5	Molla AS senza vomere/S-Tine without point
CP7416	45 x 10	105	3.9	Molla AS con vomere CP7412 / S-Tine with point CP7412
CP7417	45 x 10	170	3.7	Molla AC senza vomere/S-Tine without point
CP7418	45 x 10	170	4.1	Molla AC con vomere CP7412 / S-Tine with point CP7412. La quota 370* del disegno diventa *420 per questo articolo.
CP7412	40 x 6	-	0.37	Vomere reversibile / Reversible point
CP1358	10 x 38	-	0.03	Bullone testa ovale con quadro 10 mm.

MOLLE LIVELLATRICI 45X10

DENTS VIBRO 45X10

LEVELLING TINES 45X10

SCHLEPPZINKEN 45X10

MUELLES NIVELADORES 45X10

Note: Le misure sono indicative e possono essere soggette a variazioni senza alcun obbligo di preavviso da parte nostra.

Notes: Indicated measures are approximate and can be changed without advise from our side.

Art./Ref.	Sezione/Section	Telaio/Telaio	A mm	B mm	C mm	D mm	E mm	Peso Kg/Weight Kg	Blister/Packaging	Note/Note
CP7419	45 x 10	50 x 50	146	363	138	96	90	3.18	200	Molla livellatrice senza vomere - 2 fori vomere da 13 mm, interasse 45 mm / S-Tine without point - 2 holes 13 mm for point distance 45 mm.
CP7420	45 x 10	50 x 50	146	363	138	96	45	3.16	200	Molla livellatrice senza vomere - 3 fori vomere da 13 mm, interasse 45 mm / S-Tine without point - 3 holes 13 mm for point, distance 45 mm.
CP7421	45 x 10	70 x 70	153	363	138	122	35	3.35	200	Molla livellatrice senza vomere - 3 fori vomere da 13 mm, interasse 45 mm / S-Tine without point - 3 holes 13 mm for point, distance 45 mm.



MOLLE LIVELLATRICI 80X10
DENTS VIBRO 80X10
LEVELLING LINES 80X10
SCHLEPPZINKEN 80X10
MUELLES NIVELADORES 80X10

Note: Le misure sono indicative e possono essere soggette a variazioni senza alcun obbligo di preavviso da parte nostra.

Notes: Indicated measures are approximate and can be changed without advise from our side.

Art./Ref.	Sezione/ Section	Telaio/ Telaio	A mm	B mm	C mm	D mm	E mm	Peso Kg/ Weight Kg	Blister/ Packaging	Note/Note
CP7422	80 x 10	70 x 70	153	363	138	122	35	6.1	112	Molla livellatrice senza vomere - 3 fori vomere da 13 mm, interasse 45 mm/ S-Tine without point - 3 holes 13 mm for point, distance 45 mm.

PALETTE PER MOLLE LIVELLATRICI
PLAQUES D'USURE POUR DENTS VIBRO
POINTS FOR LIVELLING LINES
SCHAR FUER SCHLEPPZINKEN
PLETINAS PARA MUELLES NIVELADORES

Art./Ref.	Sezione/Section	Spessore mm/Thickness mm	Peso Kg/Weight Kg	Note/Note
CP7423	45 x 10	-	0.6	Paletta diritta / Straight point
CP7424	45 x 10	-	0.78	Paletta piegata / Folded point
CP7425	100 x 8	-	1.4	Paletta piegata / Folded point
CP7426	150 x 8	-	2.35	Paletta piegata / Folded point
CP7427	-	8 mm	2.4	Paletta con denti / Crust breaker point

STAFFE PER MOLLE LIVELLATRICI

BRIDES POUR DENTS VIBRO

CLAMPS FOR LIVELLING LINES

HALTERUNG FUER ZINKEN

Á NGULOS PARA MUELLES NIVELADORES



Art./Ref.	Sezione/Section	Telaio/Telaio	A mm	Filettatura/Thread	Peso Kg/Weight Kg	Note/Note
CP7428	70 x 8	50 x 50	-	-	0.61	Staffa per molla 45x10 / Clamp for tine 45x10
CP7429	70 x 8	60 x 60	-	-	0.71	Staffa per molla 45x10 / Clamp for tine 45x10
CP7430	70 x 8	65 x 65	-	-	0.76	Staffa per molla 45x10 / Clamp for tine 45x10
CP7431	70 x 8	70 x 70	-	-	0.81	Staffa per molla 45x10 / Clamp for tine 45x10
CP7432	110 x 10	50 x 50	-	-	1.26	Staffa per molla 80x10 / Clamp for tine 80x10
CP7433	110 x 10	60 x 60	-	-	1.4	Staffa per molla 80x10 / Clamp for tine 80x10
CP7434	110 x 10	65 x 65	-	-	1.49	Staffa per molla 80x10 / Clamp for tine 80x10
CP7435	110 x 10	70 x 70	-	-	1.58	Staffa per molla 80x10 / Clamp for tine 80x10
RC0742	12 x 80	-	80	M 12	0.11	Bullone 8.8
RC0743	12 x 90	-	90	M 12	0.12	Bullone 8.8
RC0744	12 x 100	-	100	M 12	0.13	Bullone 8.8
RC0745	12 x 110	-	110	M 12	0.14	Bullone 8.8

MOLLE TIPO ROMPIRACCI A E RINFORZI

DENTS EFFACEURS ET RENFORTS

STIFFENER AND SPRINGS

SPURLOCKERERZINKEN UND VERSTAERKUNGEN

MUELLES TIPO ROMPIRACCI A Y RINFORZI

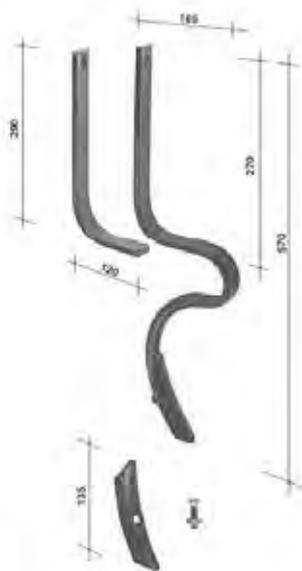

Note: Le misure sono indicative e possono essere soggette a variazioni senza alcun obbligo di preavviso da parte nostra.

Notes: Indicated measures are approximate and can be changed without advise from our side.

Art./Ref.	Sezione/Section	Peso Kg/Weight Kg	Note/Note
CP1369B	32 x 10	1.69	Molla rompitraccia senza vomerina
CP1369	32 x 10	1.9	Molla rompitraccia con vomerina CP1472C
CP1471	32 x 10	0.855	Rinforzo rompitraccia
CP1472C	40 x 5	0.18	Vomerina curva per molle gare con foro e molle rompitraccia.
CP1358	10 x 38	0.03	Bullone testa ovale con quadro 10 mm.

MOLLE TIPO ROMPITRACCIA E RINFORZI
DENTS EFFACEURS ET RENFORTS
STIFFENER AND SPRINGS
SPURLOCKERERZINKEN UND VERSTAERKUNGEN
MUELLES TIPO ROMPITRACCIA Y RINFORZI

Note: Le misure sono indicative e possono essere soggette a variazioni senza alcun obbligo di preavviso da parte nostra.

Notes: Indicated measures are approximate and can be changed without advise from our side.

Art./Ref.	Sezione/Section	Peso Kg/Weight Kg	Note/Note
CP1473	32 x 10	2.08	Molla rompitraccia senza vomerina. Interasse fori 28 mm.
CP1474	32 x 10	2.415	Molla rompitraccia con vomerina. Interasse fori 28 mm.
CP1475	32 x 8	0.285	Vomerina strozzata per molla rompitraccia. Interasse fori 28 mm.
RC0760A	10 x 30	0.03	bullone

MOLLE TIPO ROMPITRACCIA E RINFORZI
DENTS EFFACEURS ET RENFORTS
STIFFENER AND SPRINGS
SPURLOCKERERZINKEN UND VERSTAERKUNGEN
MUELLES TIPO ROMPITRACCIA Y RINFORZI

Note: Le misure sono indicative e possono essere soggette a variazioni senza alcun obbligo di preavviso da parte nostra.

Notes: Indicated measures are approximate and can be changed without advise from our side.

Art./Ref.	Sezione/Section	Peso Kg/Weight Kg	Note/Note
CP1477	40 x 10	2.71	Molla rompitraccia senza vomerina
CP1478	40 x 10	3.01	Molla rompitraccia con vomerina
CP1479	40 x 10	1.69	Rinforzo rompitraccia
CP1360	40 x 6	0.3	Per molle flex varie e molle rompitraccia.
CP1358	10 x 38	0.03	Bullone testa ovale con quadro 10 mm.

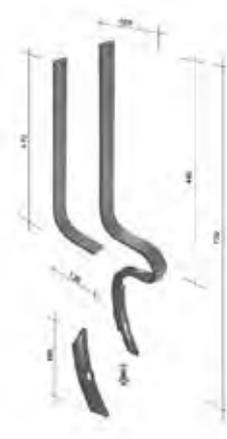
MOLLE TIPO ROMPITRACCIA E RINFORZI
DENTS EFFACEURS ET RENFORTS
STIFFENER AND SPRINGS
SPURLOCKERERZINKEN UND VERSTAERKUNGEN
MUELLES TIPO ROMPITRACCIA Y RINFORZI

Note: Le misure sono indicative e possono essere soggette a variazioni senza alcun obbligo di preavviso da parte nostra.

Notes: Indicated measures are approximate and can be changed without advise from our side.

Art./Ref.	Sezione/Section	Peso Kg/Weight Kg	Note/Note
CP1480	32 x 10	1.76	Molla rompitraccia senza vomerina
CP1481	32 x 10	2.06	Molla rompitraccia con vomerina
CP1482	32 x 10	1.1	Rinforzo rompitraccia
CP1360	40 x 6	0.3	Per molle flex varie e molle rompitraccia.
CP1358	10 x 38	0.03	Bullone testa ovale con quadro 10 mm.

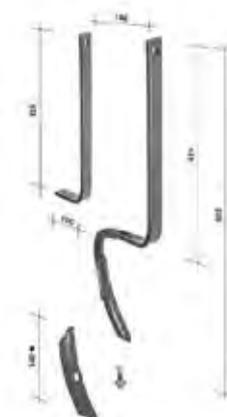

MOLLE PER VIBROCOLTIVATORI

DENT DE VIBROCOLTEUR
 SPRING TINES FOR CULTIVATORS
 KULTIZINKE FÜR VIBRATIONSEGGE
 MUELLES TIPO PARA VIBROCOLTIVADORES

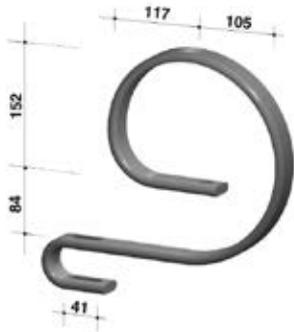

Note: Le misure sono indicative e possono essere soggette a variazioni senza alcun obbligo di preavviso da parte nostra.
Notes: Indicated measures are approximate and can be changed without advise from our side.

Art./Ref.	Sezione/Section	Peso Kg/Weight Kg	Note/Note
CP7511	32 x 12	2.56	Molla sarchiatrice / Weeder tine

MOLLA ADATTABILE SIDERMAN 45X12

DENT ADAPTABLE SIDERMAN 45X12
 TINE SUITABLE TO SIDERMAN 45X12
 ZINKE PASSEND ZU SIDERMAN 45X12
 BRAZO ADAPTABLE SIDERMAN 45X12

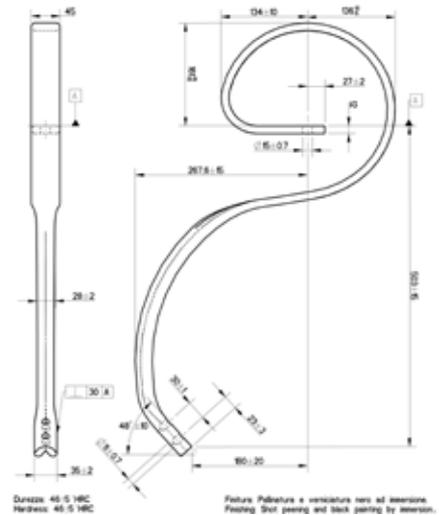

Note: Le misure sono indicative e possono essere soggette a variazioni senza alcun obbligo di preavviso da parte nostra.
Notes: Indicated measures are approximate and can be changed without advise from our side.

Art./Ref.	Note/Note
CP1349C	Foro bloccaggio molla mm 15.

RINFORZI PER MOLLE FLEX

RENFORT DENTS FLEX
 FLEX AUXILIARY SPRINGS
 VERSTAERKUNG FÜR KULTIZINKE FLEX
 REFUERZO PARA MUELLES "FLEX"



Note: Le misure sono indicative e possono essere soggette a variazioni senza alcun obbligo di preavviso da parte nostra.
Notes: Indicated measures are approximate and can be changed without advise from our side.

Art./Ref.	Tipo/Type	Sezione/Section	Peso Kg/Weight Kg
CP1352C	Con occhio per flex 45x12	45 x 10	2.58

VOMERE A LANCIA PER MOLLA ADATTABILE SIDERMAN 60X12

SOC A' LANCE POUR DENT ADAPTABLE SIDERMAN 60X12
 ARROW POINT FOR TINE SUITABLE TO SIDERMAN 60X12
 SCHAR FUER ZINKE PASSEND ZU SIDERMAN 60X12
 REJA DE LANZA PARA BRAZO ADAPTABLE SIDERMAN 60X12

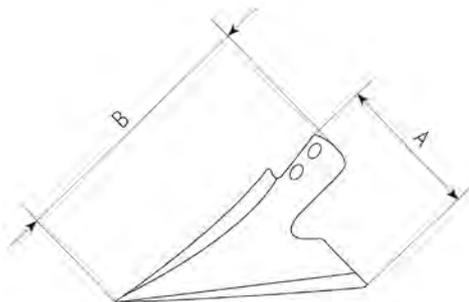

Art./Ref.	A mm	B mm	Spessore mm/Thickness mm	Peso Kg/Weight Kg	Note/Note
CP1384A	200	175	6 mm	1.02	due fori da mm 10,5 con interasse di 30 mm

VOMERE A LANCIA DIRITTA PER MOLLA ADATTABILE SIDERMAN 60X12

SOC A' LANCE DROITE POUR DENT ADAPTABLE SIDERMAN 60X12
 STRAIGHT ARROW POINT FOR TINE SUITABLE TO SIDERMAN 60X12
 SCHAR FUER ZINKE PASSEND ZU SIDERMANN 60X12
 REJA DE LANZA RECTA PARA BRAZO ADAPTABLE SIDERMAN 60X12

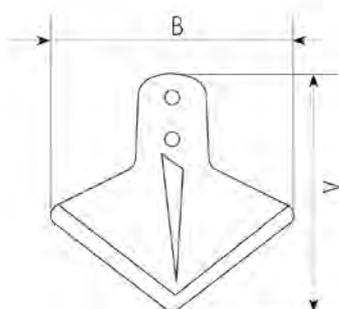

Art./Ref.	A mm	B mm	Spessore mm/Thickness mm	Peso Kg/Weight Kg	Note/Note
CP1385A	150	175	6 mm	0.85	due fori da mm 10,5 con interasse di 30 mm

VOMERE A SCALPELLO PER MOLLA ADATTABILE SIDERMAN 60X12

SOC CHISEL POUR DENT ADAPTABLE SIDERMAN 60X12
 POINT FOR TINE SUITABLE TO SIDERMAN 60X12
 MEISSEL-SCHAR FUER ZINKE PASSEND ZU SIDERMAN 60X12
 REJA DE FORMÓN PARA BRAZO ADAPTABLE SIDERMAN 60X12

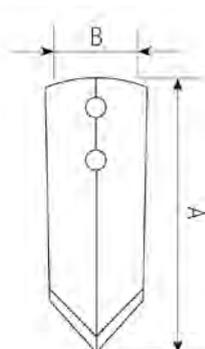

Art./Ref.	A mm	B mm	Spessore mm/Thickness mm	Note/Note
CP1387	180	70	6 mm	due fori da mm 10,5 con interasse di 30 mm

MOLLE PER VIBROCOLTIVATORI 60X12

DENT DE VIBROULTEUR 60X12
 SPRING TINES FOR CULTIVATORS 60X12
 KULTIZINKE FÜR VIBRATIONSEGGE 60X12
 MUELLES TIPO PARA VIBROCOLTIVADORES 60X12



Note: Le misure sono indicative e possono essere soggette a variazioni senza alcun obbligo di preavviso da parte nostra.

Notes: Indicated measures are approximate and can be changed without advise from our side.

Art./Ref.	Sezione/Section	Peso Kg/Weight Kg	Note/Note
CP1382C	60 x 12	7.2	Molla senza vomere / Spring tine without point. Altezza sotto telaio mm 550. Interasse fori 28 mm.
CP1382F	60 x 12	8	Molla con vomere CP1360A / Spring tine with point CP1360A. Altezza sotto telaio mm 550. Interasse fori 28 mm.

RINFORZO PER MOLLA 60X12

RENFORT POUR DENT 60X12
 TINE REINFORCEMENT 60X12
 VERSTAERKUNG FUER ZINKE 60X12
 REFUERZO PARA BRAZO 60X12



Note: Le misure sono indicative e possono essere soggette a variazioni senza alcun obbligo di preavviso da parte nostra.

Notes: Indicated measures are approximate and can be changed without advise from our side.

Art./Ref.	Sezione/Section	Peso Kg/Weight Kg	Note/Note
CP1389C	60 x 10	3.45	Rinforzo molla con occhio / Helper with eye

STAFFE PER MOLLE 60X12

BRIDE POUR DENT VIBROULTEUR 60X12
 VIBROTILLER TINE FRAME 60X12
 HALTERUNG FÜR EINFACHE ZINKE 60X12
 ESTRIBOS PARA MUELLES 60X12



Art./Ref.	Sezione/Section	Telaio/Telaio	Peso Kg/Weight Kg	Note/Note
CP1359D	90 x 8	60 x 60	0.94	Staffa per molla 60x12 / Clamp for tine 60x12
CP1359B	90 x 8	60 x 60	1.00	Staffa per molla 60x12 e rinforzo 60x10 / Clamp for tine 60x12 and helper 60x10

VOMERE A LANCIA PIATTO PER MOLLA 45X12 E 60X12

SOC UN LANCE PLATE POUR DENT 45X12 E 60X12

FLAT SWEEP POINT FOR S TINE 45X12 AND 60X12

SCHAR FLAT FUER ZINKE 45X12 UND 60X12

REJA DE LANZA PISO PARA BRAZO 45X12 Y 60X12

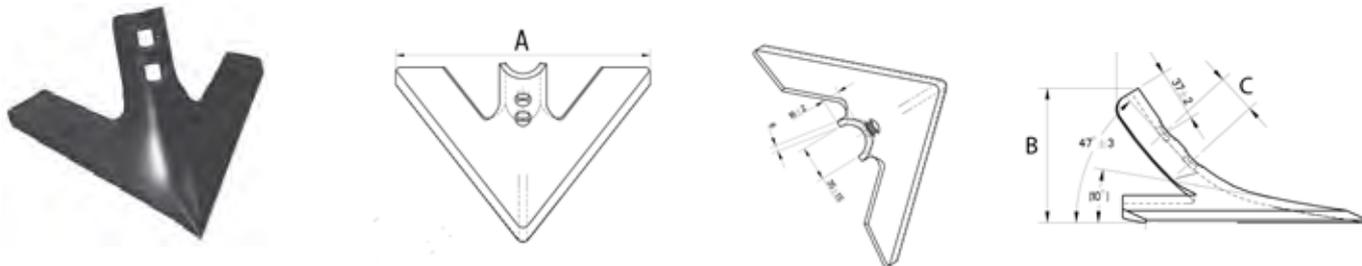

Art./Ref.	A mm	B mm	C mm	Spessore mm/Thickness mm	Peso Kg/Weight Kg	Note/Note
CP7507	150	90	28	6 mm	0.73	Fori svasati da 20 mm e quadro da 10,5 mm.
CP7508	175	90	28	6 mm	0.8	Fori svasati da 20 mm e quadro da 10,5 mm.
CP7509	200	90	28	6 mm	0.87	Fori svasati da 20 mm e quadro da 10,5 mm.
CP7510	250	90	28	6 mm	1.01	Fori svasati da 20 mm e quadro da 10,5 mm.

VOMERE A LANCIA PER MOLLA 45X12 E 60X12

DENT "FLEX" CHISEL POUR DENT 45X12 & 60X12

HARROW POINT FOR S TINE 45X12 AND 60X12

SCHAR FLEX FUER ZINKE 45X12 UND 60X12

REJA DE LANZA PARA BRAZO 45X12 Y 60X12

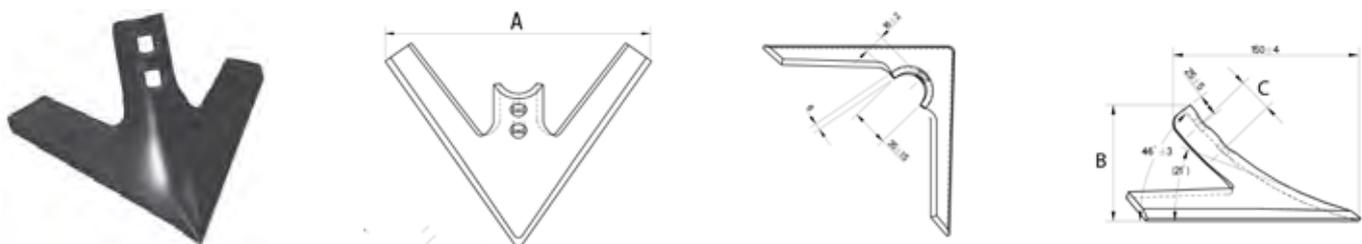

Art./Ref.	A mm	B mm	C mm	Spessore mm/Thickness mm	Peso Kg/Weight Kg	Note/Note
CP7503	150	101	28	6 mm	0.66	Fori svasati da 20 mm e quadro da 10,5 mm.
CP7504	175	101	28	6 mm	0.74	Fori svasati da 20 mm e quadro da 10,5 mm.
CP7505	200	101	28	6 mm	0.82	Fori svasati da 20 mm e quadro da 10,5 mm.
CP7506	250	101	28	6 mm	0.98	Fori svasati da 20 mm e quadro da 10,5 mm.

VOMERE REVERSIBILE PER MOLLA 60X12

SOC POUR DENT CULTIVATEUR 60X12

SHARE FOR COLTIVATOR TINE 60X12

SCHAR FÜR BLATTFEDERZINKE 60X12

REJAS ABATIBLES PARA MUELLES 60X12



Art./Ref.	Sezione/Section	Peso Kg/Weight Kg	Note/Note
CP7551	60 x 6	0.69	Vomere reversibile / Reversible point

MOLLA FLEX 45X12 DUE FORI

DENT "FLEX" 45X12 A' 2 TROUS

S TINE 45X12 2 HOLES

ZINKE FLEX 45X12 2 BOHRUNGEN

BRAZO 45 X 12 DOS TALADROS

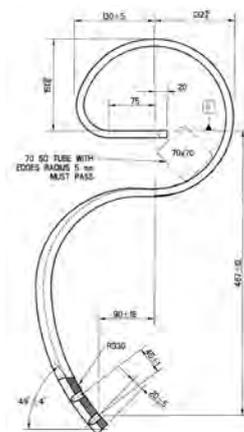
Note: Le misure sono indicative e possono essere soggette a variazioni senza alcun obbligo di preavviso da parte nostra.

Notes: Indicated measures are approximate and can be changed without advise from our side.

Art./Ref.	Peso Kg/Weight Kg	Note/Note
CP1349B	5.00	Foro bloccaggio molla mm 13.

RINFORZI PER MOLLE FLEX

RENFORT DENTS FLEX

FLEX AUXILIARY SPRINGS

VERSTAERKUNG FÜR KULTIZINKE FLEX

REFUERZO PARA MUELLES "FLEX"

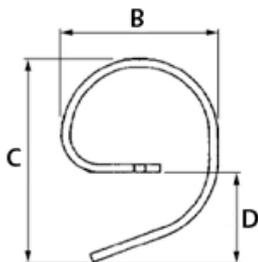
Note: Le misure sono indicative e possono essere soggette a variazioni senza alcun obbligo di preavviso da parte nostra.

Notes: Indicated measures are approximate and can be changed without advise from our side.

Art./Ref.	Tipo/Type	Sezione/Section	B mm	C mm	D mm	Peso Kg/Weight Kg
CP1352	Con occhio per flex 45x12	45 x 10	215	305	170	2.58

VOMERE A LANCIA PER MOLLA 45X12 E 60X12

DENT "FLEX" CHISEL POUR DENT 45X12 & 60X12

HARROW POINT FOR S TINE 45X12 AND 60X12

SCHAR FLEX FUER ZINKE 45X12 UND 60X12

REJA DE LANZA PARA BRAZO 45X12 Y 60X12

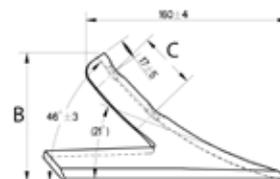
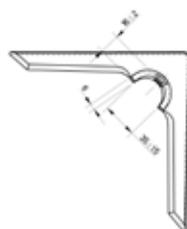
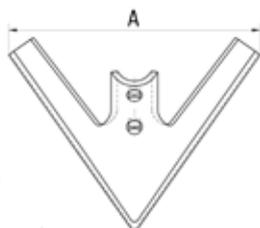

Art./Ref.	A mm	B mm	C mm	Spessore mm/Thickness mm	Peso Kg/Weight Kg	Note/Note
CP1943	150	101	45	6 mm	0.66	Fori svasati da 20 mm e quadro da 10,5 mm.
CP1944	175	101	45	6 mm	0.74	Fori svasati da 20 mm e quadro da 10,5 mm.
CP1945	200	101	45	6 mm	0.82	Fori svasati da 20 mm e quadro da 10,5 mm.
CP1946	250	101	45	6 mm	0.98	Fori svasati da 20 mm e quadro da 10,5 mm.

VOMERE A LANCIA PIATTO PER MOLLA 45X12 E 60X12

SOC UN LANCE PLATE POUR DENT 45X12 E 60X12

FLAT SWEEP POINT FOR S TINE 45X12 AND 60X12

SCHAR FLAT FUER ZINKE 45X12 UND 60X12

REJA DE LANZA PISO PARA BRAZO 45X12 Y 60X12

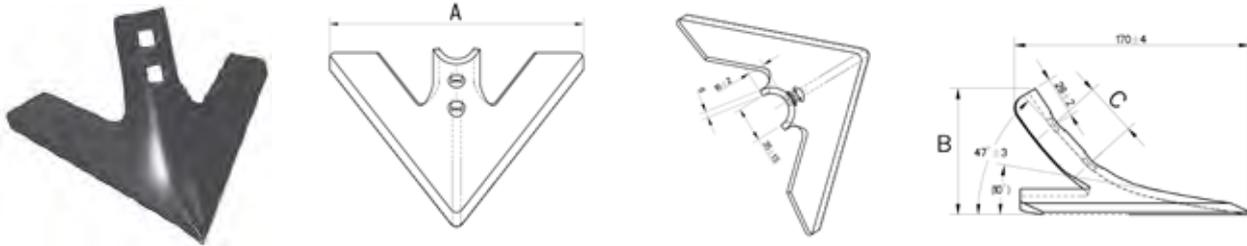

Art./Ref.	A mm	B mm	C mm	Spessore mm/Thickness mm	Peso Kg/Weight Kg	Note/Note
CP7400	150	90	45	6 mm	0.73	Fori svasati da 20 mm e quadro da 10,5 mm.
CP7401	175	90	45	6 mm	0.8	Fori svasati da 20 mm e quadro da 10,5 mm.
CP7402	200	90	45	6 mm	0.87	Fori svasati da 20 mm e quadro da 10,5 mm.
CP7403	250	90	45	6 mm	1.01	Fori svasati da 20 mm e quadro da 10,5 mm.

VOMERE FLEX A DOPPIA PUNTA PER MOLLA 45X12 E 60X12

SOC DOUBLE POINTE POUR DENT 45X12 & 60X12

DOUBLE POINT FOR S TINE 45X12 AND 60X12

SCHAR FLEX DOPPEL-SPITZE FUER ZINKE 45X12 UND 60X12

REJA DE DOBLE PUNTA PARA BRAZO 45X12 Y 60X12

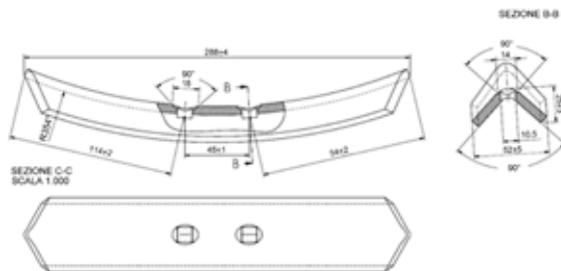

Art./Ref.	Spessore mm/Thickness mm
CP1947	6 mm

MOLLE ADATTABILI ITALIANO PER VIBROCOLTIVATORI

DENT ADAPTABLE ITALIEN POUR VIBROCOLTEUR

SPRINGS FOR VIBROTILLER SUITABLE TO ITALIAN

ZINKEN PASSEND ZU ITALIEN

MUELLES ADAPTABLE ITALIANO PARA VIBROCOLTIVADORES

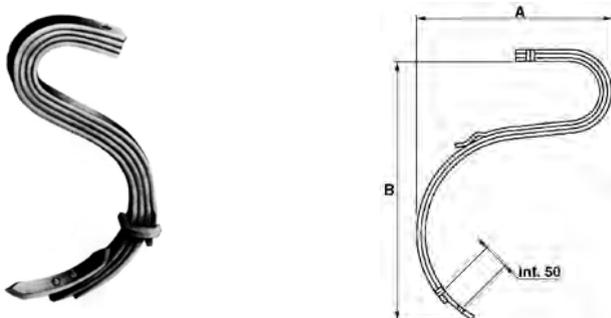

Note: Le misure sono indicative, e possono essere soggette a variazioni senza alcun obbligo di preavviso da parte nostra.

Notes: Indicated measures are approximate and can be changed without advise from our side.

Art./Ref.	Tipo/Type	Sezione/Section	A mm	B mm	Peso Kg/Weight Kg	Note/Note
CP1456A	Standard	45 x 7	307	480	4.7	n° Foglie/Sheets 2 - 1/2
CP1456	Standard	45 x 7	307	480	5.4	n° Foglie/Sheets 2 - 1/2 - Con vomere art. CP1325
CP1330A	Standard	45 x 7	331	520	7.45	n° Foglie/Sheets 3 - 1/2
CP1330	Standard	45 x 7	331	520	8.05	n° Foglie/Sheets 3 - 1/2 - Con vomere art. CP1325
CP1331A	Standard	45 x 7	345	530	9.48	n° Foglie/Sheets 4 - 1/2
CP1331	Standard	45 x 7	345	530	10.08	n° Foglie/Sheets 4 - 1/2 - Con vomere art. CP1325

VOMERE PER MOLLE ADATTABILI ITALIANO E VENTZKY

SOC POUR DENTS ADAPTABLES ITALIENS ET VENTZKY
 SHARE FOR SPRINGS, SUITABLE TO ITALIAN AND VENTZKY
 SCHAR FÜR ZINKEN PASSEND ZU ITALIEN UND VENTZKY
 REJA PARA MUELLES ADAPTABLES ITALIANO Y VENTZKY

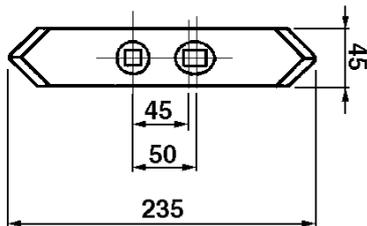

Art./Ref.	Spessore mm/Thickness mm	Note/Note
CP1325	7 mm	N.2 fori svasati con quadro mm 11 di cui uno con asola.

STAFFE PER MOLLE ADATTABILI ITALIANO E VENTZKY

BRIDES POUR DENTS ADAPTABLE ITALIEN ET VENTZKY
 SPRINGS CLAMP SUITABLE TO ITALIAN AND VENTZKY
 HALTERUNGEN FÜR ZINKEN PASSEND ZU ITALIEN UND VENTZKY
 ESTRIBOS PARA MUELLES ADAPTABLE ITALIANO Y VENTZKY

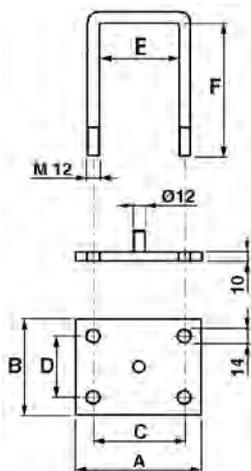

Art./Ref.	A mm	B mm	C mm	D mm	E mm	F mm
CP1332	120	100	85	65	73	130
CP1333	130	100	95	65	83	140

VOMERE REVERSIBILE

SOC
 SHARE
 SCHAR
 REJAS ABATIBLES

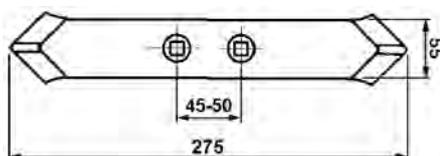

Art./Ref.	Spessore mm/Thickness mm	Note/Note
CP1325A	15 mm	N.2 fori svasati con quadro mm 12,5 di cui uno con asola.

MOLLE TIPO CHISEL PER VIBROCOLTIVATORI

CHISEL POUR CULTIVATEUR

CHISEL SPRINGS FOR VIBROTILLER

ZINKEN TYP CHISEL FÜR VIBRATIONSEGGE

MUELLES TIPO CHISEL PARA VIBROCOLTIVADORES

Note: Le misure sono indicative e possono essere soggette a variazioni senza alcun obbligo di preavviso da parte nostra.

Notes: Indicated measures are approximate and can be changed without advise from our side.

Art./Ref.	A mm	B mm	C mm	D mm	Peso Kg/Weight Kg	Note/Note
CP1305	540	495	415	60	7.7	Molla monolama junior 55x20.
CP1306	635	600	500	60	9.1	Molla monolama 55x20.
CP1307	635	600	500	60	11.3	Molla monolama 55x25.

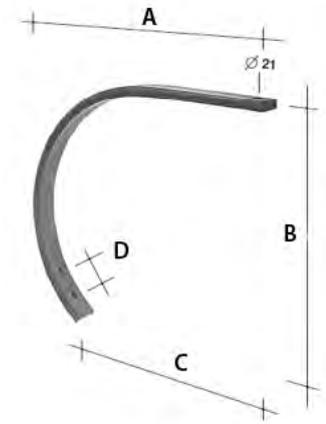

MOLLE TIPO CHISEL PER VIBROCOLTIVATORI

CHISEL POUR CULTIVATEUR

ZINKEN TYP CHISEL FÜR VIBRATIONSEGGE

ZINKEN TYP CHISEL FÜR VIBRATIONSEGGE

MUELLES TIPO CHISEL PARA VIBROCOLTIVADORES

Note: Le misure sono indicative e possono essere soggette a variazioni senza alcun obbligo di preavviso da parte nostra.

Notes: Indicated measures are approximate and can be changed without advise from our side.

Art./Ref.	A mm	B mm	C mm	D mm	Peso Kg/Weight Kg	Note/Note
CP1308	655	600	500	60	16.8	Molla bilama 55x20 + 55x20.
CP1309	655	600	500	60	18.9	Molla bilama 55x25 + 55x20 (riforzo dorso).
CP1309A	655	600	500	60	19.1	Molla bilama 55x25 + 55x25

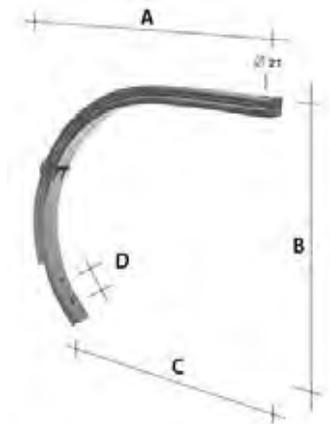

STAFFA PER MOLLE TIPO CHISEL

BRIDE POUR CHISEL

CLAMP FOR CHISEL SPRINGS

HALTERUNG FÜR ZINKEN TYP CHISEL

ESTRIBO PARA MUELLES TIPO CHISEL

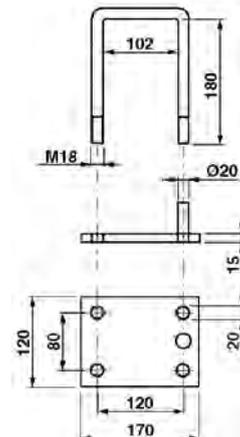

Art./Ref.	Titolo Prodotto/Titolo Prodotto
CP1610	STAFFA PER MOLLA CHISEL TELAIO 100X100

STAFFE PER MOLLE TIPO CHISEL

SUPPORT POUR DENTS CHISEL
 SPRING BRACKET TYPE CHISEL
 HALTER FUER FEDER TYP CHISEL
 ESTRIBOS MUELLES TIPO CHIESEL

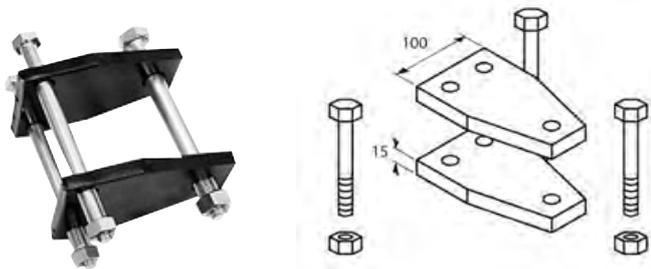

Art./Ref.	Sezione/Section	Telaio/Telaio	Peso Kg/Weight Kg	Note/Note
CP1310	100 x 15	100 x 100	4.43	Staffa bilama completa per molla 55x25 + 55x20 (rinforzo dorso)
CP1311	100 x 15	100 x 100	7.32	Staffa monolama completa per molla 55x25
CP1315	100 x 15	80 x 80	3.36	Staffa monolama completa per molla 55x20

VOMERE PER MOLLE TIPO CHISEL

SOC POUR CHISEL
 SHARE FOR CHISEL SPRINGS
 SCHAR FÜR ZINKEN TYP CHISEL
 REJAS PARA MUELLES TIPO CHISEL

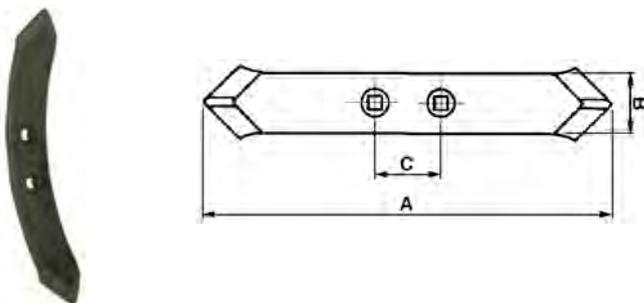

Art./Ref.	A mm	B mm	C mm	Spessore mm/Thickness mm	Note/Note
CP1862	360	55	45-75	15 mm	N.2 fori svasati con quadro mm 13 di cui uno con asola. Applicabile su molle chisel e su molle quadre.

VOMERE DOPPIO CUORE TIPO TEDESCO

SOC DOUBLE COEUR TYPE ALLEMAND
 DOUBLE HEART SHARE GERMAN TYPE
 DOPPELSCHAR HERZFORM TYP DEUTSCHLAND
 REJA DOBLE CORAZÓN TIPO ALEMÁN

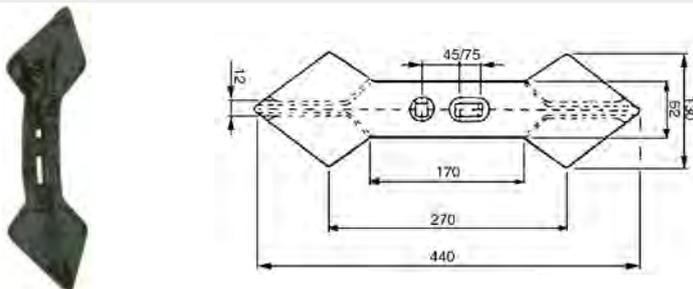

Note: Tutti i prodotti presenti in tabella vengono forniti non verniciati.

Notes: All products in the table are supplied unpainted.

Art./Ref.	Spessore mm/Thickness mm	Note/Note
CP1326	15 mm	Interasse fori mm 45-75. Applicabile anche su ancora tipo Gruber - Art.CP1457-CP3929.

VOMERE DOPPIO CUORE TIPO TEDESCO

SOC DOUBLE COEUR TYPE ALLEMAND
 DOUBLE HEART SHARE GERMAN TYPE
 DOPPELSCHAR HERZFORM TYP DEUTSCHLAND
 REJA DOBLE CORAZÓN TIPO ALEMÁN

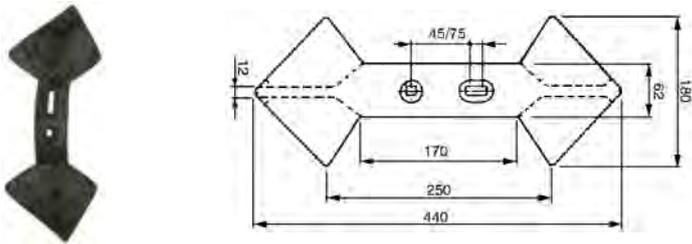

Note: Tutti i prodotti presenti in tabella vengono forniti non verniciati.

Notes: All products in the table are supplied unpainted.

Art./Ref.	Spessore mm/Thickness mm	Note/Note
CP1326A	15 mm	Interasse fori mm 45-75. Applicabile anche su ancora tipo Gruber - Art.CP1457-CP3929.

MOLLE TIPO QUADRO A DOPPIA SPIRA PER ESTIRPATORI

DENT CARRE DOUBLE
 SQUARE SPRING - DOUBLE TURN
 VIERKANTIGE ZINKEN DOPPELTWINDUNG FÜR SCHAREGGE
 MUELLES TIPO CUADRO EN DOBLE ESPIRAL PARA EXTIRPADORES

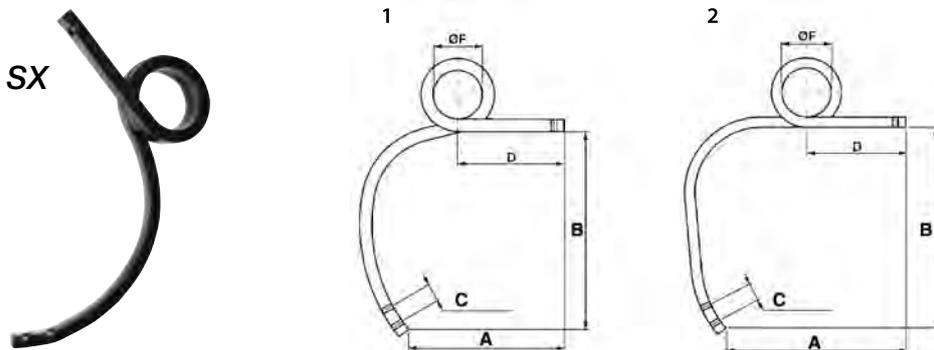

Note: Le misure sono indicative e possono essere soggette a variazioni senza alcun obbligo di preavviso da parte nostra. La molla fotografata è sinistra.

Notes: Indicated measures are approximate and can be changed without advise from our side. The picture is a left spring

Art./Ref.	Pos.	Sezione/Section	A mm	B mm	C mm	D mm	F mm	Note/Note
CP1391	2	Rinforzo dorso 20 x 20	290	400	45	225	Ø90	DX/RH - Foro bloccaggio molla mm 14,5
CP1392	2	Rinforzo dorso 20 x 20	290	400	45	225	Ø90	SX/LH - Foro bloccaggio molla mm 14,5
CP1280	1	Rinforzo dorso 25 x 25	365	455	45	240	Ø120	DX/RH - Foro bloccaggio molla mm 13
CP1281	1	Rinforzo dorso 25 x 25	365	455	45	240	Ø120	SX/LH - Foro bloccaggio molla mm 13
CP1282	2	Rinforzo dorso 25 x 25	310	520	45	240	Ø120	DX/RH - Foro bloccaggio molla mm 13
CP1283	2	Rinforzo dorso 25 x 25	310	520	45	240	Ø120	SX/LH - Foro bloccaggio molla mm 13
CP1284	1	Rinforzo dorso 30 x 30	365	535	45	280	Ø120	DX/RH - Foro bloccaggio molla mm 17
CP1285	1	Rinforzo dorso 30 x 30	365	535	45	280	Ø120	SX/LH - Foro bloccaggio molla mm 17
CP1286	2	Rinforzo dorso 30 x 30	310	635	45	280	Ø120	DX/RH - Foro bloccaggio molla mm 17
CP1287	2	Rinforzo dorso 30 x 30	310	635	45	280	Ø120	SX/LH - Foro bloccaggio molla mm 17
CP1288	1	Rinforzo dorso 35 x 35	400	635	75	280	Ø145	DX/RH - Foro bloccaggio molla mm 17
CP1289	1	Rinforzo dorso 35 x 35	400	635	75	280	Ø145	SX/LH - Foro bloccaggio molla mm 17

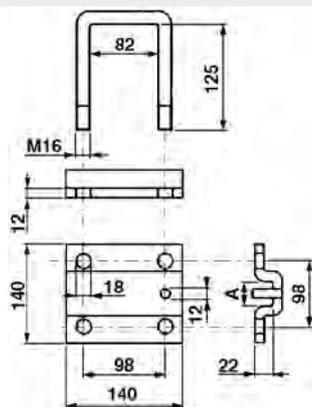
STAFFE PER MOLLE TIPO QUADRO
BRIDES POUR DENT CARRÉ
CLAMPS FOR SQUARE SPRINGS
HALTERUNG FÜR VIERKANTIGE ZINKEN
ESTRIBOS PARA MUELLE TIPO CUADRO

Art./Ref.	A mm	Note/Note
CP1868	28	Quadro della molla/Spring square 25 mm. Staffa completa di cavallotti. Trave 80 mm.
CP1869	32	Quadro della molla/Spring square 30 mm. Staffa completa di cavallotti. Trave 80 mm.
CP1869B	32	Quadro della molla/Spring square 30 mm. Staffa completa di cavallotti. Trave 100 mm.
CP1869A		Cavallotto per staffa molla quadra da 25 e da 30 mm con trave da 80 mm

STAFFA COMPLETA PER MOLLA DOPPIA SPIRA A SEZIONE QUADRATA
CHASSIS COMPLETE POUR RESSORT DOUBLE A SECTION CARREE
COMPLETE BRACKET FOR DOUBLE COIL SPRING SQUARED SECTION
HALTER KOMPLETT FUER DOPPELWINDUNG VIERKANTPROFILZINKEN
ESTRIBO COMPLETO DE MUELLE ESPIRAL DOBLE CON SECCION CUADRADA

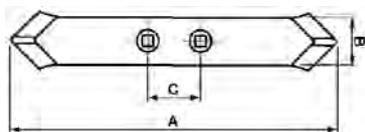

Art./Ref.	Sezione/Section	Telaio/Telaio	Peso Kg/Weight Kg	Note/Note
CP1329C	80x12	80x80	3.07	Per molla quadra 25x25
CP1329A	80x12	80x80	3.29	Per molla quadra 30x30
CP1329B	80x12	100x100	3.85	Per molla quadra 30x30
CP1329	100x15	100x100	5.89	Per molla quadra 35x35

VOMERINI PER MOLLE TIPO QUADRO
SOCS POUR DENT CARRÉ
SHARES FOR SQUARE TYPE SPRINGS
SCHAREN FÜR VIERKANTIGE ZINKEN
REJAS PARA MUELLES TIPO CUADRO

Art./Ref.	A mm	B mm	C mm	Spessore mm/Thickness mm	Note/Note
CP1861	275	40	45	16 mm	N.2 fori svasati con quadro mm 13.
CP1862	360	55	45-75	15 mm	N.2 fori svasati con quadro mm 13 di cui uno con asola. Applicabile su molle chisel e su molle quadre./

VOMERINA PER MOLLA QUADRA

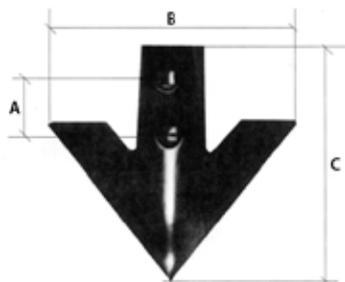
SOC POUR DENT CARRÉ
 SHARE FOR SQUARE SPRING
 SCHAR FUER
 REJA MUELLE CUADRADO



Art./Ref.	A mm	B mm	C mm	Spessore mm/Thickness mm
SAR6199	45	195	170	5 mm

VOMERINA CENTRALE ESTIRPATORE

SOC
 PLOUGHSHARES
 SCHAR
 REJA CENTRAL ESTIRPADOR

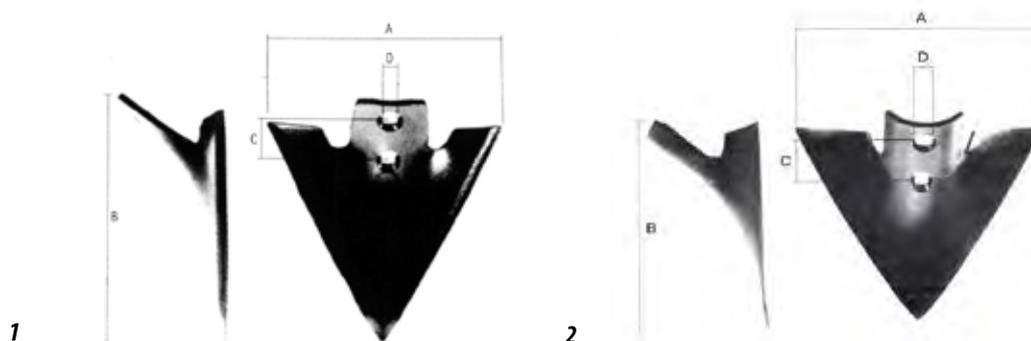

Art./Ref.	Pos.	A mm	B mm	C mm	D mm	Spessore mm/Thickness mm	Peso Kg/Weight Kg
CP1296	1	215	230	45-50	12.5	6 mm	1.16
SAR6212	2	220	175	45-50	12.5	6 mm	1.12
SAR6213	2	260	200	45-50	12.5	6 mm	1.42

VOMERINA PER MOLLA QUADRA

SOC POUR DENT CARRÉ
 SHARE FOR SQUARE SPRING
 SCHAR FUER
 REJA MUELLE CUADRADO



Art./Ref.	A mm	B mm	C mm	D mm	Spessore mm/Thickness mm	Peso Kg/Weight Kg
SAR6487	200	190	45	12.5	8 mm	1.350
SAR6488	250	190	45	12.5	8 mm	1.550

VOMERINO PER MOLLE COLTIVATORE

SOC POUR DENT CULTIVATEUR
 SHARE FOR CULTIVATOR SPRINGS
 SCHAR FÜR ZINKEN TYP EGGE
 REJAS PARA MUELLES CULTIVADOR

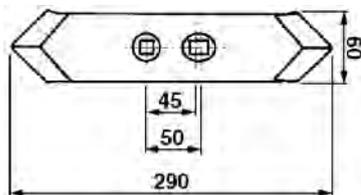

Art./Ref.	Spessore mm/Thickness mm
CP1324	12 mm.

VOMERINA PER COLTIVATORI

SOCS ET POINTES DE CULTIVATEURS
 CULTIVATORS POINT
 KULTIVATORSCHAREN UND GRUBBERSCHAREN
 REJA PARA CULTIVADORES

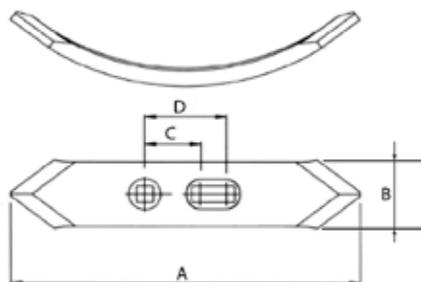

Art./Ref.	A mm	B mm	C mm	D mm	Spessore mm/Thickness mm
CP1324A	230	58	42	48	8 mm

VOMERINE PER COLTIVATORI

SOCS ET POINTES DE CULTIVATEURS
 CULTIVATORS POINTS
 KULTIVATORSCHAREN UND GRUBBERSCHAREN
 REJAS PARA CULTIVADORES

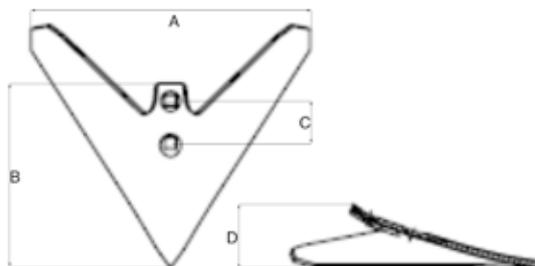

Art./Ref.	A mm	B mm	C mm	D mm	Spessore mm/Thickness mm	Peso Kg/Weight Kg	Note/Note
SAR6499A	330	180	45	62	6 mm	1,33	Fori da 11 mm
SAR6499B	270	180	45	62	6 mm	1,20	Fori da 11 mm

VOMERINA PER COLTIVATORI

SOC DE CULTIVATEURS

CULTIVATORS POINT

KULTIVATORSCHAREN UND GRUBBERSCHAREN

REJA PARA CULTIVADORES

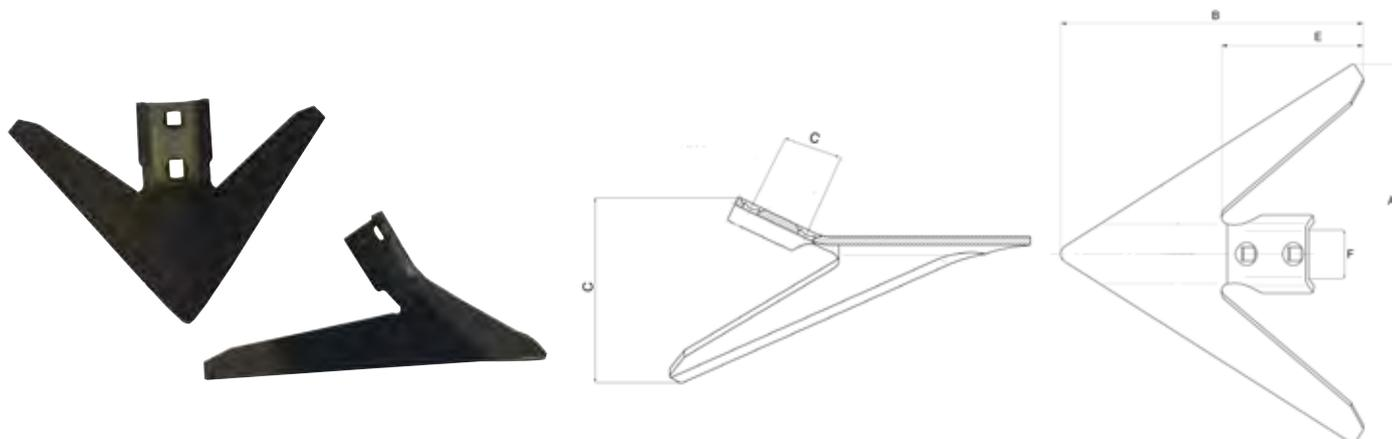

Art./Ref.	A mm	B mm	C mm	D mm	E mm	F mm	Spessore mm/Thickness mm	Peso Kg/Weight Kg	Note/Note
SAR6499	333	264	45	108	124	43	6 mm	1,37	Fori da 12,5 mm

VOMERINA PER COLTIVATORI

SOC DE CULTIVATEURS

CULTIVATORS POINT

KULTIVATORSCHAREN UND GRUBBERSCHAREN

REJA PARA CULTIVADORES

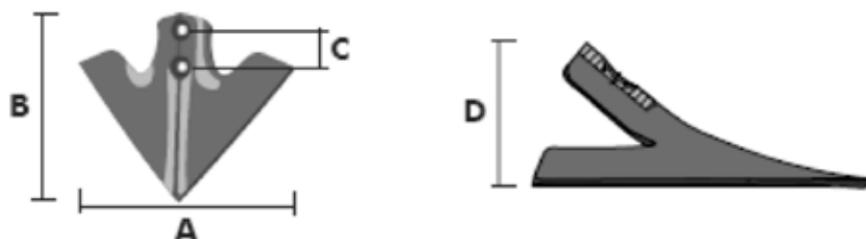

Art./Ref.	A mm	B mm	C mm	D mm	Spessore mm/Thickness mm
SAR6199A	280	210	45	85	6 mm

VOMERINE PER COLTIVATORI

SOCS ET POINTES DE CULTIVATEURS

CULTIVATORS POINTS

KULTIVATORSCHAREN UND GRUBBERSCHAREN

REJAS PARA CULTIVADORES

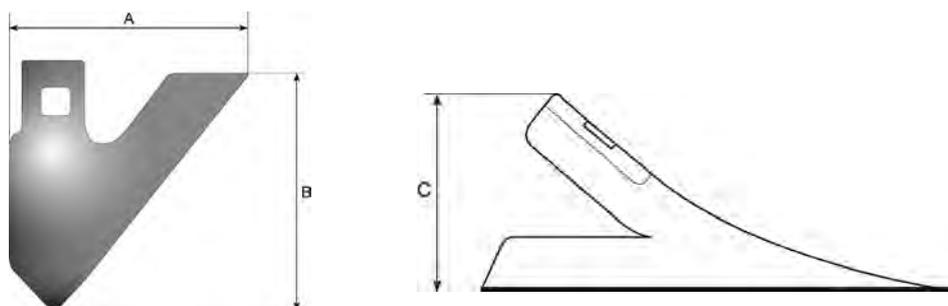

Art./Ref.	A mm	B mm	C mm	Spessore mm/Thickness mm	Note/Note
SAR6490	125	115	55	4 mm	DX
SAR6491	125	115	55	4 mm	SX

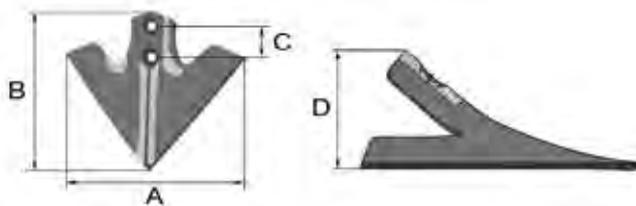
VOMERINE PER COLTIVATORI
SOC DE CULTIVATEURS
CULTIVATORS POINT
KULTIVATORSCHAREN UND GRUBBERSCHAREN
REJA PARA CULTIVADORES

Art./Ref.	A mm	B mm	C mm	D mm	Spessore mm/Thickness mm	Peso Kg/Weight Kg	Note/Note
SAR6476	225	205	30-45	80	5 mm	0,85	Fori quadri da 11,8 mm di cui uno con asola.
SAR6477	280	225	30-45	80	5 mm	1,15	Fori quadri da 11,8 mm di cui uno con asola.

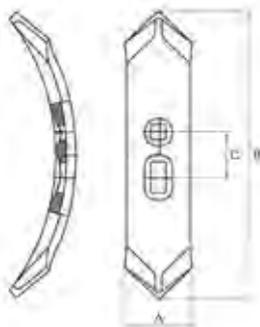
VOMERINA REVERSIBILE PER COLTIVATORI
SOC REVERSIBLE DE CULTIVATEURS
CULTIVATOR REVERSIBLE POINT
KULTIVATORSCHAREN UND GRUBBERSCHAREN
REJA REVERSIBLE PARA CULTIVADORES

Art./Ref.	A mm	B mm	C mm	Spessore mm/Thickness mm	Peso Kg/Weight Kg	Note/Note
SAR6478	52	225	30-45	8 mm	0,67	Fori quadri da 11,8 mm di cui uno con asola.

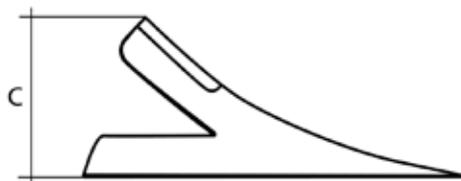
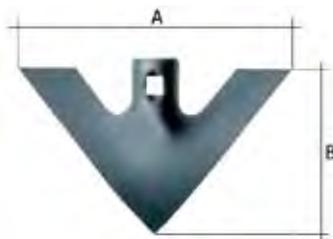
VOMERINE PER COLTIVATORI
SOC DE CULTIVATEURS
CULTIVATORS POINT
KULTIVATORSCHAREN UND GRUBBERSCHAREN
REJA PARA CULTIVADORES

Art./Ref.	A mm	B mm	C mm	Spessore mm/Thickness mm
SAR6492	200	115	55	4 mm

VOMERINA REVERSIBILE PER COLTIVATORI

SOCS REVERSIBLE DE CULTIVATEURS

CULTIVATOR REVERSIBLE POINT

KULTIVATORSCHAREN UND GRUBBERSCHAREN

REJA REVERSIBLE PARA CULTIVADORES



Art./Ref.	A mm	B mm	C mm	Spessore mm/Thickness mm
SAR6494	41	230	10.5	6 mm

VOMERINA REVERSIBILE PER COLTIVATORI

SOC REVERSIBLE DE CULTIVATEURS

CULTIVATOR REVERSIBLE POINT

KULTIVATORSCHAREN UND GRUBBERSCHAREN

REJA REVERSIBLE PARA CULTIVADORES

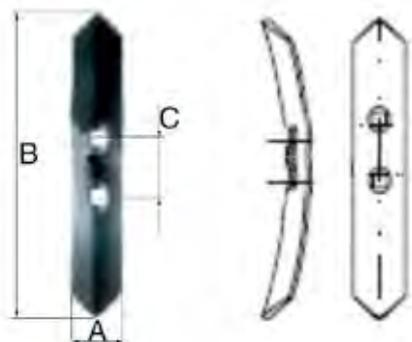

Art./Ref.	A mm	B mm	C mm	Spessore mm/Thickness mm	Note/Note
SAR6495	41	230	45	6 mm	Fori quadri da 10,5 mm.

VOMERINA REVERSIBILE PER COLTIVATORI

SOC REVERSIBLE DE CULTIVATEURS

CULTIVATOR REVERSIBLE POINT

KULTIVATORSCHAREN UND GRUBBERSCHAREN

REJA REVERSIBLE PARA CULTIVADORES

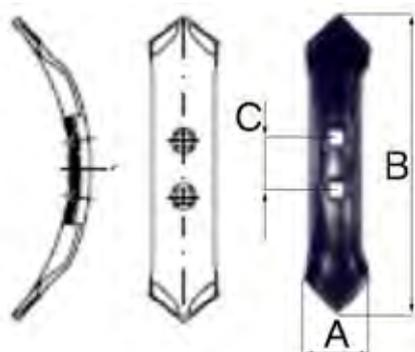

Art./Ref.	A mm	B mm	C mm	Spessore mm/Thickness mm	Note/Note
SAR6497	50	237	45	6 mm	Fori quadri da 11 mm.

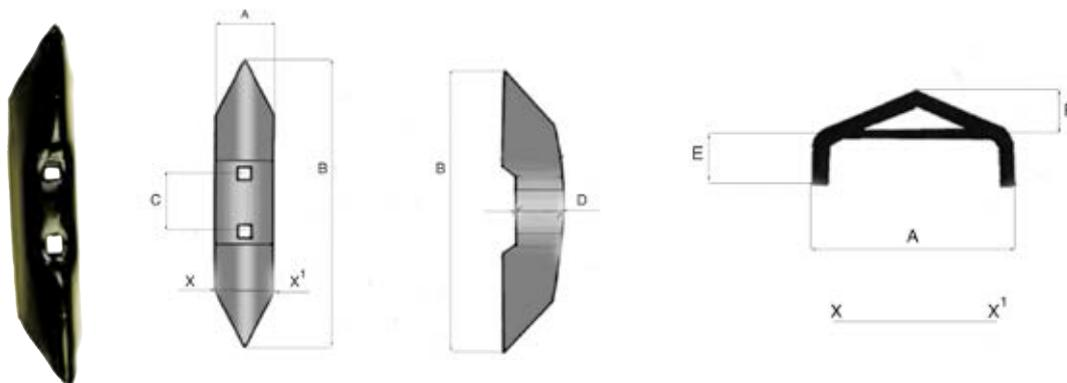
VOMERINA REVERSIBILE PER COLTIVATORI
SOC REVERSIBLE DE CULTIVATEURS
CULTIVATOR REVERSIBLE POINT
KULTIVATORSCHAREN UND GRUBBERSCHAREN
REJA REVERSIBLE PARA CULTIVADORES

Art./Ref.	A mm	B mm	C mm	D mm	E mm	F mm	Spessore mm/Thickness mm	Note/Note
SAR6498	40	215	45	30	25	15	4,5 mm	Fori quadri da 11 mm.

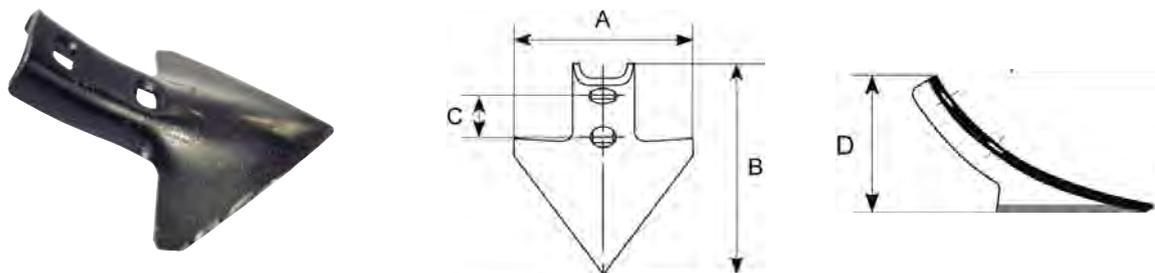
VOMERINA PER COLTIVATORI
SOC DE CULTIVATEURS
CULTIVATORS POINT
KULTIVATORSCHAREN UND GRUBBERSCHAREN
REJA PARA CULTIVADORES

Art./Ref.	A mm	B mm	C mm	D mm	Spessore mm/Thickness mm
SAR6493	130	145	45	85	4 mm

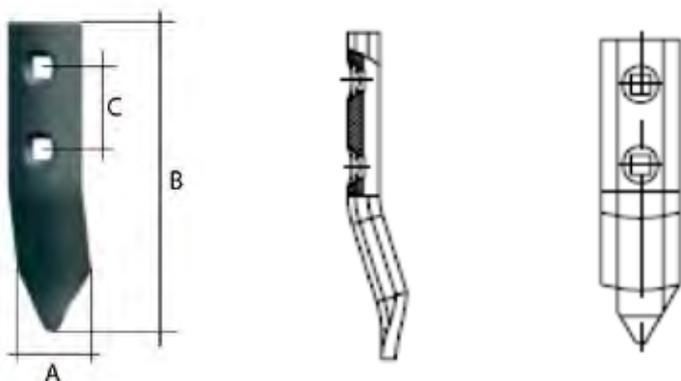
VOMERINA PER COLTIVATORI
SOC DE CULTIVATEURS
CULTIVATORS POINT
KULTIVATORSCHAREN UND GRUBBERSCHAREN
REJA PARA CULTIVADORES

Art./Ref.	A mm	B mm	C mm	Spessore mm/Thickness mm
CP1948	50	165	45	7 mm

MOLLA TITAN

DENT TITAN
 SPRING TINES TITAN
 ZINKEN TITAN
 MUELLE TITAN



Note: La molla viene fornita completa di bulloneria ma non assemblata.

Notes: The spring is supplied complete with mounting hardware but not assembled

Art./Ref.	Peso Kg/Weight Kg	Note/Note
CP1460	17.85	Molla senza vomere / Spring tine without point
CP1461	18.90	Molla con vomere CP1466 / Spring tine with point CP1466

RICAMBI PER MOLLA TITAN

RECHANGES POUR DENT TITAN
 SPARE PARTS FOR TITAN SPRING
 ERSATZTEILE FUER FEDER TITAN
 RECAMBIOS MUELLE TITAN



Art./Ref.	Sezione/Section	Telaio/Telaio	Peso Kg/Weight Kg	Note/Note
CP1462	150 x 12	80 x 80	13.22	Spirale / Spring
CP1463	45 x 20	-	4.18	Dente / Tine/Dente
CP1464	16	-	0.3	Cavallotto e dadi / " U " Screw and nuts
CP1465	16 x 50	-	0.13	Bullone dente / Bolt for tine
CP1466	65 x 8	-	0.91	Vomere reversibile int.45 mm/ Reversible point dist.45 mm
CP1467	12 x 50	-	0.065	Bullone vomere / Bolt for point

STAFFA PER MOLLA TITAN

SUPPORT DENT TITAN
 TITAN SPRING BRACKET
 HALTER FUER FEDER TITAN
 ESTRIBO MUELLE TITAN



Art./Ref.	Sezione/Section	Telaio/Telaio	Peso Kg/Weight Kg	Note/Note
CP1468	-	80 x 80	1.76	Staffa completa / Complete clamp
CP1469	40 x 12	-	0.73	Staffa / Clamp
CP1470	M 16	-	1.03	Cavallotti e dadi n.2 / 2 " U " Screws and nuts

MOLLE BF

DENT BF
 SPRING TINES BF
 ZINKEN BF
 MUELLE BF

Note: La molla viene fornita completa di bulloneria ma non assemblata.

Notes: The spring is supplied complete with mounting hardware but not assembled

Art./Ref.	Peso Kg/Weight Kg	Note/Note
CP7436	13.15	Molla BF senza vomere / Spring tine BF without point
CP7437	14.05	Molla BF con vomere CP7440 / Spring tine BF with point CP7440

RICAMBI PER MOLLA BF

RECHANGES POUR DENT BF
 SPARE PARTS FOR BF SPRING
 ERSATZTEILE FUER FEDER BF
 RECAMBIOS MUELLE BF

Art./Ref.	Sezione/Section	Telaio/Telaio	Peso Kg/Weight Kg	Note/Note
CP7438	150 x 10	100 x 15	10.14	Spirale BF / Spring BF
CP7439	50 x 13	-	2.88	Dente BF / Tine BF
CP1465	16 x 50	-	0.13	Bullone dente / Bolt for tine
CP7440	65 x 6 x 265	-	0.77	Vomere reversibile / Reversible point
CP1467	12 x 50	-	0.065	Bullone vomere / Bolt for point

MOLLE BFR

DENT BFR
 SPRING TINES BFR
 ZINKEN BFR
 MUELLE BFR

Note: La molla viene fornita completa di bulloneria ma non assemblata.

Notes: The spring is supplied complete with mounting hardware but not assembled

Art./Ref.	Peso Kg/Weight Kg	Note/Note
CP7441	10.76	Molla BFR senza vomere / Spring tine BFR without point
CP7442	11.66	Molla BFR con vomere CP7445 / Spring tine BFR with point CP7445



RICAMBI PER MOLLA BFR

RECHANGES POUR DENT BFR

SPARE PARTS FOR BFR SPRING

ERSATZTEILE FUER FEDER BFR

RECAMBIOS MUELLE BFR

Art./Ref.	Sezione/Section	Telaio/Telaio	Peso Kg/Weight Kg	Note/Note
CP7443	65 x 16	65 x 65	8.14	Spirale BFR / Spring BFR
CP7444	50 x 10	-	2.44	Dente BFR / Tine BFR
CP1465A	16 x 45	-	0.13	Bullone dente / Bolt for tine
CP7445	65 x 6 x 265	-	0.77	Vomere reversibile / Reversible point
CP1467	12 x 50	-	0.065	Bullone vomere / Bolt for point

**STAFFE PER MOLLE BFR**

BRIDES POUR DENTS BFR

CLAMPS FOR SPRING TINE BFR

HALTERUNGEN FÜR ZINKEN BFR

ESTRIBOS PARA MUELLES BFR

Art./Ref.	Sezione/Section	Telaio/Telaio	Peso Kg/Weight Kg	Note/Note
CP7446	90 x 10	50 x 50	0.98	Staffa per molla 65x16 / Clamp for tine 65x16
CP7447	90 x 10	60 x 60	1.12	Staffa per molla 65x16 / Clamp for tine 65x16
CP7448	90 x 10	65 x 65	1.19	Staffa per molla 65x16 / Clamp for tine 65x16
RC0752	16 x 100	-	0.21	Bullone per staffa / Bolt for clamp
RC0753	16 x 110	-	0.22	Bullone per staffa / Bolt for clamp

**MOLLE DV N5-N7 4F**

DENT DV N5-N7 4F

SPRING TINES DV N5-N7 4F

ZINKEN DV N5-N7 4F

MUELLE DV N5-N7 4F

Note: La molla viene fornita completa di bulloneria ma non assemblata.

Notes: The spring is supplied complete with mounting hardware but not assembled

Art./Ref.	Peso Kg/Weight Kg	Note/Note
CP7449	14.89	Molla DV N5 4F senza vomere / Spring tine DV N5 4F without point
CP7450	16.2	Molla DV N5 4F con vomere CP7458 / Spring tine DV N5 4F with point CP7458
CP7451	18.15	Molla DV N7 4F senza vomere / Spring tine DV N7 4F without point
CP7452	19.46	Molla DV N7 4F con vomere CP7458 / Spring tine DV N7 4F with point CP7458. La quota 590* del disegno diventa *690 per questo articolo.



RICAMBI PER MOLLE DV N5-N7 4F

RECHANGES POUR DENT DV N5-N7 4F
 SPARE PARTS FOR DV N5-N7 4F SPRING
 ERSATZTEILE FUER FEDER DV N5-N7 4F
 RECAMBIOS MUELLE DV N5-N7 4F

Art./Ref.	Sezione/Section	Telaio/Telaio	Peso Kg/Weight Kg	Note/Note
CP7453	150 x 10	80 x 80	11.54	Spirale DV N5 4F
CP7454	50 x 13	-	3.15	Dente DV / Tine DV
CP7456	150 x 12	80 x 80	13.7	Spirale DV N7 4F / Spring DV N7 4F
CP7457	50 x 16	-	4.25	Dente DV / Tine DV
CP7455	10	-	0.07	Cavallotto e dadi DV / "U" screw and nuts DV
CP1465A	16 x 45	-	0.13	Bullone dente / Bolt for tine
CP7458	65 x 8 x 295	-	1.17	Vomere reversibile / Reversible point
CP1467A	12 x 60	-	0.07	Bullone vomere / Bolt for point

STAFFA PER MOLLE DV N5-N7 4F

CHASSIS POUR DENTS DV N5-N7 4F
 CLAMP FOR SPRING TINE DV N5-N7 4F
 HALTER FÜR ZINKEN DV N5-N7 4F
 ESTRIBO PARA MUELLES DV N5-N7 4F

Art./Ref.	Sezione/Section	Telaio/Telaio	Peso Kg/Weight Kg	Note/Note
CP7459	-	80 x 80	0.7	Staffa completa per molla DV N5-N7 4F / Complete clamp for tine DV N5-N7 4F
CP7460	M 14	-	0.35	Cavallotto con dadi per molla DV N5-N7 4F / "U" screw and nuts for tine DV N5-N7 4F

MOLLE DV N6-N8 2F

DENT DV N6-N8 2F
 SPRING TINES DV N6-N8 2F
 ZINKEN DV N6-N8 2F
 MUELLE DV N6-N8 2F

Note: La molla viene fornita completa di bulloneria ma non assemblata.

Notes: The spring is supplied complete with mounting hardware but not assembled

Art./Ref.	Peso Kg/Weight Kg	Note/Note
CP7461	15.03	Molla DV N6 2F senza vomere / Spring tine DV N6 2F without point
CP7462	16.34	Molla DV N6 2F con vomere CP7458 / Spring tine DV N6 2F with point CP7458
CP7463	18.35	Molla DV N8 2F senza vomere / Spring tine DV N8 2F without point
CP7464	19.66	Molla DV N8 2F con vomere CP7458 / Spring tine DV N8 2F with point CP7458. La quota 590* del disegno diventa *690 per questo articolo.



RICAMBI PER MOLLE DV N6-N8 2F

RECHANGES POUR DENT DV N6-N8 2F
 SPARE PARTS FOR DV N6-N8 2F SPRING
 ERSATZTEILE FUER FEDER DV N6-N8 2F
 RECAMBIOS MUELLE DV N6-N8 2F

Art./Ref.	Sezione/Section	Telaio/Telaio	Peso Kg/Weight Kg	Note/Note
CP7465	150 x 10	80 x 80	11.68	Spirale DV N6 2F / Spring DV N6 2F
CP7454	50 x 13	-	3.15	Dente DV / Tine DV
CP7466	150 x 12	80 x 80	13.9	Spirale DV N8 2F / Spring DV N8 2F
CP7457	50 x 16	-	4.25	Dente DV / Tine DV
CP7455	10	-	0.07	Cavallotto e dadi DV / "U" screw and nuts DV
CP1465A	16 x 45	-	0.13	Bullone dente / Bolt for tine
CP7458	65 x 8 x 295	-	1.17	Vomere reversibile / Reversible point
CP1467A	12 x 60	-	0.07	Bullone vomere / Bolt for point

STAFFA PER MOLLE DV N6-N8 2F

BRIDES POUR DENTS DV N6-N8 2F
 CLAMP FOR SPRINGS DV N6-N8 2F
 HALTERUNGEN FÜR ZINKEN DV N6-N8 2F
 ESTRIBOS PARA MUELLES DV N6-N8 2F

Art./Ref.	Sezione/Section	Telaio/Telaio	Peso Kg/Weight Kg	Note/Note
CP7467	200 x 10	80 x 80	3.64	Staffa per molla 150x10 / Clamp for tine 150x10
CP7468	-	80 x 80	3.67	Staffa per molla 150x12 / Clamp for tine 150x12
CP7469	14 x 120	-	0.18	Bullone / Bolt/Bullone

MOLLE GT N0-N1-N4 FC

DENT GT N0-N1-N4 FC
 SPRING TINES GT N0-N1-N4 FC
 ZINKEN GT N0-N1-N4 FC
 MUELLE GT N0-N1-N4 FC

Note: La molla viene fornita completa di bulloneria ma non assemblata.

Notes: The spring is supplied complete with mounting hardware but not assembled

Art./Ref.	Peso Kg/Weight Kg	Note/Note
CP7470	21.33	Molla GT N0 FC senza vomere / Spring tine GT N0 FC without point
CP7471	24.01	Molla GT N0 FC con vomere CP7483 / Spring tine GT N0 FC with point CP7483
CP7472	23.6	Molla GT N1 FC senza vomere / Spring tine GT N1 FC without point
CP7473	26.28	Molla GT N1 FC con vomere CP7483 / Spring tine GT N1 FC with point CP7483
CP7474	27.93	Molla GT N4 FC senza vomere / Spring tine GT N4 FC without point
CP7475	30.6	Molla GT N4 FC con vomere CP7483 / Spring tine GT N4 FC with point CP7483. La quota 725* del disegno diventa *815 per questo articolo.



RICAMBI PER MOLLE GT N0-N1-N4 FC

RECHANGES POUR DENT GT N0-N1-N4 FC
 SPARE PARTS FOR GT N0-N1-N4 FC SPRING
 ERSATZTEILE FUER FEDER GT N0-N1-N4 FC
 RECAMBIOS MUELLE GT N0-N1-N4 FC



Art./Ref.	Sezione/Section	Telaio/Telaio	Peso Kg/Weight Kg	Note/Note
CP7476	150 x 12	100 x 100	14.92	Spirale GT N0 FC / Spring GT N0 FC
CP7479	150 x 14	100 x 100	17.2	Spirale GT N1 FC / Spring GT N1 FC
CP7477	50 x 22	-	6.13	Dente GT / Tine GT
CP7478	12	-	0.15	Cavallotto e dadi GT 22 / "U" screw and nuts GT 22
CP1465	16 x 50	-	0.13	Bullone dente / Bolt for tine
CP7480	150 x 16	100 x 100	19.8	Spirale GT N4 FC / Spring GT N4 FC
CP7481	50 x 26	-	7.8	Dente GT / Tine GT
CP7482	16	-	0.2	Cavallotto e dadi GT / "U" screw and nuts GT
RC0747	16 x 60	-	0.14	Bullone dente / Bolt for tine
CP7483	55 x 15	-	2.53	Vomere reversibile / Reversible point
CP1467A	12 x 60	-	0.07	Bullone vomere / Bolt for point

STAFFA PER MOLLE GT N0-N1-N4 FC

BRIDES POUR DENTS GT N0-N1-N4 FC
 CLAMP FOR SPRINGS GT N0-N1-N4 FC
 HALTERUNGEN FÜR ZINKEN GT N0-N1-N4 FC
 ESTRIBOS PARA MUELLES GT N0-N1-N4 FC



Art./Ref.	Sezione/Section	Telaio/Telaio	Peso Kg/Weight Kg	Note/Note
CP7484	-	80 x 80	1.86	Staffa GT80 completa per molla GT N0-N1-N4 FC / Complete clamp GT80 for tine GT N0-N1-N4 FC
CP7485	140 x 10	-	1.35	Staffa GT80 per molla GT N0-N1-N4 FC / Clamp GT80 for tine GT N0-N1-N4 FC
RC0748	16 x 130	-	0.25	Bullone / Bolt
CP7486	-	90 x 90	2	Staffa GT90 completa per molla GT N0-N1-N4 FC / Complete clamp GT90 for tine GT N0-N1-N4 FC
CP7487	140 x 10	-	1.45	Staffa GT90 per molla GT N0-N1-N4 FC / Clamp GT90 for tine GT N0-N1-N4 FC
RC0749	16 x 140	-	0.27	Bullone / Bolt
CP7488	-	100 x 100	2.17	Staffa GT100 completa per molla GT N0-N1-N4 FC / Complete clamp GT100 for tine GT N0-N1-N4 FC
CP7489	140 x 10	-	1.55	Staffa GT100 per molla GT N0-N1-N4 FC / Clamp GT100 for tine GT N0-N1-N4 FC
RC0749A	16 x 150	-	0.31	Bullone / Bolt

MOLLE GT N2-N3 FA

DENT GT N2-N3 FA

SPRING TINES GT N2-N3 FA

ZINKEN GT N2-N3 FA

MUELLE GT N2-N3 FA

Note: La molla viene fornita completa di bulloneria ma non assemblata.**Notes:** The spring is supplied complete with mounting hardware but not assembled

Art./Ref.	Peso Kg/Weight Kg	Note/Note
CP7490	25.61	Molla GT N2 FA senza vomere / Spring tine GT N2 FA without point
CP7491	28.29	Molla GT N2 FA con vomere CP7483 / Spring tine GT N2 FA with point CP7483
CP7492	28.89	Molla GT N3 FA senza vomere / Spring tine GT N3 FA without point
CP7493	31.55	Molla GT N3 FA con vomere CP7483 / Spring tine GT N3 FA with point CP7483

**RICAMBI PER MOLLE GT N2-N3 FA**

RECHANGES POUR DENT GT N2-N3 FA

SPARE PARTS FOR GT N2-N3 FA SPRING

ERSATZTEILE FUER FEDER GT N2-N3 FA

RECAMBIOS MUELLE GT N2-N3 FA

Art./Ref.	Sezione/Section	Telaio/Telaio	Peso Kg/Weight Kg	Note/Note
CP7494	150 x 14	100 x 100	19.2	Spirale GT N2 FA / Spring GT N2 FA
CP7477	50 x 22	-	6.13	Dente GT / Tine GT
CP7478	12	-	0.15	Cavallotto e dadi GT 22 / "U" screw and nuts GT 22
CP1465	16 x 50	-	0.13	Bullone dente / Bolt for tine
CP7495	150 x 16	100 x 100	22	Spirale GT N3 FA / Spring GT N3 FA
CP7496	50 x 24	-	6.58	Dente GT / Tine GT
CP7497	12	-	0.17	Cavallotto e dadi GT 24 / "U" screw and nuts GT 24
RC0747	16 x 60	-	0.14	Bullone dente / Bolt for tine
CP7483	55 x 15	-	2.53	Vomere reversibile / Reversible point
CP1467A	12 x 60	-	0.07	Bullone vomere / Bolt for point

**STAFFA PER MOLLE GT N2-N3 FA**

BRIDES POUR DENTS GT N2-N3 FA

CLAMP FOR SPRINGS GT N2-N3 FA

HALTERUNGEN FÜR ZINKEN GT N2-N3 FA

ESTRIBOS PARA MUELLES GT N2-N3 FA

Art./Ref.	Sezione/Section	Telaio/Telaio	Peso Kg/Weight Kg	Note/Note
CP7498	200 x 12	80 x 80	4.28	Staffa per molla 150x14 / Clamp for tine 150x14
CP7499	200 x 12	90 x 90	4.5	Staffa per molla 150x14 / Clamp for tine 150x14
CP7500	200 x 12	100 x 100	4.72	Staffa per molla 150x14 / Clamp for tine 150x14
CP7501	200 x 12	90 x 90	4.88	Staffa per molla 150x16 / Clamp for tine 150x16
CP7502	200 x 12	100 x 100	5.25	Staffa per molla 150x16 / Clamp for tine 150x16
RC0748	16 x 130	-	0.25	Bullone / Bolt/Bullone
RC0749	16 x 140	-	0.27	Bullone / Bolt/Bullone
RC0749A	16 x 150	-	0.31	Bullone / Bolt/Bullone



DENTI PER FORCONE

DENT POUR CHARGEUR
TINE FOR LOADER
GREIFERZINKE
DIENTES PARA HORQUILLA

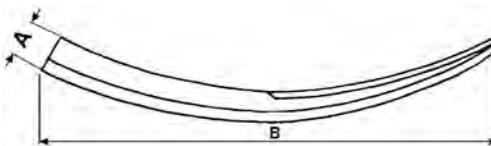

Note: Tutti i prodotti presenti in tabella vengono forniti non verniciati.

Notes: All products in the table are supplied unpainted.

Art./Ref.	A mm	B mm	Note/Note
CP1453	47	540	Leggero/Light
CP1454	56	600	Pesante/Heavy
CP1455	56	600	Pesante rinforzato/Heavy reinforced

DENTE STRIGLIATORE

DENTS
TEETH
STRIEGELZINKEN
DIENTE ALMOMAZADOR

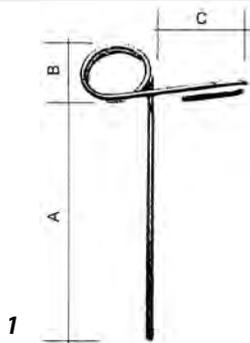

2

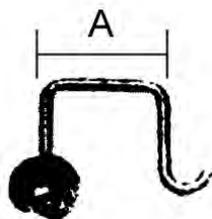

Note: Tutti i prodotti presenti in tabella vengono forniti non verniciati.

Notes: All products in the table are supplied unpainted.

Art./Ref.	Pos.	A mm	B mm	C mm	Note/Note
CP1367	1	330	100	130	Dente strigliatore - Ø mm. 10
CP1368	2	53	-	-	Brida, rondella, dado, per tubolare 50x50

DENTE STRIGLIATORE

DENTS
TEETH
STRIEGELZINKEN
DIENTE ALMOMAZADOR

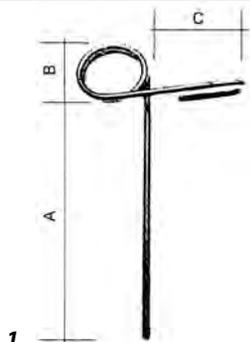

2

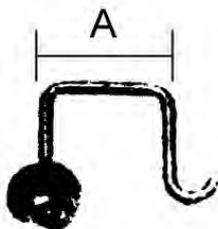

Note: Tutti i prodotti presenti in tabella vengono forniti non verniciati.

Notes: All products in the table are supplied unpainted.

Art./Ref.	Pos.	A mm	B mm	C mm	Note/Note
CP1367A	1	330	100	90	Dente strigliatore - Ø mm. 8
CP1368A	2	53	-	-	Brida, rondella, dado, per tubolare 50x50
CP1368E	2	32	-	-	Brida, rondella, dado, per tubolare 30x30

DENTE STRIGLIATORE

DENTS

TEETH

STRIEGELZINKEN

DIENTE ALMOMAZADOR

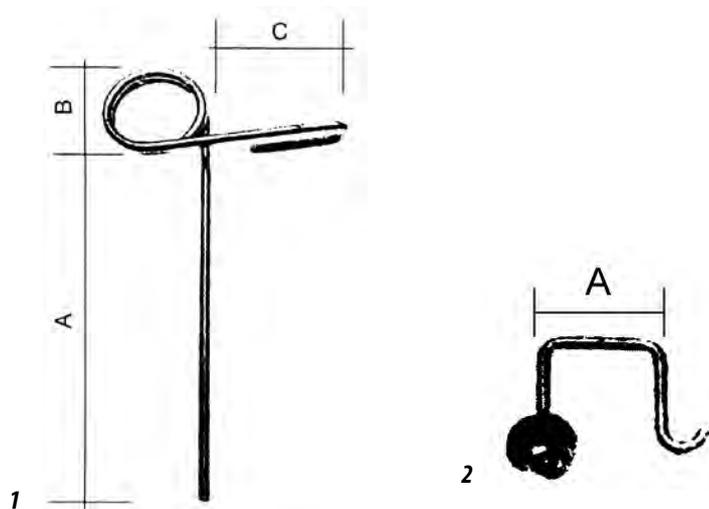

Note: Tutti i prodotti presenti in tabella vengono forniti non verniciati.

Notes: All products in the table are supplied unpainted.

Art./Ref.	Pos.	A mm	B mm	C mm	Note/Note
CP1367B	1	460	100	130	Dente strigliatore - Ø mm. 10
CP1368	2	53	-	-	Brida, rondella, dado, per tubolare 50x50

DENTE STRIGLIATORE

DENTS

TEETH

STRIEGELZINKEN

DIENTE ALMOMAZADOR

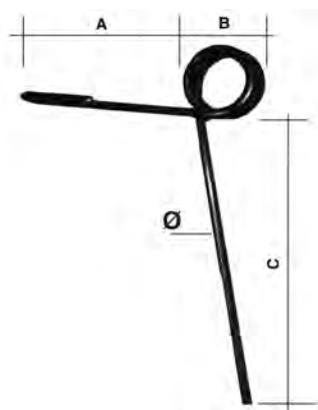

Note: Tutti i prodotti presenti in tabella vengono forniti non verniciati.

Notes: All products in the table are supplied unpainted.

Art./Ref.	Tipo/Type	A mm	B mm	C mm	Note/Note
CP1573	Anteriore - Front	135	65	260	Dente strigliatore - Ø mm. 10 con 4 spire
CP1574	Posteriore - Back	135	65	260	Dente strigliatore - Ø mm. 10 con 3 spire
CP1575	Anteriore - Front	130	65	220	Dente strigliatore - Ø mm. 8 con 4 spire
CP1576	Posteriore - Back	130	65	220	Dente strigliatore - Ø mm. 8 con 3 spire

MOLLE ERPICETTO PER SEMINATRICI

RESSORTS POUR SEMOIRS

SPRINGS FOR SEEDING MACHINE

ZINKEN FÜR SÄMACHINEN

MUELLES PARA SEMBRADORA

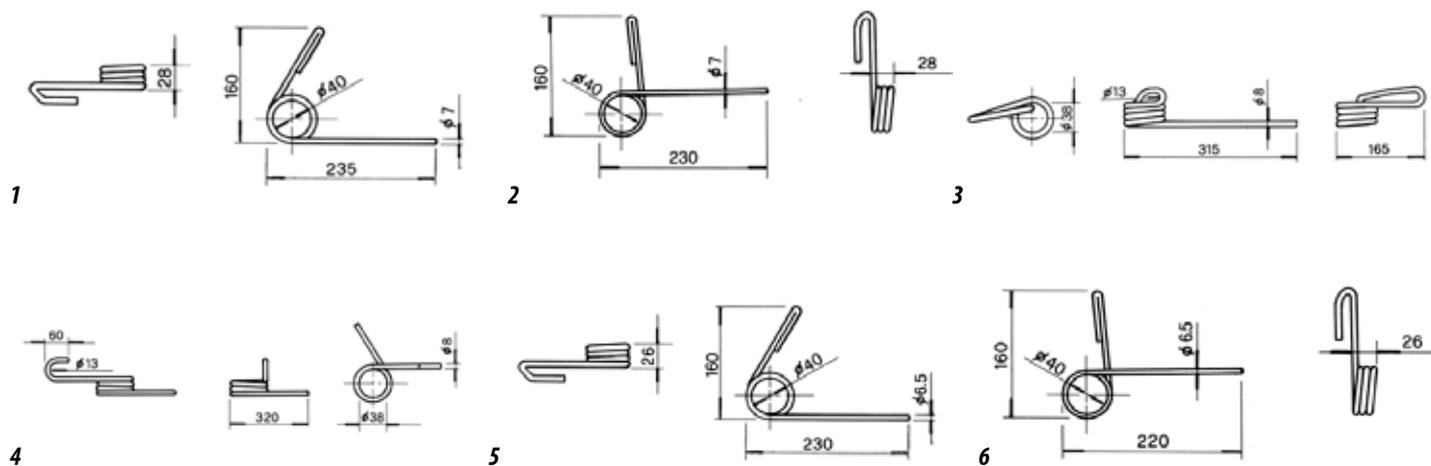

Note: Tutti i prodotti presenti in tabella vengono forniti non verniciati.

Notes: All products in the table are supplied unpainted.

Art./Ref.	Pos.	Tipo/Type	Note/Note
CP1990	1	Anteriore DX - Front DX	ADATTABILE IMA LA ROCCA - CIMAC
CP1991	2	Posteriore SX - Back SX	ADATTABILE IMA LA ROCCA - CIMAC
CP1992	3	Anteriore DX - Front DX	ADATTABILE MARZIA
CP1993	4	Posteriore SX - Back SX	ADATTABILE MARZIA
CP1994	5	Anteriore DX - Front DX	ADATTABILE OMA
CP1995	6	Posteriore SX - Back SX	ADATTABILE OMA

1.10.4 Denti e coltelli per erpici rotanti

Tines and knives for rotating harrows



Ricambi & accessori per macchine agricole SPARE PARTS & ACCESSORIES FOR AGRICULTURAL MACHINE

Tutti gli articoli della presente sezione, prodotti da AMA SPA e/o da terzi per conto di AMA, sono adattabili ("non originali") alle marche indicate ai sensi di quanto previsto dal REG. CE n. 1400/2002. I diritti sui marchi citati appartengono ai legittimi proprietari ed il loro uso ha l'esclusiva finalità di consentire all'utilizzatore la comparazione dei diversi prodotti. All items of this section, manufactured by AMA SPA and/or any third party on behalf of AMA, are adaptable ("non-original") to the brands listed under the provisions of the REG. CE n. 1400/2002. The rights on the trademarks belong to their respective owners and their usage is only aimed to allow the user to compare different products.

DENTI E COLTELLI PER ERPICHI ROTANTI
TINES AND KNIVES FOR ROTATING HARROWS
DENTS ET COUTEAUX POUR HERSES ROTATIVES
KREISELEGGENZINKEN FÜR KREISELEGGEN
DIENTES Y CUCHILLAS PARA TRAILLERAS ROTANDES

Brand	Art./Ref.	Rif. Orig./ Orig. Ref.	Modello/Model	Ø Foro mm/ Hole Ø mm	Interasse fori/Distance between hole centers mm	Peso Kg/ Weight Kg	Immagine/Image
AGRATOR	00555	-	-	M22	-	1260	
AGRAMEC	05781	-	Dx/Rh	17	60	1960	
	07335	-	Sx/Lh	17	60	1960	
	10074	-	Dx/Rh	17	50	1660	

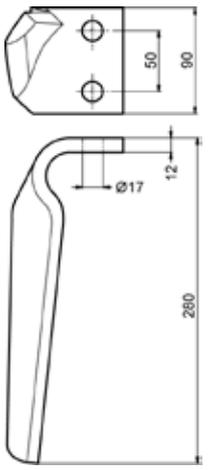
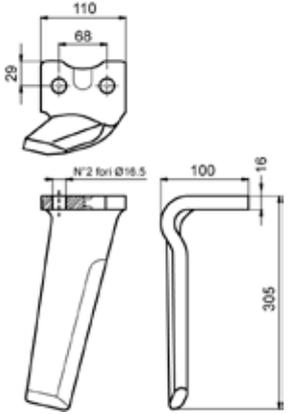
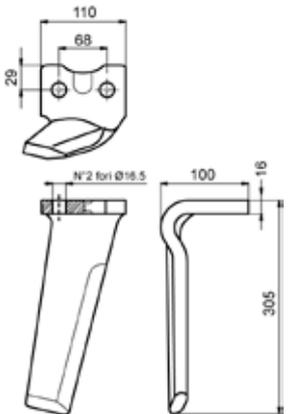
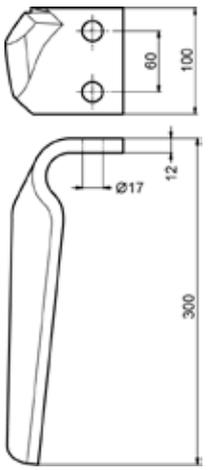
Brand	Art./Ref.	Rif. Orig./ Orig. Ref.	Modello/Model	Ø Foro mm/ Hole Ø mm	Interasse fori/Distance between hole centers mm	Peso Kg/ Weight Kg	Immagine/Image
AGROMECC	10075	-	Sx/Lh	17	50	1660	
	65826	-	Dx/Rh	16.5	68	2950	
	65827	-	Sx/Lh	16.5	68	2950	
ALPEGO	05781	-	Dx/Rh	17	60	1960	

Brand	Art./Ref.	Rif. Orig./ Orig. Ref.	Modello/Model	Ø Foro mm/ Hole Ø mm	Interasse fori/Distance between hole centers mm	Peso Kg/ Weight Kg	Immagine/Image
ALPEGO	07335	-	Sx/Lh	17	60	1960	
	65830	1270	Dx/Rh	17	60	1960	
	65831	1271	Sx/Lh	17	60	1960	
	65838	-	Dx/Rh	17	60	2350	

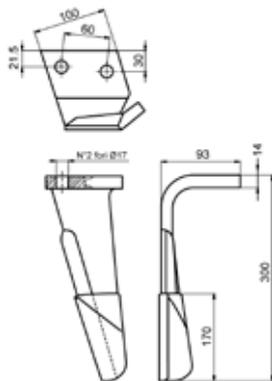
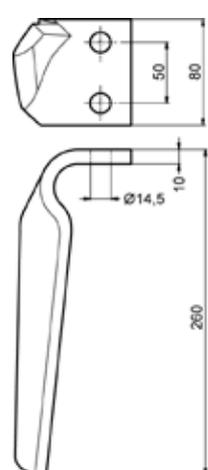
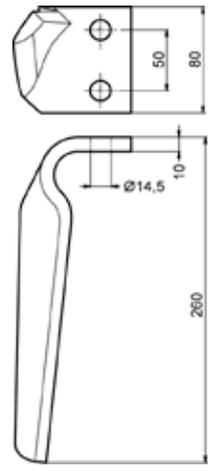
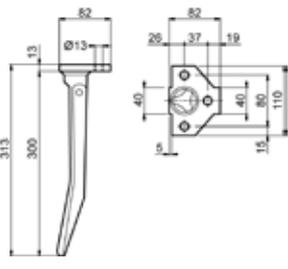
Brand	Art./Ref.	Rif. Orig./ Orig. Ref.	Modello/Model	Ø Foro mm/ Hole Ø mm	Interasse fori/Distance between hole centers mm	Peso Kg/ Weight Kg	Immagine/Image
ALPEGO	65839	-	Sx/Lh	17	60	2350	
	65842	-	Dx/Rh	14.5	50	1180	
	65843	-	Sx/Lh	14.5	50	1180	
AMAZONE	11035	-	-	13	-	1680	

Brand	Art./Ref.	Rif. Orig./ Orig. Ref.	Modello/Model	Ø Foro mm/ Hole Ø mm	Interasse fori/Distance between hole centers mm	Peso Kg/ Weight Kg	Immagine/Image
AMAZONE	52049	65743	Dx/Rh	19	-	3000	
	52050	65753	Sx/Lh	19	-	3000	
	65848	954426	Dx/Rh	19	-	2700	
	65849	954427	Sx/Lh	19	-	2700	
BREVIGLIERI	05781	0088310D	Dx/Rh	17	60	1960	

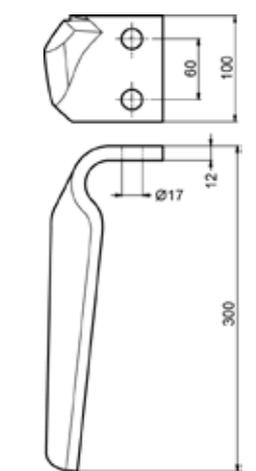
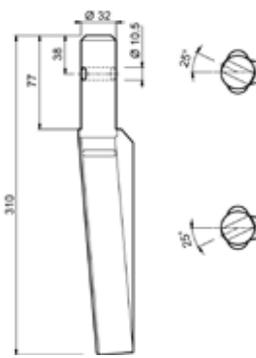
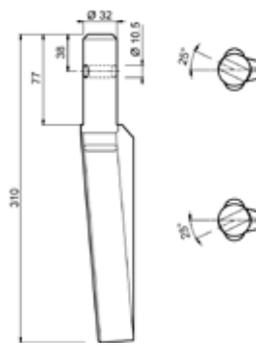
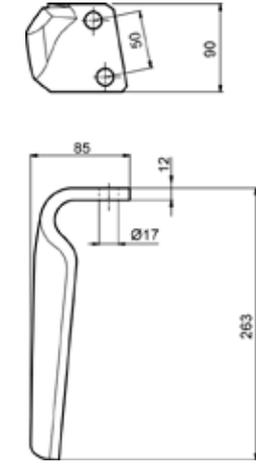
Brand	Art./Ref.	Rif. Orig./ Orig. Ref.	Modello/Model	Ø Foro mm/ Hole Ø mm	Interasse fori/Distance between hole centers mm	Peso Kg/ Weight Kg	Immagine/Image
BREVIGLIERI	07335	00883105	Sx/Lh	17	60	1960	
	10042	-	Dx/Rh	10.5	-	1370	
	10043	-	Sx/Lh	10.5	-	1370	
	65856	177401	Dx/Rh	17	50	1600	

Brand	Art./Ref.	Rif. Orig./ Orig. Ref.	Modello/Model	Ø Foro mm/ Hole Ø mm	Interasse fori/Distance between hole centers mm	Peso Kg/ Weight Kg	Immagine/Image
BREVIGLIERI	65857	277401	Sx/Lh	17	50	1600	
	65862	33054		13	55	1200	
	65914	8831X	Dx/Rh	17	60	1900	
	65915	8831X	Sx/Lh	17	60	1900	

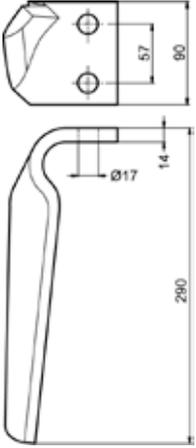
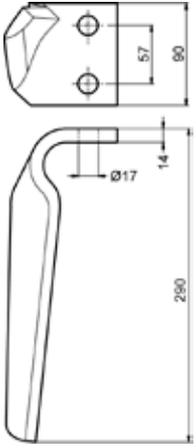
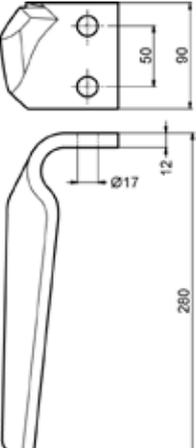
Brand	Art./Ref.	Rif. Orig./ Orig. Ref.	Modello/Model	Ø Foro mm/ Hole Ø mm	Interasse fori/Distance between hole centers mm	Peso Kg/ Weight Kg	Immagine/Image
CARRARO	65868	-	Dx/Rh	17	57	2300	
CARRARO- AGRITALIA	10044	-	-	4	-	1080	
	65868	-	Dx/Rh	17	57	2300	
CELLI	10074	-	Dx/Rh	17	50	1660	

Brand	Art./Ref.	Rif. Orig./ Orig. Ref.	Modello/Model	Ø Foro mm/ Hole Ø mm	Interasse fori/Distance between hole centers mm	Peso Kg/ Weight Kg	Immagine/Image
CELLI	10075	-	Sx/Lh	17	50	1660	
DOWDESWELL	65875	-	Dx/Rh	17.5	76	3400	
	65876	-	Sx/Lh	17.5	76	3400	
EMY-ELENER	65877	2901271	Dx/Rh	17	66	2400	

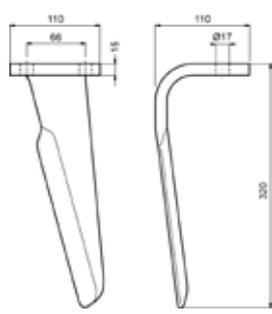
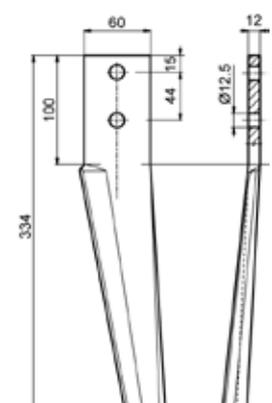
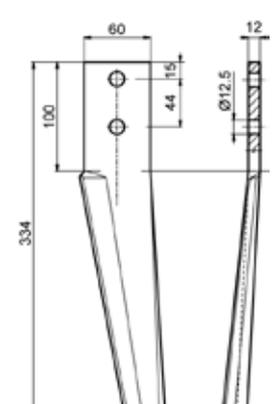
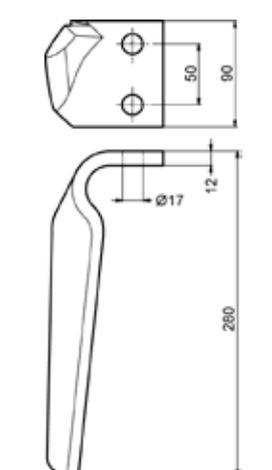
Brand	Art./Ref.	Rif. Orig./ Orig. Ref.	Modello/Model	Ø Foro mm/ Hole Ø mm	Interasse fori/Distance between hole centers mm	Peso Kg/ Weight Kg	Immagine/Image
EMY-ELENFER	65878	2901270	Sx/Lh	17	66	2400	
FALC	06434	202002	Dx/Rh	12.5	44	1500	
	06435	292003	Sx/Lh	12.5	44	1500	
	10074	512075	Dx/Rh	17	50	1660	

Brand	Art./Ref.	Rif. Orig./ Orig. Ref.	Modello/Model	Ø Foro mm/ Hole Ø mm	Interasse fori/Distance between hole centers mm	Peso Kg/ Weight Kg	Immagine/Image
FALC	10075	512076	Sx/Lh	17	50	1660	
	11611	-	-	10	-	750	
FERABOLI	00617	-	-	M20	-	1220	
	10062	-	-	12.3	-	1370	

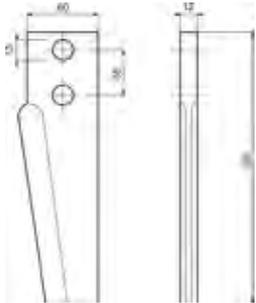
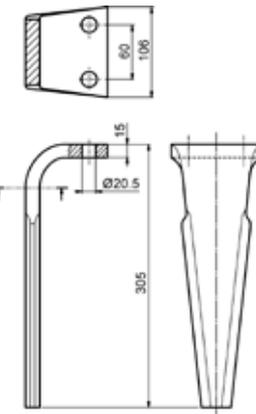
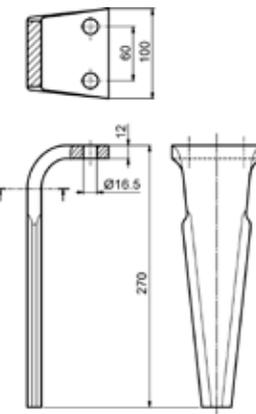
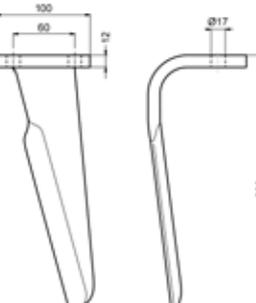
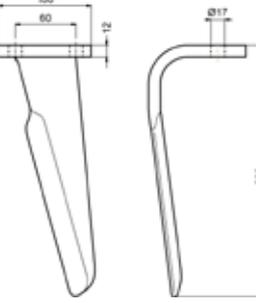
Brand	Art./Ref.	Rif. Orig./ Orig. Ref.	Modello/Model	Ø Foro mm/ Hole Ø mm	Interasse fori/Distance between hole centers mm	Peso Kg/ Weight Kg	Immagine/Image
FERABOLI	10078	-	Sx/Lh	13	65	1400	
	10080	-	-	20.5	60	2950	
	10081	48010	-	16.5	60	2000	
	34639	-	Dx/Rh	17	60	1740	
	34640	-	Sx/Lh	17	60	1740	

Brand	Art./Ref.	Rif. Orig./ Orig. Ref.	Modello/Model	Ø Foro mm/ Hole Ø mm	Interasse fori/Distance between hole centers mm	Peso Kg/ Weight Kg	Immagine/Image
FERABOLI	34641	-	Dx/Rh	21	60	2400	
	34642	-	Sx/Lh	21	60	2400	
	65887	-	-	14.3	-	1780	
FORIGO- ROTERTALIA	10046	-	-	M20	-	1500	
	65890	RLM58001	-	17	50	2250	

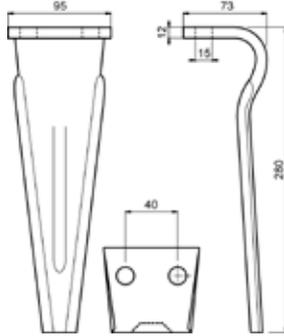
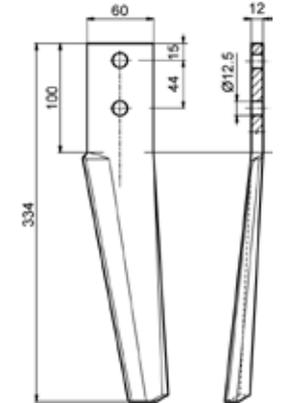
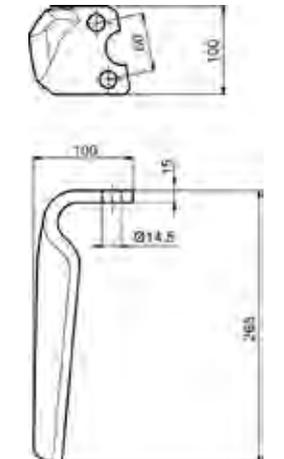
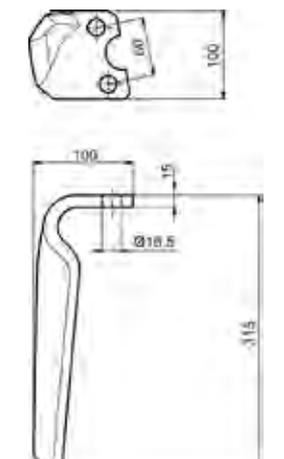
Brand	Art./Ref.	Rif. Orig./ Orig. Ref.	Modello/Model	Ø Foro mm/ Hole Ø mm	Interasse fori/Distance between hole centers mm	Peso Kg/ Weight Kg	Immagine/Image
FORIGO- ROTERTALIA	65891	-	-	15	40	1700	
GRAVELY	06434	-	Dx/Rh	12.5	44	1500	
HOWARD ROTAVATOR	52064	182938	-	14.5	60	2350	
	65903	185506	Dx/Rh	16.5	60	2500	

Brand	Art./Ref.	Rif. Orig./ Orig. Ref.	Modello/Model	Ø Foro mm/ Hole Ø mm	Interasse fori/Distance between hole centers mm	Peso Kg/ Weight Kg	Immagine/Image
HOWARD ROTAVATOR	65904	185505	Sx/Lh	16.5	60	2500	
KRONE	52067	-	-	-	-	1200	
KUHN	02085	-	-	17	-	1400	
	06800	525604	Dx/Rh	17.5	68	2900	

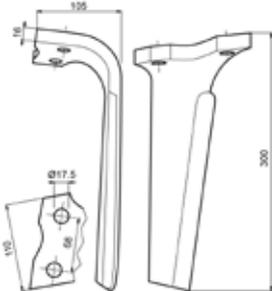
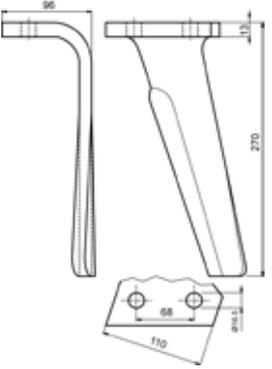
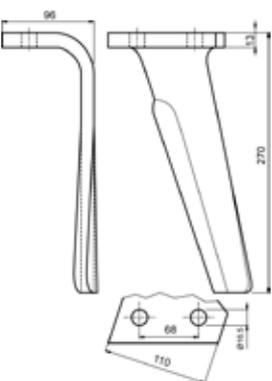
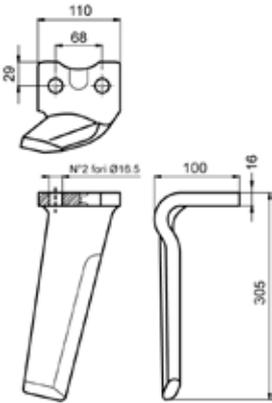
Brand	Art./Ref.	Rif. Orig./ Orig. Ref.	Modello/Model	Ø Foro mm/ Hole Ø mm	Interasse fori/Distance between hole centers mm	Peso Kg/ Weight Kg	Immagine/Image
KUHN	06978	525605	Sx/Lh	17.5	68	2900	
	10070	-	Dx/Rh	16.5	68	2080	
	10071	-	Sx/Lh	16.5	68	2080	
	65826	525394	Dx/Rh	16.5	68	2950	

Brand	Art./Ref.	Rif. Orig./ Orig. Ref.	Modello/Model	Ø Foro mm/ Hole Ø mm	Interasse fori/Distance between hole centers mm	Peso Kg/ Weight Kg	Immagine/Image
KUHN	65827	525395	Sx/Lh	16.5	68	2950	
	65918	525964	Dx/Rh	19.5	-	3200	
	65919	525965	Sx/Lh	19.5	-	3200	
	65924	-	Sx/Lh	19	-	3500	

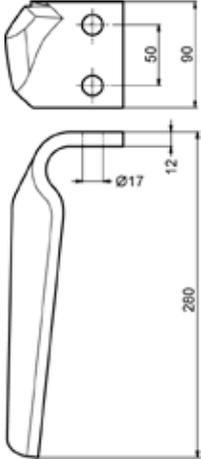
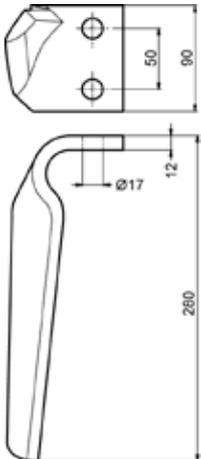
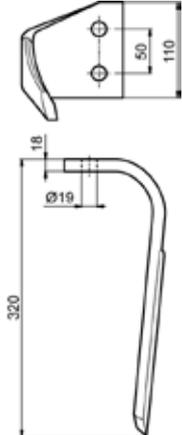
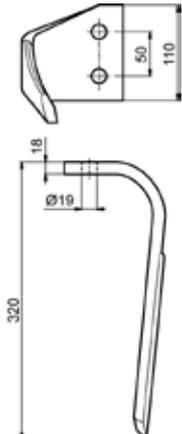
Brand	Art./Ref.	Rif. Orig./ Orig. Ref.	Modello/Model	Ø Foro mm/ Hole Ø mm	Interasse fori/Distance between hole centers mm	Peso Kg/ Weight Kg	Immagine/Image
KVERNELAND	10074	010146	Dx/Rh	17	50	1660	
	10075	020146	Sx/Lh	17	50	1660	
	65925	080146	Dx/Rh	19	50	3050	
	65926	070146	Sx/Lh	19	50	3050	

Brand	Art./Ref.	Rif. Orig./ Orig. Ref.	Modello/Model	Ø Foro mm/ Hole Ø mm	Interasse fori/Distance between hole centers mm	Peso Kg/ Weight Kg	Immagine/Image
LAWN-BOY	06435	-	Sx/Lh	12.5	44	1500	
LELY	00616	-	-	M20	-	970	
	00617	-	-	M20	-	1220	
	06249	-	-	M20	-	1280	

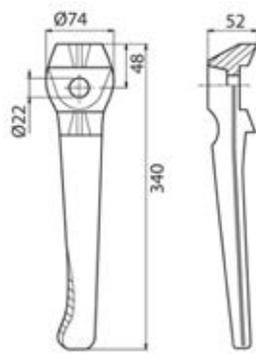
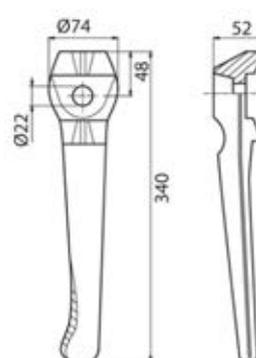
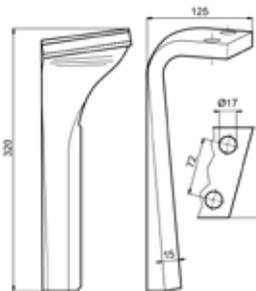
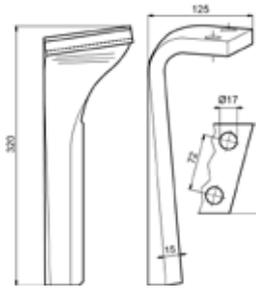
Brand	Art./Ref.	Rif. Orig./ Orig. Ref.	Modello/Model	Ø Foro mm/ Hole Ø mm	Interasse fori/Distance between hole centers mm	Peso Kg/ Weight Kg	Immagine/Image
LELY	52076	-	Dx/Rh	22	-	2000	
	52077	-	Sx/Lh	22	-	2000	
LEMKEN	65936	-	Dx/Rh	17	72	2960	
	65937	-	Sx/Lh	17	72	2960	

Brand	Art./Ref.	Rif. Orig./ Orig. Ref.	Modello/Model	Ø Foro mm/ Hole Ø mm	Interasse fori/Distance between hole centers mm	Peso Kg/ Weight Kg	Immagine/Image
MASCHIO	05781	36100210	Dx/Rh	17	60	1960	
	06434	10100225	Dx/Rh	12.5	44	1500	
	06435	10100226	Sx/Lh	12.5	44	1500	
	07335	36100211	Sx/Lh	17	60	1960	

Brand	Art./Ref.	Rif. Orig./ Orig. Ref.	Modello/Model	Ø Foro mm/ Hole Ø mm	Interasse fori/Distance between hole centers mm	Peso Kg/ Weight Kg	Immagine/Image
MASCHIO	10072	10100262	Dx/Rh	12.5	44	1250	
	10073	10100263	Sx/Lh	12.5	44	1250	
	10074	27100210, 27100210-A	Dx/Rh	17	50	1660	
	10075	27100209	Sx/Lh	17	50	1660	

Brand	Art./Ref.	Rif. Orig./ Orig. Ref.	Modello/Model	Ø Foro mm/ Hole Ø mm	Interasse fori/Distance between hole centers mm	Peso Kg/ Weight Kg	Immagine/Image
MASCHIO	11041	38100222	Dx/Rh	17	50	2100	
	11042	38100223	Sx/Lh	17	50	2100	
	11045	36100312	-	M16	60	210	
	11046	38100218	-	M16	50	190	
	52079	-	Dx/Rh	12.5	44	1380	

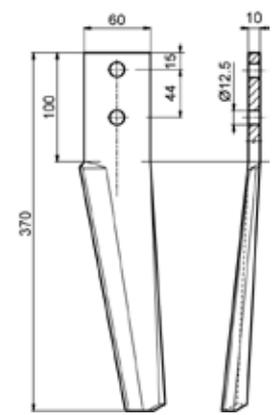
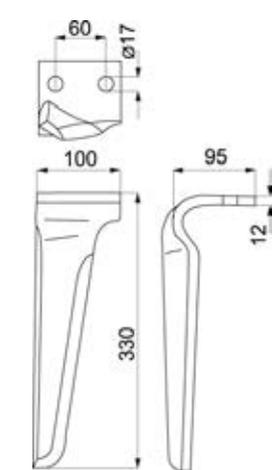
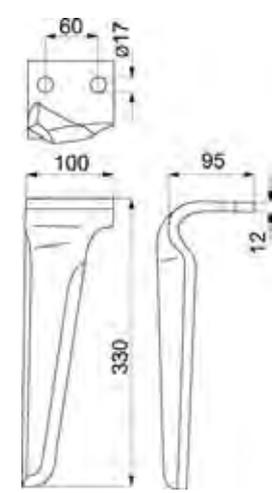
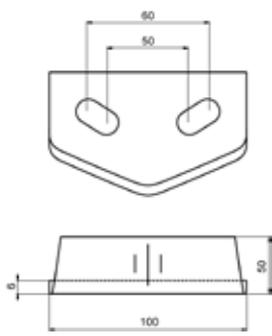
Brand	Art./Ref.	Rif. Orig./ Orig. Ref.	Modello/Model	Ø Foro mm/ Hole Ø mm	Interasse fori/Distance between hole centers mm	Peso Kg/ Weight Kg	Immagine/Image
MASCHIO	52080	-	Sx/Lh	12.5	44	1380	
	52081	-	Dx/Rh	17	-	2000	
	52082	-	Sx/Lh	17	-	2000	
	52083	38100215	-	-	-	480	

Brand	Art./Ref.	Rif. Orig./ Orig. Ref.	Modello/Model	Ø Foro mm/ Hole Ø mm	Interasse fori/Distance between hole centers mm	Peso Kg/ Weight Kg	Immagine/Image
MASCHIO	65940	04400310	Dx/Rh	17	50	1380	
	65941	04400311	Sx/Lh	17	50	1380	
	65942	-	Dx/Rh	17	60	2000	
	65943	-	Sx/Lh	17	60	2000	

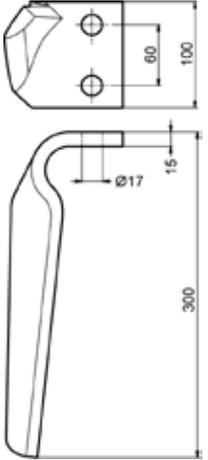
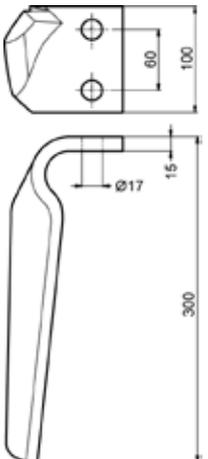
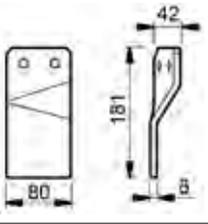
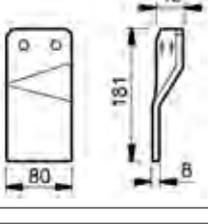
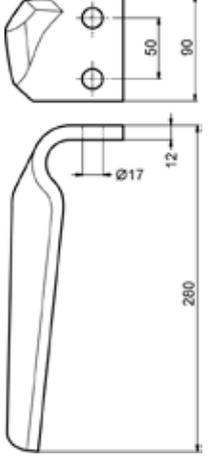
Brand	Art./Ref.	Rif. Orig./ Orig. Ref.	Modello/Model	Ø Foro mm/ Hole Ø mm	Interasse fori/Distance between hole centers mm	Peso Kg/ Weight Kg	Immagine/Image
MASCHIO	65944	36100215	Dx/Rh	17	60	2600	
	65945	36100216	Sx/Lh	17	60	2600	
	66873	26100417	Dx/Rh super kobra	14.5	44.5	850	
	66874	26100418	Sx/Lh super kobra	14.5	44.5	850	
MERITANO	10074	-	Dx/Rh	17	50	1660	

Brand	Art./Ref.	Rif. Orig./ Orig. Ref.	Modello/Model	Ø Foro mm/ Hole Ø mm	Interasse fori/Distance between hole centers mm	Peso Kg/ Weight Kg	Immagine/Image
MERITANO	10075	-	Sx/Lh	17	50	1660	
MORENI	10063	-	-	M20	-	980	
	65940	-	Dx/Rh	17	50	1380	
	65941	-	Sx/Lh	17	50	1380	

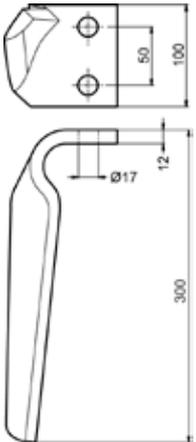
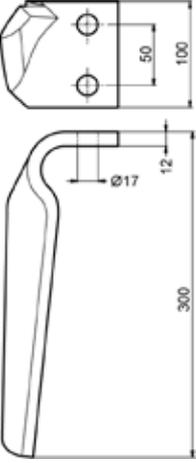
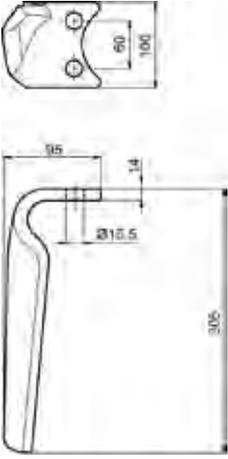
Brand	Art./Ref.	Rif. Orig./ Orig. Ref.	Modello/Model	Ø Foro mm/ Hole Ø mm	Interasse fori/Distance between hole centers mm	Peso Kg/ Weight Kg	Immagine/Image
MORENI	65950	-	Dx/Rh	17	50	1960	
	65951	-	Sx/Lh	17	50	1960	
MORRA	65954	7993	Dx/Rh	16.5	60	2400	
	65955	7994	Sx/Lh	16.5	60	2400	

Brand	Art./Ref.	Rif. Orig./ Orig. Ref.	Modello/Model	Ø Foro mm/ Hole Ø mm	Interasse fori/Distance between hole centers mm	Peso Kg/ Weight Kg	Immagine/Image
MURATORI	10074	-	Dx/Rh	17	50	1660	
	10075	-	Sx/Lh	17	50	1660	
	65956	-	Dx/Rh	17	50	2300	
	65957	-	Sx/Lh	17	50	2300	

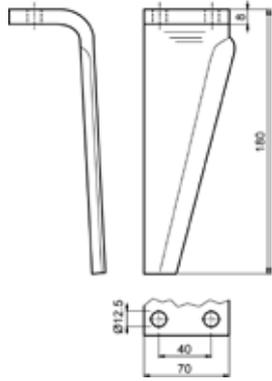
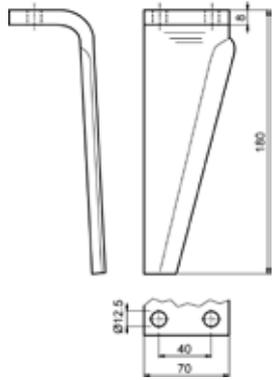
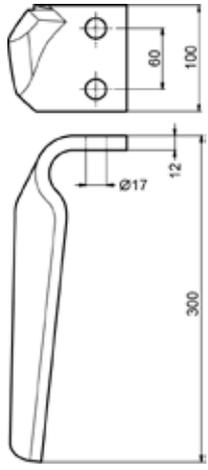
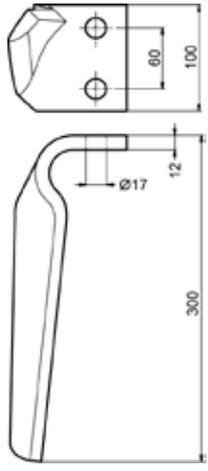
Brand	Art./Ref.	Rif. Orig./ Orig. Ref.	Modello/Model	Ø Foro mm/ Hole Ø mm	Interasse fori/Distance between hole centers mm	Peso Kg/ Weight Kg	Immagine/Image
MURATORI	65958	-	Dx/Rh	12.5	40	800	
	65959	-	Sx/Lh	12.5	40	800	
ORTOLAN	05781	-	Dx/Rh	17	60	1960	
	07335	-	Sx/Lh	17	60	1960	

Brand	Art./Ref.	Rif. Orig./ Orig. Ref.	Modello/Model	Ø Foro mm/ Hole Ø mm	Interasse fori/Distance between hole centers mm	Peso Kg/ Weight Kg	Immagine/Image
ORTOLAN	10074	-	Dx/Rh	17	50	1660	
	10075	-	Sx/Lh	17	50	1660	
	65842	72700003	Dx/Rh	14.5	50	1180	
	65843	72700004	Sx/Lh	14.5	50	1180	

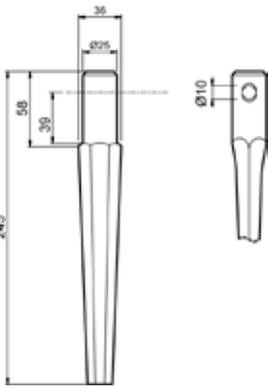
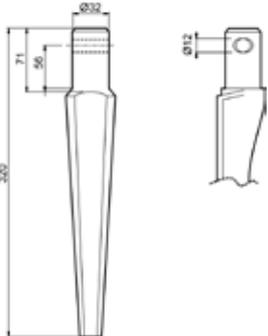
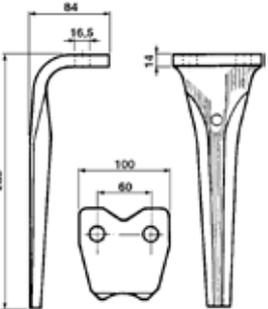
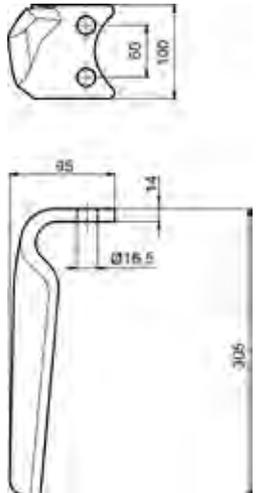
Brand	Art./Ref.	Rif. Orig./ Orig. Ref.	Modello/Model	Ø Foro mm/ Hole Ø mm	Interasse fori/Distance between hole centers mm	Peso Kg/ Weight Kg	Immagine/Image
PEGORARO	00574	-	-	10	-	630	
	00593	-	-	12	-	1450	
	10076	-	-	16.5	60	1820	
	65954	7869	Dx/Rh	16.5	60	2400	

Brand	Art./Ref.	Rif. Orig./ Orig. Ref.	Modello/Model	Ø Foro mm/ Hole Ø mm	Interasse fori/Distance between hole centers mm	Peso Kg/ Weight Kg	Immagine/Image
PEGORARO	65955	7870	Sx/Lh	16.5	60	2400	
PERUGINI CONCEPT	02195	-	Dx/Rh	17	66	2600	
	07556	-	Sx/Lh	17	66	2600	
	10077	-	Dx/Rh	13	65	1400	
	10078	-	Sx/Lh	13	65	1400	

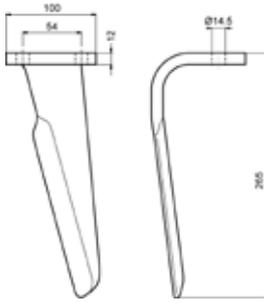
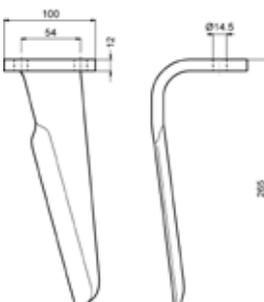
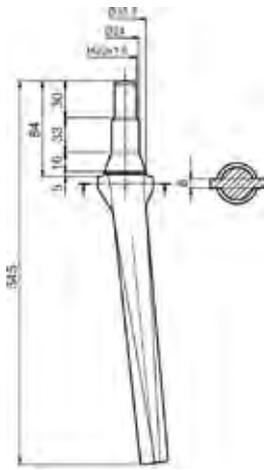
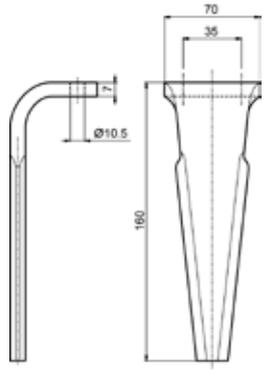
Brand	Art./Ref.	Rif. Orig./ Orig. Ref.	Modello/Model	Ø Foro mm/ Hole Ø mm	Interasse fori/Distance between hole centers mm	Peso Kg/ Weight Kg	Immagine/Image
PERUGINI CONCEPT	11038	-	Dx/Rh	14.5	54	1680	
	11039	-	Sx/Lh	14.5	54	1680	
	52054	-	-	M20	-	1420	
R2	-	65977	-	10.5	35	420	

Brand	Art./Ref.	Rif. Orig./ Orig. Ref.	Modello/Model	Ø Foro mm/ Hole Ø mm	Interasse fori/Distance between hole centers mm	Peso Kg/ Weight Kg	Immagine/Image
RABEWERK	02195	84045001	Dx/Rh	17	66	2600	
	07556	84045002	Sx/Lh	17	66	2600	
	10082	84091201	Dx/Rh	15	40	1960	
	10083	84091202	Sx/Lh	15	40	1960	
	65984	-	-	M16	66	250	

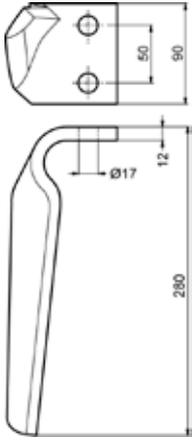
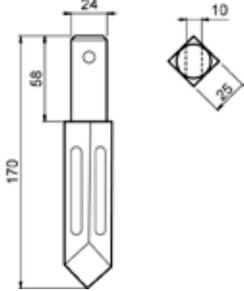
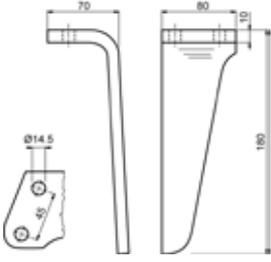
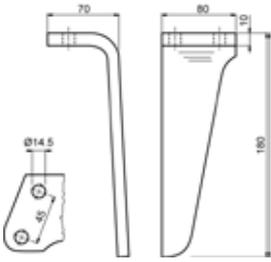
Brand	Art./Ref.	Rif. Orig./ Orig. Ref.	Modello/Model	Ø Foro mm/ Hole Ø mm	Interasse fori/Distance between hole centers mm	Peso Kg/ Weight Kg	Immagine/Image
RAU	10074	E44502	Dx/Rh	17	50	1660	
	10075	E44501	Sx/Lh	17	50	1660	
	11611	-	-	10	-	750	
RINIERI	65993	-	Dx/Rh	14.5	45	820	
	65994	-	Sx/Lh	14.5	45	820	

Brand	Art./Ref.	Rif. Orig./ Orig. Ref.	Modello/Model	Ø Foro mm/ Hole Ø mm	Interasse fori/Distance between hole centers mm	Peso Kg/ Weight Kg	Immagine/Image
SICMA/OSTRA VETERE	10050	-	-	-	-	1400	
	10074	-	Dx/Rh	17	50	1660	
	10075	-	Sx/Lh	17	50	1660	
	11041	-	Dx/Rh	17	50	2100	

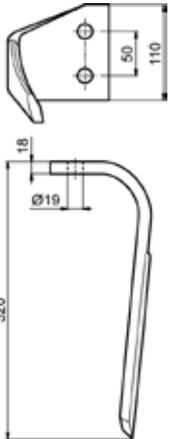
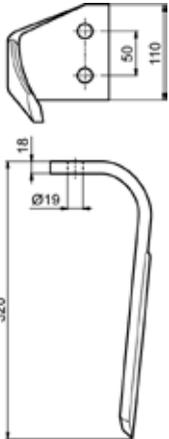
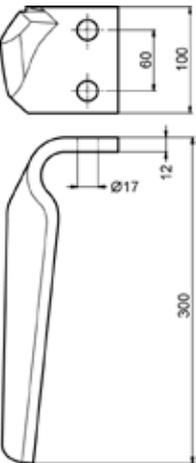
Brand	Art./Ref.	Rif. Orig./ Orig. Ref.	Modello/Model	Ø Foro mm/ Hole Ø mm	Interasse fori/Distance between hole centers mm	Peso Kg/ Weight Kg	Immagine/Image
SICMA/OSTRA VETERE	11042	-	Sx/Lh	17	50	2100	
	65925	-	Dx/Rh	19	50	3050	
	65926	-	Sx/Lh	19	50	3050	
SOVEMA	05781	-	Dx/Rh	17	60	1960	

Brand	Art./Ref.	Rif. Orig./ Orig. Ref.	Modello/Model	Ø Foro mm/ Hole Ø mm	Interasse fori/Distance between hole centers mm	Peso Kg/ Weight Kg	Immagine/Image
SOVEMA	07335	-	Sx/Lh	17	60	1960	
	65940	-	Dx/Rh	17	50	1380	
	65941	-	Sx/Lh	17	50	1380	
SPAPPERI	10074	-	Dx/Rh	17	50	1660	

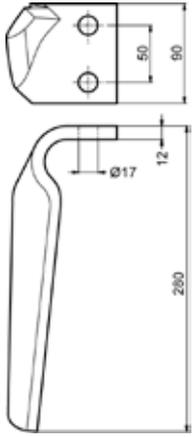
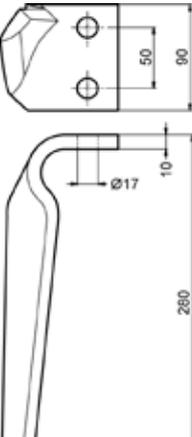
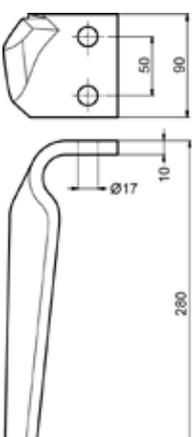
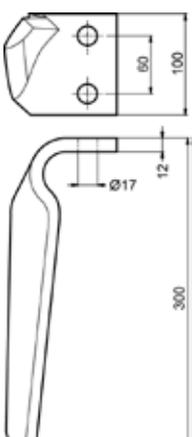
Brand	Art./Ref.	Rif. Orig./ Orig. Ref.	Modello/Model	Ø Foro mm/ Hole Ø mm	Interasse fori/Distance between hole centers mm	Peso Kg/ Weight Kg	Immagine/Image
SPAPPERI	10075	-	Sx/Lh	17	50	1660	
TERANOVA	65940	-	Dx/Rh	17	50	1380	
	65941	-	Sx/Lh	17	50	1380	
TORTELLA	05781	-	Dx/Rh	17	60	1960	

Brand	Art./Ref.	Rif. Orig./ Orig. Ref.	Modello/Model	Ø Foro mm/ Hole Ø mm	Interasse fori/Distance between hole centers mm	Peso Kg/ Weight Kg	Immagine/Image
TORTELLA	07335	-	Sx/Lh	17	60	1960	
	10074	-	Dx/Rh	17	50	1660	
	10075	-	Sx/Lh	17	50	1660	
	65842	-	Dx/Rh	14.5	50	1180	

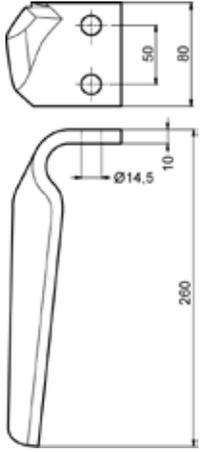
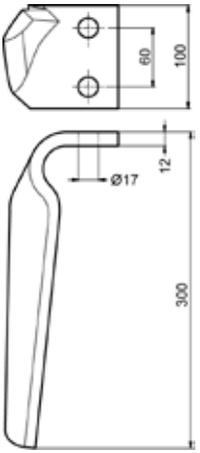
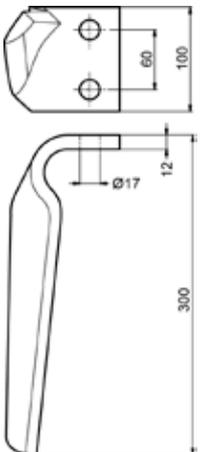
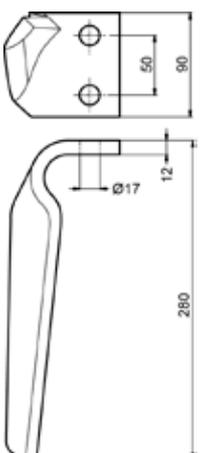
Brand	Art./Ref.	Rif. Orig./ Orig. Ref.	Modello/Model	Ø Foro mm/ Hole Ø mm	Interasse fori/Distance between hole centers mm	Peso Kg/ Weight Kg	Immagine/Image
TORTELLA	65843	-	Sx/Lh	14.5	50	1180	
VIGOLO	05781	-	Dx/Rh	17	60	1960	
	07335	-	Sx/Lh	17	60	1960	
	10074	-	Dx/Rh	17	50	1660	

Brand	Art./Ref.	Rif. Orig./ Orig. Ref.	Modello/Model	Ø Foro mm/ Hole Ø mm	Interasse fori/Distance between hole centers mm	Peso Kg/ Weight Kg	Immagine/Image
VIGOLO	10075	-	Sx/Lh	17	50	1660	
	34641	-	Dx/Rh	21	60	2400	
	34642	-	Sx/Lh	21	60	2400	

TRIDENTI PER ERPICI TIPO HOWARD
TRIDENT POUR HERSE "HOWARD"
TRIDENT FOR HARROWS "HOWARD"
EGGENZINKE TYP "HOWARD"
TRIDENTES PARA GRADAS DE DIENTES TIPO "HOWARD"

Art./Ref.	Peso Kg/Weight Kg	Note/Note
02729	1700	Acciaio
02739	1800	Ghisa

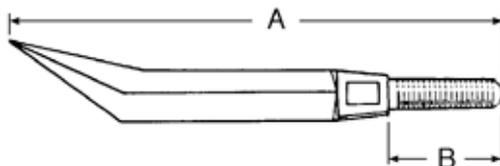

DENTI ERPICE TIPO QUADRO*DENTS POUR HERSE TYPE CARRÉ**TINES FOR HARROWS SQUARE TYPE**EGGENZINKE VIERKANTIG**DIENTES PARA GRADAS DE DIENTES TIPO CUADRO*

Art./Ref.	A mm/A mm	B mm/B mm	Filettatura/Thread	Note/Note
00921	248	50	16 MA	Tipo/Type 3 -Quadro/Square 20x24
00922	270	64	20 MA	Tipo/Type 4 -Quadro/Square 23x21
00923	305	65	20 MA	Tipo/Type 5 -Quadro/Square 24x26
00924	320	65	22 MA	Tipo/Type 6 -Quadro/Square 24x26
00939	360	70	24 MA	Tipo/Type 8 -Quadro/Square 32x32

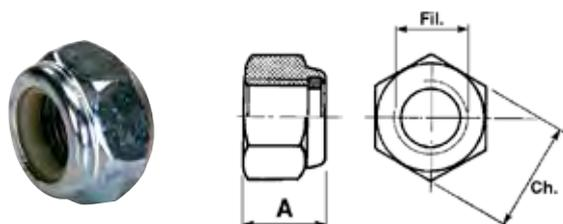
DADI AUTOBLOCCANTI PER DENTI ERPICE*ECROUS DENTS DE HERSE**SELF-LOCKING NUT FOR HARROW TINES**MUTTER ZINKEN FÜR EGGE**TUERCAS PARA DIENTES DE GRADA DE PLÍAS*

Art./Ref.	A mm	Filettatura/Thread	Chiave/Key	Note/Note
00941	19	20x1,5	30	Conico
06663	18	22x1,5	32	Basso

1.10.5 Vanghe per vangatrici

Spades for diggings machines

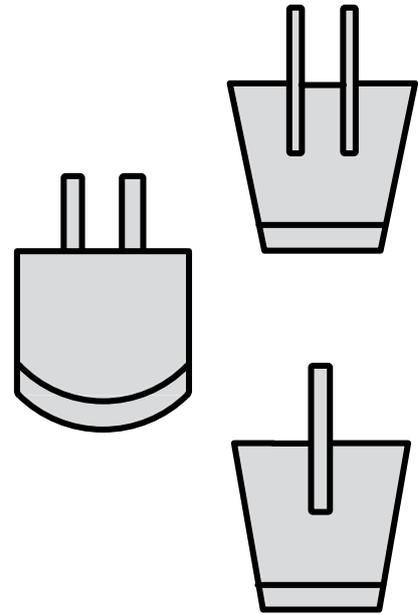

Ricambi & accessori per macchine agricole

SPARE PARTS & ACCESSORIES FOR AGRICULTURAL MACHINE

Tutti gli articoli della presente sezione, prodotti da AMA SPA e/o da terzi per conto di AMA, sono adattabili ("non originali") alle marche indicate ai sensi di quanto previsto dal REG. CE n. 1400/2002. I diritti sui marchi citati appartengono ai legittimi proprietari ed il loro uso ha l'esclusiva finalità di consentire all'utilizzatore la comparazione dei diversi prodotti. All items of this section, manufactured by AMA SPA and/or any third party on behalf of AMA, are adaptable ("non-original") to the brands listed under the provisions of the REG. CE n. 1400/2002. The rights on the trademarks belong to their respective owners and their usage is only aimed to allow the user to compare different products.

VANGHE PER VANGATRICI
BECHES POUR MACHINES A BECHER
SPADES FOR DIGGING MACHINES
SPATEN FÜR SPATENMASCHINEN
AZADAS PARA ESCARIFICADORAS

Brand	Art./Ref.	H mm	L mm	Ø Foro mm/Hole Ø mm	Interasse Fori mm/Distance between hole centers mm	Peso Kg/Weight Kg	Piatto/Plate mm	Immagine/Image
SICMA/MIGLIANICO	65815	340	170	14.5	70	3400	10	
	65816	340	200	14.5	70	3950	10	
TORTELLA	65818	340	170	14.5	65	3400	10	

1.10.6 Coltelli scavafossi

Blades for tranchers

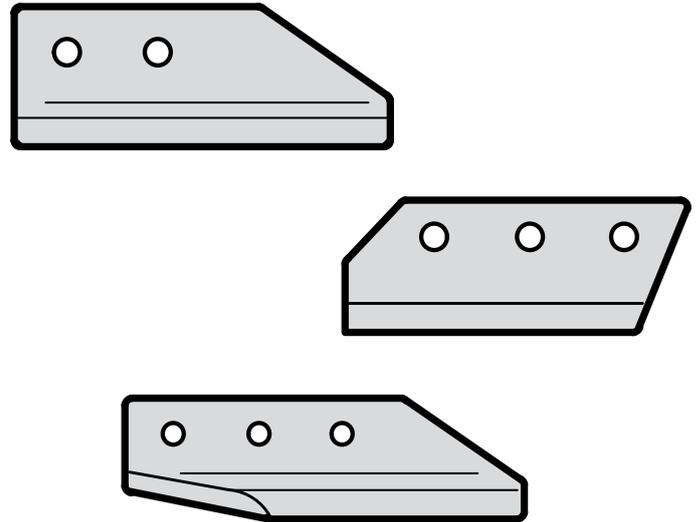

Ricambi & accessori per macchine agricole

SPARE PARTS & ACCESSORIES FOR AGRICULTURAL MACHINE

Tutti gli articoli della presente sezione, prodotti da AMA SPA e/o da terzi per conto di AMA, sono adattabili ("non originali") alle marche indicate ai sensi di quanto previsto dal REG. CE n. 1400/2002. I diritti sui marchi citati appartengono ai legittimi proprietari ed il loro uso ha l'esclusiva finalità di consentire all'utilizzatore la comparazione dei diversi prodotti. All items of this section, manufactured by AMA SPA and/or any third party on behalf of AMA, are adaptable ("non-original") to the brands listed under the provisions of the REG. CE n. 1400/2002. The rights on the trademarks belong to their respective owners and their usage is only aimed to allow the user to compare different products.

COLTELLI PER SCAVAFOSSI ADATTABILI ALLA PRODUZIONE BREVIGLIERI
COUTEAUX POUR FOSSEYEUSES ADAPTABLES A LA PRODUCT BREVIGLIERI
BLADES FOR TRENCHERS SUITABLE TO BREVIGLIERI PRODUCTION
MESSER FÜR GRABENFRASEN FÜR PFLUGKÖRPER PASSEND ZU BREVIGLIERI
CUCHILLAS PARA ZANJADORAS ADAPTABLE A LA PRODUCCION BREVIGLIERI

Brand	Art./Ref.	H mm	L mm	Ø Foro mm/Hole Ø mm	Interasse Fori mm/Distance between hole centers mm	Peso Kg/Weight Kg	Piatto/Plate mm	Immagine/Image
BREVIGLIERI	65714	-	160	12.5	50	560	60 x 10	
DAVIS	65720	68	125	17	50	770	90 x 8	
DONDI	65722	-	120	12.5	50	600	60 x 12	
	65723	60	185	12.5	50	850	90 x 8	

1.10.7 Zappe per motozappe, motocoltivatori, frese

Blades for motor hoes, walking tractors, rotary hoes



Ricambi & accessori per macchine agricole

SPARE PARTS & ACCESSORIES FOR AGRICULTURAL MACHINE

Tutti gli articoli della presente sezione, prodotti da AMA SPA e/o da terzi per conto di AMA, sono adattabili ("non originali") alle marche indicate ai sensi di quanto previsto dal REG. CE n. 1400/2002. I diritti sui marchi citati appartengono ai legittimi proprietari ed il loro uso ha l'esclusiva finalità di consentire all'utilizzatore la comparazione dei diversi prodotti. All items of this section, manufactured by AMA SPA and/or any third party on behalf of AMA, are adaptable ("non-original") to the brands listed under the provisions of the REG. CE n. 1400/2002. The rights on the trademarks belong to their respective owners and their usage is only aimed to allow the user to compare different products.

ZAPPE PER MOTOZAPPE, MOTOCOLTIVATORI, FRESE ADATTABILI ALLA PRODUZIONE ADRIATICA

COUTEAUX POUR MOTOFRAISEUSES ET MOTOCULTEURS ADAPTABLES A LA PRODUCTION ADRIATICA

BLADES FOR MOTOR HOES, WALKING TRACTORS, ROTARY HOES SUITABLE TO ADRIATICA PRODUCTION

MESSER FÜR BODENFRÄSEN FÜR PFLUGKÖRPER PASSEND ADRIATICA

AZADA PARA MOTOAZADAS, MOTOCULTIVADORES, FRESAS ADAPTABLES A LA PRODUCCION ADRIATICA

Brand	Art./Ref.	Cod. Comp. NAF	Rif. Orig./Orig. Ref.	Modello/Model	H mm	L mm	S mm	Ø Foro mm/Hole Ø mm	Interasse fori/Distance between hole centers mm	Piatto/Plate mm	Peso gr/Peso gr	Note/Note	Immagine/Image	
ADRIATICA	66023	-	-	DX/RH	80	205	40	8.5	70	35 x 6	400	ACF400 nuovo tipo curva		
	66024	-	-	SX/LH	80	205	40	8.5	70	35 x 6	400	ACF400 nuovo tipo curva		
AGRATOR	10176	ZHOW24D0BC	3901	DX/RH	132	180	20	13	57	80 x 7	1000	Bronty-Ripuntatore rompitraccia squadro		
	10177	ZHOW24S0BC	3900	SX/LH	132	180	20	13	57	80 x 7	1000	Bronty-Ripuntatore rompitraccia squadro		
AGRIA	51851	-	-	DX/RH	50	175	21	9	70	30 x 4	180	2100 corta squadro		
	51852	-	-	SX/LH	50	175	21	9	70	30 x 4	180	2100 corta ang. - elic.		
	66051	-	-	DX/RH	50	195	21	9	70	30 x 4	200	2100 - 4000 - 6000 squadro		
	66052	-	-	SX/LH	50	195	21	9	70	30 x 4	200	2100 - 4000 - 6000 squadro		
	66053	-	-	DX/RH	35	116	-	6.5	0	40 x 4	170	1 Foro curva		
	66054	-	-	SX/LH	35	116	-	6.5	0	40 x 4	170	1 Foro curva		
	66055	-	-	DX/RH	95	170	20	10.5	29-29	60 x 6	60 x 6	650	2700 a 3 fori squadro	
	66056	-	-	SX/LH	95	170	20	10.5	29-29	60 x 6	60 x 6	650	2700 a 3 fori squadro	
	66061	-	-	DX/RH	60	135	-	10.5	38	50 x 5	50 x 5	290	6623/6624	
	66062	-	-	SX/LH	60	135	-	10.5	38	50 x 5	50 x 5	290	6623/6624	
	51856	-	-	DX/RH	83	195	10	10.5	38	50 x 5	50 x 5		1767/12868 curva 1767/12869	
AGRIC	66069	ZIMC07D0BC	-	DX/RH	135	165	27	11.5	35	60 x 6	670	324/1-325/1 AFMJ 10 curva.		
	66070	ZIMC07S0BC	-	SX/LH	135	165	27	11.5	35	60 x 6	670	324/1-325/1 AFMJ 10 curva.		

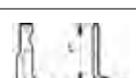
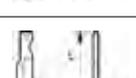
Brand	Art./Ref.	Cod. Comp. NAF	Rif. Orig./ Orig. Ref.	Modello/ Model	H mm	L mm	S mm	Ø Foro mm/ Hole Ø mm	Interasse fori/ Distance between hole centers mm	Piatto/ Plate mm	Peso gr/ Peso gr	Note/Note	Immagine/Image
BADALINI	66095	-	777	DX/RH	55	138	-	10.5	30	50 x 6	360	F/777 angolata	
	66096	-	777	SX/LH	55	138	-	10.5	30	50 x 6	360	F/777 angolata	
	66097	-	-	DX/RH	140	193	30	12.5	54	70 x 7	820	EC 2-3 3226 arco - elic.	
	66098	-	-	SX/LH	140	193	30	12.5	54	70 x 7	820	EC 2-3 3226 curva	
BARBIERI	66137	-	-	DX/RH	195	60	-	9	68	40 x 5	330	Z3 - BL75-85 curva	
	66138	-	-	SX/LH	195	60	-	9	68	40 x 5	330	Z3 - BL75-85 curva	
	66141	-	-	DX/RH	176	104	-	10.5	42	60 x 6	600	Fresa 29 - HP 16- 18 5323/4 curva	
	66142	-	-	SX/LH	176	104	-	10.5	42	60 x 6	600	Fresa 29 - HP 16- 18 5323/4 curva	
	66143	ZGOL16D0BC	-	DX/RH	195	70	-	10.5	80	45 x 5	330	Fresa 21 Mondial S.600 - 8833/4	
	66144	ZGOL16S0BC	-	SX/LH	195	70	-	10.5	80	45 x 5	330	Fresa 21 Mondial S.600 - 8833/4	
BARONI	66145	-	-	DX/RH	139	238	-	14.5	56	60 x 7	700	Export curva	
	66146	-	-	SX/LH	139	238	-	14.5	56	60 x 7	700	Export curva	
BCS	66157	-	BCS06	DX/RH	56	130	-	10.5	27	40 x 6	310	735 curva	
	66158	-	BCS06X	SX/LH	56	130	-	10.5	27	40 x 6	310	735 curva	
	66161	-	BCS10	DX/RH	74	173	25	12.5	46	60 x 7	650	745 Sicilia curva	
	66162	-	BCS10X	SX/LH	74	173	25	12.5	46	60 x 7	650	745 Sicilia curva	
	66165	-	BCS14	DX/RH	55	170	18	8.5	55	30 x 6	250	Fresa 20 corta squadro	
	66166	-	BCS14X	SX/LH	55	170	18	8.5	55	30 x 6	250	Fresa 20 corta squadro	

Brand	Art./Ref.	Cod. Comp. NAF	Rif. Orig./ Orig. Ref.	Modello/ Model	H mm	L mm	S mm	Ø Foro mm/ Hole Ø mm	Interasse fori/ Distance between hole centers mm	Piatto/ Plate mm	Peso gr/ Peso gr	Note/Note	Immagine/Image
BENASSI	66137	-	-	DX/RH	60	195	-	9	68	40 x 5	330	Z3 - BL75-85 curva	
	66138	-	-	SX/LH	60	195	-	9	68	40 x 5	330	Z3 - BL75-85 curva	
	66171	-	-	DX/RH	70	217	-	10.5	68	40 x 6	450	RL308-BL100 curva	
	66172	-	-	SX/LH	70	217	-	10.5	68	40 x 6	450	RL308-BL100 curva	
	66177	-	-	DX/RH	55	164	-	9	68	30 x 5	200	RT10-12/BN9-10 curva	
	66178	-	-	SX/LH	55	164	-	9	68	30 x 5	200	RT10-12/BN9-10 curva	
	66181	-	-	DX/RH	60	207	-	10.5	68	40 x 5	340	RL 303-304 curva	
	66182	-	-	SX/LH	60	207	-	10.5	68	40 x 5	340	RL 303-304 curva	
	66191	-	-	DX/RH	60	195	-	9	68	40 x 5	330	Z4 BL75-85 squadro	
	66199	-	-	DX/RH	70	218	15	10.5	68	40 x 6	470	S.308 squadro	
	66200	-	-	SX/LH	70	218	15	10.5	68	40 x 6	470	S.308 squadro	
	66207	-	-	DX/RH	55	198	-	9	65	30 x 4	160	RL 5 serie 350 curva	
66208	-	-	SX/LH	55	198	-	9	65	30 x 4	160	RL 5 serie 350 curva		
BERTOLINI	66167	-	-	DX/RH	72	190	20	10.5	66	30 x 6	290	1400 - 1700 S curva	
	66168	-	-	SX/LH	72	190	20	10.5	66	30 x 6	290	1400 - 1700 S curva	
	66217	-	-	DX/RH	80	245	-	12.5	90	50 x 6	570	S.310/S - 12522/3 curva	
	66218	-	-	SX/LH	80	245	-	12.5	90	50 x 6	570	S.310/S - 12522/3 curva	
	66220	-	-	SX/LH	88	145	-	10.5	28	50 x 6	410	S. 315 - 13014/5 curva	
	66233	-	-	DX/RH	52	170	15	8.5	58	25 x 5	180	Motocoltivatore top - max 305 curva	
	66234	-	-	SX/LH	52	170	15	8.5	58	25 x 5	180	Motocoltivatore top - max 305 curva	

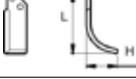
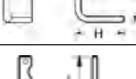
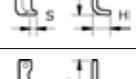
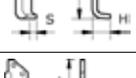
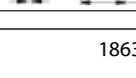
Brand	Art./Ref.	Cod. Comp. NAF	Rif. Orig./ Orig. Ref.	Modello/ Model	H mm	L mm	S mm	Ø Foro mm/ Hole Ø mm	Interasse fori/ Distance between hole centers mm	Piatto/ Plate mm	Peso gr/ Peso gr	Note/Note	Immagine/Image
BERTOLINI- YABE	66217	-	-	DX/RH	80	245	-	12.5	90	50 x 6	570	S.310/S - 12522/3 curva	
	66218	-	-	SX/LH	80	245	-	12.5	90	50 x 6	570	S.310/S - 12522/3 curva	
	66220	-	-	SX/LH	88	145	-	10.5	28	50 x 6	410	S. 315 - 13014/5 curva	
	66233	-	-	DX/RH	52	170	15	8.5	58	25 x 5	180	Motocoltivatore top - max 305 curva	
	66234	-	-	SX/LH	52	170	15	8.5	58	25 x 5	180	Motocoltivatore top - max 305 curva	
BONFIGLIOLI	66237	-	-	DX/RH	72	232	38	10.5	105	35 x 8	550	Interfilare curva	
	66238	-	-	SX/LH	72	232	38	10.5	105	35 x 8	550	Interfilare curva	
BREVIGLIERI	11051	ZGOL53D0BC	-	DX/RH	120	170	10	12.5	40	70 x 6	680	4RM 300/400 450 curva	
	11052	ZGOL53S0BC	-	SX/LH	120	170	10	12.5	40	70 x 6	680	4RM 300/400 450 curva	
	51858	ZBRE12D0BC	-	DX/RH	120	170	10	12.5	40	70 x 6	720	B1,B45 8300022/23 squadro	
	51859	ZBRE12S0BC	-	SX/LH	120	170	10	12.5	40	70 x 6	720	B1,B45 8300022/23 squadro	
	66241	-	-	DX/RH	105	218	-	14.5	39-76	90 x 8	1200	B300 0066046 curva	
	66242	-	-	SX/LH	105	218	-	14.5	39-76	90 x 8	1200	B300 0066046 curva	
	51860	ZBRE29D0BC	0040103D	DX/RH	135	180	15	12.5	57	80 x 7	1020	B50 squadro	
	51861	ZBRE29S0BC	0040103S	SX/LH	135	180	15	12.5	57	80 x 7	1020	B50 squadro	
	51862	ZBRE01D0BC	-	DX/RH	52	185	6	9	70	30 x 6	280	M21 - 15219 squadro	
	51863	ZBRE01S0BC	-	SX/LH	52	185	6	9	70	30 x 6	280	M21 - 15219 squadro	
	51864	ZBRE10D0BC	-	DX/RH	60	133	6	10.5	35	50 x 6	340	FP squadro	
	51865	ZBRE10S0BC	-	SX/LH	60	133	6	10.5	35	50 x 6	340	FP squadro	

Brand	Art./Ref.	Cod. Comp. NAF	Rif. Orig./ Orig. Ref.	Modello/ Model	H mm	L mm	S mm	Ø Foro mm/ Hole Ø mm	Interasse fori/ Distance between hole centers mm	Piatto/ Plate mm	Peso gr/ Peso gr	Note/Note	Immagine/Image
BREVIGLIERI	11049	ZBRE18D0BC	-	DX/RH	116	170	10	12.5	40	60 x 6	570	B10, B20 - 0030104 curva	
	11050	ZBRE18S0BC	-	SX/LH	116	170	10	12.5	40	60 x 6	570	B10, B20 - 0030104 curva	
	66245	DBRE33D0BC	-	DX/RH	210	-	-	16.5	44	60 x 10	900	B200V dente 50175	
	66246	DBRE33S0BC	-	SX/LH	210	-	-	16.5	44	60 x 10	900	B200V dente 50175	
	66247	ZBRE37D0BC	-	DX/RH	100	220	22	14.5	46	80 x 8	1130	B3, B14 B101 0003061 curva	
	66248	ZBRE37S0BC	-	SX/LH	100	220	22	14.5	46	80 x 8	1130	B3, B14 B101 0003061 curva	
	66251	ZCEL21D0BC	0064811D	DX/RH	136	195	12	14.5	57	80 x 8	1200	G HP100 oltre curva	
	66252	ZCEL21S0BC	0064811S	SX/LH	136	195	12	14.5	57	80 x 8	1200	G HP100 oltre curva	
	66253	ZCEL22D0BC	-	DX/RH	136	180	12	14.5	57	80 x 8	1230	T 4 pesante squadro	
	66254	ZCEL22S0BC	-	SX/LH	136	180	12	14.5	57	80 x 8	1230	T 4 pesante squadro	
	10178	ZBRE37D0BC	0040105D	DX/RH	140	183	-	12.5	57	80 x 7	1000	Mod.40105 / U-E 9948/49 curva	
	10179	ZBRE37S0BC	0040105S	SX/LH	140	183	-	12.5	57	80 x 7	1000	Mod.40105 / U-E 9948/49 curva	
	81256	ZBRE21D0BC	-	DX/RH	115	188	10	12.5	40	70 x 6	680	Zappetta 10279 curva	
	81257	ZBRE21S0BC	-	SX/LH	115	188	10	12.5	40	70 x 6	680	Zappetta 10279 curva	
BRUMITAL	66275	-	-	DX/RH	70	220	-	10.5	70	40 x 6	400	DS10 curva	
	66276	-	-	SX/LH	70	220	-	10.5	70	40 x 6	400	DS10 curva	
	66283	-	-	DX/RH	60	205	-	10.5	70	40 x 6	390	DS10 interna curva	
	66284	-	-	SX/LH	60	205	-	10.5	70	40 x 6	390	DS10 interna curva	
BRUMITAL- AGRIS	66275	-	-	DX/RH	70	220	-	10.5	70	40 x 6	400	DS10 curva	
	66276	-	-	SX/LH	70	220	-	10.5	70	40 x 6	400	DS10 curva	

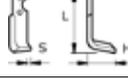
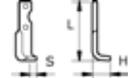
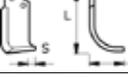
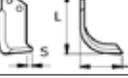
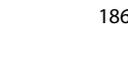
Brand	Art./Ref.	Cod. Comp. NAF	Rif. Orig./ Orig. Ref.	Modello/ Model	H mm	L mm	S mm	Ø Foro mm/ Hole Ø mm	Interasse fori/ Distance between hole centers mm	Piatto/ Plate mm	Peso gr/ Peso gr	Note/Note	Immagine/Image
BRUMITAL- AGRIS	66283	-	-	DX/RH	60	205	-	10.5	70	40 x 6	390	DS10 interna curva	
	66284	-	-	SX/LH	60	205	-	10.5	70	40 x 6	390	DS10 interna curva	
	66289	-	-	DX/RH	70	220	15	10.5	70	45 x 6	470	DS10 interna angolata	
	66290	-	-	SX/LH	70	220	15	10.5	70	45 x 6	470	DS10 interna angolata	
CALDERONI	66329	-	-	DX/RH	85	220	59	10.5	106	40 x 8	640	FP interfilare curva	
	66330	-	-	SX/LH	85	220	59	10.5	106	40 x 8	640	FP interfilare curva	
CARRARO ANTONIO	66335	-	-	DX/RH	65	185	178	8.5	55	30 x 6	270	Carrarino Mini HP 8 curva	
	66336	-	-	SX/LH	65	185	178	8.5	55	30 x 6	270	Carrarino Mini HP 8 arco - elic.	
CASORZO	66353	-	-	DX/RH	60	220	15	9	72	35 x 6	400	Vigneto lunga SU4 squadro	
	66354	-	-	SX/LH	60	220	15	9	72	35 x 6	400	Vigneto lunga SU4 ang/el.	
CELLI	66251	ZCEL21D0BC	722537	DX/RH	136	195	12	14.5	57	80 x 8	1200	G HP100 oltre curva	
	66252	ZCEL21S0BC	722538	SX/LH	136	195	12	14.5	57	80 x 8	1200	G HP100 oltre curva	
	66253	ZCEL22D0BC	722533	DX/RH	136	180	12	14.5	57	80 x 8	1230	T 4 pesante squadro	
	66254	ZCEL22S0BC	722534	SX/LH	136	180	12	14.5	57	80 x 8	1230	T 4 pesante squadro	
	66367	ZCEL11D0BC	322518	DX/RH	136	195	12	14.5	57	80 x 6	820	B HP25/55 interfi- lare ar/curva	
	66368	ZCEL11S0BC	322519	SX/LH	136	195	12	14.5	57	80 x 6	820	B HP25/55 interfi- lare ar/curva	
	66369	ZCEL12D0BC	322516	DX/RH	136	180	12	14.5	57	80 x 6	840	B HP25/55 interfi- lare ar/curva	
	66370	ZCEL12S0BC	322517	SX/LH	136	180	12	14.5	57	80 x 6	840	B HP25/55 interfi- lare ar/curva	
	10170	ZCEL17D0BC	422514	Dx/Rh	136	195	12	14.5	57	80 x 7	980	EMF curva	
	10171	ZCEL17S0BC	422515	Sx/Lh	136	195	12	14.5	57	80 x 7	980	EMF curva	

Brand	Art./Ref.	Cod. Comp. NAF	Rif. Orig./ Orig. Ref.	Modello/ Model	H mm	L mm	S mm	Ø Foro mm/ Hole Ø mm	Interasse fori/ Distance between hole centers mm	Piatto/ Plate mm	Peso gr/ Peso gr	Note/Note	Immagine/Image
CELLI	10172	ZCEL16D0BC	422512	DX/RH	136	180	12	14.5	57	80 x 7	1000	GS squadro	
	10173	ZCEL16S0BC	422513	SX/LH	136	180	12	14.5	57	80 x 7	1000	GS squadro	
	66375	-	522600	DX/RH	111	174	20	12.5	44	60 x 6	580	AL-BA-HBA-FBA curva	
	66376	-	522601	SX/LH	111	174	20	12.5	44	60 x 6	580	AL-BA-HBA-FBA curva	
	66377	-	522602	DX/RH	110	174	20	12.5	44	60 x 6	610	AL-BA-HBA-FBA squadro	
	66378	-	522603	SX/LH	110	174	20	12.5	44	60 x 6	610	AL-BA-HBA-FBA squadro	
	10174	-	422530	DX/RH	202	-	-	16.5	45	50 x 12	850	Lama Frangizolle	
	10175	-	422531	SX/LH	202	-	-	16.5	45	50 x 12	850	Lama Frangizolle	
	66383	-	331528	DX/RH	136	196	12	14.5	50	70 x 7	870	Tipo CE curva	
	66384	-	331529	SX/LH	136	196	12	14.5	50	70 x 7	870	Tipo CE curva	
	66385	-	331526	DX/RH	136	180	20	14.5	50	70 x 7	900	Tipo CE squadro	
	66386	-	331527	SX/LH	136	180	20	14.5	50	70 x 7	900	Tipo CE squadro	
	66387	-	531511	DX/RH	111	164	20	12.5	40	60 x 6	580	Tipo AG curva	
	66388	-	531512	SX/LH	111	164	20	12.5	40	60 x 6	580	Tipo AG curva	
COMEB	66413	-	-	DX/RH	55	135	-	10.5	32	50 x 5	280	FP CP7 mais curva	
	66414	-	-	SX/LH	55	135	-	10.5	32	50 x 5	280	FP CP7 mais curva	
	66417	-	-	DX/RH	40	120	-	10.5	32	50 x 5	220	FL FP CP8 bietola corta curva	
	66418	-	-	SX/LH	40	120	-	10.5	32	50 x 5	220	FL FP CP8 bietola corta curva	
DEL MORINO	66443	ZDLM01D0BC	HOL154D	DX/RH	110	160	16	12.5	34	60 x 6	580	Fresa URT-OL curva	
	66444	ZDLM01S0BC	HOL215D	SX/LH	110	160	16	12.5	34	60 x 6	580	Fresa URT-OL curva	
DIESE	66447	-	-	DX/RH	70	220	-	10,5- 19x10,5	65-73	40 x 6	420	Zappa Con asola t.medio curva	

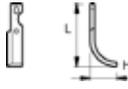
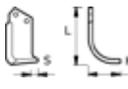
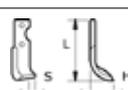
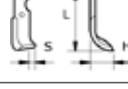
Brand	Art./Ref.	Cod. Comp. NAF	Rif. Orig./ Orig. Ref.	Modello/ Model	H mm	L mm	S mm	Ø Foro mm/ Hole Ø mm	Interasse fori/ Distance between hole centers mm	Piatto/ Plate mm	Peso gr/ Peso gr	Note/Note	Immagine/Image
DIESSE	66448	-	-	SX/LH	70	220	-	10,5- 19x10,5	65-73	40 x 6	420	Zappa Con asola t.medio curva	
DONDI	66453	ZDON11D0BC	-	DX/RH	120	190	20	12.5	40	70 x 7	850	0 n.t. per DCM curva	
	66454	ZDON11S0BC	-	SX/LH	120	190	20	12.5	40	70 x 7	850	0 n.t. per DCM curva	
	66457	-	-	DX/RH	116	215	10	14.5	54	80 x 8	1220	R arco/elic.	
	66458	-	-	SX/LH	116	215	10	14.5	54	80 x 8	1220	R arco/elic.	
	66459	ZDON18D0BC	-	DX/RH	112	228	22	14.5	46	80 x 8	1220	B (più aperta) Dondi B1 curva	
	66460	ZDON18S0BC	-	SX/LH	112	228	22	14.5	46	80 x 8	1220	B (più aperta) Dondi B1 curva	
	66461	ZGOL51D0BC	-	DX/RH	113	205	22	12.5	54	70 x 6	720	Fresa 40 F.27/28 Universal 9506/7 curva	
	66462	ZGOL51S0BC	-	SX/LH	113	205	22	12.5	54	70 x 6	720	Fresa 40 F.27/28 Universal 9506/7 curva	
	11053	ZDON17D0BC	-	DX/RH	110	205	22	14.5	46	80 x 8	1170	B (908/909)- Don- di B curva	
	11054	ZDON17S0BC	-	SX/LH	110	205	22	14.5	46	80 x 8	1170	B (908/909)- Don- di B curva	
EMY-ELENFER	66471	ZMAL06D0BC	-	DX/RH	107	175	20	14.5	40	60 x 7	700	PL nuovo ModellO curva	
	66472	ZMAL06S0BC	-	SX/LH	107	175	20	14.5	40	60 x 7	700	PL nuovo ModellO curva	
EUROSY- STEMS	66477	-	-	DX/RH	69	196	17	8.5	73	35 x 5	270	Euro 6 - curva	
	66478	-	-	SX/LH	69	196	17	8.5	73	35 x 5	270	Euro 6 - curva	
	66483	-	-	DX/RH	78	183	-	10.5	65	25 x 5	190	Tipo 300 curva	
	66484	-	-	SX/LH	78	183	-	10.5	65	25 x 5	190	Tipo 300 curva	

Brand	Art./Ref.	Cod. Comp. NAF	Rif. Orig./ Orig. Ref.	Modello/ Model	H mm	L mm	S mm	Ø Foro mm/ Hole Ø mm	Interasse fori/ Distance between hole centers mm	Piatto/ Plate mm	Peso gr/ Peso gr	Note/Note	Immagine/Image
EUROSY- STEMS	66485	-	-	DX/RH	80	217	-	10.5	73	40 x 6	440	G72 curva	
	66486	-	-	SX/LH	80	217	-	10.5	73	40 x 6	440	G72 curva	
FALC	10170	ZCEL17D0BC	-	Dx/Rh	136	195	12	14.5	57	80 x 7	980	EMF curva	
	10171	ZCEL17S0BC	-	Sx/Lh	136	195	12	14.5	57	80 x 7	980	EMF curva	
FALCONERO	10170	ZCEL17D0BC	-	Dx/Rh	136	195	12	14.5	57	80 x 7	980	EMF curva	
	10171	ZCEL17S0BC	-	Sx/Lh	136	195	12	14.5	57	80 x 7	980	EMF curva	
FERRARI	66163	-	-	DX/RH	55	193	18	8.5	55	30 x 6	270	Motocoltivatore XB40-SB30 curva	
	66164	-	-	SX/LH	55	193	18	8.5	55	30 x 6	270	Motocoltivatore XB40-SB30 curva	
	66483	-	-	DX/RH	78	183	-	10.5	65	25 x 5	190	Tipo 300 curva	
	66484	-	-	SX/LH	78	183	-	10.5	65	25 x 5	190	Tipo 300 curva	
	66485	-	-	DX/RH	80	217	-	10.5	73	40 x 6	440	G72 curva	
	66486	-	-	SX/LH	80	217	-	10.5	73	40 x 6	440	G72 curva	
	66505	-	-	DX/RH	92	163	20	10.5	25	50 x 6	430	72 Super curva	
	66506	-	-	SX/LH	92	163	20	10.5	25	50 x 6	430	72 Super curva	
	66509	-	-	DX/RH	88	195	-	10.5	65	35 x 6	350	91/92 curva	
	66510	-	-	SX/LH	88	195	-	10.5	65	35 x 6	350	91/92 curva	

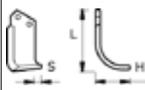
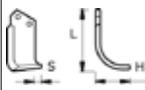
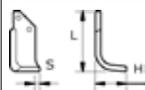
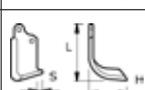
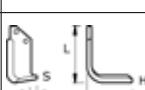
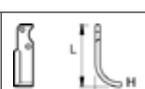
Brand	Art./Ref.	Cod. Comp. NAF	Rif. Orig./ Orig. Ref.	Modello/ Model	H mm	L mm	S mm	Ø Foro mm/ Hole Ø mm	Interasse fori/ Distance between hole centers mm	Piatto/ Plate mm	Peso gr/ Peso gr	Note/Note	Immagine/Image
FERRI & SIMONI	66459	-	-	DX/RH	112	228	22	14.5	46	80 x 8	1220	B (piú aperta) Dondi B1 curva	
	66460	-	-	SX/LH	112	228	22	14.5	46	80 x 8	1220	B (piú aperta) Dondi B1 curva	
FORIGO- ROTERTALIA	66523	-	-	DX/RH	120	175	10	12.5	46	70 x 7	740	F2 curva	
	66541	ZMAS21D0BC	-	DX/RH	135	196	15	14.5	48	80 x 7	980	U curva	
	66542	ZMAS21S0BC	-	SX/LH	135	196	15	14.5	48	80 x 7	980	U curva	
	66545	-	-	DX/RH	109	175	10	12.5	46	70 x 7	820	Squadro	
	66546	-	-	SX/LH	109	175	10	12.5	46	70 x 7	820	Squadro	
FORT	66553	-	-	DX/RH	80	215	-	10.5	65	45 x 6	490	Tigrotto FT3 curva	
	66554	-	-	SX/LH	80	215	-	10.5	65	45 x 6	490	Tigrotto FT3 curva	
	66561	-	-	DX/RH	64	190	-	9	70	35 x 5	280	Micro 1-2-3 curva	
	66562	-	-	SX/LH	64	190	-	9	70	35 x 5	280	Micro 1-2-3 curva	
	66141	-	-	DX/RH	104	176	-	10.5	42	60 x 6	600	Fresa 29 - HP 16- 18 5323/4 curva	
	66142	-	-	SX/LH	104	176	-	10.5	42	60 x 6	600	Fresa 29 - HP 16- 18 5323/4 curva	
GOLDONI	66141	-	-	DX/RH	104	176	-	10.5	42	60 x 6	600	Fresa 29 - HP 16- 18 5323/4 curva	
	66142	-	-	SX/LH	104	176	-	10.5	42	60 x 6	600	Fresa 29 - HP 16- 18 5323/4 curva	
	66143	ZGOL16D0BC	8834	DX/RH	70	195	-	10.5	80	45 x 5	330	Fresa 21 Mondial S.600 - 8833/4	
	66144	ZGOL16S0BC	8833	SX/LH	70	195	-	10.5	80	45 x 5	330	Fresa 21 Mondial S.600 - 8833/4	
	66461	ZGOL51D0BC	9506	DX/RH	113	205	22	12.5	54	70 x 6	720	Fresa 40 F.27/28 Universal 9506/7 curva	
	66462	ZGOL51S0BC	9507	SX/LH	113	205	22	12.5	54	70 x 6	720	Fresa 40 F.27/28 Universal 9506/7 curva	

Brand	Art./Ref.	Cod. Comp. NAF	Rif. Orig./ Orig. Ref.	Modello/ Model	H mm	L mm	S mm	Ø Foro mm/ Hole Ø mm	Interasse fori/ Distance between hole centers mm	Piatto/ Plate mm	Peso gr/ Peso gr	Note/Note	Immagine/Image
GOLDONI	66571	-	2064	DX/RH	70	180	-	9	30	35 x 8	430	Export 2064/5 curva	
	66572	-	2065	SX/LH	70	180	-	9	30	35 x 8	430	Export 2064/5 curva	
	66573	ZGOL37D0BC	3935	DX/RH	110	250	-	12.5	99	60 x 6	700	Export 518 - fresa 28 3935/6	
	66574	ZGOL37S0BC	3936	SX/LH	110	250	-	12.5	99	60 x 6	700	Export 518 - fresa 28 3935/6	
	66575	-	5624312	DX/RH	90	170	15	10.5	42	60 x 6	510	Fresa 22 M - 29 4265/4312 curva	
	66576	-	5624256	SX/LH	90	170	15	10.5	42	60 x 6	510	Fresa 22 M - 29 4265/4312 curva	
	66577	ZGOL11D0BC	14191	DX/RH	71	176	-	10.5	70	40 x 6	340	Fresa 21 Tipo Corto 14191/2 squadro	
	66578	ZGOL11S0BC	14193	SX/LH	71	176	-	10.5	70	40 x 6	340	Fresa 21 Tipo Corto 14191/2 squadro	
	66579	-	2070	DX/RH	80	185	-	9-12x9	30-33	35 x 6	330	Special fresa 22 2070/01 foro 0 curva	
	66580	-	2071	SX/LH	80	185	-	9-12x9	30-33	35 x 6	330	Special fresa 22 2070/01 foro 0 curva	
	66583	ZGOL17D0BC	9402	DX/RH	80	190	-	10.5	33	45 x 5	400	Special fresa 22 9401/2	
	66584	ZGOL17S0BC	9401	SX/LH	80	190	-	10.5	33	45 x 5	400	Special fresa 22 9401/2	
	66585	ZGOL36D0BC	434	DX/RH	110	240	-	10.5	99	60 x 6	700	Super-Export 434/5	
	66586	ZGO36S0BC	435	SX/LH	110	240	-	10.5	99	60 x 6	700	Super-Export 434/5	
	66587	ZGOL22D0BC	2692	DX/RH	67	199	-	10.5	80	45 x 5	360	Mondial F.21 002692/3	
	66588	ZGOL22S0BC	2693	SX/LH	67	199	-	10.5	80	45 x 5	360	Mondial F.21 002692/3	
	66589	ZGOL39D0BC	9417	DX/RH	103	187	10	12.5	42-46	60 x 6	580	Fresa 50 - Mod. 719 9417/8	
	66590	-	9418	SX/LH	103	187	10	12.5	42-46	60 x 6	580	Fresa 50 - Mod. 719 9417/8	
11057	-	13546	DX/RH	86	147	-	10.5	39	50 x 5	330	Fresa 21 M - S.600 13545/6		

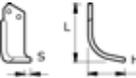
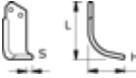
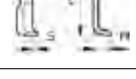
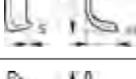
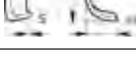
Brand	Art./Ref.	Cod. Comp. NAF	Rif. Orig./ Orig. Ref.	Modello/ Model	H mm	L mm	S mm	Ø Foro mm/ Hole Ø mm	Interasse fori/ Distance between hole centers mm	Piatto/ Plate mm	Peso gr/ Peso gr	Note/Note	Immagine/Image
GOLDONI	11058	-	13545	SX/LH	86	147	-	10.5	39	50 x 5	330	Fresa 21 M - S.600 13545/6	
	11055	-	14486	DX/RH	100	190	20	10.5	42	45 x 5	400	Fresa tipo nuovo 14486/7	
	11056	-	14487	SX/LH	100	190	20	10.5	42	45 x 5	400	Fresa tipo nuovo 14486/7	
	66597	-	4312	DX/RH	102	170	15	10.5	42	60 x 6	490	Fresa 22M tipo nuovo 4312/4265	
	66598	-	4265	SX/LH	102	170	15	10.5	42	60 x 6	490	Fresa 22M tipo nuovo 4312/4265	
GRAMEGNA	66601	-	-	DX/RH	115	197	-	12.5	55	80 x 8	1070	Curva	
	66602	-	-	SX/LH	115	197	-	12.5	55	80 x 8	1070	Curva	
GRILLO	66153	-	-	DX/RH	165	55	20	9	55	25 x 6	200	Motocoltivatore 1000 curva	
	66154	-	-	SX/LH	165	55	20	9	55	25 x 6	200	Motocoltivatore 1000 curva	
	66167	-	-	DX/RH	190	72	20	10.5	66	30 x 6	290	1400 - 1700 S curva	
	66168	-	-	SX/LH	190	72	20	10.5	66	30 x 6	290	1400 - 1700 S curva	
	66169	-	-	DX/RH	152	72	23	10.5	40	50 x 6	370	532 tipo nuovo curva	
	66170	-	-	SX/LH	152	72	23	10.5	40	50 x 6	370	532 tipo nuovo curva	
	66609	-	-	DX/RH	195	61	20	9	55	30 x 6	320	Motocoltivatore 126/127 rinforza- ta x 4 curva	
	66610	-	-	SX/LH	195	61	20	9	55	30 x 6	320	Motocoltivatore 126/127 rinforza- ta x 4 curva	
	66611	-	-	DX/RH	210	69	-	10.5	66	40 x 6	400	Motozappa 12000 curva	
	66612	-	-	SX/LH	210	69	-	10.5	66	40 x 6	400	Motozappa 12000 curva	

Brand	Art./Ref.	Cod. Comp. NAF	Rif. Orig./ Orig. Ref.	Modello/ Model	H mm	L mm	S mm	Ø Foro mm/ Hole Ø mm	Interasse fori/ Distance between hole centers mm	Piatto/ Plate mm	Peso gr/ Peso gr	Note/Note	Immagine/Image
HONDA	66637	-	-	DX/RH	46	205	-	9	70	30 x 5	240	F300 curva	
	66638	-	-	SX/LH	46	205	-	9	70	30 x 5	240	F300 curva	
	66639	-	-	DX/RH	70	230	50	11	80	35 x 5	350	501 sciabola curva	
	66640	-	-	SX/LH	70	230	50	11	80	35 x 5	350	502 sciabola curva	
	66641	-	-	DX/RH	70	230	50	11	80	35 x 5	350	510-560 sciabola curva	
	66642	-	-	SX/LH	70	230	50	11	80	35 x 5	350	510-560 sciabola curva	
	66645	-	-	DX/RH	70	203	-	9	70	30 x 6	260	F400/79 curva	
HOWARD ROTAVATOR	10178	ZBRE37D0BC	9949	DX/RH	140	183	-	12.5	57	80 x 7	1000	Mod.40105 / U-E 9948/49 curva	
	10179	ZBRE37S0BC	9948	SX/LH	140	183	-	12.5	57	80 x 7	1000	Mod.40105 / U-E 9948/49 curva	
	10180	ZHOW11D0BC	9954	DX/RH	140	175	-	11.5	57	75 x 6	840	P-HL 9953/54 curva	
	10181	ZHOW11S0BC	9953	SX/LH	140	175	-	11.5	57	75 x 6	840	P-HL 9953/54 curva	
	10182	ZHOW12D0BC	9900	DX/RH	140	170	-	11.5	57	75 x 6	840	P-HL 9923/24 9900/01 squadra	
	10183	ZHOW12S0BC	9901	SX/LH	140	170	-	11.5	57	75 x 6	840	P-HL 9923/24 9900/01 squadra	
	10176	ZHOW24D0BC	3900	DX/RH	132	180	20	13	57	80 x 7	1000	Bronty-Ripunta- tore rompitraccia squadro	
	10177	ZHOW24S0BC	3901	SX/LH	132	180	20	13	57	80 x 7	1000	Bronty-Ripunta- tore rompitraccia squadro	
	66655	ZHOW23D0BC		DX/RH	130	210	20	13	57	80 x 8	1150	U rinforzata curva	
	66656	ZHOW23S0BC		SX/LH	130	210	20	13	57	80 x 8	1150	U rinforzata curva	
	66657	ZHOW24D0BC		DX/RH	132	180	20	13	57	80 x 8	1150	U rinforzata squadro	
	66658	ZHOW24S0BC		SX/LH	132	180	20	13	57	80 x 8	1150	U rinforzata squadro	
	10186	ZHOW06D0BC	9941	DX/RH	105	273	20	11.5	114	40 x 8	780	Rotacadet 9941/42 curva	
	10187	ZHOW06S0BC	9942	SX/LH	105	273	20	11.5	114	40 x 8	780	Rotacadet 9941/42 curva	

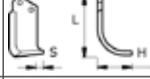
Brand	Art./Ref.	Cod. Comp. NAF	Rif. Orig./ Orig. Ref.	Modello/ Model	H mm	L mm	S mm	Ø Foro mm/ Hole Ø mm	Interasse fori/ Distance between hole centers mm	Piatto/ Plate mm	Peso gr/ Peso gr	Note/Note	Immagine/Image
HOWARD ROTAVATOR	66661	ZHOW81D0BC	9862	DX/RH	138	180	20	16.5	51	80 x 10	1500	M-KU 9919/20 9862/63 squadra	
	66662	ZHOW81S0BC	9863	SX/LH	138	180	20	16.5	51	80 x 10	1500	M-KU 9919/20 9862/63 squadra	
	11043	ZHOW52D0BC	756785	DX/RH	150	200	-	16.5	75	105 x 8	1700	T. 756784/5 2719/29 squadra	
	11044	ZHOW52S0BC	756784	SX/LH	150	200	-	16.5	75	105 x 8	1700	T. 756784/5 2719/29 squadra	
	66663	-	624401	DX/RH	132	180	-	11.5	57	80 x 7	1000	HA 624400/1 squadra	
	66664	-	624400	SX/LH	132	180	-	11.5	57	80 x 7	1000	HA 624400/1 squadra	
	09140	ZHOW09D0BC	647255	DX/RH	-	235	-	16.5	50	50 x 12	1030	Rotalabour 647250/255	
	10185	ZHOW09S0BC	647250	SX/LH	-	235	-	16.5	50	50 x 12	1030	Rotalabour 647250/255	
	66671	ZHOW42D0BC	3901	DX/RH	140	170	-	13	57	90 x 6	1080	E, AR, HR20-&30 3900/01 squadra	
	66672	ZHOW42S0BC	3900	SX/LH	140	170	-	13	57	90 x 6	1080	E, AR, HR20-&30 3900/01 squadra	
	66681	-	9877	DX/RH	100	175	10	11.5	57	80 x 6	750	9876/77 curva	
	66682	-	9876	SX/LH	100	175	10	11.5	57	80 x 6	750	9876/77 curva	
	10184	-	653256	SX/LH	-	235	-	16.5	50	60 x 12	1250	Rotalabour t.pesante 653256/57	
KRONE	66705	-	-	DX/RH	128	190	-	14.5	35	65 x 7	760	RE/S 35-32-3-KS squadra	
	66706	-	-	SX/LH	128	190	-	14.5	35	65 x 7	760	RE/S 35-32-3-KS squadra	
	05670	ZKRO17D0BC	-	DX/RH	138	188	-	14.5	57	80 x 7	1000	REV/S-BK/G 35- 32-5/S squadra	
	07413	ZKRO17S0BC	-	SX/LH	138	188	-	14.5	57	80 x 7	1000	REV/S-BK/G 35- 32-5/S squadra	
KUHN	66725	-	-	DX/RH	100	240	-	12.5	105	40 x 8	660	EL 25 DX/ SX Rif.orig. 520115/520116 curva	
	66726	-	-	SX/LH	100	240	-	12.5	105	40 x 8	660	EL 25 DX/ SX Rif.orig. 520115/520116 curva	
	66743	-	523248	DX/RH	135	165	-	16.5	57	90 x 8	1270	EL131 DX/ SX Rif.orig. 523248/523249 squadra	

Brand	Art./Ref.	Cod. Comp. NAF	Rif. Orig./ Orig. Ref.	Modello/ Model	H mm	L mm	S mm	Ø Foro mm/ Hole Ø mm	Interasse fori/ Distance between hole centers mm	Piatto/ Plate mm	Peso gr/ Peso gr	Note/Note	Immagine/Image
KUHN	66749	-	523590	SX/LH	135	203	-	16.5	76	100 x 8	-	EL201 SX/ DX Rif.orig. 523591/523590 squadro	
	66750	-	523591	DX/RH	135	203	-	16.5	76	100 x 8	1600	EL201 SX/ DX Rif.orig. 523591/523590 squadro	
	66777	-	-	DX/RH	135	186	16	14.5	57	80 x 7	980	EL80N-81- 100N Rif.orig. 519370/519371 curva	
	66778	-	-	SX/LH	135	186	16	14.5	57	80 x 7	980	EL80N-81- 100N Rif.orig. 519370/519371 curva	
KVERNELAND- MALETTI	10170	ZCEL17D0BC	-	Dx/Rh	136	195	12	14.5	57	80 x 7	980	EMF curva	
	10171	ZCEL17S0BC	-	Sx/Lh	136	195	12	14.5	57	80 x 7	980	EMF curva	
	10172	ZCEL16D0BC	-	DX/RH	136	180	12	14.5	57	80 x 7	1000	GS squadro	
	10173	ZCEL16S0BC	-	SX/LH	136	180	12	14.5	57	80 x 7	1000	GS squadro	
	66459	ZMAL12D0BC	-	DX/RH	112	228	22	14.5	46	80 x 8	1220	B (più aperta) Dondi B1 curva	
	66460	ZMAL12S0BC	-	SX/LH	112	228	22	14.5	46	80 x 8	1220	B (più aperta) Dondi B1 curva	
	11053	ZMAL21D0BC	500077	DX/RH	110	205	22	14.5	46	80 x 8	1170	B (908/909)- Don- di B curva	
	11054	-	500078	SX/LH	110	205	22	14.5	46	80 x 8	1170	B (908/909)- Don- di B curva	
	66471	-	1302177	DX/RH	107	175	20	14.5	40	60 x 7	700	PL nuovo ModelLO curva	
	66472	-	132178	SX/LH	107	175	20	14.5	40	60 x 7	700	PL nuovo ModelLO curva	
	51881	-	500079	DX/RH	115	207	22	14.5	46	80 x 8	1290	B squadro	
	51882	-	500080	SX/LH	115	207	22	14.5	46	80 x 8	1290	B squadro	
	66781	-	700077	DX/RH	133	223	34	14.5	44-44	75 x 10	1280	G a 3 fori curva	
	66782	-	700078	SX/LH	133	223	34	14.5	44-44	75 x 10	1280	G a 3 fori curva	
	66785	-	100077	DX/RH	110	200	22	14.5	45	70 x 8	970	PM curva	
66786	-	100078	SX/LH	110	200	22	14.5	45	70 x 8	970	PM curva		
11059	-	100079	DX/RH	110	200	22	14.5	45	70 x 8	1030	PM squadro		

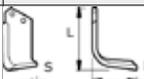
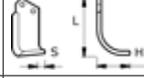
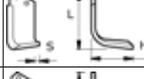
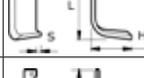
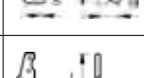
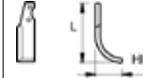
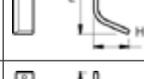
Brand	Art./Ref.	Cod. Comp. NAF	Rif. Orig./ Orig. Ref.	Modello/ Model	H mm	L mm	S mm	Ø Foro mm/ Hole Ø mm	Interasse fori/ Distance between hole centers mm	Piatto/ Plate mm	Peso gr/ Peso gr	Note/Note	Immagine/Image
KVERNELAND- MALETTI	11060	-	100080	SX/LH	110	200	22	14.5	45	70 x 8	1030	PM squadro	
	66787	-	1300077	DX/RH	105	185	20	14.5	45	60 x 7	710	PL curva	
	66788	-	1300078	SX/LH	105	185	20	14.5	45	60 x 7	710	PL curva	
	66789	-	1300078	DX/RH	105	175	20	14.5	45	60 x 7	710	PL squadro	
	66790	-	1300078	SX/LH	105	175	20	14.5	45	60 x 7	760	PL squadro	
	66791	-	1300078	DX/RH	90	248	-	12.5	106	40 x 8	650	L curva	
	66792	-	1300078	SX/LH	90	248	-	12.5	106	40 x 8	650	L curva	
	66801	-	-	DX/RH	70	180	-	14.5	45	80 x 8	890	Tipo K modulo lama media	
LAMPACRE- SCIA2	66153	-	-	DX/RH	55	165	20	9	55	25 x 6	200	Motocoltivatore 1000 curva	
	66154	-	-	SX/LH	55	165	20	9	55	25 x 6	200	Motocoltivatore 1000 curva	
	66811	-	-	DX/RH	74	217	-	10.5	70	45 x 6	450	VMC 150 curva	
	66812	-	-	SX/LH	74	217	-	10.5	70	45 x 6	450	VMC 150 curva	
	66813	-	-	DX/RH	70	195	-	10.5	70	45 x 6	400	Motozappa 115 curva	
	66814	-	-	SX/LH	70	195	-	10.5	70	45 x 6	400	Motozappa 115 curva	
MAB	66821	-	-	DX/RH	62	195	-	8.5	55	40 x 5	350	Agro 2519 curva	
	66822	-	-	SX/LH	62	195	-	8.5	55	40 x 5	350	Agro 2519 curva	
	66823	-	5161	DX/RH	95	162	-	10.5	30	45 x 6	430	Talpa TL 85 5161 curva	
	66824	-	5161	SX/LH	95	162	-	10.5	30	45 x 6	430	Talpa TL 85 5161 curva	
	66831	-	-	DX/RH	67	219	-	10.5	85	40 x 5	390	Formica NF1 - T4 squadro	

Brand	Art./Ref.	Cod. Comp. NAF	Rif. Orig./ Orig. Ref.	Modello/ Model	H mm	L mm	S mm	Ø Foro mm/ Hole Ø mm	Interasse fori/ Distance between hole centers mm	Piatto/ Plate mm	Peso gr/ Peso gr	Note/Note	Immagine/Image	
MAB	66832	-	-	SX/LH	67	219	-	10.5	85	40 x 5	390	Formica NF1 - T4 squadro		
	66839	-	-	DX/RH	62	246	-	10.5	85	40 x 6	540	Formica lunga 4152 squadro		
	66840	-	-	SX/LH	62	246	-	10.5	85	40 x 6	540	Formica lunga 4152 squadro		
MASCHIO	66541	ZMAS12D0BC	29100405	DX/RH	135	196	15	14.5	48	80 x 7	980	U curva		
	66542	ZMAS12S0BC	29100406	SX/LH	135	196	15	14.5	48	80 x 7	980	U curva		
	66845	ZMAS01D0BC	19100417	DX/RH	115	194	12	12.5	44	60 x 6	610	A curva		
	66846	ZMAS01S0BC	19100418	SX/LH	115	194	12	12.5	44	60 x 6	610	A curva		
	66847	ZMAS02D0BC	19100415	DX/RH	115	190	12	12.5	44	60 x 6	660	A squadro		
	66848	ZMAS02S0BC	19100416	SX/LH	115	190	12	12.5	44	60 x 6	660	A squadro		
	10188	ZMAS21D0BC	01110426	DX/RH	142	225	29	14.5	56	80 x 8	1300	B curva		
	10189	ZMAS21S0BC	01110427	SX/LH	142	225	29	14.5	56	80 x 8	1300	B curva		
	10190	ZCEL27D0BC	01110428	DX/RH	142	215	25	14.5	56	80 x 8	1350	B squadro		
	10191	ZCEL27S0BC	01110429	SX/LH	142	215	25	14.5	56	80 x 8	1350	B squadro		
	66849	-	13100418	DX/RH	142	209	19	14.5	56	80 x 10			C (ex F) curva	
	66850	-	13100419	SX/LH	142	209	19	14.5	56	80 x 10	1500		C (ex F) curva	
	66855	ZMAS08D0BC	19100421	DX/RH	110	187	8	12.5	44	70 x 6	760		A - E squadro	
	66856	ZMAS08S0BC	19100422	SX/LH	110	187	8	12.5	44	70 x 6	760		A - E squadro	
	66857	ZMAS14MD0BC	02108430	DX/RH	135	186	14	14.5	56	80 x 6	850		NC curva	
	66858	ZMAS14MS0BC	02108431	SX/LH	135	186	14	14.5	56	80 x 6	850		NC curva	
	66859	ZMAS11MD0BC	00566103	DX/RH	135	175	14	14.5	56	80 x 6	850		NC squadro	

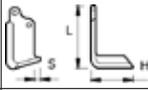
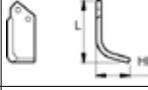
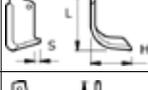
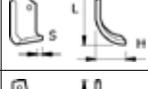
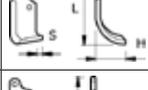
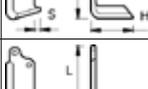
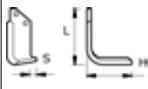
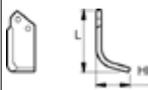
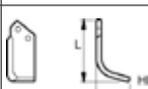
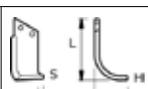
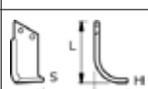
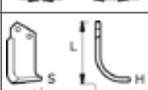
Brand	Art./Ref.	Cod. Comp. NAF	Rif. Orig./ Orig. Ref.	Modello/ Model	H mm	L mm	S mm	Ø Foro mm/ Hole Ø mm	Interasse fori/ Distance between hole centers mm	Piatto/ Plate mm	Peso gr/ Peso gr	Note/Note	Immagine/Image
MASCHIO	66860	ZMAS11MS0BC	00566153	SX/LH	135	175	14	14.5	56	80 x 6	850	NC squadro	
	11061	-	24100406	DX/RH	83	195	-	12.5	65	60 x 6	580	SP 2 - 3 curva	
	11062	-	24100407	SX/LH	83	195	-	12.5	65	60 x 6	580	SP 2 - 3 curva	
	66861	ZMAS32D0BC	20100404	DX/RH	145	236	20	16.5	56	90 x 8	1650	S curva	
	66862	ZMAS32S0BC	20100405	SX/LH	145	236	20	16.5	56	90 x 8	1650	S curva	
	66871	ZMAS07D0BC	19100423	DX/RH	110	193	16	12.5	44	70 x 6	740	A - E curva	
	66872	ZMAS07S0BC	19100424	SX/LH	110	193	16	12.5	44	70 x 6	740	A - E curva	
	66875	ZMAS13D0BC	29100407	DX/RH	135	192	17	14.5	48	80 x 7	1000	U squadro	
	66876	ZMAS13S0BC	29100408	SX/LH	135	192	17	14.5	48	80 x 7	1000	U squadro	
	66877	ZMAS14D0BC	02108432	DX/RH	135	186	14	14.5	56	80 x 7	950	NC rinforzata curva	
	66878	ZMAS14S0BC	02108433	SX/LH	135	186	14	14.5	56	80 x 7	950	NC rinforzata curva	
	66879	ZMAS11D0BC	2108430	DX/RH	135	175	14	14.5	56	80 x 7	950	NC rinforzata squadro	
66880	ZMAS11S0BC	2108431	SX/LH	135	175	14	14.5	56	80 x 7	950	NC rinforzata squadro		
MEAAT	51864	-	-	DX/RH	60	133	6	10.5	35	50 x 6	340	FP squadro	
	51865	-	-	SX/LH	60	133	6	10.5	35	50 x 6	340	FP squadro	
	66901	-	-	DX/RH	88	170	-	12.5	42	60 x 6	500	N.F.592/598 curva	
	66902	-	-	SX/LH	88	170	-	12.5	42	60 x 6	500	N.F.592/598 curva	
MERITANO	66911	-	-	DX/RH	106	205	22	14.5	50	80 x 8	1150	Tipo pesante curva	
	66912	-	-	SX/LH	106	205	22	14.5	50	80 x 8	1150	Tipo pesante curva	
	66915	-	-	DX/RH	115	180	22	14.5	50	80 x 7	900	TL curva	

Brand	Art./Ref.	Cod. Comp. NAF	Rif. Orig./ Orig. Ref.	Modello/ Model	H mm	L mm	S mm	Ø Foro mm/ Hole Ø mm	Interasse fori/ Distance between hole centers mm	Piatto/ Plate mm	Peso gr/ Peso gr	Note/Note	Immagine/Image
MERITANO	66916	-	-	SX/LH	115	180	22	14.5	50	80 x 7	900	TL curva	
	66917	-	-	DX/RH	115	180	24	14.5	50	80 x 7	1000	TLS squadro	
	66918	-	-	SX/LH	115	180	24	14.5	50	80 x 7	1000	TLS squadro	
MURATORI	66931	ZMUR28D0BC	120058	DX/RH	155	210	10	14.5	57	80 x 8	1250	MH 130-230 squadro	
	66932	ZMUR28S0BC	120059	SX/LH	155	210	10	14.5	57	80 x 8	1250	MH 130-230 squadro	
	66935	ZMUR16D0BC	12002801	DX/RH	145	168	10	12.5	46	70 x 7	760	Curva	
	66936	ZMUR16S0BC	12002901	SX/LH	145	168	10	12.5	46	70 x 7	760	Curva	
	66937	ZMUR13D0BC	1200301	DX/RH	110	180	10	12.5	46	60 x 6	720	Squadro	
	66938	ZMUR13S0BC	1200401	SX/LH	110	180	10	12.5	46	60 x 6	720	Squadro	
	66939	ZMUR12D0BC	1200101	DX/RH	110	190	10	12.5	46	60 x 6	680	MS 3P curva	
	66940	ZMUR12S0BC	1200201	SX/LH	110	190	10	12.5	46	60 x 6	680	MS 3P curva	
	66943	ZMUR06D0BC	12005102	DX/RH	115	144	-	10.5	27	50 x 5	390	M85 - 125 spost MZ2S curva	
	66944	ZMUR06S0BC	12005002	SX/LH	115	144	-	10.5	27	50 x 5	390	M85 - 125 spost MZ2S curva	
	66947	ZMUR21D0BC	12002200	DX/RH	145	168	10	12.5	46	70 x 7	920	Squadro lungo	
	66948	ZMUR21S0BC	12002300	SX/LH	145	168	10	12.5	46	70 x 7	920	Squadro lungo	
	66955	ZMUR36D0BC	12013701	DX/RH	136	190	14	14.5	56	80 x 6	820	MZ8 - MZ8C - 105- 205 curva	
	66956	ZMUR36S0BC	12013801	SX/LH	136	190	14	14.5	56	80 x 6	820	MZ8 - MZ8C - 105- 205 curva	
	66963	ZSOV12D0BC	12000500	DX/RH	113	190	10	12.5	46	70 x 7	800	MS 3P curva	
	66964	ZSOV12S0BC	12000600	SX/LH	113	190	10	12.5	46	70 x 7	800	MS 3P curva	
	66965	ZMUR22D0BC	-	DX/RH	113	190	10	14.5	46	70 x 7	800	Curva	
66966	ZMUR22S0BC	-	SX/LH	113	190	10	14.5	46	70 x 7	800	Curva		

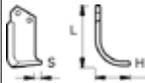
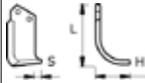
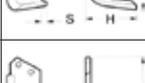
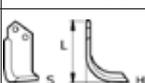
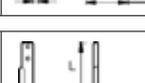
Brand	Art./Ref.	Cod. Comp. NAF	Rif. Orig./ Orig. Ref.	Modello/ Model	H mm	L mm	S mm	Ø Foro mm/ Hole Ø mm	Interasse fori/ Distance between hole centers mm	Piatto/ Plate mm	Peso gr/ Peso gr	Note/Note	Immagine/Image
MURATORI	66967	-	-	DX/RH	113	205	10	14.5	46	80 x 8	1050	Curva	
	66968	-	-	SX/LH	113	205	10	14.5	46	80 x 8	1050	Curva	
	51893	-	-	DX/RH	140	165	-	12.5	46	70 x 7	850	Zappetta curva	
NARDI	66971	ZNAR11D0BC	-	DX/RH	115	155	-	12.5	55	75 x 7	730	4 C 5012	
	66972	ZNAR11S0BC	-	SX/LH	115	155	-	12.5	55	75 x 7	730	4 C 5012	
	66973	ZNAR05D0BC	-	DX/RH	106	205	30	12.5	45	60 x 6	620	5 C 5009	
	66974	ZNAR05S0BC	-	SX/LH	106	205	30	12.5	45	60 x 6	620	5 C 5009	
	66975	ZNAR12D0BC	-	DX/RH	116	173	-	12.5	55	75 x 7	810	5 C 5012	
	66976	ZNAR12S0BC	-	SX/LH	116	173	-	12.5	55	75 x 7	810	5 C 5012	
	66977	ZNAR02D0BC	-	DX/RH	71	135	-	10.5	40	60 x 6	420	5C 5015	
	66978	ZNAR02S0BC	-	SX/LH	71	135	-	10.5	40	60 x 6	420	5C 5015	
	66983	ZNAR06D0BC	-	DX/RH	106	190	25	12.5	45	70 x 7	810	6 C 5009	
	66984	ZNAR06S0BC	-	SX/LH	106	190	25	12.5	45	70 x 7	810	6 C 5009	
	66989	ZNAR13D0BC	-	DX/RH	134	185	30	12.5	55	75 x 7	880	5 C 5013	
	66990	ZNAR13S0BC	-	SX/LH	134	185	30	12.5	55	75 x 7	880	5 C 5013	
NIBBI BRUNO-YABE	66993	-	-	DX/RH	76	223	-	10.5	56	35 x 8	520	B curva	
	66994	-	-	SX/LH	76	223	-	10.5	56	35 x 8	520	B curva	
	66995	-	-	DX/RH	66	185	-	9	37	35 x 6	350	Ev. tipo G 519 curva	
	66996	-	-	SX/LH	66	185	-	9	37	35 x 6	350	Ev. tipo G 519 curva	

Brand	Art./Ref.	Cod. Comp. NAF	Rif. Orig./ Orig. Ref.	Modello/ Model	H mm	L mm	S mm	Ø Foro mm/ Hole Ø mm	Interasse fori/ Distance between hole centers mm	Piatto/ Plate mm	Peso gr/ Peso gr	Note/Note	Immagine/Image
NIBBI BRUNO-YABE	66997	-	-	DX/RH	78	190	20	12.5	42	60 x 6	540	G 119 curva	
	66998	-	-	SX/LH	78	190	20	12.5	42	60 x 6	540	G 119 curva	
	67001	-	-	DX/RH	70	170	-	10.5	42	50 x 6	400	G 519 n.tipo 600-700 squadro	
	67002	-	-	SX/LH	70	170	-	10.5	42	50 x 6	400	G 519 n.tipo 600-700 squadro	
	66233	-	-	DX/RH	52	170	15	8.5	58	25 x 5	180	Motocoltivatore top - max 305 curva	
	66234	-	-	SX/LH	52	170	15	8.5	58	25 x 5	180	Motocoltivatore top - max 305 curva	
OMMAS	66965	ZMUR22D0BC	-	DX/RH	113	190	10	14.5	46	70 x 7	800	Curva	
	66966	ZMUR22S0BC	-	SX/LH	113	190	10	14.5	46	70 x 7	800	Curva	
ORTOLAN	67027	ZORT02D0BC	-	DX/RH	90	200	12	12.5	65	60 x 6	520	L	
	67028	ZORT02S0BC	-	SX/LH	90	200	12	12.5	65	60 x 6	520	L	
	67029	ZORT01D0BC	-	DX/RH	90	185	12	12.5	65	60 x 6	480	G	
	67030	ZORT01S0BC	-	SX/LH	90	185	12	12.5	65	60 x 6	480	G	
PALLADINO	66253	ZCEL22D0BC	-	DX/RH	136	180	12	14.5	57	80 x 8	1230	T 4 pesante squadro	
	66254	ZCEL22S0BC	-	SX/LH	136	180	12	14.5	57	80 x 8	1230	T 4 pesante squadro	
PASBO	66485	ZPAB11D0BC	-	DX/RH	80	217	-	10.5	73	40 x 6	440	G72 curva	
	66486	ZPAB11S0BC	-	SX/LH	80	217	-	10.5	73	40 x 6	440	G72 curva	
	67037	ZPAB06D0BC	-	DX/RH	70	195	-	8.5	73	35 x 6	350	G51 curva	
	67038	ZPAB06S0BC	-	SX/LH	70	195	-	8.5	73	35 x 6	350	G51 curva	

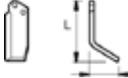
Brand	Art./Ref.	Cod. Comp. NAF	Rif. Orig./ Orig. Ref.	Modello/ Model	H mm	L mm	S mm	Ø Foro mm/ Hole Ø mm	Interasse fori/ Distance between hole centers mm	Piatto/ Plate mm	Peso gr/ Peso gr	Note/Note	Immagine/Image
PASBO	67041	ZPAB16D0BC	-	DX/RH	80	227	-	10.5	73	50 x 6	550	G14 - G84 Grottaglie curva	
	67042	ZPAB16S0BC	-	SX/LH	80	227	-	10.5	73	50 x 6	550	G14 - G84 Grottaglie curva	
	67045	ZPAB17D0BC	-	DX/RH	82	230	-	10.5	73	60 x 6	720	G94	
	67046	ZPAB17S0BC	-	SX/LH	82	230	-	10.5	73	60 x 6	720	G94	
PASQUALI	66163	-	-	DX/RH	55	193	18	8.5	55	30 x 6	270	Motocoltivatore XB40-SB30 curva	
	66164	-	-	SX/LH	55	193	18	8.5	55	30 x 6	270	Motocoltivatore XB40-SB30 curva	
	66169	-	-	DX/RH	72	152	23	10.5	40	50 x 6	370	532 tipo nuovo curva	
	66170	-	-	SX/LH	72	152	23	10.5	40	50 x 6	370	532 tipo nuovo curva	
	66901	-	-	DX/RH	88	170	-	12.5	42	60 x 6	500	N.F.592/598 curva	
	66902	-	-	SX/LH	88	170	-	12.5	42	60 x 6	500	N.F.592/598 curva	
	67051	ZPSQ31D0BC	-	DX/RH	88	185	-	12.5	42	60 x 6	500	N.F. 592/598 squadro	
	67052	ZPSQ31S0BC	-	SX/LH	88	185	-	12.5	42	60 x 6	500	N.F. 592/598 squadro	
	67055	-	-	DX/RH	53	157	-	10.5	32	50 x 6	350	F912/923 (HP13-15) squadro	
	67056	-	-	SX/LH	53	157	-	10.5	32	50 x 6	350	F912/923 (HP13-15) squadro	
	67057	-	-	DX/RH	50	172	-	9	68	25 x 5	190	532 curva	
	67058	-	-	SX/LH	50	172	-	9	68	25 x 5	190	532 curva	
	67059	-	-	DX/RH	88	167	-	12.5	42	60 x 6	450	N.F. 557 corta squadro	
	67060	-	-	SX/LH	88	167	-	12.5	42	60 x 6	450	N.F. 557 corta squadro	
	67061	-	-	DX/RH	88	185	-	12.5	42	60 x 6	550	EKF curva	

Brand	Art./Ref.	Cod. Comp. NAF	Rif. Orig./ Orig. Ref.	Modello/ Model	H mm	L mm	S mm	Ø Foro mm/ Hole Ø mm	Interasse fori/ Distance between hole centers mm	Piatto/ Plate mm	Peso gr/ Peso gr	Note/Note	Immagine/Image
PASQUALI	67062	-	-	SX/LH	88	185	-	12.5	42	60 x 6	550	EKF curva	
	67063	-	-	DX/RH	80	188	20	10.5	68	30 x 6	290	532 t.nuovo curva	
	67064	-	-	SX/LH	80	188	20	10.5	68	30 x 6	290	532 t.nuovo curva	
PEGORARO	67065	-	1852	DX/RH	133	182	20	12.5	54	70 x 7	820	TN-TB 1852/3 curva	
	67066	-	1853	SX/LH	133	182	20	12.5	54	70 x 7	820	TN-TB 1852/3 curva	
	67071	-	5329	DX/RH - SX/LH	30	170	-	12.5	50	60 x 10	670	LB 5329 coltello	
	67073	-	5333	DX/RH - SX/LH	30	185	-	14.5	50	70 x 10	930	LM 5333 coltello	
	67076	-	6955	DX/RH - SX/LH	45	195	-	16.5	-	60 x 10	810	LC 6955 per flangia sp.12 pegolama	
	67081	-	6729	DX/RH	50	140	-	10.5	38	50 x 6	320	FA 6729/0 d. 360 curva	
	67082	-	6730	SX/LH	50	140	-	10.5	38	50 x 6	320	FA 6729/0 d. 360 curva	
	67095	-	3590	DX/RH	-	215	-	16.5	-	-	1000	LC - LD 3590 pegodent	
	67096	-	3590	SX/LH	-	215	-	16.5	-	-	1000	LC - LD 3590 pegodent	
PERUGINI CONCEPT	10170	ZCEL17D0BC	-	Dx/Rh	136	195	12	14.5	57	80 x 7	980	EMF curva	
	10171	ZCEL17S0BC	-	Sx/Lh	136	195	12	14.5	57	80 x 7	980	EMF curva	
	10188	ZMAS21D0BC	-	DX/RH	142	225	29	14.5	56	80 x 8	1300	B curva	
	10189	ZMAS21S0BC	-	SX/LH	142	225	29	14.5	56	80 x 8	1300	B curva	
	67061	-	-	DX/RH	88	185	-	12.5	42	60 x 6	550	EKF curva	
	67062	-	-	SX/LH	88	185	-	12.5	42	60 x 6	550	EKF curva	

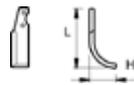
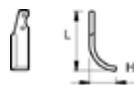
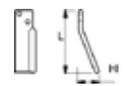
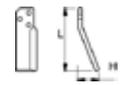
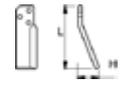
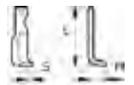
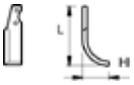
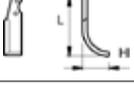
Brand	Art./Ref.	Cod. Comp. NAF	Rif. Orig./ Orig. Ref.	Modello/ Model	H mm	L mm	S mm	Ø Foro mm/ Hole Ø mm	Interasse fori/ Distance between hole centers mm	Piatto/ Plate mm	Peso gr/ Peso gr	Note/Note	Immagine/Image
PRATER	66811	-	-	DX/RH	74	217	-	10.5	70	45 x 6	450	VMC 150 curva	
	66812	-	-	SX/LH	74	217	-	10.5	70	45 x 6	450	VMC 150 curva	
RAU	67117	-	35920	DX/RH	-	170	-	10.2	-	30 x 30	850	35920-95000 innesto diam.24	
	67118	-	35920	SX/LH	-	170	-	10.2	-	30 x 30	850	35920-95000 innesto diam.24	
RENTER L.M.T.	67123	-	-	DX/RH	65	195	-	14.5	37	60 x 10	880	RTM RTO colt.2 fori	
	67124	-	-	SX/LH	65	195	-	14.5	37	60 x 10	880	RTM RTO colt.2 fori	
	67129	-	-	DX/RH	75	225	-	14.5	32-32	60 x 12	1200	RTG Colt.3 fori	
	67130	-	-	SX/LH	75	225	-	14.5	32-32	60 x 12	1200	RTG Colt.3 fori	
SANDRI	66253	ZCEL22D0BC	-	DX/RH	136	180	12	14.5	57	80 x 8	1230	T 4 pesante squadro	
	66254	ZCEL22S0BC	-	SX/LH	136	180	12	14.5	57	80 x 8	1230	T 4 pesante squadro	
SEP	66153	-	-	DX/RH	55	165	20	9	55	25 x 6	200	Motocoltivatore 1000 curva	
	66154	-	-	SX/LH	55	165	20	9	55	25 x 6	200	Motocoltivatore 1000 curva	
	66167	-	-	DX/RH	72	190	20	10.5	66	30 x 6	290	1400 - 1700 S curva	
	66168	-	-	SX/LH	72	190	20	10.5	66	30 x 6	290	1400 - 1700 S curva	
	66811	-	-	DX/RH	74	217	-	10.5	70	45 x 6	450	VMC 150 curva	
	66812	-	-	SX/LH	74	217	-	10.5	70	45 x 6	450	VMC 150 curva	
	66813	-	-	DX/RH	70	195	-	10.5	70	45 x 6	400	Motozappa 115 curva	
	66814	-	-	SX/LH	70	195	-	10.5	70	45 x 6	400	Motozappa 115 curva	

Brand	Art./Ref.	Cod. Comp. NAF	Rif. Orig./ Orig. Ref.	Modello/ Model	H mm	L mm	S mm	Ø Foro mm/ Hole Ø mm	Interasse fori/ Distance between hole centers mm	Piatto/ Plate mm	Peso gr/ Peso gr	Note/Note	Immagine/Image
SEP	67139	-	-	DX/RH	65	183	-	9	70	30 x 6	250	Motozappa 35 40 50 curva	
	67140	-	-	SX/LH	65	183	-	9	70	30 x 6	250	Motozappa 35 40 50 curva	
	67141	-	-	DX/RH	70	200	-	10.5	70	35 x 6	340	Motozappa 60 70 100 -1700S curva	
	67142	-	-	SX/LH	70	200	-	10.5	70	35 x 6	340	Motozappa 60 70 100 -1700S curva	
	67144	-	-	SX/LH	70	175	-	10.5	35	50 x 6	400	Motozappa 140 squadro	
	67145	-	-	DX/RH	60	140	-	10.5	27	40 x 6	280	VMC 130 squadro	
	67146	-	-	SX/LH	60	140	-	10.5	27	40 x 6	280	VMC 130 squadro	
SICMA/ MIGLIANICO	67155	ZSIC01D0BC	4811281	DX/RH	110	180	10	12.5	42	60 x 6	600	ZLL SB ZLS curva	
	67156	ZSIC01S0BC	4811282	SX/LH	110	180	10	12.5	42	60 x 6	600	ZLL SB ZLS curva	
	67157	ZSIC18D0BC	4818223	DX/RH	135	190	14	14.5	55	80 x 7	950	SM curva	
	67158	ZSIC18S0BC	4818222	SX/LH	135	190	14	14.5	55	80 x 7	950	SM curva	
	67163	ZSIC16D0BC	4812426	DX/RH	130	180	15	14.5	50	80 x 7	980	SD curva	
	67164	ZSIC16S0BC	4812425	SX/LH	130	180	15	14.5	50	80 x 7	980	SD curva	
	67169	ZSIC06D0BC	4811400	DX/RH	115	185	10	12.5	42	70 x 6	700	CS-SF curva	
	67170	ZSIC06S0BC	4811401	SX/LH	115	185	10	12.5	42	70 x 6	700	CS-SF curva	
	67181	ZSIC17D0BC	4812427	DX/RH	135	170	14	14.5	55	80 x 7	970	SD-ST squadro	
	67182	ZSIC17S0BC	4812428	SX/LH	135	170	14	14.5	55	80 x 7	970	SD-ST squadro	
	67183	ZSIC03D0BC	4811785	DX/RH	130	162	-	12.5	35	60 x 6	570	FLB-FLBR curva	
	67184	ZSIC03S0BC	4811786	SX/LH	130	162	-	12.5	35	60 x 6	570	FLB-FLBR curva	

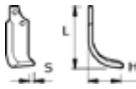
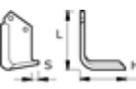
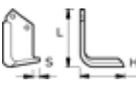
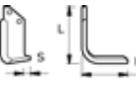
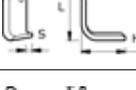
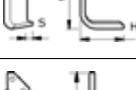
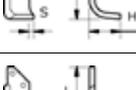
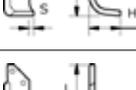
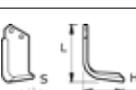
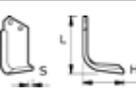
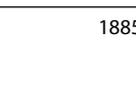
Brand	Art./Ref.	Cod. Comp. NAF	Rif. Orig./ Orig. Ref.	Modello/ Model	H mm	L mm	S mm	Ø Foro mm/ Hole Ø mm	Interasse fori/ Distance between hole centers mm	Piatto/ Plate mm	Peso gr/ Peso gr	Note/Note	Immagine/Image
SICMA/ MIGLIANICO	67185	ZSIC05D0BC	4811285	DX/RH	110	157	8	12.5	42	60 x 6	550	ZLL-SB curva	
	67186	ZSIC05S0BC	4811286	SX/LH	110	157	8	12.5	42	60 x 6	550	ZLL-SB curva	
SICMA/OSTRA VETERE	10176	ZHOW24D0BC	-	DX/RH	132	180	20	13	57	80 x 7	1000	Bronty-Ripunta- tore squadro	
	10177	ZHOW24S0BC	-	SX/LH	132	180	20	13	57	80 x 7	1000	Bronty-Ripunta- tore romptraccia squadro	
SOVEMA	66545	-	-	DX/RH	109	175	10	12.5	46	70 x 7	820	Squadro	
	66546	-	-	SX/LH	109	175	10	12.5	46	70 x 7	820	Squadro	
	66937	ZMUR13D0BC	-	DX/RH	110	180	10	12.5	46	60 x 6	720	Squadro	
	66938	ZMUR13S0BC	-	SX/LH	110	180	10	12.5	46	60 x 6	720	Squadro	
	66939	ZMUR12D0BC	-	DX/RH	110	190	10	12.5	46	60 x 6	680	MS 3P curva	
	66940	ZMUR12S0BC	-	SX/LH	110	190	10	12.5	46	60 x 6	680	MS 3P curva	
	66963	ZSOV12D0BC	-	DX/RH	113	190	10	12.5	46	70 x 7	800	MS 3P curva	
	66964	ZSOV12S0BC	-	SX/LH	113	190	10	12.5	46	70 x 7	800	MS 3P curva	
	66965	ZMUR22D0BC	-	DX/RH	113	190	10	14.5	46	70 x 7	800	Curva	
	66966	ZMUR22S0BC	-	SX/LH	113	190	10	14.5	46	70 x 7	800	Curva	
	66967	ZSOV16D0BC	-	DX/RH	113	205	10	14.5	46	80 x 8	1050	Curva	
	66968	ZSOV16S0BC	-	SX/LH	113	205	10	14.5	46	80 x 8	1050	Curva	
	67205	-	-	DX/RH	113	200	10	14.5	46	80 x 8	1180	Squadro	
	67206	-	-	SX/LH	113	200	10	14.5	46	80 x 8	1180	Squadro	

Brand	Art./Ref.	Cod. Comp. NAF	Rif. Orig./ Orig. Ref.	Modello/ Model	H mm	L mm	S mm	Ø Foro mm/ Hole Ø mm	Interasse fori/ Distance between hole centers mm	Piatto/ Plate mm	Peso gr/ Peso gr	Note/Note	Immagine/Image
TORTELLA	10174	-	2915	DX/RH	202	-	-	16.5	45	50 x 12	850	Lama Frangizolle	
	10175	-	2915	SX/LH	202	-	-	16.5	45	50 x 12	850	Lama Frangizolle	
	67218	-	2985206	SX/LH	134	183	20	14.5	56	80 x 8	1140	T3 T4 curva	
VALPADANA	11051	-	-	DX/RH	120	170	10	12.5	40	70 x 6	680	4RM 300/400 450 curva	
	11052	-	-	SX/LH	120	170	10	12.5	40	70 x 6	680	4RM 300/400 450 curva	
	66811	-	-	DX/RH	74	217	-	10.5	70	45 x 6	450	VMC 150 curva	
	66812	-	-	SX/LH	74	217	-	10.5	70	45 x 6	450	VMC 150 curva	
	67145	-	-	DX/RH	60	140	-	10.5	27	40 x 6	280	VMC 130 squadro	
	67146	-	-	SX/LH	60	140	-	10.5	27	40 x 6	280	VMC 130 squadro	
	67237	-	-	DX/RH	82	190	-	10.5	35	50 x 6	470	VMC 15 curva	
	67238	-	-	SX/LH	82	190	-	10.5	35	50 x 6	470	VMC 15 curva	
	67241	-	-	DX/RH	84	207	-	10.5	45	60 x 6	600	MC 18-4 RM20 curva	
	67242	-	-	SX/LH	84	207	-	10.5	45	60 x 6	600	MC 18-4 RM20 arco	
	67245	-	-	DX/RH	72	167	-	10.5	35	50 x 6	400	VMC 14 curva	
	67246	-	-	SX/LH	72	167	-	10.5	35	50 x 6	400	VMC 14 curva	
	67248	-	-	SX/LH	96	213	-	10.5	46	60 x 6	640	VMC 18 nuovo tipo curva	
VIGOLO	67255	-	-	DX/RH	73	268	-	14.5	56-56	80 x 8	1280	3 fori curva	
	67256	-	-	SX/LH	73	268	-	14.5	56-56	80 x 8	1280	3 fori curva	
ZAPPATOR	66857	ZMAS14MD0BC	-	DX/RH	135	186	14	14.5	56	80 x 6	850	NC curva	
	66858	ZMAS14MS0BC	-	SX/LH	135	186	14	14.5	56	80 x 6	850	NC curva	

1.10.8 Mazze per trincia e decespugliatori

Sticks for choppers and flail mowers



Ricambi & accessori per macchine agricole

SPARE PARTS & ACCESSORIES FOR AGRICULTURAL MACHINE

Tutti gli articoli della presente sezione, prodotti da AMA SPA e/o da terzi per conto di AMA, sono adattabili ("non originali") alle marche indicate ai sensi di quanto previsto dal REG. CE n. 1400/2002. I diritti sui marchi citati appartengono ai legittimi proprietari ed il loro uso ha l'esclusiva finalità di consentire all'utilizzatore la comparazione dei diversi prodotti. All items of this section, manufactured by AMA SPA and/or any third party on behalf of AMA, are adaptable ("non-original") to the brands listed under the provisions of the REG. CE n. 1400/2002. The rights on the trademarks belong to their respective owners and their usage is only aimed to allow the user to compare different products.

MAZZE PER TRINCIA ADATTABILI ALLA PRODUZIONE DI:
COUTEAUX POUR BROYEURS ADAPTABLES A LA PRODUCTION DE:
KNIVES FOR CHOPPERS SUITABLE TO PRODUCTION OF:
KLINGENMESSERFÜR HACKSLER PASSEND ZU:
CUCHILLOS PARA TRITURADORAS ADAPTABLE A LA PRODUCCION DE:

Brand	Art./Ref.	Rif. Orig./Orig. Ref.	Descrizione/Description	H mm	L mm	S mm	Diametro mm/Diameter mm	Peso gr/Peso gr	Immagine/Image
A.C.M.A.	07394	-	Tipo pesante	110	120	40	16,5	1350	
	07404	-	-	95	85	40	14,5	750	
AEDES-PIRCHER	07396	-	Tipo pesante	88	195	70	16,5	2000	
AGRAM	07395	-	-	110	120	40	18,5	1350	
AGRICOM	07396	-	Tipo pesante	88	195	70	16,5	2000	
	07398	-	-	95	137	40	16,5	1600	
	07387	-	-	90	120	40	16,5	1150	
	07394	-	Tipo pesante	110	120	40	16,5	1350	
AGRIMASTER	07404	-	-	95	85	40	14,5	750	
	65038	-	KP - KA - FA - TA	100	100	40	20,5	600	
	07384	-	-	100	150	55	20,5	1650	
	07410	-	Tipo forestale	80	70	60	30,5	1700	
	07388	-	Tipo leggero	90	120	40	20,5	1150	
	65062	-	Tipo leggero diam. 19,5	90	120	40	19,5	1150	
BECCHIO-BERFRALK	07387	-	-	90	120	40	16,5	1150	
	07394	-	Tipo pesante	110	120	40	16,5	1350	

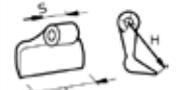
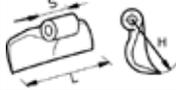
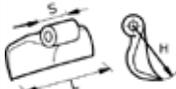
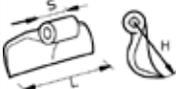
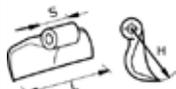
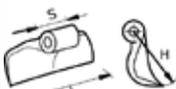
Brand	Art./Ref.	Rif. Orig./Orig. Ref.	Descrizione/Description	H mm	L mm	S mm	Diametro mm/Diameter mm	Peso gr/Peso gr	Immagine/Image
BERTI	07398	-	-	95	137	40	16,5	1600	
	65078	-	-	100	137	40	16,5	1150	
BREVIGLIERI	07398	-	-	95	137	40	16,5	1600	
BOMFORD-TURNER	07375	-	-	65	75	80	19,5	715	
CABE/NUOVA CABE/COMAGRI/ AGRIEURO	07397	-	-	88	195	70	20,5	2000	
	65124	-	-	110	120	40	20,5	1350	
	07388	-	Tipo leggero	90	120	40	20,5	1150	
CALDERONI	07384	-	-	100	150	55	20,5	1650	
CELLI	65078	-	-	100	137	40	16,5	1150	
COSMA	65078	-	-	100	137	40	16,5	1150	
DESVOYS	65124	-	-	110	120	40	20,5	1350	
DRAGONE	65161	-	Diam. 18,5	98	100	75	18,5	1260	
	65164	-	Leggera tipo nuovo	76	78	13	16,5	300	
FAE	07410	-	Tipo forestale	80	70	60	30,5	1700	
FALC	65179	-	VKP	96	144	54	25,5	2300	
	65180	-	Zenit	96	100	54	25,5	1800	
FALCONERO	07383	-	-	100	150	55	16,5	1650	

Brand	Art./Ref.	Rif. Orig./Orig. Ref.	Descrizione/Description	H mm	L mm	S mm	Diametro mm/Diameter mm	Peso gr/Peso gr	Immagine/Image
FAUSTINI	07398	-	-	95	137	40	16,5	1600	
	65078	-	-	100	137	40	16,5	1150	
FERRI	07376	-	-	100	180	70	17	2350	
	65223	-	-	100	110	22	16,5	770	
	07386	-	-	90	120	40	14,5	1150	
	65225	-	-	120	105	42	16,5	1300	
	07387	-	-	90	120	40	16,5	1150	
FISCHER	07393	-	-	85	155	70	16,5	1500	
FORIGO-ROTERITALIA	65124	-	-	110	120	40	20,5	1350	
GL1 SRL	07375	-	-	65	75	80	19,5	715	
	07405	-	-	95	85	40	16,5	750	
HERMES	07398	-	-	95	137	40	16,5	1600	
HMF FREI	07393	-	-	85	155	70	16,5	1500	
	07371	-	-	80	170	70	16,5	1600	
	65308	-	-	94	75	22	16,5	700	
HUMUS	07391	-	TSL - FB Rif.5716270	88	150	60	20,5	1450	
HYMACH	07405	-	-	95	85	40	16,5	750	

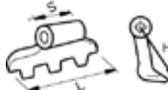
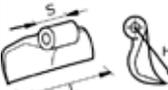
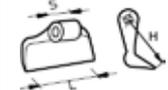
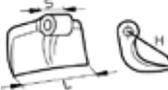
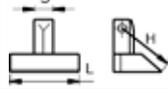
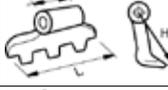
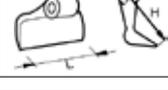
Brand	Art./Ref.	Rif. Orig./Orig. Ref.	Descrizione/Description	H mm	L mm	S mm	Diametro mm/Diameter mm	Peso gr/Peso gr	Immagine/Image
KUHNS	07392	-	-	110	155	90	20,5	1800	
	65350	-	BNE - VKD - TT	110	115	36	16,5	1150	
MASCHIO	07384	-	-	100	150	55	20,5	1650	
	07388	-	Tipo leggero	90	120	40	20,5	1150	
	65124	-	-	110	120	40	20,5	1350	
MEAT	07394	-	Tipo pesante	110	120	40	16,5	1350	
	07398	-	-	95	137	40	16,5	1600	
	07399	-	Foro 18,5	95	137	40	18,5	1600	
	65078	-	-	100	137	40	16,5	1150	
MERITANO	65401	-	-	82	105	30	16,5	1270	
MURATORI	07384	-	-	100	150	55	20,5	1650	
NOBILI	65179	-	VKP	96	144	54	25,5	2300	
	07392	-	-	110	155	90	20,5	1800	
	65350	6061700	BNE - VKD - TT	110	115	36	16,5	1150	
	65444	2555002	BNU 255502 06	175	88	51	26	2190	
OMARV	07395	-	-	110	120	40	18,5	1350	
ORSI	07404	00023006	-	95	85	40	14,5	750	

Brand	Art./Ref.	Rif. Orig./Orig. Ref.	Descrizione/Description	H mm	L mm	S mm	Diametro mm/Diameter mm	Peso gr/Peso gr	Immagine/Image
ORSI	07384	00023012	-	100	150	55	20,5	1650	
	07394	00023066	Tipo pesante	110	120	40	16,5	1350	
OSMA	07410	-	Tipo forestale	80	70	60	30,5	1700	
PALLADINO	07371	-	-	80	170	70	16,5	1600	
	07393	-	-	85	155	70	16,5	1500	
PEGORARO	07393	-	-	85	155	70	16,5	1500	
PERFECT	65223	-	-	100	110	22	16,5	770	
PERUGINI CONCEPT	07405	-	-	95	85	40	16,5	750	
	07394	-	Tipo pesante	110	120	40	16,5	1350	
PERUZZO	07405	-	-	95	85	40	16,5	750	
PROCOMAS	07405	-	-	95	85	40	16,5	750	
RINIERI	65542	-	-	88	150	60	20,5	1750	
	07394	-	Tipo pesante	110	120	40	16,5	1350	
SEPPI	07410	-	Tipo forestale	80	70	60	30,5	1700	
	07387	-	-	90	120	40	16,5	1150	
	07394	-	Tipo pesante	110	120	40	16,5	1350	
	07411	-	-	110	70	60	36	2400	

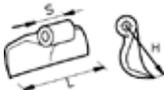
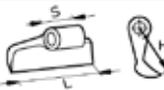
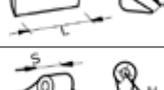
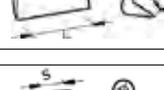
Brand	Art./Ref.	Rif. Orig./Orig. Ref.	Descrizione/Description	H mm	L mm	S mm	Diametro mm/Diameter mm	Peso gr/Peso gr	Immagine/Image
SICMA	07383	-	-	100	150	55	16,5	1650	
SICMA/ MIGLIANICO	07391	5716270	TSL - FB Rif.5716270	88	150	60	20,5	1450	
	65542	-	-	88	150	60	20,5	1750	
	07388	-	Tipo leggero	90	120	40	20,5	1150	
	07405	-	-	95	85	40	16,5	750	
	07392	5706109	-	110	155	90	20,5	1800	
	07394	-	Tipo pesante	110	120	40	16,5	1350	
SOVEMA	07383	-	-	100	150	55	16,5	1650	
TIERRE	07405	-	-	95	85	40	16,5	750	
	07394	-	Tipo pesante	110	120	40	16,5	1350	
TORTELLA	07387	-	-	90	120	40	16,5	1150	
	65078	-	-	100	137	40	16,5	1150	
	07394	-	Tipo pesante	110	120	40	16,5	1350	
	65664	-	TR10	115	165	98	22,5	2000	
UBALDI	07405	-	-	95	85	40	16,5	750	
	07384	-	-	100	150	55	20,5	1650	
	65675	-	-	120	105	42	20,5	1300	
VIGOLO	65308	-	-	94	75	22	16,5	700	

Brand	Art./Ref.	Rif. Orig./Orig. Ref.	Descrizione/Description	H mm	L mm	S mm	Diametro mm/Diameter mm	Peso gr/Peso gr	Immagine/Image
VIGOLO	07398	-	-	95	137	40	16,5	1600	
	65223	-	-	100	110	22	16,5	770	
WILLIBALD	07408	-	Tipo pesante	87	205	87	20,5	2180	
	07392	-	-	110	155	90	20,5	1800	
ZAPPATOR	07388	-	Tipo leggero	90	120	40	20,5	1150	
	07384	-	-	100	150	55	20,5	1650	
	65124	-	-	110	120	40	20,5	1350	

RONDELLE DENTATE

RONDELLES DENTEES
 TOOTHED WASHERS
 ZAHNRING
 ARANDELA DENTELLADA

Art./Ref.	H mm	Diametro mm/Diameter mm	Peso gr/Peso gr	N° denti/Teeth n°
07763	16	45	210	20
07764	20	65	410	21
07765	20	90	720	35
07767	18	80	680	72
07769	20	120	1160	35



SUPPORTI PER MAZZE TRINCIAMENTI

SUPPORTS POUR MARTEAUX DE BROyeurs
 SUPPORTS FOR STICK SEEDS-CUTTINGS
 LAGER FUER ZWICKSTIFTE-SCHNEIDEMASCHINEN
 SOPORTES PARA MAZAS DESMENUZADORAS DE SEMILLA

Art./Ref.	Descrizione/Description	Note/Note	Immagine/Image
07402	Altezza 53mm, larghezza 50mm, Ø interno 20,5mm, esagono 30,5mm.	Con esagono	
38743	Altezza 53mm, larghezza 50mm, Ø interno 20,5mm.	Senza esagono	

1.10.9 Coltelli e spatole per trincia e decespugliatori

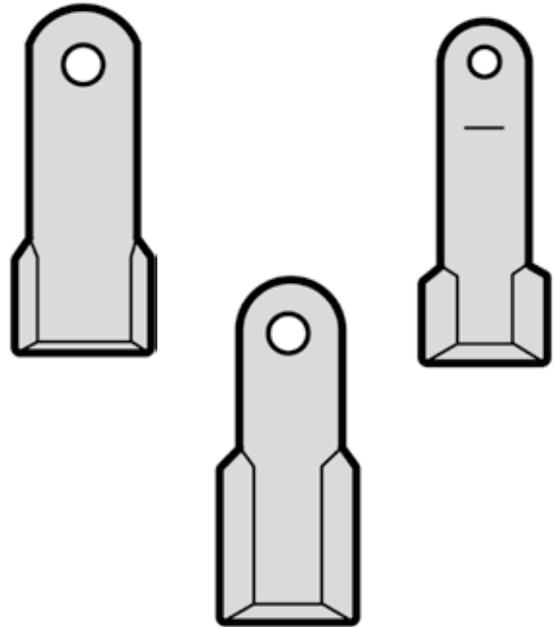
english



Ricambi & accessori per macchine agricole SPARE PARTS & ACCESSORIES FOR AGRICULTURAL MACHINE

Tutti gli articoli della presente sezione, prodotti da AMA SPA e/o da terzi per conto di AMA, sono adattabili ("non originali") alle marche indicate ai sensi di quanto previsto dal REG. CE n. 1400/2002. I diritti sui marchi citati appartengono ai legittimi proprietari ed il loro uso ha l'esclusiva finalità di consentire all'utilizzatore la comparazione dei diversi prodotti. All items of this section, manufactured by AMA SPA and/or any third party on behalf of AMA, are adaptable ("non-original") to the brands listed under the provisions of the REG. CE n. 1400/2002. The rights on the trademarks belong to their respective owners and their usage is only aimed to allow the user to compare different products.

COLTELLI PER TRINCIASARMENTI, DECESPUGLIATORI E RASAERBA
COUTEAUX POUR BROYEURS, DEBROUSSAILLEUSES ET TONDEUSES
KNIVES FOR CHOPPERS, FLAIL-MOWERS AND GRASS CUTTERS
KLINGENMESSER FÜR HACKSLER, BOSCHUNGSMÄHER UND RASENMAHER
CUCHILLOS PARA TRITURADORAS, DESBROZADORAS Y CORTACEPED

Brand	Art./Ref.	Rif. Orig./ Orig. Ref.	Descrizione/Description	H mm	L mm	Piatto/Plate mm	Diametro foro mm/ Hole diameter mm	Peso gr/Peso gr	Immagine/Image
A.C.M.A.	09136	-	Coltello Y	55	200	60x10	25.5	930	
	65000	-	MT2 coltello Y	42	114	35x5	14.5	200	
	65001	-	Coltello Y	25	80	35x5	14.5	120	
	65006	-	Coltello Y tipo leggero	58	176	60x10	25.5	850	
AGRAM	09138	-	Coltello Y	47	215	65x7	29	670	
AGRICOM	10092	-	Coltello Y	60	203	60x8	25.5	720	
	65020	-	Coltello Y	52	115	40x8	16.5	310	
	84411	-	Coltello Y	60	147	60x8	25.5	520	
AGRIMASTER	10085	3000323	Coltello a Y	55	118	40x8	20.5	300	
	10086	3000106	Coltello a Y	55	150	60x10	25.5	650	
	65001	-	Coltello Y	25	80	35x5	14.5	120	
	65000	3000650	MT2 coltello Y	42	114	35x5	14.5	200	
	65026	3000107	Coltello diritto	-	150	60x10	25.5	610	
	65048	-	Coltello con asola	42	82	40x5	30x14	140	
	65049	-	Coltello con asola diritto	-	82	40x5	30x14	120	
	84413	-	Coltello con asola	45	80	40x80	30x14	200	
	84414	-	Trituratore 18RM-B9-B12 t. vecchio	66	234	60x8	25.5	950	

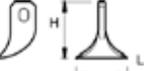
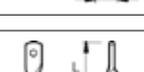
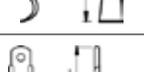
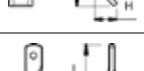
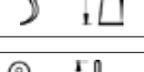
Brand	Art./Ref.	Rif. Orig./ Orig. Ref.	Descrizione/Description	H mm	L mm	Piatto/Plate mm	Diametro foro mm/ Hole diameter mm	Peso gr/Peso gr	Immagine/Image
AGRIMASTER	84415	-	Coltello diritto	-	150	60x8	25.5	450	
	84416	-	spatola	79	70	70x3	25x14	160	
AGROTEC	65048	-	Coltello con asola	42	82	40x5	30x14	140	
	65049	-	Coltello con asola diritto	-	82	40x5	30x14	120	
ASSALONI	09133	-	Dente	-	160	40x10	20.5	450	
BECCHIO- BERFRALK	09136	-	Coltello Y	55	200	60x10	25.5	930	
	26149	-	Coltello Y	50	204	60x8	25.5	740	
BERTI	65080	-	EKR coltello Y	70	113	50x8	25.5	400	
	84417	-	Coltello con asola	35	82	40x15	27x13	120	
BOMFORD- TURNER	65048	-	Coltello con asola	42	82	40x5	30x14	140	
	65093	-	Coltello stampato Y	40	99	45x8	39x16	200	
	65104	-	BG 59 coltello con asola	42	101	40x5	26x14	150	
BREVIGLIERI	65048	-	Coltello con asola	42	82	40x5	30x14	140	
	65107	-	Coltello Y	65	210	60x10	25.5	1000	
BRUNI	09133	-	Dente	-	160	40x10	20.5	450	
	65115	-	Spatola	42	150	45x5	20.5	240	
	65118	-	Dente girato tipo nuovo	-	160	50x10	20.5	560	
CABE/NUOVA CABE/COMAGRI/ AGRIEURO	10087	-	Coltello a Y	50	228	60x7	28.5	700	
	65001	-	Coltello Y	25	80	35x5	14.5	120	

Brand	Art./Ref.	Rif. Orig./ Orig. Ref.	Descrizione/Description	H mm	L mm	Piatto/Plate mm	Diametro foro mm/ Hole diameter mm	Peso gr/Peso gr	Immagine/Image
CABE/NUOVA CABE/COMAGRI/ AGRIEURO	65127	-	Coltello con asola	43	87	40x6	30x14	170	
CALDERONI	10085	-	Coltello a Y	55	118	40x8	20.5	300	
	10086	-	Coltello a Y	55	150	60x10	25.5	650	
	65001	-	Coltello Y	25	80	35x5	14.5	120	
CARONI	65133	CRN01	TL - TM coltello Y	38	124	40x5	12.5	200	
CELLI	65020	-	Coltello Y	52	115	40x8	16.5	310	
	65145	-	Coltello dritto	-	115	40x8	16,5	320	
COSMA	09133	-	Dente	-	160	40x10	20.5	450	
	84418	-	Coltello con asola	45	103	40x8	30x14	250	
DRAGONE	09136	-	Coltello Y	55	200	60x10	25.5	930	
	65157	-	Coltello Y	38	104	40x10	16.5	330	
ENERGREEN BY LASERJET	84411	-	Coltello Y	60	147	60x8	25.5	520	
	84415	-	Coltello dritto	-	150	60x8	25.5	450	
	84418	-	Coltello con asola	45	103	40x8	30x14	250	
FALC	09136	-	Coltello Y	55	200	60x10	25.5	930	
FALCONERO	10085	-	Coltello a Y	55	118	40x8	20.5	300	
	65001	-	Coltello Y	25	80	35x5	14.5	120	
	65020	-	Coltello Y	52	115	40x8	16.5	310	
	84418	-	Coltello con asola	45	103	40x8	30x14	250	

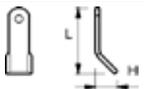
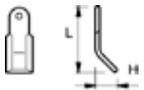
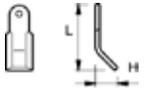
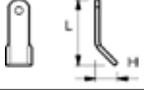
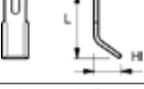
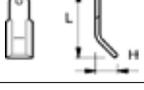
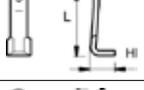
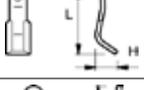
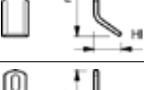
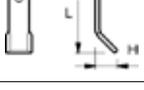
Brand	Art./Ref.	Rif. Orig./ Orig. Ref.	Descrizione/Description	H mm	L mm	Piatto/Plate mm	Diametro foro mm/ Hole diameter mm	Peso gr/Peso gr	Immagine/Image
FAUSTINI	65020	-	Coltello Y	52	115	40x8	16.5	310	
FERRI	65216	-	Coltello centrale Y	45	120	60x8	25.5	440	
	65217	-	Coltello laterale Y	65	120	60x8	25.5	480	
	65222	-	TS coltello Y stampato	60	147	60x8	25.5	520	
	65233	-	Coltello Y	50	144	60x8	25.5	500	
	65234	-	Coltello Y	40	130	40x6	12.5	250	
	65235	-	Coltello diritto	-	130	40x6	12.5	230	
	65236	-	Coltello con asola	42	82	40x6	30x14	160	
	84411	-	Coltello Y	60	147	60x8	25.5	520	
	84413	-	Coltello con asola	45	80	40x80	30x14	200	
	84414	-	Trituratore 18RM-B9-B12 t. vecchio	66	234	60x8	25.5	950	
	84415	-	Coltello diritto	-	150	60x8	25.5	450	
	84416	-	spatola	79	70	70x3	25x14	160	
	84417	-	Coltello con asola	35	82	40x15	27x13	120	
	84418	-	Coltello con asola	45	103	40x8	30x14	250	
	84420	-	Coltello y polivalente leggero	60	130	40x8	16.5	350	
	84421	-	Coltello con asola stampato	44	83	40x8	30x14	210	
84422	-	Coltello con asola tipo lungo	44	100	40x8	35x17	250		
84425	-	Coltello diritto	-	130	40x8	16.5	340		
FORIGO- ROTERTALIA	10085	-	Coltello a Y	55	118	40x8	20.5	300	

Brand	Art./Ref.	Rif. Orig./ Orig. Ref.	Descrizione/Description	H mm	L mm	Piatto/Plate mm	Diametro foro mm/ Hole diameter mm	Peso gr/Peso gr	Immagine/Image
FORIGO- ROTERTALIA	10087	-	Coltello a Y	50	228	60x7	28.5	700	
FRONTONI	09136	-	Coltello Y	55	200	60x10	25.5	930	
	10097	-	Coltello Y	40	130	40x8	16.5	380	
	65049	-	Coltello con asola diritto	-	82	40x5	30x14	120	
	84411	-	Coltello Y	60	147	60x8	25.5	520	
	84413	-	Coltello con asola	45	80	40x80	30x14	200	
	84414	-	Trituratore 18RM-B9-B12 t. vecchio	66	234	60x8	25.5	950	
	84415	-	Coltello diritto	-	150	60x8	25.5	450	
	84425	-	Coltello diritto	-	130	40x8	16.5	340	
GL1	10097	-	Coltello Y	40	130	40x8	16.5	380	
GREENTECH	10097	-	Coltello Y	40	130	40x8	16.5	380	
	65049	-	Coltello con asola diritto	-	82	40x5	30x14	120	
	65277	-	Coltello con asola	44	113	40x8	35x17	280	
	84413	-	Coltello con asola	45	80	40x80	30x14	200	
	84425	-	Coltello diritto	-	130	40x8	16.5	340	
GRILLO	65299	-	Coltello Y tipo leggero	40	100	40x5	12.5	160	
HERMES	65302	-	EM - 80 coltello con asola	40	94	40x5	23X10,5	150	
	65303	-	Castor coltello Y	68	118	50x10	16.5	500	
HMF FREI	65048	-	Coltello con asola	42	82	40x5	30x14	140	

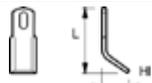
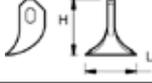
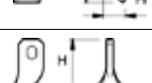
Brand	Art./Ref.	Rif. Orig./ Orig. Ref.	Descrizione/Description	H mm	L mm	Piatto/Plate mm	Diametro foro mm/ Hole diameter mm	Peso gr/Peso gr	Immagine/Image
HYMACH	65326	-	Coltello con asola 024A	44	113	40x8	30x14	280	
	65327	-	Coltello Y 024C	42	152	50x8	20.5	480	
	65334	-	Dente girato		160	50x12	20.5	650	
JF	52608	-	FH coltello Y pesante	40	116	90x6	13.5	550	
KUHN	09136	6060004	Coltello Y	55	200	60x10	25.5	930	
	10096	-	BNA coltello Y	50	130	50x10	20.5	480	
	10097	-	Coltello Y	40	130	40x8	16.5	380	
KVERNELAND- MALETTI	10093	6400080	FX coltello Y	57	194	50x10	16.5	800	
	10094	6200080	FM-FH coltello Y	40	130	40x5	14.5	200	
	84417	6200078	Coltello con asola	35	82	40x15	27x13	120	
MASCHIO	10095	-	Coltello Y	55	150	60x10	20.5	660	
	65048	-	Coltello con asola	42	82	40x5	30x14	140	
	65376	-	Coltello Y tipo leggero	60	136	45x8	16.5	410	
	84416	-	spatola	79	70	70x3	25x14	160	
MEAAT	09136	-	Coltello Y	55	200	60x10	25.5	930	
	84417	-	Coltello con asola	35	82	40x15	27x13	120	
MORIS	10097	-	Coltello Y	40	130	40x8	16.5	380	
	65049	-	Coltello con asola diritto		82	40x5	30x14	120	
	65277	-	Coltello con asola	44	113	40x8	35x17	280	

Brand	Art./Ref.	Rif. Orig./ Orig. Ref.	Descrizione/Description	H mm	L mm	Piatto/Plate mm	Diametro foro mm/ Hole diameter mm	Peso gr/Peso gr	Immagine/Image
MORIS	84413	-	Coltello con asola	45	80	40x80	30x14	200	
	84425	-	Coltello diritto		130	40x8	16.5	340	
MURATORI	10085	-	Coltello a Y	55	118	40x8	20.5	300	
	10086	-	Coltello a Y	55	150	60x10	25.5	650	
	65000	-	MT2 coltello Y	42	114	35x5	14.5	200	
	84416	-	spatola	79	70	70x3	25x14	160	
NICOLAS	65104	-	BG 59 coltello con asola	42	101	40x5	26x14	150	
NOBILI	09136	2555004	Coltello Y	55	200	60x10	25.5	930	
	10096	-	BNA coltello Y	50	130	50x10	20.5	480	
	10097	1781000	Coltello Y	40	130	40x8	16.5	380	
	65442	-	Coltello Y	53	130	45x8	16.5	400	
	65446	1781017	BNE08 coltello con asola	42	92	35x6	30x14	160	
	84414	-	Trituratore 18RM-B9-B12 t. vecchio	66	234	60x8	25.5	950	
	84425	-	Coltello diritto		130	40x8	16.5	340	
NOREMAT	65048	103006	Coltello con asola	42	82	40x5	30x14	140	
	65093	103059	Coltello stampato Y	40	99	45x8	39x16	200	
	65104	1.39.225-103049	BG 59 coltello con asola	42	101	40x5	26x14	150	
	65452	-	Coltello stampato con asola Y	40	99	35x8	33x14	190	
OMARV	09136	-	Coltello Y	55	200	60x10	25.5	930	

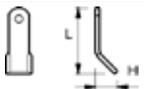
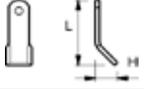
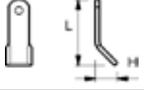
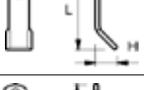
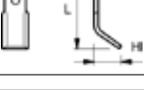
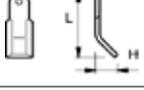
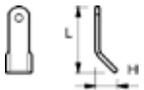
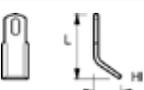
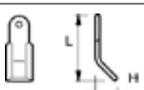
Brand	Art./Ref.	Rif. Orig./ Orig. Ref.	Descrizione/Description	H mm	L mm	Piatto/Plate mm	Diametro foro mm/ Hole diameter mm	Peso gr/Peso gr	Immagine/Image
OREC	65463	-	Coltello Y	30	100	30x4	10.5	120	
ORSI	10085	00023004	Coltello a Y	55	118	40x8	20.5	300	
	10092	00023057	Coltello Y	60	203	60x8	25.5	720	
	10097	00023000	Coltello Y	40	130	40x8	16.5	380	
	26147	00023002	Coltello Y	60	140	60x8	16.5	520	
	65001	00023013	Coltello Y	25	80	35x5	14.5	120	
	65093	-	Coltello stampato Y	40	99	45x8	39x16	200	
	65475	00023044	Dente girato Rif.00023044		152	50x10	25.5	550	
	65483	-	River 500 coltello Y	40	150	40x8	20.5	380	
	84418	00023001	Coltello con asola	45	103	40x8	30x14	250	
PALLADINO	26149	-	Coltello Y	50	204	60x8	25.5	740	
	65299	-	Coltello Y tipo leggero	40	100	40x5	12.5	160	
PEGORARO	26149	-	Coltello Y	50	204	60x8	25.5	740	
PERUGINI CONCEPT	09136	-	Coltello Y	55	200	60x10	25.5	930	
	65020	-	Coltello Y	52	115	40x8	16.5	310	
	84411	-	Coltello Y	60	147	60x8	25.5	520	
PERUZZO	65516	-	Coltello con asola Y	26	103	30x4	30x14	110	
PRE.FER.	84411	-	Coltello Y	60	147	60x8	25.5	520	

Brand	Art./Ref.	Rif. Orig./ Orig. Ref.	Descrizione/Description	H mm	L mm	Piatto/Plate mm	Diametro foro mm/ Hole diameter mm	Peso gr/Peso gr	Immagine/Image
PROCOMAS	65524	-	Coltello Y	55.0	120.0	40x6	16.5	250	
	65527	-	Coltello con asola	45	80	30x5	30x14	100	
	84411	-	Coltello Y	60	147	60x8	25.5	520	
QUIVOGNE	09136	-	Coltello Y	55	200	60x10	25.5	930	
	26149	-	Coltello Y	50	204	60x8	25.5	740	
RINIERI	65001	-	Coltello Y	25	80	35x5	14.5	120	
	84411	-	Coltello Y	60	147	60x8	25.5	520	
ROUSSEAU	10094	-	FM-FH coltello Y	40	130	40x5	14.5	200	
	65104	5.254.22	BG 59 coltello con asola	42	101	40x5	26x14	150	
	65452	-	Coltello stampato con asola Y	40	99	35x8	33x14	190	
SANDRI	84411	-	Coltello Y	60	147	60x8	25.5	520	
	84415	-	Coltello diritto	-	150	60x8	25.5	450	
	84418	-	Coltello con asola	45	103	40x8	30x14	250	
SICMA	10091	-	Coltello L	60	197	60x8	25.5	780	
	10092	-	Coltello Y	60	203	60x8	25.5	720	
	65127	-	Coltello con asola	43	87	40x6	30x14	170	
SICMA/ MIGLIANICO	09136	5816918	Coltello Y	55	200	60x10	25.5	930	
	10086	-	Coltello a Y	55	150	60x10	25.5	650	
	10092	-	Coltello Y	60	203	60x8	25.5	720	

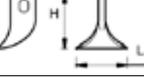
Brand	Art./Ref.	Rif. Orig./ Orig. Ref.	Descrizione/Description	H mm	L mm	Piatto/Plate mm	Diametro foro mm/ Hole diameter mm	Peso gr/Peso gr	Immagine/Image
SICMA/ MIGLIANICO	65001	-	Coltello Y	25	80	35x5	14.5	120	
	65026	-	Coltello diritto		150	60x10	25.5	610	
	65594	-	TRX -TR coltello Y Rif.5816618	60	140	60x8	25.5	520	
SICMA/OSTRA VETERE	10091	-	Coltello L	60	197	60x8	25.5	780	
	65127	-	Coltello con asola	43	87	40x6	30x14	170	
	65299	-	Coltello Y tipo leggero	40	100	40x5	12.5	160	
	65442	-	Coltello Y	53	130	45x8	16.5	400	
SMA	10094	-	FM-FH coltello Y	40	130	40x5	14.5	200	
	65048	-	Coltello con asola	42	82	40x5	30x14	140	
	65093	41654.01-HPRIM	Coltello stampato Y	40	99	45x8	39x16	200	
	65104	-	BG 59 coltello con asola	42	101	40x5	26x14	150	
	65609	-	Coltello stampato Y SM40RL	40	97	40x8	40x15.5	200	
SOVEMA	10091	-	Coltello L	60	197	60x8	25.5	780	
	10092	-	Coltello Y	60	203	60x8	25.5	720	
	65127	-	Coltello con asola	43	87	40x6	30x14	170	
	84416	-	spatola	79	70	70x3	25x14	160	
TAARUP	09138	50507000	Coltello Y	47	215	65x7	29	670	
	10104	49304000	Paletta	40	150	75x7	13.5	590	
TERANOVA	65376	-	Coltello Y tipo leggero	60	136	45x8	16.5	410	

Brand	Art./Ref.	Rif. Orig./ Orig. Ref.	Descrizione/Description	H mm	L mm	Piatto/Plate mm	Diametro foro mm/ Hole diameter mm	Peso gr/Peso gr	Immagine/Image
TERANOVA	84416	-	spatola	79	70	70x3	25x14	160	
TIERRE	10086	-	Coltello a Y	55	150	60x10	25.5	650	
	65026	-	Coltello diritto	-	150	60x10	25.5	610	
	65653	-	Pony coltello Y	43	136	40x10	16.5	450	
TORTELLA	65442	-	Coltello Y	53	130	45x8	16.5	400	
UBALDI	09136	-	Coltello Y	55	200	25.5	60x10	930	
	10097	-	Coltello Y	40	130	16.5	40x8	380	
	65001	-	Coltello Y	25	80	14.5	35x5	120	
	65006	-	Coltello Y tipo leggero	58	176	25.5	60x10	850	
	84411	-	Coltello Y	60	147	25.5	60x8	520	
	84415	-	Coltello diritto	-	150	25.5	60x8	450	
VIGOLO	65685	-	Coltello curvo tipo nuovo	80	200	60x8	25.5	800	
	84417	-	Coltello con asola	35	82	40x15	27x13	120	
ZAMPINI	10097	-	Coltello Y	40	130	40x8	16.5	380	
	65048	-	Coltello con asola	42	82	40x5	30x14	140	
	65049	-	Coltello con asola diritto	-	82	40x5	30x14	120	
	84411	-	Coltello Y	60	147	60x8	25.5	520	
	84413	-	Coltello con asola	45	80	40x80	30x14	200	
ZAPPATOR	10095	-	Coltello Y	55	150	60x10	20.5	660	
	65048	-	Coltello con asola	42	82	40x5	30x14	140	

BOCCOLE E DISTANZIALI PER COLTELLI TRINCIA
BAGUES POUR BROYEURS
BUSHING FOR CHOPPERS
BUGELSCHRAUBEN FÜR HACKSLER
CASQUILLOS PARA TRITURADORAS

Art./Ref.	Descrizione/Description	H mm	S mm	L mm	Peso gr/Peso gr
65036	Boccola Rif.00023009	20	14.5	18	20
65102	Boccola	20	12.2	24	30
65116	Boccola	20.3	12.5	12	30
65035	Boccola RMU	25	16.5	48.5	120
65211	Boccola	25	12.8	63.8	200
65214	Boccola	25	17	28	60
10100	Boccola rif.40-881-100	28	20.5	39	90
65213	Boccola rif. 1101005	40	25.3	27	80
65212	Distanziale	35	12.5	8	30
10103	Distanziale	38	29	13	60
84419	Distanziale	51	25.3	13.4	400

BRIDA PER COLTELLI TRINCIASARMENTI, DECESPUGLIATORI E RASAERBA
BRIDE POUR COUTEAUX BROYEURS, DEBROUSSILLEUSES ET TONDEUSES
CLAMPS FOR CHOPPERS, FLAIL-MOWERS AND GRASS CUTTERS KNIVES
BUCHSEN FÜR KLINGENMESSER FÜR HACKSLER, BOSCHUNGMAHER UND RASENMAHER
BRIDAS PARA CUCHILLOS TRITURADORAS, DESBROZADORAS Y CORTACEPED

Art./Ref.	Descrizione/Description	Peso gr/Peso gr	Immagine/Image
52606	Brida	680	
10101	Brida rif.40-880-000	500	

GRILLI PER COLTELLI TRINCIASARMENTI, DECESPUGLIATORI E RASAERBA
MANILLES A VISSER POUR COUTEAUX BROYEURS, DEBROUSSILLEUSES ET TONDEUSES
D SHACKLES FOR CHOPPERS, FLAIL-MOWERS AND GRASS CUTTERS KNIVES
SCHAKEL FÜR KLINGENMESSER FÜR HACKSLER, BOSCHUNGMAHER UND RASENMAHER
HORQUILLAS PARA CUCHILLOS TRITURADORAS, DESBROZADORAS Y CORTACEPED

Art./Ref.	Descrizione/Description	H mm	L mm	Diametro foro mm/Hole diameter mm	Diametro filo mm/Wire Diameter mm	Peso gr/Peso gr	Immagine/Image
84426	Grillo fissaggio	42	46	9	8	60	
65053	Grillo fissaggio	48	65	11.5	11	130	
84412	Grillo fissaggio	48	65	12.5	11	130	
65294	Grillo fissaggio	49	72	16.5	13	200	

VITI PER COLTELLI TRINCIA
VIS POUR BROYEURS
SCREWS FOR CHOPPERS
SCHRAUBEN FÜR HACKSLER
TORNILLOS PARA TRITURADORAS

Art./Ref.	Note/Note	Peso gr/Peso gr	Immagine/Image
65195	Con dado autobloccante. Per grilli di fissaggio	60	