

Ready for Research™

2024 CATALOG

PERFUSION SYSTEMS

TEMPERATURE CONTROL

AMPLIFIERS & STIMULATORS

ELECTROPHYSIOLOGY RIGS

RODENT FIXATION SYSTEMS

MANIPULATORS & PULLERS

VIBRATION ISOLATION

AUTO PATCH CLAMPING

MULTI-ELECTRODE ARRAYS

PERFUSION CHAMBERS





NEUROSCIENCE

We build the tools so you can do the science.

You probably didn't go into biology to build your own electronics. Why waste months working the bugs out of a home-made perfusion system? Spend your time learning how the brain works instead of soldering cables.

AutoMate Scientific has manufactured scientific instrumentation since 1992.

We compete with larger companies by using our **experience** to build better products with more perfusion features you need. Our engineers work constantly to create **innovative** new tools to extend your research while keeping costs

down. Each system is built for your specific application – so you can start using it right out of the box. We design **quality** into every product using first-class components and suppliers to manufacture the best equipment possible.

Maximize **value** by ordering a complete system, or save money buying just the pieces you need. Our **service** doesn't stop until everything is working exactly how you want it to.

From anesthesia to *Xenopus* research, scientists world-wide place their trust in AutoMate Scientific's products and service every day. Imagine what you can do with the extra time you save.



MICROFLUIDICS



PHYSIOLOGY

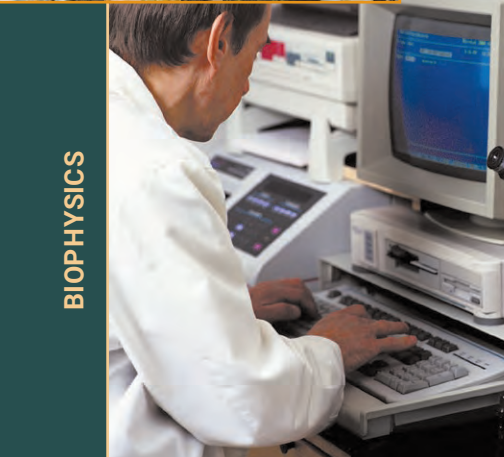

BIOPHYSICS

Through our partnerships we bring you innovation.

One company cannot be good at everything. This is why we have partnered with some of the best companies in laboratory instrumentation. Our partners share our same values and passion for quality and excellence. We work hand in hand to offer you the best possible selection of instruments for all of your research needs. From data acquisition to brain slice chambers, we've got it all thanks to teamwork. At AutoMate Scientific, we are proud to work with our partners, and we stand by their products the same way we stand behind our own.

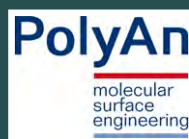
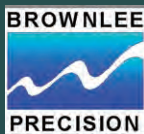

CELLULAR IMAGING



PHARMACOLOGY



DRUG DISCOVERY



ELECTROCHEMISTRY



Your new electrophysiology rig from AutoMate Scientific.

One stop. One order for all your needs.

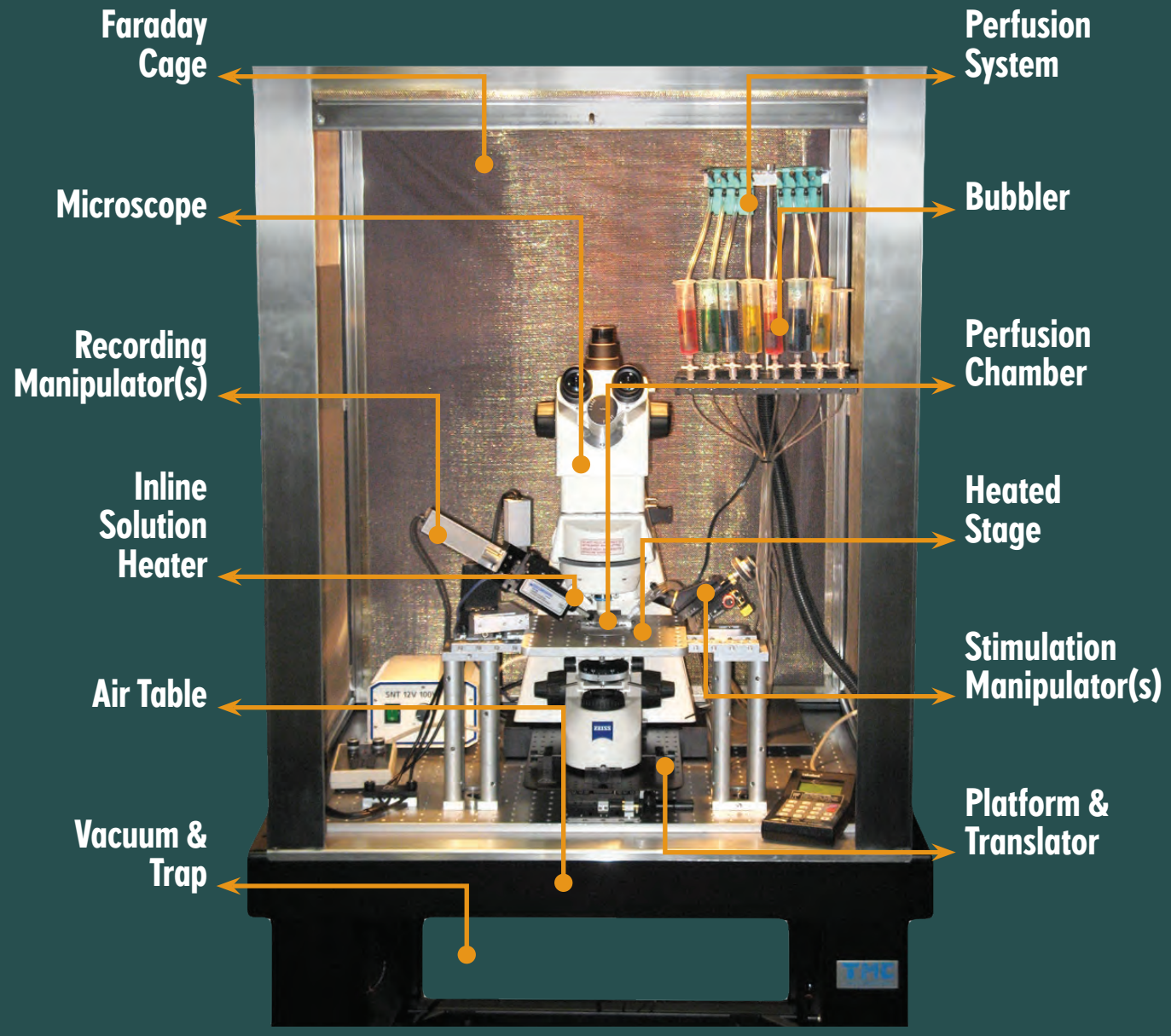

Complete Electrophysiology Rig

With over 25 years of experience designing and manufacturing electrophysiology equipment combined with partnerships with the most reputable equipment manufacturers, AutoMate Scientific is in a unique position to provide you with all of the equipment to build or upgrade your electrophysiology workstation. From Axon Instruments / MDC amplifiers, digitizers, and software, Sutter Instrument microelectrode pullers, micromanipulators, and imaging products, to TMC air tables, we can provide a turn-key rig delivered to your door, or just a few pieces. Our prices are competitive, but you will keep coming back for our personalized customer service.

Assemble a complete rig online with our graphic web form at:
<https://www.autom8.com/complete-electrophysiology-rig/>

Contact our sales scientist at AutoMate Scientific to get a quote today. Put our experience to work combining all of the hardware and software you need to record... and publish. We offer configurations for patch clamping, extracellular and intracellular microelectrode recording, Xenopus oocytes, and multielectrode array systems.

State-of-the-art Recording Workstation



Ordering Information

Part No.	Electrophysiology Rig	Price
	MDC/AXON INSTRUMENTS	
MultiClamp	MultiClamp 700B amplifier	\$ 22,522
Digidata	Digidata 1550B1	\$ 9,451
pClamp	pCLAMP 11 Software for Windows	\$ 9,090
	BROWNLIE PRECISION	
04-40	Model 440 instrumentation amplifier	\$ 4,350
	AUTOMATE SCIENTIFIC	
13-21-53	ValveBank8 PTFE-Inert perfusion system	\$ 4,327
01-39	Un-regulated perfusion reservoir gas bubbler	\$ 140
	SISKIYOU	
MXMS-115	Microscope translator	\$ 3,500
BPS2	Platform hardware	\$ 1,364
R-MX7600/45DR	Micro-manipulator & MC1100e controller	\$ 6,625
SD-160R	Manipulator with rotating base (MX-RS)	\$ 1,950
	HEATED STAGE and PERFUSION CHAMBER	
QS-H-12UP-TT-ZM	QuickStage Heated 12 mm diamond / round coverslip chamber (upright) with ToolTray, stage adapter for Zeiss/Leica M, and ThermoClamp® temperature controller.	\$ 1,892
	TMC	
TM-63-7590E	CleanBench high-performance lab air table	\$ 7,005
TM-81-333-03	Type II Faraday cage	\$ 2,490
TM-81-7590	Full perimeter enclosure	\$ 465

U.S./Canada prices shown. International prices add 15-20%. Email or visit web store for latest prices.

TMC Air Table and Faraday Cage



Build your rig on a solid foundation with an industry-standard TMC air table and Faraday cage for ideal vibration isolation.



PERFUSION SYSTEM



TEMPERATURE CONTROL



PERFUSION CHAMBERS



SMARTSQUIRT

Table of Contents

Perfusion Systems	6-20
Perfusion Systems	6
ValveLink8.3® Controller	13
ValveBank® Controller	15
Perfusion Accessories	17
EasyCode® Software	20
Pressurized Superfusion	21-23
Pressurized Superfusion & Oxygen8™	21
Perfusion Pencil® Multi-Barrel Manifold	23
ThermoClamp® Temperature Control	24-35
BubbleStop® Syringe Heater	26
QuickStage™ Heated Perfusion Chambers and Stage Adapters	27
Cool Solutions Peltier Heater/Cooler	34
SmartSquirt® Micro-Perfusion	36-37
Perfusion Chambers	38-41
StageHands™ Magnetic Tool Holders	38
Oocyte Perfusion Chamber	40
Petri Dish Perfusion Chamber	41
Rodent Fixation Systems	42-43
Brain Slice & Tissue Chambers	44-47
Amplifiers & Stimulators	48-58
Hum Bug Noise Eliminator	48
Brownlee Instrumentation Amplifiers	50
Equipment Racks and Shelves	52
NeuroLog Modular System	54
DS2A, DS3 & DS4 Stimulators	57
DG2A Train Delay Generator	59
Sutter Instrument	61-63
Manipulators	61
Micropipette Fabrication	61
Optical Instruments & Microinjection	62

Siskiyou Mechanicals	64-81
Platforms, Translators	64
Manipulators	70
Accessories	78
Piezo Switcher	80
Multi-electrode Array	82-87
Alpha MED64 System	82
Alpha MED64 Probes	84
Alpha MED64 Mobius Software	85
Alpha MED64 Perfusion	87
Axon CNS Instruments	88-98
MultiClamp	88
Axoclamp	90
Axopatch & Accessories	92
pCLAMP Software	96
DigiData Acquisition & Ordering Information	97
TMC Air Tables	99-105
Laboratory Air Tables, Breadboards & Accessories	99
Faraday Cages	103
CleanBench Aktiv Tables	104
Active TableTops - Series 66	105
Pico Patch Clamp Amp & Digitizer	106
Biopetechs Heated Chambers	107-113
DeltaT® Open Dish Heater	107
DeltaT® Accessories	109
Perfusion Pump & Software	112
Automated Patch Clamping	114-117
ChannelMAX Mini & Twin, ez-gSEAL	114
ez-gSEAL	117
EcigAero™ Aerosol Exposure	118-122
Ordering Information	124-125
Customer Service	124
Prices & Payment	124
Warranty	124
Returns & Repairs	125

RODENT FIXATION SYSTEM



PRESSURIZED SUPERFUSION

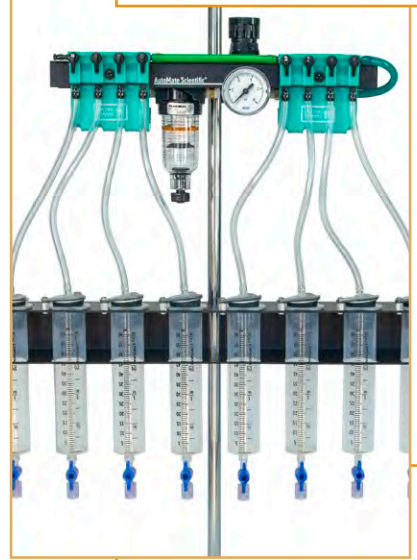

MANIPULATORS



MICROPIPETTE FABRICATION



Perfusion Systems



13-01-53 ValveBank8 PTFE-Inert Perfusion System

Valve Controllers



ValveLink Controller



ValveBank Controller

Reservoirs



You can choose 15, 35, 60 or 140ml reservoirs

How to configure and order a perfusion system.

AutoMate Scientific sells complete perfusion systems as well as individual components. This can make it confusing for customers to determine which pieces they need to order. We hope this guide helps. All of the items mentioned below are explained in more detail on the following pages, or you can quickly customize a complete perfusion system on our web site at <https://www.autom8.com/build-your-own/>.

1. Gravity, bath perfusion systems
2. Pressurized, fast, local drug application
3. Temperature control
4. Putting it all together

1. Gravity, bath perfusion systems

Our Perfusion Systems are complete gravity, bath perfusion systems. You can choose the number of channels (liquids), one of two valve controllers (ValveBank® or ValveLink®), and one of three different kinds of valves (pinch, PTFE-inert, and Lee valves). Everything you need for a regular gravity perfusion system is included: controller, valves, reservoirs, ringstand, 1/16" i.d tubing and 4-, 8-, or 16-into-1 micro-manifold with flow regulator. Gravity PTFE-inert systems include drippers and a reservoir bracket.

This Perfusion System is ideal for switching solutions flowing into a perfusion chamber for slice electrophysiology, oocytes, imaging, etc. with flow rates from near zero up to 6-10 ml/minute. We usually recommend pinch valves (cheapest and easiest to clean) unless you need faster switching. Our ValveLink controller is designed for customers who have digital/TTL

Gravity Perfusion Systems Ordering Information

Part No.	Electrophysiology
17-pp-54	ValveLink8 Pinch Valve Perfusion System
2x #01-05	Low-noise grounding packages (4 valves each)
01-20	Full BNC cable or alternate cable for Heka amplifiers

Part No.	Imaging or no digital outputs
13-pp-54	ValveBank8 Pinch Valve Perfusion System
	You can choose 15, 35, 60 or 140ml reservoirs.

outputs from their computer -- from data acquisition software like pCLAMP, Patchmaster, SutterPatch, WinWCP, MetaMorph, etc. or I/O hardware with software like LabView or MATLAB. Alternatively, our ValveBank controller is completely programmable without needing a computer. It is ideal for setups without computer control or imaging software with only 1-2 digital trigger or shutter outputs.

2. Pressurized, fast, local drug application

For customers needing faster switching times (ligand-gated channels, etc.) we recommend local drug application -- often called "spritzing" or "superfusion." This means the perfusion tubes meet in a smaller manifold with a tiny tip ideal for squirting solution directly at a patch or region of interest. AutoMate Scientific's Perfusion Pencil® can achieve switching times below 10 milliseconds WITHOUT the need of "steppers" or piezo switchers. This manifold combines 4, 8 or 16 tubes into a single, removable tip with a micro dead volume of 2-3 µl. When the perfusion system's valves upstream switch from one liquid to the next, the change happens inside the Perfusion Pencil tip, resulting in very fast switching times.

For researchers who need faster switching times, steadier flow rates, fine microliter delivery or small pipette tips, we recommend adding a Pressure Upgrade to the perfusion system. These pressurized syringe reservoirs with regulator push liquids out much faster than gravity, especially with small Perfusion Pencil tips. Air pressure is much more quiet (electrically and audibly), more smooth and more reliable than peristaltic pumps.

Electrophysiologists often need their solutions bubbled with Carbogen for slice oxygenation. For many years, AutoMate Scientific's Pressure Upgrade Kit was incompatible with bubbling because the syringe reservoirs are closed air-tight. However, we have created the Oxygen8™ Bubbled Pressure Upgrade which simultaneously bubbles and pressurizes all of the solutions.

Pressurized Local Drug Application Ordering Information

Part No.	4 Channels
04-04-xxx	Perfusion Pencil with 100, 250 or 360µm tip
09-04	Perfusion Pressure Upgrade
09-14	Oxygen8 Bubbled Pressure Upgrade

Part No.	8 Channels
04-08-xxx	Perfusion Pencil with 100, 250 or 360µm tip
09-08	Perfusion Pressure Upgrade
09-18	Oxygen8 Bubbled Pressure Upgrade

Perfusion Pencil



04-08-250 Perfusion Pencil

Perfusion Pressure Upgrade



09-08 Perfusion Pressure Upgrade

Oxygen8 Bubbled Pressure

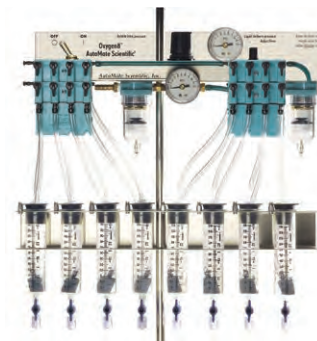

09-18 Oxygen8 Bubbled Pressure Upgrade



ThermoClamp Heater



03-18-xxx ThermoClamp
Inline Heater

BubbleStop

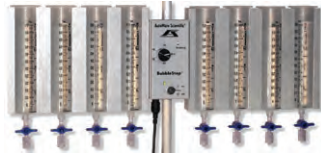

10-8-60-G BubbleStop Syringe
Heater - Gravity

QuickStage Chamber

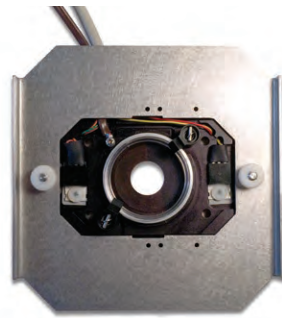

QS-H-35W-TT-UU
QuickStage Heated 35mm WillCo
Petri perfusion chamber

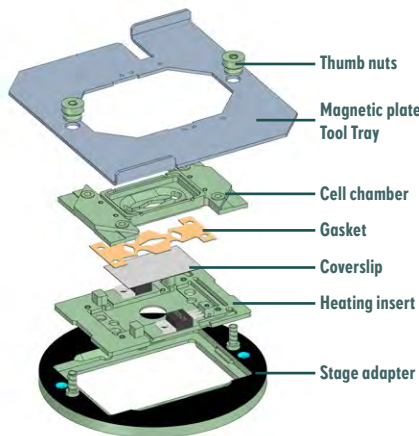

QS-H-12UP-TT-N
QuickStage Heated 12mm diamond
perfusion chamber

3. Temperature control

AutoMate Scientific's standard perfusion systems are all room-temperature by default, but we offer several temperature control options: 1) ThermoClamp® inline heater, 2) BubbleStop® syringe reservoir heater, 3) QuickStage™ stage heaters, 4) Cool Solutions peltier heater/cooler, and 5) objective heaters. Most of the thermal mass your cells experience originates from the liquids flowing over them. Therefore, the most effective temperature control is a good inline solution heater (or cooler) which is positioned as close to the prep as possible. Our ThermoClamp-3 maintains your solution and bath temperature to within 1.0°C (often within 0.1°C) using a thermocouple in your perfusion chamber and another in the heater. It shares a similar design to our Perfusion Pencils mentioned previously, allowing for rapid solution switching from a fine removable tip while also maintaining 37°C or any desired temperature between ambient and 50°C.

When used with cold solutions (i.e. stored in the refrigerator overnight), inline heaters can create bubbles inside their tubing. Many people mistakenly believe these bubbles come from air leaking into the tubing, but they actually form because warm liquids cannot hold as much gas as cold solutions. The solutions release gas when heated, and cause bubbles which can interrupt your perfusion flow. AutoMate Scientific has designed an economical syringe heater block called the BubbleStop which pre-heats the liquids so they off-gas before entering your tubing.

The AutoMate Scientific QuickStage is designed to fit directly into your microscope stage or platform to hold a perfusion chamber or 35mm Petri dish. The heated version of the QuickStage uses AutoMate Scientific's popular ThermoClamp temperature controller to maintain your set temperature from ambient to 50°C.

Temperature Control Ordering Information

Part No.	4 Channels
03-14-xxx	ThermoClamp Inline Heater
10-4-60-G	BubbleStop Syringe Heater - Gravity
10-4-60-P	BubbleStop Syringe Heater - Pressure

Part No.	8 Channels
03-18-xxx	ThermoClamp Inline Heater
10-8-60-G	BubbleStop Syringe Heater - Gravity
10-8-60-P	BubbleStop Syringe Heater - Pressure

Part No.	QuickStage Chamber and Heater
QS-H-35W-TT-UU	QuickStage Heated 35mm WillCo Petri perfusion chamber
QS-H-12UP-TT-N	QuickStage Heated 12mm diamond perfusion chamber

4. Putting it all together

To order a pressurized or temperature-controlled perfusion system, you should start with one of our unheated gravity systems, and add the additional pieces you need. Here are some examples:

Example Simple Systems Ordering Information

Part No.	4-Channel Pressurized Perfusion System
17-01-23	ValveLink8 PTFE-inert Perfusion System
09-04	Perfusion Pressure Upgrade
04-04-100	Perfusion Pencil with 100µm tip
01-29	USB cable

Part No.	8-Channel Heated Perfusion System
13-11-57	ValveBank8 Lee Valve Perfusion System
03-18-360	ThermoClamp Inline Heater with 360µm tip
10-8-60-G	BubbleStop Syringe Heater - Gravity
VB-1600	Heka EPC-10 ValveBank Interface Cable

Example Advanced Systems Ordering Information

Part No.	8-Channel Heated Imaging System
13-01-53	ValveBank8 PTFE-inert Perfusion System
01-03-2000	EasyCode ValveBank Programming Software
09-T18	Oxygen8 Bubbled Pressure Kit - Top Half
10-8-60-G	BubbleStop Syringe Heater - Bottom
03-18-250	ThermoClamp Inline Heater with 250µm tip
01-15	ValveBank Parallel Port Cable to MetaMorph
QS-H-12IN	QuickStage heated 12mm diamond chamber and stage adapter
vac	Vacuum Pump
canister	Vacuum Trap

Part No.	8-Channel Slice Electrophys System
17-11-57	ValveLink8 Lee Valve Perfusion System
01-05 x 2	Low-noise Grounding Packages
01-20	Full BNC cable to DigiData
09-T18	Oxygen8 Bubbled Pressure Kit - Top Half
10-8-60-G	BubbleStop Syringe Heater - Bottom
03-18-250	ThermoClamp Inline Heater with 250µm tip
S-BSC1	Brain Slice Chamber-1: Interface and Submerged
S-PTC03	Chamber Temperature Controller
canister	Vacuum Trap

We offer a great web form to help build you own perfusion system. Just answer a few questions, enter your contact info, and click Submit for a customized quote at: <https://www.autom8.com/build-your-own/>.

Perfusion Packages

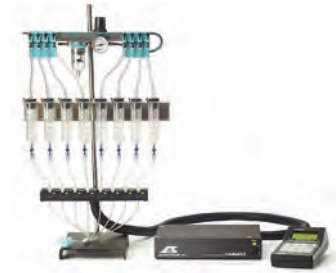

- 13-11-57 ValveBank8 Lee Valve Perfusion System
- 01-05 Low-noise grounding package
- 09-08 Perfusion Pressure Kit

Brain Slice Chambers



- S-BSC1 Brain Slice Chamber-1: Interface and Submerged

Accessories



Custom BNC cables



"I am writing to tell you how pleased I am with the ValveBank8 Perfusion System. It's great that I can load the reservoirs, press go, and start recording. I can read papers rather than fussing with solutions and switching valves every 10-15 minutes. Since solutions are switched at exactly the same time from one experiment to the next, I have been able to automate my data analysis protocols as well."

Brain Slice Field Recording

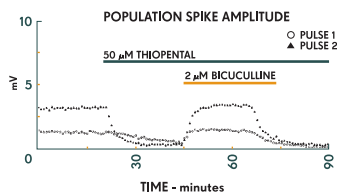

Unattended solution delivery using a ValveBank8 AutoPrime Perfusion System

**Dr. M. Bruce MacIver,
M.Sc., Ph.D.**

Department of Anesthesia
Stanford University
Medical Center

Increase reproducibility with fewer hours in lab.



Gravity Perfusion Systems

- Unattended solution switching**
 Avoid vibrations from switching valves by hand. The ValveBank® or ValveLink® controller handles all solution delivery so you can watch results – not switch stopcocks. Many special features are included for easy perfusion control. Low noise circuitry.
- Increased reproducibility**
 Valve switching is accurate to 0.01 seconds with programs up to 99 hours long under microprocessor control. Consistent liquid delivery means better data.
- Pinch, PTFE-Inert and Lee™ Valves**
 Choose between speed, cost, and ease of cleaning. Several options are available for fittings and reservoirs.
- Manual and external valve control**
 Flexible design. Easy cleaning and calibration. Primary/secondary mode valve operation controlled by your computer, pClamp, Patchmaster, SutterPatch, LabView, AxoGraph, etc.

Valve Choices:

- **Pinch Valves for Reduced Maintenance**

Easiest valves to clean and switch tubing. Liquids never touch the valves. Switches in 30-50 ms. 1/32" i.d. silicone tube passes through, and is pinched closed by solenoid activation. All AutoMate Scientific valves include an individual indicator LED. Our aluminum enclosure keeps the valves dry from spills and offers luer lock ports for syringe reservoirs.

- **PTFE-Inert Valves for Fast Switching**

Required for fast kinetics applications. Excellent chemical and corrosion resistance. Non-stick surface resists particles and chemical deposits. Switches in less than 10 ms, with 20 µl of dead volume from port to port. Threaded female inlet and outlet ports accept Hose Barb, Luer Lock and Nut & Ferrule fittings (see diagrams next page).

- **Lee™ Mini Valves for Extremely Fast Switching and Minimal Pressure Pulse**

For the most demanding applications AutoMate Scientific offers tiny valves from the Lee Company. Enclosed in our aluminum box with luer locks for syringe reservoirs, these valves can open and close in 1.5-4 ms with a ValveLink8.3 controller.

Perfusion Systems Include:

Controller, valves, 60 ml syringe reservoirs, 2-way stopcocks, (reservoir bracket and drippers in PTFE-Inert systems only), ringstand, 1/16" i.d. tubing and four-, eight- or sixteen-into-one micro-manifold with built-in flow control. 5, 15, 35, 60 or 140 ml syringe reservoirs available.

The Economy Pinch Valve System includes a ValveLink8 controller, four pinch valves, 35 ml syringes, 2-way stopcocks, ringstand, 1/16" i.d. tubing and four-into-one micro-manifold with built-in flow control.

Computer Interfacing:

Perfusion systems can be controlled by a computer using data acquisition hardware (i.e., DigiData, ITC-16, or National Instruments board) and software (i.e., pCLAMP, Patchmaster, SutterPatch, or LabView). Both ValveBanks and ValveLinks accept real-time TTL inputs to control valves. Most acquisition software already being used in your experiments can talk to our controllers. AutoMate Scientific offers an optional program called EasyCode® for the Macintosh and PC/Windows to program ValveBanks (not ValveLinks). This software is used before an experiment – valve sequences are downloaded into the memory of the ValveBank where they are run. An article by AutoMate Scientific can be found in Axon Instrument's AxoBits 17 newsletter outlining these strategies – accessible on our web site.

Pinch Valves



PTFE-Inert Valves



Lee™ Valves



Luer-lock Fittings in PTFE-Inert Valves



Luer-lock fittings in PTFE-Inert valves allow direct connection of syringe reservoirs for minimal dead volume.

PTFE-Inert Valve Fitting Choices

Hose Barb



- Standard
- Available for 1/8" and 1/16" i.d. soft tubing

Lure-Lock



- For direct attachment of syringes
- Eliminates extra tubing between reservoirs and valves
- Includes 2-way stopcocks and syringes

Nut & Ferrule



- HPLC-like, screw-in fittings for rigid, small-diameter (1/16" o.d.) tubing



Ordering Information

Part No.	Perfusion Systems	Price
17-21-20	ValveLink [®] 4.3 Economy Pinch Valve Perfusion System	\$ 1,762
13-01-23	ValveBank [®] 4 PTFE-Inert Perfusion System	\$ 2,667
13-pp-24	ValveBank4 Pinch Valve Perfusion System - 1/32" i.d. silicone tube	\$ 2,207
13-21-27	ValveBank4 Lee Mini Valve Perfusion System	\$ 2,707
17-01-23	ValveLink4.3 PTFE-Inert Perfusion System	\$ 2,622
17-pp-24	ValveLink4.3 Pinch Valve Perfusion System - 1/32" i.d. silicone tube	\$ 2,162
17-21-27	ValveLink4.3 Lee Mini Valve 1.5 to 4 ms Perfusion System	\$ 2,662
13-01-53	ValveBank8 PTFE-Inert Perfusion System	\$ 4,327
13-pp-54	ValveBank8 Pinch Valve Perfusion System - 1/32" i.d. silicone tube	\$ 3,607
13-21-57	ValveBank8 Lee Mini Valve Perfusion System	\$ 4,397
17-01-53	ValveLink8.3 PTFE-Inert Perfusion System	\$ 3,782
17-pp-54	ValveLink8.3 Pinch Valve Perfusion System - 1/32" i.d. silicone tube	\$ 3,062
17-21-57	ValveLink8.3 Lee Mini Valve 1.5 to 4 ms Perfusion System	\$ 3,852
17-01-83	ValveLink16.3 PTFE-Inert Perfusion System	\$ 6,957
17-pp-84	ValveLink16.3 Pinch Valve Perfusion System - 1/32" i.d. silicone tube	\$ 5,817
17-11-87	ValveLink16.3 Lee Mini Valve 1.5 to 4 ms Perfusion System	\$ 8,317

U.S./Canada prices shown. International prices add 15%. Email or visit web store for latest prices.

xx-[TB]-xx Indicate [T]op inflow and [B]ottom outflow PTFE-Inert valve fittings:
 [0]=1/8" i.d. hose barb, [1]=1/16" i.d. hose barb, [2]=Luer-lock female with stopcocks and 35 ml syringes,
 [3]=10-32 threaded nut & ferrules for 1/16" o.d. tubing (add \$30/set of 4), [pp]=Pinch valves have no fittings

Systems include: Controller, user manual, valves, 35 ml or 60 ml syringes, stopcocks, (reservoir bracket and drippers in PTFE-Inert systems only), ringstand, 1/16" i.d. Tygon tubing, and 4-, 8- or 16-into-1 micro-manifold with flow control. 5, 15, 35, 60 or 140 ml syringe reservoirs available.

Visit <https://www.autom8.com/build-your-own/> to configure a perfusion system and quote.

Ordering Information

Part No.	Valves & Fittings	Price
	Each pair of 4 valves ordered together will be mounted in a case of 8.	
02-01-02	Set of 4 PTFE-Inert valves - cabled and mounted	\$ 1,055
02-pp-04	Set of 4 Pinch valves - cabled and mounted, 1/32" i.d. silicone tube	\$ 745
02-21-07	Set of 4 Lee mini valves - cabled and mounted	\$ 1,230
02-01-02i	Individual PTFE-Inert replacement valve	\$ 195
02-pp-04i	Individual Pinch replacement valve	\$ 155
02-21-08i	Individual Lee mini replacement valve	\$ 245
01-05	Low-noise, valve and case grounding package (per 4 valves) A grounding wire attached to all valves extending back to the controller. This item is recommended for electrophysiology and required for CE conformity.	\$ 75
02-06	Valve extension cables - 2 meter RCA M/F (set of 4 cables)	\$ 15
05-01	Luer-lock fittings - with 2-way stopcocks (set of 4)	\$ 10
05-02	Nut & ferrule fittings - for 1/16" o.d. tubing (set of 4)	\$ 45

U.S./Canada prices shown. International prices add 15%. Email or visit web store for latest prices.

02-[TB]-02 Indicate [T]op inflow and [B]ottom outflow PTFE-Inert valve fittings:
 [0]=1/8" i.d. hose barb, [1]=1/16" i.d. hose barb, [2]=Luer-lock female with stopcocks,
 [3]=10-32 threaded nut & ferrules for 1/16" o.d. tubing (add \$30/set of 4),
 [pp]=Pinch valves have no fittings

Open and close valves in record time.



ValveLink8.3® Controller

- **ValveGuard™ technology detects bad valves**
Prevent damage to your ValveLink8.3® and easily observe problem valves.
- **Run experiments automatically – even unattended**
By running experiments automatically, AutoMate Scientific systems will leave you free to accomplish other tasks – saving you both time and money.
- **Microprocessor-based for accuracy and flexibility**
Our low-cost ValveLink8.3 controller has powerful perfusion commands and capabilities not offered by competing valve drivers: open single or multiple valves, master channel for control/buffer solution, computer control.
- **Low noise & low voltage valve control**
Designed for electrophysiology. CE marked for Europe.
- **Manual, TTL (digital), analog, and USB inputs**
Control valves manually (by pushbutton) or by computer – simultaneously thanks to the microprocessor design. Optional spill sensor protects your equipment when a leak is detected.

“Our lab has been using ValveLink controllers for years with good, reliable results. The new ValveLink8.3 is even smaller and faster than its predecessor. It also looks cool and the buttons feel nicer than the previous version. I use it manually or programmed by outputs from my stimulator. I haven’t observed any noise from the valve system on my electrophysiology rig.”

Hillel Adesnik, Ph.D.

Department of Cellular and
Molecular Pharmacology
University of California,
San Francisco



ValveLink8.3 Controller



- Manual pushbuttons
- Red/green LED indicators
- 1.5 amp, 12V AC supply included
- Dimensions: 9.28" x 1.6" x 5.13"
- Weight: 3 lbs. (1.4 kg.)



- Eight TTL inputs directly activate 8 valves
- Or control 16 valves with only four digital outputs

Additional Features

- One analog input can control eight valves
- Analog event marker allows you to record all valve activity
- An optional spill sensor stops all valves when a leak is detected to protect your microscope and table. All LEDs blink until you press a button to continue.

Free ValveLink PC Software



- Control valves directly from your PC screen by USB
- Network multiple ValveLinks into a single, virtual instrument



ValveLink8.3s can switch 12V DC solenoid valves open and closed in one millisecond using full power, then hold-in at 1/2 power to prevent thermal transfer to your solutions. Low noise circuitry minimizes recording artifacts in electrophysiology. The ValveLink8.3 is less expensive than AutoMate Scientific's ValveBank controller. It is the controller of choice for dose response work. Both ValveLink8.3s and ValveBanks are designed for use with pClamp, Patchmaster, SutterPatch, et al. All AutoMate Scientific products include a one-year warranty.

ValveGuard™ technology detects bad valves to prevent damage to your ValveLink8.3 and easily observe problem valves. Front-panel LEDs are dark for broken or disconnected valves, or blink for short-circuited valves. Automatic networking lets you connect up to eight ValveLink8.3s to a USB hub and PC to create a single 64-channel controller. A ValveLink8.3 can power individual valves up to 1 amp (12 watts), and a total of 2 amps for all valves open simultaneously.

ValveBank or ValveLink8.3: Which controller is right for you?

Features	ValveBank	ValveLink8.3
CHANNELS	4 or 8 channels available	8 channels each + USB network to 64 channels
COMPUTER I/O	8 digital in, 8 digital out, serial (RS-232)	8 digital in, USB, analog input, event marker out
DIGITAL INPUTS	One pulse can start a ValveBank program, or TTL inputs each control 1 valve	One TTL input per valve, or demultiplex and control up to 16 valves with 4 inputs
PROGRAMMABLE	Yes- ValveBank keypad, EasyCode software or digital outputs from your data acquisition software	Only using real-time analog or digital outputs from your computer / data acquisition software.
SOFTWARE	Optional "EasyCode" software to pre-program ValveBanks (up to 16 ch.)	Free Windows real-time USB control and networking software for up to 64 valves at once
MANUAL CONTROL	External keypad	Front panel buttons
MANUAL FEATURES	1-on, primary channel, timed open, TTL outputs	1-on, primary channel
SPEED	10 milliseconds	1 millisecond
VALVE POWER	4 watts per channel or 8 watts total	Up to 12 watts (1 amp) per channel, 24 watts (2 amps) total
PRICE	Higher	Lower

Ordering Information

Part No.	ValveLink8.3 Controller	Price
01-18	ValveLink®8.3 digital/manual controller	\$ 1,150
01-26	ValveLink®16.3 digital/manual controller	\$ 2,300
01-19	BNC cable - ValveLink8.3 to pCLAMP/Digidata, et al., 4 BNC plugs to DB-9	\$ 120
01-27	BNC cable - ValveLink16.3 to pCLAMP/Digidata, et al., 5 BNC plugs to DB-15	\$ 210
01-29	USB cable - USB-A male, USB-B male 10' cable	\$ 9
01-30	USB hub - 4 port unpowered	\$ 24
01-17	Rack-mounting brackets - ValveLink8.3 to standard 19" rack	\$ 80
	Cables for Heka/InstruTECH and LabView	\$ call

U.S./Canada prices shown. International prices add 15%. Email or visit web store for latest prices.

Behind every great perfusion system is a reliable valve controller.



ValveBank® Controller

- **Run experiments automatically – even unattended**
By running experiments automatically, AutoMate Scientific systems will leave you free to accomplish other tasks – saving you both time and money.
- **Microprocessor-based for accuracy and flexibility**
The ValveBank® can store sixteen user programs with 10 millisecond switching accuracy. It includes powerful perfusion commands and capabilities not offered by competing valve drivers: open single or multiple valves, master channel for control/buffer solution, and computer control.
- **Low noise & low voltage valve control**
Designed for electrophysiology. CE marked for Europe.
- **Manual, TTL (digital), and serial (RS-232) inputs**
Control valves manually (by keypad) or by computer – simultaneously thanks to the microprocessor design.
- **Low cost & low profile, simple design**
Optional BNC cables and 19" rack-mounting brackets.

"We use the ValveBank in electrophysiology on a Xenopus oocyte recording rig. We have run a twelve-channel manual perfusion delivery system for several years with timed solenoid valves. The ValveBank and accompanying EasyCode Macintosh software allow us to program full wash and delivery sequences in advance with significantly more accurate switching. The new manual perfusion timing option allowed the ValveBank to perform exactly like the controller we had built before. Basically, the ValveBank saves us the worries of monitoring reagent-delivery, and it works."

Dr. David Julius
Nobel Prize in Physiology or Medicine 2021
Department of Cellular and Molecular Pharmacology
University of California,
San Francisco

Made to last



Original ValveBank from 1994 still in daily use in David Julius' lab at UCSF. Photo taken July 2013.



ValveBank4 & 8



- Dimensions: 10" x 7.5" x 2"
Weight: 5 lbs. (2.27 kg.)



- User-selectable for normally open or closed valves
- 1.5 amp, 12V AC power supply included



- Back-lit LCD display
- Detached 16-key membrane keypad
- Easy menu-driven interface
- 16 or 32 user programs of 256 commands up to 99 hours long

EasyCode Software

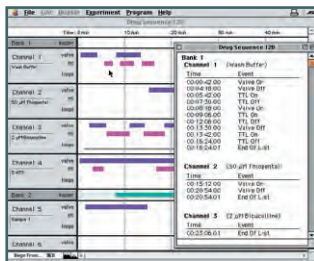

- Program up to sixteen channels of valves and digital outputs.
- Open multiple experiment windows. List sequences to screen or printer. Copy and paste. Zoom in and out of your experiment. Please see page 20.



All AutoMate Scientific valve controllers switch 12V DC solenoid valves open and closed rapidly using full power, then hold-in at 1/2 power to prevent thermal transfer to your solutions. Low noise circuitry minimizes recording artifacts in electrophysiology. ValveBanks are designed for use with pClamp, Patchmaster, et al. All AutoMate Scientific products include a one-year warranty.

The ValveBank® remains the only programmable valve controller for physiology that does not require a computer. ValveBanks include digital and manual control, plus programming through their keypad and LCD screen or EasyCode® software from a PC. ValveBanks run user valve sequences without a computer and include eight programmable digital outputs for control of external devices such as stimulators, pumps and recording devices. Entire ValveBank programs can even be triggered by a single TTL pulse.

EasyCode® - Expand the computing power of your ValveBank

Optional EasyCode software helps you program your ValveBank with a PC-Windows using easy "click-and-drag" time bars. Download your valve sequences into the ValveBank's memory with the included cable. Run programs on the ValveBank, which can be disconnected from the computer.

ValveBank or ValveLink8.3: Which controller is right for you?

Features	ValveBank	ValveLink8.3
CHANNELS	4 or 8 channels available	8 channels each + USB network to 64 channels
COMPUTER I/O	8 digital in, 8 digital out, serial (RS-232)	8 digital in, USB, analog input, event marker out
DIGITAL INPUTS	One pulse can start a ValveBank program, or TTL inputs each control 1 valve	One TTL input per valve, or demultiplex and control up to 16 valves with 4 inputs
PROGRAMMABLE	Yes- ValveBank keypad, EasyCode software or digital outputs from your data acquisition software	Only using real-time analog or digital outputs from your computer / data acquisition software.
SOFTWARE	Optional "EasyCode" software to pre-program ValveBanks (up to 16 ch.)	Free Windows real-time USB control and networking software for up to 64 valves at once
MANUAL CONTROL	External keypad	Front panel buttons
MANUAL FEATURES	1-on, primary channel, timed open, TTL outputs	1-on, primary channel
SPEED	10 milliseconds	1 millisecond
VALVE POWER	4 watts per channel or 8 watts total	Up to 12 watts (1 amp) per channel, 24 watts (2 amps) total
PRICE	Higher	Lower

Ordering Information

Part No.	ValveBank Controller	Price
01-01	ValveBank®4 programmable controller	\$ 1,195
01-08	ValveBank®8 programmable controller	\$ 1,695
01-09	BNC cable - ValveBank to pCLAMP/Digidata, et al., 4 BNC plugs to DB-25	\$ 120
01-07	Rack-mounting brackets - ValveBank to standard 19" rack	\$ 35
01-06	ValveBank keypad 6' extension cable	\$ 20
	Cables for Heka/InstruTECH and LabView	\$ call

U.S./Canada prices shown. International prices add 15%. Email or visit web store for latest prices.

Save time by purchasing disposable perfusion accessories from one source.

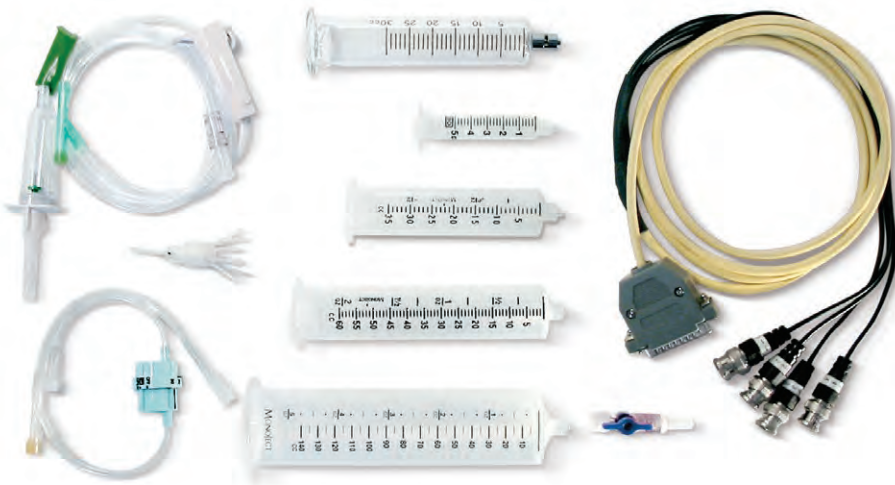

Perfusion Accessories

Syringe reservoirs

Replacement syringes and reservoirs are available for all perfusion systems. Luer lock 5, 15, 35, 60 and 140 ml plastic syringe reservoirs are standard. 35 ml glass syringes and PTFE-Inert tubing are available with our "Volatiles Pressure Upgrade" for researchers with volatile agents in solution. 800 ml beakers with luer lock fittings are available as replacements for the In Vivo Perfusion System.



Pressurized reservoirs

Custom, closed, pressurized Nalgene HDPE reservoir bottles are available in 1, 2, and 10 liter sizes with ringstand holders. Why keep refilling buffer all day? These require an AutoMate Scientific Pressurized Perfusion System or regulated pressure source.

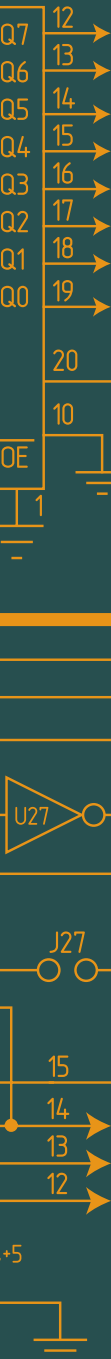



Micro-manifolds and stoppers

4-, 8-, and 16-into-1 PTFE-Inert micro-manifolds for both perfusion combine multiple tubes (1/16" (1.6 mm) i.d. or o.d.) into a single outflow tube. The manifolds include a built-in flow adjustment screw to decrease flow rate without adding dead volume. The 1/4 inch (6.35 mm) outflow is interchangeable with manifolds from Warner Instruments and all AutoMate Scientific perfusion chambers. PTFE-Inert Stoppers are available to temporarily close unneeded holes.



Hospital I.V. perfusion accessories

Disposable hospital I.V. drippers (drip chambers) get flow started in empty tubes and help visualize flow rates. Flow regulators restrict perfusion flow rates like the adjustment screw in our micro-manifolds. They are helpful in matching perfusion inflow rate to outflow rate. Both use 1/8" i.d. tubing. Case pricing available.

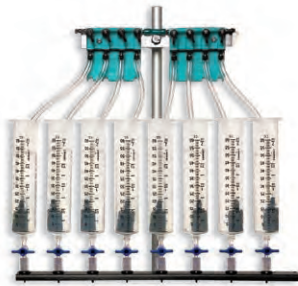

Perfusion reservoir gas bubbler

Available with or without an oxygen-safe regulator, the Perfusion reservoir gas bubbler is used to split a gas bottle like oxygen, carbogen, or CO₂ into multiple perfusion reservoirs. The included high-quality stones create a stream of fine bubbles to evenly saturate your solutions with gas. Each gas line can be individually adjusted. Replacement stones also available.



Tubing

Tygon, PTFE-Inert, Silicone pinch valve, and Polyethylene tubing available in any length over 10 feet (3 meters).



Vacuum pump and trap

For labs without an easy vacuum source we offer a quiet Lab-duty oil-free vacuum pump with muffler for both 110V and 220V mains. Our large 10 liter polypropylene Vacuum Trap means you won't have to empty it as often. This Nalgene bottle includes easy luer lock fittings for vacuum tube connections and all necessary tubing to the pump and chamber.

Ordering Information

Part No.	Perfusion Accessories and Tubing	Price
06-05c	Case of 50x 5 ml syringes	\$ 35
06-15c	Case of 80x 15 ml syringes	\$ 45
06-30c	Case of 30x 35 ml syringes	\$ 55
06-60c	Case of 20x 60 ml syringes	\$ 35
06-140c	Case of 20x 140 ml syringes	\$ 480
06-1Kp	Pressurized 1 Liter reservoir with bracket, fittings & tube (requires pressure)	\$ 110
06-2Kp	Pressurized 2 Liter reservoir with bracket, fittings & tube (requires pressure)	\$ 165
06-10Kp	Pressurized 10 Liter reservoir with fittings & tube (requires pressure)	\$ 349
05-04	Micro-manifold, 4-into-1 PTFE-Inert with flow control	\$ 75
05-08	Micro-manifold, 8-into-1 PTFE-Inert with flow control	\$ 96
05-16	Micro-manifold, 16-into-1 PTFE-Inert with flow control	\$ 124
05-05	Micro-manifold stoppers (set of four)	\$ 16
06-21	Disposable flow regulator	\$ 20
06-21c	Case of 48x disposable flow regulators	\$ 850
06-04	Disposable drippers (set of 4)	\$ 42
06-04c	Case of 48x disposable drippers	\$ 320
01-34	Regulated perfusion reservoir gas bubbler - 4 channel	\$ 395
01-35	Un-regulated perfusion reservoir gas bubbler - 4 channel	\$ 90
01-36	Regulated perfusion reservoir gas bubbler - 8 channel	\$ 425
01-39	Un-regulated perfusion reservoir gas bubbler - 8 channel	\$ 140
01-40	Bubbler stones - set of 4	\$ 9.50
05-11	Tygon vinyl tubing - 1/16" i.d.	\$ 0.52/ft
05-13	PTFE-Inert tubing - 1/16" o.d. for use with nut & ferrule fittings	\$ 2.20/ft
05-14	Silicon pinch valve tubing - 1/32" i.d. x 1/16" o.d.	\$ 3.90/ft
canister	2 Liter Perfusion vacuum trap with tubing	\$ 88
vac	Lab-duty oil-free vacuum pump (115 VAC)	\$ 643
compressor	Quiet air compressor (115 VAC) - 220V also available	\$ 1,063

U.S./Canada prices shown. International prices add 15%. Email or visit web store for latest prices. First set of disposables included in perfusion systems. Please order a minimum of 10' of tubing.

Quiet air compressor



"The EasyCode software you provided is simple to use. We use a large screen Macintosh for creating and storing protocols. We especially like the ability to create new protocols and download them directly to the ValveBank; it really couldn't be easier."

Dr. Susan Abrahamson
University of California,
Berkeley

EasyCode Dialog Box

- Enter start and stop times accurate to 0.01 sec.
- Use all ValveBank commands including multi-channel looping and interface triggering

Free your computer during experiments

Transfer and run programs stored in the ValveBank, which can be disconnected from the computer – leaving it available for data acquisition.

Expand the computing power of your ValveBank system.

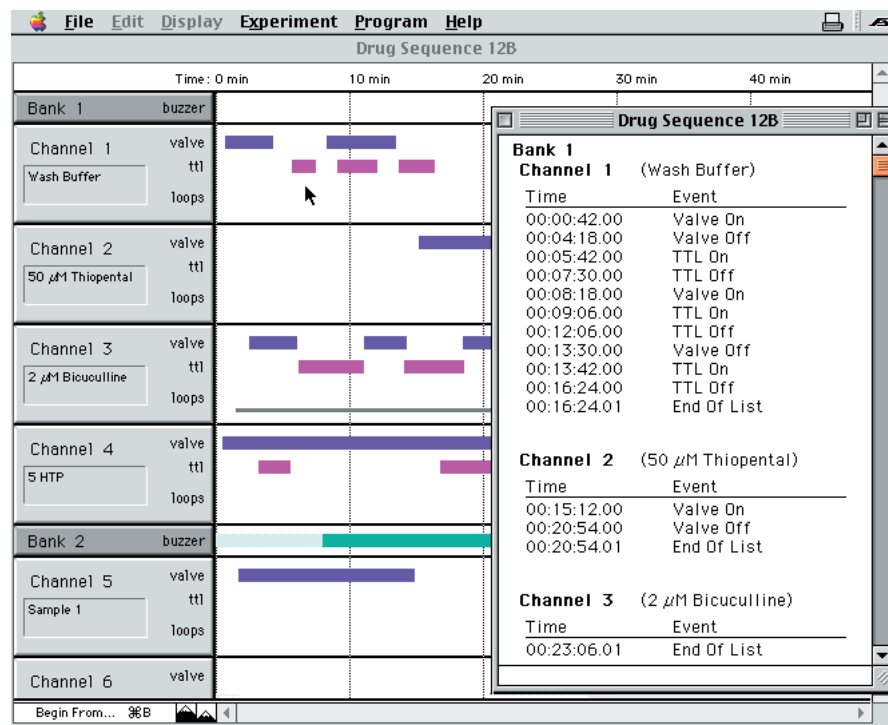

EasyCode® Software

Program your ValveBank® with a Macintosh or PC using easy "click-and-drag" time bars. Save and load unlimited programs to disk, print out program listings, then download your sequences into the ValveBank's memory with the included serial cable in one simple step.

- **Program up to sixteen channels of valves and digital outputs**
Open multiple experiment windows. List sequences to screen or printer. Copy and paste. Zoom in and out of your experiment.

Ordering Information

Part No.	EasyCode Software	Price
01-03-2000	EasyCode® PC - ValveBank programming software - Windows 98-XP	\$ 249
USB	USB to serial converter - PC or Macintosh	\$ 52

U.S./Canada prices shown. International prices add 15%. Email or visit web store for latest prices.

Precise control for whole-cell or single-cell superfusion.



Pressurized Superfusion

For anyone who needs:

- **Faster switching and steady flow**
- **Fine microliter perfusion and microinjecting**

Easy to add to any new or existing gravity perfusion system from AutoMate Scientific, any third-party manufacturer, or even homemade rigs. Connect to house air or compressor (30 to 100 psi). Does not introduce bubbles into solution; helps overcome flow problems due to bubbles. Available in four-, eight- or sixteen-channel configurations. Syringe reservoirs may be placed in a water bath for temperature control. Elegant design allows individual control of each air line.

Liquid Switching in 3-4 msec.

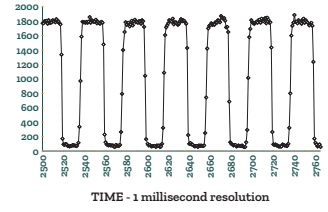

Fast Flow Rhodamine B Fluorescence Switching - 40 ms period using the AutoMate Scientific Pressurized Perfusion System at 2 psi

Thilo Lacoste
Materials Science Division
Lawrence Berkeley National
Laboratory

Precision Components



- 5 micron filter and gauge
- Precision regulator delivers 0-10 psi



Several sizes of plastic syringe reservoirs or 35 ml glass syringes and PTFE-Inert tubing as our "Volatiles Pressure Upgrade."

Rubber Stoppers



Pressure Upgrade available with 35 or 60 ml syringes and rubber stoppers shown in this photo, or 50 ml screw-cap reservoirs.



Precision Components

- Stainless steel construction
- 5 micron filter and gauge
- Precision regulator delivers 0-15 psi
- Convenient toggle switch completely closes gas connection to tank when not in use

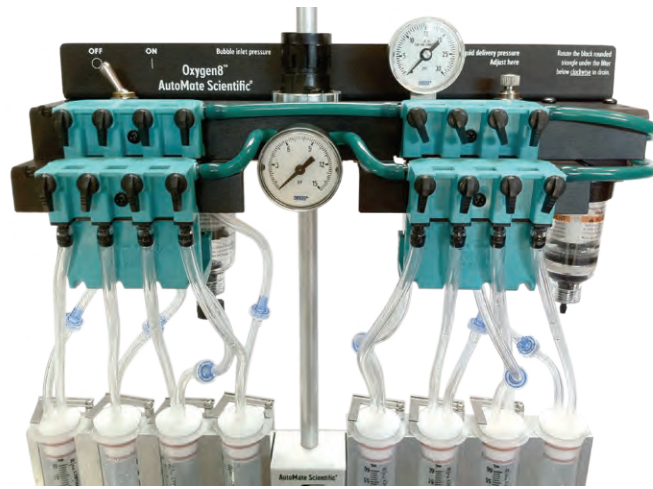

Oxygen8™ Bubbled Pressure Kit

You need rapid liquid switching with oxygenated solutions. How do you bubble Carbogen gas into closed, pressurized reservoirs? That's the engineering problem AutoMate Scientific has solved with several years of research: bubbled, pressurized perfusion.

You can add the Oxygen8 to any new or existing gravity perfusion system from AutoMate Scientific, any third-party manufacturer, or even homemade rigs. Connect to your desired gas (30 to 100 psi). Available in four- or eight-channel configurations. Syringe reservoirs may be placed in a water bath for temperature control or combine with the AutoMate BubbleStop® syringe heater.

Ordering Information

Part No.	Pressurized Superfusion	Price
09-04	Perfusion Pressure Upgrade - 4 channel	\$ 545
09-08	Perfusion Pressure Upgrade - 8 channel	\$ 795
09-16	Perfusion Pressure Upgrade - 16 channel	\$ 1,295
	with 35 or 60 ml plastic syringes, filter, regulator, and manifolds	
09-04n	Perfusion Pressure Upgrade - 4x 50 ml screw-cap reservoirs	\$ 545
09-08n	Perfusion Pressure Upgrade - 8x 50 ml screw-cap reservoirs	\$ 795
09-16n	Perfusion Pressure Upgrade - 16x 50 ml screw-cap reservoirs	\$ 1,295
06-50n	Replacement 50ml screw-cap reservoir	\$ 38
	with 50ml plastic screw-cap reservoirs, filter, regulator, and manifolds	
09-04v	Volatiles Pressure Upgrade - 4 channel	\$ 750
09-08v	Volatiles Pressure Upgrade - 8 channel	\$ 1,130
09-16v	Volatiles Pressure Upgrade - 16 channel	\$ 1,920
	with 35 ml glass syringes, PTFE tube, filter, regulator and manifolds	
06-30g	Glass 30cc Syringes - set of four	\$ 192
09-14	Oxygen8™ Bubbled Pressure - 4 channel	\$ 1,865
09-18	Oxygen8™ Bubbled Pressure - 8 channel	\$ 2,552
	with 35 or 60 ml plastic syringes, filter, regulator, and manifolds	

U.S./Canada prices shown. International prices add 15%. Email or visit web store for latest prices.

Liquid switching times in milliseconds without moving sewer pipes.



Perfusion Pencil® Multi-Barrel Manifold Tip

- **Rapid solution change with micro-liter dead volume**
No piezo or stepper motor translation. No clumsy rotating valves.
- **Single-cell and patch delivery**
For mounting on any micromanipulator. Easy to connect and clean.
- **Vacuum cross-contamination prevention**
Use one tube to vacuum the tip volume clear between solution changes.

Ordering Information

Part No.	Perfusion Pencil®	Price
04-04-[x]	Multi-barrel Perfusion Pencil® - 4-into-1 with 100, 250 or 360 µm i.d. tip	\$ 280
04-08-[x]	Multi-barrel Perfusion Pencil® - 8-into-1 with tip	\$ 280
04-16-[x]	Multi-barrel Perfusion Pencil® - 16-into-1 with tip	\$ 405
04-[x]	Replacement removable tips	\$ 45
	[x] = specify -100, -250, or -360 µm i.d. removable tip or [ZDV] for Zero Dead Volume Pencil (see ThermoClamp page)	

U.S./Canada prices shown. International prices add 15%. Email or visit web store for latest prices.

Pencil Tip Cross Section



4 to 16 micro-bore tubes into 1 outflow

360 Micron Removable Tip

Flow rates (±0.05):
 Gravity 1.15 ml/min
 2 psi 3.98 ml/min
 8 psi 10.66 ml/min

250 Micron Removable Tip



Flow rates (±0.05):
 Gravity .35 ml/min
 2 psi 1.66 ml/min
 8 psi 5.16 ml/min

100 Micron Removable Tip



Flow rates:
 Gravity zero flow
 2 psi 0.07 ml/min
 8 psi 0.25 ml/min

100, 250 and 360 micron internal diameter removable delivery tips available

All tubing now PTFE lined



Heated Perfusion Pencil with Neoprene Sleeve Removed



Easy luer-lock connections and manipulator mounting. Thermodynamic design maintains temperature with 5 ml/minute flow from both tips without any metal tubing.

Temperature Sensors Included



Separate chamber bath and Perfusion Pencil thermocouples included.

See previous page for flow rates.

See next section for syringe warmer to minimize bubbles.

Dual-channel ThermoClamp[®]3.2 Temperature Controller



For simultaneous heating of Perfusion Pencil[®] inline heater and microscope stage.

Accurate temperature control, rapid solution switching and fast wash-out.



ThermoClamp[®]-3 Temperature Control System

US Patent 11,686,656

- Combination inline heater plus multi-channel focal drug delivery**
 Maintain bath temperature and rapid drug wash-out with a high-flow bath line while quickly switching 4-8 preheated solutions through the Perfusion Pencil.[®] Steady 37°C at 5 ml/minute flow rates through both the bath line and tip.
- Advanced auto-tuning temperature lock**
 Fuzzy logic PID software maintains chamber or reagent temperature to within 1°C of setpoint or better. The ThermoClamp calibrates its own tuning for ideal temperature control - no need to guess "loop speed" settings.
- Designed for physiology research**
 No metal anywhere in the flow path - unlike some competitors. Low noise for electrophysiology with internal and external grounding plus electrical isolation between liquids and heating elements.
- Ready to use**
 Includes everything you need for heated perfusion: power supply, temperature sensors, and inline heater with easy luer lock tube connections.

You can have rapid switching, fast wash-out, and accurate temperature control at the same time. Set the ThermoClamp temperature from ambient to 50°C. A front-panel BNC provides an analog output of current temperature for recording. Different sizes of replaceable tips are interchangeable with our standard Perfusion Pencil. The tips have microliter dead volume for rapid switching. No messy water jacket is required, but the separate high-flow line is capable of heating a perfusion chamber with water jacket if desired.

Do you need to change your prep's temperature over the course of an experiment? A programmable "ramp and hold" feature can automatically vary the setpoint over time. The ThermoClamp system includes bath and Perfusion Pencil thermocouple sensors. Automatic overtemp and thermocouple failure protection alerts you to any problems. Incorporate temperature control into your perfusion rig with simple micromanipulator mounting.

Operation

Connect multiple reagent tubes from any perfusion system to the heated Perfusion Pencil on a manipulator directed into your chamber. If desired, connect a separate buffer line to the "high-flow" bath luer connection on the Pencil, and the outflow to your chamber. If your chamber includes a water jacket, you can use the high-flow line with a constant flow of water to heat the chamber. Place the bath thermocouple sensor in the chamber. Set your desired temperature on the controller and begin liquid flow. The ThermoClamp monitors bath temperature and heats the liquids flowing through the Perfusion Pencil keeping the chamber at exactly the desired temperature. Your perfusion system can quickly change solutions through the Perfusion Pencil tip and also deliver buffer for fast wash-out. Sophisticated circuitry will "auto tune" the ThermoClamp heating parameters based on your flow rates, chamber, and tubing to clamp the temperature and minimize over/undershoot.

Ordering Information

Part No.	ThermoClamp® Temperature Control System	Price
03-11-LL	ThermoClamp® 3 - 1 channel with controller, heated Pencil and sensors	\$ 1,421
03-14-[x]	ThermoClamp® 3 - 4 channel with controller, heated Pencil and sensors	\$ 1,781
03-18-[x]	ThermoClamp® 3 - 8 channel with controller, heated Pencil and sensors	\$ 1,781
	[x] = specify -100, -250, or -360 µm i.d. removable tip or [ZDV] for Zero Dead Volume Pencil (see right column)	
01-173	Rack-mounting brackets - ThermoClamp-3 to 19" rack	\$
03-02	1 Channel replacement heated ThermoClamp Perfusion Pencil®	\$ 310
03-04	4 Channel replacement heated ThermoClamp Perfusion Pencil®	\$ 625
03-08	8 Channel replacement heated ThermoClamp Perfusion Pencil®	\$ 625
03-sensor	Replacement bath thermocouple sensor	\$ 112
03-22-b	ThermoClamp® -3.2 controller with power cord	\$ 2,285
03-sub2	Substitute a ThermoClamp® -3.2 for ThermoClamp® -3	\$ 800

U.S./Canada prices shown. International prices add 15%. Email or visit web store for latest prices. Manipulator not included.

Easy to Read or Record



- Large LCD 0.1°C temperature display
- Analog temperature output

ThermoClamp-3



- Dimensions: 11.5" x 2" x 7"
- Weight: 4 lbs. (1.8 kg.)



Low noise - designed for electrophysiology.



Zero Dead Volume Pencils



All AutoMate Scientific Perfusion Pencils (ThermoClamp, SmartSquirt and regular Perfusion Pencils) are now available in a "Zero Dead Volume" configuration with all internal tubes extended 2 cm out of the tip.

The "ZDV" Pencils do not use removable tips since all of the tubes go all the way to your prep. This eliminates the possibility of backflow and decreases solution switching times down to nearly zero.



Features

- Easy to remove full syringes
- Analog DC heating circuitry means low noise for electrophysiology
- Completely shielded electronics plus external power supply
- Spill-proof design
- Range: ambient to 50°C liquid temperature
- Mounts to standard 1/2" rod

Available with gravity and pressurized syringes

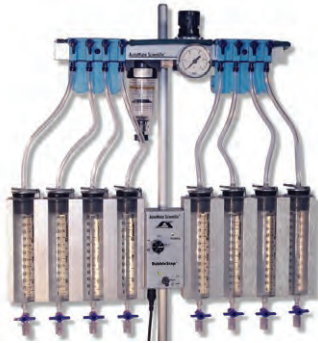

Off-gassing with pressurized perfusion

Note: the BubbleStop is NOT sufficient to warm solutions for delivery into a perfusion chamber without an inline heater like our ThermoClamp. The BubbleStop only helps stop bubbles.

Stop bubbles by pre-warming solutions.

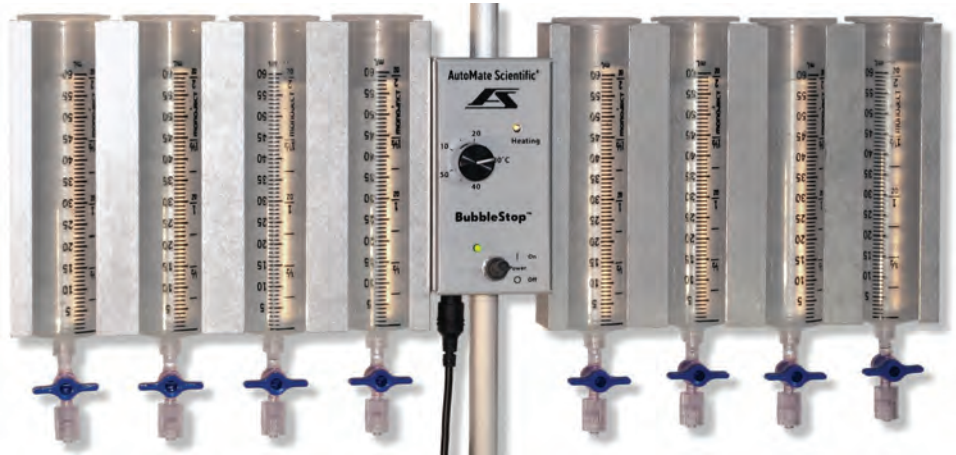

BubbleStop® Syringe Heater

Bubbles in perfusion systems are caused by solution temperature changes. As solutions warm, they cannot hold as much gas, so they off-gas. This forms bubbles in perfusion tubing. It is especially true in inline heaters where the temperature rises dramatically. The best cure for bubbles is to pre-warm your solutions. AutoMate Scientific makes the BubbleStop® Syringe Heater with integrated temperature sensor and feedback. Set the temperature on the BubbleStop a few degrees higher than room temperature or your inline heater, and the warmed solutions will off-gas in the syringe reservoirs to the maximum gas concentration for that temperature. Even if they cool and re-heat again inside the perfusion tubing, they will not off-gas.

Ordering Information

Part No.	BubbleStop®	Price
10-4-60-G	BubbleStop4 60ml Syringe Heater - Gravity	\$ 875
10-8-60-G	BubbleStop8 60ml Syringe Heater - Gravity	\$ 1,035
10-4-60-P	BubbleStop4 60ml Syringe Heater - Pressurized	\$ 1,260
10-8-60-P	BubbleStop8 60ml Syringe Heater - Pressurized	\$ 1,450
10-4-35-G	BubbleStop4 35ml Syringe Heater - Gravity	\$ 875
10-8-35-G	BubbleStop8 35ml Syringe Heater - Gravity	\$ 1,035
10-4-35-P	BubbleStop4 35ml Syringe Heater - Pressurized	\$ 1,260
10-8-35-P	BubbleStop8 35ml Syringe Heater - Pressurized	\$ 1,450
	Including 60ml or 35ml syringes, stopcocks and tubing. Pressurized version includes regulator, filter and gauge.	

U.S./Canada prices shown. International prices add 15%. Email or visit web store for latest prices.

Don't keep your cells waiting.

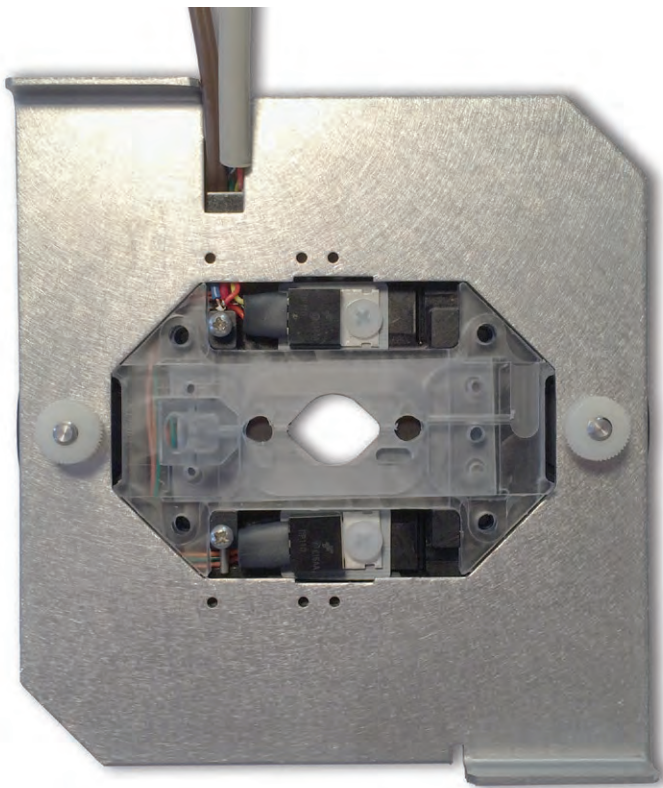

Assembly View

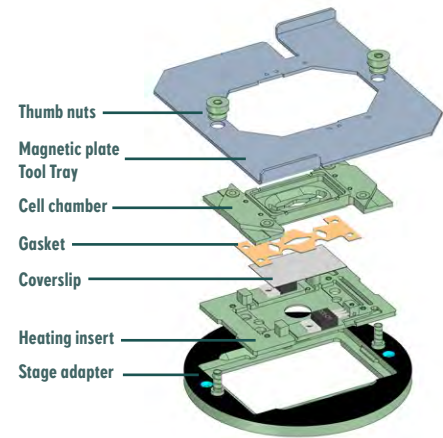

Release two thumb nuts to change coverslips and clean the entire stack, while the magnetic Tool Tray holds your tubes and electrodes for the next experiment. See next page for more photos.

QuickStage™ microscope stage adapters and heated perfusion chambers

- Integrated spill channel
- Magnetic stainless steel tool platform
- For Nikon, Olympus, Zeiss and Leica upright & inverted microscopes

The AutoMate Scientific QuickStage is designed to fit directly into your Olympus, Nikon, Zeiss (K & M), Leica, Siskiyou, Scientifica, Narishige, Thor Labs, ASI, Prior, Märzhäuser or Sutter microscope stage or platform. With a simple twist of two locking nuts, the entire stainless magnetic Tool Tray lifts off with all of your magnetic tools still attached. The underlying chamber and coverslip are then free for easy cleaning and replacement. Optical #1 thickness cover slips provide a perfect imaging surface for upright or inverted microscopy.

The heated version of the QuickStage uses AutoMate Scientific's popular ThermoClamp temperature controller to maintain your set temperature from ambient to 50°C. Disassembly and cleaning of the heated chamber is just as simple as the unheated version. The ferro-stainless Tool Tray can be removed with all of your tubes and electrodes intact. A silicone gasket ensures leak-free performance without messy grease. Stage heating is maintained while coverslips are replaced so you can begin recording again sooner.

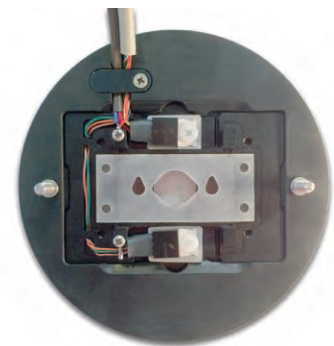

Shown with Tool Tray removed. Gasket and heaters visible with two studs for fast disassembly. Standard 24 x 40 mm coverslip lies under gasket.

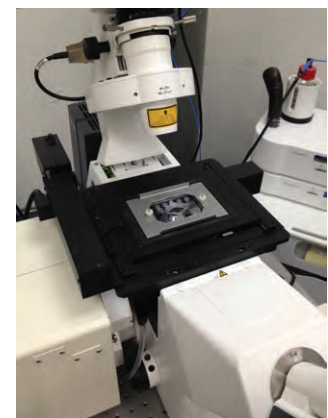

12
Q7 13
Q6 14
Q5 15
Q4 16
Q3 17
Q2 18
Q1 19
Q0 20
10
OE
1
U27
J27
15
14
13
12
+5

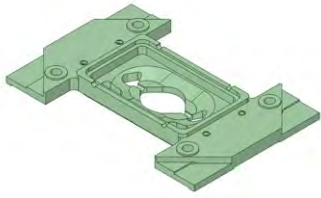

12 mm chamber
All of these chambers take a 24x40 mm coverslip on the bottom. One included.

QuickStage Perfusion Chambers

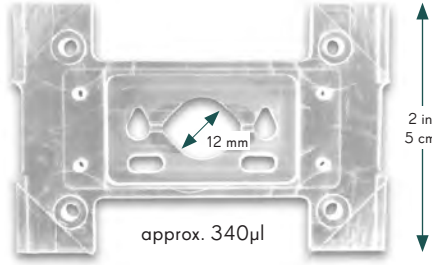

Standard laminar flow chamber for inverted microscopes (QS-H-12IN) also accepts 12 mm round coverslips

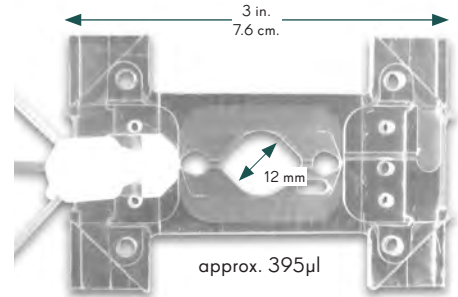

Standard laminar flow chamber for upright microscopes (QS-H-12UP) also accepts 12 mm round coverslips shown with separate inflow manifold

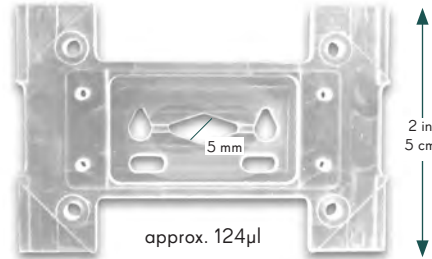

Small laminar flow chamber for inverted microscopes (QS-H-5IN) also accepts 5 mm round coverslips

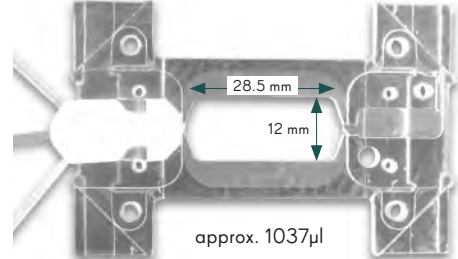

Large bath or slice chamber for upright microscopes (QS-H-LS) shown with separate inflow manifold

Unheated Perfusion Chambers

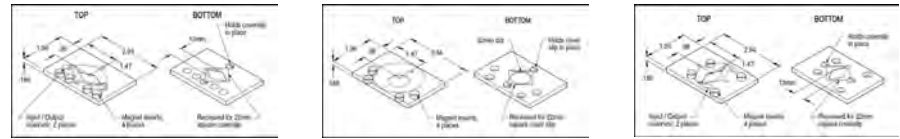

Unheated perfusion chambers: horizontal, round, and vertical (QS-U-H, -V & -R)
These use 22 mm square #1 coverslips on the bottom, and accept 13 mm round coverslips on top.
These work with any of the stage adapters to the left.

35mm Petri Dish Holders and Heaters

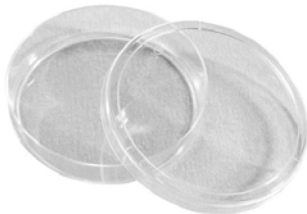

Adapters for Nunc, WillCo, Falcon, In Vitro (D35-10-1-N), Corning, Mattek, and In Vitro (D29-10-1-N) 35mm dishes available.

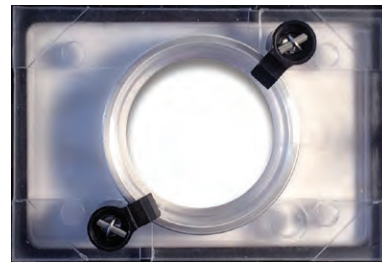

Unheated 35mm Petri dish holder (QS-U-35) with spring clips and Nunc adapter ring
This adapter also holds full-size slides

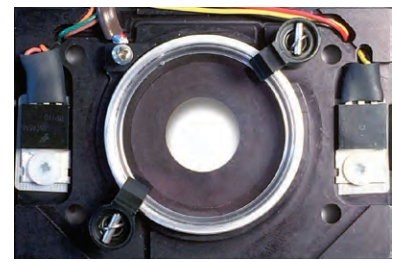

Heated 35mm Petri dish holder (QS-H-35) with spring clips and Corning adapter ring

Microscope Stage Adapters



Olympus, Narishige, Scientifica, Gibraltar 110 mm (-O)



Nikon, Sutter MT-150/LZ, MT-1000 and Siskiyou 108 mm with locking tabs (-N)



Universal Adapter (-UU)
Leveling screws front and rear. Flexible stainless steel mounting plate.



Zeiss / Leica M (-ZM)



Zeiss / Leica K, ASI, Märzhäuser, Prior, Sutter MT/MP-78 (-ZK)

See chart on the next three pages to select the appropriate stage adapter for your microscope and stage.

Retainers

Tool Trays are ferro-magnetic stainless steel plates designed to hold your perfusion chamber down to the stage adapter while also providing a large surface for StageHands™ magnetic tool holders. Round stage adapters (i.e. Olympus and Nikon) include a square Tool Tray (4.25 in / 10.8 cm wide x 4.56 / 11.6 cm deep). Rectangular stage adapters (i.e. Zeiss and Universal) include a rectangular Tool Tray (5 in. / 12.7 cm x 3.5 in / 8.9 cm deep).

If you don't have room on your stage for a Tool Tray, or think it is too large, you can order your QuickStage with Clamps instead. They hold the perfusion chamber down to the stage adapter using the same two thumb nuts on each side. For heated cell chambers (not unheated chambers or 35 mm dish holders), Clamps also require four small screws to hold the chamber, gasket and coverslip to the heating adapter.



QS-U-R-TT-O
Round unheated chamber in Olympus round stage adapter and square Tool tray with StageHands.



Zeiss K stage adapter showing rectangular Tool Tray with thumb screws removed.

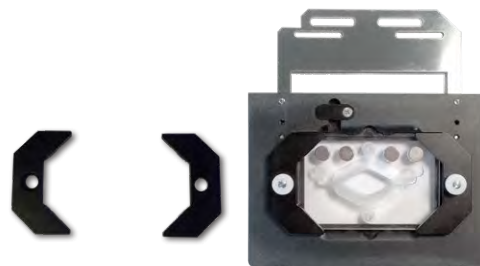

QS-U-H-C-UU
Clamps (left) installed on a universal stage adapter (right) holding an unheated horizontal chamber.

Q7	12
Q6	13
Q5	14
Q4	15
Q3	16
Q2	17
Q1	18
Q0	19
	20
	10
OE	
1	
U27	
J27	
15	
14	
13	
12	
+5	



Microscope	Configuration	Model	Stage Type	Detachable (Single Plate) or Non (3 Plate)	AutoMate Stage Adapter		
ZEISS	Inverted	Axiovert 100	Mechanical	Detachable Object Guide	ZM = Zeiss M		
		Axiovert 135		Non Detachable	ZK = Zeiss K		
		Axiovert 200	Mechanical	Detachable Object Guide	ZM = Zeiss M		
		LSM META Confocal		Non Detachable	ZK = Zeiss K		
			Electronic	Non Detachable	ZK = Zeiss K		
		Axio Observer	Mechanical	Non Detachable	ZK = Zeiss K		
		Electronic	Non Detachable				
	Upright	Upright	Axioskop 2 FS	Mechanical	Non Detachable	UU = Universal	
			Axioskop FS				
			LSM META FS MOT				
			Axio Examiner	Electronic	Non Detachable	UU = Universal	
LSM 710 NLO							
			Various Options		Please email		
OLYMPUS			Inverted	IX50	Mechanical	Non Detachable	O = Olympus Ring
				IX70			
				IX51	Electronic	Detachable	UU = Universal
	IX71						
	IX81						
	IX51	Electronic		Märzhäuser IM 120X80	ZK = Zeiss K		
	IX71						
	IX81						
	BX FS WI	Olympus Bridge Stage		WI XYS Stage Fixed	O = Olympus Ring		
				Microscope Mover			
		Fixed Stage		Narishige			
				Microscope Translator	ThorLabs		
		Mechanical		Non Detachable			
	BX FS WI	Mechanical		Non Detachable	UU = Universal		
BX Stage Focus							
BX51 TF , TRF							
BX61 TF, TRF							
BX FS WI	ThorLabs	Avt Mounted Stand	O = Olympus Ring				

Electronic Stages: if the insert cannot be definitively identified, the customer should test that the stage adapter does not interfere with stage components during motion.

Microscope	Configuration	Model	Stage Type	Detachable (Single Plate) or Non (3 Plate)	AutoMate Stage Adapter	
NIKON	Inverted	Diaphot TMD	Mechanical	Non Detachable	N = Nikon Ring	
		TMS				
		Diaphot 200				
		Diaphot 300				
		TE200				
		TE300				
	Ti					
	Orange rows = not available		Ti	Mechanical	Detachable	N/A
			Ti-S-E	Nikon Motorized	Non Detachable	N=Nikon Ring
			Ti-S-ER			
Ti-S-E			ASI Flat Top & Piezo	Non Detachable	ZK = Zeiss K	
Ti-S-ER						
TE200			Electronic	Mäzh Scan IM Stages	ZK = Zeiss K	
TE300						
Upright		FN1		Mechanical	Non Detachable	FN1 = Nikon Ring
				Nikon	Nikon Stage	
				ThorLabs	Thorlabs MPM-XYRS	
		FN1		Fixed	Static	O = Olympus Ring
			Narishige	ITS-N		
			ThorLabs	PHYS24		
Inverted	TS100	Mechanical	Detachable	UU = Universal		
LEICA	Inverted	DMI 3000-6000	Mechanical	Attachable To Micromanipulator	Holding Frame N/A	
		DMIRB		Slim Fixed Stage		
		DMI 3000-6000	Mechanical	Non Detachable	ZK = Zeiss K	
				Non Detachable	ZP = Zeiss Plane	
				Non Detachable Slim	88 mm Ring N/A	
		DMI 3000-6000	Electronic	Motorized 3 Plate	ZK = Zeiss K	
				Motorized 3 Plate	ZP = Zeiss Plane	
				Slim Motorized 3 Plate	88 mm Ring N/A	
				Leica Scanning 127X83	ZK = Zeiss K	
				Prior Pro Scan	ZK = Zeiss K	
			ITK LMT200	ZK = Zeiss K		
		DMI 3000-6000	Electronic	Mäzh Scan IM 130X85	ZK = Zeiss K	
		DMIRB				
		DMIL				
		DMI 3000-6000	Mechanical	Detachable Object Guide	ZM = Zeiss M	
DMIRB						
DMIL						
DMIRB	Mechanical	Non Detachable	Square Adapter N/A			
DMIL						



Microscope	Configuration	Model	Stage Type	Detachable (Single Plate) or Non (3 Plate)	AutoMate Stage Adapter
LEICA	Upright	DM6000 FS	Mechanical	Non Detachable	UU = Universal
		DM6000 B	Electronic	Non Detachable	
		DM5500 B			
		DM6000 B	Mechanical	Non Detachable	
		DM5000 B			
		DM4000 B			
NARISHIGE	Upright Olympus	E600FN	Microscope Translator	Narishige ITS-N	O = Olympus Ring
		BX50WI		Narishige ITS-O	
		BX51WI		Narishige ITS-O2	
		BX61WI		Narishige ITS-O2	
	Zeiss	Axioskop FS		Narishige ITS-Z	
		Axioskop 2FS		Narishige ITS-Z2	
		Axio Examiner		Narishige ITS-Z3	
	Leica		DMLFS	Narishige ITS-L	
THORLABS	Upright Olympus	Gibraltar	Microscope Translator	Gibraltar	O = Olympus Ring
		BX50WI		BX Series	
	IX70		IX70		
	Zeiss	Axioskop FS		FS Series	
		Axioskop 2 FS		FS Series	
	Leica		DMLFS	LFS Series	
SUTTER		MT-150/Trapini Tower	MT-1000		N = Nikon Ring
		MT-78, MP-78	MT-78		ZK = Zeiss K
SISKIYOU		8090P	8090P		N = Nikon Ring

Electronic Stages: if the insert cannot be definitively identified, the customer should test that the stage adapter does not interfere with stage components during motion.

Dual-channel ThermoClamp®-3.2 Temperature Controller



Two independent channels for simultaneous heating of Environmental Lid or Perfusion Pencil® inline heater and heated QuickStage.

Heated Environmental Lid for 35mm dishes



Heated glass lid with perfusion and gas control attaches magnetically to the top of our 35mm dish holders. Control the temperature of a large 30 mm coverslip lid to minimize condensation while maintaining gas and temperature control over your 35mm dish. Separate perfusion inflow, aspiration outflow, gas connection, temperature sensor and grounding provided.

QuickStage™ Part Numbers

QS- (H)eated	–	Perfusion Chamber:	–	Retainer:	–	Microscope Stage Adapter:		
CELL CHAMBER HEATING INSERT with ThermoClamp controller	\$1,500	12IN =12 mm diamond / round coverslip (inverted)	\$85	TT=Tool tray	\$48	ZM =Zeiss/Leica M	\$259	
		5IN =5 mm diamond / round coverslip (inverted)	\$85	C=Clip	\$23	ZK =Zeiss/Leica K / ASI / Prior / März Sutter MT/MP-78	\$259	
		12UP =12 mm diamond / round coverslip (upright)	\$85			ZP =Zeiss/Leica plane	\$259	
		LS =large slice chamber (upright)	\$85			O =Olympus/Narishige/Gibraltar/Scientifica/ThorLabs 110mm ring	\$239	
		The four above use 24x40 mm rectangular #1 coverslips bases (one included)						
35 mm Petri dish heaters:				TT=Tool tray	\$48	N =Nikon/Siskiyou/Sutter MT-150, MT-1000 108mm ring	\$239	
35 mm DISH HEATING INSERT with ThermoClamp controller	\$1,640	35N =35 mm Nunc Spacer rings each:	\$20	C=Clamp	\$52	FN1 =Nikon FN1	\$259	
		35W =35 mm WillCo	\$20			UU =Universal adapter	\$395	
		35F =35 mm Falcon / In Vitro (D35-10-1-N)	No ring required	\$0				
		35C =35 mm Corning / Mattek	\$20					
		35V =35 mm In Vitro (D29-10-1-N)	\$20					
QS- (U)nheated	–	Perfusion Chamber:	–	Retainer:	–	Microscope Stage Adapter:		
CELL CHAMBERS UNHEATED	\$0	H =horizontal diamond	\$150	TT=Tool tray	\$48	ZM (Same choices as above)	\$259	
		V =vertical diamond	\$150	C=Clamp	\$52	ZK	\$259	
		R =round	\$150			ZP	\$259	
		The three above use 22 mm square bases, and accept 13 mm round #1 coverslips on top					UU	\$395
		35 mm Petri dish holders:					O	\$239
35 mm DISH HOLDER UNHEATED	\$200	35N =35 mm Nunc Spacer rings each:	\$20			N	\$239	
		35W =35 mm WillCo	\$20			FN1	\$259	
		35F =35 mm Falcon / In Vitro (D35-10-1-N)	No ring required	\$0				
		35C =35 mm Corning / Mattek	\$20					
		35V =35 mm In Vitro (D29-10-1-N)	\$20					

U.S./Canada prices shown. International prices add 15%. Email or visit web store for latest prices.

Example part numbers:

QS-H-12IN-TT-ZM = QuickStage - Heated - 12mm diamond chamber - Tool tray - Zeiss M stage adapter

QS-U-35W-C-UU = QuickStage - Unheated - 35mm Willco dish holder - Clamp - Universal stage adapter

Ordering Information (sample combinations shown)

Part No.	QuickStage	Price
	Heated:	
QS-H-12IN-TT-ZM	QuickStage Heated diamond 12mm perfusion chamber for Zeiss or Leica M inverted microscope with Tool Tray, gasket and ThermoClamp®-3 temperature controller	\$ 1,892
QS-H-35W-C-UU	QuickStage Heated 35mm WillCo perfusion chamber with clamp, Universal stage adapter and ThermoClamp-3 temperature controller	\$ 2,107
	3 add'l chambers + many 35mm dishes & stage adapters available	\$ 1,847-2,107
QS-CS2440	Replacement 24x40 mm #1 coverslips (box of approx. 75 pcs.)	\$ 42
QS-35(N-V)	Additional 35mm adapter rings	\$ 20
QS-GSK- xxx	Replacement Gasket - specify chamber (pack of 5)	\$ 48
	Unheated:	
QS-U-H-TT-N	QuickStage Unheated horizontal perfusion chamber and stage adapter for Nikon microscope and Siskiyou platforms	\$ 417
QS-U-35N-TT-O	QuickStage Unheated 35mm Nunc holder, Tool Tray, and stage adapter for Olympus et al. microscope stages	\$ 507
	3 add'l chambers + many 35mm dishes & stage adapters available	\$417-667
	Heated Environmental Lid for 35mm dishes:	
QS-HLID	with ThermoClamp-3 controller and bath sensor	\$ 1,905
QS-H2LID	with ThermoClamp-3.2 controller and bath sensor (replacing the ThermoClamp-3 included with any heated QuickStage chamber)	\$ 1,706

U.S./Canada prices shown. International prices add 15%. Email or visit web store for latest prices.

800.998.MATE

ThermoClamp-3 Controller



Included with all heated chambers. Two-channel controller available.

Q7 12
Q6 13
Q5 14
Q4 15
Q3 16
Q2 17
Q1 18
Q0 19
20
10
OE
1
U27
J27
15
14
13
12
+5

"My lab has been using the Cool Solutions device for over ten years, and it has been a fantastic unit for characterizing the properties of thermosensitive TRP channels, both native and cloned. Its Peltier cooling and heating provide accurate and quiet thermal stimuli in our electrophysiology and imaging experiments, with superior range, speed, and reliability."

Dr. David Julius
Nobel Prize in Physiology or Medicine 2021
 Department of Physiology
 University of California,
 San Francisco

Your thermoTRP channels won't know what hit them.



Cool Solutions CS-1 Peltier Thermal Stimulus Delivery System



The main controller is ready for 19" rack mounting (size 2U).
 483mm w x 90mm h x 395mm deep
 19" w x 3.5" tall x 15.5" deep
 6.5 kg = 14 lbs.



Three externally amplified temperature sensors including an optically isolated bath sensor, for virtually noise-free operation

- Heat from 20 to 50°C in 3 seconds, then cool to 2°C in just a few more seconds — all controlled by your electrophysiology software
- Display Peltier, heatsink or bath temperature
- Set the desired temperature from the front panel or from your computer: The CS-1 can generate any desired timecourse of temperature change, by simply converting a voltage from your interface into a temperature
- Optically isolated bath sensor for low noise
- Suitable for single channel (no detectable noise added), whole cell patch clamping, or fluorescent ion imaging of groups of cells
- Optional water cooling for low-temperature work
- Two output BNCs to monitor and record two temperatures externally (e.g. Peltier and bath)
- All components included - five minute setup
- Tried and tested design, used in major thermoTRP labs for over a decade (see list of publications)

Peltier heating/cooling element

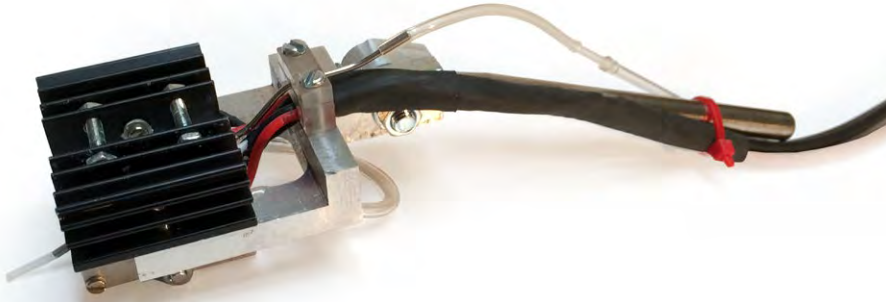

12V batteries and charger included for noise-free heating and cooling

This temperature controller is for superfusing small areas (e.g. groups of cells) in a recording bath, at a precisely controlled and rapidly adjustable local temperature. The system has been especially developed for patch clamp experiments in order to apply thermal stimuli without introducing noise or interference. It is also very suitable for intracellular ion imaging in cultured cells or tissue slices, oocyte recording, intracellular microelectrode recording or extracellular (e.g. brain slice) recording.



Special 0.1°C error thermocouple for exceptional accuracy

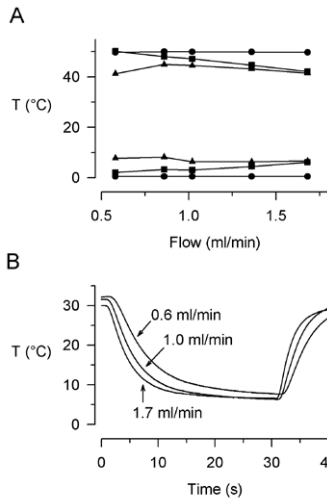

Effect of flow rate on the static temperature and on the rate of temperature change.

(A) Static temperature at the Peltier element (circles), in the solution leaving the Peltier element (squares), and at the cell (triangles) at flow rates between 0.6 and 1.7 ml/min. Command temperatures were 50 °C and 0 °C, and feedback was from the Peltier element.

(B) Temperature at the cell during step temperature commands at flow rates of 0.6, 1.0 and 1.7 ml/min. The initial temperature at the heating/cooling chamber was 32 °C and the command temperature was stepped to 0 °C for 30 s, then back to 32 °C.

Reid, et al, *J Neuroscience Methods*, 2001

Transition from 2°C to 50°C

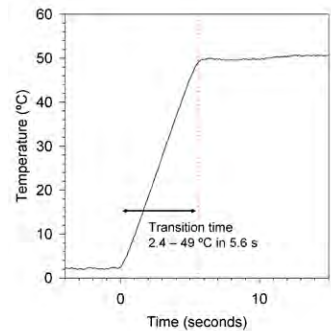

Transition from 36°C to 2°C

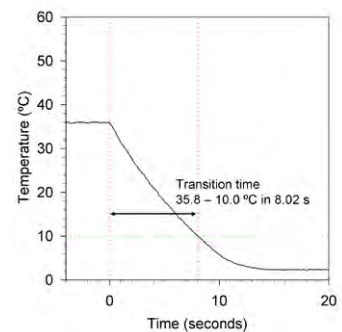

Ordering Information

Part No.	Cool Solutions	Price
CO-CS-1	Heat/Cooled Temperature Control System CS-1 controller, peltier, cables, two batteries, special 0.1 °C thermocouple, battery charger, etc.	\$ 4,471

U.S./Canada prices shown. International prices add 5%. Email or visit web store for latest prices. Manipulator not included.

12
13
14
15
16
17
18
19
20
10
OE
1
U27
J27
15
14
13
12
+5

"I just wanted to tell you that I have been using the SmartSquirt nearly every day, and I am very pleased with it. I have tested for cross contamination, and I believe it is very low. To prevent hydrostatic flow from the cryostat tubes into the bath, one line must continue perfusing bath solution after all other valves are closed. Your design changes help hold all of the fittings tightly and keep them from leaking or flowing backwards. I would also rate your company as being excellent for your immediate response to problems and questions on your products."

Dr. John G. Starkus

The Queen's Medical Center
Honolulu, Hawaii

Perfuse microliter volumes of precious solutions.



SmartSquirt® Micro-Perfusion System

- **Deliver microliter volumes starting with only 100 microliters of precious drugs**
Switch between eight solutions in milliseconds from a single tip.
- **Minimize cross-contamination with BackStop™ back-flow prevention**
Special 3-way relief valve design stops liquid flow quickly.
- **Valves and pressure controls in a small box near microscope - no stand necessary**
Includes pressurized large-volume reservoir for buffer.

**All tubing
now PTFE
lined**

Programmable dispensing, microinjection, perfusion or spritzing of reproducible microliter volumes. Up to eight solutions are stored in cryo tubes with easy syringe refill ports. Included pneumatic valves deliver regulated air pressure to push liquids out of the SmartSquirt Perfusion Pencil tip. An AutoMate Scientific (or other) valve controller offers programmable, manual or computer-controlled valve selection for switching which reagent is delivered from the tip. Pulse a valve quickly for microliter delivery, or leave it on for constant perfusion. The short delivery path saves expensive reagents. Integrated BackStop™ check valves prevent backflow found in competing micro-perfusion systems.

Detached SmartSquirt now standard with longer Pencil

No room on your microscope stage for the SmartSquirt? The Perfusion Pencil for the SmartSquirt now uses longer tubes for mounting the Reservoir Block up to 30 cm away from the delivery location. The Pencil itself is also 30 cm long for easier mounting on wide stages. Both standard.

SmartSquirt Reservoir Block

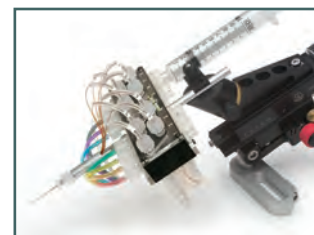

- Uses standard 2.5 ml cryo-tubes as reservoirs
- Minimize cross-contamination with BackStop™ back-flow prevention: one-way check valves inside the reservoir block prevent liquid backflow from the tip
- Easy ports for refilling reservoirs
- Convenient manipulator mounting
- Luer lock tips are interchangeable with our standard Perfusion Pencil®

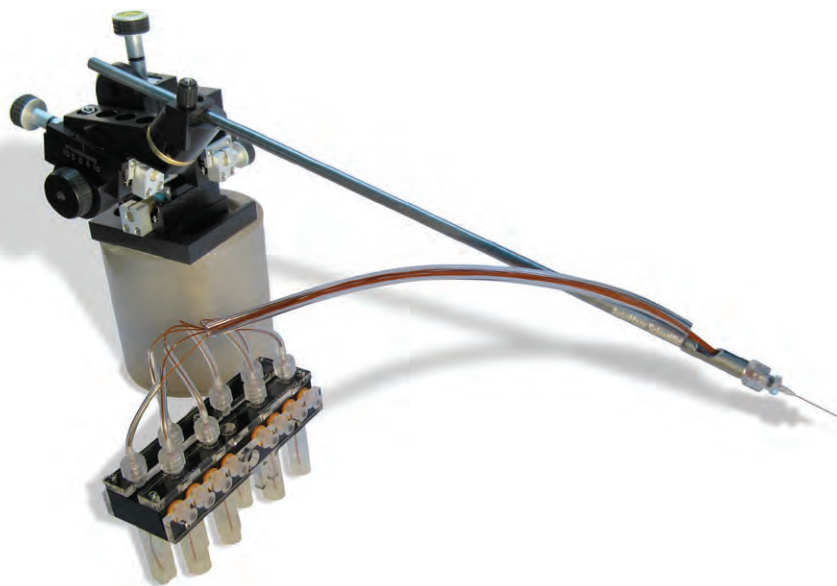

Integrated Pressure Regulator



Precision regulator, gauge, 5 micron filter and electric valves are built-in.

The 0-10 psi regulator and air filter require a compressed air or other gas source -- bottle, compressor or lab air.

Ordering Information

Part No.	SmartSquirt® Micro-Perfusion System	Price
07-04-[x]	SmartSquirt® 4 Micro-Perfusion System	\$ 2,240
07-08-[x]	SmartSquirt8 Micro-Perfusion System - SmartSquirt Valve Pressure Unit, Reservoir Block & Perfusion Pencil	\$ 2,620
	Systems with Valve Controllers:	
07-VL-04-[x]	SmartSquirt4 ValveLink Micro-Perfusion System	\$ 3,390
07-VL-08-[x]	SmartSquirt8 ValveLink Micro-Perfusion System	\$ 3,770
07-VB-04-[x]	SmartSquirt4 ValveBank Micro-Perfusion System	\$ 3,435
07-VB-08-[x]	SmartSquirt8 ValveBank Micro-Perfusion System	\$ 4,315
	[x] = specify -100, -250, or -360 µm i.d. removable tip or [ZDV] for Zero Dead Volume Pencil (see ThermoClamp page)	
06-25	SmartSquirt Cryo vials - 2.5 ml - Qty 8	\$ 3
06-25c	SmartSquirt Cryo vials - 2.5 ml - Bag of 100	\$ 25
02-01-08i	Replacement SmartSquirt Valve	\$ 64
05-07	Colored SmartSquirt Tubing - 1/16" i.d. (per foot)	\$ 7
07-04-c	Replacement SmartSquirt Perfusion Pencil® - 4 channels	\$ 295
07-08-c	Replacement SmartSquirt Perfusion Pencil® - 8 channels	\$ 295

U.S./Canada prices shown. International prices add 15%. Email or visit web store for latest prices. Manipulator not included.

See page 23 for flow rates.





StageHand with magnetic base, two "arms" and dual tube holder.



StageHand with magnetic base, two straight arms, locking ball joint and single tube holder.



Manifold holder (manifold not included) (SH-MH-MS)



Single (SH-TH) and dual (SH-DTH) tube holders



Right angle adapters (SH-OFF-RAB & SH-RAB)



Regular arm (SH-STA) and right-angle (SH-RAA) arm



"Interlocking" arms hold other arms at 90° angles (SH-ISTA & -IRAA)

Need a hand?

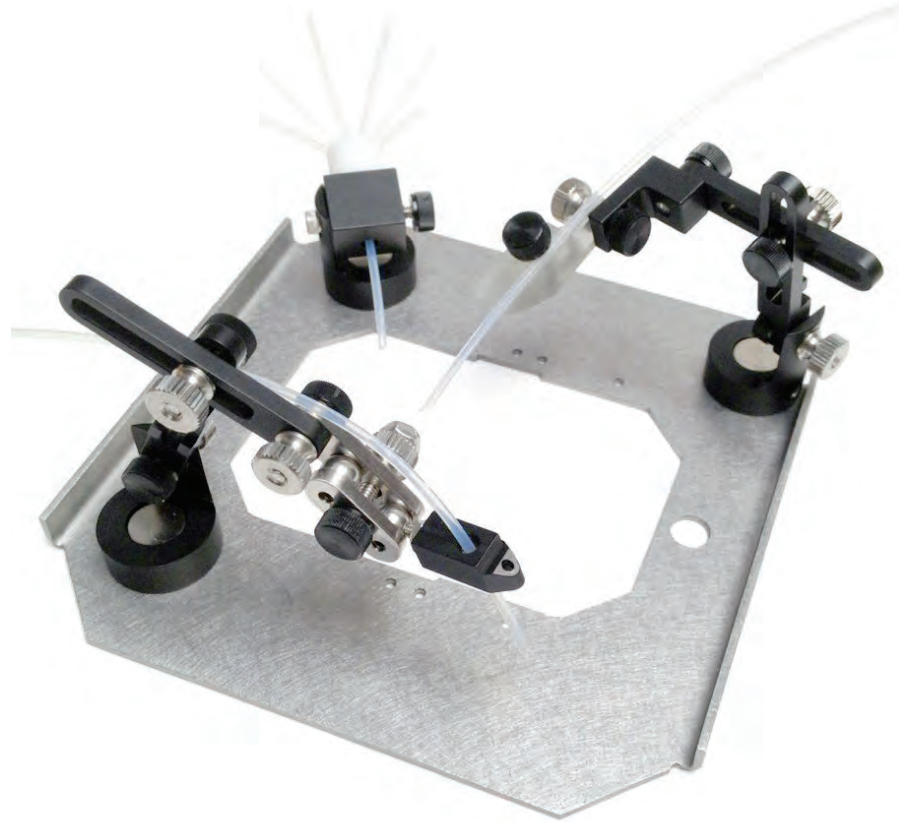

StageHands Kit #1 (SH-1) includes the three black metal holders shown above

StageHands™ Magnetic Tool Holders

Magnetic base, arms, manifold and tube holders mount everything securely on your microscope stage for electrophysiology and perfusion. The magnetic base of these different StageHands are designed to stick tightly to a steel ring around your perfusion chamber like our QuickStage™, or any steel surface nearby. They include a 1/4-20 screw to insert into a non-magnetic platform or air table.

Footprint: 0.75" (19 mm), adjustable in all axes, extends to over 4.5" (12 cm) long. Can be used to hold electrodes, tubes, manifolds, temperature sensors, glass capillaries, agar bridges, etc. Thumbscrews allow easy adjustment without needing any tools. All stainless steel and anodized aluminum parts so they won't oxidize or corrode.

Start with our StageHands Kit #1 (SH-1) which includes two magnetic bases with a pair of 1.5" (4 cm) arms, one locking ball joint, both a single and double tube/ electrode holder, plus a separate manifold holder. Add more arms, holders or bases as desired.

Ordering Information

Part No.	StageHands™	Price
SH-1	StageHands Magnetic tool holder Kit 1	\$ 399
SH-BJ-TH	StageHands ball-joint arm with tube holder	\$ 216
SH-ST-DTH	StageHands straight 2x arm with double tube holder	\$ 128
SH-MH-MS	Manifold Holder + Magnetic / Screw Stand	\$ 73
SH-TH	Tubing Holder	\$ 29
SH-DTH	Double Tool Holder	\$ 32
SH-OFF-RAB	Offset Right Angle Bracket	\$ 15
SH-RAB	Right Angle Bracket assembly	\$ 18
SH-STA	Straight Arm 1.5" piece	\$ 16
SH-RAA	Right Angle Arm 1.5" piece	\$ 16
SH-ISTA	Interlocking Straight Arm 1.5" piece	\$ 23
SH-IRAA	Interlocking Right Angle Arm 1.5" piece	\$ 23

U.S./Canada prices shown. International prices add 15%. Email or visit web store for latest prices.

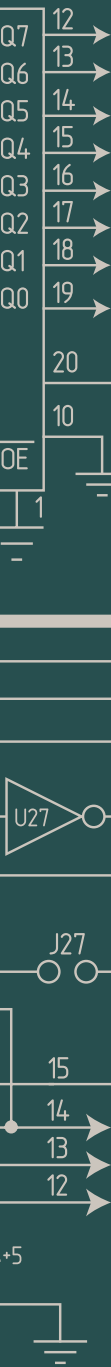

Oocyte Chamber Diagram

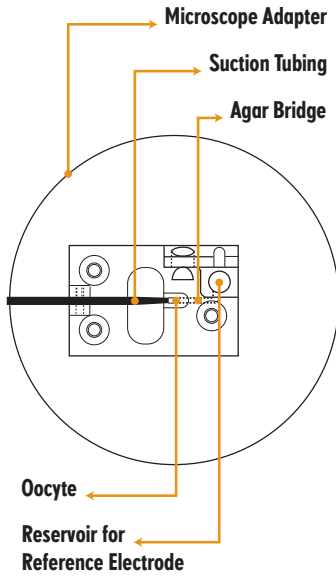

- Integrated outflow tube and agar bridge
- Chamber dimensions: 45 x 30 x 10 mm
- Slot for virtual ground electrode

Oocyte Chamber Side View

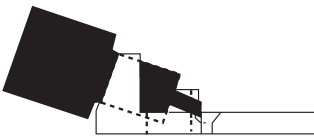

Insert micro-manifold for very low dead space

Low working volume means fast exchange times.

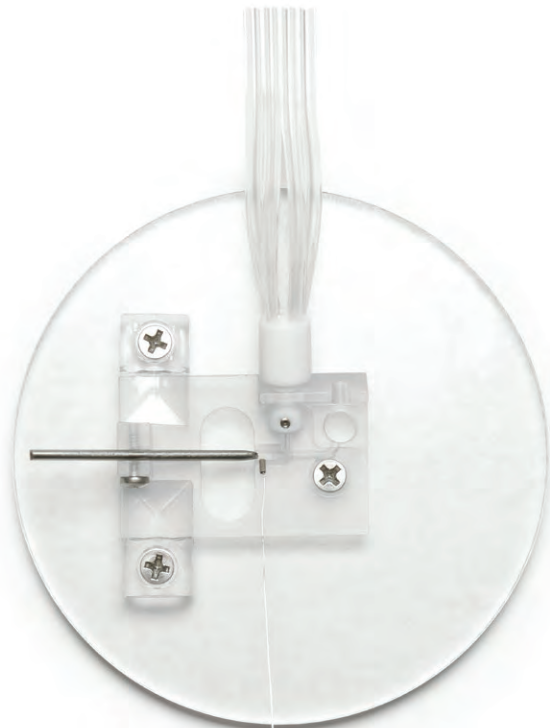

Oocyte Perfusion Chamber

- Small working volume (< 20 µl)
- Fast solution exchange

Expression of recombinant receptors in oocytes has been a favorite choice for researchers to assess the pharmacology of signal transduction pathways. Since the oocytes are 1 - 1.5 mm in diameter, however, fast solution exchange around the oocyte was difficult. After several years of electrophysiological research, we have designed a *Xenopus* oocyte perfusion chamber for use in automated and unattended experiments. Combined with an automated perfusion system, this chamber allows researchers to obtain dose-response data quickly and easily.

Ordering Information

Part No.	Oocyte Perfusion Chamber	Price
OPC-1	Oocyte perfusion chamber - specify 80, 90, 100, 108, 110 or 120 mm stage adapter (Micro-manifold also recommended)	\$ 250

U.S./Canada prices shown. International prices add 15%. Email or visit web store for latest prices.

Why transfer to coverslips?



“We do, indeed, get a rapid change of solution (depending, of course, on the adjusted fluid level), with mechanical stability otherwise very good, and no problems with noise, and the system is otherwise rather easy to set up. I could confidently recommend it to any investigator who works with cells that adhere strongly to the substrate.”

Dr. Jonathan E. Freedman, Ph.D.
 Department of
 Pharmaceutical Sciences
 Northeastern University

Petri Dish Perfusion Chamber

- **Perfuse cells right in your Petri dish**

Cells cultured in Petri dishes are a popular research tool used in applications from patch clamping to intracellular ion probe imaging. True perfusion (continuous inflow and outflow) of solutions in the dish can be difficult to configure. This forces scientists to plate cells on cover slips for placement into specially designed perfusion chambers. The PCP-1 chamber was designed by scientists after years of patch clamp research to overcome this problem. Perfuse cells right in your Petri dish with any perfusion system and an optional PTFE-Inert manifold (sold separately). Ideal for inverted microscopy using optically clear Petri dishes. Adjustable metal suction tube included. Dimensions: 35 mm outside dia. x 20 mm tall.

Petri Chamber Diagram

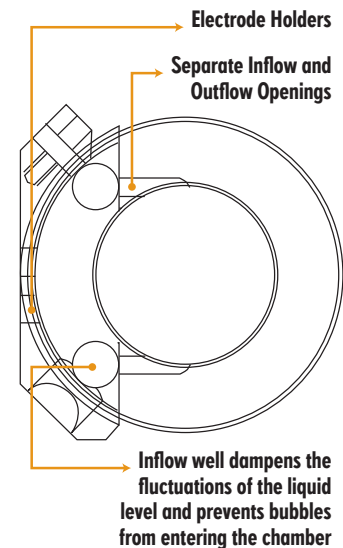

Ordering Information

Part No.	Petri Dish Perfusion Chamber	Price
PCP-1	Petri dish perfusion chamber insert - optional specify Corning, Falcon, Nunc (Micro-manifold also recommended)	\$ 195

U.S./Canada prices shown. International prices add 15%. Email or visit web store for latest prices.

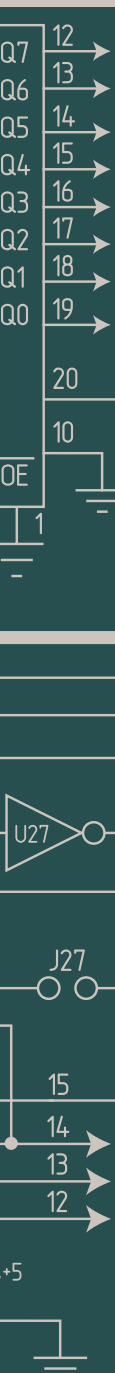

"I can perfuse up to five animals an hour; plus it costs no more than a tube of enzyme."

Dr. Vien Ming Kuo
University of California,
San Francisco

Mouse Brain Striatal Section

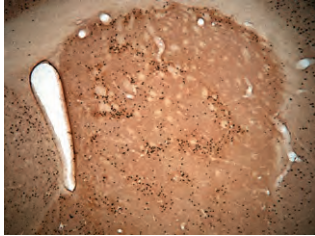

"Easy switch from saline to fixative—just turn the stopcock"

Dr. Sharon Smart
University of California,
San Francisco

2-way Manual Stopcock



Easy one-handed operation to switch solutions.

We've built a great fixation system so you don't have to.



In Vivo Manual Gravity Perfusion Systems
Rat 800 ml (91 cm tall) and mouse 140 ml (61 cm tall) systems shown

- **Consistent results**
Steady gravity-fed delivery of buffer and fixative results in complete perfusion.
- **Easy to setup, use and clean**
Complete system with everything down to the needles.
Fits in standard hoods.
- **Fraction of the cost of a peristaltic pump and more reliable**

AutoMate Scientific is providing an option for the scientist who would rather do science than design a system, source parts, phone, buy, etc. Let us take the guesswork out of your new animal fixation system.

One or two users can perfuse two mice simultaneously with the Double In Vivo system. Four reservoirs and two stopcocks are mounted for two independent wash buffer and fixative deliveries on the same ringstand.



Ordering Information

Part No.	Rodent Fixation Systems	Price
11-140	In Vivo Perfusion System - 140 ml mouse	\$ 260
11-04-140	Double In Vivo Perfusion System - 4x 140 ml mouse	\$ 365
11-20s	In Vivo needle - 20 ga x 1" sharp straight needle for mouse - Qty 4	\$ 1
11-20s-cs	In Vivo needle - 20 ga x 1" sharp straight needle for mouse - Box of 100	\$ 21
11-24bf	In Vivo needle - 25 ga x 3/4" sharp butterfly needle for mouse - Each	\$ 1.25
11-24bf-cs	In Vivo needle - 25 ga x 3/4" sharp butterfly needle for mouse - Box of 50	\$ 55
11-117	Wax dissection tray - Aluminum Tray for Mice - 11"x 7"	\$ 44
11-800	In Vivo Perfusion System - 800 ml rat	\$ 275
11-18s	In Vivo needle - 18 ga x 1" sharp straight needle for rat - Qty 4	\$ 1
11-18s-cs	In Vivo needle - 18 ga x 1" sharp straight needle for rat - Box of 100	\$ 19
11-20bf	In Vivo needle - 20 ga x 3/4" sharp butterfly needle for rat - Each	\$ 1.25
11-20bf-cs	In Vivo needle - 20 ga x 3/4" sharp butterfly needle for rat - Box of 50	\$ 50
11-139	Wax dissection tray - Aluminum Tray for Rats - 13"x 9"	\$ 47

U.S./Canada prices shown. International prices add 15%. Email or visit web store for latest prices.



Versatile, precision engineered tools for long service.

Brain Slice Chamber

Diagram Key

(Diagram below)

1. Bubble trap
2. Heat exchanger for perfusion fluid submerged/ interface mode
3. Heat exchanger for perfusion fluid to sloped insert
4. Control temperature sensor
5. Heating element
6. Oxygen/carbon dioxide gas bubbler
7. Exit for perfusion fluid via suction line

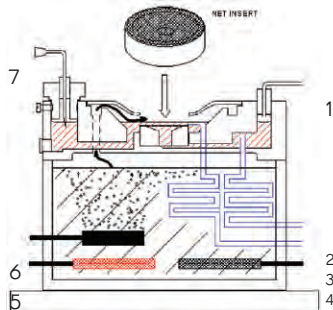

Brain Slice & Tissue Chambers

Brain Slice Chamber - 1: Interface and Submerged

- "Oslo" type chamber for submerged preparations
- Removable net type insert
- Sloped insert for small volume interface experiments
- Low noise temperature control

Brain Slice Chamber - 2: Interface

- "Haas" type chamber for interface preparations
- Templates for single or dual wells
- Minimal fluid dead space
- Stable recordings for many hours

Brain Slice Chamber - 3: 2, 3, 4, 6 Channel

- Two, three, four or six well chamber with independent lines
- Interface or submerged preparations
- Fluid level adjustable in each well
- Removable nylon net and insert
- High throughput pharmacological studies





Microscope Stage Chamber - 1: Submerged for Upright

- 1 ml capacity flow- through upright stage chamber
- Unique profiled contour for rotary and swing type turrets for par-focal viewing
- Glass coverslip base
- Easy removal for cleaning



Microscope Stage Chamber - 3: Interface

- Interface chamber for use on an upright microscope
- Template for single or dual channel use
- Glass coverslip base allows use of normal condenser optics

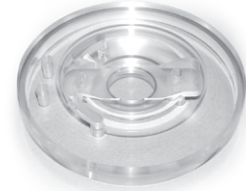

Microscope Stage Chamber - 4: Submerged for Inverted

- 1 ml capacity flow through inverted microscope stage chamber
- Glass coverslip base
- Temperature control unit available



Microscope Stage Chamber - 5: Submerged Coverslips

- Approx 2 ml capacity flow through microscope stage chamber
- Unique design for supporting cover slips from incubated preparations
- Glass coverslip base
- Easy chamber removal for cleaning
- In-line perfusion solution temperature control unit available



Proportional Temperature Controller for Brain Slice Chambers

- Very low noise direct current output
- High output power for rapid heating
- Compatible with our range of heating devices



Membrane Chamber

- Upright or inverted microscope access to a well perfused, perfectly flat and transparent in vitro slice preparation
- Slice viability increased beyond 16 hours as demonstrated with LFP recordings
- High mechanical stability, high flow rate and Bernoulli effect to optimize nutrient access for slices



Brain Slice Keeper 1: Single

- Brain slice keeper for pre-incubation of slices
- Hooks into standard Buchner filter funnel, beaker or optional Brain Slice Keeper Vessel (beaker) for bubbling carbogen into ACSF
- Unique curved bottom design keeps bubbles away from slices while promoting fresh solution flow over slices
- Needle valve for adjusting gas flow included



Brain Slice Keeper (S-BSK) + Brain Slice Keeper Vessel (S-BSKV) = Complete System (S-BSK Combo)

Brain Slice Keeper 2: Low Volume

- Minimum 5ml incubating media for expensive test solutions
- Modular design allows efficient cleaning
- Simple to set up and maintain
- Slices supported on a quick-change nylon net



Brain Slice Keeper 4: Quad

- Holds four sets of brain slices
- Container with lid and integrated air stone for bubbling carbogen into ACSF. Needle valve for adjusting gas flow included.
- Unique curved bottom design keeps bubbles away from slices while promoting fresh solution flow over slices

Brain Slice Keeper 5: Interface

- Slices maintained for many hours at an interface with incubating media
- Four separate rings allow separation of different types of preparations
- Slices supported on a quick change nylon net with optional attached porous membrane
- Modular design simple to set up and maintain





Brain Slice Keeper 6: Separate Solutions

- Minimum 4ml per incubating well for expensive test solutions
- Modular design allows efficient cleaning between experiments
- Slices supported on a quick-change nylon net
- Simple to set up and maintain



Brain Slice Keeper 12: High Capacity

- Slices maintained for many hours in incubating media
- Twelve separate rings allow separation of different types of preparations
- Slices supported on a quick-change nylon net
- Modular design simple to set up and maintain



Slice anchor (aka "harp" or "U-net")

- Stainless steel device with nylon mesh for holding slices down
- Heavy gauge steel minimizes floating
- Razor blade shown for scale



Ordering Information

Part No.	Brain Slice & Tissue Chamber	Price
S-BSC1	Brain slice chamber-1: Interface and Submerged	\$ 2,959
S-BSC2	Brain slice chamber-2: Interface	\$ 2,066
S-BSC3-2	Brain slice chamber-3-2: Two Channel Chamber	\$ 2,277
S-BSC3-3	Brain slice chamber-3-3: Three Channel Chamber	\$ 2,492
S-BSC3-4	Brain slice chamber-3-4: Four Channel Chamber	\$ 2,752
S-BSC3-6	Brain slice chamber-3-6: Six Channel Chamber	\$ 3,236
S-MS1	Microscope stage chamber-1: Submerged - for upright microscopes	\$ 637
S-MS3	Microscope stage chamber-3: Interface	\$ 1,573
S-MS4	Microscope stage chamber-4: Submerged - for inverted microscopes	\$ 453
S-MS5	Microscope stage chamber-5: For coverslips	\$ 487
S-PTC03	Proportional Temperature Controller For BSC	\$ 2,370
S-MC	Membrane Chamber	\$ 1,101
S-BSK1	Brain Slice Keeper 1: Single	\$ 315
S-BSK2	Brain Slice Keeper 2: Low 5ml volume	\$ 405
S-BSK4	Brain Slice Keeper 4: Quad	\$ 872
S-BSK5	Brain Slice Keeper 5: Interface	\$ 543
S-BSK6-6-4	Brain Slice Keeper 6: Separate solutions (avail. 2, 3, 4, 6 wells)	\$ 1,808
S-BSK12	Brain Slice Keeper 12: High capacity	\$ 994
S-BSKV	Brain Slice Keeper Vessel	\$ 120
S-BSK1 Combo	Brain Slice Keeper 1 and Vessel	\$ 441
S-SH18	Slice Anchor or Harp	\$ 154

U.S./Canada prices shown. International prices add 20%. Email or visit web store for latest prices.

Specifications:**Physical**

Standard steel instrument box with cast aluminum base

- W-6.5" D-7.5" H-1.3"
(32.2 x 18.1 x 3.1 cm)
- Weight - 2.8 lbs. (1.3 kg)

Power

- 115-120 VAC at 60 Hz
- 230-240 VAC at 50/60 Hz

Input Voltages

Input protection: 50 volts peak-to-peak

Maximum input signal recognized by the adaptor: 5 volts peak-to-peak

Maximum noise amplitude for complete cancellation: 1 volt peak-to-peak

Frequency Response

Input to output: DC to greater than 500 kHz

Hz and harmonics cancellation: 50/60 Hz to 4 kHz

Eliminate 50/60 Hz noise and harmonics without filtering.

**Hum Bug Noise Eliminator**

- **Eliminates electrical interference**
Simple 50/60 Hz sine waves
Mixtures of 50/60 Hz harmonics
Noise spikes from dimmers
Complex noise from fluorescent lamps
- **No waveform distortion**
No frequency loss or DC voltage shift
No signal attenuation or phase error

The Hum Bug is a powerful device for canceling electrical interference in real-time, avoiding all of the traditional problems associated with notch filters. The Hum Bug constructs a replica of noise present on the input signal and continuously subtracts this replica from the signal as it passes through the instrument. It performs this function in the presence of biological activity even when noise characteristics evolve over time.

The Hum Bug is not a filter. It does not create phase delays, amplitude errors, DC shifts or waveform distortion. Simply connect it between your preamplifier and any analysis equipment and it will automatically eliminate 50/60 Hz noise and harmonics with frequencies up to several kHz. Noise is eliminated without altering the signal of interest even when frequencies within the signal overlap with noise components. No settings or adjustments are required.

The Hum Bug can eliminate 50/60 Hz noise from virtually any analog signal. It is equally effective at removing noise associated with inadequate grounding, ground loops, and electrical pickup. Common applications include noise elimination from signals recorded using microelectrodes, skin electrodes (EKG, EMG, EEG), high gain amplifiers, magnetic sensors, and audio equipment.

Controls

- Bypass:** halts noise cancellation by routing input directly to output
- Hold:** suspends adaptation to evolving noise characteristics
- Clear:** clears the noise replica

Display

- LED indicates changing noise levels
 - Green: decreasing amplitude of the noise replica
 - Red: increasing amplitude of the noise replica

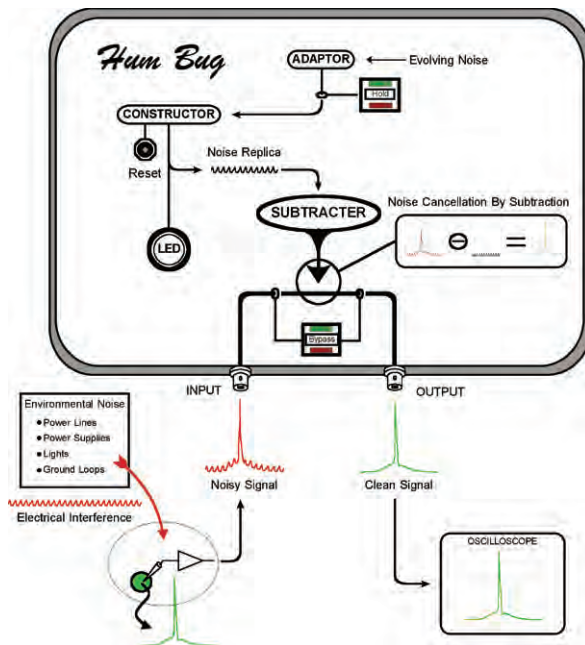

Ordering Information

Part No.	Hum Bug Noise Eliminator	Price
Q-HUMBUG	Hum Bug - 50/60Hz active noise eliminator	\$ 1,890

U.S./Canada prices shown. International prices add 15%. Email or visit web store for latest prices.



Brownlee Precision Model 410

The Model 440 adds controls for a highpass filter, notch filter, digital volt meter, auto zero, and input impedance on each channel.

Gain, Lowpass Filter, and Highpass Filter generally step through the following values

1.0, 1.1, 1.2, 1.3, ... 1.9,
2.0, 2.2, 2.4, 2.6, ... 4.8,
5.0, 5.5, 6.0, 6.5, ... 9.5,
and multiples of 10 thereof.

Gain

Range: 0.1 to 10,000

Steps: 0.1, 0.15, 0.2, 0.25, 0.3,
0.4, 0.5, 0.6, 0.7, 0.8, 0.9, then as
above for gains 1.0 to 10,000

Gain Accuracy: < 2% error.

Lowpass Filter

Range: 20 Hz to 50 kHz (8 pole),
plus 80 kHz (2 pole) and wideband.

Steps: as above for frequencies
20 Hz to 15 kHz, then 18,
20, 22, 25, 33, 40, 50, 80
(all kHz), and wideband.

Characteristic: 8 pole Bessel
(8 pole Butterworth may be
substituted on any or all channels;
contact AutoMate Scientific).

Wideband Frequency Response:
500 kHz min. all gains.

High performance four-channel amplifier and signal conditioner in one quiet package.

**Brownlee Precision Model 440 Amplifier**

The Brownlee Precision Model 440 incorporates four channels of sophisticated amplifier and filter circuitry in a friendly, easy to use instrument. Each channel consists of a high gain/low noise amplifier, an 8-pole Bessel lowpass filter, a highpass filter, a line notch filter, and output offset controls. A control knob sets the amplifier parameters, and the values are displayed on a bright LED alphanumeric readout.

- **Key Features**

- Clear front panel controls for all settings
- Gains from 0.1 to 10,000 in fine, calibrated steps
- Single-ended or differential inputs
- 8 pole Bessel lowpass filter with range 20 Hz to 50 kHz
- Highpass filter with frequency range .01 Hz to 100 Hz
- Output offset control to shift output up to ± 10 Volts
- Auto-Zero feature to reset the output to the baseline level
- Notch filter to suppress line noise
- Digital Voltmeter on channels 1 and 2
- Powerful output which can directly drive transducers
- Wide bandwidth: greater than 500 kHz on all gains

Precise

The Brownlee Precision Model 440 is a rugged, flexible, and precise laboratory amplifier. It was designed with particular attention to the needs of electrophysiology research. These requirements include: high gain, low noise, clean pulse response, adjustable filtering, removal of offset levels, high input impedance, and ease of use.

The 8 pole Bessel lowpass filter is ideal for removing high frequency noise while accurately amplifying the shape of input pulses. Overshoot and ringing are negligible, even with fast rise and fall times and at high gains. There are 108 different cutoff frequencies available over a range from 20 Hz to 50 kHz.

The input bias current is also very low at 20 pA. The input resistance may be set for 1 M or $10^{12}\Omega$. These characteristics make the amplifier almost "invisible" to the source, allowing the direct connection of many types of electrodes.

Easy To Use

The Model 440's front panel interface preserves the simplicity and "feel" of older analog instruments while taking advantage of the benefits of digital circuitry.

Changing an amplifier setting is as easy as pushing a parameter button ("Gain" for example) and turning the control knob up or down until reaching the desired setting. Unlike a potentiometer however, the settings increment or decrement through discrete, calibrated steps. The bright LED alphanumeric readout displays the exact value ("Gain=850" for example).

Multiple setups may be stored for each channel in memory. All the input and output BNC connectors are conveniently located on the front panel. Each channel functions independently and is internally shielded to prevent crosstalk.

If the input signal has a drifting DC offset voltage, it can be removed using the Highpass Filter. The Output Offset control can shift the output baseline level from -10 V to +10 V in 100 mV steps. This is helpful if the output level must match the input range of a computer's A/D board, for example.

The Model 440's powerful output stage can drive ± 100 mA, and is stable even driving capacitive loads. A notch filter is available to remove line noise.

Ordering Information

Part No.	Brownlee Precision Model 410 Amplifier	Price
04-40	BP 440 - High performance 4-channel amplifier and signal conditioner	\$ 4,350

U.S./Canada prices shown. International prices add 20%. Email or visit web store for latest prices.

Highpass Filter (AC Coupling)

Range: .01 Hz to 100 Hz

Steps: DC, AutoZero DC, then as above

Input

Selection: A, -B, A-B, or Grounded

Impedance: 1 M Ω or $10^{12}\Omega$, 20 pF

Bias Current: 20 pA

Offset Voltage: 15 μ V max.

Voltage Range: ± 10 V

CMRR: > 70 dB all gains

Noise: 1.5 μ V_{rms}
(10 μ V_{peak to peak}) @ 10 kHz

Output

Voltage Range: ± 10 V

Current Capability: ± 100 mA

Slew Rate: 10 V/ μ S

Output Offset Control Range: ± 10 V
in 100 mV steps

Noise: 500 μ V_{rms}
(3 mV_{peak to peak}) @ 10 kHz

Auto-Zero

Pressing "Auto-Zero" will reset the output to the baseline level (when the Highpass Filter is on) and self-calibrate the amplifier's internal offset voltages.

DVM

Channels 1 and 2 include a handy Digital Voltmeter to quickly and easily measure the input level.

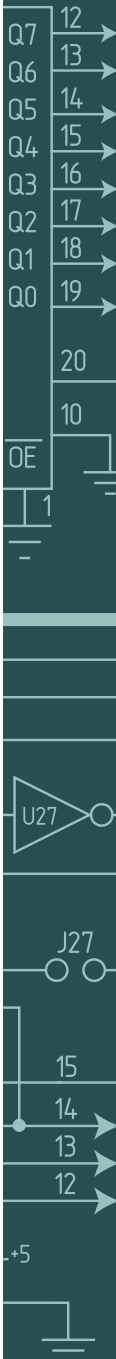

Panel Rail Mounted Heavy Duty Shelf

- Allows easy rack mounting of narrow equipment or items that do not have rack mounting capabilities.
- Shelves feature formed 14-gauge steel construction
- 15" Deep x 3.5" (2U) high = 100 pound weight load rating
- Rear lip stiffener folded up for extra strength & acts as a rear equipment retainer
- Mounts to rack rails either as an internal shelf or external shelf/work area
- Rugged textured - powder paint finish
- Requires mounting hardware



Flat Pack Shipping

Shipped in a flat pack container for handling ease & protection. Perfect for tight access areas or 1 person installations.

Rack is knocked down into 5 easy to handle parts (ie...two sides, top, bottom and a pack of 4 panel rails)

Panel Rails



Floor-standing and table-top equipment racks.



Floor-standing Equipment Rack

- Standard 19" panel width (21.34" wide overall)
- Usable depth of 24.5" (23.5" deep overall)
- Knockdown rack unit is shipped in a flat pack container for handling ease & protection (see above)
- Perfect for tight access areas or 1 person installations as unit is knocked down into 5 easy to handle parts (ie...2 sides, top, bottom and 4 rails)
- Complete with; 4 infinitely adjustable - combination rack mount rails, on E.I.A. universal spacing (5/8 - 5/8 - 1/2 inch) - drilled & tapped for 10-32 screws (see close up right) and 4 leveling feet
- Removable gland plate (over 10" long X 1.5" high opening) with knockouts on rear bottom of rack for easy cable access
- Simple assembly using one bolt in each corner to lock the sides to the top and bottom (hardware included)
- Heavy duty 16 gauge steel top, bottom and sides
- Rails are made of 10 gauge steel (zinc plated finish for grounding capabilities)
- Recommended maximum weight, 1,000 pounds
- Finished in rugged textured powder paint

Table-Top Equipment Rack

Features

- Standard 19" rack panel width mounting
- Rack mounting, on E.I.A. universal spacing (5/8 - 5/8 - 1/2 inch)
- Round hole punched for 10-32 clip nuts (included)
- Choice of two heights, 21" (12U) or 28" (16U)
- Heavy duty construction, 14 gauge steel
- Supplied unassembled (four pieces), shipped in a flat pack container for handling ease & protection
- Includes all hardware and four rubber feet
- Recommended maximum weight (RRTT1928 tested) - 350 pounds
- Rugged powder paint, textured black finish

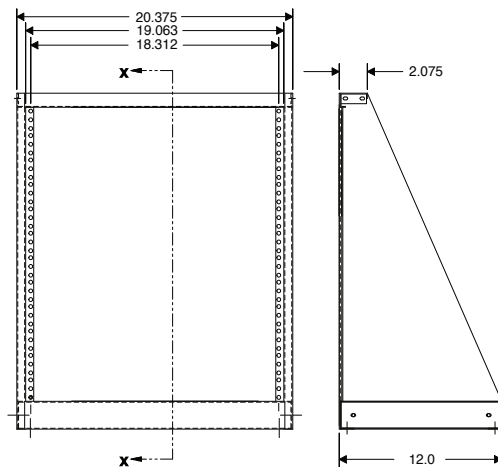

Light Duty Shelf

- Allows easy rack mounting of narrow equipment or items that do not have rack mounting capabilities.
- Mounts to rack rails either as an internal shelf or external shelf/work area (e.g. for a keyboard)
- Shelves feature formed 16-gauge steel construction
- 7" Deep x 1.75" (1U) high = 40 pound weight load rating
- Front & back edge folded - acting as both stiffeners and equipment retainers
- Shelves include tie down slots on each side & four tie down holes
- Rugged textured - black powder paint finish
- Requires mounting hardware



Ordering Information

Part No.	Equipment Racks and Shelves	Price
FR-TT21	Table-top rack - short 21" (12U) tall x 19" wide rack	\$ 205
FR-TT28	Table-top rack - tall 28" (16U) tall x 19" wide rack	\$ 210
FR-TT-Shelf	Table-top Rack Shelf 7" deep x 19" wide rack x 1.75" tall	\$ 62
FR-EQ35	Equipment Rack 35" (20 U) tall x 19" wide rack x 24" deep	\$ 993
FR-EQ42	Equipment Rack 42" (24 U) tall x 19" wide rack x 24" deep	\$ 1,108
FR-EQ63	Equipment Rack 63" (36 U) tall x 19" wide rack x 24" deep	\$ 1,350
FR-EQ-Shelf	Equipment Rack Shelf 15" deep x 19" wide rack x 3.47" tall	\$ 75
FR-1425PHD	Equipment rack casters - Heavy duty (600 lbs) set of 4	\$ 87.46
FR-1425PL	Equipment rack casters - Light duty (400 lbs) set of 4	\$ 62
	More sizes and accessories available. Contact AutoMate.	

U.S./Canada prices shown. International prices add 15%. Email or visit web store for latest prices.

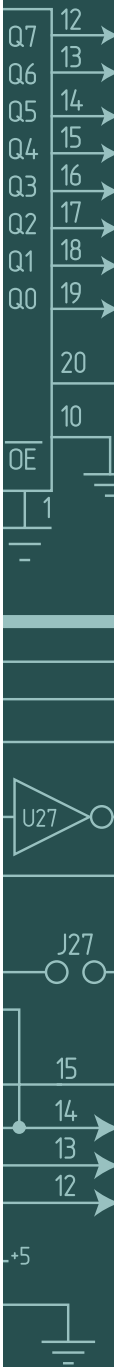

A complete solution to your electrophysiology needs.

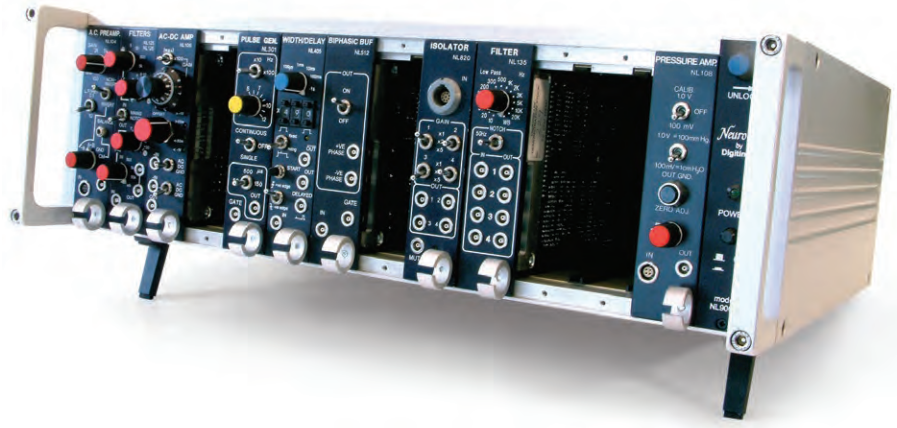

NL905 Small Case System and Power Unit



This smaller case holds four NeuroLog modules instead of thirteen.

NeuroLog Modular System

The NeuroLog System provides a modular and highly versatile means of carrying out intracellular, extracellular or transducer-based recordings, signal conditioning, pulse generation or electrical stimulation within one compact device.

The NL900D Case & Power Supply unit allows up to thirteen modules to be installed. This means a single NeuroLog System can be used to amplify several different parameters, such as extracellular spikes, intracellular potentials or even blood pressure, as well as produce outgoing trigger pulses to other pieces of equipment or electrically stimulate a preparation.

Amplification & Signal Conditioning

The NeuroLog System provides AC or DC coupled amplification of biological signals from transducers, single electrode or multi electrode configurations. DC coupled amplifiers output absolute voltage levels and are most commonly employed for intracellular or transducer recording where baseline membrane potentials or slow voltage shifts are of interest.

With AC coupled amplifiers, the “DC baseline” is removed by high-pass filtering. Such amplifiers are used for extracellular recording of action potentials in neuronal preparations, ECG, EMG or EEG waveforms. The variety of NeuroLog pre-amplification and amplification modules means that users can develop systems specifically suited to their particular application. The NeuroLog range also contains a number of filter and signal conditioning modules which can be used prior to final data acquisition.



Extracellular AC Recording

The NL100AK head-stage and NL104A AC PRE-AMPLIFIER provide an excellent combination suitable for extracellular recordings from neuronal preparations with sharp electrodes. They can be used in single-sided or differential recording modes, provide impedance matching for micro-electrode recording and feature low noise amplification. Continuously adjustable bandpass filtering from 0.1 Hz to >50 kHz is available through the NL125/6 FILTERS. In addition, the NL201 SPIKE TRIGGER can be used to convert spikes into uniform TTL pulses which can then be counted, converted to frequency or further analyzed using other modules. Use of the NL120S AUDIO AMPLIFIER and NL985S LOUDSPEAKER would allow the spikes to be monitored audibly.

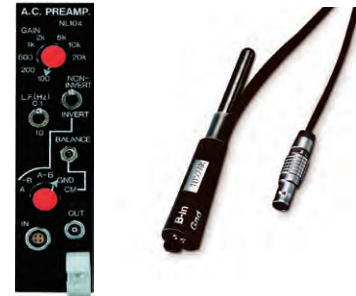

Intracellular DC Recording

The NL102G DC PREAMPLIFIER is a suitable amplifier for intracellular recording (it can also be used for extracellular micro-electrode recordings). Used with the NL106 AC/DC AMPLIFIER it provides a total gain up to x1,000, while the NL125/6 FILTERS give continuously adjustable bandpass (and notch) filtering from DC to >50 kHz. The NL102G features capacitance neutralization, current injection (up to 100 nA) and impedance checking. Internally generated current injection and impedance checking can both be controlled by other devices or NeuroLog modules. The NL102G now includes the NL412 PULSE box, allowing remote and full activation of the capacitance compensation circuitry. This “buzz” process can aid penetration during electrode impalement.



Four Channel Isolated Amplification for EEG, EMG or ECG Recording

An ideal system for multi-channel AC recording of physiological signals such as EEG, EMG or ECG in the research environment. The system provides a wide range of amplification and filter settings. The NL844 4-CHANNEL PREAMPLIFIER can be positioned near the recording site, reducing the length of the electrode cables and minimizing interference. The outputs are connected to the NL820A ISOLATOR (housed in the NeuroLog case), where further amplification of the signals can be selected on a channel by channel basis. Further filtering can be carried out by the various NL134/5/6 or NL144 FILTERS, while the signal can be conditioned for ADC input using the NL530 CONDITIONER.

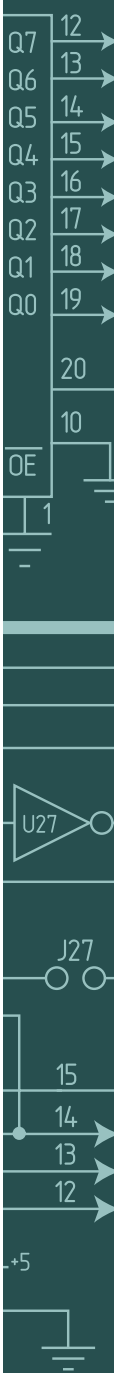



Transducer Measurements

The NL108A PRESSURE AMPLIFIER provides an easy method of monitoring physiological pressure changes and can be used in combination with your own or our disposable (NL108T2) / reusable (NL108T4, shown opposite) pressure transducers. A pressure transducer and appropriate lead connects to the NL108A module, allowing continuous monitoring of parameters such as blood or intra-tracheal pressures. The output of the NL108A can be fed directly to a chart recorder or ADC interface for PC-based acquisition.



Pulse Generation & Electrical Stimulation

The NeuroLog range includes several modules capable of pulse generation. Pulse patterns can be pre-defined in a variety of ways, allowing you to control other modules within the NeuroLog rack or send TTL compatible trigger pulses to external devices, such as stimulators or acquisition systems. The NeuroLog range includes the small constant current NL800A STIMULUS ISOLATOR which can be controlled by other NeuroLog modules. Our NL512 BIPHASIC BUFFER allows one or two NL800A's to be controlled by an analog waveform, such as that produced by a computer controlled DAC.

Ordering Information

Part No.	NeuroLog Modular System	Price
NL-900D	NeuroLog® case and power supply	\$ 3,555
NL-905	NeuroLog® small case and power supply	\$ 2,575
NL100AK	NeuroLog Pre Amp Head Stage (for NL104A) Headstage, including NL973A Accessory Kit	\$ 835
NL100RK	NeuroLog Pre-Amp with Stimulus Relay, NL100AKS Headstage & NL100C Stimulus Controller	\$ 2,541
NL101	NeuroLog Electrode Chamber (specify pin # and o.d.)	\$ 200
NL102G	NeuroLog DC Pre-Amplifier with Pulse Buzz (NL 412)	\$ 3,855
NL104A	NeuroLog AC Pre-Amplifier	\$ 1,735
NL106	NeuroLog AC/DC Pre-Amplifier	\$ 1,735
NL120S	NeuroLog Audio Amplifier	\$ 895
NL125/6	NeuroLog Filter (Lo-cut, Hi-cut, 50/60Hz notch)	\$ 1,565
NL136	4-channel Low-Pass Filter + 60Hz Notch	\$ 3,175
NL144	4-channel High-Pass Filter	\$ 2,615
NL201	NeuroLog Spike Trigger	\$ 1,520
NL301	Pulse Generator (replaces NL300)	\$ 820
NL703	NeuroLog EMG Integrator	\$ 1,140
NL820A	NeuroLog 4 Channel Isolation Amplifier	\$ 2,905
NL822/P	2mm plugs, with BLACK insulator, for NL822/824 etc. (pack of 10)	\$ 85
NL844	NeuroLog 4 channel AC Preamplifier	\$ 4,550
NL985S	Loudspeaker for NL120S (with safety plugs)	\$ 235
AutoMate Scientific offers a complete line of Digitimer NeuroLog modules.		

International prices add 20%. Email or visit web store for latest prices in US Dollars.

Deliver precise constant voltage or current stimuli.



DS2A Constant Voltage, DS3 Constant Current, DS4 Bi-phasic Stimulus Isolators

Brief pulses of electricity are used in various biomedical research applications as a stimulus to excite nerve or muscle fibers. Several factors need to be considered when choosing the right stimulator.

- In order to minimize artifacts introduced into electrophysiological data, it is desirable to electrically isolate the stimulator from both ground and the trigger device.
- The voltage required to send current through tissues can vary greatly, making it important to have control over the stimulus driving force.
- Large impedance variations during an experiment can result in loss of the stimulus. In this event, a constant current stimulator may be more suitable.

Our three isolated stimulators either provide constant voltage (DS2A), constant current (DS3), or bi-phasic output (DS4) giving you the ability to choose the stimulator which best suits your experimental needs.

DS2A Constant Voltage Stimulator

- External control of pulse duration.
- Overload protection circuit preventing current in excess of 50 mA being delivered.

DS3 Constant Current Stimulator

- Four current ranges allow precise control of output between 2 µA and 32 mA.
- Output discharge (Clamp) circuit prevents capacitance build-up during stimulus trains, which is important to prevent stimulus loss.
- 90 V compliance provided.

DS2A & DS3 Features:

- Accurate and reproducible stimulus characteristics.
- Switchable polarity, variable output and duration ranges (20 µs to 2 sec).
- External pulse duration control through the BNC trigger input.
- A single-shot button, which operates irrespective of trigger inputs.
- Cases manufactured from insulating material may be rack mounted using an optional mounting frame (Model D121-11) available from AutoMate Scientific.
- Power provided by standard batteries. Note that current is only drawn during pulse delivery.

DS4 Bi-phasic Stimulator

- Voltage input ranges of ±1V, ±2.5V, ±5V and ±10V.
- Output in 4 overlapping ranges of ±10µA, ±100µA, ±1mA & ±10mA)
- ±48 V compliance provided.
- GATE input allows multiple DS4's connected to one DAC out.

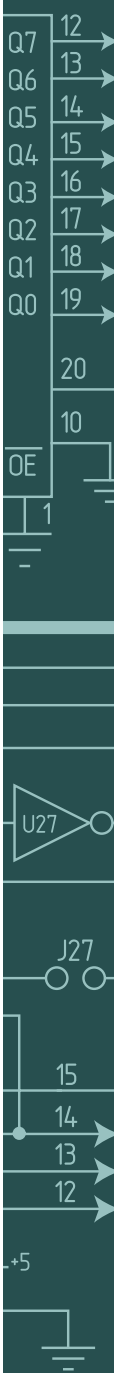

Additional Specifications

DS2A & DS3 Trigger

A positive pulse between 3 V and 20 V is required to trigger these stimulators. The trigger input current varies from 6 mA to 62 mA over the above voltage range. Trigger pulse duration should not normally be less than 4 μ s.

DS2A & DS3 Pulse Duration

Range: 20 μ s to 2 sec. One dial allows continuous adjustment from 2 to 20, while another is used to select the range (from 10 μ s, 100 μ s, 1 ms, 10 ms, 100 ms or external source) with \pm 10% accuracy.

Trigger Isolation

Optical coupling is employed between the trigger source and the stimulator circuitry. The capacity coupling is less than 3 pF.

Batteries (DS2a & DS3)

11 x PP3 9V, IEC-6R61 style batteries. Current is only drawn when delivering a pulse. Note that battery test sockets are built-in.

Batteries (DS4)

The DS4 includes a \pm 15V external power supply or accepts 10x 12V GP23A batteries.

Mounting

One or two stimulators may be mounted in a 19" rack using a specially fabricated frame (model D121-11) available from AutoMate Scientific.

Dimensions

Panel size: 190 mm x 110 mm.

Weight

800 g complete with batteries

Output terminals

A pair of 2 mm touch-proof sockets on the front panel spaced at 0.75".

Indicator

An LED operates for the duration of each output pulse.

Technical Specifications

- Output:**

DS2A-Mk.II (Constant voltage): Two ranges provide 99 V (high) and 9 V (low) maximum output. A multi-turn dial allows output to be selected as a percentage of maximum. Square wave pulse profile with typical rise time <1 μ s and fall time <3 μ s into resistive load.

DS3 (Constant current): Output between 2 μ A and 32 mA. Control is achieved by a variable range switch with four selections (10 μ A, 100 μ A, 1mA, 10 mA) and a three-turn dial. Pulses from high impedance stimulators (constant current units) can result in cells "charging-up" between stimuli, leading to stimulus loss. This problem has been overcome in the DS3, which has an Output Discharge (Clamp) Circuit that operates for 20 μ s after each stimulus pulse. This will discharge cells with capacitances as high as 1000 pF.

DS4 (Bi-phasic): Bi-phasic constant current proportional to the input voltage up to 5 kHz signals. \pm 10 μ A; \pm 100 μ A; \pm 1mA; \pm 10mA for a full scale input. >2 μ s duration. An "inactivity sensor" reduces battery usage and damaging "leak currents" during infrequent stimulation, while maintaining low levels of zero crossing distortion for repetitive waveforms.



Ordering Information

Part No.	Isolated Stimulators	Price
DS2A	Constant voltage stimulator	\$ 1,695
DS3	Constant current stimulator	\$ 1,895
DS4	Bi-phasic stimulator	\$ 3,225
D121-11	19" rack frame for two stimulators or DG2A	\$ 135

International prices add 20%. Email or visit web store for latest prices.

Compact, free-standing, battery powered pulse generator.

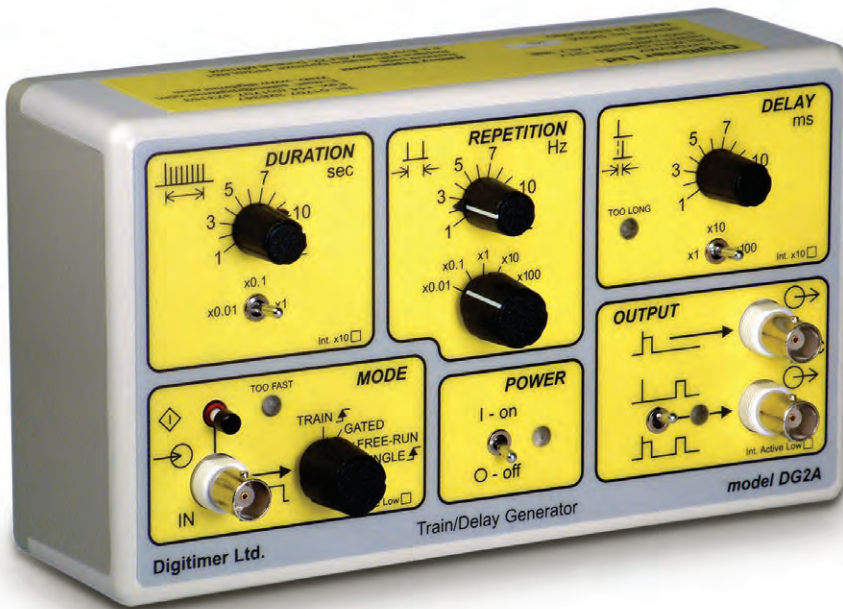

DG2A Train/Delay Generator

The DG2A is a compact, free-standing, battery powered instrument which can be used to generate trigger pulses required for repetitive stimulation. Also featuring DELAY controls, it is useful for determining nerve or axonal Effective Refractory Period (ERP) through the production of a delayed second pulse.

Various modes allow output pulses to be produced singularly (SINGLE), continuously (FREE-RUN & GATED) or in a burst (TRAIN), with the burst/train duration and pulse frequency determined by the front panel controls. In each of the modes (except FREE-RUN), outputs can be initiated either by the front panel push button, a TTL compatible trigger/gating pulse or a suitable foot switch.

The unit has control of train duration over three full decades, pulse repetition rate (or frequency) within that train over five decades and control of the delayed pulse over three decades. It has two BNC output sockets (i) the SYNC output produces a pulse to trigger recording devices or synchronize other equipment and (ii) the OUT output produces either a delayed version of the same or pairs of delayed and non-delayed pulses.

Additional Specifications

Delay

Total range: 1 ms - 1200 ms in three overlapping ranges

Control: Single turn control marked 1 - 12 ms with intermediate integer panel marks

Accuracy: $\pm 1\%$ at '1' and '12' marks, $\pm 5\%$ at intermediate marks

Multiplier: x1 ; x10 ; x100

Internal Jumper: Enable "x10" - giving a 10 ms - 12 sec total range. The front panel provides a check-box for marking with a waterproof pen when enabled.

Indicator: "TOO LONG" Red LED that flashes if DELAY is longer than can be produced for each pulse.



Outputs - SYNC

Connector: BNC socket

Signal: Positive going, 200µs pulse, TTL compatible pulse (5V amplitude).

Outputs - OUT

Connector: BNC socket

Signal: Positive going, 200 µs pulse, TTL compatible pulse (5 V amplitude).

Control: Selection of only the Delayed pulse (upwards) or both the Sync and Delayed pulses.

Indicator: Amber LED flashes for each OUT output pulse.

Internal Jumper: Enable "Active Low" - giving an Output that is Low during its active phase. The front panel provides a check-box to mark with a waterproof pen when enabled.

Power

Consumption: <2 mA

Internal: 9V PP3 - (IEC-6LR61) style. Alkaline preferred

Battery Life: Approximately 250 Hours with Ever Ready 6LF22 or Duracell MN1604

Dimensions

Size: 188 x 110 x 60 mm (w h d)

Weight: 490 grams (1 lb.) with battery fitted.

Please note that no accessories, other than a battery, are supplied.

Specifications of the DG2A

The unit always produces a pulse to synchronize other equipment at SYNC and a pulse delayed from SYNC by DELAY controls.

- **Modes:**

Control: Four position rotary switch. Movement of this control will immediately terminate any cycle and keep it in a Reset state for about 1 second. This is a useful feature should an exceedingly long cycle be selected by accident. Functions: SINGLE - Input signal triggers a single Output pulse. FREE-RUN - Continuous Output pulses as set by REPETITION controls. GATED - Input signal enables unit to produce pulses as set by REPETITION controls. TRAIN - Input signal Triggers unit to produce pulses as set by REPETITION controls for the time as set by the DURATION controls.

- **Input:**

Connector: BNC socket. Levels: TTL high (>1.5 V), TTL low (<0.8 V). Polarity: Active High (GATE/TRAIN) and Positive edge (SINGLE) or Active Low and Negative edge by Internal Jumper. Internal Jumper: Enable "Active Low" - allows a Low Input during its active phase. The front panel provides a check-box to mark with a waterproof pen when enabled. In Active Low an external contact closure can be used. Push-button: Has same function as a valid input signal. Indicator: "TOO FAST" Red LED flashes if a Trigger is received while the unit is busy.

- **Duration:**

Total range: 10 ms - 12 seconds in three overlapping ranges. Control: Single turn control marked 1 - 12 sec with intermediate integer panel marks. Accuracy: ±1% at '1' and '12' marks, ±5% at intermediate marks. Multiplier: x0.01 ; x0.1 ; x1. Internal Jumper: Enable "x10" - giving a 100 ms - 120 sec total range. The front panel provides a check-box to mark with a waterproof pen when enabled.

- **Repetition (Frequency):**

Total range: 0.01 - 1200 Hz in five overlapping ranges. Control: Single turn control marked 1 - 12 Hz with intermediate integer panel marks. Accuracy: ±1% at '1' and '12' marks, ±5% at intermediate marks. Multiplier: x0.01 ; x0.1 ; x1 ; x10 ; x100.

Ordering Information

Part No.	Isolated Stimulators	Price
DG2A	Train/Delay generator	\$ 1,255

International prices add 20%. Email or visit web store for latest prices.

Great service and great prices on Sutter Instruments.



Sutter Instrument

Manipulators

Sutter Instrument's expertise in electromechanical engineering and stepper-motor control is evident in the sub-micron resolution of their highly stable motorized and mechanical micromanipulators. Whether your application requires the extensive programmable capabilities of the MP-285, the multiple manipulator control of the MPC-200, or one of their traditional, manual style manipulators, Sutter Instrument provides the total control essential to your experiments.

Micropipette Fabrication

As the world leader in micropipette fabrication technology, Sutter Instrument's advanced pullers are essential to biomedical research and emerging analytical techniques using sub-micron probes and pipettes. Their innovations in puller design include sophisticated velocity sensing circuitry to maximize reproducibility, and the laser-based P-2000 puller capable of pulling fused silica.

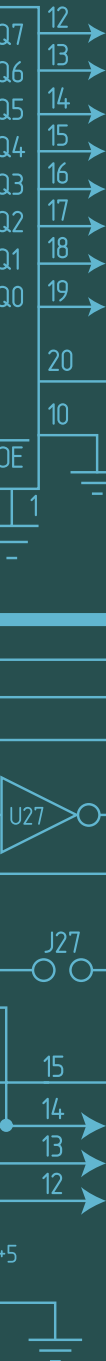



Optical Instruments

Sutter Instrument has combined extensive years of motor control experience and in-house precision CNC machined parts to create a line of robust and versatile optical products to serve the tremendous growth in photonics, optical research, and imaging techniques. Their latest developments are the SmartShutter, a full-featured controllable shutter, and the Lambda 10-3 controller, capable of commanding up to three wheels and two shutters.



Microinjection

XenoWorks™ is a modular system designed to meet a wide variety of microinjection application needs. Sutter Instrument's experience with precision motor control has culminated in this state of the art system including the XenoWorks™ Micromanipulator and Digital Microinjector for Zygote pronuclear DNA microinjection, embryonic stem cell blastocyst transfer, Intracytoplasmic Sperm Injection (ICSI), adherent cell microinjection, and somatic cell nuclear transfer.

Sutter Instrument Ordering Information

AutoMate Scientific is an authorized distributor for the entire Sutter Instrument product line. Please call or email us for a quote on any Sutter items at competitive prices, including the latest P-1000 puller:

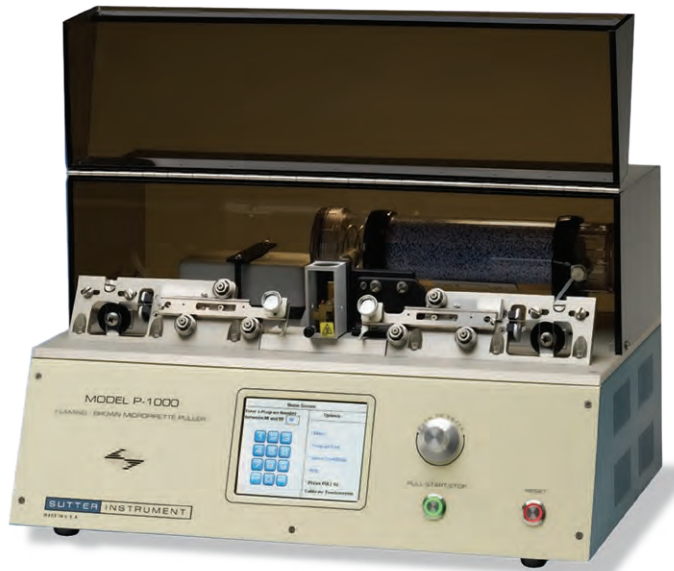

Ordering Information

Part No.	Sutter Instrument Manipulators	Price
SU-MPC-325	MP-225 manipulator, MPC-200 controller, and ROE-200	\$ 10,227
SU-MPC-365	MP-265 Narrow manipulator, MPC-200 controller, and ROE-200	\$ 12,340
SU-MPC-385	MP-285 manipulator, MPC-200 controller, and ROE-200	\$ 11,833
SU-MP-285	Motorized manipulator and controller unit	\$ 11,833
SU-MP-225A	Motorized manipulator and controller unit	\$ 7,099
SU-3DMS	3-Dimensional Motorized Stage	\$ 11,272
SU-MP-85	Manual manipulator and controller unit - spec. left or right handed	\$ 8,387
SU-MM-33	MM-33 Coarse Manipulator	\$ 1,671
SU-MT-2000	Motorized X-Y translation system w/MT-800 and columns	\$ 14,082
SU-MT-800	Motorized X-Y translation system and controller unit	\$ 11,408
SU-MT-1000	X-Y translation system w/MT-500 and columns	\$ 7,916
SU-MT-500	X-Y translator for fixed-stage upright microscopes	\$ 5,238
SU-MT-70/71	Micromanipulator stands - 3, 6, 9, & 12 in. towers avail.	\$ 380+
SU-MT-75	Gantry style micromanipulator stands - adjustable	\$ 1,016
SU-MT-75/LS	Gantry style stands with linear slide - adjustable	\$ 1,737
SU-MT-78	Fixed & Motorized Platform Stage	\$ 4,695
SU-MD-Series	Micromanipulator platforms - microscope dependent	\$ 615



**Sutter list prices shown.
For even better prices,
ask for a quote.**

Part No.	Sutter Instrument Micropipette Fabrication	Price
SU-P-2000/G	Laser-based pipette puller (spec. greater or less than 0.6mm glass)	\$ 21,336
SU-P-1000	Next Generation micropipette puller	\$ 10,963
SU-P-97	Flaming/Brown micropipette puller	\$ 10,475
SU-P-30	Vertical micropipette puller - with Pt/Ir or Nichrome filament	\$ 4,865
SU-BV-10	Microelectrode Beveler - also avail. w/impedance meter & microscope	\$ 4,577
SU-MANUAL	Manual Injector - several sizes of syringe available	\$ 1,818



Part No.	Sutter Instrument Optical Instruments	Price
SU-LB10-3	Lambda 10-3 filter wheel changer - wheels & shutters avail.	\$ 3,011
SU-LB10-2	Lambda 10-2 filter wheel changer & wheel - shutters avail.	\$ 6,056
SU-IQ25	SmartShutter™ with housing	\$ 1,367
SU-LS-FS30	Xenon arc lamp 300W light source and power supply	\$ 6,681



Part No.	Sutter Instrument Amplifiers	Price
SU-IPA	IPA Integrated Patch Amplifier	\$ 16,730
SU-IPA-2	Double IPA Integrated Patch Amplifier	\$ 21,551
SU-dPATCH	dPATCH Low-noise Ultra-fast Digital Patch Clamp Amplifier	\$ 28,767
SU-dPATCH-2	Double dPATCH Low-noise Ultra-fast Digital Patch Clamp Amp	\$ 34,786
SU-EH-P170	Polycarbonate Electrode Holder 1.0 To 1.7 OD	\$ 259



**Fixed Platform System #1 -
Parts Required as pictured
(right)**

Model	Quantity
8090P	1
PSR-6	3
BB-5.0	2
RTC-0.5	1
RTC-A3	1
AS-1A	3
PH-1	1

Basic Platform System 2



**Fixed Platform System #2 -
Parts Required as pictured
(above)**

Model	Quantity
8090P	1
1280P	2
PSR-6	4
AS-1A	4
PH-1	1

**Fixed Platform System #3 -
Parts Required (not pictured)**

Model	Quantity
1280P	1
AS-1A	1
BB-1	2
RTC-0.5	1
RTC-A3	1
PH-1	1

Adapt your microscope to any application.



Basic Platform Systems

Fixed platforms, stages and shelves can be built from custom pieces or from standard configurations. Many platforms begin with the model 8090P perfusion chamber holder or mounting plates. The platform is held up by several spacers and support rods or towers.

Please contact AutoMate Scientific with your microscope model and application (patch clamping, multi-site patch clamping, blind patch or extracellular work, etc.) and we can configure an economical platform for your inverted or upright microscopes.

Manual and motorized microscope mounting.

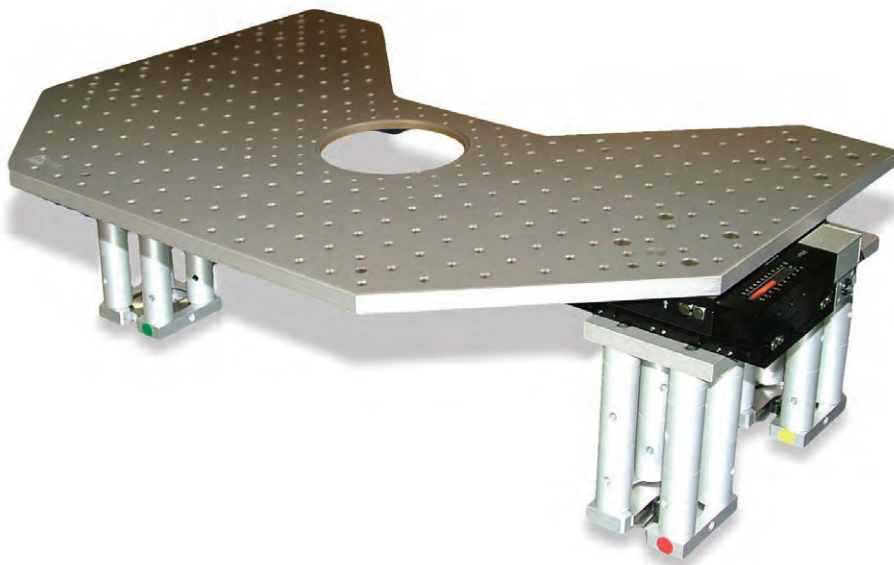

Manual & Motorized Microscope Platform

The MXZP platform system can be custom tailored to suit your needs. The platform configuration shown is just one of many that Siskiyou can produce.

The system is supported by our 100cr series stages (crossed roller). They are available in manual or motorized versions. A full 25mm of travel is provided on both models. The manual versions, can be fitted with either 20, 40, 80, or 100 TPI adjustment screws with resolution from 20 μm down to 5 μm , respectively. Please specify which pitch of adjustment screw you require when ordering. Replace -xx in the Model Number with the desired thread.

Motorized versions can be controlled with any e series and MC2000 controllers. Our controllers drive the stage through a closed loop interface between the controller and the motor encoder. The closed loop connection ensures 0.2 μm and 0.1 μm resolution, respectively. The encoder coupling also enables the use of the DR1000 digital readout for repeated or relative positioning requirements. All cables are shielded to ensure noise-free operation during sensitive electrophysiology experiments.



Features

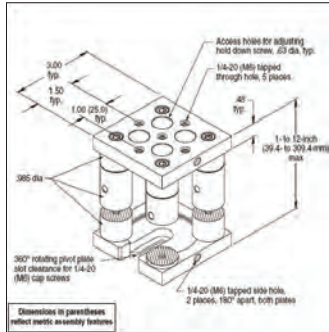

- 2.5- to 12.0-inch vertical adjustability
- Solid aluminum construction
- Flexible mounting design
- Vacuum compatible versions available upon request

MX512P Platform



A versatile platform for mounting a variety of hardware.

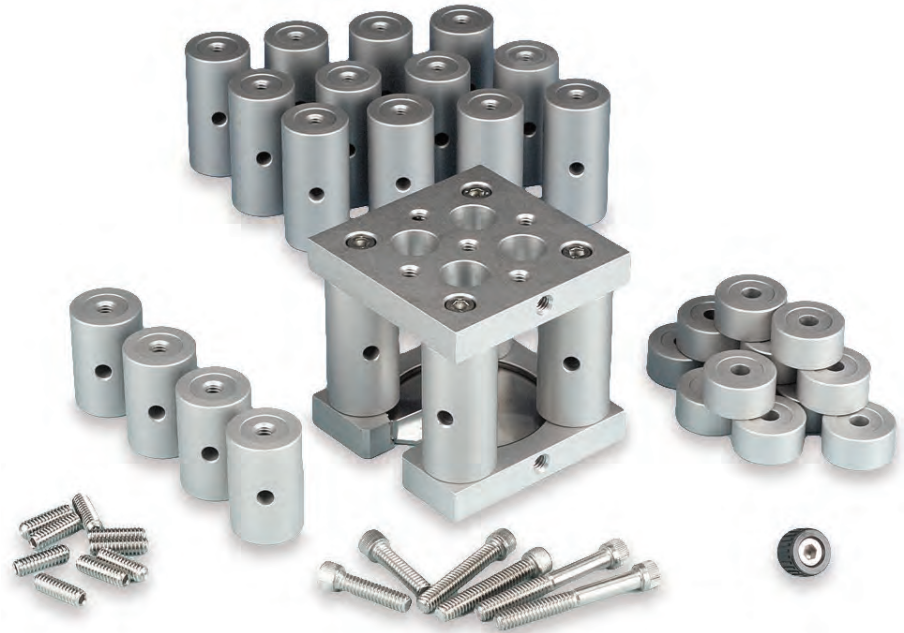

MX312P & MX512P Vertical Platforms

The MX312P is a versatile platform for mounting a variety of hardware at any level on an isolation table or platform. A complete set of AS series spacers allows flexible vertical adjustment from 2.5- to 12.0-inches in 0.5-inch increments.

To adjust the height of the platform, AS-1.5 and AS-2.0 series spacers are screwed together using 1/4-20 set screws. The top and the base plates are attached to the four columns with 1/4-20 cap screws through the counterbored holes. Smaller height adjustments are made by adding AS-.5 and AS-1.0 spacers to the top of the longer AS spacers. These are secured by the final attachment of the top plate with long 1/4-20 screws that go through the top plate and short spacers.

The MX312P base plate is equipped with a unique hold down pivot that allows secure single bolt mounting anywhere on the mounting surface. The top mounting surface is 3" x 3" and has five 1/4-20 tapped holes for maximum mounting flexibility. The top plate is also drilled and tapped with 1/4-20 holes on two sides. These attachment points are designed to accept our MX-APC-T and MX-APT-T top plates. These adapter plates allow the experimenter to remove and replace equipment accurately and easily by loosening two flathead screws.

A solid support solution.



Platform Support Rods & Spacers

Platform Support Rods

The PSR series platform support rods are a solid solution for supporting platforms or other mechanical hardware. Our PSR platform support rods are specifically designed to be used with our 1200 and 12000 series platforms. PSR platform support rods are cross drilled to accept a 3/16 hex wrench. This cross hole enables secure tightening to AS spacers, isolation table tops, or other mechanical devices. When used in conjunction with AS aluminum spacers, accurate placement of our platforms, manipulators, or other devices is easily achieved.

Aluminum Spacers

Use AS aluminum spacers for spacing of any device that needs to be adjusted in either the vertical or horizontal plane. AS spacers can be used by themselves or with ABP series base plates. They are also useful for added height adjustment on top of our PSR platform support rods. For horizontal applications use our BB-1.0 building block cube attached to the top of an AS spacer, then bolt another AS spacer to one or more of the four sides. Individual size spacers are available in packages of 4. The assortment kit (AS-1A) includes one(1) each of AS-0.125, AS-0.25, AS-0.50, AS-1.0, AS-1.50 & AS-2.0 spacers size plus two (2) 1/4-20 x 5/8 stainless steel set screws for attaching the AS-1.50 to the AS-2.00.

Features

- 2.5- to 12.0-inch vertical adjustability
- Solid aluminum construction
- Flexible mounting design
- Vacuum compatible versions available upon request

PRS Series



AS Series



Ordering Information

Part No.	Siskiyou Fixed Platform	Price
SD-BB-5.0	Building block, 5.0 inch	\$ 26
SD-RTC-0.5	Rotation/translation clamp, 0.5 inch	\$ 30
SD-RTC-A3	RTC adapter, 1/4-20 or M6 clearance, pkg of 3	\$ 22
SD-PH-1	Platform hardware kit, assortment	\$ 28
SD-8090P	Platform, 8.0"x 9.0", 10.8cm aperture	\$ 320
SD-1280P	Platform, 12.0"x 8.0", beveled	\$ 320
SD-BB-1	Building block, 1.0 inch	\$ 24

Part No.	Siskiyou Manual & Motorized Platform	Price
SD-MXZPi.2	Motorized platform with one '200cr' motorized crossed roller XY stage and one 'floater' '200cr' crossed roller XY stage	\$ 11,150
SD-MXOP-SL	Manual platform with one '100cr' XY stage with either 20, 40, 80, or 100 TPI adjustment screws and three 'floater' '100cr' crossed roller XY stages	\$ 9,750

Part No.	Siskiyou Tower	Price
SD-MX312-P	Coarse vertical adjustment platform, 3.0"x3.0"	\$ 365
SD-MX312P-T	MX312P top plate	\$ 105
SD-MX312P-B	MX312P base plate	\$ 160

Part No.	Siskiyou Spacer	Price
SD-PSR-4.0	1.5" diameter Platform Support Rods x 4.0 inch tall	\$ 62
SD-PSR-6.0	1.5" diameter platform support rod, 6.0 inch	\$ 67
SD-PSR-10.0	1.5" diameter platform support rod, 10.0 inch	\$ 85
SD-AS-1A	Aluminum spacer kit assortment	\$ 32
SD-AS-.125	Aluminum spacers, .125", pkg of 4	\$ 18
SD-AS-.250	Aluminum spacers, .250", pkg of 4	\$ 19
SD-AS-.500	Aluminum spacers, .500", pkg of 4	\$ 22
SD-AS-1.00	Aluminum spacers, 1.00", pkg of 4	\$ 27
SD-AS-1.50	Aluminum spacers, 1.50", pkg of 4	\$ 30
SD-AS-2.00	Aluminum spacers, 2.00", pkg of 4	\$ 32
SD-AS-4.00	Aluminum spacers, 4.00", pkg of 1	\$ 38
SD-AS-6.00	Aluminum spacers, 6.00", pkg of 1	\$ 44
SD-PSR-100	1.5" diameter platform support rod, 100 mm tall	\$ 62
SD-PSR-150	1.5" diameter platform support rod, 150 mm	\$ 67
SD-PSR-250	1.5" diameter platform support rod, 250 mm	\$ 85
SD-AS-25A M	Aluminum spacer kit assortment -metric	\$ 32
SD-AS-3	Aluminum spacers, 3 mm, pkg of 4	\$ 18
SD-AS-7	Aluminum spacers, 7 mm, pkg of 4	\$ 19
SD-AS-015	Aluminum spacers, 15 mm, pkg of 4	\$ 22
SD-AS-25-4	Aluminum spacers, 25 mm, pkg of 4	\$ 27
SD-AS-40	Aluminum spacers, 40 mm, pkg of 4	\$ 30
SD-AS-50	Aluminum spacers, 50 mm, pkg of 4	\$ 32
SD-AS-100	Aluminum spacers, 100 mm, pkg of 1	\$ 38
SD-AS-150	Aluminum spacers, 150 mm, pkg of 1	\$ 44

U.S./Canada prices shown. International prices add 20%. Email or visit web store for latest prices.

Move the microscope, not the experiment.

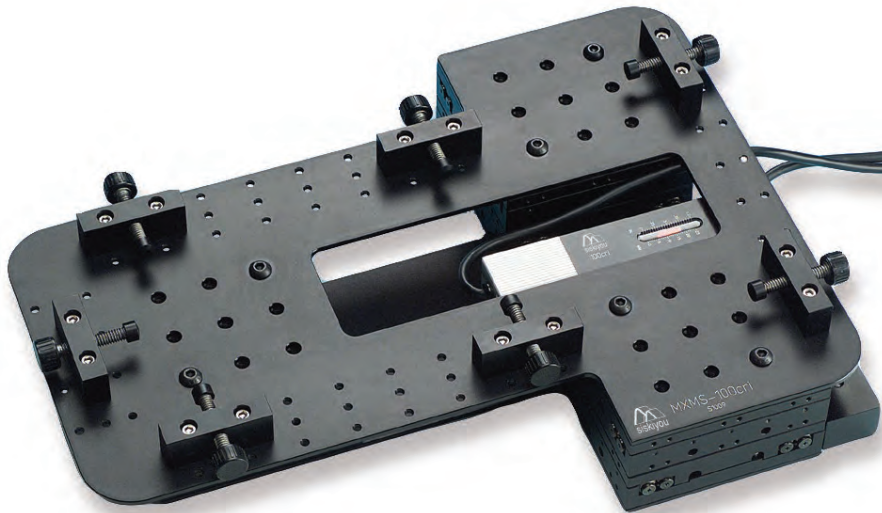

Manual & Motorized Microscope Translator

MXMS-115cr series microscope translators are designed to be stable XY translators for fixed stages experiments. MXMS-115cr series translators have a full 25 mm of XY translation and have full crossed roller bearing stages in all three locations.

MXMS crossed roller translators are available in motorized and manual versions. Motorized versions can be controlled with any e series and MC2000 controllers. Controllers drive the stage through a closed loop interface between the controller and the motor encoder. The closed loop connection ensures 0.2 μm and 0.1 μm resolution, respectively. The encoder coupling also enables the use of the DR1000 digital readout for repeated or relative positioning requirements. All cables are shielded to ensure noise-free operation during sensitive electrophysiology experiments. Manual versions can be fitted with either 20, 40, 80, or 100 TPI adjustment screws with resolution from 20 μm down to 5 μm , respectively.

MXMS-115cr series stages can be sized to fit most microscopes. Please include the manufacturer name and model of your microscope when ordering. A clamp kit appropriate for your microscope will be included.

Features

- 20-, 40-, 80-, or 100-pitch drive screws
- Compatible with fixed stage microscopes
- Full crossed roller stage support

Performance Specifications

- Maximum load 200 lbs, centered
- Travel / axis 1.0 inch (25 mm)
- Minimum controllable motion:
 - Manual
 - 20 TPI 10 μm
 - 40 TPI 5 μm
 - 80 TPI submicron
 - 100 TPI submicron
 - Motorized
 - Backlash \leq 5 μm
 - Point to point accuracy \pm 2 μm

Economy Translator

- MXMS-115 series translators have a full 25 mm of XY translation and use ball transfer pads in the back two bearing locations instead of full crossed rollers.

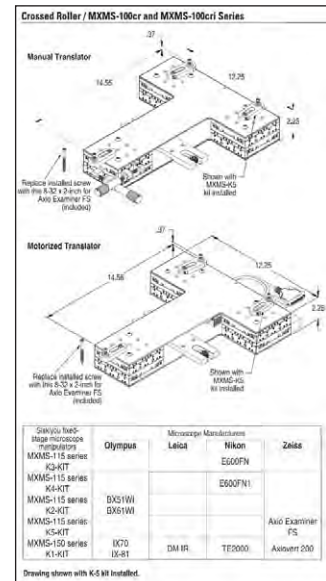

Stability and full features at a great price.

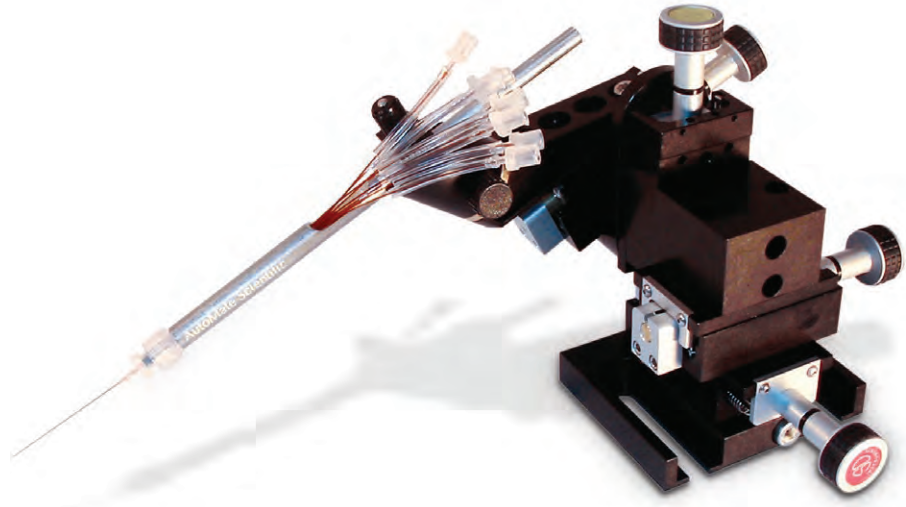

Manual Base Mount Micromanipulators

- Four-axis control with soft touch knobs on all models shown
- Five or ten micron accuracy
- Combine with a Perfusion Pencil[®] for focal drug application

The AutoMate Scientific Perfusion Pencil makes a perfect companion to these four-axis micromanipulators. Mount the Perfusion Pencil for micron accurate drug delivery and rapid rotational change-out. The small SD-10 manipulator offers 5 μm resolution. Its compact size makes it ideal for stimulator applications. The SD-130 manipulator is designed to maximize available space. Its narrow profile allows several manipulators to be placed in one quadrant. With a long 22 mm (0.86 inches) of travel on its probe axis and X axis, the SD-160 is ideal for axial cell probing. It includes an adapter mounted to the Θ axis with a rotational stop for convenient electrode/pipette replacement.

SD-130 Narrow Space-saving Manipulator

The SD-130 Manipulator is designed to maximize available space. The narrow profile design allows multiple manipulators to be placed in one quadrant. The SD-130 provides 38 mm coarse and 5 mm fine positioning travel in the X axis. Two-and-a-half turns of the coarse adjustment knob will fully retract the device in the X axis. The assembly is fitted with an MXC-45 probe clamp for easy changing of electrodes or other implements.

Y and Z axis adjustments are accomplished with the fine adjustment screws mounted on the back of the device. Additionally the Z axis adjustment screw may be configured with the knob on the top or the bottom, whichever provides the best access. The device angle is easily set by loosening the locking screw. The RTC-0.5 mounting base provides coarse rotational positioning and flexible mounting options of either base or post support. Left- or right-hand models allow additional flexibility to suit your application.

The extra length dovetail stage of the X axis combined with the spring loaded pivot mechanism (pat.# 6590723) of the other two axes allow for a high level of stability. This allows for smooth and precise adjustments.

SD-160 Full-featured Manipulator

Unlike stages with rack and pinion drive, the SD-160 uses a spring loaded lead screw design against a solid stop, ensuring drift-free operation. The SD-160 incorporates fast-pitch, screw drive positioning, and smooth ball bearing motion in the X, Y, Z, and Θ axes for precision positioning. Color coded knobs are used to identify axis location in low light conditions.

For added positioning versatility, the top stage tilts at any angle through 360°, and includes 22 mm of linear travel along the probe axis. This feature plus 22 mm of X-axis travel make the SD-160 ideal for axial cell probing.

The SD-160 has an MXC-45 mounted to the Θ axis. The MXC-45's built-in rotational stop allows easy electrode/pipette replacement. SD-160s come standard with the ABP-R mounting plate. The mounting plate design enables coarse positioning between platform mounting holes as well as 360° of coarse rotational positioning. If rotation with a solid submicron level stop is required, the MX-RS rotation stage is designed to mount directly into the ABP-R as well as the SD-160.

SD-130 Micromanipulator

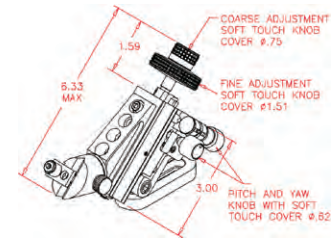

SD-130 Performance Specs



- Repeating probe holder
- Combined coarse and fine control on X axis
- Narrow space saving design
- Resolution 5 μ m

SD-160 Performance Specs

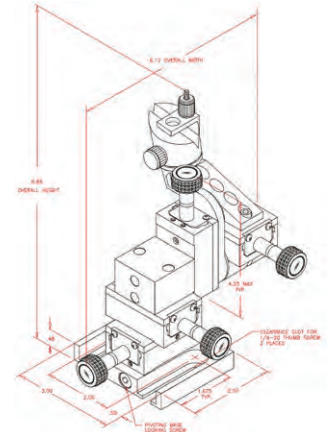

- Rotatable mounting base
- Axial approach on 4th axis
- Repeating probe holder
- Maximum load 2 lbs
- Travel/axis 0.86 inch (22 mm)
- Min. controllable motion 10 μ m



SD-10 Micromanipulator

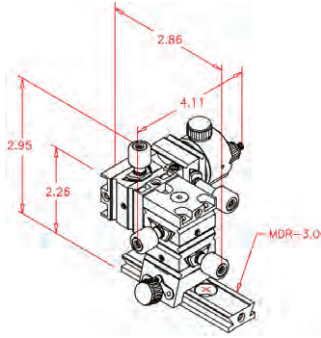

Only 4.11 x 2.95" (10.44 x 7.49 cm)



- 10 mm travel in all 4 axes
- Dovetail mounting rail for easy removal or replacement
- Maximum load 0.5 lbs
- Travel/axis 0.39 inch (10 mm)
- Resolution 5 µm

SD-MX110 Micromanipulator

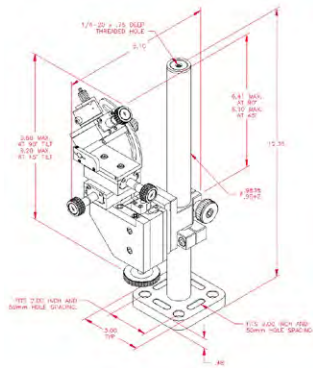

SD-10 Miniature Micromanipulator

The SD-10 is a miniature micromanipulator ideal for positioning applications requiring micron-level resolution. DT100 series stages use a precision-rolled 80 TPI lead screw for smooth positioning along their entire travel. The miniature dovetail slide uses an adjustable spring-loaded gib design. This feature ensures stability, straightness of travel and also works as a locking mechanism. The device is equipped with a fourth axis which can be set at any angle through 360° of motion.

The compact size of the SD-10 makes it ideal for stimulator applications. The mounting method makes removal and replacement very straightforward. The addition of a simple stop allows repeatable placement.

SD-MX110 Post-mount Micromanipulator

- Rotatable post mount
- Mounting rod and base included
- Maximum load 2 lbs
- Travel/axis 0.86 inch (22 mm)
- Resolution 10 µm

Unlike stages with rack and pinion drive, the SD-MX110 uses a spring-loaded lead screw design against a solid stop, which ensures drift-free operation. The SD-MX110 incorporates fast-pitch, screw drive positioning, and smooth ball bearing motion in the X, Y, Z, and probe axes for precision positioning.

For added positioning versatility, the top stage tilts at any angle from 0° to 90°, and includes 22-mm of linear travel along the probe axis. This feature plus 22-mm of X-axis travel make the SD-MX110 ideal for axial cell probing.

To make probe replacement efficient, the SD-MX110 can be rotated away from the microscope and returned back to the original position using an adjustable stop. Color coded knob caps are used to identify axis location in low light conditions.

Ordering Information

Part No.	Siskiyou Manual Manipulator	Price
SD-10	4 axis mini micromanipulator (specify right or left hand)	\$ 775
SD-MX110	Manual post-mount 4 axis micromanipulator	\$ 2,000
SD-130	4 axis compact micromanipulator	\$ 925
SD-160	4 axis full micromanipulator	\$ 1,950

U.S./Canada prices shown. International prices add 20%. Email or visit web store for latest prices.

Exceptionally smooth linear travel and drift-free operation.



Siskiyou Motorized Manipulators

Siskiyou manipulators are well-known for their reliable performance in electrophysiology recording and stimulation. Motorized manipulators are available with push-button, joystick, dial and computer controllers for single or multiple manipulators. Headstage and electrode mounts are available for major amplifier brands.

Motorized Manipulators, Four-axis Base Mount

The MX7600 motorized crossed roller bearing micromanipulator is ideal for patch recording experiments. Offering exceptionally smooth linear travel and a precision preloaded lead screw to ensure drift-free operation. The motorized 4-axis micromanipulator incorporates our MXC-45 pipette holder mounted to an adjustable clamp on the θ axis. This clamp allows the MXC-45 and θ axis to be adjusted to the desired angle of approach from 0° to 180° for true axial approach. The MXC-45's built in rotational stop allows easy pipette replacement. The MX7600 can be used with our e series and MC2000 controllers to drive the 7600 stage through a closed loop interface between the controller and the

Features

- 1.7 mm/second rapid positioning
- Axial approach on 4th axis
- Repeating probe holder

Performance Specifications

- Maximum load 2 lbs
- Travel / axis 0.80 inch (20 mm)
- Minimum controllable motion $0.1 \mu\text{m}$
- Backlash $\leq 5 \mu\text{m}$
- Point to point accuracy $\pm 2 \mu\text{m}$

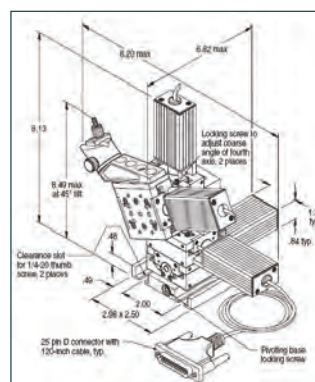

Q7 12
 Q6 13
 Q5 14
 Q4 15
 Q3 16
 Q2 17
 Q1 18
 Q0 19
 20
 10
 OE
 1
 U27
 J27
 15
 14
 13
 12
 +5

motor encoder. The closed loop connection ensures $0.2\ \mu\text{m}$ and $0.1\ \mu\text{m}$ resolution, respectively.

MX7600 series stages come standard with our ABP-R mounting plate. The design of this mounting plate enables coarse positioning between platform mounting holes as well as 360° of coarse rotational positioning. If rotation with a solid submicron level stop is required, the MX-RS rotation stage is designed to mount directly into the ABP-R and has mounting holes to attach to the base of the MX7600.

Push-Button Controller

The MC1000e is a simple push-button controller with submicron positioning capability that is compatible with our 800 and 7000 series actuators, manipulators, and stages.

The MC1000e 4-axis controller has two preset speed settings: rapid (1.7 mm/second) and medium (300 μm /second). The third speed selector (slow) has a variable 330° potentiometer that enables settings from high speed (50 μm /second) to low speed (2 μm /second). With the speed selector set at the slowest settings, consistent $0.2\ \mu\text{m}$ moves are easily made by the simple bump of an axis button.



All of the Siskiyou controllers on these two pages use encoder feedback from the motor to drive the device. This encoder coupling enables the use of the DR1000 digital readout for repeated positioning requirements.

The MC1000e controllers also use a wall mounted power supply as their source for clean DC power. All cables are shielded and a central ground lug is located on the junction-box to ensure noise-free operation during sensitive electrophysiology experiments.

Four-axis Closed Loop Dial Controller

The MC1000e-R/T 4-axis dial controller acts as a remote micrometer control for 800 & 7000 series actuators, manipulators, and stages. It uses encoder feedback from our closed loop devices to create an electronic link between the controller dial and the device being driven. This direct coupling to the encoder ensures smooth and coordinated motion between the controller and the drive.

A two-position rocker switch is conveniently located on the top of the controller. The rapid setting is set to maximize speed (1.7 mm/second) when the dial is turned at 180 RPM. The slow setting is set to maximize resolution ($0.2\ \mu\text{m}$) but still allow coarse positioning (800 μm /second).



Three-axis Closed Loop Joystick Controller

The MC1000e-J joystick controller is designed for coarse micron level positioning of our 800 and 7000 series actuators, manipulators, and stages.

The joystick control is proportional from slow to high through the travel range of the joystick motion. A two-position rocker switch is conveniently located on the top of the controller. The rapid setting is set to maximize speed (1.7 mm/second) when the joystick is moved to its farthest position from center. The slow setting is set to maximize resolution (0.2 μm , 30 μm /second).

Polarity switches on the junction box allow the joystick motion to be set to match the output of the device being driven. This feature ensures intuitive interaction between the joystick operator and the operation.



Four-axis Closed Loop Push-Button with Target

The MC1100e uses the same control features as our popular MC1000e controller with a TARGET/RETRACT feature on one axis. The TARGET/RETRACT allows the user to set a target location at a desired point. When it becomes necessary to back away from the experiment area, the user simply depresses the RETRACT button. The stage/actuator plugged into that axis then automatically retracts to its full negative limit. The user then can return to the previously set position by simply depressing the TARGET button.

The MC1100e 4-axis controller has two preset speed settings: rapid (1.7 mm/second) and medium (300 μm /second). The third speed selector (slow) has a variable 330° potentiometer that enables settings from high speed (50 μm /second) to low speed (2 μm /second). With the speed selector set at the slowest settings, consistent 0.2 μm moves are easily made by the simple bump of an axis button.



Controller Switch Box

Our easy to use ABDC switching box allows control of one to four 4-axis micromanipulators by one controller (MC2000 excluded). The basis of the design is simple and requires only an extra controller junction box for each added micromanipulator or motor drive group (up to four per group). Junction boxes must be purchased separately, however this is more cost-effective than individual handheld control units.

When used with the MC1100e controller, the user can save a "target" location for each manipulator independent of the operation of the others even after switching between micromanipulators. The switch box comes with enough cables to attach four junction boxes, and all connections are shielded.

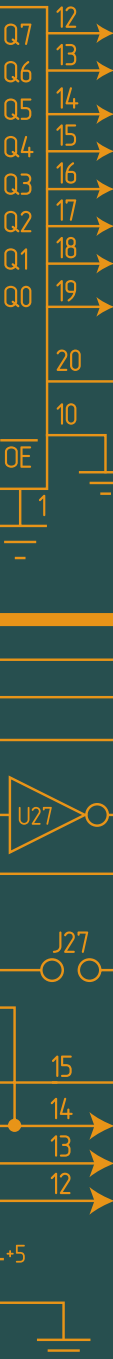



Features

- Unique swing-out design
- Spring-loaded lock knob
- Compatible with Axon 200/700 series, HEKA EPC-10, and A-M Systems model 2400

Repeatable Headstage and Probe Clamps

Axon 200/700 Headstage Mount

The MXC-45D's unique design allows repeatable electrode replacement with a simple but accurate rotating clamp. The top clamp of the MXC-45D is designed to be compatible with Axon CV200B, CV-7A, and HEKA EPC-10 headstages. The rotating portion is configured such that the probe /pipette rotates up and away from the experiment at a 45° angle through a full 180°. The repeatable stop returns to its location with micron level accuracy and the stop's orientation can be changed simply by loosening a single 1/4-20 cap screw.

Probe Clamp

The MXC-45's unique design allows repeatable electrode replacement with a simple but accurate rotating clamp. The top clamp of the MXC-45 is designed to be compatible with headstage mounting rods from 3- to 10-mm in diameter. The rotating portion is configured such that the probe /pipette rotates up and away from the experiment at a 45° angle through a full 180°. The repeatable stop returns to its location with micron level accuracy and the stop's orientation can be changed simply by loosening a single 1/4-20 cap screw.

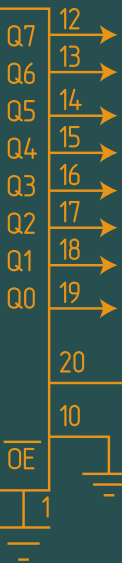

+5

Ordering Information

Part No.	Siskiyou Motorized Manipulator	Price
SD-MX7600L or R	Motorized manipulator, 4-axis, base mount with round clamp	\$ 5,275
SD-MX7600/45DL	Motorized manipulator, 4-axis, base mount with dovetail clamp (left or right-hand)	\$ 5,350

Part No.	Siskiyou Controller and Accessory	Price
SD-MC1000e-Std	Controller, 4-axis closed loop push-button	\$ 1,300
SD-MC1000e-R/T	Controller, 4-axis closed loop dial	\$ 3,675
SD-MC1000e-J	Controller, 3-axis closed loop Joystick	\$ 1,525
SD-MC1100e	Controller, 4-axis target	\$ 1,750
SD-SB-MC1000e/R	Switch box & cables for MC1000e, MC1000e-R and-MC1000e-R1	\$ 175
SD-JB-MC1000e-Std	Junction box for MC1000e	\$ 725
SD-JB-MC1000e-R0	Junction box for MC1000e-R	\$ 1,150
SD-SB-MC1100e	Switch box and cables for MC1100e	\$ 175
SD-JB-MC1100e	Junction box for MC1100e	\$ 1,000
SD-SB-MC1000e-J	Switch box and cables for MC1000e-J	\$ 175
SD-JB-MC1000e-J	Junction box for MC1000e-J	\$ 800

Part No.	Siskiyou Headstage & Pipette Holder	Price
SD-MXC-45DR	Repeatable headstage mount for Axon 200/700 series and HEKA EPC-10 (left or right-hand)	\$ 235
SD-MXC-45R	Repeatable probe clamp, rh	\$ 200
SD-MXC-45L	Repeatable probe clamp, lh	\$ 200
SD-2A-45D	Axon 2A amplifier mount for MXC-45D series	\$ 50
SD-CV4-45D	Axon CV4 amplifier mount for MXC-45D series	\$ 50

U.S./Canada prices shown. International prices add 20%. Email or visit web store for latest prices.



Outfit your entire rig with Siskiyou accessories.

3 Axis Shuttle System

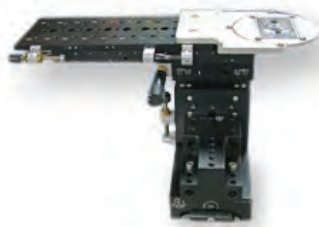

Shown in retracted position

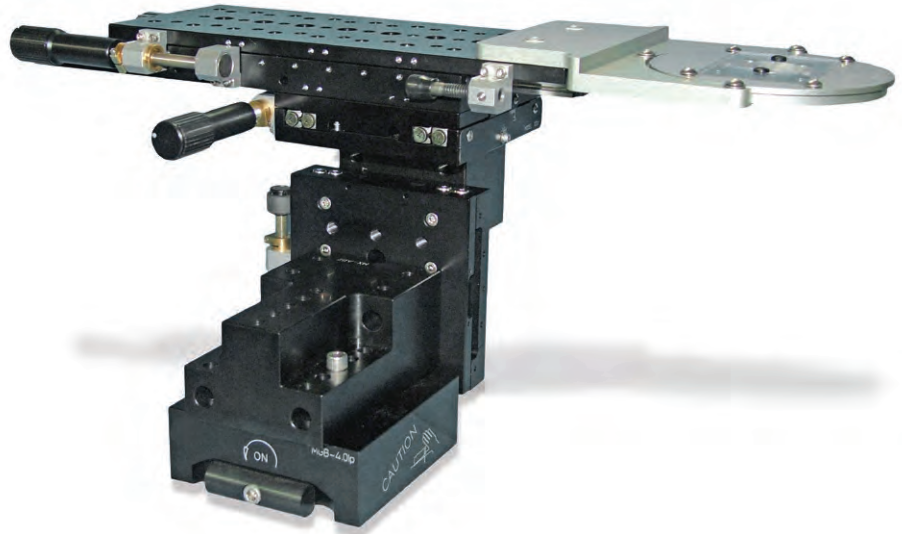

Horizontal



Vertical



Round



Chamber Shuttle System: 3 Axis

One inch working travel in XYZ. Choice of 20, 40, 80, and 100 TPI adjustment screws. Magnetic coupling (pat. pend) allows quick withdrawal of perfusion chamber from working area.

Perfusion Chambers: Horizontal, Vertical, Round

The PC series perfusion chambers have embedded magnets that are conveniently located to retain perfusion plumbing and ground plugs. They are designed to fit into our 8090c fixed stage platform. A standard 22 mm cover slip is used to create the chamber bottom that is attached with vacuum grease, silicon, or parafilm. There are two plastic retention screws for added security. Both openings accept 13-mm round cover slips for cultured specimens. PC series chambers come in three styles: horizontal, vertical, and round. All models have two small but very powerful magnets located next to the input/output reservoirs and two more located closer to the recording chamber.



The 8090c Platform

The 8090c perfusion chamber platform is specifically designed with the electrophysiologist in mind. With adequate mounting holes and a drainage trough around the perimeter for solution overflows. The 8090c is ideal for fixed stage electrophysiology setups. The drainage trough is designed to protect your expensive microscope optics by funneling the solution to the outer edge of the platform and down the drainage tube to a safe location. The chamber receiver is located off of center and accepts our PC series perfusion chambers. Clearance holes along the right and left hand edges allow mounting as a stand-alone fixed stage or as the center chamber platform in a bridged platform setup.

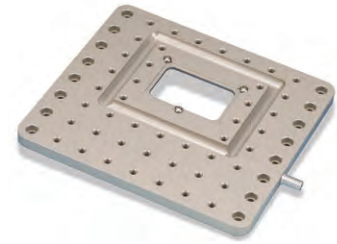

PC-A Chamber Adapter

The PC-A chamber adapter allows the user to mount our PC-V and PC-H chambers into our 8090P platform. Their 10.8-cm diameter is also compatible with Olympus microscope stages and allows 360° rotation of the chamber.



Amplifier Electrode Holders

The Stable-tip electrode holders eliminate the final instability in the electrophysiology experimental setup. We've taken a thermally stable base material and coated it with aluminaoxide. This coating has two benefits: first, it is non-conductive so the holder does not act as an electrical antenna; second, it is very resistant to corrosion. Under conditions of a high resistance electrode seal (gigaseal), the ST series electrode holder has a noise level of 0.79–0.80 pA RMS (5kHz filter); polycarbonate measured 0.78–0.79 pA. The base material of the Stable-tip has a thermal expansion coefficient of 23 $\mu\text{m}/\text{m}^\circ\text{C}$ versus 70 $\mu\text{m}/\text{m}^\circ\text{C}$ of a polycarbonate holder. That is an improvement by a factor of three.



Ordering Information

Part No.	Siskiyou Accessories	Price
SD-Shuttle	Three axis Chamber Shuttle System	\$ 4,250
SD-PC-H	Horizontal Perfusion Chamber w/4 magnetic clips	\$ 150
SD-PC-V	Vertical Perfusion Chamber w/4 magnetic clips	\$ 150
SD-PC-R	Round Perfusion Chamber w/4 magnetic clips	\$ 150
SD-8090c	Perfusion Chamber Platform, 8.0 x 9.0" w/drain	\$ 330
SD-PC-A	Perfusion chamber adapter, 10.8cm or 11cm diameter	\$ 315
Co-48510-00	Coverslips, borosilicate 22x22mm square #1, ~156 pcs.	\$ 68
SD-ST50-200/HS	Electrode holder fits Axon 200/700 & HS-2A amplifiers	\$ 150
SD-ST50-BNC	Electrode holder fits amplifiers with BNC connectors	\$ 150
SD-ST50-CV	Electrode holder fits Axon CV-4 amplifiers	\$ 150

U.S./Canada prices shown. International prices add 20%. Email or visit web store for latest prices.



Low-profile variation

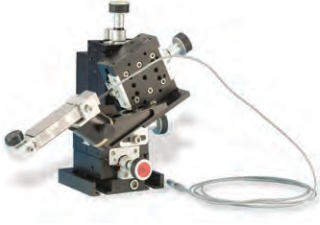

Performance Specifications

PZT head

- Travel 300 μm
- Minimum controllable motion 0.3 nm
- Command input -10 V to +10 V

MX1640 manual manipulator

- Maximum load 2 lbs
- Travel / axis 0.80 inch [20 mm]
- Minimum controllable motion 5 μm

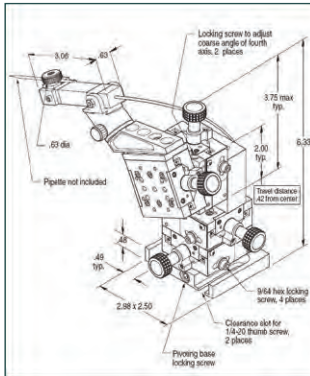

High-speed piezo solution switcher.



Fast piezo solution switcher

The piezo solution switcher uses a high-speed piezo flexure guided nanopositioner to move pipette tips in solution switching applications. It can move an electrode tip across a 5 μm thick theta glass septum. This system is ideal for measuring cellular response to drugs or other elements in solution.

Piezo movement can be triggered by either input from common recording amplifier equipment or by Siskiyou software via a LabVIEW™ interface that can control distance, frequency and dwell time. The piezo also includes the piezo amplifier box and the Input-Shaping® board, which significantly reduces pipette tip vibration and can be programmed to virtually eliminate resonances from your specific system.

The piezo flexure guided nanopositioner is mounted to our ultra-stable MX1640 crossed roller micromanipulator. The MX1640 has 20mm of travel in all four axes. The fourth axis can be set at any angle to select the desired approach angle. This adjustable fourth axis incorporates our MXC-45 to allow rotation of the piezo/pipette assembly up and out of the experiment for easy glass replacement. The base of the MX1640 also has a built-in coarse adjustment for rotation of the entire manipulator, or can also be used with our MX-RS rotation stage for more precise motion.

Rapid Pipette Sweeping: Eliminating Unwanted Switching

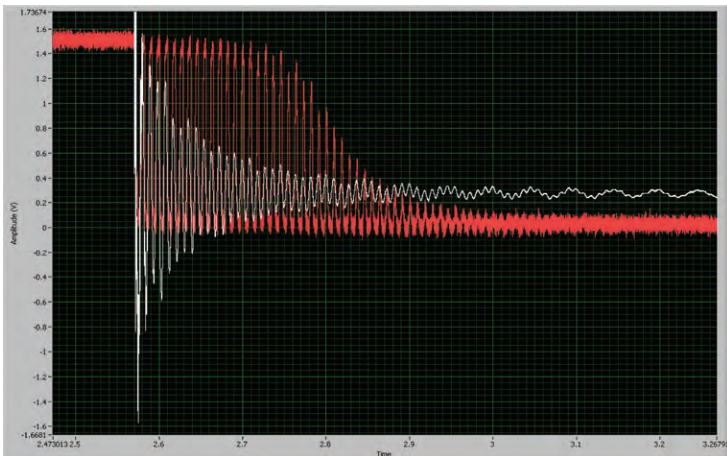

Rapid theta-glass transitions cause ringing of the mechanical structure. Zoomed-in view at target position. White: vibrometer real-time position output. Red: HEKA amp current. Correlation between physical position and HEKA amp output is evident. The vibration of the theta-glass pipette assembly causes repetitive switching of the patch-clamp signal.

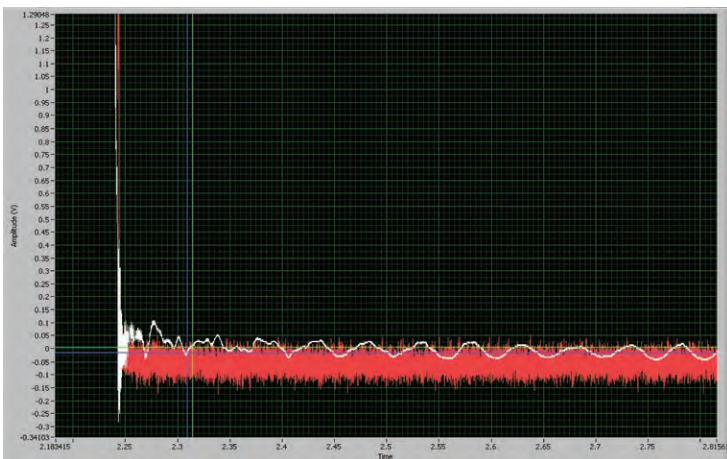

Same as graph above, using patented vibration-cancellation technology. The undesirable rapid switching of the HEKA amp output (red) due to rapid recoil-driven structural oscillations of the theta glass is eliminated.

Ordering Information

Part No.	Fast Piezo	Price
SD-Piezo	Fast Piezo Perfusion Switcher	\$ 11,500
SU-QT120-90	7.5 Quartz Theta Tubing - 50 pieces, 1.20 mm o.d. / 0.9 i.d., 7.5cm	\$ 114
SU-BT-150-10	Borosilicate Theta Tubing - 100 pieces, 1.50 mm o.d. / 1.17 i.d., 10cm	\$ 129

U.S./Canada prices shown. International prices add 15%. Email or visit web store for latest prices.



Applications Include

- Evoked or Spontaneous Activity (fEPSPs, Spiking)
- Synaptic Plasticity (LTP, LTD)
- Spontaneous Rhythmic Activities and Oscillations
- Pacing and Propagation in Myocytes
- Safety Pharmacology (CNS Toxicity and QT Prolongation)
- Chronic Drug Testing with Cultures
- Stem Cell Research

Amplifier Specifications**MED64 Head Amplifier**

- Number of Channels: 64
- Input Impedance: 100 M Ω
- Output Impedance: 10 k Ω
- Gain: x10 (60 dB)
- Bandwidth: 0.1 Hz to 100 kHz (+0dB to -3dB)

Built-in Stimulator

- Number of Channels: 2
- Output Format: Constant current
- Maximum input voltage: ± 4 V
- Max output current: ± 200 μ A

MED64 Main Amplifier

- Gain: 1-217
- Bandwidth: 0.1 Hz to 10 kHz (+0dB to -3dB)
- Analog Low Cut Filter: 0.1, 1, 10, 100 Hz (-12 dB/oct)

Built-in USB Digitizer

- Resolution: 16 bit
- Sampling rate: 20 kHz

General

- Power supply:
 - AC 100-240V, 50-60 Hz
- Internal power: ± 12 V DC
- Weight: 6.6 + 5.9 kg
- Dimensions: W430 x H74 x D437 mm x two boxes

Watch the whole network without pulling electrodes.

**MED64 Multi-electrode Array**

Acquire continuous, reliable, long-term evoked and spontaneous field potentials across 64 channels with two-dimensional, real-time analysis of neuronal/myocardial activity without the difficulties of a patch-clamp rig.

Features**Record extracellular signals across 64 channels without pulling glass electrodes**

- Evoked potentials or spontaneous activity (fEPSPs, spiking) are acquired with 64 planar microelectrodes patterned on the patented MED probe.
- Any of the 64 electrodes can be used for stimulation (up to two at once).
- Can be used with patch clamping, imaging and external stimulation.
- User friendly software guides you through experimental setup, stimulation parameters, drug testing, data recording and analysis.

Low noise and High S/N recording

- Very low impedance planar microelectrodes (typ. 7-10 k Ω at 1 kHz – the lowest on the market) means the MED64 system is relatively unaffected by exogenous noise and does not usually require a Faraday cage.
- High-quality signals can be acquired easily even from acute slices. The low-impedance electrodes result in very low Johnson noise.

Effective stimulation

- The planar microelectrodes coated with platinum black have tremendously high capacitance values enabling high-frequency stimulation with large current amplitudes (up to 200 μ A / 0.2 msec).
- Stimulus artifacts have very short durations, so high-quality electrically-evoked signals can be recorded soon after without interference.

Long-term observation without damage to tissue

- Dissociated cells, slices and explants can be cultured directly on the probe.
- The MED probe and connector can be placed in an incubator with 100% humidity. Responses can be recorded for days to months without risking damage to tissue by the planar microelectrodes.

Components

MED64 Integrated Amplifier

- Reliable, low-noise, 64 channel amplifier
- High-bandwidth of 0.1 Hz-10 kHz allows users to record several types of extracellular potentials. Samples at 20 kHz/ch
- Built-in stimulator allows users to study the effects of realistic spatio-temporal stimulation patterns by programming complex induction sequences from any of the two built-in stimulation units
- Fast, easy switching of stimulation sites

MED64 Connector

- Interfaces between the MED64 probe and amplifier
- Provides a stable platform for the MED64 probe
- Multi-layer electrical shielding rejects hum noise and provides excellent signal-to-noise ratios
- No onboard active circuitry, enabling long-term recordings in a humidified incubator
- Heated version available with built-in thermocouple which maintains bath temperature within 1°C (usually < 0.1°C) using a low-noise ThermoClamp controller with or without perfusion.

Comparison of Electrode Impedance

Our proprietary platinum black coating process gives the MED64 probes significantly lower impedance (green line = 20 μ m square electrodes, and red line = 50 μ m square electrodes in graph to the right) than competing electrodes (purple line = 30 μ m round electrodes). This lower impedance means:

- Better signal-to-noise ratio
- Smaller stimulus artifacts. Higher current stimulation (e.g. 200 μ A) can also be applied.
- No pre-amplifier required. Connector can be used with long cables and placed in an incubator for long term studies.
- Easy to acquire signals even from acute slices without unnecessary "3D" electrodes or "perforated" dishes.

Connector Specifications



- Now available heated
- Probe securing mechanism: Screw down
- Material: Aluminum
- Contact resistance: <30 milliohms
- Printed Wiring: 4 layers (rejects hum noise by a multi-shield structure)
- Dimensions: W174 x H21 x D150mm
- Weight: 480 g



Complete line of specialized perfusion equipment available.

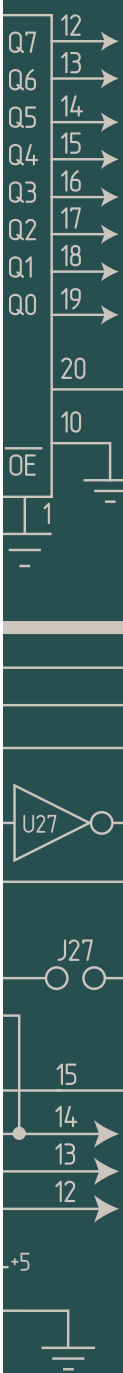
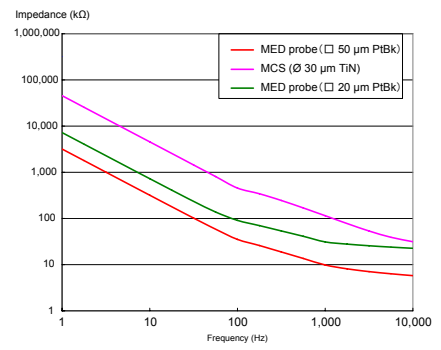

Specifications

Substrate

Glass Substrate:
50 x 50 x 0.7 mm
Glass cylindrical chamber:
ID=22, OD=25 mm
Conducting layer:
Indium tin oxide (ITO) (0.15 μm)
Insulation layer:
Polyimide

Recording/stimulating electrode

Number of electrodes:
64 (61 for MED-2Hxxx)
Material: ITO + Platinum Black
Size: 50 x 50 μm square
20 x 20 μm (MED-P210x)
Diameter: 20 μm (MED-P2H07x)
50 μm (MED-P5001x & P5002x)
Impedance:
<22 k Ω (MED-P5xxxx)
<40 k Ω (MED-P2xxxx)
(1kHz, 50 mV sine wave)
Maximum voltage: 1 V
Maximum current:
200 μA , 0.1 msec

Reference electrodes

Number of electrodes: 4
Material: ITO + Platinum Black
Size: 200 x 200 μm
Diameter 100 μm x 4 (MED-P2H07x, MED-P5001x)
Impedance:
<2.2 k Ω (1 kHz, 50mV sinusoidal wave)

Available in two chamber depths and four inter-electrode spacings

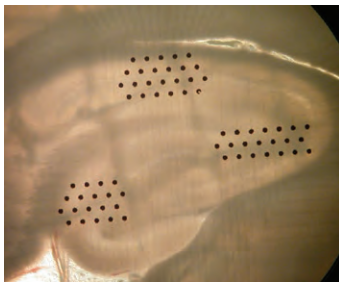

Hippocampal slice on our MED-P5001A probe designed with electrode groups located at CA1, CA3 and DG.

Effortless electrophysiology.



MED64 Probes

Acute or cultured biological preparations are placed or grown directly on a grid of 64 planar microelectrodes, with the capability for stimulation and signal recording.

The standard MED probe has 64 planar microelectrodes arranged in an 8 x 8 grid embedded in the center of a transparent glass plate. The surrounding glass or plastic cylinder makes the MED probe a self-contained recording chamber. Four models with inter-electrode spacings of 100, 150, 300, and 450 μm enable detailed evaluation of network interactions across a sample. Each electrode is 50 μm x 50 μm in size for 150, 300, and 450 μm spacing configuration, or 20 μm x 20 μm for 100 μm spacing configuration.

Also available are probes featuring an electrode pattern specific to hippocampus anatomy and a hexagonal pattern, as well as 2- and 4-well MED probes for increasing throughput.

MED64 Ordering Information

Many sizes of probes, electrodes and spacing available. Please see web site for all sizes and part numbers. Minimum order quantity 10 pieces on probes. Please call or email for a quote.

Highly-sophisticated, user-friendly software.

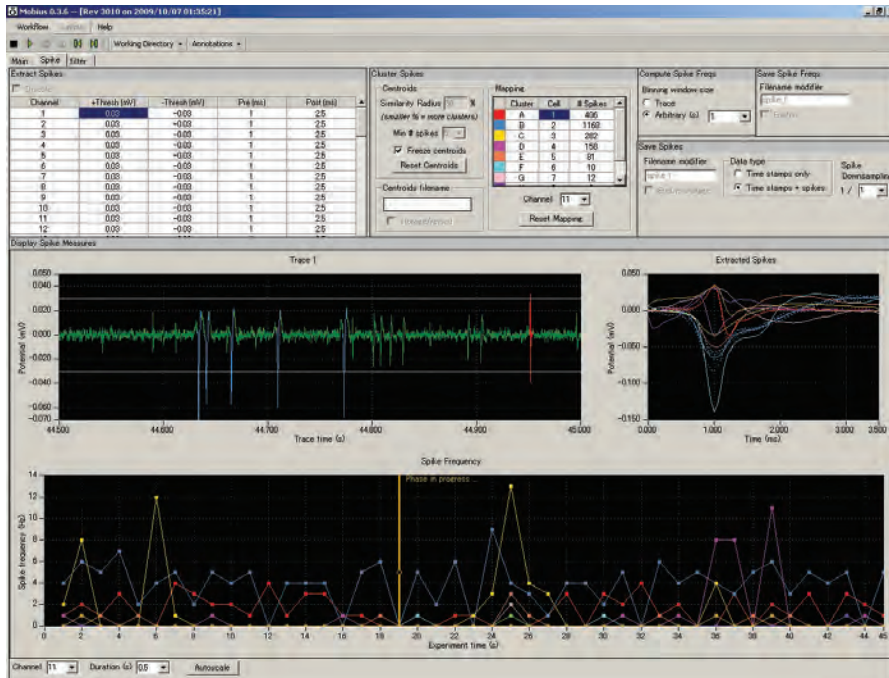

MED64 Mobius software

Highly-sophisticated, user-friendly software. MED64 Mobius software is a data acquisition and analysis package for the MED64 system, featuring a broad set of analysis functions available both online (i.e. during acquisition) and offline (i.e. post-acquisition). It is designed to be easy for beginners and powerful enough for advanced users. Mobius comes in various application-specific packages including “Evoked Potential Measurements”, “Spike Sorter”, “QT”, as well as combined packages for multi-application users.

The Mobius user interface consists of various task-specific control panels, which can be quickly combined using a simple workflow editor to create custom experimental protocols and workflows. However, convenient pre-defined “workflow templates” are available for users who want to quickly set-up and run standard types of experiments.

Software Packages EP (Evoked Potential) measurement package

- Evoked local field potentials (e.g. fEPSPs) on all 64 channels can be recorded in response to customizable user-defined stimulation parameters.
- Parameters for acquisition and stimulation including stimulus current amplitude and wave forms are designed easily with a simple control panel.
- Users can design and apply complex stimulation sequences independently for each stimulator. Templates are included for delivery of repetitive (e.g. theta) stimuli.
- Analysis of amplitude, slope and area parameters can be performed automatically during or after acquisition, and graphed independently for each channel. An arbitrary number of measures can be enabled, limited only by the processing power of your PC.

Spike Sorter Package

- Spikes are collected, extracted and sorted on 64 channels on-line and off-line.
- Spike time-stamps, waveforms of extracted spikes, and spike frequency charts can be saved in ASCII text file (csv) format, even WITHOUT saving raw data.
- Raw data can be exported to binary or ASCII text file (csv) formats.

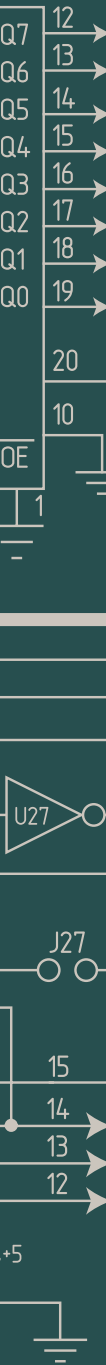

Features

- Ideal for recording and analysis of cardiomyocyte preparations, including iPES/ES cell-derived cardiomyocytes, primary myocyte cultures, and acute heart tissue.

- Signals are recorded at any of 64 channels according to user-defined acquisition parameters.

- Acquisition parameters and channels for analysis are selected easily in a simple control panel.

- Cardiomyocyte signals are automatically extracted according to user-defined thresholds and analyzed for beat frequencies and inter-spike intervals.

- Multiple types of slope, amplitude, time, and area measurements can be performed automatically on extracted signals.

- Field potential duration (FPD) can be also measured from extracted waveforms for studying QT prolongation with the “Time of Amplitude Minimum (or Max) to Minimum (or Max)” measure

- Averages and standard deviations for the beat frequencies, inter-spike intervals, and waveform analyses on all 64 channels can be automatically computed and graphed for each user-defined phase of an experiment. Dose-response curves can thus be easily constructed.

Data Output

Raw data can be exported in binary or ASCII text file (csv) format. Extracted spikes and all measurement charts can be saved as “csv” formatted text files.

Mobius QT

Mobius QT software allows MED64 users to acquire and analyze myocardial signals online and offline. It is the perfect solution for QT screening with iPES/ES cell derived cardiomyocytes.

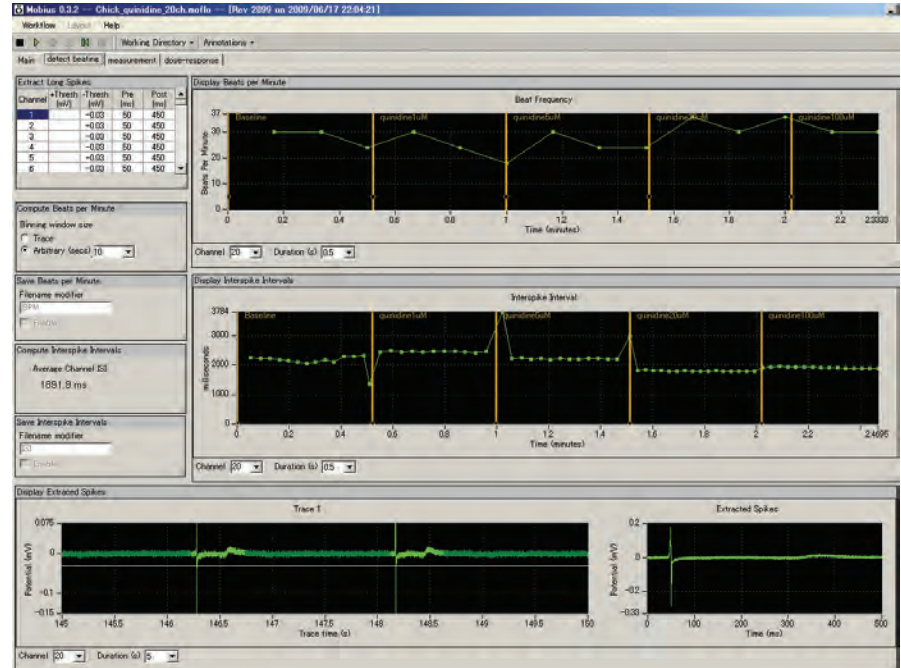

Beat frequency and inter-beat interval are measured. Myocardial signals are detected (highlighted in bright green).

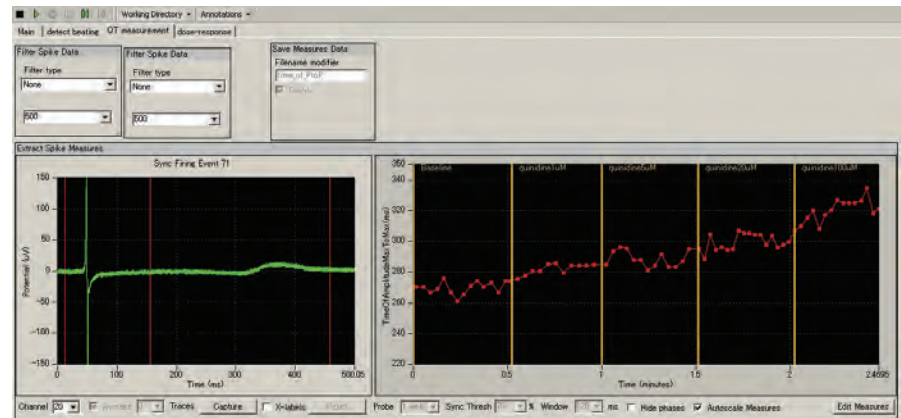

The time between peaks (i.e. QT interval) is measured and plotted over time.

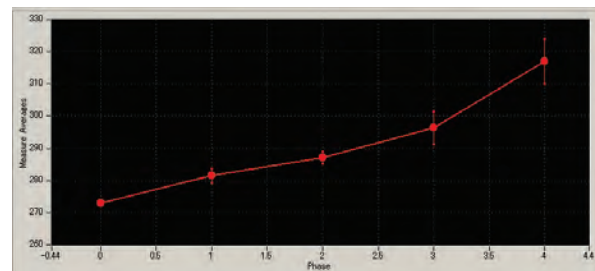

A dose-response curve is generated.

Perfusion is our specialty.



Keep your cells happy with heated, continuous perfusion

AutoMate Scientific offers a wide array of perfusion options and accessories for the Alpha MED64 system. The Perfusion Cap shown above is ideal for both gas and solution delivery and removal. For applications requiring an open top such as imaging or conventional microelectrode electrophysiology, the Perfusion Pipes shown in the side column make perfusion inflow and outflow easy. Both of these options can be used with AutoMate Scientific's widely-used perfusion systems and ThermoClamp inline heater.

Choose a complete multi-channel drug delivery system with rapid valve switching under computer control, or just a single heated solution line into your probe. We can configure gravity, air pressure or peristaltic pump driven liquid delivery and removal. Take a look at the Perfusion System chapter of our catalog or visit http://www.autom8.com/build_your_own.html. Take the guesswork out of your multielectrode array system with AutoMate Scientific's perfusion experience.

Perfusion Pipes



The Perfusion Pipes are ideal for liquid delivery and extraction when you need the top of the MED64 probe open for imaging or microelectrode electrophysiology.

Peristaltic Pump



Dual-channel peristaltic pump for solution delivery and removal.

ThermoClamp Inline Heater



Inline solution heater pre-heats liquids as they enter the probe. Available with multiple tubes for rapid switching. Internal tubes are all plastic to protect your cells. See the ThermoClamp page.

Incubator



Culture cells on MED64 probes in our incubator. With our modification, you can even record from MED64 probes while inside the incubator. Alpha MED is the only commercially available MEA system suitable for recording while incubating.

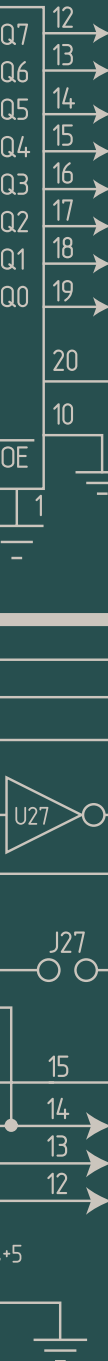

Internal automatic mode switch

Instantly switch recording modes by using the membrane potential as the trigger. Pre-set a voltage threshold in current-clamp mode, and the MultiClamp 700B amplifier will automatically switch to voltage-clamp when the membrane potential reaches that voltage level. A user-specified delay will allow you to perform creative new experiments.

Oscillation suppression

Sudden changes in membrane or pipette parameters may result in undesirable oscillations during whole cell recording. The MultiClamp 700B amplifier will detect current or voltage oscillations and automatically disable or intelligently reduce compensation settings to protect your cell from damage.

Slow current injection

Slight voltage drift—often due to changing electrode properties—may contaminate an otherwise decent current-clamp recording. In order to maintain the membrane potential at a consistent level, the MultiClamp 700B amplifier will automatically inject compensatory current over a user-defined time course.

Axon CNS amplifiers for the quietest recordings.



MultiClamp 700B Amplifier

Computer-Controlled Dual Channel Resistive-Feedback Patch Clamp and High-Speed Current Clamp Amplifier

The MultiClamp 700B amplifier is useful for a wide variety of intracellular or extracellular recording, including:

- High-speed Current Clamp (sharp-electrode or field potentials)
- Patch Clamp (whole-cell, macro-patch or excised patch)
- Voltammetry / Amperometry
- Ion-selective measurement
- Bilayer recording

Software Control

Instead of the usual front panel knobs and switches, the MultiClamp 700B amplifier is controlled by the MultiClamp 700B Commander, a program that runs on a host computer and communicates with the amplifier via a USB cable. This control interface provides automation of bridge balance, pipette offset, pipette and whole-cell capacitance compensation, in addition to "smart" features such as protection from oscillations and threshold-based mode change. Amplifier settings such as gain, filter frequency, whole-cell capacitance, recording mode and also input / output scale factors are automatically telegraphed to the data acquisition software via "messaging" through the computer operating system.

Optional SoftPanel Controller

Although the MultiClamp 700B amplifier is a computer-controlled amplifier, the mouse and/or keyboard is not the only means of controlling the instrument. The optional SoftPanel controller was designed for those who prefer a more conventional feel to amplifier control. By way of a USB connection, the SoftPanel controller physically replicates all essential amplifier functions by acting as a hardware extension of the MultiClamp 700B Commander software. SoftPanel knobs replicate continuous mouse controls ("gliders"), while buttons replicate single-click mouse controls.

Headstages



The MultiClamp 700B amplifier comes standard with two identical but independent CV-7B headstages, each of which contains both current-to-voltage and voltage-following circuitry. This design allows the user to rapidly switch between patch clamp recording and true high-speed current clamp recording. Thus, with two headstages, the MultiClamp 700B amplifier can perform the function of two patch clamps, two current clamps, or a combination of patch and current clamp amplifiers. Furthermore, two optional voltage-follower headstages (HS-2 type) can be connected to auxiliary inputs to allow third and fourth-point voltage recording.

The MultiClamp 700B amplifier supports up to four simultaneous headstages. Two CV-7B headstages come standard; the HS-2A headstages are optional.

The CV-7B headstage was designed for low noise and flexible recording features. However, some specialized applications require even more flexibility. For example, the rather large membrane capacitance in bilayer recording demands greater capacitance compensation. The optional CV-7B/BL headstage was developed for this purpose. Another optional headstage, the CV-7B/EC, was designed for large (± 2 V) commands required during electrochemistry recording (amperometry, voltammetry).

Requirements:

Computer Control

The MultiClamp 700B Commander program runs on the Windows Vista/XP/2000/ME/98/7/10 32- or 64-bit operating systems,

A USB port is required to connect the MultiClamp 700B amplifier. An additional USB port is required if the optional SoftPanel controller is used to control the amplifier.

Experimental Control and Data Acquisition

Although the MultiClamp 700B amplifier is controlled by a software interface, it remains a conventional analog input/output amplifier. Thus, it requires a system for controlling your stimulus protocols and recording the output.

Our pCLAMP software and Digidata 1550B digitizer provide the most complete, integrated solution. Note: pCLAMP 9 or higher is required for automatic telegraphing.

Q7 12
Q6 13
Q5 14
Q4 15
Q3 16
Q2 17
Q1 18
Q0 19

20

10

OE 1
-

U27

J27

15

14

13

12

+5

Requirements:**Computer Control**

The Axoclamp 900A Commander program runs on US Windows Vista/XP/2000 32-bit operating systems.

Two USB 2.0 ports are required to connect the computer to the Axoclamp 900A amplifier: one for amplifier control and one for Monitor signal display on the computer screen for discontinuous modes. An additional USB port is required if the optional SoftPanel controller is used to control the amplifier.

Experimental Control and Data Acquisition**

Although the Axoclamp 900A amplifier is controlled by a software interface, it remains a conventional analog input/output amplifier. Thus, it requires a separate system for controlling stimulus protocols and recording the output, such as a digitizer and data acquisition software. The Digidata 1440A digitizer and pCLAMP 11 data acquisition and analysis software from MDS Analytical Technologies, work together to provide the most complete, integrated solution.

** Automatic telegraphing of the Axoclamp 900A amplifier requires pCLAMP 10 software and a Digidata 1440A or Digidata 1320 series digitizer.

A complete microelectrode current-clamp and voltage-clamp amplifier.

**Axoclamp 900A Amplifier**

The Axoclamp 900A amplifier is a complete microelectrode current-clamp and voltage-clamp amplifier, useful for a wide range of intracellular microelectrode recording techniques. Like its predecessor, the Axoclamp-2B amplifier, the Axoclamp 900A amplifier has a wide range of functionality and has many enhancements that improve amplifier recording capability, make the amplifier easier to use, and help your experiments last longer.

The Axoclamp 900A amplifier has several modes of operation:

- I-Clamp: two independent bridge amplifiers for voltage measurements
- DCC: discontinuous current clamp for accurate voltage measurements, even when electrode resistance changes
- TEVC: high-compliance two-electrode voltage clamp for oocytes and mammalian cells
- dSEVC: discontinuous single-electrode voltage clamp for small cells with large currents
- HVIC: high-voltage current clamp for extracellular applications such as iontophoresis

Software Control

Instead of the usual front panel knobs and switches, the Axoclamp 900A amplifier is controlled by the Axoclamp 900A Commander, a program that runs on a Windows PC computer and communicates with the amplifier via a USB interface. This control interface reports resistance, voltage, and current measurements and provides automation of Bridge Balance, Pipette Offset, and Pipette Capacitance Neutralization. In addition it has "smart" features that protect cells from potentially damaging signal oscillations and automate mode changes based on internal signal thresholds or externally-applied signals. Amplifier settings such as gain, filter frequency, recording mode and input/output scale factors are automatically telegraphed to the pCLAMP 11 data acquisition software via the USB connection.

Comprehensive Manual

We also provide a detailed User Guide that serves as a handbook of procedures for microelectrode users. Tutorials written by MDS Analytical Technologies staff and scientific consultants provide a useful guide to the operation of the instrument and are informative references for several electrophysiological techniques.

More Information

The Axoclamp 900A* main unit comes standard with:

- One Remote BUZZ Box: works for both channels
- One Clamp-1U model cell
- Two HL-U electrode holders
- One Axoclamp 900A Commander software CD
- Two USB 2.0 cables
- Two headstage baseplates
- Theory and Operation User Guide (printed)

* Two HS-9A headstages (e.g., HS-9A x0.1, HS-9A x1 or HS-9A x10) must be ordered with the Axoclamp 900A.



Advantages

Pipette Offset

The Axopatch 200B amplifier provides ± 250 mV of offset potential.

Seal Test

The convenient seal test may be used in voltage clamp mode (5 mV pulse) or in current clamp mode (50 pA ($\beta=1$) or 500 pA ($\beta=0.1$)).

Dual Command Potentials

Two separate command potential inputs allow you to sum command input signals from two different sources. The back panel command is scaled to afford greater range (up to ± 1 V), and so is quite useful for electrochemical measurements.

Holding Command

The Holding Command of the Axopatch 200B has been enhanced over that of its predecessors with the addition of a X1 and X5 switch that allows you to choose either 0 - 200 mV or 0 -1 V ranges. An ON/OFF switch can disable this control when an external command from a computer is used to establish the holding potential.

Pipette Capacitance Compensation

In operation in both voltage- or current-clamp modes, controls the magnitude and tau of two time constants, Fast and Slow.

Cell Capacitance Compensation

Compensate up to 100 pF ($\beta=1$) or 1000 pF ($\beta=0.1$) to allow recording from a large range of cell sizes.

Output Gain

Ten gain settings spanning a 1000-fold range may be selected to scale the output to the most desirable level, a range double that previously available.

Bringing patch-clamp noise down to unprecedented levels.



Axopatch 200B Amplifier

The Axopatch 200B patch clamp offers the lowest-noise patch-clamp amplifier technology. The open circuit (amplifier) noise in patch-mode has been reduced to unprecedentedly low levels: < 15 femtoAmps (rms) below 1 kHz bandwidth, < 60 femtoAmps (rms) below 5 kHz bandwidth, and < 130 femtoAmps (rms) below 10 kHz bandwidth, all measured with an 8-pole Bessel filter. Noise is still low (145 femtoAmps rms below 10 kHz bandwidth) with a pipette holder attached. This translates into lower noise during actual recordings; this noise performance is achieved in part by cooling the input field-effect transistors inside the headstage to well below 0° C.

Better noise performance is only part of the story. The redesigned, slim headstage improves electrode access to the preparation by making it easier to fit under your microscope. We now include BOTH whole-cell ranges (previously available only in two separate headstages) in one headstage.

The 200B amplifier includes all of the features of the 200A amplifier, and a few more. Enhancements include three recording configurations in a single headstage (one patch and two whole cell ranges, with capacitance compensation ranges of 100 pF and 1000 pF), increased voltage and current command ranges (to ± 1 V) for electrochemical measurements, built-in capacitance dithering capability for capacitance measurements, and addition of series resistance compensation to the current clamp circuitry to improve performance. Seal Test now provides current steps in current clamp mode as well as voltage steps in voltage clamp mode. Leak Subtraction is now more

sensitive in the most important resistance range. The recording bandwidth has been doubled to up to 100 kHz. Command and bandwidth ranges are larger. Series Resistance compensation is now active in current clamp as well as in voltage clamp mode to enable bridge balance to be used.

A Superb Instrument

The Axopatch 200B amplifier is the latest version of the premier Axon Instruments patch-clamp amplifier incorporating the innovative Capacitor-Feedback technology for single-channel recording, and resistive-feedback for whole-cell recording, providing the best possible performance for single-channel and whole-cell patch clamping. Convenient features include ZAP (to rupture patches when going whole cell), dual-speed current clamp (to allow faster current clamping in small cells), Holding Command to set voltage commands in voltage clamp and current commands in current clamp, and a choice of three gain settings on the dedicated current output (for patch, whole-cell and loose-patch modes). The Axopatch 200B amplifier provides the lowest-noise single-channel recording available. The amazingly low open-circuit noise of 0.13 pA rms (10 kHz) increases to only 0.145 pA rms when a patch-pipette holder is attached to the headstage input and the pipette capacitance is fully compensated (to eliminate capacitance charging transients). The power of capacitor-feedback technology is capacitor feedback at room-temperature is clearly superior to resistive feedback technology; cooled capacitor-feedback is even better! An unprecedented achievement in the field of ultra-low noise recordings!

Unparalleled Performance, Utility and Ease of Use

Efficient controls for whole-cell capacitance compensation, a unique "super-charging" form of series-resistance compensation that complements the conventional "correction" form, and a variable LAG control; output gain with 1000-fold dynamic range; 4-pole Bessel filter; onboard leak subtraction; dual external-command inputs; versatile panel meter displaying Holding Command, rms current noise, membrane potential, tracking potential and current at the headstage input; telegraph output of values for output gain, filter frequency, headstage mode (gain) and measured cell capacitance; ZAP; and dual-speed current clamp. Also, with the Axopatch 200B amplifier the bath is grounded for convenience of use and straightforward addition of command and compensation potentials.

Quiet Single-Channel Recording

Integrating Headstage Mode

With unprecedented low noise and superb linearity, the Axopatch 200B capacitor-feedback integrating headstage is ideal for measuring sub-picoamp current signals.

Bilayers

Headstages useful in artificial bilayer experiments must be stable with large input-capacitance loads. The Axopatch 200B amplifier is rock solid with an input capacitance of 1000 pF.

Superb Whole-Cell Performance

Resistive Headstage Mode

In whole-cell recording more current noise is produced by the cell and the environment than by the patch clamp amplifier. Hence, the benefits of a low-noise capacitor-feedback headstage cannot be effectively utilized in whole-cell mode. For this reason, the Axopatch 200B amplifier uses traditional resistor feedback headstage electronics for the whole-cell mode of patch clamp recording. The CV 203BU headstage includes two feedback resistors to provide a wide range of current-passing capacity in the whole-cell mode. The 500 megaohm feedback resistor ($\beta=1$) provides both low noise and a large current passing ability (20 nA). For larger currents, one can switch to the 50 megaohm feedback-resistor ($\beta=0.1$) to pass up to 200 nA.



Genuine Axon CNS components for every experiment.

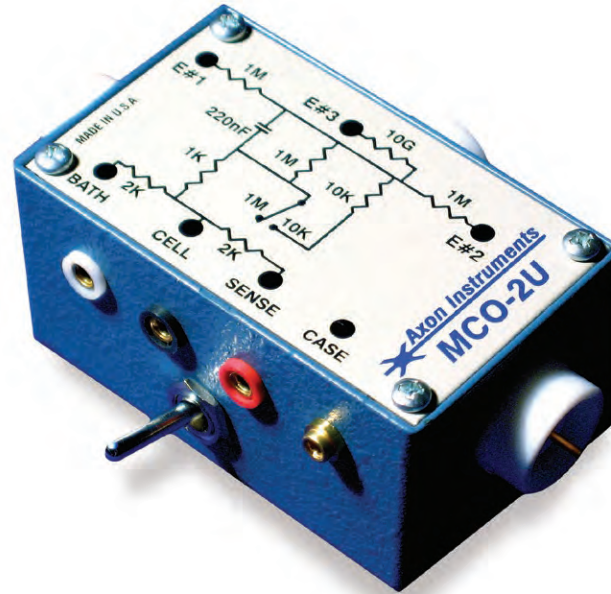

Optional CV-5 Series Headstages for the GeneClamp 500B amplifier

- CV-5-100GU patch-clamp headstage (100 mV/pA)
- CV-5B-100GU bilayer patch-clamp headstage (100 mV/pA)
- CV-5-1GU macro-patch headstage (1 mV/pA)
- CV-5-100MU voltammetry headstage (100 mV/nA)

CV-5 headstages operate with the GeneClamp 500 amplifier. Each headstage has one feedback resistor for current-to-voltage conversion. The transfer resistance of the 100G, 1G and 100M versions are 100 G Ω , 1 G Ω and 100 M Ω , respectively. The "B" version has an extended capacitance compensation range suitable for bilayers. The 100G version is ideal for single-channel recording and vesicular-release amperometry. The 1G version is suitable for macropatch applications. The 100M version is used for fast cyclic voltammetry using carbon-fiber microelectrodes.

Headstages, holders, model cells, cables, odd bits

Headstages

HS-2 and HS-2A unity-gain headstages

The HS-2 and HS-2A headstages are used with Axoclamp 2 and GeneClamp amplifiers. They are all unity-gain voltage recording headstages but they come in a variety of different current-passing gains for applications as diverse as extracellular recording, bath-potential recording, ion-sensitive recording, ionophoresis and intracellular recording from small or large cells. For ultra-high impedance electrodes, special circuitry inside the headstage prevents any DC current from leaking into the input through the capacitance neutralization circuit.

HS-4-x1MGU relay-switched unity-gain headstage

HS-4 headstages may be used with Axoclamp 2 amplifiers to maximize the voltage across the electrode during two-electrode voltage clamp. In all other modes the HS-4 acts like an HS-2 headstage. Available only with current-passing gain x1MG. The VG-2 headstage must be used for current measurement.

Q7 12
 Q6 13
 Q5 14
 Q4 15
 Q3 16
 Q2 17
 Q1 18
 Q0 19
 20
 10
 OE 1
 U27
 J27
 15
 14
 13
 12
 +5

VG-2 virtual-ground headstage

The VG-2 virtual ground headstage may be optionally used with Axoclamp 2 amplifiers to measure whole-bath current. Standard current-measurement gains are x0.1, x1 and x10. x100 is also available. Current recording ranges for these virtual ground headstages are: ±0.1 µA (x0.1), ±1 µA (x1), ±10 µA (x10), ±100 µA (x100).

VG-2A-x100 bath clamp headstage

The VG-2A-x100 bath-clamp headstage may optionally be used with Axoclamp 2 or GeneClamp amplifiers to clamp the bath potential at zero volts. This eliminates the effect of series resistance in the bath grounding electrode and the bath solution. It can also minimize the extent of DC voltage shifts resulting from changes in the bath solution or temperature.

Holders

Headstage pipette holders and replacement parts available for all Axon CNS Instruments headstages. Please see our web page: <https://www.autom8.com/mdcaxon-instruments-overview/headstages-holders/> for complete parts list.

Model Cells

Model Cell	Headstages		
	HS non-U type 2 mm socket	CV non-U type 1 mm socket	HS & CV U type 1 mm socket
Non-U type 2 mm pins Clamp-1, MCB-1, MCO-1 E1, E2*, MCW-1	No adapter needed	2 mm socket to 1 mm pin APN 1-2200-063	2 mm socket to 1 mm pin APN 1-2200-063
Non-U type, recessed 1 mm pins MCO-1 E3*, Patch-1	1 mm socket to 2 mm pin APN 1-2200-083	1 mm socket to 1 mm pin APN 1-2200-062	1 mm socket to 1 mm pin APN 1-2200-062
U type 1 mm pins Clamp-1U, MCB-1U, MCO-1U E1, E2, E3*, MCW-1U, Patch-1U	1 mm socket to 2 mm pin APN 1-2200-083	1 mm socket to 1 mm pin APN 1-2200-062	No adapter needed

*E - electrode input # All ground connections on model cells and headstages have 2 mm sockets, except the CV203BU headstage, which has a 1 mm ground socket.

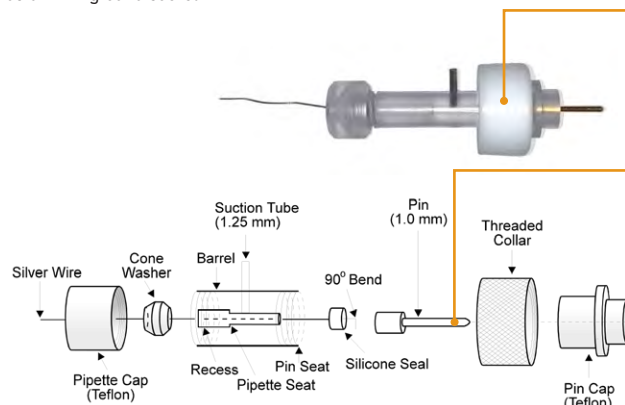

Mechanical Mounting Options

A 4" (102 mm) long removable insulated mounting rod is provided at no charge with most headstages. Diameter is 5/16" (7.9 mm) unless 1/4" or 3/8" (6.3 or 9.5 mm) is specified by purchaser. Additionally, all headstages include an insulated mounting plate. Many manufacturers of micromanipulators provide custom mounting brackets for Axon CNS headstages.

Clamp 1U-model cell

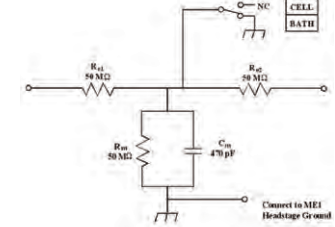

Patch 1U-model cell

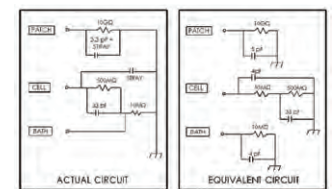

MCO 2U-oocyte model cell

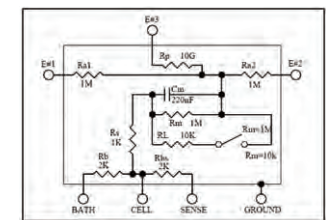

Electrode Holders

HL-U: Connects to all U-type headstages. How to know which pipette holder you need:

- Is the collar (where the holder attaches to the headstage) threaded or smooth?
- If it is threaded, then you need the HL-U (most common)
- If it has threads, then you need to measure the input pin on the headstage (you can measure from your old electrode holder)
- If it is 1 mm diameter, then you need HL-1
- If it is 2 mm diameter, then you need HL-2. HL-1 and HL-2 are only for smooth collets, not threaded

Features

- Membrane Test calculates R_a and C_m per sweep during a recording
- Membrane and Seal Tests combined into a single resizable window
- Support for four stimulus waveforms (with the Digidata 1440A digitizer or higher)
- Control of eight digital outputs per epoch during a sweep
- Control of split-clock sampling per epoch during a sweep
- Leak subtraction automatically saves both raw and corrected traces
- All protocol durations are entered in time units
- Support of the Digidata 1550B digitizer
- Support of the Axoclamp 900A amplifier
- ABF 2.0 file format

Applications

pCLAMP 11 is suitable for a wide variety of applications.

Uses:

- Action Potentials (APs)
- Current-clamp
- Electromyography (EMG)
- Electrooculography (EOG)
- Excitatory Post-Synaptic Currents (EPSCs)
- Excitatory Post-Synaptic Potentials (EPSPs)
- Inhibitory Post-Synaptic Currents (IPSCs)
- Inhibitory Post-Synaptic Potentials (IPSPs)
- Long-Term Depression (LTD)
- Long-Term Potentiation (LTP)
- Miniature excitatory potentials (Minis)
- Ratio dyes (with PMTs)
- Single-channels
- Slices
- Spike trains
- Synaptic networks
- Voltage-clamp
- Whole-cell

The most widely-used patch clamp data acquisition and analysis program.

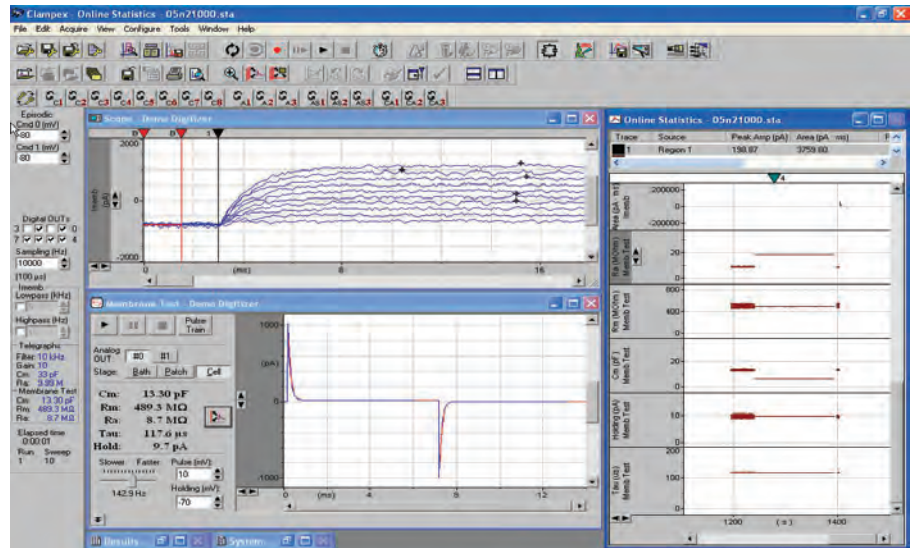

pCLAMP 11 Software

The pCLAMP 11 software suite fulfills many different experimental needs, such as synchronized stimulation, event detection, and online analysis. It is the most widely-used data acquisition and analysis program for the control and recording of voltage-clamp, current-clamp, and patch-clamp experiments. Three separate programs are included: Clampex 11, AxoScope 11, Clampfit 11.

Clampex 11 expands the range and quality of your data acquisition experiments. These improvements should prove useful for a wide variety of applications, allowing more flexibility in your experimental protocols.

Requirements

Minimum:

- Windows 7 Pro (32 bit), 2 GHz CPU, 1.2 GB RAM, 1440 x 900 display, 1 USB 1 port (for security dongle), 1 USB 2 port (for Digidata), Digidata 1440 or 1550 series

Recommended:

- Windows 10 Pro (32- or 64-bit), 2 GHz CPU, 4 GB RAM, 1920 x 1080 display or higher, 3 USB 2.0 ports, Digidata 1550B digitizer, network connection

USB 2.0 interface means extremely easy installation and setup.



Digidata 1550B0, B1 & B4 Data Acquisition - with HumSilencer

Presenting the latest Digidata 1550B digitizer for low-noise experiments. This high-resolution 16-bit data acquisition system is self-contained and communicates with the host computer via a USB 2.0 interface, which means extremely easy installation and setup. Designed for ease-of-use and fast results, the Digidata 1550B comes with versatile AxoScope for Windows software and is ready to take data immediately after installation. Absolutely no programming is necessary.

The Digidata 1550B has a maximum sampling rate of 500 kHz per channel, with an outstanding total data throughput rate of 4 megasamples per second. Both the inherent digitizer noise and channel crosstalk noise are rated at less than ± 1 mV average p-p at 10 kHz, within a ± 10 V input range. The front panel is well laid out with eight analog input channels and eight analog output channels, eight general digital outputs, one dedicated digital output to trigger devices such as oscilloscopes, trigger inputs to start acquisition and to tag data. The back panel has four additional analog instrument telegraph inputs, as well as a DB-25 connector for the digital outputs.

Easy to Use

Designed to support continuous data acquisition within a multitasking operating system, the Digidata 1550B digitizer is fully supported by our AxoScope 10 for Windows and pCLAMP 11 for Windows electrophysiology software.

With its USB 2.0 interface, you can easily connect the Digidata 1550B to a laptop computer without the need for a peripheral PC card.

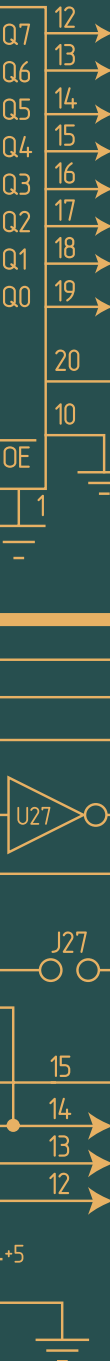

Specifications

Analog Inputs

- Input channels: 8 single-ended
- ADCs: 8
- Sampling rates**: 1 Hz - 500 kHz
- Resolution: 16-bit
- Input range: -10 to +10 V
- Input resistance: >1 M Ω
- Gain value: 1

**Maximum aggregate throughput rate is 500 kHz x 8 input channels = 4 Megasamples/sec

Analog Outputs

- Channels: 8
- DACs: 8
- Sampling rates: 1 Hz - 500 kHz
- Resolution: 16-bit
- Output range: -10 to +10 V
- Output impedance: < 0.5 Ω
- Output short circuit to signal ground: ± 25 mA

Digital Inputs

- Input type: TTL compatible
- Trigger Inputs
- Input type: TTL compatible
- TAG: rising-edge sensitive
- START: rising-edge sensitive

Digital Outputs

- Number of bits: 8 (of 16) supported in software
- SCOPE: dedicated trigger output
- Output driver: advanced CMOS (AC) compatible
- Output current: ± 4 mA source, ± 32 mA sink

Cable

Type: USB 2.0 braided
Length: 3 meters

AxoScope

AxoScope software is turn-key data acquisition and analysis software for Windows, designed to replace oscilloscopes, chart recorders, and FM tape recorders. AxoScope software provides up to sixteen channels of analog acquisition and four different acquisition modes. Acquire data continuously in Gap-Free mode with simultaneous display, at up to the speed of the digitizer. Set a trigger threshold for the Fixed-Length Events, Variable-Length Events or High-Speed Oscilloscope modes. Tag and add comments to the data in real time. Set analog output holding values. Open Axon-format ABF data files and quickly analyze sections of interest with an array of browsing and basic analysis tools. Preview data and page layout before printing. Additional features include voice tags, which allow tagging of data with spoken comments (requires a microphone and sound card), low-pass and high-pass digital filtering of incoming data, and Store Trace, which freezes a snapshot of a waveform on the screen for comparison with subsequent input.

The Digidata 1550B rack mountable main unit comes standard with:

- USB 2.0 cable
- External auto-switching power supply
- Power cable
- AxoScope 10 software CD
- Printed manual

Ordering Information

Part No.	MDS Analytical Technologies/Axon CNS	Price
MultiClamp	MultiClamp 700B computer-controlled current & patch clamp amp	\$22,522
Axoclamp	Axoclamp 900A computer-controlled current & voltage clamp	\$ 15,054
Axopatch	Axopatch 200B-2 capacitor feedback patch clamp amp	\$ 19,284
Digidata 1550B0	Digidata 1550B0 data acquisition system	\$ 8,246
Digidata 1550B1	Digidata 1550B1 data acquisition system with 1x HumSilencer	\$ 9,451
Digidata 1550B4	Digidata 1550B4 data acquisition system with 4x HumSilencer	\$ 11,260
pCLAMP	pCLAMP 11 Standard electrophysiology software (Windows)	\$ 9,090
Mo-1-CV-7B	Headstage CV-7B patch clamp (standard) for MultiClamp 700B	\$ 5,432
Mo-HL-U	Electrode holder for all Universal (U)-type headstages	\$ 270
Mo-HS-9A-x10U	HS-9A headstage for Axoclamp 900A (choose x0.1, x1, x10 U)	\$ 1,158
HL-U	Electrode Holder for 1.0-1.7 mm glass	\$ 270
	Complete Axon CNS cellular neuroscience product line avail.	

U.S./Canada prices shown. International prices add 15%. Email or visit web store for latest prices.

No shake, rattle, or roll.



Series 63 CleanBench High-Performance Laboratory Tables

TMC 63 Series CleanBench High-Performance Lab Tables provide an excellent vibration-free working surface for loads up to 350 lb (160 kg). Now with modular construction, these tables are recommended for use in such diverse applications as electrophysiology, cell injection, ultramicrotomy, photomicroscopy, scanning tunnel microscopy, and confocal laser scanning microscopy.

• Gimbal Piston Isolators

TMC's Patented Gimbal Piston™ Isolator has been proven by independent tests to consistently outperform the competition. It achieves both horizontal and vertical isolation down to very low input levels.

• Thin-Wall Rolling Diaphragms

An integral part of the Gimbal Piston, the thin-wall, dacron-reinforced, rolling diaphragm air seals are only 0.020 in. (0.5 mm) thick and extremely flexible. They do not stiffen the spring as thicker rubber diaphragms do.

Isolator Natural Frequency High Input Specifications

Vertical 1.2 Hz
Horizontal 1.0 Hz

Low Input Specifications

Vertical 1.5 - 2.0 Hz
Horizontal 1.2 - 1.7 Hz

Isolation Efficiency @ 5 Hz

Vertical 70 - 85%
Horizontal 75 - 90%

Isolation Efficiency @ 10 Hz

Vertical 90 - 97%
Horizontal 90 - 97%

Gross Load Capacity

1,400 lbs. (640kg)

Net Load Capacity

350 lbs. (160kg)

Finish

Medium texture black powder coat frame; stainless steel top.

Facilities Required

80 psi nitrogen or air

Accessories

- Front Support Bar
- Rear Support Bar
- Armrest Pads
- Sliding Shelves
- Articulated ArmRest
- Sub Shelf
- Clear Acrylic Enclosures
- Fixed Full Perimeter Enclosures
- Precision Control Valves
- Casters

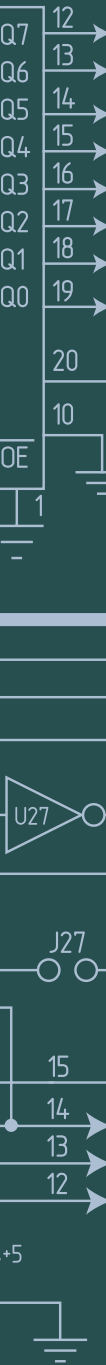

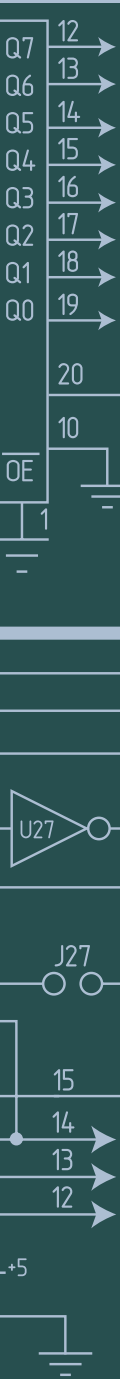

- **All-Aluminum Height Control Valves**

All systems are equipped with rugged all-aluminum height control valves. Virtually unbreakable, they are finger adjustable with no need for tools. The standard model maintains height to ± 0.050 in. (± 1 mm); the precision model, to ± 0.005 in. (± 0.1 mm).

- **Internal Piston Travel Restraint**

Unique in the industry, Technical Manufacturing Corp provides husky, tamperproof, built-in piston travel restraints. The restraints are completely independent of the table valves and have been ram-tested at forces above those produced by the pistons operating at full pressure. They cannot be decoupled accidentally and do not interfere with setting up and using the table, but simply protect against overtravel without the use of external bars that create hazardous pinch points. Heavy loads, including the top plate, can be safely removed from a table in full operation.

- **Tiebar Gussets**

Exclusive TMC tiebar gussets increase table frame rigidity. They compensate for the elimination of the front tiebar in order to provide kneewell space.

- **Rugged Built-in Leveling Feet**

Table legs include built-in fine-thread 3 in. (75 mm) diameter screw jack levelers with 1/2 in. (13 mm) travel, provision for external adjustment and a handy adjustment wrench. The base is a solid, slightly domed shape to assure solid, wobble-free contact with sloping or irregular floors.

- **Superior Table Tops**

Our standard laminated tops provide an attractive stainless steel ferromagnetic working surface with highly damped, high stiffness construction at low cost. For applications requiring the ultimate stiffness and damping or mounting holes, specify TMC's patented CleanTop® II honeycomb top.

Accessories for 63 Series

Tables may be fitted with armrests and rigidly supported sliding side shelves just above the table top. The sliding shelves must be used in conjunction with a front support bar and a rear support bar that are fastened to the table legs. The bars can be retrofitted, but cannot be used with the full perimeter enclosure or Faraday Cage.

Front Support Bar

This adjustable steel rail mounts on the table's front legs. It has a slot in which the shelves mount, and is normally ordered with the armrest pads. The bar may be centered along the length of the table or cantilevered to suit your application.

Rear Support Bar

This adjustable rail mounts on the rear table legs and supports the rear end of the sliding shelves. It may also be cantilevered.

Armrest Pads

Adjustable leather forearm rests which fasten to the front support bar. An armrest pad is now available which fastens to the perimeter enclosure.

Sliding Shelves

Shelves are made of wood with white plastic laminate covering all sides. A metal bracket on the front edge of the shelf fits into the slot in the front support bar. Shelves slide freely from side to side and are easily lifted off the support bars. Built-in stops prevent shelves from sliding out of slots. When ordering sliding shelves, you must order front and rear support bars.

Sub Shelf

For additional storage space, a shelf mounted beneath the isolated table top is available and may be retrofit at any time.

Clear Acrylic Enclosures

The clear acrylic enclosure provides protection from drafts and dust. Custom configurations allow for acoustic and light protection. Features include: clear acrylic panels; solid top; triple-track front section with a three-piece sliding front panel.

Fixed Full Perimeter Enclosures

A fixed, welded-steel structure that completely surrounds the table top to provide non-isolated support for Faraday Cages, raised rear shelves Plexiglas enclosures and other special fixtures. Cannot be used with sliding shelves or support bars.

Precision Control Valves

To minimize bottled air supply usage, standard TMC height control valves have a small "dead band," resulting in a height return accuracy of ± 0.05 in. (± 0.13 mm). Precision valves control height to within ± 0.005 in. (0.13 mm) but have a slight, constant leak. To specify precision height control valves with a table, add the letter 'P' after the basic table model number.

Casters

A set of four retractable casters, with a total weight capacity of 1000 lbs (450 kg) can be mounted to the base of the table legs.

Armrest Pads

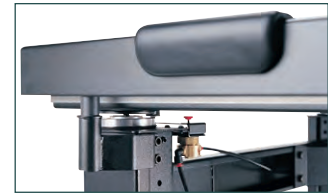

Casters

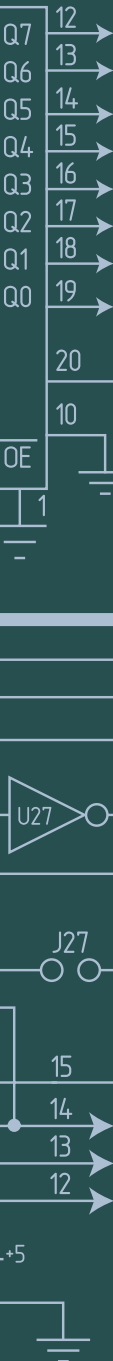

Quiet air compressor



Breadboards



Breadboard Specifications

Core

Steel honeycomb, closed-cell,
0.010 in. (0.2mm) thick foil

Core Shear Modulus

275,000 psi
(19,300 kg/cm²)

Core Cell Size

<0.5 in.²
(3cm²)

Core Density

13.3 lb/ft³
(230 kg/cm³)

Top Skin

430 series stainless steel, 0.075in.
(2 mm) thick

Bottom Skin

400 series stainless steel, 0.075in.
(2 mm) thick

Ordering Information

Part No.	TMC Air Table	Price
TM-63-7590	63 Series CleanBench High-Performance Lab Air Tables	\$ 7,005+
TM-81-301-012	Front support bar 63-500 Series	\$ 280+
TM-81-302-012	Rear support bar 63-500 Series	\$ 280+
TM-90-7590	OnTrak pre-assembled roll off feature	\$ 675+
compressor	Quiet air compressor	\$ 1,063
Complete TMC product line available. Call or email for part numbers.		

U.S./Canada prices shown. International prices add 15%. Email or visit web store for latest prices.

Breadboards

Another in a long line of TMC innovations, the 75 Series Breadboards minimize both weight and cost. A patented manufacturing technique allows us to form countersunk, tapped holes in a thin top skin of stainless steel. The holes are not drilled or punched, but fabricated in a way that effectively "thickens" the skin in a small ring around the threads. No inserts are used and the tapped holes are 3 threads deep.

These tops have relatively high levels of rigidity, as they utilize our standard steel core. They are ideal when light loads are anticipated and low weight and/or cost are the most crucial factors.

This lightweight design is available from stock in several sizes. A full range of sizes and materials is available on a custom basis.

- Ultra-lightweight design weighs less than 9 lbs/ft² (44 kg/m²).
- Ferromagnetic Stainless steel top and bottom skins.
- Aluminum and carbon steel versions available.
- Formed holes are countersunk and tapped 3 threads.
- Formed holes in top skin add to rigidity.
- CleanTop® individual cups under each hole make the core spillproof.

Ordering Information

Part No.	TMC Breadboard	Price
TM-75SSC-103-02	Breadboard 19 x 23" 75 Series (metric sizes with M6 holes	\$ 1,255
TM-75SSC-104-12	Breadboard 19 x 47" 75 Series (available)	\$ 1,645
TM-75SSC-115-12	Breadboard 23" x 35" 75 Series	\$ 1,630
TM-75SSC-135-02	Breadboard 35 x 47" 75 Series	\$ 2,435
Complete TMC product line available. Call or email.		

U.S./Canada prices shown. International prices add 15%. Email or visit web store for latest prices.

Industry-standard electrical noise protection.



Type II Faraday Cages

The Type II Faraday Cage offers improved access and simplified assembly. The “window-shade” type retracting front panel is easier to operate than hinged doors and causes less disturbance when adjusted. This front panel may be positioned anywhere between fully opened and closed and stays in position without a fastener. The front door is shipped assembled and the entire unit may be assembled in a few minutes with a screwdriver (provided).

This cage incorporates the same stainless steel frame and copper-mesh material as previous versions. It mounts to (and requires) TMC’s full-perimeter enclosures and mounts to our 63-500 Series tables.

Ordering Information

Part No.	TMC Air Table	Price
TM-81-333-03	Type II Faraday Cage, 40 in.	\$2,490+
TM-81-334-03	BenchTop Faraday Cage	\$2,835+
	Complete TMC product line available. Call or email for part numbers.	

U.S./Canada prices shown. International prices add 15%. Email or visit web store for latest prices.

BenchTop Faraday Cage

Until recently, TMC’s Faraday Cages have only been available as part of a complete vibration isolation table system. The cages required our Perimeter Enclosure option and could not be assembled without a TMC 63-500 Series Vibration Isolation Table as its base.

We now offer the same line of 40 in. tall cages with a baseplate which allows the cage to be used on a bench-top without a corresponding TMC table. The base of the cage is a reinforced stainless steel plate which can support a compact vibration isolation system, microscope, or other instrument.

Options and Features

Type II Cages

- 2 in. diameter holes on three sides for cable passage
- Optional armrest pads are now available with Faraday Cages
- Optional "U" shaped hanging shelf
- Optional non-isolated sliding shelf oriented front-to-rear
- Full perimeter enclosure required to mount cage

BenchTop Faraday Cage

- BenchTop cage includes stainless steel baseplate
- Bench-mounted cage does not require vibration table



Isolator natural frequency**Low Input**

Vertical 0.5 Hz (actively suppressed)
Horizontal 0.7 Hz

Isolation efficiency @ 1 Hz

Vertical = 65%
Horizontal = 15%

Net Load Capacity

580 lbs. (263 kg)

Finish

Medium texture black powder coat frame; stainless steel top.

Facilities required

3 CFM @ 80 psi air or nitrogen
120-240 VAC, 500W power supply

Features

- Hybrid active and passive vibration cancellation
- Ergonomic design, with a kneewell on the long side
- Available with either a smooth surface or a grid of tapped holes, either ¼-20 (imperial) or M6 (metric)
- CE marked
- Vibration isolation bandwidth 0.7-1000 Hz
- Advanced vibration sensor technology. Incorporates geophone type velocity sensors for sub-Hz performance. Better low frequency sensitivity than accelerometers.
- Ease of installation and setup featuring retractable casters and a roll-off crate.

Applications

- Atomic Force Microscopes
- Scanning Probe Microscopes
- Commercial Interferometers
- Electrophysiology Recording
- Semiconductor Inspection Equipment

State-of-the-art vibration isolation performance.

**CleanBench Aktiv Vibration Isolation Tables**

TMC's Active Vibration Isolation Table features state-of-the-art vibration isolation performance. Designed to isolate ultra-precision instruments from building floor vibration down to below 1 Hz, CleanBench Aktiv is ideal for optical microscopes, scanning probe microscopes, interferometers, and other surface metrology instruments.

It combines TMC's patented Everstill active vibration cancellation technology with our MaxDamp air isolators. While Everstill provides outstanding low frequency vibration cancellation starting at 0.5 to 0.7 Hz, MaxDamp provides aggressive higher frequency isolation. The result is a system that isolates better than even our industry standard CleanBench table across the entire frequency range of interest, 0-50 Hz.

Ordering Information

Part No.	TMC Air Table	Price
TM-29-9012S	CleanBench Aktiv Vibration Isolation Tables	\$38,075+
	Complete TMC product line available. Call or email for part numbers.	

U.S./Canada prices shown. International prices add 15%. Email or visit web store for latest prices.

Lightweight system with exceptional low frequency passive vibration isolation.

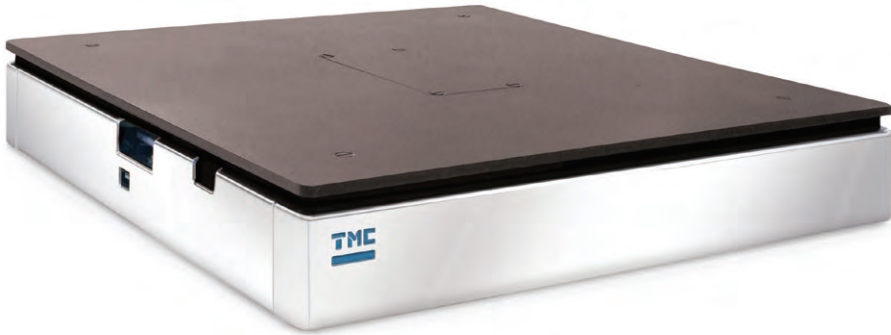

General Specifications

Net Load Capacity

150 lbs, 67 kg

Facilities Required

80 psi air or nitrogen

Finish

Electropolished Stainless Steel Sides and Base. Textured Powder Coat Carbon Steel Top Plate

Dimensions

18(w) x 20(d) x 3"(h)
(458 x 508 x 76mm)

Weight

50 lbs (22kg)

66 SERIES Active TableTop™ CSP®

High-Performance Vibration Isolation System with Compact Sub-Hertz Pendulum Technology

Benefits

- Self-leveling design with height control valves
- Electropolished stainless steel chassis with powder finish steel top plate
- Incorporates patented CSP isolator design
- Lightweight, low-profile

Features

- Exceptional passive vibration isolation, comparable to our full-size industry standard 63-500 Series Tables
- Lightweight, Compact Design (less than 50 lbs) is easily portable

Ordering Information

Part No.	TMC Air Table	Price
TM-66-501	TableTop CSP Isolation Systems	\$ 3,855
	Complete TMC product line available. Call or email for part numbers.	

U.S./Canada prices shown. International prices add 15%. Email or visit web store for latest prices.

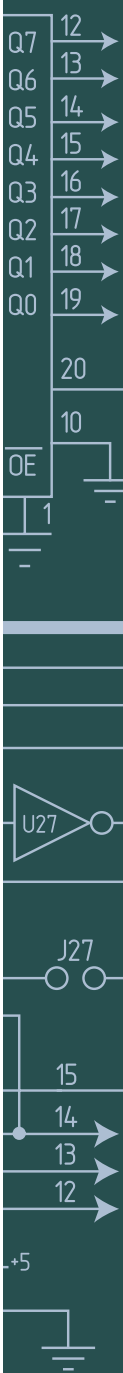

Integrated Digitizer

- 40 kHz sampling rate
- 16-bit A/D (18-bit internal resolution)
- Stimulus voltage ranges: ± 250 mV and ± 2000 mV
- Zap voltage range of ± 1000 mV



Feedback Gain Settings

- 10 M Ω , 100 M Ω , 1 G Ω , 3.3 G Ω , 10 G Ω

Low RMS Noise (DC to 3kHz)

- 0.3pA @ 10G Ω , 1.0pA @ 1G Ω , 7pA @ 100M Ω

Compensations

- Up to 4 Cap. Compensations
Cfast x 1, Cslow x 3
- 0-100 pF per compensation
- Series Resistance Compensation
Offset Compensation (± 250 mV) Optional Active Leak Compensation

Current Clamp

- ± 2 nA range with 1.25 pA res.
- ± 20 nA range with 12.5 pA res.
- ± 200 nA range with 125 pA res.

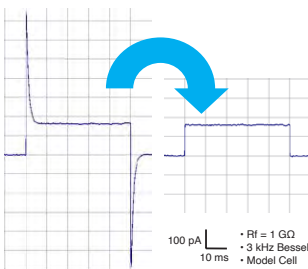

The patented Spread Frequency Compensation can automatically compensate any arbitrary capacitance profile in approximately 3 seconds.

The smallest patch clamp system available...



USB-powered Miniature Patch Clamp Amplifier and Digitizer

Full-featured 1-channel amplifier

Pico is a feature-rich, low-noise patch clamp amplifier with an integrated digitizer and headstage. Pico is ideally suited for whole cell (Vclamp and Iclamp) and single channel (patch, planar lipid bilayer and synthetic nanopore) recording, as well as cellular electrochemistry.

Voltage Clamp and Current Clamp

Clean Head Switching™ technology allows software-controlled switching between voltage clamp and current clamp, or between multiple feedback resistors, without introducing any artifacts. This enables one Pico to support a wide range of applications including whole cell, single channel, multi-cell, bilayers, electrochemistry, and current clamp.

Software

Compatible with: WinWCP by the University of Strathclyde. jClamp by SciSoft Company. TecellaLab software, with Data Export to ATF, tab-formats. SDK/API available. Other 3rd party software support.

Ordering Information

Part No.	Pico 2	Price
Te-Pico 2	Pico 2 Mini electrophys. amp, BOB, and digitizer	\$ 7,500
Te-Trigger Cable	Optional cable to control external devices with WinWCP	\$ 500
Te-jClamp32	jClamp Pico Software academic license (call for non-acad)	\$ 3,050

Heat your cells and media, not the stage.

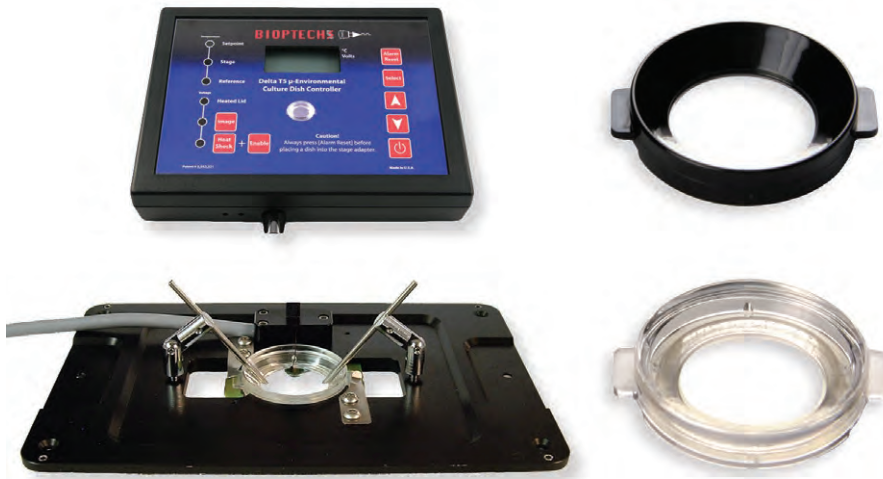

Bioprotechs Delta T[®] Controlled Culture Dish System

Finally a culture dish system specifically designed for live-cell microscopy! Now you can have accurate temperature control and high-numeric aperture compatibility in a convenient disposable culture dish system that even works in confocal applications.

- Easily adapted to a variety of specimen types from monolayered adherent cells to brain slice and tissue preps
- Low mass to thermo-regulate as opposed to conventional stage heaters
- Plate, incubate and observe without the need to transfer your cells
- Fast thermal recovery after perfusion (within seconds)
- Compatible with inverted and upright microscope stands
- Coverglass bottom for optimum optical compatibility
- No need for warm air blowers or stage heaters
- Direct first-surface heating to your cells
- Can also be cooled below ambient
- Perfusion available
- No pre-heating

Bioprotechs is now introducing the next generation Open Culture Dish Micro-Environmental Control System: the Delta T4. In addition to the improvements to the popular Delta TC3 control algorithm, Bioprotechs has incorporated years of customer requests into the Delta T4.

Features

- Mode indicator (dynamic or imaging)
- TTL interface and footswitch mode activation
- Cold start acceleration
- Temperature output port for recording
- Heat shock activation
- Heated Lid power supply
- Remote setpoint port
- Temperature output (for analog recording)



Limitations of Traditional Technique

- Stage heaters are inefficient, slow, and inaccurate
- Plastic dishes are poor conductors of heat
- Temperature does not recover quickly during or after perfusion
- Plastic dishes are not suitable for high resolution or polarization microscopy
- Nonuniform temperature distribution
- Unnecessary dead volume
- Usable aperture of dish limited by the opening in heat transfer plate
- Surface evaporation significantly contributes to non-linearity of temperature distribution

Advantages of the Delta T® Dish System

- Place cells onto coverglass and observe
- Highly accurate temperature control
- Fast thermal recovery
- Superior optical image
- Stage adapters to fit most popular microscopes
- Designed for inverted microscopes but ideal for water immersion objectives on uprights
- Immediate alarm if cell temperature changes
- Rigid mount for X, Y stability
- Uniform temperature distribution
- Cells unaffected by surface evaporation
- Numerous specimen adapters available

The Biopetechs, Inc. Delta T Culture Dish System is designed to simulate host conditions on the stage of your microscope and provide an optimal optical environment for microscopy. This two-step system allows you to plate your cells and observe them without having to transfer them to another structure. The system components are, the Controller, Stage Adapter, and Dishes. Accessories for Tissue Slice, Brain Slice, and other specimens are available.

An intelligent feedback loop passes an electrical current through a thin film coating on the underside surface of the glass substrate on which the cells are grown. Heat is applied directly to the cells without the inefficiencies associated with peripheral heating by traditional culture dish warmers. Biopetechs exclusively offers opaque culture dishes which eliminates the unwanted ambient light background for fluorescence imaging.

The controller features a real-time temperature display and fast learning curve to compensate for cooling due to surface evaporation while responding to temperature changes due to perfusion. There is also an alarmed protection circuit to safeguard the cells and an internal reference for the user adjustable calibration. The standard controller has a temperature range of ambient to 50 degrees C. Extended ranges are available upon request.

Delta T dishes have 35mm O.D. and a 23mm central aperture. The peripheral region of the dish is tapered to reduce the dead-volume and the height of the dish is 6mm to allow better access for micro-injection and micromanipulation. The dishes are a hybrid of polystyrene plastic and Desag 263 glass. The outer structure of the dish is available in opaque black or clear and come with a clear 0.5mm or no.1.5 glass coverslip bottom bonded to it. The dishes are also available in a plain glass unheated version.

You will find the Delta T® a reliable and indispensable addition to your microscope.

Delta T Stage Adapters and Accessories

Controller and Dish Accessories



Hinged Perfusion Adapter

The Biopetechs Hinged Perfusion Adapter provides Delta T users with a convenient and inexpensive method of supporting perfusion needles in the culture dish. The typical application is to maintain low-volume perfusion over cells during long term-experiments. Perfusion adapters are sold in pairs. One hinge and needle is a supply, the other is a drain. The balance between supply and drain can be maintained continuously with the use of the Micro Perfusion Pump. Additional supports can be added to hold gas jets, pH probes, cooling apparatus, or other items which do not require critical positioning.

Hinged Perfusion Adapter



Coverglass Lid

The Coverglass Lid is a cover for the Delta T Culture Dish to be used when imaging to create an optical surface onto the liquid in the dish. This eliminates the optical effect of fluid motion at the air to liquid surface above the cells that causes the contrast of the image to change. Therefore, when acquiring a series of images in a transmitted light, contrast enhancing mode of microscopy, all images will have a uniform contrast.

Forming an optically flattened glass to media surface on the top of the cells eliminates this problem. The Coverglass Lid fits loosely on the Delta T Culture Dish and supports a 1 mm x 22 mm coverglass in the center of the field 3mm above the specimen. The Coverglass Lid is reusable and helps the Delta T bridge the gap between an open dish and a closed

Perfusable

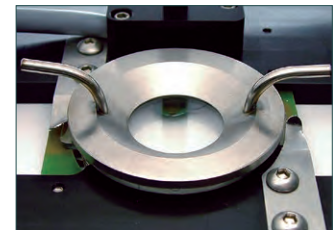

Non-perfusable

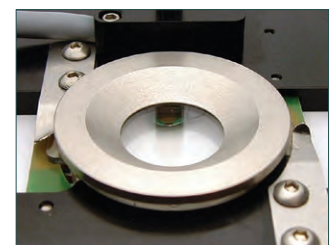

Heated Lid**Heated Lid**

The Biopetechs Delta T Heated Lid is a device which will provide a condensate free optical surface on the top of a Delta T Dish through which specimens can be perfused and trans-illuminated on an inverted microscope. It is reusable and powered by a 2.5 volt source from either a battery or the optional auxiliary power supply in the Delta T Controller. A CO2 port is included.

The Biopetechs Delta T Heated Lid w/ Perfusion is a device which will provide a condensate free optical surface on the top of a Delta T Dish through which specimens can be perfused and trans-illuminated on an inverted microscope. Specimens can be perfused by attaching perfusion tubing to the ports provided. It is recommended to use the Biopetechs Micro-Perfusion Pump with the dual perfusion tubing for this purpose.

Cooling Ring**Delta T Cooling Ring**

The Biopetechs Cooling Ring is an immersion device which absorbs heat from the specimen by providing a thermally conductive physical barrier between chilled fluid passing through the ring and the fluid surrounding the specimen. This cooling ring is made of autoclaveable 304 stainless steel and provides the microscopist with a convenient and inexpensive method of reducing the temperature of specimens in Delta T culture dishes. The cooling ring is supported on the stage adapter and translates along with the dish. It is easily flipped out of the way to enable easy exchange of dishes in the stage adapter

Brain Slice Adapter**Brain Slice Adapter**

The Biopetechs Brain Slice Adapter is combined with the Delta T® Culture Dish System to provide a convenient method of observing thick cut sections of brain or other tissue in a perfusable, temperature controlled, optical environment on an inverted microscope. Perfusion ports are made of 304 stainless steel and are compatible with 1/16" tubing. As with all Biopetechs Delta T® Culture Dish Adapters, the specimen is adjustable in the Z axis plane to accommodate the working distance of the objective. Custom geometry adapters are available upon special order to accommodate specimens having unique geometry.

Biotechs Delta T Stage Adapters

The Biotechs Delta T Stage adapter reads the temperature of the Delta T Dishes, provides electrical contacts to power the dishes and supports the dish on the stage for translation. All Delta T systems require a Stage Adapter. These pictures are provided to assist in selecting a stage adapter appropriate for your microscope.

Stage Adapters

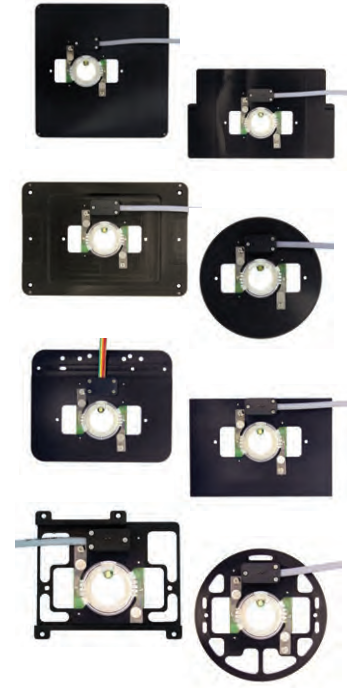

Ordering Information

Part No.	Delta T	Price
Bi-0420-4-Start	Delta T Starter Kit - Heated Dish Stage Incl: Delta T Controller, 10pk of Delta T Dishes, Coverglass Lid, Heated Lid with CO ₂ port, Culture Cylinder Pack and Standard Stage Adapter	\$ 4,138
Bi-0420-4-03	Delta T4 Culture Dish Controller	\$ 3,732
Bi-04202003	Delta T Culture Dish Stage Adapters 96-Well Plate Sized	\$ 821+
Bi-0420042105C	Delta T Culture Dishes (10/pk) 0.5mm thick glass (clear)	\$ 66.13
Bi-0420040500	Delta TPG Uncoated (no temperature control) Culture Dishes (10/pk) 0.5mm thick glass	\$ 40.25
Bi-0420201918	Delta T Tissue Slice Adapter	\$ 522
Bi-0420201919	Delta T Brain Slice Adapter	\$ 597
Bi-0420081601	Delta T Hinged Perfusion Adapter Set (2/set)	\$ 448
Bi-04200318	Delta T Cooling Ring	\$ 224
Bi-0420080316	Delta T Perfusable Heated Lid	\$ 559
Bi-070303-1919	Glass Culture Cylinder Starter Set (2, 4, 6, 8, 10 mm i.d x 5mm high)	\$ 187
Bi-070303-01	Glass Culture Cylinders -several sizes available	\$ 37.32+
Bi-260700	Boekel Warmer	\$ 394
	Complete Biotechs product line available.	

U.S./Canada prices shown. International prices add 15%. Email or visit web store for latest prices.



Micro-Perfusion Pump Features:

- Compact
- Usable as either single or dual channel
- Precise speed setting feature
- Flow rates of 0.2 to 180 ml/hr
- Compatible with 1/16" tubing
- External DC power supply with internal 9 volt backup battery
- Can be operated on internal battery if desired
- Computer interface available

Program and record perfusion flow and temperature over USB.

**Perfusion Pump and Software**

When imaging cells in a rigid structure such as a chamber having a coverslip as an observation surface, one must appreciate the fact that any rapid changes in flow rate will translate to microdynamic changes in pressure within the optical cavity of the chamber. This causes the coverslip to behave like a diaphragm thus flexing out of focus due to the narrow depth of field of the microscope objective. To eliminate this problem at the lower flow rates and significantly reduce it at higher flow rates, Biotech's recommends the Micro-Perfusion pump for use with all its micro-observation systems.

The Micro-Perfusion Pump is a miniature, single or dual, channel, full-featured peristaltic pump designed specifically for low-flow rates. Unlike most peristaltic pumps that are driven by stepper motors, the Micro-Perfusion pump is driven by a tachometer regulated, multi-stage DC gear motor. This assures a smooth analog rotation of the roller spindle, free of instantaneous steps. It is regulated by either the internal control circuitry adjustable from 0.2-180 ml/hr or it can be interfaced with a computer through a DAIO port. Biotech's provides a kit for this purpose that includes all cabling, software, and hardware needed for a dual pump setup. The pump comes with an external 9 volt AC adapter and also contains an internal 9 volt battery which can function as the primary power supply if needed.

The pump includes a single .062" I.D. tube and a dual tube that has two .062" I.D. tubes for use as a dual channel pump. Although other tubing sizes are available, this size is generally best suited for imaging applications. The pump tubes are available in silicone rubber and C-Flex. They are terminated with a 1/16" tubing barb. The base of the pump is threaded for easy mounting to a stand or fixture near the microscope.

Perfusion / Temperature Control Computer Interface

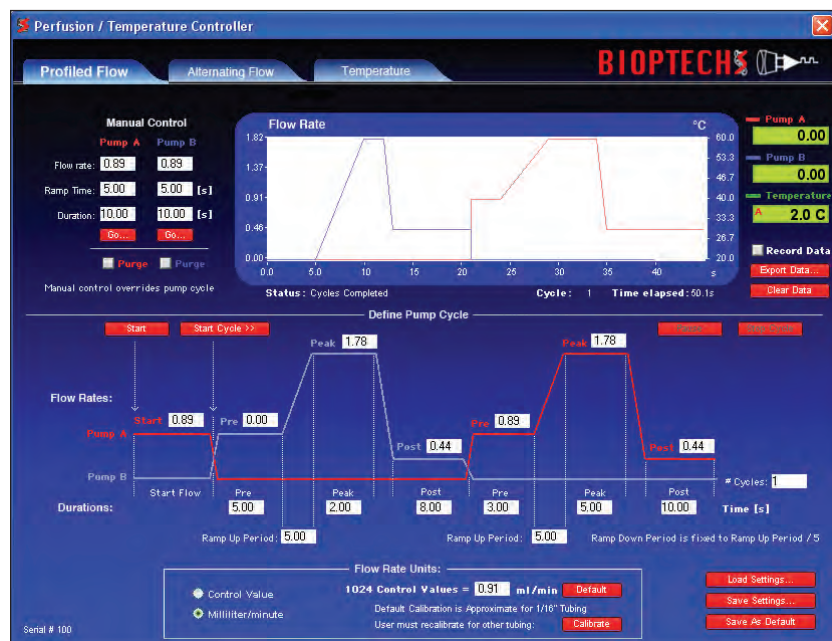

The live-cell microscopy Perfusion and Temperature Control Interface from Bioptechs™ features:

- Extreme ease of use with precise and repeatable control
- Dual or single micro-perfusion pumps
- Flow profile to reduce dead volume delays
- Temperature and perfusion recording
- Data logging of perfusion and temperature
- Multi flow-rate calibration
- Temperature profiling and cycling
- Saving and reloading settings
- Graphic display of events

Ordering Information

Part No.	Perfusion Pump	Price
Bi-0420131616	Micro-Perfusion Pump -specify desired flow rate(s)	\$ 1,675
Bi-13161603-13	Perfusion/ Temperature Controller (USB interface)	\$ 3,680
Bi-60319192016	Single Channel Pump Tubing Assembly (4/pk) C-Flex	\$ 145
Bi-16181303	Perfusion Pump Rod Mounting Clamp	\$ 50
	Complete Bioptechs product line available.	

U.S./Canada prices shown. International prices add 15%. Email or visit web store for latest prices.

This intuitive control interface system is optimized for time lapse imaging of live-cell activity. It provides a convenient, accurate, reliable, and repeatable method of controlling fluid and temperature for chemically or thermally induced change experiments in live-cell chambers. It is WYSIWYG on both Mac and Windows platforms!

USB Data Acquisition Function Module

Plugs into the USB port on Windows or Macintosh computers.

Pumps

Plug the pumps into the USB Data Acquisition Function Module and control two separate perfusion sources.

Computer Control

Control and Record Experiments!

Plug the FCS2, Delta T or Objective Heater into the USB Data Acquisition Function Module and have temperature control of your experiment, with the ability to record temperature data.



Specifications

Major Components

- Two micro-manipulators, each one includes a motorized linear stage and a manual XY stage
- One perfusion chamber I and platform
- One PCI data acquisition board with BNC interface
- Mechanical error: $< \pm 0.05$ mm
- Dimension: 8 in x 12 in x 9.5 in
- Weight: 10 lb
- Line voltage: 100 VAC to 120 VAC, or 220 VAC to 240 VAC

Motorized Stage

- Travel: 28 mm
- Resolution: $0.05 \mu\text{m}$
- Maximum speed: 4 mm/s
- Lowest speed: $0.5 \mu\text{m/s}$
- Serial/USB interface

Manual XY Stage

- Modular Dovetail Linear Stages
- Set, lock, and forget; less susceptible to shock and vibration
- 0.5 in travel

Data Acquisition Board

- Sixteen analog inputs, 16-bit, 250 kS/s, Input Impedance: $> 10 \text{ G}\Omega$ in parallel with 100pF
- Two 16-bit analog outputs, 740 kS/s per channel. Output impedance: 0.2Ω
- 24 digital I/O lines, 32-bit counters; digital triggering
- Analog input range: $\pm 10 \text{ V}$
- Analog output range: $\pm 10 \text{ V}$

Perfusion Chamber

- Accepts 1/16" tubing

Computer Requirements

- Windows XP with 2.0 GHz CPU
- At least 1 USB port
- 1 PCI slot

Faster automated patch clamping without a microscope.

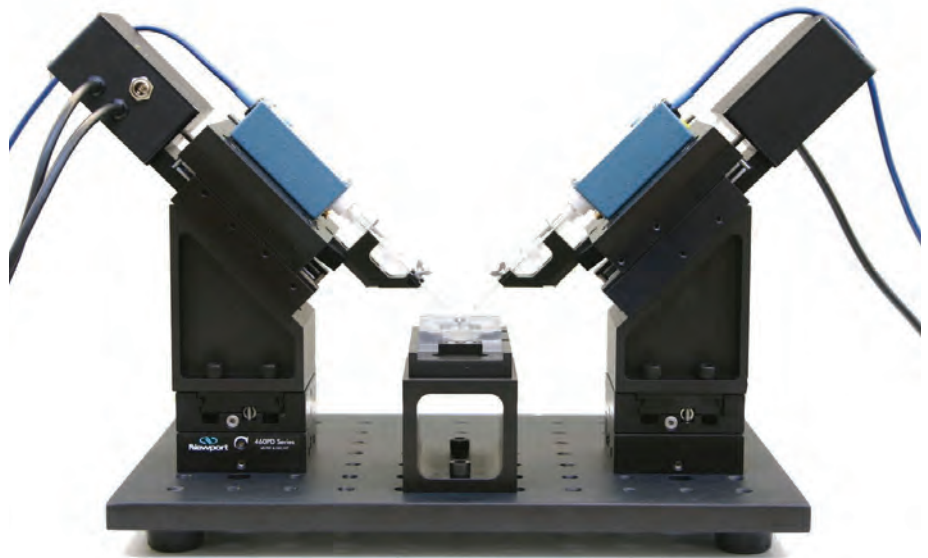

ChannelMAX 100A Mini and Twin + ez-gSEAL Pressure Controller

ChannelMAX 100A Mini

A system for both oocyte and cell patch clamp and two-electrode voltage clamp

This patent-pending design is based on the PatchMAX 100A, but comes with two computer controlled manipulators. With the additional micromanipulator, the system can do two patch clamp experiments simultaneously, or one two-electrode voltage clamp experiment. With this design, the system increases efficiency, decreases equipment cost, and saves space. As the system is controlled by computer, experiments become less labor intensive.

Run two patch clamp experiments simultaneously

The ChannelMAX 100A Mini comes with two computer-controlled manipulators, allowing users to run two patch clamp experiments simultaneously. Doing two experiments at the same time allows for better decision making: Single channel activities are random events. It is difficult to understand what is going on by looking at the channel open and close, especially when you are working on a new channel. For example, it is hard to distinguish a channel with two open stages from two channels in the same

patch. With two patches that are treated with the same conditions you have more information that could be critical in making the right decisions while working on the precious seals.

High quality patch clamp

As in the PatchMAX 100A, the ChannelMAX 100A patch clamp is noise free and low drift. The computer controlled system eliminates human errors so the success rate of making gigaohm seals using the ChannelMAX 100A is over 90%.

Run two independent patch clamp experiments

It is very easy to change the configuration to run two independent experiments. You can easily have two perfusion chambers on the same setup.

Automated two-electrode voltage clamp

For two-electrode voltage clamp, impalement is controlled by computer so no microscope is needed. When the electrode enters the oocyte, the membrane potential changes and the movement is stopped. The user can define the membrane potential threshold and the delay to stop movement after the electrode enters the oocyte.

Save on equipment cost & space

This system is more cost effective than a traditional electrophysiology setup. The equipment cost would be much higher to achieve the same functionality and productivity using a traditional setup. Lower cost and better quality.

Save space

As the system can be used for both two-electrode voltage clamp and patch clamp, less lab space is required. You do not need two data acquisition systems. All the data is on one computer, so it is easy for you to compare.

Switching between patch clamp and two-electrode voltage clamp is easy

The system is designed so that it can switch from patch clamp to two-electrode voltage clamp easily. With all of the adjustable parts, the system can easily be adapted to different glass electrode lengths and sizes, and different amplifiers.

Use with traditional two-electrode voltage clamp experiments

It is possible to use the ChannelMAX 100A Mini with a traditional two electrode voltage clamp to run two two-electrode voltage clamp experiments simultaneously.

High efficiency, less labor-intensive

As the system is automated, it is easy to run experiments in parallel to increase efficiency. Patch clamp and two-electrode voltage clamp should not be labor-intensive. Let the equipment do the hard work for you!

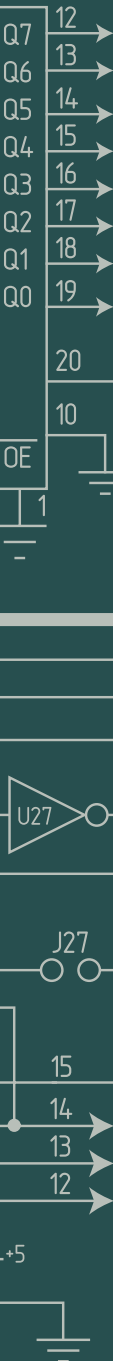

Specifications

Major Components

- Four micro-manipulators, each one includes a motorized linear stage and a manual XY stage
- Two perfusion chamber I and platform
- One PCI data acquisition board with BNC interface
- Mechanical error: $< \pm 0.05$ mm
- Dimension: 12 in x 12 in x 9.5 in
- Weight: 15 lb
- Line voltage: 100 VAC to 120 VAC, or 220 VAC to 240 VAC

Motorized Stage

- Travel: 28 mm
- Resolution: 0.05 μ m
- Maximum speed: 4 mm/s
- Lowest speed: 0.5 μ m/s
- Serial/USB interface

Manual XY Stage

- Modular Dovetail Linear Stages
- Set, lock, and forget; less susceptible to shock and vibration
- 0.5 in travel

Data Acquisition Board

- Sixteen analog Inputs, 16-bit, 250 kS/s, Input Impedance: > 10 G Ω in parallel with 100pF
- Two 16-bit analog outputs, 740 kS/s per channel. Output impedance: 0.2 Ω
- 24 digital I/O lines, 32-bit counters; digital triggering
- Analog input range: ± 10 V
- Analog output range: ± 10 V

Perfusion Chamber

- Accepts 1/16" tubing

Computer Requirements

- Windows 2000 or XP with 2.0 GHz CPU
- At least 1 USB port
- 1 PCI slot

ChannelMAX 100A Twin

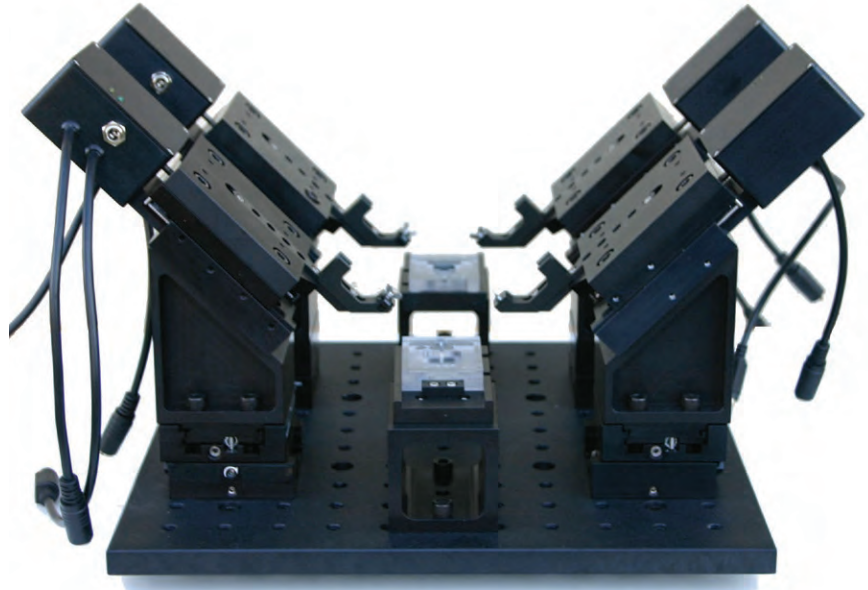

This system is similar to the ChannelMAX 100A Mini except it can be used for doing two two-electrode voltage clamp experiments or up to four patch clamp experiments simultaneously.

Key Features

Run dual two-electrode voltage clamp or four patch experiments simultaneously

With two additional micromanipulators, the system can do dual two-electrode voltage clamp (TEVC) experiments simultaneously. Designed to be affordable to the scientific community, this system increases productivity significantly. Additional units can be run in parallel to further increase TEVC throughput. As each manipulator can do one patch clamp experiment, the ChannelMAX 100A Twin can run up to four patch clamp experiments at the same time. This system significantly increases productivity for patch clamping.

High quality single channel recording

Since the computer controlled manipulators guide the patch pipettes to touch the cell membrane in a more precise and consistent manner than manually controlled manipulators, the success rate of making seals is over 90%. The system possesses the same high quality, noise free, low drift and vibration free data acquisition as the PatchMAX 100A system.

Best value

This system is more cost effective than a traditional electrophysiology setup. In order to reach the same functionality and productivity using a traditional setup, the equipment cost is more expensive, plus labor cost. Lower cost and better quality. If you work on 50 oocytes per week using a traditional two-electrode voltage clamp system, now you can extract data from 100 oocytes per week.

ez-gSEAL Pressure Controller



The ez-gSEAL 100B pressure controller is designed mainly for automated patch clamping, but it can also be used for many other applications. With the ez-gSEAL, patch clamping becomes as easy as a click of a button. You can use it with our automated clamp systems for fully automated experiments, or use it as a stand-alone product on a traditional rig. You can also use the controller for puffing drugs or studying stretch channels. The software-controlled pressure controller comes with pumps so air tanks are not required.

Key Features

The ez-gSEAL pressure controller makes patch clamping easy. Click the first button to set the positive pressure, the second button to set negative pressure for making seals, and the third button to set the holding pressure for long-lasting seals. By clicking a single button, you apply pulses to break into the cell.

The ez-gSEAL control software helps you measure the pressure you use for making seals and breaking in. In addition, many types of cells and tissues, such as HEK293 cells, brain slice and oocytes, have been tested and seal parameters are available for them. New users can usually use these parameters to make seals and break on the first attempt.

When used with the ezPATCH 100A manipulator, all you need to do is to aim the patch pipette at the cell you want to patch. After you click a button, it will touch the cell and make seal, or even go whole cell automatically.

Ordering Information

Part No.	ChannelMAX 100A & ez-gSEAL	Price
Ne-ChannelMAX 100A Twin	ChannelMAX 100A Twin	\$ 36,400
Ne-ChannelMAX 100A Mini	ChannelMAX 100A Mini	\$ 19,700
Ne-ez-gSEAL	ez-gSEAL Pressure Controller	\$ 6,490
Complete NeoBiosystems product line available.		

U.S./Canada prices shown. International prices add 10%. Email or visit web store for latest prices.

Specifications

- Pressure range: -250 mmHg to 250 mmHg
- Pressure resolution: +/- 1.5 mmHg
- Minimal pulse duration: 7 ms
- Minimal pulse interval: 7 ms
- Computer interface: USB
- Line voltage: 110 to 240 VAC
- Dimensions: 17"x14"x3.5" rack mount or desktop
- Weight: 10 lbs

Computer Requirements

- 32-bit Windows 2000, XP, Vista, or Win 7 with 2.0 GHz CPU
- 1 USB port

Pressure control for stretch channel study

The ez-gSEAL pressure controller can be used for pressure clamping for stretch channel study. The pressure sensitivity is 1.5 mmHg and the pressure range is from -250 mmHg to 250 mmHg — good enough for most stretch channels.

Pressure control for drug application

The ez-gSEAL pressure controller can also be used for local drug application. A series of pressure pulses can be given at defined pressures for defined durations.

PatchXpress Testing

The auto-seal algorithm is similar to what is used in the PatchXpress® automated patch-clamp system. PatchXpress users can use it to test their seal parameters under a microscope for easier trouble shooting and lower costs.

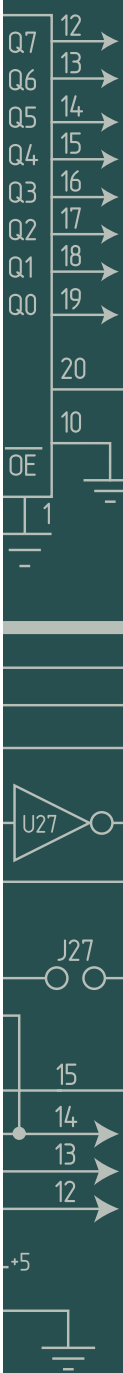

Plasma nicotine and cotinine concentrations

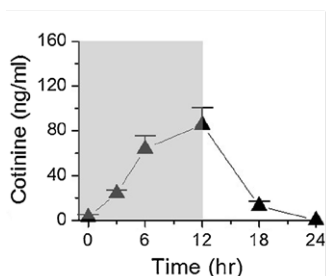
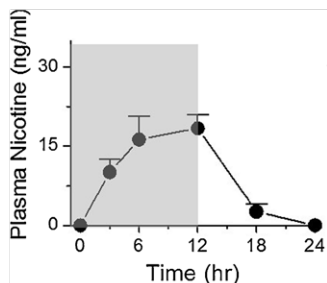

Plasma nicotine and cotinine concentrations (mean ± SE) as a function of time. Mice were exposed to intermittent E-cig aerosol from 0 to 12 h in the dark phase of 12/12-h circadian dark/light cycle (shaded area indicates exposure to ECigs) for 9 consecutive days. The exposure dose: puff duration = 4 s; 3 puffs per episode with an inter-puff interval = 30 s; one episode per 30 min amounting to a total 24 episodes during the 12-h dark phase. Blood samples were taken in day 9 by the end of the h time point indicated. Time point 0 is the time right before the first episode of daily 12 h exposure of day 9. It is equivalent to time point 24 h of day 8. Plasma nicotine and cotinine levels were measured (n = 3-5 mice per time point).

X.M. Shao, et al.

Journal of Neuroscience Methods

Easy pharmacokinetics and addiction aerosol studies



EcigAero™ Aerosol Exposure Apparatus
 Patent Pending | NIH Grant 1R41DA044788

The EcigAero provides an important tool for studying the acute effects of vaping electronic cigarettes (ECigs) and the chronic effects of multiple ECigarettes a day for long periods of time by repeatedly exposing rodents to ECig aerosol in a home cage-like environment. Our system provides a powerful toolkit for in vivo studies of ECig effects on cardiovascular, respiratory and nervous systems, metabolism and carcinogenesis as well as facilitating new therapeutic discovery. ECig addiction studies will have important implications in nicotine replacement therapy (NRT) for smoking cessation.

As electronic cigarettes are a relatively new product, studies are needed to determine their long-term detrimental effects. ECigs may contribute to nicotine addiction and are unlikely to discourage conventional cigarette smoking among youths, thus, generating a new market for nicotine dependence.

ECigs generate aerosol, not simple nicotine vapor as incorrectly claimed by the ECig industry. Mainstream and second-hand ECig aerosols not only contain nicotine and propylene glycol and/or glycerin, but also detectable levels of toxins including carcinogens and heavy metals such as formaldehyde, benzene, nitrosamines, cadmium and lead. Therefore health

Q7 12
 Q6 13
 Q5 14
 Q4 15
 Q3 16
 Q2 17
 Q1 18
 Q0 19
 20
 10
 OE
 U27
 J27
 15
 14
 13
 12



risk and toxicology studies on animal models exposed to ECig aerosol, not limited to nicotine, are urgently needed.

In order for drug abuse studies with animal models to be relevant to humans, it is necessary that the routes of drug administration, the physical properties (vapor or aerosol), the pharmacokinetics (PK) and target tissue concentrations of the drug are comparable between humans and animals.

Front View



Rear View

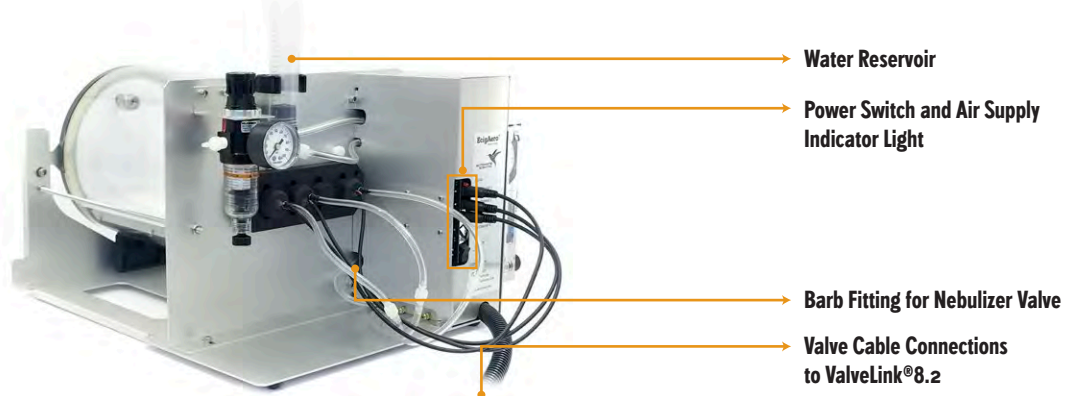

Flow Schematic

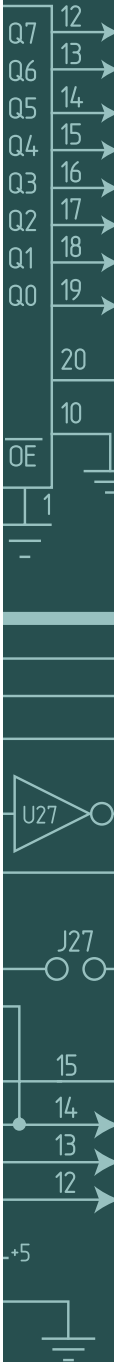
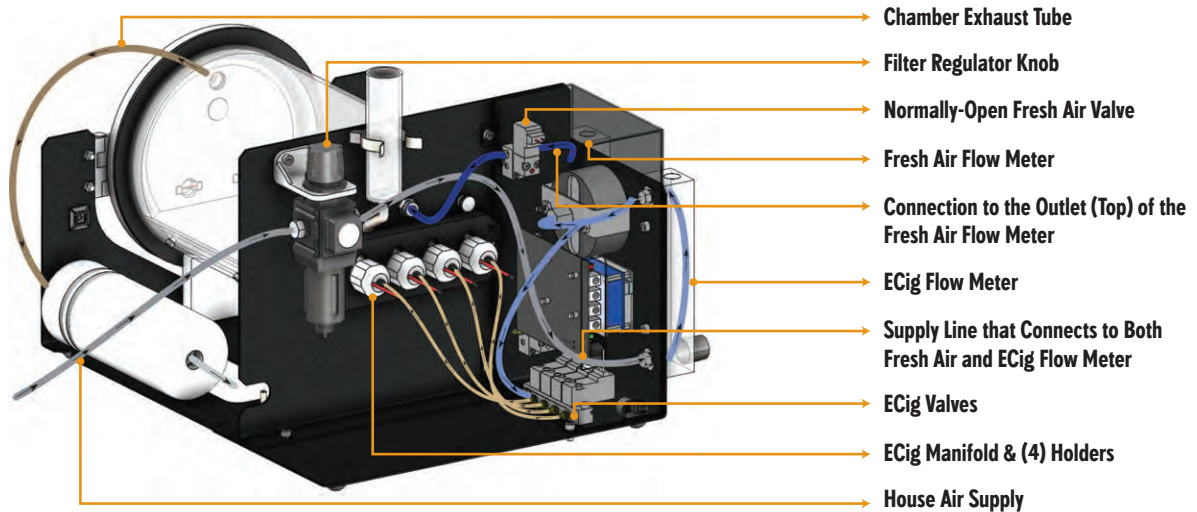

Accessories

AutoMate Scientific offers a number of products which complement the EcigAero: Aerosol Nebulizer, ECig Manifolds specific to manufacturer, Exposure Control Software (Windows) and ValveLink8.3 WiFi/digital/manual controller.

Aerosol nebulizer with direct connections to cylinder

Part #19-N



EcigAero™ myblu Liquidpods

Part #19-BL



EcigAero™ JUULpod manifold

Part #19-J



EcigAero™ Battery-powered (bluPLUS+) manifold

Part #19-BP



Key Features

Direct delivery for ideal aerosol

No tubing, bends, mixing chambers, fans or pumps between the ECig and the rodent chamber. Aerosols deteriorate rapidly during transport and dilution when passing through tubing and chambers due to droplet coagulation, condensation and vaporization. We have characterized the particle size distribution of the ECig aerosol in our chamber†. The EcigAero maintains consistent aerosol characteristics to those at the mouthpiece where humans inhale ECig aerosol. The pulmonary distribution of the aerosol generated in this device correlates with that generated by ECigs during typical human use.

Multiple “real” electronic cigarettes

The EcigAero will accommodate up to four (4):

- First generation Blu PLUS+ ECigs (battery powered)
- Second generation JUULpods™ or myblu™ Liquidpods
- Third generation “mod” tanks with universal “510” industry-standard threads
- Can be used along with any aerosol via nebulizer (optional)

The aerosols are delivered at a highly regulated pressure with a flow rate between 0 and 4 liters per minute (LPM). Pods and tanks are precisely energized with 0.1V accuracy. The EcigAero tests the inhalation exposure of REAL ECigs rather than de novo generated mixtures of nicotine + E-liquid. The exposure doses of our rodent models were verified by plasma nicotine levels/PK and with our software can be controlled by varying the number of ECigs simultaneously activated, puff duration, inter-puff intervals and frequency of puffs.

The capacity for multiple ECigs allows for:

- Longer experiments than a single ECig battery or tank
- Higher concentrations of aerosol if multiple ECigs are delivered simultaneously
- Side-by-side testing of different ECig flavors or nicotine concentrations

Fresh air

For chronic intermittent ECig aerosol exposure with animals, there should be fresh air flow between aerosol deliveries (when ECigs are not activated) which removes the residual ECig aerosol and provides fresh air for normal breath of rodents. Proper air flow is important for consistence of ECig exposure and for the health of the rodents during chronic experiments in the exposure chamber, as it more closely mimics human behavior of ECig devices. The EcigAero delivers fresh air at 0 to 5 LPM for up to 40-50 air changes per hour (ACH).

Fully programmable

The ECig aerosol, nebulizer aerosol and fresh air can all be independently programmed with 10 millisecond accuracy to regulate the dose of aerosol exposure and simulate the vaping pattern of ECig users. Programs can last up to 72 hours allowing researchers to coordinate aerosol delivery with simulated wake-sleep, day-night schedules at their convenience. In human vapers, exposure to e-cigarettes is chronic and intermittent with episodic inhalations during wakefulness and abstinence during sleep leading to circadian fluctuations of blood nicotine levels. As with conventional cigarette smoking, the episodic inhalation patterns of ECig users can induce cycles of activation, desensitization and resensitization of nicotinic acetylcholine receptors (nAChRs) in body systems that may contribute to a number of different aspects of nicotine effects, e.g. addiction and cardiovascular effects.

Telemetry

The EcigAero can hold a short-range antenna below the chamber for implanted telemetry systems such as the DSI PhysioTel® Implantable Telemetry that remotely measures blood pressure, ECG and other physiological parameters of the freely-moving rodent and continuously during acute or chronic exposure experiments. Our electronics and valves are isolated from the antenna and have been tested to avoid interference with the ultra-low power transmissions from implantable devices.

Additional Features

- The EcigAero accommodates up to 5 unrestrained, unanesthetized, freely-moving mice or 1 rat. It comes equipped with a water reservoir and removable tray for easy cleaning.
- Replaceable HEPA filter for use in a fume hood or lab bench.
- Small, light footprint: 16 in x 10 in, 12 in (h). Recommended table space: 18 in x 18 in.
- You can learn more about the included valve controller at <https://www.autom8.com/perfusion-systems-overview/valvelink8-2-controller>.

† A mouse model for chronic intermittent electronic cigarette exposure T exhibits nicotine pharmacokinetics resembling human vapers. Xuesi M. Shao, T. Friedman, et al. Journal of Neuroscience Methods, Vol 326, October 2019. <<https://doi.org/10.1016/j.jneumeth.2019.108376>>

EcigAero™ Universal "510" thread manifold

Part #19-510



Can accommodate most vape tanks that are either 22mm or 24mm in diameter with 510 battery threads and air entry ports on the end near the battery threads. The holders will not fit tanks that have air entry ports near the front (mouthpiece), and they will only fit tanks with a round outer diameter and overall length greater than 1.75". The holders use O-rings to seal to the outer diameter of the tanks, so tanks with large grooves or embossed designs on the body may not seal. Please contact AutoMate Scientific if you have questions about whether a specific tank will fit.

Ecig Tank Sizing Chart

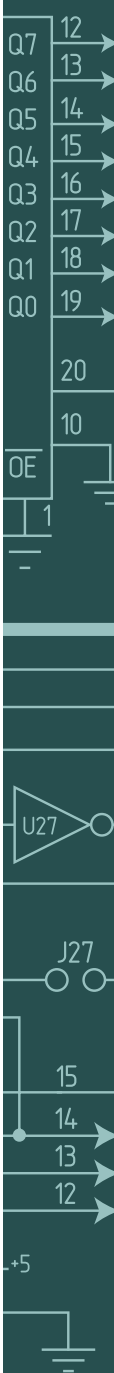
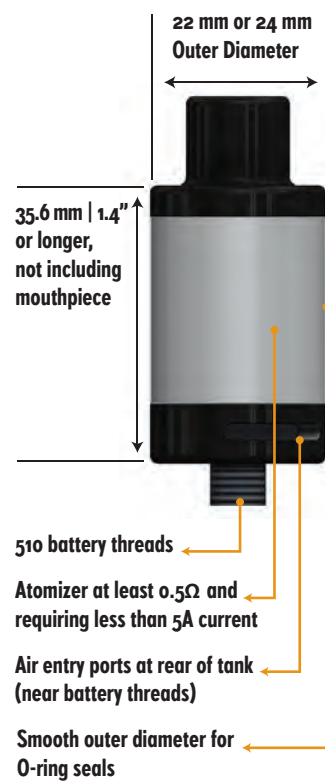

ValveLink®8.3
WiFi/digital/manual controller
 Part #01-18w



Ordering information

Part No.	ECigAero™ Aerosol Exposure Apparatus	Price
19-4-R	EcigAero Rodent aerosol exposure apparatus	\$ 7,075

U.S./Canada prices shown. International prices add 15%. Email or visit web store for latest prices.

Part No.	ECig Manifolds	Price
19-J	EcigAero JUULpod™ manifold	\$ 693
19-BP	EcigAero blu PLUS+ manifold (battery-powered)	\$ 700
19-510	EcigAero Universal "510" thread vape "tank" manifold	\$ 995
19-BL	EcigAero myblu™ Liquidpods manifold	\$ 769
19-N	Aerosol nebulizer with direct connections to cylinder for ECig	\$ 4,593

Order one or more ECig manifolds separately.
 U.S./Canada prices shown. International prices add 15%. Email or visit web store for latest prices.

Part No.	ValveLink, Software and Accessories	Price
19-ECS	EcigAero Windows Exposure Control Software	\$ 633
01-18w	ValveLink8.3 WiFi/digital/manual controller	\$ 1,250
19-H2O	Replacement rodent drinking reservoir and sipper tube	\$ 17
19-HEPA	Replacement HEPA filter	\$ 178
compressor	Quiet air compressor (115 VAC) - 220V also available	\$ 1,063

U.S./Canada prices shown. International prices add 15%. Email or visit web store for latest prices.



Customer Service



Our knowledgeable and friendly Customer Service Representatives are ready to assist you Monday-Friday, 9 a.m. to 5 p.m. PST.

Credit Cards Accepted



Warranty

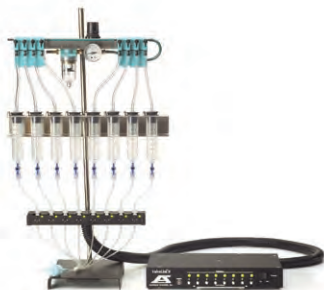

- All AutoMate Scientific-manufactured products carry a one-year Limited Warranty. See Terms and Conditions for more complete information.
- Non-AutoMate Scientific-branded/third-party products are sold "AS IS" by AutoMate Scientific, but generally include their manufacturers' standard warranties.

Contact Information

US Phone:	(800) 998-MATE or (800) 998-6283
Telephone:	(510) 845-6283
Fax:	(510) 280-3795
Email:	info@autom8.com
Web Site:	www.autom8.com
Web Store:	www.autom8.com/shop
International Distributors:	www.autom8.com/contact.html
Customer Service:	www.autom8.com/contact.html

Terms and Conditions

A summary of AutoMate Scientific's Terms and Warranty appear below. Our complete terms can be found at <http://www.autom8.com/terms/>.

• Prices & Payment

Prices are in U.S. Dollars plus any applicable sales tax and shipping charges. Orders originating outside the U.S. or Canada will be charged higher prices than shown in this catalog (generally +15%) due to increased shipping, regulatory and communication expenses. Our web store will show accurate international prices for registered guests, or you can always request a quotation. Purchases may be charged to a Visa or MasterCard account, or placed via a Purchase Order showing billing and shipping addresses, as well as end-user's name, address, department and complete contact information (phone, e-mail, fax). Purchase Order minimum is \$20.00 inside USA and \$25 outside USA. Payment terms are Net 30 Days for established domestic customers. Advance payment, credit card or binding Irrevocable Letter of Credit (add \$850 fee) in U.S. funds drawn on a U.S. bank is required for international orders. All shipments are F.O.B. origin. Discounts may be available for educational and multiple-unit orders.

• Warranty

All new AutoMate Scientific-manufactured products carry a one-year Limited Warranty against defects in materials and workmanship unless otherwise stated in the product's manual or our Terms web page. This warranty is only valid when the equipment is used for its intended purpose and does not cover equipment which has been modified without written approval from AutoMate Scientific or which has been damaged by abuse, neglect, accident or connection to incompatible equipment. Non-AutoMate Scientific-branded/third-party products are sold "AS IS" by AutoMate Scientific, but may be accompanied by their manufacturers' standard warranties. If you have questions about any manufacturers' warranties that accompany such products, please call or email us. Warranty and technical support coverage may be suspended for institutions with outstanding balances over 30-days past due.

Due to the nature of clinical laboratory applications, AutoMate Scientific will NOT accept the return of any products which have been used with HAZARDOUS MATERIALS or harmful environment.

AutoMate Scientific equipment is intended for research use only. We cannot be responsible for any harm resulting from use on humans.

• Returns

Please inspect your shipping carton for damage upon receipt. Shipments with visible damage should be noted on the shipper delivery slip prior to sign-off and reported to AutoMate Scientific no more than 5 days after delivery. Retain damaged containers for insurance claims. Items received should be inspected upon receipt and any shortages must be reported within 5 days of receipt. Unopened and unused products can generally be returned without cause within 30 days of receipt without penalty except for a 10% restocking fee for credit card orders that have already been charged. The customer is responsible for return shipping charges. Product returns after 30 days without cause will be handled on a case-by-case basis at AutoMate Scientific's discretion. A minimum 15% restocking fee will apply. Invoiced shipping charges will not be refunded. Special order items may not be returnable.

• Repairs

Please contact AutoMate Scientific for any necessary repair work before returning equipment to obtain an RMA (Return Authorization) number. Package any returned goods securely to avoid further damage. Ship the package prepaid and insured with a written explanation of the problem to our address with the RMA number visible. Out-of-warranty repairs will receive an initial estimate before work is begun.

• Catalog

AutoMate Scientific has worked hard to provide the most complete and up-to-date information possible in this catalog; however, we cannot be responsible for any errors or omissions. AutoMate Scientific reserves the right to make changes to prices, product descriptions, specifications, or other information without notice. Refer to AutoMate Scientific's web site for the latest information. No part of this catalog may be reproduced or transmitted in any form, by any means, without AutoMate Scientific's authorization. Copyright © 2006-2023 AutoMate Scientific, Inc. All rights reserved.

ValveBank, ValveLink, SmartSquirt, Perfusion Pencil, ThermoClamp, BubbleStop and EasyCode are registered trademarks of AutoMate Scientific, Inc. AutoPrime, Ready for Research, BackStop, ValveGuard, Oxygen8, QuickStage, and StageHands are trademarks of AutoMate Scientific, Inc. TEFLON resin is a registered trademark of DuPont. Macintosh is a registered trademark of Apple Computer, Inc. pClamp and AxoGraph are trademarks of Axon CNS Instruments, Inc. Windows is a registered trademark of Microsoft, Corp. Gimbal Piston, Compact Sub-Hertz Pendulum, Precision Electronic Positioning System, CleanTop and TMC are trademarks of Technical Manufacturing Corp. Delta T, Focht Chamber System 2 (FCS2), Objective Heater System and Objective Controller are trademarks of Bioprotechs Inc. Other corporate names and trademarks are the property of their respective companies.

Returns



- Unopened and unused products can generally be returned without cause within 30 days of receipt without penalty except for a 10% restocking fee for credit card orders that have already been charged.
- A minimum 15% restocking fee will apply for returns after 30 days.

Catalog



- Please visit our web store for international and updated pricing.
- Call or email us to receive regular catalog updates.



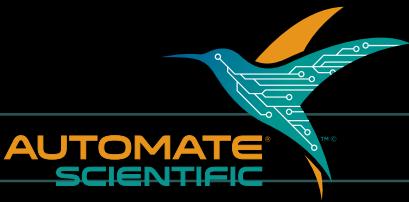
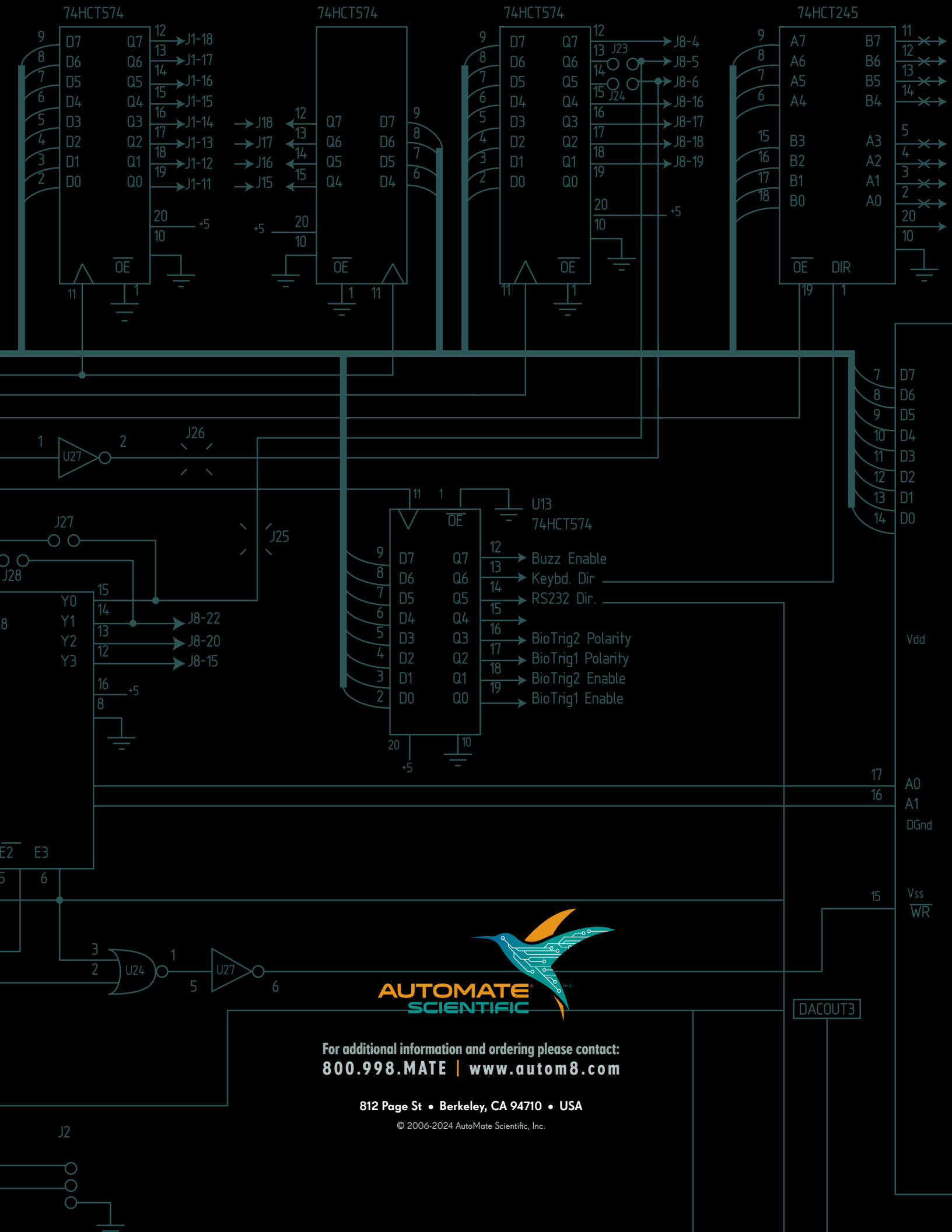

For additional information and ordering please contact:
800.998.MATE | www.autom8.com

812 Page St • Berkeley, CA 94710 • USA

© 2006-2024 AutoMate Scientific, Inc.

DACOUT3