

Excerpted from: Browne, F. G. 1961. **The biology of Malayan SCOLYTIDAE and PLATPODIDAE.** Malayan Forest Records. No. 22. 255 pages. Excerpt is pages 100 – 174. References.

7. SUBFAMILY IPINAE : TRIBE XYLEBORINI

The Xyleborini form, in number of species if not of genera at present recognized, the largest single tribe of the Scolytidae. It is represented in all, or almost all, territories that support tree growth, but, as we have seen in the introductory chapters, it is a much more important component of the Scolytid fauna of the tropics, and particularly of the humid tropics, than of the temperate regions, where the number of species is usually small. The tribe is phylogenetically rather closely related to the *Ozopemon—Coccotrypes—Poecilips* group of the Crypturgini and, as in these genera, the social organisation is always one of extreme polygamy; but xylo-mycetophagy, a habit unknown in the Crypturgini, is constant in the Xyleborini.

Genus *Xyleborus* Eichhoff

The genus *Xyleborus*, as it stands at present, includes well over a thousand species, found in nearly all regions of tree growth but particularly in the tropics. It dominates the Malayan Scolytid fauna, containing about 46 per cent of all known species.

The definition and present classification of the genus leave much to be desired, as it has necessarily been permitted to expand in a rather haphazard way. Occasional attempts to revise it, however, have usually been made in territories that have a very limited number of species, and consequently little success has been achieved. No real improvement can be expected until a world revision of the whole tribe becomes possible, and in the meantime it is rash to try to split the principal genus, except for the separation of a few very distinctive groups. For this reason we shall regard *Xyleborus* as a collection of numerous species-groups or subgenera, bearing in mind that many of them may eventually have to be recognised as distinct genera. It must be realised, however, that this plan has drawbacks, particularly in the necessarily wide separation of some related groups. The *truncatus* group of species, for example, is here retained in *Xyleborus*, and thus rather widely separated from *Pseudoxyleborus*, which is considered as a good genus, although it is clear that the relationship of the two groups is very close.

The species of *Xyleborus*, and of the whole tribe, are all ambrosia beetles, with a social organisation of extreme polygamy. The sexual dimorphism is very strongly developed, and the ratio of females to males is high. The males are most frequently, but by no means invariably, smaller than the females, and often show peculiar modifications, particularly of the prothorax, that suggest that they played a more active part in the social life of the species in the not too distant past. They are flightless, short-lived, and normally never leave the vicinity of the parent nest, although they frequently, and perhaps usually, crawl out into the open to die. The whole responsibility for the care of the new generation thus rests on the female, who, after mating, flies to a new host, where she makes her nest and remains with her offspring until they are mature. In Malayan conditions, as far as is known, no female raises more than one brood, and she dies in her nest soon after her offspring have left it.

In their detailed habits the various groups show considerable diversity, although for the most part there is fair uniformity within a group. Some infest small twigs and shoots, others larger branches and poles, and others again are found in large timber, while some appear ready to nest in material

of almost any size. Some are highly host-selective, associated with one particular plant family, whereas others will breed in almost any woody species or woody part of a plant, such as a hard fruit. With some little variation, however, they all require rather high humidity, and none have the ability, found in some Cryphalini and Crypturgini, of infesting dry vegetable matter. This need presumably arises from the requirements of the ambrosia fungi, but, very possibly as a consequence, the beetles themselves have apparently not acquired a resistance to dry conditions, in which they do not long survive.

The form of the nest also varies widely. Some species never enter the wood at all, but breed in tunnels that merely engrave its surface. Others penetrate to varying depths, and their tunnels may be irregularly or simply branched, or may be a simple or intricate pattern of galleries expanded here and there to form brood-chambers, but no species makes individual larval or pupal cells. Within a single subgenus or smaller group, however, variation of habits is much less marked: closely related species usually have the same form of nest, select the same hosts, and infest material of similar size.

It is usually only unhealthy or newly felled trees that become infested by species of *Xyleborus*. But some species are capable of attack if only a slight set-back has been administered to a host by such inevitable causes as transplanting or by temporarily unfavourable conditions such as a short drought. A few have become aggressive in certain circumstances, and have thus attained the status of important pests of living plants.

Xyleborus (the *semiopacus* group)

This small group, which is possibly worth generic rank, is represented in Malaya by two species, one of which is abundant and widely distributed.

X. semiopacus Eichh. This very widely distributed species ranges throughout the African and Asiatic tropics, and extends well into the Pacific, the territories in which it has actually been recorded being tropical east and west Africa, Madagascar, Mauritius, Seychelles, Ceylon, India, Burma, the Andaman Islands, Malaya, Sumatra, Java, Borneo, Celebes, the Philippines, Samoa, Hong Kong and Japan.

Throughout its range, *X. semiopacus* shows a considerable variation in size, from a length of 1.9 to about 3 mm., and all sizes between these limits have been found. In Malaya, however, and also in Borneo, the species occurs in two fairly well defined size grades, without intermediate forms, which have been described as distinct species, *X. semigranosus* Blandf., in which the adult female has a body length of about 2.4 to 2.5 mm., and *X. declivi-granulatus* Sch., with a length of 1.9 to 2.2 mm. If we consider the species as a whole, it is clear that these two forms cannot be regarded as distinct, but within the limited territory of Malaya it is convenient, and perhaps even advisable, to refer to them, provisionally at least, as separate varieties.

The variety **semigranosus** is very common throughout Malaya, where it has been recorded from the following hosts.

Araliaceae: *Arthrophyllum diversifolium*.

Burseraceae: Unidentified sp.

Caricaceae: *Carica papaya*.

Dipterocarpaceae: *Dipterocarpus grandiflorus*, *Dryobalanops oblongifolia*, *Shorea leprosula*, *S. macroptera*, *S. parvifolia*, *S. uliginosa*.

Euphorbiaceae: *Elateriospermum tapos*.

Lauraceae: *Litsea megacarpa*.
 Meliaceae: *Swietenia macrophylla*.
 Myrtaceae: *Achras sapota*.
 Sterculiaceae: *Scaphium* sp.
 Styracaceae: *Styrax benzoin*.
 Urticaceae: *Artocarpus* sp.

TABLE 6
 Host families of *Xyleborus semiopacus*

Family	Number of host species recorded in				
	var. <i>semigranosus</i>				var. <i>declivigranulatus</i>
	India Ceylon Burma	Malaya	Sunda Islands	W. Africa	Malaya Borneo
Ampelidaceae	1	—	—	—	—
Anacardiaceae	1	—	1	—	1
Annonaceae	1	—	—	1	—
Araliaceae	—	1	—	—	—
Burseraceae	—	1	1	2	2
Caricaceae	—	—	1	—	—
Casuarinaceae	—	—	1	—	—
Combretaceae	1	—	—	2	—
Compositae	—	—	2	—	—
Dilleniaceae	1	—	—	—	—
Dipterocarpaceae	2	7	1	—	9
Euphorbiaceae	1	1	1	—	1
Fagaceae	1	—	2	—	—
Gramineae	1	—	—	—	—
Guttiferae	1	—	—	—	—
Hamamelidaceae	—	—	1	—	—
Lauraceae	1	1	—	—	1
Leguminosae	4	—	2	7	3
Lythraceae	1	—	—	—	—
Malvaceae	—	—	1	1	—
Marcgraviaceae	—	—	—	—	1
Meliaceae	2	1	—	11	2
Myrtaceae	1	1	—	—	2
Ochnaceae	—	—	—	1	—
Palmaceae	—	—	2	—	—
Polygalaceae	—	—	—	—	2
Rubiaceae	—	—	1	1	1
Sapotaceae	—	1	1	—	1
Sterculiaceae	1	1	2	2	1
Styracaceae	—	1	—	—	1
Theaceae	1	—	2	—	—
Urticaceae	—	1	1	6	1
Verbenaceae	—	—	1	—	2

The smaller variety **declivigranulatus** is even more abundant in Malaya than *semigranosus*, and has been recorded from the following identified hosts.

Anacardiaceae: *Buchanania sessilifolm*.
 Dipterocarpaceae: *Dipterocarpus baudii*, *D. Kunstleri*, *Dryobalanops oblongifolia*, *Shorea* sp., *S. bracteolata*, *S. guiso*, *S. leprosula*, *S. parvifolia*, *S. uliginosa*.
 Euphorbiaceae: Unidentified sp.
 Lauraceae: *Litsea megacarpa*.
 Leguminosae: *Adenanthera pavonina*, *Pithecellobium lobatum*, *Whitfordiodendron pubescens*.
 Marcgraviaceae: *Tetramerista glabra*.

Meliaceae: *Aphanamixa rohituka*, *Swietenia macrophylla*.
 Myrtaceae: *Rhodamnia trinervia*.
 Polygalaceae: *Xanthophyllum* sp., *X. afile*.
 Rubiaceae: *Adina rubescens*.
 Sapotaceae: *Palaquium gutta*.
 Sterculiaceae: *Sterculia macrophylla*
 Styracaceae: *Styrax benzoin*.
 Urticaceae: *Artocarpus* sp.
 Verbenaceae: *Gmelina arborea*, *Vitex pubescens*.

These two lists have a good deal in common, which may lead us to suppose that, although the species certainly cannot be described as highly selective in its choice of hosts, it nevertheless shows some preferences. Indeed, in West Africa, Jones (1958) reports that it has a fairly well marked preference for the Meliaceae and Leguminosae (Mimosaceae), and further indications of plant families that attract the species are provided by table 6. Even allowing for differences in the size of the plant families and the abundance of their species, there is an indication that not only the two families previously mentioned, but also the Dipterocarpaceae, Sterculiaceae and Urticaceae, and possibly a few others, provide particularly attractive hosts. It may also be noted that a few families, such as the Myristicaceae, that are rather well represented in the forests of the eastern tropics, are absent from the long host list.

The two Malayan varieties of *X. semiopacus* have quite similar habits. They most usually infest cut poles and branches of small, to moderate, size, down to a minimum diameter of about 1.5 cms., but they not infrequently attack large logs, and will bore and breed successfully in newly sawn timber. They will attack living trees through bark injuries, and have been found in dead saplings. The species has also been reported, in New Zealand, in hardwood crates from Samoa. No clear instances of primary infestation of living trees have been observed in Malaya. In Ghana, however, Jones (l. c.) has noted heavy attacks on saplings of forest trees shortly after transplanting; the principal point of infestation was the root collar, where the stems were virtually girdled, and many of them were killed. In Java it has been found in apparently healthy *Cinchona*, and in sickly tea bushes.



Fig. 13. Transverse sections of small branches, with nests of *Xyleborus semiopacus*. Approx. nat. size.

In small material the nest (fig. 13) is usually bifurcated and circumferential, sometimes with an additional branch, or the main branches may be joined by a cross-tunnel. In larger hosts it has a few more branches, all lying more or less in one transverse plane, and occasionally the tunnels may be slightly and irregularly widened, but there are no definite brood-chambers. The frass is pushed out in the form of very compact cylinders, which do not break until they have reached a length of 2 to

3 cms., and in Malaya it is usually possible to diagnose the presence of *X. semiopacus* by its long cylinders of frass. Similar cylinders are formed by *X. foersteri* and *X. pruinosis*, but these are considerably larger species, the cylinders are therefore thicker, and they are almost invariably found in Burseraceae.

According to Beeson (1930), the life cycle in India varies in length from 6 weeks to 3 months. In Malaya, in nests of var. *semigranosus*, fully grown larvae have been found 5 weeks after cutting a host tree; in another host, swarming of a new generation was observed 40 days after initial infestation; and in sawn timber, with a moisture content of 82 to 86 per cent, nests of var. *declivigranulatus* showed all larval stages and one pupa 20 to 21 days after infestation. The young adult females fly mainly at dusk and dawn, and are attracted to light.

X. mascareniformis Egg. occurs also in Sumatra. In Malaya it is known from a single record, at an altitude of 3,400 feet in Perak.

Xyleborus (the major group)

This is a fairly widely distributed group, which is well represented in the Oriental region, and 17 species are known to occur in Malaya. It includes some of the largest species of *Xyleborus*. Several of them show a strong host association with the Dipterocarpaceae, but others are relatively unselective. The nest is usually of a rather simple pattern, with a few very regular branches lying in one transverse plane.

X. latus Egg. This species, which occurs also in Borneo, is one of the largest of the Malayan Scolytid ambrosia beetles, and is fairly common from sea level up to an altitude of at least 2500 feet. It has been found in dying and fallen trees of the following species:

Dipterocarpaceae: *Shorea* sp., *S. balanocarpoides*, *S. leprosula*.

Fagaceae: *Castanopsis sumatrana*, *Pasania sundaica*.

Leguminosae: *Intsia palembanica*.

Rosaceae: *Parinari griffithianum*.

In Sarawak it has also been found in a species of *Castanopsis*, and although it is apparently not highly host-selective, these records carry a suggestion that it may have some preference for the Dipterocarpaceae and Fagaceae. The observed infested material has varied in diameter from about 5 to 25 cms.

X. sarawakensis Egg. This is another very large species. It is found in Borneo, and is not uncommon in Malaya, where it has been taken from dying and cut trees of an unidentified species of the family Annonaceae, *Lophopetalum* sp. of the Celastraceae, *Xanthophyllum* sp. of the Polygalaceae, and *Parinari* sp. of the Rosaceae. There is no indication that it is at all selective in the choice of a host family and, although it has usually been found in large logs, it will also infest poles and branches down to a diameter of about 8 cms. The nest has a few regular branches, all in one transverse plane.

X. major Steb. This species, which is a shot-hole borer of moderate size, occurs in Burma and the Andamans, in Dipterocarpaceae. It is not common in Malaya, where it has been found, in Selangor, in a small log of *Shorea leprosula* of the family Dipterocarpaceae, but also in a dying *Palaquium* of the Sapotaceae. In the nest a short entrance tunnel is slightly expanded at its inner end, and from this expansion a few regular, curved branches lead off in one transverse plane.

X. siclus Sch. This is a shot-hole borer of moderately large size, which occurs also in Borneo. In Malaya it is rather common in dying or newly felled trees of the Dipterocarpaceae, in which family it has been recorded in *Dipterocarpus baudii*, *Dryobalanops oblongifolia*, *Shorea bracteolata*, *S. leprosula* and *S. materialis*. In Sarawak it has been found in *Shorea ovata* and another unidentified species of the same genus, and also in *Vatica*. It usually infests logs of at least 15 cms. diameter, but has occasionally been taken from 5 cm. material. The tunnels of the nest lie in one transverse plane. The entrance tunnel forks at a wide angle at a short distance below the surface of the wood, and the branches also fork at intervals to form a very regular pattern; there may be up to about 8 branches altogether, and the larvae pupate at the ends of these. The ejected frass is in the form of compact cylinders.

X. macropterus Sch. This species, which is of about the same size as *X. siclus*, is evidently widely distributed in the Dipterocarp forests of Malaysia, as it occurs also in Borneo and the Philippines. In Malaya it has, up to the present, been found only in Pahang, where it is not very rare, in association with the family Dipterocarpaceae, although it has never been taken in abundance. Recorded hosts in Malaya are felled trees of *Balanocarpus heimii*, *Shorea macroptera* and *S. ovalis*. In Sarawak it has been found in one species of *Shorea* and two of *Vatica*, and the only host recorded in the Philippines is also a Dipterocarp.

X. tortuosus Sch. has been found only twice, both times in Perak, and nothing is known of its habits.

X. xanthophyllus Sch. has been found only once in Malaya, in Pahang, in the wood of a cut tree, *Xanthophyllum* sp. of the family Polygalaceae. It evidently occurs also in Borneo, as Schedl (1955) records it, at Brisbane, in a newly imported log of "Borneo cedar",—almost certainly a Dipterocarp of the genus *Shorea*.

X. orbiculatus Sch. was discovered at an altitude of 5,000 feet at Cameron Highlands in Pahang, and has not been found again. Nothing is known of its habits.

X. pseudopilifer Sch. This species occurs in Malaya and Borneo, and is very common in both territories. It is, in fact, possibly the most abundant large Scolytid shot-hole borer of the Dipterocarpaceae, a family with which it appears to be strictly associated. In Malaya it has been recorded from *Balanocarpus heimii*, *Dipterocarpus baudii*, *D. grandiflorus*, *D. kunstleri*, *Dryobalanops aromatica*, *Shorea acuminata*, *S. bracteolata*, *S. lepidota*, *S. leprosula*, *S. ovalis*, *S. parvifolia* and several unidentified species of *Vatica*. In Sarawak, in addition to various species of *Shorea* and *Vatica*, it has been found in an unidentified species of *Cotylelobium*, and has been taken from *Dryobalanops aromatica* at an altitude of nearly 3,000 feet. No hosts other than Dipterocarpaceae have been reported.

X. pseudopilifer infests newly felled logs, unhealthy and dead trees, trees attacked by termites, and also healthy trees through bark injuries, but it has not yet been observed attacking sawn timber. In its choice of a host it is not highly size selective, and although it is most commonly found in logs of at least moderate size, it will infest small poles and branches, down to a minimum diameter of about 3 or 4 cms.

The nest (fig. 14) comprises a straight, more or less radial entrance tunnel, and a few very regular branches, all lying in one transverse plane, and the frass is pushed out of the tunnels in the form of compact cylinders.

Even when very small material is attacked, the mother beetle does not modify the normal pattern of the nest; consequently the breeding space may sometimes be very restricted, and the size of the brood that is successfully raised may vary widely in accordance with the size of the host. Young adults of the new generation, ready to swarm, have been observed in nests in a tree felled 45 days previously.

X. sexspinatus Sch. This large species has, up to the present, been found only in Malaya. It is not at all common, but has been recorded in Perak, Pahang and Selangor, infesting large logs of *Shorea macroptera*, *S. ovalis*, *S. parvifolia* and *S. uliginosa* of the family Dipterocarpaceae, with which it is probably strictly associated.

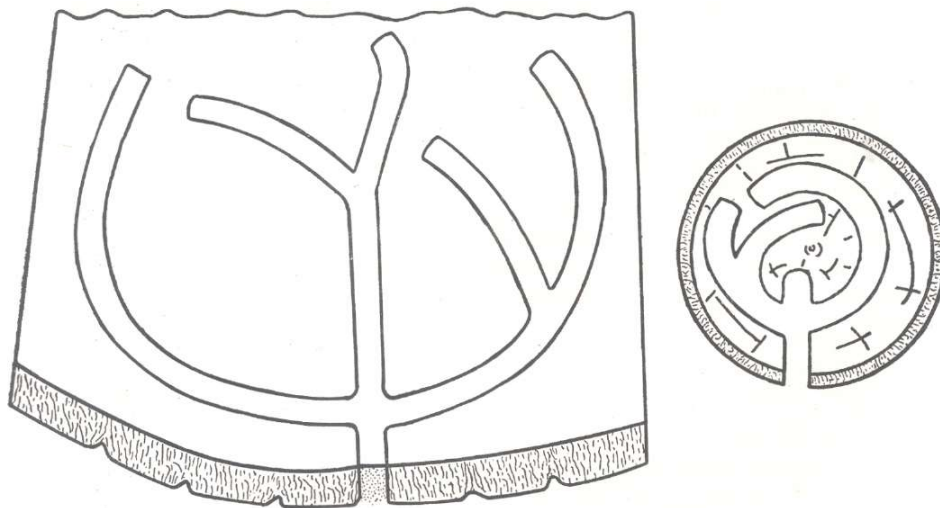

Fig. 14. Transverse sections of wood, with nests of *Xyleborus pseudopilifer*.
Approx. nat. size.

X. sundaensis Sch. This fairly large species, which was originally discovered in Java, is not common in Malaya, but has been found in Kelantan and Selangor. No Malayan hosts have been identified, but in Java, where it is evidently more abundant, it is recorded from diseased, dead or dying trees of two species of the family Anacardiaceae and one species of each of the families Leguminosae, Meliaceae, Urticaceae and Verbenaceae. It is therefore not included among the highly host-selective species of the group.

In Malaya, in spite of its rather large size, it has been observed infesting only very small, cut or dead trees. In one of these hosts, of 2 to 3 cms. diameter, the entrance tunnel of the nest led straight to the middle of the stem, where there was a longitudinal tunnel on both sides of it, a marked contrast with nests of *X. pseudopilifer* in similar material. In the longitudinal tunnels was a brood including half-grown larvae, fully grown larvae, and a few young adults.

X. vigilans Sch. This species occurs also in Java and Borneo. It is rare in Malaya, where it has been found in Kelantan, infesting dying and cut trees of small and moderate size. No host plants have been identified, and the nest has not been studied.

X. scapularis Sch. has been found only once, in the lowlands of Selangor, and nothing is known of its habits.

X. kajangensis Sch. The name of this species refers to Bukit Kajang, near Raub in Pahang, and not to the better known town in Selangor. It was taken from the wood of a cut *Canarium*, of the family Burseraceae, but has not been found again since its original discovery.

X. desectus Egg. was originally discovered in the Philippines, and occurs also in Java. It has been found only once in Malaya, in Selangor, and there have been no observations on its habits. In Java, Kalshoven (1959) records it from a species of the family Leguminosae, and describes its nest as a simple tunnel with a few branches.

X. obtusicollis Sch. is evidently widely distributed in Malaysia, as it was first found in the Philippines. In Malaya however, it has only been found once, in Pahang, infesting the wood of a log of *Vatica* sp., of the family Dipterocarpaceae. In the Philippines its only recorded host belongs to the same genus.

X. trolaki Sch. This fairly large shot-hole borer occurs in Malaya and Borneo, but is not very common in either of these territories. It has been found in Perak and Kelantan, in the wood of cut trees, *Cinnamomum* sp., of the family Lauraceae, and *Lophopetalum* sp. of the Celastraceae. In Sarawak it has been recorded in several dying (poisoned) trees of different but unidentified species. It is evidently not highly selective in its choice of hosts.

***Xyleborus* (the *quadricostatus* group)**

This is a group of rather small shot-hole borers, which usually infest twigs and small branches. They do not appear to be highly selective in their choice of hosts.

X. quadricostatus Sch. This species occurs also in Java, where it has been found at an altitude of about 2,500 feet, and in Borneo. In Malaya it has been found only in Selangor, infesting a small branch of *Shorea leprosula* of the family Dipterocarpaceae. In Sarawak it has been taken from small branches of a dying *Garcinia*, of the family Guttiferae, and old nests have been observed in the branches of *Camposperma* of the family Anacardiaceae.

It attacks the larger twigs and minor branches, of about 1 to 5 cms. diameter, of unhealthy, dead or fallen trees, but also lives and breeds in unhealthy or senile parts of the crowns of otherwise healthy trees. The short, radial entrance tunnel of the nest (fig. 15A) bifurcates, or else encircles the host without branching, in the transverse plane, and there are also one or two more or less longitudinal branches, which may be straight or spiral, and are usually irregular and of very variable width. The young broods live in these longitudinal branches, and pupate in them. The walls of the tunnels are typically stained quite black. Nests are often colonised by small ants, sometimes even before all the adults of the new generation have flown, but these ants do not seem to destroy the young beetles.

X. curvidentis Sch. This species occurs both in Malaya and Borneo, and in the former of these territories it has been found, up to the present, only in Selangor. Recorded hosts are a cut sapling of *Shorea leprosula*, of the family Dipterocarpaceae; the larger twigs of a young *Balanocarpus heimii* tree, of the same family, that had been killed by a root fungus; and a small, cut liane, *Fissistigma elegans* of the Annonaceae. In Sarawak it has been found in a twig of a cut *Shorea*. The *Shorea leprosula* sapling had been cut about 2 months previously, and its twigs were rather dry. The nest is very similar to that of *X. quadricostatus*.

Xyleborus (the *Ambrosiodmus* group)

The genus *Ambrosiodmus* of Hopkins has rarely found recognition as such, but it is fairly well defined and may one day have to be accorded generic rank. It is not a large group, but is sparsely represented in most tropical regions, and has spread northwards to the United States of America, Japan and Korea. Three species are known to occur in Malaya.

The species do not appear to be highly selective in their choice of hosts, and they will infest both small poles and branches, and large timber, but none is known to live and breed in shoots and twigs.

X. tegalensis Egg. This species is a rather large shot-hole borer, found in Assam, Burma, Sumatra, Java and Borneo. In Malaya it is not common in the lowlands, but there are several records of it in the hills, up to an altitude of about 4,000 feet. At lower levels it has rarely been found, and only one host, *Pometia pinnata* of the family Sapindaceae, has been identified. To judge by records in other countries, however, it is not at all selective in its choice of specific hosts. In India and Burma, Beeson (1941) records two host species in the family Lauraceae and one species each in the Dipterocarpaceae and Meliaceae. In Java, Kalshoven (1959) cites 3 host species in each of the families Leguminosae and Urticaceae, and one each in the Anacardiaceae, Compositae, Fagaceae, Hamamelidaceae, Lauraceae, Malvaceae, Melastomaceae, Myristicaceae, Pinaceae, Rutaceae, Sapotaceae, Staphyleaceae, Symplocaceae and Theaceae. Its apparent relative abundance in India and Java, and scarcity in Malaya, except, perhaps, at high levels, suggest that it is not really at home in an equatorial climate.

X. tegalensis has been found in diseased, dying and cut trees, the infested material varying considerably in size. The adult female flies at or after dusk, and is attracted to light.

X. lewisi Eichh. The true *X. lewisi* is found in Japan, Korea and Formosa, but is also represented in Malaya by a variety to which no separate name has yet been given. The Malayan form, - which is a shot-hole borer of moderate size, and which differs from the Japanese form by having markedly smaller tubercles on the declivity of the elytra, is by no means abundant, and infestation of host trees is usually light. It has been found in Kelantan and Selangor, in cut trees of large pole size, the identified hosts being *Dipterocarpus baudii*, *Parashorea lucida* and *Shorea leprosula*, all of which are included in the family Dipterocarpaceae, but it has also been taken from another unidentified host in a different family. It is possible that it does show some preference for the Dipterocarpaceae. Although, in various parts of its range, Murayama (1930, 1934, 1953, 1955) cites *X. lewisi lewisi* as infesting 17 host species in widely separated families, both of broad-leaved trees and of conifers, the Fagaceae predominate in this host-list, and there are several instances, among the Malaysian Scolytid fauna, where a preference for the Fagaceae in one species is changed to a preference for the Dipterocarpaceae in others closely related to it.

X. rubricollis Eichh. This species, which is found in Japan, is the smallest Malayan representative of the group, and also the most common although it is not abundant. It has been found infesting dead saplings and cut poles, of diameter varying from about 2 to 15 cms., of the following species.

Apocynaceae: *Dyera costulata*.

Burseraceae: *Canarium littorale*.

Dipterocarpaceae: *Dipterocarpus baudii*, *Shorea leprosula*, *S. singka-wang*.

Elaeocarpaceae: *Elaeocarpus petiolatus*.

Lauraceae: *Cinnamomum* sp.

In Japan Murayama cites 4 species in as many families as host plants. It therefore appears evident that *X. rubricollis* is not highly host-selective, and the high frequency of the Dipterocarpaceae in the Malayan list probably merely reflects the relative abundance of trees of this family.

Xyleborus (the *solidus* group)

This is a group of stout, convex beetles, found mainly in the Oriental region but also in Australia, Japan, the Pacific and tropical America. The species, of which 6 are known to occur in Malaya, are divided into two well defined sub-groups, but these are rather closely related and it is convenient to place them together.

In spite of their bulky form, they typically infest shoots, twigs and small poles, the larvae living together in one or two straight or spiral, longitudinal branch tunnels in the pith of small material. No species has yet become an important pest, but as shoot-borers they must always be suspect.

X. ater Egg. Most specimens of this species have previously been identified as the very closely related *X. mutilatus* Blandf., which apparently replaces it in Java and also occurs in Japan. *X. ater* was originally discovered in the Batoe Islands, and is very common in Malaya, where it has been recorded from the following hosts.

Dipterocarpaceae: *Dryobalanops oblongifolia*, *Shorea bracteolata*, *S. leprosula*, *S. sumatrana*.

Lauraceae: *Cinnamomum* sp., *Dehaasia cuneata* and 2 unidentified spp.

Leguminosae: *Adenantha pavonina*.

Meliaceae: *Swietenia macrophylla*.

Sapindaceae: *Pometia pinnata*.

Sapotaceae: *Palaquium stellatum*.

Tiliaceae: *Grewia latifolia*

Urticaceae: *Artocarpus* sp.

Verbenaceae: *Vitex pubescens*.

The species therefore cannot be described as highly host-selective although the unusually high frequency of the Lauraceae in the list is of interest.

X. ater infests shoots, stout twigs and very small poles, of about 1.5 to 5 cms. diameter, of cut, dead or unhealthy trees, but it has not yet been found as a primary borer of transplants. The nest normally comprises a circumferential tunnel in the transverse plane, although this may be scarcely developed in very small material, and a longitudinal tunnel, often exceeding a length of 5 cms., in the pith.

The size of young broods in nests examined in Malaya has varied from 9 to 29 individuals, and typical broods that have been observed are: (a) 8 fully grown larvae, 2 female pupae, 1 male pupa; (b) 20 rather young larvae of the same instar, 8 female pupae and one adult male; (c) 8 half-grown larvae, 2 fully grown female larvae and one young male pupa; (J) 15 female pupae, 3 young adult females, 2 adult males. These observations show that, as usual in the genus, the mother beetle lays clusters of eggs at intervals for some time, and the males develop more rapidly than the females. The ratio of females to males is evidently of the order of 8 to 10: 1.

It is believed that the female passes through 4 larval instars. A nest examined 9 to 10 days after initial infestation was found to contain eggs, and also larvae apparently belonging to 3 different instars. In another instance, a young male pupa and fully grown female larvae were present in a

tree cut 22 days previously. It therefore seems probable that the emergence of successive generations can be expected at intervals of about 4 weeks.

X. ursa Egg., which occurs also in Sumatra and New Guinea and presumably in the intervening territories, is known in Malaya from only a single record. It was found in Perak at an altitude of 3,000 feet.

X. ursulus Egg., which occurs also in Thailand, Java, Bali, Borneo and the Batoe Islands, is apparently mainly a hill species. In Malaya it has been recorded only rarely, and then at altitudes varying from 2,000 to 4,500 feet in Selangor and Pahang. Bornean records are also from altitudes of 3,000 to 5,000 feet, but in Java it has been found in the lowlands as well as at higher levels. Possibly the equatorial climate of the Malayan and Bornean lowlands is not entirely suited to it.

In Java, Schedl (1951) and Kalshoven (1959) record it from 2 species in each of the families Lauraceae, Leguminosae and Urticaceae, and in one species each in the Anacardiaceae, Araliaceae, Compositae, Cunoniaceae, Fagaceae, Malvaceae, Myristicaceae, Pinaceae, Rubiaceae, Staphyleaceae and Symplocaceae. No host plants have been identified in Malaya. It has been found in cut or unhealthy poles and branches, but has not occurred as a primary pest of young transplants.

X. comans Samps. This species, which occurs also in Java, Sumatra and Borneo, is the largest member of the group in Malaya, and is not abundant. It has been found infesting very small, cut poles and branches, usually of about 3 to 5 cms. in diameter, and has been recorded from the following hosts.

Dipterocarpaceae: *Shorea bracteolata*, *S. leprosula*.

Meliaceae: *Aphanamixa rohituka*, *Swietenia macrophylla*.

Myrtaceae: *Rhodamnia trinervia*.

As usual in the group, the nest comprises a circumferential gallery in the transverse plane, and a longitudinal tunnel in which the young brood lives.

X. globus Blandf. (Synonyms: *X. ursus* Egg., *X. fuscus* Egg.). This species, which is only a little smaller than *X. comans*, has been found in Sumatra, Java,—where it occurs up to altitudes exceeding 3,000 feet,—Borneo, the Philippines, New Guinea and the Solomon Islands. It is very common in Malaya, both in the lowlands and in the hills up to an altitude of more than 4,000 feet, and has been recorded from the following hosts.

Burseraceae: *Canarium littorale* and an unidentified species.

Dipterocarpaceae: *Dryobalanops oblongifolia*, *Shorea leprosula*.

Lauraceae: *Cinnamomum* sp., *Litsea megacarpa*.

Leguminosae: *Intsia palembanica*.

Meliaceae: *Dysoxylum* sp., *Swietenia macrophylla*.

Urticaceae: *Artocarpus* sp.

This list of host families bears some resemblance to the longer one already given for *X. ater*. In Java, however, the list of recorded hosts is very different, including 3 species of the Fagaceae, 2 species of each of the families Euphorbiaceae and Urticaceae, and one species each of the Compositae, Piperaceae, Rutaceae, Sterculiaceae and Symplocaceae.

X. globus usually breeds in material of about 1.5 to 4 cms. diameter, up to a maximum of about 10 cms., and often looks much too big to live comfortably in its host. It is most frequently found in the

branches of cut trees, but attack on *Intsia palembanica* saplings, transplanted a few days previously, has been noted, and it is very possible that, of the Malayan species of the group, it is potentially the most injurious.

The nest comprises a circumferential gallery in the transverse plane, and on each side of this there are one, two or even more longitudinal tunnels, straight or spiral, in which the young brood lives. In boring, the wood is cut in the form of short, coarse fragments, each about 0.5 to 1.0 mm. long and equally wide, which, when pushed out of the nest, adhere to form rather loose cylinders which soon break up. In Malaya, young adults of the new generation have been observed 30 days after the cutting of the host tree. In Java, Kalshoven (1959) records broods of up to 40 individuals and estimates the ratio of females to males at between 5 and 10 : 1.

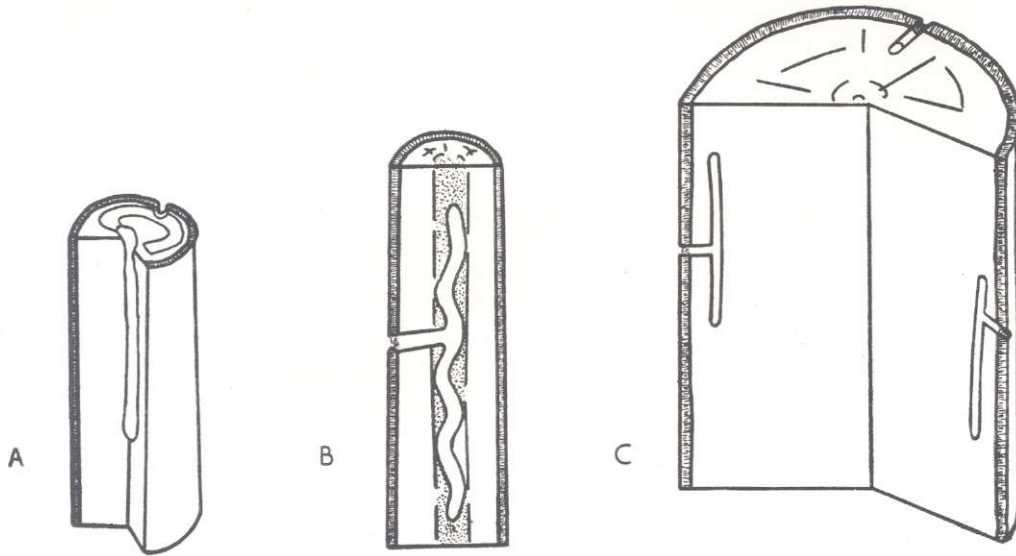

Fig. 15. A, section of twig, with nest of *Xyleborus quadricostatus*. B, section of twig, with nest of *Xyleborus improcerus*. C, section of small branch, with nests of *Xyleborus quadrispinosulus*. Approx. nat. size.

X. improcerus Samps. This rather distinctive species, which has bicoloured elytra as in some species of *Cnestus*, occurs in Thailand and Borneo, and is fairly common in most parts of Malaya, including the Langkawi Islands. The following are the recorded Malayan hosts, and it will be seen that, although the list is shorter than those available for *X. ater* and *X. globus*, it has some points of similarity with them.

Burseraceae: *Canarium littorale* and an unidentified species.

Dipterocarpaceae: *Dipterocarpus cornutus*, *D. costatus*, *D. kunstleri*.

Lauraceae: Unidentified sp.

X. improcerus normally infests the twigs and smaller branches of cut trees, breeding in material of diameter varying from about 1 to 5 cms., but it has not occurred as a more or less primary borer of transplants. The nest (fig. 15 B) comprises a circumferential gallery in the transverse plane, although the curvature of this tunnel may be scarcely developed in very small material, and either one or two longitudinal tunnels, up to about 3 or 4 cms. long, which are usually spiral in the pith of small hosts. The young brood lives in the longitudinal tunnel, the larvae lying, and later pupating,

in single file. The following brood has been observed in a nest 30 days after the cutting of the host tree: 2 fully grown larvae, 2 female pupae, 15 young adult females, 1 adult male.

Xyleborus (the *mucronatus* group)

This group of rather small beetles contains about 20 known species, mainly Oriental but also represented in tropical Africa. On the whole the species form a compact group although without very well defined extremities.

Most of them breed mainly in small branches and poles, but they are not included among the more aggressive twig-borers and are of relatively little economic importance. Seven species have been found in Malaya.

X. apiculatus Sch. is known from only one record. It was found in Selangor, in a branch of a fallen tree, *Dipterocarpus baudii* of the family Dipterocarpaceae.

X. approximatus Sch. This species, which also occurs in Java, is fairly common in Malaya, where it has been recorded from the following host plants:

Dipterocarpaceae: *Dryobalanops oblongifolia*, *Shorea leprosula* (several records), *S. macroptera*.

Meliaceae: *Swietenia macrophylla*.

Myrtaceae: *Rhodamnia trinervia*.

Verbenaceae: *Vitex pubescens*.

It is apparently not highly host-selective although the Dipterocarpaceae seem to be very attractive to it. It infests cut, stout twigs and small branches, varying in diameter from about 1.5 to 4 cms., and the nest has longitudinal tunnels which sometimes coalesce to form very irregular chambers. The tunnels do not penetrate deeply into the wood, and the species is not an aggressive borer of young, living trees. An almost mature brood, comprising 4 half-grown larvae, 6 pupae and 12 young adults, has been found in a nest 5 weeks after the cutting of the host tree.

X. haberkorni Egg. This small pinhole borer is widely distributed, and was originally discovered in East Africa, but most subsequent records have been from the Oriental region. It has been found in tropical India, Ceylon, Burma and Java, where it has been recorded at an altitude of 2,500 feet, and it is common in Malaya, where the following host plants have been identified:

Dipterocarpaceae: *Dryobalanops oblongifolia*: *Shorea bracteolata*, *S. leprosula*, *S. sumatrana*.

Leguminosae: *Adenanthera pavonina*.

Meliaceae: *Swietenia macrophylla*.

Sapotaceae: *Palaquium maingayi*.

Styracaceae: *Styrax benzoin*.

Verbenaceae: *Vitex pubescens*.

Table 7 compares the above list with the hosts recorded in India, Burma and Java, and it will be seen that the beetle has been found in 24 species of 14 plant families. It is therefore certainly not highly host selective, but there is a suggestion that the Dipterocarpaceae, Leguminosae and Meliaceae may be particularly attractive to it.

The species attacks unhealthy, dead or cut trees, infesting the small branches of about 2 to 8 cms.,—but most usually 2 to 3 cms.—diameter. It has also been found in dead transplants, but has apparently not been responsible for their death. Infestation is often heavy, and the larvae live

crowded together in a longitudinal tunnel in the middle of a branch. The tunnels typically show a dense growth of mycelium, which Muller (1933) says is an ambrosia fungus of *Monilia* type.

TABLE 7
HOST FAMILIES OF XYLEBORUS HABERKORNI

Family	Number of host species recorded in		
	India/ Burma	Malaya	Java
Anacardiaceae	1	—	—
Combretaceae	1	—	—
Dipterocarpaceae	1	4	—
Erythroxylaceae	—	—	1
Leguminosae	1	1	2
Meliaceae	—	1	2
Myrtaceae	1	—	—
Piperaceae	—	—	1
Rubiaceae	—	—	1
Salicaceae	1	—	—
Sapotaceae	—	1	—
Staphyleaceae	—	—	1
Styracaceae	—	1	—
Verbenaceae	—	1	1

X. quadrispinosulus Egg. This species, which is known also in Burma, Sumatra and Java, is rather common in Malaya, where it has been recorded from the following hosts:

- Dipterocarpaceae: *Shorea leprosula*, *S. sumatrana*.
- Leguminosae: *Adenantha pavonina*.
- Meliaceae: *Swietenia macrophylla*.
- Sapindaceae: *Pometia pinnata*.
- Verbenaceae: *Vitex pubescens*.

This list has much in common with those already given for *X. approximatus* and *X. haberkorni*. In Java and Sumatra it has been found in one species of each of the families Compositae, Erythroxylaceae, Leguminosae, Meliaceae, Myristicaceae, Rubiaceae and Sapindaceae. It has been recorded from coffee bushes, but apparently only as a secondary borer.

X. quadrispinosulus usually infests the smaller branches and larger twigs of cut trees. The nest (fig. 15C) comprises an entrance tunnel leading to the middle of the twig, where there is a longitudinal tunnel, 2 to 3 cms. long, in which the young stages live crowded together. The frass is pushed out in the form of fine cylinders. In one host, cut about 6 weeks previously, a nest was found to contain 12 young larvae, 14 half-grown larvae (probably 2 males), 21 female pupae and 2 male pupae. It is thus evident that the eggs are produced in batches at intervals for some time, and the ratio of females to males is probably of the order 9 : 1. The largest brood recorded by Kalshoven (1959) in Java contained 25 eggs and 45 young larvae.

X. justus Sch. This species, which also occurs in Java, has been found only once in Malaya, in Selangor, and no host-plant has been identified, but in Java it has been recorded from one species in each of the families Compositae, Lauraceae, Leguminosae, Rhizophoraceae and Urticaceae. In Malaya it was found infesting a small, cut pole, of about 3 cms. diameter. The tunnels branched irregularly in both transverse and longitudinal planes, and there was an irregular brood-chamber, rather less than 1 cm. square, in the longitudinal plane. The brood was fairly large, and included half-grown larvae, pupae and young adults.

X. mucronatus Egg. This pinhole borer, which also occurs in Java, is not uncommon in Malaya, where it has been found infesting small, cut poles and branches, of about 1.5 to 15 cms. diameter, of *Dyer a costulata* of the family Apocynaceae, *Arthrophyllum diversifolium* of the Araliaceae, *Grewia latifolia* of the Tiliaceae, and *Gmelina arborea* of the Verbenaceae. In Java it has been found in species of the Burseraceae, Hamamelidaceae and Rubiaceae, and its recorded hosts include coffee and quinine, but it has not occurred as a primary borer. These short host lists give no hint of any marked preferences.

The material infested may be rather dry wood as well as sappy, broken, still living branches. The tunnels may include very irregular brood-chambers in the longitudinal plane.

X. ciliatiformis Sch. belongs to the fringes of the *mucronatus* group. Unlike the species previously discussed, it is mainly a pinhole borer of fairly large timber, although it will also infest branches and poles down to a diameter of about 10 cms. It was originally discovered at Brisbane, in imported logs of "Borneo cedar".—almost certainly a species of *Shorea* of the family Dipterocarpaceae,—and it has since been recorded, in Borneo, in a *Shorea* of the same group, as well as in one of another subgenus (*Eushorea*). It is rare in Malaya, but has been found, in Kelantan and Selangor, in cut trees of *Shorea balanocarpoides*, and of *Pasania sundaica* of the Fagaceae. It probably has a marked preference for the Dipterocarpaceae.

In one nest that has been examined there was an irregular, terminal brood-chamber in the longitudinal plane, and fully grown larvae have been found 6 weeks after the cutting of the host tree. The tunnels do not penetrate deeply into the wood, and the species is of little economic importance.

***Xyleborus* (the *indicus* group)**

This is a rather small group of cylindrical pinhole-borers, which are, however, widely distributed. It is represented in Malaya by 3 common species. They are of some economic importance as borers of large timber, as their irregularly branched tunnels, which are not provided with brood chambers, penetrate fairly deeply into the wood, and infestation by them is often heavy.

X. indicus Eichh. This rather variable species is widely distributed, and has now been found in tropical west and east Africa, India, Ceylon, Burma, Indo-China, Malaya, Sumatra, Java, Borneo, the Philippines, New Guinea, Queensland, the New Hebrides and Fiji. Its tolerance of a considerable range of climatic conditions is also indicated by its altitudinal distribution, from sea level up to about 6,000 feet in some of these territories.

In Malaya, *X. indicus* is common but not abundant, and has been recorded from *Endospermum malaccense*, of the family Euphorbiaceae, *Koompassia malaccensis* of the Leguminosae, *Parinari* sp. of the Rosaceae, and *Artocarpus scortechinii* of the Urticaceae. This short list is compared in table 8 with the host families found in some other territories, and it will be noticed that the West African list is so much longer than any other that we may perhaps suspect the beetle of not being

very aptly named. In spite of the 8 host families recorded in Ghana and the Ivory Coast, however, Jones (1958) considers *X. indicus* to be rather selective, with a marked preference for the Meliaceae and Urticaceae (Ulmaceae). This view receives some support from table 9, but we should probably add the Leguminosae, which provide hosts in all the territories listed. Of the remaining 11 families, only 3, the Euphorbiaceae, Sterculiaceae and Verbenaceae, appear in more than one column of the table. The absence of the Dipterocarpaceae from all available host-lists is noteworthy.

X. indicus is a rather small pinhole-borer, found in Malaya in dying, dead, and newly felled trees; it has not been observed in unseasoned sawn timber, and it normally infests material of moderate to large size. The nest comprises tunnels with numerous irregular branches, and without brood chambers, penetrating the wood to a depth of several inches.

X. parvulus Eichh. This small pinhole borer has been found in India, Ceylon, Burma, Thailand, Java, Borneo, the Philippines and Fiji. In Malaya it is the least abundant species of the group, but is nevertheless not uncommon, and has been found in unhealthy trees of *Hevea brasiliensis*, of the family Euphorbiaceae, and in felled trees of *Garcinia* sp. of the Guttiferae, *Eugenia* sp. of the Myrtaceae, and *Artocarpus polyphema* of the Urticaceae. In Sarawak it has been found in dying trees of another species of *Artocarpus*, and of an unidentified species of the Leguminosae. These records convey no suggestion of strong host preferences.

TABLE 8
HOST FAMILIES OF XYLEBORUS INDICUS

Family	Number of host species recorded in			
	W. Africa	India	Malaya	Malay Archipelago
Apocynaceae	1	—	—	—
Combretaceae	3	—	—	—
Ebenaceae	—	1	—	—
Euphorbiaceae	—	—	1	1
Leguminosae	2	1	1	2
Malvaceae	—	—	—	2
Meliaceae	4	—	—	2
Myristicaceae	2	—	—	—
Rosaceae	—	—	1	—
Rubiaceae	2	—	—	—
Rutaceae	—	—	—	1
Sterculiaceae	1	1	—	2
Symplocaceae	—	—	—	1
Urticaceae	7	1	1	2
Verbenaceae	—	1	—	1

The species usually infests stems of moderate to large size, and it has not been observed attacking unseasoned sawn timber. The nest is a much branched tunnel, without brood chambers, more or

less confined to one transverse plane and penetrating for several inches into the wood. The flight of the adult female is nocturnal, and she is attracted to light.

In Malaya, Sharpies (1918) has suspected *X. parvulus* of being a vector of a serious disease, *Ustulina zonata*, of Para rubber trees (*Hevea brasiliensis*). As the beetle, however, is never a primary borer, apparently shows no particular attraction to *Hevea*, and is less abundant than some other Scolytids and Platypodids that attack the tree, its role as a vector is probably at the most a minor and sporadic one.

X. similis Ferr. This pinhole borer might well be considered as merely a relatively large variety of *X. parvulus*, and it has a rather similar distribution, occurring in tropical India, Ceylon, Burma, the Andaman Islands, Malaya, Java, Borneo, the Philippines, New Guinea, the Solomon Islands, Queensland, Formosa, Guam and Christmas Island. There is also a record of it in New South Wales, but this is probably only of a temporary importation.

In Malaya, *X. similis* is much more abundant than the smaller *X. parvulus*, and has been found in 19 host species in 14 plant families, as listed below.

Annonaceae: Unidentified sp.

Apocynaceae: *Alstonia spathulata*.

Araliaceae: *Arthrophyllum diversifolium*.

Dipterocarpaceae: *Dipterocarpus baudii*, *Dryobalanops aromatica*, *Shorea leprosula*.

Elaeocarpaceae: *Elaeocarpus petiolatus*.

Euphorbiaceae: *Hevea brasiliensis*.

Guttiferae: *Calophyllum* sp., *Garcinia* sp.

Lauraceae : Unidentified sp.

Leguminosae: *Albizzia falcata*, *Intsia palembanica*.

Rhizophoraceae: *Bruguiera parviflora*, *Pellacalyx saccardiana*.

Sterculiaceae: *Sterculia macrophylla*.

Styracaceae: *Styrax benzoin*.

Urticaceae: *Artocarpus scortechinii*.

Verbenaceae: *Vitex pubescens*.

Table 9 compares this host list with those available in other territories and shows a typical host-pattern of a very unselective species. It includes 28 host families and only about twice that number of species. None of the major tree families of the region, with the possibly noteworthy exception of the Meliaceae, is missing, and the relatively frequent recurrence of the Dipterocarpaceae, Euphorbiaceae, Leguminosae, Sterculiaceae and Urticaceae is probably no more than may be expected from their abundance and general attraction to ambrosia beetles. More than half the families have provided hosts in only one of the wide territorial units of the table.

X. similis is very common in open, agricultural country as well as in dense forest, and the females often fly into houses in the early evenings or after dark, when they are attracted to light. The species has been found in unhealthy and dead trees, cut trees, and in charred stumps in new clearings, but has not yet been observed attacking unseasoned sawn timber. It is not highly size-selective, but has most frequently been found in rather small stems of about 8 to 25 cms. diameter, and the lowest limit of host size is about 4 cms. The nest is similar to that of *X. parvulus*, consisting of a much branched tunnel, without brood chambers, usually more or less confined to one transverse plane. Young adults of the new generation have been found in a nest 5 weeks after the cutting of the host tree.

TABLE 9
HOST FAMILIES OF XYLEBORUS SIMILIS

Family	Number of host species recorded in			
	Indian Area	Malaya	Malay Archipelago	Australia and Pacific
Anacardiaceae	4	—	—	—
Annonaceae	—	1	—	1
Apocynaceae	—	1	—	—
Araliaceae	—	1	—	—
Bignoniaceae	1	—	—	—
Boraginaceae	1	—	—	—
Bursaceae	1	—	—	—
Combretaceae	5	—	—	—
Cornaceae	1	—	—	—
Datisaceae	1	—	—	—
Dilleniaceae	—	—	1	—
Dipterocarpaceae	3	3	—	—
Elaeocarpaceae	—	1	—	—
Euphorbiaceae	2	1	—	2
Fagaceae	—	—	1	—
Guttiferae	—	2	—	—
Lauraceae	—	1	—	—
Leguminosae	6	2	1	—
Malvaceae	3	—	—	—
Myristicaceae	1	—	—	—
Myrtaceae	2	—	—	—
Rhizophoraceae	1	2	—	—
Rubiaceae	2	—	—	—
Sapotaceae	1	—	1	—
Sterculiaceae	3	1	—	1
Styracaceae	—	1	—	—
Urticaceae	2	1	—	1
Verbenaceae	2	1	—	—

***Xyleborus* (the *perparvus* group)**

This is a fairly large and widely distributed group of small, cylindrical pinhole borers. It is represented in Malaya by 4 species, of which 3 are rather common, but they are mainly borers of branches and small poles, and therefore of little economic importance,

X. perparvus Samps. This little species occurs in north-eastern India, Burma, the Andaman Islands and Borneo, and is common in the lowlands of Malaya, where it possibly originated in recent times, or more probably, whether it has spread from the north, as it is rare in Borneo and not yet known elsewhere in Malaysia. The host plants recorded in Malaya are listed below.

Dipterocarpaceae: *Dipterocarpus baudii*, *Dryobalanops aromatica*, *Shorea leprosula*, *S. macroptera*, *S. parvifolia*, *S. sumatrana* and 2 unidentified *Shorea* spp.

Elaeocarpaceae: *Elaeocarpus petiolatus*.

Euphorbiaceae: *Elateriospermum tapos*, *Macaranga* sp.

Fagaceae: *Castanopsis sumatrana*.

Lauraceae: Unidentified sp.

Sapotaceae: *Palaquium stellatum*.

In India and Burma it has been found in 2 species of the Dipterocarpaceae, and one species in each of the families Anacardiaceae, Burseraceae and Sapotaceae; and the only Bornean record is from *Vatica* sp. of the Dipterocarpaceae. It is apparently not highly selective in its choice of hosts, although the Dipterocarpaceae are evidently strongly attractive to it.

X. perparvus is a pinhole borer of cut branches and poles, of diameter varying from about 3 to 15 cms., also of small, unhealthy trees, and infestation may continue until the wood is rather dry. The tunnels are irregularly branched, and the nest is also provided with several small brood-chambers in the longitudinal plane. The frass is pushed out in the form of fine, compact cylinders, which reach a length of about 1 cm. before breaking.

X. nudibrevis Sch. This species has been found only in Malaya, where it is fairly common, at least locally, in small poles and in branches of cut or unhealthy trees, and infestation may continue until the wood is rather dry and shows incipient decay. The recorded hosts are *Arthrophyllum diversifolium* of the family Araliaceae, *Shorea leprosula* of the Dipterocarpaceae, *Elateriospermum tapos* of the Euphorbiaceae, and *Castanopsis sumatrana* of the Fagaceae.

The nest comprises an irregularly branched tunnel, with several small brood-chambers, in the longitudinal plane, at intervals along it. To judge by the fact that all instars may be found simultaneously in one nest, the mother beetle continues to lay eggs, in clusters, for a considerable time, the offspring from each cluster of eggs inhabiting a separate brood chamber.

Heavy infestation has been observed in a small, fallen branch when the wood showed distinct decay, was also infested by termites, and had a moisture content as low as 22 to 28 per cent. It has also been found in a small, rotting pole, where all instars were present and eggs were still being laid. Although the wood of both these hosts was rather exceptionally dry, however, they were lying in moist places and the microclimate of the nests must have been very humid; when the hosts were removed to the relatively dry atmosphere of the laboratory, the whole beetle population, in all stages of development, died within 24 hours.

X. abbreviatus Sch. is known in Malaya only, and has only been found twice, in Selangor. It has been recorded as infesting a cut sapling, of 2 to 3 cms. diameter, of *Shorea leprosula* of the family Dipterocarpaceae.

X. minutus Blandf. (Synonyms: *X. brevisculus* Sch., *X. pernitidus* Sch.). This species is not very closely related to *X. perparvus*, but may possibly be considered a member of the same group, and at least this is a convenient place to include it. It probably occurs throughout Malaysia, and has been recorded in Java, Borneo and Japan. It is not uncommon in Malaya as a pinhole borer of cut poles and branches of about 2 to 18 cms. diameter, and has also been found in newly sawn timber. Its recorded hosts in Malaya are *Dipterocarpus baudii* and *Shorea uliginosa* of the family Dipterocarpaceae, *Elaeocarpus petiolatus* of the Elaeocarpaceae, and *Achras sapota* of the Sapotaceae. In Borneo it has been found in a species of *Shorea* and, in Japan (Murayama, 1955), in a species of *Camellia* of the family Theaceae. It is apparently not an aggressive species, and is likely to do serious damage only when it attacks seasoning stacks in sawmill yards.

***Xyleborus* (the *exiguus* group)**

The species included here perhaps form a rather artificial group, but they are few in number and it is convenient to place them together. They are mainly pinhole borers but their small tunnels are

enlarged by brood- chambers. *X. caelator*, however, is exceptional in never penetrating the wood, but living and breeding on its surface beneath the bark.

X. andrewesi Blandf. This small pinhole borer is widely distributed in the tropics of the Old World, and has now been recorded in East Africa, Seychelles, India, Burma, Indo-China, the Andaman Islands, Java and Borneo.

TABLE 10
HOST FAMILIES OF XYLEBORUS ANDREWESI

Family	Number of host species recorded in			
	India	Malaya	Java	Borneo
Anacardiaceae	4	—	3	—
Apocynaceae	—	—	1	—
Burseraceae	2	—	2	—
Combretaceae	2	—	—	—
Dilleniaceae	1	—	—	—
Dipterocarpaceae	3	2	—	1
Fagaceae	—	1	2	—
Guttiferae	—	1	1	1
Lauraceae	—	—	1	—
Leguminosae	3	1	2	—
Malvaceae	1	—	—	—
Meliaceae	—	—	3	—
Myristicaceae	1	—	—	—
Myrtaceae	—	—	1	—
Rubiaceae	—	—	1	—
Rutaceae	—	—	1	—
Sapindaceae	—	1	—	—
Sapotaceae	—	1	—	—
Sterculiaceae	2	—	1	—
Theaceae	—	—	1	—
Tiliaceae	—	—	1	—
Urticaceae	—	—	1	—

Although it is common in Malaya, however, it has never been found in abundance, and only a few hosts, listed below, have been identified. In India and Java it appears to be more plentiful, and it possibly prefers a climate more seasonal than that of Malaya or Borneo. In Java it is reported to be common both in the plains and in the hills of the cultivated area, up to an altitude of about 3,500 feet.

Host plants recorded in Malaya are *Shorea leprosula* and *S. ovalis* of the family Dipterocarpaceae, *Castanopsis sumatrana* of the Fagaceae, *Mesua ferrea* of the Guttiferae, *Pometia* sp. of the Sapindaceae, and *Palaquium stellatum* of the Sapotaceae. These hosts are compared, in table 10, with the host families recorded in other territories, and give no strong suggestion of marked

preferences, except possibly in the frequency of the Anacardiaceae in India and Java. Among plants of agricultural importance, the species has been taken from cocoa, quinine and tea, but is neither a primary nor an important pest.

TABLE 11
HOST FAMILIES OF XYLEBORUS EXIGUUS

Family	Number of host species recorded in				
	India etc.	Malaya	Sumatra/Borneo	Java	Philippines/Pacific
Anacardiaceae	—	—	—	2	1
Apocynaceae	—	—	—	2	—
Burseraceae	1	—	—	—	—
Combretaceae	1	—	—	—	—
Dipterocarpaceae	1	—	1	—	—
Euphorbiaceae	—	—	—	1	—
Fagaceae	—	1	—	1	—
Hypericaceae	—	—	1	—	—
Lauraceae	—	1	—	—	—
Leguminosae	1	1	—	2	—
Malvaceae	—	—	1	—	—
Meliaceae	—	—	—	—	2
Myrtaceae	—	1	—	—	—
Palmaceae	—	—	—	—	1
Rutaceae	—	—	—	—	1
Sterculiaceae	—	—	—	1	—
Theaceae	—	—	—	1	—
Urticaceae	1	1	—	—	1
Verbenaceae	—	—	—	1	—

The tunnels (fig. 16) of *X. andrewesi* do not penetrate very deeply into the wood. The entrance tunnel of the nest is radial or oblique to a depth of about 2 cms., and then takes a circumferential course for a short distance, encircling the pith in small hosts. At the end of the tunnel is a rather large brood chamber in the longitudinal plane, and this is usually markedly deeper below than above the tunnel. Five broods examined by Kalshoven (1959) in Java showed from 22 to 39 (average 32) individuals, with an average ratio of females to males of 7.5 : 1.

X. exiguus Walk. This little species is distributed throughout the Oriental region, and extends far across the Pacific. It has been found in Ceylon, Burma, the Andaman Islands, Sumatra, Java, Borneo, the Buru Islands, Philippines, New Guinea, Samoa, Fiji and Tahiti. It also has a moderately wide altitudinal range in these countries; in Java it is common up to 1,000 feet, and occurs to more than 3,000 feet, and its distribution in Ceylon is similar. In Malaya, however, like *X. andrewesi*, it is rather common but has never been found in abundance, its hosts being usually only very lightly infested.

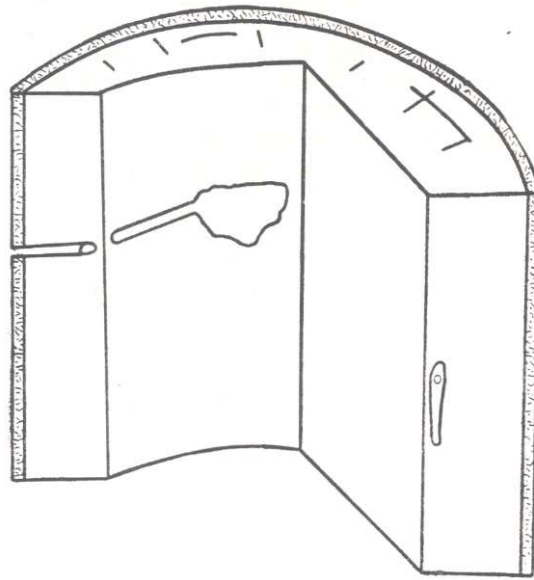

Fig. 16. Section of branch, with nests of *Xyleborus andrewesi*. Approx. nat. size.

In Malaya, *X. exiguus* has been recorded from dying and cut trees of *Quercus* sp. of the family Fagaceae, *Cinnamomum iners* of the Lauraceae, *Parkia speciosa* of the Leguminosae, *Eucalyptus deglupta* of the Myrtaceae, and *Artocarpus* sp. of the Urticaceae. Table 11 compares this short list with the host families recorded in other territories, and there is no suggestion of selectivity. Of plants of value in agriculture it has been associated with coconut, rubber and tea, but not as a pest of any importance.

The species is not very size-selective in its choice of a host, and will attack fairly small branches and poles as well as large logs, but it does not infest twigs, and has not yet been found in unseasoned sawn timber. The nest is of the same general form as that of *X. andrewesi*. The entrance tunnel, which is radial, oblique or slightly curved, is short, and penetrates the wood at most to a depth of little more than 1 cm., where there is a rather large brood chamber, usually about 1 cm. square but sometimes twice as large; it normally lies in the longitudinal plane, but, according to Speyer (1923), it may be oblique or even in the transverse plane; beyond the chamber the tunnel often continues for a short distance.

Speyer (I.e.) has found up to 20 individuals in one brood in Ceylon. In Java Kalshoven (1959) found up to 77 individuals in young broods, but the largest mature brood observed by him contained 37 individuals; he found only 8 males among 200 females, but there is evidence to suggest that a normal ratio is about 9 : 1 .

The young adult female often flies at dusk, and is attracted to light, but has also been observed on the wing, even in open country, in the heat of the day.

X. metacuneolus Egg. This species, which is known to occur also in Java and Formosa, has been found only once in Malaya, in Selangor. It was infesting an unidentified, small, dead tree. The tunnels of the nest were irregularly branched, with several small brood-chambers lying in the

longitudinal plane. In Java it has been recorded from dead and dying branches and poles of 3 species of the family Anacardiaceae and one species of the Meliaceae.

X. cuneiformis Sch. is known in Malaya only, and is not common. It has been found, in Selangor, infesting a small, cut pole, of about 5 cms. diameter, of *Shorea leprosula* of the family Dipterocarpaceae, and also in a 3 cm. branch, fallen and rather dry, of *Shorea gysbertsiana*. The tunnels are branched, with small brood-chambers lying in the longitudinal plane.

X. caelator Brne. This little species, which is barely more than 1 mm. long and one of the smallest of Malaysian Xyleborini, is not uncommon in both Malaya and Borneo, but has yet to be found in other neighbouring territories. In Malaya it has been recorded from dying and cut trees of *Shorea macroptera* and *S. parvifolia* of the family Dipterocarpaceae, and in Sarawak it has been found in cut trees of *Shorea ovata* and several other species of the same genus. It appears to have a strict host association with the Dipterocarpaceae. It usually infests large logs, but will also breed in fairly small branches and poles. Infestation is sometimes heavy, but the nests are very small and competition for space is not severe.

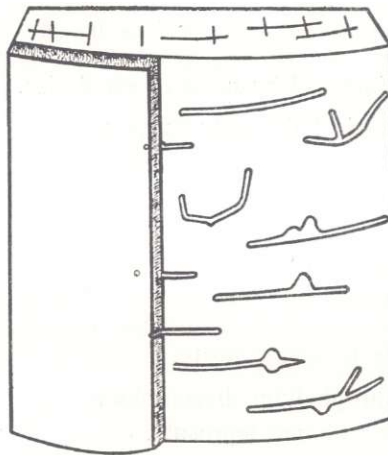

Fig. 17. Surface of log, with nests of *Xyleborus caelator*. Approx. nat. size.

X. caelator is one of the few species of *Xyleborus* that live entirely between the bark and the wood, into which it does not penetrate. Engraving the surface of the wood, the mother beetle makes a rather short tunnel (plate 5, and fig. 17), which is usually transverse but often irregular and sometimes branched, and in this she lays clusters of eggs. At a later stage the tunnel is widened in places to form small chambers, and this appears to be at least partly the work of the larvae.

The broods that have been observed are rather small. In Malaya, fully grown larvae have been found in a nest 7 weeks after the cutting of the host tree, and young adults, ready to swarm, have been found after 10 weeks; probably, however, the period required for development is much shorter than this. In Sarawak, 32 days after the cutting of the host tree, a brood comprised 4 eggs, 5 young larvae, and one fully grown larva. In another host, 39 days after a host had been cut, two broods included: (a) 4 eggs, 3 half-grown and 8 fully grown larvae; and (b) 2 half-grown larvae, 4 fully grown larvae, 4 female pupae and one male pupa. It is evident from these observations that the eggs are laid in small clusters at intervals, and it is believed that the female passes through 3 larval instars.

Predaceous larvae of the family Cleridae are very common in nests of *X. caelator*.

***Xyleborus* (the *Euwallacea* group)**

Euwallacea is another of Hopkins' genera that has never been accepted, but it shows some distinctive characters and it is possible that, in a world revision of the tribe, it would be found necessary to raise it to generic rank. It is a moderately large group, mainly Oriental, and 12 species are known to occur in Malaya. A few of the species are important pests, both in forestry and agriculture.

In natural conditions the species are not, as a general rule, highly selective in their choice of hosts, but some of them nevertheless show signs of distinct preferences, and in certain circumstances two of them, *X. fornicatus* and *X. destruens*, are particularly interesting in having adapted themselves to specific host plants. The typical nest of the group is a rather simply and widely branched tunnel, lying more or less in one transverse plane, and without brood chambers, but this pattern may be modified to some extent to suit the restrictions imposed by hosts of small size.

X. interjectus Blandf. This fairly large shothole borer is very widely distributed. It is known to occur in tropical India, Ceylon, Borneo, the Andaman Islands, Malaya, Sumatra, Java, Bantam, Borneo, the Batoe Islands, the Philippines, Indo-China and Japan, and recently Schedl (1958) has identified specimens from East Africa. According to Beeson (1930), it is the most abundant large shothole borer of the wetter parts of tropical India. In Java it occurs from sea level up to an altitude of about 4,000 feet. In Malaya it is common in all districts, to the Langkawi Islands in the north, and has been recorded from the following hosts:

Araliaceae: *Arthrophyllum diversifolium*.

Dipterocarpaceae: *Shorea leprosula*.

Euphorbiaceae: *Endospermum malaccense*, *Hevea brasiliensis*.

Lauraceae: Unidentified sp.

Leguminosae: *Koompassia malaccensis*.

Polygalaceae: *Xanthophyllum* sp.

Urticaceae: *Artocarpus elasticus*, *A. scortechinii*.

Table 12 compares this list with the host families recorded in some other territories, and contains points of interest both in the similarity and the divergence of the hosts found in the various countries. It is evident that the beetle will readily infest trees in numerous plant families, but it is apparently more strongly attracted to some, notably the Urticaceae, than to others. In the Malayan and Bornean lists the frequency of hosts in the Dipterocarpaceae is perhaps unusually low. Of families that are usually well represented in Oriental forests, the Myristicaceae and Sapotaceae are absent from the lists.

X. interjectus has been found in injured trees, dying trees, and recently cut logs. It normally infests timber of moderate to large size, down to a diameter of about 15 cms., but is occasionally found in material as small as 7 or 8 cms. The nest (fig. 18) has a rather short entrance tunnel which soon branches at a wide angle, the branches tending to lie in one transverse plane and to follow the curvature of the log; there are no brood chambers. According to Beeson (1941), the nest is a simple, branched tunnel, which rings or partially encircles the sapwood of poles, and runs with many short branches to the heart of large logs. The latter type, however, has not been observed in Malaya or Borneo, where the branch tunnels are typically rather few and the depth of penetration into the wood does not exceed a few inches. In Ceylon, according to Speyer (1923), the nests consists of much branched, horizontal galleries, penetrating to a depth of about 3 inches and covering an area of about 7 square inches.

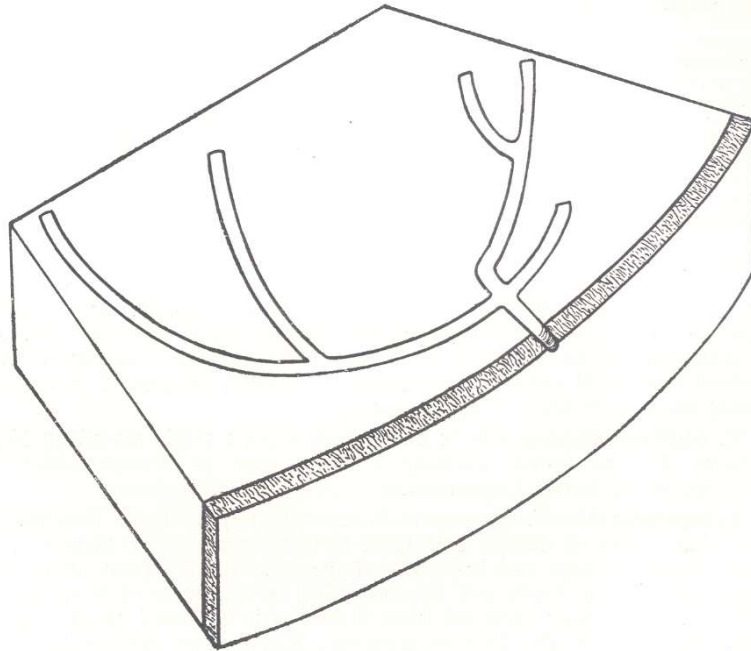

Fig. 18. Transverse section of wood, with nests of *Xyleborus interjectus*. Approx. nat. size.

X. whitfordiendrus Sch. is known only from a single record, in Negri Sembilan. It was found infesting a fallen tree of *Whitjordiendron pubescens*, of the family Leguminosae.

X. asperatus Blandf. (Synonym: *X. nepotulomorphus* Egg.) This species, which also occurs in Ceylon and Java, is fairly common in Malaya. It is usually found in twigs and branches, of diameter varying from about 1 to 12 cms., but is apparently not very selective in its choice of host species. In Malaya it has been recorded from 5 species in as many plant families, *Shorea leprosula* of the Dipterocarpaceae, *Elaeocarpus petiolatus* of the Elaeocarpaceae, *Adenanthera pavonina* of the Leguminosae, *Artocarpus* sp. of the Urticaceae, and *Gmelina arborea* of the Verbenaceae. In Ceylon it has been found in 2 species of the Leguminosae; and, in Java, in 2 species of the Urticaceae and one species in each of the families Euphorbiaceae, Fagaceae, Sapotaceae, Theaceae and Verbenaceae.

Writing of the species in Ceylon, where it has been found at altitudes varying from about 1,500 to 4,500 feet, Speyer (1923) says that it infests dying and dead branches even at the tops of the tallest trees. In small twigs the tunnel first encircles the stem and then branches longitudinally on both sides; and even in larger material the branches tend to be longitudinal, with a length of 7 or 8 cms. The eggs are laid in clusters of about 10 to 15, up to a total exceeding 40, and one month is said to be sufficient for the complete metamorphosis even at the higher altitudes. Speyer also estimates the ratio of females to males at 5 : 2; this is an unusually low ratio for the genus, however, and it is possible that some of the young females had already left the nests that he observed.

X. asperatus has not occurred as a primary borer of young trees, and can still be considered as of no economic importance.

TABLE 12
HOST FAMILIES OF XYLEBORUS INTERJECTUS

Family	Number of host species recorded in			
	Indian area	Malaya	Java	Borneo
Aceraceae	1	—	—	—
Anacardiaceae	2	—	—	—
Annonaceae	—	—	—	1
Araliaceae	—	1	—	—
Burseraceae	1	—	—	—
Combretaceae	2	—	—	—
Datiaceae	1	—	—	—
Dipterocarpaceae	3	—	—	—
Euphorbiaceae	2	2	1	—
Fagaceae	1	—	—	—
Lauraceae	—	1	—	—
Leguminosae	8	1	1	—
Magnoliaceae	1	—	—	—
Malvaceae	3	—	—	—
Meliaceae	1	—	—	—
Polygalaceae	—	1	—	—
Rubiaceae	2	—	1	—
Rutaceae	—	—	1	—
Samydaceae	1	—	—	—
Sterculiaceae	5	—	1	—
Urticaceae	5	2	1	4
Verbenaceae	2	—	1	—

X. rudis Egg. occurs also in Ceylon and southern India, where Beeson (1941) records it from *Artocarpus integrifolius* of the family Urticaceae. In Malaya it has been found only twice, in Selangor, and the only identified host was a dead (poisoned) tree of *Shorea leprosula* of the family Dipterocarpaceae.

X. semirudis Blandf. (Synonym: *X. sereinus* Egg.). This small shot-hole borer is common in Malaya, and occurs also in Sumatra, Java and Borneo. In its general habits, and also in its choice of hosts, it resembles *X. interjectus*, but it more readily infests small material, down to a diameter of about 2 cms., as well as the largest logs. The following hosts have been recorded in Malaya.

Apocynaceae: *Dyera costulata*.

Araliaceae: *Arthropodium diversifolium*.

Leguminosae: *Whitfordiodendron pubescens*.

Malvaceae: *Hibiscus macrophyllus*.

Sterculiaceae: *Sterculia macrophylla*.

Urticaceae: *Artocarpus* sp., *A. scortechinii*, *Ficus* sp.

In Sarawak it has been found in *Artocarpus anisophyllus*', and in Java, where it occurs up to an altitude of at least 4,500 feet, it has been taken from 3 species of the Urticaceae and from one species in each of the families Leguminosae and Myristicaceae. There seems to be no doubt of the strong attraction of the Leguminosae to it; and it is perhaps worth recording that the Dipterocarpaceae, rather unusually poorly represented among the hosts of *X. interjectus*, are absent from the admittedly short host list of *X. semirudis*.

In large branches and logs, the nest resembles that of *X. interjectus*, with a few branch tunnels at a wide angle, lying more or less in one transverse plane and penetrating the wood at most to a depth

of little more than 8 cms. In small branches the tunnel encircles the stem, and has one or two longitudinal branches in which the young brood lives. The frass is pushed out of the tunnels in the form of compact cylinders.

X. andamanensis Blandf. (Synonym: *X. siobanus* Egg.). This shot-hole borer is widely distributed in Malaysia, and has been recorded from Burma, the Andaman Islands, Java, Borneo, the Buru Islands and New Guinea. It is not, however, very common in Malaya, where it has been found in cut poles, of moderate size, of *Saraca* sp., of the family Leguminosae, and *Xanthophyllum* sp. of the Polygalaceae. In Burma and the Andamans, Beeson (1941) records it from one species in each of the families Leguminosae, Malvaceae and Urticaceae; in Java, Schedl (1951, 1954) and Kalshoven (1959a) cite two hosts in the Urticaceae, and one in each of the families Euphorbiaceae, Leguminosae, Sapotaceae, Symplocaceae and Theaceae; and in Sarawak heavy infestation has been found in an unidentified liane. These short lists give little suggestion of any strong host preferences, although the Leguminosae are probably attractive to it, as they are to many ambrosia beetles.

The nest is similar to that of other common species of the group, simply branched, more or less in one transverse plane, and without brood chambers.

X. neohybridus Sch. is known from only a single record. It was found in Selangor, in the wood of *Artocarpus scortechinii* of the family Urticaceae.

X. fornicatus Eichh. The "shothole borer of tea", which is a major agricultural pest in some countries, has been found in Ceylon, India, Burma, Indo-China, Java, Borneo, New Guinea, Formosa, Fiji and Hawaii, and has been the subject of many scientific papers. It has not attained the status of an important pest in Malaya, where it is, however, very common, has been recorded from the following identified hosts: *Fissistigma elegans* of the family Annonaceae, *Arthrophyllum diversifolium* of the Araliaceae, *Pajanelia longifolia* of the Bignoniaceae, *Bixa orellana* of the Bixaceae, an both on the mainland and on adjacent islands, such as Langkawi and Tioman, and unidentified species of the Burseraceae, *Shorea* sp. of the Dipterocarpaceae, 2 species of *Castanopsis* in the family Fagaceae, *Intsia palembanica* of the Leguminosae, *Fagraea gigantea* of the Loganiaceae, *Scaphium affine* and *Theobroma cacao* of the Sterculiaceae and *Gmelina arborea* of the Verbenaceae.

The above list is compared with the host families found in some other countries in table 13, which contains features of interest and bears some resemblance to the host lists of *X. interjectus*. Nearly every major woody plant family of the Oriental tropics is included, the two most noteworthy exceptions being the Sapotaceae and Myristicaceae. Among the families included, the Leguminosae, Euphorbiaceae and Verbenaceae, and possibly also the Anacardiaceae, Rubiaceae and Sterculiaceae, seem to have a strong general attraction for the species. On the other hand the Dipterocarpaceae are unusually poorly represented, and the Urticaceae, although fairly well represented, do not provide such a high proportion of hosts as they do for *X. interjectus* and some other species of the group. The principal plants of agricultural value with which *X. fornicatus* has been associated include Avocado pear, castor, citrus, cocoa, Derris, quinine, rubber and, above all, tea.

In natural forest conditions in Malaya, *X. fornicatus* attacks the stouter twigs and smaller branches, up to a usual maximum diameter of about 15 cms., of unhealthy or recently cut trees. It will also infest saplings for several weeks after transplanting, weak cuttings, and moribund branches of otherwise healthy trees. It occasionally shows unusual habits; in Malaya it has been observed

breeding successfully in an unidentified, fallen, rather hard fruit, and Kalshoven (1958a) mentions an attempted attack on banana stems. In most branches of forestry and agriculture, it is mainly as a borer of the stems of young transplants that it is to be feared.

TABLE 13
HOST FAMILIES OF XYLEBORUS FORNICATUS

Family	Number of host species recorded in				
	India	Ceylon	Malaya	Sunda Islands	Pacific
Anacardiaceae	1	—	—	3	1
Annonaceae	—	—	1	—	—
Apocynaceae	—	—	—	1	—
Araliaceae	—	—	1	1	—
Bignoniaceae	—	—	1	—	—
Bixaceae	—	1	1	—	—
Burseraceae	—	—	1	3	—
Combretaceae	1	—	—	—	—
Dipterocarpaceae	—	—	1	—	—
Euphorbiaceae	1	2	—	4	1
Fagaceae	—	—	2	2	—
Lauraceae	—	1	—	—	1
Lecythidaceae	—	—	—	1	—
Leguminosae	1	6	1	10	4
Loganiaceae	—	—	1	—	—
Magnoliaceae	—	—	—	1	—
Malvaceae	—	—	—	3	—
Melastomaceae	—	1	—	—	—
Meliaceae	—	—	—	1	—
Moringaceae	—	—	—	1	—
Musaceae	—	—	—	1	—
Myrtaceae	—	1	—	—	1
Palmaceae	—	1	—	—	—
Proteaceae	—	1	—	—	—
Rosaceae	—	1	—	—	—
Rubiaceae	1	1	—	1	—
Rutaceae	—	1	—	1	1
Sapindaceae	—	1	—	1	—
Staphyleaceae	—	—	—	1	—
Sterculiaceae	—	1	2	2	—
Theaceae	1	2	—	1	—
Urticaceae	1	—	—	3	—
Verbenaceae	1	3	1	1	—

In certain circumstances *X. fornicatus* can be very injurious to plants of agricultural value, and in Ceylon and southern India it has become notorious as a pest of tea. In these territories, according to Beeson (1941), its most frequent hosts are provided by weak bushes of castor, *Ricinus communis* of the family Euphorbiaceae, but it has become so closely associated with tea that it has developed a biological race, *fornicator* Egg., recognisable morphologically, that is responsible for most of the damage done. In Ceylon, *fornicator* occurs in greatest abundance at altitudes between 1500 and 3000 feet, and is rare at higher and at very low levels. It is the most healthy tea bushes that are most liable to attack, and a considerable loss of leaf production is sustained, sometimes through the death of twigs and small branches, more often through breakage of branches at the point of infestation. In southern India *fornicator* is relatively rare, and the species is a less important pest

than in Ceylon; in northern India, Malaya and Java, *fornicator* has not appeared, and the species is not a major pest. It has not been shown to be a vector of any fungal disease to which tea is subject and, according to Speyer (1923), the nest is modified when parts of the plant tissue have become infected by fungi, the course of the tunnels avoiding the infected zones.

Kalshoven (1958a) has also described primary infestation of *Schleichera oleosa*, of the family Sapindaceae, a tree that provides an oil seed of some importance in Java. Again it is the best developed trees that are most subject to attack and, although only very heavy infestation can kill them, their vigour may be seriously affected and recovery is slow. In one area examined, 80 per cent, of the trees had been infested, and 8 per cent, killed. No important predators or parasites have been observed in these plantations, but outbreaks of *X. fornicatus* often come to a sudden end for unknown reasons.

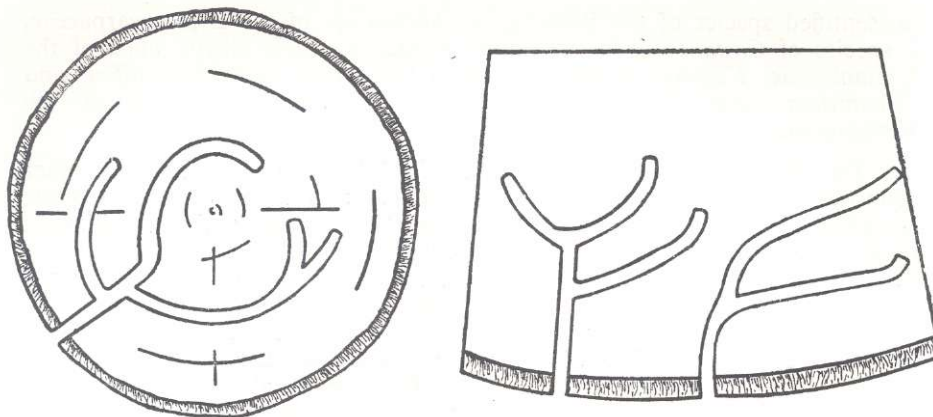

Fig. 19. Transverse sections of small and large branches, with nests of *Xyleborus fornicatus*. Approx. nat. size.

The adult females of *X. fornicatus* fly by day, and therefore cannot be attracted to light, but they tend to settle on white objects. Their powers of dispersal by direct flight are not very strong and, according to Judenko (1956), they rarely fly, on tea plantations, at a height exceeding 5 feet. In twigs and small branches the mother beetle makes a bifurcated or simple tunnel encircling the stem in the transverse plane (fig. 19), and then, but only if the material is very small, one or two longitudinal branch tunnels, which may be straight or spiral and often exceed a length of 5 cms. Egg-laying begins as soon as the entrance tunnel has been completed. The eggs are laid in small clusters and in Malaya their production continues fairly steadily for about 10 days, after which there is a marked decline although laying may proceed at intervals for at least a further 10 days. Kalshoven (1958a) reports that broods in Java may include 15 to 20 individuals; in Ceylon, Gadd (1941) cites the maximum number as 34 individuals; and in Malaya, three nests in *Pajanelia* averaged 28.3 individuals of the new generation. Males are produced continuously, and develop more rapidly than the females. The larvae live in the longitudinal tunnels in small twigs, and in the transverse branch galleries in larger material. In Malaya, although they show considerable variation in over-all size and head-width, a reasonable grouping suggests that the female larvae pass through 3 instars, and the same number has been found by Gadd in Ceylon. The larvae pupate together in the tunnels and, after emergence from the pupal stage, the young females remain in the nest for some days, during which they are fertilised by the males. They then leave, by way of the

original entrance tunnel, in search of new hosts. The small males cannot fly and do not normally leave the parent nest, although Kalshoven (I.e.) has noticed that they sometimes come out and crawl about on the surface of the bark, in which they gnaw small holes. In Malaya, at least, the mother beetle raises only one brood, and dies when her offspring have flown.

The available data of the time required for the various stages of development are summarised in table 14. It is evident that the pupal period varies considerably with the temperature but the larval period even more so; Gadd (1947) found that, at altitudes of 4,500 feet or more in Ceylon, with average temperatures varying from 16° to 25 °C mortality was very high and the larval period was prolonged to as much as 33 days. In the lowlands of Malaya, a total life-cycle of about 29 to 33 days may be expected but, because of the continued production of eggs for about 3 weeks, it is possible that the emergence of adults from the host may continue for a similar period, and the following figures of individuals in various stages, found in 3 nests of *Pajanelia*, are of interest.

	Eggs	Larvae (1st instar)	Larvae (2nd)	Larvae (3rd)	Pupae	Young adults
Frequency ...	9	6	13	23	22	2
Per cent. ...	10.6	7.1	15.3	30.8	25.9	2.4

Using these figures in conjunction with the observed Malayan developmental period (table 14), we may expect roughly 4 per cent, of the new generation to emerge from the nest 30 to 35 days after initial infestation; 20 per cent, after 36 to 40 days; 40 per cent, after 41 to 45 days; 15 per cent, after 46 to 50 days; another 15 per cent, after 51 to 55 days; and the remaining 6 per cent, after 56 to 60 days. But in natural conditions such emergencies often appear to be telescoped, possibly because of variation in the rate of development, sometimes possibly because of the death of the mother and subsequent destruction of the remaining immature instars by invading predators. The majority of the new generation, however, may be expected to swarm about 5 to 6 weeks after infestation of the host has occurred.

TABLE 14
DEVELOPMENTAL PERIODS OF XYLEBORUS FORNICATUS

	Altitude (feet)	Mean temperature (°C)	Days				
			Flight and initial boring	Egg	Larva	Pupa	Maturation of adult
Malaya	200	27 (21-32)	4-5	5-6	12	4-5	4-5
Ceylon	—	28	—	5-6	9-19	4-6	—
"	3000-3500	—	10	7	15	8	5
"	3500	23	—	7-8	—	—	—
"	4500	20 (16-25)	—	—	18-33	10	—

In comparison with that of many other Xyleborini, the ratio of females to males is rather low. In Java, Kalshoven (I.e.) estimates it as 9 : 1; in Ceylon, in the other hand, Beeson (1941) estimates 4 : 1, and Judenko (1956) not less than 3:1. In Malaya, examination of a few complete broods suggests a normal ratio of 4 or 5 females to each male. Nevertheless it is not unusual to find broods without males, which have presumably died during development, and Judenko has suggested that parthenogenesis may then occur. Gadd (1949), however, notes that fairly large numbers of females bore into new hosts but do not breed, and he suggests that these are females that have had no

opportunity of mating. It seems most likely that Gadd's view is correct, but the question remains in doubt.

A preliminary study of the ambrosia fungi associated with *X. fornicatus* in Ceylon was made by Speyer (1923), who found mycelium consisting of rather long, narrow, sparsely septate hyphae, and rounded conidial bodies were not observed, but, in addition, spores of *Monacrosporium* were constantly found among the hyphae. More recently, Gadd (1947) has succeeded in rearing the larvae under laboratory conditions on a *Monacrosporium ambrosium* culture on nutrient agar.

Populations of *X. fornicatus* in Ceylonese tea gardens have been studied (Gadd, 1941, 1944) in relation to the usual pruning cycle of 3 years. Attack usually begins about 6 months after pruning, and the population increases from month to month to a peak in the second half of the second year, after which there is a decline. The introduction of a longer pruning cycle is therefore worth consideration. Gadd also found that manurial treatments designed to increase yields often have the opposite effect, as they appear to favour a rapid increase of *X. fornicatus*. He suggests that such treatments influence the population through changes in the internal condition of the bushes, probably by affecting the rate of growth of the ambrosia fungi. But on the whole the size of the population seems to depend less on manurial treatments than on the time that has elapsed since the last pruning.

X. destruens Blandf. This species, a shothole borer of moderate size, evidently occurs throughout Malaysia and extends well into the Pacific, as it has been recorded in Sumatra, Java, Borneo, Gilolo, New Guinea, the New Hebrides and Fiji. It is not very common in Malaya, but has occasionally been found, in Kelantan and Pahang, infesting cut or unhealthy trees of various sizes down to a minimum diameter of about 7 cms. Recorded hosts are *Intsia palembanica*, of the family Leguminosae, and *Artocarpus elasticus* of the Urticaceae. In Sarawak it has been found in 3 species of *Artocarpus*, and, in Java, in cocoa,—*Theobroma cacao* of the Sterculiaceae,—*Turpinia latifolia* of the Staphyleaceae, and teak,—*Tectona grandis* of the Verbenaceae. In natural conditions, therefore, it does not appear to be highly selective in its choice of hosts, although there is a suggestion that the Urticaceae are strongly attractive to it, as they are to many other species of the *Euwallacea* group.

Since about 1920, however, *X. destruens* has become an increasingly important pest in teak plantations in Java. It usually only becomes seriously injurious in pure or almost pure stands of teak, and prefers to attack through bark wounds or after a decline in the vigour of the trees, but it also infests apparently healthy trees of about 10 to 20 cms. diameter. The wood often becomes so riddled by the tunnels of the beetle, and so stained by the associated fungi, that it is useless for anything but fuel and inferior pole-wood.

Van Alphen de Veer (1956) has discussed the relationship of climate with the incidence of the species as a pest. In Java, all infested teak areas have an average annual rainfall exceeding 79 inches, and up to nearly 157 inches, and the ratio of wet (more than 4 inches) to dry (less than 2 inches) months is as low as 7 : 3 in only one district, all the others being more uniformly wet, with corresponding ratios sometimes as high as 12 : 0. Teak shows its best development, with freedom from infestation, in parts of the country that have an average rainfall of less than 79 inches, and a ratio of wet to dry months lower than 7 : 3.

If we apply these data to Malaya, we find that the whole country falls within the climatic limits favourable to *X. destruens* but not to teak. It is possible that small areas in the north-west semi-monsoon climate may be fairly suitable for teak plantations and, indeed, the tree has there

been grown, in very small patches, with some success. But established meteorological stations in that part of Malaya show average annual rainfall, and ratios of wet to dry months, well above the limits cited by Van Alphen de Veer, and if teak plantations are ever formed on a large scale, as has sometimes been suggested, *X. destruens* may have to be reckoned with as a major pest.

In host material of at least moderate size, the nest is of the pattern typical of the group, the galleries branching widely from the entrance tunnel and with a few secondary branches, all lying more or less in one transverse plane according to Kalshoven (1920), the wood may be penetrated to a depth about 15 cms., and the total length of all tunnels in the nest may be as much as 1.4 meters. Sometimes, however, and particularly in rather small poles longitudinal tunnel may lead off from near the entrance, and this gives rise to further systems of transverse galleries at intervals (fig. 20).

The flight of the young females is nocturnal, and they are attracted to light.

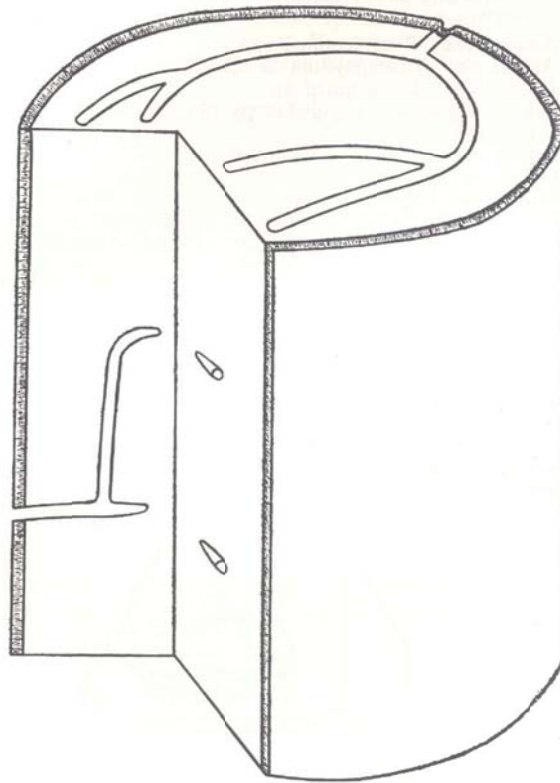

Fig. 20. Section of a pole, with nests of *Xyleborus destruens*. Approx. nat. size.

X. pseudobarbatus Sch. is doubtfully distinct from *X. destruens*. The flight of the young adult female is nocturnal, and it has been taken at light in Selangor.

X. perakensis is very closely related to *X. destruens* but larger. It has been found in Borneo at altitudes varying from 1,000 to 5,000 feet. In Malaya, it is known from a single record at light in the lowlands of Perak.

X. procerissimus Sch. was discovered at Cameron Highlands in Pahang. It has not been found again, and nothing is known of its habits.

Xyleborus (the *nugax* group)

This is a small Oriental group, of which 3 species are known to occur in Malaya. They are small pinhole borers, and only one of them is common.

X. nugax Sch. (Synonym: *X. pertuberculatus* Egg.). This little species, which occurs also in Java and Borneo, is very common in Malaya, both on the mainland and on the adjacent islands. It has been recorded from the following hosts.

Annonaceae: 3 unidentified spp.

Araliaceae: *Arthropodium diversifolium*.

Burseraceae: Unidentified sp.

Dipterocarpaceae: *Dryobalanops oblongifolia*, *Shorea leprosula*, *S. macroptera*.

Fagaceae: *Castanopsis sumatrana*.

Guttiferae: *Garcinia* sp.

Lauraceae: Unidentified sp.

Leguminosae: *Whitfordiodendron pubescens*.

Melastomaceae: *Memecylon* sp.

Meliaceae: *Swietenia macrophylla*.

Olacaceae: *Strombosia javanica*.

Polygalaceae: *Xanthophyllum* sp.

Sterculiaceae: *Scaphium* sp.

Urticaceae: *Artocarpus lanceaefolius*.

In Java, where it has been found only in the lowlands, up to an altitude of about 1,500 feet, the recorded hosts are *Hevea brasiliensis*, of the family Euphorbiaceae, and *Tectona grandis* of the Verbenaceae. The fairly long list shows little sign of any marked host preferences, but the species has not yet been found in several common plant families, such as the Myristicaceae and Sapotaceae.

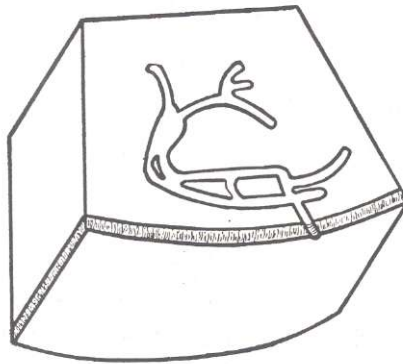

Fig. 21. Transverse section of wood, with a nest of *Xyleborus nugax*. Approx. nat. size.

X. nugax usually breeds in cut poles and branches of about 3 to 20 cms. diameter, and infestation may continue until decay of the sapwood is clearly evident. Penetration of the wood rarely exceeds a depth of about 3 cms., and the nest (fig. 21) is complex, consisting of an irregularly branched tunnel, usually not all in one plane, expanded here and there to form brood chambers in the transverse plane. Very few Malayan species make these transverse brood chambers, the

longitudinal type being much more common. In hosts with thick bark, false surface galleries are sometimes made.

X. diversicolor Egg. This pinhole borer, which occurs in the Philippines and New Guinea, and probably in at least some other Malaysian territories, is not very common in Malaya, but has occasionally been found on both sides of the peninsula from Selangor northwards. Its recorded hosts are cut trees of *Endospermum malaccense*, of the family Euphorbiaceae, *Pasania sundaica* of the Fagaceae, and *Nephelium* sp. of the Sapindaceae. In the Philippines it has been recorded from the Burseraceae. Almost fully grown larvae have been observed in a nest 7 weeks after the cutting of the host tree.

X. myristicae Sch. This species occurs in Java and Sumatra. It has been recorded once in Singapore, and it is possible that it was imported in Sumatran timber, but more likely that it is indigenous but rare.

In Java, where it appears to be rather common, it has been recorded (Kalshoven, 1959) from 2 species in each of the families Malvaceae and Urticaceae, and in one species of each of the families Apocynaceae, Leguminosae, Meliaceae, Sterculiaceae, Theaceae, Tiliaceae and Verbenaceae; and, in Sumatra, from the cultivated nutmeg, *Myristica fragrans* of the Myristicaceae, from which it takes its name. It is usually a borer of moribund branchwood, or of the branches of diseased trees. The complete nest has not been studied but, while still incomplete, the tunnels show few branches, with occasional very small expansions. The numerous specimens from *Myristica* in Sumatra indicate that the ratio of females to males may be about 9 : 1 .

***Xyleborus* (the *punctatissimus* group)**

This is a small Oriental group. Its species, which show considerable diversity in size, are elliptical rather than cylindrical in cross-section, so that the holes that they make in wood are often not perfectly circular, as they are in nearly all other ambrosia beetles. Four species occur in Malaya, but none of them is abundant.

X. punctatissimus Eichh. (Synonym: *X. spatulatus* Blandf.). This fairly large species is known to occur also in Sumatra, Java and Borneo, and in Java it has been taken at an altitude of 2,500 feet. In Malaya, it is by no means common, and has been found mostly at altitudes exceeding 1,500 feet, but also in the lowlands of Kelantan and Pahang. The only identified host in Malaya was a cut tree, *Xanthophyllum* sp. of the family Polygalaceae, and in Java it has been recorded from *Symplocos* sp. of the Symplocaceae.

X. puer Egg. This species, which bears a general resemblance to *X. punctatissimus*, but is considerably smaller, occurs also in Borneo and New Guinea, and presumably in some of the intervening territories. It is not common in Malaya, but has been found in Kelantan, infesting the stems of cut trees of various sizes, from a pole of 3 cms. diameter up to the largest logs. The only identified host plant in Malaya is *Intsia palembanica* of the family Leguminosae, and in Sarawak it has been found in *Shorea* (*Eushorea*) sp. of the Dipterocarpaceae.

Because of the slightly flattened shape of the adult beetle, its tunnels tend to be elliptical rather than circular in cross-section. In Malaya the complete nest has not been observed, but the adults have been found boring short tunnels directly into the wood, the tunnels, however, tending to take the form of irregular cavities, widest at the inner end, where the eggs are laid- In Sarawak *X. puer* has been found to make an irregular surface chamber (fig. 22 A) between bark and wood, from which one or two branched tunnels penetrate directly into the wood, but only for a short distance.

X. scabrior Sch. This small species occurs also in Borneo, where it has been found from sea level up to an altitude of 2,600 feet. In Malaya it has been recorded from *Shorea macroptera* and 2 other species of the same genus of the Dipterocarpaceae. In Sarawak it has also been found in cut Dipterocarpaceae, including 2 species of *Shorea* and one of *Vatica*, but there is also a record of it from *Castanopsis* sp. of the family Fagaceae. It is probable that it has an almost fixed host association with the former of these two families, but will accept alternative hosts in the second.

The adult female makes a narrow, more or less transverse surface gallery between bark and wood. It is possible that she never penetrates directly into the wood, but there has as yet been no opportunity of examining complete nests.

X. obstipus Sch. This peculiar species is very doubtfully placed in this group. It has been found only in Malaya, and is apparently a hill species, occurring at altitudes of 4,000 feet and more. Nothing is known of its habits.

Xyleborus (the *concisus* group)

This is a small and not very well defined Oriental group, represented in Malaya by one very common and 4 rare species. They are pinhole borers of small to moderate size, and, as far as it is known, the nest consists of a system of irregularly branched tunnels without brood chambers.

X. concisus Blandf. (Synonyms: *X. marginatus* Egg., *X. sordicaudulus* Egg., *X. peguensis* Egg.). This species, which is one of the most common Scolytid ambrosia beetles of Malaya, is known also in Bengal, Burma, Java, Borneo, the Philippines and Japan, and presumably occurs in the various Malaysian territories that lie between. In Malaya it has been recorded from the following identified hosts.

- Dipterocarpaceae: *Balanocarpus heimii*, *Dipterocarpus baudii*, *D. kunstleri*, *Shorea leprosula*, *S. ovalis*.
- Euphorbiaceae: *Endospermum malaccense*.
- Fagaceae: *Pasania* sp., *P. sundaica*.
- Lauraceae: Unidentified sp.
- Leguminosae: *Intsia palembanica*, *Saraca* sp.
- Loganiaceae: *Fagraea gigantea*.
- Meliaceae: *Chisocheton glomeratus*.
- Myristicaceae: Unidentified sp.
- Polygalaceae: *Xanthophyllum* spp. (2 spp.).
- Rosaceae: *Parinari* sp.
- Sterculiaceae: *Scaphium* sp.
- Urticaceae: *Artocarpus* sp., *A. elasticus*, *Sloetia elongata*.

Table 15 compares the host families recorded in Malaya with the lists available in some other territories. Although, at first sight, this table gives little impression of selectivity, the collection of many more records may provide information of great interest. It is perhaps noteworthy that several common tree families of the region, particularly the Annonaceae, Sapotaceae and Verbenaceae, are not included, while others, which provide several hosts in two or more territories, may be particularly attractive to *X. concisus*. The species is certainly not size-selective, and readily infests the largest logs as well as poles and small branches, down to a minimum diameter of about 3 cms.; but it does not attack shoots and twigs. It has been found in unhealthy trees, dead trees, green logs, and a cut liane.

TABLE 15
HOST FAMILIES OF XYLEBORUS CONCISUS

Family	Number of host species recorded in				
	India/ Burma	Malaya	Java	Borneo	Japan
Compositae	—	—	1	—	—
Dipterocarpaceae	—	5	—	1	—
Euphorbiaceae	1	1	2	—	—
Fagaceae	—	2	1	1	2
Guttiferae	—	—	1	1	—
Lauraceae	—	1	—	—	—
Leguminosae	2	2	2	1	—
Loganiaceae	—	1	—	—	—
Melastomaceae	—	—	1	—	—
Meliaceae	—	1	1	—	—
Myristicaceae	—	1	1	—	—
Myrtaceae	—	—	—	1	—
Polygalaceae	—	2	—	—	—
Rosaceae	—	1	—	—	—
Rubiaceae	—	—	1	—	—
Sterculiaceae	—	1	—	—	—
Symplocaceae	—	—	1	—	—
Theaceae	—	—	1	—	—
Thymeleaceae	—	—	—	1	—
Urticaceae	—	3	2	—	1

When the host has a fairly thick bark, false surface galleries, transverse and usually about 3 cms. long, are often made. Within the wood the tunnels are irregularly branched, without brood chambers, and generally lie more or less in one transverse plane. The frass is pushed out in the form of cylinders.

In Malaya a new generation has been observed swarming from a host cut 6 weeks previously. The flight occurred during the day, and probably this is usual as, although the species is abundant, there is no record of its attraction to light.

X. depressus Egg. This species, which also occurs in Sumatra, is known in Malaya from only one record. It was found in a sawmill yard in Selangor, where a few of the beetles were attacking newly sawn timber of *Shorea uliginosa*, of the family Dipterocarpaceae, in the seasoning sheds. A nest opened 29 days later, during which time the moisture content of the wood had varied between 82 and 75 per cent, contained larvae ready to pupate. The nest comprises branched tunnels without brood chambers.

X. latecarinatus Sch. This species is known only in Malaya, and is rare. It has been found in Kelantan, Pahang and Selangor, in light infestations of large logs of *Shorea parvifolia*, of the family Dipterocarpaceae, and an unidentified species of the Myristicaceae.

X. mangoensis Sch. has been found only once, in Malacca, in *Mangifera* sp. of the family Anacardiaceae.

X. sejugatus Sch. was discovered in Perak, in *Elaeocarpus ferrugineus* of the family Elaeocarpaceae. It has not been found again.

***Xyleborus* (the *javanus* group)**

This is a small group, with a few species scattered in various territories of the Oriental region, chiefly Malaysia. It is represented in Malaya by only one species, which is, however, very common.

X. javanus Egg. (Synonym: *X. perdix* Sch.). This species occurs also in Sumatra, Borneo and Java, and in the last of these territories it has been found both in the lowlands and in the hills, up to an altitude of at least 3,500 feet. In Malaya it is one of the most common Scolytid ambrosia beetles that breed in small poles and branches, and has now been found in almost all districts, including the Langkawi Islands. It has been recorded from the following identified hosts.

Dipterocarpaceae: *Dipterocarpus baudii*, *Dryobalanops oblongifolia*, *Shorea* sp., *S. leprosula*, *S. parvifolia*, *S. sumatrana*.

Meliaceae: *Swietenia macrophylla*.

Myrtaceae: *Eugenia* sp.

Polygalaceae: *Xanthophyllum* sp.

Tiliaceae: *Grewia tomentosa*.

Urticaceae: *Artocarpus* sp.

TABLE 16 HOST FAMILIES OF XYLEBORUS JAVANUS

	Number of species recorded in		
	Malaya	Sumatra/ Borneo	Java
Anacardiaceae	—	—	1
Burseraceae	—	1	—
Compositae	—	—	1
Dipterocarpaceae	6	—	—
Fagaceae	—	—	1
Guttiferae	—	1	—
Leguminosae	—	—	1
Meliaceae	1	—	1
Myrtaceae	1	1	—
Polygalaceae	1	—	—
Rubiaceae	—	—	1
Sapindaceae	—	2	—
Tiliaceae	1	—	—
Urticaceae	1	1	1
Verbenaceae	—	—	1

Table 16 compares this list with the host families recorded in other territories. The species is evidently by no means very selective, and the table gives little indication of any marked preferences. Several very common tree families, however, are still absent from the lists, and many more data are required to establish exactly how unselective *X. javanus* is.

The species is usually found in small branches of about 3 to 9 cms, diameter, but it sometimes infests bigger poles and even large logs. It does not attack very small shoots and twigs. Where infestation occurs it is often very heavy, but it has not been found as a primary pest or attacking young transplants. Heavy infestation may considerably weaken very small poles, but in large timber it occurs only rarely, and the depth of penetration of the tunnels is then too slight to be of any great importance.

In small material the entrance tunnel of the nest (fig. 22 B) may lead straight to the pith, where it has one or two longitudinal branches, about 3 cms. long; or the entrance tunnel may encircle the host in the transverse plane before the longitudinal tunnels are formed. In slightly larger material the tunnels may be irregularly branched in various planes, and sometimes irregularly enlarged at intervals, although without definite brood chambers, and there is nearly always at least one

longitudinal tunnel in which the young brood lives. The nest is typically densely lined with white mycelium. The frass is pushed out in the form of fine cylinders.

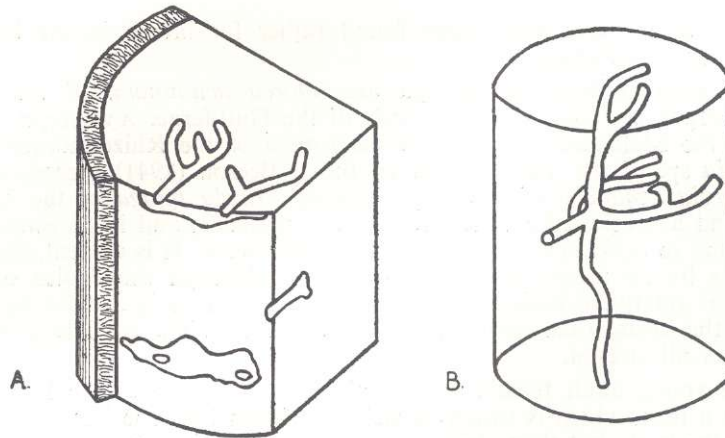

Fig. 22. A, section of wood, with nests of *Xyleborus puer*. B, a nest of *Xyleborus javanus* in a small branch, shown as a transparency. Approx. nat size.

In a host cut 30 days previously, young adults of the new generation, as well as pupae, have been observed; in another, cut 31 days previously, a nest contained all stages from young larvae to pupae; and fully grown larvae have been found in a host cut 28 days previously. In Java, Kalshoven (1959a) found a brood containing 49 adult females and one male; but he nevertheless estimates the average ration of females to males at about 10 : 1.

Xyleborus (the *Progenius* group)

This compact group, to which Blandford gave generic rank, includes some half-dozen very closely related species, which are of interest because they are almost exclusively inhabitants of mangrove swamps and other coastal forests, and are only rarely found far inland. As the fallen trees that usually provide their hosts are very liable to be carried out to sea by the tide, and transported for long distances by ocean currents, some of the species have become widely dispersed around the shores of the Malay Archipelago, and of the Indian and Pacific Oceans.

The typical nest of the group consists of rather simply branched tunnels, lying more or less in one transverse plane, and there are no brood chambers, but false surface galleries are a common feature.

X. riehli Eichh. This coastal species evidently occurs in most of the humid tropical territories around the shores of Malaysia and of the Indian Ocean, and it has now been recorded in East Africa, India, Sumatra, Borneo, Sumbawa and Celebes. It has been found in Java, and probably occurs there, but the record is uncertain as it was infesting timber newly imported from the Philippines (Schedl. 1942), where its occurrence has also not been definitely established. In Malaya it is common in the mangrove forests, but

X. sejugatus Sch. was discovered in Perak, in *Elaeocarpus ferrugineus* of the family Elaeocarpaceae. It has not been found again.

Xyleborus (*the javanus group*)

This is a small group, with a few species scattered in various territories of the Oriental region, chiefly Malaya. It is represented in Malaya by only one species, which is, however, very common.

X. javanus Egg. (Synonym: *X. perdix* Sch.). This species occurs also in Sumatra, Borneo and Java, and in the last of these territories it has been found both in the lowlands and in the hills, up to an altitude of at least 3,500 feet. In Malaya it is one of the most common Scolytid ambrosia beetles that breed in small poles and branches, and has now been found in almost all districts, including the Langkawi Islands. It has been recorded from the following identified hosts.

- Dipterocarpaceae: *Dipterocarpus baudii*, *Dryobalanops oblongifolia*, *Shorea* sp., *S. leprosula*, *S. parvifolia*, *S. sumatrana*.
- Meliaceae: *Swietenia macrophylla*.
- Myrtaceae: *Eugenia* sp.
- Polygalaceae: *Xanthophyllum* sp.
- Tiliaceae: *Grewia tomentosa*.
- Urticaceae: *Artocarpus* sp.

TABLE 16 Host families of *Xyleborus javanus*

	Number of species recorded in		
	Malaya	Sumatra/ Borneo	Java
Anacardiaceae	—	—	1
Burseraceae	—	1	—
Compositae	—	—	1
Dipterocarpaceae	6	—	—
Fagaceae	—	—	1
Guttiferae	—	1	—
Leguminosae	—	—	1
Meliaceae	1	—	1
Myrtaceae	1	1	—
Polygalaceae	1	—	—
Rubiaceae	—	—	1
Sapindaceae	—	2	—
Tiliaceae	1	—	—
Urticaceae	1	1	1
Verbenaceae	—	—	1

Table 16 compares this list with the host families recorded in other territories. The species is evidently by no means very selective, and the table gives little indication of any marked preferences. Several very common tree families, however, are still absent from the lists, and many more data are required to establish exactly how unselective *X. javanus* is.

The species is usually found in small branches of about 3 to 9 cms. diameter, but it sometimes infests bigger poles and even large logs. It does not attack very small shoots and twigs. Where infestation occurs it is often very heavy, but it has not been found as a primary pest or attacking young transplants. Heavy infestation may considerably weaken very small poles, but in large timber it occurs only rarely, and the depth of penetration of the tunnels is then too slight to be of any great importance.

They are generally very unselective in their choice of host species, and most of them will infest material of almost any size except small shoots and twigs. The typical nest comprises an irregularly and much branched tunnel, without brood chambers, usually more or less confined to one transverse plane and penetrating the wood to a depth of several inches.

TABLE 17 HOST FAMILIES OF XYLEBORUS PERFORANS

Family	Number of host species recorded in			
	India etc.	Malaya	Sunda Islands	Philippines and Pacific
Amaryllidaceae	—	1	—	—
Anacardiaceae	7	—	—	—
Annonaceae	—	1	—	—
Aquifoliaceae	—	—	—	1
Araliaceae	—	1	—	—
Bignoniaceae	1	—	—	—
Boraginaceae	1	—	—	—
Burseraceae	2	2	—	—
Combretaceae	9	—	—	—
Cornaceae	1	—	—	—
Dilleniaceae	1	—	—	—
Dipterocarpaceae	4	10	2	1
Ebenaceae	2	—	—	—
Euphorbiaceae	1	2	2	1
Fagaceae	1	—	1	—
Gramineae	—	—	1	2
Hypericaceae	—	—	1	—
Lauraceae	1	1	—	1
Leguminosae	10	4	3	7
Liliaceae	—	—	—	1
Loganiaceae	—	1	—	—
Lythraceae	1	—	—	—
Malvaceae	3	2	—	—
Meliaceae	2	1	1	1
Myristicaceae	1	1	—	1
Myrtaceae	2	1	—	1
Olacaceae	—	1	—	—
Palmaceae	2	2	—	1
Pinaceae	—	—	—	1
Rhizophoraceae	2	3	—	—
Rubiaceae	2	—	—	1
Rutaceae	—	—	—	1
Sapindaceae	1	1	—	1
Sapotaceae	2	1	—	—
Sterculiaceae	5	—	—	—
Styracaceae	—	1	—	—
Symplocaceae	—	—	1	—
Tiliaceae	2	1	—	1
Urticaceae	5	2	3	5
Verbenaceae	3	—	—	—

X. perforans Woll. (Principal synonyms: *X. testaceus* Walk., *X. kraatzi* Eichh.). This very widely distributed species is probably the most abundant wood-boring Scolytid of Malaya, where it occurs both in the lowlands and in the hills up to an altitude of at least 4,000 feet. Its origin is uncertain, but it is now almost cosmopolitan in the humid tropics, and often appears in imported timber in temperate climates, where, however, it has failed to establish itself. In Malaya it has been recorded from the following identified hosts.

- Amaryllidaceae: Agave sp.
- Annonaceae: Unidentified sp.
- Araliaceae: Arthropodium diversifolium.
- Burseraceae: 2 unidentified spp.

Dipterocarpaceae: *Dipterocarpus baudii*, *Dryobalanops aromatica*, *D. oblongifolia*, *Shorea bracteolata*, *S. leprosula*, *S. uliginosa*, and 4 other *Shorea* spp.
 Euphorbiaceae: *Elateriospermum tapos*, *Hevea brasiliensis*.
 Lauraceae: Unidentified sp.
 Leguminosae: *Adenanthera pavonina*, *Intsia palembanica*, *Koompassia malaccensis*, *Parkia speciosa*.
 Loganiaceae: *Fagraea fragrans*.
 Malvaceae: *Durio* sp., *D. zibethinus*.
 Meliaceae: *Aphanamixa rohituka*.
 Myristicaceae: Unidentified sp.
 Myrtaceae: *Eucalyptus deglupta*.
 Olacaceae: *Ochanostachys amentacea*.
 Palmaceae: *Elaeis guineensis*, *Livistona* sp.
 Rhizophoraceae: *Bruguiera parviflora*, *Rhizophora apiculata*, *R. mucronata*.
 Sapindaceae: *Pometia pinnata*.
 Sapotaceae: *Achras sapota*.
 Styracaceae: *Stryax benzoin*.
 Tiliaceae: *Grewia* sp.
 Urticaceae: *Artocarpus lakoocha*, *A. lanceaefolius*.

This rather long list is compared, in table 17, with available host records in some other countries in the Oriental region and the Pacific. It will be seen that the lists include Dicotyledons, Monocotyledons and Gymnosperms, that none of the major woody plant families of the region is absent from them, and the recurrence of some of them in the table is probably no more frequent than may be expected from their relative abundance. *X. perforans* is clearly a very unselective species, and any slight preferences that it may have cannot yet be determined.

The species may attack living trees through injuries or diseased patches of bark, but is more often found in dying or dead trees, green logs or newly sawn timber. It first became noteworthy as causing considerable damage to beer-casks in India (Blandford, 1893); it has also been recorded as a pest of sugar cane; and on one occasion it has been found in an *Agave* leaf. It is not size-selective, and will infest branches and poles of about 5 cms. diameter as well as the largest logs, but it does not attack small shoots and twigs. In wood it tends to tunnel more deeply than most other Malayan Scolytidae, and thus may do considerable damage, especially in sawn but unseasoned timber.

X. perforans is common in open, agricultural country as well as in dense forest. The adult females fly at dusk or after dark, and are frequently attracted to light in houses, where they tend to settle on white objects. The nest (fig. 24) comprises a tunnel with numerous irregular branches but no brood chambers, lying more or less in one transverse plane and usually penetrating to a depth of about 8 to 10 cms. In thick-barked material the first branch tunnel of the nest frequently, but by no means invariably, takes the form of a transverse, false surface gallery, which eventually enters the wood obliquely. The frass is pushed out in the form of fine cylinders.

In Malaya there are no data of the time required for development. Writing of the species in relation to sugar cane, Dammerman (1929) says that it usually tunnels in at the joints of the cane, and that its whole life cycle can be completed in 3 weeks. This is probably breeding in optimum natural conditions, and it is likely that there is considerable variation in the developmental period in different parts of the wide range of the species. In northern India, according to Beeson (1941), populations of *X. perforans* show marked seasonal fluctuation.

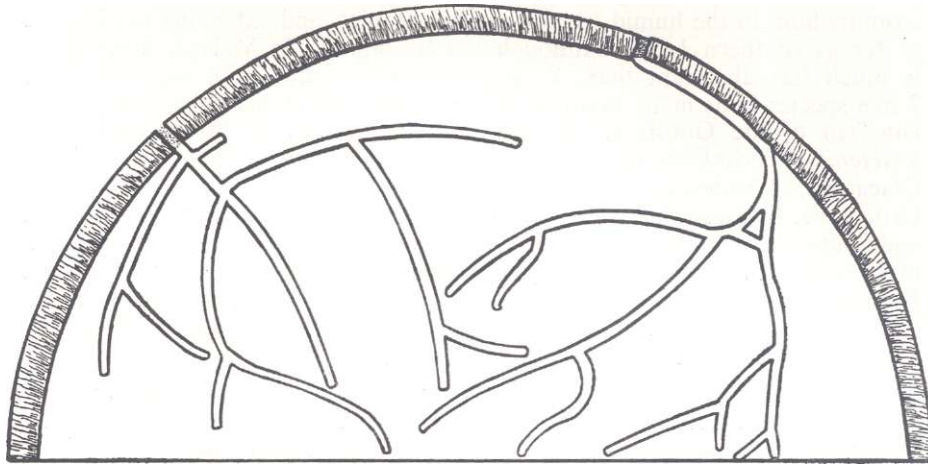

Fig. 24. Transverse section of log, with nests of *Xyleborus perforans*.
Approx. nat. size.

X. apertus Sch. This species, which is very similar to *X. perforans* but a little larger, is known to occur also in Borneo and New Guinea, and is probably present in many Malaysian territories. It is common in Malaya, both in the lowlands and in the hills up to an altitude of at least 4,000 feet. It is often taken at light, while in flight after dusk, and it has been recorded from the following host plants.

Anacardiaceae: *Pentaspadon* sp.

Apocynaceae: *Dyera costulata*.

Dipterocarpaceae: *Balanocarpus heimii*, *Shorea leprosula*, *S. uliginosa*.

Leguminosae: *Koompassia malaccensis*.

Sapotaceae: *Palaquium* sp.

Urticaceae: *Artocarpus* sp., *A. elasticus*.

In Sarawak it has been found in *Parartocarpus* and 2 species of *Artocarpus* of the family Urticaceae, *Eugenia* of the Myrtaceae, and *Agathis dammara* of the Pinaceae. It is evidently not highly selective in its choice of hosts, although the Urticaceae appear to be strongly attractive to it.

X. apertus breeds in green timber of all sizes, and in branches and poles down to a minimum diameter of about 3 or 4 cms., but it does not attack small shoots and twigs. The nest is similar to that of *X. perforans*, with simple, irregularly branched galleries lying more or less in one transverse plan.

X. torquatus Eichh. (Synonym: *X. badius* Eichh.). This species is perhaps even more widely distributed than *X. perforans*, being now almost cosmopolitan in the humid tropics and sub-tropics, and extending northwards as far as southern Japan. Although not uncommon in Malaya, however, it is much less abundant than *X. perforans*, but it has been recorded from 7 tree species in as many families, *Shorea acuminata* of the Dipterocarpaceae, *Garcinia* of the Guttiferae, *Koompassia malaccensis* of the Leguminosae, *Swietenia macrophylla* of the Meliaceae, *Ochanostachys amentacea* of the Olacaceae, *Theobroma cacao* of the Sterculiaceae, and *Ficus* sp. of the Urticaceae. In Sarawak it has been found in Dipterocarpaceae, Melastomaceae and Palmaceae; in India, in Palmaceae and Urticaceae; in the Philippines, in a species of the Malvaceae; and in Japan, in Aquifoliaceae, Euphorbiaceae, Fagaceae, Lauraceae, Leguminosae

and Theaceae. In West Africa, Jones (1958) has found no evidence of marked host preferences, and, indeed, it is apparently just as unselective as *X. perforans*.

It has on one occasion been found in a dry cocoa-pod in Malaya, and its ability to survive in such material doubtless has much to do with its present wide distribution. In tropical America it has been reported as damaging rum puncheons, just as *X. perforans* has damaged beer casks in the eastern tropics. More usually, however, it breeds in green wood of almost any size except small twigs. The nest is a system of irregularly branched tunnels lying more or less in one transverse plane.

X. cognatus Blandf. This species, which resembles *X. perforans* but is larger and very darkly coloured when mature, is recorded as occurring in India, Burma, the Andaman Islands, Indo-China, Sumatra, Java, Borneo, New Guinea, the Solomon Islands and Fiji. It is primarily a coastal species, and has probably by now been dispersed by sea currents to the wooded shores of most, if not all, territories within this area.

In Malaya it is common in the mangrove swamps, and its recorded hosts, *Bruguiera* sp., *Rhizophora apiculata* and *R. mucronata*, in which it has been frequently found, are mangrove trees of the family Rhizophoraceae. In spite of its limited habitat, however, it has not formed a fixed host association with this family. Beeson (1941) cites 16 other host species in 12 families, the Anacardiaceae, Burseraceae, Combretaceae, Dipterocarpaceae, Ebenaceae, Euphorbiaceae, Leguminosae, Lythraceae, Malvaceae, Myrtaceae, Sapotaceae and Sterculiaceae; and in the Sunda Islands it has been recorded from one species in each of the families Apocynaceae and Malvaceae, as well as Rhizophoraceae. It thus retains the very unselective character typical of the group.

The adult female flies at night, and is attracted to light. The nest is very similar to that of *X. perforans*, consisting of a tunnel with numerous irregular branches lying more or less in one transverse plane, and false surface galleries, running transversely between bark and wood, and then entering the wood obliquely, are commonly formed in thick-barked material. The tunnels may penetrate large logs to a depth of 10 cms. or more and, according to Beeson (1930), tend to be crowded in decaying patches, which

is not a common habit of the genus. In heavy infestations two or more nests may intersect, thus providing a possible opportunity for cross-fertilisation; and boring may begin from the entrance tunnel made by another beetle. The frass is pushed out in the form of slender cylinders.

There are no data on the time required for development, or on the size of the broods. Beeson (I.e.) estimates the ratio of females to males as 17.5 : 1.

X. mascarensis Eichh. This species is as widely distributed as *X. perforans*, and now almost cosmopolitan in the tropics and subtropics. It is fairly common in Malaya, where it has most frequently been observed in flight at dusk, or attracted to light after dark, but it has also been found in cut trees of the following species.

Dipterocarpaceae: *Shorea bracteolata*, *S. leprosula*, *S. macroptera*.

Leguminosae: *Parkia speciosa*.

Urticaceae: *Artocarpus scortechinii*.

In West Africa its recorded hosts are much more numerous, including 34 species in 13 plant families in Ghana, and 17 species in 10 families in the Ivory Coast, but nevertheless Jones (1958) considers that it shows a preference for the Meliaceae and Sterculiaceae. Taking both the African and the shorter Malayan list into account, however, it would appear that at least the

Dipterocarpaceae, Leguminosae and Urticaceae are also strongly attractive to it. In addition to the host-trees mentioned above, it has been found in a palm fruit in Malaya, and coconut fronds in Fiji, and it doubtless owes much of its wide distribution to its ability to survive in such material.

X. mascarensis is not size-selective, and has been found in material smaller than that usually infested by *X. perforans*. In Ghana, Jones (I.e.) has observed attack on saplings just after transplanting, infestation being concentrated near the root collar, where the plants were virtually girdled and many killed. In hosts of at least moderate size, the nest is similar to that of *X. perforans*, an irregularly branched tunnel, lying more or less in one transverse plane and penetrating fairly deeply into the wood.

X. repositus Sch. was originally discovered in Kedah, and has not been found again. Nothing is known of its habits.

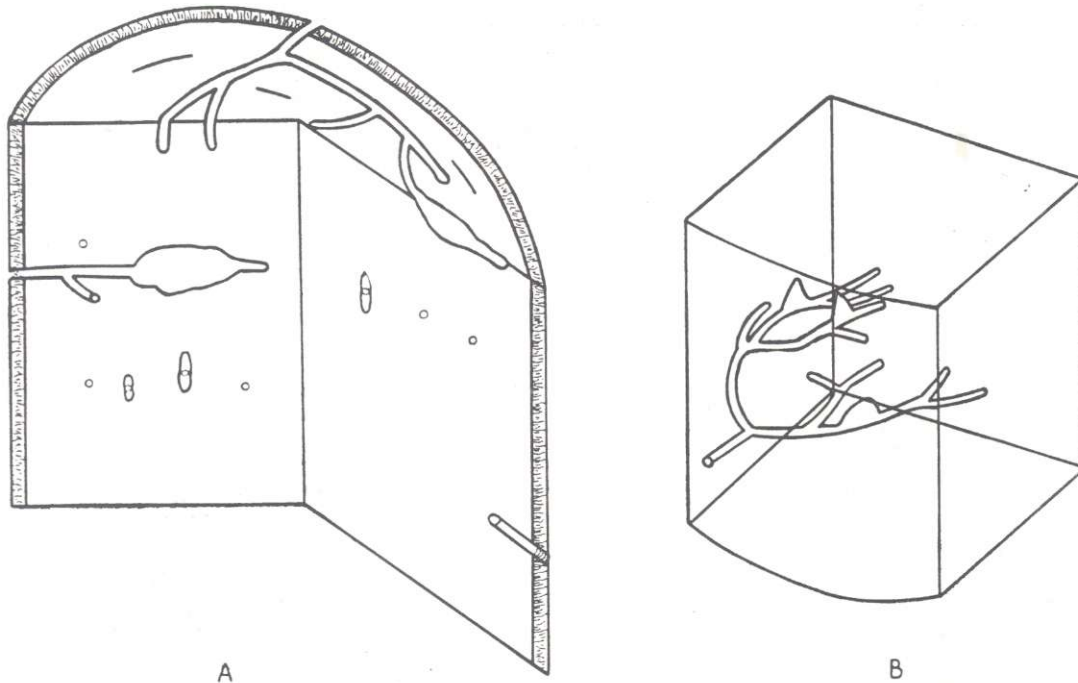

Fig. 25. A, section of wood, with nests of *Xyleborus laevis*. B, a nest of *Xyleborus bicolor* in a small pole, shown as a transparency. Approx. nat. size.

***Xyleborus* (the submarginatus group)**

This is a moderately large group of small, cylindrical pinhole borers, of which 7 species have been found in Malaya. Some of them show distinct host preferences, but others are relatively unselective. The typical nest consists of a branched tunnel with small brood chambers at intervals, but many modifications of this general pattern are found.

X. laevis Egg. This species evidently occurs throughout Malaysia, as it has been found in Java, Borneo, the Philippines and New Guinea. It is not abundant in Malaya, where it has been recorded as breeding in an unidentified species of the Burseraceae. In Sarawak it has been found in *Eugenia* sp. of the Myrtaceae; in Java, in one species of each of the families Anacardiaceae, Apocynaceae, Euphorbiaceae, Fagaceae, Guttiferae, Malvaceae, Meliaceae, Sterculiaceae, Urticaceae and

Verbenaceae; and in the Philippines, in a species of the Sapotaceae. All its known hosts thus belong to different plant families, and there is no indication of any preferences. In Java it has attacked cankered cocoa trees (*Theobroma cacao*).

X. laevis usually infests cut poles and branches up to a diameter of about 15 cms., and may attack stout twigs as small as 1 cm. In the larger material, the entrance tunnel of the nest (fig. 25 A) may be straight and radial, or else curved, penetrating the wood to a depth of at most about 1.5 cms., where it ends in an oblong brood-chamber, which lies in the longitudinal plane and is longer (up to about 1 cm. or more) than high (at most little more than 0.5 cms.). The pupal period has been observed to occupy 4 days in the lowlands of Malaya, so it is probable that the whole life cycle can be completed in about 4 weeks.

X. artelaevis Sch. This species is found also in Borneo. It is rare in Malaya, where it has been recorded in Perak and Kelantan, its only observed host being an unidentified species of the family Annonaceae; but in Sarawak it has been found in a dying *Parartocarpus* of the Urticaceae, and an unidentified, cut tree belonging to the family Leguminosae. It has been observed infesting large stems as well as branches of about 8 cms. diameter.

X. pometianus Sch. This very small species is known only in Malaya, where it has been found in Pahang, Selangor and Negri Sembilan. It appears to be rather rare, but it is possible that it is more common than the few records of it suggest, and that it escapes frequent observation both because of its small size and because it is evidently associated with the Sapindaceae, a family of little commercial importance in Malayan forests. Its recorded hosts are *Nephelium* sp., *Pometia* sp., and *Xerospermum* spp., all of the one family.

X. limatus Sch. has been recorded in Java, Borneo and the Philippines, and also in Fiji, where it has been found at an altitude of 2,500 feet. It is not very common in Malaya, where it has, however, been taken from large, cut branches and poles of *Whitfordiodendron pubescens*, of the family Leguminosae, and of *Xanthophyllum* sp. and *X. curtisii* of the Polygalaceae. In Sarawak it has been recorded in Leguminosae and Sapindaceae, and in Java in Malvaceae.

X. pumilus Egg. This species occurs also in Assam, Burma, the Andaman Islands, Sumatra, Java, Borneo and the Philippines. It is not uncommon in Malaya, but has never been found in abundance, and only 3 host plants have been identified, namely *Artocarpus* sp., *A. elasticus* and *A. scortechinii* of the family Urticaceae. A further 3 hosts, *Artocarpus* spp. and *Parartocarpus* sp., of the same family, have been recorded in Sarawak, and 2 others in Java. As hosts in other territories, Beeson (1941) cites 3 more Urticaceae in the genera *Artocarpus* and *Ficus*, but adds 2 others in the families Combretaceae and Sterculiaceae. A very strong preference for the Urticaceae is evident, with alternative hosts in a few other families.

X. pumilus infests cut or unhealthy stems of almost any size down to a minimum recorded diameter of about 10 cms. The entrance tunnel of the nest is more or less radial, and ends in a brood chamber in the longitudinal plane, the whole gallery system penetrating the wood only to a depth of about 2 to 3 cms.

X. bicolor Blandf. (Synonyms: *X. rameus* Sch., *X. subparallelus* Egg.). This rather variable little pinhole borer is widely distributed, and is known to occur in India, Burma, the Andaman Islands, Java, Borneo, the Philippines, Samoa, Fiji and Japan. It is common throughout Malaya, but only a few of its hosts have been identified, these being *Arlhrophyllum diversifolium* of the family Araliaceae, an unidentified species of the Burseraceae, *Shorea leprosula* of the Dipterocarpaceae,

Aglaia sp. of the Meliaceae, and *Artocarpus elasticus* of the Urticaceae. Table 18 compares these host families with those recorded in other territories, and gives no indication of any strong preferences. The list of families is long in relation to the number of species, only two appear in more than two columns, and none is very strongly represented in any column.

X. bicolor attacks cut or unhealthy trees, normally breeding in material of rather small size, from about 2 to 18 cms. diameter, but it is occasionally found in large logs. Infestation is often rather heavy. The nest (fig. 25 B) comprises a tunnel with only a few branches, lying more or less in one transverse plane, combined with several small brood-chambers in the longitudinal plane. The frass is pushed out of the entrance hole in the form of compact cylinders.

TABLE 18
HOST FAMILIES OF XYLEBORUS BICOLOR

	Number of host species recorded in			
	India/ Burma	Malaya	Malay Archipelago	Japan
Araliaceae	—	1	—	—
Burseraceae	—	1	—	—
Combretaceae	1	—	—	—
Cornaceae	1	—	—	—
Dipterocarpaceae	1	1	1	—
Euphorbiaceae	—	—	1	—
Fagaceae	1	—	1	2
Lauraceae	1	—	1	1
Leguminosae	2	—	1	—
Liliaceae	—	—	1	—
Lythraceae	1	—	—	—
Malvaceae	—	—	1	—
Melastomaceae	—	—	1	—
Meliaceae	1	—	—	1
Myristicaceae	1	—	—	—
Myrtaceae	1	—	—	—
* Rubiaceae	—	—	1	—
Rutaceae	—	—	1	—
Sapotaceae	1	—	1	—
Sterculiaceae	1	—	—	—
Symplocaceae	—	—	1	—
Theaceae	—	—	1	—
Thymeleaceae	—	—	1	—
Urticaceae	—	1	3	—
Verbenaceae	—	—	1	—

X. submarginatus Egg. is known to occur also in Java and the Phillip- pines, and will probably eventually be found in the intervening islands. It is not very common in Malaya, but has on three occasions been found infesting cut trees of *Fagraea fragrans*, of the family Loganiaceae, and once in *Dyera costulata* of the Apocynaceae. In Java it has been recorded in species of the Rubiaceae, Sapotaceae and Symplocaceae.

In the thick bark of *Fagraea* it frequently makes false surface galleries, which may, however, be branched and may contain most of the young brood. But often the tunnels penetrate directly into the wood, where they are irregularly branched. The depth of penetration is never more than about 3 cms.

***Xyleborus* (the *artestriatus* group)**

This is a group of small, cylindrical pinhole borers, but although it contains rather numerous species, few of them are abundant in Malaya. They vary considerably in their habits, and it is possible that the group should be further divided.

X. *artestriatus* Eichh. This species, which has also been found in Burma, Java and northern Queensland, is rare in Malaya, where it has occasionally been attracted to light in Perak, Kelantan and Pahang, but no host plants have been recorded. In Burma it has been found in a species of the family Rosaceae; and in Java, in 3 species of the Leguminosae and one species of each of the families Anacardiaceae and Burseraceae. Its nest is a branched tunnel, with several small brood chambers lying in the longitudinal plane.

X. *agnatus* Egg. This species, which is closely related to *X. artestriatus*, is probably the most common representative of the group in Malaya, and is known to occur also in Java, Borneo, the Philippines and New Guinea. The host plants recorded in Malaya are listed below.

Dipterocarpaceae: *Balanocarpus heimii*, *Dipterocarpus kunstleri*, *Dryobalanops oblongifolia*, *Shorea* sp., *S. bracteolata*, *S. leprosula*, *S. macroptera*, *S. uliginosa*.

Fagaceae: *Castanopsis* sp.

Sterculiaceae: *Scaphium* sp.

There are fairly numerous records of the species in several of the Dipterocarpaceae mentioned above, and there can be no doubt of its very strong attraction to the family, although it quite readily accepts alternative hosts in other families. In Sarawak it has been found in several species of *Shorea*, but also in 3 other hosts belonging to the Burseraceae, Myrtaceae and Sapotaceae. In Java, where the Dipterocarps are very poorly represented, it has been found, up to an altitude of about 2,500 feet, in one species of each of the families Flacourtiaceae, Melastomaceae, Tiliaceae, Urticaceae and Verbenaceae.

X. agnatus is not size selective. It will infest cut or unhealthy trees of any size from about 4 cms. diameter up, and occasionally even smaller material, and it attacks newly sawn timber in sawmill yards. The nest consists of a tunnel with a few branches, mainly in the transverse plane, and at least one brood chamber in the longitudinal plane. The frass is pushed out in the form of fine cylinders, infestation is often heavy, and the species must be considered as a Dipterocarp pinhole borer of some little importance, especially in relation to sawn timber.

Pupae and young adults have been found in a nest 9 weeks after cutting the host tree; and in sawn timber, with moisture content varying from 83 to 60 per cent., mature larvae, ready to pupate, have been observed 26 days after the initial infestation. In the latter instance we can estimate the period of metamorphosis from egg to adult at about 26 days, and the whole life-cycle at about 5 weeks, but it is probable that development may sometimes be more rapid in normal forest conditions.

X. *kelantanus* Sch. This species is known only in Malaya, and is rare, but has been found in Kelantan and Selangor, infesting a large log of an unidentified species of *Shorea* of the family Dipterocarpaceae, and newly sawn timber of *Shorea uliginosa*. It may well be that, like *X. agnatus*,

it is mainly a pinhole borer of Dipterocarps, and it appears to have similar habits. Mature larvae have been observed in a nest between 3 and 4 weeks after initial attack.

X. nutans Sch. is known from only two records, one in Malaya and one in Sarawak. In both instances it was found infesting cut trees of unidentified species of the Burseraceae, but its particular association with this family cannot be taken as established.

X. triangi Sch. is also known from only two records, both in Negri Sembilan. In one instance, several adult females were found tunneling into a living tree of *Balanocarpus heimii*, of the family Dipterocarpaceae, that had also been attacked by termites. The other record is from a log of *Shorea laevis*, of the same family.

X. dimidiatus Egg. was discovered in Perak, and has not been found again. Nothing is known of its habits.

X. decumans Sch. This species is known only in Malaya, where it is not uncommon although it has only been observed in very light infestations, never in abundance. It has been found in 5 species of the Dipterocarpaceae, *Dipterocarpus kunstleri*, *Shorea bracteolata*, *S. leprosula* (several records), *S. macroptera* (several records) and *S. ovalis*, and there can be little doubt of its strong preference for this family although there is also a record of it from *Coccoceras muticum* of the Euphorbiaceae. It has always been found in cut poles and branches, of 2 to 18 cms. diameter.

X. tunggali Sch. This species, which also occurs in Borneo, is not uncommon in Malaya, but has not been found in abundance. It has been observed in the following hosts.

Burseraceae: unidentified sp.

Dipterocarpaceae: *Dryobalanops aromatica*, *Shorea* sp., *S. laevis*, *S. talura*.

Fagaceae: *Castanopsis* sp.

Sterculiaceae: *Heritiera javanica*.

In Borneo (Sarawak) its only recorded host is a species of *Shorea*, and it is probable that, like *X. agnatus*, it prefers Dipterocarpaceae but fairly readily accepts alternative hosts in other families.

X. perminutissimus Egg. (Synonym: *X. angustatus* Sch.). This species, which also occurs in Java up to an altitude of at least 2,500 feet, is not common in Malaya, where it has, however, been recorded from *Dipterocarpus kunstleri*, *Hopea* sp. and *Shorea sumatrana*, all of the family Dipterocarpaceae, and from an unidentified species of the Burseraceae. All these hosts were cut poles and branches, their diameter varying from about 4 to 10 cms. In Java it has been found in 2 species of the Palmaceae, including cut rattans, and in a species of the Melastomaceae.

X. amarantus Sch. has been found only once, at an altitude of 4,000 feet on the border of Selangor and Pahang. Nothing is known of its habits.

X. cristatulus Sch., which is very doubtfully placed in this group, is known in Malaya only, and is rare. No host plants have been identified, but it has been found in very small, dead or cut trees of 2 to 3 cms. diameter. Its tunnels branch irregularly, and are not confined to one plane.

X. reddens Samps. (Synonyms: *X. crassitarsus* Sch., *X. minusculus* Egg.). This is a fairly widely distributed species, recorded in India, Burma, the Andaman Islands, Java, Borneo, the Philippines and New Guinea, but it appears to be only thinly spread over this large area. It is certainly rare in Malaya, where its only identified host is *Styrax benzion* of the family Styraceae. Beeson (1941) records it from one species in each of the families Dipterocarpaceae and Leguminosae in India, and Schedl (1938) from a species of the Acanthaceae in the Philippines.

X. micrographus Sch. is known in Malaya only and, is rare. It has been found in *Shorea gysbertsiana* of the family Dipterocarpaceae, in small branches of about 2 cms. diameter, that had fallen some time previously, were rather dry and showed incipient decay. The tunnels are branched, not confined to one plane, and there are several small brood chambers in the longitudinal plane.

X. rugipennis Sch. This species, which occurs also in Tenasserim, has been found only once in Malaya. It was attracted to light at an altitude of 5000 feet in Pahang.

X. fragosus Sch. This curious little species, which also occurs in Sumatra and Java, is rather rare in Malaya, but has been recorded in Kelantan, Selangor and Singapore. It has been found in small, cut trees of about 8 cms. diameter, but none of its host plants have been identified and the form of the nest has not been observed. In other parts of its range it has been recorded from species of the families Myristicaceae, Sterculiaceae and Tiliaceae, and it has also been attracted to light.

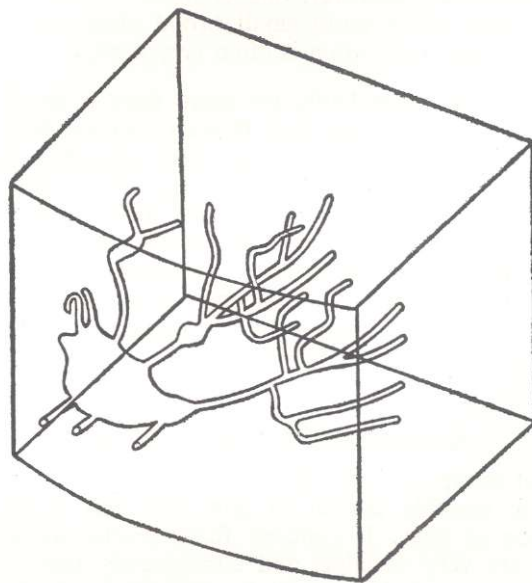

Fig. 26. A nest of *Xyleborus leprosulus* in a block of wood, shown as a transparency. Approx. nat. size.

X. leprosulus Sch. is known only from the type series, which was found in Selangor, in a large, dead tree of *Shorea leprosula* of the family Dipterocarpaceae. Its nest (fig. 26) is complex, the tunnels being much and irregularly branched, not confined to one plane and often changing direction abruptly, and there are a number of brood chambers which lie in the transverse plane. The tunnels are not tipst a hrnnH nf ahnut 7ft inHivirinals in all stapes from epes to nnae.

***Xyleborus* (the *dolosus* group)**

The few species of this group are fairly small, cylindrical pinhole borers, bearing a close general resemblance to *X. subemarginatus* and its allies, but probably more closely related to the *Coptoborus* group, and the nests in which they live and breed also resemble those of many species of *Coptoborus*. The two species recorded in Malaya are very doubtfully more than varieties of one species.

X. dolosus Blandf. (Synonym: *X. persimilis* Egg.). This species is known in Borneo and the Philippines, and probably occurs also in at least some other Malaysian territories. It is fairly common in Malaya, where it has been found only in association with the family Dipterocarpaceae, the recorded hosts being *Balanocarpus heitnii*, *Dipterocarpus crinitus*, *Shorea* sp., *S. leprosula*, *S. macroptera* and *S. parvifolia*. In Borneo its only identified host is a species of *Hopea*, of the same family.

X. dolosus infests logs and stems of moderate to large size, and breeds mainly between the bark and the wood, making surface galleries combined with irregular, usually more or less triangular brood chambers (fig. 27); from the surface galleries, however, one or more tunnels penetrate directly into the wood, where a few more small brood chambers may be formed in the longitudinal plane. Infestation is often very heavy.

X. subdolosus Sch. is probably no more than a small variety of *X. dolosus*. It occurs in Sumatra, Java and Borneo, and has been recorded only once in Malaya, where no host plant has been identified, but in Sarawak it appears to be more common than the larger form. Hosts observed in Sumatra and Borneo are all cut or unhealthy Dipterocarps of the genera *Dryobalanops*, *Hopea* and *Shorea*, and its habits closely resemble those of *X. dolosus*. The nest, shown in plate 6, comprises branched tunnels with several small brood-chambers, both on the surface and within the wood. In Sarawak, mature larvae, mostly ready to pupate, have been found in a nest 36 days after the felling of the host tree.

***Xyleborus* (the *Coptoborus* group)**

This Oriental group was considered by Hopkins to be a distinct genus, and he was quite possibly correct in this view, but it has never gained general acceptance as such. It contains fairly numerous species, some of which, however, are very variable, and consequently there has been much synonymy, which has probably yet to be completely clarified. Malaya has 12 known species, a few of which are very common.

Most of the species, particularly the more common ones, are relatively unselective in their choice of hosts, but some appear to show distinct preferences for certain plant families, notably the Urticaceae. The form of the nest is to some extent variable in the group, but the tunnels of nearly all species contain several brood-chambers lying in the longitudinal plane. In some of the more common species these chambers are combined with surface galleries between bark and wood, but there is also nearly always some penetration directly into the wood, where more brood chambers are formed.

X. emarginatus Eichh. (Synonyms: *X. cordatus* Hag., *Ips cinchonae* Veen). This rather variable species is a shothole borer of moderate size, with a wide distribution in Malayasia. It has been recorded in Burma, Java, Borneo, Moluccas and New Guinea, and also has a considerable altitudinal range, having been found at a level of about 5000 feet in Malaya and at more than 7000 feet in Borneo. It is very common throughout Malaya, in the lowlands as well as in the hills, and has been recorded from the following hosts.

Burseraceae: Unidentified sp.

Dipterocarpaceae: *Balanocarpus heimii*, *Dipterocarpus baudii*, *Shorea leprosula*, *S. uliginosa*.

Leguminosae: *Intsia palembanica*, *Koompassia malaccensis*.

Loganiaceae: *Fagraea gigantea*.

Table 19 compares this list with the host records available in Java and Borneo, and it will be seen that, although a few families, particularly the Dipterocarpaceae and Leguminosae, appear to be generally attractive to *X. emarginatus*, there is no strong evidence of any well marked preferences.

TABLE 19 HOST FAMILIES OF XYLEBORUS EMARGINATUS

Family	Number of host species recorded in		
	Malaya	Java	Borneo
Burseraceae	1	—	—
Dipterocarpaceae	4	1	3
Fagaceae	—	3	—
Flacourtiaceae	—	1	—
Guttiferae	—	1	—
Hamamelidaceae	—	1	—
Hypericaceae	—	—	1
Lauraceae	—	2	1
Leguminosae	2	1	1
Loganiaceae	1	—	—
Malvaceae	—	2	—
Myristicaceae	—	2	—
Myrtaceae	—	—	1
Pinaceae	—	1	—
Rubiaceae	—	2	—
Rutaceae	—	1	—
Symplocaceae	—	1	—
Thymeleaceae	—	—	1
Urticaceae	—	1	2

The flight of the adult females is nocturnal, and they are attracted to light. The species is most frequently found in large logs, but will infest stems down to a diameter of about 15 cms., and occasionally even smaller material. It attacks unhealthy, dead or recently cut trees, and has also been found boring in newly sawn, unseasoned timber. At one time it was thought to be a primary pest of *Cinchona* in Java, but there can be little doubt that, in attack on living trees, it has always followed more serious causes of disease. In logs that have not had their bark removed, *X. emarginatus* makes a transverse surface gallery between bark and wood, associated with a surface brood-chamber, in which lives the larger part of the young brood; but other tunnels branch off at right angles from the surface gallery and penetrate directly into the wood, where they may have secondary branch galleries with more brood chambers in the longitudinal plane. In de-barked logs, which are also attacked, and in sawn timber, surface galleries cannot, of course, be formed.

Nests in sawn timber, examined 28 days after initial attack, were found to contain eggs and also larvae in all stages of development. The moisture content of the wood during this time varied between 83 and 75 per cent. It is probable that development may often be more rapid under forest conditions.

X. dentatus Blandf. This species, which rather closely resembles *X. emarginatus*, was originally discovered in Ceylon. In Malaya it has been recorded only once, at an altitude of more than 5000 feet in Pahang.

X. amplexicauda Hag., which may well lie within the limits of variation of *X. dentatus*, is found also in Sumatra and Borneo. In Malaya it is much less common than *X. emarginatus*, but has similar habits, except that its few host plants that have been recorded are all Dipterocarpaceae, namely *Balanocarpus heimii*, *Dryobalanops aromatica*, *Hopea* sp., *Shorea* sp., and *S. acuminata*. In Sarawak, however, it has also been recorded from a species of the Lauraceae. It has only been found in fairly large logs, and the nest is very similar to that of *X. emarginatus*, comprising tunnels and brood chambers both on the surface and within the wood.

X. ampicranoides Hag. This rather handsome species, which occurs also in Sumatra, Java and Borneo, with a variety in the Philippines, is not very common in Malaya, but has occasionally been found in Kelantan and Selangor, where its only identified host is *Artocarpus scortechinii* of the family Urticaceae. In Sarawak it has been found in *Artocarpus elasticus* and *Parartocarpus* sp. of the same family. In Java it has been also recorded from 2 species of Urticaceae, but also from one species in each of the families Euphorbiaceae, Palmaceae and Verbenaceae. It appears to have a strong preference for the Urticaceae, but evidently accepts alternative hosts very readily.

It attacks dying or newly felled trees, or otherwise healthy trees through injuries or patches of diseased bark, and most often breeds in material of fairly large size, although in Java it has been found in cut canes. It does not make surface galleries, but its tunnels do not penetrate very deeply into the wood, where they have a few branch galleries in various planes, and brood chambers in the longitudinal plane.

X. birmanus Egg. This species, which resembles *X. ampicranoides* rather closely but is smaller, also occurs in Burma and Thailand. In Malaya it has as yet been found only in Kelantan, where, however, it is not uncommon, infesting cut trees of all sizes down to a minimum diameter of about 3 cms. Its only identified host plant in Malaya is *Intsia palembanica*, of the family Leguminosae, a large log of which had been lying in the forest for a considerable time, and the sapwood of which was beginning to decay. In Burma it has been recorded from one species each of the Bignoniaceae and Leguminosae. It is probably not highly selective in its choice of hosts.

The nest resembles that of *X. ampicranoides*. It lies entirely within the wood, and has a few branch galleries, associated with brood chambers in the longitudinal plane.

X. fallax Eichh. This pinhole borer is probably the most common representative of the *Coptoborus* group over a large area, and has been recorded from Assam, Burma, Sumatra, Java, Borneo, the Philippines and New Guinea. In Malaya it has been found in most districts and also in the off-shore Langkawi Islands, and is generally abundant up to an altitude of at least 3000 feet. It has been recorded from the following identified host plants.

Dipterocarpaceae: *Dipterocarpus baudii*, *Shorea* sp., *S. leprosula*, *S. macroptera*, *S. ovalis*,
S. uliginosa.

Leguminosae: *Dialium* sp., *Intsia palembanica*, *Koompassia excelsa*, *K. malaccensis*.

Polygalaceae: *Xanthophyllum* sp.

Sapotaceae: *Achras sapota* and an unidentified sp.

Urticaceae: *Artocarpus elasticus*

When the abundance of *X. fallax* is considered, the number of host families in the Malayan list is not large, but it is considerably increased in table 20, which includes the hosts recorded in India, Burma, Java and Borneo. From this table we can only say that several families, such as the Dipterocarpaceae and Leguminosae, which are attractive to many ambrosia beetles, also attract *X. fallax*. But the species is certainly not highly selective.

TABLE 20 HOST FAMILIES OF XYLEBORUS FALLAX

Family	Number of host species recorded in			
	India/ Burma	Malaya	Java	Borneo
Anacardiaceae	1	—	—	—
Dipterocarpaceae	1	6	—	4
Euphorbiaceae	—	—	1	—
Fagaceae	1	—	1	1
Guttiferae	—	—	1	—
Lauraceae	—	—	1	—
Leguminosae	1	4	—	1
Pinaceae	—	—	—	1
Polygalaceae	—	1	—	—
Sapindaceae	—	—	—	1
Sapotaceae	—	2	—	—
Staphyleaceae	—	—	1	—
Thymeleaceae	—	—	—	1
Urticaceae	—	1	—	1

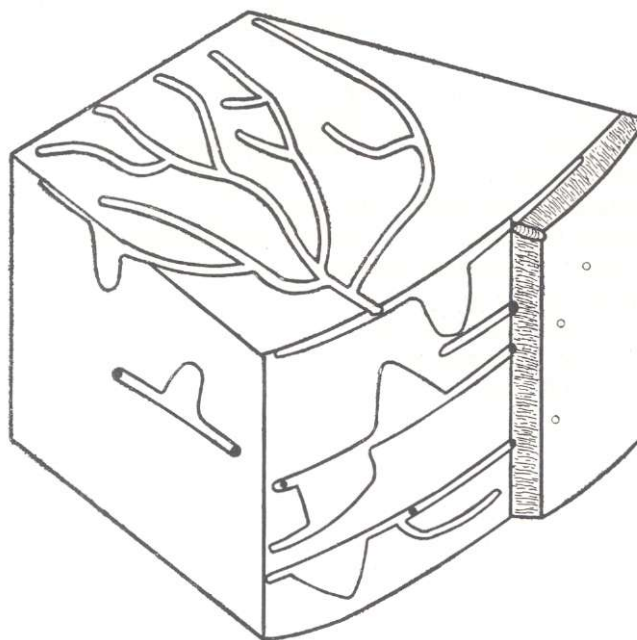

Fig. 27. Section of wood, with nests of *Xyleborus fallax*. Approx. nat. size.

The adult female normally flies at dusk or dawn, or at night, when she is attracted to light. The species infests dying or cut trees of all sizes down to a minimum diameter of about 8 cms., and will

also attack newly sawn but unseasoned timber. When the bark has not been removed from the host stem or log, *X. fallax* almost invariably makes a more or less transverse surface gallery, associated with a brood chamber of moderate size, and most of the young brood develop between bark and wood; but other tunnels lead directly into the wood, where more brood chambers, lying in the longitudinal plane and often parallel, or almost so, with the surface of the log, are formed (fig. 27). Like *X. emarginatus*, however, it will successfully attack timber when the bark has been removed and no surface galleries can be formed.

In a nest observed in Malaya, about 24 to 28 days after initial infestation of the host, development of the brood was found to be almost complete; it contained young adults, pupae and a few well grown larvae.

X. cylindricus Egg. This species, a rather small pinhole borer, is known to occur also in the Philippines, and is therefore presumably widely distributed in Malaysia. It is not very common in Malaya, but has been found in Kelantan and Selangor, infesting *Artocarpus scortechinii* and another species of the same genus in the Urticaceae, with which family it may possibly be closely associated. It has been found in cut and dying trees, of diameter varying from 20 to 50 cms. Its tunnels branch in several planes in the wood, and are provided with small brood-chambers in the longitudinal plane. The frass is pushed out in the form of fine, rather loose cylinders, which soon break up.

X. pseudocylindricus Egg. (Synonym: *X. artecylindrus* Sch.). This pinhole borer occurs also in Sumatra, Java and Borneo. It is not uncommon in Malaya, where it has been recorded from *Shorea macroptera* and *S. uliginosa*, of the family Dipterocarpaceae, and from *Artocarpus elasticus* and *A. scortechinii* of the Urticaceae. In Sarawak it has been found in 2 species of *Artocarpus* and one of *Shorea*; and, in Java, in 2 more species of other genera of the Urticaceae. It seems probable that it has a preference for the Urticaceae, but will readily accept Dipterocarpaceae as alternative hosts.

X. pseudocylindricus has been found in dying and cut trees of all sizes down to a minimum diameter of about 5 cms., and has also been observed in seasoning sheds, attacking newly sawn timber at a moisture content of about 82 per cent.

X. neocylindricus Sch. The type of this species was discovered in Selangor, but nothing further is known of it.

X. cylindromorphus Egg. is known to occur also in Borneo and the Philippines. In Malaya it has been found only once, in Kelantan, infesting a large log of *Balanocarpus heimii* of the family Dipterocarpaceae. In Borneo the only recorded host is also a Dipterocarp, a *Shorea* of the Red Meranti group.

X. spinatus Egg., which also occurs in Sumatra, is rare in Malaya, but has been found in Kelantan and Selangor, once infesting the stem of an unidentified, small cut tree, and once in flight at dusk.

X. vestitus Sch. This small pinhole borer is known to occur also in Java, where it has been found up to an altitude of about 2,500 feet, and in Borneo. In Malaya there are very few records of it. all from Kelantan, where it has been observed in small, dead or cut trees varying in diameter from about 3 to 15 cms. It does not appear to be very selective in its choice of hosts; in Malaya it has been found in *Eugenia* sp., of the family Myrtaceae, and in *Xanthophyllum* sp. of the Polygalaceae; and in Java, in 2 species of the Meliaceae and one species of each of the families Apocynaceae, Compositae, Euphorbiaceae, Fagaceae, Lauraceae, Rutaceae and Sapotaceae.

Kalshoven (1959a) has described the nest. In small material the tunnel encircles the pith, and in larger hosts it is once or twice forked, with a total length of only about 7 or 8 cms.; there are no brood chambers, and the formation of surface galleries has not been observed. Kalshoven also found only rather small broods of up to about 18 individuals, and he suggests that the ratio of females to males is probably about 5:1.

Xyleborus (the *truncatus* group)

This is a fairly distinctive group, although closely related to the genus *Pseudoxyleborus*, in which it might perhaps be included in spite of differences in the structure of the antennal club. It contains a moderate number of species, mainly in the Oriental region, Australia and the Pacific, with outliers in tropical Africa. It is represented in Malaya by 6 known species, but several others, known only from single specimens, remain to be named.

Most of the better known species are not highly selective in their choice of hosts, but one is closely associated with the plant family Fagaceae. The nest, as far as is known, always consists of an unbranched entrance tunnel in the transverse plane, and one large, terminal brood chamber in the longitudinal plane.

X. mancus Blandf. (Synonym: *X. abruptus* Samps.). This is a widely distributed species, known to occur in East Africa, Madagascar, southern India, Ceylon, Java, the Philippines and Formosa, and it is probably present in many of the intervening territories, although it is surprising that it has not yet been discovered in Borneo. It is very common in Malaya, where it has been found in the wood of the following identified hosts.

Dipterocarpaceae: *Dryobalanops oblongifolia*, *Shorea* sp., *S. bracteolata*, *S. leprosula*, *S. macroptera*, *S. sumatrana*.

Lauraceae: *Litsea megacarpa* and an unidentified sp.

Leguminosae: *Adenantha pavonina*

Malvaceae: *Hibiscus macrophyllus*.

Meliaceae: *Aphanamixis rohituka*, *Swietenia macrophylla*.

Sapindaceae: *Nephelium lappaceum*, *Pometia pinnata*.

Sterculiaceae: *Theobroma cacao*.

Styracaceae: *Styrax benzoin*.

Tiliaceae: *Grewia* sp.

Verbenaceae: *Vitex pubescens*.

Table 21 compares these hosts with the lists available in some other countries, and contains some points of interest, notably the frequent recurrence of the Anacardiaceae, Meliaceae and Sterculiaceae. However, the species certainly cannot be described as highly selective, and many more records are required to establish the existence of any distinct preferences.

The young adult females fly at night, and are attracted to light. The species normally breeds in cut poles and branches, of about 2 to 10 cms. diameter and, in Malaya at least, has not been found in large timber, but it has also been recorded, in Johore, from a fallen fruit of *Dipterocarpus lowii*. In wood the nest normally shows a radial or slightly curved, unbranched entrance tunnel in the transverse plane, ending in one large, oblong brood chamber in the longitudinal plane, the chamber either continuing the radial course of the entrance tunnel or else following the curvature of the host. In very small hosts this typical pattern may be modified, with a strongly curved entrance

tunnel and an irregular, wide, longitudinal brood tunnel. The frass is pushed out in the form of cylinders.

TABLE 21 HOST FAMILIES OF XYLEBORUS MANCUS

Family	Number of host species recorded in			
	India/ Ceylon	Malaya	Java	Philippines
Anacardiaceae	1	—	1	1
Bixaceae	—	—	—	1
Boraginaceae	1	—	—	—
Combretaceae	—	—	1	—
Dipterocarpaceae	—	6	—	—
Guttiferae	—	—	1	—
Lauraceae	—	2	—	—
Leguminosae	—	1	2	—
Malvaceae	—	1	—	—
Meliaceae	1	2	2	—
Sapindaceae	—	2	—	—
Sterculiaceae	1	1	—	1
Styracaceae	—	1	—	—
Tiliaceae	—	1	—	—
Verbenaceae	—	1	1	—

In small material and favourable conditions, development is apparently fairly rapid. Infested material, in which a few nests were opened and found to contain mainly eggs, with some young larvae, was caged and kept under observation in Malaya; some nests were opened 9 days later, and found to contain mainly pupae, with some half-grown larvae; and one brood was almost ready for flight after a further 5 days. In another host, fully grown larvae and almost mature pupae have been found 4 weeks after the tree was cut. The pupal period of a male was observed to occupy 4 days. The brood usually contains 20 to 30 individuals, and the adults of even one brood may vary considerably in size.

The rather large brood chambers of *X. mancus* may considerably reduce the strength of the small poles that it frequently infests, but on the whole the economic importance of the species is slight.

X. versicolor Samps. This species, which is smaller than *X. mancus*, occurs in Burma, Java and Borneo, and is very common throughout the lowlands of Malaya, where it has been recorded from 18 hosts in 14 plant families.

These host plants include *Alstonia* sp., of the family Apocynaceae, *Shorea leprosula*, *S. macroptera*, *S. ovalis* and *S. parvifolia* of the Dipterocarpaceae, *Elaeocarpus petiolatus* (Elaeocarpaceae), *Macaranga* sp. (Euphorbiaceae), *Pasania* sp. (Fagaceae), 2 unidentified species of the Lauraceae, *Whitfordiodendron pubescens* (Leguminosae), *Fagraea fragrans* (Loganiaceae), *Swietenia macrophylla* (Meliaceae), *Strombosia javanica* (Olacaceae), *Palaquium stellatum* (Sapotaceae), *Barringtonia macrostachya* (Sterculiaceae), *Artocarpus scortechinii* (Urticaceae) and *Gmelina arborea* of the Verbenaceae. In Burma it has been found in a species of the Anacardiaceae; in Java, in one species each of the Anacardiaceae and Burseraceae; and in Sarawak, in one species each of the Guttiferae and Burseraceae, as well as various unidentified trees in other families. The number of host families is thus very large in relation to the number of recorded host species, and there is no indication of any marked preferences shown by the beetle.

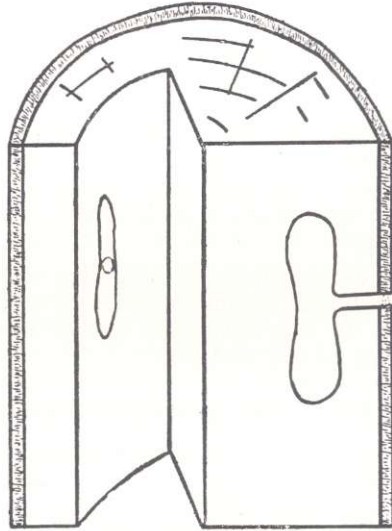

Fig. 28. Section of wood, with nests of *Xyleborus versicolor*. Approx. nat. size.

X. versicolor infests cut poles and branches of about 2 to 20 cms. diameter, and has not been found in large timber. In the nest (fig. 28) the entrance tunnel, which is usually straight and radial, leads to an oblong brood-chamber in the longitudinal plane, and the whole penetration of the wood rarely exceeds a depth of 4 or 5 cms. The brood chamber may measure as much as 5 by 1 cms., and the broods are rather large, frequently including more than 50 individuals. Mature larvae have been found in a nest 29 days after the cutting of the host tree. Information on the ratio of females to males is scanty, but it seems to lie between 5 and 10 : 1.

The species is of practically no economic importance, although the large brood-chambers may considerably weaken very small poles.

X. foveicollis Brne. is known from only one record, in Selangor, where it occurred in a heavy infestation of a cut pole of *Palaquium stellatum* of the family Sapotaceae. The nest is of the normal pattern of the group, with an unbranched entrance tunnel ending in one large, terminal brood-chamber in the longitudinal plane.

X. striatotruncatus Sch. This species occurs in Java and also in Borneo, where it has been found up to an altitude of about 2,500 feet. It is not very common in Malaya, where it has, however, been observed in light infestations of *Shorea leprosula*, of the family Dipterocarpaceae, *Madhuca* sp. of the Sapotaceae, and *Scaphium* sp. of the Sterculiaceae. In Java it has been found in a species of the Staphyleaceae; and in Sarawak, in one species of each of the families Dipterocarpaceae, Myrtaceae and Pinaceae. There is no suggestion of any preferences.

All its observed hosts have been cut poles, varying in diameter from about 3 to 15 cms. The nest, as usual in the group, has an unbranched entrance tunnel and a large, terminal brood-chamber in the longitudinal plane.

X. dasyurus Brne. is known only from the type, which was found, in dense forest at about midday, in flight and settling on an unidentified, recently cut tree in Kelantan.

X. uniseriatus Egg. This species, which also occurs in Java, is fairly common in Malaya, and is exceptional among the known species of the group in showing a strong host association with one plant family, the Fagaceae. Its known hosts in this family in Malaya include *Castanopsis sumatrana* and a number of unidentified species of both *Castanopsis* and *Pasania*, and in Java it is recorded from *Castanea* and *Quercus*. But in Malaya it has also once been found in an alternative host, *Shorea macroptera* of the Dipterocarpaceae.

The nest is of the usual pattern of the group, with a rather short, more or less radial entrance tunnel ending in a large, cblong brood-chamber in the longitudinal plane. In one nest, fully grown larvae have been found 4 weeks after the cutting of the host tree.

***Xyleborus* (the *punctatopilosus* group)**

This is a small group, occurring in the Oriental and Australian regions, and represented in Malaya by 4 species, of which 2 are fairly common. Some of them, at least, are very selective in their choice of hosts.

X. punctatopilosus Sch. This species also occurs in Java and Borneo, and in Malaya it has frequently been found in Kelantan, Selangor and Negri Sembilan. It is very selective in its choice of hosts, being associated with one plant family, the Fagaceae. In Malaya it has been recorded from *Castanopsis sumatrana*, *Pasania sundaica*, *Quercus wrayi*, and a number of other unidentified species of these genera; and in Java and Borneo it has also been found in various species of *Quercus*. No alternative hosts have yet been observed.

It infests unhealthy or recently cut trees of any size down to a minimum diameter of about 5 cms. The tunnels of the nest lie more or less in one transverse plane, and have only a few branches, but are usually provided with small, rather irregular brood-chambers in the longitudinal plane. Fully grown larvae have been found in a nest 4 weeks after the cutting of the host tree; and, in another host, cut 1\ weeks previously, broods of young adults, ready for flight, have been observed. The males develop more rapidly than the females, and the ratio of females to males appears to be relatively low for the genus, but no exact data are available. The male is unusual, in the Xyleborini, in being considerably larger than the female.

X. punctilicoliis Sch. was originally discovered in Perak, and has not been found again. Nothing is known of its habits.

X. cryphaloides Sch. This species, which shows considerable variation in size, is not uncommon in Malaya, and also occurs in Borneo. It is highly host-selective, associated with the family Dipterocarpaceae. In Malaya it has been recorded from *Shorea* sp., *S. leprosula*, *S. parvifolia* and *S. uliginosa*, and in Sarawak it has been found in species of *Dipterocarpus* and *Vatica*, as well as in several species of *Shorea*. No alternative hosts in other plant families have been noted.

It infests cut trees of any size down to a minimum diameter of about 5 cms., and has also been known to attack newly sawn, unseasoned boards in sawmill yards. The tunnels of the nest are simply branched, and expanded here and there to form small irregular brood-chambers in the longitudinal plane.

X. punctipennis Sch. is doubtfully placed in this group, to which, however, it is probably at least fairly closely related. In Malaya it has been found only once, in Kelantan, infesting a very small, diameter about 2 cms., cut tree of the family Euphorbiaceae. There is also a single record of it in Sarawak, where it was taken from *Vatica* sp. of the Dipterocarpaceae, a cut tree of about 5 cms. diameter.

The nest is of the Webbine type, with an unbranched entrance tunnel and a single terminal brood-chamber in the longitudinal plane. In Sarawak, fully grown larvae, pupae and a young adult male have been observed in a nest 34 days after the cutting of the host tree.

Xyleborus (the *circumcisis* group)

This is a very small group, and in fact possibly contains only one species. Its taxonomic position is doubtful, and it may eventually have to be regarded as a distinct genus; it appears to occupy a position intermediate between the typical Xyleborini and the Webbini.

X. circumcisis Samps. (Synonym: *X. obtusus* Egg.). This species occurs in Sumatra, Java and Borneo, and is common in Malaya. It has a wide altitudinal range, and has been found, in the territories mentioned, from sea level up to about 5,000 feet, a distribution that may be related to its host preferences.

X. circumcisis infests Fagaceae, and up to the present no alternative hosts in other plant families have been recorded. In Malaya the known hosts are 3 species of *Pasania*, including *P. sundaica*, and 3 species of *Castanopsis*, including *C. megacarpa* and *C. sumatrana*. In Java it has been found in *Quercus* sp. and, in Sarawak, in several species of *Castanopsis*. It normally infests the wood of dying, dead or recently cut trees, and is not highly size-selective, attacking material of any diameter down to a minimum of about 3 cms. In Java, however, Kalshoven (1959a) has also found it, apparently breeding, in a large, fallen acorn.

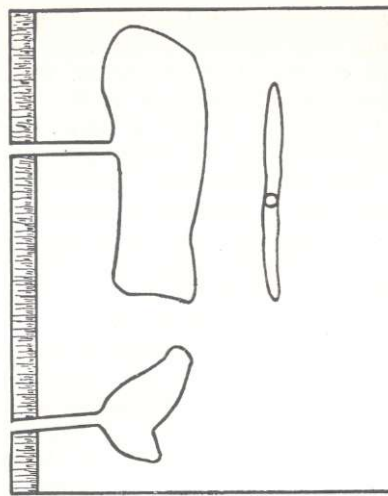

Fig. 29. Section of wood, with nests of *Xyleborus circumcisis*.
Approx. nat. size.

In wood the main entrance tunnel of the nest (fig. 29) may branch rather irregularly, more or less in one transverse plane, but is more often unbranched, and there is always only one terminal brood-chamber, roughly oblong in shape and generally measuring about 2 by 1 cms., in the longitudinal plane. The frass is pushed out of the nest in the form of rather loose cylinders.

X. subobtusus Sch. is doubtfully more than a variation of *X. circumcisis*. There is only one Malayan record of it, in Pahang, where it was found infesting the wood of a cut tree, *Quercus* sp. of the family Fagaceae.

Xyleborus (the *pruinosis* group)

This group of about a dozen species is probably wrongly placed in *Xyleborus*, and its recognition as a distinct genus of the tribe Webbini may be necessary; but, on the other hand, the limits of the Xyleborini, Eccoptoterini and Webbini have still to be satisfactorily defined. The group occurs throughout Malaysia, from Sumatra to New Guinea, and there is also a species in Formosa; 5 species have been recorded in Malaya, but only 2 of these are at all common, one being abundant as a borer of Burseraceae, and some others have been found only at high altitudes.

The species have the usual general biological characteristics of both the Xyleborini and the Webbini. They are ambrosia beetles with strongly developed sexual dimorphism and a social organisation of extreme polygamy, the males being relatively scarce, short-lived, and never leaving the parent nest. The nest is of the simple Webbini type, with an entrance tunnel and one large, terminal brood-chamber.

X. pruinus Blandf. (Synonym: *X. decipiens* Egg.). This shothole borer is known to occur also in Sumatra, Borneo and the Solomon Islands, and will probably eventually be found in at least many of the intervening territories. It is very common in Malaya, where it has been recorded from the following hosts.

Burseraceae: *Canarium littorale*, *C. patentinervium*, *Dacryodes* sp., *D. rostrata*, *Santiria griffithii* and numerous unidentified spp.

Dipterocarpaceae: *Balanocarpus heimii*, *Dryobalanops aromatica*.

Leguminosae: *Pithecellobium* sp.

In Sarawak it has been found, from sea level up to an altitude of more than 2,000 feet, in 4 species of the Burseraceae, and there can be no doubt of its strong host association with this family. In Malaya, in fact, it is unusual to find a tree of the Burseraceae, cut and in a condition suitable for infestation that has not been attacked by *X. pruinus*. The species will, however, accept some alternative hosts, and it was originally discovered, in Paris, in tobacco bales from Sumatra, but further details of the nature of this infestation are lacking.

X. pruinus breeds in unhealthy, dead or cut trees, and is not size-selective, readily infesting large logs as well as branches and poles down to a minimum diameter of about 3 cms. The nest comprises an unbranched entrance tunnel, which may be radial or curved, ending in a single large, narrow brood-chamber in the longitudinal plane; this chamber is usually to 3 cms. long and about 1.5 cms. wide, the width either following the radial course of the entrance tunnel or, especially in small hosts, following the curvature of the host stem. The frass is pushed out in the form of conspicuous, very compact cylinders, composed of fine shavings, each about 0.5 to 0.7 mm. long and 0.05 to 0.1 mm. wide, which may attain a length of cms. or more before breaking.

The eggs are laid in clusters at intervals for some time, and there is some evidence to suggest that the larval stage of the female includes 4 instars. The male, which is larger than the female, nevertheless develops more rapidly and may possibly have fewer larval instars. In one host, examined 30 days after cutting, a nest was found to contain all but the youngest larvae, and many pupae, one young adult male and a few young adult females. Another host was located just after the entrance tunnels had been completed and, 20 days later, nests in it contained all stages from eggs to pupae and a very few young adult males. In normal forest conditions in Malaya, it is probably that the whole life cycle can be completed in from 4 to 5 weeks, but the emergence of young adults from the host may then continue, at intervals of a few days, for several weeks. Most advanced broods that have been observed have contained about 20 individuals, but in one instance,

28 days after the host was felled, a brood was found to contain 10 eggs, 32 larvae of various instars, and 3 pupae.

X. foersteri Hag. This shothole borer, which is really only a large form of *X. pruinus* and has similar habits, is known to occur in Sumatra and Borneo, and is fairly common in Malaya, almost entirely as a borer of Burseraceae. Its recorded hosts are:

Burseraceae: *Canarium littorale*, *Santiria griffithii*, and 6 unidentified spp.

Dipterocarpaceae: *Shorea leprosula*. In Sarawak it has been found, in *Santiria* sp. of the Burseraceae, at an altitude of 2,300 feet.

The species has been found in unhealthy, dead or cut trees of almost any size down to a minimum diameter of about 3 cms. The nest is exactly similar to that of *X. pruinus* except that the tunnel and brood-chamber are larger, and the conspicuous cylinders of frass, which may reach a length of 3 to 4 cms. before breaking, are stouter.

X. sisyrnophorus Hag. This species, which occurs also in Sumatra, is rare in Malaya, but has been recorded in Pahang, Selangor and Johore, infesting logs of an unidentified species of the family Burseraceae, *Dryobalanops aromatica* of the Dipterocarpaceae, and *Xerospermum* sp. of the Sapindaceae.

X. destrietus Sch. was discovered, at Fraser's Hill in Pahang, at an altitude of 2,300 feet. Nothing further is known of it.

X. lativentris Sch. was discovered, at an altitude of 5,000 feet at Cameron Highlands in Pahang. It has not been found again, and nothing is known of its habits.

***Xyleborus* (miscellaneous species)**

In this section are included a few species that do not belong to any of the principal groups that have already been discussed. They either stand alone, without known close relations, or else belong to small and unimportant groups not otherwise represented in Malaya.

X. percorthylus Sch. This distinctive species is probably most closely related to the *tnajor* group, in which, however, it cannot be included without an undesirable broadening of the diagnosis. It occurs both in Malaya and Borneo, but is by no means very common in either territory. In Malaya it has been recorded from 4 species of *Shorea*, including *S. leprosula* and *S. ovalis*; and, in Sarawak, from 3 other species of the same genus. It therefore seems probable that it has at least a strong preference for, and possibly a fixed host association with, the Dipterocarpaceae. All the observed hosts have been large logs.

At least the main part of the nest comprises an irregular cavity, about 1.5 cms. long and equally wide, lying between the bark and the wood, the surface of which is deeply engraved, but whether the beetles ever penetrate directly into the wood has not been established with certainty. In one such cavity nest, a brood has been observed to contain about 20 individuals, including 10 young adult females, the remainder being mainly pupae with a few mature or almost mature larvae. The male is still unknown.

X. corporaali Egg. This species represents a small group that also includes a few other species in the Indo-Malayan area. It occurs in Java, and is rare in Malaya, where it has been found infesting a dead, 30 cms. diameter stem of *Shorea leprosula* of the family Dipterocarpaceae. In the nest (fig. 30), the entrance tunnel was radial to a depth of barely a centimetre, and then expanded to form a more or less rectangular brood chamber, about 2 cms. long and 1 cm. wide, in the transverse plane;

from the distal corners of this chamber, tunnels again ran off to a maximum depth of about 2 cms. *X. corporaali* is one of the only 3 Malayan Scolytidae known, up to the present, to make brood-chambers in the transverse plane, the others being *X. nugax* and *X. leprosulus*

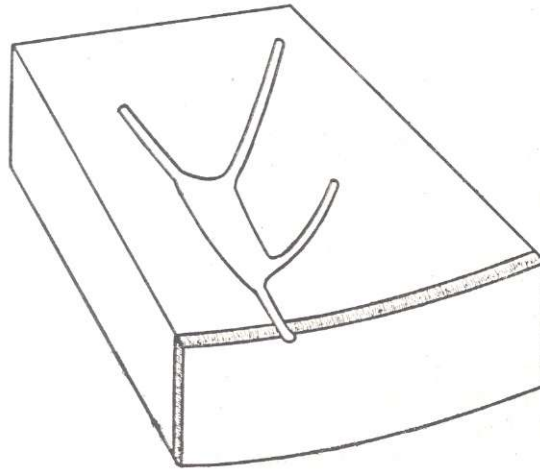

Fig. 30. Transverse section of wood, with a nest of *XyleBorus corporaali*. Approx. nat. size.

X. armaticeps Sch. was discovered in Pahang, in the wood of a cut tree, *Shorea leprosula* of the family Dipterocarpaceae. It has not been found again.

X. scoipius Sch. The type of this species was attracted to light in Perak. Nothing further is known of its habits.

X. planotruncatus Sch. has also been found only once, at an altitude of 4.500 feet in Perak. Nothing is known of its habits.

X. bellus Samps. This shothole borer, which occurs also in Borneo and the Moluccas, is possibly to be regarded as a form transitional to the tribe Webbini. It has been found only twice in Malaya, on both occasions in Kelantan, and no host plants have been specifically identified, but one belonged to the Euphorbiaceae, and one was a species of another family. In Sarawak it has been found in *Vatica* sp. of the family Dipterocarpaceae.

Although *X. bellus* is a rather large, stout species, it has only been found infesting very small stems and branches of about 3 to 5 cms. diameter, but it is not a true twig-borer. The nest is of the typical Webbini form, with an unbranched, radial or slightly curved entrance tunnel, and one terminal brood-chamber in the longitudinal plane. In the smallest material that the species infests, both the chambers, which are apparently never modified to form irregular, longitudinal tunnels, and the broods may be small, and a brood containing as few as 4 fully grown larvae has been observed. In Sarawak mature larvae have been found in nests 39 days after the host tree was felled, and after 52 days there were practically no beetles left in this host, nearly all the young females having flown.

One of the observed hosts in Malaya was a living tree, without any marked indications of ill health. Numerous young females of *X. bellus* had penetrated into the wood to a depth about equal to their own length, but had then died.

Genus *Xylosandrus* Reitter

This genus, which is often treated as part of *Xyleborus*, includes barely a dozen small, stout, convex species, some of which are of economic importance as shoot-borers. The group is evidently Oriental in origin, but one species is widely distributed in northern, temperate countries, and some of the tropical forms have spread to Africa and South America. Six species are known to occur in Malaya.

Like all Xyleborini, the species are ambrosia beetles, with a social organisation of extreme polygamy. The ratio of females to males is high, and the males never leave the vicinity of the parent nest, so that the care of the young brood is entirely the responsibility of the females. They typically breed in small material, twigs, shoots and minor branches, but some are occasionally found in large logs.

X. difficilis (Egg.). This species occurs also in Assam, Sumatra, Java, Borneo and Celebes, and extends across the Pacific as far as Fiji. In Java it has been found up to an altitude of about 5,000 feet. It is common in Malaya, where it has been recorded from the following hosts.

Burseraceae: Unidentified sp.

Dipterocarpaceae: *Dipterocarpus kunstleri*, *Shorea* sp., *S. leprosula*, *S. macroptera*, *S. ovalis*.

Euphorbiaceae: *Macaranga* sp.

Polygalaceae: *Xanthophyllum* spp (2 spp.).

Rubiaceae: Unidentified sp.

Urticaceae: *Artocarpus elasticus*.

It has been reported in Assam from Verbenaceae; in Borneo from Apocynaceae and Dipterocarpaceae; in Celebes from cut canes of the Palmaceae; and, in Java, from 2 species each of the Euphorbiaceae and Urticaceae, and one species in each of the families Compositae, Fagaceae, Hamamelidaceae, Lauraceae, Magnoliaceae, Staphyleaceae, Sterculiaceae, Theaceae and Verbenaceae. If it has any strong preferences, they are not revealed by these lists.

The species normally infests stout twigs and small poles and branches, from about 1 to 15 cms. diameter, but it is occasionally also found in large logs. In small material the nest (fig. 31 A) comprises a straight or circumferential tunnel, often with 2 or 3 branches, one of which ends in an irregular, longitudinal tunnel or chamber, in which the young brood lives. In larger logs, according to Kalshoven (1959a), it makes small chambers in the cambial zone. The tunnels are typically lined with a dense, whitish mycelium. A mature brood of the new generation has been found in a nest 44 days after the cutting of the host tree.

X. difficilis has not yet been recorded as a serious pest of bushes or young transplants. As a borer of large timber, the penetration of its tunnels is so slight that it is of no importance.

X. morigerus (Blandf.). This species, which is very like *X. difficilis* but smaller, is evidently Oriental in origin, but has now been recorded from East Africa, Madagascar, Ceylon, Indo-China, Sumatra, Java, Borneo, Celebes, the Philippines, New Guinea, Queensland, Samoa, Fiji and, rather recently, from Brazil. It is known principally as a pest of coffee, and also as a borer in the stems of orchids. It is rather variable in colour in different localities; in the lowlands of Java, for instance, it is brown, whereas at relatively high altitudes it is black; and all known Malayan specimens are black or at least extremely dark brown.

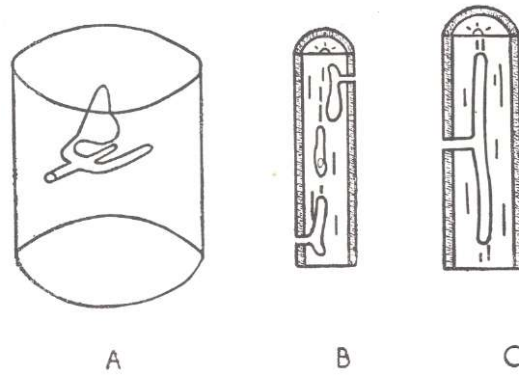

Fig. 31. A, a small branch, with a nest of *Xylosandrus difficilis*, shown as a transparency. Also longitudinal sections of twigs, with nests of B, *Xylosandrus morigerus*, and C, *Cnestus aterrimus*. Approx. nat. size.

The species is common in Malaya, but there is as yet no report of it as a major pest. It has been recorded from the following hosts.

Annonaceae: *Fissistigma elegans*. Araliaceae: *Arthropodium diversifolium*. Bixaceae: *Bixa orellana*.

Dipterocarpaceae: *Dryobalanops oblongifolia*, *Shorea leprosula*. Euphorbiaceae: *Macaranga* sp. Fagaceae: *Castanopsis* sp.

Leguminosae: *Adenanthera pavonina*, *Intsia palembanica*.

Table 22 compares the above list with the host families reported in India, Ceylon and Java; and the species has also been taken from orchids in New Guinea and Queensland, and from cut canes (Palmaceae) in Celebes. It seems evident that, although *X. morigerus* cannot be described as highly selective, at least in natural conditions, certain plant families are distinctly more attractive than others to it, and, indeed, we must assume some degree of selectivity in order to account for its role as a pest of coffee. Another interesting aspect of the table is that, although the lists of India-Ceylon and Java have a good deal in common, the Malayan list is almost completely different, only 2 out of its 7 families being represented among the hosts recorded in the other territories. It seems possible that the very dark brown form common in Malaya is a distinct race.

Kalshoven (1951) has given an account of the species in Java, particularly in relation to coffee, to which it is very injurious. It is chiefly a pest of *Coffea robusta*, less so of *excelsa*, breeding in the small twigs and very occasionally in the berries. The nest consists of a short, radial entrance tunnel, usually on the lower side of horizontal twigs, and, in the middle of the twig, an irregular chamber, sometimes with longitudinal tunnels on either side in the pith. The adult female feeds on the ambrosia fungus before beginning to lay her eggs. Egg-laying and enlargement of the nest then continue for some time, and the nest may eventually contain up to 80 offspring in various stages of development, a very large number for a twigborer. Development from egg to adult occupies about 3 weeks, and copulation occurs in or very close to the nest, the small, apterous male never leaving the host in which it was bred.

TABLE 22
HOST FAMILIES OF XYLOSANDRUS MORIGERUS

Family	Number of host species recorded in		
	India/ Ceylon	Malaya	Java
Annonaceae	—	1	—
Araliaceae	—	1	—
Bixaceae	—	1	—
Dipterocarpaceae	—	2	—
Erythroxylaceae	—	—	1
Euphorbiaceae	1	1	1
Fagaceae	—	1	—
Lauraceae	2	—	—
Leguminosae	4	2	6
Loranthaceae	1	—	—
Malvaceae	1	—	—
Meliaceae	3	—	2
Orchidaceae	1	—	3
Rubiaceae	1	—	2
Sapindaceae	1	—	—
Sterculiaceae	—	—	1
Theaceae	1	—	—
Urticaceae	—	—	1
Verbenaceae	1	—	1
Zingiberaceae	—	—	1

Important damage is done by the associated fungi in the tissues in and around the nest. In slender twigs these may rapidly spread over the whole circumference, and the infested parts die or readily snap off; this happens most easily in periods of dry weather. Young seedlings are always rapidly killed when attacked by the beetle.

Infestation is usually primary, but the beetle prefers weak or senile plants, and is sometimes found in seriously diseased plants. It is less successful in periods of vigorous growth, and also where humidity is low, possibly because these conditions do not favour the development of the ambrosia fungi. Gardens where nematodes are abundant, or the soil poor, are particularly liable to infestation. In its attacks it is often accompanied by other twig-boring Scolytidae, and its abandoned nests are often colonised by ants and termites.

In addition to coffee, *X. morigerus* frequently finds alternative hosts in nurse and cover crops, such as *Albizzia* and *Centrosema*, and it freely attacks young *Derris* stumps, often killing stumps even as large as 4 cms. diameter. In some hosts, but apparently not in coffee, it bores into the roots to a considerable depth below the ground.

In east Java there is generally a marked increase in the population of *X. morigerus* during the rainy season. Its numbers are again reduced mainly by parasitic Hymenoptera, particularly a species of *Tetrastichus* which, however, lays its eggs between bark and wood, so that it can only reach broods living in very slender twigs.

In Malaya, *X. morigerus* has been found most frequently in small twigs, but also in poles and branches, usually of cut trees, up to a maximum diameter of about 15 cms. It has only once been found in a living tree, an *Intsia palembanica* sapling shortly after transplanting. In twigs the nest (fig. 31 B) is as described by Kalshoven, with a radial entrance tunnel and an irregular, longitudinal tunnel or chamber. In larger material there is a tunnel with a few branches in the transverse plane, and a brood chamber in the longitudinal plane, very similar to the nest of *X. difficilis*. Broods in Malaya have usually been found to be rather small. One nest, 4 weeks after the host tree was cut, contained 25 individuals in all stages up to pupae. A mature brood, ready to swarm, has been observed in a host cut 44 days previously.

X. discolor Blandf. This species occurs in tropical India, Ceylon, Burma, Sumatra and Java, and in the last of these territories it has been found up to an altitude of about 4,500 feet. It is rare in Malaya, where it has only been recorded from a cut *Swietenia macrophylla*, of the family Meliaceae. It is a borer of twigs and shoots. The nest comprises a short entrance tunnel and one or more longitudinal tunnels in which the young brood lives, and which is typically densely lined with white mycelium.

Beeson (1941) records as hosts 14 species in 10 families, the Leguminosae providing 4 of these species and the Meliaceae 2. In Ceylon, Speyer (1923) cites one host species in each of the families Euphorbiaceae, Leguminosae and Proteaceae, the first of these being a young rubber tree (*Hevea brasiliensis*). Kalshoven (1951) has noted it as a primary borer of coffee in Sumatra and Java, and (1959a) records 2 host species in the Meliaceae and one in each of the families Bixaceae, Compositae, Fagaceae, Hamamelidaceae, Leguminosae, Rubiaceae, Sterculiaceae (*Theobroma*) and Urticaceae.

In Ceylon, according to Speyer (I.e.), development of the brood may be remarkably rapid. He writes that the tunnels are complete, and eggs laid, 2 days after initial attack, and that the larval period may be as short as 3 days. However, this observation is open to some little doubt, and it is certain that such a brief larval period could occur only in unusually favourable conditions. Speyer also notes that the broods are usually small, rarely containing more than 8 individuals, and that there is considerable variation in the size of the adults. In India, Beeson (1930) also found only small broods of about 10 individuals.

Although it has never yet appeared in abundance in Malaya, *X. discolor* must be suspect as a shoot-borer of some potential importance.

X. mediocris Sch. This species is known in Malaya only, and is not common. It has been found in Pahang and Negri Sembilan, where its recorded hosts are *Dipterocarpus cornutus* and *Shorea dasyphylla*, of the Dipterocarpaceae, and an unidentified species of another family.

X. pygmaeus Egg. This species occurs also in Java, where it has been found up to an altitude of about 5,000 feet. It is not common in Malaya, but has been found in cut trees of *Litsea amara*, of the family Lauraceae, and *Vitex pubescens* of the Verbenaceae. In Java it is recorded from species of the Rubiaceae (*Coffea*) and the Sapindaceae, and is apparently sometimes a primary borer of coffee bushes.

The material attacked is usually very small, less than 1 cm. diameter, and infestation of rather dry twigs may occur. The nest has a straight or circumferential entrance tunnel and, in the pith, one or more longitudinal, straight or spiral tunnels, up to about 2 or 3 cms. long. In an unidentified host cut 52 days previously, a small brood of 8 fully grown larvae was found.

X. morstatti Hag. This is a widely distributed species that is known chiefly as a pest of coffee, and to a lesser extent as a pest of Avocado pear and cocoa. It is now known to occur in tropical east and west Africa, Madagascar, Mauritius, Seychelles, southern India, Indo-China, Sumatra, Java, Borneo, Celebes and Fiji, and is fairly common in Malaya, where it has been recorded from the following host plants.

- Dipterocarpaceae: Shorea sp. (meranti). S. sumatrana.
- Leguminosae: Adenantha pavonina, Desmodium ovifolium.
- Meliaceae: Swietenia macrophylla.
- Sterculiaceae: Theobroma cacao.
- Tiliaceae: Muntingia calabura.

These hosts are compared in table 23 with the records available in some other territories. The lists are not very long, and have a good deal in common, half of the families cited, particularly the Meliaceae and Rubiaceae, recurring in more than one area, and to these should be added the Lauraceae, which provide common hosts in some other territories. Although, therefore, X. morstatti is not associated with any single plant family, it evidently shows some preferences, and the probability of its becoming seriously injurious to cultivated species in the favoured families should not be overlooked.

TABLE 23
HOST FAMILIES OF XYLOSANDRUS MORSTATTI

Family	Number of host species recorded in			
	Tropical Africa	India	Malaya	Sunda Islands
Anacardiaceae	1	—	—	—
Compositae	—	—	—	1
Dipterocarpaceae	—	1	2	—
Erythroxylaceae	—	—	—	1
Lauraceae	—	—	—	1
Leguminosae	2	—	2	—
Meliaceae	1	3	1	1
Orchidaceae	—	1	—	1
Palmaceae	—	—	—	1
Rubiaceae	1	1	—	1
Sterculiaceae	1	—	1	—
Tiliaceae	—	—	1	—

X. morstatti is principally a borer of seedlings, shoots and small twigs, but it will also breed in cut branches and poles up to a diameter of about 6 cms., rarely(in larger material. In small hosts the nest is similar to that of X. morigerus, with a simple or bifurcated entrance tunnel, and a longitudinal chamber or irregular tunnel in which the young brood lives. The size of the broods has been very variably reported. Those observed in Malaya have rarely exceeded 10 individuals, and, in the Seychelles, the largest brood observed by Brown (1954) included 2 eggs and 7 larvae. But Chevalier (1931) records broods of 30 to 50 in tropical Africa, and, in Fiji, Lever (1928) has found

26 individuals of all instars in one nest. The eggs are laid in clusters of about 2 to 7. The details of times required for development have not been ascertained in Malaya, but in the French Cameroons Lavabre (1958-59) found that eggs were laid 7—8 days after the mother had entered the twig, the egg, larval and pupal stages average about 4—5, 11 and 7 days respectively, the adult integument hardened in 2 days, and the females reached sexual maturity in about 6 days; there were only 2 larval instars, and the ratio of females to males was approximately 9 : 1 .

The ambrosia fungi associated with *X. morstatti* have received some study, from which it would appear that they vary in different parts of the world, and that more than one species may be associated with the beetle even in a single host. In Indonesia, Miller (1933) found ambrosia fungus of the *Monilia* type, and a *Fusarium* in the outer tunnels. In the Seychelles, Brown (l.c.) reports that fungi in a nest showed a mixture of *Cladosporium cladosporoides* and *Penicillium pallidum*.

Although less notorious, at least in Malaysia, than *X. morigerus*, the species is regarded as a serious pest in many coffee-producing countries and, indeed, Kalshoven (1951) states that it has largely replaced *X. morigerus* in some parts of Java; while in the French Cameroons, Lavabre (l.c.) reports a loss, caused by *X. morstatti*, of about 20 per cent of the crop. Different species or varieties of coffee, however, appear to vary in their susceptibility to infestation. According to Coste (1955), *arabica* and all varieties of the *canephora* group are freely attacked, *indeniocarpa* is very resistant, and *liberica* and *stenophylla* are classed by him as immune; but in the Cameroons, Lavabre (l.c.) has found it prefers *robusta*, and causes little damage to *arabica*.

In isolated island territories, such as Mauritius, Seychelles and Fiji, *X. morstatti* is more commonly known as a species injurious to Avocado pear (*Persea gratissima*). The studies of Brown (l.c.) in the Seychelles, however, led him to the conclusion that it is not a very important pest. Other agricultural crops with which it has been associated in various territories are cocoa and oil-palm. In Malaya there is only one known instance where *X. morstatti* has been responsible for serious injury in a forest nursery, attacking 8-months old seedlings of *Muntingia calabura*. Writing of this infestation, K. D. Menon (i.l.) says: "There are about 1,440 young seedlings in the nursery, and 30 per cent of these have so far been attacked and killed. In most cases there is only one beetle gallery per plant, at the base."

Genus *Streptocranus* Schedl

This genus is sometimes included in *Xyleborus*, but it is distinct enough. It occurs in the Oriental region and in Africa, and is represented in Malaya by 5 species, none of which is abundant or of any considerable economic importance. They have all the general biological characteristics of the Xyleborini. The typical nest consists of a tunnel with a few branches, which are often irregularly widened but never form a definite pattern of brood chambers.

S. longicauda Brne. This species occurs also in Borneo, but is not common either there or in Malaya. It has been found in Selangor in a fallen *Castanopsis sumatrana*, of the family Fagaceae, and in Sarawak in an unidentified, dying (poisoned) tree; both trees were of about 15 cms. diameter at the point of infestation. The *Castanopsis* had been cut 7 weeks previously, and the nest (fig. 32 A) contained all instars of the new generation up to young adults, living together in two slightly irregular, longitudinal tunnels placed close together.

S. bicuspis (Egg.). (Synonym: *S. recurvus* Brne.). This species occurs also in Java and Borneo. It is rare in Malaya, where it has only been found in Kelantan, in an unidentified, small, cut branch of

about 10 cms. diameter. In Sarawak it has been taken, at an altitude of 2,300 feet, from a cut *Castanopsis* of the family Fagaceae.

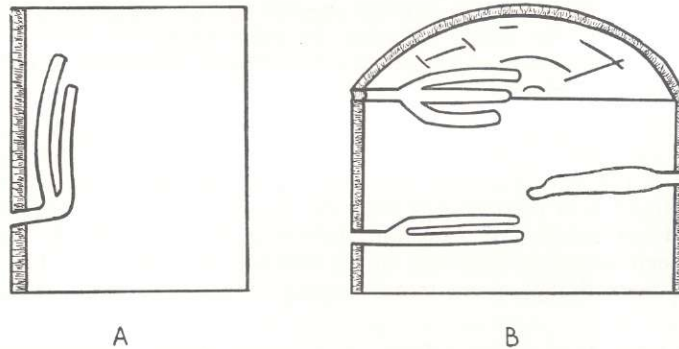

Fig. 32. Sections of wood, with nests of A, *Streptocranus longicauda*, and B, *Streptocranus capucinulus*. Approx. nat. size.

S. capucinulus Sch. (Synonym: *S. penangensis* Brne.). This species occurs also in Java, where it has been recorded in *Canarium* sp., of the family Burseraceae. It has been found only once in Malaya, in Penang, infesting an unidentified, small, cut tree of about 5 cms. diameter. The nest (fig. 32 B), has a short entrance tunnel, which soon breaks up into a few branches which are more or less transverse, not longitudinal as in the nests of *S. longicauda* that have been observed; these branch tunnels are placed close together, usually slightly widened, and may coalesce to form a very irregular sort of brood chamber. The total depth of penetration into the wood is at most about 3 cms.

S. bicolor Brne. is known only in Malaya, and is rare, but has been found in *Eugenia* sp. of the family Myrtaceae, and in *Palaquium stellatum* of the Sapotaceae. These hosts were small, cut trees of about 3 to 10 cms. diameter. The only nest that has been observed showed a few, more or less transverse branch tunnels, and a short, irregularly widened branch in the longitudinal plane.

S. fragilis Brne. This little species is probably the least uncommon of the Malayan representatives of *Streptocranus*, but is so small and slender that it is apt to be overlooked. It is known in Malaya only, and has twice been taken in association with *S. bicolor*, in small, cut trees of *Eugenia* sp., of the family Myrtaceae, and *Palaquium stellatum* of the Sapotaceae, as well as from a few other unidentified hosts of between 3 and 10 cms. diameter. The only complete nest that has been found showed a short, radial entrance tunnel and one very irregular longitudinal tunnel.

Genus *Pseudoxyleborus* Eggers

Pseudoxyleborus is a small Oriental genus, very closely related to the *truncatus* group of *Xyleborus*, but with a few distinctive characters. It contains about 9 described species, and the known distribution is very restricted, extending only from Assam and Indo-China to the great Sunda islands. Five species are known to occur in Malaya, but none is abundant.

The species are fairly large shothole borers, and in their general habits they closely resemble the *Xyleborus* species of the *truncatus* group except that they tend to be more selective in their choice of hosts. The nest comprises an unbranched entrance tunnel ending in one large brood chamber in the longitudinal plane.

P. aspersus (Samps.). This species also occurs in Thailand and Borneo, but is not abundant in Malaya, where it has been recorded in Kelantan and Pahang. It is the only Malayan ambrosia beetle that is known with certainty to have a fixed host relationship with the family Myrtaceae, and all records of it are from species of *Eugenia*, including *E. bernardii*. In Sarawak it has also been found in *Eugenia*, at an altitude of 2,500 feet. The observed hosts have been dying or cut trees, varying in diameter from about 3 to 15 cms.

The nest is of the typical form of the genus, with a more or less radial, unbranched entrance tunnel, and one terminal, large, oblong or subrectangular brood-chamber in the longitudinal plane.

P. batoerradensis Sch. This species, which was originally discovered in Java, has been recorded only once in Malaya, in Penang, infesting stems of the cultivated nutmeg, *Myristica fragrans* of the family Myristicaceae.

P. opalescens Sch., which also occurs in Borneo, is apparently a high level form. In Malaya it has been found only once, at an altitude of 4,800 feet in Pahang, and in Borneo it has been taken at levels varying from 2,500 to 4,000 feet. No host plants have been identified in Malaya, but in Sarawak it has been recorded from *Eugenia* and *Tristania*, both of the Myrtaceae, and it is possible that, like *P. aspersus*, it has a fixed association with this family.

P. beelsoni Egg. This species is known to occur also in Burma and Borneo, but does not seem to be very common in Malaya, possibly because its hosts are trees of little forest importance, and it is therefore rarely noticed. It apparently has a fixed host association with the family Sapindaceae, and has been found in *Xerospermum intermedium* in Malaya and in species of *Nephelium* in Burma and Borneo. It infests unhealthy or cut trees, and its recorded hosts have varied in diameter from about 18 to 30 cms. The nest has the usual unbranched entrance tunnel and a large, terminal brood-chamber in the longitudinal plane. The frass is pushed out of the nest in the form of compact cylinders.

P. glaucus (Samps.) was discovered in Penang in 1913, and has not been found again. Nothing is known of its habits.

Genus *Cnestus* Sampson

Cnestus is a small genus of about 10 known species, most of which were originally described in *Xyleborus*; it is, however, quite distinctive and must be given generic rank. It is distributed throughout Malaysia from Assam and Indo-China eastwards, but is also represented by a species in Ceylon, and almost certainly by another in Japan. A few species have a fairly wide range within this area, but others are rare and have a very restricted distribution.

As far as is known, the species are shoot-boring and twig-boring ambrosia beetles, with all the usual biological characteristics of the Xyleborini. As such they must be suspect as potential pests, but so far none has occurred as a primary borer of living trees.

C. aterrimus (Egg.). (Synonyms: *Xyleborus glaberrimus* Sch., *Cnestus nitens* Brne.). This species, which also occurs in Sumatra and Java, is at least locally common in Malaya, where it has been recorded from *Fissistigma elegans*, of the family Annonaceae, *Canarium littorale* (Burseraceae), *Shorea acuminata* (Dipterocarpaceae), *Elaeocarpus petiolatus* (Elaeocarpaceae), *Castanopsis sumatrana* (Fagaceae), *Swietenia macrophylla* (Meliaceae), *Scorodocarpus borneensis* (Olacaceae), and *Clerodendron villosum* and *Vitex pubescens* of the Verbenaceae. Elsewhere its only recorded host is *Cinchona*, of the family Rubiaceae, in Java. The number of

observed host families is thus almost as large as the number of species, and the beetle is certainly not very selective.

C. aterrimus infests the shoots and twigs of cut trees, but is also found in the smaller branches, up to a maximum diameter of about 5 cms. In small material the entrance of the nest (fig. 31 C) runs radially to the pith, where a longitudinal tunnel, sometimes rather irregular, is made on both sides of it, and here the young brood lives and pupates. The eggs are laid in fairly large clusters, up to about 15 in a cluster. The time required for development is unknown, but in a host that had been felled only a few weeks previously, only young adults of the new generation, with the old mother beetles, were found. Among 43 adults, probably representing two broods, only 2 were mates.

C. pseudopunetulus Sch. The type of this species was attracted to light in Selangor. Nothing more is known of it.

C. bicomioides (Sch.). This species is known to occur also in the Philippines. In Malaya, where its distribution appears to be localised, and where it is less common than *C. aterrimus*, its only identified hosts are twigs of cut trees of *Shorea sumatrana*, of the family Dipterocarpaceae, and *Swietenia macrophylla* of the Meliaceae. The nest, which is of the same pattern as that of *C. aterrimus*, with a radial entrance tunnel and a longitudinal tunnel on each side of it in the pith, is densely lined with white mycelium. Complete nests, containing half-grown larvae, have been found in a host tree cut 3 weeks previously.

PLATE IV

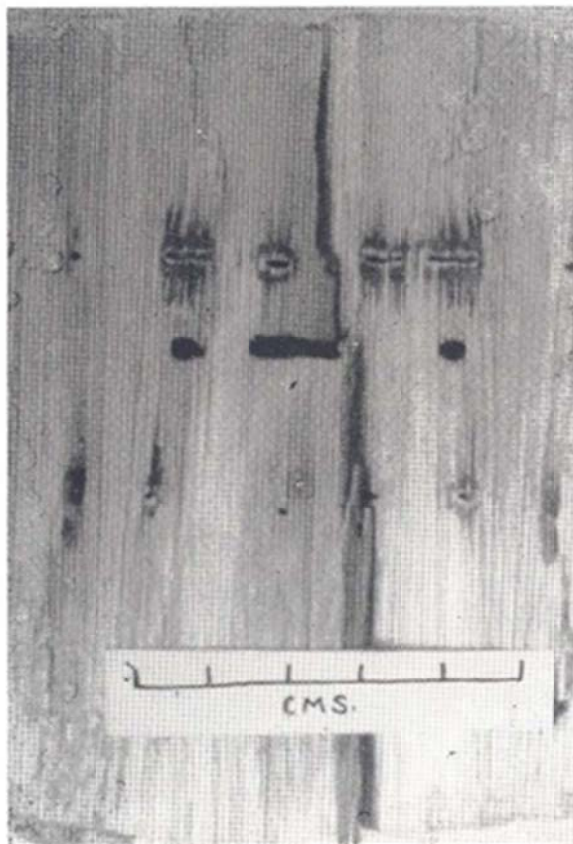

Tunnels of ambrosia beetles (*Xyleborus* spp.), showing stining caused by associated fungi.

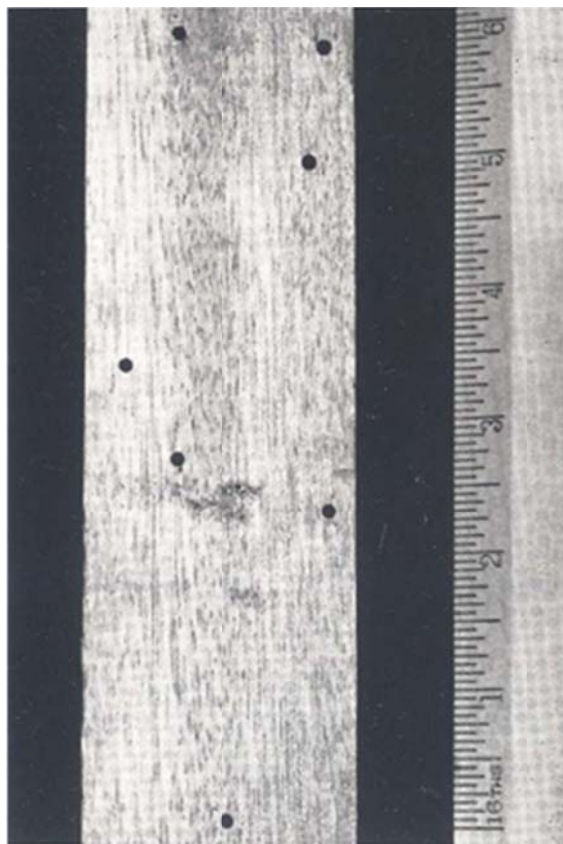

Shot holes in a Red Meranti board, made by *Dendroplatypus impar*.

Photo: F.R.I. Kepong

PLATE V



Surface nests of *Xyleborus caelator*. the vertical tunnel on the right is the work of another insect.



False surface galleries of *Platypus curtus*: the large irregular cavity is the work of a Cerambycid larva.

PLATE VI

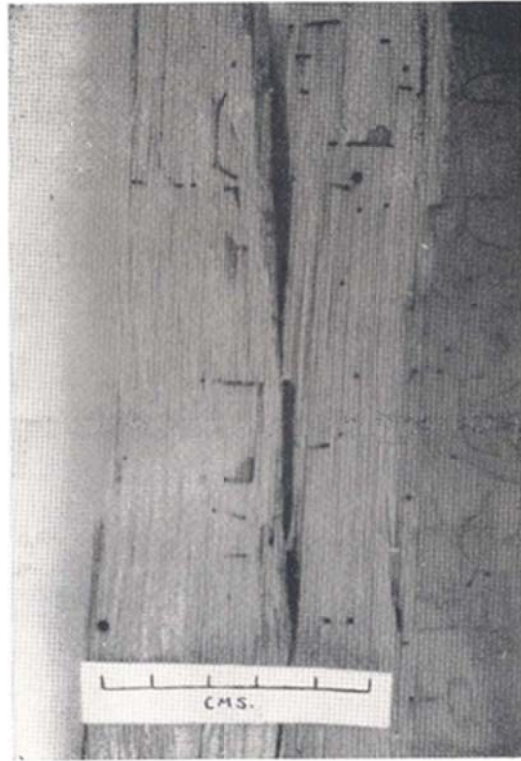
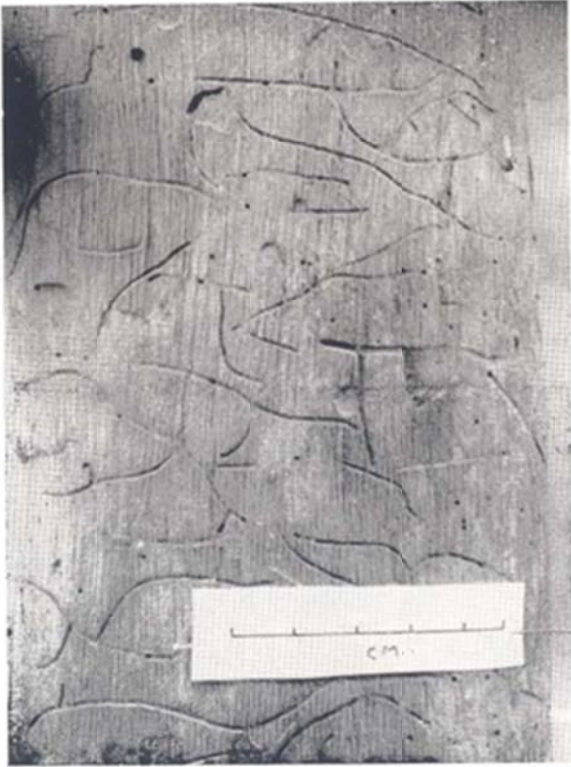

Left: surface galleries and brood-chambers, mainly of *Xyleborus subdolosus*; Right: the same, showing penetration into the wood.

BIBLIOGRAPHY

- Anderson, R. F. 1948. *J. Econ. Ent.*, 41, 4 : 596-602.
- Anonymous. 1951. *Ann. Rept. W. Afr. Cacao Res. Inst.*, 1949-50.
- Bach, J. A. and Massey, C. L. 1945. *Bull. Duke Sch. For.*, No. 10.
- Baker, J. M. 1958. Unpublished report.
- Bakshi, B. K. 1950. *Trs. Brit. Mycol. Soc.*, 33 : 111-120.
- Becker, G. 1951. *Z. angew. Ent.*, 33, 1-2 : 186-209.
- Beeson, C. F. C. 1925. *Ind. For. Rec.*, XI, 4, 11 : 1-8.
- Beeson, C. F. C. 1926. *t.c.*, XII, 8 : 1-16.
- Beeson, C. F. C. 1930. *t.c.*, XIV, 10 : 209-272.
- Beeson, C. F. C. 1941. *Forest insects of India and the neighbouring countries.*
- Bergamin, J. 1943. *Arq. Inst. biol.*, 14 : 31-72.
- Bergamin, J. 1944. *t.c.*, 15 : 197-208.
- Blackman, M. W. 1942. *Proc. U.S. nat. Mus.*, 92, No. 3154.
- Blandford, W. H. F. 1893. *Report on the destruction of beer casks in India.*
- Blandford, W. H. F. 1896. *Trs. ent. Soc. London*, pt. 2 : 191.
- Blandford, W. H. F. 1898. *t.c.* pt. 4 : 423.
- Blankswardt, H. F. H. 1953. *Ned. Boschb. Tijdschr.*, 28, 6 : 141-150.
- Bramble, W. C. and Hoist, E. C. 1945. *Phytopathology*, 30, 11 : 881-899.
- Brown, E. S. 1954. *Bull. ent. Res.*, 40, 4 : 707-710.
- Browne, F. G. 1936. *Imp. For. Inst, techn. Paper No. 3.*
- Browne, F. G. 1938. *Malay. Forester*, VII, 2 : 77-86.
- Browne, F. G. 1939. *t.c.*, VIII : 107-115. 1950.
- Browne, F. G. 1950. *t.c.*, XIII, 3 : 167-168.
- Browne, F. G. 1952. *t.c.*, XV : 197-206.
- Browne, F. G. 1955. *Sarawak Mus. J.*, VI, 5 (N.S.) : 343-373.
- Browne, F. G. 1958. *Malay. Forester*, XXI, 3 : 164-182.
- Browne, F. G. 1959. *t.c.*, XXII, 4 : 292-300.
- Browne, F. G. and Foenander, 1937. *Malay. Forester*, VI : 240-254. E. C.
- Brues, C. T. 1946. *Insect dietary.*

- Buchanan, W. D. 1941. *J. econ. Ent.*, 34 : 367-369.
- Cachan, P. 1957. *Theses Fac. Sci. de l'Univ. de Paris, Ser. A. No. 3784.*
- Carter, W. 1949. *J. econ. Ent.*, 42, 5 : 761-766.
- Chamberlin, W. J. 1939. *The bark and timber beetles of N. America.*
- Chapman, J. A. 1958. *Proc. 10th int. Congr. Ent. Vol. 4 (1956) : 375-380.*
- Chevalier, A. 1931. *Rev. Biol. Appl.*, 11 : 661-665.
- Cleare, L. D. 1938. *Agric. J. Brit. Guiana*, 9 : 237-245.
- Collins, W. B. 1958. *The perpetual forest.*
- Corbett, G. H. 1933. *Malay agric. J.*, XXI : 8-22.
- Coste, R. 1955. *Les cafeiers et les cafes du monde.*
- Dammerman, K. W. 1929. *Agricultural zoology of the Malay Archipelago.*
- De Mesa, A. 1931. *Makiling Echo*, X, 1 : 15-19.
- De Mesa, A. 1934. *t.c.*, XIII, 4 : 245-250.
- De Mesa, A. 1935. *t.c.*, XIV, 2 : 94-98.
- Duval, G. 1949. *Biologico*, 15 : 85-102.
- Findlay, W. P. K. 1959. *For. Abs.*, 20 : 1-7.
- Fischer, M. 1954. *Pflanzenschutzberichte*, 12 : 9-12, 137-180.
- Fisher, R. C., Thomson, G. H. and Webb, W. E. 1954. *For. Abs.*, 14, 4 and 15, 1 (Repr. No. 20).
- Forest Dept., S. Africa . 1947. *Annual Rept. for the year 1946-47.*
- Franz., J. 1948. *Zool. Jb. (Syst.)* 77, 6 : 426-442.
- Fuchs, G. 1914. *Verh. Ges. dtsh. Naturf. Aerzte*, 85 : 688-692.
- Gadd, C. H. 1941. *Tea Quart.*, 14 : 132-146.
- Gadd, C. H. 1944. *Ann. Appl. Biol.*, 31, 3 : 250-254.
- Gadd, C. H. 1946. *Bull. Tea res. Inst. Ceylon*, 27 : 30-36.
- Gadd, C. H. 1947. *Ann. appl. Biol.*, 32, 2 : 197-208.
- Gadd, C. H. 1949. *Tea Quart.*, 20, 2 : 61-65; 66-76.
- Graham, K. 1959. *Nature*, 184 (4682; Suppl. No. 5) : 283-284.
- Graham, K. and Boyes, E. C. 1950. *B. C. Lumberman*, 34, 8 : 42, 106.
- Graham, K. and Werner, A. E. 1956. *Bi-m. Progr. Rep. Div. For. Biol., Dep. Agric., Canada*, 12, 1 : 3-4.
- Greze, N. S. 1926. *Trud. Lesn. Opuitn. Delw. Ukrain*, pt. 4.

- Hagan, T. W. 1948. J. Dep. Agric. Victoria, 46 : 73-80.
- Hanson, H. S. 1937. Bull. ent. Res., 28, 2 : 185-236.
- Hopf, H. S. 1938. Ann. appl. Biol., 25 : 390-405.
- Hopkins, A. D. 1915. U.S. Dep. Agric. Tech. Ser., No. 17, 2 : 165-232.
- Hopkins, A. D. 1916. U.S. Dep. Agr. Progr. of Work, 1917 : 353.
- Illankoon, B. L. 1956. Tea Quart., 27, 4 : 112-113.
- Janse, J. M. 1898. Meded. v. Lands Plantent, 28.
- Jones, T. 1959. W. Afr. Timber Borer Research Unit, Techn. Bull, No. 2.
- Jones, T. and Roberts, H. 1959. W. Afr. Timber Borer Research Unit, Rept., 1955-58.
- Hopping, G. R. 1948. Canad. Ent., 79, 7-8 : 150-153.
- Jover, H. 1952. Rev. Path, veg., 31, 2 : 73-81.
- Judenko, E. 1956. Tea Quart., 27, 4 : 103-105.
- Kalshoven, L. G. E. 1920. Tectona, XIII : 32-57.
- Kalshoven, L. G. E. 1924. Arch. v. de Rubbercultuur, VIII, 6 : 1-11.
- Kalshoven, L. G. E. 1951. De plagen van de Cultuurgewaseen in Indonesia, II.
- Kalshoven, L. G. E. 1954. Contrib. Gen. Agric. Res. Stat. Bogor.
- Kalshoven, L. G. E. 1958. Tijdschr. v. Ent., 101, 3-4 : 157-180.
- Kalshoven, L. G. E. 1958A Ent. Bericht., 18, 1 VIII : 147-160.
- Kalshoven, L. G. E. 1958B t.c., 18 : 1, IV : 185-190.
- Kalshoven, L. G. E. 1959. Tijdschr. v. Ent., 102, 1 : 135-173.
- Keen, F. P. 1952. Misc. Publ. U.S. Dep. Agric., No. 273 (rev.).
- Knight, F. B. 1958. J. econ. Ent., 51, 5 : 603-607.
- Kraemer, G. D. 1950. Z. angew. Ent, 31, 3 : 349-430.
- Lavabre, E. M. 1959. Cafe, Cacao, The, 2, 3 : 119-130.
- Leach, J. G., Hodson, A. C. Chilton, St. J. P. and Christensen, C. M. 1940. Phytopathology, 30 : 227-236.
- Lever, R. J. A. W. 1928. Agric. J. Fiji, 9 : 20-21.
- Mason, F. R. 1931. Malay agric. J., 19, 4.
- Massey, C. L. and Wygant, N. D. 1954. Circ. U.S. Dep. Agric., No. 944.
- Miller, H. G. A. 1933. Versl. Afd. Med. Oost-Indie, med. ent., 1.
- Monti, J. R. 1954. Bull, agric. Congo beige, 45 : 817-885.

- Murayama, J. J. 1930. *J. Chosen nat. Hist. Sco.*, 11 : 1-34.
- Murayama, J. J. 1934. *Annot. Zool. Japan*, 14, 3 : 287-300.
- Murayama, J. J. 1953. *Trs. Shikoku ent. Soc.*, 3, 5-6 : 144-163.
- Murayama, J. J. 1954. *Bull. For. Agric. Yamaguti Univ.*, 5 : 149-212.
- Murayama, J. J. 1955. *t.c.*, 6 : 81-106.
- Murayama, J. J. 1957. *Pan-Pacif. Ent.*, XXXIII, 1 : 35-38.
- Murayama, J. J. 1959. *Forestry Leaves*, XI, 3 : 25-32.
- Nagel, R. H., McComb, D. and Knight, F. B. 1957. *J. For.* 55, 12 : 894-898.
- Nijijima, Y. 1942. *Trs. Sapporo nat. Hist. Soc.*, 17, 69.
- Nunberg, M. 1950. *Ann. Mus. Zool. Polon*, XIV. 9 : 135-140.
- Nusslin, O. 1913. *Leitfaden der Forstinsektenkunde*.
- Oldham, J. N. 1920. *J. Helminth.*, 2 : 239-248.
- Parkin, E. A. 1940. *J. exptl. Biol.*, XVII, 4 : 364-377.
- Pesson, P., Toumanoff, C. and Hararas, C. 1955. *Ann. Epiphyt.* 6, 3:315: 328.
- Pfeffer, A. 1955. *Fauna Czecho-Slovakia*, 6, Scolytoidea.
- Posthumus, O. 1931. *Leidsche Geol. Meded.*, 5 : 485-508.
- Reid, R. W. 1958. *Canad. Ent.*, 90, 9 : 505-509.
- Ridley, H. N. 1896. *Agric. Bull. Malay. Penin.*, 5, 91.
- Roberts, H. 1960. *W. Afr. Timber Borer Res. Unit, Rept.*, 1959-60.
- Schedl, K. E. 1938. *Philipp. J. Sci.*, 67 : 424.
- Schedl, K. E. 1942. *Tijdschr. v. Ent.*, 85 : 1-49.
- Schedl, K. E. 1951. *Occ. Papers, B. P. Bishop Mus.*, XX, 10 : 131- 156.
- Schedl, K. E. 1951A. *Mitteil. Forste—Versuch, Mariabrunn*, 47 : 74- 100.
- Schedl, K. E. 1951B. *Tijdschr. v. Ent.*, 93 : 41-98.
- Schedl, K. E. 1954. *Philipp. J. Sci.*, 83, 2 : 137-159.
- Schedl, K. E. 1957. *J. N. York Ent. Soc.*, LXV : 191-194.
- Schedl, K. E. 1958. *Tijdschr. v. Ent.*, 101, 3-4 : 141-155.
- Schedl, K. E. 1958A. *Proc. 10th int. Congr. Ent.*, 1 (1956) : 185-197.
- Schedl, K. E. 1959. *Malay. Forester*, XXII : 167-169.
- Schimitschek, E. 1939. *Z. Argew. Ent.*, 26, 4 : 545-582.
- Schmitz, G. and Crisinel, P. 1956. *La Lutte contre Stephanoderes hampei*.

- Schvester, D. 1957. *Ann. Epiphyt.*, 8 (num. hors serie).
- Sharpies, A. 1918. *Ann. appl. Biol.*, IV, 4 : 153-178.
- Smith, J. H. 1935. *Queensld. Dep. Agric. Bull*, No. 12.
- Speyer, E. R. 1923. *Bull ent. Res.*, XIV, 1 : 11-23.
- Stark, V. N. 1926. *Def. d Plantes*, 3 : 164-167.
- Stark, V. N. 1952. *Fauna U.S.S.R.*, No. 49 (Tom. 31).
- Strohmeyer, H. 1912. *Coleopt. Catalogus (Junk and Schenkling)*, pt. 44.
- Strohmeyer, H. 1929. *Tropenpflanze*, 32, 1 : 36-38.
- Struble, G. R. 1947. *J. For.*, 45, 1 : 148-150.
- Swaine, J. M. 1918. *Canada Dep. Agr., ent. Br., Bull. No. 14.*
- Swaine, J. M. 1928. *Proc. 3rd Brit. Emp. for Conf.*, 187-207.
- Thomas, A. V. and Browne, F. G. 1950. *Malay. Forester*, XIII, 4 : 214-223.
- Thompson, W. R. 1929. *Bull. ent. Res.*, XX, 4 : 457-462.
- Umbgrove, J. H. F. 1949. *Structural history of the East Indies.*
- Van Alphen de Veer, E. J. 1956. *Pengh. Balai Penyelidikan Kehutanan Indonesia*, No. 56.
- Vite, J. P. and Rudinsky, J. A. 1957. *For. Sci.*, 3, 2 : 156-167.
- Wadley, F.H. and Wolf enbarger, D. O. 1944. *J. agric. Res.*, 69, 7 : 299-308.
- Walter, T. E. 1956. *Tea Quart.*, 27, 4 : 107-111.
- Webb, S. 1945. *Proc. roy. Soc. Victoria*, 57 (N.S.) : 57-80.
- Webb, W. E. and Jones, T. 1955. *W. Afr. Timber Borer Res. Unit Rept.*, 1953-55.
- Wichmann, H. E. 1927. *Biologie der Tiere Deutschlands*, 351.
- Wichmann, H. E. 1952. *Z. angew Ent.*, 35, 2 : 201-206.
- Wood, S. L 1954. *Univ. Kansas Sci. Bull.*, XXXVI, 11.
- Wyatt-Smith, J 1952. *Malay. Nat J.*, 7, 2 : 42-55.
- Yakubyuk, A. 1927. *Def. d. Plantes*, 4 : 222-226.