

# HORTICULTURAL SUPPLY *Catalog*

2021-2022



[www.bfgsupply.com](http://www.bfgsupply.com)  
800-883-0234

# About BFG Supply Co



Founded in 1972, BFG Supply has a long history of serving the Green Industry including professional growers, lawn & garden centers, landscapers, and indoor growing stores. As an established industry leader, BFG provides the highest levels of customer service, the broadest product range, and innovative technology solutions. BFG is a true single source supplier for all of your Green Industry needs from watering tools and control solutions to multi-acre fully integrated professional greenhouse structures.

In a world full of change you can take comfort in knowing that BFG Supply is focused on caring for your business needs. We look forward to providing the best customer service in the industry and supporting the growth of our customers.

Contact us Today



For more information, to speak with a BFG representative or to ask about a specific product call us at (800) 883-0234.

## Highlights

- In business for 45+ years with Industry leading customer service
- Focus on the Professional Grower, Independent Lawn & Garden, Landscape and Indoor Growing industries
- Professional field sales force dedicated to customer success
- Broad product selection with 15,000+ skus in stock and 100,000+ skus available to order
- Fourteen modern distribution facilities to efficiently serve customers
- Leading technology to improve ordering and delivery efficiency

## Your Single Source For Horticultural, Lawn & Garden & Plant Products



### Grower Products

Over 12,000 products growers need to thrive from more than 400 suppliers.



### Lawn & Garden

Suppling retailers with products from a wide range of categories including landscaping, outdoor living, decor, pots and more!



### Exclusive Brands

BFG's exclusive brands are profitable "stand alone" high quality product lines focused on your business needs.



### Plant Connection

Resources to connect you with the plant material that is right for you with access to over 90 suppliers.



### BFG Expos

Come see hundreds of the top manufacturers for the Lawn & Garden, Nursery & Greenhouse Industry. Connect with BFG!





# Table of Contents

## **Greenhouse Structures..... 11-52**

Shade Houses, Shade Curtains, Benching

## **Coverings..... 53-72**

Film Coverings, Shade Products, Ground Cover

## **Containers..... 73-172**

Hanging Baskets, Plug Trays, Flats, Growing Pots

## **Media .....173-196**

Professional Growing Mixes, Additives, Components

## **Fertilizer.....197-246**

Water Soluble, Controlled Release, Plant Food

## **Crop Protection.....247-348**

Fungicides .....248-273

Insecticides.....276-299

Herbicides.....329-342

## **Irrigation .....349-374**

Valves, Tubings, Sprinklers, Regulators and More

## **Equipment & Supplies.....375-428**

Heating, Ventilation, Lighting, Carts, Plant Sleeves, Safety Gear, Radios, Labeling

## **Index.....429-440**

BROWSE BFG SUPPLY'S

# *vast product assortment*

BFG offers more than just horticulture items!



To browse all additional categories and items available at BFG Supply please see our full catalog lineup or visit [www.bfgsupply.com](http://www.bfgsupply.com) today!

## *Categories*

Horticultural Supplies  
Lawn & Garden  
Plants  
Seeds  
Indoor Growing

## *Catalogs*

Lawn & Garden  
Horticultural Supplies  
Indoor Growing  
Wetsel Seed Reference Guide  
The Plant Connection Spring Trials  
Michael Carr Designs  
Grower/Gardener Select  
Turf & Landscaping Supplies  
Greenhouse Structures

Grower

Lawn and  
Garden

Plants and  
Seeds

Indoor  
Growing

*wide variety*



BFG SUPPLY CO.

# Exclusive Brands

Profitable "stand alone" high quality product lines offered exclusively by BFG Supply Co.!



**GardenerSelect**

**Quality gardening products at an affordable price!**

Products include bird baths, planters, watering cans, and more

**GrowerSelect**

**All the products you need to keep growing!**

Products include fertilizer, containers, growing media, benching, and more.



**Setting the hottest new trends!**

Resin, statuary, indoor & outdoor pottery, Liconfiber and more



**Custom blends for all!**

Products include seed packet assortments, bulk garden seed, turf, forage, wildlife, and more.



**New varieties are available every year!**

Colorful combinations & eye-catching displays along with exciting new colors



**Keep your feathered friends coming back all year!**

Great quality feeders, suet, nectar, and more at affordable prices.



**99.9% weed free and disease-resistant!**

Blends that feature WaterGard QS enhanced w/Quickstart Micro Nutrients



**Greenhouse structures for both retail & grower!**

Talk to our experts about benching, irrigation, coverings, and more.

*Exclusive Brands*

# TERMS & CONDITIONS OF SALE

## 2021

### RELATIONSHIP TO ACCOUNT APPLICATION

These Terms and Conditions together with the Account Application and any fully executed Agreements between the parties contain the entire understanding between the parties as to all matters referred to herein. No other representations, covenants, undertakings or prior or contemporaneous agreements, whether oral or written, regarding any matters that are not specifically contained and incorporated in this Agreement, shall be deemed to have any effect or binding impact upon the parties. The language of this Agreement shall be construed according to its fair meaning and in accordance with its purpose and without regard to whom may have drafted any particular provision herein. For purposes of these Terms and Conditions "Customer" shall mean the legal entity that is a part to any BFG Supply Co. Account Application, or any Order placed with BFG Supply Co. and "Guarantor" shall mean any individual that executes the BFG Supply Co. Account Application as a guarantor.

### ACCOUNT APPLICATION

Payment terms are stated on your invoice. Discounts may be offered on certain products in certain situations and will be specified on the invoice. These discounts, if offered, are only available on invoices paid and received into the BFG office within the terms outlined on your invoice via cash or check and payments via credit card are not eligible for discounts. Buyer is responsible for mail time and discounts are only available if BFG actually receives eligible payments during the time frame set forth in these Terms and Conditions. Post marks will not be considered. A finance charge of 2% per month (24% annually) will be assessed on invoices not paid within invoice term date. Payments received towards balance will first be applied to finance charges unless otherwise stated in writing by BFG. BFG reserves the right to assess the maximum amount of finance charges permitted by applicable law. BFG has the absolute discretion to place an account on C.O.D. status until past due balances, including finance charges, are satisfied in full and BFG has determined that Buyer is eligible for the reestablishment of a credit line in BFG's sole discretion. Any failure of the Buyer to satisfy any of its obligations under a Account Application with BFG, including but not limited to the failure to satisfy amounts due within payment terms shall comprise an event of default. In the event of default, if BFG must employ a collection agency or attorney to collect any past due account, Buyer shall be responsible for the satisfaction of all amounts incurred in collection of any past due account including collection costs and attorney fees.

### PAYMENTS

Visa, MasterCard, Discover and American Express are acceptable payments at the time of purchase up to \$10,000 or higher as approved by BFG. Payments made after a finalized sale that require (or per request) a change in terms will be charged a 3% convenience fee. Please call BFG Accounts Receivable department at 800-883-0234 Ext 4997. Mail payments by check to BFG Supply Co., 3874 Solutions Center, Chicago, IL 60677-3008

### ACCOUNT APPLICATION AND TAX EXEMPT FORMS

Account can be established by submitting a completed BFG Supply Co. Account Application. Allow three to four weeks for complete processing. In addition, a tax-exempt form for your state must be on file with BFG or taxes will be charged on all purchases. The Account Application must be completed in its entirety to avoid processing delays. Failure to provide all information will result in adverse action with respect to Buyer's application for credit, including declining the application.

### INVOICES/STATEMENTS

Product will be invoiced on the date product is shipped from BFG or when delivery information is received from a manufacturer shipping direct. BFG will make good faith efforts to transmit monthly Account Statements at the beginning of each calendar month. Account Statements are reminders of open invoices, however, Account Statements do not grant an additional amount of time to remit payment. Please follow the terms indicated on your individual invoice. Copies of invoices can be located at [www.bfgsupply.com](http://www.bfgsupply.com) or contact BFG at 800- 883-0234. All these documents may be mailed, faxed, or e-mailed. Please contact BFG Supply Co., LLC or visit [www.bfgsupply.com](http://www.bfgsupply.com) with your choice preference.

### RETURNS

Our merchandise is sold on an outright sale basis and is not subject to return unless mis-shipped, damaged or defective. Any shipments refused for reasons other than freight damage will be subject to freight charges both ways as well as a restocking charge. If merchandise is mis-shipped, please contact our office for return authorization. We will arrange return transport and credit.

### DAMAGE/SHORTAGE/DEFECTIVE ITEMS CLAIMS

Damage in shipment claims on items shipped via Fed-Ex/UPS/ etc., must be made within one (1) business day (24 hours) of receipt of the merchandise. All claims for shortages and defective items must be reported to us within one (1) business day (24 hours) of delivery. All claims regarding billing errors, (pricing, terms, etc.) must be reported to BFG Supply or our representative within 30 days of delivery. Immediately upon receipt of truck shipments, examine the shipment carefully before signing the freight bill. If damage or shortage is evident, do not accept shipment without notation on the freight bill by the driver. Failure to do so may prevent you from filing a claim with the carrier. If you need assistance regarding damage claims, please contact your nearest BFG service location. A photograph of damaged product needs to be included with any damage claim. Merchandise found to be defective will be picked up (or field destroyed if you are advised to do so) and full credit will be issued provided the merchandise does not look like it has been abused or misused and is in accordance with the manufacturer's warranty policy. BFG Supply is not liable for damages, injuries or loss of revenue as a result of a manufacturer's defective item.

### DELIVERIES

Title and risk of loss pass to the Buyer upon delivery of the Product. BFG delivers to customers in designated delivery areas according to an established daily routing schedule. Although we do our best to run the same routes on the same days each week, unavoidable circumstances may arise which prevent us from adhering to our normal schedule. Please note that we will do our best to make sure you receive the product you need when you need it. BFG delivery charges vary by location. Please contact your local BFG service center for pricing. Or ask your Sales Representative or Customer Service Rep for current delivery charges. Backorders may be subject to delivery charge. Delivery via BFG vehicles or trucks is subject to the equipment available at the BFG Service Center and the ease of access to the destination. Please contact your delivering service center for details. Some orders may be shipped via Fed-Ex/UPS/ Etc. at the buyer's expense and are subject to an additional order handling charge. Deliveries outside of our designated area may not ship via BFG and additional freight charges may apply. Please check with the local BFG location for complete details. Please note: all flower and vegetable seed for plant growers are shipped from our Harrisonburg Facility. No orders may be shipped via UPS for a C.O.D. purchase. These orders must be prepaid. Advanced payment arrangements must be made with your local BFG Service Center for all BFG truck deliveries. BFG drivers do not carry cash. Important: All orders for delivery via BFG tractor-trailer must be phoned or faxed in at least 48 hours prior to your scheduled delivery day. BFG will accept "add-on" orders before 10:00 a.m. on the business day prior to your scheduled delivery day but cannot guarantee that they will fit on the trailer. It is necessary that the customer has appropriate personnel present to assist our drivers in unloading.



## TERMS & CONDITIONS OF SALE

2021

### WILL CALLS

Customers who wish to pick up merchandise from our warehouses are most welcome to do so. However, merchandise is not available in all locations; please call to verify if item is stocked. To help expedite your order, please call your order in ahead. Orders for pick up in the morning should be called into the office by 5:00 p.m. the day before. You may pick up items between 8:00 am-4:30 pm.

### RECOMMENDATIONS

All recommendations made by BFG are compiled from recognized horticultural sources or BFG's knowledge of recognized industries. BFG makes no warranties regarding any recommendation made and BFG is not responsible for any alleged losses of Buyer due to any recommendations given by BFG Supply Co. or its personnel.

### NOTICE TO PURCHASER

Seller's and manufacturer's only obligations shall be to replace such quantity of product proved to be defective. Before using, users shall determine the suitability of the product for their intended use, and users assume all risk and liability whatsoever in connection therewith.

### WARRANTIES

BFG makes no warranty of any kind, whether that be expressed or implied. Except as expressly provided in these Terms and Conditions, all implied warranties or conditions (whether statutory or otherwise) are excluded to the fullest extent permitted by Law. BFG makes no warranty respecting the merchantability of the products or their suitability or fitness for any particular purpose, non-infringement of third-party rights nor does BFG make any warranties against latent defects. Some product(s) sold by BFG may be accompanied by manufacturer warranties from the party that provided BFG with the product(s). All such warranties shall be the responsibility of the manufacturer of the product(s) purchased from BFG, if any warranties exist. Credits are limited to the amount of the original sale. Because of varied interpretations of standards at the local level, Seller cannot warrant that the product meets the requirements of the Occupational Safety and Health Act, or of any local acts or codes that may apply. In the event of litigation through the courts arising from any purchase, the Buyer consents to and submits to the jurisdiction and venue of the courts of Marion County, Indiana. Mail, phone, and internet orders accepted are subject to these terms and the Buyer in acceptance of the shipment agrees to these terms. BFG Supply warrants to the extent of the purchase price that seeds or bulbs sold are as described on the container. Subject to the limitation of liability set forth in the preceding sentence, BFG provides a limited warranty that at the time of delivery, seeds or bulbs sold by BFG are as described on the container, within recognized tolerances. As set forth above, BFG gives no other or further warranty, expressed or implied.

Note: Every effort has been made to provide current, accurate product information. Product guides/catalogs are intended to represent the many products offered by BFG Supply Co. Call your servicing BFG warehouse for updated product information or if you don't see a product or size you need. Chances are we can help you. Here are three points to keep in mind as you prepare to place your order:

1. Order early because stock availability of some items is unpredictable.
2. Prices included in any BFG product guides are intended as instructive guidelines only.
3. Prices may change without notice.

### FORCE MAJEURE

BFG is not liable for failure to fulfill its obligations for any accepted order or for delays in delivery due to causes beyond BFG's reasonable control including, but not limited to, acts of God, natural or artificial disaster, riot, war, strike, delay by carrier, shortage of products, acts or omissions of other parties, acts or omissions of civil or military authority, government priorities, changes in law, material shortages, fire, strikes, floods, epidemics, quarantine restrictions, acts of terrorism, delays in transportation or inability to obtain labor, materials or products through its regular sources, which shall be considered as an event of force majeure excusing BFG from performance and barring remedies for non-performance. In an event of force majeure condition, the BFG's time for performance shall be extended for a period equal to the time lost because of the force majeure condition without subjecting BFG to any liability or penalty. BFG may, at its option, cancel the remaining performance, without any liability or penalty, by giving notice of such cancellation to the Buyer.

### PROVISION OF AND RELIANCE UPON ACCURATE FINANCIAL INFORMATION

BFG makes all decisions related to the extension of credit to the Customer based upon the disclosures made by the Customer in the BFG Supply Co. Account Application. All parties executing these Terms and Conditions and the Account Application represent and warrant that the information provided to BFG Supply Co. are true and accurate in all respects. BFG Supply Co. is a wholesale distributor and does not as a part of its general practice sell to individuals. All parties executing these Terms and Conditions and the Account Application further represent and warrant that the Customer is a legal entity validly existing and authorized to do business in the State of its formation at the time of the execution of the BFG Supply Co. Account Application and that any changes in the status of the Customer as a legal entity will be disclosed to BFG Supply Co. within ten (10) business days of the occurrence of any changes in the status of the Customer. If Customer is a limited liability company, corporation, or a partnership, Customer must provide BFG Supply Co. with its Tax Identification Number contemporaneous with the execution of these Terms and Conditions. If Customer is a sole proprietorship, Customer shall provide BFG Supply Co. with Schedule C to its tax return. These Terms and Conditions may be found at [www.bfgsupply.com](http://www.bfgsupply.com). These Terms and Conditions of Sale are subject to revision and change by BFG Supply Co. without notice, however, the then current Terms and Conditions maintained at [www.bfgsupply.com](http://www.bfgsupply.com) shall be applicable to an given order at the time it is made and shall control. Customer and, if applicable, all Guarantors hereby execute and agree to these Terms and Conditions and agree to be fully bound by the same.





# ACCOUNT APPLICATION

ACCOUNT #
SALES REPRESENTATIVE
APPROVED CREDIT LIMIT

OFFICE USE ONLY

## COMPANY INFORMATION

COMPLETE LEGAL NAME *BFG Supply Co., LLC is a wholesale distributor and does not sell to individuals.		DBA / PARENT COMPANY (IF DIVISION OF OR OWNED BY ANOTHER COMPANY)		
BILLING ADDRESS		CITY	STATE	ZIP
SHIPPING ADDRESS		CITY	STATE	ZIP
COUNTY	BUSINESS PHONE#	BUSINESS FAX#	E-MAIL ADDRESS	
STORE HOURS		RECEIVING HOURS	RECEIVING CONTACT	
TYPE OF BUSINESS: <input type="checkbox"/> Corporation <input type="checkbox"/> Partnership <input type="checkbox"/> LLC <input type="checkbox"/> Sole Proprietor - <small>Must provide a current Schedule C of tax return.</small>		STATE OF INCORPORATION	FEDERAL ID#	
BUSINESS EST. DATE	YEARS UNDER CURRENT OWNER	DO YOU OWN THIS BUSINESS PROPERTY? IF NOT, WHO DOES?	TAX EXEMPT? <input type="checkbox"/> Yes <input type="checkbox"/> No If YES, PLEASE ATTACH CERTIFICATE.	

Applicant affirms and certifies that the information provided on the Account Application is true and correct. \_\_\_\_\_ (initial)

<b>TYPE OF BUSINESS: PLEASE CHECK ALL THAT APPLY</b>				
OPEN:	<input type="checkbox"/> ALL YEAR	<input type="checkbox"/> SEASONAL	<input type="checkbox"/> OTHER (Please explain) _____	
<input type="checkbox"/> Landscaping	<input type="checkbox"/> Hydroponics	<input type="checkbox"/> Retail/Garden Center	<input type="checkbox"/> Grower/Type of Product: _____	
<b>Order Preferences:</b>				
Backorders OK?	<input type="checkbox"/> Yes <input type="checkbox"/> No	Substitutions OK?	<input type="checkbox"/> Yes <input type="checkbox"/> No	P.O. Required? <input type="checkbox"/> Yes <input type="checkbox"/> No
Lift Gate Required?	<input type="checkbox"/> Yes <input type="checkbox"/> No	Fork Lift Available?	<input type="checkbox"/> Yes <input type="checkbox"/> No	Loading Dock? <input type="checkbox"/> Yes <input type="checkbox"/> No
				Pricing on Pick Tickets? <input type="checkbox"/> Yes <input type="checkbox"/> No
				Appointment Needed? <input type="checkbox"/> Yes <input type="checkbox"/> No

## OWNERS/OFFICERS/PARTNER INFORMATION (NOTE: Copy of Driver's License is required for Sole Proprietor or Individual Applying for Credit)

NAME #1	Title		NAME #2	Title	
SSN#	% OWNED		SSN#	% OWNED	
MOBILE	ALT. PHONE #		MOBILE	ALT. PHONE #	
ADDRESS (if different from above)			ADDRESS (if different from above)		
CITY	STATE	ZIP	CITY	STATE	ZIP

## DOCUMENT PREFERENCES - please choose how you would like the following documents to be delivered to you

ACKNOWLEDGMENTS	<input type="checkbox"/> E-MAIL:	<input type="checkbox"/> FAX:	<input type="checkbox"/> U.S. MAIL:
INVOICE/CREDITS	<input type="checkbox"/> E-MAIL:	<input type="checkbox"/> FAX:	<input type="checkbox"/> U.S. MAIL:
STATEMENTS	<input type="checkbox"/> E-MAIL:	<input type="checkbox"/> FAX:	<input type="checkbox"/> U.S. MAIL:

## WOULD YOU LIKE TO APPLY FOR A LINE OF CREDIT WITH BFG SUPPLY?

NO - I want to prepay for my orders  
\*Please sign terms and conditions page

YES - Please complete references. Credit Limit Desired \$ \_\_\_\_\_  
\*Please sign both the terms and conditions and declaration page

## BUSINESS CHECKING ACCOUNT REFERENCES

BANK NAME	ACCOUNT NUMBER	CONTACT PERSON	BANK PHONE NUMBER
-----------	----------------	----------------	-------------------

## BUSINESS TRADE REFERENCES (include horticulture companies, if possible) - only complete if applying for credit

COMPANY NAME	ACCOUNT #	TELEPHONE #	FAX #	EMAIL

# DECLARATION OF APPLICANT

**Account Application.** Applicant has requested credit from BFG Supply Co., LLC (referred to herein as "BFG Supply Co."). Whenever "BFG Supply Co." or "Secured Party" are used throughout this Application, such terms shall include both of the entities identified above and either of the entities identified above shall be entitled to rights, interests, and remedies set forth in this Account Application. By its execution of the Account Application the Applicant affirms and certifies that the information provided on the Credit Application is true and correct.

**Release of Credit Information.** The signing of this application authorizes BFG Supply Co. to perform credit investigation(s) of the Applicant. Applicant authorizes any references to release information necessary for BFG Supply Co. to make an informed credit decision. BFG Supply Co., is authorized to make all inquiries deemed necessary to determine the credit worthiness of Applicant including with any third parties with which the Applicant has or is conducting business and any additional third parties that BFG Supply Co. deems relevant. BFG Supply Co. is hereby authorized to answer questions about its credit experience with Applicant and to provide information regarding its credit experience with Applicant. If the undersigned individual is not the Applicant, but an authorized representative of Applicant, then the undersigned individual recognizes that his or her individual credit history may be a factor in the evaluation of the credit history of Applicant and hereby authorizes BFG Supply Co., to perform the necessary credit investigation and make all inquiries deemed necessary to determine the creditworthiness of the undersigned individual.

**Grant of Security Interest.** Grant of Security Interest. To secure payment and performance of all obligations, now existing or hereinafter arising, Applicant hereby grants Secured Party, a continuing security interest in all inventory, equipment, and goods manufactured by, supplied, or distributed by Secured Party, whenever sold, consigned, leased, rented or delivered, directly or indirectly (including via retail establishments/stores), to or for the benefit of Applicant by Secured Party, including but not limited to greenhouses and/or nursery supplies, soils, fertilizers, chemicals, and containers, polycarbonate materials, bamboo materials, and seeds, wherever located, now owned and hereafter acquired, including but not limited to all Secured Party, brand products and any replacement products, parts, accessories and supplies including repossessions and returns, all proceeds from the sale, lease or rental thereof and all existing or subsequently arising accounts and accounts receivable and supporting obligations which may from time to time hereafter come into existence during the time any obligations to Secured Party, remain outstanding (the "Collateral"). Applicant agrees to execute and deliver to Secured Party, upon request, such instruments and assurances as Secured Party deems necessary or desirable to establish, confirm and maintain perfection of Secured Party's rights and interest in the Collateral. In connection with the security interest granted by Applicant, Secured Party may file and/or record any financing statements and/or fixture filings deemed necessary by Secured Party to protect its rights and interests in the Collateral. Applicant hereby authorizes Secured Party to file all financing, continuation and amendment statements and such other documents as Secured Party deems necessary or desirable to protect its right, title and interest in the Collateral. In addition, Applicant hereby ratifies its authorization for Secured Party to have filed in any jurisdiction any financing statements or amendments thereto if filed prior to the date hereof. Applicant authorizes Secured Party to file a Uniform Commercial Code (the "UCC") Financing Statements in the filing office of any jurisdiction(s) Secured Party deems to be appropriate pursuant to the UCC. Debtor waives its right to receive a verification statement evidencing the registration of a UCC/PPSA Financing Statement or UCC/PPSA Change Statement.

**Covenants of Applicant.** Applicant will maintain the Collateral in original condition but for the ordinary wear and tear and will insure the Collateral against all expected risks. Applicant will not subject the Collateral to any adverse encumbrance or lien, or sale or other transfer other than as approved in writing by BFG Supply Company, LLC. Applicant will not locate the Collateral at any location other than as known to BFG Supply Co. Applicant will promptly advise BFG Supply Co. of any change of Applicant's name or business nature, location, and business openings and closings.

**Account Application.** The following constitute Applicant defaults: (i) non-payment in timely fashion of Applicant's indebtedness to BFG Supply Co., (ii) bankruptcy, insolvency or assignment for the benefit of creditors or (iii) misrepresentation or breach in respect of any provision of this or any agreement between BFG Supply Co. and Applicant. In the account application, BFG Supply Co. may declare all unpaid balances due and payable and/or may require Applicant to assemble the Collateral and make it available to allow BFG Supply Co. to take possession or dispose of the Collateral. Applicant further agrees to pay all reasonable attorneys' fees and all other costs and expenses incurred by BFG Supply Co., in the collection of any obligation of Applicant under this Account Agreement or related to any amounts that are or become due from Applicant to BFG Supply Co. In the account application, BFG Supply may remove Applicant's credit limit with no requirement for written notice to Applicant of the same and may conduct any credit investigation on the Applicant or any Guarantor upon an account application. The Applicant agrees that any statute of limitations related to pursuing any claims against the Applicant or any obligors on any debt incurred under this Account Application, shall be "tolled", postponed, extended, and delayed such that the same begin to run for the date of the last payment made on any indebtedness owed under the Account Application.

**Miscellaneous.** The information contained herein is submitted by Applicant for the purpose of obtaining credit. Applicant expressly agrees to make payment in full to BFG Supply Co. for any purchases made from BFG Supply Co. in accordance with the terms of all invoice(s) issued by BFG Supply Co. Should Applicant default in any such payment, Applicant expressly agrees to pay a late charge on any amounts in default of 2% per month (annual rate 24%), and, all amounts owed to BFG Supply Co. by Applicant may, at the option of BFG Supply Co., become immediately due and payable. The terms and conditions of sale are subject to and will be construed in accordance the terms and conditions of sale in effect for BFG Supply Co. and with the laws of the State of Ohio. The latest version of Terms and Conditions is listed at [www.bfgsupply.com](http://www.bfgsupply.com). The parties hereto hereby agree that any such litigation between them may be filed, tried and litigated in a federal or state court located in the State of Ohio or the State of Indiana. In connection with the foregoing, the parties hereto irrevocably consent to the jurisdiction and venue of such courts and expressly waive any claims or defenses of lack of jurisdiction or of proper venue by such court. This Agreement and any purchase orders between the parties constitute the entire agreement of the parties hereto with respect to the subject matter hereof and shall be deemed to supersede all prior and contemporaneous agreements, representations, and understandings, whether written or oral.

**Severability.** This Agreement is intended to be in compliance with all laws and regulations. In the event that any one or more of the provisions or terms contained in this Agreement should be adjudged to be invalid, illegal or unenforceable in any respect, the validity, legality and enforceability of the remaining provisions and terms contained in this Agreement shall not in any way be affected or impaired thereby, and shall be otherwise valid, legal and enforceable.

**IF AN INDIVIDUAL for unincorporated entity:**

(Name as appears on driver's license) \_\_\_\_\_

Signature

Printed Name

Date

**IF ON BEHALF of an INCORPORATED entity:**

(By a legally authorized officer or owner) \_\_\_\_\_

Signature

Printed Name

Title

Date

(BFG Does Not Accept  
Electronic Signatures)

## GUARANTY

In consideration of credit being extended by BFG Supply Co. to the Applicant identified above, whether Applicant be an individual or individuals, a proprietorship, a partnership, a corporation, or other entity, the undersigned guarantor or guarantors (collectively, the "Guarantors") each hereby (jointly and severally if more than one) unconditionally guarantee to BFG Supply Co. the faithful payment, when due, of all obligations of the Applicant to BFG Supply Co. together with all fees and expenses incurred in a suit to enforce this Guaranty. The Guarantors each hereby expressly waive (i) all notice of acceptance of this guaranty, (ii) all notice of extensions of credit to Applicant, (iii) presentment and demand for payment, (iv) protest and notice to the Guarantors of dishonor or default by Applicant, and (v) all other notices to the Guarantors and all defenses given to sureties or guarantors at law or in equity other than payment. By signing below, the Guarantors authorize BFG Supply Co. to make all inquiries deemed necessary to determine the creditworthiness of the Guarantors. BFG Supply Co., is authorized to answer questions about its credit experience with the Guarantors and to provide information regarding its credit experience with the Guarantors. The Guarantors acknowledge that execution of this guaranty is a material part of the consideration upon which BFG Supply Co., is relying on to extend credit to the Applicant, that this guaranty is executed as an inducement to BFG Supply Co. to consummate such extension of credit, and that this Guaranty is in the Guarantors' interest and to the Guarantors' direct or indirect benefit.

**IN HIS/HER INDIVIDUAL CAPACITY:** \_\_\_\_\_ (Seal)

Signature

Printed Name

Date

**IN HIS/HER INDIVIDUAL CAPACITY:** \_\_\_\_\_ (Seal)

Signature

Printed Name

Date

Please mail, email or fax completed application and tax exempt certificate (if applicable) to:

BFG Supply Co., LLC  
14500 Kinsman Road  
P.O. Box 479  
Burton, OH 44021

Email: [credit@bfgsupply.com](mailto:credit@bfgsupply.com)  
Fax: 800-579-0465 PHONE: (800) 883-0234 Ext. 4997



For your current pricing and availability please scan the item using our mobile app, give us a call or visit our website at [www.bfgsupply.com](http://www.bfgsupply.com)!

**Grower Select® Wine Barrel**

With a down-home, country-style feel, this wine barrel creates the perfect combination of elegance and simplicity to your outdoor or indoor living space. HDR construction for a lightweight and durable planter that will last longer than traditional wooden barrels and can withstand outdoor seasonal elements and everyday use. They also include UV protectors to increase resistance to cracking and fading. Your vibrant colored flower or vegetable arrangements will provide a pleasing pop of color in these dark, faux-wood planters.



18in



**Kentucky Walnut With Black Band - 17.7in D x 12.8in H, Max Liquid Volume: 8.5gal**  
**STPCF023319** Min. Buy 1cs/ 8ea



Barcode

**Kentucky Walnut With Black Band - 17.7in D x 12.8in H, Max Liquid Volume: 8.5gal**

**STPCF023319** Item #      Min. Buy 1cs/ 8ea Case Qty

**BARCODE**  
 Tips & Tricks

Having issues reading barcodes? Due to the large amount of products in this catalog it is possible barcodes may read incorrectly. Isolate the intended barcode with paper before scanning.

*Barcode reading issues?*



18in

**Kentucky Walnut With Black Band - 17.7in D x 12.8in H, Max Liquid Volume: 8.5gal**  
**STPCF023319** Min. Buy 1cs/ 8ea



# Greenhouse *Structures*



# BFG GREENHOUSE *Construction and Solutions*



# BFG Greenhouse Construction and Solutions

The BFG Greenhouse Solutions Team assists growers all across the United States with their greenhouse structure needs. Everything from the design, planning, construction and maintenance of new or existing sites, upgrades or remodels, our team is excited and ready to help! We offer a full range of products that include:

- Greenhouse Construction
- Coverings
- Heating & Cooling
- Ventilation
- Climate Control
- Irrigation
- Technical Support
- Lighting
- Horticultural Supplies & Services

Our experienced team has the technical expertise to guide you through the process and provide the information you need to make the best choice for your operation!



## Tap Into Our Resources

Our team is committed to you! Whatever wants or needs you have we are here to help and make the process as seamless as possible. Whether it's a re-cover, improving efficiencies or complete installation, we take pride in providing the resources you need.

## Over 4 Decades of Experience

With our team of dedicated professionals, BFG brings decades of experience to each project. Based on our proven success in numerous installation projects we know we can put your mind at ease.

## The BFG & DeCloet Advantage

- Highly engineered to reduce installation labor
- Wide bay spacing available in order to maximize production greenhouse efficiency
- Superior gutter design to reduce corrosion and maintenance
- 11 Gauge heavy gutter provides added strength and structural integrity
- Posts, gutters and trusses are galvanized after manufacture for longer rust-free life
- One piece oval bows provide consistency in strength and integrity, available on 4ft and 6ft centers
- Custom designs to meet your special requirements and maximize your footprint
- Available in widths of 18ft, 21ft, 24ft, 32ft, 36ft, 42ft and 48ft
- Single, double, triple span up to 48ft wide



**From start to finish, we can provide you the best solutions and service available in the market.**



# From Concept to Completion

Having control of your growing facility makes all the difference. The BFG approach is to begin with your end goal in mind and work together to design and engineer the perfect structure and systems. With a BFG controlled environment greenhouse you'll have the optimal growing environment for your crop, *whatever that maybe*.

## Consulting

Before you get started, you should know where to start. BFG provides complete solutions and our services span across all phases of operations - from design to growing/cultivation, and we can assist you plan for future expansion saving valuable time and money.

## Systems & Controls Integration

The BFG design philosophy revolves around systems Integration: each grow facility corresponds to a system of systems, each one optimized and integrated to work together. Every element must be in perfect balance for the highest level of control so you can consistently raise high-yield crops.

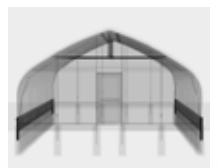
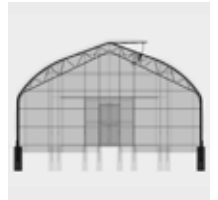
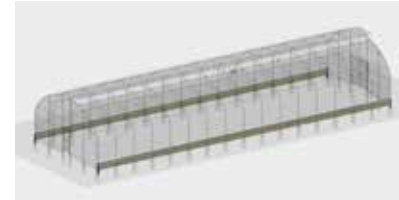
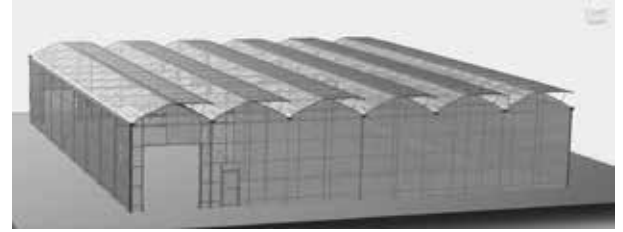

## Talk to one of our Experts About Your Next Greenhouse

### Featured project: Plantpeddler Phase2 Step2 – Cresco, IA

Structure: Custom DeCloet 8 bays of 43' wide X 216' long double poly roof

Roof vents & vertical vents – providing EXCELLENT natural ventilation

Custom connector to existing building

Growing Facility integrated with Loading Docks

**Total Space: 77,000 sf**

Pictures below represent – conceptual design, elevation drawing, docks (external and internal) and full rotation of PREMIUM crops: spring, summer/fall crops and poinsettia crop.

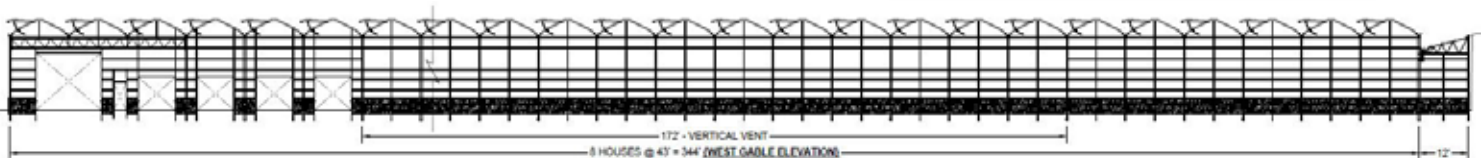

Scan to  
watch GHS  
Videos!







**CUSTOMER**  
*Testimonial*

**Plantpeddler (Cresco, Iowa)** "We are a year into our first DeCloet greenhouse structure and have completed the first full rotation of finished crops through the open roof ventilated structures. The quality and consistency of the plants produced in this structure have been spectacular. We have been working with BFG for many years and knew that the combination of the DeCloet structure and the BFG support would not disappoint. From the ease of construction to the terrific communication and support from both BFG and DeCloet, that premonition definitely held true." *Jason Sbiral (Facility Manager)*



# Tap Into Our Resources



BFG offers a wide variety of resources outside of the design, planning, construction and maintenance of a greenhouse. Our full portfolio of offerings include greenhouse structures, coverings, ventilation and heating equipment, shading systems, benching, environmental controls, lighting, irrigation and fertilization.

BFG has assembled a team of all-stars who, you could say, bring you tried and true growing methods mixed with the perfect dose of cutting edge technology! We can provide you with structures that will have an ideal flow for supplies from the time they come in all the way to the finished crop leaving your doors. BFG has the full array of components providing you with the best available and complete greenhouse projects. After your structure is completed we can provide you with ALL your growing needs, as we have for the last 45 years!

We can provide you the best solutions and service available in the market from start to finish.

The right heating and cooling systems are essential for running your greenhouse evenly and efficiently.

BFG offers a full range of greenhouse coverings to ensure you have the best option to help your business grow.

Air movement in a greenhouse not only makes you more comfortable, it can also make a huge difference in keeping your plants healthy and insect and disease free.



**CLIMATE CONTROL**

Climate Control - designed to maximize crop yields, help manage energy costs and optimize thermal comfort. Environmental Controllers and Light and Energy Curtains







**LIGHTING**

Choosing the correct lighting configuration is critical for the optimal growth and health of your crops.





**IRRIGATION**

We are constantly developing our product line to bring you the best the industry has to offer. Our team welcomes the opportunity to design a system that meets your particular needs.





**HORTICULTURAL SUPPLIES & SERVICES**

We have all the equipment and supplies you need to keep growing! Great quality, great pricing.



**TECHNICAL SUPPORT**

If you are even thinking about building or remodeling, talk to our experts! We'll help improve your efficiencies.



**Contact your BFG Sales Rep today**  
for a comprehensive consultation!  
For more information please call (800) 883.0234,  
email: [greenhousesolutions@bfgsupply.com](mailto:greenhousesolutions@bfgsupply.com)  
or visit [www.bfgsupply.com](http://www.bfgsupply.com) today!



We've teamed up with **Evergreen Equipment Finance** to offer a financing program for **Carts, Greenhouses, Equipment & More** Terms from 24 to 60 months.

Contact your BFG Sales Representative and inquire about Greenhouse & Equipment Financing options today or call Will Bean direct at 253-988-0808.

## CUSTOMER Testimonials

**Meadowridge Inc (Zeeland, MI)** – “We have been building DeCloet Greenhouses with BFG for over 20 years, these strong structures are well built and able to withstand the harsh west Michigan winter conditions. DeCloet’s greenhouse design has fewer parts than most making it easier and more efficient to build. We really like the 36ft double peak with 2 roof vents per bay, we also have integrated our production and shipping space easily and efficiently using the same greenhouse frame. We look forward to using BFG and DeCloet for our future structure needs.”

- Jordan Blauwkamp

**Darrell Norris Greenhouse (Racine, OH)** – “Looking back, selecting BFG & DeCloet Greenhouses was one of the best decisions we made. The DeCloet Greenhouses are tough and built to withstand our climate. They go together easy and when we are ready to add more square footage their expandability is great. The BFG team is truly the best, from providing the greenhouse design to construction, furnishing the proper greenhouse equipment and last but not least plant grower expertise, BFG has the experts we need. We value our relationship and we see BFG as a partner in the supply chain of horticultural supplies, we work together and succeed together. I would recommend the BFG Greenhouse Solutions team to anyone looking for a greenhouse and horticultural supplies.”

- Darrell Norris

**Brower Greenhouse (Hudsonville, MI)** – “We have been building greenhouses with BFG and DeCloet since 1991, the heavy duty structure from DeCloet combined with the products and services BFG has to offer have been a winning combination for our company. Whether it’s construction or supply needs, we truly value our relationship and will continue to do business with DeCloet and BFG Supply in the years to come.”

- Kurt Brower

## Production Greenhouse



We know that time is money and we can tailor our services to meet your needs. You can spend your time focused on quality plant growth and we'll focus on building you a quality greenhouse! Our goal is to provide you a piece of mind throughout the design, planning and implementation of your project.

Whether you are looking for professional advice OR complete greenhouse solutions, BFG is at your service. Between our exclusive brands and supplier partners we have the latest structures, equipment and controls to make your production facility efficiently produce outstanding crops. In addition, our team also puts emphasis on streamlining product flow in and out of your facility to help ensure a faster return on investment.

## Retail Garden Center



Scan to  
watch GHS  
Videos!



BFG understands the importance when it comes to Retail Greenhouses. It's not just about having the best merchandising, it's about providing a comfortable shopping experience in a setting that is pleasant for your customers and efficient for your staff.

Our team and expertise does not stop once construction is done. BFG supplies Garden Centers nationwide with the latest and most innovative products but we all know it starts with a sound design. That is why we begin each project with the full picture in mind, from curb appeal to product flow to environmental impact. The BFG solutions team will guide you from the design stage to the day you open your doors!



www.decloetgreenhouse.com

## DeCloet® Greenhouse Superstructures

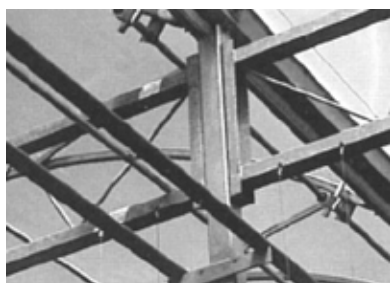

### Bows

Rectangular shaped oval adds strength. Our own exclusive designs 1-5/8in x 2-3/8in & 1-5/8in x 2-3/4in made from galvalume tubing coated with duratube U.V.C. clearcoat to protect poly. Does not stain.



### Heavy Duty Standard Gutter

Gutters are formed and punched from 11 gauge steel and are hot dipped galvanized after manufacturing.

Trusses are of welded construction and are hot dipped galvanized after manufacturing.

Engineered to carry heavy loads and withstand strong winds.

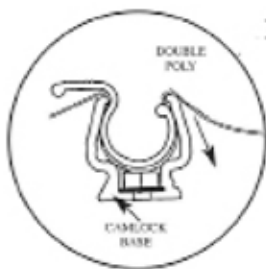

**Poly Fastening Camlock System**  
The Fast System

Two piece aluminum extrusion, insert snaps into base, locking poly. Never lets go, does not cut poly and can be used repeatedly.



### Wire Lock

For sidewalls and gables, low cost, easy to install, use over and over again.

### Stub Post

Swaged to fit inside main post.

- Stub posts and posts are manufactured from the highest quality steel.
- The post tops are welded to the post, then the entire post is hot dipped galvanized.
- Under-gutter post heights are available from 8ft to 18ft. Standard post sizes are listed below.

MATERIAL	16ft	18ft	21ft	24ft	32ft	36ft	42ft	48ft
2.5in x 3.5in x .125 wall								
3in x 4in x .125 wall								
4in x 4in x .125 wall								
5in x 5in x .125 wall								

Post and windbracing are 1-1/2in female and 1-5/16in male insert.

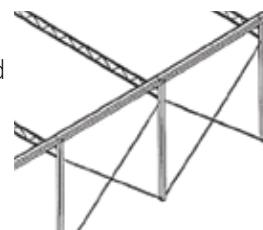

Concrete

# Production Greenhouse

## Gutter Connected

DeCloet Gutter Connected Greenhouses are custom designed to meet your needs as well as your crop requirements. Complying with all industry building codes, DeCloet's gutter connected ensures a strong and long lasting growing environment.



- 11 Gauge heavy-duty metal gutters provide added strength to structurally withstand the elements. They are incredibly strong and large enough to walk in, but small enough to minimize shadowing. Posts, gutters and trusses are all galvanized after they've been manufactured to ensure a longer rust-free life.
- One piece oval bows provide consistency in strength, integrity and ease of construction, available on 4ft and 6ft centers
- Highly engineered design for faster and easier assembly and construction
- Exclusive and unique design reduces clutter and maximizes growing space
- Increased light transmission
- Expandability: When you want to expand, you can easily do so without disrupting your existing growing business
- The gutter is designed for expansion and does not require disassembling existing houses
- This is the most economical greenhouse for a large operation
- **Custom Sizes Available, including up to 48ft available**



*Standard Gothic*  
18ft 21ft 24ft



*Twin & Triple Peak Series*  
28ft 32ft 36ft 42ft 48ft



# Max Cool

Max Cool is DeCloet's solution for growers that want to maximize their productivity and efficiencies. The Max Cool is a gutter connected structure.

- Triple Peak 42ft wide frame
- Similar cooling to an open roof structure
- Raised rack and pinion system
- Leading edge of the vent can be raised from the gutter to above the peak
- Maximum cooling
- Proven reliable ridder rack and pinion system
- Easy to cover with 16ft poly tubes
- Up to 35% vent to floor space ratio



Raised Rack and Pinion for Heat Retention System above the Truss

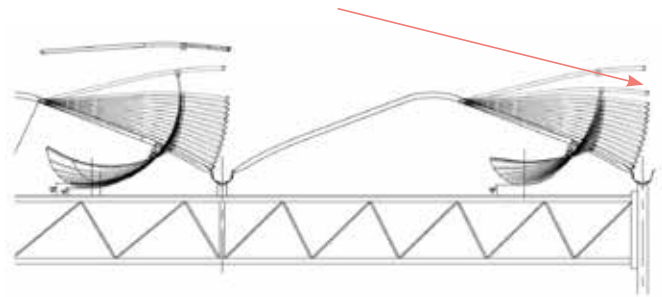

Raised Rack and Pinion: Vent Opening and Easy Curtain Installation

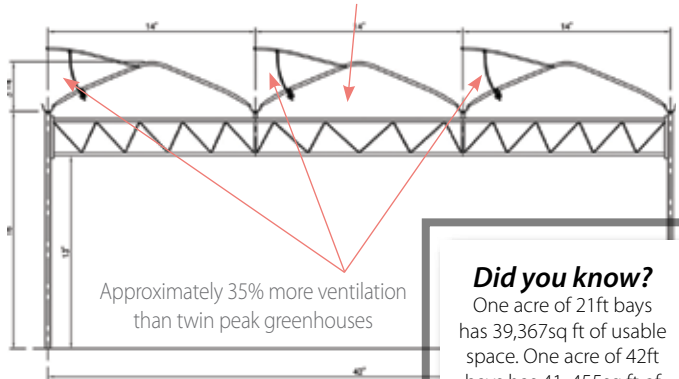

Approximately 35% more ventilation than twin peak greenhouses

**Did you know?**  
One acre of 21ft bays has 39,367sq ft of usable space. One acre of 42ft bays has 41,455sq ft of usable space.



## Venlo Glass

DeCloet's world class Venlo Greenhouse combines European design and North American engineering providing a structure with the latest in design for maximum light transmission and a lifetime of successful production. With the tempered glass roof and aluminum glazing system, you get the best value and the least maintenance for your business. It offers our clients a structure capable of withstanding extreme climate conditions with long term protection. The diffused glass option has been a popular option among our latest projects improving the environment climate and increasing production.

### *The DeCloet Advantage*

- Hot dipped galvanized steel structure
- Aluminum roof and sidewall glazing bars
- Clear or diffused tempered glass
- Under gutter height up to 24ft
- Up to 42ft wide triple peak
- Push/Pull vent system





# Freestanding

Freestanding Greenhouses, also called Ground to Ground, are suited for professional growers who require unique environments for different crops. They provide the economical growing space and versatility needed. DeCloet's Freestanding and cold frame greenhouses are affordable and versatile structures. With a wide variety of options and sizes available, these greenhouses are practical and easy to assemble.



## Freestanding Ground To Ground Options

### *Sunmaster* 24ft 27ft 30ft Widths

Used as both a cold frame and grower house, this series represents our most practical and cost-effective greenhouse. It comes with our exclusive oval tubing for the roof and a full selection of options. Available in 4ft and 5ft bow spacing.

### *Growers Choice* 30ft 35ft Widths

Excellent for both growing and as a retail house. It is stronger than anything else on the market, featuring all welded truss style hoops in the roof, with taller sidewalls. Designed to hold more hanging baskets than any other structure.

### *Grow Max* 30ft 40ft Widths

This webbed truss design offer more benefits and features. Features include more weight support, standard 50lbs snow load on 6ft centers, 7-12ft high straight sidewall above grade. Increased hanging basket capacity.





www.decloetgreenhouse.com

## DeCloet® Greenhouses

### SunMaster Series

The Most Popular Free Standing Ground-to-Ground

### Available in 24ft • 27ft • 30ft Widths

- 4ft, 5ft bow spacing
- 30in heavy duty ground stake
- 2 piece bow construction made from Galvalume heavy duty oval tubing, 1-5/8in x 2-3/8in & 1-5/8in x 2-3/4in, coated with Duratube U.V.C. clearcoat to protect poly.
- Heavy duty center ridge, 1in x 3in - 14gauge
- Two rows of additional purlins  
- Four rows for 30ft wide.
- With or without cross-ties.
- Metal endwall frames optional.
- Single or double doors available.
- Polycarbonate endwall covering available.

Poly Roof Vents and Polycarbonate Ends



Roll-Up Side

### Ventilating Options:

- Poly roof vents
- Exhaust fans and shutters
- Roll up sides



DeCloet 30ft Ground to Ground with  
Optional Cross Ties



DeCloet 30ft Web Truss House



DeCloet 30ft Web Truss House with Roof Vent

### DeCloet® Greenhouse Doors

Roller - 48in x 96in

**DECLDOF8201** Min. Buy 1 EA

Swinging - 37in x 80in

**DECLDOF8206** Min. Buy 1 EA



DeCloet 30ft Ground to Ground with  
Roll-Up Door

## Cold Frames

These 14ft and 15ft cold frames are designed for overwintering nursery stock or as a temporary growing area. An optional extended stake package is available for extra height. The house can be purchased without stakes and can be made portable by using a baseboard to connect the bows. Most often used with a single purlin with hoop/bow spacing at 4ft O.C. to help eliminate pocketing. (Build your own endwall to complete the structure). Simple design for easy installation. Add-on options include: purlin runs and baseboard clamps.

# GrowerSelect®

## Cold Frame Bows & Structures

### 14ft Bow

For Center Height: 6ft 5in Without Stakes - Use 24ft Poly  
For Center Height: 8ft 5in with 48in Stakes - Use 28ft Poly

**GSA01540** Stocked in Kalamazoo, MI

### 15ft Bow

For Center Height: 7ft - Use 24ft Poly

**GS98-1000A** Stocked in Burton, OH



*For a complete Grower Select cold frame quote  
Please contact your BFG Representative*

## High Tunnels



High tunnels are used to extend the growing season by providing protection for early or late season production, or they may be used for year-round growing. High tunnels are becoming increasingly more popular due to the low start-up cost and quick rate of return on investment. They are a quick and inexpensive way to lengthen your growing season, protect your crop from pests and disease, decrease water usage and increase your crop yield.

Options are available with a roll-up side for optimal ventilation and ease of use. Choose from economical frame-only pricing or standard package pricing to finish your structure. Hoop spacing is available in 4ft or 6ft sections depending on the manufacturer and it can be designed to best fit your use and the needs of your location.





Permanent Retail Greenhouses  
 Seasonal Retail Greenhouses  
 Commercial Greenhouses



Photo shows slide-side ventilation option.

### The Garden Mart®

The Garden-Mart® is designed to be a modular, low-cost, sales building for added spring plant sales. Our most popular selling model has been engineered for superior strength, easy future expansion, and simplified setup. It offers protection for your plants and shopping comfort for your customers.

Standard package includes roll-up side ventilation, double sliding door, hanging basket purlins, roof and endwall poly, Wiggle Wire, and hold down system. Options include galvanized bench packages and slide-side ventilation.

#### Features:

- Width: 21ft
- Length: 24ft-96ft (in 6ft increments)
- Sidewall height: 6ft
- Height to apex: 11ft 4in
- Frame spacing: 6ft
- Door: 6ft wide x 6ft 8in tall
- Roof Cover: clear or white 6 mil UVI treated polyethylene
- End wall cover: clear 6 mil UVI treated polyethylene
- Frame: 2in o.d. 14 gauge galvanized steel tubing

Size	Benching Area
21ft x 24ft	360sq ft
21ft x 48ft	864sq ft
21ft x 60ft	1,116sq ft
21ft x 96ft	2,016sq ft
6ft Additional Sections	126sq ft



### Kool House™

Tired of everything that you don't get with other cold frames on the market? Our Kool House™ packages have so many standard features you won't have any surprises when it comes to the final price. We think it's the best value on the market and we know your wallet will agree.

- 14ft x 96ft
- 16ft x 96ft
- 18ft x 96ft
- 20ft x 96ft

Priced with 4ft bow spacing.



FieldPro Gable



Gothic High Tunnel

### FieldPro® High Tunnels

Extend your growing season with the new FieldPro® Gable or Gothic High Tunnel. High tunnel use in field crop growing has been shown to offer better disease protection and increase yield and profits. The Field Pro is available in two roof styles, three standard widths and can be easily configured to meet your needs.

Call today and start growing like a pro.

#### Field Pro Gable

- 20ft x 96ft
- 24ft x 96ft
- 30ft x 96ft

Priced with 4ft bow spacing.

#### Gothic High Tunnel

- 20ft x 96ft
- 24ft x 96ft
- 30ft x 96ft

Priced with 4ft bow spacing.



## Sunstopper

The Sunstopper will protect your valuable product from over exposure and windburn, while reducing water requirements. It features straightforward assembly, options for future expansion and is built tough with 2.5in x 12 gauge, galvanized steel for years of trouble free service. Available in 10ft x 20ft and 20ft x 20ft standard blocks, the Sunstopper is also offered in custom configurations to meet your existing layout.



Size	Square Feet
20ft x 20ft	400
20ft x 40ft	800
20ft x 60ft	1,200
40ft x 40ft	1,600
40ft x 60ft	2,400
40ft x 80ft	3,200
60ft x 60ft	3,600
60ft x 80ft	4,800
60ft x 100ft	6,000
100ft x 100ft	10,000
200ft x 200ft	40,000



Peaked Roof W-Truss



Standard Roof W-Truss

## Shadehouse W-Truss

The W-Truss is a sturdy shade structure for your plants and customers. Increase customer comfort and reduce the amount of water used and time spent keeping your live product in top-selling shape. Its rugged 3in x 3in vertical posts combine with a strong horizontal truss system to give you one of the best built and most attractive shade structures on the market. It comes standard in 20ft x 20ft blocks with 30%-90% shade cloth and can be customized to fit your exact needs.

Size	Square Feet	Size	Square Feet
20ft x 20ft	400	40ft x 60ft	2,400
20ft x 40ft	800	60ft x 60ft	3,600
40ft x 40ft	1,600	60ft x 80ft	4,800

## Sun Shadow

The Sun Shadow is designed to be the simple, low-cost shade solution for your seasonal garden center. Protect your plants from the sun and provide a cool, comfortable shopping environment for your customers. The easy-to-assemble, modular design features galvanized steel construction and an extended base plate that allows you to use your palletized product for hold-down.

Size	Square Feet
20ft x 20ft	400

(Custom Sizes Available)



## Roof & Side Vents

Ventilation is an essential component for the greenhouse growing environment. Types of ventilation can be forced air or passive ventilation. When designing a new greenhouse, we always take into consideration the passive ventilation incorporating roof & side vents to increase air flow and produce excellent quality crops.

We have the leading-edge technology for gutter vents in the greenhouse industry. We offer raised rack and pinion systems to ensure plenty of room for heat retention systems as well as hinged shaft hangers for easy maintenance in your gutter connect or ground to ground greenhouse.

If your greenhouse does not offer satisfactory ventilation, our team can offer retrofitting options to enhance air flow with your existing structures. Our retrofitting packages are easy to install and will provide significant improvements to your existing structure.



# Remodeling & Improvements to Increase Efficiency

Our team has the experience to provide options for your existing structures and ways to help improve your efficiencies. We can assist with improving air flow, improving product flow and the presentation of your greenhouse.

## What Are You Looking For?

- Retro fit roof vents for your existing structure
- Rollup or vertical side or end vents
- Recover your gable ends & sidewalls
- Connect your freestanding greenhouses with a header house
- Add loading docks
- Replace old doors



# Retail Garden Centers

## Garden Centers

Our Retail Garden Center Structures are a combination of beauty and efficiency. The curb appeal alone will make an impression and attract customers but if you combine that with great ventilation and lighting you are sure to create an enjoyable and memorable shopping experience.

Extending beyond the shopping area, we take into consideration the replenishment area making sure that you have an efficient space to stage and replenish inventory. Coverings available include glass, polycarbonate, poly and steel roofing perfect for displays, warehouses, offices, utility rooms and more.





## Rimol Matterhorn

The Rimol Matterhorn stands alone as our most attractive Garden Center Structure, rugged and traditionally peaked styled gutter-connected greenhouse. The Matterhorn greenhouse is a high-quality, strong and attractive structure ideally suited for garden centers, growers and schools in any climate in North America. The Matterhorn can withstand heavy snow loads and wind loads, which means you can get a good night's sleep during even the worst winter storms. It offers different glazing options to fit your budget and presentation desires.

*The Rimol Matterhorn makes an excellent choice for Garden Centers!*



*Available in 20ft, 24ft & 30ft widths*

- Lean-to style available in 10ft, 12ft and 15ft widths
- Typical truss spacing on 12ft centers allows for any length in an increment of 12ft
- Super easy to assemble beginning with starter column installation. Four footlong starter column is used for setting the lower section of the column, then the remaining length of column is spliced for an easy installation
- Columns with base plates available
- Columns are 4in x 4in, 13ga galvanized steel
- Non-welded trusses are quality assurance when assembled and allows for easy shipping and assembly
- Trusses consist of 2in, 15ga and 1.5in, 16ga galvanized steel
- Extra purlins near gutter provide additional snow load support in Northern climates. This prevents premature wear on polycarbonate and eliminates leaking
- 6/12 roof pitch
- Large 12ga steel gutter allows easy access to roof and downspouts. They are designed to be located anywhere in the gutter for maximum flexibility
- Can be glazed with 8mm polycarbonate, corrugated polycarbonate, polyethylene film or glass (walls only)



# Institutional Research & Educational Greenhouses

BFG and its partners design and manufacture education, teaching and research greenhouses. We can help you design your research or education research facility no matter the size. We work with schools around the country and know what is important to the end user: quality, safety and long-lasting performance. We have experience in designing and building state-of-the-art research facilities as well as small greenhouses for a high school program or other educational and developmental programs.

## Featured:

Institutional facility in Holland, Michigan  
DeCloet Greenhouse Structure  
Rimol Matterhorn



# CEA *Indoor Growing*



Controlled-environment agriculture (CEA) is a technology-based approach toward food production utilizing greenhouses structures or a building/grow room to provide protection and maintain optimal growing conditions throughout the development of the crop. Plants are often grown using hydroponic methods in order to supply the proper amounts of water and nutrients to the root zone. CEA optimizes the use of resources such as water, energy, space, capital and labor.

BFG offers a complete line of systems for CEA/Indoor Growing and can help you design and implement an efficient system where you'll have the optimal growing environment for your crop, whatever that maybe.



**Rolling Benches  
EBB & Flow Benches**



**Light Deprivation**



**Irrigation Systems**



**Growing Lights  
LED & HPS**

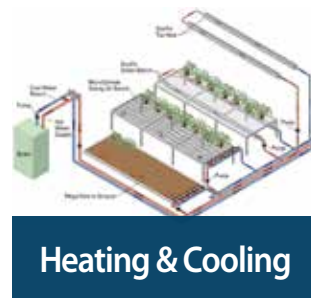

**Heating & Cooling**



**Ventilation &  
Dehumidification**



**Fertigation**



**Water Treatment**

DeCloet Greenhouses are a great option for CEA. They were originally designed with the purpose of growing vegetable crops hence its heavy-duty design to support hanging systems. Even with the market changes over the last few decades, DeCloet maintained its heavy-duty design making our structures perfect for today's changes and CEA providing protection and maintaining optimal growing conditions throughout the development of the crop.

When we look at lights and lighting, Greenhouses are by far the best way to raise and cultivate crops. Greenhouse structures allow growers and cultivators to harness the power of the sun maximizing the natural lighting combined with supplemental lighting.

## *Lighting Design:*

BFG partnered with LED cutting edge technology companies to provide you the best lighting solution. We can customize systems to optimize production and minimize costs using new technologies, traditional technologies and a hybrid between the two: HPS/ LED



HPS



LED





Bench Growing Systems – EbbFlow | Expanded Metal | Ultra Plastic | Stationary | Rolling



EBB Flow Benching



Ultra Bench



Production Benching

Our team has the ability to provide the best greenhouse structure solution for your needs in:

- Aquaponics
- Hydroponics
- Aeroponics
- Aquaculture
- Vertical Farming



**Featured project: DeCloet Venlo with diffused glass**

Phase 1 completed Summer 2018 – 50,000 sf

Phase 2 completed Fall 2020 – 100,000 sf

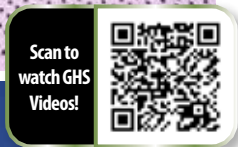

# Special Purpose Greenhouse

DeCloet Greenhouse Mfg Ltd has supplied many growers with special custom designed and manufactured greenhouse structures to be used for reasons other than growing. These special houses can be used for a variety of purposes, such as, mechanical rooms, head houses, shipping/staging areas and loading docks.

## Custom Options

- Wide post spacing up to 48ft
- High side wall heights
- Multitude of roof coverings may include shaded polycarbonate or steel roofing with insulation
- Natural ventilation or exhaust fans
- Large overhead doors
- Loading docks
- Warehouse & Storage Spaces



## Heat Retention Curtains

### Heat Retention Curtains

An economical, long lasting heat retention, thermal shading, or blackout system. Save heating and cooling costs with a proven VRE® Shade & Save System.

#### Benefits for Growers:

- Reduced heating and cooling costs
- Reduced water consumption
- Reduced condensate drip damage
- Improved air and soil temperature control
- More comfortable working environment
- Less plant stretch and stress
- Better quality and more consistent crops
- More balanced environment, i.e. control of light, temperature and humidity

VRE® manufactures and installs both sliding and suspended thermal curtain systems with a patented VRE® seal.

#### The VRE patented seal offers:

- Positive seal when closed
- Smaller curtain bundles when open
- Support for any system configuration
- Simple installation, no more messy support wires or brackets
- Electrically operated drive unit with gear reduction, built in limit switches, and VRE reversing control

## Blackout and Shade Curtain Systems

### Greenhouse Applications

The type of crops grown will generally determine whether a blackout system or a partial shade system will best suit your needs.

#### 1. Blackout or Short Day Length Control Fabrics

These will provide the total light control required to produce crops that require blackout periods to induce flowering. These generally include a porous, two-layer fabric for the top covers with a reflective top surface. Generally fabric for the vertical side walls and gable end coverage are nonporous and are installed as center roll-up walls.

#### 2. Shade Fabrics

These can be utilized for any crop. The most common types are made of alternating strips of clear and aluminized polyester which are available in 15% to 85% shade value percentages to suit the application.



Gutter to Gutter System



Gutter to Gutter Blackout System



VRE designs each curtain system to suit your particular requirement. VRE offers supervisory or complete curtain installation service.

OBSCURA 10070 FR WB+B



OBSCURA 10075 FB A+BW

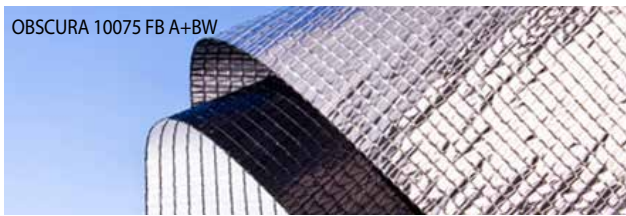

## *Obscura - Product Family for Light Restriction or Total Blackout*

### **Obscura Screens**

The double layered Obscura screen has been giving plants a good night's rest for over 20 years. It does this by providing total blackout from daylight – up to 99.9 percent. And in the last ten years, single layer Obscura has been preventing supplemental lighting from escaping greenhouses at night. This lets neighbors get a good night's sleep and complies with industry legislation.

In both cases, the unique knitted structure provides good moisture managing properties.

### **Twice as versatile**

The double layer also allows more options as the top and bottom of the screen can have different surfaces. Aluminium on the top, for example, provides the greatest energy saving at night, whereas white provides better cooling in sunny weather. White is also useful as a bottom layer for intensifying light inside the greenhouse, whereas black is better for absorbing and restricting interior light.

### **Where and when you can expect to find Obscura**

For short-day plants, such as chrysanthemum, Obscura is ideal for delivering flowers in bloom – on time – for important market dates. Obscura is also popular where supplemental lighting is needed and night time light emission is a problem. This has now proven to be a good investment, as the intensified lighting increases productivity.

- Total control over day length for most sensitive plants.
- Effective cooling when a reflective upper surface is chosen.
- High energy savings, especially if one layer is aluminium.
- Light Emission control that satisfies neighbors and legislation.
- Increased productivity when used with supplemental lighting.
- More uniformity from supplemental lighting in the growing area.
- Good moisture management.

**Please Call for Pricing**



**LUITEN**  
GREENHOUSE TECH  
SHADING SPECIALISTS  
We Put Our Energy Into Saving Yours

## Shading systems

We specialize in all kind of shading systems. Utilizing our professional, able and experienced staff to completes each project to the highest standard of satisfaction. Each project must be handled with the highest degree of skill and flexibility during production and installation from start to finish.

1100 Foster Ave. Kalamazoo, MI 49048  
arie@luitenshading.com www.luitenshading.com



**LUITEN**  
GREENHOUSE TECH  
SHADING SPECIALISTS  
We Put Our Energy Into Saving Yours



**Curtain Systems**

## PowerPull® Energy Curtain System

Reduce energy costs year round. Save 30%-40% on energy consumption. Increase plant quality and worker comfort. For new construction or retrofitting existing greenhouses, Wadsworth systems are flexible in design and easily installed.

### Features:

- Superior design virtually eliminates maintenance on systems that lasts for decades.
- Quiet and dependable operation
- Quick and easy install whether new building or retrofitting
- Rack and pinion drive — no cables to re-tension
- Design offers optimal management of cold air spill
- Durable fabric
- Small bundle sizes ensure minimal shade when open
- Available with monofilament or stationary stainless steel lines
- Drive unit centrally positioned in greenhouse for least disruption
- Built-in safety limits protect your system

Each PowerPull energy curtain system is custom designed to offer the best system for your greenhouse.



Dual curtain system (shade and blackout).

## Vent Automation

Our drive units set the standard for smooth operation and reliability.



### VC-100A & VC-2000

- VC-100A: This ILS, thermal protection, continuous duty unit lifts up to 75ft of 4ft polycarbonate roof ridge vent or 125ft of 4ft polycarbonate side vent
- VC-2000: This ILS thermal protection, continuous duty unit lifts up to 325ft of 4ft polycarbonate roof ridge vent or 400ft of 4ft polycarbonate side vent

WADSM1098	21-0820E	M-1098 VC-100A Motor and Gearbox 1-3/8 in.
WADSM1099	21-0820F	M-1099 VC-100A Motor and Gearbox 1-5/8 in.
WADSM1198	21-0810L	M-1198 VC-2000 Motor and Gearbox 1-3/8 in.
WADSM1199	21-0810M	M-1199 VC-2000 Motor and Gearbox 1-5/8 in.

## Rack and Pinion Systems

Connecting the vent to the shaft, the rack pushes the vent open or pulls it closed.

### Features:

- Aluminum rack and pinion
- Corrosion-proof pinion gear
- Easy alignment, the rack works even when it's not perfectly square with vent
- Available in straight or curved, to accommodate tight spaces



PowerRack Curved



PowerRack Straight

## Wadsworth Driveshaft Coupling

Coupling to join two lengths of drive shaft



**1 3/8in**

**WADSF0909**

Min. Buy 1EA



## Retail Merchandising Products

### Maine Attractions

Maine Attractions are cedar frames with green vinyl coated wire mesh. They are very attractive and used for merchandising a wide variety of garden products. The cedar is an excellent product for the wet applications of plant sales and the coated mesh is galvanized before coating. The mesh stays clean and there is never any algae growth. These are available in many sizes of single and two tier units as well as end caps and octagon tables. Custom staining is also available.

### Benchmates

Benchmates are galvanized stackable tables with a cedar trim. These are ideal for both growing and retailing. These heavy duty galvanized tables can be stacked or not stacked and come in many sizes; fully assembled or unassembled. End caps and custom sizes are also available, as are wheels and leg levelers.



Maine Attractions



Benchmates

**Contact Your BFG Sales Representative for Customized Design & Pricing**

# BENCHMASTER™



### Single-Sided Step Displays



**Configurations:** 2-Step, 3-Step, 4-Step

**Lengths:** 36in, 66in, 96in

**Add-ons:** Plant Hanger Plus, Waterbed™

### Pyramid Displays



**Configurations:** 3-Step, 5-Step, Wide

**Lengths:** 36in, 66in, 96in

**Add-ons:** Plant Hanger Plus, Waterbed™



## ***Retail & Production Benching***

BFG Grower Select benching represents the most efficient, flexible and presentable benching available in the marketplace. Don't just use "block and board" for your presentation – we produce both double deck and modular benching, with re-supply racks underneath.

Our retail benching features complete coverage of sharp expanded metal edges, corner protectors and plastic caps on all tube ends and legs. A highly efficient and flexible way to enhance the image of your operation and present your products.

BFG Grower Select production benching can be ordered as rolling or stationary benches, in freestanding or cemented styles, even customized to fit your specific needs – all at a very economical price. These production benches are loaded with features designed to maximize your efficiency and assist in your profitability. Available with expanded galvanized top panels or plastic panels.

Production benching available in 3ft to 8ft wide and many custom lengths (widths vary by style). Check with your BFG Sales Representative for the size to maximize your space and footprint.



*For More Information Please Contact Your BFG Sales Rep or Customer Service*

# GrowerSelect®

## Retail Benching

### Quality Products Need Quality Displays!

Grower Select® works with some of the largest and most well-known retailers to provide them with benching that is efficient, flexible, and presentable. Our retail benching features complete coverage of the sharp expanded metal ends, corner protectors, and plastic caps on all legs and tube ends.



Complete Retail Bench Sets or Bench Tops Only  
Available in the Following Sizes:

- 3ft x 8ft
- 5ft x 8ft
- 3.5ft x 10ft
- 6ft x 10ft
- 4ft x 12ft
- 3.5ft x 8ft
- 6ft x 8ft
- 4ft x 10ft
- 3ft x 12ft
- 4ft x 8ft
- 3ft x 10ft
- 5ft x 10ft
- 3.5ft x 12ft
- 5ft x 12ft
- 6ft x 12ft



Corner Protector



Freestanding Bench



Ultra Bench

### Available in the Following Sizes:

- 4ft X 8ft Ultra Retail Bench Complete
- 4ft X 12ft Ultra Retail Bench Complete
- 6ft X 8ft Ultra Retail Bench Complete
- 4ft X 8ft Collapsible Ultra Retail Bench

## ULTRA Plastic Top Benching

Grower Select® ULTRA benches include all the features of our traditional benching – aluminum side rails, molded corner protectors and plastic caps on all tube ends and legs – combined with durable, smooth, non-porous plastic bench tops that allow trays, flats, and pots to slide across the surface without snagging.

The polypropylene panels feature 1.1in x 2.1in rectangular holes for easy cleaning, and will not rot, crack, or splinter like wood products nor corrode or rust like expanded metal or wire tops.

We produce thousands of square feet of rolling benches every year. Our benches can be rolling or stationary, freestanding or cemented. We can usually customize to fit your needs at a very economical price. Free engineering and layout planning is available along with a full list of references.

Our production benches feature a 20lb/sq ft load capacity and have 3/4in pre-galvanized expanded metal tops. Our special aluminum side rails completely cover all of the sharp expanded metal edges and no more torn pants with our corner protectors. Expanded metal can be flattened for plug trays or left standard. You can also chose plastic panel tops. Anti-tip/roller spacers are optional. Allow four weeks for delivery.



## Production Benching

### Available as Rolling or Stationary

#### Aluminum Side Rails

No exposed expanded metal edges. Extra Strength. Enhances appearance.

#### 1-1/2in Hat Section Crosspieces

Wider base to support the expanded metal. Standard spacing 2ft o.c. (optional 12in or 16in spacing)

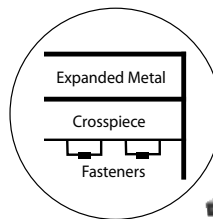

**1.315in Rollers**  
Swaged ends.  
Plastic caps.  
No connectors to interfere with rolling.

#### Anti-Tip/Roller Aligner

Wider aisles.  
Off loading from either side.  
Constantly aligns rollers.

**Please Call for Pricing**

For More Information Please Contact Your BFG Sales Rep or Customer Service

**Contact Your BFG Sales Rep  
for More Options**



**Angled Bench Display  
PX7009**

The FB3009 angled bench display will prop up your flats to create a dazzling display of color. The top bench is raised 20 degrees to allow better viewing and easier access to your product. Specifications: 73 x 30 x 30



**The Basket Hanger  
BH3000 W/CASTERS**

Display your hanging baskets in style. Allows easy access to plants for your customers. Holds approximately 2 dozen baskets. Optional casters. Specifications: 72 x 73 x 82



**Bench Display  
PX7006**

The FB3006 bench display is great for creating inexpensive runs of benching in a variety of settings. The basic design and sturdy construction make it very versatile. Easily sets up in many configurations to fit your needs. Specifications: 72 x 37.5 x 30



**Tri-Step Display  
PX7020**

Create a cascading display of color. The bench tops are 18in, 24in, and 36in deep. Expanded metal benchtops are available. Optional 40 inch high purlin holds 6-10 inch baskets. Specifications: 73.25in x 40in x 44.5in  
With Optional Purlin  
Specifications: 73.25 x 40 x 92



**Double Tri-Step Display  
PX7021**

The FB3021 is great for creating aisle after aisle of eye-catching color. It has the "stepped" bench tops of our popular tri-step display and the cost saving convenience of an all-in-one display that can be shopped from both sides. Specifications: 73.25 x 75.5 x 44.5



**Flat Mate Display  
PX7025**

Designed to solve the problem of displaying your plants in tight quarters. This bench protrudes only 26in from your wall. Holds 21 flats. Optional casters. Specifications: 73.5 x 26.5 x 44.5



**3-5-7 Display**

This circular island display is a paradise for large merchandise. Oversized pots, baskets, garden décor and accessories will fit—and shine—on the new 357 display. With a 7ft diameter base, 5ft middle tier and 3ft top, you'll get 65 square feet of merchandising opportunity in one display. Specifications: 84in x 84in x 56 1/4in



**Mulch and Rock Display  
PX704**

The new MD3000 offers you an easy-to-view display for your customers. Showcase a variety of mulch, soils, decorative landscape rock, bulbs and other bulk goods in divided bins. Specifications: 24in x 24in x 72in



**Half A-Frame  
PX704**

This sturdy display is ideal for your plants or other seasonal items. May be used against a wall or fence. Comes standard with expanded metal bench tops. Holds 24-1020 style flats per 6 ft. Optional 40 inch high purlin holds 6-10 inch baskets. Optional casters. Specifications: 73.25 x 41.25 x 44.5  
With Optional Purlin  
Specifications: 73.25 x 41.25 x 92

## Structure & Benching Components

### Greenhouse Structures

#### DeCloet® Aluminum Door

Aluminum swinging door with 16mm polycarbonate



37in x 80in

DECLDOF8206

Min. Buy 1ea



#### DeCloet® Corner Flashing

Corner flashing used in greenhouse construction



DECLFLF-8259

Min. Buy 1ea

#### DeCloet® Aluminum Door

Aluminum door with single roller and 16mm polycarbonate



48in x 96in

DECLDOF8201

Min. Buy 1ea

#### DeCloet® Drip Gutter Assembly

Drip gutter assembly used in greenhouse construction



24ft

DECL21-3213

Min. Buy 1ea

#### DeCloet® Aluminum Door

Aluminum door with double roller and 16mm polycarbonate



8ft x 8ft

DECLDOF8200

Min. Buy 1ea



#### DeCloet® Drive Pipe

Drive pipe used in greenhouse ventilation construction



24ft - 1in ID

DECLGLF-1419

Min. Buy 1ea



#### DeCloet® 2 Hole Angle Bracket

2 Hole angle bracket used in greenhouse construction



2in Square

DECLBRF-9711

Min. Buy 1ea



#### DeCloet® Drive Shaft Hanger

Drive shaft hanger used in greenhouse construction



DECLGVF-9611

Min. Buy 1ea



#### DeCloet® 4 Hole Angle Bracket

4 Hole angle bracket used in greenhouse construction



1 1/2in Square

DECLBRF-9712

Min. Buy 1ea

2in Square

DECLBRF-9713

Min. Buy 1ea



#### DeCloet® Endwall Post

Endwall post used in greenhouse construction



22ft - 2in x 3in

DECLWF-8823

Min. Buy 1ea

24ft - 2in x 3in

DECLWF-8818

Min. Buy 1ea

#### DeCloet® Adaptor Plate

Adaptor plate used in greenhouse construction



12ft

DECLGUF-7862

Min. Buy 1ea



#### DeCloet® Camlock Punched Base With Inserts

Camlock poly film fastening system



DECLCLF-0088

Min. Buy 1ea

#### DeCloet® Energy Truss

Energy truss used in greenhouse construction



24ft

DECLETF-7364

Min. Buy 1ea



## Structure & Benching Components

### Greenhouse Structures

#### DeCloet® Gutter Vent Pressure Relief Valve

Pressure relief valve used to relieve excess pressure while opening a gutter ventilation system



**DECLGVF-9629** Min. Buy 1ea



#### DeCloet® Single Stack Inflation Kit

Single stack inflation kit used to inflate a double layer of poly film



**DECLPIF-8550** Min. Buy 1ea



#### DeCloet® Standard Gutters

Standard Gutters used in the construction of Gutter Connected Greenhouses 12ft in length and 6ft hoop spacing.



**Used for Greenhouses 18ft - 42 ft wide**  
**DECLGUF-7850** Min. Buy 1ea



#### DeCloet® Stub Posts

Stub posts are nailed to trusses and truss supports based upon the truss spacing shown on the truss drawings.



**2.5in x 3in - .5in x 42in**  
**DECL21-3237** Min. Buy 1ea  
**2.5in X 3.5in X 60in**  
**DECLSPF7131** Min. Buy 1ea  
**3in X 4in X 60in**  
**DECLSPF7145** Min. Buy 1ea  
**4in x 4in x 48in**  
**DECLSPF-7149** Min. Buy 1ea  
**4in X 4in X 60in**  
**DECLSPF7151** Min. Buy 1ea

#### DeCloet® Lean To Ground Stake

Ground stake used in lean to greenhouse construction



**DECLGSF-7204** Min. Buy 1ea

#### DeCloet® Oval Ground Stake

Oval ground stake used with oval bows in greenhouse construction



**30in**  
**DECLGSF-7202** Min. Buy 1ea



#### DeCloet® Swaged Purlin Square

Square swaged purlin



**1.5in x 1.5in x 24ft 4in**  
**DECLPUF-7719** Min. Buy 1ea  
**2in x 2in x 24ft 4in**  
**DECLPUF-7718** Min. Buy 1ea



#### DeCloet® Purlin Bracket

Components to be used for greenhouse structures or for benching. Many sizes to choose from to create the layout of your choice.



**1.5in**  
**DECLBRF-9708** Min. Buy 1ea  
**2in Square**  
**DECLBRF-9715** Min. Buy 1ea



#### DeCloet® Swaged Stub Post

Swaged stub post used in greenhouse construction



**2.5in x 3.5in x 48in**  
**DECLSPF-7129** Min. Buy 1ea  
**2.5in x 3.5in x 54in**  
**DECLSPF-7130** Min. Buy 1ea

#### DeCloet® Rollup Vent Shaft

Rollup vent shaft used in greenhouse ventilation construction



**21ft - 1 1/14in OD**  
**DECLGLF-8575** Min. Buy 1ea



#### DeCloet® Tek Screw

Self-drilling stainless screws.



**#14 x 1in Screw**  
**DECLHDF-9190** Min. Buy 1ea



## Structure & Benching Components

### Greenhouse Structures

#### DeCloet® U-Bolt

U-Bolt with nuts



5/16in x 1 5/8in 3 1/4 in

**DECLHDF-9288** Min. Buy 1ea



#### DeCloet® Universal Gable Extrusion

Universal gable extrusion holds roof poly and polycarbonate or wood at the gable ends, includes zig zag wire.



17ft

**DECLALF-9663** Min. Buy 1ea

19ft

**DECLALF-9664** Min. Buy 1ea

23ft

**DECLALF-9665** Min. Buy 1ea

27ft

**DECLALF-9666** Min. Buy 1ea



#### DeCloet® Vent Shaft Coupling Set

Coupling to join two lengths of vent shaft



**DECL21-2449B** Min. Buy 1ea

#### DeCloet® Windbracing

Add these braces to your greenhouse for added strength against winds.



Left - for 15ft or 22ft Houses

**DECL21-2109A** Min. Buy 1ea

Right - for 15ft or 22ft Houses

**DECLWBF-8003/4** Min. Buy 1ea



### Greenhouse Benching

#### Grower Select® Anti-Tip Device for Greenhouse Benching

Anti-tip device for use with 1.315 inch roller. Used to prevent accidental tipping of product off benching causing expensive profit loss.



1.315in

**DLSNB06480** Min. Buy 1ea

1.66in

**DLSNB06500** Min. Buy 1ea

#### Grower Select® Baseboard Clamps

Baseboard clamps used to attach a baseboard to a grower select gothic style greenhouse.



1.66in

**DLSNB05040** Min. Buy 1ea

#### Grower Select® Hat Section for Greenhouse Benching

Galvanized bench top crossbar support.



2ft - 18ga

**DLSNZ2770E** Min. Buy 1ea

2.5ft - 18ga

**DLSNB06360** Min. Buy 1ea

3ft - 18ga

**DLSNB06370** Min. Buy 1ea

3.5ft - 18ga

**DLSNB06380** Min. Buy 1ea

4ft - 18ga

**DLSNB06390** Min. Buy 1ea

5ft - 18ga

**DLSNB06400** Min. Buy 1ea

5.5ft - 18ga

**DLSNB06410** Min. Buy 1ea

6ft - 18ga

**DLSNB06420** Min. Buy 1ea

7ft - 18ga

**DLSNB06440** Min. Buy 1ea

7.5ft - 18ga

**DLSNB06445** Min. Buy 1ea

8ft - 18ga

**DLSNB06450** Min. Buy 1ea

10ft - 18ga

**DLSNB06460** Min. Buy 1ea

10.66ft - 18ga

**DLSNB06465** Min. Buy 1ea

12ft - 18ga

**DLSNB06470** Min. Buy 1ea



#### Grower Select® Pre-Galvanized Expanded Metal Section

Components to be used for greenhouse structures or for benching. Many sizes to choose from to create the layout of your choice.



14ga, 4ft x 3ft

**MDWMB00590** Min. Buy 1ea

14ga, 4ft x 3ft 6in

**MDWMB00600** Min. Buy 1ea

14ga, 4ft x 3ft 6in - Flattened

**MDWMB00870** Min. Buy 1ea

14ga, 4ft x 4ft

**MDWMB00610** Min. Buy 1ea

14ga, 4ft x 5ft

**MDWMB00630** Min. Buy 1ea

14ga, 4ft x 5ft 6in

**MDWMB00640** Min. Buy 1ea

14ga, 5ft x 5ft 6in

**MDWMB00750** Min. Buy 1ea

14ga, 4ft x 7ft

**MDWMB00670** Min. Buy 1ea

14ga, 5ft x 6ft

**MDWMB00740** Min. Buy 1ea





## Structure & Benching Components

### Greenhouse Benching

#### Grower Select® Round Clamp Half

Round clamp half used for benching.



1.315in

DLSNB06510

Min. Buy 1ea



#### Grower Select® Square Clamp Half

Square clamp half used for benching.



1in

DLSNMD3000

Min. Buy 1ea



#### Grower Select® Ultra Plastic Top Collapsible Bench

Include all the features of our traditional benching - aluminum side rails, molded corner protectors and plastic caps on all tube ends and legs - combined with durable, smooth, non-porous plastic bench tops that allow trays, flats, and pots to slide across the surface without snagging. The polypropylene panels feature 1.1in x 2.1in rectangular holes for easy cleaning, and will not rot, crack or splinter like wood products nor corrode or rust like expanded metal or wire tops.



4ft x 8ft

GSA12250

Min. Buy 1ea

### Greenhouse Structures

#### Grower Select® Aluminum End Cap

Used for top, bottom and side closure in roof applications in conjunction with the Bar Base and Bar Cap for polycarbonate sheets. Fasten to the structure with wood screws or standard tek screws. When used as a base, weep holes should be drilled every 12in to allow the condensate to drain. Sold by the piece.



8mm - 20ft

GSB01720

Min. Buy 1ea



#### Grower Select® Aluminum F Rail

Components to be used for greenhouse benching.



4ft

GSB06230

Min. Buy 1ea

8ft

GSB06290

Min. Buy 1ea

12ft

GSB06330

Min. Buy 1ea

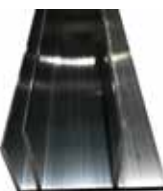

#### Grower Select® Aluminum H-Profile 8mm

Available in 12ft sections, it is used to splice the panels on sidewalls and gables and is used in conjunction with our U-profile. Fasten to structure with wood screws or self tapping tek screws.



Double Splice - 12ft

GSS13693

Min. Buy 1ea



#### Grower Select® Aluminum U-Profile 8mm

Used as a perimeter cap on sidewalls and gables and is used in conjunction with our H-profile to provide structure for polycarbonate panels. Fasten to the structures (on sidewalls and gable ends) with wood screws or self-tapping tek screws. When used as a base, weep holes should be drilled every 12in to allow the condensate to drain.



Single Splice - 12ft - 8mm

GSS15102

Min. Buy 1ea



#### Grower Select® Aluminum U-Profile 8mm

Used as a perimeter cap on sidewalls and gables and is used in conjunction with our H-profile to provide structure for polycarbonate panels. Fasten to the structures (on sidewalls and gable ends) with wood screws or self-tapping tek screws. When used as a base, weep holes should be drilled every 12in to allow the condensate to drain.



Single Splice - 12ft - 8mm

GSS15102

Min. Buy 1ea



#### Grower Select® Bar Base

Used in conjunction with our Bar Cap to splice panels over bows or span purlins with a maximum recommended span of 4ft x 6ft. Fasten to the structure with wood screws or standard tek screws.



8mm - 24ft

GSB01640

Min. Buy 1ea



#### Grower Select® Bar Cap

Used to fasten down the polycarbonate once it's been installed within the Bar Base framework. 1/2in cap screws should be used to secure it to the bar base every 12in. Can be used with or without neoprene gaskets which are sold separately.



8mm - 24ft

GSB01600

Min. Buy 1ea



#### Grower Select® Brace Band

Components to be used for greenhouse benching.



1.375in x .75in

GSB05030

Min. Buy 1ea



#### Grower Select® Camlock Insert

Three pieces are needed for single cam lock base and six pieces are needed for double cam lock base. 450 sections per bundle.



4ft Cam Section Only

GSS13699

Min. Buy 1ea



## Structure & Benching Components

### Greenhouse Structures

#### Grower Select® Carriage Bolt

Components to be used for greenhouse structures or for benching.



**.25in x 3.5in**

**WMNBCRBG025056** Min. Buy 1ea



#### Grower Select® Carriage Bolt

Components to be used for greenhouse structures or for benching.



**5/16in x 2in**

**BLDF21-2118** Min. Buy 1ea

#### Grower Select® Cold Frames / High Tunnel Ground Stake

14 gauge galvanized round tubing ground stake with drilled holes.



**14ga, 1.25in x 3.5ft**

**OHGT98-0972A** Min. Buy 1ea



#### Grower Select® Cold Frames / High Tunnels

Designed for overwintering nursery stock or as a temporary growing area. An optional extended stake package is available for extra height. The house can be purchased without stakes and can be made portable by using a baseboard to connect the bows. Most often used with a single purlin with hoop/bow spacing at 4ft O.C. to help eliminate pocketing. (Build your own endwall to complete the structure). Simple design for easy installation. Add-on options include: purlin runs and baseboard clamps.



**1.315in x 48in Stake for Cold Frame or Hoop House - Swage End**

**GSA01595** Min. Buy 1ea



**14ft Cold Frame Bow**

**GSA01540** Min. Buy 1ea

**15ft Cold Frame Bow**

**GS98-1000A** Min. Buy 1ea



**Swaged Purlin - 1.25in x 12ft with 3ft Swage (Not Drilled) - 16gauge**

**GS98-2000** Min. Buy 1ea

**Swaged Purlin - 1.315in x 21ft - 17gauge**

**GRFSB08680** Min. Buy 1ea

**Swaged Purlin - 1/315in x 12ft - 17gauge**

**GRFSB08670** Min. Buy 1ea



**1.315in x 48in Stake for Cold Frame or Hoop House - Plain End**

**GSA01592** Min. Buy 1ea



**3FT GROUND STAKE - 1in X 15ga X 36in**

**OHGTBFG 3' GROUND STAKE** Min. Buy 1ea

#### Grower Select® Crossbar Uprights

GS Gothic Style house crossbar uprights



**1.315in x 18in**

**GSA01620** Min. Buy 1ea



#### Grower Select® Double Camlock Base

12 foot double cam lock base only. Used for locking multiple sheets of poly film down on the greenhouse. 6 pieces of cam section needed to complete the lock. Usually needed for roll up sides. Sold by the each.



**Base Only - 12ft**

**GSS13697** Min. Buy 1ea

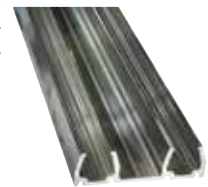

#### Grower Select® Hex Nut

Components to be used for greenhouse structures or for benching.



**.25in**

**BLDF98-1533** Min. Buy 1ea

**.375in**

**BLDFB05180** Min. Buy 1ea



## Structure & Benching Components

### Greenhouse Structures

#### Grower Select® Permaseal Washer - Neoprene Backed

Components to be used for greenhouse structures or for benching.



**1.18in, Usually Used with Polycarbonate**

**WMNB38-0245** Min. Buy 1ea



#### Grower Select® PVC Clips

PVC clip for attaching poly to a roll up shaft.



**4.25in**

**SYN5C23** Min. Buy 1ea



#### Grower Select® Roll-Up Shaft Splice

Grower Select® Roll-up Sidewall System has been designed as a low-cost ventilation system with no additional electrical requirements or costs to operate. The customized aluminum roll-up shaft comes in 12ft lengths and has been designed to accept our standard Grower Select® Spring Lock Spring for easy attachment of the poly to the shaft. We offer two different gear boxes; one for houses under 100ft and the other for houses over 100ft but less than 240ft.



**1.5in x 12in**

**GS38-0807** Min. Buy 1ea



#### Grower Select® Round Galvanized Tubing Support Rails

Components to be used for greenhouse structures or for benching. Many sizes to choose from to create the layout of your choice.



**14ga, 1.25in x 23ft**

**OHGT98-1000B** Min. Buy 1ea

**17ga, 1.315in x 96in**

**GRFSB08625** Min. Buy 1ea

**17ga, 1.315in x 96in - Swaged**

**GRFSB08665** Min. Buy 1ea

**17ga, 1.315in x 144in**

**GRFSB08640** Min. Buy 1ea



#### Grower Select® Round Machine Head Screw

Components to be used for greenhouse structures or for benching.



**.25 x .625in**

**BLDFB05150** Min. Buy 1ea



#### Grower Select® Single Camlock Base

12 foot single cam lock base only. Used for locking multiple sheets of poly film down on the greenhouse. 3 pieces of cam section needed to complete the lock. Sold by the piece. Universal extrusions not only hold roof poly, they also cap off polycarbonate or wood gable ends.



**Base Only - 12ft**

**GSS13698** Min. Buy 1ea



#### Grower Select® Spring Lock Base

Spring lock doesn't pinch, bind, or weaken the material it secures and can be formed to the top of curved bows. It can be secured to any structural members, and can be installed around gable ends. Works by pulling the material across the channel and inserting the spring into place in the bottom channel. Can hold from 2 to 20 mil thickness and multiple layers. Requires two pieces of zigzag wire, also called zipper, wiggle wire or springlock spring (Item GSE09560) to complete the lock.



**Base Only - 12ft**

**GSS14498** Min. Buy 1ea



#### Grower Select® Spring Lock Roll-Up Shaft

Aluminum spring lock roll up shaft used for sidewall ventilation. Wires and couplers sold separately. Grower Select® Roll-up Sidewall System has been designed as a low-cost ventilation system with no additional electrical requirements or costs to operate. The customized aluminum roll-up shaft comes in 12ft lengths and has been designed to accept our standard Grower Select® Spring Lock Spring for easy attachment of the poly to the shaft. We offer two different gear boxes; one for houses under 100ft and the other for houses over 100ft but less than 240ft.



**12ft**

**GS38-0806** Min. Buy 1ea



## Structure & Benching Components

### Greenhouse Structures

#### Grower Select® Square Galvanized Tubing

Components to be used for greenhouse structures or for benching. Many sizes to choose from to create the layout of your choice.



<b>14ga, 1.25in x 30in</b>	
<b>GRFSB07760</b>	Min. Buy 1ea
<b>14ga, 1.25in x 40in</b>	
<b>GRFSB07780</b>	Min. Buy 1ea
<b>14ga, 1.25in x 48in</b>	
<b>GRFSB07790</b>	Min. Buy 1ea
<b>14ga, 1.25in x 54in</b>	
<b>GRFSB07800</b>	Min. Buy 1ea
<b>14ga, 1.25in x 96in</b>	
<b>GRFSB07850</b>	Min. Buy 1ea
<b>14ga, 1.25in x 288in</b>	
<b>GRFSB07870</b>	Min. Buy 1ea
<b>14ga, 2in x 288in</b>	
<b>GSB07730</b>	Min. Buy 1ea
<b>16ga, 1in x 30in</b>	
<b>GRFSB07610</b>	Min. Buy 1ea
<b>16ga, 1in x 36in</b>	
<b>GRFSB07620</b>	Min. Buy 1ea
<b>16ga, 1in x 40in</b>	
<b>GRFSB07630</b>	Min. Buy 1ea
<b>16ga, 1in x 60in</b>	
<b>GRFSB07660</b>	Min. Buy 1ea
<b>16ga, 1in x 66in</b>	
<b>GRFSB07670</b>	Min. Buy 1ea
<b>16ga, 1in x 72in</b>	
<b>GRFSB07680</b>	Min. Buy 1ea
<b>16ga, 1in x 78in</b>	
<b>GRFSB07690</b>	Min. Buy 1ea
<b>16ga, 1in x 168in</b>	
<b>GRFSB07852</b>	Min. Buy 1ea
<b>16ga, 1in x 195in</b>	
<b>GRFSB07853</b>	Min. Buy 1ea
<b>16ga, 1.5in x 288in</b>	
<b>GRFS21-0002</b>	Min. Buy 1ea
<b>16ga, 2in x 288in</b>	
<b>GRFSB08200</b>	Min. Buy 1ea



#### Grower Select® Tek screw with Neoprene Washer

Components to be used for greenhouse structures or for benching.



<b>#14 x 1in</b>	
<b>WMNBHBT2014016</b>	Min. Buy 1ea
<b>#14 x 1.25in</b>	
<b>WMNB38-0236</b>	Min. Buy 1ea



#### Grower Select® Tek Screw with Zinc Washer

Components to be used for greenhouse structures or for benching.



<b>#12 x 1.5in</b>	
<b>BLDF26-1103</b>	Min. Buy 1ea



#### Grower Select® WoodTite™ Self Tapping Screws

Components to be used for greenhouse structures or for benching.



<b>#10 x .75in, Type-17 Point</b>	
<b>BLDFB05210</b>	Min. Buy 1ea
<b>#10 x 1.5in, Type-17 Point</b>	
<b>BLDFB05110</b>	Min. Buy 1ea



#### Grower Select® Self-Tapping Tek Screw

Components to be used for greenhouse structures or for benching.



<b>.75in</b>	
<b>BLDF45-1200</b>	Min. Buy 1ea



#### Grower Select® Galvanized Nut

Components to be used for greenhouse structures or for benching.



<b>5/16in</b>	
<b>BLDF21-2119DA</b>	Min. Buy 1ea



### Greenhouse Structures

#### Jaderloon® Cross Connector

Jaderloon's® unique, 2-piece, aluminum cross connector retains 100% of the frame's strength. Comes complete with bolts and nuts. Use it to connect 1-5/8" tubing or pipe to 1-3/8" tubing or pipe.



<b>1-5/8in x 1-3/8in</b>	
<b>JA5PN0001</b>	Min. Buy 1ea



#### Jaderloon® Inflation Blower Mounting Bracket

Small inflation blower bracket with deflector. Blower sold separately.



<b>For 60CFM Blower</b>	
<b>JA4PN0030</b>	Min. Buy 1ea
<b>For 148CFM Blowers</b>	
<b>JA4PN0035</b>	Min. Buy 1ea



#### Jaderloon® Jumper Hose

Jumper kits are designed to pass pressure from one section of double poly to an adjoining section. Ideal for inflating sides and endwalls.



<b>36in</b>	
<b>JA4PN0024</b>	Min. Buy 1ea



## Structure & Benching Components

### Greenhouse Structures

#### Advancing Alternatives Double WireLock Base

Aluminum extrusion accepts three layers of wires and multi-layers of poly for curtain system roll-up/lock-down. Designed to attach the roof covering to the top clasp and the roll-up curtain to the lower clasp.



**8ft**

**ADVDWL8**

Min. Buy 20ea

**12ft**

**ADVVDWL12**

Min. Buy 20ea



#### Advancing Alternatives EZ Snap Rope Hook

Aluminum hook to provide a method of securing rope by inserting into standard WireLock base.



**1in**

**ADVEZSNAP**

Min. Buy 1ea



#### Advancing Alternatives Gear Crank 5:1 w/ Brake

Component for ADVGCP5:1BX1.3 S/P which is DNR



**ADV63GC51B**

Min. Buy 1ea

#### Advancing Alternatives Gears & Adapters

13:1 gear, manual operator with guide wheels, internal brake and input loop.



**Gear and Adaptors for roll up walls**

**ADV63GC131**

Min. Buy 1ea

#### Advancing Alternatives Gears & Adapters

Short handle, fits over and bolts to input loop.



**Gear and Adaptors for roll up walls**

**ADV64CH**

Min. Buy 1ea

#### Advancing Alternatives Gears & Adapters

Adapter 1/2" Shaft X 2.3".



**Gear and Adaptors for roll up walls**

**ADV65RBA1223**

Min. Buy 1ea

#### Advancing Alternatives Gears & Adapters

Guide pipe, 7' long with hole at one end for mounting hardware (order guide pipe hardware separately).



**Gear and Adaptors for roll up walls**

**ADVGP7**

Min. Buy 1ea



#### Advancing Alternatives Posi-Clasp Roll-Lock

Creates a sealed covering at the bottom of the roll-up sides. Designed to clasp single or multi-layer curtain material.



**8ft**

**ADVRL8**

Min. Buy 4ea

**12ft**

**ADVRL12**

Min. Buy 4ea

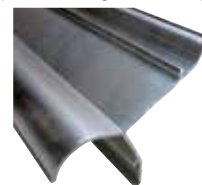

#### Advancing Alternatives Roll-Bar Cap

Clasp single or double layers of poly for the full length of existing pipe Roll-Bars. The pre-drilled Aluminum Roll-Bar Cap clasps against any standard 1.31in OD pipe with self-drilling Tek Screws (recessed) so curtains can roll uniformly.



**8ft**

**ADVRBC8**

Min. Buy 1ea

**12ft**

**ADVRBC12**

Min. Buy 1ea



#### Advancing Alternatives Stationary Mounted Gear Crank

Manual rollup curtain system with internal brake. Stationary unit allows for left, right or two sided output. Gear Crank uses a 1.315in OD Guide Pipe (not included).



**Gear Ratio 13:1**

**ADVGC13:1**

Min. Buy 1ea



### Greenhouse Benching

#### AV Plastic Greenhouse Bench Tops

Polypropylene, UV Protected. Durable and lightweight. No sagging when properly supported. Can withstand extremely cold and hot temperatures. Installs on any type of frame with screws or pop rivets. Easy interlocking assembly. Flats, plug trays and pots slide easily over surface, no tipping. Easy to clean and disinfect. Will not rust or decay. Inorganic and will not support the growth of mold and fungus.



**18in x 36in x 9/16in**

**AV18X36**

Min. Buy 1ea

**24in x 48in x 7/8in**

**AV24X48**

Min. Buy 1ea

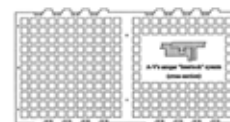

## Structure & Benching Components

### Greenhouse Benching

**SOUTHWEST AGRI-PLASTICS, INC.**

### Southwest Agri-Plastics Inc Dura-Bench Ultra

The Dura-Bench Ultra is our newest greenhouse bench top. The plastic bench top is tougher, smoother, and is a longer lasting growing surface for your plants. With increased airflow, easier installation and a lower cost per square foot, the latest Dura-Bench Ultra will fit your needs and budget. 2ft x 4ft & 3ft x 4ft (8 or 12sq ft, nominal) high impact abrasion resistant polypropylene plastic panels weigh 4.5lbs each for the 2ft wide and 6.6 lbs for the 3ft wide. 1.1in x 2.1in rectangular holes. Panel ends connect with a four tab and receiving hole system. 4ft sides interconnect with easy to install black nylon clips. Pre-molded screw attachment rails and outer screw attachments tabs for easy installation with stainless steel screws. Dura-Bench Ultra panels allow for any combination of bench sizes. Bench panels can be attached parallel or perpendicular to the length of the bench depending on needs and frame design. 12" and 18" panels can easily be created by cutting between double-ribbed center sections on each size panel. Substructure frame cross supports placed on any incremental interval (such as 16in or 24in centers) based on the weight of the plants per square foot.

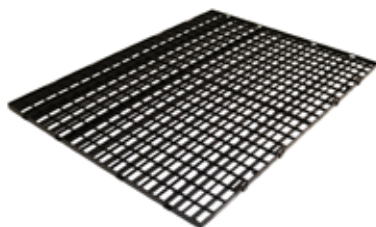

**36in x 48in Top**  
SWAPDBU36X48B Min. Buy 1ea

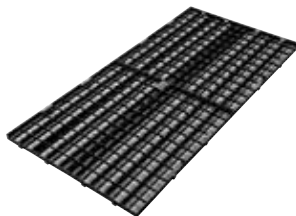

**24in x 48in Top**  
SWAP45-2013 Min. Buy 1ea



**Dura-Bench Ultra Clips**  
SWAP45-2013A Min. Buy 1ea

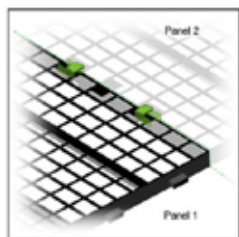

*Dura-Bench Ultra Assembly Clip locked in position (in Clip Receivers)*

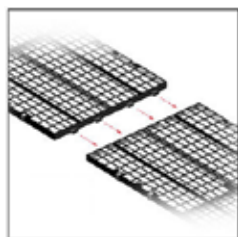

*Tabs/Receiver Holes: End-to-End Assembly*

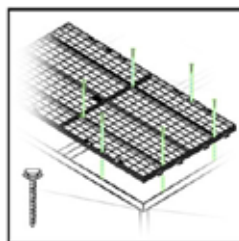

*Tek Screw Installed in Screw Attachment Rail (Left: Metal Substructure Stainless Steel Tek Screws. Right: Wood Substructure No. 10 Wood Screws)*

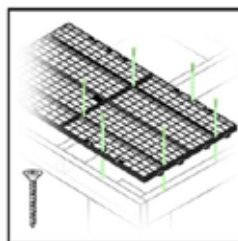

### Features:

- 2ft x 4ft & 3ft x 4ft (8sq ft. & 12sq ft., nominal) high impact abrasion resistant polypropylene plastic panel
- 1.1in x 2.1in rectangular holes
- 2ft & 3ft ends connect with a four tab and receiving hole system
- 4ft sides interconnect with easy to install black nylon clips
- Multiple pre-molded screw attachment rails and outer screw attachment tabs for easy installation with stainless steel screws
- Weight 4.5lbs & 6.6 lbs/panel

### Table Layout/Design

- Dura-Bench Ultra panels allow for any combination of bench sizes
- Bench panels can be attached parallel or perpendicular to the length of the bench depending on needs and frame design
- 12" and 18" wide panels can easily be created by cutting between double-ribbed center sections on each size panel
- Substructure frame can be made from metal, wood or pipe
- Substructure frame cross supports placed on any incremental interval (such as 16in or 24in centers) based on the weight of the plants per square foot

### Southwest Agri-Plastics Inc Dura-Bench Original

The DURA-BENCH Original Overlap design is 2ft wide by 4ft long panel with connections on all four sides. This design utilizes four interlocking tabs along the 4ft side allowing the parts to be adjoined. The 2ft side uses an overlap connection only requiring one cross support.\*



**Overlap - 24in x 49.5in Top**  
SWAP45-2011 Min. Buy 1ea





# Coverings



## Helpful Tips About Greenhouse Films

### Greenhouse Films

#### Fold Methods

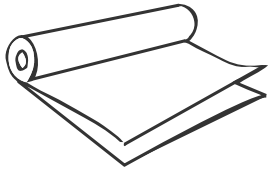

Double-Wound Sheet

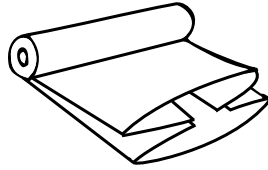

GT: Gusseted Tube

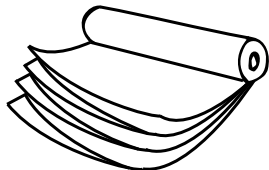

Double Fold

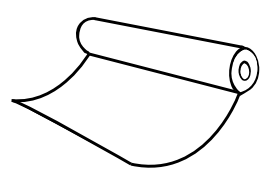

LF: Layflat

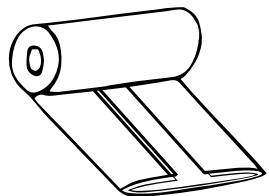

TDF: Tubing Double Folded

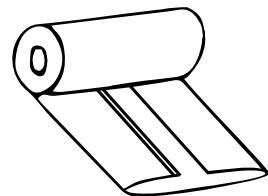

CSTF: Center-Slit  
Tubing Folded

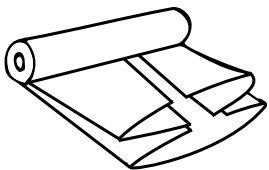

GS: Center-Slit Gusseted

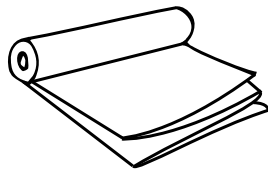

WF: W-Fold Sheet or  
M-Sheet

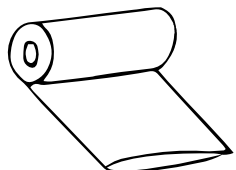

FT: Layflat Tubing

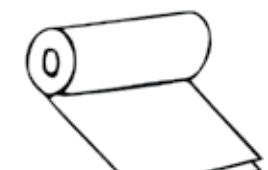

CF: Centerfold

- UFGS: U Fold Center Slit Gusseted Sheet
- UFT: U Fold Tube



#### Installation Hints

- When installing, make certain the film is placed on top of the greenhouse according to the folds.
- The film should be installed during the early morning hours (cooler without wind).
- Do not stretch the film on hot days as it will contract when cool and may weaken.
- Static air pressure between the two layers should be between 0.2 and 0.4 inches of water on a manometer.
- Use outside air to inflate as it's less humid and less likely to contain chemicals.
- Avoid direct spraying of chemicals on film surfaces.
- Paint all metal and wood surfaces touching the poly with white latex paint. Never use oil-base paint. Do not use chemically treated lumber.
- Avoid contact with PVC and vinyl.
- Smooth the surface of metal and wood parts.
- Use only repair tape recommended for poly.

#### Poly Accessories

BFG also offers a variety of poly accessories



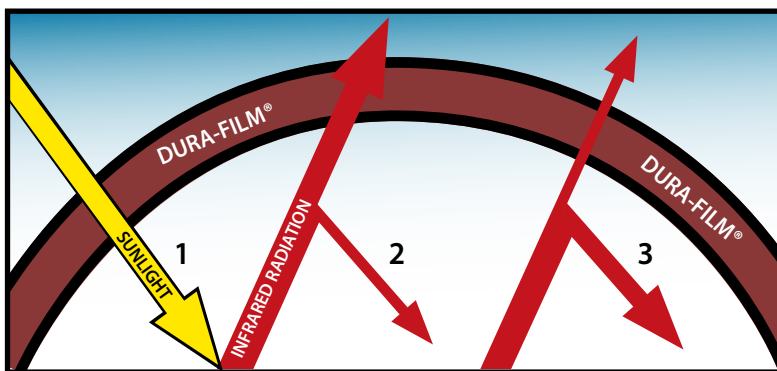

1. Sunlight strikes the earth, which radiates heat as infrared rays. 2. Regular greenhouse film trap some of the heat. 3. Thermal greenhouse film traps more heat.



**Full Replacement**  
 Warranty Against Manufacturing  
 Defects Up to 4 Years,  
 Depending on Product Category

**THERMAX**<sup>®</sup>  
 Anti-condensate Film

## Save Energy Dollars with Thermal Films

The greatest energy loss in a greenhouse is through conduction and the greatest savings are realized with a double layer glazing system, such as the typical inflated double poly house. Studies have shown that a properly inflated double poly house can save over 40% in fuel costs compared to a single layer glazing.

An additional 15%-20% can be saved by using a thermal film as one of the layers. Thermal films lower energy costs by reducing the radiant heat loss from the greenhouse, acting as a shield between your warm plants and the cold night sky. Since the radiant heat loss is reduced, heaters cycle less often and burn less energy to maintain their set point temperature.

Thermal films should be installed as the bottom layer of a double poly system to take advantage of the anti-condensate properties. Although there is no harm in using two layers of thermal films, a second layer of thermal film doesn't add significantly to the energy savings.

### How thermal films work:

During the day in a greenhouse, the sunlight – comprised of both visible light and short wave infrared light – is absorbed by the plants, soil, and materials of construction, which results in them heating up. During the night, all objects that have absorbed this energy from the sun will release it as long wave infrared radiation. A thermal film will absorb and reflect this energy, keeping its warmth within the greenhouse environment, resulting in higher nighttime temperatures within the greenhouse.

### Crop response to thermal films:

Many growers report earlier color and/or more compact plants. This is most likely due to the increase in nighttime plant tissue temperature associated with reduced radiant heat loss. While these effects are subtle, you should expect crop development to be slightly accelerated when using DuraFilm<sup>®</sup> Thermax.

### Infra Red Film

#### Dura-Film<sup>®</sup> Thermax

Every grower strives to produce the best crop they can while keeping production costs to a minimum. Dura-Film Thermax greenhouse poly combines all of these extras into one package. Superior drip control, energy savings, and bee compatibility are all packaged together to provide growers with one film at one cost.

Dura-Film<sup>®</sup> Thermax is available in a selection of stock sizes and is available during certain "runs or campaigns" at predetermined widths without minimums. All other widths are considered custom product.

- Superior drip control
- Energy savings
- Reduces radiant heat loss
- Bee compatibility
- Guaranteed longer life, 4 years



#### Dura-Film<sup>®</sup> Thermax Tubes 6 Mil 4 Year Film Standard Sizes

<b>18ft x 150ft Tube</b>	
<b>AT8964590</b>	Min. Buy 1ea
<b>20ft X 150ft Tube</b>	
<b>AT8963769</b>	Min. Buy 1ea
<b>24ft x 100ft Tube</b>	
<b>AT8963866</b>	Min. Buy 1ea
<b>24ft X 150ft Tube</b>	
<b>AT8963770</b>	Min. Buy 1ea

#### Dura-Film<sup>®</sup> Thermax Sheets 6 Mil 4 Year Film Standard Sizes

<b>24ft x 100ft</b>	
<b>AT8963765</b>	Min. Buy 1ea
<b>32ft x 100ft</b>	
<b>AT8963766</b>	Min. Buy 1ea
<b>36ft x 100ft</b>	
<b>AT8963892</b>	Min. Buy 1ea
<b>40ft x 150ft</b>	
<b>AT8963888</b>	Min. Buy 1ea
<b>40ft x 100ft</b>	
<b>AT8963767</b>	Min. Buy 1ea
<b>48ft x 100ft</b>	
<b>AT8963858</b>	Min. Buy 1ea
<b>48ft x 150ft</b>	
<b>AT8963861</b>	Min. Buy 1ea

Custom lengths can be ordered in a 75ft minimum length and 5ft increments.

Shorter than 75ft will be subject to an upcharge.

#### Custom Widths

The following minimums production requirements apply for custom poly orders per width/gauge/opacity:

- Up to 20ft - 7,500lbs
- 21ft to 31ft - 15,000lbs
- 32ft to 40ft - 20,000lbs
- >40ft - 30,000lbs



**Infra Red Film**

**Dura-Film® Thermax**

Every grower strives to produce the best crop they can while keeping production costs to a minimum. Dura-Film Thermax greenhouse poly combines all of these extras into one package. Superior drip control, energy savings, and bee compatibility are all packaged together to provide growers with one film at one cost.

**Standard Width Sizes**

**Sheet:** 10ft, 12ft, 16ft, 20ft, 24ft, 28ft, 32ft, 40ft, 42ft, 48ft, 50ft  
**Tubes:** 5ft, 6ft, 8ft, 10ft, 12ft, 14ft, 16ft, 18ft, 20ft, 21ft, 24ft, 25ft

**Dura-Film® Thermax Sheets  
Standard Sizes**



**40ft x 150ft Sheet**  
**AT8963768** Min. Buy 1ea

**Dura-Film® Thermax™ IR-AC Film**



**6m- 28ft x 100ft**  
**AT8963794** Min. Buy 1ea



**Multi Year Film**

**Dura-Film® Super4™**

Dura-Film® Super 4™ offers the best value in a 6-mil, 4-year greenhouse film with the following improved properties over older generations of greenhouse coverings. Superior strength and toughness. Higher light transmission. Guaranteed longer life – 4 years. Folds up to 210% stronger. Tear strength up to 164% higher. Puncture force up to 12% higher.

Advanced UV up to 33% longer life.

- Superior strength and toughness
- Higher light transmission
- Guaranteed longer life, 4 years
- Folds up to 210% stronger
- Tear strength up to 164% higher



Dura-Film® Super 4™ is Also Available with 55% White Opacity in Selected Sizes. Ask Sales Representative for Details.

**Standard Width Sizes**

**Dura-Film® Super 4™ Clear - 6mil / 4-Year**

**Sheet:** 10ft, 12ft, 16ft, 20ft, 24ft, 28ft, 32ft, 40ft, 42ft, 48ft, 50ft  
**Tubes:** 5ft, 6ft, 8ft, 10ft, 12ft, 14ft, 16ft, 18ft, 20ft, 21ft, 24ft, 25ft

*Custom lengths can be ordered in a 75ft minimum length and 5ft increments.*

*Shorter than 75ft will be subject to an upcharge.*

*Custom Widths*

The following minimums production requirements apply for custom poly orders per width/gauge/opacity:

- Up to 20ft - 7,500lbs
- 21ft to 31ft - 15,000lbs
- 32ft to 40ft - 20,000lbs
- >40ft - 30,000lbs

**Tubes**



**20ft X 100ft Tube**  
**AT6750399** Min. Buy 1ea

**20ft X 110ft Tube**  
**AT6750059** Min. Buy 1ea

**20ft X 150ft Tube**  
**AT6750056** Min. Buy 1ea

**24ft X 100ft Tube**  
**AT6750080** Min. Buy 1ea

**24ft X 150ft Tube**  
**AT6750079** Min. Buy 1ea

**Sheets**

**12ft x 100ft**  
**AT6750559** Min. Buy 1ea

**16ft X100ft**  
**AT6750070** Min. Buy 1ea

**20ft X 100ft**  
**AT6750301** Min. Buy 1ea

**24ft X 100ft**  
**AT6750063** Min. Buy 1ea

**24ft X 110ft**  
**AT6750062** Min. Buy 1ea

**24ft X 150ft**  
**AT6750085** Min. Buy 1ea

**28ft X 100ft**  
**AT6750038** Min. Buy 1ea

**28ft X 150ft**  
**AT6750607** Min. Buy 1ea





### Multi Year Film

#### Dura-Film® Super4™

Dura-Film® Super 4™ offers the best value in a 6-mil, 4-year greenhouse film with the following improved properties over older generations of greenhouse coverings. Superior strength and toughness. Higher light transmission. Guaranteed longer life – 4 years. Folds up to 210% stronger. Tear strength up to 164% higher. Puncture force up to 12% higher.

Advanced UV up to 33% longer life.

- Superior strength and toughness
- Higher light transmission
- Guaranteed longer life, 4 years
- Folds up to 210% stronger
- Tear strength up to 164% higher



#### Standard Width Sizes

##### Dura-Film® Super 4™ Clear - 6mil / 4-Year

**Sheet:** 10ft, 12ft, 16ft, 20ft, 24ft, 28ft, 32ft, 40ft, 42ft, 48ft, 50ft

**Tubes:** 5ft, 6ft, 8ft, 10ft, 12ft, 14ft, 16ft, 18ft, 20ft, 21ft, 24ft, 25ft

#### Sheets

##### 32ft X 100ft

AT6750042

Min. Buy 1ea



##### 32ft X 110ft

AT6750061

Min. Buy 1ea



##### 32ft X 150ft

AT6750041

Min. Buy 1ea



##### 36ft X 100ft

AT6750397

Min. Buy 1ea



##### 36ft X 150ft

AT6750534

Min. Buy 1ea



##### 40ft X 100ft

AT6750040

Min. Buy 1ea



##### 40ft X 110ft

AT6750055

Min. Buy 1ea



##### 40ft X 150ft

AT6750039

Min. Buy 1ea



##### 42ft X 100ft

AT6750084

Min. Buy 1ea



##### 42ft X 150ft

AT6750081

Min. Buy 1ea



##### 48ft X 100ft

AT6750043

Min. Buy 1ea



##### 48ft X 150ft

AT6750045

Min. Buy 1ea



##### 50ft X 100ft

AT6751236

Min. Buy 1ea



### Multi Year Film

#### Tufflite® 6M Greenhouse Film

Protection and clarity. This clear, 4 year, 6mil, durable greenhouse film was designed for excellent PAR light transmission, exceeding 91%. Tufflite IV is made with a high strength proprietary polymer blend and UV stabilization that will protect and keep a greenhouse operation growing for up to 4 years.

#### Standard Width Sizes

##### Tufflite IV Clear – 6mil / 4-Year

**Sheet:** 10ft, 12ft, 14ft, 16ft, 20ft, 24ft, 28ft, 32ft, 36ft, 40ft, 42ft, 48ft, 50ft, 56ft

**Tubes:** 5ft, 6ft, 7ft, 8ft, 10ft, 12ft, 14ft, 16ft, 18ft, 20ft, 21ft, 24ft, 25ft, 28ft



##### Clear - 21ft x 150ft Tube

BERRY\*T4 621150T Min. Buy 1ea



##### Clear - 24ft x 100ft

BERRYT4 624 Min. Buy 1ea



##### Clear - 36ft x 100ft

BERRY\*T4 636100 Min. Buy 1ea



##### Clear - 42ft x 100ft

BERRYT4 642 Min. Buy 1ea



##### Clear - 48ft x 100ft

BERRYT4 648 Min. Buy 1ea



##### Clear - 56ft x 100ft

BERRYTIV656 Min. Buy 1ea



##### White - 55% - 24ft x 100ft

BERRYTW624 Min. Buy 1ea



### Infra Red Film

#### Tufflite® 6M Infrared Greenhouse Film

Four year covering, UV protection, and anti-drip additive that reduces condensation build-up—plus an additive that disperses light and helps delay the exit of heat from the greenhouse.



##### Clear - 24ft x 100ft

BERRYTES624 Min. Buy 1ea



##### Clear - 32ft x 100ft Tube

BERRYTES632 Min. Buy 1ea



##### Clear - 48ft x 100ft

BERRYTES648 Min. Buy 1ea





### Over Wintering Film

#### Tufflite® 3M Greenhouse Film

This Nursery Film will cover all your needs for a single season. This is a tri-layer polyethylene film for maximum protection and ease of installation. Offers high clarity to allow the most light possible.



**White - 70% - 24ft x 100ft**  
**BERRYNW324100** Min. Buy 1ea



**White - 70% - 24ft x 110ft**  
**BERRYNW324110** Min. Buy 1ea



**White - 70% - 24ft x 150ft**  
**BERRYNW324150** Min. Buy 1ea



**White - 70% - 32ft x 100ft**  
**BERRYNW332100** Min. Buy 1ea



**White - 70% - 36ft x 100ft**  
**BERRYNW336100** Min. Buy 1ea



**White - 70% - 40ft x 100ft**  
**BERRYNW340100** Min. Buy 1ea



Custom lengths can be ordered in a 75ft minimum length and 5ft increments.

Shorter than 75ft will be subject to an upcharge.

#### Custom Widths

The following minimums production requirements apply for custom poly orders per width/gauge/opacity:

- Up to 31ft - 5,000lbs
- >32ft - 10,000lbs

#### Tufflite® Nursery Clear 3M Overwintering Film

This Nursery Film will cover all your needs for up to one year. This is a tri-layer polyethylene film for maximum protection and ease of installation. Offers high clarity to allow the most light possible.



**Clear - 24ft x 100ft**  
**BERRYNC424** Min. Buy 1ea



**Clear - 24ft x 110ft**  
**BERRYNC324110** Min. Buy 1ea



**Clear - 28ft x 110ft**  
**BERRYNC328110** Min. Buy 1ea



**Clear - 42ft x 100ft**  
**BERRYNC342100** Min. Buy 1ea



Horticulture films that help your business grow



Bee Friendly

### SUPER4™

Greenhouse Film

#### The Durability and Toughness You Need

Super 4™ is a super clear, super tough, longlife product that provides the best value in a 6-mil, 4-year greenhouse film. Super 4™ is also available with 55% white opacity in selected sizes.

### THERMAX™

Anti-condensate Film

#### Durability, Energy Savings, Plus Condensation Control

Thermax™ combines outstanding thermal qualities and exceptional condensation control properties in one revolutionary, diffused greenhouse film.

### LUMINANCE™

Tunnel Film

#### The Results You Want

LUMINANCE™ has been specially engineered to give you the results you need from a highly diffused greenhouse and high tunnel film.



# Tough and Versatile



## Greenhouse Coverings

**TuffliteIV™**

A high clarity, tri-layer covering for 4 years with UV protection and anti-dust additive

**Tufflite®**  
InfraRed

Four year covering with UV protection and anti-drip additive that reduces condensation build-up. Also includes an additive that disperses light and helps delay the exit of heat from the greenhouse.

## Overwintering Films

**Tufflite®**  
Nursery

Tufflite Nursery films provide superior protection from the harsh elements. The products are UV stabilized for up to 1 year and are available in a variety of sizes, gauges and opacity.

# Green.tek

## Covering Accessories

### Green-Tek® Aluminum Foil Tape

In addition to a wide range of custom converting solutions, including cut to size, custom taping, and grommet installation, Green-Tek offers a complete range of plastic fasteners and connectors that are suitable for poly, energy curtains, nets, screens and shade cloth. The connectors are easy and quick to install and are designed for different applications. Produced from top quality plastic with UV protection, each type of connector is designed to be used for a specific type of netting and is specific to the manner in which the netting covers the structure.



**1in x 150ft**  
**GRTK26-0823**

Min. Buy 1ea



### Green-Tek® Aluminum Vent Tape

In addition to a wide range of custom converting solutions, including cut to size, custom taping, and grommet installation, Green-Tek offers a complete range of plastic fasteners and connectors that are suitable for poly, energy curtains, nets, screens and shade cloth. The connectors are easy and quick to install and are designed for different applications. Produced from top quality plastic with UV protection, each type of connector is designed to be used for a specific type of netting and is specific to the manner in which the netting covers the structure.



**2in x 150ft**  
**GRTKE03690**

Min. Buy 1ea



### Green-Tek® No-Thrip Insect Screen

The most exclusive screen available, with a hole size of only 150 microns. Tough monofilament construction can be fabricated in any size.



**Mesh 75 Sold by the Square Foot**  
**GRTKNO THRIP**

Min. Buy 1ea



### Green-Tek® Vertical Closure Strip

This foam strip for use in installation of corrugated polycarbonate sheeting. Sold by the each.



**36in**  
**GRTK26-1962**

Min. Buy 1ea



## Infra Red Film



### Green-Tek® GT 4YR IRAC MAX 6M

New GT IRAC - MAX is the new versatile king of the market. IR TREATMENT: Preserves the sun's IR heat radiation at night. ANTI-CONDENSATE: Reduces/eliminates droplets and light stopping fog on the inside layer from forming. HIGH DIFFUSION: 75% diffusion! New feature spreads light throughout the canopy of your crop. More diffusion = less shadows! UV OPEN: An industry first! Transmits UV light to crops that need it for color, flavonoids, cannabis, roses and more.



**32ft x 100ft**  
**GRTK47-9003**

Min. Buy 1ea



**40ft x 100ft**  
**GT4IRAC640100**

Min. Buy 1ea



**48ft x 145ft**  
**GRTK IRAC 48X145 6M**

Min. Buy 1ea



**24ft x 100ft**  
**GRTK47-9000**

Min. Buy 1ea



**24ft x 75ft**  
**GRTKGT4IR62475**

Min. Buy 1ea

### Green-Tek® GT-4

GT4 is produced using advanced technology, resulting in a greenhouse film that is tough and clear long lasting greenhouse film.

- Superior Strength and Toughness
- Higher Light Transmission



**Clear - 24ft x 100ft Tube**  
**GRTK47-9906**

Min. Buy 1ea



**Clear - 32ft x 100ft**  
**GRTK47-9915**

Min. Buy 1ea



**Clear - 42ft x 100ft**  
**GRTK47-9921**

Min. Buy 1ea



**Clear - 48ft x 125ft**  
**GRTKGT448125**

Min. Buy 1ea



**White - 24ft x 100ft**  
**GRTK47-9000A**

Min. Buy 1ea

Over Wintering Film

**Green-Tek® Overwinter**

GT Films offer traditional overwinter poly with protection with 1 season UV life. Offers UV resistance with 2.4 mil and 5.0 mil thickness available in Clear and White. Contact your BFG Sales Rep for custom length sizes and availability



**24ft x 110ft**  
**GRTK47-9949** Min. Buy 1ea



**32ft x 100ft**  
**GTOCL332100** Min. Buy 1ea



**42ft x 100ft**  
**GRTK47-9950** Min. Buy 1ea



**42ft x 100ft**  
**GTOCL342100** Min. Buy 1ea



**42ft x 110ft**  
**GRTK47-9951** Min. Buy 1ea



**White - 24ft x 100ft**  
**GRTK47-9948** Min. Buy 1ea



**Green-Tek® Thinwall Clear ThermaGlas®**

Thermaglas multi-wall polycarbonate sheets offer high light transmission, maximum impact resistance, and superior insulation. This combination yields a strong, energy efficient, and lightweight sheet that is optimum for greenhouse applications. ThermaGlas Plus products feature built-in condensation control so durable and effective it's warranted for 10 years. The result is higher light transmission and reduced moisture-related disease.

ThermaGlas 8mm triple-wall polycarbonate offers excellent light transmission, while providing up to 60% more energy efficiency than glass, and 25% more efficiency than 8mm twin-wall acrylic.

- Weather and UV resistant
- Rigid, yet capable of cold-forming to an arch
- Easy to work with and install using ordinary tools
- Rigid, yet capable of cold-forming to an arch



**8mm - 71.25in x 11ft**  
**GRTKTWIN-71.2511** Min. Buy 1ea



**8mm - 71.25in x 13ft**  
**GRTKTWIN-71.2513** Min. Buy 1ea



**8mm - 71.25in x 14ft**  
**GRTKTWIN-71.2514** Min. Buy 1ea



**8mm - 71.25in x 20ft**  
**GRTKTWIN-71.2520** Min. Buy 1ea



**8mm - 71.25in x 9ft**  
**GRTKTWIN-71.259** Min. Buy 1ea



**8mm Clear / 72.25in x 10ft**  
**GRTKTWIN-71.2510** Min. Buy 1ea



Poly Carbonate

**Green-Tek® Horizontal Closure Strip**

This foam strip for use in installation of corrugated polycarbonate sheeting. Sold by the each.



**39in**  
**GRTK26-0812** Min. Buy 1ea



**Green-Tek® ThermaGlas® Twin-Wall**

ThermaGlas® Multi-wall Polycarbonate Sheet is designed and engineered specifically for commercial greenhouse use. The multiwall design and light weight of the sheet enables a reduction in the cost of the supporting structure. Shatterproof polycarbonate coupled with integrated UV resistant co-extruded layer yields long service periods.

**8mm - Clear - 71.25in x 15ft**  
**GRTKTWIN-71.2515** Min. Buy 1ea



**8mm - Clear - 71.25in x 16ft**  
**GRTKTWIN-71.2516** Min. Buy 1ea



**8mm - Clear - 71.25in x 22ft**  
**GRTKTWIN-71.2522** Min. Buy 1ea



Check with your BFG rep for volume discounts and minimum order for prepaid freight.

Custom sizes are available in 4ft (48in) and 6ft (72in) widths and up to 48ft lengths for all of these items.

# Green.tek



## Shade Coverings

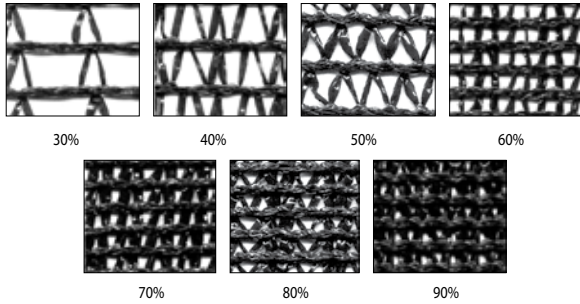

### Green-Tek® Shade Rite - Black Shade Cloth

Shade Rite knitted shade cloth from Green-Tek offers open lockstitch design for better ventilation and a reduction in wind speed and heat buildup in structures. Shade Rite is available cut-to-size with no minimums.

- Crop protection for UV and heat sensitive plants
- Better ventilation and water permeable
- Lightweight and easy to install
- U.V. protection: U.V. resistant, high density polyethylene
- Chemical resistant: resists most horticultural chemicals, sprays and detergents
- Tough lockstitch knitted construction. Resists rips, tears and fraying. Shade levels remain constant during product life
- Cost effective: No edge taping and minimal sewing required thanks to knitted lockstitch
- Wide widths available up to 34 feet

### Green-Tek® Shade Rite - Knitted Black Shade Cloth

<b>30% Black by the Square Foot</b> <b>GRTK30% BLACK</b> Min. Buy 1ea	
<b>40% Black by the Square Foot</b> <b>GRTK40% BLACK</b> Min. Buy 1ea	
<b>50% Black - Order by the Square Foot</b> <b>GRTK50% BLACK</b> Min. Buy 1ea	
<b>60% Black by the Square Foot</b> <b>GRTK60% BLACK</b> Min. Buy 1ea	
<b>70% Black by the Square Foot</b> <b>GRTK70% BLACK</b> Min. Buy 1ea	
<b>80% Black by the Square Foot</b> <b>GRTK80% BLACK</b> Min. Buy 1ea	
<b>90% Black by the Square Foot</b> <b>GRTK90% BLACK</b> Min. Buy 1ea	



### Green-Tek® Shade Rite - Knitted Black Shade Cloth Extras

#### Grommets

**Brass Grommets**  
**GRTK29-0064** Min. Buy 1ea

**Plastic Grommets**  
**GRTKPLASTIC GROMMET** Min. Buy 1ea

#### Seam Charges

**Seaming Charge**  
**GRTKE10300** Min. Buy 1ea

**Taping Charge**  
**GRTKE10320** Min. Buy 1ea

### Green-Tek® Aluminet™ "Cool Shade" Shade Cloth

Aluminet is a high quality reflective metalized HDPE knitted screen used as a greenhouse thermal screen and as an alternative to black shade cloth. It's specially treated to prevent oxidation, and: Protects against frost radiation damages Repels pests and thrips Moderates day/night temperatures Prevents condensation build-up on screens and dripping on plants. Easy to install due to light weight and high elasticity.



**30% - Order by the Square Foot**  
**GRTK30% ALUMINET** Min. Buy 1ea

**50% by the Square Foot**  
**GRTK50% ALUMINET** Min. Buy 1ea

**60% by the Square Foot**  
**GRTK60% ALUMINET** Min. Buy 1ea

**70% by the Square Foot**  
**GRTK70% ALUMINET** Min. Buy 1ea

### Green-Tek® Shade Rite - Woven Black Shade Cloth

**30% Black by the Square Foot**  
**GRTK30PCTWSBLK** Min. Buy 1ea

**47% Black by the Square Foot**  
**GRTK47PCTWSBLK** Min. Buy 1ea

**55% Black by the Square Foot**  
**GRTK55PCTWSBLK** Min. Buy 1ea

**63% Black by the Square Foot**  
**GRTK63PCTWSBLK** Min. Buy 1ea

**73% Black by the Square Foot**  
**GRTK73PCTWSBLK** Min. Buy 1ea

**80% Black by the Square Foot**  
**GRTK80PCTWSBLK** Min. Buy 1ea

**95% Black by the Square Foot**  
**GRTK95PCTWSBLK** Min. Buy 1ea

#### Shade-Rite® WOVEN Shade Cloth

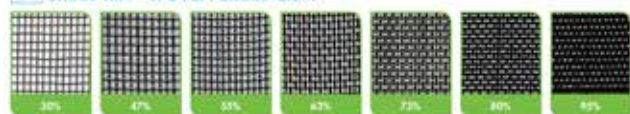



# B.J. Williamson

## Covering Accessories

### Carolina Plastics inc® Vinyl Batten Tape

Vinyl batten tape is used as a quick fastening method for stapling plastic film to wood framing. When you're ready to change poly, simply pull off the tape and the staples come with it.



<b>3/4in x 500ft</b>	
<b>CAR25-0043</b>	Min. Buy 1ea
<b>3/4in x 1000ft</b>	
<b>CAR916101</b>	Min. Buy 1ea



# GrowerSelect®

## Ground Cover

### Grower Select® Deluxe Ground Cover

Premium 22 x 11 fine weave with tucked and woven edges. Resists tearing, puncturing and weed penetration. It is approved for most government weed control applications. Ideal for greenhouses, outdoor displays and as a weed barrier for plantings without topical coverings where a weed-free environment is a must. Striped every 12in to aid in plant alignment and is UV stabilized to last even in direct sunlight.



<b>10ft x 300ft - 3.2oz</b>	
<b>GSSBLT10300D</b>	Min. Buy 1ea
<b>12ft x 300ft - 3.2oz</b>	
<b>GSSBLT12300D</b>	Min. Buy 1ea
<b>15.5ft x 300ft - 3.2oz</b>	
<b>GSSBLT155300D</b>	Min. Buy 1ea
<b>3ft x 300ft - 3.2oz</b>	
<b>GSSBLT3300D</b>	Min. Buy 1ea
<b>4ft x 300ft - 3.2oz</b>	
<b>GSSBLT4300D</b>	Min. Buy 1ea
<b>6ft x 300ft - 3.2oz</b>	
<b>GSSBLT6300D</b>	Min. Buy 1ea



## Covering Accessories

### Grower Select® Spring Lock Spring

Also referred to as wiggle wire, zippers, or zigzag wire. Works with aluminum spring lock base (GSS14498, Sold Separately) to lock single sheet of poly film down on the greenhouse.



<b>6ft 6in - Sold by Bundle of 20</b>	
<b>GSE09560</b>	Min. Buy 1ea



### Grower Select® Webbing Tape

Black webbed tape is used to hold poly tightly against the greenhouse frame. Prevents flopping of poly during high winds.



<b>2-3/4in x 300ft</b>	
<b>PAK234X300WEBBING</b>	Min. Buy 1ea



### Grower Select® Garden Staple - 8 Gauge

Used to secure polypropylene ground cover.



<b>8in x 1in</b>	
<b>WIREP29-0028B</b>	Min. Buy 1ea

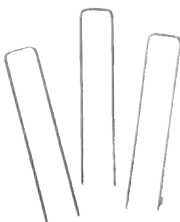



### Covering Accessories

#### X-Tra Stick Adhesive Additive

X-TRA Stick increases Kool Ray liquid shade's adhesion, wear, and overall life.



<b>1qt</b>	
<b>CO741231</b>	Min. Buy 1ea
<b>1gal</b>	
<b>CO741231GL</b>	Min. Buy 1ea



#### Kool Ultra Ray® Liquid Shade

KOOL RAY CLASSIC is the new name, but its formula is the original KOOL RAY Ezy-Off. KOOL RAY CLASSIC is specifically designed to lower inside greenhouse temperatures during the warmer spring and summer growing seasons. Dilution Ratios: KOOL RAY is a super concentrated formula designed to be diluted with water. Standard dilution rate is 1 part KOOL RAY to 8 parts water. Ratios can be adjusted according to the grower's particular needs. Coverage: Coverage will vary according to application, applicator, and dilution ratio. Spray will normally provide the best coverage of approximately 175 square feet per gallon after dilution.



<b>1gal</b>	
<b>CO9-1316 1G</b>	Min. Buy 1ea
<b>5gal</b>	
<b>CO9162105</b>	Min. Buy 1ea
<b>55gal (Special Order)</b>	
<b>CO9-1316 55G</b>	Min. Buy 1ea



### Covering Accessories



#### DeWitt® Deluxe Overwinter Fabric - 0.5oz

This 0.5oz fabric keeps temperatures up to 4° higher than outside conditions and creates an excellent microenvironment for seed germination and seedling growth. In fact, this fabric provides 90%-95% average seed germination compared to 60%-65% with straw.



<b>7ft x 500ft</b>	
<b>DEWDELUXE7</b>	Min. Buy 1ea
<b>12ft x 1000ft</b>	
<b>DEWDELUXE12-1</b>	Min. Buy 1ea



#### DeWitt® Deluxe Plus Overwinter Fabric - 1.0oz

This 1.0oz fabric protects vegetation from frost by raising temperatures beneath the fabric by 4° to 6°. In addition to providing protection against cold, wind, birds, insects, and scorching sun, Deluxe Plus helps produce larger, earlier and more bountiful yields.



<b>12ft x 1000ft</b>	
<b>DEWDELUXEPLUS12</b>	Min. Buy 1ea



#### DeWitt® Supreme Crop Cover - 1.5oz

This 1.5oz fabric is ideal for protecting flowering annuals, bedding plants and vegetables from severe cold and freezing. Temperatures underneath the fabric are 6° to 8° warmer than outside conditions. Lengthen harvest time and extend your flowering season.



<b>6ft x 500ft</b>	
<b>DEWSUPREME6</b>	Min. Buy 1ea



#### DeWitt® Ultimate Winter Crop Cover - 2.5oz

This ultimate 2.5oz fabric provides freeze protection or greater plant protection during extreme conditions. Durable and effective for "all winter" protection of your perennials and other ornamentals. Designed to hold in heat and allow irrigation and rain to pass through, this fabric will not cause foliage burn even on sunny days.



<b>3ft x 250ft</b>	
<b>DEWULTIMATE3</b>	Min. Buy 1ea
<b>6ft x 250ft</b>	
<b>DEWULTIMATE6</b>	Min. Buy 1ea
<b>12ft x 250ft</b>	
<b>DEWULTIMATE12</b>	Min. Buy 1ea

**Covering Accessories**

**DeWitt® Woven Shade Cloth**

DeWitt's® woven polypropylene shade cloth protects plants from direct sun and helps reduce water evaporation.

Polypropylene shade cloth is ideal for greenhouses, outdoor display areas, or for use as a weed barrier for a variety of applications. Available in a wide range of shade percentages, DeWitt's® woven shade cloth resists tearing, puncturing, and weed penetration. UV stabilized to hold up under the most extreme solar conditions.

- **Shade Percentages:** 30%, 47%, 55%, 63%, 73% and 80%
- **Construction:** Sewn, Double-Stitched 100% Black Polypropylene
- **Applications:** Greenhouse, Shade Structure, Nursery, Fish Ponds, Tarpaulin/Product, Containment, Windbreak, Nursery Stock Transport Covers

DeWitt also offers  
Knitted Shade Cloth

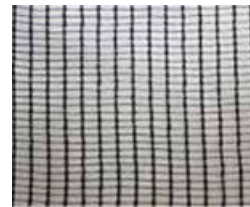

30%



55%



73%



DeWitt shade cloth is available seamed, taped, and grommetted.

Additional charges apply for orders under 1,000sf.

Please check with your BFG sales rep.

Item #	Description	Standard Widths*	U/M	Barcode
DEWWS30	30% Black	10ft, 12ft	Square foot	
DEWWS47	47% Black	6ft, 10ft, 12ft, 15ft	Square foot	
DEWWS55	55% Black	6ft, 10ft, 12ft, 15ft	Square foot	
DEWWS73	73% Black	4ft, 6ft, 7.5ft, 10ft, 12ft, 15ft	Square foot	
DEWWS80	80% Black	6ft, 10ft, 12ft, 15ft	Square foot	



**Johnson Paper & Supply**



**Covering Accessories**

**Astro Foam 1/4in Overwintering Blanket**

Astro Foam is a strong, tear-resistant, product for use underneath a layer of 4 or 6 mil overwintering film for maximum protection of over-wintered nursery stock.



**6ft x 250ft**  
**JPS29-0652**

Min. Buy 1ea

**Covering Accessories**

**SunClear®**

Stops condensate dripping, increases light, and reduces heating costs. 1gal treats 40,000sq ft. Average dilution is 1:100 with water.



**5gal**  
**SLSN29-1025**

Min. Buy 1ea



**BFG Stocks**

Stretch Wrap for All Your Packing Needs

**Sigma Steel 70**

Sigma steel offers incredible load containment, stiff multilayer formulation, outstanding value and yield, high puncture resistance, and one-side cling. Stretches and locks, keeping costs down and containment levels up.



**18in x 1476ft x 0.47mil**  
**SHIP11285**

Min. Buy 1ea





**Infra Red Film**

**RKW Klerks K4 IR-AC 4 Year Layflat Tube For Venlo Style Greenhouse Structures**

Ultraviolet light stabilized for 4 years of outdoor exposure allows growers to keep their film roofs on longer, reducing labor costs and risks associated with film installation. Special infrared heat additives save growers up to 20% in nighttime heating costs. Long lasting anti-condensation control reduces water droplet formation by sheeting condensed water down the curvature of the film.

- 4 year, 4mil, greenhouse film
- High light diffusion, 53% leads to reduced overhead shadowing and uniform plant growth and crop dry down
- Bee friendly



**14.33ft x 220ft Layflat Tube**  
**KL47-7015B** Min. Buy 1ea

**RKW Klerks K50/K50IRAC 2 In 1**

Klerks is the only greenhouse film manufacturer to offer Two in One rolls that contain 2 separate sheets rolled together in one roll, reducing labor needed when installing double layer film. Two In One rolls are available in 20ft & 24ft width sheets enabling growers to install K50 Clear as the top layer and either K50 IR-AC or KoolLite Plus as the bottom layer in half the time. Two In Ones allow installers to pull the bottom layer a little tighter than the top sheet as they secure the film in the poly lock (almost impossible to achieve using a tube). This helps remove belly ripples running down the length of the film and improves the flow of the anti-condensate feature in drip control films.



**6mil x 24ft x 155ft**  
**KLK50K50IRAC624155** Min. Buy ea

**Two In One Roll Configuration**

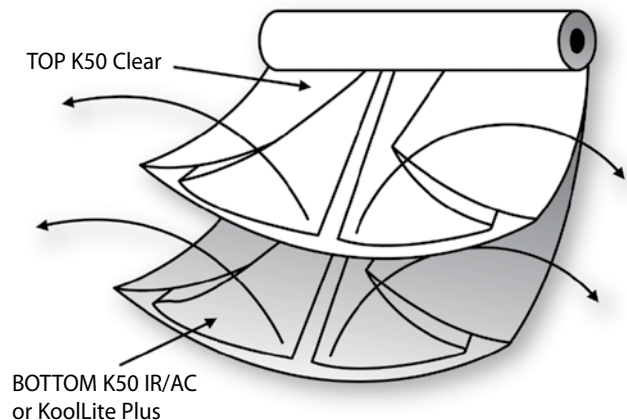

**Infra Red Film**

**RKW Klerks K50 IR-AC Thermal Anti Condensate 6mil Film**

Special IR additives absorb and re-radiate nighttime infrared heat back down to the crop, saving up to 15% on nighttime heating costs. High light diffusion means uniform plant growth and crop dry down times.

- Tri-layer extrusion with EVA copolymer resin for excellent durability
- Par light transmission of 88% through a single layer of K50 IRAC
- Two directional anti-condensate control means you never have to guess if the drip control side is facing the crop
- Ultraviolet light stabilized for long life outdoor exposure
- Bee friendly film



- 24ft x 100ft**  
**KLK50IRAC624100** Min. Buy 1ea
- 24ft x 150ft**  
**KLK50IRAC624150** Min. Buy 1ea
- 28ft x 100ft**  
**KLK50IRAC628100** Min. Buy 1ea
- 32ft x 100ft**  
**KLK50IRAC632100** Min. Buy 1ea
- 36ft x 150ft**  
**KLK50IRAC636150** Min. Buy 1ea
- 40ft x 100ft**  
**KLK50IRAC640100** Min. Buy 1ea
- 42ft x 100ft**  
**KLK50IRAC642100** Min. Buy 1ea
- 48ft x 100ft**  
**KLK50IRAC648100** Min. Buy 1ea
- 48ft x 150ft**  
**KLK50IRAC648150** Min. Buy 1ea
- 6mil x 24ft x 200ft**  
**KLK50IRAC624200** Min. Buy 1ea

**Over Wintering Film**

**RKW Klerks Overwintering Film**

One season UV stabilized films are available as clear or white in 3, 4, 5 & 6 mil thicknesses. White films are produced in 35%, 55%, & 70% opacities. Tri-Layer extrusion of tough copolymer resins provide needed protection to endure harsh winter environments.



- 3mm White - 24ft x 150ft**  
**KLOWT324150** Min. Buy 1ea
- 24ft x 100ft**  
**KLOWT324100** Min. Buy 1ea
- 24ft x 110ft**  
**KLOWT324110** Min. Buy 1ea
- 28ft x 100ft**  
**KLOWT328100** Min. Buy 1ea
- 28ft x 110ft**  
**KLOWT328110** Min. Buy 1ea
- 32ft x 100ft**  
**KLOWT332100** Min. Buy 1ea
- 32ft x 150ft**  
**KLOWT332150** Min. Buy 1ea
- 36ft x 100ft**  
**KLOWT336100** Min. Buy 1ea
- 40ft x 100ft**  
**KLOWT340100** Min. Buy 1ea



**Infra Red Film**

**RKW Klerks K50 Clear 6mil Film**

(K50 - 50 Months Average Life). Tri-layer extrusion with strong EVA copolymer resin for excellent outdoor durability. 92% PAR light transmission per layer of film. Anti-dust additive that resist dirt and dust buildup. Ultraviolet light stabilized for long life outdoor exposure. Bee friendly film: Transmits a small portion of the ultraviolet light spectrum used in bee navigation.

- Tri-layer extrusion with EVA copolymer resin for excellent durability
- 92% Par light transmission per layer of film
- Anti-dust additive that resist dirt and dust buildup
- Ultraviolet light stabilized for long life outdoor exposure
- Bee friendly film



<b>12ft x 100ft</b> <b>KL885CL009</b>	Min. Buy 1ea		
<b>16ft x 100ft</b> <b>KL47-6971</b>	Min. Buy 1ea	<b>32ft x 150ft</b> <b>KL47-7000C</b>	Min. Buy 1ea
<b>20ft x 100ft</b> <b>KL47-6981</b>	Min. Buy 1ea	<b>36ft x 100ft</b> <b>KL47-7031</b>	Min. Buy 1ea
<b>24ft x 100ft</b> <b>KL47-7001</b>	Min. Buy 1ea	<b>36ft x 150ft</b> <b>KL47-7031B</b>	Min. Buy 1ea
<b>24ft x 100ft Tube</b> <b>KL47-7003</b>	Min. Buy 1ea	<b>40ft x 100ft</b> <b>KL47-7041</b>	Min. Buy 1ea
<b>24ft x 150ft</b> <b>KL47-7006</b>	Min. Buy 1ea	<b>40ft x 150ft</b> <b>KLK50640150</b>	Min. Buy 1ea
<b>28ft x 100ft</b> <b>KL47-7021</b>	Min. Buy 1ea	<b>42ft x 100ft</b> <b>KL47-7055A</b>	Min. Buy 1ea
<b>28ft x 100ft</b> <b>KLK50628150</b>	Min. Buy 1ea	<b>48ft x 100ft</b> <b>KL47-7061</b>	Min. Buy 1ea
<b>32ft x 100ft</b> <b>KL47-7000</b>	Min. Buy 1ea	<b>48ft x 150ft</b> <b>KL47-7061B</b>	Min. Buy 1ea



**Covering Accessories**

**Ken-Bar® Inflation Kit**

Inflation pressure between layers of double poly adds insulation without blocking sunlight and reduces condensation between the layers of poly. 148cfm.



**Single Stack**  
**KB26D02** Min. Buy 1ea



**Double Stack**  
**KB26D03** Min. Buy 1ea

**Ken-Bar® Row Cover Support Wire**

Use support wire to create low tunnels with slitted or punched row covers, or use wires to support floating row covers. Support hoops keep the row covers off of foliage, protecting plants from frost damage and providing them with better air movement. Pre-cut number 10 smooth galvanized wire in a bundle of 100 wires. Wires measure 76in long and may be used with machines designed for installing hoops and covers.



**100/Bundle**  
**KB05042-851** Min. Buy 1ea



**Shade Coverings**

**Mardenkro® ReduHeat® Shading Coating**

ReduHeat sets itself apart from other, more traditional shading agents due to its different ratio between light transmission and heat reflection. It is a coating that contains a special pigment which has the ability to transmit growth light (PAR) while increasing the reflection of heat radiation (NIR). Another major advantage of ReduHeat is the adjustable shading effect. It gives you more control over the climate inside your greenhouse. Removeable with ReduClean.



**15kg Pail**  
**MARD29-1069** Min. Buy 1ea



**ReduSystems® ReduFuse**

ReduFuse is a coating that diffuses the light when it enters the greenhouse. Diffused light penetrates deeper into the crop and can improve production and quality. Removeable with ReduClean.



**15kg**  
**MARD REDUFUSE** Min. Buy 1ea





**Shade Coverings**

**Mardenkro® ReduClean® Shade Remover**

ReduClean® removes all Mardenkro® shading coatings from glass, polycarbonate, and plastic film. It must be diluted with clean water before use in a ratio of 1 part ReduClean® to 7 parts water. Add ReduClean® to the water while stirring and Apply ReduClean evenly to a dry greenhouse surface and allow it to soak in for at least 15 minutes before brushing. Or apply ReduClean when a considerable amount of rain is expected within one week.



**20L Pail - HAZARDOUS**  
**MARDREDCLEAN** Min. Buy 1ea



**Mardenkro® ReduSol® Shading Coating**

ReduSol has been specifically developed for applications where the coat of whitewash applied to the greenhouse must last for a whole season. It provides an attractive white, even shading coat which can be easily removed using ReduClean at the end of the season. ReduSol is exceptionally resistant to the effects of frost and rain, and is UV stabilized. ReduSol's shading effect can be adjusted according to need. A lighter shading effect can be provided in the spring, for example, than in the summer.

- Optimal shading effect
- Adheres to the greenhouse throughout the season
- Easy to apply
- Removable with ReduClean



**20kg Pail**  
**MARDRESOL** Min. Buy 1ea



**“Advanced” Polyethylene Films**  
Custom-Made to Meet Specific Needs

High quality film at competitive pricing that saves money without sacrificing quality. Extensive inventory with 1-3 week lead times. Free Freight with order of 3,000 lbs. or more.

**Infra Red Film**

**Poly-AG SunView Therm® Four Year**

Specifically formulated for optimum performance related to crop response. Light diffusion increases photosynthetic efficiency by providing more homogeneous light from all directions. The film reduces shadows, helps minimize burning and ensures better distribution of light.

- Energy Savings
- Minimized Condensation Issues
- Consistent Plant Canopy - Light Diffusion
- 87% Light Transmission
- Thermal
- Anti-Condensation



**Clear - 6mil - 24ft x 100ft**  
**PASVIRAC241001624**  
**Clear - 6mil - 32ft x 100ft**  
**PASVIRAC321001632**

**Clear - 6mil - 24ft x 150ft**  
**PASVIRAC241501624**



**Technical Features**

**3-Layer Extrusion**

- Prime Resin Proprietary Formulation
- 30% and 55% Light Diffusion Available
- 80% Thermicity
- Dart Impact (Puncture) > 900 Grams

**THERMICITY:** Special properties are incorporated within the film which block IR radiation and help maintain a controlled temperature in the greenhouse, providing plant insulation and less cycling of heaters at night. Two varieties of thermal films are available. One of which offers 30% Light diffusion. The second has an industry-leading 55% Light Diffusion!

**ANTI-CONDENSATION:** The properties modify the film surface; as a result water droplets are spread into a continuous water layer which subsequently runs down along the slope of the film. These films increase light transmission and reduce water drip.

Description	UV Stabilized	T.L.T.	Gauge	Standard Widths*
SunView Therm® Clear - AC/IR/30% Diffusion	4 Years	90%	6	SHEETS - 10ft, 12ft, 14ft, 16ft, 18ft, 20ft, 24ft, 28ft, 32ft, 36ft, 40ft, 42ft, 48ft, 50ft TUBES - 12ft, 14ft, 16ft, 18ft, 20ft, 21ft, 24ft, 25ft
SunView Therm MD® AC/IR/55% Diffusion	4 Years	87%	6	SHEETS - 10ft, 12ft, 14ft, 16ft, 18ft, 20ft, 21ft, 24ft, 28ft, 32ft, 36ft, 40ft, 42ft, 48ft, 50ft, 52ft, 56ft TUBES - 12ft, 14ft, 16ft, 18ft, 20ft, 21ft, 24ft, 25ft, 26ft, 28ft
SunView® Cool IR/70-75% Diffusion	3-4 Years	85-87%	6	SHEETS - 16ft, 18ft, 20ft, 24ft, 32ft, 40ft, 48ft TUBES - 16ft, 18ft, 20ft, 24ft





## “Advanced” Polyethylene Films

Custom-Made to Meet Specific Needs

High quality film at competitive pricing that saves money without sacrificing quality. Extensive inventory with 1-3 week lead times. Free Freight with order of 3,000 lbs. or more.

### Multi Year Film

#### SunView 4® Four Year Poly - Clear

Designed to transmit more light while maintaining superior mechanical properties. The total light transmission of the greenhouse covering is extremely important for photosynthetically active radiation, 400 - 700 nanometers. The intensity of these wave lengths in the PAR range directly influences the growth and development of the plants. These high-technology greenhouse films are based on the latest developments and technologies in the manufacturing process.

- Durable
- Excellent Top Layer Performance
- Superior Puncture Resistance
- 90% Light Transmission
- Made from Latest Resin Technologies
- High Clarity



**6mil Clear - 24ft x 100ft**  
PASV4CLR241001624

**6mil Clear - 24ft x 150ft**  
PASV4CLR241501624

**6mil Clear - 32ft x 100ft**  
PASV4CLR321001632

**6mil Clear - 32ft x 110ft**  
PASV4CLR321101632

**6mil Clear - 40ft x 100ft**  
PASV4CLR401001640

**6mil Clear - 40ft x 150ft**  
PASV4CLR401501640

**6mil Clear - 42ft x 100ft**  
PASV4CLR421001642

**6mil Clear - 48ft x 100ft**  
PASV4CLR481001648

**6mil Clear - 48ft x 150ft**  
PASV4CLR481501648

#### Technical Features

- 3-Layer Extrusion
- Prime Resin Proprietary Formulation
- 90% Light Transmission
- 25% Light Diffusion
- Dart Impact (Puncture) > 900 Grams

Description	UV Stabilized	Gauge	Standard Widths*
Clear	4 Years	6	SHEETS - 10ft, 12ft, 14ft, 16ft, 18ft, 20ft, 24ft, 28ft, 32ft, 36ft, 40ft, 42ft, 48ft, 50ft, 52ft, 56ft TUBES - 12ft, 14ft, 16ft, 18ft, 20ft, 21ft, 24ft, 25ft, 26ft, 28ft

#### SunView 4® Four Year Poly - White

Same features as the SunView 4® with 45% Light Transmission and 70% Light Diffusion.



**White 55% - 6mil - 20ft x 100ft**  
PASVWHT321001632 Min. Buy 1 EA

Description	UV Stabilized	Gauge	Standard Widths*
55% - White	4 Years	6	SHEETS - 16ft, 18ft, 20ft, 24ft, 32ft, 40ft, 48ft, 50ft TUBES - 16ft, 18ft, 20ft, 21ft, 24ft, 25ft

### Over Wintering Film

#### Poly-AG SunView 1® One Year

Developed to meet the growing needs of the growers in North America to produce quality crops and provide protection from harsh winter climates. Designed with consistent opacities while maintaining superior material properties.

- Durable
- Excellent Winter Weather Performance
- Superior Puncture Resistance
- Consistent Opacity
- Made from Latest Resin Technologies

#### Technical Features

- 3-Layer Extrusion
- Prime Resin Proprietary Formulation
- 3 Mil Dart Impact (Puncture) > 300 Grams



**Clear - 3mil - 24ft x 100ft**  
PASV1CLR241001324 Min. Buy 1ea

Description	UV Stabilized	Gauge	Light Transmission	Light Diffusion	Standard Widths*
Clear	1 Year	3	92%	15%	20ft, 24ft, 28ft, 32ft, 40ft
Clear	1 Year	4	90%	18%	12ft, 16ft, 24ft, 28ft, 32ft, 36ft, 40ft, 42ft, 48ft
Clear	1 Year	5	90%	20%	28ft, 32ft, 40ft, 48ft
55%	1 Year	5	45-50%	-	Production Minimums Apply

Custom widths and lengths available on most items. If your size is not listed please give us a call to get you the right size.

See charts with available sizes.





## “Advanced” Polyethylene Films

Custom-Made to Meet Specific Needs

High quality film at competitive pricing that saves money without sacrificing quality. Extensive inventory with 1-3 week lead times. Free Freight with order of 3,000 lbs. or more.



### Over Wintering Film

#### Poly-AG SunView Overwinter® Film

Available in various opacities: 30%, 55% and 70% White, as well as clear. All of the overwinter films are tri-layered and specifically formulated for optimum performance related to crop response.

Developed to provide protection from harsh winter climates.

Designed with consistent opacities while maintaining superior material properties.

- Durable
- Excellent Winter Weather Performance
- Superior Puncture Resistance
- Consistent Opacity
- Made from Latest Resin Technologies

#### Technical Features

- 3-Layer Extrusion
- Prime Resin Proprietary Formulation
- 30%, 55%, 70% Opacities
- Available in White or Clear
- 3 Mil Dart Impact (Puncture) > 300 Grams

#### White Poly



**White 70% - 3mil - 24ft x 100ft**  
PASVOW241001324

**White 70% - 3mil - 24ft x 110ft**  
PASVOW241101324

**White 70% - 3mil - 24ft x 120ft**  
PASVOW241201324

**White 70% - 3mil - 24ft x 150ft**  
PASVOW241501324

**White 70% - 3mil - 26ft x 110ft**  
PASVOW281101328

**White 70% - 3mil - 28ft x 100ft**  
PASVOW281001328

**White 70% - 3mil - 32ft x 100ft**  
PASVOW321001332

**White 70% - 3mil - 32ft x 150ft**  
PASVOW321501332

**White 70% - 3mil - 36ft x 100ft**  
PASVOW361001336

**White 70% - 3mil - 40ft x 100ft**  
PASVOW401001340

**White 70% - 3mil - 42ft x 100ft**  
PASVOW421001342

**White 70% - 5mil - 24ft x 100ft**  
PASVOW241001524

Description	UV Stabilized	Gauge	Light Transmission	Standard Widths*
70% White	8 Month - Non UV	3	30%	
55% White	8 Month - Non UV	3	40%	10ft, 12ft, 16ft, 20ft, 24ft, 28ft, 32ft, 36ft, 40ft, 42ft, 48ft, 50ft
30% White	8 Month - Non UV	3	65%	
Clear	8 Month - Non UV	3	92%	Production Miniumums Apply
70% White	8 Month - Non UV	4	30%	Production Miniumums Apply
55% White	8 Month - Non UV	4	40%	Production Miniumums Apply
30% White	8 Month - Non UV	4	65%	Production Miniumums Apply
55% White	8 Month - Non UV	5	40%	10ft, 12ft, 16ft, 20ft, 24ft, 28ft, 32ft, 36ft, 40ft, 42ft, 48ft, 50ft
70% White	8 Month - Non UV	5	30%	24ft, 28ft, 32ft, 40ft, 48ft, 50ft

#### Clear Poly



**Clear - 3m - 24ft x 110ft**  
PASVOWC24110264

**Clear - 3m - 28ft x 120ft**  
PASVOWC28110308

**Clear - 3m - 32ft x 100ft**  
PASVOWC3210032

**Clear - 3m - 42ft x 100ft**  
PASVOWC421001342

**Clear - 4m - 32ft x 100ft**  
PASVOWC32100432

### Covering Accessories

#### Poly Tape - NO Backing

Poly patch tape without backing, used to repair tears in poly film.



**2in x 108ft**  
VIP1460-2X108 Min. Buy 1ea

**4in x 108ft**  
VIP1502X Min. Buy 1ea

**6in x 108ft**  
VIP1460 6X108 Min. Buy 1ea



#### Poly Tape with Backing

Poly patch tape with backing, used to repair tears in poly film.



**2in x 48ft**  
VIP1560L2X48 Min. Buy 1ea

**4in x 48ft**  
VIP1560L4X48 Min. Buy 1ea

**6in x 48ft**  
VIP1560L6X48 Min. Buy 1ea

**10in x 48ft**  
VIP1560L10X48 Min. Buy 1ea







**Many Other Sizes Available!**  
Popular stock sizes are listed

**Covering Accessories**

**Warp's® Poly-Cover® Clear, 2mil Poly**

All Warp's genuine poly-cover plastic sheeting is guaranteed to be full weight, full measure and thickness. Tough, for tear resistance and long life. Warp's poly-cover plastic sheeting is available in widths ranging from 4ft to 50ft and in thickness from .75 mil to 10 mil and is available in clear and sun-resistant black. Made in the U.S.A.

- Meets building code specs
- Made in the U.S.A
- For tough jobs in construction and agriculture



**4mil Poly-Cover® Black**



**12ft x 100ft**  
**WA412B** Min. Buy 1ea  
**16ft x 100ft**  
**WA416B** Min. Buy 1ea

**6mil Poly-Cover® Black**



**40ft x 100ft**  
**WA640B** Min. Buy 1ea



**2mil Poly-Cover® Clear**



**4.166ft x 400ft**  
**WA2X42CC** Min. Buy 1ea  
**8.166ft x 200ft**  
**WA208C** Min. Buy 1ea  
**12ft x 200ft**  
**WA212C** Min. Buy 1ea  
**20ft x 200ft**  
**WA220C** Min. Buy 1ea

**4mil Poly-Cover® Clear**



**4ft x 200ft**  
**WA404CC** Min. Buy 1ea  
**6ft x 100ft**  
**WA406C** Min. Buy 1ea  
**8ft x 100ft**  
**WA408C** Min. Buy 1ea  
**10ft x 100ft**  
**WA410C** Min. Buy 1ea

**12ft x 100ft**  
**WA412C** Min. Buy 1ea  
**14ft x 100ft**  
**WA414C** Min. Buy 1ea  
**16ft x 100ft**  
**WA416C** Min. Buy 1ea  
**32ft x 100ft**  
**WA432C** Min. Buy 1ea

**Warp's® Seamless Polyethylene Sheeting**

Tough plastic for tough jobs in construction and agriculture applications. Sun-resistant black outperforms clear poly for outdoor projects. Plastic is tear resistance and guaranteed to be full weight, full measure and thickness. Made in U.S.A.

- Meets building code specs
- Made in the U.S.A
- For tough jobs in construction and agriculture

**1.5mil Polyethylene Sheeting**



**Black - 4ft x 1,000ft**  
**WA104B** Min. Buy 1ea

**4mil Polyethylene Sheeting**



**Black - 10ft x 100ft**  
**WA410B** Min. Buy 1ea  
**Black - 14ft x 100ft**  
**WA414B** Min. Buy 1ea  
**Black - 20ft x 100ft**  
**WA420B** Min. Buy 1ea

**6mil Polyethylene Sheeting**



**Black - 6ft x 200ft**  
**WA606BB** Min. Buy 1ea

**Warp's® Construction & Agriculture Poly Film**

Construction and agriculture grade poly film. Made in the USA.

**4mil Poly Film**



**Clear - 3ft x 200ft**  
**WA4X3-CC** Min. Buy 1ea



## Shading systems

We specialize in all kind of shading systems. Utilizing our professional, able and experienced staff to completes each project to the highest standard of satisfaction. Each project must be handled with the highest degree of skill and flexibility during production and installation from start to finish.

### What we have to offer:

- Tailor-made systems
- Energy-saving systems
- Singular, double and multiple installations
- Two installations on one wire bed
  
- Shading systems
- Roll-Screens
- Slope flat slope type installations
- Outdoor installations
- Black-out systems
- Twin-roll screens
- Roof-roll screens



### We differentiate ourselves with:

- Long Life Span Products
- Great Services
- Professional horticultural solutions

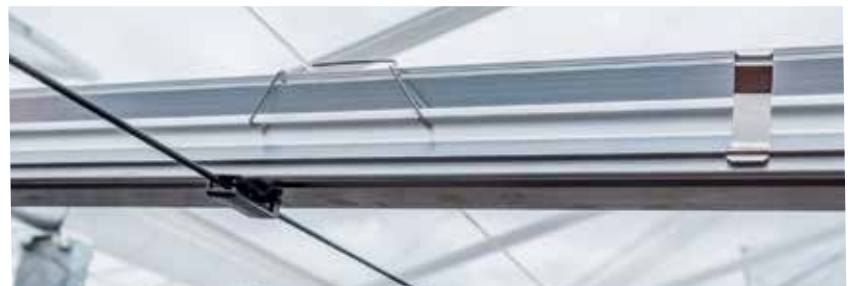



# Containers



## Co-Extruded Containers

### Grower Select® Round Co-Extruded Standard Pot

Standard round co-extruded pot, economical for the greenhouse. Sturdy pots to fit grower needs, including a dark inner lining to protect plant roots. Custom fit to be a perfect match to our carry trays.



Product	Top Diam	Height	Liquid Volume	Coordinating Carry Tray	Color	Case Pack	Sold By	Barcode
<b>RIPHSP400BLK</b> 4in Standard Round	4in	3.5in	1pt	RIPHST400-10cs RIPHST400-15cs	Black	1900	Case	
<b>RIPHSP400TC</b> 4in Standard Round					Terra Cotta			
<b>RIPHSP433BLK1850</b> 4.33in Standard Round	4.33in	3.75in	1.25pt	RIPHST433-10cs RIPHST433-15cs	Black	1850	Case	
<b>RIPHSP433TC1850</b> 4.33in Standard Round					Terra Cotta			
<b>RIPHSP433WBLK</b> 4.33in Wide Bottom Round	4.33in	3.75in	1.3pt	RIPHST433W-10cs	Black	1800	Case	
<b>RIPHSP433DTC</b> 4.33in Standard Round	4.33in	5.125in	1.71pt		Terra Cotta	1550	Case	
<b>RIPHSP500BLK</b> 5in Azalea Round	5.0in	3.63in	1.75pt	RIPHST500-8cs	Black	1120	Case	
<b>RIPHSP500TC</b> 5in Azalea Round					Terra Cotta			
<b>RIPHSP600BLK</b> 6in Azalea Round	6.0in	4.5in	1.5qt	RIPHST600-6cs	Black	660	Case	
<b>RIPHSP600TC</b> 6in Azalea Round					Terra Cotta			
<b>RIPHSP800BK</b> 8in Round Mum Pan	8in	6.0in	3.54qt	N/A	Black	300	Case	
<b>RIPHSP800TC</b> 8in Round Mum Pan					Terra Cotta			
<b>RIPHSP800BKPL</b> 8in Round Mum Pan					Black	3220	Case	
<b>RIPHSP800TCPL</b> 8in Round Mum					Terra Cotta			
<b>RIPHSP900BK</b> 9in Round Mum	9in	6.26in	1.26gal	N/A	Black	240	Case	
<b>RIPHSP900TC</b> 9in Round Mu					Terra Cotta			
<b>RIPHSP900BKPL</b> 9in Round Mum					Black	2760	Case	
<b>RIPHSP900TCPL</b> 9in Round Mum					Terra Cotta			



## Vacuum Formed Containers

### Grower Select® Square Co-Extruded Standard Pot

Standard thermoformed (vacuum formed) pot, economical for the greenhouse. Sturdy pots to fit grower needs. Square pots maximize bench and cart space. Custom fit to be a perfect match to our carry trays.



Product	Diameter	Height	Liquid Volume	Coordinating Carry Tray	Case Pack	Sold By	Barcode
<b>RIPHSCP350</b> 3.5in Standard Square	3.5in	3.5in	1.08pt	RIPHST35018	684	Case	
<b>RIPHSCP450</b> 4.5in Standard Square	4.2in	3.62in	1.25pt	RIPHST45015	450	Case	
<b>RIPHSCP450D</b> 4.5in Deep Square	4.2in	4.91in	1.72qt	RIPHST45015	420	Case	

## Carry Trays

### Grower Select® Transport Trays

Holds pots upright on benches. Makes it easy to move the smaller pots without tipping within the greenhouse. Thermoformed plastic construction.



For Square Pots	Length	Width	Height	Fits Qty Pots	Weight	Coordinating Co-Ex Pot	Case Pack	Sold By	Barcode
<b>RIPHST35018</b> 3.5in Square Pot Tray	21.25in	10.83in	1.97in	18	175g	RIPHSCP350	110	Case	
<b>RIPHST45015</b> 4.5in Square Pot Tray	20.86in	12.40in	2.36in	15	185g	RIPHSCP450 & RIPHSCP450D	70	Case	

For Round Pots	Length	Width	Height	Fits Qty Pots	Weight	Coordinating Co-Ex Pot	Case Pack	Sold By	Barcode
<b>RIPHST350-12TScs</b> 3.5in Round Pot Tray	21.25in	7in	3.625in	12	125g	N/A	90	Case	
<b>RIPHST400-10cs</b> 4in Round Pot Tray	20in	8in	3.625in	10	135g	RIPHSP400	75	Case	
<b>RIPHST400-15cs</b> 4in Round Pot Tray	20in	12in	3.625in	15	220g	RIPHSP400	70	Case	
<b>RIPHST433-10cs</b> 4.33in Round Pot Tray	21.63in	8.63in	3.75in	10	155g	RIPHSP433	100	Case	
<b>RIPHST433-15cs</b> 4.33in Round Pot Tray	21.80in	12.38in	4.33in	15	250g	RIPHSP433	90	Case	
<b>RIPHST433W-10cs</b> 4.33in Wide Round Tray	21.63in	8.63in	3.78in	10	155g	RIPHSP433W	75	Case	
<b>RIPHST500-8cs</b> 5in Round Pot Tray	19.63in	9.63in	4in	8	155g	RIPHSP500	90	Case	
<b>RIPHST600-6cs</b> 6in Round Pot Tray	18in	12in	4.6in	6	190g	RIPHSP600	100	Case	

## Propagation & Plug Trays

### Grower Select® Plug Trays

Features a glossy finish for easy dislodging of your plugs. Standard tray size of 21.25in L x 11in W



50 Square Cell Plug Tray



72 Square Cell Plug Tray



105 Square Cell Plug Tray



128 Square Cell Plug Tray



288 Square CE Cell Plug Tray

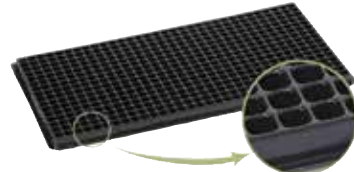

512 Square CE Cell Plug Tray

Product	Cell Dimensions/Information					Case Pack	Sold By	Barcode
	Top	Bottom	Depth	Volume	Cell Shape			
<b>BUMS50/135/100</b> 50 Cells - 135g - Line 5x10	1.97in	1.19in	1.81in	73CC	Square	100	Case	
<b>BUMS72/135/100</b> 72 Cells - 135g - Line 6x12	1.42in	0.875in	1.97in	34CC	Square	100	Case	
<b>BUMS105/135/100</b> 105 Cells - 135g - Line 7x15	1.23in	0.80in	1.89in	30CC	Square	100	Case	
<b>BUMS128/165/100</b> 128 Cells - 165g - Line 8x16	1.11in	0.67in	1.625in	17.5CC	Square	100	Case	
<b>BUMS288CE-165/100</b> 288 Cells - 165g - Line 12x24	0.73in	0.43in	1.32in	7.4CC	Square CE NON-Vented	100	Case	
<b>BUMS512CE-165/80</b> 512 Cells - 165g - Line 16x32	0.61in	0.37in	1.02in	3.4CC	Square CE NON-Vented	80	Case	



## Decorative Planters



### Grower Select® Ashbridges Planter

Textured pattern molded into the lightweight plastic planter. Features tag slots.



12in

**Chestnut - 12.0in Diam x 9.6in H, 3.0gal Max Volume**

**GSDP1416HBCT** Min. Buy 1cs/31ea

**Powdered Taupe - 12.0in Diam x 9.6in H, 3.0gal Max Volume**

**GSDP1416HDTP** Min. Buy 1cs/31ea

**Shaded Greystone - 12.0in Diam x 9.6in H, 3.0gal Max Volume**

**GSDP1416HSGT** Min. Buy 1cs/31ea



### Grower Select® Gala Tall Planter

Create a high-end contemporary look with these high gloss duo-tone finish planters. Durable, lightweight plastic.



14in

**Glossy Burgundy - 14in D x 15in H, 7gal Max Volume**

**GSTP1132DGBUCK** Min. Buy 1cs/9ea

**Glossy Pewter - 14in D x 15in H, 7gal Max Volume**

**GSTP1132DGPTCK** Min. Buy 1cs/9ea

**High Gloss Black/Chalk Rim - 14.0in Diam x 15.0in H, 7.0gal Max Volume**

**GSTP1132DGBKCK** Min. Buy 1cs/9ea

**High Gloss White/Chalk Rim - 14.0in Diam x 15.0in H, 7.0gal Max Volume**

**GSTP1132DGWHCK** Min. Buy 1cs/9ea



### Grower Select® Castella Planter

Traditional design in a lightweight, durable plastic planter.



17in

**Aged Black - 17.3in Diam x 12.6in H, 7.0gal Max Volume**

**GSPN099AAB** Min. Buy 1cs/29ea

**Aged Cappuccino - 17.3in Diam x 12.6in H, 7.0gal Max Volume**

**GSPN099AAC** Min. Buy 1cs/29ea

**Brushed Champagne - 17.3in Diam x 12.6in H, 7.0gal Max Volume**

**GSPN099ABG** Min. Buy 1cs/29ea



21in

**Aged Black - 21.0in Diam x 15.0in H, 12.6gal Max Volume**

**GSPN099AAAB** Min. Buy 1cs/15ea

**Aged Cappuccino - 21.0in Diam x 15.0in H, 12.6gal Max Volume**

**GSPN099AAAC** Min. Buy 1cs/15ea

**Brushed Champagne - 21.0in Diam x 15.0in H, 12.6gal Max Volume**

**GSPN099AABG** Min. Buy 1cs/15ea

**Galvanized Metal - 21.0in Diam x 15.0in H, 12.6gal Max Volume**

**GSPN099AAGS** Min. Buy 1cs/15ea



### Grower Select® Decorative Round Trio Planter

Lightweight planters, made from recycled plastic. Feature a classic, round-shaped design and an antique wash finish that is fade resistant.



13in

**Gold Wash - 13in Diam x 9.5in H, 2.9gal Max Volume**

**STPCF036470** Min. Buy 1cs/36ea

**Aged Black - 13in Diam x 9.5in H, 2.9gal Max Volume**

**GS11301301-AGED BLK** Min. Buy 1cs/36ea

**Aged Terra Cotta - 13in Diam x 9.5in H, 2.9gal Max Volume**

**GS11301301-AGED TC** Min. Buy 1cs/36ea

# GrowerSelect®

## Decorative Planters

### Grower Select® Beth Planter

The Beth Planters feature an artsy, modern pattern, rolled rim and washed finish. These durable planters will look great inside or out on a patio, showcasing your favorite plants.



13in

**Copper Wash - 13.11in D x 10.24in H - 3.04gal Max Volume**

**GSLF11012COP** Min. Buy 1cs/ 24ea

**Copper Wash - BULK - 13.11in D x 10.24in H - 3.04gal Max Volume**

**GSLF11012COPBULK** Min. Buy 1pl/ 2090ea

**Gold Wash - 13.11in D x 10.24in H - 3.04gal Max Volume**

**GSLF11012GOL** Min. Buy 1cs/ 24ea

**Gold Wash - BULK - 13.11in D x 10.24in H - 3.04gal Max Volume**

**GSLF11012GOLBULK** Min. Buy 1pl/ 2090ea

**Red Wash - 13.11in D x 10.24in H - 3.04gal Max Volume**

**GSLF11012RED** Min. Buy 1cs/ 24ea

**Red Wash - BULK - 13.11in D x 10.24in H - 3.04gal Max Volume**

**GSLF11012REDBULK** Min. Buy 1pl/ 2090ea

**Silver Wash - 13.11in D x 10.24in H - 3.04gal Max Volume**

**GSLF11012SIL** Min. Buy 1cs/ 24ea

**Silver Wash - BULK - 13.11in D x 10.24in H - 3.04gal Max Volume**

**GSLF11012SILBULK** Min. Buy 1pl/ 2090ea

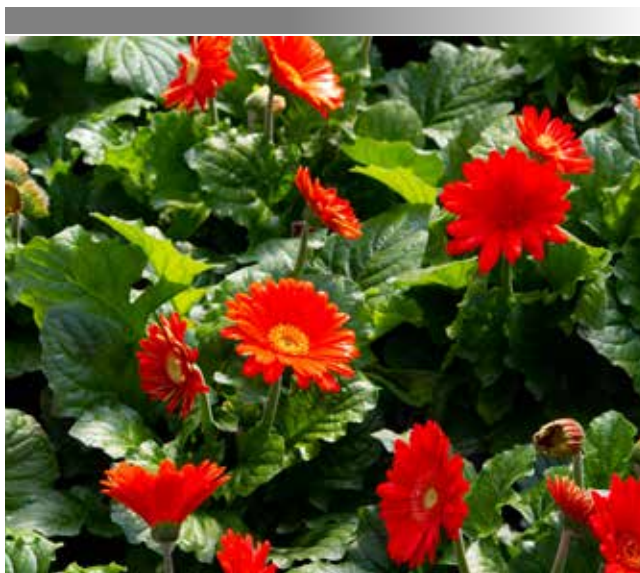

### Grower Select® Alex Collection

Subtle yet stylish describes the Alex Collection, with beautiful detailing that will compliment any decor, indoors or out. Durable and lightweight polypropylene.

#### Alex Pot



13.5in

**Black/Bronze Wash -**

**13.5in D x 9in H -**

**Max Liquid Volume: 3.3gal**

**GSRALEX135**

Min. Buy 1cs/30ea



#### Alex Bowl



12in

**Black/Bronze Wash -**

**12in D x 4.2in H -**

**Max Liquid Volume: 1.2gal**

**GSB-ALEX12 BOWL CASES**

Min. Buy 1cs/ 70ea



### Grower Select® Birch Oval Planter

The birch oval planter collection offer a unique shape and finish. These planters are lightweight for easy handling. Weather-resistant to withstand outdoor elements. Durable design is built to last and supports a wide variety of plant types.



12in

**White - 12in D x 5.5in H,**

**Max Liquid Volume: 1.2gal**

**GSRB1371H**

Min. Buy 1cs/ 25ea



16in

**White - 16in OD x 6.5in H, Max Liquid Volume: 2.5gal**

**GSRB1371C**

Min. Buy 1cs/ 24ea

### Grower Select® Birch Planter

Poly planter with a finish that resembles birch bark. Perfect for creating that natural look at a cabin or cottage.



14in

**White - 14in D x 11.7in H,**

**Max Liquid Volume: 4.79gal**

**GSDP1371D**

Min. Buy 1cs/ 26ea





## Decorative Planters



### Grower Select® Dixie Planter

The stylish drip design of the Dixie Planter is perfect for adding a pop of color! Available in multiple sizes and colors for all your planting needs. Coordinates with the Dixie Hanging Planter.



8.5in

**Red Brown Drip - 8.5in D x 5.75in H - Max Liquid Volume: 4.35qt**  
**GS4.35DIXI3533QT13** Min. Buy 1cs/ 40ea

**Red Light Blue Drip - 8.5in D x 5.75in H - Max Liquid Volume: 4.35qt**  
**GS4.35DIXI3533QT27** Min. Buy 1cs/ 40ea

**Red Royal Blue Drip - 8.5in D x 5.75in H - Max Liquid Volume: 4.35qt**  
**GS4.35DIXI3533QT23** Min. Buy 1cs/ 40ea



11in

**Red Brown Drip - 11in D x 7.125in H, Max Liquid Volume: 2.23gal**  
**GS2.23GDIXIE13** Min. Buy 1cs/ 40ea

**Red Green Drip - 11in D x 7.125in H - Max Liquid Volume: 2.23gal**  
**GS2.23GDIXIE35** Min. Buy 1cs/ 40ea

**Red Light Blue Drip - 11in D x 7.125in H - Max Liquid Volume: 2.23gal**  
**GS2.23GDIXIE27** Min. Buy 1cs/ 40ea

**Red Royal Blue Drip - 11in D x 7.125in H - Max Liquid Volume: 2.23gal**  
**GS2.23GDIXIE23** Min. Buy 1cs/ 40ea



13in

**Red Brown Drip - 13.07in D x 10.47in H - Max Liquid Volume: 4.13gal**  
**GS4.13GDIXI13** Min. Buy 1cs/ 36ea

**Red Green Drip - 13.07in D x 10.47in H - Max Liquid Volume: 4.13gal**  
**GS4.13GDIXI35** Min. Buy 1cs/ 36ea

**Red Light Blue Drip - 13.07in D x 10.47in H - Max Liquid Volume: 4.13gal**  
**GS4.13GDIXI27** Min. Buy 1cs/ 36ea

**Red Royal Blue Drip - 13.07in D x 10.47in H - Max Liquid Volume: 4.13gal**  
**GS4.13GDIXI23** Min. Buy 1cs/ 36ea



### Grower Select® Cask Planter

Enjoy the the traditional look of wood these durable plastic planters offer, without the weight! Multiple sizes and colors to enhance any landscape.



10in

**Aged Cappuccino - 9.8in D x 6.6in H - Max Liquid Volume: 1.58gal**  
**GSDP1094MACP** Min. Buy 1cs/ 35ea

**Chestnut Brown - 9.8in D x 6.6in H - Max Liquid Volume: 1.58gal**  
**GSDP1094MCT** Min. Buy 1cs/ 35ea



12in

**Aged Cappuccino - 11.8in D x 8in H - Max Liquid Volume: 2.3gal**  
**GSDP1094KACP** Min. Buy 1cs/ 25ea

**Chestnut Brown - 11.8in D x 8in H - Max Liquid Volume: 2.3gal**  
**GSDP1094KCT** Min. Buy 1cs/ 25ea



16in

**Aged Cappuccino - 15.7in D x 11in H - Max Liquid Volume: 3.83gal**  
**GSDP1094DACP** Min. Buy 1cs/ 25ea

**Chestnut Brown - 15.7in D x 11in H - Max Liquid Volume: 3.83gal**  
**GSDP1094DCT** Min. Buy 1cs/ 25ea



**Assorted Sizes and Colors - Pallet Display includes 42 each of 12in Aged Cappuccino and 12in Chestnut Brown and 30 each of 16in Aged Cappuccino and 16in Chestnut Brown Cask Pots.**  
**GSPDQ1** Min. Buy 1cs/ 1ea



### Grower Select® Naomi

Combination of round shape and vintage look. This lightweight, decorative container is made from recycled plastic and features an round shape design with an antique wash finish that is fade-resistant.



13in

**Aged Cappuccino Tan Brush - 13.2in OD x 10.2in H x 7.12 B - Max Liquid Volume: 2.95gal**

**GSWRR13226AC** Min. Buy 1cs/ 12ea

**Gold Brush - 13.2in OD x 10.2in H x 7.12 B - Max Liquid Volume: 2.95gal**

**GSWRR13226GB** Min. Buy 1cs/ 12ea

**Silver Brush - 13.2in OD x 10.2in H x 7.12 B - Max Liquid Volume: 2.95gal**

**GSWRR13226SB** Min. Buy 1cs/ 12ea

# Grower Select®

## Decorative Planters



### Grower Select® Calabria Grapevine Pot

Calabria Grapevine Pots are beautifully detailed with a raised grapevine design on the outside of the pot. Lightweight polypropylene plastic makes these pots weather resistant and durable for use indoors or outdoors.



21in

**Black - 21in D - Max Liquid Volume: 12gal**

**GSGP0502BLK** Min. Buy 1cs/ 1ea

**Blue Wash/Black - 21in D - Max Liquid Volume: 12gal**

**GSGP0502-735** Min. Buy 1cs/ 1ea

**Bronze Wash/Black - 21in D - Max Liquid Volume: 12gal**

**GSGP0502-744** Min. Buy 1cs/ 1ea

**Gold Wash/Black - 21in D - Max Liquid Volume: 12gal**

**GSGP0502-742** Min. Buy 1cs/ 1ea

**Red Wash/Black - 21in D - Max Liquid Volume: 12gal**

**GSGP0502-0737** Min. Buy 1cs/ 1ea

**Terra Cotta - 21in D - Max Liquid Volume: 12gal**

**GSGP0502 - TERRACOTTA** Min. Buy 1cs/ 1ea

### Grower Select® Grapevine Pot

Attractive Tuscan design on this pot styled with grapevines.



18in

**Black/Bronze Wash - 18in D x 14.2in H - Max Liquid Volume: 8.8gal**

**GSR-GRAPE 18cs** Min. Buy 1cs/ 12ea



### Grower Select® Fancy Rolled Rim Planter

Decorative planter features a rolled rim, washed finish and cross-hatch patterned band. An elegant addition to any container garden.



18in

**Black/Gold Wash - 17.75in D x 12in H - Max Liquid Volume: 7.5gal**

**GSFL1106BLKGOLD** Min. Buy 1cs/ 12ea

**Black/Silver Wash - 17.75in D x 12in H - Max Liquid Volume: 7.5gal**

**GSFL1106BLKSIL** Min. Buy 1cs/ 12ea

**Black/Silver Wash - BULK - 17.75in Diam x 12in H - Max Liquid Volume: 7.5gal**

**GSFL1106BLKSILBULK** Min. Buy 1pl/ 690ea

**Black/Copper Wash - 17.75in D x 12in H - Max Liquid Volume: 7.5gal**

**GSFL1106BLKCOP** Min. Buy 1cs/ 12ea

**Black/Copper Wash - BULK - 17.75in D x 12in H - Max Liquid Volume: 7.5gal**

**GSFL1106BLKCOPBULK** Min. Buy 1pl/ 690ea



### Grower Select® Nondas Lattice Pot

These durable, yet elegant planters with a lattice pattern will add a touch of class to any porch or patio. Made of weather resistant plastic with a rolled rim.



11in

**Aged Cappuccino - 10.827in D x 8.734in H - Max Liquid Volume: 1.9gal**

**TZ20991ACcs** Min. Buy 1cs/ 50ea

**Black/Bronze Wash - 10.827in D x 8.734in H - Max Liquid Volume: 1.9gal**

**TZ20991BBcs** Min. Buy 1cs/ 50ea

**Black/Copper Wash - 10.827in D x 8.734in H - Max Liquid Volume: 1.9gal**

**TZ20991BCcs** Min. Buy 1cs/ 50ea

**Black/Silver Wash - 10.827in D x 8.734in H - Max Liquid Volume: 1.9gal**

**TZ20991BScs** Min. Buy 1cs/ 50ea

## Decorative Containers

### Grower Select Dune Collection

Elegant wave pattern mimics the natural lines of dune sand on these planters.



### Grower Select® Tall Dune Planter



14in

**Brushed Champagne - 14in D x 15in H - Max Liquid Volume: 6.6gal**  
**GSTP821JBG** Min. Buy 1cs/ 14ea

**Warm Copper - 14in D x 15in H - Max Liquid Volume: 6.6gal**  
**GSTP821JWC** Min. Buy 1cs/ 14ea

**White - 14in D x 15in H - Max Liquid Volume: 6.6gal**  
**GSTP821JWH** Min. Buy 1cs/ 14ea

### Grower Select® Dune Flat Rim Planter



12in

**Brushed Champagne - 12in D x 10.2in H - Max Liquid Volume: 3gal**  
**GSTF821HBG** Min. Buy 1cs/ 25ea

**Warm Copper - 12in D x 10.2in H - Max Liquid Volume: 3gal**  
**GSTF821HWC** Min. Buy 1cs/ 25ea



### Grower Select® Dune Rolled Rim Planter



12in

**Brushed Champagne - 12in D x 9.4in H - Max Liquid Volume: 2.5gal**  
**GSDP821MBG** Min. Buy 1cs/ 35ea

**Warm Copper - 12in D x 9.4in H - Max Liquid Volume: 2.5gal**  
**GSDP821MWC** Min. Buy 1cs/ 35ea



### Grower Select® Pedestal Urn

Dress up your container plantings with this fluted pedestal urn. Lightweight polypropylene construction provides weather resistance and durability.



12in

**Black/Bronze Wash - 12in D x 10.87in H - Max Liquid Volume: 1.64gal**  
**GSR-CZ305H URN** Min. Buy 1cs/ 38ea

**White - 12in D x 10.87in H - Max Liquid Volume: 1.64gal**  
**GSCZ305HWHITE** Min. Buy 1cs/ 24ea



### Grower Select® Euro Tall Planter

Lightweight, durable plastic planter. Smooth finish. Soil saver design creates a tall elegant shape without all the extra required soil. Also available in a square planter



15in

**Faux Concrete - 15.0in Diam x 20.0in H, 9.0gal Max Volume**  
**GSTP102EFCC** Min. Buy 1cs/ 4ea

**Galvanized - 15.0in Diam x 20.0in H, 9.0gal Max Volume**  
**GSTP102EGS** Min. Buy 1cs/ 4ea



### Grower Select® Euro Square Plastic Planter (Fused Rim)

Lightweight, durable planter designed to look like galvanized metal for that industrial look.



11in

**Gray - 10.8in D x 12.2in H - Max Liquid Volume: 3.7gal**  
**GSSD102HGLM** Min. Buy 1cs/ 6ea

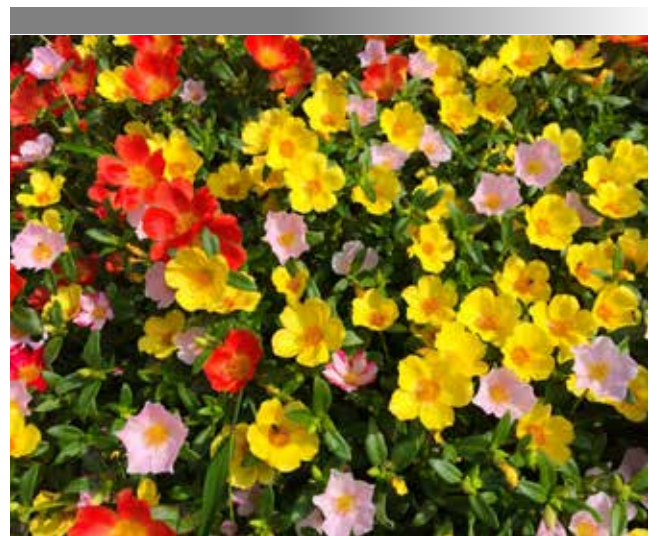

# GrowerSelect®

## Decorative Containers

### Grower Select Enviroblend Collection

Made from 38% stone powder, 32% porcelain powder, 30% recycled plastic and coated with 100% lead-free water-based paint. These planters are lightweight for easy handling. Weather-resistant to withstand outdoor elements. Durable design is built to last and supports a wide variety of plant types.



### Grower Select® Enviroblend™ Tumbled Scroll Planter



16in

Stone - 15.75in D x 13in H - Max Liquid Volume: 3.9gal

GS5014 Min. Buy 1cs/ 12ea

Earth - 15.75in D x 13in H - Max Liquid Volume: 3.9gal

GS86414 Min. Buy 1cs/ 12ea

Terra Cotta - 15.75in D x 13in H - Max Liquid Volume: 3.9gal

GS6644 Min. Buy 1cs/ 12ea



20in

Stone - 20in D x 14in H - Max Liquid Volume: 8.9gal

STPCF023302 Min. Buy 1cs/ 6ea



### Grower Select® Enviroblend™ Handled Jar Planter



16in

Stone - 16in D x 11in H -  
Max Liquid Volume: 5.34gal

STPCF036609 Min. Buy 1cs/ 8ea



20in

Stone - 20in D x 16in H - Max Liquid Volume: 11.44gal

STPCF036616 Min. Buy 1cs/ 8ea

### Grower Select® Enviroblend™ Lattice Planter



16in

Weathered Black - 15.75in D x 13in H -  
Max Liquid Volume: 3.9gal

GS66014 Min. Buy 1cs/ 12ea



20in

Weathered Black - 20in D x 14in H - Max Liquid Volume: 8.9gal

STPCF036586 Min. Buy 1cs/ 6ea



### Grower Select® Enviroblend™ Handled Urn



16in

Stone - 16in D x 21in H -  
Max Liquid Volume: 8.11gal

STPCF036630 Min. Buy 1cs/ 4ea



### Grower Select® Enviroblend™ Tumbled Scroll Urn



16in

Weathered Black - 16in D x 21in H -  
Max Liquid Volume: 5gal

STPCF036579 Min. Buy 1cs/ 4ea



## Decorative Planters



### Grower Select® Kacey Planter

An elegant design makes the Kacey Planter great for indoor or outdoor use. Available in multiple wash finishes.



16in

**Copper Wash - 15.98in D x 11.22in H - Max Liquid Volume: 4.76gal**  
**GSLF1209COP** Min. Buy 1cs/ 24ea

**Copper Wash - BULK - 15.98in D x 11.22in H, Max Liquid Volume: 4.76gal**  
**GSLF1209COPBULK** Min. Buy 1pl/ 1020ea

**Gold Wash - 15.98in D x 11.22in H - Max Liquid Volume: 4.76gal**  
**GSLF1209GOL** Min. Buy 1cs/ 24ea

**Gold Wash - BULK - 15.98in D x 11.22in H, Max Liquid Volume: 4.76gal**  
**GSLF1209GOLBULK** Min. Buy 1pl/ 1020ea

**Red Wash - 15.98in D x 11.22in H - Max Liquid Volume: 4.76gal**  
**GSLF1209RED** Min. Buy 1cs/ 24ea

**Red Wash - BULK - 15.98in D x 11.22in H, Max Liquid Volume: 4.76gal**  
**GSLF1209REDBULK** Min. Buy 1pl/ 1020ea

**Silver Wash - 15.98in D x 11.22in H - Max Liquid Volume: 4.76gal**  
**GSLF1209SIL** Min. Buy 1cs/ 24ea

**Silver Wash - BULK - 15.98in D x 11.22in H, Max Liquid Volume: 4.76gal**  
**GSLF1209SILBULK** Min. Buy 1pl/ 1020ea



### Grower Select® Scalloped Flare Planter

Lightweight, durable plastic planter with a decorative flared top.



13in

**Antique Concrete - 13.0in Diam x 11.5in H, 4.1gal Max Volume**  
**GSTD903EVCON** Min. Buy 1cs/ 25ea

**Vintage Copper - 13.0in Diam x 11.5in H, 4.1gal Max Volume**  
**GSTD903EVC** Min. Buy 1cs/ 25ea

**Warm Copper - 13.0in Diam x 11.5in H, 4.1gal Max Volume**  
**GSTD903EWC** Min. Buy 1cs/ 25ea



16in

**Antique Concrete - 16.0in Diam x 14.2in H, 7.7gal Max Volume**  
**GSTD903CVCON** Min. Buy 1cs/ 18ea

**Vintage Copper - 16.0in Diam x 14.2in H, 7.7gal Max Volume**  
**GSTD903CVC** Min. Buy 1cs/ 18ea

**Warm Copper - 16.0in Diam x 14.2in H, 7.7gal Max Volume**  
**GSTD903CWC** Min. Buy 1cs/ 18ea



20in

**Antique Concrete - 20.0in Diam x 16.0in H, 11.1gal Max Volume**  
**GSDP903ABVCON** Min. Buy 1cs/ 11ea

**Vintage Copper - 20.0in Diam x 16.0in H, 11.1gal Max Volume**  
**GSDP903ABVC** Min. Buy 1cs/ 11ea

**Warm Copper - 20.0in Diam x 16.0in H, 11.1gal Max Volume**  
**GSDP903ABWC** Min. Buy 1cs/ 11ea



### Grower Select® Octagon Planter

This lightweight, decorative container is made from recycled plastic and features an octagon-shaped design with an antique wash finish that is fade-resistant.



11in

**Aged Cappuccino Tan Brush - 11in OD x 7.5in H x 6.37 B - Max Liquid Volume: 1.64gal**  
**GSOPS11020AC** Min. Buy 1cs/ 45ea

**Gold Brush - 11in OD x 7.5in H x 6.37 B - Max Liquid Volume: 1.64gal**  
**GSOPS11020GB** Min. Buy 1cs/ 45ea

**Silver Brush - 11in OD x 7.5in H x 6.37 B - Max Liquid Volume: 1.64gal**  
**GSOPS11020SB** Min. Buy 1cs/ 45ea



14in

**Aged Black - 13.6in D x 9.1in H, Max Liquid Volume: 3.17gal**  
**GS11121301-AGED BLK** Min. Buy 1cs/ 36ea

**Washed Terra Cotta - 13.6in D x 9.1in H, Max Liquid Volume: 3.17gal**  
**GS11121301-TC** Min. Buy 1cs/ 36ea

# Grower Select®

## Decorative Planters



### Grower Select® Orbit Deco Planter

These pots make an attractive addition to any outdoor container garden. A nice decorative grower's pot. Constructed of a polypropylene plastic.

10in



**Black/Copper Wash - 10.375in D x 7.625in H - Max Liquid Volume: 1.91gal**

**GMSL10BLKCOPPER** Min. Buy 1cs/ 48ea

**Black /Copper Wash - BULK - 10.375in Diam x 7.625in H- Max Liquid Volume: 1.91gal**

**GMSL10BLKCOPPERBULK** Min. Buy 1pl/ 3450ea

**Black/Gold Wash - 10.375in D x 7.625in H- Max Liquid Volume: 1.91gal**

**GMSL10BLKGOLD** Min. Buy 1cs/ 48ea

**Black/Gold Wash - BULK - 10.375in Diam x 7.625in H- Max Liquid Volume: 1.91gal**

**GMSL10BLKGOLDBULK** Min. Buy 1pl/ 3450ea

**Black/Silver Wash - 10.375in D x 7.625in H- Max Liquid Volume: 1.91gal**

**GMSL10BLKSILVER** Min. Buy 1cs/ 48ea

**Black/Silver Wash - BULK - 10.375in Diam x 7.625in H- Max Liquid Volume: 1.91gal**

**GMSL10BLKSILVERBULK** Min. Buy 1pl/ 3450ea

**Terra Cotta - 10.375in D x 7.625in H - Max Liquid Volume: 1.91gal**

**GMSL10 - TERRACOTTA** Min. Buy 1cs/ 46ea

**Mocha - 10.375in D x 7.625in H - Max Liquid Volume: 1.91gal**

**GMSL10 - MOCHA** Min. Buy 1cs/ 46ea



12in



**Black/Copper Wash - 12.44in D x 9.18in H - Max Liquid Volume: 3.4gal**

**GMSL12BLKCOPPER** Min. Buy 1cs/ 36ea

**Black/Gold Wash - 12.44in D x 9.18in H - Max Liquid Volume: 3.4gal**

**GMSL12BLKGOLD** Min. Buy 1cs/ 36ea

**Black/Gold Wash - BULK - 12.44in Diam x 9.18in H - Max Liquid Volume: 3.4gal**

**GMSL12BLKGOLDBULK** Min. Buy 1pl/ 2025ea

**Black/Silver Wash - 12.44in D x 9.18in H - Max Liquid Volume: 3.4gal**

**GMSL12BLKSILVER** Min. Buy 1cs/ 36ea

**Black/Silver Wash - BULK - 12.44in Diam x 9.18in H - Max Liquid Volume: 3.4gal**

**GMSL12BLKSILVERBULK** Min. Buy 1pl/ 2025ea

**Terra Cotta - 12.44in D x 9.18in H - Max Liquid Volume: 3.4gal**

**GMSL12 - TERRACOTTA** Min. Buy 1cs/ 45ea

**Chocolate - 12.44in D x 9.18in H - Max Liquid Volume: 3.4gal**

**GMSL12 - CHOCOLATE** Min. Buy 1cs/ 45ea

**Mocha - 12.44in D x 9.18in H - Max Liquid Volume: 3.4gal**

**GMSL12 - MOCHA** Min. Buy 1cs/ 45ea

14in



**Black/Copper Wash - 14.06in D x 10.3in H - Max Liquid Volume: 5.5gal**

**GMSL14BLKCOPPER** Min. Buy 1cs/ 24ea

**Black/Gold Wash - 14.06in D x 10.3in H - Max Liquid Volume: 5.5gal**

**GMSL14BLKGOLD** Min. Buy 1cs/ 24ea

**Black/Silver Wash - 14.06in D x 10.3in H - Max Liquid Volume: 5.5gal**

**GMSL14BLKSILVER** Min. Buy 1cs/ 24ea

**Terra Cotta - 14.06in D x 10.3in H - Max Liquid Volume: 5.5gal**

**GMSL14 - TERRACOTTA** Min. Buy 1cs/ 33ea

**Mocha - 14.06in D x 10.3in H - Max Liquid Volume: 5.5gal**

**GMSL14 - MOCHA** Min. Buy 1cs/ 33ea

## Decorative Planters

### Grower Select Cove Collection

A large rim and an elegant brushed, lightly textured surface on these planters set them apart.



### Grower Select® Tara Planter

Attractive, durable planters available in three different wash finishes to complement every landscape.

10in



**Copper Wash - 10.83in D x 7.68in H - Max Liquid Volume: 1.72gal**  
GSLF1102COP Min. Buy 1cs/ 48ea

**Copper Wash - BULK - 10.83in D x 7.68in H - Max Liquid Volume: 1.72gal**  
GSLF1102COPBULK Min. Buy 1pl/ 3520ea

**Gold Wash - 10.83in D x 7.68in H - Max Liquid Volume: 1.72gal**  
GSLF1102GOL Min. Buy 1cs/ 48ea

**Gold Wash - BULK - 10.83in D x 7.68in H - Max Liquid Volume: 1.72gal**  
GSLF1102GOLBULK Min. Buy 1pl/ 3520ea

**Silver Wash - 10.83in D x 7.68in H - Max Liquid Volume: 1.72gal**  
GSLF1102SIL Min. Buy 1cs/ 48ea

**Silver Wash - BULK - 10.83in D x 7.68in H - Max Liquid Volume: 1.72gal**  
GSLF1102SILBULK Min. Buy 1pl/ 3520ea

### Grower Select® Square Cove Planter

14in



**Warm Copper - 14in D x 12in H - Max Liquid Volume: 5.4gal**

GSSD292FWC Min. Buy 1cs/ 20ea



### Grower Select® Round Cove Planter

14.5in



**Brushed Champagne - 14.5in D x 12in H - Max Liquid Volume: 4.66gal**

GSDP292FBG Min. Buy 1cs/ 30ea

**Brushed Champagne - BULK - 14.5in D x 12in H - Max Liquid Volume: 4.66gal**

GSDP292FBGBULK Min. Buy 1pl/ 1836ea

**Warm Copper - 14.5in D x 12in H - Max Liquid Volume: 4.66gal**

GSDP292FWC Min. Buy 1cs/ 30ea

**Warm Copper - BULK - 14.5in D x 12in H - Max Liquid Volume: 4.66gal**

GSDP292FWCBULK Min. Buy 1pl/ 1836ea



### Grower Select® Jessie Rolled Rim Pot

Lightweight, durable plastic planter with a rolled rim.

13.5in



**Aged Cappuccino - 13.5in D x 7.4in H - Max Liquid Volume: 3.67gal**  
GSR-JESSIE 760 AGED CAPP Min. Buy 1cs/ 20ea

**Black - 13.5in D x 7.4in H - Max Liquid Volume: 3.67gal**  
GSR-JESSIE 760 Min. Buy 1cs/ 20ea

**Black/Bronze Wash - 13.5in D x 7.4in H - Max Liquid Volume: 3.67gal**  
GSR-JESSIE BLACK/BRONZE Min. Buy 1cs/ 20ea

16in



**Aged Cappuccino - 15.75in D x 12in H - Max Liquid Volume: 5.75gal**  
GSR-JESSIE760 16 AGED CA Min. Buy 1cs/ 12ea

**Black/Bronze Wash - 15.75in D x 12in H - Max Liquid Volume: 5.75gal**  
GSR-JESSIE760 16 BLK/BRO Min. Buy 1cs/ 12ea

**Black - 15.75in D x 12in H - Max Liquid Volume: 5.75gal**  
GSR-JESSIE760 16BLK Min. Buy 1cs/ 12ea



# GrowerSelect®

## Decorative Planters

### Grower Select Sandthach Collection

The sandthach collection offers a contemporary design providing versatility as a bowl or planter..

#### Grower Select® Sandthatch Planter



14in

Powdered Ginger - 14in D x 15in H -  
Max Liquid Volume: 7.6gal  
GSTTP339HPG Min. Buy 1cs/ 5ea



#### Grower Select® Sandthach Bowl



14in

Powdered Ginger - 14in D x 6in H  
- Max Liquid Volume: 2.8gal  
GSTBL339ECPG Min. Buy 1cs/ 20ea



Powdered Ginger - 17in D x 6in H  
- Max Liquid Volume: 2.2gal  
GSBV339FCPG Min. Buy 1cs/ 20ea

17in

### Grower Select Rattan Collection

The Rattan collection features a brushed texture finish with a rattan band. Available in a variety of shapes and sizes including: Rattan Bowl, Rattan Square Planter and a Rattan Rolled Rim Planter.

#### Grower Select® Rattan Rolled Rim Planter



17in

Antique Brass - 17.2in D x 12in H -  
Max Liquid Volume: 6.5gal  
GSDP929DBA Min. Buy 1cs/ 20ea



20in

Antique Brass - 20in D x 15.2in H - Max Liquid Volume: 10.87gal  
GSDP919BAN Min. Buy 1cs/ 12ea

#### Grower Select® Rattan Square Planter



11in

Aged Cappuccino - 11in D x 8.5in H -  
Max Liquid Volume: 1.98gal  
GSSD919MAC Min. Buy 1cs/ 32ea



#### Grower Select® Wave Planter

Lightweight planters, made from recycled plastic. Feature a classic, round-shaped design and full rings with brush tones that mimics waves making an elegant solution for planters.



16in

Copper Brush - 16in OD x 11.8in H x 8.56in B -  
Max Liquid Volume: 4.65gal  
GSWPR16020CB Min. Buy 1cs/ 25ea

Gold Brush - 16in OD x 11.8in H x 8.56in B -  
Max Liquid Volume: 4.65gal  
GSWPR16020GB Min. Buy 1cs/ 25ea

Silver Brush - 16in OD x 11.8in H x 8.56in B -  
Max Liquid Volume: 4.65gal  
GSWPR16020SB Min. Buy 1cs/ 25ea



#### Grower Select® Stout Planter

Lightweight planters, made from recycled plastic. Feature a classic, round-shaped design and full rings with brush tones making an elegant solution for planters.



13in

Gold Brush - 13.3in OD x 9.5in H x 8in B -  
Max Liquid Volume: 2.94gal  
GSSRFR13020GB Min. Buy 1cs/ 15ea

Copper Brush - 13.3in OD x 9.5in H x 8in B -  
Max Liquid Volume: 2.94gal  
GSSRFR13020CB Min. Buy 1cs/ 15ea

Silver Brush - 13.3in OD x 9.5in H x 8in B -  
Max Liquid Volume: 2.94gal  
GSSRFR13020SB Min. Buy 1cs/ 15ea



## Decorative Planters



### Grower Select® Rolled Rim Planter

These rolled rim planters will look anything but basic when they are filled with flowers and plants! Versatile, durable and stylish, the rolled rim planter comes in multiple sizes and colors.



14in

**Black/Gold - 14in D - Max Liquid Volume: 4gal**

**GSAB380BLACKGOLD** Min. Buy 1cs/ 1ea

**Black/Silver - 14in D - Max Liquid Volume: 4gal**

**GSAB380BLACKSILVER** Min. Buy 1cs/ 1ea

**Mocha - 14in D - Max Liquid Volume: 4gal**

**GSAB380 - MOCHA** Min. Buy 1cs/ 1ea

**Terra Cotta - 14in D - Max Liquid Volume: 4gal**

**GSAB380 - TERRACOTTA** Min. Buy 1cs/ 1ea



16in

**Black/Gold - 16in D - Max Liquid Volume: 6.81gal**

**GSAB460BLACKGOLD** Min. Buy 1cs/ 1ea

**Black/Silver - 16in D - Max Liquid Volume: 6.81gal**

**GSAB460BLACKSILVER** Min. Buy 1cs/ 1ea

**Mocha - 16in D - Max Liquid Volume: 6.81gal**

**GSAB460 - MOCHA** Min. Buy 1cs/ 1ea

**Terra Cotta - 16in D - Max Liquid Volume: 6.81gal**

**GSAB460 - TERRACOTTA** Min. Buy 1cs/ 1ea



### Grower Select® PW Bulb / Succulent Pan

Versatile bowl design for your bulb and succulent offering. Elegant leaf design decorates the side of the pot.



8in

**Aged Cappuccino - 8in D x 2.93in H - Max Liquid Volume: 0.4gal**

**GSTZ749CASESACP** Min. Buy 1cs/ 30ea



12in

**Aged Cappuccino - 12in D x 3.85in H - Max Liquid Volume: 1.19gal**

**GSTZ750CASESACP** Min. Buy 1cs/ 30ea

**Black/Copper Wash - 12in D x 3.85in H - Max Liquid Volume: 1.19gal**

**GSTZ-750CASE** Min. Buy 1cs/ 30ea

### Grower Select® Sloan Square Planter

Durable plastic planter with a contemporary ribbed design.



10in

**Black - 10.25in D x 12in H -**

**Max Liquid Volume: 3.5gal**

**GSTZ1541915SMALLBLK**

Min. Buy 1cs/ 36ea

**Black/Bronze Wash - 10.25in D x 12in H -**

**Max Liquid Volume: 3.5gal**

**GSTZ1541915SMALLBLKBNZ**

Min. Buy 1cs/ 36ea



12in

**Black - 12.25in D x 15in H -**

**Max Liquid Volume: 6.58gal**

**GSS-A-915BLK**

Min. Buy 1cs/ 15ea



### Grower Select® Hendrix Tall Square Planter

Elegant two-tone durable, plastic planter



17in

**Antique White Top/Aged Black Bottom -**  
**17.01in D x 19.0in H, 15.19gal Max Volume**

**GSTS1555CAWAB** Min. Buy 1cs/ 13ea

**Brown/White - 17.01in D x 19.0in H,**  
**15.19gal Max Volume**

**GSTS1555CFWI** Min. Buy 1cs/ 13ea



### Grower Select® Sienna Square

"A knockout for pansies."



9.5in

**Black/Green Wash - 9.5in D x 5.9in H -**  
**Max Liquid Volume: 1.4gal**

**GSSIENNA SLF-975** Min. Buy 1cs/ 60ea



### Grower Select® Sydney Plain Square Pot

Display your patio plants in style with this durable planter. Molded from polypropylene in an attractive finish. Includes a sturdy plastic sign on a 10in high arched loop.



10in

**Black/Copper - 9.75in D x 8.3in H -**  
**Max Liquid Volume: 2gal**

**GS10.00 SYDNEY SQ BLK/CO** Min. Buy 1cs/ 40ea



# GrowerSelect®

## Decorative Planters

### Grower Select® Lattice Flowerpot

Grape leaves line the top and lattice work adorns this planter. An elegant solution for planting combos.



12in

**Aged Cappuccino - 12.25in Diam x 9.2in H, 2.5gal Max Volume**  
GSRACFP1225ACP Min. Buy 1cs/ 40ea

**Black/Silver Wash - 12.25in Diam x 9.2in H, 2.5gal Max Volume**  
GSRACFP1225SILVER Min. Buy 1cs/ 40ea

**Black/Copper Wash - 12.25in Diam x 9.2in H, 2.5gal Max Volume**  
GSRACFP1225COPPER Min. Buy 1cs/ 40ea

**Black/Bronze Wash - 12.25in D x 9.2in H - Max Liquid Volume: 2.5gal**  
GSR-A-CFP-12.25BRZ Min. Buy 1cs/ 40ea

### Grower Select® Deb Lattice Pot

Distinctive lattice design sets this tough polypropylene pot apart.



12in

**Black/Silver Wash - 11.8in D x 9.5in H - Max Liquid Volume: 2.5gal**  
GSTZ-031 CASES Min. Buy 1cs/ 40ea



14in

**Aged Cappuccino - 13.8in D x 10.3in H - Max Liquid Volume: 3.5gal**  
GSR-A-CFP-014 AGE/ CAPP Min. Buy 1cs/ 30ea

**Black/Silver Wash - 13.8in Diam x 10.3in H, 3.5galMax Volume**  
GSRACFP014SILVER Min. Buy 1cs/ 30ea

**Black/Bronze Wash - 13.8in D x 10.3in H - Max Liquid Volume: 3.5gal**  
GSR-A-CFP-014 Min. Buy 1cs/ 30ea

**Black/Copper Wash - 3.8in Diam x 10.3in H, 3.5galMax Volume**  
GSRACFP014COPPER Min. Buy 1cs/ 30ea



18in

**Black/Copper Wash - 17.71in D x 14.1in H - Max Liquid Volume: 7.45gal**  
GSR18LATTBLKCOPP Min. Buy 1cs/ 15ea

**Black/Bronze Wash - 17.71in D x 14.1in H - Max Liquid Volume: 7.45gal**  
GSR-18LATTICE BLACK BRON Min. Buy 1cs/ 15ea

**Black/Cappuccino Wash - 17.71in D x 14.1in H - Max Liquid Volume: 7.45gal**  
GSR-18LATTICE BLACK CAPP Min. Buy 1cs/ 15ea

**Black/Silver Wash - 17.71in D x 14.1in H - Max Liquid Volume: 7.45gal**  
GSR-18LATTICE BLACK SILV Min. Buy 1cs/ 15ea

**Black/Silver Wash - BULK - 17.71in D x 14.1in H - Max Liquid Volume: 7.45gal**  
GSR-18LATTICE Min. Buy 1cs/ 1ea

**Aged Cappuccino - 17.71in D x 14.1in H - Max Liquid Volume: 7.45gal**  
GSR-18LATTICEaGECAPPcs Min. Buy 1cs/ 15ea



## Decorative Planters



### Grower Select® Randy-Lynn 3pk Planter

Three pack of planters with a coordinating tray. Perfect for a window herb garden or succulents. Each planter measures 4.5in D x 3.5in H.



4.5in

**Aged Cappuccino**

**GSTZ458RANDILYNNACP**

Min. Buy 1cs/ 108ea

**Black**

**GSTZ458RANDILYNNBLK**

Min. Buy 1cs/ 108ea

### Grower Select® Laci Pot

Attractive, vintage looking pot. Great for flowering plants. The Laci Collection is available in both bowls and hanging baskets.



11in

**Aged Cappuccino - 11.09in D x 5.53in H -  
Max Liquid Volume: 1.5gal**

**GSLACEY 1 AGED CAPUCCINO** Min. Buy 1cs/ 40ea

**Black/Cappuccino - 11.09in D x 5.53in H -  
Max Liquid Volume: 1.5gal**

**GSLACEY 1 BLK/CAP** Min. Buy 1cs/ 40ea



### Grower Select® Serenity Bowl

Lightweight, durable plastic planter bowl. Excellent for planting up succulents or pansies. Also available in coordinating hanging basket.



12in

**Black/Gold Wash - 12.0in Diam x 5.43in H,  
1.24gal Max Volume**

**GSLF11012BLKGOLD** Min. Buy 1cs/ 72ea

**Black /Silver Wash - 12.0in Diam x 5.43in H,  
1.24gal Max Volume**

**GSLF11012BLSILVER** Min. Buy 1cs/ 72ea



### Grower Select® Jane Bowl

Versatile contemporary container for your bowl crop offering.



11.5in

**Black/Copper - 11.5in D x 6in H -  
Max Liquid Volume: 2.46gal**

**GSJANE 6 CASES** Min. Buy 1cs/ 40ea



### Grower Select® Marissa Pot

A classic, traditional design with an aged-copper finish for a modern twist. Fade-resistant and weatherproof for extended outdoor life.



10in

**Black/Copper Wash - 10in D x 8.4in H -  
Max Liquid Volume: 1.6gal**

**GSTL-1181COP CASES** Min. Buy 1cs/ 60ea



### Grower Select® Grace Planter

Premium design durable plastic planter.



18.5in

**Galvanized Metal Look - 18.5in D x 14.1in H,  
8.1galMax Volume**

**GSPN888BGS** Min. Buy 1cs/ 22ea



### Grower Select® Morris Planter

Versatile planter works in just about any décor setting - contemporary or traditional. A great planter for growers to plant up due to its nice patio planter size.



15in

**Sandalwood - 15in Pot - 15.2in Diam x 11.7in H,  
6.0galMax Volume**

**GSDP1426csW** Min. Buy 1cs/ 32ea



### Grower Select® Kim Pot

The rustic look to this charming pot is great for your summer and fall plants.



10in

**Aged Cappuccino - 10.1in D x 7.3in H -  
Max Liquid Volume: 1.56gal**

**GSR-KIM10- AGED CAPPUCCI** Min. Buy 1cs/ 70ea



### Grower Select® Helen Hexagon Planter

Soil volume galore for your floor plants! This lightweight, decorative container is made from recycled plastic and features a hexagon-shaped design with an antique wash finish that is fade resistant.



14in

**Terra Cotta - 14in D x 9.9in H -  
Max Liquid Volume: 3.95gal**

**GSHELEN HEX14** Min. Buy 1cs/ 25ea



### Grower Select® Diane Pot

Features raised drainage. Great for mums.



11in

**Aged Cappuccino - 11in D x 7.17in H -  
Max Liquid Volume: 2gal**

**GSDIANE TZ-071** Min. Buy 1cs/ 60ea



# GrowerSelect®

## Decorative Planters

### Grower Select Harvest Garden Collection

Wood-look planter with the durability of plastic.

### Grower Select® Harvest Garden Window Box



24in



**Mahogany - 24in L x 13.5in H -  
Max Liquid Volume: 14.5gal**

**GSTWD117HMA** Min. Buy 1cs/ 12ea

### Grower Select® Harvest Garden Square Planter



17in



**Mahogany - 17in D x 13.5in H -  
Max Liquid Volume: 8.3gal**

**GSTSD117EMA** Min. Buy 1cs/ 12ea

### Grower Select® Harvest Garden Planters



**Pallet Display - Includes 30 each 17in Square and 30 each 24in Window Box Mahogany planters.**

**GSPDQ2** Min. Buy 1cs/ 1ea

### Grower Select® Beth Rope Handle Bushel Basket

The look of wood with the durability of plastic! Large bushel basket with decorative rope handles.



14in



**Aged Cappuccino - 14in D x 11.36in H -  
Max Liquid Volume: 5.1gal**

**GSTZ-252CAP** Min. Buy 1cs/ 20ea

### Grower Select® Wine Barrel

With a down-home, country-style feel, this wine barrel creates the perfect combination of elegance and simplicity to your outdoor or indoor living space. HDR construction for a lightweight and durable planter that will last longer than traditional wooden barrels and can withstand outdoor seasonal elements and everyday use. They also include UV protectors to increase resistance to cracking and fading. Your vibrant colored flower or vegetable arrangements will provide a pleasing pop of color in these dark, faux-wood planters.



18in



**Kentucky Walnut With Black Band - 17.7in D x  
12.8in H, Max Liquid Volume: 8.5gal**

**STPCF023319** Min. Buy 1cs/ 8ea

### Grower Select® Bushel Pot Planter

10in top outside diameter x 6in high. 1.4gal Liquid Volume.



10in



**Tan With Brown Wash - 10in**

**STPCF023289** Min. Buy 1cs/ 24ea

### Grower Select® Norm "Wood" Barrel Planter

Get the look of a classic wood bucket with the outdoor hardiness you need. Wood-grained plastic in an authentic-looking brown finish.



12in



**Aged Cappuccino - 12in D x 9.8in H -  
Max Liquid Volume: 2.9gal**

**GSNORM12 AGED CAPPUC**

Min. Buy 1cs/ 40ea

**Aged Cappuccino - BULK - 12in D x 9.8in H -  
Max Liquid Volume: 2.9gal**

**GSNORM12 AGGED CAPPU**

Min. Buy 1pl/ 2520ea

### Grower Select® Barrel Planter

Wood-look planter with the durability of plastic.



17in



**Black/Silver Wash - 16.7in D x 12.09in H -  
Max Liquid Volume: 6.82gal**

**GSCT430M R-B 16.7BARREL**

Min. Buy 1cs/ 25ea

### Grower Select® Wicker Planter

Lightweight and decorative planter with excellent wicker-look detailing.



22in



**Coffee Cream - 21.9in D x 18.7in H -  
Max Liquid Volume: 20.5gal**

**GSTP931C** Min. Buy 1cs/ 15ea

### Grower Select® Brenda Pot

Basket weaving makes this pot stand apart from the pack.



11.5in



**Brown - 11.5in D x 9.7in H -  
Max Liquid Volume: 2.5gal**

**GSTZ-080 BRENDA CASE**

Min. Buy 1cs/ 46ea

## Hanging Baskets



### Grower Select® Combo Pot

A great pot that has the versatility to be used as a patio pot or a hanging basket! Hanger sold separately.



10.5in

**Green - 10.5in D x 6.75in H - Max Liquid Volume: 1.68gal**  
**GS792000GR** Min. Buy 1cs/ 50ea

**Clay - 10.5in D x 6.75in H - Max Liquid Volume: 1.68gal**  
**GS792000TC** Min. Buy 1cs/ 50ea

**Brown - 10.5in D x 6.75in H - Max Liquid Volume: 1.68gal**  
**GS792000BR** Min. Buy 1cs/ 50ea

**Mocha - 10.5in D x 6.75in H - Max Liquid Volume: 1.68gal**  
**GS792000MO** Min. Buy 1cs/ 50ea

**White - 10.5in D x 6.75in H - Max Liquid Volume: 1.68gal**  
**GS792000WH** Min. Buy 1cs/ 50ea

**Black - 10.5in D x 6.75in H - Max Liquid Volume: 1.68gal**  
**GS792000BK** Min. Buy 1cs/ 50ea



### Grower Select® Twist Hanging Basket

Simple twist hanging basket. Includes coordinating four-strand hanger.



12in

**Black - 11.85in Diam x 7.24in H, 2.32gal Max Volume**  
**GSHB1201BLK** Min. Buy 1cs/ 50ea

**Black - PALLET - 11.85in Diam x 7.24in H, 2.32gal Max Volume**  
**GSHB1201BLKPL** Min. Buy 1pl/ 1932ea

**Brown - 11.85in Diam x 7.24in H, 2.32gal Max Volume**  
**GSHB1201BRN** Min. Buy 1cs/ 50ea

**Brown - PALLET - 11.85in Diam x 7.24in H, 2.32gal Max Volume**  
**GSHB1201BRNPL** Min. Buy 1pl/ 1932ea

**Green - 11.85in Diam x 7.24in H, 2.32gal Max Volume**  
**GSHB1201GRN** Min. Buy 1cs/ 50ea

**Green - PALLET - 11.85in Diam x 7.24in H, 2.32gal Max Volume**  
**GSHB1201GRNPL** Min. Buy 1pl/ 1932ea

**White - 11.85in Diam x 7.24in H, 2.32gal Max Volume**  
**GSHB1201WHT** Min. Buy 1cs/ 50ea

**White - PALLET - 11.85in Diam x 7.24in H, 2.32gal Max Volume**  
**GSHB1201WHTPL** Min. Buy 1pl/ 1932ea

**Mocha - 11.85in Diam x 7.24in H, 2.32gal Max Volume**  
**GSHB1201MO** Min. Buy 1cs/ 50ea

**Mocha - PALLET - 11.85in Diam x 7.24in H, 2.32gal Max Volume**  
**GSHB1201MOPL** Min. Buy 1pl/ 1932ea

### Grower Select® Serenity Hanging Basket

Perfect for cascading flowers and plants in your greenhouse! With a ribbed design and choice of colors, the Serenity hanging basket looks great in every setting. Includes a coordinating hanger.



11in

**Black/Gold - 11in D x 6.5in H - Max Liquid Volume: 1.58gal**  
**GSLF1119GOLD** Min. Buy 1cs/ 72ea

**Black/Silver - 11in D x 6.5in H - Max Liquid Volume: 1.58gal**  
**GSLF1119SILVER** Min. Buy 1cs/ 72ea

**Chocolate - 11in D x 6.5in H - Max Liquid Volume: 1.58gal**  
**GSLF1119CHOC** Min. Buy 1cs/ 72ea

**Mocha - 11in D x 6.5in H - Max Liquid Volume: 1.58gal**  
**GSLF1119MO** Min. Buy 1cs/ 72ea



# Grower Select®

## Hanging Baskets



### Grower Select® Dune Hanging Basket

Elegant wave pattern mimics the natural lines of dune sand on these planters. Hanger is included.



12in

**Brushed Champagne - 12in D x 6.7in H - Max Liquid Volume: 2.06gal**

**GSHG821HBG** Min. Buy 1cs/ 50ea

**Warm Copper - 12in D x 6.7in H - Max Liquid Volume: 2.06gal**

**GSHG821HWC** Min. Buy 1cs/ 50ea

### Grower Select® Lattice Hanging Basket

Includes an 18in 4-strand hanger.



12in

**Black/Gold Brush - 12in D x 7in H -**

**Max Liquid Volume: 2gal**

**STPCF023272** Min. Buy 1cs/ 50ea



14in

**Black/Gold Brush - 14.2in D x 7.9in H -**

**Max Liquid Volume: 2.7gal**

**STPCF036463** Min. Buy 1cs/ 50ea



### Grower Select® Laci Hanging Basket

Attractive, vintage looking pot. Great for flowering plants. The Laci Collection is available in both bowls and hanging baskets. Includes a coordinating hanger.



12in

**Black/Cappuccino - 12.39in D x 6.72in H - Max Liquid Volume: 2gal**

**GSLACEY 2 HB CAP/BLK** Min. Buy 1cs/ 36ea

**Aged Cappuccino - 12.39in D x 6.72in H - Max Liquid Volume: 2gal**

**GSLACEY 2 HB AGED CAPP** Min. Buy 1cs/ 36ea



### Grower Select® Boxwood Hanging Basket

Decorative boxwood pattern is molded into the outer design of this hanging basket. Includes a coordinating hanger.



12in

**Aged Cappuccino - 12in D x 6.6in H - Max Liquid Volume: 2.17gal**

**GSHG787FAC** Min. Buy 1cs/ 50ea

**Mahogany - 12in D x 6.6in H - Max Liquid Volume: 2.17gal**

**GSHG787FMA** Min. Buy 1cs/ 50ea



### Grower Select® Wicker Hanging Basket

Molded wicker design will help this basket stand out from the rest. Includes a coordinating hanger.



12in

**Aged Cappuccino - 12in D x 6.69in H - Max Liquid Volume: 2.62gal**

**GSHG931HAC** Min. Buy 1cs/ 50ea

**Chestnut Brown - 12in D x 6.69in H - Max Liquid Volume: 2.62gal**

**GSHG931HCT** Min. Buy 1cs/ 50ea

## Hanging Baskets



### Grower Select® Grass Hanging Basket

Wire frame wrapped with natural grass. Includes plastic liner, wire hanger and wire stand.



**12in Round Cone**

**GSRA6971**

Min. Buy 1cs/ 20ea

12in

**14in Square Cone**

**GSRA6970**

Min. Buy 1cs/ 20ea

14in

### Concept Greenhouse Hanging Cone

With wire hanger and stand.



**Brushwood and Maize Rope - 14in Round**

**CPT2000205-14**

Min. Buy 1cs/ 15ea

14in

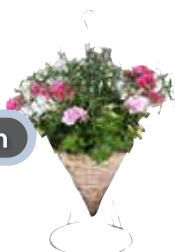

### Grower Select® Dixie Hanging Basket

Decorative hanging baskets coordinate with Dixie Planters, allowing for eye-catching style at multiple levels. Hanging baskets include plastic hanger and cap dish.



12in

**Red Brown Drip - 11.97in D x 6.69in H - Max Liquid Volume: 1.6gal**

**GS12HBDIXI13**

Min. Buy 1cs/ 36ea

**Red Green Drip - 11.97in D x 6.69in H - Max Liquid Volume: 1.6gal**

**GS12HBDIXI35**

Min. Buy 1cs/ 36ea

**Red Light Blue Drip - 11.97in D x 6.69in H - Max Liquid Volume: 1.6gal**

**GS12HBDIXI27**

Min. Buy 1cs/ 36ea

**Red Royal Blue Drip - 11.97in D x 6.69in H - Max Liquid Volume: 1.6gal**

**GS12HBDIXI23**

Min. Buy 1cs/ 36ea

### Grower Select® Bushel Hanging Basket

Designed to look like wood, but with the durability of plastic. Includes a coordinating hanger.



10in

**Tan With Brown Wash - 10in D x 6in H - Max Liquid Volume: 1.19gal**

**STPCF036500**

Min. Buy 1cs/ 24ea



### Grower Select® Seneca Planter

Decorative Seneca collection



13in

**White - 13in D x 8in H - Max Liquid Volume: 3.4gal**

**GSHG1239CWH**

Min. Buy 1cs/ 63ea



### Grower Select® Hanging Basket

Plastic lined for water retention. Comes with wire hanger.



14in

**Sphagnum Moss - 14in**

**GS14MB**

Min. Buy 1cs/ 22ea

**Sphagnum Moss - 16in**

**GS16MB**

Min. Buy 1cs/ 16ea

**Sphagnum Moss - 18in**

**GS18MB**

Min. Buy 1cs/ 12ea

**Sphagnum Moss - 24in**

**GS24MB**

Min. Buy 1cs/ 7ea

16in

18in

24in



# GrowerSelect®

## Hanging Basket - Hangers

### The HC Companies® E-10L 3- Strand Plastic Hanger (Long)

Plastic 3-strand clip hanger fits a variety of pots.



**Chocolate Brown 3-strand - 19.5in**

**DLNHZP3E103E21D050**

Min. Buy 1cs/ 50ea

### The HC Companies® Wire Hangers

Wire 3-strand hanger.



**Metal 3-strand - 21in**

**DLNHZSL210D050**

Min. Buy 1cs/ 50ea

### Grower Select® 4 Sure Wire S-Hook

Galvanized Coated 10 gauge 0.135 diameter. Can be used for many things including hanging baskets extension hooks.



**6in**

**4SW35-0050**

Min. Buy 1cs/ 25ea

**12in**

**4SW35-0052**

Min. Buy 1cs/ 25ea

**15in**

**4SW35-0053**

Min. Buy 1cs/ 25ea

**18in**

**4SW35-0054**

Min. Buy 1cs/ 25ea

**20in**

**4SW35-0055**

Min. Buy 1cs/ 25ea

**24in**

**4SW35-0056**

Min. Buy 1cs/ 25ea

**36in**

**4SW35-0059**

Min. Buy 1cs/ 25ea



## Wall & Hanging Planters

### Grower Select® Galvanized Cone Transport Stand

Sturdy, galvanized wire cone stand for transport and bench growing. Fits 12in, 14in and 16in cone baskets. Transport stand only; plants and planters sold separately.



**Stand only.**

**SSCCTS**

Min. Buy 1ea





## Specialty Containers

### Grower Select® Halloween Cover Pots

Get ready for Halloween with this plastic cover pot; perfect for use with mum pan drop-ins.



**Green - 8.5in D x 5.72in H -  
Max Liquid Volume: 1.06gal**

**GSBIG FRANKIE #1** Min. Buy 1cs/ 100ea

8.5in



**Purple - 8.5in D x 5.72in H -  
Max Liquid Volume: 1.06gal**

**GSHH-FUN FREDDY** Min. Buy 1cs/ 100ea

8.5in



### Grower Select® Harvey Pumpkin Cover Pot

Get ready for fall with this pumpkin cover pot; perfect for use with mum pan drop-ins.



**Orange With Face - 9.17in D x 5.9in  
H - Max Liquid Volume: 1.15gal**

**GSHHLITTLEHARV9** Min. Buy 1cs/ 90ea

9in



**Orange No Face - 9.17in D x 5.9in  
H - Max Liquid Volume: 1.15gal**

**GSLITTLE HARV CASES** Min. Buy 1cs/ 90ea

9in



**Orange No Face - 12.25in D x 9.1in  
H - Max Liquid Volume: 3.12gal**

**GSHARV1 CASES** Min. Buy 1cs/ 40ea

12in



### Grower Select® Fall Cover Pot

Great for use with pre-planted baskets as drop ins for fall mums.



**Black/Bronze Wash - 8.66in D x 5.5in H - Max Liquid Volume: 1.06gal**

**GSHH-TZ128-FALL2 BLK/BRO** Min. Buy 1cs/ 124ea

9in

**Black/Copper Wash - 8.66in D x 5.5in H - Max Liquid Volume: 1.06gal**

**GSHH-TZ128-FALL2 8 BLK/C** Min. Buy 1cs/ 124ea



**Black/Bronze Wash - 10.75in D x 6.73in H - Max Liquid Volume: 1.75gal**

**GSHH-TZ078-FALL1 BLK/BRO** Min. Buy 1cs/ 50ea

11in

**Black/Copper Wash - 10.75in D x 6.73in H - Max Liquid Volume: 1.75gal**

**GSHH-TZ078-FALL1 BLK/CO** Min. Buy 1cs/ 50ea

### Grower Select® Snowflake Cover Pot

Spruce up your winter plants with this seasonal cover pot. Great for use with 10in hanging basket drop-ins. No drain hole.



**Black/Silver - 10.75in D x 6.73in H -  
Max Liquid Volume: 1.75gal**

**GS84-0295A** Min. Buy 1cs/ 60ea

11in



### Grower Select® Adriana

Contemporary cover pot great for use with mum pan drop ins.



**Aged Cappuccino - 7.793in D x 6.269in H -  
Max Liquid Volume: 0.9gal**

**GSTZ-061CAP** Min. Buy 1cs/ 80ea

8in



### Grower Select Decorative Sign Planters

Display your patio plants in style with this durable planter. Molded from polypropylene in an attractive finish. Includes a sturdy plastic sign on a 10in high arched loop.



### Grower Select® Welcome Rope Planter with Sign



**Black/Bronze - 12in D x 8.3in H - Max Liquid Volume: 2.2gal**

**GSA-SAY ANYTHING 718** Min. Buy 1cs/ 30ea

12in

**Black/Silver - 12in D x 8.3in H - Max Liquid Volume: 2.2gal**

**GSA-SAY ANYTHING 718.BLK** Min. Buy 1cs/ 30ea

### Grower Select® Welcome Weave Planter with Sign



**Black/Silver - 12in D x 8.3in H - Max Liquid Volume: 2.2gal**

**GSA-SAY ANYTHING 516SIL** Min. Buy 1cs/ 30ea

12in

**Black/Bronze - 12in D x 8.3in H - Max Liquid Volume: 2.2gal**

**GSA-SAY ANYTHING 516BRZ** Min. Buy 1cs/ 30ea

### Grower Select® American Flag Planter



**Black - 12in D x 8.3in H - Max Liquid Volume: 2.2gal**

**GSA-AMERICANFLAGBLK** Min. Buy 1cs/ 30ea

12in

# Grower Select®

## Specialty Containers



### Grower Select® Watering Can Planter

Durable galvanized zinc construction with an Acid Wash finish. Sprinkling can planter features a detachable spout and handle for easy shipping. A pre-planted azalea pot fits directly into this container.

**7.5in**

#### Fuschia - 7.5in

**GS850005B** Min. Buy 1cs/ 12ea

#### Assorted Colors - 7.5in

**GS0044** Min. Buy 1cs/ 12ea

#### Acid Wash - 7.5in

**GS0048** Min. Buy 1cs/ 12ea

#### Copper - 7.5in

**GS0046** Min. Buy 1cs/ 12ea

**10in**

#### Fuschia - 10.125in x 8.25in High. 2.09gal Liquid Volume

**GS850001A** Min. Buy 1cs/ 12ea

#### Green - 10.125in x 8.25in High. 2.09gal Liquid Volume

**GS850002A** Min. Buy 1cs/ 12ea

#### Orange - 10.125in x 8.25in High. 2.09gal Liquid Volume

**GS850003A** Min. Buy 1cs/ 12ea

#### Yellow - 10.125in x 8.25in High. 2.09gal Liquid Volume

**GScs10KBF004** Min. Buy 1cs/ 12ea

#### Assorted Colors - 10.125in x 8.25in High. 2.09gal Liquid Volume

**GS0045** Min. Buy 1cs/ 12ea

#### Acid Wash - 10.125in x 8.25in High. 2.09gal Liquid Volume

**GS0049** Min. Buy 1cs/ 12ea

#### Copper - 10.125in x 8.25in High. 2.09gal Liquid Volume

**GS0047** Min. Buy 1cs/ 12ea

### Grower Select® Untreated Wood Baskets

Wood packaging has been used primarily in farming for thousands of years. Since 1950, wood packaging (baskets) was the main package used to ship fresh fruits and vegetables.

**8in**

#### Brown - 8in x 6in

**GSRB-002BNH** Min. Buy 1cs/ 12ea

#### Natural - 8in x 6in

**GSRB-002NNH** Min. Buy 1cs/ 12ea

**11in**

#### Brown - 11in x 7in

**GSRB-001BNH** Min. Buy 1cs/ 12ea

#### Natural - 11in x 7in

**GSRB-001NNH** Min. Buy 1cs/ 12ea

**14.5in**

#### Brown - 14.5in x 9.425in

**GSHBUS-B** Min. Buy 1cs/ 12ea

#### Natural - 14.5in x 9.425in

**GSHBUS-N** Min. Buy 1cs/ 12ea

### Grower Select® Bushel Tub Basket with 2 Loop Handle

Wood packaging has been used primarily in farming for thousands of years. Since 1950 wood packaging (baskets) was the main package used to ship fresh fruits and vegetables.

**17.5in**

#### Brown - 17.5in x 11.5in

**GS04032B** Min. Buy 1cs/ 12ea

#### Green With Red Band - 17.5in x 11.5in

**GS04032G** Min. Buy 1cs/ 12ea

### Grower Select® Floor Planter with Ball Feet

Rust-resistant, powder-coated finish. Includes coco liner.

**22in**

#### Black - 22in L x 15in W x 9in H, 3.95gal Max Volume

**SSCRCFLU22** Min. Buy 5cs/ 5ea

## Specialty Containers



### Grower Select® Tee Pee Pot

Attractive trellis planter. Height with Trellis is 20.827in.



13in

**Aged Cappuccino - 13.217in D x 8.996in H -  
Max Liquid Volume: 3.3gal**

**GSC-TEEPPE ACP CASES** Min. Buy 1cs/ 12ea

**Bronze - 13.217in D x 8.996in H - Max Liquid Volume: 3.3gal**

**GSC-TEEPPE BLK/BRONZE CA** Min. Buy 1cs/ 12ea

### Grower Select® Kathy Caged Pot

Tomatoes love this strong, attractive trellis planter.



11.5in

**Black - 11.5in D x 8.39in H -  
Max Liquid Volume: 2.5gal**

**GSC-6622** Min. Buy 1cs/ 40ea

**Black - BULK - 11.5in D x 8.39in H -**

**Max Liquid Volume: 2.5gal**

**GSC-6622 BLACK** Min. Buy 1cs/ 1260ea



### Grower Select® Diedra Pot with Veggie Cage

Subdued finish on the Diedra Pot makes your plants the focus. Comes complete with vegetable cage for easy container gardening.



10in

**Black - 9.84in D x 6.12in H -  
Max Liquid Volume: 2gal**

**GSC-TZ-013BLKcs** Min. Buy 1cs/ 30ea

**Black - BULK - 9.84in D x 6.12in H -**

**Max Liquid Volume: 2gal**

**GSC-TZ-013** Min. Buy 1cs/ 1700ea



### Grower Select® Katie Square Tower Caged Pot

Attractive trellis planter. Cage height is 19in.



10in

**Black - 9.84in D x 9in H -  
Max Liquid Volume: 2gal**

**GSC-KATIE212BLK** Min. Buy 1cs/ 40ea



### Grower Select® Trellis Square Pot

Decorative planter to compliment your climbing plants. Great for flowering vines.



**Black - 8in D x 6.16in H -  
Max Liquid Volume: 1gal**

**GSC-TRELLISX8** Min. Buy 1cs/ 40ea

**Black - 10in D x 8.27in H -  
Max Liquid Volume: 2gal**

**GSC-TRELLISX10** Min. Buy 1cs/ 40ea

8in

10in



### Grower Select® Grab-n-Go Trellis

The Grab-n-Go trellis is the perfect product for your climbing plants! Pick up your plants by the trellis without any spilling, separation or risk of destroying the plant. Easily snaps onto co-ex pot rims.



**Small - 3.25in Top W**

**GST-TZ-229** Min. Buy 1cs/ 10ea

**Medium - 9.014in W x 7.5in Base W x 15.75in H**

**GST-TZ-230** Min. Buy 1cs/ 10ea

**Large - 10.903in Top W x 9.5in Base W x 18.0in**

**HGST-TZ-231** Min. Buy 1cs/ 10ea



### Grower Select® Lattice Round Planter With Trellis Cage

Fully encompassing, ornate round trellis wraps around the top of this decorative lattice planter. Perfect for flowering vines.



**Black With White Wash - 13in**

**STPCF023265** Min. Buy 1ea





Leader in  
Horticultural  
Containers

### Fiber Containers

#### The HC Companies® EcoGrow® Round Pot

- Manufactured with the environment in mind in our North American, closed loop water recycling production facility.
- Automation friendly carry trays available in all sizes.
- Built-in denesting lugs for ease of handling.
- EcoGrow® pots hold up for retailers, yet degrade quickly when planted in the ground.
- An ideal choice for vegetables, herbs, annuals, and more!



Part Code	Item #	Type	Dimensions in Inches		Liquid Volume	Compatible Tray	Case Qty	Barcode
			Outside Diam.	Height				
EcoGrow® Round Pot								
FRS03501	<b>ITMLFRS03501RBIC720</b>	STD	3.50	3.25	9.3oz	TCR12350	720	
FRS03750	<b>ITMLFRS03750RBIC625</b>	STD	3.88	3.38	12.4oz	FCT10400	625	
FRS04000	<b>ITMLFRS04000RBIC625</b>	STD	4.00	3.50	14.4oz	TCR10406	625	
FRS04250	<b>ITMLFRS04250RBIC500</b>	GER	4.25	3.62	1.13pt	TCG10430	500	
FRS04500	<b>ITMLFRS04500RBIC322</b>	GER	4.50	3.75	1.27pt	TRS10450	322	
FRA05000	<b>ITMLFRA05000RBIC336</b>	AZ	5.00	3.62	1.48pt	TCA08500	336	
FRS05000	<b>ITMLFRS05000RBIC272</b>	STD	5.00	4.75	1.92pt	TRS08510	272	
FRA06000	<b>ITMLFRA06000RBIC156</b>	AZ	6.00	4.25	1.32pt	TCA06600	156	
FNP06060	<b>ITMLFNP06060BRD080</b>	NP	6.50	6.00	2.67qt	-	80	
FNP11090	<b>ITMLFNP11090BRD025</b>	NP	11.50	9.25	3.34gal	-	25	





Leader in Horticultural Containers

The HC Companies® FiberGrow® Round

Superior Growing Containers that breathe like clay, improve aeration and promote healthier root systems by insulating them from temperature fluctuations. Attractive FiberGrow Planters enhance patios, pools and garden settings.

Fiber Containers



FRS04040



FRA05050



FRA06050



FNP06060TW



FNP06070TW



FNP07070



FNP08090TW



FNP08080



FRP08550



FPP10040



FRP09060

Part Code	Item #	Dimensions in Inches			Volume	QTY	Barcode
		Outside Diam.	Inside Diam.	Height			
4.50in FiberGrow® Geranium Pot							
FRS04040	<b>ITMLFRS04040RBRC400</b>	4.75	4.00	3.75	1.28pt	400	
5.00in FiberGrow® Standard Round Pot							
FRA05050	<b>ITMLFRA05050RBRC250</b>	5.50	5.00	3.75	1.00qt	250	
6.00in FiberGrow® Azalea Pot							
FRA06050	<b>ITMLFRA06050RBRD100</b>	5.75	5.00	5.50	1.67qt	100	
5.75in x 6.5in FiberGrow® Thin Wall Nursery Pot							
FNP06060(TW)	<b>ITMLFNP06060RBRD070TW</b>	5.75	-	6.50	2.23qt	70	
6.00in x 7.00in FiberGrow® Thin Wall Nursery Pot							
FNP06070TW	<b>ITMLFNP06070RBRD070TW</b>	6.00	-	7.00	2.81qt	70	
7.50in x 7.00in FiberGrow® Nursery Pot							
FNP07070	<b>ITMLFNP07070RBRD070</b> <b>ITMLFNP07070RBRB013</b>	7.50	-	7.00	1.04gal	70 BULK: 1,350	
8.25in x 8.75in FiberGrow® Thin Wall Rose Pot							
FNP08090TW	<b>ITMLFNP08090RBRD040TW</b>	8.25	-	8.75	2.40gal	40	
8.50in x 8.25in FiberGrow® Nursery Pot							
FNP08080	<b>ITMLFNP08080RBRD035</b>	8.50	-	8.25	1.59gal	35	
8.50in FiberGrow® Mum Pan							
FRP08550	<b>ITMLFRP08550RBRD050</b> <b>ITMLFRP08550RBRB012</b>	9.00	8.75	5.25	1.05gal	50 BULK: 1,200	
10.00in x 4.00in FiberGrow® Shallow Patio Planter							
FPP10040	<b>ITMLFPP100405BRD070</b>	10.00	9.00	4.00	3.31qt	70	
9.00in FiberGrow® Pan							
FRP09060	<b>ITMLFRP09060RBRD025</b>	10.50	9.25	6.50	1.75gal	25	



Leader in  
Horticultural  
Containers

### The HC Companies® FiberGrow® Round

Superior Growing Containers that breathe like clay, improve aeration and promote healthier root systems by insulating them from temperature fluctuations. Attractive FiberGrow Planters enhance patios, pools and garden settings.

#### Fiber Containers



FRP09060TW

FNP10090

FNP10110

FNP11120

FPP12050

FNP12110

FNP121000WA1

FNP12090

FNP13120

FNP15100

Part Code	Item #	Dimensions in Inches			Volume	QTY	Barcode
		Outside Diam.	Inside Diam.	Height			
9.00in FiberGrow® Thin Wall Pan							
FRP09060TW	<b>ITMLFRP09060RBRB008TW</b>	10.50	9.50	6.50	1.75gal	BULK: 860	
10.50in x 8.50in FiberGrow® Nursery Pot							
FNP10090	<b>ITMLFNP10090RBRD025</b>	10.50	-	8.50	2.50gal	25	
10.50in x 10.50in FiberGrow® Nursery Pot							
FNP10110	<b>ITMLFNP10110RBRD025</b>	10.50	-	10.50	2.90gal	25	
11.50in x 11.50in FiberGrow® Nursery Pot							
FNP11120	<b>ITMLFNP11120RBRD020</b>	11.50	-	11.50	3.79gal	20	
12.00in x 5.00in FiberGrow® Shallow Patio Planter							
FPP12050	<b>ITMLFPP12050RBRD060</b>	12.00	11.00	5.00	1.48gal	60	
12.00in x 10.75in FiberGrow® Nursery Pot							
FNP12110	<b>ITMLFNP12110RBRD020</b>	12.00	-	10.75	4.13gal	20	
12.00in x 10.00in WaxTough Hexagon Patio Planter							
FNP12100WA1	<b>ITMLFPP12100WA1D020</b>	12.00	11.00	10.00	4.03gal	20	
12.25in x 8.50in FiberGrow® Nursery Pot							
FNP12090	<b>ITMLFNP12090RBRD025</b>	12.25	-	8.50	3.47gal	25	
13.00 x 11.75in FiberGrow® Nursery Pot							
FNP13120	<b>ITMLFNP13120RBRD020</b>	13.00	-	11.25	5.21gal	20	
14.75in x 9.75in FiberGrow® Nursery Pot							
FNP15100	<b>ITMLFNP15100RBRD020</b>	14.75	-	9.75	6.00gal	20	





Leader in Horticultural Containers

**Fiber Containers**

**The HC Companies® FiberGrow® Round**  
 Superior Growing Containers that breathe like clay, improve aeration and promote healthier root systems by insulating them from temperature fluctuations. Attractive FiberGrow Planters enhance patios, pools and garden settings.



FPP15060

FPP15080



FNP15140

FNP15120

Part Code	Item #	Dimensions in Inches			Volume	QTY	Barcode
		Outside Diam.	Inside Diam.	Height			
15.00in x 6.00in FiberGrow® Shallow Patio Planter							
FPP15060	<b>ITMLFPP15060RBRD025</b>	15.00	14.00	6.00	3.19gal	25	
15.00in x 8.00in FiberGrow® Decagon Patio Planter							
FPP15080	<b>ITMLFPP15080RBRD020</b>	15.00	14.00	8.00	4.45gal	20	
15.00in x 13.25in FiberGrow® Nursery Pot							
FNP15140	<b>ITMLFNP15140RBRD015</b>	15.00	-	13.25	7.69gal	15	
15.50in x 11.75in FiberGrow® Nursery Pot							
FNP15120	<b>ITMLFNP15120RBRD015</b>	15.50	-	11.75	6.85gal	15	



**Fiber Containers - Carry Tray**

**The HC Companies® FiberGrow® Carry Tray**

Used for 4in EcoGrow Pots (FRS04000). Alternative to using plastic.



**10ct**  
**ITMLFCT10400RBRD010** Min. Buy 1cs/ 10ea





Leader in  
Horticultural  
Containers

### Fiber Containers

#### The HC Companies® FiberGrow® Square Containers

Superior Growing Containers that breathe like clay, improve aeration and promote healthier root systems by insulating them from temperature fluctuations. Attractive FiberGrow Planters enhance patios, pools and garden settings.



FSQ04040



FPP10070



FPP12070WA1

Part Code	BFG Product #	Dimensions in Inches			Volume	QTY	Barcode
		Outside Diam.	Inside Diam.	Height			
FiberGrow® Square Pot							
FSQ04040	<b>ITMLFSQ04040RBRC400</b>	4.25	3.75	4.00	1.22pt	400	
FiberGrow® Square Patio Planter							
FPP10070	<b>ITMLFPP10070RBRD032</b>	10.00	9.00	7.00	1.72gal	32	
FiberGrow® WaxTough Square Patio Planter							
FPP12070WA1	<b>ITMLFPP12070WA1D032</b>	12.63	11.63	6.50	2.39gal	32	

#### The HC Companies® FiberGrow® Garden Pak

Promote healthy root development for optimal plant growth. Manufactured using recycled materials. Easy de-nesting with no sharp corners.



Part Code	BFG Product #	Dimensions in Inches			Volume	QTY	Barcodes
		Outside Diam	Inside Diam	Height			
128 FiberGrow® Garden Pak							
FPK01280	<b>ITMLFPK01280RBRC500</b>	5.50	5.00	2.75	1.62pt	500	
135 FiberGrow® Garden Pak							
FPK01350	<b>ITMLFPK01350RBRC500</b>	6.75	5.50	2.50	1.98qt	500	
144 FiberGrow® Garden Pak							
FPK01440	<b>ITMLFPK01440RBRC250</b>	7.50	5.00	2.75	1.35qt	250	
160 FiberGrow® Garden Pak							
FPK01600	<b>ITMLFPK01600RBRC200</b>	10.25	6.25	3.00	2.16qt	200	

#### The HC Companies® FiberGrow® Balcony Planters (Rectangle)

Superior Growing Containers that breathe like clay, improve aeration and promote healthier root systems by insulating them from temperature fluctuations. Attractive FiberGrow Planters enhance patios, pools and garden settings.



Part Code	BFG Product #	Dimensions in Inches			Volume	QTY	Barcodes
		Outside Diam	Inside Diam	Height			
FiberGrow® Balcony Planters							
FPP16060	<b>ITMLFPP16060RBRC024</b>	16.00	15.00	5.50	2.53gal	24	
FPP24060	<b>ITMLFPP24060RBRC012</b>	24.00	23.00	5.75	3.56gal	12	





Leader in Horticultural Containers

Fiber Containers - Hanging Baskets



The HC Companies® FiberGrow® Hanging Baskets

- Manufactured using recycled materials.
- Provides durability in moist/humid growing conditions
- Broad assortment of sizes, shapes, and styles to choose from to differentiate your products
- WaxTough fortified hanging baskets are an aesthetically pleasing, rich, dark, earth tone
- Insulates roots from extreme variations in temperature
- Easy to assemble, attractive and cost effective alternative to moss or coco.



FHB1000WAXGR FHB1200WAXGR FHB12XL0WAXGR FHE1200WAXGR FHE12XL0WAXGR FHE1400WAXGR



FHS1200WAXGR FHS1250WAXGR FHF1200WAXGR FHR1200WAXGR FHR1400WAXGR

Part Code	Item #	Dimensions in Inches			Volume	QTY	Barcode
		Outside Diam.	Inside Diam.	Height			
WaxTough Hanging Baskets with Grommets							
FHB1000WAXGR	<b>ITMLFHB1000WAXD012GR</b>	11.00	10.00	6.00	1.64gal	12	
FHB1200WAXGR	<b>ITMLFHB1200WAXD012GR</b>	12.50	11.63	7.00	2.12gal	12	
FHB12XL0WAXGR	<b>ITMLFHB12XL0WAXD012GR</b>	13.00	12.00	9.00	2.73gal	12	
WaxTough Beehive Hanging Baskets with Grommets							
FHE1200WAXGR	<b>ITMLFHE1200WAXD012GR</b>	12.00	11.00	6.00	1.87gal	12	
FHE12XL0WAXGR	<b>ITMLFHE12XL0WAXD012GR</b> <b>ITMLFHE12XL0WAXE689GR</b>	13.00	11.25	7.00	2.12gal	12 BULK: 689	
FHE1400WAXGR	<b>ITMLFHE1400WAXD006GR</b>	14.25	12.87	8.75	3.43gal	6	
WaxTough Square Hanging Baskets with Grommets							
FHS1200WAXGR	<b>ITMLFHS1200WAXD012GR</b>	12.00	12.00	7.00	2.38gal	12	
FHS1250WAXGR	<b>ITMLFHS1250WAXD012GR</b>	13.25	12	7.25	2.79gal	12	
WaxTough Floral Hanging Baskets with Grommets							
FHF1200WAXGR	<b>ITMLFHF1200WAXD012GR</b>	12.75	11.25	7	2.12gal	12	
WaxTough WaterSaver Hanging Baskets with Grommets							
FHR1200WAX(GR)	<b>ITMLFHR1200WAXD012GR</b>	12.88	11.88	6.38	2.12gal	12	
FHR1400WAX(GR)	<b>ITMLFHR1400WAXD006GR</b>	15.50	14.00	9.00	4.61gal	6	



Leader in Horticultural Containers

**Fiber Containers - Hanging Baskets**

**The HC Companies® FiberGrow® Hanging Baskets**

- Manufactured using recycled materials.
- Provides durability in moist/humid growing conditions
- Broad assortment of sizes, shapes, and styles to choose from to differentiate your products
- WaxTough fortified hanging baskets are an aesthetically pleasing, rich, dark, earth tone
- Insulates roots from extreme variations in temperature
- Easy to assemble, attractive and cost effective alternative to moss or coco.



Part Code	Item #	Dimensions in Inches			Volume	QTY	Barcode
		Outside Diam.	Inside Diam.	Height			
WaterSaver Hanging Basket							
FHR16000	<b>ITMLFHR16000RBRD006</b>	17.13	16.13	10.00	6.62gal	6	
WaxTough WaterSaver Hanging Baskets							
FHR14000WA1	<b>ITMLFHR14000WA1D006</b>	15.50	14.00	9.00	4.61gal	6	
FHR16000WA1	<b>ITMLFHR16000WA1D006</b>	17.13	16.13	10.00	6.62gal	6	
FHR18000WA1	<b>ITMLFHR18000WA1D006</b>	19.00	18.00	9.75	7.30gal	6	



Part Code	Item #	Color	Length in Inches	QTY	Barcode
20.00 4 Strand Plastic FiberGrow® Hanger Brown					
HZP4LFG6	<b>ITMLHZP4LFG6E28D024</b>	Brown	20.00	24	

**The HC Companies® FiberGrow® Hangers**

For 16in hanging baskets w/out grommets. 16in wire cage and 23in swivel clip-on hanger included.



**23in**  
**ITMLFHZA160C036CA** Min. Buy 1cs/ 36ea





Leader in Horticultural Containers

**Thermoformed & Coextruded Containers**

**The HC Companies® Round Co-Extruded Pots**

- Co-Extruded with dual color layering with a dark interior for maximum root protection from light.
- Lightweight, yet durable polypropylene for greater cost efficiency.
- Multi-level drain holes for efficient drainage.
- Strong rims for efficient use in high-speed automated system.

Standard Colors



Custom Colors

Specialty colors available with minimum order quantities.



XST04002



XGR04500



XAZ05000



XAL05000



XAZ05500



XAZ06001



EU170S50



EU170T50

Part Code	Item #	Color	Dimensions in Inches		Max Liquid Volume	Tray Compatibility	QTY	Barcodes	
			Outside Diam.	Height					
4.00 Standard Prop Pot with TagSlot									
XST04002	P	<b>DLNXST04002X18K126</b>	Terra Cotta/Black	4.00	4.00	1.00pt	XTR15400 XTR10400 TCR1040, TIS40120	1,260	
4.50 Geranium Pot with TagSlot									
XGR04500	P	<b>DLNXGR04500X03C720</b> <b>DLNXGR04500G18C720</b> <b>DLNXGR04500G18B357</b> <b>DLNXGR04500X18C720</b>	Green/Black Black Terra Cotta/Black	4.50	3.75	1.26pt	XTG15450 XTG12450 XTG10450 TIS45120	720 BULK: 35,712	
5.00 Azalea Short Pot									
XAZ05000		<b>DLNXAZ05000G18C675</b>	Black	5.00	3.75	1.76pt	TCA08503	675	
5.00 Azalea Tall Pot									
XAL05000	P	<b>DLNXAL05000G18C600</b>	Black	5.00	5.75	1.25qt	TRS5T800	600	
5.50 Azalea Traditional Pot									
XAZ05500	P	<b>DLNXAZ05500G18C496</b> <b>DLNXAZ05500X03C496</b>	Black Green/Black	5.25	4.50	1.25qt	TCA08552 TCA06551 TIS55064	496	
6.00 Azalea Pot									
XAZ06001		<b>DLNXAZ06001X03C864</b> <b>DLNXAZ06001G18C864</b>	Green/Black Black	5.90	4.25	1.28qt	TCA06605 TIS55080 TIS60061	864	
6.62 Euro Short Mum Pot									
EU170S50	P WM	<b>DLNEU170S50G18C300</b> <b>DLNEU170S50X03C300</b>	Black Green/Black	6.62	5.00	2.00qt	TRS06171 TIS66651	300	
6.62 Euro Pot									
EU170T50		<b>DLNEU170T50G18C294</b> <b>DLNEU170T50X18C294</b>	Black Terra Cotta/Black	6.62	6.00	2.58qt	TRS06170 TIS66650 TIS66651	294	

P = Offset printing available | WM = Compatible with water mat irrigation



Leader in Horticultural Containers

Thermoformed & Coextruded Containers

The HC Companies® Round Co-Extruded Pots

- Co-Extruded with dual color layering with a dark interior for maximum root protection from light.
- Lightweight, yet durable polypropylene for greater cost efficiency.
- Multi-level drain holes for efficient drainage.
- Strong rims for efficient use in high-speed automated system.

Standard Colors



Custom Colors

Specialty colors available with minimum order quantities.



XNT0TQT3



XRD16002



XNS0T1G3



EU190T51



XAM08000



XAM09001

Part Code	Item #	Color	Dimensions in Inches		Max Liquid Volume	Tray Compatibility	QTY	Barcodes	
			Outside Diam.	Height					
4.75 - 1.00qt Perennial Pot Prop with TagSlot									
XNT0TQT3	P WM	<b>DLNXNT0TQT3G18C432</b>	Black	4.75	5.25	1.00qt	TRS12QD0 TRS10QD0 TIS66651 TCR081QC TCR081Q3	432	
6.29 Pot with 4 TagSlots									
XRD16002	P	<b>DLNXRD16002G18C200</b>	Black	6.29	6.69	2.50qt	YAT06160 YAT06161 TIS66651	200	
6.50 - 1.00 Gallon True Squat Prop Pot with TagSlot									
XNS0T1G3	P	<b>DLNXNS0T1G3G18C140</b>	Black	6.50	6.50	2.50qt	TCR06SG1 TCF06SG0 TIS5G034 TIS66651	140	
7.50 Euro Tall Pot									
EU190T51	P	<b>DLNEU190T51G18C132</b>	Black	7.50	7.37	1.00gal	TIS19020	132	
8.00 x 5.00 Mum Pan									
XAM08000	P	<b>DLNXAM08000G18C170</b> <b>DLNXAM08000G18B097</b> <b>DLNXAM08000X18C170</b> <b>DLNXAM08000X18B097</b>	Black Terra Cotta/Black	8.00	5.00	2.78qt	TCM04800	170 BULK: 9,720	
9.00 x 6.25 Mum Pan									
XAM09001		<b>DLNXAM09001B66B027</b> <b>DLNXAM09001B66B054</b> <b>DLNXAM09001G18B027</b> <b>DLNXAM09001G18C090</b> <b>DLNXAM09001X18B027</b> <b>DLNXAM09001X18C090</b>	Green/Black Black Terra Cotta/Black	9.00	6.25	1.20gal	TVM09201	90 BULK: 2,700	

P = Offset printing available | WM = Compatible with water mat irrigation



Leader in Horticultural Containers

Injection Molded Containers

The HC Companies® Round Containers

Made from high-grade polypropylene. Bulk packaging available for most sizes, making shipping and storage more efficient and providing additional savings to the grower. Various sizes are created and customizable with offset printing capabilities.

Standard Colors



STG03500



STG04000



AZE04500



STG04500



STG04501



NRT001Q1



AZE05000



AZM06000



STG06000

Part Code	BFG Product #	Color	Dimensions in Inches		Liquid Volume	Tray Compatibility	QTY	Barcode	
			Outside Diam.	Height					
3.50 Standard Thinwall with TagSlot									
STG03500	P	<b>DLNSTG03500B66K122</b> <b>DLNSTG03500G18K122</b>	Green Black	3.50	3.25	0.698pt	TCR12350	1,225	
4.00 Standard Thinwall									
STG04000	P	<b>DLNSTG04000B66K155</b> <b>DLNSTG04000G18K155</b>	Green Black	4.00	3.50	1.01pt	TRS15400 TCR10400	1,550	
4.50 Elite Azalea Pot									
AZE04500		<b>DLNAZE04500B66K100</b>	Green	4.50	3.25	1.28pt	TRS15450 TCG12450	1,000	
4.50 Geranium Thinwall									
STG04500	P	<b>DLNSTG04500B66C850</b> <b>DLNSTG04500B66B344</b> <b>DLNSTG04500G18C850</b> <b>DLNSTG04500G18B344</b>	Green Black	4.50	3.81	1.26pt	TCG15450 TCG12450 TCG08450 TIS45120	850  BULK: 34,410	
4.50 Geranium Thinwall with TagSlot									
STG04501	P	<b>DLNSTG04501B66C850</b>	Green	4.50	3.81	1.26pt	TCG15450 TCG12450 TCG08450 TIS45120	850	
1.00 Quart True Per Pot Thinwall with TagSlot									
NRT001Q1	P	<b>DLNVRT001Q1G18C475</b>	Black	4.75	4.75	1.00qt	TCR121Q0 TCR018Q4	475	
5.50 Elite Azalea Pot									
AZE05000	P	<b>DLNAZE05000B66C750</b>	Green	5.00	3.50	0.81qt	TRS08510	750	
5.50 Azalea Thinwall									
AZM06000	P	<b>DLNAZM06000G18C544</b>	Black	5.40	4.56	1.36qt	TCA08550 TCA08552 TIS60060 TIS60061	544	
6.00 Standard Thinwall									
STG06000		<b>DLNSTG06000B66C440</b> <b>DLNSTG06000G18C440</b>	Green Black	6.00	5.75	1.87qt	TCR06600	440	

P = Offset printing available



Leader in Horticultural Containers

**Injection Molded Containers**

**The HC Companies® Round Containers**

Made from high-grade polypropylene. Bulk packaging available for most sizes, making shipping and storage more efficient and providing additional savings to the grower. Various sizes are created and customizable with offset printing capabilities.

Standard Colors



Part Code	BFG Product #	Color	Dimensions in Inches		Max Liquid Volume	Tray Compatibility	QTY	Barcode
			Outside Diam.	Height				
<b>6.00 Azalea Pot</b>								
AZA06000	<b>DLNAZA06000G18C640</b> <b>DLNAZA06000G18B260</b> <b>DLNAZA06000B66C640</b> <b>DLNAZA06000B66B260</b>	Black Green	6.00	4.25	1.39qt	TCA06600 TRS066E0 TCA06605 HZIP3C101	640  BULK: 26,025	
<b>6.00 Azalea Jumbo Thinwall</b>								
AZJ06001	P <b>DLNAZJ06001B66C528</b>	Green	6.06	4.93	1.70qt	TIS60060 TIS60061	528	
<b>6.50 Azalea Pot</b>								
AZA06500	<b>DLNAZA06500G18C438</b> <b>DLNAZA06500B66C438</b>	Black Green	6.50	4.62	1.81qt	TRS06650	438	
<b>6.50 Azalea Traditional Thinwall Pot</b>								
AZN06501	<b>DLNAZN06501B66C240</b> <b>DLNAZN06501G18C240</b>	Green Black	6.50	4.93	2.01qt	TCA665J2 TIA06500	240	
<b>1.00 Trade G #1 T1G 2 WD with TagSlot</b>								
NRT0T1G3	<b>DLNRT0T1G3G18C128</b>	Black	6.50	7.00	2.88qt	TCR06Tg0 TCF06SG0 TRPTGALO TCW03TG0 TIS1G060	128	
<b>7.00 Elite Azalea</b>								
AZE07000	<b>DLNAZE07000B66C250</b>	Green	7.00	5.00	2.20qt	-	250	
<b>7.50 Elite Azalea</b>								
AZE07500	<b>DLNAZE07500B66C200</b>	Green	7.50	5.50	2.73qt	-	200	
<b>8.00 Elite Azalea</b>								
AZE08000	<b>DLNAZE08000B66C270</b>	Green	8.00	5.62	3.85qt	-	270	
<b>8.00 Standard Stock Thinwall</b>								
STS08000	<b>DLNSTS08000G18C100</b> <b>DLNSTS08000B66C100</b>	Black Green	8.43	7.12	1.01gal	HZIP3C101 HZIP3E103	100	

P = Offset printing available



Leader in Horticultural Containers

Injection Molded Containers

The HC Companies® Round Containers

Made from high-grade polypropylene. Bulk packaging available for most sizes, making shipping and storage more efficient and providing additional savings to the grower. Various sizes are created and customizable with offset printing capabilities.

Standard Colors



Part Code	BFG Product #	Color	Dimensions in Inches		Max Liquid Volume	Tray Compatibility	QTY	Barcode	
			Outside Diam.	Height					
8.00 x 5.00 Mum Pan									
AZM08000	P	<b>DLNAZM08000G18C150</b>	Black	8.00	5.06	3.07qt	TCM04800	150	
8.00 Bulb Pan									
PAN08001		<b>DLNPAN08001B66C096</b>	Green	8.13	4.00	2.86qt	-	96	
8.00 Azalea Thinwall with TagSlot									
AZG08501	P	<b>DLNAZG08501B66C130</b> <b>DLNAZG08501G18C130</b>	Green Black	8.31	5.81	3.85qt	-	130	
9.00 x 6.50 Mum Pan Thinwall									
AZM09000	P	<b>DLNAZM09000E24B053</b> <b>DLNAZM09000E24C054</b> <b>DLNAZM09000G18C054</b>	Terra Cotta Black	9.00	6.56	1.25gal	-	54 BULK: 5,3000	
10.00 Elite Azalea									
AZE10001		<b>DLNAZE10001B66C150</b>	Green	9.87	7.25	1.58gal	-	150	
AZE10000		<b>DLNAZE10000G18C100</b>	Black	10.00	7.14	1.65gal	-	100	
10.00 Bulb Pan									
PAN10001		<b>DLNPAN10001B66C096</b>	Green	10.06	5.06	1.32gal	-	96	

P = Offset printing available





Leader in  
Horticultural  
Containers

### The HC Companies® Pocket Carry Tray - Round Pots

Durable and rigid construction delivers consistent handling performance in every step of the supply chain. Designed to work on roller conveyors and automated potting systems. Works well in automated tray dispensers.

#### Carry Trays



TRS06170

TCR06TG0

XTR10400

TRS15409

XTR15400

TCG08430

XTG10430

TCG10430

TCG08450

TCG12450

XTG15450

TCG10450

Part Code	BFG Product #	Color	Dimensions in inches			Pot Compatibility	QTY	Barcode	
			Length	Width	Height				
6-Pocket Tray for Round 17cm Co-Ex Pots									
TRS06170	WM	<b>DLNTRS06170G18D050</b>	Black	20.25	13.25	5.00	EU170T50	50	
6 Pocket Geranium Carry Tray for 1 Gallon Round Pots									
TCR06TG0		<b>DLNTR06TG0G18C050</b>	Black	20.62	13.87	7.12	NRT0T1G3	50	
10-Pocket Tray for 4.00 Co-Ex Pots									
XTR10400	WM	<b>DLNXTR10400G18C050</b>	Black	20.62	8.25	4.00	XST04002	50	
15-Pocket Tray for 4.00 Azalea & Standard Round Pots									
TRS15409		<b>DLNTRS15409G18D050</b>	Black	20.25	12.12	3.63	STG04000	50	
15-Pocket Tray for 4.00 Co-Ex Pots									
XTR15400		<b>DLNXTR15400G18C050</b>	Black	20.55	12.29	4.00	XST04002	50	
8-Pocket Geranium Carry Tray Spaced for 4.25 Round Pots									
TCG08430		<b>DLNTR08430G18C050</b>	Black	20.00	10.00	4.25	STG04253	50	
10-Pocket Tray for 4.25 Co-Ex Round Pots									
XTG10430		<b>DLNXTG10430G18C050</b>	Black	21.00	8.50	5.50	XGR04251	50	
10-Pocket Geranium Carry Tray For 4.25 Round Pots									
TCG10430		<b>DLNTR0430G18C050</b>	Black	21.50	8.37	4.25	STG04253	50	
8-Pocket Geranium Carry Tray For 4.50 Round Pots									
TCG08450		<b>DLNTR08450G18C050</b>	Black	19.62	10.00	4.00	STG04500 STD04500	50	
10-Pocket Geranium Carry Tray For 4.50 Pots									
TCG12450		<b>DLNTR12450G18C050</b>	Black	18.25	14.00	3.75	STG04500 STD04500	50	
15-Pocket Tray for 4.50 Co-Ex Pots									
XTG15450		<b>DLNXTG15450G18C050</b>	Black	23.00	14.00	3.75	XGR04500	50	
10-Pocket Offset Geranium Carry Tray for 4.50 Round Pots									
TCG10450		<b>DLNTR10450G18C050</b>	Black	21.25	8.50	5.38	XAL04253	50	





Leader in  
Horticultural  
Containers

**The HC Companies® Pocket Carry Tray - Round Pots**  
Durable and rigid construction delivers consistent handling performance in every step of the supply chain. Designed to work on roller conveyors and automated potting systems. Works well in automated tray dispensers.

**Carry Trays**

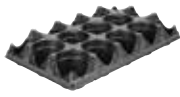

TCG15450



XTG10450



TRS10450



TRS15459



TCR081Q4



TCA08503



TCA08500



TCA06605



TCR06600



TCA06600



TCF06SG0

Part Code	BFG Product #	Color	Dimensions in inches			Pot Compatibility	QTY	Barcode
			Length	Width	Height			
15-Pocket Geranium Tray For 4.50 Pots								
TCG15450	DLNXTG15450G18C050	Black	22.75	13.75	4.00	STG04500 STD04500	50	
10-Pocket Tray for 4.50 Co-Ex Pots								
XTG10450	DLNXTG10450G18B015 DLNXTG10450G18C050	Black	23.00	9.50	3.75	XGR04500	50 BULK: 1,500	
10-Pocket Tray for 4.50 Azalea & Standard Round Pots								
TRS10450	DLNTRS10450G18D050	Black	23.25	9.37	4.00	XGR04500 STG04500 STD04500 AZE04500	50	
15-Pocket Tray for 4.50 Azalea & Standard Round Pots								
TRS15459	K DLNTRS15459G18D050	Black	22.50	13.75	4.00	STD04500 AZE04500	50	
8-Pocket Reveal Carry Tray for 1.00 Quart Round Pots								
TCR081Q4	DLNTR081Q4G18C050	Black	19.50	10.00	4.75	NRT001Q1	50	
8-Pocket Azalea Carry Tray for 5.00 Co-Ex Round Pots								
TCA08503	DLNTCA08503G18C050	Black	19.87	9.87	3.75	XAZ05000	50	
8-Pocket Azalea Carry Tray For 05.00 Azalea								
TCA08500	DLNTCA08500G18C050	Black	19.87	9.87	3.75	AZE05000	50	
6-Pocket Azalea Carry Tray for 6.00 Co-Ex Round Pots								
TCA06605	DLNTCA06605G18C050	Black	18.50	12.37	4.25	XAZ06001	50	
6-Pocket Carry Tray for 6.00 Round Pots								
TCR06600	DLNTR06600G18C050	Black	18.50	12.37	5.00	XST06000, STG06000	50	
6-Pocket Azalea Carry Tray For 6.00 Round Pots								
TCA06600	DLNTCA06600G18C050	Black	18.50	12.37	4.37	AZA06000	50	
6-Pocket Tray for 1.00 Round Trade Gallon Pots								
TCF06SG0	DLNTR06600G18C050	Black	20.00	13.00	2.50	XNS0T1G3 NRT0T1G3	50	

K = Heavy, thick wall version available | WM = Compatible with water mat irrigation



Leader in  
Horticultural  
Containers

### Carry Trays

#### The HC Companies® Universal Spacer Tray

- Self adjusting pot cavities for multiple sized containers to fit the same tray.
- Perfect for spacing containers for optimal plant growth
- Tall pot wells support pots for easy handling of fully loaded trays.



Part Code	Item #	Color	Dimensions in Inches			Pot Compatibility	QTY	Barcodes
			Length	Width	Height			
1.00 Trade Gallon Pot 6-Pocket Universal Injection Spacer Tray								
TIS66651	<b>DLNTIS66651G18D025</b> <b>DLNTIS66651G18B013</b>	Black	19.00	12.60	2.60	XRD16002, XNS0T1G3, NSR001G0, NBB001G0, NRS0T1G0, TFR001G0, TFH001G0, TFT025Q0, BM.03000, BMS03000	25 BULK: 1,350	

#### The HC Companies® Injection Spacer Trays - Round Pots

Open design provides optimal air circulation which prevents algae bloom and stimulates plant growth. Lock pots safely inside the tray making them ideal for multiple transport, growing, and shipping applications. Also perfect for capillary mats, ebb and flood, or flooded floor watering systems

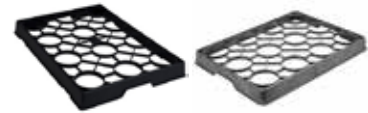

Part Code	Item #	Color	Dimensions in Inches			Pot Compatibility	QTY	Barcodes
			Length	Width	Height			
4.00 Pot 12 Pocket Injection Spacer Tray								
TIS40120	<b>DLNTIS40120G18D025</b>	Black	19.50	14.25	2.00	XST04002	25	
4.50 Pot 12 Pocket Injection Spacer Tray								
TIS45120	<b>DLNTIS45120G18D025</b>	Black	21.62	16.00	2.00	XGR04500, STG04500 STD04500	25	





Leader in Horticultural Containers

**Thermoformed & Coextruded Containers**

**The HC Companies® Deep Press Fit Pot (Square)**

Co-extruded with dual color layering with a dark interior for maximum root protection from light. Lightweight, yet durable polypropylene for greater cost efficiency. Multi-level drain holes for efficient drainage. Strong rims for efficient use in high-speed automated systems.



SVP03001



SVP03250



SVP03252



SPV04001



SPV04501



SVP0450D



XSQ00M60



XSQ05500

Part Code	BFG Product #	Color	Dimensions in Inches		Max Liquid Volume	Tray Compatibility	Qty	Barcode	
			Outside Diam.	Height					
3.00 Square Deep Vacuum Pot - Press Fit									
SVP03001	WM	DLNSVP03001G18C800	Black	2.62	3.50	9.47oz	TCS32300, TCS25300, TCS14301	800	
3.25 Square Deep Vacuum Pot									
SVP03250		DLNSVP03250G18K120	Black	3.25	3.62	1.00pt	TCS12330, TCS18330	1,200	
3.25 Square Deep Vacuum Pot - Press Fit									
SVP03252		DLNSVP03252G18C450	Black	3.25	3.62	15.50oz	TCS12330, TCS18330	450	
4.00 Square Deep Vacuum Pot - Press Fit									
SPV04001		DLNSVP04001G18C450	Black	3.50	3.50	1.08pt	TCS8401	450	
4.50 Square Vacuum Pot - Press Fit									
SVP04501		DLNSVP04501G18C375	Black	4.12	3.62	1.65pt	TCS10452, TCS12450, TCS15451	375	
4.50 Square Deep Vacuum Pot - Press Fit									
SVP0450D		DLNSVP0450DG18C375	Black	4.12	5.00	1.20qt	TCS15451, TCS15452, TCS12450, TCS10452	375	
5.00 M6 Square Pot									
XSQ00M60	WM	DLNSXQ00M60G18C468	Black	5.00	5.37	1.50qt	TCS08M60	468	
5.50 Square 2 Quart Pot									
XSQ05500		DLNSXQ05500G18C200	Black	5.25	6.00	2.00qt	TCS08551	200	

WM = Compatible with water mat irrigation



Leader in Horticultural Containers

**Injection Molded Containers**

**The HC Companies® Traditional Thinwall Pot (Square)**

High quality construction for maximum root protection from light penetration.



Part Code	Item #	Color	Dimensions in Inches		Max Liquid Volume	Tray Compatibility	QTY	Barcode
			Outside Diam.	Height				
<b>3.50 Square Traditional Pot</b>								
SQN03500	<b>DLNSQN03500B66C504</b>	Green	3.50	3.00	12.20oz	TKP18350, TRK12350	504	
<b>4.00 Square Traditional Pot Thinwall</b>								
SQA04000	<b>DLNSQA04000B66C900</b>	Green	3.87	3.37	1.16pt	TCS15400	900	
<b>4.00 Square Pot with TagSlot Thinwall</b>								
SQK04001	<b>DLNSQK04001B66C846</b> <b>DLNSQK04001G18C846</b>	Green Black	3.96	3.62	1.35pt	TRK15400, TRK15400 (K), TRK10400	846	
<b>4.00 Kord Lite Square Pot</b>								
SQK04005	<b>DLNSQK04005B66C960</b> <b>DLNSQK04005G18C960</b>	Green	4.00	3.50	1.36pt	TRK15400, TRK15400 (K) TCS15401, TRK10400	960	
<b>4.50 Square Traditional Thinwall</b>								
SQA04500	<b>DLNSQA04500B66C765</b>	Green	4.12	3.50	1.35pt	TCS15450	765	
<b>5.50 Jumbo Square Thinwall Pot with TagSlot</b>								
SQJ05502	<b>DLNSQJ05502G18C288</b> <b>DLNSQJ05502G18B100</b>	Black	5.03	5.62	1.89qt	TCS08M60	288 BULK: 10,000	



**The HC Companies® 4.50 Square Quick Lock Pot**

Four levels of drainage that are water mat compatible. Features WaveLock tag slots on all four sides (top and bottom insertion keeps tags in place). Can be easily inserted into Quick Lock trays for manual automation. Designed to allow for ease of denesting in automated filling equipment.



Part Code	Item #	Color	Dimensions in Inches		Max Liquid Volume	Tray Compatibility	QTY	Barcode
			Outside Diam.	Height				
<b>4.25 Square Quick Lock Pot with WaveLock TagSlot</b>								
SQQ04500	<b>DLNSQQ04500G18C660</b> <b>DLNSQQ04500G18B348</b> <b>DLNSQQ04500B66C660</b> <b>DLNSQQ04500B66B348</b> <b>DLNSQQ04500A10C660</b>	Black Green White	4.25	3.84	1.59pt	TRK15450 (K), TRK12450, TRK10450, TRK10451	660 BULK: 34,848	



Leader in Horticultural Containers

**Injection Molded Containers**



**The HC Companies® Deep Perennial Systems Pot**

Designed with large soil capacity to specifically accommodate perennial root systems. Use in conjunction with trays to assist in handling and labor savings.

Part Code	Item #	Color	Dimensions in Inches		Max Liquid Volume	Tray Compatibility	QTY	Barcode
			Outside Diam.	Height				
Square Deep Perennial Pot with TagSlot								
SQL03501	<b>DLNSQL03501G18C832</b> <b>DLNSQL03501B16B300</b>	Black	3.37	3.93	1.01qt	TCS18350, TCS12330, TCS18351	832	
							BULK: 30,000	
SQL04501	<b>DLNSQL04501G18C441</b>	Black	4.21	4.93	1.03qt	TCS15452, TCS10450	441	
SQL05502	<b>DLNSQL05502G18C256</b>	Black	5.25	5.93	2.04qt	TCS08550	256	



**The HC Companies® Square Pot with Wave Lock®**

Guaranteed to denest in automation. Unique, secure, anti-theft Wave-Lock for easy tag installation (top or bottom). Fits both hanging tags and upright tags with locking capability. Four levels of drainage for all irrigation types - flood floor, watermat (WM), standard drip. Includes side drip to maximize flood floor watering.

Part Code	Item #	Color	Dimensions in Inches		Max Liquid Volume	Tray Compatibility	QTY	Barcode
			Outside Diam.	Height				
4.00 Square Pint with Wave Lock								
SQU03500	<b>DLNSQU03500G18C864</b>	Black	3.33	4.12	1.00pt	TCS12331, TCS18331	BULK: 34,560	
4.00 Square Quart with Wave Lock								
SQU04000	<b>DLNSQU04000G18B220</b>	Black	3.94	5.78	1.00qt	TSI104Q0, TCS10406	BULK: 22,032	

**Carry Trays**

**The HC Companies® Ribbed Carry Tray (Square Pots - Deep Perennial Systems Tray)**

Durable and rigid construction delivers consistent handling performance in every step of the supply chain. Designed to work on roller conveyors and automated potting systems. Works well in automated tray dispensers.



TCS10450



TCS08551

Part Code	BFG Product #	Color	Dimensions in Inches			Pot Compatibility	QTY	Barcode
			Length	Width	Height			
10-Pocket Square Carry Tray - Short Ribbed								
TCS10450	<b>DLNTCS10450G18C050</b>	Black	21.00	8.50	3.00	SQL04501	50	
8-Pocket Carry Tray for 5.50in Square Pots								
TCS08551	<b>DLNTCS08551G18C050</b>	Black	21.25	10.62	3.87	XSQ05500, SQL05502	50	



Leader in  
Horticultural  
Containers

### Carry Trays

#### The HC Companies® Ribbed Carry Tray (Square Pots)

Durable and rigid construction delivers consistent handling performance in every step of the supply chain. Designed to work on roller conveyors and automated potting systems. Works well in automated tray dispensers. Select trays are ideal for water mat irrigation systems, see the "WM" symbol for exact compatibility.



TCS32300



TCS12330



TCS18330



TCS18401



TRK15400



TCS10452



TCS15451



TRK10450



TCS08M61



TCS08M60

Part Code	BFG Product #	Color	Dimensions in Inches			Pot Compatibility	QTY	Barcodes
			Length	Width	Height			
32-Pocket Carry Tray for 3.00in Square Press Fit Pots								
TCS32300	<b>DLNTCS32300G18C050</b>	Black	21.12	10.62	1.87	SVP03001	50	
12-Pocket Carry Tray for 3.25in Square Pot								
TCS12330	<b>DLNTCS12330G18C100</b>	Black	19.50	6.62	1.87	SVP03250, SVP03252	100	
18-Pocket Carry Tray for 3.25in Square Press Fit Pots								
TCS18330	<b>DLNTCS18330G18C050</b>	Black	19.87	9.87	1.87	SVP03250, SVP03252	50	
18-Pocket Carry Tray for 4.00in Square Press Fit Pots								
TCS18401	<b>DLNTCS18401G18C050</b>	Black	21.25	10.63	2.38	SVP04001, INP18011	50	
15-Pocket Tray for 4.00in Square Injection Pots								
TRK15400	<b>DLNTRK15400G18D050</b>	Black	20.25	12.25	2.00	SQV00940, SQK04001, INP15400	50	
10-Pocket Carry Tray for 4.50in Square Press Fit Pots								
TCS10452	<b>DLNTCS10452G18C050</b>	Black	21.25	8.62	2.00	SVP04501, SVP0450D	50	
15-Pocket Carry Tray for 4.50in Square Injection Press Fit Pots								
TCS15451	<b>DLNTCS15451G18C050</b>	Black	21.25	13.00	2.00	SVP04501, SVP0450D	50	
10-Pocket Carry Tray for 4.50in Square Injection Pots								
TRK10450	<b>DLNTRK10450G18D050</b>	Black	21.00	8.50	2.00	SQQ04500	50	
8-Pocket Carry Tray for 6.00in Square Pots								
TCS08M61	WM <b>DLNTCS08M61G18B020</b>	Black	19.75	9.875	3.75	XSQ00M60, SQJ05502	2,000	
8-Pocket Carry Tray for 6.00in Square Pots								
TCS08M60	<b>DLNTCS08M60G18C050</b>	Black	19.75	9.87	3.75	XSQ00M60, SQJ05502	50	

WM = Compatible with water mat irrigation



Leader in Horticultural Containers

Carry Trays

The HC Companies® Ribbed Carry Tray (Square Pots)

Durable and rigid construction delivers consistent handling performance in every step of the supply chain. Designed to work on roller conveyors and automated potting systems. Works well in automated tray dispensers. Select trays are ideal for water mat irrigation systems, see the “WM” symbol for exact compatibility.



TKP18350



TCS15400



TCS15401



TCS18351

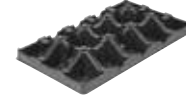

TCS15450



TCS15452



TRK15450



TCS10406



TRT184T0

Part Code	BFG Product #	Color	Dimensions in Inches			Pot Compatibility	QTY	Barcodes
			Length	Width	Height			
18-Pocket Tray For 3.50 Square Injection Pots								
TKP18350	<b>DLNTP18350G18C050</b>	Black	20.50	10.50	2.25	SQN03500, INP18350	50	
15-Pocket Carry Tray For 4.00in Square Injection Pots								
TCS15400	<b>DLNTP15400G18C050</b>	Black	19.50	11.75	3.37	SQA04000	50	
15-Pocket Square Carry Tray For 4.00 Pot ( Locator Lock)								
TCS15401	<b>DLNTP15401G18C050</b>	Black	20.25	12.25	2.00	SQK04001	50	
18-Pocket Square Tray For 3.25 Pot (Press Fit)								
TCS18351	<b>DLNTP18351G18C050</b>	Black	19.875	9.875	1.87	SQL03501	50	
15-Pocket Carry Tray For 04.50in Square Injection Pot								
TCS15450	<b>DLNTP15450G18C050</b>	Black	20.63	12.50	3.50	INP45150, SQA04500, SQL04501	50	
15-Pocket Square Carry Tray For 04.50 Pot (Press Fit)								
TCS15452	<b>DLNTP15452G18C050</b>	Black	21.25	13.00	2.00	SQK04501	50	
15-Pocket Tray For 04.50in Square Injection Pot								
TRK15450	<b>DLNTP15450G18C050</b>	Black	21.25	12.75	2.00	SQN04500, SQQ04500	50	
10-Pocket Tray For 4.00 Square Co-Ex Pots								
TCS10406	<b>DLNTP10406G18B022</b>	Black	19.87	7.88	2.65	SQU04000	2,200	
18-Pocket Tray For 1801 Deep Insert								
TRT184T0	<b>DLNTP184T0G18D050</b>	Black	20.00	10.00	2.25	IJT18010	50	



Leader in Horticultural Containers

Carry Trays

The HC Companies® Jr Market Basket with Handle

Injection molded polypropylene. Holds up to eight 3.5in square traditional pots.



White - 15in L x 8in W x 4in H - Max Liquid Volume: 6.34qt  
DLNMPB08350A103050 Min. Buy 1cs/ 50ea



The HC Companies® Utility Handle

Injection molded polypropylene handles for basket packs. Compatible Packs: IJS01201, IJS02240, IJT01080



White - 16.25in  
DLNSPH2DPC0A10K100 Min. Buy 1cs/ 1000ea



Specialty Containers

The HC Companies® Support Systems

Designed to aid in healthy, upright growth of a wide range of top-heavy plants. Cage systems fit The HC Companies Thinwall pots, Hanging Poinsettia Pots, Standard Stock Pots and 10 Color Pot 3 for added convenience. Support rings are a cost-effective alternative for tall plant support and are compatible with any pot size.



Azalea Cages

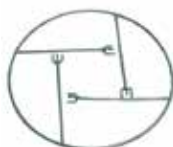

Azalea Support Rings



Point Cages

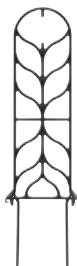

Support Trellis



Part Code	Item #	Color	Dimensions in inches		Pot Compatibility	QTY	Barcodes
			Length	Height			
Azalea Cages							
SPG06501	<b>DLNSPG06501B66C060</b>	Green/CS	8.00	4.75	AZA06500	60	
Azalea Support Rings							
SR.07000	<b>DLNSR07000B66C720</b>	Green/CS	7.00	4.37	AZE07000	720	
Point Cages							
SPG08001	<b>DLNSPG08001B66C100</b>	Green/CS	10.00	5.00	STS08000	100	
Support Trellis							
SPT001G0	<b>DLNSPT001G0G18C128</b>	Black/CS	-	17.00	NRT051G3	128	





Leader in Horticultural Containers

**Hanging Baskets**

**The HC Companies® Traditional Hanging Baskets**

Traditional and classic design. Inside divider featuring center drain with water reservoir. Greater soil volume for larger plants. Available accessories: 3-strand plastic “snap” or wire hangers for 6in, 8in, 10in or 11in hanging baskets, 4-strand plastic “snap” hanger for 12in hanging baskets.

Standard Colors



HTI10002



HTS10000



HTI10754



HTS11002



HTI12000



HTS12000



HTO08750



HTO10752



HTO11501

Part Code	BFG Product #	Color	Dimensions in Inches		Max Liquid Volume	Hanger Compatibility	Disk	QTY	Barcode
			Outside Diam.	Height					
Traditional Saucerless Hanging Basket									
HTI10002	<b>DLNHTI10002B661050</b> <b>DLNHTI10002B66B032</b>	Green	10.00	5.81	1.40gal	HZP3E100, HZP3E103, HZS21002, HZP3LSNO	SDD10000	50 BULK: 3,200	
HTS10000	<b>DLNHTS10000A101050</b> <b>DLNHTS10000B661050</b> <b>DLNHTS10000B66B030</b>	White Green	10.75	5.87	1.47gal	HZP3E100, HZP3E103, HZS21002, HZP3LSNO, HZS21002	SDD10000	50 BULK: 3,000	
HTI10754	<b>DLNHTI10754A101050</b> <b>DLNHTI10754A10B024</b> <b>DLNHTI10754B661050</b> <b>DLNHTI10754B66B024</b>	White Green	10.75	6.93	1.64gal	HZP3E103, HZP3E100, HZS.L170, HZS.L210, TIA10000	SDD10000	50 BULK: 2,400	
HTS11002	<b>DLNHTS11002A101050</b> <b>DLNHTS11002B661050</b> <b>DLNHTS11002B66B035</b>	White Green	10.75	6.50	1.73gal	HZP3E100, HZP3E103, HZS21002, HZP3LSNO, HZS21002	SDD10000	50 BULK: 3,500	
HTI12000	<b>DLNHTI12000A101050</b> <b>DLNHTI12000A10B018</b> <b>DLNHTI12000B661050</b> <b>DLNHTI12000B66B018</b> <b>DLNHTI12000E321050</b>	White Green Terra Cotta	12.00	7.12	2.21gal	HZP4E120, HZS.L210, HZS.L240, HZP4E120	SDD12000	50 BULK: 1,800	
HTS12000	<b>DLNHTS12000A101050</b> <b>DLNHTS12000A10B018</b> <b>DLNHTS12000B661050</b> <b>DLNHTS12000B66B018</b>	White Green	13.00	7.50	2.77gal	HZP4E120, HZS.L240, HZPALSNO	SDD12000	50 BULK: 1,800	
Traditional Hanging Basket With Saucers									
HTO08750	<b>DLNHTO08750A101050</b> <b>DLNHTO08750B661050</b>	White Green	8.75	5.06	2.86qt	HZP3E103, HZP3E100, HZS.L170, HZS.L210	-	50	
HTO10752	<b>DLNHTO10751A101050</b> <b>DLNHTO10752A10B024WS</b> <b>DLNHTO10752B661050</b> <b>DLNHTO10752B66B024WS</b>	White Green	10.75	6.90	1.60gal	HZS.L170, HZS.L210, HZP3E103, HZP3E100, HZS21002	-	50 BULK: 2,400	
HTO11501	<b>DLNHTO11501A101050WS</b> <b>DLNHTO11501B661050WS</b>	White Green	11.70	6.50	1.77gal	HZP4E120, HZSL240	-	50	



Leader in  
Horticultural  
Containers

### Hanging Baskets

#### The HC Companies® Decostone Collection Hanging Basket

Flexible, sturdy containers are perfect for patio, porch, or deck use, adding charm to any location. Constructed from convenient and durable lightweight resin for easy care. Accommodate metal or plastic hangers



Part Code	BFG Product #	Color	Dimensions in Inches		Max Liquid Volume	Hanger Compatibility	QTY	Barcode
			Outside Diam.	Height				
Decostone Hanging Basket								
SHH12000	<b>DLNSHH12000E261050</b>	Standstone	12.87	7.00	2.17gal	HZP4E120	50	

#### The HC Companies® Centabella Collection Hanging Basket

Classic, fluted design. Engineered for high volume production in commercial grower applications.



Part Code	BFG Product #	Color	Dimensions in Inches		Max Liquid Volume	Hanger Compatibility	QTY	Barcode
			Outside Diam.	Height				
Centabella Hanging Basket with TagSlot								
CBH11000	<b>DLNCBH11000E221100</b>	Clay	10.87	7.00	1.81gal	HZPLSN0	100	
CBH12000	<b>DLNCBH12000E221050</b> <b>DLNCBH12000E261050</b> <b>DLNCBH12000E26B030</b>	Clay Sandstone	12.37	7.00	2.30gal	HZP4E120, HZPAMSN0	50	
							BULK: 3,000	
CBH13000	<b>DLNCBH13000E221050</b>	Clay	13.00	7.50	2.80gal	HZP4E120, HZPAMSN0	50	

#### The HC Companies® Kord Hanging Basket

Traditional design basket that includes a large water reservoir for better plant performance and superior aeration with high-chimney capillary dish side air vents.



Part Code	BFG Product #	Color	Dimensions in Inches		Max Liquid Volume	Hanger Compatibility	QTY	Barcode
			Outside Diam.	Height				
Kord Hanging Basket								
HNI10000	<b>DLNHNI10000A102100</b> <b>DLNHNI10000B662100</b>	White Green	10.75	6.75	1.66gal	HZP3LSN0, HZP3E1000	100	
HNI12000	<b>DLNHNI12000A102050</b> <b>DLNHNI12000B662050</b>	White Green	12.75	7.50	2.74gal	HZP4E120, HZP4MSN0	50	



Leader in Horticultural Containers

**Hanging Baskets**

**The HC Companies® Mojave Hanging Basket**

Authentic look and texture of stone with a classic swirl design. Finish is UV protected and can be used indoor or outdoors. Includes inner reservoir disk and hanger.



Part Code	BFG Product #	Color	Dimensions in Inches		Max Liquid Volume	Hanger Compatibility	Dish	QTY	Barcode
			Outside Diam.	Height					
Mojave Hanging Basket									
MOH14000	<b>DLNMOH14000A05C012</b> <b>DLNMOH14000E02C012</b>	Standstone Mesquite	15.00	7.75	3.38gal	HZPAW140	MOD14000	12	

**The HC Companies® Cascade Series Hanging Basket**

Renowned for its stylish swirled design, this saucerless hanging basket has an internal capillary dish that creates a reservoir to promote longer plant life. Accommodates metal or plastic hangers - sold separately.



Part Code	BFG Product #	Color	Dimensions in Inches		Max Liquid Volume	Hanger Compatibility	QTY	Barcode
			Outside Diam.	Height				
Cascade Series Hanging Basket								
HCA1000	<b>DLNHCA10000A101100</b> <b>DLNHCA10000A10B048</b> <b>DLNHCA10000B661100</b>	White Green	10.00	6.12	1.34gal	HZP3E102, HZPE3100, HZS.L170, HZS.L210, TIA10000	100 BULK: 4,800	

**The HC Companies® Tuscan Saucerless Hanging Baskets**

A "fluted" design gives this hanging basket a bold, impressive appearance. Features a bottom water reservoir and center drain.



Part Code	BFG Product #	Color	Dimensions in Inches		Max Liquid Volume	Hanger Compatibility	QTY	Barcode
			Outside Diam.	Height				
Tuscan Series Hanging Basket								
TUH10000	<b>DLNTUH10000A101100</b> <b>DLNTUH10000A10B048</b> <b>DLNTUH10000B661100</b>	White Green	10.00	5.78	1.27	HZP3E103, HZP3E100, HZS.L170, HZS.L210	100 BULK: 4,800	

**The HC Companies® Cordova Collection Hanging Basket**

Flexible, sturdy containers are perfect for patio, porch, or deck use, adding charm to any location. Constructed from convenient and durable lightweight resin for easy care. Accommodate metal or plastic hangers.



Part Code	BFG Product #	Color	Dimensions in Inches		Max Liquid Volume	Hanger Compatibility	QTY	Barcode
			Outside Diam.	Height				
Cordova Hanging Basket								
CDH12000	<b>DLNCDH12000E221025</b>	Clay	13.00	8.50	3.14gal	HZP4E120, HZS12HA0	25	



Leader in  
Horticultural  
Containers

### Hanging Baskets

#### The HC Companies® Panterra Series Hanging Basket

Traditional and classic design. Includes inside divider, featuring center drain with water reservoir. Greater soil volume for larger plants.



Part Code	Item #	Color	Dimensions in Inches		Max Liquid Volume	Hanger & Tray Compatibility	Disk	QTY	Barcode
			Outside Diam.	Height					
Panterra Hanging Basket with TagSlot									
HPI10000	<b>DLNHPI10000E221100</b>	Clay	10.37	6.00	1.36gal	HZP3LSNO, NZS.L210	SDD1000	100	

#### The HC Companies® Euro Series Hanging Basket

Renowned for its stylish swirled design, saucerless hanging basket. Hangers sold separately. 8in size features three tag slots and a new style chimney which eliminates the need for a cap dish.



Part Code	Item #	Color	Dimensions in Inches		Max Liquid Volume	Hanger & Tray Compatibility	Disk	QTY	Barcode
			Outside Diam.	Height					
Euro Saucerless Hanging Basket									
HSI06000	<b>DLNHSI06000A101100</b> <b>DLNHSI06000B661100</b>	White Green	6.50	4.25	1.59qt	HZP3E100, HZP3E100, HZS.L170	SCD0800	100	
HSI08008	<b>DLNHSI08008A101050</b> <b>DLNHSI08008B661050</b>	White Green	8.00	5.56	3.23qt	HZP3E103, HZP3E100, HZS.L170, HZS.L210	-	50	
HSI1000B	<b>DLNHSI1000BA101050</b> <b>DLNHSI1000BB661050</b>	White Green	10.00	6.12	1.39	HZP3E103, HZP3E100, HZS.L170, HZS.L210, HZS21002, TIA1000	SDD10000	50	
HSI12000	<b>DLNHSI12000A101050</b> <b>DLNHSI12000A10B020</b> <b>DLNHSI12000B661050</b> <b>DLNHSI12000B66B020</b>	White Green	11.75	7.25	2.39gal	HZP4E120, HZS.L240	SDD10000	50	
								BULK: 2080	



#### The HC Companies® Elite Series Hanging Basket

A "fluted" design gives this hanging basket a bold, impressive appearance. Features a bottom water reservoir and center drain. Hangers sold separately.

Part Code	Item #	Color	Dimensions in Inches		Max Liquid Volume	Hanger & Tray Compatibility	Disk	QTY	Barcode
			Outside Diam.	Height					
Elite Series Hanging Basket									
HES10001	<b>DLNHES10001A101050</b> <b>DLNHES10001B661050</b> <b>DLNHES10001B66B032</b>	White Green	10.00	6.12	1.41gal	HZP3E103, HZP3E100, HZS.L170, HZS.L210, TIA1000	SDD1000	50 BULK: 3,200	



Leader in Horticultural Containers

**Hanging Baskets**



**The HC Companies® Ultra Series Hanging Basket**

Classic style with a rough textured finish, featuring large soil volume for larger plants. Inside divider featuring center drain water reservoir. TagSlot for plant identification details. Hangers sold separately.

Part Code	Item #	Color	Dimensions in Inches		Max Liquid Volume	Hanger & Tray Compatibility	Disk	QTY	Barcode
			Outside Diam.	Height					
Ultra Series Hanging Basket									
ULH11000	<b>DLNULH11000E26C100</b> <b>DLNULH11000E30C100</b>	Sand Taupe	11.00	6.50	1.65gal	HZP3LSN0, HZP3E100	SDD1000	100	
ULH12000	<b>DLNULH12000E261050</b>	Sand	12.00	7.00	2.15gal	HZP4E120, HZP4MSN0, NZP4E120	SDD1000	50	

**The HC Companies® Wrapt Hanging Basket**

Injection molded polypropylene hanging basket. Hangers not included.



Part Code	Item #	Color	Dimensions in Inches		Max Liquid Volume	Hanger & Tray Compatibility	Disk	QTY	Barcode
			Outside Diam.	Height					
Wrapt Hanging Basket									
HWA11005	<b>DLNHWA11005G181025</b> <b>DLNHWA11005E211025</b> <b>DLNHWA11005E21B036</b> <b>DLNHWA11005B661025</b> <b>DLNHWA11005B66B036</b> <b>DLNHWA11005E261025</b>	Black Chocolate Green Sandstone	11.00	6.55	1.70gal	HZP3E103, HZS.L210	SDD1000	25  BULK: 3,600	
HWA13001	<b>DLNHWA13001G181025</b> <b>DLNHWA13001G18B025</b> <b>DLNHWA13001E211025</b> <b>DLNHWA13001B661025</b> <b>DLNHWA13001E261025</b>	Black Chocolate Green Sandstone	13.00	7.75	2.73gal	HZP4E120, HZS.L4W0	SDD1000	25  BULK: 2,520	

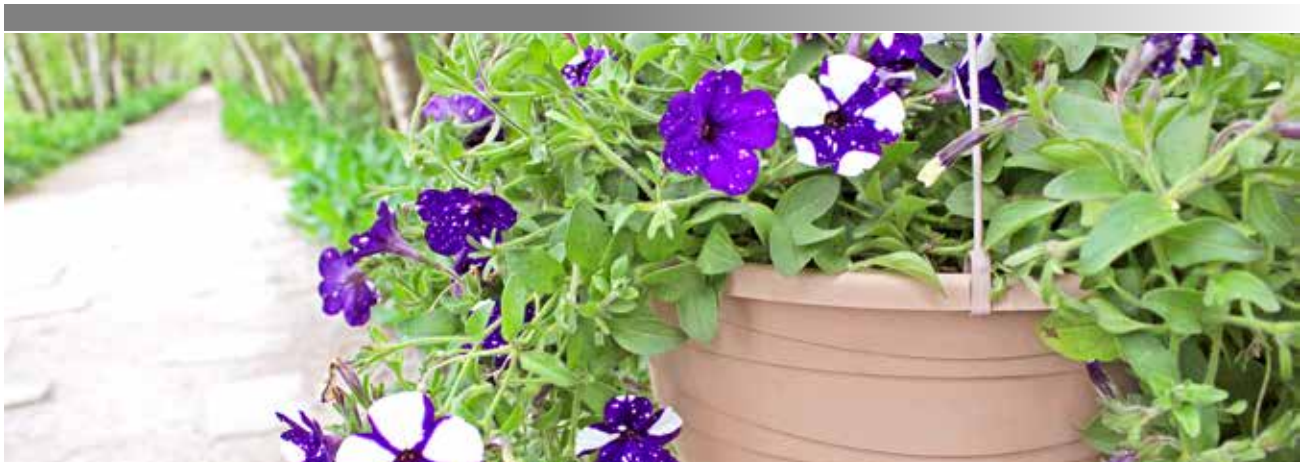



Leader in  
Horticultural  
Containers

### Hanging Baskets



#### The HC Companies® Color Series Hanging Basket

Flexible yet sturdy plastic containers with drainage holes in bottom. Perfect for patio, porch or deck.

Part Code	Item #	Color	Dimensions in Inches		Max Liquid Volume	Hanger & Tray Compatibility	QTY	Barcode
			Outside Diam.	Height				
Color Series Saucerless Hanging Basket								
CPH12000	<b>DLNCPH12000E221025</b>	Clay Mocha	12.18	7.25	2.29	HXP4E120, HZP4E121	25	
	<b>DLNCPH12000E22B018</b>						BULK: 1,800	
	<b>DLNCPH12000E321025</b>							

#### The HC Companies® East Wind RiverStone Hanging Basket

East Wind series hanging baskets come in a number of classic styles and finishes. Baskets features chimney style drainage. Inspired by natural and robust textures with a premium high-quality, glossy finish finish. Made from durable polypropylene.



Part Code	Item #	Color	Dimensions in Inches		Max Liquid Volume	Hanger & Tray Compatibility	Disk	QTY	Barcode
			Outside Diam.	Height					
East Wind RiverStone Hanging Basket									
YVH12000	<b>DLNYVH12000Y166025</b>	Rosso Sulfur	12.00	7.00	2.50gal	HZP4E120	SDD10000	25	
	<b>DLNYVH12000Y176025</b>								

#### The HC Companies® Roman Hanging Basket

Roman Saucerless Hanging Basket



Part Code	Item #	Color	Dimensions in Inches		Max Liquid Volume	Hanger & Tray Compatibility	Disk	QTY	Barcode
			Outside Diam.	Height					
Roman Saucerless Hanging Basket									
RNH10001	<b>DLNRNH10001B78B032X</b>	Green	10.00	6.12	1.50gal	HZP3E103, HZP3E100, HZS.L170, HZS.L210	SDD10000	3,200	





Leader in Horticultural Containers

Standard Colors

- B66 Green
- A10 White
- E32 Mocha
- E21 Chocolate
- E22 Clay
- E26 Sandstone

Ask Customer Service For Standard & Stocking Colors.

**Hanging Basket Hangers**

Part Code	Item #	Color - Pack	Length in Inches	Case	Bag	Barcode
<b>E-10 3-Strand Hanger</b>						
HZP3E100	<b>DLNHZP3E100A10C800</b> <b>DLNHZP3E100A10D050</b> <b>DLNHZP3E100B66C800</b> <b>DLNHZP3E100B66D050</b> <b>DLNHZP3E100E32D050</b>	White - CASE White - BAG Green - CASE Green - BAG Mocha - BAG	16.00	800	50	
<b>E-10 3-Strand Hanger (Long)</b>						
HZP3E103	<b>DLNHZP3E103A10C450</b> <b>DLNHZP3E103A10D050</b> <b>DLNHZP3E103G18D050</b> <b>DLNHZP3E103B66D050</b> <b>DLNHZP3E103E22D050</b> <b>DLNHZP3E103E32D050</b>	White - CASE White - BAG Black - BAG Green - BAG Clay - BAG Mocha - BAG	19.50	450	50	
<b>Long "Snap" Hanger (3-Strand)</b>						
HZP3LSN0	<b>DLNHZP3LSN0A10C025</b> <b>DLNHZP3LSN0A10C500</b> <b>DLNHZP3LSN0B66D025</b> <b>DLNHZP3LSN0E26D025</b>	White - BAG White - CASE Green - BAG Sandstone - BAG	18.00	500	25	
<b>E-12 4-Strand Hanger</b>						
HZP4E120	<b>DLNHZP4E120A10D025</b> <b>DLNHZP4E120G18D025</b> <b>DLNHZP4E120B66D025</b> <b>DLNHZP4E120E22D025</b> <b>DLNHZP4E120E32D025</b>	White - BAG Black - BAG Green - BAG Clay - BAG Mocha - BAG	22.00	375	25	



Part Code	Item #	Length in Inches	SLV QTY	Case Bag	Disk	Barcode
<b>17.00in 3-Strand Wire Hanger C-105</b>						
HZSL170	<b>DLNHZSL170D050</b>	17.00	50	800	0.1	
<b>21.00in Long 4-Strand Wire Hanger</b>						
HZSL4W0	<b>DLNHZSL4W0D050</b>	21.00	50	500	0.04277	
<b>24.00in 4-Strand Wire Hanger Extra Long</b>						
HZSL240	<b>DLNHZSL240D050</b>	24.00	50	250	0.05997	
<b>14.00in Metal Hoop/Hanger Assembly</b>						
HZS14HA0	<b>DLNHZS14HA0000C022</b>	25.50	-	22	0.54773	



Part Code	Item #	Color	Case Pack	Barcode
<b>10.00 Cap Dish IT</b>				
SDD10000	<b>DLNSDD10000G18K160</b>	Black	1600	
SDD10000	<b>DLNSDD10000G18C800</b>	Black	800	
<b>12.00 Cap Dish Vacuum</b>				
SDD12000	<b>DLNSDD120000G18C300</b>	Black	300	





Leader in  
Horticultural  
Containers

### Decorative Planters

#### The HC Companies® Centabella Planter

Classic, fluted design that fits most any setting. Features an extra wide base for stability, sturdy heavy rim and a dual-drain bottom for root aeration and increased airflow. De-nests easily. Engineered for high-volume production in commercial growing applications.



Part Code	Item #	Color	Dimensions in Inches		Max Liquid Volume	QTY	Barcode
			Outside Diam.	Height			
Centabella Planter with TagSlot							
CBU12500	<b>DLNCBU12500E22C024</b> <b>DLNCBU12500E26C024</b>	Clay Sandstone	12.50	9.50	3.25gal	24	
CBU15500	<b>DLNCBU15500E22C012</b>	Clay	15.50	12.50	6.19gal	12	
CBU19000	<b>DLNCBU19000E22C012</b> <b>DLNCBU19000E26C012</b>	Clay Sandstone	19.00	15.00	11.40gal	12	

#### The HC Companies® Decostone Collection Planter (Round)

Distinctively designed texture has a stone-like appearance. Create an upscale look for combos, tropicals and foliage. Extra-wide base for stability.



Part Code	Item #	Color	Dimensions in Inches		Max Liquid Volume	QTY	Barcode
			Outside Diam.	Height			
Decostone Collection Planter							
SH.11500	<b>DLNSH11500E22C050</b>	Clay	11.00	8.50	2.00gal	50	
SH.13500	<b>DLNSH13500E22C025</b> <b>DLNSH13500E26C025</b>	Clay Sandstone	13.37	10.00	3.38gal	25	
SH.16000	<b>DLNSH16000E22C020</b> <b>DLNSH16000E26C020</b>	Clay Sandstone	15.75	12.00	5.28gal	20	

#### The HC Companies® Cordova Collection Pot (Round)

Flexible, sturdy containers are perfect for patio, porch, or deck use, adding charm to any location. Constructed from convenient and durable lightweight resin for easy care.



Part Code	Item #	Color	Dimensions in Inches		Max Liquid Volume	QTY	Barcode
			Outside Diam.	Height			
Cordova Collection Planter							
CDA14000	<b>DLNCDA14000E22C022</b>	Clay	15.00	10.00	5.20gal	22	





Leader in Horticultural Containers

Standard Colors

E22 Clay

E21 Chocolate Brown

E32 Mocha



Decorative Planters

The HC Companies® Color Collection

Flexible yet sturdy plastic containers with drainage holes in bottom. Perfect for patio, porch or deck.

Part Code	Item #	Color	Dimensions in Inches		Max Liquid Volume	QTY	Barcode
			Outside Diam.	Height			
Color Collection Round Pot with TagSlot							
CPA06003	<b>DLNCPA06003E22C098</b>	Clay	6.81	5.50	2.12qt	98	
CPA08002	<b>DLNCPA08002E22C058</b> <b>DLNCPA08002E32C058</b>	Clay Mocha	8.93	6.06	1.01gal	58	
CPA10002	<b>DLNCPA10002E22C050</b> <b>DLNCPA10002E32C050</b>	Clay Mocha	9.87	7.87	1.67gal	50	
CPA12001	<b>DLNCPA12001E22B015</b> <b>DLNCPA12001E32C040</b>	Clay Mocha	11.81	9.50	2.87gal	40 BULK: 1,500	
Color Collection Round Pot							
CPA10003	<b>DLNCPA10003E22C058</b> <b>DLNCPA10003E22B024</b> <b>DLNCPA10003E32C058</b>	Clay Mocha	11.00	7.75	2.00gal	58 BULK: 2,400	
CPA12000	<b>DLNCPA12000E21B015</b> <b>DLNCPA12000E21C028</b> <b>DLNCPA12000E22B015</b> <b>DLNCPA12000E22C028</b> <b>DLNCPA12000E32C028</b>	Chocolate Clay Mocha	13.37	9.50	3.62gal	28 BULK: 1,500	
CPA14000	<b>DLNCPA14000E22C020</b>	Clay	15.53	11.31	5.66gal	20	
Color Collection Oval							
CPP12000	<b>DLNCP12000E22C088</b>	Clay	12.96	5.00	1.06gal	88	
CPP16000	<b>DLNCP16000E22C043</b>	Clay	16.93	5.87	2.06gal	43	
CPP20000	<b>DLNCP20000E22C028</b>	Clay	20.87	6.00	2.72gal	28	
Color Collection Round Bowl							
CPB10001	<b>DLNCPB10001E22C082</b>	Clay	9.93	4.75	1.02gal	82	
CPB12000	<b>DLNCPB12000E22C042</b> <b>DLNCPB12000E32C042</b>	Clay Mocha	12.68	5.18	1.85gal	42	
CPB14000	<b>DLNCPB14000E22C045</b>	Clay	14.75	5.62	2.57gal	45	
CPB16000	<b>DLNCPB16000E22C025</b>	Clay	16.87	6.25	3.60gal	25	
Color Collection Square Planter							
CPS08000	<b>DLNCP508000E22C056</b>	Clay	8.00	7.06	1.30gal	56	
CPS12000	<b>DLNCP512000E22C032</b>	Clay	11.37	10.00	3.08gal	32	
CPS15000	<b>DLNCP515000E22C010</b> <b>DLNCP515000E32C010</b>	Clay Mocha	14.37	12.37	6.50gal	10	



Leader in Horticultural Containers

Decorative Planters

The HC Companies® Panterra Collection Standard Pot

Features a dual-drain bottom for drainage and aeration. Designed to accommodate drop-in liners BDS1000 and BMS1600. Tag slot for grower and retail tags are available on the 10in and 12in. Also has snap hanger capabilities.



Part Code	Item #	Color	Dimensions in Inches		Max Liquid Volume	Compatibility	QTY	Barcode
			Outside Diam.	Height				
Panterra Collection Standard Pot								
PA.10000	<b>DLNPA10000E22C100</b>	Clay	11.12	7.75	1.92gal	SPA10000, SPC10000	100	
PA.12000	<b>DLNPA12000E22C058</b>	Clay	13.25	9.50	3.35gal	SPA12000	58	
PA.14000	<b>DLNPA14000E22C025</b>	Clay	15.62	11.37	5.54gal	-	25	
Panterra Collection Standard Pot with TagSlot								
PA.09000	<b>DLNPA09000E22C100</b>	Clay	10.00	7.75	1.56gal	SPA08000	100	



The HC Companies® Panterra Collection Bowl

This classic bowl design in a textured finish features a wide base for increased stability, soil volume and water retention. Features a dual-drain bottom for drainage and aeration.



Part Code	Item #	Color	Dimensions in Inches		Max Liquid Volume	Compatibility	QTY	Barcode
			Outside Diam.	Height				
Panterra Collection Bowl								
PAB08000	<b>DLNPAB08000E22C250</b>	Clay	8.00	3.87	2.17qt	SPA08000	250	
PAB10000	<b>DLNPAB10000E22C100</b>	Clay	10.00	4.87	1.05gal	SPA10000	100	

The HC Companies® East Wind Canyon Tall Planter (Square)

The paint finish on these pots accentuates the engrained texture of the container. Inspired by natural and robust textures, these durable containers are designed to complement your home from the inside and out. Premium finish includes high-quality, glossy finish. Made from durable polypropylene.



**Black Cherry - 14in D x 16in H - Max Liquid Volume: 8.5gal**  
**DLNYMT14000Y43C012** Min. Buy 1cs/ 12ea

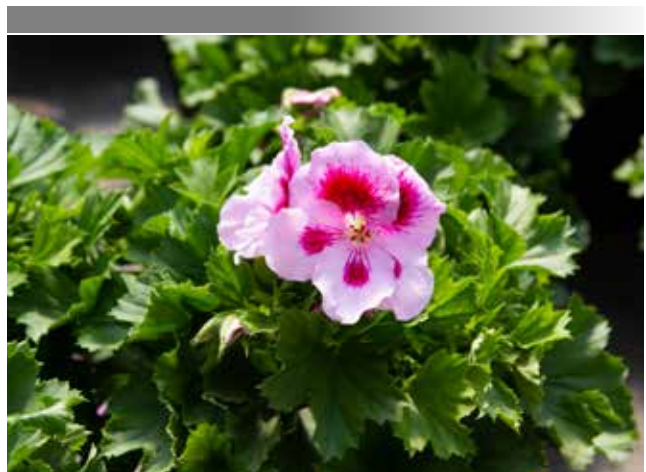



Leader in Horticultural Containers

Flats

The HC Companies® Vacuum Flat

Vacuum formed flats are constructed from sturdy gauge polystyrene material for durability. Designed for consistent performance in automated filling and handling equipment.



Part Code	Product Description	Item #	Dimensions in Inches			QTY	Barcode
			Length	Width	Height		
TVT.R6.1	R6 1020 True Vacuum Full Depth Flat	<b>DLNTVTR61G18C100</b>	20.00	10.00	2.63	100	
TVT.R8.1	R8 1020 True Vacuum Full Depth Flat	<b>DLNTVTR81G18D100</b>	20.00	10.00	2.63	100	
TVA11210	1020 Standard Full Depth Vacuum Flat	<b>DLNTVA11210G18C100</b>	21.00	10.50	2.38	100	
TVA11210J	1020 Standard Full Depth (No Hole Flat)	<b>DLNTVA11210G18C100J</b>	21.00	10.50	2.38	100	
TVA.R6.0	1020 R6 Standard Full Depth Vacuum Flat	<b>DLNTVAR60G18C100</b>	21.00	10.50	2.38	100	
TVTR120	R12 1020 True Vacuum Full Depth Flat	<b>DLNTVTR120G18C100</b>	20.00	10.00	2.63	100	

The HC Companies® Open Web Carry Tray

Injection flats deliver increased flexibility and are economically constructed using quality, blended, recycled raw material with additives. Designed for consistent performance in automated filling and handling equipment.

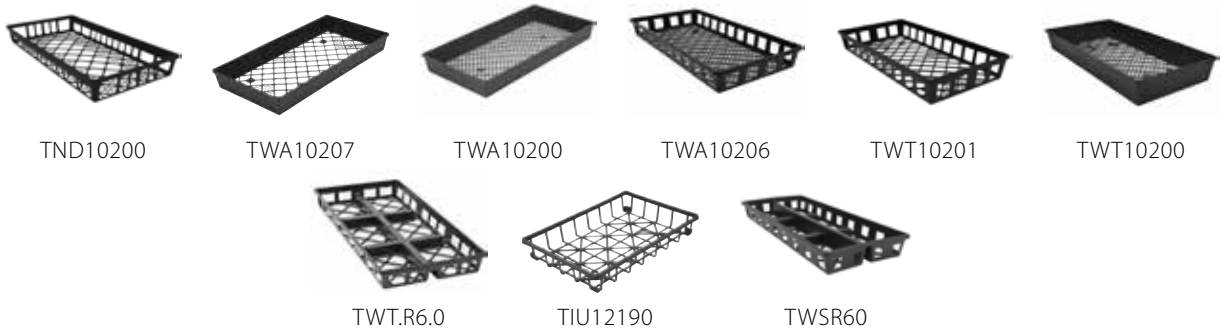

Part Code	Product Description	Item #	Dimensions in Inches			QTY	Barcode
			Length	Width	Height		
TND10200	1020 Daisy Tray - Open Tray	<b>DLNTND10200G18D050</b>	21.00	10.75	2.38	50	
TWA10207	1020 Standard Medium Weight Flat	<b>DLNTWA10207G18D050</b>	21.12	10.00	2.50	50	
TWA10200	1020 Standard Heavy Weight Flat	<b>DLNTWA10200G18D050</b>	21.00	10.50	2.50	50	
TWA10206	1020 Standard Light Weight Flat	<b>DLNTWA10206G18D050</b>	21.13	10.50	2.50	50	
TWT10201	1020 True Light Weight Flat	<b>DLNTWT10201G18D050</b> <b>DLNTWT10201G18B030</b>	20.00	10.00	2.50	50 BULK: 3,000	
TWT10200	1020 True Medium Weight Flat	<b>DLNTWT10200G18D050</b>	20.00	10.00	2.50	50	
TWT.R6.0	1020 R6 True Flat	<b>DLNTWTR60G18D050</b>	20.00	10.00	2.00	50	
TIU12190	Sunnyside Flat - Open Tray	<b>DLNTIU12190G18D025</b>	19.38	12.00	2.88	25	
TWSR60	Slim Jim Flat Long Flat	<b>DLNTWSR62G18D050</b>	21.00	8.25	2.00	50	



Leader in  
Horticultural  
Containers

### Inserts

## The HC Companies® Standard & Traditional Inserts

Vacuum formed, high quality bedding plant containers. Precision burned holes and die cut trims deliver consistent performance.



IJA06060



INA06060



INA08010



INA08040



INA08060



INA08061



INA08090



INA12010



INA12020



INA12030



INA12040

Part Code	Item #	Max Liquid Volume	Outside Dimensions in Inches			Compatible Tray	QTY	Barcode
			Length	Width	Height			
606 Standard Jumbo Insert								
IJA06060	<b>DLNIA06060G18C100</b>	1.33qt	20.00	10.00	3.25	TND10200, TR..K100, TWA10201, TWA10200, TVA11210, TVA11210J, TVA11212, TVA.R6.0	100	
D606 Standard Insert								
INA06060	<b>DLNINA06060G18C100</b>	1.90pt	21.00	10.50	2.25	TND10200, TR..K100, TWA10201, TWA10200, TVA11210, TVA11210J, TVA11212, TVA.R6.0	100	
D801 Standard Insert								
INA08010	<b>DLNINA08010G18C100</b>	1.71pt	21.00	10.50	2.25	TND10200, TR..K100, TWA10201, TWA10200, TVA11210, TVA11210J, TVA11212, TVA.R8.0	100	
D804 Standard Insert								
INA08040	<b>DLNINA08040G18C100</b>	1.37pt	21.00	10.50	2.25	TND0200, TR..K100, TWA10201, TWA10200, TVA11210, TVA11210J, TVA11212, TVA.R8.0	100	
D806 Standard Insert								
INA08060	<b>DLNINA08060G18C100</b>	1.29pt	21.00	10.50	2.25	TND0200, TR..K100, TWA10201, TWA10200, TVA11210, TVA11210J, TVA11212, TVA.R8.0	100	
D806R Standard Reverse Insert								
INA08061	<b>DLNINA08061G18C100</b>	1.29pt	21.00	10.50	2.25	TND0200, TR..K100, TWA10201, TWA10200, TVA11210, TVA11210J, TVA11212, TVA.R8.0	100	
D809 Standard Insert								
INA08090	<b>DLNINA08090G18C100</b>	1.12pt	21.00	10.50	2.25	TND0200, TR..K100, TWA10201, TWA10200, TVA11210, TVA11210J, TVA11212, TVA.R8.0	100	
D1201 Standard Insert								
INA12010	<b>DLNINA12010G18C100</b>	1.04pt	21.00	10.50	2.25	TND10200, TR..K100, TWA10201, TWA10200, TVA11210, TVA11210J, TVA11212, TVA.R6.0	100	
D1202 Standard Insert								
INA12020	<b>DLNINA12020G18C100</b>	1.01pt	21.00	10.50	2.25	TND10200, TR..K100, TWA10201, TWA10200, TVA11210, TVA11210J, TVA11212, TVA.R6.0	100	
D1203 Standard Insert								
INA12030	<b>DLNINA12030G18C100</b>	13.80fl oz	21.00	10.50	2.25	TND10200, TR..K100, TWA10201, TWA10200, TVA11210, TVA11210J, TVA11212, TVA.R6.0	100	
D1204 Standard Insert								
INA12040	<b>DLNINA12040G18C100</b>	11.82fl oz	21.00	10.50	2.25	TND10200, TR..K00, TWA10201, TWA10200, TVA11210, TVA11210J, TVA11212, TVA.R6.0	100	



Leader in Horticultural Containers

Inserts

The HC Companies® Standard & Traditional Inserts

Vacuum formed, high quality bedding plant containers. Precision burned holes and die cut trims deliver consistent performance.



INA12060



INA18010



INA24010



IJA18010



IJT18010

Part Code	Item #	Max Liquid Volume	Outside Dimensions in Inches			Compatible Tray	QTY	Barcode
			Length	Width	Height			
D1206 Standard Insert								
INA12060	<b>DLNINA12060G18C100</b>	11.80fl oz	21.00	10.50	2.25	TND10200, TR..K100, TWA10201, TWA10200, TVA11210, TVA1210J, TVA11212, TVA.R6.0	100	
D1801 Standard Insert								
INA18010	<b>DLNINA18010G18C100</b>	9.81 fl oz	21.00	10.50	2.25	TND10200, TR..K100, TWA10201, TWA10200, TVA11210, TVA11210J, TVA11212	100	
2401 Traditional Insert								
INA24010	<b>DLNINA24010G18C100</b>	0.21qt	21.00	10.50	2.25	TND10200, TR..K100, TWA10201, TWA10200, TVA1210, TVA11210J, TVA11212	100	
1801 Deep Traditional Insert Cut/Uncut								
IJA18010	<b>DLNIJA18010G18C100</b>	13.00fl oz	21.00	10.50	3.00	TND10200, TR..K100, TWA10201, TWA10200	100	
1801 Deep Insert								
IJT18010	<b>DLNIJT18010G18D100</b>	-	20.00	10.00	3.13	TVT.P180	100	



The HC Companies® Slim Jim Inserts (Short Jumbo)

Vacuum formed, high quality bedding plant containers. Precision burned holes and die cut trims deliver consistent performance.

Part Code	Product Description	BFG Product #	Max Liquid Volume	Outside Dimensions in Inches			Compatible Tray	QTY	Barcode
				Length	Width	Height			
IJS06060	606 Slim Jim Short Jumbo Insert	<b>DLNIJS06060G18C100</b>	1.86 pt	20.00	8.50	3.125	TVS.R6.0, TVS.R8.0, TVS85200, TWS.R6.2	100	
IJS12040	1204 Slim Jim Short Jumbo Insert	<b>DLNIJS12040G18C100</b>	13.80 fl oz	19.50	8.50	3.125	TWS.R6.0, TVS85200	100	





Leader in Horticultural Containers

Inserts

The HC Companies® True Series Insert

Vacuum formed, high quality bedding plant containers. Precision burned holes and die cut trims deliver consistent performance.



IJT03060

IJT06060

INT08040

INT08060

INT12030

INT12040

INT12060

Part Code	Item #	Max Liquid Volume	Outside Dimensions in Inches			Compatible Tray	QTY	Barcode
			Length	Width	Height			
306 True Basket Pack Insert								
IJT03060	<b>DLNIJT03060A10C300</b>	2.21qt	10.00	6.75	3.50	TVT.R3.0, TVT10201, TTD10200, TWT10201, TWT10200, THT10200, TCS12330, SPH2DPCO	300	
606 True Jumbo Insert								
IJT06060	<b>DLNIJT06060G18C100</b>	1.19qt	20.00	10.00	3.25	TVT10201, TVT.R6.1, TTD10200, TWT10201, TWT10200, THT10200, TVT.R6.0	100	
T804 True Insert								
INT08040	<b>DLNINT08040G18C100</b>	1.31pt	20.00	10.00	2.50	TVT10201, TTD10200, TWT10201, TWT10200, THT10200, TVT.R8.1	100	
T806 True Insert								
INT08060	<b>DLNINT08060G18C100</b>	1.16pt	20.00	10.00	2.50	TVT10201, TTD10200, TWT10201, TWT10200, THT10200, TVT.R8.1	100	
T1203 True Insert								
INT12030	<b>DLNINT12030G18C100</b>	15.20floz	20.00	10.00	2.50	TVT10201, TTD10200, TWT10201, TWT10200, THT10200, TVTR120	100	
T1204 True Insert								
INT12040	<b>DLNINT12040G18C100</b> <b>DLNINT12040G18B050</b>	13.50floz	20.00	10.00	2.50	TVT10201, TTD10200, TWT10201, TWT10200, THT10200, TVTR120	100 BULK: 5,000	
T1206 True Insert								
INT12060	<b>DLNINT12060G18C100</b>	11.80floz	20.00	10.00	2.50	TVT10201, TTD10200, TWT10201, TWT10200, THT10200, TVTR120	100	





Leader in Horticultural Containers

Sheet Pots

The HC Companies® Sheet of Pots (Square Cells)

Vacuum formed, high quality bedding plant containers. Precision burned holes and die cut trims deliver consistent performance. Create a cost-efficient system from growing to retail. Smooth finish ideal for easy label adhesion. Sheet of Pots an economic alternative to single pots.



INP18010



INP18350



INP45150



INP18012



INP45100



INP45101

Part Code	Item #	Max Liquid Volume	Outside Dimensions in Inches			Compatible Tray	QTY	Barcode
			Length	Width	Height			
1801 Standard Perennial Sheet of Pots								
INP18010	<b>DLNINP18010G18C100</b>	14.50fl oz	21.00	10.50	3.50	TCS8401	100	
3.50 Square 18 Count Sheet of Pots								
INP18350	<b>DLNINP18350G18C100</b>	15.50fl oz	20.50	10.50	3.50	TKP18350	100	
1501 Deep Perennial Sheet Pots								
INP45150	<b>DLNINP45150G18C050</b>	1.75pt	20.75	12.50	4.75	TCS15450	50	
1801 True Perennial Sheet Pots								
INP18012	<b>DLNINP18012G18C100</b>	13.50fl oz	20.00	10.00	3.50	TVT.P180, TRT184T0	100	
4510 Annual Sheet of Pots								
INP45100	<b>DLNINP45100G18C050</b>	1.37pt	21.65	8.25	4.00	TCS10450	50	
4510 Annual Sheet of Pots with TagSlot								
INP45101	<b>DLNINP45101G18C050</b>	1.67pt	20.75	8.25	5.00	TCS10450	50	

Propagation & Plug Trays

The HC Companies® Propagation Sheets & Plug Trays

Unmatched variety, quality and economy for any grower requirement. Ideal for seed germination or vegetative propagation. Precision punched holes guarantee optimal drainage and air pruning performance. Trays available with stacking notches for quick and easy de-nesting in automated equipment.



PGA105H0



PGA288C0



PRO050R0

Part Code	Product Description	Item #	Dimensions in Inches				Vol	QTY	Barcode
			Diam	Length	Width	Height			
PGA105H0	105 Heavy Duty Hexagon Standard Vacuum Strip Plug Tray	<b>DLNPGA105H0G18C050</b>	1.06	20.75	10.25	1.75	2.66qt	50	
PGA288C0	288 Common Element Standard Vacuum Plug Tray	<b>DLNPGA288C0G18C050</b>	0.81	20.50	10.25	1.06	3.04qt	50	
PRO050R0	DPS50 Propagation Sheet (Round Cell)	<b>DLNPRO050R0G18C100</b>	1.88	20.75	10.31	2.37	4.76qt	100	



### Nursery Containers

#### Nursery Supplies® Blow-Molded - Classic Line

Offers exceptional durability, strength, and value. This line of containers are typically ribbed, but some are also available with smooth sides. Sizes range from #SP-4 all the way up to large #45 and #65. We also give you a choice of container weight to match your needs.



Item #	Pot Style	Trade Size	Color	Qty per Case	Cases per Pallet	Dimensions in Inches		Capacity		Barcode
						Diam.	Depth	US	Metric	
Classic Custom™ Blow-Molded Pot - Economy Line										
NS01-00250-0291	300CU	#1	Black	100	92	6.375	7.25	0.73gal	2.78L	
NS01-00200-1361	300SCU	#1 - Squat	Black	106	98	6.50	6.50	0.63gal	2.37L	
NS01-00270-0301	350CU	Small Mum Pan	Black	130	64	8.00	5.125	0.77gal	2.90L	
NS01-00300-0900	400CU	True #1	Black	92	70	7.75	7.00	1.00gal	3.79L	
NS01-00430-0551	550CU	Large Mum Pan	Black	97	50	9.00	6.125	1.21gal	4.58L	
NS01-00450-1381	600CU	#2	Black	105	50	9.00	8.50	1.50gal	5.68L	
NS01-00490-0331	900CU	#2	Black	83	46	9.50	9.125	1.94gal	7.33L	
NS01-00540-0361	1200SCU	#2+ Squat	Black	60	32	11.00	7.50	2.32gal	8.78L	
NS01-00500-0861	1000CU	10 Foliage	Black	70	36	10.125	9.125	2.25gal	8.52L	
NS01-00510-0130	1000SCU	#2 - Squat	Black	75	36	10.125	7.50	1.95gal	7.36L	
NS01-00550-1111	1200CU	True #3	Black	56	32	11.00	9.50	3.00gal	11.36L	
NS01-00590-0251	1600SCU	#3 - Squat	Black	47	28	11.875	7.875	2.87gal	10.85L	
NS01-00580-0521	1600CU	#5	Black	47	28	11.875	10.125	3.58gal	13.55L	
NS01-00600-0561	2000CU	#5	Black	44	28	11.875	11.00	3.84gal	14.55L	
NS01-00620-0400	2100CU	#5	Black	31	27	14.00	9.875	5.17gal	19.58L	
NS01-00650-0661	2800CU	#7 Trade	Black	31	27	14.00	11.50	6.08gal	23.02L	
Olympian® Blow-Molded Pot										
NS01-00700-0211	4000BXL	#10	Black	27	16	15.75	15.00	9.16gal	34.65L	
NS01-00730-0171	6900SBXL	#10 - Squat	Black	19	15	18.375	12.125	10.66gal	40.37L	
NS01-00740-0301	6900BXL	#15	Black	18	15	18.375	15.125	13.35gal	50.53L	
NS01-00850-0200	C10000BXL	#25	Black	10	15	23.75	18.125	27.17gal	102.89L	
Classic Blow-Molded Pot - Heavy Weight										
NS01-00900-0100	18000CL	#45	Black	5	9	30.00	20.125	45.28gal	171.44L	
NS01-00920-0100	26000CL	#65	Black	5	9	30.75	23.125	60.67gal	229.70L	











**Nursery Containers**

**Nursery Supplies® Grip-Lip® Blow-Molded Pots**

Grip-Lip® containers are designed to provide maximum stacking and shipping strength. They ease the strain of maneuvering plants and trees because the lip becomes a rigid handle. This lip design makes the Grip-Lip® comfortable to lift, yet strong enough to be carried by a forklift.











Item #	Pot Style	Trade Size	Color	Qty per Case	Cases per Pallet	Dimensions in Inches		Capacity		Barcode
						Diam.	Depth	US	Metric	
Grip-Lip® Blow-Molded Pot										
<b>NS01046500541</b>	GL2800	#7	Black	20	32	13.75	12.00	6.08gal	23.02L	
<b>NS01-04700-0561</b>	GL4000	#10	Black	19	18	14.25	14.25	9.16gal	34.68L	
<b>NS01047400801</b>	GL6900	#15	Black	17	10	17.25	15.125	13.19gal	49.93L	
<b>NS01-04800-0101</b>	GL8000	#20	Black	16	8	19.50	17.00	19.50gal	73.82L	
<b>NS01-04820-0551</b>	GL10000S	#20 - Squat	Black	14	12	22.75	13.125	20.51gal	77.63L	
<b>NS01-04850-0500</b>	GL10000	#25	Black	10	15	22.75	18.125	27.59gal	104.44L	

**Nursery Supplies® Econo-Grip® Blow-Molded Pot**

Blow molded container is an economy weight version of Grip-Lip®. It has the same great features as the Grip-Lip® in a lighter weight, making it the perfect choice for the liner of a Pot-In-Pot or AGS® Above Ground System application.



Item #	Pot Style	Trade Size	Color	Qty per Case	Cases per Pallet	Dimensions in Inches		Capacity		Barcode
						Diam.	Depth	US	Metric	
Econo-Grip® Blow-Molded Pot										
<b>NS01-04600-0261</b>	EG2000	#5	Black	35	28	10.875	11.125	3.93gal	14.88L	
<b>NS01046500031</b>	EG2800	#7	Black	20	32	13.75	12.00	6.08gal	23.02L	
<b>NS01-04700-0041</b>	EG4000	#10	Black	19	18	14.25	14.25	9.16gal	36.64L	
<b>NS01-04730-0271</b>	EG6900S	#10 - Squat	Black	17	10	17.25	12.125	10.69gal	40.46L	
<b>NS01047400301</b>	EG6900	#15	Black	17	10	17.25	15.125	13.19gal	49.92L	
<b>NS01-04800-0141</b>	EG8000	#20	Black	16	8	19.50	17.00	19.50gal	73.82L	
<b>NS01-04820-0141</b>	EG10000S	#20 - Squat	Black	14	12	22.75	13.125	20.51gal	77.63L	
<b>NS01-04850-0100</b>	EG10000	#25	Black	10	15	22.75	18.125	27.58gal	104.40L	





### Nursery Containers

#### Nursery Supplies® Pressure-Formed Containers

Pressure-formed containers are light, strong and resilient, consistent in weight, and uniform in design. Economical and tougher than blow-molded containers, and features a top banding and rolled edged rim that increases top rigidity. The smooth surface is perfect for labeling and printing. Automation compatible for use in potting machines and fork systems.



Item #	Pot Style	Type	Color	Qty per Case	Cases per Pallet	Dimensions		Capacity		Barcode
						Diam.	Depth	US	Metric	
Premier® Pressure-Formed Container										
<b>NS01081700011</b>	PF250	#1	Black	93	92	6.125	6.125	0.63gal	2.37L	
<b>NS01-08250-0061</b>	PF310	#1	Black	80	92	6.125	7.00	0.65gal	1046L	
<b>NS01-08300-0211</b>	PF400CU	True #1	Black	85	64	7.50	7.125	1.00gal	3.74L	
<b>NS01-08450-0101</b>	PF600CU	#2	Black	90	46	8.50	8.50	1.50gal	5.68L	
<b>NS01-08400-0181</b>	PF800CU	True #2	Black	87	46	8.875	9.375	2.00gal	7.57L	
<b>NS01-08550-0721</b>	PF1200CU	True #3	Black	71	32	10.50	9.375	3.00gal	11.36L	
Mum Pan										
<b>NS01083500222</b>	PF550	Mum Pan	Black	-	36	9.50	6.00	1.55gal	5.87L	
<b>NS01083500223</b>				91	-					
Knock Out Rose Container										
<b>NSPF400 KNOCK OUT ROSE</b>	PF400	1gal Rose	-	85	64	7.50	7.125	1.00gal	2.37L	
<b>NSKNOCK OUT ROSE PF800</b>	PF800	2gal Rose	-	87	46	8.875	8.50	2.00gal	7.57L	
<b>NSKNOCK OUT ROSE PF1200</b>	PF1200	3gal Rose	-	71	32	10.50	7.75	3.00gal	11.36L	
Drift Rose Container										
<b>NSPF800 DRIFT ROSE</b>	PF800	2gal Drift Rose	-	87	46	8.875	8.50	2.00gal	7.57L	
<b>NSPF1200 DRIFT ROSE</b>	PF1200	3gal Drift Rose	-	71	32	10.50	7.75	3.00gal	11.36L	

### Injection Molded Containers

#### Nursery Supplies® PI Injection Molded Containers

Economical PI injection-molded containers. Strong and rigid. Tier stacking. Label, hot stamp and printing compatible



Item #	Pot Style	Trade Size	Color	Qty per Case	Cases per Pallet	Dimensions in Inches		Capacity		Barcode
						Diam.	Depth	US	Metric	
PI Injection Molded Containers										
<b>NS0105300011</b>	PC-1D	#1	Black	53	118	6.00	6.75	0.71gal	2.69L	
<b>NS01-05400-0111</b>	PC-2	#2	Black	61	60	8.375	8.375	1.78gal	6.74L	
<b>NS01-05450-0100</b>	PC-3	#3	Black	45	40	10.00	9.25	2.77gal	10.49L	
<b>NS01055550311</b>	CA-5	Egg Can	Black	46	-	10.00	11.50	3.62gal	13.70L	
<b>NS01055500411</b>	PC-5S	#5 Squat	Black	42	36	10.75	10.50	4.08gal	15.45L	
<b>NS01057000201</b>	PC-10	#10	Black	27	18	15.25	14.50	10.27gal	38.88L	

**Decorative Containers**



**Nursery Supplies® Dec-Grow® Decorative Container**

Decorative container tough enough to grow in. Choice of side or bottom holes. Versatile nursery container that easily moves from field to retail shelf to customer's patio.

Item #	Pot Style	Trade Size	Color	Qty per Case	Cases per Pallet	Dimensions in Inches		Capacity		Barcode
						Diam.	Depth	US	Metric	
Dec-Grow® Decorative Containers										
<b>NS01-02500-0691</b>	10DG	#2	Terra Cotta	45	32	9.875	8.75	2.12gal	8.03L	
<b>NS01-02600-0451</b>	12DG	#5	Terra Cotta	36	20	11.875	10.75	3.78gal	14.31L	

**Specialty Containers**



**Nursery Supplies® "Air Root Pruning System™" Accelerator® Container**

Promotes healthy lateral root growth and eliminates root circling. Produces greater survivability rates when planted in native landscape. Trees will flourish while field harvested trees are recovering from up to 75% of their roots being left in the ground. Not just for trees. Get outstanding air root pruning results for all types of plants.

Item #	Pot Style	Trade Size	Color	Qty per Case	Cases per Pallet	Dimensions in Inches		Capacity		Barcode
						Diam.	Depth	US	Metric	
Accelerator® Containers										
<b>NS01-30003-0100</b>	AP-3	#3	Black	41	28	12.00	8.00	2.68gal	10.14L	
<b>NS01-30015-0100</b>	AP-15	#15	Black	19	15	18.00	15.50	12.00gal	45.42L	





### Thermoformed & Coextruded Containers

#### Summit Plastic® Round JanorPot®

Thermoformed, thinwalled round pots. Each JanorPot® container is designed with a dual-drainage system to ensure optimum air/water exchange to maximize plant growth potential. The wide bottom offers stability in and out of a tray and each pot has a black interior also promoting an ideal rooting environment. The smooth rolled lip, ease in destining and no sharp edges or projections make these containers perfect for automation. Every pot is Duo™ - two layers of polypropylene in each pot. The exterior layer may be customized with any color while the interior is always a black layer made from recycled materials.



Item #	Pot Style	Configuration	Color Outside	QTY	Dimensions in Inches		Liquid Volume	Barcode
					Diam.	Depth		
Round JanorPot								
<b>SUM05-3012B</b> <b>SUM090H50BTCCB</b>	9cm H	3.5in Standard Pot	Black Terra Cotta	2340	3.5625	3.50	12.20fl oz	
<b>SUM05-3012A</b> <b>SUM10CMTBLKcs</b>	10cm T	4in Standard Pot	Terra Cotta Black	1680	3.937	3.5625	1.03pt	
<b>SUMJJ110H80BTCCB</b> <b>SUM11CMHBLKcs</b>	11cm H	4.25in Standard Pot	Terra Cotta Black	2000	4.375	3.5625	1.10pt	
<b>SUMJJ120H80BBKCB</b> <b>SUM12CMHBLKBULK</b> <b>SUMJJ120H80BWTCB</b> <b>SUMJJ120H80BTCCB</b>	12cm H	4.5in Geranium Pot	Black Black/White Terra Cotta	1425 BULK: 12,900	4.75	3.9375	1.58pt	
<b>SUM05-3011Q</b> <b>SUM12CMTTCcs</b>	12cm T	4.5in Tall Quart Pot	Black Terra Cotta	1425	4.75	5.00	1.00qt	
<b>SUM05-3015D</b> <b>SUMJJ130H50BTCCB</b> <b>SUM13CMHTCBULK</b>	13cm H	5in Standard Pot	Black Terra Cotta	960 BULK: 9180	5.175	4.8125	1.06 qt	
<b>SUM15CMLBLKcs</b> <b>SUMJJ150L50BTCCB</b>	15cm T	6in Azalea Pot	Black Terra Cotta	600	5.9375	4.50	1.31qt	
<b>SUM16CMTBLKcs</b>	16cm T	Trade 1gal Pot	Black	385	6.25	6.75	2.50qt	
<b>SUMJJ170H50BTCCB</b> <b>SUMJJ170H50BBKCB</b>	17cm H	Trade 1gal	Terra Cotta Black	360	6.6875	4.9375	2.75qt	
<b>SUM05-3037B</b> <b>SUM190L50BTCCB</b> <b>SUM19CMLWHTcs</b>	19cm L	3qt Low Profile	Black Terra Cotta White	360	7.50	6.00	3.00qt	
<b>SUM05-3031B</b> <b>SUM05-3031T</b> <b>SUM05-3031TB</b>	19cm T	True 1gal Pot	Black Terra Cotta	270 BULK: 7,560	7.50	7.25	1.00gal	
<b>SUM22CMTBLKcs</b> <b>SUM22CMTTCcs</b>	22cm T	8.5in Standard Pot	Black Terra Cotta	150 BULK: 1,955	8.625	7.875	1.50gal	

**Injection Molded Containers**

**Summit Plastic® Nu-Pots™**

Nu-Pot™ sets are an industry standard – people ask for them by name! All pots contain generous amounts of media and feature side and bottom drainage with side-flutes – a Summit innovation – minimizes root circling.

Item #	Item Style	Color	Qty per Case	Dimensions in Inches			Liquid Volume	Barcode
				Length	Width	Height		
Nu-Pots Square Pots								
<b>SUM52300BKBKNSC</b>	<b>NuPot 4</b>	Black	1600	3.25	3.25	3.875	1.00 Pint	
<b>SUM05-0024B</b>	<b>NuPot 5</b>	Black	450	4.375	4.375	4.75	1.00 Quart	



**Carry Trays**

**Summit Plastic® Nu-Tray™**

NuTrays™ are designed to fit perfectly with NuPots™ greenhouse containers and are offered in a variety of sizes from pints through trade gallon.

Item #	Item Style	Color	QTY	Dimensions in Inches			Configuration Style	Barcode
				Length	Width	Height		
Nutray- 1.00 Pint Pot Filling Tray								
<b>SUM53025BKBKNSC</b>	<b>NuTray 5-10</b>	Black	90	22.00	8.75	2.50	2x5	
<b>SUM05-0023A</b>	<b>NuTray 4-18</b>	Black	90	19.50	10	2	3x6	
<b>SUM53300BKBKNSC</b>	<b>NuTray 4-16</b>	Black	100	13.25	13.25	3.25	4x4	

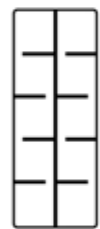

**Specialty Containers**

**JanorPot® 3D® Systems Pot**

A 3D line of patented containers, in one pint to three quart sizes with matching trays. Designed with careful consideration, keeping in mind the needs of the users across the growing, shipping and selling channels. Direction - These pots go into trays correctly the first time; they can't go in incorrectly. To orient they don't need to be twisted, turned or locked, saving time on the production line. The pot/tray system goes through a flat filler, pots get "stuck" then to the growing area. Dimension - While not completely round nor completely square, these containers go into matching rectangular trays - pot tight - to maximize cubing through the entire process. Up to 32% more compared to their round counterparts. Display - Besides more retail facings, 3D containers project your message loudly. There is no need to turn the pot to read the message - the flat front provides plenty of space for an easily viewed label. And for additional information a label may also be applied to the back surface.



Item #	Color	Qty per Case	Cases per Pallet	Cell Dimensions in Inches			Liquid Volume	Barcode
				Length	Width	Height		
3D Systems Pot								
<b>SUMJJF100POBBKCB</b>	Black	1440	16	3.50	3.50	3.847	1.00 Pint	
<b>SUMJJF100QOBBKCB</b>	Black	900	16	4.33	4.20	5.50	1.00 Quart	
<b>SUM01530180010</b>	Black	400	16	5.80	5.80	6.00	2.00 Quart	

**Carry Trays**

Item #	Color	QTY	Dimensions in Inches			Configuration Style	Barcode
			Length	Width	Height		
1.00 Pint, 1-2.5 Quart Pot Filling Tray							
<b>SUMSS51910BKBKNSS</b>	Black	100	21.00	7.00	4.41	2x6	
<b>SUMSS51920BKBKNSS</b>	Black	100	20.82	8.52	5.82	2x5	
<b>SUMSS51940BKBKNSS</b>	Black	50	18	11.5	5	2x3	





### Pots & Carry Trays

#### Summit Plastic® Filling Tray

Snug interiors for pot stability in the greenhouse, field, on trucks and on display. Opened-up sides give an improved graphics viewing area - a tray and a merchandiser. These trays feature a soil deflecting design which means less wasted media while the bottom design guarantees easy-slide transfer onto racks and store presentation. These trays meet the needs with numerous built-in elements - side and end landing areas and slits and slots for labels and large and small locking tags. Minimizing the foot-print, while still supporting the pots, means savings efficiencies during the grow stage and then when shipping and merchandising. Plant, grow and ship in Summit's filling trays.

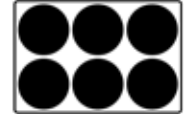
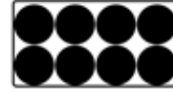
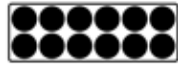
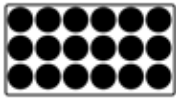

Item #	Fits Pot	Configuration	Qty per Case	Cases per Pallet	Tray Dimensions - Inches			Barcode
					Length	Width	Depth	
Filling Trays								
<b>SUM51050BKBKNSC</b>	9cm H	18 Filling Tray - 3 x 6	50	48	21.00	10.50	3.50	
<b>SUM05-0016A</b>	9cm H	12 Filling Tray - 2 x 6	100	32	21.00	7.00	3.50	
<b>SUM10CMT10FILL</b>	10cm T	10 Filling Tray - 2 x 5	100	44	19.75	8.00	3.75	
<b>SUM10CMT6FILL</b>	10cm T	6 Filling Tray - 2 x 3	200	44	11.875	8.00	3.75	
<b>SUM4.25-10</b>	11cm H	10 Filling Tray - 2 x 5	100	36	21.00	7.25	3.50	
<b>SUM05-0043B</b>	12cm H	15 Filling Tray - 3 x 5	50	30	23.312	13.75	4.00	
<b>SUM05-0043</b>	12cm H	8 Filling Tray - 2 x 4	100	32	18.50	9.00	4.125	
<b>SUM12CMT10FILL</b>	12cm T	10 Filling Tray - 2 x 5	100	30	23.25	9.00	5.25	
<b>SUM12CMT8FILL</b>	12cm T	8 Filling Tray - 2 x 4	100	24	18.50	9.00	5.25	
<b>SUM05-0031G</b>	13cm H	8 Filling Tray - 2 x 4	50	36	20.00	10.00	5.00	
<b>SUM15CML-6 FILLING TRAY</b>	15cm T	6 Filling Tray - 2 x 3	50	42	18.00	11.50	4.50	
<b>SUM05-0082</b>	16cm T	6 Filling Tray - 2 x 3	50	28	19.00	12.75	6.875	
<b>SUM51225BKBKNSC</b>	17cm H	6 Filling Tray - 2 x 3	50	24	20.00	13.25	6.25	

### Specialty Containers

#### Summit Plastic® Round Rice Pot 9cm, eco360, Bulk

Rice Pot greenhouse containers, made from spent rice hull fibers, are completely plantable, biodegradable, rigid-sided pots. These round nursery pots are durable enough to withstand rough automation handling yet ideal for direct planting in place. Round rice pot containers are compatible with our JanorPot® round filling trays and flats.



**3-1/2in x 3-5/16in, 14256/pl**

**SUM05-3000H** Min. Buy 1 cs/ 14256ea



### Trays, Inserts & Flats

#### Summit Plastic® Market Mate 6 Pack Basket Black

MarketMate™ packs come in a variety of colors and configurations to fit several growing footprints. Generous cell dimensions for strong plant growth, automation ready to go through flat fillers, and several handle hole configurations to accommodate a variety of handle lengths and tamper-resistant locking points.



**20in x 10in, 150/cs, 48cs/pl**

**SUM05-0038A** Min. Buy 1 cs/ 150ea

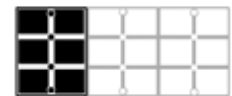

**Specialty Containers**

**Al's Flower Pouch™**

The original vertical garden that brings fresh, cascading color to entryways, backyards, fences, balconies and more. Plant with all kinds of bedding plants and annuals, tropicals, succulents, fall mums, herbs and leafy greens, strawberries, tomatoes, decorative chillies and more.



**Al's Flower Pouch™ Grower 10 Hole Pouch**

10 Hole Pouch for most annuals, strawberries, fall mums. Holes form two rows of five down the length of the pouch.



**21.25in L x 8.5in W, 1.59gal/6L Max Volume**

**AF000012-02** Min. Buy 1 cs/ 1ea

**Al's Flower Pouch™ Grower 5 Hole Pouch**

5 Hole Pouch for premium annuals like new guinea impatiens, wave petunias. Holes are down the centre of the pouch.



**21.25in L x 8.5in W, 1.59gal/6L Max Volume**

**AF000013-02** Min. Buy 1 cs/ 1ea

**Al's Flower Pouch™ Mini 6 Hole Pouch**

6 hole pouch, approximately 2/3 the size of the 10 Hole Pouch. Great for herbs, annuals, mums. Holes form two rows of three down the length of the pouch.



**13.5in L x 8.5in W, 1.06gal/4L Max Volume**

**AF000014-02** Min. Buy 1 cs/ 1ea



**Al's Flower Pouch™ Thirst Quencher**

The Thirst Quencher Watering Tube makes watering Al's Flower Pouch easy. It creates a channel to allow water to "wick" to the bottom of the pouch. It speeds up your watering too. It's reusable so save it for next season. It's great for large pots too.



**AF00000801**

Min. Buy 1 cs/ 1ea



**Ellepots by A.M.A. Plug Tray**

Precise specifications with 80% very high quality Canadian peat, 10% fine perlite, 10% coir, starter charge, wetting agent, RootShield. Target pH Ranges: 5.4 - 5.9; Target EC Ranges: 0.5-1.0. Open one up to see the quality of peat and perlite - no mud balls. FP Paper allows root penetration and is stable throughout the propagation, finishing and retailing process. It typically degrades in 12-24 months depending on soil and weather conditions. Ellepots by A.M.A. Offer: Faster, Healthier Rooting, Greater Take Rates, Even Growth, Easier Sorting & Grading, Faster Transplanting, Reduced Labor Cost.



**1.18in Ellepots**

**78 Octagon Vent (3x26 Strips) - Standard Mix**

**AF803019SBB** Min. Buy 1 cs / 11 Trays

**1.58in Ellepots**

**50 Octagon Vent - Grow Mix**

**AF804002NTB** Min. Buy 1 pl / 384 Trays







**Other Sizes Available**  
call for details

### Hanging Baskets

#### Belden Plastics® Saucerless Hanging Basket

Made in the U.S.A. injection molded round plastic pot with a sleek, contemporary design. Superior in quality, provide innovative grower friendly features all with 100% recycled materials. Internal disc allows for great water reservoir. So sturdy that holes can be drilled into the sides, if desired. Hangers included.





Item #	Color	Case QTY	Dimensions in Inches		Volume	Barcode
			Width	Height		
12in Hanging Basket with 4-Strand Wire Hanger						
<b>BP690611</b>	Black	25	11.75	7.00	2.28gal	
12in Hanging Basket with 4-Strand 19in Flex Hanger						
<b>BP690625</b>	Green	25	11.75	7.00	2.28gal	
14in Hanging Basket with Color Coated 26in Flexible Hanger						
<b>BP690816</b> <b>BP690809</b> <b>BP690808</b>	Black White Green	25	14.00	8.25	3.96gal	
16in Hanging Basket with Color Coated 26in Flex Hanger						
<b>BP690933</b> <b>BP690901</b>	Black Green	15	16.00	9.75	5.00gal	

#### Belden Plastics® Classic Hanging Basket

Made in the U.S.A. injection molded round plastic pots. Superior in quality, provide innovative grower friendly features all with 100% recycled materials. Removable saucer and hangers included.





Item #	Color	Case QTY	Dimensions in Inches		Volume	Barcode
			Width	Height		
6in Hanging Basket with Plastic Hanger						
<b>BP6903021</b>	Green	50	6.00	4.25	49.00fl oz	
10in Textured Hanging Basket with Wire Hanger						
<b>BP690502</b> <b>BP690501</b>	Green White	50	10.00	5.50	1.32gal	

### Trays, Inserts & Flats

#### Belden Plastics® Tray

Made in the U.S.A. injection molded plastic tray with convenient tag slots. Superior in quality, provide innovative grower friendly features all with 100% recycled materials.



Item #	Color	Case QTY	Dimensions in Inches			Barcode
			Length	Width	Height	
Jumbo Square Pot Tray						
<b>BP698140</b>	Black	50	21.25	10.90	3.25	
WEBSITE 4515 Tray - Holds 4.5 Standard Pots						
<b>BP694214</b>	Black	50	21.25	13.00	2.00	
1020 Web Flat Heavy Tray						
<b>BP694213</b>	Black	50	21.00	11.00	2.50	



## Injection Molded Containers



### Belden Plastics® Square Plastic Pots

Made in the U.S.A. injection molded square plastic pots. Superior in quality, provide innovative grower friendly features all with 100% recycled materials.

Item #	Color/Size	Qty per Case	Dimensions in Inches		Volume	Barcode
			Width	Height		
Maxi Square Plastic Pots						
<b>BP691705</b>	Black - 3.50in	540	3.50	3.50	16.00fl oz	
Square Plastic Pots						
<b>BP691405</b>	Black - 4.50in	450	4.125	3.50	25.30fl oz	
Jumbo Junior Square Plastic Pots						
<b>BP691525</b>	Black - 4.50in	375	4.125	5.00	35.10fl oz	
Jumbo Square Plastic Pots						
<b>BP6915150</b>	Black - 5.25in	200	5.25	5.25	56.80fl oz	
Jumbo Senior Square Plastic Pots						
<b>BP691535</b>	Black - 5.25in	200	5.25	6.50	67.60fl oz	

### Belden Plastics® Round Pots

Made in the U.S.A. injection molded plastic pots. Superior in quality, provide innovative grower friendly features all with 100% recycled materials.



Item #	Color/Size	Qty per Case	Dimensions in Inches		Volume	Barcode
			Width	Height		
Geranium Pot						
<b>BP693405</b>	Black - 4.5in	600	4.50	3.875	22.30fl oz	
Standard Pot						
<b>BP693608</b>	Black - 6.00in	300	6.00	6.00	62.20fl oz	
Plastic Azalea Pots						
<b>BP692108</b> <b>BP692107</b>	Black - 6in Green - 6in	300	6.00	4.50	50.70fl oz	
<b>BP692213</b>	Black - 6.5in	300	6.50	4.75	62.50fl oz	
<b>BP692408</b>	Black - 7.5in	200	7.50	5.625	94.60fl oz	
<b>BP692508</b>	Textured Black - 8in	100	8.00	6.00	118.30fl oz	
<b>BP692606</b>	Black - 8.5in	100	8.50	6.50	1.05gal	
<b>BP692772</b>	Textured Black - 10in	40	10.00	7.50	1.76gal	
Cut Flower Bucket						
<b>BP696804</b>	Black - 9in	50	9.625	9.00	2.24gal	

# ECKERT'S GREENHOUSE

## Hanging Baskets



### Eckert Weekender Hanging Planter

Takes the worry out of going away. Established plants are nourished when root moisture absorption occurs. Therefore, only requiring watering every 3 to 4 days. Designed with an innovative wicking system that makes it easier for non established or plants that are normally shallow rooted to receive water from the reservoir. Withstands heat to 220°F and cold to -40°F and has an overflow feature to prevent over watering. Made in the USA and is 100% recyclable.

### Planter With 3-Strand Decorative Matte Black Twisted Hanger

16in Diameter x 10in High - 1gal Water Reservoir

#### Forest Green

EGH792631 Min. Buy 1 cs/ 12ea 

#### Black

EGH79-2636 Min. Buy 1 cs/ 12ea 

#### Sandstone

EGH79-2630 Min. Buy 1 cs/ 12ea 

#### Seafoam Green

EGH79-2634 Min. Buy 1 cs/ 12ea 

#### Terra Cotta

EGH79-2638 Min. Buy 1 cs/ 12ea 

#### White

EGH79-2632 Min. Buy 1 cs/ 12ea 

#### Assorted Case - 12 pc 6ea Black and 6ea Seafoam Green

EGH79-2636BS Min. Buy 1 cs/ 12ea 

### Planter With 3-Strand Galvanized Steel Swivel Hanger

16in Diameter x 10in High - 1gal Water Reservoir

#### Black

EGH79-2626 Min. Buy 1 cs/ 12ea 

#### Sandstone

EGH79-2620 Min. Buy 1 cs/ 12ea 

#### Seafoam Green

EGH79-2624 Min. Buy 1 cs/ 12ea 

#### Terra Cotta

EGH79-2628 Min. Buy 1 cs/ 12ea 

#### White

EGH79-2622 Min. Buy 1 cs/ 12ea 



### Eckert H2O Labor Saver Hanging Planter

Takes the worry out of going away. Established plants are nourished when root moisture absorption occurs. Therefore, only requiring watering every 3 to 4 days. Designed with an innovative wicking system that makes it easier for non established or plants that are normally shallow rooted to receive water from the reservoir. Withstands heat to 220°F and cold to -40°F and has an overflow feature to prevent over watering. Made in the USA and is 100% recyclable.

### 23in Planter with 4-Strand Swivel Hanger or Chrome Chain - 2.46gal Water Reservoir

Min. Buy 1 cs/ 6ea



**Black**  
EGH79-2600



**Brown**  
EGH79-2606



# ECKERT'S GREENHOUSE

## Hanging Baskets

### Eckert Iron Accessories

Take your project to another level by adding our iron to your existing poles or create a whole new "flower tower" with our customizable display poles. All our iron is hot rolled and powder coated black (unless specially ordered). Our iron brackets and hangers can fit existing poles from 3.5" to 8" in diameter or they can be customized for larger poles.

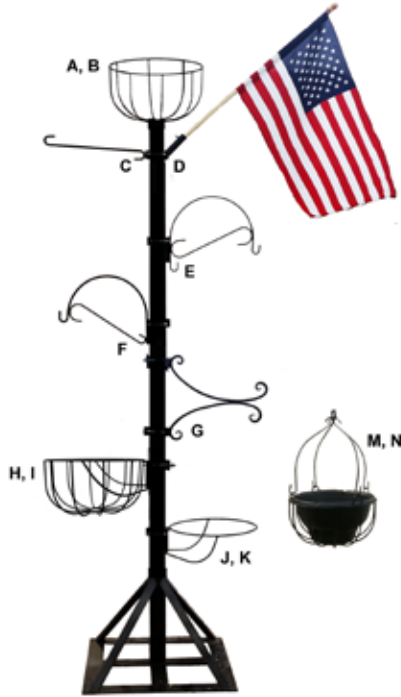

#### Black - 8ft Display Pole

ECK8FTSTEM Min. Buy 1 cs/ 1ea



#### Black - 10ft Display Pole

ECK10FTSTEM Min. Buy 1 cs/ 1ea



#### Black - 3ft Iron Base For Display Poles

EGHIRONBASE Min. Buy 1 cs/ 1ea



#### A - 16in Weekender Pole Topper

EGH16INTOPPER Min. Buy 1 cs/ 1ea



#### B - 23in H2O Labor Saver Pole Topper

EGH23INTOPPER Min. Buy 1 cs/ 1ea



#### C - Adjustable Banner Arm Bracket

EGHIRONBANNERARM Min. Buy 1 cs/ 1ea



#### D - Adjustable Flag Pole Holder

ECKSDJFLAGHLDR Min. Buy 1 cs/ 1ea



#### E - Adjustable Flat Iron Hook Bracket

EGH23INIRON Min. Buy 1 cs/ 1ea



#### F - Adjustable Round Iron Hook Bracket

ECKADJRNDHK Min. Buy 1 cs/ 1ea



#### G - Adjustable Dovetail Bracket

ECKADJDOVEHK Min. Buy 1 cs/ 1ea



#### H - 16in Adjustable Weekender Onion Bracket

ECKWONIONBRKT Min. Buy 1 cs/ 1ea



#### I - 23in Adjustable H2O Labor Saver Onion Bracket

ECKLBONIONBRKT Min. Buy 1 cs/ 1ea



#### J - 16in Weekender Iron Hoop Bracket

EGH79-2642 Min. Buy 1 cs/ 1ea



#### K - 23in H2O Labor Saver Hoop Bracket

EGH79-2643 Min. Buy 1 cs/ 1ea



#### M - 16in Adjustable Acorn Cage

ECK16ACORN Min. Buy 1 cs/ 1ea



#### N - 23in Adjustable Acorn Cage

ECK23ACORN Min. Buy 1 cs/ 1ea

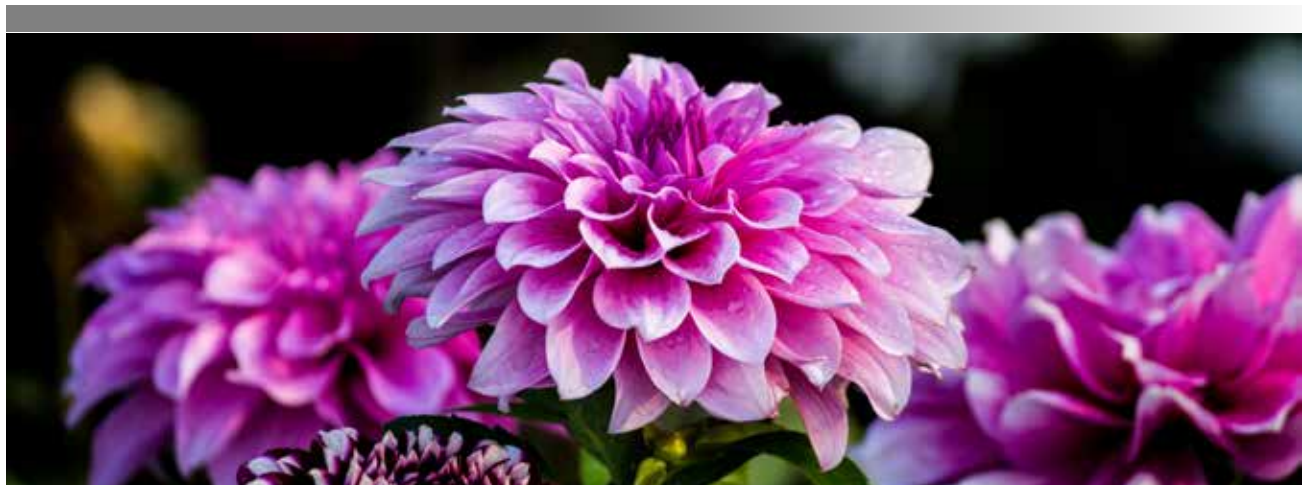



## Fiber Containers

### Jiffystrip® & Jiffypot® Peat Pots and Strips

Manufactured from raw materials, consisting of a minimum of 50% sphagnum peat, wood fiber and lime to adjust the pH. The peat content provides a combination of superior root penetration, good drainage and aeration while the wood fibers strengthen the pot, and they are 100% biodegradable. The strips can be easily broken apart and all Jiffy peat products can be planted 'pot 'n all' resulting in zero transplant shock at the time of transplanting. OMRI Listed.

BFG Item #	Style	Drainage	Peat Pot Size L x W x D	# of Pots per Tray	Qty per Case	Total Pots per Case	Barcode
JiffyPot® Poly-Pak Square Peat Pots in Tray							
<b>JIF70000486</b>	218	With Hole	2in x 2in x 2in	50	46	2300	
<b>JIF70000468</b>	220	Slit	2in x 2in x 3in	50	40	2000	
<b>JIF70000512</b>	330	Slit	3in x 3in x 3in	18	44	792	
<b>JIF70000507</b>	440	Slit	3.5in x 3.5in x 4in	18	31	558	



BFG Item #	Style	Drainage	Peat Pot Size L x W x D	# of Pots per Strip	Qty per Case	Total Pots per Case	Barcode
JiffyStrip® Square Peat Pot Strips							
<b>JIF70000428</b>	512	-	1.25in x 1.25in x 2in	12	624	7488	
<b>JIF7000005</b>	516	-	1.75in x 1.75in x 2in	10	510	5100	
<b>JIF70000510</b>	517	-	1.75in x 1.75in x 2in	12	390	4680	
<b>JIF70000513</b>	522	With Hole	2.25in x 2.25in x 2in	12	210	2520	
<b>JIF700000552</b>	525	With Hole	2.5in x 2.5in x 2.25in	8	288	2304	
<b>JIF70000481</b>	527	With Hole	2.5in x 2.5in x 3in	8	320	2560	
<b>JIF70000365</b>	530	Slit	3in x 3in x 3in	6	210	1260	



Item #	Style	Drainage	Peat Pot Size L x W x D	Qty per Case	Barcode
JiffyPot® Square Peat Pots					
<b>JIF70000504</b>	217	With Hole	2in x 2in x 2in	3500	
<b>JIF70000362</b>	230	With Hole	3in x 3in x 3in	1260	
<b>JIF70000461</b>	240	With Hole	3.5in x 3.5in x 4in	800	
JiffyPot® Round Peat Pots					
<b>JIF70000494</b>	122	With Hole	2.25in Diam x 2.25in	2816	
<b>JIF70000503</b>	-	With Hole	3in Diam x 3in	1404	
<b>JIF70000293</b>	144	With Hole	4in Diam x 3.75in	1100	
<b>JIF70000871</b>	340	With Hole	4.33in Diam x 4in	960	
<b>JIF70000479</b>	-	With Hole	6in Diam x 5in	198	

### Jiffy-7® Peat Pellet

A convenient, no-mess way to start flower and vegetable seeds and cuttings. Just add water, pellets expand to form pot and soil in one. Made with Canadian sphagnum peat moss that provides a rich, high quality growing environment. Transplant directly into the ground or larger containers minimizing transplant shock and root damage. OMRI Listed.



**1.75in**

**JIF70000116** Min. Buy 1 cs/ 1000ea



## Decorative Planters

### Landmark® Botanica Collection

Our Botanica Collection of planters and containers are a premium decorative series without premium prices. Great for container gardens, combination planters, patios and house plants. Featuring a textured, matte finish.



Tiffany Bulb Pan



Tiffany Octagon



Garden Weave



Saturn Decorative



Planter Box

Item #	Color	Qty per Case	Dimensions in Inches		Max. Liquid Volume	Max. Dry Volume	Barcode
			Diameter	Height			
Tiffany Bulb Pan - 8in Pan							
<b>LNDKTRD8104CT</b> <b>LNDKTRD8105CT</b>	Chocolate Brown Tan	100	8.00	3.00	0.42gal	97.6cu in	
Tiffany Bulb Pan - 10in Pan							
<b>LNDKTRD10104CT</b> <b>LNDKTRD10105CT</b> <b>LNDKTRD10236CT</b>	Chocolate Brown Tan Slate	100	10.00	3.25	0.72gal	165.6cu in	
Tiffany Bulb Pan - 12in Pan							
<b>LNDKTRD12102CT</b> <b>LNDKTRD12104CT</b>	Terra Cotta Chocolate Brown	50	12.00	3.50	1.13gal	261.2cu in	
Tiffany Octagon Container							
<b>LNDKTOB13BK</b>	Black	25	13.00	8.92	2.50gal	578.20cu in	
Garden Weave Series							
<b>LNDKGWB12BK</b> <b>LNDKGWB12CB</b>	Black Chocolate Brown	50	12.00	5.07	2.00gal	464.60cu in	
Saturn Decorative Container							
<b>LNDK-SAT8TC</b>	Terra Cotta	100	8.78	5.73	3.42qt	197.40cu in	
Universal Saucer For Saturn Decorative Container							
<b>LNDKSC875100CT</b> <b>LNDKSC875102CT</b> <b>LNDKSC875104CT</b> <b>LNDKSC875105CT</b>	Black Terra Cotta Chocolate Tan	50	8.75	0.75	-	-	
Planter Box							
<b>LNDX-714PBG</b>	Green	100	14.00 L x 7.00 W	4.50	1.36gal	315cu in	



# LANDMARK PLASTIC

## Propagation & Plug Trays

### Landmark® Plug Tray

Our diverse line of high-quality plug trays represent true innovation. Precision manufactured for trouble-free use in seedling and transplanting equipment.



P-50



P-72SQ



P-72SQD



P-98



P-128



P-200CR

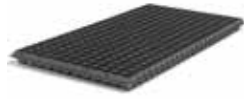

P-288SQ

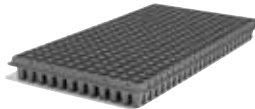

P-288SQD



P-392



P-406



P-512



C-T50

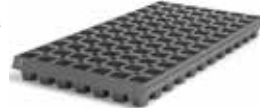

C-T84



C-T288

Item #	Style Number	Configuration	Cells per Tray	Qty per Case	Cell Dimensions Inches/Cubic Inches			Tray Dimensions in Inches			Barcode
					Top Diam.	Center to Center	Dry Volume	Length	Width	Depth	
Square Cells											
<b>LNDP-50</b>	P-50	5 x 10	50	100	1.75	2.06 x 2.06	5.19	21.38	11.05	2.25	
<b>LNDP-72SQ</b>	P-72SQ	6 x 12	72	100	1.25	1.76 x 1.74	1.71	21.38	11.05	1.75	
<b>LNDP-72SQD</b>	P-72SQD	6 x 12 - Deep	72	100	1.63	1.70 x 1.71	4.45	21.38	11.05	2.38	
<b>LNDP-98</b>	P-98	7 x 14	98	100	1.25	1.44 x 1.47	1.92	21.38	11.05	2.00	
<b>LNDP-128</b>	P-128	8 x 16	128	100	1.25	1.23 x 1.28	1.68	21.38	11.05	2.00	
<b>LNDP-200CR</b>	P-200CR	10 x 20 - Center Rib	200	100	0.88	0.99 x 0.99	1.29	21.28	11.05	1.75	
<b>LNDP-288SQ</b>	P-288SQ	12 x 24 - CE Compliant	288	100	0.75	0.85 x 0.85	0.75	21.38	11.05	1.00	
<b>LNDP-288SQD</b>	P-288SQD	12 x 24 - Deep CE Compliant	288	100	0.75	0.85 x 0.85	0.61	21.38	11.05	1.75	
<b>LNDP-392</b>	P-392	14 x 28	392	100	0.63	0.73 x 0.73	0.28	21.38	11.05	1.00	
<b>LNDP-406</b>	P-406	14 x 29	406	100	0.68	0.69 x 0.70	0.28	21.38	11.05	1.00	
<b>LNDP-512</b>	L512	16 x 32 - CE Compliant	512	100	0.56	0.63 x 0.64	0.24	21.38	11.05	1.00	
True Series / T-Series											
<b>LNDC-T50</b>	C-T50	5 x 10	50	70	1.45	1.95 x 1.98	2.04	20.00	10.00	1.63	
<b>LNDC-T84</b>	C-T84	7 x 12	84	100	1.13	1.40 x 1.65	1.41	20.00	10.00	1.63	
<b>LNDC-T288</b>	C-T288	12 x 24	288	65	0.81	0.81 x 0.82	0.49	20.00	10.00	1.13	

## Propagation & Plug Trays

### Landmark® Plug Trays & Sheets

Our diverse line of high-quality plug trays represent true innovation. Precision manufactured for trouble-free use in seedling and transplanting equipment.

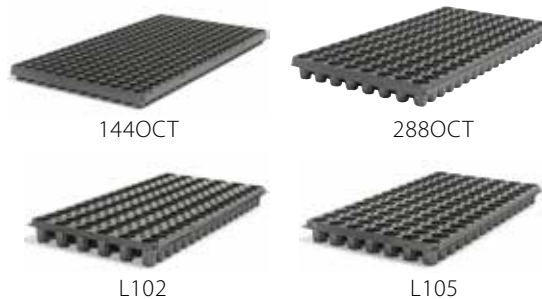

Item #	Style Number	Configuration	Cells per Tray	Qty per Case	Cell Dimensions Inches/Cubic Inches			Tray Dimensions in Inches			Barcode
					Top Diam.	Center to Center	Dry Volume	Length	Width	Depth	
Octagon Series Plug Trays											
<b>LNDC-144OCT</b>	144OCT	8 x 18	144	100	1.09	1.28 x 1.13	1.03	20.82	10.54	1.50	
<b>LNDC-288OCT-AIRHOLE</b>	288OCT	12 x 24	288	100	0.83	0.85 x 0.85	0.41	20.82	10.54	1.00	
Hexagon Series Plug Trays											
<b>LNDC-102HX</b>	L102	6 x 17	102	100	1.16 x 1.34	1.75 x 1.21	1.34	20.99	10.67	1.63	
<b>LNDC-105SSNL</b>	L105	7 x 15 - Root Channels	105	100	1.25 x 1.38	1.46 x 1.36	1.40	20.99	10.68	1.50	



Item #	Style Number	Configuration	Cells per Tray	Qty per Case	Cell Dimensions Inches/Cubic Inches		Tray Dimensions in Inches			Barcode	
					Top Diam.	Dry Volume	Length	Width	Depth		
Burned Drainage Plug Sheets											
<b>LNDX-38PS</b>	38PS	3 x 8 / 2 x 7 - Round	24/14	100	2.25	6.80	20.85	10.42	2.38		
<b>LNDX-50PS</b>	50PS	5 x 10 - Round with Circ. Ridge Bottom	50	100	2.00	4.60	20.85	10.42	2.38		
<b>LNDX-72PS</b>	72PS	6 x 12 - Round with Circ. Ridge Bottom	72	100	1.50	2.54	20.85	10.42	2.38		
<b>LNDX-72SPS</b>	72SPS	6 x 12 - Square with Root Channels	72	100	1.63	4.09	20.85	10.45	2.38		

### Landmark® Seeder Trays

High-quality tray manufactured for trouble-free use in seedling and transplanting equipment. Features root channels and step-bottom drainage, ideal for deciduous and evergreen ornamentals.

**THESE ITEMS ARE SEASON RUN ITEMS THAT ONLY RUN ONCE OR TWICE A YEAR – check on availability with your BFG Rep.**

Item #	Style Number	Configuration	Qty per Case	Tray Dimensions in Inches			Barcode
				Length	Width	Depth	
Seeder Trays							
<b>LNDP-SEED10</b>	PSEED10	10 Rows	100	21.50	11.00	1.25	
<b>LNDP-SEED20</b>	PSEED20	20 Rows	100	21.50	11.00	1.25	
<b>LNDP-OPENST</b>	136ST	Open Tray	100	21.23	10.80	1.38	



# LANDMARK PLASTIC

## Propagation & Plug Trays

### Landmark® Seedling Trays

High-quality tray manufactured for trouble-free use in seedling and transplanting equipment. Features root channels and step-bottom drainage, ideal for deciduous and evergreen ornamentals.



Item #	Style Number	Configuration	Cells per Tray	Qty per Case	Cell Dimensions in Inches		Tray Dimensions in Inches		Barcode
					Diam.	Height	Length	Width	
Seedling Trays - Rose Shape with Channels									
<b>LNDX-21STPP</b>	X-21STPP	3 x 7	21	65	2.88	3.50	21.23	10.80	
<b>LNDX-38ST</b>	X-38ST	3 x 8/2 x 7	38	50	2.25	5.00	21.23	10.80	
<b>LNDX-72ST</b>	X-72ST	6 x 12	72	50	1.63	3.25	21.23	10.80	
Seedling Trays - Octagonal Shape with Round Bottom									
<b>LNDX-50ST</b>	X-50ST	5 x 10	50	55	1.88	4.50	21.23	10.80	

## Hanging Baskets

### Landmark® Deco-Swirl Saucerless Hanging Basket

Attractive, functional and ready to use by both growers and consumers. Featuring a Maxi-Mizer® drainage system, a saucerless basket that lets water flow through while providing a water reservoir at the bottom.



Item #	Color	QTY	Dimensions in Inches		Liquid Volume	Barcode
			Diam	Height		
Deco-Swirl Saucerless Hanging Basket - 12in						
<b>LNDI-DS12GR25cs</b> <b>LNDI-DS12GRBB</b> <b>LNDI-DS12WH25cs</b>	Green White	25 BULK : 950	11.81	7.22	2.25gal	

### Landmark® Wrapped Wire Hanger

For use with 12in hanging baskets.



**24in Long - 4-Strand**

**LNDZ-24164STW** Min. Buy 1 cs/ 50ea



## Injection Molded Pots

### Landmark® Injection Molded Pots

Our injection-molded square and round pots are made with high-quality polypropylene resin for durability and versatility. Choose from Maxi-Grow pots with bi-level drainage holes that inhibit seal-off, or Maxi-Grow Plus with a wider lip plus side and bottom drainage.



Item #	Style Number	Color	Size	Qty per Case	Cases per Pallet	Dimensions in Inches		Max Liquid Volume	Barcode
						Diam	Height		
Maxi-Grow™ Geranium Pots									
<b>LNDI-G450MGBK-N</b>	I-G450MG	Black	4.5in Geranium	900	36	4.50	4.00	1.27pt	
Maxi-Grow™ Plus Nursery Pots									
<b>LNDI-NCTGALBK</b> <b>LNDI-NCTGALTC-S</b>	I-NCTGAL	Black Terra Cotta	Trade 1gal	68	42	6.13	6.87	2.64qt	
<b>LNDI-NCT2GALBK</b>	I-NCT2GAL	Black	Trade 2gal	65	29	8.04	8.50	1.47gal	
<b>LNDI-NcsGALBK-S</b>	I-NCTSGAL	Black	True 1gal	75	30	7.15	7.00	1.01gal	



## Thermoformed & Coextruded Containers



### Landmark® Co-Ex Thermoformed Pots

Our thermoformed round pots feature bi-level drainage to promote air pruning and discourage root circling, for healthier plants. Incorporate your branding with a duotone printing, co-extruded colors, or direct printing on the pot's surface.

Item #	Style Number	Color	Size	Qty per Case	Cases per Pallet	Dimensions in Inches		Max Liquid Volume	Barcode
						Diam	High		
Azalea Maxi-Grow Thermoformed Pots									
<b>LNDX-6AMGTT</b> <b>LNDX-6AMGT</b>	X-6AMGT	Terra Cotta Black	6.00in	220	48	6.00	4.38	1.40qt	
<b>LNDX-75AMGTBK-N</b>	X-75AMGT	Black	7.50in	220	27	7.50	5.71	3.02qt	
Round Maxi-Grow Thermoformed Pots									
<b>LNDX-4RMGTB</b> <b>LNDX-4RMGTBBULK</b>	X-4RMGT	Black	4in Standard	825 BULK: 21,8000	42	4.00	3.49	1.02pt	
<b>LND43RMGT100CT</b>	43RMGT	Black	4.33in Standard	765	36	4.33	3.90	1.25pt	
<b>LND45RMGT100CT</b>	45RMGT	Black	4.50in Geranium	450	48	4.50	4.02	1.37pt	
<b>LNDX-5RMGT</b> <b>LNDX-5RMGT-N</b>	X-5RMGT	Black	5in Standard	360 BULK: 9,792	48	5.00	4.57	1.06qt	
<b>LNDX-8MPMGTB</b> <b>LNDX-8MPMGTB-N</b>	X-8MPMGT	Black	8in Mum Pan	300 BULK: 7,800	20	8.00	5.00	3.04qt	
<b>LNDX-9MPMGTB</b> <b>LNDX-9MPMGTTC</b>	X-9MPMGT	Black Terra Cotta	9in Mum Pan	100	40	9.00	5.90	4.18gal	
Nursery Trade Gallon Maxi-Grow Thermoformed Pots									
<b>LNDX-65NTGTBK</b> <b>LNDX-65NT-GTBK-N11550</b>	X-65NTGT	Black	Trade 1gal	200 BULK: 11,550	48	6.50	6.50	2.50qt	
<b>LNDX-85NT2GBK</b> <b>LNDX-85NT2GTC</b>	X-85NT2G	Black Terra Cotta	Trade 2gal	100	24	8.50	8.50	1.50gal	



# LANDMARK PLASTIC

## Carry Trays

### Landmark® Transport Tray

Durable, tear resistant trays with bottom drainage and easy, finger-tip extraction. Includes de-nesting notches for automation equipment.



4TP15B



LN4TP10



43TP



45TPP8



45TP10



45TP12



45TPPP



T5TP



T13TPPP



6TP



65TP



QTPP8



3QTCT



4QTCT



TGOF6

Item #	Style Number	Tray Information	# of Pots it Holds	Qty per Case	Cases per Pallet	Trim Size			Barcode
						Length	Width	Depth	
Transport Trays for 4.5in Pots and Smaller									
<b>LNDX-4TP15B</b>	4TP15B	4.00 Transport Tray (Polystyrene Only)	15	85	14	20.25	12.13	3.50	
<b>LNDX-LN4TP10B</b>	LN4TP10	4.00 Transport Tray	10	75	40	20.38	8.13	3.72	
<b>LNDX-43TPB</b>	43TP	4.33 Transport Tray	10	100	40	21.63	8.63	4.06	
<b>LNDX-45TPP8</b>	45TPP8	4.50 Transport Tray	8	50	36	19.50	10.00	4.25	
<b>LNDX-4.5TP10B</b>	45TP10	4.50 Transport Tray (Polystyrene Only)	10	75	40	22.40	8.90	4.19	
<b>LNDX-4TP15B-T</b>	4TP15PS	4.00 Transport Tray (Polystyrene Only)	15	85	14	20.25	12.13	3.50	
<b>LNDX-4.5TPB12</b>	45TP12	4.50 Transport Tray	12	75	24	18.99	14.11	3.96	
<b>LNDX-4.5TPPPB</b>	45TPPP	4.50 Transport Tray	15	90	16	23.06	14.06	3.94	
Transport Trays for 5in Pots and Larger									
<b>LNDX-T5TPPB</b>	T5TP	5.00 Azalea Transport Tray	8	100	36	20.00	10.00	3.75	
<b>LNDX-T13TPPPB</b>	T13TPPP	5.00 Round Standard Transport Tray	8	100	24	20.00	10.00	4.74	
<b>LNDX-6TPPB</b>	6TP	6.00 Azalea Transport Tray	6	100	30	17.64	11.50	4.25	
<b>LNDX-6.5TPPB</b>	65TP	6.50 Transport Tray	6	100	28	19.63	13.00	5.25	
<b>LNDX-QTPP8</b>	QTPP8	True Quart Transport Tray	8	75	36	19.50	10.00	5.30	
Transport Trays for Nursery Containers									
<b>LNDX-3QTCTPP</b>	3QTCT	300 Nursery Carrying Tray (S/B Drainage)	6	50	36	19.50	12.75	2.50	
<b>LNDX-4QTCTPP</b>	4QTCT	400 Nursery Container Carrying Tray	6	50	24	22.50	14.89	2.50	
<b>LNDXTGOF6BKT</b>	TGOF6	Trade Gallon Open Flat Bottom	6	50	42	19.63	13.00	6.63	

## Thermoformed & Coextruded Containers

### Landmark® Thermoformed Square Pot

Thermoformed square pots are part of an economical, easy-to-use growing system for virtually any crop. Easily accommodates automation equipment. Precision-formed pots with uniform drainage.



Item Number	Style Number	Color	Size	Qty per Case	Cases per Pallet	Dimensions in Inches		Max Liquid Volume	Barcode
						Diam	Height		
<b>LNDX-225P1920</b>	225P	Black	2.25 Square Pot	1920	36	2.19	3.00	4.90fl oz	
<b>LNDX-3P800</b>	3PF800	Black	2.63in Square Press Fit Pot	800	52	2.63	2.25	6.00fl oz	
<b>LNDX-3PD</b>	3PD800	Black	3.00 Square Pot Deep (Root Channels)	800	48	2.63	3.50	9.50fl oz	
<b>LNDX-3PXD400</b>	3PXD400	Black	3.00 Square Pot Extra Deep	400	72	3.00	4.25	13.30fl oz	
<b>LNDC-TP900E</b>	TPOT	Black	3.25 Square T-Pots	900	36	3.25	3.50	14.40fl oz	
<b>LNDX-4P LNDX-4P450T</b>	4PF450	Gray Terra Cotta	4.00 Square Press Fit Pot	450	48	3.50	3.50	1.05pt	
<b>LNDX-4PXD</b>	4PXD	Gray	4.00 Square Pot Extra Deep (root channels)	450	32	3.50	5.02	1.52pt	
<b>LNDX-4.5P300 /cs new 04-5</b>	45P300	Black	4.50 Square Press Fit Pot	300	35	4.19	3.63	1.69pt	
<b>LNDX-4.5P LNDX-4.5P375E</b>	45P375	Black Econ. Gray	4.50 Square Press Fit Pot	375	28	4.19	3.63	1.69pt	
<b>LNDX-4.5PD</b>	45PD	Black	4.50 Square Pot Deep	375	28	4.19	4.88	1.15qt	

### Landmark® Sheet of Pots

Thermoformed square pots are part of an economical, easy-to-use growing system for virtually any crop. Easily accommodates automation equipment. Precision-formed pots with uniform drainage.



Item #	Style Number	Size	# of Pots per Sheet	Qty per Case	Cases per Pallet	Dimensions in Inches		Max Liquid Volume	Barcode
						L x W	H		
<b>LNDX-3SQSP</b>	3SQSP	3.00 Sheet of Pots	32	100	24	2.45 x 2.47	3.05	6.20fl oz	
<b>LNDX-3.5SPWB</b>	35SPWB	3.50 Sheet of Pots	18	100	32	3.53 x 3.51	3.00	13.40 fl oz	
<b>LNDX-3.5SPD</b>	35SPD	3.50 Square Pots Deep	18	100	32	3.49 x 3.46	3.23	13.60fl oz	
<b>LNDX-4.5SP15</b>	45SP	4.50 Square Pots	15	100	16	4.09 x 4.09	3.65	1.55pt	
<b>LNDX-4.5SPD</b>	45SPD	4.50 Square Pots Deep	15	100	16	4.24 x 4.24	4.88	1.97fl oz	
<b>LNDC-T1801SP</b>	T1801SP	T 1801 Sheet of Pots	18	100	36	3.14 x 3.18	3.27	12.50fl oz	
<b>LNDC-T1801SPE</b>	T1801SPE	T 1801 Sheet of Pots Economy	18	100	36	3.14 x 3.18	3.27	12.50fl oz	



**Carry Trays**

**Landmark® Transport Tray**

Transport trays are ready for growing, loading for travel and boosting retail sales. A wide variety of sizes match our injection molded and thermoformed pots, giving you added flexibility at retail. Durable, tear resistant trays with bottom drainage and easy, finger-tip extraction. Includes de-nesting notches for automation equipment.

Item #	Style Number	Pot Size Information	# of Pots it Holds	Qty per Case	Cases per Pallet	Trim Size			Barcode
						Length	Width	Depth	
Square Pot Trays									
<b>LNDX-2SPT32</b>	2SPT32	2.25 Square Pot Tray	32	100	40	18.10	9.12	2.25	
<b>LNDX-3PXDT20</b>	3PXDT20	3.00in Square Extra Deep Tray	20	100	36	15.19	12.19	2.00	
<b>LNDL-PF32TRAY</b>	LPF32TRY	3.00in Square Press Fit Tray	32	100	32	21.23	10.79	1.50	
<b>LNDL-PF18TRAY</b>	LPF18TRY	4.00in Square Press Fit Tray	18	100	32	21.23	10.79	2.31	
<b>LNDL-4.5PF12</b>	L45PF12	4.50in Square Press Fit	12	100	20	16.97	12.75	2.31	
<b>LNDX-45SPT10</b>	45SPT10	4.50in Square Pot Tray	10	90	30	20.94	8.44	2.02	
<b>LNDL-PF15TRAY</b>	LPF15TRY	4.50in Square Press Fit Tray	15	50	32	21.10	12.71	2.31	
<b>LNDC-TPT6</b>	TPT6	T Pot Tray - Handle Available	6	255	32	10.11	6.73	1.55	
<b>LNDC-TPT18</b>	TPT18	T Pot Tray	18	100	36	20.00	10.00	2.31	

**Trays, Flats & Inserts**

**Landmark® Landscape Tray**

Landscape trays have the shelf appeal, quality and design to attract both landscapers and consumers. So even the selling process is hassle-free. Manufactured with high quality, tear-resistant materials. Inegrated water channels ensure all cells receive even water distribution.



**T18 - 18 Cells - Cells: 2.98in L x 2.90in W x 3.47in D - Tray: 10in W x 20in L x 3.47in D**

**LNDL-TLF18** Min. Buy 1 cs/ 100ea



**Landmark® Water-Matics® Tray**

Enables growers to conserve water and chemical costs by channelling most of the water back to the plant. Allows leafed plants that develop a dense "canopy" to feed from the collection of water and fertilizer. More conservation means more time saved. Allows for maximized growing space while promoting air circulation. For greenhouse or outdoor use. Durable: when used properly this tray can be used for multiple crops or seasons.

**SEASONAL RUN ITEM ORDERS NEED TO BE PLACED BY AUGUST 15TH AND SUBJECT TO COLLECTIVE ORDER VOLUME**



**For Use with X-4.5P Pots - Holds 15ea 4.5in Square Pots - 12.61in L x 12.61in W x 2.44in D**

**LNDX-4.5SWM** Min. Buy 1 cs/ 50ea



**Landmark® L Series Injection Molded Web Tray**

1020 Standard Series injection molded web tray, made of high-quality plastic resins for easy de-nesting, specifically designed to accommodate automation equipment.



**L1020 ALT Solid Side - 21.13in L x 10.67in W x 2.39in D - Black**

**LNDI-L1020ISS-T**  
Min. Buy 1 cs/ 50ea



**L1020 Solid Side - 21.13in L x 10.67in W x 2.39in D - Black**

**LNDI-L1020SS-T**  
Min. Buy 1 cs/ 50ea



## Trays, Flats & Inserts

### Landmark® L Series Pack (20.85in x 10.42in)

L series insert ideal for filling, growing and transporting. Made of high-quality plastic resins for easy de-nesting, specifically designed to accommodate automation equipment, precision perforation between pack.

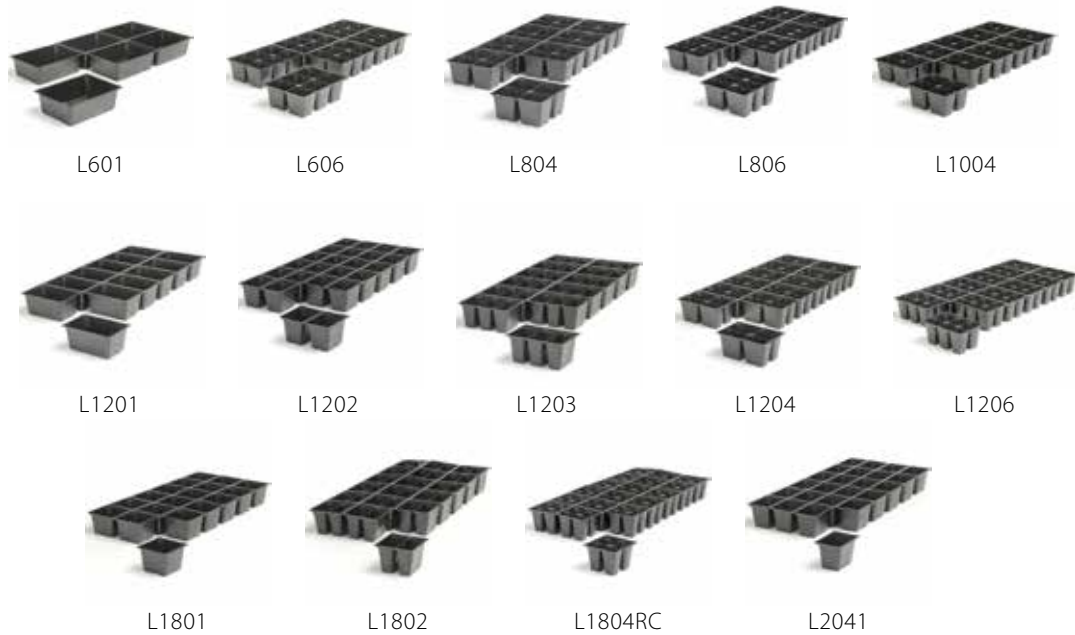

Item #	Style Number	Pack Type	Cells per Tray	Qty per Case	Cases per Pallet	Cell Dimensions in Inches			Cell Liquid Volume	Cell Dry Volume	Barcode
						Length	Width	Height			
L Series Pack											
<b>LNDL-601</b>	L601	Singles	6	100	32	6.44	4.85	2.33	1.13qt	60.05cu in	
<b>LNDL-606</b>	L606	6-Pack	36	100	32	2.35	2.15	2.33	5.09fl oz	9.18cu in	
<b>LNDL-804</b>	L804	4-Pack	32	100	32	2.35	2.35	2.33	5.92fl oz	10.68cu in	
<b>LNDL-806</b>	L806	6-Pack	48	100	32	2.35	1.55	2.33	3.58fl oz	6.47cu in	
<b>LNDL-1004</b>	L1004	4-Pack	40	100	32	2.40	1.85	2.33	4.36fl oz	1.09pt	
<b>LNDL-1201</b>	L1201	Singles	12	100	32	4.85	3.15	2.33	1.01pt	29.29cu in	
<b>LNDL-1202</b>	L1202	2-Pack	24	100	32	3.10	2.25	2.33	-	-	
<b>LNDL-1203</b>	L1203	3-Pack	36	100	32	3.15	1.55	2.33	4.77fl oz	8.60cu in	
<b>LNDL-1204</b>	L1204	4-Pack	48	100	32	2.35	1.45	2.33	3.48fl oz	6.29cu in	
<b>LNDL-1206</b>	L1206	6-Pack	72	100	32	1.55	1.55	2.33	2.00fl oz	3.60cu in	
<b>LNDL-1801</b>	L1801	Singles	18	100	32	3.10	3.10	2.33	10.28fl oz	18.55cu in	
<b>LNDL-1802</b>	L1802	2-Pack									
<b>LNDL-1804</b>	L1804RC	4-Pack	72	100	32	1.38	1.38	2.33	1.02fl oz	1.84cu in	
<b>LNDL-2401</b>	L2041	Singles	24	100	32	3.10	2.25	2.33	7.07fl oz	12.75cu in	

# LANDMARK PLASTIC

## Trays, Flats & Inserts

### Landmark® L Series Super Jumbo

L series insert ideal for filling, growing and transporting. Made of high-quality plastic resins for easy de-nesting, specifically designed to accommodate automation equipment, precision perforation between pack.



Item #	Style Number	Pack Type	Cells per Tray	Qty per Case	Cases per Pallet	Cell Dimensions in Inches			Cell Volume		Barcode
						Length	Width	Height	Liquid	Dry	
<b>LNDL-606SJ</b>	L606SJ	6-Pack	36	100	32	2.35	2.15	3.13	6.90fl oz	12.45cu in	
<b>LNDL-804SJ</b>	L804SJ	4-Pack	32	100	32	2.46	2.47	3.05	6.20fl oz	11.11cu in	
<b>LNDL-806SJ</b>	L806SJ	6-Pack	48	100	32	2.35	1.60	3.12	4.37fl oz	7.88cu in	
<b>LNDL-1204D</b>	L1204D	4-Pack	48	100	32	2.63	1.72	2.75	4.10fl oz	7.40cu in	

### Landmark® True Series Insert

True series insert ideal for filling, growing and transporting. Made of high-quality plastic resins for easy de-nesting, specifically designed to accommodate automation equipment, precision perforation between pack. Fits trays 20.00in x 10.00in.



Item #	Style Number	Cells per Tray	QTY	Cases per Pallet	Cell Dimensions in Inches			Cell Volume		Barcode
					Length	Width	Height	Liquid	Dry	
True Series Inserts										
<b>LNDC-T804</b>	T804	32	100	36	2.28	2.24	2.61	6.10fl oz	11.00cu in	
<b>LNDC-T806</b>	T806	48	100	36	2.28	1.50	2.61	3.78fl oz	6.82cu in	
<b>LNDC-T1203</b> <b>LNDC-T1203-N</b>	T1203	36	100 BULK: 4,500	36	3.03	1.53	2.61	5.18fl oz	9.35cu in	
<b>LNDC-T1204</b> <b>LNDC-T1204-N</b>	T1204	48	100 BULK: 4,500	36	2.25	1.45	2.61	3.76fl oz	6.79cu in	
True Series Super Jumbo Deep Inserts										
<b>LNDC-T1202SJ-B</b>	T1202	24	100	36	3.30	2.13	3.25	9.35fl oz	16.87cu in	
<b>LNDC-T606SJ</b>	T606	36	100	36	2.21	2.03	3.25	6.05fl oz	10.92cu in	



## Trays, Flats & Inserts

### Landmark® L Series Tray (21.22in x 10.80in)

L Series tray, made of high-quality plastic resins for easy de-nesting, specifically designed to accommodate automation equipment.



Item #	Style Number	Pot Size Information	Qty per Case	Cases per Pallet	Trim Size			Barcode
					Length	Width	Depth	
L Series Trays								
<b>LNDL-1020R12</b>	L1020 R12	12 Ribs	100	32	21.22	10.80	2.33	
<b>LNDL-R18IND</b>	L1020 R18	Individual Cells - 18 Ribs	100	32	21.22	10.80	2.33	
<b>LNDL-1020R8</b>	L1020 R8	8 Ribs	100	32	21.22	10.80	2.33	
<b>LNDL-1020CR</b>	L1020CR	Center Rib	100	32	21.22	10.80	2.33	
<b>LNDL1020NCRNNOHOLE</b> <b>LNDL1020NCRWITHHOLE</b>	L1020NCRN	No Center Rib	100	32	21.22	10.80	2.33	

### Landmark® True Series Tray

True series tray, made of high-quality plastic resins for easy de-nesting, specifically designed to accommodate automation equipment.



Item #	Style Number	Ribs per Tray	Qty per Case	Cases per Pallet	Tray Dimensions in Inches			Barcode
					Length	Width	Depth	
True Series Trays								
<b>LNDC-TR12NXD</b>	TR12NXD - Extra Deep	12	100	36	20.00in	10.00in	2.71in	
<b>LNDC-TR18XDE-B</b>	TR18XDE - Individual Economy	18	100	36	20.00in	10.00in	2.71in	
<b>LNDC-TR6NXD-B</b>	TR6NXD - Extra Deep	6	100	36	20.00in	10.00in	2.71in	
<b>LNDC-TR8XD</b>	TR8XD - Extra Deep	8	100	36	20.00in	10.00in	2.71in	

### Landmark® TSS Series Packs (7.5in x 20in)

Made of high-quality plastic resins for easy de-nesting, specifically designed to accommodate automation equipment.



**TSS306 - 18 Cells - Cell: 2.30in W x 3.10in L x 3.34in D - Tray: 7.5in W x 20in L x 3.34in D - Black**  
**LNDC-TSS306** Min. Buy 1 cs/ 100ea



**TSS R6 No Center Rib - 6 Ribs - 19.88in L x 7.50in W x 1.75in D - Black**  
**LNDC-TSSR6NCR** Min. Buy 1 cs/ 100ea



### Landmark® Handle

19in split end locking handle for use with market packs.



**1in W x 19in L - White**  
**LNDX-19SEHW30** Min. Buy 1 cs/ 300ea



### Landmark® TS Series Packs (8.5in x 20in)

De-nesting is easy thanks to high-quality plastic resins, precise manufacturing and smart design. Precision perforation between packs for easy separation. Design accommodates your automation equipment. Easy integration - just fill, grow and transport.



**TS606JRC - Super Jumbo Pack Recessed Cell - 36 Cells - Cell: 2.06in L x 1.90in W x 3.25in D**  
**LNDC-TS606JRC** Min. Buy 1 cs/ 100ea



### Landmark® Thermoformed Pot Pack

Manufactured with high quality, tear-resistant materials. Features integrated water channels that ensure all cells receive even water distribution.



**White - TPP6 - 6 Pack - 10.11in L x 6.73 W x 1.55in D Tray**  
**LNDC-TPP6W** Min. Buy 1 cs/ 300ea

**Black - TPP6 - 6 Pack - 10.11in L x 6.73 W x 1.55in D Tray - Black**  
**LNDC-TPP6** Min. Buy 1 cs/ 300ea





# PÖPPELMANN

## Hanging Baskets

### Pöppelmann TEKU® Hanging Basket

Rapid growth, healthy plants, outstanding machinability – Pöppelmann TEKU® is not only characterised by the leading product range, but also offers the optimal solution for your culture. Water overflow with tag lock.



Item #	Includes Hanger	Color	Qty per Case	Bulk Count	Dimensions		Max. Liquid Volume	Barcode
					Diam	Height		
TEKU® Hanging Baskets								
PPMAN20WHT	No	White	132	-	8.00in	5.25in	0.75gal	
PPMAN25MOCHABULK3264	No	Mocha	-	3264	10.00in	6.00in	1.31gal	
PPMAL271065BLACK PPMAL27ZBLACKBULK	No	Black	50	3264	10.625in	6.50in	1.57gal	
PPMAL27ZCHOCcs PPMAL27ZCHOCBULK	No	Chocolate	50	3264	10.625in	6.50in	1.57gal	
PPMAL27GRN PPMAL27ZGREENBULK	No	Green	50	3264	10.625in	6.50in	1.57gal	
PPMAL271065MOCHA PPMAL27ZMOCHABULK	No	Mocha	50	3264	10.625in	6.50in	1.57gal	
PPMAL27ZCOMBOLIME	Yes	Lime	50	-	10.625in	6.50in	1.57gal	
PPMAL27ZCOMBOLTBLU	Yes	Light Blue	50	-	10.625in	6.50in	1.57gal	
PPMAL27ZCOMBOORANGE	Yes	Orange	50	-	10.625in	6.50in	1.57gal	
PPMAL27ZCOMBOPINK	Yes	Pink	50	-	10.625in	6.50in	1.57gal	
PPMAL27ZCOMBOPURPLE	Yes	Purple	50	-	10.625in	6.50in	1.57gal	
PPMAL27ZREDBULK PPMAL27ZCOMBORED	No Yes	Red	50	3264	10.625in	6.50in	1.57gal	
PPMAL271065WHITE PPMAL27ZWHITEBULK	No	White	50	3264	10.625in	6.50in	1.57gal	
PPMAL27ZCOMBOYELLOW	Yes	Yellow	50	-	10.625in	6.50in	1.57gal	
PPMAL33GRN	No	Green	60	-	13.00in	7.50in	2.80gal	

### Pöppelmann TEKU® 3-Strand Hanger

The stable hanger ensures secure hanging both in the greenhouse and for the end customer. Quick and easy hanger assembly, due to its universal fixing method, reduces labour costs.



#### Chocolate - 18in

PPMHJ40CHOC Min. Buy 1 cs/ 348ea

#### Green - 18in

PPMHJ40 Min. Buy 1 cs/ 58ea

#### Mocha - 18in

PPMHJ40MOCHA Min. Buy 1 cs/ 348ea

#### White - 18in

PPMHJ40WHT Min. Buy 1 cs/ 348ea

#### Black - 18in

PPMHJ40BK Min. Buy 1 cs/ 58ea





**Thermoformed and CoExtruded Containers**
**Pöppelmann TEKU® CoExtruded Containers**

Fast watering and drainage and optimum pot machine properties – these small details are often what makes a big difference. In other words: precision work. This is a decisive factor for the quality of the TEKU® plant pots. And it's the decisive factor for something else: your success. Has a multi hole, profile bottom.



Item #	Color	Qty per Case	Bulk Count	Dimensions		Max. Liquid Volume	Barcode
				Diam	Height		
<b>TEKU® Square Coextruded Containers</b>							
<b>PPVQF858595</b>	Black	2352	-	3.33in	3.75H	1.00pt	
<b>PPVQF111115cs840</b>	Black	840	-	11.00in	11.50in	1.25qt	
<b>TEKU® Round Coextruded Containers</b>							
<b>PPVCC10F BLK</b>	Black	2668	-	4.00in	3.625in	1.00pt	
<b>PPVCC110450BLK</b>	Black	1896	-	4.33in	3.75in	1.31pt	
<b>PPVCC12FUS-0475BLK</b>	Black	1440	-	4.75in	4.75in	1.00qt	
<b>PPVCC165KBLACK PPVCC165BULK</b>	Black	430	9856	6.50in	6.125in	2.50qt	
<b>PPVCC220865BULK</b>	Black	-	3096	8.66in	7.50in	1.27gal	
<b>TEKU® Azalea Round CoExtruded Pot</b>							
<b>PPVTD15US0600TC</b>	Terra Cotta	780	-	6.00in	4.25in	1.34qt	
<b>PPVCD165BLK</b>	Black	530	-	6.50in	5.00in	2.04qt	
<b>PPVCD21D0825BLK</b>	Black	288	-	8.25in	5.00in	3.00qt	

**Injection Molded Containers**
**Pöppelmann TEKU® Square Pots With Tag Lock**

Fast watering and drainage and optimum pot machine properties – these small details are often what makes a big difference. In other words: precision work. This is a decisive factor for the quality of the TEKU® plant pots. And it's the decisive factor for something else: your success. – Take advantage of the TEKU® AddedValues and discover what makes the MQD, MQC truly exceptional.



**Black - 13in x 13in x 13in**  
**PPMQD131313BLK** Min. Buy 1 cs/ 396ea

**Decorative Containers**
**Pöppelmann TEKU® Decorative Container**

Fast watering and drainage and optimum pot machine properties – these small details are often what makes a big difference. In other words: precision work. This is a decisive factor for the quality of the TEKU® plant pots. And it's the decisive factor for something else: your success. Has a cross bottom.



**Light Green - 12.62in x 10.75in**  
**PPPDB32LTGREEN** Min. Buy 1 cs/ 12ea



**Yellow - 12.62in x 10.75in**  
**PPPDB32YELLOW** Min. Buy 1 cs/ 12ea





### Carry Trays

#### Pöppelmann TEKU® Transport Tray

Transport and Cultivations trays have innovative bottom designs for every application. Punched bottom holes.



Item #	Color	Pot Compatibility	Qty per Case	Bulk Count	Trim Size			Barcode
					Length	Width	Depth	
TEKU® Tray								
PPUT10/10F	Black	10 - VCC 10F Pots	48	-	12.00	8.125	3.75	
PPUT12/8F	Black	8 - VCC12F Pots	58	-	19.25	8.625	4.875	
PPST2254AZDcs56	Black	10 - 11x11AZD	56		21.25	8.50	3.125	
PPUT11STDBLK BULK	Black	15 - VCC 11	-	1512	21.875	13.25	3.875	
PPUT15/6 AZ	Black		65	-				
PPUT1656STD	Black	6 - VCC 116.5, VCH 17	50		16.50	6.00		

### Specialty Planters

#### Pöppelmann TEKU® Plant Support

The firmly fixed plant supports protect sensitive shoots in the cultivation during transport and sales. Fits: VCD 16.5, VCC 16.5, VCC 16.5 K; MCH 17, MCL 17



**Dark Green - 7.88in x 3.75in**  
PPSTG165DGRNBULK Min. Buy 1ea



### Trays, Flats & Inserts

#### Pöppelmann TEKU® Nursery Plant Tray

Rapid growth, healthy plants, outstanding machinability – Pöppelmann TEKU® is not only characterised by the leading product range, but also offers the optimal solution for your culture.

With bottom for plugs.



**Black - 19.67in x 11in x 2in**  
PPJP305028BLK Min. Buy 1 cs/ 192ea



### Flats, Trays & Peat Pots

#### PlantBest® Biodegradable Coconut Coir Pots

Seed and cuttings flourish in our biodegradable, plantable coconut coir pots. Coconut coir helps ensure less mold growth occurs when compared to peat and/or paper based pots.



**2.25in Diam Pots, 12pk**  
PPR3488 Min. Buy 24ea



#### PlantBest® Biodegradable Coconut Coir Pots

Seed and cuttings flourish in our biodegradable, plantable coconut coir pots. Coconut coir helps ensure less mold growth occurs when compared to peat and/or paper based pots.



**3.25in Diam Round Pots, 8pk**  
PPR3489 Min. Buy 24ea



#### PlantBest® Biodegradable Coconut Coir Pots

Seed and cuttings flourish in our biodegradable, plantable coconut coir pots. Coconut coir helps ensure less mold growth occurs when compared to peat and/or paper based pots.



**4.50in Diam Round Pots, 6pk**  
PPR3490 Min. Buy 24ea



## Propagation & Plug Trays

### OASIS® FERTISS® Plant Propagation System

Ready-to-use plugs in a pre-filled propagation tray. Consistent and even media blend, pH adjusted. The loose, open mix makes it easy to insert and stick cuttings and the uniquely developed trays promote natural air pruning, encouraging development of a dense, fibrous root system. Ideal for slow-to-root cultivars. A long-lasting wetting agent is added to enhance water-holding capabilities. Easy to transplant and transport. Stacked trays do not compress the plug media.



Item #	Cells per Tray	Plug Shape	Qty per Case	Cases per Pallet	Plug Dimensions		Barcode
					Diam.	Depth	
<b>SM55305C2</b>	105 - Tray	Square	14	18	3cm	4cm	
<b>SM55305P2</b>			-	400			
<b>SM55325C</b>	25 - Strip	Round	1500	18	3cm	4cm	
<b>SM5325P</b>			1192	-			
<b>SM55326P</b>	26 - Strip	Round	26312	-	3cm	4cm	
<b>SM55326C</b>			1500	12			
<b>SM55350P2</b>	50 - Strip	Round	16000	-	4cm	5cm	
<b>SM55350LP2</b>	50 - Stripl	Round	15200	-	4cm	6cm	
<b>SM55372P2</b>	72 - Tray	Square	34560	-	3.2cm	3.5cm	



### OASIS® ROOTCUBES® Growing Medium

OASIS® Rootcubes® growing medium is manufactured in sheet form, with individual rooting cells shaped like cubes. Rootcubes® are available in sheets of various configurations or liners that fit conveniently into a standard "1020" plastic tray. Crops most commonly propagated from unrooted cuttings in Rootcubes media are poinsettias, geraniums, hibiscus, New Guinea impatiens, fuchsia, foliage, perennials, and woody ornamentals. A specialized medium that was designed specifically for a clean, healthy start for unrooted cuttings. Provides the perfect balance of air and water to encourage plant growth and get unrooted cuttings off to a strong start. Contains just the right amount of starter nutrients and are considered an especially economical propagation media.



Item #	Cube Size	Cubes per Sheet	Configuration	Qty per Case	Cases per Pallet	Sheet Dimensions			Barcode
						Length	Width	Depth	
Growing Medium									
<b>SM55005</b>	1.00in	162	9 x 18	3,240	24	10.00	10.00	1.50	
Growing Medium Strip									
<b>SM55020</b>	2.00in	10	1 x 10	1,900	24	20.00	1.00	1.50	

### OASIS® Terra-Plug

Terra Plug is a bonded media manufactured using a unique horticultural-friendly patented technology. With this technology, a wide variety of media may be used. The Terra Plugs are made by loose filling the propagation trays and stabilizing the media. Plugs do not shrink, are easy to re-water and ready to use. Made for automated processes and easy extraction.



#### 105Ct Cell Standard Mix

**SM8761105** Min. Buy 1 cs/ 360ea



# OASIS®

## GROWER SOLUTIONS

### Propagation & Plug Trays

#### OASIS® HORTICUBES® Growing Medium

A low density, high-drainage foam, HORTICUBES® growing medium is specially engineered for hydroponics seed germination of vegetables and herbs. Growers will appreciate the simplicity this medium brings to the challenges of hydroponics production. The excellent performance of HORTICUBES® medium is based upon its unique cell structure, which closely resembles the cellular structure of plants. This growing media is designed to drain off excess water from the base of the seed, allowing an optimal balance of oxygen and water, even when the foam is completely saturated. HORTICUBES® growing medium is sterile upon receipt and provides a clean start, pathogen-free environment, which reduces disease and insect problems for plant germination. All HORTICUBES® media is manufactured in a "sheet" style which fits easily on a bench or into industry standard "1020" trays. Each sheet is pre-scored for easy removal of a single cube, block of cubes, or strip of cubes.



1in



1in



1.5in

Item #	Cube Size	Cubes per Sheet	Qty per Case	Cases per Pallet	Sheet Dimensions			Center Hole Distance	Barcode
					Length	Width	Depth		
<b>SM55225</b>	1in	162	20	24	10.00	20.00	1.50	1-1/8in	
<b>SM55231</b>	1in Thin Cut	276	20	24	10.00	20.00	1.50	7/8in	
<b>SM55245</b>	1-1/2in	50	20	24	10.00	20.00	1.50	1-1/4in	

#### OASIS® WEDGE® Growing Medium

OASIS® WEDGE® growing media tapers in shape from top to bottom. This unique shape aids in directing root development downward for rapid root development, resulting in greater crop turnover and overall productivity for the grower. In transplanting, the WEDGE® product minimizes the need for dibbling. Each cell is singulated, therefore, there is no tangling of the fibrous root systems. Products come preloaded in either a strip or tray, and are immediately ready to use by a grower upon receipt. This format is ideal for automation and simplifies the packaging and shipping process. WEDGE® media comes in a wide variety of choices to suit many plant needs.

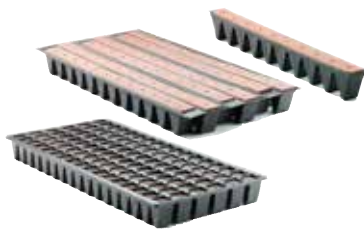

#### 34ct Double Strip - 34 Cells per Strip (2 x 17 Configuration)

**SM55625** Min. Buy 1 cs/ 1ea



#### 102ct Tray with Medium - 102 Cells per Tray (6 x 17 Configuration)

**SM55643** Min. Buy 1 cs/ 1ea



#### Wedge Medium Only - Refill for 5625, 5641 and 5643 - 17 Cells per Strip (1 x 17 Configuration)

**SM55615** Min. Buy 1 cs/ 1ea

#### OASIS® WEDGE® Plus Growing Medium

Designed to improve the rooting performance of poinsettias. By tailoring the media to address the specific rooting needs of poinsettias, propagation time can be reduced by five days. Features a unique, tapered shape that directs root growth downward for healthy, rapid development. When it's time to transplant, you'll find minimal need for dibbling, no transplant delay and plants that establish quickly and easily.



#### 10ct Strip - 224 Strips per case - without Clips

**SM8750010** Min. Buy 1 cs/ 2240ea



#### 13ct Strip - 224 Strips per case - with Clips

**SM87-55013** Min. Buy 1 cs/ 1ea



#### 13ct Strip - 224 Strips per case - without Clips

















**SM8750013** Min. Buy 1 cs/ 2912ea



### Thermoformed Containers

#### T.O. Plastics Square Vacuum Traditional & Deep Pots

100% recycled resins are extruded, then formed into high-impact polystyrene square plant pots. Durable, dependable and environmentally responsible plant pots with the efficiency of our Press-Fill system.











Item #	Style	Pot Size - Color	Carton-Pot Stack Configuration	QTY	Cases per Pallet	Dimensions in Inches			Volume		Barcode
						Top	Bottom	Depth	Max Dry (cu in)	Max Liquid	
Square Vacuum Traditional Pots											
<b>T0700070C</b>	SVT-400	4.00in - Black	4 x 5	500	30	3.66	2.95	3.11	32.83	1.13pt	
<b>T0700076C</b>	SVT-450	4.50in - Black	3 x 4	300	32	4.20	3.42	3.62	49.73	1.72pt	
<b>T0700087C</b>	SVT-450	4.50in - Black	3 x 5	375	28	4.20	3.42	3.62	49.73	1.72pt	
<b>T0700081C</b>	SVT-450	4.50in - Black	4 x 5	500	24	4.20	3.42	3.62	49.73	1.72pt	
Square Vacuum Deep Pots											
<b>T0700003C</b>	SVD-250	2.50in - Black	4 x 8	800	48	2.60	1.65	3.44	14.46	7.84fl oz	
<b>T0700005C</b>	SVD-250	2.50in - Terra Cotta	4 x 8	800	48	2.60	1.65	3.44	14.46	7.84fl oz	
<b>T0700014C</b>	SVD-325	3.25in - Black	3 x 6	450	48	3.31	2.50	3.50	28.56	16oz	
<b>T0700022C</b>	SVD-325	3.25in - Black	4 x 5	900	28	3.31	2.50	3.50	28.56	1pt	
<b>T0700024C</b>	SVD-350	3.50in - Red	3 x 6	450	48	3.52	2.56	3.50	31.43	1.08pt	
<b>T0700026C</b>	SVD-350	3.50in - Black	3 x 6	450	48	3.52	2.56	3.50	31.43	1.08pt	
<b>T0700027C</b>	SVD-350	3.50in - Green	3 x 6	450	48	3.52	2.56	3.50	31.43	1.08pt	
<b>T0700028C</b>	SVD-350	3.50in - Terra Cotta	3 x 6	450	48	3.52	2.56	3.50	31.43	1.08pt	
<b>T0700035C</b>	SVD-355-NP	3.55in - Black	-	450	40	3.52	2.56	5.00	42.45	1.50pt	
<b>T0700051C</b>	SVD-450	4.50in - Black	3 x 5	375	28	4.20	3.42	4.91	65.42	1.13qt	
<b>T0700062C</b>	SVD-450	4.50in - Black	4 x 5	500	24	4.20	3.42	4.91	65.42	1qt	
<b>T0700099C</b>	SVD-550	5.50in - Black	2 x 4	200	32	5.36	4.18	6.00	116.56	2.06qt	

### Carry Trays

#### T.O. Plastics Square Pot Carry Trays

100% recycled resins extruded into high impact carry trays. You are sure to save time and money with the ease of the Press-Fill system.



Item #	Style	Fits Pot Size	Fits Qty of Pots	Qty per Case	Cases per Pallet	Tray Dimensions			Barcode
						Length	Width	Height	
Square Pot Carry Trays									
<b>T0705105C</b>	SPT-250-32-PF	2.50in	32	100	24	21.19	10.75	2.50	
<b>T0705119C</b>	SPT-325-18-PF	3.25in	18	50	40	20.00	10.00	1.88	
<b>T0705130C</b>	SPT-350-18-PF	3.50in	18	100	24	21.25	10.81	1.93	
<b>T0705137C</b>	SPT-355-18-DP	3.55in	18	50	24	21.25	10.81	3.50	
<b>T0705142C</b>	SPT-400-15-PF	4.00in	15	50	48	18.75	11.25	1.94	
<b>T0705144C</b>	SPT-400-20-PF	4.00in	20	50	20	18.75	15.00	1.88	
<b>T0705150C</b>	SPT-450-10-PF	4.50in	10	100	30	21.19	8.75	2.13	
<b>T0705155C</b>	SPT-450-12-PF	4.50in	12	50	30	17.00	12.88	2.13	
<b>T0705160C</b>	SPT-450-12-HW	4.50in	12	50	45	17.00	12.88	3.19	
<b>T0705165C</b>	SPT-450-15-PF	4.50in	15	50	24	21.19	12.88	2.13	
<b>T0705193C</b>	SPT-550-8	5.50in	8	25	32	21.44	10.94	3.03	

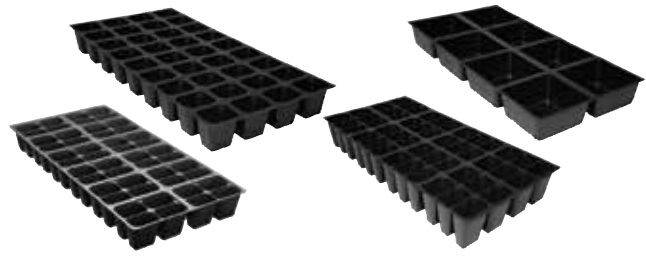

Trays, Flats, & Inserts

T.O. Plastics Standard Insert

T.O. Plastics thermoforms quality plastic plant trays including standard inserts and flats. Standard inserts have straight walls that offer greater soil capacity for a larger, healthier crop, and they are engineered to de-nest easily. Standard inserts are designed for use with 1020 standard flats, which are sturdy, yet lightweight for easy handling. These standard inserts combined with our standard flats create an efficient system that is ideal for filling, growing and shipping plants.

- Standard Inserts 10.56in x 21.06in perimeter trim.

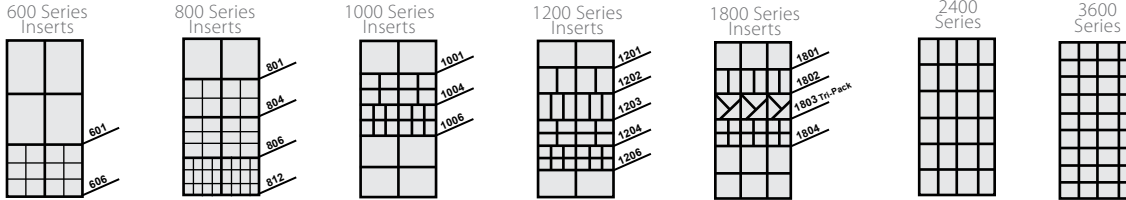

Item #	Style	Qty per Case	Cases per Pallet	Cell Dimensions (Inches)			Volume per Cell		Barcode
				Width	Length	Depth	Max Dry (cu in)	Max Liquid	
600 Series Inserts									
<b>T0715348C</b>	STI-606	100	32	1.94	2.23	2.23	42.42	1.47pt	
800 Series Inserts									
<b>T0715352C</b>	STI-801	100	36	4.86	4.86	2.27	45.65	1.58pt	
<b>T0715353C</b>	STI-804	100	72	2.40	2.40	2.23	35.52	1.23pt	
<b>T0715357C</b>	STI-806	100	72	1.50	2.38	2.25	37.68	1.30pt	
<b>T0715364C</b>	STI-812	100	56	1.15	1.59	2.25	29.29	1.01pt	
1000 Series Inserts									
<b>T0715366C</b>	STI-1001	100	32	3.73	4.80	2.25	33.56	1.16pt	
<b>T0715367C</b>	STI-1004	100	63	2.35	1.81	2.24	26.85	14.88fl oz	
<b>T0715369C</b>	STI-1006	100	64	1.50	1.77	2.25	21.97	12.17fl oz	
1200 Series Inserts									
<b>T0715371C</b>	STI-1201	100	32	3.13	4.88	2.25	30.50	1.05pt	
<b>T0715373C</b>	STI-1202	100	63	3.10	2.28	2.27	25.02	13.86fl oz	
<b>T0715374C</b>	STI-1203	100	63	3.38	1.50	2.27	22.27	12.34fl oz	
<b>T0715377C</b>	STI-1204	100	72	1.50	2.38	2.26	23.48	13.00fl oz	
<b>T0715382C</b>	STI-1206	100	64	1.50	1.50	2.23	21.36	11.82fl oz	
1800 Series Inserts									
<b>T0715385C</b>	STI-1801	100	40	3.11	3.11	2.25	17.7	9.80fl oz	
<b>T0715387C</b>	STI-1802	100	32	1.49	3.11	2.27	14.04	7.78fl oz	
<b>T0715389C</b>	STI-1803-TRI PACK	100	72	2.42	1.59	2.27	14.65	8.12fl oz	
<b>T0715394C</b>	STI-1804	100	63	1.55	1.55	2.27	13.60	7.54 fl oz	
2400 Series Inserts									
<b>T0715399C</b>	STI-2401	100	63	2.19	3.00	2.25	12.50	6.93fl oz	
3600 Series Inserts									
<b>T0715401C</b>	STI-3601	100	32	1.94	2.23	2.23	7.32	4.05fl oz	
Deep Series Inserts									
<b>T0715405C</b>	STI-606-DP	100	63	2.00	2.25	3.25	75.16	1.30qt	
<b>T0715408C</b>	STI-806-DP	100	32	1.56	2.36	3.13	45.77	1.60pt	





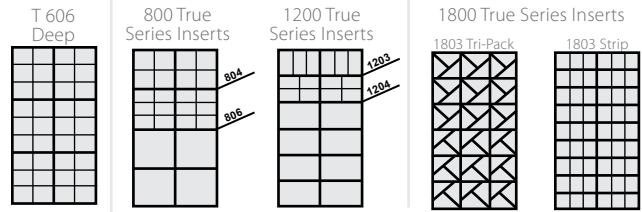

### Trays, Flats, & Inserts

#### T.O. Plastics True Insert

Optimum cell size for greater soil capacity. Community watering prevents dry cells. Designed for easy de-nesting. For use with true size tray. 9.69in x 19.69in Perimeter Trim.













Item #	Style	Qty per Case	Cases per Pallet	Cell Dimensions (Inches)			Volume per Cell		Barcode
				Width	Length	Depth	Max Dry (cu in)	Max Liquid	
600 Series Deep True Inserts									
<b>T0715335C</b>	TRI-606-DP	100	72	2.00	2.12	3.31	53.04	1.84pt	
800 Series True Inserts									
<b>T0715320C</b>	TRI-804	100	72	2.15	2.18	2.63	38.40	1.33pt	
1200 Series True Inserts									
<b>T0715323C</b>	TRI-1203	100	72	1.42	2.88	2.63	24.60	13.63fl oz	
<b>T0715325C</b>	TRI-1204	100	63	1.43	2.22	2.63	18.30	10.14fl oz	
1800 Series True Inserts									
<b>T0715328C</b>	TRI-1803-STRIP	100	72	1.50	1.75	2.65	12.06	6.69fl oz	



#### T.O. Plastics Flats



For use with standard and true inserts. Sturdy, yet lightweight for easy handling.



Item #	Style	Qty per Case	Cases per Pallet	Tray Dimensions (Inches)			Barcode
				Width	Length	Depth	
Standard Flats							
<b>T0710245C</b>	STF-1020-OPEN	100	40	10.94	21.44	2.44	
<b>T0710251C</b>	STF-1020-OPEN-NH	100	40	10.94	21.44	2.44	
<b>T0710274C</b>	STF-1020-R-12	100	32	10.94	21.44	2.44	
<b>T0710280C</b>	STF-1020-R-18-TP (Tall)	100	32	10.81	21.25	2.56	
<b>T0790920C</b>	STF-1020-WEB-50	50	48	10.75	21.26	2.40	
<b>T0760549C</b>	STF-1020-CLEAR-DOME	50	56	11.00	21.50	2.10	
Standard Half Flats							
<b>T0710341C</b>	ST-F-1010-BK-100	100	32	10.13	10.13	2.30	
<b>T0710342C</b>	ST-F-1010-NH-BK-100	100	32	10.13	10.13	2.30	
True Flats							
<b>T0710215C</b>	TRF-1020-R-6	100	40	10.00	20.00	2.88	
<b>T0710222C</b>	TRF-1020-R-12	100	40	10.00	20.00	2.88	

#### T.O. Plastics Germination Trays

Sturdy, yet lightweight for easy handling.

Item #	Style	Qty per Case	Cases per Pallet	Tray Dimensions (Inches)		Barcode
				Width	Length	
Germination Tray						
<b>T0745730C</b>	1020 Germination Flat	100	36	10.81	21.125	
<b>T0745731C</b>	1020 Germination Tray - no holes	100	36	10.81	21.125	





## Thermoformed Containers

### T.O. Plastics Sheet Pots

Ideal for nursery propagation and landscape groundcovers. High quality economical pots are connected in one sheet and easily separate for individual use. Sheet pots are designed to de-nest easily, saving you time and effort.



Item #	Style	Pots per Sheet	Tray Compatibility	Qty per Case	Cases per Pallet	Tray Dimensions		Cell Dimensions		Volume per Cell		Barcode
						Width	Length	Top	Depth	Max Dry (cu in)	Max Liquid	
Sheet Pots												
<b>T0730645C</b>	SOP-18	18	Standard Open 1020 Flats & STF-1020-R-18-TP	100	40	10.56	21.06	3.25	3.14	26.06	14.44fl oz	
Deep Sheet Pots												
<b>T0730649C</b>	SOP-18-DP	18	STF-1020-R18-TP	50	56	10.56	21.06	3.38	3.55	27.83	15.43fl oz	
<b>T0730654C</b>	SOP-32-DP	32	Standard Open 1020 Flats & SPT-250-32	100	40	10.56	21.06	2.59	3.00	11.59	6.42fl oz	
True Series Sheet Pots												
<b>T0730630C</b>	SOP-T-18	18	True Open Flats & TR-F-1020-R-18	100	40	9.69	19.69	2.89	3.00	18.91	10.48fl oz	

### T.O. Plastics Liner Trays

Thermoformed high-quality, multi-purpose liner trays are an economical choice. They are produced as a solid sheet with no perforations and fit many of our standard trays. They are available in standard and true formats as well as deep. Available in heavy weight version by special order.

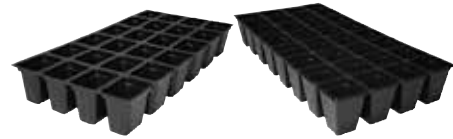

Item #	Style	Pots per Sheet	Tray Compatibility	Qty per Case	Cases per Pallet	Tray Dimensions		Cell Dimensions		Volume per Cell		Barcode
						Width	Length	Top	Depth	Max Dry (cu in)	Max Liquid	
Liner Trays												
<b>T0735680C</b>	LIN-24	24	Standard Open 1020 Flats	100	54	10.56	21.06	3.1 x 2.25	3.0	15.26	8.43fl oz	
<b>T0735683C</b>	LIN-32	32	Standard Open 1020 Flats & SPT-250-32-PF	100	40	10.56	21.06	2.59	3.0	11.59	6.42fl oz	

## Carry Trays

### T.O. Plastics Round Pot Carry Trays

Designed to fit most manufacturer's round standard pots.



Item #	Style	Fits Pot Size	Fits Qty of Pots	Qty per Case	Cases per Pallet	Tray Dimensions			Barcode
						Length	Width	Height	
Round Pot Carry Trays - Fits most manufacturer's round standard pots.									
<b>T0755830C</b>	RPT-450-GV-10	4.50in Geranium	10	75	50	23.02	9.19	4.05	
<b>T0755838C</b>	RPT-450-GV-15	4.50in Geranium	15	50	42	23.02	13.80	4.05	











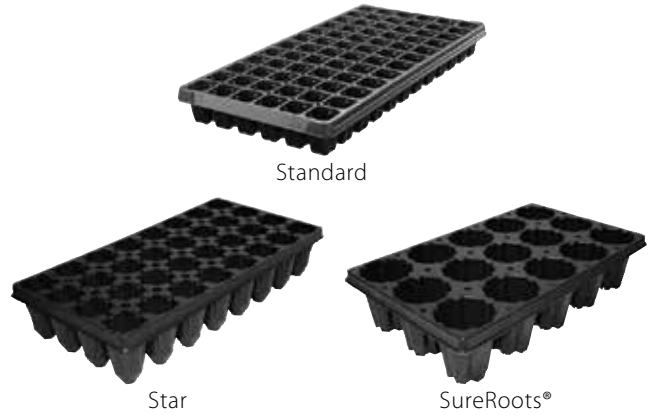





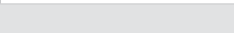

**Propagation & Plug Trays**

**T.O. Plastics Plug Trays**

Maximum cell sizes for optimum soil capacity. Optional ventilation holes for greater air movement. Larger label ramps to meet most grower requirements. Precisely centered, punched drain holes. Cell bottom buttons slightly elevate trays on benches. Cell wall "root ribs" and star trays for enhanced downward root growth.

- Standard plug trays 11 in x 21.22in perimeter trim.
- PL-32-STAR-DP-HW-STY 11 in x 21.5in perimeter trim.
- Star plug trays 10.94in x 21.44in perimeter trim.
- PL-SR-15 12.88in x 21.19in perimeter trim.
- PL-SR-50 10.94in x 21.44in perimeter trim.

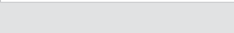

Item #	Style	Qty per Case	Cases per Pallet	Cell Foot Print	Drain Hole	Vent Hole	Cell Dimensions (Inches)		Volume per Cell		Barcode
							Depth	Top	Max Dry (cu in)	Max Liquid	
<b>Standard Plug Trays</b>											
<b>TO720463C</b>	PL-50	100	24	5 x 10	0.37	0.25	2.37	1.90	6.77	3.75fl oz	
<b>TO720469C</b>	PL-72	100	24	6 x 12	0.37	0.25	2.25	1.52	3.60	1.99fl oz	
<b>TO720477C</b>	PL-98	100	24	7 x 14	0.37	0.25	2.00	1.34	2.26	1.25fl oz	
<b>TO720487C</b>	PL-128	100	32	8 x 16	0.31	0.18	2.00	1.19	1.53	0.85fl oz	
<b>TO720507C</b>	PL-200-1.5	50	40	10 x 20	0.25	N/A	1.50	0.86	0.67	0.37fl oz	
<b>TO720528C</b>	PL-288-1.25	50	40	12 x 24	0.31	N/A	1.25	0.76	0.43	0.24fl oz	
<b>TO720532C</b>	PL-288-1.5	50	40	12 x 24	0.31	N/A	1.50	0.76	0.67	0.37fl oz	
<b>TO720536C</b>	PL-392	50	40	14 x 28	0.31	0.15	1.15	0.70	0.37	0.20fl oz	
<b>Star Plug Trays</b>											
<b>TO720556C</b>	PL-32-STAR-DP-HW-STY	50	24	4 x 8	0.62	0.62	4.00	2.22	10.07	5.58fl oz	
<b>TO720557C</b>	PL-36-STAR	50	48	4 x 9	0.62	0.50	3.00	2.12	7.32	4.06fl oz	
<b>TO720562C</b>	PL-38-STAR-DP	25	32	3x8 2x7	0.75	N/A	5.00	2.13	13.43	7.44fl oz	
<b>TO720578C</b>	PL-38-STAR-4.0	50	32	3x8 2x7	0.75	N/A	4.00	2.13	10.37	5.74fl oz	
<b>TO720568C</b>	PL-50-STAR-DP	50	24	5 x 10	0.62	0.50	4.50	1.94	8.66	4.80fl oz	
<b>TO720582C</b>	PL-72-STAR-DP	50	32	6 x 12	0.43	0.50	3.00	1.56	4.27	2.37fl oz	
<b>SureRoots® Plug Trays</b>											
<b>TO720720C</b>	PL-SR-15-VH	25	56	3 x 5	1.25	0.50	4.59	3.55	34.42	19.07fl oz	
<b>TO720715C</b>	PL-SR-15-HW-VH	25	42	3 x 5	1.25	0.50	4.59	3.55	33.07	18.33fl oz	
<b>TO720700C</b>	PL-SR-50-DP-VH	25	32	5 x 10	0.625	0.25	5.00	2.00	11.90	6.59fl oz	





## Propagation & Plug Trays

### T.O. Plastics Propagation Sheets

Optimized cell sizes allow for abundant soil capacity, community watering channels prevent dry cells, and trays de-nest easily to maximize your time and effort.

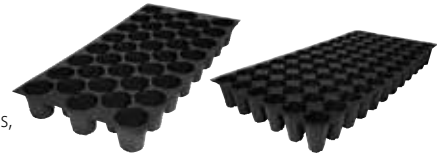

Item #	Style	Qty per Case	Cases per Pallet	Drain Hole	Cells Per Sheet	Cell Dimensions (Inches)		Volume per Cell		Barcode
						Depth	Top	Max Dry (cu in)	Max Liquid	
Propagation Trays- Round Cells										
<b>T0725601C</b>	PROP-38-RD	100	48	Burned	38	2.31	2.25	7.20	3.99fl oz	
<b>T0725602C</b>	PROP-50-RD	100	40	Burned	50	2.31	1.93	4.88	2.71fl oz	
<b>T0725607C</b>	PROP-72-RD	100	40	Burned	72	2.31	1.46	2.50	1.39fl oz	
<b>T0725610C</b>	PROP-98-RD	100	40	Burned	98	1.50	1.34	1.65	0.91fl oz	
Propagation Trays- Square Cells										
<b>T0725616C</b>	PROP-50-SQ-DC	100	40	Die Cut - Punched	50	2.38	1.93	4.88	2.71fl oz	



## Hanging Baskets

### Western Pulp® Heavy Duty Hooked Wire Hanger

Heavy-Duty 16 Gauge Wire Hanger. Recommended For Use With 14X1rd Basket. May Also Be Used With Eyeleted 10 And 12 Hanging Baskets.



**26In -Fits 10In, 12In And 14In Baskets With Eyelets**

**WP888899** Min. Buy 1 cs/ 1ea



### Western Pulp® Heavy Duty 4-Strand Wire Swivel Hangers

Heavy-Duty Wire For Use With Eyelet Pots Like 14X1rd. Swivels 360 Degrees.



**26In**  
**WP888612** Min. Buy 1 cs/ 20ea



### Western Pulp® 4-Strand Nylon Clip-On Hanger

Attaching Clip-On Hangers Significantly Saves Time. Just Attach 2 Opposing Clips At Once And Snap On The Other 2. Notches Built Into The Rolled Rim Make Positioning Easy. Can Be Easily Removed And Reused.



**Fits 10In And 12In Baskets Without Eyelets**

**WP888534** Min. Buy 1 cs/ 22ea



### Western Pulp® 4-Strand Nylon Barbed Hanger

Extra-Strong, Attractive, Easy-To-Install Snap-In Hanger.



**For 10In And 12In Hanging Basket With Eyelets**

**WP888514** Min. Buy 1 cs/ 22ea



### Western Pulp® 4-Strand Wire Hoop Hanger

Heavy-Duty Wire Hanger That Swivels 360 Degrees.



**18In -Fits 18X10 Garden Baskets**

**WP888227** Min. Buy 1 cs/ 20ea



**Fits 16X8 Garden Baskets**

**WP888127** Min. Buy 1 cs/ 20ea





## Hanging Baskets

### Western Pulp Fiber Hanging Baskets

Premium quality fully wax-permeated fiber basets for extended life and strength, fitted with attractive rust-free eyelets.



Square



Round



Cascade



Round Reservoir



XL Round



Garden Basket

Item #	Style Number	Eye-lets	Hanger Type (Hangers Sold Separately)	Qty per Case	Cases per Pallet	Outside Dimensions (In)		Volume		Barcode
						Diam.	Height	Imperial	Metric	
Fiber Hanging Baskets										
<b>WP104527</b>	10SQ Basket	Yes	Extra-Strong Nylon H-D Hooked Wire	22	48	11.00	7.25	1.84gal	6.98L	
<b>WP104577</b>	10SQ Basket	No	Clip-On Nylon	22	48	11.00	7.25	1.84gal	6.98L	
<b>WP105927</b>	12SQ Basket	Yes	Extra-Strong Nylon H-D Hooked Wire	22	36	12.875	7.75	2.80gal	10.60L	
<b>WP105977</b>	12SQ Basket	No	Clip-On Nylon	22	36	12.875	7.75	2.80gal	10.60L	
<b>WP105127</b>	10RD Basket	Yes	Extra-Strong Nylon H-D Hooked Wire	22	48	11.125	6.25	1.34gal	5.10L	
<b>WP105177</b>	10RD Basket	No	Clip-On Nylon	22	48	11.125	6.25	1.34gal	5.10L	
<b>WP105527</b>	12RD Basket	Yes	Extra-Strong Nylon H-D Hooked Wire	22	33	12.75	6.875	2.09gal	7.93L	
<b>WP105577</b>	12RD Basket	No	Clip-On Nylon	22	33	12.75	6.875	2.09gal	7.93L	
<b>WP107727</b>	10XLRD Basket	Yes	Extra-Strong Nylon H-D Hooked Wire	22	37	11.125	7.875	1.59gal	6.05L	
<b>WP107777</b>	10XLRD Basket	No	Clip-On Nylon	22	37	11.125	7.875	1.59gal	6.05L	
<b>WP107837</b>	12XLRD-II	Yes	Extra-Strong Nylon H-D Hooked Wire	22	25	12.875	8.875	2.69gal	10.20L	
<b>WP107867</b>	12XLRD-II	No	Clip-On Nylon	22	25	12.875	8.875	2.69gal	10.20L	
<b>WP106827</b>	10 Cascade	Yes	Extra-Strong Nylon H-D Hooked Wire	22	48	10.875	6.75	1.37gal	5.20L	
<b>WP106627</b>	12 Cascade	Yes	Extra-Strong Nylon H-D Hooked Wire	22	33	12.75	7.625	2.34gal	8.87L	
<b>WP106677</b>	12 Cascade	No	Clip-On Nylon	22	33	12.75	7.625	2.34gal	8.87L	
<b>WP110327</b>	12RD w/Reservoir	Yes	Extra-Strong Nylon H-D Hooked Wire	22	33	12.75	6.875	2.09gal	7.93L	
<b>WP110377</b>	12RD w/Reservoir	No	Clip-On Nylon	22	33	12.75	6.875	2.09gal	7.93L	
<b>WP107127</b>	14XLRD Basket	Yes	H-D Hooked Wire	20	18	14.75	8.75	3.96gal	15.00L	
<b>WP106927</b>	16X8 Garden Basket	No	Use w/ 16in Hanger Assembly	20	18	17.00	8.875	4.43gal	16.8L	
<b>WP103827</b>	18X10 Garden Basket	No	18in Hanger Assembly	20	12	19.75	9.00	5.99gal	22.70L	
<b>WP107787</b>	10 XL RD Basket Bulk	No	Clip-On Nylon	416	-	10.125	7.875	1.59gal	6.05L	
<b>WP107817</b>	12 XL RD-II Basket	Yes	Extra-Strong Nylon Hanger	253	-	12.875	8.875	2.69gal	10.20L	
<b>WP107887</b>	12 XL RD-II Basket	No	Extra-Strong Nylon Hanger	253	-	12.875	8.875	2.69gal	10.20L	



## Fiber Containers

### Western Pulp® Fiber Nursery Pots

Premium quality fiber pots ideal for potting bareroot roses and small fruit, shade or flowering trees. Popular for patio and balcony gardening. Packaged in moisture-resistant sleeves.



Item #	Style Number / Product Code	Qty per Case	Cases per Pallet	Interior Dimensions in Inches		Exterior Dimensions in Inches		Volume	Barcode
				Diameter	Height	Diameter	Height		
Small & Medium - Fiber Pots									
WP100127	6X6RD	44	42	6.25	6.125	7.00	6.125	2.48qt	
WP100927	8X6RD	68	20	8.50	5.75	9.00	6.125	1.04gal	
WP101127	8X8RD	40	20	8.50	8.25	9.25	8.625	1.62gal	
WP101927	11X11SQ	36	14	11.125	10.75	12.375	11.125	3.77gal	
WP101427	10X7RD	40	16	10.125	6.75	10.875	7.00	1.80gal	
WP101627	10X10RD	36	16	10.125	9.25	11.25	10	2.55gal	
WP101837	10X14RD	22	16	10.00	13.875	11.00	14.125	3.54gal	
WP102127	12X8RD	40	14	11.50	7.75	12.50	8.00	2.74gal	
WP102327	12X11RD	32	14	11.125	10.50	12.375	11.00	3.40gal	
WP102527	12X16RD	26	12	12.25	15.75	13.375	16.25	5.73gal	
WP102727	13X9RD	36	12	13.00	8.75	14.00	9.00	4.12gal	
WP102927	13X12RD	28	12	12.875	12.375	13.75	12.75	5.52gal	
WP103127	15X10RD	20	16	15.00	9.75	16.125	10.125	4.28gal	
WP103327	15X13RD	16	16	14.875	12.875	16.125	13.375	6.55gal	
WP103527	15X16RD	14	16	15.00	15.50	16.125	15.875	7.97gal	

### Western Pulp® Traditional Series Fiber Garden Planter

Made with fully wax-permeated fiber for extended life and strength, fitted with attractive rust-free eyelets. Planter has attractive sculptured sides.



Item #	Size	Qty per Case	Cases per Pallet	Interior Dimensions in Inches		Exterior Dimensions in Inches		Volume	Barcode
				Diameter	Height	Diameter	Height		
Garden Planters - Premium Waxed Containers									
WP103227	12 Traditional	16	33	12.00	9.75	13.25	10.25	3.30gal	
WP103427	14 Traditional	16	16	14.00	11.25	15.25	11.75	5.20gal	
WP109627	10 Bell	16	48	10.125	8.125	11.125	8.625	1.90gal	
WP1097027	12 Bell	16	27	12.00	9.75	13.375	10.25	3.35gal	
WP109837	14 Bell	16	16	14.00	11.125	15.125	11.5	5.28gal	



**Fiber Containers**

**Western Pulp® Large & Extra Large Containers**

Large Containers are wax-permeated at the rim and bottom, these large containers are great for B&B stock and specimen trees. Ideal for living Christmas trees, large shrubs, conifers, shade trees and container gardening. Packaged in plastic sleeves for outdoor storage.

Extra Large Containers are fully wax-permeated for long lasting strength and durability, these containers make maintenance and display of large B&B stock and ornamentals easy. Designed to work with spade diggers. Ideal for large conifers, specimen, fruit and nut trees.



Item #	Style Number / Product Code	Qty per Case	Cases per Pallet	Interior Dimensions in Inches		Exterior Dimensions in Inches		Volume	Barcode
				Diameter	Height	Diameter	Height		
Large - Round Fiber Pots									
<b>WP103727</b>	18X12RD	12	12	17.87	11.87	19.50	12.375	9.90gal	
<b>WP103927</b>	18X16RD	10	12	18.13	15.25	19.87	15.63	12.15gal	
<b>WP104037</b>	21X12RD	10	9	20.25	11.25	22.00	11.63	12.15gal	
<b>WP104147</b>	21X16RD	8	9	20.25	15.37	22.00	16.00	16.11gal	



Item #	Size	Qty per Case	Cases per Pallet	Interior Dimensions in Inches		Exterior Dimensions in Inches		Volume	Barcode
				Diameter	Height	Diameter	Height		
Patio Planters - Premium Unwaxed Containers									
<b>WP105227</b>	10 Clover	36	24	10.00	5.625	11.00	6.125	1.38gal	
<b>WP106127</b>	12 Clover	20	33	12.75	6.75	11.00	7.00	2.30gal	
<b>WP107227</b>	14 Clover	20	16	14.75	7.75	13.25	8.00	3.77gal	
<b>WP102227</b>	12X5RD	50	22	11.75	4.625	13.25	5.125	1.56gal	
<b>WP105427</b>	15X6RD	40	16	15.00	5.75	16.125	6.00	2.98gal	
<b>WP105627</b>	Dec-A-Pot	22	16	13.75	7.625	15.00	8.125	3.93gal	
<b>WP103627</b>	18X8RD	20	12	18.00	7.625	19.25	8.125	5.65gal	
<b>WP106027</b>	21X8RD	16	9	20.75	7.625	22.125	8.00	7.21gal	





BFG's plant broker service offers access to an extraordinary network of growers located all over the country

*Let our knowledgeable staff save you time and money  
by finding the best suppliers for your needs*



**Contact your Plant Connection sales representative  
or contact our main office to get started!**

[plantconnection@bfgsupply.com](mailto:plantconnection@bfgsupply.com)



# *Media*



# GrowerSelect<sup>®</sup>

## Growing Media

### Grower Select<sup>®</sup> M1 Professional Mix

M1 Professional Mix is a versatile medium-weight growing medium designed for growing in anything from small pots to large containers and hanging baskets. 55% Peat Moss, 25% Bark, 15% Perlite, 5% Vermiculite



**2.8cu ft Loose Fill Bag**

**PRBBFGGSM128N** Min. Buy 1ea

**60cu ft Loose Fill Tote / Direct Ship**

**PRBBFGGSM160** Min. Buy 2ea  
Shipping Info *DIRECT*

**2.8cu ft Loose Fill Bag**

**PRBBFGGSM128** Min. Buy 1ea



### Grower Select<sup>®</sup> M2 Professional Mix

M2 Professional Mix is a lower cost version of our ultra-popular M1 blend. M2 is a great performer on horticultural crops like bedding plants, perennials, nursery stock, perennials, hanging baskets, vegetables. 55% Peat Moss, 30% Bark, 15% Perlite



**2.8cu ft Loose Fill Bag**

**PRBBFGGSM228N** Min. Buy 1ea

**60cu ft Loose Fill Tote / Direct Ship**

**PRBBFGGSM260** Min. Buy 2ea  
Shipping Info *DIRECT*

**2.8cu ft Loose Fill Bag**

**PRBBFGGSM228** Min. Buy 1ea



### Grower Select<sup>®</sup> H2 Professional Mix

H2 Professional Mix is a heavy-weight bark mix formulated for use in larger containers and longer term crops, both in greenhouses and outdoors. H2's higher ratio of bark:peat gives it an excellent balance of porosity and water holding capacity. 55% Bark, 30% Peat Moss, 15% Perlite



**2.8cu ft Loose Fill Bag**

**PRBBFGGSH228** Min. Buy 1ea

**60cu ft Loose Fill Tote / Direct Ship**

**PRBBFGGSH260** Min. Buy 2ea  
Shipping Info *DIRECT*

**2.8cu ft Loose Fill Bag**

**PRBBFGGSH228N** Min. Buy 1ea





## Growing Media

### PRO-MIX<sup>®</sup> BX General Purpose Professional Media

General purpose peat-based professional growing medium designed for general greenhouse use and transplanting applications. Perlite and vermiculite provide a balance of moisture and nutrient retention along with good drainage creating an ideal growing environment.

- Answers the needs of most growing applications
- Light-weight, low bulk-density
- High water-holding capacity
- Vermiculite improves nutrient retention

#### BX Mixes All Contain

- 80% Canadian Sphagnum Peat Moss
- 15% Perlite
- 5% Vermiculite
- Dolomitic & Calclitic Limestone

#### Crops

- Foliage Plants
- Potted Flowers
- Greenhouse Vegetables
- Young Plant Propagation
- Vegetable Transplants
- Indoor Gardening
- Annuals
- Perennials

Also Available in  
**BULK SIZES**

Contact Your BFG Sales Representative  
for More Information

### Benefits of BIOFUNGICIDE<sup>™</sup>

(*Bacillus amyloliquefaciens* MBI-600) is a bacteria which colonizes developing root systems. It helps to prevent root disease and suppress disease causing organisms such as *Pythium*, *Rhizoctonia* and *Fusarium*.

- Enhanced germination
- Better plant growth
- Broad spectrum of action against diseases
- Protection against damping-off, crown and root rots caused by *Pythium*, *Rhizoctonia* and *Fusarium*

### Benefits of MYCORRHIZAE<sup>™</sup>

(*Glomus intraradices*) is a Biological Growth Enhancer that increases the yield of flower, fruit and vegetable plants by extending the root system to acquire the most of available nutrients in the soil. Mycorrhizae also improve resistance to root diseases and stresses.

- Improves fertilizer uptake; reduces fertilizer costs
- Increases plant's resistance to stresses; reduces maintenance costs
- Optimizes results without changing growing practices



#### PRO-MIX<sup>®</sup> BX



**2.8cu ft Loose Fill Bag**  
PRB10280RG Min. Buy 1ea

**3.8cu ft Compressed Bale**  
PRB10380RG Min. Buy 1ea

**135cu ft Compressed Bale**  
PRB11350RG Min. Buy 1ea  
Shipping Info **DIRECT**



#### PRO-MIX<sup>®</sup> BX MYCORRHIZAE<sup>™</sup>



**2.8cu ft Loose Fill Bag**  
PRB10281RG Min. Buy 1ea

**3.8cu ft Compressed Bale**  
PRB10381RG Min. Buy 1ea

**135cu ft Compressed Bale**  
PRB11351RG Min. Buy 1ea  
Shipping Info **DIRECT**



#### PRO-MIX<sup>®</sup> BX BIOFUNGICIDE<sup>™</sup> + MYCORRHIZAE<sup>™</sup>



**2.8cu ft Loose Fill Bag**  
PRB1028500RG Min. Buy 1ea

**3.8cu ft Compressed Bale**  
PRB1038500RG Min. Buy 1ea

**80cu ft Compressed Bale**  
PRB1080500RG Min. Buy 1ea  
Shipping Info **DIRECT**

**135cu ft Compressed Bale**  
PRB1135500RG Min. Buy 1ea  
Shipping Info **DIRECT**

# PROMIX®

## Growing Media

### PRO-MIX® LP15 Multi-Purpose Grower Mix

Designed to provide growing environment that offers good water retention with fibrous peat-moss and a low perlite formulation.

Offers growers the needed flexibility for multiple purposes.

- Answers the needs for short-term crops
- Light-weight, low bulk-density
- High water-holding capacity
- Economic alternative for basic use

### LP15 Mixes All Contain

- 85% Canadian Sphagnum Peat Moss
- 15% Perlite
- Dolomitic & Calclitic Limestone
- Wetting Agent

### Crops

- Vegetable Transplants
- Greenhouse Vegetables
- Potted Flowering Plants
- Foliage plants
- Annuals
- Perennials

Also Available in  
**BULK SIZES**

Contact Your BFG Sales Representative  
for More Information

### Benefits of BIOFUNGICIDE™

(*Bacillus amyloliquefaciens MBI-600*) is a bacteria which colonizes developing root systems. It helps to prevent root disease and suppress disease causing organisms such as *Pythium*, *Rhizoctonia* and *Fusarium*.

- Enhanced germination
- Better plant growth
- Broad spectrum of action against diseases
- Protection against damping-off, crown and root rots caused by *Pythium*, *Rhizoctonia* and *Fusarium*

### Benefits of MYCORRHIZAE™

(*Glomus intraradices*) is a Biological Growth Enhancer that increases the yield of flower, fruit and vegetable plants by extending the root system to acquire the most of available nutrients in the soil. Mycorrhizae also improve resistance to root diseases and stresses.

- Improves fertilizer uptake; reduces fertilizer costs
- Increases plant's resistance to stresses; reduces maintenance costs
- Optimizes results without changing growing practices



### PRO-MIX® LP15



**2.8cu ft Loose Fill Bag**

**PRB60280RG** Min. Buy 1ea

**3.8cu ft Compressed Bale**

**PRB60380RG** Min. Buy 1ea

**135cu ft Compressed Bale**

**PRB61350RG** Min. Buy 1ea

Shipping Info **DIRECT**

### PRO-MIX® LP15 MYCORRHIZAE™



**2.8cu ft Loose Fill Bag**

**PRB60281RG** Min. Buy 1ea

**3.8cu ft Compressed Bale**

**PRB60381RG** Min. Buy 1ea

**80cf**

**PRB60801RG** Min. Buy 1ea

Shipping Info **DIRECT**

**135cu ft Compressed Bale**

**PRB61351RG** Min. Buy 1ea

Shipping Info **DIRECT**

### PRO-MIX® LP15 BIOFUNGICIDE™ + MYCORRHIZAE™



**3.8cu ft Compressed Bale**

**PRB6038500RG** Min. Buy 1ea

## Growing Media

### PRO-MIX<sup>®</sup> MP Organik

OMRI listed organic multi-purpose growing medium with well balanced air/water qualities. Designed to meet crop requirements for organic growers of herbs and vegetables. All of the basic components that have been selected and formulated are OMRI listed and approved.

- Consistent formulation without the variability of products with compost
- Suitable for seed starting and will not burn seedlings
- Conforms and approved to organic standards for certified organic growers

### Crops

- Vegetable Transplants
- Greenhouse Vegetables
- Organic Crops

### Premier<sup>®</sup> PRO-MIX<sup>®</sup> MP Organik MYCORRHIZAE<sup>™</sup> Multi-Purpose Grower Mix

- 65% Sphagnum Peat Moss
- Perlite Horticultural Grade
- Coir - Horticultural Grade
- Calclitic Limestone
- Wetting Agent



**2.8cu ft Loose Fill Bag**  
PRB8028101RG Min. Buy 1ea

**3.8cu ft Compressed Bale**  
PRB8038103RG Min. Buy 1ea



Also Available in  
**BULK SIZES**

Contact Your BFG Sales Representative  
for More Information

### Benefits of BIOFUNGICIDE<sup>™</sup>

(*Bacillus amyloliquefaciens* MBI-600) is a bacteria which colonizes developing root systems. It helps to prevent root disease and suppress disease causing organisms such as *Pythium*, *Rhizoctonia* and *Fusarium*.

- Enhanced germination
- Better plant growth
- Broad spectrum of action against diseases
- Protection against damping-off, crown and root rots caused by *Pythium*, *Rhizoctonia* and *Fusarium*

### Benefits of MYCORRHIZAE<sup>™</sup>

(*Glomus intradices*) is a Biological Growth Enhancer that increases the yield of flower, fruit and vegetable plants by extending the root system to acquire the most of available nutrients in the soil. Mycorrhizae also improve resistance to root diseases and stresses.

- Improves fertilizer uptake; reduces fertilizer costs
- Increases plant's resistance to stresses; reduces maintenance costs
- Optimizes results without changing growing practices

*Don't See What You Need?*  
**Use the BFG Mobile App**  
or visit [www.bfgsupply.com](http://www.bfgsupply.com)  
to see a much larger selection of Media products!





# PRO-MIX<sup>®</sup>

## Growing Media

### PRO-MIX<sup>®</sup> BRK & BRK20

#### Bark Grower Mixes

BRK Mix is designed for long term crops such as hardy mums, offering flexibility. Combining the quality of aged pine bark and professional quality sphagnum peat moss, creates a balanced environment that will adapt to the season changes.

BRK20 is a medium weight growing medium. Peat and bark based formula adds weight, reduces water retention and ensures optimal balance between air and water. Resists long-term compaction and improves container stability.

- Increased drainage
- High bulk density ensures good pot stability
- Growers can use fertilizer regimes similar to peat-based mixes, unlike other bark-based mixes

#### Crops

- Annuals
- Perennials
- Potted Flowering Plants
- Potted Trees & Shrubs



#### BRK Bark Grower Mixes

- 50% Canadian Sphagnum Peat Moss
- 40% Processed Bark
- 10% Perlite
- Dolomitic & Calcitic Limestone
- Wetting Agent

#### PRO-MIX<sup>®</sup> BRK



**2.8cu ft Loose Fill Bag**

**PRB50280RG** Min. Buy 1ea

#### PRO-MIX<sup>®</sup> BRK with MYCORRHIZAE<sup>™</sup>



**2.8cu ft Loose Fill Bag**

**PRB50281RG** Min. Buy 1ea

#### PRO-MIX<sup>®</sup> BRK BIOFUNGICIDE<sup>™</sup> + MYCORRHIZAE<sup>™</sup>



**2.8cu ft Loose Fill Bag**

**PRB5028500RG** Min. Buy 1ea

Also Available in  
**BULK SIZES**

Contact Your BFG Sales Representative  
for More Information

### Benefits of BIOFUNGICIDE<sup>™</sup>

(*Bacillus amyloliquefaciens* MBI-600) is a bacteria which colonizes developing root systems. It helps to prevent root disease and suppress disease causing organisms such as *Pythium*, *Rhizoctonia* and *Fusarium*.

- Enhanced germination
- Better plant growth
- Broad spectrum of action against diseases
- Protection against damping-off, crown and root rots caused by *Pythium*, *Rhizoctonia* and *Fusarium*

### Benefits of MYCORRHIZAE<sup>™</sup>

(*Glomus intraradices*) is a Biological Growth Enhancer that increases the yield of flower, fruit and vegetable plants by extending the root system to acquire the most of available nutrients in the soil. Mycorrhizae also improve resistance to root diseases and stresses.

- Improves fertilizer uptake; reduces fertilizer costs
- Increases plant's resistance to stresses; reduces maintenance costs
- Optimizes results without changing growing practices



#### BRK20 Bark Grower Mixes

- 65% Canadian Sphagnum Peat Moss
- 20% Processed Bark
- 15% Perlite
- Dolomitic & Calcitic Limestone
- Wetting Agent

#### PRO-MIX<sup>®</sup> BRK20



**2.8cu ft Loose Fill Bag**

**PRB50280RGLB** Min. Buy 1ea

#### PRO-MIX<sup>®</sup> BRK20 with MYCORRHIZAE<sup>™</sup>



**2.8cu ft Loose Fill Bag**

**PRB50281RGLB** Min. Buy 1ea

#### PRO-MIX<sup>®</sup> BRK20 BIOFUNGICIDE<sup>™</sup> + MYCORRHIZAE<sup>™</sup>



**2.8cu ft Loose Fill Bag**

**PRB5028540RGLB** Min. Buy 1ea



**60cf**

**PRB5060540RG** Min. Buy 1ea

Shipping Info **DIRECT**



## Growing Media

### PRO-MIX<sup>®</sup> HP<sup>®</sup> High Porosity Grower Mix

High porosity peat-based growing medium. Perlite ensures optimum growth, especially when high air capacity and extra drainage are required. An ideal formulation for growers in need of a media adapted to watering flexibility and crop seasonality.

- Greater frequency of dry-down periods (compared to general purpose peat-based mixes)
- Grower can more easily leach fertilizer salts during crop cycle
- Difficult to over-water
- Well suited for undesirable, year-round weather conditions

### HP Mixes All Contain

- 75% Canadian Sphagnum Peat Moss
- 25% Perlite
- Dolomitic & Calcitic Limestone
- Wetting Agent

### Crops

- Annuals
- Foliage Plants
- Potted Flowers
- Greenhouse Vegetables
- Young Plant Propagation
- Vegetable Transplants

### Benefits of BIOFUNGICIDE<sup>™</sup>

*(Bacillus amyloliquefaciens MBI-600)* is a bacteria which colonizes developing root systems. It helps to prevent root disease and suppress disease causing organisms such as *Pythium*, *Rhizoctonia* and *Fusarium*.

- Enhanced germination
- Better plant growth
- Broad spectrum of action against diseases
- Protection against damping-off, crown and root rots caused by *Pythium*, *Rhizoctonia* and *Fusarium*

### Benefits of MYCORRHIZAE<sup>™</sup>

*(Glomus intraradices)* is a Biological Growth Enhancer that increases the yield of flower, fruit and vegetable plants by extending the root system to acquire the most of available nutrients in the soil. Mycorrhizae also improve resistance to root diseases and stresses.

- Improves fertilizer uptake; reduces fertilizer costs
- Increases plant's resistance to stresses; reduces maintenance costs
- Optimizes results without changing growing practices



### PRO-MIX<sup>®</sup> HP<sup>®</sup>



**3.8cu ft Compressed Bale**  
PRB20380RG Min. Buy 1ea



### PRO-MIX<sup>®</sup> HP<sup>®</sup> MYCORRHIZAE<sup>™</sup>



**2.8cu ft Loose Fill Bag**  
PRB20281RG Min. Buy 1ea

**3.8cu ft Compressed Bale**  
PRB20381RG Min. Buy 1ea



### PRO-MIX<sup>®</sup> HP<sup>®</sup> BIOFUNGICIDE<sup>™</sup> + MYCORRHIZAE<sup>™</sup>



**2.8cu ft Loose Fill Bag**  
PRB2028500RG Min. Buy 1ea

**3.8cu ft Compressed Bale**  
PRB2038500RG Min. Buy 1ea

**80cu ft Compressed Bale**  
PRB2080500RG Min. Buy 1ea  
Shipping Info **DIRECT**

**135cu ft Compressed Bale**  
PRB2135500RG Min. Buy 1ea  
Shipping Info **DIRECT**





# PROMIX

## Growing Media

### PRO-MIX® HPCC MYCORRHIZAE™ High Porosity Coir Grower Mix

A lightweight, high-porosity peat-based growing mix containing chunk coir for balanced drainage, moisture retention and increased resistance to compaction. Contains Mycorrhiza.

- Greater frequency of dry-down periods (compared to general purpose peat-based mixes)
- Grower can more easily leach fertilizer salts during crop cycle
- Difficult to over-water
- Well suited for undesirable, year-round weather conditions

#### HPCC Mix Contains

- 70% Canadian Sphagnum Peat Moss
- Perlite
- Chunk Coir
- Dolomitic and Calcitic Limestone
- Wetting Agent

#### Crops

- Annuals
- Foliage Plants
- Potted Flowers
- Greenhouse Vegetables
- Young Plant Propagation
- Vegetable Transplants

### Benefits of MYCORRHIZAE™

(*Glomus intraradices*) is a Biological Growth Enhancer that increases the yield of flower, fruit and vegetable plants by extending the root system to acquire the most of available nutrients in the soil. Mycorrhizae also improve resistance to root diseases and stresses.

- Improves fertilizer uptake; reduces fertilizer costs
- Increases plant's resistance to stresses; reduces maintenance costs
- Optimizes results without changing growing practices

### PRO-MIX® CC40 MYCORRHIZAE™ High Porosity Coir Grower Mix

A high-porosity peat-based growing medium that contains chunk coir. With high air porosity and water retention, it is ideal for long-term crops especially where subjected to drought conditions. The water retention qualities of this peat/coir mix reduce irrigation requirements and allow growers to more efficiently react to challenging environments. Contains Mycorrhizae.

- Reduced runoff due to fewer watering events
- More efficient use of water
- Preferred for hot, dry climates or drought conditions
- Reduced labor to water plants

#### CC40 Mix Contains

- 60% Canadian Sphagnum Peat Moss
- 40% Chunk Coir
- Perlite
- Dolomitic and Calcitic Limestone
- Wetting Agent

#### Crops

- Large Containers
- Perennials
- Nursery Stock



### PRO-MIX® HPCC MYCORRHIZAE™ High Porosity Coir Grower Mix



#### 2.8cu ft Loose Fill Bag

PRB2028130RG Min. Buy 1ea

#### 3.8cu ft Compressed Bale

PRB2038130RG Min. Buy 1ea

### PRO-MIX® CC40 MYCORRHIZAE™ High Porosity Grower Mix



#### 3.8cu ft Compressed Bale

PRB9038130RG Min. Buy 1ea

# PRO-MIX<sup>®</sup>

## Growing Media

### PRO-MIX<sup>®</sup> FPX Plug & Germination Mix

A fine textured plug and germination mix well adapted for water-sensitive crops by providing low water retention levels and good air porosity.

#### FPX Mixes All Contain

- 85% Sphagnum Peat Moss
- 15% Perlite
- Dolomitic & Calcitic Limestone
- Wetting Agent

#### Crops

- Plug & Germination
- Vegetable Transplants
- Young Plant Propagation

### Benefits of BIOFUNGICIDE™

*(Bacillus amyloliquefaciens MBI-600)* is a bacteria which colonizes developing root systems. It helps to prevent root disease and suppress disease causing organisms such as *Pythium*, *Rhizoctonia* and *Fusarium*.

- Enhanced germination
- Better plant growth
- Broad spectrum of action against diseases
- Protection against damping-off, crown and root rots caused by *Pythium*, *Rhizoctonia* and *Fusarium*

### PRO-MIX<sup>®</sup> PGX Plug & Germination Mix

A fine textured peat-based germination mix formulated with vermiculite for increased buffering and nutrient retention at the early stages of plant growth. Well suited for plug production and seed germination. Easy filling of plug trays

- Require less frequent watering than peat/perlite plug mixes
- Contains slightly higher fertilizer than PRO-MIX<sup>®</sup> FPX for growers wanting high fertilizer content
- Seedling root-ball holds together better at transplanting than peat / perlite germination mixes

#### PGX Mixes All Contain

- 80% Sphagnum Peat Moss
- 20% Vermiculite Plug Grade
- Dolomitic & Calcitic Limestone
- Wetting Agent

#### Crops

- Plug & Germination
- Vegetable Transplants
- Young Plant Propagation



### PRO-MIX<sup>®</sup> FPX Plug & Germination Mix



**2.8cu ft Loose Fill Bag**  
PRB0501P Min. Buy 1ea

**3.8cu ft Compressed Bale**  
PRB40380RG Min. Buy 1ea



### PRO-MIX<sup>®</sup> PGX Plug & Germination Mix



**2.8cu ft Loose Fill Bag**  
PRB30280RG Min. Buy 1ea

**3.8cu ft Compressed Bale**  
PRB30380RG Min. Buy 1ea



### PRO-MIX<sup>®</sup> PG Organik™

Organic plug and germination growing medium.



**2.8cf**  
PRB3028023RG Min. Buy 1ea

**3.8cf**  
PRB3038023RG Min. Buy 1ea





# PROMIX

## Growing Media

### PRO-MIX® BK25 Peat / Bark Mix

A medium-weight growing medium designed for the cultivation of greenhouse and nursery crops. The combination of bark, sphagnum peat and perlite create a general purpose mix that offers good drainage and low water retention.

- 55% Canadian Sphagnum Peat Moss
- 25% Processed Pine Bark
- 20% Perlite
- Starter Fertilizer
- Dolomitic & Calcitic Limestone
- Perlite – Horticultural Grade
- Wetting Agent

#### Also Available in BULK SIZES

Contact Your BFG Sales Representative  
for More Information

### Benefits of MYCORRHIZAE™

(*Glomus intraradices*) is a Biological Growth Enhancer that increases the yield of flower, fruit and vegetable plants by extending the root system to acquire the most of available nutrients in the soil. Mycorrhizae also improve resistance to root diseases and stresses.

- Improves fertilizer uptake; reduces fertilizer costs
- Increases plant's resistance to stresses; reduces maintenance costs
- Optimizes results without changing growing practices

### PRO-MIX® BK55 Peat / Bark Mix

A medium-weight growing medium designed for the cultivation of long-term greenhouse crops and perennials grown outdoors. The combination of processed pine bark, sphagnum peat moss and perlite makes for a good air/water balance. The high percent of bark adds weight, which is perfect for growers looking for container stability.

- 30% Canadian sphagnum peat moss.
- 55% processed pine bark.
- 15% perlite.
- Starter Fertilizer
- Dolomitic & Calcitic Limestone
- Perlite – Horticultural Grade
- Wetting Agent

### PRO-MIX® BK25 Peat / Bark Mix



#### 2.8cu ft Loose Fill Bag

PRB5028025RG Min. Buy 1ea

#### 60cu ft Loose Fill Tote / Direct Ship

PRB5060025RG Min. Buy 1ea

Shipping Info **DIRECT**

#### 1cu yd Bulk

PRBVR9012 Min. Buy 1ea

Shipping Info **DIRECT**



### PRO-MIX® BK55 Peat / Bark Mix



#### 2.8cu ft Loose Fill Bag

PRB5028055RG Min. Buy 1ea

#### 60cu ft Loose Fill Tote / Direct Ship

PRB5060055RG Min. Buy 1ea

Shipping Info **DIRECT**

#### 1cu yd Bulk

PRBVR9013 Min. Buy 1ea

Shipping Info **DIRECT**



### PRO-MIX® BK25 Mycorrhizae Peat / Bark Mix



#### 2.8cu ft Loose Fill Bag

PRB5028125RG Min. Buy 1ea

#### 60cu ft Loose Fill Tote / Direct Ship

PRB5060125RG Min. Buy 2ea

Shipping Info **DIRECT**



### PRO-MIX® BK55 Mycorrhizae Peat / Bark Mix



#### 2.8cu ft Loose Fill Bag

PRB5028155RG Min. Buy 1ea

#### 60cu ft Loose Fill Tote / Direct Ship

PRB5060155RG Min. Buy 2ea

Shipping Info **DIRECT**



### PRO-MIX® NCX

A heavy-weight general purpose growing medium for the cultivation of nursery and perennials grown outdoors. The combination of processed southern pine bark, sphagnum peat moss provides excellent drainage and high container stability.



#### 1cu yd Bulk

PRBVR9014 Min. Buy 1ea

Shipping Info **DIRECT**

PROMIX

### PRO-MIX® BK25V

Medium weight, general purpose media designed for a wide variety of greenhouse crops in bedding trays, pots or hanging baskets. High water holding capacity and nutrient retention.



#### 2.8cu ft Loose Fill Bag

PRB5028025RGVE Min. Buy 1ea



### PRO-MIX® BK45V

A general purpose, medium weight mix designed for a wide variety of greenhouse and perennial crops in medium and large containers. Good porosity due to its medium coarse texture.



#### 2.8cu ft Loose Fill Bag

PRB5028045RGVE Min. Buy 1ea





# PROMIX<sup>®</sup>

NOTHING SAYS GROWING MEDIA BETTER<sup>™</sup>

## VALUE-ADDED COMBINATION

 **BIOFUNGICIDE<sup>™</sup>**  
**MYCORRHIZAE<sup>™</sup>**

THESE ACTIVE INGREDIENTS WORK TOGETHER TO ENHANCE PLANT PERFORMANCE, QUALITY AND YIELD

**ENHANCE**

The use of fertilizer and water. Increase resistance to stresses. Improve plant strength and productivity. Optimize plant growth rate and uniformity.

**PROTECT**

By reducing incidence of plant root diseases (*Fusarium*, *Pythium* and *Rhizoctonia*) and risk of pathogens that develop resistance to chemical fungicides.

**SUPPRESS**

Certain insects, including fungus gnats and thrips that pupate into the growing media, by suppressing their food sources and plant susceptibility.



PRO-MIX<sup>®</sup> growing media are enriched with high performance active ingredients, MYCORRHIZAE<sup>™</sup> (*Glomus intraradices*) and BIOFUNGICIDE<sup>™</sup> (*Bacillus pumilus*). Exclusive to PRO-MIX<sup>®</sup> BIOFUNGICIDE<sup>™</sup> + MYCORRHIZAE<sup>™</sup>, ENHANCE plant growth with MYCORRHIZAE<sup>™</sup>, PROTECT against root diseases caused by specific root pathogens, and also SUPPRESS fungus gnats and thrips. (EPA Reg #: 74267-4)

Product availability may vary depending on the US region.

 **PREMIER  
TECH**





### *Growing Media*

#### **About ASB Greenworld:**

ASB Greenworld has several peat moss bogs that supply the best quality blonde sphagnum peat moss, the most preferred by horticultural growers for its coarseness and water holding properties when making growing media mixes. With peat bogs around the world, ASB Greenworld can manage the supply of peat moss on a global basis to ensure the supply of horticultural mixes for its customers. Our Canadian peat moss bog and horticultural media production plant is located in Pointe Sapin, New Brunswick, which has multiple production lines that package 2.8's, 3.8's, totes or super sacks, 110cf big bales, and retail sizes. Because our peat bog and all these production lines are together at one of the largest production facilities in the industry, we can ship mixed loads of all these products on one truck. ASB Greenworld quality, consistency, service and value supplies thousands of growers throughout North America and the world.

#### **Always Improving:**

ASB Greenworld is continually upgrading our equipment and processes to ensure your product is delivered to you as ordered on time. New screener added to our operation removes even smaller particles from our mix and cuts down on sticks. Small baler upgrades allow for better compression and better fit on the pallet. Mixing station upgrades completed in summer of 2019 ensure consistency of mix.



**Custom Mixes:**

If you have a mix that works just right for you, we can match it! ASB Greenworld has access to a wide variety of raw materials and substrates that either can enhance your present mix or duplicate it. Just ask your sales representative for a quote and we can get your custom blend to you when you need it.

**Testing:**

Quality has always been a big part of ASB's history and we support that with on site quality control laboratories to ensure your mix is given the "green light" before it leaves our facility. We test for pH, EC, particle size, porosity and moisture content. Along with our own on- site testing, each batch produced is sent to an independent lab where another set of comprehensive testing is completed. We will not ship any load unless it meets our high standards and will stand behind every load we produce.

**Support:**

We have a team of experienced technicians lead by Richard Goetze who are dedicated to improving substrate quality and performance. Richard takes pride in continuous improvement of process and product, always with attention and dedication to customers' requirements and expectations. Our team is available to answer your questions about your mix and/or any other questions you may have in regard to the growing process.





## Growing Media

### ASB Greenworld® GM Prof Mix VPW 30

Professional growing medium with extra perlite. Balanced aeration with moisture and nutrient retention. Ideal for a wide range of greenhouse uses, containers, hanging baskets and bedding plants.

- 70% Canadian sphagnum peat moss
- 25% coarse perlite
- 5% coarse vermiculite



#### 2.8cu ft loose fill bag

**ASB311390** Min. Buy 1ea

#### 3.8cu ft compressed bale

**ASB310911** Min. Buy 1ea

#### 110cu ft compressed bale

**ASB302962** Min. Buy 1ea

Shipping Info **DIRECT**



### ASB Greenworld® Seed & Plug Mix

Suitable for germination and plug production. High quality mix of triple screened sphagnum peat moss, perlite, and vermiculite.

- 80% Canadian sphagnum peat moss.
- 20% fine perlite
- 5% fine vermiculite



#### With Rootshield - 2.8cu ft loose fill bag

**ASB313113** Min. Buy 1ea

#### Without Rootshield - 2.8cu ft loose fill bag

**ASB313847** Min. Buy 1ea



### ASB Greenworld® Grower Mix 15% HydraFiber

Growing mix with 15% sustainable woodfiber that offers water retention and aeration without the addition of perlite.

- 85% Canadian sphagnum peat moss
- 15% wood fiber substrate



#### 2.8cu ft loose fill bag

**ASB314970** Min. Buy 1ea

#### 3.8cu ft compressed bale

**ASB313653** Min. Buy 1ea

#### 110cu ft compressed bale

**ASB313652** Min. Buy 1ea

Shipping Info **DIRECT**



### ASB Greenworld® Original Grower Mix

All purpose growing medium with fertilizer. Specially formulated substrate for general greenhouse use, containers and bedding plants.

- 100% Canadian sphagnum peat moss.
- NPK



#### 3.8cu ft compressed bale

**ASB302845** Min. Buy 1ea

#### 110cu ft compressed bale

**ASB302847** Min. Buy 1ea

Shipping Info **DIRECT**



### ASB Greenworld® GM Grow Mix 15% Perlite

All purpose growing medium with perlite. Specially formulated substrate for general greenhouse use, containers and bedding plants.

- 85% Canadian sphagnum peat moss
- 15% coarse perlite



#### 2.8cu ft loose fill bag

**ASB310830** Min. Buy 1ea

#### 3.8cu ft compressed bale

**ASB310909** Min. Buy 1ea

#### 110cu ft compressed bale

**ASB302846** Min. Buy 1ea

Shipping Info **DIRECT**



### ASB Greenworld® GM Grow Mix 20% Perlite

All purpose growing medium with extra perlite for enhanced aeration and drainage. Specially formulated substrate for general greenhouse use, containers and bedding plants.

- 80% Canadian sphagnum peat moss
- 20% coarse perlite



#### 2.8cu ft loose fill bag

**ASB310830-20** Min. Buy 1ea

#### 3.8cu ft compressed bale

**ASB310909-20** Min. Buy 1ea

#### 110cu ft compressed bale

**ASB312758** Min. Buy 1ea

Shipping Info **DIRECT**



### ASB Greenworld® Grower Mix VPW 420

Professional growing medium made of coarse fibrous peat moss, perlite and vermiculite for the best balance of porosity, water holding capacity, and nutrient retention. Also includes the best Mycorrhizae fungi by Mycorrhizal Applications, which increases plant establishment, drought protection, improves healthy soil biology for better nutrient uptake and reduces production costs.

- 70% Canadian sphagnum peat moss
- 25% coarse perlite



#### 3.8cu ft compressed bale

**ASB313780** Min. Buy 1ea



### ASB Greenworld® GM Prof Mix VPW 20

Professional growing medium with perlite. Balanced aeration with moisture and nutrient retention. Ideal for a wide range of greenhouse uses, containers, hanging baskets and bedding plants.

- 80% Canadian sphagnum peat moss
- 15% coarse perlite
- 5% coarse vermiculite



#### 2.8cu ft loose fill bag

**ASB310832** Min. Buy 1ea

#### 3.8cu ft compressed bale

**ASB310345** Min. Buy 1ea





Discover the **Green** in ASB Greenworld



# Growing Media for Professional Growers



- **HydraFiber Mix** – more natural and sustainable
- **Superior porosity** – more available water for better root development
- **Greater value** – more mix per bale with better yields

**Growth is our Strength**  
asbgreenworld.com • sales@asbgreenworld.com

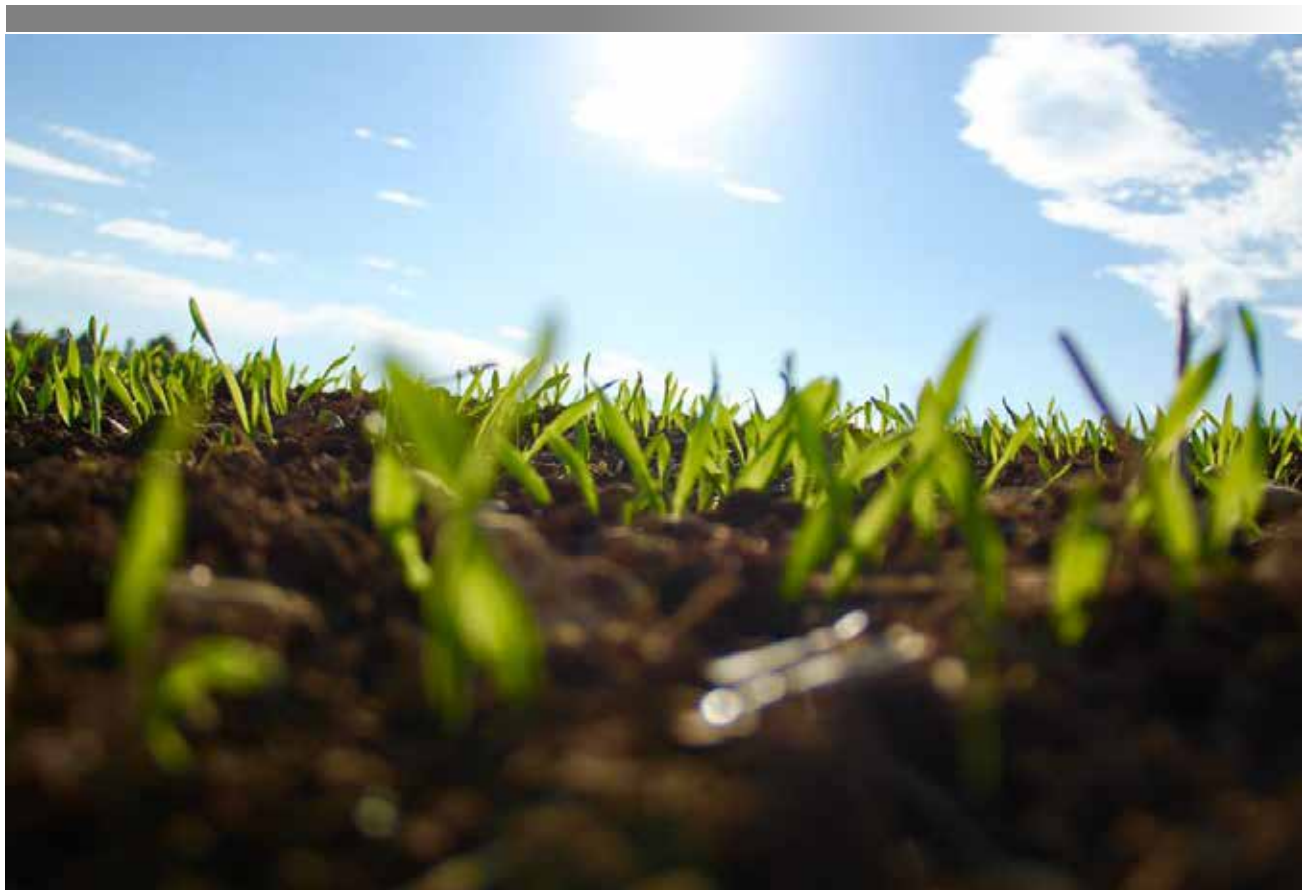

# MICHIGAN PEAT COMPANY



## Growing Media

### Michigan Peat® BACCTO® Professional Grower Mix

Light weight peat mix suited to a wide variety of greenhouse crops. High porosity combined with good moisture retention and low compaction promote healthy root development.



#### 2.0cu ft Bag

**MPC1732** Min. Buy 1ea

#### 2.8cu ft Loose Fill Bag

**MPC1428** Min. Buy 1ea

Shipping Info **DIRECT**

#### 3.8cu ft Compressed Bale

**MPC1438** Min. Buy 1ea

Shipping Info **DIRECT**

#### 70cu ft Bag

**MPC3580** Min. Buy 2ea

Shipping Info **DIRECT**



### Michigan Peat® BACCTO® High Porosity Professional Planting Mix

Pre-moistened mix provides increased drainage and faster drying for bedding and potted crops.



#### 2.0cu ft Bag

**MPC1792** Min. Buy 1ea

Shipping Info **DIRECT**

#### 60cu ft Bag

**MPC3592** Min. Buy 2ea

Shipping Info **DIRECT**



### Michigan Peat® BACCTO® High Density Professional Planting Mix

Sandy loam soil is added to our pre-moistened sphagnum peat and perlite mixture to add anchorage and stability while providing an air/water balance. Suitable for outdoor growing and interiorscapes.



#### 52cu ft Bag

**MPC3540** Min. Buy 2ea

Shipping Info **DIRECT**



### Michigan Peat® BACCTO® ELITE-hp High Porosity Growing Mix 35/65

A blend of horticultural and sphagnum peat moss and perlite for good water retention with increased air porosity. OMRI listed



#### 2.8cu ft Loose Fill Bag

**MPC1828** Min. Buy 1ea

Shipping Info **DIRECT**



### Michigan Peat® BACCTO® Organic Optimum Growers Mix

A blend of horticultural and sphagnum peat moss and perlite for an ideal balance of porosity and water retention. OMRI listed



#### 2.8cu ft bag

**MPC1728** Min. Buy 40ea





**FOR YOU, IT'S MORE THAN JUST A PLANT  
& IT'S DEFINITELY NOT YOUR HOBBY!**

**IT'S YOUR LIVELIHOOD!**

**THAT'S WHY YOU NEED A SOIL  
THAT DELIVERS A CONSISTENT BLEND  
TIME AFTER TIME - LOAD AFTER LOAD**

**BACCTO® GROWER PRODUCTS:**



52-70 CF BULK BAGS



3.8 CF BALES



LOOSE FILL BAGS

- PRO PLANTING MIX
- SEEDLING MIX
- HI-DENSITY
- HI-POROSITY
- BARK 1000
- BARK 2000
- PRO GROWER'S MIX
- TREE, SHRUB, & PERENNIAL MIX
- ORGANIC OPTIMUM MIX
- for GROWERS



**BACCTO®**  
*where growing begins.™*

**GROWER PRODUCTS**



**RETAIL PRODUCTS**



**BACCTO GROWER & RETAIL PRODUCTS CAN BE COMBINED ON THE SAME TRUCK  
TO ACHIEVE TRUCKLOAD QUANTITY!**



**NOT SOLD TO MASS MERCHANT OR BIG BOX STORES  
SUPPORTED WITH CO-OP ADVERTISING  
SUPPORTED WITH POS/POP MATERIALS  
DISCOUNTS PLUS DATED PAYMENT TERMS & MUCH MORE**

**CONTACT YOUR FAVORITE BFG SUPPLY SALES REP FOR THE COMPLETE  
BACCTO/MICHIGAN PEAT OFFERING OF DISCOUNT PROGRAMS, PRICING,  
& DELAYED PAYMENT TERMS. VISIT THE MICHIGAN PEAT/BACCTO BOOTH  
DURING THE BFG VIRTUAL SHOWS OR LIVE SHOWS IN  
MINNEAPOLIS, CLEVELAND, & DENVER**



## Growing Media

### Lambert® LM-3 All Purpose Growing Mix

A blend of coarse Canadian sphagnum peat moss, coarse perlite and medium vermiculite. This substrate is an excellent general or all purpose media.



**3cu ft**

**LP02335** Min. Buy 1ea

Shipping Info **DIRECT**

**3.8cu ft**

**LP02330** Min. Buy 1ea

Shipping Info **DIRECT**



### Lambert® LM-1 Germination Mix

A blend of fine-fibered Canadian sphagnum peat moss along with fine vermiculite and perlite to help promote aeration and ideal water holding capacity.



**3cu ft**

**LP02313** Min. Buy 1ea

Shipping Info **DIRECT**

**3.8cu ft**

**LP02310** Min. Buy 1ea

Shipping Info **DIRECT**



### Lambert® LM-2 Germination Mix

Fine Canadian sphagnum peat moss mixed with fine vermiculite to increase water retention. Formulated for plugs and transplants.



**3cu ft**

**LP02325** Min. Buy 1ea

Shipping Info **DIRECT**

**3.8cu ft**

**LP02320** Min. Buy 30ea

Shipping Info **DIRECT**



### Lambert® LM-6 High Porosity Mix

A high porosity growing media with long-fibered Canadian Sphagnum peat moss including the addition of large peat chunks and coarse perlite. Designed for crops that require higher air capacity and drainage.



**3cu ft**

**LP02365** Min. Buy 1ea

Shipping Info **DIRECT**

**3.8cu ft**

**LP02360** Min. Buy 1ea

Shipping Info **DIRECT**



### Lambert® Professional Grower Mix

Lambert Professional Growing Mix has excellent air space, water holding capacity and drains very well. This mix, although designed for professional growers, has been sought for use by amateur growers who expect the best. Eight different blends featured below, all specially designed for any type of growing need.

### Lambert® EPM-40 High Porosity Mix

A blend of coarse Canadian sphagnum peat moss and EcoPeat. The great amount of EcoPeat enhances drainage and porosity. This media is recommended for use in large container, perennials and nursery crops.



**3cu ft**

**LP6649805844** Min. Buy 1ea

Shipping Info **DIRECT**

**3.8cu ft**

**LP6649805845** Min. Buy 1ea

Shipping Info **DIRECT**



### Lambert® LM-40 High Porosity Mix

Designed with long-fibered Canadian sphagnum peat moss including the addition of large peat chunks and coarse perlite. It is perfectly suitable for hydroponic production.



**3.8cu ft**

**LP02920** Min. Buy 30ea

Shipping Info **DIRECT**



### Lambert® Bark Mix

A blend of Canadian Sphagnum peat moss with aged bark and perlite. Great for use in large container, perennials, hardy mums and nursery crops. Ideal for growers who wish to have a media that provides weight for container grown crops that tend to be top-heavy.



**2.8cu ft**

**LP02385** Min. Buy 48ea

Shipping Info **DIRECT**



### Lambert® LM-111 All Purpose Mix

A blend of coarse Canadian Sphagnum peat moss, chunks and perlite. Formulated by combining the major components of both LM-3 and LM-6.



**3cu ft**

**LP52515** Min. Buy 1ea

Shipping Info **DIRECT**

**3.8cu ft**

**LP52510** Min. Buy 1ea

Shipping Info **DIRECT**







## Growing Media

### Therm-O-Rock® Prime Gro® Growing Media for Professionals

PRIME-GRO® offers a complete line of tested and proven peat-lite, peat-bark and peat-wool mixes composed of top quality screened Canadian sphagnum peat moss, aged pine bark, perlite, vermiculite and rockwool.

#### Therm-O-Rock® Prime Gro® #1

General purpose peat-lite mix with added extra coarse vermiculite for improved moisture and nutrient retention and increased aeration and porosity.

**Ingredients;**  
80% Peat Moss  
15% Perlite  
5% Extra Coarse Vermiculite



**2.8cu ft Loose Fill Bag**  
**TROCKPG1-2.8** Min. Buy 54ea

#### Therm-O-Rock® Prime Gro® #7

Peat-lite mix with coarse rockwool for even consistent wetting, improved nutrient retention, increased aeration and resistance to shrinking and compaction.

**Ingredients;**  
75% Peat Moss  
10% Perlite  
15% Coarse Grade Rockwool



**2.8cu ft Loose Fill Bag**  
**TROCKPG7-2.8** Min. Buy 54ea

#### Therm-O-Rock® Prime Gro® #51

All-purpose peat/bark mix suitable for bedding plants, hanging baskets, containers and perennials.

**Ingredients;**  
65% Peat Moss  
20% Bark  
10% Perlite  
5% Extra Coarse Vermiculite



**2.8cu ft Loose Fill Bag**  
**TROCKPG51-2.8** Min. Buy 48ea

#### Therm-O-Rock® Prime Gro® #3

General Purpose peat-lite mix with perlite for a good balance between porosity and moisture retention. Suitable for all crops and bedding plants.

**Ingredients;**  
85% Peat Moss  
15% Perlite



**2.8cu ft Loose Fill Bag**  
**TROCKPG3-2.8** Min. Buy 54ea

#### Therm-O-Rock® Prime Gro® #11

Peat-bark mix with coarse horticultural rockwool. Excellent moisture retention properties make this an ideal mix for hanging baskets, containers, mums and late spring crops.

**Ingredients;**  
60% Peat Moss  
15% Bark  
10% Perlite  
15% Coarse Grade Rockwool



**2.8cu ft Loose Fill Bag**  
**TROCKPG11-2.8** Min. Buy 48ea

#### Therm-O-Rock® Prime Gro® #87

General purpose peat-lite mix with medium rockwool for improved wetting and nutrient retention. Resists shrinkage and promotes root development.

**Ingredients;**  
85% Peat Moss  
5% Perlite  
10% Medium Grade Rockwool



**2.8cu ft Loose Fill Bag**  
**TROCKPG87-2.8** Min. Buy 54ea

#### Therm-O-Rock® Prime Gro® #111

Peat-bark mix with medium grade horticultural rockwool. Suitable for use in both small cell trays and containers.



**2.8cu ft Loose Fill Bag**  
**TROCKPG111-2.8** Min. Buy 48ea

#### Therm-O-Rock® Prime Gro® #52

Medium-heavy weight peat-bark mix designed for perennials, nursery containers and specialty crops.



**2.8cu ft Loose Fill Bag**  
**TROCKPG52-2.8** Min. Buy 48ea

**Also Available in  
BULK SIZES  
AS DIRECT SHIP**

Contact Your BFG Sales Representative  
for More Information

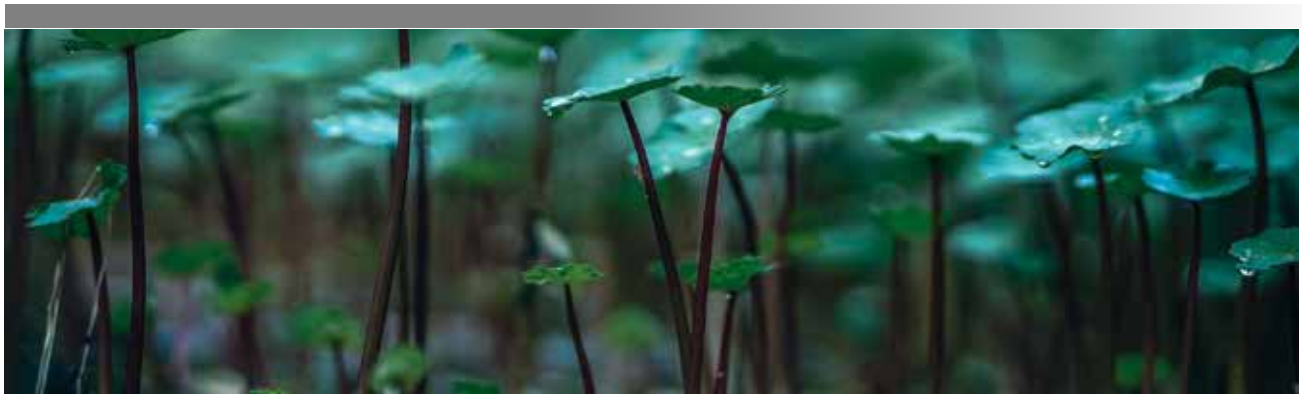



**Peat Moss**

**ASB Greenworld® Grower Grade Peat**

Grower grade organic, fibrous Canadian sphagnum peat moss.



**3.8cu ft compressed bale**  
**ASB310841** Min. Buy 1ea



**MICHIGAN PEAT COMPANY**

**Peat Moss**

**Michigan Peat® BACCTO® Professional Sphagnum Peat Moss**

Michigan sphagnum peat is blended to provide uniformity, easy handling and the highest possible consistency. Has higher water retention than Canadian peat and formulated to enhance the growth of bedding and potted crops in flats, pots and hanging baskets where higher moisture reserves and shelf life are needed in self-customized mixes.



**3.8cu ft Compressed Bale**  
**MPC1638** Min. Buy 30ea



**PROMIX®**

**Peat Moss**

**Premier® PRO-MOSS® TBK Peat Moss**

Select long-fibered, blond sphagnum peat moss for general commercial use. Provides a high degree of water retention and air porosity for a wide range of applications. OMRI listed.



**3.8cu ft Compressed Bale**  
**PRB0060P** Min. Buy 1ea



**Minerals & Amendments**

**PVP Industries® Horticultural Perlite & Vermiculite**

Perlite and vermiculite are both used to improve moisture retention and aeration in soil. They are used in a similar manner, but they are not interchangeable. Perlite and vermiculite are quite different in composition and in how they improve your soil. The way that each material retains water, and how much water is retained, makes each one suitable for different plants.

Both Perlite & Vermiculite Have these Features;

- Clean,
- Odorless,
- Non-Toxic,
- Sterile
- pH Neutral
- Free from Diseases
- Inexpensive
- Safe to Use

**PVP Industries® Horticultural Perlite**

Perlite is ideal for plants that do not require as much water and more aeration. Horticultural perlite is clean, sterile, pH neutral, non-flammable, odorless, nontoxic and neither decays nor shrinks even pests such as insects and fungi can't destroy it.



**60cu ft & 70cu ft Bulk Sizes are Available**

Contact Your BFG Sales Representative for More Information

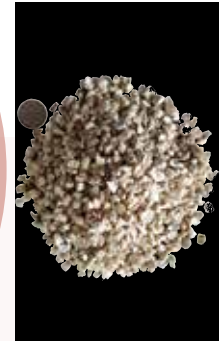

**PVP Industries® Horticultural Vermiculite**

Vermiculite is ideal for plants that prefer lots of water. Horticultural vermiculite is permanent, clean, odorless, non-toxic, sterile and pH neutral. It will not deteriorate, turn moldy or rot. Mixed with soil, peat, composted pine bark, fertilizers, pesticides and herbicides and promotes faster root growth and quick anchorage to young roots. Vermiculite granules attract and hold ammonium, potassium, calcium and magnesium needed for the growing plants. Vermiculite/peat mixture provides excellent aeration and retention of plant food and moisture.

**PVP Industries® Medium Horticultural Perlite**

Used primarily for plugs, small cells, hanging baskets and gardening.



**4cu ft Bag**  
**PVP105705** Min. Buy 1ea



**PVP Industries® Medium Horticultural Vermiculite**

Preferred for seeding, plugs, small cells and moisture retentive soil mixes.



**4cu ft Bag**  
**PVP107402** Min. Buy 1ea



**PVP Industries® Coarse Horticultural Perlite**

Used primarily in soil mixes, hydroponics and gardening. The standard Perlite.



**4cu ft Bag**  
**PVP105408** Min. Buy 1ea



**PVP Industries® Coarse Horticultural Vermiculite**

Preferred for square foot gardening.



**4cu ft Bag**  
**PVPVCH/4/EA** Min. Buy 1ea



**70cuft Mini Bulk Bag**

**PVPCP70** Min. Buy 1ea  
Shipping Info **DIRECT**

**PVP Industries® Super Coarse Horticultural Perlite**

Excellent as a substrate for hydroponics. Super coarse grade expanded perlite is clean, sterile, pH neutral, non-flammable and nontoxic. Increases aeration and drainage of growing media and helps anchor roots of young plants.



**4cu ft Bag**  
**PVP105040** Min. Buy 1ea



**PVP Industries® Super Coarse Horticultural Vermiculite**

Preferred for hydroponics and high porosity soil mixes.



**4cu ft Bag**  
**PVPVVC4EA** Min. Buy 1ea





## Minerals & Amendments

### Midwest Perlite

Perlite is an aggregate which plays a primary role in any growing mix. Each perlite particle is comprised of tiny closed air cells or bubbles. These surface cavities trap moisture and make it available to plant roots. Additionally, its porous structure allows air passages to form; making perlite a mineral catalyst that enhances the effectiveness of the soil's important components. Perlite will not compact nor deteriorate, maintaining consistent aeration and drainage. Perlite is sterile, clean and safe to handle with a neutral pH of 6.5 to 7.5. No additives or coatings are employed during production.

#### Packaging Options:

- 4 cubic foot bags (approximately 20 lbs) maximum 33 bags per pallet
- 64 cubic foot bags (approximately 250 lbs) maximum 2 bags per pallet

### Midwest Perlite® Coarse Horticultural Perlite

Used in soil mixes including peat moss, compost, bark, coir, or in native soil. Its porous surface provides space for air and water within the soil to aid an optimal root system.



#### 4.0cu ft Bag

**MWP12-0090** Min. Buy 1ea



### Midwest Perlite® Horticultural Course Perlite

Course, lightweight perlite that provides excellent aeration and moisture retention when mixed in with other soil materials. Perlite supports root growth by retaining the moisture, air, and nutrients which it releases as the plants grow. Also suitable for hydroponics greenhouses.



#### 64cuft Bag

**MWPL00595** Min. Buy 1ea  
Shipping Info **DIRECT**



## Minerals & Amendments

Also Available in  
**BULK SIZES**  
AS DIRECT SHIP

Contact Your BFG Sales Representative  
for More Information



### Therm-O-Rock® Perlite Coarse

Coarse texture adds aeration and improves drainage in growing media. Helps to support root development. Suitable for use in hydroponic substrates.



#### 4cu ft Bag

**TROCK6510H-W** Min. Buy 1ea



### Therm-O-Rock® Vermiculite Coarse #2A

Lightweight, moisture and nutrient retentive. Good for when higher aeration is required. Increases lateral water movement in growing media.



#### 4cu ft Bag

**TROCK2A-HORT** Min. Buy 1ea



### Therm-O-Rock® Vermiculite Medium #3A

Lightweight, moisture and nutrient retentive. Finer texture is suitable for use in germination, plug and rooting mixes.



#### 4cu ft Bag

**TROCK3A-HORT** Min. Buy 1ea





### Minerals & Amendments

#### Riceland® Parboiled Rice Hulls

PBH Nature's Media Amendment is a processed rice hull product from Riceland Foods, Inc. with multiple uses in the greenhouse and nursery environment. For greenhouse growers, PBH is the perfect replacement for perlite in the growing media. Advantages include dramatically less dust, plus optimum porosity, drainage and stability with little or no adjustment to fertility and irrigation. PHB rice hulls can also be used as a container topdress for weed control.

#### Use PBH Nature's Media Amendment as Replacement for Perlite

- Lower basic cost than perlite
- Creates optimum porosity, drainage and stability
- Requires little or no adjustment to fertility and irrigation
- Dramatically less dusty than perlite
- About one-third fewer deliveries than perlite – 7 PBH truckloads versus 10 of perlite
- Less freight, labor, storage and packaging
- Natural color blends well with other media components

#### Use PBH Nature's Media Amendment as a Container Topdress

- Topdressing with 1 to 2 inches dramatically improves weed control for just pennies per container
- Significantly reduces hand-weeding labor and expense
- Improves control of moss species such as liverwort
- Reduces potential for drought stress and watering
- Delivers economical, earth-friendly weed management



**Compressed 50lb Bag / Direct Ship**

**RCLND3520020237P001** Min. Buy 16ea

Shipping Info **DIRECT**

**Compressed 30cu ft Bale/ Direct Ship**

**RCLND3520020242P001** Min. Buy 1ea

Shipping Info **DIRECT**



## How Many Containers Will a Bag or Bale of Media Fill?

Container Size	Per Cubic Foot	Per 3.8 Cubic Foot Compressed Bale	Per 2.8 Cubic Foot Loose Fill Bags
----------------	----------------	------------------------------------	------------------------------------

### Azalea Pots

4in	63	451	184
5in	30	219	91
6in	19	134	54
6.5in	14	104	43
7in	11	78	33
8in	7	52	21
10in	4	29	12

### Flats

11in x 21in / 804	6	41	17
11in x 21in / 806	7	47	19
11in x 21in / 1203	6	44	18
11in x 21in / 1204	6	46	19
11in x 15in / 601	6	44	18
13in x 14in / 806	8	58	23

### Geranium Pots

4.5in	38	278	115
-------	----	-----	-----

### Hanging Baskets

6in	25	180	75
8in	12	85	37
10in	6	44	19

### Perennial & Nursery Pots

Quart	30	225	90
.5 Gallon	15	108	43
1 Gallon	9	60	30
2 Gallon	4	31	14
3 Gallon	3	22	10

Container Size	Per Cubic Foot	Per 3.8 Cubic Foot Compressed Bale	Per 2.8 Cubic Foot Loose Fill Bags
----------------	----------------	------------------------------------	------------------------------------

### Round Pots

2.25in	276	1,994	827
3in	128	912	376
3.25in	93	698	279
4in	52	369	147
5in	25	183	76
6in	15	109	45
7in	10	75	30
10in	3	22	9
12in	2	15	6

### Square Pots

2.5in	235	1,642	704
3in	136	973	417
3.5in	91	638	294
4in	55	391	173
4.5in	46	318	150
5in	29	217	87

### Jumbo Squares

5.5in	17	124	50
-------	----	-----	----





# Fertilizer



# Grower Select®

## Water Soluble Fertilizers

### Grower Select® Water Soluble Fertilizers

Grower Select fertilizers are manufactured in North America and feature the highest quality components. Each blend is based on the most popular formulations with excellent solubility and a complete micronutrient package. Save money without compromising on performance!

### Value-Based Products You Can Grow With!

We created the BFG Grower Select line of products to bring popular products to market with value-pricing. The expanding BFG Grower Select line includes growing media, carts, pots, benches, greenhouses, specialty items, and more.

Ask your sales rep about the complete BFG Grower Select line of products. It's just one more way you can count on us to keep you growing!

### Grower Select® Cal-Mag Triple Iron 16-3-16 Water Soluble Fertilizer

Similar to 17-5-17 but with lower P to prevent stretching and three forms of chelated iron to ensure Fe is available to plants even at a high substrate pH. A versatile utility player with balanced calcium and magnesium and neutral potential acidity.



25lbs

PLNTX12482 Min. Buy 1ea



### Grower Select® 17-5-17 Water Soluble Fertilizer

An economical all-in-one fertilizer featuring high levels of nitrate and no urea. You'll get 5 macronutrients in one bag (N, P, K, Ca, Mg) as well as a complete micronutrient package with chelated iron. This neutral formulation will have minimal impact on soil & water pH, making it a great option in many growing situations.



25lbs

PLNTX12481 Min. Buy 1ea  
Shipping Info **SHIPS HAZARDOUS**



### Grower Select® Mag Triple Iron 18-6-18

Great choice for Petunias, Calibrachoa, Pansies, Vinca, Verbena and other plants that benefit from extra iron. Three sources of chelated iron, potential acidity of 339lbs CaCO<sub>3</sub>, and extra magnesium ensure your plants have dark green foliage. Excellent if you have high alkalinity irrigation water because it acidifies and also adds Mg to keep your Ca to Mg ratio in balance.



25lbs

PLNTX12483 Min. Buy 1ea  
Shipping Info **HAZARDOUS**



### Grower Select® 20-20-20 Water Soluble Fertilizer

A classic blend with a balanced formula that is effective on all types of plants and can be used for general feeding when a specific formula is not called for. Like all Grower Select fertilizers, 20-20-20 has a complete micronutrient fertilizer featuring chelated iron for optimal plant availability.



25lbs

PLNTX12479 Min. Buy 1ea



### Grower Select® Fertilizer 20-10-20

Grower Select 20-10-20 serves as the backbone to a cost effective fertility program. Over 60% of nitrogen comes in nitrate form and includes magnesium as well as a complete micronutrient package featuring chelated iron. Lower phosphorous content minimizes plant stretching, making this ideal for growing in low light conditions.



25lb

PLNTX12480 Min. Buy 1ea





TRUST THE INNOVATORS OF THE HIGHEST  
QUALITY WATER SOLUBLE FERTILIZERS

# JR PETERS INC



JR Peters Inc. makes the highest quality & truly soluble nutrient blends on the market. How can we say that? Because we are here watching over every step of the process. From research & formulation design in our small batch lab, through the intense qualifying of the purest raw materials, to our long-time employees watching over each handcrafted batch. The family at JR Peters ensures that the nutrients in our blends meet the strictest standards that will grow top quality plant material.

**Jack's**  
FERTILIZERS Soluble. Available. Consistent.

[www.jrpeters.com](http://www.jrpeters.com) | 866-522-5752



**Water Soluble Fertilizers**

**FeED Water Soluble Fertilizers**

The FeED line features our most advanced chelating system and boosted levels of micronutrients to fit the specific needs of today's crops. Each product contains increased levels of iron, derived from three chelate sources (EDDHA, EDTA and DTPA) extra magnesium, low ammonium, and no urea. The proprietary blend of iron level is guaranteed to deliver iron at a much broader range of pH over the entire crop cycle.



**JR Peters® Jack's Professional®  
15-2-20 Spring Pansy FeED Fertilizer**

Designed specifically for the pansies and violas grown in the winter into spring. This product combines 3.5% calcium and 1.75% magnesium and the elevated boron, iron and manganese levels that pansies, salvias and vincas require. The 84% nitrate nitrogen and low phosphorus content control stretch.

- For use on: Fertility programs that require additional Ca, Mg, B & Mn.
- Basicity: 195 lbs CCE



**25lb**  
**JRP77720** Min. Buy 1ea  
Shipping Info **SHIPS HAZARDOUS**



**JR Peters® Jack's Professional®  
17-3-19 Fall Pansy FeED Fertilizer**

Designed specifically for pansy production in late summer and early fall. A nitrate/ammonium nitrogen system is more efficient in warmer weather. The results in a potentially acidic product that will lower media pH over time. Also contains an iron chelate system plus additional magnesium and boron which is necessary to produce a consistent, high quality crop. At 17% nitrogen content, you also use less product to achieve your desired rates.

- For use on: Designed specifically for pansy production in late summer and early fall.
- Acidic: 231 lbs CCE



**25lb**  
**JRP77730** Min. Buy 1ea



**JR Peters® Jack's Professional®  
20-3-19 Petunia FeED Fertilizer**

A proprietary blend of iron chelates are used to increase the availability of iron over a broad range of pH. Contains double the iron found in typical peat-lite formulations. Contains additional magnesium for optimum crop performance, low phosphorus level that help prevent excessive elongation, high nitrate nitrogen, moderately high potential acidity and no urea.

- For use on: Petunia, Calibrachoa, Bacopa.
- Acidic: 420 lbs CCE



**25lb**  
**JRP77770** Min. Buy 1ea



**JR Peters® Jack's Professional®  
15-4-15 Poinsettia FeED +CaMg Fertilizer**

Designed to fit the needs of the poinsettia cultivars that require micronutrients, but a lesser amount of macronutrients, containing 50% more iron, manganese, copper and zinc than found in typical poinsettia peat-lite formulations. Low boron levels help prevent toxicity problems. Extra soluble molybdenum added to the formula to reduce or eliminate the extra step of adding molybdenum to each stock tank.

- For use on: Dark leaved Varieties, Light leaved varieties.
- Basicity: 77 lbs CCE



**25lb**  
**JRP77750** Min. Buy 1ea



**JR Peters® Jack's Professional®  
22-5-16 Mum FeED Fertilizer**

Mums are heavy feeders that respond well to additional magnesium, sulfur and iron. Additional 2% Nitrogen in this formula reduces your fertilizer usage by approximately 10%, making this product not only nutritionally effective, but cost effective as well.

- For use on: Garden Mums, Iron loving warm weather plants.
- Acidic: 573 lbs CCE



**25lb**  
**JRP77740** Min. Buy 1ea



**JR Peters® Jack's Professional®  
17-5-19 Poinsettia FeED +Mg Fertilizer**

Designed to fit the needs of the poinsettia cultivars that require micronutrients, but a lesser amount of macronutrients, containing 50% more iron, manganese, copper and zinc than found in typical poinsettia peat-lite formulations. Low boron levels help prevent toxicity problems.

- For use on: Dark leaved Varieties
- Acidic: 275 lbs CCE



**25lb**  
**JRP77760** Min. Buy 1ea





Water Soluble Fertilizers

LX Water Soluble Fertilizers

The LX™ system utilizes proven acidifying solutions to keep N, P, K, Ca and Mg in concentrated form together! All formulations in this enhanced line of fertilizers are fully mixable to tailor customized blends for individual growers and water supplies. The LX system provides a peat-lite micronutrient package that is balanced throughout the product line. This ensures a consistent micronutrient level is supplied when products are tank-mixed.

JR Peters® Jack's Professional® 13-2-13 Plug LX Fertilizer

A water-soluble fertilizer ideal for plug production with 6% calcium and 3% magnesium It is formulated with 94% nitrate nitrogen and a low phosphorus content to promote compact, sturdy plugs.

- For use on: All Plants
- Basicity: 319 lbs CCE
- No Urea



25lb JRP77490 Min. Buy 1ea



JR Peters® Jack's Professional® 20-5-19 Poinsettia LX Fertilizer

Ideal fertilizer for poinsettia production with moderate to high alkalinity waters. The peat-lite level of micronutrients is adjusted to provide higher zinc and molybdenum and lower boron with over 60% nitrate nitrogen.

- For use on: Light and Dark Leaved poinsettia varieties.
- Acidic: 379 lbs CCE
- No Urea



25lb JRP77590 Min. Buy 1ea Shipping Info SHIPS HAZARDOUS



JR Peters® Jack's Professional® 15-5-15 +CaMg LX Fertilizer

A truly comprehensive formulation containing all of the macro and micro nutrients. Contains 4% calcium and 2% magnesium, which makes it an ideal choice for use with water that is low in those nutrients. Formulated with 80% nitrate nitrogen and contains a Peat-Lite level of micronutrients.

- For use on: All plants
- Basicity: 69 lbs CCE
- Urea: 3.72



25lb JRP77940 Min. Buy 1ea Shipping Info HAZARDOUS



JR Peters® Jack's Professional® 21-5-20 All Purpose LX Fertilizer

A water-soluble fertilizer Ideal for moderate to high alkalinity waters. It is formulated with over 60% nitrate nitrogen and a peat-lite level of micronutrients.

- For use on: All bedding and potted plants, can be used for plugs at low rates.
- Acidic: 407 lbs CCE
- No Urea



25lb JRP77990 Min. Buy 1ea Shipping Info HAZARDOUS



JR Peters® Jack's Professional® 17-4-17 Pure Water LX Fertilizer

Blended for growers desiring a 4:1:4 ratio for pure water. This formulation will not cause pH crash in media. Calcium is supplied at 3% with magnesium at 1.5% to add what pure water does not supply.

- For use on: All bedding plants, plugs and young plants and vegetables as finished or transplants.
- Neutral: 0 lbs CCE
- No Urea



25lb JRP77560 Min. Buy 1ea





### Water Soluble Fertilizers

#### Professional Water Soluble Fertilizers

Premier grade fertilizers formulated with highest quality components and manufacturing controls. Bob Peters improved his special blend of growth enhancing "goodies" that are included in every batch of the Jack's Professional brand.

#### JR Peters® Jack's Professional® 20-20-20 General Purpose Fertilizer

Great for maintaining plants in garden center and growing facilities. It provides fast green-up and great foliar expansion due to the high percentage of ammonium and urea nitrogen plus balanced phosphorus and potassium for excellent root and shoot growth.

- For use on: All outdoor grown plants
- Acidic: 555 lbs CCE



**25lb**  
**JRP77010** Min. Buy 1ea



#### JR Peters® Jack's Professional® 20-10-20 General Purpose Fertilizer

A water-soluble fertilizer designed to be mixed with water for the most accurate and effective nutrient delivery to the plant. It contains the traditional micronutrient levels needed for general production including propagation and all types of bedding plants. High nitrate nitrogen levels (60% of the total) provides for green foliage and more compact growth.

- For use on: All Plants
- Acidic: 555 lbs CCE
- No Urea



**25lb**  
**JRP77840** Min. Buy 1ea  
Shipping Info **SHIPS HAZARDOUS**



#### JR Peters® Jack's Professional® 15-15-15 Geranium Fertilizer

Ideal for geraniums and other neutral pH loving plants. The high phosphorus content promotes strong root growth and bud set. Great for pink hydrangeas. The high nitrate nitrogen content (56%) and the general-purpose level of micronutrients help minimize nutritional toxicities on geraniums.

- For use on: Geraniums, marigolds, and other plants with media pH requirements above 6.2
- Acidic: 151 lbs CCE



**25lb**  
**JRP77020** Min. Buy 1ea



#### JR Peters® Jack's Professional® 10-30-20 Blossom Booster Fertilizer

High phosphorus formula used during periods of bud set to increase the number and size of blossoms. Great for vegetable production.

- For use on: Flowering plants.
- Acidic: 347 lbs CCE



**25lb**  
**JRP77160** Min. Buy 1ea



#### JR Peters® Jack's Professional® 25-5-15 High Performance Fertilizer

High efficiency formula designed to maximize your NPK delivery while keeping a balance of macro secondary and micronutrients for optimum plant growth. Delivers an efficient, balanced formula even when you use less fertilizer.

- For use on: All bedding plants and vegetable transplants
- Acidic: 608 lbs CCE
- No Urea



**25lb**  
**JRP77900** Min. Buy 1ea



#### JR Peters® Jack's Professional® 15-0-15 Dark Weather Peat-Lite Fertilizer

A no phosphate water soluble fertilizer that contains calcium nitrate (CaNO<sub>3</sub>), an essential tool for regulating growth when the weather is cool with little sunlight. This will greatly reduce the potential for damage to the roots of the plant and provide solid, balanced nutrition under these conditions.

- For use on: All Plants, especially useful for plants that have a higher Ca requirement like Poinsettias and Tomatoes.
- Basicity: 319 lbs CCE
- No Urea



**25lb**  
**JRP77190** Min. Buy 1ea



#### JR Peters® Jack's Professional® 15-0-15 Dark Weather Fertilizer

A no phosphate water soluble fertilizer that contains calcium nitrate (CaNO<sub>3</sub>), an essential tool for regulating growth when the weather is cool with little sunlight. This will greatly reduce the potential for damage to the roots of the plant and provide solid, balanced nutrition under these conditions.

- For use on: All Plants, especially useful for plants that have a higher Ca requirement like Poinsettias and Tomatoes.
- Basicity: 344 lbs CCE
- No Urea



**25lb**  
**JRP77180** Min. Buy 1ea





Water Soluble Fertilizers

Professional Water Soluble Fertilizers

Premier grade fertilizers formulated with highest quality components and manufacturing controls. Bob Peters improved his special blend of growth enhancing "goodies" that are included in every batch of the Jack's Professional brand.

JR Peters® Jack's Professional® 15-16-17 Peat-Lite Fertilizer

A water-soluble fertilizer designed to be mixed with water for the most accurate and effective nutrient delivery to the plant. Similar to 20-20-20 but with over 60% nitrate nitrogen, boosted micronutrient levels and much less acidic reaction in the root media. The balanced N-P-K ratio is excellent for producing fast-growing plants or for maintaining plants in a sales environment.

- For use on: All plants especially the geranium. Great choice when trying to maintain finished plants in a garden center.
• Acidic: 122 lbs CCE



25lb JRP77220 Min. Buy 1ea



JR Peters® Jack's Professional® 21-7-7 Acid Fertilizer

A water-soluble fertilizer ideal for acid-loving plants in the nursery and landscape. Provides a rapid correction of a high pH situation. Contains no harmful chlorides.

- For use on: Acid loving plants in nursery and landscape, such as rhododendrons, azaleas, and evergreens.
• Acidic: 1539 lbs CCE



25lb JRP77130 Min. Buy 1ea



JR Peters® Jack's Professional® 21-8-18 Mag Mum Fertilizer

Mums are heavy feeders that respond well to additional magnesium, sulfur and iron. Additional 2% Nitrogen in this formula reduces your fertilizer usage by approximately 10%, making this product not only nutritionally effective, but cost effective as well.

- For use on: Garden Mums
• Acidic: 446 lbs CCE
• No Urea



25lb JRP71440 Min. Buy 1ea



JR Peters® Jack's Professional® 20-10-20 Peat-Lite Fertilizer

A water-soluble fertilizer that has approximately twice the level of micronutrients as the general purpose formulation. The additional level of micronutrients provides necessary elements absent from most commercially made peat-lite potting media.

- For use on: All greenhouse plants grown in peat-lite mixes
• Acidic: 401 lbs CCE
• No Urea



25lb JRP77860 Min. Buy 1ea Shipping Info SHIPS HAZARDOUS



JR Peters® Jack's Professional® 15-5-25 Poinsettia Peat-Lite Fertilizer

A water-soluble fertilizer that contains more than 70% nitrate nitrogen and has a micronutrient package adjusted for poinsettias (lower boron and increased magnesium, zinc and molybdenum). An ideal choice for low alkalinity waters when the feed program is supplemented with calcium-containing products.

- For use on: Poinsettias
• Acidic: 46 lbs CCE



25lb JRP77790 Min. Buy 1ea



JR Peters® Jack's Professional® 16-4-17 Oasis Hydroponic FeEd Fertilizer

An innovative formula that provides all the macro, secondary and micronutrients in a one-part system. Designed specially for hydroponically grown herbs (basil, cilantro, chives, parsley etc.), as well as, lettuce and most vegetables. Includes our proprietary blend of iron chelates that keeps iron available even as the pH varies up to a high of 8.0. Also contains a significant level of soluble calcium and magnesium, for all-around plant nutrition.

- For use on: Herbs, all types lettuce, Hydro garden crops
• Neutral: 0 lbs CCE
• No Urea
• Contains increased levels of iron from 3 chelate sources



25lb JRP71750 Min. Buy 1ea





### Water Soluble Fertilizers

#### Jack's® Nutrients FeEd 5-12-26 Part A Fertilizer

Promotes the growth of leaves and strong roots. Blended with purely soluble and available nutrients to allow the grower maximum flexibility. Specific mixtures of macro, secondary and micronutrients deliver an efficient combination of nutrients suitable for many different growing environments and crop types.



**2.2lbs**

**JRP79031** Min. Buy 1ea

**25lb Bag**

**JRP79030** Min. Buy 1ea



#### Jack's Nutrients Fertilizers

A collection of formulas that gives you choices that work for many different controlled environments without the hype or confusion of extravagant names and crazy labels.

#### Jack's® Nutrients FeEd 15-6-17 Clone Starter Fertilizer

Promotes fast root development and extensive root system growth. Best used for fertilizing young seedlings, transplants, clones and newly set root cuttings.



**2.2lb**

**JRP79071** Min. Buy 1ea

**25lb**

**JRP79070** Min. Buy 1ea



#### Jack's® Nutrients BOOST 15-0-0 Calcium Nitrate Part B Fertilizer

Promotes Calcium uptake and strong leaf growth. BOOST 15-0-0 is a pure combination of a calcium and nitrate nitrogen allowing growers flexibility to boost their levels according to different crops or stages of growth. Used in combination with Jack's Part A FeED, these two products combined to make a totally available nutrient solution.



**2.2lb**

**JRP79081** Min. Buy 1ea

**25lb**

**JRP79080** Min. Buy 1ea



#### Jack's® Nutrients FeEd 12-4-16 RO Pure Water Fertilizer

Nutrient uptake in pure and reverse osmosis waters. Designed to provide a highly soluble NPK plus enhanced micronutrient package along with 7% Calcium and 2% soluble magnesium to help replace the nutrients that are missing from pure water and RO filter water types.



**2.2lbs**

**JRP79041** Min. Buy 1ea

**25lb Bag**

**JRP79040** Min. Buy 1ea



#### Jack's® Nutrients FeEd 10-30-20 Bloom Fertilizer

Promotes root growth plus flower and fruit development. This 1:3:2 major nutrient ratio combination promotes blooming resulting in enhanced flower buds and fruit sets. Proven and trusted by professional growers for over 70 years.



**2.2lb**

**JRP79061** Min. Buy 1ea

**25lb**

**JRP79060** Min. Buy 1ea



#### Jack's® Nutrients FeEd 15-5-20 Tap Water Fertilizer

Promotes growth of leaves and strong roots. Allow your plants to drink this formula designed to provide all the macro, secondary and micro nutrients on a one-part system. Specifically formulated for alkaline tap, city or well water types. This potentially acidic formula will lower pH over time without forgetting the extra soluble Ca, Mg and the right amount of micronutrients.



**2.2lb**

**JRP79051** Min. Buy 1ea

**25lb**

**JRP79050** Min. Buy 1ea



#### Jack's® Nutrients FeEd 5-50-18 UltraViolet Fertilizer

Promotes Bud Set & Enhanced Flower Production. Get ready for a serious boost of available phosphorus. The primary goal of this formula is to assist in shutting down the strong vegetative growth stage of the plant and promote the switch to reproductive or flowering phase of plant and flower development.



**2.2lb**

**JRP79011** Min. Buy 1ea

**25lb**

**JRP79010** Min. Buy 1ea



#### Jack's® Nutrients FeEd 7-15-30 Finish Fertilizer

Promotes strong finished plants. You have always been told to finish strong. This formula is ideally formulated for this purpose to provide your plants with low N, high P and high K content to keep the whole plant happy to the end of its crop cycle.



**2.2lb**

**JRP79021** Min. Buy 1ea

**25lb**

**JRP79020** Min. Buy 1ea



## Water Soluble Fertilizers

### Jack's Nutrients Fertilizers

A collection of formulas that gives you choices that work for many different controlled environments without the hype or confusion of extravagant names and crazy labels..



### JR Peters® Jack's Nutrients BOOST 15-0-0 Cal-Trate

This product addresses specific crop and water needs. Formula can be used by itself or as a supplement to any Jack's LX tank-mixed program. It is designed to supply additional Calcium and Nitrogen as well as minor elements. 100 ppm nitrogen solution contains 120 ppm calcium. For use on All plants. Especially useful to crops that have a hard time translocating Calcium, some well known examples are: Tomatoes and Poinsettias.



**25lbs**

**JRP79170**

Min. Buy 1ea



## Basic Nutrients

### Jack's Nutrients® Epsom Salt

An essential item to the Jack's® 3-2-1 program.



**1kg, 6/cs**

**JRP79161**

Min. Buy 6ea

**25lbs**

**JRP79160**

Min. Buy 1ea





## PPM & EC

Use this chart to compare the nutrient composition of Jack's Professional products at a consistent rate of 100 ppm nitrogen.

### Water Soluble Fertilizers

#### Jack's FeEDs® Water-Soluble Fertilizers

These are the newest additions to the Jack's Professional line of fertilizers. Featuring our most advanced chelating system and boosted levels of micronutrients to fit the specific needs of today's crops. Each product contains increased levels of iron, derived from three chelate sources, EDDHA, EDTA and DTPA, to keep it available over a wide range of pH values, magnesium and low ammonium, no urea nitrogen.

Name	Item #	NO <sup>3</sup>	NH <sup>4</sup>	Urea	P	K	Ca	Mg	B	Cu
22-5-16 Mum FeED®	77740	57.0	43.0	0.0	9.9	60.6	0.0	2.3	0.091	0.045
20-3-19 Petunia FeED Plus Mg	77770	59.8	40.2	0.0	6.5	78.9	0.0	6.7	0.100	0.050
17-5-19 Poinsettia FeED Plus Mg	77760	63.5	36.5	0.0	12.8	92.8	0.0	17.6	0.040	0.075
15-4-15 Poinsettia FeED Ca-Mg	77750	80.8	19.2	0.0	11.6	83.0	26.7	13.3	0.045	0.075
17-3-19 Fall Pansy FeED	77730	65.3	34.7	0.0	7.7	93.6	0.0	17.6	0.200	0.075
15-2-20 Spring Pansy FeED	77720	84.3	15.7	0.0	5.8	111.1	23.3	11.7	0.204	0.047
16-4-17 Oasis Hydroponic	71750	78.0	21.9	0.0	10.6	86.0	24.4	12.2	0.100	0.050

#### Jack's LX™ Water-Soluble Fertilizers

The LX™ system utilizes proven acidifying solutions to keep N, P, K, Ca and Mg in concentrated form together! All formulations in this enhanced line of fertilizers are fully mixable to tailor customized blends for individual growers and water supplies. The LX system provides a peat-lite micronutrient package that is balanced throughout the product line. This ensures a consistent micronutrient level is supplied when products are tank mixed.

Name	Item #	NO <sup>3</sup>	NH <sup>4</sup>	Urea	P	K	Ca	Mg	B	Cu
21-5-20 All Purpose	77990	62.3	37.7	0.0	10.4	79.1	0.0	0.7	0.100	0.050
20-5-19 Poinsettia	77590	62.8	37.2	0.0	10.9	78.9	0.0	3.0	0.050	0.050
17-4-17 Pure Water	77560	78.1	21.9	0.0	10.3	83.0	17.6	8.8	0.100	0.050
16-2-15 Hi Alkalinity Water Plug	77600	75.0	25.0	0.0	5.5	77.8	18.8	9.4	0.100	0.050
15-5-15 CA - MG	77940	80.0	20.0	0.0	14.5	83.0	26.7	13.3	0.100	0.050
13-2-13 Plug	77490	94.0	6.0	0.0	6.7	83.0	46.2	23.1	0.100	0.050
10-0-0 Mag-Trate	79190	100.0	0.0	0.0	0.0	0.0	0.0	90.0	0.100	0.050







Name		Item #	Fe	Mn	Mo	Zn	CCE LBS	A/B	E.C. @ 100 PPM
22-5-16	Mum FeED®	77740	0.910	0.227	0.045	0.227	573	Acidity	0.67
20-3-19	Petunia FeED Plus Mg	77770	1.000	0.250	0.050	0.250	420	Acidity	0.64
17-5-19	Poinsettia FeED Plus Mg	77760	0.750	0.375	0.500	0.450	275	Acidity	0.78
15-4-15	Poinsettia FeED Ca-Mg	77750	0.750	0.375	0.500	0.450	77	Basicity	0.76
17-3-19	Fall Pansy FeED	77730	1.000	0.375	0.075	0.375	231	Acidity	0.74
15-2-20	Spring Pansy FeED	77720	0.500	0.333	0.047	0.250	195	Basicity	0.74
16-4-17	Oasis Hydroponic	71750	1.230	0.300	0.050	0.310	0	Neutral	0.78

Name		Item #	Fe	Mn	Mo	Zn	CCE LBS	A/B	E.C. @ 100 PPM
21-5-20	All Purpose	77990	0.500	0.250	0.050	0.250	407	Acidity	0.62
20-5-19	Poinsettia	77590	0.500	0.250	0.500	0.300	379	Acidity	0.64
17-4-17	Pure Water	77560	0.500	0.250	0.050	0.250	0	Neutral	0.72
16-2-15	Hi Alkalinity Water Plug	77600	0.500	0.250	0.050	0.250	76	Acidity	0.78
15-5-15	CA - MG	77940	0.500	0.250	0.050	0.250	69	Basicity	0.76
13-2-13	Plug	77490	0.500	0.250	0.050	0.250	319	Basicity	0.82
10-0-0	Mag-Trate	79190	0.500	0.250	0.050	0.250	348	Basicity	0.80





### Water Soluble Fertilizers

## PPM & EC

Use this chart to compare the nutrient composition of Jack's Professional products at a consistent rate of 100 ppm nitrogen.

### Jack's Professional® Water-Soluble Fertilizers

Premier grade fertilizers formulated with highest quality components and manufacturing controls. Special blend of growth enhancing "goodies" that are included in every bag of the Jack's Professional brand.

Name	Item #	NO <sup>3</sup>	NH <sup>4</sup>	Urea	P	K	Ca	Mg	B	Cu
27-15-12 Foliar Feed	77521	13.7	11.0	75.3	24.2	36.9	0.0	0.4	0.093	0.231
25-5-15 High Performance	77900	57.0	43.0	0.0	8.7	50.0	0.0	0.4	0.100	0.050
24-8-16 Tropical Foliage	77930	34.9	24.5	40.6	14.5	55.3	0.0	2.1	0.014	0.083
21-8-18 MagMum	71440	59.0	40.9	0.0	16.6	71.1	0.0	4.7	0.100	0.050
21-7-16 Interiorscape Special	73000	28.9	23.0	48.0	14.5	63.2	0.0	4.7	0.010	0.240
21-7-7 Acid	77130	0.0	54.6	45.4	14.5	27.7	0.0	3.3	0.032	0.017
20-20-20 General Purpose	77010	30.3	19.2	50.5	43.6	83.0	0.0	0.3	0.034	0.018
20-10-20 General Purpose	77840	60.0	40.0	0.0	21.8	83.0	0.0	0.8	0.034	0.018
20-10-20 Peat-Lite	77860	60.0	40.0	0.0	21.8	83.0	0.0	0.8	0.100	0.050
20-0-20 Hi Cal Peat-Lite	77660	54.0	1.7	44.3	0.0	83.0	30.0	0.0	0.100	0.050
17-5-24 Low Acid Peat-Lite	77430	68.6	31.4	0.0	12.8	117.2	0.0	11.8	0.100	0.050
15-30-15 Hi Phosphate	77080	27.7	35.2	37.1	87.3	83.0	0.0	1.7	0.045	0.024
15-16-17 Peat-Lite	77220	61.7	21.0	17.3	46.6	94.1	0.0	0.08	0.100	0.050
15-15-15 Geranium	77020	56.0	19.2	24.6	43.6	83.0	0.0	0.3	0.045	0.024
15-11-29 Peat-Lite	77230	71.5	28.5	0.0	32.0	160.5	0.0	0.8	0.100	0.050
15-10-30 Pot Mum Finisher	77110	52.6	11.1	36.3	29.1	166.0	0.0	1.7	0.045	0.024
15-5-25 Poinsettia Peat-Lite	77790	71.9	28.1	0.0	14.5	138.4	0.0	17.7	0.045	0.500
15-0-15 Dark Weather	77190	80.8	3.9	15.3	0.0	83.0	73.3	0.0	0.045	0.024
15-0-15 Dark Weather Peat-Lite	77180	90.0	10.0	0.0	0.0	83.0	71.3	0.0	0.100	0.050
10-30-20 Blossom Booster	77160	50.0	50.0	0.0	130.9	166.0	0.0	20.3	0.068	0.036
9-45-15 Plant Starter	77140	0.0	100.0	0.0	218.2	138.4	0.0	0.6	0.076	0.040
5-12-26 Part A	79030	100.0	0.0	0.0	104.7	431.7	0.0	126.4	1.000	0.300
15-0-0 Cal-Trate	79170	93.0	7.0	0.0	0.0	0.0	120.0	0.0	0.100	0.050





Name		Item #	Fe	Mn	Mo	Zn	CCE LBS	A/B	E.C.@ 100PPM
27-15-12	Foliar Feed	77521	0.463	0.231	0.002	0.231	923	Acidity	0.22
25-5-15	High Performance	77900	0.500	0.252	0.050	0.252	608	Acidity	0.57
24-8-16	Tropical Foliage	77930	0.208	0.104	0.004	0.083	737	Acidity	0.40
21-8-18	MagMum	71440	0.480	0.250	0.050	0.250	446	Acidity	0.72
21-7-16	Interiorscape Special	73000	0.480	0.240	0.000	0.240	672	Acidic	0.60
21-7-7	Acid	77130	0.714	0.119	0.004	0.012	1539	Acidity	0.60
20-20-20	General Purpose	77010	0.250	0.125	0.005	0.013	555	Acidity	0.42
20-10-20	General Purpose	77840	0.250	0.125	0.005	0.013	407	Acidity	0.64
20-10-20	Peat-Lite	77860	0.500	0.250	0.050	0.250	401	Acidity	0.64
20-0-20	Hi Cal Peat-Lite	77660	0.500	0.250	0.050	0.250	0	Neutral	0.48
17-5-24	Low Acid Peat-Lite	77430	0.500	0.250	0.050	0.250	133	Acidity	0.76
15-30-15	Hi Phosphate	77080	0.333	0.167	0.006	0.017	696	Acidity	0.58
15-16-17	Peat-Lite	77220	0.500	0.250	0.050	0.250	122	Acidity	0.68
15-15-15	Geranium	77020	0.333	0.167	0.006	0.017	151	Acidity	0.70
15-11-29	Peat-Lite	77230	0.500	0.250	0.050	0.250	58	Acidity	0.96
15-10-30	Pot Mum Finisher	77110	0.333	0.167	0.006	0.017	98	Acidity	0.70
15-5-25	Poinsettia Peat-Lite	77790	0.500	0.280	0.500	0.333	46	Acidity	0.82
15-0-15	Dark Weather	77190	0.333	0.167	0.006	0.017	319	Basicity	0.74
15-0-15	Dark Weather Peat-Lite	77180	0.500	0.250	0.050	0.250	344	Basicity	0.78
10-30-20	Blossom Booster	77160	0.500	0.250	0.009	0.025	347	Acidity	0.98
9-45-15	Plant Starter	77140	0.556	0.278	0.010	0.028	965	Acidity	1.20
5-12-26	Part A	79030	6.000	1.000	0.200	0.300	211	Basicity	2.10
15-0-0	Cal-Trate	79170	0.500	0.250	0.050	0.250	367	Basicity	0.74



## Labels

Use these charts to compare the guaranteed analyses of Jack's Professional Products.

### Water Soluble Fertilizers

#### Jack's FeEDs® Water-Soluble Fertilizers

These are the newest additions to the Jack's Professional line of fertilizers. Featuring our most advanced chelating system and boosted levels of micronutrients to fit the specific needs of today's crops. Each product contains increased levels of iron, derived from three chelate sources, EDDHA, EDTA and DTPA, to keep it available over a wide range of pH values, magnesium and low ammonium, no urea nitrogen.

Products			% Nitrogen				%P	%K	%Ca	%Mg	%B
Name		Item #	Total	NO <sup>3</sup>	NH <sup>4</sup>	Urea	P <sup>2</sup> O <sup>5</sup>	K <sup>2</sup> O			
22-5-16	Mum FeED®	77740	22.00	12.54	9.46	0.00	5.00	16.00	0.00	0.50	0.0200
20-3-19	Petunia FeED Plus Mg	77770	20.00	11.96	8.04	0.00	3.00	19.00	0.00	1.34	0.0200
17-5-19	Poinsettia FeED Plus Mg	77760	17.00	10.79	6.21	0.00	5.00	19.00	0.00	3.00	0.0068
15-4-15	Poinsettia FeED Ca-Mg	77750	15.00	12.12	2.88	0.00	4.00	15.00	4.00	2.00	0.0068
17-3-19	Fall Pansy FeED	77730	17.00	11.10	5.90	0.00	3.00	19.00	0.00	3.00	0.0340
15-2-20	Spring Pansy FeED	77720	15.00	12.64	2.36	0.00	2.00	20.00	3.50	1.75	0.0306
16-4-17	Oasis Hydroponic	71750	16.00	12.80	3.60	0.00	4.00	17.00	4.00	2.00	0.0160

#### Jack's LX™ Water-Soluble Fertilizers

The LX™ system utilizes proven acidifying solutions to keep N, P, K, Ca and Mg in concentrated form together! All formulations in this enhanced line of fertilizers are fully mixable to tailor customized blends for individual growers and water supplies. The LX system provides a peat-lite micronutrient package that is balanced throughout the product line. This ensures a consistent micronutrient level is supplied when products are tank mixed.

Products			% Nitrogen				%P	%K	%Ca	%Mg	%B
Name		Item #	Total	NO <sup>3</sup>	NH <sup>4</sup>	Urea	P <sup>2</sup> O <sup>5</sup>	K <sup>2</sup> O			
21-5-20	All Purpose	77990	21.00	13.08	7.92	0.00	5.00	20.00	0.00	0.15	0.0210
20-5-19	Poinsettia	77590	20.00	12.56	7.44	0.00	5.00	19.00	0.00	0.60	0.0100
17-4-17	Pure Water	77560	17.00	13.27	3.73	0.00	4.00	17.00	3.00	1.50	0.0170
16-2-15	Hi Alkalinity Water Plug	77600	16.00	12.00	4.00	0.00	2.00	15.00	3.00	1.50	0.0160
15-5-15	CA - MG	77940	15.00	12.00	3.00	0.00	5.00	15.00	4.00	2.00	0.0150
13-2-13	Plug	77490	13.00	12.22	0.78	0.00	2.00	13.00	6.00	3.00	0.0130
10-0-0	Mag-Trate	79190	10.00	10.00	0.00	0.00	0.00	0.00	0.00	9.00	0.0100





Products			%Cu	%Fe	%Mn	%Mo	%Zn	CCE LBS	A/B
Name		Item #							
22-5-16	Mum FeED®	77740	0.0100	0.2000	0.0500	0.0100	0.0500	573	Acidity
20-3-19	Petunia FeED Plus Mg	77770	0.0100	0.2000	0.0500	0.0100	0.0500	420	Acidity
17-5-19	Poinsettia FeED Plus Mg	77760	0.0128	0.1275	0.0638	0.0850	0.0765	275	Acidity
15-4-15	Poinsettia FeED Ca-Mg	77750	0.0112	0.1125	0.0563	0.0750	0.0675	77	Basicity
17-3-19	Fall Pansy FeED	77730	0.0128	0.1700	0.0638	0.0128	0.0638	231	Acidity
15-2-20	Spring Pansy FeED	77720	0.0070	0.0750	0.0500	0.0070	0.0375	195	Basicity
16-4-17	Oasis Hydroponic	71750	0.0090	0.1000	0.0500	0.0080	0.0400	0	Neutral

Products			%Cu	%Fe	%Mn	%Mo	%Zn	CCE LBS	A/B
Name		Item #							
21-5-20	All Purpose	77990	0.0105	0.1050	0.0525	0.0105	0.0525	407	Acidity
20-5-19	Poinsettia	77590	0.0100	0.1000	0.0500	0.1000	0.0600	379	Acidity
17-4-17	Pure Water	77560	0.0085	0.0850	0.0425	0.0085	0.0425	0	Neutral
16-2-15	Hi Alkalinity Water Plug	77600	0.0080	0.0800	0.0400	0.0080	0.0400	76	Acidity
15-5-15	CA - MG	77940	0.0075	0.0750	0.0375	0.0075	0.0375	69	Basicity
13-2-13	Plug	77490	0.0065	0.0650	0.0325	0.0065	0.0325	319	Basicity
10-0-0	Mag-Trate	79190	0.0050	0.0500	0.0250	0.0050	0.0250	348	Basicity





## Labels

Use these charts to compare the guaranteed analyses of Jack's Professional Products.

### Water Soluble Fertilizers



### Jack's Professional® Water-Soluble Fertilizers

Premier grade fertilizers formulated with highest quality components and manufacturing controls. Special blend of growth enhancing "goodies" that are included in every bag of the Jack's Professional brand.

Products			% Nitrogen				%P	%K	%Ca	%Mg	%B
Name		Item #	Total	NO <sup>3</sup>	NH <sup>4</sup>	Urea	P <sup>2</sup> O <sup>5</sup>	K <sup>2</sup> O			
27-15-12	Foliar Feed	77521	27.00	3.71	2.96	20.33	15.00	12.00	0.00	0.10	0.0250
25-5-15	High Performance	77900	25.00	14.25	10.75	0.00	5.00	15.00	0.00	0.10	0.0250
24-8-16	Tropical Foliage	77930	24.00	8.37	5.89	9.74	8.00	16.00	0.00	0.50	0.0034
21-8-18	MagMum	71440	21.00	12.40	8.60	0.00	8.00	18.00	0.00	1.00	0.0210
21-7-16	Interiorscape Special	73000	21.00	6.08	4.83	10.09	7.00	16.00	0.00	1.00	0.0030
21-7-7	Acid	77130	21.00	0.00	11.47	9.53	7.00	7.00	0.00	0.70	0.0068
20-20-20	General Purpose	77010	20.00	6.07	3.83	10.10	20.00	20.00	0.00	0.05	0.0068
20-10-20	General Purpose	77840	20.00	12.00	8.00	0.00	10.00	20.00	0.00	0.15	0.0068
20-10-20	Peat-Lite	77860	20.00	12.00	8.00	0.00	10.00	20.00	0.00	0.15	0.0200
20-0-20	Hi Cal Peat-Lite	77660	20.00	10.79	0.34	8.87	0.00	20.00	6.00	0.00	0.0200
17-5-24	Low Acid Peat-Lite	77430	17.00	11.67	5.33	0.00	5.00	24.00	0.00	2.00	0.0170
15-30-15	Hi Phosphate	77080	15.00	4.15	5.28	5.57	30.00	15.00	0.00	0.25	0.0068
15-16-17	Peat-Lite	77220	15.00	9.25	3.15	2.60	16.00	17.00	0.00	0.12	0.0150
15-15-15	Geranium	77020	15.00	8.40	2.88	3.72	15.00	15.00	0.00	0.05	0.0068
15-11-29	Peat-Lite	77230	15.00	10.73	4.27	0.00	11.00	29.00	0.00	0.12	0.0150
15-10-30	Pot Mum Finisher	77110	15.00	7.89	1.67	5.44	10.00	30.00	0.00	0.25	0.0068
15-5-25	Poinsettia Peat-Lite	77790	15.00	10.79	4.21	0.00	5.00	25.00	0.00	2.65	0.0068
15-0-15	Dark Weather	77190	15.00	12.12	0.58	2.30	0.00	15.00	11.00	0.00	0.0068
15-0-15	Dark Weather Peat-Lite	77180	15.00	13.50	1.50	0.00	0.00	15.00	10.69	0.00	0.0150
10-30-20	Blossom Booster	77160	10.00	5.00	5.00	0.00	30.00	20.00	0.00	2.03	0.0068
9-45-15	Plant Starter	77140	9.00	0.00	9.00	0.00	45.00	15.00	0.00	0.05	0.0068
5-12-26	Part A	79030	5.00	5.00	0.00	0.00	12.00	26.00	0.00	6.32	0.0500
15-0-0	Cal Nit Part B	79080	15.50	14.42	1.08	0.00	0.00	0.00	18.00	0.00	0.0000
	MOST	77391	N/A	N/A	N/A	N/A	N/A	N/A	N/A	0.40	1.3500
	MOST NO BORON	77392	N/A	N/A	N/A	N/A	N/A	N/A	N/A	2.00	0.0000
	Ammonium Molybdate	77743	N/A	N/A	N/A	N/A	N/A	N/A	N/A	N/A	N/A



Products			%Cu	%Fe	%Mn	%Mo	%Zn	CCE LBS	A/B
Name		Item #							
27-15-12	Foliar Feed	77521	0.0625	0.1250	0.0625	0.0006	0.0625	923	Acidity
25-5-15	High Performance	77900	0.0125	0.1250	0.0630	0.0125	0.0630	608	Acidity
24-8-16	Tropical Foliage	77930	0.0200	0.0500	0.0250	0.0009	0.0200	737	Acidity
21-8-18	MagMum	71440	0.0110	0.1050	0.0530	0.0110	0.0530	446	Acidity
21-7-16	Interiorscape Special	73000	0.0500	0.1000	0.0500	0.0009	0.0500	672	Acidity
21-7-7	Acid	77130	0.0036	0.1500	0.0250	0.0009	0.0025	1539	Acidity
20-20-20	General Purpose	77010	0.0036	0.0500	0.0250	0.0009	0.0025	555	Acidity
20-10-20	General Purpose	77840	0.0036	0.0500	0.0250	0.0009	0.0025	407	Acidity
20-10-20	Peat-Lite	77860	0.0100	0.1000	0.0500	0.0100	0.0500	401	Acidity
20-0-20	Hi Cal Peat-Lite	77660	0.0100	0.1000	0.0500	0.0100	0.0500	0	Neutral
17-5-24	Low Acid Peat-Lite	77430	0.0085	0.0850	0.0425	0.0085	0.0425	133	Acidity
15-30-15	Hi Phosphate	77080	0.0036	0.0500	0.0250	0.0009	0.0025	696	Acidity
15-16-17	Peat-Lite	77220	0.0075	0.0750	0.0375	0.0075	0.0375	122	Acidity
15-15-15	Geranium	77020	0.0036	0.0500	0.0250	0.0009	0.0025	151	Acidity
15-11-29	Peat-Lite	77230	0.0075	0.0750	0.0375	0.0075	0.0375	58	Acidity
15-10-30	Pot Mum Finisher	77110	0.0036	0.0500	0.0250	0.0009	0.0025	98	Acidity
15-5-25	Poinsettia Peat-Lite	77790	0.0075	0.0750	0.0420	0.0750	0.0500	46	Acidity
15-0-15	Dark Weather	77190	0.0036	0.0500	0.0250	0.0009	0.0025	319	Basicity
15-0-15	Dark Weather Peat-Lite	77180	0.0075	0.0750	0.0375	0.0075	0.0375	344	Basicity
10-30-20	Blossom Booster	77160	0.0036	0.0500	0.0250	0.0009	0.0025	347	Acidity
9-45-15	Plant Starter	77140	0.0036	0.0500	0.0250	0.0009	0.0025	965	Acidity
5-12-26	Part A	79030	0.0150	0.3000	0.0500	0.0100	0.0150	211	Basicity
15-0-0	Cal Nit Part B	79080	0.0000	0.0000	0.0000	0.0000	0.0000	400	Basicity
	MOST	77391	2.3000	7.5000	8.0000	0.0400	4.5000	N/A	N/A
	MOST NO BORON	77392	2.3000	7.5000	8.0000	0.0400	4.5000	N/A	N/A
	Ammonium Molybdate	77743	N/A	N/A	N/A	54.3000	N/A	N/A	N/A



Jack's FeED®

		Nitrogen Breakdown			A/B	To deliver 100 ppm N	Urea Free	Extra Mg	Low P	Extra Fe	with Ca	Plugs	Hard Water	Root & Bloom	Foliar Feeding	Boosted Micro
		NO <sub>3</sub>	NH <sub>4</sub>	%Fe												
Mum FeED®	22-5-16	12.54	9.46	0.2000	Acidity	6.1 oz/100 gallons	✓	✓	✓	✓		✓			✓	
Petunia FeED Plus Mg	20-3-19	11.96	8.04	0.2000	Acidity	6.8 oz/100 gallons	✓	✓	✓	✓		✓			✓	
Boosted Base FeED	18-2-18	6.55	11.5	0.2529	Acidity	7.5 oz/100 gallons	✓	✓	✓	✓					✓	
Poinsettia FeED Plus Mg	17-5-19	10.79	6.21	0.1275	Acidity	7.9 oz/100 gallons	✓	✓	✓	✓		✓			✓	
Poinsettia FeED Ca-Mg	15-4-15	12.12	2.88	0.1125	Basicity	9.0 oz/100 gallons	✓	✓	✓	✓	✓				✓	
Fall Pansy FeED	17-3-19	11.10	5.90	0.1700	Acidity	7.9 oz/100 gallons	✓	✓	✓	✓		✓			✓	
Spring Pansy FeED	15-2-20	12.64	2.36	0.0750	Basicity	9.0 oz/100 gallons	✓	✓	✓	✓	✓				✓	

Jack's LX™

		Nitrogen Breakdown			A/B	To deliver 100 ppm N	Urea Free	Extra Mg	Low P	Extra Fe	with Ca	Plugs	Hard Water	Root & Bloom	Foliar Feeding	Boosted Micro
		NO <sub>3</sub>	NH <sub>4</sub>	%Ca												
All Purpose	21-5-20	13.08	7.92	0.00	Acidity	6.4 oz/100 gallons	✓		✓			✓				✓
Poinsettia	20-5-19	12.56	7.44	0.00	Acidity	6.8 oz/100 gallons	✓		✓			✓				✓
Pure Water	17-4-17	13.27	3.73	3.00	Neutral	7.9 oz/100 gallons	✓	✓	✓							✓
Hi Alkalinity Water Plug	16-2-15	12.00	4.00	3.00	Acidity	8.4 oz/100 gallons	✓	✓	✓		✓	✓	✓			✓
CA - MG	15-5-15	12.00	3.00	4.00	Basicity	9.0 oz/100 gallons	✓	✓	✓		✓	✓				✓
Dark Weather Plus Mag	15-0-14	12.40	2.60	5.00	Basicity	9.0 oz/100 gallons	✓	✓	✓		✓	✓				✓
Plug	13-2-13	12.22	0.78	6.00	Basicity	10.4 oz/100 gallons	✓	✓	✓		✓	✓				✓

Jack's Professional®

		Nitrogen Breakdown			A/B	To deliver 100 ppm N	Urea Free	Extra Mg	Low P	Extra Fe	with Ca	Plugs	Hard Water	Root & Bloom	Foliar Feeding	Boosted Micro
		NO <sub>3</sub>	NH <sub>4</sub>	%Ca												
High Performance	25-5-15	14.25	10.75	0.00	Acidity	5.4 oz/100 gallons	✓		✓	✓		✓				
MagMum	21-8-18	12.40	8.60	0.00	Acidity	6.4 oz/100 gallons	✓	✓		✓		✓				✓
Acid	21-7-7	0.00	11.47	0.00	Acidity	6.4 oz/100 gallons				✓						
GP	20-20-20	6.07	3.83	0.00	Acidity	6.8 oz/100 gallons						✓		✓		
GP	20-10-20	12.00	8.00	0.00	Acidity	6.8 oz/100 gallons	✓					✓				
Peat-Lite	20-10-20	12.00	8.00	0.00	Acidity	6.8 oz/100 gallons	✓			✓		✓				
Peat-Lite	15-16-17	9.25	3.15	0.00	Acidity	9.0 oz/100 gallons										
Geranium	15-15-15	8.40	2.88	0.00	Acidity	9.0 oz/100 gallons										
Dark Weather	15-0-15	12.12	0.58	11.00	Basicity	9.0 oz/100 gallons			✓		✓					
Dark Weather Peat-Lite	15-0-15	13.50	1.50	10.69	Basicity	9.0 oz/100 gallons	✓		✓		✓					
Blossom Booster	10-30-20	5.00	5.00	0.00	Acidity	13.5 oz/100 gallons	✓	✓					✓	✓		
Plant Starter	9-45-15	0.00	9.00	0.00	Acidity	15 oz/ 100 gallons	✓						✓			
Orchid- Well Water	16-4-20	12.20	3.80	3.00	Neutral	8.44 oz/100 gallons	✓	✓	✓	✓	✓					✓
Orchid- R.O. Water	12-3-15	11.60	0.40	7.00	Basicity	11.25 oz/100 gallons	✓	✓	✓	✓	✓					✓
Media Mix Plus III	10-5-10					13.5 oz/100 gallons										
Mix of Soluble Traces (MOST)							✓									
Oasis Hydroponic	16-4-17	12.80	3.60	0.1000	Neutral	8.4 oz/100 gallons	✓	✓	✓	✓	✓					✓

Jack's Nutrients

		Nitrogen Breakdown			A/B	To deliver 100 ppm N	Urea Free	Extra Mg	Low P	Extra Fe	with Ca	Prop	Hard Water	Pure Water	Root & Bloom	Boosted Micro
		NO <sub>3</sub>	NH <sub>4</sub>	%Ca												
Part A	5-12-26	5.00	0.00	0.00	Basicity	26 oz/100 gallons	✓	✓	✓	✓			✓			✓
Part B	Cal Nit	14	1	18	Basicity	9oz/ 100 gallons	✓		✓		✓		✓			✓
RO	12-4-16	11.80	0.20	7.00	Basicity	11.3oz/100 gallons	✓	✓	✓	✓	✓		✓			✓
Tap	15-5-20	12.00	3.00	3.00	Basicity	9oz/100 gallons	✓	✓	✓	✓	✓	✓	✓			✓
Bloom	10-30-20	5.00	5.00	0.00	Acidic	13.5oz/ 100 gallons	✓					✓		✓		✓
Clone	15-6-17	12.00	3.00	4.00	Basicity	9oz/100 gallons	✓	✓	✓	✓	✓	✓	✓	✓		✓
UltraViolet	5-50-18	0.00	5.00	0.00	Acidic	27oz/100 gallons	✓	✓				✓		✓		✓
Finish	7-15-30	4.00	3.00	0.00	Acidic	19oz/100 gallons	✓	✓				✓				
Outdoor	18-8-23	11.50	6.50	0.00	Acidic	7.5oz/100 gallons	✓		✓			✓				
Cal-Trate	15-0-0	13.95	1.05	18.00	Basicity	9.0 oz/100 gallons	✓		✓		✓					✓
K-Trate	14-5-38	10.46	0.00	0.00	Basicity	9.64 oz/100 gallons			✓							✓
Mag-Trate	10-0-0	10.00	0.00	0.00	Basicity	13.50 oz/100 gallons	✓	✓	✓							✓





# The world's purest water-soluble fertilizer



# Peters®

Only the highest-quality ingredients are used to make Peters water-soluble fertilizer. Clean, clear formulations result in total solubility, reducing labor and product costs by eliminating precipitate build-up, clogged emitters, and repeated applications. Our exclusive M-77 chelating formula provides the vital nutrients, trace elements and efficient uptake needed for outstanding quality and brilliant color. Contact ICL today to learn more about Peters—the clear choice in water-soluble fertilizer.



### Water Soluble Fertilizers

#### Plantex Solutions® 18-9-18 pH Reducer Fertilizer

A high nitrate fertilizer that works to decrease media pH levels while providing enhanced micronutrients. Eliminates or reduces the need for acid when water bicarbonate levels are 100-150 ppm.

- For use on: Pansies, Garden Mums, Bedding Plants
- Acidic: 716 lbs CCE
- No Urea



25lb

PLNTX11076 Min. Buy 1ea  
Shipping Info **HAZARDOUS**



#### Plantex Solutions® 19-2-19 Fertility Plus Fertilizer

A high nitrate fertilizer ideal for heavy feeders. With elevated magnesium, enhanced micronutrients, and a lower phosphorus content, this maximum performance formulation is designed for modern heavy feeding.

- For use on: Pansies, Garden Mums, Bedding Plants
- Acidic: 309 lbs CCE
- No Urea



25lb

PLNTX11078 Min. Buy 1ea  
Shipping Info **HAZARDOUS**



#### Plantex Solutions® 17-5-17 Complete Fertilizer

The convenience of an all-in-one nutritional program, in one tank. This balanced formulation has high nitrate, complete calcium and magnesium along side an enhanced micronutrient package, and little impact on media pH.

- For use on: Garden Mums, Bedding Plants, Pansies, Poinsettias
- Acidic: 105 lbs CCE
- No Urea



25lb Duo Bag

PLNTX10132 Min. Buy 1ea  
Shipping Info **HAZARDOUS**



#### Plantex Solutions® 19-8-13 Complete Plus Fertilizer

A modification of the Complete formulation with more acidic potential. A complete nutritional program in one bag reduces the need to alternate formulations. Includes an enhanced micronutrient package.

- For use on: Poinsettias, Pansies, Garden Mums, Bedding Plants
- Acidic: 300 lbs CCE
- No Urea



25lb Duo Bag

PLNTX11242 Min. Buy 1ea



#### Plantex® 20-20-20 Classic Fertilizer

Very effective on all types of plants. This balanced formulation may be used whenever a more general feed program is required. Its high percentage of ammoniacal and urea nitrogen provides rapid green up and leaf expansion, while the balanced phosphorous and potassium encourages root and shoot growth.

- Acidic: 570 lbs CCE



25lb

PLNTX10392 Min. Buy 1ea



#### Plantex® 20-10-20 All Purpose High Nitrate Fertilizer

This all purpose formulation has 60% of its nitrogen in the nitrate form, and a complete micronutrient package including a higher level of molybdenum, as required for soilless mixes. This is an ideal formulation for use in low light conditions.

- Acidic: 437 lbs CCE
- No Urea



25lb

PLNTX10388 Min. Buy 1ea  
Shipping Info **HAZARDOUS**



#### Plantex® 10-52-10 High Phosphate Fertilizer

A fully soluble starter formulation that supplies the necessary high phosphorus levels for young plants to initiate rapid root development. A very safe fertilizer with a low salt index, contains no sulfates or harmful chlorides. Use when transplanting seedlings or bedding plants, or whenever a high phosphorus fertilizer is required.

- Acidic: 900 lbs CCE



25lb

PLNTX10368 Min. Buy 1ea



#### Plantex® 20-2-20 Acidic High N Low Phosphate Fertilizer

Helps keep the pH low and contributes very little phosphorus. This formulation in combination with Plantex 14-0-14 is ideal for plugs and bedding plants. Because of its high potential acidity it is useful in maintaining an ideal pH balance in plug media. Can also be used for production of blue hydrangeas and Easter lilies when excess phosphorus is not required.

- For use on: Plugs, Bedding Plants, Blue Hydrangeas, Easter Lilies
- Acidic: 535 lbs CCE
- No Urea



25lb

PLNTX10386 Min. Buy 1ea  
Shipping Info **HAZARDOUS**



#### Plantex® 18-6-20 Poinsettia Plus Fertilizer

A great choice for the production of poinsettias for its balance of nutrients. Contains over 60% of its nitrogen in the nitrate form, a high level of magnesium, an increased level of molybdenum, a low boron level and chelated micronutrients.

- For use on: Poinsettias
- Acidic: 304 lbs CCE
- No Urea



25lb

PLNTX11675 Min. Buy 1ea  
Shipping Info **HAZARDOUS**



## Water Soluble Fertilizers

### Plantex<sup>®</sup> 21-7-7 Acid Fertilizer

A potential acidity powerhouse. This formulation is ideal for when irrigation water has a high bicarbonate level and for use with acid loving plants, such as azaleas, rhododendrons, and evergreens. If used in a continuous feeding program, the pH should be monitored to ensure that it does not go below the desired level.

- Acidic: 1580 lbs CCE



25lb

PLNTX10394 Min. Buy 1ea



### Plantex<sup>®</sup> 21-5-20 High Nitrate Low P Fertilizer

This general feed formulation is the ideal base for any soilless media fertilizer program. With high nitrate, low phosphorus, elevated magnesium, and enhanced iron.

- Acidic: 440 lbs CCE
- No Urea



25lb

PLNTX11381 Min. Buy 1ea  
Shipping Info **HAZARDOUS**



### Plantex 14-0-14 Cal Mag Fertilizer

A completely soluble prilled formulation specifically for growing in multiple cells or when a higher level of calcium and magnesium is required. Calcium to magnesium ratio is 2:1.

- Basicity: 326 lbs CCE
- No Urea



25lb

PLNTX10372 Min. Buy 1ea



### Plantex<sup>®</sup> 12-2-14 Cal Mag + P Fertilizer

Designed to optimize the growth of seedlings in multiple cells. Contains a complete micronutrient package including high molybdenum. More than 97% of its nitrogen is in the form of nitrate.

- For use on: Bedding Plants, Garden Mums, Plugs, Orchids
- Basicity: 383 lbs CCE
- No Urea



25lb

PLNTX10370 Min. Buy 1ea



### Plantex<sup>®</sup> 15-0-15 Cal Plus Fertilizer

A completely soluble prilled formulation with a high calcium level. This calcium nitrate and potassium nitrate mixture includes chelated micronutrients. Very effective under low light conditions, especially during winter months.

- Basicity: 325 lbs CCE



25lb

PLNTX10375 Min. Buy 1ea



### Plant-Prod MJ 12-8-26 Grow No Dye

This ideal ratio of nitrogen, phosphorus and potassium promotes optimal growth to ensure a sufficient plant structure to support target yields. The added magnesium ensures no signs of deficiency. Grow contains an enhanced micronutrient package with additional EDDHA iron to ensure efficient uptake at a wide range of pH levels.



25lb, 80/pl

PLNTX12279 Min. Buy 1ea



### Plant-Prod MJ 10-30-20 Bloom No Dye

Plant-Prod MJ Bloom 10-30-20 is an essential formulation for optimal bud formation and fill. This high phosphorous, moderate potassium formulation encourages full bud set and improves bud filling. The added magnesium ensures no signs of deficiency. Bloom also contains an enhanced micronutrient package with additional EDDHA iron to ensure efficient uptake at a wide range of pH levels.



25lb, 80/pl

PLNTX12206 Min. Buy 1ea



### Plant-Prod MJ 4-31-37 Finisher No Dye

Plant-Prod MJ Finisher 4-31-37 is a finishing formulation with elevated phosphorus and potassium to encourage fullness and density of buds. During these last few weeks of production, this elevated potassium supports plant turgidity and disease resistance, while the phosphorus optimizes photosynthesis. The added nitrogen ensures no signs of deficiency.



25lb, 80/pl

PLNTX12280 Min. Buy 1ea



### Plant-Prod MJ 15-0-14 Cal Kick

Plant-Prod MJ Cal Kick is a high calcium formulation that should be used as the main calcium source throughout the production cycle when levels in water source are not adequate. Calcium is vital to plant rigidity and bud formation.



25lb, 80/pl

PLNTX12305 Min. Buy 1ea



### Plant-Prod MJ Spike (CaMg)

The absence of nitrogen, phosphorus and potassium allows the use of this formulation at any stage of production. Ideal for supplemental feeding of calcium and magnesium. Use should be limited to 2 times per week.



25lb, 80/pl

PLNTX12310 Min. Buy 1ea



### Plant-Prod MJ 15-30-15 Boost

Plant-Prod MJ 15-30-15 Boost has a low salt index and contains no sulphates or harmful chlorides, making it a very safe fertilizer for young transplants to initiate rapid root development. When plants are of a sufficient level of maturity, feeding with 15-30-15 provides a boost of phosphorus to promote vigorous bud setting and sizing.



25lb, 80/pl

PLNTX12278 Min. Buy 1ea





## Water Soluble Fertilizers

Plantex<sup>®</sup> and Plantex Solutions<sup>™</sup> EC (mmhos)

Plantex <sup>®</sup>									
Parts Per Million (ppm) Nitrogen	Hydroponic 7-11-27	High P 10-52-10	Cal Mag +P 12-2-14	Cal Mag 14-0-14	Cal Plus 15-0-15	Pansy 17-4-19	Poinsettia Plus 18-6-20	All Purpose High Nitrate 20-10-20	Classic 20-20-20
50	0.75	0.40	0.46	0.41	0.46	0.47	0.44	0.37	0.24
100	1.75	0.81	0.89	0.84	0.84	0.91	0.86	0.73	0.49
150	2.15	1.21	1.24	1.24	1.22	1.35	1.28	1.09	0.74
200	2.84	1.61	1.68	1.61	1.60	1.79	1.69	1.45	0.98
250	3.50	2.00	2.12	2.00	1.98	2.22	2.10	1.80	1.21
300	4.14	2.39	2.72	2.35	2.35	2.64	2.50	2.15	1.45
350	4.77	2.78	2.97	2.72	2.73	3.06	2.89	2.50	1.68
400	5.36	3.16	3.37	3.08	3.11	3.47	3.29	2.84	1.90
450	5.95	3.53	3.78	3.42	3.49	3.88	3.67	3.18	2.12

Total soluble salts is a measure, in the form of electrical conductivity, of the amount of fertilizer in solution. Most nutrients or other elements that are soluble will contribute to the conductivity of the solution. The electrical conductivity (EC) increases as the fertilizer concentration is increased.

Electrical conductivity is measured in mhos. The conductivity of fertilizer solutions is sufficiently small that it is measured in terms of millimhos (mmhos, one one-thousandth of a mho) or micromhos ( $\mu$ mhos, one one-millionth of a mho). Conductivity meters measure in either mmhos or  $\mu$ mhos. Since most meters used by our growers are calibrated in mmhos, the data given here on our fertilizers uses the same measurement. Meters that are calibrated to millisiemens (mS) do not require adjustment as mmhos and mS are interchangeable.

By knowing the electrical conductivity (EC) of a fertilizer blend, you can predict the parts per million (ppm) of nutrients your plants are receiving, or that remain in your run off water. The following table can be used to measure the accuracy of fertilizer injector systems by following these steps:

1. Take a conductivity reading of clear irrigation water.
2. Take a conductivity reading of final fertilizer solution.
3. Subtract the conductivity reading value of clear water from the conductivity reading of fertilizer solution.
4. Compare the answer found in 3 to the corresponding value in the table in order to find the concentration of fertilizer.



Plantex®				Plantex Solutions™							
High Nitrate Low P 21-5-20	Acid 21-7-7	Foliage 24-8-16	High Capacity High Nitrate 25-4-15	Cal-Mag Royal 13-2-13	No-Stretch 15-0-20	Complete 17-5-17	pH Buffer 18-6-24	pH Reducer 18-9-18	Fertility Plus 19-2-19	Complete Plus 19-8-13	
0.36	0.40	0.25	0.41	0.63	0.44	0.36	0.38	0.44	0.39	0.28	
0.72	0.78	0.49	0.82	1.19	0.91	0.69	0.76	0.88	0.78	0.56	
1.07	1.15	0.73	1.23	1.74	1.37	1.02	1.14	1.30	1.16	0.85	
1.42	1.52	0.97	1.63	2.30	1.82	1.35	1.51	1.72	1.54	1.12	
1.77	1.89	1.20	2.03	2.85	2.27	1.67	1.88	2.14	1.92	1.40	
2.11	2.25	1.44	2.42	3.41	2.72	2.00	2.26	2.55	2.29	1.67	
2.45	2.61	1.67	2.81	3.97	3.16	2.33	2.62	2.95	2.65	1.94	
2.79	2.96	1.90	3.20	4.52	3.59	2.66	2.99	3.35	3.02	2.21	
3.13	3.31	2.13	3.58	5.08	4.02	2.98	3.35	3.74	3.38	2.47	

#### Example:

Conductivity of clear irrigation water is 0.60 mmhos / mS.

Conductivity of the final fertilizer solution using 20-10-20 is 2.05 mmhos / mS.

The conductivity due to the fertilizer is 2.05 mmhos / mS - 0.60 mmhos / mS = 1.45 mmhos / mS.

For 20-10-20, a conductivity reading of 1.45 mmhos / mS corresponds to a feeding rate of roughly 200 ppm of Nitrogen (N).

**Note:** The values on this chart were obtained under laboratory conditions using distilled water and a Plant-Prod® conductivity meter. The values obtained by the grower under field conditions could therefore vary slightly (+/-10%) from the values listed here. EC values are available for reference on product label.

Plantex, Plantex Solutions and No-Stretch are registered trademarks of Master Plant-Prod Inc.  
© Master Plant-Prod Inc. 2021. All Rights Reserved.



## Water Soluble Fertilizers

## Plantex® and Plantex Solutions™ Nutrient Concentrations (ppm)

Plantex®																		
Nutrients (ppm)	Hydroponic 7-11-27		High P 10-52-10		Cal Mag +P 12-2-14		Cal Mag 14-0-14		Cal Plus 15-0-15		Pansy 17-4-19		Poinsettia Plus 18-6-20		All Purpose High Nitrate 20-10-20		Classic 20-20-20	
Total Nitrogen (N)	100	200	100	200	100	200	100	200	100	200	100	200	100	200	100	200	100	200
Nitrate N	36	72	0	0	97	193	91	182	89	179	64	130	64	128	60	120	30	59
Ammoniacal N	3	7	69	138	2	5	9	17	11	21	35	71	36	72	40	80	20	39
Urea N	0	0	28	57	0	0	0	0	0	0	0	0	0	0	0	0	51	102
Available Phosphate (P <sub>2</sub> O <sub>5</sub> )	62	124	507	1014	17	33	0	0	0	0	23	47	33	67	50	100	100	200
Soluble Phosphorus (P)	27	54	220	441	7	13	0	0	0	0	10	20	14	29	22	43	44	87
Soluble Potash (K <sub>2</sub> O)	152	304	98	195	116	231	100	200	100	200	111	224	111	222	100	200	100	200
Soluble Potassium (K)	126	252	81	162	96	191	83	165	83	166	91	183	92	184	83	166	83	166
Calcium (Ca)	71	214	0	0	50	99	42	84	73	147	0	0	0	0	0	0	0	0
Magnesium (Mg)	21	43	0	0	25	50	21	41	0	0	19	38	11	22	1	1	0	0
Sulfur (S)	33	65	0	0	0	0	0	0	0	0	23	47	14	28	1	2	0	0
Iron (Fe)	0.563	1.125	0.975	1.950	0.825	1.650	0.713	1.425	0.668	1.335	1.053	2.120	0.555	1.110	0.503	0.998	0.503	0.998
Manganese (Mn)	0.478	0.956	0.488	0.975	0.413	0.825	0.356	0.713	0.334	0.668	0.293	0.589	0.278	0.555	0.251	0.499	0.251	0.499
Zinc (Zn)	0.169	0.338	0.488	0.975	0.413	0.825	0.356	0.713	0.334	0.668	0.293	0.589	0.278	0.555	0.251	0.499	0.251	0.499
Copper (Cu)	0.023	0.046	0.488	0.975	0.413	0.825	0.356	0.713	0.334	0.668	0.293	0.589	0.278	0.555	0.251	0.499	0.251	0.499
Boron (B)	0.154	0.307	0.195	0.390	0.165	0.330	0.143	0.285	0.134	0.267	0.205	0.412	0.056	0.111	0.101	0.200	0.101	0.200
Molybdenum (Mo)	0.051	0.101	0.005	0.010	0.124	0.248	0.107	0.214	0.100	0.200	0.088	0.177	0.333	0.666	0.075	0.150	0.003	0.005
Potential Acidity / Basicity (lb. CaCO <sub>3</sub> / ton)	B 176		A 900		B 383		B 326		B 325		A 265		A 304		A 437		A 570	
oz. of fertilizer / gal. of water (1:100)	7.5	15																
	5 oz. Calcium Nitrate (GG)	10 oz. Calcium Nitrate (GG)	13	26	11	22	9.5	19	8.9	17.8	7.8	15.7	7.4	14.8	6.7	13.3	6.7	13.3

Plantex, Plantex Solutions and No-Stretch are registered trademarks of Master Plant-Prod Inc.  
© Master Plant-Prod Inc. 2021. All Rights Reserved.



Plantex®								Plantex Solutions™													
High Nitrate Low P 21-5-20		Acid 21-7-7		Foliage 24-8-16		High Capacity High Nitrate 25-4-15		Cal-Mag Royal 13-2-13		No-Stretch 15-0-20		Complete 17-5-17		pH Buffer 18-6-24		pH Reducer 18-9-18		Fertility Plus 19-2-19		Complete Plus 19-8-13	
100	200	100	200	100	200	100	200	100	200	100	200	100	200	100	200	100	200	100	200	100	200
61	123	10	20	20	40	57	115	92	185	81	163	71	142	65	131	47	94	64	127	64	127
38	77	62	126	19	37	43	86	8	15	19	37	29	58	34	69	53	105	36	72	36	72
0	0	27	54	62	121	0	0	0	0	0	0	0	0	0	0	0	0	0	0	0	0
<b>24</b>	<b>48</b>	<b>33</b>	<b>67</b>	<b>34</b>	<b>66</b>	<b>16</b>	<b>32</b>	<b>15</b>	<b>31</b>	<b>0</b>	<b>0</b>	<b>29</b>	<b>59</b>	<b>33</b>	<b>67</b>	<b>50</b>	<b>100</b>	<b>11</b>	<b>21</b>	<b>42</b>	<b>84</b>
10	20	14	29	14	28	7	14	6	12	0	0	12	25	14	29	22	43	4	8	18	36
<b>95</b>	<b>191</b>	<b>33</b>	<b>67</b>	<b>67</b>	<b>132</b>	<b>60</b>	<b>120</b>	<b>100</b>	<b>200</b>	<b>134</b>	<b>267</b>	<b>100</b>	<b>200</b>	<b>133</b>	<b>266</b>	<b>100</b>	<b>200</b>	<b>100</b>	<b>200</b>	<b>68</b>	<b>137</b>
78	158	27	55	55	109	49	100	82	165	111	222	82	166	110	221	83	165	82	165	56	112
0	0	0	0	0	0	0	0	46	92	20	40	18	35	0	0	0	0	0	0	13	26
1	1	0	0	0	1	1	1	23	46	10	20	6	12	0	0	1	2	8	16	5	11
1	2	61	124	15	29	1	2	0	0	0	0	0	0	0	0	31	61	10	20	0	0
0.591	1.191	0.473	0.953	0.420	0.825	0.497	1.003	0.612	1.230	1.669	3.338	0.585	1.178	0.555	1.110	1.388	2.775	1.313	2.625	1.313	2.625
0.236	0.476	0.236	0.476	0.210	0.413	0.199	0.401	0.459	0.923	0.501	1.001	0.293	0.589	0.278	0.555	0.416	0.833	0.394	0.788	0.394	0.788
0.236	0.476	0.236	0.476	0.210	0.413	0.199	0.401	0.153	0.308	0.501	1.001	0.293	0.589	0.278	0.555	0.416	0.833	0.394	0.788	0.394	0.788
0.236	0.476	0.236	0.476	0.210	0.413	0.199	0.401	0.077	0.154	0.334	0.668	0.293	0.589	0.278	0.555	0.278	0.555	0.263	0.525	0.263	0.525
0.095	0.191	0.095	0.191	0.084	0.165	0.080	0.161	0.092	0.185	0.134	0.267	0.117	0.236	0.111	0.222	0.111	0.222	0.105	0.210	0.105	0.210
0.071	0.143	0.002	0.005	0.002	0.004	0.060	0.120	0.008	0.017	0.100	0.200	0.088	0.177	0.083	0.167	0.083	0.167	0.079	0.158	0.079	0.158
A	A	A	A	A	A	A	A	B	B	A	A	A	A	A	A	A	A	A	A	A	A
440	1580	848	643	324	154	105	296	716	309	300											
6.3	12.7	6.3	12.7	5.6	11	5.3	10.7	10.2	20.5	8.9	17.8	7.8	15.7	7.4	14.8	7.4	14.8	7	14	7	14

Plantex, Plantex Solutions and No-Stretch are registered trademarks of Master Plant-Prod Inc.  
 © Master Plant-Prod Inc. 2021. All Rights Reserved.



# Peters Excel®

## Water Soluble Fertilizers

### Peter's Excel Water Soluble Fertilizer

Featuring unique formulations providing the ability to deliver complete plant nutrition using only a single-concentrate stock tank, taking into account the quality of water irrigation. This will decrease labor and overall costs. All Peters Excel products are completely water soluble, keeping your emitters clean.

#### ICL Specialty Fertilizers Peters® Excel 13-2-13 Plug & Bedding Plant Special Fertilizer

Ideal for plugs, liners, bedding plants and vegetable transplants with high nitrate and low phosphate levels to encourage healthy, compact growth. This all-purpose formulation provides constant, balanced nutrition. Contains calcium, magnesium and other minor elements.

- Basicity: 335 lbs CCE



25lb

EVR99120

Min. Buy 1ea



#### ICL Specialty Fertilizers Peters® Excel 15-5-15 Cal-Mag Special Fertilizer with Black Iron

Water soluble fertilizer with an excellent all-purpose formulation that combines high nitrate and low phosphate with extra calcium and magnesium. This all-purpose formulation provides constant, balanced nutrition. Contains a complete range of essential micronutrients. M-77 Black Iron chelating formula for fast, efficient nutrient uptake.

- For use on: A broad range of plants, especially effective when irrigation water is alkaline
- Basicity: 131 lbs CCE



25lb

EVR99140

Min. Buy 1ea

Shipping Info **HAZARDOUS**



#### ICL Specialty Fertilizers Peters® Excel 15-2-20 Pansy, Salvia & Vinca Fertilizer

Ideal for compact growth and bright blossoms on pansy, salvia, vinca, etc. with high nitrate, low phosphate and extra boron. This all-purpose formulation provides constant, balanced nutrition. Contains calcium, magnesium and other minor elements.

- Basicity: 234 lbs CCE



25lb

EVR99130

Min. Buy 1ea

Shipping Info **HAZARDOUS**



#### ICL Specialty Fertilizers Peters® Excel 21-5-20 Multi-Purpose Fertilizer

A moderately acidic formulation that serves as an excellent all-purpose fertilizer for Types 2, 3 and 4 irrigation water. Contains a complete range of essential micronutrients.

- For use on: demanding plants like petunia.
- Acidic: 377 lbs CCE



25lb

EVR99150

Min. Buy 1ea

Shipping Info **HAZARDOUS**



#### ICL Specialty Fertilizers Peters® Excel pHLow™ 19-11-21 Multi-Purpose Fertilizer with Black Iron

Provides your plants with the nutrition they need to thrive while easily and conveniently managing alkalinity of your irrigation water. pHLow products are different from the other Peters Excel products. Contains Pekacid® and combats alkalinity in a different manner. M-77 Black Iron chelating formula for fast, efficient nutrient uptake.

- Acidic: 290 lbs CCE
- No Urea



25lb

EVR99001

Min. Buy 1ea

Shipping Info **HAZARDOUS**



#### ICL Specialty Fertilizers Peters® Excel pHLow™ 21-7-7 Acid Hammer

Feeds acid loving plants and reduces growing Media pH levels

- Acidic: 1218 lbs CCE
- No Urea



25lb

ICL99002

Min. Buy 1ea





## Water Soluble Fertilizers

### ICL Specialty Fertilizers (ICL-SF) Peters® Professional 21-7-7 Acid Special Fertilizer

Specifically formulated for acid-loving plants. Provides a rapid correction of high pH conditions; ideal for acid-loving plants in the nursery and landscape. Promotes lush vegetation and better blooms. A favorite for azaleas and rhododendrons!

- Acidic: 1518 lbs CCE
- Urea: 50.5



**251b**

**EVR99330** Min. Buy 1ea



### Peter's Professional Water Soluble Fertilizer

Peters Professional fertilizers are the world's leading 100% water-soluble fertilizers. The exclusive M-77 chelating formula of Peters Professional assures that nutrients and trace elements remain readily available for fast and easy uptake. M-77 "unlocks" the rooting area, allowing an effective increase in the absorption of nutrients.

### ICL Specialty Fertilizers (ICL-SF) Peters® Professional 10-30-20 "Bloom Booster" Fertilizer

A specially developed water soluble fertilizer designed exclusively for flowering plants. It particularly stimulates the development of flowering buds.

- Acidic: 365 lbs CCE
- No Urea



**251b**

**EVR99350** Min. Buy 1ea



### ICL Specialty Fertilizers (ICL-SF) Peters® Professional 15-0-15 Peat-Lite® Dark Weather Fertilizer

Classic high-nitrate formula for bulbs or any crop that needs extra calcium and magnesium, lower phosphate and slightly higher growing media pH. Ideal for Water Types 1 and 2. Provides a full range of micronutrients.

- Basicity: 221 lbs CCE
- No Urea



**251b**

**EVR99260** Min. Buy 1ea



### ICL Specialty Fertilizers (ICL-SF) Peters® Professional 15-3-25 Flowering Crop Special plus Black Iron

A water-soluble fertilizer with a formulation of three chelated Irons, including black Iron. This new M-77® chelated system is specifically designed for petunias and other high Iron demanding plants. Black Iron is the strongest iron chelate used for growing ornamentals, making iron available to plants over the widest range of pH.

- For use on: Bedding plants and hanging baskets
- Acidic: 34 lbs CCE
- No Urea



**251b**

**EVR99321** Min. Buy 1ea



### ICL Specialty Fertilizers (ICL-SF) Peters® Professional 18-8-17 Peat-Lite® High Mag Special Fertilizer

Highly effective stand-alone fertilizer with extra magnesium to maintain deep green foliage. Formulation for constant, balanced nutrition. Excellent stand-alone for Water Types 3 and 4; use as a base in Water Types 1 and 2. Contains a complete range of essential micronutrients.

- Acidic: 381 lbs CCE
- No Urea



**251b**

**EVR99240** Min. Buy 1ea

Shipping Info **HAZARDOUS**



### ICL Specialty Fertilizers (ICL-SF) Peters® Professional 15-16-17 Peat-Lite® Special Fertilizer

A professional grade, water-soluble fertilizer used for soilless mixes with low or no trace element additions. Reduced ammonium toxicity potential. A non-acidifying high nitrate source (53%) formula. Sufficient molybdenum for poinsettias. Use as a general purpose feed for bedding plants, pot plants and nursery stock in soilless mixes with little or no trace element additions. Especially good for soilless mixes containing bark.

- For use on: Geraniums and Poinsettias
- Acidic: 202 lbs CCE
- Urea: 26.7



**251b**

**EVR99210** Min. Buy 1ea



### ICL Specialty Fertilizers (ICL-SF) Peters® Professional 15-5-25 Peat-Lite® Flowering Crop Special Fertilizer

Proven high-nitrate, low-phosphate formula for poinsettias and many other flowering crops that are sensitive to boron. Effective for all Water Types. Contains extra magnesium plus a full range of essential micronutrients.

- For use on: Bedding plants and general use.
- Acidic: 48 lbs CCE
- No Urea



**251b**

**EVR99220** Min. Buy 1ea

Shipping Info **HAZARDOUS**





### Water Soluble Fertilizers

#### ICL Specialty Fertilizers (ICL-SF) Peters® Professional 20-10-20 General Purpose Fertilizer

Crops that are sensitive to excess micronutrients thrive with this classic formula with its acidifying action that corrects an overload of growing media pH. Effective for all Water Types. Contains a full range of essential micronutrients.

- For use on: All Plants
- Acidic: 404 lbs CCE
- No Urea



25lb

**EVR99300** Min. Buy 1ea  
Shipping Info **HAZARDOUS**



#### ICL Specialty Fertilizers (ICL-SF) Peters® Professional 20-3-19 Petunia Special with Black Iron

A water-soluble fertilizer with a formulation of three chelated Irons, including black Iron. This new M-77® chelated system is specifically designed for petunias and other high Iron demanding plants. Black Iron is the strongest iron chelate used for growing ornamentals, making iron available to plants over the widest range of pH.

- For use on: Petunia's
- Acidic: 378 lbs CCE
- No Urea



25lb

**EVR99091** Min. Buy 1ea  
Shipping Info **HAZARDOUS**



#### ICL Specialty Fertilizers (ICL-SF) Peters® Professional 20-20-20 General Purpose Fertilizer

All purpose water soluble fertilizer. It is a balanced blend of Nitrogen, Phosphorus and Potassium with fully chelated trace elements that works on all plant materials as a general-purpose fertilizer. Indoors it is especially effective on foliage plants to keep leaves green and happy.

- For use on: All Plants
- Acidic: 576 lbs CCE
- Urea: 52.0



25lb

**EVR99290** Min. Buy 1ea



#### ICL Specialty Fertilizers (ICL-SF) Peters® Professional 5-11-26 Hydroponic Special Fertilizer

Designed exclusively for hydroponic culture, this classic formula is ideal for most hydroponic crops, especially tomatoes, cucumbers and lettuce. Effective for all Water Types. Buffered to help maintain acceptable working solution pH.

- Basicity: 215 lbs CCE
- No Urea



25lb

**EVR99310** Min. Buy 1ea



#### ICL Peters 22-5-16 Mum Special Black Iron

An effective formulation of three chelated irons specifically designed for mums and other high iron demanding plants. Black iron is the most effective iron chelate used for growing ornamentals, effective over the widest range of media pH levels. Specifically formulated for mums and other high iron demanding plants. Effective for all water types. High nitrate / low phosphate levels encourage dense compact growth. Elevated levels of magnesium balance the calcium / magnesium ratio in hard water environments. Contains a full range of essential micronutrients. Can be used alone or rotated with a customizing component.



25lb

**EVR99334** Min. Buy 80ea



#### ICL Specialty Fertilizers (ICL-SF) Peters® Professional 17-3-17 Peat-Lite® Neutral Cal-Mag Fertilizer

Premium all-purpose formulation produces a nearly neutral reaction to help maintain steady pH in growing media. An all-purpose formulation for constant, balanced nutrition. Ideal for Water Types 1 and 2. Contains calcium, magnesium and other minor elements.

- For Use on: A wide variety of plants, because it is neutral formulation many use this in low alkalinity water
- Basicity: 27 lbs CCE
- No Urea



25lb

**EVR99230** Min. Buy 1ea



#### ICL Specialty Fertilizers (ICL-SF) Peters® Professional 20-10-20 Peat-Lite® Fertilizer

Designed to be mixed with water for the most accurate and effective nutrient delivery to the plant. Contains an increased level of micronutrients to provide the necessary elements absent from most commercially made peat-lite potting media.

- For use on: All Plants
- Acidic: 415 lbs CCE
- No Urea



25lb

**EVR99250** Min. Buy 1ea  
Shipping Info **HAZARDOUS**



#### ICL Specialty Fertilizers (ICL-SF) Peters® Professional 25-5-15 High Performance Fertilizer

high efficiency formula designed to maximize your NPK delivery while keeping a balance of macro secondary and micronutrients for optimum plant growth. Best as a continuous feed for heavy feeding plants in moderate to warm temperatures. Micronutrient levels are comparable to Peat-Lite formulas. Can be used as a nutrient booster for great green-up for almost all varieties.

- Acidic: 593 lbs CCE
- No Urea



25lb

**EVR99087** Min. Buy 1ea  
Shipping Info **HAZARDOUS**







**Water Soluble Fertilizers**

**Sustane® Hi-N® WDF Fertilizer 12-0-1**

A high analysis, water dispersible, nitrogen fertilizer. Specifically formulated to promote rapid and durable greening and plant growth. Efficiently delivers a unique blend of soluble organic nitrogen sources to support plant growth. It can be used on diverse plants produced in a wide variety of growing systems.

- For use on: Hydroponics and greenhouse fertigation programs
- Microsized to provide complete and balanced plant soil builders.



**1lb**  
SNF70552001 Min. Buy 12ea

**3lb**  
SNF70552003 Min. Buy 12ea



**Sustane® Flourish WDF Fertilizer 8-2-4**

Sustane Flourish 8-2-4 WDF is an all-in-one input designed for manual fertigation. Sustane Flourish WDF provides powdered organic nutrients and biostimulants and is well suited for the production of diverse plants, indoors and outdoors.

- For use on: Manual fertigation, amended soils and potting mixes
- Microsized to provide complete and balanced plant soil builders.



**1lb**  
SNF70502001 Min. Buy 12ea

**3lb**  
SNF70502003 Min. Buy 12ea



**SUSTANE® WDF FERTILIZERS  
ALSO AVAILABLE IN A 20LB PAIL**

call for details

**A LINE-UP OF ORGANIC AND NATURAL GRANULAR FERTILIZERS LIKE NO OTHER BRAND.**



Sustane is committed to producing the highest quality organic and natural-based fertilizers built upon Sustane's nutrient-rich, microbially diverse aerobic compost. Sustane products support sustainable environments and productive plant materials through healthy soils. Find out why Sustane is the one family of organic crop inputs available throughout North America and to growers in over 60 countries worldwide.



**Sustane® - Known world-wide as... simply the best... fertilizers and soil builders.**

Visit [www.sustane.com](http://www.sustane.com) today for more information or call +1 (507) 263 3003 or 1 (800) 352 9245.

## Controlled Release

### Osmocote® Plus 15-9-12 Fertilizer

A complete fertilizer that will continue to feed the plants after they are sold and will improve the customer's overall success. Works great on hanging baskets and potted plants grown in greenhouse production, as well as container grown nursery plants and in landscape containers and beds. Adding a controlled release fertilizer to baskets that contain plants that have a higher demand for nutrients allows you to have a base of nutrients and supplement with a water soluble program.

- For use on: Greenhouse, nursery and foliage production, container gardens, interiorscapes and landscapes
- Resin-coated N-P-K
- Micronutrients



### 3-4 Month Standard Release Fertilizer



50lb

EVRE903206 Min. Buy 1ea



### 5-6 Month Standard Release Fertilizer



50lb

EVRE903226 Min. Buy 1ea



### 8-9 Month Standard Release Fertilizer



50lb

EVRE903246 Min. Buy 1ea



### Osmocote Plus

Designed for general nursery and greenhouse production, high value crops, and dibbling equipment. Osmocote Plus can be incorporated or surface applied. Get the best return on your fertilizer investment, safely and consistently, by matching the nutrient release patterns with plant needs for optimal quality.

Hi-Start

Standard

Lo-Start

**Patterned Release Formulations;**

- Hi-Start - Commonly used on perennials and other fast growing plants as nutrients release at a high rate earlier in the growth cycle.
- Standard Release - Releases at an even release rate over the determined release period.
- Lo-Start - Releases small amounts of nutrients early in the growth cycle and more toward the end of the stated release period

### 8-9 Month Hi-Start Fertilizer



50lb

EVRE90583 Min. Buy 1ea



### 8-9 Month Lo-Start Fertilizer



50lb

EVRE903266 Min. Buy 1ea



### ICL Specialty Fertilizers Osmocote® Plus 15-8-11 Tablets Plus Minors

Provides all the nutrition plants need in a single application, including two sources of iron, making it ideal for high value color. Cores are glued together with water-soluble glue for convenient, ready to use, easy application to containers or beds. Can also be used in conjunction with water soluble programs or as an all in one growing solution

- Coated Micronutrients



7.5g Tablets / 1000ct

EVRE90336 Min. Buy 1ea





**Controlled Release**

**ICL Specialty Fertilizers Osmocote® Classic 18-6-12 8-9mo. Fertilizer**

For use in nursery, foliage and greenhouse production, container gardens, interiorscapes and landscapes. Homogeneous Osmocote® N-P-K delivers nutrition consistently within specified longevities. For optimum results, incorporate in combination with Micromax® Micronutrients.



**50lb**  
**EVRE90555** Min. Buy 1ea



**ICL Specialty Fertilizers (ICL-SF) Osmocote® Classic 14-14-14 3-4mo. Fertilizer**

General purpose formulation for a wide variety of plant types especially those needing a boost of phosphorus. Excellent as a base feed for heavy feeding greenhouse crops in combination with Peters water-soluble. Ideal for topdressing established hanging baskets, perennials and foliage plants. Safe and easy long-term feeding of interior foliage plants. Great for combination planters, container gardens and landscape beds requiring N-P-K. For optimum results, incorporate in combination with Micromax® Micronutrients.

- For use on: Nursery, foliage, greenhouse production, container gardens, interiorscapes and landscapes
- Homogeneous Osmocote resin coated N-P-K



**50lb**  
**EVRE90550** Min. Buy 1ea



**Osmocote® Blend Fertilizers by ICL Specialty Fertilizers®**

This selection of products include blends of various fertilizer technologies designed to meet specific growing needs. Some are designed to be used in greenhouse production, some in nurseries, a couple that stick to the surface of the pot and stay put if the fall over and some are quick responding topdress products. All our blends are high quality performers.

**Controlled Release**

- Blended product – may contain coated, uncoated and/or slow release components
- Now available: blends with 100% coated, homogeneous N-P-K prills – no Urea
- Added micronutrients
- Specified longevity of N-P-K
- Designed for general nursery production and outdoor applications. Can be incorporated or surface applied.
- Osmocote controlled release fertilizer delivers dependable, safe performance for a good cost-in-use value.



**ICL Specialty Fertilizers Osmocote® Blend 18-5-12 Fertilizer Enhanced with QuickStart® Nutrients**

Works great in container grown nursery plants and is commonly used in landscape containers and flower beds. The quickstart portion of the blend helps the plants in newly planted flower beds and containers establish and fill in quickly. The 100% resin-coated nutrient cores take in moisture and slowly feed the plants for up to 6 months.

- For use on: Nurseries, landscape containers and flower beds
- Resin-coated N-P-K
- STEP Hi-Mag micronutrients



**5-6 Month Release Fertilizer**  
**50lb**  
**EVRE98620** Min. Buy 1ea



**8-9 Month Release Fertilizer**  
**50lb**  
**EVRE98605** Min. Buy 1ea



**ICL Specialty Fertilizers Osmocote® Blend 23-4-8 Fertilizer Enhanced with E-Max Technology™ & QuickStart®**

The addition of the E-Max Coated urea allows for an enhanced release of Nitrogen earlier in the growth cycle that will support the quick-growing plants and get them up to size sooner. The resin-coated N-P-K backbone takes over and gently feeds the plants until they finish growing. It contains urea, not recommend its use in covered greenhouse production. The STEP® Hi-Mag is uncoated in this blend, so it is important that it is not in direct contact with young, sensitive plants.



**5-6 Month Fertilizer**  
**50lb**  
**EVRE90249** Min. Buy 1ea



**8-9 Month Fertilizer**  
**50lb**  
**EVRE90250** Min. Buy 1ea



## Controlled Release

### ICL Specialty Fertilizers Blend Topdress Special 22-5-6 4-5mo Fertilizer Enhanced with QuickStart® Micronutrients

Is a great topdress in cooler weather. The response after application to this product is not immediate, but it is able to hold color and boost the plant earlier in the season compared with coated fertilizers. The Poly-S® extends the Nitrogen release out to 4 to 5 months. The most common applications of this topdress are on conifers, perennials and grasses.

- For use on: Nursery stock, foliage and in landscape
- IBDU
- Phosphorous
- STEP Hi-Mag micronutrients



**50lb**

**EVRE90174** Min. Buy 1ea



### Osmocote® Blend Fertilizers by ICL Specialty Fertilizers®

This selection of products include blends of various fertilizer technologies designed to meet specific growing needs. Some are designed to be used in greenhouse production, some in nurseries, a couple that stick to the surface of the pot and stay put if they fall over and some are quick responding topdress products. All our blends are high quality performers.

#### Controlled Release

- Blended product – may contain coated, uncoated and/or slow release components
- Now available: blends with 100% coated, homogeneous N-P-K prills – no Urea
- Added micronutrients
- Specified longevity of N-P-K
- Designed for general nursery production and outdoor applications. Can be incorporated or surface applied.
- Osmocote Pro controlled release fertilizer delivers dependable, safe performance for a good cost-in-use value.



### ICL Specialty Fertilizers Osmocote® Blend 17-5-11 Fertilizer

Generally blended into the growing media, but it can be topdressed in the pot, subdressed or dibbled. It is recommended that the pot is thoroughly watered before or directly after planting to release the minor nutrients from the Micromax granules and disperse it into the media. This product is widely used as a single source of nutrients in both greenhouses and nursery container grown plants. Its balanced offering of nutrients makes it a great choice for growers that are looking for a more economical option to our top of the line product.

- For use on: Greenhouse, nursery and landscape
- Resin-coated N-P-K
- Micromax
- No urea



#### 3-4 Month Release Fertilizer

**50lb**

**EVRE90179** Min. Buy 1ea



#### 5-6 Month Release Fertilizer

**50lb**

**EVRE90180** Min. Buy 1ea



#### 8-9 Month Release Fertilizer

**50lb**

**EVRE90181** Min. Buy 1ea



### ICL Specialty Fertilizers Osmocote® Blend 18-5-8 Fertilizer Enhanced with E-Max Technology™

Latest blended formulation which combines our Osmocote 100% resin coat prills with our newest E-max polymer coated technologies. Micronutrients are derived from multiple sources to provide a starter charge and two different controlled release coated forms for sustained delivery throughout the predefined product release period. Great when growing with high alkalinity irrigation water, high growing media pH.

- For use on: Greenhouse, Nurseries, and Landscape
- Resin-coated N-P-K
- Micromax
- 18% Nitrogen
- High Sulfur



#### 3-4 Month Release Fertilizer

**50lb**

**ICL90175** Min. Buy 1ea



#### 5-6 Month Release Fertilizer

**50lb**

**ICL90176** Min. Buy 1ea



#### 8-9 Month Release Fertilizer

**50lb**

**ICL90177** Min. Buy 1ea





**Controlled Release**

**ICL Specialty Fertilizers (ICL-SF) Osmocote® Blend 19-6-9 5-6mo. Fertilizer with Fusion Technology™**

Is intended to be topdressed in arc-shaped piles on the surface of the media away from the plant's stem. Putting it on in a thicker pile, helps the Fusion Technology® bind the fertilizer to the surface. The intended use is on trees that have been grown in the pot for a while, so the media is filled with roots and is stable. The fertilizer portion is formulated to give the plant a quick boost after application to get the plant growing in the second season of growth. The resin-coated portion will then kick in and feed for 5-6 months.

- For use on: Nurseries
- Resin-coated N-P-K
- STEP Hi-Mag micronutrients



**50lb**  
**EVRE99400** Min. Buy 1ea



**Osmocote® Blend Fertilizers by ICL Specialty Fertilizers®**

This selection of products include blends of various fertilizer technologies designed to meet specific growing needs. Some are designed to be used in greenhouse production, some in nurseries, a couple that stick to the surface of the pot and stay put if they fall over and some are quick responding topdress products. All our blends are high quality performers.

**Controlled Release**

- Blended product – may contain coated, uncoated and/or slow release components
- Now available: blends with 100% coated, homogeneous N-P-K prills – no Urea
- Added micronutrients
- Specified longevity of N-P-K
- Designed for general nursery production and outdoor applications. Can be incorporated or surface applied.
- Osmocote Pro controlled release fertilizer delivers dependable, safe performance for a good cost-in-use value.



**ICL Specialty Fertilizers (ICL-SF) Osmocote® Blend 22-3-8 5-6mo. Fertilizer Enhanced with QuickStart® Nutrients**

A popular general purpose product as an inexpensive base fertilizer mixed into the media or topdressed onto nursery containers. Fast-growing perennials, grasses and foliage plants respond very well to this formulation. It also make a versatile topdress for overwintered plants once they have been uncovered or lined out in the nursery. Another popular use is on container-grown conifers.

- For use on: Nursery stock, foliage and in landscape
- Resin-coated N-P-K
- Poly-S coated Urea
- Poly-S coated Nitrogen
- STEP Hi-Mag micronutrients



**50lb**  
**EVRE90152** Min. Buy 1ea



**ICL Specialty Fertilizers (ICL-SF) Osmocote® Blend 19-5-8 8-9mo. Fertilizer**

Used in outside container nurseries as a multi-purpose fertilizer. It is used on a wide variety of plants that are grown in bark mixes. Nursery stock and foliage plants do well with this blend. It is also used in landscapes beds and in large outdoor containers.

- For use on: Nursery stock, foliage and in landscape
- Resin-coated N-P-K
- Poly-S coated Urea
- STEP Hi-Mag micronutrients



**50lb**  
**EVRE901316** Min. Buy 1ea



**ICL Specialty Fertilizers (ICL-SF) Osmocote® Blend 20-4-8 8-9mo. Fertilizer**

Is used in outside container nurseries, foliage plants, and landscapes as a multi-purpose fertilizer. It does well when used on a wide variety of plants that are grown in bark mixes. The IBDU starts the earliest in the cool season. The Poly-S® in this formulation releases a bit stronger push of Nitrogen in the earlier stages of the re-lease period and the resin-coated fertilizer continues the feed out to the 8-9 month range. It is also used on landscape bed soils and in large outdoor containers for a season long feed.

- For use on: Nursery stock, foliage and in landscape
- Resin-coated N-P-K
- Poly-S coated Urea
- IBDU
- STEP Hi-Mag micronutrients



**50lb**  
**EVRE90170** Min. Buy 1ea



**ICL Specialty Fertilizers (ICL-SF) Osmocote® Blend 20-4-7 8-9mo. Fertilizer with Fusion Technology™**

Is intended to be topdressed in arc-shaped piles on the surface of the media away from the plant's stem. Putting it on in a thicker pile, helps the Fusion Technology® bind the fertilizer to the surface. The intended use is on trees that have been grown in the pot for a while, so the media is filled with roots and is stable. The fertilizer portion is formulated to give the plant a quick boost after application to get the plant growing in the second season of growth. The resin-coated portion will then kick in and feed for 8-9 months.

- For use on: Nurseries
- Resin-coated N-P-K
- STEP Hi-Mag micronutrients



**50lb**  
**EVRE99410** Min. Buy 1ea





**Controlled Release**

**ICL Specialty Fertilizers (ICL-SF) Osmocote® Bloom 12-7-18 2-3mo.**

Contains a complete package of N-P-K, blended with magnesium and essential micronutrients encouraging faster, stronger root development, resulting in more compact, consistently sized plants. This provides more nutrition to the plant and not down the drain. This smaller size provides better uniformity and even distribution of nutrition in smaller containers, optimizing plant utilization.

- For use on: Plants grown in smaller containers
- N-P-K
- Coated Micronutrients



**50lb**  
**EVRE90100**    Min. Buy 1ea



The power of Osmocote—right at your fingertips

Download the *Osmocote Explorer Mobile App* and get the product and rate information you need faster and easier than ever.

**ICL Specialty Fertilizers (ICL-SF) Agriform® 20-10-5 Planting Tablets Plus Minors**

Two-year planting tablets for root zone feeding of trees, shrubs and ground covers. Contains a high-nitrogen formula specifically engineered to help deliver bigger, greener plants.



**10g Tablets / 1000ct**  
**EVRE90805**    Min. Buy 1ea

**21g Tablets / 500ct**  
**EVRE90026**    Min. Buy 1ea

**5g Tablets / 2,100ct**  
**EVRE90915**    Min. Buy 1ea



**Controlled Release**

Item #	Size/ # Per Pallet	Brand	Formulation	Release Months @ 70° F	Application	Micros
EVRE903206	50 Lb (40/PI)	Osmocote Plus	15-9-12	3-4	Top Dress/Media Incorporation	Coated
EVRE903226				5-6		
EVRE903266				8-9		
EVRE903246	50 Lb (40/PI)	Osmocote Plus	15-9-12	8-9	Top Dress/Media Incorporation	Coated
EVRE90583	50 Lb (40/PI)	Osmocote Plus Lo-Start	15-9-12	8-9	Top Dress/Media Incorporation	Coated
EVRE90336	1000/Cs (80/PI)	Osmocote Plus 7.5G Tablets	15-8-11	8-9	Insertion Into Media	Coated
EVRE90100	50 Lb (40/PI)	Osmocote Bloom	12-7-18	2-3	Top Dress/Media Incorporation	Coated
EVRE90550	50 Lb (40/PI)	Osmocote	14-14-14	3-4	Top Dress/Media Incorporation	No
EVRE90555	50 Lb (40/PI)	Osmocote Lo-Start	18-6-12	8-9	Top Dress/Media Incorporation	No
ICL90175	50 Lb (40/PI)	Osmocote Blend	18-5-8	3-4	Top Dress/Media Incorporation	Coated & Granular
ICL90176				5-6		
ICL90177				8-9		
EVRE90179	50 Lb (40/PI)	Osmocote Blend	17-5-11	3-4	Top Dress/Media Incorporation	Yes
EVRE90180				5-6		
EVRE90181				8-9		
EVRE90170	50 Lb (40/PI)	Osmocote Blend	20-4-8	8-9	Top Dress/Media Incorporation	Yes
EVRE90152	50 Lb (40/PI)	Osmocote Blend	22-3-8	5-6	Top Dress/Media Incorporation	Yes
EVRE901316	50 Lb (40/PI)	Osmocote Blend	19-5-8	8-9	Top Dress/Media Incorporation	Yes
EVRE90249	50 Lb (40/PI)	Osmocote Blend	23-4-8	5-6	Top Dress/Media Incorporation	Yes
EVRE90250				8-9		
EVRE98620	50 Lb (40/PI)	Osmocote Blend w/ Quickstart	18-5-12	5-6	Top Dress/Media Incorporation	Yes
EVRE98605				8-9		
EVRE99400	50 Lb (40/PI)	Osmocote Blend w/ Fusion	19-6-9	5-6	Top Dress	Yes
EVRE99410	50 Lb (40/PI)	Osmocote Blend w/ Fusion	20-4-7	8-9	Top Dress	Yes
EVRE90174	50 Lb (40/PI)	Osmocote Blend Topdress	22-5-6	4-5 (N only)	Top Dress	Yes
EVR90915	2100/Cs (80/PI)	Agriform 5G Tablets	20-10-5	Up to 2 Years	Insertion Into Soil	Yes
EVRE90805	1000/Cs (80/PI)	Agriform 10G Tablets				
EVRE90026	500/Cs (80/PI)	Agriform 21G Tablets				

**Controlled Release**

Green-house Crops	Outdoor Potted Crops	In-ground Production	Land-scapes	Interior-scapes	Comments
4"+ Pots, Baskets	Yes	Yes	Yes	Yes	Great for greenhouse crops at lower rates with or without supplemental Peters WSF.
4"+ Pots, Baskets	Yes	Yes	Yes	Yes	Lo-Start pattern release. Commonly used in propagation and when planting stock to be overwintered. Helps maintain low salt levels during storage and rooting.
4"+ Pots, Baskets	Yes	Yes	Yes	Yes	Hi-Start pattern release distributes more fertilizer earlier in the growth cycle.
Qt+ Pots, Baskets	Yes	Yes	Yes	Yes	Easy to apply. Add to containers at the point of sale for several months of ongoing fertilization.
4"-12" Pots	Yes	Yes	Yes	Yes	For small container plants with a production time of 6-12 weeks. Prill size is 1/5 standard Osmocote—more prills per gram for better distribution in small containers.
4"+ Pots, Baskets	Yes	Yes	Yes	Yes	Excellent for a wide variety of crops with micronutrient supplementation from Micromax or Peters WSF.
No	Yes	No	No	No	Used with woody plants and perennials to be propagated or overwintered. Needs to be supplemented with micros.
4"+ Pots, Baskets	Yes	Yes	Yes	Yes	Our best blend—great for crops prone to chlorosis and environments with high alkalinity irrigation water, or high media pH.
4"+ Pots, Baskets	Yes	Yes	Yes	Yes	Safe, reliable formulation contains homogenous NPK resin-coated CRF blended with Micromax micronutrients.
No	Yes	Yes	Yes	No	Multi-purpose fertilizer ideal for use on a wide variety of plants grown in bark mixes.
No	Yes	Yes	Yes	No	General purpose product commonly used as base fertilizer mix or topdressed in nursery containers. Great for fast-growing perennials, grasses and foliage plants.
No	Yes	Yes	Yes	No	Multi-purpose product formulated for use in outside container nurseries. Can be used on a wide variety of plants grown in bark mixes.
No	Yes	Yes	Yes	No	For general purpose production of nursery stock, foliage and landscapes. Great for second year topdress applications.
No	Yes	Yes	Yes	No	Quick Start formulation provides fast initial release for quick green-up. Coated prills continue to release as crop matures.
No	Yes	No	No	No	Fusion bonding technology prevents loss of CRF on outdoor potted crops exposed to high winds and tip-overs.
No	Yes	No	No	No	Fusion bonding technology prevents loss of CRF on outdoor potted crops exposed to high winds and tip-overs.
No	Yes	Yes	Yes	No	Cool weather topdress for use on conifers, perennials and grasses. Works well on ground covers, perennials and shrubs.
No	No	Yes	Yes	No	Complete plant nutrition program feeds trees, shrubs and ground covers for up to two years. Compact, easy-to-use tablets eliminate the need for repeated fertilizer applications.
				Yes	
				Yes	



### Controlled Release

#### GAL-XeONE® Controlled Release Fertilizer

GAL-XEONE® is a controlled-release fertilizer with a new, advanced polymer coating technology. It delivers optimal nutrients to the plant at a daily rate that matches a plant's uptake requirements.

GAL-XEONE® reactive layer coating was created with support from NASA. It allows water to seep into the prill and then carry the nutrients out through a semi-permeable membrane and into the soil.

#### Benefits

- Nutrient availability to match a plant's uptake pattern
- Controlled nutrient release from 2 months to 18 months
- Reduced losses from volatilization and leaching
- Reduced labor and logistics costs from fewer applications

#### Florikan® Gal-XeOne® 17-5-11 NPK Plus Fertilizer

Is a 100% polymer coated fertilizer providing the grower a complete nutritional program. Each longevity is designed to provide plant nutrients from the beginning to end of the crop cycle.

- For use on: Trees, flowering ornamentals, woody ornamental, perennials, ferns, greenhouse, ground cover, mum and hanging baskets
- Total Fertilizer Containing NPK and Micronutrients
- 100% Polymer Coated Fertilizer
- Coating Technology Provides Predictable Release
- No Urea

#### 140 Day Release



50lb

FLOR17-5-11-140 Min. Buy 1ea



#### 180 Day Release



50lb

FLOR17-5-11-180 Min. Buy 1ea

#### Florikan® Gal-XeOne® 16-5-11 NANO™ Advantage Fertilizer - 90 Day Release

Is a controlled-release fertilizer with an advanced polymer coating technology. It delivers optimal nutrients to the plant at a pace that matches a plant's uptake requirements. Provides gradual release of plant nutrients to match a plant's growth cycle as needed. It improves efficiency, limits plant damage and reduces nutrient loss. Features: Total Fertilizer Containing NPK and Micronutrients, 100% Polymer Coated, Small Nano prill allowing for optimal prill distribution, Desired nutritional ratio, Prills contain a chelated iron component for excellent plant uptake, Applied as topdress, subdress or incorporation.



50lb

FLOR16-5-11-090-NANO Min. Buy 1ea



#### Florikan® Gal-XeOne® 12-4-11 Advantage Fertilizer

Is designed specifically for nursery operations specializing in crops desiring long term calcium. With a unique level of polymer coated calcium nitrate, it will provide the essential nutrients for the entire crop cycle. The balanced nitrogen and potassium along with low phosphorus to reduce plant stretch makes it ideal for crops striving on calcium.

- For use on: Boxwood, hydrangea, roses, perennials, flowering ornamentals, young trees, tomato citrus and hydroponics
- 100% Polymer Coated NPK plus Micronutrients
- Contains Florikan Polymer Coated Calcium Nitrate
- Very High Rate of Nitrate Nitrogen for Readily Available Nitrogen

#### 100 Day Release



50lb

FLOR12-4-11-100 Min. Buy 1ea



#### 180 Day Release



50lb

FLOR12-4-11-180 Min. Buy 1ea



#### Florikan® Gal-XeOne® 14-14-14 NPK Fertilizer - 90 Day Release

Features: 100% homogenous NPK formulation, Traditional 1:1 N to K Ratio, Great for short term crops, Economical use rate.



50lb

FLOR14-14-14-090 Min. Buy 1ea

#### Florikan® 12-6-8 NPK Pro Fertilizer

Is a blend of controlled release fertilizer and granular fertilizer that provides macro-nutrients for the majority of container or field grown crops. Additional micro-nutrients are provided in the blend to help adjust for deficiencies. Is excellent as a kicker/starter, maintenance feed or finisher providing a quick green up.

- For use on: Ixora, Hibiscus, Gardenia, Ornamental Grass, Madevilla, Palms, Bougainvillea, Clusia and Landscape Shrubs
- Nitrogen in Granular and Coated Form
- Innovative GAL-XeONE Coated N Provides Predictable Release
- Coated and Uncoated NPK and Homogeneous Micronutrients

#### 90 Day Release



50lb

FLOR12-6-8-090 Min. Buy 1ea



#### 90 Day Release with Fast Start



50lb

FLOR12-6-8-090-FS Min. Buy 1ea

Product	% Coated	N	Nirate	Ammoniacal N	Urea	Insoluble N	P	K	Ca	Mg	S	B	Cu	Fe	Chelated Fe	Mn	Mo	Zn
<b>12-4-11</b> 180-Day	100%	12%	7.50%	4.50%			4%	11%	5.50%	1.14%	3%		0.046%	0.44%	0.34%	0.045%		0.03%
<b>12-4-11</b> 100-Day	100%	12%	7.50%	4.50%			4%	11%	5.50%	1.14%	3%		0.046%	0.44%	0.34%	0.045%		0.03%
<b>12-6-8</b> 90-Day	10%	12%		2.30%	6.70%	3%	6%	8%	4.10%	3.80%	10%		0.1%	3.40%		0.650%		0.14%
<b>12-6-8</b> 90-Day Fast Start	22%	12%		3.60%	7.70%	0.70%	6%	8%		2.90%			0.05%	2%	0.08%	0.09%		0.05%
<b>14-14-14</b> 90-Day	100%	14%	5.90%	8.10%			14%	14%			5.50%							
<b>16-5-11</b> 90-Day Nano	100%	16%	7.50%	8.50%			5%	11%		1.20%	6%		0.05%	0.6%		0.1%		0.05%
<b>17-5-11</b> 140-Day	100%	17%	8%	9%			5%	11%		1%	5.50%			0.5%	0.34%	0.050%		0.05%
<b>17-5-11</b> 180-Day	100%	17%	8%	9%			5%	11%		1%	5.50%			0.5%	0.34%	0.050%		0.05%
<b>Max</b>	0%	0%					0%	0%		14%	7.60%	0.02%	0.680%	17.81%	1.43%	1.33%	0.190%	0.02%
<b>Sapphire Coated Aluminum Sulfate</b>	100%	0%					0%	0%			12%							
<b>Iron Sulfate 180-Day</b>	100%										17%			28%				



The Wetsel Brand has been offered since 1911.



### Bulk Seed Bags

Retail or Grower friendly packaging that is a moisture resistant clear poly bag sure to keep your seeds fresh!

# Nutricote®

## Controlled Release

### Nutricote® Total Control Released Fertilizer with Minor Nutrients

Blends of Nutricote Total controlled release homogenous fertilizers with minor nutrients for nursery and greenhouse uses.

Every particle is homogenous, coated with a unique pliable resin that allows very predictable release rates.

Release period is specified by TYPE. A Type 100 means it will release over a period of 100 days at 77°F. Warmer temperatures will shorten release time and cooler temperatures will extend release time.

- Nutricote NPK = Slow release fertilizer containing NPK only
- Nutricote Total = our slow release fertilizer containing NPK and minor/micro nutrients.
- Nutricote Total Blends = a blend of at least 2 different "Nutricote Totals".

### Nutricote® Total 18-6-8 Fertilizer with Minors

A blend of nutricote controlled release fertilizer with minor nutrients for nursery and greenhouse uses. Every particle is homogenous, meaning N, P, K and minor nutrients are contained in each individual prill. Nutricote's coating is a pliable resin that provides very predictable release rates. Warmer temperatures will shorten release time and cooler temperatures will extend release time.



**T140**

**50lb**

**AGRVTOTAL 18-6-8T140** Min. Buy 1ea

**T180**

**50lb**

**AGRV14-2380** Min. Buy 1ea

### Nutricote® NPK 14-13-13 Fertilizer

A blend of nutricote controlled release fertilizer for nursery and greenhouse uses. Every particle is homogenous, meaning N, P, K nutrients are contained in each individual prill. Nutricote's coating is a pliable resin that provides very predictable release rates. Warmer temperatures will shorten release time and cooler temperatures will extend release time. NPK only; no micronutrients.



**T100**

**50lb**

**AGRVNPK 14-13-13T100** Min. Buy 1ea

**T140**

**50lb**

**AGRVNPK 14-13-13T140** Min. Buy 1ea

### Nutricote® Total 13-11-11 Fertilizer with Minors

A blend of nutricote controlled release fertilizer with minor nutrients for nursery and greenhouse uses. Every particle is homogenous, meaning N, P, K and minor nutrients are contained in each individual prill. Nutricote's coating is a pliable resin that provides very predictable release rates. Warmer temperatures will shorten release time and cooler temperatures will extend release time.



**T100**

**50lb**

**AGRVTOTAL131111T100** Min. Buy 1ea

**T140**

**50lb**

**AGRVTOTAL131111T140** Min. Buy 1ea

**T180**

**50lb**

**AGRVTOTAL131111T180** Min. Buy 1ea





**Controlled Release Fertilizers**

**Sustane® 4-6-4 All Purpose Fertilizer**

A natural organic all purpose professional landscape fertilizer. For plant establishment, greenhouse and nursery growing and organic crop production. Adds approximately 10% humates by volume and increases the nutrient and water holding capacity of the soil. Also strengthens plants tolerance against hot dry conditions, provides greater root development, improves buffering against changes in soil pH, increases the soil's ability to suppress plant pathogens and helps increased soil porosity and stability for greater root development and water holding capacity.

- For use on: Landscaped areas, overseeding and turf establishment, certified organic crops, rapid vegetative establishment



**50lb**  
**SNF30201111** Min. Buy 1ea

**Sustane® 16-4-8 Fertilizer - 180 Day Release**

Was developed as a combination fertilizer to provide nursery stock with a time released 4-1-2 nutrient package blended with a 50% Sustane humus rich, premium organic base. Derived from aerobically composted turkey litter, polymer coated urea, polymer coated MAP, and polymer coated potassium nitrate.

- For use on: Perennials and Woody ornamentals Azalea, Holly, Weigelia, Crape Myrtle, Cotoneaster, Boxwood, Spiraea, Salvia, Hibiscus, and Daylily.
- Rich in humic acids
- Strengthens plants tolerance against hot dry conditions



**50lb**  
**SNF50501111** Min. Buy 1ea

**Sustane® 18-1-8 +Fe Topdress Fertilizer - 90 Day Release**

Is a two-part blend combining Sustane organic with four-way release of nitrogen for enhanced and long lasting color. The most economical coverage of any organic based fertilizer.

- For use on: golf course fairways and roughs, lawns, and sports fields
- Combines 4 different forms of nitrogen: 3 types of slow release including Sustane organic N, PCSCU, methylene urea and 1 form of quick release nitrogen from ammonium sulfate.
- 15.3% (85% of total N) is slow release nitrogen



**50lb**  
**SNF40901111** Min. Buy 1ea

**Sustane® Root Zone 16-4-8 Feeder Pak Fertilizer**

Sustane 16-4-8 Root Zone Feeder Paks provide single dose applications of Sustane Organic + CRF designed to provide long-lasting plant nutrition in a completely biodegradable paper filter pack. This product is designed to provide a continuous release of nutrients for up to 8 months at 70° F (23° C) soil temperature.



**21g Paks / 250ct**  
**SNF80502020** Min. Buy 1ea

**Sustane® 8-2-4 All Natural Fertilizer**

Provides 6 - 12 weeks of nitrogen in the organic slow release form. Sustane replenishes the soil with a rich supply of humus (stabilized organic matter) and all of the essential nutrients required for quality growth. Also provides a combination of plant nutrients and organic substances derived from biologically stable compost plus natural sulfate of potash and feather meal.

- For use on: Certified organic crops, turfgrass and landscape maintenance, greenhouse bedding plants and annual establishment
- Rich in humic acids



**50lb**  
**SNF30551111** Min. Buy 1ea

**Sustane® 8-4-4 All Natural Fertilizer**

Is a high nitrogen organic fertilizer designed specifically for professional nursery and greenhouse applications. When used in containers the nutrient release profile is 45 days. Composed of aerobically composted turkey litter, feather meal, and sulfate of potash

- For use on: production of bedding and foliage crops, hanging baskets, herbs and vegetables. Begonias, Petunias, Impatiens, Geraniums, Caladiums, Chrysanthemums, and vegetable crops
- Provides six to eight weeks of nutrient release in containers



**50lb**  
**SNF30571111** Min. Buy 1ea

**Sustane® 12-12-12 Organic + Controlled Release Fertilizer**

Developed as a combination fertilizer to provide all floral and nursery stock with a complete, balanced and controlled release nutrient package. Provides plant essential nutrients in both controlled release and slow release organic form by combining coated CRF with nutrient rich aerobically composted turkey litter. The controlled release portion of the material is made from industry leading polymer coated urea, polymer coated mono-ammonium phosphate and polymer coated potassium nitrate.

- For use on: Production of bedding plants other short term annuals, Begonias, Petunias, Impatiens, Geraniums, Caladiums, Chrysanthemums, herbs and vegetable crops
- Rich in humic acids
- Strengthens plants tolerance against hot dry conditions



**50lb**  
**SNF50451111** Min. Buy 1ea

**Sustane® Root Zone 4-6-4 Feeder Pak Fertilizer**

This permeable fertilizer pack can be left to steep in a watering can overnight to make a Compost Tea brew for topical application; or installed in the soil or potting mix as a Root Zone Feeder Pack. Sustane 4-6-4 Root Zone Feeder Packs provide single dose applications of Sustane organic slow release nitrogen fertilizer. Sustane Feeder Packs are designed to provide lasting plant nutrition in a completely biodegradable filter pack. Sustane 4-6-4 Root Zone Feeder Pack is designed for use in all flowers, trees, shrubs and perennial plantings including landscape areas, potted plants and hanging baskets.

- Assures controlled dose applications
- Made from Sustane nutrient dense compost based fertilizer



**21g Paks / 250ct**  
**SNF80202020** Min. Buy 1ea



**Controlled Release Fertilizers**

**Urea Formaldehyde (Blue Chip) 38-0-0**

Slow release urea fertilizer, great for broadcast, topdress, or incorporation.

- Provides nitrogen to the soil
- Applications: Turf grass, lawn care, hydroseeding, trees, shrubs. Not for use on food crops.
- Rate: Varies depending on application.



**50lb**

**REGALUF38-0-0** Min. Buy 1ea



**NATURE'S SOURCE®**

**Liquid**

**Nature's Source® 10-4-3 Professional Plant Food**

A Complete plant food that contains oilseed extract, a renewable source of plant nutrition, which promotes strong plant and root development. Brings out the best in everything you grow. Growers report improved plant growth and enhanced root development resulting in compact, toned plants with early flowering and beautiful, deep green plants.



**4.7gal**

**DANL7510US** Min. Buy 1ea

**55gal Drum**

**DANL7547US** Min. Buy 1ea

**275gal Tote**

**DANL7513US** Min. Buy 1ea

Shipping Info **SHIPS DIRECT**



**Nature's Source Organic® Plant Food 3-1-1**

Organic liquid fertilizer that provides consistent toned growth and for quick green-up when needed, providing sustainability in your organic greenhouse, nursery or farm. Promotes rapid nutrient response and hearty plant growth.



**4.7gal**

**DANL7546US** Min. Buy 1ea



**DRAMMATIC®**

**Liquid**

**Drammatic™ "ONE" Fertilizer**

Drammatic fish protein hydrolysates contain the natural oils and proteins of fish, which break down slowly to become available over a longer period of time. Pure liquid fish hydrolysate stabilized with phosphoric acid, Chilean nitrate, and kelp extract. Plus Drammatic energizer which is composed of fulvic acid and humic acid.



**2.5gal**

**DRM1024252** Min. Buy 1ea

**55gal**

**DRMFFONE55G** Min. Buy 1ea

Shipping Info **DIRECT**



**Drammatic™ "O" 2-5-0.2 Fertilizer**

Pure liquid fish hydrolysate stabilized with phosphoric acid. Drammatic fish protein hydrolysates contain the natural oils and proteins of fish, which break down slowly to become available over a longer period of time. OMRI Listed.



**55gal**

**DRMFFO55G** Min. Buy 1ea

Shipping Info **DIRECT**

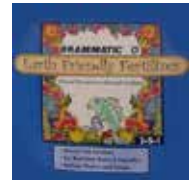

**Drammatic® "K" Liquid Fertilizer**

Pure liquid fish protein hydrolysate stabilized with phosphoric acid and kelp extract. Drammatic fish protein hydrolysates contain the natural oils and proteins of fish, which break down slowly to become available over a longer period of time.



**2.5gal**

**DRM1024251** Min. Buy 1ea

**55gal**

**DRMFFK55G** Min. Buy 1ea

Shipping Info **DIRECT**





**Liquid**

**ON-Gard® 5-0-0 Fertilizer**

ON-Gard is a 100% plant derived fertilizer that increases stress tolerance, increases growth and enhances nutrient uptake and overall absorption. It is suitable for all plants. OMRI listed.



**2.5gal**

**BW1FR102A24** Min. Buy 1ea  
Shipping Info [DIRECT](#)

**5gal**

**BW1FR102A55** Min. Buy 1ea  
Shipping Info [DIRECT](#)

**30gal Drum**

**BW1FR102A38** Min. Buy 1ea  
Shipping Info [DIRECT](#)



**Liquid**

**Growth Products® Essential® Plus 1-0-1 Fertilizer**

Essential Plus is a soil amendment and root enhancer derived from potassium Humate, 21 natural L-amino acids, enzymes, simple & complex sugars, vitamins, kelp extracts, carbohydrates, cellulose, lignin, hydrolyzed organic proteins and a natural wetting agent. Use at plug production to ensure seed germination and good rooting.

- Enhances beneficial microbe populations and provides a necessary food source.
- Applications: Turf grass, lawn care, hydroseeding, trees, shrubs. Not for use on food crops.



**1gal**

**GRWP60110** Min. Buy 1ea

**2.5gal**

**GRWP60120** Min. Buy 1ea



**Micronutrients**

**BASF® Sprint® 138 6% EDDHA Iron Chelate**

A 6% EDDHA chelated iron micronutrient that can be applied as a soil application or as a foliar spray to correct iron deficiencies. Provides an iron source that is readily available to plants, even at higher than ideal soil pH. Sprint 138 will make iron plant-available at a higher soil pH than Sprint 330.

- For correction of iron deficiency in alkaline and calcareous soils. Can be used in nurseries, gardens, landscape planting and turf.
- 6% fully chelated EDDHA iron for the most challenging alkaline soil.



**5lb**

**BAS59013436** Min. Buy 1ea



**Micronutrients**

**CalOx® FT 8-0-0**

An advanced liquid nutritional and crop enhancement product for a wide range of agricultural and horticultural crops. The unique patented Ca™ technology in CalOx FT improves calcium mobility and distribution beyond traditionally applied calcium products to support a better crop health and performance.

- Longer shelf life
- Active ingredient: Calcium and Nitrogen
- Signal Word: Danger
- Rate: varies. See label



**2.5 Gallon Bottle**

**BSF450025** Min. Buy 1ea

**5 Gallon Bottle**

**BSF45005** Min. Buy 1ea



**BASF® Sprint® 330 10% DTPA Iron Chelate**

A 10% DTPA chelated iron micronutrient that can be applied as a soil application or as a foliar spray to correct iron deficiencies. Provides an iron source that is readily available to plants, even at higher than ideal soil pH.

- For correction of iron deficiency in slightly acid to slightly alkaline soils. Can be used in nurseries, gardens, landscape planting and turf.
- Prevents iron from binding with other compounds in the soil, allowing it to stay in a form readily available for plant and turf use.



**5lb**

**BAS59013439** Min. Buy 1ea

**50lb**

**BAS59013097** Min. Buy 1ea





### Micronutrients

#### ON-Gard® Calcium

ON-Gard® Calcium is an organic liquid calcium formulated with plant derived soy protein hydrolysate for the treatment and prevention of calcium deficiency in crops.

- Active ingredient: Calcium Chloride and Soy Protein
- Rate: 8 to 16 oz per 100 gal
- Use as directed on all ornamental and edible crops



#### 2.5gal Bottle

**BW1FR110A24** Min. Buy 1ea  
Shipping Info [DIRECT](#)

#### 5gal Pail

**BW1FR110A55** Min. Buy 1ea  
Shipping Info [DIRECT](#)

#### 30gal Drum

**BW1FR110A38** Min. Buy 1ea  
Shipping Info [DIRECT](#)

### Micronutrients

#### Iron Sulfate 20% Granular

Uncoated iron sulfate. Can be incorporated into growing media to supplement iron levels.

- Acidifies soil, lowers pH and corrects high alkalinity
- Applications: Lawns, trees, shrubs and gardens.



#### 50lb

**WFLS14-0258** Min. Buy 1ea

#### Sulfur 90% Granular

A high-quality, pastille sulfur with individually formed, slow-release, hemispherical granules. This formulation virtually eliminates dust formation during handling and helps to ensure consistent application rates.

- Increased nitrogen utilization, phosphate and nutrient uptake.
- Can be applied alone or blended with granular fertilizers



#### 50lb

**WFLS19-0573B** Min. Buy 1ea

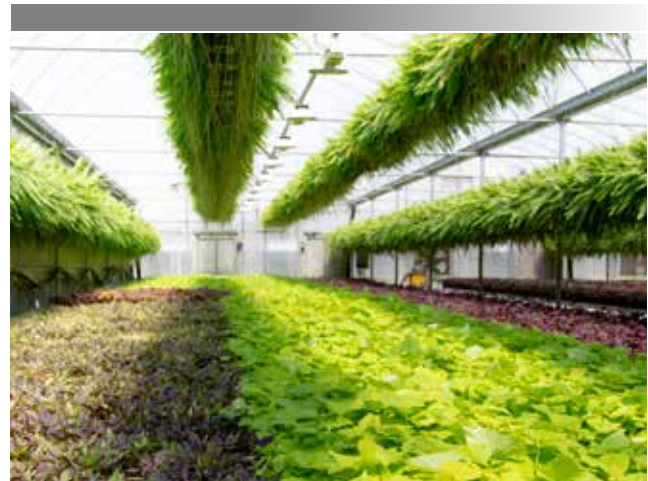

#### Solubor® Boron Fertilizer

A concentrated soluble powder boron fertilizer. Solubor helps to correct boron deficiencies in a variety of crops including ornamentals, fruit trees, vegetables and berries. Boron is essential to plant nutrition. Can be soil or foliar applied.

- Dissolves quickly in liquid and leaves minimal residue when used as a foliar spray.



#### 50lb

**WFLS14-0264A** Min. Buy 1ea

## Micronutrients

### Sequestar Iron Chelate 6% Fe EDDHA

Sequestar is a water soluble form of iron EDDHA that is readily available to plants. It can be applied to prevent or correct iron deficiency. Sequestar can be used on vegetable crops, vine and berry crops, fruit and nut trees, and ornamental shrubs, bedding plants and groundcovers.

- For correction of iron deficiency in alkaline and calcareous soils. Can be used in nurseries, gardens, landscape planting and turf.
- Prevents iron from binding with other compounds in the soil, allowing it to stay in a form readily available for plant and turf use.



**5lb**

**BRANDT2955-01-050 Min. Buy 1ea**

**25lb**

**BRANDT2955-01-025 Min. Buy 1ea**



### Sequestar Iron Chelate 11% Fe DTPA

Sequestar is a water soluble form of iron DTPA that is readily available to plants. It can be applied to prevent or correct iron deficiency. Sequestar can be used on vegetable crops, vine and berry crops, fruit and nut trees, and ornamental shrubs, bedding plants and groundcovers.

- For correction of iron deficiency in slightly acid to slightly alkaline soils.
- Prevents iron from binding with other compounds in the soil, allowing it to stay in a form readily available for plant and turf use.



**25lb**

**BRANDT SEQUESTAR 11% FE Min. Buy 1ea**



### Manni-Plex Nickel Foliar Supplement

Manni-Plex NI is a foliar supplement that provides highly mobile and available nickel to plant growing points. It helps to prevent and correct nickel deficiencies and enhances overall plant health.

- Nickel is an essential nutrient that plays a key role in plant metabolism and the plant's ability to fight disease.
- Use on vegetable, fruit, tree, vine and ornamental crops.



**2.5gal Bottle**

**BRANDT2357-01-100 Min. Buy 1ea**



## Micronutrients

### Ferrous Sulfate

Designed to reduce soil Ph over an extended period of time, while providing the essential elements of iron and sulfur.

Patented polymer coating technology is used to fully coat FeSO<sub>4</sub> providing a gradual release. This reduces labor by reducing the need for additional applications and provides a more consistent adjustment in PH creating improved growing conditions.



**50lbs**

**FLORFE-SO4-180 Min. Buy 1ea**

### Florikan® Max Micronutrients

Features homogenous micronutrient package, 8 essential minerals for plant growth. For uniform homogenous prill to aid in distribution, multiple forms of iron and magnesium for green color and formulated for better color even under challenging Ph conditions. Includes chelate, sulfate, and succrate forms for better adsorption across a wider range of ph.



**50lb**

**FLOR-MAX Min. Buy 1ea**



### Florikan® Sapphire Aluminum Sulfate

Is designed to increase the development of the blue flower color in blue Hydrangeas. Florikan's patented polymer coating technology sustains the release of nutrients to reduce the potential nutrient runoff and leaching into the environment. The controlled release technology also reduces the need for multiple applications..

- For use on: Hydrangeas



**50lb**

**FLORAL-SO4-090 Min. Buy 1ea**





**Micronutrients**

**ICL Specialty Fertilizers STEP® Hi-Mag Micronutrients**

Specially formulated to improve the overall performance of your major nutrient program. Provides important secondary and micronutrients to support initial and continued growth of container-grown and landscape ornamentals. Formulation provides a higher level of magnesium, in addition to a combination of readily available and slowly available forms of micronutrients.



**50lb**  
**EVR8435** Min. Buy 1ea



**Micronutrients**

**JR Peters® Jack's Professional® Calcium Chloride Dihydrate**

Calcium Chloride can be used to correct a calcium deficiency detected by growing media or foliar analysis. It is most commonly used as a foliar application.



**1lb**  
**JRP74374** Min. Buy 1ea



**25lb**  
**JRP74371** Min. Buy 1ea



**4lb**  
**JRP74376** Min. Buy 1ea

**ICL Specialty Fertilizers Micromax® Micronutrients Fertilizer**

Micromax granular formulation is designed to increase the efficiency of the major nutrient program and to maximize plant growth by boosting micronutrient levels in the root zone.



**50lb**  
**EVRE90505** Min. Buy 1ea



**JR Peters® Jack's Professional® Ammonium Molybdate**

Ammonium Molybdate can be used to correct a Molybdenum deficiency detected by media or foliar analysis. It is an essential part of any Poinsettia fertility program.



**1lb**  
**JRP74742** Min. Buy 1ea



**ICL Specialty Fertilizers Peters® Granular S.T.E.M. Fertilizer**

A fully water soluble fertilizer and broad spectrum minor element product that is ideal for "quick fixes" on ornamental plants. Can be used for corrective purposes on micronutrient deficient crops. It can also be applied as a remedial foliar spray on ornamental plants like: potted tropical foliage, flowering plants, cut flowers and orchids.



**25lb**  
**EVR99900** Min. Buy 1ea



**ICL Specialty Fertilizers Peters® Liquid S.T.E.M. Fertilizer**

Ready-to-mix liquid formulation. Goes from the jug to the tank in one easy step with no solubility issues. This fertilizer and broad spectrum minor element product is ideal for "quick fixes" on ornamental plants. Can be used for corrective purposes on micronutrient deficient crops. It can also be applied as a remedial foliar spray on ornamental plants like: potted tropical foliage, flowering plants, cut flowers and orchids.



**2.64gal**  
**EVRE99068** Min. Buy 1ea



**Micronutrients**

**JH Biotech Biomin® Boron**

Biomin® Boron contains boron for soil and/or foliar application. Completely bioavailable and non-phytotoxic to plants when applied in accordance to directions. Designed to prevent and correct boron deficiencies and to boost crops during critical or fast growing periods. May be applied with nitrogen fertilizers.



**2.5gal**

**JH051001**

Min. Buy 1ea



**JH Biotech Biomin® Manganese**

Biomin® Manganese contains nitrogen and chelated manganese for soil and/or foliar applications. It is completely bioavailable and nonphytotoxic to plants when applied in accordance to directions. Biomin® Manganese is designed to prevent and correct manganese deficiency and to boost crops during critical or fast growing periods. Biomin® Manganese may be applied with nitrogen fertilizers.



**2.5gal**

**JH051012**

Min. Buy 1ea



**JH Biotech Biomin® Calcium**

Biomin® Calcium contains chelated calcium designed for soil and foliar application. It is completely bioavailable and non-phytotoxic to plants when applied in accordance to directions. Designed to prevent and correct micronutrient deficiencies and to boost crops during critical or fast growing periods. May be applied with nitrogen fertilizer.



**2.5gal**

**JH051005**

Min. Buy 1ea



**JH Biotech Biomin® Magnesium**

Biomin® Magnesium contains chelated magnesium for soil and/or foliar application. Completely bioavailable and non-phytotoxic to plants when applied in accordance to directions. Designed to prevent and correct magnesium deficiencies and to boost crops during critical or fast growing periods. May be applied with nitrogen fertilizers.



**2.5gal**

**JH051011**

Min. Buy 1ea



**JH Biotech Biomin® Copper**

Biomin® Copper contains chelated copper for soil and/or foliar application. Completely bioavailable and non-phytotoxic to plants when applied in accordance to directions. Designed to prevent and correct copper deficiencies and to boost crops during critical or fast growing periods. May be applied with nitrogen fertilizers.



**2.5gal**

**JH051008**

Min. Buy 1ea



**JH Biotech Biomin® Molybdenum**

Biomin® Molybdenum contains molybdenum for soil and/or foliar application. Completely bioavailable and non-phytotoxic to plants when applied in accordance to directions. Designed to prevent and correct molybdenum deficiencies and to boost crops during critical or fast growing periods. May be applied with nitrogen fertilizers.



**2.5gal**

**JH051014**

Min. Buy 1ea

**JH Biotech Biomin® Iron**

Biomin® Iron contains chelated iron for soil and/or foliar application. Completely bioavailable and non-phytotoxic to plants when applied in accordance to directions. Designed to prevent and correct iron deficiencies and to boost crops during critical or fast growing periods. May be applied with nitrogen fertilizers.



**2.5gal**

**JH051010**

Min. Buy 1ea



**JH Biotech Biomin® Zinc**

Biomin® Zinc contains chelated zinc for soil and/or foliar application. Completely bioavailable and non-phytotoxic to plants when applied in accordance to directions. Designed to prevent and correct zinc deficiencies and to boost crops during critical or fast growing periods. May be applied with nitrogen fertilizers.



**2.5gal**

**JH051021**

Min. Buy 1ea





# Usalco LLC

## Micronutrients

### Manganese Chelate EDTA 13.5%

Manganese deficiency results in reduced photosynthetic activity. Conditions of high pH, low organic matter or sandy soils will reduce the availability of manganese. Plant-Prod Manganese Chelate can be used to correct deficiencies in ornamentals, turf, field crops and fruit trees.



55lb

PLNTX13-0130A Min. Buy 1ea



## Micronutrients

### Aluminum Sulfate

Used to lower the soil pH and supplement with additional aluminum in order to turn Hydrangea macrophylla flowers from pink to blue.



50lb

USALASRICE50P Min. Buy 1ea



## Basic Nutrients

### Superfine Dolomitic Limestone

Superfine is a very fine grind of lime as well as a fast acting lime. It can be applied at any time of the year and be used on new lawns, established lawns, in gardens and media. It neutralizes soil acids and raises PH.



50lb

WAUKM03890 Min. Buy 1ea



## Basic Nutrients

### Yara Calcium Nitrate 15.5-0-0 Greenhouse Grade

A fully water soluble nitrogen and calcium fertilizer. It is a free flowing, fine granular or prilled material which dissolves quickly in water without any residues. Suited to application through all fertigation systems.



50lb

YARA6031 CN Min. Buy 1ea



**Basic Nutrients**

**11-0-0 9.3% Mg  
Magnesium Nitrate Magnific™**

A soluble fertilizer that provides nitrogen and magnesium.



**55lb**  
**PLNTX10268** Min. Buy 1ea



**Media Starter Charge**

**ICL Specialty Fertilizers (ICL-SF) Peters® Professional Uni-Mix® 11-5-11 Growing Media Nutrient Charge**

Nutrient charge contains all essential major, secondary and micro-elements. Flexible granular formula can be incorporated in growing media. Provides immediate and slow release nutrient characteristics. Granular nature allows easy, uniform distribution when incorporated into growing media.



**50lb**  
**EVR99930** Min. Buy 1ea



**Soluble Urea 46-0-0**

Highly concentrated and highly efficient source of available nitrogen. Provides strong, sustained and green growth.



**50lb**  
**PLNTX10426** Min. Buy 1ea



**Mono-Potassium Phosphate**

Often used as a nutrient source in greenhouses while minimizing the escape of ammonia by keeping the pH at a relatively low level.



**55lb**  
**PLNTX10279** Min. Buy 1ea



**Media Starter Charge**

**Magnesium Sulfate (Epsom Salt)**

Epsom salts is a source of magnesium for plant nutrition.



**50lb**  
**PLNTX11029** Min. Buy 1ea



**Plantex® 1-3-4 Premix Fertilizer**

Designed to be incorporated into the media prior to planting.



**50lb**  
**PLNTX10588** Min. Buy 1ea





## Verdanta

### Verdanta® EcoVita 7-5-10 Fertilizer

A homogeneous organic granular fertilizer, EcoVita (7-5-10) provides organic phosphorus to promote fast rooting.

EcoVita's organic blend is ideal for diverse applications, well suited for potting mixes, leafy vegetables, top dressing for fruiting vegetables, and all ornamentals. Delivers long-lasting and continuous nutrient availability for up to 100 days.

- Granular formulation
- Rate: Varies depending on application method.



**40lb**

**BW1FR86A08** Min. Buy 1ea

### Verdanta® OFE 3-0-0 Fertilizer

OFE chelated iron foliar spray (3-0-0 + 3% iron) is derived from both organic and mineral sources. Iron moves readily into the plant leaf tissue for quick green up. An excellent foliar feed, OFE leaves no residue.

- Ships direct from the vendor.
- Rate: Varies depending on application method.



**1gal**

**BW1FR44A23030000** Min. Buy 1ea

### Verdanta® K-Vita 2-0-20 Fertilizer

Derived from 100% organic sources (2-0-20). Provides extra potassium to assist in producing stockier, more robust plants with shorter internodes. OMRI listed.

- Granular formulation
- Rate: Varies depending on application method.



**4lb Bag**

**BW14-3102** Min. Buy 1ea

### Verdanta® PL-2 2-0-6 Fertilizer

Derived from 100% organic ingredients (2-0-6). Can be used as an organic liquid feed to supplement potassium for any crop. Low salt index means lower ECs in the growing medium.

- Stimulates microbial activity in the root zone.
- Ships direct from the vendor.
- Rate: Varies depending on application method.



**1gal**

**BW1FR44A23020006** Min. Buy 1ea

**2.5gal**

**BW1FR44A24020006** Min. Buy 1ea

### Verdanta® N-Vita 9-4-3 Fertilizer

A homogeneous organic granular fertilizer, N-Vita (9-4-3) delivers a higher nitrogen formulation with excellent performance on all crops.

N-Vita is a MINIGRAN Technology with uniform composition in each granule, consisting of the same amount of N, P and K for precise nutrient distribution and availability to plants.

- Ships direct from the vendor.
- Rate: Varies depending on application method.



**35lb**

**BW1FR96A60** Min. Buy 1ea

### Verdanta® RM-1 4-30-0 Fertilizer

A high phosphorus mixture (4-30-0) of organic and mineral nutrient sources. Stimulates rooting. Enhances flowering in short-term crops with initial application or on longer crops with a second topdressed application.

- Provides nutrients for up to 100 days of 60o F
- Useful in high pH soils and in cold temperatures
- Rate: Varies depending on application method.



**40lb Bag**

**BW1FR44A08043000** Min. Buy 1ea







# Crop *Protection*



# Fungicide / Bactericide Reference Chart

**Always Refer to Product Label!**

Product	Active Ingredient	OMRI Listed	Alternaria	Anthracoze	Bacterial spots	Black Spot	Botrytis	Cylindrocladium	Downy Mildew	Fire Blight	Fusarium	Leaf Spot	Phytophthora	Powdery Mildew	Pseudomonas	Pythium	Rhizoctonia	Rust	Scab	Thielaviopsis	Xanthomonas	
3336	Thiophanate-Methyl			X	X	X	X	X		X	X	X		X			X	X	X	X		
6672	Thiophanate-Methyl			X	X	X	X	X		X	X	X		X			X	X	X	X		
Actinovate	Streptomyces lydicus	OMRI	X	X			X		X		X	X	X	X		X	X	X				
Adorn	Fluopicolide								X				X			X						
Affirm	Polyoxin D zinc salt		X	X			X		X			X		X			X			X	X	
Agri-Mycin 50	Streptomycin sulfate				X					X		X			X							X
Aliette	Aluminum tris		X	X	X				X	X			X		X	X		X				X
Areca	Aluminum tris		X		X		X	X	X	X	X	X	X			X						X
Astun	Isofetamid						X															
Banner Maxx	Propiconazole		X	X		X					X	X		X			X	X	X			
Banol	Propamocarb hydrochloride												X			X						
Banrot	Etridiazole, Thiophanate-Methyl									X		X		X		X	X			X		
Botrystop	Ulocladium Oudemansii						X															
Broadform	Fluopyram, Trifloxystrobin		X	X		X	X		X			X	X	X			X	X	X			
Camelot O	Copper Octanoate	OMRI	X	X	X		X		X	X		X		X	X		X	X				X
Cease	Bacillus subtilis	OMRI	X	X	X	X	X		X		X	X	X	X	X	X	X	X	X	X		X
Chipco 26GT	Iprodione		X				X	X			X	X					X					
Chipco 26019	Iprodione		X				X	X			X	X					X					
Compass	Trifloxystrobin		X	X		X	X	X	X			X	X	X		X	X	X	X	X		X
Daconil	Chlorothalonil		X	X		X	X	X			X	X	X	X			X	X	X			
Decree	Fenhexamid						X							X								
Eagle	Myclobutanil			X		X					X	X		X			X	X	X			
EcoSwing	Extract of Swinglea glutinosa	OMRI	X				X				X		X									
Empress	Pyraclostrobin										X		X			X	X					
Fame	Fluoxastrobin		X	X			X		X		X	X	X	X		X	X	X				
FungOUT	Citric Acid	OMRI				X			X	X				X			X			X		X
Grotto	Copper Octanoate	OMRI	X	X	X	X	X		X	X		X	X	X	X		X	X	X			X
Heritage	Azoxystrobin		X	X		X	X	X	X		X	X	X	X		X	X	X	X			
Kleengrow	Didecyl dimethyl ammonium chloride				X		X		X		X	X	X	X	X	X	X				X	X
Medallion	Fludioxonil		X				X	X			X	X					X				X	
Micora	Mandipropamid								X				X									
Milstop	Potassium Bicarbonate	OMRI	X	X		X	X		X			X		X				X	X			
Mural	Azoxystrobin, Benzovindiflupyr		X	X		X	X	X	X		X	X	X	X		X	X	X	X			
Nordox	Cuprous Oxide	OMRI	X	X	X	X	X		X	X		X	X	X	X		X	X	X			X

# Fungicide / Bactericide Reference Chart

*continued*

**Always Refer to Product Label!**

Product	Active Ingredient	OMRI Listed	Alternaria	Anthracoze	Bacterial spots	Black Spot	Botrytis	Cylindrocladium	Downy Mildew	Fire Blight	Fusarium	Leaf Spot	Phytophthora	Powdery Mildew	Pseudomonas	Pythium	Rhizoctonia	Rust	Scab	Thielaviopsis	Xanthomonas	
Obtego	Trichoderma Asperellum, gamsii	OMRI									X		X			X	X				X	
Orkestra	Fluxapyroxad, Pyraclostrobin		X	X			X	X	X		X	X	X	X		X	X	X	X	X	X	
Orvego	Ametoctradin, Dimethomorph								X				X									
OxiPhos	Hydrogen peroxide, Phosphorous acid				X		X		X	X	X	X	X	X	X	X				X		X
Pageant	Pyraclostrobin, Boscalid		X	X			X	X	X		X	X	X	X		X	X	X	X			
Palladium	Cyprodinil, Fludioxonil		X	X			X	X			X	X		X			X		X			
Phostrol	Mono and dibasic sodium, potassium, and ammonium phosphites			X	X	X			X	X			X		X	X	X			X		X
Phyton 35	Copper Sulphate Pentahydrate				X	X	X	X	X					X	X					X		X
Prostar	Flutolanil											X					X	X				
Protect	Mancozeb		X	X	X	X	X	X	X		X	X	X			X	X	X	X			
Pipron	Piperalin													X								
Regalia	Extract of Reynoutria sachalinensis	OMRI	X	X	X		X		X	X	X	X	X	X	X	X	X	X	X	X		X
RootShield	Trichoderma harzianum	OMRI						X			X					X	X				X	
RootShield Plus	Trichoderma harzianum & virens	OMRI						X			X		X			X	X				X	
Segovis	Oxathiapiprolin								X				X									
Segway O	Cyazofamid								X				X			X						
Spectro 90	Chlorothalonil, Thiophanate methyl		X	X		X	X	X	X		X	X	X	X			X	X	X			
Spirato	Fludioxonil		X				X	X			X	X		X			X				X	
Stargus	Bacillus amyloliquefaciens Strain F727	OMRI			X	X	X		X		X	X	X	X		X	X					X
Stature	Dimethomorph								X				X									
Subdue MAXX	Mefenoxam								X				X			X						
Terraclor 400	Pentachloronitrobenzene (PCNB)											X					X					
Terraguard	Triflumizole		X				X	X	X		X	X		X			X	X	X	X		X
Terrazole L	Etridiazole												X			X						
Terrazole WP	Etridiazole												X			X						
Thymox	Thyme Oil				X		X		X					X								
Transom	Thiophanate-Methyl			X		X	X	X		X	X	X		X			X	X	X	X		X
Triathlon BA	Bacillus amyloliquefaciens	OMRI	X	X	X	X	X		X	X	X	X	X	X	X	X	X	X	X	X		X
Trinity TR	Triticonazole		X				X	X	X		X			X			X					
Truban	Etridiazole												X			X						
Zerotol	Hydrogen Peroxide, Peroxyacetic Acid	OMRI	X	X	X	X	X		X		X	X	X	X	X	X	X	X	X	X	X	X

# REFERENCE GUIDE for GREENHOUSE and NURSERY PRODUCTION FUNGICIDES

## RESISTANCE MANAGEMENT

As with other pesticides, fungicides must be used in a program to avoid or delay resistance. Do not rely on products with the same mode of action. Rotation of products with different modes of action, and using product combinations with different modes of action are parts of a resistance management strategy. Be especially careful when using products considered to be high risk for resistance development. This category includes many of our newer products. See the explanation of resistance risk at the end of the fungicide section.

Most fungicides work more effectively to prevent disease from becoming established, rather than eradicating disease that is already present. Constant monitoring – and modification where possible – of environmental conditions and scouting crops for signs of disease symptoms are vital parts of effective fungicide use and resistance management.

Always read the label and check with local authorities for further information regarding resistance management.

**\*\*Use Site(s) Key:** GH = Greenhouse, N = Nursery



## Fungicides

(by Mode of Action Group and Class)

MOA Code* & Group	Class	Common Name	Trade Name	REI	Use Site(s)**	Company	
1	Thiophanates	Thiophanate-methyl	<b>OHP 6672</b> <sup>†</sup>	12	GH/N	<b>OHP, Inc.</b>	
			3336 <sup>™</sup>	12	GH/N	Nufarm	
MBC-fungicides (Methyl Benzimidazole Carbamates) Resistance risk: <b>High</b> (See explanation of resistance risk following the mode of action listing)							
2	Dicarboximides	Iprodione	<b>OHP Chipco</b> <sup>®</sup> <b>26019</b>	12	GH/N	<b>OHP, Inc.</b>	
			Chipco <sup>®</sup> 26019 FLO	12	GH/N	Bayer Environmental Science	
Resistance risk: <b>Medium to High</b>							
3	Imidazoles	Triflumizole	<b>Terraguard</b> <sup>†</sup>	12	GH/N	<b>OHP, Inc.</b>	
			Rubigan <sup>†</sup>	12	N	Gowan Company	
	Pyrimidines	Fenarimol	Banner <sup>†</sup> MAXX <sup>®</sup> II	12	N	Syngenta	
			Myclobutanil	Eagle <sup>†</sup> 20 EW	24	GH/N	Corteva Agriscience
			Triticonazole	Trinity <sup>†</sup>	12	GH/N	BASF
		Trinity <sup>†</sup> TR	4-12	GH	BASF		
DMI-fungicides (DeMethylation Inhibitors) Resistance risk: <b>Medium</b>							
4	Acylamines	Metalaxyl-M (=Mefenoxam)	Subdue <sup>†</sup> MAXX <sup>®</sup>	0-48	GH/N	Syngenta	
PA-fungicides (PhenyAmides) Resistance risk: <b>Medium to High</b>							
5	Piperadines	Piperalin	Pipron <sup>†</sup>	12	GH	SePRO Corp.	
Amines ("Morpholines") Resistance risk: <b>Low to Medium</b>							
7	Thiopene amides	Isofetamid	<b>Astun</b> <sup>†</sup>	12	GH/N	<b>OHP, Inc.</b>	
	Phenyl-Benzamides	Flutolanil	ProStar <sup>†</sup>	12	GH/N	Bayer Environmental Science	
SDHI (Succinate dehydrogenase inhibitors) Resistance risk: <b>Medium to High</b>							

\* Depends on Greenhouse ventilation

\*\* Greenhouse and/or nursery uses depend on the formulation. Check labels for uses.



# Fungicides *continued*

(by Mode of Action Group and Class)

MOA Code* & Group	Class	Common Name	Trade Name	REI	Use Site(s)**	Company
11	Oximino-acetates	Trifloxystrobin	Compass <sup>®</sup> O	12	GH/N	Bayer Environmental Science
	Methoxy-acrylates	Azoxystrobin	Heritage <sup>®</sup>	4	GH/N	Syngenta
	Methoxy-carbamates	Pyraclostrobin	Empress <sup>™</sup> Intrinsic	12	GH/N	BASF
	Imidazolinones	Fenamidone	FenStop <sup>®</sup>	12	GH	Gowan Company
		Fluoxastrobin	Fame SC	12	GH/N	FMC
QoI-fungicides (Quinone outside inhibitors) Resistance risk: <b>High</b>						
12	Phenylpyrroles	Fludioxonil	Medallion <sup>®</sup>	12	GH/N	Syngenta
			Spirato	12	GH/N	Nufarm
PP-fungicides (PhenylPyrroles) Resistance risk: <b>Low to Medium</b>						
14	Aromatic Hydrocarbons	PCNB	Terraclor <sup>®</sup>	12	GH/N	<b>OHP, Inc.</b>
			Thiadiazole	Etridiazole	Terrazole <sup>®</sup>	12
				Truban <sup>®</sup>	12	GH/N
AH fungicides (Aromatic Hydrocarbons) Resistance risk: <b>Low to Medium</b>						
17	Hydroxyanilides	Fenhexamid	Decree <sup>®</sup>	12	GH/N	SePRO Corp.
(SBI: Class III) Resistance risk: <b>Low to Medium</b>						
19	Polyoxins	Polyoxin-D	Affirm <sup>™</sup>	4	GH/N	Nufarm
Polyoxins Resistance risk: <b>Low to Medium</b>						
21	Cyano-imidazole	Cyazofamid	Segway <sup>®</sup> O	12	GH/N	<b>OHP, Inc.</b>
Qil-fungicide (Quinone inside inhibitor) Resistance risk: <b>Medium to High</b>						
28	Carbamates	Propamocarb	Banol <sup>®</sup>	24	GH/N	Bayer Environmental Science
			Carbamates Resistance risk: <b>Low to Medium</b>			
40	Cinnamic Acid Amides	Dimethomorph	Stature <sup>®</sup> SC	12	GH/N	BASF
	Mandelic Acid Amides	Mandipropamid	Micora <sup>™</sup>	4	GH/N	Syngenta
CAA-fungicides (Carboxylic Acid Amides) Resistance risk: <b>Low to Medium</b>						
43	Pyridinylmethyl-benzamides	Fluopicolide	Adorn <sup>®</sup>	12	GH/N	Nufarm
Benzamides Resistance risk: <b>Unknown</b>						
49	Piperidinyl-thiazole-isoxazolines	Oxathiapiprolin	Segovis <sup>®</sup>	4	GH/N	Syngenta
Piperidinyl-thiazole-isoxazolines Resistance risk: <b>Medium to High</b>						
BM 01	Fungal	Extract from the cotyledons of lupine plantlets ("BLAD") C108	Regime <sup>™</sup>	4	GH/N	FMC Corporation
Resistance risk: <b>Unknown</b>						

\* Depends on Greenhouse ventilation

\*\* Greenhouse and/or nursery uses depend on the formulation. Check labels for uses.



# Fungicides *continued*

(by Mode of Action Group and Class)

MOA Code* & Group	Class	Common Name	Trade Name	REI	Use Site(s)**	Company
BM 01	Biopesticide	<i>Singlea glutinosa</i>	EcoSwing™	4	GH/N	Gowan Company
Resistance risk: <b>Unknown</b>						
BM 02	<i>Bacillus</i> sp. and the fungicidal lipopeptides produced	<i>Bacillus amyloliquefaciens</i> strain D747	<b>Triathlon® BA</b>	4	GH/N	<b>OHP, Inc.</b>
		<i>Bacillus subtilis</i> GB03	Companion®	4	GH/N	Growth Products
		<i>Bacillus subtilis</i> MBI600	Subtilex™ NG	4	GH	BASF
		<i>Bacillus subtilis</i> QST713	Cease®	4	GH/N	BioWorks, Inc.
		<i>Bacillus amyloliquefaciens</i> F727	Stargus™	4	GH/N	Marone Bio Innovations
	Biopesticide	<i>Streptomyces lydicus</i> WYEC108	Actinovate® SP	4	GH/N	Mycorrhizal Applications, LLC
	Polypeptide (lectin)	<i>Trichoderma asperellum</i> (ICC 012) <i>Trichoderma gamsii</i> (ICC 080)	Obtego™	4	GH/N	SePRO Corp.
	Fungal	<i>Gliocladium virens</i> GL21	<b>SoilGard®</b>	4	GH/N	<b>OHP, Inc.</b>
	Biopesticide	<i>Trichoerma harzianum</i> T22	PlantShield® HC	0	GH/N	BioWorks, Inc.
		<i>Trichoderma harzianum</i> T22 + <i>Trichoderma virens</i> G41	RootShield® RootShield® Plus	0 0	GH/N GH/N	BioWorks, Inc. BioWorks, Inc.
Resistance risk: <b>Unknown</b>						
M 01	Inorganic	Copper octanoate Copper sulfate	<b>Grotto™</b> Cuproxat®	4 24	GH/N GH/N	<b>OHP, Inc.</b> Nufarm
			Phyton® 27	24	GH/N	Phyton Corp.
			Phyton® 35	24	GH/N	Phyton Corp.
		Copper hydroxide	CuPro™ 5000 T/N/O	48	GH/N	SePro Corp.
			<b>Kalmor®</b>	24	GH/N	<b>OHP, Inc.</b>
Inorganic		Cuprous Oxide	Nordox 75WG	12	GH/N	Nordox AS
Resistance risk: <b>Low</b>						
M 03	Dithiocarbamates and relatives	Mancozeb	Dithane®	24	GH/N	Corteva Agriscience
			Fore®	24	GH/N	Corteva Agriscience
			Junction™	24	GH/N	SePRO Corp.
			Pentathlon™	24	GH/N	SePRO Corp.
Dithiocarbamates and relatives		Manganese + zinc	Protect™ DF	24	GH/N	Nufarm
Resistance risk: <b>Low</b>						
M 05	Chloronitriles (phthalonitriles)	Chlorothalonil	Daconil® Ultrex®	12	GH/N	Syngenta
Dithiocarbamates and relatives			AllPro® Exotherm Termil	*	GH	Value Garden Supply
Resistance risk: <b>Low</b>						
P 05	Ethanol Extract	<i>Reynoutria sachalinensis</i>	Regalia®	4	GH/N	Marrone Bio Innovations
Resistance risk: <b>Unknown</b>						
P 07	Ethyl Phosphonates	Fosetyl-Al	Alliette®	12	GH/N	Bayer Environmental Innovations
			<b>Areca®</b>	12	GH/N	<b>OHP, Inc.</b>
Phosphonates	Phosphite	Phosphorous acid	Alude™	4	GH/N	Nufarm
Resistance risk: <b>Low</b>						

\* Depends on Greenhouse ventilation

\*\* Greenhouse and/or nursery uses depend on the formulation. Check labels for uses.



# Fungicides *continued*

(by Mode of Action Group and Class)

MOA Code* & Group	Class	Common Name	Trade Name	REI	Use Site(s)**	Company
NC	Biopesticide	<i>Ulocladium oudemansii</i> (U3 Strain)	BotryStop™	4	GH/N	BioWorks, Inc.
			Actino Iron	4	GH/N	Mycorrhizal Applications, LLC
	Biocarbonate	Potassium bicarbonate	Carb-O-Nator™	4	GH/N	Certis USA, LLC
			MilStop™	1	GH/N	BioWorks, Inc.
	Hydrogen Dioxide/Peroxide	Hydrogen dioxide + peroxyacetic acid	ZeroTol™	0-1	GH/N	Biosafe Systems
			X3™	0-2	GH/N	Phyton Corp.
	Oils	Carified hydrophobic extract of neem oil (also classified by EPA as a biopesticide) Petroleum Oil	<b>Triact™ 70</b>	4	GH/N	<b>OHP, Inc.</b>
			Suffoil-X™	4	GH/N	BioWorks, Inc.
	Quaternary Ammonium	Quaternary Amines	Greenshield™	0	GH	BASF
			KleenGrow™	0	GH	Pace 49
Soaps	Potassium salts of fatty acids	<b>Kopa™ Insecticidal Soap</b>	12	GH/N	<b>OHP, Inc.</b>	
	potassium salts of fatty acids	M-Pede™	12	GH/N	Gowan Company	
Resistance risk: <b>Unknown</b>						
1+2	Thiophanate + Dicarboxamide	Thiophanate-methyl + Iprodione	26/36™	12	GH/N	Nufarm
1+14	Thiophanate + Thiadiazole	Thiophanate-methyl + Etridiazole	Banrot™	12	GH/N	IC Specialty Fertilizers
1+ M 05	Thiophanate + Chloronitrile	Thiophanate -methyl + Chlorothalonil	Spectro™ 90	12	GH/N	Nufarm
3+11	Demethylation Inhibitors (DMI fungicides) + Strobilurins	Triadimefon + Trifloxystrobin	Trigo™	12	GH/N	Bayer Environmental Science
3+M 05	Demethylation inhibitor + Chloronitrile	Propiconazole + Chlorothalonil	Concert™ II	12	N	Syngenta
7+11	SDHI + Strobilurin	Boscalid + Pyraclostrobin	Pageant™ Intrinsic™	12	GH/N	BASF
		Fluopyram + Trifloxystrobin	Broadform™	12	GH/N	Bayer Environmental Science
		Benzovindiflupyr + Azoxystrobin	Mural™	12	GH/N	Syngenta
		Fluxapyroxad + Pyraclostrobin	Orkestra™ Intrinsic™	12	GH/N	BASF
45+40	Triazolo-pyrimidylamines + Cinnamic Acid Amides	Ametoctradin + Dimethomorph	Orvego™	12	GH/N	BASF
9+12	Anilo-pyrimidine +	Cyprodinil + Fludioxinil	Palladium™	12	GH/N	Syngenta

\* Depends on Greenhouse ventilation

\*\* Greenhouse and/or nursery uses depend on the formulation. Check labels for uses.

# \*Fungicides Modes of Action

1. Inhibition of tubulin formation in mitosis
2. MAP histidine-kinase in osmotic signal transduction, E3
3. DMI (DeMethylation Inhibitors) Demethylase in sterol biosynthesis
4. Phenylamidoes-Affect RNA synthesis
5. Inhibition of reductase and isomerase in sterol biosynthesis
7. Inhibitors of succinate-dehydrogenas (SDHs) and respiration
11. Quinone outside inhibitors (Qo)
12. MAP histidine-kinase in osmotic signal transduction E2
14. Cell peroxidatrin (proposed)
17. 3-keto reductase during C4 demethylation
19. Chitin synthase inhibition in cell wall development
21. Quinone inside inhibitors (Qi)
28. Affect cell membrane permeability, fatty acids (proposed)
40. Cell wall biosynthesis: cellulose synthase
43. Delocalization of spectrin-like proteins
45. Respiration Complex III: cytochrome bc1 (ubiquinone reductase) at Qo site
49. Lipid homeostatis and transfer/storage
- BM. Biologicals with multiple modes of action.
- BM 02. Microbial disruptors of pathogen cell membranes (Biologicals)
- M. Multi-site activity. Chemicals that act at several sites, which may differ among the group members.
- NC. Unknown: *The mode of action cannot be placed within any other defense*
- P. Host plant defense induction

## Explanation of Resistance Risk

This list is from the U.S. Environmental Protection Agency, in cooperation with the Fungicide Resistance Action Committee (FRAC). FRAC is a technical working group within the Global Crop Protection Federation (GCPF). More information on the Fungicide Resistance Action Committee and the Mode of Action Classification is available from: [www.frac.info](http://www.frac.info). Resistance risk categories were developed by FRAC. There are ways to estimate the potential for resistance development. The resistance risk is generally based on whether the fungicide mode of action (MOA) is single or multi-site. Single site MOA products have a higher resistance risk than multi site MOA products. The pathogen types targeted by the fungicides also are factors.

Fungicides should always be used by rotating MOA types. Users need to be especially careful not to rotate or alternate among fungicides in any one high resistance risk category. Follow resistance management instructions on product labels.





## Fungicides and Bactericides

### 26GT® Fungicide

by BAYER CROPSCIENCE

A broad spectrum fungicide that can be applied to a wide range of ornamental plants, either as a foliar spray, dip, or drench. Provides 14 days or longer control with quick knockdown.

REI 12 Hrs

RATE 32 to 80oz per 100gal

ACTIVE INGREDIENT Iprodione

CONTROLS Rhizoctonia, Fusarium, Botrytis, Alternaria



2.5gal bottle

PROKZ4250930 Min. Buy 1ea



### Actinovate® SP Biological Fungicide

by MYCORRHIZAL APPLICATIONS LLC

Actinovate® SP Biological Fungicide suppresses and controls root rot, damping-off fungi and foliar fungal pathogens. When used as a soil drench, it also suppresses and controls soil-borne fungi.

REI 1 Hr

RATE Varies according to application method. See label.

ACTIVE INGREDIENT Streptomyces lydicus

CONTROLS Phythium, Phytophthora, Verticillium, Fusarium, Rhizoctonia, Powdery Mildew, Downy Mildew, Botrytis and other root and foliar fungi.



18oz

NOV5000-725 Min. Buy 1ea



### 3336® EG Fungicide

by NUFARM AMERICAS INC.

A broad-spectrum disease control for turf and ornamental plants. Combines the power of thiophanate-methyl with the convenience of an extruded granular formulation for control of troublesome plant diseases such as Rhizoctonia. A low-dust extruded granule with quick-dissolve properties, 3336 EG extends many benefits to the user including easy measuring and easy mixing.

REI 12 hours

RATE Varies according to application method. See label.

ACTIVE INGREDIENT Thiophanate-methyl

CONTROLS Anthracnose, Brown Rot, Leaf Scabs, Fusarium, Rhizoctonia, and many more.



5lb

NTS10556045 Min. Buy 1ea



### Affirm™ WDG Fungicide

by NUFARM AMERICAS INC.

A concentrated, easy-to-mix water dispersible granule formulation that delivers excellent disease control and minimal spray residues. Use for disease control on turf, ornamentals, Christmas trees and various crops including: cucurbit vegetables, fruit vegetables, pome fruits, strawberries, non-bearing fruit vines and non-bearing fruit and nut trees.

REI 4 Hrs

RATE 4 to 8oz per 100gal

ACTIVE INGREDIENT Polyoxin D

CONTROLS Alternaria, Anthracnose, Apple scab, Botrytis, Powdery mildew, Rhizoctonia aerial blight, Rhizoctonia, Scabs



2.4lb

NTS10500324 Min. Buy 1ea



### 3336® F Fungicide

by NUFARM AMERICAS INC.

3336 F is a broad spectrum fungicide for control of a wide range of diseases in turf and ornamentals. Use for annual and perennial flowers, bedding and foliage plants, turf, trees and evergreens.

REI 12 hours

RATE 2 to 6 oz per 1,000 sq ft

ACTIVE INGREDIENT Thiophanate-methyl

CONTROLS Anthracnose, Brown Rot, Leaf Scabs, Fusarium, Rhizoctonia, and many more.



32oz

NTS10498121 Min. Buy 1ea

2.5gal

NTS10498225 Min. Buy 1ea

Shipping Info HAZARDOUS



### Agri-Mycin® 50 Fungicide

by NUFARM AMERICAS INC.

Agri-Mycin 50 is a bactericide for control of bacterial blight, soft rot, bacterial spot and more on select vegetable and fruit crops.

REI 12 hours

RATE Varies according to application method. See label.

ACTIVE INGREDIENT Streptomycin sulfate

CONTROLS Bacterial diseases.



3lb Bag

NTS10719063 Min. Buy 1ea



### Adorn® Fungicide

by NUFARM AMERICAS INC.

Adorn fungicide controls ornamental plant diseases such as Downy Mildew, Phytophthora and Pythium in greenhouse ornamentals, outdoor nurseries, landscape ornamentals and shrubs. Can be used as a spray or drench.

REI 12 Hrs

RATE 1 to 4oz per 100gal

ACTIVE INGREDIENT Fluopicolide

CONTROLS Downy Mildew, Phytophthora, Pythium.



32oz

VAL61510.928 Min. Buy 1ea



### Aliette® WDG Fungicide

by BAYER CROPSCIENCE

Provides long lasting Phytophthora and Downy Mildew control. Aliette has a unique upward and downward systemic activity to protect the entire plant for up to 30 days.

REI 48 Hrs

RATE 2.5 to 5lbs per 100gal

ACTIVE INGREDIENT Aluminum Tris

CONTROLS Phytophthora, Pythium, Downy Mildew and more.



5lb

BYR84956465 Min. Buy 1ea



## Fungicides and Bactericides

**Areca® Fungicide**

by OHP, INC.

Areca is an up-and-down systemic fungicide that may be applied to a wide range of ornamental flowering and foliage plants for control of diseases caused by Pythium, Phytophthora and Downy Mildew pathogens. Areca may be used on ornamentals and bedding plants grown in field nursery, greenhouse, landscape and conifer nurseries.

REI 12 Hrs

**RATE** Varies depending on application method. See label.

**ACTIVE INGREDIENT** Aluminum tris**CONTROLS** Pythium, Phytophthora, Downy Mildew and more.**5lb****OHP981145** Min. Buy 1ea**Astun® Ornamental Fungicide**

by OHP, INC.

Astun Ornamental Fungicide provides preventative and early curative activity on botrytis diseases of plants grown in commercial greenhouses and nurseries. Astun is most effective when used as a protectant fungicide and applied before the disease damages the crop.

REI 12 Hrs

**RATE** 10 to 17oz per 100gal**ACTIVE INGREDIENT** Isfetamid**CONTROLS** Botrytis**32oz****OHP981150** Min. Buy 1ea**Badge® SC Fungicide**

by GOWAN

Badge fungicide controls a wide range of fungal diseases on vegetable crops, fruit and nut trees, ornamental plants, herbs in greenhouses and nurseries.

REI 24 hours in enclosed structures

**RATE** Varies depending on application method. See label.

**ACTIVE INGREDIENT** Copper Oxchloride and Hydroxide**CONTROLS** Phytophthora, Pythium, Powdery Mildew, and more.**2.5gal Bottle****GOW60903** Min. Buy 1ea**Banner® Maxx® II Fungicide**

by SYNGENTA CROP PROTECTION

Banner Maxx II provides broad-spectrum control of foliar diseases on ornamentals grown in the landscape and outdoor nurseries. Works quickly and controls diseases for up to 28 days.

REI 12 Hrs

**RATE** Varies depending on application method. See label.

**ACTIVE INGREDIENT** Propiconazole**CONTROLS** Rusts, Phomopsis, Alternaria, Cercospora, Septoria leaf spots, Anthracnose, Scabs, Rhizoctonia**1gal AGENCY****SYN39961** Min. Buy 1ea**Banol® Fungicide**

by BAYER CROPS SCIENCE

Banol is an outstanding control product for Pythium and Phytophthora. Labeled for turf applications and as a drench in greenhouse and container grown ornamentals.

REI 24 Hrs

**RATE** 2 to 4oz per 1000sq ft, Drench: 20-30oz per 100gal**ACTIVE INGREDIENT** Propamocarb hydrochloride**CONTROLS** Pythium and Phytophthora.**1gal Bottle****PROKZ4192957** Min. Buy 1ea**2.5gal AGENCY****BYR79895402** Min. Buy 1ea**Banrot® 40WP Fungicide**

by ICL/SPECIALTY FERTILIZERS

A broad spectrum fungicide for use in commercial greenhouses and nurseries to control damping-off, root and stem rot diseases of ornamental and nursery crops caused by Pythium, Phytophthora, Rhizoctonia, Fusarium and Thielaviopsis. 40 WP is a wettable powder formulation for liquid applications

REI 12 Hrs

**RATE** 4 to 8oz per 100gal**ACTIVE INGREDIENT** Etridiazole, Thiophanate Methyl**CONTROLS** Pythium, Phytophthora, Thielaviopsis, Fusarium, Rhizoctonia**2lb****EVR957252E** Min. Buy 1ea**Banrot® 8G Fungicide**

by ICL/SPECIALTY FERTILIZERS

A broad spectrum fungicide for use in commercial greenhouses and nurseries to control damping-off, root and stem rot diseases of ornamental and nursery crops caused by Pythium, Phytophthora, Rhizoctonia, Fusarium and Thielaviopsis. Banrot 8G is a granular formulation for incorporation into growing media

REI 12 Hrs

**RATE** 8oz per 1cu yd**ACTIVE INGREDIENT** Etridiazole, Thiophanate Methyl**CONTROLS** Pythium, Phytophthora, Thielaviopsis, Fusarium, Rhizoctonia**40lb****EVR950241E** Min. Buy 1ea

## Fungicides and Bactericides

## BioWorks® MilStop® SP Foliar Fungicide

by **BIOWORKS INC.**

MilStop® SP is a broad spectrum foliar fungicide. Highly effective on powdery mildews, it also helps prevent other foliar diseases. Use sites include greenhouse, nursery and field crops. It can also be used on interiorscapes and woody herbs.

REI 1 hour

RATE 1 to 5 lbs per 100 gallons

ACTIVE INGREDIENT Potassium bicarbonate

CONTROLS Powdery Mildew and other foliar diseases.



5lb bag

BW1M112B04 Min. Buy 1ea

25lb Pail

BW1M112B06 Min. Buy 1ea

Shipping Info **DIRECT**

## Bioworks® PERpose Plus®

by **BIOWORKS INC.**

A broad-spectrum algacide and fungicide for the prevention, suppression and control of fungus and algae on equipment and hard surfaces, in all stages of crop production, and for post-harvest and storage applications. Labeled for use in greenhouses, garden centers, landscapes, agricultural crops, nurseries and interiorscapes.

REI 0 to 1 hour

RATE 1 oz per gallon of water,

ACTIVE INGREDIENT Hydrogen peroxide and Hydrogen dioxide

CONTROLS Kills algae and fungus on contact



5gal

BW1HP44A55 Min. Buy 1ea

Shipping Info **HAZARDOUS**

30gal

BW1HP44A38 Min. Buy 1ea

Shipping Info **DIRECT HAZARDOUS**

55gal

BW1HP44A57 Min. Buy 1ea

Shipping Info **HAZARDOUS**

## BotryStop® Biofungicide

by **BIOWORKS INC.**

BotryStop is a biological fungicide for the control of Botrytis and Sclerotinia. Labeled for use on a wide variety of field or greenhouse grown vegetables, grapes and other small fruits. Also for use on ornamentals in the greenhouse or nursery. OMRI listed.

REI 4 Hrs

RATE 2 to 4lbs per 100gal

ACTIVE INGREDIENT Ulocladium oudemansii (U3 strain)

CONTROLS Botrytis and Sclerotinia.



6lb

BW1U98A70 Min. Buy 1ea

Shipping Info **DIRECT**

12lb

BW1U98A61 Min. Buy 1ea

Shipping Info **DIRECT**

## Broadform™ Fungicide

by **BAYER CROPSCIENCE**

Broadform is a broad spectrum fungicide that helps maximize foliar disease control on key pathogens including Botrytis, leaf spot and dieback diseases. Two modes of action control multiple diseases that could be attacking the plant at a given time. Labeled for use on greenhouse and nursery-grown ornamentals, including fruits, nuts and Christmas trees.

REI 12 Hrs

RATE 2 to 8oz per 100gal

ACTIVE INGREDIENT Fluopyram and Trifloxystrobin

CONTROLS Controls 50+ diseases including Botrytis, Diplodia, Botryosphaeria, Phomopsis black spot, anthracnose, rusts, and powdery mildew



12oz AGENCY

BYR85758497 Min. Buy 1ea



## Camelot™ O Fungicide / Bactericide

by **SEPRO CORPORATION**

A liquid copper formulation using proven technology to provide broad-spectrum bacterial and fungal disease control on a wide variety of ornamental plants, greenhouse vegetable / herb crops and turf grass. Formulated with fixed copper combined with fatty acids to form a true soap providing outstanding performance. Requires minimal elemental copper for excellent disease control through its superior coverage ability and foliar adherence.

REI 4 Hrs

RATE 0.5 to 2gal per 100gal

ACTIVE INGREDIENT Copper Octanoate

CONTROLS Bacterial and Fungal pathogens.



1gal

SEPRO19-0452A Min. Buy 1ea



## CEASE® Microbial Fungicide / Bactericide

by **BIOWORKS INC.**

Cease microbial fungicide controls a wide array of fungal and bacterial pathogens, both foliar and soil-borne. For use on ornamentals, trees, shrubs and greenhouse vegetables.

OMRI listed.

REI 4 Hrs

RATE 96 to 192oz per 100gal

ACTIVE INGREDIENT Bacillus subtilis strain QST 713

CONTROLS Botrytis, Powdery Mildew, Fusarium, Pythium and more.



1gal

BW300100 Min. Buy 1ea

2.5gal

BW1C19A24 Min. Buy 1ea



## Chipco® 26019 Fungicide

by **BAYER CROPSCIENCE**

Broad spectrum fungicide for use as a spray, drench, or dip for the control of diseases on a wide range of ornamental plants and turf applications.

REI 12 Hrs

RATE 32-80oz per 100gal

ACTIVE INGREDIENT Iprodione

CONTROLS Botrytis, Phytophthora, Pythium, Downy Mildew, Brown Patch, Fusarium Blight and more.



2.5gal bottle

PROKZ4251007 Min. Buy 1ea



## Fungicides and Bactericides

### Compass® 50WG Fungicide

by **BAYER CROPSCIENCE**

Compass is a broad spectrum fungicide for the prevention and treatment of foliar and soil pathogens. Mesostemic and translaminar movement provides disease control in and around the plant tissue.

REI 12 Hrs

RATE 2oz per 100gal

ACTIVE INGREDIENT Trifloxystrobin

CONTROLS Fusarium, Rhizoctonia, Black Spot, Botrytis, Downy Mildew, Powdery Mildew and more. See label.



1lb

BYR2584569 Min. Buy 1ea



### CuPRO® 5000 Fungicide

by **SEPRO CORPORATION**

CuPRO 5000 is an advanced copper fungicide/bactericide technology that delivers excellent disease control with all the advantages of a dry flowable: decreased handling, decreased dust exposure, easier packaging, and shortened loading times. Use CuPRO 5000 for control of bacterial and fungal diseases of foliage, flowers, and stems on ornamentals in greenhouses, shadehouses, outdoor nurseries, and outdoor landscape plantings.



3lb Bag

SEPRO19-0711M Min. Buy 1ea



### Daconil Ultrex® Fungicide

by **SYNGENTA CROP PROTECTION**

A contact fungicide that exhibits a multi-site mode of action which can delay or prevent resistance to single-site fungicides. It contains a built-in surfactant to provide superior sticking power for extended coverage and unsurpassed protection of the leaf surface, even after heavy rains or watering Registered for control of 50 diseases on more than 75 ornamental plants and provides residual control for 14 to 21 days.

REI 12 Hrs

RATE 2 to 3oz per 1,000sq ft

ACTIVE INGREDIENT 82.5% Chlorothalonil

CONTROLS Dollar Spot, Leaf Spot, Brown Patch, Anthracnose and more.



5lb AGENCY

SYN31215 Min. Buy 1ea



### Daconil WeatherStik® Fungicide

by **SYNGENTA CROP PROTECTION**

For control of turf and ornamental diseases. Works as a contact fungicide for the control of many turf and ornamental diseases and has low resistance risk. Sticks and stays for broad spectrum disease control for up to 14 days. Contains a sticking agent that keeps the fungicide on the plant.

REI 12 Hrs

RATE 22oz per acre

ACTIVE INGREDIENT Chlorothalonil

CONTROLS Botrytis, Rust, powdery mildew, anthracnose, leaf spots, scabs, and more



2.5gal AGENCY

SYN31217 Min. Buy 1ea



### Daconil ZN® Fungicide

by **SYNGENTA CROP PROTECTION**

For control of turf and ornamental diseases. Works as a contact fungicide for the control of many turf and ornamental diseases and has low resistance risk. Registered for control of 50 diseases on more than 75 ornamental plants. Provides residual control for 14 to 21 days.

REI 12 Hrs

RATE 5oz per 1,000gal

ACTIVE INGREDIENT 38.5% Chlorothalonil

CONTROLS Dollar Spot, Leaf Spot, Brown Patch, Anthracnose and more.



2.5gal AGENCY

SYN31214 Min. Buy 1ea



### Decree® 50WDG Fungicide

by **SEPRO CORPORATION**

With excellent crop safety and no residue concerns, Decree Fungicide is an exceptional tool throughout the season. Decree's 12-hour REI allows for Botrytis control in propagation and at retail, while its residual control gives growers the best value per application.

REI 12 Hrs

RATE 1 to 1.5lb per 100gal

ACTIVE INGREDIENT Fenhexamid

CONTROLS Botrytis



2.5lb

SEPRO19-0460 Min. Buy 1ea



### Dithane 75DF Fungicide

by **Corteva**

A broad-spectrum protectant fungicide labeled for use on outdoor or greenhouse grown crops and turfgrass.

REI 24 hours

RATE 6 to 8oz per 1,000sq ft.

ACTIVE INGREDIENT Mancozeb

CONTROLS Rhizoctonia, Fusarium, Gray and Pink

Snow Mold, and more.



12lb Bag

DOW19-0512 Min. Buy 1ea



### Eagle® 20EW Fungicide

by **Corteva**

Systemic protectant fungicide for use on ornamentals in greenhouses, nurseries and landscapes as well as turf and golf applications. Controls key diseases like powdery mildew, rust, scab and anthracnose.

REI 24 hours

RATE 1 to 3 oz per 1,000 sq ft

ACTIVE INGREDIENT Myclobutanil

CONTROLS Thrips, lepidopterous larvae, foliage feeding worms and many more. See label for complete list.



16oz

DOW173917 Min. Buy 1ea

1gal

DOW19-2505B Min. Buy 1ea





# ON GUARD

Shield your greenhouse and nursery crops from chewing and sucking insect pests, including thrips, whiteflies, aphids, caterpillars and leaf-feeding beetles. As part of a preventive pest management strategy, put Mainspring® GNL insecticide on guard to keep pests out and crops clean.

- Systemic activity provides extended protection to save you time and labor on repeated applications
- Four-hour restricted-entry interval makes it less disruptive to work schedules
- Alternative to neonicotinoid chemistries
- Compatible with many biological control agents

**Contact me to learn more.**

Chris Threadgill | [chris.threadgill@syngenta.com](mailto:chris.threadgill@syngenta.com) | 573-201-1483  
[GreenCastOnline.com/MainspringGNL](http://GreenCastOnline.com/MainspringGNL)



**Mainspring® GNL**  
Insecticide

syngenta®

All photos are the property of Syngenta unless otherwise noted.

©2017 Syngenta. **Important: Always read and follow label instructions. Some products may not be registered for sale or use in all states or counties. Please check with your local Extension Service to ensure registration status.** Mainspring®, the Alliance Frame, the Purpose Icon and the Syngenta Logo are trademarks of a Syngenta Group Company. Syngenta Customer Center: 1-866-SYNGENT(A) (796-4368).

## Fungicides and Bactericides

## EcoSwing® Botanical Fungicide

by GOWAN

EcoSwing botanical fungicide controls fungal diseases on outdoor and greenhouse food crops, ornamental plants, flowers, trees and shrubs.

REI 4 Hrs

RATE 24 to 32oz per Acre

ACTIVE INGREDIENT Swinglea glutinosa

CONTROLS Botrytis, Powdery Mildew, Alternaria, Stem rots



32oz

GOW76811

Min. Buy 1ea



## Grotto™ Fungicide

by OHP, INC.

Grotto™ is a liquid copper fungicide for broad spectrum control of fungal and bacterial diseases on greenhouse and shadehouse vegetables and herbs, ornamentals and turf. OMRI listed for organic production.

REI 4 hours

RATE Varies according to application. See label.

ACTIVE INGREDIENT Copper Octanoate

CONTROLS Bacterial diseases, Botrytis, Downy Mildew, Powdery Mildew and more.



1 Gallon

OHP982900

Min. Buy 1ea



## Empress® Intrinsic® Fungicide

by BASF CORP

Drench application with Empress fungicide will protect young, susceptible plants from root-infecting pathogens in rooted plug, propagation and transplant stages of production. Intrinsic brand fungicides enhance growth efficiency for strong, dense root growth.

REI 12 Hrs

RATE 3 to 6oz per 100gal

ACTIVE INGREDIENT Pyraclostrobin

CONTROLS Fusarium, Phytophthora, Pythium, Rhizoctonia.



24 oz bottle

BAS59014402

Min. Buy 1ea



## Heritage® SC Fungicide

by SYNGENTA CROP PROTECTION

Heritage SC fungicide protects plants from root to leaf tip, providing exceptional disease control for extended intervals. Broad-spectrum control of over 25 turf diseases and over 30 ornamental diseases. Hazardous via air.

REI 4 Hrs

RATE Varies by application. See label.

ACTIVE INGREDIENT Azoxystrobin

CONTROLS Phomopsis Blight, Alternaria Leaf Spot, Downy Mildew, Anthracnose, Botrytis, Rhizoctonia, and more.



4oz

SYN69643

Min. Buy 1ea



## Fame® SC Fungicide

by FMC

Fame fungicide for the control of foliar, stem and root diseases in turf and ornamentals. Foliar spray or soil drench applications providing fast penetration into leaf tissues and rain fast within 15 minutes. For commercial production and in landscape areas around residential, municipal and commercial properties, field grown ornamentals and ornamentals in greenhouses, interiorscapes and other enclosed structures.

REI 12 hours

RATE 1 to 4oz per 100gal

ACTIVE INGREDIENT Fluoxastrobin

CONTROLS Anthracnose, Brown Spot, Dollar Spot, Fusarium, Powdery Mildew and more.



16oz AGENCY

FMC10064759

Min. Buy 1ea



## Heritage® WDG Fungicide

by SYNGENTA CROP PROTECTION

Heritage WDG is a broad-spectrum fungicide for control of more than 33 diseases including all four classes of pathogens. Labeled for use on greenhouse ornamentals, vegetable and herb plants, fruit and nut trees.

REI 4 Hrs

RATE 1 to 4oz per 100gal

ACTIVE INGREDIENT Azoxystrobin

CONTROLS Phomopsis Blight, Alternaria Leaf Spot, Downy Mildew, Anthracnose, Rose Blackspot, Powdery Mildews, Rusts, Botrytis, Rhizoctonia, Sclerotium, Fusarium



1lb AGENCY

SYN74240

Min. Buy 1ea

6lb AGENCY

SYN74818

Min. Buy 1ea



## FungOut® Fungicide

by AEF GLOBAL INC.

FungOut® forms a protective barrier on the surface of the leaves that inhibits pathogen development. Anti-fungal and anti-bacterial properties offer disease protection for food and non food crops. Labeled for use on both outdoor and greenhouse crops.

REI 4 hours

ACTIVE INGREDIENT Citric Acid

CONTROLS Powdery mildew, Downy mildew, bacterial canker and black spot.



2.5 Gallon

AEF10025

Min. Buy 1ea



## JH Biotech Fosphite®

by JH BIOTECH, INC.

For control of Phytophthora, Pythium, and Downy Mildew on food crops, turf, and ornamentals. Fosphite® is an effective systemic fungicide. It has been approved by the EPA as a 'Reduced Risk Pesticide' for control of Phytophthora, Pythium, and Downy Mildew on food crops, ornamentals and bedding plants, Phytophthora in conifers and Pythium in turf.



2.5gal

JH011005

Min. Buy 1ea



**Junction®**

by **SEPRO CORPORATION**

Two chemistries combined to create a broad-spectrum fungicide/bactericide. The new formulation is highly soluble, easily mixes into suspension, and can be sprayed through screens and nozzles. Labeled for turf and ornamental, Junction® provides disease control in a wide array of greenhouse and nursery crops.



**5lb bottle**

**SEPRO103385** Min. Buy 1ea

**Kalmor® Fungicide/Bactericide**

by **OHP, INC.**

A copper-hydroxide based product that controls a number of diseases in both greenhouses and nurseries including bacterial diseases. The high-quality formulation allows for gradual release of copper and may be used on ornamentals, fruits, and vegetables.

**REI** 24-48 Hrs

**RATE** 0.5 to 2.00lbs per acre

**ACTIVE INGREDIENT** Copper Hydroxide

**CONTROLS** Bacterial Leaf Spots, Anthracnose, Botrytis, Cercospora, Downy Mildew and more



**2.5lbs**

**OHP984900** Min. Buy 1ea



**KleenGrow™ Disinfectant / Bactericide / Algacide / Fungicide**

by **PACE 49 INC.**

KleenGrow™ is a biodegradable, 4th generation DDAC quaternary ammonium which provides curative and preventative broad - spectrum control of algae, fungi, and bacteria on greenhouse flowers and ornamentals. KleenGrow can safely be applied as a spray, drench, or drip on crops, from propagation, bulbs/seeds, to finished crops, while offering residual disease control by way of membrane disruption with no worry of crop resistance. Kleengrow can also be used to control algae, bacteria, and viruses on hard surfaces. Product can safely be used to disinfect greenhouse structures, floors, benches, cool pads, irrigation lines, plastic pots/trays, tools, coolers, and in footbaths to reduce the spread of algae and diseases.

**REI** 12 Hrs - For Recirculated Water, 48 Hrs - For Use On Crops, 0 Hrs

**RATE** 6-25oz per 100gal (see label for rate per crop size), 0.5-2oz per 1gal Hard Surface Disinfecting, 0.34-1.20oz per 100gal in Irrigation Water

**ACTIVE INGREDIENT** Didecylidimethyl ammonium chloride

**CONTROLS** Algae, foliar diseases, crown and root rots, Powdery Mildew, Botrytis, Pythium, Phytophthora, Fusarium, Erwinia and Xanthomonas



**1gal**

**PAC4919-0603I** Min. Buy 1ea

Shipping Info **HAZARDOUS**

**5gal**

**PAC4919-0603J** Min. Buy 1ea

Shipping Info **HAZARDOUS**

**30gal Drum**

**PAC4919-0603K** Min. Buy 1ea

Shipping Info **HAZARDOUS**

**55gal Drum**

**PAC4919-0603B** Min. Buy 1ea

Shipping Info **HAZARDOUS**



**Medallion® WDG Fungicide**

by **SYNGENTA CROP PROTECTION**

Formulated as a water dispersible granule, providing growers with a more user-friendly way to control major foliar, root and stem diseases. Delivers 21-28 day residual control as a drench and 7-14 day residual control as a foliar spray. Labeled for use in greenhouses, shade houses, outdoor nurseries, interiorscapes and landscapes.

**REI** 12 Hrs

**RATE** 1 to 4oz per 100gal

**ACTIVE INGREDIENT** Fludioxonil

**CONTROLS** Botrytis, Fusarium, Rhizoctonia and more.



**8oz AGENCY**

**SYN51008** Min. Buy 1ea



**Mefenoxam 2AQ Fungicide**

by **CONTROL SOLUTIONS, INC.**

Water-based formulation features low odor. Systemic mode of action and translocation through the plant can provide up to 3 weeks protection. Flowable formulation is effective for the control of numerous diseases in various ornamental, nursery and turf crops caused by the Oomycete class of fungi.

**REI** 48 Hrs

**RATE** Varies depending on application method.

**ACTIVE INGREDIENT** Mefenoxam

**CONTROLS** Pythium, Phytophthora, Downy Mildew



**1gal**

**QCM83013852** Min. Buy 1ea

**2.5gal**

**QCM83013861** Min. Buy 1ea

**32oz**

**QCM83013851** Min. Buy 1ea



**Micora® Fungicide**

by **SYNGENTA CROP PROTECTION**

Provides immediate contact protection and long-lasting disease control by locking to the leaf surface and slowly flowing into the leaf over an extended period of time. May be used as a spray to control downy mildew diseases and stem blights caused by Phytophthora spp. or as a drench to control Phytophthora crown and root rots on a variety of crops

**REI** 4 Hrs

**RATE** 4 to 8oz per 100gal

**ACTIVE INGREDIENT** Mandipropamid

**CONTROLS** Downy Mildew and Phytophthora.



**32oz AGENCY**

**SYN47280** Min. Buy 1ea



**Mural® Fungicide**

by **SYNGENTA CROP PROTECTION**

Two active ingredients provide broad-spectrum disease control in one versatile solution. Powered by an advanced generation SDHI and Heritage® fungicide to control the widest range of root diseases in ornamental and vegetable plants. Mural provides control of key foliar, stem and root diseases including Botrytis, Rhizoctonia and leaf spots like powdery mildew and anthracnose. Provides disease control in both nursery and greenhouse operations and prevents and controls more than 50 root and foliar diseases.

**REI** 12 Hrs

**RATE** 4 to 7oz per 100gal

**ACTIVE INGREDIENT** Azoxystrobin, Benzovindiflupyr

**CONTROLS** Botrytis, Fusarium, Rhizoctonia and more.



**1lb AGENCY**

**SYN56731** Min. Buy 1ea



# BOTRYTIS *Control Strategies*

## **Background:**

Botrytis affects numerous ornamentals and vegetables. Botrytis can also cause many problems such as stem cankers, damping off, leaf spots and blighting. Botrytis belongs to the family Sclerotiniaceae. There are about 30 different species. The most common species is *Botrytis cinerea*.

## **Symptoms:**

Botrytis produces large areas of gray spores that usually infect lower leaves that are close to the moist soil and underneath the plant canopy. It can also infect dead plant parts that are either in the pot or on the table or floor that can then be a source of future infections. It can start out as a small spot and then get larger and kill the leaf and then it can spread into the stem and kill the entire plant.

## **Favorable Development Conditions/Disease Cycle:**

The favorable conditions for the development of Botrytis are when there is high humidity, cool temperatures and moisture present. Water is needed for the spores to germinate and then to infect the plant. Botrytis quickly produces spores that infect the plant, grow, and then produce more spores which can start the cycle again. It has a repeating disease cycle that can last the life of the plant and allows it to build up disease pressure. In some cases the spores can lie dormant on a plant for the life of the plant.

## **Cultural Control:**

There are several ways to help prevent Botrytis. Prune lower leaves so that there is better air circulation underneath the plant canopy. Water in the morning so plants have a chance to dry out before nightfall. Space plants farther apart so that the humidity between them is lower and air circulation is better. After the crop has left make sure to clean up any leaves or dead plants that are left so that Botrytis doesn't have a chance of starting on them. All these ways would be possibilities to help prevent Botrytis.

## **Chemical Control:**

There are a number of fungicides that are labeled and are effective for Botrytis.



*Always read and follow label directions before applying any pesticide and follow state and local regulations*

**For more information or to place an order**

Please contact your BFG Sales Representative or our Customer Service Team!





**Pageant Intrinsic** 1lb BAS59012349 12lb BAS59012429 TR BAS59012766



(Boscalid, Pyraclostrobin) Group 7,11. Caution. 12hr REI. Rate: 12-18oz/100gal. Contact. Labeled for use in the greenhouse and nursery as well as vegetables.



**Daconil Ultrex** 5lb SYN31215



(Chlorothalonil) Group M05. Danger. 12hr REI. Rate: 1.4lb/100gal. Contact. Labeled for use in the greenhouse and nursery. Do not use on Ferns, Schefflera or green or variegated Pittosporum.



**Decree** 2.5lb SEPRO19-0460



(Fenhexamid) Group 17. Caution. 12hr REI. Rate: 1-1.5lb/100gal. Contact. Labeled for use in the greenhouse and nursery as well as vegetables and herbs.



**Chipco 26019** 2lb OHP981462



(Iprodione) Group 2. Caution. 12hr REI. Rate: 1-2.5lb/100gal. Contact. Labeled for use in the greenhouse and nursery. Do not use as a drench on Impatiens or Pothos. Do not use on Spathiphyllum.



**Affirm WDG** 0.5lb NTS10500415 2.4lb NTS10500324



(Polyoxin D zinc salt) Group 19. Caution. 4hr REI. Rate: 4-8oz/100gal. Contact. Labeled for use in the greenhouse and nursery as well as vegetables.



**Bayer 26GT** 2.5gal PROKZ4250930



(Iprodione) Group 2. Caution. 12hr REI. Rate: 1-2.5qts/100gal. Contact. Labeled for use in the greenhouse and conifer nursery. Do not use on Spathiphyllum and as a drench on Impatiens and Pothos.



**BotryStop** 6lb BW1U98A70 12lb BW1U98A61



(Ulocladium oudemansii) OMRI Group UN. Caution. 4hr REI. Rate: 2-4lbs/100gal. Contact. Labeled for use in the greenhouse and nursery as well as vegetables, fruits, and tree nuts.



**Palladium** 2lb SYN38781



(Cyprodinil, Fludioxonil) Groups 9,12. Caution. 12hr REI. Rate: 4-6oz/100gal. Contact and Systemic. Labeled for use in the greenhouse and nursery. Do not use Palladium of leather leaf fern.

## Fungicides and Bactericides

**Nordox 75 WG Fungicide**by **BRANDT CONSOLIDATED INC.**

A high performance natural copper fungicide / bactericide for high retention and effectiveness in adverse weather conditions. A wettable granule used to control fungal and bacterial diseases on fruits, vegetables, flowers and ornamentals. OMRI® listed

REI 12 Hrs when used in enclosed structures

**ACTIVE INGREDIENT** Cuprous Oxide**CONTROLS** Anthracnose, Fusarium, Downy Mildew and many more.**12.5lb****BRANDT3000-01-020** Min. Buy 1ea**Obtego® Fungicide**by **SEPRO CORPORATION**

Obtego® Fungicide and Plant Symbiont serves as a multi-functional tool for growers by protecting the plant from damaging soil-borne pathogens and enhancing root growth. Obtego and plant roots live in a mutually beneficial symbiosis. As Obtego colonizes the root system, the Obtego fungi promote competition and parasitism of plant damaging pathogens in the soil.

REI 4 Hrs

**RATE** 2.5 to 7.5oz per 100gal**ACTIVE INGREDIENT** Trichoderma asperellum (ICC 012), T. gamsii (ICC 080)**CONTROLS** Fusarium, Phytophthora, Pythium, Rhizoctonia, Sclerotium**1lb AGENCY****SEPRO1017121** Min. Buy 1eaShipping Info **DIRECT****5lb AGENCY****SEPRO101045** Min. Buy 1eaShipping Info **DIRECT****OHP 6672® 4.5F Fungicide**by **OHP, INC.**

OHP 6672 4.5F fungicide controls a broad spectrum of diseases of bedding, flowering, herbaceous, vegetable plants, shrubs and trees grown in the greenhouse, nursery, landscapes and interiorscapes.

REI 12 Hrs

**RATE** 10 to 20oz per 100gal**ACTIVE INGREDIENT** Thiophanate-methyl**CONTROLS** Anthracnose, Botrytis, Fusarium, Thielaviopsis, and many more.**2.5gal****OHP986125** Min. Buy 1eaShipping Info **HAZARDOUS****OHP 6672® 50WP Fungicide**by **OHP, INC.**

OHP 6672 50WP fungicide controls a broad spectrum of diseases of bedding, flowering, herbaceous, vegetable plants, shrubs and trees grown in the greenhouse, nursery, landscapes and interiorscapes.

REI 12 Hrs

**RATE** 10 to 20oz per 100gal**ACTIVE INGREDIENT** Thiophanate-methyl**CONTROLS** Anthracnose, Botrytis, Fusarium, Thielaviopsis, and many more.**2lb****OHP986188** Min. Buy 1ea**OHP Chipco® 26019 N/G Fungicide**by **OHP, INC.**

Chipco 26019 is a broad spectrum fungicide that may be applied safely to a wide range of ornamental flowering and foliage plants, either as a foliar spray, drench, or dip.

REI 12 Hrs

**RATE** 1 to 2lbs per 100gal**ACTIVE INGREDIENT** Iprodione**CONTROLS** Rhizoctonia, Fusarium, Botrytis and more.**2lb****OHP981462** Min. Buy 1ea**Orkestra® Intrinsic® Fungicide**by **BASF CORP**

Orkestra Intrinsic brand fungicide provides nursery and greenhouse growers with fast, long-acting disease control during production, resulting in healthier, more consistent, high quality plants. Orkestra Intrinsic brand fungicide provides preventive, early curative and residual protection against key ornamental diseases, quickly stopping the growth of fungal cells. Delivers dual modes of action for better efficacy and resistance management.

REI 12 Hrs

**RATE** 4 to 10oz per 100gal**ACTIVE INGREDIENT** Fluxapyroxad & Pyraclostrobin**CONTROLS** Botrytis, rust, powdery mildew, downy mildew, anthracnose, leaf spots, thielaviopsis, aerial phytophthora**16 oz bottle AGENCY****BAS59014379** Min. Buy 1ea**80 oz bottle AGENCY****BAS59016487** Min. Buy 1ea**Orvego® Fungicide**by **BASF CORP**

Controls Phytophthora and Downey Mildew on ornamentals. Orvego offers a quick knockdown of spores to stop the disease from spreading. Use in greenhouses, lathouses, container and field nurseries and interiorscapes.

REI 12 Hrs

**RATE** 11 to 14oz per 100gal**ACTIVE INGREDIENT** Ametoctradin & Dimethomorph**CONTROLS** Phytophthora, Downey Mildew.**28 oz bottle****BAS59012736** Min. Buy 1ea**OxiDate® 2.0 Bactericide/Fungicide**by **BIOSAFE SYSTEMS**

Treat and control plant pathogens on a wide range of crops. It is a keystone chemistry that strengthens conventional and organic IPM programs by reducing disease pressure.

**RATE** 32 to 64oz per 100gal.**ACTIVE INGREDIENT** Hydrogen peroxide and peroxyacetic acid**CONTROLS** Bacterial and Fungal pathogens.**2.5gal Bottle****BSF510025** Min. Buy 1eaShipping Info **HAZARDOUS**

## Fungicides and Bactericides

### OxiPhos® Fungicide / Bactericide

by BIOSAFE SYSTEMS

Use throughout the season to treat and control pythium, phytophthora, bacterial blights, downy mildew, and more. OxiPhos has a dual mode of action (systemic and contact) and can be applied as a foliar spray or root drench and is tank mix compatible with ZeroTol® 2.0 and AzaGuard®.

REI 4 Hrs

**ACTIVE INGREDIENT** Phosphorus acid and Hydrogen Peroxide

**CONTROLS** Pythium, Phytophthora and Downy Mildew.



**2.5gal**

**BSF7700-2.5**

Min. Buy 1ea

Shipping Info

**HAZARDOUS**

**55 Gal drum**

**BSF770055**

Min. Buy 1ea

Shipping Info

**HAZARDOUS**



### Pageant® Intrinsic® Fungicide

by BASF CORP

Pageant is a broad-spectrum fungicide that is effective on many plant diseases. Pageant Intrinsic brand fungicide also provides plant health benefits such as improved tolerance to stress and increased efficiency of plant processes.

REI 12 Hrs

**RATE** 4 to 18oz per 100gal

**ACTIVE INGREDIENT** Boscalid & Pyraclostrobin

**CONTROLS** Fusarium, Rhizoctonia, Pythium, Phytophthora, Botrytis and fungal leaf spots.



**1 lb bottle AGENCY**

**BAS59012349**

Min. Buy 1ea

**12 lb bag AGENCY**

**BAS59012429**

Min. Buy 1ea



### Palladium® Fungicide

by SYNGENTA CROP PROTECTION

Combines two active ingredients to provide contact and systemic activity. Effective on a wide range of foliar and stem diseases found in the nursery and greenhouse, including Botrytis, Rhizoctonia, powdery mildew and certain leaf-spotting and stem rot pathogens. Provides preventive and curative disease control with 7-14 days of residual activity.

REI 12 Hrs

**RATE** 2 to 4oz per 100gal

**ACTIVE INGREDIENT** Cyprodinil and Fludioxonil

**CONTROLS** Botrytis, Fusarium, Rhizoctonia and more.



**2lb AGENCY**

**SYN38781**

Min. Buy 1ea



### Pageant® TR Intrinsic® Fungicide

by BASF CORP

Pageant is a broad-spectrum fungicide that is effective on many plant diseases. Pageant Intrinsic brand fungicide also provides plant health benefits such as improved tolerance to stress and increased efficiency of plant processes. Total release fogger. Can also be used in the cargo area of trucks to protect plants during transportation.

REI 12 Hrs

**RATE** One can Covers up to 3,000sq ft. Must be used in a closed greenhouse or truck.

**ACTIVE INGREDIENT** Boscalid & Pyraclostrobin

**CONTROLS** Alternaria, Botrytis, Cercospora, Cylindrocladium, Myrothecium, powdery mildew and rust (Uromyces).



**3 oz aerosol**

**BAS59012766**

Min. Buy 1ea



### Phostrol Fungicide

by NUFARM AMERICAS INC.

Phostrol provides both preventive and curative treatments for pythium and yellow tuft diseases in a clear, odorless liquid formulation. Combining easily with other fungicides, Phostrol is an essential component of any broad spectrum fungicidal program.

REI 4 hours

**RATE** 2 to 5 pints per acre

**ACTIVE INGREDIENT** Mono- and dibasic sodium, potassium and ammonium phosphites

**CONTROLS** Phytophthora, Downy mildew, Pythium



**2.5 gal bottle**

**NTS10264225**

Min. Buy 1ea



## Fungicides and Bactericides

## Phyton 27®

by PHYTON CORP

Phyton 27 is a broad spectrum bactericide/fungicide effective against many pathogens including Botrytis, Leaf Spot, Powdery Mildew, and more. The active ingredient works systemically and provides residual control for up to 21 days. Labeled for use on turf, greenhouse and field grown ornamentals, and nursery stock.

REI 24 hours

RATE Varies depending on application.

ACTIVE INGREDIENT Copper Sulfate Pentahydrate.

CONTROLS Botrytis, Leaf Spot, Downy Mildew, Anthracnose, Powdery Mildew and many more.



1 liter bottle

PHTNP27-101031 Min. Buy 1ea

1 gal bottle

PHTNP27-101011 Min. Buy 1ea



## Phyton 35®

by PHYTON CORP

A broad-spectrum systemic bactericide + fungicide labeled for use on fruit, vegetables, and herbs, as well as ornamentals. Quickly absorbed into plants, enabling the active ingredient to move throughout the plant and be retained in the plant. Leaves no visible residue and won't clog spray nozzles. Formulated for use from propagation up to the time of harvest, it is effective against your most stubborn disease challenges like Botrytis, Bacterial Leaf Spot, Powdery Mildew, Pythium, and more.

REI 48 hours

RATE Varies depending on application.

ACTIVE INGREDIENT Copper Sulfate Pentahydrate.

CONTROLS Botrytis, Leaf Spot, Downy Mildew, Anthracnose, Powdery Mildew and many more.



1 liter bottle

PHTNP35-300034 Min. Buy 1ea

1 gal bottle

PHTNP35-300128 Min. Buy 1ea



## Pipron® Fungicide

by SEPRO CORPORATION

Fast, reliable control of powdery mildew for greenhouse ornamentals. Pipron is a contact fungicide, which provides excellent eradication activity on powdery mildew. It is fast acting, reliable and non-phytotoxic to most species. Pipron boasts a visible mildew kill the same day as it is used, but has no residual activity.

REI 12 Hrs

RATE 4 to 8oz per 100gal

ACTIVE INGREDIENT Piperalin

CONTROLS Powdery mildew



32oz

SEPRO19-0560 Min. Buy 1ea



## ProStar® 70WG Fungicide

by BAYER CROPSCIENCE

ProStar WG is a locally systemic fungicide that includes control of Rhizoctonia and rust diseases. It is the standard control for Sclerotium rolfsii (Southern blight).

REI 12 Hrs

RATE 3 to 12 oz per 100gal

ACTIVE INGREDIENT Flutolanil

CONTROLS Fairy Ring, Brown Patch, Gray Snow Mold, Southern Blight and more.



3lb

BYR80007809 Min. Buy 1ea



## Protect™ DF Fungicide

by NUFARM AMERICAS INC.

Protect DF fungicide provides control of many key diseases in commercial turf, field ornamentals and shade trees, golf courses, groundcovers and herbaceous plants.

REI 24 Hrs

RATE 6 to 8oz per 1,000sq ft

ACTIVE INGREDIENT Mancozeb

CONTROLS Rust, Leaf Spot, Red Thread, Copper Spot, Fusarium and more.



6lb

NTS10506660 Min. Buy 1ea



## Regalia® CG Fungicide / Bactericide

by MARRONE BIO INNOVATIONS

Regalia CG is a preventative biofungicide for control of many foliar and soil borne diseases. Use sites include greenhouse crops, ornamental plants, turf, edible crops, and field crops. Labeled for use on fruits, vegetables, herbs and spices, ornamentals and more.

REI 4 hours

RATE 6 to 11 oz per 100 gal

ACTIVE INGREDIENT Reynoutria sachalinensis

CONTROLS Anthracnose, Downy Mildew, Botrytis, Powdery Mildew, and more.



1qt

MB10084 Min. Buy 1ea

1gal

MB10081 Min. Buy 1ea

2.5 Gallon

MB10096 Min. Buy 1ea

55gal Drum

MB10090 Min. Buy 1ea



## Don't See What You Need?

Use the BFG Mobile app or visit [www.bfgsupply.com](http://www.bfgsupply.com) to see a much larger selection of Fungicides

**RootShield® Biofungicide**

by **BIOWORKS INC.**

RootShield grows on roots, "shielding" them against fungi. One application protects for up to 12 weeks. OMRI listed.



**RootShield® Granules Biofungicide**

by **BIOWORKS INC.**

REI 4 Hrs

**RATE** Varies depending on application method. See label.

**ACTIVE INGREDIENT** Trichoderma harzianum Rifai strain T-22

**CONTROLS** Soilborne plant pathogens and root diseases.



**10lb**

**BW2H03A05** Min. Buy 50ea

Shipping Info [DIRECT](#)

**40lb**

**BW2H03A08** Min. Buy 1ea

Shipping Info [DIRECT](#)

**500lb**

**BW2H03A10** Min. Buy 1ea

Shipping Info [DIRECT](#)

**1,000lb**

**BW2H03A11** Min. Buy 1ea

Shipping Info [DIRECT](#)

**RootShield® PLUS+ Granules Biofungicide**

by **BIOWORKS INC.**

REI 4 Hrs

**RATE** Varies depending on application method. See label.

**ACTIVE INGREDIENT** Trichoderma harzianum Rifai strain T-22 and Trichoderma virens strain G-41

**CONTROLS** Pythium, Rhizoctonia, Fusarium, Cylindrocladium, Thielaviopsis, Phytophthora



**10lb**

**BW2HR46A05** Min. Buy 50ea

Shipping Info [DIRECT](#)

**40lb**

**BW2HR46A08** Min. Buy 1ea

Shipping Info [DIRECT](#)

**500lb**

**BW2HR46A10** Min. Buy 1ea

Shipping Info [DIRECT](#)

**1,000lb**

**BW2HR46A11** Min. Buy 1ea

Shipping Info [DIRECT](#)

**RootShield® WP Biofungicide**

by **BIOWORKS INC.**

REI 4Hrs

**RATE** Varies depending on application method. See label.

**ACTIVE INGREDIENT** Trichoderma harzianum Rifai strain T-22

**CONTROLS** Soilborne plant pathogens and root diseases.



**1lb**

**BWRSWP1** Min. Buy 1ea

Shipping Info [DIRECT](#)

**3lb**

**BW2H02A03** Min. Buy 1ea

Shipping Info [DIRECT](#)

**30lb**

**BW2H02A07** Min. Buy 1ea

Shipping Info [DIRECT](#)

**RootShield® PLUS+ WP Biofungicide**

by **BIOWORKS INC.**

REI 4 Hrs

**RATE** Varies depending on application method. See label.

**ACTIVE INGREDIENT** Trichoderma harzianum Rifai strain T-22 and Trichoderma virens strain G-41

**CONTROLS** Pythium, Rhizoctonia, Fusarium, Cylindrocladium, Thielaviopsis, Phytophthora



**1lb**

**BW2HR45A02** Min. Buy 1ea

Shipping Info [DIRECT](#)

**3lb**

**BW2HR45A03** Min. Buy 1ea

Shipping Info [DIRECT](#)

**30lb**

**BW2HR45A07** Min. Buy 1ea

Shipping Info [DIRECT](#)

NEW

**Pradia** solves your  
insect puzzle.



- New & unique MOA combination
- Controls whiteflies, thrips, aphids & other chewing insects
- Excellent 30 day control
- Translaminar & systemic activity
- Compatible with beneficial insects

**Pradia**<sup>™</sup>  
Insecticide

#pradia 

@OHPsolutions 

ohp.com

(800) 356-4647



⋮ INSECTICIDES  
FUNGICIDES  
MITICIDES  
PGRS  
HERBICIDES

**ohp** | Partners  
with  
solutions

## Fungicides and Bactericides

## Segovis® Fungicide

by SYNGENTA CROP PROTECTION

Segovis® fungicide sets a higher standard for control of downy mildew and Phytophthora spp. diseases. Its strong activity and systemic properties provide long-lasting control when applied as a drench or foliar spray at low use rates. Novel mode of action provides a good tool for growers to diversify rotation programs and manage resistance concerns.

REI 4 Hrs

RATE 0.6 to 3.2oz per 100gal

ACTIVE INGREDIENT Oxathiapiprolin

CONTROLS Downy Mildew, Phytophthora.



16oz

SYN58199 Min. Buy 1ea



## Segway O® Fungicide

by OHP, INC.

A flowable suspension concentrate formulation that controls Pythium, crown and root rots, and aerial phytophthora and downy mildews on ornamental plants and vegetables and herbs grown in commercial greenhouses. Should be utilized as a protectant fungicide and applied before conditions are favorable for disease development. Depending on disease pressure, Segway O offers protection for a period of 7 to 28 days.

REI 12 Hrs

RATE 1.5 to 6oz per 100gal

ACTIVE INGREDIENT Cyazofamid

CONTROLS Pythium, Phytophthora, Downy Mildew.



16oz

OHP987200 Min. Buy 1ea

64oz

OHP987245 Min. Buy 1ea



## Spectro® 90WDG Fungicide

by NUFARM AMERICAS INC.

Spectro 90 WDG combines two broad-spectrum fungicides to deliver contact and systemic protection. It prevents and controls disease in turf, annual and perennial flowers, as well as bedding plants, groundcovers and trees and shrubs.

REI 12 Hrs

RATE 1 to 2lbs per 100gal

ACTIVE INGREDIENT Chlorothalonil and Thiophanate-methyl

CONTROLS Anthracnose, Brown Rot, Leaf Scabs, Fusarium, Rhizoctonia and many more.



5lb

NTS10501045 Min. Buy 1ea



## Spirato® GHN Fungicide

by NUFARM AMERICAS INC.

Spirato GHN fungicide controls foliar, stem and root diseases in ornamentals grown in greenhouses and landscapes. Also labeled for control of certain diseases on select vegetable plants.

REI 12 Hrs

RATE 2 to 4oz per 100gal

ACTIVE INGREDIENT Fludioxanil

CONTROLS Rhizoctonia, Botrytis, Fusarium and more.



16oz

NTS10726861 Min. Buy 1ea



## Stargus® Fungicide

by MARRONE BIO INNOVATIONS

Stargus® is a biological fungicide for control of fungal and bacterial plant diseases. Use sites include field and greenhouse crops. Can be used on bushberries and caneberries, bulb vegetables, citrus crops and most vegetables.

REI 4 hours

RATE Varies according to application. See label for rate information.

ACTIVE INGREDIENT bacillus amyloliquefaciens strain F727

CONTROLS Downy Mildew, Black Spot, Botrytis, Fusarium, Pythium, Rhizoctonia and more.



2.5 Gallon

MB10077 Min. Buy 1ea



## Stature® SC Fungicide

by BASF CORP

Stature SC fungicide is a flowable formulation of dimethomorph. Proven performance for preventative control of Phytophthora and Downy mildew diseases. Can be applied as a spray, drench, or through chemigation.

REI 12 Hrs

RATE 3.06 to 12.25oz per 100gal

ACTIVE INGREDIENT Dimethomorph

CONTROLS Downy Mildew, Aerial Phytophthora, Phytophthora Root/Crown/Stem Rot



25oz

BAS59011288 Min. Buy 1ea



## Subdue MAXX® Fungicide

by SYNGENTA CROP PROTECTION

Subdue MAXX is a systemic fungicide that provides control of damping off, root and stem diseases caused by Pythium and Phytophthora as well as foliar diseases including Downy Mildew. Labeled for use on ornamentals, foliar and flowering plants, non bearing fruit and nut trees and landscapes and interiorscapes.

REI 48 Hrs

RATE 1oz per 100gal

ACTIVE INGREDIENT Mefenoxam

CONTROLS Phytophthora, Pythium, Downy Mildew.



32oz

CH149 Min. Buy 1ea

1gal AGENCY

SYN53195 Min. Buy 1ea

10gal Link Pak AGENCY

SYN53185 Min. Buy 1ea



## Subdue® G Fungicide

by SYNGENTA CROP PROTECTION

A granular formulation of Subdue Maxx. Use on bedding plants, flowers, perennials, shrubs and other ornamental plants in outdoor landscapes and interiorscapes to control damping-off, downy mildew and root and stem rot diseases caused by Pythium and Phytophthora. Apply either as a soil surface application or incorporate into the soil at the time of seeding and transplanting.

REI 48 Hrs

RATE 1.6 to 8oz per cubic yard

ACTIVE INGREDIENT Mefenoxam

CONTROLS Phytophthora, Pythium, Downy Mildew.



25lb

SYN53181 Min. Buy 1ea



## Fungicides and Bactericides

**Terraclor 400® Fungicide**

by OHP, INC.

An effective ornamental soil fungicide for prevention and control of soil borne diseases caused by Rhizoctonia solani and other soil borne diseases. For use on ornamentals and vegetable bedding plants. Works primarily as a preventative agent through contact activity and should be applied before disease symptoms appear in order to achieve optimum results. Applications at first sign of disease have curative properties as well.

REI 12 Hrs

RATE 6 to 12oz per 100gal

ACTIVE INGREDIENT PCNB

CONTROLS Root Rot/Stem Rot, Bulb Rot/Crown Rot, Magnolia Leaf Spot.



1gal

OHP988464 Min. Buy 1ea

**Terraguard® SC Fungicide**

by OHP, INC.

A locally systemic fungicide that provides protection of hard to control diseases. Can be used as a cutting soak, soil drench, foliar spray or through chemigation for control of diseases on ornamental plants and greenhouse grown tomatoes and cucumbers in enclosed commercial structures, shade houses and interiorscapes. It prevents diseases from attacking leaf surfaces as it penetrates the plant where applied to stop disease development.

REI 12 Hrs

RATE 2 to 16oz per 100gal

ACTIVE INGREDIENT Triflumizole

CONTROLS Rhizoctonia, Powdery Mildew, Thielaviopsis and more.



32oz

OHP988466 Min. Buy 1ea

**Tourney® Fungicide**

by NUFARM AMERICAS INC.

Controls a broad spectrum of diseases affecting outdoor woody ornamental plants in nursery and landscape settings, including powdery mildew, apple scab, rusts, leaf spots, anthracnose and Rhizoctonia root and crown rot-all with just one product. Also takes out tough diseases in turf like anthracnose, brown patch, summer patch, take-all patch, fairy ring, dollar spot, necrotic ring spot, gray leaf spot, snow mold and other patch diseases.

REI 12 Hrs

RATE 1 to 4oz per 100gal

ACTIVE INGREDIENT Metconazole

CONTROLS Anthracnose, Brown Rot, Leaf Scabs, Fusarium, Rhizoctonia and many more.



5lb

VAL19-0401A Min. Buy 1ea

**Transom™ 4.5F Fungicide**

by PROKOZ, INC

A liquid flowable systemic turf and ornamental fungicide for control of a broad spectrum of diseases of herbaceous, bedding, flowering and tropical foliage plants, shrubs, trees and flowers in the landscape, interiorscape, nursery and greenhouse, containerized woody shrubs and trees and turf grass.

REI 12 Hrs

RATE 12 to 20oz per 100gal

ACTIVE INGREDIENT Thiophanate-Methyl

CONTROLS Anthracnose, Botrytis, Powdery Mildew, Rhizoctonia and more.



2.5gal bottle

PROKZ10349225 Min. Buy 1ea

Shipping Info HAZARDOUS

**Terrazole® 35W Fungicide**

by OHP, INC.

An effective soil fungicide for prevention and control of damping-off, root rot and stem diseases caused by Pythium and Phytophthora species in ornamental, nursery crops and golf course tees and greens.

REI 12 Hrs

RATE 3.5 to 10 oz per 100gal

ACTIVE INGREDIENT Etridiazole

CONTROLS Pythium and Phytophthora.



2lb

OHP988472 Min. Buy 1ea

**Terrazole® L Fungicide**

by OHP, INC.

An effective soil fungicide for prevention and control of damping-off, root rot and stem diseases caused by Pythium and Phytophthora species in ornamental, nursery crops and golf course tees and greens.

REI 12 Hrs

RATE 2.5 to 7 oz per 100gal

ACTIVE INGREDIENT Etridiazole

CONTROLS Pythium and Phytophthora.



32oz

OHP988478 Min. Buy 1ea

**Triathlon BA® Biofungicide / Bactericide**

by OHP, INC.

A broad-spectrum preventative biofungicide for control of a wide variety of fungal and bacterial diseases on ornamentals, fruits, vegetables, herbs and spices grown in greenhouses, nurseries and shade houses, Triathlon BA is approved for use in organic production.

REI 4 Hrs

RATE Varies depending on application method. See label.

ACTIVE INGREDIENT Bacillus amyloliquefaciens strain D747

CONTROLS Botrytis, Powdery Mildew, Downy Mildew and more.



1gal

OHP988544 Min. Buy 1ea





**Trinity® TR Fungicide**

by **BASF CORP**

Provides broad spectrum control of several key diseases. Total release fogger. For use in greenhouses on bedding plants, cut flowers, flowering hanging baskets, foliage, potted flowering plants, ornamentals and perennials.

REI 12 Hrs

RATE One can Covers 1,500sq ft

ACTIVE INGREDIENT Triconazole

CONTROLS Alternaria, Botrytis, Cylindrocladium, Fusarium, Myrothecium, Powdery Mildew, and Rhizoctonia.



4 oz aerosol

BAS59012781 Min. Buy 1ea



**Truban® 25EC Fungicide**

by **ICL/SPECIALTY FERTILIZERS**

Soil fungicide for the control of damping off, root and stem rot diseases caused by Pythium and Phytophthora in bedding plants, ornamental and nursery crops. Labeled for use in commercial greenhouses and nurseries. Liquid formulation.

REI 12 Hrs

RATE 4 to 8oz per 100gal

ACTIVE INGREDIENT Etridiazole

CONTROLS Damping Off, Stem and Root Rot Diseases caused by Pythium and Phytophthora



32oz

EVR950441E Min. Buy 1ea



**Truban® 30 WP Fungicide**

by **ICL/SPECIALTY FERTILIZERS**

Soil fungicide for the control of damping off, root and stem rot diseases caused by Pythium and Phytophthora in bedding plants, ornamental and nursery crops. Labeled for use in commercial greenhouses and nurseries. Wettable powder formulation.

REI 12 Hrs

RATE 3 to 10oz per 100gal

ACTIVE INGREDIENT Etridiazole

CONTROLS Damping Off, Stem and Root Rot Diseases caused by Pythium and Phytophthora



2lb

EVR957001E Min. Buy 1ea



**ZeroTol® 2.0 Fungicide / Bactericide**

by **BIOSAFE SYSTEMS**

Treat and control foliar and root diseases on contact. ZeroTol 2.0 is ideal for flowering plants, trees and shrubs, food crops, cannabis/hemp, and more. Leaves no harmful residue and can be applied as a foliar spray or drench.

REI 1 Hr

RATE Varies according to application method. See label.

ACTIVE INGREDIENT Hydrogen peroxide and peroxyacetic acid

CONTROLS Botrytis, Powdery Mildew, Phytophthora, Pythium and more.



2.5gal

BSF600025 Min. Buy 1ea

Shipping Info HAZARDOUS

30gal Drum

BSFTO600030 Min. Buy 1ea

Shipping Info HAZARDOUS

55gal Drum

BSFTO600055 Min. Buy 1ea

Shipping Info HAZARDOUS



**ZeroTol® HC Hydro**

by **BIOSAFE SYSTEMS**

Quickly eliminate plant pathogens such as powdery mildew, botrytis, and pythium. ZeroTol HC is ideal for the indoor or hydroponics grower with under 500 sq. ft. Use as a foliar spray, hard surface treatment, and in hydroponics or aquaponics systems.

RATE .75 to 1 oz per gallon

ACTIVE INGREDIENT Hydrogen peroxide and peroxyacetic acid

CONTROLS Algae, Powdery Mildew, Botrytis, and more



1 Gallon

BSF62001 Min. Buy 1ea



**Zio® Fungicide**

by **SEPRO CORPORATION**

Zio® Fungicide is a revolutionary bacteria hand-selected from a library of 60k+ microbes to protect plants against destructive diseases and improve quality. It colonizes the plant while producing compounds to control harmful plant pathogens including Rhizoctonia (Brown Patch), Pythium and anthracnose. Zio has been scientifically proven to provide preventative control of resistant fungi utilizing multiple modes-of-action (MoA).

REI 4 Hrs

ACTIVE INGREDIENT Pseudomonas chlororaphis strain AFS009

CONTROLS Dollar Spot, Rhizoctonia, Pythium, Phytophthora, Botrytis, Anthracnose, Fusarium, Brown Patch and Pythium Blight



5lb AGENCY

SEPRO454545 Min. Buy 1ea



# PYTHIUM/PHYTOPHTHORA ROOT ROTS

## *Control Strategies*

### **Background:**

Pythium infects a wide host range and is more common in the greenhouse. Phytophthora is less common in the greenhouse and more common in the nursery and is more host-specific. Phytophthora has been shown to be more aggressive than Pythium. Both of them can survive for many years in the soil and on debris in the greenhouse. Pythium and Phytophthora are referred to as the water molds and they are both in the family Pythiaceae.

### **Symptoms:**

Pythium can cause damping off, and crown/stem rots. Phytophthora causes root/crown rots as well as foliar blight. Symptoms on the leaves are the first to show because the roots are too compromised to take up the nutrients needed for the plant. The leaves could be yellow, stunted or wilted. When the roots are examined they will be soft and mushy and may appear to be water soaked, glassy, and dark brown. The outer covering of the root will separate easily from the inner root by gently pulling on it and it will appear slimy. Healthy roots are white and hard, so it is very easy to tell when you have Pythium or Phytophthora. To differentiate between the two though a sample will need to be sent to a lab for identification.

### **Favorable Development Conditions/Disease Cycle:**

The favorable conditions for Pythium and Phytophthora are wet soils, mild temperatures, high soil EC and low oxygen in the soil. They can be spread by fungus gnats and shore flies. They can also be spread by using spore contaminated media, supplies or water. Recirculation of contaminated irrigation water in an irrigation system can spread the disease as well. The spores can last a long time until the roots are stressed and then that allows the spores to infect the roots and then the disease will spread.

### **Cultural Control:**

Previously used pots or supplies need to be washed and disinfected before use. If using field soil, have it disinfected before use. Throw away infected plants as soon as possible to limit the spread of the disease. If using recycled irrigation water, have it tested and treat if necessary. Sanitation of all areas is key to limiting the spread of the disease.

### **Chemical Control:**

There are a number of fungicides that are labeled and are effective for Pythium/Phytophthora root rots. Some species of Pythium in the greenhouse have been shown to be resistant to Subdue Maxx. All fungicides for Pythium and Phytophthora control should be applied as a drench.



*Always read and follow label directions before applying any pesticide and follow state and local regulations*

### **For more information or to place an order**

Please contact your BFG Sales Representative or our Customer Service Team!



**Empress** 24oz BAS59014402



(Pyraclostrobin) Group 11. Warning. 12hr REI. Rate: 1-6oz/100gal. Contact. Labeled for use in the greenhouse and nursery, and on fruit and nut trees. Do not use on grapes, nine bark, and wintercreeper.



**Terrazole 35WP** 2lb OHP988472



(Etridiazole) Group 14. Caution. 12hr REI. Rate: 3.5-10oz/100gal. Contact. Labeled for use in the greenhouse and nursery.



**Segway O** 16oz OHP987200 64oz OHP987245



(Cyazofamid) Group 21. Caution. 12hr REI. Rate: 1.5-6oz/100gal. Contact, Limited Systemic. Labeled for use in the greenhouse and nursery, as well as on some vegetables and herbs.



**Aliette WDG** 5lb BYR84956465



(Aluminum Tris) Group 33. Caution. 12hr REI. Rate: 6-12oz/100gal. Systemic. Labeled for use in the greenhouse and nursery, as well as on some vegetables and herbs.



**RootShield Plus WP** 1lb BW2HR45A02 3lb BW2HR45A03 30lb BW2HR45A07



(Trichoderma harzianum Rifai strain T-22, Trichoderma virens strain G-41) OMRI Group BM-02. Caution. 4hr REI. Rate: 3-8oz/100gal. Contact. Labeled for use in the greenhouse and nursery, as well as on fruits, vegetables, herbs, and tree nuts.



**Adorn** 32oz VAL61510.928



(Fluopicolide) Group 43. Caution. 12hr REI. Rate: 1-4oz/100gal. Locally Systemic, Translaminar. Labeled for use in the greenhouse and nursery. Should trial for phytotoxicity on plants not on label prior to use. Adorn must be tank mixed with another product labeled for Pythium/Phytophthora for resistance management.



**Subdue Maxx** 1gal SYN53195 32oz CH149



(Mefanoxam) Group 4. Caution. 48hr REI. Rate: 0.5-1oz/100gal. Systemic. Labeled for use in the greenhouse and nursery.



**Phostrol** 2.5gal NTS10264225



(Mono and dibasic sodium, potassium, and ammonium phosphites) Group 33. Caution. 4hr REI. Rate: 5-10oz/100gal. Systemic. Labeled for use in the greenhouse and nursery, as well as on vegetables, fruits, and herbs.

**Beneficial Soil Inoculant****BioWorks® R.S.S.I.™ WP Microbial Inoculant**by **BIOWORKS INC.**

R.S.S.I.™ is a microbial soil inoculant that can be drenched on all types of vegetables, herbs, ornamentals and tree seedlings. It will augment the natural microbial activity in the soil and increase the available nutrients to the plant.

**RATE** 4 to 8 oz per 100 gallons**ACTIVE INGREDIENT** Trichoderma harzianum strain T-22 + Trichoderma virens strain G-41**30lb bag****BW2HR41A07** Min. Buy 1eaShipping Info **DIRECT****Nature's Source® Plant Probiotic**by **BALL DPF, LLC**

Contains a beneficial microbial complex to feed your soil. Aids in nutrient breakdown, availability, and absorption while reducing nutrient leaching. Reduce planting/transplant shock for better plant establishment. Stimulates root development and nutrient uptake also increases tolerance to environmental stress.

**5lb****DANL7502US** Min. Buy 1eaShipping Info **DIRECT****PerFect Amendment Soil Additive**by **AL-PAR PEAT CO.**

Patented beneficial Streptomyces on an iron and humic acid carrier that when added to the soil produces healthier plants that more effectively resist stress and may reduce or eliminate the need for chemical fungicides. PerFect Amendment allows for faster and stronger rooting, more robust root zones, larger, healthier plants, long term greening and vigor. Enhances root development. Includes complexed iron & humic acid. Promotes plant vigor & strength. For Greenhouse, Nursery, Turf Grass and Agricultural use. Substitute for Actino-Iron

**REI** 0 Hours**ACTIVE INGREDIENT** Streptomyces, Iron, Humic Acid**50lb****ALP10020** Min. Buy 1ea**TerraGrow® Beneficial Soil Inoculant**by **BIOSAFE SYSTEMS**

A beneficial soil inoculant designed to improve soil characteristics and plant stress tolerance. Quickly re-establishes beneficial bacteria/fungal populations in and around the root zone.

**RATE** 1 to 4oz per 100gal**ACTIVE INGREDIENT** Blend of six microbial organisms.**4lb****BSF71004** Min. Buy 1eaShipping Info **DIRECT****10lb****BSF710010** Min. Buy 1eaShipping Info **DIRECT****25lb****BSF710025** Min. Buy 1eaShipping Info **DIRECT****Sustane® Bolster® MycoBio™**by **SUSTANE NATURAL FERTILIZER INC**

Bolster® MycoBio™ is a blend of endo mycorrhizae species and beneficial bacteria, with humic acid and compost to support the proliferation of soil microorganisms. Bolster® MycoBio™ is used for inoculating soils and growing media with beneficial microbiology for improved nutrient cycling and to amend soil to improve seedling success and promote vigorous plant establishment.

**1lb (12/cs) Case Only****SNF60606061** Min. Buy 1ea**6lb (4/cs) Case Only****SNF60606065** Min. Buy 1ea**40lb (40/pl)****SNF60606060** Min. Buy 1ea**"BOLSTER" PLANT GROWTH,  
AND YOUR BOTTOM LINE!****SUSTANE**  
Naturally...**NEW!**

Proven products to promote rapid root development, superior growth, and protect roots from drought, stress, transplant shock, pathogens, and soil contaminants.

Known world-wide as... *simply the best...*  
fertilizers and soil builders.

Visit [www.sustane.com](http://www.sustane.com) today for more information  
or call +1 (507) 263 3003 or 1 (800) 352 9245.

**Mycorrhizae**

**MycoApply® Professional Products**

by MYCORRHIZAL APPLICATIONS LLC

These beneficial fungi greatly increase the effective rooting area of plants, thereby enhancing plant growth, vigor, and tolerance of environmental extremes.

**MycoApply Injector Endo**

by MYCORRHIZAL APPLICATIONS LLC

MycoApply Injector Endo is a suspendable powder mycorrhizal inoculum, formulated for use with horticulture injector dosing equipment.

REI 0 hours

RATE See label

ACTIVE INGREDIENT 4 species of Endomycorrhizae.



100gr

MAAS1011504455 Min. Buy 1ea



**MycoApply® Endo**

by MYCORRHIZAL APPLICATIONS LLC

MycoApply Endo is a granular material containing mycorrhizal propagules, which colonize roots and extend into the surrounding soil forming an essential link between plants and soil resources. Increasing the root area allows improved access to water and nutrients, promoting plant quality and crop performance.

ACTIVE INGREDIENT 4 species of Endomycorrhizae.

Glomus intraradices, Glomus mosseae, Glomus aggregatum, Glomus etunicatum



40lbs

MAFMAEN40 Min. Buy 1ea

Shipping Info [DIRECT](#)



**MycoApply® Endo / Ecto**

by MYCORRHIZAL APPLICATIONS LLC

MycoApply Endo/Ecto is a granular mycorrhizal inoculum.

ACTIVE INGREDIENT 4 species of Endomycorrhizae. Plus 7 species of Ectomycorrhizae.



40lbs

MAFMAENEC40 Min. Buy 1ea

Shipping Info [DIRECT](#)



**MycoApply® Soluble MAXX**

by MYCORRHIZAL APPLICATIONS LLC

MycoApply Soluble Maxx is a suspendable powder mycorrhizal inoculum.

ACTIVE INGREDIENT 9 species of Endomycorrhizae. Plus 10 species of Ectomycorrhizae. Plus 12 species of beneficial bacteria and 2 species of Trichoderma.



1lb

MAFMASOLMX10 Min. Buy 1ea



**MycoApply® Ultrafine Endo**

by MYCORRHIZAL APPLICATIONS LLC

MycoApply Ultrafine Endo is a suspendable powder mycorrhizal inoculum consisting of 4 species of endomycorrhizal fungi. OMRI Listed. Bullet Points: 4 species Endomycorrhizae, Glomus intraradices, Glomus mosseae, Glomus aggregatum, Glomus etunicatum, 130,000 Endomycorrhizal Propagules per lb.

ACTIVE INGREDIENT 4 species of Endomycorrhizae.



1lb

MAAS1000304455 Min. Buy 10ea

20lbs

MAFMAUEN20 Min. Buy 1ea

Shipping Info [DIRECT](#)



**MycoApply® Ultrafine Endo / Ecto**

by MYCORRHIZAL APPLICATIONS LLC

MycoApply Ultrafine Endo/Ecto is a suspendable powder mycorrhizal inoculum consisting of 4 species of endomycorrhizal fungi and 7 species of ectomycorrhizal fungi. OMRI Listed. Bullet Points: 4 species Endomycorrhizae, Glomus intraradices, Glomus mosseae, Glomus aggregatum, Glomus etunicatum, 130,000 Endomycorrhizal Propagules per lb., 7 species Ectomycorrhizae, Rhizopogon villosulus, Rhizopogon luteolus, Rhizopogon amylopogon, Rhizopogon fulvigleba, Pisolithus tinctorius, Scleroderma cepa, Scleroderma citrinum, 110 million Ectomycorrhizal Propagules per lb.

ACTIVE INGREDIENT 4 species of Endomycorrhizae. Plus 7 species of Ectomycorrhizae.



1lb

MAAS1050204455 Min. Buy 1ea

20lb

MAFMAUENEC20 Min. Buy 1ea

Shipping Info [DIRECT](#)



**PRO-MIX® Mycorrhizal Inoculant**

by PREMIER TECH

PRO-MIX® Mycorrhizal Inoculant is a highly concentrated formulation designed to help professional growers to CONNECT and improve the value of their crops. Based on the growth cycle of plants, it is intended to be applied at key moments to ensure a quick connection in order to establish an extra radicular network. The extended root system resulting from the symbiotic relationship allows to enhance water and nutrient uptake, resulting in stronger, healthier crops.



250gr

PRBMC025179NPBX Min. Buy 1ea



5.5lb

PRBMC250179NP Min. Buy 1ea

Shipping Info [DIRECT](#)



# REFERENCE GUIDE for GREENHOUSE and NURSERY PRODUCTION INSECTICIDES / MITICIDES

## RESISTANCE MANAGEMENT

Pest populations that are over exposed to a single pesticide may develop resistance to that pesticide. Resistance is due to the innate ability of some individuals in the pest population to survive even after being treated with a pesticide. When using pesticides repeatedly for crop protection, it is important to manage pesticide resistance by rotating chemicals with different modes of action (MOA) on the target pest or combining chemicals with different modes of action in the tank/spray mix.

When labels permit, make two (2) applications of a product or tank mix in sequence, then rotate to products with different modes of action to improve coverage on target life stages of the pest. Try to avoid applying pesticides with the same mode of action to more than one generation of the pest per cycle.

Good resistance management starts with accurate identification of the pest problem and good record-keeping of all pesticide applications.

Time pesticide applications to coincide with the susceptible life stage of the pest based on their life cycle.

The appropriate and labeled (legal) method of application is also a very important factor to consider.

Low volume (L.V.) applications (smoke generator, thermal fog, cold fog, aerosol, and electrostatic) are commonly used in greenhouses. Low volume sprays generally are more effective against adults than immature stages. Use high volume sprays, directed under the leaves for best results against insect and mite eggs and nymphs.

Always read the label and check with your state or county extension specialists for further information regarding resistance management.

**\*\*Use Site(s) Key:** GH = Greenhouse N = Nursery



### (by Mode of Action Group and Class)

MOA Group*	Class	Common Name	Trade Name	REI	Use Site(s)**	Company
1A	Carbamates	Carbaryl	Sevin <sup>®</sup>	12	N	Bayer Environmental Science
		Methiocarb	Mesuro <sup>®</sup>	24	GH/N	Gowan Company
1B	Organophosphates	Acephate	Orthene <sup>®</sup> TT&O	24	GH/N	Amvac Chemical Corp.
		Chlorpyrifos	Orthene <sup>®</sup> TR	24	GH	BASF
			DuraGuard <sup>®</sup> ME	24	GH/N	BASF
			Dursban <sup>®</sup> 50 WP	24	N	Corteva Agriscience
		Malathion	Gowan Malathion 8F	12	N	Gowan Company
		Phosmet	Imidan <sup>®</sup> 70W	24	N	Gowan Company
2B	Phenylpyrazoles	Fipronil	TopChoice <sup>®</sup>	24	N	Bayer Environmental Science
3	Pyrethroids	Bifenthrin	Talstar <sup>®</sup>	12	GH/N**	FMC Corp.
			OnyxPro <sup>®</sup>	12	N	FMC Corp.
			Attain <sup>®</sup> TR	12	GH	BASF
			<b>Decathlon<sup>®</sup></b>	12	GH/N	<b>OHP, Inc.</b>
		Fenpropathrin	Tame <sup>®</sup>	24	GH/N	Nufarm
		Fluvalinate	Mavrik <sup>®</sup> Aquaflo	12	GH/N	Wellmark International
		Lambda-Cyhalothrin	Scimitar <sup>®</sup> GC	24	GH/N	Syngenta
		Permethrin	Astro <sup>®</sup>	12	GH	FMC Corp.
			Permethrin 3.2 EC	12	GH/N***	Helena / Agri-Enterprise
			Ambush <sup>®</sup>	12	GH/N***	Amvac Chemical Corp.
				*** Greenhouse roses only		
Botanicals	Pyrethrins	Pyrethrum <sup>®</sup> TR	12	GH	BASF	
		PyGanic <sup>®</sup>	12	GH/N	Mycorrhizal Applications	

\* Depends on Greenhouse ventilation

\*\* Greenhouse and/or nursery uses depend on the formulation. Check labels for uses.



# Insecticides / Miticides *continued*

(by Mode of Action Group and Class)

MOA Group*	Class	Common Name	Trade Name	REI	Use Site(s)**	Company
4A	Neonicotinoids	Acetamiprid	TriStar <sup>®</sup>	12	GH/N	Nufarm
		Dinotefuran	Safari <sup>®</sup>	12	GH/N	Nufarm
		Imidacloprid	<b>Marathon<sup>®</sup></b>	0-12	GH/N	<b>OHP, Inc.</b>
			Corectect Tree & Shrub Tablets™	12	GH/N	Bayer Environmental Science
	Thiamethoxam	Flagship <sup>®</sup>	12	GH/N	Syngenta	
4D	Butenolides	Flupyradifrone	Altus™	4	GH/N	Bayer Environmental Science
5	Spinosyns	Spinosad	Conserve <sup>®</sup>	4	GH/N	Corteva Agriscience
			Entrust <sup>®</sup>	4	GH/N	Corteva Agriscience
6	Glycosides	Abamectin	Avid <sup>®</sup>	12	GH/N	Syngenta
		Milbemectin	Ultiflora <sup>®</sup>	12	N	Gowan Company
7A	Juvenile hormone mimics	s-Kinoprene	Enstar <sup>®</sup> AQ	12	GH	Wellmark International
7B	Juvenile hormone mimics	Fenoxycarb	Award <sup>®</sup>	12	N	Syngenta
7C	Pyridine - Insect Growth Regulators	Pyriproxyfen	Distance <sup>®</sup>	12	GH/N	Nufarm
			<b>Fulcrum<sup>®</sup></b>	12	GH/N	<b>OHP, Inc.</b>
9A	Pyridine azomethines	Pymetrozine	Endeavor <sup>®</sup>	12	GH/N	Syngenta
9B	Pyridine azomethines	Pyrifluquinazon	Rycar <sup>®</sup>	12	GH	SePRO Corp.
10A	Tetrazines	Clofentezine	<b>Notavo<sup>®</sup></b>	12	GH/N	<b>OHP, Inc.</b>
	Thiazolidinones	Hexythiazox	Hexygon <sup>®</sup> IQ	12	GH/N	Gowan Company
10B	2, 4 - Diphenyloxzoline Derivatives	Etoxazole	TetraSan <sup>®</sup>	12	GH/N	Nufarm
			Beethoven™ TR	4-24*	GH	BASF
11	Biopesticides	<i>Bacillus thuringiensis</i> Kurstaki	DiPel <sup>®</sup> Pro DF	4	GH/N	Nufarm
		<i>Bacillus thuringiensis</i> Israelensis	Gnatrol <sup>®</sup>	4	GH/N	Nufarm
13	Pyrroles	Chlorfenapyr	Pylon <sup>®</sup>	12	GH	BASF
15	Benzoylureas - Insect Growth Regulators	Diflubenzuron	<b>Adept<sup>®</sup></b>	12	GH	<b>OHP, Inc.</b>
			<b>Dimilin<sup>®</sup> WP</b>	12	GH/N**	<b>OHP, Inc.</b>
			<b>Pedestal<sup>®</sup></b>	12	GH/N	<b>OHP, Inc.</b>
16	Buprofezin	Buprofezin	Talus <sup>®</sup>	12	GH/N	SePRO Corp.
17	Cyromazine - Insect Growth Regulators	Cyromazine	Citation <sup>®</sup>	12	GH/N	Syngenta

\* Depends on Greenhouse ventilation

\*\* Greenhouse and/or nursery uses depend on the formulation. Check labels for uses.

# Insecticides / Miticides *continued*

(by Mode of Action Group and Class)

MOA Group*	Class	Common Name	Trade Name	REI	Use Site(s)**	Company	
18	Diacylhydrazines	Tebufenozide	Confirm <sup>®</sup>	4	N	Gowan Company	
		Methoxyfenozide	Intrepid <sup>®</sup>	4	GH/N	Corteva Agriscience	
20A	Trifluoromethyl Aminohydrazone	Hydramethylnon	Amdro <sup>®</sup> Pro	12	N	BASF	
20B	Napthoquinone Derivatives	Acequinocyl	<b>Shuttle<sup>®</sup> O</b>	12	GH/N	<b>OHP, Inc.</b>	
20D	Carbazates	Bifenazate	<b>Floramite<sup>®</sup></b>	12	GH/N	<b>OHP, Inc.</b>	
21A	METI Acaricides and Insecticides	Pyridaben	Sanmite <sup>®</sup>	12	GH/N	Gowan Company	
		Fenpyroximate	Akari <sup>®</sup>	12	GH	SePRO Corp.	
		Tolfenpyrad	Hachi-Hachi <sup>®</sup>	12	GH	SePRO Corp.	
		Fenazaquin	Magus <sup>®</sup>	12	GH/N	Gowan Company	
22B	Semicarbazone	Metaflumizone	Siesta <sup>™</sup>	12	GH/N	BASF	
23	Tetronic acids	Spiromesifen	Savate <sup>®</sup>	12	GH/N	Bayer Environmental Science	
		Tetramic acids	Spirotetramat	Kontos <sup>®</sup>	0-24	GH/N	Bayer Environmental Science
25A	Beta-ketonitrile	Cyflumetofen	Sultan <sup>™</sup>	12	GH/N	BASF	
28	Anthranillic diamide	Cyantraniliprole	Mainspring <sup>®</sup>	4	GH/N	Syngenta	
		Chlorantraniliprole	Acelepryn <sup>®</sup>	4	GH/N	Syngenta	
		Diamide	Cyclaniliprole	<b>Sarisa<sup>®</sup></b>	4	GH/N	<b>OHP, Inc.</b>
29	Pyridine carboxamides	Fonicamid	Aria <sup>®</sup>	12	GH/N	FMC Corp.	
UN	Biopesticide Insect	Azadirachtin	<b>Azatin<sup>®</sup> O</b>	4	GH/N	<b>OHP, Inc.</b>	
		Pyridalyl	Pyridalyl	Overture <sup>®</sup>	12	GH	Nufarm
UNF	Biopesticides: Fungal Agents	<i>Beauveria bassiana</i>	BotaniGard <sup>®</sup>	4	GH/N	BioWorks Inc.	
			BioCeres WP <sup>®</sup>	4	GH/N	Biosafe Systems	
			Mycotrol <sup>®</sup> O	4	GH/N	BioWorks, Inc.	
			<i>Isaria fumosorosea</i> Apopka Strain 97 (ATCC20874)	<b>Ancora<sup>®</sup></b>	4	GH/N	<b>OHP, Inc.</b>
UNE	Oils	Botanical oil	Captiva <sup>®</sup>	4	GH/N	Gowan Company	
		Clarified hydrophobic extract of neem oil	<b>Triact 70<sup>®</sup></b>	4	GH/N	<b>OHP, Inc.</b>	
UNM	Soaps	Potassium salts of fatty acids	AllPro <sup>®</sup> Insecticidal Soap	12	GH/N	Value Garden Supply	
			<b>Kopa<sup>™</sup> Insecticidal Soap</b>	12	GH/N	<b>OHP, Inc.</b>	
			M-Pede <sup>®</sup>	12	GH/N	Gowan Company	
			Mineral oil	Ultra-Pure <sup>™</sup> Oil	4	GH/N	BASF
			Suffoil-X <sup>™</sup>	4	GH/N	BioWorks, Inc.	

\* Depends on Greenhouse ventilation

\*\* Greenhouse and/or nursery uses depend on the formulation. Check labels for uses.





# Insecticides / Miticides *continued*

(by Mode of Action Group and Class)

MOA Group*	Class	Common Name	Trade Name	REI	Use Site(s)**	Company
3+UN	Pyrethrins + Oils	Pyrethrins + Canola Oil	<b>Pycana</b> ®	12	GH/N	<b>OHP, Inc.</b>
	Pyrethrins	Pyrethrins + Piperonyl butoxide	Evergreen® Pro 60-6	12	GH/N	Mycorrhizal Applications
1+3	Organophosphate + Pyrethroid	Chlorpyrifos + Cyfluthrin	DuraPlex® TR	24	GH	BASF
3+4A	Pyrethroid + Neonicotinoid	Cyfluthrin + Imidacloprid	<b>Discus</b> ® L	12	GH/N	<b>OHP, Inc.</b>
4C+5	Sulfoximines + Spinosyns	Sulfoxaflor + Spinetoram	Xxpire	12	GH/N	Corteva Agriscience
6 + 20D	Glycoside+Carbazate	Abamectin + Bifenazate	<b>Sirocco</b> ®	12	GH/N	<b>OHP, Inc.</b>
28 + 29	Diamide + Pyridine carboxamides	Cyclanilprole + Flonicamid	<b>Pradia</b> ®	12	GH/N	<b>OHP, Inc.</b>

## \*Insecticides / Miticides Mode of Action

1. Acetylcholinesterase inhibitors. Inhibition of the enzyme acetylcholinesterase, interrupting the transmission of nerve impulses.
2. GABA-gated chloride channel antagonists: Interferes with GABA receptors of insect neurons, leading to repetitive nervous discharges.
3. Sodium channel modulators: Acts as an axonic poison by interfering with the sodium channels of both the peripheral and central nervous system stimulating repetitive nervous discharges, leading to paralysis.
4. Nicotinic acetylcholine receptor (nAChR) agonists. Binds to nicotinic acetylcholine receptor disrupting nerve transmission.
5. Nicotine acetylcholine receptor allosteric modulators - Site I.
6. Glutamate-gated chloride channel allosteric modulators.
7. Juvenile hormone mimics (Insect growth regulator): Mimic juvenile hormones, which prevent molting from the larval to the adult stage.
9. Chordotonal organ TRPV channel modulators.
10. Mite growth inhibitors affecting CHS1
11. Microbial disruptors of insect midgut membranes.
12. Inhibitors of mitochondrial ATP synthase.
13. Uncoupler of oxidative phosphorylation via disruption of the proton gradient.
15. Inhibitors of chitin biosynthesis affecting CHS1
16. Inhibit chitin biosynthesis – type 1
17. Molting disruptor, Dipteran
18. Ecdysone receptor agonists.
20. Mitochondrial complex III electron transport inhibitors. Energy metabolism.
21. Mitochondrial complex I electron transport inhibitors
22. Voltage-dependent sodium channel blockers: Nerve action
23. Inhibitors of acetyl CoA carboxylase
25. Mitochondrial complex II electron transport inhibitors
28. Ryanodine receptor modulators
29. Chordotonal organ Modulators – undefined target site: Nerve
- UN Products with unknown or uncertain MoA
- UNE Botanical essence including synthetic, extracts and unrefined oils with unknown or uncertain MoA
- UNF Fungal agents of unknown or uncertain MoA
- UNM Non-specific mechanical disruptors

This list is from the U.S Environmental Protection Agency, in cooperation with the Insecticide Resistance Action Committee (IRAC). IRAC is a technical working group within the Global Crop Protection Federation (GCPF). More information on the Insecticide Resistance Action Committee and the Mode of Action Classification is available from: [www.irac-online.org](http://www.irac-online.org).

# Insecticide Reference Chart

**Always Refer to Product Label!**

Product	Active Ingredient	OMRI Listed	Aphids	Beetles	Borers	Caterpillars	Fungus Gnats	Leafhoppers	Leafminers	Leafrollers	Mealybugs	Mites	Plant Bug	Scale	Shore Flies	Slugs & Snails	Thrips	Whiteflies
Acephate 97 WDG	Acephate		X	X	X	X		X	X	X	X		X	X			X	X
Adept	Diflubenzuron						X		X						X			
Akari 5SC	Fenpyroximate										X	X						X
Altus	Flupyradifurone		X	X				X	X		X		X	X			X	X
Ancora	Isaria fumosorosea Apopka Strain 97	OMRI	X			X			X		X	X	X				X	X
Aria	Flonicamid		X					X			X		X	X			X	X
Astro	Permethrin		X	X	X	X	X	X	X	X	X		X				X	X
Attain TR	Bifenthrin		X			X	X			X	X	X	X	X			X	X
Avalon	Bifenthrin		X	X	X	X	X	X	X	X	X	X	X	X			X	X
Avid	Abamectin		X						X			X					X	X
Aza-Direct	Azadirachtin	OMRI	X	X	X	X	X	X	X	X	X	X		X	X		X	X
AzaGuard	Azadirachtin	OMRI	X	X	X	X	X	X	X	X	X	X		X	X		X	X
Azatin O	Azadirachtin	OMRI	X	X	X	X	X	X	X	X	X	X		X	X		X	X
Beethoven TR	Etoxazole											X						X
Benefit 60WP	Imidacloprid		X	X	X		X	X	X		X			X			X	X
BioCeres WP	Beauveria bassiana		X	X	X								X				X	X
BotaniGard	Beauveria bassiana		X	X				X			X		X				X	X
Botanigard Maxx	Beauveria bassiana, Pyrethrins		X	X	X	X	X	X		X	X	X	X				X	X
Captiva Prime	Capsicum, Garlic Oil, Soybean Oil	OMRI			X	X		X			X	X	X				X	X
Citation	Cyromazine						X		X						X			
Conserve SC	Spinosad			X		X			X	X					X		X	
CoreTect	Imidacloprid		X	X	X			X	X	X	X		X	X			X	X
Deadline Ornamental	Metaldehyde															X		
Decathlon 20WP	Cyfluthrin		X	X		X	X	X		X	X		X				X	X
Dimilin 25W	Diflubenzuron					X	X		X						X			X
DiPel Pro DF	Bacillus thuringiensis kurstaki	OMRI			X	X				X								
Discus L	Cyfluthrin, Imidacloprid		X	X		X	X	X	X		X	X	X	X			X	X
Distance IGR	Pyriproxyfen		X				X		X		X			X	X			X
Duraguard ME	Chlorpyrifos		X	X		X	X	X	X		X	X	X	X	X		X	
Dursban 50W	Chlorpyrifos		X	X	X	X		X	X	X	X	X	X	X			X	X
Endeavor	Pymetrozine		X															X
Enstar AQ	S-Kinoprene		X				X		X		X			X			X	X
Entrust SC	Spinosad	OMRI		X		X			X	X					X		X	
EverGreen Pro	Pyrethrins, Piperonyl butoxide		X	X	X	X	X	X		X	X		X				X	X
Flagship 25WG	Thiamethoxam		X	X			X	X	X		X		X	X			X	X
Floramite SC	Bifenazate											X						
Forbid 4F	Spiromesifen											X						X
Fulcrum	Pyriproxyfen						X		X		X			X	X			X
Gnatrol WDG	Bacillus Thuringiensis israelensis	OMRI					X											
Grandevo	Chromobacterium	OMRI	X	X	X	X		X	X	X	X	X	X	X			X	X
Hachi-Hachi SC	Tolfenpyrad		X			X		X			X			X			X	X
Hexygon IQ	Hexythiazox											X						
IronFist	Sodium Ferric EDTA															X		

# Insecticide Reference Chart

*continued*

**Always Refer to  
Product Label!**

Product	Active Ingredient	OMRI Listed	Aphids	Beetles	Borers	Caterpillars	Fungus Gnats	Leafhoppers	Leafminers	Leafrollers	Mealybugs	Mites	Plant Bug	Scale	Shore Flies	Slugs & Snails	Thrips	Whiteflies
Kontos	Spirotetramat		X					X			X	X		X			X	X
Kopa	Potassium salts Fatty Acid	OMRI	X	X		X		X			X	X	X	X				X
Mainspring GNL	Cyantranilprole		X	X	X	X			X				X	X			X	X
Magus	Fenazaquin											X						X
Mallet .5G	Imidacloprid		X	X	X		X	X	X		X			X			X	X
Mallet 2F	Imidacloprid		X	X	X		X	X	X		X			X			X	X
Marathon 1G	Imidacloprid		X	X	X		X	X	X		X			X			X	X
Marathon II	Imidacloprid		X	X	X		X	X	X		X			X			X	X
Mavrik Aquaflow	Tau-fluvalinate		X	X		X		X			X	X	X				X	X
Millenium	Steinernema carpocapsae						X								X			
Minx 2	Abamectin		X						X			X					X	X
M-Pede	Potassium salts Fatty Acid	OMRI	X	X		X		X			X	X	X	X				X
Mycotrol	Beauveria bassiana	OMRI	X	X				X			X		X				X	X
Nemashield	Steinernema feltiae						X										X	
Nemasys	Steinernema feltiae						X										X	
NoFly WP	Isaria fumosorosea FE 9901	OMRI	X	X			X	X			X	X	X				X	X
Notavo	Clofentezine											X						
Onyx Pro	Bifenthrin		X	X	X	X	X	X	X	X	X	X	X	X			X	X
Orthene	Acephate		X	X		X	X	X	X	X	X	X	X	X			X	X
Overture	Pyridalyl					X											X	
Pedestal	Novaluron					X			X				X				X	X
Pradia	Cyclanilprole, Flonicamid		X	X	X	X			X	X	X		X	X			X	X
Pycana	Pyrethrins, Canola oil	OMRI	X	X	X	X	X	X	X	X	X	X	X	X			X	X
Pyronyl Crop Spray	Pyrethrins, Piperonyl butoxide		X	X	X	X	X	X	X	X	X		X				X	X
Pyganic Specialty	Pyrethrins	OMRI	X	X	X	X	X	X	X	X	X	X	X	X	X		X	X
Pylon	Chlorfenapyr					X	X					X					X	
Pyrethrum TR	Pyrethrins		X	X		X	X	X			X	X		X			X	X
Rycar	Pyrifluquinazon		X					X			X						X	X
Safari 20SG	Dinotefuran		X	X	X	X	X	X	X		X		X	X			X	X
Sanmite SC	Pyridaben		X					X				X						X
Sarisa	Cyclanilprole		X	X	X	X			X	X	X			X			X	X
Savate	Spiromesifen											X						X
Scimitar GC	Lambda-cyhalothrin		X	X		X		X	X	X	X	X	X	X			X	X
Sevin SL	Carbaryl		X	X	X	X		X	X	X	X	X	X	X			X	X
Shuttle O	Acequinocyl											X						
Sirocco	Bifentate, Abamectin		X						X			X					X	X
Spear-T	GS-Omega/Kappa-HXTA-HV1A		X									X					X	X
Suffoil-X	Mineral Oil	OMRI	X	X			X	X		X	X	X	X	X			X	X
Sultan	Cyflumetofen											X						
Talstar	Bifenthrin		X	X	X	X	X	X	X	X	X	X	X	X			X	X
Talus 70DF	Buprofenzin							X			X			X				X
Tame 2.4EC	Fenpropathrin		X	X		X		X	X	X	X	X	X	X			X	X
TetraCURB	Rosemary Oil		X								X	X					X	X

# Insecticide Reference Chart *continued*

**Always Refer to Product Label!**

Product	Active Ingredient	OMRI Listed	Aphids	Beetles	Borers	Caterpillars	Fungus Gnats	Leafhoppers	Leafminers	Leafrollers	Mealybugs	Mites	Plant Bug	Scale	Shore Flies	Slugs & Snails	Thrips	Whiteflies
TetraSan 5WDG	Etoxazole											X						
Triact 70	Neem oil	OMRI	X					X			X	X	X					X
Tristar 8.5SL	Acetamiprid		X	X	X	X	X	X	X	X	X	X	X	X			X	X
Ultra-Pure Oil	Mineral Oil		X	X			X	X	X	X	X	X	X	X			X	X
Velifer	Beauveria bassiana strain PPRI 5339		X								X	X					X	X
Venerate CG	Burkholderia spp. Strain A396 cells	OMRI	X		X	X		X	X	X	X	X	X	X			X	X
Ventigra	Afidopyropen		X								X		X					X
XXpire	Spinetoram, Sulfoxaflor		X	X		X				X	X	X	X	X	X		X	X



**Acelepryn® Insecticide**

by SYNGENTA CROP PROTECTION

Acelepryn insecticide provides season long grub control with a single application in April or May. Also controls many surface feeding pests including beetles and weevils. Liquid formulation for foliar ornamental applications.

REI 4 hours

RATE 2 to 8oz per 100gal.

ACTIVE INGREDIENT Chlorantraniliprole

CONTROLS White Grub, Japanese Beetles, Caterpillars, Black Cutworms, Sod Webworms, Bluegrass Weevil.



4oz

SYN70042 Min. Buy 1ea

64oz Bottle AGENCY

SYN57749 Min. Buy 1ea



**Altus® Insecticide**

by BAYER CROPSCIENCE

Altus Insecticide is used for the control of insect pests in a wide variety of greenhouse vegetable and ornamental crops and in outdoor nursery and landscape ornamentals. A broad-spectrum insecticide that is acropetally systemic, moving from roots to the leaves in the case of soil applications. Moves translaminarily through the leaf tissue in the case of foliar applications and can provide control of pests on the underside of leaves.

REI 4 Hrs

RATE Foliar: 7 to 14oz per 100gal. Drench: 3.7 oz per 100gal

ACTIVE INGREDIENT Flupyradifurone

CONTROLS Adelgids, Aphids, Leafhoppers, Mealybugs, Scales and more.



64oz AGENCY

BYR84989509 Min. Buy 1ea



**Acelepryn® G Insecticide**

by SYNGENTA CROP PROTECTION

Acelepryn turf insecticide provides season long grub control with a single application in April or May. Also controls many surface feeding pests including beetles and weevils.

REI 4 Hrs

RATE 50-100lbs per Acre

ACTIVE INGREDIENT Chlorantraniliprole

CONTROLS White Grub, Caterpillars, Black Cutworms, Sod Webworms, Bluegrass Weevil.



25lb

SYN53199 Min. Buy 1ea



**Ancora® Microbial Insecticide**

by OHP, INC.

Ancora contains a naturally occurring fungus that infects both foliage and soil insect pests. Ancora is compatible with beneficial arthropods and is labeled for use on herbs, vegetables and ornamentals. Ancora has a 4-hour REI and can be used in organic production.

REI 4 Hrs

RATE 14 to 28 oz per 100gal

ACTIVE INGREDIENT Isaria fumosorosea Apopka strain 97

CONTROLS Aphids, Leafminers, Mealybugs, Thrips, Mites and more.



1lb

OHP981070 Min. Buy 1ea



**Adept® WSP Insecticide**

by OHP, INC.

An effective tool for controlling fungus gnats, shore flies and foliar feeding pests found in ornamental crops grown in greenhouses, shade houses and interiorscapes.

REI 12 Hrs

RATE 1-2oz per 100gal

ACTIVE INGREDIENT Diflubenzuron

CONTROLS Armyworms, Leafminers, Fungus Gnats, Shore Flies.



16 x 1oz Packets

OHP981012 Min. Buy 1ea



**Aria® Insecticide**

by FMC

Through contact and ingestion, the active ingredient in Aria stops both adult and immature aphids from feeding within one hour of treatment and eliminates them within three to five days as a result of dehydration and starvation. Effectively controls many species of aphids that attack greenhouse plant investments. Designed for minimized impact on birds and honeybees with no effect on coleopterans, lepidopterans or arachnids.

REI 12 hours

RATE 80 to 100grams per 100gal

ACTIVE INGREDIENT Fonicamid

CONTROLS Aphids, Thrips, Whiteflies, Mealybugs and more.



160g

FMC19-0303B Min. Buy 1ea



**Akari® 5SC Miticide / Insecticide**

by SEPRO CORPORATION

A unique "stop-feeding action" not only stops further damage to your plants but also halts the laying of eggs immediately after application. Mites are dead in 4 to 7 days. Active on all life stages, but especially effective on the plant damaging larvae, nymph and adult stages, Akari provides residual action of 21-28 days.

REI 12 Hrs

RATE 16 to 24oz per 100gal

ACTIVE INGREDIENT Fenpyroximate

CONTROLS Mites, Mealybugs, Whiteflies



32oz

SEPROAKARI Min. Buy 1ea



## Insecticides and Miticides

## Astro® Insecticide

by FMC

Astro insecticide controls insect pests on lawns, ornamental trees and shrubs, ornamental plants grown in greenhouses and perimeters of residential, industrial and commercial landscaped areas.

REI 12 Hrs

RATE 4 to 8oz per 100gal

ACTIVE INGREDIENT Permethrin

CONTROLS Aphids, Adelgids, Beetles, Leafhoppers and more.



1gal

FMC19-1001C Min. Buy 1ea



## Attain® TR Insecticide

by BASF CORP

A ready-to-use, ultra-low-volume insecticide fogger that controls a variety of greenhouse insect pests, including aphids, fungus gnats, mealybugs, mites, thrips and whiteflies, along with several other secondary insect pests.

REI 12 Hrs

RATE One 2 oz can treats up to 3,000sq ft.

ACTIVE INGREDIENT Bifenthrin

CONTROLS Aphids, Thrips, Caterpillars, Armyworms, Mealy bugs and more



2oz

BAS59011825 Min. Buy 1ea



## Avalon® GN Insecticide

by PROKOZ, INC

Provides long-lasting residual control of aphids, black vine weevils, scale and other nursery and greenhouse pests without the risk of damaging sensitive plants. It is non-staining and contains no odorous or plant-damaging solvents, so it can be applied to open blooms and colored bracts right up to the day of shipment.

REI 12 Hrs

RATE 5 to 10oz per 100gal

ACTIVE INGREDIENT Bifenthrin

CONTROLS Aphids, Black Vine Weevil, Lace Bugs, Fungus Gnats and many more. See label for complete list.



1 gal bottle

PROKZ10064852 Min. Buy 1ea

Shipping Info RESTRICTED USE



## Avid® .15EC Miticide / Insecticide

by SYNGENTA CROP PROTECTION

For control of leaf miners and mites and suppression of aphids, whiteflies and thrips on ornamental plants. Rain fast within hours of application, offering outdoor application flexibility and is odorless. Also leaves no unsightly residue on plants.

REI 12 Hrs

RATE 4 to 8oz per 100gal

ACTIVE INGREDIENT Abamectin

CONTROLS Leafminers, Mites and suppresses Aphids, Whiteflies and Thrips.



8oz

SYN25873 Min. Buy 1ea

32oz

SYN81141 Min. Buy 1ea

1gal AGENCY

SYN15128 Min. Buy 1ea



## Avid® + Mainspring® GNL

by SYNGENTA CROP PROTECTION

Avid and Mainspring GNL Multipak offers a complete, non-neonic insecticide solution for nursery and greenhouse growers. Contains one gallon Avid 0.15EC and four pints of Mainspring GNL. Minimum buy – 1 case.

REI 12 Hrs

RATE Varies according to application. See label.

ACTIVE INGREDIENT Avid - Abamectin, Mainspring GNL - Cyantraniliprole

CONTROLS Aphids, Thrips, Whiteflies and more



Multipack / Contains 1gal Avid® 0.15EC & 4ea 16oz Mainspring® GNL AGENCY

SYN60499 Min. Buy 1ea

Shipping Info

HAZARDOUS



## Aza-Direct® Biological Insecticide

by GOWAN

Aza-Direct is a broad spectrum biological insecticide that controls key insect pests on greenhouse and outdoor food crops, ornamental plants and shrubs and nursery crops. Its primary mode of action is as an insect growth regulator which inhibits molting and the development of immature insects into healthy adults. Effective repellent and antifeedant thereby affecting both immature and adult insect pests.

REI 4 Hrs

RATE 16 to 32oz per Acre

ACTIVE INGREDIENT Azadirachtin

CONTROLS Aphids, Thrips, Fungus Gnat, Whitefly and more.



2.5gal

GOW14022 Min. Buy 1ea



**Insecticides and Miticides**

**AzaGuard® Insecticide / Nematicide**

by BIOSAFE SYSTEMS

Azadirachtin-based insect control effective on more than 300 species. Acts as an insect growth regulator, anti-feedant, and ovi-position deterrent. Has no known resistance and can be used indoors and outdoors.

REI 4 Hrs

RATE Varies according to application method. See label.

ACTIVE INGREDIENT Azadirachtin

CONTROLS Insects in the larval, pupal and nymphal stages.



32oz

BSF7000-32OZ Min. Buy 1ea

1gal

BSFT070001 Min. Buy 1ea

**Azatin® O Insecticide**

by OHP, INC.

Azatin O is a biological insect growth regulator used to control the larval stage of a broad-spectrum of greenhouse and nursery pests. Azatin O is OMRI listed for organic production and is soft on beneficial insects. Suitable for use on crops such as ornamentals, vegetables, herbs and berries grown in the greenhouse, nurseries, interiorscapes, hydroponics and turf.

REI 4 Hrs

RATE 4 to 16 oz per 100gal

ACTIVE INGREDIENT Azadirachtin

CONTROLS larval stages of many insect pests. See label.



32oz

OHP981221 Min. Buy 1ea

**Beethoven® TR Miticide / Insecticide**

by BASF CORP

Beethoven TR provides control of mites including two-spotted spider mites and suppresses whiteflies. Total release fogger. Beethoven offers quick and easy application, thorough coverage and excellent plant safety.

REI 12 Hrs

RATE 1 Can per 3,000sq ft

ACTIVE INGREDIENT Etoxazole

CONTROLS Mites, Whitefly (Suppression)



2 oz aerosol

BAS5902321 Min. Buy 1ea



**Benefit® 60WSP Insecticide**

by ICL/SPECIALTY FERTILIZERS

A nursery and greenhouse insecticide in a wettable powder formula that controls the most common insect problems. Controls white grub larvae, aphids, mealybugs and other common insects and can be applied as a foliar spray or drench.

REI 12 Hrs

RATE 20g per 100gal

ACTIVE INGREDIENT Imidacloprid

CONTROLS Adelgids, Aphids, Japanese Beetles (adults), Fungus Gnat (larvae), Lacebugs, Leaf Beetles, (including Elm and Viburnum Leaf Beetles), Leafhoppers, Leafminers, Mealybugs, Psyllids, Sawfly larvae, Soft Scale, Thrips (suppression), Whiteflies



100g

EVR956601E Min. Buy 1ea



- Plant Health**
- Scouting**
- Implement Biological Control**

Implementing BioCeres WP, *Beauveria bassiana* bioinsecticide, into IPM programs can greatly reduce pest populations.



For high pest populations combine with most insecticides for additional control and resistance management.

Less extensive infestations can be controlled solely by BioCeres WP or partnered with biological organisms.



**BioSafe Systems**

1.888.273.3088 | BioSafeSystems.com

# APHID *Control Strategies*

There are many different species of Aphids (*Aphis* sp.) that are pests of horticultural crops and landscape plants. Most are small, soft bodied, pear shaped insects with piercing and sucking mouthparts that are used to suck out plant fluids. Aphids can be many colors from green, brown, or black, sometimes covered in a waxy or wooly secretion. One common identifier are the cornicles, two protrusions on their hind end. Adults are usually wingless, although they will produce wings when feeding opportunities decline so they can disperse to other crops.

Aphids can mature from newborn to adult in as little as one week, so populations can explode quickly. They are also capable of reproducing asexually and can give birth to 12 or more live nymphs per day. They typically inhabit newer shoots, leaves and stems. Aphid feeding can cause leaf yellowing, curling and distorted leaves and shoots. This insect exudes a honeydew waste that often turns black with sooty mold. Aphids are also known vectors of plant viruses.

Aphid control can be challenging when using contact insecticides if thorough coverage of the plant and the pest is not achieved. Proper spray volume, pressure, and the use of a spray adjuvant can improve results. Growers can benefit by using systemic or translaminar insecticides when good spray coverage is difficult. Soil applications of systemic insecticides can give longer term control by moving to growing shoots and remaining in the plant tissue.

Brand Name	BFG Item #	Active Ingredient	Mode of Action Group	Notes
Rycar	SEPRO1056.128	Pyrifluquinazon	UN	Contact & Translaminar Soft on Beneficials Greenhouse Only Vegetable Label
Altus	BYR84989509	Flupyradifurone	4D	Translaminar & Systemic Foliar or Drench Application Soft on Beneficials
Pradia	OHP986300	Cyclaniliprole, Fonicamid	28, 29	Contact Soft on Beneficials
Mainspring	SYN58664	Cyantraniliprole	28	Translaminar & Systemic Foliar or Drench Application Soft on Beneficials
AzaGuard	BSF7000-32OZ BSFTO70001	Azadirachtin	UN	Insect Growth Regulator Labeled for Fruits & Vegetables
Enstar AQ	WLMK100502416 WLMK100502900	S-Kinoprene	7	Insect Growth Regulator Greenhouse only
BotaniGard 22WP	BW1B15A02	Beauveria bassiana	UN	Fungal Spore that infects insects Soft on Beneficials, Vegetable label

*Always read and follow label directions before applying any pesticide and follow state and local regulations*

**For more information or to place an order**

Please contact your BFG Sales Representative or our Customer Service Team!







## BIOLOGICAL CONTROLS

The main agents are *Aphidius colemani* for smaller species of Aphids and *Aphidius ervi* for larger species of Aphids. Chrysoperla (Lacewings) are another agent that can be used.



### Rycar SEPRO1056.128



(Pyrifluquinazon) MOA: UN unknown. Caution. 12 HR REI. RATE: 2.4-3.2oz /100gal. Next Generation, new class. Insects stop feeding immediately. Alternative to neonicotinoids. Gentle on pollinators. Contact, ingestion, translaminar. Greenhouse only. Vegetable label.



### Altus BYR84989509



(Flupyradifurone) MOA: 4D. Caution. 4 HR REI. RATE: Foliar 7 - 10.5oz/100gal, Drench 2.8 - 3.7oz/100gal. Translaminar & Systemic, broad spectrum activity. Soft on Beneficials.



### Pradia OHP986300



(Cyclaniliprole, Flonicamid) MOA: 28, 29. Caution. 12 HR REI. RATE: 10 - 17.5oz/100gal. Contact. Soft on Beneficials. Quick knockdown and lasting residual control.



### Mainspring SYN58664



(Cyclaniliprole) MOA: 28. Caution. 4 HR REI. RATE: Foliar 4 - 8oz./100gal., Drench 8 - 12oz/100gal. Translaminar & Systemic. Soft on Beneficials. Broad spectrum activity & lasting residual control.



### AzaGuard BSF7000-32OZ BSFTO70001



(Azadirachtin) MOA: UN unknown. 4 HR REI. OMRI RATE: 8 - 16oz/100gal. Prevents molting, anti-feedant. Insect growth regulator. Can be used on fruits & vegetables.



### Enstar AQ WLMK100502416 WLMK100502900



(S-Kinoprene) MOA: 7. Caution. 4 HR REI. RATE: Preventative rate 16oz/100gal. Curative rate 32oz/100gal. Insect growth regulator, interrupts molting. Broad spectrum activity.



### BotaniGuard 22WP BW1B15A02



(*Beauveria bassiana*) MOA: UN unknown. Caution. 4 HR REI. RATE: 8 - 16oz/100gal. A naturally occurring fungal spore that quickly infects the target insect. Spray must contact pest. Soft on beneficial insects, labeled for vegetables.

## Insecticides and Miticides

**BioCeres® WP Insecticide**

by BIOSAFE SYSTEMS

BioCeres WP uses a proprietary strain of *Beauveria bassiana* fungus to target foliar feeding or soil-borne insect pests and is perfectly suited for reducing insecticide resistance in IPM programs.

REI 4 Hrs

RATE 1 to 3lbs per Acre

ACTIVE INGREDIENT *Beauveria bassiana*

CONTROLS Whiteflies, aphids, thrips, and plant bugs



1lb

BSF68001 Min. Buy 1ea

**BT NOW® Biological Insecticide**

by BIOSAFE SYSTEMS

BT NOW® is a water-based biological insecticide that offers broad spectrum control of Lepidoptera populations on a wide variety of crops. Labeled for outdoor food, non-food, and greenhouse crops.

REI 4 hours

RATE Varies depending on application. See label.

ACTIVE INGREDIENT *Bacillus thuringiensis* ssp. Kurstaki strain EVP-113-19

CONTROLS Armyworm, loopers, leafrollers, moths, caterpillars and more.



1 Gallon

BSF70501 Min. Buy 1ea

**Molt-X® Insect Growth Regulator**

by BIOWORKS INC.

Molt-X is an insect growth regulator for control of a wide variety of greenhouse pests. Safe for beneficial insects. Use sites include: greenhouse vegetable and ornamental crops, nursery, turf, trees and shrubs.

REI 4 Hrs

RATE 8 to 10oz per 100gal

ACTIVE INGREDIENT Azadirachtin

CONTROLS Aphids, Thrips, Whiteflies and more



32oz

BW1MX27A22 Min. Buy 1ea



1gal

BW1MX27A23 Min. Buy 1ea

**BotaniGard® 22WP Mycoinsecticide**

by BIOWORKS INC.

BotaniGard 22WP is a mycoinsecticide for the control of Whitefly, Aphids, Thrips and more. Labeled for use on ornamentals and vegetables in greenhouses, nurseries, commercial landscapes, interiorscapes and turf. Wettable powder formulation.

REI 4 Hrs

RATE 1lb per 100gal

ACTIVE INGREDIENT *Beauveria bassiana* strain GHA

CONTROLS Aphids, Thrips, Whiteflies and more



1lb

BW1B15A02 Min. Buy 1ea

**BotaniGard® ES Mycoinsecticide**

by BIOWORKS INC.

BotaniGard ES is a mycoinsecticide for the control of Whitefly, Aphids, Thrips and more. Labeled for use on ornamentals and vegetables in greenhouses, nurseries, commercial landscapes, interiorscapes and turf. Liquid formulation.

REI 4 Hrs

RATE 32oz per 100gal

ACTIVE INGREDIENT *Beauveria bassiana* strain GHA

CONTROLS Aphids, Thrips, Whiteflies and more



32oz

BW1B14A22 Min. Buy 1ea

1gal

BW1B14A23 Min. Buy 1ea

Shipping Info **DIRECT****BotaniGard® Maxx Insecticide**

by BIOWORKS INC.

BotaniGard Maxx is an insecticide for the control of Whitefly, Aphids, Thrips and more. Labeled for use on ornamentals and vegetables in greenhouses, nurseries, commercial landscapes, interiorscapes and turf. Emulsifiable dispersible oil formulation of *Beauveria bassiana* and natural pyrethrins.

REI 12 Hrs

RATE 32oz per 100gal

ACTIVE INGREDIENT *Beauveria bassiana* and natural pyrethrins

CONTROLS Aphids, Thrips, Whiteflies and more



32oz

BW1B103A22 Min. Buy 1ea

1gal

BW1B103A23 Min. Buy 1ea

2.5gal

BW1B103A24 Min. Buy 1ea

**Captiva Prime® Botanical Insecticide**

by GOWAN

Captiva Prime botanical insecticide agitates Mites and Thrips, flushing them from cover and enhancing contact with the pest. Captiva® Prime can be used as a stand-alone product to repel thrips and mites, stop their feeding and inhibit ovipositing. When used as a tank mix partner with traditional insecticides, it will enhance their activity.

REI 4 Hrs

RATE 16 to 32oz per Acre

ACTIVE INGREDIENT Capsicum extract, Garlic Oil, Canola Oil

CONTROLS Thrips, mites, whitefly



32oz

GOW65700 Min. Buy 1ea

**Citation® 75W Insect Growth Regulator**

by SYNGENTA CROP PROTECTION

Citation is an insect growth regulator that is highly effective against major dipterous pests in ornamentals. Labeled for use on greenhouse crops including ornamentals and vegetable transplants, landscape and container grown ornamentals and bedding plants.

REI 12 Hrs

RATE 2.66oz per 100gal

ACTIVE INGREDIENT Cyromazine

CONTROLS Leafminers, Fungus Gnats, Shoreflies.



1lb

SYN52855 Min. Buy 1ea



**Conserve® SC Insecticide**

by **Corteva**

A turf and ornamental insect control with a unique mode of action derived from a naturally occurring organism. Makes a great rotational insecticide and is highly active at very low use rates. Great for control of thrips and lepidopterans larvae on herbaceous and woody ornamentals grown outdoors, in nurseries or in greenhouses; tree farms or plantations; and turf grass.

REI 4 Hrs

**RATE** Varies depending on application method. See label for complete information.

**ACTIVE INGREDIENT** Spinosad

**CONTROLS** Thrips, lepidopterous larvae, foliage feeding worms and many more. See label for complete list.



**32oz**

**DOW19-0007Z** Min. Buy 1ea



**CoreTect® Insecticide Tablets**

by **BAYER CROPSCIENCE LP**

CoreTect Tree and Shrub Tablets Insecticide will control or significantly reduce populations of insects that attack containerized, newly planted or established trees and shrubs. For use in landscape, interiorscapes and forested areas.

REI 12 Hrs

**RATE** One to two tablets per gallon container.

**ACTIVE INGREDIENT** Imidacloprid

**CONTROLS** Adelgids, Aphids, Leafhoppers, Mealybugs, Scales and more.



**250ct Tablets per Bottle**

**BYR79283261** Min. Buy 1ea



**Decathlon® 20WP Insecticide**

by **OHP, INC.**

A wettable powder insecticide effective for broad spectrum control of crawling and flying insect pests on ornamental and nursery stock. Will not stain.

REI 12 Hrs

**RATE** 1.3 to 1.9 oz per 100gal

**ACTIVE INGREDIENT** Cyfluthrin

**CONTROLS** Aphids, Armyworms, Bagworms, Beetles, Caterpillar, Cutworm, Fungus Gnats, Gypsy Moths, Lace Bugs, Leaf Hopper; Mealybugs, Scales, Thrips, Webworm, Whiteflies



**8oz**

**OHP981789** Min. Buy 1ea



**Dimilin® 25W Insect Growth Regulator**

by **OHP, INC.**

Offers control of a variety of insect pests found on trees and shrubs grown in public and private forests, forest plantings and forest nurseries and Christmas tree and conifer nurseries. Dimilin is effective on foliar feeding insects like armyworms and lepidopterous leafminers.

REI 12 Hrs

**RATE** 2 to 8 oz per acre

**ACTIVE INGREDIENT** Diflubenzuron

**CONTROLS** Fungus Gnat, Shorefly, Sciarid Fly and more.



**5LB**

**OHP982380** Min. Buy 1ea

Shipping Info **RESTRICTED USE**



**DiPel® PRO DF Biological Insecticide**

by **NUFARM AMERICAS INC.**

Dipel Pro is a biological insecticide for control of lepidopterous worms in greenhouse vegetables and ornamentals and landscape plantings.

REI 4 Hrs

**RATE** Varies according to application method. See label.

**ACTIVE INGREDIENT** Bacillus thuringiensis

**CONTROLS** Armyworms, Loopers, Budworms and many more.



**1lb**

**VAL89030.169** Min. Buy 1ea



**Discus® L Insecticide**

by **OHP, INC.**

Discus L Insecticide's two active ingredients provide fast knockdown and broad-spectrum control on ornamentals and non-bearing fruit and nut trees in greenhouses and nurseries.

REI 12 Hrs

**RATE** 25 to 50oz per 100gal

**ACTIVE INGREDIENT** Cyfluthrin and Imidacloprid

**CONTROLS** Armyworms, Japanese beetles, Ticks, Aphids, Thrips, Whitefly and more.



**1gal**

**OHP982420** Min. Buy 1ea



**Distance® Insect Growth Regulator**

by **NUFARM AMERICAS INC.**

Distance insect growth regulator controls whiteflies, fungus gnats, scales and other insects by preventing eggs, larvae and pupae from maturing into adults. Labeled for use on greenhouse and outdoor ornamentals, groundcovers, shrubs and ornamental trees.

REI 12 Hrs

**RATE** 6 to 8oz per 100gal

**ACTIVE INGREDIENT** Pyriproxyfen

**CONTROLS** Fungus Gnat, Leafminers, Scales, Shore flies, Whitefly.



**32oz**

**VAL69730.915** Min. Buy 1ea



**Duraguard® ME Insecticide**

by **BASF CORP**

Broad spectrum insecticide for control of many greenhouse pests. Microencapsulated formulation gives a timed release action that can last up to 30 days. Labeled for use on bedding plants, cut flowers, blooming hanging baskets, foliage and ornamentals.

REI 24 Hrs

**RATE** 25 to 50oz per 100gal

**ACTIVE INGREDIENT** Chlorpyrifos

**CONTROLS** Ants, Aphids, Beetles, Caterpillars, Flies, Fungus Gnat, Leafhoppers, Leaf Miner, Mealybugs, Shore Flies, Spider Mites, Thrips and more



**1gal**

**BAS59011817** Min. Buy 1ea

Shipping Info **RESTRICTED USE HAZARDOUS**



## Insecticides and Miticides

**Dursban® 50W Insecticide**by *Corteva*

An insecticide in water soluble packets designed for use as a spray to control insect pests on trees, turf and ornamental plants. Long-lasting control on over 280 pests on ornamentals and nursery crops.

REI 12 Hrs

RATE 2 to 4 (4.4oz) water soluble packets per 100gal

ACTIVE INGREDIENT Chlorpyrifos

CONTROLS Aphids, Adelgids, Beetles, Leafhoppers and more.

**7 x 4oz Packets****DOW19-0079B** Min. Buy 1eaShipping Info **RESTRICTED USE** **HAZARDOUS****Entrust® SC Insecticide**by *Corteva*

Entrust SC insecticide provides control of lepidopterous larvae, leafminers, thrips and fire ants. Labeled for use on vegetable crops, fruit, herbs, turf, ornamentals and more.

REI 4 Hrs

RATE 4 to 8oz per Acre.

ACTIVE INGREDIENT Spinosad

CONTROLS Caterpillars, worms, leafminers, thrips and more.

**32oz****SA33253**

Min. Buy 1ea

Shipping Info

**HAZARDOUS****Ecotec Plus Botanical Insecticide**by *BRANDT CONSOLIDATED INC.*

Ecotec Plus is a botanical insecticide that offers broad spectrum control of many greenhouse pests. Suitable for use on ornamental and vegetable crops, herbs, fruit and berries and plants grown for medicinal purposes. OMRI® listed

RATE 16 to 64oz per 100gal

ACTIVE INGREDIENT Rosemary Oil, Geraniol and Peppermint Oil

CONTROLS Aphids, beetles, mites, mealybugs, thrips, whitefly and many more.

**2.5gal****BRANDT102601101** Min. Buy 1ea**Evergreen® Pro 60-6**by *MYCORRHIZAL APPLICATIONS LLC*

Evergreen® Pro 60-6 is a botanical based multi-purpose insecticide for use on growing crops, ornamentals, stored products, and harvested fruits and vegetables. Can be also used as a water system treatment for hydroponically grown vegetables.

REI 12 hours

RATE 12 to 24 oz per 100 gallons

ACTIVE INGREDIENT Pyrethrins and Piperonyl butoxide

CONTROLS Most insect pests. See label for complete list.

**1 Gallon****MAAS1750204012** Min. Buy 1ea**Endeavor® Insecticide**by *SYNGENTA CROP PROTECTION*

Safely eliminates sap-sucking aphids and whiteflies with its unique mode of action. When sprayed on the plant, there is some initial contact activity, but the primary mode of action and residual control occurs through insect feeding inhibition. Works in tandem with biological pest control programs to further protect plants.

REI 12 hours

RATE 3 to 5oz per 100gal

ACTIVE INGREDIENT Pymetrozine

CONTROLS Aphids and Whiteflies.

**15oz bottle****SYN62959** Min. Buy 1ea**Flagship® 25WG Insecticide**by *SYNGENTA CROP PROTECTION*

Flagship 25WG is a broad spectrum insecticide that is effective against many sucking and chewing insects when applied to the foliage and soil. Flagship has rapid translaminar movement and is readily taken up by the plant roots.

REI 12 Hrs

RATE 4 to 8oz per 100gal

ACTIVE INGREDIENT Thiamethoxam

CONTROLS Aphids, Thrips, Whiteflies, Leaf Beetles and many more.

**2lb AGENCY****SYN27748**

Min. Buy 1ea

**Enstar® AQ Insect Growth Regulator**by *CENTRAL LIFE SCIENCES*

Enstar AQ insect growth regulator offers broad-spectrum control of many insect pests. For use on ornamental plants in greenhouses, shade houses and interiorscapes.

REI 4 Hrs

RATE 16-32fl oz per 100gal

ACTIVE INGREDIENT S-Kinoprene

CONTROLS Aphids, Fungus gnats, Beetles, Mites, Thrips, Whitefly and more.

**32oz****WLMK100502416** Min. Buy 1ea**1gal****WLMK100502900** Min. Buy 1ea**Floramite® SC Miticide**by *OHP, INC.*

Produces quick knockdown through contact activity and long residual control of more than 21 days. Soft on predacious mites and beneficial insects. Provides outstanding control of a variety of mite pests on ornamental plants. Labeled for commercial greenhouses and nurseries

REI 12 Hrs

RATE 4 to 8oz per 100gal

ACTIVE INGREDIENT Bifenazate

CONTROLS Spider mites

**32oz****OHP982718**

Min. Buy 1ea



**Floramite® SC/LS Miticide**

by **OHP, INC.**

Produces quick knockdown through contact activity and long residual control of more than 21 days. Soft on predacious mites and beneficial insects. Provides outstanding control of a variety of mite pests on ornamental plants. Labeled for interiorscapes, landscapes and residential (not for plants grown for resale).

REI 12 Hrs

RATE 4 to 8oz per 100gal

ACTIVE INGREDIENT Bifenazate

CONTROLS Spider mites



8oz

OHP982714 Min. Buy 1ea



**Grandevo® CG Insecticide / Miticide**

by **MARRONE BIO INNOVATIONS**

Grandevo® is a microbial-based insecticide. Grandevo contains several active compounds that repel, stop feeding, reduce reproduction and induce mortality to prevent the development of damaging populations of sucking and chewing insects, flies and mites. Grandevo can be used on a wide range of organic and conventional crops, including fruits, vegetables, nuts and turf and ornamentals.

REI 4 hours

ACTIVE INGREDIENT Chromobacterium subsugae strain PRAA4-1

CONTROLS Aphids, Whitefly, Psyllids, Mealybugs, Thrips, and more.



11b

MB10085 Min. Buy 1ea



**Forbid® 4F Miticide**

by **BAYER CROPSCIENCE**

Offers outstanding knockdown and residual control of mites and all stages of whiteflies for four to eight weeks. Excellent translaminar activity for easier coverage and has minimal effects on beneficial insects when used according to label directions.

REI 12 Hrs

RATE 1.4 to 4oz per 100gal

ACTIVE INGREDIENT Spiromesifen

CONTROLS Spider mites, Tarsonemid mites, Whiteflies.



8oz bottle

PROKZ19-0522W Min. Buy 1ea



**Grandevo® WDG Insecticide / Miticide**

by **MARRONE BIO INNOVATIONS**

Grandevo® is a microbial-based insecticide. Grandevo contains several active compounds that repel, stop feeding, reduce reproduction and induce mortality to prevent the development of damaging populations of sucking and chewing insects, flies and mites. Grandevo can be used on a wide range of organic and conventional crops, including fruits, vegetables, nuts and turf and ornamentals.

REI 4 Hr

RATE 1 to 3lbs per 100gal

ACTIVE INGREDIENT Chromobacterium subsugae strain PRAA4-1

CONTROLS Mites, whitefly, mealybug, thrips, aphids



61b

MB10047 Min. Buy 1ea



**Fulcrum® Insect Growth Regulator**

by **OHP, INC.**

Fulcrum Insecticide is highly effective against a broad-spectrum of greenhouse and nursery insects. Fulcrum controls nymphs/larvae and pupae and negatively affects development of viable eggs. Use sites include: shrubs, ornamentals, flowering and foliage plants, ground covers and non-bearing fruit and nut trees.

REI 12 Hrs

RATE 2 to 8oz per 100gal

ACTIVE INGREDIENT Pyriproxyfen

CONTROLS Aphids, Fungus Gnats, Leafminers, Whiteflies and more.



32oz

OHP982840 Min. Buy 1ea



**Hachi-Hachi® SC Insecticide**

by **SEPRO CORPORATION**

Hachi-Hachi SC provides superior thrips and aphid control with no known resistance and excellent efficacy on scale, leafhoppers and early instar lepidopteran insects.

REI 12 Hrs

RATE 14 to 32oz per 100gal

ACTIVE INGREDIENT Tolfenpyrad

CONTROLS Thrips, Aphids, Scale, Leafhoppers, Lepidopteran Insects, Whiteflies



64oz AGENCY

SEPRO1159.464 Min. Buy 1ea



**Gnatrol® WDG Insecticide**

by **NUFARM AMERICAS INC.**

Gnatrol biological insecticide offers effective control of fungus gnat larvae in greenhouse ornamentals and vegetable plants and nurseries. Gnatrol is OMRI listed for organic production.

REI 4 Hrs

RATE 3.2 to 26oz per 100gal

ACTIVE INGREDIENT Bacillus thuringiensis

CONTROLS Fungus Gnat larvae.



16lb

VAL60215.146 Min. Buy 1ea



**Hexygon IQ Ovicide/Miticide**

by **GOWAN**

Hexygon miticide provides long-lasting control of mites in ornamental plants and nonbearing fruit trees grown in greenhouses and nurseries. Other use sites include greenhouse tomatoes and select peppers, established ornamental landscape plantings and turf.

REI 12 hours

RATE 4 to 8 oz per 100 gal

ACTIVE INGREDIENT Hexythiazox

CONTROLS Many species of spider mite



1qt

GOW76283 Min. Buy 1ea



## Insecticides and Miticides

**Kontos® Insecticide**by **BAYER CROPPSCIENCE**

Highly effective control of sucking pests including Adelgids, Aphids, Leafhoppers, Mealybugs, Psyllids, Scales, Thrips and Whiteflies. Up to 30 days of residual control. Can be applied by spray or drench application. For use in nurseries, greenhouses and interior plantscapes on ornamentals, vegetable transplants and non-bearing fruit trees.

REI 24 Hrs

RATE 1.7 to 3.4 oz per 100gal

ACTIVE INGREDIENT Spirotetramat

CONTROLS Adelgids, Aphids, Leafhoppers, Mealybugs, Scales and more.



250ml (8.45oz) AGENCY

BYR84915440 Min. Buy 1ea

**Kopa® Insecticidal Soap**by **OHP, INC.**

Kopa insecticidal soap for control of insect and mite pests on vegetables, fruits and ornamental plants grown in greenhouses and outdoors.

REI 12 Hrs

RATE 1 to 3gal per 100gal

ACTIVE INGREDIENT Potassium salts of fatty acids

CONTROLS Wide variety of soft bodied insects and powdery mildew.



2.5gal

OHP985025 Min. Buy 1ea

**LEPROTEC® bt Bioinsecticide**by **VESTARON CORPORATION**

Leprotec is a versatile, liquid formulation of the lepidopteran active Bt kurstaki strain EVB-113-19. It may be used in a wide range of crops including outdoor food, non-food and greenhouses for control of loopers, worms and other caterpillars. Leprotec is OMRI listed, giving growers the flexibility to use on conventional as well as organic acreage.

REI 4 hours

RATE 1-3.5 pints per acre

ACTIVE INGREDIENT Bacillus thuringiensis ssp. kurstaki strain EVB-113-19

CONTROLS Lepidopteran pests such as caterpillars, loopers and worms



1gal

VES192441 Min. Buy 4ea

**Magus® Miticide**by **GOWAN**

A highly effective broad-spectrum miticide with excellent contact and ingestion activity against tetranychid, eriophyid and other key mite pests. It provides quick knockdown and residual activity against mites on a wide range of ornamental crops. Magus is also highly effective at controlling powdery mildew in susceptible crops.

REI 12 Hrs

RATE 12 to 24oz per 100gal

ACTIVE INGREDIENT Fenazaquin

CONTROLS Mites and Whitefly.



32oz

GOW54293 Min. Buy 1ea

Shipping Info **HAZARDOUS****Mainspring® GNL**by **SYNGENTA CROP PROTECTION**

Mainspring GNL insecticide guards greenhouse and nursery crops from key chewing and sucking pests, including thrips, whiteflies, aphids, caterpillars, leafminers, leaf-feeding beetles, soft scales and lacebugs. Controls multiple key pests as a spray or drench, providing extended protection through its systemic and translaminar movement to prevent pest populations from building to damaging levels

REI 4 hours

RATE Foliar- 1 to 12 oz per 100 gal.

Drench - 8 to 12oz per 100 gal.

ACTIVE INGREDIENT Cyantraniliprole

CONTROLS Leafminers, Thrips, Whiteflies, Beetles and more.



16oz AGENCY

SYN58664 Min. Buy 1ea

1 Gallon AGENCY

SYN66345 Min. Buy 1ea

**Mallet® .5G Insecticide**by **NUFARM AMERICAS INC.**

Mallet 0.5G Insecticide protects plants from within, providing fast knock-down, broad-spectrum control, long-lasting grub and insect control with preventive and curative properties. Labeled for use on greenhouse ornamentals, nursery, landscape and turfgrass.

REI 12 hours

RATE 1 to 2 lbs per 1,000 sq ft

ACTIVE INGREDIENT Imidacloprid

CONTROLS Most turf insect pests including Weevils, June bugs, European Chafer, Crickets, and more.



30lb

NTS10176032 Min. Buy 1ea

**Mallet® 2F T&O Insecticide**by **NUFARM AMERICAS INC.**

Mallet 2F Insecticide is a liquid concentrate for the contact and systemic control of insect pests in nearly all residential and commercial settings. Mallet 2F is a neonicotinoid insecticide with long-lasting, residual control in ornamentals, turfgrass, nurseries, vegetable plants in greenhouses and more.

REI 12 Hrs

RATE 2oz per 100gal

ACTIVE INGREDIENT Imidacloprid

CONTROLS Aphids, Lace bugs, Mealybugs, Thrips, Whitefly and more.



1gal

NTS10432041 Min. Buy 1ea

2.5gal

NTS10432225 Min. Buy 1ea



## Insecticides and Miticides

## Marathon® G Insecticide

by OHP, INC.

A highly-active insecticide that demonstrates systemic activity in plants and offers residual control on ornamental plants. A granular formula when applied to the soil surface or incorporated into the media offers up to 8 weeks of residual control.

REI 12 Hrs

**RATE** Varies depending on application method. See label.

**ACTIVE INGREDIENT** Imidacloprid**CONTROLS** Aphids, Fungus Gnat, Whitefly and more.**5lb****OHP985495** Min. Buy 1ea**50lb****OHP985350** Min. Buy 1ea

## Mavrik Aquaflow® Insecticide / Miticide

by CENTRAL LIFE SCIENCES

The fast-acting formulation kills a broad-spectrum of greenhouse and nursery pests on contact or through ingestion. It is non-phytotoxic, even on open blooms, which makes it ideal for all plants.

REI 12 Hrs

**RATE** 4-10oz per 100gal**ACTIVE INGREDIENT** Tau-fluvalinate**CONTROLS** Aphids, Fungus gnats, Beetles, Mites, Thrips, Whitefly and more.**32oz****WLMK38060A** Min. Buy 1ea**1gal****WLMK38040A** Min. Buy 1ea

## Marathon® II Insecticide

by OHP, INC.

A highly-active insecticide that demonstrates systemic activity in plants and offers residual control on ornamental plants for resale grown in the greenhouse, nursery, and interior plantscapes. A flowable formulation that allows for a foliar spray application. At very low rates Marathon II as a spray offers 3 to 4 weeks of control on sucking and piercing insects.

REI 12 Hrs

**RATE** 50ml per 100gal**ACTIVE INGREDIENT** Imidacloprid**CONTROLS** Aphids, Fungus Gnat, Whitefly and more.**250ml (8.45oz)****OHP985250** Min. Buy 1ea

## Minx 2® Insecticide

by NUFARM AMERICAS INC.

Delivers quick and broad-spectrum mite and leafminer control in a new low volatile organic compound (VOC), water-based formula. It also works to suppress aphids, whiteflies and thrips. Compared to many other Abamectin products, Minx 2 offers added application flexibility and applicator comfort.

REI 12 Hrs

**RATE** 4 to 8oz per 100gal**ACTIVE INGREDIENT** Abamectin**CONTROLS** Mites, Leafminers, Thrips, Aphids, Whiteflies**32oz****NTS10666432** Min. Buy 1ea**1gal****NTS10666041** Min. Buy 1ea

# MIGHT VS MITE

## WE'LL BET ON MIGHT

### INTRODUCING OUR MOST POWERFUL MITE PROGRAM YET

Team proven TetraSan® and Minx™ 2 with NEW Engulf™ GHN  
Greenhouse and Ornamental Miticide to knock down mites at every life stage.



TetraSan®  
MITICIDE

Minx™ 2  
MITICIDE / INSECTICIDE

NUFARM.COM/USTURF

©2021 Nufarm. Engulf™ is a trademark of Nufarm Americas, Inc. TetraSan® is a trademark of Valent U.S.A. LLC. Minx™ is a trademark of Cleary Chemical, LLC.

**Nufarm**  
Grow a better tomorrow

## Insecticides and Miticides

## M-Pede® Insecticide / Miticide / Fungicide

by GOWAN

Natural, safe, insecticide, miticide and fungicide that provides excellent contact control of various soft bodied insects, mites and powdery mildew throughout their life cycles.

REI 12 Hrs

**RATE** Varies depending on application method. See label.

**ACTIVE INGREDIENT** Potassium Salts of Fatty Acids

**CONTROLS** Aphids, Thrips, Fungus Gnat, Whitefly and more. Effective against Powdery Mildew.



2.5gal

GOW52822

Min. Buy 1ea

## Mural® + Mainspring® GNL Fungicide / Insecticide

by SYNGENTA CROP PROTECTION

Mural fungicide and Mainspring GNL insecticide together in one multipak offers protection from ornamental diseases and pests. Multipak contains 3lbs of Mural and 2 pts of Mainspring.

REI 12 Hrs

**RATE** Varies according to application. See label.

**ACTIVE INGREDIENT** Mainspring-Cyantraniliprole, Mural-Azoxystrobin, Benzovindiflupyr

**CONTROLS** Aphids, Thrips, Whiteflies and more as well as ornamental diseases.



Multipack / Contains 3lb Mural® &amp; 2ea 16oz

Mainspring® GNL AGENCY

SYN60500

Min. Buy 1ea

## Mycotrol® ESO Mycoinsecticide

by BIOWORKS INC.

Mycotrol ESO is a mycoinsecticide for the control of Whitefly, Aphids, Thrips and more. Labeled for use on ornamentals and vegetables in greenhouses, nurseries, commercial landscapes, interiorscapes and turf. Organic version of BotaniGard.

REI 4 Hrs

**RATE** 16 to 64oz per 100gal

**ACTIVE INGREDIENT** Beauveria bassiana strain GHA

**CONTROLS** Aphids, Thrips, Whiteflies and more



32oz

BW1B16A22

Min. Buy 1ea

Shipping Info [DIRECT](#)

1gal

BA1B16A23

Min. Buy 1ea

Shipping Info [DIRECT](#)

## Mycotrol® WPO Mycoinsecticide

by BIOWORKS INC.

Mycotrol WPO is a mycoinsecticide for the control of Whitefly, Aphids, Thrips and more. Labeled for use on ornamentals and vegetables in greenhouses, nurseries, commercial landscapes, interiorscapes and turf. Organic version of BotaniGard. Wettable powder formulation.

REI 4 Hrs

**RATE** 1lb per 100gal

**ACTIVE INGREDIENT** Beauveria bassiana

**CONTROLS** Aphids, Thrips, Whiteflies and more



1lb

BW1B16A02

Min. Buy 1ea

Shipping Info [DIRECT](#)

## NoFly® WP Biological Pesticide

by BLACKSMITH BIOSCIENCE

NoFly WP is a biological pesticide for the control of many early stage greenhouse insect pests. Labeled for use on greenhouse and indoor crops, both food and ornamental.

REI 4 Hrs

**RATE** 1 to 4lbs per Acre

**ACTIVE INGREDIENT** Isaria fumosoroseus

**CONTROLS** Eggs and larvae of Whiteflies, Aphids, Thrips and Mealybugs.



2 lb bag

BBSLGNF0022

Min. Buy 1ea

Shipping Info [DIRECT](#)

## Notavo® Miticide

by OHP, INC.

Notavo Ovicide/Miticide is highly effective at controlling eggs and early instar mite stages. Notavo may be used for mite management on commercial ornamental plants grown in greenhouses, saran and shade houses, outdoor containers and field-grown nursery stock.

REI 12 Hrs

**RATE** 2 to 8oz per 100gal

**ACTIVE INGREDIENT** Clofentezine

**CONTROLS** Spider mites



16oz

OHP981081

Min. Buy 1ea

## Onyx Pro® Insecticide

by FMC

Onyx Pro insecticide prevents beetles and borers in Christmas trees and nursery grown trees. Also labeled for use on outdoor ornamentals, lawns, sod farms and golf courses to control a wide range of insect pests. Application can be made as a foliar spray or media drench.

REI 12 hours

**RATE** Varies depending on application method. See label for complete information.

**ACTIVE INGREDIENT** Bifenthrin

**CONTROLS** Beetles and borers plus a wide range of other turf and ornamental insect pests.



32oz

FMC19-0032

Min. Buy 1ea

Shipping Info [RESTRICTED USE](#)**Don't See What You Need?**

Use the BFG Mobile app or visit  
www.bfgsupply.com to see a  
much larger selection



**Ornazin® 3EC Insecticide**

by **SEPRO CORPORATION**

Insect growth regulator (IGR) that is effective as an antifeedant and as an insect repellent. Practically odorless with a superior formulation that stays in suspension and doesn't clog sprayers. Proven to be non-phytotoxic on most plants and is safe to beneficials. Can be used on ornamentals and greenhouse vegetables and herbs.



**32oz Bottle**

**SEPRO19-0557T** Min. Buy 1ea



**Overture® 35WP Insecticide**

by **NUFARM AMERICAS INC.**

A wettable powder that fights resistance and controls thrips at all life stages, including tough western flower thrips, while also controlling lepidopteran insects. Safe on most beneficial insects.

REI 12 Hrs

RATE 8oz per 100gal

ACTIVE INGREDIENT Pyridalyl

CONTROLS Thrips, Budworm and Cabbage Looper larvae and more.



**1lb**

**VAL62120.084** Min. Buy 1ea



**Pedestal® Insect Growth Regulator**

by **OHP, INC.**

Effective in controlling a variety of insect pests on ornamental plants. Provides an effective means for controlling whiteflies, thrips, leaf miners, armyworms and certain other foliar feeding insects on container and field grown ornamentals in greenhouses, shade houses and nurseries. Applied as a foliar spray to control immature stages of the target pests.

REI 12 Hrs

RATE 6 to 8oz per 100gal

ACTIVE INGREDIENT Novaluron

CONTROLS Whiteflies, Thrips, Leafminers, lepidoptera



**32oz**

**OHP986195** Min. Buy 1ea



**Pradia™**

by **OHP, INC.**

Pradia™ insecticide is a combination of two active ingredients for control of a wide variety of pests on ornamental and nursery crops. Pradia™ delivers quick knockdown and lasting residual control of Aphids, Thrips, Whiteflies, Lepidopteran species, and many more.

REI 12 hours

RATE 10 to 17 oz per 100 gallons.

ACTIVE INGREDIENT Cyflumetofenuron and Flonicamid

CONTROLS Adelgids, Gypsy Moth, Japanese Beetles Aphids, Leafminers, Mealybugs, and many more.



**32oz**

**OHP986300** Min. Buy 1ea



**Pycana® Insecticide / Miticide**

by **OHP, INC.**

Pycana™ is a OMRI Listed Insecticide/Miticide combination product containing pyrethrins and canola oil. Pycana provides quick knockdown of many insects and mites including aphids, leafhoppers, earwigs, plant bugs, psyllids, mealybugs, thrips, whiteflies and spider mites. May be used on ornamentals, fruits, vegetables and herbs grown in greenhouses, shade houses, hoop houses and container grown nurseries.

REI 12 Hrs

RATE 1 to 2% Concentration

ACTIVE INGREDIENT Canola oil and pyrethrins

CONTROLS Aphids, Leafminers, Mealybugs, Thrips, Mites and more.



**1gal**

**OHP986400** Min. Buy 1ea



**PyGanic® Specialty Insecticide**

by **MYCORRHIZAL APPLICATIONS LLC**

Pyganic Specialty is a professional botanical insecticide that rapidly knocks down and kills pests in greenhouses and nurseries. Labeled for use on ornamental plants, vegetables, fruit and nut trees.

REI 12hours

RATE 2 to 8 oz per 100 gal

ACTIVE INGREDIENT Pyrethrins (5.0 EC)

CONTROLS Aphids, Cabbage Loopers, Fungus Gnats, Whiteflies, and many more.



**1gal**

**MGK19-0545M** Min. Buy 1ea

**1qt**

**MGK7444-D30A** Min. Buy 1ea



**Pylon® Miticide / Insecticide**

by **BASF CORP**

A broad-spectrum miticide / insecticide that provides control of mites, thrips and adult fungus gnats. Controls the target insect or mite by interfering with energy production of the pests. Its translaminar movement and mode of action results in mortality of most pests in 72 hours.

REI 12 Hrs

RATE 2 to 10oz per 100gal

ACTIVE INGREDIENT Chlorfenapyr

CONTROLS Mites, Thrips, Foliar Nematodes, Caterpillars, Fungus Gnats



**16 oz bottle**

**BAS59012156** Min. Buy 1ea

**64 oz bottle AGENCY**

**BAS59012566** Min. Buy 1ea



**Pylon® TR Miticide / Insecticide**

by **BASF CORP**

Easy to use total release fogger for enclosed areas including greenhouses, shade houses and truck trailers.

REI 12 Hrs

RATE One can treats up to 3,000sq ft.

ACTIVE INGREDIENT Chlorfenapyr

CONTROLS Mites, Thrips, Foliar Nematodes, Caterpillars, Fungus Gnats



**2 oz aerosol**

**BAS59012595** Min. Buy 1ea



## Insecticides and Miticides

## Pyrethrum® TR Insecticide

by BASF CORP

Total release insecticide fogger for indoor use in Garden Centers, Greenhouses and Nurseries. Fast and easy control of many pests including Aphids, Beetles, Fungus Gnats, Caterpillars and many more. For use on ornamentals, flowering plants, vegetables, hanging baskets, bedding plants and more.

REI 12 Hrs

RATE One can treats up to 3,000sq ft.

ACTIVE INGREDIENT Piperonyl butoxide and Pyrethrins

CONTROLS Aphids, Caterpillars, Beetles, Fungus Gnats and more.



2oz aerosol

BAS59011861 Min. Buy 1ea



## Pyronyl™ Crop Spray

by CENTRAL LIFE SCIENCES

Pyronyl Crop Spray Is approved for many vegetables, herbs, fruit and nut trees, flowering and foliage plants. It provides a quick knockdown and broad-spectrum control of damaging insects and mites.

REI 12 Hrs

RATE 12 to 24fl oz per 100gal

ACTIVE INGREDIENT Pyrethrins and Piperonyl butoxide

CONTROLS Aphids, Fungus gnats, Beetles, Mites, Thrips, Whitefly and more.



32oz

WLMK100208914 Min. Buy 1ea

1gal

WLMK100208715 Min. Buy 1ea

Shipping Info

HAZARDOUS



## Rycar® Insecticide

by SEPRO CORPORATION

Excellent for controlling whiteflies and aphids. It also has extremely good activity on chilia thrips, mealybugs and leafhoppers. Perfect alternative to traditional neonicotinoids. Rycar is very gentle on both beneficial insects and pollinators.

REI 12 Hrs

RATE 1.6 to 6.4 fl oz per 100gal

ACTIVE INGREDIENT Pyriproxyfen

CONTROLS Mealybugs and Leafhoppers



8oz AGENCY

SEPRO1056.128 Min. Buy 1ea



## Safari® 20SG Insecticide

by NUFARM AMERICAS INC.

A super-systemic insecticide with quick uptake and knockdown. Controls a broad spectrum of pests including Q- and B-biotype whitefly. Used for indoor and outdoor ornamentals. Can be applied by foliar spray, soil drench, soil injection, or bark application.

REI 12 Hrs

RATE Varies according to application method. See label.

ACTIVE INGREDIENT Dinotefuran

CONTROLS Q- and B-biotype whitefly, Hemlock woolly adelgid, emerald ash borer, mealybug, leafminer, fungus gnat, black vine weevil, glassy-winged sharpshooter, armored and soft scales and aphids



12oz

VAL69712.261 Min. Buy 1ea

3lb

VAL69712.430 Min. Buy 1ea



## Sanmite® SC Insecticide

by GOWAN

Sanmite insecticide controls a broad spectrum of pests including aphids, mites, whitefly and leafhoppers on ornamental plants, flowers and foliage crops. Also labeled for use on greenhouse tomatoes and cucumbers. Sanmite provides residual control for 30-45 days.

REI 12 Hrs

RATE 6 to 9oz per Acre

ACTIVE INGREDIENT Pyridaben

CONTROLS Aphids, Thrips, Fungus Gnat, Whitefly and more.



32oz

GOW76279

Min. Buy 1ea

Shipping Info

HAZARDOUS



## Sarisa™

by OHP, INC.

Sarisa™ insecticide delivers broad spectrum control of pests on greenhouse ornamentals and nursery crops. Sarisa™ controls leaf feeding beetles and chewing-sucking insects.

REI 4 hours

RATE 10 to 27 oz per 100 gallons.

ACTIVE INGREDIENT Cyclopyridole

CONTROLS Adelgids, Gypsy Moth, Japanese Beetles, Aphids, Thrips, Leafminers, Webworms, and many more.



64oz

OHP987100

Min. Buy 1ea



## Savate® Insecticide / Miticide

by BAYER CROPSCIENCE

Savate is a staple in a spider mite rotational program and controls all stages of Mites and Whiteflies including eggs and immature stages. The translaminar movement protects upper and lower leaf surfaces and Savate's unique mode of action group (23) makes it a great rotational tool to combat resistance. Up to 30 days of residual control.

REI 12 Hrs

RATE 1 to 4 oz per 100gal

ACTIVE INGREDIENT Spiromesifen

CONTROLS Whiteflies and mites.



8oz AGENCY

BYR84907898

Min. Buy 1ea



## Scimitar® GC Insecticide

by SYNGENTA CROP PROTECTION

Scimitar GC insecticide is a microencapsulated pyrethroid formulation that provides time-release control on both surface and subsurface insects. Labeled for use on turf, greenhouse grown ornamentals and outdoor landscapes and ornamentals.

REI 24 Hrs

RATE 3 to 5oz per 100gal

ACTIVE INGREDIENT Lambda-cyhalothrin

CONTROLS Ants, Aphids, Leafminers and many more.



32oz

SYN73419

Min. Buy 1ea

Shipping Info RESTRICTED USE



**Sevin® 4SL Insecticide**

by **BAYER CROPSCIENCE LP**

Sevin 4SL insecticide is a fast-acting, broad-spectrum, contact insecticide for use on ornamentals, vegetable and fruits. Controls more than 80 ornamental pests.

REI 12 Hrs

RATE 0.75-1qt per 100gal

ACTIVE INGREDIENT Carbaryl

CONTROLS Over 80 key ornamental insect pests



**2.5gal bottle**

**PROKZ3636589** Min. Buy 1ea



**Shuttle O® Miticide**

by **OHP, INC.**

An excellent choice as a rotational tool for control of two-spotted spider mites, spruce spider mites and other mites. For use on ornamentals grown in greenhouses, container and field nurseries, lath and shade houses, arboretums, interiorscapes and on greenhouse grown fruiting vegetables.

REI 12 Hrs

RATE 6 to 12oz per 100gal

ACTIVE INGREDIENT Acequinolyl

CONTROLS Two spotted spider mites, Spruce spider mites, Strawberry spider mites and more.



**16oz**

**OHP987400** Min. Buy 1ea



**Sirocco® Miticide**

by **OHP, INC.**

Provides quick knockdown and long residual control of a wide variety of insects and pests such as thrips and mites. May be used in greenhouse, shade houses, nurseries including Christmas tree and conifer plantations, landscapes and interiorscapes.

REI 12 Hrs

RATE 3 to 6oz per 100gal

ACTIVE INGREDIENT Bifenazate + Abamectin

CONTROLS Mites, thrips, aphids, whiteflies



**8oz**

**OHP987832** Min. Buy 1ea

Shipping Info **HAZARDOUS**



**SPEAR®-Lep Bioinsecticide**

by **VESTARON CORPORATION**

Spear®-Lep is a biological insecticide that contains the peptide active ingredient GS-omega/kappa-Htx-Hv1a. It is for use on ornamental plants and edible crops. To be effective against the labelled lepidopteran and coleopteran pests, Spear®-Lep must be tank mixed with Bacillus thuringiensis (Bt) products or another product that assists in moving the active ingredient to the site of activity. When ingested at labelled rates along with Bt, Spear®-Lep functions as a central nervous system inhibitor

REI 4 hours

RATE 1-2 pints per acre

ACTIVE INGREDIENT GS-omega/kappa-Htx-Hv1a

CONTROLS Lepidopteran pests such as caterpillars, loopers and worms



**1gal**

**VES191241** Min. Buy 4ea



**Spear-T® Insecticide / Miticide**

by **VESTARON CORPORATION**

Spear-T® Liquid Concentrate is a biological insecticide/miticide for treatment of thrips, whiteflies, two spotted spider mites, broad mites and aphids in vegetables in greenhouses. It features a new mode of action, environmentally friendly, safe for honeybees. Can be sprayed or fogged, labeled for greenhouse use only.

REI 4 Hr

RATE 25% v/v

ACTIVE INGREDIENT GS-omega/kappa-Htx-Hv1a

CONTROLS Thrips, whiteflies, two-spotted spider mites, broad mites, aphids, spotted wing drosophila



**1gal**

**VESBT128** Min. Buy 1ea



**SuffOil-X® Insecticide/Miticide/Fungicide**

by **BIOWORKS INC.**

Suffocates and kills eggs, larvae, nymphs and adult soft bodied insects and mites and controls fungi including powdery mildew. The unique spray oil emulsion formulation stays in suspension better than other oils and the smaller oil particles provide uniform coverage with less chance of phytotoxicity. Use on vegetables, nursery, landscape, ornamental and greenhouse crops.

REI 4 Hrs

RATE 1 to 2gal per 100gal

ACTIVE INGREDIENT Mineral Oil

CONTROLS Many pests and diseases. See label.



**2.5gal**

**BW1SX25A24** Min. Buy 1ea

**30gal Drum**

**BW1SX25A38** Min. Buy 1ea

Shipping Info **DIRECT**



**Sultan® Miticide**

by **BASF CORP**

Sultan is a contact miticide for rapid spider mite control on ornamentals grown in greenhouses, shade houses, nurseries and residential and commercial landscapes. Sultan has excellent plant safety and has shown no adverse effects on beneficial insects.

REI 12 Hrs

RATE 13oz per 100gal

ACTIVE INGREDIENT Cyflumetofen

CONTROLS Spider mites



**16 oz bottle AGENCY**

**BAS59013978** Min. Buy 1ea

Shipping Info **HAZARDOUS**



## Insecticides and Miticides

## Talstar® Nursery Granular Insecticide

by FMC

Talstar Nursery granular insecticide penetrates soil to control target pests without altering the pH balance of the soil. Talstar Nursery features a light stable active ingredient in a sand granule allowing optimal distribution in the soil with a long lasting residual effect. Granular formulation for incorporation into potting media.

REI 12 hours

RATE 1 to 2lbs per 200cu yd of media.

ACTIVE INGREDIENT Bifenthrin

CONTROLS Fungus Gnat larvae, Mealybugs, Black Vine Weevil, White Grubs, and more.



50lb Bag

FMC19-0303H Min. Buy 1ea



## Talstar® Professional Insecticide

by FMC

Controls pests indoors and outdoors on residential, commercial and industrial buildings, greenhouses, lawns, ornamentals and more. Talstar Pro Insecticide provides broad-spectrum control of the toughest lawn and ornamental pests.

REI 12 hours

RATE 0.125 to 1.0 FL oz/per 1,000sq ft

ACTIVE INGREDIENT Bifenthrin



32oz

FMC19-0303F Min. Buy 1ea

1gal

FMC10056776 Min. Buy 1ea



## Talstar® Select Insecticide

by FMC

Talstar Select provides long-lasting residual control of aphids, black vine weevils, scale and other nursery pests without the risk of damaging sensitive plants. It is non-staining and contains no odorous or plant-damaging solvents, so it can be applied to open blooms and colored bracts right up to the day of shipment.

REI 12 hours

RATE 5 to 40oz per Acre

ACTIVE INGREDIENT Bifenthrin

CONTROLS Aphids, caterpillars, scale, mites, fungus gnats, mealybugs, thrips, whiteflies and many more



1gal

FMC19-0303G Min. Buy 1ea

Shipping Info RESTRICTED USE



## Talus® 70DF Insect Growth Regulator

by SEPRO CORPORATION

Talus delivers toxicity to pests via contact, ingestion and vapor activity. There is little or no systemic movement of Talus in plants, but its vapor activity allows it to reach leaf undersides where many pest species dwell and it helps protect new growth. In addition to its primary mode of action, Talus also suppresses egg-laying and causes egg sterility in treated adults through secondary hormonal activity.

REI 12 Hrs

RATE 6 to 14oz per 100gal

ACTIVE INGREDIENT Buprofezin

CONTROLS Whiteflies, Mealybugs, Leafhoppers, Planthoppers, Scales



3lb

SEPRO19-0307B Min. Buy 1ea



## Tame® 2.4EC Insecticide / Miticide

by NUFARM AMERICAS INC.

Broad spectrum insecticide that can be used in commercial lath houses, shade houses and greenhouses, as well as outdoors. It's gentle on delicate ornamentals and it's deadly to whitefly, aphid, scale and mites. Can be used on most ornamentals without fear of phytotoxicity.

REI 12 Hrs

RATE 5-1/3 to 10-2/3oz per 100gal

ACTIVE INGREDIENT Fenpropathrin

CONTROLS Aphids, Glassy-winged sharpshooters, Mites, Whitefly and more.



32oz

VAL69670.928 Min. Buy 1ea

Shipping Info RESTRICTED USE HAZARDOUS



## TetraCURB™ Concentrate Miticide-Insecticide

by KEMIN INDUSTRIES INC

Kills and repels mites and small soft-bodied insects such as two-spotted spider mites, aphids, whiteflies, thrips, lygus or mealybugs. Labeled for use on all crops. Controls all pest life stages. Emulsifiable concentrate, smart blend of soap and emulsifier for greater spread, efficacy and minimal phytotoxicity. Recommended application rate: 64 fl. oz./100 gal water. Foliar spray.

REI 0 Hours

RATE 32 to 128 oz per 100 gal

ACTIVE INGREDIENT Rosemary Oil

CONTROLS Mites, Whitefly, Aphids, and other small soft-bodied insects.



1gal

KEM018139GL Min. Buy 1ea

Shipping Info HAZARDOUS



## TetraSan® WDG Insecticide

by NUFARM AMERICAS INC.

With contact and translaminar movement, TetraSan controls spider mites on the underside of leaves, even when it's difficult to get good under-leaf spray coverage. Formulated to affect all stages of the mite life cycle, offers residual control up to five weeks and is safe to most beneficials.

REI 12 Hrs

RATE 8 to 16oz per 100gal

ACTIVE INGREDIENT Etoxazole

CONTROLS Mites



1lb

VAL69760.084 Min. Buy 1ea



## Triact 70® Botanical Oil

by OHP, INC.

A broad-spectrum fungicide, miticide and insecticide. Highly effective and economical botanical oil that may be used indoors as well as outdoors on ornamental flowering plants, trees, shrubs and foliage grown in greenhouses, interiorscapes and commercial landscapes. As a fungicide, it is a preventative as well as a curative. It coats fungal spores and then dehydrates them to stop the disease cycle.

REI 4 Hrs

RATE 0.5 to 2gal per 100gal

ACTIVE INGREDIENT Neem oil

CONTROLS Wide range of insect pests and powdery mildew. See label for complete list.



2.5gal

OHP988500 Min. Buy 1ea



**TriStar® 8.5SL Insecticide**

by NUFARM AMERICAS INC.

An odorless, water-based formulation that mixes easily and works with contact, systemic and translaminar activity to protect plants. Absorbs and spreads within the plant to provide quick knockdown of a wide spectrum of insects, in as little as 15 minutes as a direct spray. Up to 4 weeks residual control on bedding plants, 4 to 6 weeks on woody ornamentals and trees.

REI 12 Hrs

RATE 8 to 16oz per 100gal

ACTIVE INGREDIENT Acetamiprid

CONTROLS Aphids, Lace bugs, Mealybugs, Thrips, Whitefly and more.



**32oz**

**NTS10520432** Min. Buy 1ea

**1gal**

**NTS10520041** Min. Buy 1ea



**Ventigra® Insecticide**

by BASF CORP

Ventigra provides effective control of piercing/sucking insect pests in production and landscape ornamentals and vegetable transplants. A unique mode of action subgroup allows control of pests that have developed resistance to other insecticides. Ventigra exhibits low acute toxicity to beneficial insects and pollinators. Labeled for use in the following sites: nurseries, commercial and residential landscapes, greenhouses, shadehouses, and interiorscapes.

REI 12 hours

RATE 1.7 to 7 oz per 100 gal.

ACTIVE INGREDIENT Afidopyropen

CONTROLS Aphids, Whitefly, Mealybugs



**20 oz bottle AGENCY**

**BAS59014680** Min. Buy 1ea



**Ultra Pure® Horticultural Oil**

by BASF CORP

Ultra Pure Oil is a year round spray oil for control of insects, mites and fungus. 98% mineral oil labeled for use on fruit and nut crops, outdoor and greenhouse vegetables, flowering and foliage ornamentals, trees and shrubs. OMRI

REI 4 Hrs

RATE 0.5 to 2gal per 100gal

ACTIVE INGREDIENT Mineral Oil

CONTROLS Adult, larval and egg stages of soft-bodied insects and mites. Effective on powdery mildew.



**2.5 gal bottle**

**BAS59011962** Min. Buy 1ea

**30gal drum**

**BAS59011963** Min. Buy 1ea



**Venerate® CG Insecticide / Miticide**

by MARRONE BIO INNOVATIONS

Venerate bioinsecticide features multiple modes of action is effective against a wide variety of chewing and sucking insects and mites, yet easy on beneficials. The unique and novel modes of action will complement and improve integrated pest management and insect resistance management programs.

REI 4 hours

RATE 2 to 3 oz per 1,000 sq ft.

ACTIVE INGREDIENT Burkholderia spp. Strain A396 cells

CONTROLS Aphids, Mites, Thrips, Whitefly, Mealybugs and more



**1qt**

**MB10086** Min. Buy 1ea

**1gal**

**MB10083** Min. Buy 1ea

**2.5 Gallon**

**MB10097** Min. Buy 1ea



**UPL Acephate® 97UP Insecticide**

by UPL

Acephate 97UP is an insecticide that provides systemic control of pests on selected agricultural crops and ornamentals. Crop use includes beans, brussel sprouts, cauliflower, celery, and more. Acephate is also labeled for use on non-crop areas such as field borders, fencerows, roadsides and ditchbanks.

REI 24 hours

RATE Varies according to application. See label.

ACTIVE INGREDIENT Acephate

CONTROLS Aphids, Cabbage Looper, Grasshopper, Thrips, Whitefly, and more.



**1 lb pack**

**PROKZ742011** Min. Buy 1ea



**Velifer® Fungal Contact Insecticide/Miticide**

by BASF CORP

Velifer controls the labeled piercing and sucking insect or mite pests in enclosed commercial greenhouses on ornamentals, fruits, vegetables, herbs and spices, including vegetable, fruit, herb, and spice transplants for the consumer market. Velifer is compatible with beneficial insects.

REI 4 hours

RATE 3 to 13 oz per 100 gallons

ACTIVE INGREDIENT Beauveria bassiana strain PPRI 5339

CONTROLS Aphid, Whitefly, Thrips, Mites, Mealybug, and more.



**32 oz bottle**

**BAS59018345** Min. Buy 1ea



**XXpire™ WG insecticide**

by Corteva

Effective on 39 pests, and seven of the top 10 most troublesome ornamental insects. Controls chewing and sap-feeding insects commonly found in nurseries, greenhouses and commercial landscapes.

REI 12 hours

RATE 4 to 7 oz per acre

ACTIVE INGREDIENT sulfoxaflor and spinetoram

CONTROLS aphids, lepidopterous larvae, mealybugs, thrips, whiteflies, and more.



**1lb**

**DOW11080911** Min. Buy 1ea

Shipping Info **HAZARDOUS**



# THRIPS *Control Strategies*

**Importance:** Western Flower Thrips (*Frankliniella occidentalis*) are known to vector plant pathogens such as Impatiens necrotic spot virus, and tomato spotted wilt virus. They cause stippling, scarring, silvering of the leaf surface, distorted leaves, and corky lesions on fruits by piercing leaves with one mouthpart and sucking the plant fluids through a stylet.

**Identification:** Thrips are minute insects that have an elongated body shape. Adults have fringed wings while the immature stages are wingless, off white to translucent in color, 1/20 inch long. Feeding is evidenced by black specks of frass excrement. Scouting can be as simple as smacking a leaf over a white paper, or using yellow or blue sticky cards, then examining with at least a 10X hand lens.

**Life Cycle:** A typical life cycle is 21 days but can be as little as 14 days in high temperatures. Eggs are inserted into leaf tissue and deep in flower buds, followed by two larval stages, two non-feeding pupal stages which drop to the soil media, then adulthood.

**Control:** Chemical control is challenging due to larvae deep inside buds being protected from insecticide sprays. Some growers add irritants like Captiva Prime to their tank mix in order to draw the thrips from hiding and into contact with insecticides. Soil applied systemics may not control thrips inhabiting flower buds and blooms, as movement of these materials into flower tissues is limited. Practicing resistance management is vitally important with this pest due to rapid life cycles and the potential of resistance development to overused control agents. Avoid resistance by rotating across the mode of action groups (MOA's).

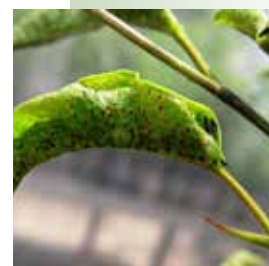

Brand Name	BFG Item #	Active Ingredient	Mode of Action Group	Notes
Overture	VAL62120.084	Pyridalyl	UN	Contact and ingestion. Greenhouse use only. Soft on beneficials.
Hachi-Hachi SC	SEPRO1159.464	Tolfenpyrad	21A	Contact. Greenhouse use only.
Pylon	BAS59012156 BAS59012566	Chlorfenarpyr	13	Contact and stomach. Greenhouse use only. Vegetable label.
Mainspring	SYN55664 SYN66345	Cyantraniliprole	28	Translaminar & Systemic. Foliar or Drench Application. Soft on Beneficials.
Pedestal	OHP986195	Novaluron	15	Insect growth regulator, excellent on immatures. Tomato label.
Safari	VAL69712.430 VAL69712.261	Dinotefuran	4A	Translaminar & Systemic. Foliar or Drench Application. Vegetable label.
Conserve	DOW19-0007Z	Spinosad	5	Contact. Fruit and Vegetable label.

*Always read and follow label directions before applying any pesticide and follow state and local regulations.*



**For more information or to place an order**

Please contact your BFG Sales Representative or our Customer Service Team!



## BIOLOGICAL CONTROLS

These agents are the predacious mites *Amblyseius cucumeris* and *Amblyseius swirskii*, whose larvae feed on the eggs and immatures of thrips. Orius (Predatory bugs) are another agent that can be used.



### Overture VAL62120.084



(Pyridalyl) MOA: UN unknown. Caution. 12 HR REI. RATE: 8oz/100 gal. Contact and ingestion. A novel mode of action, makes it a great rotation partner. Enclosed greenhouses only. Translaminar within the leaf. Controls immatures and adults. Apply no more than 2 times per crop to manage resistance. Soft on beneficials.



### Hachi-Hachi SC SEPRO1159.464



(Tolfenpyrad) MOA: 21A. Warning. 12HR REI. RATE: 21-32 0z/100 gal. Contact. Greenhouse use only. Non neonicotinoid option. Improved SC formulation allows better crop safety than original EC version. Potential phytotoxic on some species, do not apply to Geranium, Impatiens, New Guinea Impatiens, Poinsettia bracts, Vinca, Salvia.



### Pylon BAS59012156 BAS59012566



(Chlorfenapyr) MOA: 13. Caution. 12 HR REI. RATE: 5.2-10 oz/100 gal. Contact and stomach. Translaminar activity Cost effective, broad spectrum, including Chili thrips, the only product in Class 13. Greenhouse use only. Not ovicidal. No more than 3 applications per crop. 14-21 day residual. Vegetable label.



### Mainspring SYN55664 SYN66345



(Cyantraniliprole) MOA: 28. Caution. 4HR REI. RATE: Foliar spray 2-8oz /100gal, drench 8-12oz /100 gal. Unique new class, insects stop feeding immediately, Translaminar and systemic activity, soft on beneficial insects. Broad spectrum activity & lasting residual control.



### Pedestal OHP986195



(Novaluron) MOA: 15. Caution. 12 HR REI. RATE: 6-8oz /100 gal. Insect growth regulator, excellent on immatures. Do not apply to poinsettias. Compatible with IPM programs. Tomato label.



### Safari VAL69712.430 VAL69712.261



(Dinotefuran) MOA: 4A. Caution. 12 HR REI. RATE: Vegetable transplants & foliar spray 4-8oz /100 gal. Drench 12-24oz /100 gal. Quick systemic & translaminar activity. Broad spectrum.



### Conserve DOW19-0007Z



(Spinosad) MOA: 5. 4 HR REI. RATE: indoor 6oz /100 gal, outdoor rate 11oz / 100 gal. Contact activity. Labeled for fruits & vegetables. Quick kill via contact & ingestion.

# Biological Control Agents

	Aphids	Fungus Gnat	Leafminer	Shore Fly	Mealybug	Mites	Thrips	Whitefly
<i>Amblyseius andersoni</i>						X		
<i>Aphidoletes aphidimyza</i>	X							
<i>Amblyseius californicus</i>						X		
<i>Amblyseius cucumeris</i>						X	X	
<i>Amblyseius swirskii</i>							X	X
<i>Aphidius colemani</i>	X							
<i>Aphidius ervi</i>	X							
<i>Cryptolaemus montrouzieri</i>					X			
<i>Dalotia (Atheta) coriaria</i>		X (larvae)		X (larvae)				
<i>Diglyphus isaea</i>			X					
<i>Encarsia formosa</i>								X
<i>Eretmocerus eremicus</i>								X
<i>Hypoaspis miles</i>		X (larvae)					X (larvae)	
<i>Orius insidiosus</i>							X	
<i>Phytoseiulus persimilis</i>						X		
<i>Steinernema carpocapsae</i>		X (larvae)		X (larvae)				
<i>Steinernema feltiae</i>		X (larvae)					X	





**Biological Control Agents - Black Vine Weevils**

**BASF® Nemasys® L Beneficial Nematodes**  
by BASF CORP

Nemasys L (steinernema kraussei) beneficial nematodes provide biological control of the larval stage of Black Vine Weevil. Can be applied by spray or drench. They attack and kill targeted pests without affecting any other organisms. Sold in a tray containing 250 million nematodes. Minimum order is 2 trays.

REI 0 Hrs

RATE 250 Million Will Treat Approximately 5,500sq ft

ACTIVE INGREDIENT Steinernema kraussei

CONTROLS Black Vine Weevil.



**2 Trays of 250 Million**

**BAS59014482** Min. Buy 5ea

Shipping Info **DIRECT**

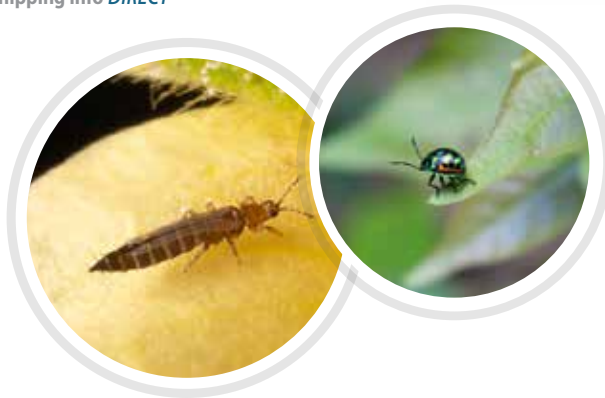

**Biological Control Agents - Fungus Gnats & Thrips**

**BASF® Nemasys® Beneficial Nematodes**  
by BASF CORP

Nemasys (steinernema feltiae) beneficial nematodes provide biological control of Thrips and the soil dwelling stages of Fungus Gnats. They attack and kill targeted pests without affecting any other organisms.

REI 0 Hrs

ACTIVE INGREDIENT Steinernema feltiae

CONTROLS Thrips and Fungus Gnats.



**5 Trays of 250 Million**

RATE 250 Million Will Treat Approximately 5,500sq ft

**BAS59014486** Min. Buy 1ea

Shipping Info **DIRECT**

**5 Trays of 50 Million**

RATE 50 Million Will Treat Approximately 1,100sq ft

**BAS59014493** Min. Buy 5ea

Shipping Info **DIRECT**



**Biological Control Agents - Shore Flies**

**Millenium® Beneficial Nematodes**  
by BASF CORP

Millenium (Steinernema carpocapsae) beneficial nematodes protect plants from damage from Shore flies and other soil dwelling insects. They attack and kill targeted pests without affecting any other organisms. Sold in a tray of 250 million nematodes. The minimum purchase is 5 trays.

REI 0 Hrs

RATE 250 Million Will Treat 2,750 to 5,400sq ft

ACTIVE INGREDIENT Steinernema carpocapsae

CONTROLS Shore flies



**5 Trays of 250 Million**

**BAS58067388** Min. Buy 1ea

Shipping Info **DIRECT**



**Plant Health from seed to shelf  
with Intrinsic® Brand Fungicides**

Incorporate Intrinsic brand fungicides into your rotation for broad-spectrum disease control and plant health benefits providing stronger, denser roots and increased growth efficiency throughout the growing cycle.

[betterplants.basf.us](http://betterplants.basf.us)

Always read and follow label directions.

Empress, Intrinsic, Orkestra and Pageant are registered trademarks of BASF.  
©2021 BASF Corporation. All rights reserved.

**Pageant®**  
Intrinsic® Brand Fungicide

**Empress®**  
Intrinsic® Brand Fungicide

**Orkestra®**  
Intrinsic® Brand Fungicide



### Biological Control Agents - Aphids

#### Adaline b™ Adalia bipunctata Aphid control

by BIOLINE AGROSCIENCES, INC.

Adalia bipunctata is also known as the two-spotted ladybug. Both larvae and adults are voracious predators of many aphid species. This ladybug consumes all aphid stages and can eat up to 100 aphids per day. Adalia bipunctata is used in many ornamental, fruit and vegetable crops. Sold as a bottle containing 250 beetles.

**RATE** Covers up to 500 sq ft

**ACTIVE INGREDIENT** Adalia bipunctata

**CONTROLS** Aphids



**250 per bottle**

**BIOLNP0041-04** Min. Buy 1ea

Shipping Info **DIRECT**

#### Aphidoline™ Aphidoletes aphidimyza Aphid Control

by BIOLINE AGROSCIENCES, INC.

Aphidoletes aphidimyza is a curative treatment for aphid infestation; larvae reported as feeding on 60 species. The emerging midges mate and then lay eggs near aphid colonies. The eggs hatch into highly visible orange larvae which feed on the colonies of all types of aphids.

**RATE** Covers up to 1,000sq ft

**ACTIVE INGREDIENT** Aphidoletes aphidimyza

**CONTROLS** Aphids



#### Loose Larvae in Bottles

**1,000 Loose Midge per Bottle**

**BIOLNP0151-01** Min. Buy 1ea

Shipping Info **DIRECT**

#### Larvae in Blister Packs

**4ea of 250 Midge per Controlled Released Blister Packs**

**BIOLNP0151-05** Min. Buy 1ea

Shipping Info **DIRECT**



#### Aphiline™ Aphidius colemani + Aphidius ervi Aphid Control

by BIOLINE AGROSCIENCES, INC.

Aphid parasite mix, ideal for ornamental producers and professional nurseries, as well as hobby gardeners. Mix contains 2 parasites (Aphidius colemani and Aphidius ervi) in one pack providing multiple control of all important aphids. Adults begin to emerge in transit ready for action.

**RATE** Covers up to 1,000sq ft

**ACTIVE INGREDIENT** Aphidius ervi and Aphidius colemani

**CONTROLS** Aphids



**500 Loose Parasites per Bottle**

**BIOLNP0182-01** Min. Buy 1ea

Shipping Info **DIRECT**



#### Aphiline™ Aphidius colemani Aphid Control

by BIOLINE AGROSCIENCES, INC.

Aphiline biological control agent contains the Braconid wasp, Aphidius colemani. This wasp stings and parasitizes smaller aphid species, such as the melon or cotton aphid, peach aphid and tobacco aphid. Suitable for all greenhouse crops.

**ACTIVE INGREDIENT** Aphidius colemani

**CONTROLS** Aphids



#### Loose Larvae in Vials or Bottles

**1,000 Loose Larvae per Hot Spot Vial**

**RATE** Covers up to 20,000sq ft

**BIOLNP0102-04** Min. Buy 1ea

Shipping Info **DIRECT**

**5,000 Loose Larvae per Bottle**

**RATE** Covers up to 100,000sq ft

**BIOLNP0102-05** Min. Buy 1ea

Shipping Info **DIRECT**



#### Larvae in Blister Packs

**10ea of 100 Larvae per Controlled Released Blister Packs**

**RATE** Covers up to 10,000sq ft

**BIOLNP0102-09** Min. Buy 1ea

Shipping Info **DIRECT**



#### Chrysoline™ Chrysoperla carnea (Lacewing) Aphid Control

by BIOLINE AGROSCIENCES, INC.

Chrysoperla carnea larvae are predators of aphids and other pests before developing into Lacewing adults. Chrysoline arrives as young larvae with full feeding potential. One larvae can eat 200 aphids. As adults they disperse and hunt down aphid colonies. Easy to observe and monitor.

**RATE** covers up to 1000 sq ft

**ACTIVE INGREDIENT** Chrysoperla carnea

**CONTROLS** Aphids



**1000 larvae per bag**

**BIOLNP0301-04** Min. Buy 1ea

Shipping Info **DIRECT**



#### Chrysoline™ Chrysoperla carnea Aphid Control

by BIOLINE AGROSCIENCES, INC.

Chrysoperla carnea larvae are predators of aphids and other pests before developing into lacewing adults. Young larvae with full feeding potential, one larva can eat 200 aphids. As adults they disperse and hunt down aphid colonies. Easy to observe and monitor.

**RATE** Covers up to 2,500sq ft

**ACTIVE INGREDIENT** Chrysoperla carnea

**CONTROLS** Aphids



**2,500 Loose Larvae per Bag**

**BIOLNP0301-07** Min. Buy 1ea

Shipping Info **DIRECT**



**Biological Control Agents - Aphids**

**Cryptoline™ Cryptolaemus montrouzieri Aphid Control**

by **BIOLINE AGROSCIENCES, INC.**

The Cryptoline vial contains 25 adult Cryptolaemus montrouzieri. Females can lay 10 eggs per day. Both the adults and larvae feed on Aphids, their eggs and their larvae. Release near Aphid infestations.

**RATE** Varies

**ACTIVE INGREDIENT** Cryptolaemus montrouzieri

**CONTROLS** Aphids



**25 beetles per bottle**

**BIOLNP0351-01** Min. Buy 1ea

Shipping Info **DIRECT**

**Erviline™ Aphidius ervi Aphid Control**

by **BIOLINE AGROSCIENCES, INC.**

Aphidius ervi females seek out and parasitize aphids. The main targets for this parasitoid in commercial crops are Macrosiphum euphorbiae and Aulacorthum solani. Erviline is supplied as emerging adult parasites in vials with a feeding strip. Adults begin to emerge in transit, so they are ready for release directly onto identified aphid colonies.

**RATE** Covers up to 5,000sq ft

**ACTIVE INGREDIENT** Aphidius ervi

**CONTROLS** Aphids



**250 Loose Adult Wasps per Bottle**

**BIOLNP0103-01** Min. Buy 1ea

Shipping Info **DIRECT**



**Biological Control Agents - Black Vine Weevils**

**Exhibitline Hb™ Heterorhabditis bacteriophora Weevil and Grub control**

by **BIOLINE AGROSCIENCES, INC.**

Heterorhabditis bacteriophora nematodes help control weevil and grub larvae. Can be applied by spray or drench. Sold in a tray of 250 million.

**RATE** One 250 Million Tray Will Cover 5,000sq ft

**ACTIVE INGREDIENT** Heterorhabditis bacteriophora

**CONTROLS** Black Vine Weevil



**250 mil tray**

**BIOLNP1021-02** Min. Buy 1ea

Shipping Info **DIRECT**

**Biological Control Agents - Caterpillars**

**Tricholine® TB Biological Insect control**

by **BIOLINE AGROSCIENCES, INC.**

Trichogramma brassicae is a parasitic wasp that controls lepidopteran pests including caterpillars and cabbage loopers. It can be used in a wide range of crops including tomato, bell peppers, aubergines, ornamentals, tobacco and bananas.

**RATE** varies

**ACTIVE INGREDIENT** Trichogramma brassicae

**CONTROLS** Lepidopteran pests, Cabbage Loopers, Caterpillars



**Parasitized Eggs Attached to Cards**

**25 Cards, 2,500 Parasitized Eggs per Card**

**BIOLNP0451-32** Min. Buy 1ea

Shipping Info **DIRECT**

**Parasitized Eggs in Capsules**

**100 Capsules, 2,700 Parasitized Eggs per Capsule**

**BIOLNP0451-23** Min. Buy 1ea

Shipping Info **DIRECT**

**Tricholine® TP Biological Insect Control**

by **BIOLINE AGROSCIENCES, INC.**

Trichogramma pretiosum is a parasitic wasp that controls lepidopteran pests. A more generalized predator, pretiosum can attack up to 200 different species of lepidoptera. It can be used in a wide range of crops including vegetables, ornamentals, vineyards, and other row crops. Sold as a case of 90 biodegradable capsules each containing 1000 parasitized eggs.

**RATE** varies

**ACTIVE INGREDIENT** Trichogramma pretiosum

**CONTROLS** Lepidopteran pests, Cabbage Loopers, Caterpillars



**Parasitized Eggs in Capsules**

**90 Capsules, 1,000 Parasitized Eggs per Capsule**

**BIOLNP0461-03** Min. Buy 1ea

Shipping Info **DIRECT**

**Parasitized Eggs Attached to Cards**

**50 Cards, 2,500 Parasitized Eggs per Card**

**BIOLNP0461-05** Min. Buy 1ea

Shipping Info **DIRECT**



### Biological Control Agents - Fungus Gnats

#### Exhibitline™ GH Mix *Steinernema feltia* - *carpocapsae* Fungus Gnat, Thrips, Cutworm control

by *BIOLINE AGROSCIENCES, INC.*

*Steinernema feltia* and *carpocapsae* together in one mix for control of Fungus Gnat, Thrips, Leather Jacket and Cutworms.

RATE Varies

ACTIVE INGREDIENT *Steinernema feltia* and *Steinernema carpocapsae*

CONTROLS Fungus Gnat, Thrips, Leather Jacket and Cutworms



1 million on sponge

BIOLNP1011-10 Min. Buy 1ea

Shipping Info **DIRECT**

6 million on sponge

BIOLNP1011-11 Min. Buy 1ea

Shipping Info **DIRECT**

24 million on sponge

BIOLNP1011-12 Min. Buy 1ea

Shipping Info **DIRECT**

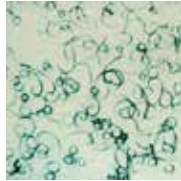

#### Exhibitline sc™ *Steinernema carpocapsae* Leather Jacket and Cutworm Control

by *BIOLINE AGROSCIENCES, INC.*

*Steinernema carpocapsae* beneficial nematodes protect plants from damage caused by shore flies (*Scatella stansalis*) and a variety of other soil-dwelling insects and borers. They also destroy the larvae of many turf, ornamental and tree pests including flea, billbug and bluegrass weevil larvae as well as cutworm, armyworm, sod webworm, tropical sod webworms and chinch bugs.

ACTIVE INGREDIENT *Steinernema carpocapsae*

CONTROLS Leather Jackets and Cutworms.



250 Million Tray

RATE One 250 Million Tray Will Cover 5,000sq ft

BIOLNP1012-01 Min. Buy 1ea

Shipping Info **DIRECT**

50 mil tray

RATE One 50 Million Tray Will Cover 1,000sq ft

BIOLNP1012-02 Min. Buy 1ea

Shipping Info **DIRECT**



#### Exhibitline sf™ *Steinernema feltia* Fungus Gnat and Thrips control

by *BIOLINE AGROSCIENCES, INC.*

*Steinernema feltia* nematodes help control Fungus Gnat and Thrips. Harmless to the ornamental crops, humans, the environment and other beneficial insects, these nematodes actively seek out fungus gnat larvae by swimming in the thin film of water on soil particles. They locate hosts by detecting carbon dioxide and other waste products. Sold in a gel tray with 50 million nematodes each.

RATE 50 mil tray will cover 1,000 sq ft

ACTIVE INGREDIENT *Steinernema feltia*

CONTROLS Fungus Gnat and Thrips



50 mil tray

BIOLNP1011-01 Min. Buy 1ea

Shipping Info **DIRECT**



### Biological Control Agents - Fungus Gnats

#### Hypoline™ *Hypoaspis miles* Fungus Gnat Control

by *BIOLINE AGROSCIENCES, INC.*

*Hypoaspis miles* attacks and kills the larvae of sciarid flies and will also consume thrips larvae that drop to the growing medium to pupate, making it a useful addition to other Western Flower Thrips control products. Also attacks and kills larvae of Fungus Gnats, but not eggs or pupae. Up to eight, first instar larvae may be attacked and consumed each day by adult *Hypoaspis*. Normally found within the top half inch of soil / growing media, females lay eggs which hatch after six days. The larvae activity feed for 10 days and continue to feed as an adult. Adults live for several months when food is readily available. Feeding on a wide range of soil / growing media pests.

ACTIVE INGREDIENT *Hypoaspis miles*

CONTROLS Fungus Gnat, Shore Fly and Thrips pupae.



125,000 Loose Larvae per Tub

RATE Covers up to 5,000sq ft

BIOLNP0091-04 Min. Buy 1ea

Shipping Info **DIRECT**

25,000 Loose Larvae per Tube

RATE Covers up to 1,000sq ft

BIOLNP0091-03 Min. Buy 1ea

Shipping Info **DIRECT**



#### Staphyline™ *Atheta coriaria* Fungus Gnat and Shore Fly Control

by *BIOLINE AGROSCIENCES, INC.*

Staphyline biological control agent contains the predatory beetle, *Atheta coriaria*. It can be used in crops such as herbs and ornamentals to protect against soil and compost pests. This rove beetle is a generalist arthropod feeder, but the adults and young stages are particularly good at feeding on the larvae of Fungus Gnat and Shore Flies. Formulation contains mixed life stages – adults, larvae, pupae and eggs – for a balanced population.

ACTIVE INGREDIENT *Atheta coriaria*

CONTROLS Fungus Gnat and Shore Flies.



3,000 Loose Larvae per Tub

RATE Covers up to 3,000sq ft

BIOLNP0061-02 Min. Buy 1ea

Shipping Info **DIRECT**

500 Loose Larvae per Tube

RATE Covers up to 500sq ft

BIOLNP0061-01 Min. Buy 1ea

Shipping Info **DIRECT**



### Biological Controls - Leafminers

#### Digline™ *Diglyphus* Leaf Miner Control

by *BIOLINE AGROSCIENCES, INC.*

*Diglyphus isaea* is a widespread parasitoid of leaf miner larvae. It is reported from a large number of host species, but commercially is of interest as a parasite of *Liriomyza bryoniae*, *L. trifolii* and *L. huidobrensis*, as well as of the Chrysanthemum Leaf miner *Phytomyza syngenesiae*. The adult wasps are very variable in size and are a dark metallic green in color. They search for host larvae of suitable size within leaf tissue and sting them through the leaf cuticle. The sting paralyzes the host larva within a short time and the female wasp then lays one or more eggs alongside it.

RATE Covers up to 5,000sq ft

ACTIVE INGREDIENT *Diglyphus isaea*

CONTROLS Leafminer pests



250 Loose Larvae per Vial

BIOLNP0551-01 Min. Buy 1ea

Shipping Info **DIRECT**

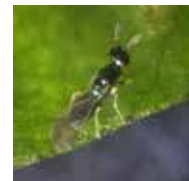

**Biological Control Agents - Mealy Bugs**

**Cryptoline Cryptolaemus montrouzieri Mealy Bug Control**

by BIOLINE AGROSCIENCES, INC.

The Cryptoline bottle contains 500 adult Cryptolaemus montrouzieri. Females can lay 10 eggs per day. Both the adults and larvae feed on Mealy bugs, their eggs and their larvae. The life cycle of the Cryptolaemus montrouzieri takes from 4 to 7 weeks depending on temperature. Release near Mealy bug infestations.

**ACTIVE INGREDIENT** Cryptolaemus montrouzieri

**CONTROLS** Mealy bugs



**500 Adult Beetles per Vial**

**BIOLNP0351-03** Min. Buy 1ea

Shipping Info **DIRECT**



**Biological Control Agents - Mites**

**Anderline™ Amblyseius andersoni Spider Mite & Rust / Russet Mite Control**

by BIOLINE AGROSCIENCES, INC.

Amblyseius andersoni is a predatory mite that can be used in the control of a range of mite pests. This predatory mite is ideal for vegetables, hardy ornamentals and fruit crops, controlling red or two-spotted spider mite, fruit-tree red spider mite and russet mites. It is active at lower temperatures than other predatory mites, which means that it can be introduced much earlier in the growing season than some other predators.

**ACTIVE INGREDIENT** Amblyseius andersoni

**CONTROLS** Mites



**Buglines (String of Sachets)**

**6ea of 328ft Buglines - A Continuous String of Controlled Release Sachets**

**RATE** Covers up to 10,000sq ft

**BIOLNP0016-05** Min. Buy 1ea

Shipping Info **DIRECT**



**Sachets on Sticks**

**1,000 Sachets on Sticks**

**RATE** One sachet covers one sq yd.

**BIOLNP0016-50** Min. Buy 1ea

Shipping Info **DIRECT**



**200 Mini Sachets on Sticks**

**RATE** One sachet covers one sq yd.

**BIOLNP0016-52** Min. Buy 1ea

Shipping Info **DIRECT**

**Sachets with Hooks**

**200 Controlled Release Mini Sachets with Hooks**

**RATE** Covers up to 4,000sq ft

**BIOLNP0016-31** Min. Buy 1ea

Shipping Info **DIRECT**



**Loose Mites in Bags, Blister Packs & Bottles**

**125,000 Loose Mites per Bag**

**RATE** Covers up to 12,500sq ft

**BIOLNP0016-02** Min. Buy 1ea

Shipping Info **DIRECT**



**4000 Bottle**

**RATE** one bottle will cover approximately 2000 sq ft.

**BIOLNP1013** Min. Buy 1ea

Shipping Info **DIRECT**

**2000 Blister Pack**

**RATE** one blister pack will cover approximately 200 sq ft.

**BIOLNP1012** Min. Buy 1ea

Shipping Info **DIRECT**



**25,000 Loose Mites per Tube**

**RATE** Covers up to 2,500sq ft

**BIOLNP0016-03** Min. Buy 1ea

Shipping Info **DIRECT**



### Biological Control Agents - Mites

#### Californiline™ Amblyseius californicus Spider Mite Control

by **BIOLINE AGROSCIENCES, INC.**

Amblyseius (Neoseiulus) californicus is an active predatory mite that has specialized in feeding on mites in the family Tetranychidae. This includes the common Red Spider Mite or Two-Spot Mite Tetranychus urticae and the Carmine Mite Tetranychus cinnabarinus. It is less specialized than Phytoseiulus persimilis and while it prefers to feed on spider mites, it can feed and reproduce on other arthropod prey or pollen. Where few spider mites are present, it is able to survive by feeding on these alternative sources of food and so can persist in a crop longer than Phytoseiulus persimilis.

**ACTIVE INGREDIENT** Amblyseius californicus

**CONTROLS** Spider Mites, Carmine Mites and other small arthropods.



#### Loose Mites in Bottles or Tubes

##### 4000 Bottle

**RATE** one bottle will cover approximately 4000 sq ft.

**BIOLNP2009** Min. Buy 1ea

Shipping Info **DIRECT**

##### 2,000 Loose Mites per Bottle

**RATE** One Bottle Covers 2,000 sq ft

**BIOLNP0013-01** Min. Buy 1ea

Shipping Info **DIRECT**

##### 25,000 Loose Mites per Tube

**RATE** One Tube Covers 10,000sq ft

**BIOLNP0013-04** Min. Buy 1ea

Shipping Info **DIRECT**



#### Sachets with Hooks

##### 200 Controlled Release Mini Sachets with Hooks

**RATE** One Sachet per sq yd

**BIOLNP0013-31** Min. Buy 1ea

Shipping Info **DIRECT**



#### Mites in Blister Packs

##### 1,000 individuals in five mini blisters of 200 each

**RATE** one blister will cover approx.250 sq ft

**BIOLNP0013-09** Min. Buy 1ea

Shipping Info **DIRECT**

#### Feltiline™ Feltiella acarisuga Spider Mite control

by **BIOLINE AGROSCIENCES, INC.**

Feltiella acarisuga is a beneficial gall midge for control of spider mites. Midge lay their eggs near spider mite eggs. The hatching midge larvae eat spider mite eggs. Sold in a tub of 250 midges.

**RATE** one tub will cover 25 sq meters

**ACTIVE INGREDIENT** Feltiella acarisuga

**CONTROLS** Spider mite



##### 250 per pkg

**BIOLNP1501-01** Min. Buy 1ea

Shipping Info **DIRECT**

#### Per-Cal Mix Mini Blister

by **BIOLINE AGROSCIENCES, INC.**

Per-Cal mix combines the quick knockdown effect of P. persimilis with the longer staying power of A. californicus for greater spider mite control. Sold in a pack of 5 blisters, each containing 200 mites (100 P. persimilis and 100 A. californicus)

**RATE** one blister will cover approx.250 sq ft

**ACTIVE INGREDIENT** Phytoseiulus persimilis and Amblyseius californicus

**CONTROLS** Spider mite



##### 1,000

**BIOLNP0321-09** Min. Buy 1ea

Shipping Info **DIRECT**



#### Phytoline™ Phytoseiulus persimilis Mite Control

by **BIOLINE AGROSCIENCES, INC.**

Phytoline biological control agent contains the predatory mite, Phytoseiulus persimilis. This well-known predator will eat large numbers of two-spotted spider mite. Recommended for spider mite control in many crops, particularly tomatoes, cucumbers, strawberries and ornamentals.

**ACTIVE INGREDIENT** Phytoseiulus persimilis

**CONTROLS** Spider mites



#### Loose Mites in Bottles or Vile

##### 1,000 per Bottle

**RATE** One Bottle Covers 1,000sq ft

**BIOLNP1201-09** Min. Buy 1ea

Shipping Info **DIRECT**

##### 2,000 per Bottle

**RATE** One Bottle Covers 2,000sq ft

**BIOLNP1201-01** Min. Buy 1ea

Shipping Info **DIRECT**

##### 20,000 per Bottle

**RATE** Covers up to 20,000sq ft

**BIOLNP1201-21** Min. Buy 1ea

Shipping Info **DIRECT**

##### 2,000 per 1oz Hot Spot Vial

**RATE** Varies depending on infestation.

**BIOLNP1201-02** Min. Buy 1ea

Shipping Info **DIRECT**



**Biological Control Agents - Thrips**

**Amblyline™ Amblyseius cucumeris Thrips Control**  
by **BIOLINE AGROSCIENCES, INC.**

Amblyseius cucumeris sachets on a stick are perfect for early propagation protection. Place one sachet on a stick in each propagation tray, pot or hanging basket. Your crop will be protected before the Thrips larvae have a chance to become a problem. Amblyseius cucumeris is a predator that feeds on a wide range of small arthropod prey. Besides small thrips and mites it will prey on spider mites, but does not offer significant control. Because Amblyseius cucumeris is small, it feeds only on the smaller thrips larvae and cannot attack large larvae or adults. For best results it is necessary to have as many predatory mites present as possible to prevent thrips larvae reaching maturity.

**ACTIVE INGREDIENT** Amblyseius cucumeris  
**CONTROLS** Thrips, Broad mites, Cyclamen mites.



**Bugline (String of Sachets)**

**6 continuous sachets, each 262.5 ft long.**

**RATE** Each Bugline covers an area 4 ft wide by 262.5 ft long.

**BIOLNP0011-27** Min. Buy 1ea

Shipping Info **DIRECT**

**6 continuous sachets, each 328 ft long.**

**RATE** Each Bugline covers an area 4 ft wide by 328 ft long.

**BIOLNP0011-26** Min. Buy 1ea

Shipping Info **DIRECT**



**6ea of 525ft Buglines - A Continuous String of Controlled Release Sachets**

**RATE** Each Bugline Covers an area 4ft W x 525ft L

**BIOLNP0011-30** Min. Buy 1ea

Shipping Info **DIRECT**

**Loose Mites in Bags & Bottles**

**100,000 Loose Mites per Bag**

**RATE** Covers Approximately 4,000sq ft.

**BIOLNP0011-12** Min. Buy 1ea

Shipping Info **DIRECT**

**250,000 Loose Mites per Bag**

**RATE** Covers Approximately 10,000sq ft

**BIOLNP0011-13** Min. Buy 1ea

Shipping Info **DIRECT**

**250,000 Loose Larvae per Bag (Bran/Vermiculite)**

**RATE** Covers Approximately 10,000sq ft.

**BIOLNP0011-17** Min. Buy 1ea

Shipping Info **DIRECT**

**50,000 Loose Mites per Bottle**

**RATE** Covers Approximately 2,000sq ft

**BIOLNP0011-04** Min. Buy 1ea

Shipping Info **DIRECT**

**50,000 Loose Mites per Tube**

**RATE** Covers Approximately 2,000sq ft

**BIOLNP0011-19** Min. Buy 1ea

Shipping Info **DIRECT**



**Mites in Blister Packs**

**2000 Blister Pack**

**RATE** one blister pack will cover approximately 200 sq ft.

**BIOLNP3034** Min. Buy 1ea

Shipping Info **DIRECT**



**Sachets with Hooks**

**200 Controlled Release Sachets with Hooks**

**RATE** 3 to 5 Sachets per 10sq ft

**BIOLNP0011-01** Min. Buy 1ea

Shipping Info **DIRECT**

**400 Controlled Release Mini Sachet with Hooks**

**RATE** One per sq yd

**BIOLNP0011-31** Min. Buy 1ea

Shipping Info **DIRECT**

**1,000 Controlled Release Mini Sachet with Hooks**

**RATE** One Sachet Covers a sq yd

**BIOLNP0011-33** Min. Buy 1ea

Shipping Info **DIRECT**

**1,000 Controlled Release Larvae Mini Sachets with Hooks**

**RATE** One Sachet Covers 6sq ft

**BIOLNP0015-33** Min. Buy 1ea

Shipping Info **DIRECT**



**Sachets on Sticks**

**500 Controlled Release Mini Sachet on Sticks**

**RATE** One per Tray or Pot

**BIOLNP0011-51** Min. Buy 1ea

Shipping Info **DIRECT**

**1,000 Controlled Release Mini Sachets on Sticks**

**RATE** One per Tray or Pot

**BIOLNP0011-50** Min. Buy 1ea

Shipping Info **DIRECT**

**2,000 Controlled Release Mini Sachets on Sticks**

**RATE** One per Tray or Pot

**BIOLNP0011-49** Min. Buy 1ea

Shipping Info **DIRECT**



### Biological Control Agents - Thrips

#### Exhibitline sf™ *Steinernema feltia* Fungus Gnat and Thrips Control

by **BIOLINE AGROSCIENCES, INC.**

*Steinernema feltia* nematodes help control Fungus Gnat and Thrips. Harmless to the ornamental crops, humans, the environment and other beneficial insects, these nematodes actively seek out fungus gnat larvae by swimming in the thin film of water on soil particles. They locate hosts by detecting carbon dioxide and other waste products.

**ACTIVE INGREDIENT** *Steinernema feltia*

**CONTROLS** Fungus Gnat and Thrips.



##### Sea of 50 Million per Tray

**RATE** One 50 Million Tray Will Cover up to 1,000sq ft

**BIOLNP1011-02** Min. Buy 1ea

Shipping Info **DIRECT**



##### Sea of 250 Million per Tray

**RATE** One 250 Million Tray Will Cover up to 5,000sq ft

**BIOLNP1011-03** Min. Buy 1ea

Shipping Info **DIRECT**

#### Oriline i™ *Orius insidiosus* Thrips Control

by **BIOLINE AGROSCIENCES, INC.**

*Orius insidiosus* is the only biological control agent that kills adult Thrips. A single Orius bug can kill up to 80 Thrips per day. Orius populations establish well on pollen rich crops. Feeding Epehstia eggs will enhance the establishment of Orius. It takes 4 to 6 weeks to establish a population.

**RATE** One Orius Covers a sq ft

**ACTIVE INGREDIENT** *Orius insidiosus*

**CONTROLS** Thrips and others.



##### 500 per Bottle

**BIOLNP1102-01** Min. Buy 1ea

Shipping Info **DIRECT**

##### 1,000 per Bottle

**BIOLNP1102-06** Min. Buy 1ea

Shipping Info **DIRECT**

##### 2,000 per Bottle

**BIOLNP1102-07** Min. Buy 1ea

Shipping Info **DIRECT**

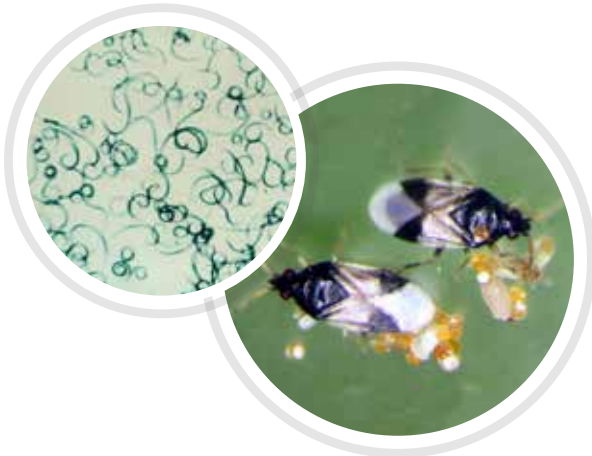

### Biological Control Agents - Whiteflies

#### Encarline™ *Encarsia formosa* + Eretline™ *Eretmocerus eremicus* Whitefly Control

by **BIOLINE AGROSCIENCES, INC.**

Encarline mix contains the hymenopterous parasites, *Encarsia formosa* and *Eretmocerus eremicus*. It controls the larvae of greenhouse whitefly and silverleaf / sweet potato whitefly. Using the two species in combination provides improved control of whitefly throughout the season.

**RATE** covers 5,000 sq yd

**ACTIVE INGREDIENT** *Encarsia formosa* and *Eretmocerus eremicus*

**CONTROLS** Whitefly



#### Wasps Attached to Cards

**250 Cards per Pack, 60 Wasps per Card**

**BIOLNP0831-15** Min. Buy 1ea

Shipping Info **DIRECT**



#### Wasps in Blister Packs

**40 Blister Packs, 250 Adults per Blister**

**RATE** Covers up to 3,000sq yd

**BIOLNP0831-02** Min. Buy 1ea

Shipping Info **DIRECT**

#### Encarline™ *Encarsia formosa* Whitefly Control

by **BIOLINE AGROSCIENCES, INC.**

*Encarsia formosa* is a hymenopterous parasite of whitefly, attacking larvae at the 3rd and 4th larval stage. It is supplied as parasitized scales (pupae) attached to cards, which are hung in the crop from where tiny wasps hatch out and attack the whiteflies. Each card will produce either a minimum of 60 or 100 female wasps.

**ACTIVE INGREDIENT** *Encarsia formosa*

**CONTROLS** Whitefly



#### Parasitized Scales Attached to Cards

**100 Cards, 60 Female Wasps per Card**

**RATE** Covers up to 2,500sq yd

**BIOLNP0801-13** Min. Buy 1ea

Shipping Info **DIRECT**

#### 250 Cards, 60 Female Wasps per Card

**RATE** Covers up to 5,000sq yd

**BIOLNP0801-15** Min. Buy 1ea

Shipping Info **DIRECT**



#### Hesperusline™ *Dicyphus hesperus* Whitefly Control

by **BIOLINE AGROSCIENCES, INC.**

Hesperusline biological control agent contains the predatory bug, *Dicyphus hesperus*. *Dicyphus hesperus* is a generalist predatory bug that is primarily released for whitefly control, but will feed on other pests such as Thrips, moth eggs and mites. It is best to establish the *Dicyphus* population with the help of mullein banker plants.

**RATE** 40 Banker Plants per Acre

**ACTIVE INGREDIENT** *Dicyphus hesperus*

**CONTROLS** Many pests, see label.



#### 250 Adults & Late Instar Nymphs per Bottle

**BIOLNP0411-02** Min. Buy 1ea

Shipping Info **DIRECT**





**Biological Control Agents - Whiteflies**

**Eretline™ Eretmoceris eremicus Whitefly Control**

by **BIOLINE AGROSCIENCES, INC.**

Eretmoceris eremicus is a parasitic wasp that attacks Greenhouse Whitefly and Sweet Potato Whitefly. Compared to Encarsia formosa, Eretmoceris is better adapted to high temperatures and those that fluctuate from day to night and is likely to last all season.

**ACTIVE INGREDIENT** Eretmoceris eremicus

**CONTROLS** Whitefly



**Wasps Attached to Cards**

**60 Hanging Cards, 50 Wasps per Card**

**RATE** One Card Covers up to 50sq ft

**BIOLNP0821-03** Min. Buy 1ea

Shipping Info **DIRECT**

**200 Hanging Cards, 50 Wasps per Card**

**RATE** One Card Covers up to 50sq ft

**BIOLNP0821-07** Min. Buy 1ea

Shipping Info **DIRECT**

**250 Hanging Cards, 60 Wasps per Card**

**RATE** One Card Covers up to 50sq ft

**BIOLNP0821-15** Min. Buy 1ea

Shipping Info **DIRECT**



**Wasps in Blister Packs**

**20 Blister Packs, 250 Wasps per Blister**

**RATE** One blister Pack Cover up to 250sq ft

**BIOLNP0821-02** Min. Buy 1ea

Shipping Info **DIRECT**

**20 Blister Packs, 500 Wasps per Blister**

**RATE** One Blister Pack Covers up to 500sq ft

**BIOLNP0821-90** Min. Buy 1ea

Shipping Info **DIRECT**



**Swirskiline™ Amblyseius swirskii Whitefly Control**

by **BIOLINE AGROSCIENCES, INC.**

Swirskiline biological control agent contains the predatory mite, Amblyseius swirskii. It is primarily used to control whiteflies and thrips but it will provide some reduction in other small pest species. In the absence of prey it can survive by feeding on pollen, allowing it to survive longer in the crop. They breed extremely quickly under warm, humid conditions. They will also survive in cooler night temperatures and through winter months in semi-protected crops. Amblyseius swirskii sachets allow you to establish a breeding colony of mites on the plants before the target pest is present. Mites emerge from the sachet over several weeks and in much higher numbers than a single broadcast release.

**ACTIVE INGREDIENT** Amblyseius swirskii

**CONTROLS** Whitefly, Thrips and more.



**Loose Mites in Bags & Bottles**

**125,000 Loose Larvae per Bag**

**RATE** 125,000 Covers 2,500sq yd

**BIOLNP0015-02** Min. Buy 1ea

Shipping Info **DIRECT**

**25,000 Loose Larvae per Tube**

**RATE** One Tube Covers 500sq yd

**BIOLNP0015-03** Min. Buy 1ea

Shipping Info **DIRECT**



**Bugline (String of Sachets)**

**6ea of 328ft Buglines - A Continuous String of Controlled Release Sachets**

**RATE** One Bugline Sachets Covers an Area 4ft W x 328ft

**BIOLNP0015-07** Min. Buy 1ea

Shipping Info **DIRECT**



**Mites in Blister Packs**

**2000 Blister Pack**

**RATE** one blister pack will cover approximately 200 sq ft.

**BIOLNP5019** Min. Buy 1ea

Shipping Info **DIRECT**

**Sachets with Hooks**

**200 Controlled Release Larvae Mini Sachets with Hooks**

**RATE** One sachet covers one sq yd.

**BIOLNP0015-34** Min. Buy 1ea

Shipping Info **DIRECT**

**500 Controlled Release Sachet with Hooks**

**RATE** One sachet covers one sq yd.

**BIOLNP0015-05** Min. Buy 1ea

Shipping Info **DIRECT**

**1,000 Mini Sachets with Hooks**

**RATE** One Sachet Covers 3sq ft

**BIOLNP0015-31** Min. Buy 1ea

Shipping Info **DIRECT**



**Sachets on Sticks**

**500 Controlled Release Larvae Mini Sachets on Sticks**

**RATE** One sachet covers one sq yd.

**BIOLNP0015-50** Min. Buy 1ea

Shipping Info **DIRECT**





### Biological Control Agents - Other

#### Bugfood E™ Ephestia eggs

by *BIOLINE AGROSCIENCES, INC.*

Ephestia Eggs are used as a supplemental food source to maintain predators such as Orius I, Dicyphus hesperus, and Chrysoperla rufilabris when pest levels are low. Sold in a 250 gram bottle.

**ACTIVE INGREDIENT** Ephestia eggs



**250 gram bottle**

**BIOLNP8141-02** Min. Buy 1ea

Shipping Info [DIRECT](#)

#### Ephestia Eggs (Beneficial Predator Food)

by *BIOLINE AGROSCIENCES, INC.*

Used as a supplemental food source to maintain predators such as Orius insidiosus, Chrysoperla rufilabris (larval stage) and Dicyphus hesperus when pest levels are low.

**ACTIVE INGREDIENT** Ephestia eggs



**10g**

**BIOLNP8141-01** Min. Buy 1ea

Shipping Info [DIRECT](#)



#### Release Boxes

by *BIOLINE AGROSCIENCES, INC.*

Keep beneficial insects safe from predators as they hatch. Suspend from a shaded location near your pest infestation and the beneficials will go where they are needed.



**BIOLNP8042-01** Min. Buy 1ea

Shipping Info [DIRECT](#)



#### Dupoline™ Duponchiela Pheromone Lure

by *BIOLINE AGROSCIENCES, INC.*

Duponchiela pheromone lure for attracting lepidopteran pests to sticky traps. Sold as a pack of 10 lures.

**ACTIVE INGREDIENT** Duponchiela pheromone



**10 per pkg.**

**BIOLNP8054-04** Min. Buy 1ea

Shipping Info [DIRECT](#)

#### Thripline™ Lure

by *BIOLINE AGROSCIENCES, INC.*

Thripline lure contains the aggregation pheromone of Western Flower Thrips, Frankliniella occidentalis. The product is designed to improve the sensitivity of monitoring traps for thrips, particularly at low levels of infestation or in easily damaged crops. Sold in a pack of 10 lures.



**10 per pkg.**

**BIOLNP8061-02** Min. Buy 1ea

Shipping Info [DIRECT](#)

#### Thripline™ Sticky Thrips Pheromone Trap

by *BIOLINE AGROSCIENCES, INC.*

Designed to improve the sensitivity of monitoring traps for thrips, particularly at low levels of infestation or in easily damaged crops. Thripline contains a synthetic version of a sexual aggregation pheromone for Western Flower Thrips (Frankliniella occidentalis). The natural pheromone is produced by males and attracts both males and females into mating aggregations. The Thrips will move to the top of the crop to look for mates and to display. Thripline combines this pheromone with Taki-traps® to catch these Thrips. The pheromone is impregnated into rubber septa which are sealed in foil sachets to maintain viability.



**10pk**

**BIOLNP8061-01** Min. Buy 1ea

Shipping Info [DIRECT](#)



**Biological Control Agents - Aphids**

**Aphidius colemani**

by *BIOWORKS INC.*

Aphidius colemani are natural aphid parasites and very useful and effective for the management of larger Aphid species. 10 blisters cover one acre as a preventative measure. Once Aphids are found 10 blisters will cover one half acre.



**10 Blisters with 100 mummies and adults per blister**

**BWAC10BP** Min. Buy 1ea

Shipping Info *DIRECT*

**50 Blisters with 100 mummies and adults per blister**

**BWAC50BP** Min. Buy 1ea

Shipping Info *DIRECT*

**Aphidius Colemani and Ervi Mix**

by *BIOWORKS INC.*

Aphidius colemani and ervi mix for control of larger aphid species in vegetable and ornamental crops. These 2-3 millimeter mini-wasps are best used for preventing the establishment of aphid infestations.



**Loose Mummies in Bottles**

**500 mummies per bottle**

**BWACE5** Min. Buy 1ea

Shipping Info *DIRECT*

**1000 mummies per bottle**

**BWACE1K** Min. Buy 1ea

Shipping Info *DIRECT*

**Mummies in Bottles**

**10 blisters with 100 mummies in each blister**

**BWACE1KBP** Min. Buy 1ea

Shipping Info *DIRECT*

**50 Blisters with 100 mummies and adults per blister**

**BWACE5KBP** Min. Buy 1ea

Shipping Info *DIRECT*

**Aphidius matricariae**

by *BIOWORKS INC.*

Predatory wasp for control of Aphids. Use in combination with Aphidius colemani for effective aphid control.

**CONTROLS** Aphids



**500 mummies and adults**

**BWAMAT5** Min. Buy 1ea

Shipping Info *DIRECT*

**5000 mummies and adults**

**BWAMAT5K** Min. Buy 1ea

Shipping Info *DIRECT*

**BioWorks® Amblyseius Abdominalis**

by *BIOWORKS INC.*

Aphelinus abdominalis is a parasitic wasp for control of many species of young aphids. Aphelinus is shipped as mummies which quickly hatch and begin feeding.

**CONTROLS** Aphids



**1,000 mummies per vial**

**BWAD10** Min. Buy 1ea

Shipping Info *DIRECT*

**250 mummies per bottle**

**BWAD25** Min. Buy 1ea

Shipping Info *DIRECT*

**BioWorks® Aphidius Colemani**

by *BIOWORKS INC.*

Aphidius colemani are natural aphid parasites and very useful and effective for the management of larger aphid species.

**CONTROLS** Aphids.



**500 mummies per bottle**

**BWAC5** Min. Buy 1ea

Shipping Info *DIRECT*

**1,000 mummies per bottle**

**BWAC10** Min. Buy 1ea

Shipping Info *DIRECT*

**5,000 mummies per bottle**

**BWAC50** Min. Buy 1ea

Shipping Info *DIRECT*

**BioWorks® Aphidius Ervi**

by *BIOWORKS INC.*

Aphidius ervi is a tiny braconid wasp that stings and parasitises large aphid species. Works very well in conjunction with Aphidius colemani. Useful and effective for the prevention and low-infestation management of various aphid species.

**CONTROLS** Aphids.



**250 mummies per bottle.**

**BWAE25** Min. Buy 1ea

Shipping Info *DIRECT*

**500 mummies per bottle**

**BWAE50** Min. Buy 1ea

Shipping Info *DIRECT*

**1,000 mummies per bottle**

**BWAE1K** Min. Buy 1ea

Shipping Info *DIRECT*

**10 blisters with 100 mummies in each blister**

**BWAE1KBP** Min. Buy 1ea

Shipping Info *DIRECT*



### Biological Control Agents - Aphids

#### BioWorks® Aphidoletes aphidimyza

by *BIOWORKS INC.*

Aphidoletes aphidimyza is a parasitic gall midge. Attracted to aphid honeydew, the adult midge lays between 60-250 eggs amongst the aphid colonies. When the larvae hatch they begin feeding voraciously. Works well as a "hot spot" treatment with a single larvae able to kill more than 35 aphids in it's lifespan.

**CONTROLS** Aphids.



##### 2,000 pupae per bottle

**BWAA2** Min. Buy 1ea

Shipping Info [DIRECT](#)

##### 10,000 pupae per bottle

**BWAA10** Min. Buy 1ea

Shipping Info [DIRECT](#)

#### BioWorks® Chrysoperla rufilabris

by *BIOWORKS INC.*

Chrysoperla rufilabris (Green Lacewing) are aphid predators. Lacewing adults feed only on nectar, pollen and honeydew but the Lacewing larvae are voracious predators of aphids and other small soft bodied insects, larvae and eggs. One larvae can consume up to 200 aphids. Lacewing eggs and larvae should be dispersed within aphid colonies. Adult Lacewing will find and lay their eggs within the aphid colony.

**CONTROLS** Aphids and other small insect larvae and eggs.



##### 5l bag 5,000 Lacewing larvae

**BWLWBG** Min. Buy 1ea

Shipping Info [DIRECT](#)

##### 4oz bottle 5,000 Lacewing eggs

**BWL5K** Min. Buy 1ea

Shipping Info [DIRECT](#)

##### 16oz bottle Lacewing larvae

**BWLWB** Min. Buy 1ea

Shipping Info [DIRECT](#)

##### .1k Lacewing adults

**BWLWA1** Min. Buy 1ea

Shipping Info [DIRECT](#)

##### .25k Lacewing adults

**BWLWA2** Min. Buy 1ea

Shipping Info [DIRECT](#)

##### 10,000 Lacewing eggs per bottle

**BWL10K** Min. Buy 1ea

Shipping Info [DIRECT](#)

##### 5,000 Lacewing eggs on cards

**BWLWCD** Min. Buy 1ea

Shipping Info [DIRECT](#)

##### 10,000 Lacewing larvae per 5L bucket

**BWLWL10K** Min. Buy 1ea

Shipping Info [DIRECT](#)

##### 1k tube Lacewing adults

**BWLWA3** Min. Buy 1ea

Shipping Info [DIRECT](#)

##### 400 Lacewing larvae per hex cell.

**BWLWFR** Min. Buy 1ea

Shipping Info [DIRECT](#)

### Biological Control Agents - Black Vine Weevils

#### Bioworks® Nemashield® Hb

by *BIOWORKS INC.*

Fast, effective biological control of root feeding grubs and larvae in the soil. The beneficial nematodes actively seek out grubs and larvae and infect them. Once infected the target pests die within a few days.



##### 1 Tray of 50 Million

**BWN33B43** Min. Buy 1ea

Shipping Info [DIRECT](#)

##### 2 Trays of 250 Million Each

**BWN33B28** Min. Buy 1ea

Shipping Info [DIRECT](#)

#### Bioworks® Nemashield® Hb Invivo

by *BIOWORKS INC.*

Fast, effective biological control of root feeding grubs and larvae in the soil. The beneficial nematodes actively seek out grubs and larvae and infect them. Once infected the target pests die within a few days. Packaged on a sponge with no clay or gel carrier means no more clogged filters.



##### 6 Million on Sponge

**BWSB4BW06** Min. Buy 1ea

Shipping Info [DIRECT](#)

##### 24 Million on Sponge

**BWSB4BW24** Min. Buy 1ea

Shipping Info [DIRECT](#)

### Biological Control Agents - Caterpillars

#### Podisus maculiventris

by *BIOWORKS INC.*

Podisus maculiventris is a larger predatory stink bug preying on caterpillars, loopers, and beetle larvae.



##### 50 nymphs

**BWSB210103700** Min. Buy 1ea

Shipping Info [DIRECT](#)

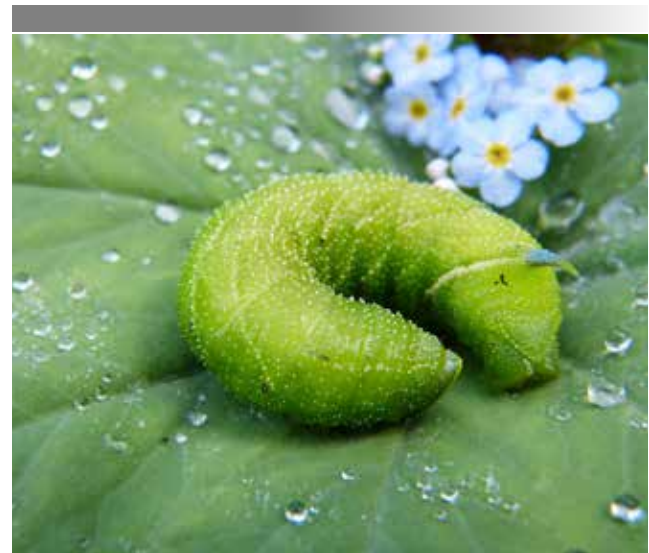

**Biological Control Agents - Fungus Gnats**

**BioWorks® Dalotia coriaria**

by **BIOWORKS INC.**

Dalotia (Atheta) coriaria is a generalist predator of soil and compost pests. This rove beetle is particularly good at feeding on the larvae of Sciarid flies, Shore flies, and Thrips pupae. Introduce early in the season to give Dalotia time to build up a good population.

**CONTROLS** Sciarid flies, Shore flies



**Loose Beetles in Bottles & Buckets**

**500 beetles per bottle**

**BWDCS** Min. Buy 1ea

Shipping Info [DIRECT](#)

**1,000 beetles per bottle - No vermiculite in carrier**

**BWDC1N** Min. Buy 1ea

Shipping Info [DIRECT](#)

**1,000 beetles per bottle**

**BWDC10** Min. Buy 1ea

Shipping Info [DIRECT](#)

**3,000 beetles per bucket - No vermiculite in carrier**

**BWDC3N** Min. Buy 1ea

Shipping Info [DIRECT](#)

**3,000 beetles per bucket**

**BWDCBK** Min. Buy 1ea

Shipping Info [DIRECT](#)

**5000 in bucket**

**BWDC5K** Min. Buy 1ea

Shipping Info [DIRECT](#)

**Bioworks® Nemashield® Sc Invivo**

by **BIOWORKS INC.**

Steinernema carpocapsae provides biological control of Shorefly, Leather jackets, Cutworms and other soil dwelling insects. They attack target pests without harming any other organisms. Safe for ornamental crops. Packaged on a sponge with no clay or gel carrier means no more clogged filters.



**6 Million on Sponge**

**BWSBBW006** Min. Buy 1ea

Shipping Info [DIRECT](#)

**24 Million on Sponge**

**BWSBBW024** Min. Buy 1ea

Shipping Info [DIRECT](#)

**Don't See What You Need?**

Use the BFG Mobile app or visit [www.bfgsupply.com](http://www.bfgsupply.com) to see a much larger selection of Fungicides

**BioWorks® Stratiolaelaps scimitus**

by **BIOWORKS INC.**

Stratiolaelaps scimitus (Hypoaspis miles) attacks and kills the larvae of sciarid flies and will also consume thrips larvae that drop to the growing medium to pupate, making it a useful addition to other Western Flower Thrips control products. Also attacks and kills larvae of Fungus Gnats. Normally found within the top half inch of soil / growing media, females lay eggs which hatch after six days. The larvae actively feed for 10 days and continue to feed as an adult. Adults live for several months when food is readily available.

**CONTROLS** Fungus gnat, Shore fly, Thrips



**Loose Mites in Bottles & Buckets**

**125,000 per bucket - No vermiculite**

**BWSSGN** Min. Buy 1ea

Shipping Info [DIRECT](#)

**125,000 per bucket**

**BWSSBK** Min. Buy 1ea

Shipping Info [DIRECT](#)

**25,000 mites per bottle - No vermiculite**

**BWSSN** Min. Buy 1ea

Shipping Info [DIRECT](#)

**25,000 mites per bottle**

**BWSS25** Min. Buy 1ea

Shipping Info [DIRECT](#)

**Bioworks® Nemashield® Sfc Invivo**

by **BIOWORKS INC.**

Steinernema feltia and carpocapsae together in one mix for control of Fungus Gnat, Thrips, Leather Jacket and Cutworms. Packaged on a sponge with no clay or gel carrier means no more clogged filters. The lack of a carrier also makes it more useful for organic production.



**6 Million on Sponge**

**BWSB3006** Min. Buy 1ea

Shipping Info [DIRECT](#)

**24 Million on Sponge**

**BWSB3024** Min. Buy 1ea

Shipping Info [DIRECT](#)

**Bioworks® Nemashield® Sf Invivo**

by **BIOWORKS INC.**

Provides excellent biological control of fungus gnats by eliminating damaging fungus gnat larvae. A single application is sufficient for preventing fungus gnat outbreaks or for control in the beginning phase of an outbreak. Effective in a Western Flower Thrips control program for treatment of pupae.



**1 Million on Sponge**

**BWSB200BW** Min. Buy 1ea

Shipping Info [DIRECT](#)

**6 Million on Sponge**

**BWSB2006** Min. Buy 1ea

Shipping Info [DIRECT](#)

**24 Million on Sponge**

**BWSB2004** Min. Buy 1ea

Shipping Info [DIRECT](#)



### Biological Control Agents - Leafminers

#### BioWorks® Diglyphus isaea

by *BIOWORKS INC.*

Diglyphus isaea is a parasitic wasp for Leafminer control. It lays its eggs next to leafminer larvae. The eggs quickly hatch and begin to feed on the larvae. Diglyphus is known to establish quickly after release in the greenhouse, making it perfect for controlling growing populations of leafminers.

**CONTROLS** Leafminer



**250 adults per bottle.**

**BWDI25** Min. Buy 1ea

Shipping Info *DIRECT*

#### Dacnusa sibirica

by *BIOWORKS INC.*

Predatory wasp for leafminer control. Very effective at low levels of leafminer infestations.

**CONTROLS** Leafminer



**250 wasps per bottle**

**BWDSIB25** Min. Buy 1ea

Shipping Info *DIRECT*

### Biological Control Agents - Mealybugs

#### BioWorks® Cryptolaemus montrouzieri

by *BIOWORKS INC.*

Cryptolaemus montrouzieri are Mealy Bug predators. Useful for controlling Mealy Bug infestations in vegetables, indoor ornamentals, and citrus trees. Both adult and juvenile Cryptolaemus are voracious predators.

**CONTROLS** Mealy Bug



**100 adults per bottle.**

**BWCR1** Min. Buy 1ea

Shipping Info *DIRECT*

**500 adults per bottle.**

**BWCR50** Min. Buy 1ea

Shipping Info *DIRECT*

### Biological Control Agents - Mites

#### BioWorks® Amblyseius andersoni

by *BIOWORKS INC.*

Amblyseius andersoni is a predatory mite for control of mite pests. This predator is ideal for vegetables, hardy ornamentals and fruit crops, controlling red or two-spotted spider mite, fruit-tree red spider mite, and russet mites. It is active at lower temperatures than other predatory mites and can be introduced much earlier in the growing season than some other predators.

**CONTROLS** Two spotted spider mites, red spider mites, and russet mites



#### Sachets with Hooks

**250 sachets with hooks containing 250 mites each**

**BWAI2H** Min. Buy 1ea

Shipping Info *DIRECT*

#### Mites in Tubes

**25,000 mites in a tube**

**BWAI25** Min. Buy 1ea

Shipping Info *DIRECT*

#### BioWorks® Amblyseius californicus

by *BIOWORKS INC.*

Amblyseius californicus is an active predatory mite that feeds on mites in the family Tetranychidae including the common Red Spider Mite or Two-Spotted Mite, and the Carmine Mite. Where few spider mites are present, it is able to survive by feeding on alternative sources of food, and so can persist in a crop longer.

**CONTROLS** Two spotted spider mites, red spider mites, and russet mites



#### Mites in Bags, Bottles & Tubes

**200,000 mites per bag**

**BWCA200K** Min. Buy 1ea

Shipping Info *DIRECT*

**5,000 mites per bottle**

**BWCA5** Min. Buy 1ea

Shipping Info *DIRECT*

**25,000 loose mites in a bottle.**

**BWCA25** Min. Buy 1ea

Shipping Info *DIRECT*

#### Sachets with Hooks

**100 sachets with hooks containing 100 mites each.**

**BWCA1H** Min. Buy 1ea

Shipping Info *DIRECT*

**500 sachets with hooks containing 100 mites each.**

**BWCA5H** Min. Buy 1ea

Shipping Info *DIRECT*



**Biological Control Agents - Mites**

**Biological Control Agents - Mites**

**BioWorks® Amblyseius fallacis**

by *BIOWORKS INC.*

Neoseiulus (Amblyseius) fallacis is an all purpose predatory mite used for the prevention and control of various spider mites including two spotted spider mites, carmine mites and several species of red mites. Fallacis mites can live off of pollen when no prey are present so they can be released early as a preventative measure. Sold in a bottle with a vermiculite carrier.

**CONTROLS** Spider mites, carmine mites, and red mites.



**2,000 mites per bottle**

**BWNF2** Min. Buy 1ea

Shipping Info [DIRECT](#)

**5,000 mites per bottle**

**BWNF5** Min. Buy 1ea

Shipping Info [DIRECT](#)

**10,000 mites per bottle**

**BWNF10** Min. Buy 1ea

Shipping Info [DIRECT](#)

**25,000 mites per bottle**

**BWNF25** Min. Buy 1ea

Shipping Info [DIRECT](#)

**BioWorks® Phytoseiulus persimilis**

by *BIOWORKS INC.*

Phytoseiulus persimilis is an active spider mite predator. This species has become the standard spider mite treatment in a wide variety of crops. Persimilis develops twice as fast as the spider mite which allows a rapid control of outbreaks.

**CONTROLS** Two Spotted Spider mites



**2,000 per bottle**

**BWPP2** Min. Buy 1ea

Shipping Info [DIRECT](#)

**2,000 per vial**

**BWPP2V** Min. Buy 1ea

Shipping Info [DIRECT](#)

**5,000 per bottle**

**BWPP5** Min. Buy 1ea

Shipping Info [DIRECT](#)

**10,000 per bottle**

**BWPP10** Min. Buy 1ea

Shipping Info [DIRECT](#)

**20,000 per bottle**

**BWPP20** Min. Buy 1ea

Shipping Info [DIRECT](#)

**25,000 per 16oz bottle**

**BWPP25** Min. Buy 1ea

Shipping Info [DIRECT](#)

**25,000 per 1L bottle**

**BWPP25L** Min. Buy 1ea

Shipping Info [DIRECT](#)

**Stethorus punctillum**

by *BIOWORKS INC.*

Stethorus punctillum is a voracious lady bug beetle for the control of Spider mites. Larvae and adults are predators and feed on all stages of several mite species such as two-spotted spider mite, spruce spider mite, southern red mite and European spider mite.

**CONTROLS** Spider mites



**50 per bottle**

**BWABSP50** Min. Buy 1ea

Shipping Info [DIRECT](#)

**100 per bottle**

**BWABSP100** Min. Buy 1ea

Shipping Info [DIRECT](#)

**BioWorks® Feltiella acarisuga**

by *BIOWORKS INC.*

Feltiella acarisuga is a predatory midge highly specialized for feeding on spider mite. This is a voracious predator best suited to curative control of established spider mite colonies.

**CONTROLS** Spider Mite



**250 midges per tray**

**BWFA25** Min. Buy 1ea

Shipping Info [DIRECT](#)

**Biological Control Agents - Thrips**

**BioWorks® Orius insidiosus**

by *BIOWORKS INC.*

Orius insidiosus is an aggressive Thrips predator and one of the few beneficial insects that can kill adult thrips. Orius takes a little longer to establish a population which makes it a good follow up treatment after Amblyseius cucumeris or Amblyseius swirskii releases.

**CONTROLS** Thrips



**In Bottles**

**500 per bottle**

**BWOIS** Min. Buy 1ea

Shipping Info [DIRECT](#)

**1,000 per bottle**

**BWOIM** Min. Buy 1ea

Shipping Info [DIRECT](#)

**2,000 per bottle**

**BWOIM2** Min. Buy 1ea

Shipping Info [DIRECT](#)

**In Buckwheat Carriers**

**1,000 adults in a buckwheat carrier**

**BWOIN** Min. Buy 1ea

Shipping Info [DIRECT](#)

**500 adults in a buckwheat carrier**

**BWOISBW** Min. Buy 1ea

Shipping Info [DIRECT](#)

**2,000 adults in a buckwheat carrier**

**BWOIM2BW** Min. Buy 1ea

Shipping Info [DIRECT](#)



### Biological Control Agents - Thrips

#### NemaShield® Steinernema Beneficial Nematodes

by *BIOWORKS INC.*

Provides excellent biological control of fungus gnats by eliminating damaging fungus gnat larvae. A single application is sufficient for preventing fungus gnat outbreaks or for control in the beginning phase of an outbreak. Effective in a Western Flower Thrips control program for treatment of pupae and pre-pupae. It will also control thrips species that spend a portion of their life cycle in the soil or potting media.

REI 0 Hrs

**RATE** Varies depending on application method. See label.

**ACTIVE INGREDIENT** Steinernema feltiae

**CONTROLS** Fungus Gnat, Thrips.



##### 100 Million Pack

**BW1N20A26** Min. Buy 1ea

Shipping Info [DIRECT](#)

##### 250 Million Pack

**BW1N20A27** Min. Buy 1ea

Shipping Info [DIRECT](#)



#### BioWorks® Amblyseius cucumeris

by *BIOWORKS INC.*

Amblyseius cucumeris is a predator that feeds on a wide range of pests including Thrips, Broad mites, and Cyclamen mites.

**CONTROLS** Thrips, Broad mites and Cyclamen mites



#### Mites in Bags or Bottles

**100,000 mites per bag in vermiculite**

**BWNC100VG** Min. Buy 1ea

Shipping Info [DIRECT](#)

**100,000 mites per bag**

**BWNCBB** Min. Buy 1ea

Shipping Info [DIRECT](#)

**250,000 mites per bag in bran carrier**

**BWNCGN** Min. Buy 1ea

Shipping Info [DIRECT](#)

**250,000 mites per bag in vermiculite**

**BWNCVG** Min. Buy 1ea

Shipping Info [DIRECT](#)

**250,000 mites per bag**

**BWNCBG** Min. Buy 1ea

Shipping Info [DIRECT](#)

**20,000 mites per bottle in vermiculite**

**BWNC20KVM** Min. Buy 1ea

Shipping Info [DIRECT](#)

**20,000 mites per bottle**

**BWNCB2** Min. Buy 1ea

Shipping Info [DIRECT](#)

**50,000 mites per bottle - no vermiculite**

**BWNCBN** Min. Buy 1ea

Shipping Info [DIRECT](#)

**50,000 mites per bottle**

**BWNCB** Min. Buy 1ea

Shipping Info [DIRECT](#)

#### Sachets on Hooks

**100 sachets with hooks containing 250 mites each**

**BWN1H** Min. Buy 1ea

Shipping Info [DIRECT](#)

**500 sachets with hooks containing 250 mites each**

**BWNC5H** Min. Buy 1ea

Shipping Info [DIRECT](#)

**1000 sachets with hooks containing 250 mites each**

**BWNC1H** Min. Buy 1ea

Shipping Info [DIRECT](#)

#### Sachets on Sticks

**500 Mini Sachets on Long Sticks containing 250 mites each**

**BWNC5KL** Min. Buy 1ea

Shipping Info [DIRECT](#)

**1000 Mini Sachets on Long Sticks containing 250 mites each**

**BWNC1KL** Min. Buy 1ea

Shipping Info [DIRECT](#)

**100 sachets on sticks containing 250 mites each**

**BWN1K** Min. Buy 1ea

Shipping Info [DIRECT](#)

**500 sachets on sticks containing 250 mites each**

**BWNC5K** Min. Buy 1ea

Shipping Info [DIRECT](#)

**1000 sachets on sticks containing 250 mites each**

**BWNC1K** Min. Buy 1ea

Shipping Info [DIRECT](#)



**Biological Control Agents - Whiteflies**

**BioWorks® Amblyseius swirskii**

by *BIOWORKS INC.*

Amblyseius swirskii is a predatory mite for control of Whitefly and Thrips. Establishment will be fastest on crops with ample pollen as the pollen acts as an alternative food source. Recommended for vegetable, ornamentals, fruit trees, citrus, and berries.

**CONTROLS** Whitefly, Thrips and more.



**Mites in Bags or Bottles**

**125,000 mites per bag no vermiculite**

**BWASGN** Min. Buy 1ea

Shipping Info *DIRECT*

**125,000 mites per bag**

**BWASBG** Min. Buy 1ea

Shipping Info *DIRECT*

**25,000 mites per bottle**

**BWASB** Min. Buy 1ea

Shipping Info *DIRECT*

**25,000 mites per bottle no vermiculite**

**BWASBN** Min. Buy 1ea

Shipping Info *DIRECT*

**50,000 mites per bottle**

**BWASB5** Min. Buy 1ea

Shipping Info *DIRECT*

**Sachets on Hooks**

**100 sachets with hooks, each containing 250 mites each**

**BWA1H** Min. Buy 1ea

Shipping Info *DIRECT*

**500 sachets with hooks, each containing 250 mites**

**BWAS5H** Min. Buy 1ea

Shipping Info *DIRECT*

**1,000 sachets with hooks, each containing 250 mites each.**

**BWAS1H** Min. Buy 1ea

Shipping Info *DIRECT*

**Sachets on Sticks**

**100 sachets on sticks, each containing 250 mites**

**BWA1K** Min. Buy 1ea

Shipping Info *DIRECT*

**500 sachets on sticks, each containing 250 mites**

**BWAS5K** Min. Buy 1ea

Shipping Info *DIRECT*

**1,000 sachets on sticks, each containing 250 mites**

**BWAS1K** Min. Buy 1ea

Shipping Info *DIRECT*

**500 sachets on long sticks, each containing 250 mites**

**BWAS5KL** Min. Buy 1ea

Shipping Info *DIRECT*

**1,000 sachets on long sticks, each containing 250 mites**

**BWAS1KL** Min. Buy 1ea

Shipping Info *DIRECT*

**BioWorks® Encarsia formosa**

by *BIOWORKS INC.*

Encarsia formosa is a parasitic wasp for control of Whitefly. It is supplied as parasitised scales attached to cards, which are hung in the crop from where they hatch out and attack the whiteflies. Each card will produce either a minimum of 50 or 100 female wasps.

**CONTROLS** Whitefly



**Wasps Attached to Cards**

**100 cards with 50 wasps per card.**

**BWEF5** Min. Buy 1ea

Shipping Info *DIRECT*

**100 cards with 100 wasps per card.**

**BWEH10** Min. Buy 1ea

Shipping Info *DIRECT*

**150 cards with 50 wasps per card.**

**BWEF75** Min. Buy 1ea

Shipping Info *DIRECT*

**150 cards with 100 wasps per card.**

**BWEH15** Min. Buy 1ea

Shipping Info *DIRECT*

**BioWorks® Encarsia formosa and Eretmocerus eremicus**

by *BIOWORKS INC.*

Encarsia and Eretmocerus mix control a wider variety of whitefly species than either alone. Cards are a 50/50 mix of the two species. Hang in the crop where they will hatch out and attack the whitefly.

**CONTROLS** Whitefly



**Wasps Attached to Cards**

**50 cards with 100 wasps per card**

**BWEM5** Min. Buy 1ea

Shipping Info *DIRECT*

**100 cards with 100 wasps per card**

**BWEM10** Min. Buy 1ea

Shipping Info *DIRECT*

**150 cards with 100 wasps per card**

**BWEM15** Min. Buy 1ea

Shipping Info *DIRECT*

**Wasps in Blister Packs**

**30 Blisters with 250 wasp pupa per blister**

**BWEM75BP** Min. Buy 1ea

Shipping Info *DIRECT*

**60 Blisters with 250 wasp pupa per blister**

**BWEM15KBP** Min. Buy 1ea

Shipping Info *DIRECT*



### Biological Control Agents - Whiteflies

#### BioWorks® Eretmocerus eremicus

by *BIOWORKS INC.*

Eretmocerus eremicus is a parasitic wasp that attacks Greenhouse Whitefly and Sweet Potato Whitefly. Compared to Encarsia formosa, Eretmocerus is better adapted to high temperatures and those that fluctuate from day to night and is likely to last all season.

**CONTROLS** Whitefly



#### Wasps in Blister Packs

**30 Blisters with 250 wasp pupa per blister**

**BWEE75BP** Min. Buy 1ea

Shipping Info [DIRECT](#)

**60 Blisters with 250 wasp pupa per blister**

**BWEE15KBP** Min. Buy 1ea

Shipping Info [DIRECT](#)

#### Wasps Attached to Cards

**50 cards with 100 wasps per card**

**BWEE5** Min. Buy 1ea

Shipping Info [DIRECT](#)

**100 cards with 100 wasps per card**

**BWEE10** Min. Buy 1ea

Shipping Info [DIRECT](#)

**150 cards with 100 wasps per card**

**BWEE15** Min. Buy 1ea

Shipping Info [DIRECT](#)

#### Wasps in Vials

**30ml vial containing 10,000**

**BWEE1L** Min. Buy 1ea

Shipping Info [DIRECT](#)

#### Delphastus catalinae

by *BIOWORKS INC.*

Delphastus catalinae is a predator beetle particularly suited for cleaning up infestations of Whitefly eggs (hotspots). Not suitable for tomato crops.



**100 per bottle**

**BWABDC100** Min. Buy 1ea

Shipping Info [DIRECT](#)

**1000 per bottle**

**BWABDC1K** Min. Buy 1ea

Shipping Info [DIRECT](#)

#### Dicyphus hesperus

by *BIOWORKS INC.*

Dicyphus hesperus is a generalist predator that should be used with Mullein banker plants. It feeds on Whitefly, Thrips, moth eggs, and mites.



**250 per bottle**

**BWSB210001600** Min. Buy 1ea

Shipping Info [DIRECT](#)

### Biological Control Agents - Other

#### BioWorks® Aphid Banker Plants

by *BIOWORKS INC.*

Banker plants are a self-contained sustainable system that supplies a non-pest prey species to support a continual source of natural enemies that disperse into the crop in search of other pests.



**4 Cherry Oat plants**

**BWBANK** Min. Buy 1ea

Shipping Info [DIRECT](#)

#### BioWorks® Ephestia kuehniella

by *BIOWORKS INC.*

Ephestia Eggs are used as a supplemental food source to maintain predators such as Orius I, Dicyphus hesperus, and Chrysoperla rufilabris when pest levels are low.



#### Loose Eggs in Bottles

**10 grams**

**BWEK10** Min. Buy 1ea

Shipping Info [DIRECT](#)

**25 grams**

**BWEK25** Min. Buy 1ea

Shipping Info [DIRECT](#)

**50 grams**

**BWEK50** Min. Buy 1ea

Shipping Info [DIRECT](#)

#### Eggs Attached to Cards

**35,000 eggs**

**BWEKH** Min. Buy 1ea

Shipping Info [DIRECT](#)

#### Universal Release Boxes

by *BIOWORKS INC.*

For distributing other organisms not sold in sachets without over-the-top applications. Ideal for flowering crops to keep buds free from debris.



**BWURB** Min. Buy 1ea

Shipping Info [DIRECT](#)



## Pest Monitoring

## Insect Monitoring Sticky Cards (Blue + Yellow)

by **BIOWORKS INC.**

Features a unique double sided yellow / blue format. The Yellow side attracts flying adult aphids, whitefly, fungus gnats, leaf miners and more. Blue side attracts flying adult thrips. Each card is 4in x 5in with 1in grid on both sides for easy monitoring. Weather resistant with a easy peel-off backing. Includes a hole punched for hanging.

**100pk****BW1GS40A41** Min. Buy 1eaShipping Info **DIRECT**

## Sensor® Yellow Sticky Cards

by **BASF CORP**

Durable, long-lasting pest monitoring and trapping cards are designed to catch a variety of pests, including aphids, leafminer, thrips, whiteflies, fungus gnat and other flying insects. Offers growers the best way to eliminate guesswork and evaluate if insect control programs are working. Features non-sticky edges for easier handling.

**RATE** One card per 500 sq feet.**ACTIVE INGREDIENT****CONTROLS** Greenhouse insect pests.**50pk****BAS45182529** Min. Buy 1ea

## Stiky Stuff® Insect Glue

by **OLSON PRODUCTS INC**

Make sticky traps with this brush on insect trapping adhesive. It spreads easily and remains tacky through repeated wetting and drying cycles. Clear and odorless.

**32 oz can****OPSS32OZ** Min. Buy 1ea

## Trapline T+ Blue Roller Trap

by **BIOLINE AGROSCIENCES, INC.**

Trapline T+ Blue Roller Trap is a non toxic, double-sided sticky tape for trapping and monitoring flying pests. Features includes specific color, patterning, adhesive and attraction pheromone to increase control of Western Flower Thrips in soft fruits, vegetables and flowers grown in greenhouses.

**6in W x 328ft L - Can Be Cut to Any Size****BIOLNP8052-15** Min. Buy 1eaShipping Info **DIRECT**

## Trapline T Roller Trap

by **BIOLINE AGROSCIENCES, INC.**

Trapline Roller Trap is a non toxic, double-sided sticky tape for trapping and monitoring flying pests.



## Blue Roller Trap

**6in W x 328ft L - Can Be Cut to Any Size****BIOLNP8052-05** Min. Buy 1eaShipping Info **DIRECT**

## Yellow Roller Trap

The yellow color is especially attractive to Whitefly.

**6in W x 328ft L - Can Be Cut to Any Size****BIOLNP8051-05** Min. Buy 1ea

## Wire Holder for Sticky Cards

by **OLSON PRODUCTS INC**

Wire holders designed for use with sticky pest monitoring cards. Holds cards above plants and off the ground.

**100ct****OP100SS12** Min. Buy 1ea

## Trapline M Yellow Sticky Trap

by **BIOLINE AGROSCIENCES, INC.**

Trapline M dry glue sticky traps are made of high impact polystyrene with dry, non toxic glue and easy to peel silicon paper covers

**10pk - 3in x 10in****BIOLNP8051-01** Min. Buy 1eaShipping Info **DIRECT**

## Yellow Sticky Tape

by **OLSON PRODUCTS INC**

Monitor and reduce populations of Whiteflies, Aphids, Thrips and Fungus Gnats. Tape is coated on both sides with safe non toxic adhesive.

**6in x 530ft****OPPCR5306** Min. Buy 1ea

## Animal Repellents and Controls

### Hawk® All-Weather Rodent Bait

by MOTOMCO LTD.

Made with bromadiolone, Hawk is a single-feed anticoagulant rodenticide with Patented gnawing edges. Use with confidence for unsurpassed control, even against warfarin resistant "super-rats." The superior formulation is irresistible to rats and mice and kills them in 4 or 5 days after eating just a single-feeding. Highly weatherable.

**ACTIVE INGREDIENT** Bromadiolone

**CONTROLS** Norway Rats, Roof Rats, House Mice



#### Bait Chunx

9lb Pail

**MT0312705** Min. Buy 1ea

#### Place Packs

150 x 1.5oz Place Packs

**MT0311654** Min. Buy 1ea



### Ramik® Green Rodenticide

by NEOGEN CORPORATION

A diphacinone anticoagulant rodenticide. Excellent rodent palatability and weather resistant packaging.

**ACTIVE INGREDIENT** Diphacinone

**CONTROLS** Norway Rats, Roof Rats, House Mice



45 x 43g Packets

**NGN116316** Min. Buy 1ea

60 x 4oz Packets

**NGN116305** Min. Buy 1ea

### Rampage® Rodent Bait Chunx

by MOTOMCO LTD.

Rampage is a key component in the fight against resistance as it contains Bromethalin, a non-anticoagulant capable of killing even anticoagulant resistant rats and mice. It delivers a proven combination of bait acceptance and speed of kill. In fact its formula can kill rodents in as little as two days after consuming a toxic dose. Using Rampage also reduces the amount of bait required for control since rodents ingesting a toxic dose may not feed again.

**ACTIVE INGREDIENT** Bromethalin

**CONTROLS** Norway Rats, Roof Rats, House Mice



#### Bait Chunx

9lb Pail

**MT0222912** Min. Buy 1ea

#### Place Packs

121 x 15g Place Packs

**MT0221212** Min. Buy 1ea



### Selontra® Rodenticide

by BASF CORP

Selontra rodent bait offers effective control of mice and rats, even anti-coagulant resistant rodents. Labeled for use in/around agricultural buildings, warehouses, homes, industrial buildings and transport vehicles. Single Feed and Stop Feed mode of action. Contains Bitrex to prevent harm to non-target animals.

**ACTIVE INGREDIENT** Cholecalciferol

**CONTROLS** Mice and rats



8lb - Approximately 182 Baits per 8lb Pail

**BAS59014503** Min. Buy 1ea

### Spring/Summer Animal Repellent

by GREAT OAK, INC.

DeerPro animal repellent reduces browsing and chewing damage from deer, rabbits, and voles. One application will protect treated plants from 3 to 6 weeks.

**REI** 24 hours

**RATE** See label

**ACTIVE INGREDIENT** Putrescent whole egg solids



2.5gal

**DP44320** Min. Buy 1ea



### Winter Animal Repellent

by GREAT OAK, INC.

DeerPro animal repellent is a long lasting solution to winter foraging animals.

Can be applied as early as October and it will still be protecting shrubs and trees in early spring. Reduces browsing and chewing damage from deer, rabbits, and voles.

**REI** 24 hours

**RATE** See label

**ACTIVE INGREDIENT** Thiram



2.5gal

**DP44318** Min. Buy 1ea

Shipping Info

**HAZARDOUS**



**DEERPRO®**  
SPRING/SUMMER ANIMAL REPELLENT

**DEERPRO®**  
WINTER ANIMAL REPELLENT

**Year-round, professional strength protection. DeerPro™: The ONLY one that works.**

learn more at [DeerProProfessional.com](http://DeerProProfessional.com)

## Animal Repellents and Controls

### Talpid Mole Worms

by BELL LABORATORIES INC

A worm-shaped mole bait that kills moles in lawns and gardens. Moles usually die in their tunnels, often within 12-24 hours of ingesting the bait.



20pk

BLI7150

Min. Buy 1ea



### Tomcat® Bullet Rodent Bait Station

by MOTOMCO LTD.

Tier-1 tamper-resistant bait station with a secure, low-profile design. Easy to clean and easy to open. Holds 4 1oz Bait Chunx on 4 vertical rods.



For Use with Bait Chunx

MTO33432

Min. Buy 6ea



### Tomcat® All-Weather Bait Chunx

by MOTOMCO LTD.

Tomcat baits are manufactured with food-grade ingredients and enhancers, resulting in a palatable bait with consistent results. All-weather 1oz block is mold and moisture resistant and can be secured in a bait station. Peanut flavored for maximum bait acceptance and performance.

ACTIVE INGREDIENT Diphacinone



4lb Pail

MTO32444

Min. Buy 1ea

18lb Pail

MTO32448

Min. Buy 1ea



## Slug and Snail Control

### Deadline® Ornamental Molluscicide

by AMVAC ENVIRONMENTAL PRODUCTS

Ornamental labeled specifically for use as a barrier around gardens or plants. Deadline uses SNARE, a powerful attractant, to lure slugs and snails to Deadline and away from plants. It is formulated into mini-pellets that are rain fast and can withstand as much as six inches of rain or heavy watering over 14 days.

REI 0 hours for adults. See label for children and pets.

RATE 0.25lb per 1,000sq ft

ACTIVE INGREDIENT Metaldehyde

CONTROLS Snails, slugs.



25lb

AMVC11534

Min. Buy 1ea



### IronFist™ Slug & Snail Bait

by BELCHIM CROP PROTECTION USA, LLC

Kills snails and slugs on turf, ornamentals, vegetables and fruit. Slug and snails ingest the bait, causing them to stop feeding and die.

Immediate plant protection will be observed through the decrease in feeding. Safe to pets and wildlife.

REI 0 Hours

RATE 10 to 40lb per Acre

ACTIVE INGREDIENT Sodium Ferric EDTA

CONTROLS Snails, slugs.



50lb

RNG700001.050 Min. Buy 1ea



## IRONFIST™ Slug & Snail Bait

### Broad Spectrum Control of Slugs and Snails

- **PROVEN** Performance- Kills Snails and Slugs
- Small, Uniform Pellet Size **MAXIMIZES** baiting points
- **EFFECTIVE** in all weather conditions, including cool and wet
- **IDEAL** for application at planting
- **REGISTERED** for use on ornamentals, shrubs, gardens, turf, citrus, vegetables, fruit trees, berries, etc..

EPA Registration No.:  
67702-32-87865



Belchim Crop Protection USA, LLC  
2751 Centerville Road | Suite 100  
Wilmington, DE 19808  
Phone: 855-445-7990  
Email: info.usa@belchim.com

# REFERENCE GUIDE for GREENHOUSE and NURSERY PRODUCTION

## PLANT GROWTH REGULATORS



**\*\*Use Site(s) Key:** GH = Greenhouse N = Nursery

### Plant Growth Regulators (PGRs)

(by Mode of Action Group and Class)

MOA Group*	Class	Activity Level**	Common Name	Trade Name	REI	Use Site(s)***	Company	
1	Pyrimidine	Medium	Ancymidol	A-Rest <sup>1</sup>	12	GH/N	SePRO Corp.	
			Flurprimidol	Topflor <sup>1</sup>	12	GH/N	SePRO Corp.	
	Quaternary Ammonium	Medium	Chlormequat chloride	Cycocel <sup>1</sup>	12	GH/N	OHP, Inc.	
			Hydrazide	Daminozide	B-Nine <sup>1</sup>	24	GH/N	OHP, Inc.
			Triazole	High	Paclobutrazol	PAC O™ <i>*formerly Paczol<sup>1</sup></i>	12	GH/N
Uniconazole-p	Sumagic <sup>1</sup>	12			GH	Nufarm		
2	Cyclohexaketone	Medium	Dikegulac-sodium	Atrimmec <sup>1</sup>	12	GH/N	PBI Gordon Crop.	
3	Fatty acid	Medium	Methyl esters of fatty acids	Off-Shoot-O <sup>1</sup>	0	GH/N	Cochran Corp.	
4	Gibberellin (GA)	High	Gibberellic acid (A3)	ProGibb <sup>1</sup> T&O	12	GH/N	Mycorrhizal Applications, LLC	
	Synthetic Cytokinin/ Gibberellin	High	Cytokinin/ Gibberellic acid	Fascination <sup>1</sup>	4	GH	Nufarm	
	Synthetic Cytokinin	High	N-(phenylmethyl)- 1H-purine-6-amine	Configure <sup>1</sup>	12	GH	Fine Agrochemicals, LTD.	
5	Organophosphorus	Medium	Ethephon	Florel Brand Pistill	48-72	GH/N	Monterey Chemical	
				Florel Brand Ethephon	48-72	GH/N	Southern Agricultural Insecticides, Inc.	
6	Rooting Hormones Synthetic Auxin		IBA	Hormodin <sup>1</sup>	0	GH/N	OHP, Inc.	
			IBA + NAA	Dip'N Grow	0-24	GH/N	Dip'N Grow, Inc.	

\*\* PGR activity varies greatly depending on product class; e.g. the triazole class is very active. The low, medium and high ratings are guides to product activity. The higher the level of activity the more care must be taken when using.

Thank you to Dr. Joyce Latimer, Virginia Tech, for help in preparing the PGR chart.

### \*Plant Growth Regulators Modes of Action

- Gibberellic Acid synthesis inhibitors
- DNA synthesis inhibitor
- Chemical pincher
- Growth promoter
- Ethylene generator
- Rooting hormones
- ABA abscisic acid
- UN. Unknown mode of action

## Plant Growth Regulators

### Advocate™ Plant Growth Stimulant

by FINE AMERICAS, INC.

Advocate is a plant biostimulant which can improve the rooting of plant cuttings for plant propagation. For use on annual, perennial, and woody ornamental cuttings.

REI 12 hours

RATE Varies, see label for more information.

ACTIVE INGREDIENT IBA (Indole-butyric acid)

CONTROLS Plant growth.



32oz Bottle AGENCY

FINE190639 Min. Buy 1ea

### Alesco® Ethylene Inhibitor

by CHRYSAL AMERICAS

Chrysal Alesco® is a foliar spray to apply before shipping to avoid ethylene damage. It prevents shrinkage and premature dropping of buds, leaves and flowers. Ensures top quality plants throughout the chain. Ethylene sensitive potted plants that have been treated with Chrysal Alesco® have more blooms in retail.

ACTIVE INGREDIENT Silver nitrate



200ml (6.76fl oz)

CHRYSALB250 Min. Buy 1ea



### A-Rest™ Plant Growth Regulator

by SEPRO CORPORATION

A-Rest provides just the right amount of growth regulation. Gentle enough on tender plugs and transplants yet strong enough to adequately regulate perennials. A-Rest reduces internode elongation resulting in a more compact plant with darker green leaves. A-Rest has no adverse effects on flowers including no flower delay, no residue and no phytotoxicity. A-Rest also strengthens and tones plants, readying them for transplanting and shipping.

REI 12 Hrs

ACTIVE INGREDIENT Ancymidol



32oz

SEPROA-REST Min. Buy 1ea

2.5gal AGENCY

SEPRO1012.225 Min. Buy 1ea

30gal Drum AGENCY

SEPRO1012.30 Min. Buy 1ea



### B-Nine® WSG Plant Growth Regulator

by OHP, INC.

Reduces plant height in ornamental plants by reducing internode length. Other benefits include a deeper green color and reduced breakage during shipping. When applied to plant foliage is absorbed into the leaf, moves within the plant to the growing points to reduce internode elongation.

REI 24 Hrs

RATE Varies depending on application method. See label.

ACTIVE INGREDIENT Daminozide



1lb

OHP981312 Min. Buy 1ea

5lb

OHP981318 Min. Buy 1ea



### Bonzi® Plant Growth Regulator

by SYNGENTA CROP PROTECTION

The leading ornamental plant growth regulator (PGR), Bonzi® keeps plants uniformly compact, hardy and looking their best. It results in one consistent crop after another, with well-proportioned plants achieving identically ideal form and color. While a small amount may be taken in through leaves, it is primarily absorbed through the stems and roots.

REI 12 Hrs

RATE Varies according to application. See label.

ACTIVE INGREDIENT Paclobutrazol



32oz

SYN13869 Min. Buy 1ea

2.5gal AGENCY

SYN27714 Min. Buy 1ea



### Citadel® Plant Growth Regulator

by FINE AMERICAS, INC.

Citadel is an effective growth regulator for use on a wide variety of ornamental crops. It reduces plant height by limiting internode elongation, resulting in more desirable, compact and marketable plants.

REI 12 Hrs

RATE Varies depending on application method. See label.

ACTIVE INGREDIENT chlormequat



1gal AGENCY

FINE19-0731A Min. Buy 1ea



### Collate® Plant Growth Regulator

by FINE AMERICAS, INC.

Used to increase lateral branching in many popular ornamental varieties, including azaleas, chrysanthemums, geraniums, lantana, petunias and verbena. It is also ideal for controlling plant height and stem topple in daffodils and hyacinth, as well as delaying flowering in a wide range of ornamental crops.

REI 12 Hrs

RATE Varies depending on application method. See label.

ACTIVE INGREDIENT ethephon



1gal AGENCY

FINE19-0638 Min. Buy 1ea



### Concise® Plant Growth Regulator

by FINE AMERICAS, INC.

Concise is an effective growth regulator for use on a wide variety of ornamental crops. It reduces plant height by limiting internode elongation, resulting in more desirable, compact and marketable plants.

REI 12 Hrs

RATE Varies depending on application method. See label.

ACTIVE INGREDIENT Uniconazole



1gal AGENCY

FINE19-0636C Min. Buy 1ea

15gal Drum AGENCY

FINE19-0636D Min. Buy 1ea



**Plant Growth Regulators****Configure® Plant Growth Regulator**

by FINE AMERICAS, INC.

Increases lateral branching and flowering in a number of popular ornamental species. Applications may reduce the height of treated plants, resulting in more compact and marketable crops. Labeled for use on containerized annual and perennial flowering and foliage crops as well as tropical plants.

REI 12 Hrs

**RATE** Varies depending on application method. See label.

**ACTIVE INGREDIENT** Benzylaminopurine**64oz AGENCY****FINE19-0163D** Min. Buy 1ea**15gal Drum AGENCY****FINE19-0163MID** Min. Buy 1ea**Crest™ Plant Growth Stimulant**

by FINE AMERICAS, INC.

Crest is a plant biostimulant which can improve the germination of seed, plant emergence in cool conditions, root growth, seedling development, and plant growth and development throughout the growing season.

REI 4 hours

**RATE** Varies, see label for more information.

**ACTIVE INGREDIENT** Cytokinin, Indole Butyric Acid, Gibberellic Acid**CONTROLS** Plant growth.**1 Gallon AGENCY****FINE190638** Min. Buy 1ea**Cycocel® Plant Growth Regulator**

by OHP, INC.

May be used on any crop in the greenhouse or nursery including but not limited to, poinsettias, hibiscus, azaleas and geraniums to reduce stem elongation, induce early flowering, improve flowering and to produce compact plants with multiple buds per shoots.

REI 12 Hrs

**RATE** Varies depending on application method. See label.

**ACTIVE INGREDIENT** Chlormequat**32oz****OHP981660** Min. Buy 1ea**1gal****OHP981661** Min. Buy 1ea**30gal Drum****OHP981662** Min. Buy 1ea**Dazide® 85WSG Plant Growth Regulator**

by FINE AMERICAS, INC.

Provides greener, stronger and more compact ornamental plants. Effective growth control that helps growers manage plant growth and development to ensure plants are more compact, stronger and better suited to cope with transportation and transplanting.

REI 12 Hrs

**RATE** Varies depending on application method. See label.

**ACTIVE INGREDIENT** Daminozide**5lb AGENCY****FIN403** Min. Buy 1ea**Dip 'N Grow® Rooting Hormone**

by DIP 'N GROW

Dip 'N Grow liquid rooting hormone for rooting new plants from cuttings. Easy to use liquid formulation.

**1pt****DIPNDG01612** Min. Buy 1ea**1gal****DIPNDG12804** Min. Buy 1eaShipping Info **HAZARDOUS****Fascination® Plant Growth Regulator**

by NUFARM AMERICAS INC.

Fascination plant growth regulator for Lilies, Poinsettias and other ornamentals. Fascination delays leaf yellowing, increases flower size and number and prolongs flowering.

REI 12 Hrs

**RATE** Varies according to application method. See label.

**ACTIVE INGREDIENT** Cytokinin/Giberrellic Acid**64oz****VAL89020.922** Min. Buy 1ea**Florel® Growth Regulator**

by BRANDT CONSOLIDATED INC.

Applied as a foliar spray, Florel will increase lateral branching, prevent flower initiation and development and inhibit internode elongation on greenhouse ornamentals.

REI 48 Hrs

**RATE** Varies according to crop

**ACTIVE INGREDIENT** Ethephon**1gal****MLGNLG4110** Min. Buy 1ea**Florgib® 4L Plant Growth Regulator**

by FINE AMERICAS, INC.

Florgib enhances stem elongation and flowering in ornamental plants.

REI 4 Hrs

**RATE** Varies depending on application method. See label.

**ACTIVE INGREDIENT** Gibberellic Acid**1gal AGENCY****FINE19-0760A** Min. Buy 1eaShipping Info **HAZARDOUS**



## Plant Growth Regulators

### Fresco® Plant Growth Regulator

by FINE AMERICAS, INC.

Provides a reduction of lower leaf yellowing in lilies and promotes bract expansion on poinsettia. Maybe used to counteract Gibberellin inhibiting PGR applications if needed.

REI 4 Hrs

RATE Varies, see label

ACTIVE INGREDIENT Cytokinin/Gibberellic Acid



32oz AGENCY

FINE19-0736A Min. Buy 1ea



### Pac O™ Plant Growth Regulator

by OHP, INC.

Pac O plant growth regulator is for use on commercially grown ornamental plants grown in containers in greenhouses and nurseries. Long lasting plant growth regulator that can be applied as a liner dip, spray, or drench

REI 12 Hrs

RATE Varies depending on application method. See label.

ACTIVE INGREDIENT Paclobutrazol



1gal

OHP986192 Min. Buy 1ea



### Hormodin® Rooting Hormone

by OHP, INC.

Hormodin enhances rooting, which reduces propagation bench time and plant loss. Hormodin is easy to use, yielding steadfast performance of rooted cuttings and zero disease migration.

REI 0 Hrs

RATE 1lb treats 35,000 cuttings

ACTIVE INGREDIENT Indole-3-butyric acid



### Hormodin® 1

by OHP, INC.

Hormodin 1 rooting hormone is a general purpose powder designed for the grower who propagates plants such as roses, carnations, poinsettias, some shrubs and most soft herbaceous plants. (00.1% (IBA).

1lb

OHP983111 Min. Buy 1ea

### Hormodin® 2

Hormodin 2 rooting hormone is prepared specially for propagating many woody and semi-woody plants, including some of the evergreens.(00.3% (IBA).

1lb

OHP983221 Min. Buy 1ea

### Hormodin® 3 Rooting Hormone

by OHP, INC.

Hormodin 3 rooting hormone is prepared specially for propagating the more difficult to root varieties, including many of the evergreens and dormant leafless cuttings. (00.8% (IBA).

.5lb

OHP983380 Min. Buy 1ea

### Phytrtronics® Hortus® IBA Water Soluble Salts™ 20%

by PHYTOTRONICS, INC.

Hortus IBA Water Soluble Salts are used to propagate new plants from cuttings. This rooting hormone uses 20% IBA Water Salts as its medium and contains No Alcohol. Because of this, it is EPA registered for "spray drip down or over the top" safe application to plants in propagation beds. No need to "dip" each individual plant.

REI 0 hours



.25 kilo

PHT0339 Min. Buy 1ea

1 kilo

PHT0337 Min. Buy 1ea



### Piccolo® 10XC Plant Growth Regulator

by FINE AMERICAS, INC.

Brings out the best in ornamentals by producing compact, consistent quality plants. By delivering outstanding height and radius control, Piccolo enhances the quality of bedding plants, flowering and foliage crops, bulb crops, perennials and woody ornamentals, making them easier to market and more profitable to produce. As a spray or drench, Piccolo has been proven in dozens of university trials and ranks among the most popular PGRs among quality-minded growers. Plus, one quart of Piccolo 10 XC equals 2.5 gallons of regular Piccolo.

REI 12 Hrs

RATE Varies according to application method

ACTIVE INGREDIENT paclobutrazol



32oz AGENCY

FINE19-0636E Min. Buy 1ea



### Piccolo® Plant Growth Regulator

by FINE AMERICAS, INC.

Brings out the best in ornamentals by producing compact, consistent quality plants. By delivering outstanding height and radius control, Piccolo enhances the quality of bedding plants, flowering and foliage crops, bulb crops, perennials and woody ornamentals, making them easier to market and more profitable to produce. As a spray or drench, Piccolo has been proven in dozens of university trials and ranks among the most popular PGRs among quality-minded growers.

REI 12 Hrs

RATE Varies according to application method

ACTIVE INGREDIENT paclobutrazol



1gal AGENCY

FINE190636 Min. Buy 1ea



## Plant Growth Regulators

### ProGibb® LV Plus T&O

by MYCORRHIZAL APPLICATIONS LLC

ProGibb LV Plus T&O enhances overall plant growth, increases stem elongation, and induces flowering and fruiting of plants. Also used to promote stem elongation of tree form plants.

REI 4 Hrs

ACTIVE INGREDIENT Gibberellic Acid



32oz

VAL22055.911 Min. Buy 1ea

Shipping Info HAZARDOUS



### Sumagic® Plant Growth Regulator

by NUFARM AMERICAS INC.

Offers a broad label for use on numerous plants, from bedding plants to woody ornamentals to poinsettias. Applications produce plants with denser, more consistent compact growth with increased plant shelf life and no phytotoxicity when used according to label directions.

REI 12 Hrs

RATE Varies according to application method. See label.

ACTIVE INGREDIENT Uniconazole-p



1gal

VAL85100.935 Min. Buy 1ea

15gal Drum

VAL85100.939 Min. Buy 1ea



### SePRO Cutless® 0.33G Plant Growth Regulator

by SEPRO CORPORATION

Cutless® is a systemic landscape and ornamental growth regulator that effectively suppresses shoot growth of perennial landscape and container grown ornamental plants. Treated plants require less trimming and maintain a more compact form.

RATE 1 to 3 grams per pot. See label for landscape rates.

ACTIVE INGREDIENT Flurprimidol



21lb

SEPRO102921 Min. Buy 1ea



### Topflor™ Plant Growth Regulator

by SEPRO CORPORATION

Topflor is a versatile PGR for ornamentals including bedding, annual and perennial plants, bulb crops and woody ornamentals. It has the strength to regulate vigorous species yet provides the proper amount of growth control for slower growing crops. Topflor can be applied using spray, drench, or pre-plant soak applications.

REI 12 Hrs

RATE Varies. See label for specific crops

ACTIVE INGREDIENT Flurprimidol



2 Liter AGENCY

SEPRO1035.42 Min. Buy 1ea

5gal AGENCY

SEPRO1035.5 Min. Buy 1ea



### SMO Floralife® EthylBloc® Truck Kit

by SMITHERS-OASIS USA

EthylBloc inhibits the negative effects of ethylene. For use by professional greenhouse and nursery growers and retail florists to protect crops from ethylene damage during handling, staging, and shipping. Truck kits protect whole trailer shipments. Also available in sachets for in-box use.



75gr

SM5FL9075K Min. Buy 1ea



# Herbicides Quick Reference Chart

**Always Refer to Product Label!**

Product	Pre-Emergent	Post-Emergent	Broadleaves	Grasses	Sedges	Greenhouse Label	Spray(S) or Granular(G)		
Axxe		X	X	X		X	S	Ammonium Nonanoate	OMRI listed herbicide labeled for greenhouse use. Nonselective contact burndown of weeds
Barricade	X		X	X			S	Prodiamine	Preemergent Sprayable herbicide for use in nurseries, turf, landscapes & noncrop areas
Basagran T&O		X	X		X		S	Bentazon	Contact herbicide for use in turf, nurseries, ornamentals & noncrop areas
Biathlon	X		X	X			G	Oxyfluorfen, Prodiamine	2 Active ingredients that control broadleaf & grassy weeds in nurseries and noncrop areas
Broadstar G	X		X	X			G	Flumioxazin	Granular for use in nurseries and landscapes. Same active ingredient as Sureguard
Casoron G	X	X	X	X	X		G	Dichlobenil	Controls tough weeds like Thistle, Horsetail, and Nutsedge. For use on woody ornamentals and noncrop areas
Cheetah Pro		X	X	X	X	X	S	Glufosinate Ammonium	Contact non-selective herbicide for use in nurseries, greenhouses, turf & noncrop areas
Confront		X	X				S	Clopyralid, Triclopyr	Broadleaf turf herbicide
Dimension	X		X	X			S	Dithiopyr	Sprayable for use in nurseries, turf, landscapes & noncrop areas
Envoy Plus		X		X		X	S	Clethodim	Postemergence control of annual & perennial grasses
Finale		X	X	X	X	X	S	Glufosinate-Ammonium	Contact non-selective herbicide for use in nurseries, greenhouses, turf & noncrop areas
FireWorxx		X	X	X		X	S	Capric and Caprylic Acid	Rapid contact non-selective herbicide for use in nurseries, greenhouses, landscape & noncrop areas
Fortress	X		X	X			G	Isoxaben, dithiopyr	Combination product with the active ingredients from Gallery and Dimension. Broad spectrum control of weeds, but with a safe profile for sensitive shrubs and perennials
Freehand G	X		X	X	X		G	Dimethenamid-P, Pendimethalin	2 Active ingredients that control broadleaf & grassy weeds and yellow nutsedge
Fuerte G	X		X	X			G	Flumioxazin, Prodiamine	Preemergent granular herbicide with two active ingredients for use in nurseries and landscape ornamentals
Fusilade II		X		X			S	Fluazifop	Postemergence control of annual & perennial grasses
Gallery SC	X		X				S	Isoxaben	Sprayable for use in nurseries, turf, landscapes & noncrop areas. Excellent crop safety
Gemini SC	X		X	X			S	Isoxaben, Prodiamine	Combination product to control wide array in containers and field ornamentals.
Goal	X	X	X	X			S	Oxyfluorfen	For use on conifers & certain woody ornamentals. Contact burn and preemergence control
Lontrel T&O		X	X				S	Clopyralid	Excellent on thistle. Sprayable for use in landscapes, nurseries & turf
Marengo SC	X		X	X		X	S	Indaziflam	Long lasting preemergent control of weeds in nurseries and greenhouses.
Marengo G	X		X	X			G	Indaziflam	Long lasting herbicide for broadcast applications in nurseries
OH2	X		X	X			G	Oxyfluorfen, Pendimethalin	Granular for container and field grown ornamentals
Pendulum Aquacap	X		X	X			S	Pendimethalin	Sprayable for use in landscapes, nurseries & noncrop areas
Pennant Magnum	X		X	X	X		S	Metolachlor	Sprayable for use in nurseries, landscapes & noncrop areas. Preemergent control of yellow nutsedge
Pramitol 25E	X	X	X	X			S	Prometon	Long lasting vegetation management. Residual control of most weeds for 1+ years
Preen Plus	X		X	X			G	Isoxaben, Trifluralin	Granular herbicide with 2 active ingredients. Labeled for use in nurseries, landscapes
Ranger Pro		X	X	X	X	X	S	Glyphosate	Sprayable nonselective systemic postemergent control of most weeds. Roundup equivalent.
RegalStar	X		X	X			G	Oxadiazon, Prodiamine	Can be applied to woody ornamental shrubs, vines, trees, and evergreens in field and container nurseries and landscapes
Reward		X	X	X		X	S	Diquat	Sprayable non-selective contact control of most weeds. Rapid burndown
Ronstar FLO	X		X	X			S	Oxadiazon	Active on shoots only with no root activity
Roundup ProMax		X	X	X	X	X	S	Glyphosate	Improved formulation of glyphosate with concentrated surfactant
Roundup QuikPro		X	X	X			S	Glyphosate, Diquat	Contains Roundup for systemic control and diquat to deliver rapid burndown
Scythe		X	X	X		X	S	Pelargonic acid	Sprayable non-selective contact control of most weeds
Sedgehammer Plus		X			X		S	Halosulfuron-methyl	Postemergence control of Nutsedge for use in turf, landscapes, & noncrop areas
Segment II		X		X			S	Sethoxydim	Selective control of grassy weeds in nursery and landscape crops
Snapshot	X		X	X			G	Isoxaben, Trifluralin	Granular for use in nurseries, landscapes and noncrop areas
Sureguard SC	X	X	X	X		X	S	Flumioxazin	Labeled for use in nurseries, landscapes and noncrop areas. Contact burndown and preemergence control
Tower	X		X	X	X		S	Dimethenamid-P	Controls broadleaf & grassy weeds and sedges in nurseries and landscapes
Treflan G	X		X	X			G	Trifluralin	Granular for use in nurseries, landscapes and noncrop areas
Vessel		X	X				S	2,4-D, Dicamba	3-Way broadleaf herbicide for turf and noncrop sites

# REFERENCE GUIDE for GREENHOUSE and NURSERY PRODUCTION

## HERBICIDES

### RESISTANCE MANAGEMENT

Herbicide rotation is just as important as the rotation of other pest control products. Herbicide mode of action (MOA) groups are listed by the Herbicide Resistance Action Committee (HRAC). Rotating MOAs on a regular basis is key to controlling weeds and maintaining the effectiveness of herbicides.

Please read and follow all label directions and precautions.

**\*\*Use Site(s) Key:**

PO = post emergence

A = Annual Grasses

S = Sedges

PR = pre emergence

BW = Broadleaf Weeds

WO = Certain Woody  
Ornamentals

SF = Soil fumigant

P = Perennials

GH = registered for use in greenhouses

MA = Most annuals



## Herbicides

(by Mode of Action Group and Class)

MOA Code* & Group	Class	Common Name	Trade Name	REI	Use Site(s)**	Company
1	Aryloxyphenoxy propionate 'FOPs'	Fenoxaprop-p-ethyl	Acclaim <sup>®</sup> Extra	24	PO; A, P	Bayer Environmental Science
		Fluazifop-P-butyl	Fusilade <sup>®</sup> II	12	PO; A, P	Syngenta
	Cyclohexanedione 'DIMs'	Clethodim	Envoy Plus <sup>®</sup>	24	PO; A, P	Nufarm
		Sethoxydim	Segment <sup>®</sup>	12	PO; A, P	BASF
2	Imidazolinone	Imazaquin	Image <sup>®</sup>	12	PR/PO; A, P, BW, S	BASF
3	Pyridine	Dithiopyr	Dimension <sup>®</sup>	12	PR;A,BW	Corteva Agriscience
	Benzamide	Pronamide	Kerb <sup>®</sup>	24	PR/PO; A, BW	Corteva Agriscience
	Dinitroaniline	Pendimethalin	Pendulum <sup>®</sup>	24	PR; A, BW	BASF
			Corral <sup>®</sup>	24	PR; A,BW	ICL Specialty Fertilizers
		Prodiamine	Barricade <sup>®</sup>	12	PR; A, BW	Syngenta
	Benzoic acid	DCPA	Dacthal <sup>®</sup>	12	PR; A,BW	Amvac Chemical Corp.
4	Pyridine carboxylic acid	Clopyralid	Lontrel <sup>®</sup>	12	PO; WO	Corteva Agriscience
5	Triazine	Simazine	Princep <sup>®</sup>	12	PR; A, BW	Syngenta
6	Benzothiadiazinone	Bentazon	Basagran <sup>®</sup> T/O	48	PO; BW, S	BASF



# Herbicides *continued*

(by Mode of Action Group and Class)

MOA Code* & Group	Class	Common Name	Trade Name	REI	Use Site(s)**	Company
9	Glycine	Glyphosate	Roundup Pro <sup>®</sup>	4	PO; A, P, BW, GH	Bayer Environmental Science
			Refuge <sup>™</sup>	12	PO; A, P, BW, GH	Syngenta
10	Phosphinic acid	Glufosinate	Finale <sup>®</sup>	12	PO; MA, P, GH	Bayer Environmental Science
12	Pyridazinone	Norflurazon	Predict <sup>®</sup>	12	PR; A, BW	Syngenta
14	Diphenylether	Oxyfluorfen	Goal <sup>®</sup>	24	PR; PO, A, BW	Corteva Agriscience
	Oxadiazole	Oxadiazon	Ronstar <sup>®</sup>	12	PR; A, BW	Bayer Environmental Science
	N-phenylphthalimides	Flumioxazin	BroadStar <sup>®</sup>	12	PR; A, BW	Nufarm
			SureGuard <sup>®</sup>	12	PR; PO, A, BW	Nufarm
15	Acetamide	Napropamide	Devrinol <sup>®</sup>	12-24	PR; A, BW	United Phosphorous
	Chloroacetamide	S-metolachlor	Pennant <sup>®</sup> Magnum	24	PR; A, BW	Syngenta
		Dimethenamid-P	Tower <sup>®</sup>	12	PR; A, BW, S	BASF
20	Nitrile	Dichlobenil	Casoron <sup>®</sup>	12	PR; A, P	OHP, Inc.
21	Benzamide	Isoxaben	Gallery <sup>®</sup>	12	PR, A, BW	Corteva Agriscience
22	Bipyridylum	Paraquat	Gramoxone <sup>®</sup> Inteon	12-24	PO; MA, P, BW	Syngenta
		Diquat	Reward <sup>®</sup>	24	PO; MA, P, GH	Syngenta
26	Unknown	Dazomet	Basamid <sup>®</sup>	24	SF; MA, P	Certis USA, LLC
		Metam	Vapam <sup>®</sup>	48	SF; MA, P	Amvac Chemical Corp.
		Pelargonic acid	Scythe <sup>®</sup>	12	PO; MA, P, GH	Gowan Company
29	Alkylazines	Indaziflam	Marengo <sup>®</sup>	12	PR; A, GH, BW	Bayer Environmental Science
			Marengo <sup>®</sup> G	12	PR; A, BW	Bayer Cropscience Science
3+21	Diphenylether + Benzamide	Prodiamine + Isoxaben	Gemini <sup>®</sup> G	12	PR; A, BW	ICL Speciality Fertilizers
14+3	Diphenylether + Dinitroaniline	Oxyfluorfen + Pendimethalin	OH2 <sup>®</sup>	24	PR; A, BW	ICL Speciality Fertilizers
14+3	Diphenylether + Dinitroaniline	Oxyfluorfen + Prodiamine	Biathlon	24	PR; A, BW	OHP, Inc.



# Herbicides *continued*

(by Mode of Action Group and Class)

MOA Code* & Group	Class	Common Name	Trade Name	REI	Use Site(s)**	Company
14+3	N-phenylphthalimides + Dinitroaniline	Flumioxazin + Proflumicarb	Fuerte <sup>®</sup>	12	PR; A, BW	OHP, Inc.
14+3	Oxadiazole + Dinitroaniline	Oxadiazon + Proflumicarb	RegalStar <sup>®</sup> II	12	PR; A, BW	Regal Chemical Co.
14+14	Diphenylether + Oxadiazole	Oxyfluorfen + Oxadiazon	Regal O-O <sup>®</sup>	24	PR; A, BW	Regal Chemical Co.
15+3	Chloroacetamide + Dinitroaniline	Dimethenamid-P + Pendimethalin	Freehand <sup>®</sup>	12	PR; A, BW, S	BASF
21+3	Benzamide + Pyridine	Isoxaben + Dithiopyr	Fortress <sup>®</sup>	12	PR; A, BW	OHP, Inc.
21+3	Benzamide + Dinitroaniline	Isoxaben + Trifluralin	Snapshot <sup>®</sup> TG	12	PR; A, BW	Coreteva Agriscience
M	Soaps	Ammonium Nonanoate	Axxe <sup>®</sup>	24	PO; GH	BioSafe Systems
		Caprylic + Capric Acid	FireWorxx	24	PO; GH	OHP, Inc.

## \*Herbicides Modes of Action

1. Inhibition of acetyl CoA carboxylase (ACCase)
2. Inhibition of acetolactate synthase ALS (acetohydroxyacid synthase AHAS)
3. Microtubule assembly inhibition
4. Action like indole acetic acid (synthetic auxins)
5. Inhibition of photosynthesis at photosystem II (C1)\*\*
6. Inhibition of photosynthesis at photosystem II (C3)\*\*
7. Inhibition of photosynthesis at photosystem II (C2)\*\*
9. Inhibition of EPSP synthase
10. Inhibition of glutamine synthetase
12. Bleaching: inhibition of carotenoid biosynthesis at the phytoene desaturase step (PDS)
14. Inhibition of protoporphyrinogen oxidase (PPO)
15. Inhibition of VLCFAs (Inhibition of cell division)
20. Inhibition of cell wall (cellulose) synthesis
21. Inhibition of cell wall (cellulose) synthesis
22. Photosystem -I- electron diversion
26. Unknown
29. Inhibit cellulose biosynthesis
- M. Miscellaneous

\*\*Subclasses with different binding behavior at the binding protein D1, or different classes

\*This mode of action listing is based on the Herbicide Resistance Action Committee (HRAC) and the Weed Science Society of America (WSSA). More information on the Herbicide Resistance Action Committee and the Mode of Action Classification is available from: [www.hracglobal.com](http://www.hracglobal.com).



## Herbicides

### AXXE® Broad Spectrum Herbicide

by BIOSAFE SYSTEMS

A non-selective, post emergence broad spectrum herbicide labeled for use on many sites including greenhouses, nurseries and landscapes. Controls grasses and broadleaf weeds, mosses, liverworts and lichens. Provides a rapid burn down of weeds within hours and then biodegrades quickly, leaving no harmful residue behind. Does not volatilize or migrate through soil and is safe to use in all areas of production, both inside and outside.

REI 4 Hrs

**RATE** Varies according to application method. See label.

**ACTIVE INGREDIENT** Ammonium nonanoate

**CONTROLS** Broadleaf weeds, grasses, moss, and liverwort



2.5gal

**BIOS7600-2.5** Min. Buy 1ea

### Barricade® 4FL Herbicide

by SYNGENTA CROP PROTECTION

Barricade 4FL for preemergence control of grasses and broadleaf weeds in established turfgrasses, container grown and landscape ornamentals, nurseries and commercial landscapes.

REI 12 Hrs

**RATE** Varies by application. See label.

**ACTIVE INGREDIENT** Proflamifone

**CONTROLS** Many broadleaf and grassy weeds. See label for complete list.



4oz

**SYN70648** Min. Buy 1ea

**1gal AGENCY**

**SYN37150** Min. Buy 1ea



### Barricade® 65WG Herbicide

by SYNGENTA CROP PROTECTION

Barricade 65 WG for preemergence control of grasses and broadleaf weeds in established turfgrasses, container grown and landscape ornamentals, nurseries and commercial landscapes.

REI 12 Hrs

**RATE** 0.5-1.5lbs per acre

**ACTIVE INGREDIENT** Proflamifone

**CONTROLS** Many broadleaf and grassy weeds. See label for complete list.



5lb AGENCY

**SYN51637** Min. Buy 1ea



### Basagran® T/O Herbicide

by BASF CORP

A turf and ornamental herbicide that offers reliable, post-emergent control of tough broadleaf weeds, yellow nutsedge and annual sedges in turf and ornamentals.

REI 48 Hrs

**RATE** 24 to 32oz per Acre

**ACTIVE INGREDIENT** Bentazon

**CONTROLS** Broadleaf weeds, yellow nutsedge, annual sedges and more. See label for complete list



1gal

**BAS59011636** Min. Buy 1ea



### Biathlon® G Herbicide

by OHP, INC.

A pre-emergent granular herbicide for control of a wide range of problem grass and broadleaf weeds. Works by creating a barrier in the soil and is active for several months. Biathlon works by inhibiting cell division and disrupting cell wall formation in shoots and roots of emerging seedling weeds.

REI 24 Hrs

**RATE** 100lb per Acre

**ACTIVE INGREDIENT** Oxyfluorfen and Proflamifone

**CONTROLS** Broadleaf and grassy weeds. See label for complete list.



50lb

**OHP981350** Min. Buy 1ea



### BroadStar® Herbicide

by NUFARM AMERICAS INC.

BroadStar herbicide controls tough broadleaf and grassy weeds with a long lasting residual activity. Low odor and dust free granular formulation for easy broadcast spreading. For use on container and field grown ornamentals, landscape ornamentals and non-bearing fruit and nut trees.

REI 12 Hrs

**RATE** 150lb per Acre

**ACTIVE INGREDIENT** Flumioxazin

**CONTROLS** Broad spectrum of annual broadleaf and grassy weeds such as spurge, bittercress, oxalis, common groundsel and crabgrass



50lb

**VAL88560.29** Min. Buy 1ea



### Casoron® 4G Fine 16-30 Mesh Herbicide

by OHP, INC.

A pre-emergent herbicide which easily handles many troublesome weeds in and around established woody landscape ornamentals, non-crop areas, fruit and nut trees and respective nurseries. It develops a vapor barrier and is active for 9-10 months after application. Applications should be made under cool weather conditions in late fall or very early spring. Active ingredient is dichlobenil, which acts by inhibiting germination and actively dividing cells of meristems of growing points and root tips.

REI 12 Hrs

**RATE** Varies depending on application method. See label.

**ACTIVE INGREDIENT** Dichlobenil

**CONTROLS** Broadleaf and grassy weeds. See label for complete list.



25lb

**OHP981520** Min. Buy 1ea



### Cheetah® Pro

by NUFARM AMERICAS INC.

Cheetah Pro is a non-selective, post-emergent herbicide that provides fast, effective control of the toughest broadleaf and grassy weeds including those resistant to glyphosate. Minimal soil residue makes it an effective pre-plant treatment for turf, ornamentals, and greenhouses.

REI 12 hours

**RATE** 5 to 20 oz per 100 gal

**ACTIVE INGREDIENT** glufosinate-ammonium

**CONTROLS** Many grassy and broadleaf weeds.



1 Gallon

**NTS10761041** Min. Buy 1ea

**2.5gal**

**NTS10761225** Min. Buy 1ea

**64oz**

**NTS10761464** Min. Buy 1ea



## Herbicides

## Dimension Ultra® WP Herbicide

by Corteva (Dow Agro)

Dimension herbicide provides pre-emergence control of more than 45 grassy and broadleaf weeds as well as post-emergence control of crabgrass. Use sites include turf, landscape and container grown ornamentals. It is safe to use on established turfgrasses and most ornamental plants.

REI 12 hours

**RATE** Varies depending on application method. See label for complete information.

**ACTIVE INGREDIENT** Dithiopyr**CONTROLS** Broadleaf weeds.

40oz

DOW19-0008D Min. Buy 1ea



## Finale® Herbicide

by BASF CORP

Provides fast, effective control of a broad spectrum of emerged annual and perennial grasses, broadleaf weeds, woody species and controls even the toughest weeds, like poison ivy, dandelion and thistle. Only kills what you spray it on and produces results in 1 to 4 days under many conditions. Shows rapid control without the regrowth of typical burndowns, has a long application window, is effective in spring and fall and does not translocate in most plants. Minimal soil-residual activity means transplanting or seeding is possible hours after application.

REI 12 hours

**RATE** 3 to 4 qts per acre**ACTIVE INGREDIENT** Glufosinate-ammonium**CONTROLS** Many broadleaf and grassy weeds

2.5gal bottle

PROKZ4193473 Min. Buy 1ea



## Dimension® 2EW Herbicide

by Corteva (Dow Agro)

A specialty selective herbicide provides pre-emergence and early post-emergence control of crabgrass, and season-long control of crabgrass, goose grass, foxtail, spurge and annual bluegrass (Poa Annua). It also is proven effective for more than 45 other grassy and small-seeded broadleaf weeds.

REI 12 hours

**RATE** Varies depending on application method. See label for complete information.

**ACTIVE INGREDIENT** Dithiopyr**CONTROLS** Broadleaf weeds.

2.5gal

DOW19-0008A Min. Buy 1ea



## Fortress® Herbicide

by OHP, INC.

Fortress is a pre-emergent herbicide containing two active ingredients that is formulated on a dust and odor-free granule. May be used on many ornamental grasses and perennials. Controls a wide range of both grassy and broadleaf weeds by creating a barrier in the soil. Fortress works by inhibiting cell division and disrupting cell wall formation in roots and shoots of emerging weed seedlings.

REI 12 Hrs

**RATE** 150lb per Acre**ACTIVE INGREDIENT** Isoxaben and Dithiopyr**CONTROLS** Many broadleaf and grassy weeds. See label for complete list.

50lb

OHP982800 Min. Buy 1ea



## Drive® XLR8

by BASF CORP

Drive XLR8 turf herbicide provides control of crabgrass, torpedograss, several broadleaf weeds and more. Drive delivers quicker uptake by the plant and is rainfast in less than an hour. Labeled for use in residential, industrial, and commercial turfgrasses, sod farms, sports and recreation fields.

REI 4 hours

**RATE** varies, see label**ACTIVE INGREDIENT** Quinclorac**CONTROLS** crabgrass and broadleaf weeds in turf grass

64oz Bottle

BAS59011404 Min. Buy 1ea



## FreeHand® 1.75G Herbicide

by BASF CORP

Features two active ingredients; Pendimethalin and Dimethenamid-P. This unique combination makes the perfect tool for pre-emergent weed control of annual grasses, sedges and many broadleaf weeds. Use sites include nurseries, residential and commercial landscapes, turfgrass.

REI 12 Hrs

**RATE** 100 to 200lb per Acre**ACTIVE INGREDIENT** Dimethenamid-P + Pendimethalin**CONTROLS** Annual grasses, sedges and many broadleaf weeds. See label for complete list.

50lb AGENCY

BAS59011296 Min. Buy 1ea



## Envoy Plus® Herbicide

by NUFARM AMERICAS INC.

Envoy Plus herbicide provides effective post-emergent control of grassy weeds. It provides over-the-top control of both annual and perennial grasses with excellent plant safety. For use on garden flowers and plants, groundcovers and ornamental trees and shrubs.

REI 12 Hrs

**RATE** 9 to 32oz per Acre**ACTIVE INGREDIENT** Clethodim**CONTROLS** Many annual and perennial grassy weeds. See label for complete list.

1gal

VAL86793.935 Min. Buy 1ea



## Fuerte™ Herbicide

by OHP, INC.

Fuerte is a selective pre-emergent herbicide for control of grassy and broadleaf weeds in field and container ornamentals. Fuerte combines two selective herbicides in a dust free granular form to provide broad spectrum weed control.

REI 12 hours

**RATE** 100 lbs per acre**ACTIVE INGREDIENT****CONTROLS** Most grassy and broadleaf weeds. See label for complete list.

50lb

OHP982825 Min. Buy 1ea





## Herbicides

**Fusilade® II Herbicide**

by SYNGENTA CROP PROTECTION

Fusilade II herbicide is a selective post emergent herbicide for control of perennial and annual grass weeds. Can be applied over-the-top or as a directed spray without damaging ornamental plants and shrubs.

REI 12 Hrs

RATE 32oz per Acre

ACTIVE INGREDIENT Fluazifop-P-Butyl

CONTROLS Grassy weeds



32oz

SYN73215 Min. Buy 1ea

**Woodace® Preen Plus®**

by LEBANON SEABOARD CORP-PROF

Combines the power of two active ingredients (Trifluralin and Isoxaben) for unsurpassed control of both grassy and broadleaf weeds. One application can prevent over 150 weeds from invading shrub beds and other landscape areas for up to eight months.

REI 12 Hrs

RATE 133-267lbs per acre

ACTIVE INGREDIENT Trifluralin, Isoxaben

CONTROLS Wide variety of broadleaf weeds and annual grasses



20lbs

WO2456320 Min. Buy 1ea

**Gallery® SC Herbicide**

by Corteva

Pre-emergent herbicide that provides excellent plant tolerance and long-lasting control of more than 95 species of broadleaf weeds for up to 6-8 months. Labeled for use on all established turf grasses and can be applied with confidence on more than 700 labeled nursery, landscape and ornamentals.

REI 12 hours

ACTIVE INGREDIENT Isoxaben

CONTROLS Broadleaf weeds.



32oz

RATE 16 oz per acre

DOW11079207 Min. Buy 1ea

2gal

RATE 0.5 oz per 1,000sq ft

DOW11103357 Min. Buy 1ea

**Lontrel® Herbicide**

by Corteva

A specialty herbicide that provides postemergence control of hard-to-manage weeds around labeled ornamentals, golf course fairways and roughs without injuring even the most sensitive turfgrasses.

REI 12 Hrs

RATE 3 to 8oz per 1,000sq ft

ACTIVE INGREDIENT Clopyralid

CONTROLS Broadleaf weeds.



32oz

DOW19-1043 Min. Buy 1ea

**Gemini® Granular Herbicide**

by ICL/SPECIALTY FERTILIZERS

Gemini G is a pre-emergent herbicide for control of over 120 grassy and broadleaf weeds. Use sites include container, field grown and landscape ornamentals and Christmas tree farms. Granular formulation for easy broadcast application.

REI 12 Hrs

RATE 100 to 200lbs per Acre

ACTIVE INGREDIENT Prodiamine, Isoxaben



50lb

EVRE95765 Min. Buy 1ea

**Gemini™ 3.7 SC Liquid Pre-Emergent Herbicide**

by ICL/SPECIALTY FERTILIZERS

Gemini 3.7 SC is a pre-emergent herbicide for control of over 120 grassy and broadleaf weeds. Use sites include container, field grown and landscape ornamentals and Christmas tree farms. Concentrated liquid formulation for easy tank mixing.

REI 12 Hrs

RATE Varies depending on use site. See Label.

ACTIVE INGREDIENT Prodiamine, Isoxaben

CONTROLS More than 120 broadleaf and annual grasses, including: Annual Bluegrass, Bittercress, Chickweed, Crabgrass, Foxtail, Goosegrass, Groundsel, Henbit, Oxalis, Spurge.



64oz

EVRE95450 Min. Buy 1ea

2.5gal

EVRE95224 Min. Buy 1ea



What's your actual cost-in-use?  
Go from rough idea to real savings

Calculate your herbicide costs at:  
[es.bayer.us/marengo-calculator](http://es.bayer.us/marengo-calculator)

**BAYER** Marengo®

Visit [EnvironmentalScience.Bayer.US/Marengo](http://EnvironmentalScience.Bayer.US/Marengo) to learn more.

ALWAYS READ AND FOLLOW LABEL INSTRUCTIONS  
Bayer Environmental Science, a Division of Bayer CropScience LP, 5000 CentreGreen Way, Suite 400, Cary, NC 27513. For additional product information, call toll-free 1-800-331-2867, [environmentalscience.bayer.us](http://environmentalscience.bayer.us). Not all products are registered in all states. Bayer, the Bayer Cross and Marengo are registered trademarks of Bayer. ©2021 Bayer CropScience. ES-0121-MAR-0029-A-R3

## Herbicides

**Marengo® G Herbicide**by **BAYER CROPSCIENCE**

Marengo is a preemergent herbicide that provides up to 8 months control of over 70 different weeds. Features a Verge carrier for uniform, virtually dust-free application. Marengo G is labeled for use in outdoor nurseries only.

REI 12 Hrs

RATE 100 to 200lb per Acre

ACTIVE INGREDIENT Indaziflam

CONTROLS Over 98 grassy and broadleaf weed species



50lb AGENCY

BYR84922757 Min. Buy 1ea

**Marengo® SC Herbicide**by **BAYER CROPSCIENCE**

Marengo is a preemergent herbicide that provides up to 8 months control of over 70 different weeds. Effective on hard to control weeds and labeled for weed control in greenhouses and outdoor nurseries.

REI 12 Hrs

RATE 7 to 15oz per Acre

ACTIVE INGREDIENT Indaziflam

CONTROLS Over 98 grassy and broadleaf weed species



18oz

BYR84927600 Min. Buy 1ea

64oz AGENCY

BYR84967874 Min. Buy 1ea

**OH2® Pre-Emergent Herbicide**by **ICL/SPECIALTY FERTILIZERS**

OH2 is a pre-emergent herbicide for container and field grown ornamentals in nurseries. OH2 combines two selective herbicides on one granule, giving the user a broad spectrum of weed control and ornamental plant tolerance. No dust, granular formulation for easy broadcast application.

REI 24 Hrs

RATE 100lb per Acre

ACTIVE INGREDIENT Pendimethalin, Oxyfluorfen

CONTROLS Bittercress, Common Chickweed, Cudweed, Dandelion, Eclipta, Fleabane, Fireweed, Groundsel, Marestail, Oxalis, Pearlwort, Pepperweed, Pigweed, Shepherdspurse, Sowthistle, Spurge Garden-Prostrate-Spotted



50lb

EVR95715 Min. Buy 1ea

**OHP Fireworxx™ Herbicide**by **OHP, INC.**

Fireworxx is a non-selective herbicidal soap containing a fatty acid blend of caprylic and capric acids. Controls weeds, grasses, and moss on contact. Fireworxx is non-systemic. Labeled for use in greenhouses, nurseries, landscapes, and outdoor areas. Fireworxx can be used around bedding plants, vegetables, trees and shrubs.

REI 12 hours

RATE 3 to 9 gallons per 100 gallons water.

ACTIVE INGREDIENT Caprylic and Capric Acids

CONTROLS Weeds, grasses, moss



1 Gallon

OHP982644 Min. Buy 1ea

**Pendulum® 2G Herbicide**by **BASF CORP**

Pendulum 2G herbicide controls more than 40 grassy and broadleaf weeds in turfgrass, container-grown ornamentals, and nonbearing fruit and nut trees.

REI 24 Hrs

RATE 75 to 100lb per acre.

ACTIVE INGREDIENT Pendamethalin

CONTROLS Crabgrass, goosegrass, oxalis, foxtail and many more.



40lb

AC54878 Min. Buy 1ea

**Pendulum® Aquacap Herbicide**by **BASF CORP**

Pendulum Aquacap is a pre-emergent herbicide effective in many broadleaf and grassy weeds. Labeled for use in nurseries, turf and landscape or grounds maintenance applications.

REI 24 Hrs

RATE 24 to 32oz per Acre

ACTIVE INGREDIENT Pendamethalin

CONTROLS Many broadleaf and grassy weeds. See label for complete list.



2.5 gal bottle

BAS59049276 Min. Buy 1ea

**Pennant Magnum® Herbicide**by **SYNGENTA CROP PROTECTION**

Pre-emergent herbicide offering long-lasting residual control of yellow nutsedge, tough annual grasses and broadleaf weeds. Can be used in a wide range of ornamentals and can be tank mixed with other herbicides for broader control.

REI 24 Hrs

RATE 20.8oz to 41.6oz per Acre

ACTIVE INGREDIENT S-metolachlor

CONTROLS Yellow nutsedge, Crabgrass and more.



1gal

SYN38782 Min. Buy 1ea

**Ranger Pro® Herbicide**by **BAYER CROPSCIENCE**

Ranger Pro is a post-emergent systemic herbicide with no residual soil activity. Ranger Pro provides broad spectrum control of many annual and perennial weeds, woody brush and trees. 41% Glyphosate with surfactant.

REI 4 Hrs

RATE Varies depending on application method. See label for complete information.

ACTIVE INGREDIENT Glyphosate

CONTROLS Annual, perennial grassy and broadleaf weeds, woody brush and trees.



2.5gal

MON339020 Min. Buy 1ea

30gal Drum

MON50030 Min. Buy 1ea

265 Gallon

MON86741296 Min. Buy 1ea

Shipping Info HAZARDOUS



## Herbicides

### RegalStar® G Pre-Emergent Herbicide

by REGAL CHEMICAL COMPANY

RegalStar G is a selective pre-emergent herbicide that combines two effective active ingredients to control many grassy and broadleaf weeds. Granular formula for easy broadcast spreading. Can be used over the top of plant material.

REI 12 hours

RATE 4 Lbs per 1,000 sq ft.

ACTIVE INGREDIENT Oxidiazon + Prodiamine.

CONTROLS Grassy and broadleaf weeds in turf and around ornamental shrubs and trees..



50lb

REGAL190478 Min. Buy 1ea



### Resolute® 65WG Herbicide

by SYNGENTA CROP PROTECTION

Resolute 65 WG for preemergence control of grasses and broadleaf weeds in established turfgrasses, container grown and landscape ornamentals, nurseries and commercial landscapes.

REI 12 Hrs

RATE 0.5-1.5lbs per acre

ACTIVE INGREDIENT Prodiamine

CONTROLS Many broadleaf and grassy weeds. See label for complete list.



5lb

SYN34443 Min. Buy 1ea



### Reward® Herbicide

by SYNGENTA CROP PROTECTION

Fast-acting, non-selective, contact herbicide for control of weeds in the greenhouse, nursery and aquatic environments. Superior formulation for fast burn-down.

REI 24 Hrs

RATE 32 to 64oz per 100gal

ACTIVE INGREDIENT Diquat dibromide

CONTROLS Aquatic, turf and landscape weeds.



1gal

SYN73711 Min. Buy 1ea

Shipping Info HAZARDOUS

2.5gal AGENCY

SYN73710 Min. Buy 1ea

Shipping Info HAZARDOUS



### Ronstar® FLO Herbicide

by BAYER CROPSCIENCE

Offers exceptional root safety on container and field-grown ornamentals. Can be applied to newly transplanted ornamentals and liners. Doesn't inhibit root growth or recovery from stress. Controls difficult to control weeds including bittercress, groundsel and oxalis.

REI 12 Hrs

RATE 80 to 120oz per Acre

ACTIVE INGREDIENT Oxadiazon

CONTROLS Crabgrass, Goosegrass, Annual Bluegrass and Annual Sedge.



2.5gal AGENCY

BYR80847505 Min. Buy 1ea



### Roundup ProMax® Herbicide

by BAYER CROPSCIENCE

Roundup ProMax® controls a broad spectrum of weeds with virtually no re-growth. The surfactant system of Roundup PROMAX allows the solution to penetrate weed leaf surfaces faster, which means it is rain fast in half the time of Roundup PRO®. Roundup ProMax® has a concentrated potassium salt formulation, so one gallon of Roundup ProMax® contains the glyphosate equivalent of 6 quarts of Roundup PRO®.

REI 4 Hrs

RATE Varies depending on application method. See label for complete information.

ACTIVE INGREDIENT Glyphosate

CONTROLS Annual, perennial grassy and broadleaf weeds, woody brush and trees.



1.67gal

MON19-1058A Min. Buy 1ea

30gal Drum

MON19-1058B Min. Buy 1ea



### Roundup QuikPRO™ Herbicide

by BAYER CROPSCIENCE

Roundup QuikPro is a post-emergent systemic herbicide with no residual soil activity. Roundup Pro provides broad spectrum control of many annual and perennial weeds, woody brush and trees. 73% Glyphosate with Diquat and surfactant. Rainfast in one hour.

REI 4 Hrs

RATE Varies depending on application method. See label for complete information.

ACTIVE INGREDIENT Glyphosate

CONTROLS Annual, perennial grassy and broadleaf weeds, woody brush and trees.



5 x 1.5oz Pack

MON88603 Min. Buy 1ea

6.8lb

MONCH362 Min. Buy 1ea



### Roundup® Custom Herbicide

by BAYER CROPSCIENCE

REI 4 Hrs

RATE Varies depending on application method. See label for complete information.

ACTIVE INGREDIENT Glyphosate

CONTROLS Aquatic weeds and annual, perennial grassy and broadleaf weeds, woody brush and trees.



2.5 gal bottle

MON12151770 Min. Buy 1ea



### Scythe® Herbicide

by GOWAN

A non-selective, contact herbicide composed of Pelargonic Acid and related fatty acids. Readily mixes with water to be applied as a foliar spray for the burn down of actively growing, emerged green vegetation of both annual and perennial broadleaf and grassy weeds as well as most mosses and cryptogams.

REI 12 Hrs

RATE Varies depending on application method. See label.

ACTIVE INGREDIENT Pelargonic Acid

CONTROLS Broadleaf and grassy weeds



2.5gal

GOW52823 Min. Buy 1ea



## Herbicides

## SedgeHammer® Herbicide

by GOWAN

SedgeHammer® turf herbicide is a selective herbicide for control of nutsedge and other weeds in turfgrass, ornamentals, and landscaped areas.

REI 12 hours

RATE one 1.33 oz pouch per 1,000 sq ft.

ACTIVE INGREDIENT Halosulfuron-methyl

CONTROLS Nutsedge, Wild Mustard, Pigweed, and many more.



10x1.33oz

GOW35720 Min. Buy 1ea



## Sedgehammer® Plus Herbicide

by GOWAN

Sedgehammer plus turf herbicide is a selective herbicide for control of nutsedge and other weeds in turfgrass, ornamentals and landscaped areas.

REI 12 hours

RATE 1 to 2 pouches per 1,000 sq ft.

ACTIVE INGREDIENT Halosulfuron-methyl

CONTROLS Nutsedge, Wild Mustard, Pigweed, and many more.



12pc Box of 13.5g Packets

GOW51516 Min. Buy 1ea



## Segment® II Herbicide

by BASF CORP

Segment II is a post-emergent herbicide for control of grassy weeds. For use on bedding plants, ground covers, field and container nurseries.

REI 12 Hrs

RATE 36oz per Acre

ACTIVE INGREDIENT Sethoxydim

CONTROLS Grassy weeds



2.5 gal bottle

BAS59014427 Min. Buy 1ea



## Snapshot® 2.5TG Herbicide

by Corteva

A granular pre-emergence herbicide for the control of certain annual grasses and broadleaf weeds. Controls or suppresses more than 111 broadleaf weeds and annual grasses. It can be used over the top of 413 field-grown and 235 container-grown ornamentals.

REI 12 hours

RATE 100 to 200 lbs per acre

ACTIVE INGREDIENT trifluralin and isoxaben

CONTROLS Broadleaf weeds.



50lb

DOW19-1067H Min. Buy 1ea



## Specticle® Total Herbicide

by BAYER CROPSCIENCE

Specticle Total herbicide has a dual action formula to knockdown existing weeds immediately with residual activity to prevent new weeds and grasses for up to 6 months. Labeled for use in non-crop areas including paths, parking lots, around buildings, hardscapes and landscape beds.

RATE 16oz per 1,000sq ft

ACTIVE INGREDIENT Glyphosate, Indizaflam, Diquat

CONTROLS Grassy and Broadleaf weeds



144oz

BYR80972768 Min. Buy 1ea



## SureGuard® SC Herbicide

by NUFARM AMERICAS INC.

SureGuard SC provides long-lasting pre-emergent and post-emergent control on a wide variety of grassy and broadleaf weeds. Use sites include established woody landscape ornamentals, bare ground applications and cracks and crevices.

REI 12 Hrs

RATE 8 to 12oz per Acre

ACTIVE INGREDIENT Flumioxazin

CONTROLS Broadleaf, grassy and aquatic weeds. See label for complete list.



16oz

NTS10698861 Min. Buy 1ea

64oz

NTS10698464 Min. Buy 1ea



## Tenacity® Herbicide

by SYNGENTA CROP PROTECTION

Manage weeds, both broadleaves and grasses, without limiting other key aspects of turf management. Systemic, selective pre- and post-emergence herbicide. Safe on established and newly seeded turf. Controls 46 broadleaf weed and grass species and kills crabgrass.

REI 12 Hrs

RATE 5 to 8oz per Acre

ACTIVE INGREDIENT Mesotrione

CONTROLS Many broadleaf and grassy weeds, including pre and post-emergence control of crabgrass



8oz

SYN46256 Min. Buy 1ea



## Tower® Herbicide

by BASF CORP

Tower is a pre-emergent herbicide for the control of numerous weeds that cause problems in field-grown and landscape ornamentals. It provides unsurpassed control of yellow nutsedge and effectively controls more than 50 other troublesome weeds.

REI 12 Hrs

RATE 0.5 to 0.75oz per 1,000sq ft

ACTIVE INGREDIENT Dimethenamid-P

CONTROLS Annual sedges, yellow nutsedge, nightshade, spurge, carpetweed, crabgrass and more.



2.5 gal bottle AGENCY

BAS59014247 Min. Buy 1ea



## Treflan™ 500G Herbicide

by KNOX FERTILIZER COMPANY INC

A pre-emergence herbicide which provides long lasting control of a wide range of annual grasses and broadleaf weeds. Recommended for use on a wide variety of ornamental trees, shrubs and flowers.



40lb

SW1103409 Min. Buy 1ea



## Vessel™ Herbicide

by PROKOZ, INC

Vessel is a post-emergent systemic herbicide for control of a wide range of broadleaf weeds. The combination of three active ingredients provide effective control of troublesome weeds in turfgrass sites including residential, commercial and industrial.



2.5gal

PROKZ9921126 Min. Buy 1ea



## *Herbicides* choosing between spray and granular products

	Spray	Granular
<b>Cost/Acre</b>	Less \$	Cost more due to bulk
<b>Ease of Use</b>	Most growers already have sprayers and are well trained to calibrate and spray herbicides.	Requires a calibration pan to check rate. Most growers don't have a herbicide spreader attached to a tractor where speed can be controlled. Belly grinder rates vary due to walking and hand crank speed.
<b>Flexibility</b>	Ability to tank mix preemergents together and option to add post-emergents to control existing weeds	Cannot be mixed with other herbicides.
<b>Weed Control-Shrubs, Large Trees</b>	Stronger herbicides like Marengo SC and Sureguard SC can be applied as a directed spray near the stem. Also can add post-emergent herbicides to tank mix to kill existing weeds.	Effective, but costs more per acre and can't be combined with post-emergent herbicides
<b>Weed Control-Shrubs, Small Trees</b>	Over the top spray options are limited to softer herbicides that won't harm foliage but also don't control weeds as well	Over the top of shrubs and small trees, Granulars are the best way to deliver a stronger herbicide (ex: Broadstar, Marengo G) safely through the canopy to the soil surface
<b>Weed Control - Perennials</b>	Softer herbicides like Gallery SC + Barricade can be safely sprayed over the top of many varieties, particularly early before they leaf out and late in the season	Granulars (ex: Snapshot, Freehand) are a good choice mid-season when spraying herbicides onto foliage is a concern
<b>Weed Control - Evergreens</b>	Evergreens are generally tolerant of sprays of Sureguard SC or Marengo over the top. However, sprays can be blocked from making contact with soil by larger evergreens	Granulars can potentially give better coverage of soil surface in large canopied evergreens due to horizontal angle of entry



### *When to Apply & How Often*

Many nurseries delay applying herbicides to new plantings until they're rooted. This is not necessary for most crops and leads to unnecessary weediness. The goal is to apply as soon as possible after planting.

Growers in the South make as many as 6 herbicide applications per year. Nurseries in the Northern states often get by with 2-3 applications due to the shorter growing season and cold weather killing annual weeds.

Key application windows:

- After planting
- Summer: One or several summer mid-season applications depending on weed pressure.
- Fall: Early Fall to prevent fall germinating weeds. Late Fall applications will carry over for spring weed prevention.

## Aquatic Herbicides and Algaecides

## Captain® XTR Algaecide

by SEPRO CORPORATION

Captain XTR is optimized to increase the penetration of copper into algae cells, enhancing the efficacy of the product. This formulation is especially impactful when targeting tough to control mat-forming, colonial, and mucilaginous species. Waters treated with Captain XTR may be used for swimming, fishing, watering livestock, and irrigation of food and non-food crops during and after application.

REI 0 hours

RATE 1 to 3 gallons per acre-foot.

ACTIVE INGREDIENT Copper Ethanolamine Complex

CONTROLS Algae.



2.5gal Bottle

SEPROCAPXTR2.5 Min. Buy 1ea



## Cutrine® Plus Algaecide

by Applied Biochemists

Contains elemental copper for control of algae in lakes, industrial ponds, water hazards.

RATE Varies according to application. See label.

ACTIVE INGREDIENT Copper Ethanolamine



1gal Bottle

PROKZ337464 Min. Buy 1ea



2.5gal Bottle

PROKZ337466 Min. Buy 1ea

## GreenClean® Pond Block

by BIOSAFE SYSTEMS

A blend of naturally occurring bacteria formulated to increase water quality and clarity by reducing excess nutrients in water sources. GreenClean Pond Block breaks down undesirable organic debris buildup and is non-toxic, easy to use, and doesn't require an application license.



5lb - Treats 5 Acre for 30-60 Days

BSF30064 Min. Buy 1ea

Shipping Info DIRECT



## Komeen® Crystal Aquatic Herbicide

by SEPRO CORPORATION

Komeen Crystal provides consistent, on-contact, broad-spectrum control of submersed aquatic weeds and bottom algae in a wide variety of application situations, including high turnover and small spot-treatment areas. This concentrated formulation allows for low use rates and improved control of nuisance aquatic weeds in deep water, high flow sites, or for spot treatments along shorelines.

RATE 20 to 60lbs per acre-foot.



20lb Bag

SEPRO118620 Min. Buy 1ea



## PAK® 27 Algaecide

by SEPRO CORPORATION

PAK 27 is an effective non-copper and environmentally compatible algaecide, delivering both selective and broad-spectrum algae control. Approved for the selective control of cyanobacteria in lakes, ponds, drinking water reservoirs, aquaculture and wastewater, PAK 27's active ingredient, sodium carbonate peroxyhydrate, creates a powerful oxidation reaction that destroys algal cell membranes and chlorophyll, providing immediate algae control. PAK 27 is the ideal choice to keep your lakes, fishing and stock ponds, aquaculture sites, and other private water bodies pleasing to the eye and safe for enjoyment. HAZARDOUS.



50lb Bag

SEPROPAK27 Min. Buy 1ea

Shipping Info HAZARDOUS



## Phoslock® Water Quality Treatment

by SEPRO CORPORATION

Phoslock is a phosphorus locking technology to restore water quality in ponds, lakes and reservoirs. Phoslock has been successfully used in water resource restoration programs around the world. Although a new technology to the United States, it is rapidly emerging as the most effective phosphorus inactivation and water quality restoration solution for ponds, lakes and reservoirs.



55lb Bag

SEPRO1092.55 Min. Buy 1ea



## SeClear® Granular Algaecide

by SEPRO CORPORATION

SeClear is the first aquatic algaecide and water quality enhancer in one designed to replace routine algaecide treatments. Delivering longer-lasting results, improved water quality and reduced maintenance through time, SeClear provides effective control of a broad-range of algae species while reducing in-water phosphorous levels with each application. Water treated with SeClear is completely safe on turfgrass and ornamental plants and can be used for irrigation immediately. The granular formulation allows penetration to deeper growing algae.

REI 0 hours

RATE 15 to 25lbs per acre-foot.

ACTIVE INGREDIENT Copper Sulfate Pentahydrate

CONTROLS Algae.



50lb Bag

SEPROSECLEARG Min. Buy 1ea



## SeClear® Liquid Algaecide

by SEPRO CORPORATION

SeClear is an aquatic algaecide and water quality enhancer in one designed to replace routine algaecide treatments. Delivering longer-lasting results, improved water quality and reduced maintenance through time, SeClear provides effective control of a broad-range of algae species while reducing in-water phosphorous levels with each application. Water treated with SeClear is completely safe on turfgrass and ornamental plants and can be used for irrigation immediately.

REI 0 hours

RATE 1.6 to 6gal per acre-foot.

ACTIVE INGREDIENT Copper Sulfate Pentahydrate

CONTROLS Algae.



2.5gal Bottle

SEPROSECLEAR Min. Buy 1ea



## Aquatic Herbicides and Algaecides

### SePRO Natural Reflection™ Pond Dye

by SEPRO CORPORATION

A proprietary blend of environmentally friendly, non-toxic, water soluble dye. Natural Reflections provides a natural reflective quality to the surface of water while reducing the amount of sunlight penetration available to undesired aquatic vegetation. One gallon covers approximately 8 acre-feet of surface water. Water maybe used for irrigation or fishing immediately after treatment. Natural Reflection will not harm fish, waterfowl, pets or wildlife.

REI 0 hours

RATE 16oz covers approximately 1 acre-foot of water

ACTIVE INGREDIENT

CONTROLS Nuisance aquatic vegetation



1gal

SEPROBKDYE Min. Buy 1ea



### SonarOne® Aquatic Herbicide

by SEPRO CORPORATION

SonarOne is the most effective solution available for controlling duckweed, watermeal, and many other undesirable aquatic weeds and eliminates unwanted vegetation from lakes or ponds for a year or longer. SonarOne is a pellet formulation that delivers an effective dose to targeted plants within the first day. The easy-to-apply pellet formulation eliminates overspray onto sensitive shoreline vegetation, making it ideal for landscapes with highly maintained vegetation, including golf courses.



20lb Bag

SEPRO117320 Min. Buy 1ea



## Sanitizers, Cleaners, and Disinfectants

### BioMat Boot Sanitation Pad

by BIOSAFE SYSTEMS

BioMat is a durable foot pad that controls plant pathogens at entryways. One BioMat holds 2.5gal of disinfecting solution to clean the soles of shoes/boots, keeping contamination out of your facility.



BSFN09574 Min. Buy 1ea



### BioSafe Systems® Peracetic Acid Test Strips

by BIOSAFE SYSTEMS

Peracetic acid (PAA) test strips are used to test and verify levels of PAA in your solution. 100 Strips per tube.



100ct

BSF9000STRIP Min. Buy 1ea

Shipping Info **DIRECT**



### SaniDate® 15.0 Sanitizer/Disinfectant

by BIOSAFE SYSTEMS

SaniDate 15.0 for use in commercial, industrial, agricultural, post harvest, and horticultural water treatment applications. Labeled for fruit and vegetable processing to control spoilage.

ACTIVE INGREDIENT Hydrogen Peroxide and Peroxyacetic Acid

CONTROLS Water-borne pathogens and their dormant spores caused by algae, bacteria and biofilm.



55gal

BSF200655 Min. Buy 1ea

Shipping Info **HAZARDOUS**



## Sanitizers, Cleaners, and Disinfectants

### GreenClean® Acid Cleaner

by BIOSAFE SYSTEMS

Removes greenhouse whitewash coatings, biofilms, organic deposits, calcium and other hard minerals. Sanitizes and disinfects most hard surfaces. The formulation of surfactants and organic acid detergents will help lift away organic mineral deposits without any odor.

REI 0-1 Hrs

RATE 5 to 10gal per Surface Acre



5gal

BSF7500-5 Min. Buy 1ea

Shipping Info **HAZARDOUS**



### GreenClean® PRO Algaecide/Fungicide/Bactericide

by BIOSAFE SYSTEMS

Treat and control algae on concrete walkways, ground cloth, or dirt, or gravel floors, and other hard surfaces to improve workplace safety. Additionally, GreenClean PRO can be used to treat water storage tanks and irrigation ponds to reduce algae and waterborne pathogens.

RATE 1 to 2lb per 1,000sq ft

ACTIVE INGREDIENT Sodium Carbonate Peroxyhydrate



50lb

BSF3300-50 Min. Buy 1ea

Shipping Info **HAZARDOUS**



### Green-Shield® II Disinfectant / Algicide

by BASF CORP

Provides greenhouse and nursery growers a biodegradable, cost-effective way to control unwanted plant pathogens and algae on hard surfaces. EPA-registered for broad-spectrum control of pathogens and algae in and around greenhouses and causes no damage to clothing from splashes. Lasts four times longer in solution than bleach and provides residual control as long as treated surfaces stay wet.

REI 12 Hrs

ACTIVE INGREDIENT Quaternary ammonium



1 gal bottle

BAS59014302 Min. Buy 1ea

Shipping Info **HAZARDOUS**

30 gal Drum

BAS59014303 Min. Buy 1ea

Shipping Info **HAZARDOUS**



## Sanitizers, Cleaners, and Disinfectants

**HORTI-KLOR™**

by PACE 49 INC.

HORTI-KLOR™ is a heavy-duty detergent that is formulated for cleaning and sanitizing throughout the food plant and grower industries. Can safely be used to clean indoor growing facilities, packing houses and coolers. HORTI-KLOR™ is an active, high-foaming detergent designed to help meet the highest food plant and greenhouse grower sanitation standards and is HACCP approved. Thorough rinse required.

REI 0 Hrs

**RATE** 2.5oz per 1gal for irrigation line cleaning, 5oz per 1gal for hard surface cleaning

**ACTIVE INGREDIENT** Sodium Hydroxide

**5gal****PAC4919-0604A** Min. Buy 1eaShipping Info **HAZARDOUS****55gal****PAC4919-0604C** Min. Buy 1eaShipping Info **HAZARDOUS****KleenGrow™ Disinfectant / Bactericide / Algaecide / Fungicide**

by PACE 49 INC.

KleenGrow™ is a biodegradable, 4th generation DDAC quaternary ammonium which provides curative and preventative broad - spectrum control of algae, fungi, and bacteria on greenhouse flowers and ornamentals. KleenGrow can safely be applied as a spray, drench, or drip on crops, from propagation, bulbs/ seeds, to finished crops, while offering residual disease control by way of membrane disruption with no worry of crop resistance. Kleengrow can also be used to control algae, bacteria, and viruses on hard surfaces. Product can safely be used to disinfect greenhouse structures, floors, benches, cool pads, irrigation lines, plastic pots/trays, tools, coolers, and in footbaths to reduce the spread of algae and diseases.

REI 12 Hrs - For Recirculated Water, 48 Hrs - For Use On Crops, 0 Hrs

**RATE** 6-25oz per 100gal (see label for rate per crop size), 0.5-2oz per 1gal Hard Surface Disinfecting, 0.34-1.20oz per 100gal in Irrigation Water

**ACTIVE INGREDIENT** Didecylidimethyl ammonium chloride

**CONTROLS** Algae, foliar diseases, crown and root rots, Powdery Mildew, Botrytis, Pythium, Phytophthora, Fusarium, Erwinia and Xanthomonas

**1gal****PAC4919-0603I** Min. Buy 1eaShipping Info **HAZARDOUS****5gal****PAC4919-0603J** Min. Buy 1eaShipping Info **HAZARDOUS****30gal Drum****PAC4919-0603K** Min. Buy 1eaShipping Info **HAZARDOUS****55gal Drum****PAC4919-0603B** Min. Buy 1eaShipping Info **HAZARDOUS****MASTER MHW™**

by PACE 49 INC.

MASTER MHW™ is a powdered detergent that easily emulsifies dirt, oils and organic material, leaving surfaces spotless. It is designed to work without producing excessive foam in high-agitation environments. The low-foaming characteristics make it ideal for removing deposits from plastic and Styrofoam plug trays and pots, using automated washing equipment.

REI 0 Hrs

**RATE** 1-2oz per 1gal

**ACTIVE INGREDIENT** Sodium Metasilicate, Sodium Carbonate, Sodium Alkylbenzene Sulfonate

**45lb****PAC4919-0600A** Min. Buy 1eaShipping Info **HAZARDOUS****Phyton X3®**

by PHYTON CORP

Triple-powered, broad-spectrum formula for efficient, cost-effective disease control and sanitation. A powerful, highly concentrated bactericide / fungicide / algaecide / sanitizer with a zero-hour re-entry and a low risk of phytotoxicity, when used as directed. Labeled for use as a fungicide/bactericide on greenhouse bedding plants, ornamentals, and flowering plants, nursery stock and trees. Can be used as a pre-plant dip to control root and stem rot diseases. Used as a soil drench, it will control soil borne diseases. As a foliar spray it works on contact to control fungi and bacteria.

REI 0 to 2 hours

**ACTIVE INGREDIENT** Hydrogen Peroxide, Peroxyacetic acid, and Octanoic acid

**CONTROLS** Algae and many plant and soil pathogens.

**96 oz bottle****PHTNX3-31096** Min. Buy 1eaShipping Info **HAZARDOUS****4 gal bottle****PHTNX3-31004** Min. Buy 1eaShipping Info **DIRECT HAZARDOUS****12 gal bottle****PHTNX3-31012** Min. Buy 1eaShipping Info **HAZARDOUS****ProKure® D**

by ProKure

ProKure D slow-release gas is the perfect solution for improving air quality and for on-going control of odors caused by mustiness, perspiration and more. 30-days of ClO2 protection. Improves air quality. Suitable for use with plants in the room.

**10gm Packet****CLRE010C12** Min. Buy 12eaShipping Info **DIRECT****50gm Packet****CLRE050C12** Min. Buy 12eaShipping Info **DIRECT**



**ProKure® G**

by ProKure

ProKure G fast release gas is EPA-registered to clean the air you breathe and remove foul odors. Kills mold and mildew, odor-causing bacteria, and chemical odors. Used in agricultural facilities, greenhouses, commercial buildings, residential properties and more. For use in un-occupied, confined spaces. \*See EPA label for claims.



**10gm Packet**

**CLRF010C12** Min. Buy 12ea

Shipping Info **DIRECT**

**25gm Packet**

**CLRF025C12** Min. Buy 12ea

Shipping Info **DIRECT**

**25gm Packet**

**CLRF025CNC20** Min. Buy 20ea

Shipping Info **DIRECT**



**ProKure® V**

by ProKure

ProKure V liquid is EPA-registered hospital-type disinfectant and deodorizer. Water-activated (ships dry). It destroys bacteria, viruses\*, mold, fungi, and odor-causing bacteria. EPA List N product. Suitable for use with plants in the room. \*See EPA label for claims.



**.042oz Packet**

**CLR0042C12** Min. Buy 12ea

Shipping Info **DIRECT**

**.17oz Packet**

**CLR017C12** Min. Buy 12ea

Shipping Info **DIRECT**

**.84oz Packet**

**CLR084C12** Min. Buy 12ea

Shipping Info **DIRECT**

**3.36oz Packet**

**CLR336C12** Min. Buy 12ea

Shipping Info **DIRECT**



**QAC Test Strips**

by PACE 49 INC.

Used to maintain correct disinfectant strength by comparing tested color with provided chart. . REI: 0



**100 Strips Per Vial**

**PAC49TXQAC001** Min. Buy 4ea

Shipping Info **DIRECT**



**SaniDate® 12.0 Sanitizer / Disinfectant**

by BIOSAFE SYSTEMS

For use in commercial, industrial, agricultural, postharvest, and horticultural water treatment applications. Labeled for fruit and vegetable processing to control spoilage.

REI 2 Hrs

**ACTIVE INGREDIENT** Hydrogen Peroxide and Peroxyacetic Acid

**CONTROLS** Water-borne pathogens and their dormant spores caused by algae, bacteria and biofilm.



**30gal Drum**

**BSF200630** Min. Buy 1ea

Shipping Info **HAZARDOUS**



**SaniDate® 5.0 Sanitizer / Disinfectant**

by BIOSAFE SYSTEMS

The ideal cleaner, sanitizer, and disinfectant for hard, nonporous surfaces and equipment with no rinse required. Foam, fog, or apply solution with a mop, cloth, sponge, brush, scrubber, or coarse spray device or by soaking..

REI 1 Hr

**RATE** Varies according to application method. See label.

**ACTIVE INGREDIENT** Hydrogen Peroxide and Peroxyacetic Acid

**CONTROLS** Pathogens



**2.5gal**

**BSF200325** Min. Buy 1ea

Shipping Info **HAZARDOUS**

**5gal**

**BSF20035** Min. Buy 1ea

Shipping Info **HAZARDOUS**

**30gal Drum**

**BSF200330** Min. Buy 1ea

Shipping Info **HAZARDOUS**

**55gal Drum**

**BSF200355** Min. Buy 1ea

Shipping Info **HAZARDOUS**



**SMO Floralife® MicroBLOC®**

by SMITHERS-OASIS USA

MicroBLOC is an antimicrobial disinfectant for disinfecting hard, nonporous surfaces such as flower buckets, tools, floors and walls of coolers, benches, and more. Effectively eliminates offensive odors caused by mold and mildew.



**30gal**

**SM5FL3930** Min. Buy 1ea

Shipping Info **HAZARDOUS**

**SMO Floralife® Strip-It®**

by SMITHERS-OASIS USA

Strip-It cleaner is designed for between season cleaning of greenhouse structures and irrigation lines as well as water storage tanks and sunshade wash.



**30gal**

**SMFL6161A** Min. Buy 1ea

Shipping Info **HAZARDOUS**



## Sanitizers, Cleaners, and Disinfectants

**STRIP-IT PRO™**

by PACE 49 INC.

STRIP-IT PRO™ is a powerful combination of cleaning and wetting agents that effectively remove whitewash coatings, algae, dirt and mineral deposits including calcium due to hard water issues. Safely removes all common soils found in and around greenhouses, grower structures during crop rotation. Unlike other cleaning products, STRIP-IT PRO™ will not harm the greenhouse structure and can safely be used to clean under benches with no harmful fumes to effect plants. Thorough rinse required.

REI 0 Hrs

**RATE** 2.5oz per 1gal for Irrigation line cleaning, 5oz per 1gal for hard surface cleaning

**ACTIVE INGREDIENT** Sulfuric Acid, Ammonium Bifluoride

**5gal****PAC4919-0603D** Min. Buy 1eaShipping Info **HAZARDOUS****30gal Drum****PAC4919-0603E** Min. Buy 1eaShipping Info **HAZARDOUS****55gal Drum****PAC4919-0604** Min. Buy 1eaShipping Info **HAZARDOUS**

## Spray Adjuvants

**CapSil® Spray Adjuvant**

by AQUATROLS CORP OF AMERICA

Waxy leaf surfaces can cause spray droplets to bead up, resulting in coverage gaps that can reduce the efficacy of foliar sprayed materials. CapSil® allows foliar sprays to spread evenly over the entire leaf surface, giving you full coverage with every application. CapSil is a 100% active blend of organo-silicone and non-ionic surfactants that enables solutions to spread over the entire leaf surface evenly.

**RATE** 6 to 16fl oz per 100gal

**ACTIVE INGREDIENT**

Polyether-polymethylsiloxanecopolymer

**1gal****AQCAP-4X1** Min. Buy 1ea**Indicate 5® pH Indicator, Acidifier, Water Conditioner & Wetter / Spreader**

by BRANDT CONSOLIDATED INC.

Indicate 5 is a multi-functional adjuvant and water conditioner that counters the detrimental effects of high pH and hard water on sensitive pesticides. It adjusts water pH and contains a patented, built-in pH indicator that turns the spray water pink as soon as the optimum pH is reached. It also acts as a wetting/spreading agent that helps create an even film of spray over the plants surface.

**RATE** 5 to 30fl oz per 100gal

**ACTIVE INGREDIENT** Alkyl Aryl Ethoxylates & Water Conditioning Agents

**1gal****PROKZ19-0409** Min. Buy 1ea**2.5gal Bottle****BRANDT2214-01-100** Min. Buy 1ea**Pentra-Bark® Penetrating Surfactant**

by QUEST PRODUCTS CORPORATION

Nonionic surfactant that improves penetration into the plant stems, leaves and through woody plant bark surfaces enabling translocation of systemic fungicides, insecticides, herbicides and fertilizers.

**RATE** 0.25-2.5% by volume (highest rate for bark applications)

**ACTIVE INGREDIENT** Alkylphenol ethoxylate, polysiloxane polyether copolymer, propylene glycol

**32oz****QPC100** Min. Buy 1ea**Super 7 Surfactant, Penetrant, Deposition Aide, Acidifier**

by BRANDT CONSOLIDATED INC.

Super 7 is an all-in-one spreader, acidifier, deposition aid and penetrant. A non-ionic, low foam surfactant that enhances the activity and effectiveness of pesticides and foliar nutrients. Provides more uniform coverage by decreasing surface tension of spray solutions, thus aiding in penetration. It may be used as an acidifying agent to lower pH of spray solutions, thus preventing alkaline hydrolysis of pesticides sensitive to high pH.

REI 0 Hrs

**RATE** 8 to 64oz per 100gal

**ACTIVE INGREDIENT** Alcohol Ethoxylate, Lecithin and Propanoic Acid

**1gal****BRANDTSUPER71.0** Min. Buy 1ea**2.5gal****BRANDTSUPER72.5** Min. Buy 1ea



## Spray Adjuvants

### Super Wetter Premium Organosilicone Wetting Agent by BRANDT CONSOLIDATED INC.

Super Wetter is an organosilicone spreader that can be tank mixed with spray oils and EC formulations. Increases coverage of fungicides, insecticides, etc. by spreading the formulation across leaf and stem surfaces for complete coverage.

REI 0 Hrs

RATE 3 to 16oz per 100gal

ACTIVE INGREDIENT Siloxane polyalkyleneoxide copolymer and polyalkyleneoxide



1gal

BRANDT1047BRN101 Min. Buy 1ea

## Tank Cleaner

### Pesticide Equipment Cleaner by BRANDT CONSOLIDATED INC.

Pesticide equipment & tank cleaner will remove and deactivate residual pesticide contamination from storage tanks and spray equipment. Use before changing from one pesticide to another, or before storing equipment.

REI 0 Hrs

ACTIVE INGREDIENT Potassium Hydroxide, anticorrosion compounds, surfactants and polydimethylsiloxane



32oz

BRANDTTANKCLEAN Min. Buy 1ea

## Torpedo® Adjuvant

by BRANDT CONSOLIDATED INC.

BRANDT TORPEDO is a 99% active methylated vegetable oil, lecithin, and surfactant blend. It is designed for use with pesticides when a non-ionic surfactant, crop oil concentrate, or methylated seed oil is recommended. It is also pH neutral, which makes it well suited for systemic chemistries and nutrition products. BRANDT TORPEDO's unique multi-functional properties enhance penetration, spreading and deposition of spray droplets. It also reduces the production of fine droplets, which can go off-target. BRANDT TORPEDO may be used on agricultural, horticultural, aquatic\*, forestry, vegetation management, and other non-crop sites.

REI 4 hours

RATE varies according to application. See label.

ACTIVE INGREDIENT methyl soyate, lecithin and polyethylene



2.5gal Bottle

BRANDT05009BRN100 Min. Buy 1ea

## Wetting Agents

### AquaGro® 2000 G Media Surfactant by AQUATROLS CORP OF AMERICA

AquaGro® G ensures the continual wettability of your bark or peat based mix. It provides faster, more uniform water distribution and better moisture retention.

RATE 1lb per cu yd

ACTIVE INGREDIENT Ethoxylated Alkyl Phenols and Fatty Acid Esters



120lb

AQ2KG-120 Min. Buy 1ea

### AquaGro® L Media Surfactant by AQUATROLS CORP OF AMERICA

AquaGro® L ensures the continual wettability of your bark or peat based mix. It provides faster, more uniform water distribution and better moisture retention.

RATE 2 to 7fl oz per cubic yard

ACTIVE INGREDIENT Alkoxyated Polyols



2.5gal

AQAGPSI-2X2.5 Min. Buy 1ea

55gal Drum

AQAGPSI-55 Min. Buy 1ea

## Ultra 90 Surfactant

by BRANDT CONSOLIDATED INC.

Ultra 90 Spreader is a low cost 90% non-ionic adjuvant that improves wetting of foliage and enhances the effectiveness of spray applications. May be used on agricultural, aquatic, forestry, turf and ornamental crops.



2.5gal

BRANDT01037BRN100 Min. Buy 1ea

## Wetting Agents

### H2Pro® Wetting Agent

by ICL/SPECIALTY FERTILIZERS

H2Pro is a unique blend of surfactants with long residual activity for use in containers, pots, hanging baskets, flats, trays and more. Uniform moisture distribution creates a better root environment, eliminates dry spots and allows for an even distribution of fertilizer and or pesticide solutions added during the growing cycle. Liquid formulation for easy spray and drench application.

**RATE** 5.5 to 16oz per 100gal

**ACTIVE INGREDIENT** Ethylene oxide-propylene oxide copolymers



#### 2.5gal

**EVRG95830** Min. Buy 1ea

#### 22lb

**EVRG95820** Min. Buy 1ea

#### 30gal

**EVRG95833** Min. Buy 1ea

#### 55gal

**EVRG95835** Min. Buy 1ea



### Suffusion® Surfactant

by OHP, INC.

An effective blend of surfactants for use on all types of growing media in nurseries, greenhouses, interior plantscapes and soil production. Suffusion works by reducing surface tension of applied water, penetrating into dry and water repellent areas and linking together water-repellent soil and water. Peat, bark or alternative compost substrates are typically candidates for Suffusion.

**RATE** 4 to 6oz per cubic yard

**ACTIVE INGREDIENT** Blend of 3 surfactants



#### 2.5gal

**OHP988425** Min. Buy 1ea

#### 30gal Drum

**OHP988430** Min. Buy 1ea



### UpTake™ Soil Wetting Agent & Surfactant

by PACE 49 INC.

UpTake™ is a biodegradable soil adjuvant and wetting agent designed for turf grass, trees, nursery stock, field crops, greenhouses and orchards. UpTake™ increases penetration of water through soil, resulting in improved root growth and plant quality.

**RATE** 0.34-1.20oz per 100gal in Irrigation Water

**ACTIVE INGREDIENT** Didecylidimethyl ammonium chloride



#### 1gal

**PAC4919-0603S** Min. Buy 1ea

Shipping Info **HAZARDOUS**

#### 5gal

**PAC4919-0603T** Min. Buy 1ea

Shipping Info **HAZARDOUS**

#### 30gal Drum

**PAC4919-0603V** Min. Buy 1ea

Shipping Info **HAZARDOUS**

#### 55gal Drum

**PAC4919-0603W** Min. Buy 1ea

Shipping Info **HAZARDOUS**



## Defoamer

### Shakedown Antifoaming Agent

by BASF CORP

Eliminates unwanted foam in spray applications involving recirculating sprayers and other high agitation equipment to help ensure even distribution of pest control product applications.

**RATE** 1oz per 100gal



#### 32oz

**BAS19-0202A** Min. Buy 1ea



## Foaming Agents

### BioFoamer Foaming Agent

by BIOSAFE SYSTEMS

Additive for use in foaming equipment to enhance foam during application. Ensures that foam delivers thorough coverage and extended contact time on treated surfaces, increasing efficacy of cleaning agent or crop protection product.



#### 5gal

**BSF9005-5** Min. Buy 1ea



## Anti-Transpirants

### PlantCoatPro™

by GREAT OAK, INC.

PlantCoatPro™ is designed to reduce the transpiration of water from plants. By locking in some of the moisture, plants can be protected from sudden environmental changes that can cause damage to foliage and overall plant health. For ornamental plants, trees and shrubs. Not labeled for fruit, vegetable or other crops intended for human consumption.

**RATE** See label

**ACTIVE INGREDIENT** Emulsified acrylic polymers



**2.5 Gallon**

**DP44319** Min. Buy 1ea



## pH Adjusters

### CAL-FLO® Liquid Lime

by Burnett Lime Co

CAL-FLO liquid limestone soil can be used to increase the pH of your soilless media. It also provides a source of calcium and magnesium for plants.

**RATE** Varies depending on application method. See label.

**ACTIVE INGREDIENT** Calcium carbonate



**2.5gal**

**SA44298** Min. Buy 1ea



### CalOx® Micronized Calcium Carbonate

by BIOSAFE SYSTEMS

A micronized flowable lime made up of over 70% active ingredient and is specifically formulated to immediately raise soil pH. Ideal product for crops like geraniums, poinsettias and greenhouse tomatoes. Since it won't clog lines, it is easily direct injected as a drench application, stabilizing the soil pH for more than 35 days.

**REI** 0 Hrs

**ACTIVE INGREDIENT** Calcium carbonate



**2.5gal**

**BSF201125** Min. Buy 1ea

Shipping Info **DIRECT**



### Citric Acid pH Reducer

by GROWTH PRODUCTS

MacrOrganics is a 100% plant derived N-P-K fertilizer. Absorption takes place through both the roots and the leaf pores. It is especially effective for giving fast-growing plants, like vegetables, an extra boost during the growing season.

**ACTIVE INGREDIENT** Citric Acid



**2.5gal**

**GRWP30520** Min. Buy 1ea



### RIV Sulfuric Acid 93% HAZ

by RIVERSIDE CHEMICAL

Sulfuric acid is effective at acidifying water to reduce alkalinity.



**1gal**

**RIVSULFACID** Min. Buy 1ea

Shipping Info **HAZARDOUS**



# IRAC-MAX

And The Family of GT Performance Greenhouse Films



## NO FILM HAS EVER DONE SO MUCH FOR SO LITTLE.

New GT **IRAC-MAX** is the new versatile king of the market. Here's why:

### ✓ IR TREATMENT

Preserves the sun's IR heat radiation at night.

### ✓ ANTI-CONDENSATE

Reduces/eliminates droplets and light stopping fog on the inside layer from forming.

### ✓ HIGH DIFFUSION

**75% diffusion!** New feature spreads light throughout the canopy of your crop. More diffusion = less shadows!

### ✓ UV OPEN

**An industry first!** Transmits UV light to crops that need it for color, flavenoids, cannabis, roses and more.

**Don't need UV Open?** Use GT-4 four year clear as a top layer to block UV!

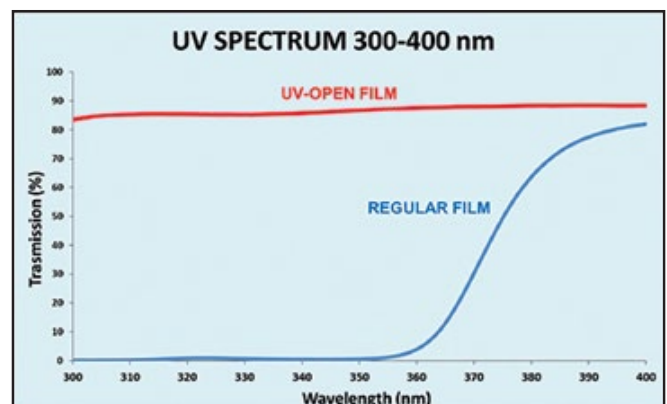



# *Irrigation*



# DRAMM

## Nozzles

### Dramm® 480PL Water Breaker® Nozzle

This plastic water breaker features micro-fine holes. Made of plastic with a stainless steel disk.



Red - 7gpm - 40psi

DRM2072602 Min. Buy 1ea



### Dramm® 170PL Water Breaker® Nozzle

This plastic water breaker is designed for small containers (hanging baskets) and is an excellent choice for watering in areas with low water pressure.



Blue - 7gpm - 40psi

DRM1072349 Min. Buy 1ea



### Dramm® 400PL Water Breaker® Nozzle

Provides fast, full-flow watering without damage to your plants. Patterned after the original 400 Aluminum water breaker, this product is made from high-impact ABS plastic and aluminum to provide a lightweight alternative.



Blue - 11.1gpm - 40psi

DRM1072346 Min. Buy 1ea

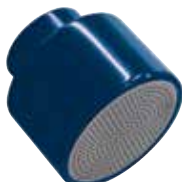

### Dramm® 400PL Water Breaker® Nozzle with Ring

Provides fast, full-flow watering without damage to your plants. Patterned after the original 400 Aluminum water breaker, this product is made from high-impact ABS plastic and aluminum to provide a lightweight alternative. This version of the ring protects the Waterbreaker from both sides and frontal impact due to the TPR Rubber bumper.



11.1gpm

DRM2072646 Min. Buy 1ea



### Dramm® Screen-Aire Water Breaker® 350PL Nozzle

Designed to water nursery containers with a gentle, concentrated aerated flow of water. A fine-mesh screen and an array of internal components combine air and water to produce a very soft, unrestricted spray. Use a Dramm In-Line Hose Filter to keep the nozzle from clogging. Made in the U.S.A.



18gpm

DRM2072550 Min. Buy 1ea



### Dramm® 1000PL Water Breaker® Narrow Nozzle

This water breaker has over 1,000 micro holes that create an ultra-soft flower shower which will not disturb delicate soil or harm tender plants. Made in USA from ABS plastic and stainless steel.



Green - 7gpm - 40psi

DRM1071100 Min. Buy 1ea



### Dramm® 1000PL Water Breaker® Wide Nozzle

This water breaker has over 1,000 micro holes that create an ultra-soft flower shower which will not disturb delicate soil or harm tender plants. Made in USA from ABS plastic and stainless steel.



Orange - 7gpm - 40psi

DRM1071200 Min. Buy 1ea



### Dramm® 1000PL Water Breaker® Nozzle

This water breaker has over 1,000 micro holes that create an ultra-soft flower shower which will not disturb delicate soil or harm tender plants. Made in USA from ABS plastic and stainless steel.



Red - 7gpm - 40psi

DRM1071000 Min. Buy 1ea



### Dramm® 400AL Water Breaker® Nozzle

The original full-flow shower head nozzle. Provides fast, full-flow watering without damage to your plants or disturbing soil. Cast aluminum and hand machined with 3/4 inch brass hose threads.



Aluminum - 11.1gpm - 40psi

DRM1072342 Min. Buy 1ea



### Dramm® 170AL Water Breaker® Nozzle

The original full-flow shower head nozzle. Provides fast, full-flow watering without damage to your plants or disturbing soil. Cast aluminum and hand machined with 3/4 inch brass hose threads.



Aluminum - 7gpm - 40psi

DRM1072343 Min. Buy 1ea



### Dramm® 480AL Water Breaker® Nozzle

Stainless steel disk. Micro-fine holes. Wider pattern.



Aluminum - 7gpm - 40psi

DRM2072601 Min. Buy 1ea



### Dramm® 540 Brass Rose Nozzle

Brass Rose features an extra wide spray pattern, which allows you to increase the speed of hand watering. Great for watering bedding plants, pots or market packs. Includes protective rubber guard and metric to inch hose thread converter. Made in Germany.



18gpm

DRM1072540 Min. Buy 1ea





# DRAMM

## Nozzles

### Dramm® Fogg-It Nozzle

Designed for misting delicate seedlings or for raising humidity around wilting plants. This nozzle has three mist jets which create a conical spray pattern. Available in four different discharge rates. Made in the U.S.A. from solid brass. 3/4 hose threads.



**1/2gpm, Super Fine**  
**DRM2072505** Min. Buy 1ea



**1gpm, Fine**  
**DRM2072506** Min. Buy 1ea



**2gpm**  
**DRM2072507** Min. Buy 1ea



**4gpm**  
**DRM2072508** Min. Buy 1ea



### Dramm® Seedling Nozzle

The Seedling Nozzle allows you to water fragile plants, delicate seedlings or plant cuttings. This high-quality nozzle produces an extra fine, hollow cone mist pattern and sprays 1/2 gallon of water per minute. Made in the U.S.A. from solid brass.



**3/4in Thread**  
**DRM2072350** Min. Buy 1ea



### Dramm® Handi-Reach™ Handle

Designed to eliminate the stretching and stooping associated with hand watering. Made in the U.S.A. from extruded aluminium tubing, forged brass hose couplings and a comfort EPDM hand grip. 3/4 male and female hose threads.



**16in, 3/4 Threads**  
**DRM116GC** Min. Buy 1ea

**24in, 3/4 Threads**  
**DRM124GC** Min. Buy 1ea

**30in, 3/4 Threads**  
**DRM130GC** Min. Buy 1ea

**36in, 3/4 Threads**  
**DRM136GC** Min. Buy 1ea

**48in, 3/4 Threads**  
**DRM148GC** Min. Buy 1ea

**48in, 3/4 Threads**  
**DRM13485** Min. Buy 1ea

**72in, 3/4 Threads**  
**DRM172G** Min. Buy 1ea



**90 Degree Bend - 36in, 3/4 Threads**  
**DRM136GBC** Min. Buy 1ea

**90 Degree Bend - 48in, 3/4 Threads**  
**DRM148GBC** Min. Buy 1ea



### Dramm® Telescoping Handi-Reach Handle

The Telescoping Handi-Reach Handle allows growers to reach over wide benches or plants that are higher with ease. The Telescoping Handle extends to 80". Storing the wand is easy as it compresses down to 50" in length when closed. Available in either a standard bend or hanging basket bends.



**Standard Bend**  
**DRM1022375** Min. Buy 1ea

**Hanging Basket Bend**  
**DRM1022376** Min. Buy 1ea

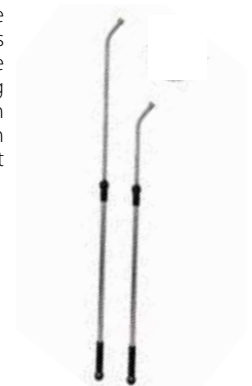

# DRAMM

## Valves

### Dramm® QAV Shut Off Valve

The QAV uses a unique, patent-pending valve design includes a single-piece ball, stem and handle assembly to reduce the time to assemble while strengthening the structure. The QAV Valve replaces our 35 Shut-Off, keeping only its price-point. The QAV offers greater durability and a larger handle for easier watering.



Blue - 13gph

DRM1072318

Min. Buy 1ea



### Dramm® OneTouch™ Valve

Fingertip water control. Zinc die cast body & nylon valve components for long life. Flow can be adjusted from off to full flow with thumb-tip precision. Flow rate 8gpm at 40 PSI



8gpm

DRM1014700

Min. Buy 1EA



### Dramm® Touch'N Flow PRO™ with Trigger

Full flow valve specialty designed for durability and ease of use. Features a one-touch lever activated valve and an ergonomic insulated grip. Offers up to 11gpm at 40psi. Made in the USA.



11gpm

DRM1073065

Min. Buy 1ea



### Dramm® OneTouch™ HighFlow Valve

Fingertip water control. Zinc die cast body and nylon valve components for long life. Flow can be adjusted from off to full flow with thumb-tip precision. Larger opening for more flow. Offers up to 16gpm at 40psi.



16gpm

DRM1074800

Min. Buy 1ea



### Dramm® Quick Disconnect

Heavy-duty quick hose connection offers full-flow (pair) without water-stop. Available as male or female only. Made in the USA.



Brass

DRM740C

Min. Buy 1ea



### Dramm® Brass Hose Swivel

The Brass Hose Swivel is a live swivel that allows for unencumbered movement between the hose and attachments under pressure. Reduces hose twisting.



18gpm

DRM1072700

Min. Buy 1ea



### Dramm® #74 Full Flow Shut Off Valve

Full flow valve specialty designed for durability and ease of use. Features a one-touch lever activated valve and an ergonomic insulated grip. Offers up to 18gpm at 40psi. Made in the USA.



18gpm

DRM1073074

Min. Buy 1ea



### Dramm® Twin Shut Off Valve

Water two places at one time. Connect the valve to your faucet to create two male connections, with each connection independently controlled. Molded from high quality ABS plastic.



Twin Cylolac - 10gpm

DRM235C

Min. Buy 1ea



### Dramm® #300 Brass Shut-Off Valve

Simply the best shut-off valve available. Provides fingertip water control at the end of a greenhouse hose. A quarter turn of the large ergonomic handle and the water is off. Full water flow design. Made in the USA from brass, durable seals and a hard chrome plated ball to provide years of service. 3/4 threads.



17gpm

DRM1073300

Min. Buy 1ea



### Dramm® #300 Full Repair Kit

Full repair kit for the 300 Brass Shut-Off valve. Includes handle and ball assembly.



DRMRKBB

Min. Buy 1EA



### Dramm® #300 AL Shut Off Valve

Aluminum shut off that offers unmatched durability and flow in a light weight package. Tested for corrosivity, our new valve holds up to high EC, low pH water with no trouble.



Aluminum - .75in Male-Female

DRM1073301

Min. Buy 1ea



### Dramm® Twisty Quick Hose Connect

Twisty Quick, a plastic quick connect hose adapter. Full water flow design. Design is made from heavy-duty plastic. 3/4 male and female hose threads. Sold as a pair



Black - .75in Thread

DRM710C

Min. Buy 1ea



# DRAMM

## Irrigation Components

### Filter

#### Dramm® Inline Filter

Inline Filter 80 Mesh With Element. 80 mesh screen filters out unwanted dirt and debris. Highly recommended for 1000PL and 350 screen air.



ILF-175

DRM2072630 Min. Buy 1ea



### Other Equipment

#### Dramm® Hanging Basket Remover Ring

Comes with 10in ring to conveniently remove hanging baskets from hard-to-reach areas above! Additional ring sizes and pole lengths are available.



36in Handle with 10in Ring

DRMHBC Min. Buy 1ea



7ft Handle

DRMHBRP Min. Buy 1ea



#### Dramm® 360 Degree Nifty Nozzle

Nifty Nozzles offer an economical solution for simple "overhead or on the bench" watering systems. These nifty nozzles produce a 10 foot diameter spray pattern when your water pipeline is 5 feet above the crop. Nifty Nozzles can be installed on the topside of the pipeline, on bottom side of the pipeline or on top of 1/2 PVC risers. Bottom side installations require no-drip check valves to prevent drip.



Blue - 2.50mm

DRM360NNBL Min. Buy 1ea



#### Dramm® Assembly Insert

Used to install nozzles without tapping threads. For all nozzles and extensions.



DRMAI

Min. Buy 1ea



#### Dramm® Pin Perfect Nozzle

The perfect nozzle watering system provides an efficient permanent over-head watering system. Use solenoids and time clocks for complete automation. Nozzles can be inserted into galvanized, rigid poly, or flexible poly pipe. Pipe should be clamped and drilled with a jig before installation.



Green - 2.65mm

DRMPPNGN Min. Buy 1ea



### Drippers

#### Dramm® Pressure Compensated Dripper

Drip irrigation system is designed for even watering with a greater range of operating pressure. Silicone diaphragms last longer. Slim, zinc-aluminum weight is easy to harvest. Durable nylon body. Available in 18in, 24in, 36in, 42in and 48in.



2 lph Drip Assembly, 18in

DRMPCAS2L18 Min. Buy 1ea

2 lph Drip Assembly, 24in

DRMPCAS2L24 Min. Buy 1ea

2 lph Drip Assembly, 36in

DRMPCAS2L36 Min. Buy 1ea



## Design the Right Irrigation System

Dramm and BFG will design a complete irrigation system for you and ship it complete along with basic assembly instructions.

Propagation Mist

Overhead Irrigation

Basket Drippers

Potted Dripper  
Manifolds



#### Dramm® Pressure Compensated Dribble Ring

The Dramm PC Dribble Ring offers even watering of trees and nursery stock. Dramm pressure compensating emitters ensure accurate watering from pot to pot. Contact your BFG representative for assistance in selecting the correct size. Available ring diameters are 4in, 6in, 8.5in, 10in and 13in

#### Dramm® Anchor Stake for Dribble Ring

Holds ring in place in pot. Use one per ring.



DRMS3ANCHOR Min. Buy 1ea

# DRAMM

## Capillary Mats



### Dramm Floraplus/Vivaplus Capillary Mat

Dramm Capillary Mat delivers a safe supply of water & nutrients while reducing runoff at the same time. The matting provides optimal dispersion of solution across the growing area and vertically within the pot. For use with overhead watering to maximize water usage or for use with Dramm PCAS Drippers to deliver exact amounts of water. Dramm offers capillary mat for lower water demand and younger crops (Floraplus) or higher water demand for more mature plants (Vivaplus). Available with or without poly backing depending on bench type. Use with Dramm Aquafoil cover to keep mat clean and extend life. Contact your BFG representative with questions on sizing and type.

## Tubing

Type	ID	OD	Color
DTS	0.045in	0.100in	Green
DTM	0.060in	0.100in	Brown
DTL	0.075in	0.125in	Blue

### Dramm® Dribble Tube DTM

Offers a simple way to water plants automatically by dripping water into each pot directly. Permanently attached always ON weight emitters. Works with other systems. Available in various standard lengths.



**Brown - 42in**

**DRMDTM42**

Min. Buy 1ea



### Dramm® DTL-E Eyelet

Used to install Dramm Dribble Tubes and Dribble Rings.



**Brass - For .060 & .045ID**

**DRMDTMSE**

Min. Buy 1ea

**Brass - For .075ID**

**DRMDTLE**

Min. Buy 1ea



## Controllers

### Dramm® ii ri Bluetooth Smart Irrigation Controller

Irrigation controller with Bluetooth connectivity, the ii ri Smart Controller can operate one solenoid valve without wiring. Use your smartphone to create watering schedules you can easily change according to your needs. CR123 battery operated, works with different valves.



**DRMIIRISVB075** Min. Buy 1ea

**DRMIIRISVB100** Min. Buy 1ea



### Dramm® Proline Irrigation Controller

Offers basic irrigation control and advanced features in a easy-to-program and affordable unit. With up to 4 programs that can run independently or simultaneously, with up to 8 start times per day and day selection capability, the ProLine provides flexibility in your watering. This modular controller starts with 4 outputs, but is expandable up to 24. Each valve can operate from 1 minute to 9 hours, 55 minutes. Seasonal adjustment allows for these values to be changed based on time of year without altering the each valve's programming. The ProLine offers manual operation of an individual valve or an entire program. Connect to your controller to monitor activity or adjust the programming from anywhere with the SmartLink upgrade (requires optional cellular connection package and air card). The SmartLink App on your phone allows easy access.



**4 Station Controller**

**DRMPL160004** Min. Buy 1ea

**8 Station Controller**

**DRMPL160008** Min. Buy 1ea

**12 Station Controller**

**DRMPL160012** Min. Buy 1ea

**24 Station Controller**

**DRMPL160024** Min. Buy 1ea



### Dramm® Jetrain Overhead Irrigation Systems

The JetRain Misting and Irrigation nozzles offer even watering with a variety of flow and distance options. Designed to operate between 40-60 PSI. A variety of mounting options make the JetRain perfect for multiple irrigation or misting situations. Please contact your BFG representative for a custom design proposal.



### Dramm® Mistime Misting Controller

The Dramm 10 zone MistTime Controller is perfect for time or temperature based control of misting valves. With the ability to program each valve independently, the MistTime offers unmatched flexibility. The timing is variable with the duration operating between 1 second and 60 minutes and interval timing operating between 1 minute and 12 hours. The MistTime can be programmed to convert the last valve to pre-start a pump to ensure the system is properly pressurized. Easy to program via the keypad and can be programmed in English, Spanish, French or Dutch. Operates on 120vAC or 220vAC and includes 24vAC output.



**10 Zones**

**DRMMT10**

Min. Buy 1ea



# DRAMM

## Hoses



### Dramm® ColorStorm™ Custom Hose Starter Kit

Make your own hose lengths easily and quickly with our Custom Hose Starter Kit. This kit makes it easier to get started cutting your own length of hose. The kit includes the DrammPress, our easy to use hose crimper, with one set of jaws, two spools of 330' ColorStorm Hose and 12 male and 12 female fittings with ferrules - enough to make 12 hoses.



**Yellow - 5/8in D**  
**DRM17626** Min. Buy 1ea

**Yellow - 3/4in D**  
**DRM17751** Min. Buy 1ea



### DRAMM® ColorStorm™ Premium Rubber Hose

Made with EPDM rubber, durable like car tires. Features crush-proof, nickel-plated couplings, hot water resistant up to 160 degrees F and designed to resist kinking. Coils easily even in cold weather. Made in the USA.



**Yellow - 5/8in D x 50ft L**  
**DRM1017003** Min. Buy 1ea



### Dramm® ColorStorm™ Professional Rubber Hose

This reinforced hose is hexagonal in shape to reduce kinking. The design of the hose allows a user to easily pull free any kinks that may occur. The hexagonal Sure-Grip™ cover creates a softer surface for a more comfortable grip. Each hose has crush-proof, nickel plated, brass fittings for an exact fit that will survive years of use.



**Yellow - 5/8in x 330ft**  
**DRM17999330** Min. Buy 1ea

**Yellow - 5/8in x Per ft**  
**DRM17999FT** Min. Buy 1ea

**Yellow - 5/8inx 75ft**  
**DRM17203** Min. Buy 1ea

**Yellow - 5/8in x 100ft**  
**DRM17303** Min. Buy 1ea

**Yellow - 3/4in x Per Ft**  
**DRM17989FT** Min. Buy 1ea

**Yellow - 3/4in x 100ft**  
**DRM17313** Min. Buy 1ea

**Yellow - 3/4in x 330ft**  
**DRM17989330** Min. Buy 1ea



## Hose Accessories

### Dramm® Fitting / Ferrule Set

Fitting and Ferrule set for use with the DrammPress Hose Crimper and ColorStorm Hose. Comes with 12ea fitting and ferrule.



**5/8in Female**  
**DRM1017815** Min. Buy 1pk

**3/4in Female**  
**DRM1017825** Min. Buy 1pk



**5/8in Male**  
**DRM1017810** Min. Buy 1pk

**3/4in Male**  
**DRM1017820** Min. Buy 1pk

### Dramm® Splice & Ferrule Set

Fitting and Ferrule set for use with the DrammPress Hose Crimper and ColorStorm Hose. Comes with 12ea fitting and ferrule.



**5/8in Thread**  
**DRM1017830** Min. Buy 1pk

**3/4in Thread**  
**DRM1017840** Min. Buy 1pk

### Dramm® Jaws

Insert jaws for DrammPress.



**5/8in Jaws Only**  
**DRMDPJ625** Min. Buy 1ea

**3/4in Jaws Only**  
**DRMDPJ750** Min. Buy 1ea



### Dramm® Press Hose Crimper

Secures fitting/ferrule to hose end. Crimper can be fitted with either 5/8 or 3/4 jaws (sold separately). Works with all Dramm ColorStorm fittings and ferrules.



**Frame Only**  
**DRMDPFRAME** Min. Buy 1ea



# No Matter the Crop or Situation Dramm has You Covered

Apply Insecticides, Fungicides, Disinfectants, Biopesticides. Spray, Foam, Fog, Drench.



Over 50 ways to spray and a team of experts to help you make the most of your pesticide applications. Call Dramm to help improve your pest management program. Want help? Download our Whitepaper.



**DRAMM**  
Integrated Plant Health  
information@dramm.com  
920.684.0227 • www.dramm.com

## NETAFIM™

### Drippers

#### Netafim™ Pressure Compensating Spray Stakes

All units stop and start at the same time. Features one directional spray. The 8in spray stake fits firmly into the media and can be angled to adjust the spray pattern according to the pot size.



**3.2gph Plum Drinker Assembly / 36in Line**  
NET40201-002020 Min. Buy 1ea



**6.6gph Grey Drinker Assembly / 36in Line**  
NET40201-002320 Min. Buy 1ea



**Plum - 3.2gph**  
NET22500-002030 Min. Buy 1ea



**6.6gph Grey Spray Stake Single Spray / 8in L**  
NET22500-002130 Min. Buy 1ea



**Grey - 6.6gph**  
NET22500-002230 Min. Buy 1ea



**3.2gph - 48in**  
NET40201-024700 Min. Buy 1ea



#### Netafim™ Slimline EZ Close™ Weight Assembly

One-hand, EZ close shut-off of individual baskets - prevents water and fertilizer spillage and waste. Snag-free slim design for easy retrieval from plants at harvest - no more lost weights. 94% flow uniformity from the first basket to the last in any system. Each pre-assembled SlimLine EZ Close™ Weight assemblies include: .5gph WPCJ Drinker with built-in check valve, Super Flex UV White™ PE tubing and weight. Sold in packs of 25.



**Pre-Assembled / 18in L**  
NET40201-015402 Min. Buy 1ea





## Netafim™ NetBow™ Drip Ring

An innovative user friendly container irrigation multi outlet dripper arc with high clogging resistance and superb water distribution.



10in

NET77470000106 Min. Buy 1ea



Drippers

## NetBow™

An innovative user-friendly container irrigation ring with multi-outlet emitters. Featuring Typhoon™, our superior clog resistant emitter for maximum water distribution. Specially designed for irrigating containerized crops.

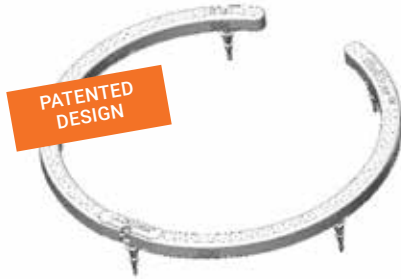

Uniform Water Distribution



Superior Clog Resistance



User Friendly

## Benefits & Features

- ✓ Superior clog resistance with Netafim Typhoon™ emitter.
- ✓ Specially designed micro-tubing with 8 evenly spaced emitters distributes water uniformly.
- ✓ Uniform surface wetting provides optimal rootzone development
- ✓ Quick action installation - place ring in the container, then connect the pre-cut micro tubing
- ✓ NetBow™ is patented by U.S. Design App. No. 29/709,373
- ✓ Multiple connection options to hub drippers: PCJ, PC, or Uniram™ with Dr. Zip™

## Specs. & Recommendations

- Compatible with 5-10g (20-40L) containers
- Diameter: 10" in (250mm)
- Flow Rate: 8 emitter outlets with flow of 0.53 GPH (2.0 l/h) each at 14.5 psi (1.0 bar)
- The flow from each emitter outlet will be determined by the hub dripper, based on the pressure developed in the NetBow inlet
  - We recommend that the flow of the hub dripper to be 0.53-2.11 GPH (2-8 l/h). If your flow is out of this determined range please follow Netafim guidelines for on-line emitter design.
- Chemical and UV resistance for durability
- Colored light gray for improved light reflection
- Max. operating pressure for hub drippers - 58.0 psi (4.0 bars)

### → CONNECTION OPTIONS

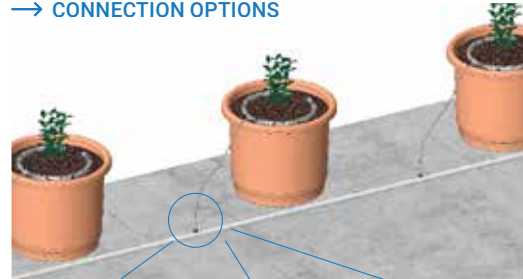

CONNECTION TO PCJ ON-LINE DRIPPER



CONNECTION TO PC ON-LINE DRIPPER

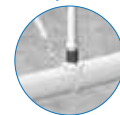

CONNECTION TO UNIRAM™



[www.netafimusa.com](http://www.netafimusa.com)



**Drippers**

**Netafim™ Woodpecker Dripper**

Designed with a barb inlet for easier installations. Features Netafim's exclusive Turbonet flow path, an innovative concept that provides the dripper's with a very large water passage, allowing contaminants to pass easily through the dripper virtually eliminating clogging. Color-coded for easy flow identification.



**.5gph**  
NET01WPS2-B Min. Buy 1ea

**Netafim™ Woodpecker Pressure Compensating Junior Dripper**

Netafim™ Woodpecker Pressure Compensating Junior Dripper



**1gph - Grey**  
NET21520-001540 Min. Buy 1ea



**1gph**  
NET21520-001410 Min. Buy 1ea



**1gph / Grey / 10.2psi / With CNL Check Valve Feature**  
NET21520-001500 Min. Buy 1EA



**2gph / Green / 10.2psi / With CNL Check Valve Feature**  
NET21520-001640 Min. Buy 1EA



**2gph**  
NET21520-001740 Min. Buy 1ea

**Netafim™ Woodpecker Pressure Compensating Junior Dripper with Post Outlet**

For use with P.C. Spray Stake.



**1.0gph Dripper / Orange/Grey**  
NET21520-001530 Min. Buy 1ea



**3.2gph Dripper Plum / Black**  
NET21520-001690 Min. Buy 1ea



**5mm Elbow Adapter**  
NET32000-002525 Min. Buy 1ea

**Netafim™ Woodpecker Pressure Compensating Junior Dripper Barbed Outlet**

Pressure compensating dripper.



**.5gph Red**  
NET21520-001040 Min. Buy 1ea



**1gph Grey**  
NET21520-001440 Min. Buy 1ea



**WPCJ Dripper**  
.5 GPH  
01WPCJL2-B  
or 21520-001040

**SuperFlex UV White™ PE Tube**  
15FPEW53-XX

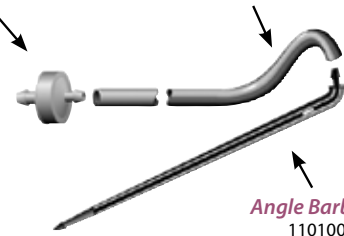

**Angle Barbed Stake**  
1101001-B or  
32000-001806

**Netafim™ Dripper Angle Barbed Stake Assembly**

.5gph - Pressure Compensating with CNL Check Valve Feature; Standard with Super Flex UV White PE Tubing. Sold in packs of 25.



**24in L**  
NET40201-020600 Min. Buy 1ea

**36in L**  
NET40201-021000 Min. Buy 1ea



**Netafim™ Angle Barbed Stake**

Angle barbed stake.



NET32000-001806 Min. Buy 1ea



**Netafim™ Slimline EZ Close Weight**

Weight for hanging basket.



**White**  
NET00130-000033 Min. Buy 1ea



**Netafim™ Non PC Spray Stake**

Non-pressure compensating spray stake.



**Yellow - 3gph**  
NET22500-001030 Min. Buy 1ea

**Green - 5gph**  
NET22500-001120 Min. Buy 1ea



**Netafim™ Insert Connector**

Insert & Barb



**5mm**  
NET32500-001125 Min. Buy 1ea







## Drippers



### Netafim™ Multi Outlet Drippers (MOD)

Feature both pressure compensation and a built-in check valve. This combination of features (referred to as PCNL) is the highest level of technology available in drippers today. This technology ensures that every plant will receive exactly the same amount of water and fertilizer regardless of where the plant is located within the system. Each dripper adjusts itself automatically to the system pressure and elevation so that even on rolling or sloped ground, the uniformity of watering is 94%. The built-in check valve prevents unwanted drainage of the system onto the lowest plants when the watering cycle is completed.

#### Manifold Versatility

When many small pots are to be watered, two manifold assemblies can be stacked together to create an 8-Way assembly. The flow per pot is then 0.25 gallons per hour (GPH).

For every 10 gallons per minute (GPM) available, 2,000 pots can be watered.

Regular set up of 4 way is preferred, requires less microtubing.

#### Flexible and Portable

The flat manifold separates for easy storage or transport in a box or bundle. The dripper supply tubing (with the dripper attached) can then be rolled up without tangling the spaghetti tubes. If a different plant spacing is desired, simply change the manifold.

### Flat 4-Way MOD Assemblies

For complete assembly order one Manifold Assembly and one Woodpecker Pressure Compensating Junior Dripper.

### Manifold Assemblies

Item #	Model #	Arrow Dripper	Tube Lengths	Qty	Barcode
<b>NET40201-003200</b>	014DM-1830F	Standard	(2) at 18in & (2) at 30in	25/pk	
<b>NET40201-002920</b>	014DM-3048F	Standard	(2) at 30in & (2) at 48in	25/pk	
<b>NET40201-005000</b>	014DM-4848F	Standard	(4) at 48in	25/pk	
<b>NET40201-004400</b>	014DM-3030F	Standard	(4) at 30in	25/pk	
<b>NET40201-003600</b>	014DM-2424F	Standard	(4) at 24in	25/pk	
<b>NET40201-003800</b>	014DM-02424FS	Short	(4) at 24in	25/pk	
<b>NET40201-008000</b>	014DMS-2424F	Standard	(4) at 24in	25/pk	
<b>NET40201-002600</b>	014DM-1818FS	Short	(4) at 18in	25/pk	
<b>NET40201-002550</b>	014DM-1818F	Standard	(4) at 18in	25/pk	
<b>NET014DM-2448F</b>	014DM-2448F	Standard	(2) at 24in & (2) at 48in	25/pk	

### Netafim™ Angle Arrow Dripper

Allows placement of drippers exactly where necessary. Allows maximum flexibility in greenhouse and nurseries (with soft PE microtubes). Unique flow channel down the length of the stake directs water into the container. Features pointed end for easy container insertion.



#### Short Angle Arrow Dripper 3 3/4in

**NET22000-000920** Min. Buy 1ea



#### Angle Arrow Dipper 6in

**NET22000-001320** Min. Buy 1ea



#### Arrow Dripper Straight

**NET22000-001120** Min. Buy 1ea



### Netafim™ Dripper Stake Assemblies

The CNL feature is an internal check valve or non-draining mechanism that eliminates refill and drainage effects. Standard with Super Flex UV White PE Tubing.



#### .5 GPH/30 inch/Pressure Compensating/CNL/ Angle Barbed Stake

**NET40201-020700** Min. Buy 1ea

### Netafim™ Barb Connector

Relatively easy to install, UV resistant and a durable one piece construction.



#### For 4/7 Tubing

**NET63000-001355** Min. Buy 1ea

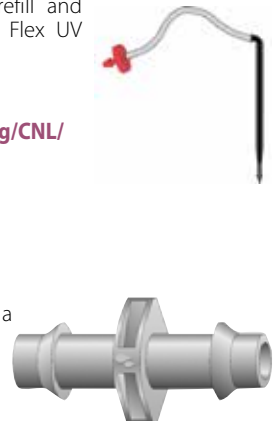



Manual Filters and Electric Values

Drippers

**Netafim™ Dripper for 4 Way Assembly**

The CNL feature is an internal check valve or non-draining mechanism that eliminates refill and drainage effects. Non-Pressure Compensating Drippers are designed with a barb inlet for easier installation. Features exclusive Turbonet flow path, an innovative concept that provides the dripper's with a very large water passage, allowing contaminants to pass easily through the dripper virtually eliminating clogging.



**2gph/CNL**  
**NET21020-001510** Min. Buy 1ea



**Netafim™ Pre-Assembled Pressure Compensating Dripper**

Offers cost savings derived from minimizing run off often associated with traditional watering methods.



**18in /.5gph WPCJ**  
**NET40201-013900** Min. Buy 1ea

**48in /.5gph WPCJ Pressure Compensating Dripper**  
**NET40210-01300** Min. Buy 1ea



**Netafim™ WPC CNL Dripper**

Pressure differential system maintains uniform flow rate at different inlet working pressures within the recommended range ensuring exact distribution of water and nutrients. Ideal for areas with difficult topographical conditions.



**1GPH, 250/bg**  
**NET21020-001433** Min. Buy 1ea



**Netafim™ PC™ Dripper**

When you need precise drip irrigation for greenhouses, vineyards and orchards with uneven land or irregular plant spacing, pressure-compensated drippers deliver a uniform flow rate no matter how difficult your topographical or water conditions.



**6GPH, 250/bg**  
**NET21000-001340** Min. Buy 1ea



**Netafim™ Goof Plug**

Dual goof plug



**3/7mm**  
**NET32000-001010** Min. Buy 1ea



**Netafim™ Manual Disc Filter**

Grooves in the disc rings crisscross to form a network that traps debris between and on the outside of the discs.



**.75in**  
**NET70640-001200** Min. Buy 1ea



**1in**  
**NET70641-001600** Min. Buy 1ea



**1.5in**  
**NET70641-003420** Min. Buy 1ea



**2in**  
**NET70641-003640** Min. Buy 1ea

**Netafim™ Disc Filter Cover O-Ring**

Netafim™ Disc Filter Cover O-Ring



**3/4in, 120 Mesh**  
**NET70620-003700** Min. Buy 1ea

**1in, 120 Mesh**  
**NET70620-003800** Min. Buy 1ea



**Netafim™ Electric Valves 24 VAC**

Simple to operate and maintain. Robust flow control stem and manual override. Reliable even in harsh conditions. Stable solenoid. Tight sealing valve with fully supported diaphragm. Integral stainless steel EasyClean® filter.



**.75in / 24V / Threaded**  
**NET71640-007355** Min. Buy 1ea

**1in / 24V / Threaded**  
**NET71640-007406** Min. Buy 1ea

**1.5in / 24V / Threaded**  
**NET71640-007425** Min. Buy 1ea

**Solenoid for Electric Valves**  
**NET71640-007141** Min. Buy 1ea



**Netafim™ Aqua Pro Control Valve**

1" Series 80 Globe Control Valve With Controller



**NET71610-013969** Min. Buy 1ea



**Netafim™ Insert Fittings**

**Netafim™ Insert Fittings**  
Dripline and polyethylene fittings.



**16mm**  
**NET32500-010720** Min. Buy 1ea



**16mm Insert Elbow**  
**NET32500-012530** Min. Buy 1ea



**16mm Insert Tee**  
**NET32500-011330** Min. Buy 1ea

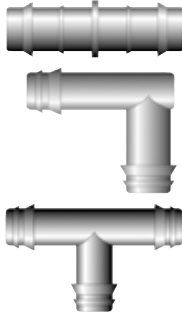

**Netafim™ Line End**  
Figure 8 line end.



**16mm PE**  
**NET32500-013030** Min. Buy 1ea

**18mm PE**  
**NET32500-014430** Min. Buy 1ea

**3/4in PE**  
**NET78241-002500** Min. Buy 1ea



**Manifolds**

**Netafim™ Manifolds**

Ideal for field applications. To create additional configurations combine the Flat 2-Way or 4-Way Stackable manifold with a 4-Way manifold. The Flat 2-Way manifold is usually combined with the 1gph WPCJL Dripper - .5gph per plant.



**2-Way Flat Manifold**  
**NET32000-002538** Min. Buy 1ea



**4-Way Flat Manifold**  
**NET32000-002570** Min. Buy 1ea



**Inline Shut-Off Valves-Barbed**

**Netafim™ Inline Shut-Off Valve**

.520 inch plastic shut off for standard 16mm irrigation tubing.



**16mm Shut-Off Valve**  
**NET00005-008960** Min. Buy 1ea

**18mm Shut-Off Valve**  
**NET00005-008970** Min. Buy 1ea

**3/4in Shut-Off Valve**  
**NET00005-008990** Min. Buy 1ea





## Design Help for Sprinkler & Fogger Systems

### Step 1 Visualize the Greenhouse

Evaluate the location of obstacles such as curtains or hanging baskets. Consider aisles and whether they can be wetted. Review cultural practices which might impact the height at which the sprinklers should be placed.

### Step 2 Select a Sprinkler Head for Watering Applications (go to Step 2b for Misting, Propagation or Cooling Applications)

All sprinkler solutions are based on an average sprinkler working pressure of 30 psi and spacing between the sprinklers of three feet.



#### Single Bench with VibroNet Sprinklers

Bench Width (ft)	Spacing Between Sprinklers (ft)	Height Above Crop	
		2' - 3'	3' - 5'
4	3	VN-BL or VN-GN	VN-BL or VN-GN
5	3	VN-BL or VN-GN	VN-BL or VN-GN
6	3	VN-BL or VN-GN	VN-BL or VN-GN

For multiple benches or bays, use 7', 8' or 9' between lines.

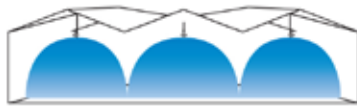

#### One Line for Single Bay or Quonset with SpinNet Sprinklers

Bay Width (ft)	Spacing Between Sprinklers (ft)	Height Above Crop		
		2' - 3'	4' - 5'	6' - 7'
10	3	R-R-BL	-	-
12	3	R-R-BL	R-R-BL	-
14	3	BR-BR-BL	BR-BR-BL	R-R-BL
15	3	R-R-GY	BR-BR-BL	R-R-BL
16	3	R-R-GY	BR-Y-GY	R-R-BL
18	3	R-R-GN	BR-Y-GY	BR-Y-GY
20	3	-	R-R-GN	BR-BR-GN
22	3	-	R-R-GN	BR-BR-GN
24	3	-	-	BR-BR-GN

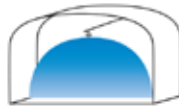

#### Two Line for Single Bay or Quonset with SpinNet Sprinklers

Bay Width (ft)	Spacing Between Sprinklers (ft)	Spacing Between Sprinkler Lines (ft)	Height Above Crop		
			3'	4' - 5'	6' - 7'
20	3	11	R-R-BL	-	-
22	3	12	R-R-BL	R-R-BL	-
24	3	12	R-R-BL	R-R-BL	R-R-BL
26	3	14	BR-BR-BL	R-R-BL	R-R-BL
28	3	15	BR-BR-BL	R-R-BL	R-R-BL
30	3	16	R-R-GY	R-R-GY	BR-BR-BL
32	3	17	R-R-GN	R-R-GY	BR-BR-BL
34	3	18	R-R-GN	R-R-GY	BR-BR-BL
36	3	19	R-R-GN	R-R-GY	R-R-GN
38	3	20	BR-BR-GN	R-R-GN	R-R-GN

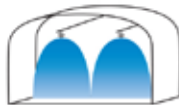

### Ordering Guide

Code	Description	Model Number	Flow* (GPH)
VN-BL	VibroNet Blue Nozzle w/Check Valve	0354040L-B	9.2
VN-GN	VibroNet Green Nozzle w/Check Valve	0354050L-B	11.7
R-R-BL	SpinNet Red Mist Control, Red Body, Blue Spinner w/Check Valve	0355120070BL-B	18.4
BR-BR-BL	SpinNet Brown Mist Control, Brown Body, Blue Spinner w/Check Valve	0355160090BL-B	23.4
R-R-GY	SpinNet Red Mist Control, Red Body, Grey Spinner w/Check Valve	03551200070L-B	18.4
BR-Y-GY	SpinNet Brown Mist Control, Yellow Body, Grey Spinner w/Check Valve	03552000090L-B	23.4
R-R-GN	SpinNet Red Mist Control, Red Body, Green Spinner w/Check Valve	03551200070GL-B	18.4
BR-BR-GN	SpinNet Brown Mist Control, Brown Body, Green Spinner w/Check Valve	03551600090GL-B	23.4

\*Average flow at 32 psi.



**BFG Technical Services:** For continuous adjacent bays - contact our technical services department

## Sprinklers & Accessories

### Netafim™ Coolnet Pro Fogger Head Assembly

Humidifying or cooling. 4 nozzles with check valve purple pin.



**8.1gph / 60psi (Opening Pressure 28psi)**  
**NET63100-058397** Min. Buy 1ea



### Netafim™ Sprinkler Head Assembly



**Red / Red / Green, 18.4GPH**  
**NET64200-010805** Min. Buy 1ea

**Red / Red / Blue, 18.4GPH**  
**NET64200-032030** Min. Buy 1ea



**Brown / Yellow / Grey, 23.4GPH**  
**NET64200-001805** Min. Buy 1ea

**Brown / Brown / Blue, 23.4GPH**  
**NET64200-033030** Min. Buy 1ea

### Netafim™ SpinNet Sprinkler Head Assembly & Check Valve

SpinNet Sprinklers offer drip-less operation – the plants below are not damaged from water dripping off the sprinkler. Sprinklers hang below the supply pipe, preventing wetting of the pipe and dripping onto the plants below. SpinNet Sprinklers with Check Valve consist of a mist control, body and spinner.



**Red, Red, Grey, 23.4gph**  
**NET64200-001302** Min. Buy 1ea

**Brown, Brown, Green, 23.4gph**  
**NET64200-014005** Min. Buy 1ea



### Netafim™ VibroNet Sprinkler

Sprinkler with leak prevention device.



**Green with Check Valve - 11.7gph at 32psi**  
**NET64300-005110** Min. Buy 1ea



### Netafim™ Female Sprinkler Adaptor

Used for connection to rigid pipe with .5in threaded connections and Netafim sprinklers.



**.5in Thread**  
**NET63000-001210** Min. Buy 1ea



### Netafim™ Misting Head

VibroNet mister with 9.2gph at 32psi. Blue nozzle. Sold in packs of 25.



**Misting & Sprinkling Head - Blue Nozzle - 9.2gph at 32psi**

**NET64300-001010** Min. Buy 25ea

**Misting & Sprinkling Head - Green Nozzle - 11.75gph at 32psi**

**NET64300-005010** Min. Buy 25ea



### Netafim™ Hanging Assembly for Sprinklers, Misters or Foggers

For connection to polyethylene (PE) pipe. Sold in packs of 25.



**12in L**  
**NET63000-004070** Min. Buy 1ea

**18in L**  
**NET63000-004460** Min. Buy 1ea

**24in L**  
**NET63000-005870** Min. Buy 1ea

**30in L**  
**NET63000-006460** Min. Buy 1ea

**36in L**  
**NET63000-007170** Min. Buy 1ea

**48in L**  
**NET63000-008361** Min. Buy 1ea

**48in Extension Barb & Tube**  
**NET63000-008461** Min. Buy 1ea



### Netafim™ Meganet Sprinkler Stand

Stake adapter, female x barb connector and 1/2in FIPT.



**Connects to PE or Oval tube 8mm Barb**  
**NET64520-002305** Min. Buy 1ea



### Netafim™ HF Vibro-Spray Sprinkler

1/2in female threaded connection.



**1gpm, 30psi**  
**NET60500-024470** Min. Buy 1ea





## Driplines

### Netafim™ Space-It Dripline

Drip system for watering potted plants. It's a thinwall drip line with pre-spaced drippers designed to be placed directly over the top of pots with the location of each dripper visibly marked on the tubing. Positioning of the pots (plants) is quick and easy - just place the pot under the mark on the drip line - saving up to 20% in installation labor costs.



**12in Spacing / 8ml / .2gph / 9,000ft per Roll**  
**NET16424-000055** Min. Buy 1ea

**18in Spacing / 8ml / .4gph / 9,000ft per Roll**  
**NET16424-000058** Min. Buy 1ea

*Custom Run: Minimum Order of 20 Rolls*

**9in Spacing / 8ml / .4GPH / 9,000ft per Roll**  
**NET16523-000107** Min. Buy 1ea

**14in Spacing / 8ml / .4gph / 9,000ft per Roll**  
**NET16424-000056** Min. Buy 1ea

**20in Spacing / 8ml / .4gph / 9,000ft per Roll**  
**NET16424-000059** Min. Buy 1ea

**22in Spacing / 8ml / .4gph / 9,000ft per Roll**  
**NET16523000135** Min. Buy 1ea



## Thinwall Dripline Fittings - TWD

### Netafim™ TWD Fittings With Blue Rings

Thinwall dripline fittings - TWD.



**TWD Coupling**  
**NET32500-016770** Min. Buy 1ea



**TWD Line End**  
**NET32500-016490** Min. Buy 1ea



**TWD x 0.400 Barb and Grommet**  
**NET00115-005150** Min. Buy 1ea



**.636in**  
**NET00115-006251** Min. Buy 1ea



## DripNet PC - Anti Siphon

### For Nurseries

Seedling Rows

15mil / .4gph / 18in / 3,200ft per Roll  
 15mil / .4gph / 24in / 3,200ft per Roll

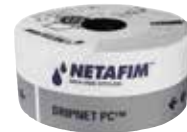

*Please Call*  
 for pricing or more information

## Tubing

### Netafim™ Super Flex UV White™ Polyethylene Micro-Tubing

Flexible tubing fully UV resistant. Made from the highest quality low density resins, the white tubing is opaque to prevent algae growth, withstand heat and harsh chemicals while producing cooler water temperatures.



**5/3mm - White 1,000ft per Roll**  
**NET40001-002500** Min. Buy 1ea



**5/3mm - Black 1,000ft per Roll**  
**NET40001-001980** Min. Buy 1ea



**Use with Spray Stakes**



**Tubing**

**Netafim™ Black Polyethylene Tubing**

Low density. To be used in irrigation systems.



**16mm / .52in Diam / Black / 100ft per Roll**  
NET19951-000093 Min. Buy 1ea

**16mm / .52in Diam / Black / 500ft per Roll**  
NET19951-000061 Min. Buy 1ea

**5/3mm - Black - 3,000ft per Roll**  
NET40001-002000 Min. Buy 1ea

**.75in / .82in Diam / Black / 100ft per Roll**  
NET19951-000025 Min. Buy 1ea

**.75in / .82in Diam / Black / 500ft per Roll**  
NET19951-000060 Min. Buy 1ea

**1in / 1.06in Diam / Black / 100ft per Roll**  
NET19951-000063 Min. Buy 1ea

**1in / 1.06in Diam / Black / 500ft per Roll**  
NET19951-000022 Min. Buy 1ea

**Netafim™ Bright White Polyethylene Tubing**

With excellent Ultra-Violet (UV) resistance, our reflective white tubing is co-extruded to prevent algae growth. It withstands heat, direct sun and harsh chemicals while producing cooler water temperatures enhancing plant growth. This white PE tubing compliments our complete line of distinctive white components and tubing. Netafim Polyethylene Tubing is made from quality low density polyethylene resins. Black inside, white outside.



**16mm / .52in Diam / White / 1000ft per Roll**  
NET19951-000033 Min. Buy 1ea

**3/4in / .82in Diam / White / 500ft per Roll**  
NET19951-000034 Min. Buy 1ea

**16mm / .52in Diam / White / 500ft per Roll**  
NET19951-000036 Min. Buy 1ea

**1in / 1.06in Inside Diameter, 1.200in Outside Diameter / 0.070in Nominal Wall Thickness / 47psi Maximum Working Pressure / 500ft per Roll**  
NET40510-000108 Min. Buy 1ea

**Netafim™ Oval Tubing**

Netafim Oval Tube is a durable and reliable round manifold which unfolds for easy installation and rolls up for relocation. Tubing is black in color with white stripes.



**1.5in, 42psi**  
NETOT 1.50-42-350W Min. Buy 1ea

**1.5in / 42psi / 350ft per Roll**  
NET43001-000029 Min. Buy 1ea

**2in / 42psi / 250ft per Roll**  
NET43001-000031 Min. Buy 1ea

**Tubing**

**Netafim™ Black Pre-Punched Tubing**

16mm tubing with pre-punched holes.



**18in / Black / 16mm x 1,000ft**  
NET19951-000101 Min. Buy 1ea

**24in / Black / 16mm x 1,000ft**  
NET19951-000028 Min. Buy 1ea

**36in Spacing, 1000ft roll**  
NET84520620-36 Min. Buy 1ea

**36in / Black / 3/4in x 500ft**  
NET19951-000113 Min. Buy 1ea

**36in / Black / 1in x 500ft**  
NET19951-000051 Min. Buy 1ea

*Custom Run: Minimum Order of 20 Rolls*

**12in Spacing, 1000ft roll**  
NET8452062012 Min. Buy 1ea

**Netafim™ Pre-Cut Super Flex UV White™**

Netafim Polyethylene Tubing is made from quality low density polyethylene resins. With Netafim's stringent quality controls, every coil undergoes a battery of tests and over 30 quality checks before leaving the factory. This means you'll receive the highest quality product with each and every coil. A soft, 5/3mm tubing with improved flexibility and all the advantages of PE tubing - UV resistant, completely opaque to prevent algae growth and able to withstand heat and harsh chemicals. The 5/3mm tubing is used with all dripper and spray stake assemblies.



**White - 5/3mm / Pre-Cut 36in Lengths - Sold in Packs of 100 / 3mm Inside Diameter, 5mm Outside Diameter**  
NET40001-003200 Min. Buy 1ea

**Pressure Regulators**

**Netafim™ Pressure Regulator**

Pressure Regulators are manufactured with non-corrosive, high quality plastic and brass, that withstands all fertilizers and chemicals in common use providing years of trouble-free operation. The one-piece sealed regulating unit - different for each pressure option - is field replaceable and easy to maintain. Instant response to variations in pressure assuring that outlet pressure will remain constant regardless of inlet pressure. Non-corrosive, high quality plastic and brass bodies withstand commonly used fertilizers and chemicals. Sealed regulating unit with stainless steel spring and a screw are field replaceable and easy to maintain.



**3/4in / 35psi / Low Flow .25-4.5gpm**  
NET31000-001200 Min. Buy 1ea



**3/4in / 35psi / 5-18gpm**  
NET30500-001600 Min. Buy 1ea



**1.5in / 12psi / 11-35gpm**  
NET30520-001100 Min. Buy 1ea



**1.5in / 35psi / 11-35gph**  
NET30520-001600 Min. Buy 1ea





**Tools and Accessories**

**Netafim™ 3mm Plastic Punch**

For use with all Netafim Drippers and Sprinkler Hanging Assemblies.



**3mm Blue**  
NET45000-001200 Min. Buy 1ea



**Netafim™ 3mm Plastic Punch**

For use with Netafim thinwall tubing connectors with a .400in barb.



**8mm**  
NET45000-001450 Min. Buy 1ea



**Netafim™ Drill Bit**

Use this drill bit to make a proper sized hole in the PVC Pipe Header. With correct hole size, the grommet and insert adapter will install easily and stay in place for long term operation.



**16.5mm**  
NET45000-002750 Min. Buy 1ea



**Netafim™ Retrofit Adapter**

Connects Netafim head assemblies to other manufacturer's fitting.



**Female x Female/Dan to Micronet**  
NET63000002515 Min. Buy 1ea



**Netafim™ Weight**

Has a shut-off feature.



**Red / Plastic**  
NET32000-002220 Min. Buy 1ea



**Netafim™ Shut Off**

Shut off cap for woodpecker dripper



NET32000-001435 Min. Buy 1ea



**Netafim™ Grommet**

Net grommet



**Use with 1.5in or larger PVC**  
NET00115-000500 Min. Buy 1ea



**Netafim™ Plug**

Replaces sprinkler/mister



**100/bg**  
NET63000-002420 Min. Buy 1ea



**Water Filtration Systems**



**Corrosion-Proof  
and Flushes at Low  
Pressure!**

**Amiad® Mini Sigma Filter**

Automatic self-cleaning filter for irrigation system, flushes at low pressures. Easy maintenance, corrosion-proof, excellent mechanical strength and low pressure loss. Can be used in a variety of systems.



**2in Mini Sigma Angle or On-Line, 80-500 micron**  
AMIAD55000000002 Min. Buy 1ea

**3in Mini Sigma Angle or On-Line, 80-500 micron**  
AMIAD55001000003 Min. Buy 1ea

**4in Mini Sigma Angle or On-Line, 80-500 micron**  
AMIAD55002000018 Min. Buy 1ea



**Amiad® Scanaway Filter**

Semi-automatic filter eliminates the need for turning off the water and extracting the filter screen for rinsing. Provides low pressure loss with no interruption of the process water flow during cleaning. Fitted with a "Clogging Indicator".



**2in, 155 Mesh, 100 micron, Yellow**  
AMIAD30002000025 Min. Buy 1ea



**Amiad® Filter with Valve**

Plastic filter for irrigation system. Easy maintenance, corrosion resistance, excellent mechanical strength and low pressure loss. Can be used in a variety of systems.



**1in, 120 Mesh, 130 Micron, Red**  
AMIAD1-1201-1151-1013 Min. Buy 1ea

**3/4in, 155 Mesh, 100 Micron, Yellow**  
AMIAD1-703-4151-8010 Min. Buy 1ea



**Amiad® Ball Valve Shut Off**

Controls water flow in the irrigation system. Can be used in a variety of systems.



**.75in - Blue**  
AMIAD8-1000-0101 Min. Buy 1ea







Reduce water consumption



Faster plant growth



Labor savings

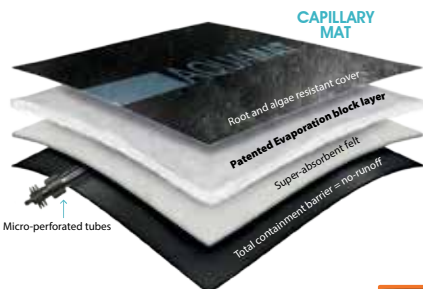

«Aquamat® has been a great tool for us: labor and water savings, less foliar diseases and flower damages, less shrinkage while having a consistent crop and a faster growth.»

Rob Swanekamp  
V.P. Sales and Production  
Kube-Pak Growers  
Allentown NJ

[aquamatsystem.com](http://aquamatsystem.com)



*Please Call*  
for pricing or more information





Please Call  
for pricing or more information

### Conservation Systems

#### FOGCO Systems

FOGCO products are becoming standard equipment for all greenhouse applications. FOGCO has become an industry leader in humidification, cooling, by developing innovative products to meet environmental needs.

Fog systems are proven to positively impact growing operations by regulating the temperature, humidity, and moisture content within the greenhouse. Fog systems are ideal for addressing and correcting the problems associated with high temperatures and/or low humidity levels. This promotes increased health and productivity within the greenhouse by eliminating "plant water stress, one of the most significant factors in the growth of all plants. Plants lose their moisture through evaporation from the leaves. They also gather carbon needed for growth in the form of carbon dioxide through the leaves. By controlling the plants' pores through the use of a properly designed fog system, the results are stronger and healthier plants with optimum growth potential. Fog systems can also be used to introduce fertilizers by injecting nutrients directly into the atmosphere. The moisture and the nutrients are absorbed by the leaves of the plant. Fogco also provides odor mitigation systems for operations regulated by odor compliance.

#### Features:

- Revolution Fan system provides 360 degree fog distribution.
- Ensures proper humidity levels
- Reduces demand for moisture
- Maintains favorable conditions
- Creates in-house propagation stock
- Reduces need for shading/whitewashing
- Reduces irrigation/water consumption



### Tubing and Assemblies

#### Jain Tube Weight Assembly

Ideal tubing for all your pot irrigation applications. Tube assembly comes with butterfly, barb and stabilizer.



<b>12in</b>	
<b>JAINP11997140</b>	Min. Buy 1ea
<b>24in</b>	
<b>JAIN11997143</b>	Min. Buy 1ea

#### Jain Chapin On/Off Tube Weight Assembly

Ideal tubing for all your pot irrigation applications. The slender design makes it easy to pull in and out of pots, you can even remove the pots allowing the weight to remain without damaging the plants. The twist-on / twist-off action makes it easy to turn the weights on and off without kinking or damaging the tubing.



<b>18in, .060 Inside Diameter, 128x060-PE Tubing / 100pk</b>	
<b>JAIN12771218</b>	Min. Buy 1ea
<b>24in, .076 Inside Diameter, 128x076-PE Tubing / 100pk</b>	
<b>JAIN12771324</b>	Min. Buy 1ea
<b>24in, .060 Inside Diameter, 128x060-PE Tubing / 100pk</b>	
<b>JAIN12771224</b>	Min. Buy 1ea
<b>36in, .060 Inside Diameter, 128x060-PE Tubing / 100pk</b>	
<b>JAIN12771236</b>	Min. Buy 1ea
<b>36in, .076 Inside Diameter, 128x076-PE Tubing / 100pk</b>	
<b>JAIN12771336</b>	Min. Buy 1ea
<b>48in, .076 Inside Diameter, 128x076-PE Tubing / 100pl</b>	
<b>JAIN12771348</b>	Min. Buy 1ea
<b>60in, .060 Inside Diameter, 128x060-PE Tubing / 100pk</b>	
<b>JAIN12771260</b>	Min. Buy 1ea





## Sprinklers and Accessories

### Jain DAN Modular Micro Sprinkler & Sprayer Group

A wide range of Micro Sprinklers and Sprayers which covers the demanding needs of an energy efficient yet extremely consistent irrigation system. The DAN Modular Group Sprinklers and Sprayers consists of a common bridge or body with multiple options for nozzle size, spray pattern, droplet size and mounting options.

- Green nozzle/green antimist 11GPH at 30PSI
- Orange nozzle/Orange Antimist 19GPH at 30PSI
- Yellow Nozzle/Yellow Antimist 25GPH at 30PSI
- Blue Nozzle/Blue Antimist 33GPH at 30PSI



#### Black-Green with LPD

**JAIN16119200** Min. Buy 1ea



#### Black-Yellow, No LPD Included

**JAINP16116600** Min. Buy 1ea



#### Black-Orange with LPD

**JAINP16119500** Min. Buy 1ea



#### Green Kiwi-Orange with LPD

**JAIN16159500** Min. Buy 1ea

### Jain Dan Mini Sprinkler

Manufactured from good quality virgin raw material, easy to install, reliable performance, interchange ability of nozzle and good application efficiency. Includes LPD (leak prevention device).



#### Yellow-Green with LPD

**JAIN16179200** Min. Buy 1ea

### Jain Modular Group Bridge

Components of Jain drip irrigation.



**100pk**

**JAINP11850600** Min. Buy 1ea

### Jain Dan 4-Way Cross For Foggers

Jain Dan 4-way connector for foggers.



**JAIN17081014** Min. Buy 1ea



### Jain Hole Punch with Replacement Tip

Components of Jain drip irrigation.



#### 2.5mm. Ejector Style

**JAINP12071006** Min. Buy 1ea

### Jain Micro PE Black Tubing

Manufactured using Union Carbide materials that offer the exclusive Fingerprint® identification feature and contain a minimum of 2% carbon black for UV protection. Strict quality procedures ensure highest uniformity and product quality. 10 Year Warranty.



#### .128in x .060in, 2,500ft

**JAIN11190813** Min. Buy 1ea



### Jain Flex PVC Hose

Flexible Vinyl Pipe offers more flexibility, durability and shock resistance to an irrigation system than standard PVC pipe can provide.



#### 0.125in x 0.187in, 1,000ft per Roll

**JAIN71190591** Min. Buy 1ea

#### 0.276in x 0.158in, 1,000ft per Roll

**JAIN11190166** Min. Buy 1ea

### Jain Pressure Regulator

Components of Jain drip irrigation.



#### 1in, 35psi

**JAIN81-1035** Min. Buy 1ea

### Jain Threaded Coupling

Components of Jain drip irrigation.



#### 1/2in x 1/2in

**JAINP17097272** Min. Buy 1ea

### Jain Low Pressure Female LPD



#### Low pressure LPD

**JAIN11990308** Min. Buy 1ea

### Jain Compression Series 600 x Swivel Adapter with Screen

Historically one of the more popular emitterline fitting options, compression fittings are a quick, low cost alternative to a locking fitting. Jain compression fittings come with easy to reference color coded inserts to assist in determining size on an already installed system.



#### 3/4in F Hose SWVXCOMP 600-CHS-WS

**JAIN12010232** Min. Buy 1ea



# Lasco® Fittings, Inc.

## Fittings

### Lasco® Fittings PVC Insert Female Adaptor

PVC insert female adaptor, for cold water only.



**.75in**  
**LF11435-007**      Min. Buy 1ea  
**1in**  
**LF11435-010**      Min. Buy 1ea



### Lasco® Fittings PVC Combo Insert Tee

Combo insert tee. For cold water only.



**.75in x .75in**  
**LF11402-007**      Min. Buy 1ea



### Lasco® Fittings PVC Insert Tee

Tee insert. For cold water only.



**.75in**  
**LF11401-007**      Min. Buy 1ea



### Lasco® Fittings PVC Insert Elbow

90 degree elbow. For cold water only.



**.75in**  
**LF11406-007**      Min. Buy 1ea



### Lasco® Fittings PVC Insert Male Adaptor

PVC insert male adaptor, for cold water only.



**.75in**  
**LF11436-007**      Min. Buy 1ea

### Lasco® Fittings PVC Reducing male Adaptor

Insert reducing male adaptor, for cold water only.



**1in x .75in**  
**LF11436-102**      Min. Buy 1ea



### Lasco® Fittings PVC Reducing male Adaptor

Insert reducing male adaptor, for cold water only.



**1in x .75in**  
**LF11436-131**      Min. Buy 1ea

### Lasco® Fittings Female Insert

For cold water only.



**.75in x .75in**  
**LF1FHT-206**      Min. Buy 1ea



### Lasco® Fittings Reducing Bushing

For cold water only.



**1in X .75in**  
**LF1439-131**      Min. Buy 1ea

### Lasco Fittings Inserts Plug

For COLD Water Only - Do Not Use In a Dwelling.



**.75in**  
**LF11449-007**      Min. Buy 1ea



## Other Irrigation

### Phytotronics® Capmat™II Capillary Matting

An economical yet highly efficient method to evenly water potted plants. Using an absorbent, resilient spunbond fabric, Capmat™ II Capillary Matting wicks water rapidly to the roots of the plant by capillary action. Besides saving time by watering all your plants at the turn of a valve, sensitive or delicate foliage is not spotted by overhead watering. Another advantage of capillary watering is that plants are not knocked over as they can be by overhead watering. Finally, capillary mat watering produces enhanced, uniform growth in a crop.



**4ft x 100ft**  
**PHT7000**      Min. Buy 1ea



### Phytotronics® Electronic Leaf Mister

The E-Leaf controller is a simple and effective way to mist cuttings. It works on the principle of evaporation. The weight of mist on the metal screen controls solenoid operation. Housing made with durable stainless steel. Includes 20ft of 18/2 wire for solenoid valve connection.



**PHT1400**      Min. Buy 1ea



### Phytotronics® Hi-Hose Watering System

The Hi-Hose Watering System is a simple, efficient way to remove the drudgery of dragging a hose over paths and around plants. Includes hoses and all cable and fittings.



**75ft System with 90ft 5/8in hose**  
**PHT6322**      Min. Buy 1ea



# Rusco

# Signature Control Systems

## Filter

### Rusco Spin-Down® Filter

Highly flexible filters designed to be utilized in a wide variety of applications from household well water systems, geothermal heating, or lawn and turf, all the way to factories, livestock feeding systems or advanced liquid cooling systems.



**1.5in 140 mesh**  
**RUSCO1-1/2-140-F** Min. Buy 1ea

**5.5in W x 17.875in L / Flow capacity 18-100gpm / Max pressure 150 PSI / Port size 2in slip, 140 Mesh**  
**RUSCO2-140-F** Min. Buy 1ea



## Irrigation Components

### Signature Control Systems® Yellow Whiz Head

When you need a large volume of water with large water droplets in 40 foot radius. Ideal for riser installs in planting areas.



**1/2in Female Threads / 40in Diam Coverage / 3.4 -4.4gpm Flow**  
**SCS1973** Min. Buy 1ea



# Storm Manufacturing Group, Inc.

## Other Irrigation

### Superior® Sterling Controller

Six independent programs that can run concurrently. Station timing adjustable from 1 minute to 24 hours in 1 minute increments. For misting applications, the time base in all six programs can be changed to seconds/minutes so that station timing is adjustable from 1 second to 24 minutes in 1 second increments. Up to 9 cycle start times per program; or, for misting applications, loop programming for unlimited cycles that can repeat immediately or after a programmed delay of 1 minute to 4 hours. Cycling can be started and stopped manually as well as automatically. Optional 78 VA transformer enables six 4-watt solenoids to operate simultaneously.



**12 stations**  
**SUPSTERLING-12** Min. Buy 1ea

**18 stations**  
**SUPSTERLING-18** Min. Buy 1ea





AGRICULTURAL IRRIGATION | A Hunter Industries Company

## Pressure Regulators

### Senninger® Pressure Regulators

Uncontrolled pressure fluctuations into emission devices result in unwanted flow deviations and lower distribution uniformities. Common causes of pressure variation include changes in system demand and/or water supply and friction loss through pipe and fittings. Proper use of pressure regulators helps maintain the overall efficiency of an irrigation system and sprinkler performance.

- Above or below ground installation
- Maintains a constant preset outlet pressure with varying inlet pressures
- Withstands severe water hammer
- Low hysteresis and friction loss
- Maximum flow path resists plugging
- 100% pressure tested for accuracy (no adjustments ever needed)



Item #	Flow Range	Preset Operating Pressure	Max Inlet Pressure	Inlet Size NPT (F)	Outlet Size NPT (F)	Flow	Barcode
SENNPRL123F3F	0.5 - 8GPM	12PSI	90PSI	3/4in	3/4in	Low	
SENNPMR15MF	2-20GPM	15PSI	95PSI	3/4in	3/4in	Mid	
SENNPRL203F3F	0.5 - 8GPM	20PSI	100PSI	3/4in	3/4in	Low	
SENNPMR40MF	2 - 20GPM	40PSI	120PSI	1in BSPT	1in BSPT	Mid	

## Sprinklers

### Senninger® Sprinklers

The Senninger mini-Wobbler™ employs a unique off-center rotary-action as the standard Wobbler®. It provides instantaneous and extremely uniform coverage over a large diameter at low pressures. Creates droplets resistant to wind-drift and evaporation and is constructed entirely of engineering-grade thermoplastics for excellent corrosion resistance.

- Low evaporative loss
- Multi-level throw, approximate angle: 0° inverted, 10° upright
- Color-coded nozzles for easy size identification
- Flow rates: 0.42 to 2.18GPM
- Operating pressures: 15 to 25PSI
- Standard inlet: 1/2in NPT male



Item #	Model Type	Nozzle Color/Size	Flow Range	Pressure Range	Diameters of Coverage	Pattern Spacing	Connection	Barcode
SENNWOB06M250	Inverted	Gold #6 - 3/32in	1.10-1.25GPM	20-25PSI	31-31.4ft	Up to 12ft	1/2in M NPT	
SENNWOB08M250	Inverted	Lavender #8 - 1/8in	1.95-2.18GPM	20-25PSI	31.5-32ft	Up to 12ft	1/2in M NPT	
SENNWOB06M200	Upright	Gold #6 - 3/32in	0.95-1.25GPM	15-25PSI	39.5-42ft	Up to 20ft	1/2in M NPT	
SENNWOB04M200	Upright	Light Blue #4 - 1/16in	0.42-0.56GPM	15-25PSI	31-34ft	Up to 20ft	1/2in M NPT	

## Accessories

### Senninger® Drain Stop Plus™

Innovative three-in-one design. The multiple functions of Senninger's Drain Stop Plus make it an excellent choice for overhead irrigation! Specially designed for overhead irrigation to prevent draining from applicators when system is shut down. Protects plants beneath applicators from damage due to overwatering. Allows lines to remain full to help expedite system start-up time. Twist dial to select: Check-Open-Closed. Easy-clean feature for debris removal. High-impact, engineering-grade thermoplastic construction for durability.



0.25-5gpm

SENNDSP2M2F

Min. Buy 1ea





# Stuppy Inc.

## Other Irrigation

### Stuppy Aqua Turret

Stuppy Aqua Turret has a broad fan shaped spray pattern that waters a large area around the base of the plant without washing out packing soil. It is designed with three orifice pins of different sizes for low, medium, or high volume. The turret assures equal volume and distribution of water and liquid feed to each plant, cuts labor, and maintenance costs to a minimum. It is perfect for use in large hanging baskets, nursery containers, and field stock.



100 per Case

STU6274

Min. Buy 1ea

## The Specialty Manufacturing Co.

### Other Irrigation

#### Specialty Mfg Plastic Shutoff

Economical shut off to be used on the end of a hose to allow full control of your water flow.



.75in Thread

SMC3548

Min. Buy 1ea



### Other Irrigation

#### Walter Gogel Co Adjustable Irrigation Clamp

Metal clamp that adjusts tightly onto any irrigation project that needs to be secured. Works with both 3/4in and 1in tubing.



GOGL35245 OR 600-016

Min. Buy 1ea



# GrowerSelect®

## Support Rails

### Aluminum Casing

#### Grower Select® Aluminum Casing

This product is used by inserting 3/4 inch polyethylene irrigation tubing into the casing for mounting in your greenhouse structure to allow for a clean and straight run.



**3/4in x 100ft**

**GSS13695 100IN** Min. Buy 1ea

**1in x 100in**

**GSS13692** Min. Buy 1ea

#### Grower Select® Round Galvanized Tubing Support Rails

Components to be used for greenhouse structures or for benching. Many sizes to choose from to create the layout of your choice.



**17ga, 1.315in x 120in**

**GSB08630** Min. Buy 1ea

**17ga, 1.315in x 126in**

**GRFSB08630** Min. Buy 1ea

**17ga, 1.315in x 180in**

**GSB08650** Min. Buy 1ea



### Nozzles & Wands

#### Gardener Select® Deluxe Shower Head Watering Wand

The Gardener Select Deluxe Shower Head Watering Wand. Includes removable micro hole disc and foam grip with filter.



**24in**

**GSARH24SWN** Min. Buy 6ea



#### Grower Select® Square Galvanized Tubing

Components to be used for greenhouse structures or for benching. Many sizes to choose from to create the layout of your choice.



**16ga, 1in x 48in**

**GSB07650** Min. Buy 1ea

**16ga, 1in x 96in**

**GSB07720** Min. Buy 1ea

**14ga, 1.25in x 60in**

**GSB07810** Min. Buy 1ea

**14ga, 1.25in x 168in**

**GSB07855** Min. Buy 1ea







# Equipment & *Supplies*



# Main Types of Greenhouse Ventilation

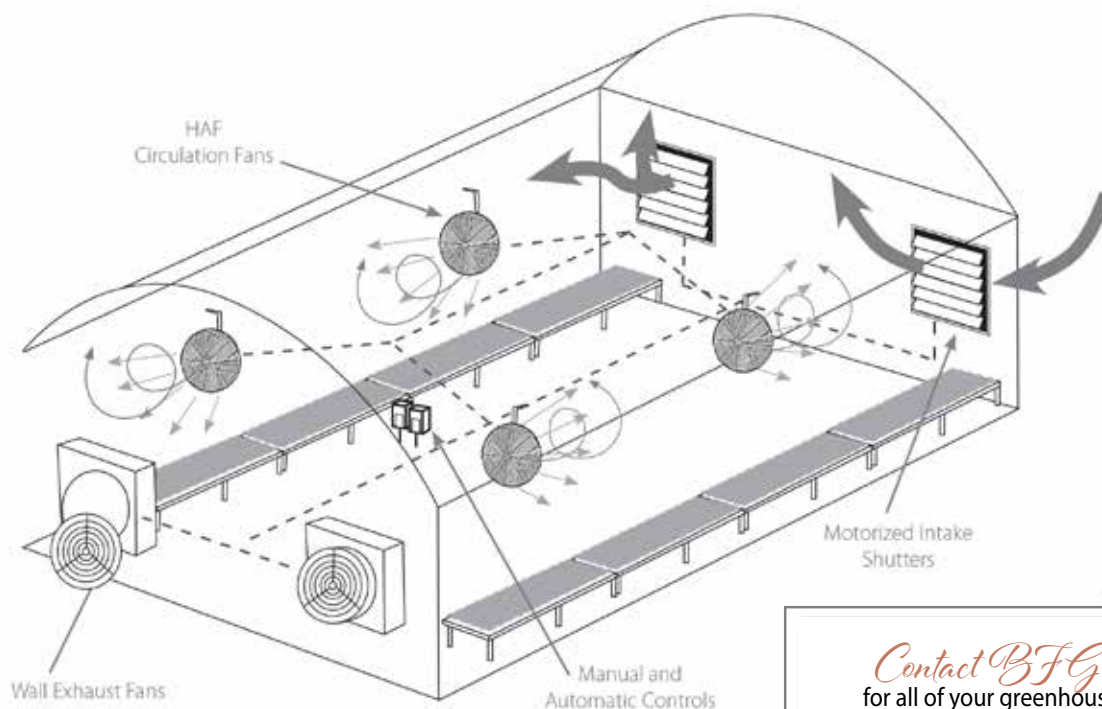

Contact BFG  
for all of your greenhouse  
ventilation needs

## 1. Air Circulation

Improve plant performance. Proper circulation encourages healthy plant growth by increasing CO<sub>2</sub> availability (required for photosynthesis), reduces disease and mildew caused by excessive moisture, and eliminates over heating on hot days. Uniform air quality throughout.

### Types:

- Jet tubes & fans
- HAF fans

## 2. Mechanical - Ventilation

### Features:

- Inexpensive setup
- Uniform air flow
- High energy consumption

### Types:

- Louvers - Shutters
- Fans
- Cooling

## 3. Natural Ventilation

### Features:

- Low energy requirements
- Very high ventilation rates are possible
- Air temperature maintained very close to outside air
- Low temperature gradients across greenhouse
- No ventilation restrictions on length of greenhouse
- All other doors can be open without interrupting ventilation
- Unused sections of greenhouse can easily be cooled in the summer
- Quiet internal working (or shopping) environment

### Types:

- Roof Vents
- Side vents
- Inflation sidewalls
- Rollup sidewalls
- Mechanical sidewalls



## Greenhouse Ventilation

### Grower Select® Convection Tubes

The convection tube is a polyethylene tube that runs the length of the house and forces air through holes spaced along the tube. This system is best suited for houses that have a lot of obstructions. Convection tube systems can be designed for a number of different uses.

#### Cooling/Air Circulation

Fan and shutter kits allow outside air to be introduced into the greenhouse environment and distributed evenly throughout the house. They can also be used with the fan alone to provide air movement throughout the house instead of HAF fans.

#### Heating

Heat Kits allow use of gas fired, electric, steam or hot water unit heaters without outside air passing through the heat exchanger. These kits use a fan system to attach to the convection tube and allow heated air from a heat source to be forced down the length of the house through the tube.

Our convection tube is available in standard stock diameters of 18in, 24in and 30in x 100ft punched. Our 4 mil UV-inhibited clear polyethylene tubing is engineered for uniform distribution and proper mixing of air to produce the best aerodynamic effect in the greenhouse. All of our convection tube is made from a UV stabilized greenhouse film.

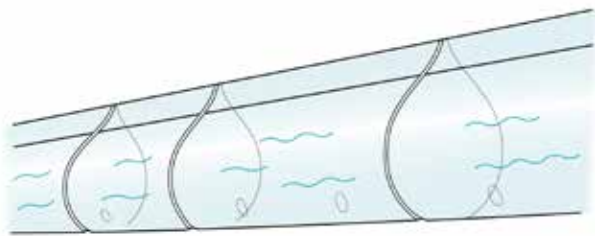

#### Standard Punch



**18in x 100ft with Standard Punch**

**GS22-9077** Min. Buy 1ea

**24in x 100ft with Standard Punch**

**GS22-9083** Min. Buy 1ea

**30in x 100ft with Standard Punch**

**GS22-9089** Min. Buy 1ea

#### Unpunched



**18in x 1500ft**

**WA22-9080** Min. Buy 1ea

**24in x 1500ft Unpunched**

**WA22-9084A** Min. Buy 1ea

**30in x 1500ft Unpunched**

**WA22-9090** Min. Buy 1ea

#### Custom Punch



**18in Custom Punch**

**GS22-9076** Min. Buy 1ea

**24in Custom Cut**

**GS22-9082** Min. Buy 1ea

**30in Custom Cut**

**GS22-9088** Min. Buy 1ea

#### Custom Punching Options

Please specify the length and punching pattern and we'll figure your hole size and hole spacing. Please allow 7-10 days for delivery on custom punched rolls.

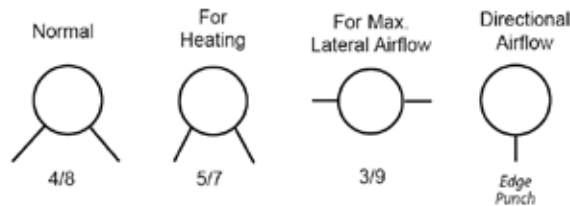

# Grower Select®

## Display Carts



### Grower Select® Hi-Cube Display Cart

A heavy-duty solution for long-distance or rough transportation, this cart features all steel construction with a hot-dip galvanized finish, solid sheet metal shelves and a cable braking system for safety.



**Cart with 5 Adjustable Shelves**  
**GS45-6507** Min. Buy 1ea



### Grower Select® All-Purpose Transport Cart

The workhorse of the Grower Select cart line. The All-Purpose Transport Cart features all steel construction with a hot-dip galvanized finish, a welded wire base and three expanded metal mesh shelves. Connect multiple All-Purpose Transport Carts together using the heavy-duty drawbar and post system.



**3 Shelves, 5in Rigid Casters, 59in L x 22in W x 82.5in H, 77lbs.**  
**GSGS2259** Min. Buy 1ea



### Grower Select® Sliding Shelf Display Cart

Cart can serve double duty for product transportation and retail display. All steel construction with a hot-dip galvanized finish, an expanded metal mesh base and three solid sheet metal shelves. Features two rigid casters, two swivel wheels, tow bar, two curved ladder end panels and shelves that slide out from either side.



**3 Shelves, 59in L x 22in W x 80.5in H, 68lbs**  
**GS48-6520** Min. Buy 1ea

## Hi-Cube Replacement Parts

### Eye Bolts



**Eye Bolt for Hi-Cube Cart**  
**GS456510** Min. Buy 1ea

### Turn Buckle



**Turn Buckle for Hi-Cube Cart**  
**GS456512** Min. Buy 1ea

### Brake Assembly



**Brake Assemble for Hi-Cube Cart**  
**GS486541** Min. Buy 1ea

## All-Purpose Replacement Parts

### Expanded Metal Hook Shelf

Additional shelf made with hot dipped galvanized expanded metal for the Transport Cart. Added shelving makes cart even more valuable in the busy season!



**For the Grower Select® #2259 Transport Cart**  
**GS48-6500A** Min. Buy 1ea

### Replacement Post

A replacement post for Transport Cart. Hot dipped galvanized metal construction.



**Replacement Post Only**  
**GS48-6500B** Min. Buy 1ea

### Grower Select® Flat Free Tire

Flat free tire



**8in x 2.5in, 3.5in centered hub**  
**GSAN80PNPF12** Min. Buy 1ea

## Sliding Shelf Replacement Parts

### Shelf

Hot dipped galvanized sliding shelf. Shelf Only! Sold by the each. For use with Grower Select® Sliding Shelf Display Cart.



**21.5in x 54.5in**  
**GS48-6520B** Min. Buy 1ea

## Display Carts

### Grower Select® Retail Nesting Shopping Cart

Nesting shopping cart perfect for customer shopping in greenhouses and garden centers. Perfect for carrying bedding plants, perennials, hanging baskets and pots. Features all steel construction with a hot-dip galvanized finish. Carts can be nested to save space when not in use.



**37in L x 24in W x 43.5in H**

**GSGS4000**

Min. Buy 1ea



## Nesting Replacement Parts

### Corner Guard

Replacement Corner Guard.



**Corner Guard Only**

**GSGS4000CC**

Min. Buy 1ea

### Bottom Shelf

Shelf only. For use with the retail nesting cart.



**Bottom Shelf Only**

**GS486501B**

Min. Buy 1ea

### Swivel Wheel

Replacement swivel wheel designed to repair the Retail Nesting Shopping Cart Models: GSGS4000 & GS48-6501S



**GSGS4000SW**

Min. Buy 1ea

### Pneumatic Wheels with Rims

Pneumatic wheels - Tire Mounted on Rim



**Pneumatic Wheels Only - Set of 4**

**GS486555**

Min. Buy 1ea

### Grower Select® Black Rubber Swivel Caster

This 5in x 2in Black Rubber Swivel Caster (Thermoplastic Rubber) features a shock-absorbing cushioned ride, while providing good floor protection and quiet rolling operation. Featuring weight capacities of 75 to 1100 pounds per wheel, the 75 Shore A TPR wheel tread is chemically bonded to a polyolefin core and has an operating temperature range of -40° to +180° Fahrenheit. It is resistant to cleaning chemicals, acids, alcohol, and water, TPR wheels are an excellent choice for wash-down applications.



**5in x 2in Wheel - 6-1/2in Overall Height - Sold by The Each**

**GS5-81-455**

Min. Buy 1ea



### Grower Select® Black Rubber Rigid Caster

This 5in x 2in Black Rubber Rigid Caster (Thermoplastic Rubber) features a shock-absorbing cushioned ride, while providing good floor protection and quiet rolling operation. Featuring weight capacities of 75 to 1100 pounds per wheel, the 75 Shore A TPR wheel tread is chemically bonded to a polyolefin core and has an operating temperature range of -40° to +180° Fahrenheit. It is resistant to cleaning chemicals, acids, alcohol, and water, TPR wheels are an excellent choice for wash-down applications.



**5in x 2in Wheel - 6-1/2in Overall Height - Sold by The Each**

**GS5-82-455**

Min. Buy 1ea



### Pneumatic Swivel Caster Wheel

Swivel caster wheel



**8in, 4in x 4.5in plate**

**GS00316**

Min. Buy 1ea

### Pneumatic Rigid Caster Wheel

Rigid caster wheel



**8in, 4in x 4.5in plate**

**GS00315**

Min. Buy 1ea



# GrowerSelect®

## Pot Covers & Foil

### Grower Select® Sleeves

Pot sleeve that protects plant and creates a decorative look to enhance the appeal and add some personality to potted plants. Made of HDPE material that is see through but has a milky white haze to it. Each size features an easy to use drop and tear design on a wood header and 50 vents which allows moisture to escape to prevent disease.

### Grower Select® Clear Sleeves



Fits 10in Pots, 13.25in Bottom W x 22in Top W x 24in H, 50 Vents / 500pk

GS09-770

Min. Buy 1ea

### Grower Select® Satin Sleeves



Fits 4in Pot, 4.5in Bottom W x 16in Top W x 18in H, 1,000/cs

GS09-0678

Min. Buy 1ea



Fits 6in Pots, 8in Bottom W x 24in Top W x 30in H, 1,000/cs

GS09-0674

Min. Buy 1ea



Fits 6in-6.5in Pot, 8in Bottom W x 20in Top W x 20in H, 1,000/cs

GS09-0675

Min. Buy 1ea

Fits 6in-6.5in Pots, 8in x 20in x 24in with 50 Vents 1000/cs

GS09-0677

Min. Buy 1ea

Fits 6in 6.5in Pot, 8in Bottom W x 24in Top W x 24in H, 1,000/cs

GS09-0676

Min. Buy 1ea



Fits 7in-8in Pots, 9in Bottom W x 30in Top W x 24in H, 1,000/cs

GS09-0673

Min. Buy 1ea



Fits 8in Pot, 10in Bottom W x 30in Top W x 30in H, 1000/cs

GS09-0671

Min. Buy 1ea



Fits 10in Pots, 13.25in Bottom W x 22in Top W x 24in H, 500/cs

GS09-0670

Min. Buy 1ea

Fits 10in Pot, 14in Bottom W x 24in Top W x 26in H, 1,000/cs

GS14X24X26

Min. Buy 1ea



Fits 10.5in Pot, 14.5in Bottom W x 30in Top W x 30in H, 500/cs

GS09-0669

Min. Buy 1ea

Fits 10.5in-11in Pot, 15in Bottom W x 30in Top W x 30in H, 500/cs

GS09-0672A

Min. Buy 1ea



1,000pk / for 12in Hanging Baskets / 15in x 24in x 24 w/50 Maxivent

GSXX

Min. Buy 1ea





## Roll-Up/Lock Down Curtain Systems Always Ready to Open Always Ready to Close

Roll-Up sidewall curtain package for free-standing or gutter connect greenhouses includes:

- **Automated or Manual** vent drives for easy operating of your ventilation curtain.
- **Controllers for automated systems** allows your curtain to roll up or down based
- **Double WireLock** to attach your roof covering to the top clasp and the roll-up curtain to the lower clasp.
- **Roll-Bar options** allow you to clasp your choice of curtain material, single or multi-layer.
- **Continuous Roll-Lock** provides an air-tight seal across the entire bottom.
- **Wind Rope System** with hooks to hold the curtain to the structure, and materials for creating end panels which the curtain laps

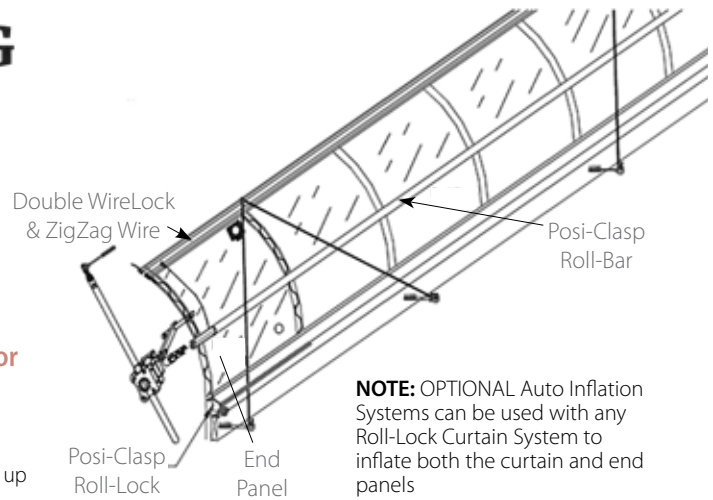

**NOTE:** OPTIONAL Auto Inflation Systems can be used with any Roll-Lock Curtain System to inflate both the curtain and end panels

### Description

Package w/Roll-Bar & top poly clasp but no Roll-Lock  
Package w/Roll-Bar & Roll-Lock but no top poly clasp  
Package w/Roll-Bar, Roll-Lock and double top poly clasp  
**All curtains must be ordered in increments of 4ft.**

### Environmental Controller

Every perfect climate starts with control. Use our all-in-one touchscreen controllers to automate your low voltage motors, fans, and heaters! They come equipped with climate and timed controls with optional weather overrides.



### Low Voltage Motors

Our low voltage vent drive line is specially designed to meet the unique demands of your greenhouse or high tunnel. They provide the torque to drive ventilation, shade, and light deprivation systems.



Please contact your BFG Sales Representative for more information.

### Gears & Adapters

#### Soft Handle

Fits over and bolts to input loop



**ADV64CH**

Min. Buy 1EA

#### Gearbox 7:1 Ratio

Gray color with loop handle & (4) 8 x 14MM metric bolts



**Gear is 1.5in W x 2.25in deep x 3.125in H**

**ADV63G71**

Min. Buy 1EA

#### Grower Select® Spring Lock Roll-Up Shaft

Aluminum spring lock roll up shaft used for sidewall ventilation.



**12ft**

**GS38-0806**

Min. Buy 1EA

#### Guide Pipe

Hole at one end for mounting hardware (order guide pipe hardware separately)



**7ft Long**

**ADVGP7**

Min. Buy 1EA

#### 13:1 Gear

Manual operator with guide wheels, internal brake and input loop



**ADV63GC131**

Min. Buy 1EA

#### Grower Select® Roll-Up Shaft Splice

Designed as a low-cost ventilation system with no additional electrical requirements or costs to operate.



**1.5in x 12in**

**GS38-0807**

Min. Buy 1EA

#### Adapter 1/2in Shaft X 2.3in



**ADV65RBA1223**

Min. Buy 1EA





**Fertilizer Injectors**



**Dosmatic™ SuperDos 20 Injector**

The SuperDos mid-high flow, fluid (water)-driven proportional injectors offer an ideal alternative to traditional electric technology.

	Item #	GPM	Ratio	Pressure	Percentage Rate	Barcode
<b>SuperDos 20 2.5%</b>	DOSM113205	0.05 - 20GPM	1:500 - 1:40	5 - 100PSI	0.20 - 2.5%	
<b>SuperDos 30 2.5%</b>	DOSM113209	0.15 - 30GPM	1:500 - 1:40	5 - 100PSI	0.20 - 2.5%	
<b>SuperDos 45 2.5%</b>	DOSM113212	0.25 - 45GPM	1:500 - 1:40	5 - 100PSI	0.2 to 2.5%	



**Dosmatic™ MiniDos Injector**

The MiniDos low-mid flow, fluid (water)-driven proportional injectors offer an ideal alternative to traditional, non-electric technology. These injectors are compact and offer the widest range of injection ratios.

	Item #	GPM	Ratio	Pressure	Percentage Rate	Barcode
<b>MiniDos 2.5%</b>	DOSM112602	0.03 - 12GPM	1:200 - 1:40	6 - 140PSI	0.50 - 2.5%	



**Dosmatic™ Chemilizer**

An industry-leading chemical injector that utilizes years of proven diaphragm technology. Powered by the existing water supply, the internal motor drives the chemical pump, injecting very precise amounts of chemical.

	Item #	GPM	Ratio	Pressure	Percentage Rate	Barcode
<b>Chemilizer - Fixed</b>	DOSMCH9000	0.02-11GPM	1:128 Fixed	3-85PSI	0.78%	



**Dosmatic™ Advantage 30 Injector**

The Advantage 30 operates without electricity to precisely inject liquid concentrates into a water supply line using fluid flow as the power source. Features: chemicals are thoroughly mixed before output, ratio easily adjustable and composite body construction.

	Item #	GPM	Ratio	Pressure	Percentage Rate	Barcode
<b>Advantage 30 2.5%</b>	DOSMSPV0182	30GPM			2.5%	

**Twist II Clean® Filter**

Just a gentle 1/4 twist of the handle begins the patented reverse flushing action, and the Twist II Clean backwashes itself from inside-out. Just a few seconds later, all debris is forcefully cleaned off the filter element and flushed from the bottom port



**1in**  
**LAK132067**

Min. Buy 1ea



**Dosmatic™ HydroFoamer Hose End**

Hose end hydro foamer for Strip-It. The HydroFoamer's unique injection concept mixes the proper amount of concentrate with both air and water to produce a thick, rich foam for longer soak time.



**For Strip-It**  
**DOSM481**

Min. Buy 1ea





## Fertilizer Injectors

### Dosmatic™ Wear Parts Kit A

Kit includes dosage piston and O-ring for SuperDos and Advantage Injectors.



**For SuperDos and Advantage injector**

**DOSM011850V** Min. Buy 1ea

### Dosmatic™ Wear Parts Kit C

Kit includes dosage piston, inner Cylinder and O-ring for MiniDos Injectors.



**For MiniDos injector**

**DOSM011045V** Min. Buy 1ea

### Dosmatic™ Wear Parts Kit C

Kit includes dosage piston, inner Cylinder and O-ring for SuperDos and Advantage Injectors.



**For SuperDos and Advantage injector**

**DOSM011850CV** Min. Buy 1ea



## Greenhouse Ventilation

### Green-Tek® High Performance HAF Fan

Great performance, energy efficiency and an air pattern that is designed for heat de-stratification. The OSHA approved guard means the fan can be mounted at any height. Our totally enclosed air over motor can be used in the harshest greenhouse environments. GT HAF Fans are easy to install and will give years of trouble free service. The ideal spacing is every 50'. Comes with a 9ft cord.



**12in, with 9ft Cord**  
**GRTKHVB12110C** Min. Buy 1ea



**20in, 1/10HP, with 9ft Cord**  
**GRTKHAF20110C** Min. Buy 1ea



**24in, with 9ft Cord**  
**GRTKHVB2412C** Min. Buy 1ea



# Pro-Grow SuppyCorp.

## Other Equipment

### Pro-Grow Supply Propagation Mat

Place flats directly on this heavy rubber mat and get even bottom heat for starting seeds and cuttings. Instructions for use in each carton with mat. Thermostat sold separately.



**22in x 60in / Cord 6ft / 200Watts @ 120Volts / 5**

**Flat Capacity / Shipping Weight 13lb**

**PGSPM-9A** Min. Buy 1ea



### Pro-Grow Supply Gro-Control Thermostat

Heavy duty construction thermostat for control of up to 2 propagation mats.



**Cord 6ft with series tap plug / 120V-720W-A8 Res, 1/6HP Ind**

**PGSGC-1** Min. Buy 1ea



**Cord 6ft with grounding plug / 120V-1500W-12.5A Res, 1/6HP Ind**

**PGSGC-4** Min. Buy 1ea



# DRAMM®

## Sprayers & Parts

### DRAMM® MSO & MS Gas Sprayers

The Dramm Heavy Duty MSO and MS-GAS sprayers might be small, but they pack a punch. With a low-flow gun and high pressure, each atomizes the spray into fine droplets for even coverage. The electric MSO operates at a maximum of 500 psi while the MS-GAS operates at a top pressure of 350 psi. Both are available as a pumpset with hose and gun alone or as part of a 20 gallon cart and tank package. Different hose lengths and gun options are available. Finally, both are available with the Bigfoot wheel package that adds pneumatic wheels and casters for more rough terrain.

### DRAMM® MSO Heavy Duty Gas Sprayer

Model MSO is a hydraulic sprayer with fully adjustable pressures, making it a highly flexible tool for the application of pesticides, fungicides, wetting agents, cleaning solutions and disinfectants. By simply twisting the spray gun knob you can adjust the pressure from a stream that throws up to 20 feet to an eight foot diameter mist. Pneumatic Turf tires are available on special order.



**Gas Two Cycle Engine, 350psi, 1/2hp, 1.8gpm, 66ft Discharge Hose, 20gal Tank**  
**DRMMMS20GAS66BF** Min. Buy 1ea

### DRAMM® Chemdose™

Portable solution for precise dosing of chemical solutions directly to the pot or root zone. Cart mounted with a 20gal tank, an 18" width and a rechargeable batter. Includes three different wand lengths.



**20gal**  
**DRMCD120** Min. Buy 1ea

### DRAMM® Ferticart

With years of experience in building carts for greenhouse chemical application systems, Dramm offers our portable injector carts. Utilizing the popular MSO cart and tank, the Dramm Injector Cart can be used with a variety of injectors. Available in a single 20 gallon tank model or in a three, 7 gallon tank model, the FertiCart offers portability and flexibility in injection.

Made from rubber coated steel with a plastic mounting plate, the Dramm Injector Cart can stand up to all greenhouse chemicals, including disinfectants and acids with no trouble. The FertiCart includes all fittings and connections. Unions on either side of the injector allow for easy installation or removal for service. Combine the Injector Cart with any of Dramm's line of watering tools to complete the package.



**Three 7gal Tanks**  
**DRMMFC3X7DT** Min. Buy 1ea

**Three 7gal Tanks with D14 Dosatron Injector**  
**DRMMFC3X7DTD14MZ2VFBPII** Min. Buy 1ea



**20gal Tank with D14 Dosatron Injector**  
**DRMMFC20DTD14MZ2VFBPII** Min. Buy 1ea



**50gal Agitation with 20gpm Dosatron Injector**  
**DRMMFC50AD45RE15VFI** Min. Buy 1ea



**100gal with Agitation**  
**FST100AD40MZ2BPVFI** Min. Buy 1ea

### DRAMM® MSO Heavy Duty Hydraulic Sprayer

Model MSO is a hydraulic sprayer with fully adjustable pressures, making it a highly flexible tool for the application of pesticides, fungicides, wetting agents, cleaning solutions and disinfectants. By simply twisting the spray gun knob you can adjust the pressure from a stream that throws up to 20 feet to an eight foot diameter mist. Pneumatic Turf tires are available on special order.



**Electric Motor, 500psi, 1/4hp, 0.5gpm, 33ft**  
**DRMMMSO** Min. Buy 1ea

**Electric Motor, 500psi, 1/4hp, 0.5gpm, 100ft Discharge Hose, 20gal Tank**  
**DRMMMS20100** Min. Buy 1ea



### DRAMM® Extension Lance

To complete your heavy duty sprayer, add an optional extension lance. The undersides of leaves can be reached with lance, therefore applying spray solution where it is needed. Excellent for whitefly control.



**For MSO, CS-5AGS or MS-GAS**  
**DRML5** Min. Buy 1ea



### DRAMM® MSO Trigger Style Spray Gun

Adjustable Output with On/Off Trigger for MSO, CS-5AGS or MS-GAS. Corrosion resistant.



**0.5gpm**  
**DRMMSTGSS** Min. Buy 1ea



### DRAMM® Chemdose™ 2

A portable, hose-end unit that connects to either an injector or hydraulic sprayer below 100 psi. This eliminates problems with hose length and power. Tank not included.



**DRMCD2** Min. Buy 1ea



# DRAMM

## Sprayers & Parts

### Dramm® Hydra™ 200 G Sprayer

The Hydra200G - 200 gallon hydraulic sprayer extends the Hydra line to larger spray capacities. Utilizing our durable and powerful triplex pump, the Hydra has capacity to utilize two hoses at a time when powered by a gasoline engine. Each reel can fit up to 250ft of hose. The 200G can also be mounted with a single, larger reel for up to 300ft capacity. The Remote Wind reel can be attached for automatic winding of the hose during spray application. In addition to the 200 gallon tank, the 200G has the capacity to add a separate 20 gallon tank for smaller jobs. Switch spray solution source on the fly to change chemicals during the application. The 200G is built on a rugged, powder coated steel frame with pneumatic tires with easy-to-manuever steering. Options for build include tank setup, manual or automatic rewind, gas or electric motor. Contact BFG for custom quote!



**Gas Engine, Two Reels, 150ft Hose, 20gal Tank**

**DRMHYDRA200G150T20** Min. Buy 1ea

**Gas Engine, Two Reels, 200ft Hose, 20gal Tank**

**DRMHYDRA200G200T20** Min. Buy 1ea

**Gas Engine, 250ft Hose**

**DRMHYDRA200G250** Min. Buy 1ea

**Gas Engine, Two Reels, 250ft Hose**

**DRMHYDRA200G2R250** Min. Buy 1ea

**Gas Engine, 250ft Hose, 20gal Tank**

**DRMHYDRA200G250T20** Min. Buy 1ea



### Dramm® Hydra™ Trigger Spray Gun

Adjustable output for Hydra™ Sprayers. Adjusts from a straight stream to a fine cone with an easy to use lever. Comes standard with the Hydra™ line of sprayer. Various nozzle tips available.



**1mm**  
**DRMMS40TG** Min. Buy 1ea

**1.5mm**  
**DRMMS40TG15** Min. Buy 1ea



### Dramm® Hydra™ Adjustable Stainless Steel Spray Gun

Adjustable output for Hydra™ Sprayers.



**Includes #4 Tip - Other Sizes Available**  
**DRMMD9** Min. Buy 1ea



### Dramm® Drench Adaptor for Hydra™ Sprayer

The Dramm Drench Adaptor works with the Hydra line of sprayers to offer drenching capabilities with a familiar tool. Consisting of a 24 Aluminum Handi-Reach Handle, a 170AL Water Breaker Nozzle, a Dramm 300 Brass Shut-Off Valve and a male, stainless steel quick connect, the Drench Adaptor allows a quick switch to drenching from spraying.



**24in**  
**DRMMS40DA** Min. Buy 1ea



### Dramm® Hydra™ 50 Sprayer

The Dramm Hydra Multi-spray Hydraulic Sprayer is a high volume hydraulic sprayer capable of performing a variety of tasks. The Hydra is perfect for the application of insecticides, fungicides, growth regulators, fertilizers, disinfectants and other chemicals. With a pump output of 4gpm, the Hydra offers enough volume to utilize a choice of guns and agitate the tank at the same time. The pump has a maximum operating pressure of 550psi with a fully adjustable regulator. This allows for a variety of droplet sizes and spray distances. The Hydra uses a close-coupled pump to eliminate belt or chain maintenance and is run by a sealed 1.5hp electric motor. The standard gun offers a choice of patterns with an output of 1.3gpm. Different nozzle tips are available for lower or higher flow rates. The Hydra comes standard with a 50 gallon tank on a maneuverable cart with rear casters for easy turning when full. The unit includes 150ft of hose on a variable drag reel. 250ft hose length available.



**Electric Motor, Single Reel, 150ft 1/4in Hose, 50gal Tank**  
**DRMHYDRA50150** Min. Buy 1ea



### Dramm® Hydra™ SprayTrax® 50 Gallon/100 Gallon

Capitalizes on years of experience in chemical applicator design to make a powerful sprayer that is easy to use. Stainless inner sleeved, triplex piston pump coupled to a 5.5 HP Honda gasoline motor producing 7 gallons per minute. The SprayTrax cart is designed for maximum maneuverability with tracking axles that both turn. The SprayTrax can turn 360 degrees within 7ft.



**Gas Engine, Single Reel, 150ft Hose, 50gal Tank**  
**DRMHYDRAGST50150** Min. Buy 1ea



### Dramm® WC20 & WC50 Battery Powered Water Cart

The WC-20 and WC-50 Watercart are rechargeable, battery operated, portable watering systems for interior or exterior use. The battery operated pump has a flow rate of 5 gallons per minute for fast watering of containers with little spillage. The smaller unit's 20 gallon tank can be refilled 15 times, for a total of 300 gallons, before the battery needs to be recharged with the included charger. A trigger valve makes watering easy and prevents spills. A variety of nozzle choices offers flexibility in watering. Each WaterCart comes equipped with a 1/2in x 25ft hose for maximum flexibility.



### Dramm® Coldfogger™

The large tank holds enough spray solution to provide up to 70,000 sq ft of coverage in as little as 70 minutes. The powerful high pressure fog projects a plume of 30-60 micron diameter spray droplets 20 - 25ft from the hand held spray gun. The quality of spray is a tremendous improvement over conventional hydraulic sprayers that produce droplets that vary in size from 100 - 400 microns. Includes 150ft of High Pressure Hose.



**3,000psi**  
**DRMCFAR20150** Min. Buy 1ea



# DRAMM®

## Sprayers & Parts

### DRAMM® AutoFog™ Automatic Chemical Application

The Dramm Autofog automatically sprays areas up to 70,000 square feet (area varies by model) with no applicator present. The ultra-fine cloud of droplets penetrates deep into the plant canopy covering all surfaces, ensuring excellent control of greenhouse pests and diseases.

The Autofog saves time and money by eliminating the labor needed to spray while reducing the amount of chemical needed to control your pests. By creating billions of tiny spray droplets, the Autofog treats large areas with less chemical solution.

Just set the timer, mix the chemical and leave. The Autofog does the rest. The next morning, ventilate the greenhouse, clean up the Autofog. **Optional stainless steel nozzle available for use with oxidizers.**



Item #	Model	Coverage Area		Power	Type	Barcode
		Machine Alone	With HAF			
DRMMLVH10A	Mini AutoFog™	Up to 3,000sq ft	Up to 5,000sq ft	120V AC	Single Nozzle	
DRMMLVH10ASS	Mini AutoFog™	Up to 3,000sq ft	Up to 5,000sq ft	120V AC	Single Nozzle	
DRMSLVH20A	AutoFog™	Up to 12,000sq ft	Up to 26,000sq ft	120V AC	Air Assist	
DRMSLVH20ASS	AutoFog™	Up to 12,000sq ft	Up to 26,000sq ft	120V AC	Air Assist	
DRMLVH20A	Large AutoFog™	Up to 30,000sq ft	Up to 70,000sq ft	208/220V AC	Air Assist	

### DRAMM® Stainless Steel Nozzle

Nozzle for AutoFog for use with corrosive chemicals to prevent damage to nozzle.



for SLVH and MLVH

**DRM129J753A2** Min. Buy 1ea

for LVH and DLVH

**DRM129J754B2** Min. Buy 1ea



### DRAMM® K-10 Portable PulsFOG®

Rapidly applies chemicals as a fog. The ultra-fine cloud of droplets penetrates deep into the plant canopy covering all surfaces, ensuring excellent control of greenhouse pests and diseases. For greenhouses. Fogs 10L in 45 minutes. Propels fog up to 65ft.



**25hp / 10L**

**DRMK10** Min. Buy 1ea



### DRAMM® PulsFOG® Turbo Hybrid Coldfogger

The PulsFOG Turbo Hybrid is an electrically powered, pneumatic coldfogger. Its high-performance turbine creates a powerful, warm flow of air that atomizes and propels the fog up to 75ft, depending on the nozzle and particle size. The output and droplet size of the Turbo Hybrid may be altered by changing the nozzle for a variety of applications and results. The Turbo Hybrid is perfect for the directed application of pesticides, fungicides and disinfectants, including corrosive chemicals. Because the unit is a cold fogger, the Turbo ULV is ideal for the application of bio-rational products. For best operation, the Turbo Hybrid requires the use of a carrier solution to help with particle atomization.



**5L Capacity**

**DRMTULV110** Min. Buy 1ea



### DRAMM® K-22 Standard PulsFOG®

Rapidly applies chemicals as a fog. The ultra-fine cloud of droplets penetrates deep into the plant canopy covering all surfaces, ensuring excellent control of greenhouse pests and diseases. For greenhouses. Fogs 10L in 30 minutes. Propels fog up to 120ft.



**50hp / 10L**

**DRMK22** Min. Buy 1ea



### DRAMM® PulsFOG® Cleaning Solution PFC

Cleaning solution for Dramm fogging equipment.



**1gal**

**DRMPFC1** Min. Buy 1ea



### DRAMM® Nutrifog™

NutriFOG for PulsFOG™ thermal foggers is a 10-3-3 foliar fertilizer and carrier solution to improve fogging performance. When used correctly, NutriFOG will improve the fog quality and coverage distance by reducing the surface tension of the water in the PulsFOG spray tank. It can be used with all chemical formulations.



**20L**

**DRMNF20** Min. Buy 1ea



# DRAMM®

## Other Equipment

### Dramm® Single Stage Thermostat

The Dramm Microfan mechanical thermostats are designed with rough environments in mind. These high quality thermostats are perfect for any situation where harsh conditions may damage less durable equipment. Protected in sealed PVC housings, these thermostats offer stainless steel coiled sensors and accuracy to 1°C. The SPDT (Single Pole Double Throw) switch contact (one set of contacts open on temperature rise as the other set closes) is a no load contact and offers superior accuracy.



**DRMT41** Min. Buy 1ea

**DRMT42** Min. Buy 1ea



## Sprayers & Parts

### Dramm® Back Pack Sprayer with Lithium Ion Battery

The Dramm BP-4 Back Pack Sprayer is a rechargeable, battery powered, high-pressure sprayer that fits comfortably on your back. Operating at a maximum of 150 psi, the BP-4 atomizes spray solutions for excellent coverage. The battery operated pump ensures even flow rates. The 4 gallon capacity is just the right size. Perfect for spot treatments or concentrated applications, but small enough to still be comfortable. Package includes a quick change battery and a quick charger. Operating time on one battery is 45 min.



**150psi**

**DRMBP4LI** Min. Buy 1ea



## Greenhouse Ventilation

### Dramm® AME Horizontal Air Flow System

The Dramm AME Horizontal Air Flow (HAF) Fans offer efficiency, flexibility, and simplicity. Utilizing an aerodynamic design and a high-efficiency motor, the AME fan is equipped to maximize the air flow potential of any situation. When combined with speed controllers, the AME Fans offer unmatched flexibility in air flow as plants grow and mature. Because of their shrouded, aerodynamic design and high-efficiency motor, Air Movement Efficiency (AME) fans cover greater distances with better, more even air speeds. The AME Fan design provides leverage for air movement. The result is not only increased forward propulsion but a pull from behind the fan as well.



**350mm**  
**DRM350** Min. Buy 1ea

**400mm**  
**DRM400** Min. Buy 1ea



### Dramm® 8L Foamer

Foam improves disinfection by increasing contact time. Air is pumped by hand into the chamber, pressurizing the spray solution. Some of that compressed air mixes with the spray solution in the nozzle to create an air-rich foam. The aerated foam slowly degrades over time, allowing for more contact time. The Foam 8L comes with three different mixing valves to allow for different air/solution ratios and different qualities of foam. Five liter tank will treat up to 500sq ft. Relief valve auto opens at 60PSI.



**8lt Comression Foamer**

**DRMFOAM8L** Min. Buy 1ea



### Dramm® FM Line Foamers

The FM line of foamers uses compressed air (not included) to propel and create a rich, aerated foam for the application of disinfectants. When connected to a compressor, the FM units can throw a foam up to 15 feet, providing excellent coverage and a persistent foam. Unlike siphon-based foamers and hose-end equipment that create suds, a foam created with compressed air is much richer and will last on surfaces longer. Compressed air foams adhere to vertical surfaces well, allowing for better disinfection. Available with our standard, solid rubber wheel package or the Big Foot Upgrade.



**20gal with 50ft Hose**

**DRMFM2050** Min. Buy 1ea



**50gal with 50ft Hose**

**DRMFM5050** Min. Buy 1ea



**50gal with 50ft Hose Big Foot**

**DRMFM5050BF** Min. Buy 1ea



**100gal SprayTrax with 50ft Hose**

**DRMFMST1001R50** Min. Buy 1ea

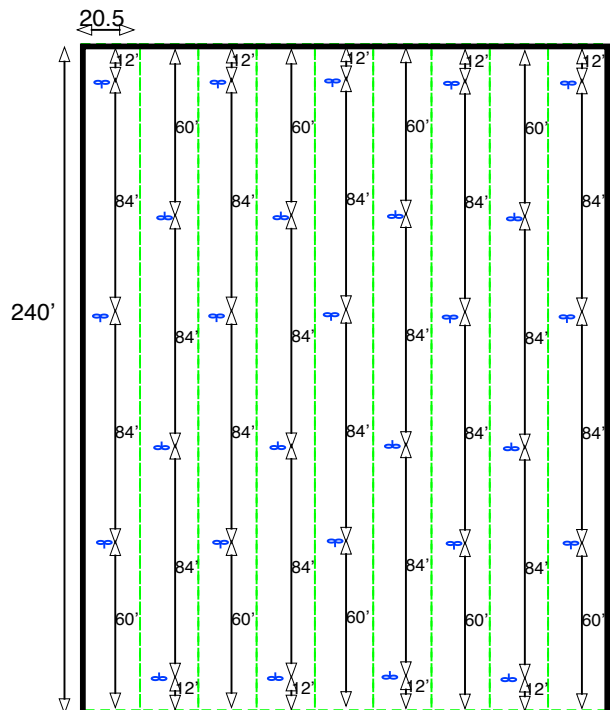



**Greenhouse Ventilation**

**ACME Ventilation Motorized Shutter Motor & Linkage**

Shutter motor for single and double panel shutter. Includes motor, mounting bracket, cam assembly, retainer spring and hardware.



**Model #316675C**  
**ACME316675C** Min. Buy 1ea

**ACME Ventilation Motorized Shutter Motor & Spring**

Shutter motor and spring for single and double panel shutter. Includes motor and spring.



**Model #697470C**  
**ACME697470C** Min. Buy 1ea



**Greenhouse Ventilation**

**American Coolair® Inlet Shutter**

Designed to allow fresh air to enter the greenhouse as the fans at the opposite side/end of the building exhaust it. Features aluminum blades, extruded aluminum frame, aluminum blade brackets and tie bars, blades pivot on nylon bushings, heavy duty gear motor and chain linkage.



**AMCALRW39E** Min. Buy 1ea



**Other Equipment**

**Bartlett Instrument Natural Ventilation Controller**

Easy, affordable, touchscreen model featuring DIF, DAY and NITE stages for better crop management. Two heat and time proportional outputs. Proportional outputs open and close in five steps with manual override. Can control one or two separate zones. Optional remote app control with Headgrower.



**BARTIRWL11X2** Min. Buy 1ea



**American Coolair® Tube Hanger Kit**

For use in hanging the Power Tube coming off the Power Tube Fan. Hanger kit includes barrel, insert and clip.



**AMCPTF-TH** Min. Buy 1ea



**Bartlett Instrument Temperature Control**

Low-cost touchscreen greenhouse temperature control that is easy to operate, install and manage. Optional remote app control with Headgrower. Provides energy cost savings and data graphs. Features include: two zone controllers; DIF, DAY and NITE settings; four cool and two HAF relay outputs; two heat outputs, automatic or manual settings; timer and alarm output and vent stage for dehumidification.



**BARTIGHK12X2** Min. Buy 1ea



**Bamboo Trellises, Stakes & Supports**

**Bamboo Supply® Natural Bamboo Fan Trellis**

Support your favorite vining plants with these lightweight, inexpensive yet strong trellises that weather well and last several seasons in the garden.



- 18in**  
BAMBBFT18 Min. Buy 1ea
- 24in**  
BAMBBFT24 Min. Buy 1ea
- 30in**  
BAMBBFT30 Min. Buy 1ea
- 36in**  
BAMBBFT36 Min. Buy 1ea
- 48in**  
BAMBBFT48 Min. Buy 1ea



**Bamboo Supply® Natural Bamboo Flair Trellis**

Natural bamboo flair trellis with two vertical stakes.



- 18in High**  
BAMBBNFT18 Min. Buy 1ea
- 24in**  
BAMBBNFT24 Min. Buy 1ea
- 30in**  
BAMBBNFT30 Min. Buy 1ea



**Bamboo Supply® Natural Bamboo Stake**

High Quality all natural stakes used for many things including plant support.



- 2ft**  
BAMBBN0206 Min. Buy 1ea  
**2.5ft, 8-10mm Diam.**  
BAMBBN02508 Min. Buy 1ea
- 3ft**  
BAMBBN0308 Min. Buy 1ea  
**3ft 12-14mm Diam.**  
BAMBBN0312 Min. Buy 1ea
- 4ft**  
BAMBBN0408 Min. Buy 1ea  
**4ft, 10-12mm Diam.**  
BAMBBN0410 Min. Buy 1ea  
**4ft, 12-14mm Diam.**  
BAMBBN0412 Min. Buy 1ea
- 6ft**  
BAMBBN0612 Min. Buy 1ea  
**6ft, 18-20mm Diam.**  
BAMBBN0618 Min. Buy 1ea  
**8ft, 24-26mm Diam.**  
BAMBBN0824 Min. Buy 1ea  
**10ft, 26-28mm Diam.**  
BAMBBN1026 Min. Buy 1ea  
**12ft, 28-30mm Diam.**  
BAMBBN1228 Min. Buy 1ea



**Bamboo Supply® Natural Bamboo "U" Trellis**

Upside down "U" for climbing plant support.



- 18in**  
BAMBBTN18 Min. Buy 1ea
- 24in**  
BAMBBTN24 Min. Buy 1ea
- 30in**  
BAMBBTN30 Min. Buy 1ea
- 36in**  
BAMBBTN36 Min. Buy 1ea
- 48in**  
BAMBBTN48 Min. Buy 1ea



**Bamboo Supply® Green Bamboo Stake**

High-Quality all-natural stakes used for many things including plant support. Poles are dyed forest green to blend into landscapes



- 18in**  
BAMBBG01504 Min. Buy 1ea
- 2ft**  
BAMBBG0204 Min. Buy 1ea  
**2.5ft, 5-7mm Diam.**  
BAMBBG02505 Min. Buy 1ea
- 3ft**  
BAMBBG0306 Min. Buy 1ea
- 4ft**  
BAMBBG0408 Min. Buy 1ea
- 5ft, 10-12mm Diam.**  
BAMBBG0510 Min. Buy 1ea
- 6ft, 10-12mm Diam.**  
BAMBBG0610 Min. Buy 1ea



**Bamboo Supply® Green Split Pointed Bamboo**

Round solid bamboo stakes with points, ideal for staking potted plants including orchids and other exotic plants.



- 12in**  
BAMBBS12 Min. Buy 1ea
- 16in L, 4-4.5mm Diam.**  
BAMBBS16 Min. Buy 1ea
- 18in L, 5-5.5mm Diam.**  
BAMBBS18 Min. Buy 1ea
- 24in L, 5-5.5mm Diam.**  
BAMBBS24 Min. Buy 1ea



**Bamboo Supply® Rubber Trellis Teepee Cap**

For making your own teepee with three bamboo stakes up to 1/2in diameter



- Green**  
BAMBRCT100 Min. Buy 1ea





**Other Equipment**

**Bluelab® 4.0 Calibration Solutions**

Calibration and conductivity standard solutions...a must in every grower's toolbox. The Bluelab® calibration and conductivity standard solutions are essential for use with all Bluelab® products. Bluelab® solutions are manufactured specifically for Bluelab® products and are referenced to high laboratory standards to ensure your Bluelab® products last longer and maintain accuracy.



**250ml Bottle**  
**BLBPH4250BL** Min. Buy 6ea

**500ml Bottle**  
**BLBPH4500BL** Min. Buy 6ea



**Bluelab® 7.0 Calibration Solutions**

Calibration and conductivity standard solutions...a must in every grower's toolbox. The Bluelab® calibration and conductivity standard solutions are essential for use with all Bluelab® products. Bluelab® solutions are manufactured specifically for Bluelab® products and are referenced to high laboratory standards to ensure your Bluelab® products last longer and maintain accuracy.



**250ml Bottle**  
**BLBPH7250BL** Min. Buy 6ea

**500ml Bottle**  
**BLBPH7500BL** Min. Buy 6ea



**Bluelab® 2.77EC Conductivity Standard Solution**

Bluelab® conductivity standard solutions are essential for use with all Bluelab® products. Bluelab® Solutions are manufactured specifically for Bluelab® products and are referenced to high laboratory standards to ensure your Bluelab® products last longer and maintain accuracy.



**250ml Bottle**  
**BLBEC277250BL** Min. Buy 6ea

**500ml Bottle**  
**BLBEC277500BL** Min. Buy 6ea



**Bluelab® pH Probe KCl Storage Solution**

The perfect solution to store and hydrate pH probes. pH probes are sensitive glass instruments which age through everyday use. Bluelab® pH Probe KCl Storage Solution is made specifically for use with Bluelab® pH Probes and Pens. It is designed to increase response time and maximize the life of Bluelab® pH Pens and pH Probes. Add KCl solution to the cap of the pH pen/probe for storage after use and hydrate in KCl solution monthly. Instructions are on the label of the bottle.



**120ml Bottle**  
**BLBSTSOL100BL** Min. Buy 6ea

**250ml Bottle**  
**BLBSTSOL250BL** Min. Buy 6ea



**Bluelab® pH Pen**

The preferred option for hand held pH meters. It provides a compact, quick and handy way to manage the success of your crops to ensure maximum uptake of nutrients. A key parameter that affects nutrient uptake is whether your solution is acid or alkaline. This is measured in the pH. Teamed with the Bluelab® Conductivity Pen you have a robust, convenient and accurate measurement system. Features: · Measures pH and temperature · Selectable units for temperature · Fully waterproof · Backlit LCD display · Double junction probe (not replaceable) · Simple two point calibration process with 30 day calibration indicator · Hold reading function · Low battery indicator · Auto off function · Automatic temperature compensation · 1 AAA replaceable battery included



**BLBPNPH** Min. Buy 1ea



**Bluelab® Conductivity Pen**

The go-to for hand held conductivity pens. The Bluelab® Conductivity Pen simply tells you the amount of nutrient in your solution. Conductivity is automatically compensated with the integrated temperature sensor. Providing a compact, quick and accurate way to measure two key parameters for crop health. Teamed with our Bluelab® pH Pen you have a robust, convenient and accurate measurement system. Features: · Measures conductivity and temperature · Selectable units for conductivity and temperature · Shows conductivity scales CF, EC, PPM 500 & PPM 700 at the touch of a button · Fully waterproof · Backlit LCD display · Calibration optional · Successful 30 day calibration indicator · Hold reading function · Low battery indicator · Auto off function · Automatic temperature compensation · 1x AAA replaceable battery included



**BLBPNCON** Min. Buy 1ea



**Bluelab® Multimedia pH Meter**

Combine the Bluelab® Multimedia pH Meter and Bluelab® Leap™ pH Probe to take fast accurate measurements in nutrient solution, soil, coco coir, rockwool, potting mix and many other media types. Calibration is simple with one push button on the meter and fresh Bluelab® Calibration Solutions. Successful calibration indicator is displayed on screen for 30 days to indicate when re-calibration is required. Team with the Bluelab® Solutions and the convenient Bluelab® Carry Case. Replacement Bluelab® pH or Leap™ pH Probe available too. Features: · Test more with a faster sensor response and direct measurements from substrates · Multimedia friendly, for measurements across a range of environments · Toughened spear tip for direct root-zone measurements · Simple two point calibration process with 30 day calibration indicator · Backlit LCD display, low battery indicator, auto off function



**2 metre / 6.6 foot standard cable**  
**BLBMETMULTI** Min. Buy 1ea



**Bluelab Truncheon® Nutrient Meter V2**

Displaying all the conductivity scales EC, CF, PPM 500 & PPM 700 on a single line. Each time you feed your plants it's essential to know the nutrient levels of your solution. Simply done with the Bluelab® Truncheon® Nutrient Meter. Flashing lights indicate your conductivity reading, which is automatically compensated with the integrated temperature sensor. Removable shroud for easy cleaning. Features: · Conductivity range up to 3.6 EC, 36 CF, 1800 ppm 500 and 2520 ppm 700 · Fully waterproof · Provided with EC, CF, ppm 700 and ppm 500 scales · Auto on/off function · No calibration required (factory calibrated) · Daylight readable blue LEDs, visible in bright or dark environments · No buttons or switches · Battery operated (3x AA batteries included) · Measure while mixing nutrients in your reservoir



**Meter length: 40cm / 16 in.**  
**BLBTRUNV2** Min. Buy 1ea





## Meters & Testers

### BlueLab® Pulse Multimedia EC/MC Meter

Spot check, correct, achieve better yield and grow healthier plants across a wide range of growing media including soil, coco coir, potting mix and nutrient solution. Automatically sends and stores all your key plant statistics in the Pulse Mobile Features: · All in one device that measures moisture content, conductivity and temperature · Quick reference visual light indicator on the device to let you know the measurement has been made and if it is in or out of range · Vibrating notification on the mobile device to let know you that measurement was received · Test more in a shorter timeframe with a fast sensor response and direct measurements in a wide range of growing media including soil, nutrient solution, coco coir and potting mix · Two extended prong spear tips with a total of 8" (200 mm) including the 2" (50 mm) active measurement tips for direct root zone measurements · Handset: 7.5" (190 mm) x 3" (76 mm) · Low battery indicator · 1 x AA alkaline battery included · Applications across agriculture, floriculture, container grown plants and greenhouses · Works with Android 5.1+ with Bluetooth 4.0+



**BLBMPULSE** Min. Buy 1ea

### BlueLab® Combo Meter

A convenient and portable solution pH, conductivity, and temperature meter all in one. Easy to read screen and push button operation, choose your preferred parameter to display. Portable with no external power supply required, this meter can be used anytime and anywhere to help manage your plant's daily nutrient requirements. Team with BlueLab® solutions and the convenient BlueLab® Carry Case. Features: · Replaceable double junction pH probe included · Shows conductivity scales CF, EC, PPM 500 & PPM 700 at the touch of a button · Large easy to read, backlit LCD display · No calibration required for conductivity and temperature (factory calibrated) · Simple two point pH calibration process with 30 day calibration indicator · Over range and under range indicators · Low battery indicator · 2x AAA alkaline batteries included · Auto off function



**BLBMPULSE** Min. Buy 1ea



**Probe cable length: 2 meters / 6.5 feet**

**BLBMPULSE** Min. Buy 1ea

### BlueLab® Guardian Monitor In-Line Connect

Threaded probe heads allow for simple installation direct into an irrigation line for effective in-line measurements. Features: · pH and EC in-line threaded probes to fit into in-line plumbing · Remote viewing with BlueLab® Connect™ Software and Apps · Replaceable double junction high pressure pH probe included · Bright, plant-safe green LED with adjustable brightness · Easy to navigate menu to program & adjust settings · Selectable conductivity and temperature scales · Simple push button pH calibration · No calibration required for conductivity and temperature (factory calibrated) · Flashing high and low alarms (non-audible) · Built with greater tolerance to RF / electronic interference · International power supply



**In-line pH probe cable length: 3 meters / 10 feet**

**BLBMONGUAACONIN** Min. Buy 1ea

### BlueLab® pH Controller

Fine-tunes the reservoir pH levels for you. Confidence - your pH is taken care of. Automatic measuring and adjusting to pre-set pH levels with optional alarms. Provides consistent control of pH in growing systems. Intuitive "on time" and "off time" allows the solution to dose and mix before the controller measures and doses again. Reassurance with safety lockouts to prevent over delivery of pH. Features: · Automatic control of pH level in systems with reservoirs up to 200 gallons / 760 litres · Dose either pH up or pH down adjusters · Replaceable double junction pH probe & peristaltic pump · Plant-safe green backlit LCD with adjustable brightness · Large, easy to read display · Easy to navigate menu to adjust settings · Simple push button pH calibration with on screen instructions · Flashing high and low alarms with control lockouts · Water resistant, wall mount design · Separate BlueLab® Temperature Probe (for pH ATC)



**Probe cable length: 2 meters / 6.5 feet**

**BLBCONTPH** Min. Buy 1ea

### BlueLab® Combo Meter Plus Replacement Probe



**BLBPROBPHLEAP** Min. Buy 1ea

### BlueLab® Guardian Monitor

Monitoring your crops 24 hours a day, with the ability to set high and low alarms for each parameter. A flashing display lets you know if your parameters move away from the optimum, allowing you to make the important adjustments quickly and effectively. The large, clear display allows readings to be viewed from a distance. The BlueLab® Guardian Monitor is mains powered and is either mounted to the wall or hung on a support and probes positioned inside your reservoir / solution. Features: · Wall mount for continuous viewing · Plant-safe green LEDs, with adjustable brightness · Large easy to read displays · Replaceable double junction pH probe included · Easy to navigate menu to program & adjust settings · Selectable conductivity and temperature scales · No calibration required for conductivity and temperature · Simple push button pH calibration · Flashing high and low alarms (non-audible) · Built with greater tolerance to RF / electronic interference · International power supply · Non-volatile memory



**Probe cable length: 2 meters / 6.5 feet**

**BLBMONGUA** Min. Buy 1ea



**Probe cable length: 2 meters / 6.5 feet**

**BLBMONGUAACON** Min. Buy 1ea

### BlueLab® Combo Meter pH Replacement Probe



**BLBPROBPH** Min. Buy 1ea



## Other Equipment

### BlueLab® Connect Stick

Collects information wirelessly from BlueLab® Connect™ devices to your computer. One BlueLab® Connect™ Stick receives data wirelessly from multiple BlueLab® Connect™ devices. Download the free BlueLab® Connect™ software, to get grow site data direct to your local computer and mobile app. Get connected...



**BLBCONSTICK** Min. Buy 1ea





**Watering Booms and Systems**



**Single Rail Boom**

Cherry Creek's Single Rail Boom is a cost-effective automatic system, designed with simplicity and efficiency in mind and ideally suited for smaller bays with simple watering requirements. Its rugged, compact housing is built to move up and down a greenhouse on one rail. It's spray bar is turned on or off by a single solenoid, and the boom waters the full width of the bay.

**Walking (Navigator) / Tower Booms**

Cherry Creek's Tower Boom is designed to be a workhorse for all of your irrigation, maintenance and crop inspection needs. It is almost completely pre-assembled at the factory, and is supported by rails mounted off the gutter posts on both sides of the bay that span the width of the greenhouse.

- Rugged construction
- Precise application of water and chemicals
- Water savings and reduction in labor
- Adaptable for conveyors and scaffolding
- Pre-assembled for easy installation
- Transportation system for equipment & humans.

**NEW TIC (Touch Irrigation Controller)**

Boom automation allows for controlled application rates of water and chemicals, which reduces overspray and results in long-term savings. Automatic irrigation will also significantly reduce labor costs. The new TIC is available on the Double Rail Booms, Walking (Navigator) Booms and Tower Booms. The TIC has the following enhancements:

- 16 Crops with their own 8 Areas that can Water, Mist and/or SSW all within the same Crop, 4 Schedules with 7 days of the week options. (ssw = step, stop, water).
- Auto Mode / Manual Mode with Queue position over-ride
- Touch Screen with Grower Friendly Menus
- Wifi capability for cell phone/iPad & remote access.

**Double Rail Boom**

Cherry Creek's Double Rail Boom offers the versatility of independent watering of the right, left, or both sides of the greenhouse, along with walk-through for walkways. With the stability of two running rails, boom sway is eliminated. Combined with the New TIC, the Double Rail Boom handles the most complicated application requirements, assuring precise rates of water and chemicals. Save significantly on both water and labor costs. Booms are nearly fully assembled and simple to install.

**ECHO Hanging Basket System – Water By Weight**

The ECHO System allows for accurate measurements of water to each basket. Additionally, fertilizer applications can be consistently controlled, resulting in faster production times, higher yields, and more crop turns per season.

The NEWWBW (Water By Weight) Controller has the following features:

- 10" Touch Screen with Wifi capability for cell phones & iPads
- Water By Time Mode / Water By Weight Mode, 7 Day Schedule with Repeat Cycle every "X" hrs., 16 Schedules.
- WBW mode has a dry weight and wet weight setting for optimal root growth.

The gentle movement of the plants as they go through the watering mode allows them to experience various lighting exposures and air movement over the surface, which promotes healthier growth. The ECHO leaves the factory fully assembled, making installation fast and simple.

**Contact your BFG Sales Rep**  
for pricing and customized solutions  
for your operation.

**Touch Irrigation Controller TIC**



**Water By Weight Controller (WBW)**



## Fertilizer Injectors

### Dosatron Non-Electrical Proportional Injectors

#### Why Dosatron?

- Proven technology used globally for over 40 years
- Consistent, accurate results
- Do-it-yourself service and support
- Outstanding service and support

#### Easy to Use

- Just turn on the water, no power needed
- Simple to install in the water line
- Dosing ratios are externally adjustable
- Built-in mixing chamber

#### The Perfect Solution For:

- Fertilizers
- Wetting Agents
- Fungicides
- Insecticides
- Acids
- Organics
- Sanitizing



Item #	GPM	Ratio	Pressure	Connection Size	Dimensions	Percentage Rate	Included Accessories
<b>D25F1</b> DOSATD25F1VFII	0.05 to 11GPM	1:100 Fixed	4.3 to 85 PSI	3/4in NPT	14in x 6-1/4in	1%	Mounting Bracket, Suction Hose, Weighted Strainer & Quick Start Guide
<b>D14MZ2</b> DOSATD14MZ2VFII	0.05 to 14GPM	1:500 to 1:50	4.3 to 85PSI	3/4in NPT	19-1/8in x 6-5/16in	0.2 to 2%	Mounting Bracket, Suction Hose, Weighted Strainer & Quick Start Guide
<b>D45RE15</b> DOSATD45RE15VFII	0.4 to 20GPM	1:500 to 1:66	7 to 70PSI	1in NPT	24in x 7-1/2in	0.2 to 1.5%	Mounting Bracket, Suction Hose, Weighted Strainer & Quick Start Guide
<b>D40MZ2</b> DOSATD40MZ2VFII	2.2 to 40GPM	1:500 to 1:50	4.3 to 116PSI	1-1/2in NPT	25-1/4in x 8-1/2in	0.2 to 2%	Mounting Bracket, Suction Hose, Weighted Strainer & Quick Start Guide
<b>D20S</b> DOSATD20SVFII	5 to 100GPM	1:500 to 1:50	2 to 120PSI	2in NPT	55in x 15in (w/ Legs); 42in x 15in (w/o Legs)	0.2 to 2%	Mounting Bracket, Set of Legs, Manual Bypass, Suction Hose, Weighted Strainer & Quick Start Guide

#### Dilution Solutions™ Li'l Bud-D Quick Hook-Up Kit

For use with the Li'l Bud-D portable fertilizer system. Fits 11gpm and 14gpm injectors. Includes: Filter, check valve, clamp, 5/8in hoses, elbows, a straight 5/8in barb to 3/4in NPT, Velcro strap and Teflon tape.



**DOSATHSPK58LB** Min. Buy 1ea



#### Dilution Solutions™ Plumbing Kit

Plumbing kit for the Dosatron® DosaCart. Dosatron unit is sold separately.



**DOSATHSPK58** Min. Buy 1ea





**Fertilizer Injectors**

**Dilution Solutions™ Li'l Bud-D**

Portable fertilization system is perfect for spot treatments. Includes 5gal bucket with lid. Accommodates the 11gpm and 14gpm injectors. Injector and hook-up kit sold separately.



**22in D x 19in W x 44 1/2in H. Tank Size: 5gal. Tire Size: 10in No-flat**

**DOSATHS15-5** Min. Buy 1ea



**Dilution Solutions™ Eco-Cart**

Portable fertilization system is perfect for garden centers and ideal for spot treatments. Includes 5gal bucket with lid, 11gpm injector and plumbing.



**15in D x 13 1/2in W x 40in H. Tank Size: 5gal. Tire Size: 7in No-flat.**

**DOSATHSECOD25F1** Min. Buy 1ea



**Dilution Solutions™ Eco-Cart**

Portable fertilization system is perfect for garden centers and ideal for spot treatments. Includes 5gal bucket with lid and plumbing. Accommodates the 11gpm and 14gpm injectors. Injector sold separately.



**15in D x 13 1/2in W x 40in H. Tank Size: 5gal. Tire Size: 7in No-flat.**

**DOSATHSECO** Min. Buy 1ea



**Dilution Solutions™ Filter Kit**

200 mesh (80 micron) filter kit includes a filter with a cleanout valve and hose couplings for quick hook-up.



**.75in - 11/14gpm**  
**DOSATAKF5AP11KIT-A** Min. Buy 1ea



**For Injector Model D45RE**  
**DOSATAKF5AP20KIT** Min. Buy 1ea

**Dosatron® Mini Maintenance Kit**

Mini maintenance kit for D14MZ2 Injector.



**For Injector Model D14MZ2**  
**DOSATPJD1116MINI-H** Min. Buy 1ea



**Dosatron® Seal Kit**

Seal kit for the 40gpm D40MZ2 injector



**For Injector Model #D40MZ2**  
**DOSATPJD1120VVF** Min. Buy 1ea



**Dosatron® Injection Seal Kit**

Injection seal kit for D14MZ2 Injector.



**For Injector Model D14MZ2**  
**DOSATPJD1116VF** Min. Buy 1ea



**Other Equipment**

**Motor Gearboxes**

De Gier Drive Systems produce a complete range of robust and durable gear motors. The GW and GXP gear motors create a solid base for complete drive systems. The various versions of gear motors are used in ventilation, screening, heating tube lifting systems, and drink and feed lines in agriculture, greenhouse horticulture and non-residential construction.

**Product characteristics of the GW and GXP gear motors:**

- Self-braking due to the application of a worm-worm gear transmission. This means that, when the gear motor is stopped, the system stays in the desired position.
- Extremely silent during use, compact, powerful, reliable and maintenance-free.
- Continuous operation S3-30% (continuous operation is limited to max. 25 minutes)
- Torque range from 10 to 2,700Nm
- RPM range from 1.3 to 30 rotations/min



**Labels, Signs & Laminators**

**DP Industries® Thermal Transfer Vinyl Wrap-Around Tag**

Thermal transfer printer compatible, vinyl material, best for use on larger plants and shrubs. Can be marked with garden pens.



**White - 1in W x 9in H / 1000 per Roll**  
**DPIWRAP91W** Min. Buy 1ea



**DP Industries® Vinyl Wrap-Around Tag "SOLD"**

Designed to easily wrap around tree or shrub branches. Preprinted "SOLD", space available to write name, date or other information.



**Red - 3/4in W x 7in H / 1000 per Roll**  
**DPIST734R** Min. Buy 1ea



**DP Industries® Garden Pen**

Thick tip, 1.2mm, plastic barrel. All-weather, fade resistant ink with UV filter to slow fading from sunlight. Xylene free and made with alcohol rather than petroleum based ink.



**Black - 0.8mm Tip**  
**DPIGM08BLK** Min. Buy 1ea  
**Black - 1.2mm Tip**  
**DPIGM77BLKBULK** Min. Buy 1ea  
**Black - 1.2mm Tip / Retail Pack**  
**DPIGM77BLKR** Min. Buy 1ea  
**Black - 1.2mm Tip / 24pc Display**  
**DPIHGM77BLKR** Min. Buy 1ea



**DP Industries® Liquid Chalk**

Liquid Chalk will not wash off from rain or general watering, but it can be removed with a moist paper towel. The makeup of these chalk markers allows them to dry and crust over to maintain water/fade protection. Once the crust has been broken, the Liquid Chalk washes away. Older writing (ghosting) can be cleaned with an alcohol based hand sanitizer. Chalk pens are convenient for use with T-signs and vinyl card signs. 0.5mm Tip.



**Assortment - Includes: Red, Yellow, Blue, Green, Orange, Pink, Violet, Black & White**  
**DPILC059PK** Min. Buy 1ea



**White**  
**DPILC05WHT** Min. Buy 1ea



**DP Industries® Plastic T-Sign Base**

This base allows Angled Top Plastic T-Signs to stand freely without the need of placing in a pot. Fits signs AT10, AT16 and AT21.



**25pk**  
**DPIBASE** Min. Buy 1ea



**DP Industries® Blank Vinyl Sign Card**

Can mark these vinyl cards with garden pens or liquid chalk.



**7in L x 5in H / 25pk**  
**DPIC57000** Min. Buy 1ea



**DP Industries® Plastic T-Sign - Angled Top**

Molded plastic T-Stakes provide cost effective signs for multiple uses. Larger writing surface and reader friendly angled tops. Works great in combination with Liquid Chalk pens. When applying Liquid Chalk you can re-use, the writing won't fade in the sun or was in the rain. Just wipe with a wet paper towel or clean with alcohol based sanitizer.



**Black - Top: 4in W x 2.5in H with 16in H Leg / 50pk**  
**DPIAT16BK** Min. Buy 1ea

**Black - Top: 6-1/4in W x 4in H with 21in H Leg / 25pk**  
**DPIAT21BK** Min. Buy 1ea



**DP Industries® Plastic T-Sign - Angled Top**

Molded plastic T-Stakes provide cost effective signs for multiple uses. Larger writing surface and reader friendly angled tops. Works great in combination with Liquid Chalk pens. When applying Liquid Chalk you can re-use, the writing won't fade in the sun or was in the rain. Just wipe with a wet paper towel or clean with alcohol based sanitizer.



**White - Top: 2in W x 1-1/4in H with 5in H Leg / 50pk**  
**DPIAT16W** Min. Buy 1ea

**White - Top: 4in W x 6-1/4in H with 20-3/4in H Leg / 25pk**  
**DPIAT21W** Min. Buy 1ea



**DP Industries® Plastic T-Sign - Straight Top**

Molded plastic T-Stakes provide signs for multiple use. Larger writing surface and reader friendly. To clean wipe with a wet paper towel or clean with alcohol based sanitizer. Easily write on them with the permanent Garden Marker or re-useable liquid chalk pens.



**Yellow - Top: 3-1/4in W x 2-1/4in H with 13in H Leg / 100pk**  
**DPITL13Y** Min. Buy 1ea

**White - Top: 2in W x 1-1/4in H with 5in H Leg / 250pk**  
**DPITL5W** Min. Buy 1ea

**White - 3-1/4in L x 2-1/4in W x 10in H / 100pk**  
**DPITL10** Min. Buy 1ea

**White - Top: 3-1/4in W x 2-1/4in H with 13in H Leg / 100pk**  
**DPITL13W** Min. Buy 1ea



**DP Industries® Natural Wood Garden Markers**

Wood labels that are not coated. These labels will biodegrade more rapidly than coated ones.



**1-1/8in W x 12in H / 250pk**  
**DPIGL12118C2** Min. Buy 1ea  
**5/8in W x 6in H / 1000pk**  
**DPIPL658M** Min. Buy 1ea  
**5/8in W x 10in H / 500pk**  
**DPIPL1058C5** Min. Buy 1ea





**Labels, Signs & Laminators**

**DP Industries® Natural Wood Field Stakes**

1/4" thickness wooden stakes. Shipped 100 per case. Mark with DPI's fade/water resistant Garden Pen. Biodegradable. Renewable. Sustainable. Environmentally Friendly.



- 18in x 1-1/8in x 1/4in / 100pk**  
**DPIF518118C** Min. Buy 1ea
- 1-3/8in W x 24in H / 100pk**  
**DPIF524138C** Min. Buy 1ea



**DP Industries® Coated Wood Garden Markers**

Provides a good writing surface and coating increases the life of the label, best for garden & field use.



- White - 1-1/8in W x 12in H / 250pk**  
**DPITGL12118C2** Min. Buy 1ea
- White - 5/8in W x 4in H / 1000pk**  
**DPITPL458M** Min. Buy 1ea
- White - 5/8in W x 6in H / 1000pk**  
**DPITPL658M** Min. Buy 1ea
- White - 5/8in W x 12in H / 500pk**  
**DPITPL1258C5** Min. Buy 1ea

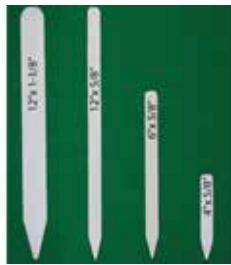

**DP Industries® Economy Plastic Bedding Labels**

Economy roll of white 0.015in thick bedding labels. Best used to identify plantings in seedling trays and bedding flats. Made from recycled styrene. Can also be used for potted plants. Mark with fade/water resistant garden pens.



- White - 1in W x 4-1/2in H / 1000 per Roll**  
**DPISL451M** Min. Buy 1ea



**DP Industries® Molded Plastic Garden Marker**

Formed in convenient sets of 8 each for easier writing. Made from recycled styrene, can be used for potted plants.



- White - 5/8in W x 4in H / 1000pk**  
**DPIIM458MW** Min. Buy 1ea
- White - 5/8in W x 5in H / 1000pk**  
**DPIIM558MW** Min. Buy 1ea
- White - 5/8in W x 6in H / 1000pk**  
**DPIIM658MW** Min. Buy 1ea
- White - 5/8in W x 8in H / 500pk**  
**DPIIM858C5W** Min. Buy 1ea

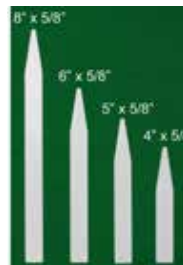

**DP Industries® Molded Plastic Garden Markers**

Formed in convenient sets of 8 each for easier writing. Thicker, more rigid than loose pack plastic labels. Best used to identify plantings in seedling trays and bedding flats. Made from recycled styrene, can be used for potted plants.



- Green - 5/8in W x 4in H / 1000pk**  
**DPIIM458MG** Min. Buy 1ea



**DP Industries® Molded Plastic Garden Markers**

Formed in convenient sets of 8 each for easier writing. Thicker, more rigid than loose pack plastic labels. Best used to identify plantings in seedling trays and bedding flats. Made from recycled styrene, can be used for potted plants.



- Yellow - 5/8in W x 5in H / 1000pk**  
**DPIIM558MY** Min. Buy 1ea
- Yellow - 5/8in W x 6in H / 1000pk**  
**DPIIM658MY** Min. Buy 1ea
- Yellow - 5/8in W x 8in H / 500pk**  
**DPIIM858C5Y** Min. Buy 1ea

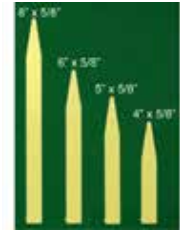

**DP Industries® Economy Plastic Garden Markers**

Made from high impact recycled styrene for a smooth writing surface. They can be used for potted plants, seedling trays and bedding flats.



- White - 5/8in W x 4in H / 1000pk**  
**DPITC458M** Min. Buy 1ea
- White - 5/8in W x 5in H / 1000pk**  
**DPITC558M** Min. Buy 1ea
- White - 5/8in W x 6in H / 1000pk**  
**DPITC658M** Min. Buy 1ea
- White - 5/8in W x 8in H / 500pk**  
**DPITC858M** Min. Buy 1ea

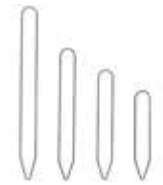

**DP Industries® Economy Vinyl Wrap-Around Tag**

Designed to easily wrap around tree or shrub branches. Best suited for use on larger plants and shrubs.



- White - 5/8in W x 5in H / 1000 per Roll**  
**DPITT558M** Min. Buy 1ea
- White - 5/8in W x 7in H / 1000 per Roll**  
**DPITT758M** Min. Buy 1ea



**DP Industries® Plain Wood Label**

Natural wood birch labels. Biodegradable. Sustainable. MADE IN USA



- 4in x .625in x .064 / 24pkgs of 24 ea**  
**DPIIHC458** Min. Buy 1ea



**Tree & Plant Supports**

**DP Industries® Metal Stake Markers with Zinc Plate**

Long lasting Zinc writing surface with metal legs for support. 1" x 2-1/2" Zinc writing plate. Mark with DPI's fade/water resistant Garden Pen. Ideal long term solution to identifying plant varieties, garden rows, garden sections, etc.



- 10in / 120pk**  
**DPIIM10** Min. Buy 1ea



**Pot Covers & Foil**

**FloPak® Pot Covers**  
Economically enhance the appeal and add a colorful decorative touch to potted plants. These pre-formed covers help to attractively display and boost plant sales by just adding some color and style to pots. Choose from a selection of colors and sizes.

**Luster Pot Covers - Evergreen**



- Evergreen - 4.5in**  
FPK45EGL      Min. Buy 1ea
- Evergreen - 6in**  
FPK6EGL      Min. Buy 1ea
- Evergreen - 6.5in**  
FPK65EGL      Min. Buy 1ea
- Evergreen - 7in**  
FPK7EGL      Min. Buy 1ea
- Evergreen - 8in**  
FPK8EGL      Min. Buy 1ea



**Luster Pot Covers - Gold**



- Gold - 4in**  
FPK4GL      Min. Buy 1ea
- Gold - 4.5in**  
FPK45GL      Min. Buy 1ea
- Gold - 6in**  
FPK6GL      Min. Buy 1ea
- Gold - 6.5in**  
FPK65GL      Min. Buy 1ea
- Gold - 7in**  
FPK7GL      Min. Buy 1ea
- Gold - 8in**  
FPK8GL      Min. Buy 1ea
- Gold - 10in**  
FPK10GL      Min. Buy 1ea

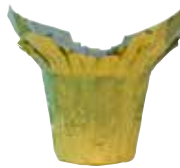

**Luster Pot Covers - Red**



- Red - 4.5in**  
FPK45RL      Min. Buy 1ea
- Red - 6in**  
FPK6RL      Min. Buy 1ea
- Red - 6.5in**  
FPK65RL      Min. Buy 1ea
- Red - 8in**  
FPK8RL      Min. Buy 1ea



**Classic Pot Covers - Evergreen**



- Evergreen - 6in**  
FPK6EGC      Min. Buy 1ea
- Evergreen - 6.5in**  
FPK65EGC      Min. Buy 1ea
- Evergreen - 7in**  
FPK7EGC      Min. Buy 1ea
- Evergreen - 8in**  
FPK8EGC      Min. Buy 1ea
- Evergreen - 10in**  
FPK10EGC      Min. Buy 1ea



**Classic Pot Covers - Fern Green**



- Fern Green - 6.5in**  
FPK65FGC      Min. Buy 1ea



**FloPak® Laminated Foil Roll**

Economically enhance the appeal and add a colorful decorative touch to potted plants. The foil rolls allow you to cut to any size needed. Use to attractively display and boost plant sales by just adding some color and style to pots. Choose from a selection



- Evergreen - Calypso Pattern - 20in x 30ft Roll**  
FPKFR2030EG      Min. Buy 1ea
- Gold - Calypso Pattern - 20in x 30ft Roll**  
FPKFR2030GD      Min. Buy 1ea
- Red - Calypso Pattern - 20in x 30ft Roll**  
FPKFR2030R      Min. Buy 1ea
- Silver - Calypso Pattern - 20in x 30ft Roll**  
FPKFR2030S      Min. Buy 1ea



**FloPak® Laminated Foil Sheet**

Use for wrapping plant pots. Foil protects plant and creates a decorative look to enhance the appeal and add some personality to potted plants.



- Red - 20in x 20in Sheet - 500 per Bundle**  
FPKFS20QR      Min. Buy 1ea
- Silver - 20in x 20in Sheet - 500 per Bundle**  
FPKFS20QS      Min. Buy 1ea
- Evergreen - 20in x 20in Sheet - 500 per Bundle**  
FPKFS20QEG      Min. Buy 1ea
- Gold - 20in x 20in Sheet - 500 per Bundle**  
FPKFS20QGD      Min. Buy 1ea



**Other Equipment**

**GE Arize L1000**

The Arize L1000 is the most advanced, flexible greenhouse grow light on the market. Current worked closely with its customers to design a top light with efficacy levels up to 3.5 micromoles per joule – making it the most efficient grow light on the market – that supports universal installation, enabling growers to grow more and consume less in any region.



**600watt 120-277volt 2/bx**  
**HA30171** Min. Buy 1ea



**GE Arize Factor ML900**

The Arize® Factor ML900 has been designed to optimize light delivery throughout the lifecycle and to help growers achieve specific cultivation goals. Spectral options are available to maximize vegetative growth rates, reduce stretching during transition, and maximize production of secondary metabolites in mature flowers. Industry-leading performance, efficiency, and versatility means the Factor ML900 can easily adapt to your grow style and help you to exceed your productivity goals.



**600w 120-277VAC**  
**HA30220** Min. Buy 1ea



**GE HPS 1000W, E-Ballast**

Arize Luminare H1000 - Designed with growers in mind, the Arize™ H1000 delivers light output, uniformity and penetration to help get the most out of your grow. The H1000 directs light deep into the canopy, ensuring even the lowest leaves receive the light they need. The H1000 offers growers the industry-leading performance and quality they expect from the Arize™ family of products, and allows us to meet the individual needs of today's growers.



**277-347volt Open Reflector**  
**HA30160** Min. Buy 1ea



**GE Arize Greenhouse Pro**

Arize Greenhouse Pro Photoperiodic LED Lamp - The GE Arize™ Greenhouse Pro LED lamp is designed to facilitate greenhouse photoperiod control. Photoperiod control allows growers to manage vegetative growth or rapid flowering throughout the year by extending or shortening day-length. This lamp will help control plant growth so the production is ready at the precise time. When selecting the best equipment for your greenhouse, choose GE Arize™ Greenhouse Pro LED flowering lamp to control and create ideal growth conditions. Low energy and high results are the focus of Arize Greenhouse Pro LED Lamp and is sure to provide optimal plant management.



**Flowering Lamp**  
**HA93042116** Min. Buy 1ea



**Other Equipment**

**Antal / Cayson Equipment Plug Popper**

Easy to use and handles any tray with the swap of an insert. Produces neat, easy-to-handle plugs with no damaged roots or stems. Operates smoothly with a foot pedal and can dislodge up to 10 trays per minute. Plugs pop up easily and cleanly regardless of moisture content or root mass.



**ANTAL34-0221** Min. Buy 1ea



**Antal / Cayson Equipment Plug Popper Insert**

Interchangeable insert for use with the Antal/Cayson Plug Popper.



**ANTALD07171** Min. Buy 1ea



**Antal / Cayson Vacuum Seeder**

Custom built seeders and seed plates for various greenhouse growing trays. Easy out of the box 5 to 10 minute set up time. There are no confusing brackets, stops, tubes with nozzles, gauges or height adjustments to malfunction. This seeder self centers itself over top of the plug tray, for accurate seed location. Change seed plates and locator frames for different plug tray formats in seconds. Plants most vegetable, flower and tree seed.



**ANTALVACSEEDER** Min. Buy 1ea







**H.E. Anderson**  
**COMPANY**  
 2100 Anderson Drive P.O. Box 1006  
 Muskogee, OK 74402-1006  
 918-687-4426 FAX 918-682-3342

## Fertilizer Injectors



### H.E. Anderson J+Advanced Series Ratio:Feeder® Injection Systems

J+Advanced Ratio:Feeder® Injector Systems can inject almost any liquid chemical into a water line at a set ratio. Most common uses include fertilizer injection, acid injection for pH stabilization, chlorination, and sanitization.

All J+ Advanced Injectors can be configured to pump multiple chemicals or solutions at different ratios. Systems can be configured to work with flows ranging from 1/4 gallon per minute to 10,000 gallons per minute. Common injection rates range from 1:100 to 1:10,000. Injectors require at least 30 psi to operate with a maximum of 125psi or 100psi depending on which blend tank is utilized. Controllers can be powered using 120VAC or 12VDC.

J+Advanced injectors can be purchased as complete assembled units which fit most common applications or as individual components sized especially for your specific application.

- J+ Advanced CONTROLLER - Connects to the water meter and pilot valve/manifold. It measures the water flow using the water meter then turns the pilot valve on and off to stroke the pump heads at the proper rate to maintain the set ratio.

- WATER METER - Used by J controller to measure water flow. Many different models are available which can measure flows from 1/4 GPM up to 10,000 GPM.

- MANIFOLD/PILOT VALVE - Pump Heads are mounted to the manifold. The Pilot Valve, which is controlled by the J Controller, provides water pressure to the pump heads to make them pump.

- PUMP HEADS - Pump Heads are what actually pump the chemicals. Many different models and sizes are available to handle almost any liquid and feed ratio.

- BLEND TANK - Ensures the chemical injected into the water line is blended uniformly ensuring even distribution and allowing for accurate measurements to be made.

### H.E. Anderson® J+Advanced Controller

Connects to the water meter and pilot valve/manifold. It measures the water flow using the water meter then turns the pilot valve on and off to stroke the pump heads at the proper rate to maintain the set ratio. Includes latest features, new backlit display and full keypad.



**120VAC**  
**HEAN15008**

Min. Buy 1ea



DB Series

DB Wall Mount Series



DD Series

### H.E. Anderson D Series Ratio:Feeder® Injector Systems

The DB & DD Series offer an inexpensive way to inject almost any liquid into a water line at an adjustable ratio. Built with the same quality and pride as the J Plus, these pumps will inject one chemical up to a 1:100 ratio with models rated for 20 or 50 GPM. These models feature an adjustable feed ratio which makes fine tuning the injection ratio as easy as twisting a knob. Injectors can be turned down to 1/10th of their maximum feed ratio.

- Industry leading quality - legendary dependability helps save time on maintenance
- Easy installation and operation
- Positive Displacement - extremely accurate injection helps save money on chemicals
- Diaphragm Operation - No sliding seals, accuracy does not degrade over time
- Volume proportioning - constant chemical levels regardless of flow rates
- Adjustable feed rate - change the feed rate while unit is operating and without recalibrating
- Filter not required
- Extremely low pressure loss
- Low power consumption
- On/Off and Pulse Button

BFG Item#	Model	Water Flow Range	Maximum Feed Rate	Typical Use
HEANDB100	DB100	1/4 to 20 GPM	1:100 or 1%	Fertilizer
HEANDB1000	DB1000	1/4 to 20 GPM	1:1000 or 0.1%	pH Adjustment/Sanitizer
HEANDB100W	DB100W	1/4 to 20 GPM	1:100	Fertilizer
HEANDB1000W	DB1000W	1/4 to 20 GPM	1:1000	pH Adjustment/Sanitizer
HEANDD100	DD100	3/4 to 50 GPM	1:100	Fertilizer
HEANDD1000	DD1000	3/4 to 50 GPM	1:1000	pH Adjustment/Sanitizer



### Fertilizer Injectors

#### H.E. Anderson® A3 Teflon® Diaphragm Kit

A3 Pumper Diaphragm Kit Includes: 1 ea 16510 A3 CS w/ Teflon Diaphragm, 1 ea 18036 A3 WS Diaphragm, and a spare parts kit.



#### Diaphragm Kit A3 Teflon

**HEAN17032** Min. Buy 1ea

#### H.E. Anderson® P2, H2 Standard Diaphragm Kit

Pumper Diaphragm Kit Includes: 1 ea 01066 #2 CS Diaphragm, 1 ea 01058 WS Diaphragm, and a spare parts kit.



#### Diaphragm Kit #2

**HEAN8913** Min. Buy 1ea

#### H.E. Anderson® Hosebarb With O-Ring

Hosebarb with o-ring



.5in

**HEAN11741** Min. Buy 1ea

#### H.E. Anderson® Injector Tubing

Acid and Sanitizer Injector black poly tubing.



3/8 OD 1/4 ID, Sold by the ft

**HEAN6892** Min. Buy 1ea

#### H.E. Anderson® Type AS Pilot Valve Repair Kit

Pilot valve Repair Kit for 1/2in Type AS Pilot Valve.



1/2in, Type AS

**HEAN19065** Min. Buy 1ea

#### H.E. Anderson® Check Valve Set

Check valve set Includes: 1 ea 09812 Suction Valve and 1 ea 09275 Discharge Valve.



**HEAN02534** Min. Buy 1ea



#### H.E. Anderson® IPF Universal Assembly

IPF universal assembly



.5in

**HEAN4094** Min. Buy 1ea

#### H.E. Anderson® Diaphragm A3/T4 CS With Teflon Face

Diaphragm A3/T4 with teflon face.



**HEAN16510** Min. Buy 1ea

#### H.E. Anderson® Diaphragm Kit #4 Standard

Diaphragm kit #4



**HEAN8939** Min. Buy 1ea

#### H.E. Anderson® Kit For IPF

Kit for IPF



.5in

**HEAN5404** Min. Buy 1ea

#### H.E. Anderson® Seal Kit Soft

Seal kit



For Type A

**HEAN19043** Min. Buy 1ea

# Hydronic Heat

BFG Supply offers a variety of components and brands for your hydronic heat options. Whether you are looking at a complete system or replacement part for your existing systems, we've got you covered. Please contact your BFG Sales Rep or BFG Customer service for a customized quote or replacement parts.

## Benefits of Hydronic Heating

1. Heats the greenhouse starting at the plant roots, resulting in faster crop production and healthier plants.
2. Saves 20% to 30% in energy bills through more efficient energy use.
3. Allows flexibility in boiler fuel choices, and the ability to supplement with renewable resources like solar and geothermal heaters.

## Options

- Radiant heat – in floor/ in ground heat
- Tubing on bench
- Fin Tubing - under bench
- Rin Tubing - top heat

Tubing on the bench



## Stuppy Hydronic Bench Heat

**Rubber Tubing:** High-quality EPDM rubber tubing set on 2-inch centers and resistant to ozone, chemicals, fertilizers, and soil temperature. Ideal for use in a hot water heating system due to its resistance to temperature and chemicals and its superior heat transfer capabilities.

**Tube Design:** Reduces water volume and enables the system to respond quickly and efficiently.

**Manifolds:** 1-inch manifolds with plastic adapters pressed fit into SCH 80 PVC pipe to the width of the bench.

**Ridged plastic spacers:** Spaced every inch to hold tube in place. Spacers can be cut to bench width of up to 8 feet wide.

# Stuppy

GREENHOUSE



## Stuppy Hydronic Heating System

The Hydronic Heating System is a rubber tube system using 135°F water temperature, and will consist of the following components:

- Piping
- EPDM Tubing
- Power Wire
- Bench Heating Material
- Air & Water Controls
- Manifold
- System Pump
- Spacers
- Electronic Controller with Built-in Digital Display
- Easy-to-Follow Instructions & Drawings, Drafted In-House
- Water Treatment
- Compatible Boiler or Grower-Supplied Hot Water Heater (if less than 450sqft)



## Spectrum Heater

With models ranging from 100-399 MBH, Spectrum Series boilers' unique design and optional corrosion-resistant, brushed stainless steel jackets make them ideal for indoor and outdoor installations in corrosive or harsh environments. A unique feature within this MBH range, the Spectrum Series' diagnostic control panel allows for easy troubleshooting, and, when coupled with the self-diagnostic light package, makes the Spectrum Series easy to assess, maintain and service. Constructed using cast iron headers for application flexibility, and feature built-in draft diverters to lower the height of the unit and, most importantly, to reduce installation costs.

- 100-399 MBH
- On/Off or 2-Stage/4-Stage
- Automatic Reset High Limit 100-200
- Manual Reset High Limit 250-400
- Built-in Draft Diverter
- Stainless Steel Burners
- Cast Iron Headers (Boilers)
- Bronze Headers (Water Heaters)
- Inlet & Outlet Thermometers
- Mounted and Wired Flow Switch
- Vent Damper (100-250 MBH Boilers Only)
- Self Diagnostic Light Package
- Pump Control
- Electronic Ignition

# BioTherm®

## Elements...Enhanced.

### BioTherm Climate Technologies - Heating

#### BioTherm greenhouse heating systems are tailored to specific climate and growing conditions.

Their systems are durable and efficient which result in high success rates and peak crops.

Contact your BFG Sales Rep for new system upgrades and replacement parts!

Note: For replacement parts, tubing and connections please be aware they are **INTERCHANGEABLE WITH OTHER BRANDS.**

This way you have the best service along with what you need.

BioTherm designs mission-critical heating systems to ENHANCE greenhouse crops. These buildings rapidly gain heat when the sun comes out and lose heat almost as fast when the sun disappears. Humidity levels can be jungle-like. The presence of water, fertilizer, and other corrosive chemicals is everywhere. They have invested over three decades into developing rugged heating solutions that are robust and designed to go the distance to help plants thrive.

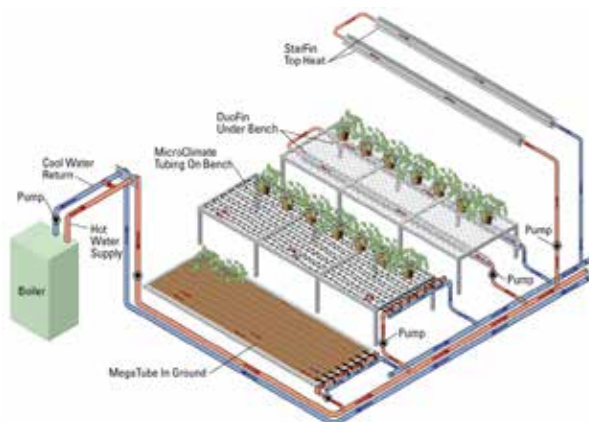

#### Roll'N Grow™

Roll'n Grow™ is the perfect way to apply Root Zone Heating (RZH) to growing beds or benches! Like a carpet, your growing surfaces can now be covered with growth-enhancing gentle heat in a fraction of the time it used to take.



#### MicroClimate™

BioTherm MicroClimate™ is the original smaller diameter heat output solution commonly used for on bench, and floor heating. Its smaller diameter allows for closely spaced loops providing a uniform and conductive heating surface.



#### Raypak Boilers

The central part of hydronic systems! BioTherm is proud to be the exclusive provider of Raypak products to the CEA industry. BioTherm offers 3 types of low mass boiler technologies: atmospheric, closed combustion, and condensing.



#### Fin Pipe - DuoFin™ & Starfin™

BioTherm DuoFin™ is the lowest heat output finned pipe commonly used for under bench, perimeter, and in-crop heating. Its unique tapered vertical fin delivers a combination of convective and radiant heating quietly and efficiently.

BioTherm StarFin™ is a high heat output finned pipe commonly used for bench, perimeter, and gutter heating. Its tapered six fin design provides maximum heat output while producing a soft, gentle heat

# BioTherm®

## Elements...Enhanced.

### BioTherm Climate Technologies - Hydro

BioTherm Hydro Sciences has one simple focus... to enhance your irrigation system and boost plant growth using cutting edge technologies with efficiency in mind. Our products are proven to increase yields, improve plant vigor, and increase resistance to diseases and pests.

### Dissolved Oxygen Infusion

A groundbreaking new way to economically boost dissolved oxygen (DO) levels in your irrigation system and enhance plant health and production. The BioTherm TOOB™ is a revolutionary, efficient method of increasing the dissolved oxygen content of irrigation water, significantly improving plant health and productivity.

BioTherm has two sizes of the TOOB™ available (2' Craft and 4' Solo) as well as a lineup of products to complete your dissolved oxygen system.



#### TOOB O2 Infuser™

TOOB Craft (2')  
TOOB Solo (4')



#### DO Stat

BioTherm DO Stat closely monitors your DO levels and controls how much DO to infuse into your system.

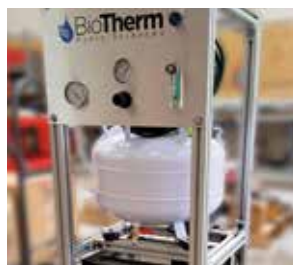

#### O2 Generator

O2 Gen connects directly into your TOOB system without needing oxygen tanks.



#### DO Meter

Dissolved oxygen level measuring in the palm of your hand.



### Flood & Cascade Floors

BioTherm's innovative Sub-Irrigation technology provides a quick responding irrigation cycle time which is critical to greater control of nutrient uptake, timing, and prevents oversoaking. BioTherm's Flood and Cascade Floor systems save water, energy, fertilizer and reduce labor costs by up to 95%.



### Irrigation Tempering

Experience optimal plant growth with tempering solutions customized to your operation. The use of BioTherm's pre-heating and pre-cooling systems will prevent thermal shock, increase rooting, and prevent disease.

### Grower Testimonial

"Our business recently started measuring dissolved oxygen (DO) levels of the source water at client farms during site visits, and we have been shocked at how many farms have source water that with DO levels below 3ppm.

We have seen positive effects on plant growth and health when using DO-enhanced water from the TOOB, and look forward to providing more in-depth data on the full benefits of the TOOB in the near future."

-Scott Skamnes,  
Crescive Soil Services



# BioTherm®

## Elements...Enhanced.

### BioTherm Climate Technologies - Air

BioTherm has proven systems designed to optimize the air inside your facility and ENHANCE your growing conditions so that even crops not normally grown in your region can flourish. They can take the temperature and humidity down just a touch, or they can close down the access to outside air and bring those factors way down. It is all in the design, and BioTherm's experienced team knows how to engineer and deliver systems made specifically for RUGGED cultivation environments using special air handlers or standalone dehumidifiers made of stainless steel.

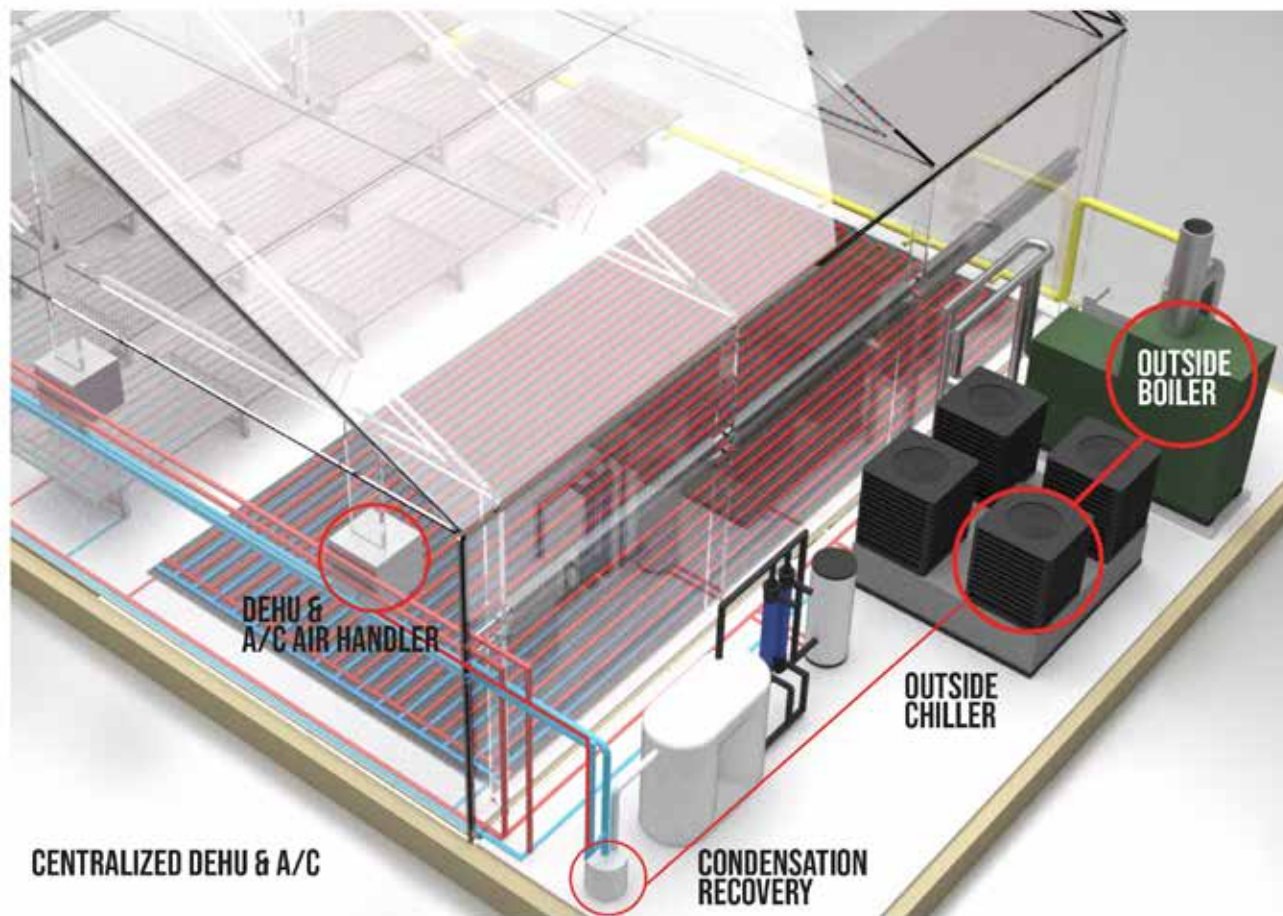

#### Air Conditioning

BioTherm has a variety of greenhouse cooling technologies. Once chilled, water can be distributed with many space-saving options, including custom air handling units and the BioTherm Fin Pipe collection.



#### CO2 Enrichment

To help your plants grow and thrive, increasing CO2 levels within your greenhouse or indoor environment is essential. BioTherm's innovative systems utilize condensing boilers to achieve elevated CO2 levels and even distribution throughout your space.



#### Dehumidification

BioTherm's lineup of high performance, energy-efficient, free-standing dehumidifiers are designed to control damaging moisture and humidity in industrial buildings and greenhouses. Sizes range from 1-ton to 25-ton units.



 **BioTherm**®

Elements...Enhanced.

**PROVIDING CULTIVATION  
CLIMATE TECHNOLOGIES SINCE 1980**

▲  
**BIO THERM  
ROLL'N GROW™  
HEATING MATS**

**1-800-GET-HEAT | [WWW.BIOTHERMSOLUTIONS.COM](http://WWW.BIOTHERMSOLUTIONS.COM)**



**Meters & Testers**

**Hanna® pH / EC / TDS Tester**

A waterproof tester that offers high accuracy pH, EC/TDS and temperature measurements in a single tester! No more switching between meters for your routine measurements. This floating, waterproof combination tester has an easy to read, LCD and an automatic shut-off. pH and EC/TDS readings are automatically temperature compensated. Includes: HI 73127 pH electrode and HI 73128 electrode removal tool, batteries and instructions.



**HIHI98130** Min. Buy 1ea



**Hanna® GroLine Waterproof Combo Meter for pH, EC, TDS**

Designed to bring simplicity to nutrient testing, the HI9814 Portable GroLine Meter is designed specifically for Hydroponic growers. The specialized electrode combines 3 sensors in a single rugged probe featuring a polypropylene body, integrated temperature sensor, and cloth junction.



**HIHI9814** Min. Buy 1ea



**Hanna® GroLine Waterproof Combo Tester for pH, EC, TDS**

A slim, lightweight, and waterproof pocket tester that measures pH, conductivity (EC), TDS (ppm), and temperature. Simple, two-button meter operation and advanced features, including a selectable EC to TDS conversion factor (0.5 - 500 ppm and 0.7 - 700 ppm). for your essential testing.



**HIHI98131** Min. Buy 1ea



**Hanna® GroLine Waterproof Hydroponic pH Tester**

The GroLine HI98118 pH/temperature tester is our latest pocket meter for measuring the pH of a hydroponic nutrient solution. This modern looking meter is only 0.7" thick and extremely ergonomic, fitting comfortably in your hand. The HI98118 has a very large easy to read LCD display that shows both pH and temperature along with calibration, stability and low battery indicators.



**HIHI98118** Min. Buy 1ea



**Hanna® Quick Calibration Solution for GroLine pH and EC Meters**

A quick calibration solution for use with Hanna's GroLine pH and/or EC/TDS meters. Using the Quick Cal function found in compatible meters allows for a single point calibration for pH and/or conductivity sensors.



**HIHI50036P** Min. Buy 1ea



**Hanna® HALO® Wireless Soil pH Meter**

Our HALO® Wireless Soil pH Meter has a triple ceramic junction in the outer reference cell, built-in temperature sensor, and the conic pH sensing tip making it ideal for pH measurements in soil samples. All readings are transmitted directly to your Apple or Android device or the edge®blu.



**HIHI12922** Min. Buy 1ea



**Hanna® pH 4.01 and 7.01 Calibration Buffer Sachets**

A set of premium quality pH 4.01 and 7.01 calibration buffer solutions that is NIST traceable and supplied with a Certificate of Analysis. Each sachet has the lot number and expiration date stamped on it and is made of light block foil ensuring freshness each time one is opened.



**HIHI774009** Min. Buy 1ea



**Hanna® Alkalinity Test Kit**

A chemical test kit that measures alkalinity by titration with hydrochloric acid. This item supplied complete with all of the reagents and equipment necessary to perform approximately 110 tests. Pre-made reagents for ease of use. Reagents marked with expiration date and lot number for traceability.



**HIHI3811** Min. Buy 1ea



**Hanna® Electrode Storage Solution**

To minimize clogging and ensure fast response time, always keep the glass bulb and the junction of your pH electrode moist. Store the electrode with a few drops of HI 70300 storage or pH 7 buffer solution in the protective cap.



**HIHI70300L** Min. Buy 1ea



**Hanna® EC Solution**

The 1413  $\mu$ S/cm calibration solution is best suited for general use. This solution is also available in combined kits with HANNA® pH 7 buffer for easy calibration of multiparameter instruments.



**HIHI7031L** Min. Buy 1ea



**Hanna® 4.01 pH Buffer Solution**

Solution is prepared according to precise formulas and is standardized with a pH meter calibrated according to the NIST standards. Batch number, expiration date and correlation table between pH and temperature included.



**500mL**  
**HIHI7004L** Min. Buy 1ea



**Hanna® 7.01 pH Buffer Solution**

pH 7.01 is the most widely used among all buffer solutions. Solution is NIST standardized.



**500mL**  
**HIHI7007L** Min. Buy 1ea





# Link4 CORPORATION

## Greenhouse Ventilation

### Link 4 Corporation

This advanced line of greenhouse controllers provides complete cloud-based monitoring and adjustment of all equipment (heaters, vents, fans, irrigation, supplemental lighting) regardless of greenhouse size or type. Customized solutions can be created based on each customer's individual needs.

### iDoser

#### Automated Fertiligation

Total control of dosing and irrigation from one centralized location. Integrated irrigation scheduling, accurate nutrient recipes, safety monitoring, alarms, EC and pH management.



### iGrow 1800

#### Advanced Climate Control

Sophisticated and flexible precision environmental control with ease of use through a straight forward interface.



### Link4 iPonic Commercial Controller

Unlike most controllers on the market, the iPonic Commercial controller allows total flexibility using software-based intelligence. This means that you can program all functions together and eliminate multiple controllers for multiple functions – the iPonic does it all: Fuzzy Logic CO2, light timer, irrigation, temperature, humidity, recycle timers, vent fans, high temperature shut-off, central air conditioning and heating – even add your own custom devices. This also means that you can change devices on the fly – add or delete devices to match the equipment in your grow house in minutes.



#### Dual Zone

L4995360208

Min. Buy 1ea

### Link4 iPonic Alert Hydroponic Alarm

A cloud-based monitoring and alarm system. With simple plug-and-play functionality, any grower can learn what is going on in their grow room – from any Internet connected device. The iPonic Alert is ideal for the cultivator that is satisfied with their current controls, but wants the extra assurance of push notifications sent to their smart phone in the event anything should go wrong.



#### Dual Zone

L4990070102

Min. Buy 1ea

### Link4 iGrow 800 Greenhouse Controller

Get real-time energy use and track run-time on greenhouse heating and cooling equipment with this easy-to-use controller system.



L4990080002

Min. Buy 1ea



## Fertilizer Injectors

### Dema® Low-Medium Flow Fertigation

The TF5, Low Medium Fertigation series is designed for low to medium water flow for fertigation, pesticide and other in-line additives. They are intended for typical fertilizers, pesticides and agriculture or irrigation additives. They are not designed for strong acids alkaline or solvents. The TF5 is designed for water flow up to 22gpm (5 m<sup>3</sup>/h). Operates up to 22gpm and have 1" NPT threaded connection for in-line mounting.



#### TF5

DEMTF5-0020N/OFF Min. Buy 1ea



## Water Powered Proportioners

# MixRite

### Dema® MixRite

Used to inject fertilizers, nutrients, sanitizers, herbicides, fungicides and insecticides. Remains proportional with changes in water pressure and flow. Various sizes for different flow rates from 1 to 110 gpm. Multiple chemical injection rates up to 10% in certain models.





Other Equipment



**B-Line Flat and Pot Filler (Model 5343)**

The B-Line is the most popular Kase Flat Filler, supporting the container sizes used by most greenhouses and nurseries. It is ideal for peat moss-based soils, is easy to operate, quiet and easily maintained.

With its generous 1.5-yard hopper, the B-Line offers a production rate up to 1,200 flats per hour, and it handles containers up to 18in wide x 12in tall. Feed your B-Line with a Kase 3561 Gobbler or 3538 Small Bale Buster.

Additional Filler Models include the high production N-Line, large capacity Super-B, and Minor-B for plug trays and smaller containers.



**Gobbler (Model 3561)**

The Gobbler is designed to process large 135 cu. ft. compressed bales (as well as smaller bales) into a fluffed and moistened potting soil, with a production rate up to 75 cubic yards per hour. The hydraulic lift gate platform is easily loaded via forklift or pallet jack. Basic start/stop controls or automated sensors allow the Gobbler to integrate with other processing equipment, such as a Kase Filler or 4300 Series Soil Conveyor. The Optional TopHopper dispenses an amendment of your choice directly into soil as it is processed through the Gobbler.



**Modular Belt Conveyors (4100 Series)**

If you are looking for versatility and portability without sacrificing durability, the Kase Modular Conveyor's simple design allows these conveyors to be easily networked to cover extended distances without sacrificing power. Conveyors are available with 10" and 15" wide belts and variable speed or reversing controls. Optional adjustable height stands are available to suit your production line.

**Soil Mixers (3400 Series)**

Kase offers four sizes of Batch Mixers to meet your needs for rapid, complete and uniform soil mixing. The 3/4 yard unit has a center discharge, while all other Kase Mixers have an end discharge. Each Mixer includes a spray apparatus for moistening soil and a safety grate with splash guard shielding the top of the unit. The 2 and 4 yard models incorporate a bolted replaceable bottom barrel, available in heavy duty abrasive resistant material.



**Kase Water Tunnel**

Watering Tunnels are used to water plant material that is planted in flats, pots, hanging baskets or other containers. Watering tables have smaller Drip Nozzles placed over the conveying unit to moisten plug trays. Watering Tunnels have water Spray Nozzles. They are self-contained using an open mesh Polyethylene conveying belt to move the product thru the machine at a variable speed rate, which is selected by the operator. The adjustable speed feature will help control the amount of water that is dispensed on your plant material. Different size nozzles are available also to control the amount of water flow. These units have water drip pans to catch all of the excess water into a drain at one end of the unit, which may be plumbed into an existing drain. The collection pans are longer than the spray area to catch the excess spray and have a area to place the plant material on the unit and an area to take the plant material away. Features: Stainless steel enclosure, Quad spray heads variety of nozzle size available, High impact poly chain and sprockets, Electric operated solenoid valve, Brass Ball Valve, Stainless slide racks Optional electronic control of water spray Variable drive speed Water Volume: 4gpm to 16gpm Belt Width: 12in, Maximum Flat Width: 16, Adjustable Height of Conveyor: 24in to 36in.



KASE2211

Min. Buy 1ea

## Other Equipment

### Kase Production Lines

With over thirty years of experience designing and manufacturing Horticulture equipment, Kase provides custom solutions like the large pot Filling Lines and Mix Line shown below. Visit [kaseworks.com](http://kaseworks.com) to see the full line of Kase Horticulture equipment.





**Wheelbarrows & Carts**

**Millside Industries® Plastic Deck Wagon**

Deck is made of an attractive green, high impact polypropylene material. The poly anti-tip steering provides effortless turning and the handle is long with a comfort-grip. The deck has a 4in high cargo lip all the way around to help keep items in place. All the metal framework has a black powder-coated finish for durability.



**20in x 38in Deck / 4in x 10in Flat Free Tires**  
**MSI03548FF** Min. Buy 1ea

**20in x 38in Deck / 4in x 10in Pneumatic Tires**  
**MSI03548** Min. Buy 1ea

**20in x 38in Deck / 4in x 10in Pneumatic Tires**  
**MSI03562** Min. Buy 1ea



**Millside Industries® Heavy-Duty Express Wagon**

Wagon has beefy pneumatic tires for a gentle quiet ride. The comfortable, large, easy-grip D-handle and metal anti-tip steering provides effortless movement and turning. Easily remove the hardwood racks if they are not needed for the job at hand.



**20in x 38in Deck / 4in x 10in Pneumatic Tires**  
**MSIHDW** Min. Buy 1EA

**Millside Industries® Metal Deck Wagon**

Ideal for garden centers, greenhouses and nurseries. Easily hauls anything that needs relocated. The long easy-grip metal handle and metal anti-tip steering provides effortless movement and turning and the 2in high cargo lip around deck helps to keep items in place. Each cart has a deep green powder-coated finish for durability.



**20in x 38in Deck / 4in x 10in Flat Free Tires**  
**MS120X38WFF** Min. Buy 1ea

**24in x 48in Deck / 4in x 10in Flat Free Tires**  
**MS1EFRWGFF** Min. Buy 1ea

**24in x 48in Deck / 4in x 10in Pneumatic Tires**  
**MS1EFRWG** Min. Buy 1ea



**Millside Industries® 2-Wheel Metal Push Cart**

Ideal for garden centers, greenhouses and nurseries. Easily hauls anything that needs relocated. The long, easy-grip, metal handles provides effortless movement and turning and the 2in high cargo lip around deck helps to keep items in place. Each cart has a deep green powder-coated finish for durability. Can carry 300lbs.



**24in x 48in Deck / 16in Pneumatic Tires**  
**MS12WGC** Min. Buy 1ea



**Millside Industries® Flat Free Wheel**

Replacement wheels with white hub. 10in with 5/8in bearings.



**4in x 10in**  
**MSI02211FF** Min. Buy 1ea



**Sprayers, Spreaders & Dusters**

**Jacto Battery Backpack Sprayer**

The Jacto PJB16 is the most innovative sprayer in its class. It features a long-life lithium-ion battery, digital display with soft touch buttons, 5 pressure settings, pace meter, battery level indicator, onboard diagnostics, auto shut off and lockable pressure setting. The Jacto PJB16 allows the user to select 5 different pressure settings. This makes the PJB16 sprayer capable of spraying herbicides, using low pressures to reduce drift and insecticides and fungicides normally applied with higher pressures for finer droplets and improved coverage. The PJB16 diaphragm pump produces 0.61gpm which is almost 60% higher than that of the competitors. The pump is protected by a suction filter to reduce the possibility of pump damage and clogging caused by impurities in the solution. The pump uses an internal pump micro pressure switch that turns the pump on when a pressure drop is seen and turns the pump off when the spray is stopped. The Jacto PJ16 sprayer is the only battery-powered sprayer that uses a Venturi, in tank, agitator to keep the chemical in solution. Ideal for use with whettable powders and other agrichemicals. The agitator lever is easily accessed even with the sprayer on your back.



**4gal**  
**JACPJB16** Min. Buy 1ea





**Greenhouse Heaters**

**Modine Effinity™ High Efficiency Natural Gas Heater**

At 93% thermal efficiency, Modine's Effinity93® condensing unit heater features the highest efficiency available in North America for gas-fired unit heaters. This industry leading efficiency is a result of the coupling of the Conservicore® secondary heat exchanger technology with robust tubular primary heat exchanger design. The Conservicore® technology features a secondary recuperative heat exchanger fabricated from AL29-4C® stainless steel. This material is superior to other lower grades of stainless steel and aluminum, resulting in outstanding ability to withstand the corrosive environment of condensing gas fired equipment. The separated combustion units draw combustion air from outside to ensure that the unit will always have plenty of fresh, clean air for combustion while increasing the overall heating efficiency. Venting material to be used is PVC, an extremely cost effective vent system.

	PTC Model Sizes									
	55 <sup>3</sup>	65 <sup>3</sup>	85 <sup>3</sup>	110 <sup>3</sup>	135	156	180	215	260	310
<b>BTU/Hr Input<sup>1</sup></b>	55,000	65,000	85,000	110,000	135,000	155,000	180,000	215,000	260,000	310,000
<b>BTU/Hr Output<sup>1</sup></b>	51,150	60,450	79,050	102,300	125,550	144,150	167,400	199,950	241,800	288,300
<b>Condensate Production (Gal/Hr)</b>	0.3	0.4	0.5	0.7	1.0	1.1	1.3	1.6	1.9	2.3
<b>Entering Airflow (CFM) @ 70°F<sup>2</sup></b>	1097	1141	1650	1750	2160	2600	3020	3865	4585	5400
<b>Air Temp Rise (°F)</b>	43	49	44	54	54	51	51	48	49	49
<b>Max. Mounting Height (ft)<sup>2</sup></b>	12	12	13	13	14	18	15	17	20	19
<b>Heat Throw (ft) @ Max. Mtg. Height</b>	43	43	48	46	51	62	53	60	70	67

**1** - Ratings shown are for elevations up to 2,000ft. For elevations above 2,000ft, ratings should be reduced at the rate of 4% for each 1,000ft above sea level. Reduction of ratings requires use of a high altitude kit.

**2** - Data taken at 65°F ambient and unit fired at full-rated input. Mounting height as measured from bottom of unit, and without deflector hoods

**3** - Also certified for residential installations.



**PTC215AS-0111 / 215,000 BTU/Hr Input, 199,950 BTU/Hr Output, Air Temp Rise 48° F, 60ft Heat Throw @ Max Mounting Height of 17ft**

**MODINPTC215AS-0111** Min. Buy 1ea

**PTC215SS-0111 / 215,000 BTU/Hr Input, 199,950 BTU/Hr Output, Air Temp Rise 48° F, 60ft Heat Throw @ Max Mounting Height of 17ft**

**MODINPTC215SS-0111** Min. Buy 1ea

**260,000 Btu/hr Input - Natural Gas**

**MODINPTC260AS-0111** Min. Buy 1ea

**260,000 Btu/hr Input - Natural Gas**

**MODINPTC260SS-0111** Min. Buy 1ea

**310,000 Btu/hr Input**

**MODINPTC310AS-0111** Min. Buy 1ea

**310,000 Btu/hr Input - Natural Gas**

**MODINPTC310SS-0111** Min. Buy 1ea

**310,000 Btu/hr Input - Propane Gas**

**MODINPTC310AS-0121** Min. Buy 1ea

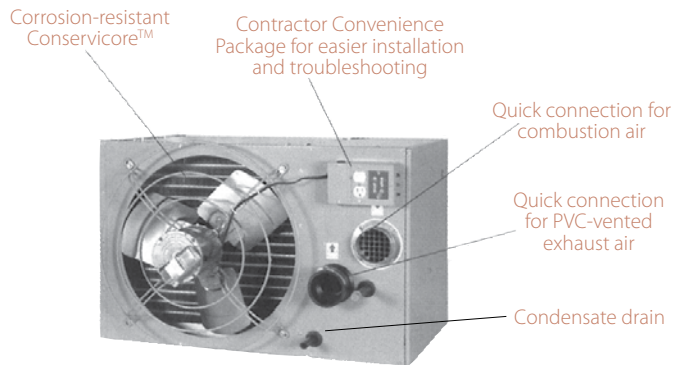

The Effinity<sup>93</sup> condensing unit heater utilizes a bent tube heat exchanger and is ready for quick PVC pipe connections.

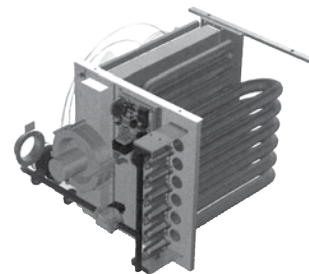

**Modine Effinity® Blower Units are Now Available!**

Built on the same successful platform as the Model PTC, these models include the same great features with the application flexibility of a blower unit heater.

**Exclusive Conservicore™ Technology**

Designed specifically for the highly corrosive environments found in greenhouses, Modine's Conservicore technology features a high-grade stainless steel secondary heat exchanger built to withstand acidic condensate. The result? Significantly longer heater life when compared to competitive units built with aluminum secondary exchangers.



**Greenhouse Heaters**

**Modine Low Profile Natural Gas Heater**

The Hot Dawg® heater is efficient and economical and can be used in parking lot houses, potting rooms, garages and even warehouses. May be installed just one inch below the ceiling. Features: 82% thermal efficiency, quick, easy install with knockouts for access to gas and electricity, power vented propeller, standard power exhauster allows the unit to be vented vertically or horizontally and 100% shut-off with continuous retry.



**125,000 Btu/hr Input**  
**MODINH125SS-0111** Min. Buy 1ea



**Modine Efinity93 High Efficiency Natural Gas Heater**

A fully condensing unit heater. Condensing technology that allows it to have an efficiency rating of 93% thermal efficiency. A well-engineered, complete package capable of heating large environments while keeping heating bills low and requiring minimal maintenance. 93% thermal efficiency. Separated combustion.



**110000 BTU**  
**MODINPTC110AS-0111** Min. Buy 1ea  
**215000 BTU**  
**MODINPTC215AS-0121** Min. Buy 1ea



**Modine High Efficiency LP Heater**

This power vented propeller heater is inexpensive to install, easy to use and offers excellent in-service economy. Features include: thermal efficiency of 83%, power exhaust that can be rotated 180 degrees, 100% shut-off, intermittent pilot-ignition system with continuous retry and a safety pressure switch to assure safe venting conditions. Designed with aluminized steel heat exchanger/burner, 115V/60Hz/1 phase power and 115V/24V IPI, 1 stg, natural gas.



**115V/60Hz/1 Phase Power & 115V/24V IPI 1 Stage Natural Gas**



- 150,000 Btu/hr Input**  
**MODINPDP150AE0130** Min. Buy 1ea
- 175000 BTU**  
**MODINPDP175AE0130** Min. Buy 1ea
- 200,000 Btu/hr Input**  
**MODINPDP200AE0130** Min. Buy 1ea
- 250,000 Btu/hr Input**  
**MODINPDP250AE0130** Min. Buy 1ea
- 250,000 Btu/hr Input**  
**MODINPDP250AE0185** Min. Buy 1ea
- 300,000 Btu/hr Input**  
**MODINPDP300AE0130** Min. Buy 1ea

	HD Model Sizes						PDP Model Sizes						
	30	45	60	75	100	125	150	175	200	250	300	350	400
<b>BTU/Hr Input<sup>1</sup></b>	30,000	45,000	60,000	75,000	100,000	125,000	150,000	175,000	200,000	250,000	300,000	350,000	400,000
<b>BTU/Hr Output<sup>1</sup></b>	24,600	36,900	49,200	61,500	82,000	102,500	124,500	145,250	166,000	207,500	249,000	290,500	332,000
<b>Entering Airflow (CFM) @ 70°F<sup>2</sup></b>	505	720	990	1160	1490	1980	2180	2550	2870	3700	4460	4870	5440
<b>Air Temp Rise (°F)</b>	44	46	45	48	50	47	51	51	52	50	50	53	54
<b>Max. Mounting Height (ft)<sup>2</sup></b>	10	10	12	14	12	16	16	17	15	19	21	20	19
<b>Heat Throw (ft) @ Max. Mtg. Height</b>	25	27	36	38	42	56	55	59	51	67	74	70	69

**Modine Tubular Natural Gas Heater**

Well suited to greenhouse applications with its corrosion resistant heat exchanger but can still perform well other environments. Tubular heat exchanger design. Stainless steel heat exchanger protected by a full 10-year warranty. Electric knockouts. Permanently lubricated motor. Power venting system. Baked polyester paint, providing excellent corrosion resistance and durability. 80% thermal efficiency.



- 150,000 BTU**  
**MODINPTP150SS-0111** Min. Buy 1ea
- 175,000 BTU**  
**MODINPTP175SS-0111** Min. Buy 1ea
- 200,000 Btu/hr Input**  
**MODINPTP200SS-0111** Min. Buy 1ea
- 200,000 BTU**  
**MODINPTP200SS-0121** Min. Buy 1ea
- 250,000 Btu/hr Input**  
**MODINPTP250SS-0111** Min. Buy 1ea
- 250,000 Btu/hr Input**  
**MODINPTP250SS-0121** Min. Buy 1ea
- 300,000 Btu/hr Input**  
**MODINPTP300SS-0111** Min. Buy 1ea
- 300,000 Btu/hr Input**  
**MODINPTP300SS-0121** Min. Buy 1ea
- 350,000 Btu/hr Input**  
**MODINPTP350SS-0111** Min. Buy 1ea
- 400,000 Btu/hr Input**  
**MODINPTP400SS-0111** Min. Buy 1ea

	PTP Model Sizes						
	150	175	200	250	300	350	400
<b>BTU/Hr Input<sup>1</sup></b>	150,000	175,000	200,000	250,000	300,000	350,000	400,000
<b>BTU/Hr Output<sup>1</sup></b>	123,000	143,500	164,000	205,000	246,000	287,000	328,000
<b>Entering Airflow (CFM) @ 70°F<sup>2</sup></b>	2140	2725	2870	3995	4545	5280	5995
<b>Air Temp Rise (°F)</b>	53	48	52	47	50	50	51
<b>Max. Mounting Height (ft)<sup>2</sup></b>	15	14	15	18	19	18	21
<b>Heat Throw (ft) @ Max. Mtg. Height</b>	51	50	53	62	69	65	74





**Pot Covers & Foil**

**Nichols All Natural Kraft Wet Strength Water Resistant Paper Sleeve**

Protect plants from damage and the elements. Made of the highest quality brown paper. A special formula glue is used in the manufacturing of these sleeves to give a superior bond. Sleeves are nested in tens and carton packed.



**For 4in-4.5in Pot, 5in Bottom W x 13in Top W x 18in H**  
**NICS418A** Min. Buy 1ea



**For 6in-6.5in Pot, 7.5in Bottom W x 24in Top W x 24in H**  
**NICS624D** Min. Buy 1ea

**For 6in-6.5in Pot, 8in Bottom W x 20in Top W x 24in H**  
**NICS624B** Min. Buy 1ea

**For 6in-6.5in Pot, 8in Bottom W x 21in Top W x 30in H**  
**NICS630A** Min. Buy 1ea

**For 6in-6.5in Pot, 8in Bottom W x 24in Top W x 30in H**  
**NICS630B** Min. Buy 1ea

**For 6in-6.5in Pot, 8in Bottom W x 24in Top W x 36in H**  
**NICS636A** Min. Buy 1ea

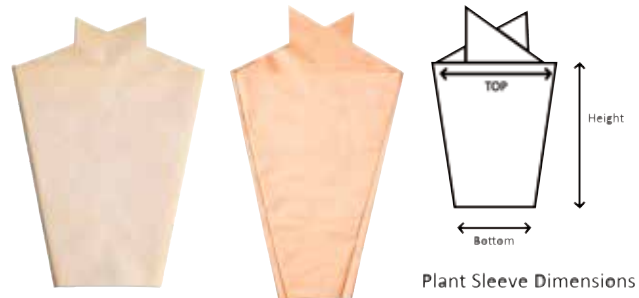

**For 7in-7.5in Pot, 9in Bottom W x 24in Top W x 30in H**  
**NICS730B** Min. Buy 1ea

**For 7in-7.5in Pot, 9in Bottom W x 24in Top W x 36in H**  
**NICS736A** Min. Buy 1ea



**Fits 8in-9in Pots, 10.5in Bottom W x 30in Top W x 42in H**  
**NICS842A** Min. Buy 1ea

**Fits 8in-9in Pots, 10.5in Bottom W x 34in Top W x 36in H**  
**NICS836C** Min. Buy 1ea



**For 10in Pot, 13.5in Bottom W x 24in Top W x 24in H, 500cs**  
**NICS1024A** Min. Buy 1ea

**For 10in Pot, 13.5in Bottom W x 30in Top W x 36in H**  
**NICS1036A** Min. Buy 1ea

**For 10in Pot, 14in Bottom W x 30in Top W x 48in H**  
**NICS1048A** Min. Buy 1ea



# DISCOVER THE POWER OF COMMERCIAL.

ASK YOUR BFG REP  
FOR A QUOTE TODAY.

## *Now available at BFG!*

Discover the Power of Motorola Solutions Commercial Two-Way Radios.

Built tough, these radios are durable and made to stand up to every day wear and tear and go the distance. BFG is now selling EVX, SL, BPR, and CP Series Commercial Two-Way Radios.

Ask your rep how you can get a quote or request a demo today!

Speaker Mics and  
Multi-Unit Chargers  
available



**WATERPROOF!**  
EVX SERIES

EVX SERIES



SL300 SERIES



BPR40 SERIES



CP185 SERIES



CP100d SERIES



CP200d SERIES



**Other Equipment**
**Motorola® DTR Series Digital Two-Way Radio**

With Motorola Solutions DTR Series radios, digital on-site communication is easier and more reliable than ever. Your team can communicate quickly, solve problems rapidly and address unexpected situations – ultimately improving operational efficiency and customer satisfaction. Enhanced features include a slim, rugged design that is simple, yet powerful. Crisp, clear audio and wide-area coverage keep employees connected and accountable wherever they are. An intuitive navigation menu ensures ease-of-use. Motorola Solutions' DTR Series radios are the perfect partner for your business – delivering all the benefits of reliable digital communications.



**Operates on 900 MHZ with 30 Channels**  
**PMIDTR600**      Min. Buy 1ea

**Motorola® DLR Series Digital Two-Way Radio**

**Operates on 900 MHZ / 2 Channels / Covers up to 300,000sq ft or 25 floors indoors / Battery life up to 14 hours per charge / Not Compatible with analog radios (CLS, XTN, RM or RDX)**

**PMIDLR1020**      Min. Buy ea



**Operates on 900 MHZ / 6 Channels / Covers up to 300,000sq ft or 25 floors indoors / Battery life up to 14 hours per charge / Not Compatible with analog radios (CLS, XTN, RM or RDX)**

**PMIDLR1060**      Min. Buy ea

**Motorola® CLS Series Two-Way Radio**

Durable but lightweight, this two way radio delivers versatility of expanded communications by enhancing safety and security, improving response time and maximizing productivity. With little or no training required, these two way radios are remarkably simple to use, making them ideal for high employee turnover industries. FCC license is required.



**1 Watt 1 Channel UHF Radio / Covers up to 200,000sq ft or 15 floors indoors / Battery life up to 14 hours per charge / 2 Year Warranty**  
**PMICLS1110**      Min. Buy 1ea



**1 Watt 4 Channels UHF Radio / Covers up to 200,000sq ft or 15 floors indoors / Battery life up to 14 hours per charge / 2 Year Warranty**  
**PMICLS1410**      Min. Buy 1ea

**Motorola® RM Series Two-Way Business Radios**

RM Series two-way radios have the business smarts to help you work better together. They combine outstanding quality with excellent affordability. With crisp, clear audio throughout the workplace and exceptional durability, RM Series radios won't quit in high noise, harsh conditions and hard use. The RM Series meet Military Standard 810C, D, E, F plus G and IP54/55 standards. These radios undergo Motorola's unique Accelerated Life Testing (ALT). This rigorous laboratory testing simulates up to 5 years of field use, including: blowing rain, vibration, salt, fog, blowing dust and extreme temperatures. Features: 4 or 8 CHANNELS, Channel Aliasing with Announcements - Assign each channel a user customized channel announcement to confirm which channel you are on, NOAA Weather Radio Channels - Dedicate a channel to monitoring weather and be automatically notified when there is an alert, Business Exclusive Frequencies - Operates 27 VHF Frequencies, and 89 UHF Frequencies, Long Battery Life - Ships with a standard lithium ion battery which lasts up to 15 hours, FCC License is required, 2 Year Warranty.



**Covers up to 220,000sq ft / 8 Channels**  
**PMIRMV2080**      Min. Buy 1ea



**Covers up to 250,000sq ft / 4 Channels**  
**PMIRMU2040**      Min. Buy 1ea



**Covers up to 250,000sq ft / 8 Channels**  
**PMIRMU2080**      Min. Buy 1ea

**Motorola® RDX Series Two-Way Radio**

Two-way radio operates on 89 Innovative business-exclusive UHF frequencies. The default factory programming on this RDX radio is set to operate in 12.5kHz mode. Enhanced audio quality, a rugged design and versatile customer programming software, make this radio an exceptional choice for all of your on-site business needs.



**Covers up to 300,000sq ft / 10 Channels / 18.5 Hours Battery Life / 4 watt / 2 year warranty**  
**PMIRDU4100**      Min. Buy 1ea



**Covers up to 350,000sq ft / 10 Channels / 18.5 Hours Battery Life / 5 watt / 2 year warranty**  
**PMIRDV5100**      Min. Buy 1ea

**Motorola® Rechargeable Battery**

A standard Original Li-Ion battery for two-way portable radios.



**RDX Series Battery**  
**PMIRLN6351**      Min. Buy 1ea



**DTR Series Battery**  
**PMI53963**      Min. Buy 1ea



**DLR Series Battery**  
**PMIHKN4013**      Min. Buy 1ea





**MOTOROLA SOLUTIONS**

Authorized Business Radio Reseller

**Other Equipment**

**Motorola® Multi Unit Charging Tray**

Keep your workstation organized with the universal multi-unit charger. Six-radio charger unit charges up to six two-way radios at one time. Charges in six hours.



**RDX series / 6 unit**

**PMIRLN6309** Min. Buy 1ea



**RM series / 6 unit**

**PMIPMLN6384** Min. Buy 1ea



**CLS series / 6 unit**

**PMI56531** Min. Buy 1ea



**DTR series / 6 unit**

**PMI53960** Min. Buy 1ea



**Motorola® Swivel Earpiece**

This earpiece features an in-line microphone and push-to-talk button that makes communication easy when your radio is not readily accessible.



**w/ Clip PTT**

**PMIHKLN4604** Min. Buy 1ea



**Motorola® Heavy-Duty Spring Action Belt Clip**

Provides extra durability for your portable two-way radio.



**PMIRLN6307** Min. Buy 1ea



**Motorola® Swivel Belt Holster**

This carry holster features a swivel clip that lets you rotate your radio into a comfortable position.



**RM Series**

**PMIHKLN4510** Min. Buy 1ea



**PMI53961** Min. Buy 1ea



**Ridder PolyDrive** The new Drive standard for Poly Greenhouses

The Ridder PolyDrive (RPD) is a compact and lightweight motor gearbox with an integrated limit switch system for driving manually-controlled or climate-controlled ventilation and screen systems in poly greenhouses. The quick and easy-to-install Ridder PolyDrive is rainproof and windproof. The PolyDrive has a high protection class (IP55) and can be used in an ambient temperature of 0-60 °C.



- Specially designed for poly greenhouses
- Suitable for ventilation and screening
- Low Maintenance
- High quality and reliability
- Easy-to-program limit switch

**HortiMaX-Go!** Plug, Play and Grow!

Unique and distinctive, the HortiMaX-Go! was designed for growers starting out in protected cultivation and looking for an entry-level automation system. Utilizing the latest technology, this modern and affordable horticultural computer has touchscreen operation and includes all necessary software. Pay only for the components needed and should needs change, extra components can easily be added to the existing system.



- Irrigated Water and Climate Control
- "Smart Switch" Intelligent Functionality
- Modern User Interface
- Plug and Play Installation
- Customized Solution
- Access anytime, anywhere & on any device

**FertiMiX-Go!** Make Every Drop Count!

Open a whole new world of irrigation capabilities with the Ridder FertiMiX-Go! Ideal for growers seeking a basic, automatic fertigation system that is both affordable and easy to use. Imagine the possibility of controlling up to eight climate zones in your greenhouse with a host of start options, fertigation recipes and up to four programmable periods.



- Quickly save on water and fertilizers
- Achieve higher yields and a fast return on investment
- Always apply the best fertigation strategy for your needs
- Control up to eight climate zones



**Display Carts**

**Poly-Tex® Tri-Step Display**

Create a cascading display of color. The bench tops are 18in, 24in and 36in deep. Expanded metal benchtops are available. Optional 40in high purlin holds six 10in hanging baskets. Specifications: 73.25in L x 40in W x 44.5in H (With Optional Purlin 92in H).



**Includes Casters & Purlin**

**POLTXPX7020CP** Min. Buy 1ea



**P.L. LIGHT SYSTEMS**  
THE LIGHTING KNOWLEDGE COMPANY

**Greenhouse Lighting**

**PL HSE NXT2 HPS Luminaire 600W**

Luminaire 600W.



**600W**

**PL1019376** Min. Buy 1ea



**PL HortiLED Top 2.0 Daylight Dim**

Luminaire 336W.



**HortiLED Top 2.0**

**PL1028490** Min. Buy 1ea



**P.L. Light Systems High Pressure Sodium (HPS) Bulb**

400 watt high pressure sodium replacement bulb.



**400W Bulb**

**PL400W HPS PHILIPS ALTO** Min. Buy 1ea



**Need Assistance?**

Do you require a special lighting design

**A Solution for Every Application**

P.L. Light Systems offers a complete range of innovative horticultural lighting products across a variety of technologies. Their systems are designed to deliver optimal lighting performance for plant growth, and are built to the highest quality of production.

**BFG is Your Source**

BFG Supply partners with P.L. Light Systems and can source what you need.

Contact your BFG Sales Representative for more information or a complete lighting design!

**Replacement Bulb**

BFG has one of the most common items needed but did you also know we can design you a customized lighting design?



# PARsource

## Lighting



### PARsource® Phantom Commercial DE Attached Light System

The Phantom Commercial Double-Ended attached light system is one of the premium double-ended light systems in the PARsource line. Available in 750 and 1000 watts and multiple voltages, this attached system combines our premium variable wattage Phantom ballast with one of our double-ended reflectors and our high-PAR Agrosun DE high-pressure sodium lamp. The commercial-grade Phantom ballast is designed with a high-precision smart microprocessor, contributing to highly efficient operation and extremely reliable performance. It has five-way dimming capabilities: Super Phantom Commercial DE Open System Boost (up to 1150W lamp output).



#### Features:

- Sleek cast design and reflector arm allowing for easy replacement or changing of the reflector specular
- Premium European aluminum hammertone reflectors for higher efficiency and maximum PAR output
- Five-way dimming capabilities
- Diagnostic LED status indicators and built-in protection shut-offs
- Premium Agrosun high PAR 2100  $\mu\text{mol/s}$  lamps
- Compatible with the Autopilot PX2 controller

#### Includes

- Phantom Commercial DE Ballast
- Open or enclosed reflector options.
- Available in voltages 120V to 480V.
- 8' power cord with plug



### PARsource® Phantom Dual 315W CMH Light System

The Phantom Dual CMh System is a highly versatile system that allows you to run a single 315W lamp or both at the same time for 630W of high-PAR CMh light. The dual reflectors can be used in the standard position or rotated 90 degrees downward to give a low-profile hanging configuration that is ideal for tight spaces. Multiple voltage, plug and spectrum options of 3100K and 4200K available.

**CMH = Ceramic Metal Halide with Philips Lamps**  
**Output: 1344  $\mu\text{mol/s}$  at 3100K, Power Cord: 8' 120V 16/3 IEC**  
**HYFPHMH601013 Min. Buy 1ea**

### Photobio-MX



680W / 1768 PPFD

### Photobio-T



330W / 846 PPFD

### Photobio-TX



680W / 1768 PPFD

### PARsource® PHOTOBIO LED Fixtures

PHOTOBIO LED fixtures are designed for greenhouse and indoor CEA applications. Robust commercial designs combine with high efficiency S4 spectrum to provide more red, far-red and blue wavelengths that deliver vigorous vegetative growth and increased flowering. The spectrum provides ideal conditions for both human and plant health to deliver better working conditions and consistent crop quality. All fixtures will operate at 100V to 277V, and a variety of NEMA plug options are available.

#### Features:

Fixture Type	Horticultural LED
Spectrum	S4 Spectrum
Efficacy	2.6 $\mu\text{mol/joule}$
Input Voltage Range	100–277V
Lifetime	Q90: > 50,000hr
Optics	120° Primary Optics
Dimmable	0–10V
Driver	IP67 Driver
Operating Environment	Wet Location
Ingress Protection Rating	IP65
Warranty Period	5 Years

#### S4 Spectrum

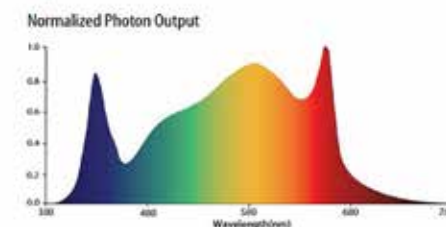



**R3**  
RELIABLE  
REDISTRIBUTION  
RESOURCE.

**Worker Protection**

**R3 Safety™ Ansell Canner & Handler Glove**

Ideal glove for safety and dexterity in the food processing industry. Made with natural rubber latex with a pinked cuff style and pebble embossed grip design. Glove features excellent dexterity, tensile strength and elasticity. The 20mil thickness provides good chemical, snag, puncture and abrasion resistance. Complies with FDA food handling requirements.



**Size 10**  
**R3220197035** Min. Buy 1ea

**R3 Safety™ Best® Nitrile Disposable Gloves**

Powder free disposable glove that features a 4mil thickness, rolled cuff for easy donning, blue textured finish and industry standard 9.5in length.



**Medium, 100pk**  
**CCP97008-MED** Min. Buy 1ea  
**Extra Large, 100pk**  
**CCP97008-XLARGE** Min. Buy 1ea

**R3® Safety™ Chemical Resistant Glove**

Versatile chemical protection that performs across a diverse range of applications. High performance nitrile compound provides an outstanding combination of chemical resistance and strength. Offers superior snag, puncture and abrasion protection over rubber or neoprene gloves. Features straight cuff and sandpatch grip. Suitable for heavy-duty cleaning applications. High levels of flexibility, comfort and dexterity. Won't swell, weaken or degrade, and does not promote contact dermatitis. Complies with FDA food handling requirements.



**XL - Box of 12**  
**R33715510** Min. Buy 1ea

**R3 Safety™ DuPont™ Tyvek® White Coverall**

Attached hood, elastic wrists and ankles all provide an effective barrier against hazardous drip particles and light non-hazardous liquid splash. Comfort fit design offers greater range of movement. Includes serged seams and a nylon zipper.



**White - Medium**  
**BMC31710485** Min. Buy 1ea  
**White - Large**  
**BMC31710484** Min. Buy 1ea  
**White - Extra Large**  
**BMC31710487** Min. Buy 1ea  
**White - 3XL**  
**R331710489** Min. Buy 1ea



**R3 Safety™ Moldex® 9000 Series Full Face Mask Respirator**

Mask boasts an extra-wide viewing lens, with an over-molded flange design. At less than 13 ounces, the respirator is ultra-lightweight and has a convenient ratchet fastening strap system and a stand-away head harness that make putting the mask on and taking it off quick and easy. The strap tabs are securely molded directly to the flange for rugged use. It is completely free of metal parts, making it ideal for mines, refineries and other work environments where metal may be hazardous. Filters are sold separately.



**Medium**  
**R3222290021** Min. Buy 1ea  
**Large**  
**R3222290031** Min. Buy 1ea

**R3 Safety™ Moldex® 7000 Series Reusable Half Mask Respirator**

Light weight design plus extra-wide sealing area provides all-day comfort. Mask drops down for convenient storage around the neck or locks down for custom fit. Adjustable head cradle and curved neck buckles for extra comfort. Low profile, compact design allows a wide field of vision, fits well under welding helmets and with safety glasses. NIOSH approved. Filters sold separately.



**Medium**  
**R3222270021** Min. Buy 1ea

**Disposable Particulate N95 Respirator 14110444**

Strong and rigid outer shell. Form-fitted mask. Molded nose bridge. Electrostatic non-woven polypropylene polyester fibers. Dual welded head straps. Latex free woven suspension straps. Lightweight construction. Soft inner lining for extended comfort. Hypo-allergenic.



**20/bx**  
**R3341557865** Min. Buy 1ea

**R3 Safety™ Moldex® Replacement Organic Vapors Filter Cartridge for Mask Respirator**

100% PVC-Free® charcoal filter cartridge that can be used with both 7000 and 9000 series respirators. NOISH approved.

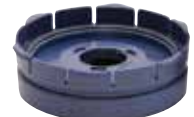

**d**  
**R3222271001** Min. Buy 1ea



Labels, Signs & Laminators

## Greenhouse & Garden Center Label & Tag Printers

### Printer Features:

- **Longer Ribbon (984ft vs. 244ft)**  
Save money with fewer ribbons & less changeovers
- **More Efficient Calibration**  
No labels or tags wasted
- **Integrated Unwinder**  
Supports both 1in & 3in cores
- **Faster Printer Speed**  
More labels & tags in less time
- **Adjustable Media Sensor**  
Supports gap, black mark and side & center notches
- **Practically Indestructible Keyboard**  
Full size, waterproof keyboard
- **Reduced Cost of Ownership**  
2 year Warranty! Print head – 6 months

### Printer Models:

#### GC-Select STA

- GC-Select Printer & Keypad
- 3 Formats

#### GC-Select DLX

- GC-Select Printer & USB Cable
- Label Design Software – Basic

#### GC-Select Pro

- GC-Select Printer & USB Cable
- Label Design Software – Professional

#### GC-Select DLX TOTAL

- GC-Select Printer & Keypad
- Label Design Software - Basic
- 3 Formats

#### GC-SELECT PRO TOTAL

- GC-SELECT Printer and Keyboard
- Label Design Software - Professional
- 3 Formats

### Total Select

#### Standalone plus PC Software

- Easily upgrade to Total Select from Standalone or PC Software.
- Quickly & conveniently print waterproof & UV Resistant labels & tags.



Three Label or Tag Formats  
Many More Available!  
Many Colors  
Are Available for  
Most Labels & Tags



Prints Outdoor Vinyl  
Tags & Labels...  
Waterproof & Sun Resistant!

### Printer Models:

Item	Description
1009158	GC Select-Sta - Stand Alone Printer
1009159	GC Select-DLX - Printer with PC Basic Software
1009161	GC Select-PRO - Printer with PC Pro Software
1009166	GC Select-DLX - Stand Alone Printer with Basic Software
1009168	GC Select-PRO - Stand Alone Printer with Pro Software

### Labels:

Item	Description
1004901	3" x 2-3/8" White Waterproof Stick on Label 7,200/cs
1005827	0.75" x 5" White 4 Across Pot Stakes 6,000/cs
1005797	0.75" x 5" Yellow 4 Across Pot Stakes 6,000/cs
1005800	1" x 7" White Wrap Around Tags 8,400/cs
1005801	1" x 7" Yellow Wrap Around Tags 8,400/cs
1005808	1" x 10" White Wrap Around Tags 6,000/cs
1005787	1" x 10" Yellow Wrap Around Tags 6,000/cs
1005786	2" x 1" White Waterproof Stick-On Label 16,560/cs
1008310	4" x 2" White Waterproof Stick-On Labels 9,000/cs
1010709	4" x 2" Yellow Waterproof Stick-On Labels 9,000/cs
1007051	4" x 6" White Waterproof Stick-On Label 900/cs
1005788	0.50" x 3" White Waterproof Stick-On Plug Tray Label 5,000/cs
1011848	0.625" x 7" Wrap Around Tree Tag 12,600/cs

### Ribbons:

Item	Description
1005841	3.3" x 244' Black Transfer Ribbon 12 Rolls/cs *For GC-1
1006393	GC-FLEX / SELECT Printer Ribbon (6 rolls/cs)

### Pricing Gun:

Item	Description
1000075	Monarch Pricing Gun
1000441	0.75" x .5" Labels Outdoor for Monarch Price Gun 12,000/slv
1008575	Monarch Large Pricing Gun
1008573	Outdoor Waterproof Labels for Large Pricing Gun 8,000/slv

Ask Your BFG Sales Rep for Details & Pricing

## Greenhouse Ventilation

### Schaefer® Versa-Kool® H.A.F. Barrel Fan

Increase safety and productivity with Versa-Kool circulation fans. The patented guard design allows for greater air movement at very low noise levels. Improve air quality and working conditions by strategically placing Versa-Kool circulation fans using optional wall or ceiling mounts. The airflow ranges from gentle to powerful and the fans have the variable speed capability which allows you to select a perfect airflow pattern.

- Available in 8in to 24in diameters
- Extremely rugged guards and housings for long life
- Guard spacing and engineered blades result in greater air movement at lower noise levels
- Depth of front guard makes fan extremely safe, but not OSHA compliant if mounted below seven feet.
- Guards are powder coated over steel for corrosion resistance.
- Heavy-duty totally enclosed, maintenance free North American motors.
- Two-year limited warranty.



**12in Diam / 1.3/1.65 Amps @  
115/230 Volts 60hz**

**SVEVK12**

Min. Buy 1ea



**20in Diam / 3.8/1.9 Amps @  
115/230 Volts 60hz**

**SVEVK20**

Min. Buy 1ea

### Typical Schaefer VK12 Pattern

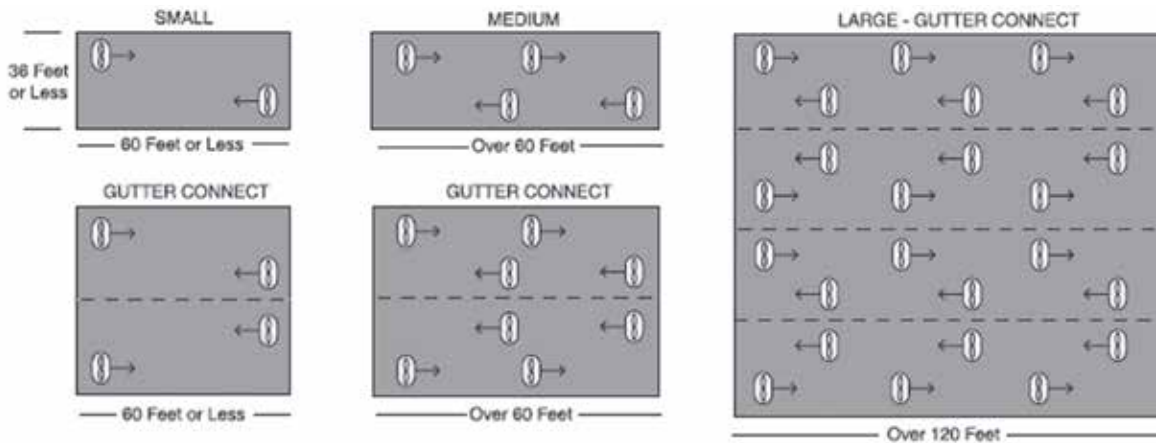

### Schaefer® Shade Pole Inflation Blower

Shaded pole inflation blowers have forward curved wheels and energy efficient, open drip proof motors. These blowers are frequently used for inflating air between two layers of greenhouse polyethylene to provide better insulation.

#### Large Inflation



**148CFM - For Greenhouses Larger than 30x100**

**SVEB148**

Min. Buy 1ea



**148CFM - For Greenhouses Larger than 30x100**

**SVEB148-E**

Min. Buy 1ea

#### Small Inflation



**60CFM - For Greenhouses Less than 30x100**

**SVEB60**

Min. Buy 1ea



**60CFM - For Greenhouses Less than 30x100**

**SVEB60-E**

Min. Buy 1ea





## Greenhouse Ventilation

### Schaefer® Aluminum Shutter

Allow airflow in a single direction and are used as building air inlets to feed exhaust fans, or on exhaust fans to prevent air entry when the fan is not operating. Aluminum shutters are built tough for long life in the most demanding environments, all at an affordable price. Constructed of heavy-duty brushed aluminum for corrosion resistance and greater durability. Interlocking louvers for maximum weather protection and lightweight for high efficiency and easy installation. Tie bar to eliminate shutter flapping.



**60.5in W x 61in H**

**SVEWS-600**

Min. Buy 1ea



### Schaefer® Large Shutter Motor

For use with Schaefer shutters over 48 inch.



**SVESHUTTERMOTOR-LG**

Min. Buy 1ea



### Schaefer® Fiberglass Exhaust Fans

Schaefer's narrow profile, fiberglass housing exhaust fans are designed to exhaust a lot of air for a long time. All fans ship fully assembled and have self-adjusting belt tensioners and heavy-duty aluminum shutters installed.

#### Features:

- Available in 36in, 48in and 52in sizes
- Heavy-duty, totally enclosed, maintenance free and energy efficient motors
- Long life pillow block bearings
- Large radius fiberglass venturi for maximum airflow, long life and good looks
- Galvanized or stainless blades for high performance and long life
- Efficient and reliable spring belt tensioning system
- Two-year limited warranty; 15-year housing warranty



Fiberglass Exhaust Fans

### Schaefer® Direct-Drive Exhaust Fans Direct-Drive Shutter Style and Flush-Mount Exhaust Fans

Schaefer's high quality, long life, exhaust fans are a cost-effective way to exhaust air and moisture from most greenhouse facilities. Designed for low to medium volume exhaust airflow and suited for a broad range of facilities. Use PFM flush-mount exhaust fans for larger exhaust airflow requirements and to enable mounting the fan flush with the interior wall and exhausting through thicker walls.

#### Features:

- Available in 9in, 12in, 16in, 20in and 24in sizes
- Heavy-duty, totally enclosed, maintenance free and energy efficient motors
- PFM flush-mount style fans have polypropylene blades, rugged polyethylene housings and PVC or aluminum shutters for long life
- Two-year limited warranty; 25-year polyethylene housing warranty



Direct-drive flush-mount style variable speed\* exhaust fan



### Schaefer® Wet Wall Evaporative Cooling System

Ideal for cooling greenhouses, warehouses, and other large facilities. Schaefer's Wet Wall Evaporative Cooling Systems, in conjunction with Schaefer exhaust fans, provide up to 30°F of cooling for large volume buildings, from the evaporation of water from wet wall pads (evaporative media).

- Custom lengths and heights available.
- Up to 5-year pad life with proper pad maintenance.
- Choice of 1 Hp and ¾ Hp Gould™ pumps; 110V or 220V.
- Single- or multi-stage automatic controls available.
- Easy to install, operate and maintain.
- Water that does not evaporate is recycled through the pads; no wasted water.

### Wet Wall Pads/ Evaporative Media

Used in Schaefer Wet Wall Cooling Systems and wet wall systems from other manufacturers, wet wall pads are fluted cellulose pads designed for maximum airflow, maximum evaporation, structural strength and long life.

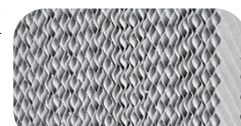

### Schaefer® Galvanized Slantwall Exhaust Fan

First choice of growers and other building owners looking for very low cost, high volume exhaust fans that flush-mount from inside the building and shed water and snow, once installed. Designed for high airflow and high efficiency and available in many sizes and configurations to meet application requirements. Fans ship fully assembled with aluminum inlet shutters, self-adjusting belt tensioner (on belt-drive models) and galvanized outlet guard. Cord not included.



**48in Diam / 8.4/4.2 Amps @ 115/230 Volts**

**60/50hz / Phase 1 / 5 Wings**

**SVE48551**

Min. Buy 1ea



### Schaefer® Eventherm® Single Phase Thermostat

Automatic controls to control fans and heaters and optimize thermal comfort.



**4.5in W x 6 3/8in L x 3in H / 16 Amps @ 120/240**

**Volts 60/50hz / Phase 1**

**SVET335TH420**

Min. Buy 1ea







## Sprayers & parts

### Greenhouse Heaters

#### Siebring Mfg Quantum Gas Heater

All controls are wired for installation. Alumina-Silica Refractor. Lightweight design offers versatile mounting options (ceiling or floor). Designed to work with a horizontal air flow pattern in large buildings. High fuel efficiency.



**Model QT180 - 180,000 BTU / Natural Gas / 3.5in W.C. / 36in W x 41in L x 50in H / 1/3hp Motor / 24in Prop**

**SMKQT180 NG** Min. Buy 1ea



#### Siebring Mfg Oil Furnace

All controls are wired for installation. Alumina-Silica Refractor. Lightweight design offers versatile mounting options (ceiling or floor). Designed to work with a horizontal air flow pattern in large buildings. High fuel efficiency.



**200,000 BTU / 1.25gph / 26in W x 77in L x 38in H / 3/4hp Motor / 2800cfm Blower**

**SMKHM203** Min. Buy 1ea

**400,000 BTU / 2.75gph / 47in W x 85in L x 45in H / 1hp Motor / 3600cfm Blower**

**SMKHM404** Min. Buy 1ea



#### Siebring Mfg Mist 'R Drencher Sprayer

Quick connect for draining or washing polyethylene tank (lid included). Ball bearing mounted hose reel for 250ft payout and rewind. Includes 3 piece nozzle for high or low misting, 1 drenching water breaker screen nozzle, 2 18in wands and 1 12in wand, 1 12in curved (hook) extension for hanging baskets, back flush connector for easy cleaning, 0 degree to 15 degree pressure nozzle and 100ft wire braid hose. Has hose reel and high pressure gun. Constant agitation suspends wettable powders.



**Electric or Gas / 800psi / 3gpm Flow / 10in "No Flat" Tires**

**SMKMD83BW** Min. Buy 1ea



#### Siebring Mfg Kruser Sprayer

Features bottom tank drain and sump in tank for maximum usage. Includes a mist nozzle assembly, an 18in wand and 100ft 1/4in wire braid hose. Has hose reel and high pressure gun. Constant agitation suspends wettable powders.



**Gas / 750psi / 1.5gpm Flow / 10in "No Flat" Tires / 25gal Poly Tank / 4hp Gas Engine**

**SMKKS-750-100** Min. Buy 1ea



**Electric / 750psi / 1.5gpm Flow / 25ft Electrical Cord / 10in "No Flat" Tires / 25gal Poly Tank**

**SMKKS750-125** Min. Buy 1ea



# SENSAPHONE<sup>®</sup>

## REMOTE MONITORING SOLUTIONS

### Other Equipment

#### Sensaphone<sup>®</sup> Monitoring System

Offers small-business owners, vacation property owners, and other property managers an easy and inexpensive way to monitor a remote facility. When the system is connected to a standard telephone line, users can record custom "Alert Condition" notifications and receive alarm messages in their own voice. This system can set off a local alarm if a phone line is cut and control a thermostat to adjust site temperature between two set points. Nonvolatile memory retains system settings in the event of power loss. The status of each monitored condition is readily obtained at the unit's installation site or remotely by telephone. Up to four external sensors monitor temperature, humidity, water and more. No monthly fees.



**Temperature-sensing range of -20 to 150 degrees F.**

**SENSPFGD-0400** Min. Buy 1ea





**Other Equipment**

**St George Company® Kasco Battery Powered Helmet Respirator**

Personal respiratory protection used while spraying pesticides and herbicides, ideal for orchard and vineyard use. Can be used with Kasco suit. High quality, fiberglass, powered air-purifying helmet respirator provides NIOSH-approved protection against organic pesticides. The helmet features a flip-up, Lexan visor with a tough fiberglass shell and adjustable headband for sizes up to 7. Can be worn with beards and spectacles. The blower/fan unit and battery are worn on a belt around the waist. 12 volt power cord plugs into the tractors cigarette lighter socket for power to operate blower/fan unit and/or charge four hour battery. Helmet is pressurized by positive pressure with 8 CFM and is vented by one-way valves. System Includes: SP8 cigarette lighter power cord, helmet blower/fan unit, air hose, belt, battery, two ZA2/P3 filters and instructions.



**STG0313195** Min. Buy 1ea

**St George Company® Kasco Respirator Clear Visor**

flip-up, Lexan visor with a tough fiberglass shell and adjustable headband for sizes up to 8. Can be worn with beards and spectacles. Clear visor for all K80S model (T-1 through T-9) Kasco helmets and Prof 88 Kasco helmets.



**For Use with K80S & PROF 88 Helmet Respirator**  
**STG1903005** Min. Buy 1ea

**St George Company® Kasco ZA1/P3 Helmet Respirator Filter**

Replacement filter for PROF 88 Kasco helmet system only.



**For Use with PROF 88 System Only**  
**STG0601047** Min. Buy 1ea



**St George Company® Kasco ZA2/P3 Helmet Respirator Filter**

Replacement filters for T1, T5 T8 & T9 Kasco helmets. Do not use with fumigants.



**For Use with T1,T5, T8 & T9 Systems Only**  
**STG0601019** Min. Buy 1ea



**St George Company® Kasco Helmet Respirator Replacement Battery**

Replacement battery for use with Kasco's T8 helmet. Battery can also be used with the T5 model as long as you use the adapter cable (not included).



**6V 6Ah, Input VDC**  
**STG0309064** Min. Buy 1ea



**Greenhouse Ventilation**

**J&D Mfg Destratification Fan**

The JD360 is an effective destratification fan that mixes the heavy, cool, dense air that is sunk to ground level with the warm, light, thin air that lingers towards the top of your facility. This provides a comfortable and uniform healthy environment from the top of the peaks to the ground of your house. It's the perfect vertical, low-air-speed circulator and it's paired with J&D's impressive IP66 rated Gold Star Motor that is covered by a 3-year warranty. It's easy to install and maintenance free. Save money on your labor and your heating bill with the JD360. You'll like the price and the pallet quantity discount!



**18in**  
**JDMJD360** Min. Buy 1ea



## Greenhouse Lighting



### TotalGrow™ Mezzo Light Bar

The TotalGrow Mezzo generates an ideal light spectrum for diverse supplemental and sole source applications with a versatile output pattern, exceptional efficiency and profound total value in a pleasant work environment. This plug-and-play solution is simple to implement, low on upfront and ongoing costs and makes it possible to sustainably grow high quality plants year-round over a very long lifetime with minimal height requirements.



**80W / 200  $\mu$ mol/s Output / 100-277 Volts**  
**TG8B21325D012BA6** Min. Buy 1EA

### TotalGrow™ UVA Bar

The TotalGrow UVA Bar generates 385nm UVA light with exceptional efficiency and reliability in an ideal form factor for simple utilization. Standard grow lights emit little or no UVA radiation. UVA stimulates several plant photoreceptors that enhance hardiness, coloration, tastes, smells, density, and potency. Combine with sunlight and/or TotalGrow full spectrum lights for ideal growth!



**30W / 45  $\mu$ mol/s Output / 100-277 Volts**  
**TG3B821107BA805** Min. Buy 1EA



### TotalGrow™ Pure Flowering 200 Lamp

The most efficient and effective solution for simulating long days to control the timing of flowering. Perfect balance of red and far-red light output for night interruption/day length extension. No wasted light output in non-photoperiodic regions. Minimal power consumption and electrical infrastructure needs with simple installations.



**17W / 100-240V / Life hrs: 50,000 / Typical Coverage: 200sq ft**  
**TG1B-3A-1104-BA4** Min. Buy 1EA



### TotalGrow™ Pure Flowering Lamp Socketed Cord

Socket cord for the Installation of TotalGrow™ Pure Flowering 200 Lamps. Socket Base Size: E26. Voltage: 100-240V. Approximate Max Power: 600W. Cable Gauge: AWG16. Plug: Polarized NEMA 1-15P



**108ft / 9ft socket spacing / 12 sockets**  
**CS-108-108** Min. Buy 1EA  
**330ft / 15ft socket spacing / 22 sockets**  
**CS-180-330** Min. Buy 1EA



### TotalGrow™ Multi-HI Light Fixture

The TotalGrow Multi-HI features multiple high intensity light bars in a thin form factor to evenly distribute the ideal intensities of light over your grow area to match your growing goals. An exceptional, customizable, full light spectrum supports efficient, quality growth for any life stage and crop variety. This plug-and-play solution with built-in daisy-chaining is simple to implement with low upfront and ongoing costs for the sustainable production of high quality crops. Standard versions include 170-640W lights for light intensities of approx. 500-1000 PPFD in 2ft x 4ft - 4ft x 4ft areas. (Initial power cord sold separately)



**170 Watts / 450  $\mu$ mol/s Output / 100-277 Volts / 2 Bar / 2'x4'**  
**TG17B21326D160BF6** Min. Buy 1EA  
**170W / 450  $\mu$ mol/s Output / 100-277 Volts / 3 Bar / 2' x 4'**  
**TG17B21326D160BD6** Min. Buy 1EA  
**240 Watts / 640  $\mu$ mol/s Output / 100-277 Volts / 3 Bar / 2'x4'**  
**TG24B21326D160BD6** Min. Buy 1EA  
**320 Watts / 850  $\mu$ mol/s Output / 100-277 Volts / 4 Bar / 2'x4'**  
**TG32B21326D160BD6** Min. Buy 1EA  
**340 Watts / 840  $\mu$ mol/s Output / 100-277 Volts / 4 Bar / 4'x4'**  
**TG34B20324D160BE6** Min. Buy 1EA  
**480 Watts / 1180  $\mu$ mol/s Output / 100-277 Volts / 6 Bar / 4'x4'**  
**TG48B20326D160BE6** Min. Buy 1EA  
**640 Watts / 1700  $\mu$ mol/s Output / 100-277 Volts / 8 Bar /4'x4'**  
**TG66B21326D160BE6** Min. Buy 1EA

### TotalGrow™ High Intensity Top Light Fixture

The TotalGrow HI-Top generates an ideal full light spectrum for diverse supplemental and sole source applications with a versatile output pattern, exceptional efficiency and profound total value in a pleasant work environment. This plug-and-play solution is simple to implement, low on upfront and ongoing costs and makes it possible to sustainably grow high quality plants year-round over a very long lifetime. 330 and 530W units replace up to 1000W HPS light fixtures.



**330 Watts / 880  $\mu$ mol/s Output / 100-277 Volts**  
**TG33B221326D160BA6** Min. Buy 1EA  
**530 Watts / 1410  $\mu$ mol/s Output / 100-277 Volts**  
**TG53B221326D160BA6** Min. Buy 1EA



**60in Power Cord with NEMA 5-15P Plug**  
**CP-N5-M19-60** Min. Buy 1EA

### TotalGrow™ Stratum Light

The TotalGrow Stratum is designed and refined to maximize yields, space and versatility while minimizing costs. The spectrum and size are ideal for low/no-sunlight growing in virtually any vertical farm, growth chamber, propagation system, tower garden and more. Exceptional efficiencies and light delivery potential, along with long, low maintenance lifespans provide long-term sustainability. Only 1.2in thick with a 5.1in width for maximum uniformity.



**40 Watts / 95  $\mu$ mol/s Output / 100-277 Volts**  
**TG4B3BA** Min. Buy 1EA  
**60 Watts / 135  $\mu$ mol/s Output / 100-277 Volts**  
**TG6B3BB** Min. Buy 1EA





**Display Carts**

**VRE Systems® Handi Cart with Solid Wheels**

Engineered and designed for customer service and retail nursery garden center transportation and moving plants and product efficiently. Our carts are designed to hold a maximum number of plants for increased sales. Holds up to 13 flats (with removable shelf option). Push/pull handle on both ends.



**22in W x 48in L Top Deck, 22in W x 36in L Bottom Deck, 8in Solid Yellow Wheels, 500lb Capacity**  
**VREHANDIS** Min. Buy 1ea



**VRE Systems® Carts**

Engineered and designed for customer service and retail nursery garden center transportation and moving plants and product efficiently. Our carts are designed to hold a maximum number of plants for increased sales.

**VRE Systems® Husky Cart with Flat Free Wheels**

Heavy duty applications require customer service carts with extra strength and capacity. Our Husky Cart is designed to handle all of your heavy duty needs. The handle can be mounted on either end of the cart based on your preference. The Husky Cart is ready for the biggest tasks.



**22in W x 56in L, Two 10in Swivel & Two 16in Flat Free Wheels, 600lb Capacity**  
**VREHUSKYFF** Min. Buy 1ea



**JānorPot.**

**3D** Direction  
 Dimension  
 Display  
**SYSTEMS**

From Summit Plastic Co.



**Other Equipment**



**Wadsworth Seed®**

A sophisticated new touchscreen climate control so intuitive it makes managing multiple zones a snap. Our most capable control to date.

- Highly intuitive – the easiest control you'll ever operate!
- Newest most responsive touchscreen technology
- Extensive information at a glance
  - Equipment Status lists current conditions
  - Why Code displays explanation for equipment status
- Easy navigation
- Modular design allows for easy expansion
- Remote access
- Precision control of your crop
- View equipment settings, overrides, lockout and setpoints from a single screen
- Manages fertigation using the H.E. Anderson J+ system

**Wadsworth Seed® 16**

Seed 16 is identical to Wadsworth's popular Seed control, but made for small-scale needs.

- Functionality and intuitive graphic interface
- Design accommodates beginners and experts
- 16-outputs, enough to support standard greenhouse cooling, heating, HAF fans, pad pump, plus lighting and irrigation
- Configured to suit grower needs, multiple zones, single zone; your choice
- Flexible electrical panel built for custom equipment
- 16-inputs – enough to support temperature and humidity sensors, an exterior weather station and multipl other sensors, like soil moisture and CO2
- Advanced sensing options include dissolved oxygen (DO), tank electrical connectivity (EC), tank pH an differential pressure (Sensors require inputs)
- Expandable



**Wadsworth Driveshaft Coupling**

Coupling to join two lengths of drive shaft.



**1 3/8in**

**WADSF0909**

Min. Buy 1ea

**WADS VC -2000/ILS 1-3/8in O.D. Shaft**

Wadsworth's most powerful drive unit. It meets the challenge of long vent runs and heavy vents. With its quiet running, low current, high output motor, the VC-2000 keeps your utility bills low. It can lift 325 feet of 4 foot polycarbonate roof ridge vent with aluminum frame on rack and pinion.



**1.2 RPM**

**WADSM1190**

Min. Buy 1ea



**3.2RPM**

**WADSM1550**

Min. Buy 1ea



# Gutter Connect Greenhouse



Horticulture, Agriculture, Commercial, Retail,  
Schools and Institutions. WE DESIGN THEM ALL!

Ventilation options include:

- Side wall vents
- Gutter vents & raised gutter vents
- Rollup walls
- Forced air systems
- Vertical up or down
- Sliding vents
- Widths available to fit your needs
- Clear Span Series up to 48'
- Double or triple arch

Custom Opening Glass Wall



Higher Light Transmission



Fast and Easy to Assemble



FOR MORE INFORMATION:  
[sungrow@decloetgreenhouse.com](mailto:sungrow@decloetgreenhouse.com)

SINCE 1986

[WWW.DECLOETGREENHOUSE.COM](http://WWW.DECLOETGREENHOUSE.COM)

CALL US 1-519-582-3081

1-888-786-4769



# *Index*



## A

26GT.....	255, 263	Ambac Environmental Products.....	323
A.M.A Horticulture Inc.....	141	Anderline.....	307
Acelepryn.....	283	Animal Control.....	322-323
Acephate.....	299	Animal Repellents.....	322
Acid Cleaner.....	341	Anocra.....	283
Acidifier.....	344	Antal/Cayson Equipment.....	398
Acids.....	347	Anti-Foaming Agents.....	346
ACME Engineering & Manufacturing.....	16, 388	Anti-Transpirants.....	347
Actinovate.....	255	Aphid Control.....	283-299, 304-305, 313-314
Adaline.....	304	Recommendations.....	287
Adept.....	283	Strategies.....	286-287
Adorn.....	255, 273	Aphidoline.....	304
Advancing Alternatives Inc.....	51, 381	Applied Biochemists.....	340
Advocate.....	325	AquaGro.....	345
Aef Global.....	260	Aquamat.....	367
Affirm.....	255, 263	Aquatic Herbicides.....	337, 340-341
Agri of Virginia Inc.....	51	Aquatrols Corp of America.....	344-345
Agriform.....	231	Areca.....	256
Agri-Mycin.....	255	A-Rest.....	325
Air Cleaners.....	342-343	Argus.....	17
Akari.....	283	Aria.....	283
Alarm.....	See Monitoring System	ASB Greenworld Inc.....	184-187, 192
Alesco.....	325	Astro.....	284
Algaecides.....	257, 261, 271, 340-343	Astun.....	256
Aliette.....	255, 273	Attain.....	284
Alkalinity Testing.....	406	AV Plastic.....	51
Al-Par Peat Co.....	274	Avalon.....	284
Altus.....	283, 287	Avid.....	284
Aluminum Sulfate Fertilizer.....	241, 244	Axe.....	333
Aluminum Tape.....	60	Aza-Direct.....	284
Amblyline.....	309	AzaGuard.....	285, 287
American Coolair Corporation.....	388	Azalea Pots.....	74, 99, 105, 107-111, 118, 143, 151-152, 159
Amiad Water Systems.....	366	Azatin.....	285



## B

B.J. Williamson.....	63
BACCTO.....	188-189
Backpack Sprayers.....	387, 410
Bactericides.....	248-249, 255, 257-258, 260-261, 264-266, 269-271, 341-343
Organic.....	257, 260-261, 264, 266, 269-271, 341, 343
Reference Chart.....	248-249
Badge.....	256
Bait.....	322-323
Ball DPF, LLC.....	238, 274
Ball Valves.....	352, 366, 373
Repair.....	352
Bamboo Supply Company.....	389
Banner Maxx.....	256
Banol.....	256
Banrot.....	256
Bark Mixes.....	174, 178, 182, 190-191
Barlett Instrument Co.....	388
Barricade.....	333



B

Bartlett Bench.....40

Basagran.....333

Baseboard Clamps.....46

BASF Corporation.. 239, 260, 263-265, 269, 271, 273, 284-285, 287, 289, 295-297, 299, 301, 303, 321-322, 333-334, 336, 338, 341, 346

Basic Nutrients .....204-205, 244-245

Baskets ..... 91-93, 96, 118-124, 142, 144, 158

Batten Tape.....63

Bayer CropScience...255-258, 263, 266, 273, 283, 287, 289, 291-292, 296-297, 335-338

Beethoven.....285

Belchim Crop Protection.....323

Belden Plastics ..... 142-143

Bell Laboratories.....323

Benching.....35, 40-42, 45-52

    Components.....45-52

Benchmaster .....40

Benefit .....285

Berry Global.....16, 55-59

Biathlon.....333

BioCeres.....285, 288

BioFoamer.....346

BioLine AgroSciences.....287, 301, 304-312, 321

Biological Control Agents.....302-320

    Aphids.....304-305, 313-314

    Beneficial Predator Food .....312, 320

    Black Vine Weevils.....303, 305, 314

    Caterpillars.....305, 314

    Fungus Gnats .....303, 306, 310, 315, 318

    Leafminers.....306, 316

    Mealybugs.....307, 316

    Mites.....307-309, 316-318, 320

    Pheromone Lure .....312

    Reference Chart.....302

    Release Boxes.....312, 320

    Shoreflies.....303, 306, 315

    Thrips.....303, 306, 309-311, 315, 317-320

    Whiteflies.....310-311, 319-320

Biological Fungicides.....255, 257, 266-267, 269-270

Biological Insecticides.....284-285, 288-289, 291-292, 294, 297, 299

BioSafe Systems.....239, 264-265, 271, 274, 285, 288, 333, 340, 341, 343, 346-347

BioTherm.....16

BioTherm Heating Systems.....16, 402-404

BioWorks Inc. . 239-240, 246, 257, 263, 267, 273-274, 287-288, 294, 297, 301, 313-321

Blackout Curtains.....37

Blacksmith Bioscience .....294

Bluelab Corporation USA Inc.....390-391

B-Nine .....325

Boilers.....402

Bolster MycoBio.....274

BontaniGuard.....287

Bonzi.....325

Booms.....392

BotaniGard.....288

BotryStop.....257, 263

Botrytis Control Strategies .....262-263

Bowl Planters .....95-96, 127-128

Brandt Consolidated Inc.....241, 264, 290, 326, 344-345

Broadform .....257

BroadStar.....333

BT Now.....288

Bulb Pans .....109, 147

Burnett Lime Co .....347

Bushel Baskets .....90

C

Cal-Flo.....347

Calibration Solutions .....406

Californiline.....308

Cal-Mag Fertilizers .....198, 200-201, 203, 217, 222, 224

CalOx.....347

Camelot .....257

Capillary Mats.....354, 367, 370

CapSil .....344

Captain.....340

Captiva Prime.....288

Carolina Plastics Inc.....63

Caroron .....333

Carry Trays.....75, 101, 110-112, 115-118, 139-140, 142, 152, 154, 160, 163, 166

Carts.....378-379, 384-385, 410, 417, 426

    Display.....378, 417

    Transport.....378

CEASE.....257

Central Life Sciences.....287, 290, 293, 296

Cheetah Pro .....333

Chemical Solutions.....386, 390

Chemical Sprayers.....384-386

Cherry Creek Systems.....17, 392

Chipco.....257, 263-264

Chrysoline .....304

Chrystal Americas.....325

Citadel.....325

Citation.....288

Cleaners.....341-345

    Equipment.....345

    Organic.....343

    Structures.....344

    Test Strips.....341, 343

Climate Control Systems.....402-404, 407, 427

Closure Strips .....60

Coconut Coir Containers .....160

CoExtruded Containers.....74, 105-106, 110-111, 113, 117, 138, 151, 153, 159

Cold Foggers.....385-386

Cold Frames .....23, 25-26, 48

Collate.....325

Compass.....258

Compressed Media .....175-177, 179-181, 186, 188

Concise.....325

Condensation Control.....65

Conductivity Pens .....390-391

Configure.....326



Conserve.....	289, 301	Daconil Ultrex.....	258, 263
Containers.....	74-171	Daconil WeatherStik.....	258
CoExtruded.....	74, 105-106, 110-111, 113, 117, 138, 151, 153, 159	Daconil ZN.....	258
Decorative.....	77-90, 126-128, 137, 147, 150, 159	Dazide.....	326
Fiber.....	98-104, 140, 146, 160, 170-171	De Gier Drive Systems.....	394
Hanging Baskets.....	91-94, 103-104, 119-124, 142, 144-145, 150, 158, 168-169	Deadline.....	323
Injection Molded.....	107-109, 114-117, 136, 139, 143, 150, 159	Decathlon.....	289
Inserts.....	130-132, 142, 146, 154-157, 160, 164-165	Dec-Grow.....	137
Plug Trays.....	76, 133, 141, 148-150, 161-162, 167-168	DeCloet Greenhouse Manufacturing.....	13, 16, 19-24, 32, 35-36, 44-46, 428
Round Nursery.....	74, 98-101, 105-112, 134-138, 143, 150-151, 159-160	Decorative Containers.....	77-90, 126-128, 137, 147, 150, 159
Specialty.....	95-97, 137, 139-141, 160	Decree.....	258, 263
Square Nursery.....	75, 102, 113-115, 139, 143, 153, 159, 163	Deer Repellent.....	322
Thermoformed.....	75, 105-106, 113, 138, 151, 153, 159, 163, 166	DeerPro.....	322
Continental Products.....	64	Defoamer.....	346
Control Solutions.....	261	Dema.....	407
Controlled Environment Agriculture.....	14-15	Deodorizers.....	342-343
Controlled Release Fertilizer.....	227-231, 234, 236-238	Deposition Aid.....	344
Organic.....	237	DeWitt Company.....	64-65
Controllers - Climate.....	407	Diamond Brand.....	240
Controllers - Environment.....	381, 391, 407	Diaphragm Pumps.....	400
Controllers - Irrigation.....	354, 360, 371, 392	Digline.....	306
Controllers - Ventilation.....	388, 407	Dilution Solutions.....	393-394
Convection Tubing.....	377	Dimension.....	334
CoreTect.....	289	Dimilin.....	289
Corteva (Dow Agro).....	258, 289-290, 299, 301, 334-335, 338	DiPel.....	289
Cover Pots.....	95	Dip'N Grow.....	326
Coveralls.....	419	Disc Filters.....	360
Covering Accessories.....	60, 62-65, 67-68, 70	Discus.....	289
Closure Strips.....	60	Disinfectants.....	261, 341-343
Insect Screen.....	60	Organic.....	343
Liquid Shade.....	64, 67-68	Display Carts.....	378, 417
Spring Locks.....	63	Displays.....	40, 42
Support Wire.....	67	Distance.....	289
Tape.....	60, 63, 70	Dithane.....	258
Coverings.....	55-59, 61, 66-71	Dosatron.....	393-394
Black.....	71	Dosmatic.....	382-383
Clear.....	68-71	DP Industries Inc.....	395-396
Infra Red Film.....	55-57, 59, 66-68	DRAMM Corporation.....	16-17, 238, 350-355, 384-387
Multi Year.....	56-57, 59, 69	Drill Bit.....	366
Over Wintering.....	58-59, 61, 64, 66, 70	Drip Irrigation.....	353-354, 356-360, 364-366, 369
Poly.....	61, 69-71	Bridge.....	369
Shade.....	62, 65	Connectors.....	358-359
White.....	69-70	Couplings.....	369
Crest.....	326	Dripline.....	354, 364-365, 369
Crop Cover.....	64	Drippers.....	353, 358-360
Cryptoline.....	305, 307	Eyelets.....	354
CuPRO.....	258	Fittings.....	364
Curtain Systems.....	39, 51, 381	Goof Plug.....	360
Motors.....	381	Manifolds.....	359
Cutless.....	328	Rings.....	353, 357
Citrine.....	340	Shut Off Caps.....	366
Cycocel.....	326	Stakes.....	353, 356, 358-359
		Tools.....	366, 369
		Weight Assembly.....	356, 358



## D

Drive.....	334
Dupoline.....	312
Dura-Film.....	55, 56, 57
Duraguard.....	289
Dursban.....	290

## E

Eagle.....	258
EC Meters.....	391, 406
Eckert's Greenhouse.....	144, 145
Econo-Grip.....	135
EcoSwing.....	260
Ecotec Plus.....	290
Empress.....	273
Encarline.....	310
Endeavor.....	290
Enstar.....	287, 290
Entrust.....	290
Envoy Plus.....	334
Epsom Salt.....	205, 245
Eretline.....	310-311
Erville.....	305
EthylBloc.....	328
Ethylene Inhibitor.....	325, 328
Evergreen.....	290
Exhibitline.....	305-306, 310
Express.....	260

## F

Fame.....	260
Fans.....	387-388, 421-422, 424
Fascination.....	326
Feltline.....	308
Fertigation Systems.....	407, 416
Fertilizer Injectors.....	382-384, 393-394
Fertilizers.....	198, 200-205, 216-217, 222-224, 226-231, 234, 236-246
Aluminum Sulfate.....	241, 244
Cal Mag.....	198, 200-201, 203, 217, 222, 224
Geraniums.....	202
Hydroponic.....	203, 224
Iron Chelate.....	241
Mums.....	200, 203, 216, 224
Organic.....	243, 245-246
Pansy.....	200, 216, 222
Peat-Lite.....	203, 223-224
Petunia.....	200, 224
Poinsettias.....	200-201, 203, 216
Water Soluble.....	198, 200-205, 216-217, 222-224, 226

## F

FERTISS.....	161
Fiber Containers.....	98-104, 140, 146, 160, 170-171
FiberGrow.....	99-104
FieldPro.....	26
Filters.....	353, 360, 366, 371, 382
Disc Filters.....	360
Injectors.....	382
Inline.....	353
Finale.....	334
Fine Americas.....	325-327
Fireworxx.....	336
Fittings.....	355, 361, 364, 370
Dripline.....	364
Hoses.....	355
Tubing.....	361
Flagship.....	290
Flats.....	129, 140, 142, 154-157, 160, 164-165
FloPak.....	397
Floralife.....	328, 343
Floramite.....	290-291
Florel.....	326
Florgib.....	326
Florikan E.S.A. Corp.....	234, 235, 241
Flow Valves.....	352, 360
Flower Pouch.....	141
FMC.....	260, 283-284, 294, 298
Foaming Agent Indicator.....	346
Foaming Sprayer.....	382, 387
Fogco.....	368
Fogger Connector.....	369
Fogger Systems.....	362, 368
Foggers.....	363, 385-386
Forbid.....	291
Fortress.....	334
Fosphite.....	260
FreeHand.....	334
Freestanding Greenhouse Structures.....	24
Fresco.....	327
Fuerte.....	334
Fulcrum.....	291
Fungicides.....	248-273, 294, 297-299, 342-343
Mode of Action Chart.....	250-254
Organic.....	255, 257, 260-261, 264, 266-267, 269-271, 294, 297-299
Recommendations.....	263, 273
Reference Chart.....	248-249
FungOut.....	260
Fungus Gnat Control.....	283-285, 288-291, 293-296, 298, 306, 310, 315, 318
Furnaces.....	See Heaters
Fusilade II.....	335





G

Gallery.....335

Gal-XeOne.....234

Garden Center Structures.....18, 30-31

GE Current.....17, 398

Gearboxes.....381, 394, 416

Gemini.....335

Geranium Pots.....99, 105, 107, 110-111, 143, 150

Germination Mixes.....181, 186, 190

Gloves.....419

Gnatrol.....291

Gowan.....256, 260, 284, 288, 291-292, 294, 296, 337-338

Grandevo.....291

Greak Oak Inc.....322, 347

GreenClean.....340-341

Greenhouse Components.....13-17, 19, 24, 29, 44-51, 55-61, 66-71, 374

    Adaptor Plates.....44

    Benching.....48-52

    Brackets.....44-45

    Camlock Base.....48-49

    Corner Flashing.....44

    Coverings.....16, 55-61, 66-71

    Doors.....24, 44

    Endwall Post.....44

    Gables.....46

    Gutters.....44-45

    Purlin.....45

    Screws.....45

    Stakes.....45, 48

    Stub Posts.....45

    Truss.....44

    Tubing.....374

Greenhouse Construction.....12-17, 36

Greenhouse Structure Cleaners.....344

Greenhouse Structures.....13-27, 29, 31-32, 36-37, 44-51

Green-Shield.....341

Green-Tek LLC.....16, 60-62, 382-383

Grip-Lip.....135

Grotto.....260

Ground Cover.....63

Ground-to-Ground Greenhouse Structures.....23-24

Grower Media Mixes.....See Soil

Grower Select.....25, 41-42, 46-50, 63, 74-97, 174, 198, 374, 377-380

Growing Media Strips.....161-162

Growth Products.....239, 347

Grub Control.....283

Gutter Connected Greenhouse Structures.....20-21, 31

H

H.E. Anderson Company.....399-400

H2Pro.....346

Hachi-Hachi.....291, 301

HAF Fans.....383, 387

Handles.....157

Hanging Basket Remover.....353

Hanging Baskets.....91-94, 103-104, 119-124, 142, 144-145, 150, 158, 168-169

    Cone.....93

    Fiber.....103-104, 169

    Hangers.....91-94, 104, 120-121, 124-125, 142, 144, 169

    Moss.....93

    Saucers.....119

Hanna Instruments.....406

Hawk.....322

Heaters.....402, 411-412, 423

Herbicides.....329-342

    Information.....339

    Mode of Action Chart.....330-332

    Organic.....333, 336

    Reference Guide.....329

Heritage.....260

Hesperuline.....310

Hexygon.....291

High Tunnels.....25-26, 48

Hormodin.....327

Horticubes.....162

Horti-Klor.....342

Hortus.....327, 370

Hoses.....352, 355, 370

    Connectors.....352

    Custom.....355

    Ferrule.....355

    Fittings.....355

    Swivels.....352

    Tools.....355

Hydraulic Sprayers.....385

Hydro Systems.....382-383

Hydronic Heating Systems.....401

Hyplast NV.....66-67

Hypoline.....306



ICL Specialty Fertilizers...	215, 222-225, 227-233, 242, 245, 256, 271, 285, 335-336, 346
Indicate 5.....	344
Indoor Growing Greenhouses.....	33-35
Inflation Fans.....	421
Inflation Kits.....	45, 67
Infra Red Film.....	55-57, 59, 66- 68
Injection Molded Containers.....	107-109, 114-117, 136, 139, 143, 150, 159
Injection Spacer Tray.....	112
Injectors.....	382-384, 393-394, 399-400
Accessories.....	383, 393-394
Filters.....	382
Inlet Shutters.....	388
Inline Filters.....	353
Insect Glue.....	321
Insect Growth Regulator.....	288-291, 295, 298
Organic.....	288
Insect Screen.....	60
Insect Traps.....	321
Insecticidal Soap.....	292
Insecticides.....	276-299
Fogger.....	284-285, 295-296
Mode of Action Chart.....	276-279
Organic.....	283, 285, 288-292, 294-295, 297-299
Reference Chart.....	280-282
Tablets.....	289
Inserts.....	130-132, 142, 146, 154-157, 160, 164-165
Peat.....	146
Intrinsic.....	260, 264-265
Iron Chelate Fertilizers.....	198, 239, 241, 243
IronFist.....	323
Irrigation Components.....	17, 352-353, 360-361, 363-366, 368-373
Adaptor.....	366, 369
Clamps.....	373
Coupling.....	369
Drip Irrigation Components.....	See Drip Irrigation
Filters.....	353, 360, 366, 371
Fittings.....	361, 370
Fogger Connector.....	369
Foggers.....	363
Grommets.....	366
Hanging Assembly.....	363
Line End.....	361
Manifold.....	361
Misters.....	363
Nozzles.....	353
Plugs.....	366, 370
Pressure Regulators.....	365, 369, 372
Sprinkler Adaptor.....	363
Sprinkler Stand.....	363
Sprinklers.....	363, 369, 371-373
Tubing.....	364-365, 369
Valves.....	352, 360, 361, 366, 372, 373
Weight Assemblies.....	366, 368
Irrigation Controllers.....	354, 360, 371, 392
Irrigation Systems.....	354, 362, 367-368, 370, 392
Irrigation Tools.....	353, 366, 369
Irrigation Tube Casing.....	374
J&D Manufacturing.....	424
J.R. Peters, Inc.....	199-214, 242
Jack's BOOST.....	204-205
Jack's Professional.....	200-203, 206-213, 242
Jacto Inc.....	410
Jaderloon.....	50
Jain Irrigation.....	368-369
JanorPot.....	138-139
Jetram Product LLC.....	397
JH Biotech.....	243, 260
Jiffy / Performa.....	146
Johnson Paper & Supply.....	65
Junction.....	261
<hr/> <i>K</i> <hr/>	
Kalmor.....	261
Kase.....	408-409
Ken-Bar Inc.....	67
Kimin Industries.....	298
KleenGrow.....	261, 342
Klerks.....	66-67
Knox Fertilizer.....	338
Komeen.....	340
Kontos.....	292
Kool Ray.....	64
Kopa.....	292
<hr/> <i>L</i> <hr/>	
Labeling Solutions.....	420
Labels.....	395-396
Lambert Peat Moss Inc.....	190
Landmark Platic Corp.....	147-157
Lasco Fittings, Inc.....	370
Leafminer Control.....	283-285, 288-293, 295-297, 306, 316
Lebanon Seaboard.....	335
Leprotec.....	292
Light Restriction Curtains.....	38
Lighting.....	17, 398, 417-418, 425
Systems.....	418
Limestone.....	244
Line Ends.....	361
Link4 Corporation.....	17, 407
Liquid Fertilizer.....	238-239, 242
Organic.....	238-239
Liquid Shade.....	64, 67-68
Lontrel.....	335
Loose Fill Media.....	175-182, 186, 188, 191
Luiten Greenhouse Tech.....	72
Luiten Shade Systems.....	17, 38
Luminance.....	58

## M

Magus.....	292
Mainspring.....	259, 284, 287, 292, 294, 301
Mallet.....	292
<b>Manifolds.....</b>	<b>359, 361</b>
Marathon.....	293
Mardenkro North America Limited.....	67-68
Marengo.....	336
Marrone Bio Innovations.....	266, 269, 291, 299
<b>Masks.....</b>	<b>419</b>
Master MHW.....	342
Master Plant Prod Inc.....	216-221, 244-245
Mavrik Aquaflow.....	293
Mealybug Control.....	283-285, 289-292, 294-296, 298-299, 307, 316
Medallion.....	261
Mefenoxam.....	261
<b>Meters.....</b>	<b>390-391, 406</b>
Conductivity.....	391
EC.....	391, 406
Nutrient.....	390
pH.....	390-391, 406
TDS.....	406
Temperature.....	391
Michigan Peat Company.....	188-189, 192
Micora.....	261
MicroBLOC.....	343
<b>Micronutrients.....</b>	<b>223, 229, 239-244</b>
Midwest Perlite Inc.....	194
Millenium.....	303
Millside Industries Inc.....	410
MilStop.....	257
Minx 2.....	293
Misters.....	363, 370
Mite Control.....	283, 290-291, 307-309, 316-318, 320
Miticides.....	276-279, 283-285, 288, 290-299
Fogger.....	295
Mode of Action Chart.....	276-279
Organic.....	288, 290, 294-295, 297-299
Modine Manufacturing Company.....	16, 411-412
Mole Bait.....	323
Molt-X.....	288
Monitoring Systems.....	391, 407, 423
Motomco Ltd.....	322, 323
Motor Gearboxes.....	381, 394, 416
Motorola Solutions.....	414-416
Mouse Control.....	322
M-Pede.....	294
Multi-Year Film Coverings.....	56-57, 59, 69
Mum Pans.....	74, 99, 106, 109, 134, 136
Mural.....	261, 294
MycosApply.....	275
Mycorrhizae.....	274-275
Mycorrhizal Applications.....	255, 275, 290, 295, 328
Mycotrol.....	294

## N

Nature's Source.....	274
Nemashield.....	314-315, 318
Nemasys.....	303
<b>Nematicide.....</b>	<b>285</b>
<b>Nematodes.....</b>	<b>303</b>
Neogen Corporation.....	322
Netafim Irrigation Inc.....	17, 356-366
Nichols Paper Products Co.....	413
NoFly.....	294
Nordox.....	264
Notavo.....	294
<b>Nozzles.....</b>	<b>350-351, 353</b>
Inserts.....	353
Misting.....	351
NSI Holdings.....	138-140
Nufarm Americas.....	255, 263, 265-266, 269-270, 273, 289, 291-293, 295-296, 298-299, 301, 326, 328, 333-334, 338
Nu-Pots.....	139
Nursery Containers.....	See Containers
Nursery Supplies Inc.....	134-137
Nu-Tray.....	139

## O

Obtego.....	264
OH2.....	336
OHP.....	256, 260-261, 263-264, 268-270, 273, 283, 285, 287, 289-298, 301, 325, 326-327, 333-334, 336, 346
Olson Products.....	321
Onyx Pro.....	294
<b>Organic Crop Protection.....</b>	<b>255, 257, 260-261, 264, 266-267, 269-271, 275, 283, 285, 288-292, 294-295, 297-299, 328, 333, 336, 340-341, 343, 345</b>
Algaecides.....	257, 271, 340-341, 343
Bactericides.....	257, 260-261, 264, 266, 269-271, 341, 343
Cleaners.....	343
Fungicides.....	255, 257, 260-261, 264, 266-267, 269-271, 294, 297-299
Herbicides.....	333, 336
Insect Growth Regulators.....	288
Insecticidal Soap.....	292
Insecticides.....	283, 285, 288, 289-292, 294-295, 297-299
Miticides.....	288, 290, 294-295, 297-299
Mycorrhizae.....	275
Plant Growth Regulators.....	328
Sanitizers.....	341
Soil Inoculant.....	275
Wetting Agents.....	345
Organic Fertilizers.....	237-240
Organic Soils.....	177, 181, 188



## Q

Quali-Pro .....	261
Quest Products Corporations .....	344
QuickStart .....	228-229

## R

R3 Safety LLC .....	419
Rabbit Repellent .....	322
Radios .....	414-416
Rail Booms .....	392
Ramik .....	322
Rampage .....	322
Ranger Pro .....	336
ReduClean .....	68
ReduHeat .....	67
ReduSol .....	68
Regal Chemical Company .....	238, 337
Regalia .....	266
RegalStar .....	337
Resolute .....	337
Respirator Mask .....	424
Retail Benching .....	40-41
Retail Displays .....	40, 42
Reward .....	337
Rice Hulls .....	195
Riceland Foods Inc. ....	195
Ridder .....	416
Rimol Greenhouse Systems .....	16, 25, 31-32
Riverside Chemical .....	347
Rockwool .....	191
Rodent Control .....	322-323
Rodenticides .....	322
Ronstar .....	337
ROOTCUBES .....	161
Rooting Hormone .....	326-327
Rootshield .....	267, 273
Round Nursery Containers .....	74, 98-101, 105-112, 134-138, 143, 150-151, 159-160
Roundup .....	337
RSSI .....	274
Rusco .....	371
Rycar .....	287, 296

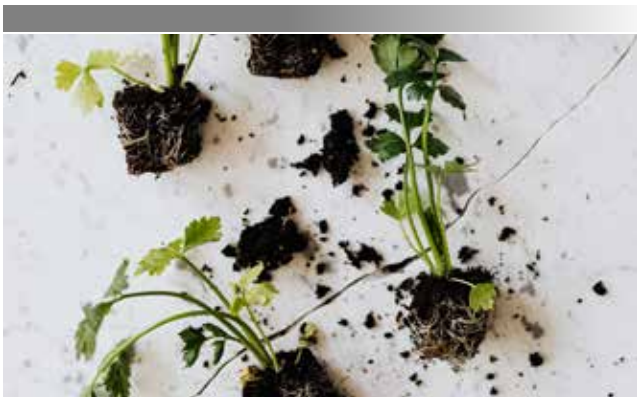

## S

Safari .....	296, 301
SaniDate .....	343
Sanitizer Pads .....	341
Sanitizers .....	341-343
Organic .....	341, 343
Test Strips .....	341, 343
Sanmite .....	296
Sarisa .....	296
Savate .....	296
Schaefer .....	16, 421-422
Scimitar .....	296
Scythe .....	337
SeClear .....	340
SedgeHammer .....	338
Seeder Trays .....	76, 149-150
Segment .....	338
Segovis .....	269
Segway .....	273
Segway O .....	269
Selontra .....	322
Senninger .....	372
Sensaphone Inc. ....	423
Sensor .....	321
Sepro Corporation 257-258, 261, 263, 264, 266, 271, 283, 287, 291, 295-296, 298, 301, 325, 328, 340-341	
SePRO Natural Reflection .....	341
Sevin .....	297
Shade Cloths .....	62, 65
Shade Coverings .....	62, 65, 67-68
Shade Curtains .....	37
Shade Structures .....	27, 38, 72
Sheet Pots .....	133, 153, 166
Ship Pac .....	65
Shopping Carts .....	379
Shorefly Control .....	283, 288-289, 303, 306, 315
Shrink Wrap .....	65
Shut-Off Valves .....	352, 361, 366, 372-373
Repair .....	352
Shutter Motors .....	388
Shutters .....	388, 422
Shuttle O .....	297
Siebring Manufacturing Co. ....	423
Sign Labels .....	395-396
Signature Control Systems .....	371
Sirocco .....	297
Slug & Snail Control .....	323
Smithers-Oasis .....	161-162, 328, 343
Snapshot .....	338
Soil .....	174-182, 186, 188, 190-191
Organic .....	177, 181, 188
Soil Amendments .....	193-195, 274
Soil Inoculant .....	274-275
Sojitz Corporation of America .....	236
SolarSun Inc. ....	65
SonarOne .....	341
Southwest Agri-Plastics Inc. ....	52
Spacer Trays .....	112



SPEAR.....	297	T.O. Platics .....	163-168
Specialty Containers .....	95-97, 137, 139-141, 160	Tags .....	420
Specticle.....	338	Talpirid.....	323
Spectro.....	269	Talstar .....	298
Sphagnum Peat Moss.....	146, 160, 176, 178-179, 181-182, 186, 188, 190-192	Talus.....	298
Spirato .....	269	Tame .....	298
Spray Adjuvants.....	344-345	TDS Meters.....	406
Sprayers .....	382, 384-385, 387, 410, 423	Temperature Meters .....	391
Accessories .....	384-385	Tenacity .....	338
Backpack.....	387, 410	Terraclor 400.....	270
Chemical Application .....	384-385	TerraGrow .....	274
Foaming.....	382, 387	Terraguard.....	270
Hydraulic.....	384-385	Terrazole.....	270, 273
Spreading Agent.....	344	Test Strips - Cleaners.....	341, 343
Sprinkler Adaptors.....	363	Tetra CURB.....	298
Sprinkler Stand.....	363	TetraSan .....	298
Sprinkler Systems.....	362	The Garden-Mart .....	26
Sprinklers.....	363, 369, 371-373	The Greenhouse Company .....	50
Square Nursery Containers.....	75, 102, 113-115, 139, 143, 153, 159, 163	The HC Companies.....	94, 98-133
Stake Supports .....	389, 396	The Specialty Manufacturing Co.....	373
Standard Pots .....	74-75, 130-131, 142-143, 152	The St. George Company .....	424
Staphyline.....	306	ThermaGlas .....	61
Stargus.....	269	Thermal Shading.....	37
Stature.....	269	Thermax.....	55-56
Stiky Stuff.....	321	Thermoformed Containers.....	75, 105-106, 113, 138, 151, 153, 159, 163, 166
Storm Manufacturing Group.....	371	Therm-O-Rock East Inc.....	191, 194
Strip-It .....	343	Thermostats .....	383, 387-388, 422
STRIP-IT PRO.....	344	Thripline .....	312
Stuppy Inc.....	373, 401	Thrips Control .....	283-285, 288-301, 306, 309-311, 315, 317-320
Subdue.....	269, 273	Recommendations.....	301
Succulent Pans .....	87	Strategies .....	300-301
SuffOil-X.....	297	Tomcat.....	323
Suffusion .....	346	Topflor.....	328
Sulfur Fertilizer .....	240	Torpedo .....	345
Sulfuric Acid.....	347	Total Grow .....	17, 425
Sultan .....	297	Tourney.....	270
Sumagic.....	328	Tower.....	338
SunClear .....	65	TR Intrinsic.....	265
SunView.....	68, 69	Transom.....	270
Super 7.....	344	Transport Carts.....	378
Super Wetter.....	345	Transport Trays .....	See Carry Trays
Super4.....	56-58	Trays.....	75-76, 154-157, 160, 164-166
Superior Sterling .....	371	Treflan .....	338
SureGuard .....	338	Trellis.....	389
Surfactant.....	344-346	Trellis Containers.....	97, 118
Sustane Natural Fertilizer Inc.....	226, 237, 274	Triact 70 .....	298
Svensson.....	38	Triathlon BA.....	270
Swirskiline.....	311	Tricholine .....	305
Syngenta Crop Protection.....	256, 258-261, 263, 265, 269, 273, 283-284, 288, 290, 292, 294, 296, 301, 325, 333, 335-338	Trinity .....	271



U

Ultra..... 345  
 Ultra Pure Horticultural Oil..... 299  
 UPL..... 299  
 UpTake..... 346  
 Urn Planters..... 81- 82  
 Usalco ..... 244

V

Valves .....352, 360-361, 372-373  
     Repair ..... 352  
 Velifer..... 299  
 Venerate ..... 299  
 Venntis Technologies LLC..... 425  
 Ventigra..... 299  
 Ventilation..... 13, 16, 28, 39, 44-45, 49, 376-377, 381, 383, 387-388, 407, 421, 424  
     Components..... 13, 16, 39, 44-45, 49, 388  
     Controller..... 388, 407  
     Convection Tubing..... 377  
     HAF Fans..... 383, 387  
     Systems..... 16, 28  
 Verdanta ..... 246  
 Vermiculite..... 186, 190-191, 193-194  
 Vessel..... 338  
 Vestaron Corporation..... 292, 297  
 Vole Repellent..... 322  
 VRE Systems..... 17, 37, 426

W

Wadsworth Control Systems..... 17, 39, 427  
 Wagons..... 410  
 Walter Cogel Co..... 373  
 Warp Brothers ..... 71  
 Water Cart ..... 385  
 Water Soluble Fertilizer ..... 198, 200-205, 216-217, 222-224, 226  
 Water Treatment..... 340-341, 343-344  
 Watering Wands ..... 351, 374  
 Waukesha Lime & Stone Co. .... 244  
 Web Trays..... 129  
 Webbing Tape..... 63  
 Wedge ..... 162  
 Weight Assemblies ..... 356, 358, 366, 368  
 Western Pulp Products Co. .... 168-171  
 Wetting Agents..... 344-346  
     Organic..... 345  
 Whitefly Control ..... 283-285, 288-299, 310-311, 319-320  
 Window Box ..... 90  
 Wine Barrel Planter ..... 90  
 Woodace..... 335

X

XXpire..... 299

Y

Yara North America, Inc..... 244

Z

ZeroTol..... 271  
 Zio..... 271





## BFG SERVICE CENTER *Locations*

### BFG Supply Headquarters

**BURTON, OH**  
14500 Kinsman Rd.  
P.O. Box 479  
Burton, OH 44021  
800-883-0234  
FAX: 800-645-6126

**CHESWICK, PA**  
460 Nixon Road, Suite 140  
Cheswick, PA 15024  
800-572-4018  
800-883-8234  
FAX: 866-551-6929

**DENVER, CO**  
12770 East 39th Ave  
Denver, CO 80239  
303-371-9790  
FAX: 303-371-4729

**FIFE, WA**  
2507 Frank Albert Rd  
Ste. C-130  
Fife, WA 98424  
800-624-2517

**GRAND RAPIDS, MI**  
4660 East Paris Ave., SE  
Grand Rapids, MI 49512  
800-224-5328  
FAX: 616-541-3010

**HARRISONBURG, VA**  
961 N Liberty St.  
Harrisonburg, VA 22802  
800-572-4018  
FAX: 888-434-4894

**JANESVILLE, WI**  
3708 Enterprise Dr.  
West Hills Industrial Park  
Janesville, WI 53546  
800-269-8816  
FAX: 866-393-5441

**KALAMAZOO, MI**  
1144 River St.  
Kalamazoo, MI 49048  
800-883-7234  
FAX: 866-551-6927

**LUBBOCK, TX**  
1400 E. Loop 289  
Lubbock, TX 79403  
806-744-8894

**SALT LAKE CITY, UT**  
360 North 700 West  
Suite J  
Salt Lake City, UT 84054  
801-936-0940  
FAX: 801-936-0942

**SAN BERNARDINO, CA**  
2552 Shenandoah Way  
San Bernardino, CA 92407  
800-624-2517

**ST. PAUL, MN**  
711 Vandalia Street  
St. Paul, MN 55114  
800-798-2891  
FAX: 866-393-5440

**WICHITA, KS**  
1515 E. 29th St. North  
Wichita, KS 67219  
316-838-1474  
FAX: 316-838-6104

**MICHAEL CARR SHOWROOM**  
3065 Chastain Meadows Pkwy  
Bldg 200  
Marietta, GA 30066  
866-358-9998



# HORTICULTURAL SUPPLY *Catalog*

2021-2022

Structures, Coverings, Irrigation, Containers,  
Media, Fertilizer, Crop Protection, Equipment & Supplies,  
Seeds and More!



14500 Kinsman Road  
PO Box 479  
Burton, Ohio 44021  
(800) 883-0234